

ETSI TS 129 275 V17.0.0 (2022-04)



**Universal Mobile Telecommunications System (UMTS);
LTE;
Proxy Mobile IPv6 (PMIPv6)
based Mobility and Tunnelling protocols;
Stage 3
(3GPP TS 29.275 version 17.0.0 Release 17)**



Reference

RTS/TSGC-0429275vh00

Keywords

LTE,UMTS

ETSI

650 Route des Lucioles
F-06921 Sophia Antipolis Cedex - FRANCE

Tel.: +33 4 92 94 42 00 Fax: +33 4 93 65 47 16

Siret N° 348 623 562 00017 - APE 7112B
Association à but non lucratif enregistrée à la
Sous-Préfecture de Grasse (06) N° w061004871

Important notice

The present document can be downloaded from:

<http://www.etsi.org/standards-search>

The present document may be made available in electronic versions and/or in print. The content of any electronic and/or print versions of the present document shall not be modified without the prior written authorization of ETSI. In case of any existing or perceived difference in contents between such versions and/or in print, the prevailing version of an ETSI deliverable is the one made publicly available in PDF format at www.etsi.org/deliver.

Users of the present document should be aware that the document may be subject to revision or change of status.

Information on the current status of this and other ETSI documents is available at

<https://portal.etsi.org/TB/ETSIDeliverableStatus.aspx>

If you find errors in the present document, please send your comment to one of the following services:

<https://portal.etsi.org/People/CommitteeSupportStaff.aspx>

If you find a security vulnerability in the present document, please report it through our
Coordinated Vulnerability Disclosure Program:

<https://www.etsi.org/standards/coordinated-vulnerability-disclosure>

Notice of disclaimer & limitation of liability

The information provided in the present deliverable is directed solely to professionals who have the appropriate degree of experience to understand and interpret its content in accordance with generally accepted engineering or other professional standard and applicable regulations.

No recommendation as to products and services or vendors is made or should be implied.

No representation or warranty is made that this deliverable is technically accurate or sufficient or conforms to any law and/or governmental rule and/or regulation and further, no representation or warranty is made of merchantability or fitness for any particular purpose or against infringement of intellectual property rights.

In no event shall ETSI be held liable for loss of profits or any other incidental or consequential damages.

Any software contained in this deliverable is provided "AS IS" with no warranties, express or implied, including but not limited to, the warranties of merchantability, fitness for a particular purpose and non-infringement of intellectual property rights and ETSI shall not be held liable in any event for any damages whatsoever (including, without limitation, damages for loss of profits, business interruption, loss of information, or any other pecuniary loss) arising out of or related to the use of or inability to use the software.

Copyright Notification

No part may be reproduced or utilized in any form or by any means, electronic or mechanical, including photocopying and microfilm except as authorized by written permission of ETSI.

The content of the PDF version shall not be modified without the written authorization of ETSI.

The copyright and the foregoing restriction extend to reproduction in all media.

© ETSI 2022.
All rights reserved.

Intellectual Property Rights

Essential patents

IPRs essential or potentially essential to normative deliverables may have been declared to ETSI. The declarations pertaining to these essential IPRs, if any, are publicly available for **ETSI members and non-members**, and can be found in ETSI SR 000 314: "*Intellectual Property Rights (IPRs); Essential, or potentially Essential, IPRs notified to ETSI in respect of ETSI standards*", which is available from the ETSI Secretariat. Latest updates are available on the ETSI Web server (<https://ipr.etsi.org/>).

Pursuant to the ETSI Directives including the ETSI IPR Policy, no investigation regarding the essentiality of IPRs, including IPR searches, has been carried out by ETSI. No guarantee can be given as to the existence of other IPRs not referenced in ETSI SR 000 314 (or the updates on the ETSI Web server) which are, or may be, or may become, essential to the present document.

Trademarks

The present document may include trademarks and/or tradenames which are asserted and/or registered by their owners. ETSI claims no ownership of these except for any which are indicated as being the property of ETSI, and conveys no right to use or reproduce any trademark and/or tradename. Mention of those trademarks in the present document does not constitute an endorsement by ETSI of products, services or organizations associated with those trademarks.

DECT™, **PLUGTESTS™**, **UMTS™** and the ETSI logo are trademarks of ETSI registered for the benefit of its Members. **3GPP™** and **LTE™** are trademarks of ETSI registered for the benefit of its Members and of the 3GPP Organizational Partners. **oneM2M™** logo is a trademark of ETSI registered for the benefit of its Members and of the oneM2M Partners. **GSM®** and the GSM logo are trademarks registered and owned by the GSM Association.

Legal Notice

This Technical Specification (TS) has been produced by ETSI 3rd Generation Partnership Project (3GPP).

The present document may refer to technical specifications or reports using their 3GPP identities. These shall be interpreted as being references to the corresponding ETSI deliverables.

The cross reference between 3GPP and ETSI identities can be found under <http://webapp.etsi.org/key/queryform.asp>.

Modal verbs terminology

In the present document "**shall**", "**shall not**", "**should**", "**should not**", "**may**", "**need not**", "**will**", "**will not**", "**can**" and "**cannot**" are to be interpreted as described in clause 3.2 of the [ETSI Drafting Rules](#) (Verbal forms for the expression of provisions).

"**must**" and "**must not**" are **NOT** allowed in ETSI deliverables except when used in direct citation.

Contents

Intellectual Property Rights	2
Legal Notice	2
Modal verbs terminology.....	2
Foreword.....	10
1 Scope	11
2 References	11
3 Definitions and abbreviations.....	13
3.1 Definitions	13
3.2 Abbreviations	13
4 General	14
4.1 PDN connection	14
4.2 PMIPv6 protocol stacks.....	14
5 Mobility Management procedures.....	15
5.1 Proxy Mobile IPv6 PDN Connection Creation procedure.....	15
5.1.1 General.....	15
5.1.1.1 Proxy Binding Update.....	15
5.1.1.2 Proxy Binding Acknowledgement	20
5.1.2 MAG procedures	23
5.1.3 LMA procedures.....	23
5.2 Proxy Mobile IPv6 PDN Connection Lifetime Extension procedure.....	24
5.2.1 General.....	24
5.2.1.1 Proxy Binding Update.....	24
5.2.1.2 Proxy Binding Acknowledgement	28
5.2.2 MAG procedures	29
5.2.3 LMA procedures.....	29
5.3 Proxy Mobile IPv6 PDN Connection Handover procedure.....	31
5.3.1 General.....	31
5.3.1.1 Proxy Binding Update.....	31
5.3.1.2 Proxy Binding Acknowledgement	36
5.3.2 MAG procedures	39
5.3.3 LMA procedures.....	39
5.4 Proxy Mobile IPv6 MAG Initiated PDN Connection Deletion procedure	40
5.4.1 General.....	40
5.4.1.1 Proxy Binding Update.....	41
5.4.1.2 Proxy Binding Acknowledgement	44
5.4.2 MAG procedures	45
5.4.3 LMA procedures.....	45
5.5 Proxy Mobile IPv6 LMA Initiated PDN Connection Deletion procedure	46
5.5.1 General.....	46
5.5.1.1 Binding Revocation Indication.....	46
5.5.2 MAG procedures	48
5.5.3 LMA procedures.....	48
5.6 Proxy Mobile IPv6 PDN Connection IPv4 address allocation procedure	48
5.6.1 General.....	48
5.6.1.1 Proxy Binding Update.....	49
5.6.1.2 Proxy Binding Acknowledgement	50
5.6.2 MAG procedures	51
5.6.3 LMA procedures.....	52
5.7 Proxy Mobile IPv6 LMA Initiated IPv4 Address Release procedure.....	52
5.7.1 General.....	52
5.7.1.1 Binding Revocation Indication.....	52
5.7.1.2 Binding Revocation Acknowledgment	53
5.7.2 MAG procedures	54

5.7.3	LMA procedures	54
5.8	Proxy Mobile IPv6 Multiple PDN Extensions	54
5.8.1	General.....	54
5.8.2	Extensions to PMIPv6 Data Structure	54
5.8.3	Extensions to PMIPv6 BULE and BCE Lookups.....	55
5.8.3.1	General	55
5.8.3.2	Extensions to PMIPv6 BCE Lookups	55
5.8.3.3	Extensions to PMIPv6 BULE Lookups.....	55
5.8.4	Extensions to PMIPv6 Procedure	56
5.8.4.1	General	56
5.8.4.2	MAG procedure	56
5.8.4.3	LMA procedure.....	56
5.9	Serving GW Procedure at Chaining Case.....	56
5.9.1	General.....	56
5.9.2	Signalling procedures	56
5.9.2.1	PMIP-based S8 Serving GW procedures	56
5.9.3	Payload packets at chained case	57
5.10	Proxy Mobile IPv6 MAG Initiated IPv4 Address Release procedure	57
5.10.1	General.....	57
5.10.1.1	Proxy Binding Update.....	57
5.10.1.2	Proxy Binding Acknowledgement	58
5.10.2	MAG procedures	59
5.10.3	LMA procedures.....	59
5.11	Proxy Mobile IPv6 LMA Initiated Update Notification procedure.....	59
5.11.1	General.....	59
5.11.1.1	Update Notification.....	60
5.11.1.2	Update Notification Acknowledgement.....	60
5.11.2	LMA procedures.....	61
5.11.3	MAG procedures	61
5.12	Proxy Mobile IPv6 Mobile Network Prefix Allocation procedure.....	61
5.12.1	General.....	61
5.12.1.1	Proxy Binding Update.....	61
5.12.1.2	Proxy Binding Acknowledgement	62
5.12.2	MAG procedures	63
5.12.3	LMA procedures.....	63
6	Tunnel Management procedures	64
6.1	General	64
6.2	MAG procedure.....	64
6.3	LMA procedure	65
6.4	Data Structures	65
6.4.1	Binding Update List Entry.....	65
6.4.2	Binding Cache Entry.....	66
6.5	Security	67
7	Path Management procedures	68
7.1	General	68
7.2	Heartbeat Mechanism.....	68
7.2.1	General.....	68
7.2.2	Heartbeat Message.....	68
7.2.2.1	Heartbeat Request	68
7.2.2.2	Heartbeat Response.....	68
7.3	Void.....	69
7.4	Void.....	69
7.5	Void.....	69
7.6	UE-specific Error Handling.....	69
7.6.1	General.....	69
7.6.2	MAG and LMA procedure	69
7.7	Void.....	69
7.8	Partial node failure requiring the removal of a subset of sessions.....	69
7.8.1	General.....	69
7.8.2	Binding Revocation Indication message.....	69

7.8.3	Binding Revocation Acknowledgement message	70
7.8.4	MAG procedures	70
7.8.5	LMA procedures	70
8	PMIP-based S5 and PMIP-based S8 description.....	71
8.1	Initial Attach procedures	71
8.1.1	General.....	71
8.1.2	Serving GW procedures.....	71
8.1.3	PDN GW procedures	71
8.2	Serving GW Initiated PDN Connection Lifetime Extension procedures	71
8.2.1	General.....	71
8.2.2	Serving GW procedures.....	71
8.2.3	PDN GW procedures	71
8.3	UE, MME or HSS initiated Detach procedures.....	71
8.3.1	General.....	71
8.3.2	Serving GW procedures.....	71
8.3.3	PDN GW procedures	71
8.4	PDN GW Initiated PDN Disconnection procedures.....	72
8.4.1	General.....	72
8.4.2	Serving GW procedures.....	72
8.4.3	PDN GW procedures	72
8.5	UE Requested Additional PDN Connectivity procedures	72
8.5.1	General.....	72
8.5.2	Serving GW procedures.....	72
8.5.3	PDN GW procedures	72
8.6	Handover procedures.....	72
8.6.1	Intra-LTE TAU and Inter-eNodeB Handover with Serving GW Relocation procedures	72
8.6.1.1	General.....	72
8.6.1.2	Serving GW procedures	72
8.6.1.3	PDN GW procedures.....	72
8.6.2	TAU/RAU or Handover between GERAN A/Gb Mode or UTRAN Iu Mode and E-UTRAN procedures.....	73
8.6.2.1	General.....	73
8.6.2.2	Serving GW procedures	73
8.6.2.3	PDN GW procedures.....	73
8.6.3	Handover from Trusted or Untrusted Non-3GPP IP Access over S2a/S2b to 3GPP Access Handover E-UTRAN over PMIP based S5/S8 without optimization procedures	73
8.6.3.1	General	73
8.6.3.2	Serving GW procedures	73
8.6.3.3	PDN GW procedures.....	73
8.6.4	Handover from Trusted or Untrusted Non-3GPP IP Access over S2a/S2b to 3GPP Access UTRAN/GERAN over PMIP based S5/S8 without optimization.....	73
8.6.4.1	General	73
8.6.4.2	Serving GW procedures	73
8.6.4.3	PDN GW procedures.....	73
8.6.5	Handover from Trusted or Untrusted Non-3GPP IP Access over S2c to 3GPP Access over PMIP based S5/S8 without optimization	74
8.6.5.1	General	74
8.6.5.2	Serving GW procedures	74
8.6.5.3	PDN GW procedures.....	74
8.6.6	Void	74
8.6.7	Void	74
8.7	UE Requested PDN Disconnection procedures.....	74
8.7.1	General.....	74
8.7.2	Serving GW procedures	74
8.7.3	PDN GW procedures	74
8.8	IPv4 Address Allocation using DHCP	74
8.8.1	General.....	74
8.8.2	Serving GW procedures.....	74
8.8.3	PDN GW procedures	74
8.9	PDN-GW Initiated IPv4 Address Delete Procedure.....	75
8.9.1	General.....	75

8.9.2	Serving GW procedures	75
8.9.3	PDN GW procedures	75
8.10	Mobile Network Prefix Allocation using DHCPv6 Prefix Delegation	75
8.10.1	General	75
8.10.2	Serving GW procedures	75
8.10.3	PDN GW procedures	75
9	Trusted Non-3GPP Access over S2a Description	75
9.0	General	75
9.1	Initial Attach procedures	75
9.1.1	General	75
9.1.2	Trusted Non-3GPP Access procedures	75
9.1.3	PDN GW procedures	75
9.2	Trusted Non-3GPP Access Initiated PDN Connection Lifetime Extension procedures	76
9.2.1	General	76
9.2.2	Trusted Non-3GPP Access procedures	76
9.2.3	PDN GW procedures	76
9.3	UE / Trusted Non-3GPP Access Initiated Detach and UE Requested PDN Disconnection procedures	76
9.3.1	General	76
9.3.2	Trusted Non-3GPP Access procedures	76
9.3.3	PDN GW procedures	76
9.4	HSS / AAA Initiated Detach procedures	76
9.4.1	General	76
9.4.2	Trusted Non-3GPP Access procedures	76
9.4.3	PDN GW procedures	76
9.5	UE Initiated Connectivity to Additional PDN procedures	77
9.5.1	General	77
9.5.2	Trusted Non-3GPP Access procedures	77
9.5.3	PDN GW procedures	77
9.6	3GPP Access to Trusted Non-3GPP IP Access with PMIPv6 on S2a Handover procedures without optimization	77
9.6.1	General	77
9.6.2	Trusted Non-3GPP Access procedures	77
9.6.3	PDN GW procedures	77
9.7	PDN GW Initiated Resource Allocation Deactivation procedures	77
9.7.1	General	77
9.7.2	Trusted Non-3GPP Access procedures	77
9.7.3	PDN GW procedures	77
9.8	IPv4 Address Allocation using DHCP	78
9.8.1	General	78
9.8.2	Trusted Non-3GPP Access procedures	78
9.8.3	PDN GW procedures	78
9.9	PDN-GW Initiated IPv4 Address Delete Procedure	78
9.9.1	General	78
9.9.2	Trusted Non-3GPP Access procedures	78
9.9.3	PDN GW procedures	78
9.10	Optimized E-UTRAN to CDMA2000 eHRPD Handover procedure	78
9.10.1	General	78
9.10.2	CDMA2000 HRPD access procedure	78
9.10.3	PDN GW procedures	78
9.11	Optimized Idle Mode Mobility: E-UTRAN Access to cdma2000 eHRPD Access procedure	79
9.11.1	General	79
9.11.2	CDMA2000 eHRPD access procedure	79
9.11.3	PDN GW procedures	79
10	Untrusted Non-3GPP Access over S2b Description	79
10.1	Initial Attach procedures	79
10.1.1	General	79
10.1.2	ePDG procedures	79
10.1.3	PDN GW procedures	80
10.2	ePDG Initiated PDN Connection Lifetime Extension procedures	80
10.2.1	General	80

10.2.2	ePDG procedures	80
10.2.3	PDN GW procedures	80
10.3	UE / ePDG Initiated Detach and UE Requested PDN Disconnection procedures	80
10.3.1	General.....	80
10.3.2	ePDG procedures	80
10.3.3	PDN GW procedures	81
10.4	HSS / AAA Initiated Detach procedures	81
10.4.1	General.....	81
10.4.2	ePDG procedures	81
10.4.3	PDN GW procedures	81
10.5	UE Initiated Connectivity to Additional PDN procedures	81
10.5.1	General.....	81
10.5.2	ePDG procedures	81
10.5.3	PDN GW procedures	82
10.6	3GPP Access to Untrusted Non-3GPP IP Access with PMIPv6 on S2b Handover procedures without optimization.....	82
10.6.1	General.....	82
10.6.2	ePDG procedures	82
10.6.3	PDN GW procedures	82
10.7	PDN GW Initiated Resource Allocation Deactivation procedures.....	82
10.7.1	General.....	82
10.7.2	ePDG procedures	82
10.7.3	PDN GW procedures	82
10.8	PDN-GW Initiated IPv4 Address Delete Procedure.....	83
10.8.1	General.....	83
10.8.2	ePDG procedures	83
10.8.3	PDN GW procedures	83
11	S2a and S2b Chaining with PMIP-based S8 Description.....	83
11.1	Initial Attach procedures	83
11.1.1	General.....	83
11.1.2	ePDG / Trusted Non-3GPP Access procedures	83
11.1.3	Serving GW procedures.....	83
11.2	ePDG / Trusted Non-3GPP Access Initiated PDN Connection Lifetime Extension procedures.....	84
11.2.1	General.....	84
11.2.2	ePDG / Trusted Non-3GPP Access procedures	84
11.2.3	Serving GW procedures.....	84
11.3	UE / ePDG / Trusted Non-3GPP Access Initiated Detach procedures	84
11.3.1	General.....	84
11.3.2	ePDG / Trusted Non-3GPP Access procedures	84
11.3.3	Serving GW procedures.....	84
11.4	HSS / AAA Initiated Detach procedures	84
11.4.1	General.....	84
11.4.2	ePDG / Trusted Non-3GPP Access procedures	84
11.4.3	Serving GW procedures.....	84
11.5	UE Initiated Connectivity to Additional PDN procedures	85
11.5.1	General.....	85
11.5.2	ePDG / Trusted Non-3GPP Access procedures	85
11.5.3	Serving GW procedures.....	85
11.6	3GPP Access to Trusted / Untrusted Non-3GPP IP Access Handover procedures without optimization.....	85
11.6.1	General.....	85
11.6.2	ePDG / Trusted Non-3GPP Access procedures	85
11.6.3	Serving GW procedures.....	85
11.7	UE Requested PDN Disconnection procedures.....	86
11.7.1	General.....	86
11.7.2	ePDG / Trusted Non-3GPP Access procedures	86
11.7.3	Serving GW procedures.....	86
11.8	PDN GW Initiated Resource Allocation Deactivation procedures.....	86
11.8.1	General.....	86
11.8.2	ePDG / Trusted Non-3GPP Access procedures	86
11.8.3	Serving GW procedures.....	86

12	Information Elements	86
12.1	Additional Proxy Mobile IPv6 Information Elements	86
12.1.1	3GPP-Specific PMIPv6 Information Elements	86
12.1.1.0	General	86
12.1.1.1	3GPP Specific PMIPv6 error code	88
12.1.1.2	Fully Qualified PDN Connection Set Identifier (FQ-CSID)	88
12.1.1.3	PDN Type Indication	89
12.1.1.4	PDN GW IP address	89
12.1.1.5	DHCPv4 Address Allocation Procedure Indication	90
12.1.1.6	Charging ID	90
12.1.1.7	Selection Mode	90
12.1.1.8	Charging Characteristics	90
12.1.1.9	Serving Network	91
12.1.1.10	Mobile Equipment Identity	91
12.1.1.11	MSISDN	91
12.1.1.12	APN Restriction	92
12.1.1.13	Maximum APN Restriction	92
12.1.1.14	Unauthenticated IMSI	92
12.1.1.15	PDN Connection ID	92
12.1.1.16	PGW Back-Off Time	93
12.1.1.17	Signalling Priority Indication	93
12.1.1.18	Static IP Address Allocation Indication	93
12.1.1.19	Additional Protocol Configuration Options	94
12.1.1.20	MME/SGSN Identifier	94
12.1.1.21	End Marker Notification	94
12.1.1.22	Trusted WLAN Mode Indication	94
12.1.1.23	UE Time Zone	95
12.1.1.24	Access Network Identifier Timestamp	95
12.1.1.25	Logical Access ID	96
12.1.1.26	Origination Time Stamp	96
12.1.1.27	Maximum Wait Time	96
12.1.1.28	TWAN Capabilities	97
13	Trusted WLAN Access over S2a Description	97
13.1	Initial Attach procedures	97
13.1.1	General	97
13.1.2	TWAN procedures	97
13.1.3	PDN GW procedures	98
13.2	TWAN Initiated PDN Connection Lifetime Extension procedures	98
13.2.1	General	98
13.2.2	TWAN procedures	98
13.2.3	PDN GW procedures	99
13.3	UE / TWAN Initiated Detach and UE/TWAN Requested PDN Disconnection procedures	99
13.3.1	General	99
13.3.2	TWAN procedures	99
13.3.3	PDN GW procedures	99
13.4	HSS / AAA Initiated Detach procedures	99
13.4.1	General	99
13.4.2	TWAN procedures	99
13.4.3	PDN GW procedures	99
13.5	PDN GW Initiated Resource Allocation Deactivation procedures	100
13.5.1	General	100
13.5.2	TWAN procedures	100
13.5.3	PDN GW procedures	100
13.6	3GPP Access to TWAN with PMIPv6 on S2a Handover procedures without optimization	100
13.6.1	General	100
13.6.2	TWAN procedures	100
13.6.3	PDN GW procedures	100
13.7	UE Initiated Connectivity to Additional PDN procedures	101
13.7.1	General	101
13.7.2	TWAN procedures	101
13.7.3	PDN GW procedures	101

14	Proxy Mobile IPv6 EPC Restoration Procedure	101
14.1	PGW triggered SGW restoration procedure	101
14.1.1	General.....	101
14.1.2	Serving GW procedures	102
14.1.3	PDN GW procedures	102
14.2	Update PDP context/Bearer at P-CSCF failure	102
14.2.1	General.....	102
14.2.2	PDN GW procedures	102
14.2.3	Serving GW, TWAN and ePDG procedures	102
14.3	Inform UE about P-CSCF failure	103
14.3.1	General.....	103
14.3.2	PDN GW procedures	103
14.3.3	Serving GW procedures.....	103
15	Proxy Mobile IPv6 End Marker Notification Procedure.....	103
15.1	General	103
15.2	Serving GW procedures	103
15.3	PDN GW procedures.....	104
Annex A:	void.....	105
Annex B (Normative):	Definition of the protocol number in pseudo-header.....	106
B.1	General	106
B.2	Interworking of different protocol number.....	106
Annex C (informative):	Change History	107
History		111

Foreword

This Technical Specification has been produced by the 3rd Generation Partnership Project (3GPP).

The contents of the present document are subject to continuing work within the TSG and may change following formal TSG approval. Should the TSG modify the contents of the present document, it will be re-released by the TSG with an identifying change of release date and an increase in version number as follows:

Version x.y.z

where:

- x the first digit:
 - 1 presented to TSG for information;
 - 2 presented to TSG for approval;
 - 3 or greater indicates TSG approved document under change control.
- y the second digit is incremented for all changes of substance, i.e. technical enhancements, corrections, updates, etc.
- z the third digit is incremented when editorial only changes have been incorporated in the document.

1 Scope

The present document specifies the stage 3 of the PMIPv6 Based Mobility and Tunneling Protocols used over the PMIP-based S2a, S2b, S5, and S8 reference points defined in 3GPP TS 23.402 [3], and are thus applicable to the Serving GW, PDN Gateway, ePDG, and Trusted Non-3GPP Access. Protocols specifications are compliant with relevant IETF RFCs. In this specification PMIP refers to PMIPv6 as defined in IETF RFC5213 [4] taking into account the corrections regarding the protocol number definition in IETF RFC6275 [8].

2 References

The following documents contain provisions which, through reference in this text, constitute provisions of the present document.

- References are either specific (identified by date of publication, edition number, version number, etc.) or non-specific.
- For a specific reference, subsequent revisions do not apply.
- For a non-specific reference, the latest version applies. In the case of a reference to a 3GPP document (including a GSM document), a non-specific reference implicitly refers to the latest version of that document *in the same Release as the present document*.

- [1] 3GPP TR 21.905: "Vocabulary for 3GPP Specifications".
- [2] 3GPP TS 23.401: "GPRS enhancements for E-UTRAN access".
- [3] 3GPP TS 23.402: "Architecture Enhancements for non-3GPP accesses".
- [4] IETF RFC 5213: "Proxy Mobile IPv6".
- [5] IETF RFC 5844: "IPv4 Support for Proxy Mobile IPv6".
- [6] IETF RFC 5846: "Binding Revocation for IPv6 Mobility".
- [7] IETF RFC 5845: "Generic Routing Encapsulation (GRE) Key Option for Proxy Mobile IPv6".
- [8] IETF RFC 6275: "Mobility Support in IPv6".
- [9] IETF RFC 4282: "The Network Access Identifier".
- [10] IETF RFC 4283: "Mobile Node Identifier Option for Mobile IPv6 (MIPv6)".
- [11] IETF RFC 5149: "Service Selection for Mobile IPv6".
- [12] 3GPP TS 23.003: "Numbering, addressing and identification".
- [13] 3GPP TS 23.007: "Restoration Procedures".
- [14] Void
- [15] Void
- [16] 3GPP TS 24.008: "Mobile radio interface Layer 3 specification; Core network protocols".
- [17] IETF RFC 5847: "Heartbeat Mechanism for Proxy Mobile IPv6".
- [18] IANA Mobile IPv6 Parameters Registry, <<http://www.iana.org/assignments/mobility-parameters>>.
- [19] 3GPP TS 33.402: "3GPP System Architecture Evolution (SAE); Security aspects of non-3GPP accesses".
- [20] IETF RFC 2784: "Generic Routing Encapsulation (GRE)".

- [21] IETF RFC 2890: "Key and Sequence Number Extensions to GRE".
- [22] 3GPP TS 29.274: "3GPP Evolved Packet System (EPS); Evolved General Packet Radio Service (GPRS) Tunnelling Protocol for Control plane (GTPv2-C); Stage 3".
- [23] 3GPP TS 23.060: "General Packet Radio Service (GPRS); Service description; Stage 2".
- [24] 3GPP TS 29.282: "Mobile IPv6 vendor specific option format and usage within 3GPP".
- [25] 3GPP TS 32.251: "Charging Management; Packet Switched (PS) domain charging".
- [26] 3GPP TS 32.298: "Charging Management; Charging Data Record (CDR) parameter description".
- [27] IETF RFC 4291: "IP Version 6 Addressing Architecture".
- [28] 3GPP TS 29.060: "General Packet Radio Service (GPRS); GPRS Tunnelling Protocol (GTP) across the Gn and Gp interface".
- [29] ITU-T Recommendation E.164: "The international public telecommunication numbering plan".
- [30] 3GPP TS 29.212: "Policy and Charging Control (PCC); Reference points".
- [31] IETF RFC 2473: "Generic Packet Tunneling in IPv6 Specification".
- [32] IANA Registry of Assigned Numbers. Mobile IPv6 parameters, Status Codes: <http://www.iana.org/assignments/mobility-parameters/mobility-parameters.xhtml#mobility-parameters-6>.
- [33] IANA Registry of Assigned Numbers. Mobile IPv6 parameters, Binding Revocation Acknowledgement Status Codes: <http://www.iana.org/assignments/mobility-parameters/mobility-parameters.xhtml#binding-revocation-status-codes>.
- [34] IETF RFC5555: "Mobile IPv6 Support for Dual Stack Hosts and Routers".
- [35] IETF RFC 7077: "Update Notifications for Proxy Mobile IPv6".
- [36] 3GPP TS 23.380: "IMS Restoration Procedures".
- [37] IETF RFC 6757: "Access Network Identifier Option".
- [38] IETF RFC 3775, "Mobility Support in IPv6".
- [39] 3GPP TS 24.302: "Access to the 3GPP Evolved Packet Core (EPC) via non-3GPP access networks; Stage 3".
- [40] IETF RFC 5905, "Network Time Protocol Version 4: Protocol and Algorithms Specification".
- [41] IETF RFC 7563: "Extensions to the Proxy Mobile IPv6 (PMIPv6) Access Network Identifier Option".
- [42] IETF RFC 3046: "DHCP Relay Agent Information Option".
- [43] IETF RFC 6463: "Runtime Local Mobility Anchor (LMA) Assignment Support for Proxy Mobile IPv6".
- [44] IETF RFC 7389: "Separation of Control and User Plane for Proxy Mobile IPv6".
- [45] IETF RFC 7148: "Prefix Delegation Support for Proxy Mobile IPv6".

3 Definitions and abbreviations

3.1 Definitions

For the purposes of the present document, the terms and definitions given in 3GPP TR 21.905 [1] and the following apply. A term defined in the present document takes precedence over the definition of the same term, if any, in 3GPP TR 21.905 [1].

The following terms used in this Technical Specification are defined in:

- the PMIPv6 specification IETF RFC 5213 [4]: IPv6 Home Network Prefix, Proxy Care-of Address, Local Mobility Anchor Address;
- the IPv4 Support for PMIPv6 specification IETF RFC 5844 [5]: IPv4 Home Address, IPv4 Local Mobility Anchor Address;
- the MIPv6 specification [8] and extended by the PMIPv6 specification IETF RFC 5213 [4]: Binding Cache Entry, Binding Update List Entry;
- the Binding Revocation for IPv6 Mobility [6]: Binding Revocation Indication and Binding Revocation Acknowledgement;
- the Separation of Control and User Plane for PMIPv6 specification IETF RFC 7389 [44]: LMA User-Plane Address.

Local Mobility Anchor: Within EPS the Local Mobility Anchor functionality consists of a PMIPv6 Local Mobility Anchor as described in the PMIPv6 specification IETF RFC 5213 [4] with support of IPv4 Support for PMIPv6 as defined in IETF RFC 5844 [5], Binding Revocation for IPv6 Mobility as defined in IETF RFC 5846 [6], GRE Key Option for PMIPv6 as defined in IETF RFC 5845 [7], and PMIPv6 Heartbeat Mechanism as defined in IETF RFC 5847 [17].

Mobile Access Gateway: Within EPS the Mobility Access Gateway functionality consists of a PMIPv6 Mobility Access Gateway as described in the PMIPv6 specification IETF RFC 5213 [4] with support of IPv4 Support for PMIPv6 as defined in IETF RFC 5844 [5], Binding Revocation for IPv6 Mobility as defined in IETF RFC 5846 [6], GRE Key Option for PMIPv6 as defined in IETF RFC 5845 [7], and PMIPv6 Heartbeat Mechanism as defined in IETF RFC 5847 [17].

PDN Connection: The association between a UE represented by one IPv4 Home Address and/or one IPv6 Home Network Prefix, and a PDN represented by an APN. On a PMIPv6 peer (MAG or LMA) there is a one-to-one mapping between a PDN connection and a PMIPv6 binding.

3.2 Abbreviations

For the purposes of the present document, the abbreviations given in 3GPP TR 21.905 [1] and the following apply. An abbreviation defined in the present document takes precedence over the definition of the same abbreviation, if any, in 3GPP TR 21.905 [1].

3GSPEC	3GPP Specific PMIPv6 Error Code
BCE	Binding Cache Entry
BRA	Binding Revocation Acknowledgement
BRI	Binding Revocation Indication
BULE	Binding Update List Entry
EPC	Evolved Packet Core
ePDG	Evolved Packet Data Gateway
GRE	Generic Routing Encapsulation
GW	Gateway
IMSI	International Mobile Subscriber Identity
IMEI	International Mobile station Equipment Identity
IPv4-LMAA	IPv4 LMAA
LMA	Local Mobility Anchor
LMAA	LMA Address

MAG	Mobility Access Gateway
MIPv6	Mobile IPv6
NAI	Network Access Identifier
PBA	Proxy Binding Acknowledgment
PBU	Proxy Binding Update
PMIPv6	Proxy MIPv6
Proxy-CoA	Proxy Care-of Address
TWAN	Trusted WLAN Access Network
UPN	Update Notification
UPA	Update Notification Acknowledgment

4 General

4.1 PDN connection

On a PMIPv6 peer (MAG or LMA) there is a one-to-one mapping between a PDN connection and a PMIPv6 binding.

Traffic sent over a given PDN connection is encapsulated with GRE [20] using different, per-interface per-PDN connection, per direction (uplink and downlink) GRE keys [21] to allow multiplexing and demultiplexing of traffic belonging to different PDN connections at MAG and LMA. For the handover between 3GPP access and non-3GPP access, the uplink GRE Key shall be the same.

4.2 PMIPv6 protocol stacks

Protocol stacks for PMIPv6 are depicted in Figure 4.2-1. The MAG functions are defined in 3GPP TS 23.402 [3], e. g., relaying DHCPv4/DHCPv6 packets between the UE and the DHCP server, forwarding the payload packets between the UE and the LMA.

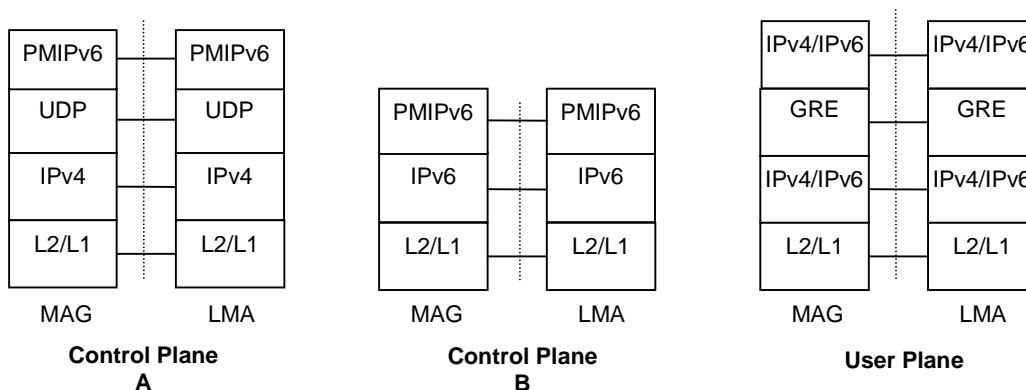

Figure 4.2-1: Protocols stacks for PMIP

The Control Plane A shall be used if PMIPv6 messages are transported over IPv4 as described in IETF RFC 5844 [5]. The Control Plane B shall be used if PMIPv6 messages are transported over IPv6 as described in IETF RFC 5213 [4]. User Plane traffic shall be transported with GRE encapsulation as described in IETF RFC 2890 [21] (see also IETF RFC 2784 [20]).

Figure 4.2-2: Void

5 Mobility Management procedures

5.1 Proxy Mobile IPv6 PDN Connection Creation procedure

5.1.1 General

The PMIPv6 PDN Connection Creation procedure is initiated by the node acting as a MAG to create a new PDN connection with the node acting as an LMA for an UE that either attaches for the first time to the EPC, or connects to an additional PDN. The procedure starts with the MAG sending a PBU including the APN to the LMA to register with the LMA a binding for the UE's PDN connection. If multiple PDN connections to the same APN function is supported by the MAG, a PDN connection ID shall also be included in the same PBU message. The LMA confirms establishment of the binding by sending a PBA to the MAG. If multiple PDN connections to the same APN function is supported by the LMA, the received PDN connection ID shall also be included in the same PBA message. Establishment of the binding achieves the following:

- **PDN selection:** The LMA select the PDN based on the APN contained in the PBU.
- **IPv6 Home Network Prefix assignment:** The LMA assigns to the UE's PDN connection an IPv6 Home Network Prefix valid in the selected PDN.
- **IPv4 Home Address assignment:** The LMA assigns to the UE's PDN connection an IPv4 Home Address valid in the selected PDN.
- **Downlink and Uplink GRE Key Assignment:** The MAG and LMA will establish downlink and uplink GRE keys to be used for GRE encapsulation of the PDN connection's downlink and uplink traffic, respectively.
- **GRE Tunnel Establishment:** A GRE tunnel is established between the MAG and LMA with the assigned GRE keys to carry uplink and downlink traffic that the UE respectively sends and receives on the PDN connection.
- **BCE Creation:** The LMA creates a BCE for the PDN connection.
- **BULE Creation:** The MAG creates a BULE for the PDN connection.
- **MAG Link Local Address assignment:** The LMA assigns the MAG link local address.
- **UE Interface Identifier (IID) assignment:** The LMA assigns to the UE an IPv6 Interface Identifier to allow formation of an UE Link Local Address from the well-known link local address prefix (fe80::/64).
- **PDN connection ID:** The PDN connection ID is provided by the MAG and accepted by LMA, if multiple PDN connections to the same APN function is supported by both MAG and LMA.
- **LMA Control Plane Address:** the LMA may assign an alternate LMAA or IPv4-LMAA, if this option is supported by both MAG and LMA.
- **LMA User Plane Address:** the LMA may assign an alternate LMA address for user plane, if this option is supported by both MAG and LMA.

Regarding the usage and support of the protocol number in the pseudo-header see Annex B.

5.1.1.1 Proxy Binding Update

The fields of a PBU message for the PMIPv6 PDN Connection Creation procedure are depicted in Table 5.1.1.1-1.

The Mobility Options in a PBU message for the PMIPv6 PDN Connection Creation procedure are depicted in Table 5.1.1.1-2. When the mobility option is present in the message, only the first instance shall be recognised. If multiple instances are included in the message, the receiver ignores all other instances.

Other flags are not used by this specification.

Table 5.1.1.1-1: Fields of a PBU message for the PMIPv6 PDN Connection Creation procedure

Information element	IE Description	Reference
Sequence Number	Set to a locally (i.e. per MAG) monotonically increasing value.	IETF RFC 5213 [4]
Acknowledge (A)	Set to "1" to request an acknowledgement message.	IETF RFC 6275 [8]
Proxy Registration Flag (P)	Set to "1" to indicate that the Binding Update message is a proxy registration.	IETF RFC 5213 [4]
Force UDP encapsulation request (F) Flag	Set to "0" to indicate that UDP encapsulation is not used for the user plane.	IETF RFC 5555 [34]
Lifetime	Set to the requested number of time units the binding shall remain valid.	IETF RFC 6275 [8]

Table 5.1.1.1-2: Mobility Options in a PBU message for the PMIPv6 PDN Connection Creation procedure

Information element	Cat.	IE Description	Reference
Mobile Node Identifier option	M	Set to the NAI identifier of the UE as specified in 3GPP TS 23.003 [12]. The format of the NAI is specified in the subclause 19.3 in 3GPP TS 23.003 [12].	3GPP TS 23.003 [12]
Ipv6 Home Network Prefix option	C	For dynamic allocation, set the Home Network Prefix to the value "0::0" and Prefix Length to the value "0" to request allocation for the UE's PDN connection of an Ipv6 Home Network Prefix in the PDN corresponding the EPS Access Point Name. For static allocation, set the Home Network Prefix to the received static allocated Ipv6 Home Network Prefix and Prefix Length to the value "64". NOTE 1.	IETF RFC 5213 [4]
Link-local Address	C	Present when Ipv6 Home Network Prefix option is present. Link-local address of the MAG. Set to ALL_ZERO (all bits set to 0), indicating that the MAG requests a link-local address to be used on the access link shared with the UE.	IETF RFC 5213 [4]
Handoff Indicator option	M	Set to the value "1" to indicate attachment over a new interface.	IETF RFC 5213 [4]
Access Technology Type option	M	Set to the 3GPP access type, i.e. GERAN, UTRAN, E-UTRAN or NB-IoT, or to the value matching the characteristics of the non-3GPP access (e.g., HRPD) the UE is using to attach to the EPS as defined in the Access Technology Type Option type values registry of the IANA Mobile Ipv6 Parameters Registry [18]. The ePDG may use the access technology type of the untrusted non-3GPP access network if it is able to acquire it; otherwise it shall indicate Virtual as the access technology. The TWAN shall set the Access Technology Type Option value to 4 i.e. "IEEE 802.11a/b/g" on the S2a interface. NOTE 2. NOTE 3.	IETF RFC 5213 [4]
Timestamp option	M	Set to the current time	IETF RFC 5213 [4]
GRE key option	M	Set to the downlink GRE key to be used for downlink GRE encapsulated packets sent over the PDN connection.	IETF RFC 5845 [7]
Ipv4 Home Address Request option	C	For dynamic allocation, set the Ipv4 Home Address to the value "0.0.0.0" and Prefix-len to the value "0" or "32" to request allocation for the UE's PDN connection of an Ipv4 Home Address in the PDN corresponding to the EPS Access Point Name. For static allocation, set the Ipv4 Home Address to the received static allocated Ipv4 Home Address and Prefix-len to the value "32". NOTE 1.	IETF RFC 5844 [5]
Service Selection Mobility Option	M	Set to the EPS Access Point Name to which the UE attaches the new PDN connection. The encoding of the APN field follows 3GPP TS 23.003 [12] subclause 9.1 but excluding the trailing zero byte. The content of the APN field shall be the full APN with both the APN Network Identifier and APN Operator Identifier being present as specified in 3GPP TS 23.003 [12] subclauses 9.1.1 and 9.1.2. NOTE 4.	IETF RFC 5149 [11]
Protocol Configuration Options	O	Contain Protocol Configuration Options.	Subclause 12.1.1.0
PDN GW IP Address	O	Contain PDN GW IP address (on S2a or S2b when used for chained S2a/S2b-PMIP based S8).	Subclause 12.1.1.4
MAG Fully Qualified PDN Connection Set Identifier	O	Contain a Fully Qualified PDN Connection Set Identifier if generated by the MAG on the S5/S8, S2a (for Trusted WLAN Access) and S2b interfaces as specified in 3GPP TS 23.007 [13].	Subclause 12.1.1.2
MME Fully Qualified PDN Connection Set Identifier	O	Contain a Fully Qualified PDN Connection Set Identifier if generated by the MME, and included by the MAG on the S5/S8 interfaces as specified in 3GPP TS 23.007 [13].	Subclause 12.1.1.2

Selection Mode	O	Contains APN selection mode (on S5/S8).	Subclause 12.1.1.7
Charging Characteristics	O	Contains the Charging Characteristics to be applied for EPC charging	Subclause 12.1.1.8
Serving Network	C	This IE shall be included on S2a (for TWAN access), S5 and S8 interfaces to identify the Serving Network. This IE may be included on S2a to identify the Serving Network of the eHRPD access network.	Subclause 12.1.1.9
Mobile Equipment Identity	O	This IE shall contain the MEI of the UE and shall be present, if available, on the S5, S8, S2a or S2b interface.	Subclause 12.1.1.10
MSISDN	O	This IE shall contain the MSISDN and shall be present, if available, on the S5, S8, S2a or S2b interfaces.	Subclause 12.1.1.11
Maximum APN Restriction	O	Contains the most stringent restriction of already active PDN connections (on S5/S8).	Subclause 12.1.1.13
Unauthenticated IMSI	O	Contains the Unauthenticated IMSI	Subclause 12.1.1.14
PDN connection ID	O	Contains the PDN connection ID	Subclause 12.1.1.15
Signalling Priority Indication	O	The SGW shall forward this IE on the S5/S8 interfaces if received from the MME/SGSN.	Subclause 12.1.1.17
Additional Protocol Configuration Options	O	Contains Additional Protocol Configuration Options.	Subclause 12.1.1.19
MME/SGSN Identifier	O	The SGW shall include the MME/SGSN Identifier on the S5 interface if the SGW supports the PGW triggered SGW restoration procedure and this information is received from the MME/SGSN as specified in 3GPP TS 23.007 [13].	Subclause 12.1.1.20
Access Network Identifier Option	O	The TWAN shall include the access network identifier on S2a.	IETF RFC 6757 [37] IETF RFC 7563 [41]
Trusted WLAN Mode Indication	O	Contains the selected trusted WLAN mode (SCM or MCM) on S2a interface.	Subclause 12.1.1.22
UE Time Zone	O	The TWAN shall include the UE Timezone on the S2a interface.	Subclause 12.1.1.23
Logical Access ID	O	Contains the Circuit-ID with the Relay Identity that allocated it.	Subclause 12.1.1.25
Redirect-Capability Mobility Option	O	The MAG shall include this IE on the S5, S8, S2a and S2b interface if it supports the capability to receive from the LMA an alternate LMAA or Ipv4-LMAA.	IETF RFC 6463 [43]
LMA User-Plane Address Mobility Option	O	The MAG shall include this IE on the S5, S8, S2a and S2b interface if it supports the capability to receive from the LMA an alternate LMA address for user plane. If so, the LMA User-Plane Address field within this Mobility Option shall be a zero-length field, or have a value of ALL_ZERO with all bits in the Ipv4 address or the Ipv6 address set to zero.	IETF RFC 7389 [44]
Origination Time Stamp	O	The SGW shall forward this IE on the S5/S8 interface if received from the MME/SGSN and if it supports the procedure specified in subclause 13.2 of 3GPP TS 29.274 [22]. The TWAN/ePDG shall include this IE on the S2a/S2b interface for the conditions specified in subclause 13.2 of 3GPP TS 29.274 [22].	Subclause 12.1.1.26
Maximum Wait Time	O	The SGW shall forward this IE on the S5/S8 interface if received from the MME/SGSN and if it supports the procedure specified in subclause 13.3 of 3GPP TS 29.274 [22]. The TWAN/ePDG shall include this IE on the S2a/S2b interface for the conditions specified in subclause 13.3 of 3GPP TS 29.274 [22].	Subclause 12.1.1.27
TWAN capabilities	O	The MAG shall include this IE on the S2a interface if any of the applicable flags is set to 1. Applicable flags are: - WLCP PDN Connection Modification Support Indication: This flag shall be set to 1 on the S2a interface if the TWAN supports the WLCP PDN Connection Modification procedure.	Subclause 12.1.1.28

NOTE 1:	At least one of the two options, namely, the IPv6 Home Network Prefix option or the IPv4 Home Address Request option shall be present. If both an IPv6 Home Network Prefix and an IPv4 Home Address are requested, both options shall be included in the same PBU message.
NOTE 2:	The methods that the ePDG may use to acquire the access technology type of the untrusted non-3GPP IP access network are not specified in this release.
NOTE 3:	The PDN-GW can be informed about the type of access network used by the UE over several reference points, see 3GPP TS 29.212 [30] for the mapping between the code values for the different access network types.
NOTE 4:	The APN field is not encoded as a dotted string as commonly used in documentation.

5.1.1.2 Proxy Binding Acknowledgement

The fields of a PBA message for the PMIPv6 PDN Connection Creation procedure are depicted in Table 5.1.1.2-1.

The Mobility Options in a PBA message for the PMIPv6 PDN Connection Creation procedure are depicted in Table 5.1.1.2-2. When the mobility option is present in the message, only the first instance shall be recognised. If multiple instances are included in the message, the receiver ignores all other instances.

Other flags are not used by this specification.

Only the message fields and mobility options used for acceptance cases are present in the following tables.

Table 5.1.1.2-1: Fields of a PBA message for the PMIPv6 PDN Connection Creation procedure

Information element	IE Description	Reference
Status	Set to indicate the result.	IETF RFC 6275 [8]
Proxy Registration Flag (P)	Set to "1" to indicate that the Binding Update message is a proxy registration.	IETF RFC 5213 [4]
Sequence Number	Set to the value received in the corresponding PBU.	IETF RFC 5213 [4]
Lifetime	Set to the granted number of time units the binding shall remain valid.	IETF RFC 6275 [8]

Table 5.1.1.2-2: Mobility Options in a PBA message for the PMIPv6 PDN Connection Creation procedure

Information element	Cat.	IE Description	Reference
Mobile Node Identifier option	M	Copied from corresponding field of PBU.	IETF RFC 5213 [4]
IPv6 Home Network Prefix option	C	Present if IPv6 Home Network Prefix is allocated. When it's present, set the Home Network Prefix to the IPv6 Home Network Prefix Allocated for the UE's PDN connection based on the selected PDN corresponding to the EPS Access Point Name for dynamic allocation, or set to the static IPv6 Home Network Prefix received in the PBU for static allocation. The Prefix Length is set to the value "64". In addition, the Interface Identifier (IID) allocated for the UE is encoded in the low order 64 bits of this option, i.e., the IPv6 Home Network Prefix option.	IETF RFC 5213 [4]
Link-local Address	C	Present when IPv6 Home Network Prefix option is present. Link-local address to be used by the MAG on the access link shared with the UE.	IETF RFC 5213 [4]
Handoff Indicator option	M	Copied from corresponding field of PBU.	IETF RFC 5213 [4]
Access Technology Type option	M	Copied from corresponding field of PBU.	IETF RFC 5213 [4]
Timestamp option	M	Copied from corresponding field of PBU, or set to the current time of LMA in case of timestamp error.	IETF RFC 5213 [4]
GRE key option	M	Set to the uplink GRE key to be used for uplink GRE encapsulated packets sent over the PDN connection.	IETF RFC 5845 [7]
IPv4 Home Address Reply Option	C	Present if IPv4 address is allocated. When it's present, set the IPv4 Home Address to the IPv4 Home Address allocated for the UE's PDN connection based on the selected PDN corresponding to the EPS Access Point Name for dynamic allocation, or set to the static IPv4 Home Address received in the PBU for static allocation. The Prefix-len is set to a non-zero value. NOTE 1	IETF RFC 5844 [5]
IPv4 Default Router Address Option	C	This option shall be present if and only if IPv4 Home Address Reply Option is present and for trusted WLAN access if the transparent Single-connection mode is used. The LMA sets the value of the UE's IPv4 default router address which belongs to the same subnet as the IPv4 Home Address allocated to the UE.	IETF RFC 5844 [5]
Service Selection Mobility Option	M	Copied from the corresponding field in the PBU message, formatted as defined in 3GPP TS 23.003 [12]. The encoding of the APN field follows 3GPP TS 23.003 [12] subclause 9.1 but excluding the trailing zero byte. The content of the APN field shall be the full APN with both the APN Network Identifier and APN Operator Identifier being present as specified in 3GPP TS 23.003 [12] subclauses 9.1.1 and 9.1.2. NOTE 2.	IETF RFC 5149[11]
PDN Type Indication	C	This option shall be present if and only if PDN type is changed in the PDN GW compared to what was requested in the PBU.	Subclause 12.1.1.3
DHCPv4 Address Allocation Procedure Indication	C	This option shall be present if and only if DHCPv4 is to be used to allocate the IPv4 address to the UE.	Subclause 12.1.1.5
Protocol Configuration Options	O	Contain Protocol Configuration Options.	Subclause 12.1.1.0
3GPP Specific PMIPv6 Error Code	O	Contain 3GPP Specific PMIPv6 Error Code (on S5/S8/S2a)	Subclause 12.1.1.1
LMA Fully Qualified PDN Connection Set Identifier	O	Contain a Fully Qualified PDN Connection Set Identifier if generated by the LMA on the S5/S8 interfaces as specified in 3GPP TS 23.007 [13].	Subclause 12.1.1.2
Charging ID	M	Contain the Charging ID information	Subclause 12.1.1.6
APN Restriction	O	Contains the restriction of this PDN connection (on S5/S8).	Subclause 12.1.1.12
PDN connection ID	O	Contains the PDN connection ID received in PBU	Subclause 12.1.1.15

PGW Back-Off Time	O	This IE may be included on the S5/S8/S2a interfaces when the PDN GW rejects the Proxy Binding Update with the 3GSPEC set to "APN congestion".	Subclause 12.1.1.16
Additional Protocol Configuration Options	O	Contains Additional Protocol Configuration Options.	Subclause 12.1.1.19
Access Network Identifier Option	O	Contains the access network identifier option received in PBU with the sub-options accepted (on S2a when TWAN access is used)	IETF RFC 6757 [37] IETF RFC 7563 [41]
Redirect Mobility Option	O	The LMA may include this IE on the S5, S8, S2a and S2b interface if the LMA supports sending an alternate LMAA or IPv4-LMAA and the MAG indicated corresponding support in the PBU message. If so, the LMA shall include one instance of this IE and set it to the alternate LMAA or IPv4-LMAA (for an IPv6 or IPv4 transport network respectively). (see NOTE 3)	IETF RFC 6463 [43]
LMA User-Plane Address Mobility Option	O	The LMA may include this IE on the S5, S8, S2a and S2b interface if the LMA supports sending an alternate LMA address for user plane and the MAG indicated corresponding support in the PBU message. If so, the LMA shall include only one instance of this IE and set it to the IPv4 or IPv6 address for user plane (for an IPv4 or IPv6 transport network respectively).	IETF RFC 7389 [44]
NOTE 1: If the PDN type is IPv4v6 and DHCPv4 is to be used to allocate the IPv4 address to the UE, the IPv4 Home Address Reply Option shall not be included.			
NOTE 2: The APN field is not encoded as a dotted string as commonly used in documentation.			
NOTE 3: As specified in IETF RFC 6463 [43], a binding for the UE's PDN connection is created at the LMA (with the alternate LMAA or IPv4-LMAA) and thus the MAG does not need to send a new PBU to that LMA for creating such a binding.			

5.1.2 MAG procedures

A MAG initiating the PMIPv6 PDN Connection Creation procedure shall follow the "Mobile Node Attachment and Initial Binding Registration" procedure described in the PMIPv6 IETF RFC 5213 [4] taking into account the corrections regarding the protocol number definition in IETF RFC6275 [8] and interworking solution specified in Annex B and IPv4 support for PMIPv6 IETF RFC 5844 [5] specifications with the following additional requirements:

1. Generate a downlink GRE key that is not already in use locally for the PDN connection's downlink traffic to that UE, as specified in the GRE Key Option for PMIPv6 specification IETF RFC 5845 [7].
2. For IP address allocation, the IPv6 Home Network Prefix option and/or the IPv4 Home Address Request option shall be present according to the UE request and the user subscription for non-3GPP access, or according to the PDN Type received from the MME/SGSN for 3GPP access.
3. If the static IPv4 Home Address and/or IPv6 Home Network Prefix are available at the MAG, set them in the IPv4 home address Request option and/or the IPv6 home prefix option in the PBU.
4. Optionally, assign a Fully Qualified PDN Connection Set Identifier that identifies a set of PDN connections belonging to an arbitrary number of UEs.
5. Provide a PDN connection ID, if multiple PDN connections to the same APN function is supported by the MAG.
6. Include the Redirect-Capability Mobility Option if the MAG supports the capability to receive from the LMA an alternate LMAA or IPv4-LMAA.
7. Include the LMA User Plane Address Mobility Option if the MAG supports the capability to receive from the LMA an alternate LMA address for user plane.
8. Set other parameters in the PBU as specified by the PBU parameters section for this procedure.

5.1.3 LMA procedures

On reception of a PBU, the LMA shall initiate the "Initial Binding Registration (New Mobility session)" and "Processing Binding Registrations" procedures described in the PMIPv6 IETF RFC 5213 [4] taking into account the

corrections regarding the protocol number definition in IETF RFC6275 [8] and interworking solution specified in Annex B and IPv4 support for PMIPv6 IETF RFC 5844 [5] specifications with the following additional requirements:

1. Select the PDN for the UE's PDN connection based on the APN present in the PBU.
2. Check if the received IPv6 Home prefix and/or IPv4 Home address are topologically correct.
3. If no static IPv6 Home Network Prefix and/or IPv4 Home Address were received in the PBU, allocate the IPv6 Home Network Prefix and/or an IPv4 Home Address for the selected PDN.
4. If a PCO with value IPv4 Address Allocation via DHCPv4 is present in the PBU,
 - if the LMA allocates an IPv4 address, it shall include the IPv4 Home Address Reply Option in the PBA message
 - if the LMA allocates an IPv6 prefix, the LMA shall not allocate an IPv4 address and shall not include the IPv4 Home Address Reply Option in the PBA message
5. Generate a uplink GRE key that is not already in use locally for the PDN connection's uplink traffic from that UE, as specified in the GRE Key Option for PMIPv6 specification IETF RFC 5845 [7].
6. Assign to the UE an IPv6 Interface Identifier to allow formation of an UE Link Local Address from the well-known link local address prefix (fe80::/64).
7. Optionally, assign a Fully Qualified PDN Connection Set Identifier that identifies a set of PDN connections belonging to an arbitrary number of UEs.
8. If PDN connection ID was received in the PBU message,
 - the LMA includes the received a PDN connection ID in the PBA message, if the multiple PDN connections to the same APN function is supported by the LMA; or
 - the LMA ignores the received PDN connection ID and does not include it in the PBA message , if the multiple PDN connections to the same APN function is not supported by the LMA.
9. If the Redirect-Capability Mobility Option was received in the PBU message, optionally assign an alternate LMAA or IPv4-LMAA.
10. If the LMA User Plane Address Mobility Option was received in the PBU message, optionally assign an alternate LMA address for user plane.
11. Set parameters in the PBA as specified by the PBA parameters section for this procedure.

5.2 Proxy Mobile IPv6 PDN Connection Lifetime Extension procedure

5.2.1 General

The PMIPv6 PDN Connection Lifetime Extension procedure is initiated by the node acting as a MAG to prolong the lifetime of an existing PDN connection with the node acting as an LMA for an UE that is already attached. This procedure may also be used when the MME is relocated and the MAG remains unchanged (see 3GPP TS 23.007 [13]). The procedure starts with the MAG sending a PBU to the LMA to extend the binding lifetime for the UE's PDN connection. The LMA confirms that the binding lifetime is extended by sending a PBA to the MAG.

5.2.1.1 Proxy Binding Update

The fields of a PBU message for the PMIPv6 PDN Connection Lifetime Extension procedure are depicted in Table 5.2.1.1-1.

The Mobility Options in a PBU message for the PMIPv6 PDN Connection Lifetime Extension procedure are depicted in Table 5.2.1.1-2. When the mobility option is present in the message, only the first instance shall be recognised. If multiple instances are included in the message, the receiver ignores all other instances.

Other flags are not used by this specification.

Table 5.2.1.1-1: Fields of a PBU message for the PMIPv6 PDN Connection Lifetime Extension procedure

Information element	IE Description	Reference
Sequence Number	Set to a locally (i.e. per MAG) monotonically increasing value.	IETF RFC 5213 [4]
Acknowledge (A)	Set to "1" to request an acknowledgement message.	IETF RFC 6275 [8]
Proxy Registration Flag (P)	Set to "1" to indicate that the Binding Update message is a proxy registration.	IETF RFC 5213 [4]
Force UDP encapsulation request (F) Flag	Set to "0" to indicate that UDP encapsulation is not used for the user plane.	IETF RFC 5555 [34]
Lifetime	Set to the requested number of time units the binding shall remain valid.	IETF RFC 6275 [8]

Table 5.2.1.1-2: Mobility Options in a PBU message for the PMIPv6 PDN Connection Lifetime Extension procedure

Information element	Cat.	IE Description	Reference
Mobile Node Identifier option	M	Set to the UE NAI that is derived from the UE IMSI if an authenticated IMSI is available, or from the UE IMEI if IMSI is not available or the IMSI is not authenticated by the network. The NAI format is specified in 3GPP TS 23.003 [12].	IETF RFC 5213 [4], 3GPP TS 23.003 [12]
IPv6 Home Network Prefix option	C	Set the Home Network Prefix to the IPv6 Home Network Prefix allocated to the UE's PDN connection based on the selected PDN and Prefix Length to the value "64". NOTE 1.	IETF RFC 5213 [4]
Link-local Address	C	Present when IPv6 Home Network Prefix option is present. Set to the link-local address already allocated to the MAG (in the previous initial binding registration) for use on the access link shared with the UE.	IETF RFC 5213 [4]
Handoff Indicator option	M	Set to the value "5" to indicate handoff state not changed (Re-registration).	IETF RFC 5213 [4]
Access Technology Type option	M	Set to the 3GPP access type, i.e. GERAN, UTRAN, E-UTRAN or NB-IoT, or to the value matching the characteristics of the non-3GPP access (e.g., HRPD) the UE is using to attach to the EPS as defined in the Access Technology Type Option type values registry of the IANA Mobile IPv6 Parameters Registry [18]. The ePDG may use the access technology type of the untrusted non-3GPP access network if it is able to acquire it; otherwise it shall indicate Virtual as the access technology. The TWAN shall set the Access Technology Type Option value to 4 i.e. "IEEE 802.11a/b/g" on the S2a interface. NOTE 2 NOTE 3	IETF RFC 5213 [4]
Timestamp option	M	Set to the current time	IETF RFC 5213 [4]
GRE Key option	M	Set to the previously exchanged downlink GRE key to be used for downlink GRE encapsulated packets sent over the PDN connection.	IETF RFC 5845 [7]
IPv4 Home Address Request option	C	Set the IPv4 Home Address to the IPv4 Home Address allocated for the UE's PDN connection based on the selected PDN and Prefix-len to the non-zero value received from LMA. NOTE 1.	IETF RFC 5844 [5]
Service Selection Mobility Option	M	Set to the EPS Access Point Name to which the UE's PDN connection is attached. The encoding of the APN field follows 3GPP TS 23.003 [12] subclause 9.1 but excluding the trailing zero byte. The content of the APN field shall be the full APN with both the APN Network Identifier and APN Operator Identifier being present as specified in 3GPP TS 23.003 [12] subclauses 9.1.1 and 9.1.2. NOTE 4.	IETF RFC 5149[11]
MME Fully Qualified PDN Connection Set Identifier	O	Contain a Fully Qualified PDN Connection Set Identifier if generated by the MME, and included by the MAG on the S5/S8 interfaces as specified in 3GPP TS 23.007 [13].	Subclause 12.1.1.2
MAG Fully Qualified PDN Connection Set Identifier	O	Contain a Fully Qualified PDN Connection Set Identifier if generated by the MAG on the S5/S8, S2a (for Trusted WLAN Access) and S2b interfaces as specified in 3GPP TS 23.007 [13].	Subclause 12.1.1.2
PDN connection ID	C	Contains the PDN connection ID if the BULE contains the PDN Connection ID.	Subclause 12.1.1.15

NOTE 1:	At least one of the two options, namely, the IPv6 Home Network Prefix option or the IPv4 Home Address Request option shall be present. If the UE has both IPv4 home address and IPv6 home network prefix registered, both the IPv6 Home Network Prefix option and IPv4 Home Address Request option shall be included in the same PBU message.
NOTE 2:	The methods that the ePDG may use to acquire the access technology type of the untrusted non-3GPP IP access network are not specified in this release.
NOTE 3:	The PDN-GW can be informed about the type of access network used by the UE over several reference points, see 3GPP TS 29.212 [30] for the mapping between the code values for the different access network types.
NOTE 4:	The APN field is not encoded as a dotted string as commonly used in documentation.

5.2.1.2 Proxy Binding Acknowledgement

The fields of a PBA message for the PMIPv6 PDN Connection Lifetime Extension procedure are depicted in Table 5.2.1.2-1.

The Mobility Options in a PBA message for the PMIPv6 PDN Connection Lifetime Extension procedure are depicted in Table 5.2.1.2-2. When the mobility option is present in the message, only the first instance shall be recognised. If multiple instances are included in the message, the receiver ignores all other instances.

Other flags are not used by this specification.

Only the message fields and mobility options used for acceptance cases are present in the following tables.

Table 5.2.1.2-1: Fields of a PBA message for the PMIPv6 PDN Connection Lifetime Extension procedure

Information element	IE Description	Reference
Status	Set to indicate the result.	IETF RFC 6275 [8]
Proxy Registration Flag (P)	Set to "1" to indicate that the Binding Update message is a proxy registration.	IETF RFC 5213 [4]
Sequence Number	Set to the value received in the corresponding PBU.	IETF RFC 5213 [4]
Lifetime	Set to the granted number of time units the binding shall remain valid.	IETF RFC 6275 [8]

Table 5.2.1.2-2: Mobility Options in a PBA message for the PMIPv6 PDN Connection Lifetime Extension procedure

Information element	Cat.	IE Description	Reference
Mobile Node Identifier option	M	Copied from corresponding field of PBU.	IETF RFC 5213 [4]
IPv6 Home Network Prefix option	C	If it is present in the corresponding PBU, set the Home Network Prefix to the IPv6 Home Network Prefix allocated to the UE's PDN connection based on the selected PDN and Prefix Length to the value "64".	IETF RFC 5213 [4]
Link-local Address	C	Present when IPv6 Home Network Prefix option is present. Set to the link-local address already allocated to the MAG (in the previous initial binding registration) for use on the access link shared with the UE.	IETF RFC 5213 [4]
Handoff Indicator option	M	Copied from corresponding field of PBU.	IETF RFC 5213 [4]
Access Technology Type option	M	Copied from corresponding field of PBU.	IETF RFC 5213 [4]
Timestamp option	M	Copied from corresponding field of PBU, or set to the current time of LMA in case of timestamp error.	IETF RFC 5213 [4]
GRE key option	M	Set to the previously exchanged uplink GRE key to be used for uplink GRE encapsulated packets sent over the PDN connection.	IETF RFC 5845 [7]
IPv4 Home Address Reply Option	C	If it is present in the corresponding PBU, set the IPv4 Home Address to the IPv4 Home Address allocated for the UE's PDN connection based on the selected PDN and Prefix-len to the non-zero value present in the corresponding PBU.	IETF RFC 5844 [5]
IPv4 Default Router Address Option	C	This option shall be present if and only if IPv4 Home Address Reply Option is present and PBU is accepted. The LMA sets the value of the UE's IPv4 default router address which belongs to the same subnet as the IPv4 Home Address allocated to the UE.	IETF RFC 5844 [5]
Service Selection Mobility Option	M	Copied from the corresponding field in the PBU message. The encoding of the APN field follows 3GPP TS 23.003 [12] subclause 9.1 but excluding the trailing zero byte. The content of the APN field shall be the full APN with both the APN Network Identifier and APN Operator Identifier being present as specified in 3GPP TS 23.003 [12] subclauses 9.1.1 and 9.1.2. NOTE 1.	IETF RFC 5149[11]
3GPP Specific PMIPv6 Error Code	O	Contain 3GPP Specific PMIPv6 Error Code (on S5/S8).	Subclause 12.1.1.1
LMA Fully Qualified PDN Connection Set Identifier	O	Contain a Fully Qualified PDN Connection Set Identifier if generated by the LMA on the S5/S8 interfaces as specified in 3GPP TS 23.007 [13].	Subclause 12.1.1.2
PDN connection ID	C	Contains the PDN connection ID received in PBU	Subclause 12.1.1.15

NOTE 1: The APN field is not encoded as a dotted string as commonly used in documentation.

5.2.2 MAG procedures

A MAG initiating the PMIPv6 PDN Connection Lifetime Extension procedure shall follow the "Extending Binding Lifetime" procedure described in the PMIPv6 [4] and IPv4 support for PMIPv6 [5] specifications, while parameters in the PBU are set as specified by the PBU parameters section for this procedure. When an MME FQ-CSID is received by the MAG during MME relocation, if the MAG supports the feature according to 3GPP TS 23.007 [13], it shall store the Node ID and CSID from the MME FQ-CSID for the PDN connection and forward the MME FQ-CSID to the LMA in the PBU.

5.2.3 LMA procedures

On reception of a PBU, the LMA shall initiate the "Binding Lifetime Extension without Handover" procedure as described in the PMIPv6 [4] and IPv4 support for PMIPv6 [5] specifications, while parameters in the PBA are set as

specified by the PBA parameters section for this procedure. When an MME FQ-CSID is received by the LMA, if the LMA supports the feature according to 3GPP TS 23.007 [13], it shall store the Node-ID and CSID from the MME FQ-CSID in place of those previously stored for the PDN connection.

5.3 Proxy Mobile IPv6 PDN Connection Handover procedure

5.3.1 General

The PMIPv6 PDN Connection Handover procedure is initiated by the node acting as a new MAG for the UE to update an existing PDN connection for an UE that is already attached to the EPC. The procedure starts with the new MAG sending a PBU including the APN to the LMA to update the binding for the UE's PDN connection. If multiple PDN connections to the same APN function is supported by the new MAG, a PDN connection ID shall also be included in the same PBU message. The LMA confirms update of the binding by sending a PBA to the MAG. If multiple PDN connections to the same APN function is supported by the LMA, the received PDN connection ID shall also be included in the same PBA message. Update of the binding achieves the following:

- **IPv6 Home Network Prefix re-assignment:** The LMA re-assigns to the UE's PDN connection the IPv6 Home Network Prefix valid in the selected PDN.
- **IPv4 Home Address re-assignment:** The LMA re-assigns to the UE's PDN connection the IPv4 Home Address valid in the selected PDN.
- **Downlink and Uplink GRE Key Assignment:** The MAG and LMA will establish downlink and uplink GRE keys to be used for GRE encapsulation of downlink and uplink traffic, respectively on the PDN connection.
- **GRE Tunnel Establishment:** A GRE tunnel is established between the MAG and LMA with the assigned GRE keys to carry uplink and downlink traffic that UE respectively sends and receives on the PDN connection.
- **BCE Update:** The LMA updates or creates the BCE for the PDN connection.
- **BULE Creation: The new MAG creates a BULE for the PDN connection.**
- **IP address(es) preservation:** the IP addresses allocated in the previous initial attachment are reused if IP address(es) preservation decision is made.
- **MAG Link Local Address re-assignment:** The LMA re-assigns the same MAG link local address.
- **UE Interface Identifier (IID) re-assignment:** The LMA re-assigns to the UE the same IPv6 Interface Identifier to allow formation of the same UE Link Local Address from the well-known link local address prefix (fe80::/64).
- **PDN connection ID:** The PDN connection ID is provided by the MAG and accepted by LMA, if multiple PDN connections to the same APN function is supported by both MAG and LMA.
- **LMA Control Plane Address:** for handover between non-3GPP and 3GPP access, the LMA may assign a possibly different alternate LMAA or IPv4-LMAA if this option is supported by both MAG and LMA. For an intra-3GPP access handover, the LMA shall re-assign the same alternate LMAA or IPv4-LMAA if such an address was allocated during the PDN connection establishment or during a handover between non-3GPP and 3GPP access.
- **LMA User Plane Address:** for handover between non-3GPP and 3GPP access, the LMA may assign a possibly different alternate LMA address for user plane, if this option is supported by both MAG and LMA. For an intra-3GPP access handover, the LMA shall re-assign the same alternate LMA address for user plane if such an address was allocated during the PDN connection establishment or during a handover between non-3GPP and 3GPP access.

The PMIPv6 LMA Initiated Update Notification procedure is then initiated by the LMA to notify the old MAG for handover with SGW relocation as specified in 3GPP TS 23.402 [3], to trigger the generation of End Marker by the MAG as specified in subclause 5.11.

5.3.1.1 Proxy Binding Update

The fields of a PBU message for the PMIPv6 PDN Connection Handover procedure are depicted in Table 5.3.1.1-1.

The Mobility Options in a PBU message for the PMIPv6 PDN Connection Handover procedure are depicted in Table 5.3.1.1-2. When the mobility option is present in the message, only the first instance shall be recognized. If multiple instances are included in the message, the receiver ignores all other instances.

Table 5.3.1.1-1: Fields of a PBU message for the PDN Connection Handover procedure

Information element	IE Description	Reference
Sequence Number	Set to a locally (i.e. per MAG) monotonically increasing value.	IETF RFC 5213 [4]
Acknowledge (A)	Set to "1" to request an acknowledgement message.	IETF RFC 6275 [8]
Proxy Registration Flag (P)	Set to "1" to indicate that the Binding Update message is a proxy registration.	IETF RFC 5213 [4]
Force UDP encapsulation request (F) Flag	Set to "0" to indicate that UDP encapsulation is not used for the user plane.	IETF RFC 5555 [34]
Lifetime	Set to the requested number of time units the binding shall remain valid.	IETF RFC 6275 [8]

Table 5.3.1.1-2: Mobility Options in a PBU message for the PMIPv6 PDN Connection Handover procedure

Information element	Cat.	IE Description	Reference
Mobile Node Identifier option	M	Set to the UE NAI that is derived from the UE IMSI if an authenticated IMSI is available, or from the UE IMEI if IMSI is not available or the IMSI is not authenticated by the network. The NAI format is specified in 3GPP TS 23.003 [12].	IETF RFC 5213 [4], 3GPP TS 23.003 [12]
IPv6 Home Network Prefix option	C	If available at the MAG, set the Home Network Prefix to the IPv6 Home Network Prefix allocated to the UE's PDN connection and Prefix Length to the value "64". Otherwise, set the Home Network Prefix to the value "0::0" and Prefix Length to the value "0" to request allocation for the UE's PDN connection of an IPv6 Home Network Prefix for the UE in the PDN corresponding to the EPS Access Point Name. NOTE 1.	IETF RFC 5213 [4]
Link-local Address	C	Present when IPv6 Home Network Prefix option is present. If available, set to the link-local address already allocated to the MAG (in the previous initial binding registration) for use on the access link shared with the UE. If not available, set to ALL_ZERO (all bits set to 0), indicating that the MAG requests a link-local address.	IETF RFC 5213 [4]
Handoff Indicator option	M	Set to the value "2" (Handoff between two different interfaces) in case the handover is an inter access handover (i.e. from 3GPP to non-3GPP, from non-3GPP to 3GPP, or between two non-3GPP accesses) and IP address(es) preservation decision is taken; or Set to the value "3" (Handoff between mobile access gateways for the same interface) in case the handover is an intra access (i.e. between two 3GPP accesses) handover; or Set to the value "4" (Handoff state unknown) in case the handover is an inter access handover (i.e. from 3GPP to non-3GPP, from non-3GPP to 3GPP, or between two non-3GPP accesses) and IP address(es) preservation decision is negative or unknown.	IETF RFC 5213 [4]
Access Technology Type option	M	Set to the 3GPP access type, i.e., to GERAN, UTRAN or E-UTRAN, or to the value matching the characteristics of the non-3GPP access (e.g., HRPD) the UE is using to attach to the EPS as defined in the Access Technology Type Option type values registry of the IANA Mobile IPv6 Parameters Registry [18]. The ePDG may use the access technology type of the untrusted non-3GPP access network if it is able to acquire it; otherwise it shall indicate Virtual as the access technology. The TWAN shall set the Access Technology Type Option value to 4 i.e. "IEEE 802.11a/b/g" on the S2a interface. NOTE 2 NOTE 3	IETF RFC 5213 [4]
Timestamp option	M	Set to the current time	IETF RFC 5213 [4]
GRE key option	M	Set to the downlink GRE key to be used for downlink GRE encapsulated packets sent over the PDN connection.	IETF RFC 5845 [7]
IPv4 Home Address Request option	C	If available at the MAG, set the IPv4 Home Address to the IPv4 Address allocated to the UE's PDN connection and Prefix-len to the value "32". Otherwise, set the IPv4 Home Address to the value "0.0.0.0" and Prefix-len to the value "0" or "32" to request allocation for the UE's PDN connection of an IPv4 Home Address in the PDN corresponding to the EPS Access Point Name. NOTE 1.	IETF RFC 5844 [5]

Service Selection Mobility Option	M	Set to the EPS Access Point Name to which the UE's PDN connection is attached. The encoding of the APN field follows 3GPP TS 23.003 [12] subclause 9.1 but excluding the trailing zero byte. The content of the APN field shall be the full APN with both the APN Network Identifier and APN Operator Identifier being present as specified in 3GPP TS 23.003 [12] subclauses 9.1.1 and 9.1.2. NOTE 4.	IETF RFC 5149[11]
Protocol Configuration Options	O	Contain Protocol Configuration Options.	Subclause 12.1.1.0
PDN GW IP Address	O	Contain PDN GW IP address (on S2a or S2b when used for chained S2a/S2b-PMIP based S8)..	Subclause 12.1.1.4
MAG Fully Qualified PDN Connection Set Identifier	O	Contain a Fully Qualified PDN Connection Set Identifier if generated by the MAG on the S5/S8 interfaces as specified in 3GPP TS 23.007 [13].	Subclause 12.1.1.2
MME Fully Qualified PDN Connection Set Identifier	O	Contain a Fully Qualified PDN Connection Set Identifier if generated by the MME, and included by the MAG on the S5/S8 interfaces as specified in 3GPP TS 23.007 [13].	Subclause 12.1.1.2
Selection Mode	C	Contains APN selection mode (on S5/S8). Shall be present if the PDN connection is initiated by S4 SGSN or MME.	Subclause 12.1.1.7
Charging Characteristics	O	Contains the Charging Characteristics to be applied for EPC charging	Subclause 12.1.1.8
Serving Network	C	This IE shall be included on S2a (for TWAN access), S5 and S8 interfaces to identify the Serving Network. This IE may be included on S2a to identify the Serving Network of the eHRPD access network.	Subclause 12.1.1.9
Mobile Equipment Identity	O	This IE shall contain the MEI of the UE and shall be present, if available, on the S5, S8, S2a or S2b interface.	Subclause 12.1.1.10
MSISDN	O	This IE shall contain the MSISDN and shall be present, if available, on the S5, S8, S2a or S2b interfaces.	Subclause 12.1.1.11
Maximum APN Restriction	O	Contains the most stringent restriction of already active PDN connections (on S5/S8).	Subclause 12.1.1.13
PDN connection ID	O	Contains the PDN connection ID	Subclause 12.1.1.15
Signalling Priority Indication	O	The SGW shall forward this IE on the S5/S8 interfaces during the handover from non-3GPP to 3GPP procedure.	Subclause 12.1.1.17
MME/SGSN Identifier	O	The SGW shall include the MME/SGSN Identifier on the S5 interface if the SGW supports the PGW triggered SGW restoration procedure and this information is received from the MME/SGSN as specified in 3GPP TS 23.007 [13].	Subclause 12.1.1.20
Access Network Identifier Option	O	The TWAN shall include the access network identifier on S2a.	IETF RFC 6757 [37] IETF RFC 7563 [41]
Trusted WLAN Mode Indication	O	Contains the selected trusted WLAN mode (SCM or MCM) on S2a interface.	Subclause 12.1.1.22
UE Time Zone	O	The TWAN shall include the UE Timezone on the S2a interface.	Subclause 12.1.1.23
Logical Access ID	O	Contains the Circuit-ID with the Relay Identity that allocated it.	Subclause 12.1.1.25
Redirect-Capability Mobility Option	O	The MAG shall include this IE on the S5, S8, S2a and S2b interface if it supports the capability to receive from the LMA an alternate LMAA or IPv4-LMAA.	IETF RFC 6463 [43]
LMA User-Plane Address Mobility Option	O	The MAG shall include this IE on the S5, S8, S2a and S2b interface if it supports the capability to receive from the LMA an alternate LMA address for user plane. If so, the LMA User Plane Address field within this Mobility Option shall be a zero-length field, or have a value of ALL_ZERO with all bits in the IPv4 address or the IPv6 address set to zero.	IETF RFC 7389 [44]

<p>TWAN capabilities</p>	<p>O</p>	<p>The MAG shall include this IE on the S2a interface if any of the applicable flags is set to 1. Applicable flags are: - WLCP PDN Connection Modification Support Indication: This flag shall be set to 1 on the S2a interface if the TWAN supports the WLCP PDN Connection Modification procedure.</p>	<p>Subclause 12.1.1.28</p>
<p>NOTE 1: At least one of the two options, namely, the IPv6 Home Network Prefix option or the IPv4 Home Address Request option shall be present. If the MAG knows the UE has both IPv4 home address and IPv6 home network prefix registered, both the IPv6 Home Network Prefix option and IPv4 Home Address Request option shall be included in the same PBU message.</p> <p>NOTE 2: The methods that the ePDG may use to acquire the access technology type of the untrusted non-3GPP IP access network are not specified in this release.</p> <p>NOTE 3: The PDN-GW can be informed about the type of access network used by the UE over several reference points, see 3GPP TS 29.212 [30] for the mapping between the code values for the different access network types.</p> <p>NOTE 4: The APN field is not encoded as a dotted string as commonly used in documentation.</p>			

5.3.1.2 Proxy Binding Acknowledgement

The fields of a PBA message for the PMIPv6 PDN Connection Handover procedure are depicted in Table 5.3.1.2-1.

The Mobility Options in a PBA message for the PMIPv6 PDN Connection Handover procedure are depicted in Table 5.3.1.2-2. When the mobility option is present in the message, only the first instance shall be recognised. If multiple instances are included in the message, the receiver ignores all other instances.

Other flags are not used by this specification.

Only the message fields and mobility options used for acceptance cases are present in the following tables.

Table 5.3.1.2-1: Fields of a PBA message for the PMIPv6 PDN Connection Handover procedure

Information element	IE Description	Reference
Status	Set to indicate the result.	IETF RFC 6275 [8]
Proxy Registration Flag (P)	Set to "1" to indicate that the Binding Update message is a proxy registration.	IETF RFC 5213 [4]
Sequence Number	Set to the value received in the corresponding PBU.	IETF RFC 5213 [4]
Lifetime	Set to the granted number of time units the binding shall remain valid.	IETF RFC 6275 [8]

Table 5.3.1.2-2: Mobility Options in a PBA message for the PMIPv6 PDN Connection Handover procedure

Information element	Cat.	IE Description	Reference
Mobile Node Identifier option	M	Copied from corresponding field of PBU.	IETF RFC 5213 [4]
IPv6 Home Network Prefix option	C	Present if IPv6 Home Network Prefix is allocated. When it's present, set the Home Network Prefix to the IPv6 Home Network Prefix Allocated for the UE's PDN connection based on the selected PDN corresponding to the EPS Access Point Name for dynamic allocation, or set to the static IPv6 Home Network Prefix received in the PBU for static allocation. The Prefix Length is set to the value "64". In addition, the Interface Identifier (IID) allocated for the UE is encoded in the low order 64 bits of this option, i.e., the IPv6 Home Network Prefix option.	IETF RFC 5213 [4]
Link-local Address	C	Present when IPv6 Home Network Prefix option is present. Set to the link-local address already allocated to the MAG (in the previous initial binding registration) for use on the access link shared with the UE.	IETF RFC 5213 [4]
Handoff Indicator option	M	Copied from corresponding field of PBU.	IETF RFC 5213 [4]
Access Technology Type option	M	Copied from corresponding field of PBU.	IETF RFC 5213 [4]
Timestamp option	M	Copied from corresponding field of PBU, or set to the current time of LMA in case of timestamp error.	IETF RFC 5213 [4]
GRE key option	M	Set to the uplink GRE key to be used for uplink GRE encapsulated packets sent over the PDN connection. The same uplink GRE key used for the UE's PDN connection with the previous MAG shall be re-assigned.	IETF RFC 5845 [7]
IPv4 Home Address Reply Option	C	Present if IPv4 address is allocated. When it's present, set the IPv4 Home Address to the IPv4 Home Address allocated for the UE's PDN connection based on the selected PDN corresponding to the EPS Access Point Name for dynamic allocation, or set to the static IPv4 Home Address received in the PBU for static allocation. The Prefix-len is set to a non-zero value.	IETF RFC 5844 [5]
IPv4 Default Router Address Option	C	This option shall be present if and only if IPv4 Home Address Reply Option is present and for trusted WLAN access if the transparent Single-connection mode is used. The LMA sets the value of the UE's IPv4 default router address which belongs to the same subnet as the IPv4 Home Address allocated to the UE.	IETF RFC 5844 [5]
Service Selection Mobility Option	M	Copied from the corresponding field in the PBU message. The encoding of the APN field follows 3GPP TS 23.003 [12] subclause 9.1 but excluding the trailing zero byte. The content of the APN field shall be the full APN with both the APN Network Identifier and APN Operator Identifier being present as specified in 3GPP TS 23.003 [12] subclauses 9.1.1 and 9.1.2. NOTE 1.	IETF RFC 5149 [11]
PDN Type Indication	C	This option shall be present if and only if PDN type is changed in the PDN GW compared to what was requested in the PBU.	Subclause 12.1.1.3
PMIPv6 DHCPv4 Address Allocation Procedure Indication	C	This option shall be present if and only if DHCPv4 is to be used to allocate the IPv4 address to the UE.	Subclause 12.1.1.5
Protocol Configuration Options	O	Contain Protocol Configuration Options.	Subclause 12.1.1.0
3GPP Specific PMIPv6 Error Code	O	Contain 3GPP Specific PMIPv6 Error Code (on S5/S8).	Subclause 12.1.1.1
LMA Fully Qualified PDN Connection Set Identifier List	O	Contain a Fully Qualified PDN Connection Set Identifiers if generated by the LMA on the S5/S8 interfaces as specified in 3GPP TS 23.007 [13].	Subclause 12.1.1.2
Charging ID	M	Contain the Charging ID information	Subclause 12.1.1.6

APN Restriction	O	Contains the restriction of this PDN connection (on S5/S8).	Subclause 12.1.1.12
PDN connection ID	O	Contains the PDN connection ID received in PBU	Subclause 12.1.1.15
Static IP Address Allocation Indication	O	Contains Static IP Address Allocation Indication if the IPv4 address and/or IPv6 Home Network Prefix is statically allocated. See NOTE 2	Subclause 12.1.1.18
Access Network Identifier Option	O	Contains the access network identifier option received in PBU with the sub-options accepted (on S2a when TWAN access is used)	IETF RFC 6757 [37] IETF RFC 7563 [41]
Redirect Mobility Option	O	The LMA may include this IE on the S5, S8, S2a and S2b interface if the LMA supports sending an alternate LMAA or IPv4-LMAA and the MAG indicated corresponding support in the PBU message. If so, the LMA shall include one instance of this IE and set it to the alternate LMAA or IPv4-LMAA (for an IPv6 or IPv4 transport network respectively). (see NOTE 3)	IETF RFC 6463 [43]
LMA User-Plane Address Mobility Option	O	The LMA may include this IE on the S5, S8, S2a and S2b interface if the LMA supports sending an alternate LMA address for user plane and the MAG indicated corresponding support in the PBU message. If so, the LMA shall include only one instance of this IE and set it to the IPv4 or IPv6 address for user plane (for an IPv4 or IPv6 transport network respectively).	IETF RFC 7389 [44]
<p>NOTE 1: The APN field is not encoded as a dotted string as commonly used in documentation.</p> <p>NOTE 2: Static IP Address Allocation Indication is used by MAG to provide dynamic IPv4/v6 address flag information as specified in 3GPP TS 32.251 [25].</p> <p>NOTE 3: As specified in IETF RFC 6463 [43], a binding for the UE's PDN connection is created at the LMA (with the alternate LMAA or IPv4-LMAA) and thus the MAG does not need to send a new PBU to that LMA for creating such a binding.</p>			

5.3.2 MAG procedures

A MAG initiating the PMIPv6 PDN Connection Handover procedure shall follow the "Mobile Node Attachment and Initial Binding Registration" procedure described in the PMIPv6 [4] and IPv4 support for PMIPv6 [5] specifications with the following additional requirements:

1. Generate a downlink GRE key that is not already in use locally for the PDN connection's downlink traffic to that UE, as specified in the GRE Key Option for PMIPv6 specification [7].
2. Provide a PDN connection ID, if multiple PDN connections to the same APN function is supported by the MAG.
3. Set other parameters in the PBU as specified by the PBU parameters section for this procedure.
4. Optionally, assign a Fully Qualified PDN Connection Set Identifier that identifies a set of PDN connections belonging to an arbitrary number of UEs.
5. Include the Redirect-Capability Mobility Option if the MAG supports the capability to receive from the LMA an alternate LMAA or IPv4-LMAA.
6. Include the LMA User Plane Address Mobility Option if the MAG supports the capability to receive from the LMA an alternate LMA address for user plane.

5.3.3 LMA procedures

On reception of a PBU, the LMA shall initiate the "Binding Lifetime Extension (After handoff)" and "Processing Proxy Binding Updates" procedures described in the PMIPv6 [4] and IPv4 support for PMIPv6 [5] specifications with the following additional requirements:

1. Re-assign the same uplink GRE key that was used by the previous MAG for the PDN connection's uplink traffic from the UE, as specified in the GRE Key Option for PMIPv6 specification [7].
2. Check if the received IPv6 Home prefix and/or IPv4 Home address are topologically correct.

3. Dynamic IP address allocation:
 - a) If Handoff Indicator option is "2" or "3": Re-allocate the IPv6 Home Network Prefix and/or the IPv4 Home Address for the selected PDN which were/was allocated during the previous attachment.
 - b) If Handoff Indicator option is "4": Make the IP address preservation decision as per the PMIPv6 specification [4].
- 3a. Static IP address allocation: If the IPv4 address and/or IPv6 Home Network Prefix is statically allocated, the LMA includes Static IP Address Allocation Indication in the PBA message.
4. Optionally, assign or reuse a Fully Qualified PDN Connection Set Identifier that identifies a set of PDN connections belonging to an arbitrary number of UEs.
5. If PDN connection ID was received in the PBU message,
 - a) the LMA updates PDN connection ID in the BCE accordingly and includes the received a PDN connection ID in the PBA message, if the multiple PDN connections to the same APN function is supported by the LMA; or
 - b) the LMA ignores the received PDN connection ID and does not include the received a PDN connection ID in the PBA message, if the multiple PDN to the same APN function is not supported by the LMA.
6. If the Redirect-Capability Mobility Option was received in the PBU message,
 - for handover between non-3GPP and 3GPP access, the LMA may assign a possibly different alternate LMAA or IPv4-LMAA;
 - for an intra-3GPP access handover, the LMA shall re-assign the same alternate LMAA or IPv4-LMAA if such an address was allocated during the PDN connection establishment or during a handover between non-3GPP and 3GPP access.
7. If the LMA User Plane Address Mobility Option was received in the PBU message,
 - for handover between non-3GPP and 3GPP access, the LMA may assign a possibly different alternate LMA address for user plane;
 - for an intra-3GPP access handover, the LMA shall re-assign the same alternate LMA address for user plane if such an address was allocated during the PDN connection establishment or during a handover between non-3GPP and 3GPP access.
8. Set parameters in the PBA as specified by the PBA parameters section for this procedure.

The LMA performs the lookup of BCE as described in subclause 5.8.3. If no existing BCE is found, the LMA shall follow the Proxy Mobile IPv6 PDN Connection Creation procedure as specified in section 5.1.3.

5.4 Proxy Mobile IPv6 MAG Initiated PDN Connection Deletion procedure

5.4.1 General

The PMIPv6 MAG Initiated PDN Connection Deletion procedure is initiated by the node acting as a MAG to tear down an existing PDN connection with the node acting as an LMA. The procedure starts with the MAG sending a PBU to the LMA to deregister with the LMA a binding for the UE's PDN connection. The LMA confirms deregistration of the binding by sending a PBA to the MAG. Deregistration of the binding achieves the following:

- **IPv6 Home Network Prefix deallocation:** When the PDN connection is released, the LMA returns the IPv6 Home Network Prefix assigned to the UE's PDN connection to the pool of free IPv6 Home Network Prefixes.
- **IPv4 Home Address deallocation:** When the PDN connection is released, the LMA returns the IPv4 Home Address assigned to the UE's PDN connection to the pool of free IPv4 Home Network Addresses.

- **Downlink and Uplink GRE Key de-assignment:** The MAG and LMA will return, respectively, the PDN connection's uplink and downlink GRE keys to their respective pool of free GRE keys.
- **GRE Tunnel Tear-down:** The GRE tunnel between the MAG and LMA is deleted.
- **BCE Deletion:** The LMA deletes the BCE for the PDN connection.
- **BULE Deletion:** The MAG deletes the BULE for the PDN connection.

5.4.1.1 Proxy Binding Update

The fields of a PBU message for the PMIPv6 MAG Initiated PDN Connection Deletion procedure are depicted in Table 5.4.1.1-1.

The Mobility Options in a PBU message for the PMIPv6 MAG Initiated PDN Connection Deletion procedure are depicted in Table 5.4.1.1-2. When the mobility option is present in the message, only the first instance shall be recognised. If multiple instances are included in the message, the receiver ignores all other instances.

Other flags are not used by this specification.

Table 5.4.1.1-1: Fields of a PBU message for the PMIPv6 MAG Initiated PDN Connection Deletion procedure

Information element	IE Description	Reference
Sequence Number	Set to a locally (i.e. per MAG) monotonically increasing value.	IETF RFC 5213 [4]
Acknowledge (A)	Set to "1" to request an acknowledgement message.	IETF RFC 6275 [8]
Proxy Registration Flag (P)	Set to "1" to indicate that the Binding Update message is a proxy registration.	IETF RFC 5213 [4]
Force UDP encapsulation request (F) Flag	Set to "0" to indicate that UDP encapsulation is not used for the user plane.	IETF RFC 5555 [34]
Lifetime	Set to "0" to request deletion of the BCE.	IETF RFC 6275 [8]

Table 5.4.1.1-2: Mobility Options in a PBU message for the PMIPv6 MAG Initiated PDN Connection Deletion procedure

Information element	Cat.	IE Description	Reference
Mobile Node Identifier option	M	Set to the UE NAI that is derived from the UE IMSI if an authenticated IMSI is available, or from the UE IMEI if IMSI is not available or the IMSI is not authenticated by the network. The NAI format is specified in 3GPP TS 23.003 [12].	IETF RFC 5213 [4], 3GPP TS 23.003 [12]
IPv6 Home Network Prefix option	C	Set the Home Network Prefix to the IPv6 Home Network Prefix allocated to the UE's PDN connection based on the selected PDN and Prefix Length to the value "64". NOTE 1.	IETF RFC 5213 [4]
Handoff Indicator option	M	Set to the value "4" to indicate Handoff state unknown.	IETF RFC 5213 [4]
Access Technology Type option	M	Set to the 3GPP access type, i.e., to GERAN, UTRAN,E-UTRAN or NB-IoT, or to the value matching the characteristics of the non-3GPP access (e.g., HRPD) the UE is using to attach to the EPS as defined in the Access Technology Type Option type values registry of the IANA Mobile IPv6 Parameters Registry [18]. The ePDG may use the access technology type of the untrusted non-3GPP access network if it is able to acquire it; otherwise it shall indicate Virtual as the access technology. The TWAN shall set the Access Technology Type Option value to 4 i.e. "IEEE 802.11a/b/g" on the S2a interface. NOTE 2 NOTE 3	IETF RFC 5213 [4]
Timestamp option	M	Set to the current time	IETF RFC 5213 [4]
IPv4 Home Request Address option	C	Set the IPv4 Home Address to the IPv4 Home Address allocated for the UE's PDN connection based on the selected PDN and Prefix-len to the non-zero value received from the LMA. NOTE 1.	IETF RFC 5844 [5]
Service Selection Mobility Option	M	Set to the EPS Access Point Name to which the UE's PDN connection is attached. The encoding of the APN field follows 3GPP TS 23.003 [12] subclause 9.1 but excluding the trailing zero byte. The content of the APN field shall be the full APN with both the APN Network Identifier and APN Operator Identifier being present as specified in 3GPP TS 23.003 [12] subclauses 9.1.1 and 9.1.2. NOTE 4.	IETF RFC 5149[11]
Protocol Configuration Options	O	Contain Protocol Configuration Options.	Subclause 12.1.1.0
PDN connection ID	C	Contains the PDN connection ID if the BULE contains the PDN Connection ID.	Subclause 12.1.1.15
Access Network Identifier Option	O	The TWAN shall include the access network identifier on S2a.	IETF RFC 6757 [37] IETF RFC 7563 [41]
UE Time Zone	O	The TWAN shall include the UE Timezone on the S2a interface.	Subclause 12.1.1.23
Access Network Identifier Timestamp	O	The TWAN shall include the timestamp on the S2a interface if the Access Network Identifier option is present. It shall indicate the time when the TWAN acquired the Access Network Identifier.	Subclause 12.1.1.24
<p>NOTE 1: At least one of the two options, namely, the IPv6 Home Network Prefix option or the IPv4 Home Address Request option shall be present. If the UE has both IPv4 home address and IPv6 home network prefix registered, both the IPv6 Home Network Prefix option and IPv4 Home Address Request option shall be included in the same PBU message.</p> <p>NOTE 2: The methods that the ePDG may use to acquire the access technology type of the untrusted non-3GPP IP access network are not specified in this release.</p> <p>NOTE 3: The PDN-GW can be informed about the type of access network used by the UE over several reference points, see 3GPP TS 29.212 [30] for the mapping between the code values for the different access network types.</p> <p>NOTE 4: The APN field is not encoded as a dotted string as commonly used in documentation.</p>			

5.4.1.2 Proxy Binding Acknowledgement

The fields of a PBA message for the PMIPv6 MAG Initiated PDN Connection Deletion procedure are depicted in Table 5.4.1.2-1.

The Mobility Options in a PBA message for the MAG Initiated PDN Connection Deletion procedure are depicted in Table 5.4.1.2-2. When the mobility option is present in the message, only the first instance shall be recognised. If multiple instances are included in the message, the receiver ignores all other instances.

Other flags are not used by this specification.

Only the message fields and mobility options used for acceptance cases are present in the following tables.

Table 5.4.1.2-1: Fields of a PBA message for the PMIPv6 MAG Initiated PDN Connection Deletion procedure

Information element	IE Description	Reference
Status	Set to indicate the result.	IETF RFC 6275 [8]
Proxy Registration Flag (P)	Set to "1" to indicate that the Binding Update message is a proxy registration.	IETF RFC 5213 [4]
Sequence Number	Set to a value received in the corresponding PBU.	IETF RFC 5213 [4]
Lifetime	Set to "0" to request deletion of the binding.	IETF RFC 6275 [8]

Table 5.4.1.2-2: Mobility Options in a PBA message for the PMIPv6 MAG Initiated PDN Connection Deletion procedure

Information element	Cat.	IE Description	Reference
Mobile Node Identifier option	M	Copied from corresponding field of PBU.	IETF RFC 5213 [4]
IPv6 Home Network Prefix option	C	If it is present in the corresponding PBU, set to the IPv6 Home Network Prefix allocated to the UE's PDN connection based on the selected PDN.	IETF RFC 5213 [4]
Handoff Indicator option	M	Copied from corresponding field of PBU.	IETF RFC 5213 [4]
Access Technology Type option	M	Copied from corresponding field of PBU.	IETF RFC 5213 [4]
Timestamp option	M	Copied from corresponding field of PBU, or set to the current time of LMA in case of timestamp error.	IETF RFC 5213 [4]
IPv4 Home Address Reply Option	C	If it is present in the corresponding PBU, set the IPv4 Home Address to the IPv4 Home Address allocated for the UE's PDN connection based on the selected PDN and Prefix-len to a non-zero value received in the corresponding PBU.	IETF RFC 5844 [5]
IPv4 Default Router Address Option	C	This option shall be present if and only if IPv4 Home Address Reply Option is present and PBU is accepted. The LMA sets the value of the UE's IPv4 default router address which belongs to the same subnet as the IPv4 Home Address allocated to the UE.	IETF RFC 5844 [5]
Service Selection Mobility Option	M	Copied from the corresponding field in the PBU message. The encoding of the APN field follows 3GPP TS 23.003 [12] subclause 9.1 but excluding the trailing zero byte. The content of the APN field shall be the full APN with both the APN Network Identifier and APN Operator Identifier being present as specified in 3GPP TS 23.003 [12] subclauses 9.1.1 and 9.1.2. NOTE 1.	IETF RFC 5149[11]
Protocol Configuration Options	O	Contain Protocol Configuration Options.	Subclause 12.1.1.0
3GPP Specific PMIPv6 Error Code	O	Contain 3GPP Specific PMIPv6 Error Code	Subclause 12.1.1.1
PDN connection ID	C	Contains the PDN connection ID received in PBU	Subclause 12.1.1.15
Access Network Identifier Option	O	Contains the access network identifier option received in PBU with the sub-options accepted (on S2a when TWAN access is used)	IETF RFC 6757 [37] IETF RFC 7563 [41]

NOTE 1: The APN field is not encoded as a dotted string as commonly used in documentation.

5.4.2 MAG procedures

A MAG initiating the PMIPv6 Initial MAG Initiated PDN Connection Deletion procedure shall follow the "Mobile Node Detachment and Binding De-Registration" procedure described in the PMIPv6 [4] and IPv4 support for PMIPv6 [5] specifications, while parameters in the PBU are set as specified by the PBU parameters section for this procedure.

5.4.3 LMA procedures

On reception of a PBU, the LMA shall initiate the "Binding De-Registration" procedure described in the PMIPv6 [4] and IPv4 support for PMIPv6 [5] specifications, while parameters in the PBA are set as specified by the PBA parameters section for this procedure.

5.5 Proxy Mobile IPv6 LMA Initiated PDN Connection Deletion procedure

5.5.1 General

In EPC the PMIPv6 LMA Initiated PDN Connection Deletion is initiated by the node acting as a LMA to notify the node acting as a MAG, that the Binding Cache Entry related to the UE is about to be deactivated, so the MAG should remove the resources related to that PDN connection. The procedure starts with the LMA sending a BRI to the MAG to revoke the binding. The MAG confirms the revocation of the binding by sending a BRA to the LMA.

The LMA Initiated PDN Connection Deletion Procedure initiated by the LMA achieves the following:

- **IPv6 Home Network Prefix release:** When the UE's PDN connection is deactivated, the LMA returns the IPv6 Home Network Prefix assigned to the UE's PDN connection to the pool of free IPv6 Home Network Prefixes.
- **IPv4 Home Address release:** When the UE's PDN connection is deactivated, the LMA returns the IPv4 Home Address assigned to the UE's PDN connection to the pool of free IPv4 Home Network Addresses.
- **Downlink and Uplink GRE keys de-assignment:** The MAG and LMA will return, respectively, the PDN connection's uplink and downlink GRE keys to their respective pool of free GRE keys.
- **GRE tunnel Deletion:** The GRE tunnel is removed from the LMA and the MAG.
- **BCE Deletion:** The LMA deletes the BCE for the PDN connection.
- **BULE Deletion:** The MAG deletes the BULE for the PDN connection.

5.5.1.1 Binding Revocation Indication

The fields of a BRI message for the PMIPv6 LMA Initiated PDN Connection Deletion procedure are depicted in Table 5.5.1.1-1.

The Mobility Options in a BRI message for the LMA Initiated PDN Connection Deletion procedure are depicted in Table 5.5.1.1-2. When the mobility option is present in the message, only the first instance shall be recognised. If multiple instances are included in the message, the receiver ignores all other instances.

Table 5.5.1.1-1: Fields of a BRI message for the PMIPv6

Information element	IE Description	Reference
Revocation Trigger	Set to a value indicating the event which triggered the revoking node to send the BRI message	IETF RFC 5846 [6]
Sequence Number	A sequence number generated by the LMA, and increased for every BRI sent.	IETF RFC 5846 [6]
Proxy Binding Flag (P)	Set to "1" to indicate that the Binding Revocation Indication is for a proxy MIPv6 binding entry.	IETF RFC 5213 [4]
IPv4 HoA Binding Only (V)	Set to "0" to request for complete binding revocation	IETF RFC 5846 [6]
Global Per-Peer Bindings (G)	Set to 0 to indicate that the request is for a specific PMIPv6 BCE.	IETF RFC 5846 [6]

Table 5.5.1.1-2: Mobility Options in a BRI message for the PMIPv6 LMA Initiated PDN Connection Deletion

Information element	Cat.	IE Description	Reference
Mobile Node Identifier option	M	Set to the UE NAI that is derived from the UE IMSI if an authenticated IMSI is available, or from the UE IMEI if IMSI is not available or the IMSI is not authenticated by the network. The NAI format is specified in 3GPP TS 23.003[12].	IETF RFC 5213 [4], 3GPP TS 23.003[12]
IPv6 Home Network Prefix option	C	Set the Home Network Prefix to the Home Network Prefix of the UE's PDN connection. Set the Prefix Length to the value "64". NOTE 1.	IETF RFC 5213 [4]
IPv4 Home Address Request option	C	Set the IPv4 Home Address to the IPv4 home address of the UE's PDN connection. Set the Prefix-len to the non-zero value which was sent to the MAG at PMIPv6 PDN connection creation procedure or Handover procedure. NOTE 1.	IETF RFC 5844 [5]
Service Selection Mobility Option	M	Set to the EPS Access Point Name to which the UE's PDN connection is attached. The encoding of the APN field follows 3GPP TS 23.003 [12] subclause 9.1 but excluding the trailing zero byte. The content of the APN field shall be the full APN with both the APN Network Identifier and APN Operator Identifier being present as specified in 3GPP TS 23.003 [12] subclauses 9.1.1 and 9.1.2. NOTE 2.	IETF RFC 5149[11]
Protocol Configuration Options	O	Contain Protocol Configuration Options.	Subclause 12.1.1.0
PDN connection ID	C	Contains the PDN connection ID if the BCE contains the PDN Connection ID.	Subclause 12.1.1.15
3GPP Specific PMIPv6 Error Code	O	For the S5/S8 and S2a/S2b interfaces, contain 3GPP Specific PMIPv6 Error Code.	Subclause 12.1.1.1
NOTE 1: At least one of the two options, namely, the IPv6 Home Network Prefix option or the IPv4 Home Address Request option shall be present. If the UE has both IPv4 home address and IPv6 home network prefix registered, both the IPv6 Home Network Prefix option and IPv4 Home Address Request option shall be included in the same BRI message.			
NOTE 2: The APN field is not encoded as a dotted string as commonly used in documentation.			

5.5.1.2 Binding Revocation Acknowledgment

The fields of a BRA message for the PMIPv6 LMA Initiated PDN Connection Deletion procedure are depicted in Table 5.5.1.2-1.

The Mobility Options in a BRA message for the LMA Initiated PDN Connection Deletion procedure are depicted in Table 5.5.1.2-2. When the mobility option is present in the message, only the first instance shall be recognised. If multiple instances are included in the message, the receiver ignores all other instances.

Only the message fields and mobility options used for acceptance cases are present in the following tables.

Table 5.5.1.2-1: Fields of a BRA message for a PMIPv6 LMA Initiated PDN Connection Deletion

Information element	IE Description	Reference
Status	Indicates the result of the BRI	IETF RFC 5846 [6]
Sequence Number	Set to the value received in the corresponding BRI.	IETF RFC 5846 [6]
Proxy Registration Flag (P)	Set to "1" to indicate that the Binding Revocation Acknowledgment is for a proxy MIPv6 binding entry.	IETF RFC 5213 [4]
IPv4 HoA Binding Only (V)	Set to "0"; the same value as for BRI	IETF RFC 5846 [6]
Global Per-Peer Bindings (G)	Set to "0"; the same value as for the BRI.	IETF RFC 5846 [6]

Table 5.5.1.2-2: Mobility Options in a BRA message for the PMIPv6 LMA Initiated PDN Connection Deletion

Information element	Cat.	IE Description	Reference
Mobile Node Identifier option	M	Copied from corresponding field of BRI.	IETF RFC 5213 [4]
IPv6 Home Network Prefix option	C	Set the Home Network Prefix to the IPv6 Home Network Prefix of the UE's PDN connection received in BRI. Set the Prefix Length to the value "64".	IETF RFC 5213 [4]
IPv4 Home Address Reply Option	C	Set the IPv4 Home Address to the IPv4 home address of the UE's PDN connection received in BRI. Set the Prefix-len to the non-zero value received in BRI.	IETF RFC 5844 [5]
Service Selection Mobility Option	M	Copied from the corresponding field in the BRI message. The encoding of the APN field follows 3GPP TS 23.003 [12] subclause 9.1 but excluding the trailing zero byte. The content of the APN field shall be the full APN with both the APN Network Identifier and APN Operator Identifier being present as specified in 3GPP TS 23.003 [12] subclauses 9.1.1 and 9.1.2. NOTE 1.	IETF RFC 5149[11]
Protocol Configuration Options	O	Contain Protocol Configuration Options	Subclause 12.1.1.0
3GPP Specific PMIPv6 Error Code	O	Contain 3GPP Specific PMIPv6 Error Code (on S5/S8).	Subclause 12.1.1.1
PDN connection ID	C	Contains the PDN connection ID received in BRI	Subclause 12.1.1.15
Access Network Identifier Option	O	The TWAN shall include the access network identifier on S2a.	IETF RFC 6757 [37]
Access Network Identifier Timestamp	O	The TWAN shall include the timestamp on the S2a interface if the Access Network Identifier option is present. It shall indicate the time when the TWAN acquired the Access Network Identifier.	Subclause 12.1.1.24
UE Time Zone	O	The TWAN shall include the UE Timezone on the S2a interface.	Subclause 12.1.1.23
NOTE 1: The APN field is not encoded as a dotted string as commonly used in documentation.			

5.5.2 MAG procedures

The MAG shall follow the "Local Mobility Anchor Revokes a PMIPv6 Binding" procedure described in the IETF RFC 5846 [6]. The MAG should release the resources associated with the UE's PDN connection referred to in the BRI message.

The MAG shall respond with a BRA.

5.5.3 LMA procedures

The LMA shall send a BRI to the MAG as described in the "Local Mobility Anchor Revokes a PMIPv6 binding" procedure described in the IETF RFC 5846 [6]. The LMA shall clear the BCE related to the UE's PDN connection after sending the BRI in case of UE detach.

5.6 Proxy Mobile IPv6 PDN Connection IPv4 address allocation procedure

5.6.1 General

The IPv4 address allocation procedure is initiated by the node acting as a MAG when DHCPv4 message is received from the UE which requires a new IPv4 address. The MAG sends a PBU to LMA requesting a new IPv4 address for an existing PDN connection. The LMA assigns a new IPv4 address by sending a PBA to the MAG. IPv4 address assignment procedure achieves the following:

- **IPv4 Home Address assignment:** The LMA assigns to the UE's PDN connection an IPv4 Home Address valid in the selected PDN.

5.6.1.1 Proxy Binding Update

The fields of a PBU message for the PMIPv6 PDN Connection IPv4 address allocation procedure are depicted in Table 5.6.1.1-1.

The Mobility Options in a PBU message for the PMIPv6 PDN Connection IPv4 address allocation procedure are depicted in Table 5.6.1.1-2. When the mobility option is present in the message, only the first instance shall be recognised. If multiple instances are included in the message, the receiver ignores all other instances.

Other flags are not used by this specification.

Table 5.6.1.1-1: Fields of a PBU message for the PMIPv6 PDN Connection IPv4 address allocation procedure

Information element	IE Description	Reference
Sequence Number	Set to a locally (i.e. per MAG) monotonically increasing value.	IETF RFC 5213 [4]
Acknowledge (A)	Set to "1" to request an acknowledgement message.	IETF RFC 6275 [8]
Proxy Registration Flag (P)	Set to "1" to indicate that the Binding Update message is a proxy registration.	IETF RFC 5213 [4]
Force UDP encapsulation request (F) Flag	Set to "0" to indicate that UDP encapsulation is not used for the user plane.	IETF RFC 5555 [34]
Lifetime	Set to the requested number of time units the binding shall remain valid.	IETF RFC 6275 [8]

Table 5.6.1.1-2: Mobility Options in a PBU message for the PMIPv6 PDN Connection IPv4 address allocation procedure

Information element	Cat.	IE Description	Reference
Mobile Node Identifier option	M	Set to the UE NAI that is derived from the UE IMSI if an authenticated IMSI is available, or from the UE IMEI if IMSI is not available or the IMSI is not authenticated by the network. The NAI format is specified in 3GPP TS 23.003 [12].	IETF RFC 5213 [4], 3GPP TS 23.003 [12]
IPv6 Home Network Prefix option	M	Set the Home Network Prefix to the IPv6 Home Network Prefix allocated to the UE's PDN connection based on the selected PDN and Prefix Length to the value "64".	IETF RFC 5213 [4]
Link-local Address	M	Set to the link-local address already allocated to the MAG (in the previous initial binding registration) for use on the access link shared with the UE.	IETF RFC 5213 [4]
Handoff Indicator option	M	Set to the value "5" to indicate handoff state not changed (Re-registration).	IETF RFC 5213 [4]
Access Technology Type option	M	Set to the 3GPP access type, i.e., to GERAN, UTRAN,E-UTRAN or NB-IoT, or to the value matching the characteristics of the non-3GPP access (e.g., HRPD) the UE is using to attach to the EPS as defined in the Access Technology Type Option type values registry of the IANA Mobile IPv6 Parameters Registry [18]. NOTE 1	IETF RFC 5213 [4]
Timestamp option	M	Set to the current time	IETF RFC 5213 [4]
IPv4 Home Address Request option	M	For dynamic allocation, set the IPv4 Home Address to the value "0.0.0.0" and Prefix-len to the value "0" or "32" to request allocation for the UE's PDN connection of an IPv4 Home Address in the PDN corresponding to the EPS Access Point Name. For static allocation, set the IPv4 Home Address to the received static allocated IPv4 Home Address and Prefix-len to the value "32".	IETF RFC 5844 [5]
Service Selection Mobility Option	M	Set to the EPS Access Point Name to which the UE's PDN connection is attached. The encoding of the APN field follows 3GPP TS 23.003 [12] subclause 9.1 but excluding the trailing zero byte. The content of the APN field shall be the full APN with both the APN Network Identifier and APN Operator Identifier being present as specified in 3GPP TS 23.003 [12] subclauses 9.1.1 and 9.1.2. NOTE 2.	IETF RFC 5149[11]
PDN connection ID	C	Contains the PDN connection ID if the BULE contains the PDN Connection ID.	Subclause 12.1.1.15
NOTE 1: The PDN-GW can be informed about the type of access network used by the UE over several reference points, see 3GPP TS 29.212 [30] for the mapping between the code values for the different access network types.			
NOTE 2: The APN field is not encoded as a dotted string as commonly used in documentation.			

5.6.1.2 Proxy Binding Acknowledgement

The fields of a PBA message for the PMIPv6 PDN Connection IPv4 address allocation procedure are depicted in Table 5.6.1.2-1.

The Mobility Options in a PBA message for the PMIPv6 PDN Connection IPv4 address allocation procedure are depicted in Table 5.6.1.2-2. When the mobility option is present in the message, only the first instance shall be recognised. If multiple instances are included in the message, the receiver ignores all other instances.

Other flags are not used by this specification.

Only the message fields and mobility options used for acceptance cases are present in the following tables.

Table 5.6.1.2-1: Fields of a PBA message for the PMIPv6 PDN Connection IPv4 address allocation procedure

Information element	IE Description	Reference
Status	Set to indicate the result.	IETF RFC 6275 [8]
Proxy Registration Flag (P)	Set to "1" to indicate that the Binding Update message is a proxy registration.	IETF RFC 5213 [4]
Sequence Number	Set to the value received in the corresponding PBU.	IETF RFC 5213 [4]
Lifetime	Set to the granted number of time units the binding shall remain valid.	IETF RFC 6275 [8]

Table 5.6.1.2-2: Mobility Options in a PBA message for the PMIPv6 PDN Connection IPv4 address allocation procedure

Information element	Cat.	IE Description	Reference
Mobile Node Identifier option	M	Copied from corresponding field of PBU.	IETF RFC 5213 [4]
IPv6 Home Network Prefix option	M	Set the Home Network Prefix to the IPv6 Home Network Prefix allocated to the UE's PDN connection based on the selected PDN and Prefix Length to the value "64".	IETF RFC 5213 [4]
Link-local Address	M	Set to the link-local address already allocated to the MAG (in the previous initial binding registration) for use on the access link shared with the UE.	IETF RFC 5213 [4]
Handoff Indicator option	M	Copied from corresponding field of PBU.	IETF RFC 5213 [4]
Access Technology Type option	M	Copied from corresponding field of PBU.	IETF RFC 5213 [4]
Timestamp option	M	Copied from corresponding field of PBU, or set to the current time of LMA in case of timestamp error.	IETF RFC 5213 [4]
IPv4 Home Address Reply option	M	Set the IPv4 Home Address to the IPv4 Home Address allocated for the UE's PDN connection based on the selected PDN corresponding to the EPS Access Point Name for dynamic allocation, or set to the static IPv4 Home Address received in the PBU for static allocation. The Prefix-len is set to a non-zero value.	IETF RFC 5844 [5]
IPv4 Default Router Address Option	M	The LMA sets the value of the UE's IPv4 default router address which belongs to the same subnet as the IPv4 Home Address allocated to the UE.	IETF RFC 5844 [5]
Service Selection Mobility Option	M	Copied from the corresponding field in the PBU message. The encoding of the APN field follows 3GPP TS 23.003 [12] subclause 9.1 but excluding the trailing zero byte. The content of the APN field shall be the full APN with both the APN Network Identifier and APN Operator Identifier being present as specified in 3GPP TS 23.003 [12] subclauses 9.1.1 and 9.1.2. NOTE 1.	IETF RFC 5149[11]
3GPP Specific PMIPv6 Error Code	O	Contain 3GPP Specific PMIPv6 Error Code (on S5/S8).	Subclause 12.1.1.1
PDN connection ID	C	Contains the PDN connection ID received in PBU	Subclause 12.1.1.15

NOTE 1: The APN field is not encoded as a dotted string as commonly used in documentation.

5.6.2 MAG procedures

The MAG initiating IPv4 Address Allocation using DHCPv4 procedure shall follow the "Extending Binding Lifetime" procedure described in the PMIPv6 [4] and "DHCP Relay Agent co-located with MAG" or "DHCP Server co-located with MAG" procedure as described in IPv4 support for PMIPv6 [5] specifications, while parameters in the PBU are set as specified by the PBU parameters section for this procedure.

1. If the static IPv4 Home Address is available at the MAG, set it in the IPv4 home address Request option in the PBU.
2. Set other parameters in the PBU as specified by the PBU parameters section for this procedure.

5.6.3 LMA procedures

On reception of a PBU, the LMA shall initiate the "Binding Lifetime Extension without Handover" procedures as described in the PMIPv6 [4] and IPv4 support for PMIPv6 [5] specifications with the following additional requirements:

1. Check if the received IPv4 Home address is topologically correct.
2. Allocate an IPv4 Home Address for the selected PDN.
3. Set parameters in the PBA as specified by the PBA parameters section for this procedure.

5.7 Proxy Mobile IPv6 LMA Initiated IPv4 Address Release procedure

5.7.1 General

In the case when UE is assigned both IPv6 HNP and IPv4 Home Address, if IPv4 Address lease expires or DHCPv4 Release procedure, the node acting as LMA initiates IPv4 Address Release procedure to notify the node acting as MAG about release of IPv4 address of UE for a certain PDN connection. LMA indicates MAG by sending a BRI and MAG confirms by replying with a BRA as described in IETF RFC 5846 [6].

LMA Initiated IPv4 Address Release procedure achieves the following:

- **IPv4 Home Address release:** The LMA returns the IPv4 Home Address assigned to the UE's PDN connection to the pool of free IPv4 Home Network Addresses.

5.7.1.1 Binding Revocation Indication

The fields of a BRI message for the PMIPv6 LMA Initiated PDN Connection Deletion procedure are depicted in Table 5.7.1.1-1.

The Mobility Options in a BRI message for the LMA Initiated PDN Connection Deletion procedure are depicted in Table 5.7.1.1-2. When the mobility option is present in the message, only the first instance shall be recognised. If multiple instances are included in the message, the receiver ignores all other instances.

Table 5.7.1.1-1: Fields of a BRI message for the LMA Initiated IPv4 Address Release

Information element	IE Description	Reference
Revocation Trigger	Set to a value indicating the event which triggered the revoking node to send the BRI message.	IETF RFC 5846 [6]
Sequence Number	A sequence number generated by the LMA, and increased for every BRI sent.	IETF RFC 5846 [6]
Proxy Binding Flag (P)	Set to "1" to indicate that the Binding Revocation Indication is for a proxy MIPv6 binding entry.	IETF RFC 5213 [4]
IPv4 HoA Binding Only (V)	Set to "1" to revoke IPv4 address only	IETF RFC 5846 [6]
Global Per-Peer Bindings (G)	Set to 0 to indicate that the request is for a specific PMIPv6 BCE.	IETF RFC 5846 [6]

Table 5.7.1.1-2: Mobility Options in a BRI message for the LMA Initiated IPv4 Address Release

Information element	Cat.	IE Description	Reference
Mobile Node Identifier option	M	Set to the UE NAI that is derived from the UE IMSI if an authenticated IMSI is available, or from the UE IMEI if IMSI is not available or the IMSI is not authenticated by the network. The NAI format is specified in 3GPP TS 23.003[12].	IETF RFC 5213 [4], 3GPP TS 23.003[12]
IPv4 Home Address Request option	M	Set the IPv4 Home Address to the IPv4 home address of the UE's PDN connection and Prefix-len to the non-zero value which was sent to the MAG at PMIPv6 PDN connection creation procedure or Handover procedure.	IETF RFC 5844 [5]
Service Selection Mobility Option	M	Set to the EPS Access Point Name to which the UE's PDN connection is attached. The encoding of the APN field follows 3GPP TS 23.003 [12] subclause 9.1 but excluding the trailing zero byte. The content of the APN field shall be the full APN with both the APN Network Identifier and APN Operator Identifier being present as specified in 3GPP TS 23.003 [12] subclauses 9.1.1 and 9.1.2. NOTE 1.	IETF RFC 5149[11]
PDN connection ID	C	Contains the PDN connection ID if the BCE contains the PDN Connection ID.	Subclause 12.1.1.15
NOTE 1: The APN field is not encoded as a dotted string as commonly used in documentation.			

5.7.1.2 Binding Revocation Acknowledgment

The fields of a BRA message for the PMIPv6 LMA Initiated PDN Connection Deletion procedure are depicted in Table 5.7.1.2-1.

The Mobility Options in a BRA message for the LMA Initiated PDN Connection Deletion procedure are depicted in Table 5.7.1.2-2. When the mobility option is present in the message, only the first instance shall be recognised. If multiple instances are included in the message, the receiver ignores all other instances.

Only the message fields and mobility options used for acceptance cases are present in the following tables.

Table 5.7.1.2-1: Fields of a BRA message for a LMA Initiated IPv4 Address Release

Information element	IE Description	Reference
Status	Indicates the result of the BRI	IETF RFC 5846 [6]
Sequence Number	Set to the value received in the corresponding BRI.	IETF RFC 5846 [6]
Proxy Binding Flag (P)	Set to "1" to indicate that the Binding Revocation Indication is for a proxy MIPv6 binding entry.	IETF RFC 5213 [4]
IPv4 HoA Binding Only (V)	Set to "1"; the same value as for BRI	IETF RFC 5846 [6]
Global Per-Peer Bindings (G)	Set to 0 to indicate that the request is for a specific PMIPv6 BCE.	IETF RFC 5846 [6]

Table 5.7.1.2-2: Mobility Options in a BRA message for the LMA Initiated IPv4 Address Release

Information element	Cat.	IE Description	Reference
Mobile Node Identifier option	M	Copied from corresponding field of BRI.	IETF RFC 5213 [4] , 3GPP TS 23.003 [12]
IPv4 Home Address Reply Option	M	Set the IPv4 Home Address to the IPv4 home address of the UE's PDN connection received in BRI. Set the Prefix-len to the non-zero value received in BRI.	IETF RFC 5844 [5]
Service Selection Mobility Option	M	Copied from the corresponding field in the BRI message. The encoding of the APN field follows 3GPP TS 23.003 [12] subclause 9.1 but excluding the trailing zero byte. The content of the APN field shall be the full APN with both the APN Network Identifier and APN Operator Identifier being present as specified in 3GPP TS 23.003 [12] subclauses 9.1.1 and 9.1.2. NOTE 1.	IETF RFC 5149[11]
3GPP Specific PMIPv6 Error Code	O	Contain 3GPP Specific PMIPv6 Error Code (on S5/S8)	Subclause 12.1.1.1
PDN connection ID	C	Contains the PDN connection ID received in BRI	Subclause 12.1.1.15
NOTE 1: The APN field is not encoded as a dotted string as commonly used in documentation.			

5.7.2 MAG procedures

The MAG shall follow the procedure for Revocation Trigger in BRI as "IPv4 HoA only" in "Binding Revocation Responder" sub-section of "Mobile Access Gateway" described in the IETF RFC 5846 [6]. The MAG shall respond with a BRA. BRA message parameters are set as per the details in BRA section of the procedure.

5.7.3 LMA procedures

The LMA shall send a BRI to the MAG as described for revoking IPv4 address only in the "Binding Revocation Initiator" sub-section of "Local Mobility Anchor" described in the IETF RFC 5846 [6]. The LMA shall delete the IPv4 Address from corresponding BCE related to the UE's PDN connection after receiving the BRA in reply to the BRI sent from LMA. BRI message parameters are set as per the details in BRI section of the procedure.

5.8 Proxy Mobile IPv6 Multiple PDN Extensions

5.8.1 General

In EPC a UE can connect or disconnect to multiple distinct PDNs in an independent manner. Thus a distinct PMIPv6 BCE and BULE exist for each of the PDN connections of an UE.

Supporting multiple PDN connections to the same APN function is optional for MAG and LMA. A MAG which supports the multiple PDN connections to the same APN function shall include PDN connection ID in the PBU message at initial attach/handover procedure. If the LMA supports the multiple PDN connections to the same APN function, it shall include the received PDN connection ID in the PBA message. If the LMA does not support the multiple PDN connections to the same APN function, it shall ignore the received PDN connection ID and shall not include the PDN connection ID in the PBA message. If the received PBA message does not contain a PDN connection ID, the MAG shall not send any PBU message for additional PDN connectivity request to the same APN for the same UE.

5.8.2 Extensions to PMIPv6 Data Structure

There shall be a unique BCE and BULE for each PDN connection. Each PDN connection can be uniquely identified by MN ID, an APN, and optionally a PDN connection ID in the BCE and BULE.

To support Multiple PDNs the MAG and LMA maintains extended data structure compared to the standard PMIPv6 as defined in IETF RFC 5213 [4]. Since multiple PDN connections of a UE can be distinguished based on an APN, both the BCE on the LMA and the BULE on the MAG need to be extended with the following additional field:

- APN of a UE's PDN connection.

Moreover, to support multiple PDN connections to the same APN function, the MAG and LMA shall maintain extended data structure compared to the PMIPv6 data structure described above. This extension is only applicable if multiple PDN connections to the same APN function is supported by both MAG and LMA.

Since the multiple PDN connections with the same APN of a UE shall be distinguished based on MN ID, an APN, and a PDN connection ID, both the BCE on the LMA and the BULE on the MAG need to be extended with the following additional field:

- PDN connection ID of a UE's PDN connection. The PDN connection ID is provided by the MAG to the LMA at PDN Connection Creation procedure or Handover procedure. For S2a/S2b interface, the MAG generates the PDN connection ID which shall be unique per MN-ID per APN. How the MAG generates the PDN Connection ID for the S2a and S2b reference points is out of scope of 3GPP. For S5/S8 interface, the MAG uses the EPS bearer identity of the default bearer as PDN connection ID.

5.8.3 Extensions to PMIPv6 BULE and BCE Lookups

5.8.3.1 General

To support Multiple PDNs the MAG and LMA perform extended lookups on the extended data structure compared to the standard PMIPv6 as defined in IETF RFC 5213 [4].

In standard PMIPv6 as defined in IETF RFC 5213 [4], a PMIPv6 BCE/BULE is looked up based on the Mobile Node Identifier (MN-Id), the access technology types (ATT) and if it exist the MN's link-layer identifier (MN-LL-Id).

In EPC the MN-LL-Id is not used and the EPC support handover between different interfaces for handover between non-3GPP and 3GPP accesses.

Distinct PMIPv6 BCE and BULE exist for each of the PDN connections of an UE.

The feature of having multiple PDN connections to the same APN is only supported if both MAG and LMA support it.

5.8.3.2 Extensions to PMIPv6 BCE Lookups

If the multiple PDN connections to the same APN feature is not supported, all PDN connections of a UE can be distinguished based on an APN and there is a one-to-one mapping between a PMIPv6 BCE, a PDN connection, and the (MN-Id, APN) tuple. An UE PDN connection can be uniquely identified by a (MN-Id, APN) tuple, the BCE is accordingly looked up on a per (MN-Id, APN) tuple basis.

If the multiple PDN connections to the same APN feature is supported, the LMA shall store the received PDN connection ID in the BCE. There is a one-to-one mapping between a PMIPv6 BCE, a PDN connection, and the (MN-Id, APN, PDN connection ID) tuple. Thus, an UE PDN connection can be uniquely identified by a (MN-Id, APN, PDN connection ID) tuple. The BCE is accordingly looked up as follows:

- If a PDN connection ID is received in the request message, the PMIPv6 BCE is looked up based on the (MN-Id, APN, PDN connection ID) tuple. If no existing binding is found based on the (MN-Id, APN, PDN connection ID) tuple, the LMA shall re-perform the PMIPv6 BCE lookup based on a per (MN-Id, APN) tuple.
- If a PDN connection ID is not received in the request message, the PMIPv6 BCE lookup is based on a per (MN-Id, APN) tuple.

5.8.3.3 Extensions to PMIPv6 BULE Lookups

If the multiple PDN connections to the same APN feature is not supported, an UE PDN connection can be uniquely identified by a (MN-Id, APN) tuple. In this case the BULE is accordingly looked up on a per (MN-Id, APN) tuple basis.

If the multiple PDN connections to the same APN feature is supported, the MAG shall generate a PDN connection ID per PDN connection and store it in the BULE. Thus, there is a one-to-one mapping between a PMIPv6 BULE, a PDN connection, and the (MN-Id, APN, PDN connection ID) tuple. An UE PDN connection can be uniquely identified by a per (MN-Id, APN, PDN connection ID) tuple. The BULE is accordingly looked up on a per (MN-Id, APN, PDN connection ID) tuple basis.

5.8.4 Extensions to PMIPv6 Procedure

5.8.4.1 General

The processing rules on the received PMIPv6 message are specified in IETF RFC 5213 [4] and IETF RFC 5844 [5]. This subclause specifies the additional PMIPv6 procedures.

5.8.4.2 MAG procedure

If the PMIPv6 PBU retransmission is triggered, a PMIPv6 PBU message with identical mobility options, except the value of the Timestamp option is new, shall be sent.

5.8.4.3 LMA procedure

If before responding to a received PMIPv6 PBU message, a new PMIPv6 PBU message with the same MN-ID, APN (and PDN connection ID) mobility options is received, then the LMA may respond to one or all of the received PMIPv6 PBU messages.

If the LMA receives a PMIPv6 PBU message with HI = 1 from the same MAG and an existing BCE with the same MN-ID, APN (and PDN connection ID) is found, the LMA may refresh the BCE or release the old BCE and create a new one based on the received PBU message.

5.9 Serving GW Procedure at Chaining Case

5.9.1 General

Chained S2a/S2b with GTP-based S8 is not supported in this release.

Chained S2a/S2b with PMIP-based S8 is used when VPLMN has business relationship with Non-3GPP Networks and Serving GW in VPLMN supporting a LMA function as local non-3GPP Anchor.

5.9.2 Signalling procedures

When either of the S2a or S2b interfaces is chained with a PMIP-based S8 interface, the Serving GW acts as the signaling endpoint for each interface. On the S2a or S2b interface, the Serving GW acts as an LMA. On the chained PMIP-based S8 interface, the Serving GW acts as MAG. When a procedure is initiated by its peer on a given interface for a given PDN connection, the Serving GW shall trigger an equivalent procedure over the chained interface for the designated PDN connection. The procedure initiated by its peer cannot be completed before the completion of the equivalent procedure initiated over the chained interface.

5.9.2.1 PMIP-based S8 Serving GW procedures

Upon receiving a PMIPv6 message over S8 for an LMA initiated procedure for a given PDN connection, the Serving GW shall initiate the corresponding LMA procedure over S2a or S2b for the designated PDN connection.

Upon receiving a PMIPv6 message over S2a or S2b for a MAG initiated procedure for a given PDN connection, the Serving GW shall initiate the corresponding MAG procedure over PMIP-based S8 for the designated PDN connection.

Table 5.9.2.1-1: procedure, message and IE mapping at PMIPv6 based S8

Initiated procedure	Messages	Initiating interface	Chained interface	Corresponding procedure Chained interface	Corresponding messages
PDN Connection Creation as specified in subclause 5.1	PBU/PBA	S2a or S2b	PMIPv6 based S8	PDN Connection Creation as specified in subclause 5.1	PBU/PBA
PDN Connection Lifetime Extension as specified in subclause 5.2	PBU/PBA	S2a or S2b	PMIPv6 based S8	PDN Connection Lifetime Extension as specified in subclause 5.2	PBU/PBA
PDN Connection Handover as specified in subclause 5.3	PBU/PBA	S2a or S2b	PMIPv6 based S8	PDN Connection Handover as specified in subclause 5.3	PBU/PBA
MAG Initiated PDN Connection Deletion as specified in subclause 5.4	PBU/PBA	S2a or S2b	PMIPv6 based S8	MAG Initiated PDN Connection Deletion as specified in subclause 5.4	PBU/PBA
LMA Initiated PDN Connection Deletion as specified in subclause 5.5	BRI/BRA	PMIPv6 based S8	S2a or S2b	LMA Initiated PDN Connection Deletion as specified in subclause 5.5	BRI/BRA

5.9.3 Payload packets at chained case

When the S2a or S2b interfaces is chained with a PMIP-based S8 interface, both uplink and downlink payload packets are forwarded by the Serving GW between the S2a or S2b PMIPv6 GRE tunnel and the S8 PMIPv6 GRE tunnel for a given PDN connection.

5.10 Proxy Mobile IPv6 MAG Initiated IPv4 Address Release procedure

5.10.1 General

In the case when UE is assigned both IPv6 HNP and IPv4 Home Address, for DHCPv4 Release procedure, the node acting as MAG initiates the selective de-registration of IPv4 home address procedure to notify the node acting as LMA about release of IPv4 address of UE for a certain PDN connection. MAG notifies LMA by sending a PBU and LMA confirms by replying with a PBA as described in IETF RFC 5844 [5]. IPv4 address release procedure achieves the following:

IPv4 Home Address release: The LMA releases an IPv4 Home Address of the UE's PDN connection.

5.10.1.1 Proxy Binding Update

The fields of a PBU message for the PMIPv6 MAG Initiated IPv4 Address Release procedure are depicted in Table 5.10.1.1-1.

The Mobility Options in a PBU message for the PMIPv6 MAG Initiated IPv4 Address Release procedure are depicted in Table 5.10.1.1-2. When the mobility option is present in the message, only the first instance shall be recognised. If multiple instances are included in the message, the receiver ignores all other instances.

Other flags are not used by this specification.

Table 5.10.1.1-1: Fields of a PBU message for the PMIPv6 MAG Initiated IPv4 Address Release procedure

Information element	IE Description	Reference
Sequence Number	Set to a locally (i.e. per MAG) monotonically increasing value.	IETF RFC 5213 [4]
Acknowledge (A)	Set to "1" to request an acknowledgement message.	IETF RFC 6275 [8]
Proxy Registration Flag (P)	Set to "1" to indicate that the Binding Update message is a proxy registration.	IETF RFC 5213 [4]
Force UDP encapsulation request (F) Flag	Set to "0" to indicate that UDP encapsulation is not used for the user plane.	IETF RFC 5555 [34]
Lifetime	Set to "0" to request deletion of the IPv4 binding.	IETF RFC 5844 [5]

Table 5.10.1.1-2: Mobility Options in a PBU message for the PMIPv6 MAG Initiated IPv4 Address Release procedure

Information element	Cat.	IE Description	Reference
Mobile Node Identifier option	M	Set to the NAI identifier of the UE as specified in 3GPP TS 23.003 [12].	3GPP TS 23.003 [12]
Handoff Indicator option	M	Set to the value "4" to indicate Handoff state unknown.	IETF RFC 5213 [4]
Access Technology Type option	M	Set to the value matching the characteristics of the non-3GPP access on S2a (e.g., HRPD) the UE is using to attach to the EPS as defined in the Access Technology Type Option type values registry of the IANA Mobile IPv6 Parameters Registry [18]. NOTE 1	IETF RFC 5213 [4]
Timestamp option	M	Set to the current time	IETF RFC 5213 [4]
IPv4 Home Address Request option	M	Set the IPv4 Home Address to the IPv4 Home Address to be released of the UE's PDN connection and Prefix-len to the non-zero value received from LMA.	IETF RFC 5844 [5]
Service Selection Mobility Option	M	Set to the EPS Access Point Name to which the UE's PDN connection is attached, formatted as defined in 3GPP TS 23.003 [12]	IETF RFC 5149[11]
NOTE 1: The PDN-GW can be informed about the type of access network used by the UE over several reference points, see 3GPP TS 29.212 [30] for the mapping between the code values for the different access network types.			

5.10.1.2 Proxy Binding Acknowledgement

The fields of a PBA message for the PMIPv6 MAG Initiated IPv4 Address Release procedure are depicted in Table 5.10.1.2-1.

The Mobility Options in a PBA message for the PMIPv6 MAG Initiated IPv4 Address Release procedure are depicted in Table 5.10.1.2-2. When the mobility option is present in the message, only the first instance shall be recognised. If multiple instances are included in the message, the receiver ignores all other instances.

Other flags are not used by this specification.

Only the message fields and mobility options used for acceptance cases are present in the following tables.

Table 5.10.1.2-1: Fields of a PBA message for the PMIPv6 MAG Initiated IPv4 Address Release procedure

Information element	IE Description	Reference
Status	Set to indicate the result.	IETF RFC 6275 [8]
Proxy Registration Flag (P)	Set to "1" to indicate that the Binding Update message is a proxy registration.	IETF RFC 5213 [4]
Sequence Number	Set to the value received in the corresponding PBU.	IETF RFC 5213 [4]
Lifetime	Set to "0" to request deletion of the IPv4 binding.	IETF RFC 5844 [5]

Table 5.10.1.2-2: Mobility Options in a PBA message for the PMIPv6 MAG Initiated IPv4 Address Release procedure

Information element	Cat.	IE Description	Reference
Mobile Node Identifier option	M	Copied from corresponding field of PBU.	IETF RFC 5213 [4]
Handoff Indicator option	M	Copied from corresponding field of PBU.	IETF RFC 5213 [4]
Access Technology Type option	M	Copied from corresponding field of PBU.	IETF RFC 5213 [4]
Timestamp option	M	Copied from corresponding field of PBU, or set to the current time of LMA in case of timestamp error.	IETF RFC 5213 [4]
IPv4 Home Address Reply Option	M	Set the IPv4 Home Address to the released IPv4 Home Address of the UE's PDN connection and Prefix-len to the non-zero value received in BRI.	IETF RFC 5844 [5]
IPv4 Default Router Address Option	M	The LMA sets the value of the UE's IPv4 default router address which belongs to the same subnet as the IPv4 Home Address allocated to the UE.	IETF RFC 5844 [5]
Service Selection Mobility Option	M	Copied from the corresponding field in the PBU message, formatted as defined in 3GPP TS 23.003 [12]	IETF RFC 5149[11]
3GPP Specific PMIPv6 Error Code	O	Contain 3GPP Specific PMIPv6 Error Code (on S5/S8).	Subclause 12.1.1.1

5.10.2 MAG procedures

The MAG initiating IPv4 Address Release using DHCPv4 procedure shall follow the "Selective De-Registration" procedure and "DHCP Server co-located with MAG" procedure as described in IPv4 support for PMIPv6 [5] specifications, while parameters in the PBU are set as specified by the PBU parameters section for this procedure.

1. Set the IPv4 home address to be released in the IPv4 home address Request option in the PBU.
2. Set other parameters in the PBU as specified by the PBU parameters section for this procedure.

5.10.3 LMA procedures

On reception of a PBU, the LMA shall initiate the "Selective De-Registration" procedures as described in the IPv4 support for PMIPv6 [5] specifications with the following additional requirements:

1. Release the IPv4 Home Address corresponding to the IPv4 home address Request option in the PBU message.
2. Set parameters in the PBA as specified by the PBA parameters section for this procedure.

5.11 Proxy Mobile IPv6 LMA Initiated Update Notification procedure

5.11.1 General

In EPC the PMIPv6 LMA Initiated Update Notification procedure is initiated by the node acting as a LMA to notify the node acting as a MAG, that the Binding Cache Entry related to the UE is about to be updated, so the MAG updates the

resources related to that PDN connection. The procedure starts with the LMA sending a PMIPv6 UPN message to the MAG. The MAG confirms by sending a PMIPv6 UPA message to the LMA.

The PMIPv6 LMA Initiated Update Notification procedure is initiated by the node acting as a LMA to notify the node acting as a MAG, to trigger the generation of End Marker by the MAG. The procedure starts with the LMA sending a PMIPv6 UPN message to the MAG. The LMA shall not request an acknowledgement message from the MAG. See clause 15.

This PMIPv6 LMA Initiated Update Notification procedure is based on the PMIPv6 notification procedure as specified in the IETF RFC 7077 [35].

5.11.1.1 Update Notification

The fields of a UPN message for the PMIPv6 LMA Initiated Update Notification procedure are depicted in Table 5.11.1.1-1.

The Mobility Options in a UPN message for the PMIPv6 LMA Initiated Update Notification procedure are depicted in Table 5.11.1.1-2. When the mobility option is present in the message, only the first instance shall be recognised. If multiple instances are included in the message, the receiver shall ignore all other instances.

Other flags are not used by this specification.

Table 5.11.1.1-1: Fields of a UPN message for the PMIPv6 LMA Initiate Update Notification procedure

Information element	Description	Reference
Sequence Number	Set to a locally (i.e. per LMA) monotonically increasing value.	IETF RFC 5213 [4]
Notification Reason	Set to the corresponding notification reason	IETF RFC 7077 [35]
Acknowledge (A)	Set to "1" to request an acknowledgement message. Set to "0" not to request an acknowledgement message.	IETF RFC 7077 [35]

Table 5.11.1.1-2: Mobility Options in a UPN message for the PMIPv6 LMA Initiated Update Notification procedure

Information element	Cat.	IE Description	Reference
Mobile Node Identifier option	M	Set to the NAI identifier of the UE as specified in 3GPP TS 23.003 [12].	3GPP TS 23.003 [12]
Service Selection Mobility Option	O	This IE shall be set to the EPS Access Point Name to which the UE's PDN connection is attached.	IETF RFC 5149 [11]
PDN connection ID	O	This IE shall contain the PDN connection ID if the BCE contains the PDN Connection ID.	Subclause 12.1.1.15
MME/SGSN Identifier	O	Contains the MME/S4-SGSN identifier	Subclause 12.1.1.20
Protocol Configuration Option	O	Contains Protocol Configuration Options.	Subclause 12.1.1.0
End Marker Notification	O	Contains the End Marker Notification (on S5/S8).	Subclause 12.1.1.21
PDN GW IP Address	O	Contains PDN GW IP address for control plane used by the PDN connection.	Subclause 12.1.1.4
GRE key option	O	Contains the uplink GRE key for control plane used by the PDN connection.	IETF RFC 5845 [7]
Additional Protocol Configuration Option	O	Contains Additional Protocol Configuration Options.	Subclause 12.1.1.19

5.11.1.2 Update Notification Acknowledgement

The fields of a UPA message for the PMIPv6 LMA Initiated Update procedure are depicted in Table 5.11.1.2-1.

The Mobility Options in a UPA message for the PMIPv6 LMA Initiated Update procedure are depicted in Table 5.11.1.2-2. When the mobility option is present in the message, only the first instance shall be recognised. If multiple instances are included in the message, the receiver shall ignore all other instances.

Other flags are not used by this specification.

Only the message fields and mobility options used for acceptance cases are present in the following tables.

Table 5.11.1.2-1: Fields of a UPA message for the PMIPv6 LMA Initiated Update Notification procedure

Information element	Description	Reference
Sequence Number	Set to the value received in the corresponding UPN.	IETF RFC 5213 [4]
Status	Indicates the result of the UPN	IETF RFC 7077 [35]

Table 5.11.1.2-2: Mobility Options in a UPA message for the PMIPv6 LMA Initiated Update Notification procedure

Information element	Cat.	IE Description	Reference
Mobile Node Identifier option	M	Copied from the corresponding field in the UPN.	3GPP TS 23.003 [12]
Service Selection Mobility Option	O	This IE shall be copied from the corresponding field in the UPN message if present.	IETF RFC 5149 [11]
PDN connection ID	C	Contains the PDN connection ID received in UPN	Subclause 12.1.1.15
3GPP Specific PMIPv6 Error Code	O	Contains a 3GPP Specific PMIPv6 Error Code.	Subclause 12.1.1.1

5.11.2 LMA procedures

A LMA initiating the PMIPv6 LMA Initiated Update Notification procedure shall follow the procedure described in IETF RFC 7077 [35], while parameters in the UPN message are set as specified by the UPN message parameters section for this procedure.

5.11.3 MAG procedures

On reception of a UPN, the MAG shall follow the procedure described in IETF RFC 7077 [35], while parameters in the UPA message are set as specified by the UPA message parameters section for this procedure.

5.12 Proxy Mobile IPv6 Mobile Network Prefix Allocation procedure

5.12.1 General

Proxy Mobile IPv6 Mobile Network Prefix Allocation procedure is initiated by the node acting as a MAG when DHCPv6 Reply message is received from the node acting as a LMA which is co-located with delegating router if the UE requests a network prefix shorter than the default /64 prefix (i.e. prefixes in addition to the default prefix) as specified in 3GPP TS 23.402 [3]. The MAG sends a PBU to LMA associating the network prefix with an existing PDN connection. The LMA confirms the assigned network prefix by sending a PBA to the MAG. Proxy Mobile IPv6 Mobile Network Prefix Allocation achieves the following:

- **Delegated Mobile Network Prefix assignment:** The LMA assigns to the UE's PDN connection the mobile network prefix shorter than the default /64 prefix valid in the selected PDN.
- **BCE Update:** The LMA includes the delegated mobile network prefix in the BCE for the PDN connection.
- **BULE Update:** The MAG includes the delegated mobile network prefix in the BULE for the PDN connection.

5.12.1.1 Proxy Binding Update

The fields of a PBU message for the PMIPv6 Mobile Network Prefix Allocation procedure are depicted in Table 5.12.1.1-1.

The Mobility Options in a PBU message for the PMIPv6 Mobile Network Prefix Allocation procedure are depicted in Table 5.12.1.1-2. When the mobility option is present in the message, only the first instance shall be recognised. If multiple instances are included in the message, the receiver ignores all other instances.

Other flags are not used by this specification.

Table 5.12.1.1-1: Fields of a PBU message for the PMIPv6 Mobile Network Prefix Allocation procedure

Information element	IE Description	Reference
Sequence Number	Set to a locally (i.e. per MAG) monotonically increasing value.	IETF RFC 5213 [4]
Acknowledge (A)	Set to "1" to request an acknowledgement message.	IETF RFC 6275 [8]
Proxy Registration Flag (P)	Set to "1" to indicate that the Binding Update message is a proxy registration.	IETF RFC 5213 [4]
Force UDP encapsulation request (F) Flag	Set to "0" to indicate that UDP encapsulation is not used for the user plane.	IETF RFC 5555 [34]
Lifetime	Set to the requested number of time units the binding shall remain valid.	IETF RFC 6275 [8]

Table 5.12.1.1-2: Mobility Options in a PBU message for the PMIPv6 Mobile Network Prefix Allocation procedure

Information element	Cat.	IE Description	Reference
Mobile Node Identifier option	M	Set to the UE NAI that is derived from the UE IMSI if an authenticated IMSI is available, or from the UE IMEI if IMSI is not available or the IMSI is not authenticated by the network. The NAI format is specified in 3GPP TS 23.003 [12].	IETF RFC 5213 [4], 3GPP TS 23.003 [12]
Delegated Mobile Network Prefix Option	M	Set the Delegated Mobile Network Prefix Option to the mobile network prefix allocated to the UE's PDN connection.	IETF RFC 7148 [45]
Link-local Address	M	Set to the link-local address already allocated to the MAG (in the previous initial binding registration) for use on the access link shared with the UE.	IETF RFC 5213 [4]
Handoff Indicator option	M	Set to the value "5" to indicate handoff state not changed (Re-registration).	IETF RFC 5213 [4]
Access Technology Type option	M	Set to the 3GPP access type, i.e., to GERAN, UTRAN or E-UTRAN.	IETF RFC 5213 [4]
Timestamp option	M	Set to the current time	IETF RFC 5213 [4]
Service Selection Mobility Option	M	Set to the EPS Access Point Name to which the UE's PDN connection is attached. The encoding of the APN field follows 3GPP TS 23.003 [12] subclause 9.1 but excluding the trailing zero byte. The content of the APN field shall be the full APN with both the APN Network Identifier and APN Operator Identifier being present as specified in 3GPP TS 23.003 [12] subclauses 9.1.1 and 9.1.2. NOTE 1.	IETF RFC 5149 [11]
PDN connection ID	C	Contains the PDN connection ID if the BULE contains the PDN Connection ID.	Subclause 12.1.1.15

NOTE 1: The APN field is not encoded as a dotted string as commonly used in documentation.

5.12.1.2 Proxy Binding Acknowledgement

The fields of a PBA message for the PMIPv6 Mobile Network Prefix Allocation procedure are depicted in Table 5.12.1.2-1.

The Mobility Options in a PBA message for the PMIPv6 Mobile Network Prefix Allocation procedure are depicted in Table 5.12.1.2-2. When the mobility option is present in the message, only the first instance shall be recognised. If multiple instances are included in the message, the receiver ignores all other instances.

Other flags are not used by this specification.

Only the message fields and mobility options used for acceptance cases are present in the following tables.

Table 5.12.1.2-1: Fields of a PBA message for the PMIPv6 Mobile Network Prefix Allocation procedure

Information element	IE Description	Reference
Status	Set to indicate the result.	IETF RFC 6275 [8]
Proxy Registration Flag (P)	Set to "1" to indicate that the Binding Update message is a proxy registration.	IETF RFC 5213 [4]
Sequence Number	Set to the value received in the corresponding PBU.	IETF RFC 5213 [4]
Lifetime	Set to the granted number of time units the binding shall remain valid.	IETF RFC 6275 [8]

Table 5.12.1.2-2: Mobility Options in a PBA message for the PMIPv6 Mobile Network Prefix Allocation procedure

Information element	Cat.	IE Description	Reference
Mobile Node Identifier option	M	Copied from corresponding field of PBU.	IETF RFC 5213 [4]
Delegated Mobile Network Prefix Option	M	Copied from corresponding field of PBU.	IETF RFC 7148 [45]
Link-local Address	M	Set to the link-local address already allocated to the MAG (in the previous initial binding registration) for use on the access link shared with the UE.	IETF RFC 5213 [4]
Handoff Indicator option	M	Copied from corresponding field of PBU.	IETF RFC 5213 [4]
Access Technology Type option	M	Copied from corresponding field of PBU.	IETF RFC 5213 [4]
Timestamp option	M	Copied from corresponding field of PBU, or set to the current time of LMA in case of timestamp error.	IETF RFC 5213 [4]
Service Selection Mobility Option	M	Copied from the corresponding field in the PBU message. The encoding of the APN field follows 3GPP TS 23.003 [12] subclause 9.1 but excluding the trailing zero byte. The content of the APN field shall be the full APN with both the APN Network Identifier and APN Operator Identifier being present as specified in 3GPP TS 23.003 [12] subclauses 9.1.1 and 9.1.2. NOTE 1.	IETF RFC 5149 [11]
3GPP Specific PMIPv6 Error Code	O	Contain 3GPP Specific PMIPv6 Error Code (on S5/S8).	Subclause 12.1.1.1
PDN connection ID	C	Contains the PDN connection ID received in PBU	Subclause 12.1.1.15

NOTE 1: The APN field is not encoded as a dotted string as commonly used in documentation.

5.12.2 MAG procedures

The MAG initiating PMIPv6 Mobile Network Prefix Allocation using DHCPv6 prefix delegation procedure shall follow the "Delegating Router Co-located with Local Mobility Anchor" procedure as described in IETF RFC 7148 [45], while parameters in the PBU message are set as specified by the PBU message parameters section for this procedure.

5.12.3 LMA procedures

On reception of a PBU, the LMA shall initiate the "Delegating Router Co-located with Local Mobility Anchor" procedures as described described in IETF RFC 7148 [45], while parameters in the PBA message are set as specified by the PBA message parameters section for this procedure.

6 Tunnel Management procedures

6.1 General

The Mobile Anchor Gateway (MAG) and the Local Mobility Anchor (LMA) establish and maintain a bi-directional tunnel for each PDN connection, which is used for routing the UE's PDN connection user-plane traffic between the MAG and the LMA. This tunnel is based on GRE encapsulation as specified in IETF RFC 2890 [21] (see also IETF RFC 2784 [20]) and is established as a result of exchanging the Proxy Binding Update (PBU) and the Proxy Binding Acknowledgment (PBA) messages between the MAG and LMA. The PBU and PBA messages establish unique Binding Cache Entry (BCE) and Binding Update List Entry (BULE) entries for each PDN connection at the LMA and the MAG respectively. The tunnel end points are:

- the Proxy-CoA at the MAG and LMAA or LMA User Plane Address (if an alternate address is used for user plane) at the LMA with GRE encapsulation (for IPv6 transport network); or
- the IPv4-Proxy-CoA at the MAG and IPv4-LMAA or LMA User Plane Address (if an alternate address is used for user plane) at the LMA with GRE encapsulation (for IPv4 transport network), as described in IETF RFC 5845 [7].

GRE encapsulation shall always be used; the GRE tunneling negotiation described in IETF RFC 5845 [7] is not applicable and the GRE Key Identifier Option shall always be present in the PBU messages for PMIPv6 PDN Connection Creation and binding registration after handover.

The LMA may assign an alternate LMAA or IPv4-LMAA during the setup of the PDN connection, if this option is supported by both MAG and LMA.

Tear down of GRE tunnels and cleanup of state is done explicitly by MAG Initiated PDN Connection Deletion or LMA Initiated PDN Connection Deletion; additionally, the tunnel is torn down when the binding lifetime expires as described in IETF RFC 5213 [4].

A PMIPv6 node (MAG or LMA), which uses the control plane A protocol stack (see subclause 4.2) shall send signalling messages specified in Section 5 with IPv4-UDP encapsulation in IPv4 transport network as specified in IETF RFC 5844 [5].

A PMIPv6 node (MAG or LMA), which uses the control plane B protocol stack (see subclause 4.2) shall send signalling messages specified in Section 5 natively, without encapsulation in IPv6 transport network as specified in IETF RFC 5213 [4].

The maximum size of an inner IP packet that may be transmitted without fragmentation by the PDN GW or the MS/UE is the same as the maximum N-PDU size that can be transmitted without IP fragmentation as defined in 3GPP TS 23.060 [23].

Recommendations on how to set the default inner MTU size at the PDN GW and UE/MS to avoid IP fragmentation of both inner IP packets (in the PDN GW or UE/MS) and outer IP packets in the backbone are specified in clause 9.3 of 3GPP TS 23.060 [23].

To avoid network overload due to excessive signalling, when sending a PBU message, the requested binding lifetime should be sufficiently large, e.g. greater than 300 seconds. After accepting a PBU request, the binding lifetime may be reset to another value by the LMA based on local configuration.

6.2 MAG procedure

When the PDN connectivity is established, the downlink GRE key for the PDN connection downlink traffic is selected by the MAG and sent to LMA in PBU message. This downlink GRE key shall be unique within the MAG for a given LMAA or IPv4-LMAA, or for a given (IPv4-)Proxy-CoA if the MAG indicates to the LMA that it supports the capability to receive an alternate LMA address for user plane.

The uplink GRE key is received from LMA in a PBA message, and also from the MME in case Serving GW relocation occurs. The MAG shall be able to send the PDN connection uplink traffic using the received uplink GRE key towards the LMAA or IPv4-LMAA or LMA User Plane Address (if an alternate address is used for user plane) before sending the PBU or before receiving the PBA.

When the PDN connection is released, the downlink GRE key shall be released by the MAG.

6.3 LMA procedure

When the PDN connectivity is established, the uplink GRE key for the PDN connection uplink traffic is selected by the LMA and sent to MAG in PBA message. This uplink GRE key shall be unique within the LMA.

The LMA function shall be able to accept the PDN connection uplink packets from any MAG without enforcing that the source IP address of the outer IP header matches the Proxy-CoA in the UE BCE.

If GTP based S5/S8 is used for E-UTRAN access and PMIP based S2a is used for HRPD access, and optimized handover from E-UTRAN to HRPD is supported, when the PGW allocates an uplink TEID for a default bearer of a GTP tunnel, it shall also reserve an uplink GRE key with the same value of the default bearer uplink TEID.

When the PDN connection is released, the uplink GRE key shall be released by the LMA.

6.4 Data Structures

6.4.1 Binding Update List Entry

MAG maintains a unique Binding Update List Entry for for each PDN connection of a UE. The required elements of BULE as per 3GPP requirements are described in table 6.4.1-1.

Table 6.4.1-1: Elements of BULE

Element	Description	Reference
Mobile Node Identifier	Set to the UE NAI that is derived from the UE IMSI if an authenticated IMSI is available, or from the UE IMEI if IMSI is not available or the IMSI is not authenticated by the network. The NAI format is specified in 3GPP TS 23.003 [12].	3GPP TS 23.003 [12], IETF RFC 5213 [4]
Access Point Name	Set to the EPS Access Point Name to which the UE's PDN connection is attached, formatted as defined in 3GPP TS 23.003 [12]	3GPP TS 23.003 [12]
Lifetime	Set to lifetime granted for the binding as received in PBA.	IETF RFC 6275 [8]
Remaining Lifetime	This lifetime is initialized from the lifetime granted for the binding and is decremented until it reaches 0.	IETF RFC 6275 [8]
Sequence Number	The sequence number of the last Proxy Binding Update message sent.	IETF RFC 6275 [8]
Timestamp	Time at which last PBU was sent.	IETF RFC 6275 [8]
Binding Flag	Set to 1 if MAG receives an ICMPv6 parameter problem, code 1, error message in response to a PBU. Set to 0 if MAG continues to send PBU.	IETF RFC 6275 [8]
IPv6 Home Network Prefix	IPv6 Home Network Prefix assigned to the UE's PDN connection.	IETF RFC 5213 [4]
Link-local Address	IPv6 Link-local address to be used by the MAG on the access link shared with the UE.	IETF RFC 5213 [4]
IPv4 Home Address	IPv4 Home Address assigned to UE's PDN connection.	IETF RFC 5213 [4]
IPv4 default-router address	The IPv4 default-router address of the mobile node.	IETF RFC 5844 [5]
LMA IPv6 Address	IPv6 Address of the LMA for control plane, and for user plane if no alternate LMA user plane address is used.	IETF RFC 6275 [8]
LMA IPv4 Address	IPv4 Address of the LMA for control plane, and for user plane if no alternate LMA user plane address is used.	IETF RFC 5844 [5]
LMA User-Plane Address	IPv4 or IPv6 Address of the LMA for user plane.	IETF RFC 7389 [44]
Downlink GRE Key	Downlink GRE key for the PDN connection as selected by MAG.	IETF RFC 5845 [7]
Uplink GRE key	Uplink GRE key for the PDN connection selected by LMA as received in GRE Key option of PBA.	IETF RFC 5845 [7]
Chained Binding Cache Entry	Reference to the corresponding BCE used for the binding on the S8 interface. It shall be present only in the Serving GW, in case of S2a/S2b - PMIP based-S8 chaining.	
PDN Connection ID	Set to the PDN Connection ID if multiple PDN connections to the same APN is supported by both MAG and LMA	Subclause 12.1.1.15

6.4.2 Binding Cache Entry

LMA maintains a unique Binding Cache Entry for each PDN connection for a UE. The required elements of BCE as per 3GPP requirements are described in table 6.4.1-2.

Table 6.4.2-1: Elements of BCE

Element	Element Description	Reference
Mobile Node Identifier	The MN-Id mobility option as received in PBU.	3GPP TS 23.003 [12], IETF RFC 5213 [4]
Access Point Name	The Service Selection Mobility option received in PBU	3GPP TS 23.003 [12]
Lifetime	Lifetime granted for the binding.	IETF RFC 6275 [8]
Sequence Number	Sequence number of last received PBU.	IETF RFC 6275 [8]
IPv6 Home Network Prefix	IPv6 Home Network Prefix assigned to the UE's PDN connection.	IETF RFC 5213 [4]
Link-local Address	The assigned IPv6 link local address to MAG for use on the access link shared with the UE.	IETF RFC 5213 [4]
IPv4 Home Address	IPv4 Home Address assigned to UE's PDN connection.	IETF RFC 5213 [4]
IPv4 default-router address	The IPv4 default-router address of the mobile node.	IETF RFC 5844 [5]
IPv6 Proxy care-of-address	MAG IPv6 Address, i.e. the source address of the IP packet in which PBU was received.	IETF RFC 6275 [8]
IPv4 Proxy care-of-address	MAG IPv4 Address.	IETF RFC 5844 [5]
LMA User-Plane Address	IPv4 or IPv6 Address of the LMA for user plane.	IETF RFC 7389 [44]
Access Technology Type	Access Technology Type as received in PBU.	IETF RFC 5213 [4]
Timestamp	Timestamp as received in PBU.	
Binding Flag	'1' as it is proxy registration.	IETF RFC 5213 [4]
Downlink GRE key	Downlink GRE key for the PDN connection selected by MAG as received in GRE key option of PBU.	IETF RFC 5845 [7]
Uplink GRE key	Uplink GRE key for the PDN connection selected by LMA.	IETF RFC 5845 [7]
Chained Binding Update List Entry	Reference to the corresponding BULE used for binding on the S2a / S2b interface. It shall be present only in the Serving GW, in case of S2a/S2b – PMIP-based S8 chaining.	
PDN Connection ID	Set to the PDN Connection ID if multiple PDN connections to the same APN is supported by both MAG and LMA	Subclause 12.1.1.15

6.5 Security

Security aspects for PMIPv6 are described in 3GPP TS 33.402 [19].

7 Path Management procedures

7.1 General

The path management for PMIPv6 is very similar to that of GTP; the main difference is the use of PMIPv6 messages instead of GTP messages.

Path failure handling procedures are specified in 3GPP TS 23.007 [13].

7.2 Heartbeat Mechanism

7.2.1 General

A LMA or MAG shall support sending Heartbeat Message to a peer MAG or LMA for Failure Detection and Restart Detection. The Heartbeat Message and procedures of Failure Detection and Restart Detection are defined in IETF RFC 5847 [17]. When and how often a Heartbeat Request message are sent is implementation specific but a periodic Heartbeat Request shall not be sent more often than every 60 s on each path.

7.2.2 Heartbeat Message

7.2.2.1 Heartbeat Request

Table 7.2.2.1-1 specifies the information elements included in the Heartbeat Request message.

Table 7.2.2.1-1: Fields of a Heartbeat message for the Heartbeat request

Information element	IE Description	Reference
R flag	Set to 0 for a request message.	IETF RFC 5847 [17]
Sequence Number	Set to a locally monotonically increasing value.	IETF RFC 5847 [17]

7.2.2.2 Heartbeat Response

Table 7.2.2.2-1 and 7.2.2.2-2 specifies the information elements included in the Heartbeat Response message.

Table 7.2.2.2-1: Fields of a Heartbeat message for the Heartbeat Response

Information element	IE Description	Reference
R flag	Set to 1 for a response message.	IETF RFC 5847 [17]
U flag	Set to 0 if the heartbeat response is sent as an answer to a heartbeat request. Set to 1 otherwise.	IETF RFC 5847 [17]
Sequence Number	Set to the value received in the corresponding Heartbeat Request message.	IETF RFC 5847 [17]

Table 7.2.2.2-2: Mobility Options in a Heartbeat message for the Heartbeat Response

Information element	IE Description	Reference
Restart Counter	indicates the current Restart Counter value	IETF RFC 5847 [17]

7.3 Void

7.4 Void

7.5 Void

7.6 UE-specific Error Handling

7.6.1 General

A PMIPv6 node (i.e., LMA or MAG) may support the UE-specific error indication such that a PMIPv6 node may send a message to the source PMIPv6 node when no binding exists for a packet received from a GRE tunnel.

7.6.2 MAG and LMA procedure

If a PMIPv6 receiving node (i.e. MAG or LMA) verifies that no PMIPv6 binding exists for a received user packet based on GRE Key, the receiving PMIPv6 node shall discard the packet. The PMIPv6 node may report the error to the peer PMIPv6 node, in the form of an ICMP message, as specified in Sections 8.1, 8.2 and 8.3 of IETF RFC2473 [31] for the node unreachable error case.

Handling of the received error in the form of an ICMP message is specified in 3GPP TS 23.007 [13].

7.7 Void

7.8 Partial node failure requiring the removal of a subset of sessions

7.8.1 General

See 3GPP TS 23.007 [13] for the description of this function.

7.8.2 Binding Revocation Indication message

The fields of a BRI message to revoke bulk PMIPv6 bindings initiated by the LMA or the MAG are depicted in Table 7.8.2-1.

The Mobility Options in a BRI message to revoke bulk PMIPv6 bindings sent by the LMA or the MAG are depicted in Table 7.8.2-2.

Table 7.8.2-1: Fields of a BRI message for the PMIPv6

Information element	IE Description	Reference
Revocation Trigger	Set to a the value of "Revoking Mobility Node Local Policy"	IETF RFC 5846 [6]
Sequence Number	A sequence number generated by the LMA, and increased for every BRI sent.	IETF RFC 5846 [6]
Proxy Binding Flag (P)	Set to "1" to indicate that the Binding Revocation Indication is for a proxy MIPv6 binding entry.	RFC 5213 [4]
IPv4 HoA Binding Only (V)	Set to "0" to request for complete binding revocation	IETF RFC 5846 [6]
Global Per-Peer Bindings (G)	Set to 1	IETF RFC 5846 [6]

Table 7.8.2-2: Mobility Options in a BRI message for the PMIPv6 LMA or MAG Initiated bulk PDN Connections Deletion for Partial Node failure

Information element	Cat.	IE Description	Reference
Mobile Node Identifier	C	Set to the IP address of the MAG, only when the BRI message is sent by the MAG.	3GPP TS 23.402[3]
Fully Qualified PDN Connection Set Identifier	M	This IE shall be included by the MAG or LMA on the S5/S8, S2a (for Trusted WLAN Access) and S2b interfaces (see 3GPP TS 23.007 [13]) and contains the Fully Qualified PDN Connection Set Identifier(s) that need to be revoked.	Subclause 12.1.1.2

7.8.3 Binding Revocation Acknowledgement message

The fields of a BRA message to revoke bulk PMIPv6 bindings for the PMIPv6 LMA or MAG Initiated PDN Connection Deletion procedure are depicted in Table 7.8.3-1.

Table 7.8.3-1: Fields of a BRA message for a PMIPv6 for a MAG or LMA Initiated bulk PDN Connections Deletion for Partial Node failure

Information element	IE Description	Reference
Status	Indicates the result of the BRI.	IETF RFC 5846 [6]
Sequence Number	Set to the value received in the corresponding BRI.	IETF RFC 5846 [6]
Proxy Registration Flag (P)	Set to "1" to indicate that the Binding Revocation Acknowledgment is for a proxy MIPv6 binding entry.	RFC 5213 [4]
IPv4 HoA Binding Only (V)	Set to "0"; the same value as for BRI	IETF RFC 5846 [6]
Global Per-Peer Bindings (G)	Set to 1; the same value as for the BRI.	IETF RFC 5846 [6]

7.8.4 MAG procedures

The MAG can be the initiator or the receiver of a BRI message to revoke bulk PMIPv6 bindings.

The MAG shall follow the "Local Mobility Anchor Revokes Bulk PMIPv6 Bindings" procedure described in the IETF RFC 5846 [6] when it receives a Binding Revocation Indication message with G bit set, removing the sessions identified by the Fully Qualified PDN Connection Set Identifier Mobility Option.

The MAG shall follow the "Mobile Access Gateway Revoke Bulk PMIPv6 Bindings" when it sends a Binding Revocation Indication message with G bit set to the LMA, including the Fully Qualified PDN Connection Set Identifier Mobility Option.

7.8.5 LMA procedures

The LMA can be the initiator or the receiver of a BRI message to revoke bulk PMIPv6 bindings.

The LMA shall follow the "Mobile Access Gateway Revokes Bulk PMIPv6 Bindings" procedure described in the IETF RFC 5846 [6] when it receives a Binding Revocation Indication message with G bit set, removing the sessions identified by the Fully Qualified PDN Connection Set Identifier Mobility Option.

The LMA shall follow the "Local Mobility Anchor Revoke Bulk PMIPv6 Bindings" when it sends a Binding Revocation Indication message with G bit set to the LMA, including the Fully Qualified PDN Connection Set Identifier Mobility Option.

8 PMIP-based S5 and PMIP-based S8 description

8.1 Initial Attach procedures

8.1.1 General

8.1.2 Serving GW procedures

The Serving GW shall follow the MAG procedure for the PMIPv6 PDN Connection Creation as outlined in subclause 5.1.2.

8.1.3 PDN GW procedures

The PDN GW shall follow the LMA procedure for the PMIPv6 PDN Connection Creation as outlined in subclause 5.1.3

8.2 Serving GW Initiated PDN Connection Lifetime Extension procedures

8.2.1 General

8.2.2 Serving GW procedures

The Serving GW shall follow the MAG procedure for the PMIPv6 PDN Connection Lifetime Extension as outlined in subclause 5.2.2.

8.2.3 PDN GW procedures

The PDN GW shall follow the LMA procedure for the PMIPv6 PDN Connection Lifetime Extension as outlined in subclause 5.2.3.

8.3 UE, MME or HSS initiated Detach procedures

8.3.1 General

8.3.2 Serving GW procedures

The Serving GW shall follow the MAG procedure for the PMIPv6 MAG Initiated PDN Connection Deletion as outlined in subclause 5.4.2 repeated for each PDN connection of the UE.

8.3.3 PDN GW procedures

The PDN GW shall follow the LMA procedure for the PMIPv6 MAG Initiated PDN Connection Deletion as outlined in subclause 5.4.3.

8.4 PDN GW Initiated PDN Disconnection procedures

8.4.1 General

8.4.2 Serving GW procedures

The Serving GW shall follow the MAG procedure for the PMIPv6 LMA Initiated PDN Connection Deletion as outlined in subclause 5.5.2.

8.4.3 PDN GW procedures

The PDN GW shall follow the LMA procedure for the PMIPv6 LMA Initiated PDN Connection Deletion for the selected PDN connection as outlined in subclause 5.5.3.

The PGW shall include the 3GPP Specific PMIPv6 error code IE and set it to the cause "Reactivation requested" when the PGW initiates the PDN GW Initiated Resource Allocation Deactivation procedure as part of the P-CSCF restoration procedure over 3GPP access, as specified in 3GPP TS 23.380 [36].

8.5 UE Requested Additional PDN Connectivity procedures

8.5.1 General

8.5.2 Serving GW procedures

If the Request Type indicates "initial attach", the Serving GW shall follow the MAG procedure for the PMIPv6 PDN Connection Creation as outlined in subclause 5.1.2.

If the Request Type indicates "Handover", the Serving GW shall follow the MAG procedure for the PMIPv6 PDN Connection Handover as outlined in subclause 5.3.2.

8.5.3 PDN GW procedures

If the Request Type indicates "initial attach", the PDN GW shall follow the LMA procedure for the PMIPv6 PDN Connection Creation as outlined in subclause 5.1.3.

If the Request Type indicates "Handover", the PDN GW shall follow the LMA procedure for the PMIPv6 PDN Connection Handover as outlined in subclause 5.3.3.

8.6 Handover procedures

8.6.1 Intra-LTE TAU and Inter-eNodeB Handover with Serving GW Relocation procedures

8.6.1.1 General

8.6.1.2 Serving GW procedures

The Serving GW shall follow the MAG procedure for the PMIPv6 PDN Connection Handover as outlined in subclause 5.3.2 repeated for each PDN connection of the UE.

8.6.1.3 PDN GW procedures

The PDN GW shall follow the LMA procedure for the PMIPv6 PDN Connection Handover as outlined in subclause 5.3.3.

8.6.2 TAU/RAU or Handover between GERAN A/Gb Mode or UTRAN Iu Mode and E-UTRAN procedures

8.6.2.1 General

8.6.2.2 Serving GW procedures

The Serving GW shall follow the MAG procedure for the PMIPv6 PDN Connection Handover as outlined in subclause 5.3.2 repeated for each PDN connection of the UE.

8.6.2.3 PDN GW procedures

The PDN GW shall follow the LMA procedure for the PMIPv6 PDN Connection Handover as outlined in subclause 5.3.3.

8.6.3 Handover from Trusted or Untrusted Non-3GPP IP Access over S2a/S2b to 3GPP Access Handover E-UTRAN over PMIP based S5/S8 without optimization procedures

8.6.3.1 General

8.6.3.2 Serving GW procedures

The Serving GW shall follow the MAG procedure for the PMIPv6 PDN Connection Handover as outlined in subclause 5.3.2 repeated for each PDN connection of the UE.

8.6.3.3 PDN GW procedures

The PDN GW shall follow the LMA procedure for the PMIPv6 PDN Connection Handover as outlined in subclause 5.3.3.

8.6.4 Handover from Trusted or Untrusted Non-3GPP IP Access over S2a/S2b to 3GPP Access UTRAN/GERAN over PMIP based S5/S8 without optimization

8.6.4.1 General

8.6.4.2 Serving GW procedures

The Serving GW shall follow the MAG procedure for the PMIPv6 PDN Connection Handover as outlined in subclause 5.3.2 repeated for each PDN connection of the UE.

8.6.4.3 PDN GW procedures

The PDN GW shall follow the LMA procedure for the PMIPv6 PDN Connection Handover as outlined in subclause 5.3.3.

8.6.5 Handover from Trusted or Untrusted Non-3GPP IP Access over S2c to 3GPP Access over PMIP based S5/S8 without optimization

8.6.5.1 General

8.6.5.2 Serving GW procedures

The Serving GW shall follow the MAG procedure for the PMIPv6 PDN Connection Handover as outlined in subclause 5.3.2 repeated for each PDN connection of the UE.

8.6.5.3 PDN GW procedures

The PDN GW shall follow the LMA procedure for the PMIPv6 PDN Connection Handover as outlined in subclause 5.3.3.

8.6.6 Void

8.6.7 Void

8.7 UE Requested PDN Disconnection procedures

8.7.1 General

8.7.2 Serving GW procedures

The Serving GW shall follow the MAG procedure for the PMIPv6 MAG Initiated PDN Connection Deletion, for the selected PDN connection as outlined in subclause 5.4.2.

8.7.3 PDN GW procedures

The PDN GW shall follow the LMA procedure for the PMIPv6 MAG Initiated PDN Connection Deletion, for the selected PDN connection as outlined in subclause 5.4.3.

8.8 IPv4 Address Allocation using DHCP

8.8.1 General

8.8.2 Serving GW procedures

The Serving GW shall follow the MAG procedure for the Proxy Mobile IPv6 PDN Connection IPv4 Address Allocation Procedure as defined in sub clause 5.6.2.

8.8.3 PDN GW procedures

The PDN GW shall follow the LMA procedure for the Proxy Mobile IPv6 PDN Connection IPv4 Address Allocation Procedure as defined in sub clause 5.6.3.

8.9 PDN-GW Initiated IPv4 Address Delete Procedure

8.9.1 General

8.9.2 Serving GW procedures

If UE is assigned both IPv6 HNP and IPv4 HoA, the Serving GW shall follow the MAG procedure for the LMA Initiated IPv4 Address Release procedure as defined in sub clause 5.7.2.

8.9.3 PDN GW procedures

If UE is assigned both IPv6 HNP and IPv4 HoA, the PDN GW shall follow the LMA procedure for the LMA Initiated IPv4 Address Release procedure as defined in sub clause 5.7.3.

If UE is assigned only IPv4 HoA, then PDN-GW initiated PDN Disconnection procedure is initiated.

8.10 Mobile Network Prefix Allocation using DHCPv6 Prefix Delegation

8.10.1 General

8.10.2 Serving GW procedures

The Serving GW shall follow the MAG procedure for the Proxy Mobile IPv6 Mobile Network Prefix Allocation procedure as defined in subclause 5.12.2.

8.10.3 PDN GW procedures

The PDN GW shall follow the LMA procedure for the Proxy Mobile IPv6 Mobile Network Prefix Allocation procedure as defined in sub clause 5.12.3.

9 Trusted Non-3GPP Access over S2a Description

9.0 General

Please refer to clause 13 for the description of the Trusted WLAN Access over S2a interface.

9.1 Initial Attach procedures

9.1.1 General

9.1.2 Trusted Non-3GPP Access procedures

In PMIPv6 mode, the Trusted Non-3GPP Access shall follow the MAG procedure for the PMIPv6 PDN Connection Creation as outlined in subclause 5.1.2.

9.1.3 PDN GW procedures

In PMIPv6 mode, the PDN GW shall follow the MAG procedure for the PMIPv6 PDN Connection Creation as outlined in subclause 5.1.3.

The PGW may include a PGW Back-Off Time IE when rejecting the PBU with the cause "APN congestion" (see subclause 4.5.8 of 3GPP TS 23.402 [3]).

9.2 Trusted Non-3GPP Access Initiated PDN Connection Lifetime Extension procedures

9.2.1 General

9.2.2 Trusted Non-3GPP Access procedures

In PMIPv6 mode, the Trusted Non-3GPP Access shall follow the MAG procedure for the PMIPv6 PDN Connection Lifetime Extension as outlined in subclause 5.2.2.

9.2.3 PDN GW procedures

In PMIPv6 mode, the PDN GW shall follow the LMA procedure for the PMIPv6 PDN Connection Lifetime Extension as outlined in subclause 5.2.3.

9.3 UE / Trusted Non-3GPP Access Initiated Detach and UE Requested PDN Disconnection procedures

9.3.1 General

9.3.2 Trusted Non-3GPP Access procedures

In PMIPv6 mode, the Trusted Non-3GPP Access shall follow the MAG procedure for the PMIPv6 MAG Initiated PDN Connection Deletion as outlined in subclause 5.4.2 for PDN Disconnection procedure,.

For Detach the Trusted Non-3GPP Access shall follow the above repeated for each PDN connection of the UE.

9.3.3 PDN GW procedures

In PMIPv6 mode, the PDN GW shall follow the LMA procedure for the PMIPv6 MAG Initiated PDN Connection Deletion as outlined in subclause 5.4.3.

9.4 HSS / AAA Initiated Detach procedures

9.4.1 General

The HSS/AAA may initiate a detach procedure resulting in a PMIPv6 De-Registration.

9.4.2 Trusted Non-3GPP Access procedures

In PMIPv6 mode, the Trusted Non-3GPP Access shall follow the MAG procedure for the PMIPv6 MAG Initiated PDN Connection Deletion as outlined in subclause 5.4.2 repeated for each PDN connection of the UE.

9.4.3 PDN GW procedures

In PMIPv6 mode, the PDN GW shall follow the LMA procedure for the PMIPv6 MAG Initiated PDN Connection Deletion as outlined in subclause 5.4.3.

9.5 UE Initiated Connectivity to Additional PDN procedures

9.5.1 General

9.5.2 Trusted Non-3GPP Access procedures

In PMIPv6 mode, if the Request Type indicates "initial attach", the Trusted Non-3GPP Access shall follow the MAG procedure for the PMIPv6 PDN Connection Creation as outlined in subclause 5.1.2. If the Request Type indicates "Handover", the Trusted Non-3GPP Access shall follow the MAG procedure for the PMIPv6 PDN Connection Handover as outlined in subclause 5.3.2.

9.5.3 PDN GW procedures

In PMIPv6 mode, if the Request Type indicates "initial attach", the PDN GW shall follow the LMA procedure for the PMIPv6 PDN Connection Creation as outlined in subclause 5.1.3. If the Request Type indicates "Handover", the PDN GW shall follow the LMA procedure for the PMIPv6 PDN Connection Handover as outlined in subclause 5.3.3.

If the Request Type indicates "initial attach" or "handover", the PGW may include a PGW Back-Off Time IE when rejecting the PBU with the cause "APN congestion" (see subclause 4.5.8 of 3GPP TS 23.402 [3]).

9.6 3GPP Access to Trusted Non-3GPP IP Access with PMIPv6 on S2a Handover procedures without optimization

9.6.1 General

9.6.2 Trusted Non-3GPP Access procedures

In PMIPv6 mode, the Trusted Non-3GPP Access shall follow the MAG procedure for the PMIPv6 PDN Connection Handover as outlined in subclause 5.3.2.

9.6.3 PDN GW procedures

In PMIPv6 mode, the PDN GW shall follow the LMA procedure for the PMIPv6 PDN Connection Handover as outlined in subclause 5.3.3.

If IPv6 network prefix preservation is supported at a handover from 3GPP Access with a GTP-based S5/S8 to non-3GPP Access, the LMA shall provide to the MAG the link-local address which is used by the PDN GW at the link shared with the UE in the 3GPP Access.

9.7 PDN GW Initiated Resource Allocation Deactivation procedures

9.7.1 General

9.7.2 Trusted Non-3GPP Access procedures

In PMIPv6 mode, the Trusted Non-3GPP Access shall follow the MAG procedure for the PMIPv6 LMA Initiated PDN Connection Deletion as outlined in subclause 5.5.2.

9.7.3 PDN GW procedures

In PMIPv6 mode, the PDN GW shall follow the LMA procedure for the PMIPv6 LMA Initiated PDN Connection Deletion as outlined in subclause 5.5.3.

9.8 IPv4 Address Allocation using DHCP

9.8.1 General

9.8.2 Trusted Non-3GPP Access procedures

The Trusted Non-3GPP Access shall follow the MAG procedure for the Proxy Mobile IPv6 PDN Connection IPv4 Address Allocation Procedure as defined in sub clause 5.6.2.

9.8.3 PDN GW procedures

The PDN GW shall follow the LMA procedure for the Proxy Mobile IPv6 PDN Connection IPv4 Address Allocation Procedure as defined in sub clause 5.6.3.

9.9 PDN-GW Initiated IPv4 Address Delete Procedure

9.9.1 General

9.9.2 Trusted Non-3GPP Access procedures

If UE is assigned both IPv6 HNP and IPv4 HoA, the Trusted Non-3GPP Access shall follow the MAG procedure for the LMA Initiated IPv4 Address Release procedure as defined in sub clause 5.7.2.

9.9.3 PDN GW procedures

If UE is assigned both IPv6 HNP and IPv4 HoA, the PDN GW shall follow the LMA procedure for the LMA Initiated IPv4 Address Release procedure as defined in sub clause 5.7.3.

If UE is assigned only IPv4 HoA, then PDN-GW initiated Resource Allocation Deactivation procedure is initiated.

9.10 Optimized E-UTRAN to CDMA2000 eHRPD Handover procedure

9.10.1 General

9.10.2 CDMA2000 HRPD access procedure

In PMIPv6 mode, the CDMA2000 HRPD access shall follow the MAG procedure for the PMIPv6 PDN Connection Handover procedure as outlined in subclause 5.3.2.

9.10.3 PDN GW procedures

In PMIPv6 mode, the PDN GW shall follow the LMA procedure for the PMIPv6 PDN Connection Handover procedure as outlined in subclause 5.3.3.

9.11 Optimized Idle Mode Mobility: E-UTRAN Access to cdma2000 eHRPD Access procedure

9.11.1 General

9.11.2 CDMA2000 eHRPD access procedure

In PMIPv6 mode, the CDMA2000 eHRPD access shall follow the MAG procedure for the PMIPv6 PDN Connection Handover procedure as outlined in subclause 5.3.2.

9.11.3 PDN GW procedures

In PMIPv6 mode, the PDN GW shall follow the LMA procedure for the PMIPv6 PDN Connection Handover procedure as outlined in subclause 5.3.3.

10 Untrusted Non-3GPP Access over S2b Description

10.1 Initial Attach procedures

10.1.1 General

If multiple authentications are supported by the network both ePDG and PDN GW shall support the corresponding procedures as specified for PAP and CHAP authentication of the UE with external networks in 3GPP TS 33.402 [19]. Multiple authentication is per PDN connection when the UE requested additional PDN connectivity as specified in subclause 10.5.

10.1.2 ePDG procedures

In PMIPv6 mode, the ePDG shall follow the MAG procedure for the PMIPv6 PDN Connection Creation as outlined in subclause 5.1.2.

If ePDG supports multiple authentication exchanges with the UE in the IKEv2 protocol, the ePDG shall send the PAP or CHAP additional authentication and authorization information received from the UE in the Additional Protocol Configuration Options IE in the PBU to the PDN-GW as specified 3GPP TS 33.402 [19]. The ePDG shall follow the multiple authentication procedures when receiving PAP or CHAP additional authentication and authorization information in the Additional Protocol Configuration Options IE in the PBA from the PDN-GW and sending the information to the UE as specified in 3GPP TS 33.402 [19].

If the UE requests the DNS IPv4/IPv6 address in the Configuration Payload (CFG_REQ) during the IPsec tunnel establishment procedure, as specified 3GPP TS 33.402 [19], and if the ePDG supports the Additional Protocol Configuration Options IE, the ePDG may include this IE in the PBU to the PDN-GW and correspondingly set "DNS IPv4/IPv6 Server Address Request" parameter. If the ePDG receives the Additional Protocol Configuration Options IE with "DNS Server IPv4/v6 Address" parameter in the PBA from the PDN-GW, the ePDG shall send this information in the Configuration Payload (CFG_REPLY) to the UE as specified in 3GPP TS 33.402 [19].

If the UE includes the P-CSCF_IP6_ADDRESS attribute, or the P-CSCF_IP4_ADDRESS attribute or both in the CFG_REQUEST configuration payload during the IPsec tunnel establishment procedure as specified in 3GPP TS 24.302 [39]), and if the ePDG supports these IKEv2 attributes and the Additional Protocol Configuration Options IE, the ePDG shall include the Additional Protocol Configuration Options IE in the PBU to the PDN-GW and correspondingly set the P-CSCF IPv6 Address Request, or P-CSCF IPv4 Address Request, or both parameters as defined in 3GPP TS 24.008 [16]. If the ePDG receives the Additional Protocol Configuration Options IE with the P-CSCF IPv4 Address, or P-CSCF IPv6 Address, or both parameters respectively in the PBA from the PDN-GW, the ePDG shall send these information in the Configuration Payload (CFG_REPLY) to the UE as specified in 3GPP TS 24.302 [39].

If the UE includes the P-CSCF_RESELECTION_SUPPORT attribute in the CFG_REQUEST configuration payload during the IPsec tunnel establishment procedure as specified in 3GPP TS 24.302 [39], and if the ePDG supports the P-CSCF restoration extension procedure for the untrusted WLAN access (see 3GPP TS 23.380 [36]), the ePDG shall include the Additional Protocol Configuration Options IE in the PBU to the PDN-GW and correspondingly set the P-CSCF_RESELECTION_SUPPORT, as defined in 3GPP TS 24.008 [16].

10.1.3 PDN GW procedures

In PMIPv6 mode, the PDN GW shall follow the LMA procedure for the PMIPv6 PDN Connection Creation as outlined in subclause 5.1.3.

If PDN GW supports multiple authentications it shall send the PAP or CHAP additional authentication and authorization information received from the ePDG in the Additional Protocol Configuration Options IE in the PBU to the external AAA server and the PDN GW shall send the PAP or CHAP additional authentication and authorization information received from the external AAA server to the ePDG in the Additional Protocol Configuration Options IE in the PBA as specified in 3GPP TS 33.402 [19].

If the PDN-GW supports Additional Protocol Configuration Options IE and if the PDN-GW receives it with the "DNS IPv4/IPv6 Server Address Request" parameter in the PBU from the ePDG, the PGW may include the Additional Protocol Configuration Options IE in the PBA and correspondingly set "DNS IPv4/IPv6 Address" as specified in 3GPP TS 24.008 [16].

If the PDN-GW supports the Additional Protocol Configuration Options IE and if the PGW receives it with the P-CSCF IPv4 Address Request, or P-CSCF IPv6 Address Request or both parameters in the PBU from the ePDG, the PGW may include the Additional Protocol Configuration Options IE in the PBA and correspondingly set it with the P-CSCF IPv4 Address, or P-CSCF IPv6 Address, or both parameters respectively as specified in 3GPP TS 24.008 [16].

10.2 ePDG Initiated PDN Connection Lifetime Extension procedures

10.2.1 General

10.2.2 ePDG procedures

In PMIPv6 mode, the ePDG shall follow the MAG procedure for the PMIPv6 PDN Connection Lifetime Extension as outlined in subclause 5.2.2.

10.2.3 PDN GW procedures

In PMIPv6 mode, the PDN GW shall follow the LMA procedure for the PMIPv6 PDN Connection Lifetime Extension as outlined in subclause 5.2.3.

10.3 UE / ePDG Initiated Detach and UE Requested PDN Disconnection procedures

10.3.1 General

10.3.2 ePDG procedures

In PMIPv6 mode, the ePDG shall follow the MAG procedure for the PMIPv6 MAG Initiated PDN Connection Deletion as outlined in subclause 5.4.2 for PDN Disconnection procedure,

For Detach the ePDG shall follow the above repeated for each PDN connection of the UE.

10.3.3 PDN GW procedures

In PMIPv6 mode, the PDN GW shall follow the LMA procedure for the PMIPv6 MAG Initiated PDN Connection Deletion as outlined in subclause 5.4.3.

10.4 HSS / AAA Initiated Detach procedures

10.4.1 General

The HSS/AAA may initiate a detach procedure resulting in a PMIPv6 De-Registration.

10.4.2 ePDG procedures

In PMIPv6 mode, the ePDG shall follow the MAG procedure for the PMIPv6 MAG Initiated PDN Connection Deletion as outlined in subclause 5.4.2 repeated for each PDN connection of the UE.

10.4.3 PDN GW procedures

In PMIPv6 mode, the PDN GW shall follow the LMA procedure for the PMIPv6 MAG Initiated PDN Connection Deletion as outlined in subclause 5.4.3.

10.5 UE Initiated Connectivity to Additional PDN procedures

10.5.1 General

10.5.2 ePDG procedures

In PMIPv6 mode, if the Request Type indicates "initial attach", the ePDG shall follow the MAG procedure for the PMIPv6 PDN Connection Creation as outlined in subclause 5.1.2. If the Request Type indicates "Handover", the ePDG shall follow the MAG procedure for the PMIPv6 PDN Connection Handover as outlined in subclause 5.3.2.

If the UE requests the DNS IPv4/IPv6 address in the Configuration Payload (CFG_REQ) during the IPsec tunnel establishment procedure, as specified 3GPP TS 33.402 [19], and if the ePDG supports the Additional Protocol Configuration Options IE, the ePDG may include this IE in the PBU to the PDN-GW and correspondingly set "DNS IPv4/IPv6 Server Address Request" parameter. If the ePDG receives the Additional Protocol Configuration Options IE with "DNS Server IPv4/v6 Address" parameter in the PBA from the PDN-GW, the ePDG shall send this information in the Configuration Payload (CFG_REPLY) to the UE as specified in 3GPP TS 33.402 [19].

If the UE includes the P-CSCF_IP6_ADDRESS attribute, or the P-CSCF_IP4_ADDRESS attribute or both in the CFG_REQUEST configuration payload during the IPsec tunnel establishment procedure as specified in 3GPP TS 24.302 [39], and if the ePDG supports these IKEv2 attributes and the Additional Protocol Configuration Options IE, the ePDG shall include the Additional Protocol Configuration Options IE in the PBU to the PDN-GW and correspondingly set the P-CSCF IPv6 Address Request, or P-CSCF IPv4 Address Request, or both parameters as defined in 3GPP TS 24.008 [16]. If the ePDG receives the Additional Protocol Configuration Options IE with the P-CSCF IPv4 Address, or P-CSCF IPv6 Address, or both parameters respectively in the PBA from the PDN-GW, the ePDG shall send these information in the Configuration Payload (CFG_REPLY) to the UE as specified in 3GPP TS 24.302 [39].

If the UE includes the P-CSCF_RESELECTION_SUPPORT attribute in the CFG_REQUEST configuration payload during the IPsec tunnel establishment procedure as specified in 3GPP TS 24.302 [39], and if the ePDG supports the P-CSCF restoration extension procedure for the untrusted WLAN access (see 3GPP TS 23.380 [36]), the ePDG shall include the Additional Protocol Configuration Options IE in the PBU to the PDN-GW and correspondingly set the P-CSCF_RESELECTION_SUPPORT, as defined in 3GPP TS 24.008 [16].

10.5.3 PDN GW procedures

In PMIPv6 mode, if the Request Type indicates "initial attach", the PDN GW shall follow the LMA procedure for the PMIPv6 PDN Connection Creation as outlined in subclause 5.1.3. If the Request Type indicates "Handover", the PDN GW shall follow the LMA procedure for the PMIPv6 PDN Connection Handover as outlined in subclause 5.3.3.

If the PDN-GW supports Additional Protocol Configuration Options IE and if the PDN-GW receives it with the "DNS IPv4/IPv6 Server Address Request" parameter in the PBU from the ePDG, the PGW may include the Additional Protocol Configuration Options IE in the PBA and correspondingly set "DNS IPv4/IPv6 Address" as specified in 3GPP TS 24.008 [16].

If the PDN-GW supports the Additional Protocol Configuration Options IE and if the PGW receives it with the P-CSCF IPv4 Address Request, or P-CSCF IPv6 Address Request or both parameters in the PBU from the ePDG, the PGW may include the Additional Protocol Configuration Options IE in the PBA and correspondingly set it with the P-CSCF IPv4 Address, or P-CSCF IPv6 Address, or both parameters respectively as specified in 3GPP TS 24.008 [16].

10.6 3GPP Access to Untrusted Non-3GPP IP Access with PMIPv6 on S2b Handover procedures without optimization

10.6.1 General

10.6.2 ePDG procedures

In PMIPv6 mode, the ePDG shall follow the MAG procedure for the PMIPv6 PDN Connection Handover as outlined in subclause 5.3.2.

If the UE includes the P-CSCF_RESELECTION_SUPPORT attribute in the CFG_REQUEST configuration payload during the IPsec tunnel establishment procedure as specified in 3GPP TS 24.302 [39], and if the ePDG supports the P-CSCF restoration extension procedure for the untrusted WLAN access (see 3GPP TS 23.380 [36]), the ePDG shall include the Additional Protocol Configuration Options IE in the PBU to the PDN-GW and correspondingly set the P-CSCF_RESELECTION_SUPPORT, as defined in 3GPP TS 24.008 [16].

10.6.3 PDN GW procedures

In PMIPv6 mode, the PDN GW shall follow the LMA procedure for the PMIPv6 PDN Connection Handover as outlined in subclause 5.3.3.

If IPv6 network prefix preservation is supported at a handover from 3GPP Access with a GTP-based S5/S8 to non-3GPP Access, the LMA shall provide to the MAG the link-local address which is used by the PDN GW at the link shared with the UE in the 3GPP Access.

10.7 PDN GW Initiated Resource Allocation Deactivation procedures

10.7.1 General

10.7.2 ePDG procedures

In PMIPv6 mode, the ePDG shall follow the MAG procedure for the PMIPv6 LMA Initiated PDN Connection Deletion as outlined in subclause 5.5.2.

10.7.3 PDN GW procedures

In PMIPv6 mode, the PDN GW shall follow the LMA procedure for the PMIPv6 LMA Initiated PDN Connection Deletion as outlined in subclause 5.5.3.

The PGW shall include the 3GPP Specific PMIPv6 error code IE and set it to the cause "Reactivation requested" when the PGW initiates the PDN GW Initiated Resource Allocation Deactivation procedure as part of the P-CSCF restoration procedure over WLAN access, as specified in 3GPP TS 23.380 [36].

10.8 PDN-GW Initiated IPv4 Address Delete Procedure

10.8.1 General

10.8.2 ePDG procedures

If UE is assigned both IPv6 HNP and IPv4 HoA, the ePDG shall follow the MAG procedure for the LMA Initiated IPv4 Address Release procedure as defined in sub clause 5.7.2.

10.8.3 PDN GW procedures

If UE is assigned both IPv6 HNP and IPv4 HoA, the PDN GW shall follow the LMA procedure for the LMA Initiated IPv4 Address Release procedure as defined in sub clause 5.7.3.

If UE is assigned only IPv4 HoA, then PDN-GW initiated Resource Allocation Deactivation procedure is initiated.

11 S2a and S2b Chaining with PMIP-based S8 Description

11.1 Initial Attach procedures

11.1.1 General

11.1.2 ePDG / Trusted Non-3GPP Access procedures

In PMIPv6 mode, the ePDG or Trusted Non-3GPP Access shall follow the MAG procedure for the PMIPv6 PDN Connection Creation. In addition to the general procedure, it shall include the PDN GW IP address received during the authorization procedure into the PBU request, encoding it into a Vendor-Specific Option (refer to clause 12.1.1.4).

11.1.3 Serving GW procedures

In PMIPv6 mode, the Serving GW shall follow:

- the LMA procedure for the PMIPv6 PDN Connection Creation on the S2a/S2b interface. In addition to the general procedure, the Serving GW shall include the PDN GW IP address received in the PBU request into the PBA, using the same encoding (refer to clause 12.1.1.4).
- the MAG procedure for the PMIPv6 PDN Connection Creation on the S8 interface. The Serving GW shall send the PBU request to the PDN GW IP address received on the chained S2a / S2b interface.

11.2 ePDG / Trusted Non-3GPP Access Initiated PDN Connection Lifetime Extension procedures

11.2.1 General

11.2.2 ePDG / Trusted Non-3GPP Access procedures

In PMIPv6 mode, the ePDG or Trusted Non-3GPP Access shall follow the MAG procedure for the PMIPv6 PDN Connection Lifetime Extension.

11.2.3 Serving GW procedures

In PMIPv6 mode, the Serving GW shall follow:

- the LMA procedure for the PMIPv6 PDN Connection Lifetime Extension on the S2a/S2b interface.
- the MAG procedure for the PMIPv6 PDN Connection Lifetime Extension on the S8 interface.

11.3 UE / ePDG / Trusted Non-3GPP Access Initiated Detach procedures

11.3.1 General

11.3.2 ePDG / Trusted Non-3GPP Access procedures

In PMIPv6 mode, the ePDG or Trusted Non-3GPP Access shall follow the MAG procedure for the PMIPv6 MAG Initiated PDN Connection Deletion repeated for each PDN connection of the UE.

11.3.3 Serving GW procedures

In PMIPv6 mode, the Serving GW shall follow:

- the LMA procedure for the PMIPv6 MAG Initiated PDN Connection Deletion on the S2a/S2b interface.
- the MAG procedure for the PMIPv6 MAG Initiated PDN Connection Deletion on the S8 interface.

11.4 HSS / AAA Initiated Detach procedures

11.4.1 General

The HSS/AAA may initiate a detach procedure resulting in a PMIPv6 De-Registration.

11.4.2 ePDG / Trusted Non-3GPP Access procedures

In PMIPv6 mode, the ePDG or Trusted Non-3GPP Access shall follow the MAG procedure for the PMIPv6 MAG Initiated PDN Connection Deletion repeated for each PDN connection of the UE.

11.4.3 Serving GW procedures

In PMIPv6 mode, the Serving GW shall follow:

- the LMA procedure for the PMIPv6 MAG Initiated PDN Connection Deletion on the S2a/S2b interface.
- the MAG procedure for the PMIPv6 MAG Initiated PDN Connection Deletion on the S8 interface.

11.5 UE Initiated Connectivity to Additional PDN procedures

11.5.1 General

11.5.2 ePDG / Trusted Non-3GPP Access procedures

In PMIPv6 mode, the ePDG or Trusted Non-3GPP Access shall follow the MAG procedure for the PMIPv6 PDN Connection Creation if the Request Type indicates "initial attach", or the PMIPv6 PDN Connection Handover if the Request Type indicates "Handover". In addition to the general procedure, it shall include the PDN GW IP address received during the authorization procedure into the PBU request, encoding it to the Vendor-Specific Option (refer to clause 12.1.1.4).

11.5.3 Serving GW procedures

In PMIPv6 mode, the Serving GW shall follow:

- the LMA procedure for the PMIPv6 PDN Connection Creation if the Request Type indicates "initial attach", or the PMIPv6 PDN Connection Handover if the Request Type indicates "Handover" on the S2a/S2b interface. In addition to the general procedure, the Serving GW shall include the PDN GW IP address received in the PBU request into the PBA, using the same encoding (refer to clause 12.1.1.4).
- the MAG procedure for the PMIPv6 PDN Connection Creation if the Request Type indicates "initial attach", or the PMIPv6 PDN Connection Handover if the Request Type indicates "Handover" on the S8 interface. The Serving GW shall send the PBU request to the PDN GW IP address received on the chained S2a / S2b interface.

11.6 3GPP Access to Trusted / Untrusted Non-3GPP IP Access Handover procedures without optimization

11.6.1 General

11.6.2 ePDG / Trusted Non-3GPP Access procedures

In PMIPv6 mode, the ePDG or Trusted Non-3GPP Access shall follow the MAG procedure for the PMIPv6 PDN Connection Handover. In addition to the general procedure, it shall include the PDN GW IP address received during the authorization procedure into the PBU request, encoding it to the Vendor-Specific Option (refer to clause 12.1.1.4).

11.6.3 Serving GW procedures

In PMIPv6 mode, the Serving GW shall follow:

- the LMA procedure for the PMIPv6 PDN Connection Handover on the S2a/S2b interface. In addition to the general procedure, the Serving GW shall include the PDN GW IP address received in the PBU request into the PBA, using the same encoding (refer to clause 12.1.1.4).
- the MAG procedure for the PMIPv6 PDN Connection Handover on the S8 interface. The Serving GW shall send the PBU request to the PDN GW IP address received on the chained S2a / S2b interface.

11.7 UE Requested PDN Disconnection procedures

11.7.1 General

11.7.2 ePDG / Trusted Non-3GPP Access procedures

In PMIPv6 mode, the ePDG or Trusted Non-3GPP Access shall follow the MAG procedure for the PMIPv6 MAG Initiated PDN Connection Deletion, for the selected PDN connection.

11.7.3 Serving GW procedures

In PMIPv6 mode, the Serving GW shall follow:

- the LMA procedure for the PMIPv6 MAG Initiated PDN Connection Deletion, for the selected PDN connection on the S2a/S2b interface.
- the MAG procedure for the PMIPv6 MAG Initiated PDN Connection Deletion, for the selected PDN connection on the S8 interface.

11.8 PDN GW Initiated Resource Allocation Deactivation procedures

11.8.1 General

11.8.2 ePDG / Trusted Non-3GPP Access procedures

In PMIPv6 mode, the ePDG or Trusted Non-3GPP Access shall follow the MAG procedure for the PMIPv6 LMA Initiated PDN Connection Deletion.

11.8.3 Serving GW procedures

In PMIPv6 mode, the Serving GW shall follow:

- the MAG procedure for the PMIPv6 LMA Initiated PDN Connection Deletion on the S8 interface.
- the LMA procedure for the PMIPv6 LMA Initiated PDN Connection Deletion on the S2a/S2b interface.

12 Information Elements

12.1 Additional Proxy Mobile IPv6 Information Elements

12.1.1 3GPP-Specific PMIPv6 Information Elements

12.1.1.0 General

This specification requires the encoding of additional 3GPP-specific Information Elements for PMIPv6 with the 3GPP Mobility Option, as defined by 3GPP TS 29.282 [24]. The 3GPP specific Information Elements defined by this specification are listed in the table 12.1.1.0-1.

Table 12.1.1.0-1: 3GPP Specific PMIPv6 Information Elements

3GPP Specific PMIPv6 Information Element	3GPP Specific PMIPv6 Information Element Description
Protocol Configuration Options	3GPP PCO data, in the format from 3GPP TS 24.008 [16] subclause 10.5.6.3, starting with octet 3.
3GPP Specific PMIPv6 error code	3GPP Vendor-Specific PMIPv6 error code, as specified in subclause 12.1.1.1
PDN GW IP address	PDN GW IP address, as specified in subclause 12.1.1.4
DHCPv4 Address Allocation Procedure Indication	DHCPv4 Address Allocation Procedure Indication, as specified in subclause 12.1.1.5.
Fully Qualified PDN Connection Set Identifier	FQ-CSID as specified in subclause 12.1.1.2
PDN Type Indication	PDN type indication as specified in subclause 12.1.1.3
Charging ID	Charging ID as specified in subclause 12.1.1.6
Selection Mode	Selection Mode as specified in subclause 12.1.1.7
Charging Characteristics	Subclause 12.1.1.8
Serving Network	Subclause 12.1.1.9
Mobile Equipment Identity	Subclause 12.1.1.10
MSISDN	Subclause 12.1.1.11
APN Restriction	Subclause 12.1.1.12
Maximum APN Restriction	Subclause 12.1.1.13
Unauthenticated IMSI	Subclause 12.1.1.14
PDN Connection ID	Subclause 12.1.1.15
PGW Back-Off Time	Subclause 12.1.1.16
Signalling Priority Indication	Subclause 12.1.1.17
Static IP Address Allocation Indication	Subclause 12.1.1.18
Additional Protocol Configuration Options	Subclause 12.1.1.19
MME/SGSN Identifier	Subclause 12.1.1.20
End Marker Notification	Subclause 12.1.1.21
Trusted WLAN Mode Indication	Subclause 12.1.1.22
UE Time Zone	Subclause 12.1.1.23
Access Network Identifier Timestamp	Subclause 12.1.1.24
Logical Access ID	Subclause 12.1.1.25
Origination Time Stamp	Subclause 12.1.1.26
Maximum Wait Time	Subclause 12.1.1.27
TWAN Capabilities	Subclause 12.1.1.28

Depending on the need for 3GPP-specific information content, there several items of this information element may be added to the PBU, PBA, BRI, BRA, UPN or UPA.

The subtype for a 3GPP specific PMIPv6 Information Element is defined in 3GPP TS 29.282 [24]. The data format of the 3GPP specific PMIPv6 Information Element is defined in this specification. If the data format is defined by another specification, that specification shall be referenced in the table above.

12.1.1.1 3GPP Specific PMIPv6 error code

Proxy Binding Acknowledgement (PBA) and Binding Revocation Acknowledgment (BRA) contain a mandatory Status information element and also may contain a 3GPP Specific PMIPv6 Error Code (3GSPEC) information element, which is coded within Mobility Options field.

NOTE: ETF RFC 5213 [4] and IETF RFC 6275 [8] specify PMIPv6 Status values for a PBA message for indicating the acceptance of a message, or for reporting an error. Up-to-date values for the Status field are specified in the IANA registry of assigned numbers [32]. IETF RFC 5846 [6] specifies PMIPv6 Status values for the BRA message. Up-to-date BRA status values are specified in the IANA registry of assigned numbers [33].

Binding Revocation Indication (BRI) may contain a 3GPP Specific PMIPv6 Error Code (3GSPEC) information element, which is coded within Mobility Options field.

The purpose of the 3GSPEC information element, which is depicted in Figure 12.1.1.1-1 is to carry a GTPv2 Cause value within PMIPv6 messages. 3GPP TS 29.274 [22] specifies GTPv2 Cause values.

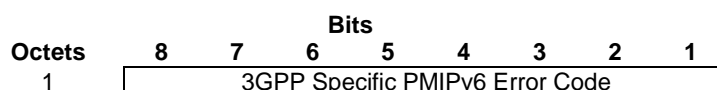

Figure 12.1.1.1-1: 3GPP Specific PMIPv6 Error Code

If MAG/SGW receives a 3GSPEC IE in Proxy Binding Acknowledgement message from LMA/PGW, which requires that the MAG/SGW shall send a GTPv2 message to MME/SGSN, then the MAG/SGW shall copy 3GSPEC value into GTPv2 Cause IE. If in such case, the MAG/SGW does not receive 3GSPEC IE with PBA, depending on the overall meaning of the PMIPv6 Status IE the MAG/SGW shall send to MME/SGSN one of the following GTPv2 Cause values with CS bit set to 1:

- "Request Accepted" (decimal 16), if the received PMIPv6 Status indicates PBU acceptance.
- "Request rejected for a PMIP reason" (decimal 112), if the received PMIPv6 Status indicates PBU rejection.

If MAG/SGW receives a 3GSPEC IE in Binding Revocation Indication message from LMA/PGW, which requires that the MAG/SGW shall send a GTPv2 message to MME/SGSN, then the MAG/SGW shall copy 3GSPEC value into GTPv2 Cause IE with CS bit set to 1.

If MAG/SGW receives a Cause IE with a GTPv2 message, which requires sending a Binding Revocation Acknowledgement message to LMA/PGW, the MAG/SGW shall copy the GTPv2 Cause value into the 3GSPEC IE.

12.1.1.2 Fully Qualified PDN Connection Set Identifier (FQ-CSID)

A fully qualified PDN Connection Set Identifier (FQ-CSID) identifies a set of PDN connections belonging to an arbitrary number of UEs on a node such as a MME, SGW or PGW. The FQ-CSID is generated by the MAG, the LMA and any other node such as the MME for 3GPP access. It is generated for each new PDN connection, and it is used in case of partial node failure to identify the PDN connections associated with a Connection Set Identifier.

The FQ-CSID is coded as follows:

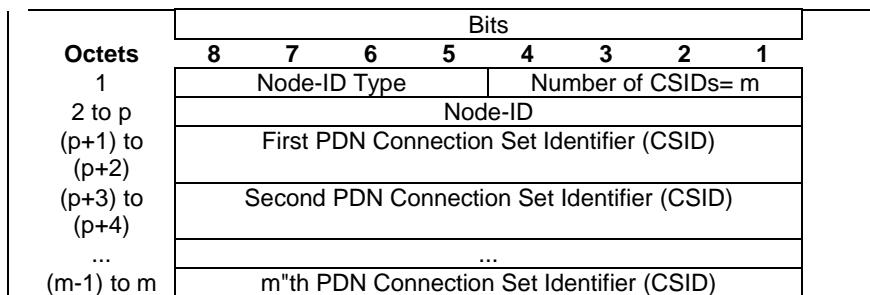

Figure 12.1.1.2-1: FQ-CSID

The details of each field and value are specified in 3GPP TS 29.274[22].

12.1.1.3 PDN Type Indication

The purpose of the PDN type indication option is to indicate the GW decision to change the PDN type and a cause for the change. This attribute is set by the LMA in the PBA.

The MAG shall set the PDN type accordingly, if this option is present in the PBA.

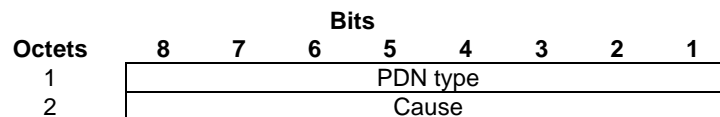

Figure 12.1.1.3-1: PMIPv6 PDN type indication

The following defines the value of the PMIPv6 PDN type indication.

PDN type value	
#1:	IPv4
#2:	IPv6
Cause value as defined in 3GPP TS 29.274[13]	
#18:	New PDN type due to network preference;

12.1.1.4 PDN GW IP address

The purpose of the PDN GW IP address information element is to carry the IP address of the PDN GW to which the receiving Serving GW shall send a PBU on the chained S8 interface. This information element shall be included in a PBU for initial attach or handover sent on S2a or S2b interface for S2a/S2b - PMIP based S8 chaining scenario.

This information element shall be included in an Update Notification message according to the conditions specified in subclause 20.2.7.1 of 3GPP TS 23.007 [13].

The content and encoding of the PDN GW IP address is depicted on Figure 12.1.1.4-1.

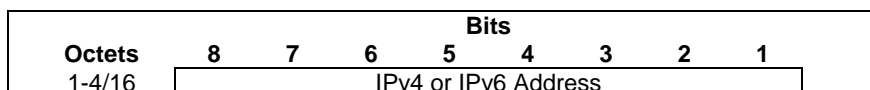

Figure 12.1.1.4-1: PDN GW IP Address

12.1.1.5 DHCPv4 Address Allocation Procedure Indication

The purpose of the DHCPv4 Address Allocation option is to indicate that DHCPv4 is to be used in allocating the IPv4 address to the UE if the option is present in the PBA message.

12.1.1.6 Charging ID

The Charging ID is defined in figure 12.1.1.6-1.

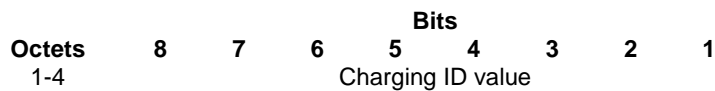

Figure 12.1.1.6-1: Charging ID

12.1.1.7 Selection Mode

Selection Mode indicates the way the MME or SGSN selected the APN: whether a subscribed APN was selected, or whether a non-subscribed APN sent by a UE or a non-subscribed APN chosen by the SGSN was selected. The Selection Mode is defined in 3GPP TS 23.060 [23]

The encoding of the Selection Mode is shown in Figure 12.1.1.7-1.

Octets	Bits							
	8	7	6	5	4	3	2	1
1	Reserved						Selection Mode	

Figure 12.1.1.7-1: Selection mode

The reserved bits shall be set to 1 by the MAG and not processed by the LMA.

The defined Selection Mode values are shown in Table 12.1.1.7-1.

Table 12.1.1.7-1: Selection Mode

Value	Selection mode value
0	MS or network provided APN, subscribed verified
1	MS provided APN, subscription not verified
2	Network provided APN, subscription not verified
3	For future use. Shall not be sent. If received, shall be interpreted as the value '2'.

12.1.1.8 Charging Characteristics

The Charging Characteristics information element is defined in 3GPP TS 32.251 [25] and is a way of informing both the SGW and PGW of the rules for producing charging information based on operator configured triggers. For the encoding of this information element see 3GPP TS 32.298 [26].

The Charging Characteristics is defined in figure 12.1.1.8-1.

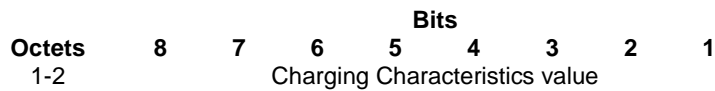

Figure 12.1.1.8-1: Charging Characteristics

12.1.1.9 Serving Network

Serving Network identifies the serving network the UE is attached to. The format of the Serving Network 3GPP-specific Information Element is defined below.

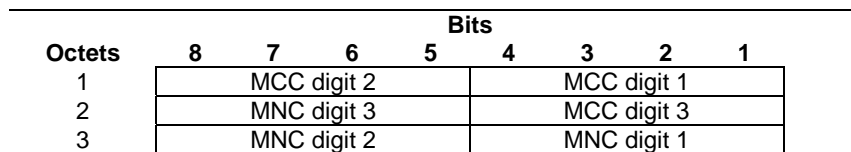

Figure 12.1.1.9-1

12.1.1.10 Mobile Equipment Identity

The purpose of the Mobile Equipment Identity (MEI) information element is used to convey the UE's terminal identity from the Serving GW, TWAN or ePDG to the PDN GW over the S5/S8, S2a or S2b interface.

The encoding of the MEI is depicted in Figure 12.1.1.10-1.

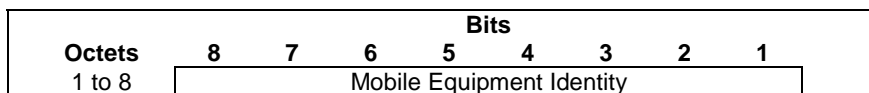

Figure 12.1.1.10-1: Mobile Equipment Identity (MEI)

The MEI contains either the IMEI or IMEISV in the format defined in subclause 6.2 of 3GPP TS 23.003 [12].

The MEI shall contain the IMEISV if it is available. If only the IMEI is available, then the last semi-octet of octet 8 of MEI shall be set to "1111". Both IMEI and IMEISV are TBCD encoded, where IMEI is 15 BCD digits and IMEISV is 16 BCD digits. Bits 5 to 8 of octet n encodes digit 2n, bits 1 to 4 of octet n encodes digit 2n-1. Digits are packed contiguously with no internal padding.

NOTE: This encoding follows that of the IMEI(SV) field in the International Mobile Equipment Identity (and Software Version) (IMEI(SV)) information element defined in clause 7.7.53 of 3GPP TS 29.060 [28].

12.1.1.11 MSISDN

The purpose of the MSISDN information element is used to convey the user's MSISDN from the Serving GW to the PDN GW over the S5/S8 interface, from the trusted non-3GPP access network to the PDN-GW over S2a and from ePDG to the PDN-GW over S2b. MSISDN is defined in 3GPP TS 23.003 [12].

The content and encoding of the MSISDN is depicted on Figure 12.1.1.11-1.

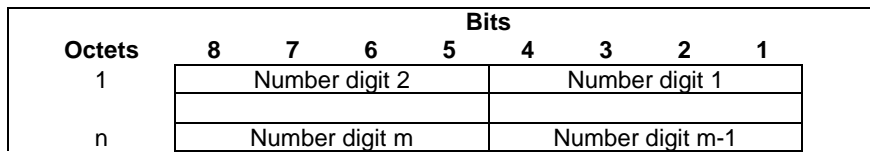

Figure 12.1.1.11-1: MSISDN

Octets 1 to n represent the MSISDN value in international number format as described in ITU-T Rec E.164 [29], encoded as TBCD digits, i.e. digits from 0 through 9 are encoded "0000" to "1001". When there is an odd number of digits, bits 8 to 5 of the last octet are encoded with the filler "1111".

12.1.1.12 APN Restriction

The APN Restriction is defined in figure 12.1.1.12-1. The APN Restriction value is specified in 3GPP TS 29.274 [22].

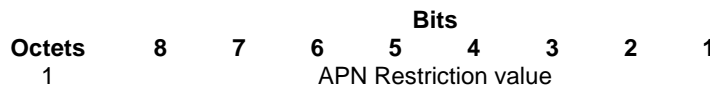

Figure 12.1.1.12-1: APN Restriction

12.1.1.13 Maximum APN Restriction

The Maximum APN Restriction is defined in figure 12.1.1.13-1. The Maximum APN Restriction value is specified in 3GPP TS 29.274 [22].

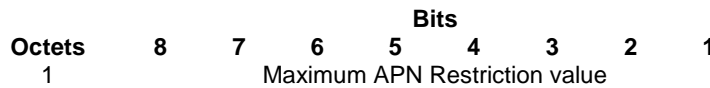

Figure 12.1.1.13-1: Maximum APN Restriction

12.1.1.14 Unauthenticated IMSI

The purpose of the Unauthenticated IMSI information element is used to convey the user's IMSI for the emergency attached UE with an IMSI which is not authenticated by the network. The format of IMSI is defined in 3GPP TS 23.003 [12].

The content and encoding of the Unauthenticated IMSI is depicted on Figure 12.1.1.14-1.

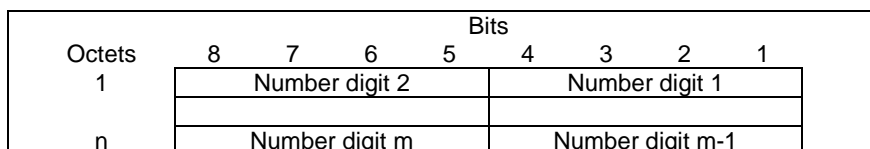

Figure 12.1.1.14-1: Unauthenticated IMSI

Octets 1 to n represent the IMSI value in international number format as described in ITU-T Rec E.164 [29], encoded as TBCD digits, i.e. digits from 0 through 9 are encoded "0000" to "1001". When there is an odd number of digits, bits 8 to 5 of the last octet are encoded with the filler "1111". The maximum number of digits is 15.

12.1.1.15 PDN Connection ID

The purpose of the PDN Connection ID information element is used to convey the PDN Connection ID.

The content and encoding of the PDN Connection ID is depicted on Figure 12.1.1.15-1.

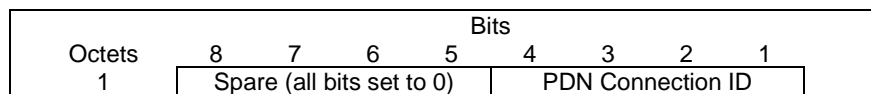

Figure 12.1.1.15-1: PDN Connection ID

NOTE: The format of the PDN connection ID is aligned with EPS bearer ID defined for GTPv2 in 3GPP TS 29.274 [22].

12.1.1.16 PGW Back-Off Time

The PGW Back-Off Time information element is coded as shown in figure 12.1.1.16-1. The timer unit and timer value are specified in 3GPP TS 29.274 [22].

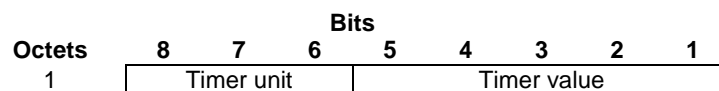

Figure 12.1.1.16-1: PGW Back-Off Time

12.1.1.17 Signalling Priority Indication

The Signalling Priority Indication information element contains signalling priority indications received from the UE for a specific PDN connection.

The Signalling Priority Indication information element is coded as shown in figure 12.1.1.17-1.

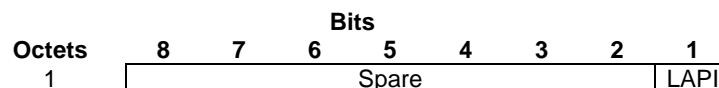

Figure 12.1.1.17-1: Signalling Priority Indication

The following bits within Octet 1 shall indicate:

- Bit 8 to 2 – Spare, for future use and set to zero.
- Bit 1 – LAPI (Low Access Priority Indication): This bit defines if the UE indicated low access priority when establishing the PDN connection. It shall be encoded as the Low Priority parameter of the Device Properties IE in 3GPP TS 24.008 [16]. The receiver shall assume the value "0" if the Signalling Priority Indication IE is applicable for a message but not included in that message by the sender. The low access priority indication may be included in charging records.

12.1.1.18 Static IP Address Allocation Indication

The Static IP Address Allocation Indication information element contains Static IP Address Allocation Indication for the Handover procedures. These indications are equivalent for the Static IPv4/IPv6 Address Flag defined in 3GPP TS 29.274 [22].

The Static IP Address Allocation Indication information element is coded as shown in figure 12.1.1.18-1.



Figure 12.1.1.18-1: Static IP Address Allocation Indication

The following bits within Octet 1 shall indicate:

- Bit 8 to 3 – Spare, for future use and set to zero.
- Bit 2 – S6PI (Static IPv6 Home Network Prefix Indication): if this bit is set to 1, it indicates that IPv6 Home Network Prefix is statically allocated.
- Bit 1 – S4AI (Static IPv4 Address Indication): if this bit is set to 1, it indicates that IPv4 address is statically allocated.

12.1.1.19 Additional Protocol Configuration Options

The Additional Protocol Configuration Options IE contains additional 3GPP protocol configuration options information. The IE is in the same format as the PCO IE specified in 3GPP TS 24.008 [16] subclause 10.5.6.3, starting with octet 3.

12.1.1.20 MME/SGSN Identifier

The purpose of the MME/SGSN Identifier information element is to carry the IP address of the MME/SGSN. The content and encoding of the MME/SGSN Identifier is depicted on Figure 12.1.1.20-1.

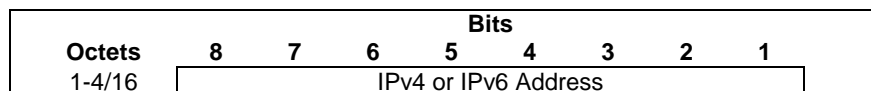

Figure 12.1.1.20-1: MME/SGSN Identifier

12.1.1.21 End Marker Notification

The purpose of the End Marker Notification information element is used to convey the End Marker Notification.

The content and encoding of the End Marker Notification is depicted on Figure 12.1.1.21-1.

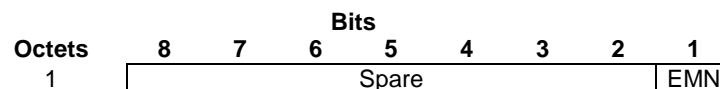

Figure 12.1.1.21-1: End Marker Notification

The following bits within Octet 1 shall indicate:

- Bit 8 to 2 – Spare, for future use and set to zero.
- Bit 1 – EMN (End Marker Notification): This bit shall be set to the value "1".

12.1.1.22 Trusted WLAN Mode Indication

The purpose of the Trusted WLAN Mode Indication information element is to convey the selected trusted WLAN Mode.

The content and encoding of the Trusted WLAN Mode Indication is depicted on Figure 12.1.1.22-1.

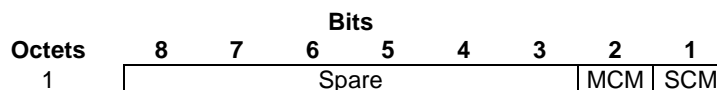

Figure 12.1.1.22-1: Trusted WLAN Mode Indication

The following bits within Octet 1 shall indicate:

- Bit 8 to 3 – Spare, for future use and set to zero.
- Bit 2 –MCM (Multiple-connection mode Indication): if this bit is set to 1, it indicates that the Multiple-connection mode is used.
- Bit 1 –SCM (Single-connection mode Indication): if this bit is set to 1, it indicates that the Single-connection mode is used.

12.1.1.23 UE Time Zone

UE Time Zone is used to indicate the offset between universal time and local time in steps of 15 minutes of where the UE currently resides. The "Time Zone" field uses the same format as the "Time Zone" IE in 3GPP TS 24.008 [5].

The content and encoding of the UE Time Zone is depicted on Figure 12.1.1.23-1.

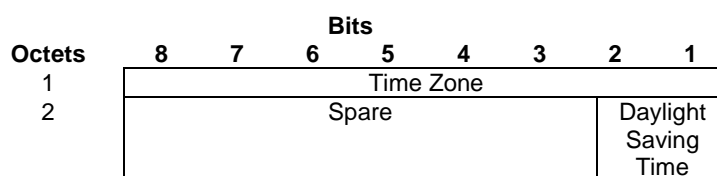

Figure 12.1.1.23-1: UE Time Zone

The value of the Time Zone field in octet 1 represents the time zone adjusted for daylight saving time.

The following bits within Octet 2 shall indicate:

- Bit 8 to 3 – Spare, for future use and set to zero.
- Bit 2 to 1 – The value of the Daylight Saving Time field specifies the adjustment that has been made. Possible values for the Daylight Saving Time field are given below in Table 12.1.1.23-2

Table 12.1.1.23-1 Possible values for the "Daylight Saving Time" field and their meanings.

Daylight Saving Time	Value (binary)	
	Bit 2	Bit 1
No adjustment for Daylight Saving Time	0	0
+1 hour adjustment for Daylight Saving Time	0	1
+2 hours adjustment for Daylight Saving Time	1	0
Spare	1	1

12.1.1.24 Access Network Identifier Timestamp

The Access Network Identifier Timestamp indicates the UTC time when the Access Network Identifier information was acquired. The content and encoding of the Access Network Identifier Timestamp is depicted on Figure 12.1.1.24-1.

Octets 1 to 4 are encoded in the same format as the first four octets of the 64-bit timestamp format as defined in section 6 of IETF RFC 5905 [40].

NOTE: The encoding is defined as the time in seconds relative to 00:00:00 on 1 January 1900

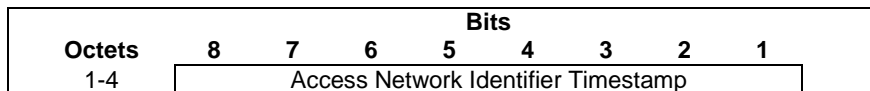

Figure 12.1.1.24-1: Access Network Identifier Timestamp

12.1.1.25 Logical Access ID

The purpose of the Logical Access ID information element is to convey the Logical Access ID. The Logical Access ID is implemented by providing both the Relay Identity which is either an IP Address or and FQDN along with the allocated Circuit-ID.

The Logical Access ID is depicted on Figure 12.1.1.25-1.

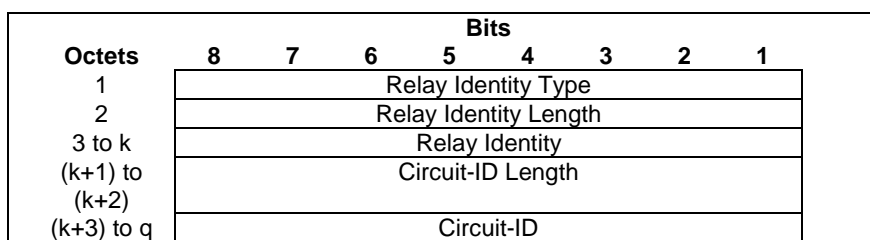

Figure 12.1.1.25-1: Logical Access ID

The Relay Identity Type is encoded in octet 1. It indicates the type of identity as described in Table 12.1.1.25-1. The Relay Identity Length is encoded in the octet 2. It indicates the length of the relay identity. The octets 3 to K contains the Relay Identity. If the Relay Identity type is set to 1 (i.e. an FQDN), it is encoded as described in section 3.1 of IETF RFC 1035 [31] but excluding the trailing zero byte. The Circuit-ID length in the octet (k+1) to (k+2) indicates the length of the Circuit-ID. The Circuit-ID is as defined in IETF RFC 3046 [42], it is encoded in octets (k+3) to q as an Octetstring and provided by the Relay.

Table 12.1.1.25-1: Relay Identity Type

Relay Identity Type	Values (Decimal)
IPv4 or IPv6 Address	0
FQDN	1

12.1.1.26 Origination Time Stamp

The Origination Time Stamp information element is coded as shown in figure 12.1.1.26-1. The Origination Time Stamp value shall be encoded as specified in 3GPP TS 29.274 [22].

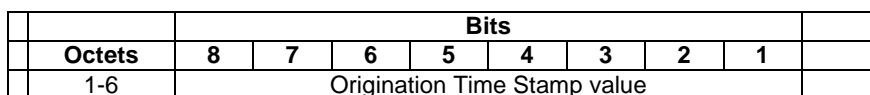

Figure 12.1.1.26-1: Origination Time Stamp

12.1.1.27 Maximum Wait Time

The Maximum Wait Time information element is coded as shown in figure 12.1.1.27-1. The Maximum Wait Time value shall be encoded as specified in 3GPP TS 29.274 [22].

	Bits							
Octets	8	7	6	5	4	3	2	1
1-2	Maximum Wait Time value							

Figure 12.1.1.27-1: Maximum Wait Time

12.1.1.28 TWAN Capabilities

The purpose of the TWAN Capabilities information element is to convey the capabilities supported by the TWAN to the PGW.

The content and encoding of the TWAN Capabilities is depicted on Figure 12.1.1.28-1.

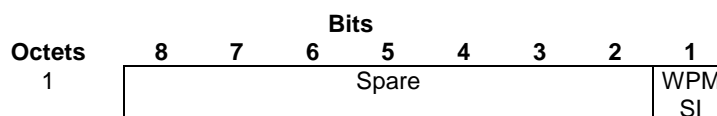

Figure 12.1.1.28-1: TWAN Capabilities

The following bits within Octet 1 shall indicate:

- Bit 8 to 2 – Spare, for future use and set to zero.
- Bit 1 – WLCP PDN Connection Modification Support Indication (WPM SI): if this bit is set to 1, it indicates that the TWAN supports the WLCP PDN Connection Modification procedure. This indication is used by the P-CSCF restoration extension procedure for TWAN access (see 3GPP TS 23.380 [36]).

13 Trusted WLAN Access over S2a Description

13.1 Initial Attach procedures

13.1.1 General

13.1.2 TWAN procedures

In PMIPv6 mode, the TWAN shall follow the MAG procedure for the PMIPv6 PDN Connection Creation as outlined in subclause 5.1.2.

If the transparent single-connection mode is used as specified in 3GPP TS 23.402 [3], the TWAN may include Additional Protocol Configuration Options IE in PBU to retrieve additional IP configuration parameters from the PGW (e.g. DNS server).

The TWAN shall include the Trusted WLAN Mode Indication for single-connection mode or multi-connection mode. It shall not do so for transparent single-connection mode. The PGW shall assume that transparent single-connection mode is used if it receives the PBU from the TWAN without this IE.

If the single-connection mode or multi-connection mode is used as specified in 3GPP TS 23.402 [3], the TWAN shall include Protocol Configuration Options IE in PBU if the TWAN receives the PCO from the UE.

The TWAN shall include the Access Network Identifier Option IE in the PBU message and set its contents as follows:

- the Access Network Identifier Option IE shall contain the SSID and, unless otherwise determined by the TWAN operator's policies, at least one of the following Information Elements:
 - the Logical Access ID in the Logical Access ID IE;

- the BSSID in the Access Network Identifier Option IE and/or
- the civic address of the access point to which the UE is attached in the Access Network Identifier Option IE.
- It may also contain the identifier of the TWAN operator, i.e. either the TWAN PLMN-ID if the TWAN is operated by a mobile operator, or the TWAN Operator Name otherwise;
- the SSID and the BSSID (when present) shall be encoded in the Network-Identifier sub-option as specified in IETF RFC 6757 [37], respectively in the "Network Name" field and the "Access-Point Name" field;
- the TWAN PLMN-ID (when present) shall be encoded in the Operator-Identifier sub-option with the "Operator-Identifier (Op-ID) Type" field set to "2" indicating realm of the operator. The TWAN PLMN-ID shall indicate the PLMN-ID of the TWAN operator and shall be encoded as specified in subclause 19.2 of 3GPP TS 23.003 [12];
- the TWAN Operator Name (when present) shall be encoded in the Operator-Identifier sub-option with the "Operator-Identifier (Op-ID) Type" field set to "2" indicating realm of the operator. The TWAN Operator Name shall indicate the realm name of the TWAN operator and shall be encoded as specified in subclause 19.8 of 3GPP TS 23.003 [12].
- the Civic Address shall be encoded in the Civic Location Sub-Option with the "Format" field set to "0" indicating that the value denotes binary encoding. The Civic Address is specified in IETF RFC 7563 [41].

NOTE: The Access Network Identifier Option IE defined in this specification contains similar information as the TWAN Identifier IE defined for GTPv2 in 3GPP TS 29.274 [22] apart from the Logical Access ID which is defined in a separate 3GPP specific IE called Logical Access ID. The Access Network Identifier Option information does not relate to the Access Network Identity (ANID) defined in 3GPP TS 24.302 [39].

The TWAN shall include the Serving Network IE in PBU and set it to the PLMN identity of the selected PLMN used for 3GPP-based access authentication. The selected PLMN is the PLMN of the 3GPP AAA Proxy in roaming case and the PLMN of the 3GPP AAA Server in non-roaming case.

The TWAN shall include the UE Time Zone IE and shall set its content as specified in subclause 12.1.1.23.

13.1.3 PDN GW procedures

In PMIPv6 mode, the PDN GW shall follow the LMA procedure for the PMIPv6 PDN Connection Creation as outlined in subclause 5.1.3.

The PDN GW may include Additional Protocol Configuration Options IE in PBA message to provide the TWAN with additional IP configuration parameters (e.g. DNS server), if a corresponding request was received in the PBU message.

The PDN GW may include Protocol Configuration Options IE in the PBA message, if the Trusted WLAN Mode Indication indicating `single-connection mode` or `multi-connection mode` was received in the PBU message.

If the PGW supports Access Network Identifier Option and the TWAN had included the Access Network Identifier Option IE in the PBU message, the PGW shall include the Access Network Identifier Option IE with the sub-option(s) that it accepted as outlined in subclause 4.2 of IETF RFC 6757 [37]. The PGW shall not alter the contents of the sub-option(s) received from the TWAN.

13.2 TWAN Initiated PDN Connection Lifetime Extension procedures

13.2.1 General

13.2.2 TWAN procedures

In PMIPv6 mode, the TWAN shall follow the MAG procedure for the PMIPv6 PDN Connection Lifetime Extension as outlined in subclause 5.2.2.

13.2.3 PDN GW procedures

In PMIPv6 mode, the PDN GW shall follow the LMA procedure for the PMIPv6 PDN Connection Lifetime Extension as outlined in subclause 5.2.3.

13.3 UE / TWAN Initiated Detach and UE/TWAN Requested PDN Disconnection procedures

13.3.1 General

13.3.2 TWAN procedures

In PMIPv6 mode, the TWAN shall follow the MAG procedure for the PMIPv6 MAG Initiated PDN Connection Deletion as outlined in subclause 5.4.2 for Detach/PDN Disconnection procedure.

The TWAN shall include the Access Network Identifier Option IE and the Access Network Identifier Timestamp IE and shall set its content as specified in subclause 13.1.2 and 12.1.1.24 respectively.

The TWAN shall include the UE Time Zone IE and shall set its content as specified in subclause 12.1.1.23.

13.3.3 PDN GW procedures

In PMIPv6 mode, the PDN GW shall follow the LMA procedure for the PMIPv6 MAG Initiated PDN Connection Deletion as outlined in subclause 5.4.3.

If the PGW supports Access Network Identifier Option and the TWAN had included the Access Network Identifier Option IE in the PBU message, the PGW shall include the Access Network Identifier Option IE with the sub-option(s) that it accepted as outlined in subclause 4.2 of IETF RFC 6757 [37]. The PGW shall not alter the contents of the sub-option(s) received from the TWAN.

13.4 HSS / AAA Initiated Detach procedures

13.4.1 General

The HSS/AAA may initiate a detach procedure resulting in a PMIPv6 De-Registration.

13.4.2 TWAN procedures

In PMIPv6 mode, the TWAN shall follow the MAG procedure for the PMIPv6 MAG Initiated PDN Connection Deletion as outlined in subclause 5.4.2.

The TWAN shall include the Access Network Identifier Option IE and the Access Network Identifier Timestamp IE and shall set its content as specified in subclause 13.1.2 and 12.1.1.24 respectively.

The TWAN shall include the UE Time Zone IE and shall set its content as specified in subclause 12.1.1.23.

13.4.3 PDN GW procedures

In PMIPv6 mode, the PDN GW shall follow the LMA procedure for the PMIPv6 MAG Initiated PDN Connection Deletion as outlined in subclause 5.4.3.

If the PGW supports Access Network Identifier Option and the TWAN had included the Access Network Identifier Option IE in the PBU message, the PGW shall include the Access Network Identifier Option IE with the sub-option(s) that it accepted as outlined in subclause 4.2 of IETF RFC 6757 [37]. The PGW shall not alter the contents of the sub-option(s) received from the TWAN.

13.5 PDN GW Initiated Resource Allocation Deactivation procedures

13.5.1 General

13.5.2 TWAN procedures

In PMIPv6 mode, the Trusted Non-3GPP Access shall follow the MAG procedure for the PMIPv6 LMA Initiated PDN Connection Deletion as outlined in subclause 5.5.2.

The TWAN shall include the Access Network Identifier Option IE and the Access Network Identifier Timestamp IE and shall set its content as specified in subclause 13.1.2 and 12.1.1.24 respectively.

The TWAN shall include the UE Time Zone IE and shall set its content as specified in subclause 12.1.1.23.

13.5.3 PDN GW procedures

In PMIPv6 mode, the PDN GW shall follow the LMA procedure for the PMIPv6 LMA Initiated PDN Connection Deletion as outlined in subclause 5.5.3.

The PGW shall include the 3GPP Specific PMIPv6 error code IE and set it to the cause "Reactivation requested" when the PGW initiates the PDN GW Initiated Resource Allocation Deactivation procedure as part of the P-CSCF restoration procedure over WLAN access, as specified in 3GPP TS 23.380 [36].

13.6 3GPP Access to TWAN with PMIPv6 on S2a Handover procedures without optimization

13.6.1 General

This procedure shall apply for a TWAN access using single-connection mode or multi-connection mode.

13.6.2 TWAN procedures

In PMIPv6 mode, the TWAN shall follow the MAG procedure for the PMIPv6 PDN Connection Handover as outlined in subclause 5.3.2.

The TWAN shall include in the PBU message:

- the Protocol Configuration Options IE if the TWAN received the PCO from the UE.
- the Access Network Identifier Option IE and set its content as specified in subclause 13.1.2.
- the Serving Network IE and set it to the PLMN identity of the selected PLMN used for 3GPP-based access authentication. The selected PLMN is the PLMN of the 3GPP AAA Proxy in roaming case and the PLMN of the 3GPP AAA Server in non-roaming case.
- the Trusted WLAN Mode Indication for single-connection mode or multi-connection mode.

The TWAN shall include the UE Time Zone IE and shall set its content as specified in subclause 12.1.1.23.

The TWAN shall include the TWAN Capabilities IE in the PBU message and set the WLCP PDN Connection Modification Support Indication flag to 1 if the TWAN supports this procedure.

13.6.3 PDN GW procedures

In PMIPv6 mode, the PDN GW shall follow the LMA procedure for the PMIPv6 PDN Connection Handover as outlined in subclause 5.3.3.

If the PGW supports Access Network Identifier Option and the TWAN had included the Access Network Identifier Option IE in the PBU message, the PGW shall include the Access Network Identifier Option IE with the sub-option(s) that it accepted as outlined in subclause 4.2 of IETF RFC 6757 [37]. The PGW shall not alter the contents of the sub-option(s) received from the TWAN.

The PDN GW may include Protocol Configuration Options IE in the PBA message.

13.7 UE Initiated Connectivity to Additional PDN procedures

13.7.1 General

This procedure only applies for a TWAN access using the multiconnection mode.

13.7.2 TWAN procedures

In PMIPv6 mode, the TWAN shall follow the MAG procedure for the PMIPv6 PDN Connection Creation as outlined in subclause 5.1.2, or the MAG procedure for the PMIPv6 PDN Connection Handover as outlined in subclause 5.3.2.

The TWAN shall include in the PBU message:

- the Protocol Configuration Options IE if the TWAN received the PCO from the UE;
- the Access Network Identifier Option IE and the UE timezone IE and set their contents as specified in subclause 13.1.2;
- the Serving Network IE and set it to the PLMN identity of the selected PLMN used for 3GPP-based access authentication. The selected PLMN is the PLMN of the 3GPP AAA Proxy in roaming case and the PLMN of the 3GPP AAA Server in non-roaming case;
- the Trusted WLAN Mode Indication for multi-connection mode;
- the TWAN Capabilities IE and set the WLCP PDN Connection Modification Support Indication flag to 1 if the TWAN supports this procedure.

13.7.3 PDN GW procedures

In PMIPv6 mode, the PDN GW shall follow the LMA procedure for the PMIPv6 PDN Connection Creation as outlined in subclause 5.1.3, or the LMA procedure for the PMIPv6 PDN Connection Handover as outlined in subclause 5.3.3.

If the PGW supports Access Network Identifier Option and the TWAN had included the Access Network Identifier Option IE in the PBU message, the PGW shall include the Access Network Identifier Option IE with the sub-option(s) that it accepted as outlined in subclause 4.2 of IETF RFC 6757 [37]. The PGW shall not alter the contents of the sub-option(s) received from the TWAN.

The PDN GW may include the Protocol Configuration Options IE in the PBA message.

14 Proxy Mobile IPv6 EPC Restoration Procedure

14.1 PGW triggered SGW restoration procedure

14.1.1 General

The PGW triggered SGW restoration procedure is specified in 3GPP TS 23.007 [13]. The Proxy Mobile IPv6 LMA Initiated Update Notification procedure specified in subclause 5.11 is used to initiate the PGW triggered SGW restoration procedure.

14.1.2 Serving GW procedures

The Serving GW shall follow the PGW triggered SGW restoration procedure as specified in subclause 27.2.3.3 of 3GPP TS 23.007 [13]. When receiving the Update Notification message with notification reason "PGW Downlink Trigger Notification", the Serving GW shall response with an Update Notification Acknowledgement message specified as the MAG procedure in subclause 5.11.

14.1.3 PDN GW procedures

The PDN GW shall follow the PGW triggered SGW restoration procedure as specified in subclause 27.2.3.4 and 20.2.7.1 of 3GPP TS 23.007 [13]. When sending the Update Notification message, the PDN GW shall follow the LMA procedure specified in subclause 5.11 as follows:

1. The notification reason shall be set to "PGW Downlink Trigger Notification".

Editor's Note: The Notification reason "PGW Downlink Trigger Notification " needs to be registered in IANA.

2. If the MME/S4-SGSN identifier was received in the last Create Session Request or Modify Bearer Request message as specified in 3GPP TS 23.007 [13], the MME/SGSN Identifier mobility option shall contain the stored MME/S4-SGSN identifier.
3. If the restoration procedure is caused by S5 path failure as specified in subclause 20.2.7.1 of 3GPP TS 23.007 [13], the Update Notification Message shall contain the PDN GW IP Address and GRE key option which shall contain the PGW IP address and uplink GRE key for control plane for the PDN connection.

14.2 Update PDP context/Bearer at P-CSCF failure

14.2.1 General

The update PDP context/Bearer at P-CSCF failure procedure is specified in subclause 5.1 of 3GPP TS 23.380 [36]. The Proxy Mobile IPv6 LMA Initiated Update Notification procedure specified in subclause 5.11 is used to inform the SGW at P-CSCF failure.

This procedure is also used from the PGW to the TWAN or ePDG to provide the UE with a list of available P-CSCF addresses as part of the P-CSCF restoration extension procedure for TWAN access and untrusted WLAN access (3GPP TS 23.380 [36]).

14.2.2 PDN GW procedures

The PDN GW shall follow the update PDP context/Bearer at P-CSCF failure procedure as specified in subclause 5.1 of 3GPP TS 23.380 [36], or the P-CSCF restoration extension procedure for TWAN access and untrusted WLAN access as specified in 3GPP TS 23.380 [36]. When sending the Update Notification message, the PDN GW shall follow the LMA procedure specified in subclause 5.11 as follows:

1. The notification reason shall be set to "PGW-TRIGGERED-PCSCF-RESTORATION-PCO".
2. The Service Selection Mobility Option shall be set to the corresponding APN to which the UE PDN connection is attached
3. The PDN connection ID Mobility Option shall contain the PDN connection ID stored in the BCE if multiple PDN connection to a given APN is supported.
4. The PCO Mobility Option (for S5/S8 and S2a) or the APCO Mobility Option (for S2b) shall contain a list of available P-CSCF addresses.

14.2.3 Serving GW, TWAN and ePDG procedures

The Serving GW shall follow the update PDP context/Bearer at P-CSCF failure procedure as specified in subclause 5.1 of 3GPP TS 23.380 [36]. When receiving the Update Notification message with notification reason "PGW triggered P-

CSCF restoration using PCO", the Serving GW shall respond with an Update Notification Acknowledgement message specified as the MAG procedure in subclause 5.11.

The TWAN and ePDG shall follow the P-CSCF restoration extension procedure for TWAN access and untrusted WLAN access as specified in 3GPP TS 23.380 [36]. When receiving the Update Notification message with notification reason "PGW triggered P-CSCF restoration using PCO", the TWAN or ePDG shall respond with an Update Notification Acknowledgement message specified as the MAG procedure in subclause 5.11.

14.3 Inform UE about P-CSCF failure

14.3.1 General

The Inform UE about P-CSCF failure procedure is specified in subclause 5.2 of 3GPP TS 23.380 [36]. The Proxy Mobile IPv6 LMA Initiated Update Notification procedure specified in subclause 5.11 is used to inform the SGW at P-CSCF failure.

14.3.2 PDN GW procedures

The PDN GW shall follow the inform UE about P-CSCF failure procedure as specified in subclause 5.2 of 3GPP TS 23.380 [36]. When sending the Update Notification message, the PDN GW shall follow the LMA procedure specified in subclause 5.11 as follows:

1. The notification reason shall be set to "PGW-TRIGGERED-PCSCF-RESTORATION-DHCP".
2. The Service Selection Mobility Option shall be set to the corresponding APN to which the UE PDN connection is attached
3. The PDN connection ID Mobility Option shall contain the PDN connection ID stored in the BCE if multiple PDN connection to a given APN is supported.
4. The PCO Mobility Option shall contain an indicator that there is P-CSCF failure.

14.3.3 Serving GW procedures

The Serving GW shall follow the inform UE about P-CSCF failure procedure as specified in subclause 5.2 of 3GPP TS 23.380 [36]. When receiving the Update Notification message with notification reason "PGW triggered P-CSCF restoration using DHCP", the Serving GW shall response with an Update Notification Acknowledgement message specified as the MAG procedure in subclause 5.11.

15 Proxy Mobile IPv6 End Marker Notification Procedure

15.1 General

Proxy Mobile IPv6 End Marker notification procedure is specified in subclause 5.7.1 and 5.7.2 of 3GPP TS 23.402 [3]. The Proxy Mobile IPv6 LMA Initiated Update Notification procedure specified in subclause 5.11 is used to initiate the Proxy Mobile IPv6 End Marker Notification Procedure.

15.2 Serving GW procedures

The Serving GW shall follow the Proxy Mobile IPv6 End Marker notification procedure as specified in subclause 5.7.1 and 5.7.2 of 3GPP TS 23.402 [3]. When receiving the Update Notification message with notification reason "VENDOR-SPECIFIC-REASON" and End Marker Notification mobility option and the serving GW has downlink user plane established, the Serving GW shall generate End Marker as specified in subclause 5.7.1 and 5.7.2 of 3GPP TS 23.402 [3]. When receiving the Update Notification message, the Serving GW shall follow the MAG procedure specified in subclause 5.11.

15.3 PDN GW procedures

The PDN GW shall follow Proxy Mobile IPv6 End Marker notification procedure as specified in subclause 5.7.1 and 5.7.2 of 3GPP TS 23.402 [3]. When sending the Update Notification message, the PDN GW shall follow the LMA procedure specified in subclause 5.11 as follows:

1. The PDN GW shall set the notification reason to "VENDOR-SPECIFIC-REASON" as specified in IETF RFC 7077 [35].
2. The PDN GW shall include End Marker Notification mobility option.
3. The PDN GW shall set the Acknowledge (A) flag to "0", thereby not requesting an acknowledgement message from the Serving GW.

Annex A: void

Annex B (Normative): Definition of the protocol number in pseudo-header

B.1 General

In this specification PMIP refers to PMIPv6 as defined in IETF RFC5213 [4] and IETF RFC5213 [4] is based on Mobile IPv6 IETF RFC 3775[8]. IETF RFC 3775[38], however, is obsolete by IETF RFC 6275 [8], which specifies protocol number 135 instead of 2 to be used in the checksum pseudo-header. For forward compatibility with future 3GPP releases, the protocol number 135 shall be supported. In addition the protocol number 2 may also be supported.

NOTE: Some nodes complying to an earlier version of this specification can be implemented according to IETF RFC 3775[38] and this could result in the use of different protocol numbers within a network.

To migrate a protocol number 2 based PMIP network into a protocol number 135 based PMIP network, the network migration may be achieved by static configuration or supporting a migration solution as specified in this Annex B. Any other alternatives for a specific development use case are possible.

B.2 Interworking of different protocol number

If a PMIPv6 node (LMA) supports both protocol numbers (2 and 135), it shall silently discard the received PBU message if the checksum value calculated from the protocol number 2 and 135 are both invalid. If one of the protocol number (2 or 135) is valid in checksum calculation, the node shall use this protocol number in the "pseudo-header" when sending any subsequent PMIPv6 messages with the same peer PMIPv6 node. If the checksum validation is skipped, the LMA shall use the configured protocol number for the subsequent PMIPv6 messages to that peer node.

If a PMIPv6 node (MAG) supports both protocol numbers (2 and 135), it shall construct PBU message using protocol number 135 which takes precedence over protocol number 2. If no response is received from LMA, the MAG sends another PBU message to the peer node using protocol number 2. The MAG shall store the protocol number of the response message and use it for the subsequent message interaction. If the checksum validation is skipped, the MAG shall use the configured protocol number for the subsequent PMIPv6 messages to that peer node.

Annex C (informative): Change History

Change history							
Date	Meeting	TDoc	CR	R ev	Cat	Subject/Comment	New version
2008-09	CT#41	CP-080476				V2.0.0 approved in CT#41	8.0.0
2008-12	CT#42	CP-080692	0002			IPv4 Address Acknowledgement option in PBA	8.1.0
		CP-080692	0006			IPv4 Address Deletion	
		CP-080692	0007			PDN-GW Initiated Resource Allocation Deactivation	
		CP-080692	0008			PDNType-IP Address Option	
		CP-080692	0009			PMIP Bulk Revocation Support.	
		CP-080692	0010			Link local address	
		CP-080692	0011			Service selection option in the PBA message	
		CP-080692	0012			PMIP IPv4 address allocation	
		CP-080692	0019			Interface Id in PBA at HO case	
		CP-080692	0022			Clarification to subclause PMIP6 LMA Initiated PDN Connection Deletion Procedure	
		CP-080692	0023			Update references to latest version of IETF documents	
		CP-080692	0025			Putting back GSM logo on front page	
		CP-080692	0026			PMIPv6 Heartbeat/Path Management Update	
		CP-080692	0031			PMIPv6 clarification	
		CP-080692	0033			Optimized E-UTRAN to CDMA2000 HRPD Handover procedure cleanup	
		CP-080692	0036			IPv4-UDP encapsulation option	
		CP-080692	0037			S5/S8 procedure corrections	
		CP-080692	0038			S2a procedure corrections	
		CP-080692	0039			S2b procedure corrections	
		CP-080692	0040			Chaining case procedure corrections	
		CP-080692	0042			DHCPv4 Address Allocation 3GPP VSO	
		CP-080692	0043			PDN type indicator	
		CP-080692	0044			FFS cleanup	
		CP-080692	0045			HI FFS cleanup	
		CP-080692	0046			Clean up on BULE and BCE	
		CP-080692	0047			Clarification on PMIPv6 Protocol Stack	
		CP-080692	0048			Modifications for S2a/S2b - PMIP based S8 chaining	
2009-03	CT#43	CP-090052	0054			3GPP VSO PDN type cause value	8.2.0
		CP-090052	0055			3GPP VSO DHCPv4 Address Allocation Procedure Indication	
		CP-090052	0056			3GPP VSO PMIP error code missing in PBA and BRA	
		CP-090052	0059			3GPP VSO PCO in PBU/PBA message	
		CP-090052	0061			Old BCE is lost at handover	
		CP-090052	0062			Partial Node Failure	
		CP-090052	0064			Alignments of cause codes	
		CP-090052	0065			UE specific Error Indication	
		CP-090052	0066			Clarification on Heartbeat Request Message	
		CP-090052	0071			Link-local Address Option	
		CP-090052	0072			IPv4 Deferred Address Allocation and PDN Type	
		CP-090052	0073			PMIP VSO Charging ID	
		CP-090052	0074			ATT Values for PMIP base S5/S8	
		CP-090052	0077			Detach or PDN Disconnection	
		CP-090052	0079			Status Field update	
		CP-090052	0080			Correction to tunnel management	
		CP-090052	0085			Carrying APN selection mode in PMIP	
		CP-090271	0086			Removing 3GPP Vendor Specific Mobility Option format	
2009-04						Correction to history table	8.2.1
2009-06	CT#44	CP-090290	0090			PMIP VSO Charging Characteristics	8.3.0
		CP-090290	0092			PDN Type Cause Value	
		CP-090290	0093			UE Requested additional PDN Connectivity Procedure	
		CP-090290	0094			IP address allocation Procedure	
		CP-090290	0095			FQ-CSID	
		CP-090290	0097			Timestamp	
		CP-090290	0098			Serving Network VSO in PBU	
		CP-090290	0099			GRE Key usage in PDN Connection Lifetime Extension	
		CP-090290	0101			PMIPv6 messages transport over IPv4	
		CP-090290	0102			PDN Type for PMIPv6	
		CP-090290	0106			Carrying MEI over PMIP based S5/S8	
		CP-090290	0107			Carrying MSISDN over PMIP based S5/S8	
		CP-090290	0109			Access technology type to be used by ePDG	
		CP-090290	0110			Binding Revocation Indication	
2009-09	CT#45	CP-090538	0114			APN Restriction for PMIPv6	8.4.0
		CP-090538	0116			The IPv4 address allocation procedure	
		CP-090538	0117			Clean up on 3GPP Specific PMIPv6 Error Code	
		CP-090538	0118			GRE Key usage in PDN Connection Lifetime Extension	
		CP-090538	0120			Defining values for 3GPP specific PMIPv6 error code	

		CP-090538	0121		Conditional 3GPP specific PMIPv6 information elements	
		CP-090538	0122		Reintroducing specific 3GPP Access Technology Types	
		CP-090538	0124		Clarifications for HO 3GPP to non-3GPP	
		CP-090538	0125		Default MTU size to avoid IP fragmentation in EPS	
		CP-090538	0126		Heartbeat Mechanism condition for path failure detection	
		CP-090538	0127		Correct on GRE key assignment	
		CP-090538	0128		E-UTRAN to HRPD optimized handover	
		CP-090538	0130		The revision of LMA's dynamic IP address allocation in handover procedure	
		CP-090729	0131		Partial failure handling alignment with stage 2	
		CP-090729	0132		Partial failure handling for S1 based handovers	
2009-12	CT#46	CP-090971	0133		UE-specific Error Indication	8.5.0
		CP-090775	0139		IPv4 Address Release for PMIPv6 based S2a	
		CP-090775	0140		Correct IPv4 Home Address Reply option IE name	
		CP-090775	0142		Clarification on Heartbeat Mechanism	
		CP-090775	0143		FFS Cleanup for Service Selection Mobility Option	
		CP-090775	0144		IPv4 Default-Router Address option	
		CP-090775	0145		Clarifications on the format of Mobile Node Identifier option	
		CP-090775	0146		Removing access type mapping table from annex B	
		CP-090775	0152		Clarifications on the format of Service Selection Mobility Option	
		CP-090775	0154		Correct fields of revocation message	
2009-12	CT#46	CP-090801	0134		IMEI based NAI	9.0.0
		CP-090801	0135		Unauthenticated IMSI	
		CP-090802	0136		Multiple PDN to the Same APN for PMIP-based Interfaces	
		CP-090802	0137		BCE extensions for MUPSAP	
2010-03	CT#47	CP-100026	0157		Correction of the UE-specific Error Indication	9.1.0
			0159		Bulk Binding Revocation Indication	
			0161		FQ-CSID option	
2010-06	CT#48	CP-100265	0167		Cause Mapping	9.2.0
2010-09	CT#49	CP-100444	0171		PMIPv6 Reference Update	9.3.0
2010-12	CT#50	CP-100669	0174		Essential correction to the mapping between PMIP 3GSPEC and GTP Cause	9.4.0
2010-12	CT#50	CP-100694	0177		IPv4 Default Router Address	10.0.0
2011-03	CT#51	CP-110081	0180		Clarification on IE using interfaces	10.1.0
		CP-110072	0189		Handling of UE specific Error Indication over the PMIP	
		CP-110072	0190		LMA initiated PDN Connection Deletion with Reactivation requested	
		CP-110208	0191		Clarification of PCO decoding	
2011-06	CT#52	CP-110369	0178		APN based congestion control	10.2.0
		CP-110369	0179		Low access priority indicator	
		CP-110372	0193		Incorrect RFC reference for the UE-specific Error Handling	
		CP-110372	0194		PDN GW IP address Correction	
2011-09	CT#53	CP-110558	0198		PMIP message format	10.3.0
		CP-110567	0201		Signalling path failure handling	
2011-09	CT#53	CP-110580	0200		Default inner MTU size	11.0.0
2011-12	CT#54	CP-110785	0211		Correction of the protocol stack for PMIP	11.1.0
		CP-110785	0212		Migration solution of the PMIP protocol stack issue	
		CP-110791	0220		Static IP Address Allocation Indication for Handover procedure	
		CP-110791	0225		Learn capability of MUPSAP from PDN connection ID	
		CP-110792	0218		Authentication with external networks over PMIP S2b	
2012-03	CT#55	CP-120018	0232		PMIP binding lifetime	11.2.0
		CP-120036	0234		PGW based provisioning of the DNS server address for the S2b interface	
2012-06	CT#56	CP-120248	0237		IPv4 Address Allocation procedure	11.3.0
		CP-120248	0239		Clarification for IPv4 Home Address Request option in dynamic IP allocation	
		CP-120248	0240		S2a related changes when Trusted WLAN Access is used	
		CP-120248	0241		Clarifying the use of Default Router Address Option in case of Trusted WLAN access	
		CP-120248	0238		Multiple PDN connections	
		CP-120248	0247		GRE key reference correction	
2012-09	CT#57	CP-120477	0249		RAT Type for EPC access via TWAN	11.4.0
		CP-120464	0250		Extensions to PMIPv6 signalling	
			0251		Correction to references for TS 29.275	
		CP-120656	0252		Reference list correction to align with the corrected TS 29.212 title	
2012-12	CT#58	CP-120729	0255		Signalling Priority Indication in handover	11.5.0
		CP-120729	0266		Static IP Address Allocation Indication	
		CP-120739	0253		New PMIP message for EPC Restoration Procedure	
		CP-120739	0254		MME/SGSN Id for the PGW triggered SGW restoration procedure	
		CP-120733	0259		MSISDN over PMIPv6 S2b/S2a interface	
		CP-120733	0262		TWAN operator identification for EPC access charging	
		CP-120733	0268		Trusted WLAN AP identity over S2a	
2013-03	CT#59	CP-130019	0272		IETF Draft Reference- Update Notifications for Proxy Mobile IPv6	11.6.0

		CP-130024	0273		Completion of replacing RFC 3775 with RFC 6275 references	
		CP-130024	0274		Protocol number used in pseudo-header Migration RFC 3775 to RFC 6275	
		CP-130027	0275		Sending SSID for SaMOG in PMIP	
2013-06	CT#60	CP-130284	0277		Lifetime in PBU message	11.7.0
2013-09	CT#61	CP-130465	0278		Clarification of operator identifier field within APN encoding	12.0.0
		CP-130465	0280		Incorrect IE description for Service Selection Mobility Option in BRA	
		CP-130464	0281		Addition of End Marker Support for Handover Scenarios with SGW Relocation	
2013-12	CT#62	CP-130609	0285		Correction of reference to Update Notifications for Proxy Mobile IPv6	12.1.0
		CP-130637	0283		Clarification on mobility options for APN congestion control over S2a PMIP	
		CP-130633	0286		3GPP Access to TWAN Handover procedures without optimization	
		CP-130633	0287		Clarification on how to use PCO on the S2a PMIP interface	
2014-03	CT#63	CP-140020	0289		Update the reference of IETF draft Update Notifications for Proxy Mobile IPv6 to RFC 7077	12.2.0
		CP-140023	0295		Reflecting back Access Network Identifier options in Proxy Binding Acknowledgement message for TWAN access	
		CP-140031	0290		Clarification on usage of APCO on the S2a PMIP interface	
		CP-140031	0293		Trusted WLAN mode indication	
		CP-140030	0291		Extension of ANI to convey other types of location information	
		CP-140030	0292		Providing the NAI in MAG Initiated PDN Connection Deletion procedure	
		CP-140030	0296		Access Network Identifier clarification	
		CP-140029	0282		Implementation error of "Apply Serving Network on S2a for eHRPD access" C4-131878.	
2014-06	CT#64	CP-140252	0298		UE Time Zone information for TWAN S2a access	12.3.0
		CP-140252	0299		Access Network Identifier Timestamp in PDN disconnection procedure	
		CP-140252	0300		TWAN ID Timestamp in Bearer Revocation Ack message for PGW initiated bearer deactivation procedure in Trusted WLAN.	
		CP-140252	0305		Encoding of the civic address	
		CP-140252	0306		A new 3GPP specific option to carry the Logical Access ID in PMIPv6	
		CP-140252	0309		Remove editor's note from TWAN procedures	
		CP-140252	0311		SSID not sufficient for TWAN location	
		CP-140261	0301		Alternate LMAA or IPv4-LMAA	
		CP-140261	0302		Alternate LMA address for user plane	
		CP-140261	0307		Alternate LMAA or IPv4-LMAA during Handover	
		CP-140261	0308		Alternate LMA address for user plane during Handover	
		CP-140247	0303		UE Initiated Connectivity to Additional PDN procedures	
		CP-140247	0304		HO procedures for non-transparent mode	
2014-09	CT#65	CP-140518	0313		PGW IP Address and GRE key in the Update Notification	12.4.0
2014-12	CT#66	CP-140779	0314		Update the reference to IETF draft on carrying Civic address in ANI IE	12.5.0
		CP-140972	0315		Removal of Optimized HO procedure from HRPD to EUTRAN	
		CP-140972	0317		Missing description on Access Technology Type option for TWAN access	
2014-12	CT#66	CP-140796	0316		Provisioning of P-CSCF address via APCO for S2b	13.0.0
2015-03	CT#67	CP-150025	0318		Update reference RFC Separation of Control and User Plane for PMIPv6	13.1.0
2015-06	CT#68	CP-150270	0320		Correction on the rejection of the PBU for APN congestion	13.2.0
		CP-150270	0321		Normative Text for the Optional IEs in the UPN and UPA	
		CP-150270	0322		Support of IPv6 Prefix Delegation over PMIP-based S5/S8	
		CP-150270	0324		Editorial corrections to clause 13	
		CP-150274	0325		Add MEI to S2a/S2b interfaces	
2015-09	CT#69	CP-150442	0326		Origination Time Stamp and Maximum Wait Time in PBU	13.3.0
2015-12	CT#70	CP-150780	0327		Extensions for P-CSCF restoration for trusted and untrusted WLAN access	13.4.0
		CP-150751	0329		Update the reference for Civic Address	
		CP-150745	0332		IANA registration of new Update Notification Reasons	
2016-06	CT#72	CP-160228	0333		Addition of NB-IoT radio access type	13.5.0
2017-03	CT#72				Update to Rel-14 version (MCC)	14.0.0
2018-06	CT#80				Update to Rel-15 version (MCC)	15.0.0
2020-07	CT#88e				Update to Rel-16 version (MCC)	16.0.0
2022-04	-	-	-	-	Update to Rel-17 version (MCC)	17.0.0

History

Document history		
V17.0.0	April 2022	Publication