

ETSI TS 129 275 V8.7.0 (2010-06)

Technical Specification

**Universal Mobile Telecommunications System (UMTS);
LTE;
Proxy Mobile IPv6 (PMIPv6) based Mobility
and Tunnelling protocols;
Stage 3
(3GPP TS 29.275 version 8.7.0 Release 8)**



Reference

RTS/TSGC-0429275v870

Keywords

LTE, UMTS

ETSI

650 Route des Lucioles
F-06921 Sophia Antipolis Cedex - FRANCE

Tel.: +33 4 92 94 42 00 Fax: +33 4 93 65 47 16

Siret N° 348 623 562 00017 - NAF 742 C
Association à but non lucratif enregistrée à la
Sous-Préfecture de Grasse (06) N° 7803/88

Important notice

Individual copies of the present document can be downloaded from:

<http://www.etsi.org>

The present document may be made available in more than one electronic version or in print. In any case of existing or perceived difference in contents between such versions, the reference version is the Portable Document Format (PDF). In case of dispute, the reference shall be the printing on ETSI printers of the PDF version kept on a specific network drive within ETSI Secretariat.

Users of the present document should be aware that the document may be subject to revision or change of status. Information on the current status of this and other ETSI documents is available at

<http://portal.etsi.org/tb/status/status.asp>

If you find errors in the present document, please send your comment to one of the following services:

http://portal.etsi.org/chaicor/ETSI_support.asp

Copyright Notification

No part may be reproduced except as authorized by written permission.
The copyright and the foregoing restriction extend to reproduction in all media.

© European Telecommunications Standards Institute 2010.
All rights reserved.

DECTTM, **PLUGTESTS**TM, **UMTS**TM, **TIPHON**TM, the TIPHON logo and the ETSI logo are Trade Marks of ETSI registered for the benefit of its Members.

3GPPTM is a Trade Mark of ETSI registered for the benefit of its Members and of the 3GPP Organizational Partners.

LTETM is a Trade Mark of ETSI currently being registered

for the benefit of its Members and of the 3GPP Organizational Partners.

GSM[®] and the GSM logo are Trade Marks registered and owned by the GSM Association.

Intellectual Property Rights

IPRs essential or potentially essential to the present document may have been declared to ETSI. The information pertaining to these essential IPRs, if any, is publicly available for **ETSI members and non-members**, and can be found in ETSI SR 000 314: "*Intellectual Property Rights (IPRs); Essential, or potentially Essential, IPRs notified to ETSI in respect of ETSI standards*", which is available from the ETSI Secretariat. Latest updates are available on the ETSI Web server (<http://webapp.etsi.org/IPR/home.asp>).

Pursuant to the ETSI IPR Policy, no investigation, including IPR searches, has been carried out by ETSI. No guarantee can be given as to the existence of other IPRs not referenced in ETSI SR 000 314 (or the updates on the ETSI Web server) which are, or may be, or may become, essential to the present document.

Foreword

This Technical Specification (TS) has been produced by ETSI 3rd Generation Partnership Project (3GPP).

The present document may refer to technical specifications or reports using their 3GPP identities, UMTS identities or GSM identities. These should be interpreted as being references to the corresponding ETSI deliverables.

The cross reference between GSM, UMTS, 3GPP and ETSI identities can be found under <http://webapp.etsi.org/key/queryform.asp>.

Contents

Intellectual Property Rights	2
Foreword.....	2
Foreword.....	9
1 Scope	10
2 References	10
3 Definitions and abbreviations.....	11
3.1 Definitions	11
3.2 Abbreviations	12
4 General	12
4.1 PDN connection	12
4.2 PMIPv6 protocol stacks.....	12
5 Mobility Management procedures.....	14
5.1 Proxy Mobile IPv6 PDN Connection Creation procedure.....	14
5.1.1 General.....	14
5.1.1.1 Proxy Binding Update.....	14
5.1.1.2 Proxy Binding Acknowledgement	16
5.1.2 MAG procedures	17
5.1.3 LMA procedures.....	18
5.2 Proxy Mobile IPv6 PDN Connection Lifetime Extension procedure.....	18
5.2.1 General.....	18
5.2.1.1 Proxy Binding Update.....	18
5.2.1.2 Proxy Binding Acknowledgement	20
5.2.2 MAG procedures	22
5.2.3 LMA procedures.....	22
5.3 Proxy Mobile IPv6 PDN Connection Handover procedure.....	23
5.3.1 General.....	23
5.3.1.1 Proxy Binding Update.....	23
5.3.1.2 Proxy Binding Acknowledgement	25
5.3.2 MAG procedures	27
5.3.3 LMA procedures.....	27
5.4 Proxy Mobile IPv6 MAG Initiated PDN Connection Deletion procedure	27
5.4.1 General.....	27
5.4.1.1 Proxy Binding Update.....	28
5.4.1.2 Proxy Binding Acknowledgement	29
5.4.2 MAG procedures	30
5.4.3 LMA procedures.....	30
5.5 Proxy Mobile IPv6 LMA Initiated PDN Connection Deletion procedure	31
5.5.1 General.....	31
5.5.1.1 Binding Revocation Indication.....	31
5.5.1.2 Binding Revocation Acknowledgment	32
5.5.2 MAG procedures	33
5.5.3 LMA procedures.....	33
5.6 Proxy Mobile IPv6 PDN Connection IPv4 address allocation procedure	33
5.6.1 General.....	33
5.6.1.1 Proxy Binding Update.....	33
5.6.1.2 Proxy Binding Acknowledgement	34
5.6.2 MAG procedures	35
5.6.3 LMA procedures.....	36
5.7 Proxy Mobile IPv6 LMA Initiated IPv4 Address Release procedure.....	36
5.7.1 General.....	36
5.7.1.1 Binding Revocation Indication.....	36
5.7.1.2 Binding Revocation Acknowledgment	37
5.7.2 MAG procedures	38

5.7.3	LMA procedures	38
5.8	Proxy Mobile IPv6 Multiple PDN Extensions	38
5.8.1	General.....	38
5.8.2	Extensions to PMIPv6 Data Structure	38
5.8.3	Extensions to PMIPv6 BULE and BCE Lookups.....	38
5.9	Serving GW Procedure at Chaining Case.....	38
5.9.1	General.....	38
5.9.2	Signalling procedures	39
5.9.2.1	PMIP-based S8 Serving GW procedures	39
5.9.3	Payload packets at chained case	39
5.10	Proxy Mobile IPv6 MAG Initiated IPv4 Address Release procedure	40
5.10.1	General.....	40
5.10.1.1	Proxy Binding Update.....	40
5.10.1.2	Proxy Binding Acknowledgement	41
5.10.2	MAG procedures	41
5.10.3	LMA procedures.....	41
6	Tunnel Management procedures	43
6.1	General	43
6.2	MAG procedure.....	43
6.3	LMA procedure	44
6.4	Data Structures	44
6.4.1	Binding Update List Entry.....	44
6.4.2	Binding Cache Entry.....	45
6.5	Security	45
7	Path Management procedures	46
7.1	General	46
7.2	Heartbeat Mechanism.....	46
7.2.1	General.....	46
7.2.2	Heartbeat Message.....	46
7.2.2.1	Heartbeat Request	46
7.2.2.2	Heartbeat Response.....	46
7.3	Void.....	47
7.4	Void.....	47
7.5	Void.....	47
7.6	UE-specific Error Handling.....	47
7.6.1	General.....	47
7.6.2	MAG and LMA procedure	47
7.7	Void.....	47
7.8	Partial node failure requiring the removal of a subset of sessions.....	47
7.8.1	General.....	47
7.8.2	Binding Revocation Indication message.....	47
7.8.3	Binding Revocation Acknowledgement message.....	48
7.8.4	MAG procedures	48
7.8.5	LMA procedures.....	48
8	PMIP-based S5 and PMIP-based S8 description.....	50
8.1	Initial Attach procedures	50
8.1.1	General.....	50
8.1.2	Serving GW procedures.....	50
8.1.3	PDN GW procedures	50
8.2	Serving GW Initiated PDN Connection Lifetime Extension procedures	50
8.2.1	General.....	50
8.2.2	Serving GW procedures.....	50
8.2.3	PDN GW procedures	50
8.3	UE, MME or HSS initiated Detach procedures.....	50
8.3.1	General.....	50
8.3.2	Serving GW procedures.....	50
8.3.3	PDN GW procedures	50
8.4	PDN GW Initiated PDN Disconnection procedures.....	51
8.4.1	General.....	51
8.4.2	Serving GW procedures.....	51

8.4.3	PDN GW procedures	51
8.5	UE Requested Additional PDN Connectivity procedures	51
8.5.1	General.....	51
8.5.2	Serving GW procedures.....	51
8.5.3	PDN GW procedures	51
8.6	Handover procedures.....	51
8.6.1	Intra-LTE TAU and Inter-eNodeB Handover with Serving GW Relocation procedures	51
8.6.1.1	General.....	51
8.6.1.2	Serving GW procedures	51
8.6.1.3	PDN GW procedures.....	51
8.6.2	TAU/RAU or Handover between GERAN A/Gb Mode or UTRAN Iu Mode and E-UTRAN procedures.....	52
8.6.2.1	General.....	52
8.6.2.2	Serving GW procedures	52
8.6.2.3	PDN GW procedures.....	52
8.6.3	Handover from Trusted or Untrusted Non-3GPP IP Access over S2a/S2b to 3GPP Access Handover E-UTRAN over PMIP based S5/S8 without optimization procedures	52
8.6.3.1	General.....	52
8.6.3.2	Serving GW procedures	52
8.6.3.3	PDN GW procedures.....	52
8.6.4	Handover from Trusted or Untrusted Non-3GPP IP Access over S2a/S2b to 3GPP Access UTRAN/GERAN over PMIP based S5/S8 without optimization.....	52
8.6.4.1	General.....	52
8.6.4.2	Serving GW procedures	52
8.6.4.3	PDN GW procedures.....	52
8.6.5	Handover from Trusted or Untrusted Non-3GPP IP Access over S2c to 3GPP Access over PMIP based S5/S8 without optimization	53
8.6.5.1	General.....	53
8.6.5.2	Serving GW procedures	53
8.6.5.3	PDN GW procedures.....	53
8.6.6	Optimised Active Handover: cdma2000 eHRPD Access to EUTRAN	53
8.6.6.1	General.....	53
8.6.6.2	Serving GW procedures	53
8.6.6.3	PDN GW procedures.....	53
8.6.7	Optimized Idle Mode Mobility: cdma2000 eHRPD Access to E-UTRAN Access	53
8.6.7.1	General.....	53
8.6.7.2	Serving GW procedures	53
8.6.7.3	PDN GW procedures.....	53
8.7	UE Requested PDN Disconnection procedures.....	53
8.7.1	General.....	53
8.7.2	Serving GW procedures	53
8.7.3	PDN GW procedures	54
8.8	IPv4 Address Allocation using DHCP	54
8.8.1	General.....	54
8.8.2	Serving GW procedures.....	54
8.8.3	PDN GW procedures	54
8.9	PDN-GW Initiated IPv4 Address Delete Procedure.....	54
8.9.1	General.....	54
8.9.2	Serving GW procedures.....	54
8.9.3	PDN GW procedures	54
9	Trusted Non-3GPP Access over S2a Description	54
9.1	Initial Attach procedures	54
9.1.1	General.....	54
9.1.2	Trusted Non-3GPP Access procedures	54
9.1.3	PDN GW procedures	54
9.2	Trusted Non-3GPP Access Initiated PDN Connection Lifetime Extension procedures.....	55
9.2.1	General.....	55
9.2.2	Trusted Non-3GPP Access procedures	55
9.2.3	PDN GW procedures	55
9.3	UE / Trusted Non-3GPP Access Initiated Detach and UE Requested PDN Disconnection procedures	55
9.3.1	General.....	55

9.3.2	Trusted Non-3GPP Access procedures	55
9.3.3	PDN GW procedures	55
9.4	HSS / AAA Initiated Detach procedures	55
9.4.1	General.....	55
9.4.2	Trusted Non-3GPP Access procedures	55
9.4.3	PDN GW procedures	55
9.5	UE Initiated Connectivity to Additional PDN procedures	56
9.5.1	General.....	56
9.5.2	Trusted Non-3GPP Access procedures	56
9.5.3	PDN GW procedures	56
9.6	3GPP Access to Trusted Non-3GPP IP Access with PMIPv6 on S2a Handover procedures without optimization.....	56
9.6.1	General.....	56
9.6.2	Trusted Non-3GPP Access procedures	56
9.6.3	PDN GW procedures	56
9.7	PDN GW Initiated Resource Allocation Deactivation procedures.....	56
9.7.1	General.....	56
9.7.2	Trusted Non-3GPP Access procedures	56
9.7.3	PDN GW procedures	56
9.8	IPv4 Address Allocation using DHCP	57
9.8.1	General.....	57
9.8.2	Trusted Non-3GPP Access procedures	57
9.8.3	PDN GW procedures	57
9.9	PDN-GW Initiated IPv4 Address Delete Procedure.....	57
9.9.1	General.....	57
9.9.2	Trusted Non-3GPP Access procedures	57
9.9.3	PDN GW procedures	57
9.10	Optimized E-UTRAN to CDMA2000 eHRPD Handover procedure.....	57
9.10.1	General.....	57
9.10.2	CDMA2000 HRPD access procedure.....	57
9.10.3	PDN GW procedures	57
9.11	Optimized Idle Mode Mobility: E-UTRAN Access to cdma2000 eHRPD Access procedure.....	58
9.11.1	General.....	58
9.11.2	CDMA2000 eHRPD access procedure.....	58
9.11.3	PDN GW procedures	58
10	Untrusted Non-3GPP Access over S2b Description	58
10.1	Initial Attach procedures	58
10.1.1	General.....	58
10.1.2	ePDG procedures	58
10.1.3	PDN GW procedures	58
10.2	ePDG Initiated PDN Connection Lifetime Extension procedures.....	58
10.2.1	General.....	58
10.2.2	ePDG procedures	58
10.2.3	PDN GW procedures	58
10.3	UE / ePDG Initiated Detach and UE Requested PDN Disconnection procedures	59
10.3.1	General.....	59
10.3.2	ePDG procedures	59
10.3.3	PDN GW procedures	59
10.4	HSS / AAA Initiated Detach procedures	59
10.4.1	General.....	59
10.4.2	ePDG procedures	59
10.4.3	PDN GW procedures	59
10.5	UE Initiated Connectivity to Additional PDN procedures	59
10.5.1	General.....	59
10.5.2	ePDG procedures	59
10.5.3	PDN GW procedures	59
10.6	3GPP Access to Untrusted Non-3GPP IP Access with PMIPv6 on S2b Handover procedures without optimization.....	60
10.6.1	General.....	60
10.6.2	ePDG procedures	60
10.6.3	PDN GW procedures	60

10.7	PDN GW Initiated Resource Allocation Deactivation procedures.....	60
10.7.1	General.....	60
10.7.2	ePDG procedures	60
10.7.3	PDN GW procedures	60
10.8	PDN-GW Initiated IPv4 Address Delete Procedure.....	60
10.8.1	General.....	60
10.8.2	ePDG procedures	60
10.8.3	PDN GW procedures	60
11	S2a and S2b Chaining with PMIP-based S8 Description.....	61
11.1	Initial Attach procedures	61
11.1.1	General.....	61
11.1.2	ePDG / Trusted Non-3GPP Access procedures	61
11.1.3	Serving GW procedures.....	61
11.2	ePDG / Trusted Non-3GPP Access Initiated PDN Connection Lifetime Extension procedures.....	61
11.2.1	General.....	61
11.2.2	ePDG / Trusted Non-3GPP Access procedures	61
11.2.3	Serving GW procedures.....	61
11.3	UE / ePDG / Trusted Non-3GPP Access Initiated Detach procedures	61
11.3.1	General.....	61
11.3.2	ePDG / Trusted Non-3GPP Access procedures	61
11.3.3	Serving GW procedures.....	62
11.4	HSS / AAA Initiated Detach procedures	62
11.4.1	General.....	62
11.4.2	ePDG / Trusted Non-3GPP Access procedures	62
11.4.3	Serving GW procedures.....	62
11.5	UE Initiated Connectivity to Additional PDN procedures	62
11.5.1	General.....	62
11.5.2	ePDG / Trusted Non-3GPP Access procedures	62
11.5.3	Serving GW procedures.....	62
11.6	3GPP Access to Trusted / Untrusted Non-3GPP IP Access Handover procedures without optimization	63
11.6.1	General.....	63
11.6.2	ePDG / Trusted Non-3GPP Access procedures	63
11.6.3	Serving GW procedures.....	63
11.7	UE Requested PDN Disconnection procedures.....	63
11.7.1	General.....	63
11.7.2	ePDG / Trusted Non-3GPP Access procedures	63
11.7.3	Serving GW procedures.....	63
11.8	PDN GW Initiated Resource Allocation Deactivation procedures.....	63
11.8.1	General.....	63
11.8.2	ePDG / Trusted Non-3GPP Access procedures	63
11.8.3	Serving GW procedures.....	64
12	Information Elements.....	64
12.1	Additional Proxy Mobile IPv6 Information Elements.....	64
12.1.1	3GPP-Specific PMIPv6 Information Elements.....	64
12.1.1.0	General	64
12.1.1.1	3GPP Specific PMIPv6 error code.....	65
12.1.1.2	Fully Qualified PDN Connection Set Identifier (FQ-CSID)	65
12.1.1.3	PDN Type Indication	66
12.1.1.4	PDN GW IP address.....	66
12.1.1.5	DHCPv4 Address Allocation Procedure Indication	66
12.1.1.6	Charging ID.....	66
12.1.1.7	Selection Mode	67
12.1.1.8	Charging Characteristics	67
12.1.1.9	Serving Network.....	67
12.1.1.10	Mobile Equipment Identity	67
12.1.1.11	MSISDN	68
12.1.1.12	APN Restriction	68
12.1.1.13	Maximum APN Restriction.....	68
Annex A (informative):	Error Code mapping table	69

Annex B (informative): **Change History**70
History72

Foreword

This Technical Specification has been produced by the 3rd Generation Partnership Project (3GPP).

The contents of the present document are subject to continuing work within the TSG and may change following formal TSG approval. Should the TSG modify the contents of the present document, it will be re-released by the TSG with an identifying change of release date and an increase in version number as follows:

Version x.y.z

where:

- x the first digit:
 - 1 presented to TSG for information;
 - 2 presented to TSG for approval;
 - 3 or greater indicates TSG approved document under change control.
- y the second digit is incremented for all changes of substance, i.e. technical enhancements, corrections, updates, etc.
- z the third digit is incremented when editorial only changes have been incorporated in the document.

1 Scope

The present document specifies the stage 3 of the PMIPv6 Based Mobility and Tunneling Protocols used over the PMIP-based S2a, S2b, S5, and S8 reference points defined in 3GPP TS 23.402 [3], and are thus applicable to the Serving GW, PDN Gateway, ePDG, and Trusted Non-3GPP Access. Protocols specifications are compliant with relevant IETF RFCs. In this specification PMIP refers to PMIPv6 as defined in IETF RFC5213 [4].

2 References

The following documents contain provisions which, through reference in this text, constitute provisions of the present document.

- References are either specific (identified by date of publication, edition number, version number, etc.) or non-specific.
- For a specific reference, subsequent revisions do not apply.
- For a non-specific reference, the latest version applies. In the case of a reference to a 3GPP document (including a GSM document), a non-specific reference implicitly refers to the latest version of that document *in the same Release as the present document*.

- [1] 3GPP TR 21.905: "Vocabulary for 3GPP Specifications".
- [2] 3GPP TS 23.401: "GPRS enhancements for E-UTRAN access".
- [3] 3GPP TS 23.402: "Architecture Enhancements for non-3GPP accesses".
- [4] IETF RFC 5213: "Proxy Mobile IPv6".
- [5] IETF Draft, "IPv4 Support for Proxy Mobile IPv6", draft-ietf-netlmm-pmip6-ipv4-support-17, work in progress.
- [6] IETF Draft, "Binding Revocation for IPv6 Mobility", draft-ietf-mext-binding-revocation-14, work in progress.
- [7] IETF Draft, "GRE Key Option for Proxy Mobile IPv6", draft-ietf-netlmm-grekey-option-09, work in progress.
- [8] IETF RFC 3775, "Mobility Support in IPv6".
- [9] IETF RFC 4282: "The Network Access Identifier".
- [10] IETF RFC 4283: "Mobile Node Identifier Option for Mobile IPv6 (MIPv6)".
- [11] IETF RFC 5149: "Service Selection for Mobile Ipv6".
- [12] 3GPP TS 23.003: "Numbering, addressing and identification".
- [13] 3GPP TS 23.007: "Restoration Procedures".
- [14] Void
- [15] Void
- [16] 3GPP TS 24.008: "Mobile radio interface Layer 3 specification; Core network protocols".
- [17] IETF Draft, draft-ietf-netlmm-pmip6-heartbeat-07, "Heartbeat Mechanism for Proxy Mobile IPv6", work in progress.
- [18] IANA Mobile Ipv6 Parameters Registry, <<http://www.iana.org/assignments/mobility-parameters>>.

- [19] 3GPP TS 33.402: "3GPP System Architecture Evolution (SAE); Security aspects of non-3GPP accesses".
- [20] IETF RFC 2784: "Generic Routing Encapsulation (GRE)".
- [21] IETF RFC 2890: "Key and Sequence Number Extensions to GRE".
- [22] 3GPP TS 29.274: "3GPP Evolved Packet System (EPS); Evolved General Packet Radio Service (GPRS) Tunnelling Protocol for Control plane (GTPv2-C); Stage 3".
- [23] 3GPP TS 23.060: "General Packet Radio Service (GPRS); Service description; Stage 2".
- [24] 3GPP TS 29.282: "Mobile IPv6 vendor specific option format and usage within 3GPP".
- [25] 3GPP TS 32.251: "Charging Management; Packet Switched (PS) domain charging".
- [26] 3GPP TS 32.298: "Charging Management; Charging Data Record (CDR) parameter description".
- [27] IETF RFC 4291: "IP Version 6 Addressing Architecture".
- [28] 3GPP TS 29.060: "General Packet Radio Service (GPRS); GPRS Tunnelling Protocol (GTP) across the Gn and Gp interface".
- [29] ITU-T Recommendation E.164: "The international public telecommunication numbering plan".
- [30] 3GPP TS 29.212: "Policy and Charging Control over Gx reference point".
- [31] IETF RFC 2473: "Generic Packet Tunneling in IPv6 Specification".

3 Definitions and abbreviations

3.1 Definitions

For the purposes of the present document, the terms and definitions given in 3GPP TR 21.905 [1] and the following apply. A term defined in the present document takes precedence over the definition of the same term, if any, in 3GPP TR 21.905 [1].

The following terms used in this Technical Specification are defined in the PMIPv6 specification IETF RFC 5213 [4]: IPv6 Home Network Prefix, Proxy Care-of Address, Local Mobility Anchor Address. The following terms used in this Technical Specification are defined in the IPv4 Support for PMIPv6 specification IETF Draft draft-ietf-netlmm-pmip6-ipv4-support [5]: IPv4 Home Address, IPv4 Local Mobility Anchor Address. The following terms used in this Technical Specification are defined in the MIPv6 specification [8] and extended by the PMIPv6 specification IETF RFC 5213 [4]: Binding Cache Entry, Binding Update List Entry. The following terms used in this specification are defined in the Binding Revocation for MIPv6 Mobility [6]: Binding Revocation Indication and Binding Revocation Acknowledgement.

Local Mobility Anchor: Within EPS the Local Mobility Anchor functionality consists of a PMIPv6 Local Mobility Anchor as described in the PMIPv6 specification IETF RFC 5213 [4] with support of IPv4 Support for PMIPv6 as defined in IETF Draft draft-ietf-netlmm-pmip6-ipv4-support [5], Binding Revocation for IPv6 Mobility as defined in IETF Draft draft-ietf-mext-binding-revocation [6], GRE Key Option for PMIPv6 as defined in IETF Draft draft-ietf-netlmm-grekey-option [7], and PMIPv6 Heartbeat Mechanism as defined in IETF Draft draft-netlmm-pmip6-heartbeat [17].

Mobile Access Gateway: Within EPS the Mobility Access Gateway functionality consists of a PMIPv6 Mobility Access Gateway as described in the PMIPv6 specification IETF RFC 5213 [4] with support of IPv4 Support for PMIPv6 as defined in IETF Draft draft-ietf-netlmm-pmip6-ipv4-support [5], Binding Revocation for IPv6 Mobility as defined in IETF Darft draft-ietf-mext-binding-revocation [6], GRE Key Option for PMIPv6 as defined in IETF Draft draft-ietf-netlmm-grekey-option [7], and PMIPv6 Heartbeat Mechanism as defined in IETF Draft draft-netlmm-pmip6-heartbeat [17].

PDN Connection: The association between a UE represented by one IPv4 Home Address and/or one IPv6 Home Network Prefix, and a PDN represented by an APN. On a PMIPv6 peer (MAG or LMA) there is a one-to-one mapping between a PDN connection and a PMIPv6 binding.

3.2 Abbreviations

For the purposes of the present document, the abbreviations given in 3GPP TR 21.905 [1] and the following apply. An abbreviation defined in the present document takes precedence over the definition of the same abbreviation, if any, in 3GPP TR 21.905 [1].

BCE	Binding Cache Entry
BRA	Binding Revocation Acknowledgement
BRI	Binding Revocation Indication
BULE	Binding Update List Entry
EPC	Evolved Packet Core
GRE	Generic Routing Encapsulation
GW	Gateway
IPv4-LMAA	IPv4 LMAA
LMA	Local Mobility Anchor
LMAA	LMA Address
MAG	Mobility Access Gateway
MIPv6	Mobile IPv6
PBA	Proxy Binding Acknowledgment
PBU	Proxy Binding Update
PMIPv6	Proxy MIPv6
Proxy-CoA	Proxy Care-of Address

4 General

4.1 PDN connection

On a PMIPv6 peer (MAG or LMA) there is a one-to-one mapping between a PDN connection and a PMIPv6 binding.

Traffic sent over a given PDN connection is encapsulated with GRE [20] using different, per-interface per-PDN connection, per direction (uplink and downlink) GRE keys [21] to allow multiplexing and demultiplexing of traffic belonging to different PDN connections at MAG and LMA. For the handover between 3GPP access and non-3GPP access, the uplink GRE Key shall be the same.

4.2 PMIPv6 protocol stacks

Protocol stacks for PMIPv6 are depicted in Figure 4.2-1. The MAG functions are defined in 3GPP TS 23.402 [3], e. g., relaying DHCPv4/DHCPv6 packets between the UE and the DHCP server, forwarding the payload packets between the UE and the LMA.

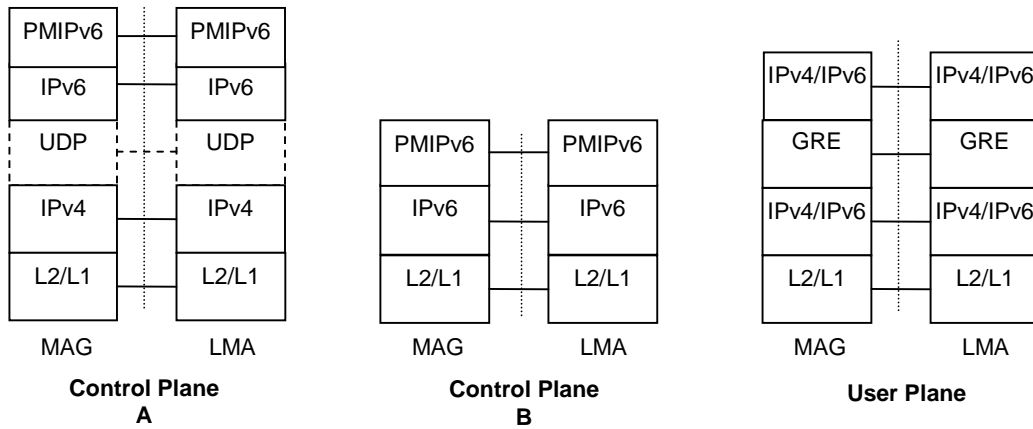

Figure 4.2-1: Protocols stacks for PMIP

The Control Plane A is for PMIPv6 signals transported over IPv4, and the Control Plane B is for PMIPv6 signals transported over IPv6. When IPv4 transport is used, UDP encapsulation may be used as described in draft-ietf-netlmm-pmip6-ipv4-support [5].

5 Mobility Management procedures

5.1 Proxy Mobile IPv6 PDN Connection Creation procedure

5.1.1 General

The PMIPv6 PDN Connection Creation procedure is initiated by the node acting as a MAG to create a new PDN connection with the node acting as an LMA for an UE that either attaches for the first time to the EPC, or connects to an additional PDN. The procedure starts with the MAG sending a PBU including the APN to the LMA to register with the LMA a binding for the UE's PDN connection. The LMA confirms establishment of the binding by sending a PBA to the MAG. Establishment of the binding achieves the following:

- **PDN selection:** The LMA select the PDN based on the APN contained in the PBU.
- **IPv6 Home Network Prefix assignment:** The LMA assigns to the UE's PDN connection an IPv6 Home Network Prefix valid in the selected PDN.
- **IPv4 Home Address assignment:** The LMA assigns to the UE's PDN connection an IPv4 Home Address valid in the selected PDN.
- **Downlink and Uplink GRE Key Assignment:** The MAG and LMA will establish downlink and uplink GRE keys to be used for GRE encapsulation of the PDN connection's downlink and uplink traffic, respectively.
- **GRE Tunnel Establishment:** A GRE tunnel is established between the MAG and LMA with the assigned GRE keys to carry uplink and downlink traffic that the UE respectively sends and receives on the PDN connection.
- **BCE Creation:** The LMA creates a BCE for the PDN connection.
- **BULE Creation:** The MAG creates a BULE for the PDN connection.
- **MAG Link Local Address assignment:** The LMA assigns the MAG link local address.
- **UE Interface Identifier (IID) assignment:** The LMA assigns to the UE an IPv6 Interface Identifier to allow formation of an UE Link Local Address from the well-known link local address prefix (fe80::/64).

5.1.1.1 Proxy Binding Update

The fields of a PBU message for the PMIPv6 PDN Connection Creation procedure are depicted in Table 5.1.1.1-1.

The Mobility Options in a PBU message for the PMIPv6 PDN Connection Creation procedure are depicted in Table 5.1.1.1-2.

Other flags are not used by this specification.

Table 5.1.1.1-1: Fields of a PBU message for the PMIPv6 PDN Connection Creation procedure

Information element	IE Description	Reference
Sequence Number	Set to a locally (i.e. per MAG) monotonically increasing value.	IETF RFC 5213 [4]
Lifetime	Set to the requested number of time units the binding shall remain valid.	IETF RFC 3775 [8]
Acknowledge (A)	Set to "1" to request an acknowledgement message.	IETF RFC 3775 [8]
Proxy Registration Flag (P)	Set to "1" to indicate that the Binding Update message is a proxy registration.	IETF RFC 5213 [4]

Table 5.1.1.1-2: Mobility Options in a PBU message for the PMIPv6 PDN Connection Creation procedure

Information element	Cat.	IE Description	Reference
Mobile Node Identifier option	M	Set to the NAI identifier of the UE as specified in 3GPP TS 23.003 [12]. The format of the NAI is specified in the subclause 19.3 in 3GPP TS 23.003 [12].	3GPP TS 23.003 [12]
IPv6 Home Network Prefix option	C	For dynamic allocation, set to the value "0::/0" to request allocation for the UE's PDN connection of an IPv6 Home Network Prefix in the PDN corresponding the EPS Access Point Name. For static allocation, set to the received static allocated IPv6 Home Network Prefix. NOTE 1.	IETF RFC 5213 [4]
Link-local Address	C	Present when IPv6 Home Network Prefix option is present. Link-local address of the MAG. Set to ALL_ZERO (all bits set to 0), indicating that the MAG requests a link-local address to be used on the access link shared with the UE.	IETF RFC 5213 [4]
Handoff Indicator option	M	Set to the value "1" to indicate attachment over a new interface.	IETF RFC 5213 [4]
Access Technology Type option	M	Set to the 3GPP access type, i.e. GERAN, UTRAN or E-UTRAN, or to the value matching the characteristics of the non-3GPP access (e.g., HRPD) the UE is using to attach to the EPS as defined in the Access Technology Type Option type values registry of the IANA Mobile IPv6 Parameters Registry [18]. The ePDG may use the access technology type of the untrusted non-3GPP access network if it is able to acquire it; otherwise it shall indicate Virtual as the access technology. NOTE 2. NOTE 3.	IETF RFC 5213 [4]
Timestamp option	M	Set to the current time	IETF RFC 5213 [4]
GRE key option	M	Set to the downlink GRE key to be used for downlink GRE encapsulated packets sent over the PDN connection.	draft-ietf-netImm-grekey-option [7]
IPv4 Home Address Request option	C	For dynamic allocation, set to the value "0.0.0.0" to request allocation for the UE's PDN connection of an IPv4 Home Address in the PDN corresponding to the EPS Access Point Name. For static allocation, set to the received static allocated IPv4 Home Address. NOTE 1.	draft-ietf-netImm-pmip6-ipv4-support [5]
Service Selection Mobility Option	M	Set to the EPS Access Point Name to which the UE attaches the new PDN connection. The encoding the APN field follows 3GPP TS 23.003 [12] subclause 9.1 but excluding the trailing zero byte. The content of the APN field shall be the full APN with both the APN Network Identifier and default APN Operator Identifier being present as specified in 3GPP TS 23.003 [12] subclauses 9.1.1 and 9.1.2. NOTE 4.	IETF RFC 5149[11]
Protocol Configuration Options	O	Contain Protocol Configuration Options.	Subclause 12.1.1.0
PDN GW IP Address	O	Contain PDN GW IP address (on S2a or S2b when used for chained S2a/S2b-PMIP based S8).	Subclause 12.1.1.4
Fully Qualified PDN Connection Set Identifier	O	Contain a Fully Qualified PDN Connection Set Identifier if generated by the MAG on the S5/S8 interfaces as specified in 3GPP TS 23.007 [13].	Subclause 12.1.1.2
Fully Qualified PDN Connection Set Identifier	O	Contain a Fully Qualified PDN Connection Set Identifier if generated by the MME, and included by the MAG on the S5/S8 interfaces as specified in 3GPP TS 23.007 [13].	Subclause 12.1.1.2
Selection Mode	O	Contains APN selection mode (on S5/S8).	Subclause 12.1.1.7
Charging Characteristics	O	Contains the Charging Characteristics to be applied for EPC charging	Subclause 12.1.1.8
Serving Network	C	This IE shall be included on S5 and S8 interfaces to identify the Serving Network	Subclause 12.1.1.9
Mobile Equipment	O	Contains the MEI of the UE (on S5/S8)	Subclause 12.1.1.10

Identity			
MSISDN	O	Contains the MSISDN of the user (on S5/S8)	Subclause 12.1.1.11
Maximum APN Restriction	O	Contains the most stringent restriction of already active PDN connections (on S5/S8).	Subclause 12.1.1.13
NOTE 1: At least one of the two options, namely, the IPv6 Home Network Prefix option or the IPv4 Home Address Request option shall be present. If both an IPv6 Home Network Prefix and an IPv4 Home Address are requested, both options shall be included in the same PBU message.			
NOTE 2: The methods that the ePDG may use to acquire the access technology type of the untrusted non-3GPP IP access network are not specified in this release.			
NOTE 3: The PDN-GW can be informed about the type of access network used by the UE over several reference points, see 3GPP TS 29.212 [30] for the mapping between the code values for the different access network types.			
NOTE 4: The APN field is not encoded as a dotted string as commonly used in documentation.			

5.1.1.2 Proxy Binding Acknowledgement

The fields of a PBA message for the PMIPv6 PDN Connection Creation procedure are depicted in Table 5.1.1.2-1.

The Mobility Options in a PBA message for the PMIPv6 PDN Connection Creation procedure are depicted in Table 5.1.1.2-2.

Other flags are not used by this specification.

Table 5.1.1.2-1: Fields of a PBA message for the PMIPv6 PDN Connection Creation procedure

Information element	IE Description	Reference
Status	Set to indicate the result.	IETF RFC 3775 [8]
Sequence Number	Set to the value received in the corresponding PBU.	IETF RFC 5213 [4]
Lifetime	Set to the granted number of time units the binding shall remain valid.	IETF RFC 3775 [8]
Proxy Registration Flag (P)	Set to "1" to indicate that the Binding Update message is a proxy registration.	IETF RFC 5213 [4]

Table 5.1.1.2-2: Mobility Options in a PBA message for the PMIPv6 PDN Connection Creation procedure

Information element	Cat.	IE Description	Reference
Mobile Node Identifier option	M	Copied from corresponding field of PBU.	IETF RFC 5213 [4]
IPv6 Home Network Prefix option	C	Present if IPv6 Home Network Prefix is allocated. When it's present, set to the IPv6 Home Network Prefix Allocated for the UE's PDN connection based on the selected PDN corresponding to the EPS Access Point Name for dynamic allocation, or set to the static IPv6 Home Network Prefix received in the PBU for static allocation. In addition, the Interface Identifier (IID) allocated for the UE is encoded in the low order 64 bits of this option, i.e., the IPv6 Home Network Prefix option.	IETF RFC 5213 [4]
Link-local Address	C	Present when IPv6 Home Network Prefix option is present. Link-local address to be used by the MAG on the access link shared with the UE.	IETF RFC 5213 [4]
Handoff Indicator option	M	Copied from corresponding field of PBU.	IETF RFC 5213 [4]
Access Technology Type option	M	Copied from corresponding field of PBU.	IETF RFC 5213 [4]
Timestamp option	M	Copied from corresponding field of PBU, or set to the current time of LMA in case of timestamp error.	IETF RFC 5213 [4]
GRE key option	M	Set to the uplink GRE key to be used for uplink GRE encapsulated packets sent over the PDN connection.	draft-ietf-netlmm-grekey-option [7]
IPv4 Home Address Reply Option	C	Present if IPv4 address is allocated. When it's present, set to the IPv4 Home Address allocated for the UE's PDN connection based on the selected PDN corresponding to the EPS Access Point Name for dynamic allocation, or set to the static IPv4 Home Address received in the PBU for static allocation. NOTE 1	draft-ietf-netlmm-pmip6-ipv4-support [5]
IPv4 Default Router Address Option	C	Set to the UE's IPv4 default router address. This option shall be present if and only if IPv4 Home Address Reply Option is present.	draft-ietf-netlmm-pmip6-ipv4-support [5]
Service Selection Mobility Option	M	Copied from the corresponding field in the PBU message, formatted as defined in 3GPP TS 23.003 [12]	IETF RFC 5149[11]
PDN Type Indication	C	This option shall be present if and only if PDN type is changed in the PDN GW compared to what was requested in the PBU.	Subclause 12.1.1.3
DHCPv4 Address Allocation Procedure Indication	C	This option shall be present if and only if DHCPv4 is to be used to allocate the IPv4 address to the UE.	Subclause 12.1.1.5
Protocol Configuration Options	O	Contain Protocol Configuration Options.	Subclause 12.1.1.0
3GPP Specific PMIPv6 Error Code	O	Contain 3GPP Specific PMIPv6 Error Code	Subclause 12.1.1.1
Fully Qualified PDN Connection Set Identifier	O	Contain a Fully Qualified PDN Connection Set Identifier if generated by the LMA on the S5/S8 interfaces as specified in 3GPP TS 23.007 [13].	Subclause 12.1.1.2
Charging ID	M	Contain the Charging ID information	Subclause 12.1.1.6
APN Restriction	O	Contains the restriction of this PDN connection (on S5/S8).	Subclause 12.1.1.12
NOTE 1: If the PDN type is IPv4v6 and DHCPv4 is to be used to allocate the IPv4 address to the UE, the IPv4 Home Address Reply Option shall not be included.			

5.1.2 MAG procedures

A MAG initiating the PMIPv6 PDN Connection Creation procedure shall follow the "Mobile Node Attachment and Initial Binding Registration" procedure described in the PMIPv6 [4] and IPv4 support for PMIPv6 [5] specifications with the following additional requirements:

1. Generate a downlink GRE key that is not already in use locally for the PDN connection's downlink traffic to that UE, as specified in the GRE Key Option for PMIPv6 specification [7].
2. For IP address allocation, the IPv6 Home Network Prefix option and/or the IPv4 Home Address Request option shall be present according to the UE request and the user subscription for non-3GPP access, or according to the PDN Type received from the MME/SGSN for 3GPP access.
3. If the static IPv4 Home Address and/or IPv6 Home Network Prefix are available at the MAG, set them in the IPv4 home address Request option and/or the IPv6 home prefix option in the PBU.
4. Optionally, assign a Fully Qualified PDN Connection Set Identifier that identifies a set of PDN connections belonging to an arbitrary number of UEs.

Set other parameters in the PBU as specified by the PBU parameters section for this procedure.

5.1.3 LMA procedures

On reception of a PBU, the LMA shall initiate the "Initial Binding Registration (New Mobility session)" and "Processing Binding Registrations" procedures described in the PMIPv6 [4] and IPv4 support for PMIPv6 [5] specifications with the following additional requirements:

1. Select the PDN for the UE's PDN connection based on the APN present in the PBU.
2. Check if the received IPv6 Home prefix and/or IPv4 Home address are topologically correct.
3. If no static IPv6 Home Network Prefix and/or IPv4 Home Address were received in the PBU, allocate the IPv6 Home Network Prefix and/or an IPv4 Home Address for the selected PDN.
4. If a PCO with value IPv4 Address Allocation via DHCPv4 is present in the PBU,
 - if the LMA allocates an IPv4 address, it shall include the IPv4 Home Address Reply Option in the PBA message
 - if the LMA allocates an IPv6 address, the LMA shall not allocate an IPv4 address and shall not include the IPv4 Home Address Reply Option in the PBA message
5. Generate a uplink GRE key that is not already in use locally for the PDN connection's uplink traffic from that UE, as specified in the GRE Key Option for PMIPv6 specification [7].
6. Assign to the UE an IPv6 Interface Identifier to allow formation of an UE Link Local Address from the well-known link local address prefix (fe80::/64).
7. Optionally, assign a Fully Qualified PDN Connection Set Identifier that identifies a set of PDN connections belonging to an arbitrary number of UEs.
8. Set parameters in the PBA as specified by the PBA parameters section for this procedure.

5.2 Proxy Mobile IPv6 PDN Connection Lifetime Extension procedure

5.2.1 General

The PMIPv6 PDN Connection Lifetime Extension procedure is initiated by the node acting as a MAG to prolong the lifetime of an existing PDN connection with the node acting as an LMA for an UE that is already attached. This procedure may also be used when the MME is relocated and the MAG remains unchanged (see 3GPP TS 23.007 [13]). The procedure starts with the MAG sending a PBU to the LMA to extend the binding lifetime for the UE's PDN connection. The LMA confirms that the binding lifetime is extended by sending a PBA to the MAG.

5.2.1.1 Proxy Binding Update

The fields of a PBU message for the PMIPv6 PDN Connection Lifetime Extension procedure are depicted in Table 5.2.1.1-1.

The Mobility Options in a PBU message for the PMIPv6 PDN Connection Lifetime Extension procedure are depicted in Table 5.2.1.1-2.

Other flags are not used by this specification.

Table 5.2.1.1-1: Fields of a PBU message for the PMIPv6 PDN Connection Lifetime Extension procedure

Information element	IE Description	Reference
Sequence Number	Set to a locally (i.e. per MAG) monotonically increasing value.	IETF RFC 5213 [4]
Lifetime	Set to the requested number of time units the binding shall remain valid.	IETF RFC 3775 [8]
Acknowledge (A)	Set to "1" to request an acknowledgement message.	IETF RFC 3775 [8]
Proxy Registration Flag (P)	Set to "1" to indicate that the Binding Update message is a proxy registration.	IETF RFC 5213 [4]

Table 5.2.1.1-2: Mobility Options in a PBU message for the PMIPv6 PDN Connection Lifetime Extension procedure

Information element	Cat.	IE Description	Reference
Mobile Node Identifier option	M	Set to the NAI identifier of the UE as specified in 3GPP TS 23.003 [12]. The format of the NAI is specified in the subclause 19.3 in 3GPP TS 23.003 [12].	3GPP TS 23.003 [12]
IPv6 Home Network Prefix option	C	Set to the IPv6 Home Network Prefix allocated to the UE's PDN connection based on the selected PDN. NOTE 1.	IETF RFC 5213 [4]
Link-local Address	C	Present when IPv6 Home Network Prefix option is present. Set to the link-local address already allocated to the MAG (in the previous initial binding registration) for use on the access link shared with the UE.	IETF RFC 5213 [4]
Handoff Indicator option	M	Set to the value "5" to indicate handoff state not changed (Re-registration).	IETF RFC 5213 [4]
Access Technology Type option	M	Set to the 3GPP access type, i.e. GERAN, UTRAN or E-UTRAN, or to the value matching the characteristics of the non-3GPP access (e.g., HRPD) the UE is using to attach to the EPS as defined in the Access Technology Type Option type values registry of the IANA Mobile IPv6 Parameters Registry [18]. The ePDG may use the access technology type of the untrusted non-3GPP access network if it is able to acquire it; otherwise it shall indicate Virtual as the access technology. NOTE 2 NOTE 3	IETF RFC 5213 [4]
Timestamp option	M	Set to the current time	IETF RFC 5213 [4]
GRE Key option	M	Set to the previously exchanged downlink GRE key to be used for downlink GRE encapsulated packets sent over the PDN connection.	draft-ietf-netimm-grekey-option [7]
IPv4 Home Address Request option	C	Set to the IPv4 Home Address allocated for the UE's PDN connection based on the selected PDN. NOTE 1.	draft-ietf-netimm-pmip6-ipv4-support [5]
Service Selection Mobility Option	M	Set to the EPS Access Point Name to which the UE's PDN connection is attached. The encoding the APN field follows 3GPP TS 23.003 [12] subclause 9.1 but excluding the trailing zero byte. The content of the APN field shall be the full APN with both the APN Network Identifier and default APN Operator Identifier being present as specified in 3GPP TS 23.003 [12] subclauses 9.1.1 and 9.1.2. NOTE 4.	IETF RFC 5149[11]
MME Fully Qualified PDN Connection Set Identifier	O	Contain a Fully Qualified PDN Connection Set Identifier if generated by the MME, and included by the MAG on the S5/S8 interfaces as specified in 3GPP TS 23.007 [13].	Subclause 12.1.1.2
MAG Fully Qualified PDN Connection Set Identifier	O	Contain a Fully Qualified PDN Connection Set Identifier if generated by the MAG on the S5/S8 interfaces as specified in 3GPP TS 23.007 [13].	Subclause 12.1.1.2
NOTE 1: At least one of the two options, namely, the IPv6 Home Network Prefix option or the IPv4 Home Address Request option shall be present. If the UE has both IPv4 home address and IPv6 home network prefix registered, both the IPv6 Home Network Prefix option and IPv4 Home Address Request option shall be included in the same PBU message.			
NOTE 2: The methods that the ePDG may use to acquire the access technology type of the untrusted non-3GPP IP access network are not specified in this release.			
NOTE 3: The PDN-GW can be informed about the type of access network used by the UE over several reference points, see 3GPP TS 29.212 [30] for the mapping between the code values for the different access network types.			
NOTE 4: The APN field is not encoded as a dotted string as commonly used in documentation.			

5.2.1.2 Proxy Binding Acknowledgement

The fields of a PBA message for the PMIPv6 PDN Connection Lifetime Extension procedure are depicted in Table 5.2.1.2-1.

The Mobility Options in a PBA message for the PMIPv6 PDN Connection Lifetime Extension procedure are depicted in Table 5.2.1.2-2.

Other flags are not used by this specification.

Table 5.2.1.2-1: Fields of a PBA message for the PMIPv6 PDN Connection Lifetime Extension procedure

Information element	IE Description	Reference
Status	Set to indicate the result.	IETF RFC 3775 [8]
Sequence Number	Set to the value received in the corresponding PBU.	IETF RFC 5213 [4]
Lifetime	Set to the granted number of time units the binding shall remain valid.	IETF RFC 3775 [8]
Proxy Registration Flag (P)	Set to "1" to indicate that the Binding Update message is a proxy registration.	IETF RFC 5213 [4]

Table 5.2.1.2-2: Mobility Options in a PBA message for the PMIPv6 PDN Connection Lifetime Extension procedure

Information element	Cat.	IE Description	Reference
Mobile Node Identifier option	M	Copied from corresponding field of PBU.	IETF RFC 5213 [4]
IPv6 Home Network Prefix option	C	If it is present in the corresponding PBU, set to the IPv6 Home Network Prefix allocated to the UE's PDN connection based on the selected PDN.	IETF RFC 5213 [4]
Link-local Address	C	Present when IPv6 Home Network Prefix option is present. Set to the link-local address already allocated to the MAG (in the previous initial binding registration) for use on the access link shared with the UE.	IETF RFC 5213 [4]
Handoff Indicator option	M	Copied from corresponding field of PBU.	IETF RFC 5213 [4]
Access Technology Type option	M	Copied from corresponding field of PBU.	IETF RFC 5213 [4]
Timestamp option	M	Copied from corresponding field of PBU, or set to the current time of LMA in case of timestamp error.	IETF RFC 5213 [4]
GRE key option	M	Set to the previously exchanged uplink GRE key to be used for uplink GRE encapsulated packets sent over the PDN connection.	draft-ietf-netlmm-grekey-option [7]
IPv4 Home Address Reply Option	C	If it is present in the corresponding PBU, set to the IPv4 Home Address allocated for the UE's PDN connection based on the selected PDN.	draft-ietf-netlmm-pmip6-ipv4-support [5]
IPv4 Default Router Address Option	C	Set to the UE's IPv4 default router address. This option shall be present if and only if IPv4 Home Address Reply Option is present and PBU is accepted.	draft-ietf-netlmm-pmip6-ipv4-support [5]
Service Selection Mobility Option	M	Copied from the corresponding field in the PBU message. The encoding the APN field follows 3GPP TS 23.003 [12] subclause 9.1 but excluding the trailing zero byte. The content of the APN field shall be the full APN with both the APN Network Identifier and default APN Operator Identifier being present as specified in 3GPP TS 23.003 [12] subclauses 9.1.1 and 9.1.2. NOTE 1.	IETF RFC 5149[11]
3GPP Specific PMIPv6 Error Code	O	Contain 3GPP Specific PMIPv6 Error Code	Subclause 12.1.1.1
LMA Fully Qualified PDN Connection Set Identifier	O	Contain a Fully Qualified PDN Connection Set Identifier if generated by the LMA on the S5/S8 interfaces as specified in 3GPP TS 23.007 [13].	Subclause 12.1.1.2

NOTE 1: The APN field is not encoded as a dotted string as commonly used in documentation.

5.2.2 MAG procedures

A MAG initiating the PMIPv6 PDN Connection Lifetime Extension procedure shall follow the "Extending Binding Lifetime" procedure described in the PMIPv6 [4] and IPv4 support for PMIPv6 [5] specifications, while parameters in the PBU are set as specified by the PBU parameters section for this procedure. When an MME FQ-CSID is received by the MAG during MME relocation, if the MAG supports the feature according to 3GPP TS 23.007 [13], it shall store the Node ID and CSID from the MME FQ-CSID for the PDN connection and forward the MME FQ-CSID to the LMA in the PBU.

5.2.3 LMA procedures

On reception of a PBU, the LMA shall initiate the "Binding Lifetime Extension without Handover" procedure as described in the PMIPv6 [4] and IPv4 support for PMIPv6 [5] specifications, while parameters in the PBA are set as specified by the PBA parameters section for this procedure. When an MME FQ-CSID is received by the LMA, if the LMA supports the feature according to 3GPP TS 23.007 [13], it shall store the Node-ID and CSID from the MME FQ-CSID in place of those previously stored for the PDN connection.

5.3 Proxy Mobile IPv6 PDN Connection Handover procedure

5.3.1 General

The PMIPv6 PDN Connection Handover procedure is initiated by the node acting as a new MAG for the UE to update an existing PDN connection for an UE that is already attached to the EPC. The procedure starts with the MAG sending a PBU including the APN to the LMA to update the binding for the UE's PDN connection. The LMA confirms update of the binding by sending a PBA to the MAG. Update of the binding achieves the following:

- **IPv6 Home Network Prefix re-assignment:** The LMA re-assigns to the UE's PDN connection the IPv6 Home Network Prefix valid in the selected PDN.
- **IPv4 Home Address re-assignment:** The LMA re-assigns to the UE's PDN connection the IPv4 Home Address valid in the selected PDN.
- **Downlink and Uplink GRE Key Assignment:** The MAG and LMA will establish downlink and uplink GRE keys to be used for GRE encapsulation of downlink and uplink traffic, respectively on the PDN connection.
- **GRE Tunnel Establishment:** A GRE tunnel is established between the MAG and LMA with the assigned GRE keys to carry uplink and downlink traffic that UE respectively sends and receives on the PDN connection.
- **BCE Update:** The LMA updates or creates the BCE for the PDN connection.
- **BULE Creation:** The new MAG creates a BULE for the PDN connection.
- **IP address(es) preservation:** the IP addresses allocated in the previous initial attachment are reused if IP address(es) preservation decision is made.
- **MAG Link Local Address re-assignment:** The LMA re-assigns the same MAG link local address.
- **UE Interface Identifier (IID) re-assignment:** The LMA re-assigns to the UE the same IPv6 Interface Identifier to allow formation of the same UE Link Local Address from the well-known link local address prefix (fe80::/64).

5.3.1.1 Proxy Binding Update

The fields of a PBU message for the PMIPv6 PDN Connection Handover procedure are depicted in Table 5.3.1.1-1.

The Mobility Options in a PBU message for the PMIPv6 PDN Connection Handover procedure are depicted in Table 5.3.1.1-2.

Table 5.3.1.1-1: Fields of a PBU message for the PDN Connection Handover procedure

Information element	IE Description	Reference
Sequence Number	Set to a locally (i.e. per MAG) monotonically increasing value.	IETF RFC 5213 [4]
Lifetime	Set to the requested number of time units the binding shall remain valid.	IETF RFC 3775 [8]
Acknowledge (A)	Set to "1" to request an acknowledgement message.	IETF RFC 3775 [8]
Proxy Registration Flag (P)	Set to "1" to indicate that the Binding Update message is a proxy registration.	IETF RFC 5213 [4]

Table 5.3.1.1-2: Mobility Options in a PBU message for the PMIPv6 PDN Connection Handover procedure

Information element	Cat.	IE Description	Reference
Mobile Node Identifier option	M	Set to the NAI identifier of the UE as specified in 3GPP TS 23.003 [12]. The format of the NAI is specified in the subclause 19.3 in 3GPP TS 23.003 [12].	3GPP TS 23.003 [12]
IPv6 Home Network Prefix option	C	If available at the MAG, set to the IPv6 Home Network Prefix allocated to the UE's PDN connection. Otherwise, set to the value "0::0" to request allocation for the UE's PDN connection of an IPv6 Home Network Prefix for the UE in the PDN corresponding to the EPS Access Point Name. NOTE 1.	IETF RFC 5213 [4]
Link-local Address	C	Present when IPv6 Home Network Prefix option is present. Set to the link-local address already allocated to the MAG (in the previous initial binding registration) for use on the access link shared with the UE.	IETF RFC 5213 [4]
Handoff Indicator option	M	Set to the value "2" (Handoff between two different interfaces) in case the handover is an inter access handover (i.e. from 3GPP to non-3GPP, from non-3GPP to 3GPP, or between two non-3GPP accesses) and IP address(es) preservation decision is taken; or Set to the value "3" (Handoff between mobile access gateways for the same interface) in case the handover is an intra access (i.e. between two 3GPP accesses) handover; or Set to the value "4" (Handoff state unknown) in case the handover is an inter access handover (i.e. from 3GPP to non-3GPP, from non-3GPP to 3GPP, or between two non-3GPP accesses) and IP address(es) preservation decision is negative or unknown.	IETF RFC 5213 [4]
Access Technology Type option	M	Set to the 3GPP access type, i.e., to GERAN, UTRAN or E-UTRAN, or to the value matching the characteristics of the non-3GPP access (e.g., HRPD) the UE is using to attach to the EPS as defined in the Access Technology Type Option type values registry of the IANA Mobile IPv6 Parameters Registry [18]. The ePDG may use the access technology type of the untrusted non-3GPP access network if it is able to acquire it; otherwise it shall indicate Virtual as the access technology. NOTE 2 NOTE 3	IETF RFC 5213 [4]
Timestamp option	M	Set to the current time	IETF RFC 5213 [4]
GRE key option	M	Set to the downlink GRE key to be used for downlink GRE encapsulated packets sent over the PDN connection.	draft-ietf-netlmm-grekey-option [7]
IPv4 Home Address Request option	C	If available at the MAG, set to the IPv4 Address allocated to the UE's PDN connection. Otherwise, set to the value "0.0.0.0" to request allocation for the UE's PDN connection of an IPv4 Home Address in the PDN corresponding to the EPS Access Point Name. NOTE 1.	draft-ietf-netlmm-pmip6-ipv4-support [5]
Service Selection Mobility Option	M	Set to the EPS Access Point Name to which the UE's PDN connection is attached. The encoding the APN field follows 3GPP TS 23.003 [12] subclause 9.1 but excluding the trailing zero byte. The content of the APN field shall be the full APN with both the APN Network Identifier and default APN Operator Identifier being present as specified in 3GPP TS 23.003 [12] subclauses 9.1.1 and 9.1.2. NOTE 4.	IETF RFC 5149[11]
Protocol Configuration Options	O	Contain Protocol Configuration Options.	Subclause 12.1.1.0
PDN GW IP Address	O	Contain PDN GW IP address (on S2a or S2b when used for chained S2a/S2b-PMIP based S8)..	Subclause 12.1.1.4
Fully Qualified PDN Connection Set	O	Contain a Fully Qualified PDN Connection Set Identifier if generated by the MAG on the S5/S8 interfaces as	Subclause 12.1.1.2

Identifier		specified in 3GPP TS 23.007 [13].	
Fully Qualified PDN Connection Set Identifier	O	Contains a Fully Qualified PDN Connection Set Identifier if generated by the MME, and included by the MAG on the S5/S8 interfaces as specified in 3GPP TS 23.007 [13].	Subclause 12.1.1.2
Selection Mode	C	Contains APN selection mode (on S5/S8). Shall be present if the PDN connection is initiated by S4 SGSN or MME.	Subclause 12.1.1.7
Charging Characteristics	O	Contains the Charging Characteristics to be applied for EPC charging	Subclause 12.1.1.8
Serving Network	C	This IE shall be included on S5 and S8 interfaces to identify the Serving Network	Subclause 12.1.1.9
Mobile Equipment Identity	O	Contains the MEI of the UE (on S5/S8)	Subclause 12.1.1.10
MSISDN	O	Contains the MSISDN of the user (on S5/S8)	Subclause 12.1.1.11
Maximum APN Restriction	O	Contains the most stringent restriction of already active PDN connections (on S5/S8).	Subclause 12.1.1.13
NOTE 1: At least one of the two options, namely, the IPv6 Home Network Prefix option or the IPv4 Home Address Request option shall be present. If the MAG knows the UE has both IPv4 home address and IPv6 home network prefix registered, both the IPv6 Home Network Prefix option and IPv4 Home Address Request option shall be included in the same PBU message.			
NOTE 2: The methods that the ePDG may use to acquire the access technology type of the untrusted non-3GPP IP access network are not specified in this release.			
NOTE 3: The PDN-GW can be informed about the type of access network used by the UE over several reference points, see 3GPP TS 29.212 [30] for the mapping between the code values for the different access network types.			
NOTE 4: The APN field is not encoded as a dotted string as commonly used in documentation.			

5.3.1.2 Proxy Binding Acknowledgement

The fields of a PBA message for the PMIPv6 PDN Connection Handover procedure are depicted in Table 5.3.1.2-1.

The Mobility Options in a PBA message for the PMIPv6 PDN Connection Handover procedure are depicted in Table 5.3.1.2-2.

Other flags are not used by this specification.

Table 5.3.1.2-1: Fields of a PBA message for the PMIPv6 PDN Connection Handover procedure

Information element	IE Description	Reference
Status	Set to indicate the result.	IETF RFC 3775 [8]
Sequence Number	Set to the value received in the corresponding PBU.	IETF RFC 5213 [4]
Lifetime	Set to the granted number of time units the binding shall remain valid.	IETF RFC 3775 [8]
Proxy Registration Flag (P)	Set to "1" to indicate that the Binding Update message is a proxy registration.	IETF RFC 5213 [4]

Table 5.3.1.2-2: Mobility Options in a PBA message for the PMIPv6 PDN Connection Handover procedure

Information element	Cat.	IE Description	Reference
Mobile Node Identifier option	M	Copied from corresponding field of PBU.	IETF RFC 5213 [4]
IPv6 Home Network Prefix option	C	Present if IPv6 Home Network Prefix is allocated. When it's present, set to the IPv6 Home Network Prefix Allocated for the UE's PDN connection based on the selected PDN corresponding to the EPS Access Point Name for dynamic allocation, or set to the static IPv6 Home Network Prefix received in the PBU for static allocation. In addition, the Interface Identifier (IID) allocated for the UE is encoded in the low order 64 bits of this option, i.e., the IPv6 Home Network Prefix option.	IETF RFC 5213 [4]
Link-local Address	C	Present when IPv6 Home Network Prefix option is present. Set to the link-local address already allocated to the MAG (in the previous initial binding registration) for use on the access link shared with the UE.	IETF RFC 5213 [4]
Handoff Indicator option	M	Copied from corresponding field of PBU.	IETF RFC 5213 [4]
Access Technology Type option	M	Copied from corresponding field of PBU.	IETF RFC 5213 [4]
Timestamp option	M	Copied from corresponding field of PBU, or set to the current time of LMA in case of timestamp error.	IETF RFC 5213 [4]
GRE key option	M	Set to the uplink GRE key to be used for uplink GRE encapsulated packets sent over the PDN connection. The same uplink GRE key used for the UE's PDN connection with the previous MAG shall be re-assigned.	draft-ietf-netlmm-grekey-option [7]
IPv4 Home Address Reply Option	C	Present if IPv4 address is allocated. When it's present, set to the IPv4 Home Address allocated for the UE's PDN connection based on the selected PDN corresponding to the EPS Access Point Name for dynamic allocation, or set to the static IPv4 Home Address received in the PBU for static allocation.	draft-ietf-netlmm-pmip6-ipv4-support [5]
IPv4 Default Router Address Option	C	Set to the UE's IPv4 default router address. This option shall be present if and only if IPv4 Home Address Reply Option is present.	draft-ietf-netlmm-pmip6-ipv4-support [5]
Service Selection Mobility Option	M	Copied from the corresponding field in the PBU message. The encoding the APN field follows 3GPP TS 23.003 [12] subclause 9.1 but excluding the trailing zero byte. The content of the APN field shall be the full APN with both the APN Network Identifier and default APN Operator Identifier being present as specified in 3GPP TS 23.003 [12] subclauses 9.1.1 and 9.1.2. NOTE 1.	IETF RFC 5149[11]
PDN Type Indication	C	This option shall be present if and only if PDN type is changed in the PDN GW compared to what was requested in the PBU.	Subclause 12.1.1.3
PMIPv6 DHCPv4 Address Allocation Procedure Indication	C	This option shall be present if and only if DHCPv4 is to be used to allocate the IPv4 address to the UE.	Subclause 12.1.1.5
Protocol Configuration Options	O	Contain Protocol Configuration Options.	Subclause 12.1.1.0
3GPP Specific PMIPv6 Error Code	O	Contain 3GPP Specific PMIPv6 Error Code	Subclause 12.1.1.1
Fully Qualified PDN Connection Set Identifier List	O	Contain a Fully Qualified PDN Connection Set Identifiers if generated by the LMA on the S5/S8 interfaces as specified in 3GPP TS 23.007 [13].	Subclause 12.1.1.2
Charging ID	M	Contain the Charging ID information	Subclause 12.1.1.6
APN Restriction	O	Contains the restriction of this PDN connection (on S5/S8).	Subclause 12.1.1.12

NOTE 1: The APN field is not encoded as a dotted string as commonly used in documentation.

5.3.2 MAG procedures

A MAG initiating the PMIPv6 PDN Connection Handover procedure shall follow the "Mobile Node Attachment and Initial Binding Registration" procedure described in the PMIPv6 [4] and IPv4 support for PMIPv6 [5] specifications with the following additional requirements:

1. Generate a downlink GRE key that is not already in use locally for the PDN connection's downlink traffic to that UE, as specified in the GRE Key Option for PMIPv6 specification [7].
2. Set other parameters in the PBU as specified by the PBU parameters section for this procedure.
3. Optionally, assign a Fully Qualified PDN Connection Set Identifier that identifies a set of PDN connections belonging to an arbitrary number of UEs.

5.3.3 LMA procedures

On reception of a PBU, the LMA shall initiate the "Binding Lifetime Extension (After handoff)" and "Processing Proxy Binding Updates" procedures described in the PMIPv6 [4] and IPv4 support for PMIPv6 [5] specifications with the following additional requirements:

1. Re-assign the same uplink GRE key that was used by the previous MAG for the PDN connection's uplink traffic from the UE, as specified in the GRE Key Option for PMIPv6 specification [7].
2. Check if the received IPv6 Home prefix and/or IPv4 Home address are topologically correct.
3. Dynamic IP address allocation:
 - a) If Handoff Indicator option is "2" or "3": Re-allocate the IPv6 Home Network Prefix and/or the IPv4 Home Address for the selected PDN which were/was allocated during the previous attachment.
 - b) If Handoff Indicator option is "4": Make the IP address preservation decision as per the PMIPv6 specification [4].
4. Optionally, assign or reuse a Fully Qualified PDN Connection Set Identifier that identifies a set of PDN connections belonging to an arbitrary number of UEs.
5. Set parameters in the PBA as specified by the PBA parameters section for this procedure.

If no existing BCE is found, the LMA shall follow the Proxy Mobile IPv6 PDN Connection Creation procedure as specified in section 5.1.3.

5.4 Proxy Mobile IPv6 MAG Initiated PDN Connection Deletion procedure

5.4.1 General

The PMIPv6 MAG Initiated PDN Connection Deletion procedure is initiated by the node acting as a MAG to tear down an existing PDN connection with the node acting as an LMA. The procedure starts with the MAG sending a PBU to the LMA to deregister with the LMA a binding for the UE's PDN connection. The LMA confirms deregistration of the binding by sending a PBA to the MAG. Deregistration of the binding achieves the following:

- **IPv6 Home Network Prefix deallocation:** When the PDN connection is released, the LMA returns the IPv6 Home Network Prefix assigned to the UE's PDN connection to the pool of free IPv6 Home Network Prefixes.
- **IPv4 Home Address deallocation:** When the PDN connection is released, the LMA returns the IPv4 Home Address assigned to the UE's PDN connection to the pool of free IPv4 Home Network Addresses.
- **Downlink and Uplink GRE Key de-assignment:** The MAG and LMA will return, respectively, the PDN connection's uplink and downlink GRE keys to their respective pool of free GRE keys.

- **GRE Tunnel Tear-down:** The GRE tunnel between the MAG and LMA is deleted.
- **BCE Deletion:** The LMA deletes the BCE for the PDN connection.
- **BULE Deletion:** The MAG deletes the BULE for the PDN connection.

5.4.1.1 Proxy Binding Update

The fields of a PBU message for the PMIPv6 MAG Initiated PDN Connection Deletion procedure are depicted in Table 5.4.1.1-1.

The Mobility Options in a PBU message for the PMIPv6 MAG Initiated PDN Connection Deletion procedure are depicted in Table 5.4.1.1-2.

Other flags are not used by this specification.

Table 5.4.1.1-1: Fields of a PBU message for the PMIPv6 MAG Initiated PDN Connection Deletion procedure

Information element	IE Description	Reference
Sequence Number	Set to a locally (i.e. per MAG) monotonically increasing value.	IETF RFC 5213 [4]
Lifetime	Set to "0" to request deletion of the BCE.	IETF RFC 3775 [8]
Acknowledge (A)	Set to "1" to request an acknowledgement message.	IETF RFC 3775 [8]
Proxy Registration Flag (P)	Set to "1" to indicate that the Binding Update message is a proxy registration.	IETF RFC 5213 [4]

Table 5.4.1.1-2: Mobility Options in a PBU message for the PMIPv6 MAG Initiated PDN Connection Deletion procedure

Information element	Cat.	IE Description	Reference
Mobile Node Identifier option	M	Set to the NAI identifier of the UE as specified in 3GPP TS 23.003 [12]. The format of the NAI is specified in the subclause 19.3 in 3GPP TS 23.003 [12].	3GPP TS 23.003 [12]
IPv6 Home Network Prefix option	C	Set to the IPv6 Home Network Prefix allocated to the UE's PDN connection based on the selected PDN. NOTE 1.	IETF RFC 5213 [4]
Handoff Indicator option	M	Set to the value "4" to indicate Handoff state unknown.	IETF RFC 5213 [4]
Access Technology Type option	M	Set to the 3GPP access type, i.e., to GERAN, UTRAN or E-UTRAN, or to the value matching the characteristics of the non-3GPP access (e.g., HRPD) the UE is using to attach to the EPS as defined in the Access Technology Type Option type values registry of the IANA Mobile IPv6 Parameters Registry [18]. The ePDG may use the access technology type of the untrusted non-3GPP access network if it is able to acquire it; otherwise it shall indicate Virtual as the access technology. NOTE 2 NOTE 3	IETF RFC 5213 [4]
Timestamp option	M	Set to the current time	IETF RFC 5213 [4]
IPv4 Home Request Address option	C	Set to the IPv4 Home Address allocated for the UE's PDN connection based on the selected PDN. NOTE 1.	draft-ietf-netlmm-pmip6-ipv4-support [5]
Service Selection Mobility Option	M	Set to the EPS Access Point Name to which the UE's PDN connection is attached. The encoding the APN field follows 3GPP TS 23.003 [12] subclause 9.1 but excluding the trailing zero byte. The content of the APN field shall be the full APN with both the APN Network Identifier and default APN Operator Identifier being present as specified in 3GPP TS 23.003 [12] subclauses 9.1.1 and 9.1.2. NOTE 4.	IETF RFC 5149[11]
Protocol Configuration Options	O	Contain Protocol Configuration Options.	Subclause 12.1.1.0
<p>NOTE 1: At least one of the two options, namely, the IPv6 Home Network Prefix option or the IPv4 Home Address Request option shall be present. If the UE has both IPv4 home address and IPv6 home network prefix registered, both the IPv6 Home Network Prefix option and IPv4 Home Address Request option shall be included in the same PBU message.</p> <p>NOTE 2: The methods that the ePDG may use to acquire the access technology type of the untrusted non-3GPP IP access network are not specified in this release.</p> <p>NOTE 3: The PDN-GW can be informed about the type of access network used by the UE over several reference points, see 3GPP TS 29.212 [30] for the mapping between the code values for the different access network types.</p> <p>NOTE 4: The APN field is not encoded as a dotted string as commonly used in documentation.</p>			

5.4.1.2 Proxy Binding Acknowledgement

The fields of a PBA message for the PMIPv6 MAG Initiated PDN Connection Deletion procedure are depicted in Table 5.4.1.2-1.

The Mobility Options in a PBA message for the MAG Initiated PDN Connection Deletion procedure are depicted in Table 5.4.1.2-2.

Other flags are not used by this specification.

Table 5.4.1.2-1: Fields of a PBA message for the PMIPv6 MAG Initiated PDN Connection Deletion procedure

Information element	IE Description	Reference
Status	Set to indicate the result.	IETF RFC 3775 [8]
Sequence Number	Set to a value received in the corresponding PBU.	IETF RFC 5213 [4]
Lifetime	Set to "0" to request deletion of the binding.	IETF RFC 3775 [8]
Proxy Registration Flag (P)	Set to "1" to indicate that the Binding Update message is a proxy registration.	IETF RFC 5213 [4]

Table 5.4.1.2-2: Mobility Options in a PBA message for the PMIPv6 MAG Initiated PDN Connection Deletion procedure

Information element	Cat.	IE Description	Reference
Mobile Node Identifier option	M	Copied from corresponding field of PBU.	IETF RFC 5213 [4]
IPv6 Home Network Prefix option	C	If it is present in the corresponding PBU, set to the IPv6 Home Network Prefix allocated to the UE's PDN connection based on the selected PDN.	IETF RFC 5213 [4]
Handoff Indicator option	M	Copied from corresponding field of PBU.	IETF RFC 5213 [4]
Access Technology Type option	M	Copied from corresponding field of PBU.	IETF RFC 5213 [4]
Timestamp option	M	Copied from corresponding field of PBU, or set to the current time of LMA in case of timestamp error.	IETF RFC 5213 [4]
IPv4 Home Address Reply Option	C	If it is present in the corresponding PBU, set to the IPv4 Home Address allocated for the UE's PDN connection based on the selected PDN.	draft-ietf-netlmm-pmip6-ipv4-support [5]
IPv4 Default Router Address Option	C	Set to the UE's IPv4 default router address. This option shall be present if and only if IPv4 Home Address Reply Option is present and PBU is accepted.	draft-ietf-netlmm-pmip6-ipv4-support [5]
Service Selection Mobility Option	M	Copied from the corresponding field in the PBU message. The encoding the APN field follows 3GPP TS 23.003 [12] subclause 9.1 but excluding the trailing zero byte. The content of the APN field shall be the full APN with both the APN Network Identifier and default APN Operator Identifier being present as specified in 3GPP TS 23.003 [12] subclauses 9.1.1 and 9.1.2. NOTE 1.	IETF RFC 5149[11]
Protocol Configuration Options	O	Contain Protocol Configuration Options.	Subclause 12.1.1.0
3GPP Specific PMIPv6 Error Code	O	Contain 3GPP Specific PMIPv6 Error Code	Subclause 12.1.1.1

NOTE 1: The APN field is not encoded as a dotted string as commonly used in documentation.

5.4.2 MAG procedures

A MAG initiating the PMIPv6 Initial MAG Initiated PDN Connection Deletion procedure shall follow the "Mobile Node Detachment and Binding De-Registration" procedure described in the PMIPv6 [4] and IPv4 support for PMIPv6 [5] specifications, while parameters in the PBU are set as specified by the PBU parameters section for this procedure.

5.4.3 LMA procedures

On reception of a PBU, the LMA shall initiate the "Binding De-Registration" procedure described in the PMIPv6 [4] and IPv4 support for PMIPv6 [5] specifications, while parameters in the PBA are set as specified by the PBA parameters section for this procedure.

5.5 Proxy Mobile IPv6 LMA Initiated PDN Connection Deletion procedure

5.5.1 General

In EPC the PMIPv6 LMA Initiated PDN Connection Deletion is initiated by the node acting as a LMA to notify the node acting as a MAG, that the Binding Cache Entry related to the UE is about to be deactivated, so the MAG should remove the resources related to that PDN connection. The procedure starts with the LMA sending a BRI to the MAG to revoke the binding. The MAG confirms the revocation of the binding by sending a BRA to the LMA.

The LMA Initiated PDN Connection Deletion Procedure initiated by the LMA achieves the following:

- **IPv6 Home Network Prefix release:** When the UE's PDN connection is deactivated, the LMA returns the IPv6 Home Network Prefix assigned to the UE's PDN connection to the pool of free IPv6 Home Network Prefixes.
- **IPv4 Home Address release:** When the UE's PDN connection is deactivated, the LMA returns the IPv4 Home Address assigned to the UE's PDN connection to the pool of free IPv4 Home Network Addresses.
- **Downlink and Uplink GRE keys de-assignment:** The MAG and LMA will return, respectively, the PDN connection's uplink and downlink GRE keys to their respective pool of free GRE keys.
- **GRE tunnel Deletion:** The GRE tunnel is removed from the LMA and the MAG.
- **BCE Deletion:** The LMA deletes the BCE for the PDN connection.
- **BULE Deletion:** The MAG deletes the BULE for the PDN connection.

5.5.1.1 Binding Revocation Indication

The fields of a BRI message for the PMIPv6 LMA Initiated PDN Connection Deletion procedure are depicted in Table 5.5.1.1-1.

The Mobility Options in a BRI message for the LMA Initiated PDN Connection Deletion procedure are depicted in Table 5.5.1.1-2.

Table 5.5.1.1-1: Fields of a BRI message for the PMIPv6

Information element	IE Description	Reference
Sequence Number	A sequence number generated by the LMA, and increased for every BRI sent.	draft-ietf-mext-binding-revocation [6]
Revocation Trigger	Set to a value indicating the event which triggered the revoking node to send the BRI message	draft-ietf-mext-binding-revocation [6]
Proxy Binding Flag (P)	Set to "1" to indicate that the Binding Revocation Indication is for a proxy MIPv6 binding entry.	IETF RFC 5213 [4]
IPv4 HoA Binding Only (V)	Set to "0" to request for complete binding revocation	draft-ietf-mext-binding-revocation [6]
Global Per-Peer Bindings (G)	Set to 0 to indicate that the request is for a specific PMIPv6 BCE.	draft-ietf-mext-binding-revocation [6]

Table 5.5.1.1-2: Mobility Options in a BRI message for the PMIPv6 LMA Initiated PDN Connection Deletion

Information element	Cat.	IE Description	Reference
Mobile Node Identifier option	M	Set to the NAI identifier of the UE, as specified in 3GPP TS 23.003[12]. The format of the NAI is specified in the subclause 19.3 in 3GPP TS 23.003 [12].	3GPP TS 23.003[12]
IPv6 Home Network Prefix option	C	Set to the Home Network Prefix of the UE's PDN connection. NOTE 1.	IETF RFC 5213 [4]
IPv4 Home Request Address option	C	Set to the IPv4 home address of the UE's PDN connection. NOTE 1.	draft-ietf-netlmm-pmip6-ipv4-support [5]
Service Selection Mobility Option	M	Set to the EPS Access Point Name to which the UE's PDN connection is attached. The encoding the APN field follows 3GPP TS 23.003 [12] subclause 9.1 but excluding the trailing zero byte. The content of the APN field shall be the full APN with both the APN Network Identifier and default APN Operator Identifier being present as specified in 3GPP TS 23.003 [12] subclauses 9.1.1 and 9.1.2. NOTE 2.	IETF RFC 5149[11]
Protocol Configuration Options	O	Contain Protocol Configuration Options	Subclause 12.1.1.0
NOTE 1: At least one of the two options, namely, the IPv6 Home Network Prefix option or the IPv4 Home Address Request option shall be present. If the UE has both IPv4 home address and IPv6 home network prefix registered, both the IPv6 Home Network Prefix option and IPv4 Home Address Request option shall be included in the same BRI message.			
NOTE 2: The APN field is not encoded as a dotted string as commonly used in documentation.			

5.5.1.2 Binding Revocation Acknowledgment

The fields of a BRA message for the PMIPv6 LMA Initiated PDN Connection Deletion procedure are depicted in Table 5.5.1.2-1.

The Mobility Options in a BRA message for the LMA Initiated PDN Connection Deletion procedure are depicted in Table 5.5.1.2-2.

Table 5.5.1.2-1: Fields of a BRA message for a PMIPv6 LMA Initiated PDN Connection Deletion

Information element	IE Description	Reference
Sequence Number	Set to the value received in the corresponding BRI.	draft-ietf-mext-binding-revocation [6]
Status	Indicates the result of the BRI	draft-ietf-mext-binding-revocation [6]
Proxy Registration Flag (P)	Set to "1" to indicate that the Binding Revocation Acknowledgment is for a proxy MIPv6 binding entry.	IETF RFC 5213 [4]
IPv4 HoA Binding Only (V)	Set to "0"; the same value as for BRI	draft-ietf-mext-binding-revocation [6]
Global Per-Peer Bindings (G)	Set to "0"; the same value as for the BRI.	draft-ietf-mext-binding-revocation [6]

Table 5.5.1.2-2: Mobility Options in a BRA message for the PMIPv6 LMA Initiated PDN Connection Deletion

Information element	Cat.	IE Description	Reference
Mobile Node Identifier option	M	Copied from corresponding field of BRI.	IETF RFC 5213 [4]
IPv6 Home Network Prefix option	C	Set to the IPv6 Home Network Prefix of the UE's PDN connection received in BRI.	IETF RFC 5213 [4]
IPv4 Home Address Reply Option	C	Set to the IPv4 home address of the UE's PDN connection received in BRI.	draft-ietf-netlmm-pmip6-ipv4-support [5]
Service Selection Mobility Option	M	Copied from the corresponding field in the PBU message. The encoding the APN field follows 3GPP TS 23.003 [12] subclause 9.1 but excluding the trailing zero byte. The content of the APN field shall be the full APN with both the APN Network Identifier and default APN Operator Identifier being present as specified in 3GPP TS 23.003 [12] subclauses 9.1.1 and 9.1.2. NOTE 1.	IETF RFC 5149[11]
Protocol Configuration Options	O	Contain Protocol Configuration Options	Subclause 12.1.1.0
3GPP Specific PMIPv6 Error Code	O	Contain 3GPP Specific PMIPv6 Error Code	Subclause 12.1.1.1

NOTE 1: The APN field is not encoded as a dotted string as commonly used in documentation.

5.5.2 MAG procedures

The MAG shall follow the "Local Mobility Anchor Revokes a PMIPv6 Binding" procedure described in the draft-ietf-mext-binding-revocation [6]. The MAG should release the resources associated with the UE's PDN connection referred to in the BRI message.

The MAG shall respond with a BRA.

5.5.3 LMA procedures

The LMA shall send a BRI to the MAG as described in the "Local Mobility Anchor Revokes a PMIPv6 binding" procedure described in the draft-ietf-mext-binding-revocation [6]. The LMA shall clear the BCE related to the UE's PDN connection after sending the BRI in case of UE detach.

5.6 Proxy Mobile IPv6 PDN Connection IPv4 address allocation procedure

5.6.1 General

This procedure is initiated by the node acting as a MAG when DHCPv4 message is received from the UE which requires a new IPv4 address. The MAG sends a PBU to LMA requesting a new IPv4 address for an existing PDN connection. The LMA assigns a new IPv4 address by sending a PBA to the MAG. IPv4 address assignment procedure achieves the following:

- **IPv4 Home Address assignment:** The LMA assigns to the UE's PDN connection an IPv4 Home Address valid in the selected PDN.

5.6.1.1 Proxy Binding Update

The fields of a PBU message for the PMIPv6 PDN Connection IPv4 address allocation procedure are depicted in Table 5.6.1.1-1.

The Mobility Options in a PBU message for the PMIPv6 PDN Connection IPv4 address allocation procedure are depicted in Table 5.6.1.1-2.

Other flags are not used by this specification.

Table 5.6.1.1-1: Fields of a PBU message for the PMIPv6 PDN Connection IPv4 address allocation procedure

Information element	IE Description	Reference
Sequence Number	Set to a locally (i.e. per MAG) monotonically increasing value.	IETF RFC 5213 [4]
Lifetime	Set to the requested number of time units the binding shall remain valid.	IETF RFC 3775 [8]
Acknowledge (A)	Set to "1" to request an acknowledgement message.	IETF RFC 3775 [8]
Proxy Registration Flag (P)	Set to "1" to indicate that the Binding Update message is a proxy registration.	IETF RFC 5213 [4]

Table 5.6.1.1-2: Mobility Options in a PBU message for the PMIPv6 PDN Connection IPv4 address allocation procedure

Information element	Cat.	IE Description	Reference
Mobile Node Identifier option	M	Set to the NAI identifier of the UE as specified in 3GPP TS 23.003 [12]. The format of the NAI is specified in the subclause 19.3 in 3GPP TS 23.003 [12].	3GPP TS 23.003 [12]
IPv6 Home Network Prefix option	M	Set to the IPv6 Home Network Prefix allocated to the UE's PDN connection based on the selected PDN.	IETF RFC 5213 [4]
Link-local Address	M	Set to the link-local address already allocated to the MAG (in the previous initial binding registration) for use on the access link shared with the UE.	IETF RFC 5213 [4]
Handoff Indicator option	M	Set to the value "5" to indicate handoff state not changed (Re-registration).	IETF RFC 5213 [4]
Access Technology Type option	M	Set to the 3GPP access type, i.e., to GERAN, UTRAN or E-UTRAN, or to the value matching the characteristics of the non-3GPP access (e.g., HRPD) the UE is using to attach to the EPS as defined in the Access Technology Type Option type values registry of the IANA Mobile IPv6 Parameters Registry [18]. NOTE 1	IETF RFC 5213 [4]
Timestamp option	M	Set to the current time	IETF RFC 5213 [4]
IPv4 Home Request Address option	M	For dynamic allocation, set to the value "0.0.0.0" to request allocation for the UE's PDN connection of an IPv4 Home Address in the PDN corresponding to the EPS Access Point Name. For static allocation, set to the received static allocated IPv4 Home Address.	draft-ietf-netlmm-pmip6-ipv4-support [5]
Service Selection Mobility Option	M	Set to the EPS Access Point Name to which the UE's PDN connection is attached. The encoding the APN field follows 3GPP TS 23.003 [12] subclause 9.1 but excluding the trailing zero byte. The content of the APN field shall be the full APN with both the APN Network Identifier and default APN Operator Identifier being present as specified in 3GPP TS 23.003 [12] subclauses 9.1.1 and 9.1.2. NOTE 2.	IETF RFC 5149[11]
NOTE 1: The PDN-GW can be informed about the type of access network used by the UE over several reference points, see 3GPP TS 29.212 [30] for the mapping between the code values for the different access network types.			
NOTE 2: The APN field is not encoded as a dotted string as commonly used in documentation.			

5.6.1.2 Proxy Binding Acknowledgement

The fields of a PBA message for the PMIPv6 PDN Connection IPv4 address allocation procedure are depicted in Table 5.6.1.2-1.

The Mobility Options in a PBA message for the PMIPv6 PDN Connection IPv4 address allocation procedure are depicted in Table 5.6.1.2-2.

Other flags are not used by this specification.

Table 5.6.1.2-1: Fields of a PBA message for the PMIPv6 PDN Connection IPv4 address allocation procedure

Information element	IE Description	Reference
Status	Set to indicate the result.	IETF RFC 3775 [8]
Sequence Number	Set to the value received in the corresponding PBU.	IETF RFC 5213 [4]
Lifetime	Set to the granted number of time units the binding shall remain valid.	IETF RFC 3775 [8]
Proxy Registration Flag (P)	Set to "1" to indicate that the Binding Update message is a proxy registration.	IETF RFC 5213 [4]

Table 5.6.1.2-2: Mobility Options in a PBA message for the PMIPv6 PDN Connection IPv4 address allocation procedure

Information element	Cat.	IE Description	Reference
Mobile Node Identifier option	M	Copied from corresponding field of PBU.	IETF RFC 5213 [4]
IPv6 Home Network Prefix option	M	Set to the IPv6 Home Network Prefix allocated to the UE's PDN connection based on the selected PDN.	IETF RFC 5213 [4]
Link-local Address	M	Set to the link-local address already allocated to the MAG (in the previous initial binding registration) for use on the access link shared with the UE.	IETF RFC 5213 [4]
Handoff Indicator option	M	Copied from corresponding field of PBU.	IETF RFC 5213 [4]
Access Technology Type option	M	Copied from corresponding field of PBU.	IETF RFC 5213 [4]
Timestamp option	M	Copied from corresponding field of PBU, or set to the current time of LMA in case of timestamp error.	IETF RFC 5213 [4]
IPv4 Home Address Reply option	M	Set to the IPv4 Home Address allocated for the UE's PDN connection based on the selected PDN corresponding to the EPS Access Point Name for dynamic allocation, or set to the static IPv4 Home Address received in the PBU for static allocation.	draft-ietf-netlmm-pmip6-ipv4-support [5]
IPv4 Default Router Address Option	M	Set to the UE's IPv4 default router address.	draft-ietf-netlmm-pmip6-ipv4-support [5]
Service Selection Mobility Option	M	Copied from the corresponding field in the PBU message. The encoding the APN field follows 3GPP TS 23.003 [12] subclause 9.1 but excluding the trailing zero byte. The content of the APN field shall be the full APN with both the APN Network Identifier and default APN Operator Identifier being present as specified in 3GPP TS 23.003 [12] subclauses 9.1.1 and 9.1.2. NOTE 1.	IETF RFC 5149[11]
3GPP Specific PMIPv6 Error Code	O	Contain 3GPP Specific PMIPv6 Error Code	Subclause 12.1.1.1

NOTE 1: The APN field is not encoded as a dotted string as commonly used in documentation.

5.6.2 MAG procedures

The MAG initiating IPv4 Address Allocation using DHCPv4 procedure shall follow the "Extending Binding Lifetime" procedure described in the PMIPv6 [4] and "DHCP Relay Agent co-located with MAG" or "DHCP Server co-located with MAG" procedure as described in IPv4 support for PMIPv6 [5] specifications, while parameters in the PBU are set as specified by the PBU parameters section for this procedure.

1. If the static IPv4 Home Address is available at the MAG, set it in the IPv4 home address Request option in the PBU.

2. Set other parameters in the PBU as specified by the PBU parameters section for this procedure.

5.6.3 LMA procedures

On reception of a PBU, the LMA shall initiate the "Binding Lifetime Extension without Handover" procedures as described in the PMIPv6 [4] and IPv4 support for PMIPv6 [5] specifications with the following additional requirements:

1. Check if the received IPv4 Home address is topologically correct.
2. Allocate an IPv4 Home Address for the selected PDN.
3. Set parameters in the PBA as specified by the PBA parameters section for this procedure.

5.7 Proxy Mobile IPv6 LMA Initiated IPv4 Address Release procedure

5.7.1 General

In the case when UE is assigned both IPv6 HNP and IPv4 Home Address, if IPv4 Address lease expires or DHCPv4 Release procedure, the node acting as LMA initiates IPv4 Address Release procedure to notify the node acting as MAG about release of IPv4 address of UE for a certain PDN connection. LMA indicates MAG by sending a BRI and MAG confirms by replying with a BRA as described in draft-ietf-mext-binding-revocation [6].

LMA Initiated IPv4 Address Release procedure achieves the following:

- **IPv4 Home Address release:** The LMA returns the IPv4 Home Address assigned to the UE's PDN connection to the pool of free IPv4 Home Network Addresses.

5.7.1.1 Binding Revocation Indication

The fields of a BRI message for the PMIPv6 LMA Initiated PDN Connection Deletion procedure are depicted in Table 5.7.1.1-1.

The Mobility Options in a BRI message for the LMA Initiated PDN Connection Deletion procedure are depicted in Table 5.7.1.1-2.

Table 5.7.1.1-1: Fields of a BRI message for the LMA Initiated IPv4 Address Release

Information element	IE Description	Reference
Sequence Number	A sequence number generated by the LMA, and increased for every BRI sent.	draft-ietf-mext-binding-revocation [6]
Revocation Trigger	Set to a value indicating the event which triggered the revoking node to send the BRI message.	draft-ietf-mext-binding-revocation [6]
Proxy Binding Flag (P)	Set to "1" to indicate that the Binding Revocation Indication is for a proxy MIPv6 binding entry.	draft-ietf-netlmm-proxymip6 [4]
IPv4 HoA Binding Only (V)	Set to "1" to revoke IPv4 address only	draft-ietf-mext-binding-revocation [6]
Global Per-Peer Bindings (G)	Set to 0 to indicate that the request is for a specific PMIPv6 BCE.	draft-ietf-mext-binding-revocation [6]

Table 5.7.1.1-2: Mobility Options in a BRI message for the LMA Initiated IPv4 Address Release

Information element	Cat.	IE Description	Reference
Mobile Node Identifier option	M	Set to the NAI identifier of the UE, as specified in 3GPP TS 23.003[12]. The format of the NAI is specified in the subclause 19.3 in 3GPP TS 23.003 [12].	3GPP TS 23.003[12]
IPv4 Home Address Request option	M	Set to the IPv4 home address of the UE's PDN connection.	draft-ietf-netlmm-pmip6-ipv4-support [5]
Service Selection Mobility Option	M	Set to the EPS Access Point Name to which the UE's PDN connection is attached. The encoding the APN field follows 3GPP TS 23.003 [12] subclause 9.1 but excluding the trailing zero byte. The content of the APN field shall be the full APN with both the APN Network Identifier and default APN Operator Identifier being present as specified in 3GPP TS 23.003 [12] subclauses 9.1.1 and 9.1.2. NOTE 1.	IETF RFC 5149[11]
NOTE 1: The APN field is not encoded as a dotted string as commonly used in documentation.			

5.7.1.2 Binding Revocation Acknowledgment

The fields of a BRA message for the PMIPv6 LMA Initiated PDN Connection Deletion procedure are depicted in Table 5.7.1.2-1.

The Mobility Options in a BRA message for the LMA Initiated PDN Connection Deletion procedure are depicted in Table 5.7.1.2-2.

Table 5.7.1.2-1: Fields of a BRA message for a LMA Initiated IPv4 Address Release

Information element	IE Description	Reference
Sequence Number	Set to the value received in the corresponding BRI.	draft-ietf-mext-binding-revocation [6]
Status	Indicates the result of the BRI	draft-ietf-mext-binding-revocation [6]
Proxy Binding Flag (P)	Set to "1" to indicate that the Binding Revocation Indication is for a proxy MIPv6 binding entry.	draft-ietf-netlmm-proxymip6 [4]
IPv4 HoA Binding Only (V)	Set to "1"; the same value as for BRI	draft-ietf-mext-binding-revocation [6]
Global Per-Peer Bindings (G)	Set to 0 to indicate that the request is for a specific PMIPv6 BCE.	draft-ietf-mext-binding-revocation [6]

Table 5.7.1.2-2: Mobility Options in a BRA message for the LMA Initiated IPv4 Address Release

Information element	Cat.	IE Description	Reference
Mobile Node Identifier option	M	Copied from corresponding field of BRI.	draft-ietf-netlmm-proxymip6 [4]
IPv4 Home Address Reply Option	M	Set to the IPv4 home address of the UE's PDN connection received in BRI.	draft-ietf-netlmm-pmip6-ipv4-support [5]
Service Selection Mobility Option	M	Copied from the corresponding field in the PBU message. The encoding the APN field follows 3GPP TS 23.003 [12] subclause 9.1 but excluding the trailing zero byte. The content of the APN field shall be the full APN with both the APN Network Identifier and default APN Operator Identifier being present as specified in 3GPP TS 23.003 [12] subclauses 9.1.1 and 9.1.2. NOTE 1.	IETF RFC 5149[11]
3GPP Specific PMIPv6 Error Code	O	Contain 3GPP Specific PMIPv6 Error Code	Subclause 12.1.1.1
NOTE 1: The APN field is not encoded as a dotted string as commonly used in documentation.			

5.7.2 MAG procedures

The MAG shall follow the procedure for Revocation Trigger in BRI as "IPv4 HoA only" in "Binding Revocation Responder" sub-section of "Mobile Access Gateway" described in the draft-ietf-mext-binding-revocation [6]. The MAG shall respond with a BRA. BRA message parameters are set as per the details in BRA section of the procedure.

5.7.3 LMA procedures

The LMA shall send a BRI to the MAG as described for revoking IPv4 address only in the "Binding Revocation Initiator" sub-section of "Local Mobility Anchor" described in the draft-ietf-mext-binding-revocation [6]. The LMA shall delete the IPv4 Address from corresponding BCE related to the UE's PDN connection after receiving the BRA in reply to the BRI sent from LMA. BRI message parameters are set as per the details in BRI section of the procedure.

5.8 Proxy Mobile IPv6 Multiple PDN Extensions

5.8.1 General

In EPC a UE can connect or disconnect to multiple distinct PDNs in an independent manner. Thus a distinct PMIPv6 BCE and BULE exist for each of the PDN connections of an UE.

5.8.2 Extensions to PMIPv6 Data Structure

There shall be a unique BCE and BULE for each PDN connection. Each PDN connection can be uniquely identified by the APN in the BCE and BULE. To support Multiple PDNs the MAG and LMA maintains extended data structure compared to the standard PMIPv6 as defined in IETF RFC 5213 [4]. Since multiple PDN connections of a UE can be distinguished based on an APN, both the BCE on the LMA and the BULE on the MAG need to be extended with the following additional field:

- APN of a UE's PDN connection.

5.8.3 Extensions to PMIPv6 BULE and BCE Lookups

To support Multiple PDNs the MAG and LMA perform extended lookups on the extended data structure compared to the standard PMIPv6 as defined in IETF RFC 5213 [4].

In standard PMIPv6 as defined in IETF RFC 5213 [4], a PMIPv6 BCE is looked up based on the Mobile Node Identifier (MN-Id), the access technology types (ATT) and if it exist the MN's link-layer identifier (MN-LL-Id).

In EPC the MN-LL-Id is not used and the EPC support handover between different interfaces for handover between non-3GPP and 3GPP accesses. Since a distinct PMIPv6 BCE exists for each of the PDN connections of an UE, and since multiple PDN connections of a UE can be distinguished based on an APN, there is a one-to-one mapping between a PMIPv6 BCE, a PDN connection, and the (MN-Id, APN) tuple.

Thus, an UE PDN connection can be uniquely identified by a (MN-Id, APN) tuple, the BCE and BULE are accordingly looked up on a per (MN-Id, APN) tuple basis.

5.9 Serving GW Procedure at Chaining Case

5.9.1 General

Chained S2a/S2b with GTP-based S8 is not supported in this release.

Chained S2a/S2b with PMIP-based S8 is used when VPLMN has business relationship with Non-3GPP Networks and Serving GW in VPLMN supporting a LMA function as local non-3GPP Anchor.

5.9.2 Signalling procedures

When either of the S2a or S2b interfaces is chained with a PMIP-based S8 interface, the Serving GW acts as the signaling endpoint for each interface. On the S2a or S2b interface, the Serving GW acts as an LMA. On the chained PMIP-based S8 interface, the Serving GW acts as MAG. When a procedure is initiated by its peer on a given interface for a given PDN connection, the Serving GW shall trigger an equivalent procedure over the chained interface for the designated PDN connection. The procedure initiated by its peer cannot be completed before the completion of the equivalent procedure initiated over the chained interface.

5.9.2.1 PMIP-based S8 Serving GW procedures

Upon receiving a PMIPv6 message over S8 for an LMA initiated procedure for a given PDN connection, the Serving GW shall initiate the corresponding LMA procedure over S2a or S2b for the designated PDN connection.

Upon receiving a PMIPv6 message over S2a or S2b for a MAG initiated procedure for a given PDN connection, the Serving GW shall initiate the corresponding MAG procedure over PMIP-based S8 for the designated PDN connection.

Table 5.9.2.1-1: procedure, message and IE mapping at PMIPv6 based S8

Initiated procedure	Messages	Initiating interface	Chained interface	Corresponding procedure Chained interface	Corresponding messages
PDN Connection Creation as specified in subclause 5.1	PBU/PBA	S2a or S2b	PMIPv6 based S8	PDN Connection Creation as specified in subclause 5.1	PBU/PBA
PDN Connection Lifetime Extension as specified in subclause 5.2	PBU/PBA	S2a or S2b	PMIPv6 based S8	PDN Connection Lifetime Extension as specified in subclause 5.2	PBU/PBA
PDN Connection Handover as specified in subclause 5.3	PBU/PBA	S2a or S2b	PMIPv6 based S8	PDN Connection Handover as specified in subclause 5.3	PBU/PBA
MAG Initiated PDN Connection Deletion as specified in subclause 5.4	PBU/PBA	S2a or S2b	PMIPv6 based S8	MAG Initiated PDN Connection Deletion as specified in subclause 5.4	PBU/PBA
LMA Initiated PDN Connection Deletion as specified in subclause 5.5	BRI/BRA	PMIPv6 based S8	S2a or S2b	LMA Initiated PDN Connection Deletion as specified in subclause 5.5	BRI/BRA

5.9.3 Payload packets at chained case

When the S2a or S2b interfaces is chained with a PMIP-based S8 interface, both uplink and downlink payload packets are forwarded by the Serving GW between the S2a or S2b PMIPv6 GRE tunnel and the S8 PMIPv6 GRE tunnel for a given PDN connection.

5.10 Proxy Mobile IPv6 MAG Initiated IPv4 Address Release procedure

5.10.1 General

In the case when UE is assigned both IPv6 HNP and IPv4 Home Address, for DHCPv4 Release procedure, the node acting as MAG initiates the selective de-registration of IPv4 home address procedure to notify the node acting as LMA about release of IPv4 address of UE for a certain PDN connection. MAG notifies LMA by sending a PBU and LMA confirms by replying with a PBA as described in draft-ietf-netlmm-pmip6-ipv4-support [5]. IPv4 address release procedure achieves the following:

IPv4 Home Address release: The LMA releases an IPv4 Home Address of the UE's PDN connection.

5.10.1.1 Proxy Binding Update

The fields of a PBU message for the PMIPv6 MAG Initiated IPv4 Address Release procedure are depicted in Table 5.10.1.1-1.

The Mobility Options in a PBU message for the PMIPv6 MAG Initiated IPv4 Address Release procedure are depicted in Table 5.10.1.1-2.

Other flags are not used by this specification.

Table 5.10.1.1-1: Fields of a PBU message for the PMIPv6 MAG Initiated IPv4 Address Release procedure

Information element	IE Description	Reference
Sequence Number	Set to a locally (i.e. per MAG) monotonically increasing value.	IETF RFC 5213 [4]
Lifetime	Set to '0' to request deletion of the IPv4 binding.	draft-ietf-netlmm-pmip6-ipv4-support [5]
Acknowledge (A)	Set to "1" to request an acknowledgement message.	IETF RFC 3775 [8]
Proxy Registration Flag (P)	Set to "1" to indicate that the Binding Update message is a proxy registration.	IETF RFC 5213 [4]

Table 5.10.1.1-2: Mobility Options in a PBU message for the PMIPv6 MAG Initiated IPv4 Address Release procedure

Information element	Cat.	IE Description	Reference
Mobile Node Identifier option	M	Set to the NAI identifier of the UE as specified in 3GPP TS 23.003 [12].	3GPP TS 23.003 [12]
Handoff Indicator option	M	Set to the value "4" to indicate Handoff state unknown.	IETF RFC 5213 [4]
Access Technology Type option	M	Set to the value matching the characteristics of the non-3GPP access on S2a (e.g., HRPD) the UE is using to attach to the EPS as defined in the Access Technology Type Option type values registry of the IANA Mobile IPv6 Parameters Registry [18]. NOTE 1	IETF RFC 5213 [4]
Timestamp option	M	Set to the current time	IETF RFC 5213 [4]
IPv4 Home Address Request option	M	Set to the IPv4 Home Address to be released of the UE's PDN connection.	draft-ietf-netlmm-pmip6-ipv4-support [5]
Service Selection Mobility Option	M	Set to the EPS Access Point Name to which the UE's PDN connection is attached, formatted as defined in 3GPP TS 23.003 [12]	IETF RFC 5149[11]
NOTE 1: The PDN-GW can be informed about the type of access network used by the UE over several reference points, see 3GPP TS 29.212 [30] for the mapping between the code values for the different access network types.			

5.10.1.2 Proxy Binding Acknowledgement

The fields of a PBA message for the PMIPv6 MAG Initiated IPv4 Address Release procedure are depicted in Table 5.10.1.2-1.

The Mobility Options in a PBA message for the PMIPv6 MAG Initiated IPv4 Address Release procedure are depicted in Table 5.10.1.2-2.

Other flags are not used by this specification.

Table 5.10.1.2-1: Fields of a PBA message for the PMIPv6 MAG Initiated IPv4 Address Release procedure

Information element	IE Description	Reference
Status	Set to indicate the result.	IETF RFC 3775 [8]
Sequence Number	Set to the value received in the corresponding PBU.	IETF RFC 5213 [4]
Lifetime	Set to '0' to request deletion of the IPv4 binding.	draft-ietf-netlmm-pmip6-ipv4-support [5]
Proxy Registration Flag (P)	Set to "1" to indicate that the Binding Update message is a proxy registration.	IETF RFC 5213 [4]

Table 5.10.1.2-2: Mobility Options in a PBA message for the PMIPv6 MAG Initiated IPv4 Address Release procedure

Information element	Cat.	IE Description	Reference
Mobile Node Identifier option	M	Copied from corresponding field of PBU.	IETF RFC 5213 [4]
Handoff Indicator option	M	Copied from corresponding field of PBU.	IETF RFC 5213 [4]
Access Technology Type option	M	Copied from corresponding field of PBU.	IETF RFC 5213 [4]
Timestamp option	M	Copied from corresponding field of PBU, or set to the current time of LMA in case of timestamp error.	IETF RFC 5213 [4]
IPv4 Home Address Reply Option	M	Set to the released IPv4 Home Address of the UE's PDN connection.	draft-ietf-netlmm-pmip6-ipv4-support [5]
IPv4 Default Router Address Option	M	Set to the UE's IPv4 default router address.	draft-ietf-netlmm-pmip6-ipv4-support [5]
Service Selection Mobility Option	M	Copied from the corresponding field in the PBU message, formatted as defined in 3GPP TS 23.003 [12]	IETF RFC 5149[11]
3GPP Specific PMIPv6 Error Code	O	Contain 3GPP Specific PMIPv6 Error Code	Subclause 12.1.1.1

5.10.2 MAG procedures

The MAG initiating IPv4 Address Release using DHCPv4 procedure shall follow the "Selective De-Registration" procedure and "DHCP Server co-located with MAG" procedure as described in IPv4 support for PMIPv6 [5] specifications, while parameters in the PBU are set as specified by the PBU parameters section for this procedure.

3. Set the IPv4 home address to be released in the IPv4 home address Request option in the PBU.
4. Set other parameters in the PBU as specified by the PBU parameters section for this procedure.

5.10.3 LMA procedures

On reception of a PBU, the LMA shall initiate the "Selective De-Registration" procedures as described in the IPv4 support for PMIPv6 [5] specifications with the following additional requirements:

4. Release the IPv4 Home Address corresponding to the IPv4 home address Request option in the PBU message.

5. Set parameters in the PBA as specified by the PBA parameters section for this procedure.

6 Tunnel Management procedures

6.1 General

The Mobile Anchor Gateway (MAG) and the Local Mobility Anchor (LMA) establish and maintain a bi-directional tunnel for each PDN connection, which is used for routing the UE's PDN connection user-plane traffic between the MAG and the LMA. This tunnel is based on GRE [20] encapsulation and is established as a result of exchanging the Proxy Binding Update (PBU) and the Proxy Binding Acknowledgment (PBA) messages between the MAG and LMA. The PBU and PBA messages establish unique Binding Cache Entry (BCE) and Binding Update List Entry (BULE) entries for each PDN connection at the LMA and the MAG respectively. The tunnel end points are the Proxy-CoA and LMAA with GRE encapsulation (for IPv6 transport network) or IPv4-Proxy-CoA and IPv4-LMAA with GRE encapsulation (for IPv4 transport network), as described in draft-ietf-netlmm-grekey-option [7]. GRE encapsulation shall always be used; the GRE tunneling negotiation described in [7] is not applicable and the GRE Key Identifier Option shall always be present in the PBU messages for PMIPv6 PDN Connection Creation and binding registration after handover.

Tear down of GRE tunnels and cleanup of state is done explicitly by MAG Initiated PDN Connection Deletion or LMA Initiated PDN Connection Deletion; additionally, the tunnel is torn down when the binding lifetime expires as described in IETF RFC 5213 [4].

Signalling messages as specified in Section 4 are sent natively without encapsulation in IPv6 transport network and with IPv4 or IPv4-UDP encapsulation in IPv4 transport network as specified in IETF draft-ietf-netlmm-pmip6-ipv4-support [5].

A PMIPv6 node (MAG or LMA) that has no unicast IPv6 address but has a unicast IPv4 address shall be able to receive a PMIPv6 message with this IPv4 address in the destination address field of the outer IPv4 header, and the corresponding IPv4-mapped IPv6 address in the destination address field of the inner IPv6 header. When such a PMIPv6 node sends a PMIPv6 message to a PMIPv6 peer, it shall send the PMIPv6 message with its IPv4 address in the source address field in the outer IPv4 header, and the corresponding IPv4-mapped IPv6 address in the source address field of the inner IPv6 header. This IPv4-mapped IPv6 shall not be provisioned in the DNS.

When a PMIPv6 node (MAG or LMA) sends a PMIPv6 message to a PMIPv6 peer for which it does not have a unicast IPv6 address but has a unicast IPv4 address, it shall send the PMIPv6 message with its peer IPv4 address in the destination address field in the outer IPv4 header, and the corresponding IPv4-mapped IPv6 address in the destination address field of the inner IPv6 header.

The IPv4-mapped IPv6 address is constructed from an IPv4 address as specified in IETF RFC 4291[27].

The maximum size of an inner IP packet that may be transmitted without fragmentation by the PDN GW or the MS/UE is the same as the maximum N-PDU size that can be transmitted without IP fragmentation as defined in 3GPP TS 23.060 [23].

It is recommended to set the default inner MTU size at the PDN GW to 1280 octets in order to avoid IP fragmentation of both inner IP packets (in the PDN GW or UE/MS) and outer IP packets in the backbone.

NOTE: The UE/MS, or a server in an external network, may determine the inner MTU path by methods such as MTU discovery and hence fragment correctly at the source.

6.2 MAG procedure

When the PDN connectivity is established, the downlink GRE key for the PDN connection downlink traffic is selected by the MAG and sent to LMA in PBU message. This downlink GRE key shall be unique within the MAG for a given LMAA or IPv4-LMAA.

The uplink GRE key is received from LMA in a PBA message, and also from the MME in case Serving GW relocation occurs. The MAG shall be able to send the PDN connection uplink traffic using the received uplink GRE key towards the LMAA or IPv4-LMAA before sending the PBU or before receiving the PBA.

When the PDN connection is released, the downlink GRE key shall be released by the MAG.

6.3 LMA procedure

When the PDN connectivity is established, the uplink GRE key for the PDN connection uplink traffic is selected by the LMA and sent to MAG in PBA message. This uplink GRE key shall be unique within the LMA.

The LMA function shall be able to accept the PDN connection uplink packets from any MAG without enforcing that the source IP address of the outer IP header matches the Proxy-CoA in the UE BCE.

If GTP based S5/S8 is used for E-UTRAN access and PMIP based S2a is used for HRPD access, and optimized handover between E-UTRAN and HRPD is supported, when the PGW allocates an uplink TEID for a default bearer of a GTP tunnel, it shall also reserve an uplink GRE key with the same value of the default bearer uplink TEID.

When the PDN connection is released, the uplink GRE key shall be released by the LMA.

6.4 Data Structures

6.4.1 Binding Update List Entry

MAG maintains a unique Binding Update List Entry for for each PDN connection of a UE. The required elements of BULE as per 3GPP requirements are described in table 6.4.1-1.

Table 6.4.1-1: Elements of BULE

Element	Description	Reference
Mobile Node Identifier	Set to the NAI identifier of the UE as specified in 3GPP TS 23.003 [12].	3GPP TS 23.003 [12], draft-ietf-netlmm-proxymip6 [4]
Access Point Name	Set to the EPS Access Point Name to which the UE's PDN connection is attached, formatted as defined in 3GPP TS 23.003 [12]	3GPP TS 23.003 [12]
Lifetime	Set to lifetime granted for the binding as received in PBA.	IETF RFC 3775 [8]
Remaining Lifetime	This lifetime is initialized from the lifetime granted for the binding and is decremented until it reaches 0.	IETF RFC 3775 [8]
Sequence Number	The sequence number of the last Proxy Binding Update message sent.	IETF RFC 3775 [8]
Timestamp	Time at which last PBU was sent.	IETF RFC 3775 [8]
Binding Flag	Set to 1 if MAG receives an ICMPv6 parameter problem, code 1, error message in response to a PBU. Set to 0 if MAG continues to send PBU.	IETF RFC 3775 [8]
IPv6 Home Network Prefix	IPv6 Home Network Prefix assigned to the UE's PDN connection.	draft-ietf-netlmm-proxymip6 [4]
Link-local Address	IPv6 Link-local address to be used by the MAG on the access link shared with the UE.	IETF RFC 5213 [4]
IPv4 Home Address	IPv4 Home Address assigned to UE's PDN connection.	draft-ietf-netlmm-proxymip6 [4]
IPv4 default-router address	The IPv4 default-router address of the mobile node.	draft-ietf-netlmm-pmip6-ipv4-support [5]
LMA IPv6 Address	IPv6 Address of the LMA.	IETF RFC 3775 [8]
LMA IPv4 Address	IPv4 Address of the LMA.	draft-ietf-netlmm-pmip6-ipv4-support [5]
Downlink GRE Key	Downlink GRE key for the PDN connection as selected by MAG.	draft-ietf-netlmm-grekey-option [7]
Uplink GRE key	Uplink GRE key for the PDN connection selected by LMA as received in GRE Key option of PBA.	draft-ietf-netlmm-grekey-option [7]
Chained Binding Cache Entry	Reference to the corresponding BCE used for the binding on the S8 interface. It shall be present only in the Serving GW, in case of S2a/S2b - PMIP based-S8 chaining.	

6.4.2 Binding Cache Entry

LMA maintains a unique Binding Cache Entry for each PDN connection for a UE. The required elements of BCE as per 3GPP requirements are described in table 6.4.1-2.

Table 6.4.2-1: Elements of BCE

Element	Element Description	Reference
Mobile Node Identifier	The MN-Id mobility option as received in PBU.	3GPP TS 23.003 [12], draft-ietf-netlmm-proxymip6 [4]
Access Point Name	The Service Selection Mobility option received in PBU	3GPP TS 23.003 [12]
Lifetime	Lifetime granted for the binding.	IETF RFC 3775 [8]
Sequence Number	Sequence number of last received PBU.	IETF RFC 3775 [8]
IPv6 Home Network Prefix	IPv6 Home Network Prefix assigned to the UE's PDN connection.	draft-ietf-netlmm-proxymip6 [4]
Link-local Address	The assigned IPv6 link local address to MAG for use on the access link shared with the UE.	IETF RFC 5213 [4]
IPv4 Home Address	IPv4 Home Address assigned to UE's PDN connection.	draft-ietf-netlmm-proxymip6 [4]
IPv4 default-router address	The IPv4 default-router address of the mobile node.	draft-ietf-netlmm-pmip6-ipv4-support [5]
IPv6 Proxy care-of-address	MAG IPv6 Address, i.e. the source address of the IP packet in which PBU was received.	IETF RFC 3775 [8]
IPv4 Proxy care-of-address	MAG IPv4 Address.	draft-ietf-netlmm-pmip6-ipv4-support [5]
Access Technology Type	Access Technology Type as received in PBU.	draft-ietf-netlmm-proxymip6 [4]
Timestamp	Timestamp as received in PBU.	
Binding Flag	"1" as it is proxy registration.	draft-ietf-netlmm-proxymip6 [4]
Downlink GRE key	Downlink GRE key for the PDN connection selected by MAG as received in GRE key option of PBU.	draft-ietf-netlmm-grekey-option [7]
Uplink GRE key	Uplink GRE key for the PDN connection selected by LMA.	draft-ietf-netlmm-grekey-option [7]
Chained Binding Update List Entry	Reference to the corresponding BULE used for binding on the S2a / S2b interface. It shall be present only in the Serving GW, in case of S2a/S2b – PMIP-based S8 chaining.	

6.5 Security

Security aspects for PMIPv6 are described in 3GPP TS 33.402 [19].

7 Path Management procedures

7.1 General

The path management for PMIPv6 is very similar to that of GTP; the main difference is the use of PMIPv6 messages instead of GTP messages.

The restoration procedures that are triggered by path failure detection are specified in 3GPP TS 23.007 [13].

7.2 Heartbeat Mechanism

7.2.1 General

A LMA or MAG shall support sending Heartbeat Message to a peer MAG or LMA for Failure Detection and Restart Detection. The Heartbeat Message and procedures of Failure Detection and Restart Detection are defined in IETF Draft draft-ietf-netlmm-pmipv6-heartbeat [17]. When and how often a Heartbeat Request message are sent is implementation specific but a periodic Heartbeat Request shall not be sent more often than every 60 s on each path.

7.2.2 Heartbeat Message

7.2.2.1 Heartbeat Request

Table 7.2.2.1-1 specifies the information elements included in the Heartbeat Request message.

Table 7.2.2.1-1: Fields of a Heartbeat message for the Heartbeat request

Information element	IE Description	Reference
R flag	Set to 0 for a request message.	draft-ietf-netlmm-pmipv6-heartbeat[17]
Sequence Number	Set to a locally monotonically increasing value.	draft-ietf-netlmm-pmipv6-heartbeat [17]

7.2.2.2 Heartbeat Response

Table 7.2.2.2-1 and 7.2.2.2-2 specifies the information elements included in the Heartbeat Response message.

Table 7.2.2.2-1: Fields of a Heartbeat message for the Heartbeat Response

Information element	IE Description	Reference
R flag	Set to 1 for a response message.	draft-ietf-netlmm-pmipv6-heartbeat [17]
U flag	Set to 0 if the heartbeat response is sent as an answer to a heartbeat request. Set to 1 otherwise.	draft-ietf-netlmm-pmipv6-heartbeat [17]
Sequence Number	Set to the value received in the corresponding Heartbeat Request message.	draft-ietf-netlmm-pmipv6-heartbeat [17]

Table 7.2.2.2-2: Mobility Options in a Heartbeat message for the Heartbeat Response

Information element	IE Description	Reference
Restart Counter	indicates the current Restart Counter value	draft-ietf-netlmm-pmipv6-heartbeat [17]

7.3 Void

7.4 Void

7.5 Void

7.6 UE-specific Error Handling

7.6.1 General

A PMIPv6 node (i.e., LMA or MAG) may support the UE-specific error indication such that a PMIPv6 node may send a message to the source PMIPv6 node when no binding exists for a packet received from a GRE tunnel.

7.6.2 MAG and LMA procedure

If a PMIPv6 receiving node (i.e. MAG or LMA) verifies that no PMIPv6 binding exists for a received user packet based on GRE Key, the receiving PMIPv6 node shall discard the packet. The PMIPv6 node may report the error to the peer PMIPv6 node, in the form of an ICMP message, as specified in Sections 8.2 and 8.3 of IETF RFC2473 [31] for the node unreachable error case.

7.7 Void

7.8 Partial node failure requiring the removal of a subset of sessions

7.8.1 General

See 3GPP TS 23.007[13] for the description of this function.

7.8.2 Binding Revocation Indication message

The fields of a BRI message to revoke bulk PMIPv6 bindings initiated by the LMA or the MAG are depicted in Table 7.8.2-1.

The Mobility Options in a BRI message to revoke bulk PMIPv6 bindings sent by the LMA or the MAG are depicted in Table 7.8.2-2.

Table 7.8.2-1: Fields of a BRI message for the PMIPv6

Information element	IE Description	Reference
Sequence Number	A sequence number generated by the LMA, and increased for every BRI sent.	draft-ietf-mext-binding-revocation [6]
Revocation Trigger	Set to a the value of "Revoking Mobility Node Local Policy"	draft-ietf-mext-binding-revocation [6]
Proxy Binding Flag (P)	Set to "1" to indicate that the Binding Revocation Indication is for a proxy MIPv6 binding entry.	RFC 5213 [4]
Global Per-Peer Bindings (G)	Set to 1	draft-ietf-mext-binding-revocation [6]

Table 7.8.2-2: Mobility Options in a BRI message for the PMIPv6 LMA or MAG Initiated bulk PDN Connections Deletion for Partial Node failure

Information element	Cat.	IE Description	Reference
Mobile Node Identifier	C	Set to the IP address of the MAG, only when the BRI message is sent by the MAG.	3GPP TS 23.402[3]
Fully Qualified PDN Connection Set Identifier	M	This IE shall be included by the MAG or LMA on the S5/S8 interfaces (see 3GPP TS 23.007 [13]) and contains the Fully Qualified PDN Connection Set Identifier(s) that need to be revoked.	Subclause 12.1.1.2

7.8.3 Binding Revocation Acknowledgement message

The fields of a BRA message to revoke bulk PMIPv6 bindings for the PMIPv6 LMA or MAG Initiated PDN Connection Deletion procedure are depicted in Table 7.8.3-1.

Table 7.8.3-1: Fields of a BRA message for a PMIPv6 for a MAG or LMA Initiated bulk PDN Connections Deletion for Partial Node failure

Information element	IE Description	Reference
Sequence Number	Set to the value received in the corresponding BRI.	draft-ietf-mext-binding-revocation [6]
Status	Indicates the result of the BRI.	draft-muhanna-mext-binding-revocation [6]
Proxy Registration Flag (P)	Set to "1" to indicate that the Binding Revocation Acknowledgment is for a proxy MIPv6 binding entry.	RFC 5213 [4]
Global Per-Peer Bindings (G)	Set to 1; the same value as for the BRI.	draft-ietf-mext-binding-revocation [6]

7.8.4 MAG procedures

The MAG can be the initiator or the receiver of a BRI message to revoke bulk PMIPv6 bindings.

The MAG shall follow the "Local Mobility Anchor Revokes Bulk PMIPv6 Bindings" procedure described in the draft-ietf-mext-binding-revocation [6] when it receives a Binding Revocation Indication message with G bit set, removing the sessions identified by the Fully Qualified PDN Connection Set Identifier Mobility Option.

The MAG shall follow the "Mobile Access Gateway Revoke Bulk PMIPv6 Bindings" when it sends a Binding Revocation Indication message with G bit set to the LMA, including the Fully Qualified PDN Connection Set Identifier Mobility Option.

7.8.5 LMA procedures

The LMA can be the initiator or the receiver of a BRI message to revoke bulk PMIPv6 bindings.

The LMA shall follow the "Mobile Access Gateway Revokes Bulk PMIPv6 Bindings" procedure described in the draft-ietf-mext-binding-revocation [6] when it receives a Binding Revocation Indication message with G bit set, removing the sessions identified by the Fully Qualified PDN Connection Set Identifier Mobility Option.

The LMA shall follow the "Local Mobility Anchor Revoke Bulk PMIPv6 Bindings" when it sends a Binding Revocation Indication message with G bit set to the LMA, including the Fully Qualified PDN Connection Set Identifier Mobility Option.

8 PMIP-based S5 and PMIP-based S8 description

8.1 Initial Attach procedures

8.1.1 General

8.1.2 Serving GW procedures

The Serving GW shall follow the MAG procedure for the PMIPv6 PDN Connection Creation as outlined in subclause 5.1.2.

8.1.3 PDN GW procedures

The PDN GW shall follow the LMA procedure for the PMIPv6 PDN Connection Creation as outlined in subclause 5.1.3

8.2 Serving GW Initiated PDN Connection Lifetime Extension procedures

8.2.1 General

8.2.2 Serving GW procedures

The Serving GW shall follow the MAG procedure for the PMIPv6 PDN Connection Lifetime Extension as outlined in subclause 5.2.2.

8.2.3 PDN GW procedures

The PDN GW shall follow the LMA procedure for the PMIPv6 PDN Connection Lifetime Extension as outlined in subclause 5.2.3.

8.3 UE, MME or HSS initiated Detach procedures

8.3.1 General

8.3.2 Serving GW procedures

The Serving GW shall follow the MAG procedure for the PMIPv6 MAG Initiated PDN Connection Deletion as outlined in subclause 5.4.2 repeated for each PDN connection of the UE.

8.3.3 PDN GW procedures

The PDN GW shall follow the LMA procedure for the PMIPv6 MAG Initiated PDN Connection Deletion as outlined in subclause 5.4.3.

8.4 PDN GW Initiated PDN Disconnection procedures

8.4.1 General

8.4.2 Serving GW procedures

The Serving GW shall follow the MAG procedure for the PMIPv6 LMA Initiated PDN Connection Deletion as outlined in subclause 5.5.2.

8.4.3 PDN GW procedures

The PDN GW shall follow the LMA procedure for the PMIPv6 LMA Initiated PDN Connection Deletion for the selected PDN connection as outlined in subclause 5.5.3.

8.5 UE Requested Additional PDN Connectivity procedures

8.5.1 General

8.5.2 Serving GW procedures

If the Request Type indicates "initial attach", the Serving GW shall follow the MAG procedure for the PMIPv6 PDN Connection Creation as outlined in subclause 5.1.2.

If the Request Type indicates "Handover", the Serving GW shall follow the MAG procedure for the PMIPv6 PDN Connection Handover as outlined in subclause 5.3.2.

8.5.3 PDN GW procedures

If the Request Type indicates "initial attach", the PDN GW shall follow the LMA procedure for the PMIPv6 PDN Connection Creation as outlined in subclause 5.1.3.

If the Request Type indicates "Handover", the PDN GW shall follow the LMA procedure for the PMIPv6 PDN Connection Handover as outlined in subclause 5.3.3.

8.6 Handover procedures

8.6.1 Intra-LTE TAU and Inter-eNodeB Handover with Serving GW Relocation procedures

8.6.1.1 General

8.6.1.2 Serving GW procedures

The Serving GW shall follow the MAG procedure for the PMIPv6 PDN Connection Handover as outlined in subclause 5.3.2 repeated for each PDN connection of the UE.

8.6.1.3 PDN GW procedures

The PDN GW shall follow the LMA procedure for the PMIPv6 PDN Connection Handover as outlined in subclause 5.3.3.

8.6.2 TAU/RAU or Handover between GERAN A/Gb Mode or UTRAN Iu Mode and E-UTRAN procedures

8.6.2.1 General

8.6.2.2 Serving GW procedures

The Serving GW shall follow the MAG procedure for the PMIPv6 PDN Connection Handover as outlined in subclause 5.3.2 repeated for each PDN connection of the UE.

8.6.2.3 PDN GW procedures

The PDN GW shall follow the LMA procedure for the PMIPv6 PDN Connection Handover as outlined in subclause 5.3.3.

8.6.3 Handover from Trusted or Untrusted Non-3GPP IP Access over S2a/S2b to 3GPP Access Handover E-UTRAN over PMIP based S5/S8 without optimization procedures

8.6.3.1 General

8.6.3.2 Serving GW procedures

The Serving GW shall follow the MAG procedure for the PMIPv6 PDN Connection Handover as outlined in subclause 5.3.2 repeated for each PDN connection of the UE.

8.6.3.3 PDN GW procedures

The PDN GW shall follow the LMA procedure for the PMIPv6 PDN Connection Handover as outlined in subclause 5.3.3.

8.6.4 Handover from Trusted or Untrusted Non-3GPP IP Access over S2a/S2b to 3GPP Access UTRAN/GERAN over PMIP based S5/S8 without optimization

8.6.4.1 General

8.6.4.2 Serving GW procedures

The Serving GW shall follow the MAG procedure for the PMIPv6 PDN Connection Handover as outlined in subclause 5.3.2 repeated for each PDN connection of the UE.

8.6.4.3 PDN GW procedures

The PDN GW shall follow the LMA procedure for the PMIPv6 PDN Connection Handover as outlined in subclause 5.3.3.

8.6.5 Handover from Trusted or Untrusted Non-3GPP IP Access over S2c to 3GPP Access over PMIP based S5/S8 without optimization

8.6.5.1 General

8.6.5.2 Serving GW procedures

The Serving GW shall follow the MAG procedure for the PMIPv6 PDN Connection Handover as outlined in subclause 5.3.2 repeated for each PDN connection of the UE.

8.6.5.3 PDN GW procedures

The PDN GW shall follow the LMA procedure for the PMIPv6 PDN Connection Handover as outlined in subclause 5.3.3.

8.6.6 Optimised Active Handover: cdma2000 eHRPD Access to EUTRAN

8.6.6.1 General

8.6.6.2 Serving GW procedures

The Serving GW shall follow the MAG procedure for the PMIPv6 PDN Connection Handover as outlined in subclause 5.3.2 repeated for each PDN connection of the UE.

8.6.6.3 PDN GW procedures

The PDN GW shall follow the LMA procedure for the PMIPv6 PDN Connection Handover as outlined in subclause 5.3.3.

8.6.7 Optimized Idle Mode Mobility: cdma2000 eHRPD Access to E-UTRAN Access

8.6.7.1 General

8.6.7.2 Serving GW procedures

The Serving GW shall follow the MAG procedure for the PMIPv6 PDN Connection Handover as outlined in subclause 5.3.2 repeated for each PDN connection of the UE.

8.6.7.3 PDN GW procedures

The PDN GW shall follow the LMA procedure for the PMIPv6 PDN Connection Handover as outlined in subclause 5.3.3..

8.7 UE Requested PDN Disconnection procedures

8.7.1 General

8.7.2 Serving GW procedures

The Serving GW shall follow the MAG procedure for the PMIPv6 MAG Initiated PDN Connection Deletion, for the selected PDN connection as outlined in subclause 5.4.2.

8.7.3 PDN GW procedures

The PDN GW shall follow the LMA procedure for the PMIPv6 MAG Initiated PDN Connection Deletion, for the selected PDN connection as outlined in subclause 5.4.3.

8.8 IPv4 Address Allocation using DHCP

8.8.1 General

8.8.2 Serving GW procedures

The Serving GW shall follow the MAG procedure for the Proxy Mobile IPv6 PDN Connection IPv4 Address Allocation Procedure as defined in sub clause 5.6.2.

8.8.3 PDN GW procedures

The PDN GW shall follow the LMA procedure for the Proxy Mobile IPv6 PDN Connection IPv4 Address Allocation Procedure as defined in sub clause 5.6.3.

8.9 PDN-GW Initiated IPv4 Address Delete Procedure

8.9.1 General

8.9.2 Serving GW procedures

If UE is assigned both IPv6 HNP and IPv4 HoA, the Serving GW shall follow the MAG procedure for the LMA Initiated IPv4 Address Release procedure as defined in sub clause 5.7.2.

8.9.3 PDN GW procedures

If UE is assigned both IPv6 HNP and IPv4 HoA, the PDN GW shall follow the LMA procedure for the LMA Initiated IPv4 Address Release procedure as defined in sub clause 5.7.3.

If UE is assigned only IPv4 HoA, then PDN-GW initiated PDN Disconnection procedure is initiated.

9 Trusted Non-3GPP Access over S2a Description

9.1 Initial Attach procedures

9.1.1 General

9.1.2 Trusted Non-3GPP Access procedures

In PMIPv6 mode, the Trusted Non-3GPP Access shall follow the MAG procedure for the PMIPv6 PDN Connection Creation as outlined in subclause 5.1.2.

9.1.3 PDN GW procedures

In PMIPv6 mode, the PDN GW shall follow the MAG procedure for the PMIPv6 PDN Connection Creation as outlined in subclause 5.1.3.

9.2 Trusted Non-3GPP Access Initiated PDN Connection Lifetime Extension procedures

9.2.1 General

9.2.2 Trusted Non-3GPP Access procedures

In PMIPv6 mode, the Trusted Non-3GPP Access shall follow the MAG procedure for the PMIPv6 PDN Connection Lifetime Extension as outlined in subclause 5.2.2.

9.2.3 PDN GW procedures

In PMIPv6 mode, the PDN GW shall follow the LMA procedure for the PMIPv6 PDN Connection Lifetime Extension as outlined in subclause 5.2.3.

9.3 UE / Trusted Non-3GPP Access Initiated Detach and UE Requested PDN Disconnection procedures

9.3.1 General

9.3.2 Trusted Non-3GPP Access procedures

In PMIPv6 mode, the Trusted Non-3GPP Access shall follow the MAG procedure for the PMIPv6 MAG Initiated PDN Connection Deletion as outlined in subclause 5.4.2 for PDN Disconnection procedure,.

For Detach the Trusted Non-3GPP Access shall follow the above repeated for each PDN connection of the UE.

9.3.3 PDN GW procedures

In PMIPv6 mode, the PDN GW shall follow the LMA procedure for the PMIPv6 MAG Initiated PDN Connection Deletion as outlined in subclause 5.4.3.

9.4 HSS / AAA Initiated Detach procedures

9.4.1 General

The HSS/AAA may initiate a detach procedure resulting in a PMIPv6 De-Registration.

9.4.2 Trusted Non-3GPP Access procedures

In PMIPv6 mode, the Trusted Non-3GPP Access shall follow the MAG procedure for the PMIPv6 MAG Initiated PDN Connection Deletion as outlined in subclause 5.4.2 repeated for each PDN connection of the UE.

9.4.3 PDN GW procedures

In PMIPv6 mode, the PDN GW shall follow the LMA procedure for the PMIPv6 MAG Initiated PDN Connection Deletion as outlined in subclause 5.4.3.

9.5 UE Initiated Connectivity to Additional PDN procedures

9.5.1 General

9.5.2 Trusted Non-3GPP Access procedures

In PMIPv6 mode, if the Request Type indicates "initial attach", the Trusted Non-3GPP Access shall follow the MAG procedure for the PMIPv6 PDN Connection Creation as outlined in subclause 5.1.2. If the Request Type indicates "Handover", the Trusted Non-3GPP Access shall follow the MAG procedure for the PMIPv6 PDN Connection Handover as outlined in subclause 5.3.2.

9.5.3 PDN GW procedures

In PMIPv6 mode, if the Request Type indicates "initial attach", the PDN GW shall follow the LMA procedure for the PMIPv6 PDN Connection Creation as outlined in subclause 5.1.3. If the Request Type indicates "Handover", the PDN GW shall follow the LMA procedure for the PMIPv6 PDN Connection Handover as outlined in subclause 5.3.3.

9.6 3GPP Access to Trusted Non-3GPP IP Access with PMIPv6 on S2a Handover procedures without optimization

9.6.1 General

9.6.2 Trusted Non-3GPP Access procedures

In PMIPv6 mode, the Trusted Non-3GPP Access shall follow the MAG procedure for the PMIPv6 PDN Connection Handover as outlined in subclause 5.3.2.

9.6.3 PDN GW procedures

In PMIPv6 mode, the PDN GW shall follow the LMA procedure for the PMIPv6 PDN Connection Handover as outlined in subclause 5.3.3.

If IPv6 network prefix preservation is supported at a handover from 3GPP Access with a GTP-based S5/S8 to non-3GPP Access, the LMA shall provide to the MAG the link-local address which is used by the PDN GW at the link shared with the UE in the 3GPP Access.

9.7 PDN GW Initiated Resource Allocation Deactivation procedures

9.7.1 General

9.7.2 Trusted Non-3GPP Access procedures

In PMIPv6 mode, the Trusted Non-3GPP Access shall follow the MAG procedure for the PMIPv6 LMA Initiated PDN Connection Deletion as outlined in subclause 5.5.2.

9.7.3 PDN GW procedures

In PMIPv6 mode, the PDN GW shall follow the LMA procedure for the PMIPv6 LMA Initiated PDN Connection Deletion as outlined in subclause 5.5.3.

9.8 IPv4 Address Allocation using DHCP

9.8.1 General

9.8.2 Trusted Non-3GPP Access procedures

The Trusted Non-3GPP Access shall follow the MAG procedure for the Proxy Mobile IPv6 PDN Connection IPv4 Address Allocation Procedure as defined in sub clause 5.6.2.

9.8.3 PDN GW procedures

The PDN GW shall follow the LMA procedure for the Proxy Mobile IPv6 PDN Connection IPv4 Address Allocation Procedure as defined in sub clause 5.6.3.

9.9 PDN-GW Initiated IPv4 Address Delete Procedure

9.9.1 General

9.9.2 Trusted Non-3GPP Access procedures

If UE is assigned both IPv6 HNP and IPv4 HoA, the Trusted Non-3GPP Access shall follow the MAG procedure for the LMA Initiated IPv4 Address Release procedure as defined in sub clause 5.7.2.

9.9.3 PDN GW procedures

If UE is assigned both IPv6 HNP and IPv4 HoA, the PDN GW shall follow the LMA procedure for the LMA Initiated IPv4 Address Release procedure as defined in sub clause 5.7.3.

If UE is assigned only IPv4 HoA, then PDN-GW initiated Resource Allocation Deactivation procedure is initiated.

9.10 Optimized E-UTRAN to CDMA2000 eHRPD Handover procedure

9.10.1 General

9.10.2 CDMA2000 HRPD access procedure

In PMIPv6 mode, the CDMA2000 HRPD access shall follow the MAG procedure for the PMIPv6 PDN Connection Handover procedure as outlined in subclause 5.3.2.

9.10.3 PDN GW procedures

In PMIPv6 mode, the PDN GW shall follow the LMA procedure for the PMIPv6 PDN Connection Handover procedure as outlined in subclause 5.3.3.

9.11 Optimized Idle Mode Mobility: E-UTRAN Access to cdma2000 eHRPD Access procedure

9.11.1 General

9.11.2 CDMA2000 eHRPD access procedure

In PMIPv6 mode, the CDMA2000 eHRPD access shall follow the MAG procedure for the PMIPv6 PDN Connection Handover procedure as outlined in subclause 5.3.2.

9.11.3 PDN GW procedures

In PMIPv6 mode, the PDN GW shall follow the LMA procedure for the PMIPv6 PDN Connection Handover procedure as outlined in subclause 5.3.3.

10 Untrusted Non-3GPP Access over S2b Description

10.1 Initial Attach procedures

10.1.1 General

10.1.2 ePDG procedures

In PMIPv6 mode, the ePDG shall follow the MAG procedure for the PMIPv6 PDN Connection Creation as outlined in subclause 5.1.2.

10.1.3 PDN GW procedures

In PMIPv6 mode, the PDN GW shall follow the MAG procedure for the PMIPv6 PDN Connection Creation as outlined in subclause 5.1.3.

10.2 ePDG Initiated PDN Connection Lifetime Extension procedures

10.2.1 General

10.2.2 ePDG procedures

In PMIPv6 mode, the ePDG shall follow the MAG procedure for the PMIPv6 PDN Connection Lifetime Extension as outlined in subclause 5.2.2.

10.2.3 PDN GW procedures

In PMIPv6 mode, the PDN GW shall follow the LMA procedure for the PMIPv6 PDN Connection Lifetime Extension as outlined in subclause 5.2.3.

10.3 UE / ePDG Initiated Detach and UE Requested PDN Disconnection procedures

10.3.1 General

10.3.2 ePDG procedures

In PMIPv6 mode, the ePDG shall follow the MAG procedure for the PMIPv6 MAG Initiated PDN Connection Deletion as outlined in subclause 5.4.2 for PDN Disconnection procedure,

For Detach the ePDG shall follow the above repeated for each PDN connection of the UE.

10.3.3 PDN GW procedures

In PMIPv6 mode, the PDN GW shall follow the LMA procedure for the PMIPv6 MAG Initiated PDN Connection Deletion as outlined in subclause 5.4.3.

10.4 HSS / AAA Initiated Detach procedures

10.4.1 General

The HSS/AAA may initiate a detach procedure resulting in a PMIPv6 De-Registration.

10.4.2 ePDG procedures

In PMIPv6 mode, the ePDG shall follow the MAG procedure for the PMIPv6 MAG Initiated PDN Connection Deletion as outlined in subclause 5.4.2 repeated for each PDN connection of the UE.

10.4.3 PDN GW procedures

In PMIPv6 mode, the PDN GW shall follow the LMA procedure for the PMIPv6 MAG Initiated PDN Connection Deletion as outlined in subclause 5.4.3.

10.5 UE Initiated Connectivity to Additional PDN procedures

10.5.1 General

10.5.2 ePDG procedures

In PMIPv6 mode, if the Request Type indicates "initial attach", the ePDG shall follow the MAG procedure for the PMIPv6 PDN Connection Creation as outlined in subclause 5.1.2. If the Request Type indicates "Handover", the ePDG shall follow the MAG procedure for the PMIPv6 PDN Connection Handover as outlined in subclause 5.3.2.

10.5.3 PDN GW procedures

In PMIPv6 mode, if the Request Type indicates "initial attach", the PDN GW shall follow the LMA procedure for the PMIPv6 PDN Connection Creation as outlined in subclause 5.1.3. If the Request Type indicates "Handover", the PDN GW shall follow the LMA procedure for the PMIPv6 PDN Connection Handover as outlined in subclause 5.3.3.

10.6 3GPP Access to Untrusted Non-3GPP IP Access with PMIPv6 on S2b Handover procedures without optimization

10.6.1 General

10.6.2 ePDG procedures

In PMIPv6 mode, the ePDG shall follow the MAG procedure for the PMIPv6 PDN Connection Handover as outlined in subclause 5.3.2.

10.6.3 PDN GW procedures

In PMIPv6 mode, the PDN GW shall follow the LMA procedure for the PMIPv6 PDN Connection Handover as outlined in subclause 5.3.3.

If IPv6 network prefix preservation is supported at a handover from 3GPP Access with a GTP-based S5/S8 to non-3GPP Access, the LMA shall provide to the MAG the link-local address which is used by the PDN GW at the link shared with the UE in the 3GPP Access.

10.7 PDN GW Initiated Resource Allocation Deactivation procedures

10.7.1 General

10.7.2 ePDG procedures

In PMIPv6 mode, the ePDG shall follow the MAG procedure for the PMIPv6 LMA Initiated PDN Connection Deletion as outlined in subclause 5.5.2.

10.7.3 PDN GW procedures

In PMIPv6 mode, the PDN GW shall follow the LMA procedure for the PMIPv6 LMA Initiated PDN Connection Deletion as outlined in subclause 5.5.3.

10.8 PDN-GW Initiated IPv4 Address Delete Procedure

10.8.1 General

10.8.2 ePDG procedures

If UE is assigned both IPv6 HNP and IPv4 HoA, the ePDG shall follow the MAG procedure for the LMA Initiated IPv4 Address Release procedure as defined in sub clause 5.7.2.

10.8.3 PDN GW procedures

If UE is assigned both IPv6 HNP and IPv4 HoA, the PDN GW shall follow the LMA procedure for the LMA Initiated IPv4 Address Release procedure as defined in sub clause 5.7.3.

If UE is assigned only IPv4 HoA, then PDN-GW initiated Resource Allocation Deactivation procedure is initiated.

11 S2a and S2b Chaining with PMIP-based S8 Description

11.1 Initial Attach procedures

11.1.1 General

11.1.2 ePDG / Trusted Non-3GPP Access procedures

In PMIPv6 mode, the ePDG or Trusted Non-3GPP Access shall follow the MAG procedure for the PMIPv6 PDN Connection Creation. In addition to the general procedure, it shall include the PDN GW IP address received during the authorization procedure into the PBU request, encoding it into a Vendor-Specific Option (refer to clause 12.1.1.4).

11.1.3 Serving GW procedures

In PMIPv6 mode, the Serving GW shall follow:

- the LMA procedure for the PMIPv6 PDN Connection Creation on the S2a/S2b interface. In addition to the general procedure, the Serving GW shall include the PDN GW IP address received in the PBU request into the PBA, using the same encoding (refer to clause 12.1.1.4).
- the MAG procedure for the PMIPv6 PDN Connection Creation on the S8 interface. The Serving GW shall send the PBU request to the PDN GW IP address received on the chained S2a / S2b interface.

11.2 ePDG / Trusted Non-3GPP Access Initiated PDN Connection Lifetime Extension procedures

11.2.1 General

11.2.2 ePDG / Trusted Non-3GPP Access procedures

In PMIPv6 mode, the ePDG or Trusted Non-3GPP Access shall follow the MAG procedure for the PMIPv6 PDN Connection Lifetime Extension.

11.2.3 Serving GW procedures

In PMIPv6 mode, the Serving GW shall follow:

- the LMA procedure for the PMIPv6 PDN Connection Lifetime Extension on the S2a/S2b interface.
- the MAG procedure for the PMIPv6 PDN Connection Lifetime Extension on the S8 interface.

11.3 UE / ePDG / Trusted Non-3GPP Access Initiated Detach procedures

11.3.1 General

11.3.2 ePDG / Trusted Non-3GPP Access procedures

In PMIPv6 mode, the ePDG or Trusted Non-3GPP Access shall follow the MAG procedure for the PMIPv6 MAG Initiated PDN Connection Deletion repeated for each PDN connection of the UE.

11.3.3 Serving GW procedures

In PMIPv6 mode, the Serving GW shall follow:

- the LMA procedure for the PMIPv6 MAG Initiated PDN Connection Deletion on the S2a/S2b interface.
- the MAG procedure for the PMIPv6 MAG Initiated PDN Connection Deletion on the S8 interface.

11.4 HSS / AAA Initiated Detach procedures

11.4.1 General

The HSS/AAA may initiate a detach procedure resulting in a PMIPv6 De-Registration.

11.4.2 ePDG / Trusted Non-3GPP Access procedures

In PMIPv6 mode, the ePDG or Trusted Non-3GPP Access shall follow the MAG procedure for the PMIPv6 MAG Initiated PDN Connection Deletion repeated for each PDN connection of the UE.

11.4.3 Serving GW procedures

In PMIPv6 mode, the Serving GW shall follow:

- the LMA procedure for the PMIPv6 MAG Initiated PDN Connection Deletion on the S2a/S2b interface.
- the MAG procedure for the PMIPv6 MAG Initiated PDN Connection Deletion on the S8 interface.

11.5 UE Initiated Connectivity to Additional PDN procedures

11.5.1 General

11.5.2 ePDG / Trusted Non-3GPP Access procedures

In PMIPv6 mode, the ePDG or Trusted Non-3GPP Access shall follow the MAG procedure for the PMIPv6 PDN Connection Creation if the Request Type indicates "initial attach", or the PMIPv6 PDN Connection Handover if the Request Type indicates "Handover". In addition to the general procedure, it shall include the PDN GW IP address received during the authorization procedure into the PBU request, encoding it to the Vendor-Specific Option (refer to clause 12.1.1.4).

11.5.3 Serving GW procedures

In PMIPv6 mode, the Serving GW shall follow:

- the LMA procedure for the PMIPv6 PDN Connection Creation if the Request Type indicates "initial attach", or the PMIPv6 PDN Connection Handover if the Request Type indicates "Handover" on the S2a/S2b interface. In addition to the general procedure, the Serving GW shall include the PDN GW IP address received in the PBU request into the PBA, using the same encoding (refer to clause 12.1.1.4).
- the MAG procedure for the PMIPv6 PDN Connection Creation if the Request Type indicates "initial attach", or the PMIPv6 PDN Connection Handover if the Request Type indicates "Handover" on the S8 interface. The Serving GW shall send the PBU request to the PDN GW IP address received on the chained S2a / S2b interface.

11.6 3GPP Access to Trusted / Untrusted Non-3GPP IP Access Handover procedures without optimization

11.6.1 General

11.6.2 ePDG / Trusted Non-3GPP Access procedures

In PMIPv6 mode, the ePDG or Trusted Non-3GPP Access shall follow the MAG procedure for the PMIPv6 PDN Connection Handover. In addition to the general procedure, it shall include the PDN GW IP address received during the authorization procedure into the PBU request, encoding it to the Vendor-Specific Option (refer to clause 12.1.1.4).

11.6.3 Serving GW procedures

In PMIPv6 mode, the Serving GW shall follow:

- the LMA procedure for the PMIPv6 PDN Connection Handover on the S2a/S2b interface. In addition to the general procedure, the Serving GW shall include the PDN GW IP address received in the PBU request into the PBA, using the same encoding (refer to clause 12.1.1.4).
- the MAG procedure for the PMIPv6 PDN Connection Handover on the S8 interface. The Serving GW shall send the PBU request to the PDN GW IP address received on the chained S2a / S2b interface.

11.7 UE Requested PDN Disconnection procedures

11.7.1 General

11.7.2 ePDG / Trusted Non-3GPP Access procedures

In PMIPv6 mode, the ePDG or Trusted Non-3GPP Access shall follow the MAG procedure for the PMIPv6 MAG Initiated PDN Connection Deletion, for the selected PDN connection.

11.7.3 Serving GW procedures

In PMIPv6 mode, the Serving GW shall follow:

- the LMA procedure for the PMIPv6 MAG Initiated PDN Connection Deletion, for the selected PDN connection on the S2a/S2b interface.
- the MAG procedure for the PMIPv6 MAG Initiated PDN Connection Deletion, for the selected PDN connection on the S8 interface.

11.8 PDN GW Initiated Resource Allocation Deactivation procedures

11.8.1 General

11.8.2 ePDG / Trusted Non-3GPP Access procedures

In PMIPv6 mode, the ePDG or Trusted Non-3GPP Access shall follow the MAG procedure for the PMIPv6 LMA Initiated PDN Connection Deletion.

11.8.3 Serving GW procedures

In PMIPv6 mode, the Serving GW shall follow:

- the MAG procedure for the PMIPv6 LMA Initiated PDN Connection Deletion on the S8 interface.
- the LMA procedure for the PMIPv6 LMA Initiated PDN Connection Deletion on the S2a/S2b interface.

12 Information Elements

12.1 Additional Proxy Mobile IPv6 Information Elements

12.1.1 3GPP-Specific PMIPv6 Information Elements

12.1.1.0 General

This specification requires the encoding of additional 3GPP-specific Information Elements for PMIPv6 with the 3GPP Mobility Option, as defined by 3GPP TS 29.282 [24]. The 3GPP specific Information Elements defined by this specification are listed in the table 12.1.1.0-1.

Table 12.1.1.0-1: 3GPP Specific PMIPv6 Information Elements

3GPP Specific PMIPv6 Information eElement	3GPP Specific PMIPv6 Information Element Description
Protocol Configuration Options	3GPP PCO data, in the format from 3GPP TS 24.008 [16] subclause 10.5.6.3
3GPP Specific PMIPv6 error code	3GPP Vendor-Specific PMIPv6 error code, as specified in subclause 12.1.1.1
PDN GW IP address	PDN GW IP address, as specified in subclause 12.1.1.4
DHCPv4 Address Allocation Procedure Indication	DHCPv4 Address Allocation Procedure Indication, as specified in subclause 12.1.1.5.
Fully Qualified PDN Connection Set Identifier	FQ-CSID as specified in subclause 12.1.1.2
PDN Type Indication	PDN type indication as specified in subclause 12.1.1.3
Charging ID	Charging ID as specified in subclause 12.1.1.6
Selection Mode	Selection Mode as specified in subclause 12.1.1.7
Charging Characteristics	Subclause 12.1.1.8
Serving Network	Subclause 12.1.1.9
Mobile Equipment Identity	Subclause 12.1.1.10
MSISDN	Subclause 12.1.1.11
APN Restriction	Subclause 12.1.1.12
Maximum APN Restriction	Subclause 12.1.1.13

Depending on the need for 3GPP-specific information content, there several items of this information element may be added to the PBU, PBA, BRI, or BRA.

The subtype for a 3GPP specific PMIPv6 Information Element is defined in 3GPP TS 29.282 [24]. The data format of the 3GPP specific PMIPv6 Information Element is defined in this specification. If the data format is defined by another specification, that specification shall be referenced in the table above.

12.1.1.1 3GPP Specific PMIPv6 error code

The purpose of the 3GPP Specific PMIPv6 error code information element is to carry an additional PMIPv6 error code which is relevant to 3GPP.

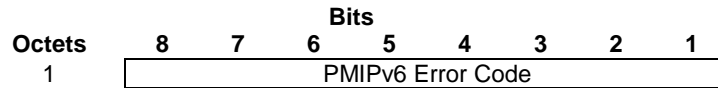

Figure 12.1.1.1-1: 3GPP Specific PMIPv6 error code

The 3GPP Specific PMIPv6 Error Codes are used in Proxy Binding Acknowledgement message and Binding Revocation Acknowledgement message. The 3GPP Specific PMIPv6 Error Code uses the GTPv2 Cause Value name space as defined in 3GPP TS 29.274 [22]. The GTPv2 cause values applicable as 3GPP Specific PMIPv6 Error Code are listed in table 12.1.1.1-1. 3GPP TS 29.274 [22] reserves a PMIP Cause Value range for the 3GPP Specific PMIPv6 Error Codes defined in table 12.1.1.1-2.

Table 12.1.1.1-1: GTPv2 Cause Value applicable as 3GPP Specific PMIPv6 Error Code

GTPv2 Cause Value
Mandatory IE incorrect
Mandatory IE missing
Optional IE incorrect
No memory is available
Missing or unknown APN
APN access denied – no subscription
GRE key not found

Table 12.1.1.1-2: Other 3GPP Specific PMIPv6 Error Code

Error Code	Value
MISSING_TIMESTAMP_OPTION	220
MULTIPLE_HNP_NOT_ALLOWED	221

12.1.1.2 Fully Qualified PDN Connection Set Identifier (FQ-CSID)

A fully qualified PDN Connection Set Identifier (FQ-CSID) identifies a set of PDN connections belonging to an arbitrary number of UEs on a node such as a MME, SGW or PGW. The FQ-CSID is generated by the MAG, the LMA and any other node such as the MME for 3GPP access. It is generated for each new PDN connection, and it is used in case of partial node failure to identify the PDN connections associated with a Connection Set Identifier.

The FQ-CSID is coded as follows:

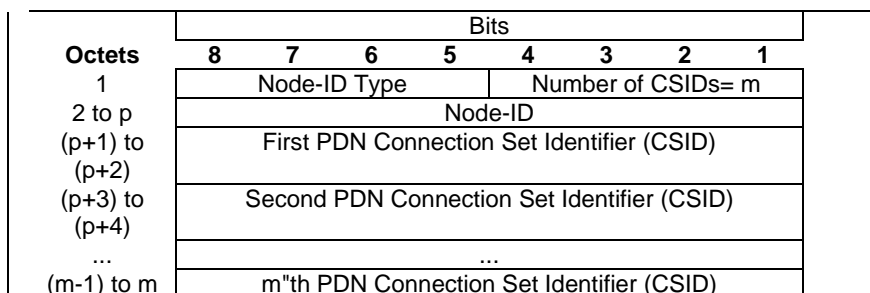

Figure 12.1.1.2-1: FQ-CSID

The details of each field and value are specified in 3GPP TS 29.274[22].

12.1.1.3 PDN Type Indication

The purpose of the PDN type indication option is to indicate the GW decision to change the PDN type and a cause for the change. This attribute is set by the LMA in the PBA.

The MAG shall set the PDN type accordingly, if this option is present in the PBA.

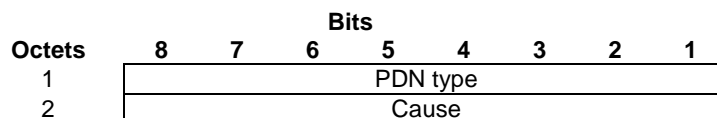

Figure 12.1.1.3-1: PMIPv6 PDN type indication

The following defines the value of the PMIPv6 PDN type indication.

PDN type value	
#1:	IPv4
#2:	IPv6
Cause value as defined in 3GPP TS 29.274[13]	
#18:	New PDN type due to network preference;

12.1.1.4 PDN GW IP address

The purpose of the PDN GW IP address information element is to carry the IP address of the PDN GW to which the receiving Serving GW shall send a PBU on the chained S8 interface. This information element shall be included only in a PBU for initial attach or handover sent on S2a or S2b interface for S2a/S2b - PMIP based S8 chaining scenario. The content and encoding of the PDN GW IP address is depicted on Figure 12.1.1.4-1.

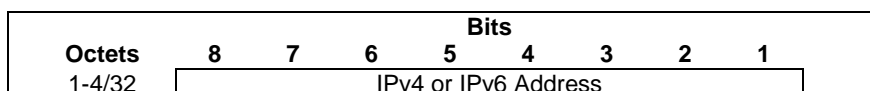

Figure 12.1.1.4-1: PDN GW IP Address

12.1.1.5 DHCPv4 Address Allocation Procedure Indication

The purpose of the DHCPv4 Address Allocation option is to indicate that DHCPv4 is to be used in allocating the IPv4 address to the UE if the option is present in the PBA message.

12.1.1.6 Charging ID

The Charging ID is defined in figure 12.1.1.6-1.

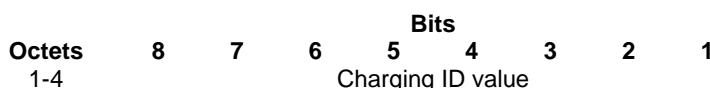

Figure 12.1.1.6-1: Charging ID

12.1.1.7 Selection Mode

Selection Mode indicates the way the MME or SGSN selected the APN: whether a subscribed APN was selected, or whether a non-subscribed APN sent by a UE or a non-subscribed APN chosen by the SGSN was selected. The Selection Mode is defined in 3GPP TS 23.060 [23]

The encoding of the Selection Mode is shown in Figure 12.1.1.7-1.

Octets	Bits							
	8	7	6	5	4	3	2	1
1	Reserved						Selection Mode	

Figure 12.1.1.7-1: Selection mode

The reserved bits shall be set to 1 by the MAG and not processed by the LMA.

The defined Selection Mode values are shown in Table 12.1.17-1.

Table 12.1.1.7-1: Selection Mode

Value	Selection mode value
0	MS or network provided APN, subscribed verified
1	MS provided APN, subscription not verified
2	Network provided APN, subscription not verified
3	For future use. Shall not be sent. If received, shall be interpreted as the value '2'.

12.1.1.8 Charging Characteristics

The Charging Characteristics information element is defined in 3GPP TS 32.251 [25] and is a way of informing both the SGW and PGW of the rules for producing charging information based on operator configured triggers. For the encoding of this information element see 3GPP TS 32.298 [26].

The Charging Characteristics is defined in figure 12.1.1.8-1.

Octets	Bits							
	8	7	6	5	4	3	2	1
1-2	Charging Characteristics value							

Figure 12.1.1.8-1: Charging Characteristics

12.1.1.9 Serving Network

Serving Network identifies the serving network the UE is attached to. The format of the Serving Network 3GPP-specific Information Element is defined below.

Octets	Bits							
	8	7	6	5	4	3	2	1
1	MCC digit 2				MCC digit 1			
2	MNC digit 3				MCC digit 3			
3	MNC digit 2				MNC digit 1			

Figure 12.1.1.9-1

12.1.1.10 Mobile Equipment Identity

The purpose of the Mobile Equipment Identity (MEI) information element is used to convey the UE's terminal identity from the Serving GW to the PDN GW over the S5/S8 interface.

The encoding of the MEI is depicted in Figure 12.1.1.10-1.

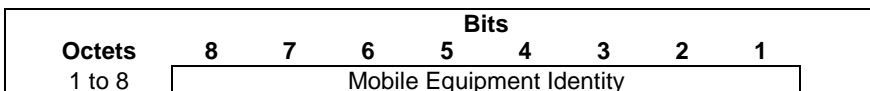

Figure 12.1.1.10-1: Mobile Equipment Identity (MEI)

The MEI contains either the IMEI or IMEISV in the format defined in subclause 6.2 of 3GPP TS 23.003 [12].

The MEI shall contain the IMEISV if it is available. If only the IMEI is available, then the last semi-octet of octet 8 of MEI shall be set to "1111". Both IMEI and IMEISV are TBCD encoded, where IMEI is 15 BCD digits and IMEISV is 16 BCD digits. Bits 5 to 8 of octet n encodes digit 2n, bits 1 to 4 of octet n encodes digit 2n-1. Digits are packed contiguously with no internal padding.

NOTE: This encoding follows that of the IMEI(SV) field in the International Mobile Equipment Identity (and Software Version) (IMEI(SV)) information element defined in clause 7.7.53 of 3GPP TS 29.060 [28].

12.1.1.11 MSISDN

The purpose of the MSISDN information element is used to convey the user's MSISDN from the Serving GW to the PDN GW over the S5/S8 interface. MSISDN is defined in 3GPP TS 23.003 [12].

The content and encoding of the MSISDN is depicted on Figure 12.1.1.11-1.

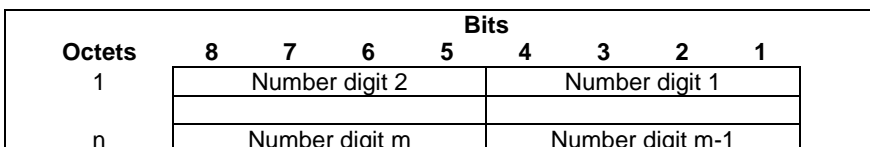

Figure 12.1.1.11-1: MSISDN

Octets 1 to n represent the MSISDN value in international number format as described in ITU-T Rec E.164 [29], encoded as TBCD digits, i.e. digits from 0 through 9 are encoded "0000" to "1001". When there is an odd number of digits, bits 8 to 5 of the last octet are encoded with the filler "1111".

12.1.1.12 APN Restriction

The APN Restriction is defined in figure 12.1.1.12-1. The APN Restriction value is specified in 3GPP TS 29.274 [22].

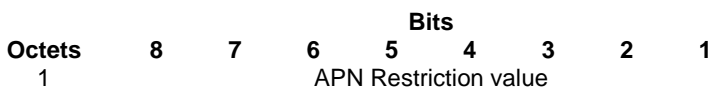

Figure 12.1.1.12-1: APN Restriction

12.1.1.13 Maximum APN Restriction

The Maximum APN Restriction is defined in figure 12.1.1.13-1. The Maximum APN Restriction value is specified in 3GPP TS 29.274 [22].

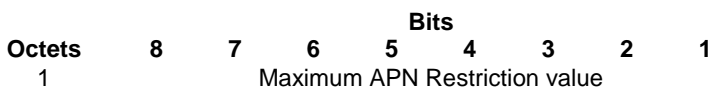

Figure 12.1.1.13-1: Maximum APN Restriction

Annex A (informative): Error Code mapping table

This table is used in SGW for mapping between GTP Cause and PMIPv6 Status in case S5/S8 is based on PMIPv6 protocol.

Table A-1: Error Code Mapping Table

GTP Cause	PMIPv6 Status
No resources available	Insufficient resources
Service not supported	PROXY_REG_NOT_ENABLED NOT_LMA_FOR_THIS_MOBILE_NODE MAG_NOT_AUTHORIZED_FOR_PROXY_REG
Mandatory IE incorrect	TIMESTAMP_MISMATCH TIMESTAMP_LOWER_THAN_PREV_ACCEPTED
Mandatory IE missing	MISSING_HOME_NETWORK_PREFIX_OPTION MISSING_MN_IDENTIFIER_OPTION MISSING_HANDOFF_INDICATOR_OPTION MISSING_ACCESS_TECH_TYPE_OPTION
User authentication failed	NOT_AUTHORIZED_FOR_HOME_NETWORK_PREFIX
Context not found	BCE_PBU_PREFIX_SET_DO_NOT_MATCH

Annex B (informative): Change History

Change history							
Date	TSG #	TSG Doc.	CR	Rev	Subject/Comment	Old	New
2008-09	CT#41	CP-080476			V2.0.0 approved in CT#41	2.0.0	8.0.0
2008-12	CT#42	CP-080692	0002		IPv4 Address Acknowledgement option in PBA	8.0.0	8.1.0
		CP-080692	0006	2	IPv4 Address Deletion		
		CP-080692	0007		PDN-GW Initiated Resource Allocation Deactivation		
		CP-080692	0008	2	PDNType-IP Address Option		
		CP-080692	0009	4	PMIP Bulk Revocation Support.		
		CP-080692	0010	1	Link local address		
		CP-080692	0011		Service selection option in the PBA message		
		CP-080692	0012	4	PMIP IPv4 address allocation		
		CP-080692	0019		Interface Id in PBA at HO case		
		CP-080692	0022		Clarification to subclause PMIP6 LMA Initiated PDN Connection Deletion Procedure		
		CP-080692	0023		Update references to latest version of IETF documents		
		CP-080692	0025		Putting back GSM logo on front page		
		CP-080692	0026		PMIPv6 Heartbeat/Path Management Update		
		CP-080692	0031		PMIPv6 clarification		
		CP-080692	0033		Optimized E-UTRAN to CDMA2000 HRPD Handover procedure cleanup		
		CP-080692	0036	1	IPv4-UDP encapsulation option		
		CP-080692	0037	2	S5/S8 procedure corrections		
		CP-080692	0038	1	S2a procedure corrections		
		CP-080692	0039		S2b procedure corrections		
		CP-080692	0040	1	Chaining case procedure corrections		
		CP-080692	0042	1	DHCPv4 Address Allocation 3GPP VSO		
		CP-080692	0043	1	PDN type indicator		
		CP-080692	0044		FFS cleanup		
		CP-080692	0045		HI FFS cleanup		
		CP-080692	0046		Clean up on BULE and BCE		
		CP-080692	0047	2	Clarification on PMIPv6 Protocol Stack		
		CP-080692	0048	3	Modifications for S2a/S2b - PMIP based S8 chaining		
2009-03	CT#43	CP-090052	0054	1	3GPP VSO PDN type cause value	8.1.0	8.2.0
		CP-090052	0055		3GPP VSO DHCPv4 Address Allocation Procedure Indication		
		CP-090052	0056	1	3GPP VSO PMIP error code missing in PBA and BRA		
		CP-090052	0059	1	3GPP VSO PCO in PBU/PBA message		
		CP-090052	0061	1	Old BCE is lost at handover		
		CP-090052	0062	2	Partial Node Failure		
		CP-090052	0064	2	Alignments of cause codes		
		CP-090052	0065	4	UE specific Error Indication		
		CP-090052	0066		Clarification on Heartbeat Request Message		
		CP-090052	0071	2	Link-local Address Option		
		CP-090052	0072	1	IPv4 Deferred Address Allocation and PDN Type		
		CP-090052	0073	3	PMIP VSO Charging ID		
		CP-090052	0074	1	ATT Values for PMIP base S5/S8		
		CP-090052	0077		Detach or PDN Disconnection		
		CP-090052	0079		Status Field update		
		CP-090052	0080	1	Correction to tunnel management		
		CP-090052	0085	2	Carrying APN selection mode in PMIP		
		CP-090271	0086	6	Removing 3GPP Vendor Specific Mobility Option format		
2009-04					Correction to history table	8.2.0	8.2.1
2009-06	CT#44	CP-090290	0090	2	PMIP VSO Charging Characteristics	8.2.1	8.3.0
		CP-090290	0092		PDN Type Cause Value		
		CP-090290	0093	1	UE Requested additional PDN Connectivity Procedure		
		CP-090290	0094	1	IP address allocation Procedure		
		CP-090290	0095	1	FQ-CSID		
		CP-090290	0097	2	Timestamp		
		CP-090290	0098	2	Serving Network VSO in PBU		
		CP-090290	0099		GRE Key usage in PDN Connection Lifetime Extension		
		CP-090290	0101	3	PMIPv6 messages transport over IPv4		
		CP-090290	0102	3	PDN Type for PMIPv6		
		CP-090290	0106	2	Carrying MEI over PMIP based S5/S8		
		CP-090290	0107	2	Carrying MSISDN over PMIP based S5/S8		
		CP-090290	0109	2	Access technology type to be used by ePDG		
		CP-090290	0110	1	Binding Revocation Indication		
2009-09	CT#45	CP-090538	0114	1	APN Restriction for PMIPv6	8.3.0	8.4.0
		CP-090538	0116		The IPv4 address allocation procedure		

		CP-090538	0117	1	Clean up on 3GPP Specific PMIPv6 Error Code		
		CP-090538	0118	1	GRE Key usage in PDN Connection Lifetime Extension		
		CP-090538	0120	1	Defining values for 3GPP specific PMIPv6 error code		
		CP-090538	0121	1	Conditional 3GPP specific PMIPv6 information elements		
		CP-090538	0122	1	Reintroducing specific 3GPP Access Technology Types		
		CP-090538	0124	1	Clarifications for HO 3GPP to non-3GPP		
		CP-090538	0125	2	Default MTU size to avoid IP fragmentation in EPS		
		CP-090538	0126	1	Heartbeat Mechanism condition for path failure detection		
		CP-090538	0127	2	Correct on GRE key assignment		
		CP-090538	0128	1	E-UTRAN to HRPD optimized handover		
		CP-090538	0130	2	The revision of LMA's dynamic IP address allocation in handover procedure		
		CP-090729	0131	1	Partial failure handling alignment with stage 2		
		CP-090729	0132	3	Partial failure handling for S1 based handovers		
2009-12	CT#46	CP-090971	0133	5	UE-specific Error Indication	8.4.0	8.5.0
		CP-090775	0139	1	IPv4 Address Release for PMIPv6 based S2a		
		CP-090775	0140	2	Correct IPv4 Home Address Reply option IE name		
		CP-090775	0142	3	Clarification on Heartbeat Mechanism		
		CP-090775	0143		FFS Cleanup for Service Selection Mobility Option		
		CP-090775	0144	1	IPv4 Default-Router Address option		
		CP-090775	0145	1	Clarifications on the format of Mobile Node Identifier option		
		CP-090775	0146	1	Removing access type mapping table from annex B		
		CP-090775	0152	1	Clarifications on the format of Service Selection Mobility Option		
		CP-090775	0154		Correct fields of revocation message		
2010-03	CT#47	CP-100026	0156	1	Correction of the UE-specific Error Indication	8.5.0	8.6.0
		CP-100026	0158	1	Bulk Binding Recovation Indication		
		CP-100026	0160		FQ-CSID option		
2010-06	CT#48	CP-100265	0166		Cause Mapping	8.6.0	8.7.0

History

Document history		
V8.1.0	January 2009	Publication
V8.2.1	April 2009	Publication
V8.3.0	June 2009	Publication
V8.4.0	October 2009	Publication
V8.5.0	January 2010	Publication
V8.6.0	April 2010	Publication
V8.7.0	June 2010	Publication