

# ETSI TS 129 274 V17.9.0 (2023-07)



**Universal Mobile Telecommunications System (UMTS);  
LTE;  
5G;  
3GPP Evolved Packet System (EPS);  
Evolved General Packet Radio Service (GPRS)  
Tunnelling Protocol for Control plane (GTPv2-C);  
Stage 3  
(3GPP TS 29.274 version 17.9.0 Release 17)**



---

**Reference**

RTS/TSGC-0429274vh90

---

**Keywords**

5G,LTE,UMTS

**ETSI**

650 Route des Lucioles  
F-06921 Sophia Antipolis Cedex - FRANCE

---

Tel.: +33 4 92 94 42 00 Fax: +33 4 93 65 47 16

Siret N° 348 623 562 00017 - APE 7112B  
Association à but non lucratif enregistrée à la  
Sous-Préfecture de Grasse (06) N° w061004871

---

**Important notice**

The present document can be downloaded from:

<https://www.etsi.org/standards-search>

The present document may be made available in electronic versions and/or in print. The content of any electronic and/or print versions of the present document shall not be modified without the prior written authorization of ETSI. In case of any existing or perceived difference in contents between such versions and/or in print, the prevailing version of an ETSI deliverable is the one made publicly available in PDF format at [www.etsi.org/deliver](http://www.etsi.org/deliver).

Users of the present document should be aware that the document may be subject to revision or change of status.

Information on the current status of this and other ETSI documents is available at

<https://portal.etsi.org/TB/ETSIDeliverableStatus.aspx>

If you find errors in the present document, please send your comment to one of the following services:

<https://portal.etsi.org/People/CommitteeSupportStaff.aspx>

If you find a security vulnerability in the present document, please report it through our  
Coordinated Vulnerability Disclosure Program:

<https://www.etsi.org/standards/coordinated-vulnerability-disclosure>

---

**Notice of disclaimer & limitation of liability**

The information provided in the present deliverable is directed solely to professionals who have the appropriate degree of experience to understand and interpret its content in accordance with generally accepted engineering or other professional standard and applicable regulations.

No recommendation as to products and services or vendors is made or should be implied.

No representation or warranty is made that this deliverable is technically accurate or sufficient or conforms to any law and/or governmental rule and/or regulation and further, no representation or warranty is made of merchantability or fitness for any particular purpose or against infringement of intellectual property rights.

In no event shall ETSI be held liable for loss of profits or any other incidental or consequential damages.

Any software contained in this deliverable is provided "AS IS" with no warranties, express or implied, including but not limited to, the warranties of merchantability, fitness for a particular purpose and non-infringement of intellectual property rights and ETSI shall not be held liable in any event for any damages whatsoever (including, without limitation, damages for loss of profits, business interruption, loss of information, or any other pecuniary loss) arising out of or related to the use of or inability to use the software.

---

**Copyright Notification**

No part may be reproduced or utilized in any form or by any means, electronic or mechanical, including photocopying and microfilm except as authorized by written permission of ETSI.

The content of the PDF version shall not be modified without the written authorization of ETSI.

The copyright and the foregoing restriction extend to reproduction in all media.

© ETSI 2023.  
All rights reserved.

---

# Intellectual Property Rights

## Essential patents

IPRs essential or potentially essential to normative deliverables may have been declared to ETSI. The declarations pertaining to these essential IPRs, if any, are publicly available for **ETSI members and non-members**, and can be found in ETSI SR 000 314: "*Intellectual Property Rights (IPRs); Essential, or potentially Essential, IPRs notified to ETSI in respect of ETSI standards*", which is available from the ETSI Secretariat. Latest updates are available on the ETSI Web server (<https://ipr.etsi.org/>).

Pursuant to the ETSI Directives including the ETSI IPR Policy, no investigation regarding the essentiality of IPRs, including IPR searches, has been carried out by ETSI. No guarantee can be given as to the existence of other IPRs not referenced in ETSI SR 000 314 (or the updates on the ETSI Web server) which are, or may be, or may become, essential to the present document.

## Trademarks

The present document may include trademarks and/or tradenames which are asserted and/or registered by their owners. ETSI claims no ownership of these except for any which are indicated as being the property of ETSI, and conveys no right to use or reproduce any trademark and/or tradename. Mention of those trademarks in the present document does not constitute an endorsement by ETSI of products, services or organizations associated with those trademarks.

**DECT™**, **PLUGTESTS™**, **UMTS™** and the ETSI logo are trademarks of ETSI registered for the benefit of its Members. **3GPP™** and **LTE™** are trademarks of ETSI registered for the benefit of its Members and of the 3GPP Organizational Partners. **oneM2M™** logo is a trademark of ETSI registered for the benefit of its Members and of the oneM2M Partners. **GSM®** and the GSM logo are trademarks registered and owned by the GSM Association.

---

# Legal Notice

This Technical Specification (TS) has been produced by ETSI 3rd Generation Partnership Project (3GPP).

The present document may refer to technical specifications or reports using their 3GPP identities. These shall be interpreted as being references to the corresponding ETSI deliverables.

The cross reference between 3GPP and ETSI identities can be found under <https://webapp.etsi.org/key/queryform.asp>.

---

# Modal verbs terminology

In the present document "**shall**", "**shall not**", "**should**", "**should not**", "**may**", "**need not**", "**will**", "**will not**", "**can**" and "**cannot**" are to be interpreted as described in clause 3.2 of the [ETSI Drafting Rules](#) (Verbal forms for the expression of provisions).

"**must**" and "**must not**" are **NOT** allowed in ETSI deliverables except when used in direct citation.

# Contents

Intellectual Property Rights .....	2
Legal Notice .....	2
Modal verbs terminology.....	2
Foreword.....	11
1 Scope .....	13
2 References .....	13
3 Definitions, symbols and abbreviations .....	17
3.1 Definitions .....	17
3.2 Symbols.....	17
3.3 Abbreviations .....	17
4 General .....	19
4.1 GTP Tunnel .....	19
4.2 Protocol stack .....	19
4.2.0 General.....	19
4.2.1 UDP header and port numbers .....	20
4.2.1.0 General .....	20
4.2.1.1 Initial Messages.....	21
4.2.1.2 Triggered Messages .....	21
4.2.1.3 Piggybacked Messages.....	21
4.2.2 IP header and IP addresses.....	21
4.2.2.1 Initial Messages.....	21
4.2.2.2 Triggered Messages .....	22
4.2.2.3 Piggybacked Messages.....	23
4.2.3 Layer 2 .....	23
4.2.4 Layer 1 .....	23
4.2.5 Messages with GTPv2 defined replies: Classification of Initial and Triggered Messages .....	23
4.3 Transmission Order and Bit Definitions.....	24
5 GTP Header for Control Plane .....	24
5.1 General format.....	24
5.2 Control Plane GTP Extension Header .....	24
5.3 GTP-C header for Echo and Version Not Supported Indication messages .....	24
5.4 EPC specific GTP-C header .....	25
5.5 Usage of the GTPv2-C Header.....	25
5.5.1 General.....	25
5.5.2 Conditions for sending TEID=0 in GTPv2-C header .....	26
5.6 Format of the GTPv2-C Message .....	28
6 GTP-C Message Types and Message Formats .....	29
6.0 General .....	29
6.1 Message Format and Type values .....	29
6.1.0 Message Type .....	29
6.1.1 Presence requirements of Information Elements .....	33
6.1.2 Grouped Information Elements.....	34
6.1.3 Information Element instance .....	35
6.2 Message Granularity.....	35
7 GTP-C messages .....	36
7.1 Path Management Messages.....	36
7.1.0 General.....	36
7.1.1 Echo Request .....	36
7.1.2 Echo Response.....	37
7.1.3 Version Not Supported Indication .....	37
7.2 Tunnel Management Messages .....	37
7.2.0 General.....	37

7.2.1	Create Session Request .....	37
7.2.2	Create Session Response .....	61
7.2.3	Create Bearer Request .....	75
7.2.4	Create Bearer Response .....	84
7.2.5	Bearer Resource Command .....	89
7.2.6	Bearer Resource Failure Indication .....	92
7.2.7	Modify Bearer Request .....	95
7.2.8	Modify Bearer Response .....	118
7.2.9	Delete Session Request and Delete Bearer Request .....	125
7.2.9.1	Delete Session Request .....	125
7.2.9.2	Delete Bearer Request .....	131
7.2.10	Delete Session Response and Delete Bearer Response .....	140
7.2.10.1	Delete Session Response .....	140
7.2.10.2	Delete Bearer Response .....	144
7.2.11	Downlink Data Notification messages .....	148
7.2.11.1	Downlink Data Notification .....	148
7.2.11.2	Downlink Data Notification Acknowledge .....	152
7.2.11.3	Downlink Data Notification Failure Indication .....	154
7.2.12	Delete Indirect Data Forwarding Tunnel Request .....	154
7.2.13	Delete Indirect Data Forwarding Tunnel Response .....	155
7.2.14	Modify Bearer Command and Failure Indication .....	156
7.2.14.1	Modify Bearer Command .....	156
7.2.14.2	Modify Bearer Failure Indication .....	158
7.2.15	Update Bearer Request .....	160
7.2.16	Update Bearer Response .....	169
7.2.17	Delete Bearer Command and Failure Indication .....	174
7.2.17.1	Delete Bearer Command .....	174
7.2.17.2	Delete Bearer Failure Indication .....	176
7.2.18	Create Indirect Data Forwarding Tunnel Request .....	179
7.2.19	Create Indirect Data Forwarding Tunnel Response .....	182
7.2.20	Void .....	184
7.2.21	Release Access Bearers Request .....	184
7.2.22	Release Access Bearers Response .....	185
7.2.23	Stop Paging Indication .....	187
7.2.24	Modify Access Bearers Request .....	187
7.2.25	Modify Access Bearers Response .....	191
7.2.26	Remote UE Report Notification .....	194
7.2.27	Remote UE Report Acknowledge .....	195
7.3	Mobility Management Messages .....	195
7.3.1	Forward Relocation Request .....	195
7.3.2	Forward Relocation Response .....	212
7.3.3	Forward Relocation Complete Notification .....	215
7.3.4	Forward Relocation Complete Acknowledge .....	216
7.3.5	Context Request .....	217
7.3.6	Context Response .....	220
7.3.7	Context Acknowledge .....	234
7.3.8	Identification Request .....	237
7.3.9	Identification Response .....	238
7.3.10	Forward Access Context Notification .....	239
7.3.11	Forward Access Context Acknowledge .....	240
7.3.12	Detach Notification .....	240
7.3.13	Detach Acknowledge .....	241
7.3.14	Change Notification Request .....	242
7.3.15	Change Notification Response .....	245
7.3.16	Relocation Cancel Request .....	246
7.3.17	Relocation Cancel Response .....	247
7.3.18	Configuration Transfer Tunnel .....	247
7.3.19	RAN Information Relay .....	249
7.3.20	ISR Status Indication .....	249
7.3.21	UE Registration Query Request .....	250
7.3.22	UE Registration Query Response .....	250
7.4	CS Fallback and SRVCC related messages .....	251

7.4.1	Suspend Notification.....	251
7.4.2	Suspend Acknowledge.....	252
7.4.3	Resume Notification .....	253
7.4.4	Resume Acknowledge .....	254
7.4.5	CS Paging Indication .....	254
7.4.6	Alert MME Notification .....	255
7.4.7	Alert MME Acknowledge .....	255
7.4.8	UE Activity Notification.....	255
7.4.9	UE Activity Acknowledge.....	256
7.5	Non-3GPP access related messages .....	256
7.5.1	Create Forwarding Tunnel Request .....	256
7.5.2	Create Forwarding Tunnel Response.....	256
7.6	Reliable Delivery of Signalling Messages.....	257
7.7	Error Handling.....	258
7.7.0	Handling Piggybacked Messages .....	258
7.7.1	Protocol Errors.....	258
7.7.2	Different GTP Versions .....	259
7.7.3	GTP Message of Invalid Length.....	259
7.7.4	Unknown GTP Message .....	259
7.7.5	Unexpected GTP Message.....	259
7.7.6	Missing Information Elements.....	260
7.7.7	Invalid Length Information Element .....	260
7.7.8	Semantically incorrect Information Element .....	261
7.7.9	Unknown or unexpected Information Element .....	261
7.7.10	Repeated Information Elements.....	262
7.7.11	TFT Error Handling .....	262
7.8	Path Failure .....	262
7.9	Restoration and Recovery .....	262
7.9.0	General.....	262
7.9.1	Delete PDN Connection Set Request.....	262
7.9.2	Delete PDN Connection Set Response .....	263
7.9.3	Update PDN Connection Set Request.....	263
7.9.4	Update PDN Connection Set Response .....	264
7.9.5	PGW Restart Notification.....	264
7.9.6	PGW Restart Notification Acknowledge.....	264
7.9.7	PGW Downlink Triggering Notification .....	265
7.9.8	PGW Downlink Triggering Acknowledge .....	265
7.10	Fallback to GTPv1 mechanism .....	266
7.11	Fallback to GTPv0.....	266
7.12	Trace Management Messages.....	267
7.12.1	Trace Session Activation .....	267
7.12.2	Trace Session Deactivation.....	268
7.13	MBMS Messages .....	269
7.13.1	MBMS Session Start Request.....	269
7.13.2	MBMS Session Start Response .....	270
7.13.3	MBMS Session Update Request.....	271
7.13.4	MBMS Session Update Response .....	272
7.13.5	MBMS Session Stop Request .....	272
7.13.6	MBMS Session Stop Response.....	272
8	GTP-C Information Elements .....	273
8.1	Information Element Types .....	273
8.2	Information Element Format .....	277
8.2.1	General.....	277
8.2.1A	Information Element with an IE Type Extension field .....	278
8.2.2	Handling ASN.1/PER encoded parameters .....	278
8.3	International Mobile Subscriber Identity (IMSI).....	278
8.4	Cause .....	279
8.5	Recovery (Restart Counter).....	286
8.6	Access Point Name (APN).....	287
8.7	Aggregate Maximum Bit Rate (AMBR) .....	287
8.8	EPS Bearer ID (EBI).....	287

8.9	IP Address .....	288
8.10	Mobile Equipment Identity (MEI).....	288
8.11	MSISDN.....	288
8.12	Indication.....	289
8.13	Protocol Configuration Options (PCO).....	294
8.14	PDN Address Allocation (PAA) .....	295
8.15	Bearer Quality of Service (Bearer QoS).....	296
8.16	Flow Quality of Service (Flow QoS).....	296
8.17	RAT Type.....	297
8.18	Serving Network .....	298
8.19	EPS Bearer Level Traffic Flow Template (Bearer TFT).....	298
8.20	Traffic Aggregate Description (TAD).....	299
8.21	User Location Information (ULI).....	299
8.21.1	CGI field .....	299
8.21.2	SAI field .....	300
8.21.3	RAI field.....	300
8.21.4	TAI field.....	301
8.21.5	ECGI field.....	301
8.21.6	LAI field .....	301
8.21.7	Macro eNodeB ID field .....	301
8.21.8	Extended Macro eNodeB ID field .....	302
8.22	Fully Qualified TEID (F-TEID) .....	302
8.23	TMSI .....	304
8.24	Global CN-Id.....	304
8.25	S103 PDN Data Forwarding Info (S103PDF).....	305
8.26	S1-U Data Forwarding (S1UDF).....	305
8.27	Delay Value.....	306
8.28	Bearer Context.....	306
8.29	Charging ID.....	306
8.30	Charging Characteristics .....	306
8.31	Trace Information.....	307
8.32	Bearer Flags.....	307
8.33	Void.....	308
8.34	PDN Type.....	308
8.35	Procedure Transaction ID (PTI) .....	308
8.36	Void.....	309
8.37	Void.....	309
8.38	MM Context.....	309
8.39	PDN Connection .....	319
8.40	PDU Numbers .....	320
8.41	Packet TMSI (P-TMSI).....	320
8.42	P-TMSI Signature.....	321
8.43	Hop Counter .....	321
8.44	UE Time Zone .....	321
8.45	Trace Reference.....	322
8.46	Complete Request Message.....	322
8.47	GUTI .....	322
8.48	Fully Qualified Container (F-Container).....	323
8.49	Fully Qualified Cause (F-Cause).....	324
8.50	PLMN ID.....	325
8.51	Target Identification.....	326
8.51.1	General.....	326
8.51.2	RNC ID.....	326
8.51.3	Macro eNodeB ID.....	327
8.51.4	Home eNodeB ID .....	328
8.51.5	Extended Macro eNodeB ID.....	328
8.51.6	Cell Identifier.....	329
8.51.7	gNodeB ID.....	329
8.51.8	Macro ng-eNodeB ID .....	329
8.51.9	Extended Macro ng-eNodeB ID .....	330
8.51.10	en-gNB ID .....	330
8.52	Void.....	331

8.53	Packet Flow ID .....	331
8.54	RAB Context .....	331
8.55	Source RNC PDCP context info .....	332
8.56	Port Number .....	332
8.57	APN Restriction .....	332
8.58	Selection Mode .....	333
8.59	Source Identification .....	333
8.60	Void .....	334
8.61	Change Reporting Action .....	334
8.62	Fully qualified PDN Connection Set Identifier (FQ-CSID) .....	334
8.63	Channel needed .....	335
8.64	eMLPP Priority .....	335
8.65	Node Type .....	336
8.66	Fully Qualified Domain Name (FQDN) .....	336
8.67	Private Extension .....	337
8.68	Transaction Identifier (TI) .....	337
8.69	MBMS Session Duration .....	337
8.70	MBMS Service Area .....	338
8.71	MBMS Session Identifier .....	338
8.72	MBMS Flow Identifier .....	338
8.73	MBMS IP Multicast Distribution .....	338
8.74	MBMS Distribution Acknowledge .....	339
8.75	User CSG Information (UCI) .....	339
8.76	CSG Information Reporting Action .....	340
8.77	RFSP Index .....	341
8.78	CSG ID .....	341
8.79	CSG Membership Indication (CMI) .....	341
8.80	Service indicator .....	342
8.81	Detach Type .....	342
8.82	Local Distinguished Name (LDN) .....	343
8.83	Node Features .....	343
8.84	MBMS Time to Data Transfer .....	344
8.85	Throttling .....	345
8.86	Allocation/Retention Priority (ARP) .....	345
8.87	EPC Timer .....	346
8.88	Signalling Priority Indication .....	347
8.89	Temporary Mobile Group Identity (TMGI) .....	347
8.90	Additional MM context for SRVCC .....	347
8.91	Additional flags for SRVCC .....	348
8.92	Void .....	348
8.93	MDT Configuration .....	348
8.94	Additional Protocol Configuration Options (APCO) .....	349
8.95	Absolute Time of MBMS Data Transfer .....	350
8.96	H(e)NB Information Reporting .....	350
8.97	IPv4 Configuration Parameters (IP4CP) .....	350
8.98	Change to Report Flags .....	351
8.99	Action Indication .....	351
8.100	TWAN Identifier .....	352
8.101	ULI Timestamp .....	353
8.102	MBMS Flags .....	353
8.103	RAN/NAS Cause .....	354
8.104	CN Operator Selection Entity .....	355
8.105	Trusted WLAN Mode Indication .....	355
8.106	Node Number .....	356
8.107	Node Identifier .....	356
8.108	Presence Reporting Area Action .....	357
8.109	Presence Reporting Area Information .....	359
8.110	TWAN Identifier Timestamp .....	359
8.111	Overload Control Information .....	360
8.112	Load Control Information .....	360
8.113	Metric .....	360
8.114	Sequence Number .....	361



8.115	APN and Relative Capacity .....	361
8.116	WLAN Offloadability Indication .....	361
8.117	Paging and Service Information .....	362
8.118	Integer Number .....	362
8.119	Millisecond Time Stamp .....	363
8.120	Monitoring Event Information .....	363
8.122	Remote UE Context.....	364
8.123	Remote User ID.....	365
8.124	Remote UE IP Information.....	365
8.125	CIoT Optimizations Support Indication .....	365
8.126	SCEF PDN Connection .....	366
8.127	Header Compression Configuration .....	366
8.128	Extended Protocol Configuration Options (ePCO) .....	367
8.129	Serving PLMN Rate Control .....	368
8.130	Counter .....	368
8.131	Mapped UE Usage Type .....	368
8.132	Secondary RAT Usage Data Report.....	369
8.133	UP Function Selection Indication Flags .....	370
8.134	Maximum Packet Loss Rate.....	370
8.135	APN Rate Control Status.....	371
8.136	Extended Trace Information.....	371
8.137	Monitoring Event Extension Information.....	372
8.138	Additional RRM Policy Index.....	373
8.139	V2X Context .....	373
8.140	PC5 QoS Parameters .....	373
8.141	Services Authorized .....	374
8.142	Bit Rate.....	374
8.143	PC5 QoS Flow.....	374
8.144	SGi PtP Tunnel Address.....	375
8.145	PGW Change Info .....	376
8.146	PGW FQDN.....	376
8.147	Group Id .....	376
8.148	PSCell ID.....	377
8.149	UP Security Policy .....	377
8.150	Alternative IMSI .....	378
9	Security.....	378
10	IP - The Networking Technology used by GTP.....	378
10.1	IP Version.....	378
10.2	IP Fragmentation .....	378
10.3	DSCP.....	378
11	Notification of supported features between peer GTP-C entities.....	379
11.1	General .....	379
11.1.1	Introduction.....	379
11.1.2	Defining a feature .....	379
11.2	Dynamic discovery of supported features .....	379
11.2.1	General.....	379
11.2.2	Features supported by direct peer GTP-C entities .....	379
12	GTP-C load & overload control mechanism .....	380
12.1	General .....	380
12.1.1	GTP-C overload problem.....	380
12.1.2	Scenarios leading to overload .....	380
12.1.3	Load & overload control concepts.....	381
12.2	Load control solution.....	381
12.2.1	Principles of load control .....	381
12.2.2	Applicability to 3GPP and non-3GPP access based interfaces .....	382
12.2.3	Node level load control.....	382
12.2.4	APN level load control .....	383
12.2.4.1	General .....	383
12.2.4.2	Justifications for APN load control support.....	383

12.2.4.3	Elements of APN load control .....	383
12.2.5	Load Control Information .....	384
12.2.5.1	Definition .....	384
12.2.5.1.1	General description .....	384
12.2.5.1.2	Parameters .....	385
12.2.5.1.3	Handling of parameters .....	387
12.2.5.2	Frequency of inclusion .....	387
12.2.5.3	Limit on maximum number of instances .....	387
12.2.6	Discovery of the support of the feature by the peer node .....	388
12.2.7	Issues in the network with partial support of the feature .....	388
12.3	Overload control solution .....	388
12.3.1	Principles of overload control .....	388
12.3.2	Applicability to 3GPP and non-3GPP access based interfaces .....	389
12.3.3	Node level overload control .....	389
12.3.4	APN level overload control .....	390
12.3.4.1	General .....	390
12.3.4.2	Elements of APN overload control .....	390
12.3.5	Overload Control Information .....	390
12.3.5.1	Definition .....	390
12.3.5.1.1	General description .....	390
12.3.5.1.2	Parameters .....	391
12.3.5.1.3	Handling of parameters .....	393
12.3.5.2	Frequency of inclusion .....	394
12.3.5.3	Limit on maximum number of instances .....	394
12.3.6	Propagating the MME/S4-SGSN identity to the PGW .....	394
12.3.7	Updating the PGW with overload control information of the target MME/S4-SGSN .....	395
12.3.8	The interaction with APN congestion control using the PGW Back-Off Time .....	395
12.3.9	Message throttling .....	396
12.3.9.1	General .....	396
12.3.9.2	Throttling algorithm – "Loss" .....	396
12.3.9.2.1	Description .....	396
12.3.9.3	Message prioritization .....	396
12.3.9.3.1	Description .....	396
12.3.9.3.2	Based on procedures .....	397
12.3.9.3.3	Based on session parameters .....	398
12.3.9.3.4	Based on the Message Priority signalled in the GTP-C message .....	398
12.3.10	Enforcement of overload control .....	399
12.3.10.1	General .....	399
12.3.10.2	Aspects related to enforcement of the overload control .....	399
12.3.10.2.1	Good throughput of the network .....	399
12.3.10.2.2	Message processing efficiency at the source GTP-C entity .....	399
12.3.10.2.3	Self-protection by the overloaded GTP-C entity .....	399
12.3.10.3	Enforcement of overload control between GTP-C entities in direct contact .....	400
12.3.10.4	Enforcement of overload control between remote GTP-C entities .....	400
12.3.10.4.1	Description .....	400
12.3.11	Discovery of the support of the feature by the peer node .....	400
12.3.12	Issues in the network with partial support of the feature .....	400
12.3.13	Implicit overload control mechanisms .....	401
13	Detection and handling of late arriving requests .....	401
13.1	General .....	401
13.2	Detection and handling of requests which collide with an existing session context .....	401
13.2.1	General .....	401
13.2.2	Principles .....	401
13.3	Detection and handling of requests which have timed out at the originating entity .....	402
13.3.1	General .....	402
13.3.2	Principles .....	402
14	Handling of Bearer Contexts Mismatch .....	403
14.1	General .....	403
14.2	Detection of Bearer Context Mismatch .....	403
14.3	Handling of Bearer Context Mismatch .....	403

14.3.1	General.....	403
14.3.2	Exceptional scenarios .....	404
<b>Annex A (Informative):</b>	<b>Backward Compatibility Guidelines for Information Elements .....</b>	<b>405</b>
<b>Annex B (Informative):</b>	<b>Transparent copying of RANAP/S1AP/NGAP IEs into GTP IEs.....</b>	<b>406</b>
B.1	General .....	406
B.2	Handover/Relocation related generic transparent Containers over RANAP, S1-AP and GTP.....	406
B.3	Other RANAP and S1-AP and NGAP IEs .....	408
<b>Annex C (Normative):</b>	<b>MME/S4-SGSN mapping table between S11/S4 and NAS Cause values.....</b>	<b>409</b>
<b>Annex D (Informative):</b>	<b>GTP-C load and overload control mechanism.....</b>	<b>415</b>
D.1	GTP-C interfaces not supporting Load Control .....	415
D.2	GTP-C interfaces not supporting Overload Control.....	415
D.3	"Loss" throttling algorithm.....	416
D.3.1	Example of possible implementation .....	416
D.4	Enforcement of overload control between remote GTP-C entities .....	416
D.4.1	Example of possible implementation .....	416
<b>Annex E (Normative):</b>	<b>TWAN mapping table between GTPv2 S2a Cause and non-3GPP access Cause values.....</b>	<b>418</b>
<b>Annex F (Informative):</b>	<b>Change History .....</b>	<b>422</b>
History .....		442

---

# Foreword

This Technical Specification has been produced by the 3rd Generation Partnership Project (3GPP).

The contents of the present document are subject to continuing work within the TSG and may change following formal TSG approval. Should the TSG modify the contents of the present document, it will be re-released by the TSG with an identifying change of release date and an increase in version number as follows:

Version x.y.z

where:

- x the first digit:
  - 1 presented to TSG for information;
  - 2 presented to TSG for approval;
  - 3 or greater indicates TSG approved document under change control.
- y the second digit is incremented for all changes of substance, i.e. technical enhancements, corrections, updates, etc.
- z the third digit is incremented when editorial only changes have been incorporated in the document.

In the present document, modal verbs have the following meanings:

- shall** indicates a mandatory requirement to do something
- shall not** indicates an interdiction (prohibition) to do something

The constructions "shall" and "shall not" are confined to the context of normative provisions, and do not appear in Technical Reports.

The constructions "must" and "must not" are not used as substitutes for "shall" and "shall not". Their use is avoided insofar as possible, and they are not used in a normative context except in a direct citation from an external, referenced, non-3GPP document, or so as to maintain continuity of style when extending or modifying the provisions of such a referenced document.

- should** indicates a recommendation to do something
- should not** indicates a recommendation not to do something
- may** indicates permission to do something
- need not** indicates permission not to do something

The construction "may not" is ambiguous and is not used in normative elements. The unambiguous constructions "might not" or "shall not" are used instead, depending upon the meaning intended.

- can** indicates that something is possible
- cannot** indicates that something is impossible

The constructions "can" and "cannot" are not substitutes for "may" and "need not".

- will** indicates that something is certain or expected to happen as a result of action taken by an agency the behaviour of which is outside the scope of the present document
- will not** indicates that something is certain or expected not to happen as a result of action taken by an agency the behaviour of which is outside the scope of the present document
- might** indicates a likelihood that something will happen as a result of action taken by some agency the behaviour of which is outside the scope of the present document

**might not** indicates a likelihood that something will not happen as a result of action taken by some agency the behaviour of which is outside the scope of the present document

In addition:

**is** (or any other verb in the indicative mood) indicates a statement of fact

**is not** (or any other negative verb in the indicative mood) indicates a statement of fact

The constructions "is" and "is not" do not indicate requirements.

---

# 1 Scope

The present document specifies the stage 3 of the control plane of the GPRS Tunnelling Protocol, Version 2 (GTPv2-C).

GTPv2-C shall be used over:

- the S2a, S2b, S3, S4, S5, S8, S10, S11, S16, Sm and Sn signalling interfaces in EPC, specified in 3GPP TS 23.401 [3] and 3GPP TS 23.402 [45].
- the N26 signalling interface between EPC and 5GC, specified in 3GPP TS 23.501 [82] and 3GPP TS 23.502 [83].

GTPv2-C based protocols shall also be used over the Sv (see 3GPP TS 29.280 [15]) and S101/S121 (see 3GPP TS 29.276 [14]) interfaces.

In this document, unless otherwise specified, the S2a, S2b, S5 and S8 interfaces refer to the GTP-based S2a, S2b, S5 and S8 interfaces respectively.

The present document specifies functions, procedures and information which apply to GERAN Iu mode. However, functionality related to GERAN Iu mode is neither maintained nor enhanced.

---

# 2 References

The following documents contain provisions which, through reference in this text, constitute provisions of the present document.

- References are either specific (identified by date of publication, edition number, version number, etc.) or non-specific.
- For a specific reference, subsequent revisions do not apply.
- For a non-specific reference, the latest version applies. In the case of a reference to a 3GPP document (including a GSM document), a non-specific reference implicitly refers to the latest version of that document *in the same Release as the present document*.

- [1] 3GPP TR 21.905: "Vocabulary for 3GPP Specifications".
- [2] 3GPP TS 23.003: "Numbering, addressing and identification".
- [3] 3GPP TS 23.401: "General Packet Radio Service (GPRS) enhancements for Evolved Universal Terrestrial Radio Access Network (E-UTRAN) access".
- [4] 3GPP TS 29.060: "General Packet Radio Service (GPRS); GPRS Tunnelling Protocol (GTP) across the Gn and Gp interface".
- [5] 3GPP TS 24.008: "Mobile radio interface Layer 3 specification; Core network protocols; Stage 3".
- [6] IETF RFC 791 (STD 0005): "Internet Protocol", J. Postel.
- [7] IETF RFC 768 (STD 0006): "User Datagram Protocol", J. Postel.
- [8] 3GPP TS 32.251: "Telecommunication Management; Charging Management; Packet Switched (PS) domain charging.
- [9] 3GPP TS 32.298: "Telecommunication Management; Charging Management; Charging Data Record (CDR) parameter classification.
- [10] 3GPP TS 36.413: "Evolved Universal Terrestrial Radio Access Network (E-UTRAN); S1 Application Protocol (S1AP)".
- [11] 3GPP TS 33.102: "3G security; Security architecture".

- [12] 3GPP TS 33.401: "3GPP System Architecture Evolution (SAE); Security architecture".
- [13] 3GPP TS 29.281: "General Packet Radio System (GPRS) Tunnelling Protocol User Plane (GTPv1-U)".
- [14] 3GPP TS 29.276: "3GPP Evolved Packet System (EPS); Optimized handover procedures and protocols between E-UTRAN Access and cdma2000 HRPD Access; Stage 3".
- [15] 3GPP TS 29.280: "Evolved Packet System (EPS); 3GPP Sv interface (MME to MSC, and SGSN to MSC) for SRVCC".
- [16] IETF RFC 2460: "Internet Protocol, Version 6 (IPv6) Specification".
- [17] 3GPP TS 23.007: "Restoration procedures".
- [18] 3GPP TS 32.422: "Telecommunication management; Subscriber and equipment trace; Trace control and configuration management".
- [19] 3GPP TS 36.300: "Evolved Universal Terrestrial Radio Access (E-UTRA) and Evolved Universal Terrestrial Radio Access Network (E-UTRAN); Overall description; Stage 2".
- [20] 3GPP TS 36.414: "Evolved Universal Terrestrial Radio Access Network (E-UTRAN); S1 data transport".
- [21] 3GPP TS 23.272: "Circuit Switched (CS) fallback in Evolved Packet System (EPS); Stage 2".
- [22] 3GPP TS 29.118: "Mobility Management Entity (MME) - Visitor Location Register (VLR) SGs interface specification".
- [23] 3GPP TS 24.301: "Non-Access-Stratum (NAS) protocol for Evolved Packet System (EPS); Stage 3".
- [24] void
- [25] ITU-T Recommendation E.164: "The international public telecommunication numbering plan".
- [26] 3GPP TS 29.275: "Proxy Mobile IPv6 (PMIPv6) based Mobility and Tunnelling protocols; Stage 3".
- [27] 3GPP TS 44.018: "Mobile radio interface layer 3 specification; Radio Resource Control Protocol".
- [28] 3GPP TS 48.008: "Mobile Switching Centre - Base Station System (MSC-BSS) interface; Layer 3 specification".
- [29] 3GPP TS 29.212: "Policy and Charging Control (PCC); Reference points".
- [30] 3GPP TS 24.007: "Mobile radio interface signalling layer 3; General Aspects".
- [31] IETF RFC 1035: "Domain Names - Implementation and Specification".
- [32] 3GPP TS 29.303: "Domain Name System Procedures; Stage 3".
- [33] 3GPP TS 25.413: "UTRAN Iu interface Radio Access Network Application Part (RANAP) signalling".
- [34] 3GPP TS 48.018: "General Packet Radio Service (GPRS); Base Station System (BSS) - Serving GPRS Support Node (SGSN); BSS GPRS protocol (BSSGP)".
- [35] 3GPP TS 23.060: "General Packet Radio Service (GPRS); Service description; Stage 2".

- [36] 3GPP TS 32.295: "Telecommunication management; Charging management; Charging Data Record (CDR) transfer".
- [37] 3GPP TS 23.246: "Multimedia Broadcast/Multicast Service (MBMS); Architecture and functional description".
- [38] 3GPP TS 29.061: "Interworking between the Public Land Mobile Network (PLMN) supporting packet based services and Packet Data Networks (PDN) ".
- [39] IETF RFC 3588: "Diameter Base Protocol ".
- [40] IETF RFC 4607: "Source-Specific Multicast for IP".
- [41] 3GPP TS 29.002: "Mobile Application Part (MAP) specification".
- [42] 3GPP TS 29.010: "Information element mapping between Mobile Station - Base Station System (MS - BSS) and Base Station System - Mobile-services Switching Centre (BSS - MSC); Signalling procedures and the Mobile Application Part (MAP)".
- [43] 3GPP TS 23.216: "Single Radio Voice Call Continuity (SRVCC); Stage 2".
- [44] 3GPP TS 32.423: "Telecommunication management; Subscriber and equipment trace: Trace data definition and management".
- [45] 3GPP TS 23.402: "Architecture enhancements for non-3GPP accesses.
- [46] 3GPP TR 25.999: "HSPA Evolution (FDD)".
- [47] 3GPP TS 23.292: "IP Multimedia Subsystem (IMS) centralized services".
- [48] 3GPP TS 23.203: "Policy and charging control architecture; Stage 2".
- [49] ITU-T Recommendation X.691 (07/2002): "Information technology – ASN.1 encoding rules: Specification of Packed Encoding Rules (PER)".
- [50] 3GPP TS 33.402: "3GPP System Architecture Evolution (SAE); Security aspects of non-3GPP accesses".
- [51] 3GPP TS 23.139: "3GPP system - fixed broadband access network interworking; Stage 2".
- [52] IEEE Std 802.11-2012: "IEEE Standard for Information technology - Telecommunications and information exchange between systems - Local and metropolitan area networks - Specific requirements - Part 11: Wireless LAN Medium Access Control (MAC) and Physical Layer (PHY) Specifications".
- [53] IETF RFC 5905: "Network Time Protocol Version 4: Protocol and Algorithms Specification".
- [54] 3GPP TS 32.299: "Telecommunication Management; Charging Management; Diameter charging applications.
- [55] 3GPP TS 23.251: " Network Sharing; Architecture and Functional Description".
- [56] 3GPP TS 23.271: "Location Services".
- [57] 3GPP TS 29.173: "Diameter-based SLh interface for Control Plane LCS".
- [58] IETF RFC 5453: "Reserved IPv6 Interface Identifiers".
- [59] IETF RFC 4776: "Dynamic Host Configuration Protocol (DHCPv4 and DHCPv6) Option for Civic Addresses Configuration Information".
- [60] IETF RFC 3046: "DHCP Relay Agent Information Option".
- [61] 3GPP TS 23.380: "IMS Restoration Procedures".
- [62] 3GPP TS 22.153: "Multimedia Priority Service".



- [63] 3GPP TS 24.302: "Access to the 3GPP Evolved Packet Core (EPC) via non-3GPP access networks; stage 3".
- [64] ITU-T Recommendation E.212: "The international identification plan for mobile terminals and mobile users".
- [65] IETF RFC 2474: "Definition of the Differentiated Services Field (DS Field) in the IPv4 and IPv6 Headers".
- [66] 3GPP TS 24.244: "Wireless LAN control plane protocol for trusted WLAN access to EPC".
- [67] IETF RFC 7296: "Internet Key Exchange Protocol Version 2 (IKEv2)".
- [68] 3GPP TS 29.273: "3GPP EPS AAA Interfaces".
- [69] 3GPP TS 29.336: "Home Subscriber Server (HSS) diameter interfaces for interworking with packet data networks and applications".
- [70] 3GPP TS 29.272: "Mobility Management Entity (MME) and Serving GPRS Support Node (SGSN) related interfaces based on Diameter protocol".
- [71] 3GPP TS 23.161: "Network-Based IP Flow Mobility (NBIFOM); Stage 2".
- [72] 3GPP TS 23.303: "Proximity-based services (ProSe); Stage 2".
- [73] 3GPP TS 24.161: "Network-Based IP Flow Mobility (NBIFOM); Stage 3".
- [74] 3GPP TS 23.682: "Architecture enhancements to facilitate communications with packet data networks and applications".
- [75] 3GPP TS 23.040: "Technical realization of the Short Message Service (SMS)".
- [76] 3GPP TS 36.323: "Evolved Universal Terrestrial Radio Access (E-UTRA); Packet Data Convergence Protocol (PDCP) specification".
- [77] IETF RFC 4995: "The RObust Header Compression (ROHC) Framework".
- [78] 3GPP TS 43.020: "Security related network functions".
- [79] 3GPP TS 36.444: "EUTRAN M3 Application Protocol (M3AP)".
- [80] 3GPP TS 29.244: "Interface between the Control Plane and the User Plane of EPC Nodes; stage 3".
- [81] IETF RFC 2474: "Definition of the Differentiated Services Field (DS Field) in the IPv4 and IPv6 Headers".
- [82] 3GPP TS 23.501: "System Architecture for the 5G System; Stage 2".
- [83] 3GPP TS 23.502: "Procedures for the 5G System; Stage 2".
- [84] 3GPP TS 38.413: "NG-RAN; NG Application Protocol (NGAP)".
- [85] 3GPP TS 33.250: "Security assurance specification for the PGW network product class".
- [86] 3GPP TS 33.501: "Security Architecture and Procedures for 5G System".
- [87] 3GPP TS 24.501: "Non-Access-Stratum (NAS) protocol for 5G System (5GS); Stage 3".
- [88] 3GPP TS 29.502: "5G System; Session Management Services; Stage 3".
- [89] 3GPP TS 23.287: "Architecture enhancements for 5G System (5GS) to support Vehicle-to-Everything (V2X) services".
- [90] 3GPP TS 23.256: "Support of Uncrewed Aerial Systems (UAS) connectivity, identification and tracking; Stage 2".

## 3 Definitions, symbols and abbreviations

### 3.1 Definitions

For the purposes of the present document, the terms and definitions given in TR 21.905 [1] and the following apply. A term defined in the present document takes precedence over the definition of the same term, if any, in TR 21.905 [1].

**GTP-PDU:** GTP Protocol Data Unit is either a GTP-C Message or a GTP-U Message. GTP-U Message may be either a signalling message across the user plane tunnel, or a G-PDU (see clause 6).

- **Signalling Message:** any GTP-PDU (GTP-C or GTP-U) except the G-PDU.
- **G-PDU:** GTP user plane message, which carries the original packet (payload). G-PDU consists of GTP-U header and a T-PDU.
- **T-PDU:** original packet, for example an IP datagram, from an UE or a network node in an external packet data network. A T-PDU is the payload that is tunnelled in the GTP-U tunnel.
- **GTP-C Message:** GTP control plane message type of a GTP-PDU. GTP-C message consists of GTP-C header, which is followed by zero or more information elements.
- **GTP-U Message:** GTP user plane message. The user plane messages are used to carry user data packets, and also signalling messages e.g. for path management and error indication. Therefore, GTP-U message consists of GTP-U header, which is followed by either a T-PDU, or zero or more information elements.

**GTP Tunnel:** A GTP tunnel is a communication tunnel between two GTP nodes (see clause 4.1 "GTP Tunnel").

**PDN Connection:** "PDN Connection" in this specification only refers to the PDN connection through the SGW and PGW.

**RLOS attached UE:** A UE is attached only for accessing Restricted Local Operator Services.

**SCEF PDN Connection:** The PDN connection to the SCEF. Unless otherwise indicated in a clause or clause, "PDN Connections" do not refer to any SCEF PDN Connection.

**Tunnel Endpoint:** A tunnel endpoint is identified with a TEID, an IP address and a UDP port number (see clause 4.1 "GTP Tunnel").

**Tunnel Endpoint Identifier (TEID):** unambiguously identifies a tunnel endpoint in scope of a path (see clause 4.1 "GTP Tunnel").

### 3.2 Symbols

For the purposes of the present document, the following symbols apply:

S1-U	Interface between SGW and eNodeB
X2	Interface between eNodeBs

### 3.3 Abbreviations

For the purposes of the present document, the abbreviations given in TR 21.905 [1] and the following apply. An abbreviation defined in the present document takes precedence over the definition of the same abbreviation, if any, in TR 21.905 [1].

5GC	5G Core Network
AMBR	Aggregate Maximum Bit Rate
APN	Access Point Name
APN-NI	Access Point Name Network Identifier
APN-OI	Access Point Name Operator Identifier
C-MSISDN	Correlation MSISDN
EBI	EPS Bearer ID

eNodeB	Evolved Node B
EPC	Evolved Packet Core
ePDG	Evolved Packet Data Gateway
EPS	Evolved Packet System
F-TEID	Fully Qualified Tunnel Endpoint Identifier
G-PDU	GTP-U non-signalling PDU
GPRS	General Packet Radio Service
GTP	GPRS Tunnelling Protocol
GTP-PDU	GTP-C PDU or GTP-U PDU
GTPv2-C	GTP version 2, control plane
GTPv2-U	GTP version 2, user plane
IMSI	International Mobile Subscriber Identity
IP	Internet Protocol
LBI	Linked EPS Bearer ID
L1	Layer 1
L2	Layer 2
LGW	Local Gateway
LIPA	Local IP Access
MBMS	Multimedia Broadcast/Multicast Service
MEI	Mobile Equipment Identity
MSISDN	Mobile Subscriber ISDN Number
MT-EDT	Mobile Terminated Early Data Transmission
NBIFOM	Network-based IP Flow Mobility
NTP	Network Time Protocol
PAA	PDN Address Allocation
PCO	Protocol Configuration Options
PDU	Protocol Data Unit
PDN	Packet Data Network or Public Data Network
PGW	PDN Gateway
PTI	Procedure Transaction Id
PSCell	Primary SCG (Secondary Cell Group) Cell
QoS	Quality of Service
RAT	Radio Access Technology
RIM	RAN Information Management
RLOS	Restricted Local Operator Services
SGW	Serving Gateway
SPID	Subscriber Profile ID for RAT/Frequency Priority
STN-SR	Session Transfer Number for SRVCC
TEID	Tunnel Endpoint Identifier
TEID-C	Tunnel Endpoint Identifier, control plane
TEID-U	Tunnel Endpoint Identifier, user plane
TFT	Traffic Flow Template
TLIV	Type Length Instance Value
TWAN	Trusted WLAN Access Network
UAS	Uncrewed Aerial System
UAV	Uncrewed Aerial Vehicle
UDP	User Datagram Protocol
ULI	User Location Information
USS	UAS Service Supplier

---

## 4 General

### 4.1 GTP Tunnel

GTP tunnels are used between two nodes communicating over a GTP based interface, to separate traffic into different communication flows.

A GTP tunnel is identified in each node with a TEID, an IP address and a UDP port number. The receiving end side of a GTP tunnel locally assigns the TEID value the transmitting side has to use. The TEID value shall be assigned in a non-predictable manner for PGW S5/S8/S2a/S2b interfaces (see 3GPP TS 33.250 [85]). The TEID values are exchanged between tunnel endpoints using GTP-C or S1-MME or Iu-PS messages. The GTPv2 entity communicates to the peer GTPv2 entity the TEID value at which it expects to receive all subsequent control plane messages related to that GTP tunnel via the:

- "Sender F-TEID for Control Plane" IE,
- "PGW S5/S8/S2a/S2b F-TEID for PMIP based interface or for GTP based Control Plane interface" IE,
- "MSC Server Sv TEID for Control Plane" IE,
- "S3/S16/S10 Address and TEID for Control Plane" IE, or
- "MME/SGSN Sv TEID for Control Plane" IE.

The criteria defining when the same or different GTP tunnels shall be used between the two nodes differs between the control and the user plane, and also between interfaces.

For the control plane, for each end-point of a GTP-C tunnel:

- The TEID-C shall be unique per PDN-Connection on GTP based S2a, S2b, S5 and S8 interfaces. The same tunnel shall be shared for the control messages related to all bearers associated to the PDN-Connection. A TEID-C on the S2a/S2b/S5/S8 interface shall be released after all its associated EPS bearers are deleted.
- There shall be only one pair of TEID-Cs per UE on each of the S3, S10, S16 and N26 interfaces. The same tunnel shall be shared for the control messages related to the same UE operation. A TEID-C on the S3/S10/S16/N26 interface shall be released after its associated UE context is removed or the UE is detached. For the S3 interface, when ISR is active for the UE, during I-RAT handover between the ISR associated nodes, the existing S3 TEID-C may be re-used or new S3 TEID-C may be allocated. During this scenario, if the node decides to allocate new S3 TEID-C, it shall release its own old S3 TEID-C.
- There shall be only one pair of TEID-C per UE over the S11 and the S4 interfaces. The same tunnel shall be shared for the control messages related to the same UE operation. A TEID-C on the S11/S4 interface shall be released after all its associated EPS bearers are deleted.
- There shall be only one pair of TEID-C per MBMS Bearer Service (i.e. per TMGI and MBMS Flow Identifier, if the MBMS Flow Identifier is provided; or per TMGI, if the MBMS Flow Identifier is not provided) over the Sm and Sn interfaces respectively. The same tunnel shall be shared for the control messages related to the same MBMS Bearer Service. A TEID-C on the Sm/Sn interface shall be released after the MBMS Bearer Session is stopped.

For GTP-U, a TEID-U is used according to 3GPP TS 29.281 [13].

NOTE: GTP-U is based on GTP version 1 (GTPv1).

### 4.2 Protocol stack

#### 4.2.0 General

The protocol stack for GTPv2 shall be as depicted in Figure 4.2.0-1.

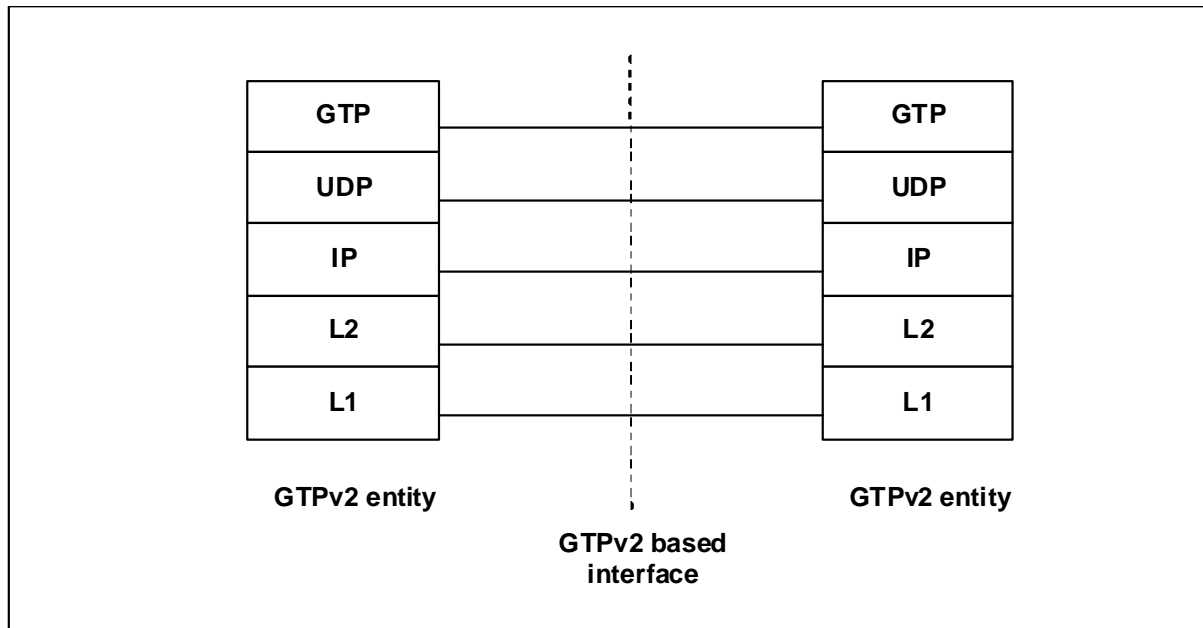

**Figure 4.2.0-1: GTPv2 stack**

The GTPv2 headers are specified in the respective clauses of this specification.

The source and destination IP addresses and UDP ports used for each GTP-C message depend on the role that the message plays in a message exchange. A message can be an Initial message, or a Triggered message, or a Triggered Reply message to Triggered message. An Initial message is sent to a peer GTP entity with a sequence number chosen by the sending entity (see clause 7.6). A Triggered message is sent in response to an Initial message. Triggered Reply message may be sent in response to a Triggered message. See clause 7.6 for the sequence number usage.

Typically, a Request message is an Initial message, but a Request message may be a Triggered messages in certain procedures where they are triggered by an Initial Command message. See clause 4.2.5 for classification of the Initial messages and their possible Triggered messages, as well as cases where there are Triggered Reply messages to the Triggered messages.

Piggybacking is an optional feature, which is described in Annex F of 3GPP TS 23.401 [3]. If the feature is supported, then the piggybacking of the initial messages on triggered response messages for EUTRAN Initial Attach, a Handover from Trusted or Untrusted Non-3GPP IP Access to E-UTRAN (see clauses 8.6 and 16.11 of 3GPP TS 23.402 [45]) and UE-requested PDN Connectivity procedures shall be implemented as per requirements in clauses 4.2.0 and 5.5.1 of this specification. When piggybacking is used, a common IP header and a common UDP header shall be used for the triggered response message and the piggybacked initial message as depicted in Figure 4.2.0-2. Immediately following the triggered response message is the piggybacked initial message, following which no additional information shall be present. The clause 5.5 specifies the usage of piggybacking-specific fields in the GTP-C header.

IP header	UDP header	Triggered response message (P=1)	Piggybacked initial message (P=0)
-----------	------------	----------------------------------	-----------------------------------

**Figure 4.2.0-2: Packet Format for the Piggybacking of messages**

## 4.2.1 UDP header and port numbers

### 4.2.1.0 General

A User Datagram Protocol (UDP) compliant with IETF RFC 768 [7] shall be used.

### 4.2.1.1 Initial Messages

The UDP Destination Port number for GTPv2 Initial messages shall be 2123. It is the registered port number for GTP-C.

The UDP Source Port for a GTPv2 Initial message is a locally allocated port number at the sending GTP entity.

If GTPv2 and GTP' v2 modules are using the same IP address for sending messages, the implementation shall ensure that while some source port number is used by GTPv2 messages, the same source port number shall not be used by GTP' v2 messages. Otherwise, the IP interface may have difficulty to delivering a response message to the right protocol entity.

### 4.2.1.2 Triggered Messages

The UDP Destination Port value of a GTPv2 Triggered message and for a Triggered Reply message shall be the value of the UDP Source Port of the corresponding message to which this GTPv2 entity is replying, except in the case of the SGSN pool scenario.

The UDP Source Port of a GTPv2 Triggered message and for a Triggered Reply message shall be the value from the UDP Destination Port of the corresponding message to which this GTPv2 entity is replying, except in the case of the SGSN pool scenario.

In the SGSN pool scenario, if the Identification Request, the Context Request or the Suspend Notification messages have been forwarded by another SGSN in the pool, the UDP Destination Port for the Identification Response, the Context Response or the Suspend Acknowledge message shall be determined in the following way. The value from the information element "UDP Source Port Number", which was sent in the corresponding forwarded request, shall be copied into the UDP Destination Port field. The UDP Source Port for the Identification Response, the Context Response or the Suspend Acknowledge message may be a locally allocated port number at the sending GTP entity.

In the handover scenario when the CIoT feature is deployed, if the Forward Relocation Request message has been forwarded by the target MME, the UDP Destination Port for the Forward Relocation Response shall be set to the value of Source UDP Port Number IE included in the Forward Relocation Request message; the UDP Source Port for the Forward Relocation Response message may be a locally allocated port number at the sending GTP entity.

### 4.2.1.3 Piggybacked Messages

A piggybacked initial message is carried as a concatenation after a triggered response message and they share a common UDP header (see Figure 4.2.0-2).

The UDP Destination port for the IP packet containing both the triggered response message and the piggybacked initial message shall be the same as the port number used for the triggered response message.

The UDP Source port for the IP packet containing both the triggered response message and the piggybacked initial message shall be the same as the port number used for the triggered response message.

## 4.2.2 IP header and IP addresses

### 4.2.2.1 Initial Messages

The IP Destination Address of a GTPv2 Initial message shall be an IP address of the destination GTPv2 entity.

During the establishment of the GTP tunnel, the GTPv2 entity selects and communicates to the peer GTPv2 entity the IP Destination Address at which it expects to receive subsequent control plane Initial messages related to that GTP tunnel via the:

- "Sender F-TEID for Control Plane" IE,
- "PGW S5/S8/S2a/S2b F-TEID for PMIP based interface or for GTP based Control Plane interface" IE,
- "MSC Server Sv Address for Control Plane" IE,
- "S3/S16/S10 Address and TEID for Control Plane" IE, or

- "MME/SGSN Sv Address for Control Plane" IE.

A Create Session Request shall only include in the Sender F-TEID the same IP address type as the destination address used in the IP header. An IPv4/IPv6 capable SGW and PGW may advertise an IPv4 address and/or an IPv6 address in the F-TEID of the above IEs.

Upon a change of MME, SGSN or SGW, the new MME, SGSN or SGW may switch to a different IP address type (e.g. IPv6 address) in the IP header if a different IP address type was advertised by the SGW or PGW earlier. A Modify Bearer Request shall only include in the Sender F-TEID the same IP address type as the destination address used in the IP header.

NOTE 1: Advertising a single IP address type in a Create Session Request or a Modify Bearer Request ensures that both GTP-C peers know without ambiguity the IP address type to be used in subsequent control plane Initial messages in the reverse direction related to that GTP-C tunnel, and it avoids intempestive IP address switching during the establishment of the GTP-C tunnel or during an established communication between two GTP-C peers.

NOTE 2: IP switching between IPv4 and IPv6 can occur upon a change of MME/SGSN or SGW in deployments with MME/SGSNs or SGWs with different IPv6 capabilities.

EXAMPLE 1: If an MME gets IPv4 addresses from the DNS for the SGW, the MME only includes an IPv4 address in the Sender F-TEID IE of the Create Session Request. In the response, the SGW advertises an IPv4 address and optionally an IPv6 address, and the SGW uses IPv4 addressing in subsequent control plane Initial messages it sends to the MME related to that GTP-C tunnel.

EXAMPLE 2: As a continuation of EXAMPLE 1, upon a subsequent change of MMEs, assuming the source MME only supports IPv4 and the target MME supports IPv4 and IPv6, the target MME can switch to IPv6 addressing by sending a Modify Bearer Request to the SGW using the SGW S11 IPv6 address in the IP header and including a Sender F-TEID with an MME S11 IPv6 address only.

During the network triggered service restoration procedure (see 3GPP TS 23.007 [17]), if an MME/S4-SGSN sends a Downlink Data Notification Failure Indication message to the SGW, then the destination address for this message shall be the SGW IP address signalled via the Sender F-TEID for Control Plane IE in the Downlink Data Notification message (if present in the message), otherwise the source IP address of the Downlink Data Notification message received earlier.

The IP Source Address of a GTPv2 Initial message shall be an IP address of the source GTPv2 entity from which the Initial message is originating.

#### 4.2.2.2 Triggered Messages

The IP Destination Address of a GTPv2 Triggered message and for a Triggered Reply message shall be copied from the IP Source Address of the message to which this GTPv2 entity is replying, except in the case of the SGSN pool scenario.

The IP Source Address of a GTPv2 Triggered message and for a Triggered Reply message shall be copied from the IP destination address of the message to which this GTPv2 entity is replying, except in the case of SGSN pool scenario and handover scenario when the CIoT feature is deployed.

In the SGSN pool scenario, if the Identification Request, the Context Request or the Suspend Notification messages have been forwarded by another SGSN in the pool, the IP Source address for the Identification Response, the Context Response or the Suspend Acknowledge messages shall be locally allocated by the sending GTP entity. The IP Destination Address for the Identification Response, the Context Response or the Suspend Acknowledge messages shall be determined in the following way. The value from the information element "Address for Control Plane", which was sent in the corresponding Identification Request or the Suspend Notification message; or the value from the information element "S3/S16/S10 Address and TEID for Control Plane", which was sent in the corresponding Context Request message, shall be copied into the IP Destination Address field.

In the handover scenario when the CIoT feature is deployed, if the Forward Relocation Request message has been forwarded by the target MME, the IP Source address of the Forward Relocation Response shall be locally allocated by the sending GTP entity. The IP Destination Address field of the Forward Relocation Response shall be set to the value of the "Sender's F-TEID for Control Plane" IE received in the Forward Relocation Request message.

### 4.2.2.3 Piggybacked Messages

A piggybacked initial message is carried as a concatenation after a triggered response message and they share a common IP header (see Figure 4.2.0-2).

The IP Source Address for the IP packet containing both the triggered response message and the piggybacked initial message shall be the same as the IP Address used for the triggered response message.

The IP Destination Address for the IP packet containing both the triggered response message and the piggybacked initial message shall be the same as the IP Address used for the triggered response message.

## 4.2.3 Layer 2

Typically Ethernet should be used as a Layer 2 protocol, but operators may use any other technology.

## 4.2.4 Layer 1

Operators may use any appropriate Layer 1 technology.

## 4.2.5 Messages with GTPv2 defined replies: Classification of Initial and Triggered Messages

An Initial message is a GTPv2 message that is not triggered as a response to another GTPv2 message across the given interface.

The expected reply to a Request message is a Triggered message and the reply has the same message name as the Request but with "Response" replacing "Request".

NOTE 1: If the SGW receives a "Create Session Request" on S11/S4, this can trigger either of the following GTPv2 messages across S5/S8: "Create Session Request" or "Modify Bearer Request". However, neither of these messages across S5/S8 is considered to be a Triggered message.

If a Request message is a reply to a Command message, then the Request message is a Triggered message; otherwise the Request message is an Initial message. Responses do not have replies except when a "Context Acknowledge" is required as a reply to "Context Response" message as specified in relevant Stage 2 procedures. Context Acknowledge is always triggered message and does not have a reply.

NOTE 2: The "Context Acknowledge" message is sent only if the "Context Response" message is received with the acceptance cause.

A message whose name ends in "Command" is always an initial message. If a "Command" message fails, the name of the reply message is constructed by replacing "Command" with "Failure Indication". Apart from "Downlink Data Notification Failure Indication" message, a "Failure Indication" is a Triggered message. The "Failure Indication" message does not have a reply. If a "Command" message is successful, its reply will be a Request as specified in relevant Stage 2 procedures.

A message whose name ends in "Notification" is always an Initial message, The expected Triggered message in reply has the same message name but with "Acknowledge" replacing "Notification", except for the case of the message "Downlink Data Notification" which has the reply "Downlink Data Notification Acknowledge" and "PGW Restart Notification" which has the reply "PGW Restart Notification Acknowledge". An "Acknowledge" message does not have a reply.

CS Paging Indication, Stop Paging Indication, RAN Information Relay, Configuration Transfer Tunnel, Trace Session Activation, Trace Session Deactivation, ISR Status Indication and Downlink Data Notification Failure Indication messages are Initial messages that do not have a reply.

A Version Not Supported Indication message is a Triggered message.



## 4.3 Transmission Order and Bit Definitions

The messages in this document shall be transmitted in network octet order starting with octet 1 with the Most Significant Bit sent first.

The most significant bit of an octet in a GTP message is bit 8. If a value in a GTP message spans several octets and nothing else is stated, the most significant bit is bit 8 of the octet with the lowest number.

# 5 GTP Header for Control Plane

## 5.1 General format

Control Plane GTP uses a variable length header. Control Plane GTP header length shall be a multiple of 4 octets. Figure 5.1-1 illustrates the format of the GTPv2-C Header.

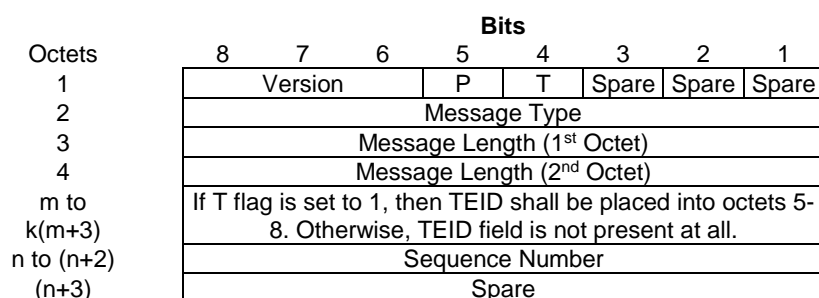

**Figure 5.1-1: General format of GTPv2 Header for Control Plane**

Where:

- if T = 0, TEID field is not present, k = 0, m = 0 and n = 5;
- if T = 1, TEID field is present, k = 1, m = 5 and n = 9.

The usage of GTPv2-C header across the EPC specific interfaces is defined in the clause 5.5 "Usage of the GTPv2-C Header". Octet 1 bits shall be coded as follows:

- Bits 6-8 represent the Version field.
- Bit 5 represents the Piggybacking flag (P).
- Bit 4 represents the TEID flag (T).
- Bits 3-1 are spare, the sender shall set them to "0" and the receiving entity shall ignore them.

## 5.2 Control Plane GTP Extension Header

The legacy Extension Header mechanism is not used for the GTP version 2 control plane (GTPv2-C). Future extensions will be implemented by adding Information Elements in the message body if new parameters are needed.

## 5.3 GTP-C header for Echo and Version Not Supported Indication messages

The GTPv2-C message header for the Echo Request, Echo Response and Version Not Supported Indication messages shall not contain the TEID field, but shall contain the Sequence Number fields, followed by one spare octet as depicted in figure 5.3-1. The spare bits shall be set to zero by the sender and ignored by the receiver. For the Version Not Supported Indication message header, the Sequence Number may be set to any number and shall be ignored by the receiver.

Octets	Bits							
	8	7	6	5	4	3	2	1
1	Version		P	T=0	Spare	Spare	Spare	
2	Message Type							
3	Message Length (1 <sup>st</sup> Octet)							
4	Message Length (2 <sup>nd</sup> Octet)							
5	Sequence Number (1 <sup>st</sup> Octet)							
6	Sequence Number (2 <sup>nd</sup> Octet)							
7	Sequence Number (3 <sup>rd</sup> Octet)							
8	Spare							

Figure 5.3-1: The format of Echo and Version Not Supported Indication messages Header

## 5.4 EPC specific GTP-C header

Apart from the Echo Request, Echo Response and Version Not Supported Indication messages, the GTP-C message header shall contain the TEID and Sequence Number fields followed by one spare octet. A typical GTP-C header is depicted in figure 5.4-1. The spare bits shall be set to zero by the sender and ignored by the receiver.

Octets	Bits							
	8	7	6	5	4	3	2	1
1	Version		P	T=1	MP	Spare	Spare	
2	Message Type							
3	Message Length (1 <sup>st</sup> Octet)							
4	Message Length (2 <sup>nd</sup> Octet)							
5	Tunnel Endpoint Identifier (1 <sup>st</sup> Octet)							
6	Tunnel Endpoint Identifier (2 <sup>nd</sup> Octet)							
7	Tunnel Endpoint Identifier (3 <sup>rd</sup> Octet)							
8	Tunnel Endpoint Identifier (4 <sup>th</sup> Octet)							
9	Sequence Number (1 <sup>st</sup> Octet)							
10	Sequence Number (2 <sup>nd</sup> Octet)							
11	Sequence Number (3 <sup>rd</sup> Octet)							
12	Message Priority				Spare			

Figure 5.4-1: The format of EPC specific GTPv2 Control Plane message Header

## 5.5 Usage of the GTPv2-C Header

### 5.5.1 General

The format of the GTPv2-C header is specified in clause 5.1 "General format". The usage of the GTP-C header across e.g. S101/S121 (3GPP TS 29.276 [14]) and Sv (3GPP TS 29.280 [15]) interfaces are defined in their respective specifications.

The usage of the GTPv2-C header for EPC specific interfaces shall be as defined below.

The first octet of the header shall be used is the following way:

- Bits 8 to 6, which represent the GTP-C version, shall be set to decimal 2 ("010").
- Bit 5 represents a "P" flag. If the "P" flag is set to "0", no piggybacked message shall be present. If the "P" flag is set to "1", then another GTPv2-C message with its own header and body shall be present at the end of the current message.

When present, a piggybacked message shall have its "P" flag set to "0" in its own header. If a Create Session Response message (as part of EUTRAN initial attach, a Handover from Trusted or Untrusted Non-3GPP IP Access to E-UTRAN (see clauses 8.6 and 16.11 of 3GPP TS 23.402 [45]) or UE-requested PDN connectivity procedure) has the "P" flag set to "1", then a single Create Bearer Request message shall be present as the

piggybacked message. As a response to the Create Bearer Request message, if the Create Bearer Response has the "P" flag set to "1", then a single Modify Bearer Request (as part of EUTRAN initial attach, a Handover from Trusted or Untrusted Non-3GPP IP Access to E-UTRAN (see clauses 8.6 and 16.11 of 3GPP TS 23.402 [45]) or UE-requested PDN connectivity procedure) shall be present as the piggybacked message. A Create Bearer Response with "P" flag set to "1" shall not be sent unless a Create Session Response with "P" flag set to "1" has been received for the same procedure. Apart from Create Session Response and Create Bearer Response messages, all the EPC specific messages shall have the "P" flag set to "0".

- Bit 4 represents a "T" flag, which indicates if TEID field is present in the GTP-C header or not. If the "T" flag is set to 0, then the TEID field shall not be present in the GTP-C header. If the "T" flag is set to 1, then the TEID field shall immediately follow the Length field, in octets 5 to 8. Apart from the Echo Request, Echo Response and Version Not Supported Indication messages, in all EPC specific messages the value of the "T" flag shall be set to "1".
- Bit 3 represents a "MP" flag. If the "MP" flag is set to "1", then bits 8 to 5 of octet 12 shall indicate the message priority.
- Bit 2 is a spare bit. The sending entity shall set it to "0" and the receiving entity shall ignore it.
- Bit 1 is a spare bit. The sending entity shall set it to "0" and the receiving entity shall ignore it.

The usage of the fields in octets 2 - n of the header shall be as specified below.

- Octet 2 represents the Message type field, which shall be set to the unique value for each type of control plane message. Message type values are specified in Table 6.1-1 "Message types for GTPv2".
- Octets 3 to 4 represent the Message Length field. This field shall indicate the length of the message in octets excluding the mandatory part of the GTP-C header (the first 4 octets). The TEID (if present) and the Sequence Number shall be included in the length count. The format of the Length field of information elements is specified in clause 8.2 "Information Element Format".
- A piggybacked initial message and the preceding triggered response message present in the common IP/UDP packet shall have their own length and sequence number in their respective GTP-C headers. The overall length of the IP/UDP packet shall indicate the total length of the two GTP-C messages.
- For EPC specific interfaces, T=1, and therefore octets 5 to 8 represent the Tunnel Endpoint Identifier (TEID) field. This field shall unambiguously identify a tunnel endpoint in the receiving GTP-C entity. The Tunnel Endpoint Identifier is set by the sending entity in the GTP header of all control plane messages to the TEID value provided by the corresponding receiving entity (see clause 4.1). If a peer's TEID is not available the TEID field shall be present in a GTPv2-C header, but its value shall be set to "0", as specified in clause 5.5.2 "Conditions for sending TEID=0 in GTPv2-C header".

**NOTE:** The TEID in the GTP header of a Triggered (or Triggered Reply) message is set to the TEID value provided by the corresponding receiving entity regardless of whether the source IP address of the Initial (or Triggered) message and the IP Destination Address provided by the receiving entity for subsequent control plane Initial messages (see clause 4.2.2.1) are the same or not.

- Octets 9 to 11 represent GTP Sequence Number field.
- Bits 8 to 5 of octet 12 shall indicate the relative priority of the GTP-C message, if the "MP" flag is set to 1 in Octet 1. It shall be encoded as the binary value of the Message Priority and it may take any value between 0 and 15, where 0 corresponds to the highest priority and 15 the lowest priority.

If the "MP" flag is set to "0" in Octet 1, bits 8 to 5 of octet 12 shall be set to "0" by the sending entity and ignored by the receiving entity.

- Bits 4 to 1 of octet 12 are spare bits. The sending entity shall set them to "0" and the receiving entity shall ignore them.

## 5.5.2 Conditions for sending TEID=0 in GTPv2-C header

If a peer's TEID is not available, the TEID field still shall be present in the header and its value shall be set to "0" in the following messages:

- Create Session Request message on S2a/S2b/S5/S8
- Create Session Request message on S4/S11, if for a given UE, the SGSN/MME has not yet obtained the Control TEID of the SGW.
- Create Indirect Data Forwarding Tunnel Request message on S4/S11, if the SGW selected by the MME/S4-SGSN for indirect data forwarding is different from the SGW used as anchor.
- Identification Request/Response messages.
- Forward Relocation Request message over the S10, S16 and N26 interfaces, and over the S3 interface during I-RAT handover when ISR is not active.
- Forward Relocation Request message over the S3 interface during I-RAT handover between ISR associated nodes, when ISR is active for the UE, and if the node decides to allocate new S3 TEID-C.
- Context Request message over the S10, S16, S3 and N26 interfaces.
- Relocation Cancel Request message over the S10, S16, S3 and N26 interfaces, except for the case where the old SGSN/MME or AMF has already been assigned the Tunnel Endpoint Identifier Control Plane of the new SGSN/MME or AMF.
- Relocation Cancel Response message over the S10, S16, S3 and N26 interfaces if the new SGSN/MME or AMF does not have the Tunnel Endpoint Identifier Control Plane of the old SGSN/MME or AMF.
- Delete PDN Connection Set Request/Response messages.
- Configuration Transfer Tunnel message.
- RAN Information Relay message.
- If a node receives a message and the TEID-C in the GTPv2 header of the received message is not known, it shall respond with "Context not found" Cause in the corresponding response message to the sender, the TEID used in the GTPv2-C header in the response message shall be then set to zero.
- If a node receives a request message containing protocol error, e.g. Mandatory IE missing, which requires the receiver to reject the message as specified in clause 7.7, it shall reject the request message. For the response message, the node should look up the remote peer's TEID and accordingly set the GTPv2-C header TEID and the message cause code. As an implementation option, the node may not look up the remote peer's TEID and set the GTPv2-C header TEID to zero in the response message. However in this case, the cause code shall not be set to "Context not found".
- MBMS Session Start Request message.
- PGW Restart Notification / PGW Restart Notification Acknowledge messages.
- Downlink Data Notification message sent on S11/S4 as part of the Network Triggered Service Restoration procedure (see 3GPP TS 23.007 [17]), and corresponding Downlink Data Notification Acknowledge and Downlink Data Notification Failure Indication if the SGW did not include the Sender F-TEID for Control Plane IE in the Downlink Data Notification message.
- Stop Paging Indication message is sent to the the restarted CN node (or another node in the same pool) as part of the Network Triggered Service Restoration procedure with ISR (see 3GPP TS 23.007 [17]).
- Suspend Notification and Suspend Acknowledge messages: over S16 interface; over S3 interface when ISR is not active.
- PGW Downlink Triggering Notification message on S5 and S11/S4, PGW Downlink Triggering Acknowledge message on S11/S4, and PGW Downlink Triggering Acknowledge message on S5 if the PGW did not include the Sender F-TEID for Control Plane IE in the PGW Downlink Triggering Notification message.
- UE Registration Query Request and UE Registration Query Response messages over S3 interface.

NOTE: Legacy implementation conforming to earlier versions of this specification can send the Change Notification Request/Response messages on the TEID zero in spite of the peer's node TEID being available.

## 5.6 Format of the GTPv2-C Message

The GTP-C header may be followed by subsequent information elements dependent on the type of control plane message.

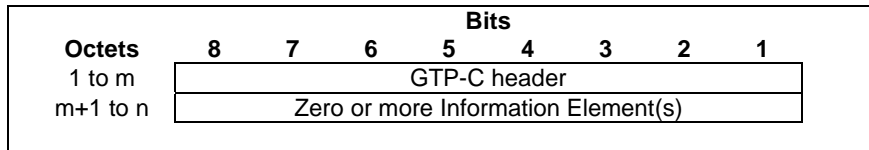

Figure 5.6-1: GTP-C Header followed by subsequent Information Elements

---

## 6 GTP-C Message Types and Message Formats

### 6.0 General

A GTP-C message is sent across a GTP control plane tunnel. In a message, the GTP-C header is followed by zero or more information elements. The GTP-C messages are used for the control plane path management, for the control plane tunnel management and for mobility management.

A T-PDU is an original packet, for example an IP datagram, from an UE, or from a network node in an external packet data network.

### 6.1 Message Format and Type values

#### 6.1.0 Message Type

GTP defines a set of messages between two associated EPC network elements. The messages to be used shall be as defined in Table 6.1-1.

**Table 6.1-1: Message types for GTPv2**

Message Type value (Decimal)	Message	Reference	Initial	Triggered
0	Reserved			
1	Echo Request		X	
2	Echo Response			X
3	Version Not Supported Indication			X
4 to 16	Reserved for S101 interface	TS 29.276 [14 ]		
17 to 24	Reserved for S121 interface	TS 29.276 [14 ]		
25 to 31	Reserved for Sv interface	TS 29.280 [15 ]		
	<b>SGSN/MME/ TWAN/ePDG to PGW (S4/S11, S5/S8, S2a, S2b)</b>			
32	Create Session Request		X	
33	Create Session Response			X
36	Delete Session Request		X	
37	Delete Session Response			X
	<b>SGSN/MME/ePDG to PGW (S4/S11, S5/S8, S2b)</b>			
34	Modify Bearer Request		X	
35	Modify Bearer Response			X
	<b>MME to PGW (S11, S5/S8)</b>			
40	Remote UE Report Notification		X	
41	Remote UE Report Acknowledge			X
	<b>SGSN/MME to PGW (S4/S11, S5/S8)</b>			
38	Change Notification Request		X	
39	Change Notification Response			X
42 to 63	For future use			
164	Resume Notification		X	
165	Resume Acknowledge			X
	<b>Messages without explicit response</b>			
64	Modify Bearer Command (MME/SGSN/ TWAN/ePDG to PGW – S11/S4, S5/S8, S2a, S2b)		X	
65	Modify Bearer Failure Indication (PGW to MME/SGSN/ TWAN/ePDG – S5/S8, S11/S4, S2a, S2b)			X
66	Delete Bearer Command (MME/SGSN to PGW – S11/S4, S5/S8)		X	
67	Delete Bearer Failure Indication (PGW to MME/SGSN – S5/S8, S11/S4))			X
68	Bearer Resource Command (MME/SGSN/TWAN/ePDG to PGW – S11/S4, S5/S8, S2a, S2b)		X	
69	Bearer Resource Failure Indication (PGW to MME/SGSN/TWAN/ePDG – S5/S8, S11/S4, S2a, S2b)			X
70	Downlink Data Notification Failure Indication (SGSN/MME to SGW – S4/S11)		X	
71	Trace Session Activation (MME/SGSN/ TWAN/ePDG to PGW – S11/S4, S5/S8, S2a, S2b)		X	
72	Trace Session Deactivation (MME/SGSN/ TWAN/ePDG to PGW – S11/S4, S5/S8, S2a, S2b)		X	
73	Stop Paging Indication (SGW to MME/SGSN – S11/S4)		X	
74 to 94	For future use			
	<b>PGW to SGSN/MME/ TWAN/ePDG (S5/S8, S4/S11, S2a, S2b)</b>			
95	Create Bearer Request		X	X
96	Create Bearer Response			X
97	Update Bearer Request		X	X
98	Update Bearer Response			X
99	Delete Bearer Request		X	X
100	Delete Bearer Response			X
	<b>PGW to MME, MME to PGW, SGW to PGW, SGW to MME, PGW to TWAN/ePDG, TWAN/ePDG to PGW (S5/S8, S11, S2a, S2b)</b>			
101	Delete PDN Connection Set Request		X	
102	Delete PDN Connection Set Response			X
	<b>PGW to SGSN/MME (S5, S4/S11)</b>			
103	PGW Downlink Triggering Notification		X	
104	PGW Downlink Triggering Acknowledge			X



Message Type value (Decimal)	Message	Reference	Initial	Triggered
105 to 127	For future use			
	<b>MME to MME, SGSN to MME, MME to SGSN, SGSN to SGSN, MME to AMF, AMF to MME (S3/S10/S16/N26)</b>			
		<b>S3 S10 S16 N26</b>		
128	Identification Request	X X X X	X	
129	Identification Response	X X X X		X
130	Context Request	X X X X	X	
131	Context Response	X X X X		X
132	Context Acknowledge	X X X X		X
133	Forward Relocation Request	X X X X	X	
134	Forward Relocation Response	X X X X		X
135	Forward Relocation Complete Notification	X X X X	X	
136	Forward Relocation Complete Acknowledge	X X X X		X
137	Forward Access Context Notification	- X X -	X	
138	Forward Access Context Acknowledge	- X X -		X
139	Relocation Cancel Request	X X X X	X	
140	Relocation Cancel Response	X X X X		X
141	Configuration Transfer Tunnel	- X - X	X	
142 to 148	For future use			
152	RAN Information Relay	X - X -	X	
	<b>SGSN to MME, MME to SGSN (S3)</b>			
149	Detach Notification		X	
150	Detach Acknowledge			X
151	CS Paging Indication		X	
153	Alert MME Notification		X	
154	Alert MME Acknowledge			X
155	UE Activity Notification		X	
156	UE Activity Acknowledge			X
157	ISR Status Indication		X	
158	UE Registration Query Request		X	
159	UE Registration Query Response			X
	<b>SGSN/MME to SGW, SGSN to MME (S4/S11/S3) SGSN to SGSN (S16), SGW to PGW (S5/S8)</b>			
162	Suspend Notification		X	
163	Suspend Acknowledge			X
	<b>SGSN/MME to SGW (S4/S11)</b>			
160	Create Forwarding Tunnel Request		X	
161	Create Forwarding Tunnel Response			X
166	Create Indirect Data Forwarding Tunnel Request		X	
167	Create Indirect Data Forwarding Tunnel Response			X
168	Delete Indirect Data Forwarding Tunnel Request		X	
169	Delete Indirect Data Forwarding Tunnel Response			X
170	Release Access Bearers Request		X	
171	Release Access Bearers Response			X
172 to 175	For future use			
	<b>SGW to SGSN/MME (S4/S11)</b>			
176	Downlink Data Notification		X	
177	Downlink Data Notification Acknowledge			X
179	PGW Restart Notification		X	
180	PGW Restart Notification Acknowledge			X
	<b>SGW to SGSN (S4)</b>			
178	Reserved. Allocated in earlier version of the specification.			
181 to 199	For future use			
	<b>SGW to PGW, PGW to SGW (S5/S8)</b>			
200	Update PDN Connection Set Request		X	
201	Update PDN Connection Set Response			X
202 to 210	For future use			
	<b>MME to SGW (S11)</b>			
211	Modify Access Bearers Request		X	
212	Modify Access Bearers Response			X
213 to 230	For future use			
	<b>MBMS GW to MME/SGSN (Sm/Sn)</b>			

Message Type value (Decimal)	Message	Reference	Initial	Triggered
231	MBMS Session Start Request		X	
232	MBMS Session Start Response			X
233	MBMS Session Update Request		X	
234	MBMS Session Update Response			X
235	MBMS Session Stop Request		X	
236	MBMS Session Stop Response			X
237 to 239	For future use			
	<b>Other</b>			
240 to 247	Reserved for Sv interface (see also types 25 to 31)	TS 29.280 [15]		
248 to 255	For future use			

### 6.1.1 Presence requirements of Information Elements

There are four different presence requirements (Mandatory, Conditional, Optional, or Conditional-Optional) for an IE within a given GTP-PDU:

- Mandatory means that the IE shall be included by the sending side, and that the receiver diagnoses a "Mandatory IE missing" error, when detecting that the IE is not present. A response including a "Mandatory IE missing" cause, shall include the type of the missing IE.
- Conditional means:
  - that the IE shall be included by sending entity if the conditions specified in the relevant protocol specification are met;
  - the receiver shall check the conditions as specified in the corresponding message type description, based on the parameter combination in the message and/or on the state of the receiving node, to infer if a conditional IE shall be expected. Only if a receiver has sufficient information the following applies. A conditional IE, which is absolutely necessary for the receiving entity to complete the procedure, is missing, then the receiver shall abort the procedure.
- Conditional-Optional means:
  - that the IE shall be included by the up-to-date sending entity, if the conditions specified in the relevant protocol specification are met. An entity, which is at an earlier version of the protocol and therefore is not up-to-date, obviously cannot send such new IE.
  - the receiver need not check the presence of the IE in the message. If the receiver checks the presence of the Conditional-Optional IE, then the IE's absence shall not trigger any of the error handling procedures. The handling of an absence or erroneous such IEs shall be treated as Optional IEs as specified in clause 7.7 "Error Handling".
- Optional means:
  - that the IE shall be included as a service option. Therefore, the IE may be included or not in a message. The handling of an absent optional IE, or an erroneous optional IE is specified in clause 7.7 "Error Handling".

For conditional IEs, the clause describing the GTP-PDU explicitly defines the conditions under which the inclusion of each IE becomes mandatory or optional for that particular GTP-PDU. These conditions shall be defined so that the presence of a conditional IE only becomes mandatory if it is critical for the receiving entity. The definition might reference other protocol specifications for final terms used as part of the condition.

For grouped IEs, the presence requirement of the embedded IE shall follow the rules:

- The grouped IE is Mandatory within a given message: the presence requirements of individual embedded IEs are as stated within the Mandatory grouped IE for the given message.
- The grouped IE is Conditional within a given message: if the embedded IE in the grouped IE is Mandatory or Conditional, this embedded IE is viewed as Conditional IE by the receiver. If the embedded IE in the grouped IE is Conditional-Optional, this embedded IE is viewed as Optional IE by the receiver. If the embedded IE in the grouped IE is Optional, this embedded IE is viewed as Optional IE by the receiver.

- The grouped IE is Conditional-Optional within a given message: if the embedded IE in the grouped IE is Mandatory or Conditional, this embedded IE is viewed as Conditional-Optional IE by the receiver. If the embedded IE in the grouped IE is Conditional-Optional, this embedded IE is viewed as Optional IE by the receiver. If the embedded IE in the grouped IE is Optional, this embedded IE is viewed as Optional IE by the receiver.
- The grouped IE is Optional within a given message: all embedded IEs in the grouped IE are viewed as Optional IEs by the receiver.

In all of the above cases, appropriate error handling as described in clause 7.7 shall be applied for protocol errors of the embedded IEs.

Only the Cause information element at message level shall be included in the response if the Cause contains a value that indicates that the request is not accepted regardless of whether there are other mandatory or conditional information elements defined for a given response message.

The following are exceptions:

- Optionally, the Protocol Configuration Options, Recovery, User Location Information (ULI), Load Control Information, Overload Control Information, Bearer Context and Local Distinguished Name (LDN) information elements may be included.
- For the rejection response of a Forward Relocation Request, the Forward Relocation Response message may also include an F-Cause IE as specified in clause 7.3.2.
- For the rejection response of a SRVCC PS to CS Request, the SRVCC PS to CS Response message may also include an SRVCC Cause IE as specified in clause 5.2.3 in 3GPP TS 29.280 [15].
- A Downlink Data Notification Acknowledge (with or) without an indication of success may also include a DL low priority traffic Throttling IE and the IMSI IE.
- The PGW Back-Off Time IE may also be returned when rejecting a Create Session Request with the cause "APN Congestion".
- Change Notification Response message may also include the IMSI and MEI information elements.
- Failure Indication type messages do not have "Accept" types of Cause values, i.e. all used values indicate the rejection, therefore for Failure Indication type of triggered messages, other information elements, other than the Cause IE, shall also be included according to the conditions of presence specified in the respective message, if they are available.
- The Context Response message (sent by an SGSN or MME) should also include the IMSI IE if the Cause IE contains the value "P-TMSI Signature mismatch", except if the UE is emergency or RLOS attached and the UE is UICCless.
- The Create Bearer Response message, the Update Bearer Response message and the Delete Bearer Response message shall include the RAN/NAS Cause IE according to the conditions specified in clauses 7.2.4, 7.2.16 and 7.2.10.2.
- The UE Registration Query Response message shall include IMSI to allow the SGSN to correlate the response message with the corresponding request.

If the Cause information element at Grouped IE level contains a value that indicates that the Grouped IE is not handled correctly, e.g. "Context Not Found" at Bearer Context IE level, the other information elements in this Grouped IE, other than the Cause IE, may not be included.

## 6.1.2 Grouped Information Elements

Information elements can contain other IEs. This type of IE is called "Grouped IEs".

Grouped IEs have a length value in the TLIV encoding, which includes the added length of all the embedded IEs. Overall coding of a grouped information element with 4 octets long IE header is defined in clause 8.2 "Information Element Format". Each information element within a grouped IE also shall also contain 4 octets long IE header.

Grouped IEs are not marked by any flag or limited to a specific range of IE type values. The clause describing an IE in this specification shall explicitly state if it is grouped.

NOTE 1: Each entry into each Grouped IE creates a new scope level. Exit from the grouped IE closes the scope level. The GTPv2 message level is the top most scope. This is analogous to the local scope of a subroutine/function.

If more than one grouped information elements of the same type, but for a different purpose are sent with a message, these IEs shall have different Instance values.

If more than one grouped information elements of the same type and for the same purpose are sent with a message, these IEs shall have exactly the same Instance value to represent a list.

NOTE 2: For instance, all "Bearer Contexts Modified" IEs of the type "Bearer Context" in a "Modify Bearer Response" message shall have the Instance value of 0, while all "Bearer Contexts Marked for Removal" IEs of the type "Bearer Context" in the same message shall have the Instance value of 1.

### 6.1.3 Information Element instance

Every GTPv2 message and grouped IE within a message in this specification has a column documenting the instance value of each IE.

When a GTPv2 message is encoded for use the instance value of each included IE is encoded in the Instance field of the IE for the message scope. See clause 7 and clause 8.2 for details of that encoding.

An Information Element in an encoded GTPv2 message or encoded grouped IE is identified by the pair of IE Type and Instance values and described by a specific row in the corresponding tables in clauses of 7 in the present document.

If several Information Elements with the same Type and Instance values are included in an encoded GTPv2 message, they represent a list for the corresponding IE name and row identified in the message grammar in clauses of clause 7.

If several Information Elements with the same Type and Instance values are included in an encoded grouped IE, they represent a list for the corresponding IE name and row identified in the grouped IE grammar in clauses of clause 7.

In tables in this document the instance value for "Private Extension" is marked as VS (Vendor Specific). While an instance value must be encoded by the sender the value can be Vendor and even Private Extension specific.

The same IE name might be used in different messages (on the top level or within grouped IEs) in this specification. The instance value and name of an IE is only meaningful within the scope of the message definition. The combination of Type value and Instance value uniquely identifies a specific row in a message description table.

## 6.2 Message Granularity

The GTPv2-C messages shall be sent per UE on the S3, S10, S16 and N26 interfaces.

The GTPv2-C messages shall be sent per PDN-Connection on the S2a, S2b, S4, S11, S5 and S8 interfaces apart from the following exclusion.

The following GTPv2-C messages are sent per UE on the S4 and S11 interfaces:

- Downlink Data Notification / Acknowledge / Failure Indication;
- Stop Paging Indication;
- Delete Indirect Data Forwarding Tunnel Request/Response;
- Delete Session Request/Response with Scope Indication set to 1 during following procedures with SGW change:
  - Tracking Area Update procedure;
  - Routing Area Update procedure;
  - Handover procedure;
  - SRNS Relocation Cancel Using S4;

- Inter RAT handover Cancel procedure;
- S1 based handover cancel procedure;
- Delete Bearer Request/Response during a TAU/RAU/Handover procedure if the Cause value "ISR deactivation" is included in the Delete Session Request message, or when it is sent to delete the bearer resources on the other ISR associated CN node if the ISRAI flag is not set in the Modify Bearer Request/Modify Access Bearers Request message.
- Release Access Bearers Request/Response;
- Create Indirect Data Forwarding Tunnel Request/Response;
- Trace Session Activation;
- Trace Session Deactivation;
- Create Forwarding Tunnel Request/Response.

The following GTPv2-C messages are sent per UE on the S11 interface:

- Modify Access Bearers Request/Response.

The following GTPv2-C messages are sent per GTP-C entity on the S2a, S2b, S5, S8, and S11 interfaces:

- Delete PDN Connection Set Request/Response.

The following GTPv2-C messages are sent per GTP-C entity on the S5 and S8 interfaces:

- Update PDN Connection Set Request/Response.

The following GTPv2-C messages are sent per GTP-C entity on the S4 and S11 interfaces:

- PGW Restart Notification/Acknowledge.

The following GTPv2-C path management messages are sent per GTP-C entity on all GTPv2-C interfaces:

- Echo Request/Response;
- Version Not Supported Indication.

---

## 7 GTP-C messages

### 7.1 Path Management Messages

#### 7.1.0 General

Three path management messages are specified for GTP-C: Echo Request, Echo Response and Version Not Supported Indication.

The usage of Echo Request / Response procedure is specified in 3GPP TS 23.007 [17].

#### 7.1.1 Echo Request

Table 7.1.1-1 specifies the information elements included in the Echo Request message.

The Recovery information element contains the local Restart Counter, which is specified in 3GPP TS 23.007 [17])

The optional Private Extension contains vendor or operator specific information.

**Table 7.1.1-1: Information Elements in Echo Request**

Information elements	P	Condition / Comment	IE Type	Ins.
Recovery	M		Recovery	0
Sending Node Features	CO	This IE shall be sent towards a peer node on any GTPv2 interface if the sending node supports at least one feature on this interface or if the sending node supports at least one feature and does not know the interface type towards the peer node. This IE may be present otherwise.	Node Features	0
Private Extension	O		Private Extension	VS

## 7.1.2 Echo Response

Table 7.1.2-1 specifies the information elements included in the Echo Response message.

The Recovery information element contains the local Restart Counter, which is specified in 3GPP TS 23.007 [17])

The optional Private Extension contains vendor or operator specific information.

**Table 7.1.2-1: Information Elements in Echo Response**

Information elements	P	Condition / Comment	IE Type	Ins.
Recovery	M		Recovery	0
Sending Node Features	CO	This IE shall be sent towards a peer node on any GTPv2 interface if the sending node supports at least one feature on this interface or if the sending node supports at least one feature and does not know the interface type towards the peer node. This IE may be present otherwise.	Node Features	0
Private Extension	O		Private Extension	VS

**NOTE:** Having no Cause IE in the Echo Response message is an exceptional case for a triggered message. Hence, a GTP entity that detects a GTP protocol error, e.g Mandatory IE missing, in the Echo Request message, ignores the IE(s) that are in error and sends Echo Response. In addition it can log the error.

## 7.1.3 Version Not Supported Indication

This message contains only the GTPv2 header and indicates the latest GTP version that the sending entity supports.

# 7.2 Tunnel Management Messages

## 7.2.0 General

A node shall include the Recovery information element if it is in contact with the node's peer for the first time, or if the node or the node's peer has restarted recently and the new Restart Counter value has not yet been indicated to the peer. The peer receiving the Recovery information element shall handle it as when an Echo Response message is received but shall consider the rest of the message in accordance with the message semantics and parameters.

## 7.2.1 Create Session Request

The direction of this message shall be from MME/S4-SGSN to SGW and from SGW to PGW, and from ePDG/TWAN to the PGW (see Table 6.1-1).

The Create Session Request message shall be sent on the S11 interface by the MME to the SGW, and on the S5/S8 interface by the SGW to the PGW as part of the procedures:

- E-UTRAN Initial Attach when a PDN connection needs to be established through the SGW and PGW

- Handover from Trusted or Untrusted Non-3GPP IP Access to E-UTRAN with GTP on S5/S8 interface (see clauses 8.2, 8.6 and 16.11 of 3GPP TS 23.402 [45])
- UE requested PDN connectivity when a PDN connection needs to be established through the SGW and PGW
- Addition of a 3GPP access of NBIFOM procedure as specified by 3GPP TS 23.161 [71]
- Restoration of PDN connections after an PGW-C/SMF change as specified in 3GPP TS 23.007 [17]

The message shall also be sent on S4 interface by the SGSN to the SGW, and on the S5/S8 interface by the SGW to the PGW as part of the procedures:

- PDP Context Activation
- Handover from Trusted or Untrusted Non-3GPP IP Access to UTRAN/GERAN with GTP on S5/S8 interface (see clauses 8.2, 8.6 and 16.11 of 3GPP TS 23.402 [45])
- Addition of a 3GPP access of the NBIFOM procedure as specified by 3GPP TS 23.161 [71]

The message shall also be sent on the S11 interface by the MME to the SGW as part of the procedures:

- Tracking Area Update procedure with Serving GW change
- S1/X2-based handover with SGW change
- UTRAN Iu mode to E-UTRAN Inter RAT handover with SGW change
- GERAN A/Gb mode to E-UTRAN Inter RAT handover with SGW change
- 3G Gn/Gp SGSN to MME combined hard handover and SRNS relocation procedure
- Gn/Gp SGSN to MME Tracking Area Update procedure
- Restoration of PDN connections after an SGW failure if the MME and PGW support these procedures as specified in 3GPP TS 23.007 [17]
- MME triggered Serving GW relocation
- Handover from Trusted or Untrusted Non-3GPP IP Access to E-UTRAN with PMIP on S5/S8 interface (see clauses 8.2 and 16.11 of 3GPP TS 23.402 [45])

and on the S4 interface by the SGSN to the SGW as part of the procedures:

- Routing Area Update with MME interaction and with SGW change
- Gn/Gp SGSN to S4 SGSN Routing Area Update
- Inter SGSN Routing Area Update Procedure and Combined Inter SGSN RA / LA Update using S4 with SGW change
- Iu mode RA Update Procedure using S4 with SGW change
- E-UTRAN to UTRAN Iu mode Inter RAT handover with SGW change
- E-UTRAN to GERAN A/Gb mode Inter RAT handover with SGW change
- Serving RNS relocation using S4 with SGW change
- Combined hard handover and SRNS relocation using S4 with SGW change
- Combined Cell / URA update and SRNS relocation using S4 with SGW change
- Enhanced serving RNS relocation with SGW relocation
- Restoration of PDN connections after an SGW failure if the SGSN and PGW support these procedures as specified in 3GPP TS 23.007 [17]
- S4-SGSN triggered Serving GW relocation

- Handover from Trusted or Untrusted Non-3GPP IP Access to UTRAN/GERAN with PMIP on S5/S8 interface (see clauses 8.2 and 16.11 of 3GPP TS 23.402 [45])

and on the S2b interface by the ePDG to the PGW as part of the procedures:

- Initial Attach with GTP on S2b
- UE initiated Connectivity to Additional PDN with GTP on S2b
- Handover to Untrusted Non-3GPP IP Access with GTP on S2b (See clause 8.6 of 3GPP TS 23.402 [45])
- Initial Attach for emergency session (GTP on S2b)
- Addition of an access using S2b of NBIFOM procedure as specified by 3GPP TS 23.161 [71]

and on the S2a interface by the TWAN to the PGW as part of the procedure:

- Initial Attach in WLAN on GTP S2a
- Initial Attach in WLAN for Emergency Service on GTP S2a
- UE initiated Connectivity to Additional PDN with GTP on S2a
- Handover to TWAN with GTP on S2a (See clause 16.10 of 3GPP TS 23.402 [45])
- Addition of an access using S2a of NBIFOM procedure as specified by 3GPP TS 23.161 [71].

If the new Create Session Request received by the SGW collides with an existing active PDN connection context (the existing PDN connection context is identified with the tuple [IMSI, EPS Bearer ID], where IMSI shall be replaced by TAC and SNR part of ME Identity for emergency or RLOS attached UE without UICC or authenticated IMSI), this Create Session Request shall be treated as a request for a new session. Before creating the new session, the SGW should delete:

- the existing PDN connection context locally, if the Create Session Request is received with the TEID set to zero in the header, or if it is received with a TEID not set to zero in the header and it collides with the default bearer of an existing PDN connection context;
- the existing dedicated bearer context locally, if the Create Session Request collides with an existing dedicated bearer context and the message is received with a TEID not set to zero in the header.

In the former case, if the PGW S5/S8 IP address for control plane received in the new Create Session Request is different from the PGW S5/S8 IP address for control plane of the existing PDN connection, the SGW should also delete the existing PDN connection in the corresponding PGW by sending a Delete Session Request message.

NOTE 1: The SGW can send the Create Session Request and Delete Session Request over S5/S8 asynchronously, e.g. the SGW can send the Delete Session Request and then the Create Session Request without having to wait for the Delete Session Response. It does not matter if the PGW happens to receive the Delete Session Request after the Create Session Request since the PGW assigns a different S5/S8 F-TEID for control plane to the new PDN connection.

In some network deployment, e.g. when 5G Network Slice is deployed and the combined PGW-C/SMFs are connected to the UDM, the PGW may select another PGW supporting the network slice for which the UE has subscription and then forward the Create Session Request to that PGW. When forwarding the Create Session Request message, the PGW shall forward the Create Session Request message as received from the SGW but with the following modifications:

- the destination IP address of the message shall be set to the selected PGW IP address;
- the CSRMFI flag shall be set to "1";
- the source IP address and UDP port of the message shall be set to the IP address and port of the forwarding PGW.



NOTE 2: The Create Session Response message is sent back to the forwarding PGW that forwards it to the SGW. It is assumed that GTPv2/UDP/IP connectivity between the source PGW/SMF and the target PGW/SMF which are in different slices is allowed in such network deployment; otherwise, if there is no GTPv2/UDP/IP connectivity between the source PGW/SMF and the target PGW/SMF, or if the source PGW/SMF does not support forwarding the request to the target PGW/SMF, the source PGW/SMF can proceed as specified in clause 7.2.2.

If the new Create Session Request received by the PGW collides with an existing PDN connection context (the existing PDN connection context is identified with the triplet [IMSI, EPS Bearer ID, Interface type], where applicable Interface type here is S2a TWAN GTP-C interface or S2b ePDG GTP-C interface or S5/S8 SGW GTP-C interface, and where IMSI shall be replaced by TAC and SNR part of ME Identity for emergency or RLOS attached UE without UICC or authenticated IMSI), this Create Session Request shall be treated as a request for a new session. Before creating the new session, the PGW should delete:

- the existing PDN connection context, if the Create Session Request collides with the default bearer of an existing PDN connection context;
- the existing dedicated bearer context, if the Create Session Request collides with a dedicated bearer of an existing PDN connection context.

The PGW shall allocate a new PGW S5/S8 F-TEID for control plane to the new PDN connection, i.e. not the same F-TEID value as the one which was assigned to the existing PDN connection.

NOTE 3: With GTP based S2a and S2b, the EPS Bearer IDs assigned for specific UE over S2a between the TWAN and PGW and over S2b between an ePDG and PGW are independent of the EPS Bearer IDs assigned for the same UE over S5/S8 and may overlap in value (see 3GPP TS 23.402 [45] clause 4.6.2).

NOTE 4: Only the TAC and SNR part of the ME Identity is used to identify an emergency or RLOS attached UE without UICC or authenticated IMSI.

Table 7.2.1-1: Information Elements in a Create Session Request

Information elements	P	Condition / Comment	IE Type	Ins.
IMSI	C	<p>The IMSI shall be included in the message on the S4/S11 interface, and on S5/S8 interface if provided by the MME/SGSN, except for the case:</p> <ul style="list-style-type: none"> <li>- If the UE is emergency or RLOS attached and the UE is UICCless.</li> </ul> <p>The IMSI shall be included in the message on the S4/S11 interface, and on S5/S8 interface if provided by the MME/SGSN, but not used as an identifier</p> <ul style="list-style-type: none"> <li>- if UE is emergency or RLOS attached but IMSI is not authenticated.</li> </ul> <p>The IMSI shall be included in the message on the S2a/S2b interface, except for the case:</p> <ul style="list-style-type: none"> <li>- if the UE is emergency attached and the UE is UICCless.</li> </ul> <p>The IMSI shall be included in the message on the S2a/S2b interface, but not used as an identifier:</p> <ul style="list-style-type: none"> <li>- if UE is emergency attached but IMSI is not authenticated.</li> </ul>	IMSI	0
MSISDN	C	<p>For an E-UTRAN Initial Attach and a Handover from Trusted or Untrusted Non-3GPP IP Access to E-UTRAN the IE shall be included when used on the S11 interface, if provided in the subscription data from the HSS.</p> <p>For a PDP Context Activation procedure and a Handover from Trusted or Untrusted Non-3GPP IP Access to UTRAN/GERAN the IE shall be included when used on the S4 interface, if provided in the subscription data from the HSS.</p> <p>The IE shall be included for the case of a UE Requested PDN Connectivity, if the MME has it stored for that UE.</p> <p>It shall be included when used on the S5/S8 interfaces if provided by the MME/SGSN.</p> <p>The ePDG shall include this IE on the S2b interface during an Attach with GTP on S2b, UE initiated Connectivity to Additional PDN with GTP on S2b and a Handover to Untrusted Non-3GPP IP Access with GTP on S2b, Initial Attach for emergency session (GTP on S2b), if provided by the HSS/AAA.</p> <p>The TWAN shall include this IE on the S2a interface during an Initial Attach in WLAN on GTP S2a, Initial Attach in WLAN for Emergency Service on GTP S2a, UE initiated Connectivity to Additional PDN with GTP on S2a and a Handover to TWAN with GTP on S2a, if provided by the HSS/AAA.</p>	MSISDN	0
ME Identity (MEI)	C	<p>The MME/SGSN shall include the ME Identity (MEI) IE on the S11/S4 interface:</p> <ul style="list-style-type: none"> <li>- If the UE is emergency attached and the UE is UICCless; or</li> <li>- If the UE is emergency attached and the IMSI is not authenticated</li> </ul> <p>For all other cases the MME/SGSN shall include the ME Identity (MEI) IE on the S11/S4 interface if it is available.</p>	MEI	0
	CO	<p>The MME shall include the ME Identity (MEI) IE on the S11 interface:</p> <ul style="list-style-type: none"> <li>- If the UE is RLOS attached and the UE is UICCless; or</li> </ul>		

		<ul style="list-style-type: none"> <li>- If the UE is RLOS attached and the IMSI is not authenticated.</li> </ul>		
	CO	If the SGW receives this IE, it shall forward it to the PGW on the S5/S8 interface.		
	CO	<p>The TWAN/ePDG shall include the ME Identity (MEI) IE on the S2a/S2b interface:</p> <ul style="list-style-type: none"> <li>- If the UE is emergency attached and the UE is UICCless; or</li> <li>- If the UE is emergency attached and the IMSI is not authenticated.</li> </ul> <p>For all other cases, the TWAN/ePDG shall include the ME Identity (MEI) IE on the S2a/S2b interface, if it is available.</p>		
User Location Information (ULI)	C	This IE shall be included on the S11 interface for E-UTRAN Initial Attach, a Handover from Trusted or Untrusted Non-3GPP IP Access to E-UTRAN and UE-requested PDN Connectivity procedures. It shall include ECGI and TAI. The MME/SGSN shall also include it on the S11/S4 interface for TAU/RAU/X2-Handover/Enhanced SRNS Relocation procedure if the PGW/PCRF has requested location information change reporting and MME/SGSN support location information change reporting.	ULI (NOTE 10)	0
	CO	This IE shall also be included on the S4 interface for PDP Context Activation procedure. It shall include CGI/SAI, together with RAI.		
	CO	<p>This IE shall also be included on the S4/S11 interface for a TAU/RAU procedure if</p> <ul style="list-style-type: none"> <li>- the level of support (User Location Change Reporting and/or CSG Information Change Reporting) changes; or</li> <li>- the target MME/S4-SGSN cannot derive the level of support (User Location Change Reporting and/or CSG Information Change Reporting) for the source Gn/Gp SGSN. See NOTE 9.</li> </ul> <p>The MME shall include the ECGI and /or TAI in the ULI, the S4-SGSN shall include either the CGI or SAI or RAI, or CGI/SAI together with RAI in the ULI.</p>		

	CO	<p>This IE shall also be included on the S4/S11 interface for:</p> <ul style="list-style-type: none"> <li>- a TAU procedure with an S4-SGSN interaction, if the MME supports location information change reporting;</li> <li>- a RAU procedure with an MME interaction, if the S4-SGSN supports location information change reporting.</li> </ul> <p>The MME shall include the ECGI and TAI in the ULI, the S4-SGSN shall include the CGI/SAI together with RAI in the ULI.</p>		
	CO	The SGW shall include this IE on S5/S8 if it receives the ULI from MME/SGSN.		
Serving Network	C	<p>This IE shall be included on the S4/S11, S5/S8 and S2b interfaces for an E-UTRAN initial attach, a Handover from Trusted or Untrusted Non-3GPP IP Access to E-UTRAN, a PDP Context Activation, a Handover from Trusted or Untrusted Non-3GPP IP Access to UTRAN/GERAN, a UE requested PDN connectivity, an Attach with GTP on S2b, a UE initiated Connectivity to Additional PDN with GTP on S2b, a Handover to Untrusted Non-3GPP IP Access with GTP on S2b and an Initial Attach for emergency session (GTP on S2b). See NOTE 10.</p>	Serving Network	0
	CO	<p>This IE shall be included on S4/S11 for RAU/TAU/Handover with SGW relocation procedures. See NOTE 10.</p>		
	CO	<p>This IE shall be included on the S2a interface for an Initial Attach in WLAN on GTP S2a, an Initial Attach in WLAN for Emergency Service on GTP S2a, a UE initiated Connectivity to Additional PDN with GTP on S2a and a Handover to TWAN with GTP on S2a. The TWAN shall set this IE to the PLMN identity of the selected PLMN used for 3GPP-based access authentication. The selected PLMN is the PLMN of the 3GPP AAA Proxy in roaming case and the PLMN of the 3GPP AAA Server in non-roaming case.</p>		
RAT Type	M	<p>This IE shall be set to the 3GPP access type or to the value matching the characteristics of the non-3GPP access the UE is using to attach to the EPS.</p> <p>The MME shall set the RAT Type to LTE-M if it has received the LTE-M indication from the eNodeB, otherwise it shall set it to the RAT type the UE is using.</p> <p>The ePDG may use the access technology type of the untrusted non-3GPP access network if it is able to acquire it; otherwise it shall indicate Virtual as the RAT Type. The TWAN shall set the RAT Type value to "WLAN" on the S2a interface.</p> <p>If the LTE-M RAT type is received from the MME, the SGW shall signal the following RAT type to the PGW:</p> <ul style="list-style-type: none"> <li>- LTE-M RAT type, if the 'LTE-M RAT type reporting to PGW' flag is received from the MME; or</li> <li>- WB-E-UTRAN RAT type, otherwise.</li> </ul> <p>If the Satellite related RAT type is received from the MME, the SGW shall signal the following RAT type to the PGW:</p> <ul style="list-style-type: none"> <li>- The received Satellite related RAT type, if the 'Satellite RAT Type reporting to PGW Indication' flag is received from the MME; or</li> <li>- The RAT type without Satellite, i.e. LTE-M / EUTRAN-NB-IoT / WB-E-UTRAN, otherwise.</li> </ul> <p>See NOTE 3, NOTE 4, NOTE 22, NOTE 28.</p>	RAT Type	0

<p>Indication Flags</p>	<p>C This IE shall be included if any one of the applicable flags is set to 1.                  Applicable flags are:</p> <ul style="list-style-type: none"> <li>- S5/S8 Protocol Type: This flag shall be set to 1 on the S11/S4 interfaces if the chosen protocol type for the S5/S8 interface is PMIP.</li> <li>- Dual Address Bearer Flag: This flag shall be set to 1 on the S2b, S11/S4 and S5/S8 interfaces when the PDN Type, determined based on UE request and subscription record, is set to IPv4v6 and all SGSNs which the UE may be handed over to support dual addressing. This shall be determined based on node pre-configuration by the operator. (see also NOTE 5).                      The TWAN shall set this flag to 1 on the S2a interface if it supports IPv4 and IPv6 and the PDN Type determined from the UE request if single-connection mode or multi-connection mode is used (see 3GPP TS 23.402 [45]) and the user subscription data is set to IPv4v6.</li> <li>- Handover Indication: This flag shall be set to 1 on the S11/S4 and S5/S8 interface during a Handover from Trusted or Untrusted Non-3GPP IP Access to E-UTRAN, or a Handover from Trusted or Untrusted Non-3GPP IP Access to UTRAN/GERAN procedures, or an Addition of a 3GPP access of NBIFOM procedure, or during a 5GS to EPS handover without the N26 interface. This flag shall be set to 1 on the S2b interface during a Handover from 3GPP access to Untrusted Non-3GPP IP Access with GTP on S2b and IP address preservation is requested by the UE, or an Addition of an access using S2b of NBIFOM procedure.                      This flag shall be set to 1 on the S2a interface during a Handover from 3GPP access to TWAN with GTP on S2a and IP address preservation is requested by the UE, or an Addition of an access using S2a of NBIFOM procedure.</li> <li>- Operation Indication: This flag shall be set to 1 on the S4/S11 interface for a TAU/RAU procedure with SGW relocation, Enhanced SRNS Relocation with SGW relocation, X2-based handovers with SGW relocation and MME triggered Serving GW relocation.</li> <li>- Direct Tunnel Flag: This flag shall be set to 1 on the S4 interface if Direct Tunnel is used.</li> <li>- Piggybacking Supported: This flag shall be set to 1 on the S11 interface only if the MME supports the piggybacking feature as described in Annex F of 3GPP TS 23.401 [3]. This flag shall be set to 1 on S5/S8 only if both the MME and the SGW support piggybacking.</li> <li>- Change Reporting support Indication: This flag shall be set to 1 on S4/S11 and S5/S8 interfaces if the SGSN/MME supports location Info Change Reporting and if the SGSN/MME's operator policy permits reporting of location change to the operator of the PGW with which the session is being established. See NOTE2.</li> <li>- CSG Change Reporting Support Indication: This flag shall be set to 1 on S4/S11 and S5/S8</li> </ul>	<p>Indication</p>	<p>0</p>
-------------------------	--	-------------------	----------

	<p>interfaces if the SGSN/MME supports CSG Information Change Reporting and if the SGSN/MME's operator policy permits reporting of CSG Information change to the operator of the PGW with which the session is being established. See NOTE 2.</p> <ul style="list-style-type: none"> <li>- Unauthenticated IMSI: This flag shall be set to 1 on the S4/S11, S5/S8 and S2a/S2b interfaces if the IMSI present in the message is not authenticated and is for an emergency attached UE. It shall also be set to 1 on the S11 and S5/S8 interfaces if the IMSI is present in the message is not authenticated and is for an RLOS attached UE.</li> <li>- PDN Pause Support Indication: this flag shall be set to 1 on the S5/S8 interface if the SGW supports the PGW Pause of Charging procedure.</li> <li>- NBIFOM Support Indication: This flag shall be set to 1 on S11/S4 if the MME/SGSN supports NBIFOM. This flag shall be set to 1 on S5/S8 if both the SGW and the MME/SGSN support NBIFOM. This flag shall be set to 1 on S2a/S2b if the TWAN/ePDG supports NBIFOM.</li> <li>- WLCP PDN Connection Modification Support Indication: This flag shall be set to 1 on the S2a interface if the TWAN supports the WLCP PDN Connection Modification procedure.</li> <li>- UE Not Authorised Cause Code Support Indication: This flag shall be set to 1 on S4/S11 and S5/S8 interface if the SGSN/MME supports the "UE not authorised by OCS or external AAA Server" Cause Code.</li> <li>- UE Available for Signalling Indication: this flag shall be set to 1 on S11/S4 during a TAU/RAU with SGW relocation procedure if there is pending network initiated PDN connection signalling for this PDN connection. The SGW shall include this IE on S5/S8 if it receives the flag from the MME/SGSN.</li> <li>- S11-U Tunnel Flag: this flag shall be set to 1 on the S11 interface if user data is transported in NAS signalling.</li> <li>- Extended PCO Support Indication: this flag shall be set to 1 on S11 interface by the MME if the UE and the MME support ePCO; and this flag shall be set to 1 on S5/S8 interface by the SGW if the SGW supports ePCO and MME has set the flag to 1.</li> <li>- Control Plane Only PDN Connection Indication: this flag shall be set to 1 over S11 and S5/S8 if the PDN Connection is set to Control Plane Only.</li> <li>- eNB Change Reporting Support Indication: This flag shall be set to 1 on S11 and S5/S8 interfaces if the MME supports location Info Change Reporting and if the MME's operator policy permits reporting of location change to the operator of the PGW with which the session is being established. See NOTE 19.</li> <li>- LTE-M RAT Type reporting to PGW Indication: this flag shall be set to 1 on S11, based on operator</li> </ul>		
--	---	--	--

	<p>policy or roaming agreements (for Home Routed PDN connections), if the SGW needs to forward the LTE-M RAT type to the PGW.</p> <ul style="list-style-type: none"> <li>- 5GS Interworking Indication(5GSIWKI): this flag shall be set to 1 on S11, S5/S8 and S2b interfaces if the UE supports N1 mode and the PDN connection is not restricted from interworking with 5GS by user subscription (see "5GC" bit within Core-Network-Restrictions AVP and Interworking-5GS-Indicator AVP specified in 3GPP TS 29.272 [70] and 3GPP TS 29.273 [68]). (NOTE 27)</li> <li>- 5GS Interworking without N26 Indication: this flag shall be set to 1 on S11 and S5/S8 interfaces if the 5GS Interworking Indication (5GSIWKI) is set to 1 and the N26 interface is not supported. See clause 4.11.1.1 in 3GPP TS 23.502 [83]). (NOTE 23)</li> <li>- 5GCNRI (5GC Not Restricted Indication): this flag shall be set to 1 on S11, S5/S8 and S2b interfaces if access to the 5GC is not restricted for the PDN connection by user subscription (see "5GC" bit within Core-Network-Restrictions AVP and Interworking-5GS-Indicator AVP specified in 3GPP TS 29.272 [70] and 3GPP TS 29.273 [68]). (NOTE 27)</li> <li>- 5GCNRS (5GC Not Restricted Support): this flag shall be set to 1 on S11, S5/S8 and S2b interfaces if the sending node (i.e. MME or ePDG) supports setting the 5GCNRI flag. An MME or an ePDG compliant with this version of the specification shall support setting the 5GCNRI flag.</li> <li>- MTEDTA (MT-EDT Applicable): this flag shall be set to 1 on the S11 interface if MT-EDT is applicable for the PDN connection, i.e. if the UE has indicated its support of MT-EDT as part of the UE network capability and if the local policy requires so. (NOTE 26)</li> <li>- CSRMFI (Create Session Request Message Forwarded Indication): this shall be set to 1 on S5/S8 interfaces by a PGW if the Create Session Request message has been forwarded by that PGW.</li> <li>- Restoration of PDN connections after an PGW-C/SMF Change Support Indication: this flag shall be set to 1 on the S11/S2b interface if the MME/ePDG supports the Restoration of PDN connections after an PGW-C/SMF Change procedure as specified in clause 31 of 3GPP TS 23.007 [17]. This flag shall be set to 1 on the S5/S8 interface if the SGW and the MME support the Restoration of PDN connections after an PGW-C/SMF Change procedure as specified in clause 31 of 3GPP TS 23.007 [17].</li> <li>- PGW Change Indication: this flag shall be set to 1 by the MME/ePDG over the S11/S2b interface if the Create Session Request is to move an existing PDN connection to the new PGW-C/SMF as specified in clauses 31.3 and 31.3A of 3GPP TS 23.007 [17]. The SGW shall forward the flag on the S5/S8 interface.</li> </ul>		
--	---	--	--

		<ul style="list-style-type: none"><li>- PGWRNSI (PGW Redirection due to mismatch with Network Slice subscribed by UE Support Indication): this flag shall be set to 1 on the S11 and S5/S8 interfaces, if the MME supports receiving a Create Session rejection response with the cause "PGW redirection due to mismatch with network slice subscribed by the UE".</li><li>- UPIPSI (User Plane Integrity Protection Support Indication): this flag shall be set to 1 by the MME on the S11 interface, if the UE, MME and E-UTRAN supports User Plane Integrity Protection with EPS. This flag shall be set to 1 by the SGW on S5/S8 interface if the MME has set the flag to 1 over the S11 interface.</li></ul>		
--	--	---	--	--



Sender F-TEID for Control Plane	M		F-TEID	0
PGW S5/S8 Address for Control Plane or PMIP	C	This IE shall be sent on the S11 / S4 interfaces. The TEID or GRE Key is set to "0" in the E-UTRAN initial attach, a Handover from Trusted or Untrusted Non-3GPP IP Access to E-UTRAN, the PDP Context Activation, a Handover from Trusted or Untrusted Non-3GPP IP Access to UTRAN/GERAN and the UE requested PDN connectivity procedures.	F-TEID	1
Access Point Name (APN)	M		APN	0
Selection Mode	C	<p>This IE shall be included on the S4/S11 and S5/S8 interfaces for an E-UTRAN initial attach, a Handover from Trusted or Untrusted Non-3GPP IP Access to E-UTRAN, a PDP Context Activation, a Handover from Trusted or Untrusted Non-3GPP IP Access to UTRAN/GERAN and a UE requested PDN connectivity.</p> <p>This IE shall be included on the S2b interface for an Initial Attach with GTP on S2b, a Handover to Untrusted Non-3GPP IP Access with GTP on S2b, a UE initiated Connectivity to Additional PDN with GTP on S2b and an Initial Attach for emergency session (GTP on S2b).</p> <p>It shall indicate whether a subscribed APN or a non-subscribed APN chosen by the UE/MME/SGSN/ePDG/TWAN was selected, see NOTE 17.</p> <p>This IE shall be included on the S2a interface for an Initial Attach in WLAN on GTP S2a, an Initial Attach in WLAN for Emergency Service on GTP S2a, a Handover to TWAN with GTP on S2a and a UE initiated Connectivity to Additional PDN with GTP on S2a. The value shall be set to "MS or network provided APN, subscription verified".</p>	Selection Mode	0
	CO	When available, this IE shall be sent by the MME/SGSN on the S11/S4 interface during TAU/RAU/HO with SGW relocation.		
PDN Type	C	<p>This IE shall be included on the S4/S11 and S5/S8 interfaces for an E-UTRAN initial attach, a Handover from Trusted or Untrusted Non-3GPP IP Access to E-UTRAN, a PDP Context Activation, a Handover from Trusted or Untrusted Non-3GPP IP Access to UTRAN/GERAN and a UE requested PDN connectivity.</p> <p>This IE shall be set to IPv4, IPv6, IPv4v6, Non-IP or Ethernet. This is based on the UE request and the subscription record retrieved from the HSS (for MME see 3GPP TS 23.401 [3], clause 5.3.1.1, and for SGSN see 3GPP TS 23.060 [35], clause 9.2.1). See NOTE 1. See NOTE 14. See NOTE 24 and 25.</p>	PDN Type	0

<p>PDN Address Allocation (PAA)</p>	<p>C This IE shall be included the S4/S11, S5/S8 and S2a/S2b interfaces for an E-UTRAN initial attach, a Handover from Trusted or Untrusted Non-3GPP IP Access to E-UTRAN, a PDP Context Activation, a Handover from Trusted or Untrusted Non-3GPP IP Access to UTRAN/GERAN, a UE requested PDN connectivity, an Attach with GTP on S2b, a UE initiated Connectivity to Additional PDN with GTP on S2b, a Handover to Untrusted Non-3GPP IP Access with GTP on S2b, an Initial Attach for emergency session (GTP on S2b, an Initial Attach in WLAN on GTP S2a, an Initial Attach in WLAN for Emergency Service on GTP S2a, a UE initiated Connectivity to Additional PDN with GTP on S2a and a Handover to TWAN with GTP on S2a. For PMIP-based S5/S8, this IE shall also be included on the S4/S11 interfaces for TAU/RAU/Handover cases involving SGW relocation.</p> <p>The PDN type field in the PAA shall be set to IPv4, or IPv6 or IPv4v6, Non-IP or Ethernet by MME/SGSN, based on the UE request and the subscription record retrieved from the HSS (see clause 8.12 and also NOTE 5. See also NOTE 24).</p> <p>The TWAN shall set the PDN type field in the PAA to IPv4, or IPv6 or IPv4v6 based on the UE request if single-connection mode or multi-connection mode is used (see 3GPP TS 23.402 [45]), the IP versions the TWAN supports and the PDN type received in the user subscription data from the HSS/3GPP AAA Server, or based on the UE request and the TWAN Emergency Configuration Data for an Initial Attach in WLAN for Emergency Service on GTP S2a.</p> <p>The ePDG shall set the PDN type field in the PAA to IPv4, or IPv6 or IPv4v6 based on the UE request and the subscription record retrieved from the HSS/3GPP AAA Server, or based on the UE request and the ePDG Emergency Configuration Data for an Initial Attach for emergency session (GTP on S2b).</p> <p>For static IP address assignment (for MME see 3GPP TS 23.401 [3], clause 5.3.1.1, for SGSN see 3GPP TS 23.060 [35], clause 9.2.1, for ePDG see 3GPP TS 23.402 [45] clause 4.7.3, and for TWAN see 3GPP TS 23.402 [45] clause 16.1.5), the MME/SGSN/ePDG/TWAN shall set the IPv4 address and/or IPv6 prefix length and IPv6 prefix and Interface Identifier based on the subscribed values received from HSS, if available. For PDN Type IPv4v6, either one of the IP versions (i.e. IPv4 address or IPv6 prefix and Interface Identifier) or both the IP versions may be statically provisioned in the HSS. If only one of the IP versions is statically provisioned in the HSS, the MME/SGSN/ePDG/TWAN shall set the other IP version as all zeros. The value of PDN Type field shall be consistent with the value of the PDN Type IE, if present in this message.</p> <p>For a Handover to Untrusted Non-3GPP IP Access with GTP on S2b, the ePDG shall set the IPv4 address and/or IPv6 prefix length and IPv6 prefix and Interface Identifier based on the IP address(es) received from the UE.</p> <p>For IP PDN connections, if static IP address assignment is not used (e.g. static address is not received from the HSS), and for scenarios other than a Handover to Untrusted Non-3GPP IP Access with GTP on S2b, the IPv4 address shall</p>	<p>PAA</p>	<p>0</p>
-------------------------------------	---	------------	----------

		be set to 0.0.0.0, and/or the IPv6 Prefix Length and IPv6 prefix and Interface Identifier shall all be set to zero.  For Non-IP or Ethernet PDN connections, the PDN Address and Prefix field shall not be present. See NOTE 14 and 25.		
	CO	This IE shall be sent by the MME/SGSN on S11/S4 interface during TAU/RAU/HO with SGW relocation.		
Maximum APN Restriction	C	This IE shall be included on the S4/S11 and S5/S8 interfaces in the E-UTRAN initial attach, a Handover from Trusted or Untrusted Non-3GPP IP Access to E-UTRAN, PDP Context Activation, a Handover from Trusted or Untrusted Non-3GPP IP Access to UTRAN/GERAN and UE Requested PDN connectivity procedures. This IE denotes the most stringent restriction as required by any already active bearer context. If there are no already active bearer contexts, this value is set to the least restrictive type.	APN Restriction	0
Aggregate Maximum Bit Rate (APN-AMBR)	C	This IE represents the APN-AMBR. It shall be included on the S4/S11, S5/S8 and S2a/S2b interfaces for an E-UTRAN initial attach, a Handover from Trusted or Untrusted Non-3GPP IP Access to E-UTRAN, UE requested PDN connectivity, PDP Context Activation procedure using S4, a Handover from Trusted or Untrusted Non-3GPP IP Access to UTRAN/GERAN, TAU/RAU/Handover from the Gn/Gp SGSN to the S4 SGSN/MME procedures, Attach with GTP on S2b, a Handover to Untrusted Non-3GPP IP Access with GTP on S2b, UE initiated Connectivity to Additional PDN with GTP on S2b, an Initial Attach for emergency session (GTP on S2b), Initial Attach in WLAN on GTP S2a, an Initial Attach in WLAN for Emergency Service on GTP S2a, a Handover to TWAN with GTP on S2a and UE initiated Connectivity to Additional PDN with GTP on S2a.	AMBR	0
Linked EPS Bearer ID	C	This IE shall be included on S4/S11 in RAU/TAU/HO except in the Gn/Gp SGSN to MME/S4-SGSN RAU/TAU/HO procedures with SGW change to identify the default bearer of the PDN Connection	EBI	0
Trusted WLAN Mode Indication	CO	The TWAN shall include this IE on S2a interface (during initial attach, handover to TWAN with GTP on S2a procedure, UE-initiated additional PDN connectivity procedures), if the single-connection mode or multiple-connection mode is used. The TWAN shall not include this IE if transparent single-connection mode is used. The PGW shall assume that transparent single-connection mode is used if it receives this message without this IE from the TWAN.	TWMI	0
Protocol Configuration Options (PCO)	C	If MME/SGSN receives PCO from the UE during the Attach, PDN connectivity or Handover to 3GPP access procedures, the MME/SGSN shall forward the PCO IE to SGW. The SGW shall also forward it to PGW.	PCO	0
	CO	If the TWAN receives a PCO from the UE during: an initial attach, handover to TWAN or UE-initiated additional PDN connectivity with GTP on S2a procedures (in multi-connection mode or single connection mode), the TWAN shall forward the PCO IE to the PGW, see 3GPP TS 23.402 [45].		

Bearer Contexts to be created	M	Several IEs with the same type and instance value shall be included on the S4/S11 and S5/S8 interfaces as necessary to represent a list of Bearers. One single IE shall be included on the S2a/S2b interface. One bearer shall be included for E-UTRAN Initial Attach, PDP Context Activation, UE requested PDN Connectivity, Attach with GTP on S2b, UE initiated Connectivity to Additional PDN with GTP on S2b, Handovers between Untrusted Non-3GPP IP Access with GTP on S2b and 3GPP Access, Initial Attach for emergency session (GTP on S2b), Initial Attach in WLAN on GTP S2a, an Initial Attach in WLAN for Emergency Service on GTP S2a, Handovers between TWAN with GTP on S2a and 3GPP Access and UE initiated Connectivity to Additional PDN with GTP on S2a. One or more bearers shall be included for a Handover/TAU/RAU with an SGW change. See NOTE 6 and NOTE 7.	Bearer Context	0
Bearer Contexts to be removed	C	This IE shall be included on the S4/S11 interfaces for the TAU/RAU/Handover cases where any of the bearers existing before the TAU/RAU/Handover procedure will be deactivated as consequence of the TAU/RAU/Handover procedure. For each of those bearers, an IE with the same type and instance value shall be included. See NOTE 6 and NOTE 7.	Bearer Context	1
Trace Information	C	This IE shall be included on the S4/S11 interface if an SGW trace is activated, and/or on the S5/S8 and S2a/2b interfaces if a PGW trace is activated. See 3GPP TS 32.422 [18].	Trace Information	0
Recovery	C	This IE shall be included on the S4/S11, S5/S8 and S2a/2b interfaces if contacting the peer node for the first time.	Recovery	0
MME-FQ-CSID	C	This IE shall be included by the MME on the S11 interface and shall be forwarded by an SGW on the S5/S8 interfaces according to the requirements in 3GPP TS 23.007 [17].	FQ-CSID	0
SGW-FQ-CSID	C	This IE shall be included by the SGW on the S5/S8 interfaces according to the requirements in 3GPP TS 23.007 [17].	FQ-CSID	1
ePDG-FQ-CSID	C	This IE shall be included by the ePDG on the S2b interface according to the requirements in 3GPP TS 23.007 [17].	FQ-CSID	2
TWAN-FQ-CSID	C	This IE shall be included by the TWAN on the S2a interface according to the requirements in 3GPP TS 23.007 [17].	FQ-CSID	3
UE Time Zone	CO	This IE shall be included by the MME over S11 during Initial Attach, a Handover from Trusted or Untrusted Non-3GPP IP Access to E-UTRAN and UE Requested PDN Connectivity procedure. This IE shall be included by the SGSN over S4 during PDP Context Activation procedure and a Handover from Trusted or Untrusted Non-3GPP IP Access to UTRAN/GERAN. This IE shall be included by the MME/SGSN over S11/S4 TAU/RAU/Handover with SGW relocation.	UE Time Zone	0
	C	If SGW receives this IE, SGW shall forward it to PGW across S5/S8 interface.		
	O	This IE shall be included by the TWAN on the S2a interface for Initial Attach in WLAN procedure, UE-initiated Connectivity to Additional PDN with GTP on S2a and handover to TWAN with GTP on S2a procedure as specified in 3GPP TS 23.402 [45].		

User CSG Information (UCI)	CO	This IE shall be included on the S4/S11 interface for E-UTRAN Initial Attach, a Handover from Trusted or Untrusted Non-3GPP IP Access to E-UTRAN, UE-requested PDN Connectivity, PDP Context Activation and a Handover from Trusted or Untrusted Non-3GPP IP Access to UTRAN using S4 procedures, if the UE is accessed via CSG cell or hybrid cell. The MME/SGSN shall also include it for TAU/RAU/Handover procedures with SGW relocation if the UE is accessed via a CSG cell or hybrid cell or leaves a CSG or hybrid cell and the PGW/PCRF has requested CSG info reporting and MME/SGSN support CSG info reporting. NOTE 11. The SGW shall include this IE on S5/S8 if it receives the User CSG information from MME/SGSN. See NOTE 10.	UCI	0
Charging Characteristics	C	This IE shall be included on the S4/S11, S5/S8 and S2a/S2b interfaces according to 3GPP TS 32.251 [8]	Charging Characteristics	0
MME/S4-SGSN LDN	O	This IE is optionally sent by the MME to the SGW on the S11 interface and by the S4-SGSN to the SGW on the S4 interface (see 3GPP TS 32.423 [44]), when communicating the LDN to the peer node for the first time.	Local Distinguished Name (LDN)	0
SGW LDN	O	This IE is optionally sent by the SGW to the PGW on the S5/S8 interfaces (see 3GPP TS 32.423 [44]), when communicating the LDN to the peer node for the first time.	Local Distinguished Name (LDN)	1
ePDG LDN	O	This IE is optionally sent by the ePDG to the PGW on the S2b interfaces (see 3GPP TS 32.423 [44]), when contacting the peer node for the first time.	Local Distinguished Name (LDN)	2
TWAN LDN	O	This IE may be sent by the TWAN to the PGW on the S2a interfaces (see 3GPP TS 32.423 [44]), when contacting the peer node for the first time.	Local Distinguished Name (LDN)	3
Signalling Priority Indication	CO	The SGSN/MME shall include this IE on the S4/S11 interface if the UE indicates low access priority when requesting to establish the PDN connection. The SGW shall forward this IE in the Create Session Request message on the S5/S8 interfaces if received from the MME/SGSN.	Signalling Priority Indication	0
UE Local IP Address	CO	The ePDG shall include this IE on the S2b interface during an Initial Attach for emergency session (GTP on S2b). Otherwise the ePDG shall include this IE on the S2b interface based on local policy.	IP Address	0
UE UDP Port	CO	The ePDG shall include this IE on the S2b interface if NAT is detected, the UDP encapsulation is used and the UE Local IP Address is present.	Port Number	0
Additional Protocol Configuration Options (APCO)	CO	If multiple authentications are supported by the ePDG, the ePDG shall include this IE on the S2b interface and perform the corresponding procedures as specified for PAP and CHAP authentication of the UE with external networks in 3GPP TS 33.402 [50].	Additional Protocol Configuration Options (APCO)	0
	O	If the UE requests the DNS IPv4/IPv6 address in the Configuration Payload (CFG_REQ) during the IPsec tunnel establishment procedure (as specified in 3GPP TS 33.402 [50]), and if the ePDG supports the Additional Protocol Configuration Options IE, the ePDG may include this IE over S2b interface and correspondingly set the "DNS Server IPv4/v6 Address Request" parameter as defined in 3GPP TS 24.008 [5].		
	CO	If the UE includes the P-CSCF_IP6_ADDRESS attribute, or the P-CSCF_IP4_ADDRESS attribute or both in the CFG_REQUEST configuration payload during the IPsec tunnel establishment procedure as specified in 3GPP TS 24.302 [63]), and if the ePDG supports these IKEv2 attributes and the Additional Protocol Configuration Options IE, the ePDG shall include this IE over the S2b interface and correspondingly set the P-CSCF IPv6 Address Request, or P-CSCF IPv4 Address Request, or both parameters as defined in 3GPP TS 24.008 [5].		

	<p>CO If the UE includes the P-CSCF_RESELECTION_SUPPORT Private Status Type in a Notify payload within the IKE_AUTH request message during the IPsec tunnel establishment procedure as specified in 3GPP TS 24.302 [63], and if the ePDG supports the P-CSCF restoration extension procedure for the untrusted WLAN access (see 3GPP TS 23.380 [61]), the ePDG shall include this IE over the S2b interface and correspondingly set the P-CSCF_RESELECTION_SUPPORT, as defined in 3GPP TS 24.008 [5].</p>		
	<p>O The TWAN may include this IE on the S2a interface to retrieve additional IP configuration parameters from the PGW (e.g. DNS server) if the transparent single-connection mode is used as specified in 3GPP TS 23.402 [45].</p>		
	<p>CO The ePDG shall include this IE over the S2b interface and correspondingly set the PDU session ID, as defined in 3GPP TS 24.008 [5] if:</p> <ul style="list-style-type: none"> <li>- the UE includes the N1_MODE_CAPABILITY Notify payload within the IKE_AUTH request message during the IPsec tunnel establishment procedure as specified in 3GPP TS 24.302 [63];</li> <li>- the ePDG supports this IKEv2 attribute and the Additional Protocol Configuration Options IE; and</li> <li>- the PDN connection is not restricted from interworking with 5GS by user subscription (see "5GC" bit within Core-Network-Restrictions AVP and Interworking-5GS-Indicator AVP specified in 3GPP TS 29.273 [68]).</li> </ul>		
<p>H(e)NB Local IP Address</p>	<p>CO The MME/SGSN shall include this IE on S11/S4 interface if the MME/SGSN receives this information from H(e)NB in UE associated S1/Iu signalling according (see 3GPP TS 23.139 [51]) during:</p> <ul style="list-style-type: none"> <li>- E-UTRAN Initial Attach, a Handover from Trusted or Untrusted Non-3GPP IP Access to E-UTRAN, UE-requested PDN Connectivity, PDP Context Activation and a Handover from Trusted or Untrusted Non-3GPP IP Access to UTRAN using S4;</li> <li>- TAU/RAU/X2-based handover/Enhanced Serving RNS Relocation Procedure with SGW change, if the PGW/PCRF has requested H(e)NB information reporting for the PDN connection.</li> </ul> <p>The SGW shall forward this IE on S5/S8 interface if the SGW receives it from the MME/SGSN.</p>	<p>IP Address</p>	<p>1</p>
<p>H(e)NB UDP Port</p>	<p>CO The MME/SGSN shall include this IE on S11/S4 interface if the MME/SGSN receives this information from H(e)NB in UE associated S1/Iu signalling according (see 3GPP TS 23.139 [51]) during:</p> <ul style="list-style-type: none"> <li>- E-UTRAN Initial Attach, a Handover from Trusted or Untrusted Non-3GPP IP Access to E-UTRAN, UE-requested PDN Connectivity, PDP Context Activation and a Handover from Trusted or Untrusted Non-3GPP IP Access to UTRAN using S4;</li> <li>- TAU/RAU/X2-based handover/Enhanced Serving RNS Relocation Procedure with SGW relocation, if the PGW/PCRF has requested H(e)NB information reporting for the PDN connection.</li> </ul> <p>The SGW shall forward this IE on S5/S8 interface if the SGW receives it from the MME/SGSN.</p>	<p>Port Number</p>	<p>1</p>

MME/S4-SGSN Identifier	CO	If the PGW triggered SGW restoration procedure is supported, the MME/S4-SGSN shall include this IE on S11/S4 interface and the SGW shall forward this IE on S5 interface in the existing signalling as specified in 3GPP TS 23.007 [17]. If the overload control feature is supported by the MME/S4-SGSN and is activated for the PLMN to which the PGW belongs (see clause 12.3.11), the MME/S4-SGSN shall include this IE on the S11/S4 interface. In that case, the SGW shall forward this IE on the S5/S8 interface.	IP Address	2
TWAN Identifier	CO	This IE shall be included on the S2a interface for Initial Attach in WLAN procedure, UE-initiated Connectivity to Additional PDN with GTP on S2a and handover to TWAN with GTP on S2a procedure as specified in 3GPP TS 23.402 [45].	TWAN Identifier	0
ePDG IP Address	O	This IE may be included on the S2b interface based on local policy for Fixed Broadband access network interworking, see 3GPP TS 23.139 [51]. If present, it shall contain the ePDG IP address which is used as IKEv2 tunnel endpoint with the UE.	IP Address	3
CN Operator Selection Entity	CO	In shared networks, the SGSN shall include this IE on the S4 interface for a PDP Context Activation, a Handover from Trusted or Untrusted Non-3GPP IP Access to UTRAN/GERAN and RAU with SGW relocation procedures, if the information is available, to indicate whether the Serving Network has been selected by the UE or by the network.	CN Operator Selection Entity	0
	CO	The SGW shall include this IE on S5/S8 if it receives it from the SGSN.		
Presence Reporting Area Information	CO	The MME/SGSN shall include this IE in the following procedures, if the PGW/PCRF/OCS requested reporting changes of UE presence in the Presence Reporting Area(s) and the MME/SGSN supports such reporting: <ul style="list-style-type: none"> <li>- TAU/RAU/X2 Handover/Enhanced SRNS Relocation procedures with SGW relocation and MME/SGSN change. The new MME/SGSN shall then indicate whether the UE is inside or outside the PRA for each of the active Presence Reporting Area(s), or indicate that the Presence Reporting Area (s) is inactive;</li> <li>- TAU/RAU/X2 Handover/Enhanced SRNS Relocation procedures with SGW relocation and without MME/SGSN change, if the UE enters or leaves the Presence Reporting Area(s). In this case, this IE shall only include the active PRA(s) that the UE has newly entered or left.</li> </ul> Several IEs with the same type and instance value may be included as necessary to represent a list of Presence Reporting Area Actions. See NOTE 20.	Presence Reporting Area Information	0
MME/S4-SGSN's Overload Control Information	O	During an overload condition, the MME/S4-SGSN may include this IE on the S11/S4 interface if the overload control feature is supported by the MME/S4-SGSN and is activated for the PLMN to which the PGW belongs (see clause 12.3.11).  When present, the MME/S4-SGSN shall provide only one instance of this IE, representing its overload information.	Overload Control Information	0
	CO	If the SGW receives this IE and if it supports the overload control feature, it shall forward it to the PGW on the S5/S8 interface.		

SGW's Overload Control Information	O	During an overload condition, the SGW may include this IE over the S5/S8 interface if the overload control feature is supported by the SGW and is activated for the PLMN to which the PGW belongs (see clause 12.3.11).  When present, the SGW shall provide only one instance of this IE, representing its overload information.	Overload Control Information	1
TWAN/ePDG's Overload Control Information	O	During an overload condition, the TWAN/ePDG may include this IE over the S2a/S2b interface if the overload control feature is supported by the TWAN/ePDG and is activated for the PLMN to which the PGW belongs (see clause 12.3.11).  When present, the TWAN/ePDG shall provide only one instance of this IE, representing its overload information.	Overload Control Information	2
Origination Time Stamp	CO	The MME/SGSN and the TWAN/ePDG shall include this IE on the S11/S4 and S2a/S2b interface respectively, in the conditions specified in clause 13.2.  When present, the Origination Time Stamp shall contain the UTC time when the originating entity initiated the request.	Millisecond Time Stamp	0
	CO	The SGW shall include this IE on the S5/S8 interface if it receives the Origination Time Stamp from the MME/SGSN and if it supports the procedure specified in clause 13.2.		
Maximum Wait Time	CO	The MME/SGSN and the TWAN/ePDG shall include this IE on the S11/S4 and S2a/S2b interface respectively, in the conditions specified in clause 13.3.  When present, the Maximum Wait Time shall contain the duration (number of milliseconds since the Origination Time Stamp) during which the originator of the request waits for a response.	Integer Number	0
	CO	The SGW shall include this IE on the S5/S8 interface if it receives the Maximum Wait Time from the MME/SGSN and if it supports the procedure specified in clause 13.3.		
WLAN Location Information	CO	This IE shall be included on the S2b interface if the WLAN Location Information is available.	TWAN Identifier	1
WLAN Location Timestamp	CO	This IE shall be included on the S2b interface, if the WLAN Location Timestamp is available.	TWAN Identifier Timestamp	0
NBIFOM Container	CO	This IE shall be included on the S11/S4 or S2a/S2b interfaces if the MME/S4-SGSN or the TWAN/ePDG receives an NBIFOM Container from the UE as specified in TS 24.161 73]. The Container Type shall be set to 4.	F-Container	0
	CO	If the SGW receives an NBIFOM Container from the MME/S4-SGSN, the SGW shall forward this IE to the PGW on the S5/S8 interface.		
Remote UE Context Connected	CO	The MME shall include this IE on the S11 interface during a SGW relocation procedure if such information is available. Several IEs with the same type and instance value may be included as necessary to represent a list of remote UEs connected.	Remote UE Context	0
3GPP AAA Server Identifier	O	The ePDG/TWAN may include this IE on the S2a/S2b interface to provide the selected 3GPP AAA server identifier to the PGW. See NOTE 13.	Node Identifier	0
Extended Protocol Configuration Options (ePCO)	CO	If the MME receives ePCO from the UE during the Initial Attach, UE requested PDN Connectivity procedures, the MME shall forward the ePCO IE to the SGW if the MME supports ePCO.  The SGW shall also forward it to the PGW if the SGW supports ePCO. See NOTE 15.	ePCO	0



Serving PLMN Rate Control	CO	The MME shall include this IE on the S11 interface if Serving PLMN Rate control is configured by the MME operator and the PDN Connection is set to Control Plane Only: <ul style="list-style-type: none"> <li>- during an Initial Attach, or a UE Requested PDN Connectivity procedure.</li> <li>- during an inter MME TAU with SGW relocation procedure</li> </ul> See NOTE 18. The SGW shall include this IE on S5/S8 if it receives this IE from MME.	Serving PLMN Rate Control	0
MO Exception Data Counter	CO	The MME shall include the counter if it has received the counter for RRC cause "MO Exception data" in the Context Response message during a TAU with an MME and SGW change.	Counter	0
UE TCP Port	CO	The ePDG shall include this IE on the S2b interface if NAT is detected, the TCP encapsulation is used and the UE Local IP Address is present.	Port Number	2
Mapped UE Usage Type	CO	The MME/SGSN shall include this IE on the S11/S4 interface, if available. When present, this IE shall contain the mapped UE usage type applicable to the PDN connection. See NOTE 21.	Mapped UE Usage Type	0
	CO	The SGW shall include this IE on S5 if it receives it from the MME/SGSN.		
User Location Information for SGW	CO	The MME/SGSN shall include this IE on the S11/S4 interface, based on operator policy for the User Location Information to be sent to the SGW, if the user location information to be passed to the SGW is not already reported in the ULI IE in this message.  When present, this IE shall include the ECGI, TAI, eNodeB ID, RAI and/or RNC-ID, based on local policy. See NOTE 21.	ULI	1
SGW-U node name	CO	The SGW-C shall include this IE on the S5 interface, if available. See NOTE 21.	FQDN	0
Secondary RAT Usage Data Report	CO	If the PLMN has configured secondary RAT usage reporting and PDN GW Secondary RAT reporting is active, the MME shall include this IE on the S11 interface if it has received Secondary RAT usage data from eNodeB in an X2-based handover with Serving GW relocation. The MME shall also set the IRSGW flag to "0", to indicate that the Secondary RAT usage data is reported for the Source SGW, and sent via the Target SGW to the PGW. Several IEs with the same type and instance value may be included, to represent multiple usage data reports.	Secondary RAT Usage Data Report	0
UP Function Selection Indication Flags	CO	Based on operator policy, the MME/S4-SGSN shall include this IE on the S4/S11 interface, if any of the applicable flags is set to 1.  Applicable flags are: <ul style="list-style-type: none"> <li>- DCNR: This flag shall be set to 1 if it is desired to select a specific SGW-U and PGW-U for UEs supporting Dual Connectivity with NR and not restricted from using NR by user subscription, e.g. due to requirements of higher bitrates.</li> </ul> See NOTE 21.	UP Function Selection Indication Flags	0
	CO	The SGW shall include this IE on S5/S8 if it receives it from the MME/S4-SGSN.		

APN RATE Control Status	CO	If APN RATE Control Status is available in MME/S4-SGSN, APN RATE Control Status shall be transferred on the S4/S11 interface. The SGW shall include the APN RATE Control Status IE on the S5/S8 interface, if received from the MME/S4-SGSN.	APN RATE Control Status	0
APN RATE Control Status	CO	If APN RATE Control Status is available in MME/S4-SGSN, APN RATE Control Status shall be transferred on the S4/S11 interface. The SGW shall include the APN RATE Control Status IE on the S5/S8 interface, if received from the MME/S4-SGSN.	APN RATE Control Status	0
PSCell ID	CO	The MME shall include this IE on the S11 interface, if it has received this information from the eNodeB.	PSCell ID	0
Private Extension	O	This IE may be sent on the S5/S8, S4/S11 and S2a/S2b interfaces.	Private Extension	VS

- NOTE 1: The conditional PDN Type IE is redundant on the S4/S11 and S5/S8 interfaces (as the PAA IE contains exactly the same field). The receiver may ignore it. This IE is never sent on the S2a/S2b interface.
- NOTE 2: 3GPP TS 23.401 [3] (e.g. clause 5.3.2.1) and 3GPP TS 23.060 [35] (e.g. clause 9.2.2.1) defines the MME/SGSN shall send the MS Info Change Reporting Support Indication to the PGW. In such case MME/SGSN shall use the Change Reporting Support Indication and/or CSG Change Reporting Support Indication (whichever is applicable), even if stage 2 refers to MS Info Change Reporting Support Indication.
- NOTE 3: The methods that the ePDG may use to acquire the RAT type of the untrusted non-3GPP IP access network are not specified in this release.
- NOTE 4: The PDN-GW can be informed about the type of access network used by the UE over several reference points, see 3GPP TS 29.212 [30] for the mapping between the code values for the different access network types.
- NOTE 5: 3GPP TS 23.401 [3] (see clause 5.3.1.1) and 3GPP TS 23.060 [35] (see clause 9.2.1) specify the handling of the cases when UE has requested IPv4v6 PDN Type, but MME does not set the Dual Address Bearer Flag due to the MME operator using single addressing per bearer to support interworking with nodes of earlier releases.
- NOTE 6: The Bearer Context to be created IE and Bearer Context to be removed IE, together, shall contain all the bearers belonging to the given PDN connection with each bearer appearing in only one of these IEs.
- NOTE 7: During S1 based handover/ Inter RAT handover/TAU/RAU with S4-SGSN/MME and SGW change, and handover/RAU/TAU from Gn/Gp SGSN to S4-SGSN/MME, if the target MME/S4-SGSN cannot accept one or more PDN connection(s) but can accept at least one or more remaining PDN Connection(s) of the UE, the target MME/SGSN shall indicate all the non GBR bearers of the unaccepted PDN Connection in the Bearer Contexts to be created IE. The (target) MME/SGSN shall indicate all the GBR bearers of the unaccepted PDN connection in the Bearer Contexts to be removed IE.
- NOTE 8: The conditions of presence of the IEs in the Create Session Request for the MME and S4-SGSN triggered Serving GW relocation (see clause 5.10.4 of 3GPP TS 23.401 [3] and clause 9.2.2.4 of 3GPP TS 23.060 [35]) are identical to those specified respectively for X2 handover with SGW relocation and for Enhanced Serving RNS Relocation with SGW relocation.
- NOTE 9: During the TAU/RAU/Handover from Gn/Gp SGSN, the target MME/S4-SGSN cannot derive the level of support for User Location Change Reporting and/or CSG Information Change Reporting at the source Gn/Gp SGSN.
- NOTE 10: In shared networks, when the message is sent from the VPLMN to the HPLMN, the PLMN ID that is communicated in this IE shall be that of the selected Core Network Operator for supporting UEs, or that of the allocated Core Network Operator for non-supporting UEs. As an exception, based on inter-operator roaming/sharing agreement, if the information on whether the UE is a supporting or non-supporting UE is available, the PLMN ID that is communicated to the HPLMN for non-supporting UEs shall be the Common PLMN ID.  
In shared networks, when the MME/S4-SGSN and PGW pertain to the same PLMN, the Primary PLMN ID shall be communicated in the ECGI to the PGW, and the Common PLMN ID shall be communicated in SAI/CGI to the PGW, for both supporting and non-supporting UEs. The Core Network Operator PLMN ID (selected by the UE for supporting UEs or allocated by the network for non-supporting UEs) shall be communicated in the TAI, RAI, UCI and the Serving Network.  
See clause 4.4 of 3GPP TS 23.251 [55].
- NOTE 11: If the UE initiates a TAU or RAU procedure back to the old MME/old S4 SGSN before completing the ongoing TAU or RAU procedure and the UE is not accessed via a CSG cell or hybrid cell, the old MME/old S4-SGSN shall treat this case as the UE leaves a CSG or hybrid cell. .
- NOTE 12: Void
- NOTE 13: If supported, the PGW shall contact the 3GPP AAA server (identified by this IE which carries the Origin-Host and Origin-Realm included in the DEA message received by the ePDG/TWAN over SWm or STa interface) for establishing the S6b session.
- NOTE 14: Before contacting an EPC entity, e.g. to send a Create Session Request message, the MME/SGSN shall ensure, during the selection procedure, that the receiving entities support Non-IP PDN type, as specified in clause 5.9 of 3GPP TS 29.303 [32], e.g. using the Notification of Supported features procedure to learn if the candidate SGW supports the CIOT feature. See also the clause 8.83.
- NOTE 15: An MME, SGW and PGW which supports NB-IoT and/or Non-IP or Ethernet PDN type and/or inter-system change with 5GS and/or UAS services shall support ePCO. A UE supporting NB-IoT access and/or Non-IP or Ethernet PDN type and/or N1 mode and/or UAS services also support ePCO.
- NOTE 16: All the UE's SGi PDN Connections shall either have the Control Plane Only PDN Connection Indication set or not set.
- NOTE 17: If the APN was authorized based on the wildcard APN, the Selection Mode Value shall be set to indicate that the subscription is not verified, see Annex A of 3GPP TS 23.060 [35].
- NOTE 18: The MME can set the Control Plane Only Indication only during a PDN connection creation procedure, and the Serving PLMN Rate Control is only applicable to the PDN connection with Control Plane Only Indication set.  
During an inter MME with SGW relocation procedure, when the source MME has not set the Control

Plane Only Indication, and the target MME supports only the Control Plane Clot Optimizations, then the target MME shall not include the Serving PLMN Rate Control IE as the PDN connection cannot be changed to Control Plane Only.

During an inter MME with SGW relocation procedure, when the source MME has set the Control Plane Only Indication and included Serving PLMN rate control IE in the Context Response message, and the target MME supports both the Control Plane Clot Optimisation and the establishment of the User Plane, the target MME cannot stop the Serving PLMN Rate Control, i.e. the PGW will continue to enforce Serving PLMN Rate Control as the Control Plane Only Indication for this PDN connection cannot be changed during this mobility procedure.

NOTE 19: An MME which supports eNB Change Reporting shall also support Change reporting and therefore shall set both the Change Report Supporting indication and the eNB Changing Reporting Support Indication.

NOTE 20: Upon inter MME/SGSN mobility, the target MME/SGSN shall report Presence Reporting Area Information for all the active and inactive PRAs requested by the PGW. Upon intra MME/SGSN mobility with SGW relocation, the MME/SGSN shall only report active PRAs whose Presence Reporting Area Information is changed, e.g. from inside to outside, or vice versa.

NOTE 21: This information is used for the SGW-U, PGW-U or combined SGW-U/PGW-U selection (see Annex B.2 of 3GPP TS 29.244 [80]).

NOTE 22: An MME shall send the LTE-M RAT type to the SGW only if the latter is known to support it. The forwarding of the LTE-M RAT type to the PGW is controlled by the LTE-M RAT Type reporting to PGW Indication.

NOTE 23: It is assumed that the N26 interface is supported homogeneously across a PLMN.

NOTE 24: PDN connections of PDN Type "Ethernet" are not supported in GERAN/UTRAN. For PDN connections of PDN type "Ethernet", mobility to GERAN/UTRAN or Non 3GPP access from E-UTRAN is not supported. See clause 4.3.17.8a of TS 23.401 [3].

NOTE 25: Before contacting an EPC entity, e.g. to send a Create Session Request message, the MME shall ensure, during the selection procedure, that the receiving entities support Ethernet PDN type, as specified in clause 5.13 of 3GPP TS 29.303 [32], e.g. using the Notification of Supported features procedure to learn if the candidate SGW supports the ETH feature. See also the clause 8.83.

NOTE 26: The MME should select an SGW supporting MT-EDT if MT-EDT is applicable for the PDN connection.

NOTE 27: If the PGW-C/SMF receives the PDU session ID from the UE in the PCO, ePCO or APCO IE, the 5GCNRI flag is set to 1, and the PGW-C/SMF allows to transfer the PDN connection from EPC to 5GC, the PGW-C/SMF shall return the 5GS parameters as specified in 3GPP TS 23.501 [82] and 3GPP TS 23.502 [83] (e.g. mapped QoS parameters and S-NSSAI for interworking with N26 in the PCO or ePCO, S-NSSAI for interworking without N26 in the PCO or ePCO, or S-NSSAI for interworking between ePDG connected to EPC and 5GS in the APCO) in the Create Session Response message, regardless of the 5GSIWKI flag.

NOTE 28: If the LTE-M Satellite related RAT type is received from the MME, the SGW shall send the LTE-M RAT type to the PGW if the 'Satellite RAT Type reporting to PGW Indication' is not received and the 'LTE-M RAT Type reporting to PGW Indication' is received, or the SGW shall send the WB-E-UTRAN RAT type to the PGW if both of the indications are absent.

Table 7.2.1-2: Bearer Context to be created within Create Session Request

Octet 1	Bearer Context IE Type = 93 (decimal)			
Octets 2 and 3	Length = n			
Octet 4	Spare and Instance fields			
Information elements	P	Condition / Comment	IE Type	Ins.
EPS Bearer ID	M		EBI	0
TFT	O	This IE may be included on the S4/S11 interfaces.	Bearer TFT	0
S1-U eNodeB F-TEID	C	This IE shall be included on the S11 interface for X2-based handover with SGW relocation.	F-TEID	0
S4-U SGSN F-TEID	C	This IE shall be included on the S4 interface if the S4-U interface is used.	F-TEID	1
S5/S8-U SGW F-TEID	C	This IE shall be included on the S5/S8 interface for an "E-UTRAN Initial Attach", a Handover from Trusted or Untrusted Non-3GPP IP Access to E-UTRAN, a "PDP Context Activation", a Handover from Trusted or Untrusted Non-3GPP IP Access to UTRAN/GERAN or a "UE Requested PDN Connectivity".	F-TEID	2
S5/S8-U PGW F-TEID	C	This IE shall be included on the S4 and S11 interfaces for the TAU/RAU/Handover cases when the GTP-based S5/S8 is used.	F-TEID	3
	CO	For PMIP-based S5/S8, this IE shall be included on the S11/S4 interface for the TAU/RAU/Handover cases if the PGW provided an alternate address for user plane, i.e. an IP address for user plane which is different from the IP address for control plane. When present, this IE shall contain the alternate IP address for user plane and the uplink GRE key. See NOTE 1.		
S12 RNC F-TEID	CO	This IE shall be included on the S4 interface if the S12 interface is used in the Enhanced serving RNS relocation with SGW relocation procedure.	F-TEID	4
S2b-U ePDG F-TEID	C	This IE shall be included on the S2b interface for an Attach with GTP on S2b, a UE initiated Connectivity to Additional PDN with GTP on S2b, a Handover to Untrusted Non-3GPP IP Access with GTP on S2b and an Initial Attach for emergency session (GTP on S2b).	F-TEID	5
S2a-U TWAN F-TEID	C	This IE shall be included on the S2a interface for an Initial Attach in WLAN on GTP S2a, an Initial Attach in WLAN for Emergency Service on GTP S2a, a UE initiated Connectivity to Additional PDN with GTP on S2a and a Handover to TWAN with GTP on S2a.	F-TEID	6
Bearer Level QoS	M		Bearer QoS	0
S11-U MME F-TEID	CO	This IE shall be sent on the S11 interface, if S11-U is being used, during the E-UTRAN Initial Attach and UE requested PDN connectivity procedures. This IE may also be sent on the S11 interface, if S11-U is being used, during a Tracking Area Update procedure with Serving GW change, if the MME needs to establish the S11-U tunnel. See NOTE 2.	F-TEID	7
NOTE 1: The capability to receive from the LMA an alternate LMA address for user plane shall be supported homogeneously across all the SGWs, when supported over PMIP-based S5/S8.				
NOTE 2: Establishing the S11-U tunnel at once during the Create Session Request/Response procedure avoids the need for a subsequent Modify Bearer Request/Response exchange to transfer DL or UL user data.				

**Table 7.2.1-3: Bearer Context to be removed within Create Session Request**

Octet 1	Bearer Context IE Type = 93 (decimal)			
Octets 2 and 3	Length = n			
Octet 4	Spare and Instance fields			
Information elements	P	Condition / Comment	IE Type	Ins.
EPS Bearer ID	M		EBI	0
S4-U SGSN F-TEID	C	This IE shall be sent on the S4 interface if the S4-U interface is used. See NOTE 1.	F-TEID	0
NOTE 1: The conditional S4-U SGSN F-TEID IE is redundant.				

**Table 7.2.1-4: Overload Control Information within Create Session Request**

Octet 1	Overload Control Information IE Type = 180 (decimal)			
Octets 2 and 3	Length = n			
Octet 4	Spare and Instance fields			
Information elements	P	Condition / Comment	IE Type	Ins.
Overload Control Sequence Number	M	See clause 12.3.5.1.2.1 for the description and use of this parameter.	Sequence Number	0
Overload Reduction Metric	M	See clause 12.3.5.1.2.3 for the description and use of this parameter.	Metric	0
Period of Validity	M	See clause 12.3.5.1.2.2 for the description and use of this parameter. This IE should be set to "0" if the "Overload Reduction Metric" is null. This IE shall be ignored by the receiver if the "Overload Reduction Metric" is null.	EPC Timer	0

**Table 7.2.1-5: Remote UE Context Connected within Create Session Request**

Octets 1	Remote UE Context IE Type = 191 (decimal)			
Octets 2 and 3	Length = n			
Octets 4	Spare and Instance fields			
Information elements	P	Condition / Comment	IE Type	Ins.
Remote User ID	M	See clause 8.123 for the description and use of this parameter	Remote User ID	0
Remote UE IP Information	M	See clause 8.124 for the description and use of this parameter	Remote UE IP Information	0

## 7.2.2 Create Session Response

The Create Session Response message shall be sent on the S11/S4 interfaces by the SGW to the MME/S4-SGSN, on the S5/S8 interfaces by the PGW to the SGW, on the S2b interface by the PGW to the ePDG, and on the S2a interface by the PGW to the TWAN as part of the procedures listed for the Create Session Request (see clause 7.2.1).

A PGW may receive the Create Session Response message sent from another PGW (see clause 7.2.1), the PGW shall forward the Create Session response message to the SGW as received from another PGW but with the following modifications:

- the destination IP address and UDP port of the message shall be set to the source IP address and UDP port of the Create Session Request message received from the SGW;
- the source IP address and UDP port of the message shall be set to the IP address and port of the forwarding PGW.

In some network deployment, e.g. when 5G Network Slice is deployed and the combined PGW-C/SMFs are connected to the UDM, if the MME indicated in the Create Session Request that it supports PGW redirection due to mismatch with network slice subscribed by UE, the source PGW/SMF may select another PGW supporting the network slice for which the UE has a subscription and then reject the Create Session Request with the cause set to "PGW mismatch with

network slice subscribed by the UE" and with the FQDN or IP address of the other PGW that the MME should use for establishing the PDN connection.

NOTE: This can be used e.g. if there is no GTPv2/UDP/IP connectivity between PGW/SMFs pertaining to different network slices, or if the source PGW/SMF does not support forwarding the request to the target PGW/SMF as specified in clause 7.2.1.

If handling of default bearer fails, then cause at the message level shall be a failure cause.

Possible Cause values are specified in Table 8.4-1. Message specific cause values are:

- "Request accepted".
- "Request accepted partially".
- "New PDN type due to network preference".
- "New PDN type due to single address bearer only".
- "Missing or unknown APN".
- "GRE key not found".
- "Preferred PDN type not supported".
- "All dynamic addresses are occupied".
- "Remote peer not responding".
- "Semantic error in the TFT operation".
- "Syntactic error in the TFT operation".
- "Semantic errors in packet filter(s)".
- "Syntactic errors in packet filter(s)".
- "User authentication failed".
- "APN access denied – no subscription".
- "APN Restriction type incompatibility with currently active PDN Connection".
- "Version not supported by next peer".
- "Denied in RAT".
- "Protocol type not supported".
- "APN congestion".
- "Multiple PDN connections for a given APN not allowed".
- "Multiple accesses to a PDN connection not allowed".
- "Context not found".
- "UE not authorised by OCS or external AAA Server".
- "PGW mismatch with network slice subscribed by the UE".

**Table 7.2.2-1: Information Elements in a Create Session Response**

Information elements	P	Condition / Comment	IE Type	Ins.
Cause	M	See NOTE 2 and NOTE 4.	Cause	0

Change Reporting Action	C	This IE shall be included on the S5/S8 and S4/S11 interfaces with the appropriate Action field if the location Change Reporting mechanism is to be started or stopped for this subscriber in the SGSN/MME.	Change Reporting Action	0
CSG Information Reporting Action	CO	This IE shall be included on the S5/S8 and S4/S11 interfaces with the appropriate Action field if the CSG Info reporting mechanism is to be started or stopped for this subscriber in the SGSN/MME.	CSG Information Reporting Action	0
H(e)NB Information Reporting	CO	This IE shall be included on the S5/S8 and S4/S11 interfaces with the appropriate Action field if H(e)NB information reporting is to be started or stopped (during a TAU/RAU with SGW change if started earlier) for the PDN connection in the SGSN/MME.	H(e)NB Information Reporting	0
Sender F-TEID for Control Plane	C	This IE shall be sent on the S11/S4 interfaces. For the S5/S8/ S2a/S2b interfaces it is not needed because its content would be identical to the IE PGW S5/S8/ S2a/S2b F-TEID for PMIP based interface or for GTP based Control Plane interface.	F-TEID	0
PGW S5/S8/ S2a/S2b F-TEID for PMIP based interface or for GTP based Control Plane interface	C	<p>The PGW shall include this IE on the S5/S8 interfaces during the Initial Attach, a Handover from Trusted or Untrusted Non-3GPP IP Access to E-UTRAN, UE requested PDN connectivity, PDP Context Activation and a Handover from Trusted or Untrusted Non-3GPP IP Access to UTRAN/GERAN procedures.</p> <p>If the SGW receives this IE it shall forward the IE to MME/S4-SGSN on the S11/S4 interface.</p> <p>This IE shall include the TEID for GTP based S5/S8 case and the uplink GRE key in the PMIP based S5/S8 case.</p> <p>For PMIP based S5/S8, this IE shall be included on the S11/S4 interface and shall contain the PGW S5/S8 IP address for control plane; the same IP address shall be used for both control plane and the user plane communication if the Bearer Context IE does not contain a S5/S8-U PGW F-TEID IE. See NOTE 7.</p> <p>The PGW shall include this IE on the S2b interface during the Attach with GTP on S2b, UE initiated Connectivity to Additional PDN with GTP on S2b, Handover to Untrusted Non-3GPP IP Access with GTP on S2b procedures and Initial Attach for emergency session (GTP on S2b).</p> <p>The PGW shall include this IE on the S2a interface during the Initial Attach in WLAN on GTP S2a, an Initial Attach in WLAN for Emergency Service on GTP S2a, UE initiated Connectivity to Additional PDN with GTP on S2a and Handover to TWAN with GTP on S2a procedures See NOTE 6.</p>	F-TEID	1
PDN Address Allocation (PAA)	C	<p>This IE shall be included on the S5/S8, S4/S11 and S2a/S2b interfaces for the E-UTRAN initial attach, a Handover from Trusted or Untrusted Non-3GPP IP Access to E-UTRAN, PDP Context Activation, a Handover from Trusted or Untrusted Non-3GPP IP Access to UTRAN/GERAN, UE requested PDN connectivity, Attach with GTP on S2b, UE initiated Connectivity to Additional PDN with GTP on S2b, Handover to Untrusted Non-3GPP IP Access with GTP on S2b, Initial Attach for emergency session (GTP on S2b), Initial Attach in WLAN on GTP S2a, Initial Attach in WLAN for Emergency Service on GTP S2a, UE initiated Connectivity to Additional PDN with GTP on S2a and Handover to TWAN with GTP on S2a.</p> <p>The PDN type field in the PAA shall be set to IPv4, or IPv6 or IPv4v6, Non-IP or Ethernet by the PGW. See NOTE4.</p> <p>For the S4/S11 and S5/S8 interfaces, if the PGW uses DHCPv4 for IPv4 address allocation, the IPv4 address field shall be set to 0.0.0.0; otherwise, the IPv4 address field shall be set to non-zero value as specified in 3GPP TS 23.401 [3] and 3GPP TS 23.402 [45].</p>	PAA	0



		When assigning an IPv6 address the PGW shall send a non-zero Interface Identifier. See NOTE 8. For Non-IP or Ethernet PDN connections, the PDN Address and Prefix field shall not be present.		
APN Restriction	C	This IE shall be included on the S5/S8 and S4/S11 interfaces in the E-UTRAN initial attach, a Handover from Trusted or Untrusted Non-3GPP IP Access to E-UTRAN, PDP Context Activation, a Handover from Trusted or Untrusted Non-3GPP IP Access to UTRAN/GERAN and UE Requested PDN connectivity procedures. This IE shall also be included on S4/S11 during the Gn/Gp SGSN to S4 SGSN/MME RAU/TAU procedures. This IE denotes the restriction on the combination of types of APN for the APN associated with this EPS bearer Context.	APN Restriction	0
Aggregate Maximum Bit Rate (APN-AMBR)	C	This IE represents the APN-AMBR. It shall be included on the S5/S8, S4/S11 and S2a/S2b interfaces if the received APN-AMBR has been modified by the PCRF.	AMBR	0
Linked EPS Bearer ID	C	This IE shall be sent on the S4/S11 interfaces during Gn/Gp SGSN to S4-SGSN/MME RAU/TAU procedure to identify the default bearer the PGW selects for the PDN Connection.	EBI	0
Protocol Configuration Options (PCO)	C	If ePCO is not supported by the UE or the network, and if the PGW decides to return PCO to the UE during the Attach, PDN connectivity or Handover to 3GPP access procedures, PGW shall send PCO to SGW. If SGW receives the PCO IE, SGW shall forward it to MME/SGSN.	PCO	0
	CO	For trusted WLAN access, if single-connection mode or multiple-connection mode is used, the PGW may include this IE over the S2a interface to send PCO to the UE.		
Bearer Contexts created	M	EPS bearers corresponding to Bearer Contexts sent in request message. Several IEs with the same type and instance value may be included on the S5/S8 and S4/S11 as necessary to represent a list of Bearers. One single IE shall be included on the S2a/S2b interface. One bearer shall be included for E-UTRAN Initial Attach, a Handover from Trusted or Untrusted Non-3GPP IP Access to E-UTRAN, PDP Context Activation, a Handover from Trusted or Untrusted Non-3GPP IP Access to UTRAN/GERAN, UE Requested PDN Connectivity, Attach with GTP on S2b, UE initiated Connectivity to Additional PDN with GTP on S2b, Handover to Untrusted Non-3GPP IP Access with GTP on S2b, Initial Attach for emergency session (GTP on S2b), Initial Attach in WLAN on GTP S2a, an Initial Attach in WLAN for Emergency Service on GTP S2a, UE initiated Connectivity to Additional PDN with GTP on S2a and Handover to TWAN with GTP on S2a. One or more created bearers shall be included for a Handover/TAU/RAU with an SGW change. See NOTE 2.	Bearer Context	0
Bearer Contexts marked for removal	C	EPS bearers corresponding to Bearer Contexts to be removed that were sent in the Create Session Request message. For each of those bearers an IE with the same type and instance value shall be included on the S4/S11 interfaces.	Bearer Context	1
Recovery	C	This IE shall be included on the S4/S11, S5/S8 and S2a/S2b interfaces if contacting the peer for the first time	Recovery	0
Charging Gateway Name	C	When Charging Gateway Function (CGF) Address is configured, the PGW shall include this IE on the S5 interface. See NOTE 1.	FQDN	0
Charging Gateway Address	C	When Charging Gateway Function (CGF) Address is configured, the PGW shall include this IE on the S5 interface. See NOTE 1.	IP Address	0
PGW-FQ-CSID	C	This IE shall be included by the PGW on the S5/S8 and S2a/S2b interfaces and, when received from S5/S8 be forwarded by the SGW on the S11 interface according to the requirements in 3GPP TS 23.007 [17].	FQ-CSID	0
SGW-FQ-CSID	C	This IE shall be included by the SGW on the S11 interface according to the requirements in 3GPP TS 23.007 [17].	FQ-CSID	1

SGW LDN	○	This IE is optionally sent by the SGW to the MME/SGSN on the S11/S4 interfaces (see 3GPP TS 32.423 [44]), when communicating the LDN to the peer node for the first time.	Local Distinguished Name (LDN)	0
PGW LDN	○	This IE is optionally included by the PGW on the S5/S8 and S2a/S2b interfaces (see 3GPP TS 32.423 [44]), when communicating the LDN to the peer node for the first time.	Local Distinguished Name (LDN)	1
PGW Back-Off Time	○	This IE may be included on the S5/S8 and S4/S11 interfaces when the PDN GW rejects the Create Session Request with the cause "APN congestion". It indicates the time during which the MME or S4-SGSN should refrain from sending subsequent PDN connection establishment requests to the PGW for the congested APN for services other than Service Users/emergency services. See NOTE 3.	EPC Timer	0

<p>Additional Protocol Configuration Options (APCO)</p>	<p>CO</p>	<p>If multiple authentications are supported by the PGW and if PGW received the Additional Protocol Configuration Options IE in the Create Session Request, the PGW shall include this IE on the S2b interface and perform the corresponding procedures as specified for PAP and CHAP authentication of the UE with external networks in 3GPP TS 33.402 [50].</p>	<p>Additional Protocol Configuration Options (APCO)</p>	<p>0</p>
<p>O</p>	<p>If the PGW supports the Additional Protocol Configuration Options IE and if the PGW has received the Additional Protocol Configuration Options IE with the "DNS IPv4/IPv6 Server Address Request" parameter in the Create Session Request over S2b interface, the PGW may include this IE over the S2b interface with the "DNS IPv4/IPv6 Server Address" parameter as specified in 3GPP TS 24.008 [5].</p> <p>If the PGW supports the Additional Protocol Configuration Options IE and if the PGW has received the Additional Protocol Configuration Options IE with the P-CSCF IPv4 Address Request, or P-CSCF IPv6 Address Request or both parameters in the Create Session Request over the S2b interface, the PGW may include this IE over the S2b interface with the P-CSCF IPv4 Address, or P-CSCF IPv6 Address, or both parameters respectively as specified in 3GPP TS 24.008 [5].</p> <p>If the PGW supports the Additional Protocol Configuration Options IE and if the PGW has received the Additional Protocol Configuration Options IE with a PDU session ID in the Create Session Request over the S2b interface, the PGW may include this IE over the S2b interface with the S-NSSAI as specified in 3GPP TS 24.302 [63] and 3GPP TS 24.008 [5].</p>			
<p>O</p>	<p>The PGW may include this IE on the S2a interface to provide the TWAN with additional IP configuration parameters (e.g. DNS server), if a corresponding request was received in the Create Session Request message.</p>			
<p>Trusted WLAN IPv4 Parameters</p>	<p>CO</p>	<p>The PGW shall include this IE on the S2a interface to a Trusted WLAN Access if PDN Type in the PAA is set to IPv4 or IPv4v6 and the transparent single-connection mode is used as specified in 3GPP TS 23.402 [45]. This IE shall include:</p> <ul style="list-style-type: none"> <li>- The Subnet Prefix Length of the subnet from which the PGW allocates the UE's IPv4 address.</li> <li>- The IPv4 Default Router Address which belongs to the same subnet as the IPv4 address allocated to the UE.</li> </ul>		

<p>Indication Flags</p>	<p>CO</p>	<p>This IE shall be included if any one of the applicable flags is set to 1. Applicable flags are:</p> <ul style="list-style-type: none"> <li>- PDN Pause Support Indication: this flag shall be set to 1 on the S5/S8 interface if the PGW supports the PGW Pause of Charging procedure.</li> <li>- PDN Pause Enable Indication: this flag shall be set to 1 on the S5/S8 interface if the PGW enables the SGW to use the PGW Pause of Charging procedure for this PDN connection.</li> <li>- Associate OCI with PGW node's identity: The PGW shall set this flag to 1 on the S5/S8 interface or S2a/S2b interface if it has included the "PGW's Overload Control Information" and if this information is to be associated with the node identity (i.e. FQDN or the IP address received from the HSS or DNS during the PGW selection) of the serving PGW. This flag shall be set to 1 by the PGW if the "PGW's Overload Control Information" is included and the Cause IE is set to a rejection cause code. The SGW shall set this flag on the S11/S4 interface if it supports the overload control feature and if the flag is set on the S5/S8 interface.</li> <li>- Associate OCI with SGW node's identity: The SGW shall set this flag to 1 on the S11/S4 interface if it has included the "SGW's Overload Control Information" and if this information is to be associated with the node identity (i.e. FQDN or the IP address received from the DNS during the SGW selection) of the serving SGW. This flag shall be set to 1 by the SGW if the "SGW's Overload Control Information" is included and the Cause IE is set to a rejection cause code.</li> <li>- Delay Tolerant Connection Indication: the flag shall be set to 1 on the S5/S8 and S11/S4 interface if the PDN connection is "Delay Tolerant" (see clause 8.12).</li> <li>- Triggering SGSN initiated PDP Context Creation/Modification Indication: this flag shall be set to 1 on the S5/S8 interfaces if the network-initiated NBIFOM mode is used for this PDN connection. The SGW shall set this flag on the S4 interface if it supports the NBIFOM feature and the flag is set on the S5/S8 interface.</li> <li>- Notify Start Pause of charging via User plane Support Indication: this flag shall be set to 1 on the S5/S8 interface if PDN Pause Enable Indication is set to "1" and if the PGW-C and PGW-U support the Notify Start Pause of Charging via user plane feature as specified in clause 5.30 of 3GPP TS 29.244 [80].</li> </ul>	<p>Indication</p>	<p>0</p>
<p>Presence Reporting Area Action</p>	<p>CO</p>	<p>This IE shall be included on the S5/S8 and S11/S4 interfaces with the appropriate Action field if reporting changes of UE presence in a Presence Routing Area is to be started, stopped or modified for this subscriber in the MME/SGSN.</p> <p>Several IEs with the same type and instance value may be included as necessary to represent a list of Presence Reporting Area Actions. One IE shall be included per PRA to be started, stopped or modified.</p>	<p>Presence Reporting Area Action</p>	<p>0</p>

PGW's node level Load Control Information	O	The PGW may include this IE on the S5/S8 or S2a/S2b interface, providing its node level load information, if the load control feature is supported by the PGW and is activated for the PLMN to which the access network node, i.e. MME/S4-SGSN for 3GPP access network, ePDG/TWAN for non-3GPP access network, belongs (see clause 12.2.6).	Load Control Information	0
	CO	If the SGW receives this IE and if it supports the load control feature, it shall forward it to the MME/S4-SGSN on the S11/S4 interface.		
PGW's APN level Load Control Information	O	The PGW may include this IE on the S5/S8 or S2a/S2b interface, providing APN level load information, if the APN level load control feature is supported by the PGW and is activated for the PLMN to which the access network node, i.e. MME/S4-SGSN for 3GPP access network, ePDG/TWAN for non-3GPP access based network, belongs (see clause 12.2.6).  When present, the PGW shall provide one or more instances of this IE, up to maximum of 10, with the same type and instance value, each representing the load information for a list of APN(s). See NOTE 9, NOTE 11.	Load Control Information	1
	CO	If the SGW receives this IE and if it supports APN level load control feature, it shall forward it to the MME/S4-SGSN on the S11/S4 interface.		
SGW's node level Load Control Information	O	The SGW may include this IE, over the S11/S4 interface if the load control feature is supported by the SGW and is activated in the network (see clause 12.2.6).  When present, the SGW shall provide only one instance of this IE, representing its node level load information.	Load Control Information	2
PGW's Overload Control Information	O	During an overload condition, the PGW may include this IE on the S5/S8 or S2a/S2b interface, if the overload control feature is supported by the PGW and is activated for the PLMN to which the access network node, i.e. MME/S4-SGSN for 3GPP access based network, ePDG/TWAN for non-3GPP access based network, belongs (see clause 12.3.11).  When present, the PGW shall provide: <ul style="list-style-type: none"> <li>- node level overload control, in one instance of this IE; and/or</li> <li>- APN level overload control, in one or more instances of this IE, up to maximum of 10, with the same type and instance value, each representing the overload information for a list of APN(s).</li> </ul> See NOTE 10, NOTE 12.	Overload Control Information	0
	CO	If the SGW receives this IE and if it supports the overload control feature, it shall forward it to the MME/S4-SGSN on the S11/S4 interface.		
SGW's Overload Control Information	O	During an overload condition, the SGW may include this IE over the S11/S4 interface if the overload control feature is supported by the SGW and is activated in the network (see clause 12.3.11).  When present, the SGW shall provide only one instance of this IE, representing its overload information.	Overload Control Information	1
NBIFOM Container	CO	This IE shall be included on the S5/S8 or S2a/S2b interfaces if the PGW needs to send NBIFOM informations specified in 3GPP TS 23.161 [71]. The Container Type shall be set to 4.	F-Container	0
	CO	If the SGW receives an NBIFOM Container from the PGW, the SGW shall forward this IE to the MME/S4-SGSN on the S11/S4 interface.		

PDN Connection Charging ID	CO	The PGW shall include this IE on the S5/S8 or S2a/S2b interfaces, during an Initial Attach, Initial PDN connection establishment, or Addition of an access procedures, when using NBIFOM, as specified in 3GPP TS 23.161 [71].	Charging ID	0
Extended Protocol Configuration Options (ePCO)	CO	If the PGW decides to return ePCO to the UE during an Initial Attach, UE requested PDN Connectivity procedure, and if the PGW supports the ePCO and the EPCOSI flag is set to 1 in the Create Session Request message, the PGW shall send ePCO to the SGW.  If the SGW receives the ePCO IE, the SGW shall forward it to the MME. See NOTE 13.	ePCO	0
PGW node name	CO	This IE shall be included over S5/S8 interfaces by the PGW when it receives the corresponding Create Session Request message with the CSRMFI flag set to "1", and the creation of the PDN connection has been accepted.  If the SGW receives this IE, the SGW shall forward it to the MME over S11 interface. (See NOTE 14)	FQDN	1
SGi PtP Tunnel Address	CO	This IE shall be included on the S5/S8 and S4/S11 interfaces, if the PDN Type is "Non-IP" and SGi PtP tunnelling based on UDP/IP is used (see clause 4.3.17.8.3.3.2 of 3GPP TS 23.401 [3]).  When present, the IE shall contain the IPv4 or IPv6 address, and optionally the UDP port, that is allocated for the SGi PtP tunnel based on UDP/IP.	SGi PtP Tunnel Address	0
PGW Change Info	CO	This IE shall be included on the S5/S8/S2b interface by the PGW if it supports the Restoration of PDN connections after an PGW-C/SMF Change procedure as specified in clause 31 of 3GPP TS 23.007 [17] and if the "Restoration of PDN connections after an PGW-C/SMF Change Support Indication" was set to 1 in the request.  An SGW that supports the Restoration of PDN connections after an PGW-C/SMF Change procedure as specified in clause 31 of 3GPP TS 23.007 [17], shall transparently forward this IE over the S11 interface if it is received in a Create Session Response or a Modify Bearer Response message from the PGW over S5/S8.	PGW Change Info	0
Alternative PGW-C/SMF FQDN	O	This IE may be included by the PGW on the S5/S8 interfaces, when the PGW rejects the Create Session Request with the cause "PGW mismatch with network slice subscribed by the UE".  If the SGW receives this IE, the SGW shall forward it to the MME over the S11 interface.  When present, the IE shall contain the FQDN of the other PGW that the MME should use for establishing the PDN connection. Several IEs with the same type and instance value may be included to represent a list of Alternative PGW-C/SMF FQDNs. (See NOTE 15)	FQDN	3

Alternative PGW-C/SMF IP Address	O	This IE may be included by the PGW on the S5/S8 interfaces, when the PGW rejects the Create Session Request with the cause "PGW mismatch with network slice subscribed by the UE".  If the SGW receives this IE, the SGW shall forward it to the MME over the S11 interface.  When present, the IE shall contain the IP Address of the other PGW that the MME should use for establishing the PDN connection. Several IEs with the same type and instance value may be included to represent a list of Alternative PGW-C/SMF FQDNs. (See NOTE 15)	IP Address	1
UP Security Policy	CO	This IE shall be included on the S5/S8 and S11 interfaces in the E-UTRAN initial attach and UE Requested PDN connectivity procedures, if UP Integrity Protection is supported by the UE, MME and E-UTRAN (i.e. if the UPIPSI flag was set to 1) and if User Plane Integrity Protection policy is available for the PDN connection. When present, it shall indicate whether User Plane integrity protection is required, preferred or not needed for the traffic of the PDN connection.	UP Security Policy	0
Private Extension	O	This IE may be sent on the S5/S8, S4/S11 and S2a/S2b interfaces.	Private Extension	VS
<p>NOTE1: Both Charging Gateway Name and Charging Gateway Address shall not be included at the same time. When both are available, the operator configures a preferred value.</p> <p>NOTE2: If the SGW cannot accept any of the "Bearer Context Created" IEs within Create Session Request message, the SGW shall send the Create Session Response with appropriate reject Cause value.</p> <p>NOTE 3: The last received value of the PGW Back-Off Time IE shall supersede any previous values received from that PGW and for this APN in the MME/SGSN.</p> <p>NOTE4: 3GPP TS 23.401 [3] (see clause 5.3.1.1) and 3GPP TS 23.060 [35] (see clause 9.2.1) specify the handling of the cases when UE has requested IPv4v6 PDN Type, but PGW restricts the usage of IPv4v6 PDN Type.</p> <p>NOTE 5: The conditions of presence of the IEs in the Create Session Response for the MME and S4-SGSN triggered Serving GW relocation (see clause 5.10.4 of 3GPP TS 23.401 [3] and clause 9.2.2.4 of 3GPP TS 23.060 [35]) are identical to those specified respectively for X2 handover with SGW relocation and for Enhanced Serving RNS Relocation with SGW relocation.</p> <p>NOTE 6: The IP address and TEID/GRE key in "PGW S5/S8/ S2a/S2b F-TEID for PMIP based interface or for GTP based Control Plane interface" IE are only provided for the subsequent GTP-C initial messages related to this PDN connection and shall NOT be used for other PDN connections.</p> <p>NOTE 7: For PMIP based S5/S8, the 'S5/S8-U PGW F-TEID' IE and the 'PGW S5/S8/ S2a/S2b F-TEID for PMIP based interface or for GTP based Control Plane interface' IE shall contain the same uplink GRE key; the Interface Type in these IEs shall be set to the value 9 (S5/S8 PGW PMIPv6 interface).</p> <p>NOTE 8: The Interface Identifier value of zero is a reserved value (see IETF RFC 5453 [58]). Clause 5.3.1.2.2 of 3GPP TS 23.401 [3] specifies the mechanism for preventing UE's link-local address collision with the PGW's link-local address.</p> <p>NOTE 9: The receiver, not supporting the APN level load control feature, shall ignore all the occurrence(s) of this IE, i.e. "Load Control Information" IE with instance number "1". The receiver, supporting the APN level load control feature and supporting the APN level load information for the maximum of 10 APNs, shall handle the APN level load information for the first 10 APNs and ignore any more APN level load information.</p> <p>NOTE 10: The receiver, supporting the APN level overload information for the maximum of 10 APNs, shall handle the APN level overload information for the first 10 APNs and ignore any more APN level overload information.</p> <p>NOTE 11: The APN level load information, provided within and across different instances of the "PGW's APN level Load Control Information" IE(s) shall be limited to 10 different APNs.</p> <p>NOTE 12: The APN level overload information, provided within and across different instances of the "PGW's Overload Control Information" IE(s) shall be limited to 10 different APNs.</p> <p>NOTE 13: The MME shall consider the presence of the ePCO IE in the Create Session Response message as an indication that the PGW and the SGW support the ePCO. The UE considers that the PGW supports ePCO when it receives an ePCO from the PGW.</p> <p>NOTE 14: The MME shall update the PGW FQDN associated with this PDN connection using this IE.</p> <p>NOTE 15: For a given alternative PGW, either the Alternative PGW-C/SMF FQDN IE or the Alternative PGW-C/SMF IP Address IE may be present, not both.</p>				

Table 7.2.2-2: Bearer Context Created within Create Session Response

Octets 1	Bearer Context IE Type = 93 (decimal)			
Octets 2 and 3	Length = n			
Octets 4	Spare and Instance fields			
Information elements	P	Condition / Comment	IE Type	Ins.
EPS Bearer ID	M		EBI	0
Cause	M	This IE shall indicate if the bearer handling was successful, and if not, it gives information on the reason. (NOTE 1, NOTE 2, NOTE 3)	Cause	0
S1-U SGW F-TEID	C	This IE shall be included on the S11 interface if the S1-U interface is used, i.e. if the S11-U Tunnel flag was not set in the Create Session Request. . See NOTE 6.	F-TEID	0
S4-U SGW F-TEID	C	This IE shall be included on the S4 interface if the S4-U interface is used.	F-TEID	1
S5/S8-U PGW F-TEID	C	For GTP-based S5/S8, this User Plane IE shall be included on S4/S11 and S5/S8 interfaces during the "E-UTRAN Initial Attach", a Handover from Trusted or Untrusted Non-3GPP IP Access to E-UTRAN, a "PDP Context Activation", a Handover from Trusted or Untrusted Non-3GPP IP Access to UTRAN/GERAN or a "UE Requested PDN Connectivity". For PMIP-based S5/S8, this IE shall be included on the S4/S11 interface during the "E-UTRAN Initial Attach", a Handover from Trusted or Untrusted Non-3GPP IP Access to E-UTRAN, a "PDP Context Activation", a Handover from Trusted or Untrusted Non-3GPP IP Access to UTRAN/GERAN or a "UE Requested PDN Connectivity" if the PGW provided an alternate address for user plane, i.e. an IP address for user plane which is different from the IP address for control plane. When present, this IE shall contain the alternate IP address for user plane and the uplink GRE key. See NOTE 4 and NOTE 5.	F-TEID	2
S12 SGW F-TEID	C	This IE shall be included on the S4 interface if the S12 interface is used.	F-TEID	3
S2b-U PGW F-TEID	C	This IE (for user plane) shall be included on the S2b interface during the Attach with GTP on S2b, UE initiated Connectivity to Additional PDN with GTP on S2b, Handover to Untrusted Non-3GPP IP Access with GTP on S2b, and Initial Attach for emergency session (GTP on S2b).	F-TEID	4
S2a-U PGW F-TEID	C	This IE (for user plane) shall be included on the S2a interface during the Initial Attach in WLAN on GTP S2a, an Initial Attach in WLAN for Emergency Service on GTP S2a, UE initiated Connectivity to Additional PDN with GTP on S2a, and Handover to TWAN with GTP on S2a.	F-TEID	5
Bearer Level QoS	C	This IE shall be included on the S5/S8, S4/S11 and S2a/S2b interfaces if the received QoS parameters have been modified.	Bearer QoS	0
Charging Id	C	This IE shall be included on the S5/S8 interface for an E-UTRAN initial attach, a Handover from Trusted or Untrusted Non-3GPP IP Access to E-UTRAN, a PDP Context Activation, a Handover from Trusted or Untrusted Non-3GPP IP Access to UTRAN/GERAN and a UE requested PDN connectivity.	Charging Id	0
	O	If the S5/S8 interface is GTP, this IE may be included on the S4 interface, in order to support CAMEL charging at the SGSN, for a PDP Context Activation, a Handover from Trusted or Untrusted Non-3GPP IP Access to UTRAN/GERAN, inter S4-SGSN RAU with SGW change and Gn/Gp to S4-SGSN RAU.		



	CO	This IE shall be included on the S2a/S2b interface for an Initial Attach in WLAN on GTP S2a, an Initial Attach in WLAN for Emergency Service on GTP S2a, Attach with GTP on S2b, UE initiated Connectivity to Additional PDN with GTP on S2b, Handover to Untrusted Non-3GPP IP Access with GTP on S2b, Initial Attach for emergency session (GTP on S2b, UE initiated Connectivity to Additional PDN with GTP on S2a, and Handover to TWAN with GTP on S2a.		
--	----	--	--	--

Bearer Flags	O	Applicable flags are: - PPC (Prohibit Payload Compression) : this flag may be set on the S5/S8 and S4 interfaces.	Bearer Flags	0
S11-U SGW F-TEID	C	This IE shall be included on the S11 interface if the S11-U interface is used, i.e. if the S11-U Tunnel flag was set in the Create Session Request. If the SGW supports both IP address types, the SGW shall send both IP addresses within the F-TEID IE. If only one IP address is included, then the MME shall assume that the SGW does not support the other IP address type.	F-TEID	6
<p>NOTE 1: According to 3GPP TS 23.401 [3] e.g. clause 5.5.1.2.2 "S1-based handover, normal" and 3GPP TS 23.060 [35], during the handover procedure with an SGW change, except in the case of X2-handover (NOTE2 addresses X2 based HO with SGW change case), the target MME/S4-SGSN initiates the Create Session Request/Response and Modify Bearer Request/Response procedures one after the other. After receiving the "Bearer Context to be Created" IEs within Create Session Request message, the SGW may not accept some of these bearers. The SGW however shall return all bearers with the "Bearer Context Created" IEs within Create Session Response message (this table), but with different Cause values. Bearers that were not accepted by the SGW shall have an appropriate rejection value in the Cause IE. The target MME/S4-SGSN shall send these non-accepted bearers to the target SGW within the "Bearer Context to be removed" IE in a subsequent Modify Bearer Request message. Therefore, the SGW shall allocate the DL S5/S8 SGW F-TEIDs also for the non-accepted bearers. MME/S4-SGSN should remove all of the non-accepted bearers by separate procedures (e.g. an MME/S4-SGSN initiated Dedicated Bearer Deactivation procedure).</p> <p>NOTE 2: According to 3GPP TS 23.401 [3] clause 5.5.1.1.3, "X2-based handover with Serving GW relocation", and 3GPP TS 23.060 [35] clause 6.9.2.2.5A "Enhanced Serving RNS Relocation Procedure using S4", during the X2-handover procedure with an SGW change and Enhanced Serving RNS Relocation Procedure with an SGW change, the target MME/S4-SGSN shall initiate only the Create Session Request/Response procedure. The SGW shall return all bearers (including those not accepted by the SGW) with a "Bearer Context Created" IE within Create Session Response message (this table), but with different Cause values. Bearers that were not accepted by the SGW shall have an appropriate rejection value in the Cause IE, The MME/S4-SGSN should remove these non-accepted bearers by separate procedures as well.</p> <p>NOTE 3: According to 3GPP TS 23.401 [3] e.g. clause 5.3.3.1 "Tracking Area Update procedure with Serving GW change" and 3GPP TS 23.060 [35], during the RAU/TAU procedure with an SGW change, the target MME/S4-SGSN shall initiate only the Create Session Request/Response procedure. The SGW shall return all bearers (including those not accepted by the SGW) with a "Bearer Context Created" IE within Create Session Response message (this table), but with different Cause values. Bearers that were not accepted by the SGW shall have an appropriate rejection value in the Cause IE. When Active Flag or Follow-on request is set during TAU/RAU procedure, MME/S4-SGSN should not establish user plane tunnel over S1 or Iu for those bearer contexts which were not accepted by the target SGW, while in the corresponding Modify Bearer Request message, the MME/S4-SGSN shall include all accepted bearer contexts in the "Bearer Context to be modified" IE and include all non-accepted bearer contexts in the "Bearer Context to be removed" IE. The MME/S4-SGSN should remove the bearers non-accepted by either SGW or eNB/RNC by separate procedures as well.</p> <p>NOTE 4: The capability to receive from the LMA an alternate LMA address for user plane shall be supported homogeneously across all the SGWs, when supported over PMIP-based S5/S8.</p> <p>NOTE 5: For PMIP based S5/S8, the 'S5/S8-U PGW F-TEID' IE and the 'PGW S5/S8/ S2a/S2b F-TEID for PMIP based interface or for GTP based Control Plane interface' IE shall contain the same uplink GRE key; the Interface Type in these IEs shall be set to the value 9 (S5/S8 PGW PMIPv6 interface).</p> <p>NOTE 6: When Control Plane CloT EPS Optimization is supported, the IP address spaces for S1-U and S11-U may be different, based on operator's deployment. If so, the following requirements shall apply: 1) if the CPOPCI (Control Plane Only PDN Connection Indication) flag is not set in the Create Session Request message, the SGW shall include both the S11-U SGW F-TEID and S1-U SGW F-TEID in the Create Session Response message, regardless of whether the S11-U Tunnel flag is set in the Create Request Request. 2) all the MMEs in the PLMN shall support receiving both the S11-U SGW F-TEID and S1-U SGW F-TEID in the Create Session Response response; the MME shall use them according to whether the CloT Control Plane Optimization is used.</p>				

**Table 7.2.2-3: Bearer Context marked for removal within a Create Session Response**

Octet 1	Bearer Context IE Type = 93 (decimal)			
Octets 2 and 3	Length = n			
Octet 4	Spare and Instance fields			
Information elements	P	Condition / Comment	IE Type	Ins.
EPS Bearer ID	M		EBI	0
Cause	M	This IE shall indicate if the bearer handling was successful, and if not, gives the information on the reason.	Cause	0

**Table 7.2.2-4: Load Control Information within Create Session Response**

Octet 1	Load Control Information IE Type = 181 (decimal)			
Octets 2 and 3	Length = n			
Octet 4	Spare and Instance fields			
Information elements	P	Condition / Comment	IE Type	Ins.
Load Control Sequence Number	M	See clause 12.2.5.1.2.1 for the description and use of this parameter.	Sequence Number	0
Load Metric	M	See clauses 12.2.5.1.2.2 and 12.2.5.1.2.3 for the description and use of this parameter.	Metric	0
List of APN and Relative Capacity	CO	The IE shall (only) be present in the "PGW's APN level Load Control Information" IE. For indicating the APN level load, the PGW shall include one or more instances of this IE, up to maximum of 10, with the same type and instance value, representing a list of APN(s) & its respective "Relative Capacity" (sharing the same "Load Metric"). See clause 12.2.5.1.2.3 for the description and use of this parameter. See NOTE 1.	APN and Relative Capacity	0
NOTE 1: If more than 10 occurrences of "APN and Relative Capacity" IE are received within one instance of the Load Control Information IE, the receiver shall treat it as a protocol error and ignore the entire Load Control Information IE instance.				

**Table 7.2.2-5: Overload Control Information within Create Session Response**

Octet 1	Overload Control Information IE Type = 180 (decimal)			
Octets 2 and 3	Length = n			
Octet 4	Spare and Instance fields			
Information elements	P	Condition / Comment	IE Type	Ins.
Overload Control Sequence Number	M	See clause 12.3.5.1.2.1 for the description and use of this parameter.	Sequence Number	0
Overload Reduction Metric	M	See clauses 12.3.5.1.2.3 and 12.3.5.1.2.4 for the description and use of this parameter.	Metric	0
Period of Validity	M	See clause 12.3.5.1.2.2 for the description and use of this parameter. This IE should be set to "0" if the "Overload Reduction Metric" is null. This IE shall be ignored by the receiver if the "Overload Reduction Metric" is null.	EPC Timer	0
List of Access Point Name (APN)	CO	The IE may (only) be present in the "PGW's Overload Control Information" IE. For indicating the APN level overload, the PGW shall include one or more instances of this IE, up to maximum of 10, with the same type and instance value, representing a list of APN(s) (sharing the same "Overload Reduction Metric" and "Period of Validity"). See NOTE 1.	APN	0
NOTE 1: If more than 10 occurrences of APNs are received within one instance of the Overload Control Information IE, the receiver shall treat it as a protocol error and ignore the entire Overload Control Information IE instance.				

**Table 7.2.2-6: PGW Change Info within Create Session Response**

Information elements	P	Condition / Comment	IE Type	Ins.
PGW Set FQDN	C	When present, this IE shall contain the PGW Set FQDN of the PGW-C/SMF set to which the PGW-C/SMF belongs. (NOTE)	PGW FQDN	0
Alternative PGW-C/SMF IP Address	C	When present, this IE shall contain alternative PGW-C/SMF IP addresses within the PGW-C/SMF set to which the PGW-C/SMF belongs.  Several IEs with the same type and instance value may be included to represent a list of Alternative PGW-C/SMF IP Addresses. (NOTE)	IP Address	0
Alternative PGW-C/SMF FQDN	C	When present, this IE shall contain alternative PGW-C/SMF FQDN within the PGW-C/SMF set to which the PGW-C/SMF belongs.  Several IEs with the same type and instance value may be included to represent a list of Alternative PGW-C/SMF FQDNs. (NOTE)	PGW FQDN	1
Group Id	O	When present, this IE shall identify the group to which the PDN connection pertains (see clause 31.6 of 3GPP TS 23.007 [17]).	Group Id	0
NOTE: Either the PGW Set FQDN IE, the Alternative PGW-C/SMF IP Address IE, or the Alternative PGW-C/SMF FQDN IE shall be present.				

### 7.2.3 Create Bearer Request

The direction of this message shall be from PGW to SGW and from SGW to MME/S4-SGSN, and from PGW to TWAN/ePDG (see Table 6.1-1).

The Create Bearer Request message shall be sent on the S5/S8 interface by the PGW to the SGW and on the S11 interface by the SGW to the MME as part of the Dedicated Bearer Activation procedure.

The message shall also be sent on the S5/S8 interface by the PGW to the SGW and on the S4 interface by the SGW to the SGSN as part of the Secondary PDP Context Activation procedure or the Network Requested Secondary PDP Context Activation procedure.

The message shall also be sent on the S2a interface by the PGW to the TWAN as part of the Dedicated bearer activation in WLAN on GTP S2a, and on the S2b interface by the PGW to the ePDG as part of the Dedicated S2b bearer activation with GTP on S2b.

The message shall also be sent on the S5/S8 or S2a/S2b interface by the PGW to the SGW or to the TWAN/ePDG and on the S11/S4 interface by the SGW to the MME/S4-SGSN as part of the Network-initiated IP flow mobility procedure or the UE-initiated IP flow mobility procedure, as specified by 3GPP TS 23.161 [71].

**Table 7.2.3-1: Information Elements in a Create Bearer Request**

Information elements	P	Condition / Comment	IE Type	Ins.
Procedure Transaction Id (PTI)	C	This IE shall be sent on the S5/S8 and S4/S11 interfaces when the procedure was initiated by a UE Requested Bearer Resource Modification Procedure or UE Requested Bearer Resource Allocation Procedure (see NOTE 1) or Secondary PDP Context Activation Procedure. The PTI shall be the same as the one used in the corresponding Bearer Resource Command.	PTI	0
Linked EPS Bearer ID (LBI)	M	This IE shall be included to indicate the default bearer associated with the PDN connection.	EBI	0

Protocol Configuration Options (PCO)	O	This IE may be sent on the S5/S8 and S4/S11 interfaces if ePCO is not supported by the UE or the network.	PCO	0
Bearer Contexts	M	Several IEs with this type and instance values shall be included as necessary to represent a list of Bearers.	Bearer Context	0
PGW-FQ-CSID	C	This IE shall be included by the PGW on the S5/S8 and S2a/S2b interfaces and, when received from S5/S8 be forwarded by the SGW on the S11 interface according to the requirements in 3GPP TS 23.007 [17].	FQ-CSID	0
SGW-FQ-CSID	C	This IE shall be included by the SGW on the S11 interface according to the requirements in 3GPP TS 23.007 [17].	FQ-CSID	1
Change Reporting Action	C	This IE shall be included on the S5/S8 and S4/S11 interfaces with the appropriate Action field If the location Change Reporting mechanism is to be started or stopped for this subscriber in the SGSN/MME.	Change Reporting Action	0
CSG Information Reporting Action	CO	This IE shall be included on the S5/S8 and S4/S11 interfaces with the appropriate Action field if the CSG Info reporting mechanism is to be started or stopped for this subscriber in the SGSN/MME.	CSG Information Reporting Action	0

H(e)NB Information Reporting	CO	This IE shall be included on the S5/S8 and S4/S11 interfaces with the appropriate Action field if H(e)NB information reporting is to be started or stopped for the PDN connection in the SGSN/MME.	H(e)NB Information Reporting	0
Presence Reporting Area Action	CO	This IE shall be included on the S5/S8 and S11/S4 interfaces with the appropriate Action field if reporting changes of UE presence in a Presence Routing Area is to be started, stopped or modified for this subscriber in the MME/SGSN.  Several IEs with the same type and instance value may be included as necessary to represent a list of Presence Reporting Area Actions. One IE shall be included per PRA to be started, stopped or modified.	Presence Reporting Area Action	0
Indication Flags	CO	This IE shall be included if any one of the applicable flags is set to 1. Applicable flags are: <ul style="list-style-type: none"> <li>- Associate OCI with PGW node's identity: The PGW shall set this flag to 1 on the S5/S8 interface or S2a/S2b interface if it has included the "PGW's Overload Control Information" and if this information is to be associated with the node identity (i.e. FQDN or the IP address received from the HSS or DNS during the PGW selection) of the serving PGW. The SGW shall set this flag on the S11/S4 interface if it supports the overload control feature and if the flag is set on the S5/S8 interface.</li> <li>- Associate OCI with SGW node's identity: The SGW shall set this flag to 1 on the S11/S4 interface if it has included the "SGW's Overload Control Information" and if this information is to be associated with the node identity (i.e. FQDN or the IP address received from the DNS during the SGW selection) of the serving SGW.</li> <li>- Extended EBI Value Range Support Indication: The PGW shall set this flag to "1" if it supports the 15 EPS Bearers.</li> </ul>	Indication	0
PGW's node level Load Control Information	O	The PGW may include this IE on the S5/S8 or S2a/S2b interface, providing its node level load information, if the load control feature is supported by the PGW and is activated for the PLMN to which the access network node, i.e. MME/S4-SGSN for 3GPP access network, ePDG/TWAN for non-3GPP access network, belongs (see clause 12.2.6).	Load Control Information	0
	CO	If the SGW receives this IE and if it supports the load control feature, it shall forward it to the MME/S4-SGSN on the S11/S4 interface.		
PGW's APN level Load Control Information	O	The PGW may include this IE on the S5/S8 or S2a/S2b interface, providing APN level load information, if the APN level load control feature is supported by the PGW and is activated for the PLMN to which the access network node, i.e. MME/S4-SGSN for 3GPP access network, ePDG/TWAN for non-3GPP access based network, belongs (see clause 12.2.6).  When present, the PGW shall provide one or more instances of this IE, up to maximum of 10, with the same type and instance value, each representing the load information for a list of APN(s). See NOTE 2, NOTE 4.	Load Control Information	1
	CO	If the SGW receives this IE and if it supports APN level load control feature, it shall forward it to the MME/S4-SGSN on the S11/S4 interface.		

SGW's node level Load Control Information	O	<p>The SGW may include this IE, over the S11/S4 interface if the load control feature is supported by the SGW and is activated in the network (see clause 12.2.6).</p> <p>When present, the SGW shall provide only one instance of this IE, representing its node level load information.</p>	Load Control Information	2
PGW's Overload Control Information	O	<p>During an overload condition, the PGW may include this IE on the S5/S8 or S2a/S2b interface, if the overload control feature is supported by the PGW and is activated for the PLMN to which the access network node, i.e. MME/S4-SGSN for 3GPP access based network, ePDG/TWAN for non-3GPP access based network, belongs (see clause 12.3.11).</p> <p>When present, the PGW shall provide</p> <ul style="list-style-type: none"> <li>- node level overload control, in one instance of this IE; and/or</li> <li>- APN level overload control, in one or more instances of this IE, up to maximum of 10, with the same type and instance value, each representing the overload information for a list of APN(s).</li> </ul> <p>See NOTE 3, NOTE 5.</p>	Overload Control Information	0
	CO	If the SGW receives this IE and if it supports the overload control feature, it shall forward it to the MME/S4-SGSN on the S11/S4 interface.		
SGW's Overload Control Information	O	<p>During an overload condition, the SGW may include this IE over the S11/S4 interface if the overload control feature is supported by the SGW and is activated in the network (see clause 12.3.11).</p> <p>When present, the SGW shall provide only one instance of this IE, representing its overload information.</p>	Overload Control Information	1
NBIFOM Container	CO	This IE shall be included on the S5/S8 and S2a/S2b interfaces if the PGW needs to send NBIFOM information as specified in 3GPP TS 23.161 [71]. The Container Type shall be set to 4.	F-Container	0
	CO	If the SGW receives a NBIFOM Container IE from the PGW, the SGW shall forward it to the MME/S4-SGSN on the S11/S4 interface.		
PGW Change Info	CO	<p>This IE may be included on S5/S8/S2b if the PGW needs to change the PGW Change Info signaled earlier for the PDN connection. It shall be included by the PGW if the PGW S5/S8/S2b IP Address for the control plane for the PDN connection is required to be changed (see PGW triggered PDN connection restoration in clauses 31.4 and 31.4B of 3GPP TS 23.007 [17]).</p> <p>The SGW shall transparently forward this IE over the S11 interface.</p> <p>Several IEs with the same IE type and Instance may be present to request the MME/ePDG to re-establish PDN connections associated with either different FQ-CSIDs, or Group Ids or PGW-C/SMF IP addresses to different PGW-C/SMFs.</p>	PGW Change Info	0

Sender F-TEID for Control Plane	CO	<p>This IE may be included over S5/S8/S2b if the PGW Change Info is present, during a PGW triggered PDN connection restoration (see clauses 31.4 and 31.4B of 3GPP TS 23.007 [17]). When present, it shall contain the F-TEID including the TEID that the SGW or ePDG shall use when sending the Create Bearer Response message.</p> <p>This IE may be included over S11 if the PGW Change Info is present, during a Combined SGW-C/PGW-C/SMF triggered PDN connection restoration (see clause 31.4A of 3GPP TS 23.007 [17]). When present, it shall contain the F-TEID including the TEID that the MME shall use when sending the Create Bearer Response message.</p>	F-TEID	0
Private Extension	O	This IE may be sent on the S5/S8, S4/S11 and S2a/S2b interfaces.	Private Extension	VS
<p>NOTE 1: This message refers to the UE requested bearer resource allocation procedure and UE requested bearer resource modification procedures defined in 3GPP TS 24.301 [23], both are specified in 3GPP TS 23.401 [3] in the clause "UE requested bearer resource modification".</p> <p>NOTE 2: The receiver, not supporting the APN level load control feature, shall ignore all the occurrence(s) of this IE, i.e. "Load Control Information" IE with instance number "1". The receiver, supporting the APN level load control feature and supporting the APN level load information for the maximum of 10 APNs, shall handle the APN level load information for the first 10 APNs and ignore any more APN level load information.</p> <p>NOTE 3: The receiver, supporting the APN level overload information for the maximum of 10 APNs, shall handle the APN level overload information for the first 10 APNs and ignore any more APN level overload information.</p> <p>NOTE 4: The APN level load information, provided within and across different instances of the "PGW's APN level Load Control Information" IE(s) shall be limited to 10 different APNs.</p> <p>NOTE 5: The APN level overload information, provided within and across different instances of the "PGW's Overload Control Information" IE(s) shall be limited to 10 different APNs.</p>				

NOTE: In the case that the procedure was initiated by a UE Requested Bearer Resource Modification Procedure or a UE Requested Bearer Resource Allocation Procedure or Secondary PDP Context Activation Procedure, then there will be only one instance of the Bearer Contexts IE in the Create Bearer Request.



Table 7.2.3-2: Bearer Context within Create Bearer Request

Octets 1	Bearer Context IE Type = 93 (decimal)			
Octets 2 and 3	Length = n			
Octets 4	Spare and Instance fields			
Information elements	P	Condition / Comment	IE Type	Ins.
EPS Bearer ID	M	This IE shall be set to 0.	EBI	0
TFT	M	This IE can contain both uplink and downlink packet filters to be sent to the UE or the TWAN/ePDG.	Bearer TFT	0
S1-U SGW F-TEID	C	This IE shall be sent on the S11 interface if the S1-U interface is used. If SGW supports both IPv4 and IPv6, it shall send both an IPv4 address and an IPv6 address within the S1-U SGW F-TEID IE.  See NOTE 1.	F-TEID	0
S5/8-U PGW F-TEID	C	This IE shall be sent on the S4, S5/S8 and S11 interfaces for GTP-based S5/S8 interface. The MME/SGSN shall ignore the IE on S11/S4 for PMIP-based S5/S8 interface.	F-TEID	1
S12 SGW F-TEID	C	This IE shall be sent on the S4 interface if the S12 interface is used. See NOTE 1.	F-TEID	2
S4-U SGW F-TEID	C	This IE shall be sent on the S4 interface if the S4-U interface is used. See NOTE 1.	F-TEID	3
S2b-U PGW F-TEID	C	This IE (for user plane) shall be sent on the S2b interface.	F-TEID	4
S2a-U PGW F-TEID	C	This IE (for user plane) shall be sent on the S2a interface.	F-TEID	5
Bearer Level QoS	M		Bearer QoS	0
Charging Id	C	This IE shall be sent on the S5/S8 interface.	Charging Id	0
	O	If the S5/S8 interface is GTP, this IE may be sent on the S4 interface, in order to support CAMEL charging at the SGSN.		
	CO	This IE shall be sent on the S2a/S2b interface.		
Bearer Flags	O	Applicable flags are: - PPC (Prohibit Payload Compression) : this flag may be set on the S5/S8 and S4 interfaces.  - vSRVCC indicator: This IE may be included by the PGW on the S5/S8 interface according to 3GPP TS 23.216 [43]. When received from S5/S8, SGW shall forward on the S11 interface.	Bearer Flags	0
Protocol Configuration Options (PCO)	O	This IE may be sent on the S5/S8 and S4/S11 interfaces if ePCO is not supported by the UE or the network. This bearer level IE takes precedence over the PCO IE in the message body if they both exist.	PCO	0
Extended Protocol Configuration Options (ePCO)	O	This IE may be sent on the S5/S8 and S11 interfaces if the UE and the network support ePCO.	ePCO	0
Maximum Packet Loss Rate	O	This IE may be included on the S5/S8 interfaces if the PGW needs to send Maximum Packet Loss Rate as specified in clause 5.4.1 of 3GPP TS 23.401 [3]. This IE is only applicable for QCI 1.	Maximum Packet Loss Rate	0
	CO	If the SGW receives this IE, it shall forward it to the MME on the S11 interface		
NOTE 1: The SGW shall use the same F-TEID IP address and TEID values for S1-U, S4-U and S12 interfaces.				

**Table 7.2.3-3: Load Control Information within Create Bearer Request**

Octet 1	Load Control Information IE Type = 181 (decimal)			
Octets 2 and 3	Length = n			
Octet 4	Spare and Instance fields			
Information elements	P	Condition / Comment	IE Type	Ins.
Load Control Sequence Number	M	See clause 12.2.5.1.2.1 for the description and use of this parameter.	Sequence Number	0
Load Metric	M	See clauses 12.2.5.1.2.2 and 12.2.5.1.2.3 for the description and use of this parameter.	Metric	0
List of APN and Relative Capacity	CO	The IE shall (only) be present in the "PGW's APN level Load Control Information" IE. For indicating the APN level load, the PGW shall include one or more instances of this IE, up to maximum of 10, with the same type and instance value, representing a list of APN(s) & its respective "Relative Capacity" (sharing the same "Load Metric"). See clause 12.2.5.1.2.3 for the description and use of this parameter. See NOTE 1.	APN and Relative Capacity	0
NOTE 1: If more than 10 occurrences of "APN and Relative Capacity" IE are received within one instance of the Load Control Information IE, the receiver shall treat it as a protocol error and ignore the entire Load Control Information IE instance.				

**Table 7.2.3-4: Overload Control Information within Create Bearer Request**

Octet 1	Overload Control Information IE Type = 181 (decimal)			
Octets 2 and 3	Length = n			
Octet 4	Spare and Instance fields			
Information elements	P	Condition / Comment	IE Type	Ins.
Overload Control Sequence Number	M	See clause 12.3.5.1.2.1 for the description and use of this parameter.	Sequence Number	0
Overload Reduction Metric	M	See clauses 12.3.5.1.2.3 and 12.3.5.1.2.4 for the description and use of this parameter.	Metric	0
Period of Validity	M	See clause 12.3.5.1.2.2 for the description and use of this parameter. This IE should be set to "0" if the "Overload Reduction Metric" is null. This IE shall be ignored by the receiver if the "Overload Reduction Metric" is null.	EPC Timer	0
List of Access Point Name (APN)	CO	The IE may (only) be present in the "PGW's Overload Control Information" IE. For indicating the APN level overload, the PGW shall include one or more instances of this IE, up to maximum of 10, with the same type and instance value, representing a list of APN(s) (sharing the same "Overload Reduction Metric" and "Period of Validity"). See NOTE 1.	APN	0
NOTE 1: If more than 10 occurrences of APNs are received within one instance of the Overload Control Information IE, the receiver shall treat it as a protocol error and ignore the entire Overload Control Information IE instance.				

**Table 7.2.3-5: PGW Change Info within Create Bearer Request**

Octet 1	PGW Change Info IE Type = 214 (decimal)			
Octets 2 and 3	Length = n			
Octet 4	Spare and Instance fields			
Information elements	P	Condition / Comment	IE Type	Ins.
PGW Set FQDN	O	This IE may be included by a PGW if the PGW set FQDN is changed.	PGW FQDN	0
Alternative PGW-C/SMF IP Address	O	This IE may be included by a PGW if the list of alternative PGW-C/SMF IP addresses is changed.  Several IEs with the same type and instance value may be included to represent a list of Alternative PGW-C/SMF IP Addresses.	IP Address	0
Alternative PGW-C/SMF FQDN	O	This IE may be included by a PGW if the list of alternative PGW-C/SMF FQDNs is changed.  Several IEs with the same type and instance value may be included to represent a list of Alternative PGW-C/SMF FQDNs.	PGW FQDN	1
New PGW-C/SMF IP Address	C	This IE shall be included by a PGW if the PGW S5/S8/S2b IP Address for the control plane for the PDN connection is required to be changed (see PGW triggered PDN connection restoration in clauses 31.4 and 31.4B and 31.6.3 of 3GPP TS 23.007 [17]).	IP Address	1
New SGW-C IP Address	O	This IE may be included by a combined SGW/PGW to contain the SGW-C S11 IP address (pertaining to the combined SGW/PGW sending the PGW Change Info IE). The MME should use this information when deciding to which SGW-C S11 IP address should the Create Session Request message be sent, during a combined SGW-C/PGW-C/SMF triggered restoration procedure as specified in clauses 31.4a and 31.6.3A of 3GPP TS 23.007 [17].	IP Address	3
PGW-C/SMF FQ-CSID	C	This IE shall be included if the New PGW-C/SMF IP Address IE is present and if the PGW-C/SMF requests the MME/ePDG to re-establish all the PDN connections associated with a PGW-C/SMF FQ-CSID towards the PGW-C indicated in New PGW-C/SMF IP Address IE.  When present, it shall contain the PGW-C/SMF FQ-CSID for which the PDN connections are requested to be re-established.  Several IEs with the same IE type may be present to represent several FQ-CSIDsof PDN connections that need to be moved to the New PGW-C/SMF IP Address.  See also clause 31.6 of 3GPP TS 23.007 [17].	FQ-CSID	0
Group Id	C	This IE shall be included if the New PGW-C/SMF IP Address IE is present and if the PGW-C/SMF requests the MME/ePDG to re-establish all the PDN connections associated with a Group Id towards the PGW-C indicated in New PGW-C/SMF IP Address IE.  When present, it shall contain the Group Id for which the PDN connections are requested to be re-established.  Several IEs with the same IE type may be present to represent several Group Ids of PDN connections that need to be moved to the New PGW-C/SMF IP Address.  See also clause 31.6 of 3GPP TS 23.007 [17].	Group Id	0

PGW Control Plane IP Address	C	This IE shall be included if the New PGW-C/SMF IP Address IE is present and if the PGW-C/SMF requests the MME/ePDG to re-establish all the PDN connections of which PGW S5/S8/ S2a/S2b F-TEID contains the PGW Control Plane IP Address towards the PGW-C indicated in New PGW-C/SMF IP Address IE.  Several IEs with the same IE type may be present to represent several PGW-C/SMF IP addresses of PDN connections that need to be moved to the New PGW-C/SMF IP Address. See also clause 31.6 of 3GPP TS 23.007 [17].	IP Address	2
New Group Id	O	The IE may be present if the PGW-C/SMF wants to allocate a new Group Id for the PDN connection. When present, this IE shall identify the new Group Id to which the PDN connection pertains, and the MME/ePDG shall replace any earlier Group ID received for the PDN connection with the new Group ID. If absent, the Group ID associated earlier to the PDN connection, if any, shall remain unchanged.  See also clause 31.6 of 3GPP TS 23.007 [17].	Group Id	1

## 7.2.4 Create Bearer Response

The Create Bearer Response message shall be sent on the S5/S8 interface by the SGW to the PGW, and on the S11 interface by the MME to the SGW as part of the Dedicated Bearer Activation procedure.

The message shall also be sent on the S5/S8 interface by the SGW to the PGW and on the S4 interface by the SGSN to the SGW as part of Secondary PDP Context Activation procedure or the Network Requested Secondary PDP Context Activation procedure.

The message shall also be sent on the S2a interface by the TWAN to the PGW as part of the Dedicated bearer activation in WLAN on GTP S2a and on the S2b interface by the ePDG to the PGW as part of the Dedicated S2b bearer activation with GTP on S2b.

The message shall also be sent on the S5/S8 or S2a/S2b interface by the SGW or the TWAN/ePDG to the PGW and on the S11/S4 interface by the MME/S4-SGSN to the SGW as part of the Network-initiated IP flow mobility procedure or UE-initiated IP flow mobility procedure, as specified by 3GPP TS 23.161 [71].

Possible Cause values are specified in Table 8.4-1. Message specific cause values are:

- "Request accepted".
- "Request accepted partially".
- "Context not found".
- "Semantic error in the TFT operation".
- "Syntactic error in the TFT operation".
- "Semantic errors in packet filter(s)".
- "Syntactic errors in packet filter(s)".
- "Unable to page UE".
- "UE not responding".
- "Unable to page UE due to Suspension".
- "UE refuses".

- "Denied in RAT".
- "Temporarily rejected due to handover/TAU/RAU procedure in progress".
- "MME/SGSN refuses due to VPLMN Policy".
- "UE is temporarily not reachable due to power saving".
- " Request rejected due to UE capability".

**Table 7.2.4-1: Information Elements in a Create Bearer Response**

Information elements	P	Condition / Comment	IE Type	Ins.
Cause	M		Cause	0
Bearer Contexts	M	All the bearer contexts included in the corresponding Create Bearer Request shall be included. Several IEs with this type and instance value shall be included on the S4/S11, S5/S8 and S2a/S2b interfaces as necessary to represent a list of Bearers.	Bearer Context	0
Recovery	C	This IE shall be included on the S4/S11, S5/S8 and S2a/S2b interfaces if contacting the peer for the first time	Recovery	0
MME-FQ-CSID	C	This IE shall be included by the MME on the S11 interface and shall be forwarded by the SGW on the S5/S8 interfaces according to the requirements in 3GPP TS 23.007 [17].	FQ-CSID	0
SGW-FQ-CSID	C	This IE shall be included by the SGW on the S5/S8 interfaces according to the requirements in 3GPP TS 23.007 [17].	FQ-CSID	1
ePDG-FQ-CSID	C	This IE shall be included by the ePDG on the S2b interface according to the requirements in 3GPP TS 23.007 [17].	FQ-CSID	2
TWAN-FQ-CSID	C	This IE shall be included by the TWAN on the S2a interface according to the requirements in 3GPP TS 23.007 [17].	FQ-CSID	3
Protocol Configuration Options (PCO)	C	If the UE includes the PCO IE, then the MME/SGSN shall copy the content of this IE transparently from the PCO IE included by the UE. If the SGW receives PCO from MME/SGSN, SGW shall forward it to the PGW.	PCO	0
UE Time Zone	O	This IE is optionally included by the MME on the S11 interface or by the SGSN on the S4 interface.	UE Time Zone	0
	CO	The SGW shall forward this IE on the S5/S8 interface if the SGW receives it from the MME/SGSN.		
	CO	This IE shall be included by the TWAN on the S2a interface.		
User Location Information (ULI)	CO	This IE shall be included by the MME on the S11 interface or by the SGSN on the S4 interface. The CGI/SAI shall be included by SGSN and the ECGI shall be included by MME. See NOTE 1.	ULI	0
	CO	The SGW shall forward this IE on the S5/S8 interface if it receives it from the MME/SGSN.		
TWAN Identifier	CO	This IE shall be included by the TWAN on the S2a interface as specified in 3GPP TS 23.402 [45].	TWAN Identifier	0
MME/S4-SGSN's Overload Control Information	O	During an overload condition, the MME/S4-SGSN may include this IE on the S11/S4 interface if the overload control feature is supported by the MME/S4-SGSN and is activated for the PLMN to which the PGW belongs (see clause 12.3.11).  When present, the MME/S4-SGSN shall provide only one instance of this IE, representing its overload information.	Overload Control Information	0
	CO	If the SGW receives this IE and if it supports the overload control feature, it shall forward it to the PGW on the S5/S8 interface.		

SGW's Overload Control Information	O	<p>During an overload condition, the SGW may include this IE over the S5/S8 interface if the overload control feature is supported by the SGW and is activated for the PLMN to which the PGW belongs (see clause 12.3.11).</p> <p>When present, the SGW shall provide only one instance of this IE, representing its overload information.</p>	Overload Control Information	1
Presence Reporting Area Information	CO	<p>The MME/SGSN shall include this IE on S11/S4 if the PGW/PCRF/OCS has requested to start or modify reporting changes of UE presence in Presence Reporting Area(s) in the corresponding Create Bearer Request message and the MME/SGSN supports such reporting. The MME/SGSN shall then indicate whether the UE is inside or outside the newly started or modified Presence Reporting Area(s), or indicate that the Presence Reporting Area(s) is inactive.</p> <p>The SGW shall include this IE on S5/S8 if it receives the Presence Reporting Area Information from the MME/SGSN.</p> <p>Several IEs with the same type and instance value may be included as necessary to represent a list of Presence Reporting Area Information. One IE shall be included for each PRA newly started or modified.</p>	Presence Reporting Area Information	0
MME/S4-SGSN Identifier	CO	<p>If the overload control feature is supported by the MME/S4-SGSN and is activated for the PLMN to which the PGW belongs (see clause 12.3.11), the MME/S4-SGSN shall include this IE on the S11/S4 interface if the PGW has not been updated with the identity of the currently serving MME/S4-SGSN, i.e. if no other message carrying MME/S4-SGSN identity has been sent to the PGW during/after an inter-MME/S4-SGSN intra-SGW mobility procedure.</p>	IP Address (See NOTE 2)	0

TWAN/ePDG's Overload Control Information	O	During an overload condition, the TWAN/ePDG may include this IE over the S2a/S2b interface if the overload control feature is supported by the TWAN/ePDG and is activated for the PLMN to which the PGW belongs (see clause 12.3.11).  When present, the TWAN/ePDG shall provide only one instance of this IE, representing its overload information.	Overload Control Information	2
WLAN Location Information	CO	The ePDG shall include this IE on the S2b interface if the WLAN Location Information is available.	TWAN Identifier	1
WLAN Location Timestamp	CO	The ePDG shall include this IE on the S2b interface, if the WLAN Location Timestamp is available.	TWAN Identifier Timestamp	1
UE Local IP Address	CO	The ePDG shall include this IE on the S2b interface.	IP Address (See NOTE 2)	0
UE UDP Port	CO	The ePDG shall include this IE on the S2b interface if NAT is detected and the UDP encapsulation is used.	Port Number	0
NBIFOM Container	CO	This IE shall be included on the S11/S4 or S2a/S2b interfaces if the MME/S4-SGSN or the TWAN/ePDG receives a NBIFOM Container from the UE as specified in 3GPP TS 24.161 73]. The Container Type shall be set to 4.	F-Container	0
	CO	If the SGW receives a NBIFOM Container IE from the MME/S4-SGSN, the SGW shall forward it to the PGW on the S5/S8 interface.		
UE TCP Port	CO	The ePDG shall include this IE on the S2b interface if NAT is detected and the TCP encapsulation is used.	Port Number	1
PSCell ID	CO	The MME shall include this IE on the S11 interface, if it has received this information from the eNodeB.	PSCell ID	0
Private Extension	O	This IE may be sent on the S5/S8, S4/S11 and S2a/S2b interfaces.	Private Extension	VS
<p>NOTE 1: In shared networks, when the message is sent from the VPLMN to the HPLMN, the PLMN ID that is communicated in this IE shall be that of the selected Core Network Operator for supporting UEs, or that of the allocated Core Network Operator for non-supporting UEs. As an exception, based on inter-operator roaming/sharing agreement, if the information on whether the UE is a supporting or non-supporting UE is available, the PLMN ID that is communicated to the HPLMN for non-supporting UEs shall be the Common PLMN ID. In shared networks, when the MME/S4-SGSN and PGW pertain to the same PLMN, the Primary PLMN ID shall be communicated in the ECGI to the PGW, and the Common PLMN ID shall be communicated in SAI/CGI to the PGW, for both supporting and non-supporting UEs. The Core Network Operator PLMN ID (selected by the UE for supporting UEs or allocated by the network for non-supporting UEs) shall be communicated in the TAI, RAI, UCI and the Serving Network. See clause 4.4 of 3GPP TS 23.251 [55].</p> <p>NOTE 2: It is not correct that the IP Address IE type with the same instance 0 appears twice in the message table, however, there is no problem because the MME/SGSN Identifier (received over S11/S4/S5/S8) and UE Local IP Address (received over S2b) can never appear in the same message. It was not possible to change the instance of IP Address IE type since it would have been a backward incompatible change.</p>				

**Table 7.2.4-2: Bearer Context within Create Bearer Response**

Octet 1	Bearer Context IE Type = 93 (decimal)			
Octets 2 and 3	Length = n			
Octet 4	Spare and Instance fields			
<b>Information elements</b>	<b>P</b>	<b>Condition / Comment</b>	<b>IE Type</b>	<b>Ins.</b>
EPS Bearer ID	M		EBI	0
Cause	M	This IE shall indicate if the bearer handling was successful, and if not, it gives information on the reason.	Cause	0
S1-U eNodeB F-TEID	C	This IE shall be sent on the S11 interface if the S1-U interface is used.	F-TEID	0
S1-U SGW F-TEID	C	This IE shall be sent on the S11 interface. It shall be used to correlate the bearers with those in the Create Bearer Request.	F-TEID	1
S5/8-U SGW F-TEID	C	This IE shall be sent on the S5/S8 interfaces.	F-TEID	2
S5/8-U PGW F-TEID	C	This IE shall be sent on the S5/S8 interfaces. It shall be used to correlate the bearers with those in the Create Bearer Request.	F-TEID	3



S12 RNC F-TEID	C	This IE shall be sent on the S4 interface if the S12 interface is used. See NOTE1.	F-TEID	4
S12 SGW F-TEID	C	This IE shall be sent on the S4 interface. It shall be used to correlate the bearers with those in the Create Bearer Request. See NOTE1.	F-TEID	5
S4-U SGSN F-TEID	C	This IE shall be sent on the S4 interface if the S4-U interface is used. See NOTE1.	F-TEID	6
S4-U SGW F-TEID	C	This IE shall be sent on the S4 interface. It shall be used to correlate the bearers with those in the Create Bearer Request. See NOTE1.	F-TEID	7
S2b-U ePDG F-TEID	C	This IE shall be sent on the S2b interface.	F-TEID	8
S2b-U PGW F-TEID	C	This IE shall be sent on the S2b interface. It shall be used to correlate the bearers with those in the Create Bearer Request.	F-TEID	9
S2a-U TWAN F-TEID	C	This IE shall be sent on the S2a interface.	F-TEID	10
S2a-U PGW F-TEID	C	This IE shall be sent on the S2a interface. It shall be used to correlate the bearers with those in the Create Bearer Request.	F-TEID	11
Protocol Configuration Options (PCO)	CO	If the UE includes the PCO IE in the corresponding message, then the MME/SGSN shall copy the content of this IE transparently from the PCO IE included by the UE. If the SGW receives PCO from MME/SGSN, SGW shall forward it to the PGW. This bearer level IE takes precedence over the PCO IE in the message body if they both exist.	PCO	0
RAN/NAS Cause	CO	If the bearer creation failed, the MME shall include this IE on the S11 interface to indicate the RAN cause and/or the NAS cause of the bearer creation failure, if available and if this information is permitted to be sent to the PGW operator according to MME operator's policy. If both a RAN cause and a NAS cause are generated, then several IEs with the same type and instance value shall be included to represent a list of causes. The SGW shall include this IE on the S5/S8 interface if it receives it from the MME.	RAN/NAS Cause	0
	CO	If the bearer creation failed, the TWAN shall include this IE on the S2a interface to indicate the cause of the bearer creation failure, if available and if this information is permitted to be sent to the PGW operator according to the TWAN operator's policy. When present, the IE shall be encoded as a Diameter or an ESM cause. See NOTE 2.		
	CO	If the bearer creation failed, the ePDG shall include this IE on the S2b interface to indicate the cause of the bearer creation failure, if available and if this information is permitted to be sent to the PGW operator according to the ePDG operator's policy. When present, the IE shall be encoded as a Diameter or an IKEv2 cause. See NOTE 3.		
Extended Protocol Configuration Options (ePCO)	CO	If the UE includes the ePCO IE, then the MME shall copy the content of this IE transparently from the ePCO IE included by the UE.  If the SGW receives ePCO from the MME, the SGW shall forward it to the PGW.	ePCO	0

NOTE 1:	The SGW shall use the same F-TEID IP address and TEID values for S1-U, S4-U and S12 interfaces. However, when sending a Create Bearer Request message to an S4-SGSN for a UE in idle mode, the SGW can not know whether the S4-SGSN will establish a direct user plane tunnel between the RNC and the SGW. The SGW may include either the S4-U SGW F-TEID IE or the S12 SGW F-TEID IE in the Create Bearer Request message. The S4-SGSN will decide whether to establish a direct user plane tunnel or not and will provide accordingly either a S12 RNC F-TEID or a S4-U SGSN F-TEID in the Create Bearer Response message, where the interface type of the provided F-TEID may differ from the interface type of the SGW F-TEID used for bearer correlation, e.g. if the SGW includes the S4-U SGW F-TEID in the Create Bearer Request message, and if the SGSN decides to use Direct Tunnelling, the S4-SGSN shall provide the S12 RNC F-TEID in the Create Bearer Response message, together with S4-U SGW F-TEID. The SGW should not treat this as an error.
NOTE 2:	The TWAN does not exchange signalling with the 3GPP AAA Server nor with the UE in this procedure. The TWAN may include an internal failure cause for the bearer creation failure. The protocol type used to encode the internal failure cause is implementation specific.
NOTE 3:	The ePDG does not exchange signalling with the 3GPP AAA Server in this procedure. The ePDG may include an internal failure cause for the bearer creation failure. The protocol type used to encode the internal failure cause is implementation specific.

**Table 7.2.4-3: Overload Control Information within Create Bearer Response**

Octet 1	Overload Control Information IE Type = 180 (decimal)			
Octets 2 and 3	Length = n			
Octet 4	Spare and Instance fields			
Information elements	P	Condition / Comment	IE Type	Ins.
Overload Control Sequence Number	M	See clause 12.3.5.1.2.1 for the description and use of this parameter.	Sequence Number	0
Overload Reduction Metric	M	See clause 12.3.5.1.2.3 for the description and use of this parameter.	Metric	0
Period of Validity	M	See clause 12.3.5.1.2.2 for the description and use of this parameter. This IE should be set to "0" if the "Overload Reduction Metric" is null. This IE shall be ignored by the receiver if the "Overload Reduction Metric" is null.	EPC Timer	0

## 7.2.5 Bearer Resource Command

A Bearer Resource Command message shall be sent from a MME to a SGW and forwarded to PGW as a part of the UE requested bearer resource allocation procedure or UE requested bearer resource modification procedure (which is used also for a dedicated bearer deactivation or dedicated bearer activation), as specified by 3GPP TS 24.301 [23].

The message shall also be sent on the S4 interface by a SGSN to a SGW and on the S5/S8 interface by a SGW to a PGW as part of the MS initiated PDP Context modification procedure, or secondary PDP context activation procedure.

The message shall also be sent on the S11/S4 interface by an MME/S4-SGSN to a SGW and on the S5/S8 or S2a/S2b interface by a SGW or a TWAN/ePDG to a PGW as part of the UE-initiated IP flow mobility procedure and the UE requested IP flow mapping procedure, as specified by 3GPP TS 23.161 [71].

Table 7.2.5-1 specifies the presence of the IEs in the message.

**Table 7.2.5-1: Information Elements in a Bearer Resource Command**

Information elements	P	Condition / Comment	IE Type	Ins.
Linked EPS Bearer ID (LBI)	M		EBI	0
Procedure Transaction Id (PTI)	M		PTI	0

Flow Quality of Service (Flow QoS)	C	This IE shall be included on the S4/S11 interface if the "Requested New QoS"/"Required QoS" is included in the corresponding NAS message (see clause 9.5.10 and clause 9.5.4 in 3GPP TS 24.008 [5]) or the "Required traffic flow QoS" is included in the corresponding NAS message (see clause 8.3.8 and clause 8.3.10 in 3GPP TS 24.301 [23]). If SGW receives this IE, SGW shall forward it to PGW across S5/S8 interface.	Flow QoS	0
Traffic Aggregate Description (TAD)	M	The TAD consists of the description of the packet filter(s) for a traffic flow aggregate. MME shall include this IE over S11 interface.	TAD	0
	CO	If S4-SGSN receives this IE from the UE, it shall include it over S4 interface.		
	CO	If SGW receives this IE, the SGW shall forward it to PGW over S5/S8 interface. See NOTE 2.		
RAT Type	C	This IE shall be included for MS initiated PDP Context modification procedure and Secondary PDP context activation procedure.	RAT Type	0
Serving Network	O	This IE may be included in the MS initiated PDP Context modification procedure. See NOTE 3.	Serving Network	0
User Location Information (ULI)	O	This IE may be included in the MS initiated PDP Context modification procedure. See NOTE 3.	ULI	0
EPS Bearer ID	C	This IE indicates the EPS Bearer that needs to be modified. It shall be included for MS initiated PDP Context modification procedure. For EUTRAN this IE shall be present if it is triggered by the NAS Bearer Resource Modification Request message and its value shall be set to the value of the "EPS bearer identity for packet filter" IE received in that NAS message.	EBI	1

Indication Flags	CO	This IE shall be included if any one of the applicable flags is set to 1. Applicable flags: - Change Reporting Support Indication: this flag may be set to 1 in the MS initiated PDP Context modification procedure if the SGSN/MME supports location Info Change Reporting and if the SGSN/MME's operator policy permits reporting of location change to the operator of the PGW with which the session is established.  - Direct Tunnel Flag: this flag shall be set to 1 on the S4 interface, if Direct Tunnel is used in the MS initiated PDP Context Modification procedure.	Indication	0
S4-U SGSN F-TEID	C	This IE shall be included on the S4 interface when direct tunnel is not established in the MS initiated PDP Context modification procedure See NOTE 1	F-TEID	0
S12 RNC F-TEID	C	This IE shall be included on the S4 interface when direct tunnel flag is set to 1 in the MS initiated PDP Context modification procedure. See NOTE 1	F-TEID	1
Protocol Configuration Options (PCO)	O	If the UE includes the PCO IE, then the MME/SGSN shall copy the content of this IE transparently from the PCO IE included by the UE. If the SGW receives PCO from the MME/SGSN, the SGW shall forward it to the PGW.	PCO	0
Signalling Priority Indication	CO	The SGSN/MME shall include this IE on the S4/S11 interface if the UE indicates low access priority during the procedure. The SGW shall forward this IE on the S5/S8 interfaces if received from the MME/SGSN.	Signalling Priority Indication	0
MME/S4-SGSN's Overload Control Information	O	During an overload condition, the MME/S4-SGSN may include this IE on the S11/S4 interface if the overload control feature is supported by the MME/S4-SGSN and is activated for the PLMN to which the PGW belongs (see clause 12.3.11).  When present, the MME/S4-SGSN shall provide only one instance of this IE, representing its overload information.	Overload Control Information	0
	CO	If the SGW receives this IE and if it supports the overload control feature, it shall forward it to the PGW on the S5/S8 interface.		
SGW's Overload Control Information	O	During an overload condition, the SGW may include this IE over the S5/S8 interface if the overload control feature is supported by the SGW and is activated for the PLMN to which the PGW belongs (see clause 12.3.11).  When present, the SGW shall provide only one instance of this IE, representing its overload information.	Overload Control Information	1
NBIFOM Container	CO	This IE shall be included on the S11/S4 or S2a/S2b interfaces if the MME/S4-SGSN or the TWAN/ePDG receives an NBIFOM Container from the UE as specified in 3GPP TS 24.161 73]. The Container Type shall be set to 4.	F-Container	0
	CO	If the SGW receives an NBIFOM Container IE from the MME/S4-SGSN, the SGW shall forward it to the PGW on the S5/S8 interface.		
Extended Protocol Configuration Options (ePCO)	O	If the UE includes the ePCO IE, then the MME shall copy the content of this IE transparently from the ePCO IE included by the UE. If the SGW receives ePCO from the MME, the SGW shall forward it to the PGW.	ePCO	0

Sender F-TEID for Control Plane	CO	The SGW shall include this IE on the S5/S8 interfaces and set it to the last value sent to the PGW.  If the Sender F-TEID for Control Plane is received, the PGW shall only handle the Bearer Resource Command message if the Sender F-TEID for Control Plane in this message is the same as the last Sender F-TEID for Control Plane received on the given interface.	F-TEID	2
PSCell ID	CO	The MME shall include this IE on the S11 interface, if it has received this information from the eNodeB.	PSCell ID	0
Private Extension	O		Private Extension	VS
<p>NOTE 1: The conditional S4-U SGSN F-TEID and S12 RNC F-TEID IE are redundant (as the IEs will be included in Update Bearer Response message in the MS initiated PDP Context modification procedure). The receiver may ignore it.</p> <p>NOTE 2: In the secondary PDP context activation procedure, if the Bearer Resource Command message without TAD IE is received, the PGW shall reject the message with cause "UE context without TFT already activated".</p> <p>NOTE 3: In shared networks, when the message is sent from the VPLMN to the HPLMN, the PLMN ID that is communicated in this IE shall be that of the selected Core Network Operator for supporting UEs, or that of the allocated Core Network Operator for non-supporting UEs. As an exception, based on inter-operator roaming/sharing agreement, if the information on whether the UE is a supporting or non-supporting UE is available, the PLMN ID that is communicated to the HPLMN for non-supporting UEs shall be the Common PLMN ID. In shared networks, when the MME/S4-SGSN and PGW pertain to the same PLMN, the Primary PLMN ID shall be communicated in the ECGI to the PGW, and the Common PLMN ID shall be communicated in SAI/CGI to the PGW, for both supporting and non-supporting UEs. The Core Network Operator PLMN ID (selected by the UE for supporting UEs or allocated by the network for non-supporting UEs) shall be communicated in the TAI, RAI, UCI and the Serving Network. See clause 4.4 of 3GPP TS 23.251 [55].</p>				

NOTE: Depending on the protocol type on the S5/S8 interface, the SGW or the PGW will determine if the UE is requesting an Allocation/Modification operation of bearer resources for a traffic flow aggregate based on the TFT operation code and the packet filter ID value in the Traffic Aggregate (TAD) IE and/or the presence of the EPS Bearer ID IE.

**Table 7.2.5-2: Overload Control Information within Bearer Resource Command**

Octet 1	Overload Control Information IE Type = 180 (decimal)			
Octets 2 and 3	Length = n			
Octet 4	Spare and Instance fields			
<b>Information elements</b>	<b>P</b>	<b>Condition / Comment</b>	<b>IE Type</b>	<b>Ins.</b>
Overload Control Sequence Number	M	See clause 12.3.5.1.2.1 for the description and use of this parameter.	Sequence Number	0
Overload Reduction Metric	M	See clause 12.3.5.1.2.3 for the description and use of this parameter.	Metric	0
Period of Validity	M	See clause 12.3.5.1.2.2 for the description and use of this parameter. This IE should be set to "0" if the "Overload Reduction Metric" is null. This IE shall be ignored by the receiver if the "Overload Reduction Metric" is null.	EPC Timer	0

### 7.2.6 Bearer Resource Failure Indication

A Bearer Resource Failure Indication shall be sent by the PGW to an SGW and forwarded to the MME to indicate failure of the UE requested bearer resource allocation procedure or UE requested bearer resource modification procedure, as specified by 3GPP TS 24.301 [23].

The message shall also be sent by a PGW to an SGW and forwarded to an SGSN as part of the failure of an MS initiated PDP Context modification procedure or secondary PDP context activation procedure.

The message shall also be sent on the S5/S8 or S2a/S2b interface by a PGW to a SGW or to a TWAN/ePDG and the S11/S4 interface by a SGW to an MME/S4-SGSN as part of the UE-initiated IP flow mobility procedure and the UE requested IP flow mapping procedure, as specified by 3GPP TS 23.161 [71].

Table 7.2.6-1 specifies the presence of the IEs in the message.

Possible Cause values are specified in Table 8.4-1. Message specific cause values are:

- "Semantic error in the TAD operation".
- "Syntactic error in the TAD operation".
- "Semantic errors in packet filter(s)".
- "Syntactic errors in packet filter(s)".
- "Collision with network initiated request".
- "Service denied".
- "Bearer handling not supported".
- "UE context without TFT already activated".

**Table 7.2.6-1: Information Elements in a Bearer Resource Failure Indication**

Information elements	P	Condition / Comment	IE Type	Ins.
Cause	M		Cause	0

Linked EPS Bearer ID	M	See clause 6.1.1 "Presence requirements of Information Elements".	EBI	0
Procedure Transaction ID (PTI)	M	See clause 6.1.1 "Presence requirements of Information Elements".	PTI	0
Indication Flags	CO	This IE shall be included if any one of the applicable flags is set to 1. Applicable flags are: <ul style="list-style-type: none"> <li>- Associate OCI with PGW node's identity: The PGW shall set this flag to 1 on the S5/S8 interface or S2a/S2b interface if it has included the "PGW's Overload Control Information" and if this information is to be associated with the node identity (i.e. FQDN or the IP address received from the HSS or DNS during the PGW selection) of the serving PGW. The SGW shall set this flag on the S11/S4 interface if it supports the overload control feature and if the flag is set on the S5/S8 interface.</li> <li>- Associate OCI with SGW node's identity: The SGW shall set this flag to 1 on the S11/S4 interface if it has included the "SGW's Overload Control Information" and if this information is to be associated with the node identity (i.e. FQDN or the IP address received from the DNS during the SGW selection) of the serving SGW.</li> </ul>	Indication	0
PGW's Overload Control Information	O	During an overload condition, the PGW may include this IE on the S5/S8, if the overload control feature is supported by the PGW and is activated for the PLMN to which the access network node, i.e. MME/S4-SGSN for 3GPP access based network, belongs (see clause 12.3.11).  When present, the PGW shall provide <ul style="list-style-type: none"> <li>- node level overload control, in one instance of this IE; and/or</li> <li>- APN level overload control, in one or more instances of this IE, up to maximum of 10, with the same type and instance value, each representing the overload information for a list of APN(s).</li> </ul> See NOTE 1, NOTE 2.	Overload Control Information	0
	CO	If the SGW receives this IE and if it supports the overload control feature, it shall forward it to the MME/S4-SGSN on the S11/S4 interface.		
SGW's Overload Control Information	O	During an overload condition, the SGW may include this IE over the S11/S4 interface if the overload control feature is supported by the SGW and is activated in the network (see clause 12.3.11).  When present, the SGW shall provide only one instance of this IE, representing its overload information.	Overload Control Information	1
Recovery	O		Recovery	0
NBIFOM Container	CO	This IE shall be included on the S5/S8 or S2a/S2b interfaces if the PGW needs to send NBIFOM information as specified in 3GPP TS 23.161 [71]. The Container Type shall be set to 4.	F-Container	0
	CO	If the SGW receives an NBIFOM Container IE from the PGW, the SGW shall forward it to the MME/S4-SGSN on the S11/S4 interface.		
Private Extension	O		Private Extension	VS
NOTE 1: The receiver, supporting the APN level overload information for the maximum of 10 APNs, shall handle the APN level overload information for the first 10 APNs and ignore any more APN level overload information.				
NOTE 2: The APN level overload information, provided within and across different instances of the "PGW's Overload Control Information" IE(s) shall be limited to 10 different APNs.				

**Table 7.2.6-2: Overload Control Information within Bearer Resource Failure Indication**

Information elements	P	Condition / Comment	IE Type	Ins.
Overload Control Sequence Number	M	See clause 12.3.5.1.2.1 for the description and use of this parameter.	Sequence Number	0
Overload Reduction Metric	M	See clauses 12.3.5.1.2.3 and 12.3.5.1.2.4 for the description and use of this parameter.	Metric	0
Period of Validity	M	See clause 12.3.5.1.2.2 for the description and use of this parameter. This IE should be set to "0" if the "Overload Reduction Metric" is null. This IE shall be ignored by the receiver if the "Overload Reduction Metric" is null.	EPC Timer	0
List of Access Point Name (APN)	CO	The IE may (only) be present in the "PGW's Overload Control Information" IE. For indicating the APN level overload, the PGW shall include one or more instances of this IE, up to maximum of 10, with the same type and instance value, representing a list of APN(s) (sharing the same "Overload Reduction Metric" and "Period of Validity"). See NOTE 1.	APN	0
NOTE 1: If more than 10 occurrences of APNs are received within one instance of the Overload Control Information IE, the receiver shall treat it as a protocol error and ignore the entire Overload Control Information IE instance.				

## 7.2.7 Modify Bearer Request

The direction of this message shall be from MME/S4-SGSN to SGW and/or from SGW to PGW (see Table 6.1-1).

The Modify Bearer Request message shall only be sent on the S11 interface by the MME to the SGW and on the S5/S8 interfaces by the SGW to the PGW as part of the procedures:

- E-UTRAN Tracking Area Update without SGW Change
- UE triggered Service Request
- S1-based Handover
- UTRAN Iu mode to E-UTRAN Inter RAT handover
- GERAN A/Gb mode to E-UTRAN Inter RAT handover
- Tracking Area Update procedure with a RAT type change
- E-UTRAN Initial Attach
- Handover from Trusted or Untrusted Non-3GPP IP Access to E-UTRAN with GTP on S5/S8 interface (see clauses 8.2, 8.6 and 16.11 of 3GPP TS 23.402 [45])
- UE requested PDN connectivity
- 3G SGSN to MME combined hard handover and SRNS relocation procedure
- X2-based handover without SGW relocation
- UTRAN/GERAN to E-UTRAN SRVCC
- HSS-based P-CSCF restoration for 3GPP access (see 3GPP TS 23.380 [61])
- Connection Resume procedure (see clause 5.3.5A of 3GPP TS 23.401 [3])
- reception of the RRC establishment cause "MO Exception data" in the NB-IoT RAT



It shall also only be sent on the S11 interface by the MME to the SGW as part of the procedure:

- E-UTRAN Initiated E-RAB modification procedure
- Handover from Trusted or Untrusted Non-3GPP IP Access to E-UTRAN with PMIP on S5/S8 interface (see clauses 8.2 and 16.11 of 3GPP TS 23.402 [45])
- Tracking Area Update procedure with Serving GW change and data forwarding
- Mobile Originated Data transport in Control Plane CIoT EPS optimisation with P-GW connectivity
- Mobile Terminated Data Transport in Control Plane CIoT EPS optimisation with P-GW connectivity
- Establishment of S1-U bearer during Data Transport in Control Plane CIoT EPS optimisation procedure (see clause 5.3.4B.4 of 3GPP TS 23.401 [3]).

It shall also only be sent on the S4 interface by the SGSN to the SGW and on the S5/S8 interfaces by the SGW to the PGW as part of the procedures:

- Routeing Area Update with MME interaction and without SGW change
- E-UTRAN to UTRAN Iu mode Inter RAT handover
- E-UTRAN to GERAN A/Gb mode Inter RAT handover
- Inter SGSN Routeing Area Update Procedure and Combined Inter SGSN RA / LA Update to S4 SGSNs without SGW change
- Iu mode RA Update Procedure without SGW change
- Serving RNS Relocation Procedure
- Combined Hard Handover and SRNS Relocation Procedure
- Combined Cell / URA Update and SRNS Relocation Procedure
- Enhanced Serving RNS Relocation without SGW relocation
- UE Initiated Service Request Procedure
- Iu mode to A/Gb mode Intra SGSN Change
- A/Gb mode to Iu mode Intra SGSN Change
- Iu mode to A/Gb mode Inter-SGSN Change
- A/Gb mode to Iu mode Inter-SGSN Change
- Paging Response with no established user plane on S4
- PDP Context Activation Procedure
- Handover from Trusted or Untrusted Non-3GPP IP Access to UTRAN/GERAN with GTP on S5/S8 interface (see clauses 8.2, 8.6 and 16.11 of 3GPP TS 23.402 [45])
- UTRAN/GERAN to UTRAN (HSPA) SRVCC
- HSS-based P-CSCF restoration for 3GPP access (see 3GPP TS 23.380 [61])

It shall also only be sent on the S4 interface by the SGSN to the SGW as part of the procedures:

- RAB Assignment Procedure
- SRVCC from E-UTRAN to UTRAN or GERAN with DTM HO support procedures and SRVCC from UTRAN (HSPA) to UTRAN or GERAN with DTM HO support.
- Handover from Trusted or Untrusted Non-3GPP IP Access to UTRAN/GERAN with PMIP on S5/S8 interface (see clauses 8.2 and 16.11 of 3GPP TS 23.402 [45])

- Routing Area Update procedure with Serving GW change and data forwarding and only on the S5/S8 interfaces by the SGW to the PGW as part of the procedures:
- Tracking Area Update procedure with SGW change
- Gn/Gp SGSN to S4 SGSN Routing Area Update
- X2 based handover with SGW relocation
- Gn/Gp SGSN to MME Tracking Area Update
- Enhanced Serving RNS Relocation with SGW relocation
- Routing Area Update with MME interaction and with SGW change
- Inter SGSN Routing Area Update Procedure and Combined Inter SGSN RA / LA Update using S4 with SGW change
- Iu mode RA Update Procedure using S4 with SGW change
- Restoration of PDN connections after an SGW failure if the MME/SGSN and PGW support these procedures as specified in 3GPP TS 23.007 [17]
- MME triggered Serving GW relocation
- S4-SGSN triggered Serving GW relocation
- PGW Pause of Charging procedure

and on the S2b interface by the ePDG to the PGW as part of the procedures:

- UE initiated IPsec tunnel update procedure

If the optional network triggered service restoration feature is supported by the MME, SGSN and SGW, then the Modify Bearer Request message shall also be sent as part of the network triggered service restoration procedure with ISR during an intra MME TAU and an intra S4-SGSN RAU procedure for UEs that had ISR active before either the MME or the S4-SGSN has restarted, as specified in 3GPP TS 23.007 [17]:

- on the S11 interface by the MME to the SGW, if the MME detected that the ISR associated S4-SGSN has restarted and UE performs a TAU procedure;
- on the S4 interface by the S4-SGSN to the SGW, if the S4-SGSN detected that the ISR associated MME has restarted and UE performs a RAU procedure.

This message can be used as an implicit resume of the suspended bearers in the SGW and in the PGW (see 3GPP TS 23.216 [43] clauses 6.2.2.1 and 6.3.2.1, 3GPP TS 23.272 [21] clauses 6.3, 6.5 and 7.4). A Modify Bearer Request used as an implicit resume can contain zero or more IE(s), depending on the conditions of presence of the IEs specified in table 7.2.7-1. The PGW should not consider a Modify Bearer Request with zero IE as an error.

The Modify Bearer Request message may also be sent in the following cases from the S4-SGSN to the SGW/PGW to report a change of Serving Network, User CSG Information or/and UE Time Zone which occurred during a previous RAU procedure without SGSN change but which has not been reported yet to the SGW/PGW, or to indicate to the PGW that the UE is available for signalling if the PDN connection is delay tolerant and if there is pending network initiated PDN connection signalling:

- during a Service Request procedure to establish data radio bearers for the corresponding PDP context for a UE in UTRAN with an existing S4-U tunnel;
- when the SGSN receives an uplink LLC PDU for user data or any valid LLC frame serving as a paging response from a UE in GERAN with an existing S4-U tunnel.

The Modify Bearer Request message may also be sent in the following cases from the S4-SGSN to the SGW/PGW to report a change of User Location Information which occurred during a previous RAU procedure without SGSN change but which has not been reported yet to the SGW/PGW, if the S4-SGSN is configured to defer the reporting of ULI change until a RAB/user plane is established:

- during a Service Request procedure to establish data radio bearers for the corresponding PDP context for a UE in UTRAN with an existing S4-U tunnel;
- when the SGSN receives an uplink LLC PDU for user data or any valid LLC frame serving as a paging response for a UE in GERAN with an existing S4-U tunnel.

NOTE 1: the S4-SGSN can alternatively send a Change Notification Request message in the above cases, if no other information which requires the sending of a Modify Bearer Request, needs to be reported to the PGW.

The Modify Bearer Request message may also be sent by the MME to the SGW/PGW to report a change of Serving Network, User Location Information, User CSG Information, UE Time Zone or/and RAT Type, when user data is transported in NAS signalling, for a UE with an existing S11-U tunnel.

When requesting the PGW to pause or unpaue charging for a PDN connection, the SGW shall wait for the PGW acknowledgement (i.e. Modify Bearer Response) before sending a new pause or unpaue request.

NOTE 2: this ensures that the PGW always act per the most recent SGW request in particular in scenarios where the SGW would need to request the PGW to pause and unpaue charging in a row (or vice-versa) and the Modify Bearer Request messages would arrive out of order at the PGW.

Upon receipt of a request from the PGW/PCRF/OCS in a message other than Create Bearer Request and Update Bearer Request to report changes of UE presence in new or modified Presence Reporting Area(s), the MME/S4-SGSN shall immediately send a Modify Bearer Request message or a Change Notification Request message to report to the PGW whether the UE is inside or outside the new or modified Presence Reporting Area(s) or whether the Presence Reporting Area(s) is inactive.

The MME/S4-SGSN shall also send a Modify Bearer Request message or a Change Notification Request message to report any subsequent change of UE presence in the Presence Reporting Area, as specified in 3GPP TS 23.401 [3] and 3GPP TS 23.060 [35].

If the Modify Bearer Request message is sent from the old MME/SGSN as part of Tracking/Routeing Area Update procedure with SGW change and data forwarding as specified in clause 5.3.3.1A of 3GPP TS 23.401 [3], the old MME/SGSN shall only include the Bearer Contexts to be modified IE.

NOTE 3: Since the UE has left the old MME/SGSN, some information related to the UE, e.g. ULI, UE Time Zone, CSG, RAT Type in the old MME/SGSN are not valid any more.

Upon receipt of a Modify Bearer Request message that includes the Presence Reporting Area Information from the MME/S4-SGSN, the SGW shall send a Modify Bearer Request message on the S5/S8 interface if any of the following condition is met:

- ISR is not active;
- ISR is active, and the RAT Type has changed since last reported or the CPRAI flag has been set to 1.

The MME shall increment the "MO Exception data counter" by one each time the MME has received the RRC cause "MO Exception data". The MME may defer sending a Modify Bearer Request message to report a non-zero value for the MO Exception Data Counter based on local configuration.

Upon receipt of a Modify Bearer Request message that includes the Secondary RAT Usage Data Report from the MME, the SGW shall send a Modify Bearer Request message on the S5/S8 interface if the IRPGW flag is set to 1 in the Secondary RAT Usage Data Report IE.

**Table 7.2.7-1: Information Elements in a Modify Bearer Request**

Information elements	P	Condition / Comment	IE Type	Ins.
ME Identity (MEI)	C	If an SGW receives this IE from an MME/SGSN during a TAU/RAU/Handover procedure, the SGW shall forward it across the S5/S8 interface to the PGW.	MEI	0
	O	The MME/SGSN should include this IE on the S11/S4 interface if the IMSI is not available. The SGW shall forward it across the S5/S8 interface to the PGW if received. See NOTE 23.		

User Location Information (ULI)	C	<p>The MME/SGSN shall include this IE for the TAU/RAU/Handover procedures if the PGW/PCRF has requested location information change reporting and MME/SGSN support location information change reporting. An MME/SGSN which supports location information change shall include this IE for UE-initiated Service Request and UE initiated Connection Resume procedures if the PGW/PCRF has requested location information change reporting and the UE's location info has changed. See NOTE 5, NOTE 17.</p> <p>The MME shall include the ECGI and/or TAI, or TAI and Macro eNB ID, or Macro eNB ID depending on the Change Reporting Action provided to the MME. The SGSN shall include either the CGI or SAI or RAI, or CGI/SAI together with RAI in the ULI depending on the Change Reporting Action provided to the SGSN.</p> <p>When ISR is active, the MME/SGSN which supports location information change shall include this IE for UE-initiated Service Request procedure, if the PGW/PCRF has requested location information change reporting.</p>	ULI (NOTE 15)	0
	CO	<p>This IE shall also be included on the S4/S11 interface for a TAU/RAU/Handover with MME/SGSN change without SGW change procedure, if the level of support (User Location Change Reporting and/or CSG Information Change Reporting) changes.</p> <p>The MME shall include the ECGI and /or TAI in the ULI, the S4-SGSN shall include either the CGI or SAI or RAI, or CGI/SAI together with RAI in the ULI. See NOTE 10.</p>		
	CO	<p>This IE shall also be included on the S4/S11 interface for a handover procedure with SGW change procedure if</p> <ul style="list-style-type: none"> <li>- the level of support (User Location Change Reporting and/or CSG Information Change Reporting) changes; or</li> <li>- the target MME/S4-SGSN can not derive the level of support (User Location Change Reporting and/or CSG Information Change Reporting) for the source Gn/Gp SGSN. See NOTE 14.</li> </ul> <p>The MME shall include the ECGI and /or TAI in the ULI, the S4-SGSN shall include either the CGI or SAI or RAI, or CGI/SAI together with RAI in the ULI. See NOTE 10.</p>		
	CO	<p>This IE shall also be included on the S11/S4 interface during the following procedures if the MME/SGSN is configured to defer the reporting of ULI change until an E-RAB/RAB/ user plane is established, the ULI has changed during previous mobility procedures i.e. intra MME/S4-SGSN TAU/RAU, and the change has not been reported to the PGW yet:</p> <ul style="list-style-type: none"> <li>- UE initiated Service Request, TAU or RAU with a request to establish data radio bearers;</li> <li>- when the SGSN receives an uplink LLC PDU for user data or any valid LLC frame serving as a paging response for a UE in GERAN with an existing S4-U tunnel.</li> </ul>		
	CO	<p>This IE shall also be included on the S4/S11 interface for:</p> <ul style="list-style-type: none"> <li>- a TAU/Handover procedure with an S4-SGSN interaction, if the MME supports location information change reporting;</li> <li>- a RAU/Handover procedure with an MME interaction, if the SGSN supports location information change reporting.</li> </ul>		

		The MME shall include the ECGI and TAI in the ULI. The S4-SGSN shall include the RAI and, if available, the CGI/SAI information, in the ULI.		
	CO	When ISR is not active, the SGW shall include this IE on S5/S8 if it receives the ULI from MME/SGSN.  When ISR is active, the SGW shall include this IE on S5/S8 if <ul style="list-style-type: none"> <li>- it receives the ULI from MME/S4-SGSN and the RAT Type has changed since last reported; or</li> <li>- it receives the ULI from MME/S4-SGSN and the CLII flag has been set to 1.</li> </ul>		
	CO	This IE shall also be included by the MME on the S11 interface if the MME supports User Plane Integrity Protection, User Plane integrity protection has been required for the traffic of the PDN connection and the UE is moving to an E-UTRAN that does not support User Plane integrity protection with EPS.		
Serving Network	CO	This IE shall be included on S11/S4 interface during the following procedures: <ul style="list-style-type: none"> <li>- TAU/RAU/handover if Serving Network is changed.</li> <li>- TAU/RAU when the UE was ISR activated which is indicated by ISRAU flag.</li> <li>- UE triggered Service Request when UE is ISR activated.</li> <li>- UE initiated Service Request if ISR is not active, but the Serving Network has changed during previous mobility procedures, i.e. intra MME/S4-SGSN TAU/RAU and the change has not been reported to the PGW yet.</li> <li>- TAU/RAU procedure as part of the optional network triggered service restoration procedure with ISR, as specified by 3GPP TS 23.007 [17].</li> </ul>	Serving Network (NOTE 15)	0
	CO	This IE shall also be included on the S4/S11 interface during a TAU/RAU/Handover with MME/SGSN change if the source MME/SGSN has set the SNCR bit in the Change to Report Flags IE in the Forward Relocation Request or Context Response message.		
	CO	This IE shall be included on S5/S8 if the SGW receives this IE from MME/SGSN and if ISR is not active. This IE shall be included on S5/S8 if the SGW receives this IE from MME/SGSN and ISR is active and the Modify Bearer Request message needs to be sent to the PGW as specified in the 3GPP TS 23.401 [3].		
RAT Type	C	This IE shall be sent on the S11 interface for a TAU with a RAT type change, UE triggered Service Request or an I-RAT Handover. This IE shall be sent on the S4 interface for a RAU with MME interaction, a RAU with an SGSN change, a UE Initiated Service Request or an I-RAT Handover. This IE shall be sent on the S5/S8 interface if the RAT type changes.	RAT Type	0
	CO	If SGW receives this IE from MME/SGSN during a TAU/RAU/Handover with SGW change procedure, the SGW shall forward it across the S5/S8 interface to PGW. See NOTE 10.  If any condition for including the RAT Type over S5/S8 is met (e.g. the RAT type changes), and if the LTE-M RAT type or Satellite related RAT type is received from the MME, the SGW shall signal the following RAT type to the PGW:		

		<ul style="list-style-type: none"> <li>- LTE-M RAT type, if LTE-M RAT type is received and the 'LTE-M RAT type reporting to PGW' flag is received from the MME; or the WB-E-UTRAN RAT type, otherwise.</li> <li>- Satellite related RAT type, if Satellite related RAT type is received and the 'Satellite RAT Type reporting to PGW Indication' flag is received from the MME; or the RAT type without Satellite, i.e. LTE-M / EUTRAN-NB-IoT / WB-E-UTRAN, otherwise.</li> </ul> <p>See NOTE 26.</p>		
	CO	<p>The IE shall be sent on the S11/S4 interface during the following procedures:</p> <ul style="list-style-type: none"> <li>- an inter MME TAU or inter SGSN RAU when UE was ISR activated which is indicated by ISRAU flag.</li> <li>- TAU/RAU procedure as part of optional network triggered service restoration procedure with ISR, as specified by 3GPP TS 23.007 [17].</li> </ul> <p>If ISR is active, this IE shall also be included on the S11 interface in the S1-U GTP-U tunnel setup procedure during an intra-MME intra-SGW TAU procedure.</p>		
	CO	<p>The MME shall set the RAT type to LTE-M, if the eNodeB indicated this is an LTE-M UE and the LTE-M RAT Type has not been reported yet to the SGW.</p>		
	CO	<p>The MME shall set the RAT type to LTE-M Satellite related RAT type, if the eNodeB indicated this is an LTE-M UE accessing satellite E-UTRAN and the LTE-M Satellite related RAT Type has not been reported yet to the SGW.</p>		
Indication Flags	C	<p>This IE shall be included if any one of the applicable flags is set to 1.</p> <p>Applicable flags are:</p> <ul style="list-style-type: none"> <li>- Idle mode Signalling Reduction Activation Indication: This flag shall be set to 1 on S4/S11 interface, if the ISR is established between the MME and the S4 SGSN.</li> <li>- Handover Indication: This flag shall be set to 1 on the S4/S11 and S5/S8 interfaces during a Handover from Trusted or Untrusted Non-3GPP IP Access to E-UTRAN or a Handover from Trusted or Untrusted Non-3GPP IP Access to UTRAN/GERAN procedures.</li> <li>- Direct Tunnel Flag: This flag shall be set to 1 on the S4 interface, if Direct Tunnel is used.</li> <li>- Change Reporting Support Indication: shall be set to 1 on S4/S11, S5/S8 interfaces, if the SGSN/MME supports location Info Change Reporting and if the SGSN/MME's operator policy permits reporting of location change to the operator of the PGW with which the session is established. This flag should be ignored by SGW if no message is sent on S5/S8. See NOTE 4.</li> <li>- CSG Change Reporting Support Indication: shall be set to 1 on S4/S11, S5/S8, if the SGSN/MME supports CSG Information Change Reporting and if the SGSN/MME's operator policy permits reporting of the CSG Information change to the operator of the PGW with which the session is established. This flag shall be ignored by SGW if no message is sent on S5/S8. See NOTE 4.</li> </ul>	Indication	0

	<ul style="list-style-type: none"> <li>- Change F-TEID support Indication: This flag shall be set to 1 on S4/S11 for an IDLE state UE initiated TAU/RAU procedure to allow the SGW changing the GTP-U F-TEID.</li> <li>- Propagate BBAI Information Change: The MME/SGSN shall set this flag to 1 on S11/S4 in procedures without MME/SGSN change if the PGW has requested H(e)NB information reporting and the H(e)NB local IP address or UDP port number information from H(e)NB in UE associated S1/lu signalling has changed. (NOTE 8) The MME/SGSN shall set this flag to 1 on S11/S4 during TAU/RAU/Handover with MME/SGSN change procedures if the PGW has requested H(e)NB information reporting. See 3GPP TS 23.139 [51].</li> <li>- CS to PS SRVCC indication: This flag shall be set to 1 on S4/S11 and on S5/S8 during UTRAN/GERAN to E-UTRAN/UTRAN (HSPA) SRVCC procedure as specified in 3GPP TS 23.216 [43].</li> <li>- Change of Location Information Indication (CLII): This flag shall be set to 1 on S4/S11 interface only when the ISR is active for the UE. This flag shall be set to 1 by the MME/S4-SGSN if the ULI IE is included in the Modify Bearer Request message and the location information has changed since last reported by the MME/S4-SGSN. See NOTE 9. .</li> <li>- PDN Pause Support Indication: this flag shall be set to 1 on the S5/S8 interface during the TAU/RAU/handover with SGW relocation procedures if the new SGW supports the PGW Pause of Charging procedure.</li> <li>- PDN Pause On Indication: this flag shall be set to 1 on the S5/S8 interface if the SGW requests the PGW to pause the charging for the PDN connection as specified in 3GPP TS 23.401 [3]. (NOTE 13).</li> <li>- PDN Pause Off Indication: this flag shall be set to 1 on the S5/S8 interface if the SGW requests the PGW to unpause the charging for the PDN connection as specified in 3GPP TS 23.401 [3]. (NOTE 13).</li> <li>- Change of Presence Reporting Area information Indication (CPRAI): this flag shall be set to 1 on the S4/S11 interface if ISR is active for the UE and if the Presence Reporting Area Information IE is included in the Modify Bearer Request message and the Presence Reporting Area information has changed since last reported by the MME/S4-SGSN. See NOTE 9.</li> <li>- P-CSCF Restoration Indication: this flag shall be set to 1 on the S11/S4 and S5/S8 interfaces, for the IMS PDN connection, if the MME/S4-SGSN has received the indication from the HSS that a P-CSCF restoration is required for this user.</li> <li>- UE Available for Signalling Indication: this flag shall be set to 1 on S11/S4 by the MME/SGSN</li> </ul>		
--	---	--	--

	<p>during a TAU/RAU or a Service Request procedure for E-UTRAN/UTRAN, or UE initiated Connection Resume procedure for E-UTRAN, or at receipt of an uplink LLC PDU for user data or any valid LLC frame serving as a paging response for GERAN, if the PDN connection is delay tolerant and if there is pending network initiated PDN connection signalling. The SGW shall include this IE on S5/S8 if it receives the flag from the MME/SGSN.</p> <ul style="list-style-type: none"> <li>- S11-U Tunnel Flag: this flag shall be set to 1 on the S11 interface if user data is transported in NAS signalling.</li> <li>- Extended PCO Support Indication: this flag shall be set to 1 on S11 interface by the MME if the UE and the MME support ePCO. This flag shall be set to 1 on S5/S8 interface by the SGW if the SGW support ePCO and the MME has set the flag to 1 over the S11 interface. See NOTE 18.</li> <li>- NBIFOM Support Indication: this flag shall be set to 1 on S11/S4 during an inter-PLMN mobility procedure for E-UTRAN/UTRAN if the MME/SGSN supports NBIFOM. This flag shall be set to 1 on S5/S8 during an inter-PLMN mobility procedure for E-UTRAN/UTRAN if both the SGW and the MME/SGSN support NBIFOM. See NOTE 19.</li> <li>- eNB Change Reporting Support Indication: shall be set to 1 on S11, S5/S8 interfaces, if the MME supports location Info Change Reporting and if the MME's operator policy permits reporting of location change to the operator of the PGW with which the session is being established. See NOTE 21.</li> <li>- LTE-M RAT Type reporting to PGW Indication: this flag shall be set to 1 on S11, based on operator policy or roaming agreements (for Home Routed PDN connections), if the SGW needs to forward the LTE-M RAT type to the PGW.</li> <li>- MTEDTA (MT-EDT Applicable): this flag shall be set to "1" on the S11 interface if MT-EDT is applicable to the PDN connection;</li> <li>- MTEDTN (MT-EDT NOT Applicable): this flag shall be set to "1" on the S11 interface if MT-EDT is not applicable to the PDN connection;</li> <li>- Restoration of PDN connections after an PGW-C/SMF Change Support Indication: This flag shall be set to 1 by the MME on the S11 interface, during an 5GS to EPS handover using N26 interface, if the MME supports the Restoration of PDN connections after an PGW-C/SMF Change procedure as specified in clause 31 of 3GPP TS 23.007 [17]. This flag shall be set to 1 by the SGW on the S5/S8 interface if the SGW supports the supports the Restoration of PDN connections after an PGW-C/SMF Change procedure as specified in clause 31 of 3GPP TS 23.007 [17] and if the SGW received the same flag in the Create Session Request message or Modify Bearer Request, during an 5GS to EPS</li> </ul>		
--	--	--	--



		<p>Idle mode mobility using N26 interface or during an 5GS to EPS handover using N26 interface.</p> <ul style="list-style-type: none"> <li>- UPIPSI (User Plane Integrity Protection Support Indication): this flag shall be set to 1 by the MME on the S11 interface, if the UE, MME and E-UTRAN supports User Plane Integrity Protection with EPS. This flag shall be set to 1 by the SGW on S5/S8 interface if the MME has set the flag to 1 over the S11 interface. See NOTE 18.</li> <li>- Satellite RAT Type reporting to PGW Indication: this flag shall be set to 1 on S11, based on operator policy or roaming agreements (for Home Routed PDN connections), if the SGW needs to forward the Satellite related RAT type to the PGW.</li> </ul>		
Sender F-TEID for Control Plane	C	<p>The new MME/SGSN shall include this IE on the S11 and S4 interfaces for a TAU/RAU/ Handover with an MME/SGSN change and without any SGW change. See NOTE 10.</p> <p>If the SGW receives this IE and if it finds that its value is the same as the earlier received value of this IE for this UE, it should interpret this to mean that the MME/SGSN has not changed.</p> <p>The new SGW shall include this IE on the S5 and S8 interfaces for a TAU/RAU/Handover with a SGW change. See NOTE 10.</p> <p>If the PGW receives this IE and if it finds that its value is the same as the earlier received value of this IE for this PDN connection, it should interpret this to mean that the SGW has not changed.</p>	F-TEID	0
Aggregate Maximum Bit Rate (APN-AMBR)	C	The APN-AMBR shall be sent for TAU/RAU/Handover from the Gn/Gp SGSN to the S4 SGSN/MME procedures.	AMBR	0
Delay Downlink Packet Notification Request	C	This IE shall be sent on the S11 interface for a UE triggered Service Request and UE initiated Connection Resume procedures. It shall contain the delay the SGW shall apply between receiving downlink data and sending Downlink Data Notification for all UEs served by that MME (see clause 5.3.4.2 of 3GPP TS 23.401 [3]).	Delay Value	0
	CO	This IE shall be sent on the S4 interface for a UE triggered Service Request. It shall contain the delay the SGW shall apply between receiving downlink data and sending Downlink Data Notification for all UEs served by that SGSN (see clause 5.3.4.2 of 3GPP TS 23.401 [3]).		

Bearer Contexts to be modified	C	<p>This IE shall be sent on the S4/S11 interface and S5/S8 interface, except</p> <ul style="list-style-type: none"> <li>- on the S5/S8 interface for a UE triggered Service Request and UE initiated Connection Resume procedures.</li> <li>- on the S5/S8 interface for a TAU/RAU/HO without SGW change procedure. See NOTE 10.</li> <li>- on the S5/S8 interface when requesting the PGW to pause or unpause charging for the PDN connection.</li> <li>- on the S5/S8 interface for any other procedure without SGW change which requires to send a Modify Bearer Request to the PGW, e.g. HSS-based P-CSCF restoration for 3GPP access, reporting of UE presence in a Presence Reporting Area, implicit resume of suspended bearers.</li> </ul> <p>(see NOTE 6).</p> <p>When Handover Indication flag is set to 1 (i.e., for a Handover from Trusted or Untrusted Non-3GPP IP Access to E-UTRAN or a Handover from Trusted or Untrusted Non-3GPP IP Access to UTRAN/GERAN procedures), the PGW shall ignore this IE. See NOTE 1.</p> <p>Several IEs with the same type and instance value may be included as necessary to represent a list of Bearers to be modified.</p> <p>During a TAU/RAU/Handover procedure with an SGW change, the SGW includes all bearers it received from the MME/SGSN (Bearer Contexts to be created, or Bearer Contexts to be modified and also Bearer Contexts to be removed) into the list of 'Bearer Contexts to be modified' IEs, which are then sent on the S5/S8 interface to the PGW (see NOTE 2, see NOTE 10).</p> <p>During an E-UTRAN Initiated E-RAB modification procedure the MME shall send a Modify Bearer Request, including all the bearers (those modified and those not modified), per PDN connection for which at least one bearer has changed. See NOTE 11.</p>	Bearer Context	0
Bearer Contexts to be removed	C	<p>This IE shall be included on the S4 and S11 interfaces for the TAU/RAU/Handover, UE initiated Connection Resume and Service Request procedures where any of the bearers existing before the TAU/RAU/Handover procedure, UE initiated Connection Resume and Service Request procedures will be deactivated as consequence of the TAU/RAU/Handover procedure, UE initiated Connection Resume and Service Request procedures. See NOTE 3 and NOTE 6.</p> <p>For each of those bearers, an IE with the same type and instance value, shall be included.</p> <p>See NOTE 11.</p>	Bearer Context	1
Recovery	C	<p>This IE shall be included if contacting the peer for the first time</p>	Recovery	0
UE Time Zone	CO	<p>This IE shall be included by the MME/SGSN on the S11/S4 interfaces if the UE Time Zone has changed in the case of TAU/RAU/Handover or UE initiated Service Request procedure. See NOTE 5.</p>	UE Time Zone	0
	CO	<p>This IE shall also be included on the S4/S11 interface during a TAU/RAU/Handover with MME/SGSN change if the source MME/SGSN has set the TZCR bit in the Change to Report Flags IE in the Forward Relocation Request or Context Response message.</p>		
	C	<p>If SGW receives this IE, SGW shall forward it to PGW across S5/S8 interface.</p>		
MME-FQ-CSID	C	<p>This IE shall be included by MME on S11 and shall be forwarded by SGW on S5/S8 according to the requirements in 3GPP TS 23.007 [17].</p>	FQ-CSID	0
SGW-FQ-CSID	C	<p>This IE shall be included by SGW on S5/S8 according to the requirements in 3GPP TS 23.007 [17].</p>	FQ-CSID	1

User CSG Information (UCI)	CO	The MME/SGSN shall include this IE for Handover procedures, UE initiated Connection Resume and UE-initiated Service Request procedure if the PGW/PCRF has requested CSG Info reporting and the MME/SGSN support the CSG information reporting and the User CSG information has changed (i.e. the UE is accessed via a new CSG cell or hybrid cell or leaves a CSG or hybrid cell). In TAU/RAU procedure without SGW change, this IE shall also be sent if the PGW/PCRF has requested CSG info reporting and MME/SGSN supports CSG info reporting and the User CSG information has changed (i.e. the UE is accessed via a new CSG cell or hybrid cell or leaves a CSG or hybrid cell) when UE requested to activate E-RAB for all the active EPS bearers in TAU procedure or to keep the lu connection after the completion of the RAU procedure. See NOTE 5. See NOTE 10. See NOTE 16. The SGW shall include this IE on S5/S8 if it receives the User CSG Information from MME/SGSN. See NOTE 15.	UCI	0
UE Local IP Address	CO	If the UE local IP Address has changed, the ePDG shall include this IE on S2b interface based on local policy for Fixed Broadband access network interworking (see 3GPP TS 23.139 [51]).	IP Address	1
UE UDP Port	CO	The ePDG shall include this IE on S2b interface if NAT is detected and UE Local IP Address is present for Fixed Broadband access network interworking (see 3GPP TS 23.139 [51]).	Port Number	1
MME/S4-SGSN LDN	O	This IE is optionally sent by the MME to the SGW on the S11 interface and by the SGSN to the SGW on the S4 interface (see 3GPP TS 32.423 [44]), when communicating the LDN to the peer node for the first time.	Local Distinguished Name (LDN)	0
SGW LDN	O	This IE is optionally sent by the SGW to the PGW on the S5/S8 interfaces (see 3GPP TS 32.423 [44]), for inter-SGW mobility, when communicating the LDN to the peer node for the first time.	Local Distinguished Name (LDN)	1
H(e)NB Local IP Address	CO	The MME/SGSN shall include this IE on S11/S4 interface if the PGW/PCRF has requested H(e)NB information reporting and the MME/SGSN has received this information from H(e)NB in UE associated S1/lu signalling (see 3GPP TS 23.139 [51]).  The SGW shall forward this IE on S5/S8 interface if it is received from the MME/SGSN and <ul style="list-style-type: none"> <li>- the Modify Bearer Request message needs to be sent to the PGW as specified in the 3GPP TS 23.401 [3]; or</li> <li>- the Propagate BBAI information change flag is received from the MME/SGSN.</li> </ul> (NOTE 7)	IP Address	0
H(e)NB UDP Port	CO	The MME/SGSN shall include this IE on S11/S4 interface if the PGW/PCRF has requested H(e)NB information reporting and the MME/SGSN has received this information from H(e)NB in UE associated S1/lu signalling (see 3GPP TS 23.139 [51]).  The SGW shall forward this IE on S5/S8 interface if it is received from the MME/SGSN and <ul style="list-style-type: none"> <li>- the Modify Bearer Request message needs to be sent to the PGW as specified in the 3GPP TS 23.401 [3]; or</li> <li>- the Propagate BBAI information change flag is received from the MME/SGSN.</li> </ul> (NOTE 7)	Port Number	0

MME/S4-SGSN Identifier	CO	<p>If the PGW triggered SGW restoration procedure is supported, the MME/S4-SGSN shall include this IE on S11/S4 interface and the SGW shall forward this IE on S5 interface in the existing signalling as specified in 3GPP TS 23.007 [17].</p> <p>If the overload control feature is supported by the MME/S4-SGSN and is activated for the PLMN to which the PGW belongs(see clause 12.3.11), the MME/S4-SGSN shall include this IE on the S11/S4 interface during mobility procedures with MME/S4-SGSN change.</p>	IP Address	2
	CO	<p>If the overload control feature is supported by the SGW and if the currently serving MME/S4-SGSN has provided this IE (in this message or in earlier message), the SGW shall include this IE on the S5/S8 interface and shall set it to the last received value of the serving MME/S4-SGSN identity.</p>		
CN Operator Selection Entity	CO	<p>In shared networks, the SGSN shall include this IE on the S4 interface for the RAU procedure, if the information is available, and if the Serving Network IE is present in the message or if the CN Operator Selection Entity has changed, to indicate whether the Serving Network has been selected by the UE or by the network.</p>	CN Operator Selection Entity	0
	CO	<p>The SGW shall include this IE on S5/S8 if it receives it from the SGSN.</p>		

<p>Presence Reporting Area Information</p>	<p>CO</p>	<p>The MME/SGSN shall include this IE:</p> <ul style="list-style-type: none"> <li>- if the PGW/PCRF/OCS has just requested to start or modify reporting changes of UE presence in a Presence Reporting Area and the MME/SGSN supports such reporting. The MME/SGSN shall then indicate whether the UE is inside or outside the newly started or modified Presence Reporting Area(s), or indicate the Presence Reporting Area(s) is inactive. Several IEs with the same type and instance value may be included as necessary to represent a list of Presence Reporting Area Information. One IE shall be included for each Presence Reporting Area newly started or modified.</li> </ul> <p>The MME/SGSN shall also include this IE in the following procedures, if the PGW/PCRF requested to report changes of UE presence in a Presence Reporting Area and the MME/SGSN supports such reporting:</p> <ul style="list-style-type: none"> <li>- TAU/RAU/Handover procedures without SGW change and with MME/SGSN change and S1-based handover procedure with SGW change. The MME/SGSN shall then indicate whether the UE is inside or outside the Presence Reporting Area(s) for each of the active Presence Reporting Area(s), or indicate that the Presence Reporting Area(s) is inactive. Several IEs with the same type and instance value may be included as necessary to represent a list of Presence Reporting Area Information.</li> <li>- TAU/RAU/Handover/Cell Update procedures without MME/SGSN change, UE initiated Connection Resume and UE-initiated Service Request procedure if the UE enters or leaves the Presence Reporting Area(s). Several IEs with the same type and instance value may be included as necessary to represent a list of Presence Reporting Area Information. One IE shall be included for each active Presence Reporting Area that the UE has newly entered or left. See NOTE 5, NOTE 10.</li> <li>- UE initiated Service Request, if ISR is active;</li> </ul> <p>See NOTE 22.</p>	<p>Presence Reporting Area Information</p>	<p>0</p>
	<p>CO</p>	<p>When ISR is not active, the SGW shall include this IE(s) on S5/S8 if it receives the Presence Reporting Area Information from MME/SGSN.</p> <p>When ISR is active, the SGW shall include this IE(s) on S5/S8 if it receives the Presence Reporting Area Information from MME/S4-SGSN and</p> <ul style="list-style-type: none"> <li>- the RAT Type has changed since last reported; or</li> <li>- the CPRAI flag has been set to 1.</li> </ul>		
<p>MME/S4-SGSN's Overload Control Information</p>	<p>O</p>	<p>During an overload condition, the MME/S4-SGSN may include this IE on the S11/S4 interface if the overload control feature is supported by the MME/S4-SGSN and is activated for the PLMN to which the PGW belongs (see clause 12.3.11).</p> <p>When present, the MME/S4-SGSN shall provide only one instance of this IE, representing its overload information.</p>	<p>Overload Control Information</p>	<p>0</p>
	<p>CO</p>	<p>If the SGW receives this IE and if it supports the overload control feature, it shall forward it to the PGW on the S5/S8 interface.</p>		

SGW's Overload Control Information	O	<p>During an overload condition, the SGW may include this IE over the S5/S8 interface if the overload control feature is supported by the SGW and is activated for the PLMN to which the PGW belongs (see clause 12.3.11).</p> <p>When present, the SGW shall provide only one instance of this IE, representing its overload information.</p>	Overload Control Information	1
ePDG's Overload Control Information	O	<p>During an overload condition, the ePDG may include this IE over the S2b interface if the overload control feature is supported by the ePDG and is activated for the PLMN to which the PGW belongs (see clause 12.3.11).</p> <p>When present, the ePDG shall provide only one instance of this IE, representing its overload information.</p>	Overload Control Information	2
Serving PLMN Rate Control	CO	<p>The MME shall include this IE on the S11 interface if the Serving PLMN Rate is changed.</p> <p>The target MME shall also include this IE on the S11 interface during an Inter-MME mobility procedure if the Serving PLMN Rate control is configured, and if the configured value is different from the one received from the old MME.</p> <p>See NOTE 20.</p> <p>The SGW shall include this IE on S5/S8 if it receives this IE from MME via the Create Session Request or the Modify Bearer Request message.</p>	Serving PLMN Rate Control	0
MO Exception Data Counter	CO	The MME shall include this IE on the S11 interface when it needs to send a non-zero counter value for the MO Exception Data Counter. The timestamp in the counter shall be set with the time at which the counter value increased from 0 to 1.	Counter	0
	CO	The SGW shall include this IE on S5/S8 if it has received the counter from the MME.		
IMSI	O	The MME/SGSN should include the IMSI if available. See NOTE 23.	IMSI	0
User Location Information for SGW	CO	<p>The MME/SGSN shall include this IE on the S11/S4 interface, based on operator policy for the User Location Information to be sent to the SGW, if the user location information to be passed to the SGW is not already reported in the ULI IE in this message.</p> <p>When present, this IE shall include the ECGI, TAI, eNodeB ID, RAI and/or RNC-ID, based on local policy. See NOTE 25.</p>	ULI	1
WLAN Location Information	CO	This IE shall be included on the S2b interface, during a UE initiated IPsec tunnel update procedure, if the WLAN Location Information is available.	TWAN Identifier	0
WLAN Location Timestamp	CO	This IE shall be included on the S2b interface, during a UE initiated IPsec tunnel update procedure, if the WLAN Location Timestamp is available.	TWAN Identifier Timestamp	0

Secondary RAT Usage Data Report	CO	<p>If the PLMN has configured secondary RAT usage reporting, the MME shall include this IE on the S11 interface if it has received Secondary RAT usage data from eNodeB in an X2-based handover without Serving GW relocation, S1-based handover without MME or SGW relocation, or E-UTRAN initiated E-RAB modification procedure.</p> <p>The MME shall also include this IE on the S11 interface if it has received a Secondary RAT Usage Data Report from the source MME in an S1-based handover with MME relocation procedure.</p> <p>For S1-based handover with SGW relocation, the MME shall also set the IRSGW flag to "0", to indicate that the Secondary RAT usage data is reported for the Source SGW, and sent via the Target SGW to the PGW.</p> <p>Several IEs with the same type and instance value may be included, to represent multiple usage data reports.</p>	Secondary RAT Usage Data Report	0
PSCell ID	CO	The MME shall include this IE on the S11 interface, if it has received this information from the eNodeB.	PSCell ID	0
Private Extension	O		Private Extension	VS

- NOTE1: This requirement is introduced for backwards compatibility reasons. If Bearer Contexts to be modified IE(s) is received in the Modify Bearer Request message, the PGW shall include corresponding Bearer Contexts modified IE(s) in the Modify Bearer Response message.
- NOTE2: According to the description in 3GPP TS 23.401 [3] e.g. clause 5.3.3.1 "Tracking Area Update procedure with Serving GW change" and 3GPP TS 23.060 [35], during a TAU/RAU/Handover procedure with an SGW change, if the SGW receives 'Bearer Context to be removed' IEs, the SGW shall allocate the S5/8-U SGW F-TEID for those bearers and include also these bearers in the 'Bearer contexts to be modified' IE, which is then sent within this message on the S5/S8 interface to the PGW.
- NOTE3: The 'Bearer Contexts to be removed' IE signals to the SGW that these bearers will be removed by the MME/SGSN later on by separate procedures (e.g. MME/S4-SGSN initiated Dedicated Bearer Deactivation procedure). Therefore, the SGW will not delete these bearers during the ongoing TAU/RAU/Handover procedure (without an SGW change), a Handover procedure (with an SGW change except for an X2-Handover), an UE initiated Connection Resume and a Service Request procedure.
- NOTE 4: 3GPP TS 23.401 [3] (e.g. clause 5.3.2.1) and 3GPP TS 23.060 [35] (e.g. clause 9.2.2.1) defines the MME/SGSN shall send the MS Info Change Reporting Support Indication to the PGW. In such case MME/SGSN shall use the Change Reporting Support Indication and/or CSG Change Reporting Support Indication (whichever is applicable), even if stage 2 refers to MS Info Change Reporting Support Indication.
- NOTE 5: In TAU/RAU procedure, if the UE requested to activate E-RAB for all the active EPS bearers in TAU procedure or to keep the lu connection after the completion of the RAU procedure, the User Location Info/User CSG Information/UE Time Zone/Presence Reporting Area Information shall not be sent in S1-U GTP-U tunnel setup procedure during the TAU procedure when the "active flag" is set (see 3GPP TS 24.301 [23] and 3GPP TS 23.401 [3]) or in the Service Request procedure after the completion of the RAU procedure.
- NOTE 6: 3GPP TS 23.401 [3] specifies that the target MME/SGSN (for a handover with MME/SGSN change and with or without SGW change) and the MME/SGSN (for a handover without MME/SGSN change and with SGW change) shall send the Modify Bearer Request message to the SGW in the S1 based handover/ Inter RAT handover for an unaccepted PDN Connection when at least one PDN Connection of the UE was accepted by the RAN. In this case, the (target) MME shall indicate the reserved IP address to the SGW in the S1 eNodeB F-TEID and the (target) SGSN shall indicate the reserved IP address to the SGW in the S12 RNC F-TEID for all the non GBR bearers of the unaccepted PDN Connection in the Bearer Contexts to be modified IE. An implementation may provide the mentioned reserved IP address e.g. from one of the reserved IP address ranges (see RFC5735 or <http://www.iana.net/assignments/ipv4-address-space/ipv4-address-space.xml>), or the IP address may be provisioned by a configuration. The (target) MME/SGSN shall indicate all the GBR bearers of the unaccepted PDN connection in the Bearer Contexts to be removed IE.
- NOTE 7: This IE is sent on S11/S4 in the specified conditions regardless of whether the H(e)NB local IP address and UDP port number information has changed or not to enable the SGW to propagate this IE in Modify Bearer Request over S5/S8 when required for reasons other than reporting a change in the H(e)NB local IP address and UDP port number information.
- NOTE 8: H(e)NB local IP address and UDP port number information changes when the UE moves from an (e)NB to an H(e)NB, or from one H(e)NB to another H(e)NB with a change in the fixed network backhaul, or from one H(e)NB to a (e)NB.  
The SGW shall send a Modify Bearer Request on S5/S8 if any of the following condition is met:  
a) the Propagate BBAI Information Change flag is received from the MME/SGSN;  
b) ISR is active and the RAT type has changed.
- NOTE 9: When ISR is active, the CLII and CPRAI flags allow the SGW to avoid sending Modify Bearer Request message over S5/S8 interface during UE-initiated Service Request procedure, when the ULI IE and/or the Presence Reporting Area Information IE is included over S11/S4 Modify Bearer Request message but the location information and/or the Presence Reporting Area information and the RAT Type has not changed since last reported by the SGW.
- NOTE 10: The RAU/TAU/Handover procedure which requires an SGW selection for the first time, e.g. a Gn/Gp SGSN to an S4 SGSN/MME RAU/TAU/Handover procedure, shall be handled in a similar manner to the RAU/TAU/Handover with an SGW change procedure.
- NOTE 11: The Bearer Context to be modified IE and Bearer Context to be removed IE, together, shall contain all the bearers belonging to the given PDN connection with each bearer appearing in only one of these IEs. See clause 14 for the cases when a Bearer Context mismatch is detected.
- NOTE 12: The conditions of presence of the IEs in the Modify Bearer Request for the MME and S4-SGSN triggered Serving GW relocation (see clause 5.10.4 of 3GPP TS 23.401 [3] and clause 9.2.2.4 of 3GPP TS 23.060 [35]) are identical to those specified respectively for X2 handover with SGW relocation and for Enhanced Serving RNS Relocation with SGW relocation.
- NOTE 13: If this flag is set in the message, the PGW shall not interpret the absence of other IEs (e.g. MME-FQ-CSID, H(e)NB Local IP Address) as bearing any significance. The message may contain either the PDN Pause On Indication or the PDN Pause Off Indication, not both.



- NOTE 14: During the TAU/RAU/Handover from Gn/Gp SGSN, the target MME/S4-SGSN can not derive the level of support for User Location Change Reporting and/or CSG Information Change Reporting at the source Gn/Gp SGSN.
- NOTE 15: In shared networks, when the message is sent from the VPLMN to the HPLMN, the PLMN ID that is communicated in this IE shall be that of the selected Core Network Operator for supporting UEs, or that of the allocated Core Network Operator for non-supporting UEs. As an exception, based on inter-operator roaming/sharing agreement, if the information on whether the UE is a supporting or non-supporting UE is available, the PLMN ID that is communicated to the HPLMN for non-supporting UEs shall be the Common PLMN ID.  
In shared networks, when the MME/S4-SGSN and PGW pertain to the same PLMN, the Primary PLMN ID shall be communicated in the ECGI to the PGW, and the Common PLMN ID shall be communicated in SAI/CGI to the PGW, for both supporting and non-supporting UEs. The Core Network Operator PLMN ID (selected by the UE for supporting UEs or allocated by the network for non-supporting UEs) shall be communicated in the TAI, RAI, UCI and the Serving Network.  
See clause 4.4 of 3GPP TS 23.251 [55].
- NOTE 16: If the UE initiates a TAU or RAU procedure back to the old MME/old S4 SGSN before completing the ongoing TAU or RAU procedure and the UE is not accessed via a CSG cell or hybrid cell, the old MME/old S4-SGSN shall treat this case as the UE leaves a CSG or hybrid cell.
- NOTE 17: The MME/S4-SGSN may be configured to defer the reporting of ULI change until an E-RAB, RAB or user plane is established. In that case, the MME/S4-SGSN shall not send a Modify Bearer Request, unless this is required for other reasons, during TAU/RAU without MME/SGSN change or Service Request (for UTRAN) procedures not requesting to activate data radio bearer(s). For GERAN, the SGSN shall defer the reporting of ULI changes, if so configured in the SGSN, until receipt of an uplink LLC PDU for user data or any valid LLC frame serving as a paging response.  
The MME/S4-SGSN shall report ULI changes as soon as detected if it is not configured to defer the reporting of ULI changes until an E-RAB, RAB or user plane is established, or if an E-RAB, RAB or user plane is established.
- NOTE 18: During an Inter-MME/SGSN and Intra-SGW mobility procedure, if the SGW detects that the support of ePCO or User Plane Integrity Protection (i.e. UPIPSI flag) has changed, e.g. when the source MME supports ePCO or User Plane Integrity Protection while the target MME does not support it, the SGW shall trigger a Modify Bearer Request without setting the EPCOSI flag or the UPIPSI flag respectively if the Modify Bearer Request message is not sent due to other reasons. The PGW shall interpret that ePCO or User Plane Integrity Protection is not supported for this PDN Connection.
- NOTE 19: The MME/SGSN or SGW reporting this indication to the PGW during an inter-PLMN procedure does not trigger any extra signalling.
- NOTE 20: The MME can set the Control Plane Only Indication only during a PDN connection creation procedure, and the Serving PLMN Rate Control is only applicable to the PDN connection with Control Plane Only Indication set.  
During an inter MME without SGW relocation procedure, when the source MME has not set the Control Plane Only Indication, and the target MME supports only the Control Plane Clot Optimizations, then the target MME shall not include the Serving PLMN Rate Control IE as the PDN connection cannot be changed to Control Plane Only.  
During an inter MME without SGW relocation procedure, when the source MME has set the Control Plane Only Indication and included Serving PLMN rate control IE in the Context Response message, and the target MME supports both the Control Plane Clot Optimisation and the establishment of the User Plane, the target MME cannot stop the Serving PLMN Rate Control, i.e. the PGW will continue to enforce Serving PLMN Rate Control as the Control Plane Only Indication for this PDN connection cannot be changed during this mobility procedure.
- NOTE 21: An MME which supports eNB Change Reporting shall also support Change reporting and therefore shall set both the Change Report Supporting indication and the eNB Changing Reporting Support Indication.
- NOTE 22: Upon inter MME/SGSN mobility, the target MME/SGSN shall report Presence Reporting Area Information for all the active and inactive PRAs requested by the PGW. Upon intra MME/SGSN mobility, the MME/SGSN shall only report active PRAs whose Presence Reporting Area Information is changed, e.g. from inside to outside, or vice versa.
- NOTE 23: The PGW should use the IMSI or the MEI to verify if the Modify Bearer Request message is received for the right UE context. In some error scenarios, e.g. when a delete bearer request (to delete a PDN connection) is lost over S5/S8, the PGW can receive the Modify Bearer Request message for the hanging PDN connection from the MME/SGSN and SGW, if the PGW has reassigned the F-TEID of the hanging PDN connection for another UE.
- NOTE 24: The eNB Change Reporting feature should be supported homogeneously across all MMEs in the network. Otherwise the PGW would not be notified about the change of support of eNB Change Reporting when the UE moves from an MME supporting eNB Change Reporting to an MME that does not support eNB Change Reporting.
- NOTE 25: This information is used for the SGW-U selection (see Annex B.2 of 3GPP TS 29.244 [80]).
- NOTE 26: If the LTE-M Satellite related RAT type is received from the MME, the SGW shall send the LTE-M RAT type to the PGW if the 'Satellite RAT Type reporting to PGW Indication' is not received and the

'LTE-M RAT Type reporting to PGW Indication' is received, or the SGW shall send the WB-E-UTRAN RAT type to the PGW if both of the indications are absent.

**Table 7.2.7-2: Bearer Context to be modified within Modify Bearer Request**

Octets 1	Bearer Context IE Type = 93 (decimal)			
Octets 2 and 3	Length = n			
Octets 4	Spare and Instance fields			
Information elements	P	Condition / Comment	IE Type	Ins.
EPS Bearer ID	M	See NOTE 1, NOTE 2.	EBI	0
S1 eNodeB F-TEID	C	<p>This IE shall be sent on the S11 interface if the S1-U is being used:</p> <ul style="list-style-type: none"> <li>- for an E-UTRAN initial attach;</li> <li>- for a Handover from Trusted or Untrusted Non-3GPP IP Access to E-UTRAN;</li> <li>- for an UE triggered Service Request;</li> <li>- for an UE initiated Connection Resume procedure;</li> <li>- in all S1-U GTP-U tunnel setup procedure during a TAU procedure (see 3GPP TS 24.301 [23]) /handover cases;</li> <li>- in all procedures where the UE is already in ECM-CONNECTED state, e.g. E-UTRAN Initiated E-RAB modification procedure, possibly HSS-based P-CSCF restoration for 3GPP access. See NOTE 4;</li> <li>- in the Establishment of S1-U bearer during Data Transport in Control Plane Clot EPS optimisation procedure. See NOTE 7.</li> </ul> <p>If an MME is aware that the eNodeB supports both IP address types, the MME shall send both IP addresses within an F-TEID IE. If only one IP address is included, then the SGW shall assume that the eNodeB does not support the other IP address type. See NOTE 2, NOTE 5, NOTE 6.</p>	F-TEID	0
S5/8-U SGW F-TEID	C	This IE shall be sent on the S5/S8 interfaces for a Handover or a TAU/RAU with a SGW change.	F-TEID	1
S12 RNC F-TEID	C	<p>If available, this IE shall be included if the message is sent on the S4 interface if S12 interface is being used. If an S4-SGSN is aware that the RNC supports both IP address types, the S4-SGSN shall send both IP addresses within an F-TEID IE. If only one IP address is included, then the SGW shall assume that the RNC does not support the other IP address type. See NOTE 2, NOTE 6.</p>	F-TEID	2
S4-U SGSN F-TEID	C	<p>If available, this IE shall be included if the message is sent on the S4 interface, if S4-U is being used. If an S4-SGSN supports both IP address types, the S4-SGSN shall send both IP addresses within an F-TEID IE. If only one IP address is included, then the SGW shall assume that the S4-SGSN does not support the other IP address type. See , NOTE 6.</p>	F-TEID	3

S11-U MME F-TEID	CO	<p>This IE shall be sent on the S11 interface if S11-U is being used, i.e. for the following procedures:</p> <ul style="list-style-type: none"> <li>- Mobile Originated Data transport in Control Plane Clot EPS optimisation with P-GW connectivity</li> <li>- Mobile Terminated Data Transport in Control Plane Clot EPS optimisation with P-GW connectivity</li> <li>- in all procedures where the S11-U tunnel is already established, e.g. when reporting a change of User Location Information.</li> <li>- TAU/RAU with SGW change procedure and data forwarding of DL data buffered in the old SGW (see clause 5.3.3.1A of 3GPP TS 23.401 [3]) for a Control Plane Only PDN connection. See NOTE 6.</li> </ul> <p>This IE may also be sent on the S11 interface, if S11-U is being used, during a E-UTRAN Tracking Area Update without SGW Change, if the MME needs to establish the S11-U tunnel. See NOTE 8.</p>	F-TEID	4
------------------	----	---	--------	---

- NOTE 1: If only EPS Bearer ID IE is included in the Bearer Context to be modified IE during the TAU/RAU without SGW change procedure, the SGW shall remove the stored SGSN/RNC/eNodeB/MME userplane F-TEID locally.
- NOTE 2: When Direct Tunnel is used in 3G, e.g. during a Service Request procedure if the UE requests to establish a partial set of radio access bearers and if the SGSN accepts it, or during an SRNS relocation procedure with some bearer contexts being preserved, the SGSN shall provide EBI(s) without S12 RNC F-TEID(s) for these bearer context(s) without corresponding radio access bearer(s) being established. The SGW shall be able to handle these bearer context(s). However, in earlier releases this behaviour may not be supported by the SGW and hence for such SGW, the SGSN shall provide EBI together with S12 RNC F-TEID for each of the bearer context(s) in the Bearer Context to be modified IE.
- NOTE 3: It is not possible to establish or release a partial set of radio access bearers in E-UTRAN. The MME shall provide in the Bearer Contexts to be modified IE, for a UE entering or being in CONNECTED state, the EBI together with the S1 eNodeB F-TEID for all the bearers of the PDN connection affected by the Modify Bearer Request other than those possibly indicated in the Bearer Context to be removed IE.
- NOTE 4: When the PCO-based extension of the HSS based P-CSCF restoration for 3GPP access is supported as specified in clause 5.4.3 of 3GPP TS 23.380 [61], the MME shall store the S1 eNodeB F-TEID(s) of the IMS PDN connection for UEs with an IMS PDN connection in ECM-CONNECTED state, so that the MME can include all the S1 eNodeB F-TEID(s) of the IMS PDN connection for such a UE in ECM-CONNECTED state in the Modify Bearer Request message.
- NOTE 5: When the PCO-based extension of the HSS based P-CSCF restoration for 3GPP access is supported as specified in clause 5.4.3 of 3GPP TS 23.380 [61], the S4-SGSN shall store the S12 RNC F-TEID(s) (if Direct Tunneling is used) for all the bearers of the IMS PDN connection with corresponding radio access bearers established, for UEs with an IMS PDN connection in PMM-CONNECTED state, so that the S4-SGSN can include all the S4-U SGSN F-TEID(s) (if Direct Tunneling is not used) or S12 RNC F-TEID(s) (if Direct Tunneling is used) for all the bearers of the IMS PDN connection with corresponding radio access bearers established, for such a UE in PMM-CONNECTED state in the Modify Bearer Request message.
- NOTE 6: During a TAU/RAU with SGW change procedure and data forwarding of DL data buffered in the old SGW (see clause 5.3.3.1A of 3GPP TS 23.401 [3]), the old MME/SGSN shall provide the old SGW with the Forwarding F-TEID received in the Context Acknowledge message (or in the SGSN Context Acknowledge message when a Gn/Gp SGSN is involved) and encode it as either an:
- eNB F-TEID for a PDN connection not established with the CPOPCI flag set to 1 (for an old MME),
  - S11-U MME F-TEID for a PDN connection established with the CPOPCI flag set to 1 (for an old MME), or
  - S12 RNC F-TEID or S4-U SGSN F-TEID (for an old SGSN),
- regardless of the interface type set in the F-TEID received from the new MME/SGSN. This is to make the downlink data forwarding appear as a regular downlink data transmission for the old SGW, i.e. like a Service Request procedure.
- NOTE 7: In the Establishment of S1-U bearer during Data Transport in Control Plane Clot EPS optimisation procedure (see clause 5.3.4B.4 of 3GPP TS 23.401 [3]), the MME may send a Modify Bearer Request to the SGW, to request the establishment of the S1-U bearers, without sending a prior Release Access Bearers Request to tear down the S11-U bearers. In this case, the MME shall encode the bearers being switched from S11-U to S1-U in the Bearer Contexts to be modified IE and the SGW shall release the S11-U bearers upon receipt of the Modify Bearer Request requesting the establishment of the S1-U bearers.
- NOTE 8: All the SGI PDN connections of a UE in E-UTRAN shall either use S11-U or S1-U bearers at any point in time. If S11-U is used, the MME shall establish the S11-U bearer of all the UE's SGI PDN connections.

**Table 7.2.7-3: Bearer Context to be removed within Modify Bearer Request**

Octets 1	Bearer Context IE Type = 93 (decimal)			
Octets 2 and 3	Length = n			
Octets 4	Spare and Instance fields			
<b>Information elements</b>	<b>P</b>	<b>Condition / Comment</b>	<b>IE Type</b>	<b>Ins.</b>
EPS Bearer ID	M		EBI	0

**Table 7.2.7-4: Overload Control Information within Modify Bearer Request**

Information elements	P	Condition / Comment	IE Type	Ins.
Overload Control Sequence Number	M	See clause 12.3.5.1.2.1 for the description and use of this parameter.	Sequence Number	0
Overload Reduction Metric	M	See clause 12.3.5.1.2.3 for the description and use of this parameter.	Metric	0
Period of Validity	M	See clause 12.3.5.1.2.2 for the description and use of this parameter. This IE should be set to "0" if the "Overload Reduction Metric" is null. This IE shall be ignored by the receiver if the "Overload Reduction Metric" is null.	EPC Timer	0

## 7.2.8 Modify Bearer Response

The Modify Bearer Response message shall be sent on the S11/S4 interfaces by the SGW to the MME/S4-SGSN, on the S5/S8 interfaces by the PGW to the SGW and on the S2b interface by the PGW to the ePDG as part of the procedures listed for the Modify Bearer Request (see clause 7.2.7).

If the MME has sent the counter for the RRC Cause "MO Exception data" in the Modify Bearer Request, the MME shall reset the counter value when receiving the Modify Bearer Response message.

If handling of default bearer fails, then Cause at the message level shall be a failure cause.

Possible Cause values are specified in Table 8.4-1. Message specific cause values are:

- "Request accepted".
- "Request accepted partially".
- "Context not found".
- "Service not supported".

**Table 7.2.8-1: Information Elements in a Modify Bearer Response**

Information elements	P	Condition / Comment	IE Type	Ins.
Cause	M		Cause	0
MSISDN	C	This IE shall be included on S5/S8 interfaces by the PGW if it is stored in its UE context and if this message is triggered due to TAU/RAU/HO with SGW relocation.	MSISDN	0
Linked EPS Bearer ID	C	This IE shall be sent on S5/S8 when the UE moves from a Gn/Gp SGSN to the S4 SGSN or MME to identify the default bearer the PGW selects for the PDN Connection. This IE shall also be sent by SGW on S11, S4 during Gn/Gp SGSN to S4-SGSN/MME HO procedures to identify the default bearer the PGW selects for the PDN Connection.	EBI	0
APN Restriction	C	This IE denotes the restriction on the combination of types of APN for the APN associated with this EPS bearer Context. This IE shall be included over S5/S8 interfaces, and shall be forwarded over S11/S4 interfaces during: <ul style="list-style-type: none"> <li>- Gn/Gp SGSN to MME/S4-SGSN handover procedures;</li> <li>- Gn/Gp SGSN to S4 SGSN/MME RAU/TAU procedures;</li> <li>- 5GS to EPS Idle mode mobility or handover procedures.</li> </ul>	APN Restriction	0

		The target MME or SGSN determines the Maximum APN Restriction using the APN Restriction.		
Protocol Configuration Options (PCO)	C	If SGW receives this IE from PGW on GTP or PMIP based S5/S8, the SGW shall forward PCO to MME/S4-SGSN during Inter RAT handover from the UTRAN or from the GERAN to the E-UTRAN. See NOTE 2.	PCO	0
Bearer Contexts modified	C	EPS bearers corresponding to Bearer Contexts to be modified that were sent in Modify Bearer Request message. Several IEs with the same type and instance value may be included as necessary to represent a list of the Bearers which are modified.	Bearer Context	0
Bearer Contexts marked for removal	C	EPS bearers corresponding to Bearer Contexts to be removed sent in the Modify Bearer Request message. Shall be included if request message contained Bearer Contexts to be removed. For each of those bearers an IE with the same type and instance value shall be included.	Bearer Context	1
Change Reporting Action	C	This IE shall be included with the appropriate Action field if the location Change Reporting mechanism is to be started or stopped for this subscriber in the SGSN/MME.	Change Reporting Action	0
CSG Information Reporting Action	CO	This IE shall be included with the appropriate Action field if the location CSG Info change reporting mechanism is to be started or stopped for this subscriber in the SGSN/MME.	CSG Information Reporting Action	0
H(e)NB Information Reporting	CO	This IE shall be included on the S5/S8 and S4/S11 interfaces with the appropriate Action field if H(e)NB information reporting is to be started or stopped for the PDN connection in the SGSN/MME.	H(e)NB Information Reporting	0
Charging Gateway Name	C	When Charging Gateway Function (CGF) Address is configured, the PGW shall include this IE on the S5 interface during SGW relocation and when the UE moves from Gn/Gp SGSN to S4-SGSN/MME. See NOTE 1.	FQDN	0
Charging Gateway Address	C	When Charging Gateway Function (CGF) Address is configured, the PGW shall include this IE on the S5 interface during SGW relocation and when the UE moves from Gn/Gp SGSN to S4-SGSN/MME. See NOTE 1.	IP Address	0
PGW-FQ-CSID	C	This IE shall be included by PGW on S5/S8 and shall be forwarded by SGW on S11 according to the requirements in 3GPP TS 23.007 [17].	FQ-CSID	0
SGW-FQ-CSID	C	This IE shall be included by SGW on S11 according to the requirements in 3GPP TS 23.007 [17].	FQ-CSID	1
Recovery	C	This IE shall be included if contacting the peer for the first time.	Recovery	0
SGW LDN	O	This IE is optionally sent by the SGW to the MME/SGSN on the S11/S4 interfaces (see 3GPP TS 32.423 [44]), when communicating the LDN to the peer node for the first time.	Local Distinguished Name (LDN)	0
PGW LDN	O	This IE is optionally sent by the PGW to the SGW on the S5/S8 interfaces (see 3GPP TS 32.423 [44]), when communicating the LDN to the peer node for the first time.	Local Distinguished Name (LDN)Name	1



Indication Flags	CO	<p>This IE shall be included if any one of the applicable flags is set to 1.</p> <p>Applicable flags are:</p> <ul style="list-style-type: none"> <li>- Static IPv4 Address Flag: This flag shall be set to 1 on the S5/S8 interface in the TAU/RAU/Handover with SGW change procedure if the PDP/PDN IPv4 address is static as specified in 3GPP TS 32.251 [8]. See NOTE 3.</li> <li>- Static IPv6 Address Flag: This flag shall be set to 1 on the S5/S8 interface in the TAU/RAU/Handover with SGW change procedure if the PDP/PDN IPv6 address is static as specified in 3GPP TS 32.251 [8]. See NOTE 3.</li> <li>- PDN Pause Support Indication: this flag shall be set to 1 on the S5/S8 interface during the TAU/RAU/handover with SGW relocation procedures if the PGW supports the PGW Pause of Charging procedure.</li> <li>- PDN Pause Enable Indication: this flag shall be set to 1 on the S5/S8 interface during the TAU/RAU/handover with SGW relocation procedures if the PGW enables the new SGW to use the PGW Pause of Charging procedure for this PDN connection.</li> <li>- Associate OCI with PGW node's identity: The PGW shall set this flag to 1 on the S5/S8 interface or S2a/S2b interface if it has included the "PGW's Overload Control Information" and if this information is to be associated with the node identity (i.e. FQDN or the IP address received from the HSS or DNS during the PGW selection) of the serving PGW. The SGW shall set this flag on the S11/S4 interface if it supports the overload control feature and if the flag is set on the S5/S8 interface.</li> <li>- Associate OCI with SGW node's identity: The SGW shall set this flag to 1 on the S11/S4 interface if it has included the "SGW's Overload Control Information" and if this information is to be associated with the node identity (i.e. FQDN or the IP address received from the DNS during the SGW selection) of the serving SGW.</li> <li>- Delay Tolerant Connection Indication: the flag shall be set to 1 on the S5/S8 interface during a SGW relocation procedure and when the UE moves from Gn/Gp SGSN to S4-SGSN/MME if the PDN connection is "Delay Tolerant" (see clause 8.12). See NOTE 9.</li> <li>- Notify Start Pause of charging via User plane Support Indication: this flag shall be set to 1 on the S5/S8 interface during a SGW relocation procedure if PDN Pause Enable Indication is set to "1" and if the PGW-C and PGW-U support the Notify Start Pause of Charging via user plane feature as specified in clause 5.30 of 3GPP TS 29.244 [80].</li> </ul>	Indication	0
------------------	----	--	------------	---

Presence Reporting Area Action	CO	<p>This IE shall be included on the S5/S8 and S11/S4 interfaces with the appropriate Action field if reporting changes of UE presence in a Presence Routing Area is to be started, stopped or modified for this subscriber in the MME/SGSN.</p> <p>Several IEs with the same type and instance value may be included as necessary to represent a list of Presence Reporting Area Actions One IE shall be included for each Presence Reporting Area to be started, stopped or modified.</p>	Presence Reporting Area Action	0
PGW's node level Load Control Information	O	The PGW may include this IE on the S5/S8 or S2a/S2b interface, providing its node level load information, if the load control feature is supported by the PGW and is activated for the PLMN to which the access network node, i.e. MME/S4-SGSN for 3GPP access network, ePDG/TWAN for non-3GPP access network, belongs (see clause 12.2.6).	Load Control Information	0
	CO	If the SGW receives this IE and if it supports the load control feature, it shall forward it to the MME/S4-SGSN on the S11/S4 interface.		
PGW's APN level Load Control Information	O	<p>The PGW may include this IE on the S5/S8 or S2a/S2b interface, providing APN level load information, if the APN level load control feature is supported by the PGW and is activated for the PLMN to which the access network node, i.e. MME/S4-SGSN for 3GPP access network, ePDG/TWAN for non-3GPP access based network, belongs (see clause 12.2.6).</p> <p>When present, the PGW shall provide one or more instances of this IE, up to maximum of 10, with the same type and instance value, each representing the load information for a list of APN(s). See NOTE 5, NOTE 7.</p>	Load Control Information	1
	CO	If the SGW receives this IE and if it supports APN level load control feature, it shall forward it to the MME/S4-SGSN on the S11/S4 interface.		
SGW's node level Load Control Information	O	<p>The SGW may include this IE, over the S11/S4 interface if the load control feature is supported by the SGW and is activated in the network (see clause 12.2.6).</p> <p>When present, the SGW shall provide only one instance of this IE, representing its node level load information.</p>	Load Control Information	2
PGW's Overload Control Information	O	<p>During an overload condition, the PGW may include this IE on the S5/S8 or S2b interface, if the overload control feature is supported by the PGW and is activated for the PLMN to which the access network node, i.e. MME/S4-SGSN for 3GPP access based network, ePDG for non-3GPP access based network, belongs (see clause 12.3.11).</p> <p>When present, the PGW shall provide</p> <ul style="list-style-type: none"> <li>- node level overload control, in one instance of this IE; and/or</li> <li>- APN level overload control, in one or more instances of this IE, up to maximum of 10, with the same type and instance value, each representing the overload information for a list of APN(s).</li> </ul> <p>See NOTE 6, NOTE 8.</p>	Overload Control Information	0
	CO	If the SGW receives this IE and if it supports the overload control feature, it shall forward it to the MME/S4-SGSN on the S11/S4 interface.		

SGW's Overload Control Information	O	During an overload condition, the SGW may include this IE over the S11/S4 interface if the overload control feature is supported by the SGW and is activated in the network (see clause 12.3.11).  When present, the SGW shall provide only one instance of this IE, representing its overload information.	Overload Control Information	1
PDN Connection Charging ID	CO	The PGW shall include this IE on the S5/S8 interface during a TAU/RAU/HO with SGW relocation procedure, if a PDN connection Charging ID has been allocated during the initial Attach or Initial PDN connection establishment procedure.	Charging ID	0
PGW Change Info	CO	This IE shall be included by the PGW on the S5/S8 interface if it supports the Restoration of PDN connections after an PGW-C/SMF Change procedure as specified in clause 31 of 3GPP TS 23.007 [17] and if the "Restoration of PDN connections after an PGW-C/SMF Change Support Indication" was set to 1 in the Modify Bearer Request message.  This IE may be included otherwise on the S5/S8 interface or the S2b interface to change the PGW Change Info signaled earlier for the PDN connection, if the "Restoration of PDN connections after an PGW-C/SMF Change Support Indication" was set to 1 in the Create Session Request message or in an earlier Modify Bearer Request message (during an 5GS to EPS handover using N26 interface).  The SGW shall transparently forward this IE over the S11 interface.	PGW Change Info	0
Private Extension	O		Private Extension	VS
<p>NOTE 1: Both Charging Gateway Name and Charging Gateway Address shall not be included at the same time. When both are available, the operator configures a preferred value.</p> <p>NOTE 2: If MME receives the IE, but no NAS message is sent, MME discards the IE.</p> <p>NOTE 3: Static IPv4/IPv6 Address Flag is used by SGW to provide dynamic IPv4/v6 address flag information as specified in 3GPP TS 32.251 [8].</p> <p>NOTE 4: The conditions of presence of the IEs in the Modify Bearer Response for the MME and S4-SGSN triggered Serving GW relocation (see clause 5.10.4 of 3GPP TS 23.401 [3] and clause 9.2.2.4 of 3GPP TS 23.060 [35]) are identical to those specified respectively for X2 handover with SGW relocation and for Enhanced Serving RNS Relocation with SGW relocation.</p> <p>NOTE 5: The receiver, not supporting the APN level load control feature, shall ignore all the occurrence(s) of this IE, i.e. "Load Control Information" IE with instance number "1". The receiver, supporting the APN level load control feature and supporting the APN level load information for the maximum of 10 APNs, shall handle the APN level load information for the first 10 APNs and ignore any more APN level load information.</p> <p>NOTE 6: The receiver, supporting the APN level overload information for the maximum of 10 APNs, shall handle the APN level overload information for the first 10 APNs and ignore any more APN level overload information.</p> <p>NOTE 7: The APN level load information, provided within and across different instances of the "PGW's APN level Load Control Information" IE(s) shall be limited to 10 different APNs.</p> <p>NOTE 8: The APN level overload information, provided within and across different instances of the "PGW's Overload Control Information" IE(s) shall be limited to 10 different APNs.</p> <p>NOTE 9: The SGW may use the DTCL during a Network Triggered Service Restoration procedure as specified in the clause 25.2.1 of 3GPP TS 23.007 [17].</p>				

**Table 7.2.8-2: Bearer Context modified within Modify Bearer Response**

Octets 1	Bearer Context IE Type = 93 (decimal)			
Octets 2 and 3	Length = n			
Octets 4	Spare and Instance fields			
<b>Information elements</b>	<b>P</b>	<b>Condition / Comment</b>	<b>IE Type</b>	<b>Ins.</b>
EPS Bearer ID	M		EBI	0
Cause	M	This IE shall indicate if the bearer handling was successful, and if not, gives information on the reason.	Cause	0

S1-U SGW F-TEID	C	This IE shall be used on the S11 interface, if the S1 interface is used, i.e. if the S11-U Tunnel flag was not set in the Modify Bearer Request. If the 'Change F-TEID support Indication' flag was set to 1 in the Modify Bearer Request and the SGW needs to change the F-TEID, the SGW shall include the new GTP-U F-TEID value. Otherwise, the SGW shall return the currently allocated GTP-U F-TEID value. See NOTE 1	F-TEID	0
S12 SGW F-TEID	C	This IE shall be included on the S4 interface if the S12 interface is being used. If the 'Change F-TEID support Indication' flag was set to 1 in the Modify Bearer Request and the SGW needs to change the F-TEID, the SGW shall include the new GTP-U F-TEID value. Otherwise, the SGW shall return the currently allocated GTP-U F-TEID value. See NOTE 1	F-TEID	1
S4-U SGW F-TEID	C	This IE shall be present if used on the S4 interface if the S4-U interface is being used. If the 'Change F-TEID support Indication' flag was set to 1 in the Modify Bearer Request and the SGW needs to change the F-TEID, the SGW shall include the new GTP-U F-TEID value. Otherwise, the SGW shall return the currently allocated GTP-U F-TEID value. See NOTE 1	F-TEID	2
Charging ID	C	This IE shall be present on the S5/S8 interface if this message is triggered due to one of the following procedures: <ul style="list-style-type: none"> <li>- TAU/RAU/HO with SGW relocation</li> <li>- TAU/RAU/HO from Gn/Gp SGSN to MME/S4-SGSN</li> </ul>	Charging ID	0
	O	If S5/S8 interface is GTP, this IE may be sent on the S4 interface, in order to support CAMEL charging at the SGSN, for the following procedures: <ul style="list-style-type: none"> <li>- inter-SGSN RAU/Handover/SRNS Relocation without SGW change.</li> <li>- inter-SGSN Handover/SRNS Relocation with SGW change.</li> </ul>		
Bearer Flags	CO	Applicable flags are: <ul style="list-style-type: none"> <li>- PPC (Prohibit Payload Compression): This flag shall be sent on the S5/S8 and the S4 interfaces at S4-SGSN relocation.</li> </ul>	Bearer Flags	0
S11-U SGW F-TEID	C	This IE shall be present on the S11 interface if S11-U is being used, i.e. if the S11-U Tunnel flag was set in the Modify Bearer Request. If the 'Change F-TEID support Indication' flag was set to 1 in the Modify Bearer Request and the SGW needs to change the F-TEID, the SGW shall include the new GTP-U F-TEID value. Otherwise, the SGW shall return the currently allocated GTP-U F-TEID value.	F-TEID	3
<p>NOTE 1: The SGW shall use the same F-TEID IP address and TEID values for S1-U, S11-U, S4-U and S12 interfaces; as an exception, when separate IP address spaces are used for S11-U and S1-U, for Control Plane CIoT EPS Optimization, a different IP address and TEID may be used for the S11-U F-TEID. The SGW shall not change its F-TEID for a given interface during the Handover, Service Request, E-UTRAN Initial Attach, Handover from Trusted or Untrusted Non-3GPP IP Access to E-UTRAN, UE Requested PDN connectivity, PDP Context Activation, Handover from Trusted or Untrusted Non-3GPP IP Access to UTRAN/GERAN and E-UTRAN Initiated E-RAB modification procedures.</p> <p>During Handover and Service Request the target eNodeB/RNC/SGSN may use a different IP type than the one used by the source eNodeB/RNC/SGSN. In order to support such a scenario, the SGW F-TEID should contain both an IPv4 address and an IPv6 address (see also clause 8.22 "F-TEID").</p>				

**Table 7.2.8-3: Bearer Context marked for removal within Modify Bearer Response**

Octet 1	Bearer Context IE Type = 93 (decimal)			
Octets 2 and 3	Length = n			
Octet 4	Spare and Instance fields			
Information elements	P	Condition / Comment	IE Type	Ins.
EPS Bearer ID	M		EBI	0
Cause	M	This IE shall indicate if the bearer handling was successful, and if not, gives information on the reason.	Cause	0

**Table 7.2.8-4: Load Control Information within Modify Bearer Response**

Octet 1	Load Control Information IE Type = 181 (decimal)			
Octets 2 and 3	Length = n			
Octet 4	Spare and Instance fields			
Information elements	P	Condition / Comment	IE Type	Ins.
Load Control Sequence Number	M	See clause 12.2.5.1.2.1 for the description and use of this parameter.	Sequence Number	0
Load Metric	M	See clauses 12.2.5.1.2.2 and 12.2.5.1.2.3 for the description and use of this parameter.	Metric	0
List of APN and Relative Capacity	CO	The IE shall (only) be present in the "PGW's APN level Load Control Information" IE. For indicating the APN level load, the PGW shall include one or more instances of this IE, up to maximum of 10, with the same type and instance value, representing a list of APN(s) & its respective "Relative Capacity" (sharing the same "Load Metric"). See clause 12.2.5.1.2.3 for the description and use of this parameter. See NOTE 1.	APN and Relative Capacity	0
NOTE 1: If more than 10 occurrences of "APN and Relative Capacity" IE are received within one instance of the Load Control Information IE, the receiver shall treat it as a protocol error and ignore the entire Load Control Information IE instance.				

**Table 7.2.8-5: Overload Control Information within Modify Bearer Response**

Octet 1	Overload Control Information IE Type = 180 (decimal)			
Octets 2 and 3	Length = n			
Octet 4	Spare and Instance fields			
Information elements	P	Condition / Comment	IE Type	Ins.
Overload Control Sequence Number	M	See clause 12.3.5.1.2.1 for the description and use of this parameter.	Sequence Number	0
Overload Reduction Metric	M	See clauses 12.3.5.1.2.3 and 12.3.5.1.2.4 for the description and use of this parameter.	Metric	0
Period of Validity	M	See clause 12.3.5.1.2.2 for the description and use of this parameter. This IE should be set to "0" if the "Overload Reduction Metric" is null. This IE shall be ignored by the receiver if the "Overload Reduction Metric" is null.	EPC Timer	0
List of Access Point Name (APN)	CO	The IE may (only) be present in the "PGW's Overload Control Information" IE. For indicating the APN level overload, the PGW shall include one or more instances of this IE, up to maximum of 10, with the same type and instance value, representing a list of APN(s) (sharing the same "Overload Reduction Metric" and "Period of Validity"). See NOTE 1.	APN	0
NOTE 1: If more than 10 occurrences of APNs are received within one instance of the Overload Control Information IE, the receiver shall treat it as a protocol error and ignore the entire Overload Control Information IE instance.				

**Table 7.2.8-6: PGW Change Info within Modify Bearer Response**

Information elements	P	Condition / Comment	IE Type	Ins.
PGW Set FQDN	C	When present, this IE shall contain the PGW Set FQDN of the PGW-C/SMF set to which the PGW-C/SMF belongs. (NOTE)	PGW FQDN	0
Alternative PGW-C/SMF IP Address	C	When present, this IE shall contain alternative PGW-C/SMF IP addresses within the PGW-C/SMF set to which the PGW-C/SMF belongs. Several IEs with the same type and instance value may be included to represent a list of Alternative PGW-C/SMF IP Addresses. (NOTE)	IP Address	0
Alternative PGW-C/SMF FQDN	C	When present, this IE shall contain alternative PGW-C/SMF FQDN within the PGW-C/SMF set to which the PGW-C/SMF belongs.  Several IEs with the same type and instance value may be included to represent a list of Alternative PGW-C/SMF FQDNs. (NOTE)	PGW FQDN	1
Group Id	O	When present, this IE shall identify the group to which the PDN connection pertains (see clause 31.6 of 3GPP TS 23.007 [17]).  The MME/ePDG shall replace any earlier value associated to the PDN connection with the new value.	Group Id	0
NOTE: Either the PGW Set FQDN IE, the Alternative PGW-C/SMF IP Address IE, or the Alternative PGW-C/SMF FQDN IE shall be present.				

## 7.2.9 Delete Session Request and Delete Bearer Request

### 7.2.9.1 Delete Session Request

The direction of this message shall be from MME/S4-SGSN to SGW, from SGW to PGW and from TWAN/ePDG to PGW (see Table 6.1-1).

A Delete Session Request message shall be sent on the S11 interface by the MME to the SGW and on the S5/S8 interface by the SGW to the PGW for a UE having at least one PDN connection through the SGW and PGW, as part of the procedures:

- EUTRAN Initial Attach
- UE, HSS or MME Initiated Detach
- UE or MME Requested PDN Disconnection

It shall also be sent on the S4 interface by the SGSN to the SGW, and on the S5/S8 interface by the SGW to the PGW as part of

- MS, HLR or SGSN initiated detach procedure
- Combined GPRS/IMSI Attach
- MS and SGSN Initiated PDN connection Deactivation Procedure using S4

On the S11 interface by the MME to the SGW as part of the procedures:

- Tracking Area Update with SGW Change
- S1 Based Handover with SGW Change

- X2 Based Handover with SGW Relocation
- E-UTRAN to UTRAN Iu mode Inter RAT handover with SGW change
- E-UTRAN to GERAN A/Gb mode Inter RAT handover with SGW change
- Inter RAT handover cancel with SGW change
- MME to 3G Gn/Gp SGSN combined hard handover and SRNS relocation procedure
- MME to SGSN Routing Area Update
- E-UTRAN to Gn/Gp SGSN Inter RAT handover
- S1 Based handover cancel with SGW change
- Optimised Active Handover: E-UTRAN Access to CDMA2000 HRPD Access
- MME triggered Serving GW relocation

And on the S4 interface by the SGSN to the SGW as part of

- Enhanced Serving RNS Relocation with SGW relocation using S4
- Routing Area Update with SGW change
- SGSN to MME Tracking Area Update with SGW change
- SRNS Relocation Cancel Procedure Using S4
- Inter RAT with SGW change handover cancel
- Serving RNS relocation with SGW change
- UTRAN Iu mode to E-UTRAN Inter RAT handover with SGW change
- GERAN A/Gb mode to E-UTRAN Inter RAT handover with SGW change
- S4 SGSN to Gn/Gp SGSN Routing Area Update
- S4 SGSN to Gn/Gp SGSN Serving RNS Relocation Procedures
- S4 SGSN to Gn/Gp SGSN PS handover Procedures
- S4-SGSN triggered Serving GW relocation

The message shall also be sent on the S2b interface by the ePDG to the PGW as part of procedures:

- UE/ePDG Initiated Detach with GTP on S2b
- UE Requested PDN Disconnection with GTP on S2b
- HSS/AAA Initiated Detach with GTP on S2b

The message shall also be sent on the S2a interface by the TWAN to the PGW as part of procedures:

- UE/TWAN Initiated Detach and UE/TWAN Requested PDN Disconnection in WLAN on GTP S2a
- HSS/AAA Initiated Detach in WLAN on GTP S2a

This message may also be sent on S5/S8 interface by the SGW to the PGW:

- If Downlink Data Notification Acknowledge message with Context not found cause value is received.

During the detach procedure, if ISR is active and SGW receives a Delete Session Request, the SGW shall deactivate the ISR.

NOTE: The SGW can determine if it is a detach procedure based on e.g. it receives a Delete Session Request message for the last PDN Connection.

When ISR is active, during the Detach procedure the SGW shall forward the Delete Session Request message to the PGW on the S5/S8 interface after receiving both of the messages sent from the MME and the SGSN for the same PDN Connection.

If there are any procedure collisions, the Delete Session Request shall have precedence over any other Tunnel Management message.

During the handover procedure the Delete Session Request message shall not release the indirect data forwarding tunnels.

Possible Cause values are:

- "ISR deactivation".
- "Network Failure".
- "QoS parameter mismatch".

Table 7.2.9.1-1 specifies the presence of the IEs in the message.

**Table 7.2.9.1-1: Information Elements in a Delete Session Request**

Information elements	P	Condition / Comment	IE Type	Ins.
Cause	C	If ISR is being de-activated, the Cause IE shall be included on the S4/S11 interface with the value "ISR deactivation", which indicates that the SGW shall delete the bearer resources by sending Delete Bearer Request to the MME/SGSN on which ISR was activated with the same Cause value "ISR deactivation". See NOTE 3	Cause	0
	CO	The MME/SGSN shall include this IE if the message is sent due to a network failure as specified in clause 15.7 of 3GPP TS 23.060 [35] and clause 5.18 of 3GPP TS 23.401 [3]. It indicates to the PGW the reason of the failure.  The SGW shall include this IE on S5/S8 if it receives the Cause from the MME/SGSN.		
Linked EPS Bearer ID (LBI)	C	This IE shall be included on the S4/S11, S5/S8 and S2a/S2b interfaces to indicate the default bearer associated with the PDN being disconnected unless in the handover/TAU/RAU with SGW relocation procedures.	EBI	0
User Location Information (ULI)	C	The MME/SGSN shall include this IE on the S4/S11 interface for the Detach procedure. The MME shall include ECGI, SGSN shall include CGI/SAI. The SGW shall include this IE on S5/S8 if it receives the ULI from MME/SGSN. See NOTE 4.	ULI (NOTE 7)	0



	CO	The MME/SGSN shall include this IE on the S4/S11 interface for the UE or MME Requested PDN Disconnection procedure/MS and SGSN Initiated PDN connection Deactivation Procedure using S4. The MME shall include ECGL, SGSN shall include CGI/SAI. The SGW shall include this IE on S5/S8 if it receives the ULI from the MME/SGSN.		
Indication Flags	C	<p>This IE shall be included if any one of the applicable flags is set to 1.</p> <p>Applicable flags:</p> <ul style="list-style-type: none"> <li>- Operation Indication: This flag shall be set to 1 over S4/S11 interface, if the SGW needs to forward the Delete Session Request message to the PGW. This flag shall not be set if the ISR associated GTP entity sends this message to the SGW in the Detach procedure. This flag shall also not be set to 1 in the SRNS Relocation Cancel Using S4 (6.9.2.2.4a in 3GPP TS 23.060 [4]), Inter RAT handover Cancel procedure with SGW change TAU with Serving GW change, Gn/Gb based RAU (see 5.5.2.5, 5.3.3.1, D.3.5 in 3GPP TS 23.401 [3], respectively), S1 Based handover Cancel procedure with SGW change.</li> </ul> <p>This flag shall also not be set to 1 for, e.g., X2 based handover procedure with SGW change (see clause 5.5.1.1.3 in 3GPP TS 23.401 [3]), or S1 based handover procedure with SGW change (see clause 5.5.1.2.2 in 3GPP TS 23.401 [3]). See NOTE 1.</p> <ul style="list-style-type: none"> <li>- Scope Indication: This flag shall be set to 1 on the S4/S11 interface, if the request corresponds to TAU/RAU/Handover with SGW change/SRNS Relocation Cancel Using S4 with SGW change, Inter RAT handover Cancel procedure with SGW change, S1 Based handover Cancel procedure with SGW change. See NOTE 1.</li> <li>- Release Over Any Access Indication (ROAAI): This flag shall be set to 1 over the S4/S11 interface when an NB-IFOM capable MME/SGSN wishes to request release of the PDN connection over any applicable access, e.g.: <ul style="list-style-type: none"> <li>- during a basic P-CSCF restoration procedure; or</li> <li>- when the MME/SGSN wishes that the PDN connection be reestablished via another PGW for SIPTO.</li> </ul> </li> </ul> <p>See NOTE 9.</p>	Indication	0
Protocol Configuration Options (PCO)	C	If the UE includes the PCO IE, then the MME/SGSN shall copy the content of this IE transparently from the PCO IE included by the UE. If SGW receives the PCO IE, SGW shall forward it to PGW.	PCO	0
	CO	For the multi-connection mode, if the TWAN receives the PCO from the UE, the TWAN shall forward the PCO IE to the PGW.		
Originating Node	C	This IE shall be included on the S4/S11 interface if the ISR is active in MME/SGSN to denote the type of the node originating the message. The SGW shall release the corresponding Originating Node related EPS Bearer contexts information in the PDN Connection identified by the LBI.	Node Type	0

Sender F-TEID for Control Plane	O	This IE may be included on the S4/S11 interfaces except when the source MME/SGSN initiates the deletion of PDN connections not supported by the target MME/SGSN during a successful handover/TAU/RAU procedure with MME/SGSN change and without SGW change (see clauses 5.3.3.2 and 5.5.1.2.1 of 3GPP TS 23.401 [3]), in which case this IE shall not be included. See NOTE 10. If the Sender F-TEID for Control Plane is received by the SGW, the SGW shall only accept the Delete Session Request message when the Sender F-TEID for Control Plane in this message is the same as the Sender F-TEID for Control Plane that was last received in either the Create Session Request message or the Modify Bearer Request message on the given interface. If the ISR is activated, two F-TEIDs exist: one for the MME and the other for the SGSN. See NOTE 2.	F-TEID	0
	O	This IE may be included on the S5/S8 and S2a/S2b interfaces. If the Sender F-TEID for Control Plane is received by the PGW, the PGW shall only accept the Delete Session Request message when the Sender F-TEID for Control Plane in this message is the same as the Sender F-TEID for Control Plane that was last received in either the Create Session Request message or the Modify Bearer Request message on the given interface. See NOTE 6.		
	CO	The SGW shall include this IE on the S5/S8 interface if the Delete Session Request is sent to clean up a hanging PDN connection context in the PGW, i.e. as a result of receiving a Create Session Request at the SGW colliding with an existing PDN connection context (see clause 7.2.1).		
UE Time Zone	CO	This IE shall be included by the MME on the S11 interface or by the SGSN on the S4 interface, for Detach and PDN Disconnection procedures, if the UE Time Zone has changed.	UE Time Zone	0
	CO	The SGW shall forward this IE on the S5/S8 interface if the SGW receives it from the MME/SGSN, and if the Operation Indication bit received from the MME/SGSN is set to 1.		
	CO	This IE shall be included by the TWAN on the S2a interface.		
ULI Timestamp	CO	This IE shall be included on the S4/S11 interface if the ULI IE is present. It indicates the time when the User Location Information was acquired. The SGW shall include this IE on S5/S8 if the SGW receives it from the MME/SGSN. See NOTE 4.	ULI Timestamp	0
RAN/NAS Release Cause	CO	The MME shall include this IE on the S11 interface to indicate the NAS release cause to release the PDN connection, if available and this information is permitted to be sent to the PGW operator according to MME operator's policy. The SGW shall include this IE on the S5/S8 interface if it receives it from the MME and if the Operation Indication bit received from the MME is set to 1.	RAN/NAS Cause	0
	CO	The TWAN shall include this IE on the S2a interface to indicate the TWAN release cause to release the PDN connection, if this information is available and is permitted to be sent to the PGW operator according to the TWAN operator's policy. When present, the IE shall be encoded as a Diameter or an ESM cause. See NOTE 8.		
	CO	The ePDG shall include this IE on the S2b interface to indicate the release cause to release the PDN connection, if this information is available and is permitted to be sent to the PGW operator according to the ePDG operator's policy. When present, the IE shall be encoded as a Diameter or an IKEv2 cause.		
TWAN Identifier	CO	This IE shall be included by the TWAN on the S2a interface as specified in 3GPP TS 23.402 [45].	TWAN Identifier	0

TWAN Identifier Timestamp	CO	This IE shall be included by the TWAN on the S2a if the TWAN Identifier IE is present. It shall indicate the time when the TWAN acquired the TWAN Identifier information.	TWAN Identifier Timestamp	0
MME/S4-SGSN's Overload Control Information	O	During an overload condition, the MME/S4-SGSN may include this IE on the S11/S4 interface if the overload control feature is supported by the MME/S4-SGSN and is activated for the PLMN to which the PGW belongs (see clause 12.3.11).  When present, the MME/S4-SGSN shall provide only one instance of this IE, representing its overload information.	Overload Control Information	0
	CO	If the SGW receives this IE and if it supports the overload control feature, it shall forward it to the PGW on the S5/S8 interface.		
SGW's Overload Control Information	O	During an overload condition, the SGW may include this IE over the S5/S8 interface if the overload control feature is supported by the SGW and is activated for the PLMN to which the PGW belongs (see clause 12.3.11).  When present, the SGW shall provide only one instance of this IE, representing its overload information.	Overload Control Information	1
TWAN/ePDG's Overload Control Information	O	During an overload condition, the TWAN/ePDG may include this IE over the S2a/S2b interface if the overload control feature is supported by the TWAN/ePDG and is activated for the PLMN to which the PGW belongs (see clause 12.3.11).  When present, the TWAN/ePDG shall provide only one instance of this IE, representing its overload information.	Overload Control Information	2
WLAN Location Information	CO	The ePDG shall include this IE on the S2b interface if the WLAN Location Information is available.	TWAN Identifier	1
WLAN Location Timestamp	CO	The ePDG shall include this IE on the S2b interface, if the WLAN Location Timestamp is available.	TWAN Identifier Timestamp	1
UE Local IP Address	CO	The ePDG shall include this IE on the S2b interface.	IP Address	0
UE UDP Port	CO	The ePDG shall include this IE on the S2b interface if NAT is detected and UDP encapsulation is used.	Port Number	0
Extended Protocol Configuration Options (ePCO)	CO	If the UE includes the ePCO IE, then the MME shall copy the content of this IE transparently from the ePCO IE included by the UE. If the SGW receives the ePCO IE, the SGW shall forward it to the PGW.	ePCO	0
UE TCP Port	CO	The ePDG shall include this IE on the S2b interface if NAT is detected and the TCP encapsulation is used.	Port Number	1
Secondary RAT Usage Data Report	CO	If the PLMN has configured secondary RAT usage reporting, the MME shall include this IE on the S11 interface if it has received Secondary RAT usage data from eNodeB in a UE-initiated Detach procedure for E-UTRAN, MME-initiated Detach, HSS-initiated Detach, or UE or MME requested PDN disconnection. The MME shall also include this IE on the S11 interface to the Source SGW if it has received a Secondary RAT Usage Data Report from the eNB in an S1/X2-based handover with Serving GW relocation, or MME triggered Serving GW relocation procedure, or an E-UTRAN to GERAN A/Gb mode Inter RAT handover, E-UTRAN to UTRAN Iu mode Inter RAT handover, MME to 3G SGSN combined hard handover and SRNS relocation, or Routing Area Update procedures. In this case, the IRPGW flag shall be set to "0". Several IEs with the same type and instance value may be included, to represent multiple usage data reports.	Secondary RAT Usage Data Report	0
	O	The SGW shall forward this IE on the S5/S8 interface if it receives the Secondary RAT Usage Data Report with the IRPGW flag set to "1" from MME. Several IEs with the same type and instance value may be included, to represent multiple usage data reports.		
PSCell ID	CO	The MME shall include this IE on the S11 interface, if it has received this information from the eNodeB.	PSCell ID	0

Private Extension	O	This IE may be sent on the S5/S8, S4/S11 and S2a/S2b interfaces.	Private Extension	VS
<p>NOTE 1: For the Indication Flags, the combination (Operation Indication, Scope Indication) = 1,1 shall be considered an error if received.</p> <p>NOTE 2: Following an inter RAT TAU/RAU failure, the target MME/SGSN may mistakenly initiate the implicit detach procedure while the UE is managed by the other MME/SGSN. In this case, the SGW will reject the Delete Session Request message with the cause "Invalid peer".</p> <p>NOTE 3: If the UE has multiple PDN connections and only one of these is being deactivated, the MME/S4-SGSN shall not send the Cause IE with the value "ISR deactivation".</p> <p>NOTE 4: If ISR is active, after receiving both the Delete Session Request messages from the MME and the SGSN, the SGW shall include the most recent ULI timestamp and the related User Location Information in the Delete Session Request message on S5/S8 interface.</p> <p>NOTE 5: The conditions of presence of the IEs in the Delete Session Request for the MME and S4-SGSN triggered Serving GW relocation (see clause 5.10.4 of 3GPP TS 23.401 [3] and clause 9.2.2.4 of 3GPP TS 23.060 [35]) are identical to those specified respectively for X2 handover with SGW relocation and for Enhanced Serving RNS Relocation with SGW relocation.</p> <p>NOTE 6: In some scenarios, e.g. during an S11/S4 path failure, the old SGW may send a Delete Session Request towards the PGW for a PDN connection which has already been relocated to a new SGW. In this case, the PGW shall reject the Delete Session Request message with the cause "Invalid peer".</p> <p>NOTE 7: In shared networks, when the message is sent from the VPLMN to the HPLMN, the PLMN ID that is communicated in this IE shall be that of the selected Core Network Operator for supporting UEs, or that of the allocated Core Network Operator for non-supporting UEs. As an exception, based on inter-operator roaming/sharing agreement, if the information on whether the UE is a supporting or non-supporting UE is available, the PLMN ID that is communicated to the HPLMN for non-supporting UEs shall be the Common PLMN ID. In shared networks, when the MME/S4-SGSN and PGW pertain to the same PLMN, the Primary PLMN ID shall be communicated in the ECGI to the PGW, and the Common PLMN ID shall be communicated in SAI/CGI to the PGW, for both supporting and non-supporting UEs. The Core Network Operator PLMN ID (selected by the UE for supporting UEs or allocated by the network for non-supporting UEs) shall be communicated in the TAI, RAI, UCI and the Serving Network. See clause 4.4 of 3GPP TS 23.251 [55].</p> <p>NOTE 8: This IE corresponds to the TWAN Release Cause IE specified in 3GPP TS 23.402 [45].</p> <p>NOTE 9: An NB-IFOM capable MME/SGSN remains unaware of whether the PDN connection to be released is associated with multiple accesses or not (i.e. whether this is a NB-IFOM PDN connection).</p> <p>NOTE 10: During an inter-MME/SGSN and intra SGW mobility procedure, if the Modify Bearer Request message from the target MME/SGSN arrives at the SGW before the Delete Session Request message from the source MME/SGSN, and if the Sender F-TEID for the Control Plane was included in the Delete Session Request, this would lead the SGW to reject the Delete Session Request message.</p>				

**Table 7.2.9.1-2: Overload Control Information within Delete Session Request**

Octet 1	Overload Control Information IE Type = 180 (decimal)			
Octets 2 and 3	Length = n			
Octet 4	Spare and Instance fields			
<b>Information elements</b>	<b>P</b>	<b>Condition / Comment</b>	<b>IE Type</b>	<b>Ins.</b>
Overload Control Sequence Number	M	See clause 12.3.5.1.2.1 for the description and use of this parameter.	Sequence Number	0
Overload Reduction Metric	M	See clause 12.3.5.1.2.3 for the description and use of this parameter.	Metric	0
Period of Validity	M	See clause 12.3.5.1.2.2 for the description and use of this parameter. This IE should be set to "0" if the "Overload Reduction Metric" is null. This IE shall be ignored by the receiver if the "Overload Reduction Metric" is null.	EPC Timer	0

**7.2.9.2 Delete Bearer Request**

The direction of this message shall be from PGW to SGW, from SGW to MME/S4-SGSN and from PGW to TWAN/ePDG (see Table 6.1-1).

A Delete Bearer Request message shall be sent on the S5/S8 and S4/S11 interfaces as part of the following procedures:

- PGW or MME initiated bearer deactivation procedures,
- UE requested Bearer Resource Modification,
- MS and SGSN Initiated Bearer Deactivation procedure using S4 or
- PGW initiated bearer deactivation procedure using S4.

In the above cases, this Request is sent by the PGW to the SGW and shall be forwarded to the MME or S4-SGSN.

The message shall also be sent on the S4/S11 interface by the SGW to the SGSN/MME to delete the bearer resources on the other ISR associated CN node if the ISRAI flag is not set in the Modify Bearer Request/Modify Access Bearers Request message.

The message shall also be sent on the S4/S11 interface by the SGW to the SGSN/MME to delete the bearer resources on the other ISR associated CN node in the TAU/RAU/Handover procedures if the ISR related Cause IE is included in the Delete Session Request message.

The message shall also be sent on the S2b interface by the PGW to the ePDG as part of PGW Initiated Bearer Resource Allocation Deactivation procedure with GTP on S2b.

The message shall also be sent on the S2a interface by the PGW to the TWAN as part of the PGW Initiated Bearer Resource Allocation Deactivation in WLAN on GTP on S2a procedure.

The message may also be sent on the S11/S4 interface by the SGW to the MME/S4 SGSN when the SGW receives the Error Indication from PGW for the default bearer or the ICMP message from a PGW that indicates the UE specific error indication as specified in 3GPP TS 23.007 [17].

The message shall also be sent on the S5/S8 or S2a/S2b interface by the PGW to the SGW or to the TWAN/ePDG and on the S11/S4 interface by the SGW to the MME/S4-SGSN as part of the Network-initiated IP flow mobility procedure, as specified by 3GPP TS 23.161 [71].

The message shall also be sent on the S5/S8 interface by the PGW to the SGW, as part of EPS to 5GS mobility without N26 interface, ePDG/EPC to 5GS handover, EPS to 5GC/N3IWF handover, as specified in 3GPP TS 23.502 [83].

If the UE uses NB-IoT, WB-EUTRAN or GERAN Extended Coverage with increased NAS transmission delay (see 3GPP TS 24.301 [23] and 3GPP TS 24.008 [5]), the MME/SGSN should proceed as specified for a UE in ECM-IDLE state with extended idle mode DRX enabled in clause 5.4.4.1 of 3GPP TS 23.401 [3].

Possible Cause values are:

- "RAT changed from 3GPP to Non-3GPP",
- "ISR deactivation",
- "Access changed from Non-3GPP to 3GPP",
- "Reactivation requested",
- "PDN reconnection to this APN disallowed",
- "PDN connection inactivity timer expires",
- "Local release",
- "Multiple accesses to a PDN connection not allowed",
- "EPS to 5GS Mobility".

Table 7.2.9.2-1 specifies the presence of IEs in this message.

**Table 7.2.9.2-1: Information Elements in a Delete Bearer Request**

Information elements	P	Condition / Comment	IE Type	Ins.
----------------------	---	---------------------	---------	------

Linked EPS Bearer ID (LBI)	C	If the request corresponds to the bearer deactivation procedure in case all bearers belonging to a PDN connection shall be released, then this IE shall be included on the S5/S8, S4/S11 and S2a/S2b interfaces to indicate the default bearer associated with the PDN being disconnected. This IE shall be included only when the EPS Bearer ID is not present in the message.	EBI	0
	CO	During a TAU/RAU/HO if the Cause value is set to "ISR deactivation" in the Delete Session Request message, or when this message is used to delete the bearer resources on the other ISR associated CN node if the ISRAI flag is not set in the Modify Bearer Request/Modify Access Bearers Request message, an SGW shall send all LBIs for a given UE with the message on S4/S11 interface. All LBI IEs shall have the same type and instance value to represent a list of IEs (see NOTE 1 and NOTE 2).		
EPS Bearer IDs	C	This IE shall be included on S5/S8, S4/S11 and S2a/S2b interfaces for deleting bearers different from the default one, i.e. for dedicated bearers. In this case at least one dedicated bearer shall be included. This IE shall be included only when the Linked EPS Bearer ID is not present in the message. Several IEs with this type and instance values shall be included as necessary to represent a list of Bearers.	EBI	1
Failed Bearer Contexts	O	This IE may be included on the S5/S8 and S11 interfaces if the request corresponds to MME initiated bearer deactivation procedure. This IE shall contain the list of failed bearers if partial Bearer Contexts included in the Delete Bearer Command message could not be deleted.	Bearer Context	0
Procedure Transaction Id (PTI)	C	If the request corresponds to UE requested bearer resource modification procedure for an E-UTRAN, this IE shall be included on the S5/S8 and S11 interfaces.	PTI	0
Protocol Configuration Options (PCO)	C	The PGW shall include Protocol Configuration Options (PCO) IE on the S5/S8 interface, if available and if ePCO is not supported by the UE or the network. If SGW receives this IE, SGW shall forward it to SGSN/MME on the S4/S11 interface.	PCO	0
	CO	For trusted WLAN access, if the default bearer of the PDN connection is being deleted and if the multi-connection mode is used, the PGW may include this IE over the S2a interface to send PCO to the UE.		
PGW-FQ-CSID	C	This IE shall be included by the PGW on the S5/S8 and S2a/S2b interfaces, and when received from S5/S8 be forwarded by the SGW on the S11 interface according to the requirements in 3GPP TS 23.007 [17].	FQ-CSID	0
SGW-FQ-CSID	C	This IE shall be included by the SGW on the S11 interface according to the requirements in 3GPP TS 23.007 [17].	FQ-CSID	1
Cause	C	This IE shall be sent on S5/S8 and S11/S4 interfaces if the message is caused by a handover with or without optimization from 3GPP to non-3GPP (see clause 9.3.2 in 3GPP TS 23.402 [45] and clause 5.4.4.1 in 3GPP TS 23.401 [3], respectively). In this case the Cause value shall be set to "RAT changed from 3GPP to Non-3GPP". This IE shall also be sent on S11/S4 interfaces when the SGW requests to delete all bearer contexts for the given UE in an MME or S4-SGSN due to ISR deactivation, and the Cause value shall be set to "ISR deactivation". This IE shall be sent on the S2a/S2b interface if the message is caused by handover from non-3GPP to 3GPP. In this case the Cause value shall be set to "Access changed from Non-3GPP to 3GPP".	Cause	0
	CO	This IE shall be sent on the S5/S8 interface if the message is caused by EPS to 5GS mobility. In this case the Cause value shall be set to "EPS to 5GS Mobility".		

	O	This IE may be sent by a PGW on S5/S8 during PGW initiated bearer deactivation procedures for the default bearer with values of "Reactivation requested" or " PDN reconnection to this APN disallowed" or "Multiple accesses to a PDN connection not allowed" (see clause 8.4 for details).		
	O	This IE may be sent by a PGW on S5 during PGW initiated bearer deactivation procedures for the default bearer with values of "PDN connection inactivity timer expires" (see clause 8.4 for details).		
	CO	The IE shall be relayed by the SGW to the MME/S4-SGSN if received from the PGW.		
	CO	This IE shall be sent by the PGW on S5/S8 or S2a/S2b with the value "Reactivation requested", when the PGW initiates the bearer deactivation procedure for the default bearer as part of the P-CSCF restoration procedure over 3GPP access or WLAN access, as specified in 3GPP TS 23.380 [61].		
	CO	This IE shall be sent by the PGW on S5/S8 or S2a/S2b with the value "Local release", when the PGW initiates the bearer deactivation procedure, for the default bearer of the PDN connection, with local bearer release over one of the accesses associated with the NB-IFOM connection. This can be triggered, for example, as part of the P-CSCF restoration procedure specified in 3GPP TS 23.380 [61], or upon receipt by the PGW of a Delete Session Request from an MME/SGSN with the ROAA Indication set to 1. See NOTE 3.		
Indication Flags	CO	This IE shall be included if any one of the applicable flags is set to 1. Applicable flags are:  <ul style="list-style-type: none"> <li>- Associate OCI with PGW node's identity: The PGW shall set this flag to 1 on the S5/S8 interface or S2a/S2b interface if it has included the "PGW's Overload Control Information" and if this information is to be associated with the node identity (i.e. FQDN or the IP address received from the HSS or DNS during the PGW selection) of the serving PGW. The SGW shall set this flag on the S11/S4 interface if it supports the overload control feature and if the flag is set on the S5/S8 interface.</li> <li>- Associate OCI with SGW node's identity: The SGW shall set this flag to 1 on the S11/S4 interface if it has included the "SGW's Overload Control Information" and if this information is to be associated with the node identity (i.e. FQDN or the IP address received from the DNS during the SGW selection) of the serving SGW.</li> </ul>	Indication	0
PGW's node level Load Control Information	O	The PGW may include this IE on the S5/S8 or S2a/S2b interface, providing its node level load information, if the load control feature is supported by the PGW and is activated for the PLMN to which the access network node, i.e. MME/S4-SGSN for 3GPP access network, ePDG/TWAN for non-3GPP access network, belongs (see clause 12.2.6).	Load Control Information	0
	CO	If the SGW receives this IE and if it supports the load control feature, it shall forward it to the MME/S4-SGSN on the S11/S4 interface.		

PGW's APN level Load Control Information	O	The PGW may include this IE on the S5/S8 or S2a/S2b interface, providing APN level load information, if the APN level load control feature is supported by the PGW and is activated for the PLMN to which the access network node, i.e. MME/S4-SGSN for 3GPP access network, ePDG/TWAN for non-3GPP access based network, belongs (see clause 12.2.6).  When present, the PGW shall provide one or more instances of this IE, up to maximum of 10, with the same type and instance value, each representing the load information for a list of APN(s). See NOTE 3, NOTE 5.	Load Control Information	1
	CO	If the SGW receives this IE and if it supports APN level load control feature, it shall forward it to the MME/S4-SGSN on the S11/S4 interface.		
SGW's node level Load Control Information	O	The SGW may include this IE, over the S11/S4 interface if the load control feature is supported by the SGW and is activated in the network (see clause 12.2.6).  When present, the SGW shall provide only one instance of this IE, representing its node level load information.	Load Control Information	2
PGW's Overload Control Information	O	During an overload condition, the PGW may include this IE on the S5/S8 or S2a/S2b interface, if the overload control feature is supported by the PGW and is activated for the PLMN to which the access network node, i.e. MME/S4-SGSN for 3GPP access based network, ePDG/TWAN for non-3GPP access based network, belongs (see clause 12.3.11).  When present, the PGW shall provide <ul style="list-style-type: none"> <li>- node level overload control, in one instance of this IE; and/or</li> <li>- APN level overload control, in one or more instances of this IE, up to maximum of 10, with the same type and instance value, each representing the overload information for a list of APN(s).</li> </ul> See NOTE 4, NOTE 6.	Overload Control Information	0
	CO	If the SGW receives this IE and if it supports the overload control feature, it shall forward it to the MME/S4-SGSN on the S11/S4 interface.		
SGW's Overload Control Information	O	During an overload condition, the SGW may include this IE over the S11/S4 interface if the overload control feature is supported by the SGW and is activated in the network (see clause 12.3.11).  When present, the SGW shall provide only one instance of this IE, representing its overload information.	Overload Control Information	1
NBIFOM Container	CO	This IE shall be included on the S5/S8 and S2a/S2b interfaces if the PGW needs to send NBIFOM information as specified in 3GPP TS 23.161 [71]. The Container Type shall be set to 4.	F-Container	0
	CO	If the SGW receives a NBIFOM Container IE from the PGW, the SGW shall forward it to the MME/S4-SGSN on the S11/S4 interface.		
APN RATE Control Status	CO	If APN RATE Control Status is available in PGW and the delete bearer request is for the default Bearer, APN RATE Control Status shall be transferred on the S5/S8 interface. The SGW shall include the APN RATE Control Status IE on the S11/S4 interface, if received from the PGW.	APN RATE Control Status	0
Extended Protocol Configuration Options (ePCO)	CO	The PGW shall include Extended Protocol Configuration Options (ePCO) IE on the S5/S8 interface, if available and if the UE and the network support ePCO.  If the SGW receives this IE, the SGW shall forward it to the MME on the S11 interface.	ePCO	0



PGW Change Info	CO	This IE may be included on S5/S8/S2b if the PGW needs to change the PGW Change Info signaled earlier for the PDN connection. It shall be included by the PGW if the PGW S5/S8/S2b IP Address for the control plane for the PDN connection is required to be changed (see PGW triggered PDN connection restoration in clauses 31.4 and 31.4B of 3GPP TS 23.007 [17]). The SGW shall transparently forward this IE over the S11 interface.  Several IEs with the same IE type and Instance may be present to request the MME/ePDG to re-establish PDN connections associated with either different FQ-CSIDs, or Group Ids or PGW-C/SMF IP addresses to different PGW-C/SMFs.	PGW Change Info	0
Sender F-TEID for Control Plane	CO	This IE may be included over S5/S8/S2b if the PGW Change Info is present, during a PGW triggered PDN connection restoration (see clauses 31.4 and 31.4B of 3GPP TS 23.007 [17]). When present, it shall contain the F-TEID including the TEID that the SGW or ePDG shall use when sending the Delete Bearer Response message.  This IE may be included over S11 if the PGW Change Info is present, during a Combined SGW-C/PGW-C/SMF triggered PDN connection restoration (see clause 31.4A of 3GPP TS 23.007 [17]). When present, it shall contain the F-TEID including the TEID that the MME shall use when sending the Delete Bearer Response message.	F-TEID	0
Private Extension	O	This IE may be sent on the S5/S8, S4/S11 and S2a/S2b interfaces.	Private Extension	VS
<p>NOTE 1: If the SGW has sent multiple LBIs to MME/SGSN, but have received only one LBI within the Delete Bearer Response message, this indicates that the MME/SGSN is pre Rel-10. In such case, the SGW shall send separate individual Delete Bearer Request message(s) for each of remaining LBIs.</p> <p>NOTE 2: If the SGW has received Delete Session Request with Cause value set to "ISR deactivation" and has subsequently sent a Delete Bearer Request to the MME/SGSN with Cause value set to "ISR deactivation", then the MME/SGSN shall delete all PDN connections corresponding to all of the LBIs received in the Delete Bearer Request message for this UE. The MME/SGSN shall ignore any LBIs for which there are no matching PDN connections corresponding to these LBIs.</p> <p>NOTE 3: Upon receiving a Delete Bearer Request message for the default bearer of the PDN connection with cause "Local release", the MME/SGSN or TWAN/ePDG shall behave as specified in clause 5.7.3 of the 3GPP TS 23.380 [61].</p>				

NOTE: In the case that the procedure was initiated by a UE Requested Bearer Resource Modification Procedure for an E-UTRAN as specified by 3GPP TS 24.301 [23], then there will be only one instance of the EPS Bearer IDs IE in the Delete Bearer Request.

**Table 7.2.9.2-2: Bearer Context within Delete Bearer Request**

Octet 1	Bearer Context IE Type = 93 (decimal)			
Octets 2 and 3	Length = n			
Octet 4	Spare and Instance fields			
<b>Information elements</b>	<b>P</b>	<b>Condition / Comment</b>	<b>IE Type</b>	<b>Ins.</b>
EPS Bearer ID	M		EBI	0
Cause	M	This IE shall indicate the reason of the unsuccessful handling of the bearer.	Cause	0

**Table 7.2.9.2-3: Load Control Information within Delete Bearer Request**

Information elements	P	Condition / Comment	IE Type	Ins.
Octet 1	Load Control Information IE Type = 181 (decimal)			
Octets 2 and 3	Length = n			
Octet 4	Spare and Instance fields			
Load Control Sequence Number	M	See clause 12.2.5.1.2.1 for the description and use of this parameter.	Sequence Number	0
Load Metric	M	See clauses 12.2.5.1.2.2 and 12.2.5.1.2.3 for the description and use of this parameter.	Metric	0
List of APN and Relative Capacity	CO	The IE shall (only) be present in the "PGW's APN level Load Control Information" IE. For indicating the APN level load, the PGW shall include one or more instances of this IE, up to maximum of 10, with the same type and instance value, representing a list of APN(s) & its respective "Relative Capacity" (sharing the same "Load Metric"). See clause 12.2.5.1.2.3 for the description and use of this parameter. See NOTE 1.	APN and Relative Capacity	0
NOTE 1: If more than 10 occurrences of "APN and Relative Capacity" IE are received within one instance of the Load Control Information IE, the receiver shall treat it as a protocol error and ignore the entire Load Control Information IE instance.				

**Table 7.2.9.2-4: Overload Control Information within Delete Bearer Request**

Information elements	P	Condition / Comment	IE Type	Ins.
Octet 1	Overload Control Information IE Type = 180 (decimal)			
Octets 2 and 3	Length = n			
Octet 4	Spare and Instance fields			
Overload Control Sequence Number	M	See clause 12.3.5.1.2.1 for the description and use of this parameter.	Sequence Number	0
Overload Reduction Metric	M	See clauses 12.3.5.1.2.3 and 12.3.5.1.2.4 for the description and use of this parameter.	Metric	0
Period of Validity	M	See clause 12.3.5.1.2.2 for the description and use of this parameter. This IE should be set to "0" if the "Overload Reduction Metric" is null. This IE shall be ignored by the receiver if the "Overload Reduction Metric" is null.	EPC Timer	0
List of Access Point Name (APN)	CO	The IE may (only) be present in the "PGW's Overload Control Information" IE. For indicating the APN level overload, the PGW shall include one or more instances of this IE, up to maximum of 10, with the same type and instance value, representing a list of APN(s) (sharing the same "Overload Reduction Metric" and "Period of Validity"). See NOTE 1.	APN	0
NOTE 1: If more than 10 occurrences of APNs are received within one instance of the Overload Control Information IE, the receiver shall treat it as a protocol error and ignore the entire Overload Control Information IE instance.				

**Table 7.2.9.2-5: PGW Change Info within Delete Bearer Request**

Octet 1	PGW Change Info IE Type = 214 (decimal)			
Octets 2 and 3	Length = n			
Octet 4	Spare and Instance fields			
Information elements	P	Condition / Comment	IE Type	Ins.
PGW Set FQDN	O	This IE may be included by a PGW if the PGW Set FQDN is changed.	PGW FQDN	0
Alternative PGW-C/SMF IP Address	O	This IE may be included by a PGW if the list of alternative PGW-C/SMF IP addresses is changed.  Several IEs with the same type and instance value may be included to represent a list of Alternative PGW-C/SMF IP Addresses.	IP Address	0
Alternative PGW-C/SMF FQDN	O	This IE may be included by a PGW if the list of alternative PGW-C/SMF FQDNs is changed.  Several IEs with the same type and instance value may be included to represent a list of Alternative PGW-C/SMF FQDNs.	PGW FQDN	1
New PGW-C/SMF IP Address	C	This IE shall be included by a PGW if the PGW S5/S8/S2b IP Address for the control plane for the PDN connection is required to be changed (see PGW triggered PDN connection restoration in clauses 31.4 and 31.4B and 31.6.3 of 3GPP TS 23.007 [17]).	IP Address	1
New SGW-C IP Address	O	This IE may be included by a combined SGW/PGW to contain the SGW-C S11 IP address (pertaining to the combined SGW/PGW sending the PGW Change Info IE). The MME should use this information when deciding to which SGW-C S11 IP address should the Create Session Request message be sent, during a combined SGW-C/PGW-C/SMF triggered restoration procedure as specified in clauses 31.4a and 31.6.3A of 3GPP TS 23.007 [17].	IP Address	3
PGW-C/SMF FQ-CSID	C	This IE shall be included if the New PGW-C/SMF IP Address IE is present and if the PGW-C/SMF requests the MME/ePDG to re-establish all the PDN connections associated with a PGW-C/SMF FQ-CSID towards the PGW-C indicated in New PGW-C/SMF IP Address IE.  When present, it shall contain the PGW-C/SMF FQ-CSID for which the PDN connections are requested to be re-established.  Several IEs with the same IE type may be present to represent several FQ-CSIDsof PDN connections that need to be moved to the New PGW-C/SMF IP Address.  See also clause 31.6 of 3GPP TS 23.007 [17].	FQ-CSID	0
Group Id	C	This IE shall be included if the New PGW-C/SMF IP Address IE is present and if the PGW-C/SMF requests the MME/ePDG to re-establish all the PDN connections associated with a Group Id towards the PGW-C indicated in New PGW-C/SMF IP Address IE.  When present, it shall contain the Group Id for which the PDN connections are requested to be re-established.  Several IEs with the same IE type may be present to represent several Group Ids of PDN connections that need to be moved to the New PGW-C/SMF IP Address.  See also clause 31.6 of 3GPP TS 23.007 [17].	Group Id	0

PGW Control Plane IP Address	C	This IE shall be included if the New PGW-C/SMF IP Address IE is present and if the PGW-C/SMF requests the MME/ePDG to re-establish all the PDN connections of which PGW S5/S8/ S2a/S2b F-TEID contains the PGW Control Plane IP Address towards the PGW-C indicated in New PGW-C/SMF IP Address IE.  Several IEs with the same IE type may be present to represent several PGW-C/SMF IP addresses of PDN connections that need to be moved to the New PGW-C/SMF IP Address. See also clause 31.6 of 3GPP TS 23.007 [17].	IP Address	2
New Group Id	O	The IE may be present if the PGW-C/SMF wants to allocate a new Group Id for the PDN connection. When present, this IE shall identify the new Group Id to which the PDN connection pertains, and the MME/ePDG shall replace any earlier Group ID received for the PDN connection with the new Group ID. If absent, the Group ID associated earlier to the PDN connection, if any, shall remain unchanged.  See also clause 31.6 of 3GPP TS 23.007 [17].	Group Id	1

## 7.2.10 Delete Session Response and Delete Bearer Response

### 7.2.10.1 Delete Session Response

A Delete Session Response message shall be sent on the S11 interface by the SGW to the MME and on the S5/S8 interface by the PGW to the SGW as part of the following procedures:

- EUTRAN Initial Attach
- UE, HSS or MME Initiated Detach
- UE or MME Requested PDN Disconnection

It shall also be sent on the S4 interface by the SGW to the SGSN and on the S5/S8 interface by the PGW to the SGW as part of the procedures:

- MS, HLR or SGSN initiated detach procedure
- Combined GPRS/IMSI Attach
- MS and SGSN Initiated Default Bearer Deactivation Procedure using S4

On the S11 interface by the SGW to the MME as part of the procedures:

- Tracking Area Update with SGW Change
- S1 Based Handover with SGW Change
- X2 Based Handover with SGW Relocation
- E-UTRAN to UTRAN Iu mode Inter RAT handover with SGW change
- E-UTRAN to GERAN A/Gb mode Inter RAT handover with SGW change
- Inter RAT handover cancel with SGW change
- MME to 3G Gn/Gp SGSN combined hard handover and SRNS relocation procedure
- MME to SGSN Routing Area Update
- E-UTRAN to Gn/Gp SGSN Inter RAT handover

- S1 Based handover cancel with SGW change
- Optimised Active Handover: E-UTRAN Access to CDMA2000 HRPD Access
- MME triggered Serving GW relocation

And on the S4 interface by the SGW to the SGSN as part of the procedures:

- Enhanced Serving RNS Relocation with SGW relocation using S4
- Routing Area Update with SGW change
- SGSN to MME Tracking Area Update with SGW change
- Serving RNS relocation with SGW change
- UTRAN Iu mode to E-UTRAN Inter RAT handover with SGW change
- GERAN A/Gb mode to E-UTRAN Inter RAT handover with SGW change
- S4 SGSN to Gn/Gp SGSN Routing Area Update
- S4 SGSN to Gn/Gp SGSN Serving RNS Relocation Procedures
- S4 SGSN to Gn/Gp SGSN PS handover Procedures
- S4-SGSN triggered Serving GW relocation

The message shall also be sent on the S2b interface by the PGW to the ePDG as part of procedures:

- UE/ePDG Initiated Detach with GTP on S2b
- UE Requested PDN Disconnection with GTP on S2b
- HSS/AAA Initiated Detach with GTP on S2b

The message shall also be sent on the S2a interface by the PGW to the TWAN as part of procedures:

- UE/TWAN Initiated Detach and UE/TWAN Requested PDN Disconnection in WLAN on GTP S2a
- HSS/AAA Initiated Detach in WLAN on GTP S2a

This message may also be sent on S5/S8 interface by the PGW to the SGW:

- If Downlink Data Notification Acknowledge message with Context not found cause value is received.

The sending entity shall include Cause IE in the Delete Session Response message. The IE indicates if the peer has deleted the bearer, or not.

Possible Cause values are specified in Table 8.4-1. Message specific cause values are:

- "Context not found".
- "Invalid peer".

Table 7.2.10.1-1 specifies the presence of the IEs in the message.

**Table 7.2.10.1-1: Information Elements in a Delete Session Response**

Information elements	P	Condition / Comment	IE Type	Ins.
Cause	M		Cause	0
Recovery	C	This IE shall be included on the S5/S8, S4/S11 and S2a/S2b interfaces if contacting the peer for the first time	Recovery	0
Protocol Configuration Options (PCO)	C	The PGW shall include Protocol Configuration Options (PCO) IE on the S5/S8 interface, if available and if the UE or the network does not support ePCO.	PCO	0

		If SGW receives this IE, SGW shall forward it to SGSN/MME on the S4/S11 interface.		
	CO	For trusted WLAN access, if the multi-connection mode is used, the PGW may include this IE over the S2a interface to send PCO to the UE.		
Indication Flags	CO	This IE shall be included if any one of the applicable flags is set to 1. Applicable flags are: <ul style="list-style-type: none"> <li>- Associate OCI with PGW node's identity: The PGW shall set this flag to 1 on the S5/S8 interface or S2a/S2b interface if it has included the "PGW's Overload Control Information" and if this information is to be associated with the node identity (i.e. FQDN or the IP address received from the HSS or DNS during the PGW selection) of the serving PGW. The SGW shall set this flag on the S11/S4 interface if it supports the overload control feature and if the flag is set on the S5/S8 interface.</li> <li>- Associate OCI with SGW node's identity: The SGW shall set this flag to 1 on the S11/S4 interface if it has included the "SGW's Overload Control Information" and if this information is to be associated with the node identity (i.e. FQDN or the IP address received from the DNS during the SGW selection) of the serving SGW.</li> </ul>	Indication	0
PGW's node level Load Control Information	O	The PGW may include this IE on the S5/S8 or S2a/S2b interface, providing its node level load information, if the load control feature is supported by the PGW and is activated for the PLMN to which the access network node, i.e. MME/S4-SGSN for 3GPP access network, ePDG/TWAN for non-3GPP access network, belongs (see clause 12.2.6).	Load Control Information	0
	CO	If the SGW receives this IE and if it supports the load control feature, it shall forward it to the MME/S4-SGSN on the S11/S4 interface.		
PGW's APN level Load Control Information	O	The PGW may include this IE on the S5/S8 or S2a/S2b interface, providing APN level load information, if the APN level load control feature is supported by the PGW and is activated for the PLMN to which the access network node, i.e. MME/S4-SGSN for 3GPP access network, ePDG/TWAN for non-3GPP access based network, belongs (see clause 12.2.6).  When present, the PGW shall provide one or more instances of this IE, up to maximum of 10, with the same type and instance value, each representing the load information for a list of APN(s). See NOTE 1, NOTE 3.	Load Control Information	1
	CO	If the SGW receives this IE and if it supports APN level load control feature, it shall forward it to the MME/S4-SGSN on the S11/S4 interface.		
SGW's node level Load Control Information	O	The SGW may include this IE, over the S11/S4 interface if the load control feature is supported by the SGW and is activated in the network (see clause 12.2.6).  When present, the SGW shall provide only one instance of this IE, representing its node level load information.	Load Control Information	2

PGW's Overload Control Information	O	<p>During an overload condition, the PGW may include this IE on the S5/S8 or S2a/S2b interface, if the overload control feature is supported by the PGW and is activated for the PLMN to which the access network node, i.e. MME/S4-SGSN for 3GPP access based network, ePDG/TWAN for non-3GPP access based network, belongs (see clause 12.3.11).</p> <p>When present, the PGW shall provide</p> <ul style="list-style-type: none"> <li>- node level overload control, in one instance of this IE; and/or</li> <li>- APN level overload control, in one or more instances of this IE, up to maximum of 10, with the same type and instance value, each representing the overload information for a list of APN(s).</li> </ul> <p>See NOTE 2, NOTE 4.</p>	Overload Control Information	0
	CO	If the SGW receives this IE and if it supports the overload control feature, it shall forward it to the MME/S4-SGSN on the S11/S4 interface.		
SGW's Overload Control Information	O	<p>During an overload condition, the SGW may include this IE over the S11/S4 interface if the overload control feature is supported by the SGW and is activated in the network (see clause 12.3.11).</p> <p>When present, the SGW shall provide only one instance of this IE, representing its overload information.</p>	Overload Control Information	1
Extended Protocol Configuration Options (ePCO)	CO	<p>The PGW shall include Extended Protocol Configuration Options (ePCO) IE on the S5/S8 interface, if available and if the UE and the network support ePCO.</p> <p>If the SGW receives this IE, the SGW shall forward it to the MME on the S11 interface.</p>	ePCO	0
APN RATE Control Status	CO	<p>If APN RATE Control Status is available in PGW, APN RATE Control Status shall be transferred on the S5/S8 interface.</p> <p>The SGW shall include the APN RATE Control Status IE on the S11/S4 interface, if received from the PGW.</p>	APN RATE Control Status	0
Private Extension	O	This IE may be sent on the S5/S8, S4/S11 and S2a/S2b interfaces.	Private Extension	VS
<p>NOTE 1: The receiver, not supporting the APN level load control feature, shall ignore all the occurrence(s) of this IE, i.e. "Load Control Information" IE with instance number "1". The receiver, supporting the APN level load control feature and supporting the APN level load information for the maximum of 10 APNs, shall handle the APN level load information for the first 10 APNs and ignore any more APN level load information.</p> <p>NOTE 2: The receiver, supporting the APN level overload information for the maximum of 10 APNs, shall handle the APN level overload information for the first 10 APNs and ignore any more APN level overload information.</p> <p>NOTE 3: The APN level load information, provided within and across different instances of the "PGW's APN level Load Control Information" IE(s) shall be limited to 10 different APNs.</p> <p>NOTE 4: The APN level overload information, provided within and across different instances of the "PGW's Overload Control Information" IE(s) shall be limited to 10 different APNs.</p>				



**Table 7.2.10.1-2: Load Control Information within Delete Session Response**

Octet 1				
Load Control Information IE Type = 181 (decimal)				
Octets 2 and 3				
Length = n				
Octet 4				
Spare and Instance fields				
Information elements	P	Condition / Comment	IE Type	Ins.
Load Control Sequence Number	M	See clause 12.2.5.1.2.1 for the description and use of this parameter.	Sequence Number	0
Load Metric	M	See clause 12.2.5.1.2.2 for the description and use of this parameter.	Metric	0
List of APN and Relative Capacity	CO	The IE shall (only) be present in the "PGW's APN level Load Control Information" IE. For indicating the APN level load, the PGW shall include one or more instances of this IE, up to maximum of 10, with the same type and instance value, representing a list of APN(s) & its respective "Relative Capacity" (sharing the same "Load Metric"). See clause 12.2.5.1.2.3 for the description and use of this parameter. See NOTE 1.	APN and Relative Capacity	0
NOTE 1: If more than 10 occurrences of "APN and Relative Capacity" IE are received within one instance of the Load Control Information IE, the receiver shall treat it as a protocol error and ignore the entire Load Control Information IE instance.				

**Table 7.2.10.1-3: Overload Control Information within Delete Session Response**

Octet 1				
Overload Control Information IE Type = 180 (decimal)				
Octets 2 and 3				
Length = n				
Octet 4				
Spare and Instance fields				
Information elements	P	Condition / Comment	IE Type	Ins.
Overload Control Sequence Number	M	See clause 12.3.5.1.2.1 for the description and use of this parameter.	Sequence Number	0
Overload Reduction Metric	M	See clauses 12.3.5.1.2.3 and 12.3.5.1.2.4 for the description and use of this parameter.	Metric	0
Period of Validity	M	See clause 12.3.5.1.2.2 for the description and use of this parameter. This IE should be set to "0" if the "Overload Reduction Metric" is null. This IE shall be ignored by the receiver if the "Overload Reduction Metric" is null.	EPC Timer	0
List of Access Point Name (APN)	CO	The IE may (only) be present in the "PGW's Overload Control Information" IE. For indicating the APN level overload, the PGW shall include one or more instances of this IE, up to maximum of 10, with the same type and instance value, representing a list of APN(s) (sharing the same "Overload Reduction Metric" and "Period of Validity"). See NOTE 1.	APN	0
NOTE 1: If more than 10 occurrences of APNs are received within one instance of the Overload Control Information IE, the receiver shall treat it as a protocol error and ignore the entire Overload Control Information IE instance.				

## 7.2.10.2 Delete Bearer Response

The Delete Bearer Response shall be sent as a response of Delete Bearer Request.

Possible Cause values are specified in Table 8.4-1. Message specific cause values are:

- "Request accepted".
- "Request accepted partially".
- "Context not found".

- "Temporarily rejected due to handover/TAU/RAU procedure in progress".

**Table 7.2.10.2-1: Information Elements in Delete Bearer Response**

Information elements	P	Condition / Comment	IE Type	Ins.
Cause	M		Cause	0
Linked EPS Bearer ID (LBI)	C	If the response corresponds to the bearer deactivation procedure in case all the bearers associated with the default bearer of a PDN connection shall be released, this IE shall be included on the S4/S11, S5/S8 and S2a/S2b interfaces to indicate the default bearer associated with the PDN being disconnected.	EBI	0
	CO	During a TAU/RAU/HO, if an MME/SGSN has received a Delete Bearer Request message with Cause value "ISR deactivation" and multiple LBIs, the MME/SGSN shall include all these LBIs in the response message on S4/S11 interface. All LBI IEs shall have the same type and instance value to represent a list of IEs.		
Bearer Contexts	C	It shall be used on the S4/S11, S5/S8 and S2a/S2b interfaces for bearers different from default one. In this case at least one bearer shall be included. Several IEs with this type and instance values shall be included as necessary to represent a list of Bearers. Used for dedicated bearers. When used, at least one dedicated bearer shall be present. All the bearer contexts included in the EPS Bearer IDs IE of the corresponding Delete Bearer Request shall be included.	Bearer Context	0
Recovery	C	This IE shall be included on the S4/S11, S5/S8 and S2a/S2b interfaces if contacting the peer for the first time	Recovery	0
MME-FQ-CSID	C	This IE shall be included by MME the on S11 interface and shall be forwarded by the SGW on S5/S8 interface according to the requirements in 3GPP TS 23.007 [17].	FQ-CSID	0
SGW-FQ-CSID	C	This IE shall be included by the SGW on the S5/S8 interface according to the requirements in 3GPP TS 23.007 [17].	FQ-CSID	1
ePDG-FQ-CSID	C	This IE shall be included by the ePDG on the S2b interface according to the requirements in 3GPP TS 23.007 [17].	FQ-CSID	2
TWAN-FQ-CSID	C	This IE shall be included by the TWAN on the S2a interface according to the requirements in 3GPP TS 23.007 [17].	FQ-CSID	3
Protocol Configuration Options (PCO)	CO	An MME/SGSN shall include the PCO IE if such information was received from the UE. If the SGW receives this IE, the SGW shall forward it to PGW on the S5/S8 interface.	PCO	0
	CO	For the multi-connection mode, if the default bearer of the PDN connection is being deleted and if the TWAN receives the PCO from the UE, the TWAN shall forward the PCO IE to the PGW.		
UE Time Zone	CO	This IE shall be included, if available, by the MME on the S11 interface or by the SGSN on the S4 interface.	UE Time Zone	0
	CO	The SGW shall forward this IE on the S5/S8 interface if the SGW receives it from the MME/SGSN.		
	CO	This IE shall be included by the TWAN on the S2a interface.		
User Location Information (ULI)	CO	This IE shall be included by the MME on the S11 interface or by the SGSN on the S4 interface. The CGI/SAI shall be included by SGSN and the ECGI shall be included by MME. See NOTE 2.	ULI	0
	CO	The SGW shall forward this IE on the S5/S8 interface if it receives it from the MME/SGSN. See NOTE 1.		
ULI Timestamp	CO	This IE shall be included on the S4/S11 interface if the ULI IE is present. It indicates the time when the User Location Information was acquired. The SGW shall include this IE on S5/S8 if the SGW receives it from the MME/SGSN. See NOTE 1.	ULI Timestamp	0

TSN Identifier	CO	This IE shall be included by the TSN on the S2a interface as specified in 3GPP TS 23.402 [45].	TSN Identifier	0
TSN Identifier Timestamp	CO	This IE shall be included by the TSN on the S2a interface if the TSN Identifier IE is present. It shall indicate the time when the TSN acquired the TSN Identifier information.	TSN Identifier Timestamp	0
MME/S4-SGSN's Overload Control Information	O	During an overload condition, the MME/S4-SGSN may include this IE on the S11/S4 interface if the overload control feature is supported by the MME/S4-SGSN and is activated for the PLMN to which the PGW belongs (see clause 12.3.11).  When present, the MME/S4-SGSN shall provide only one instance of this IE, representing its overload information.	Overload Control Information	0
	CO	If the SGW receives this IE and if it supports the overload control feature, it shall forward it to the PGW on the S5/S8 interface.		
SGW's Overload Control Information	O	During an overload condition, the SGW may include this IE over the S5/S8 interface if the overload control feature is supported by the SGW and is activated for the PLMN to which the PGW belongs (see clause 12.3.11).  When present, the SGW shall provide only one instance of this IE, representing its overload information.	Overload Control Information	1
MME/S4-SGSN Identifier	CO	If the overload control feature is supported by the MME/S4-SGSN and is activated for the PLMN to which the PGW belongs (see clause 12.3.11), the MME/S4-SGSN shall include this IE on the S11/S4 interface when there is at least one bearer remaining for the given PDN connection after the bearer deletion, and the PGW has not been updated with the identity of the currently serving MME/S4-SGSN, i.e. if no other message carrying MME/S4-SGSN identity has been sent to the PGW during/after an inter-MME/S4-SGSN intra-SGW mobility procedure.	IP Address	0

<p>TWAN/ePDG's Overload Control Information</p>	O	<p>During an overload condition, the TWAN/ePDG may include this IE over the S2a/S2b interface if the overload control feature is supported by the TWAN/ePDG and is activated for the PLMN to which the PGW belongs (see clause 12.3.11).</p> <p>When present, the TWAN/ePDG shall provide only one instance of this IE, representing its overload information.</p>	Overload Control Information	2
<p>WLAN Location Information</p>	CO	<p>The ePDG shall include this IE on the S2b interface if the WLAN Location Information is available.</p>	TWAN Identifier	1
<p>WLAN Location Timestamp</p>	CO	<p>The ePDG shall include this IE on the S2b interface, if the WLAN Location Timestamp is available.</p>	TWAN Identifier Timestamp	1
<p>UE Local IP Address</p>	CO	<p>The ePDG shall include this IE on the S2b interface.</p>	IP Address	0
<p>UE UDP Port</p>	CO	<p>The ePDG shall include this IE on the S2b interface if NAT is detected and UDP encapsulation is used.</p>	Port Number	0
<p>NBIFOM Container</p>	CO	<p>This IE shall be included on the S11/S4 or S2a/S2b interfaces if the MME/S4-SGSN or the TWAN/ePDG receives a NBIFOM Container from the UE as specified in 3GPP TS 24.161 73]. The Container Type shall be set to 4.</p>	F-Container	0
	CO	<p>If the SGW receives a NBIFOM Container IE from the MME/S4-SGSN, the SGW shall forward it to the PGW on the S5/S8 interface.</p>		
<p>UE TCP Port</p>	CO	<p>The ePDG shall include this IE on the S2b interface if NAT is detected and TCP encapsulation is used.</p>	Port Number	1
<p>Secondary RAT Usage Data Report</p>	CO	<p>If the PLMN has configured secondary RAT usage reporting, the MME shall include this IE on the S11 interface if it has received Secondary RAT usage data from eNodeB in a PDN GW initiated bearer deactivation procedure.</p> <p>Several IEs with the same type and instance value may be included, to represent multiple usage data reports.</p>	Secondary RAT Usage Data Report	0
	O	<p>The SGW shall forward this IE on the S5/S8 interface if it receives the Secondary RAT Usage Data Report with the IRPGW flag set to "1" from MME.</p> <p>Several IEs with the same type and instance value may be included, to represent multiple usage data reports.</p>		
<p>PSCell ID</p>	CO	<p>The MME shall include this IE on the S11 interface, if it has received this information from the eNodeB.</p>	PSCell ID	0
<p>Private Extension</p>	O	<p>This IE may be sent on the S5/S8, S4/S11 and S2a/S2b interfaces.</p>	Private Extension	VS
<p>NOTE 1: If ISR is active, after receiving both the Delete Bearer Response messages from the MME and the SGSN, the SGW shall include the most recent time and the related User Location Information in the Delete Bearer Response message on S5/S8 interface.</p> <p>NOTE 2: In shared networks, when the message is sent from the VPLMN to the HPLMN, the PLMN ID that is communicated in this IE shall be that of the selected Core Network Operator for supporting UEs, or that of the allocated Core Network Operator for non-supporting UEs. As an exception, based on inter-operator roaming/sharing agreement, if the information on whether the UE is a supporting or non-supporting UE is available, the PLMN ID that is communicated to the HPLMN for non-supporting UEs shall be the Common PLMN ID.</p> <p>In shared networks, when the MME/S4-SGSN and PGW pertain to the same PLMN, the Primary PLMN ID shall be communicated in the ECGI to the PGW, and the Common PLMN ID shall be communicated in SAI/CGI to the PGW, for both supporting and non-supporting UEs. The Core Network Operator PLMN ID (selected by the UE for supporting UEs or allocated by the network for non-supporting UEs) shall be communicated in the TAI, RAI, UCI and the Serving Network. See clause 4.4 of 3GPP TS 23.251 [55].</p>				

**Table 7.2.10.2-2: Bearer Context within Delete Bearer Response**

Octet 1	Bearer Context IE Type = 93 (decimal)			
Octets 2 and 3	Length = n			
Octet 4	Spare and Instance fields			
Information elements	P	Condition / Comment	IE Type	Ins.
EPS Bearer ID	M		EBI	0
Cause	M	This IE shall indicate if the bearer handling was successful, and if not, gives information on the reason.	Cause	0
Protocol Configuration Options (PCO)	CO	An MME/SGSN shall include the PCO IE if such information was received from the UE. If the SGW receives this IE, the SGW shall forward it to PGW on the S5/S8 interface. This bearer level IE takes precedence over the PCO IE in the message body if they both exist.	PCO	0
RAN/NAS Cause	CO	The MME shall include this IE on the S11 interface to indicate the RAN release cause and/or NAS release cause to release the bearer, if this information is available and is permitted to be sent to the PGW operator according to the MME operator's policy.  If both a RAN release cause and a NAS release cause are generated, then several IEs with the same type and instance value shall be included to represent a list of causes. The SGW shall include this IE on the S5/S8 interface if it receives it from the MME. See NOTE 1.	RAN/NAS Cause	0
Extended Protocol Configuration Options (ePCO)	CO	An MME shall include the ePCO IE if such information is received from the UE.  If the SGW receives this IE, the SGW shall forward it to the PGW on the S5/S8 interface.	ePCO	0
NOTE 1: The MME may defer the deactivation of GBR bearers for a short period (in the order of seconds) upon receipt of an S1AP UE Context Release Request due to radio reasons, so as to allow the UE to re-establish the corresponding radio and S1 bearers and thus avoid the deactivation of the GBR bearers. If the MME receives then a Delete Bearer Request while it is still deferring the sending of a Delete Bearer Command, the MME shall include in the Delete Bearer Response the RAN/NAS Cause IE it would have included in the Delete Bearer Command. See clauses 5.3.5 and 5.4.4.1 of 3GPP TS 23.401 [3].				

**Table 7.2.10.2-3: Overload Control Information within Delete Bearer Response**

Octet 1	Overload Control Information IE Type = 180 (decimal)			
Octets 2 and 3	Length = n			
Octet 4	Spare and Instance fields			
Information elements	P	Condition / Comment	IE Type	Ins.
Overload Control Sequence Number	M	See clause 12.3.5.1.2.1 for the description and use of this parameter.	Sequence Number	0
Overload Reduction Metric	M	See clause 12.3.5.1.2.3 for the description and use of this parameter.	Metric	0
Period of Validity	M	See clause 12.3.5.1.2.2 for the description and use of this parameter. This IE should be set to "0" if the "Overload Reduction Metric" is null. This IE shall be ignored by the receiver if the "Overload Reduction Metric" is null.	EPC Timer	0

## 7.2.11 Downlink Data Notification messages

### 7.2.11.1 Downlink Data Notification

A Downlink Data Notification message shall be sent:

- on the S11 interface by the SGW to the MME as a part of the network triggered service request procedure;
- on the S4 interface by the SGW to the S4-SGSN as part of Paging with no established user plane on S4, SGW triggered paging with S4;
- on the S4 interface by the SGW to the S4-SGSN to re-establish all the previous released bearer(s) for a UE, upon receipt of downlink data for a UE in connected mode but without corresponding downlink bearer available;

NOTE: This may occur e.g. if the S4-SGSN releases some but not all the bearers of the UE as specified in clause 12.7.2.2 of 3GPP TS 23.060 [35].

- on S11/S4 interface by SGW to MME/S4-SGSN if the SGW has received an Error Indication (see 3GPP TS 29.281 [13]) from eNodeB/RNC/MME across S1-U/S12/S11-U interface. Respective SGW and MME/S4-SGSN functionality is specified in 3GPP TS 23.007 [17].
- on the S11/S4 interface by SGW to the MME/S4-SGSN as part of the network triggered service restoration procedure if both the SGW and the MME/S4-SGSN support this optional feature (see 3GPP TS 23.007 [17]).
- on the S11 interface by the SGW to the MME as a part of the Mobile Terminated Data Transport in Control Plane CIoT EPS optimisation with P-GW connectivity.

A Downlink Data Notification message may be sent:

- on the S4 by the SGW to the S4-SGSN if the SGW has received an Error Indication from S4-SGSN across S4-U interface.

Table 7.2.11.1-1 specifies the presence of the IEs in the message.

**Table 7.2.11.1-1: Information Elements in a Downlink Data Notification**

Information elements	P	Condition / Comment	IE Type	Ins.
Cause	CO	If SGW receives an Error Indication from eNodeB/RNC/S4-SGSN/MME, the SGW shall send the Cause IE with value "Error Indication received from RNC/eNodeB/S4-SGSN/MME" to MME/S4-SGSN as specified in 3GPP TS 23.007 [17].	Cause	0
EPS Bearer ID	CO	This IE shall be included on the S11 and S4 interfaces and shall be set as follows: <ul style="list-style-type: none"> <li>- If the Downlink Data Notification is triggered by the arrival of downlink data packets at the SGW, the SGW shall include the EPS Bearer ID stored in the EPS bearer context of the bearer on which the downlink data packet was received;</li> <li>- If the Downlink Data Notification is triggered by the receipt of an Error Indication from the eNodeB, RNC or S4-SGSN, the SGW shall include the EPS Bearer ID stored in the EPS bearer context of the bearer for which the Error Indication was received;</li> <li>- If the ISR is active and the Downlink Data Notification is triggered by the arrival of control plane signalling, the SGW shall include the EPS Bearer ID present in the control plane signalling or derived from the control plane signaling (for PMIP based S5/S8), See NOTE 3). For a Downlink Data Notification triggered by a Create Bearer Request message, the SGW shall include the EPS Bearer ID of the corresponding PDN connection's default bearer.</li> </ul>	EBI	0

		<ul style="list-style-type: none"> <li>- If both the SGW and the MME/S4-SGSN support the network triggered service restoration procedure (see 3GPP TS 23.007 [17]), and if the Downlink Data Notification is triggered by the arrival of control plane signalling, the SGW shall include the EPS Bearer ID present in the control plane signalling or derived from the control plane signalling (for PMIP based S5/S8). (See 3GPP TS 23.401[3], clause 5.3.4.3).</li> </ul> <p>More than one IE with this type and instance values may be included to represent multiple bearers having received downlink data packets or being signalled in the received control plane message. See NOTE 1.</p>		
Allocation/Retention Priority	CO	<p>This IE shall be included on the S11 and S4 interfaces and shall be set as follows:</p> <ul style="list-style-type: none"> <li>- If the Downlink Data Notification is triggered by the arrival of downlink data packets at the SGW, the SGW shall include the ARP stored in the EPS bearer context of the bearer on which the downlink data packet was received;</li> <li>- If the Downlink Data Notification is triggered by the receipt of an Error Indication from the eNodeB, RNC or S4-SGSN, the SGW shall include the ARP stored in the EPS bearer context of the bearer for which the Error Indication was received.</li> <li>- If the ISR is active and the Downlink Data Notification is triggered by the arrival of control plane signalling, the SGW shall include the ARP if present in the control plane signalling. If the ARP is not present in the control plane signalling, the SGW shall include the ARP in the stored EPS bearer context. See NOTE 3.</li> <li>- If both the SGW and the MME/S4-SGSN support the network triggered service restoration procedure (see 3GPP TS 23.007 [17]), and if the Downlink Data Notification is triggered by the arrival of control plane signalling, the SGW shall include the ARP if present in the control plane signalling. If the ARP is not present in the control plane signalling, the SGW shall include the ARP from the stored EPS bearer context.</li> </ul> <p>(See 3GPP TS 23.401[3], clause 5.3.4.3). If multiple EPS Bearers IDs are reported in the message, the SGW shall include the ARP associated with the bearer with the highest priority (i.e. the lowest ARP Priority Level value). See NOTE 1.</p>	ARP	0

IMSI	CO	This IE shall be included on the S11/S4 interface as part of the network triggered service restoration procedure if both the SGW and the MME/S4-SGSN support this optional feature (see 3GPP TS 23.007 [17]).	IMSI	0
Sender F-TEID for Control Plane	O	This IE may be included on the S11/S4 interface towards the restarted CN node or an alternative CN node (same type of mobility node as the failed one) as part of the network triggered service restoration procedure with or without ISR if both the SGW and the MME/S4-SGSN support this optional feature (see 3GPP TS 23.007 [17]). This IE shall not be included otherwise. (NOTE 2)	F-TEID	0
Indication Flags	CO	This IE shall be included if any one of the applicable flags is set to 1. Applicable flags are:  - Associate OCI with SGW node's identity: The SGW shall set this flag to 1 on the S11/S4 interface if it has included the "SGW's Overload Control Information" and if this information is to be associated with the node identity (i.e. FQDN or the IP address received from the DNS during the SGW selection) of the serving SGW.	Indication	0
SGW's node level Load Control Information	O	The SGW may include this IE, over the S11/S4 interface if the load control feature is supported by the SGW and is activated in the network (see clause 12.2.6).  When present, the SGW shall provide only one instance of this IE, representing its node level load information.	Load Control Information	0
SGW's Overload Control Information	O	During an overload condition, the SGW may include this IE over the S5/S8 interface if the overload control feature is supported by the SGW and is activated for the PLMN to which the PGW belongs (see clause 12.3.11).  When present, the SGW shall provide only one instance of this IE, representing its overload information.	Overload Control Information	0
Paging and Service Information	CO	This IE shall be included on the S11 and S4 interfaces, for an IP PDN connection, if the SGW supports the Paging Policy Differentiation feature (see clause 4.9 of 3GPP TS 23.401 [3]) and if the Downlink Data Notification is triggered by the arrival of downlink data packets at the SGW. If the preceding conditions are fulfilled, then for each bearer and for each packet that triggers a Downlink Data Notification, the SGW shall copy, into the Paging Policy Indication value within this IE, the value of the DSCP in TOS (IPv4) or TC (IPv6) information received in the IP payload of the GTP-U packet from the PGW (see IETF RFC 2474 [65]). See NOTE 4. One IE with this type and instance value shall be included per EPS Bearers ID reported in the message, See NOTE 1.	Paging and Service Information	0
DL Data Packets Size	CO	This IE shall be included on the S11 interfaces for a PDN connection if the MT-EDT is applicable and if the SGW supports MT-EDT feature as specified in clause 8.83.  When present, it shall contain the sum of DL Data Packets Size.	Integer Number	0
Private Extension	O		Private Extension	VS



NOTE 1:	The usage of this parameter at the S4-SGSN is not specified in this release.
NOTE 2:	In this version of the specification, the MME/S4-SGSN shall set the header TEID value in subsequent Downlink Data Notification Acknowledge or/and Downlink Data Notification Failure Indication to that of the SGW's Control Plane TEID if the Sender F-TEID for Control Plane IE is present in the Downlink Data Notification message. However the SGW shall be prepared to receive messages in which the header TEID value is set to zero from implementation conforming to earlier versions of this specification. When that is the case, the receiver identifies the subscriber context based on the included IMSI IE.
NOTE 3:	For PMIP based S5/S8, if the SGW cannot derive the EPS bearer ID/ARP from the control plane signalling (received over Gxx interface) the SGW should use the corresponding PDN connection's (for which the control plane signalling is received) default EPS bearer's EPS bearer ID/ARP.
NOTE 4:	Upon receiving a downlink data packet for a Non-IP or Ethernet PDN connection (see clause 5.3.1 of 3GPP TS 23.401 [3]), the Paging and Service Information shall not be included in the Downlink Data Notification message.

**Table 7.2.11.1-2: Load Control Information within Downlink Data Notification**

Octet 1	Load Control Information IE Type = 181 (decimal)			
Octets 2 and 3	Length = n			
Octet 4	Spare and Instance fields			
Information elements	P	Condition / Comment	IE Type	Ins.
Load Control Sequence Number	M	See clause 12.2.5.1.2.1 for the description and use of this parameter.	Sequence Number	0
Load Metric	M	See clause 12.2.5.1.2.2 for the description and use of this parameter.	Metric	0

**Table 7.2.11.1-3: Overload Control Information within Downlink Data Notification**

Octet 1	Overload Control Information IE Type = 180 (decimal)			
Octets 2 and 3	Length = n			
Octet 4	Spare and Instance fields			
Information elements	P	Condition / Comment	IE Type	Ins.
Overload Control Sequence Number	M	See clause 12.3.5.1.2.1 for the description and use of this parameter.	Sequence Number	0
Overload Reduction Metric	M	See clause 12.3.5.1.2.3 for the description and use of this parameter.	Metric	0
Period of Validity	M	See clause 12.3.5.1.2.2 for the description and use of this parameter. This IE should be set to "0" if the "Overload Reduction Metric" is null. This IE shall be ignored by the receiver if the "Overload Reduction Metric" is null.	EPC Timer	0

### 7.2.11.2 Downlink Data Notification Acknowledge

A Downlink Data Notification Acknowledge shall be sent from a MME/SGSN to a SGW in response to Downlink Data Notification with an indication of success, or failure when MME/SGSN has reachability or abnormal conditions.

Possible Cause values are specified in Table 8.4-1. Message specific cause values are:

- "Unable to page UE".
- "Context not found".
- "Unable to page UE due to Suspension".
- "UE already re-attached".
- "Temporarily rejected due to handover/TAU/RAU procedure in progress".
- "Rejection due to paging restriction".

Table 7.2.11.2-1 specifies the presence of the IEs in the message.

**Table 7.2.11.2-1: Information Elements in a Downlink Data Notification Acknowledge**

Information elements	P	Condition / Comment	IE Type	Ins.
Cause	M		Cause	0
Data Notification Delay	C	The MME/SGSN shall include the delay the SGW shall apply between receiving downlink data and sending Downlink Data Notification for all UEs served by that MME/SGSN (see clause 5.3.4.2 of 3GPP TS 23.401 [3]), if the rate of Downlink Data Notification event occurrence in the MME/SGSN becomes significant (as configured by the operator) and the MME/SGSN's load exceeds an operator configured value. See NOTE 4.	Delay Value	0
Recovery	C	This IE shall be included if contacting the peer for the first time	Recovery	0
DL low priority traffic Throttling	O	The MME/SGSN may send this IE to the SGW to request the SGW to reduce the number of Downlink Data Notification requests it sends for downlink low priority traffic received for UEs in idle mode served by that MME/SGSN in proportion to the Throttling Factor and during the Throttling Delay.  See NOTE 1, NOTE 2, NOTE 3.	Throttling	0
IMSI	CO	3GPP TS 23.007 [17] specifies conditions for sending this IE on the S11/S4 interface as part of the network triggered service restoration procedure, if both the SGW and the MME/S4-SGSN support this optional feature.	IMSI	0
DL Buffering Duration	CO	The MME/SGSN shall include this IE on the S11/S4 interface to indicate the duration during which the SGW shall buffer DL data for this UE without sending any further Downlink Data Notification message, if extended buffering in the SGW is required: <ul style="list-style-type: none"> <li>- for a UE in a power saving state (e.g. Power Saving Mode or extended idle mode DRX) that cannot be reached by paging at the moment, as specified in clause 5.3.4.3 of 3GPP TS 23.401 [3], or.</li> <li>- for a UE using NB-IoT, WB-EUTRAN or GERAN Extended Coverage with increased NAS transmission delay (see 3GPP TS 24.301 [23] and 3GPP TS 24.008 [5]).</li> </ul> If this IE is included in the message, the Cause IE shall be set to "Request Accepted".	EPC Timer	0
DL Buffering Suggested Packet Count	O	The MME/SGSN may include this IE on the S11/S4 interface, if the DL Buffering Duration IE is included, to suggest the maximum number of downlink data packets to be buffered in the SGW for this UE.	Integer Number	0
Private Extension	O		Private Extension	VS
<p>NOTE 1: The last received value of the Throttling Factor and Throttling Delay shall supersede any previous values received from that MME/SGSN. The reception of a Throttling Delay shall restart the SGW timer associated with that MME/SGSN. The SGW shall determine whether a bearer is for low priority traffic or not on the basis of the bearer's ARP priority level and operator policy (i.e. operator's configuration in the SGW of the ARP priority levels to be considered as priority or non-priority traffic).</p> <p>NOTE 2: For instance, if the DL low priority traffic Throttling IE indicates a Throttling Factor of 40% and a Throttling Delay of 180 seconds, the SGW drops by 40% the number of Downlink Data Notification requests it sends for downlink low priority traffic received for UEs in idle mode served by that MME/SGSN, during a period of 180 seconds.</p> <p>NOTE 3: The DL low priority traffic Throttling IE may be present whatever the value of the Cause IE.</p> <p>NOTE 4: The Data Notification Delay IE in the Data Notification Acknowledge has the same semantic and usage as the Delay Downlink Packet Notification Request IE in the Modify Bearer Request and Modify Access Bearers Request.</p>				

### 7.2.11.3 Downlink Data Notification Failure Indication

A Downlink Data Notification Failure indication shall be sent from an MME/SGSN to a SGW indicating that the UE did not respond to paging. It shall also be sent in the case that the UE responded to the page with a Service Request but that the MME has rejected the request by sending a Service Reject to the UE. It may happen, for example, because the requested service is not supported or there is a bearer context mismatch. Additionally, a Downlink Data Notification Failure indication shall be sent in case the UE has rejected the page as specified in clause 4.3.33 in 3GPP TS 23.401 [3].

This message should not be used after an MME/SGSN successfully receives the Service Request message from the UE in the Network Triggered Service Request procedure as defined in the 3GPP TS 23.401 [3].

**NOTE:** Either the Modify Bearer Request message or the Delete Bearer Command message is used by the MME/SGSN to indicate a possible failure case after an MME/SGSN successfully receives the Service Request message from the UE.

Possible Cause values are:

- "UE not responding".
- "Service denied".
- "UE already re-attached".
- "Rejection due to paging restriction".

Table 7.2.11.3-1 specifies the presence of the IEs in the message.

**Table 7.2.11.3-1: Information Elements in a Downlink Data Notification Failure Indication**

Information elements	P	Condition / Comment	IE Type	Ins.
Cause	M		Cause	0
Originating Node	CO	This IE shall be included on the S4/S11 interface if the ISR associated GTP entities i.e. MME, S4-SGSN, send this message to the SGW during the Network Triggered Service Request procedure to denote the type of the node originating the message.	Node Type	0
IMSI	CO	3GPP TS 23.007 [17] specifies conditions for sending this IE on the S11/S4 interface as part of the network triggered service restoration procedure, if both the SGW and the MME/S4-SGSN support this optional feature.	IMSI	0
Private Extension	O		Private Extension	VS

### 7.2.12 Delete Indirect Data Forwarding Tunnel Request

The Delete Indirect Data Forwarding Tunnel Request message is sent on the S4/S11 interface by the SGSN/MME to the SGW to delete the Indirect Forwarding Tunnels in the Source SGW/Target SGW as part of the following procedures:

- S1-based handover
- UTRAN Iu mode to E-UTRAN Inter RAT handover
- GERAN A/Gb mode to E-UTRAN Inter RAT handover
- E-UTRAN to UTRAN Iu mode Inter RAT handover
- E-UTRAN to GERAN A/Gb mode Inter RAT handover
- MME to 3G SGSN combined hard handover and SRNS relocation procedure
- 3G SGSN to MME combined hard handover and SRNS relocation procedure
- Inter RAT handover Cancel
- S1-based handover Cancel

- Optimised Active Handover: E-UTRAN Access to CDMA2000 HRPD Access
- EPS to 5GS handover using N26 interface
- 5GS to EPS handover using N26 interface
- N26 based Handover cancel

**Table 7.2.12-1: Information Element in Delete Indirect Data Forwarding Tunnel Request**

Information elements	P	Condition / Comment	IE Type	Ins.
Private Extension	O	Vendor or operator specific information	Private Extension	VS

### 7.2.13 Delete Indirect Data Forwarding Tunnel Response

The Delete Indirect Data Forwarding Tunnel Response message is sent on the S4/S11 interface by the SGW to the SGSN/MME as part of the following procedures:

- S1-based handover
- UTRAN Iu mode to E-UTRAN Inter RAT handover
- GERAN A/Gb mode to E-UTRAN Inter RAT handover
- E-UTRAN to UTRAN Iu mode Inter RAT handover
- E-UTRAN to GERAN A/Gb mode Inter RAT handover
- MME to 3G SGSN combined hard handover and SRNS relocation procedure
- 3G SGSN to MME combined hard handover and SRNS relocation procedure
- Inter RAT handover Cancel
- S1-based handover Cancel
- Optimised Active Handover: E-UTRAN Access to CDMA2000 HRPD Access
- EPS to 5GS handover using N26 interface
- 5GS to EPS handover using N26 interface
- N26 based Handover cancel

Possible Cause values are specified in Table 8.4-1. Message specific cause values are:

- "Request accepted".
- "Request accepted partially"
- "Context not found".

**Table 7.2.13-1: Information Element in Delete Indirect Data Forwarding Tunnel Response**

Information elements	P	Condition / Comment	IE Type	Ins.
Cause	M	This IE shall indicate if the deletion of indirect tunnel is successful, and if not, gives information on the reason.	Cause	0
Recovery	C	This IE shall be included if contacting the peer for the first time.	Recovery	0
Private Extension	O		Private Extension	VS

## 7.2.14 Modify Bearer Command and Failure Indication

### 7.2.14.1 Modify Bearer Command

The Modify Bearer Command shall be sent on the S11 interface by the MME to the SGW and on the S5/S8 interface by the SGW to the PGW as part of the HSS Initiated Subscribed QoS Modification procedure, or when the SQCI flag or the PSCI flag is set to 1 in the Context Response message.

It shall also be sent on the S4 interface by the SGSN to the SGW and on the S5/S8 interface by the SGW to the PGW as part of the HSS Initiated subscribed QoS modification procedure, or when the SQCI flag or the PSCI flag is set to 1 in the Context Response message.

When deferred reporting of subscription change procedure is homogenously supported by MMEs and SGSNs in the serving network, the MME shall defer sending Modify Bearer Command if the related UE is not reachable by the MME, e.g. when the UE is suspended, when the UE has entered into power saving mode or when the PPF is cleared in the MME, until the UE becomes reachable again as specified in 3GPP TS 23.401 [3].

**NOTE:** SGSNs do not defer the reporting of subscription change but need to support reporting the subscription change when receiving the PSCI flag in the Context Response message.

It shall also be sent on the S2a/S2b interface by the TWAN/ePDG to the PGW as part of the HSS Initiated Subscribed QoS Modification procedure.

**Table 7.2.14.1-1: Information Elements in a Modify Bearer Command**

Information elements	P	Condition / Comment	IE Type	Ins.
APN-Aggregate Maximum Bit Rate (APN-AMBR)	M	This IE shall contain the APN-AMBR value received by the MME/SGSN/ TWAN/ePDG from the HSS.	AMBR	0
Bearer Context	M	Only one IE with this type and instance value shall be included and this shall represent the Default Bearer.	Bearer Context	0
MME/S4-SGSN's Overload Control Information	O	During an overload condition, the MME/S4-SGSN may include this IE on the S11/S4 interface if the overload control feature is supported by the MME/S4-SGSN and is activated for the PLMN to which the PGW belongs (see clause 12.3.11).  When present, the MME/S4-SGSN shall provide only one instance of this IE, representing its overload information.	Overload Control Information	0
	CO	If the SGW receives this IE and if it supports the overload control feature, it shall forward it to the PGW on the S5/S8 interface.		
SGW's Overload Control Information	O	During an overload condition, the SGW may include this IE over the S5/S8 interface if the overload control feature is supported by the SGW and is activated for the PLMN to which the PGW belongs (see clause 12.3.11).  When present, the SGW shall provide only one instance of this IE, representing its overload information.	Overload Control Information	1
TWAN/ePDG's Overload Control Information	O	During an overload condition, the TWAN/ePDG may include this IE over the S2a/S2b interface if the overload control feature is supported by the TWAN/ePDG and is activated for the PLMN to which the PGW belongs (see clause 12.3.11).  When present, the TWAN/ePDG shall provide only one instance of this IE, representing its overload information.	Overload Control Information	2
Sender F-TEID for Control Plane	CO	The SGW shall include this IE on the S5/S8 interfaces and set it to the last value sent to the PGW.  If the Sender F-TEID for Control Plane is received, the PGW shall only handle the Modify Bearer Command message if the Sender F-TEID for Control Plane in this message is the same as the last Sender F-TEID for Control Plane received on the given interface.	F-TEID	0
Private Extension	O	This IE may be sent on the S5/S8, S4/S11 and S2a/S2b interfaces.	Private Extension	VS

**Table 7.2.14.1-2: Bearer Context within Modify Bearer Command**

Octet 1	Bearer Context IE Type = 93 (decimal)			
Octets 2 and 3	Length = n			
Octet 4	Spare and Instance fields			
Information elements	P	Condition / Comment	IE Type	Ins.
EPS Bearer ID	M	This IE shall contain the default bearer ID.	EBI	0
Bearer Level QoS	C	Mandatory if other parameters than the APN-AMBR have been changed	Bearer QoS	0
	CO	This IE shall also be included if the SQCI flag or PSCI flag is set to 1 in the Context Response message.		

**Table 7.2.14-3: Overload Control Information within Modify Bearer Command**

Octet 1	Overload Control Information IE Type = 181 (decimal)			
Octets 2 and 3	Length = n			
Octet 4	Spare and Instance fields			
Information elements	P	Condition / Comment	IE Type	Ins.
Overload Control Sequence Number	M	See clause 12.3.5.1.2.1 for the description and use of this parameter.	Sequence Number	0
Overload Reduction Metric	M	See clause 12.3.5.1.2.3 for the description and use of this parameter.	Metric	0
Period of Validity	M	See clause 12.3.5.1.2.2 for the description and use of this parameter. This IE should be set to "0" if the "Overload Reduction Metric" is null. This IE shall be ignored by the receiver if the "Overload Reduction Metric" is null.	EPC Timer	0

### 7.2.14.2 Modify Bearer Failure Indication

The Modify Bearer Failure Indication shall be sent on the S5/S8 interface by the PGW to the SGW and on the S11 interface by the SGW to the MME as part of failure of HSS Initiated Subscribed QoS Modification procedure, or when the SQCI flag or the PSCI flag is set to 1 in the Context Response message.

It shall also be sent on the S5/S8 interface by the PGW to the SGW and on the S4 interface by the SGW to the SGSN as part of failure of HSS Initiated subscribed QoS modification, or when the SQCI flag or the PSCI flag is set to 1 in the Context Response message.

It shall also be sent on the S2a/S2b interface by the PGW to the TWAN/ePDG as part of failure of HSS Initiated Subscribed QoS Modification procedure.

Cause IE indicates that an EPS bearer has not been updated in the PGW.

Possible Cause values are specified in Table 8.4-1. Message specific cause values are:

- "Context not found"
- "Service denied".

Table 7.2.14.2-1: Information Elements in a Modify Bearer Failure Indication

Information elements	P	Condition / Comment	IE Type	Ins.
Cause	M		Cause	0
Recovery	C	This IE shall be included on the S5/S8, S4/S11 and S2a/S2b interfaces if contacting the peer for the first time	Recovery	0
Indication Flags	CO	<p>This IE shall be included if any one of the applicable flags is set to 1.</p> <p>Applicable flags are:</p> <ul style="list-style-type: none"> <li>- Associate OCI with PGW node's identity: The PGW shall set this flag to 1 on the S5/S8 interface or S2a/S2b interface if it has included the "PGW's Overload Control Information" and if this information is to be associated with the node identity (i.e. FQDN or the IP address received from the HSS or DNS during the PGW selection) of the serving PGW. The SGW shall set this flag on the S11/S4 interface if it supports the overload control feature and if the flag is set on the S5/S8 interface.</li> <li>- Associate OCI with SGW node's identity: The SGW shall set this flag to 1 on the S11/S4 interface if it has included the "SGW's Overload Control Information" and if this information is to be associated with the node identity (i.e. FQDN or the IP address received from the DNS during the SGW selection) of the serving SGW.</li> </ul>	Indication	0
PGW's Overload Control Information	O	<p>During an overload condition, the PGW may include this IE on the S5/S8 or S2a/S2b interface, if the overload control feature is supported by the PGW and is activated for the PLMN to which the access network node, i.e. MME/S4-SGSN for 3GPP access based network, ePDG/TWAN for non-3GPP access based network, belongs (see clause 12.3.11).</p> <p>When present, the PGW shall provide</p> <ul style="list-style-type: none"> <li>- node level overload control, in one instance of this IE; and/or</li> <li>- APN level overload control, in one or more instances of this IE, up to maximum of 10, with the same type and instance value, each representing the overload information for a list of APN(s).</li> </ul> <p>See NOTE 1, NOTE 2.</p>	Overload Control Information	0
	CO	If the SGW receives this IE and if it supports the overload control feature, it shall forward it to the MME/S4-SGSN on the S11/S4 interface.		
SGW's Overload Control Information	O	<p>During an overload condition, the SGW may include this IE over the S11/S4 interface if the overload control feature is supported by the SGW and is activated in the network (see clause 12.3.11).</p> <p>When present, the SGW shall provide only one instance of this IE, representing its overload information.</p>	Overload Control Information	1
Private Extension	O	This IE may be sent on the S5/S8, S4/S11 and S2a/S2b interfaces.	Private Extension	VS
<p>NOTE 1: The receiver, supporting the APN level overload information for the maximum of 10 APNs, shall handle the APN level overload information for the first 10 APNs and ignore any more APN level overload information.</p> <p>NOTE 2: The APN level overload information, provided within and across different instances of the "PGW's Overload Control Information" IE(s) shall be limited to 10 different APNs.</p>				



**Table 7.2.14-2: Overload Control Information within Modify Bearer Failure Indication**

Information elements	P	Condition / Comment	IE Type	Ins.
Overload Control Sequence Number	M	See clause 12.3.5.1.2.1 for the description and use of this parameter.	Sequence Number	0
Overload Reduction Metric	M	See clause 12.3.5.1.2.3 for the description and use of this parameter.	Metric	0
Period of Validity	M	See clause 12.3.5.1.2.2 for the description and use of this parameter. This IE should be set to "0" if the "Overload Reduction Metric" is null. This IE shall be ignored by the receiver if the "Overload Reduction Metric" is null.	EPC Timer	0
List of Access Point Name (APN)	CO	The IE may (only) be present in the "PGW's Overload Control Information" IE. For indicating the APN level overload, the PGW shall include one or more instances of this IE, up to maximum of 10, with the same type and instance value, representing a list of APN(s) (sharing the same "Overload Reduction Metric"). See NOTE 1.	APN	0
NOTE 1: If more than 10 occurrences of APNs are received within one instance of the Overload Control Information IE, the receiver shall treat it as a protocol error and ignore the entire Overload Control Information IE instance.				

## 7.2.15 Update Bearer Request

The direction of this message shall be from PGW to SGW and/or from SGW to MME/S4-SGSN, and/or from PGW to TWAN/ePDG (see Table 6.1-1).

For GTP based S5/S8, the Update Bearer Request shall be sent by the PGW to the SGW and forwarded to the MME as part of the following procedures:

- PGW Initiated Bearer Modification with Bearer QoS Update
- HSS Initiated Subscribed QoS Modification
- PGW Initiated Bearer Modification without Bearer QoS Update
- UE Request Bearer Resource Modification procedure (see 3GPP TS 24.301 [23])
- UE requested bearer resource allocation procedure (see 3GPP TS 24.301 [23])
- P-CSCF restoration for 3GPP access (see 3GPP TS 23.380 [61])
- USS UAV Authorization/Authentication (UUAA) procedure during default PDN connection at Attach (see 3GPP TS 23.256 [90])
- USS initiated UAV Re-authorization procedure in EPS (see 3GPP TS 23.256 [90])

The message shall also be sent on the S5/S8 interface by the PGW to the SGW and on the S4 interface by the SGW to the SGSN as part of the following procedures:

- PGW Initiated EPS Bearer Modification
- Execution part of MS-Initiated EPS Bearer Modification
- SGSN-Initiated EPS Bearer Modification Procedure using S4
- P-CSCF restoration for 3GPP access (see 3GPP TS 23.380 [61])

The message shall also be sent on the S2a/S2b interface by the PGW to the TWAN/ePDG as part of the following procedures:

- PGW Initiated Bearer Modification
- HSS Initiated Subscribed QoS Modification
- P-CSCF restoration for WLAN access (see 3GPP TS 23.380 [61])

For PMIP based S5/S8, the Update Bearer Request shall be sent on the S11 interface by the SGW to the MME and on the S4 interface by the SGW to the SGSN.

The message shall also be sent on the S5/S8 or S2a/S2b interface by the PGW to the SGW or to the TWAN/ePDG and on the S11/S4 interface by the SGW to the MME/S4-SGSN as part of the Network-initiated IP flow mobility procedure or the UE-initiated IP flow mobility procedure, as specified by 3GPP TS 23.161 [71].

Table 7.2.15-1 specifies the presence requirements and the conditions of the IEs in the message.

**Table 7.2.15-1: Information Elements in an Update Bearer Request**

Information elements	P	Condition / Comment	IE Type	Ins.
Bearer Contexts	M	This IE shall contain contexts related to bearers that need QoS/TFT modification. Several IEs with this type and instance values shall be included as necessary to represent a list of Bearers. If there is no QoS/TFT modification, only one IE with this type and instance value shall be included.	Bearer Context	0
Procedure Transaction Id (PTI)	C	If the request corresponds to UE requested bearer resource modification procedure or the UE requested bearer resource allocation procedure for an E-UTRAN (see NOTE 1) or MS initiated EPS bearer modification procedure, this IE shall be included. PTI shall be the same as the one used in the corresponding Bearer Resource Command	PTI	0
Protocol Configuration Options (PCO)	C	The PGW shall include the Protocol Configuration Options (PCO) IE on the S5/S8 interface, if available and if ePCO is not supported by the UE or the network. The PCO IE shall carry a P-CSCF address list only when the UE is required to perform an IMS registration, e.g during the P-CSCF restoration procedure as defined in clause 5 of 3GPP TS 23.380 [61]. If SGW receives this IE, SGW shall forward it to SGSN/MME on the S4/S11 interface.	PCO	0
	CO	The PGW shall include the Protocol Configuration Options (PCO) IE on the S2a interface, including the list of available P-CSCF addresses, as part of the P-CSCF restoration extension procedure for the TWAN access, as specified in 3GPP TS 23.380 [61].		
Aggregate Maximum Bit Rate (APN-AMBR)	M	APN-AMBR	AMBR	0
Change Reporting Action	C	This IE shall be included on the S5/S8 and S4/S11 interfaces with the appropriate Action field. If the location Change Reporting mechanism is to be started or stopped for this subscriber in the SGSN/MME.	Change Reporting Action	0
CSG Information Reporting Action	CO	This IE shall be included on the S5/S8 and S4/S11 interfaces with the appropriate Action field if the CSG Info reporting mechanism is to be started or stopped for this subscriber in the SGSN/MME.	CSG Information Reporting Action	0
H(e)NB Information Reporting	CO	This IE shall be included on the S5/S8 and S4/S11 interfaces with the appropriate Action field if H(e)NB information reporting is to be started or stopped for the PDN connection in the SGSN/MME.	H(e)NB Information Reporting	0

Indication flags	CO	This IE shall be included if any one of the applicable flags is set to 1. Applicable flags are: <ul style="list-style-type: none"> <li>- Retrieve Location Indication: This flag shall be set to 1 on the S5/S8, S4/S11, S2a and S2b interfaces in the PGW Initiated Bearer Modification procedure if the location information is requested.</li> <li>- Associate OCI with PGW node's identity: The PGW shall set this flag to 1 on the S5/S8 interface or S2a/S2b interface if it has included the "PGW's Overload Control Information" and if this information is to be associated with the node identity (i.e. FQDN or the IP address received from the HSS or DNS during the PGW selection) of the serving PGW. The SGW shall set this flag on the S11/S4 interface if it supports the overload control feature and if the flag is set on the S5/S8 interface.</li> <li>- Associate OCI with SGW node's identity: The SGW shall set this flag to 1 on the S11/S4 interface if it has included the "SGW's Overload Control Information" and if this information is to be associated with the node identity (i.e. FQDN or the IP address received from the DNS during the SGW selection) of the serving SGW.</li> </ul>	Indication	0
PGW-FQ-CSID	C	This IE shall be included by PGW on the S5/S8 and S2a/S2b interfaces, and when received from S5/S8 be forwarded by SGW on S11 according to the requirements in 3GPP TS 23.007 [17].	FQ-CSID	0
SGW-FQ-CSID	C	This IE shall be included by SGW on S11 according to the requirements in 3GPP TS 23.007 [17].	FQ-CSID	1
Presence Reporting Area Action	CO	This IE shall be included on the S5/S8 and S11/S4 interfaces with the appropriate Action field if reporting changes of UE presence in Presence Routing Area(s) is to be started, stopped or modified for this subscriber in the MME/SGSN.  Several IEs with the same type and instance value may be included as necessary to represent a list of Presence Reporting Area Actions. One IE shall be included for each Presence Reporting Area to be started, stopped or modified.	Presence Reporting Area Action	0
PGW's node level Load Control Information	O	The PGW may include this IE on the S5/S8 or S2a/S2b interface, providing its node level load information, if the load control feature is supported by the PGW and is activated for the PLMN to which the access network node, i.e. MME/S4-SGSN for 3GPP access network, ePDG/TWAN for non-3GPP access network, belongs (see clause 12.2.6).	Load Control Information	0
	CO	If the SGW receives this IE and if it supports the load control feature, it shall forward it to the MME/S4-SGSN on the S11/S4 interface.		
PGW's APN level Load Control Information	O	The PGW may include this IE on the S5/S8 or S2a/S2b interface, providing APN level load information, if the APN level load control feature is supported by the PGW and is activated for the PLMN to which the access network node, i.e. MME/S4-SGSN for 3GPP access network, ePDG/TWAN for non-3GPP access based network, belongs (see clause 12.2.6).  When present, the PGW shall provide one or more instances of this IE, up to maximum of 10, with the same type and instance value, each representing the load information for a list of APN(s). See NOTE 2, NOTE 4.	Load Control Information	1

	CO	If the SGW receives this IE and if it supports APN level load control feature, it shall forward it to the MME/S4-SGSN on the S11/S4 interface.		
SGW's node level Load Control Information	O	The SGW may include this IE, over the S11/S4 interface if the load control feature is supported by the SGW and is activated in the network (see clause 12.2.6).  When present, the SGW shall provide only one instance of this IE, representing its node level load information.	Load Control Information	2
PGW's Overload Control Information	O	During an overload condition, the PGW may include this IE on the S5/S8 or S2a/S2b interface, if the overload control feature is supported by the PGW and is activated for the PLMN to which the access network node, i.e. MME/S4-SGSN for 3GPP access based network, ePDG/TWAN for non-3GPP access based network, belongs (see clause 12.3.11).  When present, the PGW shall provide <ul style="list-style-type: none"> <li>- node level overload control, in one instance of this IE; and/or</li> <li>- APN level overload control, in one or more instances of this IE, up to maximum of 10, with the same type and instance value, each representing the overload information for a list of APN(s).</li> </ul> See NOTE 3, NOTE 5.	Overload Control Information	0
	CO	If the SGW receives this IE and if it supports the overload control feature, it shall forward it to the MME/S4-SGSN on the S11/S4 interface.		
SGW's Overload Control Information	O	During an overload condition, the SGW may include this IE over the S11/S4 interface if the overload control feature is supported by the SGW and is activated in the network (see clause 12.3.11).  When present, the SGW shall provide only one instance of this IE, representing its overload information.	Overload Control Information	1
NBIFOM Container	CO	This IE shall be included on the S5/S8 or S2a/S2b interfaces if the PGW needs to send NBIFOM information as specified in 3GPP TS 23.161 [71]. The Container Type shall be set to 4.	F-Container	0
	CO	If the SGW receives a NBIFOM Container IE from the PGW, the SGW shall forward it to the MME/S4-SGSN on the S11/S4 interface.		
PGW Change Info	CO	This IE may be included on S5/S8/S2b if the PGW needs to change the PGW Change Info signaled earlier for the PDN connection. It shall be included by the PGW if the PGW S5/S8/S2b IP Address for the control plane for the PDN connection is required to be changed (see PGW triggered PDN connection restoration in clauses 31.4 and 31.4B of of 3GPP TS 23.007 [17]). The SGW shall transparently forward the IE over S11 interface.  Several IEs with the same IE type and Instance may be present to request the MME/ePDG to re-establish PDN connections associated with different either FQ-CSIDs, or Group Ids or PGW-C/SMF IP addresses to different PGW-C/SMFs.	PGW Change Info	0

Sender F-TEID for Control Plane	CO	<p>This IE may be included over S5/S8/S2b if the PGW Change Info is present, during a PGW triggered PDN connection restoration (see clauses 31.4 and 31.4B of 3GPP TS 23.007 [17]). When present, it shall contain the F-TEID including the TEID that the SGW or ePDG shall use when sending the Update Bearer Response message.</p> <p>This IE may be included over S11 if the PGW Change Info is present, during a Combined SGW-C/PGW-C/SMF triggered PDN connection restoration (see clause 31.4A of 3GPP TS 23.007 [17]). When present, it shall contain the F-TEID including the TEID that the MME shall use when sending the Update Bearer Response message.</p>	F-TEID	0
Private Extension	O	This IE may be sent on the S5/S8, S4/S11 and S2a/S2b interfaces.	Private Extension	VS
<p>NOTE 1: This message refers to the UE requested bearer resource allocation procedure and UE requested bearer resource modification procedures defined in 3GPP TS 24.301 [23], both are specified in 3GPP TS 23.401 [3] in the clause "UE requested bearer resource modification".</p> <p>NOTE 2: The receiver, not supporting the APN level load control feature, shall ignore all the occurrence(s) of this IE, i.e. "Load Control Information" IE with instance number "1". The receiver, supporting the APN level load control feature and supporting the APN level load information for the maximum of 10 APNs, shall handle the APN level load information for the first 10 APNs and ignore any more APN level load information.</p> <p>NOTE 3: The receiver, supporting the APN level overload information for the maximum of 10 APNs, shall handle the APN level overload information for the first 10 APNs and ignore any more APN level overload information.</p> <p>NOTE 4: The APN level load information, provided within and across different instances of the "PGW's APN level Load Control Information" IE(s) shall be limited to 10 different APNs.</p> <p>NOTE 5: The APN level overload information, provided within and across different instances of the "PGW's Overload Control Information" IE(s) shall be limited to 10 different APNs.</p>				

NOTE: In the case that the procedure was initiated by a UE Requested Bearer Resource Modification Procedure or UE Requested Bearer Resource Allocation Procedure for an E-UTRAN or MS initiated EPS bearer modification procedure, then there will be only one instance of the Bearer Contexts IE in the Update Bearer Request.

Table 7.2.15-2: Bearer Context within Update Bearer Request

Octet 1	Bearer Context IE Type = 93 (decimal)			
Octets 2 and 3	Length = n			
Octet 4	Spare and Instance fields			
Information elements	P	Condition / Comment	IE Type	Ins.
EPS Bearer ID	M		EBI	0
TFT	C	This IE shall be included on the S5/S8, S4/S11 and S2a/S2b interfaces if message relates to Bearer Modification and TFT change.	Bearer TFT	0
Bearer Level QoS	C	This IE shall be included on the S5/S8, S4/S11 and S2a/S2b interfaces if QoS modification is requested	Bearer QoS	0
Bearer Flags	O	Applicable flags: <ul style="list-style-type: none"> <li>- PPC (Prohibit Payload Compression): this flag may be set on the S5/S8 and S4 interfaces.</li> <li>- vSRVCC indicator: This IE may be included by the PGW on the S5/S8 interface according to 3GPP TS 23.216 [43]. When received from S5/S8, SGW shall forward on the S11 interface.</li> </ul>	Bearer Flags	0
Protocol Configuration Options (PCO)	CO	PGW shall include Protocol Configuration Options (PCO) IE on the S5/S8 interface, if available and if ePCO is not supported by the UE or the network. The PCO IE shall carry a P-CSCF address list only when the UE is required to perform an IMS registration, e.g during the P-CSCF restoration procedure as defined in clause 5.1 of 3GPP TS 23.380 [61]. This bearer level IE takes precedence over the PCO IE in the message body if they both exist. If the SGW receives this IE, the SGW shall forward it to the SGSN/MME on the S4/S11 interface.	PCO	0
	CO	The PGW shall include the Protocol Configuration Options (PCO) IE on the S2a interface, including the list of available P-CSCF addresses, as part of the P-CSCF restoration extension procedure for the TWAN access, as specified in 3GPP TS 23.380 [61]. This bearer level IE takes precedence over the PCO IE in the message body if they both exist.		
Additional Protocol Configuration Options (APCO)	CO	The PGW shall include the Additional Protocol Configuration Options (APCO) IE on the S2b interface, including the list of available P-CSCF addresses, as part of the P-CSCF restoration extension procedure for the untrusted WLAN access, as specified in 3GPP TS 23.380 [61].	Additional Protocol Configuration Options (APCO)	0
Extended Protocol Configuration Options (ePCO)	CO	The PGW shall include Extended Protocol Configuration Options (ePCO) IE on the S5/S8 interface, if available and if the UE and the network support ePCO. The ePCO IE shall carry a P-CSCF address list only when the UE is required to perform an IMS registration, e.g during the P-CSCF restoration procedure as defined in clause 5.1 of 3GPP TS 23.380 [61].  If the SGW receives this IE, the SGW shall forward it to the MME on the S11 interface.	ePCO	0
Maximum Packet Loss Rate	O	This IE may be included on the S5/S8 interfaces if the PGW needs to send Maximum Packet Loss Rate as specified in clause 5.4.2.1 of 3GPP TS 23.401 [3]. This IE is only applicable for QCI 1.	Maximum Packet Loss Rate	0
	CO	If the SGW receives this IE, it shall forward it to the MME on the S11 interface		

**Table 7.2.15-3: Load Control Information within Update Bearer Request**

Octet 1	Load Control Information IE Type = 181 (decimal)			
Octets 2 and 3	Length = n			
Octet 4	Spare and Instance fields			
Information elements	P	Condition / Comment	IE Type	Ins.
Load Control Sequence Number	M	See clause 12.2.5.1.2.1 for the description and use of this parameter.	Sequence Number	0
Load Metric	M	See clauses 12.2.5.1.2.2 and 12.2.5.1.2.3 for the description and use of this parameter.	Metric	0
List of APN and Relative Capacity	CO	The IE shall (only) be present in the "PGW's APN level Load Control Information" IE. For indicating the APN level load, the PGW shall include one or more instances of this IE, up to maximum of 10, with the same type and instance value, representing a list of APN(s) & its respective "Relative Capacity" (sharing the same "Load Metric"). See clause 12.2.5.1.2.3 for the description and use of this parameter. See NOTE 1.	APN and Relative Capacity	0
NOTE 1: If more than 10 occurrences of "APN and Relative Capacity" IE are received within one instance of the Load Control Information IE, the receiver shall treat it as a protocol error and ignore the entire Load Control Information IE instance.				

**Table 7.2.15-4: Overload Control Information within Update Bearer Request**

Octet 1	Overload Control Information IE Type = 180 (decimal)			
Octets 2 and 3	Length = n			
Octet 4	Spare and Instance fields			
Information elements	P	Condition / Comment	IE Type	Ins.
Overload Control Sequence Number	M	See clause 12.3.5.1.2.1 for the description and use of this parameter.	Sequence Number	0
Overload Reduction Metric	M	See clauses 12.3.5.1.2.3 and 12.3.5.1.2.4 for the description and use of this parameter.	Metric	0
Period of Validity	M	See clause 12.3.5.1.2.2 for the description and use of this parameter. This IE should be set to "0" if the "Overload Reduction Metric" is null. This IE shall be ignored by the receiver if the "Overload Reduction Metric" is null.	EPC Timer	0
List of Access Point Name (APN)	CO	The IE may (only) be present in the "PGW's Overload Control Information" IE. For indicating the APN level overload, the PGW shall include one or more instances of this IE, up to maximum of 10, with the same type and instance value, representing a list of APN(s) (sharing the same "Overload Reduction Metric" and "Period of Validity"). See NOTE 1.	APN	0
NOTE 1: If more than 10 occurrences of APNs are received within one instance of the Overload Control Information IE, the receiver shall treat it as a protocol error and ignore the entire Overload Control Information IE instance.				

**Table 7.2.15-5: PGW Change Info within Update Bearer Request**



Octet 1	PGW Change Info IE Type = 214 (decimal)			
Octets 2 and 3	Length = n			
Octet 4	Spare and Instance fields			
Information elements	P	Condition / Comment	IE Type	Ins.
PGW Set FQDN	O	This IE may be included by a PGW if the PGW Set FQDN is changed.	PGW FQDN	0
Alternative PGW-C/SMF IP Address	O	This IE may be included by a PGW if the list of alternative PGW-C/SMF IP addresses is changed  Several IEs with the same type and instance value may be included to represent a list of Alternative PGW-C/SMF IP Addresses.	IP Address	0
Alternative PGW-C/SMF FQDN	O	This IE may be included by a PGW if the list of alternative PGW-C/SMF FQDNs is changed.  Several IEs with the same type and instance value may be included to represent a list of Alternative PGW-C/SMF FQDNs.	PGW FQDN	1
New PGW-C/SMF IP Address	C	This IE shall be included by a PGW if the PGW S5/S8/S2b IP Address for the control plane for the PDN connection is required to be changed (see PGW triggered PDN connection restoration in clauses 31.4 and 31.4B and 31.6.3 of 3GPP TS 23.007 [17]).	IP Address	1
New SGW-C IP Address	O	This IE may be included by a combined SGW/PGW to contain the SGW-C S11 IP address (pertaining to the combined SGW/PGW sending the PGW Change Info IE). The MME should use this information when deciding to which SGW-C S11 IP address should the Create Session Request message be sent, during a combined SGW-C/PGW-C/SMF triggered restoration procedure as specified in clauses 31.4a and 31.6.3A of 3GPP TS 23.007 [17].	IP Address	3
PGW-C/SMF FQ-CSID	C	This IE shall be included if the New PGW-C/SMF IP Address IE is present and if the PGW-C/SMF requests the MME/ePDG to re-establish all the PDN connections associated with a PGW-C/SMF FQ-CSID towards the PGW-C indicated in New PGW-C/SMF IP Address IE.  When present, it shall contain the PGW-C/SMF FQ-CSID for which the PDN connections are requested to be re-established.  Several IEs with the same IE type may be present to represent several FQ-CSIDsof PDN connections that need to be moved to the New PGW-C/SMF IP Address.  See also clause 31.6 of 3GPP TS 23.007 [17].	FQ-CSID	0
Group Id	C	This IE shall be included if the New PGW-C/SMF IP Address IE is present and if the PGW-C/SMF requests the MME/ePDG to re-establish all the PDN connections associated with a Group Id towards the PGW-C indicated in New PGW-C/SMF IP Address IE.  When present, it shall contain the Group Id for which the PDN connections are requested to be re-established.  Several IEs with the same IE type may be present to represent several Group Ids of PDN connections that need to be moved to the New PGW-C/SMF IP Address.  See also clause 31.6 of 3GPP TS 23.007 [17].	Group Id	0

PGW Control Plane IP Address	C	This IE shall be included if the New PGW-C/SMF IP Address IE is present and if the PGW-C/SMF requests the MME/ePDG to re-establish all the PDN connections of which PGW S5/S8/ S2a/S2b F-TEID contains the PGW Control Plane IP Address towards the PGW-C indicated in New PGW-C/SMF IP Address IE.  Several IEs with the same IE type may be present to represent several PGW-C/SMF IP addresses of PDN connections that need to be moved to the New PGW-C/SMF IP Address. See also clause 31.6 of 3GPP TS 23.007 [17].	IP Address	2
New Group Id	O	The IE may be present if the PGW-C/SMF wants to allocate a new Group Id for the PDN connection. When present, this IE shall identify the new Group Id to which the PDN connection pertains, and the MME/ePDG shall replace any earlier Group ID received for the PDN connection with the new Group ID. If absent, the Group ID associated earlier to the PDN connection, if any, shall remain unchanged.  See also clause 31.6 of 3GPP TS 23.007 [17].	Group Id	1

## 7.2.16 Update Bearer Response

An Update Bearer Response shall be sent from a MME/SGSN to a SGW and forwarded to the PGW, and from TWAN/ePDG to the PGW as a response to an Update Bearer Request message.

Table 7.2.16-1 specifies the presence requirements and the conditions of the IEs in the message.

Cause IE indicates if an EPS bearer has been modified in the MME/SGSN/TWAN/ePDG or not. The EPS Bearer has not been modified in the MME/SGSN/TWAN/ePDG if the Cause IE value differs from "Request accepted" or "Request accepted partially". Possible Cause values are specified in Table 8.4-1. Message specific cause values are:

- "Request accepted".
- "Request accepted partially"
- "Context not found"
- "Semantic error in the TFT operation".
- "Syntactic error in the TFT operation".
- "Semantic errors in packet filter(s)".
- "Syntactic errors in packet filter(s)".
- "Denied in RAT".
- "UE refuses".
- "Unable to page UE".
- "UE not responding".
- "Unable to page UE due to Suspension".
- "Temporarily rejected due to handover/TAU/RAU procedure in progress".
- "MME/SGSN refuses due to VPLMN Policy".
- "UE is temporarily not reachable due to power saving"

Table 7.2.16-1: Information Elements in an Update Bearer Response

Information elements	P	Condition / Comment	IE Type	Ins.
Cause	M		Cause	0
Bearer Contexts	M	This IE shall contain all the bearer contexts included in the corresponding Update Bearer Request. Several IEs with this type and instance values shall be included as necessary to represent a list of Bearers.	Bearer Context	0
Protocol Configuration Options (PCO)	CO	An MME/SGSN shall include the PCO IE if such information was received from the UE. If the SGW receives this IE, the SGW shall forward it to PGW on the S5/S8 interface.	PCO	0
Recovery	C	This IE shall be included on the S5/S8, S4/S11 and S2a/S2b interfaces if contacting the peer for the first time	Recovery	0
MME-FQ-CSID	C	This IE shall be included by MME on S11 and shall be forwarded by SGW on S5/S8 according to the requirements in 3GPP TS 23.007 [17].	FQ-CSID	0
SGW-FQ-CSID	C	This IE shall be included by SGW on S5/S8 according to the requirements in 3GPP TS 23.007 [17].	FQ-CSID	1
ePDG-FQ-CSID	C	This IE shall be included by the ePDG on the S2b interface according to the requirements in 3GPP TS 23.007 [17].	FQ-CSID	2
TWAN-FQ-CSID	C	This IE shall be included by the TWAN on the S2a interface according to the requirements in 3GPP TS 23.007 [17].	FQ-CSID	3
Indication Flags	CO	This IE shall be included if any one of the applicable flags is set to 1. Applicable flags: - Direct Tunnel Flag: This flag shall be set to 1 on the S4 interface, if Direct Tunnel is used.	Indication	0
UE Time Zone	O	This IE is optionally included by the MME on the S11 interface or by the SGSN on the S4 interface.	UE Time Zone	0
	CO	The SGW shall forward this IE on the S5/S8 interface if the SGW receives it from the MME/SGSN.		
	CO	This IE shall be included by the TWAN on the S2a interface.		
User Location Information (ULI)	CO	This IE shall be included by the MME on the S11 interface or by the SGSN on the S4 interface. The CGI/SAI shall be included by SGSN and the ECGI shall be included by MME. See NOTE 1.	ULI	0
	CO	The SGW shall forward this IE on the S5/S8 interface if it receives it from the MME/SGSN.		
TWAN Identifier	CO	This IE shall be included by the TWAN on the S2a interface as specified in 3GPP TS 23.402 [45].	TWAN Identifier	0
MME/S4-SGSN's Overload Control Information	O	During an overload condition, the MME/S4-SGSN may include this IE on the S11/S4 interface if the overload control feature is supported by the MME/S4-SGSN and is activated for the PLMN to which the PGW belongs (see clause 12.3.11).  When present, the MME/S4-SGSN shall provide only one instance of this IE, representing its overload information.	Overload Control Information	0
	CO	If the SGW receives this IE and if it supports the overload control feature, it shall forward it to the PGW on the S5/S8 interface.		
SGW's Overload Control Information	O	During an overload condition, the SGW may include this IE over the S5/S8 interface if the overload control feature is supported by the SGW and is activated for the PLMN to which the PGW belongs (see clause 12.3.11).  When present, the SGW shall provide only one instance of this IE, representing its overload information.	Overload Control Information	1

Presence Reporting Area Information	CO	<p>The MME/SGSN shall include this IE on S11/S4 if the PGW/PCRF/OCS has requested to start or modify reporting changes of UE presence in a Presence Reporting Area in the corresponding Update Bearer Request message and the MME/SGSN supports such reporting. The MME/SGSN shall then indicate whether the UE is inside or outside the newly started or modified Presence Reporting Area(s), or indicate that the Presence Reporting Area(s) is inactive.</p> <p>The SGW shall include this IE on S5/S8 if it receives the Presence Reporting Area Information from the MME/SGSN.</p> <p>Several IEs with the same type and instance value may be included as necessary to represent a list of Presence Reporting Area Information. One IE shall be included for each Presence Reporting Area newly started or modified.</p>	Presence Reporting Area Information	0
MME/S4-SGSN Identifier	CO	<p>If the overload control feature is supported by the MME/S4-SGSN and is activated for the PLMN to which the PGW belongs (see clause 12.3.11), the MME/S4-SGSN shall include this IE on the S11/S4 interface if the PGW has not been updated with the identity of the currently serving MME/S4-SGSN, i.e. if no other message carrying MME/S4-SGSN identity has been sent to the PGW during/after an inter-MME/S4-SGSN intra-SGW mobility procedure.</p>	IP Address	0
	CO	<p>If the overload control feature is supported by the SGW, the SGW shall forward this IE on the S5/S8 interface.</p>		
TWAN/ePDG's Overload Control Information	O	<p>During an overload condition, the TWAN/ePDG may include this IE over the S2a/S2b interface if the overload control feature is supported by the TWAN/ePDG and is activated for the PLMN to which the PGW belongs (see clause 12.3.11).</p> <p>When present, the TWAN/ePDG shall provide only one instance of this IE, representing its overload information.</p>	Overload Control Information	2

WLAN Location Information	CO	The ePDG shall include this IE on the S2b interface if the WLAN Location Information is available.	TWAN Identifier	1
WLAN Location Timestamp	CO	The ePDG shall include this IE on the S2b interface, if the WLAN Location Timestamp is available.	TWAN Identifier Timestamp	1
UE Local IP Address	CO	The ePDG shall include this IE on the S2b interface.	IP Address	0
UE UDP Port	CO	The ePDG shall include this IE on the S2b interface if NAT is detected and UDP encapsulation is used.	Port Number	0
NBIFOM Container	CO	This IE shall be included on the S11/S4 or S2a/S2b interfaces if the MME/S4-SGSN or the TWAN/ePDG receives a NBIFOM Container from the UE as specified in 3GPP TS 24.161 73]. The Container Type shall be set to 4.	F-Container	0
	CO	If the SGW receives a NBIFOM Container IE from the MME/S4-SGSN, the SGW shall forward it to the PGW on the S5/S8 interface.		
UE TCP Port	CO	The ePDG shall include this IE on the S2b interface if NAT is detected and TCP encapsulation is used.	Port Number	1
PSCell ID	CO	The MME shall include this IE on the S11 interface, if it has received this information from the eNodeB.	PSCell ID	0
Private Extension	O	This IE may be sent on the S5/S8, S4/S11 and S2a/S2b interfaces.	Private Extension	VS
<p>NOTE 1: In shared networks, when the message is sent from the VPLMN to the HPLMN, the PLMN ID that is communicated in this IE shall be that of the selected Core Network Operator for supporting UEs, or that of the allocated Core Network Operator for non-supporting UEs. As an exception, based on inter-operator roaming/sharing agreement, if the information on whether the UE is a supporting or non-supporting UE is available, the PLMN ID that is communicated to the HPLMN for non-supporting UEs shall be the Common PLMN ID.</p> <p>In shared networks, when the MME/S4-SGSN and PGW pertain to the same PLMN, the Primary PLMN ID shall be communicated in the ECGI to the PGW, and the Common PLMN ID shall be communicated in SAI/CGI to the PGW, for both supporting and non-supporting UEs. The Core Network Operator PLMN ID (selected by the UE for supporting UEs or allocated by the network for non-supporting UEs) shall be communicated in the TAI, RAI, UCI and the Serving Network. See clause 4.4 of 3GPP TS 23.251 [55].</p>				

Table 7.2.16-2: Bearer Context within Update Bearer Response

Octet 1	Bearer Context IE Type = 93 (decimal)			
Octets 2 and 3	Length = n			
Octet 4	Spare and Instance fields			
Information elements	P	Condition / Comment	IE Type	Ins.
EPS Bearer ID	M		EBI	0
Cause	M	This IE Indicates if the bearer handling was successful, and if not, gives information on the reason.	Cause	0
S4-U SGSN F-TEID	C	This IE shall be included on the S4 interface when direct tunnel is not established. See NOTE 1.	F-TEID	0
S12 RNC F-TEID	C	This IE shall be included on the S4 interface when direct tunnel flag is set to 1. See NOTE 1.	F-TEID	1
Protocol Configuration Options (PCO)	CO	An MME/SGSN shall include the PCO IE if such information was received from the UE. If the SGW receives this IE, the SGW shall forward it to PGW on the S5/S8 interface. This bearer level IE takes precedence over the PCO IE in the message body if they both exist.	PCO	0
RAN/NAS Cause	CO	If the bearer modification failed, the MME shall include this IE on the S11 interface to indicate the RAN cause and/or the NAS cause of the bearer modification failure, if available and if this information is permitted to be sent to the PGW operator according to MME operator's policy. If both a RAN cause and a NAS cause are generated, then several IEs with the same type and instance value shall be included to represent a list of causes. The SGW shall include this IE on the S5/S8 interface if it receives it from the MME.	RAN/NAS Cause	0
	CO	If the bearer modification failed, the TWAN shall include this IE on the S2a interface to indicate the cause of the bearer modification failure, if available and if this information is permitted to be sent to the PGW operator according to the TWAN operator's policy. When present, the IE shall be encoded as a Diameter or an ESM cause. See NOTE 2.		
	CO	If the bearer modification failed, the ePDG shall include this IE on the S2b interface to indicate the cause of the bearer modification failure, if available and if this information is permitted to be sent to the PGW operator according to the ePDG operator's policy. When present, the IE shall be encoded as a Diameter or an IKEv2 cause. See NOTE 3.		
Extended Protocol Configuration Options (ePCO)	CO	The MME shall include the ePCO IE if such information is received from the UE.  If the SGW receives this IE, the SGW shall forward it to PGW on the S5/S8 interface.	ePCO	0
<p>NOTE 1: In some scenarios, the SGSN is unable to provide neither the S12 RNC F-TEID nor the S4-U SGSN F-TEID in the Update Bearer Response message, e.g. when Direct Tunnel is used in 3G and the UE is in IDLE mode, for a network requested user location retrieval procedure, the SGSN is unable to provide S12 RNC F-TEID. In those scenarios, the SGSN shall provide EBI(s) without S12 RNC F-TEID(s) and S4-U SGSN F-TEID. The SGW shall be able to handle these bearer context(s). However, in earlier releases this behaviour may not be supported by the SGW and hence for such an SGW, in order to be backward compatible, the SGSN shall provide EBI(s) together with either the S4-U SGSN F-TEID or the S12 RNC F-TEID.</p> <p>NOTE 2: The TWAN does not exchange signalling with the 3GPP AAA Server nor with the UE in this procedure. The TWAN may include an internal failure cause for the bearer modification failure. The protocol type used to encode the internal failure cause is implementation specific.</p> <p>NOTE 3: The ePDG does not exchange signalling with the 3GPP AAA Server in this procedure. The ePDG may include an internal failure cause for the bearer modification failure. The protocol type used to encode the internal failure cause is implementation specific.</p>				

**Table 7.2.16-3: Overload Control Information within Update Bearer Response**

Information elements	P	Condition / Comment	IE Type	Ins.
Overload Control Sequence Number	M	See clause 12.3.5.1.2.1 for the description and use of this parameter.	Sequence Number	0
Overload Reduction Metric	M	See clause 12.3.5.1.2.3 for the description and use of this parameter.	Metric	0
Period of Validity	M	See clause 12.3.5.1.2.2 for the description and use of this parameter. This IE should be set to "0" if the "Overload Reduction Metric" is null. This IE shall be ignored by the receiver if the "Overload Reduction Metric" is null.	EPC Timer	0

## 7.2.17 Delete Bearer Command and Failure Indication

### 7.2.17.1 Delete Bearer Command

A Delete Bearer Command message shall be sent on the S11 interface by the MME to the SGW and on the S5/S8 interface by the SGW to the PGW as a part of the eNodeB requested bearer release or MME-Initiated Dedicated Bearer Deactivation procedure.

The message shall also be sent on the S4 interface by the SGSN to the SGW and on the S5/S8 interface by the SGW to the PGW as part of the MS and SGSN Initiated Bearer Deactivation procedure using S4.

**Table 7.2.17.1-1: Information Elements in Delete Bearer Command**

Information elements	P	Condition / Comment	IE Type	Ins.
Bearer Contexts	M	This IE shall be used to indicate dedicated bearers. When used, at least one dedicated bearer shall be present. Several IEs with this type and instance values shall be included as necessary to represent a list of Bearers	Bearer Context	0
User Location Information (ULI)	CO	This IE shall be included by the MME on the S11 interface or by the SGSN on the S4 interface. The CGI/SAI shall be included by SGSN and the ECGI shall be included by MME. The SGW shall forward this IE on the S5/S8 interface if it receives it from the MME/SGSN. See NOTE 1.	ULI	0
ULI Timestamp	CO	This IE shall be included on the S4/S11 interface if the ULI IE is present. It indicates the time when the User Location Information was acquired. The SGW shall include this IE on S5/S8 if the SGW receives it from the MME/SGSN.	ULI Timestamp	0
UE Time Zone	CO	This IE shall be included, if available, by the MME on the S11 interface or by the SGSN on the S4 interface.	UE Time Zone	0
	CO	The SGW shall forward this IE on the S5/S8 interface if the SGW receives it from the MME/SGSN.		
MME/S4-SGSN's Overload Control Information	O	During an overload condition, the MME/S4-SGSN may include this IE on the S11/S4 interface if the overload control feature is supported by the MME/S4-SGSN and is activated for the PLMN to which the PGW belongs (see clause 12.3.11).  When present, the MME/S4-SGSN shall provide only one instance of this IE, representing its overload information.	Overload Control Information	0

	CO	If the SGW receives this IE and if it supports the overload control feature, it shall forward it to the PGW on the S5/S8 interface.		
SGW's Overload Control Information	O	During an overload condition, the SGW may include this IE over the S5/S8 interface if the overload control feature is supported by the SGW and is activated for the PLMN to which the PGW belongs (see clause 12.3.11).  When present, the SGW shall provide only one instance of this IE, representing its overload information.	Overload Control Information	1
Sender F-TEID for Control Plane	CO	The SGW shall include this IE on the S5/S8 interfaces and set it to the last value sent to the PGW.  If the Sender F-TEID for Control Plane is received, the PGW shall only handle the Delete Bearer Command message if the Sender F-TEID for Control Plane in this message is the same as the last Sender F-TEID for Control Plane received on the given interface.	F-TEID	0
Secondary RAT Usage Data Report	CO	If the PLMN has configured secondary RAT usage reporting, the MME shall include this IE on the S11 interface if it has received Secondary RAT usage data in an MME Initiated Dedicated Bearer Deactivation procedure. Several IEs with the same type and instance value may be included, to represent multiple usage data reports.	Secondary RAT Usage Data Report	0
	O	The SGW shall forward this IE on the S5/S8 interface if it receives the Secondary RAT Usage Data Report with the IRPGW flag set to "1" from MME. Several IEs with the same type and instance value may be included, to represent multiple usage data reports.		
PSCell ID	CO	The MME shall include this IE on the S11 interface, if it has received this information from the eNodeB.	PSCell ID	0
Private Extension	O		Private Extension	VS
<p>NOTE 1: In shared networks, when the message is sent from the VPLMN to the HPLMN, the PLMN ID that is communicated in this IE shall be that of the selected Core Network Operator for supporting UEs, or that of the allocated Core Network Operator for non-supporting UEs. As an exception, based on inter-operator roaming/sharing agreement, if the information on whether the UE is a supporting or non-supporting UE is available, the PLMN ID that is communicated to the HPLMN for non-supporting UEs shall be the Common PLMN ID.</p> <p>In shared networks, when the MME/S4-SGSN and PGW pertain to the same PLMN, the Primary PLMN ID shall be communicated in the ECGI to the PGW, and the Common PLMN ID shall be communicated in SAI/CGI to the PGW, for both supporting and non-supporting UEs. The Core Network Operator PLMN ID (selected by the UE for supporting UEs or allocated by the network for non-supporting UEs) shall be communicated in the TAI, RAI, UCI and the Serving Network. See clause 4.4 of 3GPP TS 23.251 [55].</p>				



Table 7.2.17.1-2: Bearer Context within Delete Bearer Command

Octet 1	Bearer Context IE Type = 93 (decimal)			
Octets 2 and 3	Length = n			
Octet 4	Spare and Instance fields			
Information elements	P	Condition / Comment	IE Type	Ins.
EPS Bearer ID	M		EBI	0
Bearer Flags	CO	Applicable flags are: <ul style="list-style-type: none"> <li>- VB (Voice Bearer) indicator shall be set to indicate a voice bearer for PS-to-CS (v)SRVCC handover.</li> <li>- Vind (vSRVCC indicator) indicator shall be set to indicate a video bearer for PS-to-CS vSRVCC handover.</li> </ul>	Bearer Flags	0
RAN/NAS Release Cause	CO	The MME shall include this IE on the S11 interface to indicate the RAN release cause and/or NAS release cause to release the bearer, if available and this information is permitted to be sent to the PGW operator according to MME operator's policy. If both a RAN release cause and a NAS release cause are generated, then several IEs with the same type and instance value shall be included to represent a list of causes. The SGW shall include this IE on the S5/S8 interface if it receives it from the MME.	RAN/NAS Cause	0

Table 7.2.17.1-3: Overload Control Information within Delete Bearer Command

Octet 1	Overload Control Information IE Type = 180 (decimal)			
Octets 2 and 3	Length = n			
Octet 4	Spare and Instance fields			
Information elements	P	Condition / Comment	IE Type	Ins.
Overload Control Sequence Number	M	See clause 12.3.5.1.2.1 for the description and use of this parameter.	Sequence Number	0
Overload Reduction Metric	M	See clause 12.3.5.1.2.3 for the description and use of this parameter.	Metric	0
Period of Validity	M	See clause 12.3.5.1.2.2 for the description and use of this parameter. This IE should be set to "0" if the "Overload Reduction Metric" is null. This IE shall be ignored by the receiver if the "Overload Reduction Metric" is null.	EPC Timer	0

### 7.2.17.2 Delete Bearer Failure Indication

A Delete Bearer Failure Indication shall be sent on the S5/S8 interface by the PGW to the SGW and on the S11 interface by the SGW to the MME as part of failure of eNodeB requested bearer release or MME Initiated Dedicated Bearer Deactivation procedure.

The message shall also be sent on the S5/S8 interface by the PGW to the SGW and on the S4 interface by the SGW to the SGSN as part of failure of MS and SGSN Initiated Bearer Deactivation procedure using S4.

This message shall be sent back if none of the bearers (not even a single one) included in the Delete Bearer Command message could be deleted.

The Cause IE indicates that the EPS bearer has not been deleted in the PGW.

When the SGW receives a Delete Bearer Failure Indication message from the PGW with the TEID set to zero in the GTPv2 header and the Cause IE is set to "Context Not Found", which implies that the PDN connection does not exist in the PGW, the SGW may send a Delete Bearer Request message to delete the PDN connection towards the MME/SGSN after sending the Delete Bearer Failure Indication message.

Possible Cause values are specified in Table 8.4-1. Message specific cause values are:

- "Context not found"

Table 7.2.17.2-1: Information Elements in a Delete Bearer Failure Indication

Information elements	P	Condition / Comment	IE Type	Ins.
Cause	M		Cause	0
Bearer Context	M	This IE shall contain the list of failed bearers. See clause 6.1.1 "Presence requirements of Information Elements". Several IEs with the same type and instance value may be included as necessary to represent a list of failed bearers.	Bearer Context	0
Recovery	C	This IE shall be included If contacting the peer for the first time.	Recovery	0
Indication Flags	CO	This IE shall be included if any one of the applicable flags is set to 1. Applicable flags are: <ul style="list-style-type: none"> <li>- Associate OCI with PGW node's identity: The PGW shall set this flag to 1 on the S5/S8 interface or S2a/S2b interface if it has included the "PGW's Overload Control Information" and if this information is to be associated with the node identity (i.e. FQDN or the IP address received from the HSS or DNS during the PGW selection) of the serving PGW. The SGW shall set this flag on the S11/S4 interface if it supports the overload control feature and if the flag is set on the S5/S8 interface.</li> <li>- Associate OCI with SGW node's identity: The SGW shall set this flag to 1 on the S11/S4 interface if it has included the "SGW's Overload Control Information" and if this information is to be associated with the node identity (i.e. FQDN or the IP address received from the DNS during the SGW selection) of the serving SGW.</li> </ul>	Indication	0
PGW's Overload Control Information	O	During an overload condition, the PGW may include this IE on the S5/S8, if the overload control feature is supported by the PGW and is activated for the PLMN to which the access network node, i.e. MME/S4-SGSN for 3GPP access based network belongs (see clause 12.3.11).  When present, the PGW shall provide <ul style="list-style-type: none"> <li>- node level overload control, in one instance of this IE; and/or</li> <li>- APN level overload control, in one or more instances of this IE, up to maximum of 10, with the same type and instance value, each representing the overload information for a list of APN(s).</li> </ul> See NOTE 1, NOTE 2.	Overload Control Information	0
	CO	If the SGW receives this IE and if it supports the overload control feature, it shall forward it to the MME/S4-SGSN on the S11/S4 interface.		
SGW's Overload Control Information	O	During an overload condition, the SGW may include this IE over the S11/S4 interface if the overload control feature is supported by the SGW and is activated in the network (see clause 12.3.11).  When present, the SGW shall provide only one instance of this IE, representing its overload information.	Overload Control Information	1
Private Extension	O		Private Extension	VS
NOTE 1: The receiver, supporting the APN level overload information for the maximum of 10 APNs, shall handle the APN level overload information for the first 10 APNs and ignore any more APN level overload information.				
NOTE 2: The APN level overload information, provided within and across different instances of the "PGW's Overload Control Information" IE(s) shall be limited to 10 different APNs.				

**Table 7.2.17.2-2: Bearer Context within Delete Bearer Failure Indication**

Octet 1	Bearer Context IE Type = 93 (decimal)			
Octets 2 and 3	Length = n			
Octet 4	Spare and Instance fields			
Information elements	P	Condition / Comment	IE Type	Ins.
EPS Bearer ID	M	See clause 6.1.1 "Presence requirements of Information Elements".	EBI	0
Cause	M	This IE shall indicate the reason of the unsuccessful handling of the bearer.	Cause	0

**Table 7.2.17-3: Overload Control Information within Delete Bearer Failure Indication**

Octet 1	Overload Control Information IE Type = 180 (decimal)			
Octets 2 and 3	Length = n			
Octet 4	Spare and Instance fields			
Information elements	P	Condition / Comment	IE Type	Ins.
Overload Control Sequence Number	M	See clause 12.3.5.1.2.1 for the description and use of this parameter.	Sequence Number	0
Overload Reduction Metric	M	See clauses 12.3.5.1.2.3 and 12.3.5.1.2.4 for the description and use of this parameter.	Metric	0
Period of Validity	M	See clause 12.3.5.1.2.2 for the description and use of this parameter. This IE should be set to "0" if the "Overload Reduction Metric" is null. This IE shall be ignored by the receiver if the "Overload Reduction Metric" is null.	EPC Timer	0
List of Access Point Name (APN)	CO	The IE may (only) be present in the "PGW's Overload Control Information" IE. For indicating the APN level overload, the PGW shall include one or more instances of this IE, up to maximum of 10, with the same type and instance value, representing a list of APN(s) (sharing the same "Overload Reduction Metric" and "Period of Validity"). See NOTE 1.	APN	0
NOTE 1: If more than 10 occurrences of APNs are received within one instance of the Overload Control Information IE, the receiver shall treat it as a protocol error and ignore the entire Overload Control Information IE instance.				

## 7.2.18 Create Indirect Data Forwarding Tunnel Request

The Create Indirect Data Forwarding Tunnel Request message shall be sent on the S11/S4 interface by the MME/SGSN to the SGW as part of the Handover procedures or TAU/RAU procedure with Serving GW change and data forwarding as specified in clause 5.3.3.1A of 3GPP TS 23.401 [3].

Table 7.2.18-1 specifies the presence requirements and the conditions of the IEs in the message.

**Table 7.2.18-1: Information Elements in a Create Indirect Data Forwarding Tunnel Request**

Information elements	P	Condition / Comment	IE Type	Ins.
IMSI	C	This IE shall be included by the MME/SGSN if the SGW that the MME/SGSN selects for indirect data forwarding is different from the SGW already in use for the UE as the anchor point except for the case: <ul style="list-style-type: none"> <li>- If the UE is emergency or RLOS attached and the UE is UICCless</li> </ul> When the IMSI is included in the message, it is not used as an identifier <ul style="list-style-type: none"> <li>- if UE is emergency or RLOS attached but IMSI is not authenticated.</li> </ul> See NOTE1.	IMSI	0
ME Identity (MEI)	C	This IE shall be included by the MME/SGSN if the SGW that the MME/SGSN selects for indirect data forwarding is different from the SGW already in use for the UE as the anchor point and if one of the following condition is satisfied: <ul style="list-style-type: none"> <li>- If the UE is emergency or RLOS attached and the UE is UICCless; or</li> <li>- If the UE is emergency or RLOS attached and the IMSI is not authenticated</li> </ul>	MEI	0
Indication Flags	CO	This IE shall be included if any one of the applicable flags is set to 1. Applicable flags are: <ul style="list-style-type: none"> <li>- Unauthenticated IMSI: This flag shall be set to 1 if the IMSI present in the message is not authenticated and is for an emergency or RLOS attached UE.</li> <li>- Indirect Data Forwarding with UPF Indication: This flag shall be set to 1 if indirect data forwarding is required for user plane routes from UPF in the 5GS to EPS handover procedure or to UPF in the EPS to 5GS handover procedure. This flag shall not be set to 1 if indirect data forwarding is used for other mobility procedures. See NOTE 2.</li> </ul>	Indication	0
Sender F-TEID for Control Plane	C	This IE shall be included by the MME/SGSN if the SGW that the MME/SGSN selects for indirect data forwarding is different from the SGW already in use for the UE as the anchor point. See NOTE1.	F-TEID	0
Bearer Contexts	M	Several IEs with this type and instance value may be included as necessary to represent a list of Bearers	Bearer Context	0
Recovery	CO	This IE shall be included if contacting the peer for the first time.	Recovery	0
Private Extension	O		Private Extension	VS
NOTE 1: The SGW which is hosting the UE's bearer(s) is considered as the (local) anchor point. Unlike the PGW, the SGW may change due to mobility between eNodeBs, or E-UTRAN and GERAN/UTRAN supported with S4 based architecture. In these cases the new SGW where the UE's bearer(s) are moved, becomes the new local anchor point. A source MME/SGSN may select an SGW for indirect data forwarding which is different than the source (anchor) SGW. Similarly, a target MME/SGSN may select an SGW for indirect data forwarding which is different than the target (anchor) SGW. NOTE 2: When indirect data forwarding for user plane routes from/to UPF is indicated, the SGW may select subnet(s) other than S1-u to create indirect data forwarding tunnel, e.g. based on local configuration.				

**Table 7.2.18-2: Bearer Context within Create Indirect Data Forwarding Tunnel Request**

Octet 1	Bearer Context IE Type = 93 (decimal)
Octets 2 and 3	Length = n

Octet 4		Spare and Instance fields		
Information elements	P	Condition / Comment	IE Type	Ins.
EPS Bearer ID	M		EBI	0
eNodeB F-TEID for DL data forwarding	C	Target eNodeB F-TEID. This IE shall be present in the message sent from the target MME to the SGW selected by the target MME for indirect data forwarding, or shall be included in the message sent from the source SGSN/MME to the SGW selected by the source MME for indirect data forwarding if the eNodeB F-TEID for DL data forwarding is included in the Forward Relocation Response message.	F-TEID	0
	CO	Target eNodeB F-TEID. This IE shall be present in the message sent from the target MME to the SGW selected by the target MME for indirect data forwarding of the DL data buffered in the old SGW during a TAU with SGW change procedure and data forwarding, without Control Plane Clot EPS optimisation, as specified in clause 5.3.3.1A of 3GPP TS 23.401 [3].		
SGW/UPF F-TEID for DL data forwarding	C	Target SGW F-TEID This IE shall be present in the message sent from the source MME/SGSN to the SGW selected by the source MME for indirect data forwarding if SGW F-TEID for DL data forwarding is included in the Forward Relocation Response message. This F-TEID is assigned by the SGW that the target MME/SGSN selects for indirect data forwarding.	F-TEID	1
	CO	Target UPF F-TEID This IE shall be present in the message sent from the source MME to the SGW selected by the source MME for indirect data forwarding if SGW/UPF F-TEID for DL data forwarding is included in the Forward Relocation Response message. This IE contains the target V-UPF F-TEID in home routed roaming scenario, or contains the PGW-U+UPF F-TEID in non-roaming or local breakout scenario.		
SGSN F-TEID for DL data forwarding	C	Target SGSN F-TEID This IE shall be present in the message sent from the target SGSN to the SGW selected by the target SGSN for indirect data forwarding in E-UTRAN to GERAN/UTRAN inter RAT handover with SGW relocation procedure, or shall be included in the message sent from the source MME to the SGW selected by the source MME for indirect data forwarding if the SGSN F-TEID for DL data forwarding is included in the Forwarding Relocation Response message.	F-TEID	2
	CO	This IE shall also be present in the message sent from the source MME to the SGW selected by the source MME for indirect data forwarding if the SGSN Address for User Traffic and the Tunnel Endpoint Identifier Data II are included in the GTPv1 Forward Relocation Response message as specified in D.3.7 of 3GPP TS 23.401 [3].  This IE shall also be present, when Direct Tunnel is not used, in the message sent from the target SGSN to the SGW selected by the target SGSN for indirect data forwarding of the DL data buffered in the old SGW during a RAU with SGW change procedure and data forwarding, as specified in clause 5.3.3.1A of 3GPP TS 23.401 [3].		
RNC F-TEID for DL data forwarding	C	Target RNC F-TEID This IE shall be present in the message sent from the target SGSN to the SGW selected by the target SGSN for indirect data forwarding in E-UTRAN to UTRAN inter RAT handover with SGW relocation procedure, or shall be included in the message sent from the source MME to the SGW selected by the source MME for indirect data forwarding if the RNC F-TEID for DL data forwarding is included in the Forwarding Relocation Response message.	F-TEID	3

	CO	This IE shall also be present in the message sent from the source MME to the SGW selected by the source MME for indirect data forwarding if the RNC IP address and TEID are included in the RAB Setup Information and/or the Additional RAB Setup Information in the GTPv1 Forwarding Relocation Response message as specified in D.3.3 of 3GPP TS 23.401 [3].  This IE shall be present, when Direct Tunnel is used, in the message sent from the target SGSN to the SGW selected by the target SGSN for indirect data forwarding of the DL data buffered in the old SGW during a RAU with SGW change procedure and data forwarding as specified in clause 5.3.3.1A of 3GPP TS 23.401 [3].		
eNodeB F-TEID for UL data forwarding	O	Target eNodeB F-TEID. If available this IE may be present in the message, which is sent during the intra-EUTRAN HO from the target MME to the SGW selected by the target MME for indirect data forwarding, or may be included in the message sent from the source MME to the SGW selected by the source MME for indirect data forwarding if the eNodeB F-TEID for data UL forwarding is included in the Forward Relocation Response message.	F-TEID	4
SGW F-TEID for UL data forwarding	O	Target SGW F-TEID If available this IE may be present in the message, which is sent during the intra-EUTRAN HO from the source MME to the SGW selected by the source MME for indirect data forwarding if SGW F-TEID for UL data forwarding is included in the Forward Relocation Response message. This F-TEID is assigned by the SGW that the target MME selects for indirect data forwarding.	F-TEID	5
MME F-TEID for DL data forwarding	CO	Target MME S11-U F-TEID This IE shall be present in the message sent from the target MME to the SGW selected by the target MME for indirect data forwarding, during a TAU procedure with SGW change and data forwarding, with Control Plane Clot EPS optimisation, as specified in clause 5.3.3.1A of 3GPP TS 23.401 [3].	F-TEID	6

## 7.2.19 Create Indirect Data Forwarding Tunnel Response

A Create Indirect Data Forwarding Tunnel Response message shall be sent by the SGW to the MME/SGSN as a response to a Create Indirect Data Forwarding Tunnel Request message.

Table 7.2.19-1 specifies the presence requirements and the conditions of the IEs in the message.

The Cause value indicates if the Indirect Data Forwarding Tunnels has been created in the SGW or not. No Indirect Data Forwarding Tunnels have been created in the SGW if the Cause differs from "Request accepted" or "Request accepted partially". Possible Cause values are specified in Table 8.4-1. Message specific cause values are:

- "Request accepted".
- "Request accepted partially".
- "Data forwarding not supported".
- "Context not found".

**Table 7.2.19-1: Information Elements in a Create Indirect Data Forwarding Tunnel Response**

Information elements	P	Condition / Comment	IE Type	Ins.
Cause	M		Cause	0
Sender F-TEID for Control Plane	C	This IE shall be included by an SGW if the SGW receives a Sender F-TEID for Control Plane IE from an MME/SGSN in a Create Indirect Data Forwarding Tunnel Request message. See also NOTE 1 in Table 7.2.18-1.	F-TEID	0
Bearer Contexts	M	Several IEs with this type and instance value may be included as necessary to represent a list of Bearers	Bearer Context	0
Recovery	CO	This IE shall be included if contacting the peer for the first time	Recovery	0
Private Extension	O		Private Extension	VS

**Table 7.2.19-2: Bearer Context within Create Indirect Data Forwarding Tunnel Response**

Octet 1		Bearer Context IE Type = 93 (decimal)		
Octets 2 and 3		Length = n		
Octet 4		Spare and Instance fields		
Information elements	P	Condition / Comment	IE Type	Ins.
EPS Bearer ID	M		EBI	0
Cause	M	This IE shall indicate if the tunnel setup was successful, and if not, gives information on the reason.	Cause	0
S1-U SGW F-TEID for DL data forwarding	C	This IE shall be included in the response sent from the SGW selected by the source MME for indirect data forwarding to the source MME. See NOTE 3.	F-TEID	0
S12 SGW F-TEID for DL data forwarding	C	S12 usage only. This IE shall be included in the response sent from the SGW selected by the source SGSN for indirect data forwarding to the source SGSN. See NOTE 3.	F-TEID	1
S4-U SGW F-TEID for DL data forwarding	C	S4-U usage only. This IE shall be included in the response sent from the SGW selected by the source SGSN for indirect data forwarding to the source SGSN. See NOTE 3.	F-TEID	2
SGW F-TEID for DL data forwarding	C	This IE shall be included in the response message sent from the SGW selected by the target MME/SGSN for indirect data forwarding to the target MME/SGSN. See NOTE 3.	F-TEID	3
S1-U SGW F-TEID for UL data forwarding	O	If available this IE may be included in the response sent during the intra-EUTRAN HO from the SGW selected by the source MME for indirect data forwarding to the source MME. See NOTE 4.	F-TEID	4
SGW F-TEID for UL data forwarding	O	If available this IE may be included in the response message sent during the intra-EUTRAN HO from the SGW selected by the target MME for indirect data forwarding to the target MME. See NOTE 4.	F-TEID	5
NOTE 1: For DL data forwarding if the SGW does not have enough information to decide which of the F-TEID instance from S1-U, S12, S4-U and SGW to include in the message, it may include all of them.				
NOTE 2: For UL data forwarding if the SGW does not have enough information to decide which of the F-TEID instance from S1-U and SGW to include in the message, it may include both of them.				
NOTE 3: For DL data forwarding the SGW shall set the interface type in the F-TEID to 23, i.e "SGW GTP-U interface for DL data forwarding" for S1-U/S4-U/S12/SGW.				
NOTE 4: For UL data forwarding the SGW shall set the interface type in the F-TEID to 28, i.e "SGW GTP-U interface for UL data forwarding" for S1-U/SGW.				



## 7.2.20 Void

## 7.2.21 Release Access Bearers Request

The Release Access Bearers Request message shall be sent on the S11 interface by the MME to the SGW as part of the S1 release procedure and eNodeB initiated Connection Suspend procedure.

It may also be sent on the S11 interface by the MME to the SGW as part of the Establishment of S1-U bearer during Data Transport in Control Plane CIoT EPS optimisation procedure (see clause 5.3.4B.4 of 3GPP TS 23.401 [3]).

**NOTE:** The S1 release procedure is also used to release the S11-U bearers for the Control Plane CIoT EPS optimisation, except in the case of data buffering in the MME.

The message shall also be sent on the S4 interface by the SGSN to the SGW as part of the procedures:

- RAB release using S4
- Iu Release using S4
- READY to STANDBY transition within the network

Table 7.2.21-1: Information Element in Release Access Bearers Request

Information elements	P	Condition / Comment	IE Type	Ins.
List of RABs	C	Shall be present on S4 interface when this message is used to release a subset of all active RABs according to the RAB release procedure. Several IEs with this type and instance values shall be included as necessary to represent a list of RABs to be released.	EBI	0
Originating Node	CO	This IE shall be sent on S11 interface, if ISR is active in the MME. This IE shall be sent on S4 interface, if ISR is active in the SGSN See NOTE 1.	Node Type	0
Indication Flags	CO	This IE shall be included if any one of the applicable flags is set to 1. Applicable flags are: <ul style="list-style-type: none"> <li>- Abnormal Release of Radio Link: This flag shall be set to 1 on the S11 interface <ul style="list-style-type: none"> <li>- if the S1 release is due to an abnormal release of the radio link, e.g. when the MME receives UE CONTEXT RELEASE REQUEST with the cause value set to Radio Connection With UE Lost, or</li> <li>- if the MME performs DL data buffering and the operator specified policy/configuration conditions for triggering the PGW pause of charging are met (e.g. number/fraction of packets/bytes dropped at MME in downlink) as specified in clause 5.3.6A of 3GPP TS23.401 [3].</li> </ul> </li> </ul>	Indication	0
Secondary RAT Usage Data Report	CO	If the PLMN has configured secondary RAT usage reporting, the MME shall include this IE on the S11 interface if it has received Secondary RAT usage data from eNodeB in a Connection Suspend, or S1 release procedure. The MME shall set the IRPGW flag to "0", to indicate that the IE shall not be forwarded to the PGW. Several IEs with the same type and instance value may be included, to represent multiple usage data reports.	Secondary RAT Usage Data Report	0
PSCell ID	CO	The MME shall include this IE on the S11 interface, if it has received this information from the eNodeB.	PSCell ID	0
Private Extension	O		Private Extension	VS
<p>NOTE 1: If SGW has the S1-U F-TEIDs for the UE, but the Originating Node IE contains value "SGSN", then the SGW shall not release the user plane and shall send a positive response to the SGSN.</p> <p>If SGW has the S12 RNC TEIDs or S4-U SGSN TEIDs for the UE, but the Originating Node IE contains value "MME", then the SGW shall not release the user plane and shall send a positive response to the MME.</p>				

## 7.2.22 Release Access Bearers Response

The Release Access Bearers Response message is sent on the S11 interface by the SGW to the MME as part of the S1 release procedure and eNodeB initiated Connection Suspend procedure.

It may also be sent on the S11 interface by the SGW to the MME as part of the Establishment of S1-U bearer during Data Transport in Control Plane CIoT EPS optimisation procedure (see clause 5.3.4B.4 of 3GPP TS 23.401 [3]).

NOTE: The S1 release procedure is also used to release S11-U bearers for the Control Plane CIoT EPS optimisation, except in the case of data buffering in the MME.

The message shall also be sent on the S4 interface by the SGW to the SGSN as part of the procedures:

- RAB release using S4
- Iu Release using S4
- READY to STANDBY transition within the network

Possible Cause values are specified in Table 8.4-1. Message specific cause values are:

- "Request accepted".
- "Request accepted partially".
- "Context not found".

**Table 7.2.22-1: Information Element in Release Access Bearers Response**

Information elements	P	Condition / Comment	IE Type	Ins.
Cause	M		Cause	0
Recovery	O	This IE shall be included if contacting the peer for the first time	Recovery	0
Indication Flags	CO	This IE shall be included if any one of the applicable flags is set to 1. Applicable flags are: <ul style="list-style-type: none"> <li>- Associate OCI with SGW node's identity: The SGW shall set this flag to 1 on the S11/S4 interface if it has included the "SGW's Overload Control Information" and if this information is to be associated with the node identity (i.e. FQDN or the IP address received from the DNS during the SGW selection) of the serving SGW.</li> </ul>	Indication	0
SGW's node level Load Control Information	O	The SGW may include this IE, over the S11/S4 interface if the load control feature is supported by the SGW and is activated in the network (see clause 12.2.6).  When present, the SGW shall provide only one instance of this IE, representing its node level load information.	Load Control Information	0
SGW's Overload Control Information	O	During an overload condition, the SGW may include this IE over the S11/S4 interface if the overload control feature is supported by the SGW and is activated in the network (see clause 12.3.11).  When present, the SGW shall provide only one instance of this IE, representing its overload information.	Overload Control Information	0
Private Extension	O		Private Extension	VS

**Table 7.2.22-2: Load Control Information within Release Access Bearers Response**

Octet 1	Load Control Information IE Type = 181 (decimal)			
Octets 2 and 3	Length = n			
Octet 4	Spare and Instance fields			
Information elements	P	Condition / Comment	IE Type	Ins.
Load Control Sequence Number	M	See clause 12.2.5.1.2.1 for the description and use of this parameter.	Sequence Number	0
Load Metric	M	See clause 12.2.5.1.2.2 for the description and use of this parameter.	Metric	0

**Table 7.2.22-3: Overload Control Information within Release Access Bearers Response**

Octet 1	Overload Control Information IE Type = 180 (decimal)			
Octets 2 and 3	Length = n			
Octet 4	Spare and Instance fields			
Information elements	P	Condition / Comment	IE Type	Ins.
Overload Control Sequence Number	M	See clause 12.3.5.1.2.1 for the description and use of this parameter.	Sequence Number	0
Overload Reduction Metric	M	See clause 12.3.5.1.2.3 for the description and use of this parameter.	Metric	0
Period of Validity	M	See clause 12.3.5.1.2.2 for the description and use of this parameter. This IE should be set to "0" if the "Overload Reduction Metric" is null. This IE shall be ignored by the receiver if the "Overload Reduction Metric" is null.	EPC Timer	0

## 7.2.23 Stop Paging Indication

A Stop Paging Indication message shall be sent on the S11/S4 interface by the SGW to the MME/SGSN as a part of the network triggered service request procedure.

Table 7.2.23-1 specifies the presence of the IEs in the message.

**Table 7.2.23-1: Information Elements in a Stop Paging Indication**

Information elements	P	Condition / Comment	IE Type	Ins.
IMSI	CO	This IE shall be included on the S11/S4 interface when the Stop Paging Indication message is sent to the restarted CN node (or another node in the same pool) as part of the network triggered service restoration procedure with ISR (see 3GPP TS 23.007 [17]).	IMSI	0
Private Extension	O		Private Extension	VS

## 7.2.24 Modify Access Bearers Request

The direction of this message shall be from MME to SGW (see Table 6.1-1).

If both the SGW and the MME support the MABR feature (see clause 8.83), an MME may send a Modify Access Bearer Request message on the S11 interface to an SGW as part of the following procedures:

- UE triggered Service Request if there is no suspended bearer for that UE,
- S1-based Handover without SGW relocation,
- X2-based handover without SGW relocation,
- Inter-MME E-UTRAN Tracking Area Update without SGW Change,
- Intra-MME E-UTRAN Tracking Area Update without SGW Change with Active Flag;
- E-UTRAN Initiated E-RAB modification procedure
- Mobile Originated Data transport in Control Plane CIoT EPS optimisation with P-GW connectivity
- Mobile Terminated Data Transport in Control Plane CIoT EPS optimisation with P-GW connectivity
- Connection Resume procedure (see clause 5.3.5A of 3GPP TS 23.401 [3])
- Establishment of S1-U bearer during Data Transport in Control Plane CIoT EPS optimisation procedure (see clause 5.3.4B.4 of 3GPP TS 23.401 [3]).

if all the following conditions are fulfilled:

- the RAT type has not changed;
- the Serving Network has not changed;
- the MME does not need to report a H(e)NB local IP address and UDP port number information change;
- the MME does not need to send UE's location and/or User CSG information or/and UE Time Zone and/or Presence Reporting Area information to the PDN GW;
- the MME does not need to send an MME-FQ-CSID as per the requirements specified in 3GPP TS 23.007 [17];
- ISR is not activated, if the Modify Access Bearers Request is sent as part of a UE triggered Service Request;
- ISR was not activated in the old MME which is indicated by the ISRAU flag in the Context Response, if the Modify Access Bearers Request is sent as part of an Inter-MME E-UTRAN Tracking Area Update without SGW change.
- the support of ePCO has not be changed during inter MME mobility.
- Secondary RAT Usage Data Report(s) is not required to be forwarded to the PGW(s) for any active PDN Connections.

The Modify Access Bearers Request message shall include all the bearer contexts of all the PDN connections of the UE.

Support of this message is optional for the MME and SGW.

**Table 7.2.24-1: Information Elements in a Modify Access Bearers Request**

Information elements	P	Condition / Comment	IE Type	Ins.
Indication Flags	C	This IE shall be included if any one of the applicable flags is set to 1. Applicable flags are: <ul style="list-style-type: none"> <li>- ISRAI: This flag shall be set to 1 if ISR is established between the MME and the S4 SGSN for an S1-based Handover without SGW relocation and for an X2-based Handover without SGW relocation.</li> <li>- Change F-TEID support Indication: This flag shall be set to 1 for an IDLE state UE initiated TAU procedure to allow the SGW changing the GTP-U F-TEID.</li> <li>- S11-U Tunnel Flag: this flag shall be set to 1 on the S11 interface if user data is transported in NAS signalling.</li> </ul>	Indication	0
Sender F-TEID for Control Plane	C	The new MME shall include this IE on the S11 interface for a TAU/Handover with MME change and without any SGW change. If the SGW receives this IE and if it finds that its value is the same as the earlier received value of this IE for this UE, it should interpret this to mean that the MME has not changed.	F-TEID	0
Delay Downlink Packet Notification Request	C	This IE shall be sent for a UE triggered Service Request and UE initiated Connection Resume procedures. It shall contain the delay the SGW shall apply between receiving downlink data and sending Downlink Data Notification for all UEs served by that MME (see clause 5.3.4.2 of 3GPP TS 23.401 [3]).	Delay Value	0

Bearer Contexts to be modified	C	Several IEs with the same type and instance value may be included as necessary to represent a list of Bearers to be modified. See NOTE 1.	Bearer Context	0
Bearer Contexts to be removed	C	This IE shall be included for the TAU/Handover, UE initiated Connection Resume and Service Request procedures where any of the bearers existing before the TAU/Handover procedure, UE initiated Connection Resume and Service Request procedures will be deactivated as consequence of the TAU/Handover procedure, UE initiated Connection Resume and Service Request procedures. For the Service Request and UE initiated Connection Resume procedures, all unaccepted bearers for this UE shall be included. For each of those bearers, an IE with the same type and instance value, shall be included. See NOTE 1.	Bearer Context	1
Recovery	C	This IE shall be included if contacting the peer for the first time.	Recovery	0
Secondary RAT Usage Data Report	CO	If the PLMN has configured secondary RAT usage reporting, and if the Secondary RAT usage data is not intended for the PGW(s) for any of active PDN Connections, the MME shall include this IE on the S11 interface if it has received Secondary RAT usage data from eNodeB in an X2-based handover without Serving GW relocation, S1-based handover without MME or SGW relocation, or E-UTRAN initiated E-RAB modification procedure. The MME shall also include this IE on the S11 interface if it has received a Secondary RAT Usage Data Report from the source MME in an S1-based handover with MME relocation but without SGW relocation. The MME shall set the IRPGW flag to "0", to indicate that the IE shall not be forwarded to the PGW. Several IEs with the same type and instance value may be included, to represent multiple usage data reports.	Secondary RAT Usage Data Report	0
PSCell ID	CO	The MME shall include this IE on the S11 interface, if it has received this information from the eNodeB.	PSCell ID	0
Private Extension	O		Private Extension	VS
NOTE 1: The Bearer Context to be modified IE and Bearer Context to be removed IE, together, shall contain all the bearers of all the existing PDN connections of the UE, with each bearer appearing in only one of these IEs. See clause 14 for the cases when a Bearer Context mismatch is detected.				

**Table 7.2.24-2: Bearer Context to be modified within Modify Access Bearers Request**

Octets 1	Bearer Context IE Type = 93 (decimal)			
Octets 2 and 3	Length = n			
Octets 4	Spare and Instance fields			
Information elements	P	Condition / Comment	IE Type	Ins.
EPS Bearer ID	M	See NOTE 1.	EBI	0
S1-U eNodeB F-TEID	C	<p>This IE shall be sent if S1-U is being used for:</p> <ul style="list-style-type: none"> <li>- an UE triggered Service Request;</li> <li>- S1-based Handover without SGW relocation;</li> <li>- X2-based handover without SGW relocation;</li> <li>- in S1-U GTP-U tunnel setup procedure during an Inter-MME E-UTRAN Tracking Area Update without SGW Change procedure or Intra-MME E-UTRAN Tracking Area Update without SGW Change procedure with Active Flag (see 3GPP TS 24.301 [23]);</li> <li>- an E-UTRAN Initiated E-RAB modification procedure;</li> <li>- an UE initiated Connection Resume;</li> <li>- the Establishment of S1-U bearer during Data Transport in Control Plane Clot EPS optimisation procedure. See NOTE 2.</li> </ul> <p>If an MME is aware that the eNodeB supports both IP address types, the MME shall send both IP addresses within an F-TEID IE. If only one IP address is included, then the SGW shall assume that the eNodeB does not support the other IP address type.</p>	F-TEID	0
S11-U MME F-TEID	CO	<p>This IE shall be sent on the S11 interface if S11-U is being used, i.e. for the following procedures:</p> <ul style="list-style-type: none"> <li>- Mobile Originated Data transport in Control Plane Clot EPS optimisation with P-GW connectivity</li> <li>- Mobile Terminated Data Transport in Control Plane Clot EPS optimisation with P-GW connectivity</li> </ul>	F-TEID	1
<p>NOTE 1: If only EPS Bearer ID IE is included in the Bearer Context to be modified IE during the TAU without SGW change procedure, the SGW shall remove the stored eNodeB/MME userplane F-TEID locally.</p> <p>NOTE 2: In the Establishment of S1-U bearer during Data Transport in Control Plane Clot EPS optimisation procedure (see clause 5.3.4B.4 of 3GPP TS 23.401 [3]), the MME may send a Modify Access Bearers Request to the SGW, to request the establishment of the S1-U bearers, without sending a prior Release Access Bearers Request to tear down the S11-U bearers. In this case, the MME shall encode the bearers being switched from S11-U to S1-U in the Bearer Contexts to be modified IE and the SGW shall release the S11-U bearers upon receipt of the Modify Access Bearers Request requesting the establishment of the S1-U bearers.</p>				

**Table 7.2.24-3: Bearer Context to be removed within Modify Access Bearers Request**

Octets 1	Bearer Context IE Type = 93 (decimal)			
Octets 2 and 3	Length = n			
Octets 4	Spare and Instance fields			
Information elements	P	Condition / Comment	IE Type	Ins.
EPS Bearer ID	M		EBI	0

## 7.2.25 Modify Access Bearers Response

If an SGW supports the MABR feature (see clause 8.83), the SGW shall send a Modify Access Bearers Response message on the S11 interface to an MME as a response to a Modify Access Bearers Request message.

If handling of all default bearers to be modified fails, then Cause at the message level shall be a failure cause.

Possible Cause values are specified in Table 8.4-1. Message specific cause values are:

- "Request accepted".
- "Request accepted partially".
- "Context not found".
- "Service not supported".
- "Modifications not limited to S1-U bearers"

The SGW shall send the cause value "Modifications not limited to S1-U bearers" if

- it can not serve the MME Request without corresponding S5/S8 signalling other than to unpause charging in the PGW, or without corresponding Gxc signalling when PMIP is used over the S5/S8 interface, or
- if there are suspended non-GBR bearers for that UE in the SGW (NOTE 3).

Upon receipt of that cause value, the MME shall repeat its request using Modify Bearer Request message per PDN connection.

NOTE 1: This cause value is introduced for forward compatibility between an MME implementing this version of the specification and an SGW implementing a more recent version requiring the SGW to send S5/S8 signalling.

NOTE 2: During an Inter-MME Intra-SGW handover/TAU, if the SGW, PGW and the old MME support the partial failure handling feature but the new MME doesn't, the SGW needs to inform the PGW about the change of FQ-CSID (see clause 16.2.5 of 3GPP TS 23.007 [17]). If the SGW receives a Modify Access Bearers Request from the new MME, it can force the MME to send individual Modify Bearer Request message per PDN connection by returning the cause value "Modifications not limited to S1-U bearers".

NOTE 3: There may be some suspended non-GBR bearers in the SGW during an Inter-MME Intra-SGW Tracking Area Update without SGW Change when the UE is coming back to E-UTRAN via a different MME than the MME serving the UE before the CSFB or SRVCC call.



Table 7.2.25-1: Information Elements in a Modify Access Bearers Response

Information elements	P	Condition / Comment	IE Type	Ins.
Cause	M		Cause	0
Bearer Contexts modified	C	EPS bearers corresponding to Bearer Contexts to be modified that were sent in Modify Access Bearers Request message. Several IEs with the same type and instance value may be included as necessary to represent a list of the Bearers which are modified.	Bearer Context	0
Bearer Contexts marked for removal	C	EPS bearers corresponding to Bearer Contexts to be removed that were sent in the Modify Access Bearers Request message. Shall be included if request message contained Bearer Contexts to be removed. For each of those bearers an IE with the same type and instance value shall be included.	Bearer Context	1
Recovery	C	This IE shall be included if contacting the peer for the first time.	Recovery	0
Indication Flags	CO	This IE shall be included if any one of the applicable flags is set to 1. Applicable flags are:  - Associate OCI with SGW node's identity: The SGW shall set this flag to 1 on the S11/S4 interface if it has included the "SGW's Overload Control Information" and if this information is to be associated with the node identity (i.e. FQDN or the IP address received from the DNS during the SGW selection) of the serving SGW.	Indication	0
SGW's node level Load Control Information	O	The SGW may include this IE, over the S11/S4 interface if the load control feature is supported by the SGW and is activated in the network (see clause 12.2.6).  When present, the SGW shall provide only one instance of this IE, representing its node level load information.	Load Control Information	0
SGW's Overload Control Information	O	During an overload condition, the SGW may include this IE over the S11/S4 interface if the overload control feature is supported by the SGW and is activated in the network (see clause 12.3.11).  When present, the SGW shall provide only one instance of this IE, representing its overload information.	Overload Control Information	0
Private Extension	O		Private Extension	VS

**Table 7.2.25-2: Bearer Context modified within Modify Access Bearers Response**

Octets 1	Bearer Context IE Type = 93 (decimal)			
Octets 2 and 3	Length = n			
Octets 4	Spare and Instance fields			
Information elements	P	Condition / Comment	IE Type	Ins.
EPS Bearer ID	M		EBI	0
Cause	M	This IE shall indicate if the bearer handling was successful, and if not, gives information on the reason.	Cause	0
S1-U SGW F-TEID	C	This IE shall be present on the S11 interface if S1-U is being used, i.e. if the S11-U Tunnel flag was not set in the Modify Access Bearers Request. The SGW may change the GTP-U F-TEID value if the 'Change F-TEID support Indication' flag was set to 1 in the Modify Access Bearers Request. Otherwise, the SGW shall return the currently allocated GTP-U F-TEID value. See NOTE 1.	F-TEID	0
S11-U SGW F-TEID	C	This IE shall be present on the S11 interface if S11-U is being used, i.e. if the S11-U Tunnel flag was set in the Modify Access Bearers Request. If the 'Change F-TEID support Indication' flag was set to 1 in the Modify Bearer Request and the SGW needs to change the F-TEID, the SGW shall include the new GTP-U F-TEID value. Otherwise, the SGW shall return the currently allocated GTP-U F-TEID value.	F-TEID	1
NOTE 1: The SGW shall not change its F-TEID for a given interface during the Handover, Service Request and E-UTRAN Initiated E-RAB modification procedures. During Handover and Service Request the target eNodeB may use a different IP type than the one used by the source eNodeB. In order to support such a scenario, the SGW F-TEID should contain both an IPv4 address and an IPv6 address (see also clause 8.22 "F-TEID").				

**Table 7.2.25-3: Bearer Context marked for removal within Modify Access Bearers Response**

Octet 1	Bearer Context IE Type = 93 (decimal)			
Octets 2 and 3	Length = n			
Octet 4	Spare and Instance fields			
Information elements	P	Condition / Comment	IE Type	Ins.
EPS Bearer ID	M		EBI	0
Cause	M	This IE shall indicate if the bearer handling was successful, and if not, gives information on the reason.	Cause	0

**Table 7.2.25-4: Load Control Information within Modify Access Bearers Response**

Octet 1	Load Control Information IE Type = 181 (decimal)			
Octets 2 and 3	Length = n			
Octet 4	Spare and Instance fields			
Information elements	P	Condition / Comment	IE Type	Ins.
Load Control Sequence Number	M	See clause 12.2.5.1.2.1 for the description and use of this parameter.	Sequence Number	0
Load Metric	M	See clause 12.2.5.1.2.2 for the description and use of this parameter.	Metric	0

**Table 7.2.25-5: Overload Control Information within Modify Access Bearers Response**

Octet 1	Overload Control Information IE Type = 180 (decimal)			
Octets 2 and 3	Length = n			
Octet 4	Spare and Instance fields			
Information elements	P	Condition / Comment	IE Type	Ins.
Overload Control Sequence Number	M	See clause 12.3.5.1.2.1 for the description and use of this parameter.	Sequence Number	0
Overload Reduction Metric	M	See clause 12.3.5.1.2.3 for the description and use of this parameter.	Metric	0
Period of Validity	M	See clause 12.3.5.1.2.2 for the description and use of this parameter. This IE should be set to "0" if the "Overload Reduction Metric" is null. This IE shall be ignored by the receiver if the "Overload Reduction Metric" is null.	EPC Timer	0

## 7.2.26 Remote UE Report Notification

The direction of this message shall be from MME to SGW and from SGW to the PGW (see Table 6.1-1).

This message is used by an MME to notify that at least one remote UE is newly connected to or disconnected from a ProSe UE-to-Network Relay when the MME receives such notification from the ProSe UE-to-Network Relay via the PDN connection established by the ProSe UE-to-Network Relay as specified in 3GPP TS 23.303 [72].

Table 7.2.26-1 specifies the presence of IEs in this message.

**Table 7.2.26-1: Information Elements in Remote UE Report Notification**

Information elements	P	Condition / Comment	IE Type	Ins.
Remote UE Context Connected	C	This IE shall be sent on the S11 interface and S5/S8 interface when the MME receives a report from the ProSe UE-to-Network Relay that a remote UE is newly connected.  The SGW shall forward this IE to the PGW.  Several IEs with the same type and instance value may be included as necessary to represent a list of remote UEs newly connected.	Remote UE Context	0
Remote UE Context Disconnected	C	This IE shall be sent on the S11 interface and S5/S8 interface when the MME receives a report from the ProSe UE-to-Network Relay that a remote UE is newly disconnected.  The SGW shall forward this IE to the PGW.  Several IEs with the same type and instance value may be included as necessary to represent a list of remote UEs newly disconnected.	Remote UE Context	1
Private Extension	O		Private Extension	VS

**Table 7.2.26-2: Remote UE Context Connected within Remote UE Report Notification**

Octets 1	Remote UE Context IE Type = 191 (decimal)			
Octets 2 and 3	Length = n			
Octets 4	Spare and Instance fields			
Information elements	P	Condition / Comment	IE Type	Ins.
Remote User ID	M	See clause 8.123 for the description and use of this parameter	Remote User ID	0
Remote UE IP Information	M	See clause 8.124 for the description and use of this parameter	Remote UE IP Information	0

**Table 7.2.26-3: Remote UE Context Disconnected with Remote UE Report Notification**

Octets 1	Remote UE Context IE Type = 191 (decimal)			
Octets 2 and 3	Length = n			
Octets 4	Spare and Instance fields			
Information elements	P	Condition / Comment	IE Type	Ins.
Remote User ID	M	See clause 8.123 for the description and use of this parameter	Remote User ID	0

## 7.2.27 Remote UE Report Acknowledge

The Remote UE Report Acknowledge message shall be sent as the response to a Remote UE Report Notification, to acknowledge the information related to the remote UE(s) is received.

Possible Cause values are specified in Table 8.4-1.

Table 7.2.27-1 specifies the presence of IEs in this message.

**Table 7.2.27-1: Information Elements in Remote UE Report Acknowledge**

Information elements	P	Condition / Comment	IE Type	Ins.
Cause	M		Cause	0
Private Extension	O		Private Extension	VS

## 7.3 Mobility Management Messages

### 7.3.1 Forward Relocation Request

A Forward Relocation Request message shall be sent from:

- the source MME to the target MME over the S10 interface as part of an S1-based handover relocation procedure;
- the source MME to the target SGSN, or from the source SGSN to the target MME over the S3 interface as part of an Inter RAT handover and combined hard handover and SRNS relocation procedures;
- the source SGSN to the target SGSN over the S16 interface as part of an SRNS Relocation and PS handover procedures;
- the source MME to the target SGSN over the S3 interface as part of an SRVCC from E-UTRAN to UTRAN or GERAN with DTM HO support procedures and from the source SGSN to the target SGSN over the S16 interface as part of SRVCC from UTRAN (HSPA) to UTRAN or GERAN with DTM HO support;
- the source MME to the target AMF, or from the source AMF to the target MME over the N26 interface as part of the EPS to 5GS handover and 5GS to EPS handover procedures.

- the source AMF to the target MME\_SRVCC over the N26 interface as part of the 5G-SRVCC from NG-RAN to UTRAN procedure.

A source MME/SGSN which supports CIoT knows whether the target MME/SGSN pool or target AMF (5GS) supports some CIoT optimisations either by using DNS procedures enhanced for DCNs or by local configuration, as specified in clause 5.9 of 3GPP TS 29.303 [32]. A source AMF knows whether the target MME pool supports SGi Non-IP or Ethernet PDN connections either by using DNS procedures enhanced for DCNs or by local configuration, as specified in clause 5.9 and 5.13 of 3GPP TS 29.303 [32]. The target MME/SGSN may forward the Forward Relocation Request to another MME/SGSN in the target MME/SGSN pool which is more suitable to serve the UE, based on the information received in the Forward Relocation Request message, e.g. required CIoT EPS optimisation(s) applicable to the given UE's attachment.

NOTE 1: The source MME/SGSN/AMF does not need to know each individual CIoT feature the target MME/SGSN pool or target AMF (5GS) supports. The source MME/SGSN/AMF can behave as if the target MME/SGSN/AMF pool supports all CIoT features when the target MME/SGSN pool is known to support CIoT; the source MME/SGSN/AMF determines then which bearer contexts were successfully transferred as specified in sunclause 7.3.2.

NOTE 2: Among the CIoT optimization features, only the support of SCEF Non-IP PDN connection and the support of SGi Non-IP PDN connection are applicable to a SGSN.

NOTE 3: 5GS supports Attach without PDU session. 5GS can also support Unstructured and Ethernet PDU session types, which are assimilated to "SGi Non-IP PDN connections" over N26.

Forward Relocation procedure across S10 interface (when  $K_{ASME}$  is taken into use) shall be performed according to the Rules on Concurrent Running of Security Procedures, which are specified in 3GPP TS 33.401 [12].

When the source MME/SGSN supports one or more of the CIoT optimization features as specified in clause 8.125, the source MME/SGSN shall transfer EPS bearer context(s) for SGi Non-IP PDN connections or for PDN connections to a SCEF only if the target serving node is known to support SGi Non-IP PDN connections or SCEF Non-IP PDN connections respectively, as specified in clause 5.5.1.2.1 and 5.5.2 of 3GPP TS 23.401 [3]. Likewise, a source AMF shall transfer EPS bearer context(s) for SGi Non-IP PDN connections only if the target MME is known to support SGi Non-IP PDN connections. The source MME/SGSN/AMF shall not proceed with the Forward Relocation Request procedure if the UE does not have any EPS bearer context(s) for SGi IP or Non-IP PDN connections that can be transferred to the target serving node, i.e. under the following conditions:

- If the UE is attached to the source MME/SGSN with only the PDN connection(s) of PDN type "non-IP" through the SGW and the PGW, with or without SCEF PDN connections, and the target serving node is known to not support SGi Non-IP PDN Connection (as specified in clause 4.3.17.8.3.3 of 3GPP TS 23.401 [3] and in clause 5.3.13.8 of 3GPP TS 23 060 [35]); or
- If the UE is attached to the source AMF (5GS) with only PDU session(s) of type "Ethernet" or "Unstructured", and the target MME is known to not support SGi Non-IP and Ethernet PDN Connection.

The source MME shall transfer the EPS bearer context(s) for the Ethernet PDN connection only if the target serving node is known to support the Ethernet PDN connection, as specified in clause 5.3.3.1 of 3GPP TS 23.401 [3]. The source MME shall not proceed with the Forward Relocation Request procedure if the UE does not have any EPS bearer context(s) that can be transferred to the target serving node, i.e. under the following conditions:

- If the UE is attached to the source MME with only the PDN connection(s) of PDN type "Ethernet" through the SGW and the PGW, and the target serving node is known to not support the Ethernet PDN connection.

Table 7.3.1-1 specifies the presence requirements and conditions of the IEs in the message.

**Table 7.3.1-1: Information Elements in a Forward Relocation Request**

Information elements	P	Condition / Comment	IE Type	Ins.
IMSI	C	The IMSI shall be included in the message, except if the UE is emergency or RLOS attached and the UE is UICCless. The IMSI shall be included in the message but not used as an identifier if UE is emergency or RLOS attached but IMSI is not authenticated.	IMSI	0

Sender's F-TEID for Control Plane	M		F-TEID	0
MME/SGSN/AMF UE EPS PDN Connections	C	<p>This IE shall be present, except:</p> <ul style="list-style-type: none"> <li>- over the S16 interface if there is no active PDP context and the source and target SGSNs supports SRNS relocation w/o PDN connection over GTPv2 (see NOTE 2);</li> <li>or</li> <li>- over the N26 interface, during 5G SRVCC handover procedure from 5GS to UTRAN, as specified in clause 6.5 of 3GPP TS 23.216 [43].</li> </ul> <p>If the target MME/SGSN is known to not support SGi Non-IP PDN Connection (as specified in clause 4.3.17.8.3.3 of 3GPP TS 23.401 [3] and in clause 5.3.13.8 of 3GPP TS 23 060 [35]), then the source MME/SGSN/AMF shall only include PDN Connections of IP PDN type.</p> <p>If the target MME is known to not support Ethernet PDN connections, or the target is an SGSN, then the source MME shall not include any Ethernet PDN connection. (See NOTE 10)</p> <p>Several IEs with this type and instance values shall be included as necessary to represent a list of PDN Connections</p>	PDN Connection	0
SGW S11/S4 IP Address and TEID for Control Plane	C	<p>This IE shall be present, except over the S16 interface if there is no active PDP context and the source and target SGSNs supports SRNS relocation w/o PDN connection over GTPv2 (see NOTE 2).</p> <p>Over the N26 interface, the source AMF shall set the IP address and TEID to the following values:</p> <ul style="list-style-type: none"> <li>- any reserved TEID (e.g. all 0's, or all 1's);</li> <li>- IPv4 address set to 0.0.0.0, or IPv6 Prefix Length and IPv6 prefix and Interface Identifier all set to zero.</li> </ul>	F-TEID	1

SGW node name	C	This IE identifies the SGW that was used by the old MME/S4-SGSN. It shall be included by the source MME/S4-SGSN, except over the S16 interface if there is no active PDP context and the source and target SGSNs supports SRNS relocation w/o PDN connection over GTPv2 (see NOTE 2).	FQDN	0
MME/SGSN/AMF UE MM Context	M		MM Context	0

Indication Flags	C	<p>This IE shall be included if any of the flags are set to 1.</p> <ul style="list-style-type: none"> <li>- Direct Forwarding Indication: This flag shall be set to 1 if direct forwarding is supported in the S1 based handover procedure or during an inter-system handover between 5GS and EPS. This flag shall not be set to 1 if the message is used for other handover procedures.</li> <li>- Idle mode Signalling Reduction Supported Indication flag: This flag shall be set to 1 if the source MME/SGSN and associated SGW are capable to establish ISR for the UE.</li> <li>- Unauthenticated IMSI: This flag shall be set to 1 if the IMSI present in the message is not authenticated and is for an emergency or RLOS attached UE.</li> <li>- Change Reporting support indication flag: This flag shall be set to 1 if the Source S4-SGSN/MME supports Location Change Reporting mechanism. See NOTE1. See NOTE 3.</li> <li>- CSG Change Reporting Support Indication flag: This flag shall be set to 1 if the Source S4-SGSN/MME supports CSG Information Change Reporting mechanism. See NOTE1. See NOTE 3.</li> <li>- Management Based MDT allowed flag: This flag shall be set to 1 for the S1 based inter-MME handover procedure over the S10 interface, if Management Based Minimization of Drive Tests (MDT) is allowed. See 3GPP TS 36.413 [10] and 3GPP TS 32.422 [18].</li> <li>- CSFB Indication: when configured to support the return to the last used PLMN after CSFB, the MME shall set this flag to 1 on the S3 interface if the PS handover procedure is due to CSFB (see clause 4.3.2 of 3GPP TS 23.272 [21]). See NOTE 5.</li> <li>- Pending MT Short Message Indication: This flag shall be set to 1 on the S10/S16/S3 interface if the source S4-SGSN/MME knows that there is one (or more) pending MT Short Message(s) in the SMS-GMSC for the UE as specified in clause 10.1 of 3GPP TS 23.040 [75], Figure 17c). See NOTE 8.</li> <li>- LTE-M UE Indication (LTEMUI): This flag shall be set to 1 if the MME/AMF knows that the UE is an LTE-M UE.</li> <li>- Return Preferred Indication (REPREFI): the MME or the AMF may set this flag to 1 on the N26 interface to indicate a preferred return of the UE to the last used EPS or 5GS PLMN (respectively) at a later access change to an EPS or 5GS shared network. See NOTE 5.</li> <li>- 5G-SRVCC HO Indication (5SRHOI): the AMF may set this flag to 1 on the N26 interface to indicate the HO is used for 5G-SRVCC as specified in 3GPP TS 23.216 [43].</li> <li>- Emergency PDU Session Indication (EMCI): the AMF may set this flag to 1 on the N26 interface to indicate that the UE has emergency PDU session,</li> </ul>	Indication	0
------------------	---	---	------------	---



		<p>as specified in 3GPP TS 23.126 [43]. The EMCI bit shall be set together with the 5SRHOI bit.</p> <ul style="list-style-type: none"><li>- LTE-M Satellite Access Indication (LTEM_SAI): This flag shall be set to 1 if the MME/AMF knows that the LTE-M UE is accessing Satellite E-UTRAN.</li></ul>		
--	--	--	--	--

E-UTRAN Transparent Container	C	This IE shall be included to contain the "Source to Target Transparent Container", if the message is used for UTRAN/GERAN to E-UTRAN inter RAT handover procedure, E-UTRAN intra RAT handover procedure, 3G SGSN to MME combined hard handover and SRNS relocation procedure, 5GS to EPS handover and EPS to 5GS handover. The Container Type shall be set to 3.	F-Container	0
UTRAN Transparent Container	C	This IE shall be included to contain the "Source to Target Transparent Container", if the message is used for PS handover to UTRAN Iu mode procedures, SRNS relocation procedure and E-UTRAN to UTRAN inter RAT handover procedure. The Container Type shall be set to 1.	F-Container	1
BSS Container	C	This IE shall be included to contain the "Source BSS to Target BSS Transparent Container" if the message is used for PS handover to GERAN A/Gb mode and E-UTRAN to GERAN A/Gb mode inter RAT handover procedure. The Container Type shall be set to 2.	F-Container	2
Target Identification	C	This IE shall be included if the message is used for SRNS relocation procedure, handover to UTRAN/E-UTRAN, 5GS to EPS handover, EPS to 5GS handover procedures and 5G-SRVCC from NG-RAN to UTRAN procedure.	Target Identification	0
	CO	This IE shall be included on the S3 interface if the message is used for PS handover from E-UTRAN to GERAN A/Gb mode.		
HRPD access node S101 IP address	C	This IE shall be included only if the HRPD pre-registration was performed at the source MME.	IP-Address	0
1xIWS S102 IP address	C	This IE shall be included only if the 1xRTT CS fallback pre-registration was performed at the source MME.	IP-Address	1
S1-AP Cause	C	This IE is the information received from the source eNodeB or derived from the information received from the source NG-RAN. The source MME or AMF shall include this IE in the message. Refer to 3GPP TS 29.010 [42] for the mapping of cause values between S1AP, RANAP, BSSGP and NGAP.	F-Cause	0
RANAP Cause	C	This IE is the information from the source RNC. The source SGSN shall include this IE in the message. Refer to the 3GPP TS 29.010 [42] for the mapping of cause values between S1AP, RANAP and BSSGP.	F-Cause	1
BSSGP Cause	C	This IE is the information received from source BSS. The source SGSN shall include this IE in the message. Refer to 3GPP TS 29.010 [42] for the mapping of cause values between S1AP, RANAP and BSSGP.	F-Cause	2
Source Identification	C	This IE shall be included on the S16 interface if the message is used for PS handover from GERAN/UTRAN to GERAN A/Gb mode.	Source Identification	0
Selected PLMN ID	C	The old MME/SGSN/AMF shall include this IE if the selected PLMN identity is available. The Selected PLMN ID IE indicates the target core network operator selected for the UE in a shared network.	PLMN ID	0
Recovery	C	This IE shall be present when contacting the peer for the first time.	Recovery	0
Trace Information	C	This IE shall be included over S10/S16/S3 when session trace is active for this IMSI/IMEI.	Trace Information	0
Subscribed RFSP Index	CO	This IE shall be included by the source MME/SGSN/AMF, if received from the HSS or UDM.	RFSP Index	0
RFSP Index in Use	CO	This IE shall be included by the source MME/SGSN/AMF, if it supports the feature.	RFSP Index	1
CSG ID	CO	This IE shall be included on the S3/S10/S16 interfaces if the source MME/SGSN receives it from the source eNodeB/RNC. It indicates the target CSG ID in case of a handover to a CSG cell or hybrid cell.	CSG ID	0
CSG Membership Indication	CO	This IE shall be included on the S3/S10/S16 interfaces by the source MME/SGSN if the CSG access mode is received from the source eNodeB/RNC and indicates the target cell is a hybrid cell, or if the UE has emergency bearer(s) and the target cell is a CSG cell.	CMI	0
UE Time Zone	CO	When available, this IE shall be included by the source MME/S4-SGSN/AMF.	UE Time Zone	0

Serving Network	CO	This IE shall be included to indicate the current Serving Network.	Serving Network	0
MME/S4-SGSN LDN	O	This IE may be sent by the MME/S4-SGSN to the peer MME/S4-SGSN on the S3/S10/S16 interfaces (see 3GPP TS 32.423 [44]), when communicating the LDN to the peer node for the first time.	Local Distinguished Name (LDN)	0
Additional MM context for SRVCC	CO	This IE shall be sent by the source MME/S4-SGSN to the target MME/S4-SGSN on the S3/S10/S16 interfaces if MS Classmark2, MS Classmark3 and the Supported Codec are available in the source MME/S4-SGSN, or by the source AMF to the target MME_SRVCC (during a 5G-SRVCC procedure as specified in clause 6.5.4 of 3GPP TS 23.216 [43]) or to the target MME (during a 5G to 4G handover) on the N26 interface if MS Classmark2 and the Supported Codec are available in the source AMF.	Additional MM context for SRVCC	0
Additional flags for SRVCC	CO	This IE shall be included if any one of the applicable flags needs to be forwarded. Applicable flags: <ul style="list-style-type: none"> <li>- ICS Indicator: This IE shall be sent by the source MME/S4-SGSN to the target MME/S4-SGSN on the S3/S10/S16 interfaces if ICS Indicator is available in the source MME/S4-SGSN.</li> <li>- vSRVCC flag: This IE shall be sent by the source MME to the target MME on the S10 interface if vSRVCC flag is available in the source MME.</li> </ul>	Additional flags for SRVCC	0
STN-SR	CO	This IE shall be sent by the source MME/S4-SGSN to the target MME/S4-SGSN on the S3/S10/S16 interfaces if STN-SR is available in the source MME/S4-SGSN, or by the source AMF to the target MME_SRVCC during a 5G-SRVCC procedure as specified in clause 6.5.4 of 3GPP TS 23.216 [43]) or to the target MME (during a 5G to 4G handover) on the N26 interface if STN-SR is available in the source AMF.	STN-SR	0
C-MSISDN	CO	This IE shall be sent by the source MME/S4-SGSN to the target MME/S4-SGSN on the S3/S10/S16 interfaces if C-MSISDN is available in the source MME/S4-SGSN, or by the source AMF to the target MME_SRVCC during a 5G-SRVCC procedure as specified in clause 6.5.4 of 3GPP TS 23.216 [43]) or to the target MME (during a 5G to 4G handover) on the N26 interface if C-MSISDN is available in the source AMF. The C-MSISDN is defined in 3GPP TS 23.003 [2].	MSISDN	0
MDT Configuration	CO	This IE shall be sent by the source MME to the target MME on the S10 interface for the S1-based handover relocation procedure, if the Job Type indicates Immediate MDT. See 3GPP TS 32.422 [18] clause 4.4.	MDT Configuration	0
SGSN node name	CO	This IE shall be sent by the source SGSN on the S3 interface if both source SGSN and associated SGW support ISR. See NOTE 4.	FQDN	1
MME node name	CO	This IE shall be sent by the source MME on the S3 interface if both source MME and associated SGW support ISR. See NOTE 4.	FQDN	2
User CSG Information (UCI)	CO	This IE shall be sent by the source MME/S4-SGSN on the S3/S10/S16 interfaces if the source MME/SGSN has reported to the PGW that the UE is in a CSG or hybrid cell. It shall then contain the last User CSG information that the source MME/S4-SGSN has reported to the PGW. The absence of this IE indicates that the UE has not been reported to the PGW as being in a CSG or hybrid cell. See NOTE 6.	UCI	0
Monitoring Event Information	CO	This IE shall be sent by the source MME/S4-SGSN on the S3/S10/S16 interfaces if monitoring events are to be continued in the target MME/S4-SGSN. More than one IE with this type and instance values may be included to represent multiple monitoring events.	Monitoring Event Information	0

Monitoring Event Extension Information	CO	This IE shall be sent by the source MME/S4-SGSN on the S3/S10/S16 interfaces if monitoring event extensions are to be sent to the target MME/S4-SGSN. More than one IE with this type and instance values may be included to represent multiple monitoring event extensions.	Monitoring Event Extension Information	0
UE Usage Type	CO	This IE shall be set to the subscribed UE Usage Type, if received from the HSS, and sent by the old MME/SGSN if the old MME/SGSN supports the Dedicated Core Networks specified in TS 23.401 [3]. This IE shall also be set to the subscribed UE Usage Type, if received from the UDM, and sent by the old AMF on N26 interface. If the UE Usage Type is not available in the old MME/SGSN/AMF, the length field of this IE shall be set to 0. See NOTE 7.	Integer Number	0
MME/SGSN UE SCEF PDN Connections	CO	This IE shall be present over the S10/S3/S16 interface if there is at least one SCEF PDN connection for this UE at the source MME/SGSN and if the target MME/SGSN is known to support SCEF Non-IP PDN Connections (as specified in clause 5.13.1 of 3GPP TS 23.682 [74]).  Several IEs with this type and instance values shall be included as necessary to represent a list of SCEF PDN Connections.	SCEF PDN Connection	0
MSISDN	CO	This IE shall be present over the S10/S3/S16 interface if the UE's MSISDN is available and if there is at least one instance of the MME/SGSN UE SCEF PDN Connection IE included in the message.	MSISDN	1
Source UDP Port Number	CO	If the target MME/SGSN/AMF, selected by the source MME/SGSN/AMF, decides to forward the Forward Relocation Request message to another more suitable MME/SGSN/AMF in the same MME/SGSN pool or AMF set, the MME/SGSN/AMF shall include this IE, set to the Source UDP Port number of the received message from the source MME/SGSN/AMF. The new target MME/SGSN/AMF shall use this UDP port as the UDP destination port in the Forward Relocation Response message.	Port Number	0
Serving PLMN Rate Control	CO	This IE shall be included by the old MME on S10 interface if the Serving PLMN Rate control was enabled when there is at least one SCEF PDN connection. See NOTE 9.	Serving PLMN Rate Control	0
Extended Trace Information	C	This IE shall be included over N26 when session trace is active for this user.	Extended Trace Information	0
Subscribed Additional RRM Policy Index	CO	This IE shall be included by the MME over the S10 interface if received from the HSS.	Additional RRM Policy Index	0
Additional RRM Policy Index in Use	CO	This IE shall be included by the MME over the S10 interface if the feature is supported by the MME.	Additional RRM Policy Index	1
Subscribed V2X Information	CO	This IE shall be present over the N26 interface if available, and sent by the old MME/AMF if the old MME/AMF supports the V2X services specified in 3GPP TS 23.287 [89].	V2X Context	0
IWK SCEF ID for Monitoring Event	CO	This IE shall be included on the S3/S10 interface if the source MME/SGSN has selected the IWK-SCEF to relay Monitoring Events.	Node Identifier	0
Alternative IMSI	CO	This IE shall be included by the old MME over the S10 interface if it has stored an Alternative IMSI as specified in TS 23.401 [3] clause 5.7.2.	Alternative IMSI	0
Private Extension	O		Private Extension	VS

NOTE 1: 3GPP TS 23.401 [3] (e.g. clause 5.3.2.1) and 3GPP TS 23.060 [35] (e.g. clause 9.2.2.1) defines the MME/SGSN shall send the MS Info Change Reporting Support Indication to the PGW. In such case MME/SGSN shall use the Change Reporting Support Indication and/or CSG Change Reporting Support Indication (whichever is applicable), even if stage 2 refers to MS Info Change Reporting Support Indication.

NOTE 2: GTPv2 shall be used for SRNS relocation w/o PDN connection if all the S4-SGSNs (between which SRNS relocation can take place) support this optional GTPv2 procedure. Otherwise GTPv1 shall be used for that procedure (see clause 7.10). The S4-SGSN can know by local configuration whether all peer S4-SGSNs support this procedure.

NOTE 3: The receiver shall ignore the per UE Change Reporting Support Indication and CSG Change Reporting Support Indication flags, as included within the Indication Flags IE above, if these flags are included per PDN connection i.e. within the Indication Flags IE of the MME/SGSN UE EPS PDN Connections IE.

NOTE 4: According to the 3GPP TS 23.401 [3], during an inter-RAT handover procedure for a UE with ISR activated, the source MME/SGSN should select the ISR associated CN node for this UE as the target CN node for the inter RAT HO when the ISR associated CN node can serve the target access. This parameter is exchanged when ISR is being activated and used in the source MME/SGSN for this decision upon subsequent inter-RAT handover.

NOTE 5: If the SGSN needs to include the last used LTE PLMN ID in the Equivalent PLMN list it sends to the UE (see 3GPP TS 23.272 [21]), the SGSN shall derive the last used LTE PLMN ID from the Serving Network IE. If an MME or AMF needs to store the last used 5GS or EPS PLMN ID (respectively), the MME or AMF shall derive the last used 5GS or EPS PLMN ID (respectively) from the Serving Network IE.

NOTE 6: In shared networks, when the message is sent from the VPLMN to the HPLMN, the PLMN ID that is communicated in this IE shall be that of the selected Core Network Operator for supporting UEs, or that of the allocated Core Network Operator for non-supporting UEs. As an exception, based on inter-operator roaming/sharing agreement, if the information on whether the UE is a supporting or non-supporting UE is available, the PLMN ID that is communicated to the HPLMN for non-supporting UEs shall be the Common PLMN ID.  
In shared networks, when the MME/S4-SGSN and PGW pertain to the same PLMN, the Primary PLMN ID shall be communicated in the ECGI to the PGW, and the Common PLMN ID shall be communicated in SAI/CGI to the PGW, for both supporting and non-supporting UEs. The Core Network Operator PLMN ID (selected by the UE for supporting UEs or allocated by the network for non-supporting UEs) shall be communicated in the TAI, RAI, UCI and the Serving Network. See clause 4.4 of 3GPP TS 23.251 [55].

NOTE 7: A UE Usage Type IE with the length field equal to 0 is used for the receiver to differentiate the case where the sender does not support the Dedicated Core Network feature from the case where the sender supports the Dedicated Core Network feature but no UE Usage type was received in UE's subscription.

NOTE 8: There may be a pending MT Short Message at the SMS-GMSC during a handover scenario, when the UE performs a Service Request towards the source MME/SGSN and a handover procedure occurs shortly afterward, before the SMS-GMSC is alerted to retransmit the pending MT Short Message.

NOTE 9: The target MME may compare the value of the Serving PLMN Rate Control received in the Forward Relocation Request message with the one configured locally, to determine if this parameter needs to be updated towards the SCEF. The Serving PLMN Rate Control does not apply to any SGI PDN Connection in this message.

NOTE 10: PDN connections with PDN Type "Ethernet" are not supported in GERAN/UTRAN. For PDN connections with PDN type "Ethernet", mobility to GERAN/UTRAN is not supported. See clause 4.3.17.8a of TS 23.401 [3].

The PDN Connection grouped IE shall be coded as depicted in Table 7.3.1-2.

**Table 7.3.1-2: MME/SGSN/AMF UE EPS PDN Connections within Forward Relocation Request**

Octet 1	PDN Connection IE Type = 109 (decimal)			
Octets 2 and 3	Length = n			
Octet 4	Spare and Instance fields			
Information elements	P	Condition / Comment	IE Type	Ins.
APN	M		APN	0
APN Restriction	C	This IE denotes the restriction on the combination of types of APN for the APN associated with this EPS bearer Context. The target MME or SGSN determines the Maximum APN Restriction using the APN Restriction. If available, the source MME/S4SGSN shall include this IE.	APN Restriction	0
Selection Mode	CO	When available, this IE shall be included by the source MME/S4-SGSN/AMF.	Selection Mode	0

IPv4 Address	C	This IE shall not be included if no IPv4 Address is assigned. See NOTE 1.	IP Address	0
IPv6 Address	C	This IE shall not be included if no IPv6 Address is assigned.	IP Address	1
Linked EPS Bearer ID	M	This IE identifies the default bearer of the PDN Connection.	EBI	0
PGW S5/S8 IP Address for Control Plane or PMIP	M	This IE shall include the TEID in the GTP based S5/S8 case and the uplink GRE key in the PMIP based S5/S8 case. See NOTE 4.	F-TEID	0
PGW node name	C	This IE shall be included if the source MME, SGSN or AMF has the PGW FQDN.	FQDN	0
	CO	This IE shall be included by the source MME over the N26 interface. See NOTE 6.		
Bearer Contexts	C	Several IEs with this type and instance values may be included as necessary to represent a list of Bearers.	Bearer Context	0
Aggregate Maximum Bit Rate (APN-AMBR)	M		AMBR	0
Charging characteristics	C	This IE shall be present if charging characteristics was supplied by the HSS to the MME/SGSN, or by the UDM to the SMF, as a part of subscription information.	Charging characteristics	0
Change Reporting Action	C	This IE shall be included whenever available at the source MME/SGSN. See NOTE 5.	Change Reporting Action	0
CSG Information Reporting Action	CO	This IE shall be included whenever available at the source MME/SGSN.	CSG Information Reporting Action	0
H(e)NB Information Reporting	CO	This IE shall be included whenever available at the source MME/SGSN.	H(e)NB Information Reporting	0
Indication Flags	CO	<p>This IE shall be included if any of the flags are set to 1.</p> <ul style="list-style-type: none"> <li>- Change Reporting support indication flag: This flag shall be set to 1 if the Source S4-SGSN/MME supports Location Change Reporting mechanism and if the S4-SGSN/MME has indicated the support for the Location Change Reporting mechanism to the PGW, during the session establishment and/or modification procedures. See NOTE 2.</li> <li>- CSG Change Reporting Support Indication flag: This flag shall be set to 1 if the Source S4-SGSN/MME supports CSG Information Change Reporting mechanism and if the S4-SGSN/MME has indicated the support for the CSG Information Change Reporting to the PGW, during the session establishment and/or modification procedures. See NOTE 2.</li> <li>- Delay Tolerant Connection Indication flag: This flag shall be set to 1 on the S3/S10/S16 interface by the source MME/SGSN if the PGW indicated that this PDN Connection is delay tolerant.</li> <li>- Extended PCO Support Indication flag: This flag shall be set to 1 on S10/N26 interface by the source MME if the UE and the source MME support Extended PCO. It shall be set to 1 on the N26 interface during a 5GS to EPS handover.</li> <li>- NO 5GS N26 mobility Indication flag: This flag shall be set to 1 on S10 interface if the PDN connection cannot be moved to 5GS via N26.</li> </ul>	Indication	0
Signalling Priority Indication	CO	The source SGSN/MME shall include this IE if the UE indicated low access priority when establishing the PDN connection.	Signalling Priority Indication	0
Change to Report Flags	CO	This IE shall be included by the SGSN if any one of the applicable flags is set to 1. See NOTE3. Applicable flags:	Change to Report Flags	0

		<ul style="list-style-type: none"> <li>- Serving Network Change to Report: This flag shall be set to 1 if the source SGSN has detected a Serving Network change during a RAU procedure without SGSN change but has not yet reported this change to the PGW.</li> <li>- Time Zone Change to Report: This flag shall be set to 1 if the source SGSN has detected a UE Time Zone change during a RAU procedure without SGSN change but has not yet reported this change to the PGW.</li> </ul>		
Local Home Network ID	CO	This IE shall be sent over the S3/S10/S16 interface if SIPTO at the Local Network is active for the PDN connection in the SIPTO at the Local Network architecture with stand-alone GW.	FQDN	1
Presence Reporting Area Action	CO	<p>This IE shall be included if the PGW requested the source MME/SGSN to report changes of UE presence in a Presence Reporting Area. The source MME/SGSN shall include the Presence Reporting Area Identifier and, if received from the PGW, the list of the Presence Reporting Area elements.</p> <p>Several IEs with the same type and instance value may be included as necessary to represent a list of Presence Reporting Area Actions. One IE shall be included for each Presence Reporting Area.</p>	Presence Reporting Area Action	0
WLAN Offloadability Indication	CO	If the MME/SGSN supports WLAN/3GPP Radio Interworking with RAN rules then this IE shall be included on S3/S10/S16 if the UE has been authorized to perform WLAN offload for at least one RAT.	WLAN Offloadability Indication	0
Remote UE Context Connected	CO	<p>The source MME shall include this IE on the S10 interface during an inter MME mobility procedure if such information is available.</p> <p>Several IEs with the same type and instance value may be included as necessary to represent a list of remote UEs connected.</p>	Remote UE Context	0
PDN Type	CO	The source MME/SGSN/AMF shall include this IE on the S10/S3/S16/N26 interface, for a Non-IP PDN Connection, during an inter MME/SGSN/AMF mobility procedure, if the target MME/SGSN/AMF supports SGI Non-IP or Ethernet PDN connections.	PDN Type	0
Header Compression Configuration	CO	This IE shall be sent over the S10 interface if the use of IP Header Compression for Control Plane Clot EPS optimisations has been negotiated with the UE and the target MME is known to support Clot EPS optimisations.	Header Compression Configuration	0
PGW Change Info	CO	This IE shall be sent over the S10 interface if available.	PGW Change Info	0
UP Security Policy	CO	This IE shall be sent by the old MME on the S10 interface or by the old AMF on the N26 interface if this information is available. When present, it shall indicate whether User Plane integrity protection is required, preferred or not needed for the traffic of the PDN connection.	UP Security Policy	0
<p>NOTE 1: For deferred IPv4 address allocation, if the MME/S4-SGSN receives the PDN address "0.0.0.0" from PGW during "eUTRAN Initial Attach", "PDP Context Activation", "UE requested PDN Connectivity", then the MME/S4-SGSN shall include this IPv4 address "0.0.0.0".</p> <p>NOTE 2: 3GPP TS 23.401 [3] (e.g. clause 5.3.2.1) and 3GPP TS 23.060 [35] (e.g. clause 9.2.2.1) defines the MME/SGSN shall send the MS Info Change Reporting Support Indication to the PGW. In such case MME/SGSN shall use the Change Reporting Support Indication and/or CSG Change Reporting Support Indication (whichever is applicable), even if stage 2 refers to MS Info Change Reporting Support Indication.</p> <p>NOTE 3: When UE is camping on the 3G and performs a Service Request procedure, as specified in the clause 6.12.1 of 3GPP TS 23.060 [35], if Service Type indicates Signalling, the signalling connection is established between the MS and the SGSN for sending upper-layer signalling messages, e.g. Activate PDP Context Request, but the resources for active PDP context(s) are not allocated, therefore the change of Serving Network or UE Time zone may not be reported to SGW/PGW for the existing PDP Contexts.</p>				

- NOTE 4: For PMIP based S5/S8, the 'PGW S5/S8 IP Address and TEID for user plane' IE and the 'PGW S5/S8 IP Address for Control Plane or PMIP' IE shall contain the same uplink GRE key; the Interface Type in these IEs shall be set to the value 9 (S5/S8 PGW PMIPv6 interface).
- NOTE 5: The target MME (respectively S4-SGSN) shall ignore this IE if it is received from an S4-SGSN (respectively an MME), i.e. over the S3 interface. In this case, the target serving node shall consider that no ULI change reporting is requested by the PGW for the target RAT, and the PGW shall request the target serving node to start ULI change reporting for the target RAT if so desired.
- NOTE 6: The PGW Node Name is used by the target AMF in the NF Service Discovery procedure to find the combined PGW-C/SMF for the PDU Session during an MME to AMF mobility procedure.

The Bearer Context grouped IE shall be coded as depicted in Table 7.3.1-3.



**Table 7.3.1-3: Bearer Context within MME/SGSN/AMF UE EPS PDN Connections within Forward Relocation Request**

Octet 1	Bearer Context IE Type = 93 (decimal)			
Octets 2 and 3	Length = n			
Octet 4	Spare and Instance fields			
Information elements	P	Condition / Comment	IE Type	Ins.
EPS Bearer ID	M	See NOTE 3.	EBI	0
TFT	C	This IE shall be present if a TFT is defined for this bearer.	Bearer TFT	0
SGW S1/S4/S12 IP Address and TEID for user plane	M	This IE shall contain the SGW S1/S4/S12 IP Address and TEID for user plane.  Over the N26 interface, the SMF (on behalf of the source AMF) shall set the IP address and TEID to the following values: <ul style="list-style-type: none"> <li>- any reserved TEID (e.g. all 0's, or all 1's);</li> <li>- IPv4 address set to 0.0.0.0, or IPv6 Prefix Length and IPv6 prefix and Interface Identifier all set to zero.</li> </ul> See NOTE2, NOTE 4.	F-TEID	0
PGW S5/S8 IP Address and TEID for user plane	C	This IE shall be present for GTP based S5/S8.	F-TEID	1
	CO	For PMIP-based S5/S8, this IE shall be included if the PGW provided an alternate address for user plane, i.e. an IP address for user plane which is different from the IP address for control plane. When present, this IE shall contain the alternate IP address for user plane and the uplink GRE key. See NOTE 1.		
Bearer Level QoS	M		Bearer QoS	0
BSS Container	CO	The MME/S4 SGSN shall include the Packet Flow ID, Radio Priority, SAPI, PS Handover XID parameters in the TAU/RAU/Handover procedure, if available. See Figure 8.48-2. The Container Type shall be set to 2.	F-Container	0
Transaction Identifier	C	This IE shall be sent over S3/S10/S16 if the UE supports A/Gb and/or lu mode. This IE should be sent over N26 if the MME has a TI stored that is linked with this EPS Bearer ID, or, the SMF provides the TI to the AMF (as part of a procedure to deliver SM context to AMF).	TI	0
Bearer Flags	CO	Applicable flags: <ul style="list-style-type: none"> <li>- vSRVCC indicator: This IE shall be sent by the source MME to the target MME on the S10 interface if vSRVCC indicator is available in the source MME.</li> <li>- ASI (Activity Status Indicator): the source S4-SGSN shall set this indicator to 1 on the S16 interface if the bearer context is preserved in the CN without an associated RAB.</li> </ul>	Bearer Flags	0
SGW S11 IP Address and TEID for user plane	CO	This IE shall be present if available. See NOTE 2.	F-TEID	2

NOTE 1: For PMIP based S5/S8, the 'PGW S5/S8 IP Address and TEID for user plane' IE and the 'PGW S5/S8 IP Address for Control Plane or PMIP' IE shall contain the same uplink GRE key; the Interface Type in these IEs shall be set to the value 9 (S5/S8 PGW PMIPv6 interface).

NOTE 2: When separate IP address spaces are used for S1-U and S11-U, the MMEs shall include both S1-U SGW F-TEID in the SGW S1/S4/S12/S11 IP Address and TEID for user plane IE and S11-U SGW F-TEID in SGW S11 IP Address and TEID for user plane, when they are available; otherwise, the source MME shall include the SGW S1/S4/S12/S11 IP Address and TEID for user plane IE, since S1-U and S11-U SGW F-TEID are the same.

NOTE 3: The support of the 15 EPS Bearers shall be homogeneously supported within an MME Pool / SGW serving area. A source MME which supports the 15 EPS Bearers, shall know whether the target MME pool also supports that by local configuration. When the target MME is known to not support the 15 EPS Bearers, the source MME shall only transfer up to 8 EPS bearer contexts with the EBI value set between '5' and '15' to the target MME and shall delete EPS bearer(s) which are not transferred, and if the default bearer is to be deleted, the corresponding PDN connection(s) shall be deleted by the source MME.

NOTE 4: During 5GS to EPS mobility procedures with N26 interface, the source AMF shall transparently transfer the MME/SGSN/AMF UE EPS PDN Connections IE received from the SMF as specified in clause 6.1.6.2.27 of 3GPP TS 29.502[88].

**Table 7.3.1-4: Remote UE Context Connected within MME/SGSN UE EPS PDN Connections within Forward Relocation Request**

Octets 1	Remote UE Context IE Type = 191 (decimal)			
Octets 2 and 3	Length = n			
Octets 4	Spare and Instance fields			
Information elements	P	Condition / Comment	IE Type	Ins.
Remote User ID	M	See clause 8.123 for the description and use of this parameter	Remote User ID	0
Remote UE IP Information	M	See clause 8.124 for the description and use of this parameter	Remote UE IP Information	0

**Table 7.3.1-5: MME UE SCEF PDN Connections within Forward Relocation Request**

Octets 1	SCEF PDN Connection IE Type = 195 (decimal)			
Octets 2 and 3	Length = n			
Octets 4	Spare and Instance fields			
Information elements	P	Condition / Comment	IE Type	Ins.
APN	M		APN	0
Default EPS Bearer ID	M	This IE shall identify the default bearer of the SCEF PDN Connection.	EBI	0
SCEF ID	M	This IE shall include the SCEF Identifier and the SCEF Realm for the APN.	Node Identifier	0

**Table 7.3.1-6: Subscribed V2X Information within Forward Relocation Request**

Octets 1	V2X Context IE Type = 208 (decimal)			
Octets 2 and 3	Length = n			
Octets 4	Spare and Instance fields			
Information elements	P	Condition / Comment	IE Type	Ins.
LTE V2X Services Authorized	C	This IE shall be included to indicate the authorization status of the UE to use the LTE sidelink for V2X services.	Services Authorized	0
NR V2X Services Authorized	C	This IE shall be included to indicate the authorization status of the UE to use the NR sidelink for V2X services.	Services Authorized	1
LTE UE Sidelink Aggregate Maximum Bit Rate	C	This IE shall be included if the UE is authorized for LTE V2X services.	Bit Rate	0
NR UE Sidelink Aggregate Maximum Bit Rate	C	This IE shall be included if the UE is authorized for NR V2X services.	Bit Rate	1
PC5 QoS Parameters	C	This IE shall be included if the UE is authorized for NR V2X services.	PC5 QoS Parameters	0

**Table 7.3.1-7: PC5 QoS Parameters within Forward Relocation Request**

Octets 1	PC5 QoS Parameters IE Type = 209 (decimal)			
Octets 2 and 3	Length = n			
Octets 4	Spare and Instance fields			
Information elements	P	Condition / Comment	IE Type	Ins.
PC5 QoS Flows	M	Several IEs with this type and same instance value may be included as necessary to represent a list of PC5 QoS Flows.	PC5 QoS Flow	0
PC5 Link Aggregated Bit Rates	O	This IE may be included for the non-GBR PC5 QoS Flows.	Bit Rate	0

**Table 7.3.1-8: PGW Change Info with Forward Relocation Request**

Information elements	P	Condition / Comment	IE Type	Ins.
PGW Set FQDN	CO	This IE shall be included by the source MME if available.  When present, this IE shall contain the PGW Set FQDN of the PGW-C/SMF set to which the PGW-C/SMF belongs. (NOTE)	PGW FQDN	0
Alternative PGW-C/SMF IP Address	CO	This IE shall be included by the source MME if available.  When present, this IE shall contain alternative PGW-C/SMF IP addresses within the PGW-C/SMF set to which the PGW-C/SMF belongs.  Several IEs with the same type and instance value may be included to represent a list of Alternative PGW-C/SMF IP Addresses. (NOTE)	IP Address	0
Alternative PGW-C/SMF FQDN	CO	This IE shall be included by the source MME if available.  When present, this IE shall contain alternative PGW-C/SMF FQDN within the PGW-C/SMF set to which the PGW-C/SMF belongs.  Several IEs with the same type and instance value may be included to represent a list of Alternative PGW-C/SMF FQDNs. (NOTE)	PGW FQDN	1
Group Id	CO	This IE shall be included by the source MME if available.  When present, this IE shall identify the group to which the PDN connection pertains (see clause 31.6 of 3GPP TS 23.007 [17]).	Group Id	0
NOTE: Either the PGW Set FQDN IE, the Alternative PGW-C/SMF IP Address IE, or the Alternative PGW-C/SMF FQDN IE shall be present.				

## 7.3.2 Forward Relocation Response

A Forward Relocation Response message shall be sent as a response to Forward Relocation Request during S1-based handover procedure, Inter RAT handover procedures, SRNS Relocation procedure and PS handover procedures, EPS to 5GS handover and 5GS to EPS handover procedures, 5G-SRVCC from NG-RAN to UTRAN procedure.

Based on the List of Set-up Bearers IE in the Forward Relocation Response, the source MME/AMF shall determine whether the bearer contexts for SGi (IP, Non-IP or Ethernet) PDN connections were successfully transferred to the target MME/AMF.

Based on the List of Set-up Bearers for SCEF PDN Connections IE in the Forward Relocation Response, the source MME shall determine whether the bearer contexts for SCEF PDN connections were successfully transferred to the target MME, and initiate procedures to release the SCEF PDN connections which were not successfully handed over.

Table 7.3.2-1 specifies the presence requirements and conditions of the IEs in the message.

Cause IE indicates if the relocation has been accepted, or not. The relocation has not been accepted by the target MME/SGSN/AMF if the Cause IE value differs from "Request accepted". Possible Cause values are specified in Table 8.4-1. Message specific cause values are:

- "Relocation failure".

**Table 7.3.2-1: Information Elements in a Forward Relocation Response**

Information elements	P	Condition / Comment	IE Type	Ins.
----------------------	---	---------------------	---------	------

Cause	M		Cause	0
Sender's F-TEID for Control Plane	C	If the Cause IE contains the value "Request accepted", the target MME/SGSN/AMF shall include this IE in the Forward Relocation Response message.	F-TEID	0
Indication Flags	C	This IE shall be included if any of the flags are set to 1. : - SGW Change Indication: this flag shall be set to 1 if the target MME/SGSN has selected a new SGW. This flag shall be set to 1 by the target AMF during the EPS to 5GS handover using N26 interface.	Indication	0
List of Set-up Bearers	C	The list of Set-up Bearers IE shall contain the EPS bearer Identifiers of the bearers that were successfully allocated in the target system during a handover procedure. This IE shall be included if the source and target access type is EUTRAN or NG-RAN and the Cause IE contains the value "Request accepted". See NOTE 1. Several IEs with this type and instance values shall be included as necessary to represent a list of Bearers.	Bearer Context	0
List of Set-up RABs	C	The list of Set-up RABs IE shall contain the RAB Identifiers of the RABs that were successfully allocated in the target system. This IE shall be included if the Cause IE contains the value "Request accepted" and - If the source access type is UTRAN and the target access type is E-UTRAN/UTRAN, - If the source access type is E-UTRAN and the target access type is UTRAN, except over the S16 interface if the Forward Relocation Request did not include the MME/SGSN UE EPS PDN Connections IE. See NOTE 1. Several IEs with this type and instance values shall be included as necessary to represent a list of Bearers.	Bearer Context	1
List of Set-up PFCs	O	The list of Set-up PFCs IE shall contain the Packet Flow Identifiers of the PFCs that were successfully allocated in the target system during a PS handover to/from GERAN or inter RAT handover to/from GERAN. If the Cause IE contains the value "Request accepted", this IE may be included. See NOTE 1. Several IEs with this type and instance values shall be included as necessary to represent a list of Bearers.	Bearer Context	2
S1-AP Cause	C	This IE shall be included if the cause value is received in an S1-AP message or derived from the cause value received in a NGAP message. Refer to the 3GPP TS 29.010 [42] for the mapping of cause values between S1AP, RANAP, BSSGP and NGAP.	F-Cause	0
RANAP Cause	C	This IE shall be included if the cause value is received in RANAP message. Refer to the 3GPP TS 29.010 [42] for the mapping of cause values between S1AP, RANAP and BSSGP.	F-Cause	1
BSSGP Cause	C	For handover to GERAN, if a cause value is received from the Target BSC, the BSSGP Cause IE shall be included and shall be set to the cause value received from the target BSC. Refer to the 3GPP TS 29.010 [42] for the mapping of cause values between S1AP, RANAP and BSSGP.	F-Cause	2
E-UTRAN Transparent Container	C	This IE shall be included to contain the "Target to Source Transparent Container" during a handover to E-UTRAN, 5GS to EPS handover and EPS to 5GS handover. If the Cause IE contains the value "Request accepted". The Container Type shall be set to 3.	F-Container	0

UTRAN Transparent Container	C	This IE shall be included to contain the "Target to Source Transparent Container" during a handover to UTRAN. If the Cause IE contains the value "Request accepted". The Container Type shall be set to 1.	F-Container	1
BSS Container	C	This IE shall be included to contain the Target BSS to Source BSS Transparent Container during a handover to GERAN. If the Cause IE contains the value "Request accepted". The Container Type shall be set to 2	F-Container	2
MME/S4-SGSN LDN	O	This IE may be sent by the MME/S4-SGSN to the peer MME/S4-SGSN on the S3/S10/S16 interfaces (see 3GPP TS 32.423 [44]), when communicating the LDN to the peer node for the first time.	Local Distinguished Name (LDN)	0
SGSN node name	CO	This IE shall be sent by the target SGSN on the S3 interface if both target SGSN and associated SGW support ISR. See NOTE 2.	FQDN	0
MME node name	CO	This IE shall be sent by the target MME on the S3 interface if both target MME and associated SGW support ISR. See NOTE 2.	FQDN	1
SGSN Number	O	This IE may be sent by the target S4-SGSN to the source MME/S4-SGSN as specified in 3GPP TS 23.271 [56].	Node Number	0
	CO	This IE shall be included if the PMTSMI flag in the Forward Relocation Request message is set to 1.		
SGSN Identifier	O	This IE may be sent by the target S4-SGSN to the source MME/S4-SGSN as specified in 3GPP TS 23.271 [56].	Node Identifier	0
MME Identifier	O	This IE may be sent by the target MME to the source MME/S4-SGSN as specified in 3GPP TS 23.271 [56].	Node Identifier	1
MME number for MT SMS	CO	This IE shall be included on the S10/S3 interface if the PMTSMI flag in the Forward Relocation Request message is set to 1.	Node Number	1
SGSN Identifier for MT-SMS	CO	This IE shall be included on the S16/S3 interface if the target S4-SGSN supports the Gdd reference point and if the PMTSMI flag in the Forward Relocation Request message is set to 1.	Node Identifier	2
MME Identifier for MT SMS	CO	This IE shall be included on the S10/S3 interface if the target MME supports the SGd reference point and if the PMTSMI flag in the Forward Relocation Request message is set to 1.	Node Identifier	3
List of Set-up Bearers for SCEF PDN Connections	CO	This IE shall contain the EPS bearer Identifiers of the Bearers of SCEF PDN connections that were successfully allocated in the target system during a handover procedure, if any. Several IEs with this type and instance values shall be included as necessary to represent a list of Bearers.	Bearer Context	3
(v)SRVCC rejected Cause	CO	This IE shall be sent by the MME_SRVCC on the N26 interface during a 5G-SRVCC from NG-RAN to UTRAN handover, if the (v)SRVCC rejected Cause IE is received in the SRVCC PS to CS Response from the MSC Server. When present, it shall contain the same value as received from the MSC Server.	SRVCC Cause	0
MSC Number	O	This IE may be sent by the MME_SRVCC to the AMF over the N26 interface during a 5G-SRVCC from NG-RAN to UTRAN procedure. When present, it shall contain the E.164 number of the MSC Server selected by the MME_SRVCC.	Node Number	2
Private Extension	O		Private Extension	VS
NOTE 1: In the Forward Relocation Request message, the inclusion of "RAN Cause" indicates that the source access type is E-UTRAN. In the Forward Relocation Request message, the inclusion of "RANAP Cause" indicates that the source access type is UTRAN. In the Forward Relocation Request message, the inclusion of "BSSGP Cause" indicates that the source access type is GERAN.				
NOTE 2: According to the 3GPP TS 23.401 [3], during an inter-RAT handover procedure for a UE with ISR activated, the source MME/SGSN should select the ISR associated CN node for this UE as the target CN node for the inter RAT HO when the ISR associated CN node can serve the target access. This parameter is exchanged when ISR is being activated and used in the source MME/SGSN for this decision upon subsequent inter-RAT handover.				

Bearer Context IE in this message is specified in Table 7.3.2-2, the source system shall use this IE for data forwarding in handover.

**Table 7.3.2-2: Bearer Context**

Information elements	P	Condition / Comment	IE Type	Ins.
Octet 1	Bearer Context IE Type = 93 (decimal)			
Octets 2 and 3	Length = n			
Octet 4	Spare and Instance fields			
EPS Bearer ID	C	This IE shall be included if the message is used for S1-Based handover procedure, 5GS to EPS handover or EPS to 5GS handover. This IE shall be included if the message is used for SRNS relocation procedure and Inter RAT handover to/from lu mode procedures.	EBI	0
Packet Flow ID	C	This IE shall be included if the message is used for PS handover and Inter RAT handover to/from A/Gb mode procedures.	Packet Flow ID	0
eNodeB/gNodeB F-TEID for DL data forwarding	C	This IE shall be included for the message sent from the target MME, if the DL Transport Layer Address and DL GTP TEID are included in the "SAE Bearers Admitted List" of the S1AP: HANDOVER REQUEST ACKNOWLEDGE and direct forwarding or indirect forwarding without SGW change is applied. This IE shall be included during a 4G to 5G handover in the message sent from the target AMF, if the Data Forwarding Response E-RAB List IE is received in the NGAP HANDOVER REQUEST ACKNOWLEDGE and direct data forwarding applies.	F-TEID	0
eNodeB F-TEID for UL data forwarding	O	This IE may be included for the message sent from the target MME during the intra-EUTRAN HO, if the UL Transport Layer Address and UL GTP TEID are included in the "SAE Bearers Admitted List" of the S1AP: HANDOVER REQUEST ACKNOWLEDGE and direct forwarding or indirect forwarding without SGW change is applied.	F-TEID	1
SGW/UPF F-TEID for DL data forwarding	C	This IE shall be included when indirect data forwarding with SGW change is applied.	F-TEID	2
	CO	This IE shall be included when using indirect data forwarding during an EPS to 5GS handover or a 5GS to EPS handover.		
RNC F-TEID for DL data forwarding	C	This RNC F-TEID shall be included in the message sent from SGSN, if the target system decides using RNC F-TEID for data forwarding.	F-TEID	3
SGSN F-TEID for DL data forwarding	C	This SGSN F-TEID shall be included in the message sent from SGSN, if the target system decides using SGSN F-TEID for data forwarding.	F-TEID	4
SGW F-TEID for UL data forwarding	O	If available this SGW F-TEID may be included when indirect data forwarding with SGW change is applied, during the intra-EUTRAN HO.	F-TEID	5
NOTE: The Bearer Context IE for an SCEF PDN connection shall only contain the EPS Bearer ID IE.				

### 7.3.3 Forward Relocation Complete Notification

A Forward Relocation Complete Notification message shall be sent to the source MME/SGSN/AMF to indicate the handover has been successfully finished.

Table 7.3.3-1 specifies the presence requirements and conditions of the IEs in the message.



**Table 7.3.3-1: Information Elements in a Forward Relocation Complete Notification**

Information elements	P	Condition / Comment	IE Type	Ins.
Indication Flags	C	This IE shall be included if any of the flags are set to 1. <ul style="list-style-type: none"> <li>- Idle mode Signalling Reduction Activation Indication: This flag shall be set to 1 if the message is used for inter-RAT handover and the UE has ISR capability. This flag is set to indicate to the source MME/SGSN whether it shall maintain the UE's context and whether it shall activate ISR.</li> <li>- Notify Source eNB Indication: This flag shall be set to 1 if the target MME receives this indication in the Handover Notify from the target eNodeB (see clause 5.5.1.2.2a of 3GPP TS 23.401 [3]).</li> <li>- Same IWK-SCEF Selected for Monitoring Event Indication: This flag shall be set to 1 to indicate that the same IWK-SCEF is selected for Monitoring Event by the target MME/SGSN. See NOTE.</li> </ul>	Indication	0
Private Extension	O		Private Extension	VS
NOTE: If the same IWK-SCEF is selected by the target MME/SGSN, the source MME/SGSN shall not delete the Monitoring Event Configuration(s) on the IWK-SCEF.				

### 7.3.4 Forward Relocation Complete Acknowledge

A Forward Relocation Complete Acknowledge message shall be sent as a response to Forward Relocation Complete Notification.

Table 7.3.4-1 specifies the presence requirements and conditions of the IEs in the message.

Possible Cause values are specified in Table 8.4-1.

**Table 7.3.4-1: Information Elements in a Forward Relocation Complete Acknowledge**

Information elements	P	Condition / Comment	IE Type	Ins.
Cause	M		Cause	0
Recovery	O		Recovery	0
Secondary RAT Usage Data Report	CO	If the PLMN has configured secondary RAT usage reporting, the MME shall include this IE on the S10 interface if it has received Secondary RAT usage data from the eNodeB in an S1-based handover with MME relocation. Several IEs with the same type and instance value may be included, to represent multiple usage data reports.	Secondary RAT Usage Data Report	0
Secondary RAT Usage Data Report from NG-RAN	CO	This IE shall be included by a source AMF if it has received Secondary RAT Usage Report Data message from the source NG-RAN after sending a Handover Command message.  The AMF shall set the EBI field in the Secondary RAT Usage Data Report to any EBI pertaining to the same PDU session.  Several IEs with the same type and instance value may be included, to represent multiple usage data reports.	Secondary RAT Usage Data Report	1
Private Extension	O		Private Extension	VS
NOTE: The MME should be configured to know if the Secondary RAT Usage Data Report from NG-RAN should be sent to H-PLMN.				

## 7.3.5 Context Request

The new MME/SGSN shall send the Context Request message to the old MME/SGSN on S3/S16/S10 interface as a part of TAU/RAU procedure and UTRAN/GERAN to E-UTRAN/UTRAN (HSPA) SRVCC procedure to get the MM and EPS bearer Contexts for the UE.

NOTE 1: During UTRAN/GERAN to E-UTRAN/UTRAN (HSPA) SRVCC procedure as specified in 3GPP TS 23.216 [43], the GUTI, RAI IE, P-TMSI IE and P-TMSI Signature IE, are not received directly from the UE but from the MSC Server over Sv interface.

The new MME shall send the Context Request message to the old AMF on N26 interface as a part of an 5GS to EPS Idle mode Mobility using N26 interface procedure, to get the MM and EPS bearer Contexts for the UE.

The new AMF shall send the Context Request message to the old MME on N26 interface as a part of an EPS to 5GS Idle mode registration using N26 interface procedure, to get the MM and EPS bearer Contexts for the UE.

If the sending/new node is a MME, it shall include in the Context Request message:

- the GUTI IE and Complete TAU Request Message IE, if the GUTI or the indication of mapped or native GUTI received from UE indicates the old node is a MME, as specified in clause 2.8.2.2.2 and 2.10.2.1.2 of 3GPP TS 23.003 [2].
- the RAI IE and the P-TMSI IE, which are derived from the GUTI received from UE, and the P-TMSI Signature that was received intact from the UE, if the GUTI or the indication of mapped or native GUTI indicates the old node is an SGSN as specified in clause 2.8.2.2.2 of 3GPP TS 23.003 [2].

If the sending/new node is an SGSN, it shall include RAI IE, P-TMSI IE and P-TMSI Signature IE in the Context Request message. If the receiving/old node is an MME, it shall construct GUTI according to the RAI IE, P-TMSI IE and P-TMSI Signature IE (see the mapping relationship between RAI, P-TMSI, P-TMSI signature and GUTI defined in 3GPP TS 23.003 [2]), and find UE context via this GUTI.

If the sending/new node is an AMF, it shall include the GUTI IE, which is derived from the 5G-GUTI received from UE, and the Complete TAU Request Message IE in the Context Request message, if the AMF receives a mapped GUTI from the UE, that is indication that the old node is an MME, as specified in clause 2.10.2.2.2 of 3GPP TS 23.003 [2].

If the receiving/old node is an AMF, it shall construct 5G-GUTI from the GUTI IE (see the mapping relationship between GUTI and 5G-GUTI defined in 3GPP TS 23.003 [2]), and find UE context via this 5G-GUTI.

The new MME differentiates the type of the old node as specified in clause 2.8.2.2.2 of 3GPP TS 23.003 [2]. If the old node is an SGSN, the GUTI shall be mapped to RAI and P-TMSI by the new MME; if the old node is a MME, the new MME include GUTI IE and Complete TAU Request Message IE in the Context Request message. The Mapping between temporary and area identities is defined in 3GPP TS 23.003 [2].

The Target PLMN ID IE shall be used in old SGSN/MME in order to decide whether un-used authentication vectors to be distributed to new SGSN/MME/AMF or not. Distribution and use of authentication vectors between different serving network domains are specified in 3GPP TS 33.401 [12]. The AMF shall not transmit un-used authentication vectors to an MME and shall discard any un-used authentication vectors received from an MME, regardless of whether the MME and AMF pertain to the same or different serving network domains.

Table 7.3.5-1 specifies the presence requirements and conditions of the IEs in the message.

**Table 7.3.5-1: Information Elements in a Context Request**

Information elements	P	Condition / Comment	IE Type	Ins.
IMSI	C	IMSI shall be included if the UE has been successfully authenticated.	IMSI	0
GUTI	C	The new MME/AMF shall include this IE over S10/N26 interface if the IMSI is not present.	GUTI	0
	CO	This IE shall be included over S10 interface if available during UTRAN/GERAN to E-UTRAN/UTRAN (HSPA) SRVCC procedure as specified in 3GPP TS 23.216 [43].		

Routeing Area Identity(RAI)	C	This IE shall be included over S3/S16 interface, if the GUTI or the indication of mapped or native GUTI indicates the old node is an SGSN, the new MME maps this IE from GUTI.	ULI (NOTE 4)	0
	CO	This IE shall be included over S3/S16 interface if available during UTRAN/GERAN to E-UTRAN/UTRAN (HSPA) SRVCC procedure as specified in 3GPP TS 23.216 [43].		
Packet TMSI(P-TMSI)	C	This IE shall be included over S3/S16 interface if the IMSI is not present. For the S3 interface, if sent by the MME, this IE is derived by the MME from the GUTI received from the UE.	P-TMSI	0
	CO	This IE shall be included over S3/S16 interface if available during UTRAN/GERAN to E-UTRAN/UTRAN (HSPA) SRVCC procedure as specified in 3GPP TS 23.216 [43].		
P-TMSI Signature	C	This IE shall be included over S3/S16 interface if it is received from the UE and if the IMSI is not present.	P-TMSI Signature	0
	CO	This IE shall be included over S3/S16 interface if available during UTRAN/GERAN to E-UTRAN/UTRAN (HSPA) SRVCC procedure as specified in 3GPP TS 23.216 [43].		
Complete TAU request message	C	The new MME/AMF shall include this IE if available, and the old MME/AMF may use this IE for integrity check. See NOTE 3.	Complete Request Message	0
S3/S16/S10/N26 Address and TEID for Control Plane	C	This IE specifies the address and the TEID for control plane message which is chosen by the new MME/SGSN/AMF. In case of SGSN pool, the IPv4 or the IPv6 address field shall be set to the same value of the Source IP address of the IP packet carrying this message, and the relaying SGSN shall not change the content of this IE when sending it to the old SGSN. See NOTE 1.	F-TEID	0

UDP Source Port Number	C	If an SGSN within the same SGSN pool as the old SGSN receives this message, the SGSN shall include the UDP Source Port number of the received message in this parameter if this IE is not present and relay the message to the old SGSN. The old SGSN shall use this UDP port as the UDP destination port of the Context Response message.	Port Number	0
RAT Type	C	The RAT Type indicates the Radio Access Technology which is used in the new system.	RAT Type	0
Indication	CO	This IE shall be included if any one of the applicable flags is set to 1. Applicable Flags are: <ul style="list-style-type: none"> <li>- The MS Validated (MSV) flag, when set to 1, indicates that the new system has successfully authenticated the UE, or the new system has validated the integrity protection of the TAU request message. See NOTE 3.</li> <li>- The ETHPDN flag, when set to 1, indicates that the target MME supports Ethernet PDN connection.</li> </ul>	Indication	0
Hop Counter	O	If an SGSN within the same SGSN pool with the old SGSN receives this message, the SGSN shall decrement the Hop Counter if this IE is present in the received message; otherwise, the SGSN may include a Hop Counter with a value of max-1, and may relay the message to the old SGSN.	Hop Counter	0
Target PLMN ID	CO	If available, this IE shall be included in order to allow old MME/SGSN to make a judgment whether un-used authentication vectors to be distributed or not.	Serving Network	0
MME/S4-SGSN LDN	O	This IE is optionally sent by the MME/S4-SGSN to the peer MME/S4-SGSN on the S3/S10/S16 interfaces (see 3GPP TS 32.423 [44]), when communicating the LDN to the peer node for the first time.	Local Distinguished Name (LDN)	0
SGSN node name	CO	This IE shall be sent by the new SGSN on the S3 interface if both new SGSN and associated SGW support ISR. See NOTE 2.	FQDN	0
MME node name	CO	This IE shall be sent by the new MME on the S3 interface if both new MME and associated SGW support ISR. See NOTE 2.	FQDN	1
SGSN Number	O	This IE may be sent by the target S4-SGSN to the source MME/S4-SGSN as specified in 3GPP TS 23.271 [56].	Node Number	0
SGSN Identifier	O	This IE may be sent by the target S4-SGSN to the source MME/S4-SGSN as specified in 3GPP TS 23.271 [56].	Node Identifier	0
MME Identifier	O	This IE may be sent by the target MME to the source MME/S4-SGSN as specified in 3GPP TS 23.271 [56].	Node Identifier	1
CloT Optimizations Support Indication	CO	This IE shall be sent by the new MME/SGSN on the S10/S3/S16/N26 interface if it supports at least one CloT optimization. This IE shall be sent by the new AMF on the N26 interface, with the AWOPDN bit set to 1 and, if Unstructured or Ethernet PDU session types are supported, with the SGNIPDN bit set to 1.	CloT Optimizations Support Indication	0
Private Extension	O		Private Extension	VS
<p>NOTE 1: The relaying SGSN shall forward the Context Request message to the interface of the old SGSN, where the interface type is matching what is indicated in the IE S3/S16/S10 Address and TEID for Control Plane.</p> <p>NOTE 2: According to the 3GPP TS 23.401 [3], during an inter-RAT handover procedure for a UE with ISR activated, the source MME/SGSN should select the ISR associated CN node for this UE as the target CN node for the inter RAT HO when the ISR associated CN node can serve the target access. This parameter is exchanged when ISR is being activated and used in the source MME/SGSN for this decision upon subsequent inter-RAT handover.</p> <p>NOTE 3: The Complete TAU request message IE is available except during UTRAN/GERAN to E-UTRAN/UTRAN (HSPA) SRVCC procedure as specified in 3GPP TS 23.216 [43]. In these procedures, the new MME shall set the Indication IE MSV (MS Validated) flag to 1.</p> <p>NOTE 4: Only RAI field in the ULI IE type shall be present in the Routing Area Identity (RAI) IE.</p>				

## 7.3.6 Context Response

A Context Response message shall be sent as a response to a previous Context Request message, in the scenarios identified in clause 7.3.5.

Possible Cause values are specified in Table 8.4-1. Message specific cause values are:

- "IMSI/IMEI not known"
- "P-TMSI Signature mismatch"
- "User authentication failed"
- "Target access restricted for the subscriber"

Based on the subscription profile, when the access to the target RAT is prohibited for the subscriber, the old MME/SGSN/AMF may reject the Context Request message with the cause "Target access restricted for the subscriber".

When the source MME/SGSN/AMF supports one or more of the CIoT optimization features as indicated through the CIoT Optimizations Support Indication IE specified in clause 8.125, and if the target node is a MME and the target MME has not set the AWOPDN bit of the CIoT Optimizations Support Indication IE set to 1 in the Context Request message as specified in clause 8.125, the source MME/SGSN/AMF shall reject the Context Request with a cause value of "Request Rejected" under the following conditions (conditions are mutually exclusive):

- If the UE is attached to the source MME/SGSN without any PDN connection through the SGW and PGW and without any SCEF PDN connection;
- if the UE is attached to the source MME/SGSN with only the PDN connection(s) of PDN type "non-IP", through the SGW and the PGW but the UE has not activated any SCEF PDN connection and the target MME/AMF has not set the SGNIPDN bit of the CIoT Optimizations Support Indication IE set to 1 in the Context Request message as specified in clause 8.125;
- if the UE is attached to the source MME/SGSN with only the SCEF PDN connection(s) but the UE has not activated any PDN connection through the SGW and PGW and the target MME has not set the SCNIPDN bit of the CIoT Optimizations Support Indication IE set to 1 in the Context Request message as specified in clause 8.125;
- if the UE is attached to the source MME/SGSN with only PDN connection(s) of PDN type "non-IP", through the SGW and the PGW and at least one SCEF PDN connection and the target MME has neither set the SGNIPDN bit nor the SCNIPDN bit of the CIoT Optimizations Support Indication IE set to 1 in the Context Request message as specified in clause 8.125;
- if the UE is registered to the source AMF without any PDU session;
- if the UE is registered to the source AMF with only PDU session(s) of type "Unstructured" or "Ethernet", and the target MME has not set the SGNIPDN bit of the CIoT Optimizations Support Indication IE set to 1 in the Context Request message as specified in clause 8.125.

NOTE 2: Among the CIoT optimization features, only the support of SCEF Non-IP PDN connection and the support of SGi Non-IP PDN connection are applicable to a SGSN.

NOTE 3: 5GS supports Attach without PDU session. 5GS can also support Unstructured and Ethernet PDU session types, which are assimilated to "SGi Non-IP PDN connections" over N26 if Ethernet PDN connection type in EPC is not supported; otherwise, the Ethernet PDU session in 5GS can move to EPC seamlessly.

If the target node is a MME and the target MME has not set the ETHPDN bit in the Indication IE to 1 in the Context Request message as specified in clause 8.12, or the target node is a SGSN, the source MME shall reject the Context Request with a cause value of "Request Rejected" if the UE is attached to the source MME with only PDN connection(s) of PDN type "Ethernet".

Table 7.3.6-1 specifies the presence requirements and conditions of the IEs in the message.

Table 7.3.6-1: Information Elements in a Context Response

Information elements	P	Condition / Comment	IE Type	Ins.
Cause	M		Cause	0
IMSI	C	<p>The IMSI shall be included in the message except for the case:</p> <ul style="list-style-type: none"> <li>- If the UE is emergency or RLOS attached and the UE is UICCless.</li> </ul> <p>The IMSI shall be included in the message but not used as an identifier</p> <ul style="list-style-type: none"> <li>- if UE is emergency or RLOS attached but IMSI is not authenticated.</li> </ul>	IMSI	0
MME/SGSN/AMF UE MM Context	C	This IE shall be included if the Cause IE has the value "Request Accepted".	MM Context	0
MME/SGSN/AMF UE EPS PDN Connections	C	<p>This IE shall be included if there is at least a PDN connection for this UE through the SGW and PGW on the sending MME/SGSN, or if there is at least a PDU session for this UE on the sending AMF.</p> <p>If the target MME/SGSN/AMF has not set the SGNIPDN bit of the ClOT Optimizations Support Indication IE to 1 in the Context Request, then the source MME/SGSN/AMF shall only include PDN Connections of IP PDN type (if any). Several IEs with this type and instance values shall be included as necessary to represent a list of PDN Connections.</p>	PDN Connection	0
Sender F-TEID for Control Plane	C	This IE shall be included if the Cause IE has the value "Request Accepted".	F-TEID	0
SGW S11/S4 IP Address and TEID for Control Plane	C	<p>This IE shall be included if a SGW is being used by the old MME/SGSN, except if:</p> <ul style="list-style-type: none"> <li>- the source and target MME/S4-SGSN support the MME/S4-SGSN triggered SGW restoration procedure, and the source MME/S4-SGSN has not performed the SGW relocation procedure after the source SGW has failed as specified in 3GPP TS 23.007 [17].</li> <li>- across the S16 interface if there is no active PDP context</li> <li>- across the S10/N26 interface if the UE does not have any PDN connection through the SGW and PGW.</li> </ul> <p>This IE shall not be included by an old AMF.</p>	F-TEID	1
SGW node name	C	<p>This IE identifies the SGW that was used by the old MME/SGSN and it shall be included by the source MME/S4-SGSN with the following exceptions:</p> <ul style="list-style-type: none"> <li>- the source and target MME/S4-SGSN support the MME/S4-SGSN triggered SGW restoration procedure, and the source MME/S4-SGSN has not performed the SGW relocation procedure after the source SGW has failed as specified in 3GPP TS 23.007 [17].</li> <li>- across the S16 interface if there is no active PDP context</li> <li>- across the S10/N26 interface if the UE does not have any PDN connection through the SGW and PGW.</li> </ul> <p>This IE shall not be included by an old AMF.</p>	FQDN	0

Indication Flags	C	<p>This IE shall be included if any of the flags are set to 1.</p> <p>Idle mode Signalling Reduction Supported Indication:</p> <ul style="list-style-type: none"> <li>- This flag shall be set to 1 if the Cause IE value indicates "Request accepted" and the old system (including old MME/SGSN and the associated SGW) has the ISR capability.</li> </ul> <p>Unauthenticated IMSI:</p> <ul style="list-style-type: none"> <li>- This flag shall be set to 1 if the IMSI present in the message is not authenticated and is for an emergency or RLOS attached UE.</li> </ul> <p>Change Reporting support indication flag:</p> <ul style="list-style-type: none"> <li>- This flag shall be set to 1 if the Source S4-SGSN/MME supports Location Change Reporting mechanism. See NOTE 1. See NOTE 2.</li> </ul> <p>CSG Change Reporting support indication flag:</p> <ul style="list-style-type: none"> <li>- This flag shall be set to 1 if the Source S4-SGSN/MME supports CSG Information Change Reporting mechanism. See NOTE 1. See NOTE 2.</li> </ul> <p>ISRAU:</p> <ul style="list-style-type: none"> <li>- This flag shall be set to 1 on S10/S16 interface if the ISR is activated for the UE before the UE moving to the new SGSN/MME.</li> </ul> <p>Management Based MDT allowed flag:</p> <ul style="list-style-type: none"> <li>- This flag shall be set to 1 for the inter-MME TAU procedure over the S10 interface, if Management Based Minimization of Drive Tests (MDT) is allowed. See 3GPP TS 36.413 [10] and 3GPP TS 32.422 [18].</li> </ul> <p>SGW Restoration Needed Indication (SRNI):</p> <ul style="list-style-type: none"> <li>- This flag shall be set to 1 if both source and target MME/S4-SGSN support the MME/S4-SGSN triggered SGW restoration procedure and the source MME/S4-SGSN has not performed the SGW relocation procedure after the source SGW has failed as specified in 3GPP TS 23.007 [17].</li> </ul> <p>CSFB Indication (CSFBI):</p> <ul style="list-style-type: none"> <li>- when configured to support the return to the last used PLMN after CSFB, the MME shall set this flag to 1 on the S3 interface if the UE has been subject to CSFB recently (see clause 4.3.2 of 3GPP TS 23.272 [21]). See NOTE 4.</li> </ul> <p>Buffered DL Data Waiting Indication (BDWI):</p> <ul style="list-style-type: none"> <li>- This flag shall be set to 1 on the S3/S10/S16/N26 interface, during TAU/RAU with or without SGW change procedures or during Idle mode mobility between 5GS and EPS with data forwarding, when it is required to forward to the UE DL data buffered in the (old) SGW or (V-)SMF/UPF, i.e. when the DL Data Buffer Expiration Time has not expired yet in the old MME/SGSN/(V-)SMF, as specified in clause 4.3.17.7 of 3GPP TS 23.401 [3] and in clauses 4.11.1.3.2A, 4.11.1.3.3A, 4.23.12.2a and 4.23.12.3a of 3GPP TS 23.502 [83].</li> </ul> <p>Pending MT Short Message Indication (PMTSMI):</p> <ul style="list-style-type: none"> <li>- This flag shall be set to 1 on the S10/S16/S3 interface if the source S4-SGSN/MME knows that there is one (or more) pending MT Short Message(s) in the SMS-GMSC for the UE as</li> </ul>	Indication	0
------------------	---	---	------------	---

		<p>specified in clause 10.1 of 3GPP TS 23.040 [75], Figure 17c).</p> <p>LTE-M UE Indication (LTEMUI):</p> <ul style="list-style-type: none"> <li>- This flag shall be set to 1 if the MME/AMF knows that the UE is an LTE-M UE.</li> </ul> <p>Return Preferred Indication (REPREFI):</p> <ul style="list-style-type: none"> <li>- the MME or the AMF may set this flag to 1 on the N26 interface to indicate a preferred return of the UE to the last used EPS or 5GS PLMN (respectively) at a later access change to an EPS or 5GS shared network. See NOTE 4.</li> </ul>		
Trace Information	C	This IE shall be included over S10/S16/S3 when session trace is active for this IMSI/IMEI.	Trace Information	0
HRPD access node S101 IP address	C	This IE shall be included only if the HRPD pre registration was performed at the old MME	IP-Address	0
1xIWS S102 IP address	C	This IE shall be included only if the 1xRTT CS fallback pre registration was performed at the old MME	IP-Address	1
Subscribed RFSP Index	CO	This IE shall be included by the MME/SGSN/AMF, if received from the HSS or UDM.	RFSP Index	0
RFSP Index in Use	CO	This IE shall be included by the MME/SGSN/AMF, if it supports the feature.	RFSP Index	1
UE Time Zone	CO	When available, this IE shall be included by the source MME/S4-SGSN/AMF.	UE Time Zone	0
MME/S4-SGSN LDN	O	This IE is optionally sent by the MME/S4-SGSN to the peer MME/S4-SGSN on the S3/S10/S16 interfaces (see 3GPP TS 32.423 [44]), when communicating the LDN to the peer node for the first time.	Local Distinguished Name (LDN)	0
MDT Configuration	CO	This IE shall be sent by the source MME to the target MME on the S10 interface for inter-MME TAU procedure, if the Job Type indicates Immediate MDT. See 3GPP TS 32.422 [18] clause 4.4.	MDT Configuration	0
SGSN node name	CO	This IE shall be sent by the old SGSN on the S3 interface if both old SGSN and associated SGW support ISR. See NOTE 3.	FQDN	1
MME node name	CO	This IE shall be sent by the old MME on the S3 interface if both old MME and associated SGW support ISR. See NOTE 3.	FQDN	2
User CSG Information (UCI)	CO	This IE shall be sent by the source MME/S4-SGSN on the S3/S10/S16 interfaces if the source MME/SGSN has reported to the PGW that the UE is in a CSG or hybrid cell. It shall then contain the last User CSG information that the source MME/S4-SGSN has reported to the PGW. The absence of this IE indicates that the UE has not been reported to the PGW as being in a CSG or hybrid cell. See NOTE 5.	UCI	0
Monitoring Event Information	CO	This IE shall be sent by the source MME/S4-SGSN on the S3/S10/S16 interfaces if monitoring events are to be continued in the target MME/S4-SGSN. More than one IE with this type and instance values may be included to represent multiple monitoring events.	Monitoring Event Information	0
Monitoring Event Extension Information	CO	This IE shall be sent by the source MME/S4-SGSN on the S3/S10/S16 interfaces if monitoring event extensions are to be sent to the target MME/S4-SGSN. More than one IE with this type and instance values may be included to represent multiple monitoring event extensions.	Monitoring Event Extension Information	0
UE Usage Type	CO	This IE shall be set to the subscribed UE Usage Type, if received from the HSS, and sent by the old MME/SGSN on the S3/S10/S16 interfaces if the old MME/SGSN supports the Dedicated Core Networks feature specified in TS 23.401 [3]. This IE shall be set to the subscribed UE Usage Type, if received from the UDM, and sent by the old AMF on the N26 interface.	Integer Number	0



		If the UE Usage Type is not available in the old MME/SGSN/AMF, the length field of this IE shall be set to 0. See NOTE 6.		
MME/SGSN UE SCEF PDN Connections	C	This IE shall be included if there is at least one SCEF PDN connection for this UE at the source MME/SGSN and if the target MME/SGSN has set the SCNIPDN bit of the Clot Optimizations Support Indication IE to 1 in the Context Request as specified in clause 8.125. Several IEs with this type and instance values shall be included as necessary to represent a list of SCEF PDN Connections.	SCEF PDN Connection	0
RAT Type	CO	This IE shall be included by the source MME, SGSN or AMF on the S10, S16, S3 and N26 interface to indicate the old RAT type where the UE was camping. See NOTE 7.	RAT Type	0

Serving PLMN Rate Control	CO	This IE shall be included by the old MME on the S10 interface if such Serving PLMN Rate control was enabled when there is at least one SGi or SCEF PDN connection with the Control Plane Only Indication set. See NOTE 8.	Serving PLMN Rate Control	0
MO Exception Data Counter	CO	This IE shall be included on the S10 interfaces if the source MME has not yet reported a non-zero MO Exception Data Counter to the PGW. The timestamp in the counter shall be set with the time at which the counter value increased from 0 to 1.	Counter	0
Remaining Running Service Gap Timer	CO	This IE shall be included on the S10 interface if the source MME has started a Service Gap Timer which has not expired yet, as specified in clauses 5.3.3.1 and 5.3.3.2 in 3GPP TS 23.401 [3]. The value of the IE indicates the remaining time before the Service Gap Timer expires in number of seconds. See NOTE 9.	Integer Number	1
Extended Trace Information	C	This IE shall be included over N26 when session trace is active for this user.	Extended Trace Information	0
Subscribed Additional RRM Policy Index	CO	This IE shall be included by the MME over the S10 interface if received from the HSS.	Additional RRM Policy Index	0
Additional RRM Policy Index in Use	CO	This IE shall be included by the MME over the S10 interface if the feature is supported by the MME.	Additional RRM Policy Index	1
IWK SCEF ID for Monitoring Event	CO	This IE shall be included on the S3/S10 interface if the source MME/SGSN has selected the IWK-SCEF to relay Monitoring Events.	Node Identifier	0
Alternative IMSI	CO	This IE shall be included by the old MME over the S10 interface if it has stored an Alternative IMSI as specified in TS 23.401 [3] clause 5.7.2.	Alternative IMSI	0
Private Extension	O		Private Extension	VS

NOTE 1: 3GPP TS 23.401 [3] (e.g. clause 5.3.2.1) and 3GPP TS 23.060 [35] (e.g. clause 9.2.2.1) defines the MME/SGSN shall send the MS Info Change Reporting Support Indication to the PGW. In such case MME/SGSN shall use the Change Reporting Support Indication and/or CSG Change Reporting Support Indication (whichever is applicable), even if stage 2 refers to MS Info Change Reporting Support Indication.

NOTE 2: The receiver shall ignore the per UE Change Reporting Support Indication and CSG Change Reporting Support Indication flags, as included within the Indication Flags IE above, if these flags are included per PDN connection i.e. within the Indication Flags IE of the MME/SGSN UE EPS PDN Connections IE.

NOTE 3: According to the 3GPP TS 23.401 [3], during an inter-RAT handover procedure for a UE with ISR activated, the source MME/SGSN should select the ISR associated CN node for this UE as the target CN node for the inter RAT HO when the ISR associated CN node can serve the target access. This parameter is exchanged when ISR is being activated and used in the source MME/SGSN for this decision upon subsequent inter-RAT handover.

NOTE 4: If the SGSN needs to include the last used LTE PLMN ID in the Equivalent PLMN list it sends to the UE (see 3GPP TS 23.272 [21]), the SGSN shall derive the last used LTE PLMN ID from the Old RAI IE received in the RAU request message. If an MME or AMF needs to store the last used 5GS or EPS PLMN ID (respectively), the MME shall derive the last used 5GS PLMN ID from the Old GUTI received in the TAU request message, the AMF shall derive the last used EPS PLMN ID from the 5GS mobile identity received in Registration request message.

NOTE 5: In shared networks, when the message is sent from the VPLMN to the HPLMN, the PLMN ID that is communicated in this IE shall be that of the selected Core Network Operator for supporting UEs, or that of the allocated Core Network Operator for non-supporting UEs. As an exception, based on inter-operator roaming/sharing agreement, if the information on whether the UE is a supporting or non-supporting UE is available, the PLMN ID that is communicated to the HPLMN for non-supporting UEs shall be the Common PLMN ID.  
In shared networks, when the MME/S4-SGSN and PGW pertain to the same PLMN, the Primary PLMN ID shall be communicated in the ECGI to the PGW, and the Common PLMN ID shall be communicated in SAI/CGI to the PGW, for both supporting and non-supporting UEs. The Core Network Operator PLMN ID (selected by the UE for supporting UEs or allocated by the network for non-supporting UEs) shall be communicated in the TAI, RAI, UCI and the Serving Network. See clause 4.4 of 3GPP TS 23.251 [55].

NOTE 6: A UE Usage Type IE with the length field equal to 0 is used for the receiver to differentiate the case where the sender does not support the Dedicated Core Network feature from the case where the sender supports the Dedicated Core Network feature but no UE Usage type was received in UE's subscription.

NOTE 7: The old RAT shall be used by the target MME/SGSN to determine if the RAT type has changed and, if so, to decide whether to maintain or deactivate the PDN connections of the UE based on the PDN-Connection-Continuity subscription parameter and operator policy, as specified in 3GPP TS 23.401 [3] and 3GPP TS 23.060 [35]. A target MME shall consider that the RAT type has changed if the target RAT is NB-IoT and a source MME (complying with an earlier version of the specification) does not include the RAT Type IE in the Context Response.

NOTE 8: The target MME may compare the value of the Serving PLMN Rate Control received in the Context Response message with the one configured locally, to determine if such parameter needs to be updated towards the SCEF and/or PGW.

NOTE 9: If the serving MME has changed after the TAU procedure, the target MME shall start Service Gap timer and should use a value that is slightly shorter than the value received in this IE.

**Table 7.3.6-2: MME/SGSN/AMF UE EPS PDN Connections within Context Response**

Octet 1	PDN Connection IE Type = 109 (decimal)			
Octets 2 and 3	Length = n			
Octet 4	Spare and Instance fields			
<b>Information elements</b>	<b>P</b>	<b>Condition / Comment</b>	<b>IE Type</b>	<b>Ins.</b>
APN	M		APN	0
APN Restriction	C	This IE denotes the restriction on the combination of types of APN for the APN associated with this EPS bearer Context. The target MME or SGSN determines the Maximum APN Restriction using the APN Restriction. If available, the source MME/S4 SGSN shall include this IE.	APN Restriction	0
Selection Mode	CO	When available, this IE shall be included by the source MME/S4-SGSN/AMF.	Selection Mode	0
IPv4 Address	C	This IE shall not be included if no IPv4 Address is assigned. See NOTE 1. See NOTE 5.	IP Address	0

IPv6 Address	C	This IE shall not be included if no IPv6 Address is assigned. See NOTE 5.	IP Address	1
Linked EPS Bearer ID	M	This IE identifies the default bearer of the PDN Connection.	EBI	0
PGW S5/S8 IP Address for Control Plane or PMIP	M	This IE shall include the TEID in the GTP based S5/S8 case and the uplink GRE key in the PMIP based S5/S8 case. See NOTE 3.	F-TEID	0
PGW node name	C	This IE shall be included if the source MME, SGSN or AMF has the PGW FQDN.	FQDN	0
	CO	This IE shall be included by the source MME over the N26 interface. See NOTE 6.		
Bearer Contexts	M	Several IEs with this type and instance values may be included as necessary to represent a list of Bearers.	Bearer Context	0
Aggregate Maximum Bit Rate (APN-AMBR)	M		AMBR	0
Charging characteristics	C	This IE shall be present if charging characteristics was supplied by the HSS to the MME/SGSN, or by the UDM to the SMF, as a part of subscription information.	Charging characteristics	0
Change Reporting Action	C	This IE shall be included whenever available at the source MME/SGSN. See NOTE 4.	Change Reporting Action	0
CSG Information Reporting Action	CO	This IE shall be included whenever available at the source MME/SGSN.	CSG Information Reporting Action	0
H(e)NB Information Reporting	CO	This IE shall be included whenever available at the source MME/SGSN.	H(e)NB Information Reporting	0

Indication flags	CO	<p>This IE shall be included if any one of the applicable flags is set to 1.</p> <p>Applicable flags:</p> <ul style="list-style-type: none"> <li>- Subscribed QoS Change Indication: This flag shall be set to 1 if the subscribed QoS profile of the related PDN connection has changed in the old MME/SGSN when the UE is in ECM-IDLE state and ISR is activated.</li> <li>- Change Reporting support indication flag: This flag shall be set to 1 if the source S4-SGSN/MME supports Location Change Reporting mechanism and if the S4-SGSN/MME has indicated the support for the Location Change Reporting mechanism to the PGW, during the session establishment and/or modification procedures. See NOTE 2.</li> <li>- CSG Change Reporting Support Indication flag: This flag shall be set to 1 if the Source S4-SGSN/MME supports CSG Information Change Reporting mechanism and if the S4-SGSN/MME has indicated the support for the CSG Information Change Reporting to the PGW, during the session establishment and/or modification procedures. See NOTE 2.</li> <li>- Pending Subscription Change Indication flag: This flag shall be set to 1 if the source MME has received Subscribed QoS profile updates for QCI/ARP/APN-AMBR from the HSS but has deferred the reporting of these updates to the PGW/PCRF because the UE was not reachable.</li> <li>- Pending Network Initiated PDN Connection Signalling Indication flag: This flag shall be set to 1 by the source MME/SGSN if there is pending network initiated signalling for the PDN connection.</li> <li>- Delay Tolerant Connection Indication flag: This flag shall be set to 1 interface by the source MME/SGSN if the PGW indicated that this PDN Connection is delay tolerant.</li> <li>- Extended PCO Support Indication flag: This flag shall be set to 1 on S10/N26 interface by the source MME if the UE and the source MME support Extended PCO. It shall be set to 1 on the N26 interface during a 5GS to EPS Idle mode mobility.</li> <li>- Control Plane Only PDN Connection Indication: This flag shall be set to 1 if the PDN Connection is set to Control Plane Only.</li> <li>- NO 5GS N26 mobility Indication flag: This flag shall be set to 1 on S10 interface if the PDN connection cannot be moved to 5GS via N26.</li> </ul>	Indication	0
Signalling Priority Indication	CO	The source SGSN/MME shall include this IE if the UE indicated low access priority when establishing the PDN connection.	Signalling Priority Indication	0

Change to Report Flags	CO	This IE shall be included by the MME/SGSN if any one of the applicable flags is set to 1. Applicable flags: <ul style="list-style-type: none"> <li>- Serving Network Change to Report: This flag shall be set to 1 if the source MME/SGSN has detected a Serving Network change during a TAU/RAU procedure without MME/SGSN change but has not yet reported this change to the PGW.</li> <li>- Time Zone Change to Report: This flag shall be set to 1 if the source MME/SGSN has detected a UE Time Zone change during a TAU/RAU procedure without MME/SGSN change but has not yet reported this change to the PGW.</li> </ul>	Change To Report Flags	0
Local Home Network ID	CO	This IE shall be sent over the S3/S10/S16 interface if SIPTO at the Local Network is active for the PDN connection in the SIPTO at the Local Network architecture with stand-alone GW.	FQDN	1
Presence Reporting Area Action	CO	This IE shall be included if the PGW requested the source MME/SGSN to report changes of UE presence in a Presence Reporting Area. The source MME/SGSN shall include the Presence Reporting Area Identifier and, if received from the PGW, the list of the Presence Reporting Area elements.  Several IEs with the same type and instance value may be included as necessary to represent a list of Presence Reporting Area Actions. One IE shall be included for each Presence Reporting Area.	Presence Reporting Area Action	0
WLAN Offloadability Indication	CO	If the MME/SGSN supports WLAN/3GPP Radio Interworking with RAN rules then this IE shall be included on S3/S10/S16 if the UE has been authorized to perform WLAN offload for at least one RAT.	WLAN Offloadability Indication	0
Remote UE Context Connected	CO	The source MME shall include this IE on the S10 interface during an inter MME mobility procedure if such information is available. Several IEs with the same type and instance value may be included as necessary to represent a list of remote UEs connected.	Remote UE Context	0
PDN Type	CO	The source MME/SGSN/AMF shall include this IE on the S10/S3/S16/N26 interface, for a Non-IP or Ethernet PDN Connection, during an inter MME/SGSN/AMF mobility procedure if the new MME/SGSN/AMF supports non-IP or Ethernet PDN connection using SGi as indicated in the Context Request message.	PDN Type	0
Header Compression Configuration	CO	This IE shall be sent over the S10 interface if the use of IP Header Compression for Control Plane Clot EPS optimisations has been negotiated with the UE and the target MME has set the IHCSI bit of the Clot Optimizations Support Indication IE to 1 in the Context Request as specified in clause 8.125.	Header Compression Configuration	0
PGW Change Info	CO	This IE shall be sent over the S10 interface if available.	PGW Change Info	0
UP Security Policy	CO	This IE shall be sent by the old MME on the S10 interface or by the old AMF on the N26 interface if this information is available. When present, it shall indicate whether User Plane integrity protection is required, preferred or not needed for the traffic of the PDN connection.	UP Security Policy	0

- NOTE 1: For deferred IPv4 address allocation, if the MME/S4-SGSN receives the PDN address "0.0.0.0" from PGW during "eUTRAN Initial Attach", "PDP Context Activation", "UE requested PDN Connectivity", then the MME/S4-SGSN shall include this IPv4 address "0.0.0.0".
- NOTE 2: 3GPP TS 23.401 [3] (e.g. clause 5.3.2.1) and 3GPP TS 23.060 [35] (e.g. clause 9.2.2.1) defines the MME/SGSN shall send the MS Info Change Reporting Support Indication to the PGW. In such case MME/SGSN shall use the Change Reporting Support Indication and/or CSG Change Reporting Support Indication (whichever is applicable), even if stage 2 refers to MS Info Change Reporting Support Indication.
- NOTE 3: For PMIP based S5/S8, the 'PGW S5/S8 IP Address and TEID for user plane' IE and the 'PGW S5/S8 IP Address for Control Plane or PMIP' IE shall contain the same uplink GRE key; the Interface Type in these IEs shall be set to the value 9 (S5/S8 PGW PMIPv6 interface).
- NOTE 4: The target MME (respectively S4-SGSN) shall ignore this IE if it is received from an S4-SGSN (respectively an MME), i.e. over the S3 interface. In this case, the target serving node shall consider that no ULI change reporting is requested by the PGW for the target RAT, and the PGW shall request the target serving node to start ULI change reporting for the target RAT if so desired.
- NOTE 5: For Non-IP or Ethernet PDN connections, neither an IPv4 address nor an IPv6 address shall be present.
- NOTE 6: The PGW Node Name is used by the target AMF in the NF Service Discovery procedure to find the combined PGW-C/SMF for the PDU Session during an MME to AMF mobility procedure.

The Bearer Context shall be coded as depicted in Table 7.3.6-3.

**Table 7.3.6-3: Bearer Context within MME/SGSN/AMF UE EPS PDN Connections within Context Response**



Octet 1		Bearer Context IE Type = 93		
Octets 2 and 3		Length = n		
Octet 4		Sparse and Instance fields		
Information elements	P	Condition / Comment	IE Type	Ins.
EPS Bearer ID	M	See NOTE 4.	EBI	0
TFT	C	This IE shall be present if a TFT is defined for this bearer.	Bearer TFT	0
SGW S1/S4/S12/S11 IP Address and TEID for user plane	C	The IE shall be present except if: <ul style="list-style-type: none"> <li>- the source and target MME/S4-SGSN support the MME/S4-SGSN triggered SGW restoration procedure, and the source MME/S4-SGSN has not performed the SGW relocation procedure after the SGW has failed as specified in 3GPP TS 23.007 [17].</li> </ul> <p>Over the N26 interface, the SMF (on behalf of the source AMF) shall set the IP address and TEID to the following values:</p> <ul style="list-style-type: none"> <li>- any reserved TEID (e.g. all 0's, or all 1's);</li> <li>- IPv4 address set to 0.0.0.0, or IPv6 Prefix Length and IPv6 prefix and Interface Identifier all set to zero.</li> </ul> <p>See NOTE 2, NOTE3 and NOTE 5.</p>	F-TEID	0
PGW S5/S8 IP Address and TEID for user plane	C	This IE shall be included for GTP based S5/S8.	F-TEID	1
	CO	For PMIP-based S5/S8, this IE shall be included if the PGW provided an alternate address for user plane, i.e. an IP address for user plane which is different from the IP address for control plane. When present, this IE shall contain the alternate IP address for user plane and the uplink GRE key. See NOTE 1.		
Bearer Level QoS	M		Bearer QoS	0
BSS Container	CO	The MME/S4 SGSN shall include the Packet Flow ID, Radio Priority, SAPI, PS Handover XID parameters in the TAU/RAU/Handover procedure, if available. The Container Type shall be set to 2.	F-Container	0
Transaction Identifier	C	This IE shall be sent over S3/S10/S16 if the UE supports A/Gb and/or Iu mode.	TI	0
SGW S11 IP Address and TEID for user plane	CO	This IE shall be sent over S3/S10/S16 if the UE supports A/Gb and/or Iu mode. This IE should be sent over N26 if the MME has a TI stored that is linked with this EPS Bearer ID, or, the SMF provides the TI to the AMF (as part of a procedure to deliver SM context to AMF).	F-TEID	2
<p>NOTE 1: For PMIP based S5/S8, the 'PGW S5/S8 IP Address and TEID for user plane' IE and the 'PGW S5/S8 IP Address for Control Plane or PMIP' IE shall contain the same uplink GRE key; the Interface Type in these IEs shall be set to the value 9 (S5/S8 PGW PMIPv6 interface).</p> <p>NOTE 2: The MME shall set the interface type in this IE to 1, i.e. "S1-U SGW GTP-U interface", for S1-U and S11-U bearers. This is done for backwards compatibility reasons, when the target serving node does not support CloT optimizations.</p> <p>NOTE 3: When separate IP address spaces are used for S1-U and S11-U, the MME shall include both S1-U SGW F-TEID in the SGW S1/S4/S12/S11 IP Address and TEID for user plane IE and S11-U SGW F-TEID in SGW S11 IP Address and TEID for user plane, when they are available; otherwise, the source MME shall include the SGW S1/S4/S12/S11 IP Address and TEID for user plane IE, since S1-U and S11-U SGW F-TEID are the same.</p> <p>NOTE 4: The support of the 15 EPS Bearers shall be homogeneously supported within an MME Pool / SGW serving area. A source MME which supports the 15 EPS Bearers, shall know whether the target MME pool also supports that by local configuration. When the target MME is known to not support the 15 EPS Bearers, the source MME shall only transfer up to 8 EPS bearer contexts with the EBI value set between '5' and '15' to the target MME and shall delete EPS bearer(s) which are not transferred, and if the default bearer is to be deleted, the corresponding PDN connection(s) shall be deleted by the source MME.</p> <p>NOTE 5: During 5GS to EPS mobility procedures with N26 interface, the source AMF shall transparently transfer the MME/SGSN/AMF UE EPS PDN Connections IE received from the SMF as specified in clause 6.1.6.2.27 of 3GPP TS 29.502[88].</p>				

**Table 7.3.6-4: Remote UE Context Connected within MME/SGSN UE EPS PDN Connections within Context Response**

Octets 1	Remote UE Context IE Type = 191 (decimal)			
Octets 2 and 3	Length = n			
Octets 4	Spare and Instance fields			
Information elements	P	Condition / Comment	IE Type	Ins.
Remote User ID	M	See clause 8.123 for the description and use of this parameter	Remote User ID	0
Remote UE IP Information	M	See clause 8.124 for the description and use of this parameter	Remote UE IP Information	0

**Table 7.3.6-5: MME/SGSN UE SCEF PDN Connections within Context Response**

Octets 1	SCEF PDN Connection IE Type = x (decimal)			
Octets 2 and 3	Length = n			
Octets 4	Spare and Instance fields			
Information elements	P	Condition / Comment	IE Type	Ins.
APN	M		APN	0
Default EPS Bearer ID	M	This IE identifies the default bearer of the SCEF PDN Connection.	EBI	0
SCEF ID	M	This IE shall include the SCEF Identifier and the SCEF Realm for the APN.	Node Identifier	0

**Table 7.3.6-6: PGW Change Info with Context Response**

Octet 1	PGW Change Info IE Type = 214 (decimal)			
Octets 2 and 3	Length = n			
Octet 4	Spare and Instance fields			
Information elements	P	Condition / Comment	IE Type	Ins.
PGW Set FQDN	CO	This IE shall be included by the source MME if available.  When present, this IE shall contain the PGW Set FQDN of the PGW-C/SMF set to which the PGW-C/SMF belongs. (NOTE)	PGW FQDN	0
Alternative PGW-C/SMF IP Address	CO	This IE shall be included by the source MME if available.  When present, this IE shall contain alternative PGW-C/SMF IP addresses within the PGW-C/SMF set to which the PGW-C/SMF belongs.  Several IEs with the same type and instance value may be included to represent a list of Alternative PGW-C/SMF IP Addresses. (NOTE)	IP Address	0
Alternative PGW-C/SMF FQDN	CO	This IE shall be included by the source MME if available.  When present, this IE shall contain alternative PGW-C/SMF FQDN within the PGW-C/SMF set to which the PGW-C/SMF belongs.  Several IEs with the same type and instance value may be included to represent a list of Alternative PGW-C/SMF FQDNs. (NOTE)	PGW FQDN	1
Group Id	CO	This IE shall be included by the source MME if available.  When present, this IE shall identify the group to which the PDN connection pertains (see clause 31.6 of 3GPP TS 23.007 [17]).	Group Id	0
NOTE:	Either the PGW Set FQDN IE, the Alternative PGW-C/SMF IP Address IE, or the Alternative PGW-C/SMF FQDN IE shall be present.			

### 7.3.7 Context Acknowledge

A Context Acknowledge message shall be sent as a response to a previous Context Response message, only if the previous Context Response message is received with the acceptance cause.

Possible cause values are specified in Table 8.4-1. Message specific cause values are:

- "User authentication failed".
- "Relocation failure due to NAS message redirection".
- "Denied in RAT".

Upon receiving cause value other than the request was accepted, the old MME/S4-SGSN shall continue as if the Context Request was never received.

Table 7.3.7-1 specifies the presence requirements and conditions of the IEs in the message.

**Table 7.3.7-1: Information Elements in a Context Acknowledge**

Information elements	P	Condition / Comment	IE Type	Ins.
Cause	M		Cause	0
Indication flags	C	<p>This IE shall be included if any one of the applicable flags is set to 1.</p> <p>Applicable Flags are:</p> <ul style="list-style-type: none"> <li>- SGW Change Indication: This flag shall be set to 1 on the S3/S10/S16 interfaces if a new SGW has been selected. The old MME/old SGSN marks in its context that the information in the GWs and the HSS are invalid. This flag shall also be set to 1 by the new AMF/new MME during the Idle mode Mobility between 5GS and EPS using N26 interface.</li> <li>- Idle mode Signalling Reduction Activation Indication: If set to 1, this flag indicates to the old system that it shall maintain the UE's contexts. This flag shall be set to 1 on the S3 interface if the Cause IE value indicates "Request accepted" and ISR is activated as specified in 3GPP TS 23.401 [3].</li> <li>- Same IWK-SCEF Selected for Monitoring Event Indication: This flag shall be set to 1 to indicate that the same IWK-SCEF is selected for Monitoring Event by the target MME/SGSN.</li> </ul> <p>See NOTE 1, NOTE 2.</p>	Indication	0
Forwarding F-TEID	CO	<p>This IE shall be included if only one bearer context was transferred in the Context Response message and data forwarding of DL data buffered in the old SGW or (V-)SMF/UPF is required, i.e. when the BDWI flag is set in the Context Response message and</p> <ul style="list-style-type: none"> <li>- the SGW is changed, during TAU/RAU procedure with SGW change and data forwarding as specified in clause 5.3.3.1A of 3GPP TS 23.401 [3]; or</li> <li>- upon idle mode mobility between EPS and 5GS with data forwarding, as specified in clauses 4.11.1.3.2A, 4.11.1.3.3A, 4.23.12.2a and 4.23.12.3a of 3GPP TS 23.502 [83].</li> </ul> <p>The interface type of the Forwarding F-TEID should be set to either:</p> <ul style="list-style-type: none"> <li>- 23 ("SGW/UPF GTP-U interface for DL data forwarding") for indirect forwarding,</li> <li>- 0 ("S1-U eNodeB GTP-U interface") or 3 ("S12 RNC GTP-U interface"), if the eNB or RNC supports such forwarding, or</li> <li>- 15 ("S4 SGSN GTP-U interface").</li> </ul>	F-TEID	0
Bearer Contexts	CO	<p>This IE shall be included if multiple bearer contexts were transferred in the Context Response message and data forwarding of DL data buffered in the old SGW or (V-)SMF/UPF is required, i.e. when the BDWI flag is set in the Context Response message and</p> <ul style="list-style-type: none"> <li>- the SGW is changed, during TAU/RAU procedure with SGW change and data forwarding as specified in the clause 5.3.3.1A of 3GPP TS 23.401 [3]; or</li> <li>- upon idle mode mobility between EPS and 5GS, as specified in clauses 4.11.1.3.2A, 4.11.1.3.3A, 4.23.12.2a and 4.23.12.3a of 3GPP TS 23.502 [83].</li> </ul> <p>Several IEs with this type and instance value may be included as necessary to represent a list of Bearers.</p>	Bearer Context	0

SGSN Number	CO	This IE shall be included on the S16/S3 interface if the PMTSMI flag in the Context Response message is set to 1.	Node Number	0
MME number for MT SMS	CO	This IE shall be included on the S10/S3 interface if the PMTSMI flag in the Context Response message is set to 1.	Node Number	1
SGSN Identifier for MT SMS	CO	This IE shall be included on the S16/S3 interface if the target S4-SGSN supports the Gdd reference point and if the PMTSMI flag in the Context Response message is set to 1.	Node Identifier	0
MME Identifier for MT SMS	CO	This IE shall be included on the S10/S3 interface if the target MME supports the SGd reference point and if the PMTSMI flag in the Context Response message is set to 1.	Node Identifier	1
Private Extension	O		Private Extension	VS
NOTE 1: For the Indication Flags, the combination (SGW Change Indication, Idle mode signalling Activation Indication) = 1,1 shall be considered as an error if received.				
NOTE 2: If the same IWK-SCEF is selected by the target MME/SGSN, the source MME/SGSN shall not delete the Monitoring Event Configuration(s) on the IWK-SCEF.				

**Table 7.3.7-2: Bearer Context within Context Acknowledge**

Octet 1	Bearer Context IE Type = 93 (decimal)			
Octets 2 and 3	Length = n			
Octet 4	Spare and Instance fields			
Information elements	P	Condition / Comment	IE Type	Ins.
EPS Bearer ID	M		EBI	0
Forwarding F-TEID	M	The interface type of the Forwarding F-TEID should be set to either: <ul style="list-style-type: none"> <li>- 23 ("SGW/UPF GTP-U interface for DL data forwarding") for indirect forwarding,</li> <li>- 0 ("S1-U eNodeB GTP-U interface") or 3 ("S12 RNC GTP-U interface"), if the eNB or RNC supports such forwarding, or</li> <li>- 15 ("S4 SGSN GTP-U interface").</li> </ul>	F-TEID	0

### 7.3.8 Identification Request

If the UE identifies itself with temporary identity and it has changed SGSN/MME since detach in Attach procedure, the new MME/SGSN shall send an Identification Request message to the old SGSN/MME/AMF over S3, S16, S10 or N26 interface to request IMSI. A new AMF may also send an Identification Request message to the old MME over the N26 interface, during a registration procedure (see clause 4.11.5.2 of 3GPP TS 23.502 [83]).

Table 7.3.8-1 specifies the presence requirements and conditions of the IEs in the message.

If the sending/new node is an MME, it shall include in the Identification Request message:

- the GUTI IE and Complete Attach Request Message IE, if the GUTI or the indication of mapped or native GUTI received from UE indicates the old node is a MME, as specified in clause 2.8.2.2.2 of 3GPP TS 23.003 [2].
- the RAI P-TMSI, which was derived from the GUTI received from UE, and the P-TMSI Signature that was received intact from the UE, if the GUTI or the indication of mapped or native GUTI indicates the old node is an SGSN as specified in clause 2.8.2.2.2 of 3GPP TS 23.003 [2].

If the sending/new node is an SGSN, it shall include RAI IE, P-TMSI IE and P-TMSI Signature IE in the Identification Request message. If the receiving/old node is an MME, it shall construct GUTI according to the RAI IE, P-TMSI IE and P-TMSI Signature IE (see the mapping relationship between RAI, P-TMSI, P-TMSI signature and GUTI defined in 3GPP TS23.003[2]), and find UE context via this GUTI.

If the sending/new node is an AMF, it shall include the GUTI IE and Complete Attach Request Message IE in the Identification Request message. The AMF shall construct the GUTI IE from the old 5G-GUTI received from the UE (mapped from the EPS GUTI by the UE), as specified in clause 2.10.2.2.3 of 3GPP TS 23.003 [2].

The new MME differentiates the type of the old node as specified in clause 2.8.2.2.2 of 3GPP TS 23.003 [2]. If the old node is an SGSN, the GUTI shall be mapped to RAI and P-TMSI by the new MME; if the old node is a MME, the new MME include GUTI IE and Complete Attach Request Message IE in the Identification Request message. The Mapping between temporary and area identities is defined in 3GPP TS 23.003 [2].

The GUTI IE shall not coexist with any of the RAI IE, P-TMSI IE and P-TMSI Signature IE in an Identification Request message. If this occurs, the receiving node shall return a corresponding cause value in the response message.

The Target PLMN ID IE shall be used in old SGSN/MME in order to decide whether un-used authentication vectors to be distributed to new SGSN/MME or not. Distribution and use of authentication vectors between different serving network domains are specified in 3GPP TS 33.401 [12].

If the receiving/old node is an AMF, it shall construct the 5G-GUTI from the GUTI IE (see the mapping relationship between GUTI and 5G-GUTI defined in clause 2.10 of 3GPP TS 23.003 [2]), and find UE context via this 5G-GUTI.

**Table 7.3.8-1: Information Elements in an Identification Request**

Information elements	P	Condition / Comment	IE Type	Ins.
GUTI	C	The new MME/AMF shall include this IE over the S10 and N26 interfaces.	GUTI	0
Routeing Area Identity(RAI)	C	This IE shall be included over S3/S16 interface, if the GUTI or the indication of mapped or native GUTI received from the UE indicates the old node is an SGSN, the new MME maps this IE from GUTI.	ULI (NOTE 1)	0
Packet TMSI(P-TMSI)	C	This IE shall be included over S3/S16 interface. For the S3 interface, if sent by the MME, this IE is derived by the MME from the GUTI received from the UE.	P-TMSI	0
P-TMSI Signature	C	This IE shall be included over S3/S16 interface, if it is received from the UE.	P-TMSI Signature	0
Complete Attach Request Message	C	The new MME/AMF shall include this IE over the S10 and N26 interfaces, and the old MME/AMF may use this IE for integrity check.	Complete Request Message	0
Address for Control Plane	O	If an SGSN within the same SGSN pool with the old SGSN receives this message, the SGSN shall include the old IP address of the received message in this optional parameter if this IE is not present and relay the message to the old SGSN.	IP Address	0
UDP Source Port Number	C	If an SGSN within the same SGSN pool as the old SGSN receives this message, the SGSN shall include the UDP Source Port number of the received message in this parameter if this IE is not present and relay the message to the old SGSN. The old SGSN shall use this UDP port as the UDP destination port of the Identification Response message.	Port Number	0
Hop Counter	O	If an SGSN within the same SGSN pool with the old SGSN receives this message, the SGSN shall decrement the Hop Counter if this IE is present in the received message; otherwise, the SGSN may include a Hop Counter with a value of max-1, and may relay the message to the old SGSN.	Hop Counter	0
Target PLMN ID	CO	If available, this IE shall be included in order to allow old MME/SGSN/AMF to make a judgment whether un-used authentication vectors to be distributed or not.	Serving Network	0
Private Extension	O	None	Private Extension	VS

NOTE 1: Only RAI field in the ULI IE type shall be present in the Routeing Area Identity (RAI) IE.

## 7.3.9 Identification Response

The old SGSN/MME/AMF shall send an Identification Response message to the new MME/SGSN/AMF as a response to a previous Identification Request message over S3/S10/S16/N26 interface.

Table 7.3.9-1 specifies the presence requirements and conditions of the IEs in the message.

For Intra Domain Connection of RAN Nodes to Multiple CN Nodes, if an old SGSN within an SGSN pool receives an Identification Request message that contains the optional parameter Address for Control Plane, the old SGSN shall use this address as destination IP address of the Identification Response message.

Possible Cause values are specified in Table 8.4-1. Message specific cause values are:

- "P-TMSI Signature mismatch"
- "User authentication failed"

Only the Cause information element shall be included in the response if the Cause contains another value than "Request accepted".

**Table 7.3.9-1: Information Elements in an Identification Response**

Information elements	P	Condition / Comment	IE Type	Ins.
Cause	M		Cause	0
IMSI	C	This IE shall be included if the Cause contains the value "Request accepted".	IMSI	0
MME/SGSN UE MM Context	C	This IE shall be included if the integrity check or the P-TMSI signature check for the Attach Request succeeds.	MM Context	0
Trace Information	CO	This IE shall be included over S10/S16/S3 when session trace is active for this IMSI/IMEI.	Trace Information	0
UE Usage Type	CO	This IE shall be set to the subscribed UE Usage Type, if received from the HSS, and sent by the old MME/SGSN on the S3/S10/S16 interfaces if the old MME/SGSN supports the Dedicated Core Networks specified in TS 23.401 [3]. It shall also be sent by the AMF on the N26 interface, if received from the UDM. If the UE Usage Type is not available in the old MME/SGSN/AMF, the length field of this IE shall be set to 0. See NOTE 1.	Integer Number	0
Monitoring Event Information	CO	This IE shall be sent by the source MME/S4-SGSN on the S3/S10/S16 interfaces if monitoring events are to be continued in the target MME/S4-SGSN. More than one IE with this type and instance values may be included to represent multiple monitoring events.	Monitoring Event Information	0
Monitoring Event Extension Information	CO	This IE shall be sent by the source MME/S4-SGSN on the S3/S10/S16 interfaces if monitoring event extensions are to be sent to the target MME/S4-SGSN. More than one IE with this type and instance values may be included to represent multiple monitoring event extensions.	Monitoring Event Extension Information	0
Extended Trace Information	C	This IE shall be included over N26 when session trace is active for this user.	Extended Trace Information	0
Private Extension	O		Private Extension	VS
NOTE 1: A UE Usage Type IE with the length field equal to 0 is used for the receiver to differentiate the case where the sender does not support the Dedicated Core Network feature from the case where the sender supports the Dedicated Core Network feature but no UE Usage type was received in UE's subscription.				

### 7.3.10 Forward Access Context Notification

A Forward Access Context Notification message shall be sent from the Old SGSN to the New SGSN over the S16 interface to forward the RNC contexts to the target system, or sent from the Old MME to the New MME over the S10 interface to forward the RNC/eNodeB contexts to the target system.

When the old SGSN receives the RANAP message Forward SRNS Context, the old SGSN shall send a Forward Access Context Notification message to the new SGSN. The new SGSN shall forward the message to the target RNC using the corresponding RANAP message.

When the old SGSN receives a BSSGP message PS handover Required and the acknowledged peer-to-peer LLC operation is used for the Bearer Context or when "delivery order" is set in the Bearer Context QoS profile, the old



SGSN shall send a Forward Access Context Notification message with the PDU Number IE to the new SGSN. The new SGSN shall forward the message to the target RNC/ target BSS using the corresponding RANAP message only for PS handover to Iu mode.

When the old SGSN receives a BSSGP message PS handover Required from source BSS/RNC for PS handover to A/Gb mode, the value part of RAB Context IE shall be empty according to its defined minimum length.

Table 7.3.10-1 specifies the presence requirements and conditions of the IEs in the message.

**Table 7.3.10-1: Information Elements in a Forward Access Context Notification**

Information elements	P	Condition / Comment	IE Type	Ins.
RAB Contexts	C	This IE shall be included for S16 only. Several IEs with this type and instance values shall be included as necessary to represent a list of Bearers. For each RAB context in the received RANAP message, the old SGSN shall include this IE in the message.	RAB Context	0
Source RNC PDCP context Info	C	If available, the old SGSN shall include an Source RNC PDCP context info in the message.	Source RNC PDCP context Info	0
PDU Numbers	C	This IE only applies to S16. The old SGSN shall include this IE in the message if the acknowledged peer-to-peer LLC operation is used for the Bearer Context or when "delivery order" is set in the Bearer Context QoS profile in A/Gb mode to Iu/A/Gb mode PS handover.	PDU Numbers	0
E-UTRAN Transparent Container	C	This IE shall be included over S10 to contain the "eNB Status Transfer Transparent Container" as specified in 3GPP TS 36.413 [10]. Container Type shall be set to 3.	F-Container	0
E-UTRAN Transparent Container	C	This IE shall be included over S10 to contain the "eNB Early Status Transfer Transparent Container" as specified in 3GPP TS 36.413 [10]. Container Type shall be set to 3.	F-Container	1
Private Extension	O		Private Extension	VS

### 7.3.11 Forward Access Context Acknowledge

A Forward Access Context Acknowledge message shall be sent to the old MME/SGSN as a response to Forward Access Context Notification.

Possible Cause values are specified in Table 8.4-1.

Table 7.3.11-1 specifies the presence requirements and conditions of the IEs in the message.

**Table 7.3.11-1: Information Elements in a Forward Access Context Acknowledge**

Information elements	P	Condition / Comment	IE Type	Ins.
Cause	M		Cause	0
Private Extension	O		Private Extension	VS

### 7.3.12 Detach Notification

A Detach Notification message shall be sent from an MME to the associated SGSN, or from an SGSN to the associated MME as a part of Detach procedure if the ISR is activated between the MME and SGSN for the UE.

Possible Cause values are:

- "Local Detach".
- "Complete Detach".

A Detach Notification message shall also be sent from an SGSN to the associated MME as a part of Detach procedure if the ISR is activated between the MME and SGSN for the UE.

Possible Cause values are:

- "IMSI Detach only".

"Local Detach" indicates that this detach is local to the MME/SGSN and so the associated SGSN/MME registration where the ISR is activated shall not be detached. The MME/SGSN that receives this message including this Cause value of "Local Detach" only deactivates the ISR. This Cause value shall be included in the procedures:

- MME/SGSN-initiated Detach Procedure in case of implicit detach.

"Complete Detach" indicates both the MME registration and the SGSN registration that the ISR is activated for, shall be detached. This "Complete Detach" Cause value shall be included in the procedures:

- UE-initiated Detach Procedure.
- MME/SGSN-initiated Detach Procedure in case of explicit detach.

For the purpose of SGs handling, the SGSN shall include Detach Type in the Detach Notification message for "Complete Detach" when the UE is combined IMSI/EPS attached and the ISR is activated.

Possible Detach Type values are:

- "PS Detach".
- "Combined PS/CS Detach".

"PS Detach" indicates that the MME shall perform explicit IMSI detach from EPS service as specified in clause 5.4, 3GPP TS 29.118 [22]. "Combined PS/CS detach" indicates that the MME shall perform explicit IMSI detach from non-EPS service as specified in clause 5.5, 3GPP TS 29.118 [22].

"IMSI Detach only" indicates that combined IMSI/EPS attached UE initiates IMSI only GPRS detach from non-GPRS service as specified in clause 4.7.4.1, 3GPP TS 24.008 [5], and both the SGSN/MME registration shall be remained. The MME shall perform explicit IMSI detach from non-EPS service for the SGs handling purpose, which is specified in clause 5.5, 3GPP TS 29.118 [22]. This "IMSI Detach only" Cause value shall be included in the procedures:

- UE-initiated Detach Procedure for GERAN/UTRAN for "IMSI Detach only".

Table 7.3.12-1 specifies the presence of the IEs in the message.

**Table 7.3.12-1: Information Elements in a Detach Notification**

Information elements	P	Condition / Comment	IE Type	Ins.
Cause	M		Cause	0
Detach Type	CO	This IE shall be included by SGSN when the Cause indicates "Complete Detach" for the combined IMSI/EPS attached UE.	Detach Type	0
Private Extension	O		Private Extension	VS

### 7.3.13 Detach Acknowledge

A Detach Acknowledge message shall be sent as a response to a Detach Notification message during Detach procedure.

Possible Cause values are specified in Table 8.4-1.

Table 7.3.13-1 specifies the presence of the IEs in the message.

**Table 7.3.13-1: Information Elements in a Detach Acknowledge**

Information elements	P	Condition / Comment	IE Type	Ins.
Cause	M		Cause	0
Recovery	O		Recovery	0
Private Extension	O		Private Extension	VS

### 7.3.14 Change Notification Request

3GPP TS 23.401 [3] and 3GPP TS 23.060 [4] specify that if PGW has requested ECGI/eNodeB ID/TAI/CGI/SAI/RAI Change Reporting or reporting of change of UE presence in Presence Reporting Area(s) or User CSG information Change Reporting and if MME/S4-SGSN supports the feature, then MME/S4-SGSN shall send the Change Notification Request message on the S11/S4 interface to the SGW. If SGW supports the feature, the SGW forwards the message on the GTP based S5/S8 interface to the PGW as part of location dependent charging related procedures.

In this version of the specification, the sender shall set the header TEID value to that of the peer node's Control Plane TEID on S11/S4 interface or to the peer node's Control Plane TEID on S5/S8 interface. However a receiver shall be prepared to receive messages in which the header TEID value is set to zero from implementation conforming to earlier versions of this specification. When that is the case, the receiver identifies the subscriber context based on the included LBI, IMSI, and/or MEI IEs.

The MME shall increment the "MO Exception Data Counter" by one each time the MME has received the RRC cause "MO Exception data". The MME may defer sending a Change Notification Request message to report a non-zero value for the "MO Exception Data Counter" based on local configuration.

If the PLMN has configured secondary RAT usage reporting and if PDN GW Secondary RAT reporting is active, the MME shall send the Change Notification Request message and include "Secondary RAT Usage Data Report" on the S11 interface to the SGW when it has received Secondary RAT usage data from the eNodeB in the following procedures, regardless of whether ULI shall be reported or not:

- Connection Suspend
- eNodeB initiated S1 release
- E-UTRAN to UTRAN Iu mode Inter RAT handover
- E-UTRAN to GERAN A/Gb mode Inter RAT handover
- MME triggered Serving GW relocation
- MME to 3G SGSN combined hard handover and SRNS relocation
- The MME may also send the send the Change Notification Request message and include "Secondary RAT Usage Data Report" on the S11 interface to the SGW when it has received periodic reporting of Secondary RAT usage data from eNodeB or as part of an MME initiated S1 release from the eNodeB, as described in 3GPP TS 23.401 [3] clause 5.7A. The SGW shall forward the "Secondary RAT Usage Data Report" to the PGW if the IRPGW flag is set to "1".

**Table 7.3.14-1: Information Element in Change Notification Request**

Information elements	P	Condition / Comment	IE Type	Ins.
IMSI	C	The MME/SGSN shall include IMSI in the message except for the case: <ul style="list-style-type: none"> <li>- If the UE is emergency attached and the UE is UICCless.</li> </ul> The IMSI shall be included in the message but not used as an identifier <ul style="list-style-type: none"> <li>- if UE is emergency attached but IMSI is not authenticated.</li> </ul>	IMSI	0

		If the SGW receives this IE, it shall forward it to the PGW on S5/S8.		
ME Identity (MEI)	C	<p>The MME/SGSN shall include the ME Identity (MEI) IE:</p> <ul style="list-style-type: none"> <li>- If the UE is emergency attached and the UE is UICCless</li> <li>- If the UE is emergency attached and the IMSI is not authenticated</li> </ul> <p>If the SGW receives this IE, it shall forward it to the PGW on S5/S8.</p>	MEI	0
Indication Flags	CO	<p>This IE shall be included if any one of the applicable flags is set to 1.</p> <p>Applicable flags are:</p> <ul style="list-style-type: none"> <li>- Unauthenticated IMSI: This flag shall be set to 1 if the IMSI present in the message is not authenticated and is for an emergency attached UE.</li> </ul>	Indication	0

RAT Type	M	See NOTE 2.	RAT Type	0
User Location Information (ULI)	C	The SGSN shall include the User Location Information IE if the MS is located in a RAT Type of GERAN, UTRAN or GAN and shall include the CGI, SAI and/or RAI.	ULI (NOTE 1)	0
	CO	The MME shall include the User Location Information IE if the UE is located in a RAT Type of E-UTRAN and shall include the ECGI and/or TAI, or TAI and Macro eNB ID, or Macro eNB ID depending on the Change Reporting Action provided to the MME.		
	CO	If the SGW receives this IE it shall forward it to the PGW, if it supports this feature.		
User CSG Information (UCI)	CO	The SGSN/MME shall include the User CSG Information IE if the MS is located in the CSG cell or the hybrid cell and the P-GW/PCRF decides to receive the CSG Information. If the SGW receives this IE it shall forward it to the PGW, if it supports this feature.	UCI	0
PGW S5/S8 GTP-C IP Address	C	This IE shall be sent on S4.	IP Address	0
	CO	This IE shall be sent on S11.		
LBI	CO	This IE, identifying the PDN connection, shall be sent by the MME/SGSN on S11/S4. If the SGW receives this IE, it shall forward it to the PGW on S5/S8.	EBI	0
Presence Reporting Area Information	CO	The MME/SGSN shall include this IE on the S11/S4 interface if: <ul style="list-style-type: none"> <li>- the PGW/PCRF/OCS has just requested to start or modify reporting of change of UE presence in a Presence Reporting Area and the MME/SGSN supports such reporting. The MME/SGSN shall then indicate whether the UE is inside or outside the newly started or modified Presence Reporting Area(s), or indicate the Presence Reporting Area(s) is inactive. Several IEs with the same type and instance value may be included as necessary to represent a list of Presence Reporting Area Actions. One IE shall be included for each Presence Reporting Area newly started or modified.</li> <li>- if the PGW/PCRF/OCS requested to report changes of UE presence in a Presence Reporting Area, the MME/SGSN supports such reporting and the UE enters or leaves the Presence Reporting Area(s). Several IEs with the same type and instance value may be included as necessary to represent a list of Presence Reporting Area Information. One IE shall be included for each active Presence Reporting Area that the UE has newly entered or left.</li> </ul>	Presence Reporting Area Information	0
	CO	The SGW shall include this IE on S5/S8 if it receives the Presence Reporting Area Information from MME/SGSN.		
MO Exception Data Counter	CO	The MME shall include this IE on the S11 interface when it needs to send a non-zero counter value for the MO Exception Data Counter. The timestamp in the counter shall be set with the time at which the counter value increased from 0 to 1.	Counter	0
	CO	The SGW shall include this IE on S5/S8 if it receives the MO Exception Data Counter from MME.		

Secondary RAT Usage Data Report	CO	If PDN GW Secondary RAT reporting is active, the MME shall include this IE on the S11 interface if it has received Secondary RAT usage data from eNodeB in a Connection Suspend, or eNodeB initiated S1 release procedure, or an MME triggered Serving GW relocation, or an E-UTRAN to GERAN A/Gb mode Inter RAT handover, E-UTRAN to UTRAN Iu mode Inter RAT handover, MME to 3G SGSN combined hard handover and SRNS relocation, or Routing Area Update procedures. In these cases, the MME shall also set the IRSGW flag to "0" and the IRPGW flag to "1".  The MME shall also include this IE on the S11 interface when it has received Secondary RAT usage data from eNodeB, e.g. as periodic reporting or in an MME initiated S1 release procedure. In these cases, the MME shall set the IRSGW flag to "1", and if PDN GW Secondary RAT reporting is active, the IRPGW flag shall be set to "1".  Several IEs with the same type and instance value may be included, to represent multiple usage data reports.	Secondary RAT Usage Data Report	0
	O	The SGW shall forward this IE on the S5/S8 interface if it receives the Secondary RAT Usage Data Report with the IRPGW flag set to "1" from MME. Several IEs with the same type and instance value may be included, to represent multiple usage data reports.		
PSCell ID	CO	The MME shall include this IE on the S11 interface, if it has received this information from the eNodeB.	PSCell ID	0
Private Extension	O	Vendor or operator specific information	Private Extension	VS
<p>NOTE 1: In shared networks, when the message is sent from the VPLMN to the HPLMN, the PLMN ID that is communicated in this IE shall be that of the selected Core Network Operator for supporting UEs, or that of the allocated Core Network Operator for non-supporting UEs. As an exception, based on inter-operator roaming/sharing agreement, if the information on whether the UE is a supporting or non-supporting UE is available, the PLMN ID that is communicated to the HPLMN for non-supporting UEs shall be the Common PLMN ID.</p> <p>In shared networks, when the MME/S4-SGSN and PGW pertain to the same PLMN, the Primary PLMN ID shall be communicated in the ECGI to the PGW, and the Common PLMN ID shall be communicated in SAI/CGI to the PGW, for both supporting and non-supporting UEs. The Core Network Operator PLMN ID (selected by the UE for supporting UEs or allocated by the network for non-supporting UEs) shall be communicated in the TAI, RAI, UCI and the Serving Network. See clause 4.4 of 3GPP TS 23.251 [55].</p> <p>NOTE 2: The PGW may ignore RAT Type as the MME/SGSN always informs the PGW about RAT Type change with the Modify Bearer Request message.</p>				

### 7.3.15 Change Notification Response

The Change Notification Response message may be sent on the S11/S4 interface by the SGW to the MME/SGSN and is sent on the S5/S8 interface by the PGW to the SGW as part of location dependent charging related procedures to acknowledge the receipt of a Change Notification Request.

If SGW does not support the feature (see clause 7.3.14 "Change Notification Request"), SGW may silently discard Change Notification Request message from MME/SGSN. If the MME/SGSN does not receive Change Notification Response, the MME/SGSN may either send Change Notification Request to the same SGW next time UE location changes, or not (marking SGW as not supporting the feature).

The Cause value indicates whether or not the Change Notification Request was received correctly. Possible Cause values are specified in Table 8.4-1. Message specific cause values are:

- "Request accepted".
- "Request accepted partially".
- "IMSI/IMEI not known".

In this version of the specification, the sender shall set the header TEID value to that of the peer node's Control Plane TEID on S11/S4 interface or to the peer node's Control Plane TEID on S5/S8 interface. However a receiver shall be

prepared to receive messages in which the header TEID value is set to zero from implementation conforming to earlier versions of this specification. When that is the case, the receiver identifies the subscriber context based on the included LBI, IMSI, and/or MEI IEs.

If the IMSI is unknown, or the IMEI is unknown when the UE is emergency attached and UICCless or the UE is emergency attached but the IMSI is not authenticated for the receiving GTP-C entity, then the message shall be silently discarded and no further processing of the IEs shall continue.

If the MME/SGSN receives Change Notification Response containing a Cause value of "IMSI/IMEI not known" and CS bit set to 1, this indicates that the associated PDN connection does not exist within the PGW. The Change Reporting mechanism shall be stopped in the receiving SGSN/MME for all Bearers of the associated PDN connection. The SGSN/MME shall then initiate PDN disconnection for all of these PDN Connections.

If the PDN Connection associated of the Change Notification Request message received by the SGW does not exist within the SGW, the SGW shall return Change Notification Response with the CS bit set to 0 to the MME/SGSN. The Change Reporting mechanism shall be stopped in the receiving SGSN/MME for all Bearers of the associated PDN connection, and the MME/SGSN shall then locally delete the PDN connection and release all associated resources.

If the location Change Reporting mechanism is to be stopped or modified for this subscriber in the SGSN/MME, then the PGW shall include the Change Reporting Action IE in the message and shall set the value of the Action field appropriately.

If the MME has sent the "MO Exception Data Counter" for the RRC Cause "MO Exception data" in the Change Notification Request, the MME shall reset the counter value when receiving the Change Notification Response message.

**Table 7.3.15-1: Information Element in Change Notification Response**

Information elements	P	Condition / Comment	IE Type	Ins.
IMSI	C	The IMSI shall be included in the message if it is received in the Change Notification Request message.	IMSI	0
ME Identity (MEI)	C	The ME Identity (MEI) shall be included in the message if it is received in the Change Notification Request message.	MEI	0
Cause	M		Cause	0
Change Reporting Action	C	This IE shall be included with the appropriate Action field if the location Change Reporting mechanism is to be started or stopped for this subscriber in the SGSN/MME.	Change Reporting Action	0
CSG Information Reporting Action	CO	This IE shall be included with the appropriate Action field if the location CSG Info reporting mechanism is to be started or stopped for this subscriber in the SGSN/MME.	CSG Information Reporting Action	0
Presence Reporting Area Action	CO	This IE shall be included on the S5/S8 and S11/S4 interfaces with the appropriate Action field if reporting changes of UE presence in a Presence Routing Area is to be started, stopped or modified for this subscriber in the MME/SGSN. Several IEs with the same type and instance value may be included as necessary to represent a list of Presence Reporting Area Actions. One IE shall be included per Presence Reporting Area to be started, stopped or modified.	Presence Reporting Area Action	0
Private Extension	O		Private Extension	VS

### 7.3.16 Relocation Cancel Request

A Relocation Cancel Request message shall be sent from the source MME/SGSN/AMF to the target MME/SGSN/AMF/MME\_SRVCC on S3/S10/S16/N26 interface as part of the Inter-RAT handover Cancel procedure, S1 Based handover Cancel procedure, SRNS Relocation Cancel Procedure, EPS to 5GS handover cancel procedure, 5GS to EPS handover cancel procedure and 5G-SRVCC from NG-RAN to UTRAN handover cancel procedure. See Table 7.3.16-1 specifies the presence of the IEs in the message.

**Table 7.3.16-1: Information Elements in Relocation Cancel Request**

Information elements	P	Condition / Comment	IE Type	Ins.
IMSI	C	The IMSI shall be included in the message except for the case: <ul style="list-style-type: none"> <li>- If the UE is emergency or RLOS attached and the UE is UICCless.</li> </ul> The IMSI shall be included in the message but not used as an identifier <ul style="list-style-type: none"> <li>- if UE is emergency or RLOS attached but IMSI is not authenticated.</li> </ul>	IMSI	0
ME Identity (MEI)	C	The MME/SGSN/AMF shall include the ME Identity (MEI) IE: <ul style="list-style-type: none"> <li>- If the UE is emergency or RLOS attached and the UE is UICCless</li> <li>- If the UE is emergency or RLOS attached and the IMSI is not authenticated</li> </ul>	MEI	0
Indication Flags	CO	This IE shall be included if any one of the applicable flags is set to 1. Applicable flags are: <ul style="list-style-type: none"> <li>- Unauthenticated IMSI: This flag shall be set to 1 if the IMSI present in the message is not authenticated and is for an emergency or RLOS attached UE.</li> </ul>	Indication	0
RANAP Cause	C	This IE shall be present in the case of SRNS relocation cancel procedure. It shall contain the cause value received from the source RNC in the Relocation Cancel message received over the lu interface.	F-Cause	0
Private Extension	O		Private Extension	VS

### 7.3.17 Relocation Cancel Response

A Relocation Cancel Response message shall be sent as a response to a previous Relocation Cancel Request message (see clause 7.3.16).

Possible Cause values are specified in Table 8.4-1. Message specific cause values are:

- "IMSI/IMEI not known".

Table 7.3.17-1 specifies the presence of the IEs in the message.

**Table 7.3.17-1: Information Elements in Relocation Cancel Response**

Information elements	P	Condition / Comment	IE Type	Ins.
Cause	M		Cause	0
Private Extension	O		Private Extension	VS

### 7.3.18 Configuration Transfer Tunnel

A Configuration Transfer Tunnel message shall be used to:

- tunnel eNodeB Configuration Transfer messages from a source MME to a target MME over the S10 interface. The purpose of the eNodeB Configuration Transfer is to transfer information from an eNodeB to a target eNodeB or an en-gNB connected to a target eNB in unacknowledged mode (see 3GPP TS 36.413 [10]).
- tunnel eNodeB Configuration Transfer messages from a source MME to a target AMF, or to tunnel Uplink RAN Configuration Transfer messages from a source AMF to a target MME, over the N26 interface. This is to transfer



RAN configuration information or inter-system SON configuration information between an eNodeB and a gNB in unacknowledged mode (see 3GPP TS 36.413 [10] and 3GPP TS 38.413 [84]).

Table 7.3.18-1 specifies the presence requirements and conditions of the IEs in the message.

**Table 7.3.18-1: Information Elements in a Configuration Transfer Tunnel Message**

Information elements	P	Condition / Comment	IE Type	Ins.
E-UTRAN Transparent Container / EN-DC Container / Inter-system SON Container	M	This IE shall contain: <ul style="list-style-type: none"> <li>- the "SON Configuration Transfer" as specified in 3GPP TS 36.413 [10]. In this case, the Container Type shall be set to 3.</li> <li>or</li> <li>- the "EN-DC SON Configuration Transfer" as specified in 3GPP TS 36.413 [10]. In this case the Container Type shall be set to 5. (NOTE 1)</li> <li>or</li> <li>- the "Inter-system SON Configuration Transfer" as specified in 3GPP TS 36.413 [10] and 3GPP TS 38.413 [84]. In this case the Container Type shall be set to 6. (NOTE 2)</li> </ul>	F-Container	0
Target eNodeB ID / en-gNB ID / gNB ID	M	This IE shall contain the ID of the target eNodeB, en-gNB or gNB.  This IE shall encode a target en-gNB ID over the S10 or N26 interface during: <ul style="list-style-type: none"> <li>- a TNL address discovery request of a candidate en-gNB via the S1 interface or via inter-system signalling.</li> </ul> This IE shall encode a target eNodeB ID: <ul style="list-style-type: none"> <li>- over the S10 interface, when no EN-DC SON Configuration Transfer IE is received from the source eNB;</li> <li>- over the S10 or N26 interface, during a TNL address discovery response of a candidate en-gNB via the S1 interface or via inter-system signalling.</li> </ul> This IE shall encode a target eNodeB ID or a target gNB ID over the N26 interface when transferring Inter-system SON configuration Transfer information from a gNB to an eNodeB or from an eNodeB to a gNB respectively.  See clauses 22.3.6.2 and 22.3.6.3 of 3GPP TS 36.300 [19].	Target Identification	0
Connected Target eNodeB ID	CO	This IE shall be present during an TNL address discovery request of a candidate en-gNB via the S1 interface (see clauses 22.3.6.2 of 3GPP TS 36.300 [19]) if the source eNB provided the ID of a target eNB connected to the target en-gNB ID.	Target Identification	1
NOTE 1: An EN-DC Container shall only be sent towards MMEs known to support TNL address discovery of a candidate en-gNB via the S1 interface or via inter-system signalling (see clauses 22.3.6.2 and 22.3.6.3 of 3GPP TS 36.300 [19]).				
NOTE 2: An Inter-system SON Container shall only be sent towards MMEs and AMFs known to support transfer of Inter-system SON configuration transfer (see clause 15.5.2 of 3GPP TS 38.300 [84]).				

### 7.3.19 RAN Information Relay

The RAN Information Relay message shall be sent on S3 interface between SGSN and MME to transfer the RAN information received by an SGSN from BSS or RNS (or GERAN Iu mode) or by an MME from eNodeB. The procedures are specified in 3GPP TS 23.401 [3].

This message shall also be sent on S16 interface to transfer the RAN information between GERAN or GERAN Iu mode or UTRAN.

For handling of protocol errors the RAN Information Relay message is treated as a Response message.

Table 7.3.19-1 specifies the presence requirements and conditions of the IEs in the message.

**Table 7.3.19-1: Information Elements in a RAN Information Relay**

Information elements	P	Condition / Comment	IE Type	Ins.
BSS Container	M	All information elements from the BSSGP RIM PDU, starting from and including the BSSGP "PDU type", shall be contained within the BSS Container and forwarded to the destination MME/SGSN in the RAN Information Relay message. The Container Type shall be set to 2.	F-Container	0
RIM Routing Address	C	This IE shall be included if the RIM Routing Address information is included in the message sent from the source RAN node. This IE identifies the destination RAN node where the RAN Information needs to be relayed to. It contains: <ul style="list-style-type: none"> <li>- the destination RNC Identity when the target is GERAN Iu mode or UTRAN; or</li> <li>- the destination Cell Identity when the target is GERAN; or</li> <li>- the Target eNodeB ID when the target is E-UTRAN.</li> </ul>	Target Identification	0
Private Extension	O	None	Private Extension	VS

### 7.3.20 ISR Status Indication

A ISR Status Indication message shall be sent on the S3 interface by the MME/SGSN to the ISR associated SGSN/MME as part of the following procedures:

- the Restoration of PDN connections after an SGW failure for UEs with ISR as specified in 3GPP TS 23.007 [17];
- the HSS Based P-CSCF restoration procedure for 3GPP access (for both basic and PCO extension) as specified in 3GPP TS 23.380 [61].

Table 7.3.20-1 specifies the presence of the IEs in the message.

**Table 7.3.20-1: Information Elements in an ISR Status Indication**

Information elements	P	Condition / Comment	IE Type	Ins.
Action Indication	M	This IE shall include one of the applicable Values: - Deactivation Indication: If the value is set to 1, this indicates a request to the ISR associated MME/SGSN to deactivate ISR and remove the UE resource locally. See 3GPP TS 23.007 [17]. - Paging Indication: If the value is set to 2, this indicates a request to the ISR associated MME/SGSN to page the UE in IDLE state. See 3GPP TS 23.007 [17]. - Paging Stop Indication: If the value is set to 3, this indicates to the ISR associated MME/SGSN to stop paging the UE. See 3GPP TS 23.380 [61].	Action Indication	0
Private Extension	O		Private Extension	VS

### 7.3.21 UE Registration Query Request

The direction of this message shall be from S4-SGSN to MME (see Table 6.1-1).

This message shall be used to support CS/PS coordination for shared UTRAN and GERAN access. When an S4-SGSN receives a UE Registration Query from a RAN node, including an indication to also query MMEs, and if the UE (identified by IMSI) is not registered in the S4-SGSN, the S4-SGSN shall send a UE Registration Query Request message to all MMEs that may hold the UE's context, as specified in the clause 7.1.6 of 3GPP TS 23.251 [55].

NOTE: How the S4-SGSN determines which MMEs it will query, is based on local configuration.

Table 7.3.21-1 specifies the presence of IEs in this message.

**Table 7.3.21-1: Information Elements in UE Registration Query Request**

Information elements	P	Condition / Comment	IE Type	Ins.
IMSI	M		IMSI	0
Private Extension	O		Private Extension	VS

### 7.3.22 UE Registration Query Response

The UE Registration Query Response message shall be sent as a response to a UE Registration Query Request, to report whether the inquired UE is registered in the MME and if so, with which Core Network Operator, as specified in the clause 7.1.6 of 3GPP TS 23.251 [55].

Possible Cause values are specified in Table 8.4-1. Message specific cause values are:

- "Request accepted", to be used when the UE is registered in the MME
- "IMSI/IMEI not known", to be used when the UE is not registered in the MME.

The IMSI received in the UE Registration Query Request message shall be included in the response, to allow correlation in the SGSN.

The Selected Core Network Operator Identifier identifies the core network operator currently serving the UE, and shall be included if the inquired UE is registered in the MME.

Table 7.3.22-1 specifies the presence of IEs in this message.

**Table 7.3.22-1: Information Elements in UE Registration Query Response**

Information elements	P	Condition / Comment	IE Type	Ins.
Cause	M		Cause	0
IMSI	M		IMSI	0
Selected Core Network Operator Identifier	M		PLMN ID	0
Private Extension	O		Private Extension	VS

## 7.4 CS Fallback and SRVCC related messages

### 7.4.1 Suspend Notification

The Suspend Notification message shall be sent on the S11 interface by the MME to the SGW and on the S5/S8 interface by the SGW to the PGW as part of the 1xRTT CS fallback procedures in 3GPP TS 23.272 [21].

The Suspend Notification message shall be sent on the S3 interface by the SGSN to the MME, on the S11 interface by the MME to the SGW, and on the S5/S8 interface by the SGW to the PGW as part of the SRVCC procedures in 3GPP TS 23.216 [43] or the CS fallback from E-UTRAN access to UTRAN/GERAN CS domain access related procedures in 3GPP TS 23.272 [21].

The Suspend Notification message shall be sent on the S16 interface as per the inter-SGSN suspend procedures in 3GPP TS 23.060 [35].

The Suspend Notification message shall be sent on the S16, the S4 and the S5/S8 interfaces as part of the SRVCC from UTRAN (HSPA) to GERAN without DTM support procedure in 3GPP TS 23.216 [43].

The Suspend Notification message shall be sent on the S4 and the S5/S8 interfaces as part of the CS fallback from E-UTRAN to GERAN CS domain related procedures in 3GPP TS 23.272 [21].

After receiving a Suspend Notification message, the SGW/PGW marks all the non-GBR bearers as suspended status. The PGW should discard packets it receives for the suspended UE.

Table 7.4.1-1 specifies the presence requirements and conditions of the IEs in the message.

Table 7.4.1-1: Information Element in Suspend Notification

Information elements	P	Condition / Comment	IE Type	Ins.
IMSI	C	This IE shall be included only on the S11 interface. See NOTE 2.	IMSI	0
Routeing Area Identity(RAI)	C	This IE shall be included only on the S3 interface. See NOTE 1.	ULI (NOTE 3)	0
	CO	This IE shall be included on the S16 interface.		
Linked EPS Bearer ID (LBI)	CO	This IE shall be included on the S11/S4 interface to indicate the default bearer associated with the PDN connection.	EBI	0
Packet TMSI(P-TMSI)	C	This IE shall be included only on the S3 interface. See NOTE 1.	P-TMSI	0
	CO	This IE shall be included on the S16 interface.		
Originating Node	CO	This IE shall be sent on S11 interface, if before MME initiates a Detach procedure (a) ISR was active in the MME and (b) the MME was in EMM-Connected state (see also 8.65). This IE shall be sent on S4 interface, if before S4-SGSN initiates a Detach procedure (a) ISR was active in the SGSN and (b) the SGSN was in PMM-Connected state (see also 8.65).	Node Type	0
Address for Control Plane	CO	If an SGSN within the same SGSN pool with the old SGSN receives this message, the SGSN shall include the source IP address of the received message in this optional parameter if this IE is not present and relay the message to the old SGSN.	IP Address	0
UDP Source Port Number	CO	If an SGSN within the same SGSN pool as the old SGSN receives this message, the SGSN shall include the UDP Source Port number of the received message in this parameter if this IE is not present and relay the message to the old SGSN. The old SGSN shall use this UDP port as the UDP destination port of the Suspend Acknowledge message.	Port Number	0
Hop Counter	O	If an SGSN within the same SGSN pool with the old SGSN receives this message, the SGSN shall decrement the Hop Counter if this IE is present in the received message; otherwise, the SGSN may include a Hop Counter with a value of max-1, and may relay the message to the old SGSN.	Hop Counter	0
Sender F-TEID for Control Plane	CO	The MME/SGSN and SGW shall include this IE on the S11/S4 and S5/S8 interfaces respectively and set it to the last value sent to the peer.  If the Sender F-TEID for Control Plane is received, the receiver shall only handle the message if the Sender F-TEID for Control Plane in this message is the same as the last Sender F-TEID for Control Plane received on the given interface.	F-TEID	0
Private Extension	O		Private Extension	VS
NOTE 1: If the ISR is not active, the MME can not suspend the bearers after receiving the Suspend Notification message from the SGSN, the GUTI can not be derived from the P-TMSI and RAI pair as the P-TMSI Signature is not included in the message. The MME shall still reply the Suspend Acknowledge to the SGSN. Suspend procedure on MME, SGW and PGW are triggered by the S1 UE Context Release message sent from the eNodeB to the MME. Refer to clause 6.3 and clause 7.4 in 3GPP TS 23.272 [21] for detail.				
NOTE 2: The IMSI is present only for backward compatibility reasons since the SGW can derive the context from the TEID in the header. In scenarios where IMSI is not present (e.g. UICCless UE during an Emergency call) a dummy IMSI shall be provided.				
NOTE 3: Only RAI field in the ULI IE type shall be present in the Routeing Area Identity (RAI) IE.				

## 7.4.2 Suspend Acknowledge

The Suspend Acknowledge message shall be sent on the S11 interface by the SGW to the MME and on the S5/S8 interface by the PGW to the SGW as part of the 1xRTT CS fallback procedures in 3GPP TS 23.272 [21].

The Suspend Acknowledge message shall be sent on the S3 interface by the MME to the SGSN, on the S11 interface by the SGW to the MME and on the S5/S8 interface by the PGW to SGW as part of the SRVCC procedures in 3GPP TS 23.216 [43] or the CS fallback from E-UTRAN access to UTRAN/GERAN CS domain access related procedures in 3GPP TS 23.272 [21].

The Suspend Acknowledge message shall be sent on the S16 interface as per the inter-SGSN suspend procedures in 3GPP TS 23.060 [35].

The Suspend Acknowledge message shall be sent on the S16, the S4 and the S5/S8 interfaces as part of the SRVCC from UTRAN (HSPA) to GERAN without DTM support procedure in 3GPP TS 23.216 [43].

The Suspend Acknowledge message shall be sent on the S4 and the S5/S8 interfaces as part of the CS fallback from E-UTRAN to GERAN CS domain related procedures in 3GPP TS 23.272 [21].

Possible Cause values are specified in Table 8.4-1.

For backward compatibility, if the IMSI IE is missing in the Suspend Notification message that is received on the S11 interface, the cause value "Mandatory IE missing" shall be used.

Table 7.4.2-1 specifies the presence requirements and conditions of the IEs in the message.

**Table 7.4.2-1: Information Element in Suspend Acknowledge**

Information elements	P	Condition / Comment	IE Type	Ins.
Cause	M		Cause	0
Private Extension	O		Private Extension	VS

### 7.4.3 Resume Notification

The Resume Notification message should be sent on the S11 interface by the MME to the SGW and forwarded on the S5/S8 interface by the SGW to the PGW as part of the resume procedure returning back to E-UTRAN in the case of CS fallback or SRVCC.

The Resume Notification message should also be sent on the S4 interface by the SGSN to the SGW and forwarded on the S5/S8 interface by the SGW to the PGW as part of the resume procedure returning from SRVCC to HSPA if there is no Modify Bearer Request message sent to the SGW and PGW as specified in 3GPP TS 23.216 [43].

The SGW may also send a Resume Notification message to the PGW on the S5/S8 interface upon receipt from the MME/S4-SGSN of a (non-empty) Modify Bearer Request used as an implicit resume of the suspended bearers in the SGW and in the PGW (see 3GPP TS 23.216 [43] clauses 6.2.2.1 and 6.3.2.1, 3GPP TS 23.272 [21] clauses 6.3, 6.5 and 7.4) if the conditions of presence of the IEs in the Modify Bearer Request specified in table 7.2.7-1 do not require any IE to be sent over S5/S8 to the PGW.

**NOTE:** This is an alternative to sending over S5/S8 a Modify Bearer Request used as an implicit resume with zero IE(s), see clause 7.2.7.

After receiving a Resume Notification message or a Modify Bearer Request used as an implicit resume of the suspended bearers, the SGW/PGW clears suspended status for all the non-GBR bearers. The PGW shall forward packets it receives for the UE. If the suspended bearers are of the type S4-U GTP-U, the SGW shall forward over the S4-U interface, packets it receives for the UE, upon receipt of Resume Notification.

Table 7.4.3-1 specifies the presence requirements and conditions of the IEs in the message.

Table 7.4.3-1: Information Element in Resume Notification

Information elements	P	Condition / Comment	IE Type	Ins.
IMSI	M	See NOTE1.	IMSI	0
Linked EPS Bearer ID (LBI)	CO	This IE shall be included on the S11/S4 interface to indicate the default bearer associated with the PDN connection.	EBI	0
Originating Node	CO	This IE shall be sent on S11 interface, if before MME initiates a Detach procedure (a) ISR was active in the MME and (b) the MME was in EMM-Connected state (see also 8.65). This IE shall be sent on S4 interface, if before S4-SGSN initiates a Detach procedure (a) ISR was active in the SGSN and (b) the SGSN was in PMM-Connected state (see also 8.65).	Node Type	0
Sender F-TEID for Control Plane	CO	The MME/SGSN and SGW shall include this IE on the S11/S4 and S5/S8 interfaces respectively and set it to the last value sent to the peer  If the Sender F-TEID for Control Plane is received, the receiver shall only handle the message if the Sender F-TEID for Control Plane in this message is the same as the last Sender F-TEID for Control Plane received on the given interface.	F-TEID	0
Private Extension	O		Private Extension	VS
NOTE 1: The IMSI is present only for backward compatibility reasons since the receiver can derive the context from the TEID in the header. In scenarios where IMSI is not present (e.g. UICCless UE during an Emergency call) a dummy IMSI shall be provided.				

## 7.4.4 Resume Acknowledge

The Resume Acknowledge message should be sent on the S11 interface by the SGW to the MME and on the S5/S8 by the PGW to the SGW as part of the resume procedure returning back to E-UTRAN in the case of CS fallback or SRVCC.

The Resume Acknowledge message should also be sent on the S4 interface by the SGW to the SGSN and on the S5/S8 interface by the PGW to the SGW as part of the resume procedure returning from SRVCC to HSPA if there is no Modify Bearer Request message sent to the SGW and PGW as specified in 3GPP TS 23.216 [43].

The PGW shall also send a Resume Acknowledge message to the SGW on the S5/S8 interface as a response to a Resume Notification message sent by the SGW upon receipt from the MME/S4-SGSN of a (non-empty) Modify Bearer Request used as an implicit resume of the suspended bearers in the SGW and in the PGW (see 3GPP TS 23.216 [43] clauses 6.2.2.1 and 6.3.2.1, 3GPP TS 23.272 [21] clauses 6.3, 6.5 and 7.4) if the conditions of presence of the IEs in the Modify Bearer Request specified in table 7.2.7-1 do not require any IE to be sent to the PGW.

Possible Cause values are specified in Table 8.4-1.

Table 7.4.4-1 specifies the presence requirements and conditions of the IEs in the message.

Table 7.4.4-1: Information Element in Resume Acknowledge

Information elements	P	Condition / Comment	IE Type	Ins.
Cause	M		Cause	0
Private Extension	O		Private Extension	VS

## 7.4.5 CS Paging Indication

The CS Paging Indication shall be sent on the S3 interface by the MME to the associated SGSN when ISR is activated as part of mobile terminated CS services. The MME gets the related information from SGsAP-PAGING-REQUEST

message as specified in 3GPP TS29.118 [21]. Table 7.4.5-1 specifies the presence requirements and the conditions of the IEs in the message.

NOTE: The SS code received on the SGs interface is not transferred to the SGSN because it is not used by the SGSN.

**Table 7.4.5-1: Information Element in CS Paging Indication**

Information elements	P	Condition / Comment	IE Type	Ins.
IMSI	M		IMSI	0
VLR Name	M		FQDN	0
TMSI	O		TMSI	0
Location area identifier	O		ULI	0
Global CN-Id	O		Global CN-Id	0
Channel needed	O		Channel needed	0
eMLPP Priority	O		eMLPP Priority	0
Service Indicator	CO	This IE shall be sent if the service type for the paging is available.	Service Indicator	0
Private Extension	O		Private Extension	VS

## 7.4.6 Alert MME Notification

An Alert MME Notification message shall be sent on the S3 interface by the MME to the associated SGSN as part of an SGs Non-EPS alert procedure (see 3GPP TS 29.118 [22]) when ISR is activated, except under the conditions specified in 3GPP TS 23.272 [21], to request to receive a notification when any activity from the UE is detected.

Table 7.4.6-1 specifies the presence requirements and the conditions of the IEs in the message.

**Table 7.4.6-1: Information Element in Alert MME Notification**

Information elements	P	Condition / Comment	IE Type	Ins.
Private Extension	O		Private Extension	VS

## 7.4.7 Alert MME Acknowledge

An Alert MME Acknowledge message shall be sent as a response to an Alert MME Notification message.

Possible Cause values are specified in Table 8.4-1.

NOTE: An SGSN implemented according to an earlier version of the specification will silently discard the Alert MME Notification message. An MME which does not receive an Alert MME Acknowledge message may not send further Alert MME Notification message to this SGSN.

Table 7.4.7-1 specifies the presence requirements and the conditions of the IEs in the message.

**Table 7.4.7-1: Information Elements in Alert MME Acknowledge**

Information elements	P	Condition / Comment	IE Type	Ins.
Cause	M		Cause	0
Private Extension	O		Private Extension	VS

## 7.4.8 UE Activity Notification

A UE Activity Notification message shall be sent on the S3 interface by the SGSN to the associated MME as part of an SGs Non-EPS alert procedure (see 3GPP TS 29.118 [22]) when ISR is activated, except under the conditions specified



in 3GPP TS 23.272 [21], to indicate that activity from a UE has been detected. Table 7.4.8-1 specifies the presence requirements and the conditions of the IEs in the message.

**Table 7.4.8-1: Information Element in UE Activity Notification**

Information elements	P	Condition / Comment	IE Type	Ins.
Private Extension	O		Private Extension	VS

## 7.4.9 UE Activity Acknowledge

A UE Activity Acknowledge message shall be sent as a response to a UE Activity Notification message.

Possible Cause values are specified in Table 8.4-1.

Table 7.4.9-1 specifies the presence requirements and the conditions of the IEs in the message.

**Table 7.4.z-1: Information Elements in UE Activity Acknowledge**

Information elements	P	Condition / Comment	IE Type	Ins.
Cause	M		Cause	0
Private Extension	O		Private Extension	VS

## 7.5 Non-3GPP access related messages

### 7.5.1 Create Forwarding Tunnel Request

A Create Forwarding Tunnel Request message shall be sent by a MME to a Serving GW as a part of the MME configures resources for indirect data forwarding during active handover procedure from E-UTRAN to CDMA 2000 HRPD access.

Table 7.5.1-1 specifies the presence requirements and the conditions of the IEs in the message.

**Table 7.5.1-1: Information Elements in a Create Forwarding Tunnel Request**

Information elements	P	Condition / Comment	IE Type	Ins.
S103 PDN Data Forwarding Info	M	The MME shall include the forwarding Information for all PDN connections of the UE requesting data forwarding towards the HSGW in the message as S103 PDN Data Forwarding Info information elements. For each of those PDN Connections, an IE with the same type and instance value shall be included. The Serving GW shall forward downlink data to the HSGW via the GRE tunnel identified by the HSGW Address and HSGW GRE Key included in this information element when it receives downlink data forwarded from the eNodeB belonging to the corresponding EPS bearers of the PDN connection.	S103PDF	0
Private Extension	O		Private Extension	VS

### 7.5.2 Create Forwarding Tunnel Response

A Create Forwarding Tunnel Response message shall be sent by a Serving GW to a MME as a response to a Create Forwarding Tunnel Request message.

Table 7.5.2-1 specifies the presence requirements and the conditions of the IEs in the message.

The Cause value indicates if Data Forwarding Resources has been created in the Serving GW or not. Data Forwarding Resources have not been created in the Serving GW if the Cause differs from "Request accepted". Possible Cause values are specified in Table 8.4-1.

Only the Cause IE shall be included in the response if the Cause IE contains another value than "Request accepted".

**Table 7.5.2-1: Information Elements in a Create Forwarding Tunnel Response**

Information elements	P	Condition / Comment	IE Type	Ins.
Cause	M		Cause	0
S1-U Data Forwarding Info	C	S1-U Data Forwarding Info shall be included in the message if the Cause contains the value "Request accepted". For each EPS bearer requesting data forwarding which is included in the S103 PDN Data Forwarding Info fields of corresponding Create Forwarding Tunnel Request message, the Serving GW shall assign a Serving GW S1-U Address and Serving GW S1-U TEID pair and included it in the response message as S1-U Data Forwarding Info information element. For each of those EPS bearers, an IE with the same type and instance value shall be included. The eNodeB shall forward downlink data of the EPS bearer to the Serving GW via the GTP-U tunnel identified by the Serving GW S1-U Address and Serving GW S1-U TEID.	S1UDF	0
Private Extension	O		Private Extension	VS

## 7.6 Reliable Delivery of Signalling Messages

Retransmission requirements in the current clause do not apply to the Initial messages that do not have Triggered messages.

Reliable delivery in GTPv2 messages is accomplished by retransmission of these messages. A message shall be retransmitted if and only if a reply is expected for that message and the reply has not yet been received. There may be limits placed on the total number of retransmissions to avoid network overload.

Initial messages and their Triggered messages, as well as Triggered messages and their Triggered Reply messages are matched based on the Sequence Number and the IP address and port rules in clause 4.2 "Protocol stack". Therefore, an Initial message and its Triggered message, as well as a Triggered message and its Triggered Reply message shall have exactly the same Sequence Number value. A retransmitted GTPv2 message (an Initial or a Triggered) has the exact same GTPv2 message content, including the GTP header, UDP ports, source and destination IP addresses as the originally transmitted GTPv2 message.

For each triplet of local IP address, local UDP port and remote peer's IP address a GTP entity maintains a sending queue with signalling messages to be sent to that peer. The message at the front of the queue shall be sent with a Sequence Number, and if the message has an expected reply, it shall be held in a list until a reply is received or until the GTP entity has ceased retransmission of that message. The Sequence Number shall be unique for each outstanding Initial message sourced from the same IP/UDP endpoint. A node running GTP may have several outstanding messages waiting for replies. Not counting retransmissions, a single GTP message with an expected reply shall be answered with a single GTP reply, regardless whether it is per UE, per APN, or per bearer

A piggybacked initial message (such as a Create Bearer Request message or Modify Bearer Request message) shall contain a Sequence Number that is assigned by sending GTP entity and the message shall be held in a list until a response is received. The response message to a piggybacked initial message may arrive without piggybacking (e.g., Create Bearer Response at PGW).

The Sequence Number in the GTP header of the triggered response message shall be copied from the respective request message.

If a request message (e.g., Create Session Request) triggers piggybacking (i.e., Create Bearer Request piggybacked on Create Session Response), re-transmission of the request message shall also trigger piggybacking. A Sequence Number used for a Command message shall have the most significant bit set to 1. A Sequence Number in a message, which was triggered by a Command message, as well as respective Triggered Reply message shall have the same Sequence

Number as the Command message (i.e. shall also have the most significant bit set to 1). This setting of the most significant bit of the Sequence Number is done to avoid potential clashes between the Sequence Number selected for a Command message, and the Sequence Number selected by a GTPv2 peer for a Request message, which was not triggered by a Command message.

A Sequence Number used for a Request message, which was not triggered by a Command message shall have the most significant bit set to 0.

A timer, denoted T3-RESPONSE, shall be started when a signalling message (for which a reply is expected) is sent. A signalling message or the triggered message has probably been lost if a reply has not been received before the T3-RESPONSE timer expires.

Once the T3-RESPONSE timer expires, the message corresponding to the T3-RESPONSE timer is then retransmitted if the total number of retry attempts is less than N3-REQUESTS times. The expiry of the timer for piggybacked request messages shall result in re-transmission of the original IP/UDP packet containing both the triggered response message and the piggybacked initial message. T3-RESPONSE timer and N3-REQUESTS counter setting is implementation dependent. That is, the timers and counters may be configurable per procedure. Multileg communications (e.g. Create Session Requests and Responses) however require longer timer values and possibly a higher number of retransmission attempts compared to single leg communication.

All received GTPv2 messages with an expected reply shall be replied to and all reply messages associated with a certain message shall always include the same information. Duplicated reply messages shall be discarded by the receiver unless the reply needs a reply. A received reply message without a matching outstanding message that is waiting for a reply should be discarded.

If a GTPv2 node is not successful with the transfer of a non-Echo signalling message, e.g. a Create Bearer Request message, it shall inform the upper layer of the unsuccessful transfer so that the controlling upper entity may take the necessary measures.

NOTE: At failure of sending a GTPv2 message after retransmissions, some information included in the message may be lost, e.g. Secondary RAT data usage report.

## 7.7 Error Handling

### 7.7.0 Handling Piggybacked Messages

For piggybacked initial messages, the following general rule shall apply: the triggered response message carrying the piggybacked message shall be processed first, according to the following clauses. Subsequently, the piggybacked initial message shall be processed independently. If the processing of dedicated bearer activation message results in an error, this shall not affect the default bearer establishment. If the default bearer establishment fails, the dedicated bearer activation related message shall be discarded.

#### 7.7.1 Protocol Errors

A protocol error is defined as a message or an Information Element received from a peer entity with unknown type, or if it is unexpected, or if it has an erroneous content.

The term silently discarded is used in the following clauses to mean that the receiving GTP entity's implementation shall discard such a message without further processing, or that the receiving GTP entity discards such an IE and continues processing the message. The conditions for the receiving GTP entity to silently discard an IE are specified in the subsequent clauses.

The handling of unknown, unexpected or erroneous GTP messages and IEs shall provide for the forward compatibility of GTP. Therefore, the sending GTP entity shall be able to safely include in a message a new conditional-optional or an optional IE. Such an IE may also have a new type value. Any legacy receiving GTP entity shall, however, silently discard such an IE and continue processing the message.

If a protocol error is detected by the receiving GTP entity, it should log the event including the erroneous message and may include the error in a statistical counter.

For Request messages and Response messages without a rejection Cause value, the following applies:

- An information element with "Mandatory" in the "Presence requirement" column of a message definition shall always be present in that message.
- An information element with "Conditional" in the "Presence requirement" column of a message definition shall be sent when the conditions detailed in the "Condition / Comment" column are met.

For Response messages containing a rejection Cause value, see clause 6.1.1.

The Version Not Supported Indication message shall be considered as a Triggered message as specified in clause 4.2.5 "Messages with GTPv2 defined replies: Classification of Initial and Triggered Messages".

The receiving GTP entity shall apply the error handling specified in the subsequent clauses in decreasing priority.

If the received erroneous message is a reply to an outstanding GTP message, the GTP transaction layer shall stop retransmissions and notify the GTP application layer of the error even if the reply is silently discarded.

## 7.7.2 Different GTP Versions

If a GTPv2 entity receives a message of an unsupported GTP version, higher than GTPv2, it shall return a Version Not Supported Indication message and silently discard the received message.

If a GTPv2 entity listens to the GTPv0 port, the entity shall silently discard any received GTPv0 message.

If a GTPv2 entity does not support GTPv1 and receives a GTPv1 message, it shall silently discard the received message.

## 7.7.3 GTP Message of Invalid Length

If a GTP entity receives a message, which is too short to contain the respective GTPv2 header, the GTP-PDU shall be silently discarded.

Apart from a piggybacked GTP message or an Echo Request message, if a GTP entity receives a Request message within an IP/UDP packet of a length that is inconsistent with the value specified in the Length field of the GTP header, then the receiving GTP entity should log the error and shall send the Response message with Cause IE value set to "Invalid Length".

Apart from a piggybacked GTP message, if a GTP entity receives a Response message within an IP/UDP packet of a length that is inconsistent with the value specified in the Length field of the GTP header, then the receiving GTP entity should log the error and shall silently discard the message.

If a GTP entity receives two GTP messages (triggered response message and a piggybacked initial message) within an IP/UDP packet of a length that is inconsistent with the total length of the two concatenated messages as indicated by Length fields of the GTP headers, then the receiving GTP entity should log the error and return an appropriate Response message with Cause IE value set to "Invalid overall length of the triggered response message and a piggybacked initial message". That is:

- for a Create Session Response message together with a piggybacked Create Bearer Request message, a Create Bearer Response message should be returned with the above Cause value.
- for a Create Bearer Response message together with a piggybacked Modify Bearer Request message, a Modify Bearer Response message should be returned with the above Cause value.

## 7.7.4 Unknown GTP Message

If a GTP entity receives a message with an unknown Message Type value, it shall silently discard the message.

## 7.7.5 Unexpected GTP Message

If a GTP entity receives an unexpected initial message (see clause 4.2 "Protocol stack"), for example a known message that is sent over an interface for which the message is not defined, or a message that is sent over an interface for which the message is defined, but the direction is incorrect, then the GTP entity shall silently discard the message and shall log an error.

If a GTP entity receives an unexpected triggered message which is not a request message (see clause 4.2 "Protocol stack"), for example a message for which there is no corresponding outstanding request, it shall discard the message and may log an error.

When a GTP entity receives an unexpected triggered message, which is a request message, triggered by a command message, i.e. the MSB of the sequence number is set "1", e.g. in Create/Update/Delete Bearer Request messages, the GTP entity may continue to handle the request, e.g. to accept the Delete Bearer Request message.

NOTE: Whether to accept or reject such a message is implementation specific.

## 7.7.6 Missing Information Elements

A GTP entity shall check if all mandatory IEs are present in the received Request message. Apart from Echo Request message, if one or more mandatory information elements are missing in the received Request message, the GTP entity should log the error and shall send a Response message with Cause IE value set to "Mandatory IE missing" together with the type and instance of the missing mandatory IE.

If a GTP entity receives a Response message with Cause IE value set to "Mandatory IE missing", it shall notify its upper layer.

A GTP entity shall check if all mandatory IEs are present in the received Response message without a rejection Cause value. If one or more mandatory information elements are missing, the GTP entity shall notify the upper layer and should log the error. If a mandatory IE is missing in a Response message, which the SGW shall forward over another interface (e.g. when SGW forwards a message from PGW to MME), the SGW shall include the rejection Cause "Invalid Reply from remote peer" (see clause 8.4) in the forwarded Response message.

A GTP entity shall check if conditional information elements are present in the received Request message, if possible (i.e. if the receiving entity has sufficient information available to check if the respective conditions were met). If one or more conditional information elements are missing, a GTP entity should log the error and shall send a Response message with Cause IE value set to "Conditional IE missing" together with the type and instance of the missing conditional IE.

A GTP entity shall check if conditional information elements are present in the received Response message without a rejection Cause value, if possible (i.e. if the receiving entity has sufficient information available to check if the respective conditions were met). If one or more conditional information elements are missing, a GTP entity shall notify the upper layer and should log the error.

For Response messages containing a rejection Cause value, see clause 6.1.1.

If the Indication IE is applicable for the message as a conditional IE and if it is not present, the GTP entity shall not reject the message unless there are other reasons to reject the message.

If the Indication IE is applicable for the message as conditional IE and if it is present with the value of all the applicable flags set to "0", the GTP entity shall not reject the message unless there are other reasons to reject the message.

Absence of an optional information element shall not trigger any of the error handling processes.

## 7.7.7 Invalid Length Information Element

An information element has invalid length when the actual length of the IE is different from the value of the Length field in the IE header. Here, the actual length of the IE means the length of the content field of the received IE.

If a GTP message contains more than one information elements and one or more of them have invalid length, the receiving GTP entity can detect which of the IEs have invalid length only in the following cases:

- If the Length value in the IE header is greater than the overall length of the message;
- If the invalid length IE is the last one in the message.

Apart from Echo Request message, if a receiving GTP entity detects information element with invalid length in a Request message, it shall send an appropriate error response with Cause IE value set to "Invalid length" together with the type and instance of the offending IE.

Other Length field handling cases are specified below:

- If the received value of the Length field and the actual length of the fixed length IE are consistent, but the length is greater than that expected by the fixed number of octets, then the extra octets shall be discarded.
- If the received value of the Length field and the actual length of the fixed length IE are consistent, but the length is less than that expected by the fixed number of octets, this shall be considered an error, IE shall be discarded and if the IE was received as a Mandatory IE or a verifiable Conditional IE in a Request message, an appropriate error response with Cause IE value set to "Invalid length" together with the type and instance of the offending IE shall be returned to the sender.
- If the received value of the Length field and the actual length of the extendable length IE are consistent, but the length is greater than that expected by the fixed number of octets preceding the extended field(s), then the extra unknown octets shall be discarded.
- If the received value of the Length field and the actual length of the extendable length IE are consistent, but the length is less than the number of fixed octets defined for that IE, preceding the extended field(s), this shall be considered an error, IE shall be discarded and if the IE was received as a Mandatory IE or a verifiable Conditional IE in a Request message, an appropriate error response with Cause IE value set to "Invalid length" together with the type and instance of the offending IE shall be returned to the sender. Please refer to Table 8.1-1 for determining the number of fixed octets of an IE.

### 7.7.8 Semantically incorrect Information Element

Apart from Echo Request message, the receiver of a GTP signalling message Request including a mandatory or a verifiable conditional information element with a semantically invalid Value shall discard the request, should log the error, and shall send a response with Cause set to "Mandatory IE incorrect" together with a type and instance of the offending IE.

The receiver of a GTP signalling message Response including a mandatory or a verifiable conditional information element with a semantically invalid Value shall notify the upper layer that a message with this sequence number has been received and should log the error.

If a GTP entity receives an information element with a value which is shown as reserved, it shall treat that information element as invalid and should log the error. If the invalid IE is received in a Request, and it is a mandatory IE or a verifiable conditional IE, the GTP entity shall send a response with Cause set to "Mandatory IE incorrect" together with a type and instance of the offending IE.

The principle is: the use of reserved values invokes error handling; the use of spare values can be silently discarded and so in the case of IEs with spare values used, processing shall be continued ignoring the spare values.

The receiver of a GTP signalling message including an optional information element with a Value that is not in the range defined for this information element value shall discard this IE, but shall treat the rest of the message as if this IE was absent and continue processing. The receiver shall not check the content of an information element field that is defined as 'spare'.

All semantically incorrect optional information elements in a GTP signalling message shall be treated as not present in the message.

### 7.7.9 Unknown or unexpected Information Element

The receiver of a GTP message including an unexpected information element with known Type value, but with the instance value that is not defined for this message shall discard the IE and log an error. The receiver shall process the message.

An information element with a Type value which is defined in clause 8.1 of the present specification but whose Instance Value is not expected in the received GTP signalling message according to the grammar defined in clause 7 of the present specification shall be silently discarded (skipped) and the rest of the message processed as if this information element was not present.

**NOTE:** An Information Element in an encoded GTPv2 message or grouped IE is identified by the pair of IE Type and Instance value.

## 7.7.10 Repeated Information Elements

An Information Element is repeated if there is more than one IE with the same IE Type and Instance in the scope of the GTP message (scope of the grouped IE). Such an IE is a member in a list.

If an information element is repeated in a GTP signalling message in which repetition of the information element is not specified, only the contents of the information element appearing first shall be handled and all subsequent repetitions of the information element shall be ignored. When repetition of information elements is specified, only the contents of specified repeated information elements shall be handled and all subsequent repetitions of the information element shall be ignored.

## 7.7.11 TFT Error Handling

TFT related error handling for EUTRAN is specified in 3GPP TS 24.301 [23] and for UTRAN/GERAN in 3GPP TS 24.008 [5].

## 7.8 Path Failure

Path failure handling procedures are specified in 3GPP TS 23.007 [17].

## 7.9 Restoration and Recovery

### 7.9.0 General

Restoration and Recovery procedures are specified in 3GPP TS 23.007 [17].

### 7.9.1 Delete PDN Connection Set Request

This message may be sent on the S2a, S2b, S5, S8, or S11 interfaces as specified in 3GPP TS 23.007 [17].

**Table 7.9.1-1: Information Elements in a Delete PDN Connection Set Request**

Information elements	P	Condition / Comment	IE Type	Ins.
MME-FQ-CSID	C	This IE shall be included when a MME reports a partial fault according to the requirements in 3GPP TS 23.007 [17]. More than one FQ-CSID may appear.	FQ-CSID	0
SGW-FQ-CSID	C	This IE shall be included when a SGW reports a partial fault according to the requirements in 3GPP TS 23.007 [17]. More than one FQ-CSID may appear.	FQ-CSID	1
PGW-FQ-CSID	C	Shall be included when a PGW reports a partial fault. More than one FQ-CSID may appear	FQ-CSID	2
ePDG-FQ-CSID	C	This IE shall be included when an ePDG reports a partial fault according to the requirements in 3GPP TS 23.007 [17]. More than one FQ-CSID may appear.	FQ-CSID	3
TWAN-FQ-CSID	C	This IE shall be included when a TWAN reports a partial fault according to the requirements in 3GPP TS 23.007 [17]. More than one FQ-CSID may appear.	FQ-CSID	4
Private Extension	O	This IE may be sent on the S2a, S2b, S5, S8 and S11 interfaces.	Private Extension	VS

TEID of 0 shall be used for the Delete PDN Connection Set Request.

Only one type of FQ-CSID shall be included in each Delete PDN Connection Set Request, A mix of different types, such as SGW-FQ-CSID and PGW-FQ-CSID shall not be used. A combined node, such as a collocated PGW/SGW,

shall send separate Delete PDN Connection Set Request for the PGW role and one for the SGW role if a partial fault impacts more than one role.

## 7.9.2 Delete PDN Connection Set Response

This message is sent as a response to the Delete PDN Connection Set Request.

**Table 7.9.2: Information Elements in a Delete PDN Connection Set Response**

Information elements	P	Condition / Comment	IE Type	Ins.
Cause	M		Cause	0
Recovery	CO	This IE shall be included if contacting the peer for the first time	Recovery	0
Private Extension	O	This IE may be sent on the S2a, S2b, S5, S8 and S11 interfaces.	Private Extension	VS

TEID of 0 shall be used for the Delete PDN Connection Set Response.

The following Cause values are defined:

- "Request Accepted"
- "Request rejected"
- "System failure".
- "Mandatory IE incorrect".
- "Conditional IE missing".
- "Invalid message format".

"Request Accepted" indicates the receiving node was capable of storing a CSID value for each PDN connection for the type of node (MME, SGW, PGW, TWAN or ePDG) in the Delete PDN Connection Set Request and has marked, or will mark immediately, the PDN connections for deletion as specified in 3GPP TS 23.007 [17]. "Request Accepted" shall be returned even if there are no PDN connections that match.

"Request rejected" shall be used when the receiver of the Delete PDN Connection Set Request is not capable of storing at least one CSID value per PDN connection for the type of node (MME, SGW, PGW, TWAN or ePDG) received in the Delete PDN Connection Set Request.

The SGW shall respond to the Delete PDN Connection Set Request independently, i.e. without waiting for replies.

## 7.9.3 Update PDN Connection Set Request

The SGW shall send this message to the PGW on S5/S8 according to the requirements in TS 23.007 [17].

**Table 7.9.3-1: Information Elements in a Update PDN Connection Set Request**

Information elements	P	Condition / Comment	IE Type	Ins.
MME-FQ-CSID	C	This IE shall be included for MME relocation without SGW relocation according to the requirements in 3GPP TS 23.007 [17].	FQ-CSID	0
SGW-FQ-CSID	C	This IE shall be included for MME relocation without SGW relocation according to the requirements in 3GPP TS 23.007 [17].	FQ-CSID	1
Private Extension	O		Private Extension	VS



## 7.9.4 Update PDN Connection Set Response

This message is sent by the PGW to the SGW on S5/S8 in response to the Update PDN Connection Set Request message.

**Table 7.9.4-1: Information Elements in a Update PDN Connection Set Response**

Information elements	P	Condition / Comment	IE Type	Ins.
Cause	M		Cause	0
PGW-FQ-CSID	C	This IE shall be included for MME relocation without SGW relocation according to the requirements in 3GPP TS 23.007 [17].	FQ-CSID	0
Recovery	CO	This IE shall be included if contacting the peer for the first time	Recovery	0
Private Extension	O		Private Extension	VS

The following Cause values are defined:

- "Request accepted"
- "Request rejected"
- "System failure".
- "Mandatory IE incorrect".
- "Conditional IE missing".
- "Invalid message format".

## 7.9.5 PGW Restart Notification

The direction of this message shall be from SGW to MME/S4-SGSN (see Table 6.1-1).

If both the SGW and the MME/S4-SGSN support the PRN feature (see clause 8.83), a PGW Restart Notification shall be sent when the SGW detects that the peer PGW has restarted, and a PGW Restart Notification may be sent when the SGW detects that the peer PGW has failed and not restarted, as specified in 3GPP TS 23.007 [17].

Table 7.9.5-1 specifies the presence of IEs in this message.

**Table 7.9.5-1: Information Elements in PGW Restart Notification**

Information elements	P	Condition / Comment	IE Type	Ins.
PGW S5/S8 IP Address for Control Plane or PMIP	M		IP Address	0
SGW S11/S4 IP Address for Control Plane	M		IP Address	1
Cause	CO	The SGW shall send the Cause IE with the value "PGW not responding" if it sends the PGW Restart Notification to notify that the peer PGW has failed and not restarted.	Cause	0
Private Extension	O		Private Extension	VS

## 7.9.6 PGW Restart Notification Acknowledge

The PGW Restart Notification Acknowledge shall be sent as a response of PGW Restart Notification to indicate that the MME/S4-SGSN deletes all the relevant PDN connections as specified in 3GPP TS 23.007 [17] if the Cause IE includes an acceptance cause.

Possible Cause values are specified in Table 8.4-1.

**Table 7.9.6-1: Information Elements in PGW Restart Notification Acknowledge**

Information elements	P	Condition / Comment	IE Type	Ins.
Cause	M		Cause	0
Private Extension	O		Private Extension	VS

## 7.9.7 PGW Downlink Triggering Notification

The direction of this message shall be from PGW to SGW and from SGW to MME(s)/S4-SGSN(s).

The PGW Downlink Triggering Notification shall be sent as part of the PGW triggered SGW restoration procedure if the MME/S4-SGSN, SGW and PGW support this optional feature as specified in 3GPP TS 23.007 [17].

**Table 7.9.7-1: Information Elements in PGW Downlink Triggering Notification**

Information elements	P	Condition / Comment	IE Type	Ins.
IMSI	M		IMSI	0
MME/S4-SGSN identifier	C	This IE shall be included over S5 /S11/S4 interface as specified in 3GPP TS 23.007 [17].	IP Address	0
PGW S5 F-TEID for GTP or PMIP Control Plane (NOTE 2)	O	This IE may be included over the S5 interface. If present, it shall contain the PGW S5 F-TEID value assigned during the PDN connection establishment. (NOTE 1)	F-TEID	0
	CO	The PGW shall include this IE over the S5 interface according to the conditions specified in clauses 20.2.7.1 of 3GPP TS 23.007 [17].		
	CO	If the SGW receives this IE it shall forward the IE to the MME/S4-SGSN over the S11/S4 interface. This IE shall include the PGW S5 IP address for control plane and TEID for GTP based S5 case or the uplink GRE key for control plane in the PMIP based S5 case.		
Private Extension	O		Private Extension	VS
NOTE 1: The SGW shall set the header TEID value in the PGW Downlink Triggering Acknowledge to the PGW's Control Plane TEID if the 'PGW S5 F-TEID for GTP or PMIP Control Plane' IE is present in the PGW Downlink Triggering Notification message.				
NOTE 2: In earlier versions of this specification, the name of this IE was 'Sender F-TEID for Control Plane'. The name was changed when extending the applicability of the IE to S4/S11.				

## 7.9.8 PGW Downlink Triggering Acknowledge

The PGW Downlink Triggering Acknowledge message shall be sent as a response to a PGW Downlink Triggering Notification message if the MME/S4-SGSN, SGW and PGW support the PGW triggered SGW restoration feature as specified in 3GPP TS 23.007 [17].

Possible Cause values are specified in Table 8.4-1. Message specific cause values are:

- "Request accepted".
- "Context not found".

**Table 7.9.8-1: Information Elements in PGW Downlink Triggering Acknowledge**

Information elements	P	Condition / Comment	IE Type	Ins.
Cause	M		Cause	0
IMSI	C	This IE shall be included on S11/S4 interface if the Cause is indicating the rejection value "Context Not Found" and if the MME/S4-SGSN identifier is included in the corresponding PGW Downlink Triggering Notification message.	IMSI	0
MME/S4-SGSN identifier	C	This IE shall be included on S11/S4 interface if the Cause is indicating the rejection value "Context Not Found" and if the MME/S4-SGSN identifier is included in the corresponding PGW Downlink Triggering Notification message.	IP Address	0
Private Extension	O		Private Extension	VS

## 7.10 Fallback to GTPv1 mechanism

An EPC entity shall assume that each GTP processing node that it is about to communicate with is GTPv2 capable. Before the first GTP tunnel is setup for a given UE/node, the EPC node shall always send a version 2 (GTPv2) message to a peer node. As an exception, during an inter-SGSN handover, even if the target SGSN is GTPv2 capable, the source SGSN shall send a GTPv1 message "Forward Relocation Request" to the target SGSN if the PDP Context(s) for this UE were established to GGSN(s), or if there is no active PDP context and the source or target SGSN does not support SRNS relocation w/o PDN connection over GTPv2 (see clause 7.3.1).

A GTPv2 entity shall fallback to GTPv1 only if either a "Version Not Supported" message in GTPv1 format as specified in 3GPP TS 29.060 [4] is received from the peer node (this indicates that the peer GTP entity does not support GTPv2), or if a GTPv2 message is received with Cause value "Fallback to GTPv1".

If a GTPv1 "Version Not Supported" message is received, a GTPv2 entity may fallback to GTPv1. 3GPP TS 23.401 [3] (see annex D) and 3GPP TS 23.060 [35] specify GTP version usage during the mobility between a UTRAN/GERAN and an E-UTRAN.

A GTPv2 entity may receive a GTPv2 message with a Cause value "Fallback to GTPv1" in the following cases:

- an S4 SGSN receives the Cause code "Fallback to GTPv1" in a GTPv2 Context Response message over S16 interface. When an UE has activated a PDP context via S4 SGSN to GGSN and inter-SGSN RAU is underway, the old S4 SGSN shall include the Cause value "Fallback to GTPv1" in a GTPv2 Context Response message over S16 interface. In this case, the new S4 SGSN shall abort the ongoing GTPv2 procedure and send a GTPv1 "SGSN Context Request" message to the old S4 SGSN. The fallback to GTPv1 is performed only for this UE in the current procedure.
- an MME receives the Cause code "Fallback to GTPv1" in a GTPv2 Context Response message over the S3 interface. When an UE has active PDP context(s) via an S4 SGSN and a TAU is underway, the old S4 SGSN may include the Cause value "Fallback to GTPv1" in a GTPv2 Context Response message over the S3 interface. In this case, the MME shall abort the ongoing GTPv2 procedure and should send a GTPv1 "SGSN Context Request" message to the old S4 SGSN. The fallback to GTPv1 is performed only for this UE.

Fallback to GTPv1 shall not occur on already established GTP tunnels without change of the peer nodes of the communication bearer.

## 7.11 Fallback to GTPv0

Fallback from GTPv2 to GTPv0 shall not be supported. Therefore, GTPv2 entity should not listen to the well-known GTPv0 port 3386.

## 7.12 Trace Management Messages

### 7.12.1 Trace Session Activation

The Trace Session Activation message shall be sent on S11/S4 by the MME/SGSN to the SGW, on S2a/S2b by the TWAN/ePDG to the PGW, and on S5/S8 by the SGW to the PGW when session trace is activated for a particular IMSI or IMEI for a UE that is attached and active or attached and idle.

Table 7.12.1-1 specifies the presence of the IEs in the message.

Table 7.12.1-1: Information Elements in a Trace Session Activation

Information elements	P	Condition / Comment	IE Type	Ins.
IMSI	C	<p>The MME/SGSN shall include the IMSI in the message on the S11/S4 interface except for the case:</p> <ul style="list-style-type: none"> <li>- If the UE is emergency or RLOS attached and the UE is UICCless.</li> </ul> <p>The IMSI shall be included in the message on the S11/S4 interface but not used as an identifier</p> <ul style="list-style-type: none"> <li>- if UE is emergency or RLOS attached but IMSI is not authenticated.</li> </ul> <p>The SGW shall forward this IE to the PGW on S5/S8 if received on S11/S4.</p> <p>The TWAN/ePDG shall include this IE on the S2a/S2b interface except for the case:</p> <ul style="list-style-type: none"> <li>- If the UE is emergency attached and the UE is UICCless.</li> </ul> <p>The IMSI shall be included in the message on the S2a/S2b interface if available, but not used as an identifier</p> <ul style="list-style-type: none"> <li>- if UE is emergency attached but IMSI is not authenticated.</li> </ul>	IMSI	0
Trace Information	M		Trace Information	0
ME Identity (MEI)	C	<p>The MME/SGSN shall include the ME Identity (MEI) IE on the S11/S4 interface:</p> <ul style="list-style-type: none"> <li>- If the UE is emergency attached and the UE is UICCless; or</li> <li>- If the UE is emergency attached and the IMSI is not authenticated.</li> </ul> <p>In other cases, the MME shall include the ME Identity (MEI) IE on the S11 interface, if available.</p> <p>The SGW shall forward this IE to the PGW on S5/S8 if received on S11/S4.</p>	MEI	0
	CO	<p>The MME/SGSN shall include the ME Identity (MEI) IE on the S11 interface:</p> <ul style="list-style-type: none"> <li>- If the UE is RLOS attached and the UE is UICCless; or</li> <li>- If the UE is RLOS attached and the IMSI is not authenticated.</li> </ul>		
	CO	<p>The TWAN/ePDG shall include the ME Identity (MEI) IE on the S2a/S2b interface:</p> <ul style="list-style-type: none"> <li>- If the UE is emergency attached and the UE is UICCless</li> <li>- If the UE is emergency attached and the IMSI is not authenticated</li> </ul> <p>In other cases, the TWAN/ePDG shall include the ME Identity (MEI) IE on the S2a/S2b interface, if available.</p>		

## 7.12.2 Trace Session Deactivation

The Trace Session Deactivation message shall be sent on S11/S4 by the MME/SGSN to the SGW, on S2a/S2b by the TWAN/ePDG to the PGW, and on S5/S8 by the SGW to the PGW when session trace is deactivated for a particular IMSI or IMEI for a UE that is attached and active or attached and idle.

Table 7.12.2-1 specifies the presence of the IEs in the message.

**Table 7.12.2-1: Information Elements in a Trace Session Deactivation**

Information elements	P	Condition / Comment	IE Type	Ins.
Trace Reference	M		Trace Reference	0

## 7.13 MBMS Messages

### 7.13.1 MBMS Session Start Request

The MBMS Session Start Request message shall be sent on the Sm/Sn interface by the MBMS GW to the MME/SGSN as specified in 3GPP TS 23.246 [37] and 3GPP TS 23.007 [13].

Table 7.13.1-1 specifies the presence of the IEs in the message.

Table 7.13.1-1: Information Elements in a MBMS Session Start Request

Information elements	P	Condition / Comment	IE Type	Ins.
Sender F-TEID for Control Plane	M		F-TEID	0
Temporary Mobile Group Identity (TMGI)	M	See NOTE 4.	TMGI	0
MBMS Session Duration	M		MBMS Session Duration	0
MBMS Service Area	M		MBMS Service Area	0
MBMS Session Identifier	C	This IE shall be forwarded to MME/SGSN if it is provided by the BM-SC.	MBMS Session Identifier	0
MBMS Flow Identifier	C	This IE shall be forwarded to MME/SGSN if it is provided by the BM-SC.	MBMS Flow Identifier	0
QoS profile	M	See NOTE 1.	Bearer QoS	0
MBMS IP Multicast Distribution	M	See NOTE 2.	MBMS IP Multicast Distribution	0
Recovery	C	This IE shall be included if contacting the peer for the first time.	Recovery	0
MBMS Time to Data Transfer	CO	This IE shall be forwarded to MME/SGSN if it is received from the BM-SC.	MBMS Time to Data Transfer	0
MBMS Data Transfer Start	CO	This IE shall be forwarded to the MME if it is received from the BM-SC.	Absolute Time of MBMS Data Transfer	0
MBMS Flags	CO	This IE shall be included if any one of the applicable flags is set to 1. Applicable flags: - MBMS Session Re-establishment Indication: this flag shall be set to 1 on the Sm/Sn interfaces if the MBMS Session Start Request message is used to re-establish an MBMS session (see 3GPP TS 23.007 [13]).	MBMS Flags	0
MBMS Alternative IP Multicast Distribution	CO	If the MBMS GW supports both IPv4 and IPv6 M1 multicast address types, the MBMS GW may include this IE on the Sm interface to provide an alternative MBMS IP Multicast Distribution Address with a different address type (i.e. IPv4 or IPv6) than the one provided in the MBMS IP Multicast Distribution IE. See NOTE 2.	MBMS IP Multicast Distribution	1
MBMS Cell List	CO	The MBMS GW shall include this IE on the Sm interface if a MBMS Cell List was received from the BM-SC. See NOTE 3.	ECGI-List	0
Private Extension	O		Private Extension	VS
<p>NOTE 1: The uplink GBR and uplink MBR shall be ignored by MME/SGSN as specified in Clause 20.5 of 3GPP TS 29.061 [38].</p> <p>NOTE 2: If the MBMS GW supports both IPv4 and IPv6 M1 multicast address types, the MBMS GW may provide both IPv4 and IPv6 MBMS IP Multicast Distribution addresses on the Sm interface by including the MBMS IP Multicast Distribution IE and the MBMS Alternative IP Multicast Distribution IE in the MBMS Session Start Request. In this case, one of these IEs shall carry an IP Multicast Distribution Address and an IP Multicast Source Address for IPv6 and the other IE shall carry IPv4 addresses. Both IEs shall contain the same C-TEID value.</p> <p>NOTE 3: The MBMS Cell List can contain from 1 up to 4096 cells (see 3GPP TS 29.061 [38]).</p> <p>NOTE 4: The PLMN ID in the TMGI IE received in the MBMS Session Start Request message may be different from the PLMN ID(s) either reported by the MCE(s) previously at the M3 Setup procedure or configured as supported PLMN(s), e.g. when shared MBMS network is deployed; the MME need not check it.</p>				

## 7.13.2 MBMS Session Start Response

The MBMS Session Start Response message shall be sent as a response to the MBMS Session Start Request message on the Sm/Sn interface by the MME/SGSN to the MBMS GW.

Table 7.13.2-1 specifies the presence of the IEs in the message.

Possible Cause values are specified in Table 8.4-1.

**Table 7.13.2-1: Information Elements in a MBMS Session Start Response**

Information elements	P	Condition / Comment	IE Type	Ins.
Cause	M		Cause	0
Sender F-TEID for Control Plane	M		F-TEID	0
MBMS Distribution Acknowledge	C	This IE shall be included on the Sn interface.	MBMS Distribution Acknowledge	0
Sn-U SGSN F-TEID	C	This IE shall be included on the Sn interface if some RNCs have not accepted IP multicast distribution.	F-TEID	1
Recovery	C	This IE shall be included if contacting the peer for the first time.	Recovery	0
Private Extension	O		Private Extension	VS

### 7.13.3 MBMS Session Update Request

The MBMS Session Update Request message shall be sent on the Sm/Sn interface by the MBMS GW to the MME/SGSN as specified in 3GPP TS 23.246 [37] and 3GPP TS 23.007 [13].

Table 7.13.3-1 specifies the presence of the IEs in the message.

**Table 7.13.3-1: Information Elements in a MBMS Session Update Request**

Information elements	P	Condition / Comment	IE Type	Ins.
MBMS Service Area	C	This IE shall be forwarded to MME/SGSN if it is provided by the BM-SC.	MBMS Service Area	0
Temporary Mobile Group Identity (TMGI)	M		TMGI	0
Sender F-TEID for Control Plane	O		F-TEID	0
MBMS Session Duration	M		MBMS Session Duration	0
QoS profile	M	See NOTE 1.	Bearer QoS	0
MBMS Session Identifier	C	This IE shall be forwarded to MME/SGSN if it is provided by the BM-SC.	MBMS Session Identifier	0
MBMS Flow Identifier	C	This IE shall be forwarded to MME/SGSN if it is provided by the BM-SC.	MBMS Flow Identifier	0
MBMS Time to Data Transfer	CO	This IE shall be forwarded to MME/SGSN if it is provided by the BM-SC.	MBMS Time to Data Transfer	0
MBMS Data Transfer Start / Update / Stop	CO	This IE shall be forwarded to the MME if it is received from the BM-SC. See NOTE 3.	Absolute Time of MBMS Data Transfer	0
MBMS Cell List	CO	The MBMS GW shall include this IE on the Sm interface if a MBMS Cell List was received from the BM-SC. See NOTE 2.	ECGI List	0
Private Extension	O		Private Extension	VS

NOTE 1: The uplink GBR and uplink MBR shall be ignored by MME/SGSN as specified in Clause 20.5 of 3GPP TS 29.061 [38].

NOTE 2: The MBMS Cell List can contain from 1 up to 4096 cells (see 3GPP TS 29.061 [38]).

NOTE 3: The MME copies the absolute time received in this IE into the Time of MBMS Data Transfer IE in the M3AP MBMS SESSION START REQUEST or MBMS SESSION UPDATE REQUEST, or into the Time of MBMS Data Stop IE in the M3AP MBMS SESSION STOP REQUEST, as appropriate. See 3GPP TS 23.246 [37] and 3GPP TS 36.444 [79].



## 7.13.4 MBMS Session Update Response

The MBMS Session Update Response message shall be sent as a response to the MBMS Session Update Request message on the Sm/Sn interface by the MME/SGSN to the MBMS GW.

Table 7.13.4-1 specifies the presence of the IEs in the message.

Possible Cause values are specified in Table 8.4-1.

**Table 7.13.4-1: Information Elements in a MBMS Session Update Response**

Information elements	P	Condition / Comment	IE Type	Ins.
Cause	M		Cause	0
MBMS Distribution Acknowledge	C	This IE shall be included on the Sn interface if service area is changed.	MBMS Distribution Acknowledge	0
Sn-U SGSN F-TEID	C	This IE shall be included on the Sn interface if any of the newly added RNCs have not accepted IP multicast distribution.	F-TEID	0
Recovery	C	This IE shall be included if contacting the peer for the first time.	Recovery	0
Private Extension	O		Private Extension	VS

## 7.13.5 MBMS Session Stop Request

The MBMS Session Stop Request message shall be sent on the Sm/Sn interface by the MBMS GW to the MME/SGSN as specified in 3GPP TS 23.246 [37] and 3GPP TS 23.007 [13].

Table 7.13.5-1 specifies the presence of the IEs in the message.

**Table 7.13.5-1: Information Elements in a MBMS Session Stop Request**

Info specified in Table 8.4-1. Information elements	P	Condition / Comment	IE Type	Ins.
MBMS Flow Identifier	C	This IE shall be forwarded to MME/SGSN if it is provided by the BM-SC. See NOTE 1.	MBMS Flow Identifier	0
MBMS Data Transfer Stop	CO	This IE shall be forwarded to the MME if it is received from the BM-SC.	Absolute Time of MBMS Data Transfer	0
MBMS Flags	CO	This IE shall be included if any one of the applicable flags is set to 1. Applicable flags: - Local MBMS Bearer Context Release Indication: this flag shall be set to 1 on the Sm/Sn interfaces if the MBMS Session Stop Request message is used to release the MBMS bearer context locally in the MME/SGSN (see 3GPP TS 23.007 [13]).	MBMS Flags	0
Private Extension	O		Private Extension	VS
NOTE 1: The conditional MBMS Flow Identifier IE is redundant as MBMS Session Stop Request message is sent over non-zero TEID header. The receiver may ignore the MBMS Flow Identifier IE.				

## 7.13.6 MBMS Session Stop Response

The MBMS Session Stop Response message shall be sent as a response to the MBMS Session Stop Request message on the Sm/Sn interface by the MME/SGSN to the MBMS GW.

Table 7.13.6-1 specifies the presence of the IEs in the message.

Possible Cause values are specified in Table 8.4-1.

Table 7.13.6-1: Information Elements in a MBMS Session Stop Response

Information elements	P	Condition / Comment	IE Type	Ins.
Cause	M		Cause	0
Recovery	CO	This IE shall be included if contacting the peer for the first time.	Recovery	0
Private Extension	O		Private Extension	VS

## 8 GTP-C Information Elements

### 8.1 Information Element Types

A GTP control plane (signalling) message may contain several information elements. In order to have forward compatible type definitions for the GTPv2 information elements, all of them shall be TLIV (Type, Length, Instance, Value) coded. GTPv2 information element type values are specified in the Table 8.1-1. The last column of this table indicates whether the information element is:

- Fixed Length: the IE has a fixed set of fields, and a fixed number of octets.
- Variable Length: the IE has a fixed set of fields, and has a variable number of octets. For example, the last octets may be numbered similar to "5 to (n+4)". In this example, if the value of the length field, n, is 0, then the last field is not present.
- Extendable: the IE has a variable number of fields, and has a variable number of octets. The last fields are typically specified with the statement: "These octet(s) is/are present only if explicitly specified". The legacy receiving entity shall ignore the unknown octets.

In order to improve the efficiency of troubleshooting, it is recommended that the information elements should be arranged in the signalling messages as well as in the grouped IEs, according to the order the information elements are listed in the message definition table or grouped IE definition table in clause 7. However the receiving entity shall be prepared to handle the messages with information elements in any order.

Within information elements, certain fields may be described as spare. These bits shall be transmitted with the value set to 0. To allow for future features, the receiver shall not evaluate these bits. GTPv2-C information elements that have similar semantics in GTPv1-C shall be converted into GTPv1-C format, as specified in TS 29.060 [4], before sending them to a pre-R8 GSN.

**Table 8.1-1: Information Element types for GTPv2**

IE Type value (Decimal)	Information elements	Comment / Reference	Number of Fixed Octets
0	Reserved		
1	International Mobile Subscriber Identity (IMSI)	Variable Length / 8.3	Not Applicable
2	Cause	Variable Length / 8.4	Not Applicable
3	Recovery (Restart Counter)	Variable Length / 8.5	Not Applicable
4 to 34	Reserved for S101 interface	See 3GPP TS 29.276 [14]	See 3GPP TS 29.276 [14]
35 to 50	Reserved for S121 interface	See 3GPP TS 29.276 [14]	See 3GPP TS 29.276 [14]
51	STN-SR	See 3GPP TS 29.280 [15]	See 3GPP TS 29.280 [15]
56	SRVCC Cause	See 3GPP TS 29.280 [15]	See 3GPP TS 29.280 [15]
52 to 70	Reserved for Sv interface	See 3GPP TS 29.280 [15]	See 3GPP TS 29.280 [15]
71	Access Point Name (APN)	Variable Length / 8.6	Not Applicable
72	Aggregate Maximum Bit Rate (AMBR)	Fixed Length / 8.7	8
73	EPS Bearer ID (EBI)	Extendable / 8.8	1
74	IP Address	Variable Length / 8.9	Not Applicable
75	Mobile Equipment Identity (MEI)	Variable Length / 8.10	Not Applicable
76	MSISDN	Variable Length / 8.11	Not Applicable
77	Indication	Extendable / 8.12	2
78	Protocol Configuration Options (PCO)	Variable Length / 8.13	Not Applicable
79	PDN Address Allocation (PAA)	Variable Length / 8.14	Not Applicable
80	Bearer Level Quality of Service (Bearer QoS)	Extendable / 8.15	22
81	Flow Quality of Service (Flow QoS)	Extendable / 8.16	21
82	RAT Type	Extendable / 8.17	1
83	Serving Network	Extendable / 8.18	3
84	EPS Bearer Level Traffic Flow Template (Bearer TFT)	Variable Length / 8.19	Not Applicable
85	Traffic Aggregation Description (TAD)	Variable Length / 8.20	Not Applicable
86	User Location Information (ULI)	Extendable / 8.21	"r+4-4" (See Figure 8.21-1)
87	Fully Qualified Tunnel Endpoint Identifier (F-TEID)	Extendable / 8.22	9/21/25
88	TMSI	Variable Length / 8.23	Not Applicable
89	Global CN-Id	Variable Length / 8.24	Not Applicable
90	S103 PDN Data Forwarding Info (S103PDF)	Variable Length / 8.25	Not Applicable
91	S1-U Data Forwarding Info (S1UDF)	Variable Length / 8.26	Not Applicable
92	Delay Value	Extendable / 8.27	1
93	Bearer Context	Extendable / 8.28	Not Applicable
94	Charging ID	Extendable / 8.29	4
95	Charging Characteristics	Extendable / 8.30	2
96	Trace Information	Variable Length / 8.31	Not Applicable
97	Bearer Flags	Extendable / 8.32	1
98	Reserved		
99	PDN Type	Extendable / 8.34	1
100	Procedure Transaction ID	Extendable / 8.35	1
101	Reserved		
102	Reserved		
103	MM Context (GSM Key and Triplets)	Extendable / 8.38	"r+1-4" (See Figure 8.38-1)
104	MM Context (UMTS Key, Used Cipher and Quintuplets)	Extendable / 8.38	"r+1-4" (See Figure 8.38-2)
105	MM Context (GSM Key, Used Cipher and Quintuplets)	Extendable / 8.38	"r+1-4" (See Figure 8.38-3)
106	MM Context (UMTS Key and Quintuplets)	Extendable / 8.38	"r+1-4" (See Figure 8.38-4)
107	MM Context (EPS Security Context, Quadruplets and Quintuplets)	Extendable / 8.38	"s+64-4" (See Figure 8.38-5)
108	MM Context (UMTS Key, Quadruplets and Quintuplets)	Extendable / 8.38	"r+1-4" (See Figure 8.38-6)
109	PDN Connection	Extendable / 8.39	Not Applicable
110	PDU Numbers	Extendable / 8.40	9
111	P-TMSI	Variable Length / 8.41	Not Applicable
112	P-TMSI Signature	Variable Length / 8.42	Not Applicable
113	Hop Counter	Extendable / 8.43	1
114	UE Time Zone	Extendable / 8.44	2
115	Trace Reference	Fixed Length / 8.45	6
116	Complete Request Message	Variable Length / 8.46	Not Applicable
117	GUTI	Variable Length / 8.47	Not Applicable
118	F-Container	Variable Length / 8.48	Not Applicable
119	F-Cause	Variable Length / 8.49	Not Applicable
120	PLMN ID	Variable Length / 8.50	Not Applicable
121	Target Identification	Variable Length / 8.51	Not Applicable
122	Reserved		
123	Packet Flow ID	Variable Length / 8.53	Not Applicable
124	RAB Context	Fixed Length / 8.54	9
125	Source RNC PDCP Context Info	Variable Length / 8.55	Not Applicable
126	Port Number	Extendable / 8.56	2
127	APN Restriction	Extendable / 8.57	1
128	Selection Mode	Extendable / 8.58	1

IE Type value (Decimal)	Information elements	Comment / Reference	Number of Fixed Octets
129	Source Identification	Variable Length / 8.59	Not Applicable
130	Reserved		
131	Change Reporting Action	Variable Length / 8.61	Not Applicable
132	Fully Qualified PDN Connection Set Identifier (FQ-CSID)	Extendable / 8.62	"q+1-4" (See Figure 8.62-1)
133	Channel needed	Variable Length / 8.63	Not Applicable
134	eMLPP Priority	Variable Length / 8.64	Not Applicable
135	Node Type	Extendable / 8.65	1
136	Fully Qualified Domain Name (FQDN)	Variable Length / 8.66	Not Applicable
137	Transaction Identifier (TI)	Variable Length / 8.68	Not Applicable
138	MBMS Session Duration	Extendable / 8.69	3
139	MBMS Service Area	Variable Length / 8.70	Not Applicable
140	MBMS Session Identifier	Extendable / 8.71	1
141	MBMS Flow Identifier	Extendable / 8.72	2
142	MBMS IP Multicast Distribution	Extendable / 8.73	"m+1-4" (See Figure 8.73-1)
143	MBMS Distribution Acknowledge	Extendable / 8.74	1
144	RFSP Index	Fixed Length / 8.77	2
145	User CSG Information (UCI)	Extendable / 8.75	8
146	CSG Information Reporting Action	Extendable / 8.76	1
147	CSG ID	Extendable / 8.78	4
148	CSG Membership Indication (CMI)	Extendable / 8.79	1
149	Service indicator	Fixed Length / 8.80	1
150	Detach Type	Fixed Length / 8.81	1
151	Local Distinguished Name (LDN)	Variable Length / 8.82	Not Applicable
152	Node Features	Extendable / 8.83	1
153	MBMS Time to Data Transfer	Extendable / 8.84	1
154	Throttling	Extendable / 8.85	2
155	Allocation/Retention Priority (ARP)	Extendable / 8.86	1
156	EPC Timer	Extendable / 8.87	1
157	Signalling Priority Indication	Extendable / 8.88	1
158	Temporary Mobile Group Identity (TMGI)	Extendable / 8.89	6
159	Additional MM context for SRVCC	Extendable / 8.90	"e-4" (See Figure 8.90-1)
160	Additional flags for SRVCC	Extendable / 8.91	1
161	Reserved		
162	MDT Configuration	Extendable / 8.93	"q-4" (See Figure 8.93-1)
163	Additional Protocol Configuration Options (APCO)	Extendable / 8.94	"m-4" (See Figure 8.94-1)
164	Absolute Time of MBMS Data Transfer	Extendable / 8.95	8
165	H(e)NB Information Reporting	Extendable / 8.96	1
166	IPv4 Configuration Parameters (IP4CP)	Extendable / 8.97	5
167	Change to Report Flags	Extendable / 8.98	1
168	Action Indication	Extendable / 8.99	1
169	TWAN Identifier	Extendable / 8.100	"k+6-4" (See Figure 8.100-1)
170	ULI Timestamp	Extendable / 8.101	4
171	MBMS Flags	Extendable / 8.102	1
172	RAN/NAS Cause	Extendable / 8.103	"m-4" (See Figure 8.103-1)
173	CN Operator Selection Entity	Extendable / 8.104	1
174	Trusted WLAN Mode Indication	Extendable / 8.105	1
175	Node Number	Extendable / 8.106	"p-4" (See Figure 8.106-1)
176	Node Identifier	Extendable / 8.107	"q-4" (See Figure 8.107-1)
177	Presence Reporting Area Action	Extendable / 8.108	"t-4" (See Figure 8.108-1)
178	Presence Reporting Area Information	Extendable / 8.109	4
179	TWAN Identifier Timestamp	Extendable / 8.110	4
180	Overload Control Information	Extendable / 8.111	Not Applicable
181	Load Control Information	Extendable / 8.112	Not Applicable
182	Metric	Fixed Length / 8.113	1
183	Sequence Number	Fixed Length / 8.114	4
184	APN and Relative Capacity	Extendable / 8.115	"m-4" (See Figure 8.115)
185	WLAN Offloadability Indication	Extendable / 8.116	1
186	Paging and Service Information	Extendable / 8.117	m-4 (See Figure 8.117-1)
187	Integer Number	Variable / 8.118	Not Applicable
188	Millisecond Time Stamp	Extendable / 8.119	6
189	Monitoring Event Information	Extendable / 8.120	"k+2-4" (See Figure 8.120-1)
190	ECGI List	Extendable / 8.121	"m*7+2" (See Figure 8.121-1)
191	Remote UE Context	Extendable / 8.122	Not Applicable
192	Remote User ID	Extendable / 8.123	"c-4" (see Figure 8.123-1)
193	Remote UE IP information	Variable Length / 8.124	Not Applicable
194	CloT Optimizations Support Indication	Extendable / 8.125	1
195	SCEF PDN Connection	Extendable / 8.126	Not Applicable
196	Header Compression Configuration	Extendable / 8.127	4
197	Extended Protocol Configuration Options (ePCO)	Variable Length / 8.128	Not Applicable

IE Type value (Decimal)	Information elements	Comment / Reference	Number of Fixed Octets
198	Serving PLMN Rate Control	Extendable / 8.129	4
199	Counter	Extendable / 8.130	5
200	Mapped UE Usage Type	Extendable / 8.131	2
201	Secondary RAT Usage Data Report	Extendable / 8.132	27
202	UP Function Selection Indication Flags	Extendable / 8.133	1
203	Maximum Packet Loss Rate	Extendable / 8.134	1
204	APN Rate Control Status	Extendable / 8.135	20
205	Extended Trace Information	Extendable / 8.136	"r-4" (see figure 8.136-1)
206	Monitoring Event Extension Information	Extendable / 8.137	"k-4" (See Figure 8.137-1)
207	Additional RRM Policy Index	Fixed Length / 8.138	4
208	V2X Context	Extendable / 8.139	Not Applicable
209	PC5 QoS Parameters	Extendable / 8.140	Not Applicable
210	Services Authorized	Extendable / 8.141	2
211	Bit Rate	Extendable / 8.142	4
212	PC5 QoS Flow	Extendable / 8.143	11
213	SGi PtP Tunnel Address	Extendable / 8.144	1
214	PGW Change Info	Extendable / 8.145	Not Applicable
215	PGW FQDN	Extendable / 8.146	m-4
216	Group Id	Variable Length / 8.147	Not Applicable
217	PSCell ID	Fixed Length / 8.148	8
218	UP Security Policy	Extendable / 8.149	1
219	Alternative IMSI	Variable Length / 8.150	Not Applicable
220 to 253	Spare. For future use.		
254	Special IE type for IE Type Extension	See NOTE 2	Not Applicable
255	Private Extension	Variable Length / 8.67	Not Applicable
256 to 65535	Spare. For future use.		

NOTE 1: The size of the TLI (Type, Length and Instance) fields, i.e "4" octets, has been subtracted from the number of the fixed octets of the "Fixed Length" and "Extendable" IEs. Hence for some of the "Extendable" IEs, for which the length is defined in terms of variable number of octets, "4" is explicitly subtracted while defining the fixed number of octets. E.g. Length of User Location Information is defined as "f+4" and fixed number of octets for the same is defined as "f+4-4".

NOTE 2: The IE Type value 254 indicates that the IE Type shall be further identified by an IE Type Extension field; see clause 8.2.1A. A GTP-C entity which does not support any IE Type encoded with an IE Type Extension field shall ignore an IE received with the IE Type value 254.

## 8.2 Information Element Format

### 8.2.1 General

Figure 8.2-1 depicts the format of an information element.

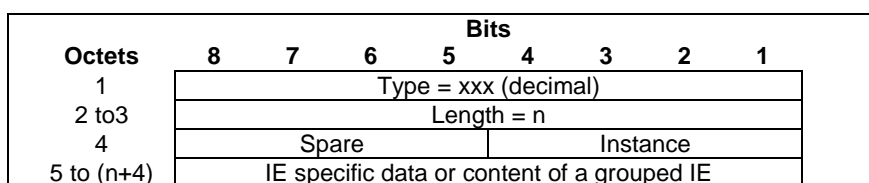

Figure 8.2-1: Information Element Format

An IE has the following mandatory fields:

- Type field: This field indicates the type of Information Element. The valid values of the IE type are defined in clause 8.1.
- Length: This field contains the length of the information element excluding the first four octets, which are common for all information elements (Type, Length and the contents of octet 4) and is denoted "n" in Figure 8.2-1. For all the length fields, bit 8 of the lowest numbered octet is the most significant bit and bit 1 of the highest numbered octet is the least significant bit.
- Instance: This field shall be used to differentiate amongst different parameters in one specific message which use the same information element type (see also clause 6.1.3 "Information Element Instance").

An IE is said to be TLIV (Type, Length, Instance, Value) encoded.

## 8.2.1A Information Element with an IE Type Extension field

Figure 8.2.1A-1 depicts the format of an information element with an IE Type Extension field.

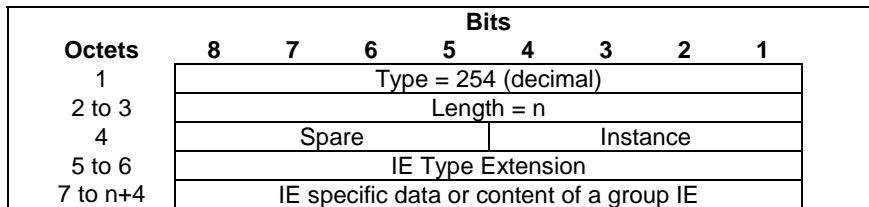

**Figure 8.2.1A-1: Information Element with an IE Type Extension field**

The IE Type in octet 1 of an information element with an IE Type Extension field shall be set to 254. Such IE shall be further identified by the value encoded in the IE Type Extension field in octets 5 and 6.

The value of the IE Type Extension shall be encoded in full hexadecimal representation (binary, not ASCII encoding) from 256 up to 65535. This field indicates the type of the Information Element and the valid values of the IE type Extension field are defined in clause 8.1.

The semantics of the Length and Instance field remain the same as specified in clause 8.2.1.

## 8.2.2 Handling ASN.1/PER encoded parameters

During the TAU/RAU/HO procedures MME/S4-SGSN GTPv2 entities send some of the RANAP/S1AP/BSSGP parameters to a GTPv2 peer. Copying of the BSSGP parameters into GTPv2 IEs is straightforward. RANAP and S1AP, however, use ASN.1/PER encoding, which is different from GTPv2 specific TLV encoding.

Transparent copying of RANAP/S1AP parameters across GTPv2 interfaces:

- a GTPv2 entity shall transparently copy the respective information into one or more octets of the GTPv2 IE as specified in Annex B and clause 8.48. With this approach, GTPv2 will not be impacted if the contents of such RANAP/S1AP parameter changes over the time.

Non-transparent copying of RANAP/S1AP parameters across GTPv2 interfaces:

- GTPv2 entity decodes ASN.1/PER parameter and shall encode the value(s) into one or more octets of the GTPv2 IE according to what is specified in the present document.

## 8.3 International Mobile Subscriber Identity (IMSI)

International Mobile Subscriber Identity (IMSI) is transferred via GTP tunnels. The sending entity copies the value part of the IMSI into the Value field of the IMSI IE. IMSI is defined in 3GPP TS 23.003 [2].

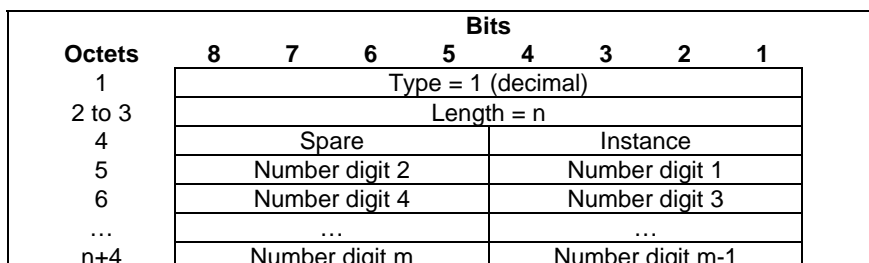

**Figure 8.3-1: IMSI**

Octets 5 to (n+4) represent the IMSI value in international number format as described in ITU-T Rec E.212 [64], encoded as TBCD digits, i.e. digits from 0 through 9 are encoded "0000" to "1001". When there is an odd number of digits, bits 8 to 5 of the last octet are encoded with the filler "1111". The maximum number of digits is 15.

## 8.4 Cause

Cause IE is coded as depicted in Figure 8.4-1.

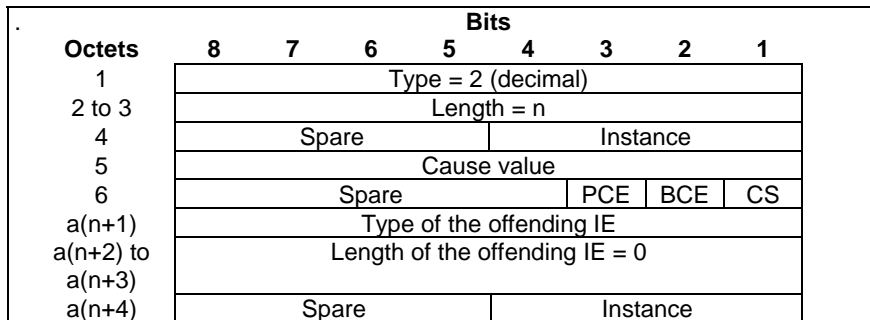

Figure 8.4-1: Cause

Cause is a variable length IE, which may have either of the following two lengths values:

- If  $n = 2$ ,  $a = 0$  and the Cause IE shall be 6 octets long. Therefore, octets "a(n+1) to a(n+4)" will not be present.
- If  $n = 6$ ,  $a = 1$  and the Cause IE will be 10 octets long.

For PMIP based S5/S8, the SGW/MAG shall do the mapping between GTPv2 Cause IE and respective PMIPv6 IE as specified in 3GPP TS 29.275 [26].

The following bits within Octet 6 indicate:

- Bits 8 to 4: Spare, for future use and set to zero
- Bit 1 – CS (Cause Source): If this bit is set to 1, it indicates that the corresponding error cause is originated by the remote node (i.e., the MME/SGSN to a PGW, or the PGW to an MME/SGSN). This bit is set to 0 to denote that the corresponding error cause is originated by the node sending the message.

The CS should be set to 1 by the SGW when the SGW relay a response message with cause value from the MME/SGSN to the PGW or from the PGW to the MME/SGSN. For PMIP based S5/S8, the SGW shall set the CS bit to 1 when the SGW/MAG relay a response message with the cause value from the PGW/LMA to the MME/SGSN.

- Bit 2 – BCE (Bearer Context IE Error): If this bit is set to 1, it indicates that the corresponding rejection cause is due to the error in the Bearer Context IE. This bit shall be discarded if the cause value is one of Acceptance cause value as given in table 8.4-1.
- Bit 3 – PCE (PDN Connection IE Error): If this bit is set to 1, it indicates that the corresponding rejection cause is due to the error in the PDN Connection IE. This bit shall be discarded if the cause value is one of Acceptance cause value as given in table 8.4-1.

The Cause value shall be included in a response message. In a response message, the Cause value indicates the acceptance or the rejection of the corresponding request message. The Cause value indicates the explicit reason for the rejection.

If the rejection is due to a mandatory IE or a verifiable conditional IE is faulty or missing, the offending IE shall be included within an additional field "a(n+1) to a(n+4)". Only Type and Instance fields of the offending IE that caused the rejection have a meaning. The length in the Octet 8-9 and spare bits in the Octet 10 shall be set to "0". In this case, the value of "n" shall be "6". Otherwise, the value of "n" is equal to "2".

The Cause may also be included in the request message. In a request message, the Cause value indicates the reason for the request.

"Request accepted" is returned when the GTPv2 entity has accepted a control plane request.

"Context Not Found" is used in the response message by a GTP entity when it receives a message for which it does not have context, e.g. TEID-C or EBI is not known. When "Context Not Found" is received at Bearer Context IE level, it means the bearer context is unknown in the peer. When "Context Not Found" is received at message level together with a known TEID-C in the GTPv2-C header in the response message, this indicates some bearer contexts are not known in



the peer; the sender of the request message should further determine, based on the bearer context(s) included in the request message, that:

- if the default bearer is unknown, this means the PDN connection is not known in the peer;
- if one or more dedicated bearers are unknown, this means only those dedicated bearer contexts are not known in the peer.

"Context Not Found" may be used by the PGW in the Create Session Response message during the non-3GPP to 3GPP access handover procedures, if the request corresponds to the handover of a PDN connection which does not exist in the PGW.

"Context Not Found" may be used by the PGW in the Create Session Response message during the 3GPP to non-3GPP access handover procedures, if the request corresponds to the handover of a PDN connection which does not exist in the PGW.

"Service not supported" is used by the GTP entity when it receives a message, which corresponds to a feature or a service which is not supported by the node.

"Service denied" is used when the requested service cannot be granted.

"System failure" is used by the GTP entity to indicate a generic error condition.

"No resources available" is used by the GTP entity to indicate the temporary unavailability of the resource(s) to process the received request.

"Semantic error in the TFT operation", "Syntactic error in the TFT operation", "Semantic errors in packet filter(s)", "Syntactic errors in packet filters(s)", "UE context without TFT already activated", "Semantic error in the TAD operation" and "Syntactic error in the TAD operation" are indications of error cases involving TFT(s)/TAD(s) as specified in clause 7.7.11 in this specification.

"Missing or unknown APN" is used by the PGW when it does not support the Access Point Name, received in Create Session Request message.

"Relocation failure" is used by the target MME/S4-SGSN to indicate the source MME/S4-SGSN that the relocation has failed.

"Relocation failure due to NAS message redirection" is used by the new MME/S4-SGSN to indicate to the old MME/S4-SGSN that the TAU/RAU procedure is not successful due to NAS message redirection as described in 3GPP TS 23.401 [3], or used by the initial AMF to indicate to the old MME that the context transfer procedure is not successful due to NAS message redirection as described in clause 4.11.1.3.4 of 3GPP TS 23.502 [83].

"Denied in RAT" is used by the GTP entity to indicate that the requested service is not accepted in the RAT.

"Preferred PDN type not supported" is used by the PGW to indicate that the PDN type received in the Create Session Request message is not supported by the PGW for the PDN corresponding to the received Access Point Name.

"Protocol type not supported" is used by the SGW to indicate that the S5/S8 protocol type requested by the MME/S4-SGSN is not supported by it.

"UE not responding" is used by the MME/S4-SGSN to indicate that the UE is not responding to the request initiated by the network, e.g. Paging.

"UE refuses" is used by the GTP entity to indicate that the UE, without specifying further detail, rejected the request from the network.

"Unable to page UE" is used by the MME/S4-SGSN to indicate its inability to page the UE, temporarily.

"User authentication failed" is used by the GTP entity to indicate that the request is rejected due to failure in authentication/security procedure, or is used by a combined PGW-C/SMF for an UAAA-SM during PDN connection establishment procedure as described in clause 5.2.3.3 of 3GPP TS 23.256 [90] or in authorization for C2 procedure as described in clause 5.2.5.3 of 3GPP TS 23.256 [90].

"APN access denied – no subscription" is used to indicate that the PGW has denied the user access to an APN because a subscription is required, but the subscriber does not have the necessary subscription.

"Remote peer not responding" is used by the SGW for the messages spanning through two interfaces. This cause value is returned by the SGW to the MME/S4-SGSN or PGW in a response message where no response message is received from the PGW or MME/S4-SGSN.

"Collision with network initiated request" is used by the PGW to indicate that the UE-initiated bearer resource allocation/modification request is rejected since the PGW has requested a bearer resource allocation/modification for the same service using a network-initiated procedure.

"Unable to page UE due to Suspension" is used by the MME/S4-SGSN to indicate that the UE has not been paged because the bearers of the UE are in a suspended state.

"APN Restriction type Incompatible with currently active PDN connection" is used by the PGW to indicate that the newly requested PDN connection has APN restriction value that is not compatible with the currently active PDN connection(s)'s APN restriction value(s).

"Invalid peer" is used by the SGW to indicate that currently the UE is being managed by the different node (e.g. MME/S4-SGSN) than the node (e.g. S4-SGSN/MME) which has sent the Delete Session Request message.

"Invalid Reply from remote peer" is used by the SGW for the messages spanning through two interfaces. This cause value is returned by the SGW to the MME/SGSN or PGW in a reply message where the corresponding reply message on S5/S8 or S11/S4 from the PGW or MME/SGSN is not decoded as valid.

"Temporarily rejected due to handover/TAU/RAU procedure in progress" is used by the MME/S4-SGSN for the bearer related procedure initiated by the PGW. When the handover/TAU/RAU with/without SGW change and/or MME/S4-SGSN change is in progress, the MME/S4-SGSN may receive Create / Update / Delete Bearer request message for the bearer creation, modification or deletion initiated by the PGW. If the handover/TAU/RAU procedure results in the SGW and/or MME/S4-SGSN change, then the bearer related procedure cannot be handled temporarily by the MME/S4-SGSN till the handover/TAU/RAU procedure is completed. In that case the MME/S4-SGSN shall reject the bearer related procedure with this rejection cause. This cause is also used to indicate that the Downlink Data Notification message is rejected temporarily due to the mobility procedures with MME or SGSN change in progress as specified in clause 5.3.4.3 in 3GPP TS 23.401 [3].

The usage of "Fallback to GTPv1" is specified in clause 7.10 "Fallback to GTPv1 mechanism".

In the PGW initiated bearer deactivation procedure for the default bearer, the PGW may include the Cause IE in the Delete Bearer Request with values "RAT changed from 3GPP to Non-3GPP", "Reactivation requested" or "Reactivation disallowed to APN".

"APN Congestion" is used by the PGW and it indicates that the PGW has detected congestion for the requested APN and performs overload control for that APN which does not allow the PDN connection to be established.

"GTP-C Entity Congestion" is used to indicate that the GTP-C entity has detected node level congestion and performs overload control at the node level, which does not allow the request to be processed.

"UE already re-attached" is used by MME/S4-SGSN for the network triggered service restoration procedure as specified in 3GPP TS 23.007 [17]. The MME/S4-SGSN may send the Downlink Data Notification Acknowledge or Downlink Data Notification Failure Indication with this cause as part of the network triggered service restoration procedure.

"PDP connection inactivity timer expires" is used by the PGW in Delete Bearer Request(s) to indicate that all the bearer(s) for the emergency PDN connection are deleted upon the inactivity timer expiry as specified in 3GPP TS 23.203 [48].

"Network failure" is used by the SGSN or MME in the Delete Session Request to indicate that the message is sent due to a network problem.

"QoS parameter mismatch" is used by the SGSN or MME in the Delete Session Request to indicate that the PDN connection can not be established due to a QoS parameter mismatch.

"MME/SGSN refuses due to VPLMN policy" is used by the MME/SGSN in the VPLMN to indicate to the PGW in the Create Bearer Response or Update Bearer Response that it does not allow the establishment or modification of the bearer due to VPLMN operator's policy.

The listed cause values for rejection response message descriptions in clause 7 are not meant to be exhaustive lists. Therefore a GTPv2 node shall use the most appropriate matching rejection response cause value that is listed in Table 8.4-1.

If a Bearer Resource Command message is related to an established PDN connection for LIPA or for SIPTO at the local network, the LGW shall reject the Bearer Resource Command with the cause value of "Bearer handling not supported".

"Multiple PDN connections for a given APN not allowed" is used by SGW for reply message to the MME/S4-SGSN when PMIP-based S5/S8 is used. If either SGW or PGW does not support the multiple PDN connections to the same APN function, the SGW shall reject the PDN connectivity request procedure with this rejection cause when receiving Create Session Request for additional PDN connectivity to the given APN from the same UE.

As specified in clause 5.3.1.1 in 3GPP TS 23.401 [3] and clause 9.2.1 in 3GPP TS 23.060 [35], the cause value "New PDN type due to network preference" indicates that the UE has requested PDN type IPv4v6 and only IPv4 or IPv6 address is allowed for the PDN based on PGW operator policy.

As specified in clause 5.3.1.1 in 3GPP TS 23.401 [3] and clause 9.2.1 in 3GPP TS 23.060 [35], the cause value "New PDN type due to single address bearer only" indicates that the MS has requested PDN type IPv4v6 and both IPv4 and IPv6 addressing is possible in the PDN but the Dual Address Bearer Flag of the Indication IE is set to 0 or the Indication IE is absent, or only single IP version addressing is possible in the PDN.

"PGW not responding" is used by the SGW in PGW Restart Notification to indicate that the peer PGW has failed and not restarted as specified in clause 7.9.5.

"UE context without TFT already activated" is used by the PGW in the Bearer Resource Failure Indication message to indicate that the PGW has received the Bearer Resource Command message without TAD IE in the secondary PDP Context Activation procedure.

"Target access restricted for the subscriber" is used by the MME/SGSN in the Context Response message to indicate that the target access is prohibited for the subscriber, based on the subscription profile.

"P-TMSI Signature mismatch" is used by the SGSN or MME in the Identification Response and Context Response message if the P-TMSI Signature stored in the old SGSN or MME does not match the value sent by the UE via the new SGSN or MME.

"Late Overlapping Request" is used by the PGW in the Create Session Response to indicate that the incoming request collides with an existing session which has a more recent time stamp than the time stamp of the new request, as specified in clause 13.2.

"Timed Out Request" is used by the SGW and PGW in the Create Session Response to indicate that the incoming request is known to have already timed out at the originating entity, as specified in clause 13.3.

"UE is temporarily not reachable due to power saving" is used by the MME/SGSN in the Create/Update Bearer Response message to reject the corresponding network initiated procedures for a Delay Tolerant PDN connection and also request the PGW to hold the network initiated procedure until it receives the subsequent Modify Bearer Request message with the UASI flag indicating that the UE is available for end to end signalling.

"UE not authorised by OCS or external AAA Server" is used by the PGW in the Create Session Response to reject the corresponding UE initiated procedures when the OCS or an external AAA Server on SGi did not authorise it and the support of the Cause Code was indicated by the SGSN/MME within the Create Session Request.

If a Create Session Request message requests the addition of an access to a PDN connection, and NBIFOM is not supported by the MME/SGSN, SGW or TWAN, the PGW should reject the request with the cause value of "Multiple accesses to a PDN connection not allowed". This cause is also used by the PGW in the Delete Bearer Request message to initiate the removal of 3GPP access from the PDN connection due to detection of the MME/SGSN or SGW not supporting NBIFOM at the inter-PLMN mobility procedure.

"Request rejected due to UE capability" is used by the MME in the Create Bearer Response to reject the request to add an EPS bearer that would exceed the UE capability (e.g. a NB-IoT UE can only support up to 2 EPS bearers). This cause value does not prevent the PGW from sending Create Bearer Request later.

"S1-U Path Failure" is used by the SGW in the Create Session Response, or in the Modify Bearer Response message, or in the Modify Access Bearer Response message to report an S1-U path failure. The SGW may include this cause code in a Downlink Data Notification message and/or a Delete Bearer Request message to report the S1-U path failure. See clause 20.3 in 3GPP TS 23.007 [17].

"EPS to 5GS Mobility" is used by the PGW, and it indicates that PGW initiated bearer deactivation procedure is due to EPS to 5GS mobility procedures.

"5GC not allowed" is used by the source MME in the Context Response message sent to the target AMF during an EPS to 5GS idle mode mobility procedure, to indicate that the UE is not allowed for 5GC, based on the subscription profile.

"PGW mismatch with network slice subscribed by the UE" is used by the PGW in the Create Session Response message during an EPS to 5GS mobility procedure, to indicate that the PGW is not serving the network slice subscribed by the UE for the APN/DNN.

"Rejection due to paging restriction" is used by the MME to indicate that the UE has not been paged because the MME holds stored Paging Restriction information for the UE that restricts the Downlink Data from causing paging as specified in clause 4.3.33.6 in 3GPP TS 23.401 [3] or the UE has rejected the page as specified in clause 4.3.33.4 in 3GPP TS 23.401 [3].

**Table 8.4-1: Cause values**

Message Type	Cause value (decimal)	Meaning
	0	Reserved. Shall not be sent and if received the Cause shall be treated as an invalid IE
Request / Initial message	1	Reserved
	2	Local Detach
	3	Complete Detach
	4	RAT changed from 3GPP to Non-3GPP
	5	ISR deactivation
	6	Error Indication received from RNC/eNodeB/S4-SGSN/MME
	7	IMSI Detach Only
	8	Reactivation Requested
	9	PDN reconnection to this APN disallowed
	10	Access changed from Non-3GPP to 3GPP
	11	PDN connection inactivity timer expires
	12	PGW not responding
	13	Network Failure
	14	QoS parameter mismatch
	15	EPS to 5GS Mobility
Acceptance in a Response / triggered message. See NOTE 1.	16	Request accepted
	17	Request accepted partially
	18	New PDN type due to network preference.
	19	New PDN type due to single address bearer only.
	20 to 63	Spare. This value range shall be used by Cause values in an acceptance response/triggered message
Rejection in a Response / triggered message. See NOTE 1.	64	Context Not Found
	65	Invalid Message Format
	66	Version not supported by next peer
	67	Invalid length
	68	Service not supported
	69	Mandatory IE incorrect
	70	Mandatory IE missing
	71	Shall not be used. See NOTE 2 and NOTE 3.
	72	System failure
	73	No resources available
	74	Semantic error in the TFT operation
	75	Syntactic error in the TFT operation
	76	Semantic errors in packet filter(s)
	77	Syntactic errors in packet filter(s)
	78	Missing or unknown APN
	79	Shall not be used. See NOTE 2 and NOTE 3.
	80	GRE key not found
	81	Relocation failure
	82	Denied in RAT
	83	Preferred PDN type not supported
	84	All dynamic addresses are occupied
	85	UE context without TFT already activated. See NOTE 6.
	86	Protocol type not supported
	87	UE not responding. See NOTE 7.
	88	UE refuses
	89	Service denied. See NOTE 7.
	90	Unable to page UE
	91	No memory available
	92	User authentication failed
	93	APN access denied – no subscription
	94	Request rejected (reason not specified)
	95	P-TMSI Signature mismatch
	96	IMSI/IMEI not known
	97	Semantic error in the TAD operation
98	Syntactic error in the TAD operation	
99	Shall not be used. See NOTE 2 and NOTE 3.	
100	Remote peer not responding	
101	Collision with network initiated request	
102	Unable to page UE due to Suspension	
103	Conditional IE missing	

	104	APN Restriction type Incompatible with currently active PDN connection
	105	Invalid overall length of the triggered response message and a piggybacked initial message
	106	Data forwarding not supported
	107	Invalid reply from remote peer
	108	Fallback to GTPv1
	109	Invalid peer
	110	Temporarily rejected due to handover/TAU/RAU procedure in progress
	111	Modifications not limited to S1-U bearers
	112	Request rejected for a PMIPv6 reason (see 3GPP TS 29.275 [26]).
	113	APN Congestion
	114	Bearer handling not supported
	115	UE already re-attached. See NOTE 7.
	116	Multiple PDN connections for a given APN not allowed
	117	Target access restricted for the subscriber
	118	Shall not be used. See NOTE 2 and NOTE 3.
	119	MME/SGSN refuses due to VPLMN Policy
	120	GTP-C Entity Congestion
	121	Late Overlapping Request
	122	Timed out Request
	123	UE is temporarily not reachable due to power saving
	124	Relocation failure due to NAS message redirection
	125	UE not authorised by OCS or external AAA Server
	126	Multiple accesses to a PDN connection not allowed
	127	Request rejected due to UE capability
	128	S1-U Path Failure. See NOTE 8.
	129	5GC not allowed
	130	PGW mismatch with network slice subscribed by the UE
	131	Rejection due to paging restriction (NOTE 7)
	132 to 239	Spare. For future use in a triggered/response message See NOTE 4.
Request / Initial message	240 to 255	Spare. For future use in an initial/request message. See NOTE 5.
NOTE 1: The listed cause values for rejection in a response/triggered message can be also used for request messages if the request message is triggered by a command message.		
NOTE 2: Clause 7.7.8 "Semantically incorrect Information Element" specifies quite strict handling of the reserved values and therefore this table shall not contain any reserved values.		
NOTE 3: This value was used in earlier versions of the spec. If received, it shall be interpreted as unspecified rejection cause. Unspecified/unrecognized rejection cause shall be treated in the same ways as the cause value 94 "Request rejected (reason not specified)".		
NOTE 4: This value is or may be used in the newer versions of the spec. If the receiver cannot comprehend the value, it shall be interpreted as unspecified rejection cause. Unspecified/unrecognized rejection cause shall be treated in the same ways as the cause value 94 "Request rejected (reason not specified)".		
NOTE 5: This value is or may be used in the newer versions of the spec. If the receiver cannot comprehend the value, it shall be interpreted as an unspecified request/initial message cause. Unspecified/unrecognized cause handling in a request/initial message shall be implementation dependent (e.g. may be ignored).		
NOTE 6: This Cause value is only used over the S4, S5 and S8 interface in the secondary PDP Context Activation procedure (see 9.2.2.1.1A in 3GPP TS 23.060 [4]).		
NOTE 7: This cause value may also be used by a Downlink Data Notification Failure Indication, which is an initial message.		
NOTE 8: This cause code may also be used in a Downlink Data Notification and a Delete Bearer Request message, which are initial messages.		

The mapping at the MME/S4-SGSN between GTP cause values received over the S11/S4 interface and the NAS cause values sent to the UE is specified in Annex C.

## 8.5 Recovery (Restart Counter)

Recovery IE is coded as depicted in Figure 8.5-1.

The Recovery (Restart Counter) is encoded as 1 octet.

Octets	Bits							
	8	7	6	5	4	3	2	1
1	Type = 3 (decimal)							
2 to 3	Length = n							
4	Spare				Instance			
5 to (n+4)	Recovery (Restart Counter)							

Figure 8.5-1: Recovery (Restart Counter)

## 8.6 Access Point Name (APN)

Access Point Name (APN) is transferred via GTP tunnels. The sending entity copies the value part of the APN into the Value field of the APN IE.

Octets	Bits							
	8	7	6	5	4	3	2	1
1	Type = 71 (decimal)							
2 to 3	Length = n							
4	Spare				Instance			
5 to (n+4)	Access Point Name (APN)							

Figure 8.6-1: Access Point Name (APN)

The encoding the APN field follows 3GPP TS 23.003 [2] clause 9.1. The content of the APN field shall be the full APN with both the APN Network Identifier and APN Operator Identifier being present as specified in 3GPP TS 23.003 [2] clauses 9.1.1 and 9.1.2, 3GPP TS 23.060 [35] Annex A and 3GPP TS 23.401 [3] clauses 4.3.8.1.

NOTE: The APN field is not encoded as a dotted string as commonly used in documentation.

## 8.7 Aggregate Maximum Bit Rate (AMBR)

Aggregate Maximum Bit Rate (AMBR) is transferred via GTP tunnels. The sending entity copies the value part of the AMBR into the Value field of the AMBR (APN-AMBR) IE.

AMBR is defined in clause 9.9.4.2 of 3GPP TS 24.301 [23], but it shall be encoded as shown in Figure 8.7-1 as Unsigned32 binary integer values in kbps (1000 bits per second).

Octets	Bits							
	8	7	6	5	4	3	2	1
1	Type = 72 (decimal)							
2 to 3	Length = 8							
4	Spare				Instance			
5 to 8	APN-AMBR for uplink							
9 to 12	APN-AMBR for downlink							

Figure 8.7-1: Aggregate Maximum Bit Rate (AMBR)

The APN-AMBR for uplink and the APN-AMBR for downlink may require converting values in bits per second to kilo bits per second when the APN-AMBR for uplink and the APN-AMBR for downlink are received from an interface other than GTPv2 interface. If such conversions result in fractions, then the value of APN-AMBR for uplink and the APN-AMBR for downlink shall be rounded upwards.

NOTE: The encoding in 3GPP TS 24.301 [23] is different from the encoding within this specification.

## 8.8 EPS Bearer ID (EBI)

EPS Bearer ID (EBI) is coded as depicted in Figure 8.8-1.

The overall length of the IE is 5 octets. In future releases of the spec additional octets may be specified and new semantic for the spare bits may be defined.



Octets	Bits							
	8	7	6	5	4	3	2	1
1	Type = 73 (decimal)							
2 to 3	Length = n							
4	Spare				Instance			
5	Spare (all bits set to 0)				EPS Bearer ID (EBI)			
6 to (n+4)	These octet(s) is/are present only if explicitly specified							

Figure 8.8-1: EPS Bearer ID (EBI)

The following bits within Octet 5 shall indicate:

- Bit 8 to 5 – Spare, for future use and set to zero.
- Bit 4 to 1 – EPS Bearer ID (EBI) field, the coding of EBI field and its value range is specified in 3GPP TS 24.007 [30], clause 11.2.3.1.5, bits 5 to 8. The sending GTPv2 entity shall include a EBI with a value between '1' and '4' only when the target GTPv2 entity is known to support 15 EPS Bearers, based on per PLMN local configuration.

## 8.9 IP Address

IP Address is coded as depicted in Figure 8.9-1. The Length field may have only two values (4 or 16) that determine if the Value field contains IPv4 or IPv6 address.

Octets	Bits							
	8	7	6	5	4	3	2	1
1	Type = 74 (decimal)							
2 to 3	Length = n							
4	Spare				Instance			
5 to (n+4)	IPv4 or IPv6 Address							

Figure 8.9-1: IP address

## 8.10 Mobile Equipment Identity (MEI)

Mobile Equipment Identity (MEI) is coded as depicted in Figure 8.10-1. MEI is defined in clause 6.2 of 3GPP TS 23.003 [2].

Octets	Bits							
	8	7	6	5	4	3	2	1
1	Type = 75 (decimal)							
2 to 3	Length = n							
4	Spare				Instance			
5 to (n+4)	Mobile Equipment (ME) Identity							

Figure 8.10-1: Mobile Equipment (ME) Identity (MEI)

The ME Identity field contains either the IMEI or the IMEISV as defined in clause 6.2 of 3GPP TS 23.003 [2]. It is encoded as specified in clause 7.7.53 of 3GPP TS 29.060 [4], beginning with octet 4 of Figure 7.7.53.1.

The IMEI(SV) digits are encoded using BCD coding where IMEI is 15 BCD digits and IMEISV is 16 BCD digits. For IMEI, bits 5 to 8 of the last octet shall be filled with an end mark coded as '1111'.

## 8.11 MSISDN

MSISDN is transferred via GTP tunnels. The sending entity copies the value part of the MSISDN into the Value field of the MSISDN IE. MSISDN is defined in 3GPP TS 23.003 [2].

Octets	Bits							
	8	7	6	5	4	3	2	1
1	Type = 76 (decimal)							
2 to 3	Length = n							
4	Spare				Instance			
5	Number digit 2				Number digit 1			
6	Number digit 4				Number digit 3			
...	...				...			
n+4	Number digit m				Number digit m-1			

Figure 8.11-1: MSISDN

Octets 5 to (n+4) represent the MSISDN value is in international number format as described in ITU-T Rec E.164 [25] and 3GPP TS 29.002 [41]. MSISDN value contains only the actual MSISDN number (does not contain the "nature of address indicator" octet, which indicates "international number" as in 3GPP TS 29.002 [41]) and is encoded as TBCD digits, i.e. digits from 0 through 9 are encoded "0000" to "1001". When there is an odd number of digits, bits 8 to 5 of the last octet are encoded with the filler "1111".

## 8.12 Indication

Indication is coded as depicted in Figure 8.12-1.

Octets	Bits							
	8	7	6	5	4	3	2	1
1	Type = 77 (decimal)							
2 to 3	Length = n							
4	Spare				Instance			
5	DAF	DTF	HI	DFI	OI	ISRSI	ISRAI	SGW CI
6	SQCI	UIMSI	CFSI	CRSI	P	PT	SI	MSV
7	RetLo c	PBIC	SRNI	S6AF	S4AF	MBM DT	ISRA U	CCRS I
8	CPRA I	ARRL	PPOF	PPON /PPEI	PPSI	CSFBI	CLII	CPSR
9	NSI	UASI	DTCI	BDWI	PSCI	PCRI	AOSI	AOPI
10	ROAA I	EPCO SI	CPOP CI	PMTS MI	S11T F	PNSI	UNAC CSI	WPM SI
11	5GSN N26	REPR EFI	5GSI WK	EEVR SI	LTEM UI	LTEM PI	ENBC RSI	TSPC MI
12	CSRM FI	MTED TN	MTED TA	N5GN MI	5GCN RS	5GCN RI	5SRH OI	ETHP DN
13	NSPU SI	PGW RNSI	RPPC SI	PGW CHI	SISS ME	NSEN BI	IDFU PF	EMCI
14	Spare	Spare	Spare	Spare	Spare	LTEM SAI	SRTPI	UPIP SI
15 to (n+4)	These octet(s) is/are present only if explicitly specified							

Figure 8.12-1: Indication

For each message the applicable flags of the Indication IE shall be clearly specified in the individual message clause. The remaining flags of the Indication IE not so indicated shall be discarded by the receiver.

The receiver shall consider the value of the applicable flags as "0", if the Indication IE is applicable for the message but not included in the message by the sender.

The following bits within Octet 5 shall indicate:

- Bit 8 – DAF (Dual Address Bearer Flag): This bit shall be set when the PDN Type, determined based on UE request and subscription record, is set to IPv4v6 and all SGSNs which the UE may be handed over to are Release 8 or above supporting dual addressing, which is determined based on node pre-configuration by the operator..
- Bit 7 – DTF (Direct Tunnel Flag): This bit shall be set when the UE is in UTRAN and Direct Tunnel is selected

- Bit 6 – HI (Handover Indication): If this bit is set to 1 over S11/S4 and S5/S8 interfaces, it shall indicate a UE handover attach. This bit is applicable during the Handover from Trusted or Untrusted Non-3GPP IP Access to E-UTRAN or a Handover from Trusted or Untrusted Non-3GPP IP Access to UTRAN/GERAN procedures (see clauses 8.2, 8.6 and 16.11 of 3GPP TS 23.402 [45]), or a 5GS to EPS handover without the N26 interface (see clause 4.11.2.2 of 3GPP TS 23.502 [83]). If this bit is set to 1 over GTP based S2a interface, it shall indicate a UE handover from 3GPP access to Trusted Non-3GPP access and UE requested IP address preservation. If this bit is set to 1 over GTP based S2b interface, it shall indicate a UE handover from 3GPP access to Untrusted Non-3GPP Access and UE requested IP address preservation.
- Bit 5 – DFI (Direct Forwarding Indication): If this bit is set to 1, it shall indicate that direct data forwarding applies between the source RAN and the target RAN during an S1 based handover procedure or during an inter-system handover between 5GS and EPS.
- Bit 4 – OI (Operation Indication):
  - If this bit is set to 1, it shall denote that the receiving SGW of a "Create Session Request" shall send a Modify Bearer Request immediately to the PGW. This allows the SGW to differentiate if the "Create Session Request" received on S4/S11 interface belongs to a TAU/RAU with an SGW relocation (OI = 1), or X2-based handover with SGW relocation (OI = 1) or Enhanced SRNS Relocation with SGW relocation (OI=1) or MME triggered Serving GW relocation (OI = 1) or S1-based handover with SGW relocation (OI = 0).
  - It shall be set to 1 on S4/S11 interface if the SGW needs to forward the Delete Session Request message to PGW.
- Bit 3 – ISRSI (Idle mode Signalling Reduction Supported Indication): If this is set to 1, it shall indicate that the old/source SGSN/MME and the associated SGW are capable to activate ISR.
- Bit 2 – ISRAI (Idle mode Signalling Reduction Activation Indication): If this bit is set to 1, it shall indicate that the ISR is established between the MME and the S4 SGSN during a TAU/RAU without an SGW change procedure or during an Inter RAT handover without an SGW change procedure. The SGW shall retain the resources for the other CN node that has its bearer resources on the SGW reserved. The old/source SGSN/MME shall maintain the UE's contexts and activate ISR.
- Bit 1 – SGWCI (SGW Change Indication):
  - If this bit is set to 1, it shall indicate that the target MME/SGSN has selected a new SGW during a TAU/RAU or handover with an SGW change procedure.
  - It shall be set to 1 by the target AMF during the EPS to 5GS handover/Idle mode Mobility using N26 interface.

The following bits within Octet 6 shall indicate:

- Bit 8 – SQCI (Subscribed QoS Change Indication): If this bit is set to 1, it indicates that the subscribed QoS profile of the related PDN connection has changed in the old MME/SGSN when the UE is in ECM-IDLE state and ISR is activated. The new MME/SGSN shall trigger the Subscribed QoS Modification procedure. See 3GPP TS 23.401 [3], clause 5.3.9.2.
- Bit 7 – UIMSI (Unauthenticated IMSI): If this bit is set to 1, it indicates that the IMSI present in the message is not authenticated and is for emergency or RLOS attached UE.
- Bit 6 – CFSI (Change F-TEID support indication): if this bit is set to 1, it indicates that the SGW can change the assigned GTP-U F-TEID in the current procedure. If the SGW needs to modify the GTP-U F-TEID and the CFSI flag is set to 1 in the corresponding request message, the SGW shall include the new F-TEID in the Modify Bearer Response/Modify Access Bearers Response message.
- Bit 5 – CRSI (Change Reporting support indication): if this bit is set to 1, it indicates that the MME/S4 SGSN supports Location Change Reporting mechanism for the corresponding session.
- Bit 4 – PS (Piggybacking Supported). This bit denotes whether the MME/SGW support piggybacking feature as described in Annex F of 3GPP TS 23.401 [3]. If set to 1, it indicates that the node is capable of processing two different GTP-C messages appearing back to back in a single UDP payload.
- Bit 3 – PT (S5/S8 Protocol Type) If this bit set to 1, it shall indicate that the protocol type for the S5/S8 interface is PMIP; this bit is set to 0 to indicate that the protocol type for the S5/S8 interface is GTP.

- Bit 2 – SI (Scope Indication): If this bit is set to 1, it indicates that all bearer resources of the UE shall be released by the SGW. This flag is set in messages during TAU/RAU/Handover with SGW change /SRNS Relocation Cancel Using S4 with SGW change/Inter RAT handover Cancel procedure with SGW change/S1 Based handover Cancel procedure with SGW change.
- Bit 1 – MSV (MS Validated): If this bit is set to 1, it shall indicate that the new MME/SGSN has successfully authenticated the UE.

The following bits within Octet 7 shall indicate:

- Bit 8 – RetLoc (Retrieve Location Indication Flag): if this bit is set to 1, it indicates that the PGW requests the MME/SGSN or TWAN/ePDG to provide the User Location Information.
- Bit 7 – PBIC (Propagate BBAI Information Change): if this bit is set to 1, it indicates a change in the H(e)NB local IP address and/or UDP port number, i.e. the UE moves from an (e)NB to a H(e)NB, or from one H(e)NB to another H(e)NB with the fixed network backhaul changed, or the UE moves from a H(e)NB to a (e)NB.
- Bit 6 – SRNI (SGW Restoration Needed Indication): if this bit is set to 1, it indicates that the source MME/S4-SGSN has not performed the SGW relocation procedure after the source SGW has failed with or without restart, when the source and target MME/S4-SGSN support the MME/S4-SGSN triggered SGW restoration procedure as specified in 3GPP TS 23.007 [17].
- Bit 5 – S6AF (Static IPv6 Address Flag): if this bit is set to 1, it indicates that PDP/PDN IPv6 address is static.
- Bit 4 – S4AF (Static IPv4 Address Flag): if this bit is set to 1, it indicates that PDP/PDN IPv4 address is static.
- Bit 3 – MBMDT (Management Based MDT allowed flag): if this bit is set to 1, it indicates that management based MDT is allowed.
- Bit 2 – ISRAU (ISR is activated for the UE): if this bit is set to 1, it indicates that ISR is activated for the UE before the UE moving to the new SGSN/MME.
- Bit 1 – CCRSI (CSG Change Reporting support indication): if this bit is set to 1, it indicates that the MME/S4-SGSN supports CSG Information Change Reporting mechanism for the corresponding session.

The following bits within Octet 8 shall indicate:

- Bit 8 – CPRAI (Change of Presence Reporting Area information Indication): when ISR is active if this bit is set to 1, it indicates that the Presence Reporting Area information, which is provided as a part of the Presence Reporting Area Information IE, has changed since last reported by the MME/S4-SGSN. The SGW shall ignore this flag when ISR is not active.
- Bit 7 – ARRL (Abnormal Release of Radio Link): if this bit is set to 1 by the MME, it indicates to the SGW that the access bearers are released due to an abnormal release of the radio link. Based on operator policy, this indication may be used by the SGW in subsequent decisions to trigger PDN charging pause if the PGW Pause of Charging feature has been enabled on that PDN connection.
- Bit 6 – PPOFF (PDN Pause Off Indication): if this bit is set to 1 by the SGW, it indicates to the PGW that the charging for the PDN connection shall be unpaused.
- Bit 5 – PPON (PDN Pause On Indication) / PPEI (PDN Pause Enabled Indication): if this bit is set to 1 by the SGW, it indicates to the PGW that the charging for the PDN connection shall be paused; if it is set to 1 by the PGW, it indicates that PGW enables the SGW to use the PGW Pause of Charging procedure for the PDN connection.
- Bit 4 – PPSI (PDN Pause Support Indication): if this bit is set to 1 by the SGW, it indicates that the SGW supports the PGW Pause of Charging procedure; if it is set to 1 by the PGW, it indicates that the PGW supports the PGW Pause of Charging procedure.
- Bit 3 – CSFBI (CSFB Indication): if this bit is set to 1, it indicates that the UE has been subject to CSFB.
- Bit 2 – CLII (Change of Location Information Indication): when ISR is active if this bit is set to 1, it indicates that the location information, which is provided as a part of ULI IE, has changed since last reported by the MME/S4-SGSN. The SGW shall ignore this flag when ISR is not active.

- Bit 1 – CPSR (CS to PS SRVCC indication): if this bit is set to 1, it indicates that a UTRAN/GERAN to E-UTRAN/UTRAN (HSPA) SRVCC procedure is underway and the associated message, i.e. Modify Bearer Request shall be forwarded to the PGW from the SGW as specified in 3GPP TS 23.216 [43].

The following bits within Octet 9 shall indicate:

- Bit 8 – NSI (NBIFOM Support Indication): if this bit is set to 1, it indicates to the PGW that the NBIFOM is supported (see clause 5.10 of 3GPP TS 23.161 [71]).
- Bit 7 – UASI (UE Available for Signaling Indication): if this bit is set to 1, it indicates that the UE is available for end to end signalling and that the PGW should re-attempt the pending network initiated procedure.
- Bit 6 – DTICI (Delay Tolerant Connection Indication): if this bit is set to 1, it indicates that the PDN connection is delay tolerant according to the local policies in the PGW, e.g. per APN. For this PDN connection the PGW supports receiving the rejection cause "UE is temporarily not reachable due to power saving" from the MME/SGSN via the SGW during a network initiated procedure and holding the network initiated procedure, until the PGW receives the subsequent Modify Bearer Request message with the UASI flag indicating that the UE is available for end to end signalling.
- Bit 5 – BDWI (Buffered DL Data Waiting Indication): if this bit is set to 1, it indicates that there is DL data buffered in the (old) SGW or (V-)SMF/UPF, i.e. that the new MME/SGSN shall invoke data forwarding if there is an SGW change as specified in clause 5.3.3.1A of 3GPP TS 23.401 [3] or upon idle mode mobility between 5GS and EPS with data forwarding as specified in clauses 4.11.1.3.2A, 4.11.1.3.3A, 4.23.12.2a and 4.23.12.3a of 3GPP TS 23.502 [83], and that it shall setup the user plane in conjunction with the TAU/RAU procedure for delivery of the buffered DL data to the UE.
- Bit 4 – PSCI (Pending Subscription Change Indication): If this bit is set to 1, it indicates that there is a pending report of the changed subscribed QoS profile of the related PDN connection in the old MME, so that the new MME/SGSN shall trigger the HSS Initiated Subscribed QoS Modification procedure towards the PGW. See clause 5.3.9.2 of 3GPP TS 23.401 [3].
- Bit 3 – PCRI (P-CSCF Restoration Indication): if this bit is set to 1, it indicates a request to trigger a P-CSCF restoration for the corresponding user (see 3GPP TS 23.380 [61]).
- Bit 2 – AOSI (Associate OCI with SGW node's Identity): if this bit is set to 1, it indicates that the SGW provided "SGW's Overload Control Information" which shall be associated with the node identity (i.e. FQDN or the IP address received from the DNS during the SGW selection) of the serving SGW.
- Bit 1 – AOPI (Associate OCI with PGW node's Identity): if this bit is set to 1, it indicates that the PGW provided "PGW's Overload Control Information" which shall be associated with the node identity (i.e. FQDN or the IP address received from the HSS or DNS during the PGW selection) of the serving PGW.

The following bits within Octet 10 shall indicate:

- Bit 8 – ROAAI (Release Over Any Access Indication): If this bit is set to 1, it indicates to the PGW that, if this is an NB-IFOM PDN connection, the PGW shall initiate the release of the corresponding PDN connection over the non-3GPP access over the S2a/S2b interface with the cause "Local release".
- Bit 7 – EPCOSI (Extended PCO Support Indication): If this bit is set to 1, it indicates to the receiver that the Extended PCO is supported, e.g. when the PGW is the receiver, it indicates that the UE, the MME and the SGW support Extended PCO; when the target MME is the receiver, during an inter-MME mobility, it indicates that UE and the source MME support Extended PCO.
- Bit 6 – CPOPCI (Control Plane Only PDN Connection Indication): If this bit is set to 1, it indicates that the PDN Connection is set to Control Plane Only, i.e. the user data pertaining to this PDN connection can only be transferred in NAS PDUs via the control plane.
- Bit 5 – PMTSMI (Pending MT Short Message Indication): If this bit is set to 1, it indicates to the target MME/S4-SGSN that there is one (or more) pending MT Short Message(s) in the SMS-GMSC, i.e. that the target MME/S4-SGSN shall provide its E.164 address and Diameter Identity if available to receive the MT Short message and maintain the signalling connection with the UE for a longer time to enable the retransmission of the Short Message.
- Bit 4 – S11-U Tunnel Flag (S11TF): This flag shall be set to 1 on the S11 interface if user data is transported in NAS signalling.

- Bit 3 – PNSI (Pending Network Initiated PDN Connection Signalling Indication): if this bit is set to 1, it indicates to the target MME/SGSN that there is pending network initiated PDN connection signalling for the PDN connection, i.e. the target MME/SGSN shall set UASI flag in the Create Session Request or Modify Bearer Request message to indicate to the PGW that the UE is available for end to end signalling.
- Bit 2 – UNACCSI (UE Not Authorised Cause Code Support Indication): If this bit is set to 1, it indicates that the Cause Code for "UE not authorized by OCS or external AAA Server" is supported by the S4-SGSN/MME.
- Bit 1 - WLCP PDN Connection Modification Support Indication (WPMSI): if this bit is set to 1, it indicates that the TWAN supports the WLCP PDN Connection Modification procedure. This indication is used by the P-CSCF restoration extension procedure for TWAN access (see 3GPP TS 23.380 [61]).

The following bits within Octet 11 shall indicate:

- Bit 8 – 5GSNN26 (5GS Interworking without N26 Indication): if this bit is set to 1 and the 5GS Interworking Indication (5GSIWKI) is set to 1, it indicates to the PGW-C+SMF that 5GS Interworking is supported without the N26 interface. If this bit is set to 0 and the 5GSIWKI (5GS Interworking Indication) is set to 1, it indicates to the PGW-C+SMF that 5GS Interworking is supported with the N26 interface.
- Bit 7 – REPREFI (Return Preferred Indication): This flag shall be set to 1 to indicate a preferred return of the UE to the last used EPS or 5GS PLMN at a later access change to an EPS or 5GS shared network.
- Bit 6 – 5GSIWKI (5GS Interworking Indication): This flag shall be set to 1 for UEs supporting N1 mode and not restricted from interworking with 5GS by user subscription (see "5GC" bit within Core-Network-Restrictions AVP and Interworking-5GS-Indicator AVP specified in 3GPP TS 29.272 [70] and 3GPP TS 29.273 [68]).
- Bit 5 – EEVRSI (Extended EBI Value Range Support Indication): if this bit is set to 1, it indicates that the sending GTPv2 entity supports the 15 EPS Bearers, i.e. it supports to use EPS Bearer ID with a value between '1' and '15'.
- Bit 4 – LTEMUI (LTE-M UE Indication): if this bit is set to 1, it indicates that the UE is a LTE-M UE (see 3GPP TS 23.401 [3]);
- Bit 3 – LTEMPPI (LTE-M RAT Type reporting to PGW Indication): if this bit is set to 1, it indicates to the SGW to forward the LTE-M RAT type to the PGW;
- Bit 2 – ENBCRSI (eNB Change Reporting Support Indication): if this bit is set to 1, it indicates that the MME supports Macro eNodeB Change Reporting mechanism for the corresponding session.
- Bit 1 – TSPCMI (Triggering SGSN initiated PDP Context Creation/Modification Indication): if this bit is set to 1, it indicates to the S4-SGSN that in the UE\_initiated PDP Context Modification procedure, when the NBIFOM container is included, the S4-SGSN accepts the UE initiated PDP Context Modification procedure and initiates SGSN initiated PDP Context Creation/modification procedures respectively towards UE to transfer the NBIFOM container received from the PGW either in Create Bearer Request or Update Bearer Request message as specified in 3GPP TS 23.161 [71].

The following bits within Octet 12 shall indicate:

- Bit 8 – CSRMFI (Create Session Request Message Forwarded Indication): if this bit is set to 1, it indicates that the Create Session Request message has been forwarded by a PGW, and the receiving PGW shall include its PGW FQDN in the Create Session Response message if the creation of the PDN connection is accepted.
- Bit 7 – MTEDTN (MT-EDT Not Applicable): if this bit is set to 1, it indicates that MT-EDT is not applicable for the PDN connection.
- Bit 6 – MTEDTA (MT-EDT Applicable): if this bit is set to 1, it indicates that MT-EDT is applicable for the PDN connection.
- Bit 5 – N5GNMI (No 5GS N26 Mobility Indication): if this bit is set to 1, it indicates that the PDN connection cannot be moved to 5GS via N26.
- Bit 4 – 5GCNRS (5GC Not Restricted Support): if this bit is set to 1, this indicates to the PGW-C+SMF that the sending node (i.e. MME or ePDG) supports setting the 5GCNRI flag. An MME or an ePDG compliant with this version of the specification shall support setting the 5GCNRI flag.

- Bit 3 – 5GCNRI (5GC Not Restricted Indication): if this bit is set to 1, this indicates to the PGW-C+SMF that access to the 5GC is not restricted for the PDN connection. If the 5GCNRS bit is set to 1 and the 5GCNRI bit is set to 0, this indicates that access to the 5GC is restricted for the PDN connection. The 5GCNRI flag shall be ignored by the PGW-C+SMF if the 5GSIWKI flag is set to 1 (i.e. 5GS Interworking is supported), except for the case noted in Note 27 in Table 7.2.1-1.
- Bit 2 – 5SRHOI (5G-SRVCC HO Indication): if this bit is set to 1, it indicates the HO is used for 5G-SRVCC as specified in 3GPP TS 23.216 [43].
- Bit 1 – ETHPDN (Ethernet PDN Support Indication): if this bit is set to 1, it indicates the support of Ethernet PDN Connection.

The following bits within Octet 13 shall indicate:

- Bit 8 – NSPUSI (Notify Start Pause of charging via User plane Support Indication): if this bit is set to 1, it indicates that the PGW-C and PGW-U support Notify Start Pause of Charging via user plane feature as specified in clause 5.30 of 3GPP TS 29.244 [80].
- Bit 7 – PGWRNSI (PGW Redirection due to mismatch with Network Slice subscribed by UE Support Indication): if this bit is set to 1, it indicates that the MME supports receiving a Create Session rejection response with the cause "PGW redirection due to mismatch with network slice subscribed by the UE" and to establish the PDN connection towards the Alternative PGW-C/SMF indicated in the Create Session rejection response.
- Bit 6 – RPPCSI (Restoration of PDN connections after an PGW-C/SMF Change Support Indication): if this bit is set to 1, it indicates that the sending GTPv2 entity, i.e. the MME/ePDG and/or the SGW, supports the Restoration of PDN connections after an PGW-C/SMF Change procedure as specified in clause 31 of 3GPP TS 23.007 [17].
- Bit 5 – PGWCHI (PGW CHange Indication): if this bit is set to 1, it indicates that the Create Session Request is triggered to move an existing PDN connection to the new PGW-C/SMF as specified in clauses 31.3 and 31.3A of 3GPP TS 23.007 [17].
- Bit 4 – SISSME (Same IWK-SCEF Selected for Monitoring Event Indication): if this bit is set to 1, it indicates that same IWK-SCEF is selected by target MME/SGSN for Monitoring Event.
- Bit 3 – NSENBI (Notify Source eNodeB Indication): if this bit is set to 1, it indicates that the source MME shall send a Handover Success to the source eNodeB (see clause 5.5.1.2.2a of 3GPP TS 23.401 [3]).
- Bit 2 – IDFUPF (Indirect Data Forwarding with UPF Indication): if this bit is set to 1, it indicates that indirect data forwarding is required for user plane routes from/to a UPF.
- Bit 1 – EMCI (Emergency PDU Session Indication): if this bit is set to 1, it indicates the UE has emergency PDU session, as specified in 3GPP TS 23.216 [43].

The following bits within Octet 14 shall indicate:

- Bits 4 to 8: Spare, for future use and set to 0.
- Bit 3 – LTEM SAI (LTE-M Satellite Access Indication): if this bit is set to 1, it indicates that the LTE-M UE is accessing Satellite E-UTRAN (see 3GPP TS 23.401 [3]);
- Bit 2 – SRTPI (Satellite RAT Type reporting to PGW Indication): if this bit is set to 1, it indicates to the SGW to forward the Satellite related RAT type to the PGW;
- Bit 1 – UPIPSI (User Plane Integrity Protection Support Indication): if this bit is set to 1, it indicates that the UE, MME and E-UTRAN supports User Plane Integrity Protection with EPS as specified in clause 4.11.0a.5 of 3GPP TS 23.502 [83].

## 8.13 Protocol Configuration Options (PCO)

Protocol Configuration Options (PCO) is transferred via GTP tunnels. The sending entity copies the value part of the PCO into the Value field of the PCO IE. The detailed coding and maximum length of the PCO field from octets 5 to (n+4) shall be specified as per clause 10.5.6.3 of 3GPP TS 24.008 [5], starting with octet 3.

Octets	Bits							
	8	7	6	5	4	3	2	1
1	Type = 78 (decimal)							
2 to 3	Length = n							
4	Spare				Instance			
5 to (n+4)	Protocol Configuration Options (PCO)							

Figure 8.13-1: Protocol Configuration Options (PCO)

## 8.14 PDN Address Allocation (PAA)

The PDN Address Allocation is coded as depicted in Figure 8.14-1.

NOTE: The Prefix Length within PAA IE has a fixed value of /64.

Octets	Bits							
	8	7	6	5	4	3	2	1
1	Type = 79 (decimal)							
2 to 3	Length = n							
4	Spare				Instance			
5	Spare				PDN Type			
6 to (n+4)	PDN Address and Prefix							

Figure 8.14-1: PDN Address Allocation (PAA)

Table 8.14-1: PDN Address Allocation

PDN type value (octet 5)			
Bits			
<b>3</b>	<b>2</b>	<b>1</b>	
0	0	1	IPv4
0	1	0	IPv6
0	1	1	IPv4v6
1	0	0	Non-IP
1	0	1	Ethernet
All other values are reserved.			
Bits 8-4 of octet 5 are spare and shall be coded as zero.			
PDN Address and Prefix (octet 6 to n+4)			
If PDN type value indicates IPv4, an IPv4 address is present in the PDN Address and Prefix from octet 6 to octet 9. Bit 8 of octet 6 represents the most significant bit of the IPv4 address and bit 1 of octet 9 the least significant bit.			
If PDN type value indicates IPv6, octet 6 contains the IPv6 Prefix Length. Octets 7 through 22 contain an IPv6 Prefix and Interface Identifier. Bit 8 of octet 7 represents the most significant bit of the IPv6 Prefix and Interface Identifier and bit 1 of octet 22 the least significant bit.			
If PDN type value indicates IPv4v6, octet 6 contains the IPv6 Prefix Length. Octets 7 through 22 contain an IPv6 Prefix and Interface Identifier. Bit 8 of octet 7 represents the most significant bit of the IPv6 Prefix and Interface Identifier and bit 1 of octet 22 the least significant bit. Octets 23 through 26 contain an IPv4 address. Bit 8 of octet 23 represents the most significant bit of the IPv4 address and bit 1 of octet 26 the least significant bit.			
If PDN type value indicates Non-IP or Ethernet, octets from 6 to 'n+4' shall not be present.			



## 8.15 Bearer Quality of Service (Bearer QoS)

Bearer Quality of Service (Bearer QoS) is transferred via GTP tunnels. The sending entity copies the value part of the Bearer QoS into the Value field of the Bearer QoS IE.

Octets	Bits							
	8	7	6	5	4	3	2	1
1	Type = 80 (decimal)							
2-3	Length = n							
4	Spare				Instance			
5	Spare	PCI	PL			Spare	PVI	
6	Label (QCI)							
7 to 11	Maximum bit rate for uplink							
12 to 16	Maximum bit rate for downlink							
17 to 21	Guaranteed bit rate for uplink							
22 to 26	Guaranteed bit rate for downlink							
27 to (n+4)	These octet(s) is/are present only if explicitly specified							

**Figure 8.15-1: Bearer Quality of Service (Bearer QoS)**

Octet 5 represents the Allocation/Retention Priority (ARP) parameter. The meaning and value range of the parameters within the ARP are defined in 3GPP TS 29.212 [29]. The bits within the ARP octet are:

- Bit 1 – PVI (Pre-emption Vulnerability): See 3GPP TS 29.212[29], clause 5.3.47 Pre-emption-Vulnerability AVP.
- Bit 2 – spare
- Bits 3 to 6 – PL (Priority Level): See 3GPP TS 29.212[29], clause 5.3.45 Priority-Level AVP. PL encodes each priority level defined for the Priority-Level AVP as the binary value of the priority level.
- Bit 7 – PCI (Pre-emption Capability): See 3GPP TS 29.212[29], clause 5.3.46 Pre-emption-Capability AVP.
- Bit 8 – spare.

Octet 6 contains the "QCI" value, as specified in 3GPP TS 23.203 [48].

The UL/DL MBR and GBR fields are encoded as kilobits per second (1 kbps = 1000 bps) in binary value. The UL/DL MBR and GBR fields may require converting values in bits per second to kilobits per second when the UL/DL MBR and GBR values are received from an interface other than GTPv2 interface. If such conversions result in fractions, then the value of UL/DL MBR and GBR fields shall be rounded upwards. For non-GBR bearers, both the UL/DL MBR and GBR should be set to zero. The range of QCI, Maximum bit rate for uplink, Maximum bit rate for downlink, Guaranteed bit rate for uplink and Guaranteed bit rate for downlink are specified in 3GPP TS 36.413 [10].

NOTE: The encoding in 3GPP TS 24.301 [23] and 3GPP TS 36.413 [10] is different from the encoding within this specification.

## 8.16 Flow Quality of Service (Flow QoS)

Flow Quality of Service (Flow QoS) is transferred via GTP tunnels. The sending entity copies the value part of the Flow QoS into the Value field of the Flow QoS IE.

Octets	Bits							
	8	7	6	5	4	3	2	1
1	Type = 81 (decimal)							
2 to 3	Length = n							
4	Spare				Instance			
5	Label (QCI)							
6 to 10	Maximum bit rate for uplink							
11 to 15	Maximum bit rate for downlink							
16 to 20	Guaranteed bit rate for uplink							
21 to 25	Guaranteed bit rate for downlink							
26 to (n+4)	These octet(s) is/are present only if explicitly specified							

**Figure 8.16-1: Flow Quality of Service (Flow QoS)**

Octet 5 contains the "QCI" value, as specified in 3GPP TS 23.203 [48].

The UL/DL MBR and GBR fields are encoded as kilobits per second (1 kbps = 1000 bps) in binary value. For non-GBR bearers, both the UL/DL MBR and GBR should be set to zero. The range of QCI, Maximum bit rate for uplink, Maximum bit rate for downlink, Guaranteed bit rate for uplink and Guaranteed bit rate for downlink are specified in 3GPP TS 36.413 [10].

NOTE: The encoding in 3GPP TS 24.301 [23] and 3GPP TS 36.413 [10] is different from the encoding within this specification.

## 8.17 RAT Type

RAT Type is coded as depicted in Figure 8.17-1.

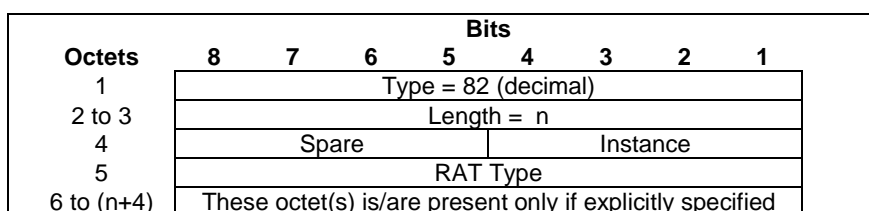

Figure 8.17-1: RAT Type

Table 8.17-1: RAT Type values

RAT Types	Values (Decimal)
<reserved>	0
UTRAN	1
GERAN	2
WLAN	3
GAN	4
HSPA Evolution	5
EUTRAN (WB-E-UTRAN)	6
Virtual	7
EUTRAN-NB-IoT	8
LTE-M	9
NR	10
WB-E-UTRAN(LEO)	11
WB-E-UTRAN(MEO)	12
WB-E-UTRAN(GEO)	13
WB-E-UTRAN(OTHERSAT)	14
EUTRAN-NB-IoT(LEO)	15
EUTRAN-NB-IoT(MEO)	16
EUTRAN-NB-IoT(GEO)	17
EUTRAN-NB-IoT(OTHERSAT)	18
LTE-M(LEO)	19
LTE-M(MEO)	20
LTE-M(GEO)	21
LTE-M(OTHERSAT)	22
<spare>	23-255

NOTE 1: For S4-SGSN, currently it is only possible to detect the difference between GERAN and UTRAN when GERAN Gb mode is used. If GERAN Iu mode is used, then an S4-SGSN may not be able to detect the difference between GERAN and UTRAN. Across the Gb interface, the SGSN may also not be able to detect the difference between GERAN and GAN. If S4-SGSN cannot detect that the HSPA Evolution 3GPP TR 25.999 [46] network is behind the Iu interface, the S4-SGSN will send the "UTRAN" RAT Type.

NOTE 2: For the Iu interface case, if the SGSN detects UTRAN or HSPA, it sets the RAT-Type to "UTRAN". If the SGSN detects HSPA+, it sets the RAT-Type to "HSPA Evolution", otherwise the SGSN will send the "UTRAN" RAT Type.

NOTE 3: The MME sets the LTE-M RAT-Type for a UE accessing E-UTRAN and indicating Category M from the eNB or sets the LTE-M Satellite RAT types for a UE accessing satellite E-UTRAN and indicating Category M from the eNB, as specified in 3GPP TS 23.401 [3].

NOTE 4: The MME sets the RAT-Type to WB-E-UTRAN(LEO) / WB-E-UTRAN(MEO) / WB-EUTRAN(GEO) / WB-E-UTRAN(OTHERSAT) for a UE accessing E-UTRAN with satellite access (EUTRAN-LEO, EUTRAN-MEO, EUTRAN-GEO or EUTRAN-OTHERSAT), and without indicating Category M satellite from the eNB.

NOTE 5: The MME sets the RAT-Type to EUTRAN-NB-IoT(LEO) / EUTRAN-NB-IoT(MEO) / EUTRAN-NB-IoT(GEO) / EUTRAN-NB-IoT(OTHERSAT) for a UE accessing EUTRAN-NB-IoT with satellite access (NBIoT-LEO, NBIoT-MEO, NBIoT-GEO or NBIoT-OTHERSAT).

NOTE 6: The MME sets the RAT-Type to LTE-M(LEO) / LTE-M(MEO) / LTE-M(GEO) / LTE-M(OTHERSAT) for a UE accessing E-UTRAN with satellite access (EUTRAN-LEO, EUTRAN-MEO, EUTRAN-GEO or EUTRAN-OTHERSAT) and indicating Category M satellite from the eNB.

## 8.18 Serving Network

Serving Network is coded as depicted in Figure 8.18-1.

Octets	Bits							
	8	7	6	5	4	3	2	1
1	Type = 83 (decimal)							
2 to 3	Length = n							
4	Spare				Instance			
5	MCC digit 2				MCC digit 1			
6	MNC digit 3				MNC digit 3			
7	MNC digit 2				MNC digit 1			
8 to (n+4)	These octet(s) is/are present only if explicitly specified							

Figure 8.18-1: Serving Network

If an Administration decides to include only two digits in the MNC, then bits 5 to 8 of octet 6 are coded as "1111".

Unless specified otherwise in the specification, this IE contains the serving core network operator ID provided by the MME, S4-SGSN or ePDG, or the PLMN identity of the selected PLMN used for 3GPP-based access authentication provided by the TWAN.

NOTE: The serving core network operator ID is the PLMN ID of the MME, S4-SGSN or ePDG which is currently serving the UE. An S4-SGSN/MME which supports multiple PLMN IDs is considered as logically different S4-SGSNs/MMEs.

## 8.19 EPS Bearer Level Traffic Flow Template (Bearer TFT)

EPS Bearer Level Traffic Flow Template (Bearer TFT) is transferred via GTP tunnels. The sending entity copies the value part of the EPS Bearer Level TFT into the Value field of the EPS Bearer Level TFT IE. The detailed coding and maximum length of the EPS Bearer Level TFT IE is specified in 3GPP TS 24.008 [5], clause 10.5.6.12, beginning with octet 3.

Octets	Bits							
	8	7	6	5	4	3	2	1
1	Type = 84 (decimal)							
2 to 3	Length = n							
4	Spare				Instance			
5 to (n+4)	EPS Bearer Level Traffic Flow Template (TFT)							

Figure 8.19-1: EPS Bearer Level Traffic Flow Template (Bearer TFT)

## 8.20 Traffic Aggregate Description (TAD)

The Traffic Aggregate Description IE is coded as depicted in Figure 8.20-1. The detailed coding and maximum length of Traffic Aggregate Description is specified in 3GPP TS 24.008 [5], clause 10.5.6.12, beginning with octet 3..

Octets	Bits							
	8	7	6	5	4	3	2	1
1	Type = 85 (Decimal)							
2 to 3	Length = n							
4	Spare				Instance			
5 to (n+4)	Traffic Aggregate Description							

Figure 8.20-1 Traffic Aggregate Description

## 8.21 User Location Information (ULI)

User Location Information (ULI) is a extendable IE that is coded as depicted in Figure 8.21-1. The CGI, SAI, RAI, TAI, ECGI and LAI identity types are defined in 3GPP TS 23.003 [2].

Octets	Bits							
	8	7	6	5	4	3	2	1
1	Type = 86 (decimal)							
2 to 3	Length = n							
4	Spare				Instance			
5	Extended Macro eNodeB ID	Macro eNodeB ID	LAI	ECGI	TAI	RAI	SAI	CGI
a to a+6	CGI							
b to b+6	SAI							
c to c+6	RAI							
d to d+4	TAI							
e to e+6	ECGI							
f to f+4	LAI							
g to g+5	Macro eNodeB ID							
g to g+5	Extended Macro eNodeB ID							
h to (n+4)	These octet(s) is/are present only if explicitly specified							

Figure 8.21-1: User Location Information

The ULI IE shall contain only one identity of the same type (e.g. more than one CGI cannot be included), but ULI IE may contain more than one identity of a different type (e.g. ECGI and TAI). The flags LAI, ECGI, TAI, RAI, SAI, CGI, Macro eNodeB ID, and Extended Macro eNodeB ID in octet 5 indicate if the corresponding type shall be present in a respective field or not. If one of these flags is set to "0", the corresponding field shall not be present at all. If more than one identity of different type is present, then they shall be sorted in the following order: CGI, SAI, RAI, TAI, ECGI, LAI, Macro eNodeB ID, Extended Macro eNodeB ID. Only one of the Macro eNodeB ID or Extended Macro eNodeB ID shall be present in the ULI IE.

The following clauses specify the coding of the fields representing different identities.

For each identity, if an Administration decides to include only two digits in the MNC, then "MNC digit 3" field of corresponding location shall be coded as "1111".

### 8.21.1 CGI field

The coding of CGI (Cell Global Identifier) is depicted in Figure 8.21.1-1. Only zero or one CGI field shall be present in ULI IE.

Octets	Bits							
	8	7	6	5	4	3	2	1
a	MCC digit 2				MCC digit 1			
a+1	MNC digit 3				MCC digit 3			
a+2	MNC digit 2				MNC digit 1			
a+3 to a+4	Location Area Code (LAC)							
a+5 to a+6	Cell Identity (CI)							

Figure 8.21.1-1: CGI field

The Location Area Code (LAC) consists of 2 octets. Bit 8 of Octet a+3 is the most significant bit and bit 1 of Octet a+4 the least significant bit. The coding of the location area code is the responsibility of each administration. Coding using full hexadecimal representation (binary, not ASCII encoding) shall be used.

The Cell Identity (CI) consists of 2 octets. Bit 8 of Octet a+5 is the most significant bit and bit 1 of Octet a+6 the least significant bit. The coding of the cell identity is the responsibility of each administration. Coding using full hexadecimal representation (binary, not ASCII encoding) shall be used.

## 8.21.2 SAI field

The coding of SAI (Service Area Identifier) is depicted in Figure 8.21.2-1. Only zero or one SAI field shall be present in ULI IE.

Octets	Bits							
	8	7	6	5	4	3	2	1
b	MCC digit 2				MCC digit 1			
b+1	MNC digit 3				MCC digit 3			
b+2	MNC digit 2				MNC digit 1			
b+3 to b+4	Location Area Code (LAC)							
b+5 to b+6	Service Area Code (SAC)							

Figure 8.21.2-1: SAI field

The Location Area Code (LAC) consists of 2 octets. Bit 8 of Octet b+3 is the most significant bit and bit 1 of Octet b+4 the least significant bit. The coding of the location area code is the responsibility of each administration. Coding using full hexadecimal representation (binary, not ASCII encoding) shall be used.

The Service Area Code (SAC) consists of 2 octets. Bit 8 of Octet b+5 is the most significant bit and bit 1 of Octet b+6 the least significant bit. The SAC is defined by the operator. See 3GPP TS 23.003 [2] clause 12.5 for more information.

## 8.21.3 RAI field

The coding of RAI (Routing Area Identity) is depicted in Figure 8.21.3-1. Only zero or one RAI field shall be present in ULI IE.

Octets	Bits							
	8	7	6	5	4	3	2	1
c	MCC digit 2				MCC digit 1			
c+1	MNC digit 3				MCC digit 3			
c+2	MNC digit 2				MNC digit 1			
c+3 to c+4	Location Area Code (LAC)							
c+5 to c+6	Routing Area Code (RAC)							

Figure 8.21.3-1: RAI field

The Location Area Code (LAC) consists of 2 octets. Bit 8 of Octet c+3 is the most significant bit and bit 1 of Octet c+4 the least significant bit. The coding of the location area code is the responsibility of each administration. Coding using full hexadecimal representation (binary, not ASCII encoding) shall be used (see 3GPP TS 23.003 [2]).

The Routing Area Code (RAC) consists of 2 octets. Only Octet c+5 contains the RAC. Octet c+6 is coded as all 1's (11111111). The RAC is defined by the operator. Coding using full hexadecimal representation (binary, not ASCII encoding) shall be used (see 3GPP TS 23.003 [2]).

## 8.21.4 TAI field

The coding of TAI (Tracking Area Identity) is depicted in Figure 8.21.4-1. Only zero or one TAI field shall be present in ULI IE.

Octets	Bits							
	8	7	6	5	4	3	2	1
d	MCC digit 2				MCC digit 1			
d+1	MNC digit 3				MCC digit 3			
d+2	MNC digit 2				MNC digit 1			
d+3 to d+4	Tracking Area Code (TAC)							

**Figure 8.21.4-1: TAI**

The Tracking Area Code (TAC) consists of 2 octets. Bit 8 of Octet d+3 is the most significant bit and bit 1 of Octet d+4 the least significant bit. The coding of the tracking area code is the responsibility of each administration. Coding using full hexadecimal representation (binary, not ASCII encoding) shall be used.

## 8.21.5 ECGI field

The coding of ECGI (E-UTRAN Cell Global Identifier) is depicted in Figure 8.21.5-1. Only zero or one ECGI field shall be present in ULI IE.

Octets	Bits							
	8	7	6	5	4	3	2	1
e	MCC digit 2				MCC digit 1			
e+1	MNC digit 3				MCC digit 3			
e+2	MNC digit 2				MNC digit 1			
e+3	Spare				ECI			
e+4 to e+6	ECI (E-UTRAN Cell Identifier)							

**Figure 8.21.5-1: ECGI field**

The E-UTRAN Cell Identifier (ECI) consists of 28 bits. The ECI field shall start with Bit 4 of octet e+3, which is the most significant bit. Bit 1 of Octet e+6 is the least significant bit. The coding of the E-UTRAN cell identifier is the responsibility of each administration. Coding using full hexadecimal representation (binary, not ASCII encoding) shall be used.

## 8.21.6 LAI field

The coding of LAI (Location Area Identifier) is depicted in Figure 8.21.6-1.

Octets	Bits							
	8	7	6	5	4	3	2	1
f	MCC digit 2				MCC digit 1			
f+1	MNC digit 3				MCC digit 3			
f+2	MNC digit 2				MNC digit 1			
f+3 to f+4	Location Area Code (LAC)							

**Figure 8.21.6-1: LAI field**

The Location Area Code (LAC) consists of 2 octets. Bit 8 of Octet f+3 is the most significant bit and bit 1 of Octet f+4 the least significant bit. The coding of the location area code is the responsibility of each administration. Coding using full hexadecimal representation (binary, not ASCII encoding) shall be used.

## 8.21.7 Macro eNodeB ID field

The coding of Macro eNodeB ID is depicted in Figure 8.21.7-1. Only zero or one Macro eNodeB ID or Extended Macro eNodeB ID field shall be present in ULI IE.

Octets	Bits							
	8	7	6	5	4	3	2	1
g	MCC digit 2				MCC digit 1			
g+1	MNC digit 3				MCC digit 3			
g+2	MNC digit 2				MNC digit 1			
g+3	Spare				Macro eNodeB ID			
g+4 to g+5	Macro eNodeB ID							

Figure 8.21.7-1: Macro eNodeB ID field

The Macro eNodeB ID consists of 20 bits. Bit 4 of Octet g+3 is the most significant bit and bit 1 of g+5 is the least significant bit. The coding of the Macro eNodeB ID is the responsibility of each administration. Coding using full hexadecimal representation (binary, not ASCII encoding) shall be used.

### 8.21.8 Extended Macro eNodeB ID field

The coding of Extended Macro eNodeB ID is depicted in Figure 8.21.8-1. Only zero or one Extended Macro eNodeB ID or Macro eNodeB ID field shall be present in ULI IE.

Octets	Bits							
	8	7	6	5	4	3	2	1
g	MCC digit 2				MCC digit 1			
g+1	MNC digit 3				MCC digit 3			
g+2	MNC digit 2				MNC digit 1			
g+3	SMeNB	Spare			Extended Macro eNodeB ID			
g+4 to g+5	Extended Macro eNodeB ID							

Figure 8.21.8-1: Extended Macro eNodeB ID field

The Extended Macro eNodeB ID consists of 21 bits. The coding of the Extended Macro eNodeB ID is the responsibility of each administration. Coding using full hexadecimal representation (binary, not ASCII encoding) shall be used.

If the SMeNB flag is not set the Extended Macro eNodeB ID field contains a Long Macro eNodeB ID with a length of 21 Bits. Bit 5 of Octet g+3 is the most significant bit and bit 1 of g+5 is the least significant bit.

If the SMeNB flag is set the Extended Macro eNodeB ID field contains a Short Macro eNodeB ID with a length of 18 Bits. Bits 3 to 5 of Octet g+3 shall be set to 0 by the sender and shall be ignored by the receiver. Bit 2 of Octet g+3 is the most significant bit and bit 1 of Octet g+5 is the least significant bit.

NOTE: Homogenous support of the Extended Macro eNodeB ID IE is expected in a PLMN.

### 8.22 Fully Qualified TEID (F-TEID)

Fully Qualified Tunnel Endpoint Identifier (F-TEID) is coded as depicted in Figure 8.22-1.

Octets	Bits							
	8	7	6	5	4	3	2	1
1	Type = 87 (decimal)							
2 to 3	Length = n							
4	Spare				Instance			
5	V4	V6	Interface Type					
6 to 9	TEID / GRE Key							
m to (m+3)	IPv4 address							
p to (p+15)	IPv6 address							
k to (n+4)	These octet(s) is/are present only if explicitly specified							

Figure 8.22-1: Fully Qualified Tunnel Endpoint Identifier (F-TEID)

The following flags are coded within Octet 5:

- Bit 8 – V4: If this bit is set to "1", then IPv4 address field exists in the F-TEID, otherwise the IPv4 address field is not present at all.
- Bit 7 – V6: If this bit is set to "1", then IPv6 address field exists in the F-TEID, otherwise the IPv6 address field is not present at all.

At least one of V4 and V6 shall be set to "1", and both may be set to "1".

- Bit 6 to Bit 1 – Interface Type: This 6 bit wide integer can take the following values representing interface type and endpoint:

0: S1-U eNodeB GTP-U interface

1: S1-U SGW GTP-U interface

2: S12 RNC GTP-U interface

3: S12 SGW GTP-U interface

4: S5/S8 SGW GTP-U interface

5: S5/S8 PGW GTP-U interface

6: S5/S8 SGW GTP-C interface

7: S5/S8 PGW GTP-C interface

8: S5/S8 SGW PMIPv6 interface (the 32 bit GRE key is encoded in 32 bit TEID field)

9: S5/S8 PGW PMIPv6 interface (the 32 bit GRE key is encoded in the 32 bit TEID field, see clause 6.3 in 3GPP TS 29.275 [26])

10: S11 MME GTP-C interface

11: S11/S4 SGW GTP-C interface

12: S10/N26 MME GTP-C interface

13: S3 MME GTP-C interface

14: S3 SGSN GTP-C interface

15: S4 SGSN GTP-U interface

16: S4 SGW GTP-U interface

17: S4 SGSN GTP-C interface

18: S16 SGSN GTP-C interface

19: eNodeB/gNodeB GTP-U interface for DL data forwarding

20: eNodeB GTP-U interface for UL data forwarding

21: RNC GTP-U interface for data forwarding

22: SGSN GTP-U interface for data forwarding

23: SGW/UPF GTP-U interface for DL data forwarding

24: Sm MBMS GW GTP-C interface

25: Sn MBMS GW GTP-C interface

26: Sm MME GTP-C interface

27: Sn SGSN GTP-C interface

28: SGW GTP-U interface for UL data forwarding



- 29: S<sub>n</sub> SGSN GTP-U interface
- 30: S<sub>2b</sub> ePDG GTP-C interface
- 31: S<sub>2b-U</sub> ePDG GTP-U interface
- 32: S<sub>2b</sub> PGW GTP-C interface
- 33: S<sub>2b-U</sub> PGW GTP-U interface
- 34: S<sub>2a</sub> TWAN GTP-U interface
- 35: S<sub>2a</sub> TWAN GTP-C interface
- 36: S<sub>2a</sub> PGW GTP-C interface
- 37: S<sub>2a</sub> PGW GTP-U interface
- 38: S<sub>11</sub> MME GTP-U interface
- 39: S<sub>11</sub> SGW GTP-U interface
- 40: N<sub>26</sub> AMF GTP-C interface
- 41: N<sub>19mb</sub> UPF GTP-U interface

Other values of "Interface Type" are spare and reserved for future use.

"Interface type" values with bit "6" set to 1 shall only be used between Rel-10 onwards GTPv2-C nodes.

NOTE 1: "Interface type" IE is defined with 5 bits only in the earlier releases of this specification, thus pre-Rel-10 GTPv2-C nodes can ignore bit "6" which is marked as "Spare" in earlier releases, allowing backward compatibility.

NOTE 2: Interface Type 8 is not used in this Release and in earlier Releases.

Octet 6 to 9 (TEID/GRE field) represent either a TEID or a GRE key. If both IPv4 and IPv6 addresses are present in F-TEID IE, then the TEID value shall be shared by both addresses.

Octets "m to (m+3)" and/or "p to (p+15)" (IPv4 address / IPv6 address fields), if present, contain respective address values.

## 8.23 TMSI

The TMSI, unambiguously associated with a given UE and Location area, is given by:

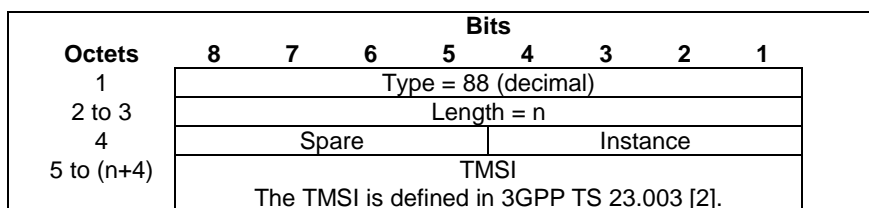

Figure 8.23-1: TMSI

## 8.24 Global CN-Id

The Global CN-Id is coded as depicted in Figure 8.24-1.

Octets	Bits							
	8	7	6	5	4	3	2	1
1	Type = 89 (decimal)							
2 to 3	Length = n							
4	Spare				Instance			
5	MCC digit 2				MCC digit 1			
6	MNC digit 3				MCC digit 3			
7	MNC digit 2				MNC digit 1			
8 to (n+4)	CN-Id The CN-Id is defined in 3GPP TS 23.003 [2].							

Figure 8.24-1: Global CN-Id

If an Administration decides to include only two digits in the MNC, then bits 5 to 8 of octet 6 are coded as "1111".

### 8.25 S103 PDN Data Forwarding Info (S103PDF)

The HSGW Address and GRE Key identify a GRE Tunnel towards a HSGW over S103 interface for a specific PDN connection of the UE. The EPS Bearer IDs specify the EPS Bearers which require data forwarding that belonging to this PDN connection. The number of EPS bearer Ids included is specified by the value of EPS Bearer ID Number.

The spare bits indicate unused bits, which shall be set to 0 by the sending side and which shall not be evaluated by the receiving side.

Octets	Bits							
	8	7	6	5	4	3	2	1
1	Type = 90 (decimal)							
2 to 3	Length = n							
4	Spare				Instance			
5	HSGW Address for forwarding Length = m							
6 to (m+5)	HSGW Address for forwarding [4..16]							
(m+6)- to (m+9)	GRE Key							
(m+10)	EPS Bearer ID Number = k							
(m+11) to (m+10+k)	Spare				EPS Bearer ID			

Figure 8.25-1: S103 PDN Data Forwarding Info

### 8.26 S1-U Data Forwarding (S1UDF)

The Serving GW Address and Serving GW S1-U TEID consists of the S1-U Tunnel information allocated by the Serving GW for an EPS Bearer identified by the EPS Bearer ID which requires data forwarding during active handover from E-UTRAN Access to cdma2000 HRPD Access.

The spare bits indicate unused bits, which shall be set to 0 by the sending side and which shall not be evaluated by the receiving side.

Octets	Bits							
	8	7	6	5	4	3	2	1
1	Type = 91 (decimal)							
2 to 3	Length = n							
4	Spare				Instance			
5	Spare				EPS Bearer ID			
6	Serving GW Address Length = m							
7 to (m+6)	Serving GW Address [4..16]							
(m+7) to (m+10)	Serving GW S1-U TEID							

Figure 8.26-1: S1-U Data Forwarding Info

## 8.27 Delay Value

Delay Value is coded as depicted in Figure 8.27-1.

Octets	Bits							
	8	7	6	5	4	3	2	1
1	Type = 92 (decimal)							
2 to 3	Length = n							
4	Spare				Instance			
5	Delay Value in integer multiples of 50 millisecs, or zero							
6 to (n+4)	These octet(s) is/are present only if explicitly specified							

Figure 8.27-1: Delay Value

Delay Value is set to zero in order to clear a previously set delay condition.

## 8.28 Bearer Context

Bearer Context is a grouped IE containing a number of other IEs. Which of those IEs are mandatory, optional or conditional and the conditions that apply are GTP message specific, and described in the corresponding clause under clause 7.

Bearer Context may be repeated within a message with exactly the same Type and Instance values to represent a list of Bearer Contexts.

Bearer Context is coded as depicted in Table 8.28-1.

Table 8.28-1: Bearer Context Grouped Type

Octet 1	Bearer Context IE Type = 93 (decimal)			
Octets 2 and 3	Length = n			
Octet 4	Spare and Instance fields			
<b>Information elements</b>	<b>P</b>	<b>Condition / Comment</b>		<b>IE Type</b>
				<b>Ins.</b>
NOTE: This table uses a 5-column format in order to match the format used in clauses of clause 7, where the usage of this IE is further detailed for each specific GTP message including it.				

## 8.29 Charging ID

The Charging ID is coded as depicted in Figure 8.29-1. It is defined in 3GPP TS 32.251[8].

Octets	Bits							
	8	7	6	5	4	3	2	1
1	Type = 94 (decimal)							
2 to 3	Length = n							
4	Spare				Instance			
5-8	Charging ID value							
9-(n+4)	These octet(s) is/are present only if explicitly specified							

Figure 8.29-1: Charging ID

## 8.30 Charging Characteristics

The charging characteristics information element is defined in 3GPP TS 32.251 [8] and is a way of informing both the SGW and PGW of the rules for producing charging information or informing the PGW to inhibit the establishment of the Gx session based on operator configured triggers. For the encoding of this information element see 3GPP TS 32.298 [9].

Octets	Bits							
	8	7	6	5	4	3	2	1
1	Type = 95 (decimal)							
2 to 3	Length = n							
4	Spare				Instance			
5 to 6	Charging Characteristics value							
7 to (n+4)	These octet(s) is/are present only if explicitly specified							

Figure 8.30-1: Charging Characteristics

### 8.31 Trace Information

Trace Information is coded as depicted in Figure 8.31-1. See 3GPP TS 32.422 [18] for details on trace related information.

Octets	Bits							
	8	7	6	5	4	3	2	1
1	Type = 96(decimal)							
2 to 3	Length = n							
4	Spare				Instance			
5	MCC digit 2				MCC digit 1			
6	MNC digit 3				MCC digit 3			
7	MNC digit 2				MNC digit 1			
8 to 10	Trace ID							
11 to 19	Triggering Events							
20 to 21	List of NE Types							
22	Session Trace Depth							
23 to 34	List of Interfaces							
35 to (n+4)	IP Address of Trace Collection Entity							

Figure 8.31-1: Trace Information

Octets 5 to 10 represent the Trace Reference parameter as defined in clause 5.6 of 3GPP TS 32.422 [18].

Triggering Events shall be encoded as the first 9 octets in clause 5.1 of 3GPP TS 32.422 [18].

List of NE Types, Session Trace Depth and IP Address of Trace Collection Entity are specified in 3GPP TS 32.422 [18].

List of Interfaces shall be encoded as the first 12 octets in clause 5.5 of 3GPP TS 32.422 [18].

See 3GPP TS 24.008 [5], clause 10.5.1.4, Mobile Identity, for the coding of MCC and MNC, whose values are obtained from the serving PLMN that the EM/NM is managing. If MNC is 2 digits long, bits 5 to 8 of octet 6 are coded as "1111".

NOTE: During a 5GS to EPS mobility, the MME derives the information to be sent in the Trace Information IE over S11 from the Extended Trace Information IE received from the AMF, if an SGW trace is activated; the PGW(+SMF) derives relevant trace information from the Trace Data that it received earlier (at the SMF), if a PGW trace is to be activated.

### 8.32 Bearer Flags

Bearer Flags is coded as depicted in Figure 8.32-1.

Octets	Bits							
	8	7	6	5	4	3	2	1
1	Type = 97 (decimal)							
2 to 3	Length = n							
4	Spare				Instance			
5	Spare				ASI	Vind	VB	PPC
6-(n+4)	These octet(s) is/are present only if explicitly specified							

Figure 8.32-1: Bearer Flags

The following bits within Octet 5 indicate:

- Bit 1 – PPC (Prohibit Payload Compression): This flag is used to determine whether an SGSN should attempt to compress the payload of user data when the users asks for it to be compressed (PPC = 0), or not (PPC = 1).
- Bit 2 – VB (Voice Bearer): This flag is used to indicate a voice bearer when doing PS-to-CS (v)SRVCC handover.
- Bit 3 – Vind (vSRVCC indicator): This flag is used to indicate that this bearer is an IMS video bearer and is candidate for PS-to-CS vSRVCC handover.
- Bit 4 - ASI (Activity Status Indicator): When set to 1, this flag indicates that the bearer context is preserved in the CN without corresponding Radio Access Bearer established. The target S4-SGSN shall keep the bearer context associated with this indicator preserved. When the target S4-SGSN sends Relocation Request message towards the target RNC, the target S4-SGSN may not request to setup the RABs for those bearer contexts associated with this indicator.

### 8.33 Void

### 8.34 PDN Type

The PDN Type is coded as depicted in Figure 8.34-1.

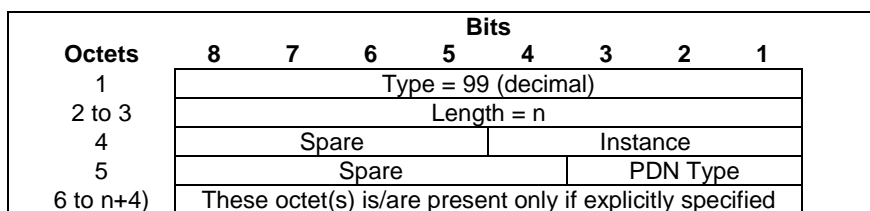

**Figure 8.34-1: PDN Type**

**Table 8.34-1: PDN Type**

PDN type value (octet 5)			
Bits			
<b>3</b>	<b>2</b>	<b>1</b>	
0	0	1	IPv4
0	1	0	IPv6
0	1	1	IPv4v6
1	0	0	Non-IP
1	0	1	Ethernet
All other values are reserved.			
Bits 8-4 of octet 5 are spare and shall be coded as zero.			

### 8.35 Procedure Transaction ID (PTI)

Procedure Transaction Id is coded as depicted in Figure 8.35-1. It is defined in 3GPP TS 24.301 [23], clause 9.4 and is coded as specified in 3GPP TS 24.007 [30], clause 11.2.3.1a Procedure transaction identity.

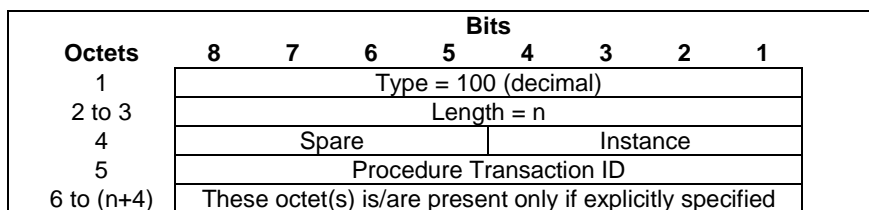

Figure 8.35-1: Procedure Transaction ID

8.36 Void

8.37 Void

8.38 MM Context

The MM Context information element contains the Mobility Management, UE security parameters that are necessary to transfer over S3/S16/S10/N26 interface.

All Spare bits are set to zeros by the sender and ignored by the receiver. Spare bits in MM Context IE shall be set to 1's before sending MM Context IE to Gn/Gp SGSN.

NOTE 1: The encoding of Spare bits in MM Context IE is different between GTPv1 and GTPv2. Spare bits in GTPv1 in MM Context IE there are set to 1s.

Security Mode indicates the type of security keys (GSM/UMTS/EPS) and Authentication Vectors (quadruplets/quintuplets/triplets) that are passed to the new MME/SGSN/AMF.

The DRX parameter coding is specified in clause 10.5.5.6 of 3GPP TS 24.008 [5]. If DRXI (DRX Indicator), bit 4 of octet 5, is set to "1", then the DRX parameter field is present, otherwise its octets are not present. During 5GS to EPS mobility procedure, the source AMF shall not send 5G DRX parameter to the target MME; and during EPS to 5GS mobility procedure, the target AMF shall discard the DRX parameter if received. The encoding of 5G DRX as specified in clause 9.11.3.2A of 3GPP TS 24.501 [87] is different from the one as specified in clause 10.5.5.6 of 3GPP TS 24.008 [5].

Uplink/downlink Subscribed UE AMBR (Aggregate Maximum Bit Rate) is coded as Unsigned32 integer values in kbps (1000 bps) for all non-GBR bearers according to the subscription of the user. The uplink/downlink Subscribed UE AMBR requires converting values in bits per second to kilobits per second when it is received from the HSS. If such conversions result in fractions, then the uplink/downlink Subscribed UE AMBR values shall be rounded upwards. If SAMBRI (Subscribed UE AMBR Indicator), bit 1 of octet 6, is set to "1", then the Uplink/downlink Subscribed UE AMBR parameter field is present, otherwise these parameters are not present. If no Subscribed UE AMBR is received from the HSS, the SAMBRI shall be set to "0". Uplink/downlink Used UE AMBR (Aggregate Maximum Bit Rate) is coded as Unsigned32 integer values in kbps (1000 bps) for all non-GBR bearers currently being used by the UE. If UAMBRI (Used UE AMBR Indicator), bit 2 of octet 6, is set to "1", then the Uplink/downlink Used UE AMBR parameter field is present, otherwise these parameters are not present.

The encoding of Mobile Equipment Identity (MEI) field shall be same as specified in clause 8.10 of this specification. If Length of Mobile Equipment Identity is zero, then the Mobile Equipment Identity parameter shall not be present. If the UE is emergency or RLOS attached and the UE is UICCless or the IMSI is unauthenticated, Mobile Equipment Identity (MEI) shall be used as the UE identity.

The UE Network Capability coding is specified in clause 9.9.3.34 of 3GPP TS 24.301 [23]. If Length of UE Network Capability is zero, then the UE Network Capability parameter shall not be present.

The MS Network Capability coding is specified in clause 10.5.5.12 of 3GPP TS 24.008 [5]. If Length of MS Network Capability is zero, then the MS Network Capability parameter shall not be present.

The Voice Domain Preference and UE's Usage Setting coding is specified in clause 10.5.5.28 of 3GPP TS 24.008 [5]. If Length of Voice Domain Preference and UE's Usage Setting is zero, then the Voice Domain Preference and UE's Usage Setting parameter shall not be present.

Used Cipher indicates the GSM ciphering algorithm that is in use.

Used NAS Cipher indicates the EPS ciphering algorithm that is in use.

The Access restriction data is composed of UNA(UTRAN Not Allowed), GENA(GERAN Not Allowed), GANA(GAN Not Allowed), INA(I-HSPA-Evolution Not Allowed), ENA(WB-E-UTRAN Not Allowed), NBNA( NB-IoT Not Allowed), ECNA (Enhanced Coverage Not Allowed) and HNNA(HO-To-Non-3GPP-Access Not Allowed).

If the SGSN support the Higher bitrates than 16 Mbps flag, the Higher bitrates than 16 Mbps flag shall be included in the MM Context if:

- the source S4-SGSN has received "Higher bitrates than 16 Mbps flag" in the RANAP Initial UE Message or in RANAP Relocation Complete as defined in TS 25.413 [33] from the RNC, or
- the source S4-SGSN has stored the "Higher bitrates than 16 Mbps flag" (received from an SGSN via the Identification Response, Context Response or Forward Relocation Request during earlier procedures).

The S4-SGSN shall set the "Higher bitrates than 16 Mbps flag" to "1" if "Higher bitrates than 16 Mbps flag" is "allowed" and to "0" if it is "not allowed". The Length of Higher bitrates than 16 Mbps flag shall be set to zero if the S4-SGSN has not received the "Higher bitrates than 16 Mbps flag".

As depicted in Figure 8.38-1, the GSM Key, Used Cipher and Authentication Triplets that are unused in the old SGSN shall be transmitted to the new SGSN for the GSM subscribers. An array of at most 5 Authentication Triplets may be included. The field 'Number of Triplet' shall be set to the value '0' if no Authentication Triplet is included (i.e. octets '16 to h' are absent).

The Authentication Triplet coding is specified in Figure 8.38-7.

Octets	Bits							
	8	7	6	5	4	3	2	1
1	Type = 103 (decimal)							
2 to 3	Length = n							
4	Spare			Instance				
5	Security Mode		Spare	DRXI	CKSN			
6	Number of Triplet		Spare		UAMB	SAMB	RI	RI
7	Spare			Used Cipher				
8 to 15	Kc							
16 to h	Authentication Triplet [1..5]							
(h+1) to (h+2)	DRX parameter							
j to (j+3)	Uplink Subscribed UE AMBR							
(j+4) to (j+7)	Downlink Subscribed UE AMBR							
i to (i+3)	Uplink Used UE AMBR							
(i+4) to (i+7)	Downlink Used UE AMBR							
q	Length of UE Network Capability							
(q+1) to k	UE Network Capability							
k+1	Length of MS Network Capability							
(k+2) to m	MS Network Capability							
m+1	Length of Mobile Equipment Identity (MEI)							
(m+2) to r	Mobile Equipment Identity (MEI)							
r+1	ECNA	NBNA	HNNA	ENA	INA	GANA	GENA	UNA
r+2	Length of Voice Domain Preference and UE's Usage Setting							
(r+3) to s	Voice Domain Preference and UE's Usage Setting							
(s+1) to (n+4)	These octet(s) is/are present only if explicitly specified							

Figure 8.38-1: GSM Key and Triplets

As depicted in Figure 8.38-2, the UMTS Key, Used Cipher and Authentication Quintuplets that are unused in the old SGSN shall be transmitted to the new SGSN when the UMTS subscriber is attached to a GSM BSS in the old system, in case the user has a ME capable of UMTS AKA. An array of at most 5 Authentication Quintuplets may be included. The field 'Number of Quintuplets' shall be set to the value '0' if no Authentication Quintuplet is included (i.e. octets '40 to h' are absent).

If the UGIPAI (Used GPRS integrity protection algorithm Indicator), bit 3 of octet 6, is set to 1, then bits 4 to 6 of octet 7 shall contain the Used GPRS integrity protection algorithm field, otherwise these bits shall be set to 0 and ignored by the receiver.

The GUPII (GPRS User Plane Integrity Indicator), bit 4 of octet 6, shall be set to 1 if the subscriber profile indicated that user plane integrity protection is required and set to 0 otherwise.

NOTE 2: The encoding of the bits is not identical with GTPv1 as the spare bits are encoded differently.

The source S4-SGSN shall include the IOV\_updates counter if it is supported and available. The IOV\_updates counter is encoded as an integer with a length of 1 octet. The use of the IOV\_updates counter is specified in 3GPP TS 43.020 [78]. If IOVI (IOV\_updates Indicator), bit 5 of octet 6, is set to "1", then the IOV\_updates counter parameter field shall be present, otherwise it shall not be present.

The Authentication Quintuplet coding is specified in Figure 8.38-8.

Octets	Bits						
	8	7	6	5	4	3	2 1
1	Type = 104 (decimal)						
2 to 3	Length = n						
4	Spare			Instance			
5	Security Mode		Spare	DRXI	CKSN/KSI		
6	Number of Quintuplets		IOVI	GUPII	UGIP AI	UAMB RI	SAMB RI
7	Spare	Used GPRS integrity protection algorithm			Used Cipher		
8 to 23	CK						
24 to 39	IK						
40 to h	Authentication Quintuplet [1..5]						
(h+1) to (h+2)	DRX parameter						
j to (j+3)	Uplink Subscribed UE AMBR						
(j+4) to (j+7)	Downlink Subscribed UE AMBR						
i to (i+3)	Uplink Used UE AMBR						
(j+12) to (i+4)	Downlink Used UE AMBR						
q	Length of UE Network Capability						
(q+1) to k	UE Network Capability						
k+1	Length of MS Network Capability						
(k+2) to m	MS Network Capability						
m+1	Length of Mobile Equipment Identity (MEI)						
(m+2) to r	Mobile Equipment Identity (MEI)						
r+1	ECNA	NBNA	HNNA	ENA	INA	GANA	GENA UNA
r+2	Length of Voice Domain Preference and UE's Usage Setting						
(r+3) to s	Voice Domain Preference and UE's Usage Setting						
s+1	Length of Higher bitrates than 16 Mbps flag						
s+2	Higher bitrates than 16 Mbps flag						
s+3	IOV_updates counter						
(s+4) to (n+4)	These octet(s) is/are present only if explicitly specified						

Figure 8.38-2: UMTS Key, Used Cipher and Quintuplets

As depicted in Figure 8.38-3, the GSM Key, Used Cipher and Authentication Quintuplets that are unused in the old SGSN shall be transmitted to the new SGSN when the UMTS subscriber is attached to a GSM BSS in the old system, in case the user has a ME no capable of UMTS AKA. An array of at most 5 Authentication Quintuplets may be included. The field 'Number of Quintuplets' shall be set to the value '0' if no Authentication Quintuplet is included (i.e. octets '16 to h' are absent).

The Authentication Quintuplet coding is specified in Figure 8.38-8.



Octets	Bits							
	8	7	6	5	4	3	2	1
1	Type = 105 (decimal)							
2 to 3	Length = n							
4	Spare				Instance			
5	Security Mode		Spare		DRXI	CKSN/KSI		
6	Number of Quintuplets		Spare			UAMB RI	SAMB RI	
7	Spare				Used Cipher			
8 to 15	Kc							
16 to h	Authentication Quintuplets [1..5]							
(h+1) to (h+2)	DRX parameter							
j to (j+3)	Uplink Subscribed UE AMBR							
(j+4) to (j+7)	Downlink Subscribed UE AMBR							
i to (i+3)	Uplink Used UE AMBR							
(i+4) to (i+7)	Downlink Used UE AMBR							
q	Length of UE Network Capability							
(q+1) to k	UE Network Capability							
k+1	Length of MS Network Capability							
(k+2) to m	MS Network Capability							
m+1	Length of Mobile Equipment Identity (MEI)							
(m+2) to r	Mobile Equipment Identity (MEI)							
r+1	ECNA	NBNA	HNNA	ENA	INA	GANA	GENA	UNA
r+2	Length of Voice Domain Preference and UE's Usage Setting							
(r+3) to s	Voice Domain Preference and UE's Usage Setting							
s+1	Length of Higher bitrates than 16 Mbps flag							
s+2	Higher bitrates than 16 Mbps flag							
(s+3) to (n+4)	These octet(s) is/are present only if explicitly specified							

**Figure 8.38-3: GSM Key, Used Cipher and Quintuplets**

As depicted in Figure 8.38-4, the UMTS Key, KSI and unused Authentication Quintuplets in the old SGSN may be transmitted to the new SGSN/MME when the UMTS subscriber is attached to UTRAN/GERAN in the old system, but it is not allowed to send quintuplets to an MME in a different serving network domain (see 3GPP TS 33.401 [12] clause 6.1.6). The MME may forward the UMTS Key, KSI and unused Authentication Quintuplets which were previously stored back to the same SGSN, for further details, refer to 3GPP TS 33.401 [12]. An array of at most 5 Authentication Quintuplets may be included. The field 'Number of Quintuplets' shall be set to the value '0' if no Authentication Quintuplet is included (i.e. octets '40 to h' are absent).

If the UGIPAI (Used GPRS integrity protection algorithm Indicator), bit 3 of octet 6, is set to 1, then bits 1 to 3 of octet 7 shall contain the Used GPRS integrity protection algorithm field, otherwise these bits shall be set to 0 and ignored by the receiver.

The GUPII (GPRS User Plane Integrity Indicator), bit 4 of octet 6, shall be set to 1 if the subscriber profile indicated that user plane integrity protection is required and set to 0 otherwise.

NOTE 3: The encoding of the bits is not identical with GTPv1 as the spare bits are encoded differently.

The source S4-SGSN shall include the IOV\_updates counter if it is supported and available. The IOV\_updates counter is encoded as an integer with a length of 1 octet. The use of the IOV\_updates counter is specified in 3GPP TS 43.020 [78]. If IOVI (IOV\_updates Indicator), bit 5 of octet 6, is set to "1", then the IOV\_updates counter parameter field shall be present, otherwise it shall not be present.

The Extended Access Restriction Data is to store the extra access restriction data received from the HSS (other than ECNA, NBNA, HNNA, ENA, INA, GANA, GENA and UNA). If Length of Extended Access Restriction Data is zero, then the field of Extended Access Restriction Data shall not be present. The Extended Access Restriction Data is composed of NRSRRA (NR as Secondary RAT Not Allowed). The presence of the Extended Access Restriction Data for the case in UMTS Key as depicted in Figure 8.38-4 is optional.

NOTE 4: In Figure 8.38-4, including the Extended Access Restriction Data allows optimized selection of SGW in case of handover from GSM/UTRAN to E-UTRAN.

The Authentication Quintuplet coding is specified in Figure 8.38-8.

Octets	Bits					
	8	7	6	5	4	3 2 1
1	Type = 106 (decimal)					
2 to 3	Length = n					
4	Spare			Instance		
5	Security Mode		Spare	DRXI	KSI	
6	Number of Quintuplets		IOVI	GUPII	UGIP AI	UAMB RI SAMB RI
7	Spare				Used GPRS integrity protection algorithm	
8 to 23	CK					
24 to 39	IK					
40 to h	Authentication Quintuplet [1..5]					
(h+1) to (h+2)	DRX parameter					
j to (j+3)	Uplink Subscribed UE AMBR					
(j+4) to (j+7)	Downlink Subscribed UE AMBR					
i to (i+3)	Uplink Used UE AMBR					
(i+4) to (i+7)	Downlink Used UE AMBR					
q	Length of UE Network Capability					
(q+1) to k	UE Network Capability					
k+1	Length of MS Network Capability					
(k+2) to m	MS Network Capability					
m+1	Length of Mobile Equipment Identity (MEI)					
(m+2) to r	Mobile Equipment Identity (MEI)					
r+1	ECNA	NBNA	HNNA	ENA	INA	GANNA GENA UNA
r+2	Length of Voice Domain Preference and UE's Usage Setting					
(r+3) to s	Voice Domain Preference and UE's Usage Setting					
s+1	Length of Higher bitrates than 16 Mbps flag					
s+2	Higher bitrates than 16 Mbps flag					
s+3	IOV_updates counter					
s+4	Length of Extended Access Restriction Data					
(s+5) to t	Spare					NRS RNA
(t+1) to (n+4)	These octet(s) is/are present only if explicitly specified					

Figure 8.38-4: UMTS Key and Quintuplets

As depicted in Figure 8.38-5, the current EPS Security Context, a non-current EPS Security Context (if available), and unused Authentication Quadruplets in the old MME may be transmitted to the new MME/AMF. If the new MME/AMF is not in the same serving network domain, then only the current EPS Security Context may be transmitted. The mapping of an EPS security context to a 5G security context in the new AMF is specified in 3GPP TS 33.501 [86]. An array of at most 5 Authentication Quadruplets may be included. The field 'Number of Quadruplets' shall be set to the value '0' if no Authentication Quadruplet is included (i.e. octets '46 to g' are absent). Authentication Quintuplets shall not be transmitted to the new MME/AMF (i.e. octets 'g+1 to h' shall be absent) even if the old MME has the Authentication Quintuplets for this UE. The field 'Number of Quintuplets' shall be set to the value '0'. The reasons for not sending Quintuplets are specified in 3GPP TS 33.401 [12] clause 6.1.6.

The current EPS Security Context may be transmitted by the old AMF to the new MME, where the mapping of a 5G security context to an EPS security context is specified in 3GPP TS 33.501 [86]. The field 'Number of Quadruplets' and 'Number of Quintuplets' shall be set to the value '0'. The AMF shall not transmit un-used authentication vectors to an MME and shall discard any un-used authentication vectors received from an MME, regardless of whether the MME and AMF pertain to the same or different serving network domains.

The Authentication Quintuplet and Authentication Quadruplet codings are specified in Figure 8.38-8 and Figure 8.38-9 respectively.

The value of the NAS Downlink Count shall be set to the value that shall be used to send the next NAS message.

The value of the NAS Uplink Count shall be set to the largest NAS Uplink Count that was in a successfully integrity verified NAS message.

In Figure 8.38-5, the fields for the Old EPS Security Context (i.e. octets from  $s$  to  $s+64$ ) may be present only in S10 Forward Relocation Request message according to the Rules on Concurrent Running of Security Procedures, which are specified in 3GPP TS 33.401 [12]. The octets for Old EPS Security Context shall be present if the OSCI (Old Security Context Indicator), bit 1 of octet 6) is set to "1"; otherwise they shall not be present.

If NHL\_old (Next Hop Indicator for old EPS Security Context), bit 8 of octet  $s$ , is set to "1", then the parameters old NH (Next Hop) and old NCC (Next Hop Chaining Count) shall be present; otherwise the octets for old NH parameter shall not be present and the value of old NCC parameter shall be ignored by the receiver. .

Multiple APN Rate Control Statuses (including the number of packets still allowed in the given time unit, the number of additional exception reports still allowed in the given time unit and the termination time of the current APN Rate Control validity period) may be included by the MME.

The MM context shall contain the APN Rate Control Status(s) for PDN connection which are released and currently not re-established. Once a PDN connection is re-established, the related APN Rate Control Status shall be deleted.

The UAMBRI shall be set to "0" by the old AMF, and then the Uplink/downlink Used UE AMBR parameter field are not present. The SAMBRI shall be set to "1" by the old AMF, if the AMF has the Uplink/downlink Subscribed UE AMBR received from the MME, or the Uplink/downlink Subscribed UE AMBR in 5G.

The RLOS indication flag (bit 7 of octet  $s$ ) shall be set to 1 if the UE is RLOS attached.

Octets	Bits							
	8	7	6	5	4	3	2	1
1	Type = 107 (decimal)							
2 to 3	Length = n							
4	Spare				Instance			
5	Security Mode		NHI	DRXI	KSI <sub>ASME</sub>			
6	Number of Quintuplets		Number of Quadruplet		UAMB RI	OSCI		
7	SAMB RI	Used NAS integrity protection algorithm		Used NAS Cipher				
8 to 10	NAS Downlink Count							
11 to 13	NAS Uplink Count							
14 to 45	K <sub>ASME</sub>							
46 to g	Authentication Quadruplet [1..5]							
(g+1) to h	Authentication Quintuplet [1..5]							
(h+1) to (h+2)	DRX parameter							
p to (p+31)	NH							
(p+32)	Spare				NCC			
j to (j+3)	Uplink Subscribed UE AMBR							
(j+4) to (j+7)	Downlink Subscribed UE AMBR							
i to (i+3)	Uplink Used UE AMBR							
(i+4) to (i+7)	Downlink Used UE AMBR							
q	Length of UE Network Capability							
(q+1) to k	UE Network Capability							
(k+1)	Length of MS Network Capability							
(k+2) to m	MS Network Capability							
(m+1)	Length of Mobile Equipment Identity (MEI)							
(m+2) to r	Mobile Equipment Identity (MEI)							
(r+1)	ECNA	NBNA	HNNA	ENA	INA	GANA	GENA	UNA
s	NHI_o ld	RLOS	old KSI <sub>ASME</sub>		old NCC			
(s+1) to (s+32)	old K <sub>ASME</sub>							
(s+33) to (s+64)	old NH							
w	Length of Voice Domain Preference and UE's Usage Setting							
(w+1) to t	Voice Domain Preference and UE's Usage Setting							
(t+1) to (t+2)	Length of UE Radio Capability for Paging information							
(t+3) to u	UE Radio Capability for Paging information							
(u+1)	Length of Extended Access Restriction Data							
(u+2) to v	Spare	Spare	Spare	NRU NA	NRUS RNA	NRNA	USSR NA	NRSR NA
(v+1)	Length of UE additional security capability							
(v+2) to x	UE additional security capability							
(x+1)	Length of UE NR security capability							
(x+2) to y	UE NR security capability							
(y+1) to (y+2)	Length of APN Rate Control Statuses							
(y+3) to l	APN Rate Control Status [1..z]							
(l+1)	Length of Core Network Restrictions							
(l+2) to (l+5)	Core Network Restrictions							
(l+6)	Length of UE Radio Capability ID							
(l+7) to z	UE Radio Capability ID							
a	Spare	Spare	Spare	Spare	Spare	Spare	ENSCT	
(a+1) to (n+4)	These octet(s) is/are present only if explicitly specified							

Figure 8.38-5: EPS Security Context and Quadruplets

If NHI (Next Hop Indicator), bit 5 of octet 5, is set to "1", then the optional parameters NH (Next Hop) and NCC (Next Hop Chaining Count) are both present, otherwise their octets are not present.

The UE Radio Capability for Paging information is specified in the clause 9.2.1.98 of 3GPP TS 36.413 [10]. If Length of UE Radio Capability for Paging information is zero, then the UE Radio Capability for Paging information shall not

be present. The old MME shall, when available, include UE Radio Capability for Paging information to the new MME in the Context Response or Forward Relocation Request message as specified in the clause 5.11.4 of 3GPP TS 23.401 [4]. If the RAT type is indicated by the new MME in the Context Request message, then the old MME shall include the UE Radio Capability for Paging for the corresponding RAT type, if available.

The Extended Access Restriction Data is composed of NRSRNA (NR as Secondary RAT Not Allowed), USSRNA (Unlicensed Spectrum in the form of LAA or LWA/LWIP as Secondary RAT Not Allowed), NRNA (NR in 5GS Not Allowed), NRUSRNA (New Radio Unlicensed as Secondary RAT Not Allowed), and of NRUNA (NR-U in 5GS Not Allowed).

NOTE 5: As specified in clause 4.11.1.2.1 of 3GPP TS 23.502 [83], NRSRNA can be provided via N26 during handover from 5GC to EPC in order to allow the MME to make appropriate handling, e.g. SGW selection based on access restriction, or whether or not to allocate resources for secondary RAT during inter RAT handover.

The UE additional security capability coding is specified in clause 9.9.3.53 of 3GPP TS 24.301 [23]. If Length of UE additional security capability is zero, then the field UE additional security capability in octets "(v+2) to x" shall not be present.

The UE NR security capability coding is specified in clause 9.11.3.54 of 3GPP TS 24.501 [87]. If Length of UE NR security capability is zero, then the field UE NR security capability in octets "(x+2) to y" shall not be present.

The Core Network Restrictions coding is specified in clause 7.2.230 of 3GPP TS 29.272 [70]. If Length of Core Network Restrictions is zero, then the field of Core Network Restrictions in octets "(1+2) to (1+5)" shall not be present.

The UE Radio Capability ID is specified in the clause 9.9.3.60 of 3GPP TS 24.301 [23]. If Length of UE Radio Capability ID is zero, then the UE Radio Capability ID shall not be present. When supporting the RACS feature, the old MME shall include the PLMN-assigned UE Radio Capability ID if available, otherwise it shall include the Manufacturer-assigned UE Radio Capability ID, to the new MME as specified in the clause 5.11.3a of 3GPP TS 23.401 [4].

NOTE 6: If the MME supports RACS and the MME detects that the selected PLMN during a service request procedure is different from the currently registered PLMN for the UE, the MME stores the UE Radio Capability ID of the newly selected PLMN in the MM context as described in clause 5.11.3a of 3GPP TS 23.401 [4], and provides this UE Radio Capability ID to the target MME during any subsequent inter-MME mobility.

The EPS NAS Security Context Type (ENSCT) shall be encoded in bits 1 and 2 of octet 'a'. ENSCT indicates the type of the Key Set Identifier, see Table 8.38-6. For EPS NAS Security Context usage see e.g. clause 6.4 in 3GPP TS 33.401 [12]. Bits 3 to 8 of octet 'a' are spare and shall be set to '0' by the sender and ignored by the receiver.

As depicted in Figure 8.38-6, the old MME will derive CK' and IK' from  $K_{ASME}$  and transmit the CK' and IK' to the new SGSN. Authentication Quintuplets, if available, shall be transmitted to the SGSN if, and only if the MME received them from this SGSN earlier, according to 3GPP TS 33.401 [12] clause 6.1.5. An array of at most 5 Authentication Quintuplets may be included. The field 'Number of Quintuplets' shall be set to the value '0' if no Authentication Quintuplet is included (i.e. octets 'g+1 to h' are absent). An array of at most 5 Authentication Quadruplets may be included. The field 'Number of Quadruplets' shall be set to the value '0' if no Authentication Quadruplet is included (i.e. octets '40 to g' are absent). A key  $K_{ASME}$  shall never be transmitted to an SGSN according to 3GPP TS 33.401 [12] clause 6.4.

The Authentication Quintuplet and Authentication Quadruplet codings are specified in Figure 8.38-8 and Figure 8.38-9 respectively.

The old SGSN/MME may deliver both Authentication Quadruplets and Authentication Quintuplets it holds to the peer combo node to optimize the procedure.

NOTE 7: 3GPP TS 33.401 [12] states that "EPS authentication data shall not be forwarded from an MME towards an SGSN". The statement above assumes that the old MME can determine by local configuration that the peer node is a combo SGSN/MME (as opposed to a single SGSN).

Octets	Bits							
	8	7	6	5	4	3	2	1
1	Type = 108 (decimal)							
2 to 3	Length = n							
4	Spare			Instance				
5	Security Mode		Spare	DRXI	KSI <sub>ASME</sub>			
6	Number of Quintuplets		Number of Quadruplet		UAMB RI	SAMB RI		
7	Spare							
8 to 23	CK							
24 to 39	IK							
40 to g	Authentication Quadruplet [1..5]							
(g+1) to h	Authentication Quintuplet [1..5]							
(h+1) to (h+2)	DRX parameter							
j to (j+3)	Uplink Subscribed UE AMBR							
(j+4) to (j+7)	Downlink Subscribed UE AMBR							
i to (i+3)	Uplink Used UE AMBR							
(i+4) to (i+7)	Downlink Used UE AMBR							
q	Length of UE Network Capability							
(q+1) to k	UE Network Capability							
k+1	Length of MS Network Capability							
(k+2) to m	MS Network Capability							
m+1	Length of Mobile Equipment Identity (MEI)							
(m+2) to r	Mobile Equipment Identity (MEI)							
r+1	ECNA	NBNA	HNNA	ENA	INA	GANA	GENA	UNA
r+2	Length of Voice Domain Preference and UE's Usage Setting							
(r+3) to s	Voice Domain Preference and UE's Usage Setting							
(s+1) to (s+2)	Length of APN Rate Control Statuses							
(s+3) to l	APN Rate Control Status [0..z]							
(l+1) to (n+4)	These octet(s) is/are present only if explicitly specified							

Figure 8.38-6: UMTS Key, Quadruplets and Quintuplets

Octets	Bits						
	8	7	6	5	4	3	2
1 to 16	RAND						
17 to 20	SRES						
21 to 28	Kc						

Figure 8.38-7: Authentication Triplet

Octets	Bits						
	8	7	6	5	4	3	2
1 to 16	RAND						
17	XRES Length						
18 to m	XRES						
(m+1) to (m+16)	CK						
(m+17) to (m+32)	IK						
m+33	AUTN Length						
(m+34) to n	AUTN						

Figure 8.38-8: Authentication Quintuplet

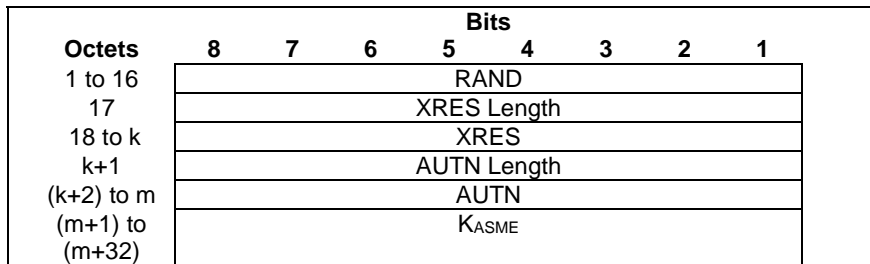

Figure 8.38-9: Authentication Quadruplet

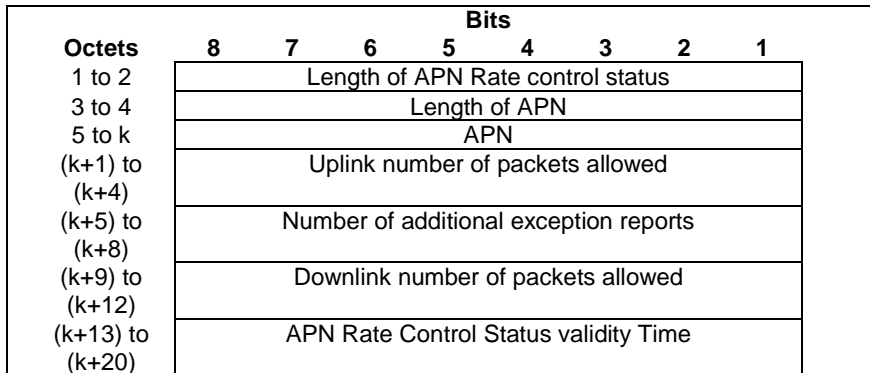

Figure 8.38-10: APN Rate Control Status

For the encoding of APN field see clause 8.6.

Octets (k+13) to (k+20) (APN Rate Control Status validity Time) are coded as the time in seconds relative to 00:00:00 on 1 January 1900 (calculated as continuous time without leap seconds and traceable to a common time reference) where binary encoding of the integer part is in the 32 most significant bits and binary encoding of the fraction part in the 32 least significant bits. The fraction part is expressed with a granularity of  $1/2^{32}$  second.

Table 8.38-1: Security Mode Values

Security Type	Value (Decimal)
GSM Key and Triplets	0
UMTS Key, Used Cipher and Quintuplets	1
GSM Key, Used Cipher and Quintuplets	2
UMTS Key and Quintuplets	3
EPS Security Context and Quadruplets	4
UMTS Key, Quadruplets and Quintuplets	5
<spare>	6-7

Table 8.38-2: Used NAS Cipher Values

Cipher Algorithm	Value (Decimal)
No ciphering	0
128-EEA1	1
128-EEA2	2
128-EEA3	3
EEA4	4
EEA5	5
EEA6	6
EEA7	7
<spare>	8-15

**Table 8.38-3: Used Cipher Values**

Cipher Algorithm	Value (Decimal)
No ciphering	0
GEA/1	1
GEA/2	2
GEA/3	3
GEA/4	4
GEA/5	5
GEA/6	6
GEA/7	7

**Table 8.38-4: Used NAS integrity protection algorithm Values**

Integrity protection Algorithm	Value (Decimal)
No integrity protection	0
128-EIA1	1
128-EIA2	2
128-EIA3	3
EIA4	4
EIA5	5
EIA6	6
EIA7	7

**Table 8.38-5: Used GPRS integrity protection algorithm Values**

Integrity protection Algorithm	Value (Decimal)
No integrity protection	0
spare	1
spare	2
spare	3
GIA4	4
GIA5	5
spare	6
spare	7

**Table 8.38-6: EPS NAS Security Context Type (ENSCT) in bits 1 and 2 of octet 'a'**

EPS NAS Security Context Type	Value (binary)
Reporting EPS NAS Security Context Type is not supported	'00'
Native EPS NAS Security Context	'01'
Mapped EPS NAS Security Context	'10'
Spare, for future use	'11'

## 8.39 PDN Connection

The PDN connection is a grouped IE containing a number of other IEs and shall be coded as depicted in Table 8.39-1.

The PDN Connection IE may be repeated within a message when more than one PDN Connection is required to be sent. If so, the repeated IEs shall have exactly the same Instance values to represent a list of grouped IEs.



**Table 8.39-1: PDN Connection Grouped Type**

Octet 1	PDN Connection IE Type = 109 (decimal)			
Octets 2 and 3	Length = n			
Octet 4	Spare and Instance fields			
<b>Information elements</b>	<b>P</b>	<b>Condition / Comment</b>	<b>IE Type</b>	<b>Ins.</b>
NOTE: This table uses a 5-column format in order to match the format used in clauses of clause 7, where the usage of this IE is further detailed for each specific GTP message including it.				

## 8.40 PDU Numbers

The PDU Numbers information element contains the sequence number status corresponding to a Bearer context in the old SGSN. This information element shall be sent only when acknowledged peer-to-peer LLC operation is used for the Bearer context or when the "delivery order" QoS attribute is set in the Bearer context QoS profile.

NSAPI identifies the Bearer context for which the PDU Number IE is intended.

DL GTP-U Sequence Number is the number for the next downlink GTP-U T-PDU to be sent to the UE when "delivery order" is set.

UL GTP-U Sequence Number is the number for the next uplink GTP-U T-PDU to be tunnelled to the S-GW when "delivery order" is set.

The Send N-PDU Number is used only when acknowledged peer-to-peer LLC operation is used for the Bearer context. Send N-PDU Number is the N-PDU number to be assigned by SNDSCP to the next down link N-PDU received from the S-GW.

The Receive N-PDU Number is used only when acknowledged peer-to-peer LLC operation is used for the Bearer context. The Receive N-PDU Number is the N-PDU number expected by SNDSCP from the next up link N-PDU to be received from the UE.

The PDU Number IE will be repeated for each Bearer Context for which this IE is required.

PDU Numbers IE is coded as depicted in Figure 8.40-1.

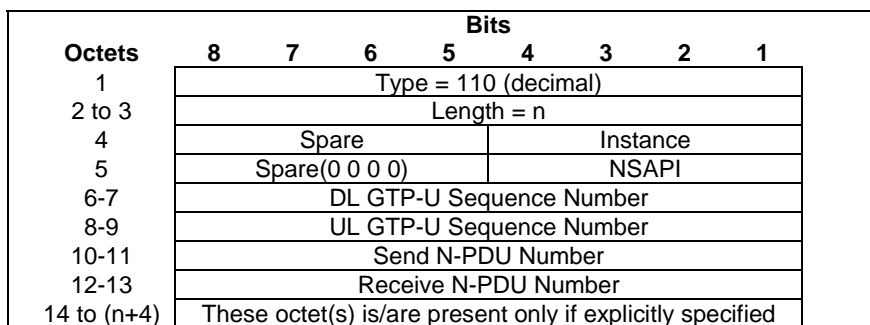

**Figure 8.40-1: PDU Numbers**

## 8.41 Packet TMSI (P-TMSI)

The P-TMSI, unambiguously associated with a given UE and routing area, is given by:

Octets	Bits							
	8	7	6	5	4	3	2	1
1	Type = 111 (decimal)							
2 to 3	Length = n							
4	Spare				Instance			
5 to (n+4)	Packet TMSI (P-TMSI) The P-TMSI is defined in 3GPP TS 23.003 [2].							

Figure 8.41-1: Packet TMSI (P-TMSI)

## 8.42 P-TMSI Signature

The content and the coding of the P-TMSI Signature information element are defined in 3GPP TS 24.008 [5].

Octets	Bits							
	8	7	6	5	4	3	2	1
1	Type = 112 (decimal)							
2 to 3	Length = n							
4	Spare				Instance			
5 to (n+4)	P-TMSI Signature							

Figure 8.42-1: P-TMSI Signature

## 8.43 Hop Counter

Where Intra Domain Connection of RAN Nodes to Multiple CN Node is applied, the Hop Counter may be used to prevent endless loops when relaying Identification Request messages and Context Request messages. The maximum value is operator specific and shall not be lower than 1.

Octets	Bits							
	8	7	6	5	4	3	2	1
1	Type = 113 (decimal)							
2 to 3	Length = n							
4	Spare				Instance			
5	Hop Counter							
6 to (n+4)	These octet(s) is/are present only if explicitly specified							

Figure 8.43-1: Hop Counter

## 8.44 UE Time Zone

UE Time Zone is used to indicate the offset between universal time and local time in steps of 15 minutes of where the UE currently resides. The "Time Zone" field uses the same format as the "Time Zone" IE in 3GPP TS 24.008 [5].

UE Time Zone is coded as this is depicted in Figure 8.44-1. The value of the Time Zone field represents the time zone adjusted for daylight saving time. The value of the Daylight Saving Time field specifies the adjustment that has been made.

The spare bits indicate unused bits, which shall be set to 0 by the sending side and which shall not be evaluated by the receiving side.

Octets	Bits							
	8	7	6	5	4	3	2	1
1	Type = 114 (decimal)							
2 to 3	Length = n							
4	Spare				Instance			
5	Time Zone							
6	Spare						Daylight Saving Time	
7 to (n+4)	These octet(s) is/are present only if explicitly specified							

Figure 8.44-1: UE Time Zone

**Table 8.44-2 Possible values for the "Daylight Saving Time" field and their meanings.**

Daylight Saving Time	Value (binary)	
	Bit 2	Bit 1
No adjustment for Daylight Saving Time	0	0
+1 hour adjustment for Daylight Saving Time	0	1
+2 hours adjustment for Daylight Saving Time	1	0
Spare	1	1

## 8.45 Trace Reference

Trace Reference shall be coded as depicted in Figure 8.45-1. See 3GPP TS 32.422 [18], clause 5.6, for the definition of Trace Reference.

See 3GPP TS 24.008 [5], clause 10.5.1.4, Mobile Identity, for the coding of MCC and MNC, whose values are obtained from the serving PLMN that the EM/NM is managing. If MNC is 2 digits long, bits 5 to 8 of octet 6 are coded as "1111".

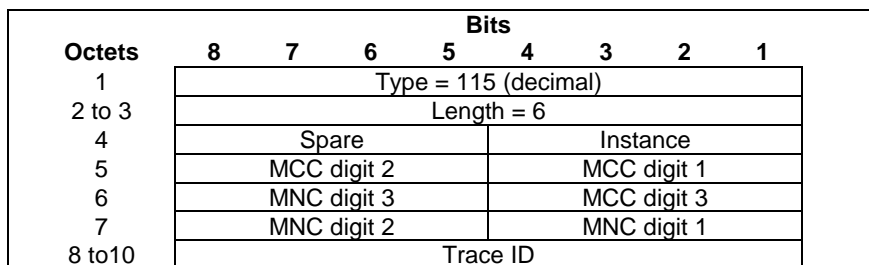

**Figure 8.45-1: Trace Reference**

## 8.46 Complete Request Message

The Complete Request Message is coded as depicted in Figure 8.46-1.

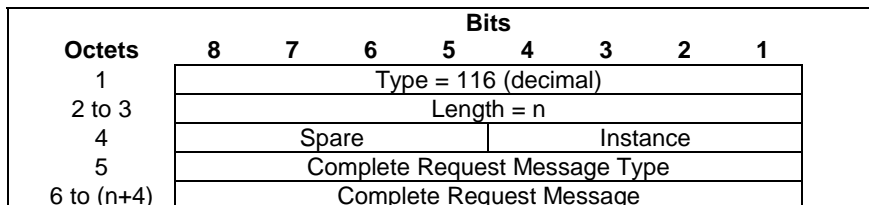

**Figure 8.46-1: Complete Request Message**

Complete Request Message type values are specified in Table 8.46-1.

**Table 8.46-1: Complete Request Message type values and their meanings**

Location Types	Values (Decimal)
Complete Attach Request Message	0
Complete TAU Request Message	1
<spare>	2-255

## 8.47 GUTI

The GUTI is coded as depicted in Figure 8.47-1.

Octets	Bits							
	8	7	6	5	4	3	2	1
1	Type = 117 (decimal)							
2 to 3	Length = n							
4	Spare				Instance			
5	MNC digit 2				MCC digit 1			
6	MNC digit 3				MCC digit 3			
7	MNC digit 2				MNC digit 1			
8 to 9	MME Group ID							
10	MME Code							
11 to (n+4)	M-TMSI							

Figure 8.47-1: GUTI

If an Administration decides to include only two digits in the MNC, then bits 5 to 8 of octet 6 are coded as "1111".

The "MME Group ID", "MME Code" and "M-TMSI" are specified in 3GPP TS 23.003 [2].

## 8.48 Fully Qualified Container (F-Container)

Fully Qualified Container (F-Container) is coded as depicted in Figure 8.48-1.

All Spare bits are set to zeros by the sender and ignored by the receiver.

Octets	Bits							
	8	7	6	5	4	3	2	1
1	Type = 118 (decimal)							
2 to 3	Length = n							
4	Spare				Instance			
5	Spare				Container Type			
6 to (n+4)	F-Container field							

Figure 8.48-1: Full Qualified Container (F-Container)

The F-Container field shall contain one of the following information, depending of the contents of the container transported by the specific GTP Information Element:

- *transparent copy* of the corresponding IEs (see clause 8.2.2):
  - the "Source to Target Transparent Container" or the "Target to Source Transparent Container" as specified in 3GPP TS 25.413 [33]; or
  - the "SON Configuration Transfer" as specified in 3GPP TS 36.413 [10] or "EN-DC SON Configuration Transfer" as specified in 3GPP TS 36.413 [10]; or
  - the "Inter-system SON Configuration Transfer" as specified in 3GPP TS 36.413 [10] and 3GPP TS 38.413 [84]; or
  - the "eNB Status Transfer Transparent Container" or eNB Early Status Transfer Transparent Container as specified in 3GPP TS 36.413 [10]; or
  - "Source BSS to Target BSS Transparent Container" or "Target BSS to Source BSS Transparent Container" as specified in 3GPP TS 48.018 [34] or 3GPP TS 25.413 [33], which contains the value part of the "Source BSS to Target BSS Transparent Container" IE or the value part of the "Target BSS to Source BSS Transparent Container" IE defined in 3GPP TS 48.018 [34], i.e. octets 3 to n, excluding octet 1 (Element ID) and octet 2, 2a (Length); or
- *transparent copy* of the value part of the "NBIFOM Container" as specified in 3GPP TS 24.161 [73].
- *transparent copy* of the octets of the encoded OCTET STRING of the "Source to Target Transparent Container" or the "Target to Source Transparent Container" specified in 3GPP TS 36.413 [10] and 3GPP TS 38.413 [84]; or
- *transparent copy* of the BSSGP RIM PDU as specified in 3GPP TS 48.018 [34]; or
- the Packet Flow ID, Radio Priority, SAPI, PS Handover XID parameters as specified in figure 8.42-2.

NOTE 1: Annex B.2 provides further details on the encoding of Generic Transparent Containers over RANAP, S1-AP and GTP. See also Annex C of 3GPP TS 36.413 [10] for further details on how the MME constructs the F-Container field from the Source to Target Transparent Container or Target to Source Transparent Container IEs received from S1-AP.

Container Type values are specified in Table 8.48-2.

**Table 8. 48-2: Container Type values**

Container Types	Values (Decimal)
Reserved	0
UTRAN Transparent Container	1
BSS Container	2
E-UTRAN Transparent Container	3
NBIFOM Container	4
EN-DC Container	5
Inter-System SON Container	6
<spare>	7-255

NOTE 2: For any other new future F-Container content types, new Container Type values may be needed, although use of RAT agnostic containers should be used whenever possible.

The BSS Container IE in the Bearer Context IE in Forward Relocation Request and Context Response messages is coded as depicted in Figure 8.48-3.

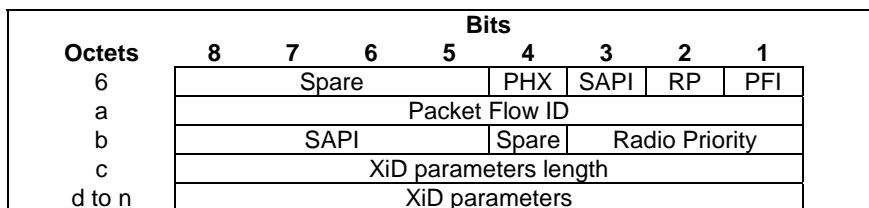

**Figure 8.48-3: BSS Container**

The flags PFI, RP, SAPI and PHX in octet 6 indicate the corresponding type of parameter (Packet FlowID, Radio Priority, SAPI and PS handover XiD parameters) shall be present in a respective field or not. If one of these flags is set to "0", the corresponding field shall not be present at all. The Spare bit shall be set to zero by the sender and ignored by the receiver.

If PFI flag is set, Packet Flow ID shall be present in Octet a.

If RP flag is set, Radio Priority shall be present in Octet b.

If SAPI flag is set, SAPI shall be present in Octet b.

If PHX flag is set:

- XiD parameters length is present in Octet c.
- XiD parameters are present in Octet d to n.

## 8.49 Fully Qualified Cause (F-Cause)

Fully Qualified Cause (F- Cause) is coded as depicted in Figure 8.49-1.

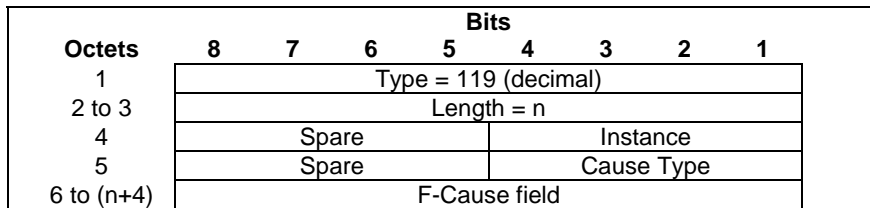

**Figure 8.49-1: Full Qualified Cause (F-Cause)**

The value of Instance field of the F-Cause IE in a GTPv2 message shall indicate whether the F-Cause field contains RANAP Cause, BSSGP Cause or S1-AP Cause.

All spare bits shall be set to zeros by the sender and ignored by the receiver.

F-Cause field is coded as follows:

- For RANAP Cause, the F-Cause field shall contain a non-transparent copy of the cause value of the corresponding IE (see clause 8.2.2), "Cause", as defined in clause 9.2.1.4 in 3GPP TS 25.413 [33]. Cause Type field shall be ignored by the receiver. The value of F-Cause field (which has a range of 1..512) is transferred over the Iu interface and encoded into two octet as binary integer.
- For BSSGP Cause, the F-Cause field shall contain a non-transparent copy of the cause value of the corresponding IE (see clause 8.2.2), "Cause", as defined in clause 11.3.8 in 3GPP TS 48.018 [34]. Cause Type field shall be ignored by the receiver. The value of F-Cause field (which has a range of 0..255) is transferred over the Gb interface and encoded into one octet as binary integer.
- For S1-AP Cause, the F-Cause field shall contain a non-transparent copy of the cause value of the corresponding IE (see clause 8.2.2), "Cause", as defined in clause 9.2.1.3 in 3GPP TS 36.413 [10]. Cause Type field shall contain the RAN Cause subcategory as specified in 3GPP TS 36.413 [10] and it shall be encoded as in Table 8.49-1. The value of F-Cause field (and the associated RAN cause subcategory) is transferred over the S1-AP interface and encoded into one octet as binary integer.

**Table 8.49-1: Cause Type values and their meanings**

Cause Type	Values (Decimal)
Radio Network Layer	0
Transport Layer	1
NAS	2
Protocol	3
Miscellaneous	4
<spare>	5 to15

## 8.50 PLMN ID

Octets 5-7 shall contain a non-transparent copy of the " PLMN Identity" parameter in 3GPP TS 36.413 [10].

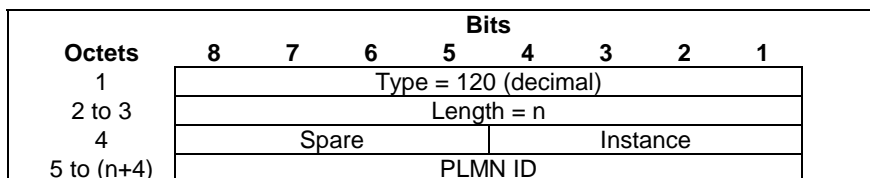

**Figure 8.50-1: PLMN ID**

The encoding of the PLMN ID field is shown in Figures 8.50-2 and 8.50-3.

If three digits are included in the MNC, octets 5 to 7 shall be encoded as shown in Figure 8.50-2.

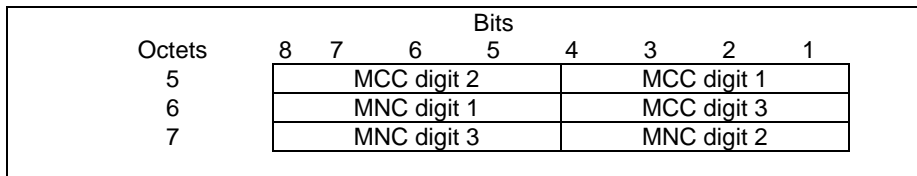

**Figure 8.50-2: PLMN ID Parameter with 3-digit MNC**

If only two digits are included in the MNC, octets 5 to 7 shall be encoded as shown in Figure 8.50-3 with bits 5 to 8 of octet 6 (MNC digit 3) coded as "1111".

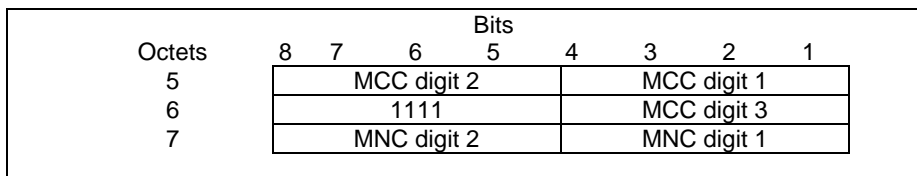

**Figure 8.50-3: PLMN ID Parameter with 2-digit MNC**

NOTE: The encoding is different from elsewhere in this document and is specified according to 3GPP TS 36.413 [10].

## 8.51 Target Identification

### 8.51.1 General

The Target Identification information element is coded as depicted in Figure 8.51-1.

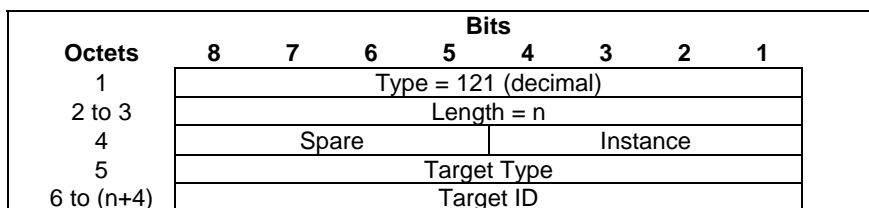

**Figure 8.51-1: Target Identification**

Target Type values are specified in Table 8.51-1.

**Table 8.51-1: Target Type values and their meanings**

Target Types	Values (Decimal)
RNC ID	0
Macro eNodeB ID	1
Cell Identifier	2
Home eNodeB ID	3
Extended Macro eNodeB ID	4
gNodeB ID	5
Macro ng-eNodeB ID	6
Extended ng-eNodeB ID	7
en-gNB ID	8
<spare>	9 to 255

### 8.51.2 RNC ID

The Target Type is RNC ID for SRNS relocation procedure, handover to UTRAN and RAN Information Relay towards UTRAN or GERAN operating in GERAN Iu mode, and 5G-SRVCC from NG-RAN to UTRAN procedure. In this case the "Target ID" field shall contain a non-transparent copy of the corresponding IEs (see clause 8.2.2) and be encoded as

specified in Figure 8.51-1a below. The "Target RNC-ID" part of the "Target ID" parameter is specified in 3GPP TS 25.413 [33] and 3GPP TS 38.413 [84].

NOTE 1: The ASN.1 parameter "Target ID" is forwarded non-transparently in order to maintain backward compatibility.

NOTE 2: The preamble of the "Target RNC-ID" (numerical value of e.g. 0x20) shall not be included into octets 6 to (n+4). Also, the optional "iE-Extensions" parameter shall not be included into the GTP IE.

Octets	Bits						
	8	7	6	5	4	3	2
6	MCC digit 2			MCC digit 1			
7	MNC digit 3			MCC digit 3			
8	MNC digit 2			MNC digit 1			
9 to 10	LAC						
11	RAC (see NOTE 3)						
12 to 13	RNC-ID						
a to (a+1)	Extended RNC-ID (optional)						

**Figure 8.51-1a: Target ID for Type RNC ID**

If only two digits are included in the MNC, then bits 5 to 8 of octet 7 (MNC digit 3) shall be coded as "1111".

The location area code (LAC) consists of 2 octets. Bit 8 of octet 9 is the most significant bit and bit 1 of octet 10 is the least significant bit. The coding of the location area code is the responsibility of each administration. Coding using full hexadecimal representation (binary, not ASCII encoding) shall be used.

During a 5G-SRVCC Handover, the AMF does not receive the target RAC in the "Target RNC-ID" part of the "Target ID" IE of the Handover Required message (see clause 9.3.1.25 of 3GPP TS 38.413 [84]). The AMF should set the RAC to a default value, e.g. hexadecimal value 'FF'. The MME\_SRVCC shall ignore the received RAC value.

The RNC-ID consists of 2 octets and contains 12 bits long value (see 3GPP TS 25.413 [7]). Bit 4 of octet 12 is the most significant bit and bit 1 of octet 13 is the least significant bit (bits 8 to 5 of octet 12 are set to 0). The coding of the RNC-ID is the responsibility of each administration. Coding using full hexadecimal representation (binary, not ASCII encoding) shall be used.

The Extended RNC-ID consists of 2 octets and contains 16 bits long value within the range 4096 to 65535. Bit 8 of octet a is the most significant bit and bit 1 of octet (a+1) is the least significant bit. The coding of the Extended RNC-ID is the responsibility of each administration. Coding using full hexadecimal representation (binary, not ASCII encoding) shall be used. If the optional Extended RNC-ID is included, then the receiver shall ignore the RNC-ID.

If the optional Extended RNC-ID is not included, then the length variable 'n' = 8 and the overall length of the IE is 13 octets. Otherwise, 'n' = 10 and the overall length of the IE is 15 octets.

NOTE 3: In the "TargetRNC-ID" ASN.1 type definition in 3GPP TS 25.413 [7] the "RAC" parameter is marked as optional. RAC is however always available at an SGSN/MME when it sends the RAC in e.g. a GTPv2 Forward Relocation Request message.

### 8.51.3 Macro eNodeB ID

The Target Type is Macro eNodeB ID for:

- handover to E-UTRAN Macro eNodeB;
- RAN Information Relay towards E-UTRAN; and
- a TNL address discovery response of a candidate en-gNB via the S1 interface or via inter-system signalling (see clauses 22.3.6.2 and 22.3.6.3 of 3GPP TS 36.300 [19]).

In this case the Target ID field shall be coded as depicted in Figure 8.51-2.



Octets	Bits						
	8	7	6	5	4	3	2
6	MCC digit 2			MCC digit 1			
7	MNC digit 3			MCC digit 3			
8	MNC digit 2			MNC digit 1			
9	Spare			Macro eNodeB ID			
10 to 11	Macro eNodeB ID						
12 to 13	Tracking Area Code (TAC)						

**Figure 8.51-2: Target ID for Type Macro eNodeB**

The Macro eNodeB ID consists of 20 bits. Bit 4 of Octet 9 is the most significant bit and bit 1 of Octet 11 is the least significant bit. The coding of the Macro eNodeB ID is the responsibility of each administration. Coding using full hexadecimal representation (binary, not ASCII encoding) shall be used.

### 8.51.4 Home eNodeB ID

The Target Type is Home eNodeB ID for handover to E-UTRAN Home eNodeB. In this case the coding of the Target ID field shall be coded as depicted in Figure 8.51-3.

Octets	Bits						
	8	7	6	5	4	3	2
6	MCC digit 2			MCC digit 1			
7	MNC digit 3			MCC digit 3			
8	MNC digit 2			MNC digit 1			
9	Spare			Home eNodeB ID			
10 to 12	Home eNodeB ID						
13 to 14	Tracking Area Code (TAC)						

**Figure 8.51-3: Target ID for Type Home eNodeB**

The Home eNodeB ID consists of 28 bits. See 3GPP TS 36.413 [10]. Bit 4 of Octet 9 is the most significant bit and bit 1 of Octet 12 is the least significant bit. The coding of the Home eNodeB ID is the responsibility of each administration. Coding using full hexadecimal representation (binary, not ASCII encoding) shall be used.

### 8.51.5 Extended Macro eNodeB ID

The Target Type is Extended Macro eNodeB ID for:

- handover to E-UTRAN Macro eNodeB;
- RAN Information Relay towards E-UTRAN; and
- a TNL address discovery response of a candidate en-gNB via the S1 interface or via inter-system signalling (see clauses 22.3.6.2 and 22.3.6.3 of 3GPP TS 36.300 [19]).

In this case the Target ID field shall be coded as depicted in Figure 8.51-4.

Octets	Bits						
	8	7	6	5	4	3	2
6	MCC digit 2			MCC digit 1			
7	MNC digit 3			MCC digit 3			
8	MNC digit 2			MNC digit 1			
9	SMeNB	Spare		Extended Macro eNodeB ID			
10 to 11	Extended Macro eNodeB ID						
12 to 13	Tracking Area Code (TAC)						

**Figure 8.51-4: Target ID for Type Extended Macro eNodeB**

The Extended Macro eNodeB ID consists of 21 bits. The coding of the Macro eNodeB ID is the responsibility of each administration. Coding using full hexadecimal representation (binary, not ASCII encoding) shall be used.

If the SMeNB flag is not set the Extended Macro eNodeB ID contains a Long Macro eNodeB ID with a length of 21 Bits. Bit 5 of Octet 9 is the most significant bit and bit 1 of Octet 11 is the least significant bit.

If the SMeNB flag is set the Extended Macro eNodeB ID contains a Short Macro eNodeB ID with a length of 18 Bits. Bits 5 to 3 of Octet 9 shall be set to 0 by the sender and shall be ignored by the receiver. Bit 2 of Octet 9 is the most significant bit and bit 1 of Octet 11 is the least significant bit.

## 8.51.6 Cell Identifier

The Target Type is Cell Identifier for E-UTRAN handover to GERAN and RAN Information Relay towards GERAN. In this case the coding of the Target ID field shall be same as the Octets 3 to 10 of the Cell Identifier IEI in 3GPP TS 48.018 [34].

## 8.51.7 gNodeB ID

The Target Type is gNodeB ID for an EPS to 5GS handover to a target gNodeB. In this case the coding of the Target ID field shall be coded as depicted in Figure 8.51.7-1.

Octets	Bits							
	8	7	6	5	4	3	2	1
6	MCC digit 2				MCC digit 1			
7	MNC digit 3				MCC digit 3			
8	MNC digit 2				MNC digit 1			
9	Spare		gNodeB ID Length					
10 to 13	gNodeB ID							
14 to 16	5GS Tracking Area Code (TAC)							

**Figure 8.51.7-1: Target ID for Type gNode ID**

The gNodeB ID Length field, in bits 1 to 6 of octet 9, indicates the length of the gNodeB ID in number of bits.

The gNodeB ID consists of 22 to 32 bits. The coding of the gNodeB ID is the responsibility of each administration. Coding using full hexadecimal representation (binary, not ASCII encoding) shall be used. Bit 1 of Octet 13 is the least significant bit. The most significant bit is determined as follows:

- if the gNodeB ID Length is 32, bit 8 of octet 10 is the most significant bit;
- if the gNodeB ID Length is 24, bit 8 of octet 11 is the most significant bit; all the bits of octet 10 shall be set to 0 by the sender and ignored by the receiver;
- if the gNodeB ID Length is between 22 and 31, other than 24, the most significant bit is the bit determined by the operation "gNodeB ID Length modulo 8", of octet 10 if the length is greater than 24, or of octet 11 if the length is smaller than 24. All the bits from bit 8 of octet 10 down to the most significant bit (excluded) shall be set to 0 by the sender and ignored by the receiver.

The 5GS TAC consists of 3 octets. Bit 8 of Octet 14 is the most significant bit and bit 1 of octet 16 the least significant bit. The coding of the tracking area code is the responsibility of each administration. Coding using full hexadecimal representation (binary, not ASCII encoding) shall be used.

## 8.51.8 Macro ng-eNodeB ID

The Target Type is Macro ng-eNodeB ID for an EPS to 5GS handover to a target Macro ng-eNodeB. In this case the coding of the Target ID field shall be coded as depicted in Figure 8.51.8-1.

Octets	Bits							
	8	7	6	5	4	3	2	1
6	MCC digit 2				MCC digit 1			
7	MNC digit 3				MCC digit 3			
8	MNC digit 2				MNC digit 1			
9	Spare		Macro eNodeB ID					
10 to 11	Macro ng-eNodeB ID							
12 to 14	5GS Tracking Area Code (TAC)							

**Figure 8.51.8-1: Target ID for Type Macro ng-eNodeB**

Octets 6 to 11 shall be encoded as specified for the Macro eNodeB (see Figure 8.51-2).

The 5GS TAC consists of 3 octets. Bit 8 of Octet 12 is the most significant bit and bit 1 of octet 14 the least significant bit. The coding of the tracking area code is the responsibility of each administration. Coding using full hexadecimal representation (binary, not ASCII encoding) shall be used.

### 8.51.9 Extended Macro ng-eNodeB ID

The Target Type is Extended Macro ng-eNodeB ID for an EPS to 5GS handover to a target Extended Macro ng-eNodeB. In this case the coding of the Target ID field shall be coded as depicted in Figure 8.51.9-1.

Octets	Bits						
	8	7	6	5	4	3	2
6	MCC digit 2				MCC digit 1		
7	MNC digit 3				MCC digit 3		
8	MNC digit 2				MNC digit 1		
9	SMeNB	Spare		Extended Macro eNodeB ID			
10 to 11	Extended Macro ng-eNodeB ID						
12 to 14	5GS Tracking Area Code (TAC)						

**Figure 8.51.9-1: Target ID for Type Extended Macro ng-eNodeB**

Octets 6 to 11 shall be encoded as specified for the Extended Macro eNodeB (see Figure 8.51-4).

The 5GS TAC consists of 3 octets. Bit 8 of Octet 12 is the most significant bit and bit 1 of octet 14 the least significant bit. The coding of the tracking area code is the responsibility of each administration. Coding using full hexadecimal representation (binary, not ASCII encoding) shall be used.

### 8.51.10 en-gNB ID

The Target Type is an en-gNB ID for:

- a TNL address discovery request of a candidate en-gNB via the S1 interface or via inter-system signalling (see clauses 22.3.6.2 and 22.3.6.3 of 3GPP TS 36.300 [19]).

In this case, the Target ID field shall be coded as depicted in Figure 8.51.10-1.

Octets	Bits						
	8	7	6	5	4	3	2
6	MCC digit 2				MCC digit 1		
7	MNC digit 3				MCC digit 3		
8	MNC digit 2				MNC digit 1		
9	5TAC	ETAC	en-gNB ID Length				
10 to 13	en-gNB ID						
p to (p+1)	Tracking Area Code (TAC)						
q to (q+2)	5GS Tracking Area Code (TAC)						

**Figure 8.51.10-1: Target ID for Type en-gNB ID**

The en-gNB ID Length field, in bits 1 to 6 of octet 9, indicates the length of the en-gNB ID in number of bits.

Bits 7 and 8 of octet 9 shall be encoded as follows:

- Bit 7 - ETAC: when set to "1", octets p to (p+1) shall be present and encode a TAC (EPS); otherwise, octets p to (p+1) shall be absent.
- Bit 8 - 5TAC: when set to "1", octets q to (q+2) shall be present and encode a 5GS TAC; otherwise, octets q to (q+2) shall be absent.

The en-gNB ID consists of 22 to 32 bits. The en-gNB ID shall be coded as the gNodeB ID field of the gNodeB ID in clause 8.51.7.

When present, the TAC shall consist of 2 octets and shall be coded as the TAC field of the Macro eNodeB ID in clause 8.51.3.

When present, the 5GS TAC shall consist of 3 octets and shall be coded as the 5GS TAC field of the gNodeB ID in ubclause 8.51.7.

## 8.52 Void

## 8.53 Packet Flow ID

The Packet Flow Id information element contains the packet flow identifier assigned to an EPS Bearer context as identified by EPS Bearer ID.

The spare bits 8 to 5 in octet 5 indicate unused bits, which shall be set to 0 by the sending side and which shall not be evaluated by the receiving side.

Octets	Bits							
	8	7	6	5	4	3	2	1
1	Type = 123 (decimal)							
2 to 3	Length = n							
4	Spare				Instance			
5	Spare				EBI			
6 to (n+4)	Packet Flow ID							

Figure 8.53-1: Packet Flow ID

## 8.54 RAB Context

The RAB Context shall be coded as is depicted in Figure 8.54-1.

Octets	Bits							
	8	7	6	5	4	3	2	1
1	Type = 124 (decimal)							
2 to 3	Length = 9							
4	Spare				Instance			
5	ULPSI	DLPSI	ULGS	DLGS	NSAPI			
6 to 7	DL GTP-U Sequence Number							
8 to 9	UL GTP-U Sequence Number							
10 to 11	DL PDCP Sequence Number							
12 to 13	UL PDCP Sequence Number							

Figure 8.54-1: RAB Context

The RAB Context IE may be repeated within a message with exactly the same Type and Instance to represent a list.

The RAB context information element contains sequence number status for one RAB in RNC, which corresponds to one PDP context. The RAB contexts are transferred between the RNCs via the SGSNs at inter SGSN hard handover.

NSAPI identifies the PDP context and the associated RAB for which the RAB context IE is intended.

The following bits within Octet 5 shall indicate:

- Bit 8 – ULPSI (UL PDCP Sequence Number Indication): This bit shall be set to "1" if the UL PDCP Sequence Number is not received from the source RNC and the UL PDCP Sequence Number field shall be set to "0";
- Bit 7 – DLPSI (DL PDCP Sequence Number Indication): This bit shall be set to "1" if the DL PDCP Sequence Number is not received from the source RNC and the DL PDCP Sequence Number field shall be set to "0";
- Bit 6 – ULGSI (UL GTP-U Sequence Number Indication): This bit shall be set to "1" if the UL GTP-U Sequence Number is not received from the source RNC and the UL GTP-U Sequence Number field shall be set to "0";

- Bit 5 – DLGSI (DL GTP-U Sequence Number Indication): This bit shall be set to "1" if the DL GTP-U Sequence Number is not received from the source RNC and the DL GTP-U Sequence Number field shall be set to "0".DL GTP-U Sequence Number is the number for the next downlink GTP-U T-PDU to be sent to the UE.

UL GTP-U Sequence Number is the number for the next uplink GTP-U T-PDU to be tunnelled to the SGW.

DL PDCP Sequence Number is the number for the next downlink PDCP-PDU to be sent to the UE.

UL PDCP Sequence Number is the number for the next uplink PDCP-PDU to be received from the UE.

### 8.55 Source RNC PDCP context info

The purpose of the Source RNC PDCP context info IE is to transfer RNC PDCP context information from a source RNC to a target RNC during an SRNS relocation.

Octets	Bits							
	8	7	6	5	4	3	2	1
1	Type = 125 (decimal)							
2 to 3	Length = n							
4	Spare				Instance			
5 to (n+4)	RRC Container							

Figure 8.55-1: Source RNC PDCP context info

### 8.56 Port Number

Port Number is coded as depicted in Figure 8.56-1.

Octets	Bits							
	8	7	6	5	4	3	2	1
1	Type = 126 (decimal)							
2 to 3	Length = 2							
4	Spare				Instance			
5 to 6	Port Number							
7 to (n+4)	These octet(s) is/are present only if explicitly specified							

Figure 8.56-1: Port Number

### 8.57 APN Restriction

The APN Restriction information element contains an unsigned integer value indicating the level of restriction imposed on EPS Bearer Contexts created to the associated APN.

The APN Restriction IE is coded as depicted in Figure 8.57-1:

Octets	Bits							
	8	7	6	5	4	3	2	1
1	Type = 127 (decimal)							
2 to 3	Length = n							
4	Spare				Instance			
5	Restriction Type value							
6 to (n+4)	These octet(s) is/are present only if explicitly specified							

Figure 8.57-1: APN Restriction Type Information Element

An APN Restriction value may be configured for each APN in the PGW. It is used to determine, on a per UE basis, whether it is allowed to establish EPS bearers to other APNs.

**Table 8.57-1: Valid Combinations of APN Restriction**

Maximum APN Restriction Value	Type of APN	Application Example	APN Restriction Value allowed to be established
0	No Existing Contexts or Restriction		All
1	Public-1	MMS	1, 2, 3
2	Public-2	Internet	1, 2
3	Private-1	Corporate (e.g. who use MMS)	1
4	Private-2	Corporate (e.g. who do not use MMS)	None

## 8.58 Selection Mode

The Selection mode information element indicates the origin of the APN in the message.

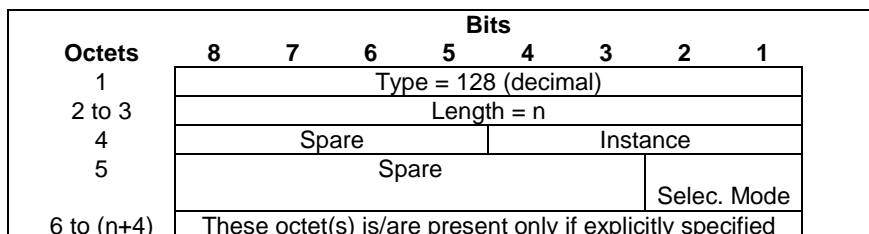

**Figure 8.58-1: Selection Mode Information Element**

**Table 8.58-1: Selection Mode Values**

Selection mode value	Value (Decimal)
MS or network provided APN, subscription verified	0
MS provided APN, subscription not verified	1
Network provided APN, subscription not verified	2
For future use. Shall not be sent. If received, shall be interpreted as the value "2".	3

## 8.59 Source Identification

The Source Identification information element is coded as depicted in Figure 8.59-1.

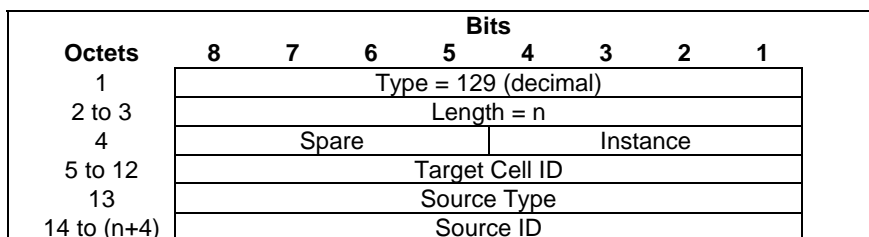

**Figure 8.59-1: Source Identification**

The Target Cell ID shall be same as the Octets 3 to 10 of the Cell Identifier IEI in 3GPP TS 48.018 [34].

Source Type values are specified in Table 8.59-1.

If the Source Type is Cell ID, this indicates PS handover from GERAN A/Gb mode. In this case the coding of the Source ID field shall be same as the Octets 3 to 10 of the Cell Identifier IEI in 3GPP TS 48.018 [34].

If the Source Type is RNC ID, this indicates PS handover from GERAN Iu mode or for inter-RAT handover from UTRAN. In this case the Source ID field shall include a transparent copy of the corresponding parameter (see clause 8.2.2), the Source RNC-ID as specified within the "Source ID" parameter in 3GPP TS 25.413 [33].

NOTE: In fact, the ASN.1/PER encoded binary value of the "Source RNC ID" shall be copied into octets 14 to (n+4).

**Table 8.59-1: Source Type values and their meanings**

Source Types	Values (Decimal)
Cell ID	0
RNC ID	1
reserved (NOTE)	2
<spare>	3-255
NOTE: This value was allocated in an earlier version of the protocol and shall not be used.	

## 8.60 Void

## 8.61 Change Reporting Action

Change Reporting Action IE is coded as depicted in Figure 8.61-1.

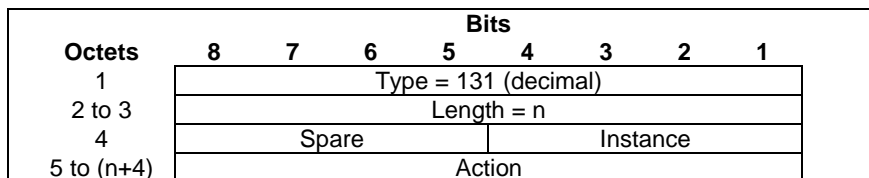

**Figure 8.61-1: Change Reporting Action**

**Table 8.61-1: Action values**

Action	Value (Decimal)
Stop Reporting	0
Start Reporting CGI/SAI	1
Start Reporting RAI	2
Start Reporting TAI	3
Start Reporting ECGI	4
Start Reporting CGI/SAI and RAI	5
Start Reporting TAI and ECGI	6
Start Reporting Macro eNodeB ID and Extended Macro eNodeB ID	7
Start Reporting TAI, Macro eNodeB ID and Extended Macro eNodeB ID	8
<spare>	9-255

Stop Reporting stops all reporting action types.

## 8.62 Fully qualified PDN Connection Set Identifier (FQ-CSID)

A fully qualified PDN Connection Set Identifier (FQ-CSID) identifies a set of PDN connections belonging to an arbitrary number of UEs on a MME, SGW, TWAN, ePDG or PGW. The FQ-CSID is used on S5, S8, S2a, S2b and S11 interfaces.

The size of CSID is two octets. The FQ-CSID is coded as follows:

Octets	Bits							
	8	7	6	5	4	3	2	1
1	Type = 132 (decimal)							
2 to 3	Length = n							
4	Spare				Instance			
5	Node-ID Type				Number of CSIDs= m			
6 to p	Node-ID							
(p+1) to (p+2)	First PDN Connection Set Identifier (CSID)							
(p+3) to (p+4)	Second PDN Connection Set Identifier (CSID)							
...	...							
q to q+1	m-th PDN Connection Set Identifier (CSID)							
(q+2) to (n+4)	These octet(s) is/are present only if explicitly specified							

Figure 8.62-1: FQ-CSID

Where Node-ID Type values are:

- 0 indicates that Node-ID is a global unicast IPv4 address and p = 9.
- 1 indicates that Node-ID is a global unicast IPv6 address and p = 21.
- 2 indicates that Node-ID is a 4 octets long field with a 32 bit value stored in network order, and p= 9. The coding of the field is specified below:
  - Most significant 20 bits are the binary encoded value of (MCC \* 1000 + MNC).
  - Least significant 12 bits is a 12 bit integer assigned by an operator to an MME, SGW, TWAN, ePDG or PGW. Other values of Node-ID Type are reserved.

Values of Number of CSID other than 1 are only employed in the Delete PDN Connection Set Request.

The node that creates the FQ-CSID, (i.e. MME for MME FQ-CSID, SGW for SGW FQ-CSID, TWAN for TWAN FQ-CSID, ePDG for ePDG FQ-CSID and PGW for PGW FQ-CSID), is responsible for making sure the Node-ID is globally unique and the CSID value is unique within that node.

When a FQ-CSID is stored by a receiving node, it is stored on a PDN basis even for messages impacting only one bearer (i.e. Create Bearer Request). See 3GPP TS 23.007 [17] for further details on the CSID and what specific requirements are placed on the PGW, TWAN, ePDG, SGW and MME.

### 8.63 Channel needed

The Channel needed shall be coded as depicted in Figure 8.63-1. Channel needed is coded as the IEI part and the value part of the Channel Needed IE defined in 3GPP TS 44.018[28]

Octets	Bits							
	8	7	6	5	4	3	2	1
1	Type = 133 (decimal)							
2 to 3	Length = n							
4	Spare				Instance			
5 to (n+4)	Channel Needed							

Figure 8.63-1: Channel needed

### 8.64 eMLPP Priority

The eMLPP-Priority shall be coded as depicted in Figure 8.64-1. The eMLPP Priority is coded as the value part of the eMLPP-Priority IE defined in 3GPP TS 48.008 [29] (not including 3GPP TS 48.008 IEI and 3GPP TS 48.008 [29] length indicator).



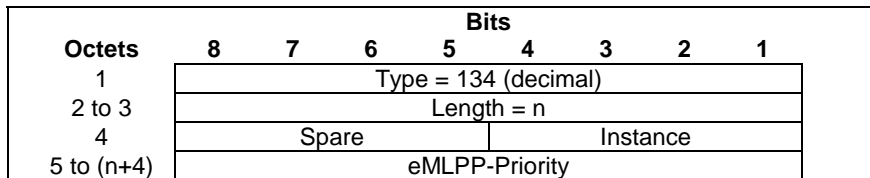

Figure 8.64-1: eMLPP Priority

The eMLPP Priority may be used to determine the required GTPv2 message priority of the GTPv2 message carrying this IE.

## 8.65 Node Type

Node Type is coded as this is depicted in Figure 8.65-1.

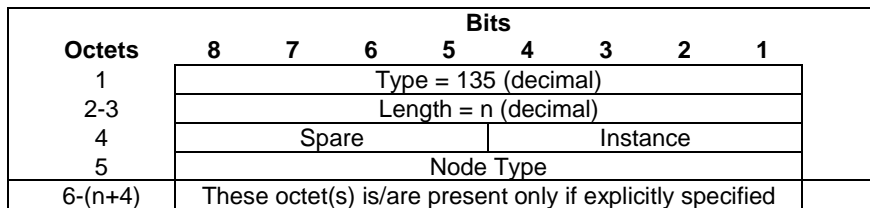

Figure 8.65-1: Node Type

Node type values are specified in Table 8.65-1.

Table 8. 65-1: Node Type values

Node Types	Values (Decimal)
MME	0
SGSN	1
<spare>	2-255

If with a Release Access Bearers Request, or Suspend Notification, or Resume an SGW receives a semantically erroneous/unexpected Originating Node, then the following applies:

- If SGW has an active connection to an MME, but the Originating Node IE contains value "SGSN", then the SGW shall not release the user plane and shall send a response to the SGSN with some appropriate cause value.
- If SGW has an active connection to an S4-SGSN, but the Originating Node IE contains value "MME", then the SGW shall not release the user plane and shall send a response to the MME with some appropriate cause value.

## 8.66 Fully Qualified Domain Name (FQDN)

Fully Qualified Domain Name (FQDN) is coded as depicted in Figure 8.66-1.

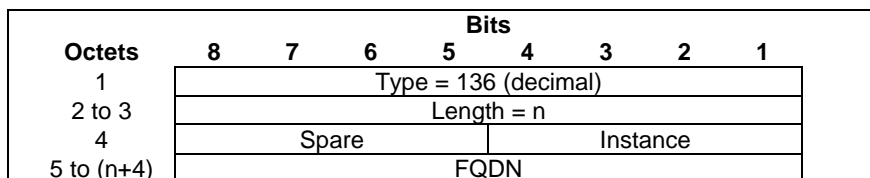

Figure 8.66-1: Fully Qualified Domain Name (FQDN)

The FQDN field encoding shall be identical to the encoding of a FQDN within a DNS message of clause 3.1 of IETF RFC 1035 [31] but excluding the trailing zero byte.

NOTE 1: The FQDN field in the IE is not encoded as a dotted string as commonly used in DNS master zone files.

A "PGW node name" IE in S3/S10/S16/S5/S8 GTP messages shall be a PGW host name as per clause 4.3.2 of 3GPP TS 29.303 [32] when the PGW FQDN IE is populated from 3GPP TS 29.303 [32] procedures. Specifically, the first DNS label is either "topon" or "topoff", and the canonical node name of the PGW starts at the third label. The same rules apply to "SGW node name" IE on S3/S10/S16 and "SGW-U node name" IE on S5.

NOTE 2: The constraint of clause 4.3.2 of 3GPP TS 29.303 format is on populating the IE by 3GPP nodes for 3GPP nodes, the receiver shall not reject an IE that is otherwise correctly formatted since the IE might be populated for a non-3GPP node.

An "MME node name" IE and an "SGSN node name" IE in S3 GTP messages indicate the associated ISR node when the ISR becomes active.

## 8.67 Private Extension

Private Extension is coded as depicted in Figure 8.67-1.

Enterprise ID can be found at IANA web site (<http://www.iana.org/assignments/enterprise-numbers>).

Octets	Bits						
	8	7	6	5	4	3	2
1	Type = 255 (decimal)						
2 to 3	Length = n						
4	Spare			Instance			
5 to 6	Enterprise ID						
7 to (n+4)	Proprietary value						

Figure 8.67-1. Private Extension

## 8.68 Transaction Identifier (TI)

Transaction Identifier is coded as depicted in Figure 8.68-1. It is defined in 3GPP TS 24.301 [23], clause 9.9.4.17 and is coded as specified in 3GPP TS 24.007 [30], clause 11.2.3.1.3 Transaction identifier.

Octets	Bits						
	8	7	6	5	4	3	2
1	Type = 137 (decimal)						
2 to 3	Length = n						
4	Spare			Instance			
5 to (n+4)	Transaction Identifier						

Figure 8.68-1: Transaction Identifier

## 8.69 MBMS Session Duration

The MBMS Session Duration is defined in 3GPP TS 23.246 [37]. The MBMS Session Duration information element indicates the estimated session duration of the MBMS service data transmission if available. The payload shall be encoded as per the MBMS-Session-Duration AVP defined in 3GPP TS 29.061 [38], excluding the AVP Header fields (as defined in IETF RFC 3588 [39], clause 4.1).

Octets	Bits						
	8	7	6	5	4	3	2
1	Type = 138 (decimal)						
2 to 3	Length = n						
4	Spare			Instance			
5 to 7	MBMS Session Duration						
8 to (n+4)	These octet(s) is/are present only if explicitly specified						

Figure 8.69-1: MBMS Session Duration

## 8.70 MBMS Service Area

The MBMS Service Area is defined in 3GPP TS 23.246 [37]. The MBMS Service Area information element indicates the area over which the Multimedia Broadcast Multicast Service is to be distributed. The payload shall be encoded as per the MBMS-Service-Area AVP defined in 3GPP TS 29.061 [38], excluding the AVP Header fields (as defined in IETF RFC 3588 [39], clause 4.1).

Octets	Bits						
	8	7	6	5	4	3	2
1	Type = 139 (decimal)						
2 to 3	Length = n						
4	Spare			Instance			
5 to (n+4)	MBMS Service Area						

Figure 8.70-1: MBMS Service Area

## 8.71 MBMS Session Identifier

The MBMS Session Identifier information element contains a Session Identifier allocated by the BM-SC. The MBMS Session Identifier value part consists of 1 octet. The content and the coding are defined in 3GPP TS 29.061 [38].

Octets	Bits						
	8	7	6	5	4	3	2
1	Type = 140 (decimal)						
2 to 3	Length = n						
4	Spare			Instance			
5	MBMS Session Identifier						
6 to (n+4)	These octet(s) is/are present only if explicitly specified						

Figure 8.71-1: MBMS Session Identifier

## 8.72 MBMS Flow Identifier

The MBMS Flow Identifier is defined in 3GPP TS 23.246 [37]. In broadcast mode, the MBMS Flow Identifier information element is included in MBMS Session Management messages to differentiate the different sub-sessions of an MBMS user service (identified by the TMGI) providing location-dependent content. The payload shall be encoded as per the MBMS-Flow-Identifier AVP defined in 3GPP TS 29.061 [38], excluding the AVP Header fields (as defined in IETF RFC 3588 [39], clause 4.1).

Octets	Bits						
	8	7	6	5	4	3	2
1	Type = 141 (decimal)						
2 to 3	Length = n						
4	Spare			Instance			
5 to 6	MBMS Flow Identifier						
7 to (n+4)	These octet(s) is/are present only if explicitly specified						

Figure 8.72-1: MBMS Flow Identifier

## 8.73 MBMS IP Multicast Distribution

The MBMS IP Multicast Distribution IE is sent by the MBMS GW to the MME/SGSN in the MBMS Session Start Request. Source Specific Multicasting is used according to IETF RFC 4607 [40].

The IP Multicast Distribution Address and the IP Multicast Source Address fields contain the IPv4 or IPv6 address. The Address Type and Address Length fields shall be included in each field:

- The Address Type, which is a fixed length code (of 2 bits) identifying the type of address that is used in the Address field.
- The Address Length, which is a fixed length code (of 6 bits) identifying the length of the Address field.
- The Address, which is a variable length field shall contain either an IPv4 address or an IPv6 address.

Address Type 0 and Address Length 4 shall be used when Address is an IPv4 address.

Address Type 1 and Address Length 16 shall be used when Address is an IPv6 address.

Other combinations of values are not valid.

MBMS HC Indicator represents an indication if header compression should be used for MBMS user plane data, as specified in 3GPP TS 25.413 [33]. MBMS HC Indicator field is encoded as a one octet long enumeration.

NOTE: Currently, 3GPP TS 25.413 [33] specifies two enumeration values: 0 (indicates "uncompressed-header") and 1 (indicates "compressed-header").

Common Tunnel Endpoint Identifier is allocated at the source Tunnel Endpoint and signalled to the destination Tunnel Endpoint. There is one Common Tunnel Endpoint Identifier allocated per MBMS bearer service. The recommendations on how to set the value of C-TEID are provided in 3GPP TS 23.246 [37].

Octets	Bits							
	8	7	6	5	4	3	2	1
1	Type = 142 (decimal)							
2 to 3	Length=n							
4	Spare				Instance			
5 to 8	Common Tunnel Endpoint Identifier							
9	Address Type				Address Length			
10 to K	IP Multicast Distribution Address (IPv4 or IPv6)							
K+1	Address Type				Address Length			
(k+2) to m	IP Multicast Source Address (IPv4 or IPv6)							
m+1	MBMS HC Indicator							
(m+2) to n	These octet(s) is/are present only if explicitly specified							

Figure 8.73-1: MBMS IP Multicast Distribution

## 8.74 MBMS Distribution Acknowledge

The MBMS Distribution Acknowledge IE is sent by the SGSN to the MBMS GW in the MBMS Session Start Response and MBMS Session Update Response. It is used by the MBMS GW to decide if an IP Multicast Distribution user plane shall be established, or a normal point-to-point user plane, or both.

Octets	Bits							
	8	7	6	5	4	3	2	1
1	Type = 143 (decimal)							
2 to 3	Length = n							
4	Spare				Instance			
5	Spare						Distr Ind	
6 to n+4	These octet(s) is/are present only if explicitly specified							

Figure 8.74-1: MBMS Distribution Acknowledge

Table 8.74-1: Distribution Indication values

Distribution Indication	Value (Decimal)
No RNCs have accepted IP multicast distribution	0
All RNCs have accepted IP multicast distribution	1
Some RNCs have accepted IP multicast distribution	2
Spare. For future use.	3

## 8.75 User CSG Information (UCI)

User CSG Information (UCI) is coded as depicted in Figure 8.75-1. The CSG ID is defined in 3GPP TS 23.003 [2].

Octets	Bits						
	8	7	6	5	4	3	2
1	Type = 145						
2 to 3	Length = n						
4	Spare			Instance			
5	MCC digit 2			MCC digit 1			
6	MNC digit 3			MCC digit 3			
7	MNC digit 2			MNC digit 1			
8	spare			CSG ID			
9 to 11	CSG ID						
12	Access mode	spare			LCSG	CMI	
13 to (n+4)	These octet(s) is/are present only if explicitly specified						

**Figure 8.75-1: User CSG Information**

For two digits in the MNC, bits 5 to 8 of octet 6 are coded as "1111".

The CSG ID consists of 4 octets. Bit 3 of Octet 8 is the most significant bit and bit 1 of Octet 11 is the least significant bit. The coding of the CSG ID is the responsibility of the operator that allocates the CSG ID by administrative means. Coding using full hexadecimal representation (binary, not ASCII encoding) shall be used.

Access mode values are specified in Table 8.75-1.

**Table 8.75-1: Access mode values and their meanings**

Access Mode	Values (Decimal)
Closed Mode	0
Hybrid Mode	1
Reserved	2-3

Leave CSG flag (LCSG) shall be set to "1" if UE leaves CSG cell/Hybrid cell, and in this case, the receiving node shall ignore the rest information in the IE.

CSG Membership Indication (CMI) values are specified in Table 8.75-2. CMI shall be included in the User CSG Information if the Access mode is Hybrid Mode. For the other values of Access Mode, the CMI shall be set to 0 by the sender and ignored by the receiver.

**Table 8.75-2: CSG Membership indication (CMI)**

CMI	Values (Decimal)
Non CSG membership	0
CSG membership	1

NOTE: Due to a specification oversight, the CMI values in the above table are reversed from the values of the CMI IE (see clause 8.79). Furthermore, the encoding is different between GTPv1 and GTPv2.

## 8.76 CSG Information Reporting Action

CSG Information Reporting Action is coded as depicted in Figure 8.76-1.

Octets	Bits						
	8	7	6	5	4	3	2
1	Type = 146						
2 to 3	Length = n						
4	Spare			Instance			
5	Spare			UCIU HC	UCIS HC	UCIC SG	
6 to (n+4)	These octet(s) is/are present only if explicitly specified						

**Figure 8.76-1: CSG Reporting Action**

The following bits within Octet 5 shall indicate:

- Bit 1 – UCICSG: When set to "1", shall indicate to start reporting User CSG Info when the UE enters/leaves/access through the CSG Cell.
- Bit 2 – UCISHC: When set to "1", shall indicate to start reporting User CSG Info when the UE enters/leaves/access through Subscribed Hybrid Cell.
- Bit 3 – UCIUHC: When set to "1", shall indicate to start Reporting User CSG Info when the UE enters/leaves/access through Unsubscribed Hybrid Cell.

All the bits 1 to 3 shall be set to 0 to stop reporting User CSG Info.

## 8.77 RFSP Index

Index to RAT/Frequency Selection Priority (RFSP Index) is coded as depicted in Figure 8.77-1, and contains a non-transparent copy of the corresponding IE (see clause 8.2.2), "Subscriber Profile ID for RAT/Frequency Priority (SPID)" as specified in 3GPP TS 36.413 [10]. The SPID is an integer between 1 and 256 and is encoded as an unsigned integer, which requires the two octets specified for the RFSP Index parameter.

Octets	Bits							
	8	7	6	5	4	3	2	1
1	Type = 144 (decimal)							
2 to 3	Length = 2							
4	Spare				Instance			
5 to 6	RFSP Index							

Figure 8.77-1. RFSP Index

## 8.78 CSG ID

CSG ID is coded as depicted in Figure 8.78-1. The CSG ID is defined in 3GPP TS 23.003 [2].

Octets	Bits							
	8	7	6	5	4	3	2	1
1	Type = 147							
2 to 3	Length = n							
4	Spare				Instance			
5	Spare				CSG ID			
6 to 8	CSG ID							
9 to (n+4)	These octet(s) is/are present only if explicitly specified							

Figure 8.78-1: CSG ID

The CSG ID consists of 4 octets. Bit 3 of Octet 5 is the most significant bit and bit 1 of Octet 8 is the least significant bit. The coding of the CSG ID is the responsibility of the operator that allocates the CSG ID by administrative means. Coding using full hexadecimal representation (binary, not ASCII encoding) shall be used.

## 8.79 CSG Membership Indication (CMI)

CSG Membership Indication is coded as depicted in Figure 8.79-1.

Octets	Bits							
	8	7	6	5	4	3	2	1
1	Type = 148							
2 to 3	Length = n							
4	Spare				Instance			
5	Spare							CMI
6 to (n+4)	These octet(s) is/are present only if explicitly specified							

Figure 8.79-1: CSG Membership Indication

Table 8.79-1: void

CSG Membership Indication (CMI) values are specified in Table 8.79-2.

**Table 8.79-2: CSG Membership indication (CMI)**

CMI	Values (Decimal)
CSG membership	0
Non CSG membership	1

NOTE: Due to a specification oversight, the CMI values in the above table are reversed from the values of the CSG-Membership-Indication AVP in 3GPP TS 32.299 [54], as well as from the values of the CMI in the UCI IE (see clause 8.75). Therefore, when the above CMI values are sent over the charging interface, the values are encoded as specified in 3GPP TS 32.299 [54].

## 8.80 Service indicator

Service indicator is coded as depicted in Figure 8.80-1.

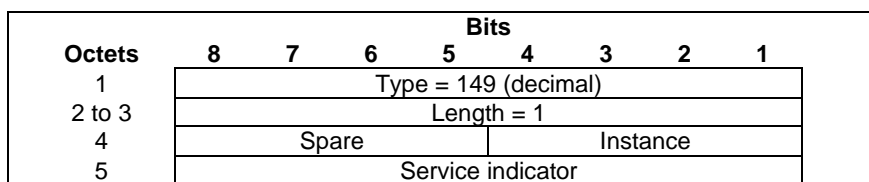

**Figure 8.80-1. Service indicator**

Service indicator values are specified in Table 8.80-1.

**Table 8.80-1: Service indicator values**

Service indicator	Values (Decimal)
<spare>	0
CS call indicator	1
SMS indicator	2
<spare>	3-255

## 8.81 Detach Type

Detach Type is coded as depicted in Figure 8.81-1.

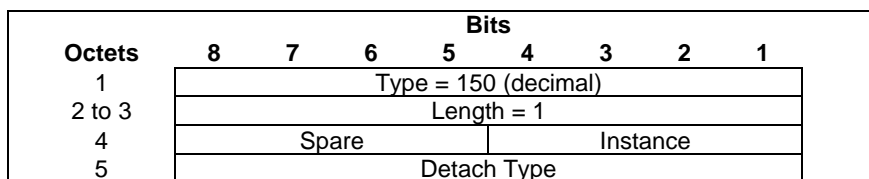

**Figure 8.81-1: Detach Type**

**Table 8.81-1: Detach Type values**

Detach Types	Values (Decimal)
<reserved>	0
PS Detach	1
Combined PS/CS Detach	2
<spare>	3-255

## 8.82 Local Distinguished Name (LDN)

Represents the Local Distinguished Name (LDN) of the network element (see 3GPP TS 32.423 [44]).

Octets	8	7	6	5	4	3	2	1
1	Type = 151 (decimal)							
2 to 3	Length = n							
4	Spare				Instance			
5 to (n+4)	LDN							

**Figure 8.82-1: Local Distinguished Name (LDN)**

The LDN field consists of 1 up to a maximum of 400 ASCII characters, i.e., from 1 up to a maximum of 400 octets.

## 8.83 Node Features

Node Features IE is coded as depicted in Figure 8. 83-1.

Octets	8	7	6	5	4	3	2	1
1	Type = 152 (decimal)							
2 to 3	Length = n							
4	Spare				Instance			
5	Supported-Features							
6 to (n+4)	These octet(s) is/are present only if explicitly specified							

**Figure 8.83-1: Node Features IE**

The Node Features IE takes the form of a bitmask where each bit set indicates that the corresponding feature is supported. Spare bits shall be ignored by the receiver. The same bitmask is defined for all GTPv2 interfaces.

The following table specifies the features defined on GTPv2 interfaces and the interfaces on which they apply.



Table 8.83-1: Node Features on GTPv2 interfaces

Feature Octet / Bit	Feature	Interface	Description
5/1	PRN	S11, S4	PGW Restart Notification. If both the SGW and the MME/S4-SGSN support this feature, the SGW shall send PGW Restart Notification message to the MME/S4-SGSN when the SGW detects that the peer PGW has restarted, and the SGW may send PGW Restart Notification message when the SGW detects that the peer PGW has failed and not restarted, as specified in clause 7.9.5.
5/2	MABR	S11	Modify Access Bearers Request. If both the SGW and the MME support this feature, the MME may modify the S1-U bearers of all the PDN connections of the UE by sending a Modify Access Bearers Request message as specified in clause 7.2.24.
5/3	NTSR	S11/S4	Network Triggered Service Restoration procedure. If both the SGW and the MME/S4-SGSN support this feature (see 3GPP TS 23.007 [17]), the SGW shall send a Downlink Data Notification message including the IMSI to the MME/S4-SGSN on the TEID 0 as part of a network triggered service restoration procedure.
5/4	CIOT	S11/S4	Cellular Internet Of Things. Support of this feature may be indicated over the S11/S4 interface, from the SGW to the MME/SGSN. See NOTE 1. If the SGW notifies the support of this feature over S11, it indicates to the MME that the SGW supports all the following CloT features: <ul style="list-style-type: none"> <li>- EUTRAN-NB-IoT RAT type,</li> <li>- Non-IP PDN type,</li> <li>- S11-U tunneling,</li> <li>- Serving PLMN Rate Control,</li> <li>- MO Exception Data indication,</li> <li>- Extended PCO</li> </ul> If the SGW notifies the support of this feature over S4, it indicates to the SGSN that the SGW supports the Non-IP PDN type.
5/5	S1UN	S11	S1-U path failure notification feature. The support of this feature may be indicated over the S11 interface, from the MME to the SGW. See clause 20.3 of 3GPP TS 23.007 [17].
5/6	ETH	S11	Ethernet PDN type Support of this feature may be indicated over the S11 interface, from the SGW to the MME.
5/7	MTEDT	S11	Support of MT-EDT Support of this feature may be indicated over the S11 interface, from the SGW to the MME.
NOTE 1: An SGW does not need to know whether the MME/SGSN support the CloT feature.			
Feature Octet / Bit: The octet and bit number within the Supported-Features IE, e.g. "5 / 1".			
Feature: A short name that can be used to refer to the octet / bit and to the feature.			
Interface: A list of applicable interfaces to the feature.			
Description: A clear textual description of the feature.			

No features have been defined on the following GTPv2 interfaces in this version of the specification: S2a, S2b, S5, S8, S10, S3, S16, Sv, S101, S121, Sm, Sn.

## 8.84 MBMS Time to Data Transfer

The MBMS Time to Data Transfer indicates the minimum time occurring between the transmission of the MBMS SESSION START REQUEST message and the actual start of the data transfer. It is coded as shown in figure 8.84-1.

Octet 5 is coded as the value part of the Time to MBMS Data Transfer IE defined in 3GPP TS 48.018 [34] (not including the IEI and length indicator octets specified in 3GPP TS 48.018 [34]).

Octets	Bits						
	8	7	6	5	4	3	2
1	Type = 153 (decimal)						
2 to 3	Length = n						
4	Spare			Instance			
5	MBMS Time to Data Transfer value part						
6 to (n+4)	These octet(s) is/are present only if explicitly specified						

Figure 8.84-1: MBMS Time to Data Transfer

## 8.85 Throttling

Throttling is coded as depicted in Figure 8.85-1.

Octets	Bits						
	8	7	6	5	4	3	2
1	Type = 154 (decimal)						
2 to 3	Length = n						
4	Spare			Instance			
5	Throttling Delay Unit			Throttling Delay Value			
6	Throttling Factor						
7 to (n+4)	These octet(s) is/are present only if explicitly specified						

Figure 8.85-1: Throttling

Table 8.85.1: Throttling information element

<p>Throttling Delay (octet 5)</p> <p>Bits 5 to 1 represent the binary coded timer value.</p> <p>Bits 6 to 8 defines the timer unit for the timer as follows:</p> <p>Bits</p> <p><b>8 7 6</b></p> <p>0 0 0 value is incremented in multiples of 2 seconds</p> <p>0 0 1 value is incremented in multiples of 1 minute</p> <p>0 1 0 value is incremented in multiples of 10 minutes</p> <p>0 1 1 value is incremented in multiples of 1 hour</p> <p>1 0 0 value is incremented in multiples of 10 hours</p> <p>1 1 1 value indicates that the timer is deactivated.</p> <p>Other values shall be interpreted as multiples of 1 minute.</p> <p>Throttling Factor (octet 6)</p> <p>The Throttling Factor indicates a percentage and may take binary coded integer values from and including 0 up to and including 100. Other values shall be considered as 0.</p>
--

## 8.86 Allocation/Retention Priority (ARP)

Allocation/Retention Priority (ARP) is coded as depicted in Figure 8.86-1.

Octets	8	7	6	5	4	3	2	1
1	Type = 155 (decimal)							
2 to 3	Length = n							
4	Spare				Instance			
5	Spare	PCI	PL			Spare	PVI	
6 to (n+4)	These octet(s) is/are present only if explicitly specified							

**Figure 8.86-1: Allocation/Retention Priority (ARP)**

The meaning and value range of the parameters within the ARP are defined in 3GPP TS 29.212 [29]. The bits within the octet 5 are:

- Bit 1 – PVI (Pre-emption Vulnerability): See 3GPP TS 29.212[29], clause 5.3.47 Pre-emption-Vulnerability AVP.
- Bit 2 – spare
- Bits 3 to 6 – PL (Priority Level): See 3GPP TS 29.212[29], clause 5.3.45 Priority-Level AVP. PL encodes each priority level defined for the Priority-Level AVP as the binary value of the priority level.
- Bit 7 – PCI (Pre-emption Capability): See 3GPP TS 29.212[29], clause 5.3.46 Pre-emption-Capability AVP.
- Bit 8 – spare.

## 8.87 EPC Timer

The purpose of the EPC Timer information element is to specify EPC specific timer values.

The EPC Timer information element is coded as shown in figure 8.87-1 and table 8.87.1

Octets	8	7	6	5	4	3	2	1
1	Type = 156 (decimal)							
2 to 3	Length = n							
4	Spare				Instance			
5	Timer unit			Timer value				
6 to (n+4)	These octet(s) is/are present only if explicitly specified							

**Figure 8.87-1: EPC Timer**

**Table 8.87.1: EPC Timer information element**

<p>Timer value Bits 5 to 1 represent the binary coded timer value.</p> <p>Timer unit Bits 6 to 8 defines the timer value unit for the EPC timer as follows: Bits</p> <p><b>8 7 6</b></p> <p>0 0 0 value is incremented in multiples of 2 seconds                  0 0 1 value is incremented in multiples of 1 minute                  0 1 0 value is incremented in multiples of 10 minutes                  0 1 1 value is incremented in multiples of 1 hour                  1 0 0 value is incremented in multiples of 10 hours                  1 1 1 value indicates that the timer is infinite</p> <p>Other values shall be interpreted as multiples of 1 minute in this version of the protocol.</p> <p>Timer unit and Timer value both set to all "zeros" shall be interpreted as an indication that the timer is stopped.</p>
--

## 8.88 Signalling Priority Indication

The Signalling Priority Indication information element contains signalling priority indications received from the UE for a specific PDN connection.

The Signalling Priority Indication information element is coded as shown in figure 8.88-1.

Octets	Bits							
	8	7	6	5	4	3	2	1
1	Type = 157 (decimal)							
2 to 3	Length = n							
4	Spare				Instance			
5	Spare							LAPI
6 to (n+4)	These octet(s) is/are present only if explicitly specified							

**Figure 8.88-1: Signalling Priority Indication**

The following bits within Octet 5 shall indicate:

- Bit 8 to 2 – Spare, for future use and set to zero.
- Bit 1 – LAPI (Low Access Priority Indication): This bit defines if the UE indicated low access priority when establishing the PDN connection. It shall be encoded as the Low Priority parameter of the Device Properties IE in 3GPP TS 24.008 [5]. The receiver shall assume the value "0" if the Signalling Priority Indication IE is applicable for a message but not included in that message by the sender. The low access priority indication may be included in charging records.

## 8.89 Temporary Mobile Group Identity (TMGI)

The TMGI contains the Temporary Mobile Group Identity allocated to the MBMS Bearer Service. The BM-SC always includes the MCC and MNC when allocating the TMGI, see 3GPP TS 29.061 [38].

It is coded as specified in Figure 8.89-1.

Octets	Bits							
	8	7	6	5	4	3	2	1
1	Type = 158 (decimal)							
2 to 3	Length = n							
4	Spare				Instance			
5-10	TMGI							
11-(n+4)	These octet(s) is/are present only if explicitly specified							

**Figure 8.89-1: TMGI**

Octets 5 to 10 shall be encoded as octets 3 to octet 8 in the figure 10.5.154 of 3GPP TS 24.008 [5].

## 8.90 Additional MM context for SRVCC

The additional MM Context for SRVCC information element contains mobile station classmarks, supported codec list that are necessary for the AMF/MME/S4-SGSN to perform SRVCC as defined in 3GPP TS 23.216 [43]. The coding of Mobile Station Classmarks and Supported Codec List fields include the IE value part as it is specified in 3GPP TS 24.008 [5].

Octets	Bits							
	8	7	6	5	4	3	2	1
1	Type = 159 (decimal)							
2 to 3	Length = n							
4	Spare				Instance			
5	Length of the Mobile Station Classmark 2							
6 to a	Mobile Station Classmark 2							
b	Length of the Mobile Station Classmark 3							
(b+1) to c	Mobile Station Classmark 3							
d	Length of the Supported Codec List							
(d+1) to e	Supported Codec List							
(e+1) to (n+4)	These octet(s) is/are present only if explicitly specified							

**Figure 8.90-1: Additional MM context for SRVCC**

For each of the Mobile Station Classmark 2, Mobile Station Classmark 3 and Supported Codec List parameters, if they are not available, then the associated length field shall be set to zero, and the particular parameter field shall not be present.

### 8.91 Additional flags for SRVCC

Additional flags for SRVCC is coded as depicted in Figure 8.91-1.

Octets	Bits							
	8	7	6	5	4	3	2	1
1	Type = 160 (decimal)							
2 to 3	Length = n							
4	Spare				Instance			
5	Spare				VF		ICS	
6-(n+4)	These octet(s) is/are present only if explicitly specified							

**Figure 8.91-1: Additional flags for SRVCC**

The following bits within Octet 5 indicate:

- Bit 1 – ICS (IMS Centralized Service): This flag indicates that UE supports ICS specific service as specified in 3GPP TS 23.292 [47].
- Bit 2 – VF (vSRVCC Flag): This flag indicates that the user is subscribed to the vSRVCC.

### 8.92 Void

### 8.93 MDT Configuration

MDT Configuration is coded as depicted in Figure 8.93-1.

Octets	Bits							
	8	7	6	5	4	3	2	1
1	Type = 162 (decimal)							
2 to 3	Length = n							
4	Spare				Instance			
5	Job Type							
6 to 9	List of Measurements							
10	Reporting Trigger							
11	Report Interval							
12	Report Amount							
13	Event Threshold for RSRP							
14	Event Threshold for RSRQ							
15	Length of Area Scope							
p to q	Area Scope							
s	Spare				PLI	PMI	MPI	CRRMI
u	Collection period for RRM measurements LTE							
v	Measurement Period LTE							
w	Positioning Method							
x	Number of MDT PLMNs							
y to z	MDT PLMN List							
r to (n+4)	These octet(s) is/are present only if explicitly specified							

Figure 8.93-1: MDT Configuration

Parameters in octets 5 to 14, p to q, u, v, w and y to z shall be encoded as specified in 3GPP TS 32.422 [18]. If Length of Area Scope equals zero, then Area Scope octets p to q shall not be present.

If CRRMI (Collection period for RRM measurements LTE Indicator), bit 1 of octet 's', is set to "1", then the Collection period for RRM measurements LTE parameter field shall be present, otherwise octet 'u' shall not be present.

If MPI (Measurement period LTE Indicator), bit 2 of octet 's', is set to "1", then the Measurement period LTE parameter field shall be present, otherwise octet 'v' shall not be present.

If PMI (Positioning Method Indicator), bit 3 of octet 's', is set to "1", then the Positioning Method parameter field shall be present, otherwise octet 'w' shall not be present.

If PLI (PLMN List Indicator), bit 4 of octet 's', is set to "1", then the Number of MDT PLMNs and MDT PLMN List parameters shall be present, otherwise octet 'x' and octets 'y to z' shall not be present.

The value of the Number of MDT PLMNs represents the number of 3-octet PLMNs contained within the MDT PLMN List parameter and shall be a number from 1 to 16. Each PLMN ID in the list shall be encoded as defined for octets 5 to 7 in clause 8.18.

## 8.94 Additional Protocol Configuration Options (APCO)

The Additional Protocol Configuration Options (APCO) information element is used to exchange additional protocol configuration options between the TWAN/ePDG and the PGW.

The Additional Protocol Configuration Options information element is specified in 3GPP TS 29.275 [26] and its GTPv2 coding is shown in figure 8.94-1.

Octets	Bits							
	8	7	6	5	4	3	2	1
1	Type = 163 (decimal)							
2 to 3	Length = n							
4	Spare				Instance			
5 to m	Additional Protocol Configuration Options (APCO)							
(m+1) to (n+4)	These octet(s) is/are present only if explicitly specified							

Figure 8.94-1: Additional Protocol Configuration Options

Octets (5 to m) of the Additional Protocol Configuration Options IE are encoded as specified in 3GPP TS 29.275 [26].

## 8.95 Absolute Time of MBMS Data Transfer

The Absolute Time of MBMS Data Transfer indicates the absolute time of the actual start, update or stop of the MBMS data transfer to ensure a synchronized session control and facilitate a graceful reallocation of resources for the MBSFN (MBMS Single Frequency Network) when needed for E-UTRAN access.

It is coded as shown in figure 8.95-1.

Octets	Bits							
	8	7	6	5	4	3	2	1
1	Type = 164 (decimal)							
2 to 3	Length = n							
4	Spare				Instance			
5 to 12	Absolute Time of MBMS Data Transfer value part							
13 to (n+4)	These octet(s) is/are present only if explicitly specified							

**Figure 8.95-1: Absolute Time of MBMS Data Transfer**

Octets 5 to 12 are coded as the time in seconds relative to 00:00:00 on 1 January 1900 (calculated as continuous time without leap seconds and traceable to a common time reference) where binary encoding of the integer part is in the 32 most significant bits and binary encoding of the fraction part in the 32 least significant bits. The fraction part is expressed with a granularity of  $1/2^{**32}$  second.

## 8.96 H(e)NB Information Reporting

H(e)NB number Information Reporting is coded as depicted in Figure 8.96-1.

Octets	Bits							
	8	7	6	5	4	3	2	1
1	Type = 165							
2 to 3	Length = n							
4	Spare				Instance			
5	Spare							FTI
6 to (n+4)	These octet(s) is/are present only if explicitly specified							

**Figure 8.96-1: H(e)NB Information Reporting**

The following bits within Octet 5 shall indicate:

- Bit 1 – FTI: When set to "1", shall indicate to start reporting H(e)NB local IP address and UDP port number information change when the UE moves from (e)NB to H(e)NB, from H(e)NB to another H(e)NB with a fixed network backhaul change, or from H(e)NB to (e)NB.

The bit 1 shall be set to 0 to stop reporting H(e)NB local IP address and UDP port number information change.

## 8.97 IPv4 Configuration Parameters (IP4CP)

The IPv4 Configuration Parameters (IP4CP) is coded as depicted in Figure 8.97-1.

Octets	Bits							
	8	7	6	5	4	3	2	1
1	Type = 166 (decimal)							
2 to 3	Length = n							
4	Spare				Instance			
5	Subnet Prefix Length							
6 to 9	IPv4 Default Router Address							
10 to (n+4)	These octet(s) is/are present only if explicitly specified							

**Figure 8. 97-1: IPv4 Configuration Parameters (IP4CP)**

## 8.98 Change to Report Flags

Change to Report Flags IE is coded as depicted in Figure 8.98-1.

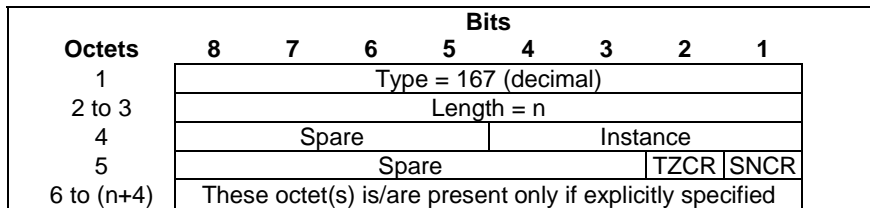

**Figure 8.98-1: Change to Report Flags**

For each message the applicable flags of the Change to Report Flags IE shall be clearly specified in the individual message clause. The remaining flags of the Change to Report Flags IE not so indicated shall be discarded by the receiver.

The receiver shall consider the value of the applicable flags as "0", if the Change to Report Flags IE is applicable for the message but not included in the message by the sender.

The following bits within Octet 5 shall indicate:

- Bit 8 to 3 – Spare, for future use and set to zero.
- Bit 2 – TZCR (Time Zone Change to Report): When set to 1, this bit indicates that a UE Time Zone change still needs to be reported to the SGW/PGW.
- Bit 1 – SNCR (Serving Network Change to Report): When set to 1, this bit indicates that a Serving Network change still need to be reported to the SGW/PGW.

## 8.99 Action Indication

Action Indication is coded as depicted in Figure 8.99-1.

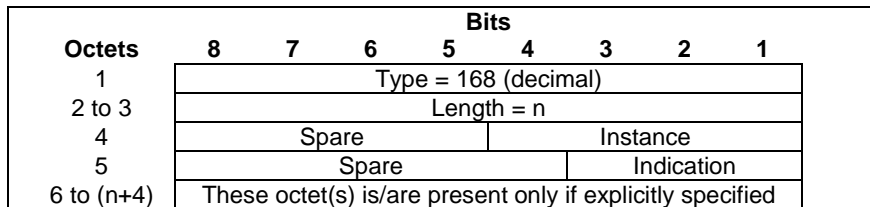

**Figure 8.99-1: Action Indication**

**Table 8.99-1: Indication**

Indication	Values (Decimal)
No Action	0
Deactivation Indication	1
Paging Indication	2
Paging Stop Indication	3
<spare>	4 to7

If "deactivation indication" is set, it indicates that the receiving entity shall deactivate ISR and remove the UE resource locally as specified in 3GPP TS 23.007 [17] clause 27.3.1.2.

If "paging indication" is set, it indicates that the receiving entity shall page the IDLE state UE as specified in 3GPP TS 23.007 [17] clause 27.3.2.2.

If "paging stop indication" is set, it indicates that the receiving entity shall stop paging the UE as specified in 3GPP TS 23.380 [61] clause 5.4.2.1 and clause 5.4.3.2.



## 8.100 TWAN Identifier

The TWAN Identifier is used for reporting UE location in a Trusted WLAN Access Network (TWAN). See 3GPP TS 23.402 [45].

TWAN Identifier shall be coded as depicted in Figure 8.100-1.

Octets	Bits							
	8	7	6	5	4	3	2	1
1	Type = 169 (decimal)							
2 to 3	Length = n							
4	Spare			Instance				
5	Spare		LAII	OPN AI	PLM NI	CIVAI	BSSIDI	
6	SSID Length							
7 to k	SSID							
(k+1) to (k+6)	BSSID							
q	Civic Address Length							
(q+1) to (q+r)	Civic Address Information							
s to (s+2)	TWAN PLMN-ID							
t	TWAN Operator Name Length							
(t+1) to (t+u)	TWAN Operator Name							
v	Relay Identity Type							
(v+1)	Relay Identity Length							
(v+2) to (v+w)	Relay Identity							
X	Circuit-ID Length							
(x+1) to (x+y)	Circuit-ID							
p to (n+4)	These octet(s) is/are present only if explicitly specified							

**Figure 8.100-1: TWAN Identifier**

The BSSID and SSID shall be encoded as described in IEEE Std 802.11-2012 [52].

The TWAN identifier shall contain the SSID and, unless otherwise determined by the TWAN operator's policies, it shall contain at least the BSSID, the civic address of the access point to which the UE is attached or the Circuit-ID with the identity of the Relay (e.g. TWAG) which has allocated it (see clause 16.1.7 of 3GPP TS 23.402 [45]). It may also contain the identifier of the TWAN operator, i.e. either the TWAN PLMN-ID if the TWAN is operated by a mobile operator or the TWAN Operator Name otherwise.

The SSID Length in octet '6' indicates the length of the SSID field. The SSID is an Octet String which shall have a maximum length of 32 octets (see IEEE Std 802.11-2012 [52]).

The BSSIDI flag in octet 5 indicates whether the BSSID in octets 'k+1' to 'k+6' shall be present. If BSSIDI is set to '1', then the BSSID shall be present. If BSSIDI is set to '0', then the BSSID shall not be present. The BSSID is an Octet String which shall be 6 octets long (see IEEE Std 802.11-2012 [52]).

The CIVAI flag in octet 5 indicates whether the Civic Address Length and Civic Address Information in octets 'q' and 'q+1' to 'q+r' shall be present. The Civic Address Length and Information shall be present if and only if the CIVAI flag is set to 1. When present, the Civic Address Information shall contain the civic address of the Access Point to which the UE is attached and it shall be encoded as defined in clause 3.1 of IETF RFC 4776 [59] excluding the first 3 octets.

The PLMNI flag in octet 5 indicates whether the TWAN PLMN-ID in octets 's' to 's+2' shall be present. The TWAN PLMN-ID shall be present if and only if the PLMNI flag is set to 1. The TWAN PLMN-ID shall be encoded as octets 5 to 7 of the Serving Network IE in clause 8.18. When present, the TWAN PLMN-ID shall indicate the PLMN-ID of the TWAN operator.

**NOTE:** the PLMN ID contained in the TWAN PLMN-ID can differ from the PLMN ID in the Serving Network IE.

The OPNAI flag in octet 5 indicates whether the TWAN Operator Name Length and TWAN Operator Name in octets 't' and 't+1' to 't+u' shall be present. The TWAN Operator Name Length and TWAN Operator Name shall be present if and

only if the OPNAI flag is set to 1. The TWAN Operator Name shall be encoded as specified in clause 19. 8 of 3GPP TS 23.003 [2]. When present, the TWAN Operator Name shall indicate the identifier of the TWAN operator.

The LAII flag in octet 5 indicates whether the Logical Access ID information is present in the TWAN Identifier IE. The Logical Access ID is encoded by the Relay Identity information in octets 'v' to 'v+w' and the Circuit-ID information in octets 'x' to 'x+y'. The Relay Identity information and the Circuit-ID information shall be present if the LAII flag is set to '1'. The Relay indicates a DHCP relay agent as defined in IETF RFC 3046 [60]. The Relay Identity Type indicates the type of the Relay Identity as described in Table 8.100-1. The Relay Identity Length indicates the length of the Relay Identity. In case the Relay Identity Type indicates an IP address, the length indicates if it is IPv4 or IPv6 address of the Relay. The length is 4 octets for IPv4 and 16 octets for IPv6. If the Relay Identity type is set to 1 (i.e. an FQDN), it is encoded as described in clause 3.1 of IETF RFC 1035 [31] but excluding the trailing zero byte. The Circuit-ID length indicates the length of the Circuit-ID. The Circuit-ID is as defined in IETF RFC 3046 [60], it is encoded as an Octetstring and provided by the Relay.

**Table 8.100-1: Relay Identity Type**

Relay Identity Type	Values (Decimal)
IPv4 or IPv6 Address	0
FQDN	1

### 8.101 ULI Timestamp

The ULI Timestamp IE is coded as shown in Figure 8.101-1. It indicates the UTC time when the user location information was acquired. Octets 5 to 8 are encoded in the same format as the first four octets of the 64-bit timestamp format as defined in clause 6 of IETF RFC 5905 [53].

NOTE: The encoding is defined as the time in seconds relative to 00:00:00 on 1 January 1900.

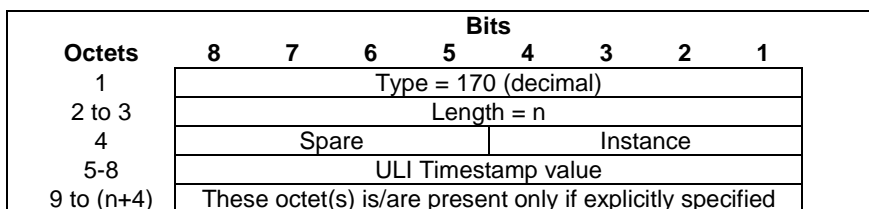

**Figure 8.101-1: ULI Timestamp**

### 8.102 MBMS Flags

MBMS Flags is coded as depicted in Figure 8.102-1.

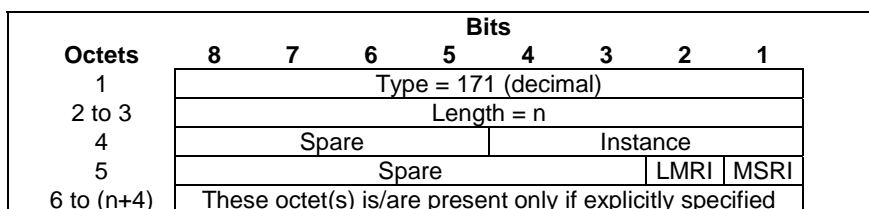

**Figure 8.102-1: MBMS Flags**

The following bits within Octet 5 indicate:

- Bit 1 – MSRI (MBMS Session Re-establishment Indication): if set to 1, this flag indicates that the MBMS Session Start Request message is used to re-establish an MBMS session (see 3GPP TS 23.007 [13])
- Bit 2 – LMRI (Local MBMS Bearer Context Release Indication): if set to 1, this flag indicates that the MBMS Session Stop Request message is used to release the MBMS Bearer Context locally in the MME/SGSN (see 3GPP TS 23.007 [13]);

- Bit 3 to 8 – Spare, for future use and set to zero.

### 8.103 RAN/NAS Cause

RAN/NAS Cause is coded as depicted in Figure 8.103-1.

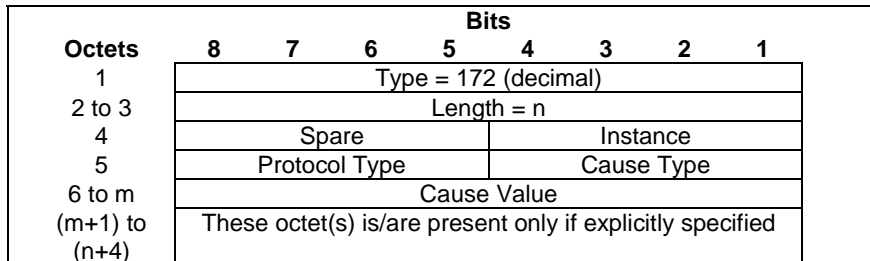

**Figure 8.103-1: RAN/NAS Cause**

The Protocol Type field shall be encoded as per Table 8.103 -0:

**Table 8.103-0: Protocol Type values**

Protocol Type	Values (Decimal)
S1AP Cause	1
EMM Cause	2
ESM Cause	3
Diameter Cause	4
IKEv2 Cause	5
<spare>	6-15

All spare bits shall be set to zeros by the sender and ignored by the receiver.

The Cause Value field shall be coded as follows:

- For S1-AP Cause, the Cause Value field shall contain a non-transparent copy of the cause value of the corresponding IE (see clause 8.2.2), "Cause", as defined in clause 9.2.1.3 in 3GPP TS 36.413 [10]. The Cause Type field shall contain the RAN Cause subcategory as specified in 3GPP TS 36.413 [10] and it shall be encoded as in Table 8.103-1. The value of the Cause Value field (and the associated RAN cause subcategory) is transferred over the S1-AP interface and encoded into one octet as binary integer.

**Table 8.103-1: Cause Type values and their meanings**

Cause Type	Values (Decimal)
Radio Network Layer	0
Transport Layer	1
NAS	2
Protocol	3
Miscellaneous	4
<spare>	5 to15

- For EMM and ESM Causes, the Cause Value field shall contain the cause value as specified respectively for the "EMM Cause" IE and "ESM Cause" IE in clauses 9.9.3.9 and 9.9.4.4 of 3GPP TS 24.301 [23], or for the "Cause" IE in clause 8.11 of 3GPP TS 24.244 [66]. The value of the Cause Value field (which has a range of 0..255) shall be transferred encoded into one octet as binary integer. The Cause Type field shall be ignored by the receiver.
- For Diameter Cause, the Cause Value field shall contain the cause value as specified for the Diameter Termination-Cause AVP in IETF RFC 3588 [39]. The Cause Value field shall be encoded into 2 octets as binary integer of the Termination-Cause AVP value. The currently assigned values for the Termination-Cause AVP can be found in the IANA registry for Termination-Cause AVP Values, IANA, "Termination-Cause AVP Values (code 295)",

<http://www.iana.org/assignments/aaa-parameters/aaa-parameters.xhtml#aaa-parameters-16>.

The Cause Type field shall be ignored by the receiver.

- For IKEv2 Cause, the Cause Value field shall contain the cause value as specified for the Internet Key Exchange Version 2 (IKEv2) Parameters, Notify message error type, in IETF RFC 7296 [67]. The Cause Value field shall be encoded into 2 octets as binary integer of the IKEv2 notify message error type value.

The currently assigned values for the IKEv2 notify message error type can be found in the IANA registry for "Internet Key Exchange Version 2 (IKEv2) Parameters",

<http://www.iana.org/assignments/ikev2-parameters/ikev2-parameters.xhtml#ikev2-parameters-14>

The Cause Type field shall be ignored by the receiver.

## 8.104 CN Operator Selection Entity

CN Operator Selection Entity is coded as depicted in Figure 8.104-1.

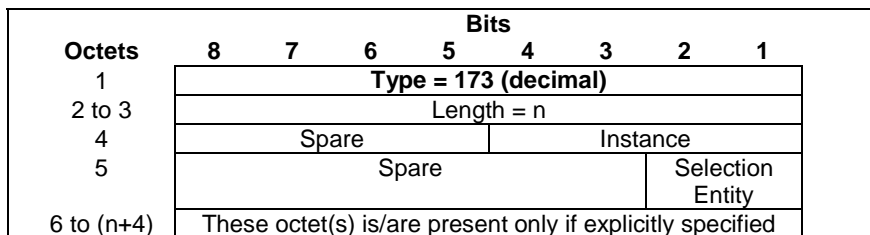

Figure 8.104-1: CN Operator Selection Entity

Table 8.104-1: Selection Entity values

Selection mode value	Value (Decimal)
The Serving Network has been selected by the UE	0
The Serving Network has been selected by the network	1
For future use. Shall not be sent. If received, shall be interpreted as the value "1".	2, 3

## 8.105 Trusted WLAN Mode Indication

The purpose of the Trusted WLAN Mode Indication information element is to convey the selected trusted WLAN Mode.

The content and encoding of the Trusted WLAN Mode Indication is depicted on Figure 8.105-1.

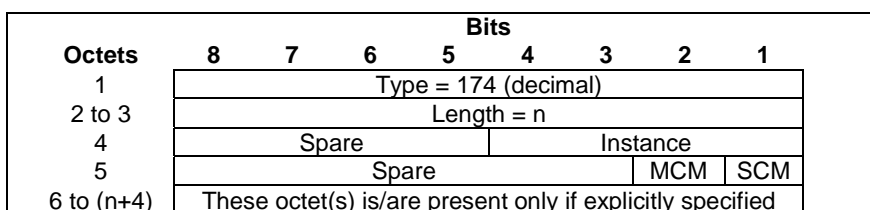

Figure 8.105-1: Trusted WLAN Mode Indication

The following bits within Octet 5 shall indicate:

- Bit 8 to 3 – Spare, for future use and set to zero.
- Bit 2 – MCM (Multiple-connection mode Indication): if this bit is set to 1, it indicates that the Multiple-connection mode is used.
- Bit 1 – SCM (Single-connection mode Indication): if this bit is set to 1, it indicates that the Single-connection mode is used.

## 8.106 Node Number

Node Number shall be coded as depicted in Figure 8.106-1.

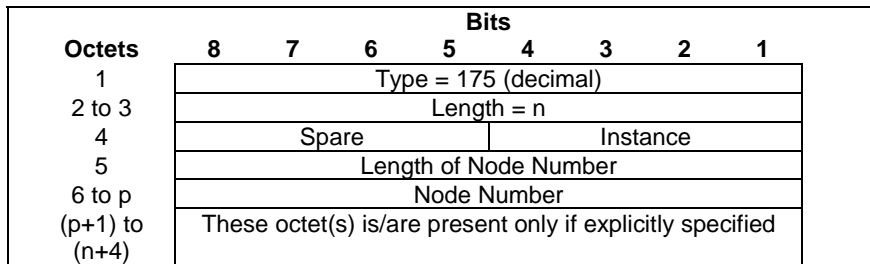

**Figure 8.106-1: Node Number**

The Node number shall carry an ISDN number.

If the Node Number carries the SGSN Number, then the SGSN number shall be coded according to the contents of ISDN-AddressString data type defined in 3GPP TS 29.002 [41]. The SGSN Number shall be in international format and the "nature of address indicator" shall indicate "international number". The SGSN Number is defined in 3GPP TS 23.003 [2]. The Length of Node Number shall not be zero.

If the Node Number carries the MME number for MT SMS, then it shall be coded according to the contents of ISDN-AddressString data type defined in 3GPP TS 29.002 [41]. The MME number for MT SMS shall be in international format and the "nature of address indicator" shall indicate "international number". The MME number for MT SMS is defined in 3GPP TS 23.003 [2]. The Length of Node Number shall not be zero.

If the Node Number carries the MSC Number, then the MSC number shall be coded according to the contents of ISDN-AddressString data type defined in 3GPP TS 29.002 [41]. The MSC Number shall be in international format and the "nature of address indicator" shall indicate "international number". The MSC Number is defined in 3GPP TS 23.003 [2]. The Length of Node Number shall not be zero.

## 8.107 Node Identifier

Node Identifier shall be coded as depicted in Figure 8.107-1.

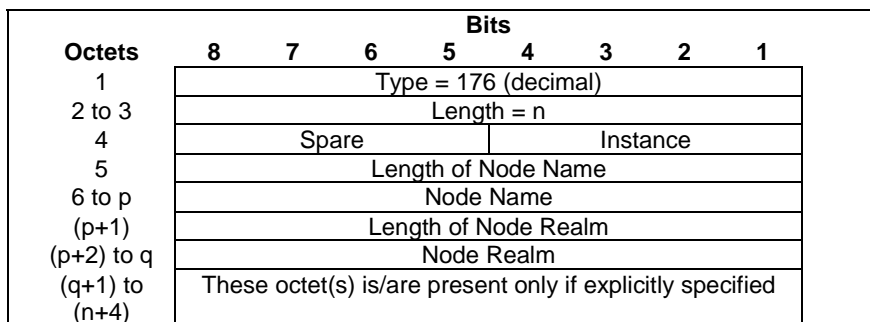

**Figure 8.107-1: Node Identifier**

The Node Identifier shall contain the Diameter Identity of the node.

If the Node Identifier contains a SGSN Identifier then:

- the Node Name shall be coded as the Diameter identity of the SGSN as defined in clause 6.4.13 of 3GPP TS 29.173 [57] and;
- the Node Realm shall be coded as the Diameter realm identity of the SGSN and as defined in clause 6.4.14 of 3GPP TS 29.173 [57] and;
- Both the Node Name and the Node Realm shall be present and neither the Length of Node Name nor the Length of Node Realm shall be zero.

If the Node Identifier contains a MME Identifier then:

- the Node Name shall be coded as the Diameter identity of the MME as defined in clause 6.4.4 of 3GPP TS 29.173 [57] and;
- the Node Realm shall be coded as the Diameter realm identity of the MME as defined in clause 6.4.12 of 3GPP TS 29.173 [57] and;
- Both the Node Name and the Node Realm shall be present and neither the Length of Node Name nor the Length of Node Realm shall be zero.

If the Node Identifier contains a 3GPP AAA Server Identifier then:

- the Node Name shall be coded as the 3GPP-AAA-Server-Name as defined in clause 8.2.3.24 of 3GPP TS 29.273 [68] and;
- the Node Realm shall be coded as the Diameter realm of the 3GPP AAA server in the format of a Diameter identity as defined in IETF RFC 3588 [39].

If the Node Identifier contains an SCEF/IWK-SCEF information, then:

- the Node Name shall be coded as the SCEF-ID as defined in clause 8.4.5 of 3GPP TS 29.336 [69] and;
- the Node Realm shall be coded as the Diameter realm of the SCEF as defined in clause 7.3.207 of 3GPP TS 29.272 [70].

## 8.108 Presence Reporting Area Action

Presence Reporting Area Action is coded as depicted in Figure 8.108-1.

Octets	Bits							
	8	7	6	5	4	3	2	1
1	Type = 177							
2 to 3	Length = n							
4	Spare				Instance			
5	Spare				INAP RA	Action		
6 to 8	Presence Reporting Area Identifier							
9	Number of TAI				Number of RAI			
10	Spare		Number of Macro eNodeB					
11	Spare		Number of Home eNodeB					
12	Spare		Number of ECGI					
13	Spare		Number of SAI					
14	Spare		Number of CGI					
15 to k	TAIs [1..15]							
(k+1) to m	Macro eNB IDs [1..63]							
(m+1) to p	Home eNB IDs [1..63]							
(p+1) to q	ECGIs [1..63]							
(q+1) to r	RAIs [1..15]							
(r+1) to s	SAIs [1..63]							
(s+1) to t	CGIs [1..63]							
t+1	Spare		Number of Extended Macro eNodeB					
(t+2) to v	Extended Macro eNB IDs [1..63]							
u to (n+4)	These octet(s) is/are present only if explicitly specified							

Figure 8.108-1: Presence Reporting Area Action

**Table 8.108-1: Action values**

Action	Value (Decimal)
Start Reporting changes of UE presence in the PRA	1
Stop Reporting changes of UE presence in the PRA	2
Modify Presence Reporting Area elements composing the PRA	3
<spare>	0, 4-7

The Action value 1 (Start Reporting change) shall be used to request to start reporting changes of UE presence in the Presence Reporting Area identified by the Presence Reporting Area Identifier and, if present, the Presence Reporting Area elements composing the Presence Reporting Area.

The Action value 2 (Stop Reporting change) shall be used to request to stop reporting changes of UE presence in a Presence Reporting Area.

The Action value 3 (Modify Presence Reporting Area elements composing the PRA) shall be used to request to modify the Presence Reporting Area elements composing the PRA and to continue reporting changes of UE presence in that Presence Report Area.

The Inactive PRA (INAPRA) flag in the Octet 5 shall be set to 1 on the S10/S16/S3 interface if the PRA is inactive in the source MME/SGSN during an inter MME/SGSN mobility procedure, i.e. the reporting change of UE presence in this Presence Reporting Area was requested by the PGW/PCRF/OCS but it was deactivated by the source MME/SGSN, e.g. due to an overload situation.

The Presence Reporting Area Identifier shall be present if the Action value requests to start, stop or modify reporting changes of UE presence in a Presence Reporting Area. If so, the Presence Reporting Area Identifier shall contain an identifier of the Presence Reporting Area and be encoded using full hexadecimal representation (binary, not ASCII encoding). The Presence Reporting Area Identifier is defined in clause 19.10 of 3GPP TS 23.003 [2].

Octets 9 to 14 shall be present if the Action value requests to start reporting change of UE presence in a Presence Reporting Area and the Presence Reporting Area is not pre-configured in the MME/SGSN, or the Action value requests to modify the Presence Reporting Area elements composing a Presence Reporting Area not pre-configured in the MME/SGSN. If so, these octets shall indicate the number of TAI (15 at most), Macro eNodeB ID (63 at most), Home eNodeB ID (63 at most), ECGI (63 at most), RAI (15 at most), SAI (63 at most) and CGI (63 at most) which compose the PRA.

TAIs in octets 15 to 'k', if any, shall be encoded as per the TAI field in clause 8.21.4. Octets 15 to 'k' shall be absent if the field 'Number of TAI' is set to the value '0'.

Macro eNB IDs in octets 'k+1' to 'm', if any, shall be encoded as per octets 6 to 11 of the Target ID for type Macro eNodeB in figure 8.51-2. Octets 'k+1' to 'm' shall be absent if the field 'Number of Macro eNodeB' is set to the value '0'.

Home eNB IDs in octets 'm+1' to 'p', if any, shall be encoded as per octets 6 to 12 of the Target ID for type Home eNodeB in figure 8.51-3. Octets 'm+1' to 'p' shall be absent if the field 'Number of Home eNodeB' is set to the value '0'.

ECGIs in octets 'p+1' to 'q', if any, shall be encoded as per the ECGI field in clause 8.21.5. Octets 'p+1' to 'q' shall be absent if the field 'Number of ECGI' is set to the value '0'.

RAIs in octets 'q+1' to 'r', if any, shall be encoded as per the RAI field in clause 8.21.3. Octets 'q+1' to 'r' shall be absent if the field 'Number of RAI' is set to the value '0'.

SAIs in octets 'r+1' to 's', if any, shall be encoded as per the SAI field in clause 8.21.2. Octets 'r+1' to 's' shall be absent if the field 'Number of SAI' is set to the value '0'.

CGIs in octets 's+1' to 't', if any, shall be encoded as per the CGI field in clause 8.21.1. Octets 's+1' to 't' shall be absent if the field 'Number of CGI' is set to the value '0'.

Extended Macro eNB IDs in octets 't+2' to 'v', if any, shall be encoded as per octets 6 to 11 of the Target ID for type Extended Macro eNodeB in figure 8.51-x. Octets 't+2' to 'v' shall be absent if the field 'Number of Extended Macro eNodeB' is set to the value '0'.

## 8.109 Presence Reporting Area Information

Presence Reporting Area Information is coded as depicted in Figure 8.109-1.

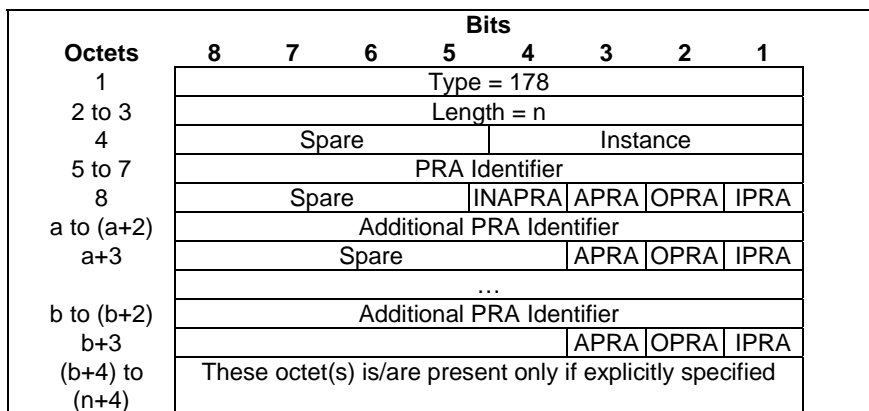

**Figure 8.109-1: Presence Reporting Area Information**

The PRA Identifier in octets 5 to 7 shall be present and shall contain the identifier of the PRA the UE is entering or leaving. It shall be encoded using full hexadecimal representation (binary, not ASCII encoding). The PRA Identifier is defined in clause 19.10 of 3GPP TS 23.003 [2].

The PRA Identifier in the Octets 5 to 7 shall be set to the PRA Set ID if the MME/SGSN is requested to report the change of UE presence in a PRA Set. In this case:

- the Additional PRA (APRA) flag in octet 8 shall be set to 1 if the reporting of change of UE presence for the PRA Set is active and the UE presence has changed for at least one PRA within the PRA Set (i.e. if the UE enters or leaves the PRA Set, or the UE moves between the PRAs within the PRA Set). The subsequent 4 octets shall then be present and shall contain the identifier of the individual PRA within the PRA Set which the UE has newly entered or left, with the information of whether the UE is inside or outside this PRA.
- the Additional PRA (APRA) flag in octet a+3 shall be set to 1 if the UE presence status has changed for more than one individual PRA within the PRA Set. In that case, the subsequent 4 Octets shall be included and encoded as specified above for the octets a to a+3. The MME/SGSN shall report each individual PRA(s) within the PRA Set that the UE has newly entered or left.
- if the reporting of change of UE presence for the PRA Set is inactive, i.e. the INAPRA flag in octet 8 is set to 1, then the Additional PRA (APRA) flag in octet 8 shall not be set to 1 and no Additional PRA Identifier shall be included.

The Inside PRA flag (IPRA) shall be set to 1 if the UE is inside or enters the Presence Reporting Area identified by the PRA Identifier.

The Outside PRA flag (OPRA) shall be set to 1 if the UE is outside or leaves the Presence Reporting Area identified by the PRA Identifier.

The Inactive PRA (INAPRA) flag in octet 8 shall be set to 1 if the PRA is inactive in the MME/SGSN, i.e. the reporting of change of UE presence in this PRA is currently deactivated in the MME/SGSN, e.g. due to an overload situation.

Either the IPRA or the OPRA flag or the INAPRA shall be set to 1, not several ones, for a given Presence Reporting Area Identifier.

## 8.110 TWAN Identifier Timestamp

The TWAN Identifier Timestamp IE is coded as shown in Figure 8.110-1. It indicates the UTC time when the TWAN Identifier information was acquired. Octets 5 to 8 shall be encoded in the same format as the first four octets of the 64-bit timestamp format as defined in clause 6 of IETF RFC 5905 [53].

NOTE: The encoding is defined as the time in seconds relative to 00:00:00 on 1 January 1900.



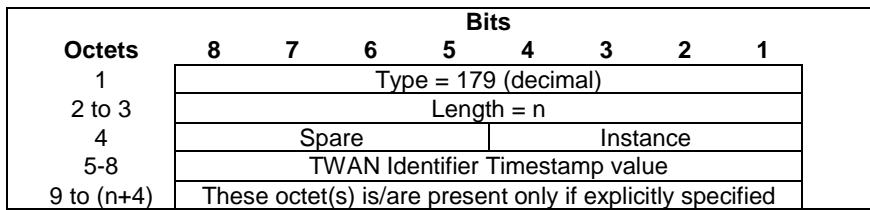

Figure 8.110-1: TWAN Identifier Timestamp

### 8.111 Overload Control Information

Overload Control Information is a grouped IE containing a number of other IEs. Which of those IEs are mandatory, optional or conditional and the conditions that apply are GTP message specific, and described in the corresponding clause under clause 7.

Overload Control Information may be repeated within a message with exactly the same Type and Instance values to represent a list of Overload Control Information.

Overload Control Information is coded as depicted in Table 8.111-1.

Table 8.111-1: Overload Control Information Grouped Type

Octet 1	Overload Control Information IE Type = 180 (decimal)			
Octets 2 and 3	Length = n			
Octet 4	Spare and Instance fields			
<b>Information elements</b>	<b>P</b>	<b>Condition / Comment</b>	<b>IE Type</b>	<b>Ins.</b>
NOTE: This table uses a 5-column format in order to match the format used in clauses of clause 7, where the usage of this IE is further detailed for each specific GTP message including it.				

### 8.112 Load Control Information

Load Control Information is a grouped IE containing a number of other IEs. Which of those IEs are mandatory, optional or conditional and the conditions that apply are GTP message specific, and described in the corresponding clause under clause 7.

Load Control Information may be repeated within a message with exactly the same Type and Instance values to represent a list of Load Control Information.

Load Control Information is coded as depicted in Table 8.112-1.

Table 8.112-1: Load Control Information Grouped Type

Octet 1	Load Control Information IE Type = 181 (decimal)			
Octets 2 and 3	Length = n			
Octet 4	Spare and Instance fields			
<b>Information elements</b>	<b>P</b>	<b>Condition / Comment</b>	<b>IE Type</b>	<b>Ins.</b>
NOTE: This table uses a 5-column format in order to match the format used in clauses of clause 7, where the usage of this IE is further detailed for each specific GTP message including it.				

### 8.113 Metric

The Metric IE is coded as shown in Figure 8.113-1. It indicates a percentage and may take binary coded integer values from and including 0 up to and including 100. Other values shall be considered as 0.

Octets	Bits							
	8	7	6	5	4	3	2	1
1	Type = 182 (decimal)							
2 to 3	Length = 1							
4	Spare				Instance			
5	Metric							

Figure 8.113-1: Metric

## 8.114 Sequence Number

The Sequence Number IE is coded as shown in Figure 8.114-1 and it contains Unsigned32 binary integer value.

Octets	Bits							
	8	7	6	5	4	3	2	1
1	Type = 183 (decimal)							
2 to 3	Length = 4							
4	Spare				Instance			
5 to 8	Sequence Number							

Figure 8.114-1: Sequence Number

## 8.115 APN and Relative Capacity

The APN and Relative Capacity IE is coded as shown in Figure 8.115-1.

Octets	Bits							
	8	7	6	5	4	3	2	1
1	Type = 184 (decimal)							
2 to 3	Length = n							
4	Spare				Instance			
5	Relative Capacity							
6	APN Length							
7 to m	Access Point Name (APN)							
(m+1) to (n+4)	These octet(s) is/are present only if explicitly specified							

Figure 8.115-1: APN and Relative Capacity

The Relative Capacity represents the resources configured for the given APN as compared to the total resources of the target PGW, in percentage. It shall take binary coded integer values from 1 up to 100. Other values shall be considered as 0.

The APN Length in octet '6' indicates the length of the APN field.

The APN field, from octet 7 to 'm' shall be encoded as octet 5 to '(n+4)' defined in clause 8.6.

## 8.116 WLAN Offloadability Indication

WLAN Offloadability Indication IE is coded as depicted in Figure 8.116-1.

Octets	Bits							
	8	7	6	5	5	3	2	1
1	Type = yyy (decimal)							
2 to 3	Length = n							
4	Spare				Instance			
5	Spare					EUTRAN indication		UTRAN indication
6 to (n+4)	These octet(s) is/are present only if explicitly specified							

**Figure 8.116-1: WLAN Offloadability Indication**

Octet 5 indicates if WLAN Offload has been authorized for the UE:

- Bit 8 to 3 Spare, for future use and set to zero.
- Bit 2 – reflects the information available at the UE regarding E-UTRAN Offloadability. When set to '1', this indicates that the UE has been authorized to perform WLAN offload from E-UTRAN. When set to '0', this indicates that the UE has not been authorized to perform WLAN offload from E-UTRAN.
- Bit 1 – reflects the information available at the UE regarding UTRAN Offloadability. When set to '1', this indicates that the UE has been authorized to perform WLAN offload from UTRAN. When set to '0', this indicates that the UE has not been authorized to perform WLAN offload from UTRAN.

### 8.117 Paging and Service Information

The Paging and Service Information IE is used to carry per bearer paging and service information. It is coded as shown in Figure 8.117-1.

Octets	Bits							
	8	7	6	5	4	3	2	1
1	Type 186 (decimal)							
2 to 3	Length = n							
4	Spare				Instance			
5	Spare (all bits set to 0)				EPS Bearer ID (EBI)			
6	Spare						PPI	
m	Spare		Paging Policy Indication value					
p to (n+4)	These octet(s) is/are present only if explicitly specified							

**Figure 8.117-1: Paging and Service Information**

The EBI field in octet 5 shall contain the value indicating the EPS Bearer ID for which the Paging and Service Information is provided. The EBI field shall be encoded as the EBI field in the EPS Bearer ID (EBI) IE type (see clause 8.8).

The PPI flag in octet 6 indicates whether the Paging Policy Indication value in octet 'm' shall be present. If PPI is set to '1', then the Paging Policy Indication value shall be present. If PPI is set to '0', then octet 'm' shall not be present.

The Paging Policy Indication value, in octet 'm', shall be encoded as the DSCP in TOS (IPv4) or TC (IPv6) information received in the IP payload of the GTP-U packet from the PGW (see IETF RFC 2474 [65]).

### 8.118 Integer Number

Integer Number is coded as depicted in Figure 8.118-1.

Octets	Bits							
	8	7	6	5	4	3	2	1
1	Type = 187 (decimal)							
2 to 3	Length = n							
4	Spare				Instance			
5 to n+4	Integer Number Value							

**Figure 8.118-1: Integer Number**

The Integer Number value is encoded with the number of octets defined in the Length field, e.g. when n=2, the range of the integer number value is from 0 to 65535.

The Integer Number value shall be encoded as further described below for the following information elements:

- Maximum Wait Time IE: the length shall be set to 2, i.e. the integer number value shall be encoded as a 16 bit unsigned integer.
- DL Buffering Suggested Packet Count IE: the length shall be set to 1 or 2;
- UE Usage Type IE: the length shall be set to 1, i.e. the integer number value shall be encoded as a 8 bit unsigned integer as specified in clause 7.3.202 of 3GPP TS 29.272 [70].
- Remaining Running Service Gap Timer IE: the length shall be set to 4, i.e. the integer number value shall be encoded as a 32 bit unsigned integer.
- DL Data Packet Size IE: the length shall be set to 2, i.e. the integer number value shall be encoded as a 16 bit unsigned integer.

### 8.119 Millisecond Time Stamp

The Millisecond Time Stamp IE is coded as shown in Figure 8.119-1. Octets 5 to 10 represent a 48 bit unsigned integer in network order format and are encoded as the number of milliseconds since 00:00:00 January 1, 1900 00:00 UTC, i.e. as the rounded value of  $1000 \times \text{the value of the 64-bit timestamp (Seconds + (Fraction / (1 \ll 32)))}$  defined in clause 6 of IETF RFC 5905 [53].

Octets	Bits							
	8	7	6	5	4	3	2	1
1	Type = 188 (decimal)							
2 to 3	Length = n							
4	Spare				Instance			
5-10	Millisecond Time Stamp value							
11 to (n+4)	These octet(s) is/are present only if explicitly specified							

Figure 8.119-1: Millisecond Time Stamp

### 8.120 Monitoring Event Information

The Monitoring Event Information contains the monitoring event parameters that are necessary to transfer over the S3/S16/S10 interface.

The Monitoring Event Information is coded as depicted in Figure 8.120-1.

Octets	Bits							
	8	7	6	5	4	3	2	1
1	Type = 189 (decimal)							
2 to 3	Length = n							
4	Spare	NSCF	NSUI	NSUR	Instance			
5 to 8	SCEF Reference ID							
9	SCEF ID Length							
10 to k	SCEF ID							
(k+1) to (k+2)	Remaining Number of Reports							
(k+3) to (n+4)	These octet(s) is/are present only if explicitly specified							

Figure 8.120-1: Monitoring Event Information

The SCEF Reference ID, the SCEF ID shall be encoded as specified in clause 8.4.4 and 8.4.5 of 3GPP TS 29.336 [69].

The SCEF ID Length indicates the length of the SCEF ID in octets.

The source MME/SGSN shall set the NSUR (Notify SCEF when UE becomes Reachable) flag to "1" to indicate that the target MME/SGSN shall send a notification to SCEF when the UE becomes reachable, if a monitoring event, with the

Monitoring-Type is set to "AVAILABILITY\_AFTER\_DDN\_FAILURE", or "UE\_REACHABILITY\_AND\_IDLE\_STATUS\_INDICATION" or "AVAILABILITY\_AFTER\_DDN\_FAILURE\_AND\_IDLE\_STATUS\_INDICATION" or "UE\_REACHABILITY".

The source MME/SGSN shall set the NSUI (Notify SCEF when UE becomes Idle) flag to "1" to indicate that the target MME/SGSN shall send a notification to SCEF when the UE gets into idle mode, if a monitoring event, with the Monitoring-Type is set to "UE\_REACHABILITY\_AND\_IDLE\_STATUS\_INDICATION" or "AVAILABILITY\_AFTER\_DDN\_FAILURE\_AND\_IDLE\_STATUS\_INDICATION".

The source MME/SGSN shall set the NSCF (Notify SCEF about Communication Failure events) flag to "1" to indicate that the target MME/SGSN shall send a notification to the SCEF if it detects a communication failure event.

**NOTE:** This enables the target MME/SGSN to notify the SCEF about communication failure events that can happen with the target RAN (e.g. radio link failure during the handover execution) before the target MME/SGSN interacts with the HSS.

The Remaining Number of Reports indicates the number of reports which are outstanding to be sent to the SCEF. It shall be encoded as specified in clause 8.4.8 of 3GPP TS 29.336 [69].

8.121 ECGI List

MBMS Cell List is an extendable IE that is coded as depicted in Figure 8.120-1. The ECGI identity types are defined in 3GPP TS 23.003 [2].

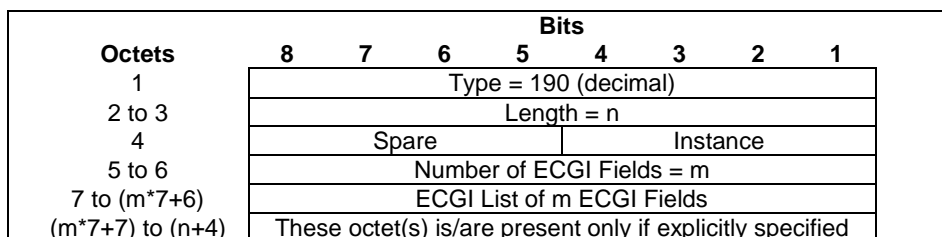

Figure 8.121-1: ECGI List

The Number of ECGI Fields shall indicate the number of ECGI fields in the ECGI List.

In the present version of this specification, the Length n shall be set to m times 7 plus 2.

The ECGI List shall consist of m ECGI fields. Each ECGI field shall be encoded as specified in clause 8.21.5 and thus is 7 octets long.

8.122 Remote UE Context

Remote UE Context is a grouped IE containing a number of other IEs. Which of those IEs are mandatory, optional or conditional and the conditions that apply are GTP message specific, and described in the corresponding clause under clause 7.

Remote UE Context may be repeated within a message with exactly the same Type and Instance values to represent a list of Remote UE Context.

Remote UE Context is coded as depicted in Table 8.122-1.

Table 8.122-1: Remote UE Context Grouped Type

Octet 1	Bearer Context IE Type = 191 (decimal)			
Octets 2 and 3	Length = n			
Octet 4	Spare and Instance fields			
<b>Information elements</b>	<b>P</b>	<b>Condition / Comment</b>	<b>IE Type</b>	<b>Ins.</b>
NOTE: This table uses a 5-column format in order to match the format used in clauses of clause 7, where the usage of this IE is further detailed for each specific GTP message including it.				

### 8.123 Remote User ID

Remote User ID is transferred via GTP tunnels and is coded as depicted in Figure 8.123-1. The Remote User ID IE shall contain one IMSI identity and, if available, one IMEI identity and/or one MSISDN identity. The flag MSISDNF in octet 5 indicates if the MSISDN shall be present in the respective field. The flag IMEIF in octet 5 indicates if the IMEI shall be present in the respective field. The IMSI field including the Length of IMSI shall be always present.

Octets	Bits							
	8	7	6	5	4	3	2	1
1	Type = 192 (decimal)							
2 to 3	Length = n							
4	Spare				Instance			
5	Spare					IMEIF		MSISDNF
6	Length of IMSI							
7 to a	IMSI							
b	Length of MSISDN							
b+1 to c	MSISDN							
d	Length of IMEI							
d+1 to e	IMEI							
(e+1) to (n+4)	These octet(s) is/are present only if explicitly specified							

Figure 8.123-1: Remote User ID

The coding of IMSI field, from octets 7 to 'a' shall be encoded as the octets 5 to n+4 of the IMSI IE type specified in clause 8.3.

The coding of MSISDN field, octets 'b+1' to 'c' shall be encoded as the octets 5 to n+4 of the MSISDN IE type specified in clause 8.11.

The coding of IMEI field, octets 'd+1' to 'e' shall be encoded as the octets 5 to n+4 of the MEI IE type specified in clause 8.10.

### 8.124 Remote UE IP Information

Remote UE IP Information is transferred via GTP tunnels and is coded as depicted in Figure 8.124-1. Remote UE IP information field, octets 5 to n+4 shall be encoded as the octets from 'j' to 'j+k' of the Remote UE Context IE specified in clause 9.9.4.20 of 3GPP TS 24.301 [23].

Octets	Bits							
	8	7	6	5	4	3	2	1
1	Type = 193 (decimal)							
2 to 3	Length = n							
4	Spare				Instance			
5 to n+4	Remote UE IP Information							

Figure 8.124-1: Remote UE IP Information

### 8.125 CloT Optimizations Support Indication

CloT Optimizations Support Indication is coded as depicted in Figure 8.125-1 below.

Octets	Bits							
	8	7	6	5	4	3	2	1
1	Type = 194 (decimal)							
2 to 3	Length = n							
4	Spare				Instance			
5	Spare	Spare	Spare	Spare	IHCSI	AWO PDN	SCNI PDN	SGNI PDN
6 to (n+4)	These octet(s) is/are present only if explicitly specified							

Figure 8.125-1: ClOT Optimizations Support Indication

Octet 5 carries the feature support bits for each of the ClOT optimization as follows:

- Bit 8 to Bit 5: Spare, for future use and set to 0.
- Bit 4 – IHCSI (IP Header Compression Support Indication): Indicates the support of IP header compression based on ROHC framework (see IETF RFC 4995 [77]) for Control Plane ClOT EPS optimisations, when set to '1'.
- Bit 3 – AWOPDN (Attach without PDN Support Indication): Indicates the support of Attach without PDN connection as specified in clause 4.3.5.10 of 3GPP TS 23.401 [3], when set to '1'. Here the word "PDN connection" implies both the PDN connection through SGW and PGW and the PDN connection through SCEF.
- Bit 2 – SCNIPDN (SCEF Non IP PDN Support Indication): Indicates the support of SCEF Non IP PDN Connection as specified in clause 5.13.1 of 3GPP TS 23.682 [74], when set to '1'.
- Bit 1 – SGNIPDN (SGi Non IP PDN Support Indication): Indicates the support of SGi Non IP PDN Connection as specified in clause 4.3.17.8.3.3 of 3GPP TS 23.401 [3] and 3GPP TS 23.060 [35], when set to '1'.

### 8.126 SCEF PDN Connection

The SCEF PDN connection is a grouped IE containing a number of other IEs and shall be coded as depicted in Table 8.126-1.

The SCEF PDN Connection IE may be repeated within a message when more than one SCEF PDN Connection is required to be sent. If so, the repeated IEs shall have exactly the same Instance values to represent a list of grouped IEs.

Table 8.126-1: PDN Connection Grouped Type

Octet 1	PDN Connection IE Type = 195 (decimal)			
Octets 2 and 3	Length = n			
Octet 4	Spare and Instance fields			
<b>Information elements</b>	<b>P</b>	<b>Condition / Comment</b>		<b>IE Type</b>
				<b>Ins.</b>
NOTE: This table uses a 5-column format in order to match the format used in clauses of clause 7, where the usage of this IE is further detailed for each specific GTP message including it.				

### 8.127 Header Compression Configuration

The Header Compression Configuration includes the information necessary for the ROHC channel setup.

The Header Compression Configuration shall be encoded as specified in Figure 8.127-1.

Octets	Bits							
	8	7	6	5	4	3	2	1
1	Type = 196 (decimal)							
2 to 3	Length = n							
4	Spare				Instance			
5 to 6	ROHC Profiles							
7 to 8	MAX_CID							
9 to (n+4)	These octet(s) is/are present only if explicitly specified							

Figure 8.127-1: Header Compression Configuration

Table 8.127-1: Header Compression Configuration

ROHC Profiles (octets 5 and 6)										
Bits										
The ROHC Profiles shall indicate which of the ROHC profiles specified in 3GPP TS 36.323 [76] are allowed to be used (i.e. have been negotiated) with the UE. When a particular bit is set to 1, this indicates that the corresponding profile is allowed to be used. The No Compression profile 0x000 shall also be considered as allowed if at least one bit is set to 1. When all the bits are set to 0, this indicates that only the No Compression profile 0x000 is allowed to be used.										
Octet 5										
<b>8</b>	<b>7</b>	<b>6</b>	<b>5</b>	<b>4</b>	<b>3</b>	<b>2</b>	<b>1</b>	<b>Profile Identifier</b>	<b>Usage</b>	
0	0	0	0	0	0	0	1	0x0002	UDP/IP	
0	0	0	0	0	0	0	1	0	0x0003 ESP/IP	
0	0	0	0	0	1	0	0	0	0x0004 IP	
0	0	0	0	1	0	0	0	0	0x0006 TCP/IP	
0	0	0	1	0	0	0	0	0	0x0102 UDP/IP	
0	0	1	0	0	0	0	0	0	0x0103 ESP/IP	
0	1	0	0	0	0	0	0	0	0x0104 IP	
1	0	0	0	0	0	0	0	0	Spare	
Octet 6										
<b>8</b>	<b>7</b>	<b>6</b>	<b>5</b>	<b>4</b>	<b>3</b>	<b>2</b>	<b>1</b>	<b>Profile Identifier</b>	<b>Usage</b>	
0	0	0	0	0	0	0	0	1	Spare	
0	0	0	0	0	0	0	1	0	Spare	
0	0	0	0	0	1	0	0	0	Spare	
0	0	0	0	1	0	0	0	0	Spare	
0	0	0	1	0	0	0	0	0	Spare	
0	0	1	0	0	0	0	0	0	Spare	
0	1	0	0	0	0	0	0	0	Spare	
1	0	0	0	0	0	0	0	0	Spare	
MAX_CID (octet 7 to 8)										
This is the maximum CID value specified in 3GPP TS 36.323 [76] allowed to be used (i.e. which has been negotiated) with the UE. This shall be encoded as a 2 byte integer with a value in the range from 1 to 16383.										

## 8.128 Extended Protocol Configuration Options (ePCO)

The detailed coding and maximum length of the Extended Protocol Configuration Options field from octets 5 to (n+4) shall be specified as per clause 9.9.4.26 of 3GPP TS 24.301 [23], starting with octet 4.



Octets	Bits							
	8	7	6	5	4	3	2	1
1	Type = 197 (decimal)							
2 to 3	Length = n							
4	Spare				Instance			
5 to (n+4)	Extended Protocol Configuration Options							

**Figure 8.128-1: Extended Protocol Configuration Options (ePCO)**

## 8.129 Serving PLMN Rate Control

Serving PLMN Rate Control may be configured in the Serving PLMN network, to protect serving network, e.g. the MME and the Signalling Radio Bearers in the E-UTRAN, from the load generated by NAS Data PDUs. It defines the maximum number of the NAS Data PDUs which can be transferred by the Serving Network per 6 minute interval.

The maximum number of the NAS Data PDUs which can be transferred for both downlink and uplink shall be configured to a value greater than 10. When the value is set to 0, it shall indicate Serving PLMN Rate Control is not applicable to the PDN Connection for the given direction.

The Serving PLMN Rate Control shall only apply to the PDN Connection(s) which is set to Control Plane Only.

Serving PLMN Rate Control Information is coded as depicted in Figure 8.129-1.

Octets	Bits							
	8	7	6	5	4	3	2	1
1	Type = 198 (decimal)							
2 to 3	Length = n							
4	Spare				Instance			
5 to 6	Uplink Rate Limit							
7 to 8	Downlink Rate Limit							
9 to (n+4)	These octet(s) is/are present only if explicitly specified							

**Figure 8.129-1: Serving PLMN Rate Control**

## 8.130 Counter

Counter IE is coded as depicted in Figure 8.130-1.

Octets	Bits							
	8	7	6	5	4	3	2	1
1	Type = 199 (decimal)							
2 to 3	Length = n							
4	Spare				Instance			
5 to 8	Timestamp value							
9	Counter value							
10 to (n+4)	These octet(s) is/are present only if explicitly specified							

**Figure 8.130-1: Counter**

Octets 5 to 8 shall be encoded in the same format as the first four octets of the 64-bit timestamp format as defined in clause 6 of IETF RFC 5905 [53].

NOTE: The encoding is defined as the time in seconds relative to 00:00:00 on 1 January 1900.

Octet 9 represents an integer with a length of 1 octet.

## 8.131 Mapped UE Usage Type

Mapped UE Usage Type shall be coded as depicted in Figure 8.131-1. Mapped UE Usage Type is defined in clause 5.8.1 of 3GPP TS 29.003 [32].

Octets	Bits							
	8	7	6	5	4	3	2	1
1	Type = 200 (decimal)							
2 to 3	Length = n							
4	Spare				Instance			
5 to 6	Mapped UE Usage Type							
7 to (n+4)	These octet(s) is/are present only if explicitly specified							

Figure 8.131-1: Mapped UE Usage Type

The Mapped UE Usage Type shall be encoded as a two octets binary integer.

### 8.132 Secondary RAT Usage Data Report

Secondary RAT Usage Data Report IE is coded as depicted in Figure 8.132-1.

Octets	Bits							
	8	7	6	5	4	3	2	1
1	Type = 201 (decimal)							
2 to 3	Length = n							
4	Spare				Instance			
5	Spare				SRUD	IRSG	IRPG	
					N	W	W	
6	Secondary RAT Type							
7	Spare (all bits set to 0)				EPS Bearer ID (EBI)			
8-11	Start timestamp							
12-15	End timestamp							
16-23	Usage Data DL							
24-31	Usage Data UL							
k	Length of Secondary RAT Data Usage Report Transfer							
(k+1) - a	Secondary RAT Data Usage Report Transfer							
(a+1) to (n+4)	These octet(s) is/are present only if explicitly specified							

Figure 8.132-1: Secondary RAT Usage Data Report

The following bits within Octet 5 shall indicate:

- Bit 8 to 4 – Spare, for future use and set to zero.
- Bit 3 – SRUDN (Secondary RAT Usage Data Report From NG-RAN): This bit indicates the presence of Length of Secondary RAT Data Usage Report Transfer and Secondary RAT Data Usage Report Transfer fields. If it is set to "1", the Length of Secondary RAT Data Usage Report Transfer and Secondary RAT Data Usage Report Transfer field shall be present, and the IRPGW bit shall be set to "1", octet 8 to 31 shall be set to "0"; otherwise, if it is set to "0", the Length of Secondary RAT Data Usage Report Transfer and Secondary RAT Data Usage Report Transfer field shall not be present.
- Bit 2 – IRSGW (Intended Receiver SGW): This bit defines if the Usage Data Report shall be used by the SGW or not. If set to 1 the SGW shall store it. If set to zero the SGW shall not store it.
- Bit 1 – IRPGW (Intended Receiver PGW): This bit defines if the Usage Data Report shall be sent to the PGW or not. If set to 1 the SGW shall forward it to PGW and PGW shall store it. If set to zero SGW shall not forward it to PGW.

Octet 6 represents Secondary RAT Type

Secondary RAT Type is coded as depicted in Table 8.132-1.

Table 8.132-1: Secondary RAT Type values

RAT Types	Values (Decimal)
NR	0
Unlicensed Spectrum	1
<spare>	2-255

The EBI field in octet 7 shall contain the value indicating the EPS Bearer ID. The EBI field shall be encoded as the EBI field in the EPS Bearer ID (EBI) IE type (see clause 8.8).

Octets 8 to 11 and 12 to 15 shall be encoded in the same format as the first four octets of the 64-bit timestamp format as defined in clause 6 of IETF RFC 5905 [53]. It indicates the UTC time when the recording of the Secondary RAT Usage Data was started and ended.

NOTE: The encoding is defined as the time in seconds relative to 00:00:00 on 1 January 1900.

Octets 16 to 23 and 24 to 31: The Usage Data UL/DL fields are encoded as octets in binary value. The range of Usage Data UL and Usage Data DL are specified in 3GPP TS 36.413 [10].

**Editors Note: The format and range is subject to be aligned with RAN specification. The timestamp and Usage Data UL and DL are received from relevant S1 messages.**

The Secondary RAT Data Usage Report Transfer field shall be encoded with the transparent copy of NGAP IE Secondary RAT Data Usage Report Transfer as specified in 3GPP TS 38.413 [84]. (See also Annex B.3)

## 8.133 UP Function Selection Indication Flags

The UP Function Selection Indication Flags information element shall be coded as depicted in Figure 8.133-1.

Octets	Bits						
	8	7	6	5	4	3	2
1	Type = 202 (decimal)						
2 to 3	Length = n						
4	Spare			Instance			
5	Spare						DCNR
6 to (n+4)	These octet(s) is/are present only if explicitly specified						

**Figure 8.133-1: UP Function Selection Indication Flags**

For each message, the applicable flags of the UP Function Selection Indication Flags IE shall be clearly specified in the individual message clause. The remaining flags of the UP Function Selection Indication Flags IE not so indicated shall be discarded by the receiver.

The receiver shall consider the value of the applicable flags as "0", if the UP Function Selection Indication Flags IE is applicable for the message but not included in the message by the sender.

The following bits within Octet 5 shall indicate:

- Bit 8 to 2 – Spare, for future use and set to zero.
- Bit 1 – DCNR (Dual connectivity with NR): If this bit is set to 1, it indicates to the SGW-C and PGW-C that it is desired to select a specific SGW-U and PGW-U for UEs supporting dual connectivity with NR and not restricted from using NR by user subscription. UE signals its support for dual connectivity with NR to the MME and S4-SGSN with the DCNR of the UE network capability IE in 3GPP TS 24.301 [23]. Subscription restriction to use NR as secondary RAT is specified in "NR as Secondary RAT Not Allowed" bit within Access Restriction Data in 3GPP TS 29.272 [70].

## 8.134 Maximum Packet Loss Rate

The Maximum Packet Loss Rate IE is used to carry bearer loss rate for uplink and downlink traffic. It is coded as shown in Figure 8.134-1.

Octets	Bits							
	8	7	6	5	4	3	2	1
1	Type = 203 (decimal)							
2 to 3	Length = n							
4	Spare				Instance			
5	Spare					DL	UL	
m to m+1	Maximum Packet Loss Rate UL							
o to o+1	Maximum Packet Loss Rate DL							
p to (n+4)	These octet(s) is/are present only if explicitly specified							

**Figure 8.134-1: Maximum Packet Loss Rate**

The UL flag in octet 5 indicates whether the Maximum Packet Loss Rate UL value in octets 'm to m+1' shall be present. If UL is set to '1', then the Maximum Packet Loss Rate UL value shall be present. If UL is set to '0', then octets 'm to m+1' shall not be present.

The DL flag in octet 5 indicates whether the Maximum Packet Loss Rate DL value in octets 'o to o+1' shall be present. If DL is set to '1', then the Maximum Packet Loss Rate DL value shall be present. If DL is set to '0', then octets 'o to o+1' shall not be present.

The Maximum Packet Loss Rate for UL and DL shall be coded as an unsigned integer in the range of 0 to 1000. It shall be interpreted as Ratio of lost packets per number of packets sent, expressed in tenth of percent.

### 8.135 APN Rate Control Status

Octets	Bits							
	8	7	6	5	4	3	2	1
1	Type = 204 (decimal)							
2 to 3	Length = n							
4	Spare				Instance			
5 to 8	Number of Uplink packets allowed							
9 to 12	Number of additional exception reports							
13 to 16	Number of Downlink packets allowed							
17 to 24	APN Rate Control Status validity Time							
25 to (n+4)	These octet(s) is/are present only if explicitly specified							

**Figure 8.135-1: APN Rate Control Status**

Octets 17 to 24 are coded as the time in seconds relative to 00:00:00 on 1 January 1900 (calculated as continuous time without leap seconds and traceable to a common time reference) where binary encoding of the integer part is in the 32 most significant bits and binary encoding of the fraction part in the 32 least significant bits. The fraction part is expressed with a granularity of  $1/2^{32}$  second.

### 8.136 Extended Trace Information

Extended Trace Information is coded as depicted in Figure 8.136-1. See 3GPP TS 32.422 [18] for details on trace related information.

Octets	Bits							
	8	7	6	5	4	3	2	1
1	Type = 205 (decimal)							
2 to 3	Length = n							
4	Spare				Instance			
5	MCC digit 2				MCC digit 1			
6	MNC digit 3				MCC digit 3			
7	MNC digit 2				MNC digit 1			
8 to 10	Trace ID							
11	Length of Triggering Events							
12 to m	Triggering Events							
m+1	Length of List of NE Types							
(m+2) to p	List of NE Types							
p+1	Session Trace Depth							
p+2	Length of List of Interfaces							
(p+3) to q	List of Interfaces							
q+1	Length of IP Address of Trace Collection Entity							
(q+2) to r	IP Address of Trace Collection Entity							
(r+1) to (n-4)	These octet(s) is/are present only if explicitly specified							

**Figure 8.136-1: Extended Trace Information**

Octets 5 to 10 represent the Trace Reference parameter as defined in clause 5.6 of 3GPP TS 32.422 [18].

Triggering Events, List of NE Types, Session Trace Depth, List of Interfaces and IP Address of Trace Collection Entity are specified in 3GPP TS 32.422 [18].

**NOTE:** The List of Triggering Events, List of NE Types and List of Interfaces include the events, NE types and List of interfaces to be traced in the target system during an EPS to 5GS or 5GS to EPS mobility, see clause 4.1.2.15.2 of 3GPP TS 32.422 [18].

See 3GPP TS 24.008 [5], clause 10.5.1.4, Mobile Identity, for the coding of MCC and MNC, whose values are obtained from the serving PLMN that the EM/NM is managing. If MNC is 2 digits long, bits 5 to 8 of octet 6 are coded as "1111".

### 8.137 Monitoring Event Extension Information

The Monitoring Event Information contains the monitoring event parameters that are necessary to transfer over the S3/S16/S10 interface.

The Monitoring Event Extension Information is coded as depicted in Figure 8.137-1.

Octets	Bits							
	8	7	6	5	4	3	2	1
1	Type = 206 (decimal)							
2 to 3	Length = n							
4	Spare				Instance			
5	Spare							L RTP
6 to 9	SCEF Reference ID							
10	SCEF ID Length							
11 to k	SCEF ID							
(h) to (h+3)	Remaining Minimum Periodic Location Reporting Time							
(g) to (n+4)	These octet(s) is/are present only if explicitly specified							

**Figure 8.137-1: Monitoring Event Extension Information**

The SCEF Reference ID, the SCEF ID shall be encoded as specified in clause 8.4.4 and 8.4.5 of 3GPP TS 29.336 [69].

The SCEF ID Length indicates the length of the SCEF ID in octets.

The following bits within Octet 5 indicate:

- Bit 1 – LRTP (Remaining Minimum Periodic Location Reporting Time Present): This flag is used to indicate that Remaining Minimum Periodic Location Reporting Time shall be present.

- Bit 2-8 Spare.

Remaining Minimum Periodic Location Reporting Time indicates the current value of the timer for minimum periodic location reporting. It shall be encoded as specified in clause 8.4.29 of 3GPP TS 29.336 [69]. The target MME/SGSN shall start the timer with the Remaining Minimum Periodic Location Reporting Time to continue detecting the location change. If the timer expires, the target MME/SGSN shall restart the timer with the value of the Periodic-Time AVP within the Monitoring-Event-Configuration AVP provided by the HSS.

### 8.138 Additional RRM Policy Index

Additional RRM Policy Index (ARPI) is coded as depicted in Figure 8.138-1 and contains a non-transparent copy of the corresponding IE (see clause 8.2.2), "Additional RRM Policy Index" as specified in 3GPP TS 36.413 [10]. The ARPI is encoded as Unsigned32 binary integer values.

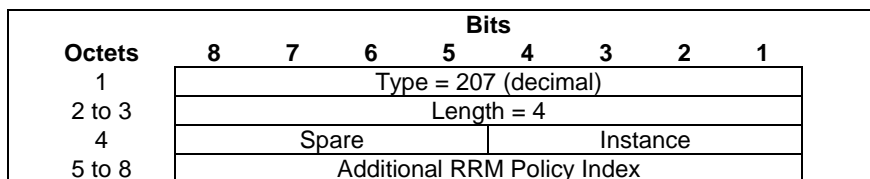

Figure 8.138-1. Additional RRM Policy Index

Editor' Note: The IE name for "Additional RRM Policy Index" in S1AP is to be confirmed.

### 8.139 V2X Context

The V2X Context is a grouped IE containing a number of other IEs and shall be coded as depicted in Table 8.139-1.

Table 8.139-1: V2X Context Grouped Type

Octet 1	V2X Context IE Type = 208 (decimal)			
Octets 2 and 3	Length = n			
Octet 4	Spare and Instance fields			
Information elements	P	Condition / Comment	IE Type	Ins.
NOTE: This table uses a 5-column format in order to match the format used in clauses of clause 7, where the usage of this IE is further detailed for each specific GTP message including it.				

### 8.140 PC5 QoS Parameters

The PC5 QoS Parameters is a grouped IE containing a number of other IEs and shall be coded as depicted in Table 8.140-1.

Table 8.140-1: PC5 QoS Parameters Grouped Type

Octet 1	PC5 QoS Parameters IE Type = 209 (decimal)			
Octets 2 and 3	Length = n			
Octet 4	Spare and Instance fields			
Information elements	P	Condition / Comment	IE Type	Ins.
NOTE: This table uses a 5-column format in order to match the format used in clauses of clause 7, where the usage of this IE is further detailed for each specific GTP message including it.				

## 8.141 Services Authorized

Services Authorized shall be coded as depicted in Figure 8.141-1.

Octets	Bits							
	8	7	6	5	4	3	2	1
1	Type = 210							
2 to 3	Length = n							
4	Spare				Instance			
5	Vehicle UE Authorized							
6	Pedestrian UE Authorized							
7 to (n+4)	These octet(s) is/are present only if explicitly specified							

**Figure 8.141-1: Services Authorized**

Vehicle UE Authorized represents an indication if the UE is authorized to use the V2X services as Vehicle UE, as specified in 3GPP TS 29.272 [70]. Vehicle UE Authorized field is encoded as a one octet long enumeration. Currently, Vehicle UE Authorized field specifies two enumeration values: 0 (indicates "authorized") and 1 (indicates "not authorized").

Pedestrian UE Authorized represents an indication if the UE is authorized to use the V2X services as Pedestrian UE, as specified in 3GPP TS 29.272 [70]. Pedestrian UE Authorized field is encoded as a one octet long enumeration. Currently, Pedestrian UE Authorized field specifies two enumeration values: 0 (indicates "authorized") and 1 (indicates "not authorized").

## 8.142 Bit Rate

Bit Rate shall be coded as depicted in Figure 8.142-1.

Octets	Bits							
	8	7	6	5	4	3	2	1
1	Type = 211							
2 to 3	Length = n							
4	Spare				Instance			
5 to 8	bit rate							
9 to (n+4)	These octet(s) is/are present only if explicitly specified							

**Figure 8.142-1: Bit Rate**

The bit rate field is encoded as kilobits per second (1 kbps = 1000 bps) in binary value.

## 8.143 PC5 QoS Flow

PC5 QoS Flow shall be coded as depicted in Figure 8.14-1.

Octets	Bits							
	8	7	6	5	4	3	2	1
1	Type = 212							
2 to 3	Length = n							
4	Spare				Instance			
5	Spare						Range	
6	Label (PQI)							
7 to 10	Guaranteed Flow Bit Rate							
11 to 14	Maximum Flow Bit Rate							
15	Range							
16 to (n+4)	These octet(s) is/are present only if explicitly specified							

Figure 8.143-1: PC5 QoS Flow

If Range, bit 1 of octet 5, is set to "1", then the Range field shall be present, otherwise octets 17 and 18 shall not be present.

Octet 6 contains the "5QI" value, as specified in 3GPP TS 23.501 [82].

The Guaranteed Flow Bit Rate and Maximum Flow Bit Rate fields are encoded as kilobits per second (1 kbps = 1000 bps) in binary value. The Guaranteed Flow Bit Rate and Maximum Flow Bit Rate fields may require converting values in bits per second to kilobits per second when the Guaranteed Flow Bit Rate and Maximum Flow Bit Rate values are received from an interface other than GTPv2 interface. If such conversions result in fractions, then the value of Guaranteed Flow Bit Rate and Maximum Flow Bit Rate fields shall be rounded upwards. For non-GBR PC5 QoS flows, both the Guaranteed Flow Bit Rate and Maximum Flow Bit Rate should be set to zero.

The Range field is in the unit of meters, and only used for groupcast communication, as specified in 3GPP TS 36.413 [10]. Range field is encoded as a one octet long enumeration.

NOTE: Currently, 3GPP TS 36.413 [10] specifies several enumeration values, i.e. 0 (indicates "m50"), 1 (indicates "m80") and etc.

### 8.144 SGi PtP Tunnel Address

SGi PtP Tunnel Address is coded as depicted in Figure 8.144-1.

Octets	Bits								
	8	7	6	5	4	3	2	1	
1	Type = 213 (decimal)								
2 to 3	Length = n								
4	Spare				Instance				
5	Spare						Port	V6	V4
m to (m+3)	IPv4 address								
p to (p+15)	IPv6 address								
q to (q+1)	Port Number								
k to (n+4)	These octet(s) is/are present only if explicitly specified								

Figure 8.144-1: SGi PtP Tunnel Address

The following flags are coded within Octet 5:

- Bit 1 – V4: If this bit is set to "1", then the IPv4 address field shall be present, otherwise it shall be absent. Bit 2 shall be set to "0" when Bit 1 is set to "1".
- Bit 2 – V6: If this bit is set to "1", then the IPv6 address field shall be present, otherwise it shall be absent. Bit 1 shall be set to "0" when Bit 2 is set to "1".
- Bit 3 – Port: If this bit is set to "1", then the Port Number field shall be present, otherwise it shall be absent.

When the IPv4 address field is present, octets m to (m+3) shall contains an IPv4 address. Bit 8 of Octet m represents the most significant bit of the IPv4 address and bit 1 of octet (m+3) the least significant bit.



When the IPv6 address field is present, octets p to (p+15) shall contain the IPv6 Prefix and Interface Identifier. Bit 8 of octet p represents the most significant bit of the IPv6 Prefix and Interface Identifier and bit 1 of octet (p+15) the least significant bit.

When the UDP port field is present, octets q to (q+1) shall contain a UDP port number. Bit 8 of Octet q represents the most significant bit of the port number and bit 1 of octet (q+1) the least significant bit.

### 8.145 PGW Change Info

PGW Change Info is a grouped IE containing several other IEs. Which of those IEs are mandatory, optional or conditional and the conditions that apply are GTP message specific and described in the corresponding clause under clause 7.

PGW Change Info is coded as depicted in Table 8.145-1.

**Table 8.145-1: PGW Change Info Grouped Type**

Octet 1	PGW Change Info IE Type = 214 (decimal)			
Octets 2 and 3	Length = n			
Octet 4	Spare and Instance fields			
<b>Information elements</b>	<b>P</b>	<b>Condition / Comment</b>	<b>IE Type</b>	<b>Ins.</b>
NOTE: This table uses a 5-column format in order to match the format used in clauses of clause 7, where the usage of this IE is further detailed for each specific GTP message including it.				

### 8.146 PGW FQDN

The PGW FQDN IE shall contain an FQDN representing the PGW Set or PGW. It shall be encoded as shown in Figure 8.146-1.

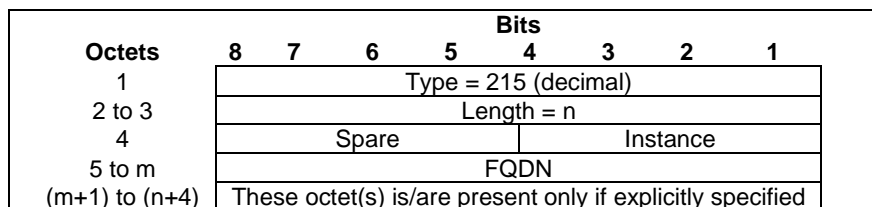

**Figure 8.146-1: PGW FQDN**

FQDN encoding shall be identical to the encoding of a FQDN within a DNS message of clause 3.1 of IETF RFC 1035 [27] but excluding the trailing zero byte.

NOTE: The FQDN field in the IE is not encoded as a dotted string as commonly used in DNS master zone files.

### 8.147 Group Id

Group Id IE shall be encoded as depicted in Figure 8.147-1. The Group Id field shall be encoded as specified in clause 8.2.198 of 3GPP TS 29.244 [80].

Octets	Bits							
	8	7	6	5	4	3	2	1
1	Type = 216 (decimal)							
2 to 3	Length = n							
4	Spare				Instance			
5 to (n+4)	Group Id							

Figure 8.147-1: Group Id

## 8.148 PSCell ID

PSCell ID shall be encoded as depicted in Figure 8.148-1. PSCell ID contains an NR Cell Identity.

Octets	Bits							
	8	7	6	5	4	3	2	1
1	Type = 217 (decimal)							
2 to 3	Length = 8							
4	Spare				Instance			
5	MCC digit 2				MCC digit 1			
6	MNC digit 3				MCC digit 3			
7	MNC digit 2				MNC digit 1			
8	Spare				NR CGI			
9 to 12	NR CGI (NR Cell Identity)							

Figure 8.148-1: PSCell ID

The "MNC digit 3" field shall be coded as "1111" if the MNC contains only two digits.

The NR CGI field shall consist of 36 bits. The NR CGI field shall start with Bit 4 of octet 8, which is the most significant bit. Bit 1 of Octet 12 is the least significant bit. The coding of the NR CGI is the responsibility of each administration. Coding using full hexadecimal representation (binary, not ASCII encoding) shall be used.

## 8.149 UP Security Policy

UP Security Policy shall be coded as depicted in Figure 8.149-1.

Octets	Bits							
	8	7	6	5	4	3	2	1
1	Type = 218 (decimal)							
2 to 3	Length = n							
4	Spare				Instance			
5	Spare				UP IP Policy			
6 to (n+4)	These octet(s) is/are present only if explicitly specified							

Figure 8.149-1: UP Security Policy

The UP IP Policy field in bits 1 and 2 of octet 5 shall be encoded as follows:

Table 8.149-1: UP IP Policy

Indication	Value (Decimal)
User Plane Integrity protection with EPS is not needed	0
User Plane Integrity protection with EPS is preferred	1
User Plane Integrity protection with EPS is required	2
Spare	3

Bits 3 to 8 in octet 5 are spare, for future use and set to 0.

## 8.150 Alternative IMSI

Alternative IMSI is transferred via GTP tunnels. The sending entity copies the value part of the Alternative IMSI into the Value field of the Alternative IMSI IE. Alternative IMSI is in the form of an IMSI as defined in 3GPP TS 23.003 [2].

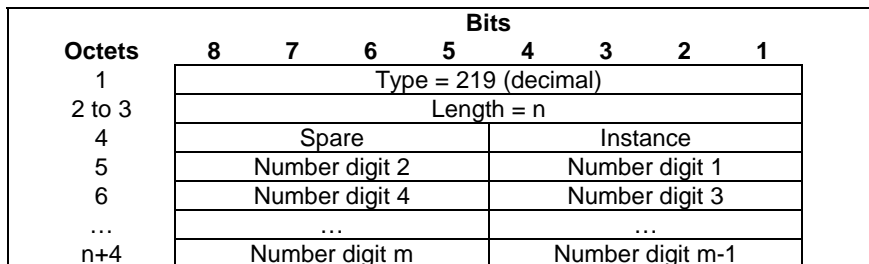

**Figure 8.150-1: Alternative IMSI**

Octets 5 to (n+4) represent the Alternative IMSI value in international number format as described in ITU-T Rec E.212 [64], encoded as TBCD digits, i.e. digits from 0 through 9 are encoded "0000" to "1001". When there is an odd number of digits, bits 8 to 5 of the last octet are encoded with the filler "1111". The maximum number of digits is 15.

---

## 9 Security

GTPv2-C communications shall be protected according to security mechanisms defined in 3GPP TS 33.401 [12].

---

## 10 IP - The Networking Technology used by GTP

### 10.1 IP Version

GTPv2 entities shall support both versions of the Internet Protocol, version 4 (IPv4) as defined by IETF RFC 791 [6], and version 6 (IPv6) as defined by IETF RFC 2460 [16].

### 10.2 IP Fragmentation

It is specified here how the fragmentation mechanism shall work with GTP-C.

Fragmentation should be avoided if possible. Examples of fragmentation drawbacks are:

- Fragmentation is inefficient, since the complete IP header is duplicated in each fragment.
- If one fragment is lost, the complete packet has to be discarded. The reason is that no selective retransmission of fragments is possible.

Path MTU discovery should be used, especially if GTPv2-C message is encapsulated with IPv6 header. The application should find out the path MTU, and thereby utilise more efficient fragmentation mechanisms.

### 10.3 DSCP

Based on operator policy, if:

- GTPv2 entities support using the GTPv2 message priority mechanism as specified in clause 5.4 and clause 12.3.9.3.4 for DSCP marking,
- the transport network utilizes DSCP marking, and

- message-dependant DSCP marking is possible for the protocol stack for transporting GTPv2 messages,

then the DSCP marking as defined by IETF RFC 2474 [81] shall be set for IP packet carrying this GTPv2 messages based on the priority set in the GTPv2 message header.

---

## 11 Notification of supported features between peer GTP-C entities

### 11.1 General

#### 11.1.1 Introduction

New functionality, i.e. functionality beyond the Rel-9 standard, which can not be specified without backward incompatible changes (e.g. requiring support of a new message or a specific receiver node's behaviour) should be introduced as a feature, see clause 11.1.2.

A GTP-C entity should verify that a backward incompatible feature is supported by its peer GTP entities before starting to use it.

**NOTE:** GTPv2 does not support a Comprehension Required mechanism allowing a sender to force the receiver to support comprehension of some specific IEs as a precondition to process a backward incompatible message.

Features may be generic node capabilities supported homogeneously for all GTP tunnels, UEs and PDN connections. Such features are referred in this specification as "Node Features". They are signalled with the granularity of a node on all GTPv2 interfaces (i.e. S11, S4, S5, S8, S10, S3, S16, Sv, S101, S121, Sm, Sn, S2a, S2b). A GTP-C entity may discover the features supported by a peer GTP-C entity with which it is in direct contact as specified in clause 11.2.1.

#### 11.1.2 Defining a feature

A feature is a function extending the base GTPv2 functionality that has a significant meaning to the operation of GTPv2, i.e. a single new parameter without a substantial meaning to the functionality of the GTPv2 endpoints should not be defined to be a new feature.

A functionality requiring the definition of a new GTPv2 message or extending the use of an existing message over a new interface should be defined as a feature.

**NOTE:** Features are ultimately defined on a case-by-case basis on the merits of defining an extension as a feature.

Features should be defined so that they are independent from each other. A GTP-C entity may support the same feature over different interfaces, e.g. an SGW may support a feature over both S11 and S4 interface, however support of a feature on a given interface shall not depend on the support of the same or another feature on another interface.

## 11.2 Dynamic discovery of supported features

### 11.2.1 General

A node supporting at least one feature defined in the Node Features IE shall support dynamic discovery of supported features as specified in the following clauses.

#### 11.2.2 Features supported by direct peer GTP-C entities

A node shall signal to a direct peer node the list of features it supports by sending the Sending Node Features IE in every Echo Request and Echo Response messages to that node.

An exception to this is where the sending node does not support or use any features towards the peer node and is not prepared to accept a message which is constructed by making use of any features.

The peer receiving the Sending Node Features IE shall store the list of features supported by the sending node per IP address and only update this list based on the Sending Node Features IE in the Echo Request and Echo Response messages, and it shall only use common supported features to initiate subsequent GTPv2 messages towards this IP address. Receipt of an Echo Request or an Echo Response message without the Sending Node Features IE shall indicate that the sending node does not support any feature specified in Table 8.83-1 on the corresponding interface.

---

## 12 GTP-C load & overload control mechanism

### 12.1 General

#### 12.1.1 GTP-C overload problem

GTP-C entities can communicate with other GTP-C peers in direct contact (e.g. MME and SGW) or remote GTP-C peers through intermediate GTP-C entities (e.g. MME and PGW via the SGW). In normal conditions, requests sent by a GTP-C entity can be processed by the receiving GTP-C entity which can send back a message indicating the result of the request (success/failure).

Overload situations in a GTP-C entity occur when the number of incoming requests exceeds the maximum request throughput supported by the receiving GTP-C entity, e.g. when the internal available resources of the GTP-C entity, such as processing power or memory, are not sufficient to serve the number of incoming requests. As a consequence of the overload situation, the receiving GTP-C entity cannot successfully process the exceeding proportion of requests. These requests can be either simply dropped or extremely delayed in the processing. At best, the GTP-C entity may have enough internal resources to send back to the request initiator a message indicating that the requests cannot be successfully processed. Whatever the behaviour of the overloaded GTP-C entities, the rate of successfully processed requests and consequently the overall performances of the network decrease.

**NOTE:** GTP-C overload control does not target to address transport network congestion. It assumes a transport network that is still capable to exchange signalling traffic.

Given the nature of GTP-C protocol in how it relies on retransmissions of unacknowledged requests (GTP-C is carried over UDP transport), when a GTP-C entity experiences overload (or severe overload) the number of unacknowledged GTP-C messages compounds exponentially and can lead to a node congestion or even collapse. An overload or failure of a node can lead to an increase of the load on the other nodes in the network and, in the worst case, turn into a complete network issue via a snowball effect.

The impact of GTP-C overload to services can be such as:

- loss of PDN connectivity (IMS, Internet ...) and associated services;
- loss of ability to setup and release radio and core network bearers necessary to support services e.g. GBR bearers for VoLTE or dedicated bearers for Voice over WLAN;
- loss of ability to report to the PGW/PCRF user's information changes, e.g. location information for emergency services and lawful intercept, changes in RAT or QoS;
- and billing errors and a loss of revenue.

#### 12.1.2 Scenarios leading to overload

Reasons for these temporary overload cases can be many and various in an operational network, such as insufficient internal resource capacity of a GTP-C entity faced with a sudden burst of requests, e.g. after network failure/restart procedures affecting a large number of users, deficiency of a GTP-C entity component leading to a drastic reduction of the overall performances of the GTP-C entity.

Examples of GTP-C signalling based scenarios which can cause GTP-C overload are:

- a traffic flood resulting from the failure of a network element, inducing a signalling spike, e.g. when the network needs to re-establish the PDN connections affected by the failure of an EPC node;
- a traffic flood resulting from a large number of users performing TAU/RAU or from frequent transitions between idle and connected mode;
- an exceptional event locally generating a traffic spike, e.g. a large amount of calls (and dedicated bearers) being setup almost simultaneously upon a catastrophic event or an exceptional but predictable event (e.g. Christmas, New year) via a 3GPP access or a WLAN access;
- Frequent RAT-reselection due to scattered non-3GPP (e.g. WiFi) coverage or massive mobility between 3GPP and non-3GPP coverage may potentially cause frequent or massive intersystem change activities, i.e. UEs trying to either create PDN connections over the new access or moving PDN connections between 3GPP and non-3GPP coverage.

Besides, GTP-C load balancing based only on semi-static DNS weights can lead to a load imbalance and thus GTP-C signalling scenarios, such as those mentioned above, may result in an overload of the SGWs or PGWs with the highest load while there is still remaining capacity on other SGWs or PGWs.

### 12.1.3 Load & overload control concepts

Load control refers to "GTP-C signalling based Load Control" as defined in clause 4.3.7.1a.1 of 3GPP TS 23.401 [3] and clause 5.3.6.1a of 3GPP TS 23.060 [35].

Overload control refers to "GTP-C signaling based Overload Control" as defined in clause 4.3.7.1a.2 of 3GPP TS 23.401 [3] and clause 5.3.6.1a of 3GPP TS 23.060 [35].

Load control and overload control are two distinct but complementary concepts:

- load control enables a GTP-C entity (e.g. an SGW/PGW) to send its load information to a GTP-C peer (e.g. an MME/SGSN, ePDG, TWAN) to adaptively balance the session load across entities supporting the same function (e.g. an SGW cluster) according to their effective load. The load information reflects the operating status of the resources of the GTP-C entity.
- overload control enables a GTP-C entity becoming or being overloaded to gracefully reduce its incoming signalling load by instructing its GTP-C peers to reduce sending traffic according to its available signalling capacity to successfully process the traffic. A GTP-C entity is in overload when it operates over its signalling capacity which results in diminished performance (including impacts to handling of incoming and outgoing traffic).

Load control allows for better balancing of the session load, so as to attempt to prevent overload in the first place (preventive action). Overload control aims at shedding the incoming traffic as close to the traffic source as possible generally when an overload has occurred (reactive action), so to avoid spreading the problem inside the network and to avoid using resources of intermediate nodes in the network for signalling that would anyhow be discarded by the overloaded node.

Load control does not trigger overload mitigation actions even if the GTP-C entity reports a high load.

Load control and overload control may be supported and activated independently in the network.

## 12.2 Load control solution

### 12.2.1 Principles of load control

The stage 2 requirements on GTP-C load control solution are defined in clause 4.3.7.1a.1 of 3GPP TS 23.401 [3] and clause 5.3.6.1a of 3GPP TS 23.060 [35]. The high level principles are summarized below:

- a) Load Control is an optional feature;
- b) a GTP-C node may signal its Load Control Information to reflect the operating status of its resources, allowing the receiving GTP-C peer node to use this information to augment the existing GW selection procedures;

- c) the calculation of the Load Control Information is implementation dependent and its calculation and transfer shall not add significant additional load to the node itself and to its corresponding peer nodes;
- d) the Load Control Information may provide load information of a GTP-C node (e.g. a PGW) or, if the APN level load control feature is supported, may provide the load information about specific APN(s);
- e) the SGW may send its Load Control Information to the MME/S4-SGSN. The PGW may send its Load Control Information to the MME/S4-SGSN via the SGW. For non-3GPP access based interfaces, the PGW may send its Load Control Information to the ePDG and TWAN;
- f) the Load Control Information shall be piggybacked in GTP-C request or response messages such that the exchange of Load Control Information does not trigger extra signalling;

NOTE: The inclusion of Load Control Information in existing messages means that the frequency of transmission of load control information increases as the session load increases, allowing for faster feedback and thus better regulation of the load.

- g) a node supporting Load Control sends Load Control Information to a peer GTP-C node based on local configuration (see clause 12.2.6);
- h) the format of the Load Control Information shall be specified with enough precision to guarantee a common interpretation of this information allowing interoperability between nodes of different vendors;
- i) for the inter-PLMN case, local configuration may restrict the exchange and use of Load Control Information across PLMNs;
- j) the GTP-C node may decide to send different values of Load Control Information on inter-network (roaming) and on intra-network (non-roaming) interfaces based on local configuration, i.e. the values sent on intra-network interfaces may differ from the values sent on inter-network interfaces. However, on intra-network interfaces, the node should send the same values between the 3GPP and non-3GPP access based interfaces.
- k) the Load Control Information received via GTP-C signalling shall be used in conjunction with the information received from the DNS, during the node selection procedure. Refer to 3GPP TS 29.303 [32] for further details.

## 12.2.2 Applicability to 3GPP and non-3GPP access based interfaces

Load Control may be supported on the 3GPP & non-3GPP access based interfaces and nodes as summarized by the Table 12.2.2-1.

**Table 12.2.2-1: Applicability of Load Control to GTP-C interfaces and nodes**

Originator	Consumer	Applicable Interfaces
PGW	MME	S5/S8, S11 SGW relays Load Control Information from S5/S8 to S11 interface.
PGW	S4-SGSN	S5/S8, S4 SGW relays Load Control Information from S5/S8 to S4 interface.
SGW	MME	S11
SGW	S4-SGSN	S4
PGW	ePDG	S2b
PGW	TWAN	S2a

NOTE: Refer to Annex D.1 for information on the GTP-C interfaces for which Load Control is not supported.

## 12.2.3 Node level load control

Node level load control refers to advertising of the load information at node level – i.e. load information at node level granularity – and selection of the target node based on this information. It helps to achieve an evenly load balanced network by the use of the dynamic load information provided within the Load Control Information.

## 12.2.4 APN level load control

### 12.2.4.1 General

APN level load control refers to advertising of the load information at APN level granularity and selection of the target node based on this information. It helps to achieve an evenly load balanced network at APN granularity by the use of the dynamic load information provided within the Load Control Information with the APN scope. Only a PGW may advertise APN level load information.

APN level load control is an optional feature that may be supported when the following pre-condition is applicable.

**Pre-Condition:**

In the given network, when the ratio of the configured APN resource to the overall capacity of the PGW is not the same across all the PGWs in the network.

NOTE: In other cases, e.g. when all the resources of the PGW are available for all the APNs served by that PGW, the node level load information is exactly the same as APN level load information, for each of its APNs, and hence performing node load control is sufficient.

If APN load control is supported and activated at the PGW, the PGW should advertise the APN load information. If the APN level load control feature is supported at the node performing the PGW selection, i.e. an MME, S4-SGSN, ePDG, TWAN, the node shall utilize this information when selecting the PGW.

### 12.2.4.2 Justifications for APN load control support

Following are the justifications to support the APN level load control in the network when the pre-condition specified in 12.2.3.1 is applicable:

- 1) To achieve load balancing at the APN level granularity:** The PGW may be configured to handle more than one APN in the network. In such a case, the PGW may be additionally configured to allocate different resources for each of the configured APNs, e.g. the PGW may be configured to handle "X" number of sessions for the "consumer" APN and to handle "Y" number of session for the "corporate" APN. The ratio of this limit, i.e. "X" and "Y", to the PGW's capacity may not be the same across all the PGWs in the network. In this case, the load information with node level granularity is not sufficient and could result in a network where one PGW has more sessions for the "consumer" APN while another PGW has more sessions for the "corporate" APN. Thus, an evenly load balanced network at APN level load granularity cannot be realized.
- 2) To ensure effective overload control in the network:** If the distribution of sessions at APN level is uneven, then there is a higher risk of overload of some PGWs, as compared to other PGWs, e.g. the PGW handling more sessions for "consumer" APN may have to handle more messages, (e.g. generated due to mobility events resulting from a change of ULI, RAT type, Serving GW, etc.) as compared to the PGW handling more sessions for the "stationary-machine" APN. Hence, the PGW handling "consumer" APN sessions may be at higher risk of overload, as compared to the other PGWs in the network, and hence, this situation may result in poor overload control of the network.
- 3) To ensure an efficient node selection algorithm:** Based on the node level load information, the source node, (e.g. the MME) may end-up selecting the PGW for a new session for the given APN. However, the selected PGW may reject the new session request, if it is running at 100% load capacity for the given APN, or the new session request may be throttled by the source node based on the overload information of the APN for the given PGW. Thus the new session request may be denied, (i.e. rejected by the selected PGW or throttled by the source node based on PGW's APN level overload information) while the other PGW may have the capacity to handle the same. Thus, the lack of APN level load information may result in inefficient node selection algorithm by the source node.

### 12.2.4.3 Elements of APN load control

To allow for an effective APN load control, at least the following information (in addition to the other applicable information for load control as defined in clause 12.2.5.1.2) is required to be advertised by the PGW, as part of the APN level load information:

**APN:** The APN for which the PGW wants to advertise the load information.



**APN-Load-Metric:** It indicates the current resource utilization for a particular APN, as a percentage, compared to the total resources reserved for that APN at the target PGW. Its computation is implementation dependent and it has same characteristics as "Load-Metric", as described in clause 12.2.5.1.2.2, when applied at the APN level.

**APN-relative-capacity:** It indicates the total resources configured for a given APN, compared to the total resources of the target PGW, as a percentage. It is a static parameter and does not change unless the resources configured for the APN change. Using APN-relative-capacity and the DNS weight-factor of the given PGW, the source node can judge the PGW's APN related resources as compared other PGWs in the network, i.e. the PGW's APN-weight-factor can be calculated by multiplying the APN-relative-capacity and DNS-weight-factor of the PGW (PGW's-APN-weight-factor = PGW's-APN-relative-capacity X DNS-weight-factor).

For the following example configuration:

PGW1-APN1-relative-capacity = 50%; PGW2-APN1- relative-capacity = 20%; PGW3-APN1- relative-capacity = 10%

PGW1-weight-factor = 20; PGW2-weight-factor = 20; PGW3-weight-factor = 60;

The APN level weight-factor for each of the PGWs can be calculated as below:

PGW1-APN1-weight-factor = 50% X 20 = 10.

PGW2-APN1-weight-factor = 20% X 20 = 4.

PGW3-APN1-weight-factor = 10% X 60 = 6.

Thus, based on the APN-weight-factor it can be concluded that the PGW1 has highest APN1 related resources reserved, as compared to the other PGWs in the network. Hence the source node should use this information to favour PGW1 over other PGWs for APN1 related new session requests.

## 12.2.5 Load Control Information

### 12.2.5.1 Definition

#### 12.2.5.1.1 General description

Within a message, one or multiple instances of the Load Control Information (LCI) IE may be included by the same GTP-C entity.

When providing load control information in a message for the first time or subsequently, the GTP-C entity shall always include the full set of load control information, i.e. all the node level and APN Level applicable instances of the Load Control Information, even if only a subset of the load control information has changed. All the instances of the LCI IE provided by a given GTP-C entity in a message shall contain the same Load-Control-Sequence-Number. The Load Control Sequence Number shall be incremented whenever the load control information is changed (see clause 12.2.5.1.2.1).

The receiver shall overwrite any stored load control information of a peer with the newly received load control information (via one or multiple instances) from the same peer node if the new load control information is more recent than the old information as indicated by the Load Control Sequence Number, e.g. if the receiver has stored 'X' instances of the load control information for a peer node, it overwrites those 'X' instances with the new set of 'Y' instances received in a message from the same peer node, where X, Y are any integer number.

The receiver shall consider all the parameters received in the same instance of the LCI IE in conjunction while using this information for node selection. When more than one instance of the LCI IE is received, the receiver shall consider the parameters included in each instance independently, when using this information for node selection.

The parameters are further defined in clauses 12.2.5.1.2 and 12.2.5.1.3.

Load control information may be extended with new parameters in future versions of the specification. Any new parameter will have to be categorized as:

- Non-critical optional parameters: the support of these parameters is *not critical* for the receiver. The receiver can successfully and correctly comprehend the load control information instance, containing one or more of these parameters, by using the other parameters and ignoring the non-critical optional parameter.
- Critical optional parameters: the support of these parameters is *critical* for the receiver to correctly comprehend the instance of the load control information containing one or more of these parameters.

The sender may include one or more non-critical optional parameters within any instance of the LCI IE without having the knowledge of the receiver's capability to support the same. However, the sender shall only include one or more critical optional parameter in any instance of the LCI IE towards a receiver if the corresponding receiver is known to support those parameters. The sender may be aware of this either via signalling methods or by configuration; (this will have to be defined when introducing any such new parameter in future).

Each instance of the LCI IE shall be associated to the node identity (FQDN or IP address of the GW node received from the HSS or the DNS) of the serving SGW or PGW, i.e. the identity determined during the SGW or PGW selection.

NOTE: The Node type is derived based on the instance number of the LCI IE.

## 12.2.5.1.2 Parameters

### 12.2.5.1.2.1 Load Control Sequence Number

The Load Control Sequence number contains a value that indicates the sequence number associated with the LCI IE. This sequence number shall be used to differentiate any two LCI IEs generated at two different instances by the same GTP-C entity. The Load Control Sequence Number shall be supported (if load control is supported) and shall always be present in the LCI IE.

The GTP-C entity generating this information shall increment the Load Control Sequence Number whenever modifying some information in the Load Control Information IE. The Load Control Sequence Number shall not be incremented otherwise. The node may use the time, represented in an unsigned integer format, of the generation of the Load Control Information to populate the Load Control Sequence Number.

When multiple instances of the LCI IE are provided in a message by a given GTP-C node, each of them shall contain the same Load Control Sequence Number value.

This parameter shall be used by the receiver of the Load Control Information IE to properly collate out-of-order load control information, e.g. due to GTP-C retransmissions. This parameter shall also be used by the receiver of the LCI IE to determine whether the newly received load control information has changed compared to load control information previously received from the same node earlier.

NOTE: The GTP-C sequence number cannot be used for collating out-of-order load control information as e.g. load control information may be sent in both GTP-C requests and responses, using independent GTP-C sequence numbering.

If the receiving entity has already received and stored load control information from the peer GTP-C entity, the receiving entity shall update its load control information only if the Load Control Sequence Number received in the new load control information is higher than the stored value of the Load Control Sequence Number associated with the peer GTP-C entity. However due to roll-over of the Load Control Sequence Number or restart of the node, the Load Control Sequence Number may be reset to an appropriate base value by the peer GTP-C entity, hence the receiving entity shall be prepared to receive (and process) a Load Control Sequence Number parameter whose value is less than the previous value.

### 12.2.5.1.2.2 Load Metric

The Load Metric parameter shall indicate the current load level of the originating node. The computation of the Load Metric is left to implementation. The node may consider various aspects, such as: the used capacity of the node based on activated bearers in relationship to maximum number of bearers the node can handle, the load that these active bearers produce in the node (e.g. memory/CPU usage in relationship to the total memory/CPU available, etc.).

The Load Metric represents the current load level of the sending node as a percentage within the range of 0 to 100, where 0 means no or 0% load and 100 means maximum or 100% load reached (i.e. no further load is desirable).

The Load Metric shall be supported (if load control is supported). The Load Metric shall always be included in the Load Control Information.

Considering the processing requirement of the receiver of the Load Control Information (e.g. handling of the new information, tuning the node selection algorithm to take the new information into account), the sender should refrain from advertising every small variation (e.g. with the granularity of 1 or 2), in the Load Metric which does not result in useful improvement in node selection logic at the receiver. During the typical operating condition of the sender, a larger variation in the Load Metric, e.g. 5 or more units, should be considered as reasonable enough for advertising the new Load Control Information and thus justifying the processing requirement (to handle the new information) of the receiver.

**NOTE:** The range of the Load Metric, i.e. 0 to 100, does not mandate the sender to collect its own load information at every increment/decrement and hence to advertise the change of Load Metric with a granularity of 1%. Based on various implementation specific criteria, such as: the architecture, session and signalling capacity, the current load and so on, the sender is free to define its own logic and periodicity with which its own load information is collected.

#### 12.2.5.1.2.3 List-of-APN\_and\_Relative Capacity

The List-of-APN\_and\_Relative Capacity parameter contains a list of the tuple (APN, Relative Capacity) and this indicates one or more APNs for which the Load Control Information is applicable. The "APN" contains the name of the APN and the Relative Capacity indicates the resources configured for a given APN, compared to the total resources configured at the target PGW, as a percentage.

When present in the LCI IE, the scope of the load information shall be the list of indicated APNs for the PGW that sends the load control information. In that case, the "Load Metric" shall be interpreted as an "APN-Load-Metric" and shall indicate the current resource utilization for the indicated APNs, as a percentage, as compared to the total resources configured for the indicated APNs at the target PGW.

Its computation is implementation dependent and it has the same characteristics as "Load Metric". Only one instance of the List-Of-APN\_and\_Relative Capacity IE may be included within one Load Control Information instance.

**NOTE 1:** The maximum number of tuples (APN, Relative Capacity) in the List-of-APN\_and\_Relative Capacity IE is set to 10. More than 10 occurrences of (APN, Relative Capacity), within one single instance of the List-of-APN\_and\_Relative Capacity IE is treated as protocol error by the receiver.

If the List-of-APN\_and\_Relative Capacity IE has not been included, the scope of the Load Control Information shall be the entire PGW node (unless restricted by other parameters in the LCI IE).

This parameter may be supported (if load control is supported) and shall be supported when APN level load control is supported.

The receiver shall handle this parameter, when it is received, if it supports APN level load control. The receiver shall ignore a Load Control Information instance applicable for an APN, if it does not support APN level load control.

**NOTE 2:** The PGW encodes the APN level load information and node level load information using different instance numbers in the message, so that the receiver will ignore the APN level load information, if it does not support the APN level load control feature.

The maximum number of APNs, for which the PGW may advertise the Load Control Information, shall be limited to 10, i.e. the maximum number of occurrences of the tuple (APN, Relative Capacity) within and across various instances of the LCI IE shall be limited to 10, for a given PGW. Hence, if the PGW supports more than 10 APNs, it shall advertise the load control information for at most 10 of the most important APNs. In future, if needed, this limit may be increased to allow the PGW to advertise the load information for more APNs. In that case, the receiver not supporting the higher limit shall handle the first 10 APNs and shall ignore the load information for the remaining APNs.

**NOTE 3:** The limit of the number of APN's takes into account various aspects such as: the processing and storage requirements at the overloaded node and the receiver, the number of important APNs for which load control advertisement will be necessary and interoperability between the nodes.

When including load control information for some APN(s), the PGW shall also provide node level load control information by providing one instance of the Load Control Information without the List-of-APN\_and\_Relative Capacity parameter.

A node selecting a PGW for a given APN shall apply the APN level load information, if available for that APN. If this parameter is not received for a given APN but it has been received for other APN(s) from the same PGW, then for this given APN, the node performing PGW selection shall calculate the load metric, as described in 3GPP TS 29.303 [32], for the target PGW.

### 12.2.5.1.3 Handling of parameters

If the PLMN supports the Load Control feature (see clause 12.2.6), the support, inclusion and handling of the parameters, within Load Control Information, is summarized in table 12.2.5.1.3-1.

**Table 12.2.5.1.3-1: Parameters of the Load Control Information**

Parameter	Support by the sender	Support by the receiver	Inclusion by the sender	Handling by the receiver
Load Control sequence number (as defined in clause 12.2.5.1.2.1)	Mandatory	Mandatory	Mandatory	Mandatory
Load Metric (as defined in clause 12.2.5.1.2.2)	Mandatory	Mandatory	Mandatory	Mandatory
List-of-APN_and_Relative Capacity (as defined in clause 12.2.5.1.2.3)	Optional (NOTE 1)	Optional (NOTE 1)	Optional (NOTE 2)	Conditional (NOTE 3)
NOTE 1: This is an optional parameter that shall be supported, if APN level load control is supported.				
NOTE 2: The PGW shall send this parameter whilst providing APN level load control information, if the APN level load control feature is supported and enabled.				
NOTE 3: If this parameter is received, the receiver supporting the APN load control feature shall handle and process APN load control information.				

### 12.2.5.2 Frequency of inclusion

How often the sender includes the load control information is implementation specific. The sender shall ensure that new/updated load control information is propagated to the target receivers within an acceptable delay, such that the purpose of the information (i.e. effective load balancing) is achieved. The sender may include the LCI IE e.g. as follows:

- the sender may include Load Control Information towards a peer only when the new/changed value has not already been provided to that peer;
- the sender may include the Load Control Information in each and every message (extended with LCI IE) towards the peer;
- the sender may include Load Control Information periodically, i.e. include the information during a first period then cease to do so during a second period.

The sender may also implement a combination of one or more of the above approaches. Besides, the sender may also decide to include the Load Control Information only in a subset of the applicable GTP-C messages.

The receiver shall be prepared to receive the load control information in any of the GTP-C messages extended with an LCI IE and upon such reception, shall be able act upon the received load control information.

### 12.2.5.3 Limit on maximum number of instances

A GTP-C entity may signal one or multiple instances of the LCI IE, with each providing load control information for a different scope. In order to limit the processing of the message on the receiver side and the size of the message on transport level, the number of load control information instances shall be limited:

- at message level: there shall be at most one instance of node level LCI IE per node (i.e. per SGW or PGW) and at most 10 APN level instances.
- at node level: the maximum number of instances of LCI IE which may be provided across multiple messages by a given node shall be the same as the maximum number of instances of LCI IE at message level.

## 12.2.6 Discovery of the support of the feature by the peer node

A GTP-C entity shall determine whether to use the load control feature (i.e. provide or handle load control information)

- within the PLMN, based on the operator's policy (local PLMN-wide configuration);
- across the PLMN boundaries, based on the operator's policy (local configuration per PLMN).

NOTE: The feature may be activated when all or some of the nodes in the PLMN support the feature. The GTP-C entity assumes that all of the peer nodes support this feature when the feature is activated, i.e. it does not need to determine which peers support the feature.

The above operator policy/local configuration may allow the use of load control at node level, load control at node level and APN level, or none.

## 12.2.7 Issues in the network with partial support of the feature

The Load Control feature should be supported homogeneously across all the SGWs and PGWs in the network. Not supporting this feature homogeneously across the SGWs and PGWs may result in poor load balancing in the network such that the SGWs or PGWs not supporting the feature may operate near their maximum capacity (thus being more vulnerable to overload conditions) while SGWs or PGWs supporting the feature have free capacity.

The Load Control feature should be supported homogeneously across all the MMEs, S4-SGSNs, ePDGs and TWANs. However, use of the feature when not all of these nodes support the feature may not necessarily create a problem since the load may remain fairly balanced across the SGWs and PGWs assuming that the network imbalance caused by the non-supporting node may get rectified by the supporting nodes making use of dynamic load information while selecting the SGWs and PGWs.

## 12.3 Overload control solution

### 12.3.1 Principles of overload control

The stage 2 requirements on GTP-C overload control are defined in clause 4.3.7.1a.2 of 3GPP TS 23.401 [3] and clause 5.3.6.1a of 3GPP TS 23.060 [35]. The high level principles are summarized below:

- a) Overload control is an optional feature;
- b) a GTP-C entity may signal its overload to its GTP-C peers by including Overload Control Information in GTP-C signalling which provides guidance to the receiving GTP-C entity to decide actions which lead to signalling traffic mitigation towards the sender of the information;
- c) the Overload Control Information may provide the overload information of a GTP-C entity, e.g. a PGW, or a specific APN(s) associated with the GTP-C entity;
- d) an MME/S4-SGSN may signal an overload to the PGW, via the SGW. An SGW may signal an overload to the MME/S4-SGSN and to the PGW. A PGW may signal an overload to the MME/S4-SGSN, via the SGW. For non-3GPP access based interfaces, a PGW may signal an overload to the ePDG and the TWAN; the ePDG and the TWAN may signal an overload to the PGW.

NOTE 1: An MME/S4-SGSN will not signal an overload to the SGW (i.e. the SGW will not perform overload control towards the MME/S4-SGSN), as this is redundant with DDN throttling (see clause 12.3.3).

- e) the overload control feature should continue to allow for preferential treatment of priority users (eMPS) and emergency services;
- f) the Overload Control Information is piggybacked in GTP control plane request or response messages such that the exchange of the Overload Control Information does not trigger extra signalling;

NOTE 2: The inclusion of Overload Control Information in existing messages means that the frequency increases as the signalling load increases, thus allowing faster feedback and better regulation.

- g) the computation and transfer of the Overload Control Information shall not add significant additional load to the GTP-C entity itself and to its corresponding peer GTP-C entities. The calculation of Overload Control Information should not severely impact the resource utilization of the GTP-C entity, especially considering the overload situation;
- h) clause 4.3.7.1a.2 of 3GPP TS 23.401 [3] and clause 4.5 of 3GPP TS 23.402 [45] provides examples of various potential overload mitigation actions based on the reception of the overload related information exchanged between GTP-C entities, for 3GPP access based interfaces and non-3GPP access based interfaces, respectively. However, the exact internal processing logics of a GTP-C entity will not be standardized;
- i) for the inter-PLMN case, local configuration may restrict the exchange and use of Overload Control Information across PLMNs;
- j) the GTP-C entity may decide to send different values of Overload Control Information on inter-network (roaming) and on intra-network (non-roaming) interfaces based on local configuration, i.e. the values sent on intra-network interfaces may differ from the values sent on inter-network interfaces. However, on intra-network interfaces, the GTP-C entity should send the same values between the 3GPP and non-3GPP access based interfaces;

## 12.3.2 Applicability to 3GPP and non-3GPP access based interfaces

The Overload Control feature may be supported on the 3GPP & non-3GPP access based interfaces and nodes as summarized by the Table 12.3.2-1.

**Table 12.3.2-1: Applicability of overload control to 3GPP & non-3GPP access based GTP-C interfaces and nodes**

Originator	Consumer	Applicable Interfaces
MME	PGW	S11, S5/S8 SGW relays Overload Control Information from S11 to S5/S8 interface.
S4-SGSN	PGW	S4, S5/S8 SGW relays Overload Control Information from S4 to S5/S8 interface.
SGW	MME	S11
SGW	S4-SGSN	S4
SGW	PGW	S5/S8 (in MME/S4-SGSN originated signalling towards the PGW)
PGW	MME	S5/S8, S11 SGW relays Overload Control Information from S5/S8 to S11 interface.
PGW	S4-SGSN	S5/S8, S4 SGW relays Overload Control Information from S5/S8 to S4 interface.
PGW	TWAN	S2a (Trusted WLAN access)
PGW	ePDG	S2b (Untrusted WLAN access)
TWAN	PGW	S2a (Trusted WLAN access)
ePDG	PGW	S2b (Untrusted WLAN access)

NOTE: Refer to Annex D.2 for information on the GTP-C interfaces for which Overload Control is not supported.

## 12.3.3 Node level overload control

Node level overload control refers to advertising of the overload information at node level, i.e. overload information at node level granularity, and applying the mitigation policies towards the target node based on this information. This helps in preventing severe overload and hence potential breakdown of the GTP-C node.

When a GTP-C entity determines that the offered incoming signalling traffic is growing (or is about to grow) beyond its nominal capacity, it may signal an Overload Control Information IE to instruct its GTP-C peers to reduce the offered load accordingly.

Overload Control is performed independently for each direction between two GTP-C entities. Overload Control may run concurrently, but independently, for each direction between the two GTP-C entities.

Overload control of SGW originated traffic towards the MME/S4-SGSN shall rely on Downlink Data Notification throttling, as specified in clause 4.3.7.4.1a of 3GPP TS 23.401 [3] and 5.3.6.5 of 3GPP TS 23.060 [35], with the addition that the SGWs should be allowed, by configuration, to throttle DDN requests for low priority, as well as normal priority traffic (the SGW shall then throttle by priority DDN requests for low priority traffic).

## 12.3.4 APN level overload control

### 12.3.4.1 General

APN level overload control refers to advertising of the overload information at APN level granularity and hence applying the mitigation policies based on this information to the signalling traffic related to this APN only. Only a PGW may advertise APN level overload information when it detects overload for certain APNs, e.g. based on shortage of internal or external resources for an APN (e.g. IP address pool).

**NOTE:** When all the internal and external resources, applicable to the APNs, are available for all the APNs served by a PGW, the node level overload information is exactly the same as APN level overload information of that PGW, for each of its APNs, and hence, performing node overload control can be sufficient.

### 12.3.4.2 Elements of APN overload control

For allowing the effective APN overload control, at least the following information (in addition to the other applicable information for overload control as defined in clause 12.3.5.1.2) are required to be advertised by the source node, as part of the APN level overload information:

**APN:** The APN for which the source node wants to advertise the overload information;

**APN-Overload-Reduction-Metric:** It indicates the requested overload reduction for the signalling traffic corresponding to a particular APN, as a percentage. Its computation is implementation dependent and it has the same characteristics as the "Overload-Reduction-Metric", described in clause 12.3.5.1.2.1, when applied at APN level.

## 12.3.5 Overload Control Information

### 12.3.5.1 Definition

#### 12.3.5.1.1 General description

Within a message, one or multiple instances of the Overload Control Information (OCI) IE may be included by the same GTP-C entity. Each instance shall provide information about the overload condition to allow the receiver to apply mitigation actions which will result in an efficient alleviation of the overload condition at the sender.

The GTP-C entity shall always include the full set of overload control information, i.e. all the node level and/or APN level applicable instances of the OCI IE, when signalling overload control information in a message for the first time or subsequently towards the receiver, even when only a subset of the overload control information has changed. All the instances of the OCI IE provided by a given GTP-C entity in a message shall contain the same Overload Control Sequence Number. The Overload Control Sequence Number shall be incremented whenever the overload control information is modified (see clause 12.3.5.1.2.1).

When including overload control information for some APN(s), the PGW should not provide any node level Overload Control Information unless the node level information is also applicable.

The receiver shall overwrite any stored overload control information of a peer with the newly received overload control information (received via one or multiple instances of OCI IE) from the same GTP-C peer entity, if the new information is more recent than the old information as indicated by the Overload Control Sequence Number, e.g. if the receiver has stored 'X' instances of the OCI IE for a peer GTP-C entity, it shall overwrite those 'X' instances with the new set of 'Y' instances received in a message from the same GTP-C peer entity, where X, Y are any integer numbers.

The receiver shall consider all the parameters received in the same instance of the OCI IE in conjunction while applying the overload mitigation action. When more than one instance of the OCI IE is included, the receiver shall consider the parameters included in each instance independently, while applying the overload mitigation action.

The parameters are further described in clauses 12.3.5.1.2 and 12.3.5.1.3.

Overload control information may be extended with new parameters in future versions of the specification. Any new parameter will have to be categorized as:

- Non-critical optional parameters: the support of these parameters is not critical for the receiver. The receiver can successfully and correctly comprehend the Overload Control Information instance, containing one or more of these parameters, by using the other parameters and ignoring the non-critical optional parameters.
- Critical optional parameters: the support of these parameters is critical for the receiver to correctly comprehend the instance of the Overload Control Information containing one or more of these parameters.

The sender may include one or more non-critical optional parameter(s) within any instance of Overload Control Information, without having the knowledge of the receiver's capability to support the same. However, the sender shall only include one or more critical optional parameter(s) in any instance of Overload Control Information towards a receiver, if the corresponding receiver is known to support these parameter(s). The sender may be aware of this either via signalling methods or by configuration; this will have to be defined when introducing any such new parameter in the future.

Each instance of the OCI shall be associated by default to the GTP-C entity corresponding to the peer node's IP address of the PDN connection, over which the OCI IE is received, i.e. to the IP address received within the "Sender F-TEID for control plane" IE, the "PGW S5/S8/ S2a/S2b F-TEID for PMIP based interface or for GTP based Control Plane interface" IE or within the "MME/S4-SGSN Identifier" IE.

Alternatively, the GW (i.e. SGW and PGW) nodes may send Overload Control Information which is associated with the GW node's identity, i.e. the FQDN or IP address of the GW node received from the HSS (for a PGW) or the DNS (for an SGW or PGW), the identity determined during the GW selection. In that case, the GW node shall provide an explicit indication that the OCI IE included in the message belongs to the GW node's identity.

## 12.3.5.1.2 Parameters

### 12.3.5.1.2.1 Overload Control Sequence Number

The GTP-C protocol requires retransmitted messages to have the same contents as the original message (see clause 7.6). Due to GTP-C retransmissions, the overload control information received by a GTP-C entity at a given time may be less recent than the overload control information already received from the same GTP-C entity. The Overload Control Sequence Number aids in sequencing the overload control information received from an overloaded GTP-C entity. The Overload Control Sequence Number contains a value that indicates the sequence number associated with the Overload Control Information IE. This sequence number shall be used to differentiate between two OCI IEs generated at two different instants, by the same GTP-C entity.

The Overload Control Sequence Number parameter shall be supported (when supporting the overload control feature) and shall always be present in the Overload Control Information IE.

The GTP-C entity generating this information shall increment the Overload Control Sequence Number whenever modifying some information in the OCI IE. The Overload Control Sequence Number shall not be incremented otherwise. The GTP-C entity may use the time, represented in an unsigned integer format, of the generation of the overload control information, to populate the Overload Control Sequence Number.

When multiple instances of the OCI IE are provided in the same message by a given GTP-C entity, each of the Overload Control Sequence Numbers shall have the same value.

This parameter shall be used by the receiver of the OCI IE to properly collate out-of-order OCI IEs, e.g. due to GTP-C retransmissions. This parameter shall also be used by the receiver of the OCI IE to determine whether the newly received overload control information has changed compared to the overload control information previously received from the same GTP-C entity. If the newly received overload control information has the same Overload Control Sequence Number as the previously received overload control information from the same GTP-C peer, then the receiver may simply discard the newly received overload control information whilst continuing to apply the overload abatement procedures, as per the previous value.



NOTE 1: The timer corresponding to the Period of Validity (see 12.3.5.1.2.2) is not restarted if the newly received overload control information has the same Overload Control Sequence Number as the previously received overload control information. If the overload condition persists and the overloaded GTP-C entity needs to extend the duration during which the overload information applies, the sender needs to provide a new overload control information with an incremented Overload Control Sequence Number (even if the parameters within the overload control information have not changed).

NOTE 2: The GTP-C Sequence Number cannot be used for collating out-of-order overload information as e.g. overload control information may be sent in both GTP-C requests and responses, using independent GTP-C sequence numbering.

If the receiving GTP-C entity already received and stored overload control information, which is still valid, from the overloaded GTP-C entity, the receiving entity shall update its overload control information, only if the Overload-Sequence-Number received in the new overload control information is larger than the value of the Overload Control Sequence Number associated with the stored information. However due to roll-over of the Overload Control Sequence Number or restart of the GTP-C entity, the Overload Control Sequence Number may be reset to an appropriate base value by the peer GTP-C entity, hence the receiving entity shall be prepared to receive (and process) an Overload Control Sequence Number parameter whose value is less than the previous value.

#### 12.3.5.1.2.2 Period of Validity

The Period of Validity indicates the length of time during which the overload condition specified by the OCI IE is to be considered as valid (unless overridden by subsequent new overload control information).

An overload condition shall be considered as valid from the time the OCI IE is received until the period of validity expires or until another OCI IE with a new set of information (identified using the Overload Control Sequence Number) is received from the same GTP-C entity (at which point the newly received overload control information shall prevail). The timer corresponding to the period of validity shall be restarted each time an OCI IE with a new set of information (identified using the Overload Control Sequence Number) is received. When this timer expires, the last received overload control information shall be considered outdated and obsolete, i.e. any associated overload condition shall be considered to have ceased.

The Period of Validity parameter shall be supported (when supporting overload control).

The Period of Validity parameter achieves the following:

- it avoids the need for the overloaded GTP-C entity to include the Overload Control Information IE in every GTP-C messages it signals to its GTP-C peers when the overload state does not change; thus it minimizes the processing required at the overloaded GTP-C entity and its GTP-C peers upon sending/receiving GTP-C signalling;
- it allows to reset the overload condition after some time in the GTP-C peers having received an overload indication from the overloaded GTP-C entity, e.g. if no signalling traffic takes place between these GTP-C entities for some time due to overload mitigation actions. This also removes the need for the overloaded GTP-C entity to remember the list of GTP-C entities to which it has sent a non-null overload reduction metric and to which it would subsequently need to signal when the overload condition ceases, if the Period of Validity parameter was not defined.

#### 12.3.5.1.2.3 Overload Reduction Metric

The Overload Reduction Metric shall have a value in the range of 0 to 100 (inclusive) which indicates the percentage of traffic reduction the sender of the overload control information requests the receiver to apply. An Overload Reduction Metric of "0" always indicates that the GTP-C entity is not in overload (that is, no overload abatement procedures need to be applied) for the indicated scope.

Considering the processing requirement of the receiver of the Overload Control Information, e.g. to perform overload control based on the updated Overload Reduction Metric, the sender should refrain from advertising every small variation, e.g. with the granularity of 1 or 2, in the Overload Reduction Metric which does not result in useful improvement for mitigating the overload situation. During the typical operating condition of the sender, a larger variation in the Overload Reduction Metric, e.g. 5 or more units, should be considered as reasonable enough for advertising a new Overload Reduction Metric Information and thus justifying the processing requirement (to handle the new information) of the receiver.

NOTE: The range of Overload Reduction Metric, i.e. 0 to 100, does not mandate the sender to collect its own overload information at every increment/decrement and hence to advertise the change of Overload Reduction Metric with a granularity of 1%. Based on various implementation specific criteria, such as the architecture, session and signalling capacity, the current load/overload situation and so on, the sender is free to define its own logic and periodicity with which its own overload control information is collected.

The computation of the exact value for this parameter is left as an implementation choice at the sending GTP-C entity.

The Overload Reduction Metric shall be supported (when supporting overload control) and shall always be present in the OCI IE.

The inclusion of the OCI IE signals an overload situation is occurring, unless the Overload Reduction Metric is set to 0, which signals that the overload condition has ceased. Conversely, the absence of the OCI IE in a message does not mean that the overload has abated.

#### 12.3.5.1.2.4 List of APNs

The List of APNs IE indicates one or more APNs for which the Overload Control Information is applicable. When present in the OCI IE, the scope of the overload control information shall be the list of the indicated APNs for the PGW that sends the overload control information. At most one instance of the List of APNs IE shall be included within one Overload Control Information instance.

NOTE 1: The maximum number of APNs in the List of APNs is set to 10. More than 10 occurrences of APN within one single instance of the List of APNs IE is treated as a protocol error by the receiver.

If the List of APNs IE has not been included, the scope of the Overload Control Information shall be the entire GTP-C entity (unless restricted by other parameters in the Overload Control Information IE).

The List of APNs parameter shall be supported (when supporting overload control). The List of APNs may be present or absent in the Overload Control Information IE (depending on the scope of the reported overload control information).

NOTE 2: The instance number of both the node-level and APN-level overload control information is "0" and the instance number is therefore not used to indicate if the scope of the overload control information is on PGW node level or APN level.

This parameter may be provided by the PGW only and it shall be used by the MME/S4-SGSN and the TWAN/ePDG only.

The maximum number of APNs, for which the PGW may advertise the Overload Control Information, shall be limited to 10, i.e. the maximum number of occurrences of APNs within and across various instances of the Overload Control Information IE shall be limited to 10 for a given PGW. Hence, if the PGW supports more than 10 APNs, it shall advertise the overload control for at most 10 of the most important APNs. In future, if needed, this limit may be increased to allow the PGW to advertise the overload information for more APNs. In that case, the receiver that does not support the higher limit shall only handle the first 10 APNs and ignore the overload information for the remaining APNs to enable future compatibility.

NOTE 3: Considering various aspects such as: the processing and storage requirements at the overloaded GTP-C entity and the receiver, the number of important APNs for which overload control advertisement could be necessary, interoperability between the nodes of various vendors, etc. it was decided to define a limit on maximum number of APNs for advertising the overload control information. It was decided to fix this limit to 10 whilst also ensuring that the mechanism exists to extend this limit in future releases, if required.

#### 12.3.5.1.3 Handling of parameters

If the PLMN supports the Overload Control feature (see clause 12.3.11), the support, inclusion and handling of the parameters, within overload control information, is summarized in table 12.3.5.1.3-1.

**Table 12.3.5.1.3-1: Parameters of the Overload Control Information**

Parameter	Support by the sender	Support by the receiver	Inclusion by the sender	Handling by the receiver
Overload Control Sequence Number (as defined in clause 12.3.5.1.2.1)	Mandatory	Mandatory	Mandatory	Mandatory
Period of Validity (as defined in clause 12.3.5.1.2.2)	Mandatory	Mandatory	Mandatory	Mandatory
Overload Reduction Metric (as defined in clause 12.3.5.1.2.3)	Mandatory	Mandatory	Mandatory	Mandatory
List of APNs (as defined in clause 12.3.5.1.2.4)	Mandatory	Mandatory	Optional (NOTE 1)	Conditional (NOTE 2)
NOTE 1: The PGW shall send this parameter whilst providing APN level overload control information.				
NOTE 2: If this parameter is received, the receiver shall handle and process APN level overload control information.				

### 12.3.5.2 Frequency of inclusion

How often or when the sender includes the overload control information is implementation specific. The sender shall ensure that new/updated overload control information is propagated to the target receivers with an acceptable delay, such that the purpose of the information, (i.e. the effective overload control protection) is achieved. The following are some of the potential approaches the sender may implement for including the OCI IE:

- the sender may include OCI IE towards a receiver only when the new/changed value has not already been provided to the given receiver;
- the sender may include the OCI IE in a subset of the messages towards the receiver;
- the sender may include the OCI IE periodically, i.e. include the information during a first period then cease to do so during a second period.

The sender may also implement a combination of one or more of the above approaches. Besides, the sender may also include the OCI IE only in a subset of the applicable GTP-C messages.

The receiver shall be prepared to receive the overload control information received in any of the GTP-C messages extended with an OCI IE and upon such reception, shall be able act upon the received information.

### 12.3.5.3 Limit on maximum number of instances

A GTP-C entity may signal one or multiple instances of the OCI IE, each instance providing overload control information for a different scope. The receiver shall handle all these instances, from each of the peer GTP-C entities, by processing, storing and acting upon the same for overload control. In order to limit the processing of the message on the receiver side and the size of the message, the number of overload control information instances shall be limited:

- at message level: there shall be at most one instance of node-level Overload Control Information IE per node and at most 10 APN-level instances.
- at node level: the maximum number of instances of the OCI IE which may be provided across multiple messages by a given node shall be the same as the maximum number of instances of the OCI IE at message level.

### 12.3.6 Propagating the MME/S4-SGSN identity to the PGW

When the Overload Control feature is supported by the MME/S4-SGSN and the SGW, and it is also activated for the PLMN to which the PGW belongs (see clause 12.3.11), the following shall apply:

- The MME/S4-SGSN shall include the MME/S4-SGSN identity towards the SGW during:
  - the PDN connection establishment, any mobility with an MME/S4-SGSN change or any SGW change procedures;

- the dedicated bearer activation procedure, PGW initiated bearer modification procedure and PGW initiated bearer deactivation procedure as per the conditions specified in the corresponding messages.
- The SGW shall forward the MME/S4-SGSN identifier to the PGW if it is received in the Create/Update/Delete Bearer Response messages. When it is received in other GTP-C messages, the SGW shall store the received MME/S4-SGSN identity and shall include the currently serving MME/S4-SGSN's identity in subsequent Modify Bearer Request messages which are sent over the S5/S8 interface, whenever there is signalling over the S5/S8 interface.

NOTE: This allows updating of the PGW with the identity of the new MME/S4-SGSN during inter-MME/SGSN mobility scenarios as early as possible and without generating extra signalling over the S5/S8 interface. Inter-MME/inter-SGSN intra SGW mobility scenarios not requiring to send any S5/S8 signalling could result in the PGW not being updated with the currently serving MME/S4-SGSN's identity, for a given subscriber, until subsequent S5/S8 signalling takes place for the same PDN connection. However, considering these scenarios are not so frequent and considering that several features anyway require S5/S8 signalling during these scenarios (e.g. for user location reporting), the PGW will most often get the identity of the currently serving MME/S4-SGSN. Hence the risk that the PGW wrongly throttles PGW initiated signalling for that PDN connection, if the old MME/S4-SGSN is in overload, is low.

- The PGW shall store the currently serving MME/S4-SGSN identity, received from the SGW, to be able to reduce the PGW initiated signalling messages for the PDN connections during an overload situation at the serving MME/S4-SGSN.

### 12.3.7 Updating the PGW with overload control information of the target MME/S4-SGSN

During inter-MME/S4-SGSN mobility without SGW change scenarios, the SGW shall forward the MME/S4-SGSN's overload control information over the S5/S8 interface only if the Modify Bearer Request message needs to be sent over the S5/S8 for another reason, e.g. if the ULI, CGI, Serving Network, needs to be reported to the PGW, i.e. the SGW shall not generate a Modify Bearer Request message over the S5/S8 interface for the sole purpose of reporting the MME/S4-SGSN's overload control information. This avoids generating extra signalling over the S5/S8 interface.

NOTE: If the MME/S4-SGSN provides overload control information during the scenarios which do not result in S5/S8 signaling, e.g. during an inter MME/S4-SGSN and intra SGW mobility, when no other information such as: the ULI, CGI or Serving Network, needs to be reported to the PGW, the overload information will not be relayed on to the PGW. Hence, the MME/S4-SGSN needs consider this when including overload control information.

### 12.3.8 The interaction with APN congestion control using the PGW Back-Off Time

When detecting that a given APN is congested, the PGW shall either use the PGW Back-Off Time mechanism (see clause 4.3.7.5 of 3GPP TS 23.401 [3]) or the APN level overload control mechanism (i.e. providing an Overload Control Information IE with an APN-List included) for that APN, but not both together for the same APN, e.g. if the PGW provides an Overload Control Information IE with an APN-List set to "APN1", it shall not reject Create Session Request messages for "APN1" with a PGW Back-Off Time until the Period-Of-Validity of the overload information previously sent has expired.

The PGW may however use both mechanisms concurrently for different APNs, e.g. the PGW may reject Create Session Request messages for the "APN2" with a PGW Back-Off Time IE, if the APN2 is also congested and if there is no on-going APN-level overload control mechanism for that APN.

When rejecting a Create Session Request due to APN congestion, the PGW shall set the "APN Congestion" cause, regardless of the aforementioned mechanisms.

If the MME/S4-SGSN or ePDG/TWAN has one mechanism active for a given APN and PGW, (e.g. an MME has received a PGW Back-Off Time) and if subsequently it receives information for the same APN and PGW for another mechanism, (e.g. the MME receives an Overload Control Info IE with APN-List included for the same APN), then it shall deactivate/stop the earlier mechanism and consider only the information received for the latter mechanism.

Different PGWs may use concurrently different mechanisms for the same APN.

## 12.3.9 Message throttling

### 12.3.9.1 General

As part of the overload mitigation, a GTP-C entity shall reduce the total number of messages, which would have been sent otherwise, towards the overloaded peer based on the information received within the Overload Control Information. This shall be achieved by discarding a fraction of the messages in proportion to the overload level of the target peer. This is called message throttling.

Message throttling shall only apply to initial messages. Triggered request or response messages should not be throttled since that would result in the retransmission of the corresponding request message by the sender.

Before piggybacking the initial message over a response message, the initial message should be subject to the message throttling in the similar manner as any other non-piggybacked initial message. If the node decides to throttle this initial message then the response message should be sent without any piggyback message.

A GTP-C entity supporting GTP-C overload control shall support and use the "Loss" algorithm as specified in this clause, for message throttling.

### 12.3.9.2 Throttling algorithm – "Loss"

#### 12.3.9.2.1 Description

An overloaded GTP-C entity shall ask its peers to reduce the number of requests they would ordinarily send by signalling Overload Control Information including the requested traffic reduction, as a percentage, within the "Overload-Reduction-Metric", as specified in clause 12.3.5.1.2.1.

The recipients of the "Overload-Reduction-Metric" shall reduce the number of requests sent by that percentage, either by redirecting them to an alternate destination if possible (e.g. the Create Session Request message may be redirected to an alternate SGW/PGW), or by failing the request and treating it as if it was rejected by the destination GTP-C entity.

For example, if a sender requests another peer to reduce the traffic it is sending by 10%, then that peer shall throttle 10% of the traffic that would have otherwise been sent to this GTP-C entity.

The overloaded GTP-C entity should periodically adjust the requested traffic reduction based e.g. on the traffic reduction factor that is currently in use, the current system utilization (i.e. the overload level) and the desired system utilization (i.e. the target load level), and/or the rate of the current overall received traffic.

Annex D.3.1 provides an (informative) example of a possible implementation of the "Loss" algorithm, amongst other possible methods.

NOTE 1: This algorithm does not guarantee that the future traffic towards the overloaded GTP-C entity will be less than the past traffic but it ensures that the total traffic sent towards the overloaded GTP-C entity is less than what would have been sent without any throttling in place. If after requesting a certain reduction in traffic, the overloaded GTP-C entity receives more traffic than in the past, whilst still in overload, leading to the worsening rather than an improvement in the overload level, then the overloaded GTP-C entity can request for more reduction in traffic. Thus, by periodically adjusting the requested traffic reduction, the overloaded node can ensure that it receives, approximately, the amount of traffic which it can handle.

NOTE 2: Since the reduction is requested as a percentage, and not as an absolute amount, this algorithm achieves a good useful throughput towards the overloaded node when the traffic conditions vary at the source nodes (depending upon the events generated towards these source nodes by other entities in the network), as a potential increase of traffic from some source nodes can possibly be compensated by a potential decrease of traffic from other source nodes.

### 12.3.9.3 Message prioritization

#### 12.3.9.3.1 Description

When performing message throttling:

- GTP requests related to priority traffic (i.e. eMPS as described in 3GPP TS 22.153 [62]) and emergency have the highest priority. Depending on regional/national requirements and network operator policy, these GTP requests shall be the last to be throttled, when applying traffic reduction, and the priority traffic shall be exempted from throttling due to GTP overload control up to the point where the requested traffic reduction cannot be achieved without throttling the priority traffic;
- for other types of sessions, messages throttling should consider the relative priority of the messages so that the messages which are considered as low priority are considered for throttling before the other messages. The relative priority of the messages may be derived from the relative priority of the procedure for which the message is being sent (as specified in clause 12.3.9.3.2) or may be derived from the session parameters (as specified in clause 12.3.9.3.3).

NOTE: A random throttling mechanism, i.e. discarding the messages without any special consideration, could result in an overall poor congestion mitigation mechanism and bad user experience.

An overloaded node may also apply these message prioritization schemes when handling incoming initial messages during an overloaded condition, as part of the self-protection mechanism (see clause 12.3.10.2.3).

### 12.3.9.3.2 Based on procedures

Message prioritization may be performed based on the relative priority of the procedure for which the message is being sent. Procedures are grouped into various categories and each of these categories is assigned a priority. Additionally, within a given category of procedures, messages may be further prioritized based on session parameters such as: APN, QCI, ARP and/or LAPI (as described in clause 12.3.9.3.3).

Subsequently, messages with a high priority shall be given lower preference to throttle and messages with low priority shall be given higher preference to throttle.

The grouping of the procedures is not performed based on an individual GTP-C entity but whilst considering all the procedures in general. A GTP-C entity should consider the procedures applicable to it and apply prioritized message throttling based on the category of the procedure, as described below. The categories are listed in decreasing order of priority with category 1 having the highest priority. For each category a non-exhaustive list of messages is provided. Any existing or newly defined message in future should be considered based on the category (as specified below) of the procedure for which the message is sent.

1. **UE session mobility within and across 3GPP or non-3GPP access:** Procedures involving active or idle mode UE mobility, such that GTP-C signalling is involved, shall be classified under this category. Some examples are X2/S1 based handover with/without an SGW change, TAU/RAU with a change of MME/SGSN with/without an SGW change, 3GPP access to trusted non-3GPP access handover, etc. Throttling of these messages, during the procedures related to UE session mobility, would result in the failure of the corresponding procedures. This could result potentially in the loss of the PDN connection and/or the interruption of the services. Hence, the messages, as identified below, when sent during the procedures belonging to this category, shall be considered with the highest priority and hence, shall be given the lowest preference to throttle.
  - Create Session Request,
  - Create Session Request with "handover" indication bit set,
  - Modify Bearer Request,
  - Modify Bearer Request with "handover" indication bit set,
  - Modify Access Bearer Request.
2. **Release of PDN connection or bearer resources:** Procedures resulting in the deactivation of an existing PDN connection, the deactivation of bearer(s) or of data forwarding tunnel of an UE leads to freeing up of the resources at the overloaded node and hence, can potentially ease the overload situation, since the freed up resources can be used for serving the remaining of the UEs. Thus, the messages belonging to this category resulting in the deactivation of PDN connection or bearer(s) or data forwarding tunnel(s), as identified below, shall be treated with the next lower level of priority and hence shall be given the corresponding preference whilst throttling:
  - Delete Session Request,

- Delete Bearer Request,
  - Delete Bearer Command,
  - Delete Indirect Data Forwarding Tunnel Request.
3. **Miscellaneous session management procedures:** This category shall consist of the session management procedures, except PDN connection creation and bearer creation/modification procedures. Some examples are location reporting, when it is not combined with other mobility procedures, Service request and S1 release procedure. These procedures do not severely impact the on-going service of the UE. Hence, the messages, as identified below, when sent during the procedures identified under this category, shall be treated with the next lower level of priority and hence, shall be given the corresponding preference whilst throttling:
- Release Access Bearer Request,
  - Modify Bearer Request,
  - Change Notification,
  - Suspend Notification,
  - Resume Notification.
4. **Request for new PDN Connection or bearer resources:** Procedures requesting the creation of PDN connection, creation or modification of bearer(s) or creation of data forwarding tunnel shall be classified in this category. Throttling of the messages belonging to this category would result in denial of new services while continuing with the existing services. However, this is the natural outcome of an overload condition, i.e. the overloaded node, due to lack of resources, is not able to provision new services while the trying to maintain the existing services and hence, the messages, as identified below, when sent during the procedures belonging to this category, shall be considered with the lowest level of priority and hence shall be given highest preference to throttle:
- Create Session Request during PDN connection request,
  - Create Bearer Request,
  - Update Bearer Request,
  - Bearer Resource Command,
  - Modify Bearer Command,
  - Create Indirect Data Forwarding Tunnel Request.

#### 12.3.9.3.3 Based on session parameters

Message prioritization may be performed based on the session parameters, such as: APN, QCI, ARP and/or Low Access Priority Indicator (LAPI). The procedures and messages associated with the higher priority sessions shall be given lesser preference whilst throttling, as compared to the procedures and messages associated with the lower priority sessions. Within each group of sessions, the messages may be further prioritized based on the category of the procedure for which the message is being sent (as described in clause 12.3.9.3.2).

**NOTE:** This type of prioritization scheme ensures a good handling of all the messages and procedures related to higher priority sessions but can lead to throttle messages related to a critical procedure, e.g. UE mobility, for lower priority sessions over messages related to less critical procedures, e.g. location reporting, for a higher priority session.

#### 12.3.9.3.4 Based on the Message Priority signalled in the GTP-C message

Message prioritization may be performed by an overloaded node, when handling incoming messages during an overloaded condition, based on the relative GTP-C message priority signalled in the GTP-C header (see clauses 5.4 and 5.5).

A GTP-C entity shall determine whether to set and use the message priority in GTP-C signalling within the PLMN and/or across the PLMN boundaries, based on operator policy and roaming agreements. The following requirements shall apply if being used.

A sending GTP-C entity shall determine the relative message priority to signal in the message according to the principles specified in clause 12.3.9.3.1. If the message affects multiple bearers (e.g. Modify Bearer Request), the relative message priority should be determined considering the highest priority ARP among all the bearers.

A GTP-C entity should set the same message priority in a Triggered message or Triggered Reply message as received in the corresponding Initial message or Triggered message respectively.

The message priority values sent on intra-network interfaces may differ from the values sent on inter-network interfaces. When messages cross PLMN boundaries, the Message Priority in the GTP-C header may be stripped or modified in these messages.

NOTE : This is to take into account that the priority definitions can vary between PLMNs and avoid messages from a foreign PLMN to gain unwarranted preferential treatment.

For incoming GTP-C messages that do not have a message priority in the GTP-C header, the receiving GTP-C entity:

- shall apply a default priority, if the incoming message is an Initial message;
- should apply the message priority sent in the Initial message or Triggered message, if the incoming message is a Triggered or Triggered Reply message (respectively).

This feature should be supported homogenously across the nodes in the network, otherwise an overloaded node will process initial messages received from the non-supporting nodes according to the default priority while initial messages received from supporting nodes will be processed according to the message priority signalled in the GTP-C message.

## 12.3.10 Enforcement of overload control

### 12.3.10.1 General

When a GTP-C entity receives Overload Control Information from its peer, it shall apply the overload abatement algorithm, based on the received information, for the messages sent towards the peer GTP-C entity. This is called "enforcement of overload control" and it involves throttling of the messages targeted for the overloaded peer.

### 12.3.10.2 Aspects related to enforcement of the overload control

#### 12.3.10.2.1 Good throughput of the network

A source GTP-C entity should avoid any mechanism resulting in over throttling of the messages. Enforcement of the overload control whilst ensuring that good throughput (i.e. measured in terms of the rate of total number of messages the overloaded GTP-C entity can successfully process) of the network remains consistent to that when no overload control is applied, should be one of the prime objective of the source GTP-C entity.

NOTE: Over throttling of messages would negatively affect end user services and cause potential additional signalling in the network e.g. if the corresponding procedure is retried at a later time.

#### 12.3.10.2.2 Message processing efficiency at the source GTP-C entity

Enforcement of overload control requires extra logic and extra processing at the source GTP-C entity. This is an overhead since the source GTP-C entity has to spend its resources in an activity other than processing of the messages. Hence, the implementation as well as the processing complexity of the enforcement of the overload control, should not result in a significantly poorer efficiency of the source GTP-C entity.

#### 12.3.10.2.3 Self-protection by the overloaded GTP-C entity

A source GTP-C entity enforcing the overload control cannot ensure that the overloaded peer will not receive more messages than what it can handle during the overload condition, e.g. the "loss" algorithm does not guarantee that the future traffic reaches perfectly that requested by the overloaded GTP-C entity. Hence, the overloaded target GTP-C entity shall protect itself from the risk of meltdown even in a network where all the sending GTP-C entities support the



overload control mechanism. As a part of this self-protection, the overloaded target GTP-C entity may reject the messages which it cannot handle during an overloaded state. A GTP-C entity which decides to not process an incoming request message due to overload should still send a reject response message, if possible, indicating the temporary unavailability of the resources; otherwise the request message may be dropped.

**NOTE:** Without a response message, the source GTP-C entity cannot determine whether the request did not reach the target GTP-C entity due to a network error or whether the target GTP-C entity was in overload and not able to process the request and send a response message. This will cause the source GTP-C entity to retransmit the request message and hence will increase further the overload at the target node.

The GTP-C entity may apply message prioritization as described in clause 12.3.9.3 when selecting the incoming request messages to be throttled.

While rejecting the message due to overload, the GTP-C entity shall set the cause to "GTP-C Entity Congestion" or "APN congestion" (for node level or APN level overload respectively) and may include the Overload Control Information in the rejection response as specified in clauses 12.3.5.1.1 and 12.3.11.

### 12.3.10.3 Enforcement of overload control between GTP-C entities in direct contact

A source GTP-C entity shall enforce overload control for traffic destined to a GTP-C entity in direct contact based on the overload reduction metric received from that peer, e.g. the MME applies the overload control for the messages targeted for the SGW based on the overload information of the SGW.

### 12.3.10.4 Enforcement of overload control between remote GTP-C entities

#### 12.3.10.4.1 Description

For messages destined to a remote GTP-C entity (i.e. a GTP-C entity not in direct contact but reached via an intermediate GTP-C entity), the source GTP-C entity shall enforce the overload control based on the overload information of the target of the message, as well as the overload information of the intermediate GTP-C entity, e.g. the MME applies the overload control for messages targeted for the PGW based on the overload information of the SGW and PGW.

For the received messages, the intermediate GTP-C entity shall not further enforce any overload control and hence, shall not reject any message towards the source GTP-C entity.

Annex D.4.1 provides an (informative) example of a possible implementation.

**NOTE 1:** This approach ensures the overload protection of the Target as well as Intermediate GTP-C entities.

**NOTE 2:** The source GTP-C entity may be connected to the same Target GTP-C entity via multiple different Intermediate GTP-C entities. The exact algorithm used at the source GTP-C entity to enforce the overload control, as per the aforementioned requirements, is implementation specific.

### 12.3.11 Discovery of the support of the feature by the peer node

A GTP-C entity shall determine whether to use the overload control feature:

- within the PLMN, based on operator's policy (local PLMN-wide configuration);
- across the PLMN boundaries, based on operator's policy (local configuration per PLMN).

**NOTE:** The feature can be activated when all or some of the nodes in the PLMN support the feature. The GTP-C entity assumes that all the peer nodes support this feature when the feature is activated, i.e. it does not need to determine which peers support the feature.

The above operator policy/local configuration may allow the use of overload control at node level and APN level, or none.

### 12.3.12 Issues in the network with partial support of the feature

The Overload Control feature should be supported homogeneously across the nodes in the network, otherwise:

- an overloaded node will get messages beyond its acceptable processing capacity, even after announcing its overload status. This may result in severe overload and possibly a breakdown of the node;
- a non-supporting node will get an unfair advantage in sending all the messages to an overloaded node, whereas a supporting node, would be requested to throttle more messages.

### 12.3.13 Implicit overload control mechanisms

Implicit overload control mechanisms are mechanisms used between GTP-C entities when GTP-C overload control is not supported or not enabled between them, e.g. across PLMN boundary based on operator's policy, to help reducing the overload at the overloaded node:

- a GTP-C entity which decides to not process an incoming request message due to overload should still send a reject response message, if possible, indicating the temporary unavailability of the resources, e.g. No resources available; otherwise the GTP-C entity may drop the incoming request message.

NOTE: Without a response message, the source GTP-C entity cannot determine whether the request did not reach the target GTP-C entity due to a network error or whether the target GTP-C entity was in overload and not able to process the request and send a response message. This will cause the source GTP-C entity to retransmit the request message and hence will increase further the overload at the target node.

- a GTP-C entity in overload may support messages throttling as a self protection mechanism and may apply message prioritization as described in clause 12.3.9.3 when selecting the incoming request messages to be throttled;
- based on the number and rate of reject responses indicating temporary unavailability of resources, e.g. No resources available, a source GTP-C entity should try to assess the overload level of the target GTP-C entity and apply correspondingly message throttling as described in clause 12.3.9 to reduce the amount of traffic sent towards the overloaded GTP-C entity.

---

## 13 Detection and handling of late arriving requests

### 13.1 General

The procedures specified in this clause aim at handling more efficiently requests which may arrive late at upstreams entities, e.g. in networks experiencing processing or transport delays.

These procedures are optional to support. When supported, the use of these procedures is dependent on operator policy.

The procedure specified in clause 13.2 may be used with or without the procedure specified in clause 13.3. The procedure specified in clause 13.3 shall only be used in conjunction with the procedure specified in clause 13.2.

### 13.2 Detection and handling of requests which collide with an existing session context

#### 13.2.1 General

This procedure enables an entity, which receives a request colliding with an existing session context, to know the time at which the new request and the existing session were originated, and to accept the new request only if it is more recent than the existing session.

The originating entities within the PLMN (i.e. MME, SGSN, TWAN and ePDG) shall be NTP synchronized.

#### 13.2.2 Principles

The following principles shall apply if this procedure is supported and enabled by operator policy.

A GTP-C entity originating a Create Session Request (i.e. MME, SGSN, TWAN or ePDG) shall include in the message the Origination Time Stamp indicating the absolute time at which the request is initiated.

The SGW shall forward this parameter over the S5/S8 interface, if it is received from the MME/SGSN.

Upon receipt of a session establishment request which collides with an existing session context, the PGW shall accept the new session establishment request only if it contains a more recent time stamp than the time stamp stored for the existing session. An incoming session request shall be considered as more recent than an existing session and be accepted if no Origination Time Stamp information was provided for at least one of the two sessions. The PGW shall reject an incoming request whose time stamp is less recent than the time stamp of the existing session with the cause 'Late Overlapping Request'.

3GPP TS 29.212 [29] and 3GPP TS 29.273 [68] further specify:

- the PGW requirements regarding the forwarding of the Origination Time Stamp parameter over the Gx and/or S6b interfaces, when received from the SGW or TWAN/ePDG;
- the handling of the Origination Time Stamp parameter by the PCRF and 3GPP AAA Server for an incoming request colliding with an existing session context.

An originating entity which detects a NTP failure shall not include the Origination Time Stamp towards other entities.

## 13.3 Detection and handling of requests which have timed out at the originating entity

### 13.3.1 General

This procedure enables an entity which receives a request to know when the request times out at the originating entity, and to stop further processing, at the receiver and further upstream entities, a request which has timed out at the originating entity.

The originating entities (i.e. MME, SGSN, TWAN and ePDG) and the receiving entities (i.e. SGW, PGW, PCRF, 3GPP AAA Server) shall be NTP synchronized. This procedure may be used between entities pertaining to the same PLMN, and if allowed by operator policy, between entities pertaining to different PLMNs.

This procedure shall not affect the setting of the retransmission timers by intermediate entities. E.g. the SGW shall set its T3 and N3 retransmission parameters as specified in this specification, irrespective of the time at which the request times out at the originating entity.

### 13.3.2 Principles

The following principles shall apply if this procedure is supported, enabled by operator policy and if the PGW pertains to the same PLMN as the originating entity or if the PGW pertains to a different PLMN and operator policy in the originating entity allows to use this procedure towards this PLMN.

A GTP-C entity originating a Create Session Request (i.e. MME, SGSN, TWAN or ePDG) shall include in the message the Origination Time Stamp indicating the absolute time at which the request is initiated, as specified in clause 13.2.2, and the Maximum Wait Time indicating the maximum time period to complete the processing of the request. The Maximum Wait Time, together with the Origination Time Stamp, indicates the absolute time at which the request times out at the originating entity.

The MME/SGSN shall set the Maximum Wait Time to a value smaller or equal to  $(N3+1) \times T3$  set in the SGW, to avoid upstream entities continuing to process requests which would have ceased to be processed by the SGW, which could result in hanging contexts in upstream entities.

NOTE 1: If the Maximum Wait Time is set to a value smaller than  $N3 \times T3$  set in the SGW, the SGW actually stops retransmitting a given GTP-C Create Session Request as soon as it receives a rejection response from the PGW due to the expiry of the Maximum Wait Time. I.e. the Maximum Wait Time actually leads to shorten the duration during which the SGW retransmits the GTP-C request.

The SGW shall forward the Origination Time Stamp over the S5/S8 interface as specified in clause 13.2.2. The SGW shall also forward the Maximum Wait Time over the S5/S8 interface, if received from the MME/SGSN.

Upon receipt of a request which contains the Origination Time Stamp and the Maximum Wait Time parameters, the receiving entity should check that the request has not already timed out at the originating entity. The receiving entity may perform additional similar checks during the processing of the request, e.g. upon receipt of a response from the next upstream entity.

The receiving entity should reject a request that is known to have timed out with the cause 'Timed Out Request'; it may alternatively drop the request. Besides, the receiving entity should initiate the release of any session it may have successfully created towards an upstream entity, to avoid hanging sessions in the network.

NOTE 2: Sending a rejection response over the last hop towards the originating node, i.e. over S11/S4 or S2a/S2b, is not useful as the request has timed out at the originated entity.

In the context of this specification, the receiving entity refers to an SGW or PGW.

3GPP TS 29.212 [29] and 3GPP TS 29.273 [68] further specify:

- the PGW requirements regarding the forwarding of the Maximum Wait Time parameter over the Gx and/or S6b interfaces, when received from the SGW or TWAN/ePDG;
- the handling of the Maximum Wait Time parameter by the PCRF and 3GPP AAA Server.

An originating entity which detects a NTP failure shall not insert the Origination Time Stamp and the Maximum Wait Time parameters towards other entities. A receiving entity which detects a NTP failure shall ignore the the Maximum Wait Time parameter.

---

## 14 Handling of Bearer Contexts Mismatch

### 14.1 General

Bearer Contexts mismatch among different EPC entities, e.g. MME/SGW/PGW, can happen due to various reasons, e.g. transport network delay, signalling overload.

### 14.2 Detection of Bearer Context Mismatch

Bearer Context mismatch can be detected by a receiving GTP-C entity in the following cases:

- when at least one dedicated bearer context in the request message is unknown; or
- when at least one dedicated bearer context is missing in the request message in comparison to the bearer contexts stored; or
- when receiving a response message indicating that one of the dedicated bearer context(s) was unknown, by using the cause code "Context not found" at the Bearer Context level. See also clause 8.4.

The Modify Bearer Request/Response and the Modify Access Bearer Request/Response in particular enables an easy detection of bearer contexts mismatch since all the bearer contexts, either of the PDN connection for a Modify Bearer Request/Response or of all the UE's PDN connections for a Modify Access Bearer Request/Response, need to be included in the messages.

### 14.3 Handling of Bearer Context Mismatch

#### 14.3.1 General

The following requirements should apply:

- 1) When an EPC entity receives a response message, where one or more dedicated bearer context(s) is associated with the Cause code "Context Not Found" while the PDN connection is known by the peer, the EPC entity shall delete the corresponding bearer context(s);
- 2) When an SGW receives a Modify Bearer Request, where one or more dedicated bearer context(s) is missing in the request message in comparison to the Bearer Context(s) stored for the UE's PDN connection, the SGW shall accept the Modify Bearer Request message and delete the corresponding bearer context(s) locally. The PGW shall apply the same behavior if the Modify Bearer Request received at the PGW includes the Bearer Contexts to be modified IE;
- 3) When a SGW receives a Modify Bearer Request, where only one or more dedicated bearer context(s) is unknown, the SGW shall accept the Modify Bearer Request message partially and set the cause code "Context Not Found" for those unknown bearer context(s) at Bearer Context level. The PGW shall apply the same behavior if the Modify Bearer Request received at the PGW includes the Bearer Contexts to be modified IE;
- 4) When a SGW receives a Modify Access Bearer Request, where one or more dedicated bearer context(s) is missing in the request message in comparison to the Bearer Context(s) stored for all the UE's PDN connections, the SGW shall delete the corresponding bearer context(s) locally;
- 5) When a SGW receives a Modify Access Bearer Request, where only one or more dedicated bearer context(s) is unknown, the SGW shall accept the Modify Access Bearer Request message partially and set the cause code "Context Not Found" for those unknown bearer context(s) at Bearer Context level.

NOTE: It is assumed the PGW can at least use a subsequent Modify Bearer Request to resolve Bearer Context mismatch, so that the SGW need not send explicit message to delete unknown Bearer Context.

### 14.3.2 Exceptional scenarios

During a dedicated bearer creation procedure, temporary Bearer Context mismatch may occur at the SGW, e.g. due to the collision between Create Bearer Request and Modify (Access) Bearer Request messages. Applying the general requirements of clause 14.3.1 may in such case lead to unnecessary signalling and cause extra latency. The SGW should handle such Bearer Context mismatch in an implementation specific way, but in such a way to accept the Modify (Access) Bearer Request message and to not locally delete the missing Bearer Context.

During a Network Triggered Service Request procedure, which is triggered by a dedicated bearer creation procedure towards a UE in Idle mode, the MME shall include only the existing Bearer Contexts (not the new Bearer Contexts just created) in the corresponding Modify (Access) Bearer Request message. The same principle shall apply when piggybacking is used, i.e. when the Modify Bearer Request is piggybacked in the Create Bearer Response message, the MME shall include only the existing Bearer Contexts (not the new Bearer Contexts just created) in the corresponding Modify (Access) Bearer Request message.

NOTE: During a Network Triggered Service Request procedure, which is triggered by a dedicated bearer creation procedure towards a UE in Idle mode, bearer mismatches can be avoided by the MME sending the Create Bearer Response only after it receives the Modify Bearer Response message, however in some rare cases, the signalling can be delayed for the UE, e.g. if the Modify Bearer Response is lost.

---

## Annex A (Informative): Backward Compatibility Guidelines for Information Elements

In order to preserve backward compatibility, the following rules should apply when adding or modifying information elements for existing messages.

- No new mandatory (M) information elements should be added.
  - No new conditional (C) information elements should be added.
  - Any new IEs should be either:
    - optional (O), having no conditions on their presence, or
    - conditional-optional (CO), having conditions that should apply only to the sender and not to the receiver.
- Such conditions should be worded generally as follows: "This IE shall be sent over the xxx interface <condition>. The receiving entity need not check the IE's presence."
- If any new conditions are added to a previously specified conditional (C) information element, these new conditions should apply only to the sender and not to the receiver.

Such additional conditions should be worded generally as follows: "This IE shall be sent over the xxx interface <condition>. For this optional condition, the receiving entity need not check the IE's presence."

Existing conditions for such conditional (C) IEs should be treated as before, and the presence of the IEs should remain conditional (C).

---

# Annex B (Informative): Transparent copying of RANAP/S1AP/NGAP IEs into GTP IEs

## B.1 General

This annex provides details on how a GTPv2 entity transparently copies information received from RANAP or S1AP or NGAP into GTPv2 IE or IE field.

RANAP and S1AP ASN.1 encoding details in this annex are informative. The reference specifications are 3GPP TS 25.413 [33], 3GPP TS 36.413 [10] and 3GPP TS 38.413 [84] respectively.

The respective RANAP/S1AP/NGAP Information Elements are transported on the Iu/S1 interface within a "protocol-IE container" which is composed of:

- an Information Element Identity (referred to below as "IE-ID"),
- an indication how the receiver shall react if the Information Element is not comprehended (referred to below as "criticality"),
- and an "open type field" which consists of a length indication ("OT-LI") and the Information Element itself (referred to below as "IE").

RANAP/S1AP/NGAP PDUs and the contained IEs are defined by means of ASN.1, the specified encoding is PER (packed encoding rule), Octet aligned variant:

- PER minimises the information sent on the respective interface to the absolute minimum;
- Hence, type definitions of fixed length are encoded without any type or length indication, only type definitions of variable length contain a length indication, e.g.
  - an OCTET STRING with indefinite length would need to contain a length indication (referred to below as "OCT-LI") followed by the actual octets (referred to below as "octets");
  - a SEQUENCE neither contains a type, nor a length-indication. Only in case of optional elements it contains a kind of bit string with each position of this bitstring indicating the presence of an OPTIONAL element (an encoded SEQUENCE type is referred to below as "sequence").

---

## B.2 Handover/Relocation related generic transparent Containers over RANAP, S1-AP and GTP

Handover/Relocation related generic transparent containers are defined in 3GPP TS 25.413 [33] and 3GPP TS 36.413 [10] ("Source to Target Transparent Container" IE and "Target to Source Transparent Container" IE) to carry UTRAN, E-UTRAN or GERAN specific information via CN interfaces in a RAT-agnostic way.

The encoding of these handover/relocation related generic transparent containers is different in RANAP and S1-AP. See 3GPP TS 36.413 [10] Annex C. The difference is that the "Source to Target Transparent Container" IE and "Target to Source Transparent Container" IE are ASN.1 encoded over RANAP as "IE-ID||criticality||OT-LI||octets" (i.e. one length field only for the open type field) and over S1AP as "IE-ID||criticality||OT-LI||OCT-LI||octets" (i.e. with 2 length fields, one for the open type field ("OT-LI"), one for the octet string encoding ("OCT-LI")), while "octets" contain the actual RAT specific handover/relocation information.

This gives the following chain of encodings (represented in the notation introduced in the Notes above) end-to-end.

### LTE to LTE

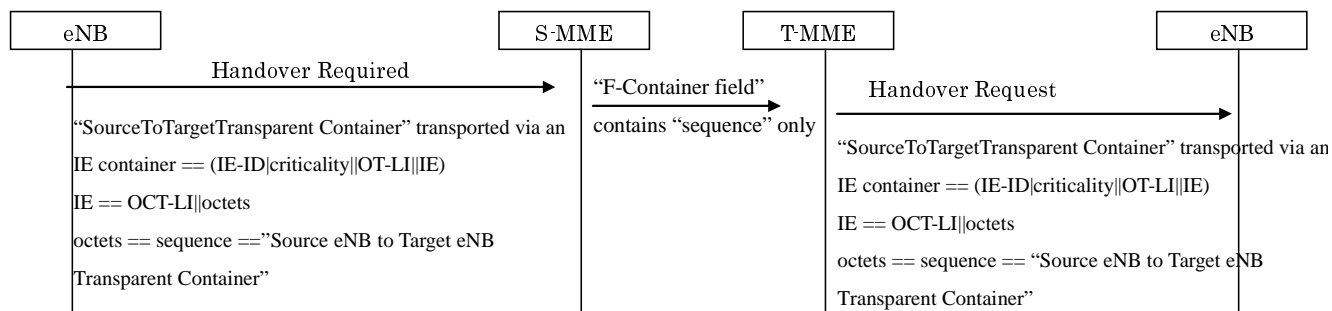

Figure B.2-1: LTE to LTE - Encoding of Generic Transparent Containers

In the case of LTE-LTE handover, the "octets" contain the "Source eNB to Target eNB Transparent Container" (defined as an ASN.1 SEQUENCE in 3GPP TS 36.413[10]).

The source MME, after decoding the HO REQUIRED message of S1AP, passes transparently the "sequence" to the target MME.

The target MME encodes similarly at target side with the same definitions: it feeds the received "sequence" into the S1AP ASN.1 encoder in order to encode the HO REQUEST message towards the target eNB. The "sequence" is then extracted from the S1AP ASN.1 of eNB and given to application part of eNB.

**LTE to 3G**

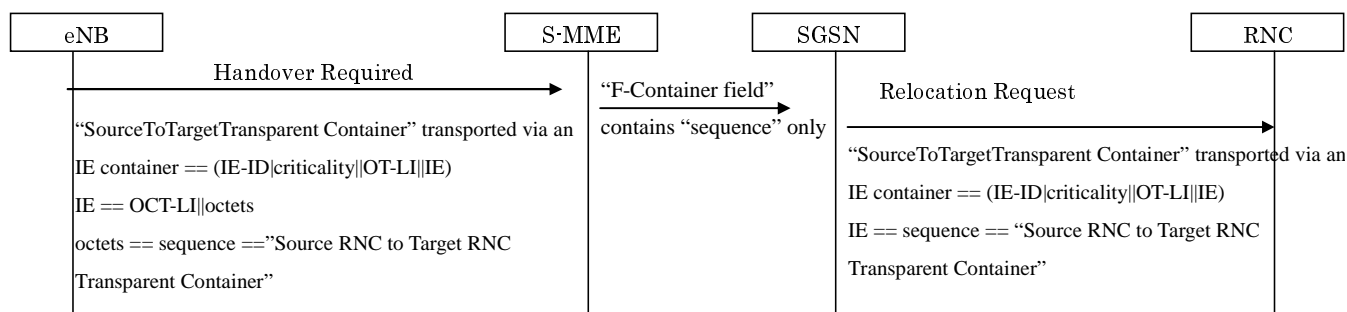

Figure B.2-2: LTE to 3G - Encoding of Generic Transparent Containers

At source side, the same encoding is done but for LTE to 3G handover, this time the "octets" on the line is the "Source RNC to Target RNC Transparent Container" (encoded according to the target system RANAP i.e. as an ASN.1 SEQUENCE in 3GPP TS 25.413 [33]).

Again the source MME passes transparently the "sequence" to the target MME i.e. the "Source RNC to Target RNC Transparent Container".

At the target side, the RANAP RELOCATION REQUEST message was not upgraded: the "sequence" received from the Gn or S3 interface ("Source RNC to Target RNC Transparent Container") is not encoded as an OCTET STRING as on S1, but directly represent the "Source To Target Transparent Container" within the RANAP:RELOCATION REQUEST message, which in case of inter-RAT handover to 3G represent the "Source RNC to Target RNC Transparent Container", transported on the Iu interface as the "IE" part of the "IE container". There is no additional length field added as on the S1 interface ("OCT-LI").

The target side remains therefore fully backwards compatible with UMTS release 7.

**3G to LTE**



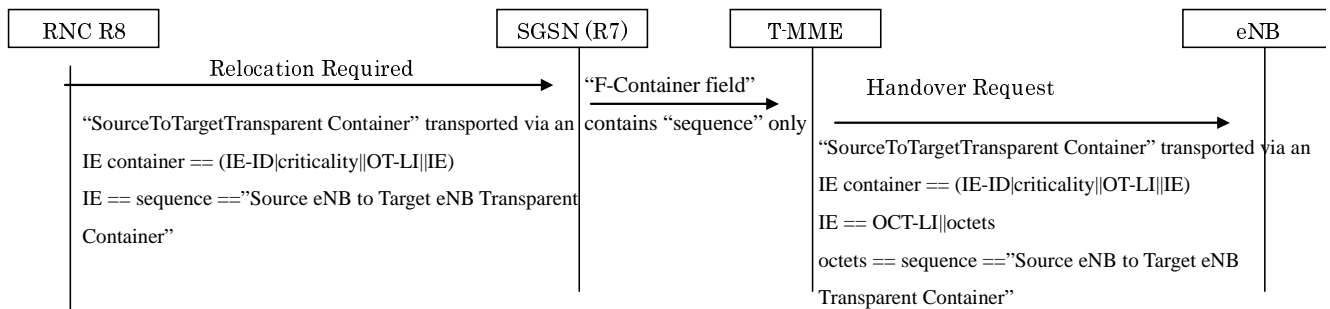

Figure B.2-3: 3G to LTE - Encoding of Generic Transparent Containers

The RELOCATION REQUIRED message was upgraded from release 8 onwards renaming the previously contained "Source RNC to Target RNC Transparent Container" to "Source to Target Transparent Container", being able to transport also a "Source eNB to Target eNB Transparent Container".

Despite being defined as an octet string, in order to not impact the R7 SGSN, the octet string was specified as "to be replaced" by either the UTRAN or E-UTRAN specific container. This fact is explained e.g. within the NOTE in the ASN.1 of 3GPP TS 25.413 [33] ], as shown in this excerpt:

```

Source-ToTarget-TransparentContainer ::= OCTET STRING
-- This IE is a transparent container, the IE shall be encoded not as an OCTET STRING but according
to the type specifications of the target system.
-- Note: In the current version of this specification, this IE may either carry the Source RNC to
-- Target RNC Transparent Container or the Source eNB to Target eNB Transparent Container IE as
-- defined in [49]
  
```

By so doing, the Release 7 source SGSN receives only one length field (the "OT-LI") instead of two (the "OT-LI and the "OCT-LI") as if it would receive an "Source RNC to Target RNC Transparent Container" from a Release 7 RNC, ensuring fully Release 7 backwards compatibility as requested by 3GPP TS 23.401 [3] Annex D. This is illustrated in Figure B.1-3 above.

As explained above, this Release 7 backwards compatibility constraint only applies to RANAP to cope with Release 7 SGSN nodes and does NOT apply to LTE. This is why the note is NOT present in the ASN.1 of 3GPP TS 36.413 [10] for LTE i.e. the S1AP octet string does not need "to be replaced".

Then "sequence" is passed transparently to the target MME. The target MME encodes the "sequence" within an OCTET STRING resulting in two length fields as expected by target eNB ASN.1 S1AP decoder.

## B.3 Other RANAP and S1-AP and NGAP IEs

When transparently copying a RANAP/S1AP/NGAP IE, other than the handover/relocation related generic transparent containers (see Annex B.1) into GTP IE, or GTP IE field the following applies:

- a transparent copy of a RANAP/S1AP/NGAP IE, which is transported on the Iu/S1/NG-C interface within a "protocol-IE container", neither includes the Information Element Identity ("IE-ID") nor the "criticality" nor the open type field related length indication ("OT-LI"), but only the Information Element itself ("IE").
- "IE" refers to all parts of the encoded type of the Information Element, i.e. including also any related length indication (in case of types with variable length) and preamble (see ITU-T X.691 [49] for the definition of the term "preamble").

---

## Annex C (Normative): MME/S4-SGSN mapping table between S11/S4 and NAS Cause values

The MME/S4-SGSN initiates session management requests towards the SGW and PGW or mobility management requests towards the source/target MME/S4-SGSN. If this operation is not successful, there are several possible cause codes, which need to be mapped to the appropriate cause codes over NAS to the UE.

Additionally, the MME/S4-SGSN initiates session management requests towards the UE. If this operation is not successful, there are several possible NAS cause codes which need to be mapped to the appropriate GTP cause codes over S11/S4 interface towards the SGW.

The MME/S4-SGSN should map these cause codes as defined in tables C.1 to C.5 unless specified otherwise in the tables.

**Table C.1: Mapping from S11/S4 to NAS Cause values – Rejection indication from SGW**

Reject indication from SGW to MME/S4-SGSN over S11/S4	NAS ESM Cause to UE (NOTE 1, NOTE 2, NOTE 3)	SM Cause to UE (NOTE 1, NOTE 2, NOTE 3)
#64 "Context not found" (during UE initiated PDN connectivity request for non-3GPP to 3GPP handover procedure)	#54 "PDN connection does not exist"	#30 "Activation rejected by GGSN, Serving GW or PDN GW" #31 "Activation rejected, unspecified"
#64 "Context not found" (during all other procedures)	#30 "Request rejected by Serving GW or PDN GW" #38 "Network failure" #43 "Invalid EPS bearer identity"	#30 "Activation rejected by GGSN, Serving GW or PDN GW" #38 "Network failure" #43 "Unknown PDP Context"
#65 Invalid Message Format	#30 "Request rejected by Serving GW or PDN GW" #38 "Network failure"	#30 "Activation rejected by GGSN, Serving GW or PDN GW" #38 "Network failure"
#66 "Version not supported by next peer"	#30 "Request rejected by Serving GW or PDN GW" #38 "Network failure"	#30 "Activation rejected by GGSN, Serving GW or PDN GW" #38 "Network failure"
#67 "Invalid length"	#30 "Request rejected by Serving GW or PDN GW" #38 "Network failure"	#30 "Activation rejected by GGSN, Serving GW or PDN GW" #38 "Network failure"
#68 "Service not supported"	#32 "Service option not supported"	#32 "Service option not supported"
#69 "Mandatory IE incorrect"	#30 "Request rejected by Serving GW or PDN GW" #38 "Network failure"	#30 "Activation rejected by GGSN, Serving GW or PDN GW" #38 "Network failure"
#70 "Mandatory IE missing"	#30 "Request rejected by Serving GW or PDN GW" #38 "Network failure"	#30 "Activation rejected by GGSN, Serving GW or PDN GW" #38 "Network failure"
#72 "System Failure"	#34 "Service option temporarily out of order" #38 "Network Failure" #30 "Request rejected by Serving GW or PDN GW"	#34 "Service option temporarily out of order" #38 "Network failure" #30 "Activation rejected by GGSN, Serving GW or PDN GW"
#73 "No Resources available"	#34 "Service option temporarily out of order" #26 "Insufficient resources"	#34 "Service option temporarily out of order" #26 "Insufficient resources"
#76 "Semantic errors in packet filter(s)"	#44 "Semantic errors in packet filter(s)"	#44 "Semantic errors in packet filter(s)"
#77 "Syntactic errors in packet filter(s)"	#45 "Syntactical error in packet filter(s)"	#45 "Syntactical error in packet filter(s)"
#78 "Missing or unknown APN"	# 27 "Missing or unknown APN"	# 27 "Missing or unknown APN"
#80 "GRE key not found"	#30 "Request rejected by Serving GW or PDN GW" #38 "Network Failure"	#30 "Activation rejected by GGSN, Serving GW or PDN GW" #38 "Network failure"
#83 "Preferred PDN type not supported"	#32 "Service option not supported" #50 "PDN type IPv4 only allowed" #51 "PDN type IPv6 only allowed"	#32 "Service option not supported" #50 "PDP type IPv4 only allowed" #51 "PDP type IPv6 only allowed"
#84 "All dynamic addresses are occupied"	#26 "Insufficient resources"	#26 "Insufficient resources"
#85 "UE context without TFT already activated"	NA	#46 "PDP context without TFT already activated"
#86 "Protocol type not supported"	#30 "Request rejected by Serving GW or PDN GW" #38 "Network Failure"	#30 "Activation rejected by GGSN, Serving GW or PDN GW" #38 "Network failure"
#89 "Service denied"	#30 "Request rejected by Serving GW or PDN GW" #31 "Request rejected, unspecified" #38 "Network failure"	#30 "Activation rejected by GGSN, Serving GW or PDN GW" #31 "Activation rejected, unspecified" #38 "Network failure"
#91 "No memory available"	#34 "Service option temporarily out of order" #26 "Insufficient resources"	#34 "Service option temporarily out of order" #26 "Insufficient resources"
#92 "User authentication failed"	#29 "User authentication failed" (NOTE 4)	#29 "User authentication failed"
#93 "APN access denied – no subscription"	#33 "Requested service option not subscribed" # 27 "Missing or unknown APN"	#33 "Requested service option not subscribed" # 27 "Missing or unknown APN"

#94 "Request rejected (reason not specified)"	#30 "Request rejected by Serving GW or PDN GW" #38 "Network Failure"	#30 "Activation rejected by GGSN, Serving GW or PDN GW" #38 "Network failure"
#97 "Semantic error in the TAD operation"	#41 "Semantic error in the TFT operation"	#41 "Semantic error in the TFT operation"
#98 "Syntactic error in the TAD operation"	#42 "Syntactical error in the TFT operation"	#42 "Syntactical error in the TFT operation"
#100 "Remote peer not responding"	#34 "Service option temporarily out of order" #38 "Network Failure"	#34 "Service option temporarily out of order" #38 "Network failure"
#101 "Collision with network initiated request"	#56 "Collision with network initiated request"	#56 "Collision with network initiated request"
#103 "Conditional IE missing"	#30 "Request rejected by Serving GW or PDN GW" #38 "Network Failure"	#30 "Activation rejected by GGSN, Serving GW or PDN GW" #38 "Network failure"
#104 "APN Restriction type Incompatible with currently active PDN connection"	#112 "APN restriction value incompatible with active EPS bearer context"	#112 "APN restriction value incompatible with active PDP context"
#107 "Invalid reply from remote peer"	#30 "Request rejected by Serving GW or PDN GW" #31 "Request rejected, unspecified"	#30 "Activation rejected by GGSN, Serving GW or PDN GW" #31 "Activation rejected, unspecified"
#112 "Request rejected for a PMIPv6 reason (see 3GPP TS 29.275 [26])."	#30 "Request rejected by Serving GW or PDN GW" #38 "Network Failure"	#30 "Activation rejected by GGSN, Serving GW or PDN GW" #38 "Network failure"
#113 "APN Congestion" #120 "GTP-C Entity Congestion"	#26 "Insufficient resources"	#26 "Insufficient resources"
#114 "Bearer handling not supported"	#60 "Bearer handling not supported"	#60 "Bearer handling not supported"
#116 "Multiple PDN connections for a given APN not allowed"	#55 "Multiple PDN connections for a given APN not allowed"	#30 "Activation rejected by GGSN, Serving GW or PDN GW" #31 "Activation rejected, unspecified"
#126 "Multiple accesses to a PDN connection not allowed"	#113 "Multiple accesses to a PDN connection not allowed"	#113 "Multiple accesses to a PDN connection not allowed"
NOTE 1: See 3GPP TS 24.301 [23] and 3GPP TS 24.008 [5] for NAS ESM and SM causes respectively.		
NOTE 2: The MME/S4-SGSN may for certain GTP cause codes trigger a new GTP procedure instead of rejecting the NAS request.		
NOTE 3: When multiple NAS Cause values are defined for a given GTP cause value, any of those NAS Cause values may be sent to the UE based on implementation choice.		
NOTE 4: The MME may send in addition the EMM cause code set to #15 "No suitable cells in tracking area" to the UE, if the PDN connectivity request is rejected due to the ESM cause #29, which is mapped from the GTPv2 cause code #92 based on operator policies. See 3GPP TS 24.301 [23]. This enables a roamer to get service in a VPLMN even when being rejected via LTE access due to e.g. no credit authorisation from the OCS.		

**Table C.2: Mapping from S11/S4 to NAS Cause values – Acceptance indication from SGW**

Acceptance indication from SGW to MME/S4-SGN over S11/S4	NAS ESM Cause to UE	SM Cause to UE
#18 "New PDN type due to network preference"	#50 "PDN type IPv4 only allowed" #51 "PDN type IPv6 only allowed" (NOTE 1)	#50 "PDP type IPv4 only allowed" #51 "PDP type IPv6 only allowed" (NOTE 1)
#19 "New PDN type due to single address bearer only"	#52 "single address bearers only allowed"	#52 "single address bearers only allowed"
NOTE 1: The actual NAS cause sent to the UE depends on the allocated IP address type.		

**Table C.3: Mapping from S11/S4 to NAS Cause values – Indication in request from SGW**

Indication in a request / initial message from SGW to MME/S4-SGSN over S11/S4	NAS ESM Cause to UE	SM Cause to UE
#8 "Reactivation Requested" (NOTE 1)	Shall be mapped to: #39 "Reactivation requested" in the NAS bearer context deactivation procedure. For the last PDN connection in E-UTRAN, "Reactivation requested" shall be mapped to "re-attach required" in the NAS detach type IE.	Shall be mapped to: #39 "Reactivation requested" in the NAS bearer context deactivation procedure.
#9 "PDN reconnection to this APN disallowed" (NOTE 1)	Implementation specific NAS cause value indicating to the UE that the APN is not currently available. For the last PDN connection, NAS detach type IE should be set to "re-attach not required".	Implementation specific NAS cause value indicating to the UE that the APN is not currently available.
NOTE 1: In Delete Bearer Request during the PGW initiated bearer deactivation procedure for the default bearer.		

**Table C.4: Mapping from NAS to S11/S4 Cause values – Rejection indication from MME/S4-SGSN**

NAS ESM Cause from UE (NOTE 1)	SM Cause from UE (NOTE 1)	Reject indication from MME/S4-SGSN to SGW over S11/S4 (NOTE 2)
#26 "Insufficient Resources"	#26 "Insufficient Resources"	#73 "No Resources available" #88 "UE refuses"
#31 "Request rejected, unspecified"	#31 "Activation rejected, unspecified"	#94 "Request rejected" #88 "UE refuses"
#41 "Semantic error in the TFT operation"	#41 "Semantic error in the TFT operation"	#74 "Semantic error in the TFT operation"
#42 "Syntactical error in the TFT operation"	#42 "Syntactical error in the TFT operation"	#75 "Syntactical error in the TFT operation"
#43 "Invalid EPS bearer identity"	#43 "Unknown PDP Context"	#64 "Context not found" #88 "UE refuses"
#44 "Semantic errors in packet filter(s)"	#44 "Semantic errors in packet filter(s)"	#76 "Semantic errors in packet filter(s)"
#45 "Syntactical error in packet filter(s)"	#45 "Syntactical error in packet filter(s)"	#77 "Syntactical error in packet filter(s)"
#47 "PTI mismatch"	NA	#94 "Request rejected" #88 "UE refuses"
NA	#48 "Request rejected, Bearer Control Mode violation"	#94 "Request rejected" #88 "UE refuses"
#81 "Invalid PTI value"	NA	#94 "Request rejected" #88 "UE refuses"
NOTE 1: See 3GPP TS 24.301 [23] and 3GPP TS 24.008 [5] for NAS ESM and SM causes respectively. NOTE 2: When multiple GTPv2 Cause values are defined for a given NAS Cause value, any of those GTPv2 Cause values may be sent to the SGW based on implementation choice.		

**Table C.5: Mapping from S3/S16 to NAS Cause values – Rejection indication from MME/S4-SGSN**

<b>Reject indication from MME/S4-SGSN to MME/S4-SGSN over S3/S16</b>	<b>NAS ESM Cause to UE (NOTE 1, NOTE 2)</b>	<b>SM Cause to UE (NOTE 1, NOTE 2)</b>
#117 "Target access restricted for the subscriber"	#15 "No suitable cells in tracking area", or #13 "Roaming not allowed in this tracking area", or #12 "Tracking area not allowed"	#15 "No suitable cells in tracking area", or #13 "Roaming not allowed in this tracking area", or #12 "Tracking area not allowed"
NOTE 1: See 3GPP TS 24.301 [23] and 3GPP TS 24.008 [5] for NAS ESM and SM causes respectively.		
NOTE 2: When multiple NAS Cause values are defined for a given GTP cause value, any of those NAS Cause values may be sent to the UE based on implementation choice.		

---

## Annex D (Informative): GTP-C load and overload control mechanism

### D.1 GTP-C interfaces not supporting Load Control

Load Control has been designed as a generic mechanism possibly applicable to any GTP-C node. However, for the reasons clarified below, in the current release, Load Control is not supported for the following GTP-C based interfaces:

- S3, S10, S16 (limited GTP-C signalling traffic, to minimize impact to the MME/S4-SGSN);
- Sm, Sn (limited GTP-C signalling traffic, to avoid impact to the MBMS GW);
- Sv (limited GTP-C signalling traffic, to avoid impact to the legacy CS products);
- S101, S121 (to avoid impacts to the legacy HRPD products);
- Gn/Gp (to avoid impact to the legacy Gn-SGSN/GGSN products and GTPv1-C protocol).

---

### D.2 GTP-C interfaces not supporting Overload Control

Overload Control has been designed as a generic mechanism possibly applicable to any GTP-C based interface and any direction. However for the reasons clarified below, in the current release, Overload Control is not supported for the following GTP-C based interfaces:

- S3, S10, S16 (see considerations below, to minimize impact to MME and S4-SGSN);
  - most of the S3 traffic would remain internal to the combo-node with the deployment of combo-MME/S4-SGSN nodes. The traffic over S10/S16 is also reduced with the deployment of MME and SGSN pools. It is therefore not essential to throttle the traffic on these interfaces when an MME or S4-SGSN experiences overload;
  - throttling signalling on these interfaces resulting from a user's mobility (inter-MME/S4-SGSN TAU, RAU and Handover) would result in bad end user's perception (handover failure, loss of PDN connections) and so needs to be avoided as far as possible;
  - an MME or S4-SGSN in overload may drop locally incoming RIM messages without causing GTP-C retransmissions (although this may cause the RAN to retransmit the message).
- S11/S4 (from an MME/S4-SGSN to an SGW, with SGW as consumer; see consideration below);
  - by allowing the SGW to throttle DDN requests for normal priority traffic, the overload control of the messages originated by the SGW towards the MME/S4-SGSN is covered and hence, an SGW performing overload control towards the MME/S4-SGSN using Overload Control Information would be redundant.
- S5/S8 (from a PGW to an SGW, with the SGW as a consumer; no signalling message, originated by the SGW towards the PGW, that is identified as requiring overload control);
- Sm, Sn (no overload scenario identified, limited GTP-C traffic, to avoid impact to the MBMS GW);
- Sv (no overload scenario identified, to avoid impact to the legacy CS products);
- S101, S121 (no overload scenario identified, to avoid impact to the legacy HRPD products);
- Gn/Gp (to avoid impact to the legacy Gn-SGSN/GGSN products and GTPv1-C protocol);



## D.3 "Loss" throttling algorithm

### D.3.1 Example of possible implementation

This clause provides an example of a possible implementation of the "Loss" algorithm, amongst other possible methods.

It is possible to make use of a statistical loss function (e.g., random selection of messages to throttle based on the indicated percentage) to decide if the given message can be sent or need to be throttled. For example, the source node generates a random number between (0, 100) for each message which is a potential candidate for throttling. To realize 10% throttling, messages with a random number 10 or less are throttled and hence this achieves approximately a 10% reduction in the overall traffic. The actual traffic reduction might vary slightly from the requested percentage, albeit by an insignificant amount.

The algorithm can select certain messages to throttle in priority. For example, implementations can distinguish between higher-priority and lower-priority messages, and drop the lower-priority messages in favour of dropping the higher priority messages, as long as the total reduction in traffic conforms to the requested reduction in effect at the time. For example, in the 50-50 distribution of high priority and low priority messages, 20% reduction to low priority messages and 0% reduction to high priority messages need to be applied in order to achieve the effective reduction in traffic by 10% towards the overloaded node.

## D.4 Enforcement of overload control between remote GTP-C entities

### D.4.1 Example of possible implementation

This clause provides an example of a possible implementation of the enforcement of overload control between remote GTP-C entities, amongst other possible methods, considering the example network topology described in Figure D.4.1-1.

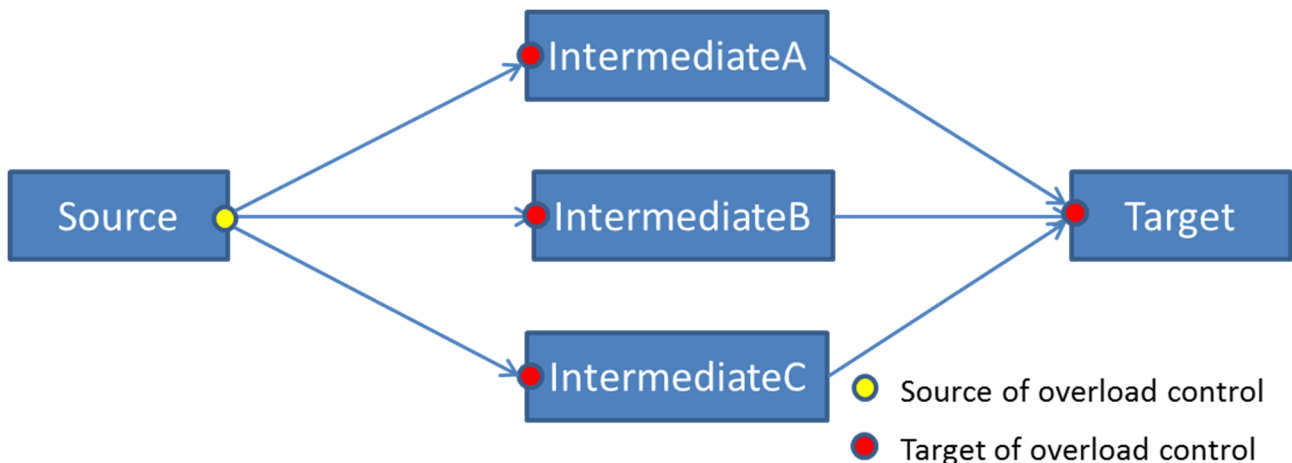

Figure D.4.1-1: Example network topology

The source GTP-C entity can apply message throttling according to the maximum of the overload reduction metric reported by the intermediate and target GTP-C entities, i.e.  $\max(\text{Intermediate\_Overload-Metric}, \text{Target\_Overload-Metric})$ , for each of the path between the source and the target GTP-C entities. Each path is considered independently whilst performing the message throttling.

Considering the following example overload condition for the topology above:

$$\text{Target\_Overload-Metric} = 30\%$$

IntermediateA\_Overload-Metric = 10%

IntermediateB\_Overload-Metric = 20%

IntermediateC\_Overload-Metric = 40%

Target\_Terminated-Messages = 100

IntermediateA-Target\_Messages = 20

IntermediateB-Target\_Messages = 50

IntermediateC-Target\_Messages = 30

the source GTP-C entity applies message throttling as follows:

Source-IntermediateA\_Messages = 14 (message throttling of 30% applied)

Source-IntermediateB\_Messages = 35 (message throttling of 30% applied)

Source-IntermediateC\_Messages = 18 (message throttling of 40% applied)

Source-Target\_Messages = 67 (the Target GTP-C entity receives 67 messages although it could have handled 70 messages in the overloaded condition).

---

## Annex E (Normative): TWAN mapping table between GTPv2 S2a Cause and non-3GPP access Cause values

The TWAN initiates session establishment requests or mobility management requests towards the PGW. If this operation is not successful, there are several possible cause codes, which need to be mapped to the appropriate cause codes over non-3GPP access to the UE.

The TWAN should map these cause codes as defined in Table E.1, Table E.2, Table E.3 and Table E.4.

**Table E.1: Mapping from GTPv2 S2a to non-3GPP access Cause values – Rejection indication from PGW**

Reject indication from PGW to TWAN over S2a	WLCP Cause to UE for MCM	Diameter Cause to 3GPP AAA Server for SCM
#64 "Context not found" (during UE initiated PDN connectivity request for 3GPP to non-3GPP handover procedure)	#54 "PDN connection does not exist"	#54 "PDN connection does not exist"
#65 Invalid Message Format	#30 "Request rejected by PDN GW" #38 "Network failure"	#30 "Request rejected by PDN GW" #38 "Network failure"
#67 "Invalid length"	#30 "Request rejected by PDN GW" #38 "Network failure"	#30 "Request rejected by PDN GW" #38 "Network failure"
#68 "Service not supported"	#32 "Service option not supported"	#32 "Service option not supported"
#69 "Mandatory IE incorrect"	#30 "Request rejected by PDN GW" #38 "Network failure"	#30 "Request rejected by PDN GW" #38 "Network failure"
#70 "Mandatory IE missing"	#30 "Request rejected by PDN GW" #38 "Network failure"	#30 "Request rejected by PDN GW" #38 "Network failure"
#72 "System Failure"	#34 "Service option temporarily out of order" #38 "Network Failure" #30 "Request rejected by PDN GW"	#34 "Service option temporarily out of order" #38 "Network Failure" #30 "Request rejected by PDN GW"
#73 "No Resources available"	#34 "Service option temporarily out of order" #26 "Insufficient resources"	#34 "Service option temporarily out of order" #26 "Insufficient resources"
#78 "Missing or unknown APN"	# 27 "Missing or unknown APN"	# 27 "unknown APN"
#83 "Preferred PDN type not supported"	#32 "Service option not supported" #50 "PDN type IPv4 only allowed" #51 "PDN type IPv6 only allowed"	#32 "Service option not supported" #50 "PDN type IPv4 only allowed" #51 "PDN type IPv6 only allowed"
#84 "All dynamic addresses are occupied"	#26 "Insufficient resources"	#26 "Insufficient resources"
#89 "Service denied"	#30 "Request rejected by PDN GW" #31 "Request rejected, unspecified" #38 "Network failure"	#30 "Request rejected by PDN GW" #31 "Request rejected, unspecified" #38 "Network failure"
#91 "No memory available"	#34 "Service option temporarily out of order" #26 "Insufficient resources"	#34 "Service option temporarily out of order" #26 "Insufficient resources"
#92 "User authentication failed"	#92 "User authentication failed"	#92 "User authentication failed"
#93 "APN access denied – no subscription"	#33 "Requested service option not subscribed" # 27 "Missing or unknown APN"	#33 "Requested service option not subscribed" # 27 "unknown APN"
#94 "Request rejected (reason not specified)"	#30 "Request rejected by PDN GW" #38 "Network Failure"	#30 "Request rejected by PDN GW" #38 "Network Failure"
#100 "Remote peer not responding"	#34 "Service option temporarily out of order" #38 "Network Failure"	#34 "Service option temporarily out of order" #38 "Network Failure"
#101 "Collision with network initiated request"	#31 "Request rejected, unspecified"	NA
#103 "Conditional IE missing"	#30 "Request rejected by PDN GW" #38 "Network Failure"	#30 "Request rejected by PDN GW" #38 "Network Failure"
#113 "APN Congestion" #120 "GTP-C Entity Congestion"	#26 "Insufficient resources"	#26 "Insufficient resources"

#116 "Multiple PDN connections for a given APN not allowed"	#55 "Multiple PDN connections for a given APN not allowed"	NA
#126 "Multiple accesses to a PDN connection not allowed"	#113 "Multiple accesses to a PDN connection not allowed"	#113 "Multiple accesses to a PDN connection not allowed"
NOTE 1: See 3GPP TS 24.244 [66] for WLCP causes. NOTE 2: When multiple non-3GPP access cause values are defined for a given GTP cause value, any of those cause values may be sent to the UE based on implementation choice.		

**Table E.2: Mapping from GTPv2 S2a to non-3GPP access Cause values – Acceptance indication from PGW**

Acceptance indication from PGW to TWAN over S2a	WLCP Cause to UE for MCM	Diameter Cause to 3GPP AAA Server for SCM
#18 "New PDN type due to network preference"	#50 "PDN type IPv4 only allowed" #51 "PDN type IPv6 only allowed"	NA
#19 "New PDN type due to single address bearer only"	#52 "single address bearers only allowed"	NA
NOTE 1: The actual WLCP cause sent to the UE depends on the allocated IP address type.		

**Table E.3: Mapping from GTPv2 S2a to WLCP Cause values – Indication in request from PGW**

Indication in disconnection message from PGW to TWAN over S2a	WLCP Cause to UE for MCM
#8 "Reactivation Requested"	#39 "Reactivation requested"
#9 "PDN reconnection to this APN disallowed" (NOTE 1)	Implementation specific WLCP cause value indicating to the UE that the APN is not currently available.
NOTE 1: In Delete Bearer Request during the PGW initiated bearer deactivation procedure for the default bearer	

**Table E.4: Mapping from WLCP to GTP Cause values – Rejection indication from TWAN**

WLCP Cause from UE	Reject indication from TWAN to PGW
#31 "request rejected, unspecified"	#94 "Request rejected" #88 "UE refuses"
NOTE 1: See 3GPP TS 24.244 [66] for WLCP causes. NOTE 2: When multiple GTPv2 Cause values are defined for a given WLCP Cause value, any of those GTPv2 Cause values may be sent to the PGW based on implementation choice.	

## Annex F (Informative): Change History

Date	TSG #	TSG Doc	CR	Rev	Cat	Subject/Comment	New
2008-12	CT#42	CP-080717				V2.0.0 approved in CT#42	8.0.0
2009-03	CT#43	CP-090050	0001	2		Delete Indirect Data Forwarding Tunnel Request/Response	8.1.0
2009-03	CT#43	CP-090050	0003	1		Relocation Cancel Req/Res	8.1.0
2009-03	CT#43	CP-090050	0004	2		Path Failure	8.1.0
2009-03	CT#43	CP-090050	0005	4		Clauses 1 through 6 Editorial Clean-up	8.1.0
2009-03	CT#43	CP-090050	0006	2		Delete Session and Delete Bearer messages	8.1.0
2009-03	CT#43	CP-090050	0008	2		Update User Plane messages	8.1.0
2009-03	CT#43	CP-090050	0017	2		Cleanup in path management and bearer command messages	8.1.0
2009-03	CT#43	CP-090050	0018	1		Create Session/Bearer Messages	8.1.0
2009-03	CT#43	CP-090050	0019	2		Modify Bearer messages	8.1.0
2009-03	CT#43	CP-090050	0020	2		IEs in CSFB related messages	8.1.0
2009-03	CT#43	CP-090050	0021	1		Command Messages	8.1.0
2009-03	CT#43	CP-090050	0022	3		Data Forwarding Info	8.1.0
2009-03	CT#43	CP-090050	0023	3		Delete Bearer messages	8.1.0
2009-03	CT#43	CP-090050	0024	2		Delete Session messages	8.1.0
2009-03	CT#43	CP-090050	0025	1		Downlink Data Notification	8.1.0
2009-03	CT#43	CP-090050	0026	2		Update Bearer messages	8.1.0
2009-03	CT#43	CP-090050	0027	2		Secondary PDP Activation	8.1.0
2009-03	CT#43	CP-090050	0028	2		Stop Paging	8.1.0
2009-03	CT#43	CP-090050	0030	1		EPS Bearer Contexts Prioritization	8.1.0
2009-03	CT#43	CP-090050	0032	2		Linked EPS Bearer ID	8.1.0
2009-03	CT#43	CP-090050	0034	1		AMBR IE encoding	8.1.0
2009-03	CT#43	CP-090050	0035	-		Authentication Failure Cause Code	8.1.0
2009-03	CT#43	CP-090050	0040	1		Forward SRNS Context Notification	8.1.0
2009-03	CT#43	CP-090050	0041	1		F-TEID IE clarification	8.1.0
2009-03	CT#43	CP-090214	0043	4		SGW Selection during TAU and corrections to Grouped IEs	8.1.0
2009-03	CT#43	CP-090050	0043	1		Identification Response algorithm information	8.1.0
2009-03	CT#43	CP-090050	0044	2		IE Type ordering	8.1.0
2009-03	CT#43	CP-090050	0045	2		Indication IE corrections	8.1.0
2009-03	CT#43	CP-090050	0048	1		MM Context enhancements	8.1.0
2009-03	CT#43	CP-090050	0050	1		Removal of Bearer ID List IE	8.1.0
2009-03	CT#43	CP-090050	0051	1		Remove unused IP Address IEs	8.1.0
2009-03	CT#43	CP-090050	0052	1		Selection Mode bits	8.1.0
2009-03	CT#43	CP-090050	0053	1		Corrections to Trace Information IE	8.1.0
2009-03	CT#43	CP-090050	0054	2		Trace Information IE to be included in S11 and S5/S8 messages	8.1.0
2009-03	CT#43	CP-090050	0055	3		Trace Session Activation/Deactivation when UE is attached	8.1.0
2009-03	CT#43	CP-090050	0059	1		New UE Time Zone IE Type	8.1.0
2009-03	CT#43	CP-090050	0060	1		Release Access Bearers Request/Response	8.1.0
2009-03	CT#43	CP-090256	0061	3		Piggybacking of Dedicated Bearer Messages	8.1.0
2009-03	CT#43	CP-090050	0063	4		Finalizing GTPv2 Error Handling clause	8.1.0
2009-03	CT#43	CP-090050	0064	1		GTPv2 clause 9 and 10 cleanup	8.1.0
2009-03	CT#43	CP-090050	0066	4		RAN Information Relay message	8.1.0
2009-03	CT#43	CP-090050	0067	2		Bearer QoS encoding	8.1.0
2009-03	CT#43	CP-090050	0068	1		Modify Bearer Response	8.1.0
2009-03	CT#43	CP-090050	0075	3		Location Change Reporting	8.1.0
2009-03	CT#43	CP-090050	0077	2		Cleanup on Cause Values	8.1.0
2009-03	CT#43	CP-090050	0080	1		Non-3GPP Requests in GTPv2	8.1.0
2009-03	CT#43	CP-090050	0082	3		Support of IP address retrieval for ANRF	8.1.0
2009-03	CT#43	CP-090050	0083	1		Support for error response for conflicting resource request	8.1.0
2009-03	CT#43	CP-090050	0085	1		Clarification of Target ID vs Cell ID	8.1.0
2009-03	CT#43	CP-090050	0089	2		TEID Value of the GTP header	8.1.0
2009-03	CT#43	CP-090050	0093	3		Header for the Format of the GTPv2-C message	8.1.0
2009-03	CT#43	CP-090050	0094	3		Finalization of Partial fault handling in GTPv2	8.1.0
2009-03	CT#43	CP-090050	0095	1		MSISDN encoding	8.1.0
2009-03	CT#43	CP-090050	0096	1		IMSI encoding	8.1.0
2009-03	CT#43	CP-090050	0097	1		PMIP error code reservation	8.1.0
2009-03	CT#43	CP-090050	0098	-		Removal of Comprehension Required from messages 7.3.1 to 7.3.13	8.1.0
2009-03	CT#43	CP-090050	0099	-		Cause value for PGW not responding	8.1.0
2009-03	CT#43	CP-090050	0100	-		Traffic Aggregate Description IE encoding	8.1.0
2009-03	CT#43	CP-090050	0101	3		Protocol Stack	8.1.0
2009-03	CT#43	CP-090050	0102	1		Reliable delivery for EPC	8.1.0
2009-03	CT#43	CP-090050	0104	-		Removal of reservation for message types of GTP-U	8.1.0
2009-03	CT#43	CP-090239	0105	1		Essential correction to grouped IE type coding	8.1.0
2009-03	-	-	-	-		Some of the table formats corrected	8.1.1
2009-06	CT#44	CP-090288	0107	-		Suspend and Resume are also used for 1xRTT CS Fallback	8.2.0
2009-06	CT#44	CP-090288	0108	1		Support for new cause code of "Unable to page UE due to CSFB" in Downlink Data Notification Acknowledgement.	8.2.0
2009-06	CT#44	CP-090288	0109	1		Corrections on GTPv2 for 1x IWS IP address	8.2.0
2009-06	CT#44	CP-090288	0110	1		Clarification of Operation Indication (OI)	8.2.0
2009-06	CT#44	CP-090288	0111	1		Usage of User Location Information (ULI) IE	8.2.0



Date	TSG #	TSG Doc	CR	Rev	Cat	Subject/Comment	New
2009-06	CT#44	CP-090288	0112	1		PGW S5/S8 IP Address in Context Response message	8.2.0
2009-06	CT#44	CP-090288	0114	1		Delete Indirect Data Forwarding Tunnel Response	8.2.0
2009-06	CT#44	CP-090288	0115	2		Error_Handling. Withdrawn	8.2.0
2009-06	CT#44	CP-090288	0117	1		PCO Extensions added to messages	8.2.0
2009-06	CT#44	CP-090288	0118	1		Clarifications to message directions	8.2.0
2009-06	CT#44	CP-090288	0119	-		Removal of specification drafting hints	8.2.0
2009-06	CT#44	CP-090288	0120	1		ISR related alignments	8.2.0
2009-06	CT#44	CP-090288	0122	1		Clarifications to grouped IE usage	8.2.0
2009-06	CT#44	CP-090288	0125	2		Clarification to Recovery IE type	8.2.0
2009-06	CT#44	CP-090288	0127	1		Missing conditions	8.2.0
2009-06	CT#44	CP-090288	0128	1		Clarification of ARP encoding	8.2.0
2009-06	CT#44	CP-090288	0129	-		Units for APN-AMBR	8.2.0
2009-06	CT#44	CP-090288	0131	2		Clarification of Mobile Equipment Identity IE encoding	8.2.0
2009-06	CT#44	CP-090288	0134	-		EPS Bearer Level TFT encoding	8.2.0
2009-06	CT#44	CP-090288	0136	2		UE-initiated procedures with one bearer only	8.2.0
2009-06	CT#44	CP-090288	0137	2		Combine UL and DL TFT IEs	8.2.0
2009-06	CT#44	CP-090288	0142	1		PGW S5/S8 IP Address and TEID for user plane	8.2.0
2009-06	CT#44	CP-090288	0143	1		Transaction Identifier information element	8.2.0
2009-06	CT#44	CP-090288	0147	1		Delete Bearer Request	8.2.0
2009-06	CT#44	CP-090288	0149	2		Modify Bearer Request for TAU without MME or SGW change	8.2.0
2009-06	CT#44	CP-090288	0150	2		Use of APN, PAA in Create Session Request, and S5/S8-U PGW F-TEID in Create Session Response	8.2.0
2009-06	CT#44	CP-090288	0151	1		Message table corrections	8.2.0
2009-06	CT#44	CP-090288	0153	-		Presence requirement for IEs in response	8.2.0
2009-06	CT#44	CP-090288	0154	2		Offending IE in the Cause IE	8.2.0
2009-06	CT#44	CP-090288	0156	1		Minor corrections	8.2.0
2009-06	CT#44	CP-090288	0157	1		FQ-CSID corrections	8.2.0
2009-06	CT#44	CP-090288	0158	-		APN and FQDN encoding clarifications	8.2.0
2009-06	CT#44	CP-090288	0159	-		Removal of Trace Information IE from Update Bearer Request	8.2.0
2009-06	CT#44	CP-090288	0160	1		Corrections in PDN Connection group IE	8.2.0
2009-06	CT#44	CP-090288	0161	1		Missing IEs in "Update Bearer Response"	8.2.0
2009-06	CT#44	CP-090288	0164	2		PDN Type	8.2.0
2009-06	CT#44	CP-090288	0168	1		IE corrections in Modify Bearer signalling	8.2.0
2009-06	CT#44	CP-090288	0169	2		Create Session Request Clarification	8.2.0
2009-06	CT#44	CP-090288	0175	-		TEID in Detach Notification/ACK	8.2.0
2009-06	CT#44	CP-090288	0176	-		Condition of bearer context in Modify Bearer messages	8.2.0
2009-06	CT#44	CP-090288	0177	1		Delete Session Request granularity	8.2.0
2009-06	CT#44	CP-090288	0178	-		Deletion of IMSI in the Update Bearer Request	8.2.0
2009-06	CT#44	CP-090288	0180	1		Delete Session Request/Response and Delete Bearer Request	8.2.0
2009-06	CT#44	CP-090288	0181	1		Detach Notification	8.2.0
2009-06	CT#44	CP-090288	0183	-		SGSN Info for Data Forwarding	8.2.0
2009-06	CT#44	CP-090288	0184	1		Delete Session Request	8.2.0
2009-06	CT#44	CP-090288	0185	1		APN AMBR clarification	8.2.0
2009-06	CT#44	CP-090288	0186	1		Delete Bearer Request when ISR activated	8.2.0
2009-06	CT#44	CP-090288	0187	1		Clarify the usage of the MS validated IE	8.2.0
2009-06	CT#44	CP-090288	0189	1		UDP Source port and IP Source Address	8.2.0
2009-06	CT#44	CP-090288	0190	-		Recovery IE	8.2.0
2009-06	CT#44	CP-090288	0192	1		APN Information	8.2.0
2009-06	CT#44	CP-090500	0193	3		Cause value	8.2.0
2009-06	CT#44	CP-090288	0195	1		Cleanup indication	8.2.0
2009-06	CT#44	CP-090288	0196	1		Cleanup the usage of some messages	8.2.0
2009-06	CT#44	CP-090288	0198	1		Linked EPS Bearer ID	8.2.0
2009-06	CT#44	CP-090288	0199	1		PCO parameter	8.2.0
2009-06	CT#44	CP-090288	0200	1		PDP Context Activation	8.2.0
2009-06	CT#44	CP-090288	0201	1		User Location Info	8.2.0
2009-06	CT#44	CP-090288	0202	2		F-Cause IE correction	8.2.0
2009-06	CT#44	CP-090288	0206	1		Message granularity	8.2.0
2009-06	CT#44	CP-090321	0209	-		Bearer Context in the Modify Bearer Command	8.2.0
2009-06	CT#44	CP-090493	0210	1		Sequence Number Extension	8.2.0
2009-06	CT#44	CP-090355	0212	-		Bearer Resource Command clarification	8.2.0
2009-06	CT#44	CP-090485	0213	1		Piggybacked message clarifications	8.2.0
2009-06	CT#44	CP-090472	0214	1		Corrections on handling Charging ID IE and Charging Characteristics IE	8.2.0
2009-09	CT#45	CP-090533	0215	-		Usage of GTPv2-C Header	8.3.0
2009-09	CT#45	CP-090533	0216	1		Create Session Request and Response	8.3.0
2009-09	CT#45	CP-090533	0217	1		Cleanup Editors Note	8.3.0
2009-09	CT#45	CP-090533	0218	1		Message format and Type values	8.3.0
2009-09	CT#45	CP-090533	0220	-		S16 Influence	8.3.0
2009-09	CT#45	CP-090533	0222	1		MM Context	8.3.0
2009-09	CT#45	CP-090533	0223	-		F-Container	8.3.0

Date	TSG #	TSG Doc	CR	Rev	Cat	Subject/Comment	New
2009-09	CT#45	CP-090533	0225	-		Change Reporting Action	8.3.0
2009-09	CT#45	CP-090533	0226	1		Procedure names	8.3.0
2009-09	CT#45	CP-090533	0228	3		Changes to Create-Session-Request and Create-Session-Response messages	8.3.0
2009-09	CT#45	CP-090533	0229	1		Changes to Modify-Bearer-Response	8.3.0
2009-09	CT#45	CP-090533	0232	2		Piggybacking Clarifications	8.3.0
2009-09	CT#45	CP-090533	0236	1		Delete Bearer Request Cause value for ISR deactivation	8.3.0
2009-09	CT#45	CP-090533	0237	2		Modify Bearer Request Bearer Level QoS	8.3.0
2009-09	CT#45	CP-090533	0239	1		Possible reject response Cause values in GTPv2 message descriptions	8.3.0
2009-09	CT#45	CP-090533	0241	1		SGW F-TEID for S1-U, S12 and S4 for User Plane	8.3.0
2009-09	CT#45	CP-090533	0243	2		Clarification on the usage of Version Not Supported Indication	8.3.0
2009-09	CT#45	CP-090533	0244	1		Clarifications on Sender-F-TEID for CP and S3/S10/S16 CP IP Addr and TEID IEs	8.3.0
2009-09	CT#45	CP-090533	0245	1		Cause Value in Echo Response	8.3.0
2009-09	CT#45	CP-090533	0246	-		Corrections in ULI IE and PDN Connection IE definitions	8.3.0
2009-09	CT#45	CP-090533	0247	3		GTPv2 Initial and Triggered Message definition and Sequence Number handling	8.3.0
2009-09	CT#45	CP-090533	0249	1		Missing Cause values in some message descriptions	8.3.0
2009-09	CT#45	CP-090533	0250	4		Add TAC to Target Identification IE	8.3.0
2009-09	CT#45	CP-090533	0256	1		IMSI and Sender F-TEID in Create Indirect Data Forwarding Tunnel Messages	8.3.0
2009-09	CT#45	CP-090534	0258	1		Indication in Forward Relocation messages	8.3.0
2009-09	CT#45	CP-090534	0259	1		Paging cause	8.3.0
2009-09	CT#45	CP-090534	0260	-		Correlate the bearers in the Create Bearer Response	8.3.0
2009-09	CT#45	CP-090534	0261	3		Cleanup cause values	8.3.0
2009-09	CT#45	CP-090534	0262	2		Delete Bearer Failure Indication	8.3.0
2009-09	CT#45	CP-090534	0263	1		Cleanup Modify Bearer Request	8.3.0
2009-09	CT#45	CP-090534	0264	2		IEs in Response	8.3.0
2009-09	CT#45	CP-090534	0266	-		CS Paging Indication	8.3.0
2009-09	CT#45	CP-090534	0267	2		Serving Network	8.3.0
2009-09	CT#45	CP-090534	0268	3		Service Handover support	8.3.0
2009-09	CT#45	CP-090534	0269	3		Fix incorrect interface name, incorrect reference and other misreading texts	8.3.0
2009-09	CT#45	CP-090534	0270	1		Clarification on cause value for Downlink Data Notification Failure Indication	8.3.0
2009-09	CT#45	CP-090534	0271	2		Clarification on the Authentication Vector handling	8.3.0
2009-09	CT#45	CP-090534	0276	1		Clarification on Authentication Vector encoding	8.3.0
2009-09	CT#45	CP-090535	0278	5		Clarification on Error indication for EPC and DT	8.3.0
2009-09	CT#45	CP-090534	0279	3		Aligning MBR units to kbps	8.3.0
2009-09	CT#45	CP-090534	0281	1		Clarification to the PGW's UP address in Create Session Response	8.3.0
2009-09	CT#45	CP-090534	0282	4		Modify Bearer procedure for X2 and S1 based handovers	8.3.0
2009-09	CT#45	CP-090534	0290	1		Add necessary cause value to the Update Bearer Response	8.3.0
2009-09	CT#45	CP-090534	0292	-		Update on Concurrent Running of Security Procedures	8.3.0
2009-09	CT#45	CP-090534	0295	2		APN Restriction IE	8.3.0
2009-09	CT#45	CP-090534	0296	1		Change Reporting IE	8.3.0
2009-09	CT#45	CP-090534	0297	1		ULI Clarification	8.3.0
2009-09	CT#45	CP-090534	0301	-		Charging ID	8.3.0
2009-09	CT#45	CP-090534	0302	1		Delete Indirect Data Forwarding Tunnel Request/Response	8.3.0
2009-09	CT#45	CP-090535	0303	1		SGW F-TEID	8.3.0
2009-09	CT#45	CP-090535	0304	1		BCM	8.3.0
2009-09	CT#45	CP-090535	0307	3		Charging Gateway Address	8.3.0
2009-09	CT#45	CP-090535	0308	1		LBI Clarifications for Gn/Gp Handovers	8.3.0
2009-09	CT#45	CP-090535	0309	1		Trace management messages and IE related clarifications	8.3.0
2009-09	CT#45	CP-090535	0310	1		Indirect Data Forwarding Tunnel clarifications	8.3.0
2009-09	CT#45	CP-090535	0311	2		Concurrent Running of Security Procedures	8.3.0
2009-09	CT#45	CP-090535	0315	1		Cause value corrections	8.3.0
2009-09	CT#45	CP-090535	0316	1		Identification Response	8.3.0
2009-09	CT#45	CP-090535	0317	1		NSAPI and EBI in Forward Relocation Response	8.3.0
2009-09	CT#45	CP-090535	0318	1		Cause in the CSFB related messages	8.3.0
2009-09	CT#45	CP-090535	0320	1		Update Bearer Complete	8.3.0
2009-09	CT#45	CP-090535	0321	1		PCO IE	8.3.0
2009-09	CT#45	CP-090535	0322	-		Cleanup Trace Management messages	8.3.0
2009-09	CT#45	CP-090535	0323	-		Cleanup clause 5.3 and 8.12	8.3.0
2009-09	CT#45	CP-090535	0324	1		APN AMBR in the Create Bearer Request	8.3.0
2009-09	CT#45	CP-090535	0325	1		UDP Source Port Number	8.3.0
2009-09	CT#45	CP-090535	0326	-		Presence Requirments for grouped IE	8.3.0
2009-09	CT#45	CP-090535	0330	1		Making PCO conditional for the Attach procedure	8.3.0
2009-09	CT#45	CP-090535	0332	-		Echo usage alignment with stage 2	8.3.0
2009-09	CT#45	CP-090535	0334	-		Trace Depth per session	8.3.0
2009-09	CT#45	CP-090535	0335	4		Backward compatibility requirements for presence	8.3.0

Date	TSG #	TSG Doc	CR	Rev	Cat	Subject/Comment	New
2009-09	CT#45	CP-090535	0338	1		ECGI encoding correction	8.3.0
2009-09	CT#45	CP-090535	0339	1		Consistant PDN type setting	8.3.0
2009-09	CT#45	CP-090535	0340	1		GTP Cause value usage	8.3.0
2009-09	CT#45	CP-090729	0341	1		Partial failure handling alignment with stage 2	8.3.0
2009-09	CT#45	CP-090729	0342	2		Partial failure handling for MME relocation w/o SGW relocation	8.3.0
2009-09	CT#45	CP-090535	0346	1		Security Specification for GTPV2-C	8.3.0
2009-09	CT#45	CP-090535	0349	1		Avoiding Source Port Overlap between GTPv2-C and GTPv2-C'	8.3.0
2009-09	CT#45	CP-090535	0350	-		Delete Bearer Command PCO removal	8.3.0
2009-09	CT#45	CP-090559	0253	2		Scope of GTP-C protocol	9.0.0
2009-09	CT#45	CP-090559	0254	4		MBMS session management messages	9.0.0
2009-09	CT#45	CP-090562	0285	1		IMEI based GTP Changes	9.0.0
2009-09	CT#45	CP-090745	0286	4		Unauthenticated IMSI for emergency in GTP	9.0.0
2009-09	CT#45	CP-090562	0343	1		IMEI based Id in GTP messages	9.0.0
2009-09	CT#45	CP-090562	0344	1		Unauthenticated IMSI in GTP messages	9.0.0
2009-10	CT#46					Editorial correction. Wrong style was used in Paragraph character 7.1.3.	9.0.1
2009-12	CT#46	CP-090769	0356	1		Selection Mode IE	9.1.0
2009-12	CT#46	CP-090798	0357	2		PTP bearer fallback	9.1.0
2009-12	CT#46	CP-090770	0359	-		Bearer QoS in Modify Bearer Request	9.1.0
2009-12	CT#46	CP-090769	0361	1		Release Access Bearer Request	9.1.0
2009-12	CT#46	CP-090770	0363	-		Bearer context in Create Session messages	9.1.0
2009-12	CT#46	CP-090770	0365	-		ISRAI flag in the Forward Relocation Complete Notification	9.1.0
2009-12	CT#46	CP-090770	0369	-		Mapping between RAI, P-TMSI, P-TMSI signature and GUTI	9.1.0
2009-12	CT#46	CP-090770	0371	1		APN IE encoding	9.1.0
2009-12	CT#46	CP-090770	0373	1		Correction on the condition for resource release of other CN node	9.1.0
2009-12	CT#46	CP-090970	0375	2		APN Restriction	9.1.0
2009-12	CT#46	CP-090770	0377	1		Cause value "Invalid reply from remote peer"	9.1.0
2009-12	CT#46	CP-090770	0380	1		Indication Flags in Delete Session Request	9.1.0
2009-12	CT#46	CP-090770	0382	1		Suspend	9.1.0
2009-12	CT#46	CP-090770	0386			Removal of forwarding Charging Gateway Address/Name to S4-SGSN	9.1.0
2009-12	CT#46	CP-090770	0388	2		Charging ID in S4-SGSN	9.1.0
2009-12	CT#46	CP-090770	0390	-		Correction of Message Direction for Create Session Response	9.1.0
2009-12	CT#46	CP-090770	0392	1		PPC (Prohibit Payload Compression) alignment with Stage-2	9.1.0
2009-12	CT#46	CP-090770	0393	3		UE TimeZone and ULI included in Bearer Response messages	9.1.0
2009-12	CT#46	CP-090804	0395	4		Support for CSG based charging	9.1.0
2009-12	CT#46	CP-090770	0397	3		User Location Information	9.1.0
2009-12	CT#46	CP-090769	0399	2		PDN type	9.1.0
2009-12	CT#46	CP-090770	0403	-		Removal of ULI from Release Access Bearer Req	9.1.0
2009-12	CT#46	CP-090770	0405	-		Removal of NSAPI IE	9.1.0
2009-12	CT#46	CP-090770	0407	2		Indication IE clarification	9.1.0
2009-12	CT#46	CP-090770	0409	3		Addition of uplink, downlink F-TEIDs in Create Indirect Data Forwarding Tunnel Request and Response messages	9.1.0
2009-12	CT#46	CP-090770	0411	2		Clarifications on use of the Sender-F-TEID for CP in HO procedure	9.1.0
2009-12	CT#46	CP-090770	0417	-		Clarifications to MSISDN coding	9.1.0
2009-12	CT#46	CP-090769	0419	2		Enhanced handling of RFSP index at the SGSN/MME	9.1.0
2009-12	CT#46	CP-090769	0423	2		TFT related error handling	9.1.0
2009-12	CT#46	CP-090769	0425	4		Essential correction to the Indirect Data Forwarding procedure	9.1.0
2009-12	CT#46	CP-090769	0434	-		Correcting misaligned IE presence type statements	9.1.0
2009-12	CT#46	CP-090769	0438	1		Correcting PCO conditions in Modify Bearer Response	9.1.0
2009-12	CT#46	CP-090769	0442	2		Delete Indirect Data Forwarding Tunnel messages	9.1.0
2009-12	CT#46	CP-090777	0448	1		SRVCC - voice bearer handling in PS HO / DTM scenarios	9.1.0
2009-12	CT#46	CP-090975	0450	2		NAS Count value	9.1.0
2009-12	CT#46	CP-090769	0452	1		Charging Characteristics value for active PDN connections	9.1.0
2009-12	CT#46	CP-090786	0453	1		eNodeB Cause and RANAP Cause corrections	9.1.0
2009-12	CT#46	CP-090769	0455	-		Change the NSAPI to EBI in the PFI IE	9.1.0
2009-12	CT#46	CP-090769	0457	-		Enhanced SRNS Relocation Procedure	9.1.0
2009-12	CT#46	CP-090769	0459	-		Forward Access Context Acknowledge	9.1.0
2009-12	CT#46	CP-090769	0461	-		Correct the message Modify Bearer Request	9.1.0
2009-12	CT#46	CP-090769	0471	1		Cleanup Suspend Notification message	9.1.0
2009-12	CT#46	CP-090769	0475	1		Forward Relocation Request: Selected PLMN ID	9.1.0
2009-12	CT#46						9.1.0
2009-12		CP-090770	0484	1		Change Reporting Action	9.1.0
2010-03	CT#47	CP-100021	0493	1		Essential clarification to MME executed TAU procedure	9.2.0
2010-03	CT#47	CP-100022	0495	5		Essential correction to the MM context IE type	9.2.0
2010-03	CT#47	CP-100021	0497	1		Resolving ambiguity for Target Identification IE coding	9.2.0
2010-03	CT#47	CP-100021	0504			PCO	9.2.0
2010-03	CT#47	CP-100021	0506	1		RFSP Index	9.2.0
2010-03	CT#47	CP-100049	0508	1		Include CSG ID and CSG Membership Indication in S3 and S10	9.2.0
2010-03	CT#47	CP-100035	0510	2		Location change reporting in EPS	9.2.0

Date	TSG #	TSG Doc	CR	Rev	Cat	Subject/Comment	New
2010-03	CT#47	CP-100019	0512			The encoding of APN IE	9.2.0
2010-03	CT#47	CP-100021	0514	1		Indirect Data Forwarding	9.2.0
2010-03	CT#47	CP-100021	0516	2		HSS/PGW initiated Bearer QoS Modification procedure	9.2.0
2010-03	CT#47	CP-100022	0518	1		APN IE description correction	9.2.0
2010-03	CT#47	CP-100022	0520	2		P-TMSI Signature	9.2.0
2010-03	CT#47	CP-100035	0521	1		Corrections to the RAN Information Management procedures	9.2.0
2010-03	CT#47	CP-100021	0523			Source Identification for E-UTRAN to GERAN handover	9.2.0
2010-03	CT#47	CP-100049	0524	1		Handovers to HeNB cells	9.2.0
2010-03	CT#47	CP-100022	0530	1		Granularity	9.2.0
2010-03	CT#47	CP-100021	0533	2		Change Reporting Support Indicator	9.2.0
2010	CT#47	CP-100021	0535			MM Context IE type correction	9.2.0
2010-03	CT#47	CP-100027	0537	2		Removal of TEIDs for PS voice bearer UP in Bearer Context for SRVCC	9.2.0
2010-03	CT#47	CP-100021	0539			Correction on the presence condition of Charging ID IE on S4	9.2.0
2010-03	CT#47	CP-100035	0541	3		Suspend	9.2.0
2010-03	CT#47	CP-100022	0548	1		Modify Octets Sequence Number of RAB Context IE	9.2.0
2010-03	CT#47	CP-100022	0550	1		Revive the cause value "User Authentication Failed" in the Create Session Response	9.2.0
2010-03	CT#47	CP-100035	0554	1		Fix PCO handling by defining it per bearer	9.2.0
2010	CT#47	CP-100022	0556	2		Fix PDN Connection Grouped Type	9.2.0
2010-03	CT#47	CP-100022	0558	2		Correction on the down link notification failure procedure	9.2.0
2010-03	CT#47	CP-100022	0565	2		Correction of the presence condition of IEs	9.2.0
2010-03	CT#47	CP-100021	0567	1		Figure number, Information element and message usage	9.2.0
2010-03	CT#47	CP-100022	0569	2		2G related parameters in the Forward Relocation Request and Context Response	9.2.0
2010-03	CT#47	CP-100022	0577	2		Essential correction to the Create Bearer Request message	9.2.0
2010-03	CT#47	CP-100022	0581	1		Essential correction to FTEID IE	9.2.0
2010-03	CT#47	CP-100022	0583	2		Essential correction to Modify Bearer Request for non-3GPP to 3GPP handover	9.2.0
2010-03	CT#47	CP-100021	0585			Removal of unnecessary cause "Unexpected repeated IE"	9.2.0
2010-03	CT#47	CP-100022	0587	1		Removal of indirect uplink data forwarding from Inter RAT handovers	9.2.0
2010-03	CT#47	CP-100021	0591	1		Trace alignment with TS 32.422	9.2.0
2010-06	CT#48	CP-100266	0599	1		Essential corrections to M-TMSI mapping	9.3.0
2010-06	CT#48	CP-100266	0603	3		Change Notification	9.3.0
2010-06	CT#48	CP-100266	0605	1		Fix missing conditional description for IEs in the context response message	9.3.0
2010-06	CT#48	CP-100266	0614	1		Change Reporting Support Indication	9.3.0
2010-06	CT#48	CP-100266	0618	1		Handover/Relocation cancel procedure	9.3.0
2010-06	CT#48	CP-100266	0624	1		ULI in the Modify Bearer Request message	9.3.0
2010-06	CT#48	CP-100266	0626	1		MM context IE encoding	9.3.0
2010-06	CT#48	CP-100266	0635	2		MBR in handover from non-3GPP to 3GPP	9.3.0
2010-06	CT#48	CP-100266	0637	1		Suspend over S16	9.3.0
2010-06	CT#48	CP-100266	0642	1		Adding Service indicator to CS Paging Indication	9.3.0
2010-06	CT#48	CP-100266	0647	3		Fallback to GTPv1	9.3.0
2010-06	CT#48	CP-100266	0650	2		Essential correction to ULI IE condition in Modify Bearer Request message	9.3.0
2010-06	CT#48	CP-100266	0657	1		TEID in Change Notification	9.3.0
2010-06	CT#48	CP-100266	0659	1		Charging ID	9.3.0
2010-06	CT#48	CP-100266	0664			Alert MME Notification / UE Activity Notification procedure on S3 interface	9.3.0
2010-06	CT#48	CP-100281	0540	4		Leave CSG Cell indication	9.3.0
2010-06	CT#48	CP-100281	0609	1		Use of Rejection Cause values	9.3.0
2010-06	CT#48	CP-100281	0616	2		Flow QoS in the Bearer Resource Command message	9.3.0
2010-06	CT#48	CP-100281	0633	1		Correction to the reference in Create indirect DF Tunnel Request	9.3.0
2010-06	CT#48	CP-100281	0638	1		Removal of FFS	9.3.0
2010-06	CT#48	CP-100281	0673	1		Message type table	9.3.0
2010-06	CT#48	CP-100281	0639	3		Implicit resume	9.3.0
2010-06	CT#48	CP-100281	0670	1		Cause IE type	9.3.0
2010-06	CT#48	CP-100281	0667	2		Clarifications to redundant IEs	9.3.0
2010-06	CT#48	CP-100281	0669	1		EBI value range and coding	9.3.0
2010-06	CT#48	CP-100281	0651	1		Cause IE enhancements to distinguish errors in the message level IE versus errors in the grouped IE within the message	9.3.0
2010-06	CT#48	CP-100281	0672	1		Bearer Resource Command usage	9.3.0
2010-06	CT#48	CP-100287	0654			Sn-U SGSN F-TEID	9.3.0
2010-06	CT#48	CP-100287	0640	2		Allocation and Retention Priority for MBMS E-RAB	9.3.0
2010-06	CT#48	CP-100266	0678	1		Handling of Create Session Request message on TEID 0 for existing PDN connection	9.3.0
2010-06	CT#48	CP-100298	0680			Essential correction for the Initial Attach procedure	9.3.0
2010-06	CT#48	CP-100276	0612			Transferring of UE's usage setting and voice capability between CN nodes	9.3.0
2010-06	CT#48	CP-100408	0544	6		Clarifying the bearers to be deactivated on the S5/S8 interface	9.3.0

Date	TSG #	TSG Doc	CR	Rev	Cat	Subject/Comment	New
2010-09	CT#49	CP-100452	0607	5		Fix Sudden disconnection after the inter RAT MM attempt	9.4.0
2010-09	CT#49	CP-100445	0630	4		IP Address IE clarification	9.4.0
2010-09	CT#49	CP-100451	0681	2		Serving Network semantics	9.4.0
2010-09	CT#49	CP-100444	0685			Originating Node	9.4.0
2010-09	CT#49	CP-100444	0687	1		Condition of ISRAI Flag	9.4.0
2010-09	CT#49	CP-100444	0689	1		PDN Connection for Subscription Data Change	9.4.0
2010-09	CT#49	CP-100580	0690	4		Clarification for Create Session Response	9.4.0
2010-09	CT#49	CP-100452	0693	2		An exception to use GTPv2	9.4.0
2010-09	CT#49	CP-100452	0694			IEs to be included in rejection response messages	9.4.0
2010-09	CT#49	CP-100452	0695	2		Ambiguity for encoding MBR/GBR	9.4.0
2010-09	CT#49	CP-100452	0696			Wrong reference to DRX parameter	9.4.0
2010-09	CT#49	CP-100452	0697			Selection Mode	9.4.0
2010-09	CT#49	CP-100452	0701	2		Stop CSG Information Reporting	9.4.0
2010-09	CT#49	CP-100452	0702			Create Session Request/Response and Modify Bearer Request/Response for RAU procedure	9.4.0
2010-09	CT#49	CP-100452	0703			Suspend message on S3 interface	9.4.0
2010-09	CT#49	CP-100445	0705	1		Cause value in Detach Notification	9.4.0
2010-09	CT#49	CP-100445	0707	1		S1 based handover cancel	9.4.0
2010-09	CT#49	CP-100445	0709	1		Used NAS integrity protection algorithm values	9.4.0
2010-09	CT#49	CP-100452	0711	2		TAU with Active Flag	9.4.0
2010-09	CT#49	CP-100452	0716	1		Trace Report File LDNs	9.4.0
2010-09	CT#49	CP-100445	0718	1		Change Notification Response	9.4.0
2010-09	CT#49	CP-100451	0723	1		Presence rules and error handling for embedded IEs	9.4.0
2010-09	CT#49	CP-100451	0724	1		Dual Address Bearer Flag	9.4.0
2010-09	CT#49	CP-100451	0726	1		Rejecting the dedicated bearer related procedure from MME to SGW and PGW	9.4.0
2010-09	CT#49	CP-100636	0727	2		Correction to condition of sending Context Acknowledge message	9.4.0
2010-09	CT#49	CP-100451	0729	2		Clarification to the OI flag usage in Delete Session Request	9.4.0
2010-09	CT#49	CP-100451	0732	1		Correcting non-existent Cause value	9.4.0
2010-09	CT#49	CP-100444	0736	1		Resume messages	9.4.0
2010-09	CT#49	CP-100444	0738	1		LAI field	9.4.0
2010-09	CT#49	CP-100444	0740	1		P-TMSI Signature	9.4.0
2010-09	CT#49	CP-100453	0744	2		Change Reporting Support Indication	9.4.0
2010-09	CT#49	CP-100451	0745	1		Error handling	9.4.0
2010-09	CT#49	CP-100451	0746	1		Flow QoS IE	9.4.0
2010-09	CT#49	CP-100444	0748	1		PDN Connection for Subscription Data Change	9.4.0
2010-09	CT#49	CP-100444	0750	1		E-UTRAN to HRPD handover	9.4.0
2010-09	CT#49	CP-100451	0751			Correcting type value of the MBMS Session Start Response message	9.4.0
2010-09	CT#49	CP-100451	0754			GTP protocol errors	9.4.0
2010-09	CT#49	CP-100451	0755	1		Essential Clarification in Forward Relocation Response message	9.4.0
2010-09	CT#49	CP-100469	0662	4		New Modify Access Bearers procedure	10.0.0
2010-09	CT#49	CP-100469	0698	6		Notification of supported features between peer GTP-C entities	10.0.0
2010-09	CT#49	CP-100469	0734	1		Length of IPv6 Prefix	10.0.0
2010-12	CT#50	CP-100695	0758	1		OI flag in Delete Session Request alignment with stage	10.1.0
2010-12	CT#50	CP-100695	0762	3		ISR in Delete Bearer Request	10.1.0
2010-12	CT#50	CP-100695	0787	4		PGW Restart Notification	10.1.0
2010-12	CT#50	CP-100695	0798	2		Feature definition for the Modify Access Bearers procedure	10.1.0
2010-12	CT#50	CP-100695	0799	1		Modify Access Bearers procedure during Inter-MME Intra-SGW TAU	10.1.0
2010-12	CT#50	CP-100695	0812	1		Clarifications to Failure Indication type of messages	10.1.0
2010-12	CT#50	CP-100695	0817	2		EPS Bearer ID in Downlink Data Notification message	10.1.0
2010-12	CT#50	CP-100695	0818	1		Clarifying possible cause value sets	10.1.0
2010-12	CT#50	CP-100695	0823	2		SGSN Failure handling	10.1.0
2010-12	CT#50	CP-100695	0835	1		Handover Indication	10.1.0
2010-12	CT#50	CP-100695	0842	1		Cause values for Delete Bearer Request	10.1.0
2010-12	CT#50	CP-100688	0848	2		MME/SGSN overload control by throttling of DL low priority traffic	10.1.0
2010-12	CT#50	CP-100675	0773	1		Suspend and Resume procedure	10.1.0
2010-12	CT#50	CP-100675	0775	1		Range for BSSGP Cause	10.1.0
2010-12	CT#50	CP-100675	0777	1		RAT Type in the Modify Bearer Request message	10.1.0
2010-12	CT#50	CP-100675	0781	-		ISR for SGW	10.1.0
2010-12	CT#50	CP-100675	0783	1		ISR in the Detach procedure	10.1.0
2010-12	CT#50	CP-100675	0789	1		Missing Cause Code mapping for IRAT Handover between GERAN and EUTRAN	10.1.0
2010-12	CT#50	CP-100675	0794	-		Voice bearer flag	10.1.0
2010-12	CT#50	CP-100675	0801	1		MBMS corrections	10.1.0
2010-12	CT#50	CP-100675	0821	1		CSG Reporting	10.1.0
2010-12	CT#50	CP-100675	0825	-		Target Identification	10.1.0
2010-12	CT#50	CP-100675	0830	2		Reporting UE Time Zone changes	10.1.0
2010-12	CT#50	CP-100675	0838	1		Essential correction for UE Timezone reporting	10.1.0
2010-12	CT#50	CP-100675	0846	2		ISR activated flag	10.1.0

Date	TSG #	TSG Doc	CR	Rev	Cat	Subject/Comment	New
2010-12	CT#50	CP-100672	0851	1		Determination of type of source node during TAU/RAU	10.1.0
2010-12	CT#50	CP-100674	0765	1		Essential correction to Create Indirect Data Forwarding Tunnel Response	10.1.0
2010-12	CT#50	CP-100686	0767	1		GTP-C Information Elements for GTP based S2b interface	10.1.0
2010-12	CT#50	CP-100686	0786	-		Delete PDN Connection Set	10.1.0
2010-12	CT#50	CP-100686	0796	-		Addition of GTP over S2b to clauses 1 to 6	10.1.0
2010-12	CT#50	CP-100686	0797	3		Create Session Request/Response & Create Bearer Request/Response	10.1.0
2010-12	CT#50	CP-100686	0802	-		Delete Session and Bearer messages	10.1.0
2010-12	CT#50	CP-100686	0804	-		Modify Bearer Command/Failure Indication and Update Bearer Req/Rsp	10.1.0
2010-12	CT#50	CP-100686	0807	-		Trace Session Activation/Deactivation for GTP-S2b	10.1.0
2010-12	CT#50	CP-100686	0839	1		Handling of Create Session Request message on header TEID = 0	10.1.0
2010-12	CT#50	CP-100687	0769	2		Downlink data notification information for MPS services	10.1.0
2010-12	CT#50	CP-100667	0828	-		UE Time Zone adjustments	10.1.0
2010-12	CT#50	CP-100669	0816	2		Essential alignment with PMIP spec	10.1.0
2011-03	CT#51	CP-110064	0921	1		Data Delay Notification	10.2.0
2011-03	CT#51	CP-110064	0916	-		Clean up with GTP-C Information Elements	10.2.0
2011-03	CT#51	CP-110064	0911	1		Inclusion of Node Type in DDN Failure Indication when the ISR is active	10.2.0
2011-03	CT#51	CP-110064	0897	1		Create Session Response	10.2.0
2011-03	CT#51	CP-110064	0896	-		UE Network Capability IE	10.2.0
2011-03	CT#51	CP-110064	0895	2		Adding "Initial", "Triggered" and "Initial or triggered by a Command" attributes to the messages in table 6.1	10.2.0
2011-03	CT#51	CP-110064	0894	1		Adding a separate clause for TEID=0	10.2.0
2011-03	CT#51	CP-110064	0893	1		Removing optional Cause IE from Echo Response	10.2.0
2011-03	CT#51	CP-110064	0875	2		RAT type clarification for S4-SGSN	10.2.0
2011-03	CT#51	CP-110064	0874	1		Essential correction to the table NOTE for the Create Session Response message	10.2.0
2011-03	CT#51	CP-110064	0872	1		Error Indication for SGW	10.2.0
2011-03	CT#51	CP-110064	0871	1		Cleanup for GTPv2	10.2.0
2011-03	CT#51	CP-110064	0870	2		RAT Type in Modify Access Bearers Request	10.2.0
2011-03	CT#51	CP-110064	0869	-		Bearer context in Modify Bearer Request	10.2.0
2011-03	CT#51	CP-110064	0860	-		S1-U eNodeB F-TEID IE in the Modify Access Bearers Request	10.2.0
2011-03	CT#51	CP-110064	0855	1		Correction for VNSI	10.2.0
2011-03	CT#51	CP-110064	0844	6		Serving Network IE	10.2.0
2011-03	CT#51	CP-110061	0856	2		APN based congestion control	10.2.0
2011-03	CT#51	CP-110061	0858	1		Low access priority indicator	10.2.0
2011-03	CT#51	CP-110060	0859	1		EBI and ARP IEs in Downlink Data Notification	10.2.0
2011-03	CT#51	CP-110049	0918	2		Protocol Configuration Options (PCO) in Delete Bearer Response	10.2.0
2011-03	CT#51	CP-110049	0901	1		UE Time Zone condition Delete Session Request	10.2.0
2011-03	CT#51	CP-110049	0889	3		Subscribed UE-AMBR in mobility procedure	10.2.0
2011-03	CT#51	CP-110049	0884	5		Essential correction to the fallback to GTPv1 feature	10.2.0
2011-03	CT#51	CP-110049	0881	1		RAT Type in the Modify bearer request message	10.2.0
2011-03	CT#51	CP-110049	0879	-		Missed procedures for the Delete Session Request and Response messages	10.2.0
2011-03	CT#51	CP-110049	0866	1		Correction to passing of LDN	10.2.0
2011-03	CT#51	CP-110049	0862	-		S103 resource release	10.2.0
2011-03	CT#51	CP-110049	0886	-		Essential correction to the to GTPv2 cause table	10.2.0
2011-03	CT#51	CP-110042	0914	1		Essential correction to the encoding of Target RNC-ID	10.2.0
2011-03	CT#51	CP-110056	0887	5		Unsupported Bearer Handling for LIPA	10.2.0
2011-03	CT#51	CP-110083	0892	3		Adding IMSI to DDN	10.2.0
2011-03	CT#51	CP-110053	0899	1		Temporary Mobile Group Identity	10.2.0
2011-03	CT#51	CP-110042	0867	1		Correcting IE Type for Bearer QoS IE from Variable to Extendable	10.2.0
2011-03	CT#51	CP-110266	0903	2		UE Time Zone condition in Modify Bearer Request	10.2.0
2011-03	CT#51	CP-110059	0915	-		Serving network in the Create Session Request message	10.2.0
2011-03	CT#51	CP-110072	0923	-		CS BIT to be available for initial message	10.2.0
2011-05						Editorial correction in clause 7.10 because of misimplentation of CT#51 agreed CR C4-110990	10.2.1
2011-06	CT#52	CP-110355	0927	2		Mapping of ASN.1/PER parameters to GTPv2 IEs	10.3.0
2011-06	CT#52	CP-110355	0940	3		Downlink Data Notification for S4	10.3.0
2011-06	CT#52	CP-110355	0964	1		IE Type Extendable Corrections	10.3.0
2011-06	CT#52	CP-110366	0930	2		Fix SRVCC related data transfer between MMEs/SGSNs	10.3.0
2011-06	CT#52	CP-110366	0932	1		UE Time Zone IE in Delete Session Request message	10.3.0
2011-06	CT#52	CP-110366	0943	1		Higher bitrates than 16 Mbps flag	10.3.0
2011-06	CT#52	CP-110366	0953	1		Temporary Rejection Cause	10.3.0
2011-06	CT#52	CP-110366	0958	1		Cause IE in DDN message	10.3.0
2011-06	CT#52	CP-110378	0928	2		Alignment with stage 2 for EPC node restart with active ISR	10.3.0
2011-06	CT#52	CP-110374	0924	1		Setting a sequence number in a Command	10.3.0
2011-06	CT#52	CP-110374	0941	1		Clarification for Create Session Response	10.3.0
2011-06	CT#52	CP-110374	0944	2		Max MBR/APN-AMBR	10.3.0

Date	TSG #	TSG Doc	CR	Rev	Cat	Subject/Comment	New
2011-06	CT#52	CP-110374	0947	3		Inactive Emergency PDN Handling	10.3.0
2011-06	CT#52	CP-110374	0948			ARP supporting on M3 interface for MBMS	10.3.0
2011-06	CT#52	CP-110374	0949			Downlink Data Notification message	10.3.0
2011	CT#52	CP-110374	0950	1		Serving Network	10.3.0
2011-06	CT#52	CP-110374	0956	2		Serving Network IE in Modify Bearer Request	10.3.0
2011-06	CT#52	CP-110369	0945			LAPI during UE initiated bearer resource allocation / modification procedures	10.3.0
2011-08						Editorial correction in clause 7.10 because of misimplentation of CT#51 agreed CR C4-110990	10.3.1
2011-09	CT#53	CP-110721	0969	1		Additional MM context for SRVCC	10.4.0
2011-09	CT#53	CP-110557	0977	1		Condition for sending Cause IE with DBReq during a HO from 3GPP to non-3GPP	10.4.0
2011-09	CT#53	CP-110557	0986	1		Essential Clarification for SGSN pool	10.4.0
2011-09	CT#53	CP-110557	0994	1		Essential correction to handling of EPDN session for UICless UE	10.4.0
2011-09	CT#53	CP-110557	0996	1		Correction to ULI and UCI IE inclusion condition in Change Notification Req	10.4.0
2011-09	CT#53	CP-110557	1000	1		Correction to header TEID of Suspend Notification over S3/S16	10.4.0
2011-09	CT#53	CP-110557	1002	1		Extended IE handling when received fields are less than expected fields	10.4.0
2011-09	CT#53	CP-110557	1016	1		Cause Code for DDN	10.4.0
2011-09	CT#53	CP-110574	0975	3		MDT configuration information	10.4.0
2011-09	CT#53	CP-110567	0980			Correction to Create Session Response LDN IEs	10.4.0
2011-09	CT#53	CP-110567	0982	2		IP address parameter	10.4.0
2011-09	CT#53	CP-110567	0967	1		Signalling path failure handling	10.4.0
2011-09	CT#53	CP-110567	0983	1		Node Type	10.4.0
2011-09	CT#53	CP-110567	0987	1		Clarification for Context Not Found	10.4.0
2011-09	CT#53	CP-110567	0988	1		Recovery IE in MBMS Session Stop Response message	10.4.0
2011-09	CT#53	CP-110567	1001			Removal of PCO from Failed Bearer Context of Delete Bearer Request	10.4.0
2011-09	CT#53	CP-110567	1006			Downlink Data Notification for S4	10.4.0
2011-09	CT#53	CP-110557	1010	1		MEI in Modify Bearer Request	10.4.0
2011-09	CT#53	CP-110577	0972	1		OI flag in Delete Session Request	11.0.0
2011-09	CT#53	CP-110577	0973	1		Clarification to DAF PAA usage	11.0.0
2011-09	CT#53	CP-110577	0974			Correcting Port Number IE type definition	11.0.0
2011-09	CT#53	CP-110584	0989	3		Add vSRVCC updates to the GTP based interfaces	11.0.0
2011-09	CT#53	CP-110577	0990	1		Clarification on the Bearer Contexts to be removed IE in Modify Access Bearers Request message	11.0.0
2011-09						CR 0914r1 title in history table corrected as in CR database.	11.0.1
2011-12	CT#54	CP-110810	1026			Delete Session Response	11.1.0
2011-12	CT#54	CP-110810	1037	1		Bearer Resource Command	11.1.0
2011-12	CT#54	CP-110810	1049			Clarification on the length restriction of PCO, TFT IE	11.1.0
2011-12	CT#54	CP-110810	1035	1		Correction on SGW-FQ-CSID	11.1.0
2011-12	CT#54	CP-110790	1051	3		Correction to Downlink Data Notification message due to control plane signalling	11.1.0
2011-12	CT#54	CP-110790	1048	2		MBMS IP Multicast Distribution IE	11.1.0
2011-12	CT#54	CP-110784	1054	2		Defining the fixed number of octets for extendable IEs	11.1.0
2011-12	CT#54	CP-110790	1063			Delete Session Request granularity	11.1.0
2011-12	CT#54	CP-110782	1058	2		Essential correction to the TAD IE inclusion in Bearer Resource Command over S4	11.1.0
2011-12	CT#54	CP-110810	1059	2		Fix inconsistency within the specification for GTP version handling	11.1.0
2011-12	CT#54	CP-110810	1036			IE conditions in some message	11.1.0
2011-12	CT#54	CP-110790	1065	1		Indirect Data Forwarding messages	11.1.0
2011-12	CT#54	CP-110790	1019	2		Referencing Information Elements defined outside GTP	11.1.0
2011-12	CT#54	CP-110810	1033	1		Scope Indication IE in Delete Session Request	11.1.0
2011-12	CT#54	CP-110810	1061	1		ULI in the Create Session Request	11.1.0
2011-12	CT#54	CP-110810	1038	1		Update PDN Connection Set Request	11.1.0
2011-12	CT#54	CP-110784	1022	2		Essential clarification on F-TEID in Create Bearer Response	11.1.0
2011-12	CT#54	CP-110784	1030	3		Modify Bearer Request as implicit resume	11.1.0
2011-12	CT#54	CP-110784	1080	2		User CSG Information in TAU/RAU procedures	11.1.0
2011-12	CT#54	CP-110784	1083	2		Missing Originating Node IE when ISR is active	11.1.0
2011-12	CT#54	CP-110784	1088	1		Correction to the Sender F-TEID IE description of the Forward Relocation Request	11.1.0
2011-12	CT#54	CP-110784	1103	2		Missing Cause Value for MUPSAP	11.1.0
2011-12	CT#54	CP-110784	1106	2		Downlink bearers release during mobility procedure	11.1.0
2011-12	CT#54	CP-110810	1027	2		SRNS relocation w/o PDN connection	11.1.0
2011-12	CT#54	CP-110810	1066	3		PDN Type and DAF dependency case	11.1.0
2011-12	CT#54	CP-110810	1072	1		TFT in the SGW for PMIP based S5/S8 interface	11.1.0
2011-12	CT#54	CP-110810	1073	1		MBMS Flow ID in the MBMS Session Stop message	11.1.0
2011-12	CT#54	CP-110810	1085	2		Change Notification Reporting with Non-Zero TEID	11.1.0
2011-12	CT#54	CP-110810	1090	1		LBI in the Delete Bearer Request	11.1.0
2011-12	CT#54	CP-110810	1091	-		DRX parameter	11.1.0

Date	TSG #	TSG Doc	CR	Rev	Cat	Subject/Comment	New
2011-12	CT#54	CP-110810	1092	-		ZUC based EEA3 and EIA3 security algorithm	11.1.0
2011-12	CT#54	CP-110810	1098	2		Suspend Notification	11.1.0
2011-12	CT#54	CP-110790	1075	1		PCO IE in the Modify Bearer Request message	11.1.0
2011-12	CT#54	CP-110790	1094	1		IMEI not known cause	11.1.0
2011-12	CT#54	CP-110790	1096	2		Correction on the bearer context for modification procedure	11.1.0
2011-12	CT#54	CP-110790	1108	-		UE Time Zone condition in Modify Bearer Request	11.1.0
2011-12	CT#54	CP-110815	1067	1		PGW restoration upon PGW failure w/o restart	11.1.0
2011-12	CT#54	CP-110792	1070	3		Authentication with external networks over GTP S2b	11.1.0
2011-12	CT#54	CP-110816	1086	-		Add vSRVCC indicator to Delete Bearer Command	11.1.0
2012-03	CT#55	CP-120017	1117	-		Handover to CSG cell with emergency bearer	11.2.0
2012-03	CT#55	CP-120017	1120	-		Pre-Rel-7 QoS description correction	11.2.0
2012-03	CT#55	CP-120017	1126	2		Reserved Bearer Context at SRNS Relocation	11.2.0
2012-03	CT#55	CP-120017	1146	2		Higher bitrates than 16 Mbps flag	11.2.0
2012-03	CT#55	CP-120017	1180	1		ULI reporting for S4	11.2.0
2012-03	CT#55	CP-120026	1133	6		UE Requested Bearer Resource Modification Procedure	11.2.0
2012-03	CT#55	CP-120026	1135	-		Presence requirements of Information Elements	11.2.0
2012-03	CT#55	CP-120026	1141	2		Max MBR/APN-AMBR in enhanced SRNS relocation procedure	11.2.0
2012-03	CT#55	CP-120026	1147	1		Clarification of Echo Response	11.2.0
2012-03	CT#55	CP-120026	1152	1		Location change reporting support indication related correction	11.2.0
2012-03	CT#55	CP-120026	1154	1		Fix Inter RAT HO issue when ISR active	11.2.0
2012-03	CT#55	CP-120036	1077	4		Bearer Context to be modified in the Modify Bearer Request message	11.2.0
2012-03	CT#55	CP-120036	1113	2		Mapping between S11/S4 and NAS Cause values	11.2.0
2012-03	CT#55	CP-120036	1114	1		Absolute time for MBMS data transfer start and stop	11.2.0
2012-03	CT#55	CP-120036	1155	1		Cause code description	11.2.0
2012-03	CT#55	CP-120036	1158	-		SRVCC PS to CS Response	11.2.0
2012-03	CT#55	CP-120036	1170	1		Charging ID for Non-3GPP IP Access	11.2.0
2012-03	CT#55	CP-120036	1171	1		Sender's F-TEID for Control Plane	11.2.0
2012-03	CT#55	CP-120036	1173	1		Clean up of the irrelevant cause codes from the GTPv2 triggered messages	11.2.0
2012-03	CT#55	CP-120036	1175	2		PGW based provisioning of the DNS server address for the S2b interface	11.2.0
2012-03	CT#55	CP-120036	1177	-		GTPv2 header	11.2.0
2012-03	CT#55	CP-120042	1159	2		New IEs for ePDG scenario	11.2.0
2012-03	CT#55	CP-120041	1161	-		Voice/Video bearer for vSRVCC	11.2.0
2012-03	CT#55	CP-120045	1163	-		Addition of GTP based S2a in clauses 1 to 6	11.2.0
2012-03	CT#55	CP-120045	1164	1		Create Session Request on GTP based S2a	11.2.0
2012-03	CT#55	CP-120045	1165	1		Create Bearer Request on GTP based S2a	11.2.0
2012-03	CT#55	CP-120045	1166	1		Delete Session Request & Delete Bearer Request on GTP based S2a	11.2.0
2012-03	CT#55	CP-120045	1167	1		Modify Bearer Command & Update Bearer Request on GTP based S2a	11.2.0
2012-03	CT#55	CP-120045	1168	1		Trace Session Activation & Deactivation on GTP based S2a	11.2.0
2012-03	CT#55	CP-120045	1169	-		Delete PDN Connection Set on GTP based S2a	11.2.0
2012-06	CT#56	CP-120230	1156	1		CSR and MBR message for SGW restoration procedure	11.3.0
2012-06	CT#56	CP-120230	1157	3		Context Response message	11.3.0
2012-06	CT#56	CP-120233	1162	2		Reporting of H(e)NB local IP address and port	11.3.0
2012-06	CT#56	CP-120228	1182	5			
2012-06	CT#56	CP-120228	1183	5		Adding Originating Node IE to the Delete Session Request for ISR cases	11.3.0
2012-06	CT#56	CP-120233	1186	1		Updated UE local IP in S2b procedure	11.3.0
2012-06	CT#56	CP-120240	1187	2		Network provided Location Information	11.3.0
2012-06	CT#56	CP-120224	1191	1		CFSI in the modify access bearers request	11.3.0
2012-06	CT#56	CP-120228	1194	-		The usage of TEID0	11.3.0
2012-06	CT#56	CP-120230	1195	-		Inclusion of MME/S4-SGSN Identifier	11.3.0
2012-06	CT#56	CP-120230	1196	1		PGW Downlink Triggering Notification/Acknowledge	11.3.0
2012-06	CT#56	CP-120234	1197	2		Additions for CS to PS SRVCC	11.3.0
2012-06	CT#56	CP-120228	1198	1		Mapping of NAS ESM/SM Cause codes to S11/S4 Cause codes	11.3.0
2012-06	CT#56	CP-120228	1199	3		Release of old S3 GTP-C TEIDs during I-RAT HO with ISR active	11.3.0
2012-06	CT#56	CP-120228	1200	2		ULI inclusion condition during Service Request procedure when ISR is active	11.3.0
2012-06	CT#56	CP-120238	1201	1		Addition of Subnet Mask and Default Router Address in Create Session Response for Trusted WLAN Access over S2a	11.3.0
2012-06	CT#56	CP-120228	1202	1		Clarify mandatory/conditional IE inclusion in error response msg	11.3.0
2012-06	CT#56	CP-120228	1210	2		TAD in the Bearer Resource Command message	11.3.0
2012-06	CT#56	CP-120228	1211	-		More choices of mapping between GTPv2 cause code to the NAS ESM/SM Cause codes	11.3.0
2012-06	CT#56	CP-120228	1213	1		Extended RNC ID in Target Identification IE	11.3.0
2012-06	CT#56	CP-120228	1214	1		Clarification to "SGW node name" & "SGW S11/S4 IP Address and TEID for Control Plane" IE presence conditions	11.3.0



Date	TSG #	TSG Doc	CR	Rev	Cat	Subject/Comment	New
2012-09	CT#57	CP-120448	1230	-		SGW DL/UL F-TEID for data forwarding in Forward Relocation Response message	11.4.0
2012-09	CT#57	CP-120477	1216	1		RAT Type for EPC access via TWAN	11.4.0
2012-09	CT#57	CP-120457	1217	-		Encoding of Absolute Time of MBMS Data Transfer	11.4.0
2012-09	CT#57	CP-120457	1219	2		Sender's F-TEID in the Forward Relocation Response	11.4.0
2012-09	CT#57	CP-120457	1221	-		Presence condition of APN-AMBR in the Modify Bearer Response message	11.4.0
2012-09	CT#57	CP-120457	1222	2		GTP Tunnel	11.4.0
2012-09	CT#57	CP-120457	1224	1		Delete Session Request usage in SGW with active ISR	11.4.0
2012-09	CT#57	CP-120457	1226	-		Context Request note error	11.4.0
2012-09	CT#57	CP-120457	1228	-		PAA clarification for PDN type IPv4v6	11.4.0
2012-09	CT#57	CP-120457	1232	2		F-TEID interface types for Indirect Forwarding	11.4.0
2012-09	CT#57	CP-120457	1233	2		Zero TEID Usage In Relocation Cancel Response	11.4.0
2012-09	CT#57	CP-120457	1235	1		PDP connection inactivity timer expires	11.4.0
2012-09	CT#57	CP-120475	1220	1		MSV flag in rSRVCC procedure	11.4.0
2012-09	CT#57	CP-120475	1236	-		Selected PLMN ID	11.4.0
2012-09	CT#57	CP-120656	1237	1		Reference list correction to align with the corrected TS 29.212 title	11.4.0
2012-12	CT#58	CP-120718	1240	1		Removal of Maximum MBR/APN-AMBR	11.5.0
2012-12	CT#58	CP-120718	1243	3		Change to Report Flags for delayed reporting of change of SN/TZ during inter-CN node mobility	11.5.0
2012-12	CT#58	CP-120718	1270	1		Additional MBR for delayed reporting of change of SN/TZ/UCI	11.5.0
2012-12	CT#58	CP-120718	1291	3		Delete Bearer Request with ISR deactivation	11.5.0
2012-12	CT#58	CP-120744	1231	4		Adding a Cause Value in Delete Session Request message	11.5.0
2012-12	CT#58	CP-120744	1238	-		Forward Relocation Request over the S3 interface	11.5.0
2012-12	CT#58	CP-120744	1244	-		Corrections to reference titles and octet numbering of IE definitions	11.5.0
2012-12	CT#58	CP-120744	1245	-		Clarifications on sending/new node and receiving/old node about Identification Request message	11.5.0
2012-12	CT#58	CP-120744	1246	-		Multiple CSID	11.5.0
2012-12	CT#58	CP-120744	1247	-		TEID of the Change Notification Request and Response messages	11.5.0
2012-12	CT#58	CP-120744	1253	3		Suspend Notification/Acknowledge message in SGSN pool	11.5.0
2012-12	CT#58	CP-120744	1254	-		Sender F-TEID IE in Modify Bearer Request message	11.5.0
2012-12	CT#58	CP-120744	1262	1		Clarification of Delete Bearer Failure Indication	11.5.0
2012-12	CT#58	CP-120744	1263	2		Cause value "ISR deactivation"	11.5.0
2012-12	CT#58	CP-120744	1264	1		IPv4 address allocation	11.5.0
2012-12	CT#58	CP-120744	1265	1		Sender F-TEID in DDN msg (network triggered service restoration procedure)	11.5.0
2012-12	CT#58	CP-120744	1268	-		Correction to IP Address Instance values in CSReq & MBReq	11.5.0
2012-12	CT#58	CP-120744	1273	-		Clarifications on value definitions of PDN Type, Security Mode and Used NAS Cipher IE	11.5.0
2012-12	CT#58	CP-120744	1276	1		Clarification on UCI in Create Session Request message during SGW relocation	11.5.0
2012-12	CT#58	CP-120744	1283	1		Change reporting requested by PCRF	11.5.0
2012-12	CT#58	CP-120744	1294	1		Selected PLMN ID	11.5.0
2012-12	CT#58	CP-120739	1271	1		Sender F-TEID in PGW Downlink Triggering Notification	11.5.0
2012-12	CT#58	CP-120739	1278	2		SGW failure when ISR is active enhancement	11.5.0
2012-12	CT#58	CP-120733	1272	2		TWAN operator identification for EPC access charging	11.5.0
2012-12	CT#58	CP-120733	1286	3		Trusted WLAN AP identity over GTP S2a	11.5.0
2012-12	CT#58	CP-120726	1279	1		H(e)NB local IP address/port in create session request	11.5.0
2012-12	CT#58	CP-120710	1257	2		Removal of TFT IE from Create Session Response message	11.5.0
2012-12	CT#58	CP-120744	1258	1		Clarifications on RAT Type Values "UTRAN" and "HSPA evolution"	11.5.0
2013-03	CT#59	CP-130021	1306	2		Populating Serving Network	11.6.0
2013-03	CT#59	CP-130021	1307	2		IMSI in Suspend Notification for UICCless Emergency Call	11.6.0
2013-03	CT#59	CP-130018	1310	2		User CSG Information reporting during inter-MME/SGSN mobility	11.6.0
2013-03	CT#59	CP-130027	1320	-		Sending SSID for SaMOG in GTP	11.6.0
2013-03	CT#59	CP-130029	1296	1		Bearer QoS	12.0.0
2013-03	CT#59	CP-130029	1297	1		Clarification of term "PS mobility"	12.0.0
2013-03	CT#59	CP-130029	1302	1		Corrections to abbreviation of Radio Access Technology and definition of cause value	12.0.0
2013-03	CT#59	CP-130029	1303	1		Corrections to descriptions of RFSP Index	12.0.0
2013-03	CT#59	CP-130029	1311	1		Correct the NOTE for Cause value	12.0.0
2013-03	CT#59	CP-130029	1312	1		Corrections to Table Content, IE and Text Color	12.0.0
2013-03	CT#59	CP-130029	1316	1		Cause value in Update PDN Connection Set Response	12.0.0
2013-03	CT#59	CP-130029	1318	1		EPS bearer ID derived for Downlink Data Notification	12.0.0
2013-03	CT#59	CP-130029	1319	1		Correcting the Flow QoS IE reference for Bearer Resource Command	12.0.0
2013-03	CT#59	CP-130031	1308	1		Clarification of Resume when S4-U is enabled	12.0.0
2013-03	CT#59	CP-130031	1313	1		Stop Paging Indication in service restoration procedure	12.0.0
2013-06	CT#60	CP-130304	1324	1		Direct Tunnel Flag	12.1.0
2013-06	CT#60	CP-130304	1322	-		Handling ASN.1/PER encoded parameters	12.1.0
2013-06	CT#60	CP-130304	1321	2		Presence requirements clarification	12.1.0
2013-06	CT#60	CP-130304	1330	3		CR on Unaccepted PDN connection during TAU and Handover	12.1.0

Date	TSG #	TSG Doc	CR	Rev	Cat	Subject/Comment	New
2013-06	CT#60	CP-130304	1343	1		TWAN Identifier	12.1.0
2013-06	CT#60	CP-130304	1339	1		Missing Recovery IE	12.1.0
2013-06	CT#60	CP-130304	1337	2		The setting EPS bearer ID/ARP for MME paging strategy	12.1.0
2013-06	CT#60	CP-130304	1336	2		Delete Bearer Request triggered by PMIP error indication message	12.1.0
2013-06	CT#60	CP-130304	1332	1		Prohibit Payload Compression Indication Corrections	12.1.0
2013-06	CT#60	CP-130296	1341	2		ULI Timestamp	12.1.0
2013-06	CT#60	CP-130378	1323	1		SIPTO at the local network	12.1.0
2013-06	CT#60	CP-130282	1346	-		Removal of TFT IE from Create Session Response message	12.1.0
2013-06	CT#60	CP-130290	1329	2		Bearer Context to be modified in Modify Bearer Request	12.1.0
2013-09	CT#61					Reporting ULI and TimeZone at MME-initiated bearer related procedures	12.2.0
		CP-130449	1350	1			
2013-09	CT#61	CP-130454	1347	1		New MBMS flags for eMBMS restoration	12.2.0
2013-09	CT#61	CP-130467	1348	1		Serving Network IE definition	12.2.0
2013-09	CT#61	CP-130467	1354	3		Indication Flags	12.2.0
2013-09	CT#61	CP-130467	1355	2		Sending Recovery IE in GTPv2-C messages	12.2.0
2013-09	CT#61	CP-130467	1361	2		Enforcing access restriction during I-RAT RAU/TAU procedures	12.2.0
2013-09	CT#61	CP-130467	1371	1		Modify Access Bearer for Intra TAU w/o SGW change	12.2.0
2013-09	CT#61	CP-130467	1372	1		GTP-C message types for rSRVCC	12.2.0
2013-09	CT#61	CP-130446	1352	1		Returning to former LTE PLMN after CSFB	12.2.0
2013-09	CT#61	CP-130443	1363	1		Inclusion of ePDG IP address of IKEv2 tunnel endpoint on S2b-GTP	12.2.0
2013-09	CT#61	CP-130453	1364	1		SIPTO at the Local Network	12.2.0
2013-09	CT#61	CP-130462	1365	1		GERAN lu Mode	12.2.0
2013-09	CT#61	CP-130470	1366	-		Update to cover the S121	12.2.0
2013-09	CT#61	CP-130583	1368	4		ULI Timestamp IE format	12.2.0
2013-12	CT#62					Reporting the RAN/NAS release cause during bearer release procedures	12.3.0
		CP-130626	1374	3			
2013-12	CT#62	CP-130626	1375	-		MM Context IE in Identification Response	12.3.0
2013-12	CT#62	CP-130626	1376	4		Core Network Operator selection origin	12.3.0
2013-12	CT#62	CP-130626	1378	1		Correct Presence requirement for Conditional IE	12.3.0
2013-12	CT#62	CP-130626	1382	1		Delete Session Request/Response	12.3.0
2013-12	CT#62	CP-130626	1383	1		Correction the ULI for RAI IE	12.3.0
2013-12	CT#62	CP-130626	1384	1		Correct the Message Type value reserved for S101	12.3.0
2013-12	CT#62	CP-130626	1385	1		Harmonisation of the abbreviation LBI	12.3.0
2013-12	CT#62	CP-130626	1391	1		Variable length parameters in GTPv2 IEs	12.3.0
2013-12	CT#62	CP-130626	1392	1		Removing APN-AMBR from Modify Bearer Response	12.3.0
2013-12	CT#62					Clarification on encoding of bit rates when converting bits per second received over Diameter interfaces to kilo bits per second over GTPv2.	12.3.0
		CP-130626	1393	1			
2013-12	CT#62	CP-130626	1396	2		Correct the value of the Selection Mode IE	12.3.0
2013-12	CT#62	CP-130626	1397	1		Cause IE condition in the Delete Session Request	12.3.0
2013-12	CT#62	CP-130626	1398	2		S1-U eNodeB F-TEID in Create Bearer Response	12.3.0
2013-12	CT#62	CP-130626	1400	2		SS code used in the Paging message	12.3.0
2013-12	CT#62	CP-130626	1405	1		PGW IP Addresses in Initial Messages	12.3.0
2013-12	CT#62	CP-130626	1406	2		PGW and SGW Charging alignment in downlink	12.3.0
2013-12	CT#62					ULI reporting in the Create Session Request and Modify Bearer Request message	12.3.0
		CP-130613	1387	2			
2013-12	CT#62	CP-130604	1390	1		Correction on Trace information	12.3.0
2013-12	CT#62					Support HO indication and additional PDN request on the S2a GTP interface	12.3.0
		CP-130633	1394	2			
2014-03	CT#63	CP-140029	1409	1		F-TEID Interface Type 8	12.4.0
2014-03	CT#63	CP-140029	1410	2		S12, S4-U, S1-U F-TEID values	12.4.0
2014-03	CT#63	CP-140029	1411	2		Triggered messages	12.4.0
2014-03	CT#63	CP-140029	1413	2		F-Container Definition Correction	12.4.0
2014-03	CT#63	CP-140029	1417	2		CSG Membership Indication values	12.4.0
2014-03	CT#63	CP-140029	1418	1		Dummy IMSI in Resume Notification	12.4.0
2014-03	CT#63	CP-140029	1419	2		Sender F-TEID in the Delete Session Request message	12.4.0
2014-03	CT#63	CP-140029	1423	1		PLMN ID communicated to the HPLMN in network sharing	12.4.0
2014-03	CT#63	CP-140030	1421	1		TWAN-ID reporting extensions for NPLI for TWAN access	12.4.0
2014-03	CT#63	CP-140030	1422	1		TWAN-ID contents extensions for NPLI for TWAN access	12.4.0
2014-03	CT#63	CP-140030	1436	-		TWAN location retrieval in Update Bearer Request	12.4.0
2014-03	CT#63	CP-140031	1429	3		Trusted WLAN mode indication	12.4.0
2014-03	CT#63	CP-140022	1431	1		Update the ULI Timestamp IE format	12.4.0
2014-03	CT#63	CP-140022	1435	2		Bearer context in Update Bearer Response when DTF is set	12.4.0
2014-03	CT#63	CP-140021	1433	1		Temporarily rejected due to mobility procedure in progress	12.4.0
2014-03	CT#64					Introduction of Node Number and Node Identifier (to carry SGSN Lgd Identifier and MME SLg identifier)	12.5.0
		CP-140261	1438	3			
2014-06	CT#64	CP-140261	1443	1		Number of authentication vectors in the MM Context IE	12.5.0
2014-06	CT#64	CP-140261	1444	2		Context Response with P-TMSI Signature mismatch	12.5.0
2014-06	CT#64	CP-140261	1448	1		Including CSG change reporting for Change Notification procedure	12.5.0
2014-06	CT#64	CP-140261	1452	1		Spare bits in MM Context	12.5.0
2014-06	CT#64	CP-140261	1455	1		User CSG Information reporting in rollback case	12.5.0

Date	TSG #	TSG Doc	CR	Rev	Cat	Subject/Comment	New
2014-06	CT#64	CP-140261	1456	1		Corrections to Node Type	12.5.0
2014-06	CT#64	CP-140261	1457	1		Update the condition of the UE Time Zone IE	12.5.0
2014-06	CT#64	CP-140261	1460	1		A new Cause Value for the case where an MME in the VPLMN refuses to setup/modify a Bearer	12.5.0
2014-06	CT#64	CP-140261	1478	2		Alternate LMA address for user plane	12.5.0
2014-06	CT#64	CP-140261	1479	1		PLMN ID communicated in the VPLMN in network sharing	12.5.0
2014-06	CT#64	CP-140261	1482	1		Version Not Supported Indication	12.5.0
2014-06	CT#64	CP-140261	1489	3		IPv6 address allocation	12.5.0
2014-06	CT#64	CP-140261	1490	3		Context Request Indication flags	12.5.0
2014-06	CT#64	CP-140235	1445	5		Update cause to indicate downlink message delivery failure due to crash with mobility event	12.5.0
2014-06	CT#64	CP-140235	1447	2		MDT configuration during inter-MME handover	12.5.0
2014-06	CT#64	CP-140242	1441	3		Reporting changes of UE presence in Presence Reporting Area	12.5.0
2014-06	CT#64	CP-140247	1451	-		PCO in the HO to TWAN procedures	12.5.0
2014-06	CT#64	CP-140247	1487	2		PCO in handover to 3GPP access	12.5.0
2014-06	CT#64	CP-140252	1439	1		TWAN Identifier Timestamp	12.5.0
2014-06	CT#64	CP-140252	1440	-		Civic address encoding	12.5.0
2014-06	CT#64	CP-140252	1459	4		Extension to the TWAN Identifier contents: new Line Identifier (Logical Access ID)	12.5.0
2014-06	CT#64	CP-140252	1481	2		SSID not sufficient for TWAN location	12.5.0
2014-06	CT#64	CP-140241	1461	1		Propagation of MME/S4-SGSN identity to PGW	12.5.0
2014-06	CT#64	CP-140241	1462	1		Updating PGW with overload control information of target MME/S4-SGSN	12.5.0
2014-06	CT#64	CP-140241	1463	1		Interaction with congestion control using APN back-off timer	12.5.0
2014-06	CT#64	CP-140241	1464	1		Discovery of the support of the GTP signalling based Load Control feature by the peer node	12.5.0
2014-06	CT#64	CP-140241	1465	1		Discovery of the support of the GTP signalling based Overload Control feature by the peer node	12.5.0
2014-06	CT#64	CP-140241	1466	1		Issues in the network with partial support of the GTP Load Control feature	12.5.0
2014-06	CT#64	CP-140241	1467	1		Issues in the network with partial support of the GTP Overload Control feature	12.5.0
2014-06	CT#64	CP-140241	1468	1		Implicit overload control mechanisms	12.5.0
2014-06	CT#64	CP-140241	1469	2		Load control solution: General aspects	12.5.0
2014-06	CT#64	CP-140241	1470	3		Overload control solution: General aspects	12.5.0
2014-06	CT#64	CP-140241	1471	1		Addition of Load & Overload Control Info IEs in session mgmt. messages	12.5.0
2014-06	CT#64	CP-140241	1472	2		Definition of new IEs for Load & Overload Control feature	12.5.0
2014-06	CT#64	CP-140241	1475	1		Overload problem, scenarios, load and overload control concepts	12.5.0
2014-06	CT#64	CP-140241	1476	1		Overload control: message throttling	12.5.0
2014-06	CT#64	CP-140241	1477	2		Enforcement of overload control	12.5.0
2014-06	CT#64	CP-140241	1480	2		Load control information	12.5.0
2014-06	CT#64	CP-140241	1488	2		Overload Control Information	12.5.0
2014-09	CT#65	CP-140512	1492	-		Handovers between non-3GPP and 3GPP access	12.6.0
2014-09	CT#65	CP-140512	1493	2		Setting Handover Indication flag	12.6.0
2014-09	CT#65	CP-140512	1507	2		Reporting the RAN/NAS cause during bearer creation/modification failure scenarios	12.6.0
2014-09	CT#65	CP-140512	1510	1		Correct procedure name for PDN connection deactivation	12.6.0
2014-09	CT#65	CP-140512	1512	1		Repeated procedure description	12.6.0
2014-09	CT#65	CP-140512	1514	-		Create Session Request received for an existing PDN connection	12.6.0
2014-09	CT#65	CP-140512	1515	2		Deferred SN/CSG/Time zone change reporting in GERAN	12.6.0
2014-09	CT#65	CP-140502	1495	2		MDT PLMN List configuration parameter	12.6.0
2014-09	CT#65	CP-140502	1509	1		Bearer contexts in Modify Access Bearers Request	12.6.0
2014-09	CT#65	CP-140505	1496	3		Inclusion of MME/S4-SGSN Identifier in the Create/Update/Delete Bearer Response message	12.6.0
2014-09	CT#65	CP-140505	1498	1		Addition of missing changes	12.6.0
2014-09	CT#65	CP-140522	1497	1		Inclusion PRA information in the Create/Update Bearer Response message	12.6.0
2014-09	CT#65	CP-140522	1500	-		Reporting changes of UE presence in a Presence Reporting Area	12.6.0
2014-09	CT#65	CP-140522	1501	2		ULI change reporting when E-RAB/RAB/user plane is established	12.6.0
2014-09	CT#65	CP-140506	1499	-		P-CSCF Restoration Indication	12.6.0
2014-09	CT#65	CP-140521	1511	3		Introduction of Dual Connectivity Function	12.6.0
2014-09	CT#65	CP-140518	1513	2		PGW F-TEID in the PGW Downlink Triggering Notification	12.6.0
2014-09	CT#65	CP-140501	1518	-		BSS container in Forward Relocation Request / Response	12.6.0
2014-12	CT#66	CP-140758	1505	3		Target Cell Identification in E-UTRAN to GERAN PS Handover	12.7.0
2014-12	CT#66	CP-140761	1540	2		P-CSCF Address Inclusion in PCO IE of Update Bearer Request	12.7.0
2014-12	CT#66	CP-140795	1519	2		Handling of load control and overload control parameters	12.7.0
2014-12	CT#66	CP-140795	1520	3		Overload control message prioritization	12.7.0
2014-12	CT#66	CP-140795	1521	2		Propagating the MME/S4-SGSN identity to the PGW	12.7.0
2014-12	CT#66	CP-140795	1542	1		Overload/Load Control Information IE on S2a/S2b/S4/S11	12.7.0

Date	TSG #	TSG Doc	CR	Rev	Cat	Subject/Comment	New
2014-12	CT#66	CP-140972	1523	1		EBI value to use in Downlink Data Notification Triggered by a Dedicated Bearer Activation procedure when ISR is active	12.7.0
2014-12	CT#66	CP-140972	1526	3		Essential clarification on the usage of cause code "Context Not Found"	12.7.0
2014-12	CT#66	CP-140972	1528	2		Pending subscription change	12.7.0
2014-12	CT#66	CP-140972	1532	3		Handovers from non-3GPP IP access to 3GPP IP access	12.7.0
2014-12	CT#66	CP-140972	1534	1		Removal of Optimized HO procedure from HRPD to EUTRAN	12.7.0
2014-12	CT#66	CP-140972	1535	-		Type value of the BSS Container IE in Context Response	12.7.0
2014-12	CT#66	CP-140972	1536	1		Length of Recovery IE	12.7.0
2014-12	CT#66	CP-140972	1541	3		Additional cause code mapping for non-availability of Services due to LTE-Roaming	12.7.0
2014-12	CT#66	CP-140972	1544	-		Missing Value definition of GUTI	12.7.0
2014-12	CT#66	CP-140972	1545	3		Message piggybacking clarification	12.7.0
2014-12	CT#66	CP-140794	1525	1		Paging stop indication for ISR during P-CSCF restoration procedure	12.7.0
2014-12	CT#66	CP-140972	1527	2		MEI in Create Session Request	12.7.0
2014-12	CT#66	CP-140794	1529	1		Bearer Contexts to be modified IE in 'Modify Bearer Request	12.7.0
2014-12	CT#66	CP-140779	1530	1		TWAN PLMN ID	12.7.0
2014-12	CT#66	CP-140780	1533	5		WLAN Offloadability transfer during mobility procedures	12.7.0
2014-12	CT#66	CP-140789	1543	1		No change S1 SGW F-TEID in E-UTRAN Initiated E-RAB modification procedure	12.7.0
2014-12	CT#66	CP-140784	1548	1		Inclusion of PCO in Delete Session/Bearer Request for TWAN access	12.7.0
2014-12	CT#66	CP-140796	1524	2		Provisioning of P-CSCF address via APCO for S2b	13.0.0
2014-12	CT#66	CP-140760	1546	1		GTP-C overload control from TWAN/ePDG to PGW	13.0.0
2015-03	CT#67	CP-150037	1547	3		MBMS Alternative IP Multicast Distribution Address	13.1.0
2015-03	CT#67	CP-150037	1550	1		Clarification of RAC encoding	13.1.0
2015-03	CT#67	CP-150037	1551	1		MBMS Flow Identifier clarification	13.1.0
2015-03	CT#67	CP-150037	1554	1		Unexpected GTP message clarification	13.1.0
2015-03	CT#67	CP-150037	1556	1		UE Registration Query	13.1.0
2015-03	CT#67	CP-150037	1557	3		Correction on definition of IMSI	13.1.0
2015-03	CT#67	CP-150037	1559	1		Bearer Contexts in Create Bearer Response, Update Bearer Response and Delete Bearer Response for partial failure and success cases.	13.1.0
2015-03	CT#67	CP-150037	1561	1		Cause IMSI not known	13.1.0
2015-03	CT#67	CP-150037	1566	1		TWAN Release Cause	13.1.0
2015-03	CT#67	CP-150025	1553	2		ULI IE condition in Create session Request message	13.1.0
2015-03	CT#67	CP-150025	1563	1		PDN Type in PAA IE for S2b case	13.1.0
2015-03	CT#67	CP-150025	1568	1		ULI change reporting upon inter-RAT mobility	13.1.0
2015-03	CT#67	CP-150041	1565	1		Paging Policy Indication in Downlink Data Notification message	13.1.0
2015-06	CT#68	CP-150254	1589	-		ARP Value in Downlink Data Notification message	13.2.0
2015-06	CT#68	CP-150254	1594	1		Contents of ULI IE in the Modify Bearer Request during Handovers to UTRAN	13.2.0
2015-06	CT#68	CP-150270	1570	3		TEID-C header value not known / Failure Indication message Cause value rules	13.2.0
2015-06	CT#68	CP-150270	1573	-		RAT Type in Change Notification Request	13.2.0
2015-06	CT#68	CP-150270	1575	2		PCO in CSReq for handover to TWAN with GTP over S2a	13.2.0
2015-06	CT#68	CP-150270	1576	2		Correction to ULI inclusion for PDP activation procedure	13.2.0
2015-06	CT#68	CP-150270	1577	3		IE inclusion for non-3GPP to 3GPP handover case	13.2.0
2015-06	CT#68	CP-150270	1578	-		Inclusion of EBI in Delete Bearer Request message	13.2.0
2015-06	CT#68	CP-150270	1581	2		User CSG Information in TAU/RAU with SGW change procedure	13.2.0
2015-06	CT#68	CP-150270	1582	2		Session/bearer release cause over S2a	13.2.0
2015-06	CT#68	CP-150270	1583	2		Session/bearer release cause over S2b	13.2.0
2015-06	CT#68	CP-150270	1599	1		At receiving Delete Bearer Failure Indication sent on zero-TEID	13.2.0
2015-06	CT#68	CP-150270	1600	1		UCI condition in Modify Bearer Request message	13.2.0
2015-06	CT#68	CP-150270	1601	2		Upon receiving unexpected triggered messages	13.2.0
2015-06	CT#68	CP-150270	1603	1		Correction to ULI for the S5/S8 interface	13.2.0
2015-06	CT#68	CP-150270	1604	1		Presence condition of embedded IEs in a Grouped IE	13.2.0
2015-06	CT#68	CP-150270	1605	1		EBI and ARP in DDN message sent to S4-SGSN	13.2.0
2015-06	CT#68	CP-150270	1606	1		Message Granularity of Restoration/Recovery and Path Management messages	13.2.0
2015-06	CT#68	CP-150274	1595	1		IMEI(SV) signalling over GTP based S2a and S2b	13.2.0
2015-09	CT#69	CP-150433	1615	-		Modify Access Bearers Request leading to unpause charging in the PGW	13.3.0
2015-09	CT#69	CP-150442	1608	1		Receipt of a Create Session Request at SGW colliding with an existing PDN connection context	13.3.0
2015-09	CT#69	CP-150442	1609	2		Detection and handling of late arriving requests	13.3.0
2015-09	CT#69	CP-150439	1610	1		eDRX impact on GTPv2 for network originated control plane procedure	13.3.0
2015-09	CT#69	CP-150454	1611	2		Enhancement in Downlink Data Notification Acknowledgement for extended buffering in the SGW	13.3.0

Date	TSG #	TSG Doc	CR	Rev	Cat	Subject/Comment	New
2015-09	CT#69	CP-150454	1612	2		Data forwarding for buffered DL data during TAU/RAU with SGW change	13.3.0
2015-09	CT#69	CP-150448	1613	1		Usage of Charging Characteristics for activating PCC function	13.3.0
2015-09	CT#69	CP-150448	1616	-		SSID and BSSID encoding clarification	13.3.0
2015-09	CT#69	CP-150448	1619	2		Monitoring Event Information	13.3.0
2015-09	CT#69	CP-150440	1620	3		UE Usage Type for Dedicated Core Network Feature	13.3.0
2015-09	CT#69	CP-150440	1621	2		Reject Cause in Context Acknowledge for Dedicated Core Network Feature	13.3.0
2015-09	CT#69	CP-150451	1625	2		MME/SGSN/SGW/TWAN/ePDG NBIFOM support indication	13.3.0
2015-12	CT#70	CP-150761	1626	1		Cell List in MBMS Session Requests	13.4.0
2015-12	CT#70	CP-150780	1627	-		Extensions for P-CSCF restoration for trusted and untrusted WLAN access	13.4.0
2015-12	CT#70	CP-150770	1628	1		Emergency PDN connection over untrusted WLAN access	13.4.0
2015-12	CT#70	CP-150770	1660	1		User Location Information reporting extensions over S2b	13.4.0
2015-12	CT#70	CP-150760	1631	2		Load and overload metrics on APN level	13.4.0
2015-12	CT#70	CP-150760	1633	2		Load and overload IE Instances	13.4.0
2015-12	CT#70	CP-150760	1635	2		Load and overload sequence numbers per node	13.4.0
2015-12	CT#70	CP-150760	1636	2		Load and overload Sequence Number check	13.4.0
2015-12	CT#70	CP-150752	1637	3		Modify Bearer Request when "Active flag" is set	13.4.0
2015-12	CT#70	CP-150752	1639	2		PCO in Create Session Request and Response	13.4.0
2015-12	CT#70	CP-150752	1641	2		Context not found in handovers	13.4.0
2015-12	CT#70	CP-150752	1645	-		Correct the wrong IE name	13.4.0
2015-12	CT#70	CP-150752	1646	-		Coding of CSG ID	13.4.0
2015-12	CT#70	CP-150752	1651	1		Extension of GTPv2 IE type	13.4.0
2015-12	CT#70	CP-150752	1653	3		Addition of new GTPv2 Cause Code for Credit Check	13.4.0
2015-12	CT#70	CP-150752	1663	1		Inclusion of RAN/NAS Cause in Delete Bearer Response	13.4.0
2015-12	CT#70	CP-150752	1665	2		F-Container Type Value	13.4.0
2015-12	CT#70	CP-150773	1642	2		Network-initiated IP flow mobility	13.4.0
2015-12	CT#70	CP-150773	1643	2		UE-initiated IP Flow Mobility and IP Flow Mapping	13.4.0
2015-12	CT#70	CP-150773	1644	2		Addition of one access to a PDN connection in NBIFOM	13.4.0
2015-12	CT#70	CP-150773	1650	1		Define a cause value for the rejection of additional access to a PDN connection	13.4.0
2015-12	CT#70	CP-150773	1669	1		NBIFOM support indication	13.4.0
2015-12	CT#70	CP-150751	1648	1		UE Radio Capability for Paging Information	13.4.0
2015-12	CT#70	CP-150751	1658	3		Mapping table between GTPv2 S2a and WLCP/Diameter	13.4.0
2015-12	CT#70	CP-150751	1667	1		Operation Indication in MME triggered Serving GW relocation procedure	13.4.0
2015-12	CT#70	CP-150776	1649	2		Transferring DTCI and PNSI during inter MME/SGSN mobility procedure	13.4.0
2015-12	CT#70	CP-150776	1652	1		Delay Tolerant Connection Indication	13.4.0
2015-12	CT#70	CP-150776	1655	1		DTCI in SGW	13.4.0
2015-12	CT#70	CP-150772	1656	2		Remote UE Report Notification	13.4.0
2015-12	CT#70	CP-150756	1662	1		Presence Reporting Area Identifier	13.4.0
2015-12	CT#70	CP-150782	1659	1		Handling of Create Session Request without Origination Timestamp	13.4.0
2015-12	CT#70	CP-150781	1668	1		UE Usage Type Coding	13.4.0
2015-12	CT#70	CP-150778	1670	-		Monitoring Events in Identification Response	13.4.0
2015-12	CT#70	CP-150778	1671	3		Remove Editor's Note on the Monitoring Event Information	13.4.0
2015-12	CT#70	CP-150765	1680	1		Instance numbers for overload control information	13.4.0
2016-03	CT#71	CP-160016	1684	1		Add cause values to TWAN mapping table	13.5.0
2016-03	CT#71	CP-160035	1682	-		Update the reference for NBIFOM container	13.5.0
2016-03	CT#71	CP-160035	1692	-		PDN Connection Charging ID	13.5.0
2016-03	CT#71	CP-160038	1685	-		Octet number in MM context IE	13.5.0
2016-03	CT#71	CP-160038	1686	1		Protocol Type in Create Session Request	13.5.0
2016-03	CT#71	CP-160038	1688	1		Incorrect use of the term "full hexadecimal representation" to mean binary encoding	13.5.0
2016-03	CT#71	CP-160038	1691	-		Use case for inclusion of the RAN/NAS Cause in Delete Bearer Response	13.5.0
2016-03	CT#71	CP-160038	1693	3		Transferring AAA identifier from the ePDG to the PGW	13.5.0
2016-03	CT#71	CP-160033	1689	3		S11-U tunneling for MO/MT data transport in control plane (SGi based) – with new S11-U F-TEIDs	13.5.0
2016-03	CT#71	CP-160033	1690	1		RAT-Type extension for NB-IoT	13.5.0
2016-03	CT#71	CP-160033	1697	6		Transfer of non IP PDN to peer MME during mobility	13.5.0
2016-03	CT#71	CP-160033	1698	1		Addition of NB-IoT radio access type to the Access-Restriction-Data feature	13.5.0
2016-03	CT#71	CP-160033	1699	1		No Delete Session Request for non-existing PDN connection	13.5.0
2016-03	CT#71	CP-160033	1700	1		No Create Session Request for Attach without PDN connection	13.5.0
2016-03	CT#71	CP-160033	1701	2		No Paging and Service Information in DDN for non-IP PDN connections	13.5.0
2016-03	CT#71	CP-160033	1704	1		Protocol change for Connection Suspend and Resume Procedure	13.5.0
2016-03	CT#71	CP-160033	1705	2		Protocol change for introducing new non-IP PDN type	13.5.0
2016-03	CT#71	CP-160025	1687	-		P-CSCF_RESELECTION_SUPPORT Private Status Type	13.5.0

Date	TSG #	TSG Doc	CR	Rev	Cat	Subject/Comment	New
2016-03	CT#71	CP-160036	1694	2		Cleanup of the editor's notes for reporting remote UE	13.5.0
2016-03	CT#71	CP-160030	1695	1		Triggering MT SM retransmission by the SMS GMSC to a UE in eDRX during inter MME/SGSN mobility procedure	13.5.0
2016-06	CT#72	CP-160214	1713	1		Correction to the inclusion of PRA IE in Create Session Request on S5/S8 interface	13.6.0
2016-06	CT#72	CP-160228	1706	4		Handover for non-NB-IoT devices using CloT optimisations	13.6.0
2016-06	CT#72	CP-160228	1707	1		S11-U bearers handling during the TAU procedure	13.6.0
2016-06	CT#72	CP-160228	1708	3		Transfer of Header Compression Configuration during inter-MME mobility	13.6.0
2016-06	CT#72	CP-160228	1714	2		Rejecting Context Request with RAT type change from/to NB-IoT	13.6.0
2016-06	CT#72	CP-160228	1715	2		Addressing Editor's Note on SCEF PDN Connections IE in Context Response	13.6.0
2016-06	CT#72	CP-160228	1719	1		MME triggered PGW pause of charging	13.6.0
2016-06	CT#72	CP-160228	1726	1		Transfer of Header Compression Configuration during inter-MME Handover	13.6.0
2016-06	CT#72	CP-160228	1734	3		Simultaneous support for CP and UP optimisation	13.6.0
2016-06	CT#72	CP-160228	1737	2		Extended Protocol Configuration Option and Support ePCO indication	13.6.0
2016-06	CT#72	CP-160228	1738	1		Selection of an EPC entity supporting CloT	13.6.0
2016-06	CT#72	CP-160234	1709	1		Clarification on inclusion of the Sending Node Features IE in Echo Request & Response messages	13.6.0
2016-06	CT#72	CP-160234	1710	4		Bearer mismatching handling	13.6.0
2016-06	CT#72	CP-160234	1718	1		Add both IP addresses within S1-U SGW F-TEID in Create Bearer Request	13.6.0
2016-06	CT#72	CP-160234	1722	1		Incorrect conditions for ULI IE in CSReq for X2 Handover and Enhanced SRNS Relocation	13.6.0
2016-06	CT#72	CP-160234	1723	-		Selection Mode value for Wildcard authorized APN	13.6.0
2016-06	CT#72	CP-160234	1727	1		Data Notification Delay in DDN Acknowledge	13.6.0
2016-06	CT#72	CP-160234	1728	-		Associate OCI with SGW node's identity	13.6.0
2016-06	CT#72	CP-160234	1733	1		A correction on the reference index of UE usage type in TS29.274	13.6.0
2016-06	CT#72	CP-160234	1740	1		Essential clarification for Modify Access Bearer Request when only EBI is present	13.6.0
2016-06	CT#72	CP-160234	1742	1		Extensions for EGPRS access security enhancements	13.6.0
2016-06	CT#72	CP-160231	1716	3		Handling of NW-initiated session/bearer release for NB-IFOM connections	13.6.0
2016-06	CT#72	CP-160231	1725	2		Clarification of the Relay Identity included in TWAN Identifier	13.6.0
2016-06	CT#72	CP-160231	1729	2		NBIFOM support indication during inter-PLMN mobility	13.6.0
2016-06	CT#72	CP-160231	1741	1		Cause value "Multiple accesses to a PDN connection not allowed" in NW-initiated PDN disconnection procedure	13.6.0
2016-06	CT#72	CP-160232	1735	1		Addition of IMEI in Remote User ID	13.6.0
2016-06	CT#72	CP-160218	1681	6		Adding eNB change reporting in Location Change Reporting	14.0.0
2016-06	CT#72	CP-160217	1736	1		GTPv2 impact for NonIP-GPRS	14.0.0
2016-09	CT#73	CP-160423	1747	1		Dedicated bearer deletion signalling for a UE using Extended Coverage	14.1.0
2016-09	CT#73	CP-160424	1745	2		Extended DL Data Buffering for Extended Coverage	14.1.0
2016-09	CT#73	CP-160423	1749	-		Data switching from CP to UP without sending a Release Access Bearers Request	14.1.0
2016-09	CT#73	CP-160423	1751	-		S11-U bearers of multiple SGI PDN connections using Data over the Control Plane	14.1.0
2016-09	CT#73	CP-160423	1765	1		Clarification on the inclusion of the Serving PLMN Rate Control during Inter MME procedure	14.1.0
2016-09	CT#73	CP-160421	1753	2		Unaccepted PDN connection during an Intra-MME/SGSN handover	14.1.0
2016-09	CT#73	CP-160421	1766	-		Inclusion of Sender' F-TEID in the Command message	14.1.0
2016-09	CT#73	CP-160422	1760	1		A new Flag from PGW to SGSN	14.1.0
2016-09	CT#73	CP-160424	1763	3		Correction on ePCO	14.1.0
2016-09	CT#73	CP-160424	1764	2		Clarification on the release of unsuccessful EPC bearer context at mobility procedures when interworking with CloT	14.1.0
2016-09	CT#73	CP-160424	1771	2		Handling of Exception Reports in the Core Network	14.1.0
2016-09	CT#73	CP-160424	1773	1		Keep the S11-U SGW F-TEID the same as the S1-U SGW F-TEID	14.1.0
2016-09	CT#73	CP-160586	1767	2		Inclusion of UE TCP Port	14.1.0
2016-09	CT#73	CP-160434	1768	1		Adding supported feature for eNB change reporting	14.1.0
2016-12	CT#74	CP-160676	1774	2		Support of multiple PRAs per PDN connection	14.2.0
2016-12	CT#74	CP-160676	1797	2		Support of PRA Set Reporting	14.2.0
2016-12	CT#74	CP-160679	1777	1		User identification for the emergency service	14.2.0
2016-12	CT#74	CP-160679	1781	1		Emergency services over WLAN for unauthenticated UEs	14.2.0
2016-12	CT#74	CP-160675	1778	3		Inclusion of IMSI in the Modify Bearer Request message	14.2.0
2016-12	CT#74	CP-160675	1782	1		Message Priority Indication over GTP	14.2.0
2016-12	CT#74	CP-160675	1784	1		Mobility support for NonIP in GPRS	14.2.0
2016-12	CT#74	CP-160675	1796	2		IP address instance in the Create Bearer Response	14.2.0
2016-12	CT#74	CP-160675	1800	2		eNB change reporting for inter MME handover	14.2.0
2016-12	CT#74	CP-160652	1780	1		IOV_updates counter	14.2.0

Date	TSG #	TSG Doc	CR	Rev	Cat	Subject/Comment	New
2016-12	CT#74	CP-160652	1802	1		Absolute Time in MBMS Session Update Request	14.2.0
2016-12	CT#74	CP-160685	1783	-		Remove SGSN applicability for ePCO in the Create Session Request message	14.2.0
2016-12	CT#74	CP-160657	1787	3		New GTP Cause to Restrict the Number of EPS Bearers for NB-IoT UE	14.2.0
2016-12	CT#74	CP-160667	1789	2		Add Bearer Context to Context Acknowledge message for Data forwarding	14.2.0
2016-12	CT#74	CP-160656	1793	1		Remove an editor's note	14.2.0
2016-12	CT#74	CP-160655	1795	-		Remote UE Context IE type in Create Session Request	14.2.0
2016-12	CT#74	CP-160680	1803	1		GW selection by S4-SGSN for Non-IP PDN type	14.2.0
2016-12	CT#74	CP-160665	1805	1		Transferring subscribed UE usage type during inter MME/SGSN mobility	14.2.0
2017-03	CT#75	CP-170026	1817	-		Bearer context mismatch during dedicated bearer creation procedure	14.3.0
2017-03	CT#75	CP-170041	1806	2		PLMN ID Check and Enhanced TV Services	14.3.0
2017-03	CT#75	CP-170039	1807	1		Enhanced Coverage	14.3.0
2017-03	CT#75	CP-170039	1813	1		PDN Continuity at Inter-RAT mobility	14.3.0
2017-03	CT#75	CP-170040	1808	1		Bearer Contexts in Delete Bearer Failure Indication	14.3.0
2017-03	CT#75	CP-170040	1809	1		Including Sender's F-TEID in Delete Session Request message for S2a/S2b	14.3.0
2017-03	CT#75	CP-170040	1814	3		Support of long and short Macro eNodeB IDs	14.3.0
2017-03	CT#75	CP-170040	1815	1		Maximum Wait Time over the S8	14.3.0
2017-06	CT#76	CP-171019	1821	1		CN Operator Selection Entity	14.4.0
2017-06	CT#76	CP-171021	1823	1		Mo Exception Data Counter	14.4.0
2017-06	CT#76	CP-171044	1819	-		AMBR encoding	15.0.0
2017-09	CT#77	CP-172020	1825	1		GTP-C Extensions for SGW-U and PGW-U selection with CUPS	15.1.0
2017-09	CT#77	CP-172014	1828	1		TAU with SGW change and Data forwarding for CP only PDN connection	15.1.0
2017-09	CT#77	CP-172014	1832	1		Use of MABR when support of ePCO is changed	15.1.0
2017-09	CT#77	CP-172025	1829	1		NR as Secondary RAT	15.1.0
2017-12	CT#78	CP-173031	1837	4		Setting of DSCP value for priority services on a GTPv2-C Interface	15.2.0
2017-12	CT#78	CP-173031	1840	1		Reporting WLAN Location during UE initiated IPsec tunnel update procedure	15.2.0
2017-12	CT#78	CP-173036	1845	4		Secondary RAT related data usage reporting	15.2.0
2017-12	CT#78	CP-173036	1847	1		SGW/PGW selection for NR	15.2.0
2017-12	CT#78	CP-173036	1848	1		Updates on the Usage Data Reporting for Dual Connectivity with NR	15.2.0
2017-12	CT#78	CP-173036	1876	2		Access Restrictions to NR as Secondary RAT on MM Context	15.2.0
2017-12	CT#78	CP-173036	1877	1		Addition of UE additional security capabilities	15.2.0
2017-12	CT#78	CP-173015	1851	-		ePCO reference to TS 24.301	15.2.0
2017-12	CT#78	CP-173034	1852	1		Extending the scope of the specification to cover the N26 interface	15.2.0
2017-12	CT#78	CP-173034	1853	1		GTP-C tunnel per UE over the N26 interface	15.2.0
2017-12	CT#78	CP-173034	1854	1		GTP-C messages over the N26 interface	15.2.0
2017-12	CT#78	CP-173034	1855	1		Forward Relocation Request over the N26 interface	15.2.0
2017-12	CT#78	CP-173034	1856	1		Forward Relocation Response over the N26 interface	15.2.0
2017-12	CT#78	CP-173034	1873	2		Support of Idle Mode Mobility procedures for single-registration mode	15.2.0
2017-12	CT#78	CP-173034	1874	-		Forward Relocation Complete Notification / Acknowledge over the N26 interface	15.2.0
2017-12	CT#78	CP-173034	1875	-		Relocation Cancel Request / Response over the N26 interface	15.2.0
2017-12	CT#78	CP-173021	1858	1		S11-U interface separation from S1-U interface	15.2.0
2017-12	CT#78	CP-173035	1871	-		Access restriction to unlicensed spectrum as secondary RAT	15.2.0
2018-03	CT#79	CP-180015	1892	1		Support of long and short Macro eNodeB IDs	15.3.0
2018-03	CT#79	CP-180027	1872	2		Data usage reporting with unlicensed spectrum used as secondary RAT	15.3.0
2018-03	CT#79	CP-180023	1879	1		Clarification to GTP-C overload control	15.3.0
2018-03	CT#79	CP-180023	1883	1		Unpredictability of GTP TEID for PGW GTP-C	15.3.0
2018-03	CT#79	CP-180023	1889	1		Service Gap Time Support	15.3.0
2018-03	CT#79	CP-180020	1880	1		Condition correction for indicating DCNR to SGW/PGW	15.3.0
2018-03	CT#79	CP-180020	1890	1		Correction for indicating DCNR to Combined SGW/PGW	15.3.0
2018-03	CT#79	CP-180026	1881	-		Create/Delete Indirect Data Forwarding Tunnel	15.3.0
2018-03	CT#79	CP-180026	1882	2		Presence Condition of some IEs in Forward Relocation req and rsp for N26 interface	15.3.0
2018-03	CT#79	CP-180026	1884	1		Temporary identity in Idle mode mobility using N26	15.3.0
2018-03	CT#79	CP-180026	1885	-		Security context transfer in interworking between EPS and 5GS	15.3.0
2018-03	CT#79	CP-180026	1886	1		GTP-C messages over N26	15.3.0
2018-03	CT#79	CP-180026	1887	2		Forward Relocation Request & Response over N26	15.3.0
2018-03	CT#79	CP-180026	1888	1		Context Request & Response over N26	15.3.0
2018-06	CT#80	CP-181115	1896	-		TWAN PLMN-ID encoding	15.4.0
2018-06	CT#80	CP-181118	1905	-		Correction of reference to the SCEF Realm	15.4.0
2018-06	CT#80	CP-181129	1900	4		Extended EPS Bearer Identity for INOBEAR	15.4.0
2018-06	CT#80	CP-181128	1914	3		Identification of LTE-M (eMTC) traffic	15.4.0

Date	TSG #	TSG Doc	CR	Rev	Cat	Subject/Comment	New
2018-06	CT#80	CP-181129	1907	1		INOBEAR for Create Bearer Request	15.4.0
2018-06	CT#80	CP-181129	1908	1		The support of INOBEAR in mobility procedures	15.4.0
2018-06	CT#80	CP-181132	1897	1		Presence condition of ePCO	15.4.0
2018-06	CT#80	CP-181132	1898	-		SGW change indication	15.4.0
2018-06	CT#80	CP-181132	1899	1		Indirect data forwarding between 5GS and EPS	15.4.0
2018-06	CT#80	CP-181132	1901	-		New RAT Type value for NR	15.4.0
2018-06	CT#80	CP-181132	1902	1		Identification Request procedure during 5GS to EPS Idle mode mobility	15.4.0
2018-06	CT#80	CP-181132	1903	4		Support of DL/UL Maximum Packet Loss Rate	15.4.0
2018-06	CT#80	CP-181132	1909	1		The use of PGW FQDN in the SMF Selection	15.4.0
2018-06	CT#80	CP-181132	1910	1		UE NR security capability	15.4.0
2018-06	CT#80	CP-181132	1912	1		5GS TAI and Global NG-RAN node ID	15.4.0
2018-06	CT#80	CP-181132	1913	-		Resolution of remaining editor's notes on N26 interface	15.4.0
2018-06	CT#80	CP-181133	1911	-		Clarification on the flag in Change Notification	15.4.0
2018-06	CT#80	CP-181133	1915	1		Accuracy of Secondary RAT data usage report	15.4.0
2018-09	CT#81	CP-182074	1917	5		Correction of APN Rate Control for PDN connection release and re-establishment	15.5.0
2018-09	CT#81	CP-182084	1918	-		UE AMBR during interworking	15.5.0
2018-09	CT#81	CP-182084	1921	-		Identification Request procedure over N26	15.5.0
2018-09	CT#81	CP-182068	1920	1		Add support for 5G Trace	15.5.0
2018-09	CT#81	CP-182067	1919	1		Secondary RAT data usage reporting using Change Notification Request	15.5.0
2018-09	CT#81	CP-182070	1923	1		Clarification on RAT Type change in Idle mode – Modify Bearer Request procedure	15.5.0
2018-09	CT#81	CP-182078	1925	1		S1-U Path Failure	15.5.0
2018-12	CT#82	CP-183092	1927	1		Notify 5GS Interworking Ind to PGW	15.6.0
2018-12	CT#82	CP-183092	1931	1		Provision of dummy SGW-u F-TEIDs	15.6.0
2018-12	CT#82	CP-183092	1932	-		Presence condition of the S1-AP Cause and RANAP Cause	15.6.0
2018-12	CT#82	CP-183091	1926	-		Secondary RAT Usage Report in Delete Bearer Command	15.6.0
2018-12	CT#82	CP-183093	1928	1		Correction of the description of Bearer Resource Command in 29.274	15.6.0
2018-12	CT#82	CP-183096	1930	1		Correction to table C.1	15.6.0
2019-03	CT#83	CP-190032	1935	-		Return Preferred indication over N26	15.7.0
2019-03	CT#83	CP-190032	1936	-		Mobility between EPC/ePDG and 5GS	15.7.0
2019-03	CT#83	CP-190032	1937	2		N26 support indication	15.7.0
2019-03	CT#83	CP-190032	1939	1		Correction to the Modify Bearer Request	15.7.0
2019-03	CT#83	CP-190170	1940	-		Enhancements to Configuration Transfer Tunnel over S10 and N26 for EN-DC	15.7.0
2019-03						CP-190170 clause numbers updated after information provided by RAN2 "See clauses 22.3.6.2 and 22.3.6.3 of 3GPP TS 36.300 [19]."	15.7.1
2019-06	CT#84	CP-191025	1944	-		Correction on CR1889 Implementation	15.8.0
2019-06	CT#84	CP-191025	1942	1		Control of notifications to SCEF	15.8.0
2019-06	CT#84	CP-191026	1941	-		Correction to the location reporting with minimum reporting interval	15.8.0
2019-06	CT#84	CP-191058	1943	3		Cause for EPS to 5GS Mobility without N26 interface	15.8.0
2019-06	CT#84	CP-191058	1948	-		5GS to EPS handover without N26 interface	15.8.0
2019-06	CT#84	CP-191058	1947	1		Interface Type of an AMF F-TEID and new cause code	15.8.0
2019-06	CT#84	CP-191045	1946	1		Support of Ethernet PDN connection in EPS	16.0.0
2019-06	CT#84	CP-191049	1945	2		Cause in Context Acknowledge	16.0.0
2019-09	CT#85	CP-192098	1956	-		IP addressing with IPv4/IPv6 capable GTP-C entities	16.1.0
2019-09	CT#85	CP-192188	1954	-		Adding 5G SRVCC Support	16.1.0
2019-09	CT#85	CP-192126	1959	1		Sequence Number in RAB Context	16.1.0
2019-09	CT#85	CP-192126	1962	2		Additional RRM Policy Index	16.1.0
2019-09	CT#85	CP-192118	1961	1		Essential Corrections for 5GS Interworking Indication	16.1.0
2019-12	CT#86	CP-193036	1970	2		5GS Interworking Indication when MME Change	16.2.0
2019-12	CT#86	CP-193036	1972	-		Identification Request procedure over N26	16.2.0
2019-12	CT#86	CP-193041	1965	1		UEs not supporting 5GC NAS with a 5GS subscription	16.2.0
2019-12	CT#86	CP-193041	1966	-		UE NR security capability	16.2.0
2019-12	CT#86	CP-193041	1968	-		Presence Reporting Area information reporting during S1 handover	16.2.0
2019-12	CT#86	CP-193041	1973	-		5GS Interworking Indication and be restricted to interworking with 5GS	16.2.0
2019-12	CT#86	CP-193041	1975	1		Unlicensed spectrum NR-U restrictions	16.2.0
2019-12	CT#86	CP-193047	1971	-		RLOS attached UEs	16.2.0
2019-12	CT#86	CP-193061	1967	1		No PDN Connection Transferred during 5G SRVCC HO procedure	16.2.0
2019-12	CT#86	CP-193061	1974	-		Adding ClassMark 2 and Supported Codec for 5G SRVCC to 29.274	16.2.0
2019-12	CT#86	CP-193062	1969	-		Transferring UE Radio Capability ID between MMEs	16.2.0
2020-03	CT#87e	CP-200033	1976	2		Idle mode mobility between EPS and 5GS with data forwarding	16.3.0
2020-03	CT#87e	CP-200033	1977	3		Support of MT-EDT	16.3.0
2020-03	CT#87e	CP-200046	1978	3		PGW Selection and the Create Session Request message	16.3.0
2020-03	CT#87e	CP-200022	1979	1		5G-SRVCC Procedure for Emergency Session	16.3.0
2020-03	CT#87e	CP-200036	1980	2		V2X information in UE Context	16.3.0



Date	TSG #	TSG Doc	CR	Rev	Cat	Subject/Comment	New
2020-06	CT#88e	CP-201052	1983	-		Clarification to Cause "Invalid Reply from remote peer"	16.3.0
2020-06	CT#88e	CP-201052	1984	1		Support of inter-RAT HO from NR SA to EN-DC	16.4.0
2020-06	CT#88e	CP-201052	1987			Wrong figure reference	16.4.0
2020-06	CT#88e	CP-201049	1985	-		V2X Context between MME and AMF	16.4.0
2020-06	CT#88e	CP-201067	1986	-		Correct the reference for MDT	16.4.0
2020-06	CT#88e	CP-201068	1989			Inter-system handover with direct data forwarding	16.4.0
2020-06	CT#88e	CP-201070	1990	1		Data Forwarding Info	16.4.0
2020-09	CT#89e	CP-202097	1991	2		DAPS Handover information	16.5.0
2020-09	CT#89e	CP-202099	1993	1		Enhancement of network event reporting	16.5.0
2020-09	CT#89e	CP-202108	1994	2		Managing RACS ID for mobility across ePLMNs	16.5.0
2020-12	CT#90e	CP-203033	1998	-		DRX in MM Context during inter AMF and MME Mobility Procedure	16.6.0
2020-12	CT#90e	CP-203033	2000	-		IWK-SCEF ID	16.6.0
2020-12	CT#90e	CP-203033	1999	1		Last used PLMN ID during TAU or Registration	16.6.0
2020-12	CT#90e	CP-203058	1996	1		Support of PGW-C/SMF change	17.0.0
2021-03	CT#91e	CP-210056	2002	-		PGW Node Name IE in Create Session Response	17.1.0
2021-03	CT#91e	CP-210056	2006	1		Essential Correction to UE NR security capability	17.1.0
2021-03	CT#91e	CP-210033	2004	2		PGW reselection by rejecting CSReq with new PGW address	17.1.0
2021-03						Corrupted styles under 7.2 fixed	17.1.1
2021-06	CT#92e	CP-211067	2016	-		LTE-M indication during mobility from 5GC to EPC	17.2.0
2021-06	CT#92e	CP-211024	2011	1		Alternative PGW-C/SMF FQDN	17.2.0
2021-06	CT#92e	CP-211025	2010	-		Support of Notify Start Pause of Charging via User Plane	17.2.0
2021-06	CT#92e	CP-211032	2017	1		Downlink Data Notification supporting MUSIM	17.2.0
2021-06	CT#92e	CP-211043	2012	2		Restoration of PDN connections affected by a partial or complete failure	17.2.0
2021-06	CT#92e	CP-211052	2009	-		GTPv2 IE with wrong octet numbering	17.2.0
2021-06	CT#92e	CP-211052	2014	-		Enable SRVCC after 5G to 4G handover	17.2.0
2021-06	CT#92e	CP-211053	2018	1		4G <-> 5GS mobility corrections to cope with areas of GERAN/UTRAN-only coverage	17.2.0
2021-09	CT#93e	CP-212074	2024	3	A	TAU reject issue during MME handover (KSI type)	17.3.0
2021-09	CT#93e	CP-212074	2027	-	A	4G to 5G Direct Data Forwarding	17.3.0
2021-09	CT#93e	CP-212046	2021	-	F	Correct the presence condition of temporary identities after integrity checking	17.3.0
2021-09	CT#93e	CP-212046	2022	1	F	PGW reselection for 5G Network Slice	17.3.0
2021-09	CT#93e	CP-212046	2025	-	C	Passing PSCell ID to SGW for EN-DC	17.3.0
2021-09	CT#93e	CP-212046	2028	1	F	Secondary RAT Usage Report	17.3.0
2021-09	CT#93e	CP-212033	2029	1	B	Restoration of PDN connections served by a combined SGW/PGW in a Set	17.3.0
2021-12	CT#94e	CP-213141	2035	1	A	Support of Inter-system SON Configuration Transfer over the N26 interface	17.4.0
2021-12	CT#94e	CP-213127	2031	1	F	Clarification on 5GCNRI flag	17.4.0
2021-12	CT#94e	CP-213127	2032	-	F	Communication Failure event	17.4.0
2021-12	CT#94e	CP-213123	2033	2	B	Support of User Plane Integrity Protection for Interworking from 5GS to EPS	17.4.0
2021-12	CT#94e	CP-213112	2037	1	F	Update user authentication failed cause	17.4.0
2022-03	CT#95e	CP-220071	2039	1	A	CR implementation errors (5G SRVCC from 5GS to 3G)	17.5.0
2022-03	CT#95e	CP-220033	2042	1	B	New SGW IP Address when moving PDN connections for a combined SGW/PGW/SMF set	17.5.0
2022-03	CT#95e	CP-220033	2049	1	B	ePDG support of Restoration of PDN connections after a PGW-C/SMF change	17.5.0
2022-03	CT#95e	CP-220044	2044	-	B	Added reference to UAV procedures	17.5.0
2022-03	CT#95e	CP-220044	2051	-	F	Correct the reference number	17.5.0
2022-03	CT#95e	CP-220044	2052	-	B	Update on the UAS services for ePCO support	17.5.0
2022-03	CT#95e	CP-220045	2048	1	B	Transferring Alternative IMSI between MMEs	17.5.0
2022-03	CT#95e	CP-220072	2040	-	F	5G-SRVCC from NG-RAN to UTRAN Handover Cancellation	17.5.0
2022-03	CT#95e	CP-220072	2047	1	F	SRVCC Cause in Forward Relocation Response	17.5.0
2022-03	CT#95e	CP-220089	2041	-	F	Incorrect references	17.5.0
2022-03	CT#95e	CP-220093	2043	2	B	RAT Type	17.5.0
2022-06	CT#96	CP-221042	2053	1	F	RAT Types for Satellite	17.6.0
2022-06	CT#96	CP-221047	2054	1	F	Clarification on 5GCNRI and 5GSIWKI flags	17.6.0
2022-06	CT#96	CP-221047	2055	1	F	Clarification on 5GS parameters in (e)PCO or APCO	17.6.0
2022-06	CT#96	CP-221047	2056	-	F	RNC ID in N26 Forward Relocation Request during 5G-SRVCC handover	17.6.0
2022-09	CT#97e	CP-222031	2061	-	F	New Interface Type N19mb in F-TEID	17.7.0
2022-09	CT#97e	CP-222040	2062	1	F	Removal of unnecessary LTE-M satellite Indication	17.7.0
2022-09	CT#97e	CP-222049	2058	-	F	UE radio capability for paging	17.7.0
2022-09	CT#97e	CP-222063	2060	-	A	MSC Server Identity in Forward Relocation Response during SRVCC handover	17.7.0
2023-03	CT#99	CP-230076	2071	1	F	Encoding of PGW FQDN IE	17.8.0
2023-03	CT#99	CP-230087	2073	-	F	CR implementation error	17.8.0
2023-06	CT#100	CP-231074	2075	1	F	PGW-C TEID in Update Bearer Response during PGW triggered PDN connection restoration	17.9.0

Date	TSG #	TSG Doc	CR	Rev	Cat	Subject/Comment	New
2023-06	CT#100	CP-231074	2077	1	F	Corrections to Restoration of PDN connections after a PGW-CSMF change	17.9.0

---

# History

<b>Document history</b>		
V17.5.0	May 2022	Publication
V17.6.0	July 2022	Publication
V17.7.0	October 2022	Publication
V17.8.0	April 2023	Publication
V17.9.0	July 2023	Publication