

ETSI TS 129 198-4 V4.8.0 (2003-12)

Technical Specification

**Universal Mobile Telecommunications System (UMTS);
Open Service Access (OSA)
Application Programming Interface (API);
Part 4: Call control
(3GPP TS 29.198-04 version 4.8.0 Release 4)**



Reference

RTS/TSGN-0529198-04v480

Keywords

UMTS

ETSI

650 Route des Lucioles
F-06921 Sophia Antipolis Cedex - FRANCE

Tel.: +33 4 92 94 42 00 Fax: +33 4 93 65 47 16

Siret N° 348 623 562 00017 - NAF 742 C
Association à but non lucratif enregistrée à la
Sous-Préfecture de Grasse (06) N° 7803/88

Important notice

Individual copies of the present document can be downloaded from:

<http://www.etsi.org>

The present document may be made available in more than one electronic version or in print. In any case of existing or perceived difference in contents between such versions, the reference version is the Portable Document Format (PDF). In case of dispute, the reference shall be the printing on ETSI printers of the PDF version kept on a specific network drive within ETSI Secretariat.

Users of the present document should be aware that the document may be subject to revision or change of status. Information on the current status of this and other ETSI documents is available at

<http://portal.etsi.org/tb/status/status.asp>

If you find errors in the present document, send your comment to:

editor@etsi.org

Copyright Notification

No part may be reproduced except as authorized by written permission.
The copyright and the foregoing restriction extend to reproduction in all media.

© European Telecommunications Standards Institute 2003.
All rights reserved.

DECTTM, **PLUGTESTS**TM and **UMTS**TM are Trade Marks of ETSI registered for the benefit of its Members.
TIPHONTM and the **TIPHON logo** are Trade Marks currently being registered by ETSI for the benefit of its Members.
3GPPTM is a Trade Mark of ETSI registered for the benefit of its Members and of the 3GPP Organizational Partners.

Intellectual Property Rights

IPRs essential or potentially essential to the present document may have been declared to ETSI. The information pertaining to these essential IPRs, if any, is publicly available for **ETSI members and non-members**, and can be found in ETSI SR 000 314: *"Intellectual Property Rights (IPRs); Essential, or potentially Essential, IPRs notified to ETSI in respect of ETSI standards"*, which is available from the ETSI Secretariat. Latest updates are available on the ETSI Web server (<http://webapp.etsi.org/IPR/home.asp>).

Pursuant to the ETSI IPR Policy, no investigation, including IPR searches, has been carried out by ETSI. No guarantee can be given as to the existence of other IPRs not referenced in ETSI SR 000 314 (or the updates on the ETSI Web server) which are, or may be, or may become, essential to the present document.

Foreword

This Technical Specification (TS) has been produced by ETSI 3rd Generation Partnership Project (3GPP).

The present document may refer to technical specifications or reports using their 3GPP identities, UMTS identities or GSM identities. These should be interpreted as being references to the corresponding ETSI deliverables.

The cross reference between GSM, UMTS, 3GPP and ETSI identities can be found under <http://webapp.etsi.org/key/queryform.asp>.

Contents

Intellectual Property Rights	2
Foreword.....	2
Foreword.....	7
Introduction	7
1 Scope	9
2 References	9
3 Definitions and abbreviations.....	10
3.1 Definitions	10
3.2 Abbreviations	10
4 Call Control SCF.....	10
4.1 Call Model Description	10
4.2 General requirements on support of methods	11
5 The Service Interface Specifications	11
5.1 Interface Specification Format	11
5.1.1 Interface Class	11
5.1.2 Method descriptions.....	12
5.1.3 Parameter descriptions.....	12
5.1.4 State Model.....	12
5.2 Base Interface.....	12
5.2.1 Interface Class IpInterface	12
5.3 Service Interfaces	12
5.3.1 Overview	12
5.4 Generic Service Interface	12
5.4.1 Interface Class IpService	12
6 Generic Call Control Service	14
6.1 Sequence Diagrams	14
6.1.1 Additional Callbacks.....	14
6.1.2 Alarm Call	15
6.1.3 Application Initiated Call.....	17
6.1.4 Call Barring 1	19
6.1.5 Number Translation 1	21
6.1.6 Number Translation 1 (with callbacks).....	23
6.1.7 Number Translation 2	25
6.1.8 Number Translation 3	27
6.1.9 Number Translation 4	29
6.1.10 Number Translation5	31
6.1.11 Prepaid	32
6.1.12 Pre-Paid with Advice of Charge (AoC)	34
6.2 Class Diagrams.....	37
6.3 Generic Call Control Service Interface Classes.....	38
6.3.1 Interface Class IpCallControlManager	39
6.3.2 Interface Class IpAppCallControlManager	42
6.3.3 Interface Class IpCall.....	45
6.3.4 Interface Class IpAppCall.....	50
6.4 Generic Call Control Service State Transition Diagrams.....	54
6.4.1 State Transition Diagrams for IpCallControlManager.....	54
6.4.1.1 Active State	54
6.4.1.2 Notification terminated State	54
6.4.2 State Transition Diagrams for IpCall.....	54
6.4.2.1 Network Released State	55
6.4.2.2 Finished State	56

6.4.2.3	Application Released State	56
6.4.2.4	Active State	56
6.4.2.5	Party in Call State	56
6.4.2.6	Parties in Call State	56
6.5	Generic Call Control Service Properties	57
6.5.1	List of Service Properties.....	57
6.5.2	Service Property values for the CAMEL Service Environment.....	57
6.6	Generic Call Control Data Definitions	59
6.6.1	Generic Call Control Event Notification Data Definitions	59
6.6.1.1	TpCallEventName.....	59
6.6.1.2	TpCallNotificationType	60
6.6.1.3	TpCallEventCriteria	60
6.6.1.4	TpCallEventInfo.....	60
6.6.2	Generic Call Control Data Definitions.....	60
6.6.2.1	IpCall.....	60
6.6.2.2	IpCallRef.....	60
6.6.2.3	IpAppCall.....	61
6.6.2.4	IpAppCallRef	61
6.6.2.5	TpCallIdentifier.....	61
6.6.2.6	IpAppCallControlManager	61
6.6.2.7	IpAppCallControlManagerRef	61
6.6.2.8	IpCallControlManager	61
6.6.2.9	IpCallControlManagerRef.....	61
6.6.2.10	TpCallAppInfo	61
6.6.2.11	TpCallAppInfoType	62
6.6.2.12	TpCallAppInfoSet	62
6.6.2.13	TpCallEndedReport.....	62
6.6.2.14	TpCallFault	62
6.6.2.15	TpCallInfoReport	63
6.6.2.16	TpCallReleaseCause	63
6.6.2.17	TpCallReport.....	64
6.6.2.18	TpCallAdditionalReportInfo	64
6.6.2.19	TpCallReportRequest.....	64
6.6.2.20	TpCallAdditionalReportCriteria.....	65
6.6.2.21	TpCallReportRequestSet.....	65
6.6.2.22	TpCallReportType	65
6.6.2.23	TpCallTreatment	66
6.6.2.24	TpCallEventCriteriaResultSet.....	66
6.6.2.25	TpCallEventCriteriaResult.....	66
7	MultiParty Call Control Service.....	66
7.1	Sequence Diagrams	66
7.1.1	Application initiated call setup	66
7.1.2	Call Barring 2	68
7.1.3	Call forwarding on Busy Service	69
7.1.4	Call Information Collect Service	71
7.1.5	Complex Card Service	74
7.1.6	Hotline Service	77
7.1.7	Use of the Redirected event	80
7.2	Class Diagrams.....	80
7.3	MultiParty Call Control Service Interface Classes	82
7.3.1	Interface Class IpMultiPartyCallControlManager	82
7.3.2	Interface Class IpAppMultiPartyCallControlManager	86
7.3.3	Interface Class IpMultiPartyCall	88
7.3.4	Interface Class IpAppMultiPartyCall.....	93
7.3.5	Interface Class IpCallLeg	95
7.3.6	Interface Class IpAppCallLeg.....	101
7.4	MultiParty Call Control Service State Transition Diagrams	106
7.4.1	State Transition Diagrams for IpMultiPartyCallControlManager.....	106
7.4.1.1	Active State	106
7.4.1.2	Interrupted State	106
7.4.1.3	Overview of allowed methods.....	106

7.4.2	State Transition Diagrams for IpMultiPartyCall.....	107
7.4.2.1	IDLE State.....	107
7.4.2.2	ACTIVE State.....	108
7.4.2.3	RELEASED State.....	108
7.4.2.4	Overview of allowed methods.....	108
7.4.3	State Transition Diagrams for IpCallLeg.....	108
7.4.3.1	Originating Call Leg.....	109
7.4.3.1.1	Initiating State.....	110
7.4.3.1.2	Analysing State.....	111
7.4.3.1.3	Active State.....	112
7.4.3.1.4	Releasing State.....	114
7.4.3.1.5	Overview of allowed methods, Originating Call Leg STD.....	115
7.4.3.2	Terminating Call Leg.....	116
7.4.3.2.1	Idle (terminating) State.....	117
7.4.3.2.2	Active (terminating) State.....	118
7.4.3.2.3	Releasing (terminating) State.....	120
7.4.3.2.4	Overview of allowed methods and trigger events, Terminating Call Leg STD.....	122
7.5	Multi-Party Call Control Service Properties.....	123
7.5.1	List of Service Properties.....	123
7.5.2	Service Property values for the CAMEL Service Environment.....	123
7.6	Multi-Party Call Control Data Definitions.....	125
7.6.1	Event Notification Data Definitions.....	125
7.6.2	Multi-Party Call Control Data Definitions.....	125
7.6.2.1	IpCallLeg.....	125
7.6.2.2	IpCallLegRef.....	125
7.6.2.3	IpAppCallLeg.....	125
7.6.2.4	IpAppCallLegRef.....	125
7.6.2.5	IpMultiPartyCall.....	125
7.6.2.6	IpMultiPartyCallRef.....	125
7.6.2.7	IpAppMultiPartyCall.....	125
7.6.2.8	IpAppMultiPartyCallRef.....	126
7.6.2.9	IpMultiPartyCallControlManager.....	126
7.6.2.10	IpMultiPartyCallControlManagerRef.....	126
7.6.2.11	IpAppMultiPartyCallControlManager.....	126
7.6.2.12	IpAppMultiPartyCallControlManagerRef.....	126
7.6.2.13	TpAppCallLegRefSet.....	126
7.6.2.14	TpMultiPartyCallIdentifier.....	126
7.6.2.15	TpAppMultiPartyCallBack.....	126
7.6.2.16	TpAppMultiPartyCallBackRefType.....	127
7.6.2.17	TpAppCallLegCallBack.....	127
7.6.2.18	TpMultiPartyCallIdentifierSet.....	127
7.6.2.19	TpCallAppInfo.....	127
7.6.2.20	TpCallAppInfoType.....	128
7.6.2.21	TpCallAppInfoSet.....	128
7.6.2.22	TpCallEventRequest.....	128
7.6.2.23	TpCallEventRequestSet.....	128
7.6.2.24	TpCallEventType.....	129
7.6.2.25	TpAdditionalCallEventCriteria.....	131
7.6.2.26	TpCallEventInfo.....	131
7.6.2.27	TpCallAdditionalEventInfo.....	132
7.6.2.28	TpCallNotificationRequest.....	132
7.6.2.29	TpCallNotificationScope.....	132
7.6.2.30	TpCallNotificationInfo.....	133
7.6.2.31	TpCallNotificationReportScope.....	133
7.6.2.32	TpNotificationRequested.....	133
7.6.2.33	TpNotificationRequestedSet.....	133
7.6.2.34	TpReleaseCause.....	133
7.6.2.35	TpReleaseCauseSet.....	133
7.6.2.36	TpCallLegIdentifier.....	134
7.6.2.37	TpCallLegIdentifierSet.....	134
7.6.2.38	TpCallLegAttachMechanism.....	134
7.6.2.39	TpCallLegConnectionProperties.....	134

7.6.2.40	TpCallLegInfoReport	134
7.6.2.41	TpCallLegInfoType	135
7.6.2.42	TpCallLegSuperviseTreatment	135
8	Common Call Control Data Types	135
8.1	TpCallAlertingMechanism	135
8.2	TpCallBearerService	135
8.3	TpCallChargePlan	136
8.4	TpCallPartyToChargeAdditionalInfo	136
8.5	TpCallPartyToChargeType	136
8.6	TpCallChargeOrderCategory	137
8.7	TpCallEndedReport	137
8.8	TpCallError	137
8.9	TpCallAdditionalErrorInfo	137
8.10	TpCallErrorType	138
8.11	TpCallInfoReport	138
8.12	TpCallInfoType	138
8.13	TpCallLoadControlMechanism	139
8.14	TpCallLoadControlIntervalRate	139
8.15	TpCallLoadControlMechanismType	139
8.16	TpCallMonitorMode	139
8.17	TpCallNetworkAccessType	140
8.18	TpCallPartyCategory	140
8.19	TpCallServiceCode	140
8.20	TpCallServiceCodeSet	140
8.21	TpCallServiceCodeType	141
8.22	TpCallSuperviseReport	141
8.23	TpCallSuperviseTreatment	141
8.24	TpCallTeleService	142
8.25	TpCallTreatment	142
8.26	TpCallTreatmentType	143
8.27	TpCallAdditionalTreatmentInfo	143
8.28	TpMediaType	143
Annex A (normative):	OMG IDL Description of Call Control SCF	144
Annex B (informative):	Change history	145
History		146

Foreword

This Technical Specification has been produced by the 3rd Generation Partnership Project (3GPP).

The contents of the present document are subject to continuing work within the TSG and may change following formal TSG approval. Should the TSG modify the contents of the present document, it will be re-released by the TSG with an identifying change of release date and an increase in version number as follows:

Version x.y.z

where:

- x the first digit:
 - 1 presented to TSG for information;
 - 2 presented to TSG for approval;
 - 3 or greater indicates TSG approved document under change control.
- y the second digit is incremented for all changes of substance, i.e. technical enhancements, corrections, updates, etc.
- z the third digit is incremented when editorial only changes have been incorporated in the document.

Introduction

The present document is part 4 of a multi-part TS covering the 3rd Generation Partnership Project: Technical Specification Group Core Network; Open Service Access (OSA); Application Programming Interface (API), as identified below. The **API specification** (3GPP TS 29.198) is structured in the following Parts:

Part 1:	Overview	
Part 2:	Common Data Definitions	
Part 3:	Framework	
Part 4:	Call Control SCF	
Part 5:	User Interaction SCF	
Part 6:	Mobility SCF	
Part 7:	Terminal Capabilities SCF	
Part 8:	Data Session Control SCF	
Part 9:	Generic Messaging SCF	(not part of 3GPP Release 4)
Part 10:	Connectivity Manager SCF	(not part of 3GPP Release 4)
Part 11:	Account Management SCF	
Part 12:	Charging SCF	

The **Mapping specification of the OSA APIs and network protocols** (3GPP TR 29.998) is also structured as above. A mapping to network protocols is however not applicable for all Parts, but the numbering of Parts is kept. Also in case a Part is not supported in a Release, the numbering of the parts is maintained.

Table: Overview of the OSA APIs & Protocol Mappings 29.198 & 29.998-family

OSA API specifications 29.198-family		OSA API Mapping - 29.998-family	
29.198-1	Part 1: Overview	29.998-1	Part 1: Overview
29.198-2	Part 2: Common Data Definitions	29.998-2	<i>Not Applicable</i>
29.198-3	Part 3: Framework	29.998-3	<i>Not Applicable</i>
29.198-4	Part 4: Call Control SCF	29.998-4-1	Subpart 1: Generic Call Control – CAP mapping
		29.998-4-2	
29.198-5	Part 5: User Interaction SCF	29.998-5-1	Subpart 1: User Interaction – CAP mapping
		29.998-5-2	
		29.998-5-3	
		29.998-5-4	Subpart 4: User Interaction – SMS mapping
29.198-6	Part 6: Mobility SCF	29.998-6	User Status and User Location – MAP mapping
29.198-7	Part 7: Terminal Capabilities SCF	29.998-7	<i>Not Applicable</i>
29.198-8	Part 8: Data Session Control SCF	29.998-8	Data Session Control – CAP mapping
29.198-9	Part 9: Generic Messaging SCF	29.998-9	<i>Not Applicable</i>
29.198-10	Part 10: Connectivity Manager SCF	29.998-10	<i>Not Applicable</i>

29.198-11	Part 11: Account Management SCF	29.998-11	<i>Not Applicable</i>
29.198-12	Part 12: Charging SCF	29.998-12	<i>Not Applicable</i>

1 Scope

The present document is Part 4 of the Stage 3 specification for an Application Programming Interface (API) for Open Service Access (OSA).

The OSA specifications define an architecture that enables application developers to make use of network functionality through an open standardised interface, i.e. the OSA APIs. The concepts and the functional architecture for the OSA are contained in 3GPP TS 23.127 [3]. The requirements for OSA are contained in 3GPP TS 22.127 [2].

The present document specifies the Call Control Service Capability Feature (SCF) aspects of the interface. All aspects of the Call Control SCF are defined here, these being:

- Sequence Diagrams
- Class Diagrams
- Interface specification plus detailed method descriptions
- State Transition diagrams
- Data definitions
- IDL Description of the interfaces

The process by which this task is accomplished is through the use of object modelling techniques described by the Unified Modelling Language (UML).

This specification has been defined jointly between 3GPP TSG CN WG5, ETSI SPAN 12 and the Parlay Consortium, in co-operation with a number of JAIN™ Community member companies.

2 References

The following documents contain provisions which, through reference in this text, constitute provisions of the present document.

- References are either specific (identified by date of publication, edition number, version number, etc.) or non-specific.
- For a specific reference, subsequent revisions do not apply.
- For a non-specific reference, the latest version applies. In the case of a reference to a 3GPP document (including a GSM document), a non-specific reference implicitly refers to the latest version of that document *in the same Release as the present document*.

- [1] 3GPP TS 29.198-1 "Open Service Access; Application Programming Interface; Part 1: Overview".
- [2] 3GPP TS 22.127: "Stage 1 Service Requirement for the Open Service Access (OSA) (Release 4)".
- [3] 3GPP TS 23.127: "Virtual Home Environment (Release 4)".
- [4] 3GPP TS 22.002: "Circuit Bearer Services Supported by a PLMN".
- [5] ISO 4217 (1995): "Codes for the representation of currencies and funds".
- [6] 3GPP TS 24.002: "GSM-UMTS Public Land Mobile Network (PLMN) Access Reference Configuration".
- [7] 3GPP TS 22.003: "Circuit Teleservices supported by a Public Land Mobile Network (PLMN)".

3 Definitions and abbreviations

3.1 Definitions

For the purposes of the present document, the terms and definitions given in TS 29.198-1 [1] apply.

3.2 Abbreviations

For the purposes of the present document, the abbreviations given in TS 29.198-1 [1] apply.

4 Call Control SCF

Two flavours of Call Control (CC) APIs have been included in 3GPP Release 4. These are the Generic Call Control (GCC) and the Multi-Party Call Control (MPCC). The GCC is the same API as was already present in the Release 99 specification (TS 29.198 v3.3.0) and is in principle able to satisfy the requirements on CC APIs for Release 4.

However, the joint work between 3GPP CN5, ETSI SPAN12 and the Parlay CC Working group with collaboration from JAIN has been focussed on the MPCC API. A number of improvements on CC functionality have been made and are reflected in this API. For this it was necessary to break the inheritance that previously existed between GCC and MPCC.

The joint CC group has furthermore decided that the MPCC is to be considered as the future base CC family and the technical work will not be continued on GCC. Errors or technical flaws will of course be corrected.

The following clauses describe each aspect of the CC Service Capability Feature (SCF).

The order is as follows:

- The Sequence diagrams give the reader a practical idea of how each of the SCF is implemented.
- The Class relationships clause shows how each of the interfaces applicable to the SCF, relate to one another.
- The Interface specification clause describes in detail each of the interfaces shown within the Class diagram part.
- The State Transition Diagrams (STD) show transition between states in the SCF. The states and transitions are well-defined; either methods specified in the Interface specification or events occurring in the underlying networks cause state transitions.
- The Data definitions clause show a detailed expansion of each of the data types associated with the methods within the classes. Note that some data types are used in other methods and classes and are therefore defined within the Common Data types part of this specification (29.198-2).

4.1 Call Model Description

The adopted call model has the following objects.

- a call object. A call is a relation between a number of parties. The call object relates to the entire call view from the application. E.g., the entire call will be released when a release is called on the call. Note that different applications can have different views on the same physical call, e.g., one application for the originating side and another application for the terminating side. The applications will not be aware of each other, all 'communication' between the applications will be by means of network signalling. The API currently does not specify any feature interaction mechanisms.
- a call leg object. The leg object represents a logical association between a call and an address. The relationship includes at least the signalling relation with the party. The relation with the address is only made when the leg is routed. Before that the leg object is IDLE and not yet associated with the address.
- an address. The address logically represents a party in the call.

- a terminal. A terminal is the end-point of the signalling and/or media for a party. This object type is currently not addressed.

The call object is used to establish a relation between a number of parties by creating a leg for each party within the call.

Associated with the signalling relationship represented by the call leg, there may also be a bearer connection (e.g., in the traditional voice only networks) or a number (zero or more) of media channels (in multi-media networks).

A leg can be attached to the call or detached from the call. When the leg is attached, this means that media or bearer channels related to the legs are connected to the media or bearer channels of the other legs that are attached to the same call. I.e., only legs that are attached can 'speak' to each other. A leg can have a number of states, depending on the signalling received from or sent to the party associated with the leg. Usually there is a limit to the number of legs that are in being routed (i.e., the connection is being established) or connected to the call (i.e., the connection is established). Also, there usually is a limit to the number of legs that can be simultaneously attached to the same call.

Some networks distinguish between controlling and passive legs. By definition the call will be released when the controlling leg is released. All other legs are called passive legs. There can be at most one controlling leg per call. However, there is currently no way the application can influence whether a Leg is controlling or not.

There are two ways for an application to get the control of a call. The application can request to be notified of calls that meet certain criteria. When a call occurs in the network that meets these criteria, the application is notified and can control the call. Some legs will already be associated with the call in this case. Another way is to create a new call from the application.

4.2 General requirements on support of methods

An implementation of this API which supports or implements a method described in the present document, shall support or implement the functionality described for that method, for at least one valid set of values for the parameters of that method.

Where a method is not supported by an implementation of a Service interface, the exception `P_METHOD_NOT_SUPPORTED` shall be returned to any call of that method.

Where a method is not supported by an implementation of an Application interface, a call to that method shall be possible, and no exception shall be returned.

5 The Service Interface Specifications

5.1 Interface Specification Format

This clause defines the interfaces, methods and parameters that form a part of the API specification. The Unified Modelling Language (UML) is used to specify the interface classes. The general format of an interface specification is described below.

5.1.1 Interface Class

This shows a UML interface class description of the methods supported by that interface, and the relevant parameters and types. The Service and Framework interfaces for enterprise-based client applications are denoted by classes with name `Ip<name>`. The callback interfaces to the applications are denoted by classes with name `IpApp<name>`. For the interfaces between a Service and the Framework, the Service interfaces are typically denoted by classes with name `IpSvc<name>`, while the Framework interfaces are denoted by classes with name `IpFw<name>`

5.1.2 Method descriptions

Each method (API method “call”) is described. Both synchronous and asynchronous methods are used in the API. Asynchronous methods are identified by a 'Req' suffix for a method request, and, if applicable, are served by asynchronous methods identified by either a 'Res' or 'Err' suffix for method results and errors, respectively. To handle responses and reports, the application or service developer must implement the relevant `IpApp<name>` or `IpSvc<name>` interfaces to provide the callback mechanism.

5.1.3 Parameter descriptions

Each method parameter and its possible values are described. Parameters described as 'in' represent those that must have a value when the method is called. Those described as 'out' are those that contain the return result of the method when the method returns.

5.1.4 State Model

If relevant, a state model is shown to illustrate the states of the objects that implement the described interface.

5.2 Base Interface

5.2.1 Interface Class IpInterface

All application, framework and service interfaces inherit from the following interface. This API Base Interface does not provide any additional methods.

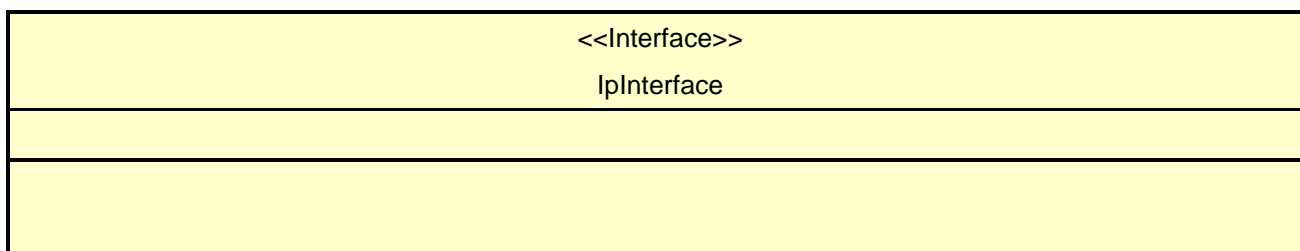

5.3 Service Interfaces

5.3.1 Overview

The Service Interfaces provide the interfaces into the capabilities of the underlying network - such as call control, user interaction, messaging, mobility and connectivity management.

The interfaces that are implemented by the services are denoted as 'Service Interface'. The corresponding interfaces that must be implemented by the application (e.g. for API callbacks) are denoted as 'Application Interface'.

5.4 Generic Service Interface

5.4.1 Interface Class IpService

Inherits from: IpInterface

All service interfaces inherit from the following interface.

<<Interface>> IpService
setCallback (appInterface : in IpInterfaceRef) : void setCallbackWithSessionID (appInterface : in IpInterfaceRef, sessionID : in TpSessionID) : void

*Method***setCallback()**

This method specifies the reference address of the callback interface that a service uses to invoke methods on the application. It is not allowed to invoke this method on an interface that uses SessionIDs.

Parameters

appInterface : in IpInterfaceRef

Specifies a reference to the application interface, which is used for callbacks

Raises

TpCommonExceptions, P_INVALID_INTERFACE_TYPE

*Method***setCallbackWithSessionID()**

This method specifies the reference address of the application's callback interface that a service uses for interactions associated with a specific session ID: e.g. a specific call, or call leg. It is not allowed to invoke this method on an interface that does not use SessionIDs.

Parameters

appInterface : in IpInterfaceRef

Specifies a reference to the application interface, which is used for callbacks

sessionID : in TpSessionID

Specifies the session for which the service can invoke the application's callback interface.

Raises

TpCommonExceptions, P_INVALID_SESSION_ID, P_INVALID_INTERFACE_TYPE

6 Generic Call Control Service

The Generic Call Control API of 3GPP Rel.4 relies on the CAMEL Service Environment (CSE) and thus some restrictions exist to the use of the interface. The most significant one is that there is no support for createCall method. The detailed description of the supported methods and further restrictions is given in the chapter 6.5.

6.1 Sequence Diagrams

6.1.1 Additional Callbacks

The following sequence diagram shows how an application can register two call back interfaces for the same set of events. If one of the call backs can not be used, e.g., because the application crashed, the other call back interface is used instead.

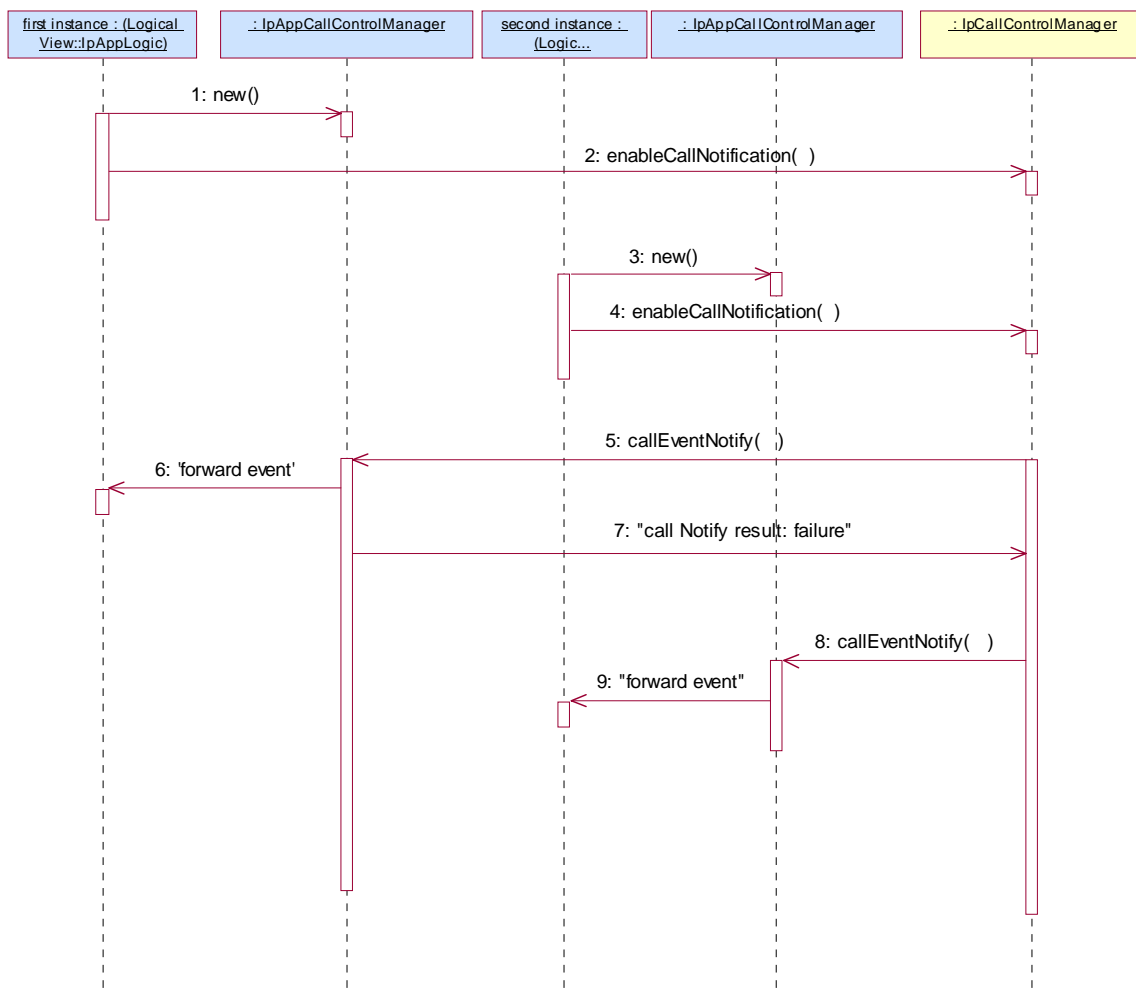

1: The first instance of the application is started on node 1. The application creates a new IpAppCallControlManager to handle callbacks for this first instance of the logic.

2: The enableCallNotification is associated with an applicationID. The call control manager uses the applicationID to decide whether this is the same application.

3: The second instance of the application is started on node 2. The application creates a new IpAppCallControlManager to handle callbacks for this second instance of the logic.

- 4: The same enableCallNotification request is sent as for the first instance of the logic. Because both requests are associated with the same application, the second request is not rejected, but the specified callback object is stored as an additional callback.
- 5: When the trigger occurs one of the first instance of the application is notified. The gateway may have different policies on how to handle additional callbacks, e.g., always first try the first registered or use some kind of round robin scheme.
- 6: The event is forwarded to the first instance of the logic.
- 7: When the first instance of the application is overloaded or unavailable this is communicated with an exception to the call control manager.
- 8: Based on this exception the call control manager will notify another instance of the application (if available).
- 9: The event is forwarded to the second instance of the logic.

6.1.2 Alarm Call

The following sequence diagram shows a 'reminder message', in the form of an alarm, being delivered to a customer as a result of a trigger from an application. Typically, the application would be set to trigger at a certain time, however, the application could also trigger on events.

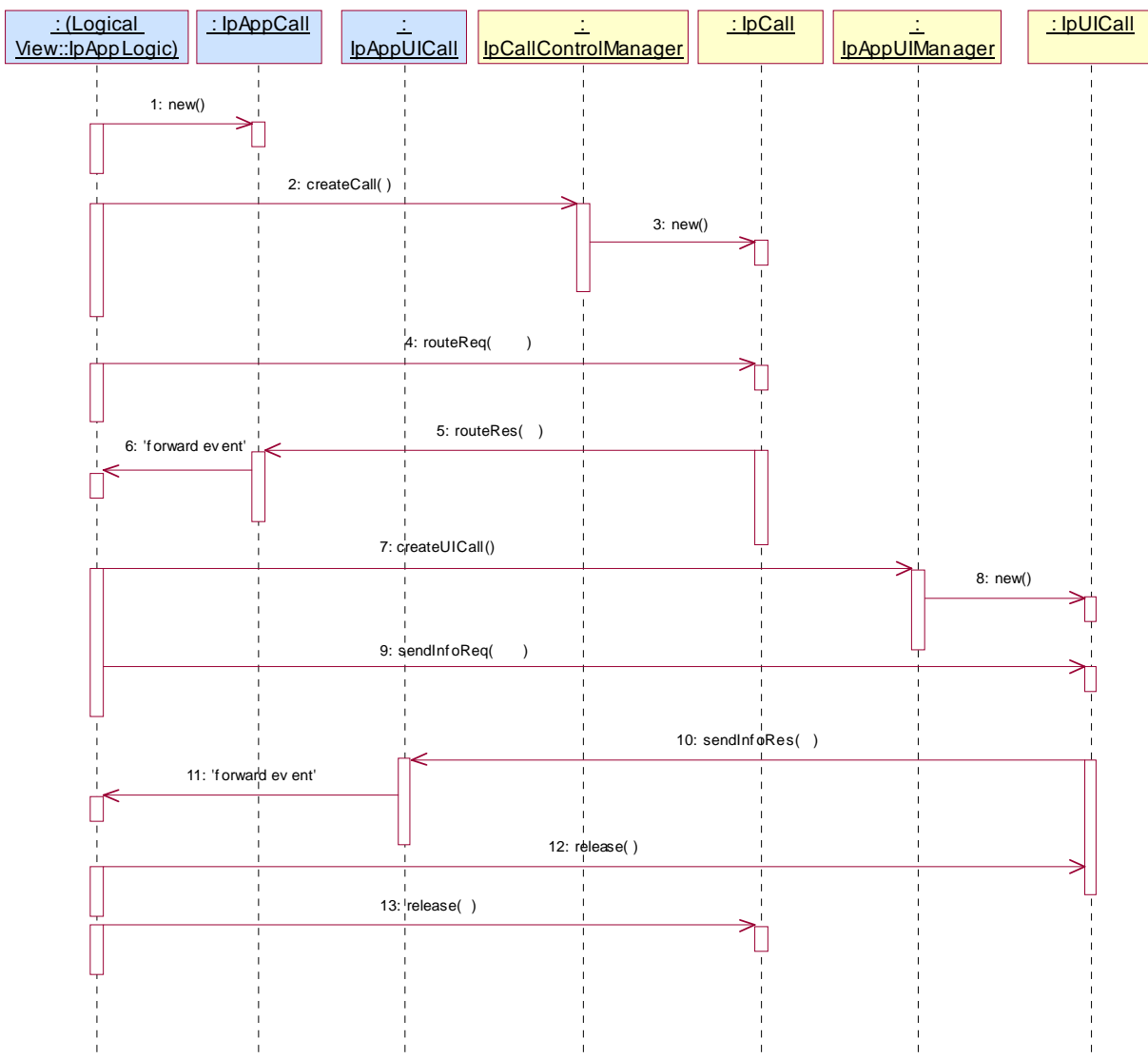

- 1: This message is used to create an object implementing the IpAppCall interface.
- 2: This message requests the object implementing the IpCallControlManager interface to create an object implementing the IpCall interface.
- 3: Assuming that the criteria for creating an object implementing the IpCall interface (e.g. load control values not exceeded) is met it is created.
- 4: This message instructs the object implementing the IpCall interface to route the call to the customer destined to receive the 'reminder message'
- 5: This message passes the result of the call being answered to its callback object.
- 6: This message is used to forward the previous message to the IpAppLogic.
- 7: The application requests a new UICall object that is associated with the call object.
- 8: Assuming all criteria are met, a new UICall object is created by the service.
- 9: This message instructs the object implementing the IpUICall interface to send the alarm to the customer's call.
- 10: When the announcement ends this is reported to the call back interface.

11: The event is forwarded to the application logic.

12: The application releases the UICall object, since no further announcements are required. Alternatively, the application could have indicated P_FINAL_REQUEST in the sendInfoReq in which case the UICall object would have been implicitly released after the announcement was played.

13: The application releases the call and all associated parties.

6.1.3 Application Initiated Call

The following sequence diagram shows an application creating a call between party A and party B. This sequence could be done after a customer has accessed a Web page and selected a name on the page of a person or organisation to talk to.

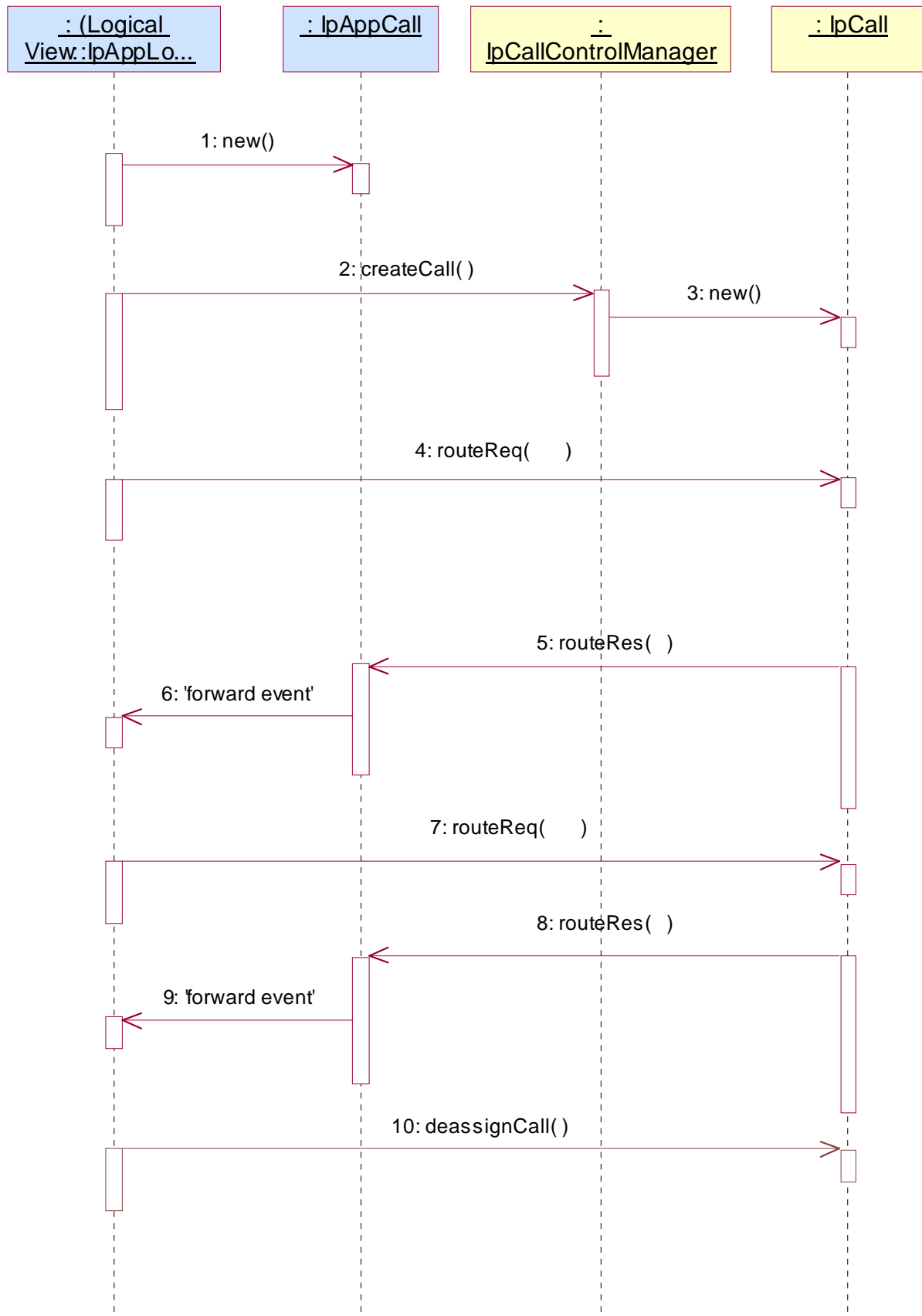

- 1: This message is used to create an object implementing the IpAppCall interface.
- 2: This message requests the object implementing the IpCallControlManager interface to create an object implementing the IpCall interface.
- 3: Assuming that the criteria for creating an object implementing the IpCall interface (e.g. load control values not exceeded) is met, it is created.
- 4: This message is used to route the call to the A subscriber (origination). In the message the application request response when the A party answers.
- 5: This message indicates that the A party answered the call.
- 6: This message forwards the previous message to the application logic.
- 7: This message is used to route the call to the B-party. Also in this case a response is requested for call answer or failure.
- 8: This message indicates that the B-party answered the call. The call now has two parties and a speech connection is automatically established between them.
- 9: This message is used to forward the previous message to the IpAppLogic.
- 10: Since the application is no longer interested in controlling the call, the application deassigns the call. The call will continue in the network, but there will be no further communication between the call object and the application.

6.1.4 Call Barring 1

The following sequence diagram shows a call barring service, initiated as a result of a prearranged event being received by the call control service. Before the call is routed to the destination number, the calling party is asked for a PIN code. The code is accepted and the call is routed to the original called party.

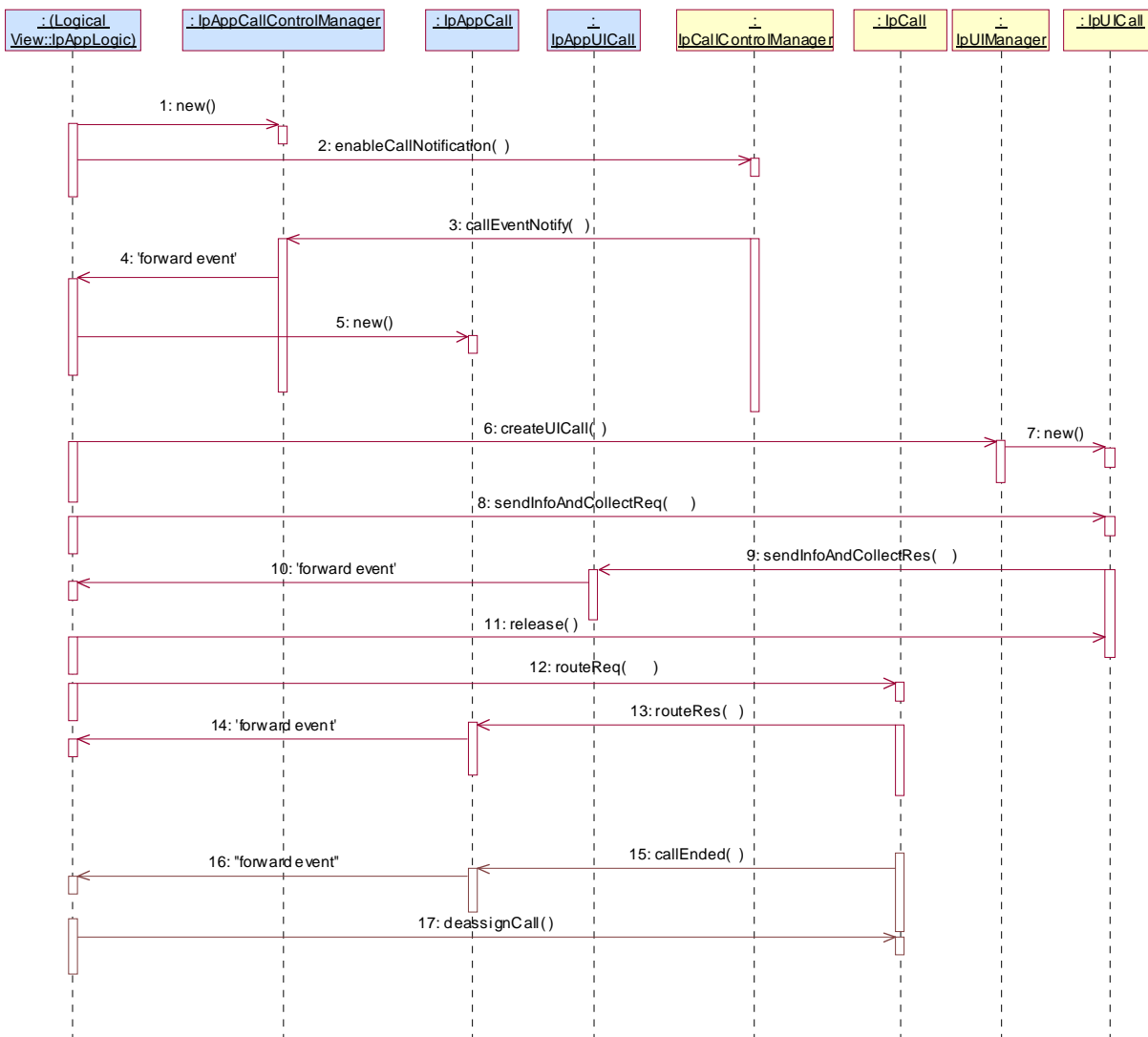

- 1: This message is used by the application to create an object implementing the IpAppCallControlManager interface.
- 2: This message is sent by the application to enable notifications on new call events. As this sequence diagram depicts a call barring service, it is likely that all new call events destined for a particular address or address range prompted for a password before the call is allowed to progress. When a new call, that matches the event criteria set, arrives a message (not shown) is directed to the object implementing the IpCallControlManager. Assuming that the criteria for creating an object implementing the IpCall interface (e.g. load control values not exceeded) is met, other messages (not shown) are used to create the call and associated call leg object.
- 3: This message is used to pass the new call event to the object implementing the IpAppCallControlManager interface.
- 4: This message is used to forward the previous message to the IpAppLogic.
- 5: This message is used by the application to create an object implementing the IpAppCall interface. The reference to this object is passed back to the object implementing the IpCallControlManager using the return parameter of the callEventNotify.
- 6: This message is used to create a new UICall object. The reference to the call object is given when creating the UICall.
- 7: Provided all the criteria are fulfilled, a new UICall object is created.
- 8: The call barring service dialogue is invoked.

- 9: The result of the dialogue, which in this case is the PIN code, is returned to its callback object.
- 10: This message is used to forward the previous message to the IpAppLogic.
- 11: This message releases the UICall object.
- 12: Assuming the correct PIN is entered, the call is forward routed to the destination party.
- 13: This message passes the result of the call being answered to its callback object.
- 14: This message is used to forward the previous message to the IpAppLogic
- 15: When the call is terminated in the network, the application will receive a notification. This notification will always be received when the call is terminated by the network in a normal way, the application does not have to request this event explicitly.
- 16: The event is forwarded to the application.
- 17: The application must free the call related resources in the gateway by calling deassignCall.

6.1.5 Number Translation 1

The following sequence diagram shows a simple number translation service, initiated as a result of a prearranged event being received by the call control service.

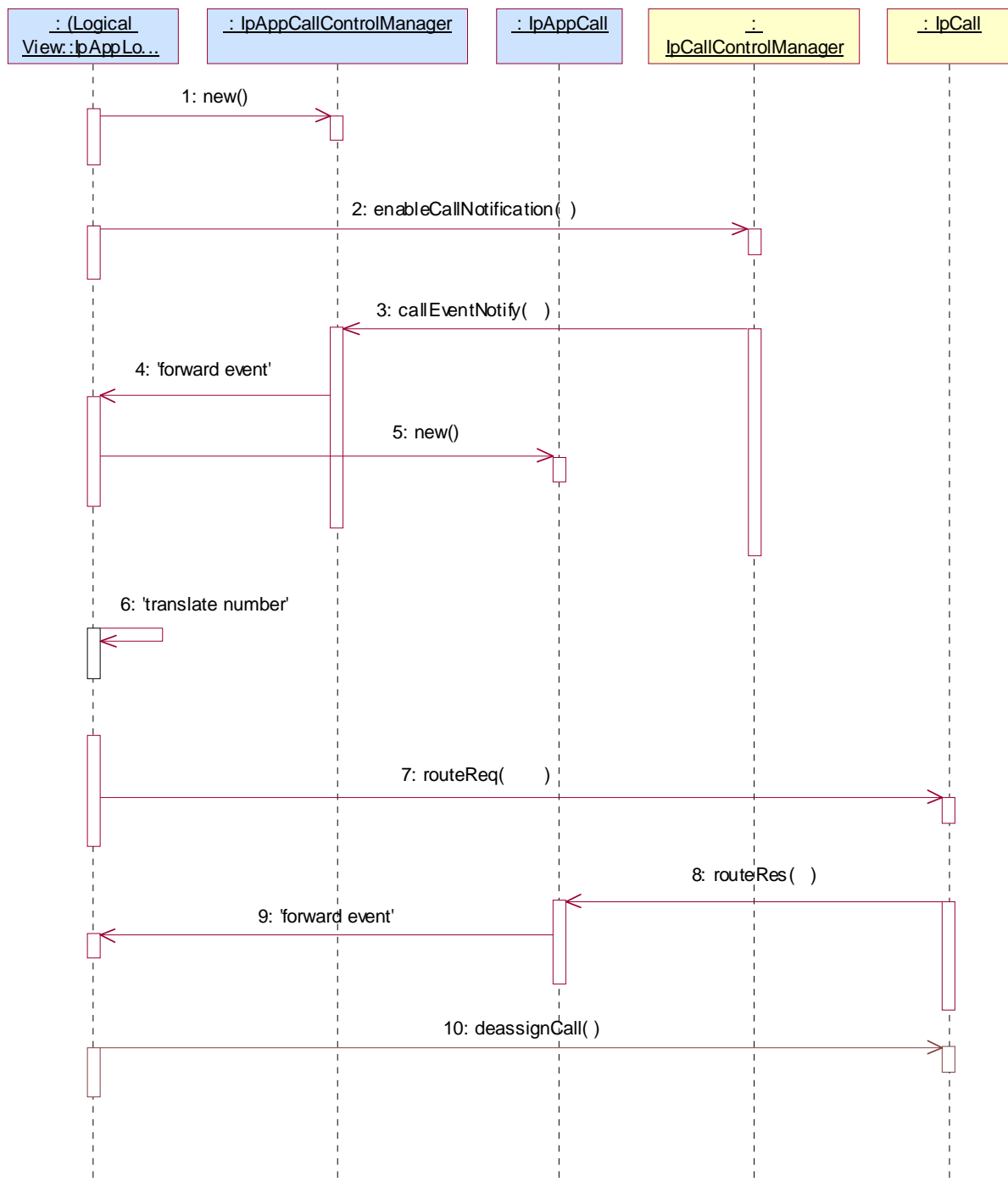

- 1: This message is used by the application to create an object implementing the IpAppCallControlManager interface.
- 2: This message is sent by the application to enable notifications on new call events. As this sequence diagram depicts a number translation service, it is likely that only new call events within a certain address range will be enabled. When a new call, that matches the event criteria set in message 2, arrives a message (not shown) is directed to the object implementing the IpCallControlManager. Assuming that the criteria for creating an object implementing the IpCall interface (e.g. load control values not exceeded) is met, other messages (not shown) are used to create the call and associated call leg object.
- 3: This message is used to pass the new call event to the object implementing the IpAppCallControlManager interface.

- 4: This message is used to forward message 3 to the IpAppLogic.
- 5: This message is used by the application to create an object implementing the IpAppCall interface. The reference to this object is passed back to the object implementing the IpCallControlManager using the return parameter of message 3.
- 6: This message invokes the number translation function.
- 7: The returned translated number is used in message 7 to route the call towards the destination.
- 8: This message passes the result of the call being answered to its callback object
- 9: This message is used to forward the previous message to the IpAppLogic.
- 10: The application is no longer interested in controlling the call and therefore deassigns the call. The call will continue in the network, but there will be no further communication between the call object and the application.

6.1.6 Number Translation 1 (with callbacks)

The following sequence diagram shows a simple number translation service, initiated as a result of a prearranged event being received by the call control service.

For illustration, in this sequence the callback references are set explicitly. This is optional. All the callbacks references can also be passed in other methods. From an efficiency point of view that is also the preferred method. The rest of the sequences use that mechanism.

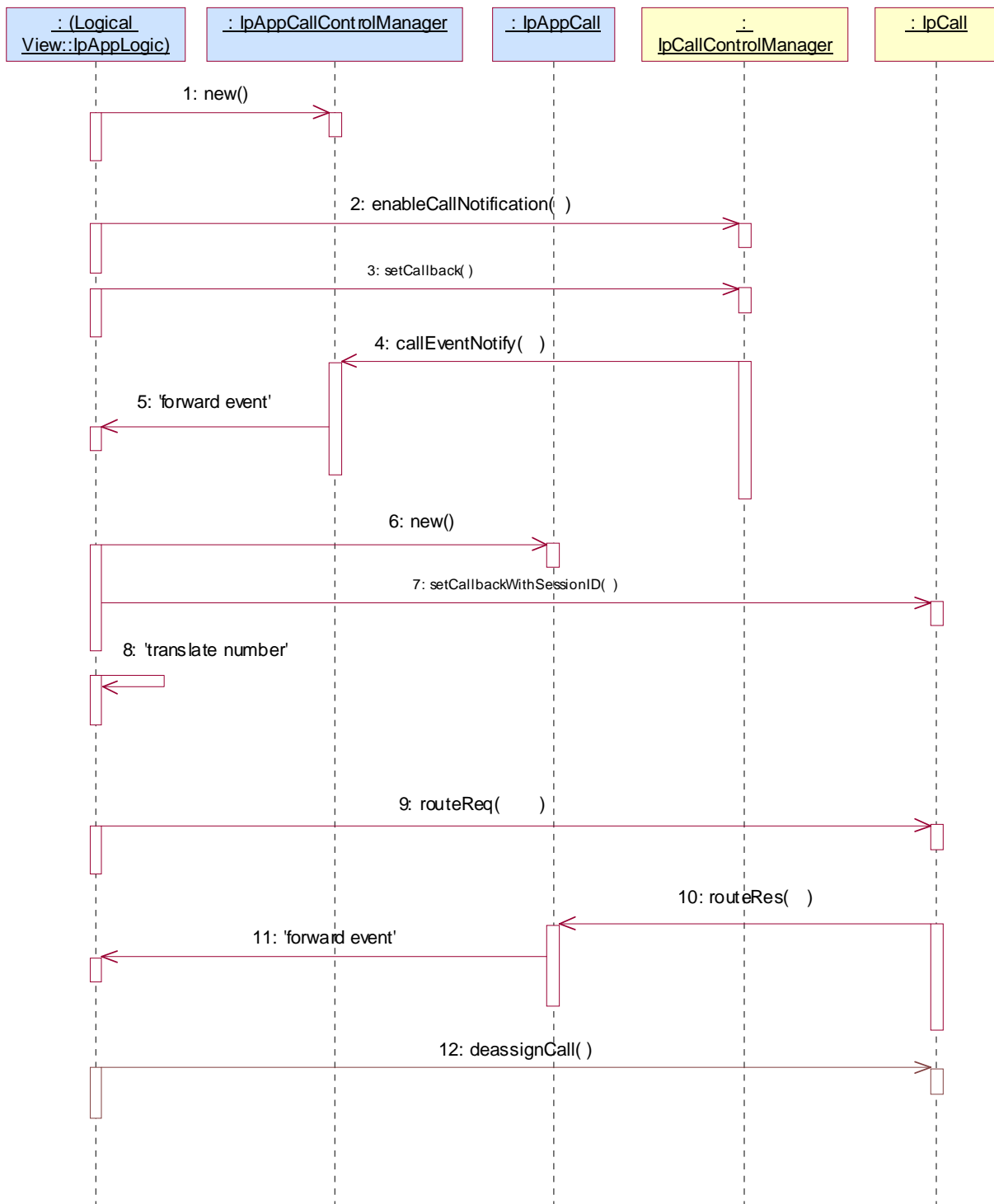

- 1: This message is used by the application to create an object implementing the IpAppCallControlManager interface.
- 2: This message is sent by the application to enable notifications on new call events. As this sequence diagram depicts a number translation service, it is likely that only new call events within a certain address range will be enabled. When a new call, that matches the event criteria set in message 2, arrives a message (not shown) is directed to the object implementing the IpCallControlManager. Assuming that the criteria for creating an object implementing the IpCall interface (e.g. load control values not exceeded) is met, other messages (not shown) are used to create the call and associated call leg object.

- 3: This message sets the reference of the IpAppCallControlManager object in the CallControlManager. The CallControlManager reports the callEventNotify to referenced object only for enableCallNotifications that do not have an explicit IpAppCallControlManager reference specified in the enableCallNotification.
- 4: This message is used to pass the new call event to the object implementing the IpAppCallControlManager interface.
- 5: This message is used to forward message 4 to the IpAppLogic.
- 6: This message is used by the application to create an object implementing the IpAppCall interface.
- 7: This message is used to set the reference to the IpAppCall for this call.
- 8: This message invokes the number translation function.
- 9: The returned translated number is used in message 7 to route the call towards the destination.
- 10: This message passes the result of the call being answered to its callback object
- 11: This message is used to forward the previous message to the IpAppLogic.
- 12: The application is no longer interested in controlling the call and therefore deassigns the call. The call will continue in the network, but there will be no further communication between the call object and the application.

6.1.7 Number Translation 2

The following sequence diagram shows a number translation service, initiated as a result of a prearranged event being received by the call control service. If the translated number being routed to does not answer or is busy then the call is automatically released.

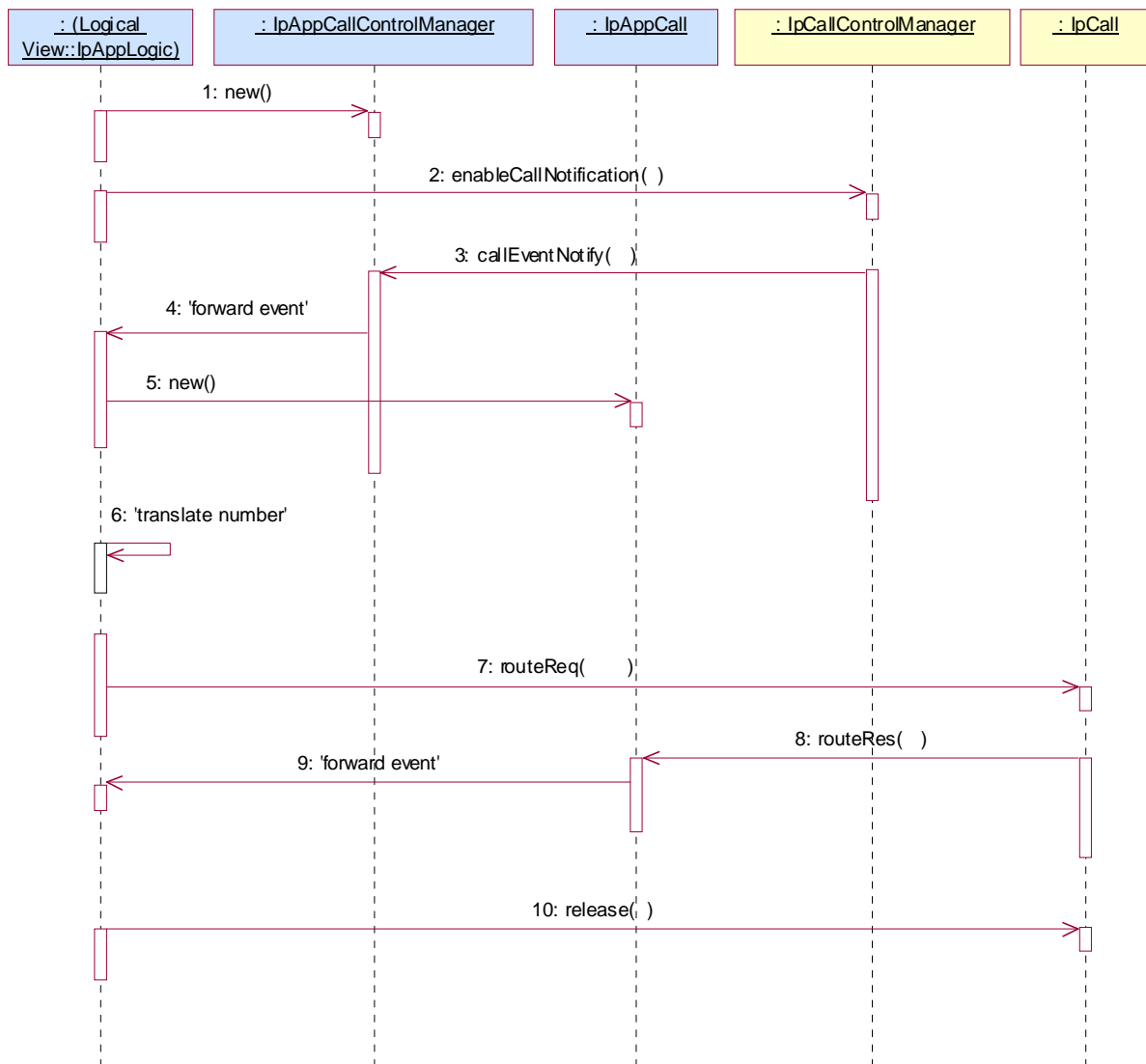

- 1: This message is used by the application to create an object implementing the IpAppCallControlManager interface.
- 2: This message is sent by the application to enable notifications on new call events. As this sequence diagram depicts a number translation service, it is likely that only new call events within a certain address range will be enabled. When a new call, that matches the event criteria, arrives a message (not shown) is directed to the object implementing the IpCallControlManager. Assuming that the criteria for creating an object implementing the IpCall interface (e.g. load control values not exceeded) is met, other messages (not shown) are used to create the call and associated call leg object.
- 3: This message is used to pass the new call event to the object implementing the IpAppCallControlManager interface.
- 4: This message is used to forward the previous message to the IpAppLogic.
- 5: This message is used by the application to create an object implementing the IpAppCall interface. The reference to this object is passed back to the object implementing the IpCallControlManager using the return parameter of the callEventNotify.
- 6: This message invokes the number translation function.
- 7: The returned translated number is used to route the call towards the destination.
- 8: Assuming the called party is busy or does not answer, the object implementing the IpCall interface sends a callback in this message, indicating the unavailability of the called party.

9: This message is used to forward the previous message to the IpAppLogic.

10: The application takes the decision to release the call.

6.1.8 Number Translation 3

The following sequence diagram shows a number translation service, initiated as a result of a prearranged event being received by the call control service. If the translated number being routed to does not answer or is busy then the call is automatically routed to a voice mailbox.

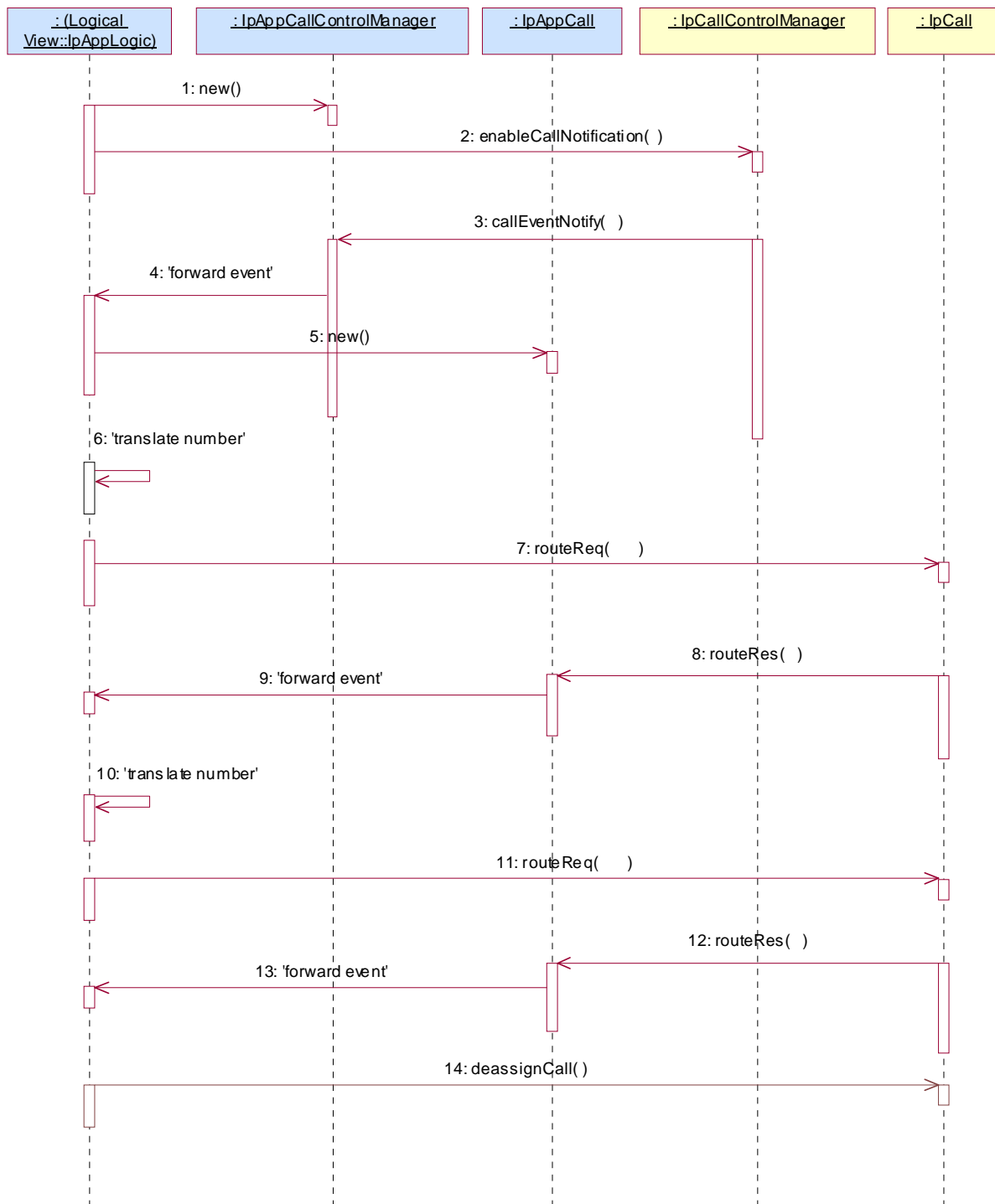

- 1: This message is used by the application to create an object implementing the IpAppCallControlManager interface.
- 2: This message is sent by the application to enable notifications on new call events. As this sequence diagram depicts a number translation service, it is likely that only new call events within a certain address range will be enabled. When a new call, that matches the event criteria, arrives a message (not shown) is directed to the object implementing the IpCallControlManager. Assuming that the criteria for creating an object implementing the IpCall interface (e.g. load control values not exceeded) is met, other messages (not shown) are used to create the call and associated call leg object.

- 3: This message is used to pass the new call event to the object implementing the IpAppCallControlManager interface.
- 4: This message is used to forward the previous message to the IpAppLogic.
- 5: This message is used by the application to create an object implementing the IpAppCall interface. The reference to this object is passed back to the object implementing the IpCallControlManager using the return parameter of the callEventNotify.
- 6: This message invokes the number translation function.
- 7: The returned translated number is used to route the call towards the destination.
- 8: Assuming the called party is busy or does not answer, the object implementing the IpCall interface sends a callback, indicating the unavailability of the called party.
- 9: This message is used to forward the previous message to the IpAppLogic.
- 10: The application takes the decision to translate the number, but this time the number is translated to a number belonging to a voice mailbox system.
- 11: This message routes the call towards the voice mailbox.
- 12: This message passes the result of the call being answered to its callback object.
- 13: This message is used to forward the previous message to the IpAppLogic.
- 14: The application is no longer interested in controlling the call and therefore deassigns the call. The call will continue in the network, but there will be no further communication between the call object and the application.

6.1.9 Number Translation 4

The following sequence diagram shows a number translation service, initiated as a result of a prearranged event being received by the call control service. Before the call is routed to the translated number, the application requests for all call related information to be delivered back to the application on completion of the call.

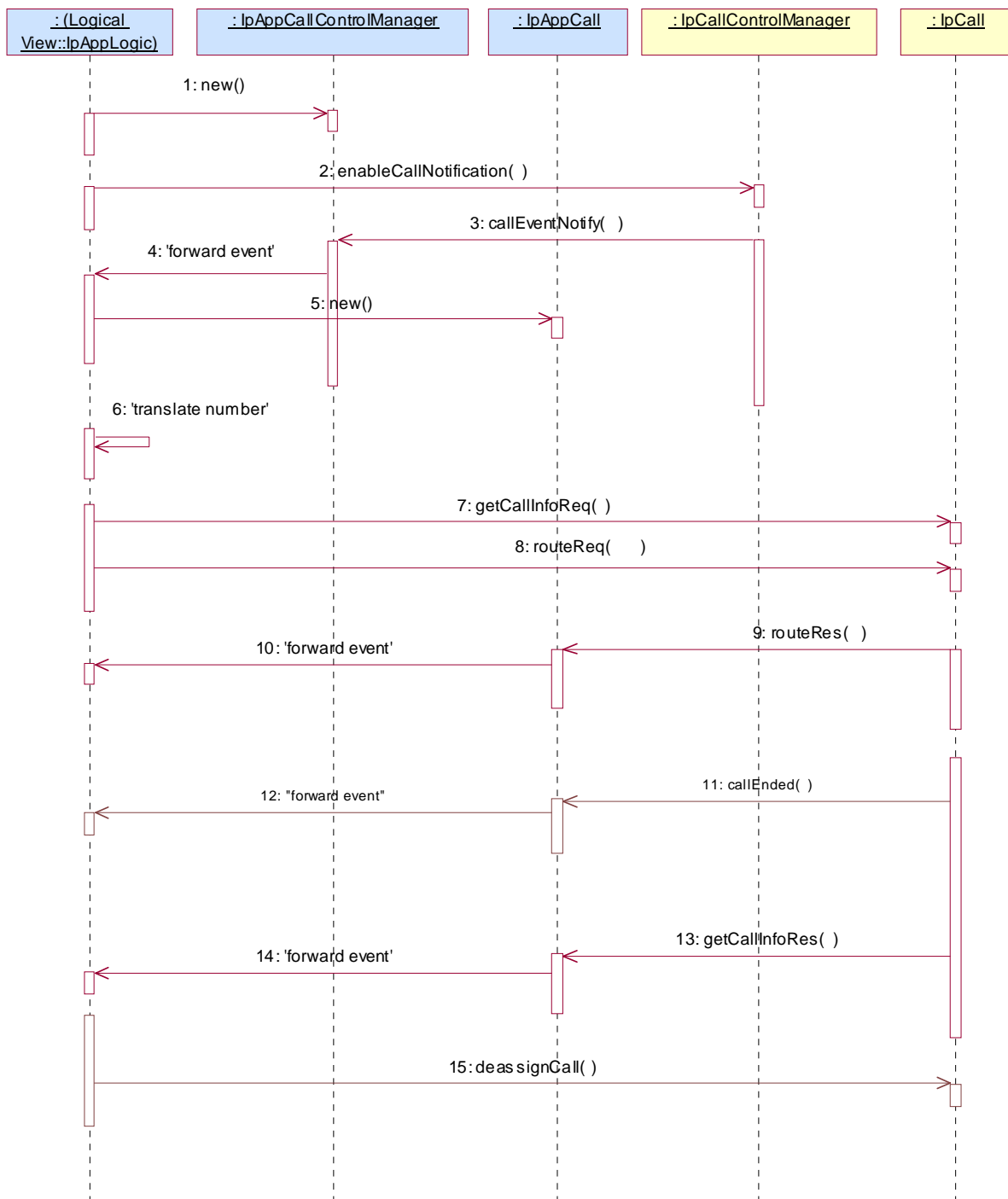

- 1: This message is used by the application to create an object implementing the IpAppCallControlManager interface.
- 2: This message is sent by the application to enable notifications on new call events. As this sequence diagram depicts a number translation service, it is likely that only new call events within a certain address range will be enabled. When a new call, that matches the event criteria, arrives a message (not shown) is directed to the object implementing the IpCallControlManager. Assuming that the criteria for creating an object implementing the IpCall interface (e.g. load control values not exceeded) is met, other messages (not shown) are used to create the call and associated call leg object.
- 3: This message is used to pass the new call event to the object implementing the IpAppCallControlManager interface.

- 4: This message is used to forward the previous message to the IpAppLogic.
- 5: This message is used by the application to create an object implementing the IpAppCall interface. The reference to this object is passed back to the object implementing the IpCallControlManager using the return parameter of the callEventNotify.
- 6: This message invokes the number translation function.
- 7: The application instructs the object implementing the IpCall interface to return all call related information once the call has been released.
- 8: The returned translated number is used to route the call towards the destination.
- 9: This message passes the result of the call being answered to its callback object.
- 10: This message is used to forward the previous message to the IpAppLogic.
- 11: Towards the end of the call, when one of the parties disconnects, a message (not shown) is directed to the object implementing the IpCall. This causes an event, to be passed to the object implementing the IpAppCall object.
- 12: This message is used to forward the previous message to the IpAppLogic.
- 13: The application now waits for the call information to be sent. Now that the call has completed, the object implementing the IpCall interface passes the call information to its callback object.
- 14: This message is used to forward the previous message to the IpAppLogic.
- 15: After the last information is received, the application deassigns the call. This will free the resources related to this call in the gateway.

6.1.10 Number Translation5

The following sequence diagram shows a simple number translation service which contains a status check function, initiated as a result of a prearranged event being received. In the following sequence, when the application receives an incoming call, it checks the status of the user, and returns a busy code to the calling party.

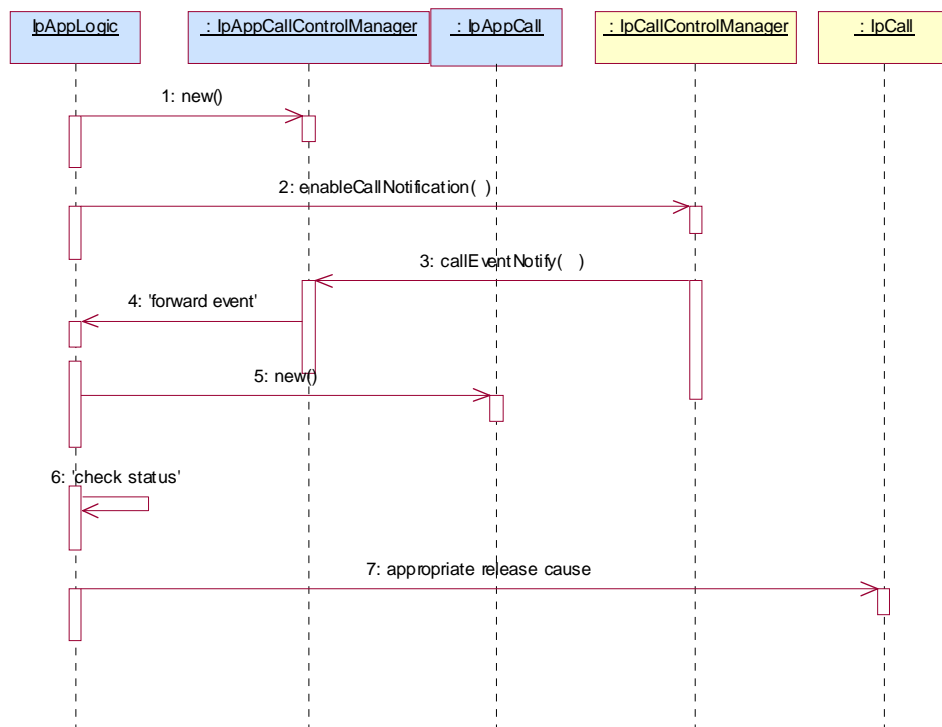

1: This message is used by the application to create an object implementing the IpAppCallControlManager interface.

2: This message is sent by the application to enable notifications on new call events. As this sequence diagram depicts a number translation service, it is likely that only new call events within a certain address range will be enabled.

When a new call, that matches the event criteria set in message 2, arrives a message (not shown) is directed to the object implementing the IpCallControlManager. Assuming that the criteria for creating an object implementing the IpCall interface (e.g. load control values not exceeded) is met, other messages (not shown) are used to create the call and associated call leg object.

3: This message is used to pass the new call event to the object implementing the IpAppCallControlManager interface.

4: This message is used to forward message 3 to the IpAppLogic.

5: This message is used by the application to create an object implementing the IpAppCall interface. The reference to this object is passed back to the object implementing the IpCallControlManager using the return parameter of message 3.

6: This message invokes the status checking function.

7: The application decides to release the call, and sends a release cause to the calling party indicating that the user is busy.

6.1.11 Prepaid

This sequence shows a Pre-paid application.

The subscriber is using a pre-paid card or credit card to pay for the call. The application each time allows a certain timeslice for the call. After the timeslice, a new timeslice can be started or the application can terminate the call. In the following sequence the end-user will receive an announcement before his final timeslice.

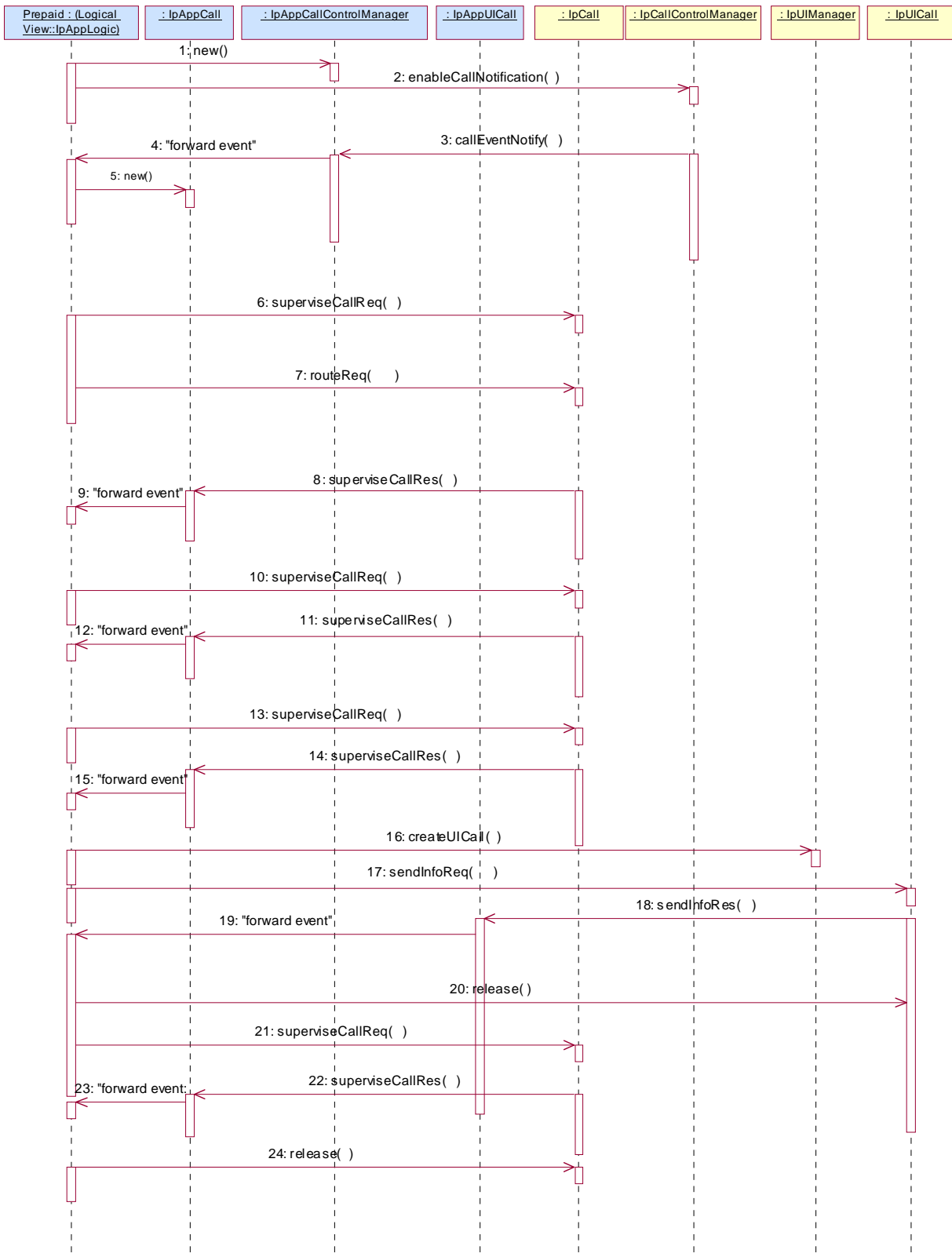

1: This message is used by the application to create an object implementing the IpAppCallControlManager interface.

- 2: This message is sent by the application to enable notifications on new call events. As this sequence diagram depicts a pre-paid service, it is likely that only new call events within a certain address range will be enabled. When a new call, that matches the event criteria, arrives a message (not shown) is directed to the object implementing the IpCallControlManager. Assuming that the criteria for creating an object implementing the IpCall interface (e.g. load control values not exceeded) is met, other messages (not shown) are used to create the call and associated call leg object.
- 3: The incoming call triggers the Pre-Paid Application (PPA).
- 4: The message is forwarded to the application.
- 5: A new object on the application side for the Generic Call object is created
- 6: The Pre-Paid Application (PPA) requests to supervise the call. The application will be informed after the period indicated in the message. This period is related to the credits left on the account of the pre-paid subscriber.
- 7: Before continuation of the call, PPA sends all charging information, a possible tariff switch time and the call duration supervision period, towards the GW which forwards it to the network.
- 8: At the end of each supervision period the application is informed and a new period is started.
- 9: The message is forwarded to the application.
- 10: The Pre-Paid Application (PPA) requests to supervise the call for another call duration.
- 11: At the end of each supervision period the application is informed and a new period is started.
- 12: The message is forwarded to the application.
- 13: The Pre-Paid Application (PPA) requests to supervise the call for another call duration. When the timer expires it will indicate that the user is almost out of credit.
- 14: When the user is almost out of credit the application is informed.
- 15: The message is forwarded to the application.
- 16: The application decides to play an announcement to the parties in this call. A new UICall object is created and associated with the call.
- 17: An announcement is played informing the user about the near-expiration of his credit limit.
- 18: When the announcement is completed the application is informed.
- 19: The message is forwarded to the application.
- 20: The application releases the UICall object.
- 21: The user does not terminate so the application terminates the call after the next supervision period.
- 22: The supervision period ends
- 23: The event is forwarded to the logic.
- 24: The application terminates the call. Since the user interaction is already explicitly terminated no userInteractionFaultDetected is sent to the application.

6.1.12 Pre-Paid with Advice of Charge (AoC)

This sequence shows a Pre-paid application that uses the Advice of Charge feature.

The application will send the charging information before the actual call setup and when during the call the charging changes new information is sent in order to update the end-user. Note: the Advice of Charge feature requires an application in the end-user terminal to display the charges for the call, depending on the information received from the application.

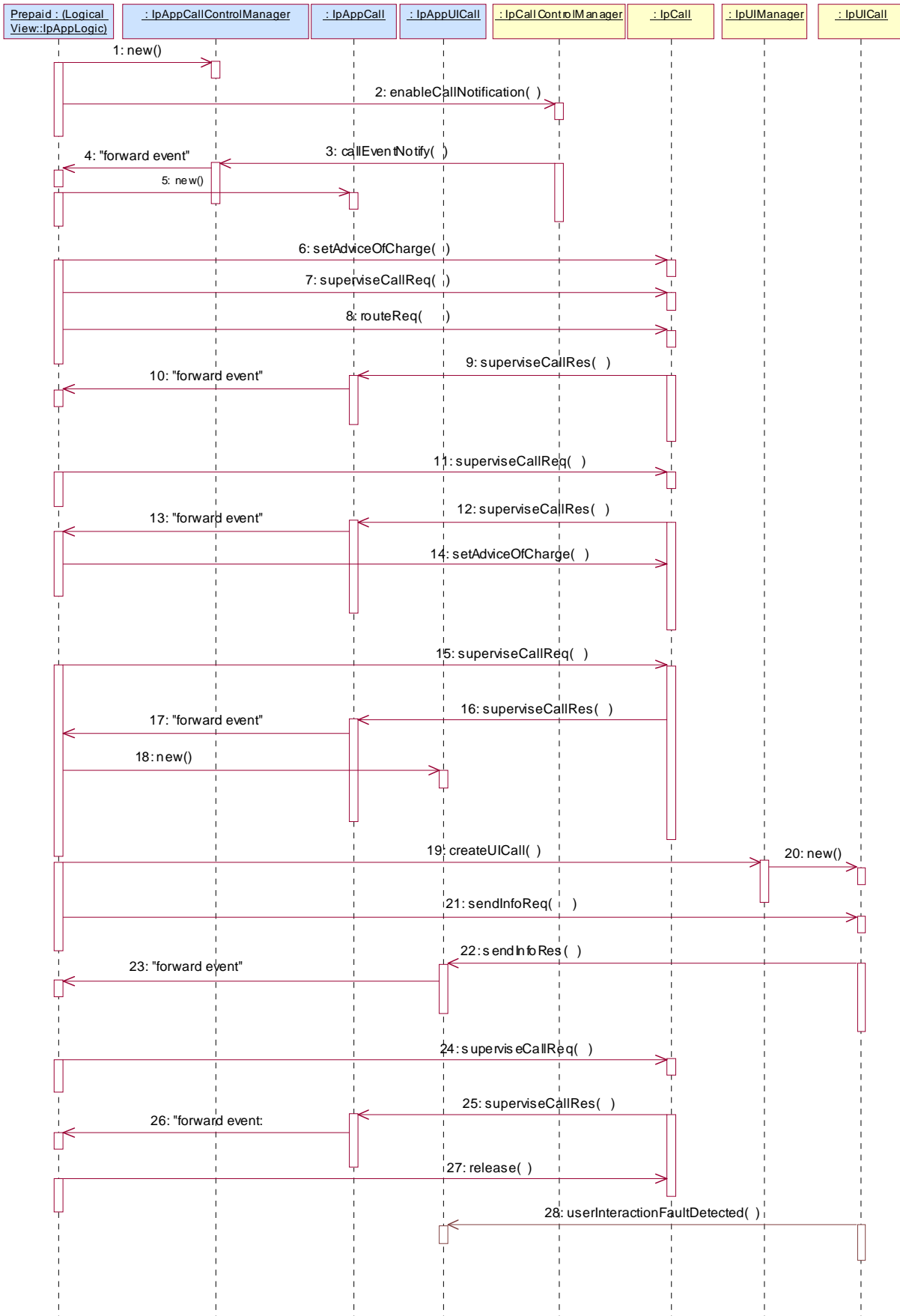

- 1: This message is used by the application to create an object implementing the IpAppCallControlManager interface.
 - 2: This message is sent by the application to enable notifications on new call events. As this sequence diagram depicts a pre-paid service, it is likely that only new call events within a certain address range will be enabled. When a new call, that matches the event criteria, arrives a message (not shown) is directed to the object implementing the IpCallControlManager. Assuming that the criteria for creating an object implementing the IpCall interface (e.g. load control values not exceeded) is met, other messages (not shown) are used to create the call and associated call leg object.
 - 3: The incoming call triggers the Pre-Paid Application (PPA).
 - 4: The message is forwarded to the application.
 - 5: A new object on the application side for the Call object is created
 - 6: The Pre-Paid Application (PPA) sends the AoC information (e.g. the tariff switch time). (it shall be noted the PPA contains ALL the tariff information and knows how to charge the user).
- During this call sequence 2 tariff changes take place. The call starts with tariff 1, and at the tariff switch time (e.g., 18:00 hours) switches to tariff 2. The application is not informed about this (but the end-user is!)
- 7: The Pre-Paid Application (PPA) requests to supervise the call. The application will be informed after the period indicated in the message. This period is related to the credits left on the account of the pre-paid subscriber.
 - 8: The application requests to route the call to the destination address.
 - 9: At the end of each supervision period the application is informed and a new period is started.
 - 10: The message is forwarded to the application.
 - 11: The Pre-Paid Application (PPA) requests to supervise the call for another call duration.
 - 12: At the end of each supervision period the application is informed and a new period is started.
 - 13: The message is forwarded to the application.
 - 14: Before the next tariff switch (e.g., 19:00 hours) the application sends a new AOC with the tariff switch time. Again, at the tariff switch time, the network will send AoC information to the end-user.
 - 15: The Pre-Paid Application (PPA) requests to supervise the call for another call duration. When the timer expires it will indicate that the user is almost out of credit.
 - 16: When the user is almost out of credit the application is informed.
 - 17: The message is forwarded to the application.
 - 18: The application creates a new call back interface for the User interaction messages.
 - 19: A new UI Call object that will handle playing of the announcement needs to be created
 - 20: The Gateway creates a new UI call object that will handle playing of the announcement.
 - 21: With this message the announcement is played to the parties in the call.
 - 22: The user indicates that the call should continue.
 - 23: The message is forwarded to the application.
 - 24: The user does not terminate so the application terminates the call after the next supervision period.
 - 25: The user is out of credit and the application is informed.
 - 26: The message is forwarded to the application.
 - 27: With this message the application requests to release the call.

28: Terminating the call which has still a UICall object associated will result in a userInteractionFaultDetected. The UICall object is terminated in the gateway and no further communication is possible between the UICall and the application.

6.2 Class Diagrams

This class diagram shows the interfaces of the generic call control service package.

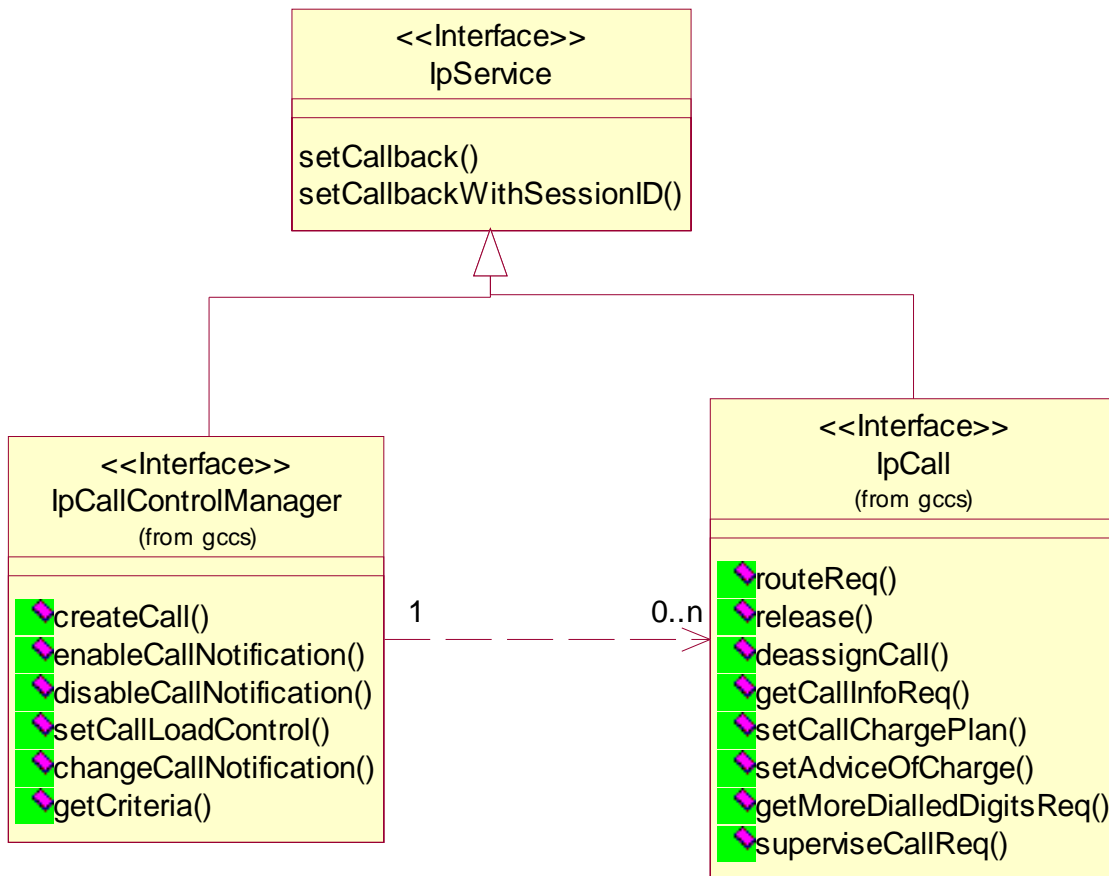

Figure: Service Interfaces

The generic call control service consists of two packages, one for the interfaces on the application side and one for interfaces on the service side.

The class diagrams in the following figures show the interfaces that make up the generic call control application package and the generic call control service package. Communication between these packages is indicated with the <<uses>> associations; e.g., the IpCallControlManager interface uses the IpAppCallControlManager, by means of calling callback methods.

This class diagram shows the interfaces of the generic call control application package and their relations to the interfaces of the generic call control service package.

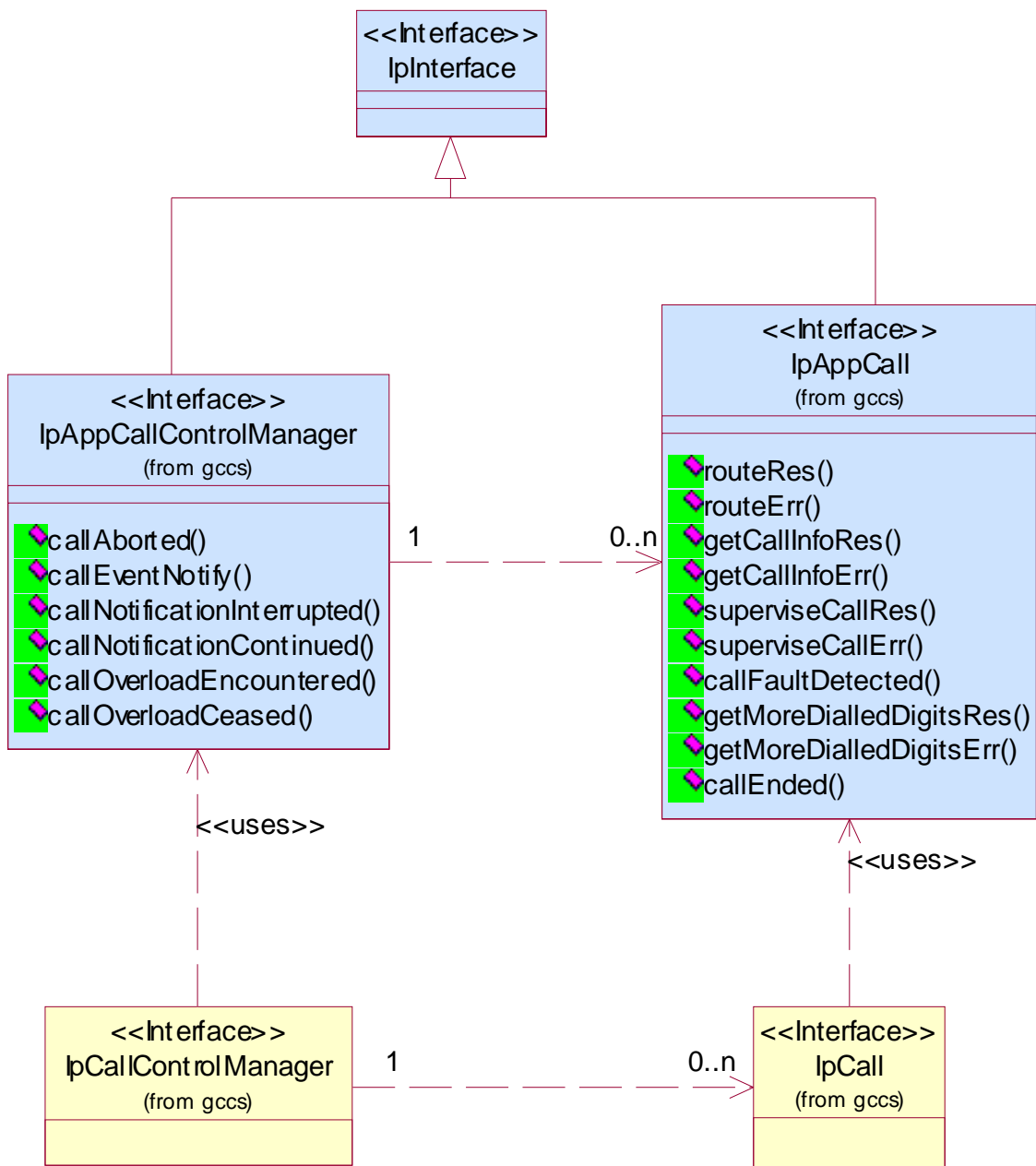

Figure: Application Interfaces

6.3 Generic Call Control Service Interface Classes

The Generic Call Control Service (GCCS) provides the basic call control service for the API. It is based around a third party model, which allows calls to be instantiated from the network and routed through the network.

The GCCS supports enough functionality to allow call routing and call management for today's Intelligent Network (IN) services in the case of a switched telephony network, or equivalent for packet based networks.

It is the intention of the GCCS that it could be readily specialised into call control specifications, for example, ITU-T recommendations H.323, ISUP, Q.931 and Q.2931, ATM Forum specification UNI3.1 and the IETF Session Initiation Protocol, or any other call control technology.

For the generic call control service, only a subset of the call model defined in clause 4 is used; the API for generic call control does not give explicit access to the legs and the media channels. This is provided by the Multi-Party Call Control Service. Furthermore, the generic call is restricted to two party calls, i.e., only two legs are active at any given time. Active is defined here as 'being routed' or connected.

The GCCS is represented by the IpCallControlManager and IpCall interfaces that interface to services provided by the network. Some methods are asynchronous, in that they do not lock a thread into waiting whilst a transaction performs. In this way, the client machine can handle many more calls, than one that uses synchronous message calls. To handle responses and reports, the developer must implement IpAppCallControlManager and IpAppCall to provide the callback mechanism.

6.3.1 Interface Class IpCallControlManager

Inherits from: IpService

This interface is the 'service manager' interface for the Generic Call Control Service. The generic call control manager interface provides the management functions to the generic call control service. The application programmer can use this interface to provide overload control functionality, create call objects and to enable or disable call-related event notifications.

This interface shall be implemented by a Generic Call Control SCF. As a minimum requirement either the createCall() method shall be implemented, or the enableCallNotification() and disableCallNotification() methods shall be implemented.

<<Interface>> IpCallControlManager
<pre> createCall (appCall : in IpAppCallRef) : TpCallIdentifier enableCallNotification (appCallControlManager : in IpAppCallControlManagerRef, eventCriteria : in TpCallEventCriteria) : TpAssignmentID disableCallNotification (assignmentID : in TpAssignmentID) : void setCallLoadControl (duration : in TpDuration, mechanism : in TpCallLoadControlMechanism, treatment : in TpCallTreatment, addressRange : in TpAddressRange) : TpAssignmentID changeCallNotification (assignmentID : in TpAssignmentID, eventCriteria : in TpCallEventCriteria) : void getCriteria () : TpCallEventCriteriaResultSet </pre>

Method

createCall()

This method is used to create a new call object. An IpAppCallControlManager should already have been passed to the IpCallControlManager, otherwise the call control will not be able to report a callAborted()

to the application (the application should invoke setCallback() if it wishes to ensure this).

Returns callReference: Specifies the interface reference and sessionID of the call created.

*Parameters***appCall : in IpAppCallRef**

Specifies the application interface for callbacks from the call created.

*Returns***TpCallIdentifier***Raises***TpCommonExceptions, P_INVALID_INTERFACE_TYPE***Method***enableCallNotification()**

This method is used to enable call notifications so that events can be sent to the application. This is the first step an application has to do to get initial notification of calls happening in the network. When such an event happens, the application will be informed by `callEventNotify()`. In case the application is interested in other events during the context of a particular call session it has to use the `routeReq()` method on the call object. The application will get access to the call object when it receives the `callEventNotify()`. (Note that the `enableCallNotification()` is not applicable if the call is setup by the application).

The `enableCallNotification` method is purely intended for applications to indicate their interest to be notified when certain call events take place. It is possible to subscribe to a certain event for a whole range of addresses, e.g. the application can indicate it wishes to be informed when a call is made to any number starting with 800.

If some application already requested notifications with criteria that overlap the specified criteria, the request is refused with `P_GCCS_INVALID_CRITERIA`. The criteria are said to overlap if both originating and terminating ranges overlap and the same number plan is used and the same `CallNotificationType` is used.

If a notification is requested by an application with the monitor mode set to notify, then there is no need to check the rest of the criteria for overlapping with any existing request as the notify mode does not allow control on a call to be passed over. Only one application can place an interrupt request if the criteria overlaps.

If the same application requests two notifications with exactly the same criteria but different callback references, the second callback will be treated as an additional callback. Both notifications will share the same `assignmentID`. The gateway will always use the most recent callback. In case this most recent callback fails the second most recent is used. In case the `enableCallNotification` contains no callback, at the moment the application needs to be informed the gateway will use as callback the callback that has been registered by `setCallback()`.

Returns `assignmentID`: Specifies the ID assigned by the generic call control manager interface for this newly-enabled event notification.

*Parameters***appCallControlManager : in IpAppCallControlManagerRef**

If this parameter is set (i.e. not NULL) it specifies a reference to the application interface, which is used for callbacks. If set to NULL, the application interface defaults to the interface specified via the `setCallback()` method.

eventCriteria : in TpCallEventCriteria

Specifies the event specific criteria used by the application to define the event required. Only events that meet these criteria are reported. Examples of events are "incoming call attempt reported by network", "answer", "no answer", "busy". Individual addresses or address ranges may be specified for destination and/or origination.

*Returns***TpAssignmentID***Raises***TpCommonExceptions, P_INVALID_CRITERIA, P_INVALID_INTERFACE_TYPE, P_INVALID_EVENT_TYPE***Method***disableCallNotification()**

This method is used by the application to disable call notifications.

*Parameters***assignmentID : in TpAssignmentID**

Specifies the assignment ID given by the generic call control manager interface when the previous enableCallNotification() was called. If the assignment ID does not correspond to one of the valid assignment IDs, the exception P_INVALID_ASSIGNMENTID will be raised. If two callbacks have been registered under this assignment ID both of them will be disabled.

*Raises***TpCommonExceptions, P_INVALID_ASSIGNMENT_ID***Method***setCallLoadControl()**

This method imposes or removes load control on calls made to a particular address range within the generic call control service. The address matching mechanism is similar as defined for TpCallEventCriteria.

Returns assignmentID: Specifies the assignmentID assigned by the gateway to this request. This assignmentID can be used to correlate the callOverloadEncountered and callOverloadCeased methods with the request.

*Parameters***duration : in TpDuration**

Specifies the duration for which the load control should be set.

A duration of 0 indicates that the load control should be removed.

A duration of -1 indicates an infinite duration (i.e., until disabled by the application)

A duration of -2 indicates the network default duration.

mechanism : in TpCallLoadControlMechanism

Specifies the load control mechanism to use (for example, admit one call per interval), and any necessary parameters, such as the call admission rate. The contents of this parameter are ignored if the load control duration is set to zero.

treatment : in TpCallTreatment

Specifies the treatment of calls that are not admitted. The contents of this parameter are ignored if the load control duration is set to zero.

addressRange : in TpAddressRange

Specifies the address or address range to which the overload control should be applied or removed.

*Returns***TpAssignmentID***Raises***TpCommonExceptions, P_INVALID_ADDRESS, P_UNSUPPORTED_ADDRESS_PLAN***Method***changeCallNotification()**

This method is used by the application to change the event criteria introduced with enableCallNotification. Any stored criteria associated with the specified assignmentID will be replaced with the specified criteria.

*Parameters***assignmentID : in TpAssignmentID**

Specifies the ID assigned by the generic call control manager interface for the event notification. If two call backs have been registered under this assignment ID both of them will be changed.

eventCriteria : in TpCallEventCriteria

Specifies the new set of event specific criteria used by the application to define the event required. Only events that meet these criteria are reported.

*Raises***TpCommonExceptions, P_INVALID_ASSIGNMENT_ID, P_INVALID_CRITERIA, P_INVALID_EVENT_TYPE***Method***getCriteria()**

This method is used by the application to query the event criteria set with enableCallNotification or changeCallNotification.

Returns eventCriteria: Specifies the event specific criteria used by the application to define the event required. Only events that meet these criteria are reported.

Parameters

No Parameters were identified for this method

*Returns***TpCallEventCriteriaResultSet***Raises***TpCommonExceptions**

6.3.2 Interface Class IpAppCallControlManager

Inherits from: IpInterface

The generic call control manager application interface provides the application call control management functions to the generic call control service.

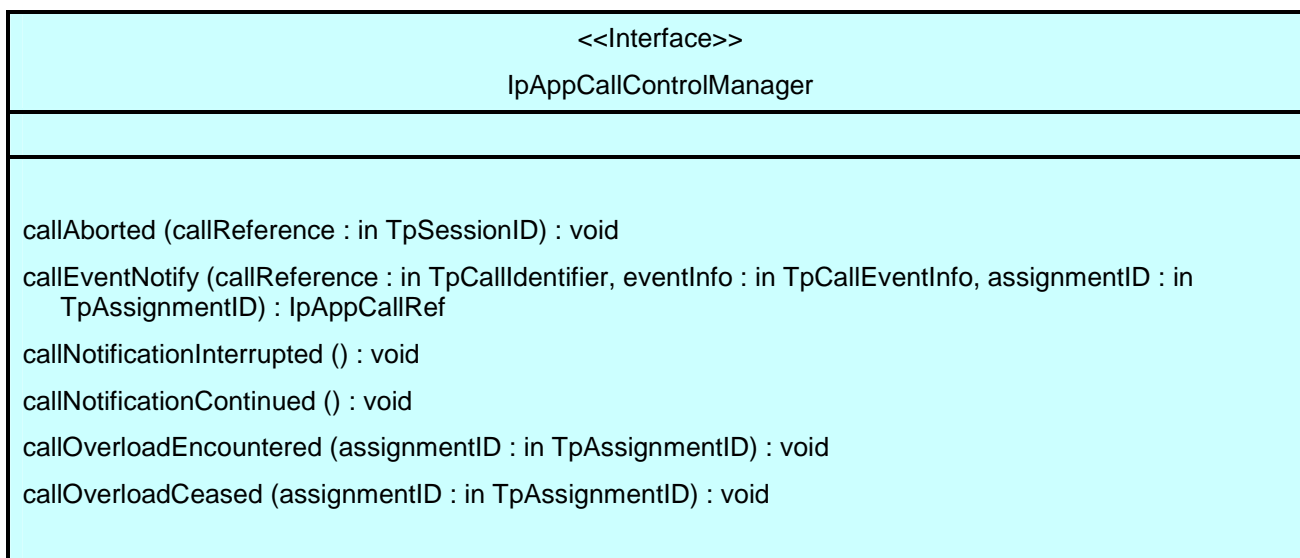

Method

callAborted()

This method indicates to the application that the call object (at the gateway) has aborted or terminated abnormally. No further communication will be possible between the call and application.

Parameters

callReference : in **TpSessionID**

Specifies the sessionID of call that has aborted or terminated abnormally.

Method

callEventNotify()

This method notifies the application of the arrival of a call-related event.

If this method is invoked with a monitor mode of **P_CALL_MONITOR_MODE_INTERRUPT**, then the APL has control of the call. If the APL does nothing with the call (including its associated legs) within a specified time period (the duration of which forms a part of the service level agreement), then the call in the network shall be released and **callEnded()** shall be invoked, giving a release cause of 102 (Recovery on timer expiry).

When this method is invoked with a monitor mode of **P_CALL_MONITOR_MODE_INTERRUPT**, the application writer should ensure that no **routeReq()** is performed until an **IpAppCall** has been passed to the gateway, either through an explicit **setCallbackWithSessionID()** invocation on the supplied **IpCall**, or via the return of the **callEventNotify()** method.

Returns **appCall**: Specifies a reference to the application interface which implements the callback interface for the new call. If the application has previously explicitly passed a reference to the **IpAppCall** interface using a **setCallbackWithSessionID()** invocation, this parameter may be null, or if supplied must be the same as that provided during the **setCallbackWithSessionID()**.

This parameter will be null if the notification is in **NOTIFY** mode.

*Parameters***callReference : in TpCallIdentifier**

Specifies the reference to the call interface to which the notification relates. If the notification is in NOTIFY mode, this parameter shall be ignored by the application client implementation, and consequently the implementation of the SCS entity invoking callEventNotify may populate this parameter as it chooses.

eventInfo : in TpCallEventInfo

Specifies data associated with this event.

assignmentID : in TpAssignmentID

Specifies the assignment id which was returned by the enableCallNotification() method. The application can use assignment id to associate events with event specific criteria and to act accordingly.

Returns

IpAppCallRef

*Method***callNotificationInterrupted()**

This method indicates to the application that all event notifications have been temporarily interrupted (for example, due to faults detected).

Note that more permanent failures are reported via the Framework (integrity management).

Parameters

No Parameters were identified for this method

*Method***callNotificationContinued()**

This method indicates to the application that event notifications will again be possible.

Parameters

No Parameters were identified for this method

*Method***callOverloadEncountered()**

This method indicates that the network has detected overload and may have automatically imposed load control on calls requested to a particular address range or calls made to a particular destination within the call control service.

*Parameters***assignmentID : in TpAssignmentID**

Specifies the assignmentID corresponding to the associated setCallLoadControl. This implies the address range for within which the overload has been encountered.

*Method***callOverloadCeased()**

This method indicates that the network has detected that the overload has ceased and has automatically removed any load controls on calls requested to a particular address range or calls made to a particular destination within the call control service.

Parameters

assignmentID : in TpAssignmentID

Specifies the assignmentID corresponding to the associated setCallLoadControl. This implies the address range for within which the overload has been ceased

6.3.3 Interface Class IpCall

Inherits from: IpService

The generic Call provides the possibility to control the call routing, to request information from the call, control the charging of the call, to release the call and to supervise the call. It does not give the possibility to control the legs directly and it does not allow control over the media. The first capability is provided by the multi-party call and the latter as well by the multi-media call. The call is limited to two party calls, although it is possible to provide 'follow-on' calls, meaning that the call can be rerouted after the terminating party has disconnected or routing to the terminating party has failed. Basically, this means that at most two legs can be in connected or routing state at any time.

This interface shall be implemented by a Generic Call Control SCF. As a minimum requirement, the routeReq (), release() and deassignCall() methods shall be implemented.

<<Interface>> IpCall
routeReq (callSessionID : in TpSessionID, responseRequested : in TpCallReportRequestSet, targetAddress : in TpAddress, originatingAddress : in TpAddress, originalDestinationAddress : in TpAddress, redirectingAddress : in TpAddress, applInfo : in TpCallAppInfoSet) : TpSessionID release (callSessionID : in TpSessionID, cause : in TpCallReleaseCause) : void deassignCall (callSessionID : in TpSessionID) : void getCallInfoReq (callSessionID : in TpSessionID, callInfoRequested : in TpCallInfoType) : void setCallChargePlan (callSessionID : in TpSessionID, callChargePlan : in TpCallChargePlan) : void setAdviceOfCharge (callSessionID : in TpSessionID, aOCInfo : in TpAoCInfo, tariffSwitch : in TpDuration) : void getMoreDialledDigitsReq (callSessionID : in TpSessionID, length : in TpInt32) : void superviseCallReq (callSessionID : in TpSessionID, time : in TpDuration, treatment : in TpCallSuperviseTreatment) : void

*Method***routeReq()**

This asynchronous method requests routing of the call to the remote party indicated by the targetAddress.

Note that in case of routeReq() it is recommended to request for 'successful' (e.g. 'answer' event) and 'failure' events at invocation, because those are needed for the application to keep track of the state of the call.

The extra address information such as originatingAddress is optional. If not present (i.e., the plan is set to P_ADDRESS_PLAN_NOT_PRESENT), the information provided in corresponding addresses from the route is used, otherwise the network or gateway provided numbers will be used.

If this method is invoked, and call reports have been requested, yet no IpAppCall interface has been provided, this method shall throw the P_NO_CALLBACK_ADDRESS_SET exception.

Returns callLegSessionID: Specifies the sessionID assigned by the gateway. This is the sessionID of the implicitly created call leg. The same ID will be returned in the routeRes or Err. This allows the application to correlate the request and the result.

This parameter is only relevant when multiple routeReq() calls are executed in parallel, e.g., in the multi-party call control service.

Parameters

callSessionID : in TpSessionID

Specifies the call session ID of the call.

responseRequested : in TpCallReportRequestSet

Specifies the set of observed events that will result in zero or more routeRes() being generated.

E.g., when both answer and disconnect is monitored the result can be received two times.

If the application wants to control the call (in whatever sense) it shall enable event reports

targetAddress : in TpAddress

Specifies the destination party to which the call leg should be routed.

originatingAddress : in TpAddress

Specifies the address of the originating (calling) party.

originalDestinationAddress : in TpAddress

Specifies the original destination address of the call.

redirectingAddress : in TpAddress

Specifies the address from which the call was last redirected.

appInfo : in TpCallAppInfoSet

Specifies application-related information pertinent to the call (such as alerting method, tele-service type, service identities and interaction indicators).

Returns **TpSessionID** *Raises* **TpCommonExceptions, P_INVALID_SESSION_ID, P_INVALID_ADDRESS, P_UNSUPPORTED_ADDRESS_PLAN, P_INVALID_NETWORK_STATE, P_INVALID_CRITERIA, P_INVALID_EVENT_TYPE** *Method***release()**

This method requests the release of the call object and associated objects. The call will also be terminated in the network. If the application requested reports to be sent at the end of the call (e.g., by means of getCallInfoReq) these reports will still be sent to the application.

The application should always either release or deassign the call when it is finished with the call, unless a callFaultDetected is received by the application.

*Parameters***callSessionID : in TpSessionID**

Specifies the call session ID of the call.

cause : in TpCallReleaseCause

Specifies the cause of the release.

Raises **TpCommonExceptions, P_INVALID_SESSION_ID, P_INVALID_NETWORK_STATE** *Method***deassignCall()**

This method requests that the relationship between the application and the call and associated objects be de-assigned. It leaves the call in progress, however, it purges the specified call object so that the application has no further control of call processing. If a call is de-assigned that has event reports, call information reports or call Leg information reports requested, then these reports will be disabled and any related information discarded.

The application should always either release or deassign the call when it is finished with the call, unless callFaultDetected is received by the application.

*Parameters***callSessionID : in TpSessionID**

Specifies the call session ID of the call.

*Raises***TpCommonExceptions, P_INVALID_SESSION_ID***Method***getCallInfoReq()**

This asynchronous method requests information associated with the call to be provided at the appropriate time (for example, to calculate charging). This method must be invoked before the call is routed to a target address.

A report is received when the destination leg or party terminates or when the call ends. The call object will exist after the call is ended if information is required to be sent to the application at the end of the call. In case the originating party is still available the application can still initiate a follow-on call using routeReq.

*Parameters***callSessionID : in TpSessionID**

Specifies the call session ID of the call.

callInfoRequested : in TpCallInfoType

Specifies the call information that is requested.

*Raises***TpCommonExceptions, P_INVALID_SESSION_ID***Method***setCallChargePlan()**

Set an operator specific charge plan for the call.

*Parameters***callSessionID : in TpSessionID**

Specifies the call session ID of the call.

callChargePlan : in TpCallChargePlan

Specifies the charge plan to use.

*Raises***TpCommonExceptions, P_INVALID_SESSION_ID***Method***setAdviceOfCharge()**

This method allows for advice of charge (AOC) information to be sent to terminals that are capable of receiving this information.

*Parameters***callSessionID : in TpSessionID**

Specifies the call session ID of the call.

aOCInfo : in TpAoCInfo

Specifies two sets of Advice of Charge parameter.

tariffSwitch : in TpDuration

Specifies the tariff switch interval that signifies when the second set of AoC parameters becomes valid.

Raises

TpCommonExceptions, P_INVALID_SESSION_ID

*Method***getMoreDialledDigitsReq()**

This asynchronous method requests the call control service to collect further digits and return them to the application. Depending on the administered data, the network may indicate a new call to the gateway if a caller goes off-hook or dialled only a few digits. The application then gets a new call event which contains no digits or only the few dialled digits in the event data.

The application should use this method if it requires more dialled digits, e.g. to perform screening.

*Parameters***callSessionID : in TpSessionID**

Specifies the call session ID of the call.

length : in TpInt32

Specifies the maximum number of digits to collect.

Raises

TpCommonExceptions, P_INVALID_SESSION_ID

*Method***superviseCallReq()**

The application calls this method to supervise a call. The application can set a granted connection time for this call. If an application calls this function before it calls a routeReq() or a user interaction function the time measurement will start as soon as the call is answered by the B-party or the user interaction system.

*Parameters***callSessionID : in TpSessionID**

Specifies the call session ID of the call.

time : in TpDuration

Specifies the granted time in milliseconds for the connection.

treatment : in TpCallSuperviseTreatment

Specifies how the network should react after the granted connection time expired.

Raises

TpCommonExceptions, P_INVALID_SESSION_ID

6.3.4 Interface Class IpAppCall

Inherits from: IpInterface

The generic call application interface is implemented by the client application developer and is used to handle call request responses and state reports.

<<Interface>> IpAppCall
<pre> routeRes (callSessionID : in TpSessionID, eventReport : in TpCallReport, callLegSessionID : in TpSessionID) : void routeErr (callSessionID : in TpSessionID, errorIndication : in TpCallError, callLegSessionID : in TpSessionID) : void getCallInfoRes (callSessionID : in TpSessionID, callInfoReport : in TpCallInfoReport) : void getCallInfoErr (callSessionID : in TpSessionID, errorIndication : in TpCallError) : void superviseCallRes (callSessionID : in TpSessionID, report : in TpCallSuperviseReport, usedTime : in TpDuration) : void superviseCallErr (callSessionID : in TpSessionID, errorIndication : in TpCallError) : void callFaultDetected (callSessionID : in TpSessionID, fault : in TpCallFault) : void getMoreDialledDigitsRes (callSessionID : in TpSessionID, digits : in TpString) : void getMoreDialledDigitsErr (callSessionID : in TpSessionID, errorIndication : in TpCallError) : void callEnded (callSessionID : in TpSessionID, report : in TpCallEndedReport) : void </pre>

Method

routeRes ()

This asynchronous method indicates that the request to route the call to the destination was successful, and indicates the response of the destination party (for example, the call was answered, not answered, refused due to busy, etc.).

If this method is invoked with a monitor mode of P_CALL_MONITOR_MODE_INTERRUPT,

then the APL has control of the call. If the APL does nothing with the call (including its associated legs) within a specified time period (the duration of which forms a part of the service level agreement), then the call in the network shall be released and callEnded() shall be invoked, giving a release cause of 102 (Recovery on timer expiry).

Parameters

callSessionID : in TpSessionID

Specifies the call session ID of the call.

eventReport : in TpCallReport

Specifies the result of the request to route the call to the destination party. It also includes the network event, date and time, monitoring mode and event specific information such as release cause.

callLegSessionID : in TpSessionID

Specifies the sessionID of the associated call leg. This corresponds to the sessionID returned at the routeReq() and can be used to correlate the response with the request.

*Method***routeErr()**

This asynchronous method indicates that the request to route the call to the destination party was unsuccessful - the call could not be routed to the destination party (for example, the network was unable to route the call, the parameters were incorrect, the request was refused, etc.).

*Parameters***callSessionID : in TpSessionID**

Specifies the call session ID of the call.

errorIndication : in TpCallError

Specifies the error which led to the original request failing.

callLegSessionID : in TpSessionID

Specifies the sessionID of the associated call leg. This corresponds to the sessionID returned at the routeReq() and can be used to correlate the error with the request.

*Method***getCallInfoRes()**

This asynchronous method reports time information of the finished call or call attempt as well as release cause depending on which information has been requested by getCallInfoReq. This information may be used e.g. for charging purposes. The call information will possibly be sent after routeRes in all cases where the call or a leg of the call has been disconnected or a routing failure has been encountered.

*Parameters***callSessionID : in TpSessionID**

Specifies the call session ID of the call.

callInfoReport : in TpCallInfoReport

Specifies the call information requested.

*Method***getCallInfoErr()**

This asynchronous method reports that the original request was erroneous, or resulted in an error condition.

*Parameters***callSessionID : in TpSessionID**

Specifies the call session ID of the call.

errorIndication : in TpCallError

Specifies the error which led to the original request failing.

*Method***superviseCallRes()**

This asynchronous method reports a call supervision event to the application when it has indicated its interest in these kind of events.

It is also called when the connection is terminated before the supervision event occurs.

Parameters

callSessionID : in **TpSessionID**

Specifies the call session ID of the call

report : in **TpCallSuperviseReport**

Specifies the situation which triggered the sending of the call supervision response.

usedTime : in **TpDuration**

Specifies the used time for the call supervision (in milliseconds).

*Method***superviseCallErr()**

This asynchronous method reports a call supervision error to the application.

Parameters

callSessionID : in **TpSessionID**

Specifies the call session ID of the call.

errorIndication : in **TpCallError**

Specifies the error which led to the original request failing.

*Method***callFaultDetected()**

This method indicates to the application that a fault in the network has been detected. The call may or may not have been terminated.

The system deletes the call object. Therefore, the application has no further control of call processing. No report will be forwarded to the application.

Parameters

callSessionID : in **TpSessionID**

Specifies the call session ID of the call in which the fault has been detected.

fault : in **TpCallFault**

Specifies the fault that has been detected.

*Method***getMoreDialledDigitsRes()**

This asynchronous method returns the collected digits to the application.

Parameters

callSessionID : in TpSessionID

Specifies the call session ID of the call.

digits : in TpString

Specifies the additional dialled digits if the string length is greater than zero.

*Method***getMoreDialledDigitsErr()**

This asynchronous method reports an error in collecting digits to the application.

Parameters

callSessionID : in TpSessionID

Specifies the call session ID of the call.

errorIndication : in TpCallError

Specifies the error which led to the original request failing.

*Method***callEnded()**

This method indicates to the application that the call has terminated in the network. However, the application may still receive some results (e.g., getCallInfoRes) related to the call. The application is expected to deassign the call object after having received the callEnded.

Note that the event that caused the call to end might also be received separately if the application was monitoring for it.

Parameters

callSessionID : in TpSessionID

Specifies the call sessionID.

report : in TpCallEndedReport

Specifies the reason the call is terminated.

6.4 Generic Call Control Service State Transition Diagrams

6.4.1 State Transition Diagrams for IpCallControlManager

The state transition diagram shows the application view on the Call Control Manager object.

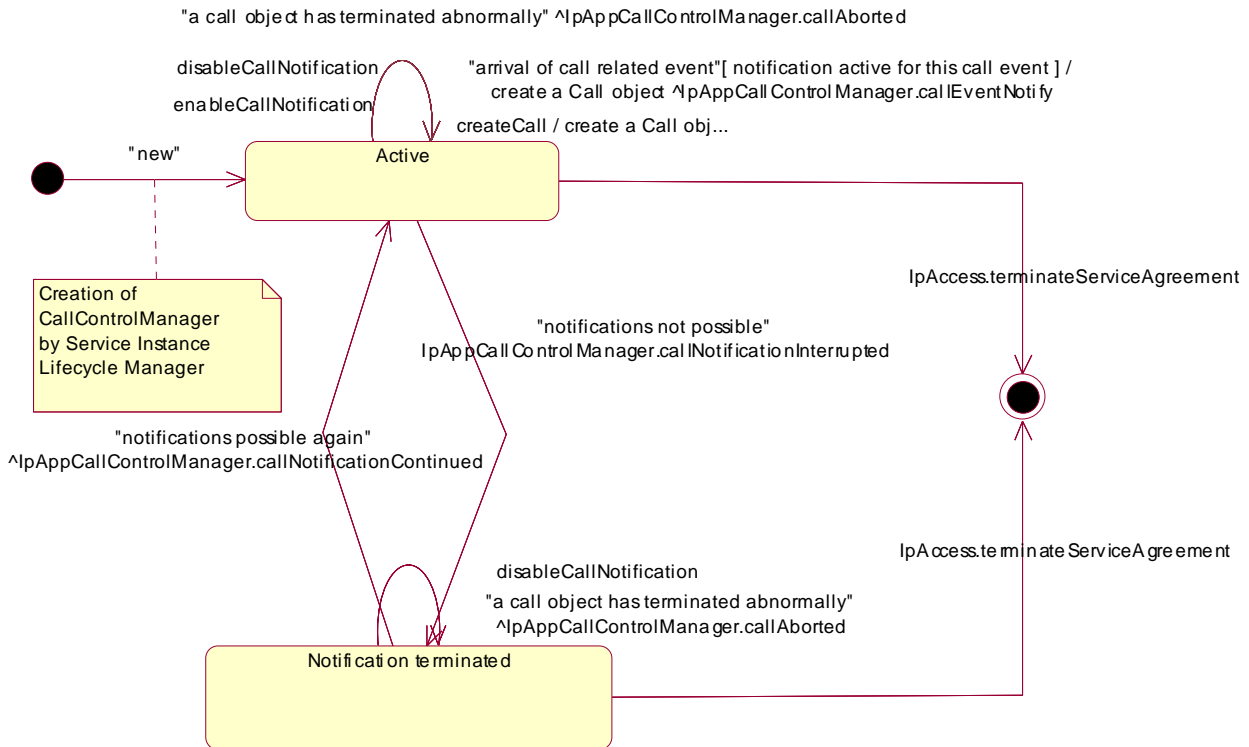

Figure : Application view on the Call Control Manager

6.4.1.1 Active State

In this state a relation between the Application and the Generic Call Control Service has been established. The state allows the application to indicate that it is interested in call related events. In case such an event occurs, the Call Control Manager will create a Call object and inform the application by invoking the operation callEventNotify() on the IpAppCallControlManager interface. The application can also indicate it is no longer interested in certain call related events by calling disableCallNotification().

6.4.1.2 Notification terminated State

When the Call Control Manager is in the Notification terminated state, events requested with enableCallNotification() will not be forwarded to the application. There can be multiple reasons for this: for instance it might be that the application receives more notifications from the network than defined in the Service Level Agreement. Another example is that the Service has detected it receives no notifications from the network due to e.g. a link failure. In this state no requests for new notifications will be accepted.

6.4.2 State Transition Diagrams for IpCall

The state transition diagram shows the application view on the Call object for 3GPP.

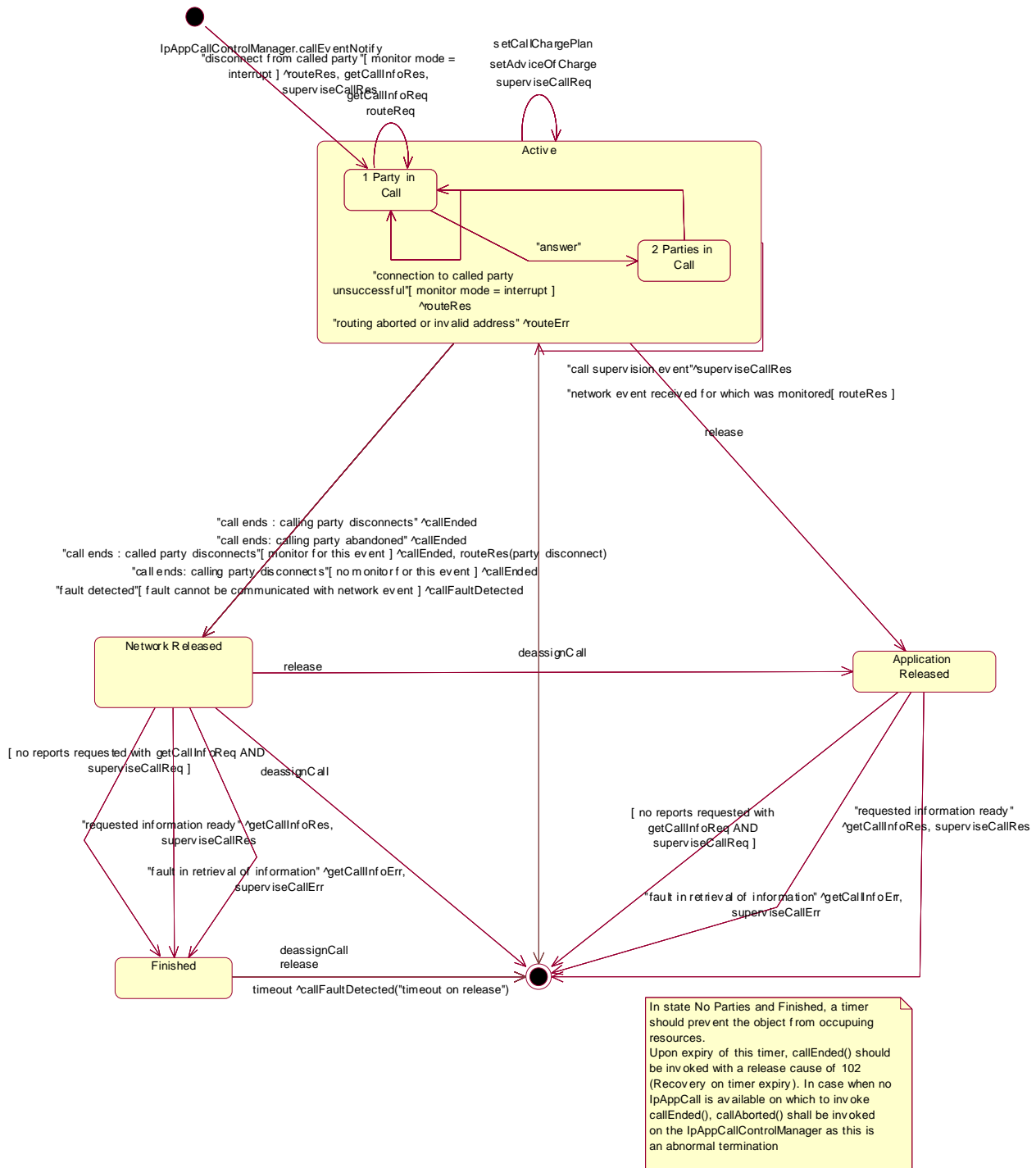

Figure : Application view on the IpCall object for 3GPP

6.4.2.1 Network Released State

In this state the call has ended and the Gateway collects the possible call information requested with `getCallInfoReq()` and / or `superviseCallReq()`. The information will be returned to the application by invoking the methods `getCallInfoRes()` and / or `superviseCallRes()` on the application. Also when a call was unsuccessful these methods are used. In case the application has not requested additional call related information immediately a transition is made to state Finished.

6.4.2.2 Finished State

In this state the call has ended and no call related information is to be send to the application. The application can only release the call object. Calling the `deassignCall()` operation has the same effect. Note that the application has to release the object itself as good OO practice requires that when an object was created on behalf of a certain entity, this entity is also responsible for destroying it when the object is no longer needed.

6.4.2.3 Application Released State

In this state the application has requested to release the Call object and the Gateway collects the possible call information requested with `getCallInfoReq()` and / or `superviseCallReq()`. In case the application has not requested additional call related information the Call object is destroyed immediately.

6.4.2.4 Active State

In this state a call between two parties is being setup or present. Refer to the substates for more details. The application can request supervision of the call by calling `superviseCallReq()`. It is also allowed to send Advice of Charge information by calling `setAdviceOfCharge()` as well as to define the charging by invoking `setCallChargePlan..`

6.4.2.5 Party in Call State

When the Call is in this state a calling party is present. The application can now request that a connection to a called party be established by calling the method `routeReq()`.

In this state the application can also request the gateway for a certain type of charging of the call by calling `setCallChargePlan()`. The application can also request for charging related information by calling `getCallInfoReq()`. The `setCallChargePlan()` and `getCallInfoReq()` should be issued before requesting a connection to a called party by means of `routeReq()`.

When the calling party abandons the call before the application has invoked the `routeReq()` operation, the gateway informs the application by invoking `callFaultDetected()` and also the operation `callEnded()` will be invoked. When the calling party abandons the call after the application has invoked `routeReq()` but before the call has actually been established, the gateway informs the application by invoking `callEnded()`.

When the called party answers the call, a transition will be made to the 2 Parties in Call state. In case the call can not be established because the application supplied an invalid address or the connection to the called party was unsuccessful while the application was monitoring for the latter in interrupt mode, the Call object will stay in this state

In this state user interaction is possible unless there is an outstanding routing request.

6.4.2.6 Parties in Call State

A connection between two parties has been established.

In case the calling party disconnects, the gateway informs the application by invoking `callEnded()`.

When the called party disconnects different situations apply:

1. the application is monitoring for this event in interrupt mode: a transition is made to the 1 Party in Call state, the application is informed with `routeRes` with indication that the called party has disconnected and all requested reports are sent to the application. The application now again has control of the call.
2. the application is monitoring for this event but not in interrupt mode. In this case a transition is made to the Network Released state and the gateway informs the application by invoking the operation `routeRes()` and `callEnded()`.
3. the application is not monitoring for this event. In this case the application is informed by the gateway invoking the `callEnded()` operation and a transition is made to the Network Released state.

In this state user interaction is possible, depending on the underlying network.

6.5 Generic Call Control Service Properties

6.5.1 List of Service Properties

The following table lists properties relevant for the GCC API.

Property	Type	Description / Interpretation
P_TRIGGERING_EVENT_TYPES	INTEGER_SET	Indicates the static event types supported by the SCS. Static events are the events by which applications are initiated.
P_DYNAMIC_EVENT_TYPES	INTEGER_SET	Indicates the dynamic event types supported by the SCS. Dynamic events are the events the application can request for during the context of a call.
P_ADDRESSPLAN	INTEGER_SET	Indicates the supported address plan (defined in TpAddressPlan.) e.g. {P_ADDRESS_PLAN_E164, P_ADDRESS_PLAN_IP}
P_UI_CALL_BASED	BOOLEAN_SET	Value = TRUE : User interaction can be performed on call level and a reference to a Call object can be used in the IpUIManager.createUICall() operation. Value = FALSE: No User interaction on call level is supported.
P_UI_AT_ALL_STAGES	BOOLEAN_SET	Value = TRUE: User Interaction can be performed at any stage during a call . Value = FALSE: User Interaction can be performed in case there is only one party in the call.
P_MEDIA_TYPE	INTEGER_SET	Specifies the media type used by the Service. Values are defined by data-type TpMediaType : P_AUDIO, P_VIDEO, P_DATA

The previous table lists properties related to capabilities of the SCS itself. The following table lists properties that are used in the context of the Service Level Agreement, e.g. to restrict the access of applications to the capabilities of the SCS.

Property	Type	Description
P_TRIGGERING_ADDRESSES	ADDRESS_RANGE_SET	Indicates for which numbers the notification may be set. For terminating notifications it applies to the terminating number, for originating notifications it applies only to the originating number.
P_NOTIFICATION_TYPES	INTEGER_SET	Indicates whether the application is allowed to set originating and/or terminating triggers in the ECN. Set is: P_ORIGINATING P_TERMINATING
P_MONITOR_MODE	INTEGER_SET	Indicates whether the application is allowed to monitor in interrupt and/or notify mode. Set is: P_INTERRUPT P_NOTIFY
P_NUMBERS_TO_BE_CHANGED	INTEGER_SET	Indicates which numbers the application is allowed to change or fill for legs in an incoming call. Allowed value set: {P_ORIGINAL_CALLED_PARTY_NUMBER, P_REDIRECTING_NUMBER, P_TARGET_NUMBER, P_CALLING_PARTY_NUMBER}.
P_CHARGEPLAN_ALLOWED	INTEGER_SET	Indicates which charging is allowed in the setCallChargePlan indicator. Allowed values: {P_TRANSPARENT_CHARGING, P_CHARGE_PLAN}
P_CHARGEPLAN_MAPPING	INTEGER_INTEGER_MAP	Indicates the mapping of chargeplans (we assume they can be indicated with integers) to a logical network chargeplan indicator. When the chargeplan supports indicates P_CHARGE_PLAN then only chargeplans in this mapping are allowed.

6.5.2 Service Property values for the CAMEL Service Environment.

Implementations of the Generic Call Control API relying on the CSE of CAMEL phase 3 shall have the Service Properties outlined above set to the indicated values :

```
P_OPERATION_SET = {  
  "IpCallControlManager.enableCallNotification",  
  "IpCallControlManager.disableCallNotification",  
  "IpCallControlManager.changeCallNotification",  
  "IpCallControlManager.getCriteria",  
  "IpCallControlManager.setCallLoadControl",  
  "IpCall.routeReq",  
  "IpCall.release",  
  "IpCall.deassignCall",  
  "IpCall.getCallInfoReq",  
  "IpCall.setCallChargePlan",  
  "IpCall.setAdviceOfCharge",  
  "IpCall.superviseCallReq"  
}
```

```
P_TRIGGERING_EVENT_TYPES = {  
  P_EVENT_GCCS_ADDRESS_COLLECTED_EVENT,  
  P_EVENT_GCCS_ADDRESS_ANALYSED_EVENT,  
  P_EVENT_GCCS_CALLED_PARTY_BUSY,  
  P_EVENT_GCCS_CALLED_PARTY_UNREACHABLE,  
  P_EVENT_GCCS_NO_ANSWER_FROM_CALLED_PARTY,  
  P_EVENT_GCCS_ROUTE_SELECT_FAILURE  
}
```

```
P_DYNAMIC_EVENT_TYPES = {  
  P_CALL_REPORT_ANSWER,  
  P_CALL_REPORT_BUSY,  
  P_CALL_REPORT_NO_ANSWER,  
  P_CALL_REPORT_DISCONNECT,  
  P_CALL_REPORT_ROUTING_FAILURE,  
  P_CALL_REPORT_NOT_REACHABLE  
}
```

```
P_ADDRESS_PLAN = {  
  P_ADDRESS_PLAN_E164  
}
```

```
P_UI_CALL_BASED = {  
  TRUE  
}
```

```
P_UI_AT_ALL_STAGES = {  
  FALSE  
}
```

```
P_MEDIA_TYPE = {  
  P_AUDIO  
}
```

6.6 Generic Call Control Data Definitions

This clause provides the GCC data definitions necessary to support the API specification.

The general format of a Data Definition specification is described below.

- Data Type

This shows the name of the data type.

- Description

This describes the data type.

- Tabular Specification

This specifies the data types and values of the data type.

- Example

If relevant, an example is shown to illustrate the data type.

All data types referenced but not defined in this clause are either in the common call control data definitions clause of the present document (clause 8) or in the common data definitions which may be found in 3GPP TS 29.198-2.

6.6.1 Generic Call Control Event Notification Data Definitions

6.6.1.1 TpCallEventName

Defines the names of event being notified. The following events are supported. The values may be combined by a logical 'OR' function when requesting the notifications. Additional events that can be requested / received during the call process are found in the TpCallReportType data-type.

Name	Value	Description
P_EVENT_NAME_UNDEFINED	0	Undefined
P_EVENT_GCCS_OFFHOOK_EVENT	1	GCCS – Offhook event This can be used for hot-line features. In case this event is set in the TpCallEventCriteria, only the originating address(es) may be specified in the criteria.
P_EVENT_GCCS_ADDRESS_COLLECTED_EVENT	2	GCCS – Address information collected The network has collected the information from the A-party, but not yet analysed the information. The number can still be incomplete. Applications might set notifications for this event when part of the number analysis needs to be done in the application (see also the getMoreDialledDigitsReq method on the call class).
P_EVENT_GCCS_ADDRESS_ANALYSED_EVENT	4	GCCS – Address information is analysed The dialled number is a valid and complete number in the network.
P_EVENT_GCCS_CALLED_PARTY_BUSY	8	GCCS – Called party is busy
P_EVENT_GCCS_CALLED_PARTY_UNREACHABLE	16	GCCS – Called party is unreachable (e.g. the called party has a mobile telephone that is currently switched off).
P_EVENT_GCCS_NO_ANSWER_FROM_CALLED_PARTY	32	GCCS – No answer from called party
P_EVENT_GCCS_ROUTE_SELECT_FAILURE	64	GCCS – Failure in routing the call
P_EVENT_GCCS_ANSWER_FROM_CALL_PARTY	128	GCCS – Party answered call.

6.6.1.2 TpCallNotificationType

Defines the type of notification. Indicates whether it is related to the originating of the terminating user in the call.

Name	Value	Description
P_ORIGINATING	0	Indicates that the notification is related to the originating user in the call.
P_TERMINATING	1	Indicates that the notification is related to the terminating user in the call.

6.6.1.3 TpCallEventCriteria

Defines the Sequence of Data Elements that specify the criteria for an event notification.

Of the addresses only the Plan and the AddrString are used for the purpose of matching the notifications against the criteria.

Sequence Element Name	Sequence Element Type	Description
DestinationAddress	TpAddressRange	Defines the destination address or address range for which the notification is requested.
OriginatingAddress	TpAddressRange	Defines the origination address or a address range for which the notification is requested.
CallEventName	TpCallEventName	Name of the event(s)
CallNotificationType	TpCallNotificationType	Indicates whether it is related to the originating or the terminating user in the call.
MonitorMode	TpCallMonitorMode	Defines the mode that the call is in following the notification. Monitor mode P_CALL_MONITOR_MODE_DO_NOT_MONITOR is not a legal value here.

6.6.1.4 TpCallEventInfo

Defines the Sequence of Data Elements that specify the information returned to the application in a Call event notification.

Sequence Element Name	Sequence Element Type
DestinationAddress	TpAddress
OriginatingAddress	TpAddress
OriginalDestinationAddress	TpAddress
RedirectingAddress	TpAddress
CallAppInfo	TpCallAppInfoSet
CallEventName	TpCallEventName
CallNotificationType	TpCallNotificationType
MonitorMode	TpCallMonitorMode

6.6.2 Generic Call Control Data Definitions

6.6.2.1 IpCall

Defines the address of an IpCall Interface.

6.6.2.2 IpCallRef

Defines a Reference to type IpCall.

6.6.2.3 IpAppCall

Defines the address of an IpAppCall Interface.

6.6.2.4 IpAppCallRef

Defines a Reference to type IpAppCall

6.6.2.5 TpCallIdentifier

Defines the Sequence of Data Elements that unambiguously specify the Generic Call object

Sequence Element Name	Sequence Element Type	Sequence Element Description
CallReference	IpCallRef	This element specifies the interface reference for the call object.
CallSessionID	TpSessionID	This element specifies the call session ID of the call.

6.6.2.6 IpAppCallControlManager

Defines the address of an IpAppCallControlManager Interface.

6.6.2.7 IpAppCallControlManagerRef

Defines a Reference to type IpAppCallControlManager.

6.6.2.8 IpCallControlManager

Defines the address of an IpCallControlManager Interface.

6.6.2.9 IpCallControlManagerRef

Defines a Reference to type IpCallControlManager.

6.6.2.10 TpCallAppInfo

Defines the Tagged Choice of Data Elements that specify application-related call information.

	Tag Element Type	
	TpCallAppInfoType	

Tag Element Value	Choice Element Type	Choice Element Name
P_CALL_APP_ALERTING_MECHANISM	TpCallAlertingMechanism	CallAppAlertingMechanism
P_CALL_APP_NETWORK_ACCESS_TYPE	TpCallNetworkAccessType	CallAppNetworkAccessType
P_CALL_APP_TELE_SERVICE	TpCallTeleService	CallAppTeleService
P_CALL_APP_BEARER_SERVICE	TpCallBearerService	CallAppBearerService
P_CALL_APP_PARTY_CATEGORY	TpCallPartyCategory	CallAppPartyCategory
P_CALL_APP_PRESENTATION_ADDRESS	TpAddress	CallAppPresentationAddress
P_CALL_APP_GENERIC_INFO	TpString	CallAppGenericInfo
P_CALL_APP_ADDITIONAL_ADDRESS	TpAddress	CallAppAdditionalAddress

6.6.2.11 TpCallAppInfoType

Defines the type of call application-related specific information.

Name	Value	Description
P_CALL_APP_UNDEFINED	0	Undefined
P_CALL_APP_ALERTING_MECHANISM	1	The alerting mechanism or pattern to use
P_CALL_APP_NETWORK_ACCESS_TYPE	2	The network access type (e.g. ISDN)
P_CALL_APP_TELE_SERVICE	3	Indicates the tele-service (e.g. telephony)
P_CALL_APP_BEARER_SERVICE	4	Indicates the bearer service (e.g. 64kbit/s unrestricted data).
P_CALL_APP_PARTY_CATEGORY	5	The category of the calling party
P_CALL_APP_PRESENTATION_ADDRESS	6	The address to be presented to other call parties
P_CALL_APP_GENERIC_INFO	7	Carries unspecified service-service information
P_CALL_APP_ADDITIONAL_ADDRESS	8	Indicates an additional address

6.6.2.12 TpCallAppInfoSet

Defines a Numbered Set of Data Elements of TpCallAppInfo.

6.6.2.13 TpCallEndedReport

Defines the Sequence of Data Elements that specify the reason for the call ending.

Sequence Element Name	Sequence Element Type	Description
CallLegSessionID	TpSessionID	The leg that initiated the release of the call. If the call release was not initiated by the leg, then this value is set to -1.
Cause	TpCallReleaseCause	The cause of the call ending.

6.6.2.14 TpCallFault

Defines the cause of the call fault detected.

Name	Value	Description
P_CALL_FAULT_UNDEFINED	0	Undefined
P_CALL_TIMEOUT_ON_RELEASE	1	This fault occurs when the final report has been sent to the application, but the application did not explicitly release or deassign the call object, within a specified time. The timer value is operator specific.
P_CALL_TIMEOUT_ON_INTERRUPT	2	This fault occurs when the application did not instruct the gateway how to handle the call within a specified time, after the gateway reported an event that was requested by the application in interrupt mode. The timer value is operator specific.

6.6.2.15 TpCallInfoReport

Defines the Sequence of Data Elements that specify the call information requested. Information that was not requested is invalid.

Sequence Element Name	Sequence Element Type	Description
CallInfoType	TpCallInfoType	The type of call report.
CallInitiationStartTime	TpDateAndTime	The time and date when the call, or follow-on call, was started as a result of a routeReq.
CallConnectedToResourceTime	TpDateAndTime	The date and time when the call was connected to the resource. This data element is only valid when information on user interaction is reported.
CallConnectedToDestinationTime	TpDateAndTime	The date and time when the call was connected to the destination (i.e. when the destination answered the call). If the destination did not answer, the time is set to an empty string. This data element is invalid when information on user interaction is reported.
CallEndTime	TpDateAndTime	The date and time when the call or follow-on call or user interaction was terminated.
Cause	TpCallReleaseCause	The cause of the termination.

A callInfoReport will be generated at the end of user interaction and at the end of the connection with the associated address. This means that either the destination related information is present or the resource related information, but not both.

6.6.2.16 TpCallReleaseCause

Defines the Sequence of Data Elements that specify the cause of the release of a call.

Sequence Element Name	Sequence Element Type
Value	TpInt32
Location	TpInt32

NOTE: The Value and Location are specified as in ITU-T Recommendation Q.850.

The following example was taken from Q.850 to aid understanding:

Equivalent Call Report	Cause Value Set by Application	Cause Value from Network
P_CALL_REPORT_BUSY	17	17
P_CALL_REPORT_NO_ANSWER	19	18,19,21
P_CALL_REPORT_DISCONNECT	16	16
P_CALL_REPORT_REDIRECTED	23	23
P_CALL_REPORT_SERVICE_CODE	31	NA
P_CALL_REPORT_NOT_REACHABLE	20	20
P_CALL_REPORT_ROUTING_FAILURE	3	Any other value

6.6.2.17 TpCallReport

Defines the Sequence of Data Elements that specify the call report and call leg report specific information.

Sequence Element Name	Sequence Element Type
MonitorMode	TpCallMonitorMode
CallEventTime	TpDateAndTime
CallReportType	TpCallReportType
AdditionalReportInfo	TpCallAdditionalReportInfo

6.6.2.18 TpCallAdditionalReportInfo

Defines the Tagged Choice of Data Elements that specify additional call report information for certain types of reports.

Tag Element Type
TpCallReportType

Tag Element Value	Choice Element Type	Choice Element Name
P_CALL_REPORT_UNDEFINED	NULL	Undefined
P_CALL_REPORT_PROGRESS	NULL	Undefined
P_CALL_REPORT_ALERTING	NULL	Undefined
P_CALL_REPORT_ANSWER	NULL	Undefined
P_CALL_REPORT_BUSY	TpCallReleaseCause	Busy
P_CALL_REPORT_NO_ANSWER	NULL	Undefined
P_CALL_REPORT_DISCONNECT	TpCallReleaseCause	CallDisconnect
P_CALL_REPORT_REDIRECTED	TpAddress	ForwardAddress
P_CALL_REPORT_SERVICE_CODE	TpCallServiceCode	ServiceCode
P_CALL_REPORT_ROUTING_FAILURE	TpCallReleaseCause	RoutingFailure
P_CALL_REPORT_QUEUED	TpString	QueueStatus
P_CALL_REPORT_NOT_REACHABLE	TpCallReleaseCause	NotReachable

6.6.2.19 TpCallReportRequest

Defines the Sequence of Data Elements that specify the criteria relating to call report requests.

Sequence Element Name	Sequence Element Type
MonitorMode	TpCallMonitorMode
CallReportType	TpCallReportType
AdditionalReportCriteria	TpCallAdditionalReportCriteria

6.6.2.20 TpCallAdditionalReportCriteria

Defines the Tagged Choice of Data Elements that specify specific criteria.

	Tag Element Type	
	TpCallReportType	

Tag Element Value	Choice Element Type	Choice Element Name
P_CALL_REPORT_UNDEFINED	NULL	Undefined
P_CALL_REPORT_PROGRESS	NULL	Undefined
P_CALL_REPORT_ALERTING	NULL	Undefined
P_CALL_REPORT_ANSWER	NULL	Undefined
P_CALL_REPORT_BUSY	NULL	Undefined
P_CALL_REPORT_NO_ANSWER	TpDuration	NoAnswerDuration
P_CALL_REPORT_DISCONNECT	NULL	Undefined
P_CALL_REPORT_REDIRECTED	NULL	Undefined
P_CALL_REPORT_SERVICE_CODE	TpCallServiceCode	ServiceCode
P_CALL_REPORT_ROUTING_FAILURE	NULL	Undefined
P_CALL_REPORT_QUEUED	NULL	Undefined
P_CALL_REPORT_NOT_REACHABLE	NULL	Undefined

6.6.2.21 TpCallReportRequestSet

Defines a Numbered Set of Data Elements of TpCallReportRequest.

6.6.2.22 TpCallReportType

Defines a specific call event report type.

Name	Value	Description
P_CALL_REPORT_UNDEFINED	0	Undefined.
P_CALL_REPORT_PROGRESS	1	Call routing progress event: an indication from the network that progress has been made in routing the call to the requested call party. This message may be sent more than once, or may not be sent at all by the gateway with respect to routing a given call leg to a given address.
P_CALL_REPORT_ALERTING	2	Call is alerting at the call party.
P_CALL_REPORT_ANSWER	3	Call answered at address.
P_CALL_REPORT_BUSY	4	Called address refused call due to busy.
P_CALL_REPORT_NO_ANSWER	5	No answer at called address.
P_CALL_REPORT_DISCONNECT	6	The media stream of the called party has disconnected. This does not imply that the call has ended. When the call is ended, the callEnded method is called. This event can occur both when the called party hangs up, or when the application explicitly releases the leg using IpCallLeg.release() This cannot occur when the app explicitly releases the call leg and the call.
P_CALL_REPORT_REDIRECTED	7	Call redirected to new address: an indication from the network that the call has been redirected to a new address.
P_CALL_REPORT_SERVICE_CODE	8	Mid-call service code received.
P_CALL_REPORT_ROUTING_FAILURE	9	Call routing failed - re-routing is possible.
P_CALL_REPORT_QUEUED	10	The call is being held in a queue. This event may be sent more than once during the routing of a call.
P_CALL_REPORT_NOT_REACHABLE	11	The called address is not reachable; e.g., the phone has been switched off or the phone is outside the coverage area of the network.

6.6.2.23 TpCallTreatment

Defines the Sequence of Data Elements that specify the treatment for calls that will be handled only by the network (for example, call which are not admitted by the call load control mechanism).

Sequence Element Name	Sequence Element Type
CallTreatmentType	TpCallTreatmentType
ReleaseCause	TpCallReleaseCause
AdditionalTreatmentInfo	TpCallAdditionalTreatmentInfo

6.6.2.24 TpCallEventCriteriaResultSet

Defines a set of TpCallEventCriteriaResult.

6.6.2.25 TpCallEventCriteriaResult

Defines a sequence of data elements that specify a requested call event notification criteria with the associated assignmentID.

Sequence Element Name	Sequence Element Type	Sequence Element Description
CallEventCriteria	TpCallEventCriteria	The event criteria that were specified by the application.
AssignmentID	TpInt32	The associated assignmentID. This can be used to disable the notification.

7 MultiParty Call Control Service

The Multi-Party Call Control API of 3GPP Rel4 relies on the CAMEL Service Environment (CSE). It should be noted that a number of restrictions exist because CAMEL phase 3 supports only two-party calls and no leg based operations. Furthermore application initiated calls are not supported in CAMEL phase 3. The detailed description of the supported methods is given in the chapter 7.5.

7.1 Sequence Diagrams

7.1.1 Application initiated call setup

The following sequence diagram shows an application creating a call between party A and party B. Here, a call is created first. Then party A's call leg is created before events are requested on it for answer and then routed to the call. On answer from Party A, an announcement is played indicating that the call is being set up to party B. While the announcement is being played, party B's call leg is created and then events are requested on it for answer. On answer from Party B the announcement is cancelled and party B is routed to the call.

The service may as a variation be extended to include 3 parties (or more). After the two party call is established, the application can create a new leg and request to route it to a new destination address in order to establish a 3 party call.

The event that causes this to happen could for example be the report of answer event from B-party or controlled by the A-party by entering a service code (mid-call event).

The procedure for call setup to party C is exactly the same as for the set up of the connection to party B (sequence 13 to 17 in the sequence diagram).

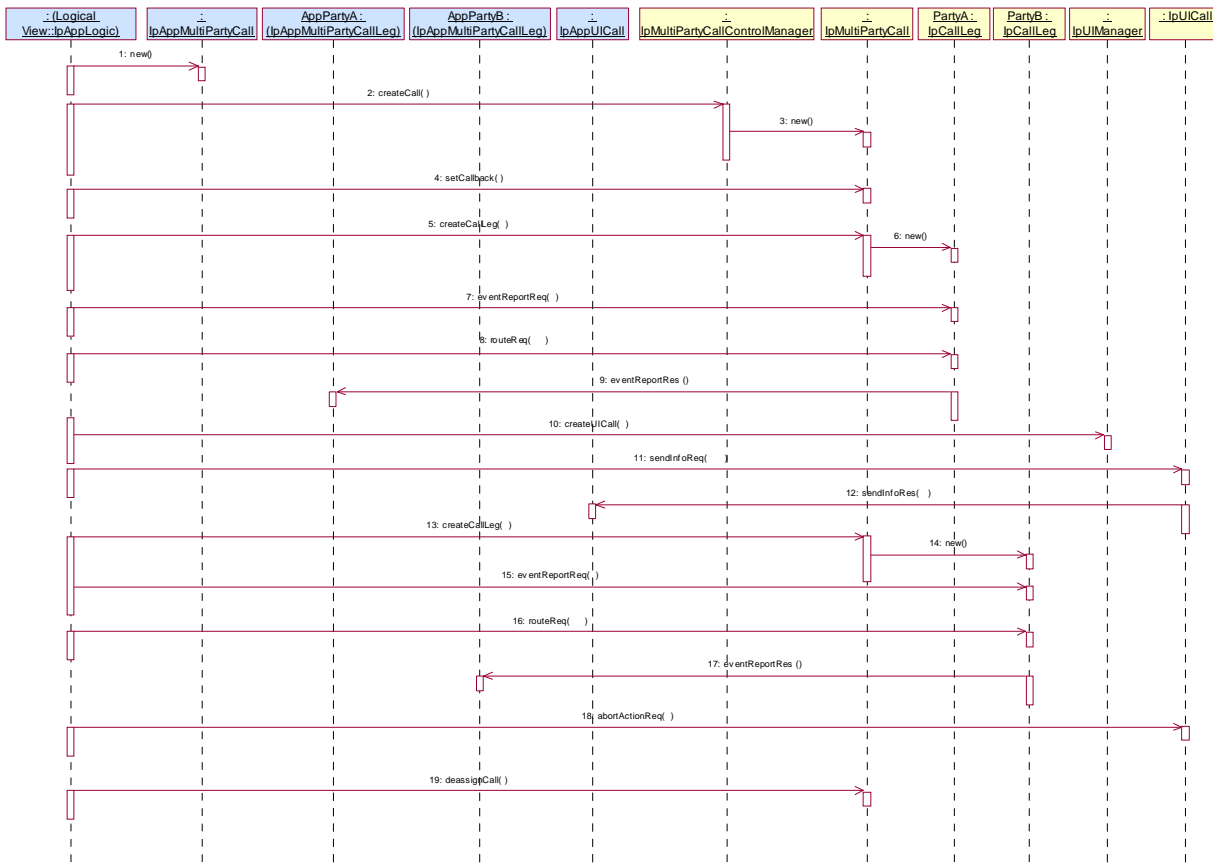

- 1: This message is used to create an object implementing the IpAppMultiPartyCall interface.
- 2: This message requests the object implementing the IpMultiPartyCallControlManager interface to create an object implementing the IpMultiPartyCall interface.
- 3: Assuming that the criteria for creating an object implementing the IpMultiPartyCall interface (e.g. load control values not exceeded) is met it is created.
- 4: Once the object implementing the IpMultiPartyCall interface is created it is used to pass the reference of the object implementing the IpAppMultiPartyCall interface as the callback reference to the object implementing the IpMultiPartyCall interface. Note that the reference to the callback interface could already have been passed in the createCall.
- 5: This message instructs the object implementing the IpMultiPartyCall interface to create a call leg for customer A.
- 6: Assuming that the criteria for creating an object implementing the IpCallLeg interface is met, message 6 is used to create it.
- 7: This message requests the call leg for customer A to inform the application when the call leg answers the call.
- 8: The call is then routed to the originating call leg.
- 9: Assuming the call is answered, the object implementing party A's IpCallLeg interface passes the result of the call being answered back to its callback object. This message is then forwarded via another message (not shown) to the object implementing the IpAppLogic interface.
- 10: A UICall object is created and associated with the just created call leg.
- 11: This message is used to inform party A that the call is being routed to party B.
- 12: An indication that the dialogue with party A has commenced is returned via message 13 and eventually forwarded via another message (not shown) to the object implementing the IpAppLogic interface.

- 13: This message instructs the object implementing the IpMultiPartyCall interface to create a call leg for customer B.
- 14: Assuming that the criteria for creating a second object implementing the IpCallLeg interface is met, it is created.
- 15: This message requests the call leg for customer B to inform the application when the call leg answers the call.
- 16: The call is then routed to the call leg.
- 17: Assuming the call is answered, the object implementing party B's IpCallLeg interface passes the result of the call being answered back to its callback object. This message is then forwarded via another message (not shown) to the object implementing the IpAppLogic interface.
- 18: This message then instructs the object implementing the IpUICall interface to stop sending announcements to party A.
- 19: The application deassigns the call. This will also deassign the associated user interaction.

7.1.2 Call Barring 2

The following sequence diagram shows a call barring service, initiated as a result of a prearranged event being received by the call control service. Before the call is routed to the destination number, the calling party is asked for a PIN code. The code is rejected and the call is cleared.

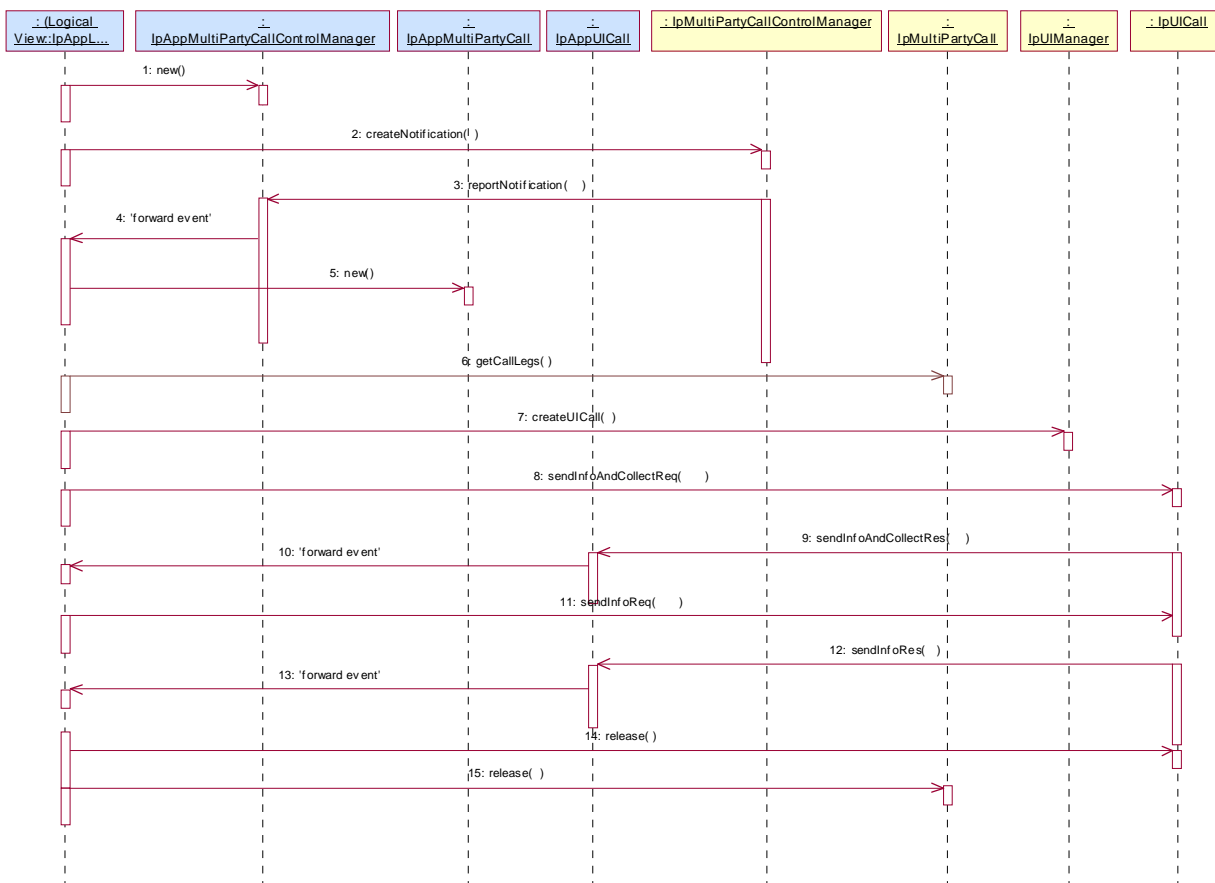

- 1: This message is used by the application to create an object implementing the IpAppMultiPartyCallControlManager interface.
- 2: This message is sent by the application to enable notifications on new call events. As this sequence diagram depicts a call barring service, it is likely that all new call events destined for a particular address or address range prompted for a password before the call is allowed to progress. When a new call, that matches the event criteria, arrives a message

(not shown) is directed to the object implementing the IpMultiPartyCallControlManager. Assuming that the criteria for creating an object implementing the IpMultiPartyCall interface (e.g. load control values not exceeded) is met, other messages (not shown) are used to create the call and associated call leg object.

3: This message is used to pass the new call event to the object implementing the IpAppMultiPartyCallControlManager interface.

4: This message is used to forward message 3 to the IpAppLogic.

5: This message is used by the application to create an object implementing the IpAppMultiPartyCall interface. The reference to this object is passed back to the object implementing the IpMultiPartyCallControlManager using the return parameter of the callEventNotify.

6: The application requests an list of all the legs currently in the call.

7: This message is used to create a UICall object that is associated with the incoming leg of the call.

8: The call barring service dialogue is invoked.

9: The result of the dialogue, which in this case is the PIN code, is returned to its callback object.

10: This message is used to forward the previous message to the IpAppLogic

11: Assuming an incorrect PIN is entered, the calling party is informed using additional dialogue of the reason why the call cannot be completed.

12: This message passes the indication that the additional dialogue has been sent.

13: This message is used to forward the previous message to the IpAppLogic.

14: No more UI is required, so the UICall object is released.

15: This message is used by the application to clear the call.

7.1.3 Call forwarding on Busy Service

The following sequence diagram shows an application establishing a call forwarding on busy.

When a call is made from A to B but the B-party is detected to be busy, then the application is informed of this and sets up a connection towards a C party. The C party can for instance be a voicemail system.

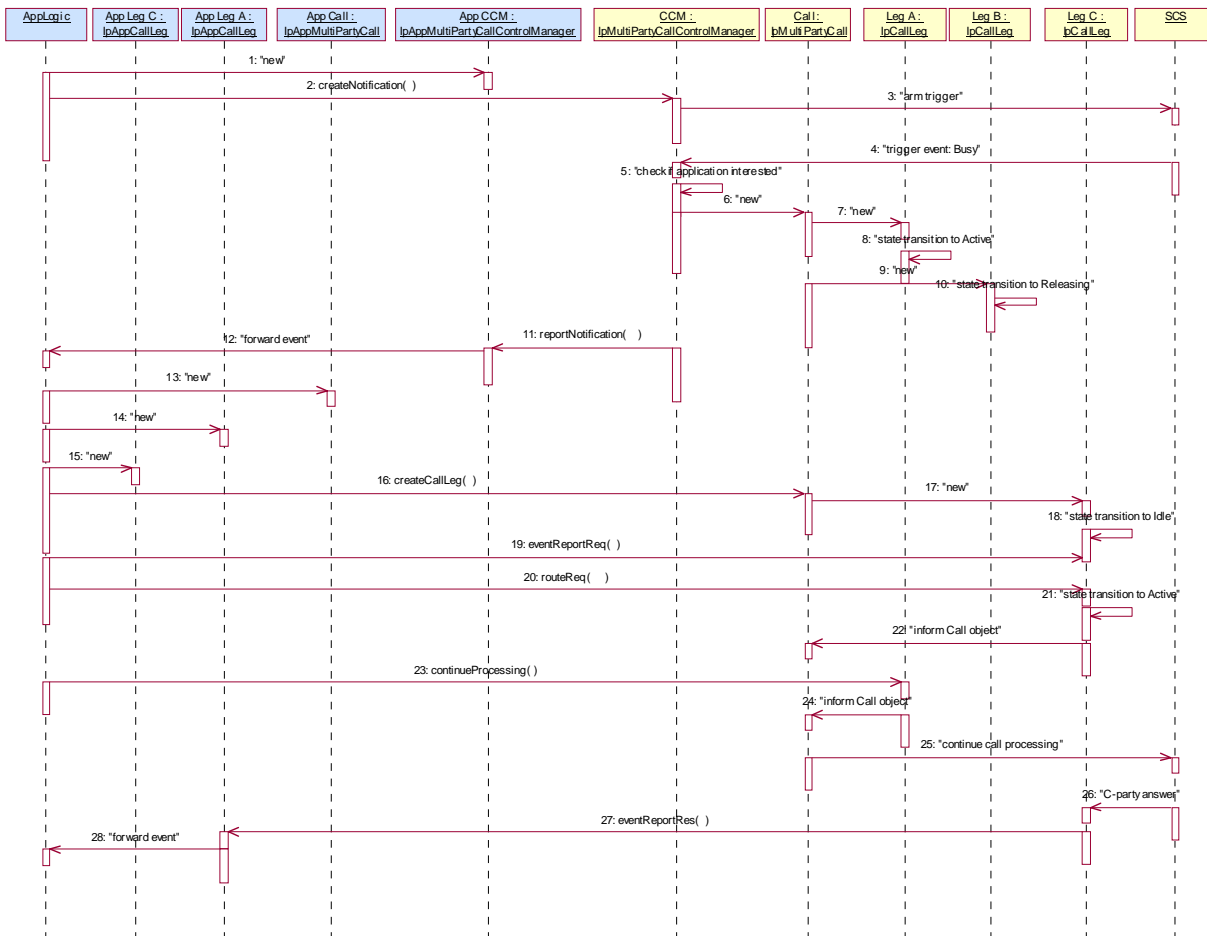

- 1: This message is used by the application to create an object implementing the IpAppMultiPartyCallControlManager interface.
- 2: This message is sent by the application to enable notifications on new call events.
- 4: When a new call, that matches the event criteria, arrives a message ("busy") is directed to the object implementing the IpMultiPartyCallControlManager. Assuming that the criteria for creating an object implementing the IpMultiPartyCall interface is met, other messages are used to create the call and associated call leg objects.
- 6: A new MultiPartyCall object is created to handle this particular call.
- 7: A new CallLeg object corresponding to Party A is created.
- 8: The new Call Leg instance transits to state Initiating.
- 11: This message is used to pass the new call event to the object implementing the IpAppMultiPartyCallControlManager interface. Applied monitor mode is "interrupt"
- 12: This message is used to forward the message to the IpAppLogic.
- 13: This message is used by the application to create an object implementing the IpAppMultiPartyCall interface. The reference to this object is passed back to the object implementing the IpMultiPartyCallControlManager using the return parameter of the reportNotification.
- 14: A new AppCallLeg is created to receive callbacks for the Leg corresponding to party A.
- 15: A new AppCallLeg C is created to receive callbacks for another leg.
- 16: This message is used to create a new call leg object. The object is created in the idle state and not yet routed in the network.

19: The application requests to be notified (monitor mode "INTERRUPT") when party C answers the call.

20: The application requests to route the terminating leg to reach the associated party C.

The application may request information about the original destination address be sent by setting up the field `P_CALL_APP_ORIGINAL_DESTINATION_ADDRESS` of `TpCallAppInfo` in the request to route the call leg to the remote party C.

23: The application requests to resume call processing for the terminating call leg to party B to terminate the leg. Alternative the application could request to deassign the leg to party B for example if it is not interested in possible requested call leg information (`getInfoRes`, `superviseRes`).

When the terminating call leg is destroyed, the `AppLeg B` is notified and the event is forwarded to the application logic (not shown).

25: The application requests to resume call processing for the originating call leg.

As a result call processing is resumed in the network that will try to reach the associated party B.

26: When the party C answers the call, the termination call leg is notified.

27: Assuming the call is answered, the object implementing party C's `IpCallLeg` interface passes the result of the call being answered back to its callback object.

28: This answer message is then forwarded to the object implementing the `IpAppLogic` interface.

7.1.4 Call Information Collect Service

The following sequence diagram shows an application monitoring a call between party A and a party B in order to collect call information at the end of the call for e.g. charging and/or statistic information collection purposes. The service may apply to ordinary two-party calls, but could also include a number translation of the dialled number and special charging (e.g. a premium rate service).

Additional call leg related information is requested with the `getInfoReq` and `superviseReq` methods.

The answer and call release events are in this service example requested to be reported in notify mode and

additional call leg related information is requested with the `getInfoReq` and `superviseReq` methods in order to illustrate the information that can be collected and sent to the application at the end of the call.

Furthermore it shows the order in which information is sent to the application: network release event followed by possible requested call leg information, then the destroy of the call leg object (`callLegEnded`) and finally the destroy of the call object (`callEnded`).

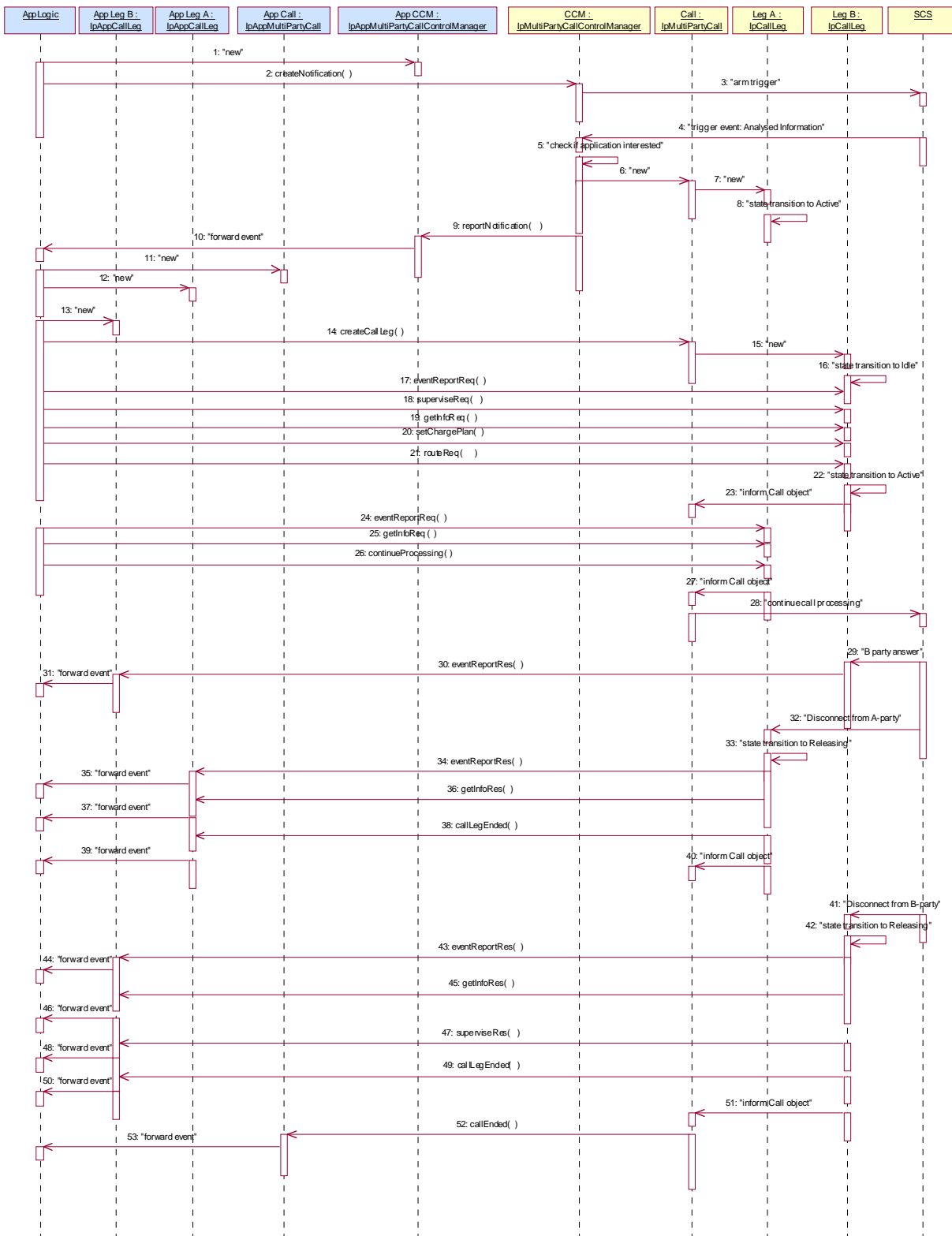

1: This message is used by the application to create an object implementing the IpAppMultiPartyCallControlManager interface.

2: This message is sent by the application to enable notifications on new call events.

4: When a new call, that matches the event criteria, arrives a message ("analysed information") is directed to the object implementing the IpMultiPartyCallControlManager. Assuming that the criteria for creating an object implementing the IpMultiPartyCall interface is met, other messages are used to create the call and associated call leg object

6: A new MultiPartyCall object is created to handle this particular call.

7: A new CallLeg object corresponding to Party A is created.

8: The new Call Leg instance transits to state Active.

9: This message is used to pass the new call event to the object implementing the IpAppMultiPartyCallControlManager interface. Applied monitor mode is "interrupt"

10: This message is used to forward message 9 to the IpAppLogic.

11: This message is used by the application to create an object implementing the IpAppMultiPartyCall interface. The reference to this object is passed back to the object implementing the IpMultiPartyCallControlManager using the return parameter of the reportNotification.

12: A new AppCallLeg is created to receive callbacks for the Leg corresponding to party A.

13: A new AppCallLeg is created to receive callbacks for another leg.

14: This message is used to create a new call leg object. The object is created in the idle state and not yet routed in the network.

15: A new CallLeg corresponding to party B is created.

16: A transition to state Idle is made after the Call leg has been created.

17: The application requests to be notified (monitor mode "NOTIFY") when party B answers the call and when the leg to B-party is released.

18: The application requests to supervise the call leg to party B.

19: The application requests information associated with the call leg to party b for example to calculate charging.

20: The application requests a specific charge plan to be set for the call leg to party B.

21: The application requests to route the terminating leg to reach the associated party B.

22: The Call Leg instance transits to state Active.

24: The application requests to be notified (monitor mode "Notify") when the leg to A-party is released.

25: The application requests information associated with the call leg to party A for example to calculate charging.

26: The application requests to resume call processing for the originating call leg.

As a result call processing is resumed in the network that will try to reach the associated party B.

29: When the B-party answers the call, the termination call leg is notified.

30: Assuming the call is answered, the object implementing party B's IpCallLeg interface passes the result of the call being answered back to its callback object (monitor mode "NOTIFY").

31: This answer message is then forwarded.

32: When the A-party releases the call, the originating call leg is notified (monitor mode "NOTIFY") and makes a transition to "releasing state".

34: The application IpAppLeg A is notified, as the release event has been requested to be reported in Notify mode.

35: The event is forwarded to the application logic

36: The call leg information is reported.

37: The event is forwarded to the application logic

38: The origination call leg is destroyed, the AppLeg A is notified.

39: The event is forwarded to the application logic

41: When the B-party releases the call or the call is released as a result of the release request from party A, i.e. a "originating release" indication, the terminating call leg is notified and makes a transition to "releasing state".

43: If a network release event is received being a "terminating release" indication from called party B, the application IpAppLeg B is notified, as the release event from party B has been requested to be reported in NOTIFY mode.

Note that no report is sent if the release is caused by propagation of network release event being a "originating release" indication coming from calling party A.

44: The event is forwarded to the application logic.

45: The call leg information is reported.

46: The event is forwarded to the application logic.

47: The supervised call leg information is reported.

48: The event is forwarded to the application logic.

49: The terminating call leg is destroyed, the AppLeg B is notified.

50: The event is forwarded to the application logic.

52: Assuming the IpCall object has been informed that the legs have been destroyed, the IpAppMultiPartyCall is notified that the call is ended .

53: The event is forwarded to the application logic.

7.1.5 Complex Card Service

The following sequence diagram shows an advanced card service, initiated as a result of a prearranged event being received by the call control service. Before the call is made, the calling party is asked for an ID and PIN code. If the ID and PIN code are accepted, the calling party is prompted to enter the address of the destination party. A trigger of '#5' is then set on the controlling leg (the calling party's leg) such that if the calling party enters a '#5' an event will be sent to the application. The call is then routed to the destination party. Sometime during the call the calling party enters '#5' which causes the called leg to be released. The calling party is now prompted to enter the address of a new destination party, to which it is then routed.

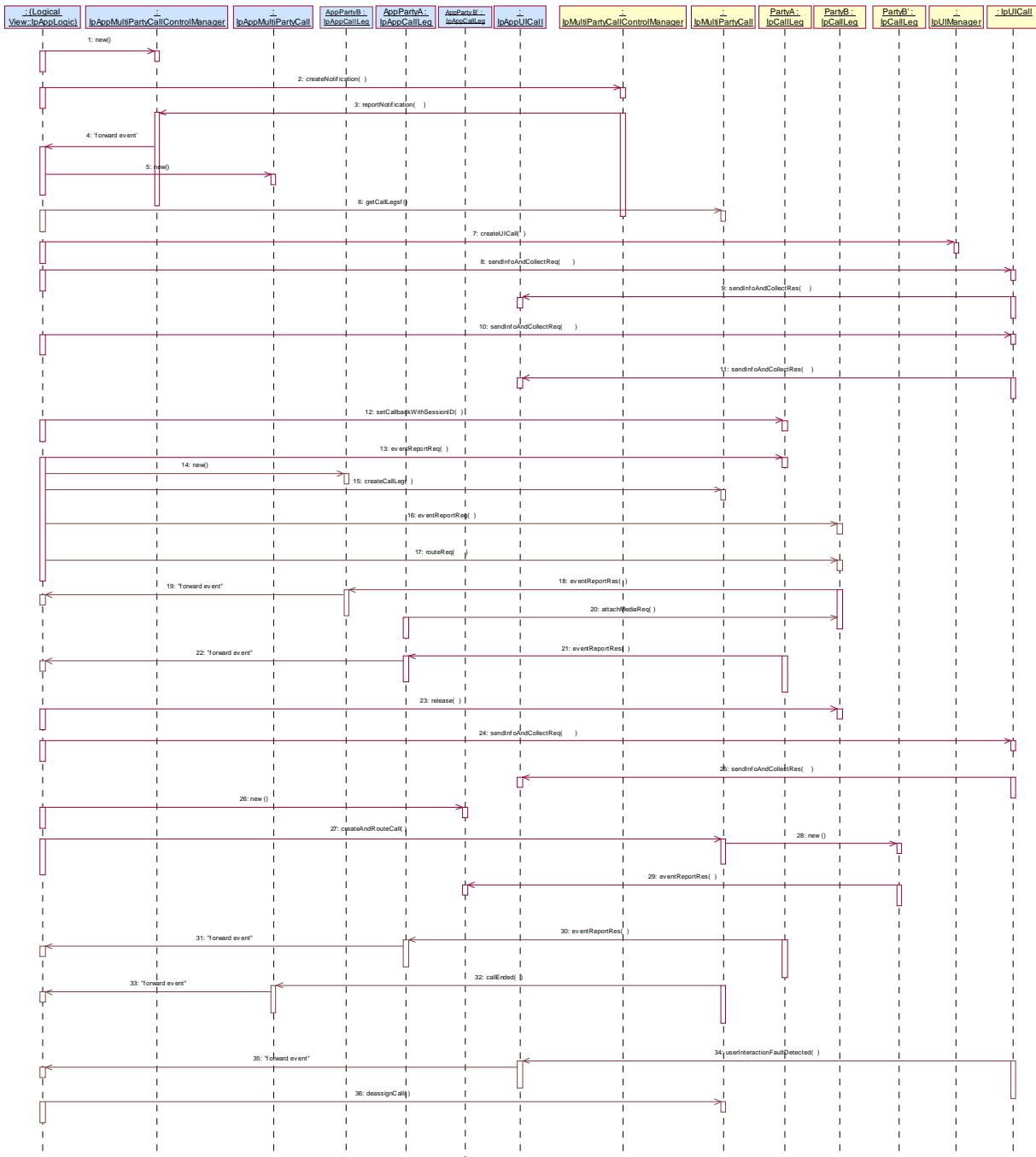

1: This message is used by the application to create an object implementing the IpAppMultiPartyCallControlManager interface.

2: This message is sent by the application to enable notifications on new call events. As this sequence diagram depicts a call barring service, it is likely that all new call events destined for a particular address or address range result in the caller being prompted for a password before the call is allowed to progress. When a new call, that matches the event criteria set in message 2, arrives a message (not shown) is directed to the object implementing the IpMultiPartyCallControlManager. Assuming that the criteria for creating an object implementing the IpMultiPartyCall interface (e.g. load control values not exceeded) is met, other messages (not shown) are used to create the call and associated call leg object.

3: This message is used to pass the new call event to the object implementing the IpAppMultiPartyCallControlManager interface.

- 4: This message is used to forward message 3 to the IpAppLogic.
- 5: This message is used by the application to create an object implementing the IpAppMultiPartyCall interface. The reference to this object is passed back to the object implementing the IpMultiPartyCallControlManager using the return parameter of message 3.
- 6: This message returns the call legs currently in the call. In principle a reference to the call leg of the calling party is already obtained by the application when it was notified of the new call event.
- 7: This message is used to associate a user interaction object with the calling party.
- 8: The initial card service dialogue is invoked using this message.
- 9: The result of the dialogue, which in this case is the ID and PIN code, is returned to its callback object using this message and eventually forwarded via another message (not shown) to the IpAppLogic.
- 10: Assuming the correct ID and PIN are entered, the final dialogue is invoked.
- 11: The result of the dialogue, which in this case is the destination address, is returned and eventually forwarded via another message (not shown) to the IpAppLogic.
- 12: This message is used to forward the address of the callback object.
- 13: The trigger for follow-on calls is set (on service code).
- 14: A new AppCallLeg is created to receive callbacks for another leg. Alternatively, the already existing AppCallLeg object could be passed in the subsequent createCallLeg(). In that case the application has to use the sessionIDs of the legs to distinguish between callbacks destined for the A-leg and callbacks destined for the B-leg.
- 15: This message is used to create a new call leg object. The object is created in the idle state and not yet routed in the network.
- 16: The application requests to be notified when the leg is answered.
- 17: The application routes the leg. As a result the network will try to reach the associated party.
- 18: When the B-party answers the call, the application is notified.
- 19: The event is forwarded to the application logic.
- 20: Legs that are created and routed explicitly are by default in state detached. This means that the media is not connected to the other parties in the call. In order to allow inband communication between the new party and the other parties in the call the media have to be explicitly attached.
- 21: At some time during the call the calling party enters '#5'. This causes this message to be sent to the object implementing the IpAppCallLeg interface, which forwards this event as a message (not shown) to the IpAppLogic.
- 22: The event is forwarded to the application.
- 23: This message releases the called party.
- 24: Another user interaction dialogue is invoked.
- 25: The result of the dialogue, which in this case is the new destination address is returned and eventually forwarded via another message (not shown) to the IpAppLogic.
- 26: A new AppCallLeg is created to receive callbacks for another leg.
- 27: The call is then forward routed to the new destination party.
- 28: As a result a new Callleg object is created.
- 29: This message passes the result of the call being answered to its callback object and is eventually forwarded via another message (not shown) to the IpAppLogic.
- 30: When the A-party terminates the application is informed.

31: The event is forwarded to the application logic.

32: Since the release of the A-party will in this case terminate the entire call, the application is also notified with this message.

33: The event is forwarded to the application logic.

34: Since the user interaction object were not released at the moment that the call terminated, the application receives this message to indicate that the UI resources are released in the gateway and no further communication is possible.

35: The event is forwarded to the application logic.

36: The application deassigns the call object.

7.1.6 Hotline Service

The following sequence diagram shows an application establishing a call between party A and pre-arranged party B defined to constitute a hot-line address. The address of the destination party is provided by the application as the calling party makes a call attempt (goes off-hook) and do not dial any number within a predefined time. In this case a pre-defined number (hot-line number) is provided by the application. The call is then routed to the pre-defined destination party.

The call release is monitored to enable the sending of information to the application at call release, e.g. for charging purposes.

Note that this service could be extended as follows:

Sometime during the call the calling party enters '#5' which causes the called leg to be released. The calling party is now prompted to enter the address of a new destination party, to which it is then routed.

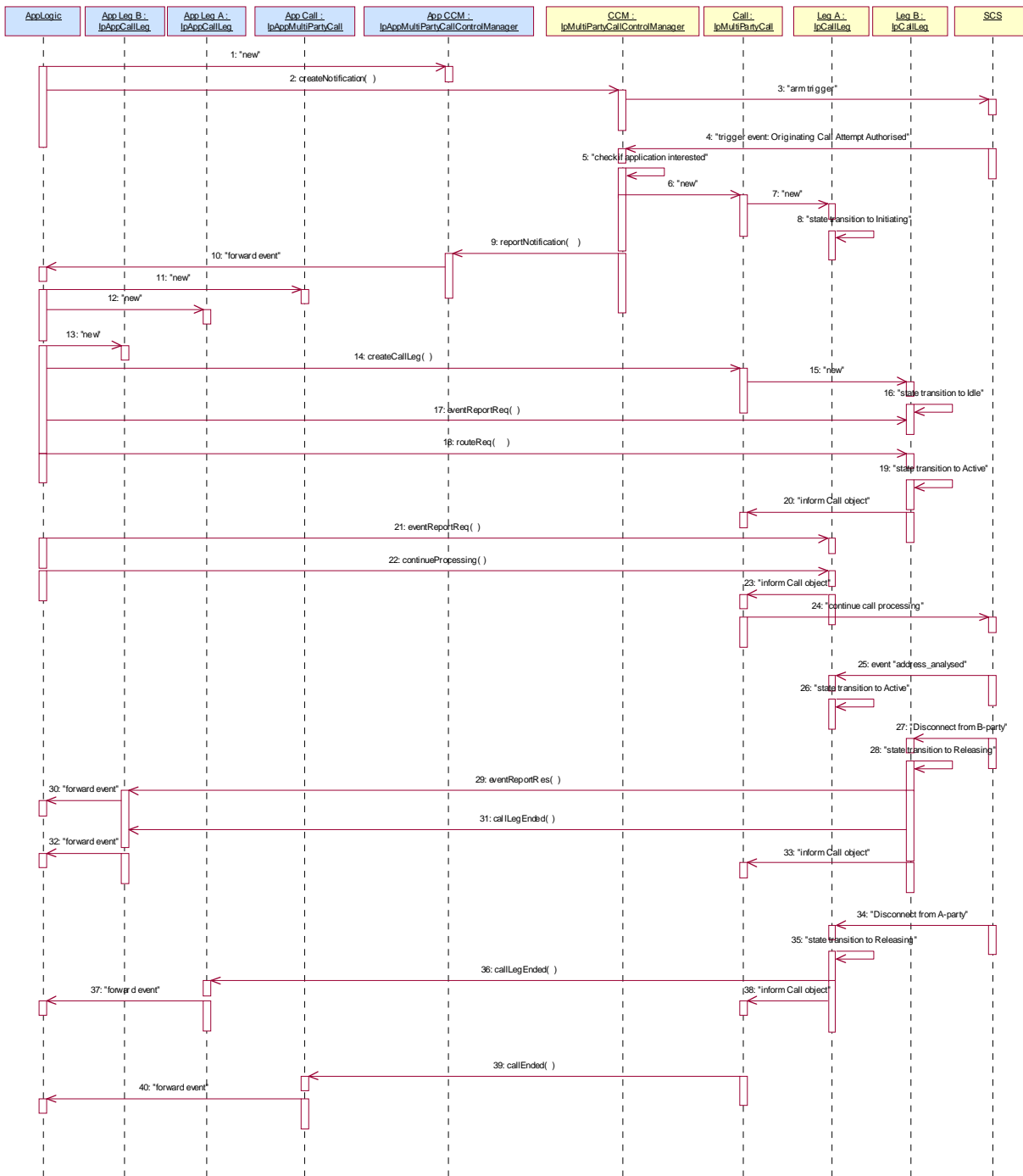

- 1: This message is used by the application to create an object implementing the IpAppMultiPartyCallControlManager interface.
- 2: This message is sent by the application to enable notifications on new call events.
- 4: When a new call, that matches the event criteria, arrives a message ("analysed information") is directed to the object implementing the IpMultiPartyCallControlManager. Assuming that the criteria for creating an object implementing the IpMultiPartyCall interface is met, other messages are used to create the call and associated call leg object
- 6: A new MultiPartyCall object is created to handle this particular call.
- 7: A new CallLeg object corresponding to Party A is created.

- 8: The new Call Leg instance transits to state Initiating.
- 9: This message is used to pass the new call event to the object implementing the IpAppMultiPartyCallControlManager interface. Applied monitor mode is "interrupt"
- 10: This message is used to forward message 9 to the IpAppLogic.
- 11: This message is used by the application to create an object implementing the IpAppMultiPartyCall interface. The reference to this object is passed back to the object implementing the IpMultiPartyCallControlManager using the return parameter of the reportNotification.
- 12: A new AppCallLeg is created to receive callbacks for the Leg corresponding to party A.
- 13: A new AppCallLeg is created to receive callbacks for another leg.
- 14: This message is used to create a new call leg object. The object is created in the idle state and not yet routed in the network.
- 15: A new CallLeg corresponding to party B is created.
- 16: A transition to state Idle is made after the Call leg has been created.
- 17: The application requests to be notified (monitor mode "NOTIFY") when the leg to party B is released.
- 18: The application requests to route the terminating leg to reach the associated party as specified by the application ("hot-line number").
- 19: The Call Leg instance transits to state Active.
- 21: The application requests to be notified (monitor mode "Notify") when the leg to A-party is released.
- 22: The application requests to resume call processing for the originating call leg.
- As a result call processing is resumed in the network that will try to reach the associated party as specified by the application (E.164 number provided by application).
- 25: The originating call leg is notified that the number (provided by application) has been analysed by the network and the originating call leg STD makes a transition to "active" state. The application is not notified as it has not requested this event to be reported.
- 27: When the B-party releases the call, the terminating call leg is notified (monitor mode "NOTIFY") and makes a transition to "Releasing state".
- 29: The application is notified, as the release event has been requested to be reported in Notify mode.
- 30: The event is forwarded to the application logic.
- 31: The terminating call leg is destroyed, the AppLeg B is notified.
- 32: This answer message is then forwarded.
- 34: When the call release ("terminating release" indication) is propagated in the network toward the party A, the originating call leg is notified and makes a transition to "releasing state". This release event (being propagated from party B) is not reported to the application.
- 36: When the originating call leg is destroyed, the AppLeg A is notified.
- 37: The event is forwarded to the application logic
- 39: When all legs have been destroyed, the IpAppMultiPartyCall is notified that the call is ended.
- 40: The event is forwarded to the application logic.

7.1.7 Use of the Redirected event

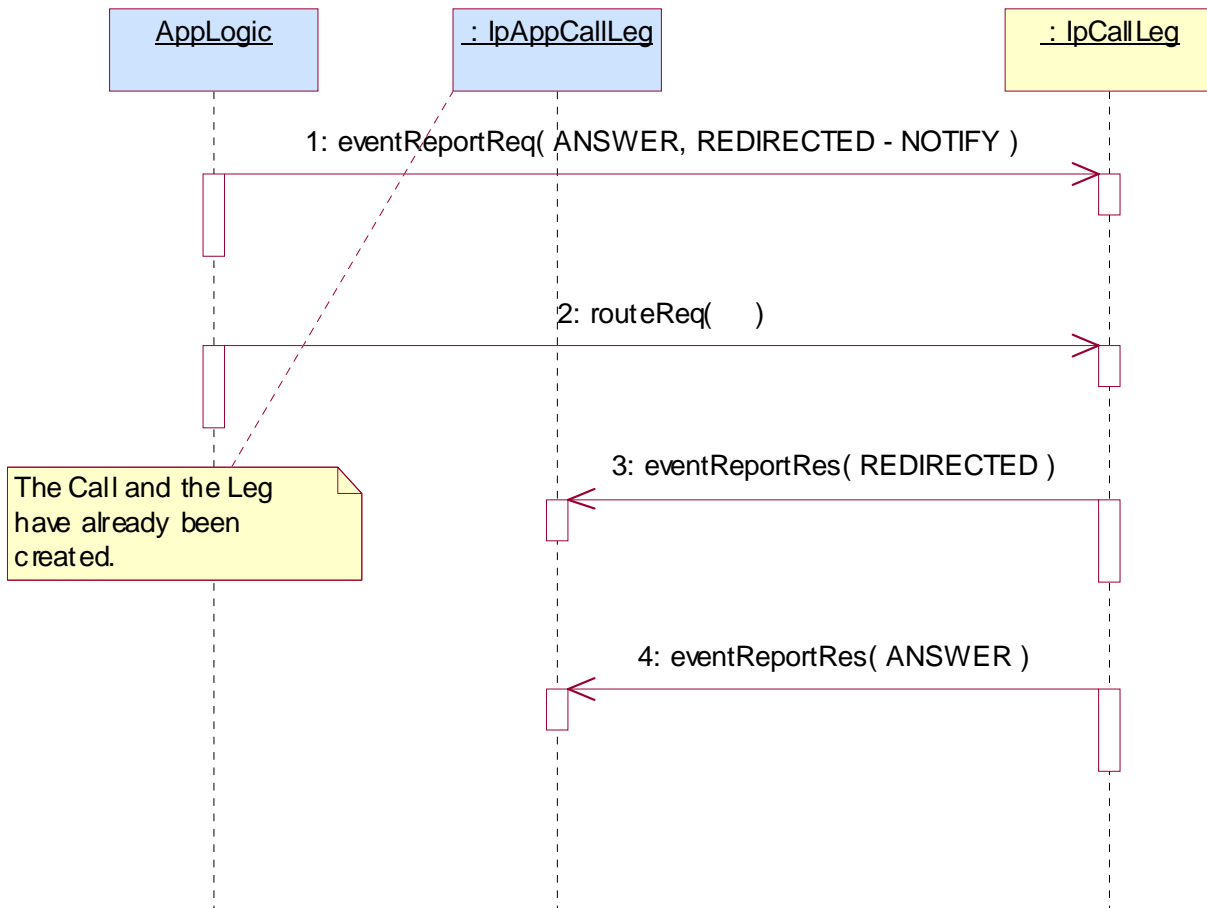

- 1: The application has already created the call and a call leg. It places an event report request for the ANSWER and REDIRECTED events in NOTIFY mode.
- 2: The application routes the call leg.
- 3: The call is redirected within the network and the application is informed. The new destination address is passed within the event. The event is not disarmed, so subsequent redirections will also be reported. Also, the same call leg is used so the application does not have to create a new one.
- 4: The call is answered at its new destination.

7.2 Class Diagrams

The multiparty call control service consists of two packages, one for the interfaces on the application side and one for interfaces on the service side.

The class diagrams in the following figures show the interfaces that make up the multi party call control application package and the multi party call control service package. This class diagram shows the interfaces of the multi-party call control application package and their relations to the interfaces of the multi-party call control service package.

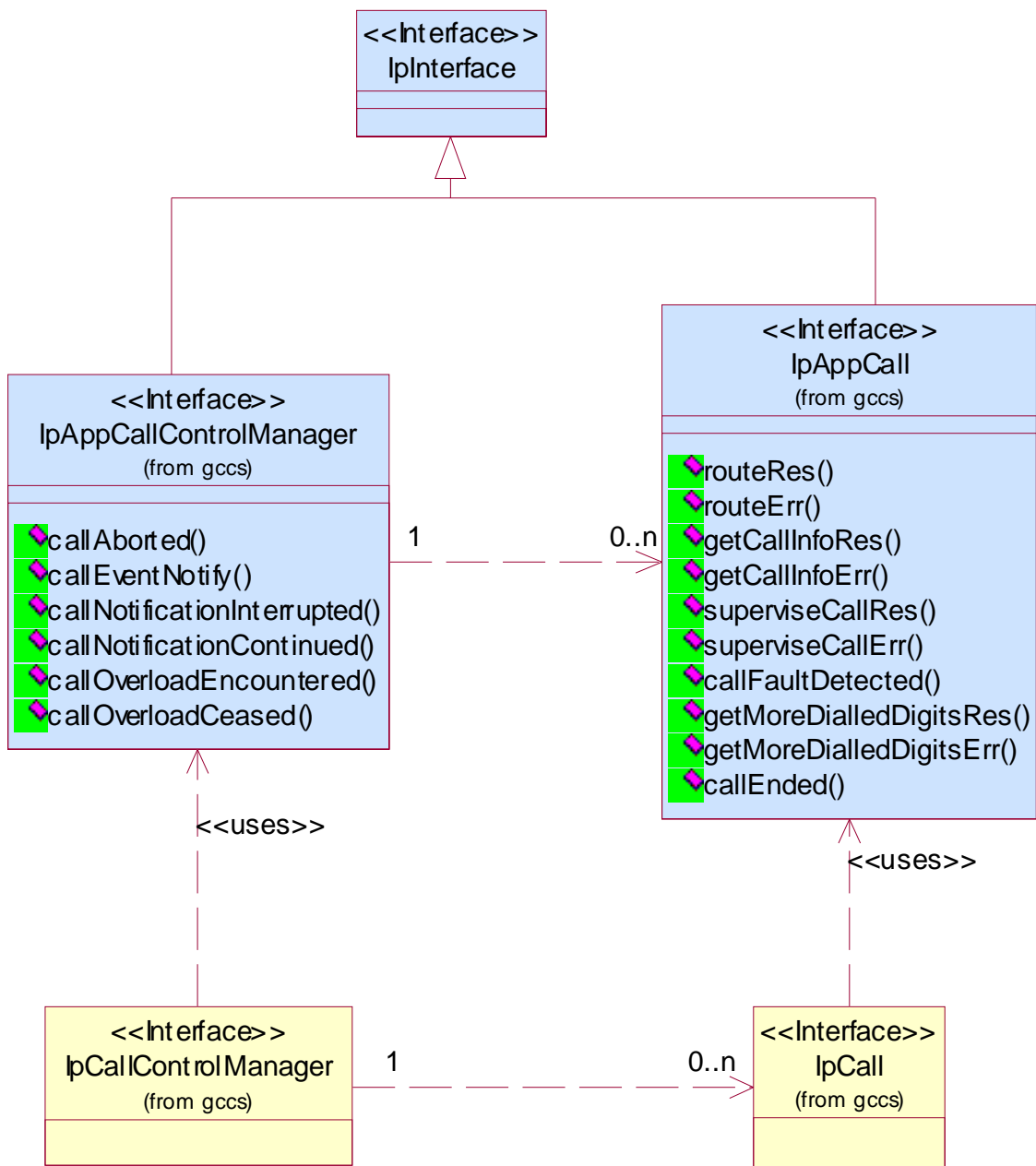

Figure: Application Interfaces

This class diagram shows the interfaces of the multi-party call control service package.

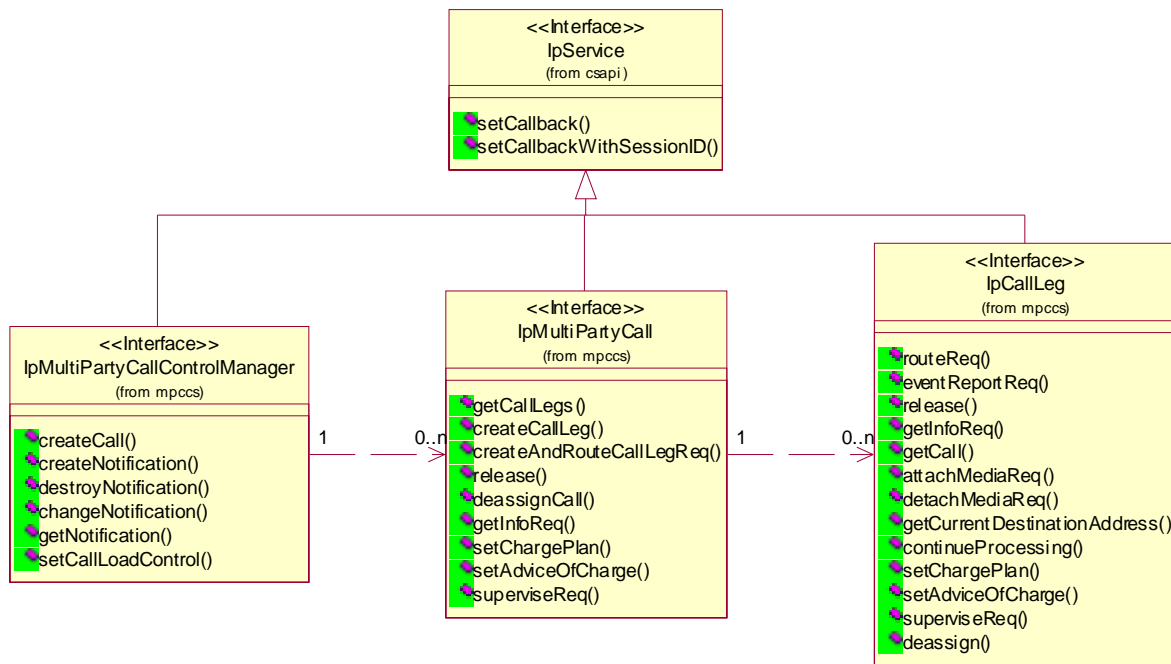

Figure: Service Interfaces

7.3 MultiParty Call Control Service Interface Classes

The Multi-party Call Control service enhances the functionality of the Generic Call Control Service with leg management. It also allows for multi-party calls to be established, i.e., up to a service specific number of legs can be connected simultaneously to the same call.

The Multi-party Call Control Service is represented by the IpMultiPartyCallControlManager, IpMultiPartyCall, IpCallLeg interfaces that interface to services provided by the network. Some methods are asynchronous, in that they do not lock a thread into waiting whilst a transaction performs. In this way, the client machine can handle many more calls, than one that uses synchronous message calls. To handle responses and reports, the developer must implement IpAppMultiPartyCallControlManager, IpAppMultiPartyCall and IpAppCallLeg to provide the callback mechanism.

7.3.1 Interface Class IpMultiPartyCallControlManager

Inherits from: IpService

This interface is the 'service manager' interface for the Multi-party Call Control Service. The multi-party call control manager interface provides the management functions to the multi-party call control service. The application programmer can use this interface to provide overload control functionality, create call objects and to enable or disable call-related event notifications. The action table associated with the STD shows in what state the IpMultiPartyCallControlManager must be if a method can successfully complete. In other words, if the IpMultiPartyCallControlManager is in another state the method will throw an exception immediately. This interface shall be implemented by a Multi Party Call Control SCF. As a minimum requirement either the createCall() method shall be implemented, or the createNotification() and destroyNotification() methods shall be implemented.

<<Interface>> IpMultiPartyCallControlManager
<pre> createCall (appCall : in IpAppMultiPartyCallRef) : TpMultiPartyCallIdentifier createNotification (appCallControlManager : in IpAppMultiPartyCallControlManagerRef, notificationRequest : in TpCallNotificationRequest) : TpAssignmentID destroyNotification (assignmentID : in TpAssignmentID) : void changeNotification (assignmentID : in TpAssignmentID, notificationRequest : in TpCallNotificationRequest) : void getNotification () : TpNotificationRequestedSet setCallLoadControl (duration : in TpDuration, mechanism : in TpCallLoadControlMechanism, treatment : in TpCallTreatment, addressRange : in TpAddressRange) : TpAssignmentID </pre>

*Method***createCall()**

This method is used to create a new call object. An IpAppMultiPartyCallControlManager should already have been passed to the IpMultiPartyCallControlManager,

otherwise the call control will not be able to report a callAborted() to the application (the application should invoke setCallback() if it wishes to ensure this).

Returns callReference: Specifies the interface reference and sessionID of the call created.

Parameters

appCall : in IpAppMultiPartyCallRef

Specifies the application interface for callbacks from the call created.

Returns

TpMultiPartyCallIdentifier

Raises

TpCommonExceptions, P_INVALID_INTERFACE_TYPE

*Method***createNotification()**

This method is used to enable call notifications so that events can be sent to the application. This is the first step an application has to do to get initial notifications of calls happening in the network. When such an event happens, the application will be informed by reportNotification(). In case the application is interested in other events during the context of a particular call session it has to use the createAndRouteCallLegReq() method on the call object or the eventReportReq() method on the call leg object. The application will get access to the call object when it receives the reportNotification(). (Note that createNotification() is not applicable if the call is setup by the application).

The createNotification method is purely intended for applications to indicate their interest to be notified when certain call events take place. It is possible to subscribe to a certain event for a whole range of addresses, e.g. the application can indicate it wishes to be informed when a call is made to any number starting with 800.

If some application already requested notifications with criteria that overlap the specified criteria, the request is refused with P_INVALID_CRITERIA. The criteria are said to overlap if both originating and terminating ranges overlap and the same number plan is used.

If a notification is requested by an application with monitor mode set to notify, then there is no need to check the rest of the criteria for overlapping with any existing request as the notify mode does not allow control on a call to be passed over. Only one application can place an interrupt request if the criteria overlaps.

If the same application requests two notifications with exactly the same criteria but different callback references, the second callback will be treated as an additional callback. Both notifications will share the same assignmentID. The gateway will always use the most recent callback. In case this most recent callback fails the second most recent is used. In case the createNotification contains no callback, at the moment the application needs to be informed the gateway will use as callback the callback that has been registered by setCallback().

Returns assignmentID: Specifies the ID assigned by the call control manager interface for this newly-enabled event notification.

Parameters

appCallControlManager : in IpAppMultiPartyCallControlManagerRef

If this parameter is set (i.e. not NULL) it specifies a reference to the application interface, which is used for callbacks. If set to NULL, the application interface defaults to the interface specified via the setCallback() method.

notificationRequest : in TpCallNotificationRequest

Specifies the event specific criteria used by the application to define the event required. Only events that meet these criteria are reported. Examples of events are "incoming call attempt reported by network", "answer", "no answer", "busy". Individual addresses or address ranges may be specified for destination and/or origination.

Returns

TpAssignmentID

Raises

TpCommonExceptions, P_INVALID_CRITERIA, P_INVALID_INTERFACE_TYPE, P_INVALID_EVENT_TYPE

Method

destroyNotification()

This method is used by the application to disable call notifications.

Parameters

assignmentID : in TpAssignmentID

Specifies the assignment ID given by the generic call control manager interface when the previous enableNotification() was called. If the assignment ID does not correspond to one of the valid assignment IDs, the exception P_INVALID_ASSIGNMENTID will be raised. If two callbacks have been registered under this assignment ID both of them will be disabled.

Raises

TpCommonExceptions, P_INVALID_ASSIGNMENT_ID

*Method***changeNotification()**

This method is used by the application to change the event criteria introduced with createNotification. Any stored criteria associated with the specified assignmentID will be replaced with the specified criteria.

Parameters

assignmentID : in TpAssignmentID

Specifies the ID assigned by the generic call control manager interface for the event notification. If two callbacks have been registered under this assignment ID both of them will be changed.

notificationRequest : in TpCallNotificationRequest

Specifies the new set of event specific criteria used by the application to define the event required. Only events that meet these criteria are reported.

Raises

TpCommonExceptions, P_INVALID_ASSIGNMENT_ID, P_INVALID_CRITERIA, P_INVALID_EVENT_TYPE

*Method***getNotification()**

This method is used by the application to query the event criteria set with createNotification or changeNotification.

Returns notificationsRequested: Specifies the notifications that have been requested by the application.

Parameters

No Parameters were identified for this method

Returns

TpNotificationRequestedSet

Raises

TpCommonExceptions

*Method***setCallLoadControl()**

This method imposes or removes load control on calls made to a particular address range within the call control service. The address matching mechanism is similar as defined for TpCallEventCriteria.

Returns assignmentID: Specifies the assignmentID assigned by the gateway to this request. This assignmentID can be used to correlate the callOverloadEncountered and callOverloadCeased methods with the request.

Parameters

duration : in TpDuration

Specifies the duration for which the load control should be set.

A duration of 0 indicates that the load control should be removed.

A duration of -1 indicates an infinite duration (i.e., until disabled by the application)

A duration of -2 indicates the network default duration.

mechanism : in TpCallLoadControlMechanism

Specifies the load control mechanism to use (for example, admit one call per interval), and any necessary parameters, such as the call admission rate. The contents of this parameter are ignored if the load control duration is set to zero.

treatment : in TpCallTreatment

Specifies the treatment of calls that are not admitted. The contents of this parameter are ignored if the load control duration is set to zero.

addressRange : in TpAddressRange

Specifies the address or address range to which the overload control should be applied or removed.

Returns

TpAssignmentID

Raises

TpCommonExceptions, P_INVALID_ADDRESS, P_UNSUPPORTED_ADDRESS_PLAN

7.3.2 Interface Class IpAppMultiPartyCallControlManager

Inherits from: IpInterface

The Multi-Party call control manager application interface provides the application call control management functions to the Multi-Party call control service.

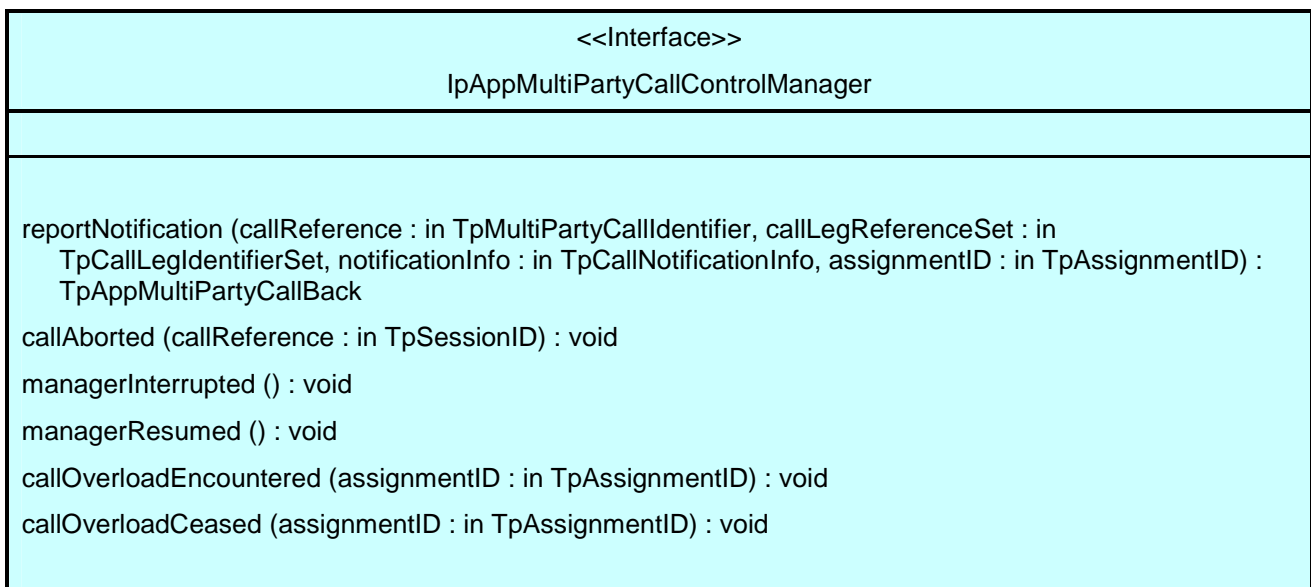

Method

reportNotification()

This method notifies the application of the arrival of a call-related event.

If this method is invoked with a monitor mode of P_CALL_MONITOR_MODE_INTERRUPT, then the APL has control of the call. If the APL does nothing with the call (including its associated legs) within a specified time period (the duration of which forms a part of the service level agreement), then the call in the network shall be released and callEnded() shall be invoked, giving a release cause of P_TIMER_EXPIRY.

Returns appCallBack: Specifies references to the application interface which implements the callback interface for the new call and/or new call leg. If the application has previously explicitly passed a reference to the callback interface using a setCallbackWithSessionID() invocation, this parameter may be set to P_APP_CALLBACK_UNDEFINED, or if supplied must be the same as that provided during the setCallbackWithSessionID().

This parameter will be set to P_APP_CALLBACK_UNDEFINED if the notification is in NOTIFY mode.

Parameters

callReference : in TpMultiPartyCallIdentifier

Specifies the reference to the call interface to which the notification relates. If the notification is being given in NOTIFY mode, this parameter shall be ignored by the application client implementation, and consequently the implementation of the SCS entity invoking reportNotification may populate this parameter as it chooses.

callLegReferenceSet : in TpCallLegIdentifierSet

Specifies the set of all call leg references. First in the set is the reference to the originating callLeg. It indicates the call leg related to the originating party. In case there is a destination call leg this will be the second leg in the set. from the notificationInfo can be found on whose behalf the notification was sent.

However, if the notification is being given in NOTIFY mode, this parameter shall be ignored by the application client implementation, and consequently the implementation of the SCS entity invoking reportNotification may populate this parameter as it chooses.

notificationInfo : in TpCallNotificationInfo

Specifies data associated with this event (e.g. the originating or terminating leg which reports the notification).

assignmentID : in TpAssignmentID

Specifies the assignment id which was returned by the createNotification() method. The application can use assignment id to associate events with event specific criteria and to act accordingly.

Returns

TpAppMultiPartyCallBack

Method

callAborted()

This method indicates to the application that the call object has aborted or terminated abnormally. No further communication will be possible between the call and application.

Parameters

callReference : in TpSessionID

Specifies the sessionID of call that has aborted or terminated abnormally.

Method

managerInterrupted()

This method indicates to the application that event notifications and method invocations have been temporarily interrupted (for example, due to network resources unavailable).

Note that more permanent failures are reported via the Framework (integrity management).

Parameters

No Parameters were identified for this method

Method

managerResumed()

This method indicates to the application that event notifications are possible and method invocations are enabled.

Parameters

No Parameters were identified for this method

Method

callOverloadEncountered()

This method indicates that the network has detected overload and may have automatically imposed load control on calls requested to a particular address range or calls made to a particular destination within the call control service.

Parameters

assignmentID : in TpAssignmentID

Specifies the assignmentID corresponding to the associated setCallLoadControl. This implies the addressrange for within which the overload has been encountered.

Method

callOverloadCeased()

This method indicates that the network has detected that the overload has ceased and has automatically removed any load controls on calls requested to a particular address range or calls made to a particular destination within the call control service.

Parameters

assignmentID : in TpAssignmentID

Specifies the assignmentID corresponding to the associated setCallLoadControl. This implies the addressrange for within which the overload has been ceased

7.3.3 Interface Class IpMultiPartyCall

Inherits from: IpService

The Multi-Party Call provides the possibility to control the call routing, to request information from the call, control the charging of the call, to release the call and to supervise the call. It also gives the possibility to manage call legs explicitly. An application may create more than one call leg.

This interface shall be implemented by a Multi Party Call Control SCF. The release() and deassignCall() methods, and either the createCallLeg() or the createAndRouteCallLegReq(), shall be implemented as a minimum requirement.

<<Interface>> IpMultiPartyCall
<pre> getCallLegs (callSessionID : in TpSessionID) : TpCallLegIdentifierSet createCallLeg (callSessionID : in TpSessionID, appCallLeg : in IpAppCallLegRef) : TpCallLegIdentifier createAndRouteCallLegReq (callSessionID : in TpSessionID, eventsRequested : in TpCallEventRequestSet, targetAddress : in TpAddress, originatingAddress : in TpAddress, appInfo : in TpCallAppInfoSet, appLegInterface : in IpAppCallLegRef) : TpCallLegIdentifier release (callSessionID : in TpSessionID, cause : in TpReleaseCause) : void deassignCall (callSessionID : in TpSessionID) : void getInfoReq (callSessionID : in TpSessionID, callInfoRequested : in TpCallInfoType) : void setChargePlan (callSessionID : in TpSessionID, callChargePlan : in TpCallChargePlan) : void setAdviceOfCharge (callSessionID : in TpSessionID, aOCInfo : in TpAoCInfo, tariffSwitch : in TpDuration) : void superviseReq (callSessionID : in TpSessionID, time : in TpDuration, treatment : in TpCallSuperviseTreatment) : void </pre>

*Method***getCallLegs ()**

This method requests the identification of the call leg objects associated with the call object. Returns the legs in the order of creation.

Returns callLegList: Specifies the call legs associated with the call. The set contains both the sessionIDs and the interface references.

Parameters

callSessionID : in TpSessionID

Specifies the call session ID of the call.

Returns

TpCallLegIdentifierSet

Raises

TpCommonExceptions, P_INVALID_SESSION_ID

*Method***createCallLeg ()**

This method requests the creation of a new call leg object.

Returns callLeg: Specifies the interface and sessionID of the call leg created.

*Parameters***callSessionID : in TpSessionID**

Specifies the call session ID of the call.

appCallLeg : in IpAppCallLegRef

Specifies the application interface for callbacks from the call leg created.

*Returns***TpCallLegIdentifier***Raises***TpCommonExceptions, P_INVALID_SESSION_ID, P_INVALID_INTERFACE_TYPE***Method***createAndRouteCallLegReq()**

This asynchronous operation requests creation and routing of a new callLeg. In case the connection to the destination party is established successfully the CallLeg is attached to the call, i.e. no explicit attachMediaReq() operation is needed. Requested events will be reported on the IpAppCallLeg interface. This interface the application must provide through the appLegInterface parameter.

The extra address information such as originatingAddress is optional. If not present (i.e., the plan is set to P_ADDRESS_PLAN_NOT_PRESENT), the information provided in corresponding addresses from the route is used, otherwise the network or gateway provided numbers will be used.

If the application wishes that the call leg should be represented in the network as being a redirection it should include a value for the field P_CALL_APP_ORIGINAL_DESTINATION_ADDRESS of TpCallAppInfo.

If this method is invoked, and call reports have been requested, yet the IpAppCallLeg interface parameter is NULL, this method shall throw the P_NO_CALLBACK_ADDRESS_SET exception.

Returns callLegReference: Specifies the reference to the CallLeg interface that was created.

*Parameters***callSessionID : in TpSessionID**

Specifies the call session ID of the call.

eventsRequested : in TpCallEventRequestSet

Specifies the event specific criteria used by the application to define the events required. Only events that meet these criteria are reported. Examples of events are "address analysed", "answer" and "release".

targetAddress : in TpAddress

Specifies the destination party to which the call should be routed.

originatingAddress : in TpAddress

Specifies the address of the originating (calling) party.

appInfo : in TpCallAppInfoSet

Specifies application-related information pertinent to the call (such as alerting method, tele-service type, service identities and interaction indicators).

appLegInterface : in IpAppCallLegRef

Specifies a reference to the application interface that implements the callback interface for the new call leg. Requested events will be reported by the eventReportRes() operation on this interface.

*Returns***TpCallLegIdentifier***Raises***TpCommonExceptions, P_INVALID_SESSION_ID, P_INVALID_INTERFACE_TYPE, P_INVALID_ADDRESS, P_UNSUPPORTED_ADDRESS_PLAN, P_INVALID_NETWORK_STATE, P_INVALID_EVENT_TYPE, P_INVALID_CRITERIA***Method***release()**

This method requests the release of the call object and associated objects. The call will also be terminated in the network. If the application requested reports to be sent at the end of the call (e.g., by means of getInfoReq) these reports will still be sent to the application.

*Parameters***callSessionID : in TpSessionID**

Specifies the call session ID of the call.

cause : in TpReleaseCause

Specifies the cause of the release.

*Raises***TpCommonExceptions, P_INVALID_SESSION_ID, P_INVALID_NETWORK_STATE***Method***deassignCall()**

This method requests that the relationship between the application and the call and associated objects be de-assigned. It leaves the call in progress, however, it purges the specified call object so that the application has no further control of call processing. If a call is de-assigned that has call information reports, call leg event reports or call Leg information reports requested, then these reports will be disabled and any related information discarded.

*Parameters***callSessionID : in TpSessionID**

Specifies the call session ID of the call.

*Raises***TpCommonExceptions, P_INVALID_SESSION_ID***Method***getInfoReq()**

This asynchronous method requests information associated with the call to be provided at the appropriate time (for example, to calculate charging). This method must be invoked before the call is routed to a target address.

A report is received when the destination leg or party terminates or when the call ends. The call object will exist after the call is ended if information is required to be sent to the application at the end of the call. In case the originating party is still available the application can still initiate a follow-on call using routeReq.

Parameters

callSessionID : in TpSessionID

Specifies the call session ID of the call.

callInfoRequested : in TpCallInfoType

Specifies the call information that is requested.

Raises

TpCommonExceptions, P_INVALID_SESSION_ID

Method

setChargePlan()

Set an operator specific charge plan for the call.

Parameters

callSessionID : in TpSessionID

Specifies the call session ID of the call.

callChargePlan : in TpCallChargePlan

Specifies the charge plan to use.

Raises

TpCommonExceptions, P_INVALID_SESSION_ID

Method

setAdviceOfCharge()

This method allows for advice of charge (AOC) information to be sent to terminals that are capable of receiving this information.

Parameters

callSessionID : in TpSessionID

Specifies the call session ID of the call.

aOCInfo : in TpAoCInfo

Specifies two sets of Advice of Charge parameter.

tariffSwitch : in TpDuration

Specifies the tariff switch interval that signifies when the second set of AoC parameters becomes valid.

Raises

**TpCommonExceptions , P_INVALID_SESSION_ID , P_INVALID_CURRENCY ,
 P_INVALID_AMOUNT**

*Method***superviseReq()**

The application calls this method to supervise a call. The application can set a granted connection time for this call. If an application calls this operation before it routes a call or a user interaction operation the time measurement will start as soon as the call is answered by the B-party or the user interaction system.

Parameters

callSessionID : in TpSessionID

Specifies the call session ID of the call.

time : in TpDuration

Specifies the granted time in milliseconds for the connection.

treatment : in TpCallSuperviseTreatment

Specifies how the network should react after the granted connection time expired.

Raises

TpCommonExceptions , P_INVALID_SESSION_ID

7.3.4 Interface Class IpAppMultiPartyCall

Inherits from: IpInterface

The Multi-Party call application interface is implemented by the client application developer and is used to handle call request responses and state reports.

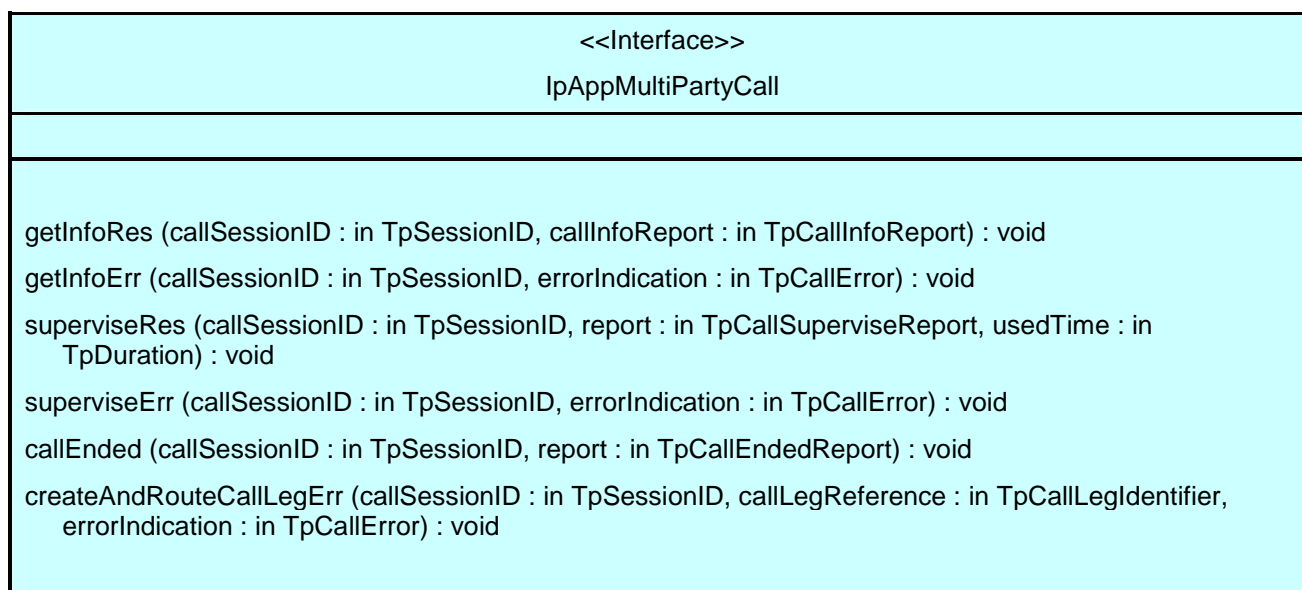

*Method***getInfoRes ()**

This asynchronous method reports time information of the finished call or call attempt as well as release cause depending on which information has been requested by getInfoReq. This information may be used e.g. for charging purposes. The call information will possibly be sent after reporting of all cases where the call or a leg of the call has been disconnected or a routing failure has been encountered.

Parameters

callSessionID : in TpSessionID

Specifies the call session ID of the call.

callInfoReport : in TpCallInfoReport

Specifies the call information requested.

*Method***getInfoErr ()**

This asynchronous method reports that the original request was erroneous, or resulted in an error condition.

Parameters

callSessionID : in TpSessionID

Specifies the call session ID of the call.

errorIndication : in TpCallError

Specifies the error which led to the original request failing.

*Method***superviseRes ()**

This asynchronous method reports a call supervision event to the application when it has indicated its interest in these kind of events.

It is also called when the connection is terminated before the supervision event occurs.

Parameters

callSessionID : in TpSessionID

Specifies the call session ID of the call

report : in TpCallSuperviseReport

Specifies the situation which triggered the sending of the call supervision response.

usedTime : in TpDuration

Specifies the used time for the call supervision (in milliseconds).

*Method***superviseErr ()**

This asynchronous method reports a call supervision error to the application.

*Parameters***callSessionID : in TpSessionID**

Specifies the call session ID of the call.

errorIndication : in TpCallError

Specifies the error which led to the original request failing.

*Method***callEnded()**

This method indicates to the application that the call has terminated in the network.

Note that the event that caused the call to end might have been received separately if the application was monitoring for it.

*Parameters***callSessionID : in TpSessionID**

Specifies the call sessionID.

report : in TpCallEndedReport

Specifies the reason the call is terminated.

*Method***createAndRouteCallLegErr()**

This asynchronous method indicates that the request to route the call leg to the destination party was unsuccessful - the call leg could not be routed to the destination party (for example, the network was unable to route the call leg, the parameters were incorrect, the request was refused, etc.). Note that the event cases that can be monitored and correspond to an unsuccessful setup of a connection (e.g. busy, no_answer) will be reported by eventReportRes() and not by this operation.

*Parameters***callSessionID : in TpSessionID**

Specifies the call session ID of the call.

callLegReference : in TpCallLegIdentifier

Specifies the reference to the CallLeg interface that was created.

errorIndication : in TpCallError

Specifies the error which led to the original request failing.

7.3.5 Interface Class IpCallLeg

Inherits from: IpService

The call leg interface represents the logical call leg associating a call with an address. The call leg tracks its own states and allows charging summaries to be accessed. The leg represents the signalling relationship between the call and an

address. An application that uses the IpCallLeg interface to set up connections has good control, e.g. by defining leg specific event request and can obtain call leg specific report and events.

This interface shall be implemented by a Multi Party Call Control SCF. The routeReq(), eventReportReq(), release(), continueProcessing() and deassign() methods shall be implemented as a minimum requirement.

<<Interface>> IpCallLeg
<pre> routeReq (callLegSessionID : in TpSessionID, targetAddress : in TpAddress, originatingAddress : in TpAddress, applInfo : in TpCallAppInfoSet, connectionProperties : in TpCallLegConnectionProperties) : void eventReportReq (callLegSessionID : in TpSessionID, eventsRequested : in TpCallEventRequestSet) : void release (callLegSessionID : in TpSessionID, cause : in TpReleaseCause) : void getInfoReq (callLegSessionID : in TpSessionID, callLegInfoRequested : in TpCallLegInfoType) : void getCall (callLegSessionID : in TpSessionID) : TpMultiPartyCallIdentifier attachMediaReq (callLegSessionID : in TpSessionID) : void detachMediaReq (callLegSessionID : in TpSessionID) : void getCurrentDestinationAddress (callLegSessionID : in TpSessionID) : TpAddress continueProcessing (callLegSessionID : in TpSessionID) : void setChargePlan (callLegSessionID : in TpSessionID, callChargePlan : in TpCallChargePlan) : void setAdviceOfCharge (callLegSessionID : in TpSessionID, aOCInfo : in TpAoCInfo, tariffSwitch : in TpDuration) : void superviseReq (callLegSessionID : in TpSessionID, time : in TpDuration, treatment : in TpCallLegSuperviseTreatment) : void deassign (callLegSessionID : in TpSessionID) : void </pre>

Method

routeReq ()

This asynchronous method requests routing of the call leg to the remote party indicated by the targetAddress.

In case the connection to the destination party is established successfully the CallLeg will be either detached or attached to the call based on the attach Mechanism values specified in the connectionProperties parameter.

The extra address information such as originatingAddress is optional. If not present (i.e. the plan is set to P_ADDRESS_PLAN_NOT_PRESENT), the information provided in the corresponding addresses from the route is used, otherwise network or gateway provided addresses will be used.

If the application wishes that the call leg should be represented in the network as being a redirection it should include a value for the field P_CALL_APP_ORIGINAL_DESTINATION_ADDRESS of TpCallAppInfo.

This operation continues processing of the call leg.

Parameters

callLegSessionID : in TpSessionID

Specifies the call leg session ID of the call leg.

targetAddress : in TpAddress

Specifies the destination party to which the call leg should be routed

originatingAddress : in TpAddress

Specifies the address of the originating (calling) party.

appInfo : in TpCallAppInfoSet

Specifies application-related information pertinent to the call leg (such as alerting method, tele-service type, service identities and interaction indicators).

connectionProperties : in TpCallLegConnectionProperties

Specifies the properties of the connection.

Raises

**TpCommonExceptions, P_INVALID_SESSION_ID, P_INVALID_NETWORK_STATE,
P_INVALID_ADDRESS, P_UNSUPPORTED_ADDRESS_PLAN**

*Method***eventReportReq()**

This asynchronous method sets, clears or changes the criteria for the events that the call leg object will be set to observe.

*Parameters***callLegSessionID : in TpSessionID**

Specifies the call leg session ID of the call leg.

eventsRequested : in TpCallEventRequestSet

Specifies the event specific criteria used by the application to define the events required. Only events that meet these criteria are reported. Examples of events are "address analysed", "answer" and "release".

Raises

**TpCommonExceptions, P_INVALID_SESSION_ID, P_INVALID_EVENT_TYPE,
P_INVALID_CRITERIA**

*Method***release()**

This method requests the release of the call leg. If successful, the associated address (party) will be released from the call, and the call leg deleted. Note that in some cases releasing the party may lead to release of the complete call in the network. The application will be informed of this with callEnded().

This operation continues processing of the call leg.

*Parameters***callLegSessionID : in TpSessionID**

Specifies the call leg session ID of the call leg.

cause : in TpReleaseCause

Specifies the cause of the release.

Raises

TpCommonExceptions, P_INVALID_SESSION_ID, P_INVALID_NETWORK_STATE

*Method***getInfoReq()**

This asynchronous method requests information associated with the call leg to be provided at the appropriate time (for example, to calculate charging). Note that in the call leg information must be accessible before the objects of concern are deleted.

Parameters

callLegSessionID : in TpSessionID

Specifies the call leg session ID of the call leg.

callLegInfoRequested : in TpCallLegInfoType

Specifies the call leg information that is requested.

Raises

TpCommonExceptions, P_INVALID_SESSION_ID

*Method***getCall()**

This method requests the call associated with this call leg.

Returns callReference: Specifies the interface and sessionID of the call associated with this call leg.

Parameters

callLegSessionID : in TpSessionID

Specifies the call leg session ID of the call leg.

Returns

TpMultiPartyCallIdentifier

Raises

TpCommonExceptions, P_INVALID_SESSION_ID

*Method***attachMediaReq()**

This method requests that the call leg be attached to its call object. This will allow transmission on all associated bearer connections or media streams to and from other parties in the call. The call leg must be in the connected state for this method to complete successfully.

Parameters

callLegSessionID : in TpSessionID

Specifies the sessionID of the call leg to attach to the call.

Raises

TpCommonExceptions, P_INVALID_SESSION_ID, P_INVALID_NETWORK_STATE

*Method***detachMediaReq()**

This method will detach the call leg from its call, i.e., this will prevent transmission on any associated bearer connections or media streams to and from other parties in the call. The call leg must be in the connected state for this method to complete successfully.

Parameters

callLegSessionID : in TpSessionID

Specifies the sessionID of the call leg to detach from the call.

Raises

TpCommonExceptions, P_INVALID_SESSION_ID, P_INVALID_NETWORK_STATE

*Method***getCurrentDestinationAddress()**

Queries the current address of the destination the leg has been directed to.

Returns the address of the destination point towards which the call leg has been routed..

If this method is invoked on the Originating Call Leg, exception P_INVALID_STATE will be thrown.

Parameters

callLegSessionID : in TpSessionID

Specifies the call session ID of the call leg.

Returns

TpAddress

Raises

TpCommonExceptions, P_INVALID_SESSION_ID

*Method***continueProcessing()**

This operation continues processing of the call leg. Applications can invoke this operation after call leg processing was interrupted due to detection of a notification or event the application subscribed its interest in.

Parameters

callLegSessionID : in TpSessionID

Specifies the call leg session ID of the call leg.

Raises

TpCommonExceptions, P_INVALID_SESSION_ID, P_INVALID_NETWORK_STATE

*Method***setChargePlan()**

Set an operator specific charge plan for the call leg.

Parameters

callLegSessionID : in TpSessionID

Specifies the call leg session ID of the call party.

callChargePlan : in TpCallChargePlan

Specifies the charge plan to use.

Raises

TpCommonExceptions, P_INVALID_SESSION_ID

*Method***setAdviceOfCharge()**

This method allows for advice of charge (AOC) information to be sent to terminals that are capable of receiving this information.

Parameters

callLegSessionID : in TpSessionID

Specifies the call leg session ID of the call party.

aOCInfo : in TpAoCInfo

Specifies two sets of Advice of Charge parameter.

tariffSwitch : in TpDuration

Specifies the tariff switch interval that signifies when the second set of AoC parameters becomes valid.

Raises

**TpCommonExceptions, P_INVALID_SESSION_ID, P_INVALID_CURRENCY,
P_INVALID_AMOUNT**

*Method***superviseReq()**

The application calls this method to supervise a call leg. The application can set a granted connection time for this call. If an application calls this function before it calls a routeReq() or a user interaction function the time measurement will start as soon as the call is answered by the B-party or the user interaction system.

Parameters

callLegSessionID : in TpSessionID

Specifies the call leg session ID of the call party.

time : in TpDuration

Specifies the granted time in milliseconds for the connection.

treatment : in TpCallLegSuperviseTreatment

Specifies how the network should react after the granted connection time expired.

Raises

TpCommonExceptions, P_INVALID_SESSION_ID

Method

deassign()

This method requests that the relationship between the application and the call leg and associated objects be de-assigned. It leaves the call leg in progress, however, it purges the specified call leg object so that the application has no further control of call leg processing. If a call leg is de-assigned that has event reports or call leg information reports requested, then these reports will be disabled and any related information discarded.

The application should not release or deassign the call leg when received a callLegEnded() or callEnded(). This operation continues processing of the call leg.

Parameters

callLegSessionID : in TpSessionID

Specifies the call leg session ID of the call leg.

Raises

TpCommonExceptions, P_INVALID_SESSION_ID

7.3.6 Interface Class IpAppCallLeg

Inherits from: IpInterface

The application call leg interface is implemented by the client application developer and is used to handle responses and errors associated with requests on the call leg in order to be able to receive leg specific information and events.

<<Interface>> IpAppCallLeg
eventReportRes (callLegSessionID : in TpSessionID, eventInfo : in TpCallEventInfo) : void eventReportErr (callLegSessionID : in TpSessionID, errorIndication : in TpCallError) : void attachMediaRes (callLegSessionID : in TpSessionID) : void attachMediaErr (callLegSessionID : in TpSessionID, errorIndication : in TpCallError) : void detachMediaRes (callLegSessionID : in TpSessionID) : void detachMediaErr (callLegSessionID : in TpSessionID, errorIndication : in TpCallError) : void getInfoRes (callLegSessionID : in TpSessionID, callLegInfoReport : in TpCallLegInfoReport) : void getInfoErr (callLegSessionID : in TpSessionID, errorIndication : in TpCallError) : void routeErr (callLegSessionID : in TpSessionID, errorIndication : in TpCallError) : void superviseRes (callLegSessionID : in TpSessionID, report : in TpCallSuperviseReport, usedTime : in TpDuration) : void superviseErr (callLegSessionID : in TpSessionID, errorIndication : in TpCallError) : void callLegEnded (callLegSessionID : in TpSessionID, cause : in TpReleaseCause) : void

Method

eventReportRes ()

This asynchronous method reports that an event has occurred that was requested to be reported (for example, a mid-call event, the party has requested to disconnect, etc.).

Depending on the type of event received, outstanding requests for events are discarded. The exact details of these so-called disarming rules are captured in the data definition of the event type.

If this method is invoked for a report with a monitor mode of P_CALL_MONITOR_MODE_INTERRUPT, then the application has control of the call leg. If the application does nothing with the call leg within a specified time period (the duration which forms a part of the service level agreement), then the connection in the network shall be released and callLegEnded() shall be invoked, giving a release cause of P_TIMER_EXPIRY.

Parameters

callLegSessionID : in TpSessionID

Specifies the call leg session ID of the call leg on which the event was detected.

eventInfo : in TpCallEventInfo

Specifies data associated with this event.

Method

eventReportErr ()

This asynchronous method indicates that the request to manage call leg event reports was unsuccessful, and the reason (for example, the parameters were incorrect, the request was refused, etc.).

*Parameters***callLegSessionID : in TpSessionID**

Specifies the call leg session ID of the call leg.

errorIndication : in TpCallError

Specifies the error which led to the original request failing.

*Method***attachMediaRes()**

This asynchronous method reports the attachment of a call leg to a call has succeeded. The media channels or bearer connections to this leg is now available.

*Parameters***callLegSessionID : in TpSessionID**

Specifies the call leg session ID of the call leg to which the information relates.

*Method***attachMediaErr()**

This asynchronous method reports that the original request was erroneous, or resulted in an error condition.

*Parameters***callLegSessionID : in TpSessionID**

Specifies the call leg session ID of the call leg.

errorIndication : in TpCallError

Specifies the error which led to the original request failing.

*Method***detachMediaRes()**

This asynchronous method reports the detachment of a call leg from a call has succeeded. The media channels or bearer connections to this leg is no longer available.

*Parameters***callLegSessionID : in TpSessionID**

Specifies the call leg session ID of the call leg to which the information relates.

*Method***detachMediaErr()**

This asynchronous method reports that the original request was erroneous, or resulted in an error condition.

*Parameters***callLegSessionID : in TpSessionID**

Specifies the call leg session ID of the call leg.

errorIndication : in TpCallError

Specifies the error which led to the original request failing.

*Method***getInfoRes()**

This asynchronous method reports all the necessary information requested by the application, for example to calculate charging.

*Parameters***callLegSessionID : in TpSessionID**

Specifies the call leg session ID of the call leg to which the information relates.

callLegInfoReport : in TpCallLegInfoReport

Specifies the call leg information requested.

*Method***getInfoErr()**

This asynchronous method reports that the original request was erroneous, or resulted in an error condition.

*Parameters***callLegSessionID : in TpSessionID**

Specifies the call leg session ID of the call leg.

errorIndication : in TpCallError

Specifies the error which led to the original request failing.

*Method***routeErr()**

This asynchronous method indicates that the request to route the call leg to the destination party was unsuccessful - the call leg could not be routed to the destination party (for example, the network was unable to route the call leg, the parameters were incorrect, the request was refused, etc.).

*Parameters***callLegSessionID : in TpSessionID**

Specifies the call leg session ID of the call leg.

errorIndication : in TpCallError

Specifies the error which led to the original request failing.

*Method***superviseRes()**

This asynchronous method reports a call leg supervision event to the application when it has indicated its interest in these kind of events.

It is also called when the connection to a party is terminated before the supervision event occurs.

Parameters

callLegSessionID : in TpSessionID

Specifies the call leg session ID of the call leg

report : in TpCallSuperviseReport

Specifies the situation which triggered the sending of the call leg supervision response.

usedTime : in TpDuration

Specifies the used time for the call leg supervision (in milliseconds).

*Method***superviseErr()***Parameters*

callLegSessionID : in TpSessionID

Specifies the call leg session ID of the call leg.

errorIndication : in TpCallError

Specifies the error which led to the original request failing.

*Method***callLegEnded()**

This method indicates to the application that the leg has terminated in the network. The application has received all requested results (e.g., getInfoRes) related to the call leg. The call leg will be destroyed after returning from this method.

Parameters

callLegSessionID : in TpSessionID

Specifies the call leg session ID of the call leg.

cause : in TpReleaseCause

Specifies the reason the connection is terminated.

7.4 MultiParty Call Control Service State Transition Diagrams

7.4.1 State Transition Diagrams for IpMultiPartyCallControlManager

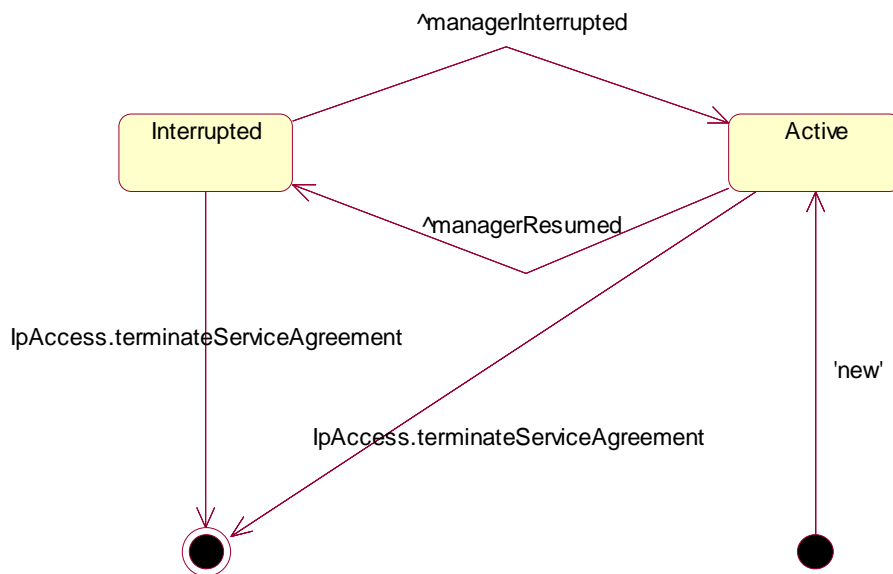

Figure : Application view and the Multi-Party Call Control Manager

7.4.1.1 Active State

In this state a relation between the Application and the Service has been established. The state allows the application to indicate that it is interested in call related events. In case such an event occurs, the Manager will create a Call object with the appropriate number of Call Leg objects and inform the application. The application can also indicate it is no longer interested in certain call related events by calling destroyNotification().

7.4.1.2 Interrupted State

When the Manager is in the Interrupted state it is temporarily unavailable for use. Events requested cannot be forwarded to the application and methods in the API cannot successfully be executed. A number of reasons can cause this: for instance the application receives more notifications from the network than defined in the Service Agreement. Another example is that the Service has detected it receives no notifications from the network due to e.g. a link failure.

7.4.1.3 Overview of allowed methods

Call Control Manager State	Methods applicable
Active	createCall, createNotification, destroyNotification, changeNotification, getNotification, setCallLoadControl
Interrupted	getNotification

7.4.2 State Transition Diagrams for IpMultiPartyCall

The state transition diagram shows the application view on the MultiParty Call object.

When an IpMultiPartyCall is created using createCall, or when an IpMultiPartyCall is given to the application for a notification with a monitor mode of P_CALL_MONITOR_MODE_INTERRUPT, an activity timer is started. The activity timer is stopped when the application invokes a method on the IpMultiPartyCall. The action upon expiry of this activity timer is to invoke callEnded() on the IpAppMultiPartyCall with a release cause of P_TIMER_EXPIRY. In the case when no IpAppMultiPartyCall is available on which to invoke callEnded(), callAborted() shall be invoked on the IpAppMultiPartyCallControlManager as this is an abnormal termination.

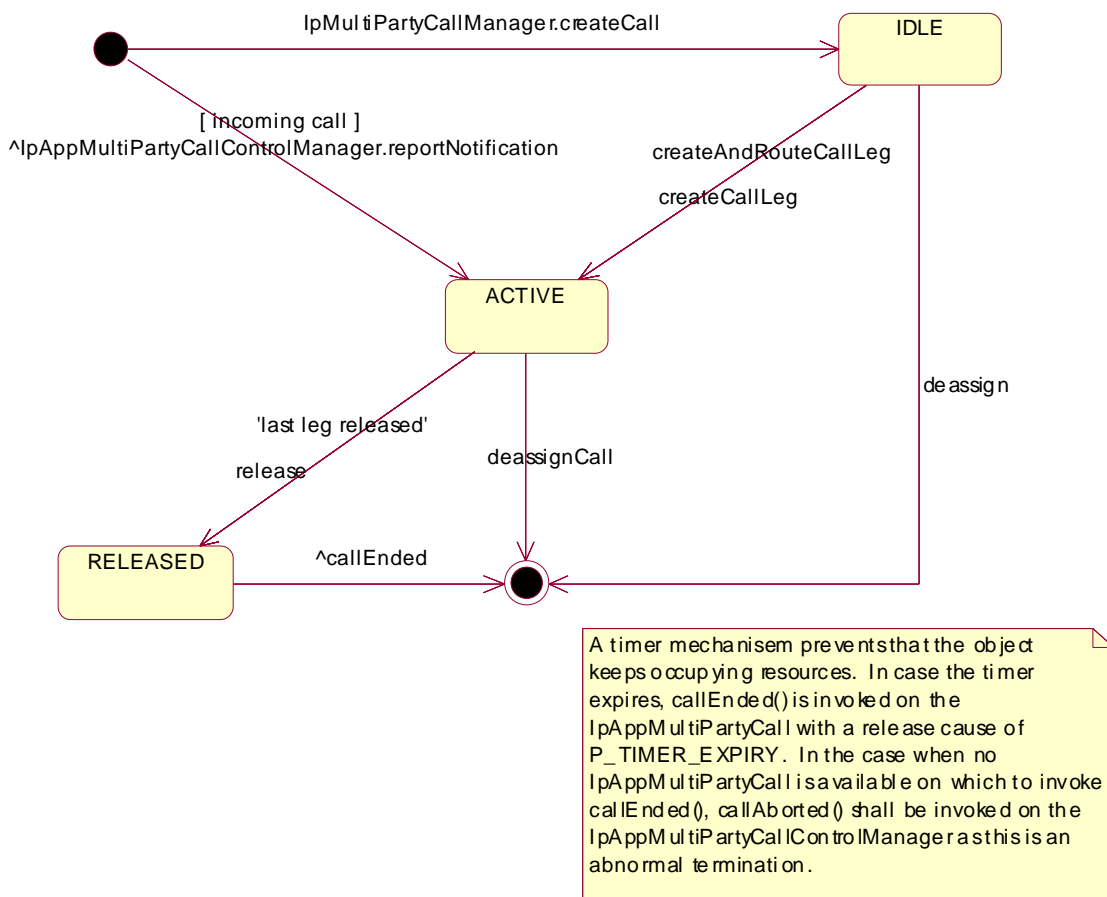

Figure : Application view on the MultiParty Call object

7.4.2.1 IDLE State

In this state the Call object has no Call Leg object associated to it.

The application can request for charging related information reports, call supervision, set the charge plan and set Advice Of Charge indicators. When the first Call Leg object is requested to be created a state transition is made to the Active state.

7.4.2.2 ACTIVE State

In this state the Call object has one or more Call Leg objects associated to it. The application is allowed to create additional Call Leg objects.

Furthermore, the application can request for call supervision. The Application can request charging related information reports, set the charge plan and set Advice Of Charge indicators in this state prior to call establishment.

7.4.2.3 RELEASED State

In this state the last Call leg object has released or the call itself was released. While the call is in this state, the requested call information will be collected and returned through getInfoRes() and / or superviseRes(). As soon as all information is returned, the application will be informed that the call has ended and Call object transition to the end state.

7.4.2.4 Overview of allowed methods

Methods applicable	Call Control Call State	Call Control Manager State	
getCallLegs,	Idle, Active, Released	-	
createCallLeg, createAndRouteCallLegReq, setAdviceOfCharge, superviseReq,	Idle, Active	Active	
release	Active	Active	
deassignCall	Idle, Active	-	
setChargePlan, getInfoReq	Idle, Active	Active	

7.4.3 State Transition Diagrams for IpCallLeg

The IpCallLeg State Transition Diagram is divided in two State Transition Diagrams, one for the originating call leg and one for the terminating call leg.

Call Leg State Model General Objectives:

- 1) Events in backwards direction (upstream), coming from terminating leg, are not visible in originating leg model.
- 2) Events in forwards direction (downstream), coming from originating leg, are not visible in terminating leg model.
- 3) States are as seen from the application: if there is no change in the method an application is permitted to apply on the IpCallLeg object, then there is no state change. Therefore receipt of e.g. answer or alerting events on terminating leg do not change state. NOTE 2
- 4) The application is to send a request to continue processing (using an appropriate method like continueProcessing) for each leg and event reported in monitor mode 'interrupt'.
- 5) In case on a leg more than one network event (for example mid-call event 'service_code') is to be reported to the application at quasi the same time, then the events are to be reported one by one to the application in the order received from the network. When for a leg an event is reported in interrupt mode, a next pending event is not to be reported to the application until a request to resume call processing for the current reported event has been received on the leg.

NOTE1: Call processing is suspended if for a leg a network event is met, which was requested to be monitored in the P_CALL_MONITOR_MODE_INTERRUPT.

NOTE2: Even though there in the Originating Call Leg STD is no change in the methods the application is permitted to apply to the IpCallLeg object for the states Analysing and Active, separate states are maintained. The states may therefore from an application viewpoint appear as just one state that may be have substates like Analysing and Active. The digit collection task in state Analysing state may be viewed as a specialised task that may not at all be applicable in some networks and therefore here described as being a state on its own.

7.4.3.1 Originating Call Leg

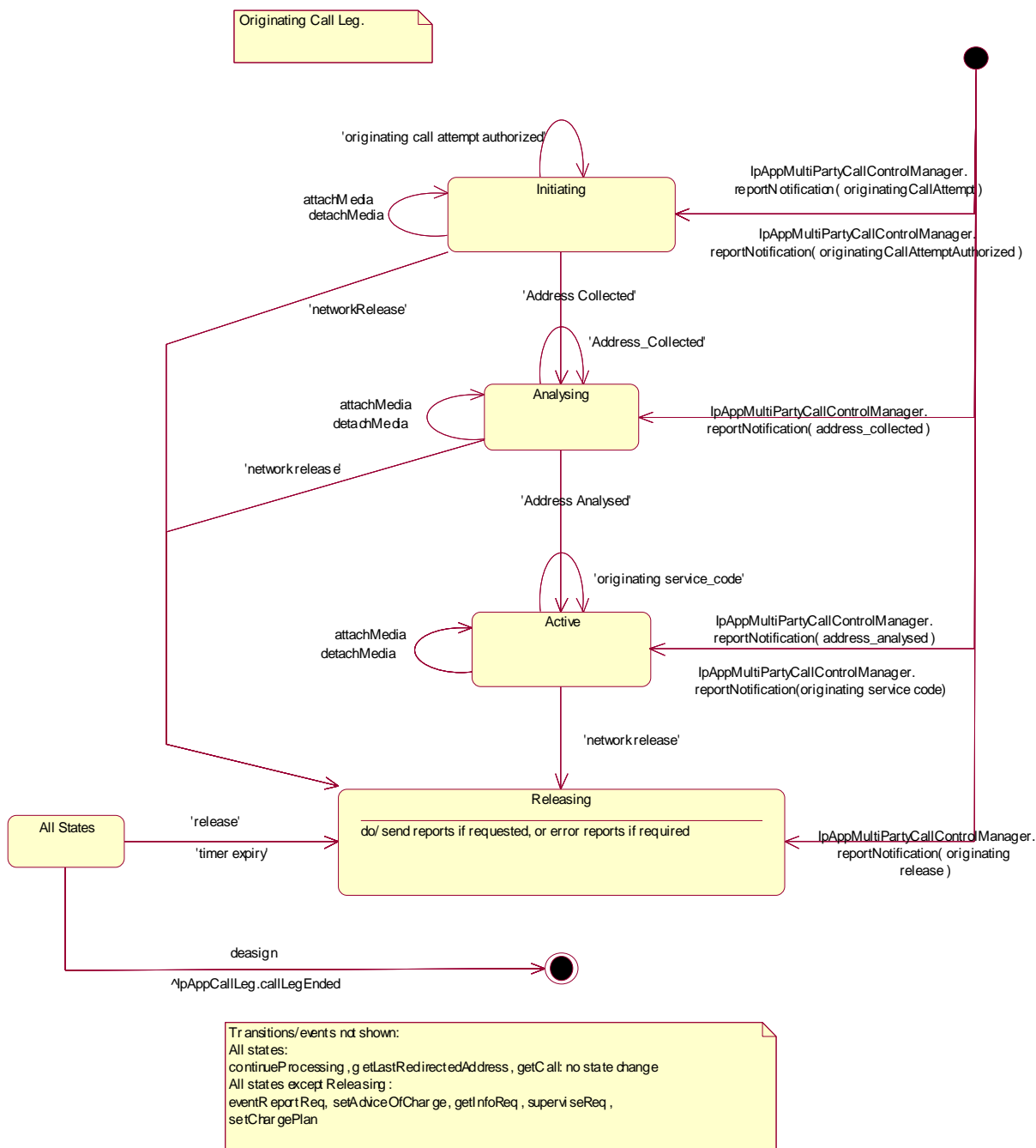

Figure : Originating Leg**7.4.3.1.1 Initiating State****Entry events:**

- Sending of a reportNotification() method by the IpMultiPartyCallControlManager for an “Originating_Call_Attempt” initial notification criterion.
- Sending of a reportNotification() method by the IpMultiPartyCallControlManager for an “Originating_Call_Attempt_Authorised” initial notification criterion.

Functions:

In this state the network checks the authority/ability of the party to place the connection to the remote (destination) party with the given properties, e.g. based on the originating party’s identity and service profile.

The setup of the connection for the party has been initiated and the application activity timer is being provided.

The figure below shows the order in which network events may be detected in the Initiating state and depending on the monitor mode be reported to the application.

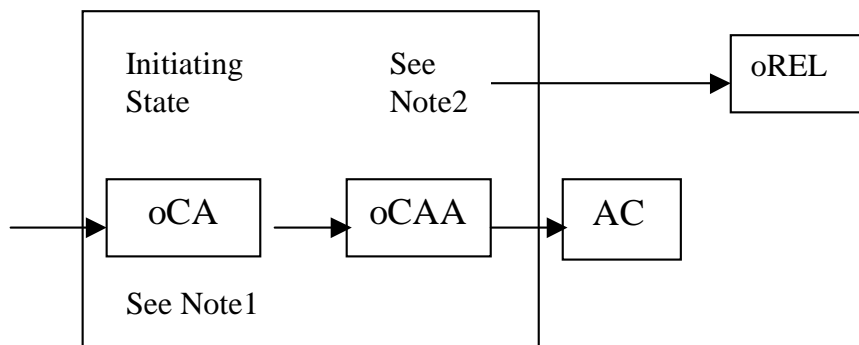

Note 1: Event oCA only applicable as an initial notification .

Note 2: The release event (oREL) can occur in any state resulting in a transition to Releasing state.

Abbreviations used for the events:

oCA: originating Call Attempt; oCAA originating Call Attempt Authorized; AC: Address Collected, oREL originating RELEase.

Figure : Application view on event reporting order in Initiating State

In this state the following functions are applicable:

- The detection of a “Originating_Call_Attempt” initial notification criterion.
- The detection of an “Originating_Call_Attempt_Authorised” initial notification criterion as a result that the call attempt authorisation is successful.
- The report of the “Originating_Call_Attempt_Authorised” event indication whereby the following functions are performed:
 - i) When the P_CALL_MONITOR_MODE_INTERRUPT is requested for the call leg event P_CALL_EVENT_CALL_ATTEMPT_AUTHORISED then the event is reported and call leg processing is suspended.

- ii) When the P_CALL_MONITOR_MODE_NOTIFY is requested for the call leg event P_CALL_EVENT_CALL_ATTEMPT_AUTHORISED then the event is notified and call leg processing continues.
- iii) When the P_CALL_MONITOR_MODE_DO_NOT_MONITOR is requested for the call leg event P_CALL_EVENT_CALL_ATTEMPT_AUTHORISED then no monitoring is performed.
- The receipt of destination address information, i.e. initial information package/dialling string as received from calling party.
- Resumption of suspended call leg processing occurs on receipt of a continueProcessing() method.

Exit events:

- Availability of destination address information, i.e. the initial information package/dialling string received from the calling party.
- Application activity timer expiry indicating that no requests from the application have been received during a certain period.
- Receipt of a deassign() method.
- Receipt of a release() method.
- Detection of a “originating release” indication as a result of a premature disconnect from the calling party.

7.4.3.1.2 Analysing State

Entry events:

- Availability of an “Address_Collected” event indication as a result of the receipt of the (complete) initial information package/dialling string from the calling party.
- Sending of a reportNotification() method by the IpMultiPartyCallControlManager for an “Address_Collected” initial notification criterion.

Functions:

In this state the destination address provided by the calling party is collected and analysed.

The received information (dialled address string from the calling party) is being collected and examined in accordance to the dialling plan in order to determine end of address information (digit) collection. Additional address digits can be collected. Upon completion of address collection the address is analysed.

The address analysis is being made according to the dialling plan in force to determine the routing address of the call leg connection and the connection type (e.g. local, transit, gateway).

The request (with eventReportReq method) to collect a variable number of more address digits and report them to the application (within eventReportRes method) is handled within this state. The collection of more digits as requested and the reporting of received digits to the application (when the digit collect criteria is met) is done in this state. This action is recursive, e.g. the application could ask for 3 digits to be collected and when report request can be done repeatedly, e.g. the application may for example request first for 3 digits to be collected and when reported request further digits.

The figure below shows the order in which network events may be detected in the Analysing state and depending on the monitor mode be reported to the application.

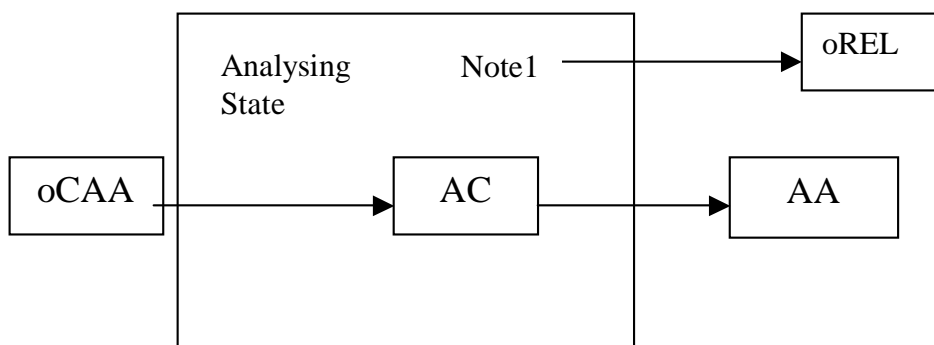

Note 1: The release event (oREL) can occur in any state resulting in a transition to Releasing state.
 Abbreviations used for the events:
 oCAA: originating Call Attempt Authorized; AC: Address Collected; AA: Address Analysed; oREL: originating RELEASE.

Figure : Application view on event reporting order in Analysing State

In this state the following functions are applicable:

- The detection of a “Address_Collected” initial notification criterion.
- On receipt of the “Address_Collected” indication the following functions are performed:
 - i) When the P_CALL_MONITOR_MODE_INTERRUPT is requested for the call leg event P_CALL_EVENT_ADDRESS_COLLECTED then the event is reported and call leg processing is suspended.
 - ii) When the P_CALL_MONITOR_MODE_NOTIFY is requested for the call leg event P_CALL_EVENT_ADDRESS_COLLECTED then the event is notified and call leg processing continues.
 - iii) When the P_CALL_MONITOR_MODE_DO_NOT_MONITOR is requested for the call leg event P_CALL_EVENT_ADDRESS_COLLECTED then no monitoring is performed.
- Receipt of a eventReportReq() method defining the criteria for the events the call leg object is to observe.
- Resumption of suspended call leg processing occurs on receipt of a continueProcessing() or a routeReq() method.

Exit events:

- Detection of an “Address_Analysed” indication as a result of the availability of the routing address and nature of address.
- Receipt of a deassign() method.
- Receipt of a release() method.
- Detection of a “originating release” indication as a result of a premature disconnect from the calling party.

7.4.3.1.3 Active State

Entry events:

- Receipt of an “Address_Analysed” indication as a result of the availability of the routing address and nature of address.
- Sending of a reportNotification() method by the IpMultiPartyCallControlManager for an “Address_Analysed” initial indication criterion.

Functions:

In this state the call leg connection to the calling party exists and originating mid call events can be received.

The figure below shows the order in which network events may be detected in the Active state and depending on the monitor mode be reported to the application.

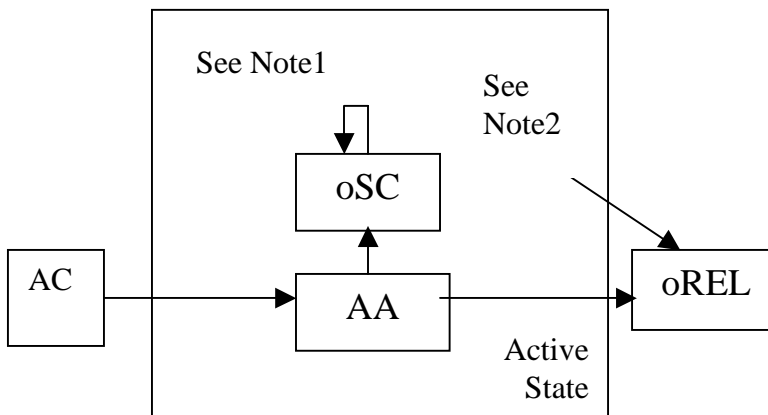

Note 1: Only the detected service code or the range to which the service code belongs is disarmed as the service code is reported to the application

Note 2: The release event (oREL) can occur in any state resulting in a transition to Releasing state.

Abbreviations used for the events:

AC: Address Collected; AA: Address Analysed; oSC: originating Service Code; oREL: originating RElease.

Figure : Application view on event reporting order Active State

In this state the following functions are applicable:

- The detection of a Address_Analysed initial indication criterion.
- On receipt of the “Address_Analysed” indication the following functions are performed:
 - i) When the P_CALL_MONITOR_MODE_INTERRUPT is requested for the call leg event P_CALL_EVENT_ADDRESS_ANALYSED then the event is reported and call leg processing is suspended.
 - ii) When the P_CALL_MONITOR_MODE_NOTIFY is requested for the call leg event P_CALL_EVENT_ADDRESS_ANALYSED then the event is notified and call leg processing continues.
 - iii) When the P_CALL_MONITOR_MODE_DO_NOT_MONITOR is requested for the call leg event P_CALL_EVENT_ADDRESS_ANALYSED then no monitoring is performed.
- Resumption of suspended call leg processing occurs on receipt of a continueProcessing() method.
- In this state the routing information is interpreted, the authority of the calling party to establish this connection is verified and the call leg connection is set up to the remote party.
- In this state a connection to the call party is established.
- Detection of a “terminating release” indication (not visible to the application) from remote party caused by a network release event propagated from a terminating party, possibly resulting in an “originating release” indication and causing the originating call leg STD to transit to Releasing state:
- Detection of a disconnect from the calling party.
- Receipt of a deassign() method.
- Receipt of a release() method.
- On receipt of the “originating_service code” indication the following functions are performed:

- i) When the P_CALL_MONITOR_MODE_INTERRUPT is requested for the call leg event P_CALL_EVENT_ORIGINATING_SERVICE_CODE then the event is reported and call leg processing is suspended.
 - ii) When the P_CALL_MONITOR_MODE_NOTIFY is requested for the call leg event P_CALL_EVENT_ORIGINATING_SERVICE_CODE then the event is notified and call leg processing continues..
 - iii) When the P_CALL_MONITOR_MODE_DO_NOT_MONITOR is requested for the call leg event P_CALL_EVENT_ORIGINATING_SERVICE_CODE then no monitoring is performed.
- Resumption of suspended call leg processing occurs on receipt of a continueProcessing() method.

Exit events:

- Detection of an “originating release” indication as a result of a disconnect from the calling party and a “terminating release” indication as a result of a disconnect from called party.
- Receipt of a deassign() method.
- Receipt of a release() method from the application.

7.4.3.1.4 Releasing State**Entry events:**

- Detection of an “Originating_Release” indication as a result of the network release initiated by calling party or called party.
- Reception of the release() method from the application.
- A transition due to fault detection to this state is made when the Call leg object is in a state and no requests from the application have been received during a certain time period (timer expiry).

Functions:

In this state the connection to the call party is released as requested by the network or by the application and the reports are processed and sent to the application if requested.

When the Releasing state is entered the order of actions to be performed is as follows:

- i) the network release event handling is performed.
- ii) the possible call leg information requested with getInfoReq() and/ or superviseReq() is collected and send to the application.
- iii) the callLegEnded() method is sent to the application to inform that the call leg object is destroyed.

In this state the following functions are applicable:

- The detection of a “originating_release” initial indication criterion..
- On receipt of the “originating_release” indication the following functions are performed:
 - The network release event handling is performed as follows:
 - i) When the P_CALL_MONITOR_MODE_INTERRUPT is requested for the call leg event P_CALL_EVENT_RELEASE then the event is reported and call leg processing is suspended.
 - ii) When the P_CALL_MONITOR_MODE_NOTIFY is requested for the call leg event P_CALL_EVENT_RELEASE then the event is notified and call leg processing continues.
 - iii) When the P_CALL_MONITOR_MODE_DO_NOT_MONITOR is requested for the call leg event P_CALL_EVENT_RELEASE then no monitoring is performed.

- Resumption of suspended call leg processing occurs on receipt of a continueProcessing() method.
- The possible call leg information requested with the getInfoReq() and/or superviseReq() is collected and sent to the application with respectively the getInfoRes() and/or superviseRes() methods.
- The callLegEnded() method is sent to the application after all information has been sent. In case that the application has not requested additional call leg related information the call leg object is destroyed immediately and additionally the application will also be informed that the connection has ended
- In case of abnormal termination due to a fault and the application requested for call leg related information previously, the application will be informed that this information is not available and additionally the application is informed that the call leg object is destroyed (callLegEnded).

Note: the call in the network may continue or be released, depending e.g. on the call state.

- In case the release() method is received in Releasing state it will be discarded. The request from the application to release the leg is ignored in this case because release of the leg is already ongoing.

Exit events:

- In case that the application has not requested additional call leg related information the call leg object is destroyed immediately and additionally the application is informed that the call leg connection has ended, by sending the callLegEnded() method.
- After the sending of the last call leg information to the application the Call Leg object is destroyed and additionally the application is informed that the call leg connection has ended, by sending the callLegEnded() method.

7.4.3.1.5 Overview of allowed methods, Originating Call Leg STD

State	Methods allowed
Initiating	attachMediaReq (as a request), detachMediaReq, (as a request) getCall , continueProcessing, release (call leg), deassign eventReportReq, getInfoReq, setChargePlan, setAdviceOfCharge, superviseReq
Analysing	attachMediaReq (as a request), detachMediaReq, (as a request) getCall , continueProcessing, release (call leg), deassign eventReportReq, getInfoReq, setChargePlan, setAdviceOfCharge, superviseReq
Active	attachMediaReq, detachMediaReq, getCall, continueProcessing, release deassign eventReportReq, getInfoReq, setChargePlan, setAdviceOfCharge, superviseReq
Releasing	getCall , continueProcessing, release deassign

7.4.3.2 Terminating Call Leg

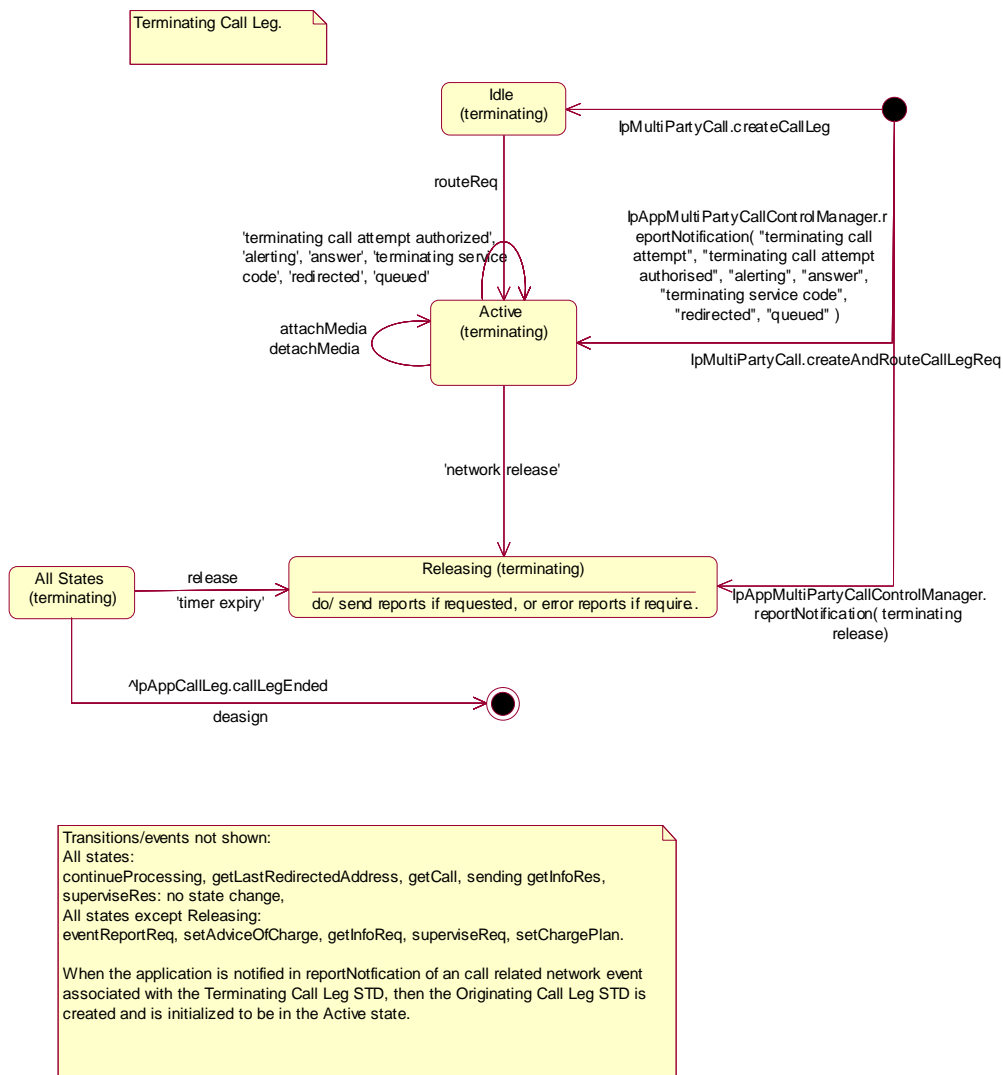

Figure : Terminating Leg

7.4.3.2.1 Idle (terminating) State

Entry events:

- Receipt of a createCallLeg() method to start an application initiated call leg connection.

Functions:

In this state the call leg object is created and the interface connection is idled.

The application activity timer is being provided.

In this state the following functions are applicable:

- Invoking routeReq will result in a request to actually route the call leg object.
- Resumption of call leg processing occurs on receipt of a routeReq() method.

Exit events:

- Receipt of a routeReq() method from the application.
- Application activity timer expiry indicating that no requests from the application have been received during a certain period to continue processing.
- Receipt of a deassign() method.
- Receipt of a release() method.
- Detection of a network release event being an “originating release” indication as a result of a premature disconnect from the calling party.

7.4.3.2.2 Active (terminating) State

Entry events:

- Receipt of an routeReq will result in actually routing the call leg object.
- Receipt of a createAndRouteCallLegReq() method to start an application initiated call leg connection.
- Sending of a reportNotification() method by the IpMultiPartyCallControlManager for the following trigger criteria: “Terminating_Call_Attempt”, “Terminating_Call_Attempt_Authorised”, “Alerting”, “Answer”, “Terminating service code”, “Redirected” and “Queued”.

Functions:

In this state the routing information is interpreted, the authority of the called party to establish this connection is verified for the call leg connection. In this state a connection to the call party is established whereby events from the network may indicate to the application when the party is alerted (acknowledge connection setup) and when the party answer (confirmation of connection setup).

Furthermore, in this state terminating service code events can be received.

The figure below shows the order in which network events may be detected in the Active state and depending on the monitor mode be reported to the application.

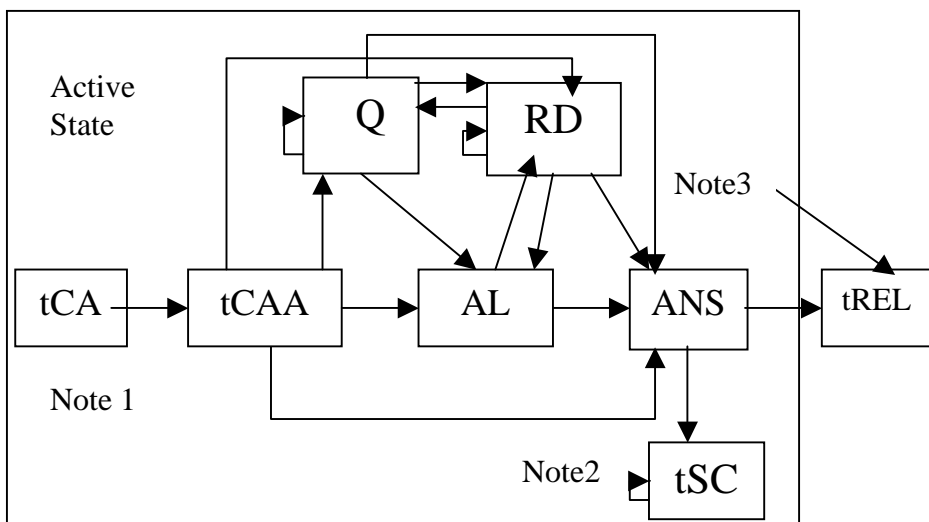

Note 1: Event tCA applicable as initial notification

Note 2: Only the detected service code or the range to which the service code belongs is disarmed as the service code is reported to the application

Note 3: The release event (tREL) can occur in any state resulting in a transition to Releasing state.

Abbreviations used for the events:

tCA: Terminating Call Attempt; tCAA: terminating Call Attempt Authorized; AL: Alerting; ANS: Answer; tREL: terminating RElease; Q: Queued; RD: ReDirected; tSC: terminating Service Code.

Figure : Application view on event reporting order in Active State

In this state the following functions are applicable:

- The detection and report of the “Terminating_Call_Attempt_Authorised” event indication whereby the following functions are performed:
 - i) When the P_CALL_MONITOR_MODE_INTERRUPT is requested for the call leg event P_CALL_EVENT_TERMINATING_CALL_ATTEMPT_AUTHORISED then the event is reported and call leg processing is suspended.
 - ii) When the P_CALL_MONITOR_MODE_NOTIFY is requested for the call leg event P_CALL_EVENT_TERMINATING_CALL_ATTEMPT_AUTHORISED then the event is notified and call leg processing continues.
 - iii) When the P_CALL_MONITOR_MODE_DO_NOT_MONITOR is requested for the call leg event P_CALL_EVENT_CALL_TERMINATING_ATTEMPT_AUTHORISED then no monitoring is performed.
- Detection of an “Queued” indication as a result of the terminating call being queued.
- On receipt of the “Queued” indication the following functions are performed:
 - i) When the P_CALL_MONITOR_MODE_INTERRUPT is requested for the call leg event P_CALL_EVENT_QUEUED then the event is reported and call leg processing is suspended.
 - ii) When the P_CALL_MONITOR_MODE_NOTIFY is requested for the call leg event P_CALL_EVENT_QUEUED then the event is notified and call leg processing continues.
 - iii) When the P_CALL_MONITOR_MODE_DO_NOT_MONITOR is requested for the call leg event P_CALL_EVENT_QUEUED then no monitoring is performed.
- On receipt of the “Alerting” indication the following functions are performed:
 - i) When the P_CALL_MONITOR_MODE_INTERRUPT is requested for the call leg event P_CALL_EVENT_ALERTING then the event is reported and call leg processing is suspended.
 - ii) When the P_CALL_MONITOR_MODE_NOTIFY is requested for the call leg event P_CALL_EVENT_ALERTING then the event is notified and call leg processing continues.
 - iii) When the P_CALL_MONITOR_MODE_DO_NOT_MONITOR is requested for the call leg event P_CALL_EVENT_ALERTING then no monitoring is performed.
- Detection of an “Answer” indication as a result of the remote party being connected (answered).
- On receipt of the “Answer” indication the following functions are performed:
 - i) When the P_CALL_MONITOR_MODE_INTERRUPT is requested for the call leg event P_CALL_EVENT_ANSWER then the event is reported and call leg processing is suspended.
 - ii) When the P_CALL_MONITOR_MODE_NOTIFY is requested for the call leg event P_CALL_EVENT_ANSWER then the event is notified and call leg processing continues.
 - iii) When the P_CALL_MONITOR_MODE_DO_NOT_MONITOR is requested for the call leg event P_CALL_EVENT_ANSWER then no monitoring is performed.
- The detection of a “service_code” trigger criterion suspends call leg processing.

- On receipt of the “service code” indication the following functions are performed:
 - i) When the P_CALL_MONITOR_MODE_INTERRUPT is requested for the call leg event P_CALL_EVENT_TERMINATING_SERVICE_CODE then the event is reported and call leg processing is suspended.
 - ii) When the P_CALL_MONITOR_MODE_NOTIFY is requested for the call leg event P_CALL_EVENT_TERMINATING_SERVICE_CODE then this is not a valid event (that event is not notified) and call leg processing continues.
 - iii) When the P_CALL_MONITOR_MODE_DO_NOT_MONITOR is requested for the call leg event P_CALL_EVENT_TERMINATING_SERVICE_CODE then no monitoring is performed.
- On receipt of the “redirected” indication the following functions are performed:
 - i) When the P_CALL_MONITOR_MODE_INTERRUPT is requested for the call leg event P_CALL_EVENT_REDIRECTED then the event is reported and call leg processing is suspended.
 - ii) When the P_CALL_MONITOR_MODE_NOTIFY is requested for the call leg event P_CALL_EVENT_REDIRECTED then the event is notified and call leg processing continues.
 - iii) When the P_CALL_MONITOR_MODE_DO_NOT_MONITOR is requested for the call leg event P_CALL_EVENT_REDIRECTED then no monitoring is performed.
- Resumption of call leg processing occurs on receipt of a continueProcessing() method.

Exit events:

- Detection of a network release event being an “terminating release” indication as a result of the following events:
 - i) Unable to select a route or indication from the remote party of the call leg connection cannot be presented (this is the network determined busy condition)
 - ii) Occurrence of an authorisation failure when the authority to place the call leg connection was denied (e.g. business group restriction mismatch).
 - iii) Detection of a route busy condition received from the remote call leg connection portion.
 - iv) Detection of a no-answer condition received from the remote call leg connection portion.
 - v) Detection that the remote party was not reachable.
- Detection of a network release event being an “originating release” indication as a result of the following events:
 - vi) Detection of a premature disconnect from the calling party.
- Receipt of a deassign() method.
- Receipt of a release() method from the application.
- Detection of a network release event being an “originating release” indication as a result of a disconnect from the calling party or a “terminating release” indication as a result of a disconnect from the called party.

7.4.3.2.3 Releasing (terminating) State**Entry events:**

- Detection of a network release event being an “originating release” indication as a result of the network release initiated by calling party or a “terminating release” indication as a result of the network release initiated by called party..
- Sending of the release() method by the application.

- A transition due to fault detection to this state is made when the Call leg object awaits a request from the application and this is not received within a certain time period.
- Detection of a network event being a “terminating release” indication as a result of the following events:
 - i) Unable to select a route or indication from the remote party of the call leg connection cannot be presented (this is the network determined busy condition)
 - ii) Occurrence of an authorisation failure when the authority to place the call leg connection was denied (e.g. business group restriction mismatch).
 - iii) Detection of a route busy condition received from the remote call leg connection portion.
 - iv) Detection of a no-answer condition received from the remote call leg connection portion.
 - v) Detection that the remote party was not reachable.
- Detection of a network release event being an “originating release” indication as a result of the following events:
 - vi) Detection of a premature disconnect from the calling party.

Functions:

In this state the connection to the call party is released as requested by the network or by the application and the reports are processed and sent to the application if requested .

When the Releasing state is entered the order of actions to be performed is as follows:

- i) the release event handling is performed.
- ii) the possible call leg information requested with getInfoReq() and/ or superviseReq() is collected and send to the application.
- iii) the callLegEnded() method is sent to the application to inform that the call leg object is destroyed.

Where the entry to this state is caused by the application, for example because the application has requested the leg to be released or deassigned or a fault (e.g. timer expiry, no response from application) has been detected, then i) is not applicable. In the fault case for action ii) error report methods are sent to the application for any possible requested reports.

In this state the following functions are applicable:

- The detection of a “Terminating Release” trigger criterion.
- On receipt of the network release event being a “Terminating Release” indication the following functions are performed:
 - The network release event handling is performed as follows:
 - i) When the P_CALL_MONITOR_MODE_INTERRUPT is requested for the call leg event P_CALL_EVENT_TERMINATING_RELEASE then the event is reported and call leg processing is suspended.
 - ii) When the P_CALL_MONITOR_MODE_NOTIFY is requested for the call leg event P_CALL_EVENT_TERMINATING_RELEASE then the event is notified and call leg processing continues.
 - iii) When the P_CALL_MONITOR_MODE_DO_NOT_MONITOR is requested for the call leg event P_CALL_EVENT_TERMINATING_RELEASE then no monitoring is performed.
- Resumption of suspended call leg processing occurs on receipt of a continueProcessing() method.
- The possible call leg information requested with the getInfoReq() and/or superviseReq() is collected and sent to the application with respectively the getInfoRes() and/or superviseRes() methods.

- The callLegEnded() method is sent to the application after all information has been sent. In case that the application has not requested additional call leg related information the call leg object is destroyed immediately and additionally the application will also be informed that the connection has ended
- In case of abnormal termination due to a fault and the application requested for call leg related information previously, the application will be informed that this information is not available and additionally the application is informed that the call leg object is destroyed (callLegEnded).

Note: the call in the network may continue or be released, depending e.g. on the call state.

- In case the release() method is received in Releasing state it will be discarded. The request from the application to release the leg is ignored in this case because release of the leg is already ongoing.

Exit events:

- In case that the application has not requested additional call leg related information the call leg object is destroyed immediately and additionally the application is informed that the call leg connection has ended, by sending the callLegEnded() method.
- After the sending of the last call leg information to the application the Call Leg object is destroyed and additionally the application is informed that the call leg connection has ended, by sending the callLegEnded() method.

7.4.3.2.4 Overview of allowed methods and trigger events, Terminating Call Leg STD

State	Methods allowed
Idle	routeReq, getCall , getCurrentDestinationAddress, release, deassign eventReportReq, getInfoReq, setChargePlan, setAdviceOfCharge, superviseReq
Active	attachMediaReq detachMediaReq getCall , getCurrentDestinationAddress, continueProcessing, release, deassign eventReportReq, getInfoReq, setChargePlan, setAdviceOfCharge, superviseReq
Releasing	getCall , getCurrentDestinationAddress, continueProcessing, release, deassign

7.5 Multi-Party Call Control Service Properties

7.5.1 List of Service Properties

The following table lists properties relevant for the MPCC API. These properties are additional to the properties of the GCC, from which the MPCC is an extension.

Property	Type	Description
P_MAX_CALLEGS_PER_CALL	INTEGER_SET	Indicates how many parties can be in one call.
P_UI_CALLEG_BASED	BOOLEAN_SET	Value = TRUE : User interaction can be performed on leg level and a reference to a CallLeg object can be used in the IpUiManager.createUICall() operation. Value = FALSE : No user interaction on leg level is supported.
P_ROUTING_WITH_CALLEG_OPERATIONS	BOOLEAN_SET	Value = TRUE : the atomic operations for routing a CallLeg are supported {IpMultiPartyCall.createCallLeg(), IpCallLeg.eventReportReq(), IpCallLeg.routeReq(), IpCallLeg.attachMediaReq()} Value = FALSE : the convenience function has to be used for routing a CallLeg.
P_MEDIA_ATTACH_EXPLICIT	BOOLEAN_SET	Value = TRUE : the CallLeg shall be explicitly attached to a Call. Value = FALSE : the CallLeg is automatically attached to a Call, no IpCallLeg.attachMediaReq() is needed when a party answers.

7.5.2 Service Property values for the CAMEL Service Environment.

Implementations of the MultiParty Call Control API relying on the CSE of CAMEL phase 3 shall have the Service Properties outlined above set to the indicated values :

```
P_OPERATION_SET = {
  "IpMultiPartyCallControlManager.createNotification",
  "IpMultiPartyCallControlManager.destroyNotification",
  "IpMultiPartyCallControlManager.changeNotification",
  "IpMultiPartyCallControlManager.getNotification",
  "IpMultiPartyCallControlManager.setCallLoadControl",
  "IpMultiPartyCall.getCallLegs",
  "IpMultiPartyCall.createCallLeg",
  "IpMultiPartyCall.createAndRouteCallLegReq",
  "IpMultiPartyCall.release",
  "IpMultiPartyCall.deassignCall",
  "IpMultiPartyCall.getInfoReq",
  "IpMultiPartyCall.setChargePlan",
  "IpMultiPartyCall.setAdviceOfCharge",
  "IpMultiPartyCall.superviseReq",
  "IpCallLeg.routeReq",
  "IpCallLeg.eventReportReq",
  "IpCallLeg.release",
  "IpCallLeg.getInfoReq",
  "IpCallLeg.getCall",
  "IpCallLeg.continueProcessing"
}
```

```
P_TRIGGERING_EVENT_TYPES = {
  P_CALL_EVENT_ADDRESS_COLLECTED,
  P_CALL_EVENT_ADDRESS_ANALYSED,
  P_CALL_EVENT_ORIGINATING_RELEASE,
  P_CALL_EVENT_TERMINATING_CALL_ATTEMPT_AUTHORISED,
  P_CALL_EVENT_TERMINATING_RELEASE
}
```

Note: P_CALL_EVENT_ORIGINATING_RELEASE only for the routing failure case, TpReleaseCause = P_ROUTING_FAILURE

```
P_DYNAMIC_EVENT_TYPES = {
  P_CALL_EVENT_ANSWER,
  P_CALL_EVENT_ORIGINATING_RELEASE,
  P_CALL_EVENT_TERMINATING_RELEASE
}
```

```
P_ADDRESS_PLAN = {
```

```
P_ADDRESS_PLAN_E164
}
```

```
P_UI_CALL_BASED = {
TRUE
}
```

```
P_UI_AT_ALL_STAGES = {
FALSE
}
```

```
P_MEDIA_TYPE = {
P_AUDIO
}
```

```
P_MAX_CALLEGS_PER_CALL = {
0,
2
}
```

```
P_UI_CALLEG_BASED = {
FALSE
}
```

```
P_MEDIA_ATTACH_EXPLICIT = {
FALSE
}
```

7.6 Multi-Party Call Control Data Definitions

This clause provides the MPCC data definitions necessary to support the API specification.

The general format of a data definition specification is described below.

- Data Type

This shows the name of the data type.

- Description

This describes the data type.

- Tabular Specification

This specifies the data types and values of the data type.

- Example

If relevant, an example is shown to illustrate the data type.

All data types referenced but not defined in this clause are either in the common call control data definitions clause of the present document (clause 8) or in the common data definitions which may be found in 3GPP TS 29.198-2.

7.6.1 Event Notification Data Definitions

No specific event notification data defined.

7.6.2 Multi-Party Call Control Data Definitions

7.6.2.1 IpCallLeg

Defines the address of an IpCallLeg Interface.

7.6.2.2 IpCallLegRef

Defines a [Reference](#) to type IpCallLeg.

7.6.2.3 IpAppCallLeg

Defines the address of an IpAppCallLeg Interface.

7.6.2.4 IpAppCallLegRef

Defines a [Reference](#) to type IpAppCallLeg.

7.6.2.5 IpMultiPartyCall

Defines the address of an IpMultiPartyCall Interface.

7.6.2.6 IpMultiPartyCallRef

Defines a [Reference](#) to type IpMultiPartyCall.

7.6.2.7 IpAppMultiPartyCall

Defines the address of an IpAppMultiPartyCall Interface.

7.6.2.8 IpAppMultiPartyCallRef

Defines a [Reference](#) to type IpAppMultiPartyCall.

7.6.2.9 IpMultiPartyCallControlManager

Defines the address of an IpMultiPartyCallControlManager Interface.

7.6.2.10 IpMultiPartyCallControlManagerRef

Defines a [Reference](#) to type IpMultiPartyCallControlManager.

7.6.2.11 IpAppMultiPartyCallControlManager

Defines the address of an IpAppMultiPartyCallControlManager Interface.

7.6.2.12 IpAppMultiPartyCallControlManagerRef

Defines a [Reference](#) to type IpAppMultiPartyCallControlManager..

7.6.2.13 TpAppCallLegRefSet

Defines a [Numbered Set of Data Elements](#) of IpAppCallLegRef.

7.6.2.14 TpMultiPartyCallIdentifier

Defines the Sequence of Data Elements that unambiguously specify the Call object

Sequence Element Name	Sequence Element Type	Sequence Element Description
CallReference	IpMultiPartyCallRef	This element specifies the interface reference for the Multi-party call object.
CallSessionID	TpSessionID	This element specifies the call session ID.

7.6.2.15 TpAppMultiPartyCallBack

Defines the Tagged Choice of Data Elements that references the application callback interfaces

Tag Element Type	
	TpAppMultiPartyCallBackRefType

Tag Element Value	Choice Element Type	Choice Element Name
P_APP_CALLBACK_UNDEFINED	NULL	Undefined
P_APP_MULTIPARTY_CALL_CALLBACK	IpAppMultiPartyCallRef	AppMultiPartyCall
P_APP_CALL_LEG_CALLBACK	IpAppCallLegRef	AppCallLeg
P_APP_CALL_AND_CALL_LEG_CALLBACK	TpAppCallLegCallBack	AppMultiPartyCallAndCallLeg

7.6.2.16 TpAppMultiPartyCallBackRefType

Defines the type application call back interface.

Name	Value	Description
P_APP_CALLBACK_UNDEFINED	0	Application Call back interface undefined
P_APP_MULTIPARTY_CALL_CALLBACK	1	Application Multi-Party Call interface referenced
P_APP_CALL_LEG_CALLBACK	2	Application CallLeg interface referenced
P_APP_CALL_AND_CALL_LEG_CALLBACK	3	Application Multi-Party Call and CallLeg interface referenced

7.6.2.17 TpAppCallLegCallBack

Defines the Sequence of Data Elements that references a call and a call leg application interface.

Sequence Element Name	Sequence Element Type	
AppMultiPartyCall	IpAppMultiPartyCallRef	
AppCallLegSet	TpAppCallLegRefSet	Specifies the set of all call leg call back references. First in the set is the reference to the call back of the originating callLeg. In case there is a call back to a destination call leg this will be second in the set.

7.6.2.18 TpMultiPartyCallIdentifierSet

Defines a [Numbered Set of Data Elements](#) of TpMultiPartyCallIdentifier.

7.6.2.19 TpCallAppInfo

Defines the [Tagged Choice of Data Elements](#) that specify application-related call information.

Tag Element Type
TpCallAppInfoType

Tag Element Value	Choice Element Type	Choice Element Name
P_CALL_APP_ALERTING_MECHANISM	TpCallAlertingMechanism	CallAppAlertingMechanism
P_CALL_APP_NETWORK_ACCESS_TYPE	TpCallNetworkAccessType	CallAppNetworkAccessType
P_CALL_APP_TELE_SERVICE	TpCallTeleService	CallAppTeleService
P_CALL_APP_BEARER_SERVICE	TpCallBearerService	CallAppBearerService
P_CALL_APP_PARTY_CATEGORY	TpCallPartyCategory	CallAppPartyCategory
P_CALL_APP_PRESENTATION_ADDRESS	TpAddress	CallAppPresentationAddress
P_CALL_APP_GENERIC_INFO	TpString	CallAppGenericInfo
P_CALL_APP_ADDITIONAL_ADDRESS	TpAddress	CallAppAdditionalAddress
P_CALL_APP_ORIGINAL_DESTINATION_ADDRESS	TpAddress	CallAppOriginalDestinationAddress
P_CALL_APP_REDIRECTING_ADDRESS	TpAddress	CallAppRedirectingAddress

7.6.2.20 TpCallAppInfoType

Defines the type of call application-related specific information.

Name	Value	Description
P_CALL_APP_UNDEFINED	0	Undefined
P_CALL_APP_ALERTING_MECHANISM	1	The alerting mechanism or pattern to use
P_CALL_APP_NETWORK_ACCESS_TYPE	2	The network access type (e.g. ISDN)
P_CALL_APP_TELE_SERVICE	3	Indicates the tele-service (e.g. telephony)
P_CALL_APP_BEARER_SERVICE	4	Indicates the bearer service (e.g. 64 kbit/s unrestricted data).
P_CALL_APP_PARTY_CATEGORY	5	The category of the calling party
P_CALL_APP_PRESENTATION_ADDRESS	6	The address to be presented to other call parties
P_CALL_APP_GENERIC_INFO	7	Carries unspecified service-service information
P_CALL_APP_ADDITIONAL_ADDRESS	8	Indicates an additional address
P_CALL_APP_ORIGINAL_DESTINATION_ADDRESS	9	Contains the original address specified by the originating user when launching the call.
P_CALL_APP_REDIRECTING_ADDRESS	10	Contains the address of the user from which the call is diverting.

7.6.2.21 TpCallAppInfoSet

Defines a [Numbered Set of Data Elements](#) of TpCallAppInfo.

7.6.2.22 TpCallEventRequest

Defines the [Sequence of Data Elements](#) that specify the criteria relating to call report requests.

Sequence Element Name	Sequence Element Type
CallEventType	TpCallEventType
AdditionalCallEventCriteria	TpAdditionalCallEventCriteria
CallMonitorMode	TpCallMonitorMode

7.6.2.23 TpCallEventRequestSet

Defines a [Numbered Set of Data Elements](#) of TpCallEventRequest.

7.6.2.24 TpCallEventType

Defines a specific call event report type.

Name	Value	Description
P_CALL_EVENT_UNDEFINED	0	Undefined
P_CALL_EVENT_ORIGINATING_CALL_ATTEMPT	1	An originating call attempt takes place (e.g. Off-hook event).
P_CALL_EVENT_ORIGINATING_CALL_ATTEMPT_AUTHORISED	2	An originating call attempt is authorised
P_CALL_EVENT_ADDRESS_COLLECTED	3	The destination address has been collected.
P_CALL_EVENT_ADDRESS_ANALYSED	4	The destination address has been analysed.
P_CALL_EVENT_ORIGINATING_SERVICE_CODE	5	Mid-call originating service code received.
P_CALL_EVENT_ORIGINATING_RELEASE	6	A originating call/call leg is released
P_CALL_EVENT_TERMINATING_CALL_ATTEMPT	7	A terminating call attempt takes place
P_CALL_EVENT_TERMINATING_CALL_ATTEMPT_AUTHORISED	8	A terminating call is authorized
P_CALL_EVENT_ALERTING	9	Call is alerting at the call party.
P_CALL_EVENT_ANSWER	10	Call answered at address.
P_CALL_EVENT_TERMINATING_RELEASE	11	A terminating call leg has been released or the call could not be routed.
P_CALL_EVENT_REDIRECTED	12	Call redirected to new address: an indication from the network that the call has been redirected to a new address (no events disarmed as a result of this).
P_CALL_EVENT_TERMINATING_SERVICE_CODE	13	Mid call terminating service code received.
P_CALL_EVENT_QUEUED	14	The Call Event has been queued. (no events are disarmed as a result of this)

EVENT HANDLING RULES:

The following general event handling rules apply to dynamically armed events:

When requesting events for one leg;

- When the monitor mode is set to P_CALL_MONITOR_MODE_DO_NOT_MONITOR all events armed for that eventtype are disarmed. The additionalEventCriteria are not taken into account.
- When requesting two events for the same event type with different criteria and/or different monitor mode the last used criteria and monitor mode apply.
- Events that are not applicable to a leg are refused with exception P_INVALID_EVENT_TYPE. The same exception is used when criteria are used that are not applicable to the leg, E.g., requesting P_CALL_EVENT_TERMINATING_SERVICE_CODE on an originating leg is refused with exception P_INVALID_CRITERIA.
When P_CALL_EVENT_ORIGINATING_RELEASE is requested with P_BUSY in the criteria the request is refused with the same exception.

When receiving events:

- If an armed event is met, then it is disarmed, unless explicit stated that it will not to be disarmed.
- If an event is met that causes the release of the related leg, then all events related to that leg are disarmed .
- When an event is met on a call leg irrespective of the event monitor mode, then only events belonging to that call leg may become disarmed (see table below) .
- If a call is released, then all events related to that call are disarmed.

NOTE 1: Event disarmed means monitor mode is set to DO_NOT_MONITOR. and event armed means monitor mode is set to INTERRUPT or NOTIFY..

The table below defines the disarming rules for dynamic events. In case such an event occurs on a call leg the table shows which events are disarmed (are not monitored anymore) on that call leg and should be re-armed by eventReportReq() in case the application is still interested in these events.

Event Occurred	Events Disarmed
P_CALL_EVENT_UNDEFINED	Not Applicable
P_CALL_EVENT_ORIGINATING_CALL_ATTEMPT	Not applicable, can only be armed as trigger
P_CALL_EVENT_ORIGINATING_CALL_ATTEMPT_AUTHORISED	P_CALL_EVENT_ORIGINATING_CALL_ATTEMPT_AUTHORISED
P_CALL_EVENT_ADDRESS_COLLECTED	P_CALL_EVENT_ADDRESS_COLLECTED
P_CALL_EVENT_ADDRESS_ANALYSED	P_CALL_EVENT_ADDRESS_COLLECTED P_CALL_EVENT_ADDRESS_ANALYSED
P_CALL_EVENT_ALERTING	P_CALL_EVENT_ALERTING P_CALL_EVENT_TERMINATING_RELEASE with criteria: P_USER_NOT_AVAILABLE P_BUSY P_NOT_REACHABLE P_ROUTING_FAILURE P_CALL_RESTRICTED P_UNAVAILABLE_RESOURCES
P_CALL_EVENT_ANSWER	P_CALL_EVENT_ALERTING P_CALL_EVENT_ANSWER P_CALL_EVENT_TERMINATING_RELEASE with criteria: P_USER_NOT_AVAILABLE P_BUSY P_NOT_REACHABLE P_ROUTING_FAILURE P_CALL_RESTRICTED P_UNAVAILABLE_RESOURCES P_NO_ANSWER
P_CALL_EVENT_ORIGINATING_RELEASE	All pending network events for the call leg are disarmed
P_CALL_EVENT_TERMINATING_RELEASE	All pending network events for the call leg are disarmed
P_CALL_EVENT_ORIGINATING_SERVICE_CODE	P_CALL_EVENT_ORIGINATING_SERVICE_CODE *) see NOTE 2
P_CALL_EVENT_TERMINATING_SERVICE_CODE	P_CALL_EVENT_TERMINATING_SERVICE_CODE *) see NOTE 2
NOTE 2: Only the detected service code or the range to which the service code belongs is disarmed.	

7.6.2.25 TpAdditionalCallEventCriteria

Defines the Tagged Choice of Data Elements that specify specific criteria.

	Tag Element Type	
	TpCallEventType	

Tag Element Value	Choice Element Type	Choice Element Name
P_CALL_EVENT_UNDEFINED	NULL	Undefined
P_CALL_EVENT_ORIGINATING_CALL_ATTEMPT	NULL	Undefined
P_CALL_EVENT_ORIGINATING_CALL_ATTEMPT_AUTHO RISED	NULL	Undefined
P_CALL_EVENT_ADDRESS_COLLECTED	TpInt32	MinAddressLength
P_CALL_EVENT_ADDRESS_ANALYSED	NULL	Undefined
P_CALL_EVENT_ORIGINATING_SERVICE_CODE	TpCallServiceCodeSet	OriginatingServiceCode
P_CALL_EVENT_ORIGINATING_RELEASE	TpReleaseCauseSet	OriginatingReleaseCauseSet
P_CALL_EVENT_TERMINATING_CALL_ATTEMPT	NULL	Undefined
P_CALL_EVENT_TERMINATING_CALL_ATTEMPT_AUTHO RISED	NULL	Undefined
P_CALL_EVENT_ALERTING	NULL	Undefined
P_CALL_EVENT_ANSWER	NULL	Undefined
P_CALL_EVENT_TERMINATING_RELEASE	TpReleaseCauseSet	TerminatingReleaseCauseSet
P_CALL_EVENT_REDIRECTED	NULL	Undefined
P_CALL_EVENT_TERMINATING_SERVICE_CODE	TpCallServiceCodeSet	TerminatingServiceCode
P_CALL_EVENT_QUEUED	NULL	Undefined

7.6.2.26 TpCallEventInfo

Defines the Sequence of Data Elements that specify the event report specific information.

Sequence Element Name	Sequence Element Type
CallEventType	TpCallEventType
AdditionalCallEventInfo	TpCallAdditionalEventInfo
CallMonitorMode	TpCallMonitorMode
CallEventTime	TpDateAndTime

7.6.2.27 TpCallAdditionalEventInfo

Defines the Tagged Choice of Data Elements that specify additional call event information for certain types of events.

Tag Element Type	
	TpCallEventType

Tag Element Value	Choice Element Type	Choice Element Name
P_CALL_EVENT_UNDEFINED	NULL	Undefined
P_CALL_EVENT_ORIGINATING_CALL_ATTEMPT	NULL	Undefined
P_CALL_EVENT_ORIGINATING_CALL_ATTEMPT_AUTHORISED	NULL	Undefined
P_CALL_EVENT_ADDRESS_COLLECTED	TpAddress	CollectedAddress
P_CALL_EVENT_ADDRESS_ANALYSED	TpAddress	CalledAddress
P_CALL_EVENT_ORIGINATING_SERVICE_CODE	TpCallServiceCode	OriginatingServiceCode
P_CALL_EVENT_ORIGINATING_RELEASE	TpReleaseCause	OriginatingReleaseCause
P_CALL_EVENT_TERMINATING_CALL_ATTEMPT	NULL	Undefined
P_CALL_EVENT_TERMINATING_CALL_ATTEMPT_AUTHORISED	NULL	Undefined
P_CALL_EVENT_ALERTING	NULL	Undefined
P_CALL_EVENT_ANSWER	NULL	Undefined
P_CALL_EVENT_TERMINATING_RELEASE	TpReleaseCause	TerminatingReleaseCause
P_CALL_EVENT_REDIRECTED	TpAddress	ForwardAddress
P_CALL_EVENT_TERMINATING_SERVICE_CODE	TpCallServiceCode	TerminatingServiceCode
P_CALL_EVENT_QUEUED	NULL	Undefined

7.6.2.28 TpCallNotificationRequest

Defines the Sequence of Data Elements that specify the criteria for an event notification

Sequence Element Name	Sequence Element Type	Description
CallNotificationScope	TpCallNotificationScope	Defines the scope of the notification request.
CallEventsRequested	TpCallEventRequestSet	Defines the events which are requested

7.6.2.29 TpCallNotificationScope

Defines a the sequence of Data elements that specify the scope of a notification request.

Of the addresses only the Plan and the AddrString are used for the purpose of matching the notifications against the criteria.

Sequence Element Name	Sequence Element Type	Description
DestinationAddress	TpAddressRange	Defines the destination address or address range for which the notification is requested.
OriginatingAddress	TpAddressRange	Defines the origination address or address range for which the notification is requested.

7.6.2.30 TpCallNotificationInfo

Defines the Sequence of Data Elements that specify the information returned to the application in a Call notification report.

Sequence Element Name	Sequence Element Type	Description
CallNotificationReportScope	TpCallNotificationReportScope	Defines the scope of the notification report.
CallAppInfo	TpCallAppInfoSet	Contains additional call info.
CallEventInfo	TpCallEventInfo	Contains the event which is reported.

7.6.2.31 TpCallNotificationReportScope

Defines the Sequence of Data Elements that specify the scope for which a notification report was sent.

Sequence Element Name	Sequence Element Type	Description
DestinationAddress	TpAddress	Contains the destination address of the call.
OriginatingAddress	TpAddress	Contains the origination address of the call

7.6.2.32 TpNotificationRequested

Defines the Sequence of Data Elements that specify the criteria relating to event requests.

Sequence Element Name	Sequence Element Type
AppCallNotificationRequest	TpCallNotificationRequest
AssignmentID	TpInt32

7.6.2.33 TpNotificationRequestedSet

Defines a numbered Set of Data Elements of TpNotificationRequested.

7.6.2.34 TpReleaseCause

Defines the reason for which a call is released.

Name	Value	Description
P_UNDEFINED	0	The reason of release is not known, because no info was received from the network.
P_USER_NOT_AVAILABLE	1	The user is not available in the network. This means that the number is not allocated or that the user is not registered.
P_BUSY	2	The user is busy.
P_NO_ANSWER	3	No answer was received
P_NOT_REACHABLE	4	The user terminal is not reachable
P_ROUTING_FAILURE	5	A routing failure occurred. For example an invalid address was received
P_PREMATURE_DISCONNECT	6	The user disconnected the call / call leg during the setup phase.
P_DISCONNECTED	7	A disconnect was received.
P_CALL_RESTRICTED	8	The call was subject of restrictions
P_UNAVAILABLE_RESOURCE	9	The request could not be carried out as no resources were available.
P_GENERAL_FAILURE	10	A general network failure occurred.
P_TIMER_EXPIRY	11	The call / call leg was released because an activity timer expired.

7.6.2.35 TpReleaseCauseSet

Defines a Numbered Set of Data Elements of TpReleaseCause.

7.6.2.36 TpCallLegIdentifier

Defines the Sequence of Data Elements that unambiguously specify the Call Leg object.

Sequence Element Name	Sequence Element Type	Sequence Element Description
CallLegReference	IpCallLegRef	This element specifies the interface reference for the callLeg object.
CallLegSessionID	TpSessionID	This element specifies the callLeg session ID.

7.6.2.37 TpCallLegIdentifierSet

Defines a Numbered Set of Data Elements of TpCallLegIdentifier.

7.6.2.38 TpCallLegAttachMechanism

Defines how a CallLeg should be attached to the call.

Name	Value	Description
P_CALLLEG_ATTACH_IMPLICITLY	0	CallLeg should be attached implicitly to the call.
P_CALLLEG_ATTACH_EXPLICITLY	1	CallLeg should be attached explicitly to the call by using the attachMediaReq() operation. This allows e.g. the application to do first user interaction to the party before he/she is placed in the call.

7.6.2.39 TpCallLegConnectionProperties

Defines the Sequence of Data Elements that specify the connection properties of the Call Leg object

Sequence Element Name	Sequence Element Type	Sequence Element Description
AttachMechanism	TpCallLegAttachMechanism	Defines how a CallLeg should be attached to the call.

7.6.2.40 TpCallLegInfoReport

Defines the Sequence of Data Elements that specify the call leg information requested.

Sequence Element Name	Sequence Element Type	Description
CallLegInfoType	TpCallLegInfoType	The type of call leg information.
CallLegStartTime	TpDateAndTime	The time and date when the call leg was started (i.e. the leg was routed).
CallLegConnectedToResourceTime	TpDateAndTime	The date and time when the call leg was connected to the resource. If no resource was connected the time is set to an empty string. Either this element is valid or the CallConnectedToAddressTime is valid, depending on whether the report is sent as a result of user interaction.
CallLegConnectedToAddressTime	TpDateAndTime	The date and time when the call leg was connected to the destination (i.e. when the destination answered the call). If the destination did not answer, the time is set to an empty string. Either this element is valid or the CallConnectedToResourceTime is valid, depending on whether the report is sent as a result of user interaction.
CallLegEndTime	TpDateAndTime	The date and time when the call leg was released.
ConnectedAddress	TpAddress	The address of the party associated with the leg. If during the call the connected address was received from the party then this is returned, otherwise the destination address (for legs connected to a destination) or the originating address (for legs connected to the origination) is returned.
CallLegReleaseCause	TpReleaseCause	The cause of the termination. May be present with P_CALL_LEG_INFO_RELEASE_CAUSE was specified.
CallAppInfo	TpCallAppInfoSet	Additional information for the leg. May be present with P_CALL_LEG_INFO_APPINFO was specified.

7.6.2.41 TpCallLegInfoType

Defines the type of call leg information requested and reported. The values may be combined by a logical 'OR' function.

Name	Value	Description
P_CALL_LEG_INFO_UNDEFINED	00h	Undefined
P_CALL_LEG_INFO_TIMES	01h	Relevant call times
P_CALL_LEG_INFO_RELEASE_CAUSE	02h	Call leg release cause
P_CALL_LEG_INFO_ADDRESS	04h	Call leg connected address
P_CALL_LEG_INFO_APPINFO	08h	Call leg application related information

7.6.2.42 TpCallLegSuperviseTreatment

Defines the treatment of the call leg by the call control service when the call leg supervision timer expires. The values may be combined by a logical 'OR' function.

Name	Value	Description
P_CALL_LEG_SUPERVISE_RELEASE	01h	Release the call leg when the call leg supervision timer expires
P_CALL_LEG_SUPERVISE_RESPOND	02h	Notify the application when the call leg supervision timer expires
P_CALL_LEG_SUPERVISE_APPLY_TONE	04h	Send a warning tone on the call leg when the call leg supervision timer expires. If call leg release is requested, then the call leg will be released following the tone after an administered time period

8 Common Call Control Data Types

The following data types referenced in this clause are defined in 3GPP TS 29.198-5:

TpUIInfo

All other data types referenced but not defined in this clause are common data definitions which may be found in 3GPP TS 29.198-2.

8.1 TpCallAlertingMechanism

This data type is identical to a `TpInt32`, and defines the mechanism that will be used to alert a call party. The values of this data type are operator specific.

8.2 TpCallBearerService

This data type defines the type of call application-related specific information (Q.931: Information Transfer Capability, and 3G TS 22.002)

Name	Value	Description
P_CALL_BEARER_SERVICE_UNKNOWN	0	Bearer capability information unknown at this time
P_CALL_BEARER_SERVICE_SPEECH	1	Speech
P_CALL_BEARER_SERVICE_DIGITALUNRESTRICTED	2	Unrestricted digital information
P_CALL_BEARER_SERVICE_DIGITALRESTRICTED	3	Restricted digital information
P_CALL_BEARER_SERVICE_AUDIO	4	3,1 kHz audio
P_CALL_BEARER_SERVICE_DIGITALUNRESTRICTED_TONES	5	Unrestricted digital information with tones/announcements
P_CALL_BEARER_SERVICE_VIDEO	6	Video

8.3 TpCallChargePlan

Defines the Sequence of Data Elements that specify the charge plan for the call.

Sequence Element Name	Sequence Element Type	Description
ChargeOrderType	TpCallChargeOrderCategory	Charge order
TransparentCharge	TpOctetSet	Operator specific charge plan specification, e.g. charging table name / charging table entry. The associated charge plan data will be send transparently to the charging records. Only applicable when transparent charging is selected.
ChargePlan	TpInt32	Pre-defined charge plan. Example of the charge plan set from which the application can choose could be : (0 = normal user, 1 = silver card user, 2 = gold card user). Only applicable when predefined charge plan is selected.
AdditionalInfo	TpOctetSet	Descriptive string which is sent to the billing system without prior evaluation. Could be included in the ticket.
PartyToCharge	TpCallPartyToChargeType	Identifies the entity or party to be charged for the call or call leg.
PartyToChargeAdditionalInfo	TpCallPartyToChargeAdditionalInfo	Contains additional information regarding the charged party.

8.4 TpCallPartyToChargeAdditionalInfo

Defines the Tagged Choice of Data Elements that identifies the entity or party to be charged.

Tag Element Type
TpCallPartyToChargeType

Tag Element Value	Choice Element Type	Choice Element Name
P_CALL_PARTY_ORIGINATING	NULL	Undefined
P_CALL_PARTY_DESTINATION	NULL	Undefined
P_CALL_PARTY_SPECIAL	TpAddress	CallPartySpecial

8.5 TpCallPartyToChargeType

Defines the type of call party to charge

Name	Value	Description
P_CALL_PARTY_ORIGINATING	0	Calling party, i.e. party that initiated the call. For application initiated calls this indicates the first party of the call
P_CALL_PARTY_DESTINATION	1	Called party
P_CALL_PARTY_SPECIAL	2	An address identifying e.g. a third party, a service provider

8.6 TpCallChargeOrderCategory

Defines the type of charging to be applied

Name	Value	Description
P_CALL_CHARGE_TRANSPARENT	0	Operator specific charge plan specification, e.g. charging table name / charging table entry. The associated charge plan data will be send transparently to the charging records
P_CALL_CHARGE_PREDEFINED_SET	1	Pre-defined charge plan. Example of the charge plan set from which the application can choose could be : (0 = normal user, 1 = silver card user, 2 = gold card user).

8.7 TpCallEndedReport

Defines the Sequence of Data Elements that specify the reason for the call ending.

Sequence Element Name	Sequence Element Type	Description
CallLegSessionID	TpSessionID	The leg that initiated the release of the call. If the call release was not initiated by the leg, then this value is set to -1.
Cause	TpReleaseCause	The cause of the call ending.

8.8 TpCallError

Defines the Sequence of Data Elements that specify the additional information relating to a call error.

Sequence Element Name	Sequence Element Type
ErrorTime	TpDateAndTime
ErrorType	TpCallErrorType
AdditionalErrorInfo	TpCallAdditionalErrorInfo

8.9 TpCallAdditionalErrorInfo

Defines the Tagged Choice of Data Elements that specify additional call error and call error specific information. This is also used to specify call leg errors and information errors.

Tag Element Type
TpCallErrorType

Tag Element Value	Choice Element Type	Choice Element Name
P_CALL_ERROR_UNDEFINED	NULL	Undefined
P_CALL_ERROR_INVALID_ADDRESS	TpAddressError	CallErrorInvalidAddress
P_CALL_ERROR_INVALID_STATE	NULL	Undefined
P_CALL_ERROR_RESOURCE_UNAVAILABLE	NULL	Undefined

8.10 TpCallErrorType

Defines a specific call error.

Name	Value	Description
P_CALL_ERROR_UNDEFINED	0	Undefined; the method failed or was refused, but no specific reason can be given.
P_CALL_ERROR_INVALID_ADDRESS	1	The operation failed because an invalid address was given
P_CALL_ERROR_INVALID_STATE	2	The call was not in a valid state for the requested operation
P_CALL_ERROR_RESOURCE_UNAVAILABLE	3	There are not enough resources to complete the request successfully

8.11 TpCallInfoReport

Defines the Sequence of Data Elements that specify the call information requested. Information that was not requested is invalid.

Sequence Element Name	Sequence Element Type	Description
CallInfoType	TpCallInfoType	The type of call report.
CallInitiationStartTime	TpDateAndTime	The time and date when the call, or follow-on call, was started.
CallConnectedToResourceTime	TpDateAndTime	The date and time when the call was connected to the resource. This data element is only valid when information on user interaction is reported.
CallConnectedToDestinationTime	TpDateAndTime	The date and time when the call was connected to the destination (i.e., when the destination answered the call). If the destination did not answer, the time is set to an empty string. This data element is invalid when information on user interaction is reported with an intermediate report.
CallEndTime	TpDateAndTime	The date and time when the call or follow-on call or user interaction was terminated.
Cause	TpReleaseCause	The cause of the termination.

A callInfoReport will be generated at the end of user interaction and at the end of the connection with the associated address. This means that either the destination related information is present or the resource related information, but not both.

8.12 TpCallInfoType

Defines the type of call information requested and reported. The values may be combined by a logical 'OR' function.

Name	Value	Description
P_CALL_INFO_UNDEFINED	00h	Undefined
P_CALL_INFO_TIMES	01h	Relevant call times
P_CALL_INFO_RELEASE_CAUSE	02h	Call release cause

8.13 TpCallLoadControlMechanism

Defines the Tagged Choice of Data Elements that specify the applied mechanism and associated parameters.

Tag Element Type	
	TpCallLoadControlMechanismType

Tag Element Value	Choice Element Type	Choice Element Name
P_CALL_LOAD_CONTROL_PER_INTERVAL	TpCallLoadControlIntervalRate	CallLoadControlPerInterval

8.14 TpCallLoadControlIntervalRate

Defines the call admission rate of the call load control mechanism used. This data type indicates the interval (in milliseconds) between calls that are admitted.

Name	Value	Description
P_CALL_LOAD_CONTROL_ADMIT_NO_CALLS	0	Infinite interval (do not admit any calls)
	1 - 60000	Duration in milliseconds

8.15 TpCallLoadControlMechanismType

Defines the type of call load control mechanism to use.

Name	Value	Description
P_CALL_LOAD_CONTROL_PER_INTERVAL	0	admit one call per interval

8.16 TpCallMonitorMode

Defines the mode that the call will monitor for events, or the mode that the call is in following a detected event.

Name	Value	Description
P_CALL_MONITOR_MODE_INTERRUPT	0	The call event is intercepted by the call control service and call processing is interrupted. The application is notified of the event and call processing resumes following an appropriate API call or network event (such as a call release)
P_CALL_MONITOR_MODE_NOTIFY	1	The call event is detected by the call control service but not intercepted. The application is notified of the event and call processing continues
P_CALL_MONITOR_MODE_DO_NOT_MONITOR	2	Do not monitor for the event

8.17 TpCallNetworkAccessType

This data defines the bearer capabilities associated with the call. (3G TS 24.002) This information is network operator specific and may not always be available because there is no standard protocol to retrieve the information.

Name	Value	Description
P_CALL_NETWORK_ACCESS_TYPE_UNKNOWN	0	Network type information unknown at this time
P_CALL_NETWORK_ACCESS_TYPE_POT	1	POTS
P_CALL_NETWORK_ACCESS_TYPE_ISDN	2	ISDN
P_CALL_NETWORK_ACCESS_TYPE_DIALUPINTERNET	3	Dial-up Internet
P_CALL_NETWORK_ACCESS_TYPE_XDSL	4	xDSL
P_CALL_NETWORK_ACCESS_TYPE_WIRELESS	5	Wireless

8.18 TpCallPartyCategory

This data type defines the category of a calling party. (Q.763: Calling Party Category / Called Party Category)

Name	Value	Description
P_CALL_PARTY_CATEGORY_UNKNOWN	0	calling party's category unknown at this time
P_CALL_PARTY_CATEGORY_OPERATOR_F	1	operator, language French
P_CALL_PARTY_CATEGORY_OPERATOR_E	2	operator, language English
P_CALL_PARTY_CATEGORY_OPERATOR_G	3	operator, language German
P_CALL_PARTY_CATEGORY_OPERATOR_R	4	operator, language Russian
P_CALL_PARTY_CATEGORY_OPERATOR_S	5	operator, language Spanish
P_CALL_PARTY_CATEGORY_ORDINARY_SUB	6	ordinary calling subscriber
P_CALL_PARTY_CATEGORY_PRIORITY_SUB	7	calling subscriber with priority
P_CALL_PARTY_CATEGORY_DATA_CALL	8	data call (voice band data)
P_CALL_PARTY_CATEGORY_TEST_CALL	9	test call
P_CALL_PARTY_CATEGORY_PAYPHONE	10	payphone

8.19 TpCallServiceCode

Defines the Sequence of Data Elements that specify the service code and type of service code received during a call. The service code type defines how the value string should be interpreted.

Sequence Element Name	Sequence Element Type
CallServiceCodeType	TpCallServiceCodeType
ServiceCodeValue	TpString

8.20 TpCallServiceCodeSet

Defines a Numbered Set of Data Elements of TpCallServiceCode.

8.21 TpCallServiceCodeType

Defines the different types of service codes that can be received during the call.

Name	Value	Description
P_CALL_SERVICE_CODE_UNDEFINED	0	The type of service code is unknown. The corresponding string is operator specific.
P_CALL_SERVICE_CODE_DIGITS	1	The user entered a digit sequence during the call. The corresponding string is an ASCII representation of the received digits.
P_CALL_SERVICE_CODE_FACILITY	2	A facility information element is received. The corresponding string contains the facility information element as defined in ITU Q.932
P_CALL_SERVICE_CODE_U2U	3	A user-to-user message was received. The associated string contains the content of the user-to-user information element.
P_CALL_SERVICE_CODE_HOOKFLASH	4	The user performed a hookflash, optionally followed by some digits. The corresponding string is an ASCII representation of the entered digits.
P_CALL_SERVICE_CODE_RECALL	5	The user pressed the register recall button, optionally followed by some digits. The corresponding string is an ASCII representation of the entered digits.

8.22 TpCallSuperviseReport

Defines the responses from the call control service for calls that are supervised. The values may be combined by a logical 'OR' function.

Name	Value	Description
P_CALL_SUPERVISE_TIMEOUT	01h	The call supervision timer has expired
P_CALL_SUPERVISE_CALL_ENDED	02h	The call has ended, either due to timer expiry or call party release. In case the called party disconnects but a follow-on call can still be made also this indication is used.
P_CALL_SUPERVISE_TONE_APPLIED	04h	A warning tone has been applied. This is only sent in combination with P_CALL_SUPERVISE_TIMEOUT
P_CALL_SUPERVISE_UI_FINISHED	08h	The user interaction has finished.

8.23 TpCallSuperviseTreatment

Defines the treatment of the call by the call control service when the call supervision timer expires. The values may be combined by a logical 'OR' function.

Name	Value	Description
P_CALL_SUPERVISE_RELEASE	01h	Release the call when the call supervision timer expires
P_CALL_SUPERVISE_RESPOND	02h	Notify the application when the call supervision timer expires
P_CALL_SUPERVISE_APPLY_TONE	04h	Send a warning tone to the originating party when the call supervision timer expires. If call release is requested, then the call will be released following the tone after an administered time period

8.24 TpCallTeleService

This data type defines the tele-service associated with the call. (Q.763: User Teleservice Information, Q.931: High Layer Compatibility Information, and 3G TS 22.003)

Name	Value	Description
P_CALL_TELE_SERVICE_UNKNOWN	0	Teleservice information unknown at this time
P_CALL_TELE_SERVICE_TELEPHONY	1	Telephony
P_CALL_TELE_SERVICE_FAX_2_3	2	Facsimile Group 2/3
P_CALL_TELE_SERVICE_FAX_4_I	3	Facsimile Group 4, Class I
P_CALL_TELE_SERVICE_FAX_4_II_III	4	Facsimile Group 4, Classes II and III
P_CALL_TELE_SERVICE_VIDEOTEX_SYN	5	Syntax based Videotex
P_CALL_TELE_SERVICE_VIDEOTEX_INT	6	International Videotex interworking via gateways or interworking units
P_CALL_TELE_SERVICE_TELEX	7	Telex service
P_CALL_TELE_SERVICE_MHS	8	Message Handling Systems
P_CALL_TELE_SERVICE_OSI	9	OSI application
P_CALL_TELE_SERVICE_FTAM	10	FTAM application
P_CALL_TELE_SERVICE_VIDEO	11	Videotelephony
P_CALL_TELE_SERVICE_VIDEO_CONF	12	Videoconferencing
P_CALL_TELE_SERVICE_AUDIOGRAPH_CONF	13	Audiographic conferencing
P_CALL_TELE_SERVICE_MULTIMEDIA	14	Multimedia services
P_CALL_TELE_SERVICE_CS_INI_H221	15	Capability set of initial channel of H.221
P_CALL_TELE_SERVICE_CS_SUB_H221	16	Capability set of subsequent channel of H.221
P_CALL_TELE_SERVICE_CS_INI_CALL	17	Capability set of initial channel associated with an active 3,1 kHz audio or speech call.
P_CALL_TELE_SERVICE_DATATRAFFIC	18	Data traffic.
P_CALL_TELE_SERVICE_EMERGENCY_CALLS	19	Emergency Calls
P_CALL_TELE_SERVICE_SMS_MT_PP	20	Short message MT/PP
P_CALL_TELE_SERVICE_SMS_MO_PP	21	Short message MO/PP
P_CALL_TELE_SERVICE_CELL_BROADCAST	22	Cell Broadcast Service
P_CALL_TELE_SERVICE_ALT_SPEECH_FAX_3	23	Alternate speech and facsimile group 3
P_CALL_TELE_SERVICE_AUTOMATIC_FAX_3	24	Automatic Facsimile group 3
P_CALL_TELE_SERVICE_VOICE_GROUP_CALL	25	Voice Group Call Service
P_CALL_TELE_SERVICE_VOICE_BROADCAST	26	Voice Broadcast Service

8.25 TpCallTreatment

Defines the Sequence of Data Elements that specify the treatment for calls that will be handled only by the network (for example, call which are not admitted by the call load control mechanism).

Sequence Element Name	Sequence Element Type
CallTreatmentType	TpCallTreatmentType
ReleaseCause	TpReleaseCause
AdditionalTreatmentInfo	TpCallAdditionalTreatmentInfo

8.26 TpCallTreatmentType

Defines the treatment for calls that will be handled only by the network.

Name	Value	Description
P_CALL_TREATMENT_DEFAULT	0	Default treatment
P_CALL_TREATMENT_RELEASE	1	Release the call
P_CALL_TREATMENT_SIAR	2	Send information to the user, and release the call (Send Info & Release)

8.27 TpCallAdditionalTreatmentInfo

Defines the Tagged Choice of Data Elements that specify the information to be sent to a call party.

Tag Element Type
TpCallTreatmentType

Tag Element Value	Choice Element Type	Choice Element Name
P_CALL_TREATMENT_DEFAULT	NULL	Undefined
P_CALL_TREATMENT_RELEASE	NULL	Undefined
P_CALL_TREATMENT_SIAR	TpUIInfo	InformationToSend

8.28 TpMediaType

Defines the media type of a media stream. The values may be combined by a logical 'OR' function.

Name	Value	Description
P_AUDIO	1	Audio stream
P_VIDEO	2	Video stream
P_DATA	4	Data stream (e.g., T.120)

Annex A (normative): OMG IDL Description of Call Control SCF

The OMG IDL representation of this interface specification is contained in text files (contained in archive 2919804IDL.ZIP) which accompany the present document.

Annex B (informative): Change history

Change history							
Date	TSG #	TSG Doc.	CR	Rev	Subject/Comment	Old	New
Mar 2001	CN_11	NP-010134	047	-	CR 29.198: for moving TS 29.198 from R99 to Rel 4 (N5-010158)	3.2.0	1.0.0
June 2001	CN_12	NP-010327	--	--	Approved at TSG CN#12 and placed under Change Control	2.0.0	4.0.0
Sep 2001	CN_13	NP-010467	001	--	Changing references to JAIN	4.0.0	4.1.0
Sep 2001	CN_13	NP-010467	002	--	Correction of text descriptions for methods enableCallNotification and createNotification	4.0.0	4.1.0
Sep 2001	CN_13	NP-010467	003	--	Specify the behaviour when a call leg times out	4.0.0	4.1.0
Sep 2001	CN_13	NP-010467	004	--	Removal of Faulty state in MPCCS Call State Transition Diagram and method callFaultDetected in MPCCS in OSA R4	4.0.0	4.1.0
Sep 2001	CN_13	NP-010467	005	--	Missing TpCallAppInfoSet description in OSA R4	4.0.0	4.1.0
Sep 2001	CN_13	NP-010467	006	--	Redirecting a call leg vs. creating a call leg clarification in OSA R4	4.0.0	4.1.0
Sep 2001	CN_13	NP-010467	007	--	Introduction of MPCC Originating and Terminating Call Leg STDs for IpCallLeg	4.0.0	4.1.0
Sep 2001	CN_13	NP-010467	008	--	Corrections to SetChargePlan() Addition of PartyToCharge parameter	4.0.0	4.1.0
Sep 2001	CN_13	NP-010467	009	--	Corrections to SetChargePlan()	4.0.0	4.1.0
Sep 2001	CN_13	NP-010467	010	--	Remove distinction between final- and intermediate-report	4.0.0	4.1.0
Sep 2001	CN_13	NP-010467	011	--	Inclusion of TpMediaType	4.0.0	4.1.0
Sep 2001	CN_13	NP-010467	012	--	Corrections to GCC STD	4.0.0	4.1.0
Sep 2001	CN_13	NP-010467	013	--	Introduction of sequence diagrams for MPCC services	4.0.0	4.1.0
Sep 2001	CN_13	NP-010467	014	--	The use of the REDIRECT event needs to be illustrated	4.0.0	4.1.0
Sep 2001	CN_13	NP-010467	015	--	Corrections to SetCallChargePlan()	4.0.0	4.1.0
Sep 2001	CN_13	NP-010467	016	--	Add one additional error indication	4.0.0	4.1.0
Sep 2001	CN_13	NP-010467	017	--	Corrections to Call Control – GCCS Exception handling	4.0.0	4.1.0
Sep 2001	CN_13	NP-010467	018	--	Corrections to Call Control – Errors in Exceptions	4.0.0	4.1.0
Dec 2001	CN_14	NP-010597	019	--	Replace Out Parameters with Return Types	4.1.0	4.2.0
Dec 2001	CN_14	NP-010597	020	--	Removal of time based charging property	4.1.0	4.2.0
Dec 2001	CN_14	NP-010597	021	--	Make attachMedia() and detachMedia() asynchronous	4.1.0	4.2.0
Dec 2001	CN_14	NP-010597	022	--	Correction of treatment datatype in superviseReq on call leg	4.1.0	4.2.0
Dec 2001	CN_14	NP-010597	023	--	Corrections to Call Control Data Types	4.1.0	4.2.0
Dec 2001	CN_14	NP-010597	024	--	Correction to Call Control (CC)	4.1.0	4.2.0
Dec 2001	CN_14	NP-010597	025	--	Amend the Generic Call Control introductory part	4.1.0	4.2.0
Dec 2001	CN_14	NP-010597	026	--	Correction in TpCallEventType	4.1.0	4.2.0
Dec 2001	CN_14	NP-010597	027	--	Addition of missing description of RouteErr()	4.1.0	4.2.0
Dec 2001	CN_14	NP-010597	028	--	Misleading description of createAndRouteCallLegErr()	4.1.0	4.2.0
Dec 2001	CN_14	NP-010597	029	--	Correction to values of TpCallNotificationType, TpCallLoadControlMechanismType	4.1.0	4.2.0
Dec 2001	CN_14	NP-010695	030	--	Correction of method getLastRedirectionAddress	4.1.0	4.2.0
Mar 2002	CN_15	NP-020106	031	--	Add P_INVALID_INTERFACE_TYPE exception to IpService.setCallback() and IpService.setCallbackWithSessionID()	4.2.0	4.3.0
Mar 2002	CN_15	NP-020106	032	--	Correction of Event Subscription/Notification Data Type	4.2.0	4.3.0
Mar 2002	CN_15	NP-020106	033	--	Correction of parameter name in IpCallLeg.routeReq() and in IpCallLeg.setAdviceOfCharge()	4.2.0	4.3.0
Mar 2002	CN_15	NP-020106	034	--	Clarification of ambiguous Event handling rules	4.2.0	4.3.0
Jun 2002	CN_16	NP-020180	035	--	Correction to TpCallChargePlan	4.3.0	4.4.0
Jun 2002	CN_16	NP-020180	036	--	Correction to CAMEL Service Property values	4.3.0	4.4.0
Sep 2002	CN_17	NP-020424	057	--	Correction on use of NULL in Call Control API	4.4.0	4.5.0
Mar 2003	CN_19	NP-030020	058	--	Correction of status of methods to interfaces in clause 6.3	4.5.0	4.6.0
Mar 2003	CN_19	NP-030020	059	--	Correction to TpReleaseCauseSet in Multi Party Call Control	4.5.0	4.6.0
Mar 2003	CN_19	NP-030020	060	--	Correction to Sequence Diagrams to remove incorrect Framework references	4.5.0	4.6.0
Mar 2003	CN_19	NP-030020	061	--	Correction to User Interaction Prepaid Sequence Diagrams	4.5.0	4.6.0
Mar 2003	CN_19	NP-030020	062	--	Correction to remove unused TpCallChargeOrder	4.5.0	4.6.0
Mar 2003	CN_19	NP-030020	063	--	Correction to TpCallEventCriteriaResult in Generic Call Control	4.5.0	4.6.0
Mar 2003	CN_19	NP-030020	064	--	Correction of status of methods to interfaces in clause 7.3	4.5.0	4.6.0
Jun 2003	CN_20	NP-030238	065	--	Correction of the description for callEventNotify & reportNotification	4.6.0	4.7.0
Dec 2003	CN_22	NP-030544	066	--	Correction of description in superviseRes and superviseCallRes	4.7.0	4.8.0

History

Document history		
V4.0.0	June 2001	Publication
V4.1.0	September 2001	Publication
V4.2.0	December 2001	Publication
V4.3.0	March 2002	Publication
V4.4.0	June 2002	Publication
V4.5.0	September 2002	Publication
V4.6.0	March 2003	Publication
V4.7.0	June 2003	Publication
V4.8.0	December 2003	Publication