

# ETSI TS 129 010 V3.5.0 (2001-03)

---

*Technical Specification*

**Digital cellular telecommunications system (Phase 2+) (GSM);  
Universal Mobile Telecommunications System (UMTS);  
Information element mapping between Mobile Station -  
Base Station System (MS - BSS) and Base Station System -  
Mobile-services Switching Centre (BSS - MSC);  
Signalling procedures and the Mobile Application Part (MAP)  
(3GPP TS 29.010 version 3.5.0 Release 1999)**

---



---

**Reference**

RTS/TSGN-0429010UR4

---

**Keywords**

GSM, UMTS

**ETSI**

650 Route des Lucioles  
F-06921 Sophia Antipolis Cedex - FRANCE

---

Tel.: +33 4 92 94 42 00 Fax: +33 4 93 65 47 16

Siret N° 348 623 562 00017 - NAF 742 C  
Association à but non lucratif enregistrée à la  
Sous-Préfecture de Grasse (06) N° 7803/88

---

**Important notice**

Individual copies of the present document can be downloaded from:

<http://www.etsi.org>

The present document may be made available in more than one electronic version or in print. In any case of existing or perceived difference in contents between such versions, the reference version is the Portable Document Format (PDF). In case of dispute, the reference shall be the printing on ETSI printers of the PDF version kept on a specific network drive within ETSI Secretariat.

Users of the present document should be aware that the document may be subject to revision or change of status. Information on the current status of this and other ETSI documents is available at <http://www.etsi.org/tb/status/>

If you find errors in the present document, send your comment to:  
editor@etsi.fr

---

**Copyright Notification**

No part may be reproduced except as authorized by written permission.  
The copyright and the foregoing restriction extend to reproduction in all media.

© European Telecommunications Standards Institute 2001.

All rights reserved.

---

## Intellectual Property Rights

IPRs essential or potentially essential to the present document may have been declared to ETSI. The information pertaining to these essential IPRs, if any, is publicly available for **ETSI members and non-members**, and can be found in ETSI SR 000 314: "*Intellectual Property Rights (IPRs); Essential, or potentially Essential, IPRs notified to ETSI in respect of ETSI standards*", which is available from the ETSI Secretariat. Latest updates are available on the ETSI Web server (<http://www.etsi.org/ipr>).

Pursuant to the ETSI IPR Policy, no investigation, including IPR searches, has been carried out by ETSI. No guarantee can be given as to the existence of other IPRs not referenced in ETSI SR 000 314 (or the updates on the ETSI Web server) which are, or may be, or may become, essential to the present document.

---

## Foreword

This Technical Specification (TS) has been produced by the ETSI 3<sup>rd</sup> Generation Partnership Project (3GPP).

The present document may refer to technical specifications or reports using their 3GPP identities, UMTS identities or GSM identities. These should be interpreted as being references to the corresponding ETSI deliverables.

The cross reference between GSM, UMTS, 3GPP and ETSI identities can be found under [www.etsi.org/key](http://www.etsi.org/key).

# Contents

Foreword.....	5
1 Scope .....	6
1.1 References .....	6
1.2 Abbreviations .....	7
2 Classification of interworking cases .....	7
2.1 Transparent procedures .....	7
2.2 Non-transparent procedures .....	7
3 Interworking in the MSC, Transparent case .....	8
3.1 General .....	8
3.2 Location area updating .....	10
3.3 Detach IMSI .....	11
3.4 Routing area updating .....	12
3.5 Authentication .....	13
3.6 Retrieval of the IMSI from the MS .....	14
3.7 Reallocation of TMSI .....	14
3.8 Retrieval of the IMEI from the MS .....	15
3.9 Tracing subscriber activity .....	15
4 Non-transparent cases.....	16
4.1 General .....	16
4.2 Outgoing call set-up (MS originating call).....	16
4.3 Incoming call set-up (MS terminating call).....	20
4.4 Cipher mode setting .....	22
4.5 Inter-MSC Handover.....	22
4.5.1 Basic Inter-MSC Handover .....	22
4.5.2 Subsequent Inter-MSC Handover back to MSC-A.....	28
4.5.3 Subsequent Inter-MSC Handover to third MSC.....	32
4.5.4 BSSAP Messages transfer on E-Interface .....	35
4.5.5 Processing in MSC-B, and information transfer on E-interface .....	36
4.5.5.1 Encryption Information .....	36
4.5.5.2 Channel Type .....	37
4.5.5.3 Classmark .....	38
4.5.5.4 Downlink DTX-Flag .....	38
4.5.5.5 Priority.....	38
4.5.5.6 MSC/BSC-Invoke Trace Information Elements.....	39
4.5.5.7 LSA Identifier List .....	39
4.5.6 Overview of the Technical Specifications GSM interworking for the Inter-MSC Handover.....	39
4.6 Inter-MSC Handover (UMTS to GSM) .....	41
4.6.1 Basic Inter-MSC Handover .....	41
4.6.2 Subsequent Inter-MSC Handover from 3G-MSC-B back to MSC-A .....	46
4.6.3 Subsequent Inter-MSC Handover to third MSC.....	50
4.6.4 BSSAP Messages transfer on E-Interface .....	54
4.6.5 Cause Code Mapping .....	54
4.7 Inter-MSC Handover (GSM to UMTS) .....	55
4.7.1 Basic Inter-MSC Handover .....	55
4.7.2 Subsequent Inter-MSC Handover from MSC-B back to 3G_MSC-A.....	61
4.7.3 Subsequent Inter-MSC Handover to third MSC.....	65
4.7.4 BSSAP Messages transfer on E-Interface .....	67
4.7.4.1 Assignment.....	67
4.7.4.2 Cipher Mode Control.....	68
4.7.4.3 Location Reporting Control.....	69
4.7.5 Processing in 3G_MSC-B, and information transfer on E-interface .....	69
4.7.5.1 Encryption Information .....	69
4.7.5.2 Channel Type .....	69
4.7.5.3 Classmark .....	70
4.7.5.4 Priority.....	70

4.7.5.5	MSC-Invoke Trace Information Elements .....	70
4.7.6	Cause Code Mapping .....	70
4.8	Inter-MSC Relocation .....	73
4.8.1	Basic Inter-MSC Relocation.....	73
4.8.2	Subsequent Inter-MSC Relocation back to 3G_MSC-A .....	78
4.8.3	Subsequent Inter-MSC Relocation to third MSC .....	82
4.8.4	RANAP Messages transfer on E-Interface .....	85
4.8.5	Processing in 3G_MSC-B, and information transfer on E-interface .....	86
4.8.5.1	Integrity Protection Information .....	86
4.8.5.2	Encryption Information .....	87
4.8.5.3	RAB Parameters .....	87
4.8.5.4	Channel Type .....	87
4.8.6	Overview of the Technical Specifications 3GPP interworking for the Inter-MSC Relocation .....	88
<b>Annex A (informative): Change history .....</b>		<b>90</b>

---

# Foreword

This Technical Specification (TS) has been produced by the 3<sup>rd</sup> Generation Partnership Project (3GPP).

The present document specifies Information element mapping between Mobile Station - Base Station System (MS - BSS) and Base Station System - Mobile-services Switching Centre (BSS - MSC) Signalling procedures and the Mobile Application Part (MAP) within the digital cellular telecommunications system.

The contents of the present document are subject to continuing work within the TSG and may change following formal TSG approval. Should the TSG modify the contents of the present document, it will be re-released by the TSG with an identifying change of release date and an increase in version number as follows:

Version x.y.z

where:

- x the first digit:
  - 1 presented to TSG for information;
  - 2 presented to TSG for approval;
  - 3 or greater indicates TSG approved document under change control.
- y the second digit is incremented for all changes of substance, i.e. technical enhancements, corrections, updates, etc.
- z the third digit is incremented when editorial only changes have been incorporated in the document.

---

# 1 Scope

The scope of the present document is:

- i) to provide a detailed specification for the interworking between information elements contained in layer 3 messages sent on the MS-MSC interface (Call Control and Mobility Management parts of GSM 04.08) and parameters contained in MAP services sent over the MSC-VLR interface (GSM 09.02) where the MSC acts as a transparent relay of information;
- ii) to provide a detailed specification for the interworking between information elements contained in BSSMAP messages sent on the BSC-MSC interface (GSM 08.08) and parameters contained in MAP services sent over the MSC-VLR interface (GSM 09.02) where the MSC acts as a transparent relay of information;
- iii) to provide a detailed specification for the interworking between information elements contained in BSSMAP messages (GSM 08.08) and RANAP (25.413)
- iv) to provide a detailed specification for the interworking as in i) and ii) above when the MSC also processes the information.

Interworking for supplementary services is given in GSM 09.11. Interworking for the short message service is given in GSM 03.40 and GSM 04.11. Interworking between the call control signalling of GSM 04.08 and the PSTN/ISDN is given in GSM 09.03, GSM 09.07 and GSM 09.08. Interworking between the 'A' and 'E' interfaces for inter-MSC handover signalling is given in GSM 09.07 and 09.08.

## 1.1 References

The following documents contain provisions which, through reference in this text, constitute provisions of the present document.

- References are either specific (identified by date of publication, edition number, version number, etc.) or non-specific.
- For a specific reference, subsequent revisions do not apply.
- For a non-specific reference, the latest version applies. In the case of a reference to a 3GPP document (including a GSM document), a non-specific reference implicitly refers to the latest version of that document *in the same Release as the present document*.

- [1] 3GPP TS 21.905: "3G Vocabulary".
- [2] 3GPP TS 23.009: "Handover procedures".
- [3] 3GPP TS 23.040: "Technical realization of the Short Message Service (SMS) Point to Point (PP)".
- [4] 3GPP TS 24.008: "Mobile Radio Interface Layer 3 specification; Core Network Protocols-Stage 3".
- [5] 3GPP TS 24.010: "Mobile radio interface layer 3 Supplementary services specification - General aspects".
- [6] 3GPP TS<sup>2</sup>24.011: "Point-to-Point (PP) Short Message Service (SMS) support on mobile radio interface".
- [7] 3GPP TS 25.413: "Iu interface RANAP signalling".
- [8] 3GPP TS 27.001: "General on Terminal Adaptation Functions (TAF) for Mobile Stations (MS)".
- [9] 3GPP TS 29.002: "Mobile Application Part (MAP) specification".
- [10] 3GPP TS 29.007: "General requirements on interworking between the Public Land Mobile Network (PLMN) and the Integrated Services Digital Network (ISDN) or Public Switched Telephone Network (PSTN)".

- [11] 3GPP TS 29.011: "Digital cellular telecommunications system (Phase 2+); Signalling interworking for supplementary services".
- [12] GSM 08.08: "Digital cellular telecommunications system (Phase 2+); Mobile Switching Centre - Base Station System (MSC - BSS) interface Layer 3 specification".
- [13] GSM 09.03: "Digital cellular telecommunications system (Phase 2+); Signalling requirements on interworking between the Integrated Services Digital Network (ISDN) or Public Switched Telephone Network (PSTN) and the Public Land Mobile Network (PLMN)".
- [14] GSM 09.08: "Digital cellular telecommunications system (Phase 2+); Application of the Base Station System Application Part (BSSAP) on the E-interface".
- [15] 3GPP TS 29.108: "Application of the Radio Access Network Application Part (RANAP) on the E-interface"

## 1.2 Abbreviations

Abbreviations used in the present document are listed in 3GPP TS 21.905.

---

# 2 Classification of interworking cases

## 2.1 Transparent procedures

The following MSC procedures require transparent mapping of BSSAP information elements into MAP parameters and vice versa (see GSM 09.02 for definitions and the use of the procedures):

- update location area;
- detach IMSI;
- forward new TMSI;
- provide IMSI;
- obtain IMEI;
- check IMEI;
- authenticate;
- trace subscriber activity.

## 2.2 Non-transparent procedures

Procedures in this class require processing in the MSC and information element mapping. These procedures include those related to:

- outgoing call set-up;
- incoming call set-up;
- handover;
- cipher mode setting.



---

## 3 Interworking in the MSC, Transparent case

### 3.1 General

When the MSC receives a forward message from the BSS (possibly forwarded transparently from the MS), it will invoke the desired MAP service and establish a cross reference between the BSSAP procedure and the MAP procedure in order to return the result of the operation to the BSS (which may forward it transparently to the MS). The cross reference is deleted when the MSC terminates the MAP procedure.

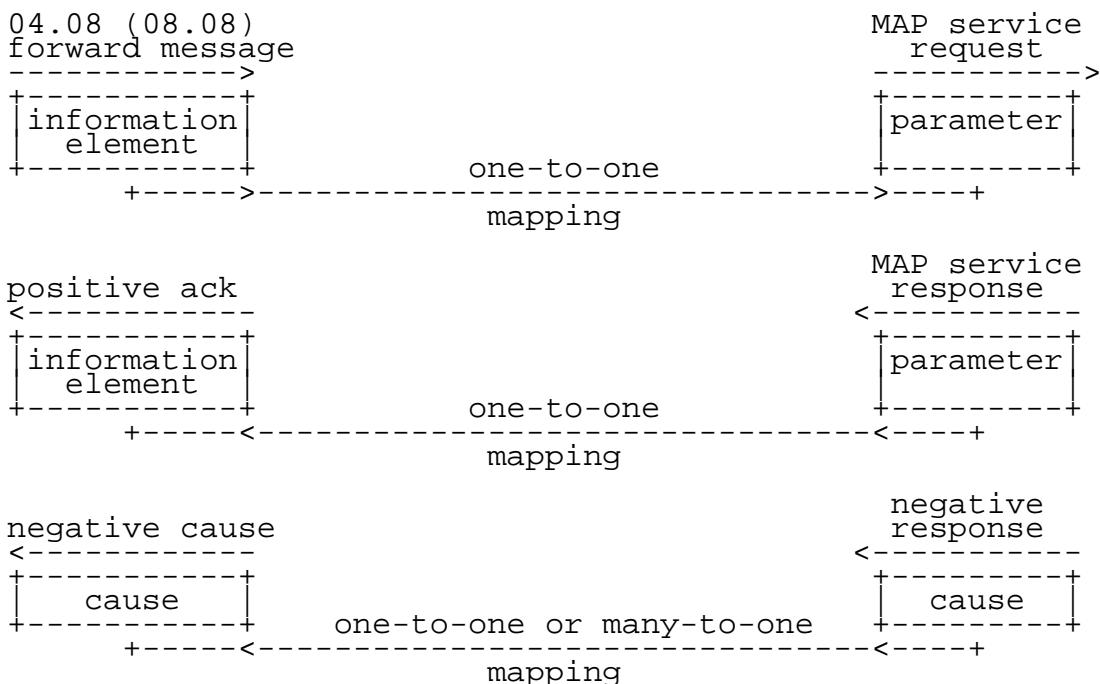
Positive or negative results of the MAP procedure are returned in the appropriate BSSAP message.

The parameters of the forward BSSAP message are mapped by a one-to-one mapping into the parameters of the MAP service. However, in some cases parameters received on the radio path may be suppressed at the MSC because they are related to another protocol entity, e.g. information related to RR-management may be included in MM-management messages. Similarly, parameters received in the (positive) MAP service response are mapped one-to-one into parameters of the corresponding backward BSSAP message.

A negative outcome, as carried in various MAP services (MAP specific service response, MAP\_U\_ABORT, MAP\_P\_ABORT, MAP\_NOTICE and premature MAP\_CLOSE, see GSM 09.02 for definitions) is mapped into a cause value in the required backward BSSAP message. In this case several negative results of MAP may be mapped into the same BSSAP cause value, i.e. without discrimination between these negative results.

**NOTE:** For O & M purposes, the MAP procedure entity in the MSC may require a more detailed overview of negative results than the MS.

These principles are illustrated in figure 1.



**Figure 1: Illustration of mapping principles in the MSC**

For each of the transparent operations listed in subclause 2.1, the following format is used to show the mapping.

	04.08 or 08.08		09.02	Notes
Forward message	MS/BSS to MSC message name information element 1 information element 2	<---> <--->	MSC to VLR MAP service request parameter 1 parameter 2	
Positive result	MSC to MS/BSS message name information element 1 information element 2	<---> <--->	VLR to MSC positive response parameter 1 parameter 2	
Negative result	MSC to MS/BSS message name cause 1 cause 2 cause 3 cause 3 cause 3	<---> <---> <---> <---> <--->	VLR to MSC negative response cause 1 cause 2 MAP_U/P_ABORT MAP_NOTICE MAP_CLOSE	

Equivalent mapping principles apply for operations invoked by the VLR towards the BSS/MS. However, negative results are generally not received from the BSS/MS but are generated in the MSC. Therefore, for such operations the interworking for negative results is not normally shown.

## 3.2 Location area updating

	08.08/04.08	09.02	Notes
Forward message	COMPLETE LAYER 3 INFO (LOCATION UPDATING REQUEST)	MAP_UPDATE_LOCATION_AREA request	
	Location area id	Previous LA Id	
	Mobile identity	IMSI or TMSI	
	Mobile station classmark 1	-	4
	Ciphering key seq number	CKSN	
	Location update type	Location update type	3
	Cell identifier	Target LA Id	1
	Chosen channel	-	
Positive results	DTAP (LOCATION UPDATING ACCEPT)	MAP_UPDATE_LOCATION_AREA response	
	Location area identity	-	
	Mobile identity	-	5
	Follow on proceed	-	
Negative results	DTAP (LOCATION UPDATING REJECT)	MAP_UPDATE_LOCATION_AREA response	
	IMSI unknown in HLR	Unknown subscriber	6
	Network failure	Unknown LA	2
	PLMN not allowed	Roaming not allowed:	
	LA not allowed	PLMN not allowed	
	Roaming not allowed in this LA	LA not allowed	
	PLMN not allowed	National Roaming not allowed	
	Illegal MS	Operator determined barring	
	Illegal ME	Illegal subscriber	
	Network failure	Illegal equipment	
	Network failure	System Failure	
	Network failure	Unexpected data value	
	Network failure	MAP_U/P_ABORT	
	Network failure	MAP_NOTICE	
	Network failure	MAP_CLOSE	

NOTE 1: The Target LA Id parameter is derived by the MSC from the Cell identifier information element.

NOTE 2: The Unknown LA error is only generated as a result of incorrect information being inserted by the MSC or BSS.

NOTE 3: This parameter can be used by the VLR to decide whether (e.g.) Authentication or IMEI checking is needed.

NOTE 4: As the mobile station classmark (1 or 2) is received by the MSC at the establishment of every RR connection, this information need not be stored in the VLR, but it is stored in the MSC as long as the RR connection exists.

NOTE 5: The mobile identity is inserted by the MSC if it is received in a MAP\_FORWARD\_NEW\_TMSI service. If a TMSI is included, the MS should respond with a TMSI REALLOCATION COMPLETE message.

NOTE 6: The HLR shall also send this error if there is an error in the type of subscription (i.e. VLR requests service for a GPRS only subscriber).

### 3.3 Detach IMSI

	04.08	09.02	Notes
Forward message	IMSI DETACH INDICATION Mobile identity Mobile Station classmark 1	MAP_DETACH_IMSI request IMSI or TMSI -	
Positive result			1
Negative result			

NOTE 1: The forward message is not acknowledged.

Depending on the state of the MS, the IMSI DETACH INDICATION may be carried in either a DTAP message or a BSSMAP COMPLETE LAYER 3 INFORMATION message.

### 3.4 Routeing area updating

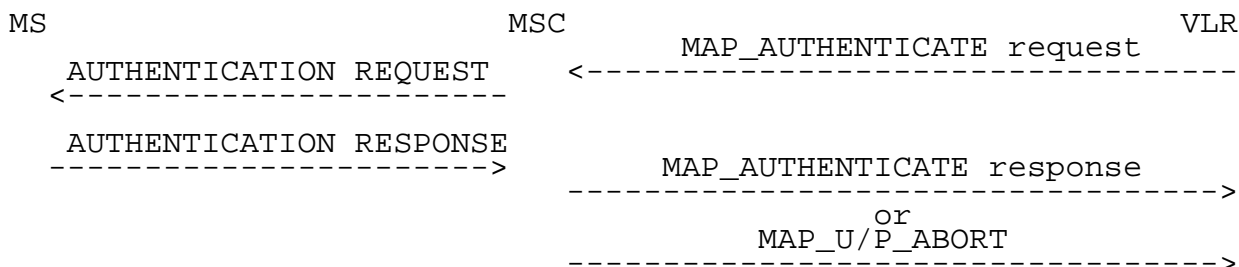
	04.08	09.02	Notes
Forward message	GMM (ROUTEING AREA UPDATE REQUEST)  MS classmark 1 MS classmark 4 GPRS Ciphering key seq number Mobile station identity Old routeing area identification	MAP_UPDATE_GPRS LOCATION request  - - - IMSI -	-
Positive results	GMM (ROUTEING AREA UPDATE ACCEPT)  Routeing area identification Mobile station identity C Mobile station C Reject: IMSI unknown in HLR C Reject: MSC temporarily not reacheable	MAP_UPDATE_GPRS LOCATION response  - - - - -	1 2 3 4
Negative results	GMM (ROUTEING AREA UPDATE REJECT)  Network failure GPRS services not allowed in this PLMN GPRS services not allowed GPRS services and non GPRS services not allowed C GPRS services not allowed C GPRS services and non-GPRS services not allowed MS identity cannot be derived by the network  GPRS services not allowed in this PLMN LA not allowed Roaming not allowed in this LA GPRS services not allowed in this PLMN Illegal MS Illegal ME Network failure Network failure Network failure Network failure Network failure	MAP_UPDATE_GPRS LOCATION response  - Unknown HLR  Unknown subscriber (no GPRS subscription) Unknown subscriber (IMSI unknown) Unknown subscriber (no GPRS subscription) Unknown subscriber (IMSI unknown) -  Roaming not allowed: PLMN not allowed  - - Operator determined barring  - - System Failure Unexpected data value MAP_U/P_ABORT MAP_NOTICE MAP_CLOSE	5 6 7 8 9 10

NOTE 1: The mobile station identity is inserted by the SGSN if the SGSN wants to deallocate or re-allocate a P-TMSI. If the SGSN wants to deallocate the P-TMSI it shall include the IMSI. If the SGSN wants to re-allocate the P-TMSI it shall include the new P-TMSI. If a P-TMSI is included, the MS shall respond with a ROUTEING AREA UPDATE COMPLETE message.

- NOTE 2: The mobile station identity is inserted by the SGSN if it is received in a BSSAP+ LOCATION UPDATE ACCEPT message from the VLR. If a TMSI is included, the MS shall respond with a ROUTEING AREA UPDATE COMPLETE message. Only used in the Combined Routeing and Location Area procedure.
- NOTE 3: This reject cause is inserted on the positive response by the SGSN if the SGSN receives a BSSAP+ LOCATION UPDATE REJECT message from the VLR indicating in the reject cause IMSI unknown in HLR. Only used in the Combined Routeing and Location Area procedure.
- NOTE 4: This reject cause is inserted on the positive response by the SGSN if the SGSN does not receive any response from the VLR to a previous BSSAP+ LOCATION UPDATE REQUEST message. Only used in the Combined Routeing and Location Area procedure.
- NOTE 5: The Unknown RA error is only generated as a result of incorrect information being inserted by the BSS.
- NOTE 6: The HLR shall send Unknown subscriber with diagnostic value No GPRS subscription if the HLR indicates that there is an error in the type of subscription (i.e. SGSN requests service for a non-GPRS only subscriber).
- NOTE 7: The HLR shall send Unknown subscriber with diagnostic value IMSI unknown if the HLR indicates that the IMSI provided by the SGSN is unknown.
- NOTE 8: The HLR shall send Unknown subscriber with diagnostic value No GPRS subscription if the HLR indicates that there is an error in the type of subscription (i.e. SGSN requests service for a non-GPRS only subscriber). Used in the Combined Routeing and Location Area procedure.
- NOTE 9: This reject cause is inserted if the SGSN receives a MAP GPRS UPDATE LOCATION negative response message indicating IMSI unknown. Used in the Combined Routeing and Location Area procedure.
- NOTE 10: This reject cause is inserted if the SGSN does not receive any response from the old SGSN to a previous SGSN CONTEXT REQUEST message.

## 3.5 Authentication

The message flow for the authentication procedure is shown in figure 2.



**Figure 2: Authentication operation**

The MSC can only act on a MAP\_AUTHENTICATE request if an RR connection exists with the MS. If such a connection does not exist, the MSC shall terminate the MAP procedure with a MAP\_U\_ABORT. The same applies if the MS does not respond to an AUTHENTICATION REQUEST message.

	04.08	09.02	Notes
Forward message	AUTHENTICATION REQUEST	MAP_AUTHENTICATE request	
	RAND	RAND	
	Ciphering key seq number	CKSN	
Backward result	AUTHENTICATION REQUEST	MAP_AUTHENTICATE response	
	SRES	SRES	

If the SRES parameter does not match the value stored in the VLR, then the ongoing MAP procedure shall be terminated with a cause 'illegal subscriber'. This shall cause the MSC to send an AUTHENTICATION REJECT message.

### 3.6 Retrieval of the IMSI from the MS

The VLR may request open identification of an MS with a MAP\_PROVIDE\_IMSI request.

The mapping of information elements is as follows:

	04.08	09.02	Notes
Forward message	IDENTITY REQUEST	MAP_PROVIDE_IMSI request	
	Identity type set to: IMSI		1
Backward result	IDENTITY RESPONSE Mobile Identity (IMSI)	MAP_PROVIDE_IMSI response	

NOTE 1: The INVOKE does not carry any parameters. The identity type is inferred from the invoke name.

The MSC shall return a MAP\_PROVIDE\_IMSI response with user error "absent subscriber" if:

- there is no RR connection with the MS when the MAP service request is received;
- there is no response from the MS.

### 3.7 Reallocation of TMSI

This operation is invoked by the VLR. The MAP\_FORWARD\_NEW\_TMSI request contains the new TMSI which is forwarded to the MS in the TMSI REALLOCATION COMMAND. When the MS acknowledges the receipt of the new TMSI, the MSC will return a MAP\_FORWARD\_NEW\_TMSI response to the VLR.

If there is no radio connection to the MS when the MSC receives the MAP service request, the MSC shall ignore the message.

	04.08	09.02	Notes
Forward message	TMSI REALLOCATION COMMAND	MAP_FORWARD_NEW_TMSI request	
	Mobile identity	TMSI	
	Location area identification	-	
Backward result	TMSI REALLOCATION COMPLETE	MAP_FORWARD_NEW_TMSI response	

### 3.8 Retrieval of the IMEI from the MS

The VLR may use the MAP\_OBTAIN\_IMEI service to request the MS to supply its IMEI, or may use the MAP\_CHECK\_IMEI service to request the MSC to check the MS's IMEI. For either MAP service the BSSAP signalling is the same.

The mapping of information elements is as follows:

	04.08	09.02	Notes
Forward message	IDENTITY REQUEST	{ MAP_CHECK_IMEI request or MAP_OBTAIN_IMEI request	
	Identity type set to: IMEI		1
Backward result	IDENTITY RESPONSE	{ MAP_CHECK_IMEI response or MAP_OBTAIN_IMEI response	
	Mobile Identity (IMEI)	IMEI	2

NOTE 1: The MAP service request does not carry any parameters. The identity type is inferred from the service name.

NOTE 2: If the MAP\_CHECK\_IMEI service was used, the MSC also returns the equipment status to the VLR in the MAP\_CHECK\_IMEI response, after a successful dialogue with the EIR using the IMEI received from the MS.

The MSC shall terminate the MAP dialogue with the VLR using a MAP\_U\_ABORT if:

- there is no RR connection with the MS when the MAP service request is received;
- there is no response from the MS.

NOTE: The MSC can also obtain the IMEI from a phase 2 MS by including appropriate information in the BSSMAP Cipher Mode Command.

### 3.9 Tracing subscriber activity

The VLR may request the MSC and/or BSS to record data about the current transaction with an MS.



	08.08	09.02	Notes
Forward message	MSC INVOKE TRACE	MAP TRACE_SUBSCRIBER_ACTIVITY request	
	Trace type	Trace type	
	TriggerId	-	
	Trace reference	Trace reference	
	TransactionId	-	
	Mobile identity(IMSI)	IMSI	1
	Mobile identity(IMEI)	IMEI	1
	OMCId	OMCId	
Backward result	none	none	

NOTE 1: The VLR may provide either an IMSI or IMEI, but not both.

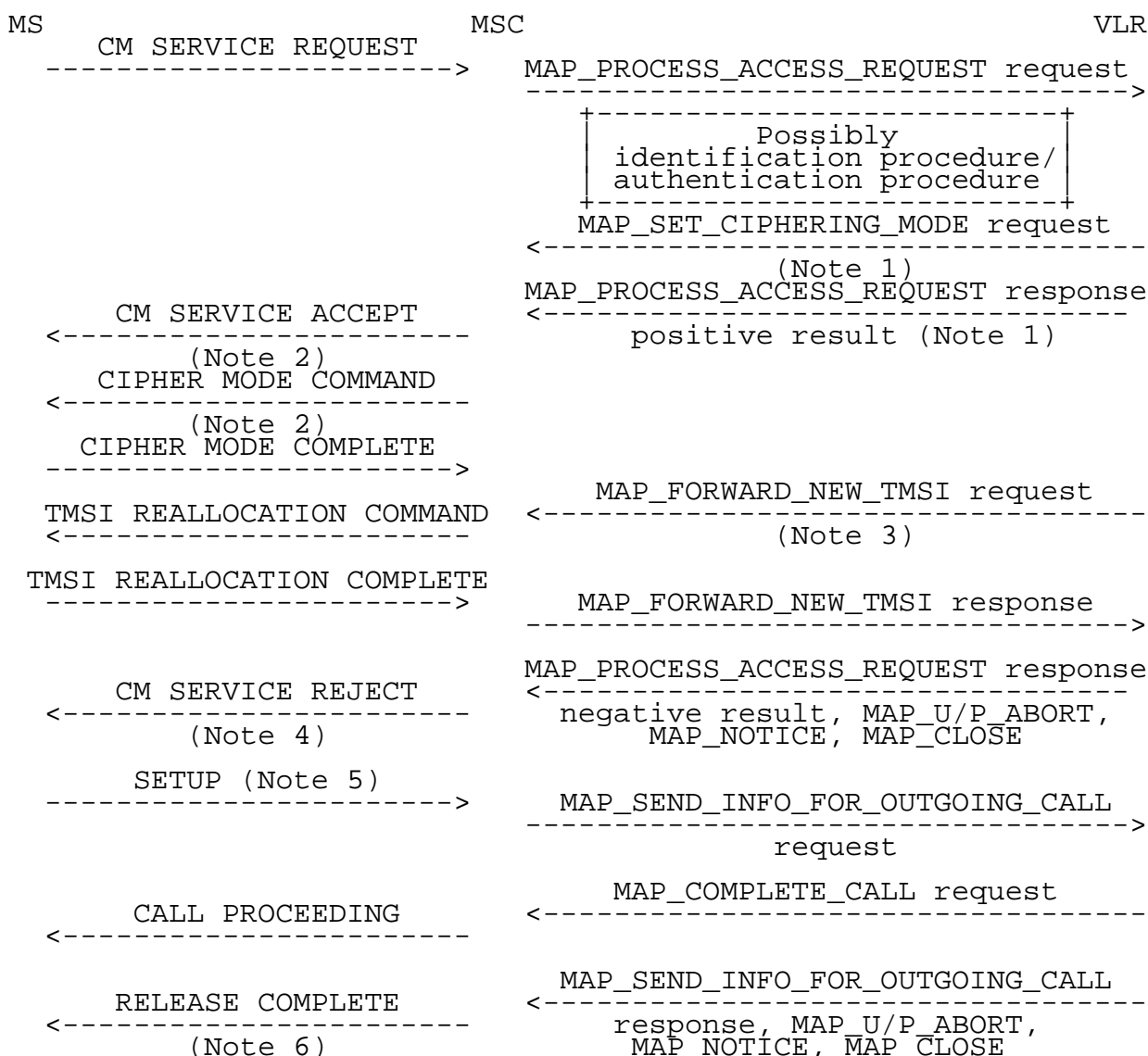
## 4 Non-transparent cases

### 4.1 General

For interworking other than the mapping of information fields, see GSM 09.08.

### 4.2 Outgoing call set-up (MS originating call)

Figure 3 shows those elements of a call set-up sequence which require interworking between BSSAP and MAP. BSSAP messages which do not require interworking with MAP are not shown.



**Figure 3: Part of outgoing call set-up sequence**

NOTE 1: If the MSC received a MAP\_SET\_CIPHERING\_MODE request, it stores it until it receives the MAP\_PROCESS\_ACCESS\_REQUEST response.

NOTE 2: CM SERVICE ACCEPT is sent only if the ciphering procedure is not invoked.

NOTE 3: TMSI reallocation need not be sequenced with other messages, but should be sent after ciphering.

NOTE 4: CM SERVICE REJECT is sent as a result of a user error parameter in the MAP\_PROCESS\_ACCESS\_REQUEST response, or termination of the MAP dialogue.

NOTE 5: The SETUP message is sent after the MS has either received a CM SERVICE ACCEPT or sent a CIPHER MODE COMPLETE.

NOTE 6: RELEASE COMPLETE is sent as a result of a user error parameter in the MAP\_SEND\_INFO\_FOR\_OUTGOING\_CALL response, or termination of the MAP dialogue.

The procedure can be considered in two parts: the handling of the CM SERVICE REQUEST and the handling of the SETUP request.

The procedure is initiated by the MS sending a CM SERVICE REQUEST message. The MSC will forward the service request to the VLR in the MAP\_PROCESS\_ACCESS\_REQUEST request. The VLR may then invoke other operations, e.g. authentication and identification. These operations are defined in subclauses 3.4 and 3.5.

If there is a positive outcome for the CM SERVICE REQUEST procedure, the VLR always sends a MAP\_PROCESS\_ACCESS\_REQUEST response. If the request is for a first MM-connection and ciphering is required, the MAP\_PROCESS\_ACCESS\_REQUEST response is preceded by a MAP\_SET\_CIPHERING\_MODE request. In this case the MSC sends a CIPHER MODE COMMAND towards the MS. The interworking for cipher mode setting is described in subclause 4.4. If the request is for an additional MM-connection or for a first MM-connection where ciphering is not required, then the positive MAP\_PROCESS\_ACCESS\_REQUEST response causes the MSC to send a CM SERVICE ACCEPT message to the MS. After cipher mode setting has been completed or the CM SERVICE ACCEPT message has been returned, the MS will send the SETUP (or EMERGENCY SETUP) message and information retrieval takes place as shown.

A negative outcome for the MAP\_PROCESS\_ACCESS\_REQUEST procedure can be signalled by a MAP\_PROCESS\_ACCESS\_REQUEST response containing a user error parameter, or by terminating the MAP dialogue between the MSC and the VLR.

A positive outcome for the call setup procedure is indicated by a MAP\_COMPLETE\_CALL request from the VLR to the MSC, which causes the MSC to send a CALL PROCEEDING message towards the MS.

A negative outcome for the call setup procedure can be signalled by a MAP\_SEND\_INFO\_FOR\_INCOMING\_CALL response or by terminating the dialogue between the MSC and the VLR.

Information element mapping is required between the messages:

- CM SERVICE REQUEST to MAP\_PROCESS\_ACCESS\_REQUEST request;
- SETUP to MAP\_SEND\_INFO\_FOR\_OUTGOING\_CALL request;
- MAP\_SEND\_INFO\_FOR\_OUTGOING\_CALL response, MAP\_U/P\_ABORT, MAP\_NOTICE or premature MAP\_CLOSE to RELEASE COMPLETE or CM SERVICE REJECT.

The information contained in the MAP\_COMPLETE\_CALL request is not transmitted on the radio interface but is used in the MSC for connecting the call.

The conversion of information elements is as follows:

	08.08/04.08	09.02	Notes
Forward	COMPLETE LAYER 3 INFO (CM SERVICE REQUEST)	MAP_PROCESS_ACCESS_REQUEST request	
	CM Service type Ciphering key sequence number Mobile identity Mobile station Classmark 2	CM Service type CKSN  TMSI or IMSI or IMEI  -	1
	Cell identifier Chosen channel -	Current LA Id - Access Connection Status	4  3
Positive result	DTAP(CM SERVICE ACCEPT)	MAP_PROCESS_ACCESS_REQUEST response	2
Negative result	DTAP(CM SERVICE REJECT)	MAP_PROCESS_ACCESS_REQUEST response	
[	IMSI unknown in VLR Requested service option not subscribed Illegal ME Network failure Network failure Network failure Network failure	Unidentified Subscriber ??????  Illegal equipment System failure MAP_U/P_ABORT MAP_NOTICE MAP_CLOSE	]
	DTAP(AUTHENTICATION REJECT)	MAP_PROCESS_ACCESS_REQUEST response  Illegal subscriber	

NOTE 1: Indicates, in this case, a mobile originating call establishment or an emergency call establishment.

NOTE 2: The CM SERVICE ACCEPT is sent when the ciphering procedure is not invoked.

NOTE 3: Indicates whether or not an RR-connection exists and whether or not ciphering has been started.

NOTE 4: The Current LA Id parameter is derived by the MSC from the Cell identifier information element.

	04.08	09.02	Notes
Forward message	SETUP	MAP_SEND_INFO_FOR_OUTGOING_CALL request	
	BC repeat indicator	-	
	Bearer capability 1	-	3
	Bearer capability 2	-	3
	Calling party subaddress	-	
	Called party BCD number	Called Number	
	Called party subaddress	-	
	LLC repeat indicator	-	
	Low layer compatibility I	-	
	Low layer compatibility II	-	
	HLC repeat indicator	-	
	High layer compatibility i	-	
	High layer compatibility ii	-	
	-	Bearer service	3
	-	Teleservice	3
	Facility	-	1
	-	CUG index	4
	-	Suppress pref CUG	4
	-	Suppress CUG OA	4
	User-user	-	
	SS version	-	
	CLIR flag	-	
Positive result			2
Negative result	RELEASE COMPLETE	MAP_SEND_INFO_FOR_OUTGOING_CALL response	
	TS GSM 04.10	Call Barred	
		Barring Service Active	
	Operator determined barring	Call Barred Operator Determined Barring	
	Network out of order	Data Missing	
	Network out of order	Unexpected Data Value	
	Network out of order	System Failure	
	Bearer capability not authorized	Bearer service not provisioned	
	Bearer capability not authorized	Teleservice not provisioned	
	[User not member of CUG]	CUG reject	
	Network out of order	MAP_U/P_ABORT	
	Network out of order	MAP_NOTICE	
	Network out of order	MAP_CLOSE	

NOTE 1: If the Facility IE contains CUG information, the CUG information is transferred to the VLR in the MAP\_SEND\_INFO\_FOR\_OUTGOING\_CALL service; any other information contained in a Facility IE is transferred to the VLR in a MAP Supplementary Services related service.

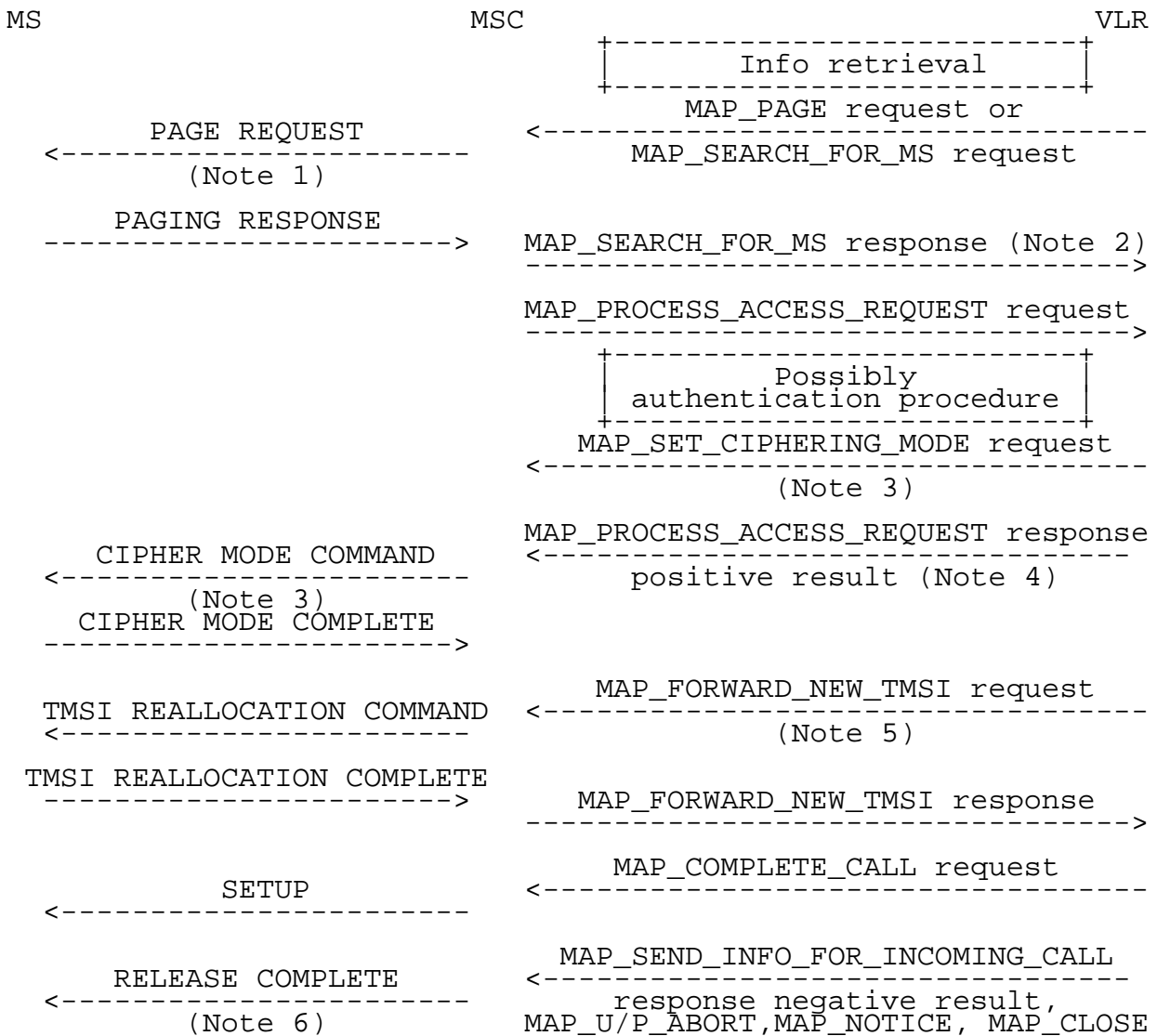
NOTE 2: The call setup parameters retrieved from the VLR are not sent to the MS. The parameters are carried in the MAP\_COMPLETE\_CALL service.

NOTE 3: The bearer capabilities can be used to derive the bearer/tele service.

NOTE 4: CUG information is derived from the contents of the Facility IE.

### 4.3 Incoming call set-up (MS terminating call)

Figure 4 shows those elements of the procedure which require interworking between MAP and GSM 04.08 procedures.



**Figure 4: Incoming call set-up**

NOTE 1: If an MM connection already exists, the PAGE REQUEST is not sent. If the call can be accepted, the MSC sends a MAP\_PROCESS\_ACCESS\_REQUEST request in response to the MAP\_PAGE request. If the call cannot be accepted the MSC sends a MAP\_PAGE response containing the error 'busy subscriber'.

NOTE 2: Sent only if MAP\_SEARCH\_FOR\_MS was used.

NOTE 3: Needed only if a ciphered MM-connection does not exist already.

NOTE 4: If the MSC received a MAP\_SET\_CIPHERING\_MODE request, it stores it until it receives the MAP\_PROCESS\_ACCESS\_REQUEST response.

NOTE 5: TMSI reallocation need not be sequenced with other messages, but should be sent after ciphering.

NOTE 6: RELEASE COMPLETE is sent as a result of a user error parameter in the MAP\_SEND\_INFO\_FOR\_OUTGOING\_CALL response, or termination of the MAP dialogue.

The paging procedure is controlled by the VLR. It may be followed by authentication (subclause 3.4), ciphering (subclause 4.4) and reallocation of TMSI(subclause 3.6). The SETUP message is sent when the MAP\_COMPLETE\_CALL request is received.

Normally there is no interworking between the MAP\_COMPLETE\_CALL request and the SETUP message. However, the MAP\_COMPLETE\_CALL request may contain a bearer service indication which will be used to establish the bearer capabilities at the MSC. The interworking between the MAP\_PAGE request or MAP\_SEARCH\_FOR\_MS request and the BSSMAP PAGING REQUEST message is as follows:

	08.08/04.08	09.02	Notes
Forward message	PAGING REQUEST	MAP_PAGE request or MAP_SEARCH_FOR_MS request	
	IMSI TMSI Cell identifier list	IMSI TMSI Stored LA Id	1
Backward message	COMPLETE LAYER 3 INFO (PAGING RESPONSE)	MAP_PROCESS_ACCESS_REQUEST request	
	- Ciphering key sequence number	CM service type CKSN	2
	Mobile identity Mobile station classmark 2	TMSI or IMSI	
	Cell Identifier	- Current LA Id	3
	- Chosen channel	Access connection status -	

NOTE 1: If TMSI is included, the TMSI is used as the mobile identity in the GSM 04.08 PAGE REQUEST message, otherwise the IMSI is used as the mobile identity.

NOTE 2: In this case the MAP CM service type is set to 'mobile terminating call'.

NOTE 3: The Target LA Id parameter is derived by the MSC from the Cell identifier information element.

## 4.4 Cipher mode setting

The interworking is as follows:

	08.08	09.02	Notes
Forward	CIPHER MODE COMMAND	MAP_SET_CIPHERING_MODE request	
	Cipher mode setting Encryption information	Ciphering mode Kc	1
Positive result	CIPHER MODE COMPLETE	None	
Negative result	CIPHER MODE REJECT	None	

NOTE 1: The key Kc is passed through the BSS to the BTS, but is not passed to the MS.

## 4.5 Inter-MSC Handover

The general principles of the handover procedures are given in GSM 03.09. GSM 09.10 gives the necessary information for interworking between the GSM 08.08 handover protocol and the GSM 09.02 MAP protocol.

### 4.5.1 Basic Inter-MSC Handover

When a Mobile Station is handed over between two MSCs, the establishment of a connection between them (described in GSM 03.09) requires interworking between A-Interface and E-Interface.

The signalling at initiation, execution, completion of the Basic Inter-MS-C handover procedure is shown in figures 5 to 10 with both possible positive or negative outcomes.

Additionally figures 5b and 5c show the possible interworking when trace related messages are transparently transferred on the E-Interface at Basic Inter-MS-C Handover initiation.

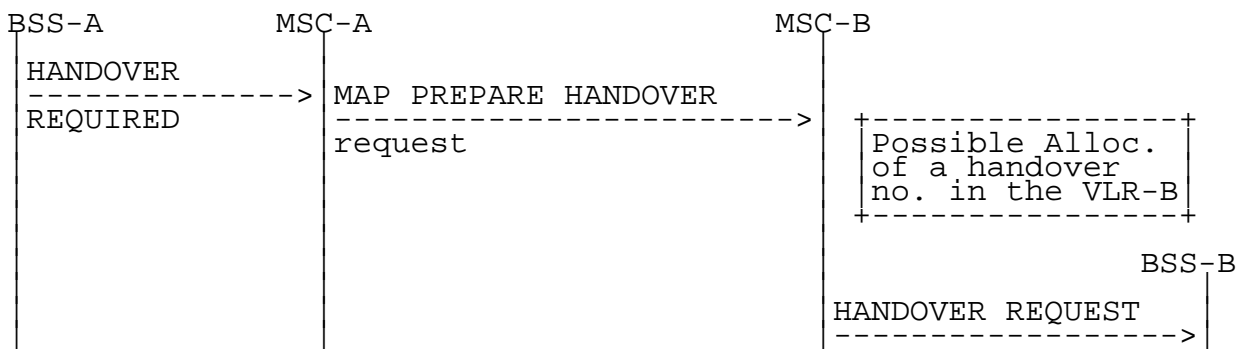


Figure 5a: Signalling for Basic Inter-MS-C Handover initiation (no trace related messages transferred)

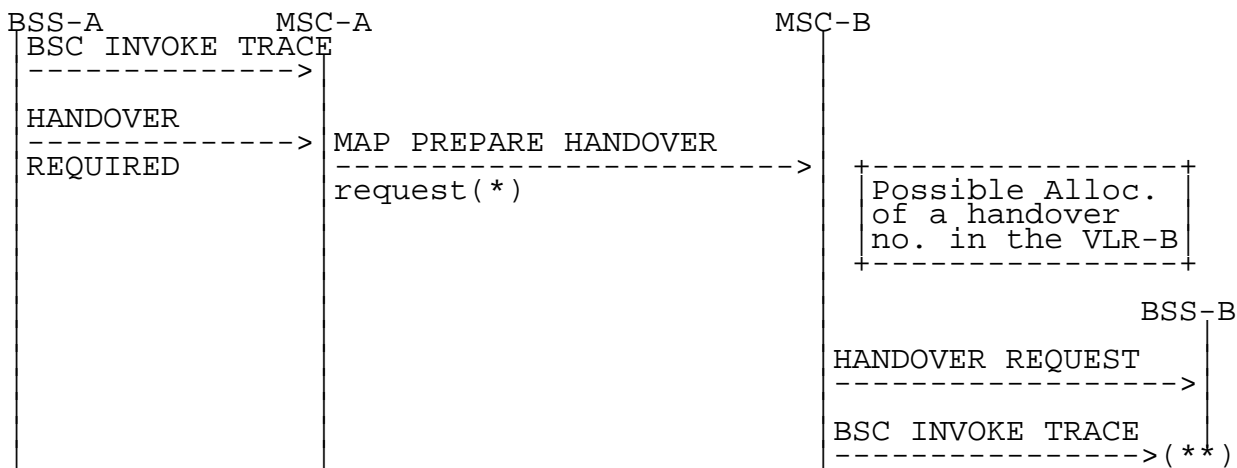


Figure 5b: Signalling for Basic Inter-MS-C Handover initiation (BSC invoke trace message transferred)

(\*): In that case, **HANDOVER REQUEST** and **BSC INVOKE TRACE** messages are included within the **BSS-apdu** parameter.

(\*\*): **BSC INVOKE TRACE** is forwarded to **BSS-B** if supported by **MSC-B**.

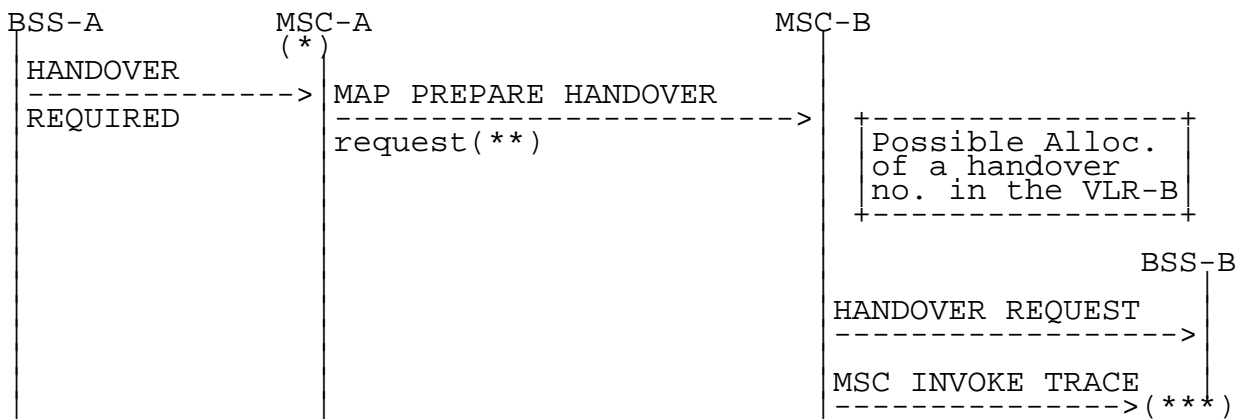


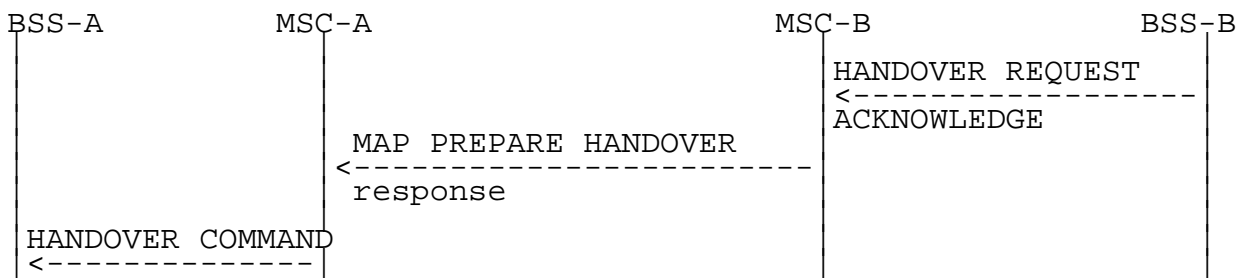
Figure 5c: Signalling for Basic Inter-MS-C Handover initiation (MSC invoke trace message transferred)



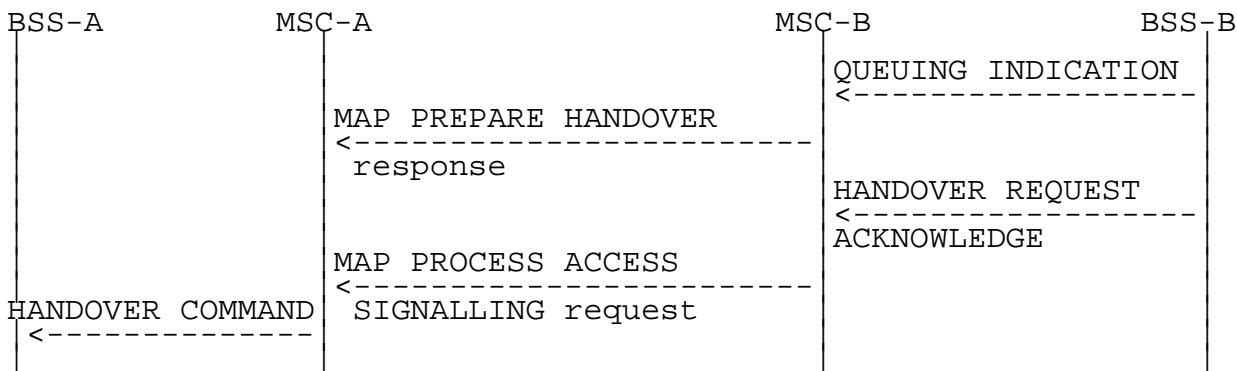
- (\*): Tracing invocation has been received from VLR.
- (\*\*): In that case, HANDOVER REQUEST and MSC INVOKE TRACE messages are included within the BSS-apdu parameter.
- (\*\*\*): MSC INVOKE TRACE is forwarded to BSS-B if supported by MSC-B.

Possible Positive outcomes:

- a) successful radio resources allocation and handover number allocation (if performed):



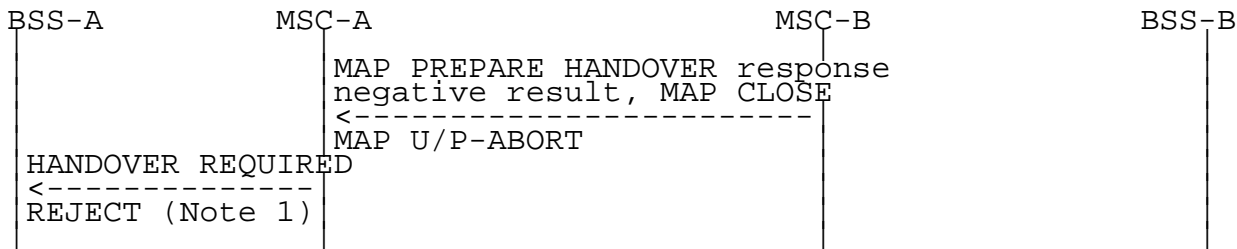
- b) radio resources allocation queued and successful handover number allocation (if performed). Later successful radio resources allocation indication:



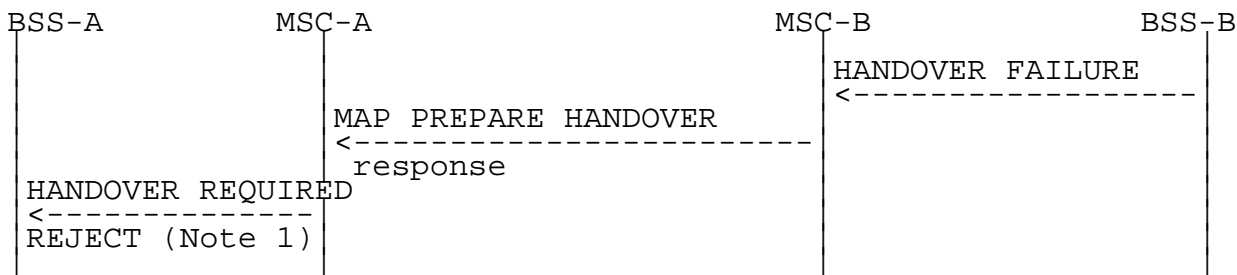
**Figure 6: Signalling for Basic Inter-MSC Handover execution (Positive outcomes)**

Possible Negative outcomes:

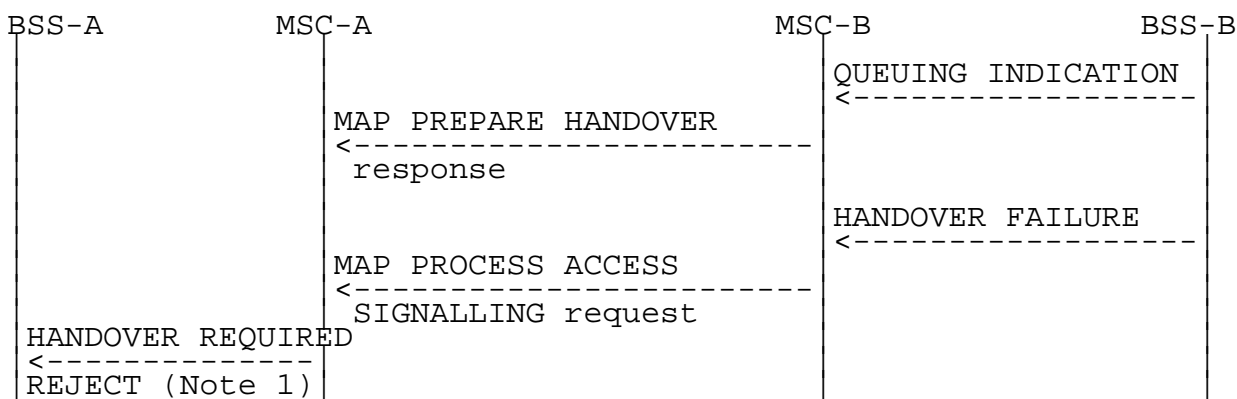
- c) user error detected, or handover number allocation unsuccessful (if performed), or component rejection or dialogue abortion performed by MSC-B:



- d) radio resources allocation failure:



e) radio resources allocation queued and successful handover number allocation (if performed). Later unsuccessful radio resources allocation:



f) unsuccessful handover execution (Reversion to the old channel):

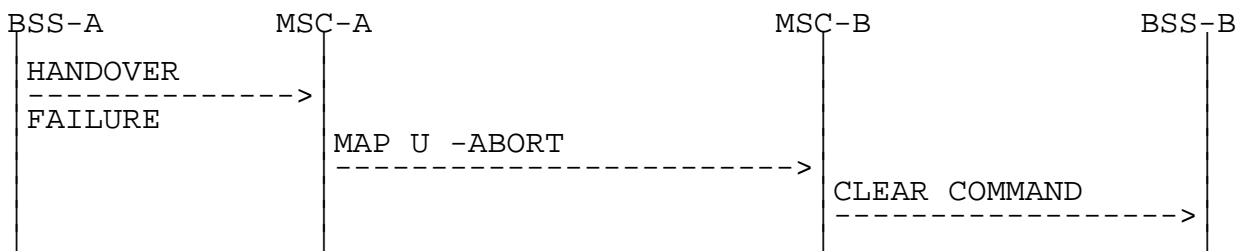


Figure 7: Signalling for Basic Inter-MSC Handover execution (Negative outcomes)

NOTE: Possible rejection of the handover because of the negative outcome of MAP or BSSMAP procedure.

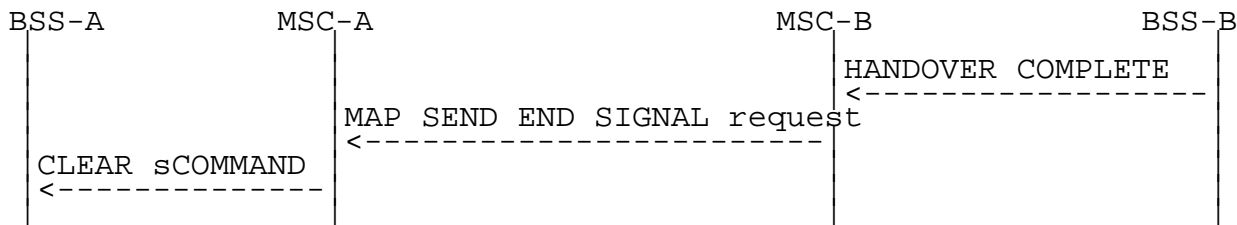
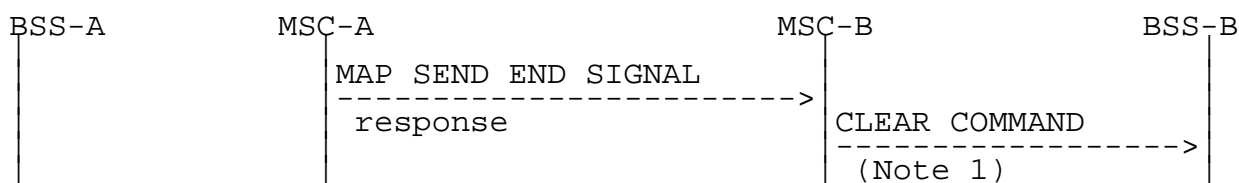


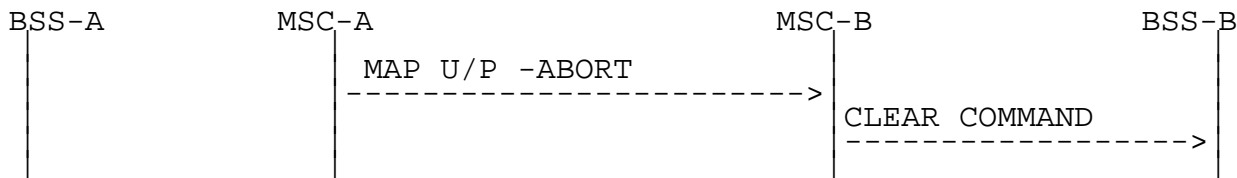
Figure 8: Signalling for Basic Inter-MSC Handover completion

Positive outcome



**Figure 9: Signalling for Basic Inter-MSC Handover completion (Positive outcome)**

Negative outcome



**Figure 10: Signalling for Basic Inter-MSC Handover completion (Negative outcome)**

NOTE: From interworking between MAP and BSSMAP point of view.

The handover procedure is normally triggered by BSS-A by sending a HANOVER REQUIRED message on A-Interface to MSC-A. The invocation of the Basic Inter-MSC handover procedure is performed and controlled by MSC-A. The sending of the MAP Prepare-Handover request to MSC-B is triggered in MSC-A upon receipt of the HANOVER REQUIRED message. For compatibility reason, the cell identity of the cell where the call is to be handed over in MSC-B area, provided in the HANOVER REQUIRED message, is mapped into targetCellId MAP parameter and the HANOVER REQUEST message is encapsulated in the bss-APDU MAP parameter of the Prepare-Handover MAP request. MSC-B can invoke another operation towards the VLR-B (allocation of the handover number described in GSM 09.02).

Additionally, if tracing activity has been invoked, the trace related messages can be transferred on the E-Interface encapsulated in the bss-APDU MAP parameter of the Prepare-Handover Request. If transferred, one complete trace related message at a time shall be included in the bss-APDU MAP parameter after the HANOVER REQUEST message.

The interworking between Prepare Handover and HANOVER REQUIRED is as follows:

	08.08		09.02	Notes
Forward message	HANDOVER REQUIRED	MAP PREPARE HANDOVER request		
	BSSMAP information elements		-ho-NumberNotRequired	1
			-targetCellId -bss-APDU( HANDOVER REQUEST, BSC INVOKE TRACE, or MSC INVOKE TRACE)	2 3
Positive result		MAP PREPARE HANDOVER response		4
Negative result	HANDOVER REQUIRED REJECT	MAP PREPARE HANDOVER		5
	equipment failure		System Failure	
	equipment failure		No Handover Number available	
	equipment failure		UnexpectedDataValue	
	equipment failure		Data Missing	
	equipment failure		MAP CLOSE	
	equipment failure		MAP U/P -ABORT	

NOTE 1: The ho-NumberNotRequired parameter is included by MSC-A, when MSC-A decides not to use any circuit connection with MSC-B. No handover number shall be present in the positive result. Any negative response from MSC-B shall not be due to handover number allocation problem.

NOTE 2: The process performed on the BSSMAP information elements received in the HANDOVER REQUIRED message is described in the GSM Recommendation 08.08.

NOTE 3: The process performed on the BSSMAP information elements received in the MSC or BSC INVOKE TRACE message is described in subclause 4.5.6.6.

NOTE 4: The response to the Prepare-Handover request can include in its bss-APDU parameter, identifying the GSM-08.06 protocol, either a BSSMAP QUEUING INDICATION, or a BSSMAP HANDOVER REQUEST ACKNOWLEDGE or a BSSMAP HANDOVER FAILURE.

In the first case, MSC-A shall wait for the radio resources allocation response from MSC-B, transmitted to MSC-A as described in subclause 4.5.4.

In the second case, the positive result triggers in MSC-A the sending on A-Interface of the HANDOVER COMMAND.

In the third case, the positive result triggers in MSC-A one of the following:

- another handover attempt is initiated by MSC-A;
- optionally the sending of the HANDOVER REQUIRED REJECT.

(The possible sending of the HANDOVER REQUIRED REJECT message upon receipt of the HANDOVER FAILURE is out of the scope of GSM 09.10 and lies in GSM 08.08).

NOTE 5: The possible sending of the HANDOVER REQUIRED REJECT message is described in GSM 08.08.

The interworking between Send End Signal and HANDOVER COMPLETE in MSC-B is as follows:

	08.08	09.02	Notes
Forward message	HANDOVER COMPLETE	MAP SEND END SIGNAL request -bss-APDU(HANDOVER COMPLETE)	
Positive result	CLEAR COMMAND -Call Control release	MAP SEND END SIGNAL response	1
Negative result	CLEAR COMMAND -Call Control release -Call Control release	MAP CLOSE MAP U/P -ABORT	2

NOTE 1: The positive empty result triggers the clearing of the Radio Resources on the A-Interface and the release of the SCCP connection between MSC-B and BSS-B. If a circuit connection is used between MSC-A and MSC-B, the 'Call Control release' clearing cause shall only be given to BSS-B when MSC-B has received a clearing indication on its circuit connection with MSC-A.

NOTE 2: The abortion of the dialogue or the rejection of the component triggers in MSC-B the clearing of its circuit connection with MSC-A, if any, of the Radio Resources on the A-Interface and the release of the SCCP connection between MSC-B and BSS-B.

The interworking between Send End Signal and CLEAR COMMAND in MSC-A is as follows:

	09.02	08.08	Notes
Forward message	MAP SEND END SIGNAL response -bss-APDU(HANDOVER COMPLETE)	CLEAR COMMAND - Handover Successful	
Positive result			
Negative result			

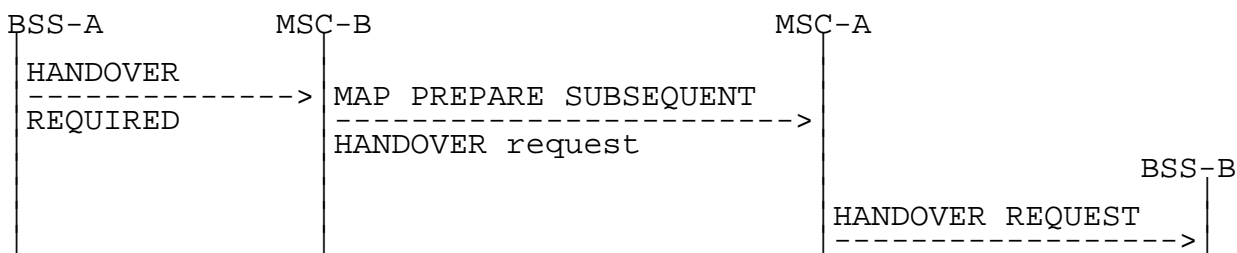
The interworking between HANDOVER FAILURE in case of reversion to old channel of the MS and User Abort in MSC-A is as follows:

	08.08	09.02	Notes
Forward message	HANDOVER FAILURE - Reversion to old channel	MAP U -ABORT	
Positive result			
Negative result			

### 4.5.2 Subsequent Inter-MS Handover back to MSC-A

When a Mobile Station is being handed over back to MSC-A, the procedure (described in GSM 03.09) requires interworking between A-Interface and E-Interface.

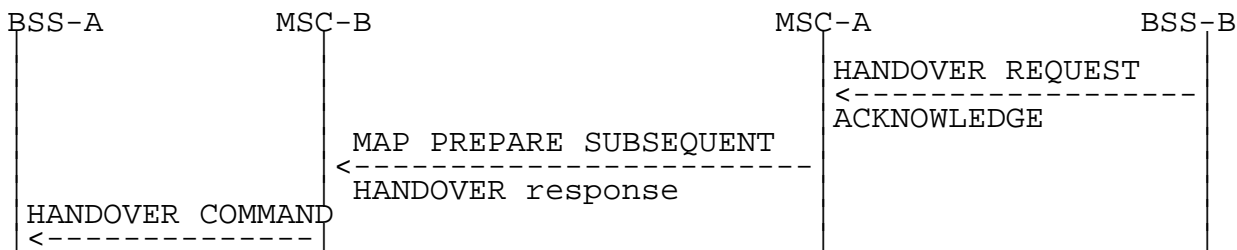
The signalling at initiation, execution and completion of the Subsequent Inter-MS handover procedure is shown in figures 11 to 15.



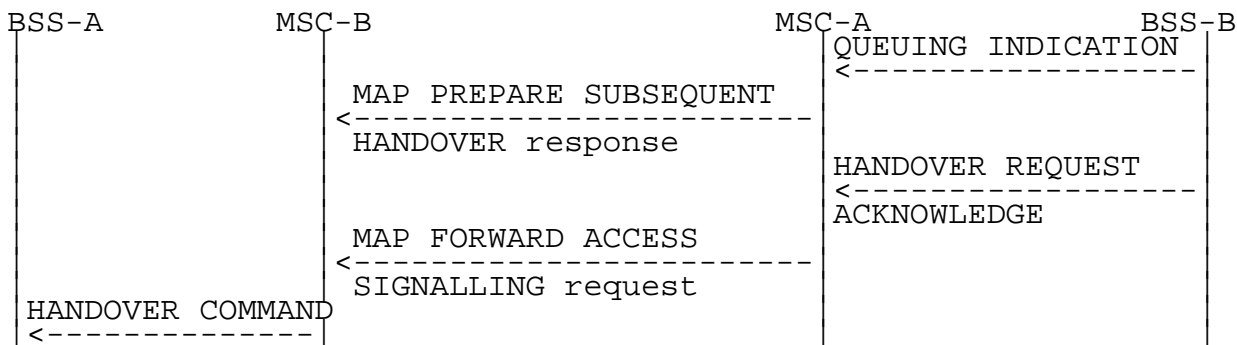
**Figure 11: Signalling for Subsequent Inter-MSC Handover back to MSC-A initiation**

Possible Positive outcomes:

a) successful radio resources allocation:



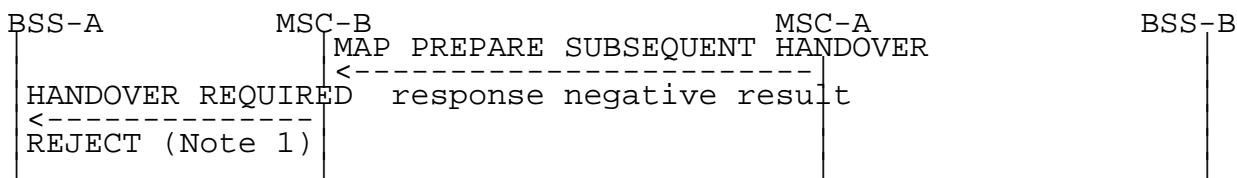
b) radio resources allocation queued. Later successful radio resources allocation indication:



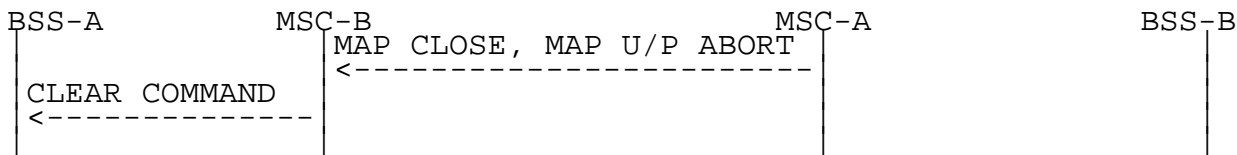
**Figure 12: Signalling for Subsequent Inter-MSC Handover back to MSC-A execution (Positive outcome)**

Possible Negative outcomes:

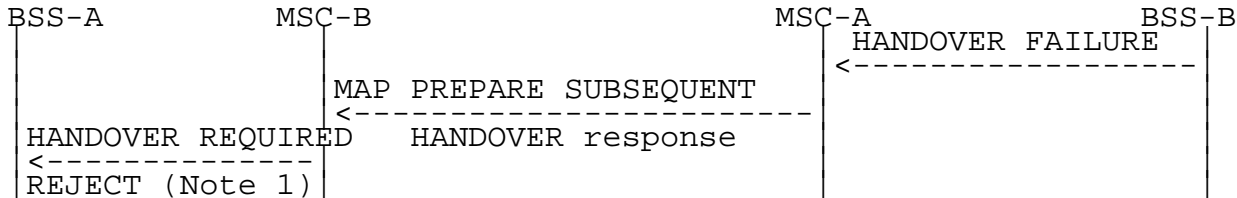
c) user error detected, or component rejection or dialogue abortion performed by MSC-A:



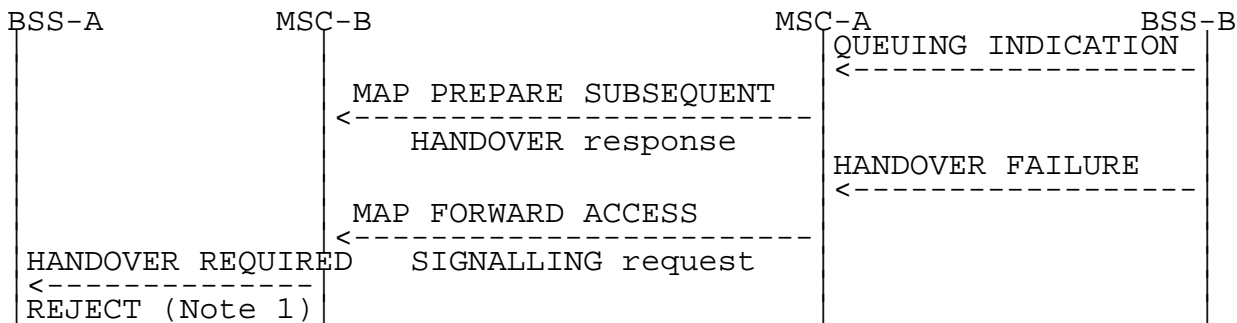
d) component rejection or dialogue abortion performed by MSC-A:



e) radio resources allocation failure:

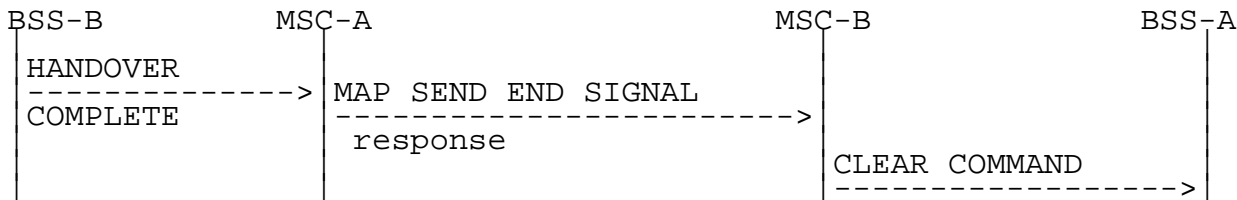


f) radio resources allocation queued. Later unsuccessful radio resources allocation:



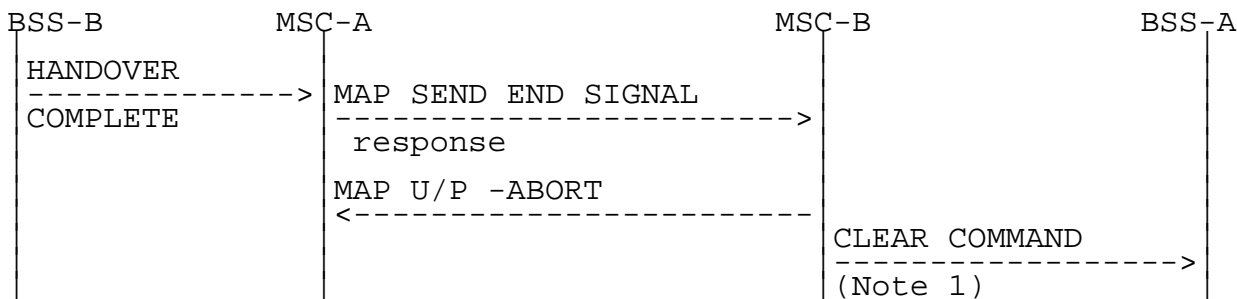
**Figure 13: Signalling for Subsequent Inter-MSC Handover back to MSC-A execution (Negative outcome)**

NOTE 1: Possible rejection of the handover because of the negative outcome of MAP or BSSMAP procedure.



**Figure 14: Signalling for Subsequent Inter-MSC Handover back to MSC-A completion (Successful completion of the procedure)**

NOTE: Positive outcome case shown in figure 9.



**Figure 15: Signalling for Subsequent Inter-MSC Handover back to MSC-A completion (Unsuccessful completion of the procedure)**

NOTE 1: Abnormal end of the procedure which triggers the clearing of all resources in MSC-B.

The interworking between Prepare Subsequent Handover and HANOVER REQUIRED is as follows:

	08.08	09.02	Notes
Forward message	HANDOVER REQUIRED MAP PREPARE	SUBSEQUENT HANDOVER request -target MSC number -targetCellId -bss-APDU(HANDOVER REQUEST)	1
Positive result	HANDOVER REQUIRED MAP PREPARE	SUBSEQUENT HANDOVER response -bss-APDU(QUEUING INDICATION or HANDOVER REQUEST ACKNOWLEDGE or HANDOVER FAILURE)	2
Negative result	HANDOVER REQUIRED REJECT equipment failure equipment failure equipment failure equipment failure CLEAR COMMAND equipment failure equipment failure	MAP PREPARE SUBSEQUENT HANDOVER response Unknown MSC Subsequent Handover Failure UnexpectedDataValue Data Missing MAP CLOSE MAP U/P -ABORT	3

NOTE 1: The processing performed on the BSSMAP information elements received in the HANDOVER REQUIRED message is out of the scope of the present document. The target MSC number is provided to MSC-A by MSC-B based on the information received from BSS-B.

NOTE 2: The response to the Prepare-Subsequent-Handover request can include in its bss-APDU parameter, identifying the GSM-0806 protocol, either a BSSMAP QUEUING INDICATION, or a BSSMAP HANDOVER REQUEST ACKNOWLEDGE or a BSSMAP HANDOVER FAILURE.

In the first case, MSC-B shall wait for the radio resources allocation response from MSC-A, transmitted to MSC-B as described in subclause 4.5.4.

In the second case, the positive result triggers in MSC-B the sending on A-Interface of the HANDOVER COMMAND.

In the third case, the positive result triggers in MSC-B one of the following:

- another handover attempt is initiated by MSC-B;
- optionally the sending of the HANDOVER REQUIRED REJECT.

(The possible sending of the HANDOVER REQUIRED REJECT message upon receipt of the HANDOVER FAILURE is out of the scope of GSM 09.10 and lies in GSM 08.08).

NOTE 3: The possible sending of the HANDOVER REQUIRED REJECT message is described in GSM 08.08.

The interworking between Send End Signal Result and HANDOVER COMPLETE in MSC-A is as follows:



	08.08	09.02	Notes
Forward message	HANDOVER COMPLETE	MAP SEND END SIGNAL response	
Positive result			
Negative result		MAP U/P -ABORT	1

NOTE 1: The abortion of the dialogue ends the handover procedure with MSC-B.

### 4.5.3 Subsequent Inter-MSC Handover to third MSC

When a Mobile Station is being handed over to a third MSC, the procedure (described in GSM 03.09) does require one specific interworking case in MSC-A (figure 20) between E-Interface from MSC-B and E-Interface from MSC-B' other than the combination of the ones described in the subclause 4.5.1 and 4.5.2.

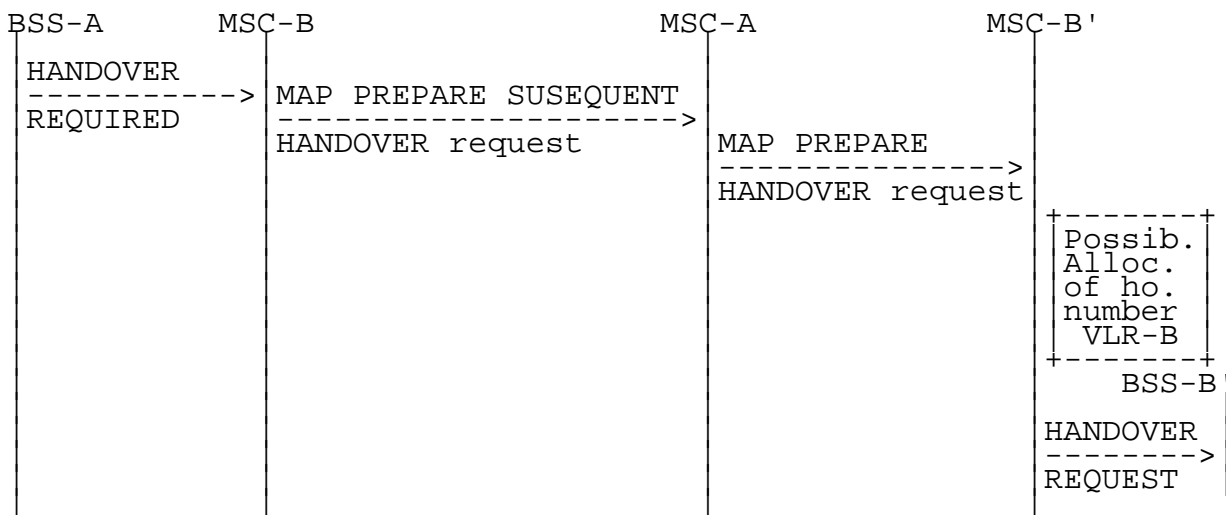
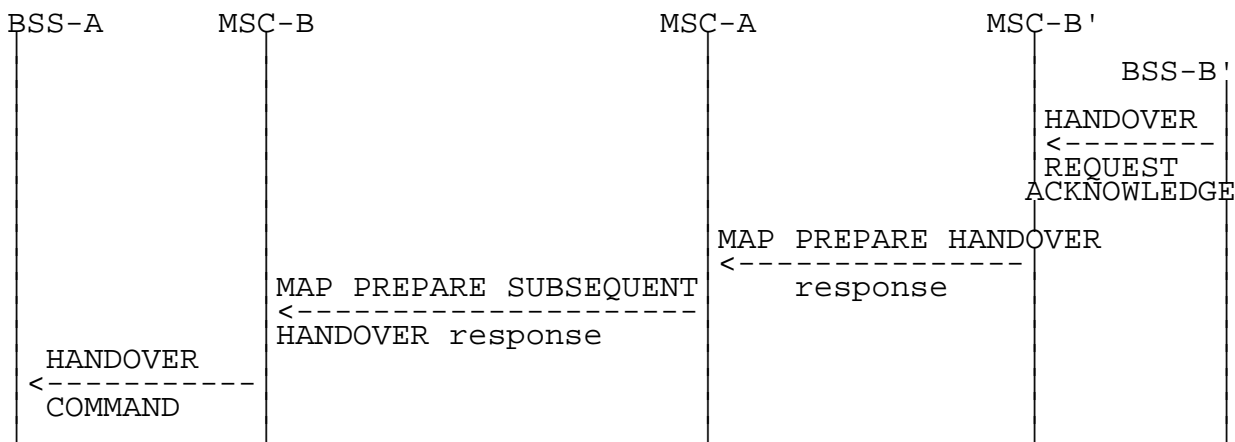


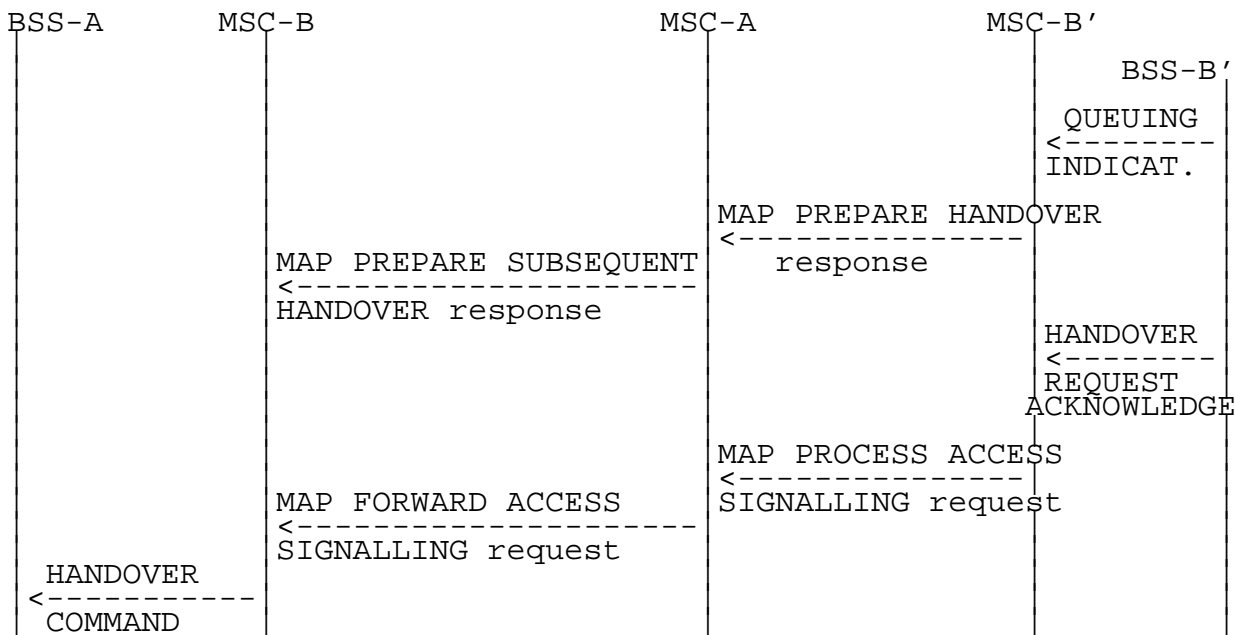
Figure 16: Signalling for Subsequent Inter-MSC Handover to third MSC (MSC-B') initiation

Possible Positive outcomes:

- a) successful radio resources allocation:



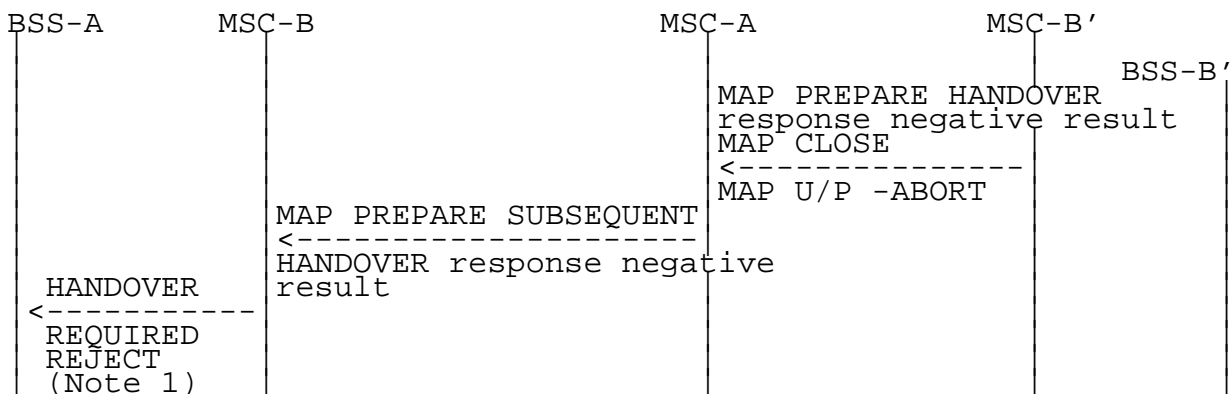
- b) radio resources allocation queued and successful handover number allocation, if performed. Later successful radio resources allocation indication:



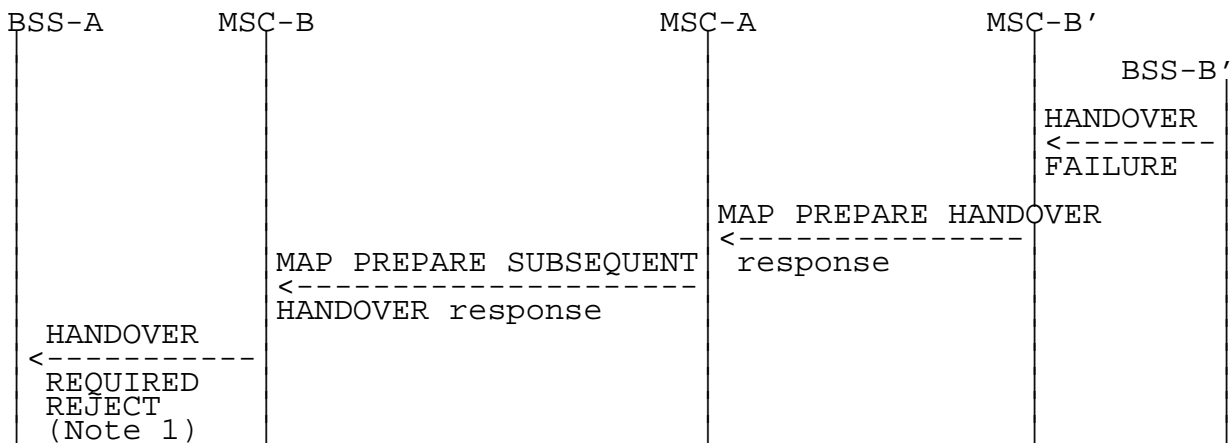
**Figure 17: Signalling for Subsequent Inter-MSC Handover to third MSC (MSC-B') execution (Positive outcome)**

Possible Negative outcomes:

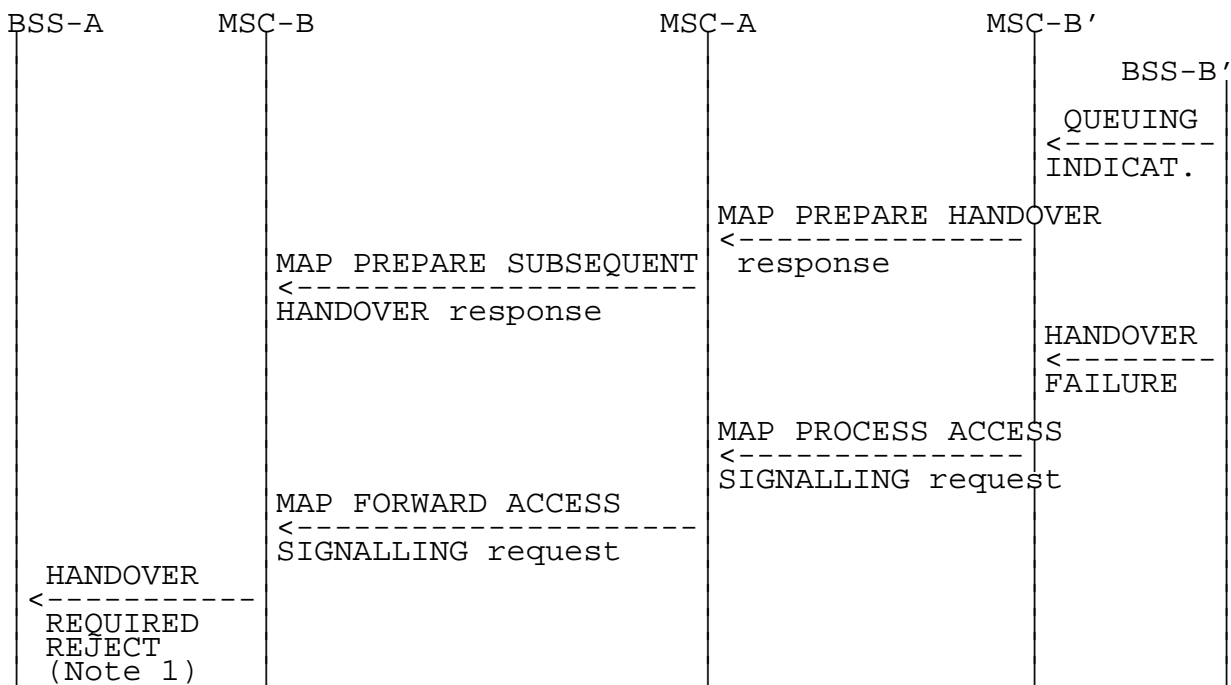
- c) user error detected, or component rejection or dialogue abortion performed by MSC-B':



- d) radio resources allocation failure:



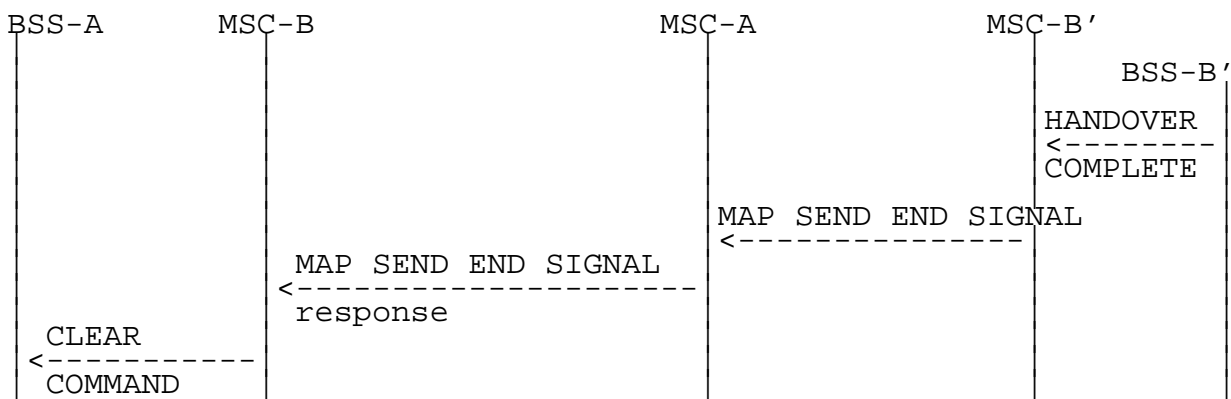
e) radio resources allocation queued and successful handover number allocation (if performed). Later unsuccessful radio resources allocation:



**Figure 18: Signalling for Subsequent Inter-MSC Handover to third MSC (MSC-B') execution (Negative outcome)**

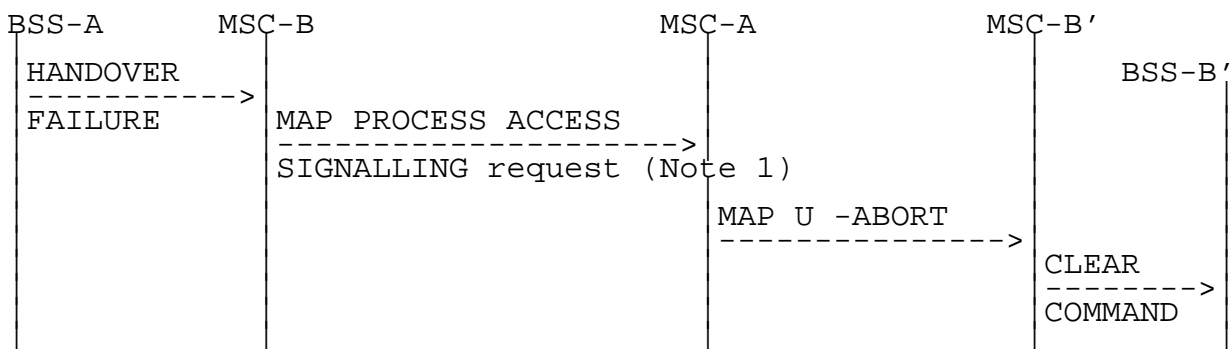
NOTE 1: Possible rejection of the handover because of the negative outcome of MAP or BSSMAP procedure.

Positive outcome:



**Figure 19: Signalling for Subsequent Inter-MSC Handover to third MSC (MSC-B') completion (Successful completion of the procedure)**

Negative outcome:



**Figure 20: Signalling for Subsequent Inter-MSC Handover to third MSC (MSC-B') completion (Unsuccessful completion of the procedure)**

NOTE 1: Specific interworking case detailed below.

The specific interworking case in MSC-A compared to the subclauses 4.5.1 and 4.5.2 occurs between HANDOVER FAILURE encapsulated in a Process Access Signalling from MSC-B and the abortion of the dialogue with MSC-B' in the case of a reversion to old channel of the MS:

	09.02	09.02	Notes
Forward message	MAP PROCESS-SIGNALLING request -bss-APDU(HANDOVER FAILURE)	MAP U -ABORT	1
Positive result			
Negative result		MAP U/P -ABORT	2

NOTE 1: The abortion of the dialogue triggers in MSC-B' the clearing of the circuit connection with MSC-A, if any, and of the Resources between MSC-B' and BSS-B'.The abortion of the dialogue ends the handover procedure with MSC-B'.

NOTE 2: The abortion of the dialogue ends the handover procedure with MSC-B.

#### 4.5.4 BSSAP Messages transfer on E-Interface

The following mapping applies to the encapsulation performed in MSC-A.

	04.08/08.08	09.02	Notes
Forward message	BSSAP messages	MAP FORWARD ACCESS SIGNALLING request -bss-APDU (BSSAP messages)	1
Positive result			2
Negative result		MAP CLOSE MAP U/P -ABORT	

NOTE 1: Complete BSSAP messages to be sent on MSC-B - BSS-B interface (BSSMAP or DTAP messages) are embedded into the bss-APDU parameter (see Annex A of GSM 08.08 for the description of the set of BSSMAP messages).

NOTE 2: The Return Result does not apply. If MSC-B returns a message, this message will arrive in an Invoke: Process Access Signalling.

The following mapping applies to the encapsulation performed in MSC-B.

	04.08/08.08	09.02	Notes
Forward message	BSSAP messages	MAP PROCESS ACCESS SIGNALLING request -bss-APDU (BSSAP messages)	1
Positive result			2
Negative result	CLEAR COMMAND equipment failure	MAP CLOSE MAP U/P -ABORT	3

NOTE 1: Complete BSSAP messages to be sent to MSC-A (BSSMAP or DTAP messages) are embedded into the bss-APDU parameter (see GSM 09.08 for the description of the set of BSSMAP messages).

NOTE 2: The Return Result does not apply. If MSC-A returns a message, this message will arrive in an Invoke: Forward Access Signalling.

NOTE 3: The abortion of the dialogue triggers the clearing of the circuit connection with MSC-A, if any, of the Radio Resources on the A-Interface and the release of the SCCP connection between MSC-B and BSS-B. The clearing of the Radio Resources (the clearing indication received from BSS-B is transmitted to MSC-A) or the loss of the SCCP connection between MSC-B and BSS-B, triggers in MSC-B the abortion of the dialogue on the E-Interface and the clearing of the circuit connection with MSC-A, if any.

## 4.5.5 Processing in MSC-B, and information transfer on E-interface

The following parameters require processing (e.g. to store the parameter, to internally generate the parameter) in MSC-B. The relevant BSSMAP procedures are mentioned to ease the comprehension, their detailed description is the scope of GSM 08.08. Each BSSMAP message listed in GSM 09.08 being transferred on E-interface shall use the mechanisms given in subclause 4.5.4 and is described in GSM 08.08.

### 4.5.5.1 Encryption Information

A sequence of possible encryption algorithms can be sent to a BSS in Cipher Mode Command or Handover Request. The BSS chooses one of the listed algorithms and reports this back to the MSC in Cipher Mode Complete or Handover Request Acknowledge respectively.

The list of algorithms, the ciphering key and the chosen algorithm shall be stored by MSC-B, and the chosen value sent to MSC-A.

Transfer of Information:

If ciphering has not been performed before Inter-MSC Handover, this will be controlled by MSC-A after the completion of Inter-MSC Handover.

Ciphering control towards MSC-B:

If Ciphering has been performed before Inter-MSC Handover:

- in the Handover Request BSSMAP message (information included).

The Handover Request Acknowledge should in this case contain the indication of the chosen algorithm.

If Ciphering has NOT been performed before Inter-MSC Handover:

- in the Cipher Mode Command procedure between MSC-A and MSC-B.

If the encryption algorithm is changed at an intra-BSS handover in BSS-B this must be reported to MSC-A in:

- the BSSMAP Handover Performed procedure.

If the encryption algorithm is changed at an intra-MSC handover in MSC-B this must be reported to MSC-A in:

- the BSSMAP Handover Performed procedure which shall be initiated by MSC-B on reception from BSS-B of the Handover Complete message (the information being previously received in the Handover Request Acknowledge message).

Note also that the chosen encryption value may be contained in the BSSMAP Assignment Complete message. This may happen if the encryption value changes e.g. at a second assignment during a call (e.g. from TCH to SDCCH).

#### 4.5.5.2 Channel Type

Assignment Request and Handover Request (BSSMAP) may give the BSS a choice, in the same way as the Encryption Algorithm above. Depending on the Channel Type Info, the chosen channel may have impact on subsequent handovers, internal in MSC-B and inter-MSC controlled by MSC-A. Some values in channel Type Info indicate that if a particular channel once has been chosen, the same type must be used for the rest of the call.

The Channel Type, and the characteristics of the chosen channel shall be stored by MSC-B, and the Chosen Channel and/or Speech Version information elements transferred to MSC-A.

Transfer of Information:

Independently of the type of resource (Signalling only (e.g. SDCCH) or TCH) assigned to the MS, the Channel Type Information is transferred to MSC-B in:

- the Handover Request BSSMAP message, and the Chosen Channel and/or Speech Version should be reported back to MSC-A in the Handover Request Acknowledge.

If a new type of resource is to be assigned after Inter-MSC Handover, this can be made with:

- the BSSMAP Assignment procedure between MSC-A and MSC-B (Chosen Channel and/or Speech Version in Assignment Complete).

If the Channel Type (the chosen channel and/or chosen speech version) is changed at an intra-BSS handover in BSS-B this must be reported to MSC-A in:

- the BSSMAP Handover Performed procedure.

If the Channel Type (the chosen channel or chosen speech version) is changed at an intra-MSC handover in MSC-B this must be reported to MSC-A in:

- the BSSMAP Handover Performed procedure which shall be initiated by MSC-B on reception from BSS-B of the Handover Complete message (the information being previously received in the Handover Request Acknowledge message).

#### 4.5.5.3 Classmark

This information shall be stored by MSC-B and might be received either from MSC-A, or from the MS when the MS initiates a Classmark Update.

Transfer of Information due to Classmark received from MSC-A:

This information shall be stored by MSC-B and is received:

- in the Handover Request BSSMAP message.

If a new type of resource is to be assigned after Inter-MSC Handover, Classmark Information MAY be included:

- in the BSSMAP Assignment procedure.

Transfer of Information, due to "Classmark Signalling Procedures".

This information shall be stored by MSC-B and can be received:

- Due to a classmark update, either requested from MSC-A (Classmark Request, Classmark Update), or an MS-Initiated Classmark Update.

This can be carried out either with:

- the BSSMAP Classmark procedure(s).

Apart from these cases there is the "odd" case where a Classmark Update can be received during an Inter-MSC Handover by MSC-B, i.e. before the MS has moved to the new channel controlled by MSC-B. This can be made with transparent transfer of BSSMAP Classmark Update.

#### 4.5.5.4 Downlink DTX-Flag

The parameter shall be stored by MSC-B to be used at internal Handover in MSC-B.

Transfer of Information:

Received by MSC-B from MSC-A in either:

If the MS has already been assigned to a TCH for speech before the Inter-MSC Handover, the DTX-flag should be sent in:

- the Handover Request BSSMAP message;

(if the type of resource is not TCH for speech, the DTX-flag shall not be included).

If a new assignment to a TCH for speech after an Inter-MSC Handover is to be performed, this can be made with:

- the BSSMAP Assignment procedure.

#### 4.5.5.5 Priority

The parameter shall be stored by MSC-B and is received according to below:

Transfer of Information:

Received by MSC-B from MSC-A in:

- the Handover Request BSSMAP message.

If a change is needed after an Inter-MSC Handover with:

- the BSSMAP Assignment procedure.

#### 4.5.5.6 MSC/BSC-Invoke Trace Information Elements

The process to be performed by MSC-B on the information elements of the MSC or BSC Invoke Trace BSSMAP messages is left for further study.

#### 4.5.5.7 LSA Identifier List

The parameter shall be stored by MSC-B and is received according to below:

Transfer of Information:

Received by MSC-B from MSC-A in:

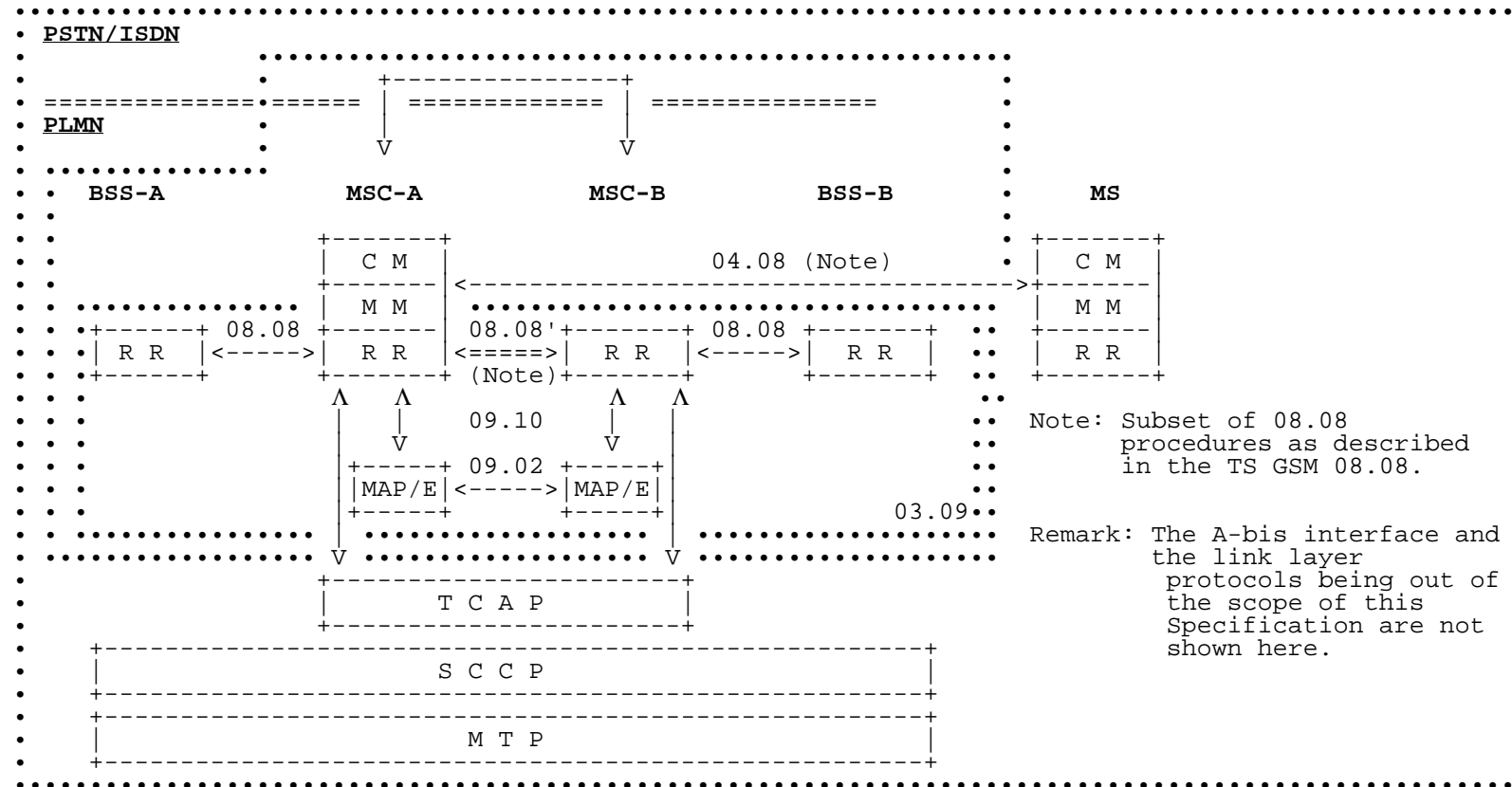
- the Handover Request BSSMAP message.

If a change is needed after an Inter-MSC Handover with:

- the LSA Information BSSMAP message.

### 4.5.6 Overview of the Technical Specifications GSM interworking for the Inter-MSC Handover





## 4.6 Inter-MSC Handover (UMTS to GSM)

The general principles of the handover procedures are given in 3GPP TS 23.009. 3GPP TS 29.010 gives the necessary information for interworking between the 3GPP TS 25.413 RANAP protocol, GSM handover procedures and the 3GPP TS 29.002 MAP protocol. The RANAP protocol is used between the RNS and the 3G-MSC.

The following three principles apply for the Inter-MSC handover UMTS to GSM:

The BSSMAP parameters required for Inter-MSC handover UMTS to GSM are generated as in GSM.

Received BSSMAP parameters, e.g. cause code or Handover command, are mapped to the appropriate RANAP parameters, e.g. cause code transparent container to source RNS.

### 4.6.1 Basic Inter-MSC Handover

When a Mobile Station is handed over between two MSCs, the establishment of a connection between them (described in 3GPP TS 23.009) requires interworking between A-Interface and E-Interface.

The signalling at initiation, execution, completion of the Basic Inter-MSC handover procedure is shown in figures 21 to 26 with both possible positive or negative outcomes.

Additionally figure 21b shows the possible interworking when the trace related message is transparently transferred on the E-Interface at Basic Inter-MSC Handover initiation.

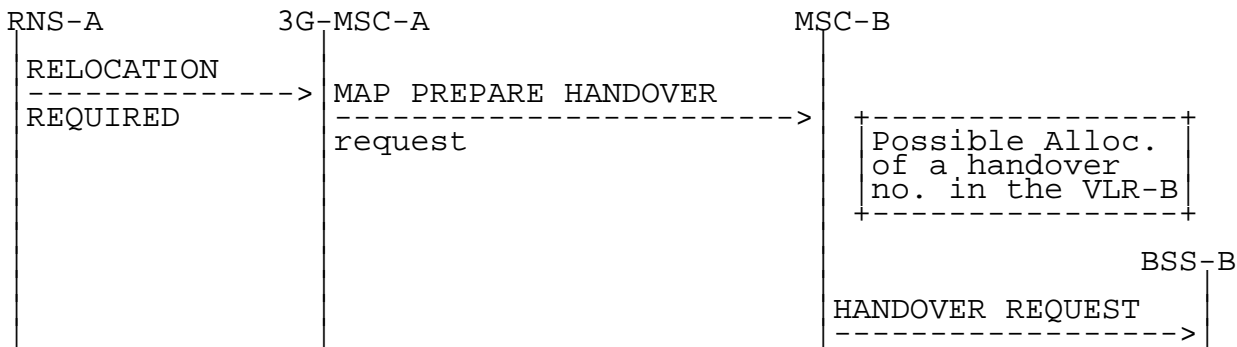


Figure 21a: Signalling for Basic Inter-MSC Handover initiation (no trace related messages transferred)

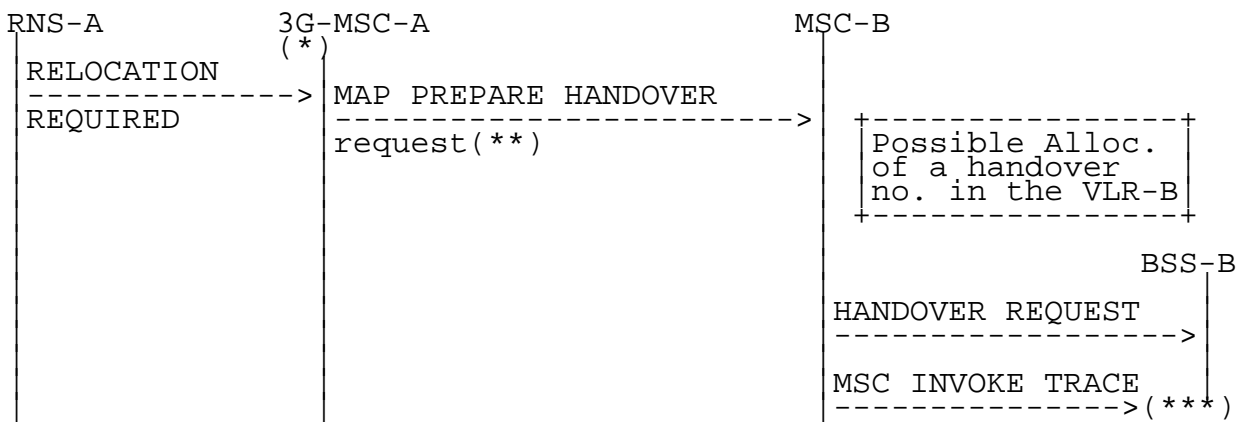


Figure 21b: Signalling for Basic Inter-MSC Handover initiation (MSC invoke trace message transferred)

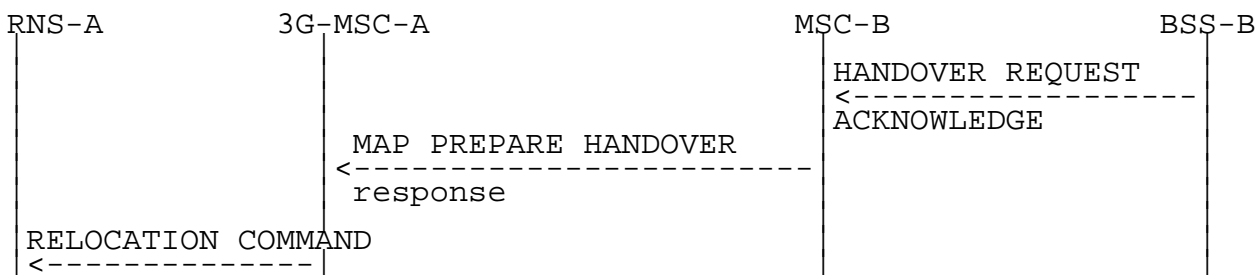
(\*): Tracing invocation has been received from VLR.

(\*\*): In that case, HANOVER REQUEST and MSC INVOKE TRACE messages are included within the BSS-apdu parameter.

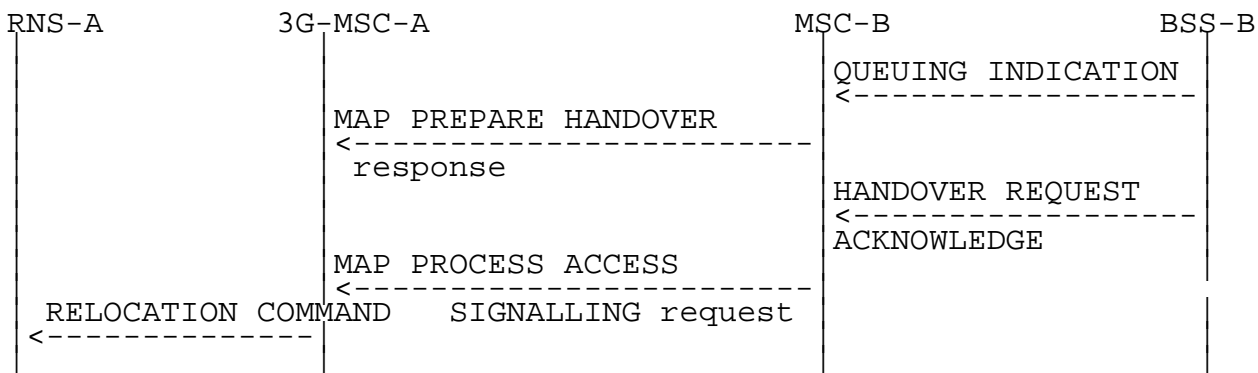
(\*\*\*) : MSC INVOKE TRACE is forwarded to BSS-B if supported by MSC-B.

Possible Positive outcomes:

a) successful radio resources allocation and handover number allocation (if performed):



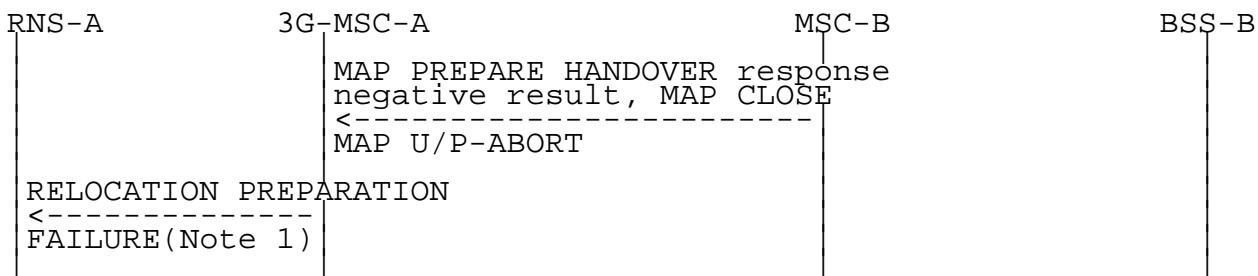
b) radio resources allocation queued and successful handover number allocation (if performed). Later successful radio resources allocation indication:



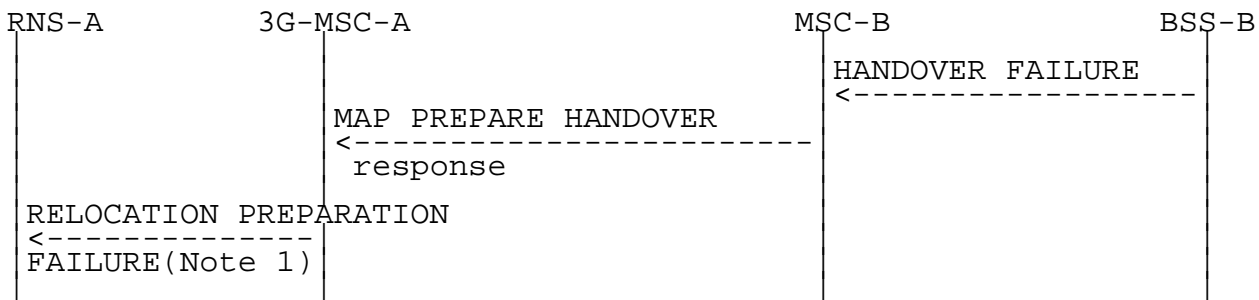
**Figure 22: Signalling for Basic Inter-MSC Handover execution (Positive outcomes)**

Possible Negative outcomes:

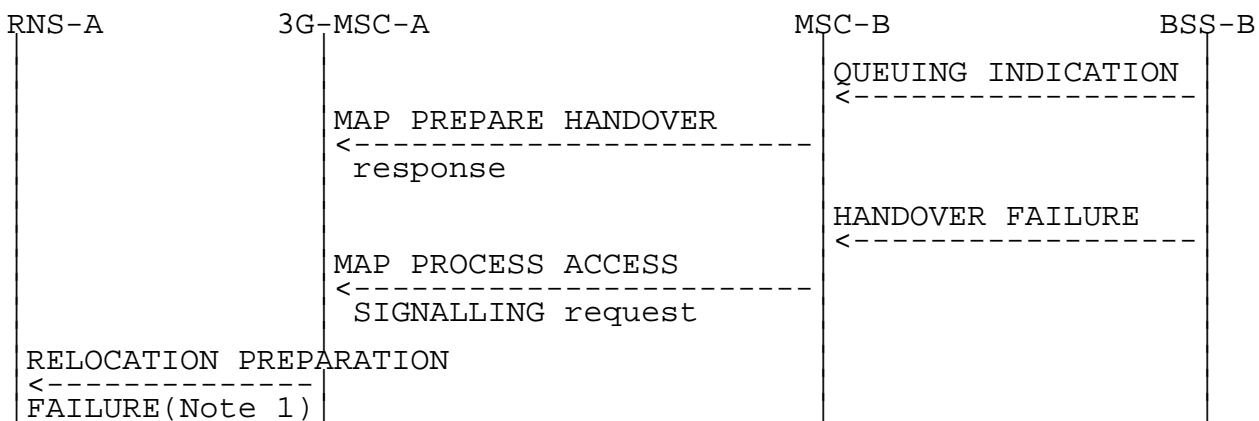
c) user error detected, or handover number allocation unsuccessful (if performed), or component rejection or dialogue abortion performed by MSC-B:



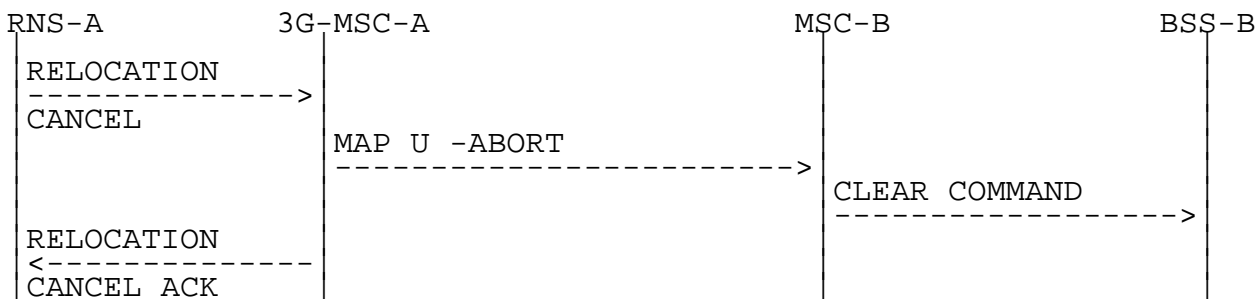
d) radio resources allocation failure:



e) radio resources allocation queued and successful handover number allocation (if performed). Later unsuccessful radio resources allocation:

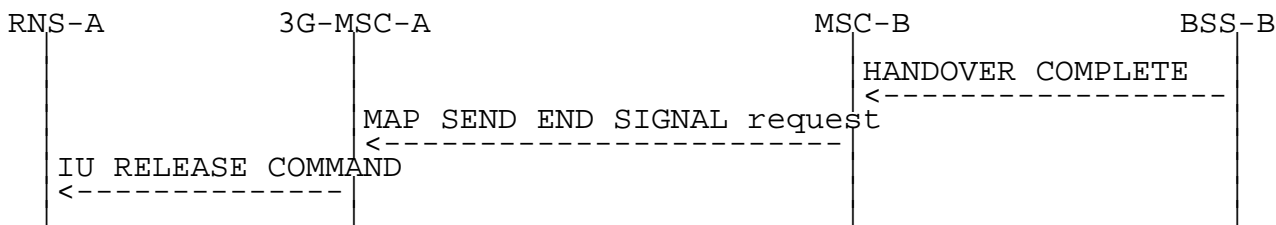


f) unsuccessful handover execution (Reversion to the old radio resources):



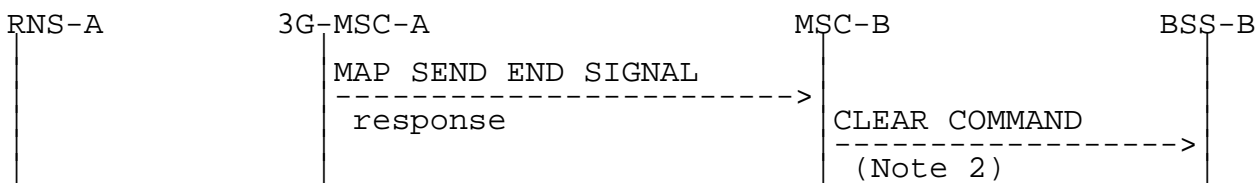
**Figure 23: Signalling for Basic Inter-MSC Handover execution (Negative outcomes)**

NOTE 1: Possible rejection of the handover because of the negative outcome of MAP or RANAP procedure.



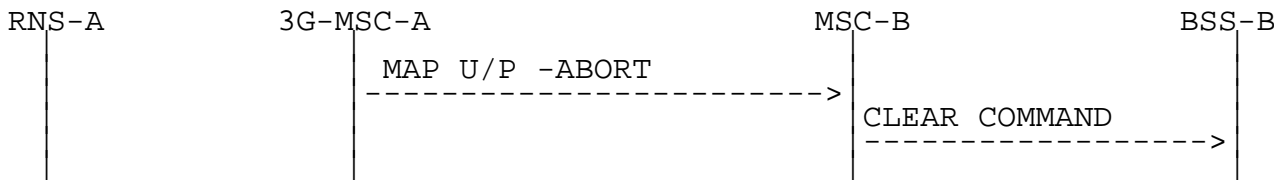
**Figure 24: Signalling for Basic Inter-MSC Handover completion**

Positive outcome:



**Figure 25: Signalling for Basic Inter-MSC Handover completion (Positive outcome)**

Negative outcome:



**Figure 26: Signalling for Basic Inter-MSC Handover completion (Negative outcome)**

NOTE 2: From interworking between MAP and BSSMAP point of view, when the call is released.

The handover procedure is normally triggered by RNS-A by sending a RELOCATION REQUIRED message on Iu-Interface to 3G-MSC-A. The invocation of the Basic Inter-MSC handover procedure is performed and controlled by 3G-MSC-A. The sending of the MAP Prepare-Handover request to MSC-B is triggered in 3G-MSC-A upon receipt of the RELOCATION REQUIRED message. For compatibility reason, the cell identity of the cell where the call is to be handed over in MSC-B area, provided in the RELOCATION REQUIRED message, is mapped into targetCellId MAP parameter and the HANDOVER REQUEST message is encapsulated in the bss-APDU MAP parameter of the Prepare-Handover MAP request. MSC-B can invoke another operation towards the VLR-B (allocation of the handover number described in 3GPP TS 29.002).

Additionally, if tracing activity has been invoked, the trace related message can be transferred on the E-Interface encapsulated in the bss-APDU MAP parameter of the Prepare-Handover Request. If transferred, one complete trace related message at a time shall be included in the bss-APDU MAP parameter after the HANDOVER REQUEST message.

The interworking between Prepare Handover and RELOCATION REQUIRED is as follows:

	25.413	29.002	Notes
Forward message	RELOCATION REQUIRED MAP PREPARE HANDOVER request		
	RANAP information elements	-ho-NumberNotRequired	1
		-targetCellId	2
		-bss-APDU(HANDOVER REQUEST, MSC INVOKE TRACE)	
Positive result	RELOCATION CMD	MAP PREPARE HANDOVER response	3
		-handover number	
		-bss-APDU(QUEUING INDICATION or HANDOVER REQUEST ACKNOWLEDGE)	
Negative result	RELOCATION PREP FAILURE	MAP PREPARE HANDOVER	4
	Relocation failure in target RNC/CN or target system	System Failure	
	" No Handover Number	available	
	" UnexpectedDataValue		
	" Data Missing		
	" MAP CLOSE		
	" MAP U/P -ABORT		

NOTE 1: The BSSMAP information elements are already stored in 3G-MSC.

The ho-NumberNotRequired parameter is included by 3G-MSC-A, when 3G-MSC-A decides not to use any circuit connection with MSC-B. No handover number shall be present in the positive result. Any negative response from MSC-B shall not be due to handover number allocation problem.

NOTE 2: The process performed on the RANAP information elements received in the RELOCATION REQUIRED message is described in the 3GPP TS 25.413.

NOTE 3: The response to the Prepare-Handover request can include in its bss-APDU parameter, identifying the GSM 08.06 protocol, either a BSSMAP QUEUING INDICATION, or a BSSMAP HANDOVER REQUEST ACKNOWLEDGE.

In the first case, 3G-MSC-A shall wait for the radio resources allocation response from MSC-B, transmitted to 3G-MSC-A as described in subclause 4.5.4.

In the second case, the positive result triggers in 3G-MSC-A the sending on Iu-Interface of the RELOCATION CMD.

In the third case, the positive result triggers in 3G-MSC-A.

NOTE 4: The possible sending of the RELOCATION PREP FAILURE message is described in the 3G 25.413.

(The possible sending of the RELOCATION PREP FAILURE message upon receipt of the HANDOVER FAILURE is out of the scope of the 3GPP TS 29.010 and lies in the 3GPP TS 25.413).

The interworking between Send End Signal and HANDOVER COMPLETE in MSC-B is as follows:

	08.08	29.002	Notes
Forward message	HANDOVER COMPLETE	MAP SEND END SIGNAL request -bss-APDU( HANDOVER COMPLETE)	
Positive result	CLEAR COMMAND -Call Control release	MAP SEND END SIGNAL response	1
Negative result	CLEAR COMMAND -Call Control release -Call Control release	MAP CLOSE MAP U/P -ABORT	2

NOTE 1: The positive empty result triggers the clearing of the Radio Resources on the A-Interface and the release of the SCCP connection between MSC-B and BSS-B. If a circuit connection is used between 3G\_MSC-A and MSC-B, the 'Call Control release' clearing cause shall only be given to BSS-B when MSC-B has received a clearing indication on its circuit connection with 3G\_MSC-A.

NOTE 2: The abortion of the dialogue or the rejection of the component triggers in MSC-B the clearing of its circuit connection with 3G\_MSC-A, if any, of the Radio Resources on the A-Interface and the release of the SCCP connection between MSC-B and BSS-B.

The interworking between Send End Signal and IU RELEASE COMMAND in 3G\_MSC-A is as follows:

	29.002	25.413	Notes
Forward message	MAP SEND END SIGNAL response -bss-APDU( HANDOVER COMPLETE)	IU RELEASE COMMAND - Successful Relocation	
Positive result			
Negative result			

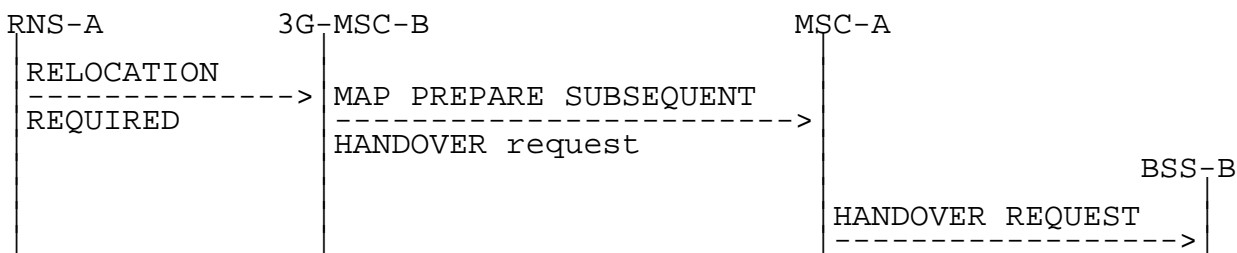
The interworking between RELOCATION CANCEL in case of reversion to old channel of the UE and User Abort in 3G-MSC-A is as follows:

	25.413	29.002	Notes
Forward message	RELOCATION CANCEL -Relocation cancelled	MAP U -ABORT	
Positive result	RELOCATION CANCEL ACKNOWLEDGEMENT		
Negative result			

#### 4.6.2 Subsequent Inter-MSC Handover from 3G-MSC-B back to MSC-A

When a Mobile Station is being handed over back to MSC-A, the procedure (described in TS 23.009) requires interworking between A-Interface, Iu-interface and E-Interface.

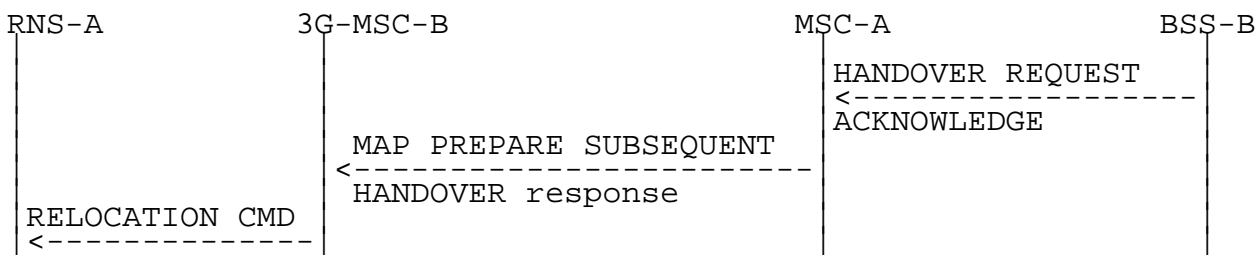
The signalling at initiation, execution and completion of the Subsequent Inter-MSC handover procedure is shown in figures 27 to 31.



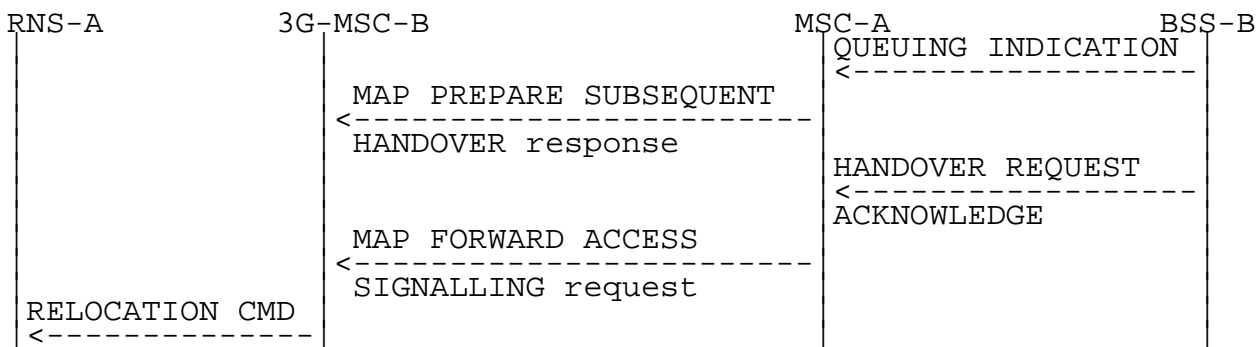
**Figure 27: Signalling for Subsequent Inter-MSC Handover back to MSC-A initiation**

Possible Positive outcomes:

a) successful radio resources allocation:



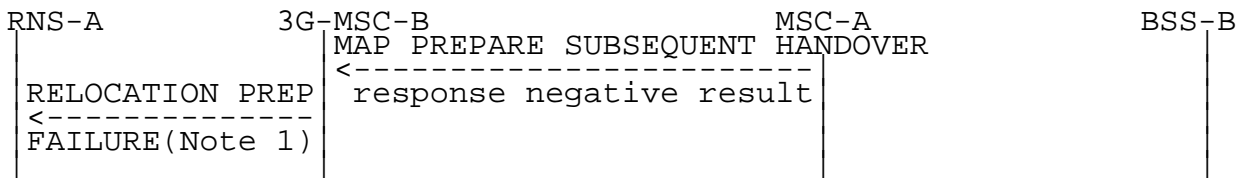
b) radio resources allocation queued. Later successful radio resources allocation indication:



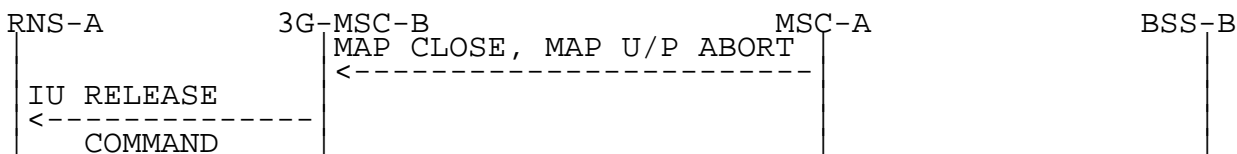
**Figure 28: Signalling for Subsequent Inter-MSC Handover back to MSC-A execution (Positive outcome)**

Possible Negative outcomes:

c) user error detected, or component rejection or dialogue abortion performed by MSC-A:

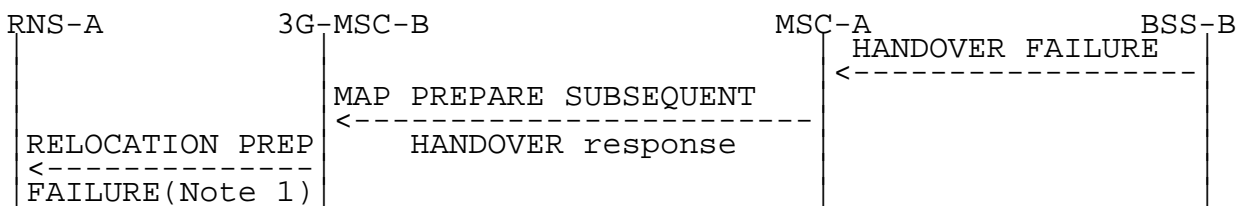


d) component rejection or dialogue abortion performed by MSC-A:

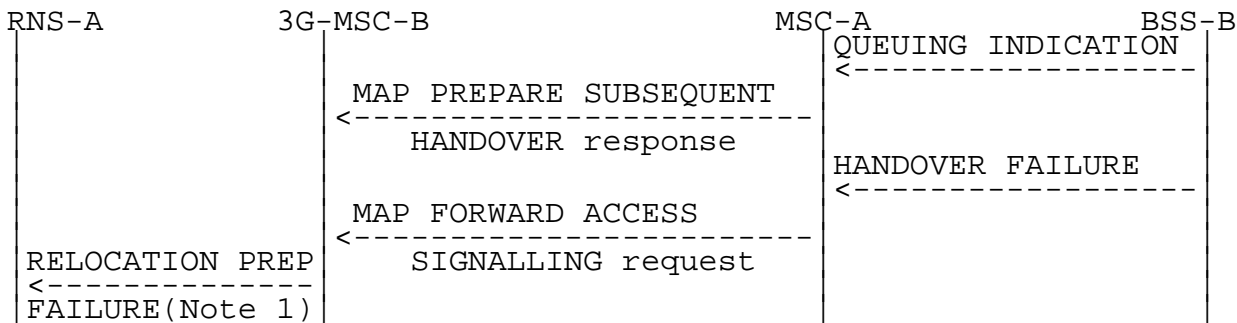


e) radio resources allocation failure:



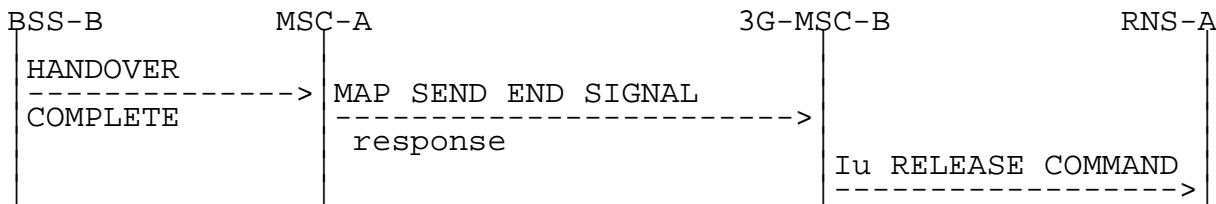


f) radio resources allocation queued. Later unsuccessful radio resources allocation:



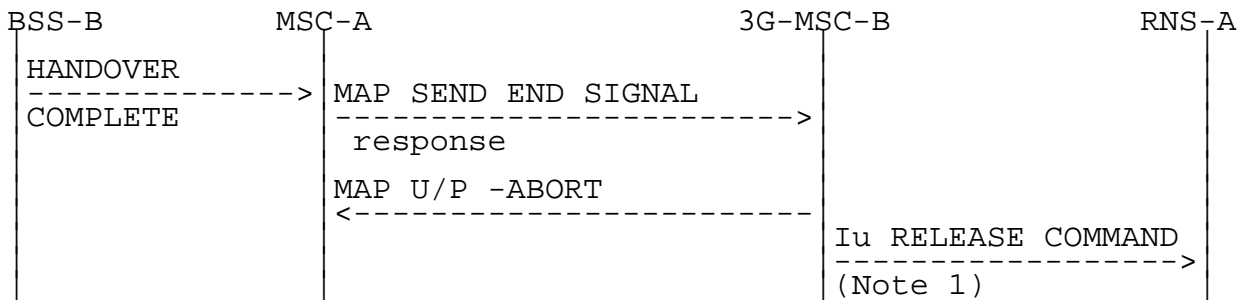
**Figure 29: Signalling for Subsequent Inter-MSC Handover back to MSC-A execution (Negative outcome)**

NOTE 1: Possible rejection of the handover because of the negative outcome of MAP or BSSMAP procedure.



**Figure 30: Signalling for Subsequent Inter-MSC Handover back to MSC-A completion (Successful completion of the procedure)**

NOTE: Positive outcome case shown in figure 9.



**Figure 31: Signalling for Subsequent Inter-MSC Handover back to MSC-A completion (Unsuccessful completion of the procedure)**

NOTE 1: Abnormal end of the procedure which triggers the clearing of all resources in 3G-MSC-B.

The interworking between Prepare Subsequent Handover and RELOCATION REQUIRED is as follows:

	25.413		29.002	Notes	
Forward message	REL. REQUIRED	MAP PREPARE	SUBSEQUENT HANDOVER request -target MSC number -targetCellId -bss-APDU(HANDOVER REQUEST)  RANAP information elements: MS Classmark 2 Source Id Target Id Cause MS Classmark 3	BSSMAP information elements: CM2 Cell Id (serving) Cell Id (target) Cause CM3  info stored/generated in/by 3G-MSC-B: Message Type Channel Type Speech version Priority Interference Band to be used	1
Positive result	RELOCATION CMD.	MAP PREPARE	SUBSEQUENT HANDOVER response -bss-APDU(QUEUING INDICATION or HANDOVER REQUEST ACKNOWLEDGE or HANDOVER FAILURE)  RANAP information elements: L3 information	BSSMAP information elements: L3 information	2
Negative result	REL. PREP. FAILURE	MAP PREPARE	SUBSEQUENT HANDOVER response		3
Unknown MSC	Relocation Failure in Target CN/RNC or Target System				
Subsequent Handover	Relocation Failure in Target CN/RNC or Target System				
UnexpectedDataValue	Relocation Failure in Target CN/RNC or Target System				
Data Missing	Relocation Failure in Target CN/RNC or Target System				
	Iu RELEASE COMMAND				
	Relocation Cancelled MAP CLOSE				
	Relocation Cancelled MAP U/P -ABORT				

NOTE 1: The mapping of cause code values between BSSMAP and RANAP is FFS.

NOTE 2: The response to the Prepare-Subsequent-Handover request can include in its bss-APDU parameter, identifying the GSM 08.06 protocol, a BSSMAP QUEUING INDICATION, or a BSSMAP HANDOVER REQUEST ACKNOWLEDGE or a BSSMAP HANDOVER FAILURE.

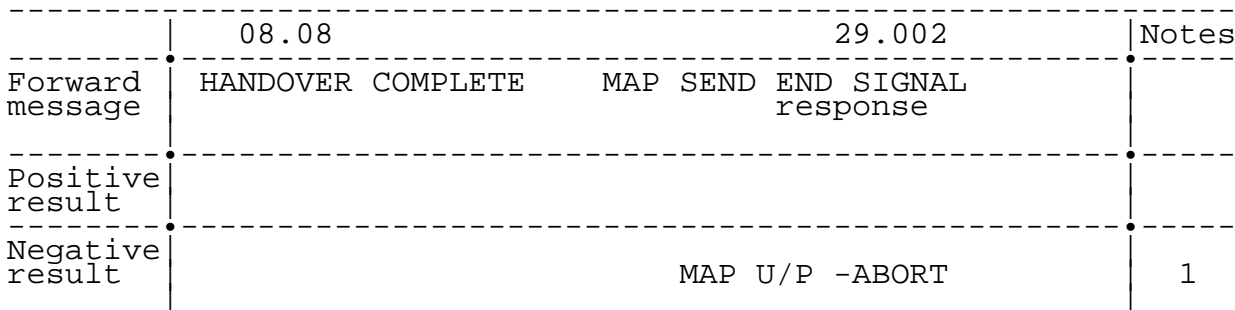
In the first case, 3G-MSC-B shall wait for the radio resources allocation response from MSC-A, transmitted to 3G-MSC-B as described in subclause 4.5.4.

In the second case, the positive result triggers in 3G-MSC-B the sending on Iu-Interface of the RELOCATION COMMAND.

In the third case, the positive result triggers in 3G-MSC-B the sending of the RELOCATION PREPARATION FAILURE.

NOTE 3: The possible sending of the RELOCATION PREPARATION FAILURE message is described in 3GPP TS 25.413.

The interworking between Send End Signal Result and HANOVER COMPLETE in MSC-A is as follows:



NOTE: The abortion of the dialogue ends the handover procedure with 3G-MSC-B.

### 4.6.3 Subsequent Inter-MSC Handover to third MSC

When a Mobile Station is being handed over to a third MSC, the procedure (described in 3GPP TS 23.009) does require one specific interworking case in MSC-A between E-Interface from 3G-MSC-B and E-Interface from MSC-B' other than the combination of the ones described in subclauses 4.6.1 and 4.6.2.

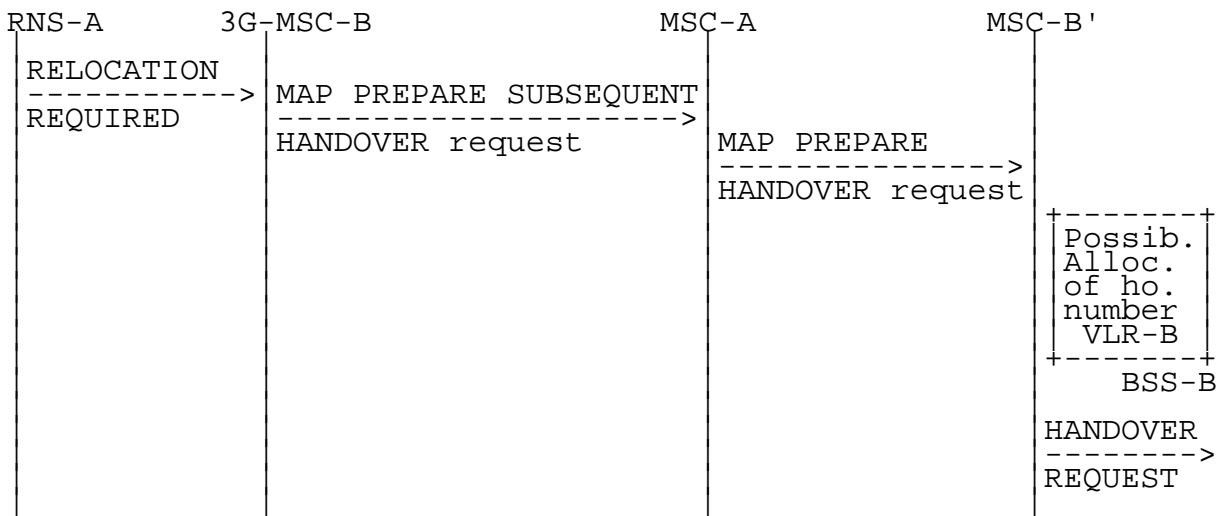
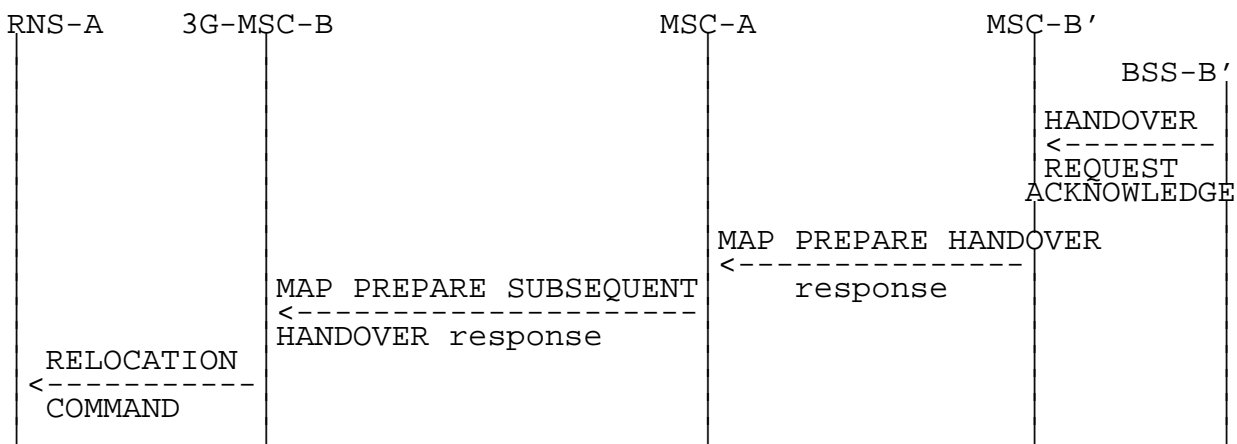


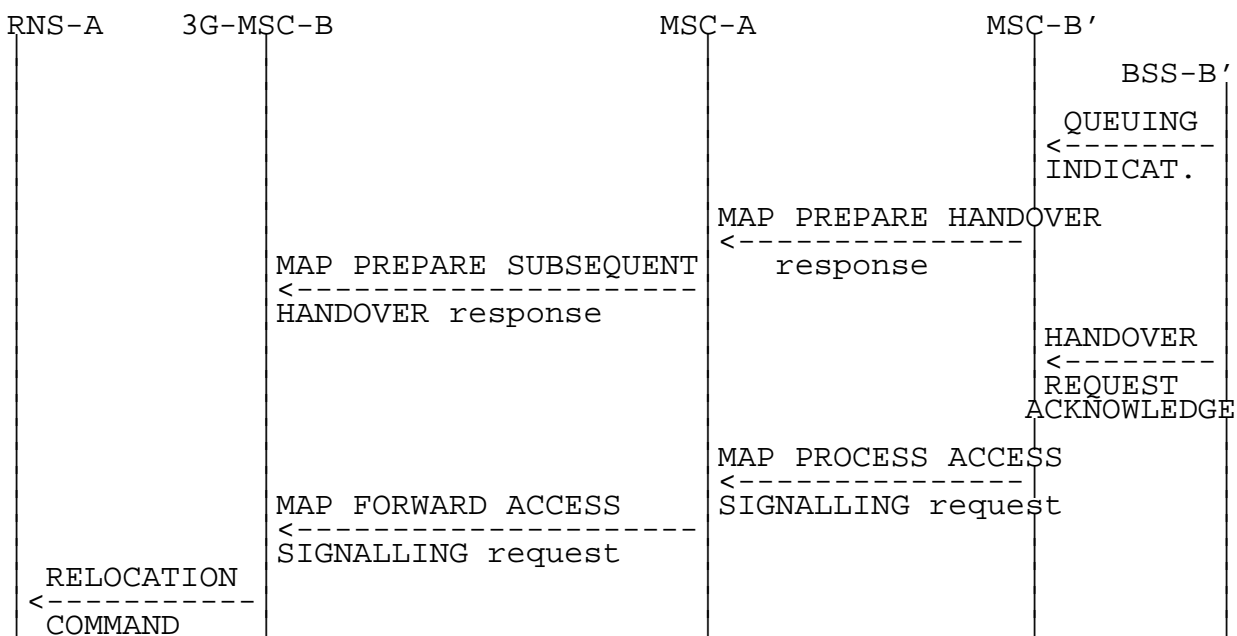
Figure 32: Signalling for Subsequent Inter-MSC Handover to third MSC (MSC-B') initiation

Possible Positive outcomes:

- a) successful radio resources allocation:



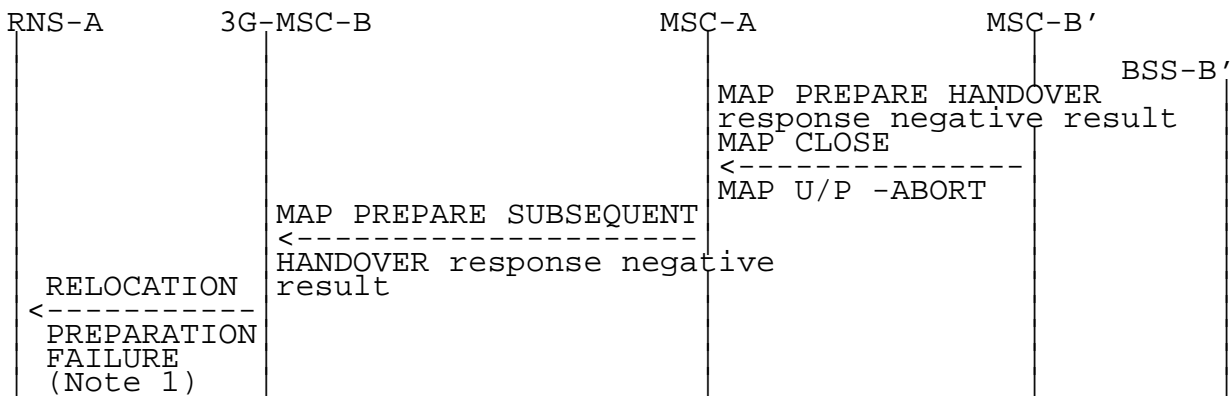
b) radio resources allocation queued and successful handover number allocation, if performed. Later successful radio resources allocation indication:



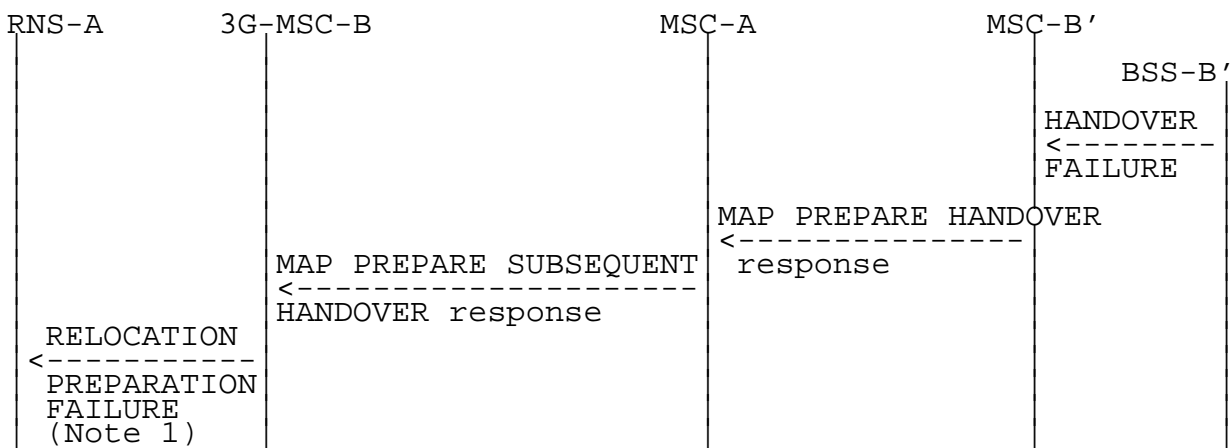
**Figure 33: Signalling for Subsequent Inter-MSC Handover to third MSC (MSC-B') execution (Positive outcome)**

Possible Negative outcomes:

c) user error detected, or component rejection or dialogue abortion performed by MSC-B':



d) radio resources allocation failure:



e) radio resources allocation queued and successful handover number allocation (if performed). Later unsuccessful radio resources allocation:

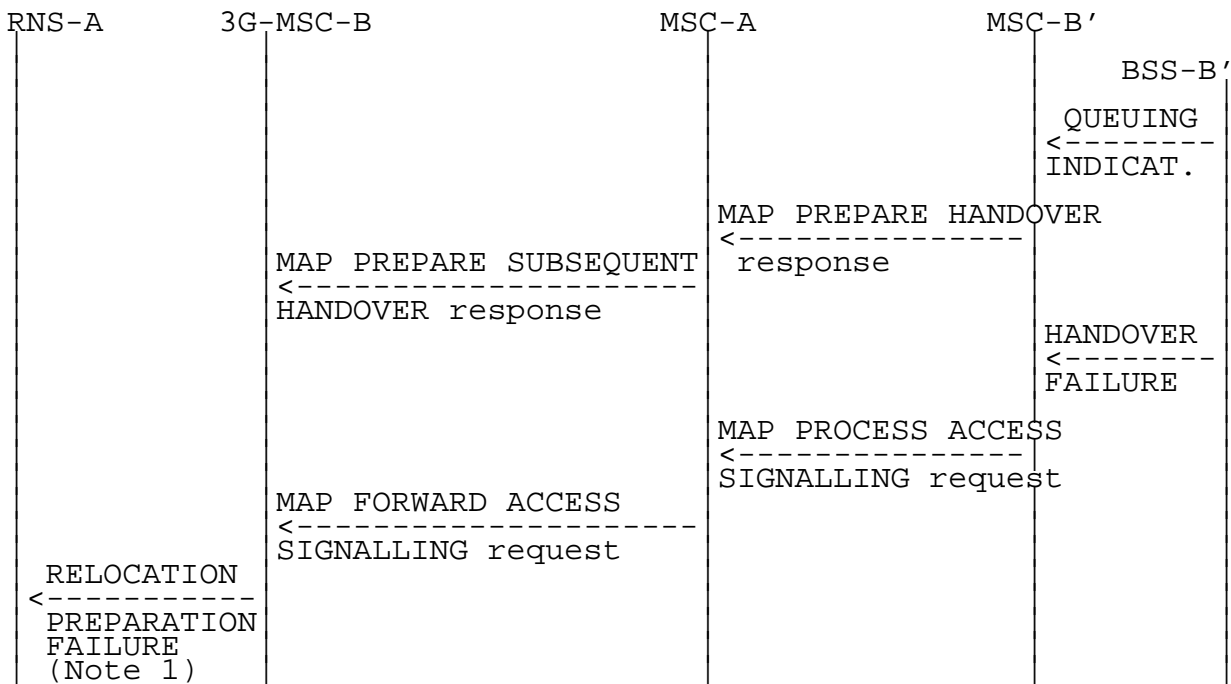
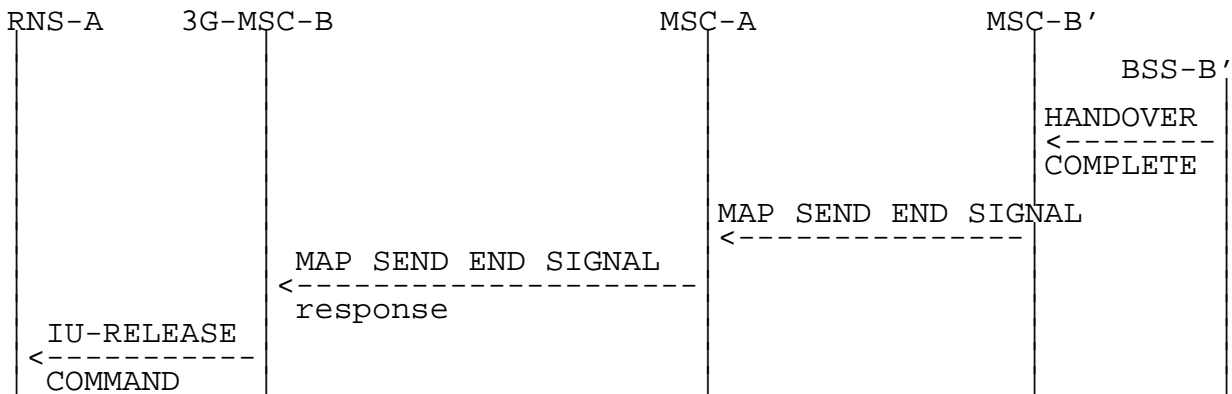


Figure 34: Signalling for Subsequent Inter-MSC Handover to third MSC (MSC-B') execution (Negative outcome)

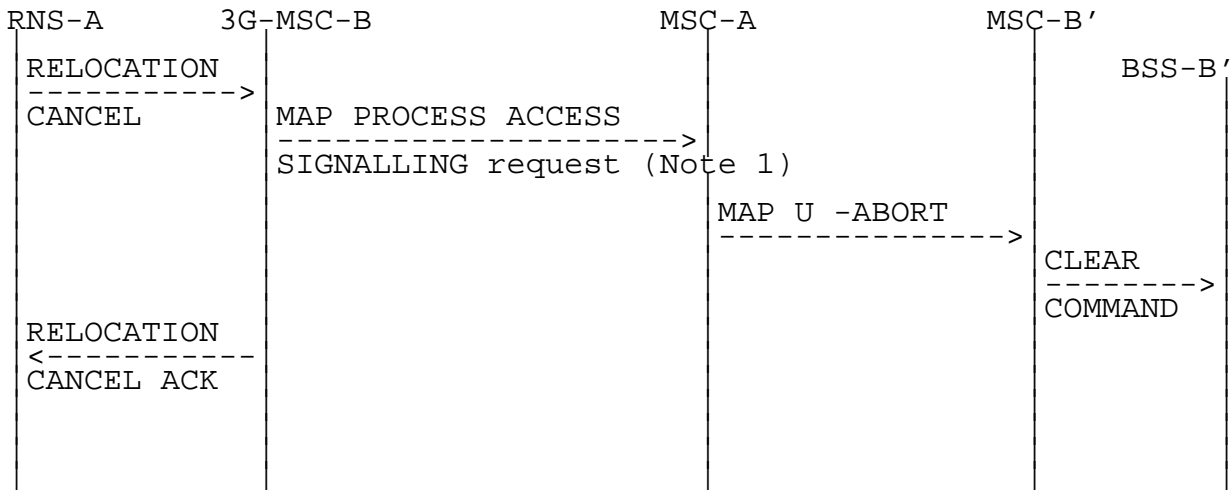
NOTE 1: Possible rejection of the handover because of the negative outcome of MAP or BSSMAP procedure.

Positive outcome:



**Figure 35: Signalling for Subsequent Inter-MSC Handover to third MSC (MSC-B') completion (Successful completion of the procedure)**

Negative outcome:



**Figure 36: Signalling for Subsequent Inter-MSC Handover to third MSC (MSC-B') completion (Unsuccessful completion of the procedure)**

NOTE 1: Specific interworking case detailed below.

The specific interworking case in MSC-A compared to the subclauses 4.5.1 and 4.5.2 occurs between HANDOVER FAILURE encapsulated in a Process Access Signalling from 3G-MSC-B and the abortion of the dialogue with MSC-B' in the case of a reversion to old channel of the MS:

	29.002	29.002	Notes
Forward message	MAP PROCESS-SIGNALLING request -bss-APDU(HANDOVER FAILURE)	MAP U -ABORT	1
Positive result			
Negative result		MAP U/P -ABORT	2

NOTE 1: The abortion of the dialogue triggers in MSC-B' the clearing of the circuit connection with MSC-A, if any, and of the Resources between MSC-B' and BSS-B'. The abortion of the dialogue ends the handover procedure with MSC-B'.

NOTE 2: The abortion of the dialogue ends the handover procedure with 3G-MSC-B.

#### 4.6.4 BSSAP Messages transfer on E-Interface

The handling is described in chapter 4.5.4.

#### 4.6.5 Cause Code Mapping

When a Mobile Station is handed over between UMTS and GSM, a mapping of the cause codes used in the RANAP and the BSSMAP protocols is needed. The mapping described here is applicable to the BSSMAP protocol even when used inside MAP in the E-interface.

The mapping between the cause codes received in RANAP Relocation Required and the cause codes sent in BSSMAP Handover Request is as follows:

25.413	08.08	Notes
RELOCATION REQUIRED	HANDOVER REQUEST	
-Time critical relocation	-Better cell	1
-Resource optimisation relocation	-Better cell	
-Relocation desirable for radio reasons	-Directed retry	
-Directed retry	-Better cell	
-Any other value		

NOTE 1: Cause code not used at inter-system handover.

The mapping between the cause codes received in RANAP Relocation Cancel and the cause codes sent in BSSMAP Clear Command is as follows:

25.413	08.08	Notes
RELOCATION CANCEL	CLEAR COMMAND	
-Trelprepexpiry	-Radio interface failure, reversion to old channel	
-Interaction with other procedure	-Radio interface failure, reversion to old channel	
-Any other value	-Radio interface failure, reversion to old channel	

The mapping between the cause codes received in BSSMAP Handover Failure and the cause codes sent in RANAP Relocation Preparation Failure is as follows:

08.08	25.413	Notes
HANDOVER FAILURE	RELOCATION PREP. FAILURE	
-Ciphering algorithm not supported	-Requested ciphering and/or integrity protection is not supported	
-Circuit pool mismatch	-Relocation failure in Target CN/RNC or target system	1
-Equipment failure	- Abstract Syntax Error	
-Invalid message contents	-Relocation failure in Target CN/RNC or target system	2
-No radio resource available	-O and M intervention	
-O and M intervention	-Relocation failure in Target CN/RNC or target system	
-Radio interface failure, reversion to old channel	-Relocation failure in Target CN/RNC or target system	
-Radio interface message failure	-Relocation failure in Target CN/RNC or target system	
-Requested speech version unavailable	-Relocation failure in Target CN/RNC or target system	
-Requested terrestrial resource unavailable	-Relocation failure in Target CN/RNC or target system	
-Requested transcoding/rate adaption unavailable	-Relocation failure in Target CN/RNC or target system	
-Switch circuit pool	-Relocation failure in Target CN/RNC or target system	1
-Terrestrial circuit already allocated	-Relocation failure in Target CN/RNC or target system	
-Any other value	-Relocation failure in Target CN/RNC or target system	

NOTE 1: Cause code not used at inter-system handover.

NOTE 2: Cause code not applicable to this traffic case.

## 4.7 Inter-MSC Handover (GSM to UMTS)

The general principles of the handover procedures are given in 3GPP TS 23.009. 3GPP TS 29.010 gives the necessary information for interworking between the 3GPP TS 25.413 RANAP protocol, GSM handover procedures and the 3GPP TS 29.002 MAP protocol. The RANAP protocol is used between the RNS and the 3G\_MSC.

The following four principles apply for the Inter-MSC handover GSM to UMTS:

The BSSMAP parameters required for Inter-MSC handover GSM to UMTS are generated as in GSM.

Received RANAP parameters, e.g. cause code or transparent container, are mapped to the appropriate BSSMAP parameters, e.g. cause code or Handover command.

The RANAP parameters required for Inter-MSC handover GSM to UMTS are generated from received or stored GSM parameters.

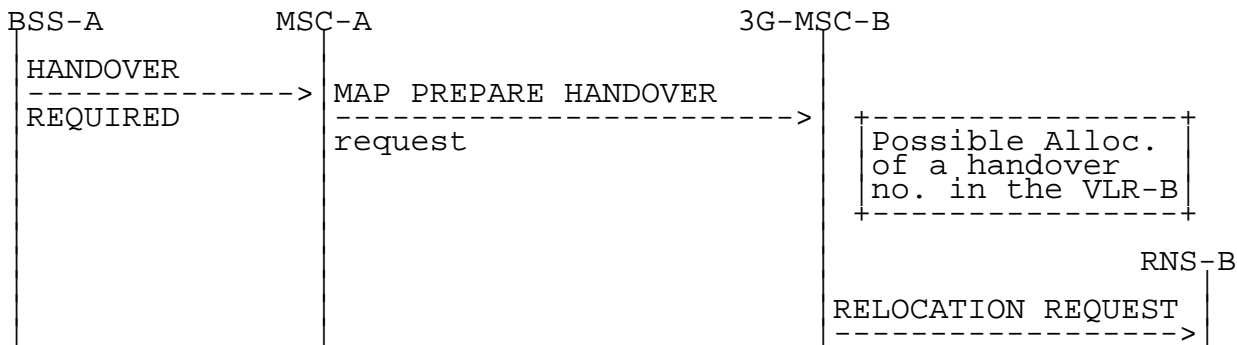
### 4.7.1 Basic Inter-MSC Handover

When a Mobile Station is handed over between two MSCs, the establishment of a connection between them (described in 3GPP TS 23.009) requires interworking between A-Interface, Iu-Interface and E-Interface.

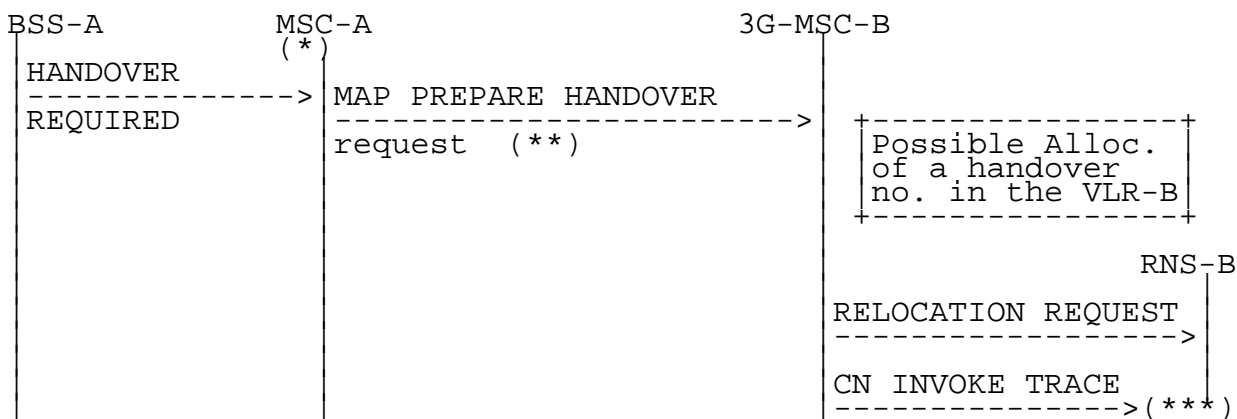
The signalling at initiation, execution and completion of the Basic Inter-MSC handover procedure is shown in figures 37 to 42 with both possible positive or negative outcomes.



Additionally figure 37b shows the possible interworking when the trace related message is transparently transferred on the E-Interface at Basic Inter-MS-C Handover initiation.



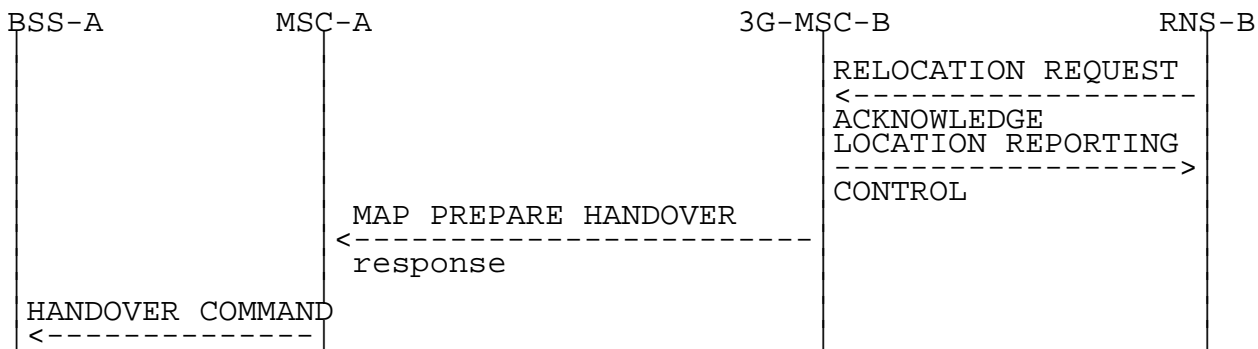
**Figure 37a: Signalling for Basic Inter-MS-C Handover initiation (no trace related messages transferred)**



**Figure 37b: Signalling for Basic Inter-MS-C Handover initiation (CN invoke trace message transferred)**

- (\*): Tracing invocation has been received from VLR.
- (\*\*): In that case, HANDOVER REQUEST and MSC INVOKE TRACE messages are included within the AN-apdu parameter.
- (\*\*\*): CN INVOKE TRACE is forwarded to RNS-B if supported by 3G\_MS-C-B.

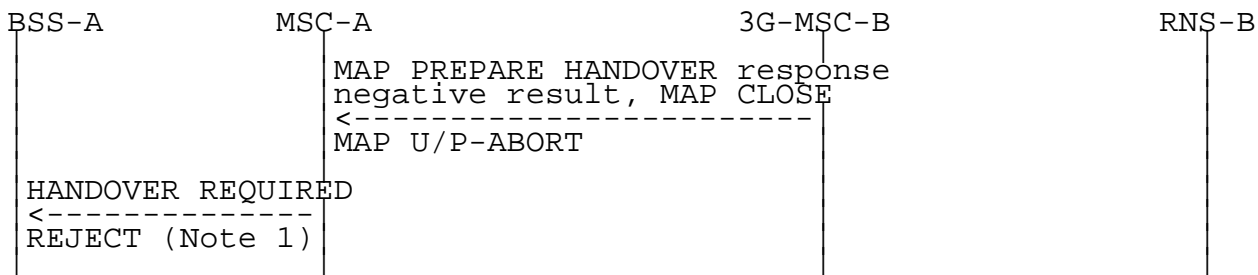
Possible Positive outcomes: successful radio resources allocation and handover number allocation (if performed):



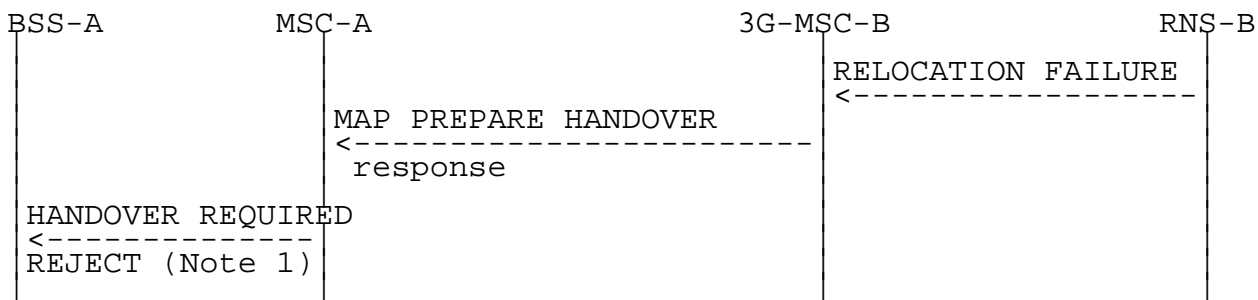
**Figure 38: Signalling for Basic Inter-MS-C Handover execution (Positive outcome)**

Possible Negative outcomes:

a) user error detected, or handover number allocation unsuccessful (if performed), or component rejection or dialogue abortion performed by 3G\_MSC-B:



b) radio resources allocation failure:



c) unsuccessful handover execution (Reversion to the old radio resources):

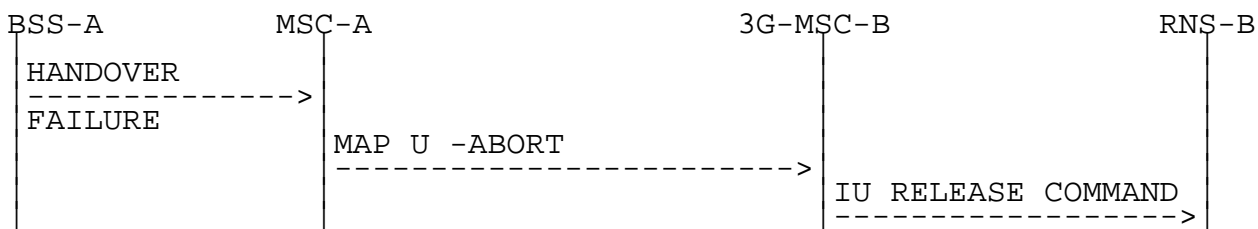


Figure 39: Signalling for Basic Inter-MSC Handover execution (Negative outcomes)

NOTE 1: Possible rejection of the handover because of the negative outcome of MAP or RANAP procedure.

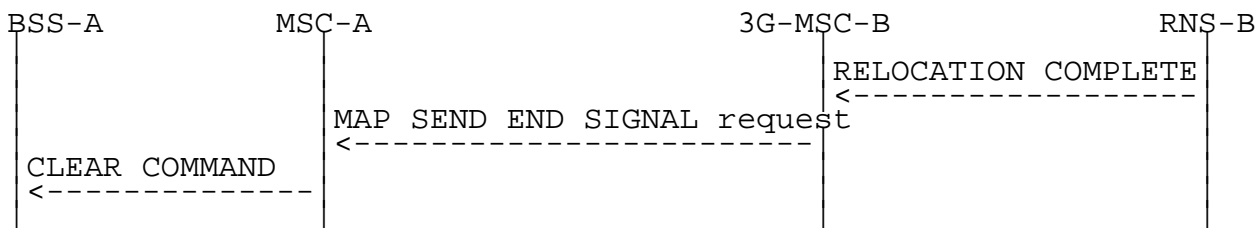


Figure 40: Signalling for Basic Inter-MSC Handover completion

Positive outcome:

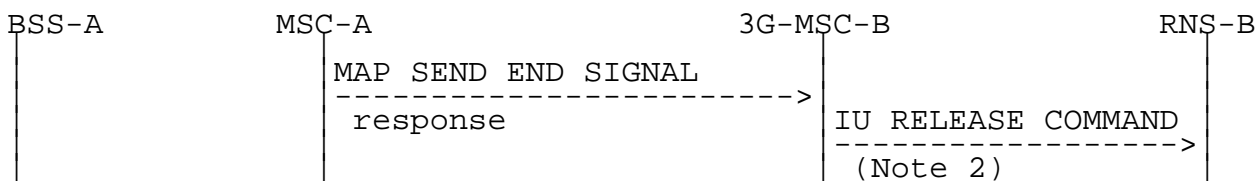
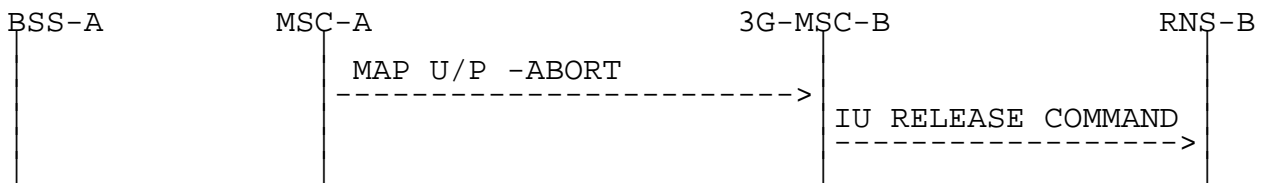


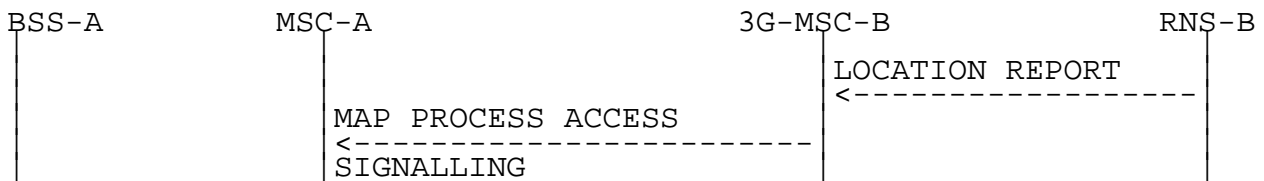
Figure 41: Signalling for Basic Inter-MSC Handover completion (Positive outcome)

Negative outcome:



**Figure 42: Signalling for Basic Inter-MSC Handover completion (Negative outcome)**

NOTE 2: From interworking between MAP and RANAP point of view, when the call is released.



**Figure 42a: Signalling for updating of anchor MSC after change of location in RNS**

The handover procedure is normally triggered by BSS-A by sending a HANOVER REQUIRED message on A-Interface to MSC-A. The invocation of the Basic Inter-MSC handover procedure is performed and controlled by MSC-A. The sending of the MAP Prepare-Handover request to 3G\_MSC-B is triggered in MSC-A upon receipt of the HANOVER REQUIRED message. The identity of the target RNC where the call is to be handed over in 3G\_MSC-B area, provided in the HANOVER REQUIRED message in the information element Cell Identifier List (Preferred), is mapped to the target RNC Id MAP parameter and the HANOVER REQUEST message is encapsulated in the an-APDU MAP parameter of the Prepare-Handover MAP request. 3G\_MSC-B can invoke another operation towards the VLR-B (allocation of the handover number described in 3GPP TS 29.002).

Additionally, if tracing activity has been invoked, the trace related message can be transferred on the E-Interface encapsulated in the an-APDU MAP parameter of the Prepare-Handover Request. If transferred, one complete trace related message at a time shall be included in the an-APDU MAP parameter after the HANOVER REQUEST message. Note: UMTS supports only CN initiated tracing.

The interworking between Prepare Handover and HANOVER REQUIRED is as follows:

	08.08	29.002	Notes
Forward message	HANDOVER REQUIRED	MAP PREPARE HANDOVER request	
	BSSMAP information elements	-ho-NumberNotRequired	1
		-target RNC Id	
		-IMSI	2
		-Integrity protection info	
		-Encryption info	3
		-an-APDU(HANDOVER REQUEST, MSC INVOKE TRACE)	4
Positive result		MAP PREPARE HANDOVER response	5
		-handover number	
		-an-APDU(HANDOVER REQUEST ACKNOWLEDGE or HANDOVER FAILURE)	
Negative result	HANDOVER REQUIRED REJECT	MAP PREPARE HANDOVER	6
	equipment failure	System Failure	
	equipment failure	No Handover Number available	
	equipment failure	UnexpectedDataValue	
	equipment failure	Data Missing	
	equipment failure	MAP CLOSE	
	equipment failure	MAP U/P -ABORT	

NOTE 1: The ho-NumberNotRequired parameter is included by MSC-A, when MSC-A decides not to use any circuit connection with 3G\_MSC-B. No handover number shall be present in the positive result. Any negative response from 3G\_MSC-B shall not be due to handover number allocation problem.

NOTE 2: Integrity protection information, encryption information and IMSI parameters are included by MSC-A, only when the MSC-A uses 29.002 as per release 99. These IEs are not included if the MSC-A is R98 or earlier.

NOTE 3: The process performed on the BSSMAP information elements received in the HANDOVER REQUIRED message is described in the GSM Recommendation 08.08.

NOTE 4: The process performed on the BSSMAP information elements received in the MSC INVOKE TRACE message is described in subclause 4.5.5.6.

NOTE 5: The response to the Prepare-Handover request can include in its an-APDU parameter, identifying the GSM 08.06 protocol, either a BSSMAP HANDOVER REQUEST ACKNOWLEDGE or a BSSMAP HANDOVER FAILURE.

In the first case, the positive result triggers in MSC-A the sending on A-Interface of the HANDOVER COMMAND.

In the second case, the positive result triggers in MSC-A optionally the sending of the HANDOVER REQUIRED REJECT.

(The possible sending of the HANDOVER REQUIRED REJECT message upon receipt of the HANDOVER FAILURE is out of the scope of 3GPP TS 29.010 and lies in GSM 08.08).

NOTE 6: The possible sending of the HANDOVER REQUIRED REJECT message is described in GSM 08.08.

The interworking between Prepare Handover and RELOCATION REQUEST in 3G\_MSC-B is as follows:

	29.002	25.413	Notes
Forward message	MAP PREPARE HANDOVER request -ho-NumberNotRequired -target RNC Id -IMSI -Integrity protection info -Encryption info -an-APDU( HANDOVER REQUEST, MSC INVOKE TRACE)  BSSMAP information elements:  Channel Type Cause sRNC to tRNC container	RELOCATION REQUEST      RANAP information elements:  RAB parameters Cause sRNC to tRNC container  info stored/generated in/by 3G_MSC-B: CN domain indicator	1
Positive result	MAP PREPARE HANDOVER response -an-APDU( HANDOVER REQUEST ACK)  BSSMAP information elements:  Layer 3 info	RELOCATION REQUEST ACK   RANAP information elements:  tRNC to sRNC container	
Negative result	MAP PREPARE HANDOVER response -an-APDU( HANDOVER FAILURE)	RELOCATION FAILURE	

NOTE 1: Integrity protection information, encryption information and IMSI parameters are included by MSC-A, only when the MSC-A uses 29.002 as per release 99. These IEs are not included if the MSC-A is R98 or earlier.

The interworking between Send End Signal and RELOCATION COMPLETE in 3G\_MSC-B is as follows:

	25.413	29.002	Notes
Forward message	RELOCATION COMPLETE	MAP SEND END SIGNAL request  -an-APDU( HANDOVER COMPLETE)	
Positive result	IU RELEASE COMMAND -Normal release	MAP SEND END SIGNAL response	1
Negative result	IU RELEASE COMMAND -Normal release -Normal release	MAP CLOSE MAP U/P -ABORT	2

NOTE 1: The positive empty result triggers the clearing of the Radio Resources on the Iu-Interface and the release of the SCCP connection between 3G\_MSC-B and RNS-B. If a circuit connection is used between MSC-A and 3G\_MSC-B, the 'Normal release' clearing cause shall only be given to RNS-B when 3G\_MSC-B has received a clearing indication on its circuit connection with MSC-A.

NOTE 2: The abortion of the dialogue or the rejection of the component triggers in 3G\_MSC-B the clearing of its circuit connection with MSC-A, if any, of the Radio Resources on the Iu-Interface and the release of the SCCP connection between 3G\_MSC-B and RNS-B.

The interworking between Send End Signal and CLEAR COMMAND in MSC-A is as follows:

	29.002	08.08	Notes
Forward message	MAP SEND END SIGNAL request	CLEAR COMMAND	
Positive result	-an-APDU(HANDOVER COMPLETE)	- Handover Successful	
Negative result			

The interworking between HANDOVER FAILURE in case of reversion to old channel of the MS and User Abort in MSC-A is as follows:

	08.08	29.002	Notes
Forward message	HANDOVER FAILURE	MAP U -ABORT	
Positive result	- Reversion to old channel		
Negative result			

### 4.7.2 Subsequent Inter-MSC Handover from MSC-B back to 3G\_MSC-A

When a Mobile Station is being handed over back to 3G\_MSC-A, the procedure (described in 3GPP TS 23.009) requires interworking between A-Interface, Iu-Interface and E-Interface.

The signalling at initiation, execution and completion of the Subsequent Inter-MSC handover procedure is shown in figures 43 to 47.

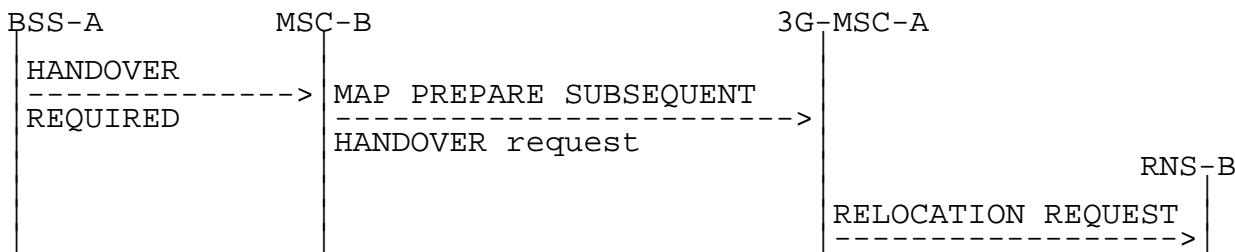


Figure 43: Signalling for Subsequent Inter-MSC Handover back to 3G\_MSC-A initiation

Possible Positive outcomes: successful radio resources allocation:

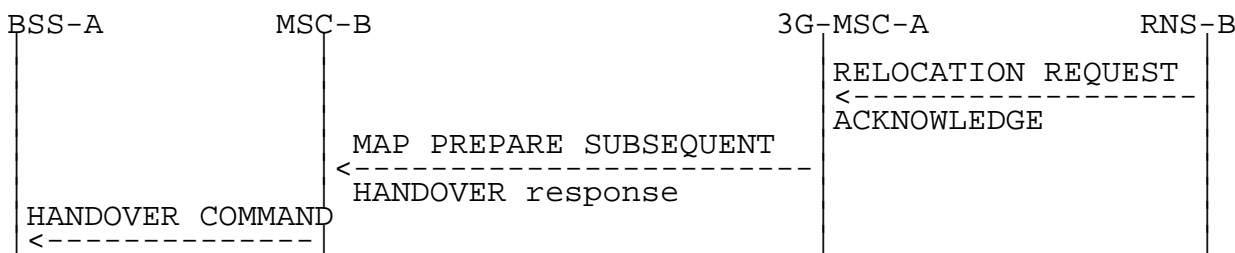
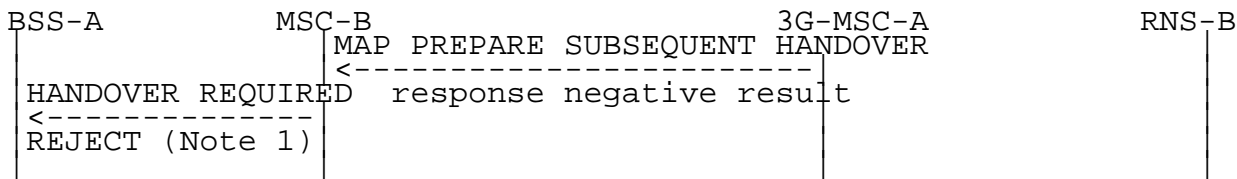


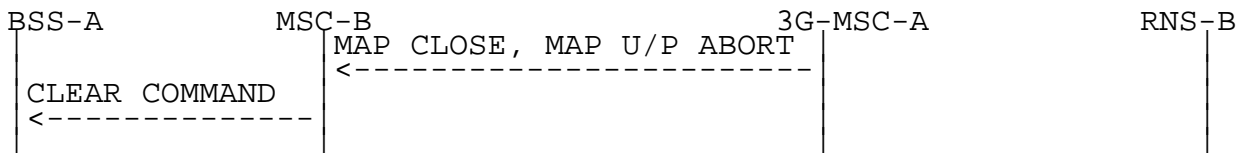
Figure 44: Signalling for Subsequent Inter-MSC Handover back to 3G\_MSC-A execution (Positive outcome)

Possible Negative outcomes:

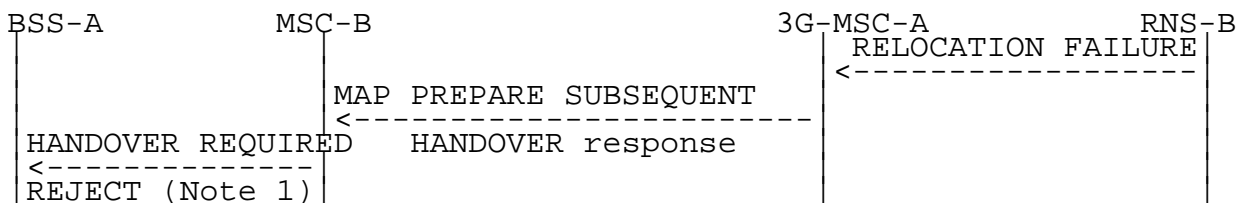
- a) user error detected, or component rejection or dialogue abortion performed by 3G\_MSC-A:



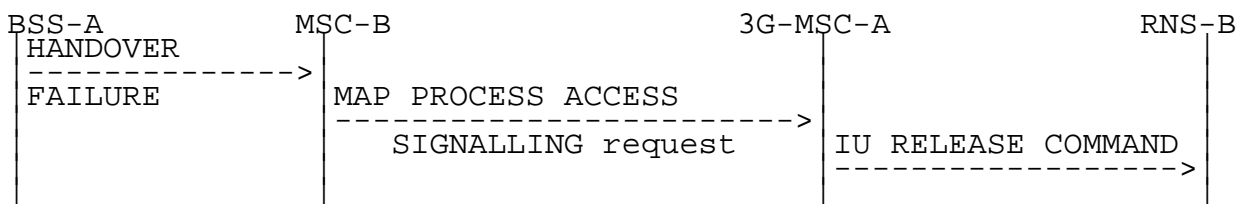
- b) component rejection or dialogue abortion performed by 3G\_MSC-A:



- c) radio resources allocation failure:

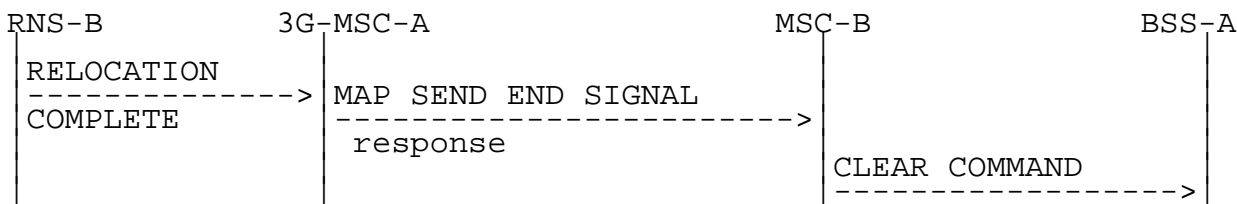


- d) unsuccessful relocation execution (reversion to the old radio resources):



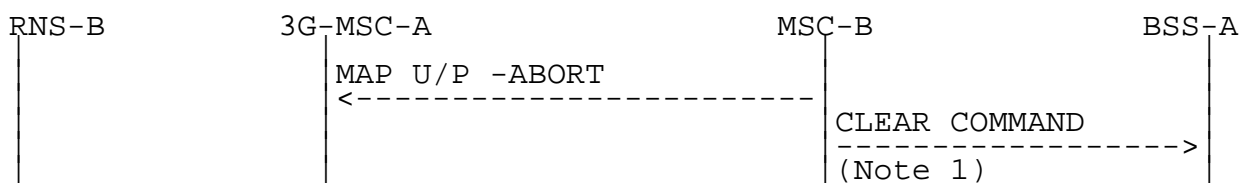
**Figure 45: Signalling for Subsequent Inter-MSC Handover back to 3G\_MSC-A execution (Negative outcome)**

NOTE 1: Possible rejection of the handover because of the negative outcome of MAP or BSSMAP procedure.



**Figure 46: Signalling for Subsequent Inter-MSC Handover back to 3G\_MSC-A completion (Successful completion of the procedure)**

NOTE: Positive outcome case shown in figure 41.



**Figure 47: Signalling for Subsequent Inter-MSC Handover back to 3G\_MSC-A completion (Unsuccessful completion of the procedure)**

NOTE 1: Abnormal end of the procedure that triggers the clearing of all resources in MSC-B.

The interworking between Prepare Subsequent Handover and HANOVER REQUIRED is as follows:

	08.08	29.002	Notes
Forward message	HANOVER REQUIRED MAP PREPARE	SUBSEQUENT HANOVER request	1
	BSSMAP information elements	-target MSC number -target RNC Id -an-APDU(HANOVER REQUEST)	
Positive result	HANOVER REQUIRED MAP PREPARE	SUBSEQUENT HANOVER response	2
		-an-APDU(HANOVER REQUEST ACKNOWLEDGE or HANOVER FAILURE)	
Negative result	HANOVER REQUIRED REJECT	MAP PREPARE SUBSEQUENT HANOVER response	3
	equipment failure equipment failure	Unknown MSC Subsequent Handover Failure	
	equipment failure equipment failure	UnexpectedDataValue Data Missing	
	CLEAR COMMAND		
	equipment failure equipment failure	MAP CLOSE MAP U/P -ABORT	

NOTE 1: The processing performed on the BSSMAP information elements received in the HANOVER REQUIRED message is out of the scope of the present document. The target MSC number is provided to 3G\_MSC-A by MSC-B based on the information received from RNS-B.

NOTE 2: The response to the Prepare-Subsequent-Handover request can include in its an-APDU parameter, identifying the GSM 08.06 protocol, either a BSSMAP HANOVER REQUEST ACKNOWLEDGE or a BSSMAP HANOVER FAILURE.

In the first case, the positive result triggers in MSC-B the sending on A-Interface of the HANOVER COMMAND.

In the second case, the positive result triggers in MSC-B optionally the sending of the HANOVER REQUIRED REJECT.

(The possible sending of the HANOVER REQUIRED REJECT message upon receipt of the HANOVER FAILURE is out of the scope of 3GPP TS 29.010 and lies in GSM 08.08).

NOTE 3: The possible sending of the HANOVER REQUIRED REJECT message is described in GSM 08.08.

The interworking between Prepare Subsequent Handover and RELOCATION REQUEST in 3G\_MSC-A is as follows:



	29.002	25.413	Notes
Forward message	MAP PREPARE SUB HANDOVER request -ho-NumberNotRequired -target RNC ID -an-APDU( HANDOVER REQUEST, MSC INVOKE TRACE)	RELOCATION REQUEST  RANAP information elements:  Cause sRNC to tRNC container	
Positive result	MAP PREPARE SUB HANDOVER response -an-APDU( HANDOVER REQUEST ACK)	RELOCATION REQUEST ACK  RANAP information elements:  Layer 3 info	
Negative result	MAP SUB PREPARE HANDOVER response -an-APDU( HANDOVER FAILURE)	RELOCATION FAILURE	

The interworking between HANDOVER FAILURE and MAP Process Signalling Request in 3G\_MSC-B is as follows:

	08.08	29.002	Notes
Forward message	HANDOVER FAILURE	MAP PROCESS-SIGNALLING request -an-APDU( HANDOVER FAILURE)	
Positive result			
Negative result			

The interworking between Send End Signal Response and RELOCATION COMPLETE in 3G\_MSC-A is as follows:

	25.413	29.002	Notes
Forward message	RELOCATION COMPLETE	MAP SEND END SIGNAL response	
Positive result			
Negative result		MAP U/P -ABORT	1

NOTE 1: The abortion of the dialogue ends the handover procedure with MSC-B.

### 4.7.3 Subsequent Inter-MSK Handover to third MSC

When a Mobile Station is being handed over to a third MSC, the procedure (described in 3GPP TS 23.009) does require one specific interworking case in MSC-A (figure 49) between E-Interface from MSC-B and E-Interface from 3G\_MSC-B' other than the combination of the ones described in the subclause 4.5.1 and 4.7.2.

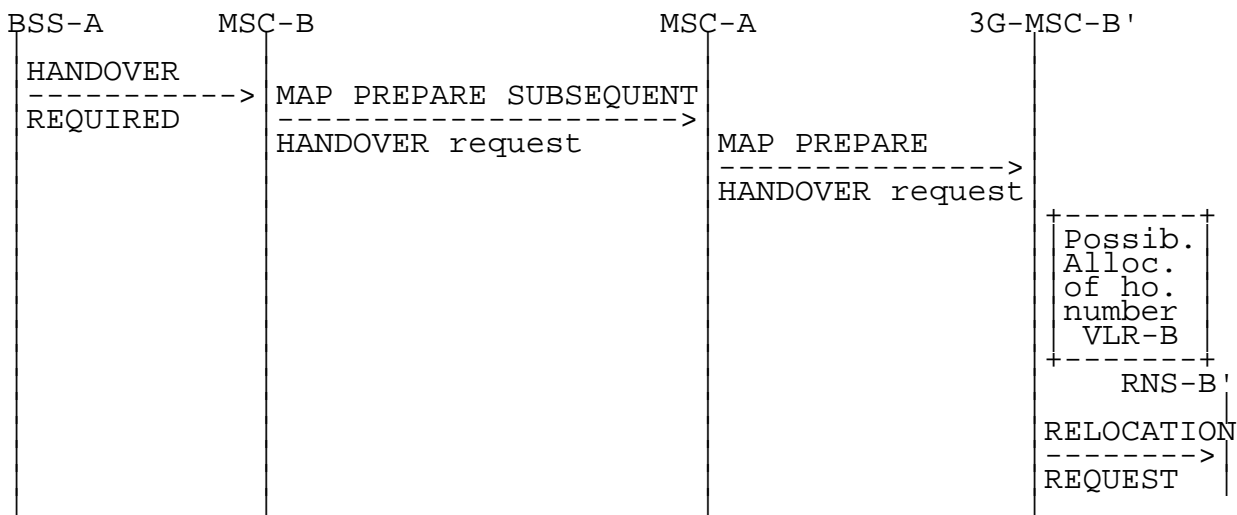


Figure 45: Signalling for Subsequent Inter-MSK Handover to third MSC (3G\_MSC-B') initiation

Possible Positive outcomes: successful radio resources allocation:

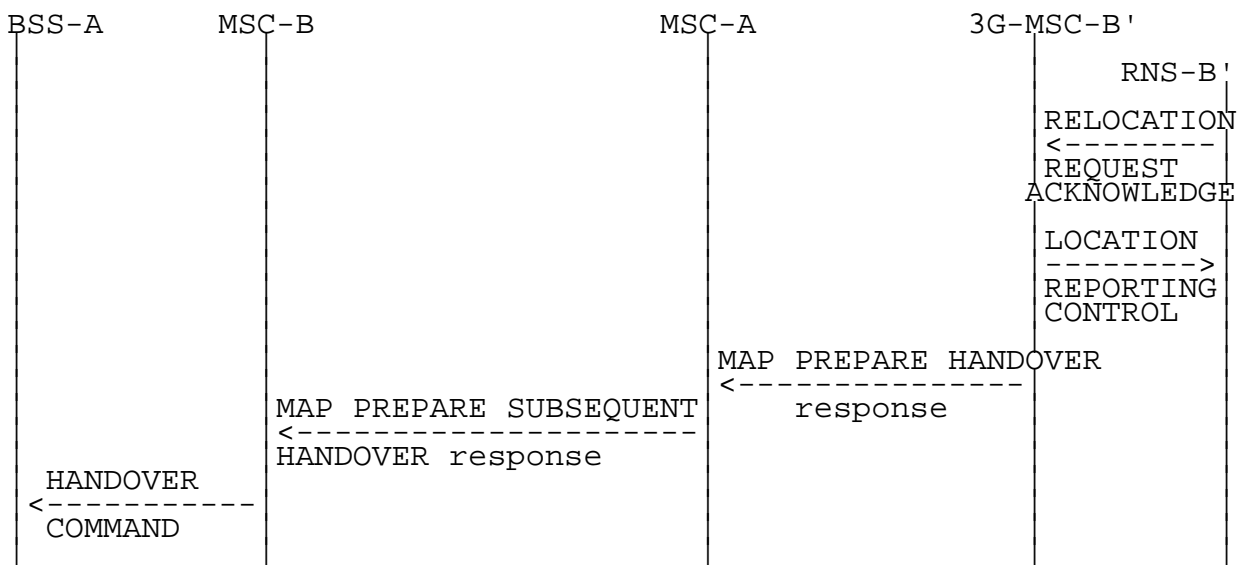
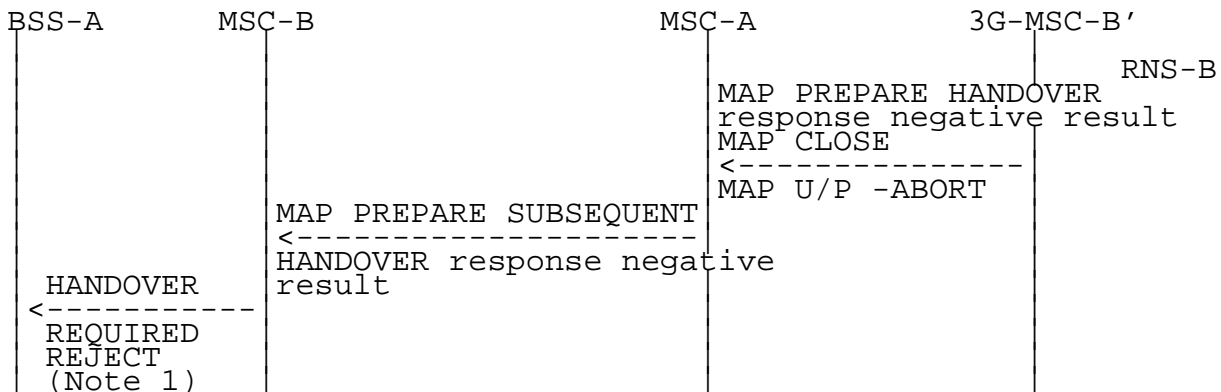


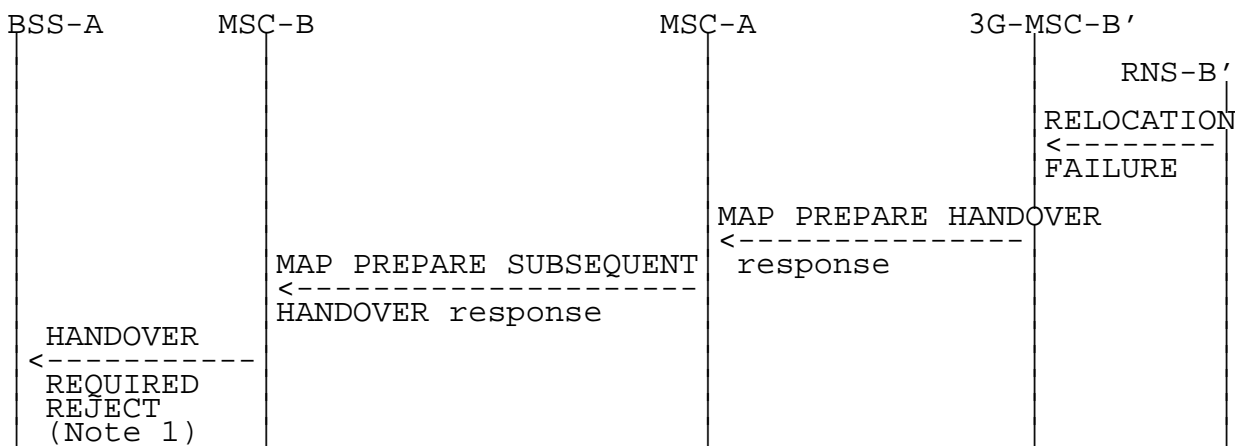
Figure 46: Signalling for Subsequent Inter-MSK Handover to third MSC (3G\_MSC-B') execution (Positive outcome)

Possible Negative outcomes:

- a) user error detected, or component rejection or dialogue abortion performed by MSC-B:



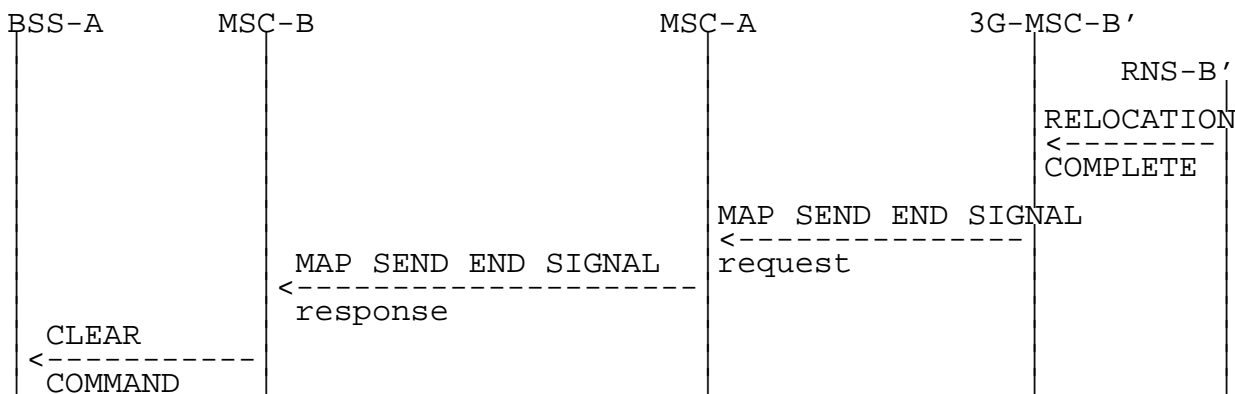
- b) radio resources allocation failure:



**Figure 47: Signalling for Subsequent Inter-MSC Handover to third MSC (3G\_MSC-B') execution (Negative outcome)**

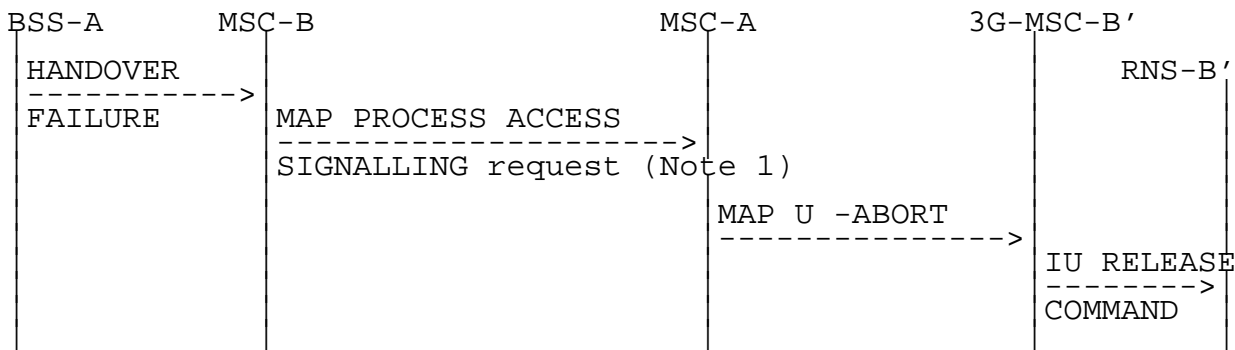
NOTE 1: Possible rejection of the handover because of the negative outcome of MAP or BSSMAP procedure.

Positive outcome:



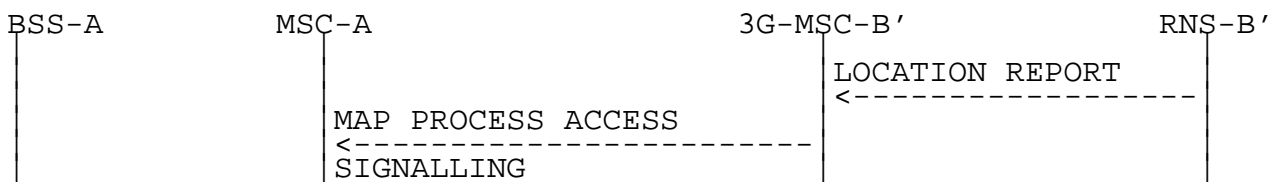
**Figure 48: Signalling for Subsequent Inter-MSC Handover to third MSC (3G\_MSC-B') completion (Successful completion of the procedure)**

Negative outcome:



**Figure 49: Signalling for Subsequent Inter-MSC Handover to third MSC (3G\_MSC-B') completion (Unsuccessful completion of the procedure)**

NOTE: Specific interworking case detailed below.



**Figure yy: Signalling for updating of anchor MSC after change of location in RNS**

The specific interworking case in MSC-A compared to the subclauses 4.5.1 and 4.7.2 occurs between HANDOVER FAILURE encapsulated in a Process Access Signalling from MSC-B and the abortion of the dialogue with 3G\_MSC-B' in the case of a reversion to old channel of the MS:

	29.002	29.002	Notes
Forward message	MAP PROCESS-SIGNALLING request -an-APDU(HANDOVER FAILURE)	MAP U -ABORT	1
Positive result			
Negative result		MAP U/P -ABORT	2

NOTE 1: The abortion of the dialogue triggers in 3G\_MSC-B' the clearing of the circuit connection with MSC-A, if any, and of the Resources between 3G\_MSC-B' and RNS-B'. The abortion of the dialogue ends the handover procedure with 3G\_MSC-B'.

NOTE 2: The abortion of the dialogue ends the handover procedure with MSC-B.

### 4.7.4 BSSAP Messages transfer on E-Interface

The handling is described in chapter 4.5.4, additional cases are described in this chapter.

#### 4.7.4.1 Assignment

The interworking between the BSSMAP assignment messages in MAP and the RANAP RAB assignment messages is as follows:

	29.002	25.413	Notes
Forward message	MAP PREPARE HANDOVER request -an-APDU( ASSIGNMENT REQUEST)	RAB ASSIGNMENT REQ	
	BSSMAP information elements:	RANAP information elements:	
	Channel Type	RAB parameters	
Positive result	MAP PREPARE HANDOVER request -an-APDU( ASSIGNMENT COMPLETE or ASSIGNMENT FAILURE)	RAB ASSIGNMENT RESPONSE (positive result) RAB ASSIGNMENT RESPONSE (negative result)	
	BSSMAP information elements:	RANAP information elements:	
	Cause	Cause	1
Negative result		MAP U/P -ABORT	

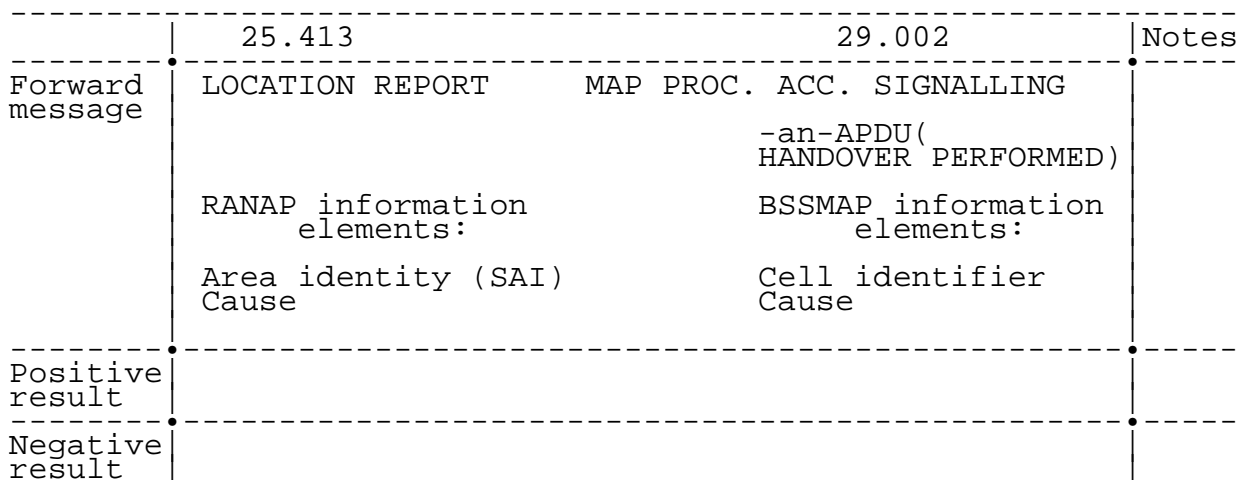
#### 4.7.4.2 Cipher Mode Control

The interworking between the BSSMAP cipher mode messages in MAP and the RANAP security mode messages is as follows:

	29.002	25.413	Notes
Forward message	MAP FORWARD ACCESS SIGN. request -an-APDU( CIPHER MODE CMD)	SECURITY MODE CMD	
	BSSMAP information elements:	RANAP information elements:	
	Encryption information	Integrity protection info Encryption info	
Positive result	MAP PROCESS ACCESS SIGN. request -an-APDU( CIPHER MODE COMPLETE or CIPHER MODE REJECT)	SECURITY MODE COMPLETE SECURITY MODE REJECT	
	BSSMAP information elements:	RANAP information elements:	
	Encryption information	Integrity protection info Encryption info	
	Cause	Cause	1
Negative result		MAP U/P -ABORT	

### 4.7.4.3 Location Reporting Control

The interworking between the RANAP location report message and the BSSMAP handover performed message in MAP is as follows:



### 4.7.5 Processing in 3G\_MSC-B, and information transfer on E-interface

The following parameters require processing (e.g. to store the parameter, to internally generate the parameter) in MSC-B. The relevant BSSMAP procedures are mentioned to ease the comprehension, their detailed description is the scope of GSM 08.08. Each BSSMAP message listed in GSM 09.08 being transferred on E-interface shall use the mechanisms given in subclause 4.5.4 and is described in GSM 08.08.

#### 4.7.5.1 Encryption Information

The list of GSM algorithms, the ciphering key and the chosen algorithm shall be stored by 3G\_MSC-B and used for generating the UMTS parameters Encryption Information and Integrity Protection Information if they are not received in MAP Prepare Handover Request (the generation of the UMTS parameters from the GSM parameters is described in TS 33.102).

Transfer of Information:

If ciphering has not been performed before Inter-MSC Handover, this will be controlled by MSC-A after the completion of Inter-MSC Handover.

Ciphering control towards 3G\_MSC-B:

If Ciphering has been performed before Inter-MSC Handover:

- in the Handover Request BSSMAP message (information included).

The Handover Request Acknowledge should in this case NOT contain the indication of the chosen algorithm.

If Ciphering has NOT been performed before Inter-MSC Handover:

- in the Cipher Mode Command procedure between MSC-A and 3G\_MSC-B.

#### 4.7.5.2 Channel Type

The Channel Type shall be stored by 3G\_MSC-B and used for generating RAB parameters.

Transfer of Information:

Independently of the type of resource (Signalling only or traffic channel) assigned to the MS, the Channel Type Information is transferred to 3G\_MSC-B in:

- the Handover Request BSSMAP message.

Chosen Channel and/or Speech Version shall NOT be reported back to MSC-A in the Handover Request Acknowledge

If a new type of resource is to be assigned after Inter-MSC Handover, this can be made with:

- the BSSMAP Assignment procedure between MSC-A and 3G\_MSC-B.

#### 4.7.5.3 Classmark

This information shall be stored by 3G\_MSC-B and might be received from MSC-A.

Transfer of Information due to Classmark received from MSC-A:

This information shall be stored by 3G\_MSC-B and is received:

- in the Handover Request BSSMAP message.

If a new type of resource is to be assigned after Inter-MSC Handover, Classmark Information MAY be included:

- in the BSSMAP Assignment procedure.

#### 4.7.5.4 Priority

The parameter shall be stored by 3G\_MSC-B and used for generating RAB parameters. It is received as detailed below:

Transfer of Information:

Received by 3G\_MSC-B from MSC-A in:

- the Handover Request BSSMAP message.

If a change is needed after an Inter-MSC Handover with:

- the BSSMAP Assignment procedure.

#### 4.7.5.5 MSC-Invoke Trace Information Elements

The process to be performed by 3G\_MSC-B on the information elements of the MSC Invoke Trace BSSMAP messages is left for further study.

Note that MSC-A does not forward BSC Invoke Trace in case of GSM to UMTS handover.

### 4.7.6 Cause Code Mapping

When a Mobile Station is handed over between GSM and UMTS, a mapping of the cause codes used in the BSSMAP and the RANAP protocols is needed. The mapping described here is applicable to the BSSMAP protocol even when used inside MAP in the E-interface.

The mapping between the cause codes received in BSSMAP Handover Required and the cause codes sent in RANAP Relocation Request is as follows:

08.08	25.413	Notes
HANDOVER REQUIRED	RELOCATION REQUEST	
-Better Cell	-Time critical reloc.	
-Directed retry	-Directed retry	
-Distance	-Time critical reloc.	
-Downlink quality	-Time critical reloc.	
-Downlink strength	-Time critical reloc.	
-O and M intervention	-O and M intervention	
-Preemption	-RAB pre-empted	
-Response to MSC invocation	-Time critical reloc.	1
-Switch circuit pool		
-Traffic	-Time critical reloc.	
-Uplink quality	-Time critical reloc.	
-Uplink strength	-Time critical reloc.	
-Any other value	-Time critical reloc.	

NOTE 1: Cause code not used at inter-system handover.

The mapping between the cause codes received in BSSMAP Handover Request and the cause codes sent in RANAP Relocation Request is as follows (the mapping is only used for the MAP-E interface):

08.08	25.413	Notes
HANDOVER REQUEST	RELOCATION REQUEST	
-Better Cell	-Time critical reloc.	
-Directed retry	- Directed retry	
-Distance	-Time critical reloc.	
-Downlink quality	-Time critical reloc.	
-Downlink strength	-Time critical reloc.	
-O and M intervention	-O and M intervention	
-Preemption	-RAB pre-empted	
-Response to MSC invocation	-Time critical reloc.	1
-Switch circuit pool		
-Traffic	-Time critical reloc.	
-Uplink quality	-Time critical reloc.	
-Uplink strength	-Time critical reloc.	
-Any other value	-Time critical reloc.	

NOTE 1: Cause code not used at inter-system handover.

The mapping between the cause codes received in BSSMAP Handover Failure and the cause codes sent in RANAP Iu Release Command is as follows:

08.08	25.413	Notes
HANDOVER FAILURE	IU RELEASE COMMAND	
-Ciphering algorithm not supported		2
-Circuit pool mismatch		1
-Equipment failure	-Relocation cancelled	
-Invalid message contents	-Abstract Syntax Error	
-No radio resource available		2
-O and M intervention	-O and M intervention	
-Radio interface failure, reversion to old channel	-Relocation cancelled	
-Radio interface message failure	-Relocation cancelled	
-Requested speech version unavailable		2
-Requested terrestrial resource unavailable		2
-Requested transcoding/rate adaption unavailable		2
-Switch circuit pool		1
-Terrestrial circuit already allocated	-Relocation cancelled	
-Any other value	-Relocation cancelled	

NOTE 1: Cause code not used at inter-system handover.



NOTE 2: Cause code not applicable to this traffic case.

The mapping between the cause codes received in RANAP Relocation Failure and the cause codes sent in BSSMAP Handover Failure is as follows (this mapping is only used for the MAP-E interface):

25.413	08.08	Notes
RELOCATION FAILURE	HANDOVER FAILURE	
-Any value	-No radio resource available	

The mapping between the cause codes received in RANAP Relocation Failure and the cause codes sent in BSSMAP Handover Request Reject is as follows:

25.413	08.08	Notes
RELOCATION FAILURE	HANDOVER REQUIRED REJECT	
-Any value	-No radio resource available	

The mapping between the RANAP and the BSSMAP assignment messages is used in the MAP-E interface. RANAP RAB Assignment Response with successful result is mapped to BSSMAP Assignment Complete; RANAP RAB Assignment Response with unsuccessful result is mapped to BSSMAP Assignment Failure. The mapping between the cause codes received in RANAP RAB Assignment Response and the cause codes sent in BSSMAP Assignment Failure is as follows (this mapping is only used for the MAP-E interface):

25.413	08.08	Notes
RAB ASSIGNMENT RESPONSE	ASSIGNMENT FAILURE	
-Requested traffic class not available	-No radio resource available	
-Invalid RAB parameters value	-Invalid msg. contents	
-Requested max bit rate not available	-No radio resource available	
-Requested max bit rate for DL not available	-No radio resource available	
-Requested max bit rate for UL not available	-No radio resource available	
-Requested guaranteed bit rate not available	-No radio resource available	
-Requested guaranteed bit rate for DL not available	-No radio resource available	
-Requested guaranteed bit rate for UL not available	-No radio resource available	
-Requested transfer delay not achievable	-No radio resource available	
-Invalid RAB param. combination	-Invalid msg. contents	
-Condition violation for SDU parameters	-Invalid msg. contents	
-Condition violation for traffic handling priority	-Invalid msg. contents	
-Condition violation for guaranteed bit rate	-Invalid msg. contents	
-User plane not supported	-No radio resource available	
-Iu UP failure	-Equipment failure	
-Tqueuing expiry	-Radio interface message failure	
-Invalid RAB id	-Invalid msg. contents	
-Request superseded	-No radio resource available	
-Relocation triggered	-No radio resource available	
-Any other value	-Radio interface message failure	

The mapping between the cause codes received in RANAP Location Report and the cause codes sent in BSSMAP Handover Performed is as follows (this mapping is only used for the MAP-E interface):

25.413	08.08	Notes
LOCATION REPORT	HANDOVER PERFORMED	
-User restriction start ind.	-O&M intervention	1
-User restriction start ind.	-O&M intervention	
-Requested report type not supported		
-Any other value	-Better cell	

NOTE 1: In this case, no Handover Performed is sent.

## 4.8 Inter-MSC Relocation

The general principles of the relocation procedures are given in Technical Specification TS 23.009. TS 29.010 gives the necessary information for interworking between the TS 25.413 relocation protocol and the TS 29.002 MAP protocol.

For intra UMTS handovers, RANAP is carried over the MAP-E interface instead of BSSAP. Please refer to 3GPP TS 29.108.

### 4.8.1 Basic Inter-MSC Relocation

When a Mobile Station is relocated between two MSCs, the establishment of a connection between them (described in TS 23.009) requires interworking between Iu-Interface and E-Interface.

The signalling at initiation, execution and completion of the Basic Inter-MSC relocation procedure is shown in figures 50 to 54 with both possible positive or negative outcomes.

Additionally figure 50b shows the possible interworking when trace related messages are transparently transferred on the E-Interface at Basic Inter-MSC Relocation initiation.

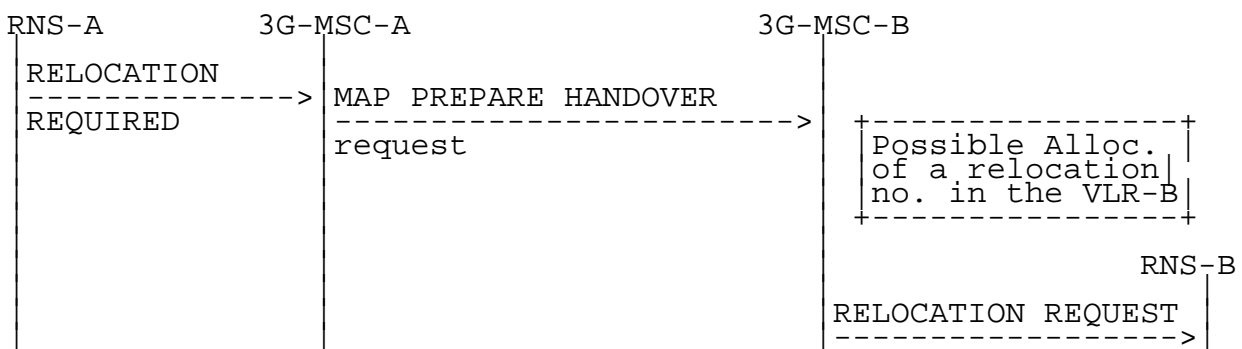
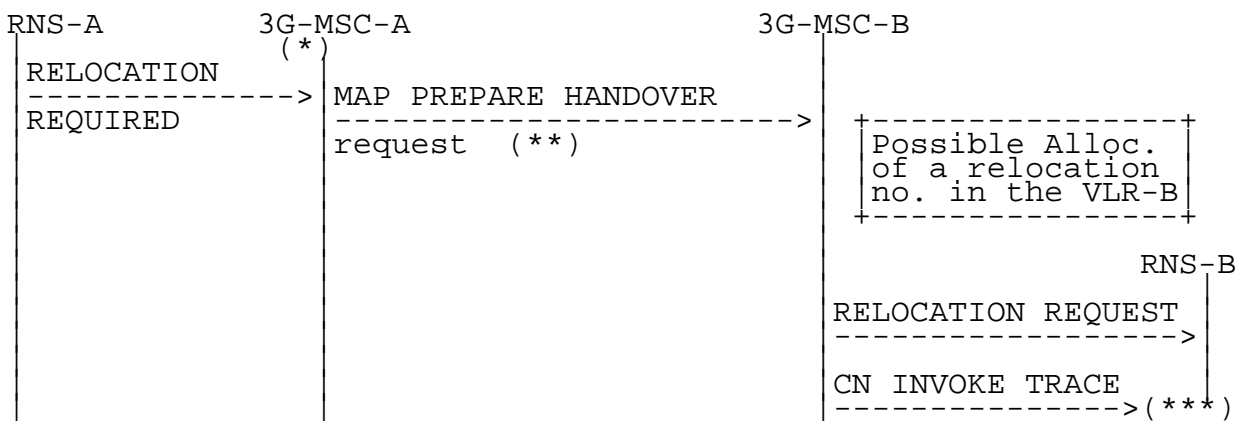


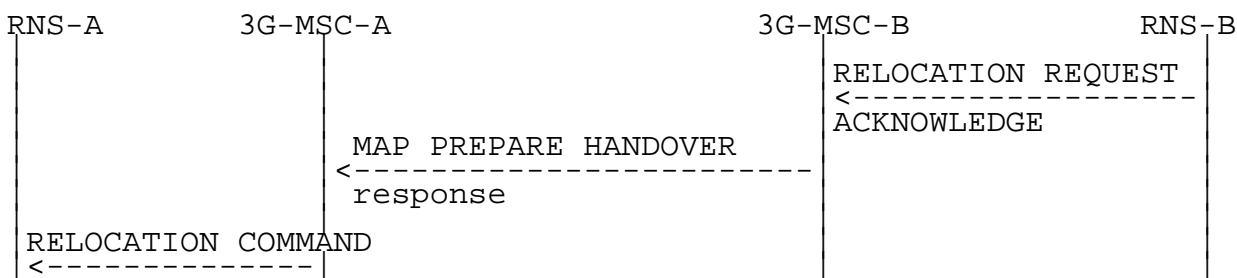
Figure 50a: Signalling for Basic Inter-MSC Relocation initiation (no trace related messages transferred)



**Figure 50b: Signalling for Basic Inter-MSC Relocation initiation (CN invoke trace message transferred)**

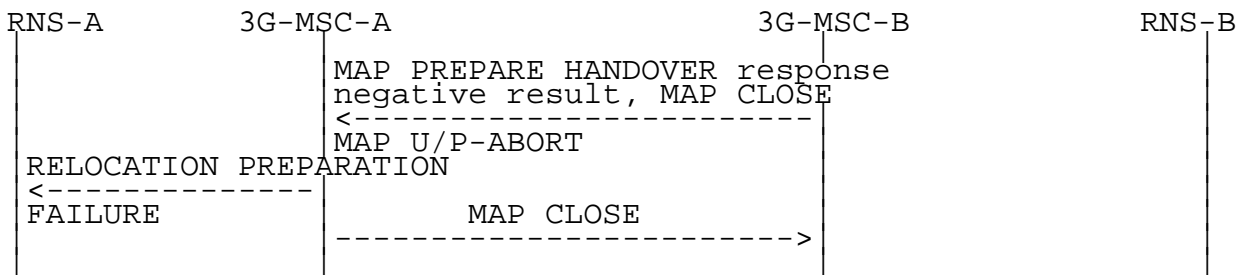
- (\*): Tracing invocation has been received from VLR.
- (\*\*): In that case, RELOCATION REQUEST and CN INVOKE TRACE messages are included within the AN-apdu parameter.
- (\*\*\*): CN INVOKE TRACE is forwarded to RNS-B if supported by 3G\_MSC-B.

Possible Positive outcomes: successful radio resources allocation and relocation numbers allocation (if performed):

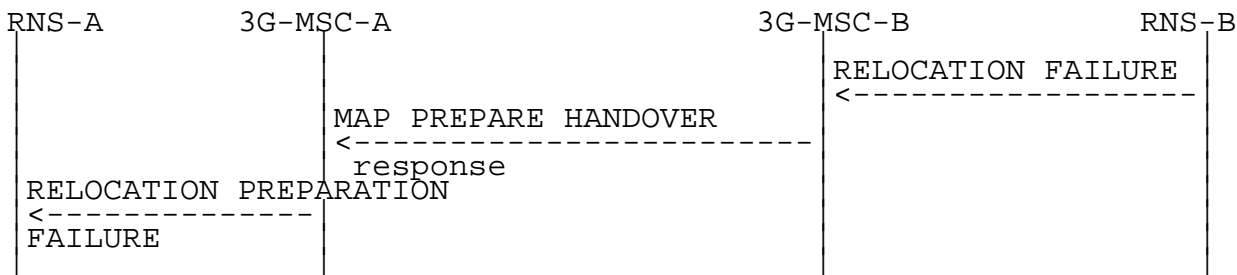


Possible Negative outcomes:

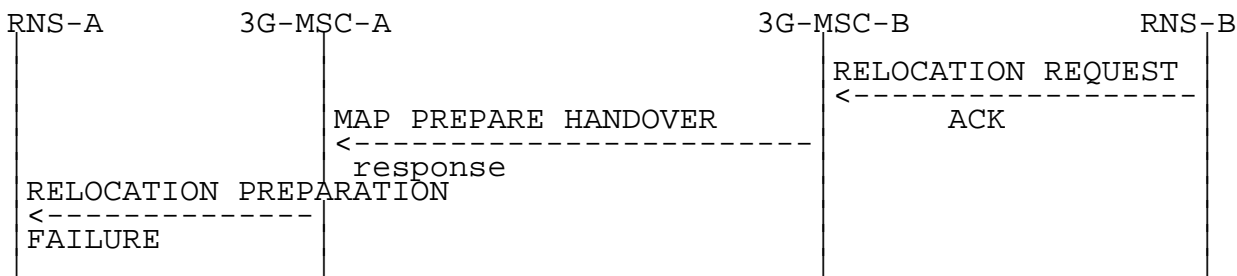
- a) user error detected, or relocation numbers allocation unsuccessful (if performed), or component rejection or dialogue abortion performed by 3G\_MSC-B:



b) radio resources allocation failure:



c) radio resources allocation partial failure (3G\_MSC-A decides to reject the relocation):



d) unsuccessful relocation execution (relocation cancelled):

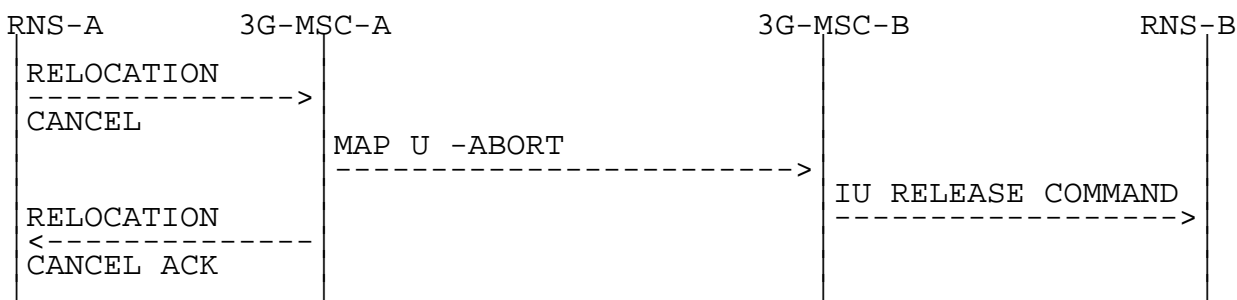


Figure 51: Signalling for Basic Inter-MSC Relocation execution (Negative outcomes)

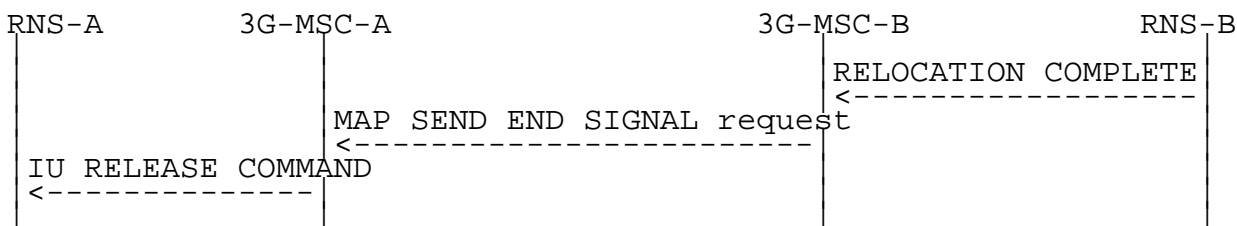
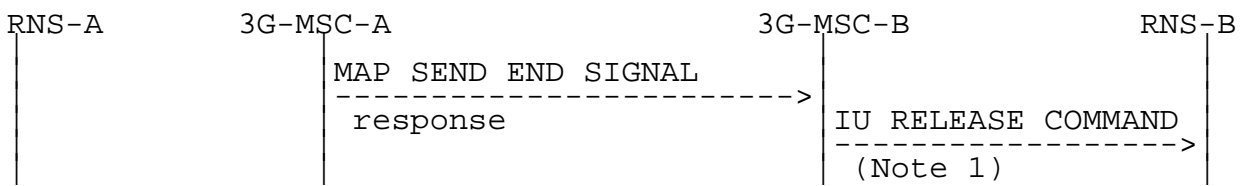


Figure 52: Signalling for Basic Inter-MSC Relocation completion

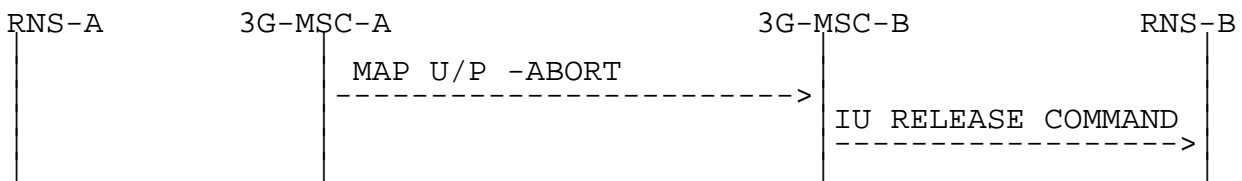
Positive outcome



**Figure 53: Signalling for Basic Inter-MSC Relocation completion (Positive outcome)**

NOTE: From interworking between MAP and RANAP point of view.

Negative outcome:



**Figure 54: Signalling for Basic Inter-MSC Relocation completion (Negative outcome)**

The relocation procedure is normally triggered by RNS-A by sending a RELOCATION REQUIRED message on Iu-Interface to 3G\_MSC-A. The invocation of the Basic Inter-MSC relocation procedure is performed and controlled by 3G\_MSC-A. The sending of the MAP Prepare-Handover request to 3G\_MSC-B is triggered in 3G\_MSC-A upon receipt of the RELOCATION REQUIRED message. The identity of the target RNC where the call is to be handed over in 3G\_MSC-B area, provided in the RELOCATION REQUIRED message, is mapped to the target RNC Id MAP parameter and the RELOCATION REQUEST message is encapsulated in the an-APDU MAP parameter of the Prepare-Handover MAP request. 3G\_MSC-B can invoke another operation towards the VLR-B (allocation of the relocation numbers described in 3GPP TS 29.002).

Additionally, if tracing activity has been invoked, the trace related messages can be transferred on the E-Interface encapsulated in the an-APDU MAP parameter of the Prepare-Handover Request. If transferred, one complete trace related message at a time shall be included in the an-APDU MAP parameter after the RELOCATION REQUEST message.

The interworking between Prepare Handover and RELOCATION REQUIRED is as follows:

	25.413	29.002	Notes
Forward message	RELOCATION REQUIRED MAP PREPARE HANDOVER request		
	RANAP information elements	-ho-NumberNotRequired -target RNC Id -Radio Resource Info -an-APDU( RELOCATION REQUEST, CN INVOKE TRACE)	1 2
Positive result	MAP PREPARE HANDOVER response		3
	RELOCATION COMMAND	-relocation numbers -an-APDU( RELOCATION REQUEST ACKNOWLEDGE	
	RELOCATION PREP FAILURE	or RELOCATION FAILURE)	
Negative result	RELOCATION PREP FAILURE	MAP PREPARE HANDOVER	
	Unspecified failure	System Failure	
	Unspecified failure	No Handover Number available	
	Unspecified failure	UnexpectedDataValue	
	Unspecified failure	Data Missing	
	Unspecified failure	MAP CLOSE	
	Unspecified failure	MAP U/P -ABORT	

NOTE 1: The RANAP information elements are already stored in 3G\_MSC.

The ho-NumberNotRequired parameter is included by 3G\_MSC-A, when 3G\_MSC-A decides not to use any circuit connection with 3G\_MSC-B. No relocation numbers shall be present in the positive result. Any negative response from 3G\_MSC-B shall not be due to relocation number allocation problem.

NOTE 2: The process performed on the RANAP information elements received in the RELOCATION REQUIRED message is described in the 3GPP TS 25.413.

NOTE 3: The response to the Prepare-Handover request can include in its an-APDU parameter, identifying the 3GPP TS 25.413 protocol, either a RANAP RELOCATION REQUEST ACKNOWLEDGE or a RANAP RELOCATION FAILURE.

In the first case, the positive result triggers in 3G\_MSC-A the sending on Iu-Interface of the RELOCATION CMD.

In the second case, the positive result triggers in 3G\_MSC-A the sending of the RELOCATION PREP FAILURE.

The interworking between Send End Signal and RELOCATION COMPLETE in 3G\_MSC-B is as follows:

	25.413	29.002	Notes
Forward message	RELOCATION COMPLETE MAP SEND END SIGNAL request	-an-APDU( RELOCATION COMPL)	
Positive result	IU RELEASE COMMAND -Normal release	MAP SEND END SIGNAL response	1
Negative result	IU RELEASE COMMAND -Normal release -Normal release	MAP CLOSE MAP U/P -ABORT	2

NOTE 1: The positive empty result triggers the clearing of the Radio Resources on the Iu-Interface and the release of the SCCP connection between 3G\_MSC-B and RNS-B. If a circuit connection is used between 3G\_MSC-A and 3G\_MSC-B, the 'Normal release' clearing cause shall only be given to RNS-B when 3G\_MSC-B has received a clearing indication on its circuit connection with 3G\_MSC-A.

NOTE 2: The abortion of the dialogue or the rejection of the component triggers in 3G\_MSC-B the clearing of its circuit connection with 3G\_MSC-A, if any, of the Radio Resources on the Iu-Interface and the release of the SCCP connection between 3G\_MSC-B and RNS-B.

The interworking between Send End Signal and IU RELEASE COMMAND in 3G\_MSC-A is as follows:

	29.002	25.413	Notes
Forward message	MAP SEND END SIGNAL request	IU RELEASE COMMAND - Successful Relocation	
Positive result			
Negative result			

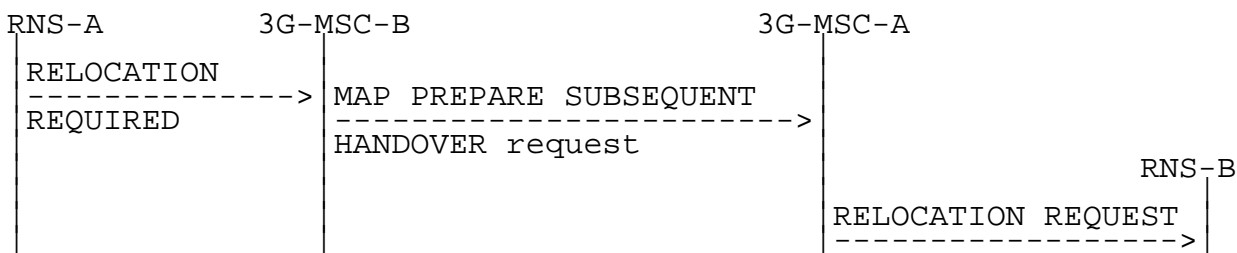
The interworking between RELOCATION CANCEL in case of relocation cancelled and User Abort in 3G-MSC-A is as follows:

	25.413	29.002	Notes
Forward message	RELOCATION CANCEL - Relocation cancelled	MAP U -ABORT	
Positive result	RELOCATION CANCEL ACKNOWLEDGEMENT		
Negative result			

#### 4.8.2 Subsequent Inter-MSC Relocation back to 3G\_MSC-A

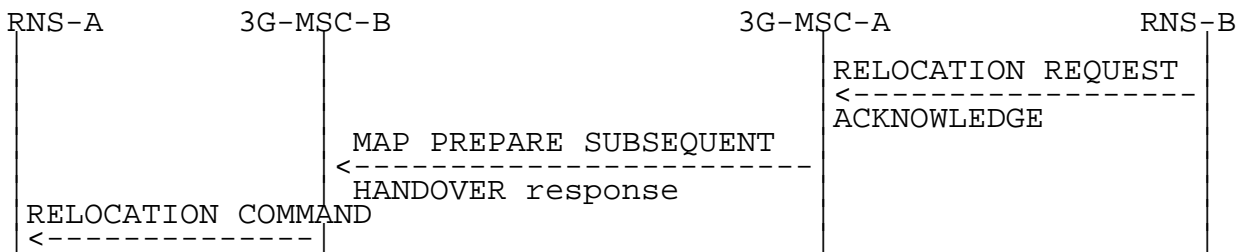
When a Mobile Station is being relocated back to 3G\_MSC-A, the procedure (described in TS 23.009) requires interworking between Iu-Interface and E-Interface.

The signalling at initiation, execution and completion of the Subsequent Inter-MSC relocation procedure is shown in figures 55 to 59.



**Figure 55: Signalling for Subsequent Inter-MSC Relocation back to 3G\_MSC-A initiation**

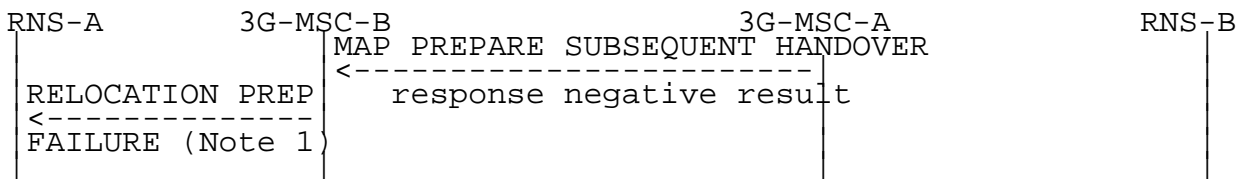
Possible Positive outcomes: successful radio resources allocation:



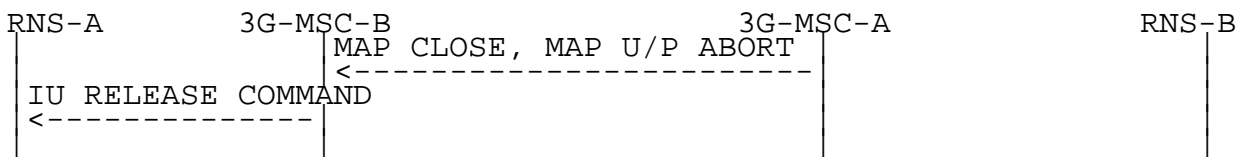
**Figure 56: Signalling for Subsequent Inter-MSC Relocation back to 3G\_MSC-A execution (Positive outcome)**

Possible Negative outcomes:

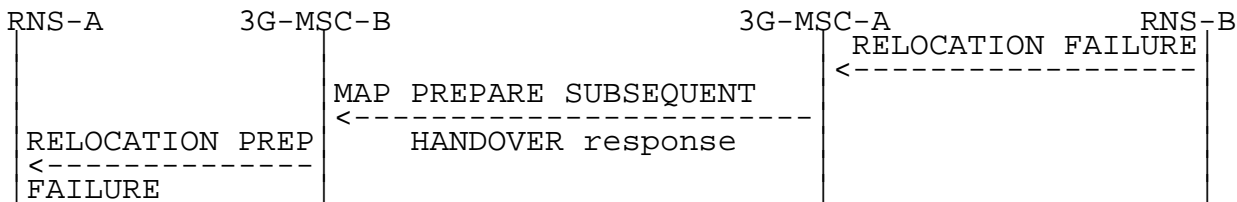
- a) user error detected, or component rejection or dialogue abortion performed by 3G\_MSC-A:



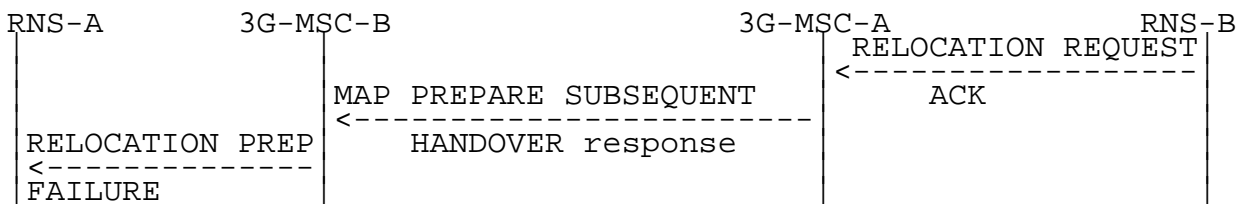
- b) component rejection or dialogue abortion performed by 3G\_MSC-A:



- c) radio resources allocation failure:

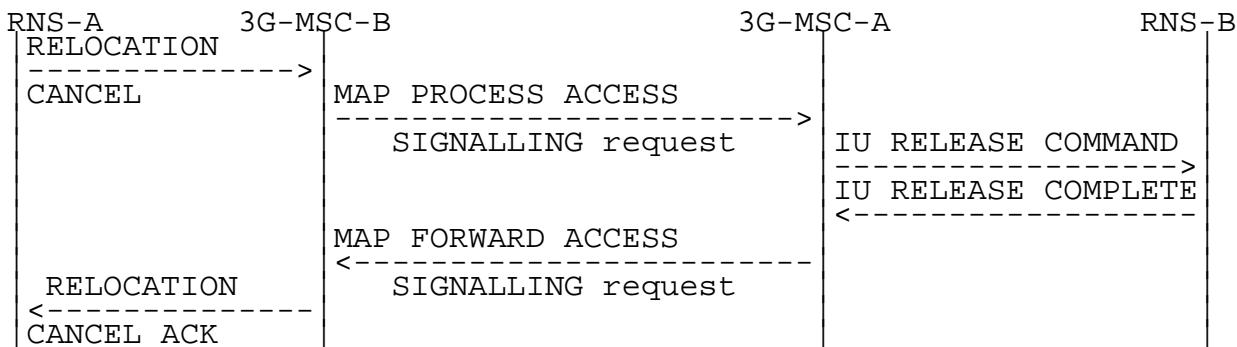


- d) radio resources allocation partial failure (3G\_MSC-A decides to reject the relocation):

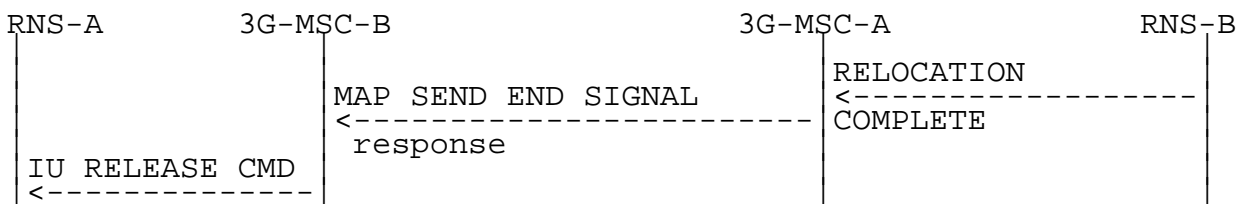




e) unsuccessful relocation execution (relocation cancelled):

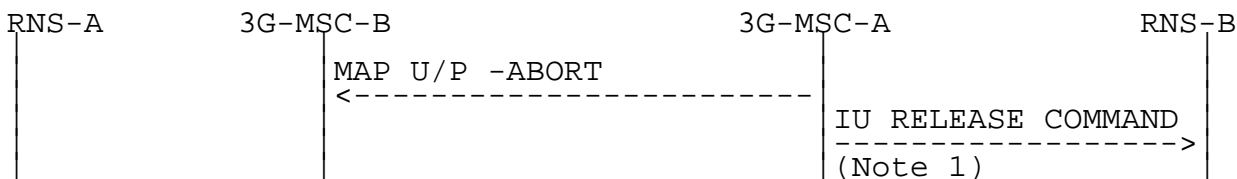


**Figure 57: Signalling for Subsequent Inter-MSB Relocation back to 3G\_MSC-A execution (Negative outcome)**



**Figure 58: Signalling for Subsequent Inter-MSB Relocation back to 3G\_MSC-A completion (Successful completion of the procedure)**

NOTE: Positive outcome case shown in figure 53.



**Figure 59: Signalling for Subsequent Inter-MSB Relocation back to 3G\_MSC-A completion (Unsuccessful completion of the procedure)**

NOTE: Abnormal end of the procedure that triggers the clearing of all resources in 3G\_MSC-B.

The interworking between Prepare Subsequent Handover and RELOCATION REQUIRED is as follows:

	25.413	29.002	Notes
Forward message	REL. REQUIRED  RANAP information elements	MAP PREPARE SUBSEQUENT HANDOVER request  -target MSC number -target RNC Id -an-APDU( RELOCATION REQ)	1
Positive result		MAP PREPARE SUBSEQUENT HANDOVER response -an-APDU( RELOCATION REQUEST ACKNOWLEDGE or RELOCATION FAILURE)	2
Negative result	REL. PREP. FAILURE Unspecified failure Unspecified failure Unspecified failure Unspecified failure Iu RELEASE COMMAND Unspecified failure Unspecified failure	MAP PREPARE SUBSEQUENT HANDOVER response Unknown MSC Subsequent Handover Failure UnexpectedDataValue Data Missing  MAP CLOSE MAP U/P -ABORT	

NOTE 1: The processing performed on the RANAP information elements received in the RELOCATION REQUIRED message is out of the scope of the present document. The target MSC number is provided to 3G\_MSC-A by 3G\_MSB-B based on the information received from RNS-B.

NOTE 2: The response to the Prepare-Subsequent-Handover request can include in its an-APDU parameter, identifying the 3GPP TS 25.413 protocol, a RANAP RELOCATION REQUEST ACKNOWLEDGE or a RANAP RELOCATION FAILURE.

In the first case, the positive result triggers in 3G\_MSC-B the sending on Iu-Interface of the RELOCATION COMMAND.

In the second case, the positive result triggers in 3G\_MSC-B the sending of the RELOCATION PREPARATION FAILURE.

The interworking between RELOCATION CANCEL and MAP Process Signalling Request in 3G\_MSC-A is as follows:

	29.002	25.413	Notes
Forward message	MAP PROCESS-SIGNALLING request -an-APDU( RELOCATION CANCEL)	IU RELEASE COMMAND	
Positive result	MAP FORWARD-SIGNALLING request -an-APDU( RELOCATION CANCEL ACK)	IU RELEASE COMPLETE	
Negative result			

The interworking between RELOCATION CANCEL and MAP Process Signalling Request in 3G\_MSC-B is as follows:

	25.413	29.002	Notes
Forward message	RELOCATION CANCEL	MAP PROCESS-SIGNALLING request -an-APDU( RELOCATION CANCEL)	
Positive result	RELOCATION CANCEL ACK	MAP FORWARD-SIGNALLING request -an-APDU( RELOCATION CANCEL ACK)	
Negative result			

The interworking between Send End Signal Result and RELOCATION COMPLETE in 3G\_MSC-A is as follows:

	25.413	29.002	Notes
Forward message	RELOCATION COMPLETE	MAP SEND END SIGNAL response	
Positive result			
Negative result		MAP U/P -ABORT	1

NOTE: The abortion of the dialogue ends the relocation procedure with 3G\_MSC-B.

### 4.8.3 Subsequent Inter-MSC Relocation to third MSC

When a Mobile Station is being relocated to a third MSC, the procedure (described in 3GPP TS 23.009) does require one specific interworking case in 3G\_MSC-A (figure 64) between E-Interface from 3G\_MSC-B and E-Interface from 3G\_MSC-B' other than the combination of the ones described in the subclause 4.8.1 and 4.8.2.

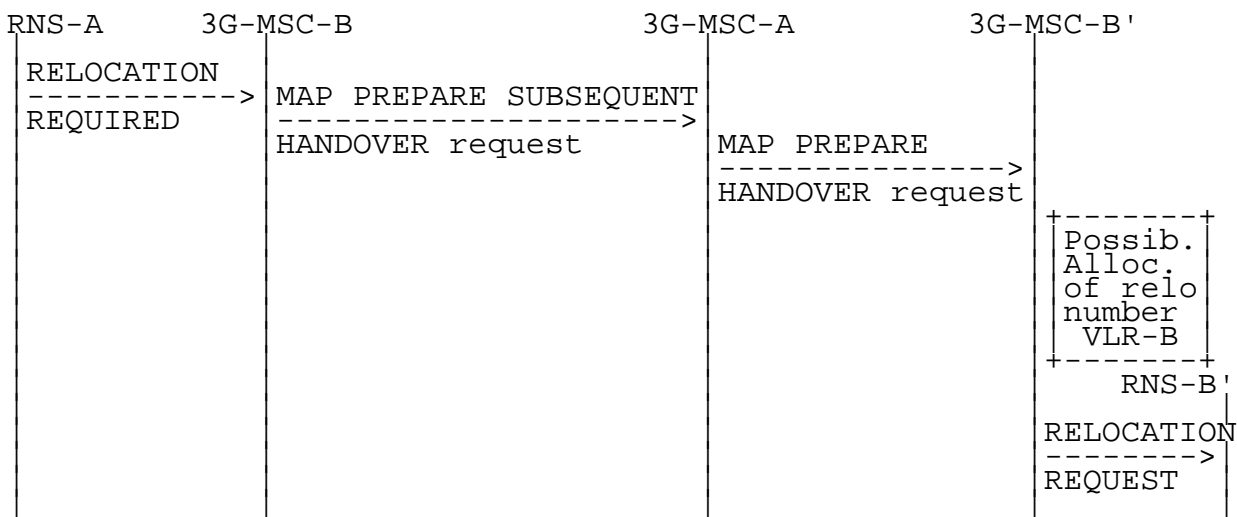
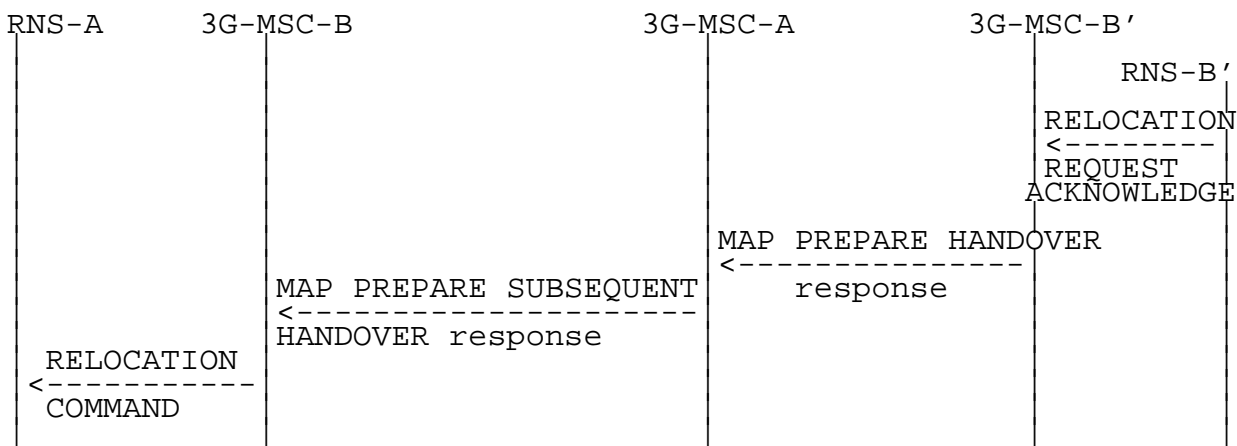


Figure 60: Signalling for Subsequent Inter-MSC Relocation to third MSC (3G\_MSC-B') initiation

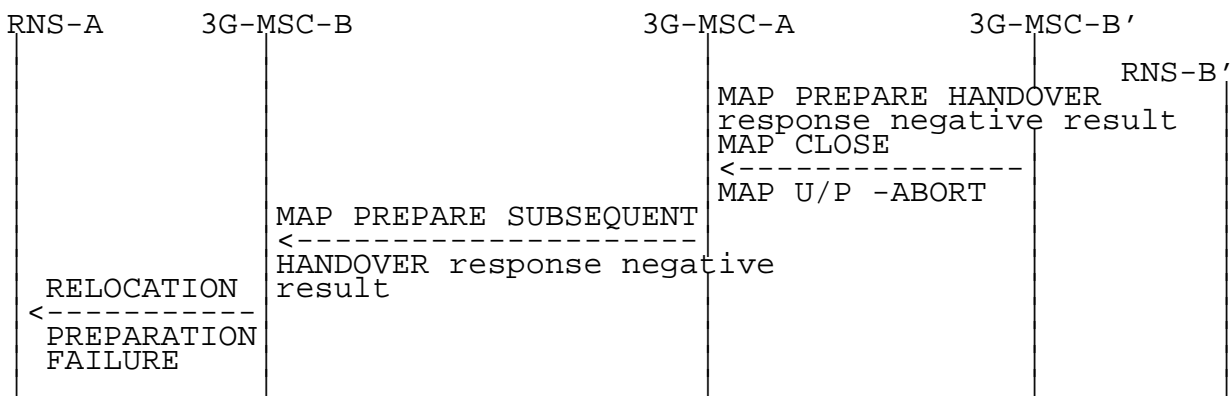
Possible Positive outcomes: successful radio resources allocation:



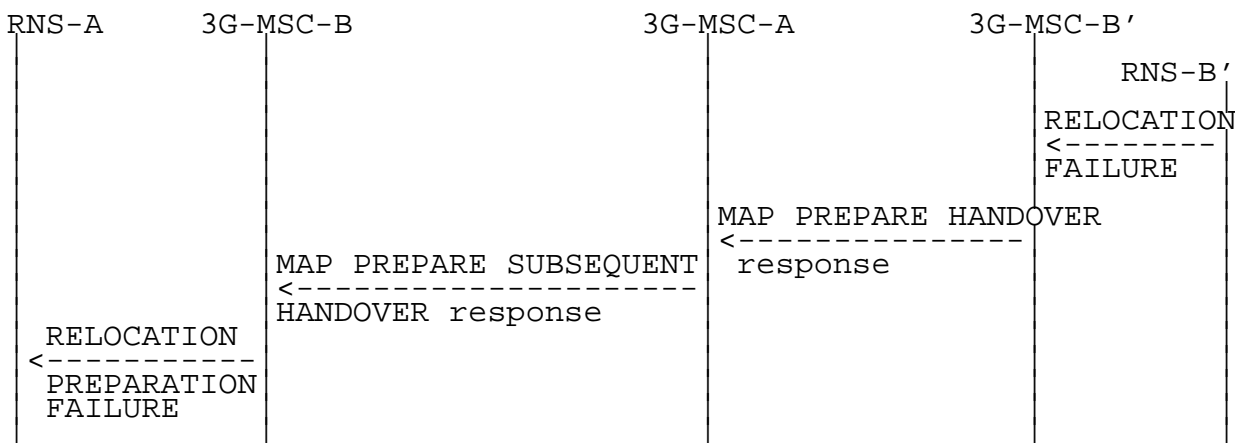
**Figure 61: Signalling for Subsequent Inter-MSC Relocation to third MSC (3G\_MSC-B') execution (Positive outcome)**

Possible Negative outcomes:

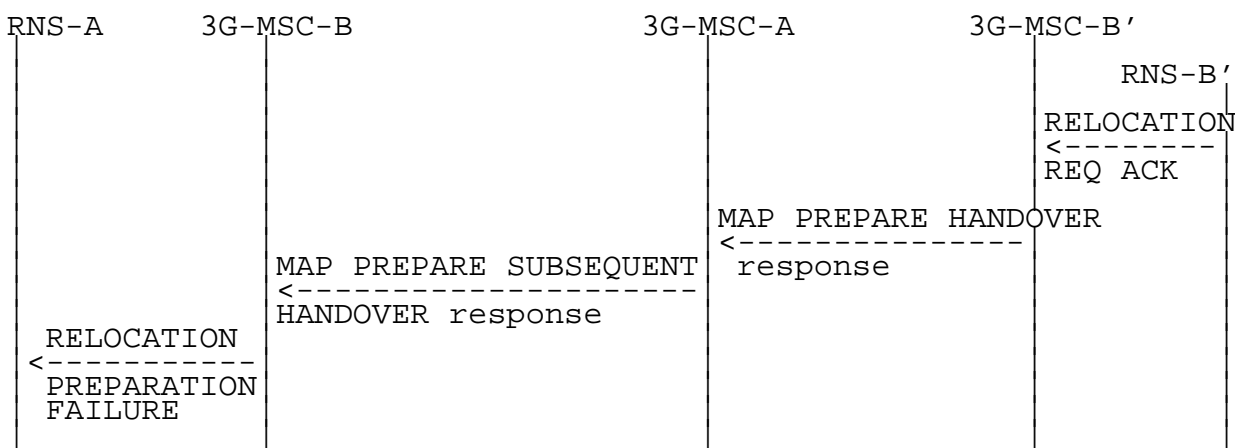
- a) user error detected, or component rejection or dialogue abortion performed by 3G\_MSC-B':



b) radio resources allocation failure:

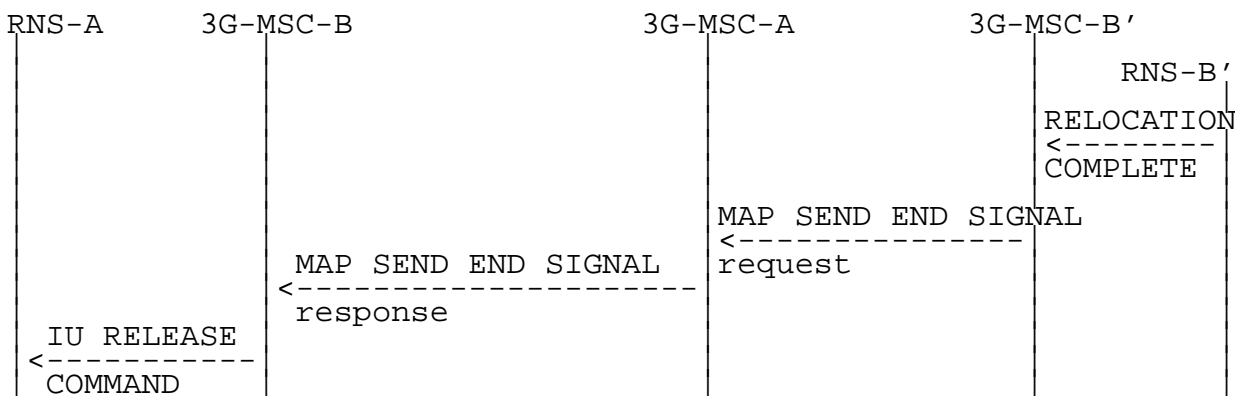


c) radio resources allocation partial failure (3G\_MSC-A decides to reject the relocation):



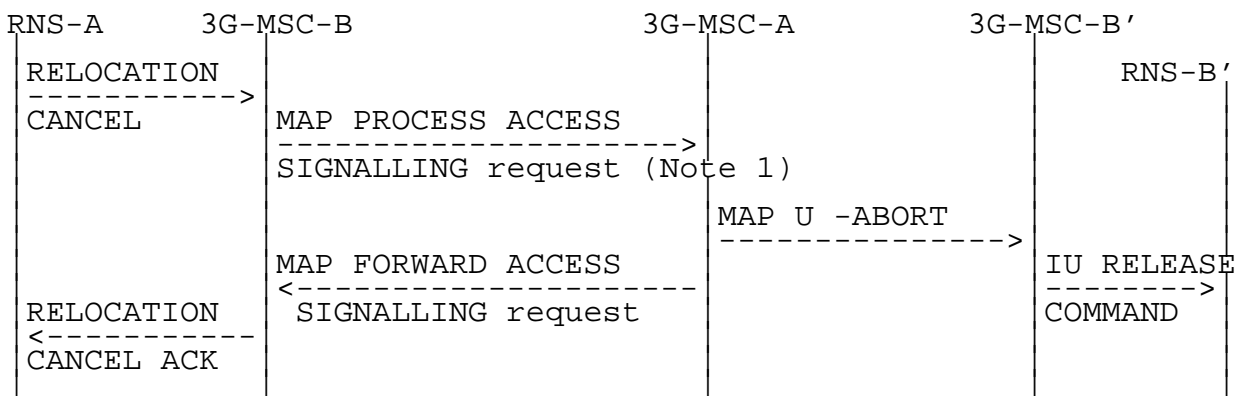
**Figure 62: Signalling for Subsequent Inter-MSC Relocation to third MSC (3G\_MSC-B') execution (Negative outcome)**

Positive outcome:



**Figure 63: Signalling for Subsequent Inter-MSC Relocation to third MSC (3G\_MSC-B') completion (Successful completion of the procedure)**

Negative outcome:



**Figure 64: Signalling for Subsequent Inter-MSC Relocation to third MSC (3G\_MSC-B') completion (Unsuccessful completion of the procedure)**

NOTE: Specific interworking case detailed below.

The specific interworking case in 3G\_MSC-A compared to the subclauses 4.8.1 and 4.8.2 occurs between RELOCATION FAILURE encapsulated in a Process Access Signalling from 3G\_MSC-B and the abortion of the dialogue with 3G\_MSC-B' in the case of relocation cancelled:

	29.002	29.002	Notes
Forward message	MAP PROCESS-SIGNALLING request -an-APDU( RELOCATION CANCEL )	MAP U -ABORT	1
Positive result	MAP FORWARD-SIGNALLING request -an-APDU( RELOCATION CANCEL ACK )		
Negative result		MAP U/P -ABORT	2

NOTE 1: The abortion of the dialogue triggers in 3G\_MSC-B' the clearing of the circuit connection with 3G\_MSC-A, if any, and of the Resources between 3G\_MSC-B' and RNS-B'. The abortion of the dialogue ends the relocation procedure with 3G\_MSC-B'.

NOTE 2: The abortion of the dialogue ends the relocation procedure with 3G\_MSC-B.

#### 4.8.4 RANAP Messages transfer on E-Interface

The following mapping applies to the encapsulation performed in 3G\_MSC-A.

	25.413	29.002	Notes
Forward message	RANAP messages	MAP FORWARD ACCESS SIGNALLING request -an-APDU (RANAP messages)	1
Positive result			2
Negative result		MAP CLOSE MAP U/P -ABORT	

NOTE 1: Complete RANAP messages to be sent on 3G\_MSC-B - RNS-B interface are embedded into the an-APDU parameter.

NOTE 2: The Return Result does not apply. If 3G\_MSC-B returns a message, this message will arrive in an Invoke: Process Access Signalling.

The following mapping applies to the encapsulation performed in 3G\_MSC-B.

	25.413	29.002	Notes
Forward message	RANAP messages	MAP PROCESS ACCESS SIGNALLING request -an-APDU (RANAP messages)	1
Positive result			2
Negative result	IU RELEASE COMMAND Unspecified failure	MAP CLOSE MAP U/P -ABORT	3

NOTE 1: Complete RANAP messages to be sent to 3G\_MSC-A are embedded into the an-APDU parameter.

NOTE 2: The Return Result does not apply. If 3G\_MSC-A returns a message, this message will arrive in an Invoke: Forward Access Signalling.

NOTE 3: The abortion of the dialogue triggers the clearing of the circuit connection with 3G\_MSC-A, if any, of the Radio Resources on the Iu-Interface and the release of the SCCP connection between 3G\_MSC-B and RNS-B. The clearing of the Radio Resources (the clearing indication received from RNS-B is transmitted to 3G\_MSC-A) or the loss of the SCCP connection between 3G\_MSC-B and RNS-B, triggers in 3G\_MSC-B the abortion of the dialogue on the E-Interface and the clearing of the circuit connection with 3G\_MSC-A, if any.

## 4.8.5 Processing in 3G\_MSC-B, and information transfer on E-interface

The following parameters require processing (e.g. to store the parameter, to internally generate the parameter) in 3G\_MSC-B. The relevant RANAP procedures are mentioned to ease the comprehension, their detailed description is the scope of the TS 25.413. Each RANAP message being transferred on E-interface shall use the mechanisms given in subclause 4.8.4 and is described in TS 25.413.

### 4.8.5.1 Integrity Protection Information

A sequence of possible integrity protection algorithms can be sent to an RNS in Security Mode Command or Relocation Request. The RNS chooses one of the listed algorithms and reports this back to the 3G\_MSC in Security Mode Complete or Relocation Request Acknowledge respectively.

The list of algorithms, the integrity protection key and the chosen algorithm shall be stored by 3G\_MSC-B.

Transfer of Information:

If integrity protection has not been performed before Inter-MSC Relocation, this will be controlled by 3G\_MSC-A after the completion of Inter-MSC Relocation.

Integrity protection control towards 3G\_MSC-B:

If Integrity protection has been performed before Inter-MSC Relocation:

- in the Relocation Request RANAP message (information included).

The Relocation Request Acknowledge should in this case contain the indication of the chosen algorithm.

If Integrity protection has NOT been performed before Inter-MSC Relocation:

- in the Security Mode Command procedure between 3G\_MSC-A and 3G\_MSC-B.

#### 4.8.5.2 Encryption Information

A sequence of possible encryption algorithms can be sent to an RNS in Security Mode Command or Relocation Request. The RNS chooses one of the listed algorithms and reports this back to the 3G\_MSC in Security Mode Complete or Relocation Request Acknowledge respectively.

The list of algorithms, the ciphering key and the chosen algorithm shall be stored by 3G\_MSC-B, and the chosen value sent to 3G\_MSC-A.

Transfer of Information:

If ciphering has not been performed before Inter-MSC Relocation, this will be controlled by 3G\_MSC-A after the completion of Inter-MSC Relocation.

Ciphering control towards 3G\_MSC-B:

If Ciphering has been performed before Inter-MSC Relocation:

- in the Relocation Request RANAP message (information included).

The Relocation Request Acknowledge should in this case contain the indication of the chosen algorithm.

If Ciphering has NOT been performed before Inter-MSC Relocation:

- in the Security Mode Command procedure between 3G\_MSC-A and 3G\_MSC-B.

#### 4.8.5.3 RAB Parameters

The parameters shall be stored by 3G\_MSC-B to be used at internal Relocation in 3G\_MSC-B.

Transfer of information:

Received by 3G\_MSC-B from 3G\_MSC-A in:

- The Relocation Request RANAP message.

If a new type of resource is to be assigned after Inter-MSC Relocation, this can be made with:

- The RAB Assignment Request RANAP message.

#### 4.8.5.4 Channel Type

Channel Type is GSM information that is required in BSSMAP Handover Request and shall be provided by 3G\_MSC-A. 3G\_MSC-B needs this information in case of an intra-UMTS to GSM handover after an inter-UMTS relocation. The Channel Type derived from the Bearer Capability that is available in 3G\_MSC-A. This mapping is described in 3GPP TS 27.001. Therefore 3G\_MSC-A must provide this information in case of an inter-UMTS relocation. The Radio Resource Information IE in the MAP Prepare Handover message refers to the Channel Type GSM information.



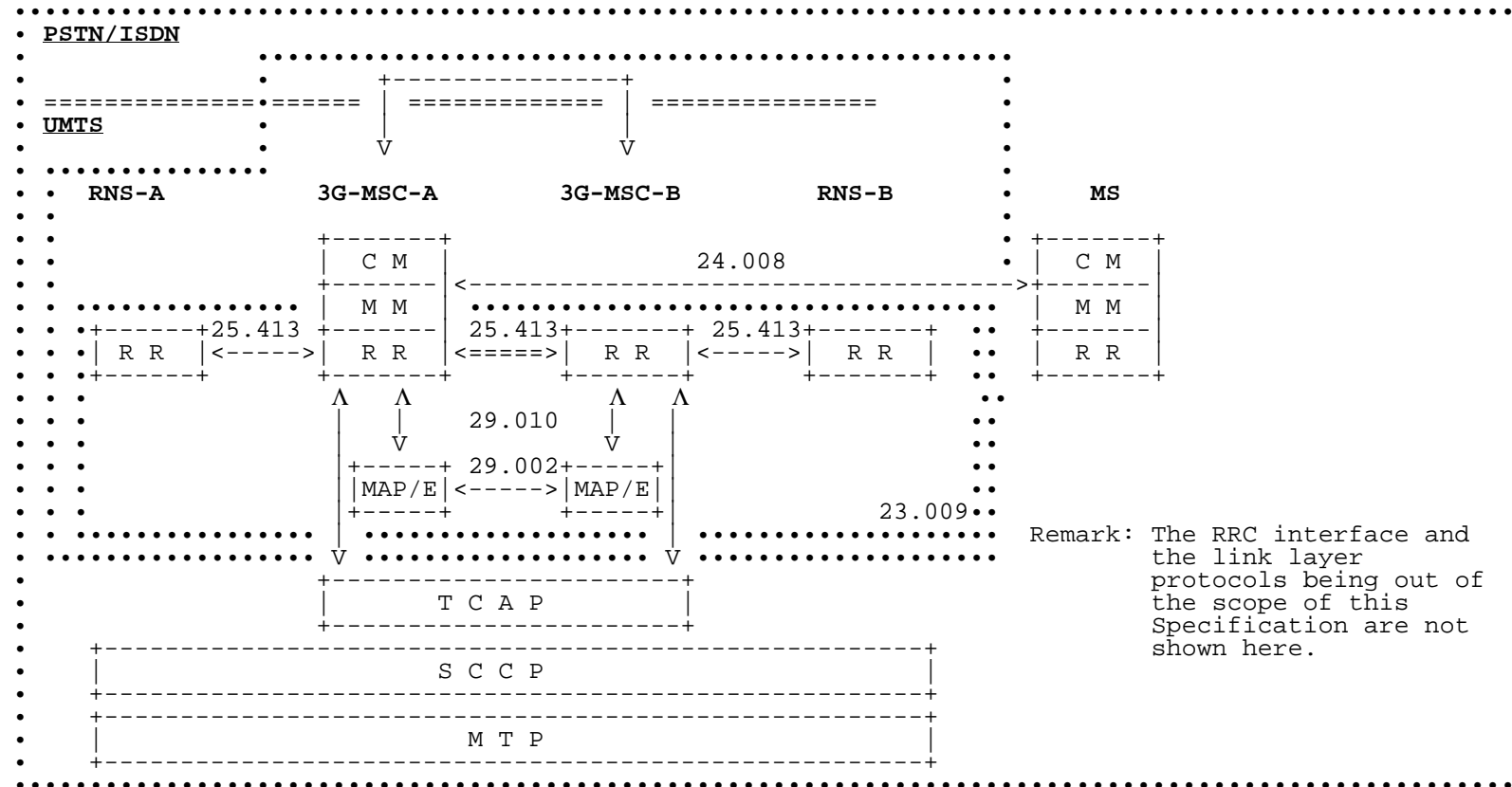
Channel Type shall be stored by 3G\_MSC-B.

Transfer of information:

Received by 3G\_MSC-B from 3G\_MSC-A in:

- The Prepare Handover Request MAP message.

#### 4.8.6 Overview of the Technical Specifications 3GPP interworking for the Inter-MSC Relocation



## Annex A (informative): Change history

Change history						
TSG CN#	Spec	Version	CR	<Phase>	New Version	Subject/Comment
Sept 1999	GSM 09.10	7.0.0				Transferred to 3GPP CN
CN#04	29.010			R99	3.0.0	Approved by mail exploder at CN#04
CN#06	29.010	3.0.0	001	R99	3.1.0	UMTS / GSM Interworking
CN#06	29.010	3.0.0	002	R99	3.1.0	Addition of LSA Information message
CN#07	29.010	3.1.0	003r1	R99	3.2.0	UMTS / GSM Interworking
CN#07	29.010	3.1.0	004r1	R99	3.2.0	GSM / UMTS Interworking
CN#07	29.010	3.1.0	005	R99	3.2.0	UMTS/UMTS Handover
CN#09	29.010	3.2.0	006r1	R99	3.3.0	Clarification of use of Radio Resource Information
CN#09	29.010	3.2.0	007r1	R99	3.3.0	Corrections and updates to align with current R99 specs
CN#10	29.010	3.3.0	008	R99	3.4.0	GSM to 3G Handover: Location Reporting in 3G_MSC-B
CN#10	29.010	3.3.0	009	R99	3.4.0	GSM to 3G Handover: Chosen IEs in Handover Request Ack
CN#10	29.010	3.3.0	010	R99	3.4.0	GSM to 3G Handover: MAP parameter Target Cell ID
CN#10	29.010	3.3.0	011r1	R99	3.4.0	GSM/UMTS Interworking: Mapping of cause codes
CN#11	29.010	3.4.0	012	R99	3.5.0	GSM to UMTS handover: addition of MAP parameter Target RNC ID
CN#11	29.010	3.4.0	013	R99	3.5.0	Inter MSC relocation: addition of MAP parameter Target RNC ID
CN#11	29.010	3.4.0	014	R99	3.5.0	Roaming restrictions for GPRS service
CN#11	29.010	3.4.0	015	R99	3.5.0	Alignment of cause mapping for 08.08 and 25.413 (Directed Retry)
CN#11	29.010	3.4.0	016	R99	3.5.0	UMTS to GSM Directed Retry cause code mapping
CN#11	29.010	3.4.0	017	R99	3.5.0	Mapping of unknown HLR error to access interface cause code

---

## History

<b>Document history</b>		
V3.1.0	January 2000	Publication
V3.2.0	March 2000	Publication
V3.3.0	September 2000	Publication
V3.4.0	December 2000	Publication
V3.5.0	March 2001	Publication