



**Universal Mobile Telecommunications System (UMTS);  
LTE;  
Telecommunication management;  
Self-Organizing Networks (SON)  
Policy Network Resource Model (NRM)  
Integration Reference Point (IRP);  
Requirements  
(3GPP TS 28.627 version 13.1.0 Release 13)**



---

Reference

RTS/TSGS-0528627vd10

---

Keywords

LTE, UMTS

**ETSI**

650 Route des Lucioles  
F-06921 Sophia Antipolis Cedex - FRANCE

Tel.: +33 4 92 94 42 00 Fax: +33 4 93 65 47 16

Siret N° 348 623 562 00017 - NAF 742 C  
Association à but non lucratif enregistrée à la  
Sous-Préfecture de Grasse (06) N° 7803/88

---

**Important notice**

The present document can be downloaded from:  
<http://www.etsi.org/standards-search>

The present document may be made available in electronic versions and/or in print. The content of any electronic and/or print versions of the present document shall not be modified without the prior written authorization of ETSI. In case of any existing or perceived difference in contents between such versions and/or in print, the only prevailing document is the print of the Portable Document Format (PDF) version kept on a specific network drive within ETSI Secretariat.

Users of the present document should be aware that the document may be subject to revision or change of status. Information on the current status of this and other ETSI documents is available at  
<http://portal.etsi.org/tb/status/status.asp>

If you find errors in the present document, please send your comment to one of the following services:  
<https://portal.etsi.org/People/CommitteeSupportStaff.aspx>

---

**Copyright Notification**

No part may be reproduced or utilized in any form or by any means, electronic or mechanical, including photocopying and microfilm except as authorized by written permission of ETSI.

The content of the PDF version shall not be modified without the written authorization of ETSI.  
The copyright and the foregoing restriction extend to reproduction in all media.

© European Telecommunications Standards Institute 2016.  
All rights reserved.

**DECT™**, **PLUGTESTS™**, **UMTS™** and the ETSI logo are Trade Marks of ETSI registered for the benefit of its Members.  
**3GPP™** and **LTE™** are Trade Marks of ETSI registered for the benefit of its Members and of the 3GPP Organizational Partners.  
**GSM®** and the GSM logo are Trade Marks registered and owned by the GSM Association.

---

## Intellectual Property Rights

IPRs essential or potentially essential to the present document may have been declared to ETSI. The information pertaining to these essential IPRs, if any, is publicly available for **ETSI members and non-members**, and can be found in ETSI SR 000 314: *"Intellectual Property Rights (IPRs); Essential, or potentially Essential, IPRs notified to ETSI in respect of ETSI standards"*, which is available from the ETSI Secretariat. Latest updates are available on the ETSI Web server (<https://ipr.etsi.org>).

Pursuant to the ETSI IPR Policy, no investigation, including IPR searches, has been carried out by ETSI. No guarantee can be given as to the existence of other IPRs not referenced in ETSI SR 000 314 (or the updates on the ETSI Web server) which are, or may be, or may become, essential to the present document.

---

## Foreword

This Technical Specification (TS) has been produced by ETSI 3rd Generation Partnership Project (3GPP).

The present document may refer to technical specifications or reports using their 3GPP identities, UMTS identities or GSM identities. These should be interpreted as being references to the corresponding ETSI deliverables.

The cross reference between GSM, UMTS, 3GPP and ETSI identities can be found under <http://webapp.etsi.org/key/queryform.asp>.

---

## Modal verbs terminology

In the present document "**shall**", "**shall not**", "**should**", "**should not**", "**may**", "**need not**", "**will**", "**will not**", "**can**" and "**cannot**" are to be interpreted as described in clause 3.2 of the [ETSI Drafting Rules](#) (Verbal forms for the expression of provisions).

"**must**" and "**must not**" are **NOT** allowed in ETSI deliverables except when used in direct citation.

# Contents

Intellectual Property Rights .....	2
Foreword.....	2
Modal verbs terminology.....	2
Foreword.....	5
Introduction .....	5
1 Scope .....	6
2 References .....	6
3 Definitions and abbreviations.....	6
3.1 Definitions .....	6
3.2 Abbreviations .....	7
4 Concepts and background .....	7
4.1 Overview .....	7
4.2 Self-Optimization Concept.....	9
4.2.1 Logical Function Blocks .....	9
4.2.1.1 Self-Optimization Input Monitoring Function (SO_MON_F) .....	9
4.2.1.2 Triggering Optimization Function (TG_F) .....	9
4.2.1.3 Optimization Fallback Function (O_FB_F) .....	9
4.2.1.4 Self-Optimization Progress Update Function (SO_PGS_UF).....	9
4.2.1.5 NRM IRP Update Function (NRM_UF).....	9
4.2.1.6 Self-Optimization Monitoring and Management Function (SO_MMF) .....	9
4.2.1.6.1 Self-Optimization Monitoring and Management Function (SO_MMF_NM) .....	9
4.2.1.6.2 Self-Optimization Monitoring and Management Function (SO_MMF_EM).....	9
4.2.1.7 Load Balancing Function (LB_F) .....	10
4.2.1.8 Interference Control Function (IC_F) .....	10
4.2.1.9 Coverage and Capacity Function (CC_F) .....	10
4.2.1.10 RACH Optimization Function (RACH_F).....	10
4.2.1.11 HandOver Optimization Function (HO_F) .....	10
4.2.1.12 NM centralized Coverage and Capacity Function (CC_F_NM) .....	10
4.3 SON Coordination Concepts .....	10
5 Business level requirements .....	10
5.1 Requirements.....	11
5.1.1 Self-Optimization Monitoring and Management .....	11
5.1.2 Load Balancing .....	11
5.1.3 Handover (HO) Parameter optimization .....	12
5.1.4 Interference control.....	12
5.1.5 Coverage and Capacity optimization .....	12
5.1.6 RACH optimization .....	12
5.1.7 SON Coordination .....	12
5.2 Actor roles .....	13
5.3 Telecommunications Resources .....	13
5.4 High-Level use case .....	13
5.4.1 Load Balancing .....	13
5.4.2 Interference control.....	15
5.4.3 Coverage and capacity optimization .....	16
5.4.4 NM centralized Coverage and Capacity Optimization .....	18
5.4.4.0 General .....	18
5.4.4.1 Use case 1: Cell coverage adapting to traffic demand.....	18
5.4.4.2 Use case 2: Coverage and accessibility.....	18
5.4.4.3 Use case 3: LTE coverage holes with underlaid UTRAN/GERAN .....	18
5.4.4.4 Use case 4: LTE Connection failure .....	19
5.4.4.5 Use case 5: Radio link quality.....	21

6	Specification level requirements .....	21
6.1	Requirements .....	21
6.1.1	Self-Optimization Monitoring and Management .....	21
6.1.1.1	Management Part .....	21
6.1.2	Load Balancing .....	22
6.1.3	Handover (HO) Parameter optimization .....	22
6.1.3.1	HO failure categorization .....	22
6.1.3.1.1	HO failures due to too late and too early HO triggering .....	22
6.1.3.2	Reducing inefficient use of network resources due to unnecessary HOs .....	23
6.1.3.3	Requirements .....	24
6.1.4	Interference control .....	24
6.1.5	Coverage and capacity optimization .....	24
6.1.6	RACH optimization .....	25
6.1.7	SON Coordination .....	25
6.1.8	NM centralized coverage and capacity optimization .....	25
6.2	Actor roles .....	25
6.3	Telecommunications Resources .....	25
6.4	Use case .....	26
6.4.1	Use case Self-Optimization Monitoring and Management .....	26
6.4.2	Use case Load Balancing Allowed/Prohibited Management .....	26
6.4.3	Use case NM centralized Coverage and Capacity Optimization .....	28
7	Functions and Architecture .....	29
7.1	Self-Optimization Logical Architecture .....	29
7.2	Self-Optimization Reference Model .....	29
<b>Annex A (informative):</b>	<b>Steps for SON self-optimization Technical Specifications .....</b>	<b>30</b>
<b>Annex B (informative):</b>	<b>General descriptions related to NM centralized CCO high level use cases.....</b>	<b>31</b>
B.1	General .....	31
B.2	Monitoring of UE distribution .....	32
<b>Annex C (informative):</b>	<b>Change history .....</b>	<b>34</b>
History .....		35

---

## Foreword

This Technical Specification has been produced by the 3<sup>rd</sup> Generation Partnership Project (3GPP).

The contents of the present document are subject to continuing work within the TSG and may change following formal TSG approval. Should the TSG modify the contents of the present document, it will be re-released by the TSG with an identifying change of release date and an increase in version number as follows:

Version x.y.z

where:

- x the first digit:
  - 1 presented to TSG for information;
  - 2 presented to TSG for approval;
  - 3 or greater indicates TSG approved document under change control.
- y the second digit is incremented for all changes of substance, i.e. technical enhancements, corrections, updates, etc.
- z the third digit is incremented when editorial only changes have been incorporated in the document.

---

## Introduction

The present document is part of a TS-family covering the 3<sup>rd</sup> Generation Partnership Project Technical Specification Group Services and System Aspects, Telecommunication management; as identified below:

- 28.627: 'Self-Organizing Networks (SON) Policy Network Resource Model (NRM) Integration Reference Point (IRP): Requirements'**
- 28.628: 'Self-Organizing Networks (SON) Policy Network Resource Model (NRM) Integration Reference Point (IRP): Information Service (IS)'
- 28.629: 'Self-Organizing Networks (SON) Policy Network Resource Model (NRM) Integration Reference Point (IRP): Solution Set (SS) definitions'

---

# 1 Scope

The present document describes concept and requirements of SON Policy management for Self-Optimization and SON coordination.

---

## 2 References

The following documents contain provisions which, through reference in this text, constitute provisions of the present document.

- References are either specific (identified by date of publication, edition number, version number, etc.) or non-specific.
- For a specific reference, subsequent revisions do not apply.
- For a non-specific reference, the latest version applies. In the case of a reference to a 3GPP document (including a GSM document), a non-specific reference implicitly refers to the latest version of that document *in the same Release as the present document*.

- [1] 3GPP TS 32.101: "Telecommunication management; Principles and high level requirements".
- [2] 3GPP TS 32.102: "Telecommunication management; Architecture".
- [3] 3GPP TS 32.150: "Telecommunication management; Integration Reference Point (IRP) Concept and definitions".
- [4] 3GPP TR 21.905: "Vocabulary for 3GPP Specifications".
- [5] 3GPP TS 32.600: "Telecommunication management; Configuration Management (CM); Concept and high-level requirements".
- [6] 3GPP TS 28.620: "Telecommunication management; Fixed Mobile Convergence (FMC) Federated Network Information Model (FNIM) Umbrella Information Model (UIM)".
- [7] 3GPP TS 37.320: "Universal Terrestrial Radio Access (UTRA) and Evolved Universal Terrestrial Radio Access (E-UTRA); Radio measurement collection for Minimization of Drive Tests (MDT); Overall description; Stage 2".
- [8] 3GPP TS 36.133: "Evolved Universal Terrestrial Radio Access (E-UTRA); Requirements for support of radio resource management".
- [9] 3GPP TS 36.213: "Evolved Universal Terrestrial Radio Access (E-UTRA); Physical layer procedures".
- [10] 3GPP TS 36.321: "Evolved Universal Terrestrial Radio Access (E-UTRA); Medium Access Control (MAC) protocol specification".
- [11] 3GPP TS 36.214: "Evolved Universal Terrestrial Radio Access (E-UTRA); Physical layer; Measurements".

---

## 3 Definitions and abbreviations

### 3.1 Definitions

For the purposes of the present document, the terms and definitions given in 3GPP TS 32.101 [1], 3GPP TS 32.102 [2], 3GPP TS 32.150 [3] and the following apply. A term defined in the present document takes precedence over the definition of the same term, if any, in TS 32.101 [1], TS 32.102 [2], TS 32.150 [3] and TR 21.905 [4], in that order.

**Target:** Target provides a clear basis for assessing performance of self-optimization functions. Targets need to be carefully specified in terms of a series of performance measurements and/or KPIs, which can be specific, and which can be used also to identify problems. A target should be expressed in terms of a specific value or specific value range. The present document does not specify the specific value or desired value range of each target since those should be set by operators according to their policy and different network situation.

**Trigger condition:** The condition at which self-optimization should be triggered. Different self-optimization algorithms may have different trigger conditions for achieving same objectives and targets.

## 3.2 Abbreviations

For the purposes of the present document, the following abbreviations apply:

CCO	Coverage and Capacity Optimization
CQI	Channel Quality Indicator
EM	Element Manager
eNodeB	evolved NodeB
EPC	Evolved Packet Core
E-UTRA	Evolved Universal Terrestrial Radio Access
E-UTRAN	Evolved Universal Terrestrial Radio Access Network
HO	Handover
ICIC	Inter Cell Interference Coordination
LB	Load Balancing
LTE	Long Term Evolution
NE	Network Element
NM	Network Manager
NRM	Network Resource Model
OAM	Operation Administration Maintenance
PRB	Physical Resource Block
RCEF	RRC Connection Establishment Failure
RLF	Radio Link Failure
RSRP	Reference Signal Received Power
RSRQ	Reference Signal Received Quality
SON	Self Organizing Networks
UE	User Equipment

---

## 4 Concepts and background

### 4.1 Overview

A self-optimization functionality will monitor input data such as performance measurements, fault alarms, notifications etc. After analyzing the input data, optimization decisions will be made according to the optimization algorithms. Finally, corrective actions on the affected network node(s) will be triggered automatically or manually when necessary.

IRPManager should be able to control the self-optimization procedures according to the operator's objectives and targets.

The following diagram is illustrated how the self-optimization functionality works:



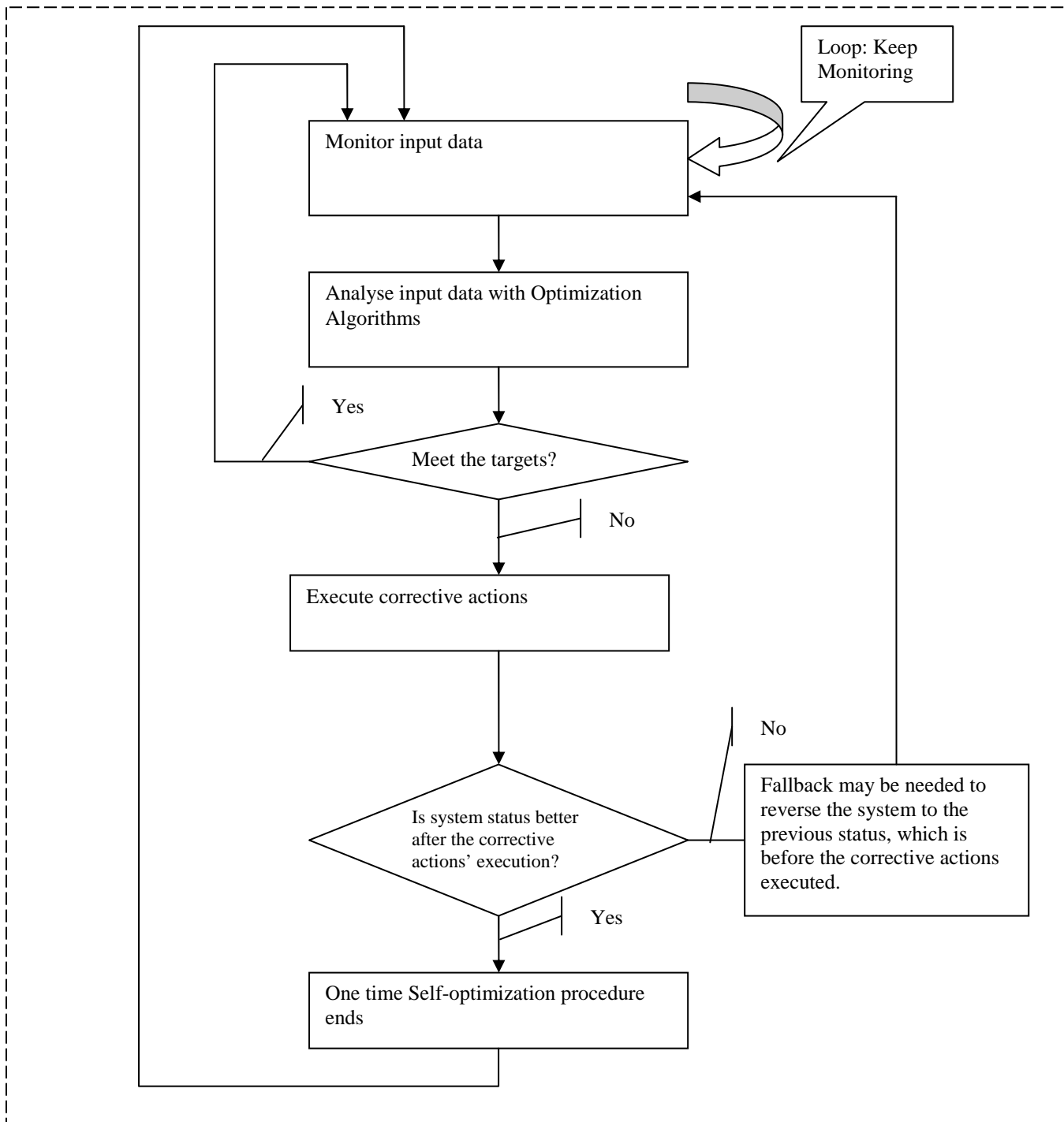

**Figure 4-1 Logical view of self-optimization procedure**

The self-optimization functionality working procedure could be interpreted logically as following:

1. The self-optimization functionality keeps monitoring input data according to the operator"s objectives and targets.
2. Whenever the objectives and targets are not met, optimization algorithms will be triggered.
3. Corrective actions are provided and executed.
4. Then the self-optimization functionality evaluates the result of the executed corrective actions.

- a) If the system status is not satisfactory after the corrective actions" execution, fallback may be needed to reverse the system configuration to the previous status, which is before the corrective actions executed.
- b) If the system status is satisfactory after the corrective actions" execution, the one time self-optimization procedure ends.

5. Self-optimization functionality returns to monitoring the input data.

## 4.2 Self-Optimization Concept

### 4.2.1 Logical Function Blocks

#### 4.2.1.1 Self-Optimization Input Monitoring Function (SO\_MON\_F)

This functional bloc supports the following functions: [SO1].

#### 4.2.1.2 Triggering Optimization Function (TG\_F)

This functional bloc supports the following functions: [SO2], [SO3].

#### 4.2.1.3 Optimization Fallback Function (O\_FB\_F)

This functional bloc supports the following functions: [SO7], [SO9], [SO10].

#### 4.2.1.4 Self-Optimization Progress Update Function (SO\_PGS\_UF)

This function updates the self-optimization progress and important events to the operator: [SO11]

#### 4.2.1.5 NRM IRP Update Function (NRM\_UF)

This function updates the E-UTRAN and EPC NRM IRP with the optimization modification if needed.

#### 4.2.1.6 Self-Optimization Monitoring and Management Function (SO\_MMF)

This function monitors the self-optimization process and provides the operator with this information. This function must be able to get information about all other functional blocs. In addition to this it allows the operator to control the execution of the self-optimization process.

This function also resolves conflicts of different SON functions trying to change or actually changing parameter values in different directions or reports such conflicts, if they cannot be solved.

##### 4.2.1.6.1 Self-Optimization Monitoring and Management Function (SO\_MMF\_NM)

SO\_MMF\_NM (IRP Manager): representing the NM portion of SO\_MMF (necessary monitoring and limited interaction capabilities to support an automated optimization), as well as related IRPManager functionality

In a centralized conflict resolution approach SO\_MMF\_NM identifies and resolves conflicts.

In distributed and hybrid conflict resolution approach SO\_MMF\_NM sends policy directions towards the SO\_MMF\_EM.

##### 4.2.1.6.2 Self-Optimization Monitoring and Management Function (SO\_MMF\_EM)

SO\_MMF\_EM (IRP Agent): representing the portion of SO\_MMF operating below Itf-N, as well as related IRPAgent functionality

In distributed and hybrid conflict resolution approach SO\_MMF\_EM identifies, resolves and/or reports conflicts, according to the policy directions received by SO\_MMF\_NM.

In case SO\_MMF\_EM is not able to solve a conflict, it will request the SO\_MMF\_NM to resolve the conflict.

#### 4.2.1.7 Load Balancing Function (LB\_F)

This function handles the load balancing optimization.

#### 4.2.1.8 Interference Control Function (IC\_F)

This function handles the interference control optimization.

#### 4.2.1.9 Coverage and Capacity Function (CC\_F)

This function handles the Coverage and Capacity Optimization.

#### 4.2.1.10 RACH Optimization Function (RACH\_F)

This function handles the RACH optimization.

#### 4.2.1.11 HandOver Optimization Function (HO\_F)

This function handles the handover optimization.

#### 4.2.1.12 NM centralized Coverage and Capacity Function (CC\_F\_NM)

This function represents the NM centralized Coverage and Capacity Optimization (operating above Itf-N) as well as the related IRP Manager functionality.

CC\_F\_NM analyses monitoring data, determines improvement actions, sends configuration data, and if necessary raises an operator action notification.

### 4.3 SON Coordination Concepts

When multiple SON functions attempt to change some (same or associated) network configuration parameters of some (same or associated) nodes, one or more of these SON functions may not be able to achieve the operator's specified SON target(s) (for individual SON function) since they may have conflicting demands on network resources. This situation is considered as 'SON functions in conflict' and requires conflict prevention or resolution. Detection of 'SON functions in conflict' can be Use Case specific (for example, two SON functions make change at the same time or during the impact time interval).

The associated network configuration parameters include parameters within the same network element or parameters of different network elements with impact between each other. For example, the associated parameters of one cell are the parameters of its neighbour cells. Another typical association example is the TX power, antenna azimuth and tilt of one cell are associated with each other.

Different SON functions may have dependencies with each other. The behaviour of one SON function may have influence on other SON functions. For example, CCO function may adjust the Neighbour Relation due to coverage optimization, and then the changed NR will have an influence on Handover Parameter Optimization function.

SON coordination is to detect, prevent or resolve conflicts or negative influences between SON functions to make SON functions comply with operator's policy.

---

## 5 Business level requirements

The following general and high-level requirement applies for the present IRP:

- A. IRP-related requirements in 3GPP TS 32.101 [2].

- B. IRP-related requirements in 3GPP TS 32.102 [3].
- C. IRP-related requirements in 3GPP TS 32.600 [5].

The NRM defined by this IRP:

- D. Shall support communications for telecommunication network management purposes, including management of converged networks.
- E. Is a member of the Federated Network Information Model (FNIM) [6] and its information is derived from FNIM Umbrella Information Model (UIM) [6]

## 5.1 Requirements

### 5.1.1 Self-Optimization Monitoring and Management

**REQ-SO\_MM-CON-1** IRPManager shall be able to control the self-optimization functions.

**REQ-SO\_MM-CON-2** The self-optimization complex corrective actions shall be executed in a consistent and coordinated way.

**REQ-SO\_MM-CON-3** Self-optimization functions shall reuse existing standardized solutions as much as possible.

**REQ-SO\_MM-CON-4** void

**REQ-SO\_MM-CON-5** The IRPAgent shall support a capability allowing the IRPManager to know the success or failure result of Self-Optimization.

**REQ-SO\_MM-CON-6** The trigger conditions of self-optimization functions should be able to be managed by the IRPManager. The trigger condition may be the scheduled time to start a self-optimization function or a period of time during which a self-optimization function is forbidden to be started or the event (i.e. do not meet objectives or targets) to start a self-optimization function. Each self-optimization function shall have its own set of trigger condition.

**REQ-SO\_MM-CON-7** For the self-optimization functions which need continuous monitoring, the IRPManager should be able to manage the execution of self-optimization actions (e.g. setting a period of time during which a self-optimization action is forbidden to be executed).

**REQ-SO\_MM-CON-8** Each self-optimization function shall have one or several related performance indicator, which may be used as objective to evaluate the performance before the self-optimization is initiated and after the self-optimization function is completed.

**REQ-SO\_MM-CON-9** For operator controlled (open loop) SON function, the IRPAgent shall support a capability allowing IRPManager to know the information about the self-optimization actions. The necessity of this capability will be decided case by case.

**REQ-SO\_MM-CON-10** The IRPAgent shall support a capability allowing IRPManager to know the information about the execution result of self-optimization actions.

### 5.1.2 Load Balancing

**REQ-SO\_LB-CON-1** The optimization of load balancing shall be performed with minimal human intervention.

**REQ-SO\_LB-CON-2** The following scenarios shall be considered in optimization of load balancing. Each scenario shall include the load balancing on intra-frequency, inter-frequency, and inter-RAT.

1. Overlapping Coverage
2. Hierarchical Coverage
3. Neighbouring Coverage

### 5.1.3 Handover (HO) Parameter optimization

**REQ-SO\_HO-CON-1** HO parameter optimization shall be performed with no human intervention as much as possible.

**REQ-SO\_HO-CON-2** HO parameter optimization function shall aim at reducing the number of HO failures as well as reducing inefficient use of network resources due to unnecessary handovers. In particular, the HO parameter optimization function shall aim at reducing the number of HO related failures that cause degradation in user experience, such as call drops, radio link failures during or shortly after HO, and reduced data rates.

### 5.1.4 Interference control

**REQ-SO\_IC-CON-1** Interference control shall be performed with as little human intervention as possible.

**REQ-SO\_IC-CON-2** The following scenarios shall be considered in interference control.

1. Uplink inter cell interference coordination
2. Downlink inter cell interference coordination

### 5.1.5 Coverage and Capacity optimization

**REQ-SO\_CC-CON-1** Coverage and capacity optimization shall be performed with minimal human intervention.

**REQ-SO\_CC-CON-2** Operator shall be able to configure the objectives and targets for the coverage and capacity optimization function.

**REQ-SO\_CC-CON-3** Operator shall be able to configure the objectives and targets for the coverage and capacity optimization functions differently for different areas of the network.

**REQ-SO\_CC-CON-4** The collection of data used as input into the coverage and capacity optimization function shall be automated to the maximum extent possible and shall require minimum possible amount of dedicated resources.

**REQ-SO\_CC-CON-5** The following scenarios shall be considered in coverage and capacity optimization.

1. E-UTRAN Coverage holes with 2G/3G coverage
2. E-UTRAN Coverage holes without any other radio coverage
3. E-UTRAN Coverage holes with isolated island cell coverage
4. E-UTRAN cells with too large coverage

**REQ-SO\_CC-CON-6** The operator shall be able to manage tradeoffs between coverage and capacity using policies.

### 5.1.6 RACH optimization

**REQ-SO\_RO-CON-1** RACH optimization shall be performed with minimal human intervention.

### 5.1.7 SON Coordination

**REQ-SON\_COORD-CON-1** SON coordination shall allow the prevention and resolution of conflicts between SON functions.

**REQ-SON\_COORD-CON-2** In case the SON coordination function is below Itf-N, the IRPAgent should support the capability for the IRPManager to define policies for the case that SON functions request conflicting parameter values. In case no policy is given, the IRPAgent shall apply default policies.

Note: A policy describes an expected behaviour from the IRPAgent. Examples for such policies:

- i) Prioritizing SON functions in case of conflicts
- ii) Assigning weights to SON targets

- iii) Prohibiting further changes of a parameter for a certain amount of time
- iv) Selecting preferred value ranges
- v) Telling the IRPAgent to report conflicts

**REQ-SON\_COORD-CON-3** For the case that the IRPAgent does not resolve the case of SON functions requesting conflicting values for parameters, the IRPAgent should support the capability for the IRPManager to decide about the parameter values.

**REQ-SON\_COORD-CON-4** The IRPAgent shall support a capability allowing the IRPManager to configure the SON coordination policy. The coordination includes the following aspects:

- 1) Coordination between SON functions below Itf-N and CM operations over Itf-N.
- 2) Coordination between different SON functions.

## 5.2 Actor roles

Managed system: The entity performing an IRPAgent role.

Managing system: The entity performing the IRPManager role.

## 5.3 Telecommunications Resources

The managed E-UTRAN/EPC network equipments are viewed as relevant telecommunications resources in this specification.

## 5.4 High-Level use case

### 5.4.1 Load Balancing

#### 1. Overlapping Coverage

In this scenario, two same size cells overlap each other. Cell A and cell B both cover the same area. The load balancing between cell A and Cell B may be considered. The load balancing could be carried out between Cell A and Cell B regardless of the UE location within the coverage of the cells.

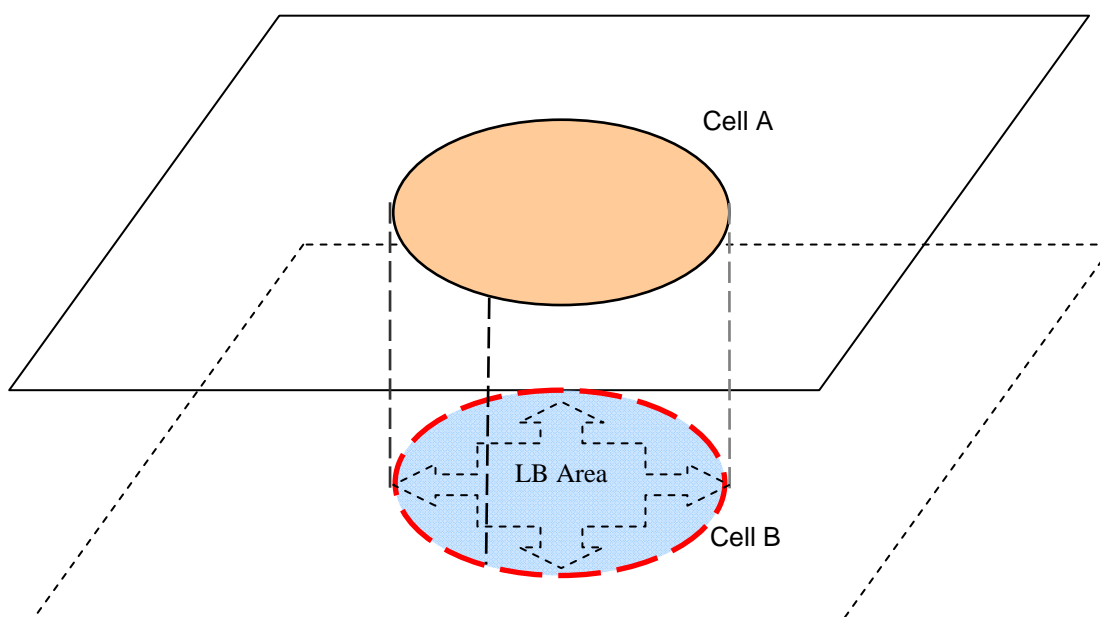

**Figure 5.4.1-1: Overlapping Coverage**

**Hierarchical Coverage**

In this scenario, two different size cells overlap each other. Cell B that has a smaller area is covered totally by cell A, which has a bigger size. The load balancing between cell A and Cell B may be considered. The load balancing could be carried out from Cell B to Cell A regardless of the UE location within the coverage of the cell B. Only UE located in the overlapping coverage could be considered in the scenario of Cell A to Cell B.

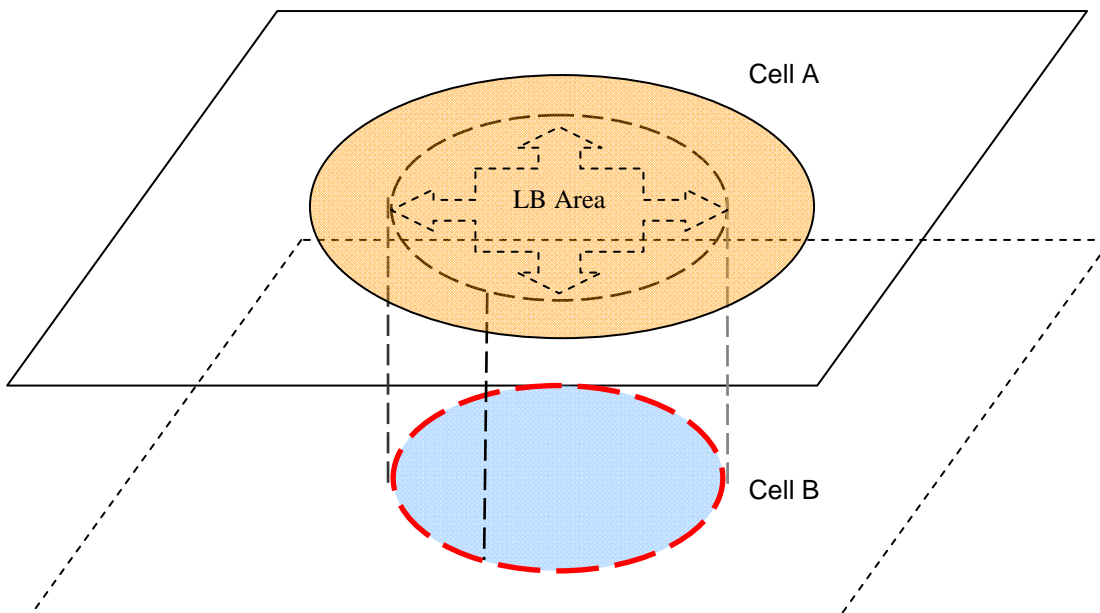

**Figure 5.4.1-2: Hierarchical Coverage**

**Neighbouring Coverage**

In this scenario, there are some overlapped area between two neighbour cell A and cell B. This is the usual neighbour cells scenario in EUTRAN. The load balancing between cell A and Cell B may be considered. Load Balancing could only be carried out for UE located in the overlapping coverage of Cell A and Cell B.

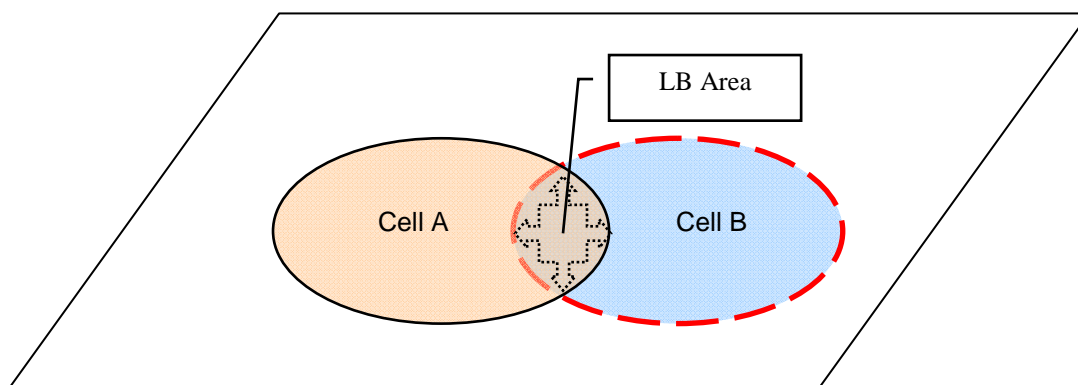

Figure 5.4.1-3: Neighbouring Coverage

## 5.4.2 Interference control

### 1. Uplink inter cell interference coordination

In this scenario, cell-edge UEs like UE A and B belong to different cell, and they are assigned the same physical resource block (PRB). When they transmit uplink messages, e.g. UE A sends message to its serving cell A, its neighbour cell B may also receives it; UE B has a similar situation. Therefore, cell A cannot judge which is signal-comes from UE A, and which is interference-comes from UE B, so as cell B. In this situation, inter cell interference coordination is essential to compensate for the system performance loss and increase cell edge users' bit rate.

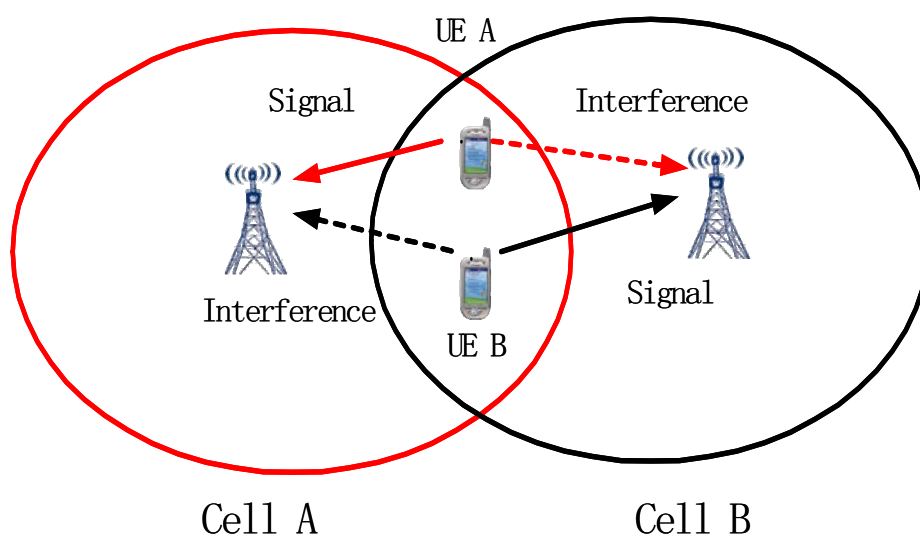

Figure 5.4.2-1: Uplink Inter Cell Interference Coordination

### 2. Downlink inter cell interference coordination

In this scenario, when UE located in cell-edge area, it is much adapted to suffer downlink interference from its neighbour cell in case that there is another UE occupying the same PRB in the same region belonging to its neighbour cell. So downlink inter cell interference coordination is essential to restrain interference and increase system capacity.



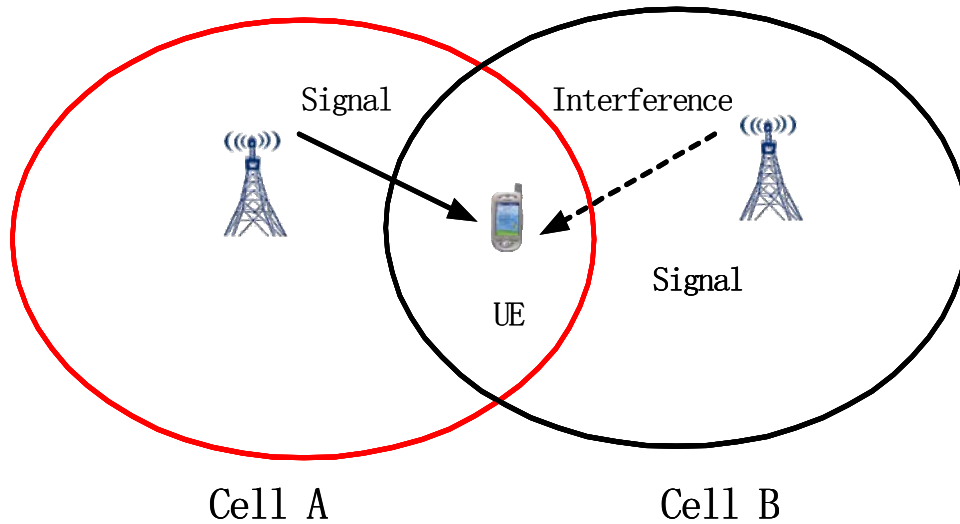

Figure 5.4.2-2: Downlink inter cell interference coordination

### 5.4.3 Coverage and capacity optimization

Although, it is of primary interest to provide coverage to users during a roll-out, it is equally important to enhance the capacity of the network during operation. As such, both coverage and capacity are considered in the use case and supported by the SON function. The CCO SON function should be configured through appropriate objectives and targets in order to meet the operator's requirement on coverage and capacity, and the prioritization between them.

#### 1. E-UTRAN Coverage holes with 2G/3G coverage

In this scenario, legacy systems, e.g. 2G/3G provide radio coverage together with E-UTRAN. However, in the first deployment stage of E-UTRAN, unsuitable planning or error parameters settings will lead to coverage holes in some area. In this scenario, there may be too many IRAT HOs. The SON use case coverage and capacity optimization should enable to detect this kind of problems on network coverage automatically. Another case similar with this is that coverage problems exist between different frequencies in E-UTRAN, i.e. inter-frequency case. For simple reasons, this case is also described here.

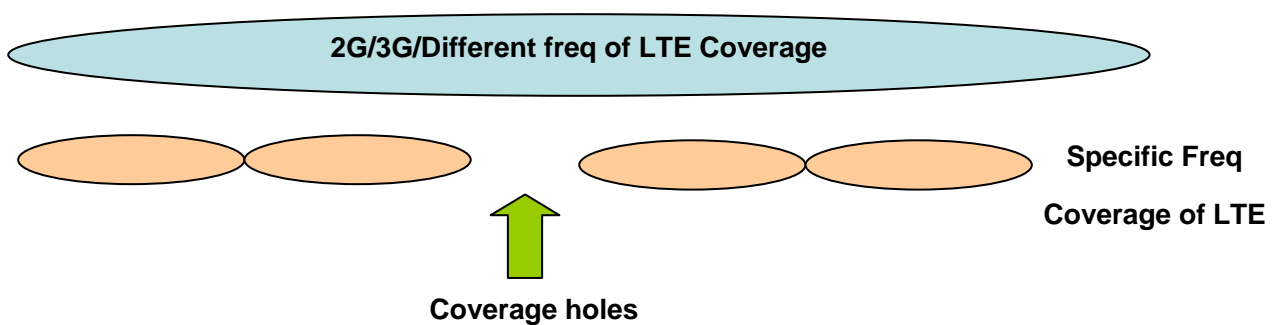

Figure 5.4.3-1: Coverage holes with 2G/3G coverage

#### 2. E-UTRAN Coverage holes without any other radio coverage

In this scenario, there is no 2G/3G coverage except E-UTRAN. In the first deployment stage of E-UTRAN, unsuitable planning or error parameters settings will lead to un-continuous coverage in some area. That will lead to many drop calls because of bad coverage. The SON use case coverage and capacity optimization should enable to detect this kind of problems on network coverage automatically.

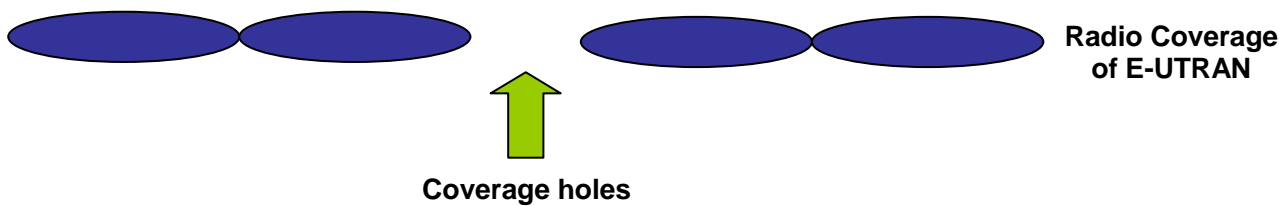

Figure 5.4.3-2: Coverage holes without any other radio coverage

**3. E-UTRAN Coverage holes with isolated island cell coverage**

In this scenario, the actual coverage area of an isolated island cell is smaller than the planned isolated island cell area. The uncovered planned cell area is the coverage holes that need to be detected and optimized by the coverage and capacity optimization.

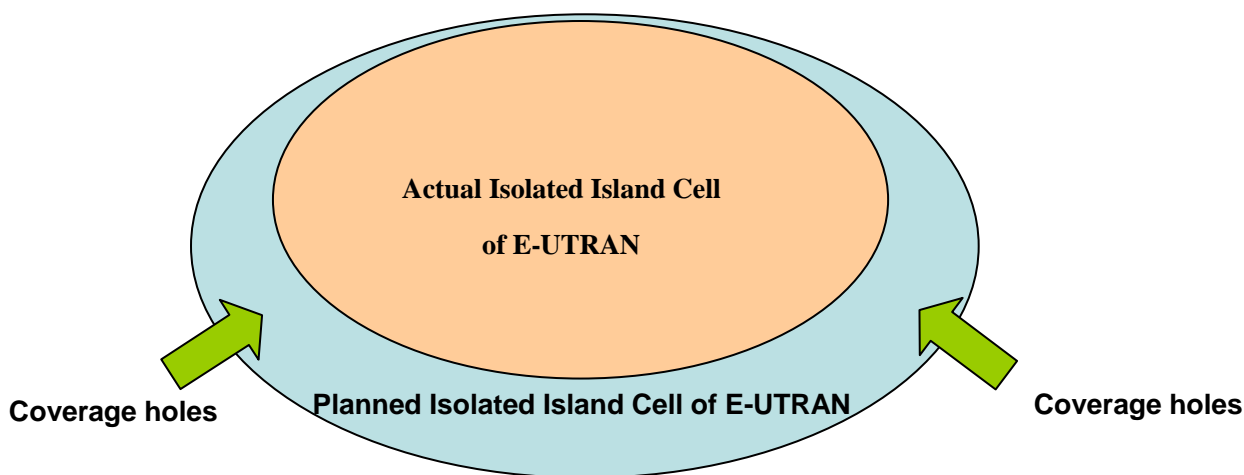

Figure 5.4.3-3: Coverage holes with isolated island cell coverage

**4. E-UTRAN cells with too large coverage**

In this scenario, the operator does a gradual network evolution using LTE cells in location where higher capacity is needed. Here the actual LTE coverage is greater than the planned LTE coverage. The overflow area is shown in figure 5.4.3.4. The problem with a too large coverage is that the planned capacity may not be reached. As such, it is important to keep the coverage within the planned area.

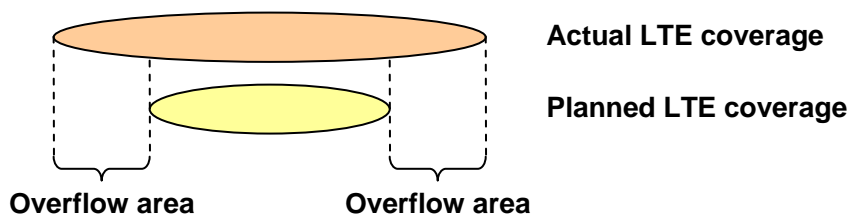

Figure 5.4.3-4: Difference between actual and planned LTE coverage

## 5.4.4 NM centralized Coverage and Capacity Optimization

### 5.4.4.0 General

Annex B gives general descriptions related to the use cases in this section.

#### 5.4.4.1 Use case 1: Cell coverage adapting to traffic demand

Cell coverage is typically estimated at the time of network planning, where exact distribution of users is hard to take into account. However, the service performance as seen by the user will depend among others on the traffic load in the particular cell, e.g. on the number of users that has to share the cell resources at a particular location. Therefore, there may be a need to adapt cell sizes to the typical distribution of traffic demand from time to time when the distribution of users or the environmental situation are changing (e.g. rush hours).

The CCO function needs to detect such service performance problems caused by load imbalances, for which it may need to collect, for example, information about number of active UEs, IP Throughput, Packet Delay, Drop, Loss Rate, Data Volume measurements and environmental information (e.g. the location of freeway, stadiums). The CCO function may also collect information of the used/available capacity estimated by the eNodeB itself, based on resource management algorithms implemented in the eNodeB. An example describing the UE location distribution via two-dimensional bins measurements is shown in Annex B.2.

Based on the collected information, the CCO function may decide to adjust capacity or coverage areas of the related cells.

#### 5.4.4.2 Use case 2: Coverage and accessibility

Typically, the network has to provide basic coverage that ensures accessibility and connectivity. Basic coverage could mean, for example, that a certain level of signal strength should be reached in the cell area and accessibility attempts, i.e. RRC connection attempts and random access attempts must reach certain level of success rate.

The CCO function may collect RSRP/RSRQ measurements (with or without location information included), RLF events, RRC setup failure reports and random access performance measurements, which could be indications of bad coverage. To further separate uplink and downlink related coverage problems, uplink interference, signal quality and power measurements may be used. The different types of reports related to the same incident and user should be possible to be correlated so the CCO function can identify the source of the problem and can take the right corrective action. A potential way is the correlation of uplink and/or downlink MDT data (e.g. M2, M3) and RLF report data (e.g. RSRP/RSRQ) may be used to analyze whether the RLF is caused by uplink coverage problem.

#### 5.4.4.3 Use case 3: LTE coverage holes with underlaid UTRAN/GERAN

LTE is typically deployed in areas with dense population in an attempt to mitigate traffic congestion during the peak hours. Therefore, initial LTE deployment may be patchy with underlaid UTRAN/GERAN networks that provide basic coverage. Figure 5.4.4.3-1 shows that there may be coverage holes between LTE cells.

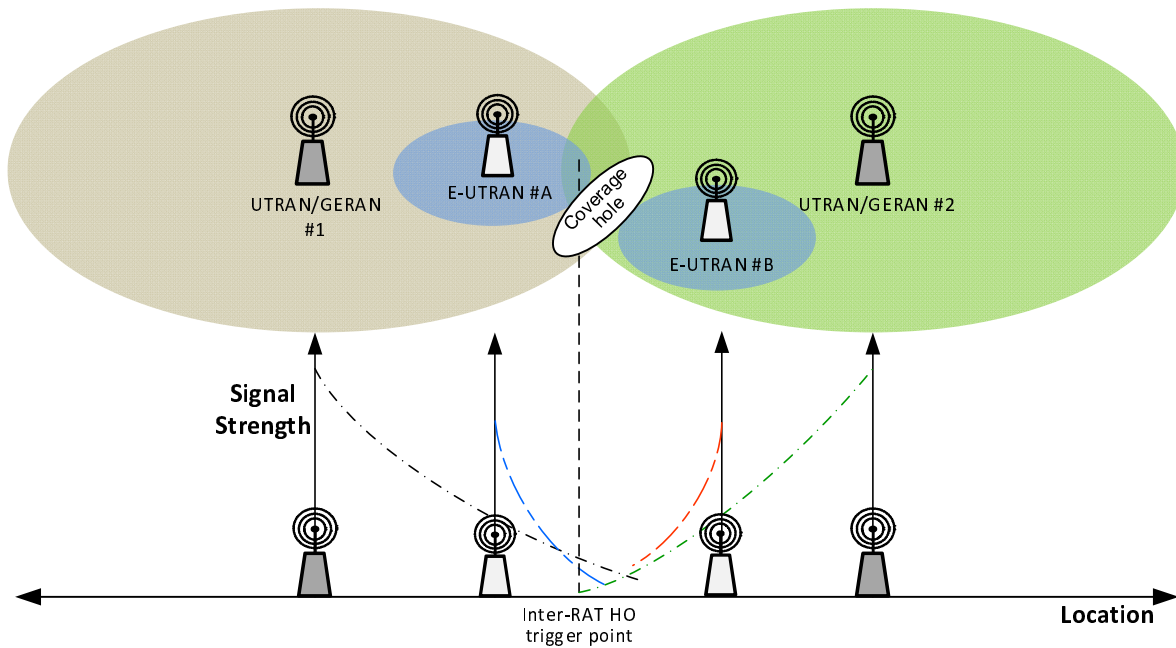
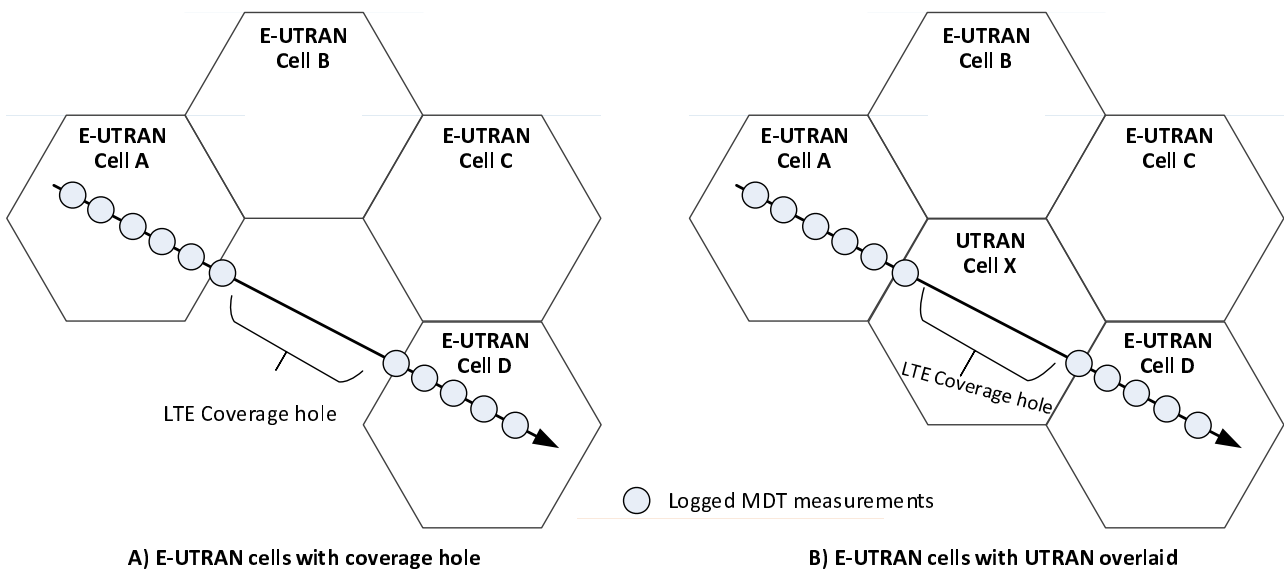

**Figure 5.4.4.3-1: LTE coverage hole with underlaid UTRAN/GERAN**

The LTE coverage holes may be detected by the Inter-RAT measurements. The network can capture measurements (e.g. RSRP, RSRQ, cell ID, location, time stamp at the time of Inter-RAT handover), which can be collected for the CCO function and used to identify coverage holes in the LTE network.

The LTE coverage holes may be detected also using measurements performed by UEs in the idle mode. When an UE is in "any cell selection" or "camped on any cell" state, the periodic logging stops. When the UE re-enters "camped normally" state and the duration timer has not expired, the periodic logging is restarted (see clause 5.1.1.2 of 3GPP TS 37.320 [7]).

Figure 5.4.4.3-2 is an example to show that an LTE coverage hole can be detected when an UE stops and resumes logging MDT measurements.



**Figure 5.4.4.3-2: LTE coverage holes with and without underlaid UTRAN detected by logged MDT**

#### 5.4.4.4 Use case 4: LTE Connection failure

While in idle mode UE enters an area of coverage problems (such as weak coverage, overshoot coverage, pilot pollution and DL and UL channel coverage mismatch etc.), the UE attempts to establish the RRC connection but fails (RCEF report is logged).

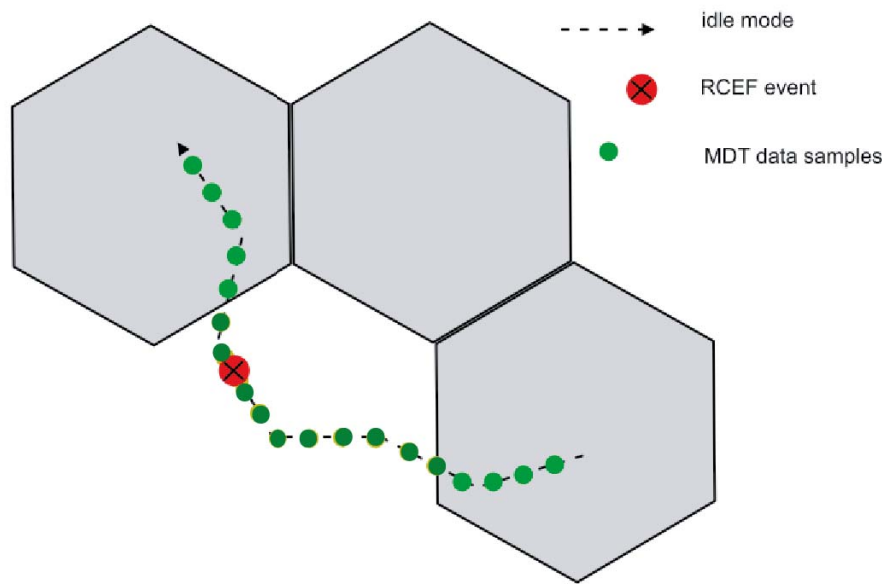

**Figure 5.4.4.4-1 Correlation of RCEF with MDT data**

Another case is when the UE is in connected mode, loses the connection and then tries to reconnect to the network but it fails.

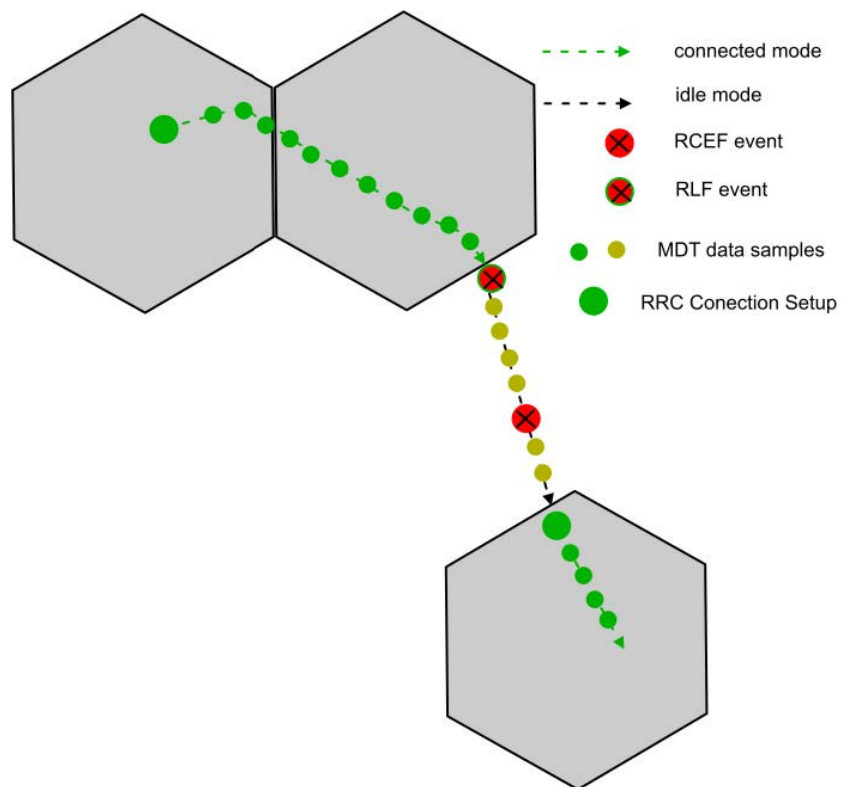

**Figure 5.4.4.4-2 Correlation of RLF and RCEF with MDT data**

In both cases the CCO function would need to identify the reason of failure, for which it may need to combine the logged RCEF report with other measurement data, potentially including also measurements made by the RAN or with other incidents and measurements reported by the UE (e.g. RLF report, RSRP/RSRQ reports). For detailed analysis of connection failures and Coverage and Capacity Optimization, all the different pieces of information connected to the occurrence of the same incident need to be combined, and the combined data will be used by the CCO function.

For detailed analysis of connection failures and CCO, information may be required about the radio conditions of the network prior to and at the moment when the connection failure occurs. In E-UTRAN this data may be collected e.g. by utilizing the potentially enhanced Logged MDT and/or Immediate MDT procedures depending on the specific failure scenario.

#### 5.4.4.5 Use case 5: Radio link quality

The service performance (e.g. throughput) as seen by the user is largely dependent on the quality of the radio link (e.g. CQI, see 3GPP TS 36.213 [9]), which is influenced by signal strength, interference, and other conditions. It should be possible for the CCO function to collect information about the radio quality combined with user performance (e.g. IP throughput, CQI, UL SINR) and determine whether the radio link is a bottleneck in service performance. The CCO function may decide to change the signal strength of the investigated cell or that of an interfering nearby cell e.g. by modifying antenna tilt or power settings in order to improve radio link quality.

The CQI can be used as a direct indicator of the Signal to Interference and Noise Ratio (SINR) conditions seen by the UE at actual data transmissions, for which neither RSRP nor RSRQ (see 3GPP TS 36.214 [11]) would be suitable. Note that RSRP is indicative only to the signal strength of the Reference Symbol (RS), while RSRQ is derived from RSRP as the ratio of RSRP versus RSSI (i.e. total received signal power in the RSSI measurement bandwidth), which is not equal to SINR. Moreover RSRP and RSRQ are measured separately from actual user plane transmissions, while CQI is measured and reported when data is actually transmitted.

For example, by observing the UE reported CQI values during a collection period (similarly to the collection period as used in case of existing MDT measurements) it is possible to determine whether the UE was in a poor radio condition at that time. Although the instantaneous CQI value is influenced by fast link variations (e.g. by fast fading), the fast fluctuations are typically around some centre value, which is characteristic to the particular radio environment and can be used by the CCO function to evaluate radio link quality.

Collecting the UE reported Rank Indicator (RI) in a similar way could be used to evaluate radio link quality from spatial multiplexing point of view. The RI reports give information about whether the UE has found the radio link quality good enough to use spatial multiplexing.

---

## 6 Specification level requirements

### 6.1 Requirements

#### 6.1.1 Self-Optimization Monitoring and Management

##### 6.1.1.1 Management Part

**REQ-SO\_MM-FUN-1** IRPManager shall be able to configure objectives and targets for the self-optimization functions.

**REQ-SO\_MM-FUN-2** For open loop, IRPManager shall be able to configure whether a confirmation is needed before the execution of optimization actions. The necessity of a confirmation will be decided case by case.

**REQ-SO\_MM-FUN-3** For open loop, IRPManager shall be able to confirm the execution of optimization actions in case IRPManager configured a confirmation is needed.

**REQ-SO\_MM-FUN-4** For open loop, IRPAgent shall provide information to the IRPManager about the optimization actions. The necessity of this capability will be decided case by case.

**REQ-SO\_MM-FUN-5** IRPAgent shall provide information to the IRPManager about the execution result of self-optimization actions.

**REQ-SO\_MM-FUN-6** The IRPAgent shall provide information to the IRPManager about the outcome of self-optimization.

**REQ-SO\_MM-FUN-7** IRPManager shall be able to configure the values of KPIs or performance counters which may be used to trigger the optimization function.

**REQ-SO\_MM-FUN-8** When the IRPAgent is aware of disruptive situations for the SON functionality, it shall support optimization functions in coping with them as much as possible without the need for an intervention from the IRPManager. Disruptive situations are e.g. an outage of a cell, the insertion of a new cell, deactivation of a cell etc.

## 6.1.2 Load Balancing

**REQ-SO\_LB-FUN-1** The IRPManager shall be able to disable/enable the load balancing function.

**REQ-SO\_LB-FUN-2** The IRPManager shall be informed about the eNodeB load.

**REQ-SO\_LB-FUN-3** The IRPManager shall be able to request that load balancing be allowed from source cell to target cell.

**REQ-SO\_LB-FUN-4** The IRPManager shall be able to request that load balancing be prohibited from source cell to target cell.

**REQ-SO\_LB-FUN-5** The IRPAgent shall inform the IRPManager about success or failure of IRPManager operations to allow load balancing, prohibit load balancing.

## 6.1.3 Handover (HO) Parameter optimization

### 6.1.3.1 HO failure categorization

#### 6.1.3.1.1 HO failures due to too late and too early HO triggering

HO failures can be categorized as follows:

- HO failures due to too late HO triggering
- HO failures due to too early HO triggering
- Failures due to HO to a wrong cell

Consequently, the HO parameter optimisation should aim at detecting and mitigating too early HOs, too late HOs and HOs to a wrong cell. The following subsections provide the scenarios for too early HO, too late HO and HO to a wrong cell triggering leading to HO failures.

##### 6.1.3.1.1.1 Too late HO triggering

Example scenario for too late HO triggering is shown in Figure 6-1. If the UE mobility is more aggressive than what the HO parameter settings allow for, the HO could be triggered when the signal strength of the serving cell is already too low or may not be triggered at all if a radio link failure preempts it. The connection may be re-established on a different cell from the serving cell. This is a common scenario in areas where user mobility is very high, such as along the highways, train lines etc.

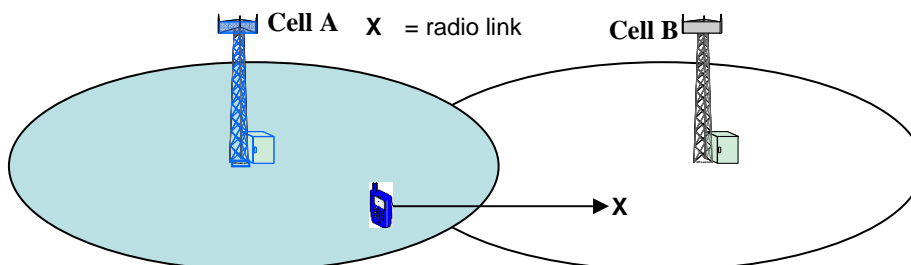

Due to fast movement and inadequate HO parameter setting, UE leaves the source cell coverage before the HO is triggered

**Figure 6-1 – Too late HO triggering scenario**

6.1.3.1.1.2 Too early HO triggering

Example scenario for too early HO triggering is shown in Figure 6-2. HO can be triggered when the UE enters unintended island of coverage of the target cell inside the intended coverage area of the serving cell. When the UE exits the island of coverage of the target cell, it cannot acquire the target cell any more and the HO fails, potentially leading to a radio link failure. This is a typical scenario for areas where fragmented cell coverage is inherent to the radio propagation environment, such as dense urban areas.

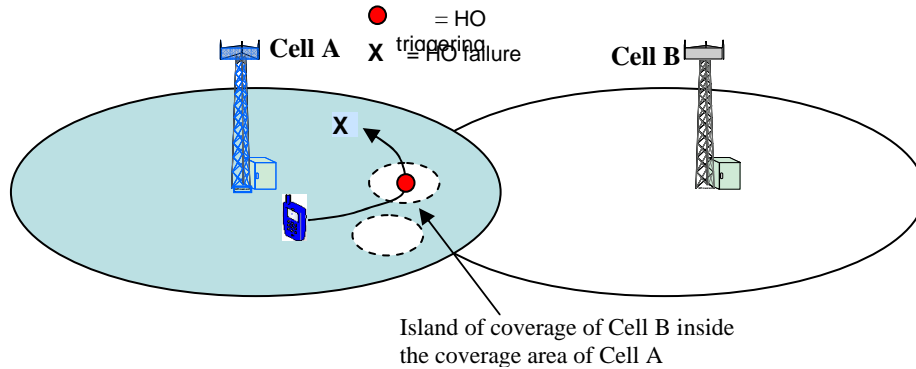

Figure 6-2 – Too early HO triggering scenarios

6.1.3.1.1.3 HO to a wrong cell

Example scenario for HO to a wrong cell is shown in Figure 6-3. In this scenario UE is moved from cell A to cell C, but because the HO parameter not optimized and a cell A sends a wrong HO command performs a handover to cell B and then a RLF happens. After that UE re-establishes connection with cell C.

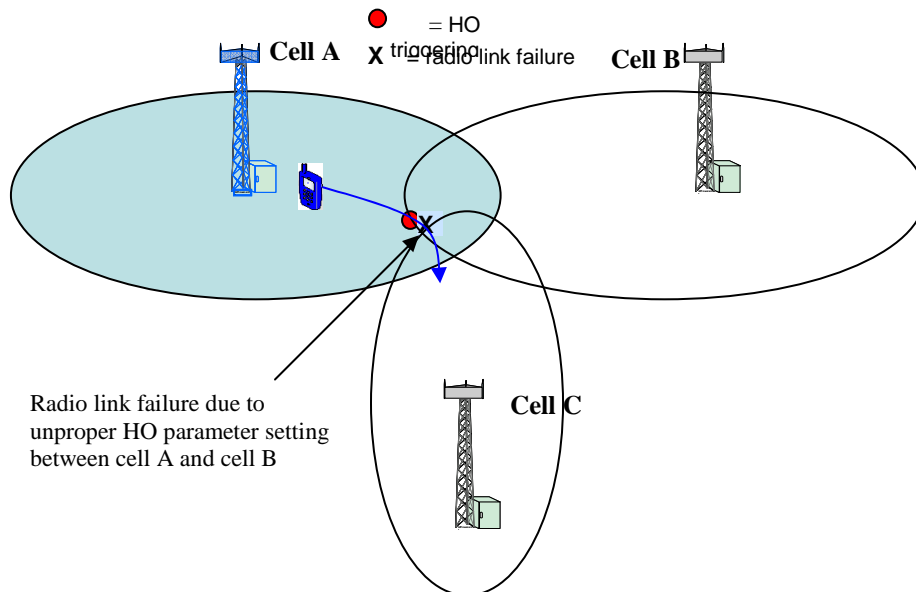

Figure 6-3 –HO to a wrong cell scenarios

6.1.3.2 Reducing inefficient use of network resources due to unnecessary HOs

HO procedure is resource-consuming and therefore costly to the network operator. Sometimes, the combination of user mobility patterns and cell coverage boundary layout can generate frequent unnecessary HOs that consume NW resources inefficiently. This scenario is illustrated in Figure 6-4a. HO parameter optimisation function should aim at detecting such scenarios. These scenarios sometimes can be remedied by HO parameter optimisation, as illustrated in Figure 6-4b. Since the goal of reducing unnecessary HOs can sometimes be opposed to the goal of reducing the number of HO failures, operators should be able to set the tradeoff point.



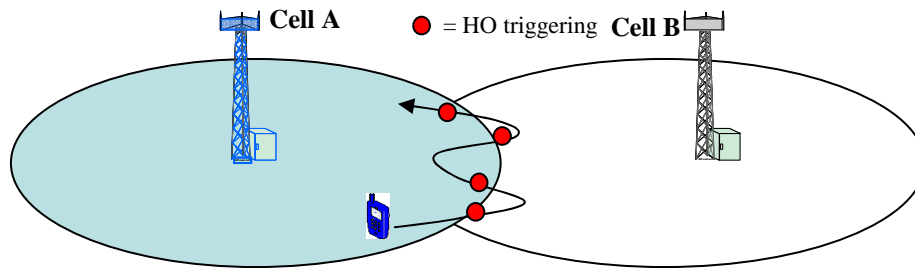

Figure 6-4a – Frequent HOs cause inefficient use of NW resources

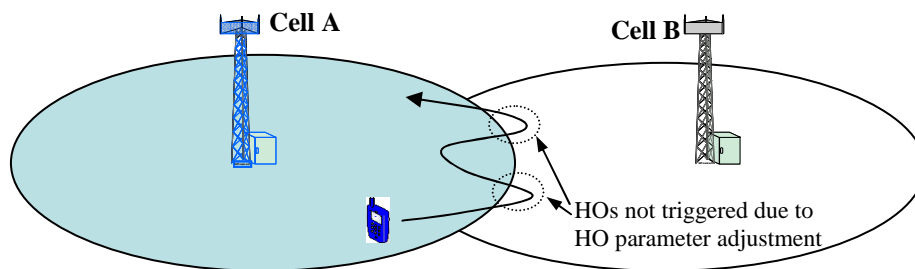

Figure 6-4b – HO parameter adjustment prevents frequent HOs

Additionally, incorrect cell reselection parameters setting may result unwanted handover right after RRC connection setup, HO parameter optimization function should also aim at detecting misalignment between cell reselection parameters and handover parameters setting and adjust the parameters to avoid such scenarios.

### 6.1.3.3 Requirements

**REQ-SO\_HO-FUN-1** HO parameter optimisation function shall aim at detecting too early handover, too late handover and handover to a wrong cell.

**REQ-SO\_HO-FUN-2** HO parameter optimisation function shall aim at detecting inefficient use of network resources due to unnecessary HOs.

**REQ-SO\_HO-FUN-3** HO parameter optimisation function shall aim at meeting the objectives and targets for the HO optimisation function

**REQ-SO\_HO-FUN-4** The objectives for the HO parameter optimisation function shall reflect the desired tradeoff between the reduction in the number of HO related failures and the reduction of inefficient use of network resources due to HOs.

**REQ-SO\_HO-FUN-5** The IRPManager shall be able to disable/enable the HO parameter optimization function.

## 6.1.4 Interference control

**REQ-SO\_IC-FUN-1** The IRPManager shall be able to disable/enable the Interference Control function.

**REQ-SO\_IC-FUN-2** The IRPManager shall be able to request that ICIC be allowed from source cell to target cell.

**REQ-SO\_IC-FUN-3** The IRPManager shall be able to request that ICIC be prohibited from source cell to target cell.

**REQ-SO\_IC-FUN-4** An IRPAgent shall inform the IRPManager about success or failure of IRPManager operations to allow ICIC, prohibit ICIC.

## 6.1.5 Coverage and capacity optimization

**REQ-SO\_CC-FUN-1** Performance measurements with geographical binning may be used as inputs into the coverage and capacity optimization function.

**REQ-SO\_CC-FUN-2** CCO function shall aim at providing optimal capacity and coverage for the radio network while considering the trade-off between capacity and coverage.

**REQ-SO\_CC-FUN-3** The IRPAgent shall support a capability allowing the IRPManager to enable or disable the CCO function.

### 6.1.6 RACH optimization

**REQ-SO\_RO-FUN-1** The IRPAgent shall support enabling and disabling the RACH optimization function.

### 6.1.7 SON Coordination

The following requirements apply when the SON coordination function is in NM layer.

**REQ-SON\_COORD-FUN-1** The IRPAgent shall provide the capability to inform the IRPManager whether a SON function is activated or not.

**REQ-SON\_COORD-FUN-2** The IRPAgent shall provide the capability to inform the IRPManager about which SON functions modified configuration parameter(s).

**REQ-SON\_COORD-FUN-3** The IRPAgent should provide the capability to inform the IRPManager about the time duration how long the configuration parameter(s) should not be modified.

**REQ-SON\_COORD-FUN-4** The IRPAgent should provide the capability to inform the IRPManager about the SON targets which are the justification for the configuration change.

The following requirements apply when the SON coordination function is below Itf-N.

**REQ-SON\_COORD-FUN-5** The IRPAgent should provide a capability to allow the IRPManager to configure the priority of SON functions in case of conflicts.

**REQ-SON\_COORD-FUN-6** The IRPAgent shall provide the capability for the IRPManager to be informed when the SON coordination function could not resolve a conflict. This information should include the involved SON functions, the involved configuration parameters and/or the involved SON targets.

### 6.1.8 NM centralized coverage and capacity optimization

**REQ-SO\_CC\_NM-FUN-1** The IRPAgent shall support a capability allowing the IRPManager to initiate needed performance measurements that are not already active and to receive performance measurements.

**REQ-SO\_CC\_NM-FUN-2** The IRPAgent shall support a capability allowing the IRPManager to order one single trace session for several job types of radio measurements (e.g. a combination of MDT/RLF/RCEF measurements) using one single operation.

**REQ-SO\_CC\_NM-FUN-3** The IRPAgent shall support a capability allowing the IRPManager to receive recorded MDT/RLF/RCEF measurements.

**REQ-SO\_CC\_NM-FUN-4** The IRPAgent shall support a capability allowing the IRPManager to configure attributes that affect coverage and capacity.

**REQ-SO\_CC\_NM-FUN-5** The IRPAgent shall support a capability allowing the IRPManager to receive indications that parameters have changed their values.

## 6.2 Actor roles

No new actor.

## 6.3 Telecommunications Resources

No new telecommunications resources.

## 6.4 Use case

### 6.4.1 Use case Self-Optimization Monitoring and Management

Use Case Stage	Evolution / Specification	<<Uses>> Related use
Goal (*)	Optimize the system in an automated manner.	
Actors and Roles (*)	IRPManager as user	
Telecom resources	The E-UTRAN/EPC network including its management system.	
Assumptions	The network is properly installed and running.	
Pre conditions	The self-optimization objectives and targets have been set by operators	
Begins when	Based on the monitored input parameters (KPIs, Alarms, etc.), targets for the objectives defined for the self-optimization functions are not met.	
Step 1 (*) (M O)	<p>The order of the bullet points in the list below does not imply any statements on the order of execution.</p> <p>[SO1] The input parameters (KPIs, Alarms, etc.) are monitored continuously.</p> <p>[SO2] When the monitored parameters do not meet the optimization targets, the optimization function is triggered.</p> <p>[SO3] Optimisation function proposes corrective actions.</p> <p>[SO4] Operator may confirm the execution/activation of the proposed actions if needed.</p> <p>[SO5] Corrective actions are executed.</p> <p>[SO6] Optimisation function monitors system status for a certain pre-defined monitoring time period.</p> <p>[SO7] The configuration prior to the corrective action is memorised if needed.</p> <p>[SO8] If the system status is satisfactory during the monitoring time period, then go to [SO1].</p> <p>[SO9] Operator may confirm if fallback is needed.</p> <p>[SO10] Fallback is executed.</p> <p>[SO11] The operator is informed about the progress and important events occurring during the self-optimization process.</p>	
Step n (M O)		
Ends when (*)	Ends when all steps identified above are successfully completed or when an exception occurs.	
Exceptions	One of the steps identified above fails and retry is unsuccessful..	
Post Conditions	System is operating normally.	
Traceability (*)	REQ-SO_MM-FUN-1, REQ-SO_MM-FUN-2, REQ-SO_MM-FUN-3, REQ-SO_MM-FUN-4, REQ-SO_MM-FUN-5, REQ-SO_MM-FUN-6	

### 6.4.2 Use case Load Balancing Allowed/Prohibited Management

Use Case Stage	Evolution / Specification	<<Uses>> Related use
Goal (*)	The load balancing (LB) can be allowed/prohibited from a source cell to a target cell by the IRPManager.	
Actors and Roles (*)	IRPManager as user	
Telecom resources	The E-UTRAN/EPC network including its OSS.	
Assumptions	There is operator's policy for LB allowing/prohibiting management. For example: LB from the higher priority cell to the lower priority cell is allowed; reverse is prohibited. LB between an eNB cell and another eNB cell which belongs to another unwanted PLMN is prohibited.	
Pre conditions	The network is operational.	
Begins when		
Step 1 (*) (M)	The IRPManager makes a decision to allow/prohibit LB from a source cell to a target cell: According to operator's policy, or According to some information got in run time. For example: LB would always fail between some particular cells in case of some inappropriate parameters setting. In that situation, the LB function located at eNB may make a decision to prohibit LB between these particular cells and notify this information to the IRPManager. After the CM parameters adjusting, the LB between those cells may be allowed again based on the good values of relative PM counters.	
Step 2 (*) (M)	The IRPAgent is instructed by the IRPManager to allow/prohibit LB from the source cell to the target cell.	
Step 3 (*) (M)	The LB is allowed / prohibited from the source cell to the target cell by the corresponding eNB(s).	
Step 4 (*) (M)	Reporting of the allowing/prohibiting LB operation result to the IRPManager.	
Ends when (*)	Ends when all steps identified above are completed or when an exception occurs.	
Exceptions	One of the steps identified above fails and retry is unsuccessful.	
Post Conditions	The LB is allowed/prohibited from a source cell to a target cell successfully or unsuccessfully.	
Traceability (*)	REQ-SO_LB-FUN-3, REQ-SO_LB-FUN-4, REQ-SO_LB-FUN-5	

### 6.4.3 Use case NM centralized Coverage and Capacity Optimization

Use Case Stage	Evolution / Specification	<<Uses>> Related use
Goal	Optimize the Coverage and Capacity in the network	
Actors and Roles	IRPManager as user and IRPAgent as client	
Telecom resources	The E-UTRAN network including its NM and DM/EM. The CCO function that is located in the NM.	
Assumptions	There is no EM centralised CCO function in operation.	
Pre-conditions	The network is operational. The CCO function requests the IRPAgent to subscribe the needed performance measurements via the IRPManager that are not already subscribed. The IRPAgent initiates the requested performance measurements that are not already active.	
Begins when	The operator turns on the CCO function.	
Step 1 (M)	The CCO function waits for performance measurements.	
Step 2 (M)	The IRPAgent delivers the performance measurements to the CCO function via the IRPManager.	
Step 3 (M)	The CCO function evaluates if there are any potential improvements to be made. If no more detailed information is needed to determine an improvement action, go to step 9.	
Step 4 (M)	The CCO function initiates detailed improvement analysis, e.g. MDT measurements, in the area for which a potential improvement has been identified, via the IRPManager to the IRPAgent.	
Step 5 (M)	The IRPAgent initiates the requested session and transfers the result to the TCE specified by the CCO function.	
Step 6 (M)	The network information is transferred to the CCO function that evaluates whether an improvement action can be applied.	
Step 7 (M)	The CCO function initiates the IRPManager to instruct the IRPAgent to apply improvement actions (re-configure some attributes).	
Step 8 (M)	The IRPAgent applies the improvement actions and informs the CCO function via the IRPManager.	
Step 9 (M)	The CCO function goes to step 1.	
Ends when	Ends when the operator turns off the CCO function.	
Exceptions	If no improvement action can be applied and the coverage and capacity situation is very bad (e.g. no coverage on any RAT is detected in an area), the operator is informed and the CCO function is turned off for that area.	
Post Conditions	The network is operational.	
Traceability	REQ-SO_CC_NM-FUN-1, REQ-SO_CC_NM-FUN-2, REQ-SO_CC_NM-FUN-3, REQ-SO_CC_NM-FUN-4 and REQ-SO_CC_NM-FUN-5.	

## 7 Functions and Architecture

### 7.1 Self-Optimization Logical Architecture

The lines between the functional blocks do not indicate specific 3GPP interfaces.

For the abbreviations used, please see the headlines of clause 3.

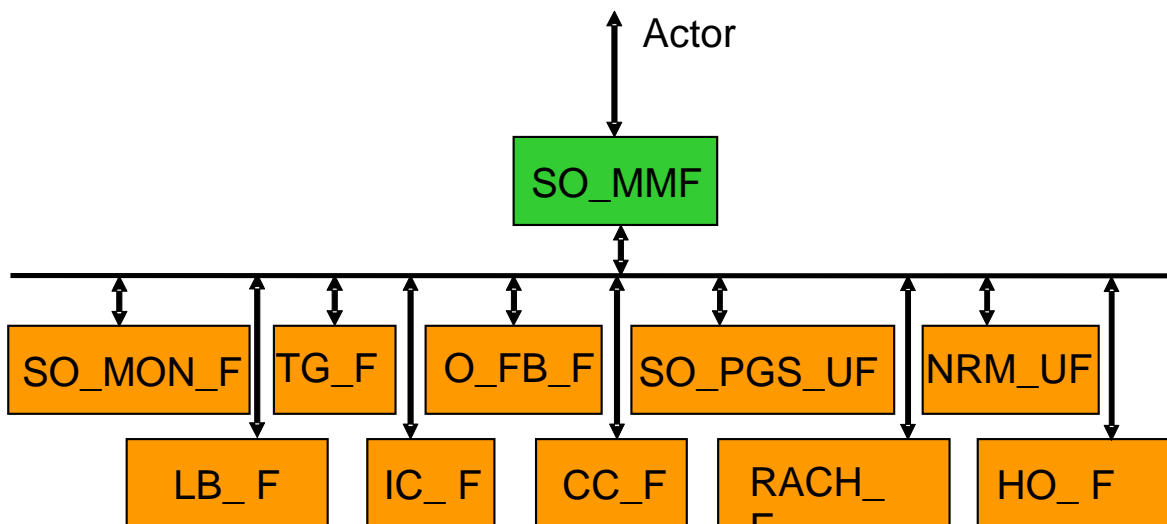

### 7.2 Self-Optimization Reference Model

The SO\_MMF has a part located in the EM and a part located at the NM.

For the abbreviations used, please refer to clause 3.

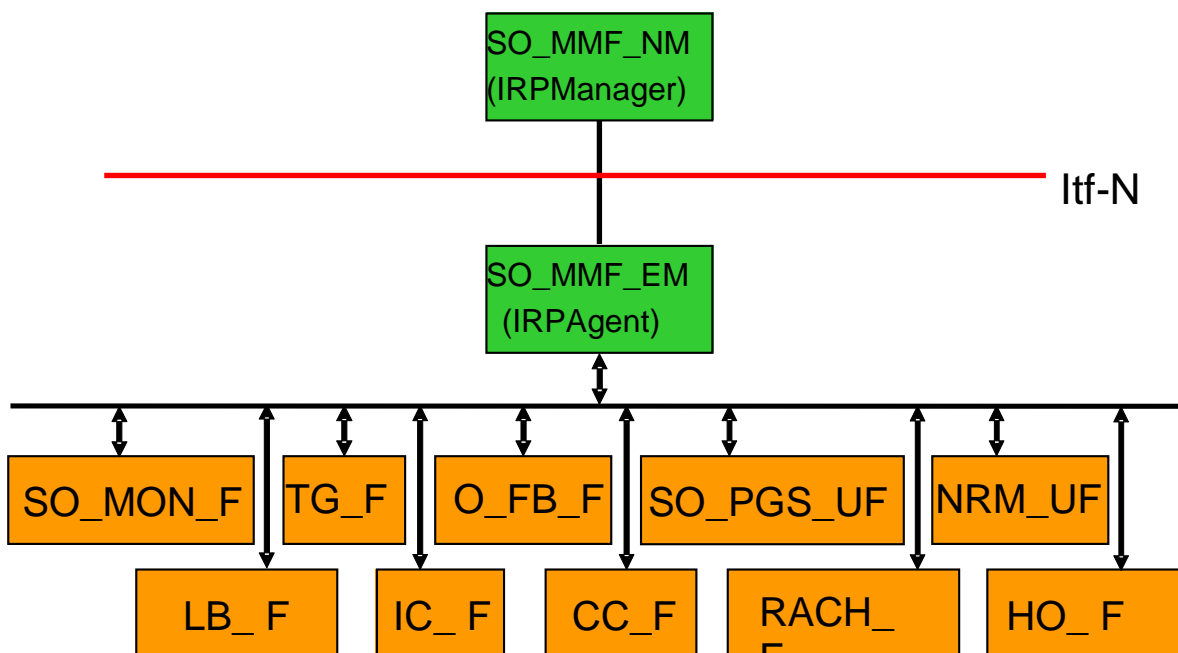

---

## Annex A (informative): Steps for SON self-optimization Technical Specifications

The TSs for SON self-optimization shall follow the steps below.

### 1. Goal

<The concise goal statement for the purpose of this self-optimization>

### 2. Problem Scenarios

The problem scenarios need to be optimized under the goal. This part may contain multiple problem scenarios

<PS 1...>

<PS 2...>

### 3. Parameters to be Optimized

The list of parameters needs to be optimized to resolve the problems under the goal. The parameters listed here are the overall parameters need to be optimized; it does not imply that all of the parameters are required to be open over Itf-N.

<Parameter 1, 2, 3...>

### 4. Architecture and Responsibilities

The suitable architecture to optimize the parameters above, it can be centralized, distributed or hybrid SON architectures.

And based on the architecture, the clear split of the responsibilities among NM, EM and NE should be stated here. This will result in the work split among 3GPP WGs.

### 5. Performance Measurements and NRMs

#### Performance measurements:

List of the performance measurements which are required via Itf-N to recognize the problem scenarios, and to monitor the result of self-optimization, based on the selected architecture and responsibilities.

This part only includes the descriptions for the performance measurements, and the detailed definitions will be defined in TS 32.425/32.426.

<Performance measurement 1>

<Performance measurement 2>

#### NRMs:

The parameters need to be modeled in NRM, to support the optimizations required over Itf-N according to the selected architecture and split responsibilities.

<Parameters 1, 2, ...>

## Annex B (informative): General descriptions related to NM centralized CCO high level use cases

### B.1 General

Coverage and capacity are two closely related characteristics of a cellular network, which largely determine the network capabilities in terms of providing a certain grade of service for a given number of customers in a given geographical area and on a given set of radio spectrum. In order to utilize cell resources in the most efficient way and to serve as many customers as possible with the required level of service, there is a need to configure cell resources according to the actual radio conditions, propagation environment and traffic needs.

Such an optimization process shall be automated with minimal manual intervention and has to be based upon actual network conditions, i.e. measured data obtained from UEs and from the network.

Looking for coverage holes or finding capacity improvement possibilities manually is particularly time consuming, costly and requires expert knowledge. Therefore, an automated CCO function can significantly contribute to OPEX reductions.

The use cases for NM centralized CCO can only work during long optimisation cycles (5 minutes or longer). This means that optimisation in or near real time is excluded. Typically, the optimization cycle for NM centralized CCO is 24 hours.

NM centralized CCO is divided into 3 stages:

- 1) Monitoring
- 2) Detailed improvement analysis
- 3) Improvement action

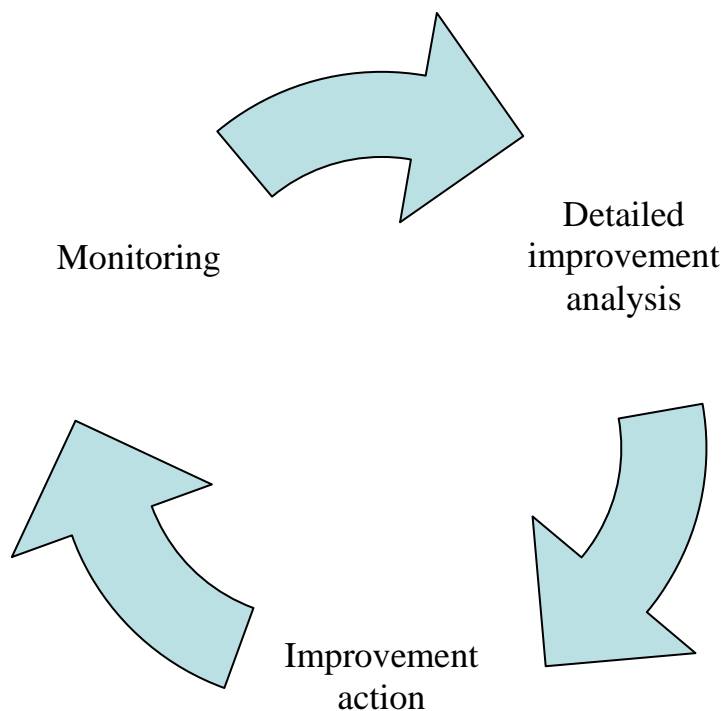

Figure B.1-1: NM Centralized CCO function stages



**Monitoring** is constantly active and monitors the whole network all the time to find potential improvements. This is done by using performance monitoring. For the monitoring step to detect improvement possibilities there is no need to continuously report fine granular detailed information, since at this stage it is wanted to detect the existence of the improvement opportunity and not necessarily the exact location and reason of the improvement opportunity. This allows aggregations in PM measurements (e.g. in space and time), which makes the continuous monitoring scalable for the whole network without losing the detection capability.

**Detailed improvement analysis** may be activated for the area where monitoring has detected an improvement opportunity in order to do a more fine grained assessment of the improvement possibility and its localisation. This is done by using a fine grained detection function/tool, e.g. MDT with periodic measurements. Detailed improvement analysis is optional and only needed if the monitoring stage does not give sufficient information.

**Improvement action** will determine and apply specific improvement action(s). The action may be to reconfigure some cell parameters, e.g. output power. To reconfigure any attribute, the existing CM operations over Itf-N are reused. When no automated corrective action can be applied, the CCO function may provide information to the operator (for example, a new base station site may be installed in the area where an improvement is needed).

## B.2 Monitoring of UE distribution

Figure B.2-1 shows an example of how the UE distribution can be monitored periodically by two-dimensional bins measurements, which are created by  $T_{ADV}$  (Timing Advanced) and AOA (Angle Of Arrival) measurements reported by connected mode UE (see clause 10.2 and 10.3 of TS 3GPP TS 36.133 [8]). In figure B.2-1, "D" denotes the distance between the base station antenna and the UE, "C" is the speed of light in air, and " $T_{ADV}$ " represents the  $T_{ADV}$ -index multiplied by  $T_s$  (the basic time unit).

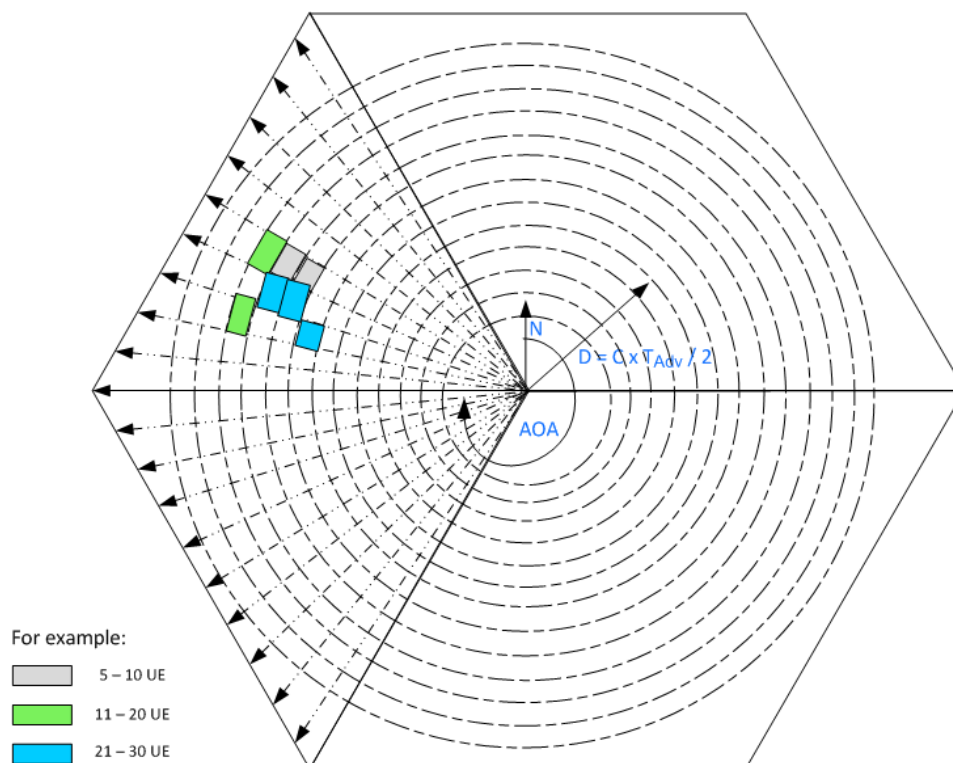

**Figure B.2-1 Two-dimensional bin measurements**

An example of a definition of two-dimensional bin measurements that show the UE distribution in a cell is shown below:

### Measurement description (example):

This measurement provides two-dimensional bins to monitor the UE distribution across geographical area (e.g. in a cell). The two-dimensional bins are formed from Timing Advance ( $T_{ADV}$ ) and Angle of Arrival (AOA),

where  $T_{ADV} = 1) N_{TA}$  – for UEs that are uplink timing aligned (TS 36.213 [4])

2) 11 bits Timing Advance value – for UEs that are not uplink timing aligned (TS 36.321 [10])

AOA (TS 36.133 [8]) = measured on any part of the uplink transmission, such as user data frame or PRACH, or via Sounding Reference Signals.

The table below illustrates an example implementation with x and y ranges [0..10] and [0..11] respectively. x and y are integers within the implementation specific ranges.

Index x – T <sub>ADV</sub> (Unit Ts) (ref. TS 36.133 [4] sect 10.3)		Index y – AOA (Unit Degree °) (ref. TS 36.133 [4] sect 10.2)											
		0	1	2	3	4	5	6	7	8	9	10	11
		0°- 30°	30° - 60°	60° - 90°	90° - 120°	120° - 150°	150° - 180°	180° - 210°	210° - 240°	240° - 270°	270° - 300°	300° - 330°	330° - 360°
0	0 ≤ T <sub>ADV</sub> < 48												
1	48 ≤ T <sub>ADV</sub> < 96												
2	96 ≤ T <sub>ADV</sub> < 144												
3	144 ≤ T <sub>ADV</sub> < 192												
4	192 ≤ T <sub>ADV</sub> < 288												
5	288 ≤ T <sub>ADV</sub> < 384												
6	384 ≤ T <sub>ADV</sub> < 576												
7	576 ≤ T <sub>ADV</sub> < 768												
8	768 ≤ T <sub>ADV</sub> < 960												
9	960 ≤ T <sub>ADV</sub> < 2048												
10	2048 ≤ T <sub>ADV</sub>												

## Annex C (informative): Change history

Change history							
Date	TSG #	TSG Doc.	CR	Rev	Subject/Comment	Old	New
June-2014	SA#64	SP-140358	001	-	remove the feature support statements	11.0.0	11.1.0
2014-09	-	-	-	-	Update to Rel-12 version (MCC)	11.1.0	<b>12.0.0</b>
2014-12	SA#66	SP-140801	003	1	Add NM centralized Coverage and Capacity Optimization (CCO) logical description	12.0.0	<b>13.0.0</b>
			004	-	Add references and abbreviations related to Coverage and Capacity Optimization (CCO)		
			005	-	Improve and correct business level requirements for Coverage and Capacity Optimization (CCO)		
			007	1	Add specification level requirements for NM centralized Coverage and Capacity Optimization (CCO)		
			008	1	Add specification level use case for NM centralized Coverage and Capacity Optimization (CCO)		
2015-03	SA#67	SP-150063	006	2	Add NM centralized Coverage and Capacity Optimization (CCO) high level use cases and general descriptions	13.0.0	<b>13.1.0</b>

---

# History

<b>Document history</b>		
V13.1.0	March 2016	Publication