

# ETSI TS 127 007 V3.4.0 (2000-03)

---

*Technical Specification*

**Digital cellular telecommunications system (Phase 2+) (GSM);  
Universal Mobile Telecommunications System (UMTS);  
AT command set for 3GPP User Equipment (UE)  
(3G TS 27.007 version 3.4.0 Release 1999)**

---



---

**Reference**

RTS/TSGT-0227007UR1

---

**Keywords**

GSM, UMTS

**ETSI**

650 Route des Lucioles  
F-06921 Sophia Antipolis Cedex - FRANCE

---

Tel.: +33 4 92 94 42 00 Fax: +33 4 93 65 47 16

Siret N° 348 623 562 00017 - NAF 742 C  
Association à but non lucratif enregistrée à la  
Sous-Préfecture de Grasse (06) N° 7803/88

---

**Important notice**

---

Individual copies of the present document can be downloaded from:

<http://www.etsi.org>

The present document may be made available in more than one electronic version or in print. In any case of existing or perceived difference in contents between such versions, the reference version is the Portable Document Format (PDF).

In case of dispute, the reference shall be the printing on ETSI printers of the PDF version kept on a specific network drive within ETSI Secretariat.

Users of the present document should be aware that the document may be subject to revision or change of status.

Information on the current status of this and other ETSI documents is available at <http://www.etsi.org/tb/status/>

If you find errors in the present document, send your comment to:

editor@etsi.fr

---

**Copyright Notification**

---

No part may be reproduced except as authorized by written permission.  
The copyright and the foregoing restriction extend to reproduction in all media.

© European Telecommunications Standards Institute 2000.

All rights reserved.

---

## Intellectual Property Rights

IPRs essential or potentially essential to the present document may have been declared to ETSI. The information pertaining to these essential IPRs, if any, is publicly available for **ETSI members and non-members**, and can be found in SR 000 314: *"Intellectual Property Rights (IPRs); Essential, or potentially Essential, IPRs notified to ETSI in respect of ETSI standards"*, which is available from the ETSI Secretariat. Latest updates are available on the ETSI Web server (<http://www.etsi.org/ipr>).

Pursuant to the ETSI IPR Policy, no investigation, including IPR searches, has been carried out by ETSI. No guarantee can be given as to the existence of other IPRs not referenced in SR 000 314 (or the updates on the ETSI Web server) which are, or may be, or may become, essential to the present document.

---

## Foreword

This Technical Specification (TS) has been produced by the ETSI 3<sup>rd</sup> Generation Partnership Project (3GPP).

The present document may refer to technical specifications or reports using their 3GPP identities, UMTS identities or GSM identities. These should be interpreted as being references to the corresponding ETSI deliverables.

The cross reference between GSM, UMTS, 3GPP and ETSI identities can be found under [www.etsi.org/key](http://www.etsi.org/key) .

# Contents

Foreword.....	7
1 Scope.....	8
2 References.....	8
3 Definitions and abbreviations .....	11
3.1 Definitions .....	11
3.2 Abbreviations.....	11
4 AT command syntax .....	12
4.1 Command line.....	12
4.2 Information responses and result codes .....	13
4.3 ITU-T V.25ter [14] TE-TA interface commands.....	13
5 General commands .....	14
5.1 Request manufacturer identification +CGMI .....	14
5.2 Request model identification +CGMM .....	14
5.3 Request revision identification +CGMR.....	15
5.4 Request product serial number identification +CGSN.....	15
5.5 Select TE character set +CSCS.....	16
5.6 Request international mobile subscriber identity +CIMI.....	17
5.7 Multiplexing mode +CMUX .....	17
5.8 ITU-T V.25ter [14] generic TA control commands.....	20
5.9 PCCA STD-101 [17] select wireless network +WS46 .....	20
5.10 Informative examples .....	21
6 Call control commands and methods.....	22
6.1 Select type of address +CSTA .....	22
6.2 ITU-T V.25ter [14] dial command D.....	22
6.3 Direct dialling from phonebooks .....	23
6.4 Call mode +CMOD.....	24
6.5 Hangup call +CHUP.....	24
6.6 Alternating mode call control method .....	25
6.7 Select bearer service type +CBST .....	27
6.8 Radio link protocol +CRLP .....	28
6.9 Service reporting control +CR.....	29
6.10 Extended error report +CEER.....	30
6.11 Cellular result codes +CRC .....	30
6.12 HSCSD device parameters +CHSD.....	32
6.13 HSCSD transparent call configuration +CHST .....	32
6.14 HSCSD non-transparent call configuration +CHSN.....	33
6.15 HSCSD current call parameters +CHSC .....	34
6.16 HSCSD parameters report +CHSR.....	34
6.17 HSCSD automatic user initiated upgrading + CHSU .....	35
6.18 HSCSD non-transparent asymmetry configuration +CHSA.....	36
6.19 Single numbering scheme +CSNS.....	36
6.20 Voice Hangup Control +CVHU.....	37
6.21 V.120 rate adaption protocol +CV120.....	38
6.22 Settings date format +CSDF .....	39
6.23 Silence Command +CSIL .....	39
6.24 Settings time format +CSTF.....	40
6.25 ITU-T V.25ter [14] call control commands.....	41
6.26 ITU-T V.25ter [14] data compression commands .....	41
6.27 Informative examples .....	41
7 Network service related commands .....	42
7.1 Subscriber number +CNUM.....	42
7.2 Network registration +CREG .....	43
7.3 Operator selection +COPS.....	44

7.4	Facility lock +CLCK .....	46
7.5	Change password +CPWD .....	47
7.6	Calling line identification presentation +CLIP .....	48
7.7	Calling line identification restriction +CLIR .....	49
7.8	Connected line identification presentation +COLP .....	50
7.9	Called line identification presentation +CDIP .....	51
7.10	Closed user group +CCUG .....	52
7.11	Call forwarding number and conditions +CCFC .....	52
7.12	Call waiting +CCWA .....	54
7.13	Call related supplementary services +CHLD .....	55
7.14	Call deflection +CTFR .....	56
7.15	Unstructured supplementary service data +CUSD .....	57
7.16	Advice of Charge +CAOC .....	58
7.17	Supplementary service notifications +CSSN .....	59
7.18	List current calls +CLCC .....	60
7.19	Preferred operator list +CPOL .....	62
7.20	Read operator names +COPN .....	62
7.21	eMLPP Priority Registration and Interrogation +CAEMLPP .....	63
7.22	Informative examples .....	63
8	Mobile Equipment control and status commands .....	65
8.1	Phone activity status +CPAS .....	66
8.2	Set phone functionality +CFUN .....	67
8.3	Enter PIN +CPIN .....	68
8.4	Battery charge +CBC .....	69
8.5	Signal quality +CSQ .....	69
8.6	Mobile Equipment control mode +CMEC .....	70
8.7	Keypad control +CKPD .....	71
8.8	Display control +CDIS .....	72
8.9	Indicator control +CIND .....	73
8.10	Mobile Equipment event reporting +CMER .....	74
8.11	Select phonebook memory storage +CPBS .....	75
8.12	Read phonebook entries +CPBR .....	76
8.13	Find phonebook entries +CPBF .....	77
8.14	Write phonebook entry +CPBW .....	78
8.15	Clock +CCLK .....	78
8.16	Alarm +CALA .....	79
8.17	Generic SIM access +CSIM .....	80
8.18	Restricted SIM access +CRSM .....	81
8.19	Secure control command +CSCC .....	82
8.20	Alert sound mode +CALM .....	83
8.21	Ringer sound level +CRSL .....	83
8.22	Vibrator mode +CVIB .....	84
8.23	Loudspeaker volume level +CLVL .....	84
8.24	Mute control +CMUT .....	85
8.25	Accumulated call meter +CACM .....	85
8.26	Accumulated call meter maximum +CAMM .....	86
8.27	Price per unit and currency table +CPUC .....	86
8.28	Call Meter maximum event +CCWE .....	87
8.29	Power class +CPWC .....	87
8.30	Set Language +CLAN .....	88
8.31	Language Event +CLAE .....	89
8.32	Set Greeting Text +CSGT .....	90
8.33	Set Voice Mail Number +CSVM .....	90
8.34	Ring Melody Playback +CRMP .....	91
8.35	Master Reset +CMAR .....	92
8.36	List all available AT commands +CLAC .....	92
8.37	Delete alarm +CALD .....	93
8.38	Postpone or dismiss an alarm +CAPD .....	93
8.39	Automatic Time Zone Update +CTZU .....	94
8.40	Time Zone Reporting +CTZR .....	94
8.41	Enter protocol mode +CPROT .....	95

8.42	Informative examples .....	96
9	Mobile Equipment errors .....	99
9.1	Report Mobile Equipment error +CMEE .....	99
9.2	Mobile Equipment error result code +CME ERROR .....	100
9.2.1	General errors.....	100
9.2.2	GPRS-related errors .....	101
9.2.2.1	Errors related to a failure to perform an Attach.....	101
9.2.2.2	Errors related to a failure to Activate a Context.....	102
9.2.2.3	Other GPRS errors .....	102
9.3	Informative examples .....	102
10	Commands for UMTS Packet Domain .....	102
10.1	Commands specific to MTs supporting the Packet Domain .....	103
10.1.1	Define PDP Context +CGDCONT .....	103
10.1.2	Define Secondary PDP Context +CGDSCONT.....	104
10.1.3	Traffic Flow Template +CGTFT.....	106
10.1.4	Quality of Service Profile (Requested) +CGQREQ .....	108
10.1.5	Quality of Service Profile (Minimum acceptable) +CGQMIN .....	110
10.1.6	3G Quality of Service Profile (Requested) +CGEQREQ.....	111
10.1.7	3G Quality of Service Profile (Minimum acceptable) +CGEQMIN.....	113
10.1.8	3G Quality of Service Profile (Negotiated) +CGEQNEG.....	116
10.1.9	PS attach or detach +CGATT .....	117
10.1.10	PDP context activate or deactivate +CGACT .....	118
10.1.11	PDP Context Modify +CGCMOD .....	119
10.1.12	Enter data state +CGDATA .....	119
10.1.13	Configure local Octet Stream PAD parameters +CGCLOSP.....	121
10.1.14	Show PDP address +CGPADDR .....	121
10.1.15	Automatic response to a network request for PDP context activation +CGAUTO.....	122
10.1.16	Manual response to a network request for PDP context activation +CGANS .....	123
10.1.17	GPRS mobile station class +CGCLASS (GPRS only).....	124
10.1.18	Configure local triple-X PAD parameters +CGCLPAD (GPRS only).....	125
10.1.18	Packet Domain event reporting +CGEREP.....	126
10.1.19	GPRS network registration status +CGREG.....	127
10.1.20	Select service for MO SMS messages +CGSMS .....	128
10.2	Modem compatibility commands .....	129
10.2.1	MT originated PDP context activation .....	129
10.2.1.1	Request Packet Domain service 'D' .....	129
10.2.1.2	Request Packet Domain IP service 'D'.....	130
10.2.2	Network requested PDP context activation.....	131
10.2.2.1	Automatic response to a network request for PDP context activation 'S0' .....	131
10.2.2.2	Manual acceptance of a network request for PDP context activation 'A' .....	131
10.2.2.3	Manual rejection of a network request for PDP context activation 'H'.....	132
11	Commands for VGCS and VBS .....	132
11.1	Commands specific to MTs supporting the VGCS and VBS .....	132
11.1.1	Accept an incoming Voice Group or Voice Broadcast Call +CAJOIN .....	132
11.1.2	Reject an incoming Voice Group or Voice Broadcast Call +CAREJ .....	133
11.1.3	Leave an ongoing Voice Group or Voice Broadcast Call +CAHLD .....	133
11.1.4	Talker Access for Voice Group Call +CAPTT .....	134
11.1.5	Voice Group Call Uplink Status Presentation +CAULEV.....	134
11.1.6	List current Voice Group and Voice Broadcast Calls +CALCC.....	135
11.1.7	Voice Group or Voice Broadcast Call State Attribute Presentation +CACSP .....	136
11.1.8	NCH Support Indication +CANCHEV .....	137
11.2	Modem compatibility commands .....	137
11.2.1	Request VGCS or VBS service 'D'.....	138
11.2.2	Termination of a Voice Group or Voice Broadcast Call 'H'.....	138
11.3	Informative examples .....	138

<b>Annex A (normative):</b>	<b>Summary of commands from other standards .....</b>	<b>139</b>
<b>Annex B (normative):</b>	<b>Summary of result codes.....</b>	<b>141</b>
<b>Annex C (informative):</b>	<b>Commands from TIA IS-101.....</b>	<b>142</b>
C.1	Introduction.....	142
C.2	Commands .....	143
C.2.1	Select mode +FCLASS.....	143
C.2.2	Buffer threshold setting +VBT .....	143
C.2.3	Calling number ID presentation +VCID.....	144
C.2.4	Receive gain selection +VGR.....	144
C.2.5	Transmit gain selection +VGT .....	144
C.2.6	Initialise voice parameters +VIP.....	145
C.2.7	Inactivity timer +VIT.....	145
C.2.8	Line selection +VLS.....	145
C.2.9	Receive data state +VRX.....	147
C.2.10	Select compression method +VSM.....	147
C.2.11	DTMF and tone generation +VTS .....	148
C.2.12	Tone duration +VTD .....	148
C.2.13	Transmit data state +VTX.....	149
<b>Annex D (informative):</b>	<b>Bibliography .....</b>	<b>150</b>
<b>Annex E (informative):</b>	<b>Mobile originated alternating voice/data call example .....</b>	<b>151</b>
<b>Annex F (informative):</b>	<b>Mobile terminated voice followed by data call example .....</b>	<b>152</b>
<b>Annex G (informative):</b>	<b>Voice call example .....</b>	<b>153</b>
<b>Annex H (informative):</b>	<b>Change History .....</b>	<b>154</b>

---

# Foreword

This Technical Specification (TS) has been produced by the 3<sup>rd</sup> Generation Partnership Project (3GPP).

The contents of the present document are subject to continuing work within the TSG and may change following formal TSG approval. Should the TSG modify the contents of the present document, it will be re-released by the TSG with an identifying change of release date and an increase in version number as follows:

Version x.y.z

where:

- x the first digit:
  - 1 presented to TSG for information;
  - 2 presented to TSG for approval;
  - 3 or greater indicates TSG approved document under change control.
- y the second digit is incremented for all changes of substance, i.e. technical enhancements, corrections, updates, etc.
- z the third digit is incremented when editorial only changes have been incorporated in the document.



# 1 Scope

The present document specifies a profile of AT commands and recommends that this profile be used for controlling Mobile Equipment (ME) functions and GSM/UMTS network services from a Terminal Equipment (TE) through Terminal Adaptor (TA). The command prefix +C is reserved for Digital Cellular in ITU-T Recommendation V.25ter [14]. The present document has also the syntax details used to construct these extended GSM/UMTS commands. Commands from ITU-T Recommendation V.25ter [14] and existing digital cellular standards (TIA IS-99 [15] and TIA IS-135 [16]) are used whenever applicable. Some of the new commands are defined such way that they can be easily applied to ME of networks other than GSM/UMTS. ITU-T T.31 [11] and T.32 [12] fax AT commands may be used for GSM/UMTS fax transmission from TE. GSM/UMTS Short Message Service AT commands are defined in 3G TS 27.005 [24]. GPRS AT commands are defined in clause 10 of this specification. The present document assumes an abstract architecture comprising a TE (e.g. a computer) and a ME interfaced by a TA (see figure 1). The span of control of the defined commands should allow to handle any physical implementation that this abstract architecture may lead to:

- TA, ME and TE as three separate entities;
- TA integrated under the ME cover, and the TE implemented as a separate entity;
- TA integrated under the TE cover, and the ME implemented as a separate entity;
- TA and ME integrated under the TE cover as a single entity.

The commands described in the present document may be observed on the link between the TE and the TA. However, most of the commands retrieve information about the ME, not about the TA.

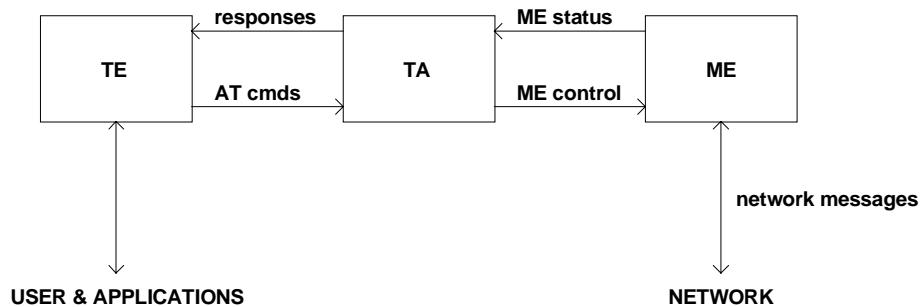

**Figure 1: Setup**

Interface between TE and TA is intended to operate over existing serial (ITU-T Recommendation V.24) cables, infrared link, and all link types with similar behaviour. For correct operation many of the defined commands require eight bit data and therefore it is recommended that TE-TA link is set to eight bits/ byte mode. (For infrared operation implementation refer informative references IrDA. For embedding AT commands and data during on-line data state refer TIA-617/ITU-T V.80.) Interface between TA and ME is dependent on the interface in the ME.

# 2 References

The following documents contain provisions which, through reference in this text, constitute provisions of the present document.

- References are either specific (identified by date of publication, edition number, version number, etc.) or non-specific.
- For a specific reference, subsequent revisions do not apply.
- For a non-specific reference, the latest version applies.

[1] 3G TS 22.002: "3rd Generation Partnership Project; Bearer Services (BS) supported by a GSM Public Land Mobile Network (PLMN)".

- [2] 3G TS 22.003: "3rd Generation Partnership Project; Teleservices supported by a GSM Public Land Mobile Network (PLMN)".
- [3] 3G TS 22.081: "3rd Generation Partnership Project; Line identification supplementary services - Stage 1".
- [4] 3G TS 22.082: "3rd Generation Partnership Project; Call Forwarding (CF) supplementary services - Stage 1".
- [5] 3G TS 22.083: "3rd Generation Partnership Project; Call Waiting (CW) and Call Hold (HOLD) supplementary services - Stage 1".
- [6] 3G TS 22.088: "3rd Generation Partnership Project; Call Barring (CB) supplementary services - Stage 1".
- [7] 3G TS 23.003: "3rd Generation Partnership Project; Numbering, addressing and identification".
- [8] GSM 04.08: "Digital cellular telecommunication system (Phase 2+); Mobile radio interface layer 3 specification".
- [9] GSM MoU SE.13, GSM MoU Permanent Reference Document SE.13: "GSM Mobile Network Codes and Names".
- [10] ITU-T Recommendation E.212: "Identification plan for land mobile stations".
- [11] ITU-T Recommendation T.31: "Asynchronous facsimile DCE control, service class 1".
- [12] ITU-T Recommendation T.32: "Asynchronous facsimile DCE control, service class 2".
- [13] ITU-T Recommendation T.50: "International Reference Alphabet (IRA) (Formerly International Alphabet No. 5 or IA5) - Information technology - 7-bit coded character set for information exchange".
- [14] ITU-T Draft new Recommendation V.25ter: "Serial asynchronous automatic dialling and control".
- [15] Telecommunications Industry Association TIA IS-99: "Data Services Option Standard for Wideband Spread Spectrum Digital Cellular System".
- [16] Telecommunications Industry Association TIA IS-135: "800 MHz Cellular Systems, TDMA Services, Async Data and Fax".
- [17] Portable Computer and Communications Association PCCA STD-101 Data Transmission Systems and Equipment: "Serial Asynchronous Automatic Dialling and Control for Character Mode DCE on Wireless Data Services".
- [18] 3G TS 24.022: "3rd Generation Partnership Project; Radio Link Protocol (RLP) for data and telematic services on the Mobile Station - Base Station System (MS - BSS) interface and the Base Station System - Mobile-services Switching Centre (BSS - MSC) interface".
- [19] 3G TS 22.030: "3rd Generation Partnership Project; Man Machine Interface (MMI) of the Mobile Station (MS)".
- [20] GSM 05.08: "Digital cellular telecommunication system (Phase 2+); Radio subsystem link control".
- [21] 3G TS 22.085: "3rd Generation Partnership Project; Closed User Group (CUG) supplementary services - Stage 1".
- [22] 3G TS 22.084: "3rd Generation Partnership Project; MultiParty (MPTY) supplementary services - Stage 1".
- [23] 3G TS 22.090: "3rd Generation Partnership Project; Unstructured Supplementary Service Data (USSD) - Stage 1".

- [24] 3G TS 27.005: "3rd Generation Partnership Project; Use of Data Terminal Equipment - Data Circuit terminating Equipment (DTE - DCE) interface for Short Message Service (SMS) and Cell Broadcast Service (CBS)".
- [25] 3G TS 23.038: "3rd Generation Partnership Project; Alphabet and language specific information".
- [26] 3G TS 22.024: "3rd Generation Partnership Project; Description of Charge Advice Information (CAI)".
- [27] 3G TS 22.086: "3rd Generation Partnership Project; Advice of Charge (AoC) supplementary services - Stage 1".
- [28] GSM 11.11: "Digital cellular telecommunication system (Phase 2+); Specification of the Subscriber Identity Module - Mobile Equipment (SIM-ME) interface".
- [29] 3G TS 22.034: "3rd Generation Partnership Project; High Speed Circuit Switched Data (HSCSD) - Stage 1".
- [30] 3G TS 22.091: "3rd Generation Partnership Project; Explicit Call Transfer (ECT) supplementary service - Stage 1".
- [31] 3G TS 22.072: "3rd Generation Partnership Project; Call Deflection (CD) supplementary service - Stage 1".
- [32] ISO/IEC10646: "Universal Multiple-Octet Coded Character Set (UCS)"; UCS2, 16 bit coding.
- [33] 3G TS 22.022: "3rd Generation Partnership Project; Personalisation of GSM Mobile Equipment (ME) Mobile functionality specification".
- [34] 3G TS 27.060: "3rd Generation Partnership Project; General requirements on Mobile Stations (MS) supporting General Packet Radio Bearer Service (GPRS)".
- [35] CCITT Recommendation V.110: "Support of data terminal equipments (DTEs) with V-Series interfaces by an integrated services digital network".
- [36] CCITT Recommendation V.120: "Support by an ISDN of data terminal equipment with V-Series type interfaces with provision for statistical multiplexing".
- [37] ITU-T Recommendation X.31: "Support of packet mode terminal equipment by an ISDN".
- [38] GSM 05.05: "Digital cellular telecommunication system (Phase 2+); Radio transmission and reception".
- [39] 3G TS 29.061: "3rd Generation Partnership Project; General Packet Radio Service (GPRS); Interworking between the Public Land Mobile Network (PLMN) supporting GPRS and Packet Data Networks (PDN)".
- [40] 3G TS 23.081: "3rd Generation Partnership Project; Technical Specification Group Core Network; Line identification supplementary services - Stage 2".
- [41] 3G TS 27.001: "3rd Generation Partnership Project; Technical Specification Group Core Network; General on Terminal Adaptation Functions (TAF) for Mobile Stations (MS)".
- [42] 3G TS 29.007: "3rd Generation Partnership Project; Technical Specification Group Core Network; General requirements on interworking between the Public Land Mobile Network (PLMN) and the Integrated Services Digital Network (ISDN) or Public Switched Telephone Network (PSTN)".
- [43] Infrared Data Association; Specification of Ir Mobile Communications (IrMC).
- [44] IrDA Object Exchange Protocol.
- [45] 3G TS 27.010: "3rd Generation Partnership Project; Terminal Equipment to User Equipment (TE-UE) multiplexer protocol User Equipment (UE)".
- [46] 3G TS 23.107: "3rd Generation Partnership Project; Quality of Service, Concept and Architecture".

- [47] 3G TS 23.060: "3rd Generation Partnership Project; General Packet Radio Service (GPRS) Service description; Stage 2".
- [48] 3G TS 23.067: "3rd Generation Partnership Project; Enhanced Multi-Level Precedence and Pre-emption service (eMLPP) - Stage 2".
- [49] GSM 03.68: "Digital cellular telecommunication system (Phase 2+); Voice Group Call service (VGCS) - Stage 2".
- [50] GSM 03.69: "Digital cellular telecommunication system (Phase 2+); Voice Broadcast Service (VBS) - Stage 2".
- [51] 3G TS 24.067: "3rd Generation Partnership Project; Enhanced Multi-Level Precedence and Pre-emption service (eMLPP) - Stage 3".
- [52] GSM 04.68: "Digital cellular telecommunication system (Phase 2+); Voice Group Call service (VGCS) - Stage 3".
- [53] GSM 04.69: "Digital cellular telecommunication system (Phase 2+); Voice Broadcast Service (VBS) - Stage 3".
- [54] 3G TS 22.067: "3rd Generation Partnership Project; Technical Specification Group Services and System Aspects; enhanced Multi-Level Precedence and Pre-emption service (eMLPP) - Stage 1".
- [55] GSM 02.68: "Digital cellular telecommunication system (Phase 2+); Voice Group Call service (VGCS) - Stage 1".
- [56] GSM 02.69: "Digital cellular telecommunication system (Phase 2+); Voice Broadcast Service (VBS) - Stage 1".
- [57] 3G TS 24.008: "3rd Generation Partnership Project; Mobile Radio Interface Layer 3 specification; Core Network Protocols-Stage 3".

---

## 3 Definitions and abbreviations

### 3.1 Definitions

For the purposes of the present document, the following syntactical definitions apply (refer also clause 4):

- <CR>** Carriage return character, which value is specified with command S3.
- <LF>** Linefeed character, which value is specified with command S4.
- <...>** Name enclosed in angle brackets is a syntactical element. Brackets themselves do not appear in the command line.
- [...]** Optional subparameter of a command or an optional part of TA information response is enclosed in square brackets. Brackets themselves do not appear in the command line. When subparameter is not given in *parameter type* commands, new value equals to its previous value. In *action type* commands, action should be done on the basis of the recommended default setting of the subparameter.
- underline** Underlined defined subparameter value is the recommended default setting of this subparameter. In *parameter type* commands, this value should be used in factory settings which are configured by V.25ter [14] command &F0. In *action type* commands, this value should be used when subparameter is not given.

### 3.2 Abbreviations

For the purposes of the present document, the following abbreviations apply:

AT	ATtention; this two-character abbreviation is always used to start a command line to be sent from TE to TA
ASCII	Advanced Speech Call Items, including VGCS, VBS and eMLPP
BCD	Binary Coded Decimal
eMLPP	Enhanced Multi-Level Precedence and Pre-emption Service
ETSI	European Telecommunications Standards Institute
FTM	Frame Tunnelling Mode (refer 3G TS 27.001 [41] and 3G TS 29.007[42])
HSCSD	High Speed Circuit Switched Data
IHOSS	Internet Hosted Octet Stream Service
IMEI	International Mobile station Equipment Identity
IRA	International Reference Alphabet (ITU-T T.50 [13])
IrDA	Infrared Data Association
ISO	International Standards Organisation
ITU-T	International Telecommunication Union - Telecommunications Standardization Sector
ME	Mobile Equipment, e.g. a GSM phone (equal to MS; Mobile Station)
MoU	Memorandum of Understanding (GSM operator joint)
OSP	Octet Stream Protocol
OSP:IHOSS	Octet Stream Protocol for Internet Hosted Octet Stream Service
PCCA	Portable Computer and Communications Association
PTT	Push to Talk
RDI	Restricted Digital Information
RLP	Radio Link Protocol
SIM	Subscriber Identity Module
TA	Terminal Adaptor, e.g. a GSM data card (equal to DCE; Data Circuit terminating Equipment)
TE	Terminal Equipment, e.g. a computer (equal to DTE; Data Terminal Equipment)
TIA	Telecommunications Industry Association
UDI	Unrestricted Digital Information
VBS	Voice Broadcast Service
VGCS	Voice Group Call Service

## 4 AT command syntax

This clause summarizes general aspects on AT commands and issues related to them. For further information refer ITU-T Recommendation V.25ter [14].

### 4.1 Command line

See figure 2 for general structure of a command line. Standardized *basic* commands are found only in V.25ter [14]. GSM/UMTS commands use syntax rules of *extended* commands. Every extended command has a *test command* (trailing =?) to test the existence of the command and to give information about the type of its subparameters. *Parameter type* commands also have a *read command* (trailing ?) to check the current values of subparameters. *Action type* commands do not store the values of any of their possible subparameters, and therefore do not have a read command.

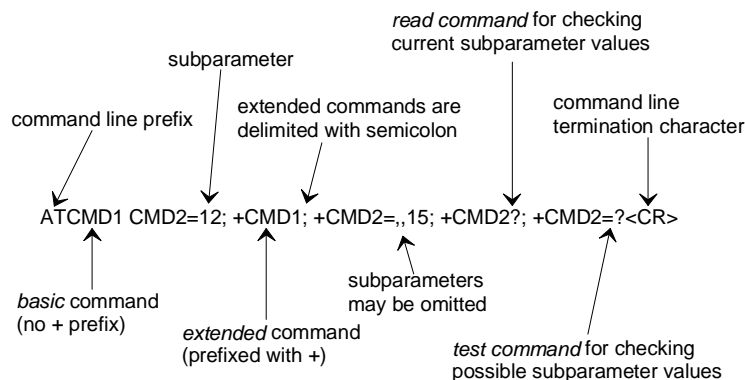

Figure 2: Basic structure of a command line

If verbose responses are enabled with command V1 and all commands in a command line has been performed successfully, result code <CR><LF>OK<CR><LF> is sent from the TA to the TE. If numeric responses are enabled with command V0, result code 0<CR> is sent instead.

If verbose responses are enabled with command V1 and subparameter values of a command are not accepted by the TA (or command itself is invalid, or command cannot be performed for some reason), result code <CR><LF>ERROR<CR><LF> is sent to the TE and no subsequent commands in the command line are processed. If numeric responses are enabled with command V0, result code 4<CR> is sent instead. ERROR (or 4) response may be replaced by +CME ERROR: <err> (refer clause 9) when command was not processed due to an error related to ME operation.

## 4.2 Information responses and result codes

The TA response for the example command line of figure 2 could be as shown in figure 3. Here, verbose response format is enabled with command V1. If numeric format V0 would have been used, <CR><LF> headers of *information responses* would have been left out and *final result code* changed to 0<CR>.

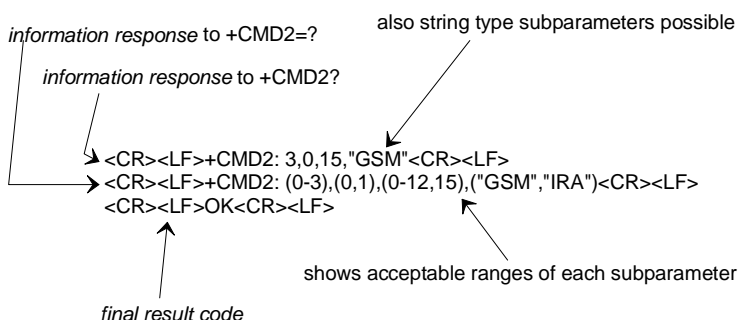

Figure 3: Response to a command line

So called *intermediate result codes* inform about progress of TA operation (e.g. connection establishment CONNECT), and so called *unsolicited result codes* indicate occurrence of an event not directly associated with issuance of a command from TE (e.g. ring indication RING).

## 4.3 ITU-T V.25ter [14] TE-TA interface commands

Table 1 summarizes V.25ter [14] commands relating to command line and response formatting, and TA-TE interface operation. All are applicable to GSM/UMTS terminals.

Table 1: V.25ter commands relating to TE-TA interface

Command	Subclause	Impl.	Use in GSM/UMTS
S3=[ <value> ]	6.2.1	mand.	command line termination character (mandatory default setting IRA 13)
S4=[ <value> ]	6.2.2	mand.	response formatting character (recommended default IRA 10)
S5=[ <value> ]	6.2.3	mand.	command line editing character (recommended default IRA 8)
E[ <value> ]	6.2.4	mand.	command echo (recommended default 1 i.e. TA echoes commands back)
Q[ <value> ]	6.2.5	mand.	result code suppression (recommended default 0 i.e. TA transmits result codes)
V[ <value> ]	6.2.6	mand.	TA response format (recommended default 1 i.e. verbose format)
X[ <value> ]	6.2.7	mand.	defines CONNECT result code format; values manufacturer specific
&C[ <value> ]	6.2.8	mand.	determines how ITU-T V.24 circuit 109 (or equivalent) relates to the detection of received line signal from remote end (recommended default 1 i.e. 109 operation relates to detection of received signal)
&D[ <value> ]	6.2.9	mand.	determines how TA responds when ITU-T V.24 circuit 108/2 (or equivalent) is changed from ON to OFF condition during online data state
+IPR=[ <value> ]	6.2.10	opt.	fixed TE data rate (recommended default 0 i.e. automatic detection)

+ICF=[ <format> [ , <parity> ] ]	6.2.11	opt.	TE-TA character framing (recommended default 3,3 i.e. eight data bits, no parity, 1 stop bit)
+IFC=[ <by_te> [ , <by_ta> ] ]	6.2.12	opt.	TE-TA local flow control (recommended default 2,2 i.e. TE uses ITU-T V.24 circuit 133 (or equivalent), and TA circuit 106 (or equivalent))
+ILRR=[ <value> ]	6.2.13	opt.	determines whether the used local TE-TA data rate is informed using intermediate result code +ILRR: <rate> before going online data state after call answering or originating

## 5 General commands

ITU-T Recommendation V.25ter [14] includes "Generic DCE Control" commands with the prefix +G. These commands are for the identification of the TA. Four of those commands are adapted here to be the identification commands of the ME. Syntax is otherwise similar but the prefix is +CG. TIA IS-99 [15] uses same commands for base station identification.

### 5.1 Request manufacturer identification +CGMI

**Table 2: +CGMI action command syntax**

Command	Possible response(s)
+CGMI	<manufacturer> +CME ERROR: <err>
+CGMI=?	

#### Description

Execution command causes the TA to return one or more lines of information text <manufacturer>, determined by the ME manufacturer, which is intended to permit the user of the TA to identify the manufacturer of the ME to which it is connected to. Typically, the text will consist of a single line containing the name of the manufacturer, but manufacturers may choose to provide more information if desired. Refer subclause 9.2 for possible <err> values.

#### Defined values

<manufacturer>: the total number of characters, including line terminators, in the information text shall not exceed 2048 characters.

Text shall not contain the sequence 0<CR> or OK<CR>

#### Implementation

Optional.

### 5.2 Request model identification +CGMM

**Table 3: +CGMM action command syntax**

Command	Possible response(s)
+CGMM	<model> +CME ERROR: <err>
+CGMM=?	

#### Description

Execution command causes the TA to return one or more lines of information text <model>, determined by the ME manufacturer, which is intended to permit the user of the TA to identify the specific model of the ME to which it is

connected to. Typically, the text will consist of a single line containing the name of the product, but manufacturers may choose to provide more information if desired. Refer to subclause 9.2 for possible <err> values.

#### Defined values

<model>: the total number of characters, including line terminators, in the information text shall not exceed 2048 characters.

Text shall not contain the sequence 0<CR> or OK<CR>

#### Implementation

Optional.

## 5.3 Request revision identification +CGMR

Table 4: +CGMR action command syntax

Command	Possible response(s)
+CGMR	<revision> +CME ERROR: <err>
+CGMR=?	

#### Description

Execution command causes the TA to return one or more lines of information text <revision>, determined by the ME manufacturer, which is intended to permit the user of the TA to identify the version, revision level or date, or other pertinent information of the ME to which it is connected to. Typically, the text will consist of a single line containing the version of the product, but manufacturers may choose to provide more information if desired. Refer subclause 9.2 for possible <err> values.

#### Defined values

<revision>: the total number of characters, including line terminators, in the information text shall not exceed 2048 characters.

Text shall not contain the sequence 0<CR> or OK<CR>

#### Implementation

Optional.

## 5.4 Request product serial number identification +CGSN

Table 5: +CGSN action command syntax

Command	Possible response(s)
+CGSN	<sn> +CME ERROR: <err>
+CGSN=?	

#### Description

Execution command causes the TA to return one or more lines of information text <sn>, determined by the ME manufacturer, which is intended to permit the user of the TA to identify the individual ME to which it is connected to. Typically, the text will consist of a single line containing the IMEI (International Mobile station Equipment Identity; refer 3G TS 23.003 [7]) number of the ME, but manufacturers may choose to provide more information if desired. Refer subclause 9.2 for possible <err> values.



**Defined values**

<sn>: the total number of characters, including line terminators, in the information text shall not exceed 2048 characters.

Text shall not contain the sequence 0<CR> or OK<CR>

**Implementation**

Optional.

## 5.5 Select TE character set +CSCS

**Table 6: +CSCS parameter command syntax**

Command	Possible response(s)
+CSCS=[ <chset> ]	
+CSCS?	+CSCS: <chset>
+CSCS=?	+CSCS: (list of supported <chset>s)

**Description**

Set command informs TA which character set <chset> is used by the TE. TA is then able to convert character strings correctly between TE and ME character sets.

When TA-TE interface is set to 8-bit operation and used TE alphabet is 7-bit, the highest bit shall be set to zero.

NOTE 1: It is manufacturer specific how the internal alphabet of ME is converted to/from the TE alphabet.

Read command shows current setting and test command displays conversion schemes implemented in the TA.

**Defined values**

<chset> (conversion schemes not listed here can be defined by manufacturers):

- "GSM" GSM 7 bit default alphabet (3G TS 23.038); this setting causes easily software flow control (XON/XOFF) problems
- "HEX" character strings consist only of hexadecimal numbers from 00 to FF; e.g. "032FE6" equals three 8-bit characters with decimal values 3, 47 and 230; no conversions to the original ME character set shall be done.

NOTE 2: If ME is using GSM 7 bit default alphabet, its characters shall be padded with 8th bit (zero) before converting them to hexadecimal numbers (i.e. no SMS-style packing of 7-bit alphabet).

- "IRA" international reference alphabet (ITU-T T.50 [13])
- "PCCPxxx" PC character set Code Page xxx
- "PCDN" PC Danish/Norwegian character set
- "UCS2" 16-bit universal multiple-octet coded character set (ISO/IEC10646 [32]); UCS2 character strings are converted to hexadecimal numbers from 0000 to FFFF; e.g. "004100620063" equals three 16-bit characters with decimal values 65, 98 and 99
- "8859-n" ISO 8859 Latin n (1-6) character set
- "8859-C" ISO 8859 Latin/Cyrillic character set
- "8859-A" ISO 8859 Latin/Arabic character set
- "8859-G" ISO 8859 Latin/Greek character set

"8859-H" ISO 8859 Latin/Hebrew character set

### Implementation

Mandatory when a command using the setting of this command is implemented.

## 5.6 Request international mobile subscriber identity +CIMI

**Table 7: +CIMI action command syntax**

Command	Possible response(s)
+CIMI	<IMSI> +CME ERROR: <err>
+CIMI=?	

### Description

Execution command causes the TA to return <IMSI>, which is intended to permit the TE to identify the individual SIM which is attached to ME. Refer subclause 9.2 for possible <err> values.

### Defined values

<IMSI>: International Mobile Subscriber Identity (string without double quotes)

### Implementation

Optional.

## 5.7 Multiplexing mode +CMUX

**Table 8: +CMUX parameter command syntax**

Command	Possible response(s)
+CMUX=<mode>[,<subset>[,<port_speed>[,<N1>[,<T1>[,<N2>[,<T2>[,<T3>[,<k>]]]]]]]]	+CME ERROR: <err>
+CMUX?	+CMUX: <mode>,[<subset>],<port_speed>,<N1>,<T1>,<N2>,<T2>,<T3>[,<k>] +CME ERROR: <err>
+CMUX=?	+CMUX: (list of supported <mode>s), (list of supported <subset>s), (list of supported <port_speed>s), (list of supported <N1>s), (list of supported <T1>s), (list of supported <N2>s), (list of supported <T2>s), (list of supported <T3>s), (list of supported <k>s)

### Description

This command is used to enable/disable the 3G TS 27.010 [45] multiplexing protocol control channel. Refer to subclause 9.2 for possible <err> values. The AT command sets parameters for the Control Channel. If the parameters are left out, the default value is used.

Read command returns the current mode and the settings.

Test command returns the supported modes and parameters.

It is recommended that the ME/TA/TE should autobaud to the +CMUX command up to and including an interface speed of 9600 bits/s.

The OK or +CME ERROR: <err> response is returned at the speed of the +CMUX command prior to entering <mode>.

It is recommended that whenever the multiplexer control channel is released the ME/TA/TE should assume an interface rate of up to and including 9600 bits/s for auto bauding purposes irrespective of any previous higher speed having been selected.

If a +CMUX command is issued whilst in any multiplexer mode then that +CMUX command shall be ignored and the ME/TA shall return an +CME ERROR: <err> response.

### Defined values

<operation> (multiplexer Transparency Mechanism)

0 Basic option

1 Advanced option

<subset>:

This parameter defines the way in which the multiplexer **control channel** is set up. A virtual channel may subsequently be set up differently but in the absence of any negotiation for the settings of a virtual channel, the virtual channel shall be set up according to the control channel <subset> setting.

0 UIH frames used only

1 UI frames used only

2 I frames used only

Default value: 0

<port\_speed> (transmission rate):

1 9 600 bit/s

2 19 200 bit/s

3 38 400 bit/s

4 57 600 bit/s

5 115 200 bit/s

6 230 400 bits/s

<N1> (maximum frame size):

1- 32768

default Value : 31 (64 if Advanced option is used)

<T1> (acknowledgement timer in units of ten milliseconds):

1-255, where 10 is default (100 ms)

<N2> (maximum number of re-transmissions):

0-100, where 3 is default

<T2> (response timer for the multiplexer control channel in units of ten milliseconds):

2-255, where 30 is default (300 ms)

NOTE: T2 must be longer than T1.

<T3> (wake up response timer in seconds):

1-255, where 10 is default

<k> (window size, for Advanced operation with Error Recovery options):

1-7, where 2 is default

### **Implementation**

Mandatory, if 3G TS 27.010 [45] supported in the ME/TA.

## 5.8 ITU-T V.25ter [14] generic TA control commands

**Table 9: V.25ter generic TA control commands**

Command	Subclause	Impl.	Use in GSM/UMTS
Z[<value>]	6.1.1	mand.	TA sets all parameters to their defaults as specified by a user memory profile or by the manufacturer, and resets TA
&F[<value>]	6.1.2	mand.	TA sets all parameters to their defaults as specified by the manufacturer
I[<value>]	6.1.3	opt.	request manufacturer specific information about the TA (software cannot use this command to determine the capabilities of a TA)
+GMI	6.1.4	mand.	request TA manufacturer identification (may equal to +CGMI)
+GMM	6.1.5	mand.	request TA model identification (may equal to +CGMM)
+GMR	6.1.6	mand.	request TA revision identification (may equal to +CGMR)
+GSN	6.1.7	opt.	request TA serial number identification (may equal to +CGSN)
+GOI	6.1.8	opt.	request ISO system global object identification of the TA (general format defined in ITU-T Recommendation X.208; encoding rules in ITU-T Recommendation X.209)
+GCAP	6.1.9	mand.	request overall capabilities of TA; the response code for a TA building on this document shall be +CGSM
+GCI=<T.35>	6.1.10	opt.	selects the country of installation for the TA using ITU-T Recommendation T.35 Annex A country codes

## 5.9 PCCA STD-101 [17] select wireless network +WS46

PCCA STD-101 [17] includes a command to select the cellular network (Wireless Data Service; WDS) to operate with the TA. PCCA calls this as WDS-Side Stack Selection. This command may be used when TA is asked to indicate the networks in which it can operate.

**Table 10: +WS46 parameter command syntax**

Command	Possible response(s)
+WS46=[<n>]	
+WS46?	<n>
+WS46=?	(list of supported <n>s)

### Description

Set command selects to WDS side stack <n> to be used by the TA. Read command shows current setting and test command displays side stacks implemented in the TA.

### Defined values

<n>:

12 GSM digital cellular

refer PCCA STD-101 [17] for other values

### Implementation

Mandatory in PCCA STD-101, but optional for GSM/UMTS.

## 5.10 Informative examples

When beginning to build a communication link, a general TE application controlling a TA needs to determine the TA and the ME to which it is connected. V.25ter [14] has seven commands for TA identification from which four are mandatory to be implemented in a TA. An example of this command sequence requesting manufacturer (+GMI), model (+GMM), revision (+GMR) and serial number (+GSN) information would be:

```
AT+GMI
Manufacturer ABC
OK
AT+GMM
GSM Ultimate Data Device
OK
AT+GMR
1.00
OK
AT+GSN
987612345-123
OK
```

The maximum lengths of the information responses are defined to be 2048 characters, but it is recommended that they are kept as simple as in the example. The serial number command is defined as optional. Another optional command is Global Object Identification command (+GOI) which should return the object identifiers of ITU-T Recommendation X.208 as numeric strings delimited by periods. The Complete Capabilities List command (+GCAP) should indicate the major capability areas of the TA. The support of different areas is presented in the response of +GCAP command. Each area may be presented by the selection command name of a specific capability area (e.g. +FCLASS for fax support) or some other predefined response. For instance, a GSM TA with fax capabilities could respond as follows:

```
AT+GCAP
+GCAP: +CGSM,+FCLASS,+W
OK
```

The first supported area in the response is presented with +CGSM. It is the response text to show that some or all GSM commands of the present document are supported. Second response text (+FCLASS) informs that some fax or voice capabilities are present, and the third text (+W) about the presence of wireless commands as specified by PCCA STD-101 [17]. Command +FCLASS=? (refer e.g. ITU-T T.31 [11] and T.32 [12]) should be used to query the supported fax capabilities and +WS46=? to query the wireless data services available:

```
AT+FCLASS=?;+WS46=?
0,1,2,2.0
(12)
OK
```

The TA of this example supports GSM data services, and fax service class 1 (TIA-578-A), 2 (manufacturer specific) and 2.0 (ITU-T T.32 [12]/ TIA-592).

The present document defines commands for ME identification which are similar to those for TA identification in V.25ter [14], for an example:

```
AT+CGMI
Mobile Manufacturer XYZ
OK
AT+CGMM
GSM Phone 1234
OK
AT+CGMR
1.00
OK
AT+CGSN
123456121234561
OK
```

Manufacturer, model and version commands work similarly as for TA, except that the serial number query returns the International Mobile Station Equipment Identity (IMEI) number. IMEI is fifteen digits long and consists of a type approval code, a final assembly code, a serial number and a spare digit (refer 3G TS 23.003 [7]). When the TA is implemented inside ME, the responses for both TA and ME queries will most likely follow the responses of ME identification.

## 6 Call control commands and methods

This clause describes the control of GSM/UMTS calls. Normal data and fax call control is done as in ITU-T Recommendations V.25ter [14], T.31 [11] and T.32 [12]. For voice call originating, refer subclause "ITU-T V.25ter dial command D".

### 6.1 Select type of address +CSTA

**Table 11: +CSTA parameter command syntax**

Command	Possible response(s)
+CSTA=[ <type> ]	
+CSTA?	+CSTA: <type>
+CSTA=?	+CSTA: (list of supported <type>s)

#### Description

Set command selects the type of number for further dialling commands (D) according to GSM/UMTS specifications. Test command returns values supported by the TA as a compound value.

#### Defined values

<type>: type of address octet in integer format (refer GSM 04.08 [8] subclause 10.5.4.7); default 145 when dialling string includes international access code character "+", otherwise 129

#### Implementation

Mandatory when other than default value allowed.

### 6.2 ITU-T V.25ter [14] dial command D

V.25ter [14] dial command D lists characters that may be used in a dialling string for making a call or controlling supplementary services in accordance with 3G TS 22.030 [19]. Their use in GSM/UMTS is listed in this subclause, as well as new dial modifiers applicable only to GSM/UMTS are introduced. For a ME supporting AT commands only, it is mandatory to support the control of supplementary services in accordance with 3G TS 22.030 [19] through the dial command or through the specific supplementary service commands (+CCFC, +CLCK, etc.), where 3G TS 22.030 [19] identifies the supplementary services as mandatory.

#### V.25ter dialling digits

1 2 3 4 5 6 7 8 9 0 \* # + A B C (implementation of these characters is mandatory for GSM/UMTS)

D (implementation of this character is optional for GSM/UMTS, and it is ignored)

#### V.25ter modifier characters

, (implementation of this character is mandatory for GSM/UMTS, but it may be ignored)

T P (implementation of these characters is mandatory for GSM/UMTS, but they are ignored)

! W @ (implementation of these characters is optional for GSM/UMTS, and they are ignored)

#### V.25ter semicolon character

In GSM/UMTS, when semicolon character is given after dialling digits (or modifiers), a voice call originated to the given address. TA returns to command state immediately (or after possible +COLP result code; refer subclause "Connected line identification presentation +COLP"). Refer Annex G for a detailed example.

### GSM/UMTS modifier characters

> (refer subclause "Direct dialling from phonebooks")

I or i (override the CLIR supplementary service subscription default value for this call; I = invocation (restrict CLI presentation) and i = suppression (allow CLI presentation); refer subclause "Calling line identification restriction +CLIR")

G or g (control the CUG supplementary service information for this call; uses index and info values set with command +CCUG; refer subclause "Closed user group +CCUG")

## 6.3 Direct dialling from phonebooks

GSM/UMTS ME and SIM can contain phonebooks which have a phone number and an alphanumeric field for each phonebook entry location. The use of V.25ter [14] dialling command ensures that direct dialling from ME and SIM phonebook is possible through ordinary communications software which just gives the phone number field to be filled and then use the D command to originate the call. Available memories may be queried with Select Phonebook Storage test command +CPBS=?, and location range for example with Read Phonebook Entries test command +CPBR=?.

### Execute commands

1. D><str>[I][G][ ; ] originate call to phone number which corresponding alphanumeric field is <str> (if possible, all available memories should be searched for the correct entry).
2. D>mem<n>[I][G][ ; ] originate call to phone number in memory *mem* entry location <n> (available memories may be queried with Select Phonebook Storage test command +CPBS=?; *mem* could be e.g. ME).
3. D><n>[I][G][ ; ] originate call to phone number in entry location <n> (it is manufacturer specific which memory storage of ME, SIM and TA is used; command Select Phonebook Memory Storage +CPBS setting is recommended to be used).

Semicolon character shall be added when voice call is originated. CLIR and CUG per call base modifiers may also be present.

### Responses

Possible error responses include +CME ERROR: <err> when error is related to ME functionality. Refer subclause 9.2 for possible error values. Otherwise TA responses can have values defined by V.25ter [14] and commands Service Reporting Control +CR and Connected Line Identification Presentation +COLP. Detailed error report of an unsuccessful originated call failed in a GSM/UMTS network error can be obtained with command Extended Error Report +CEER (if implemented).

### Defined values

<str>: string type value, which should equal to an alphanumeric field in at least one phonebook entry in the searched memories; used character set should be the one selected with Select TE Character Set +CSCS

<n>: integer type memory location should be in the range of locations available in the memory used

### Implementation

Mandatory when direct dialling is implemented. Also phonebook commands implementation is required.



## 6.4 Call mode +CMOD

**Table 12: +CMOD parameter command syntax**

Command	Possible response(s)
+CMOD= [ <mode> ]	
+CMOD?	+CMOD: <mode>
+CMOD=?	+CMOD: (list of supported <mode>s)

### Description

Set command selects the call mode of further dialling commands (D) or for next answering command (A). Mode can be either single or alternating (in the present document, terms "alternating mode" and "alternating call" refer to all GSM/UMTS bearer and teleservices that incorporate more than one basic service (voice, data, fax) within one call). When single mode is selected the call originating and hangup procedures are similar to procedures specified in ITU-T Recommendations V.25ter [14], T.31 [11] and T.32 [12]. In GSM/UMTS there can be voice followed by data (refer 3G TS 22.002 [1]), alternating voice/data (refer 3G TS 22.002 [1]) and alternating voice/fax calls (refer 3G TS 22.003 [2]). Refer next two subclauses for alternating call control methods.

Test command returns values supported by the TA as a compound value.

NOTE: +CMOD shall be set to zero after a successfully completed alternating mode call. It shall be set to zero also after a failed answering. The power-up, factory (&F) and user resets (Z) shall also set the value to zero. This reduces the possibility that alternating mode calls are originated or answered accidentally.

### Defined values

<mode>:

0 single mode

1 alternating voice/fax (teleservice 61)

2 alternating voice/data (bearer service 61)

3 voice followed by data (bearer service 81)

also all other values below 128 are reserved by the present document

### Implementation

Mandatory when alternating mode calls are implemented in the TA.

## 6.5 Hangup call +CHUP

**Table 13: +CHUP action command syntax**

Command	Possible response(s)
+CHUP	
+CHUP=?	

### Description

Execution command causes the TA to hangup the current GSM/UMTS call of the ME.

NOTE: The purpose of this command is not to replace the V.25ter [14] command H, but to give an assured procedure to terminate an alternating mode call. Refer next subclause.

### Implementation

Mandatory when alternating mode calls implemented in the TA.

## 6.6 Alternating mode call control method

This subclause describes the procedure to handle alternating mode calls with AT commands. Procedures are mandatory when alternating mode calls are implemented in the TA.

NOTE: ATH and drop DTR will not necessarily cause a hangup from voice mode. If the +CVHU is implemented the behaviour shall be controlled by its setting.

### Voice followed by data call (bearer service 81)

Figure 4 shows commands to start the call, to switch from voice to data (In-Call Modification) and to hang up the call. +CMOD and +FCLASS commands indicate the current settings before dialling or answering command, not that they shall be given just before D or A command. Refer subclause "Cellular result codes +CRC" for possible +CRING result code values. Refer Annex F for a detailed example.

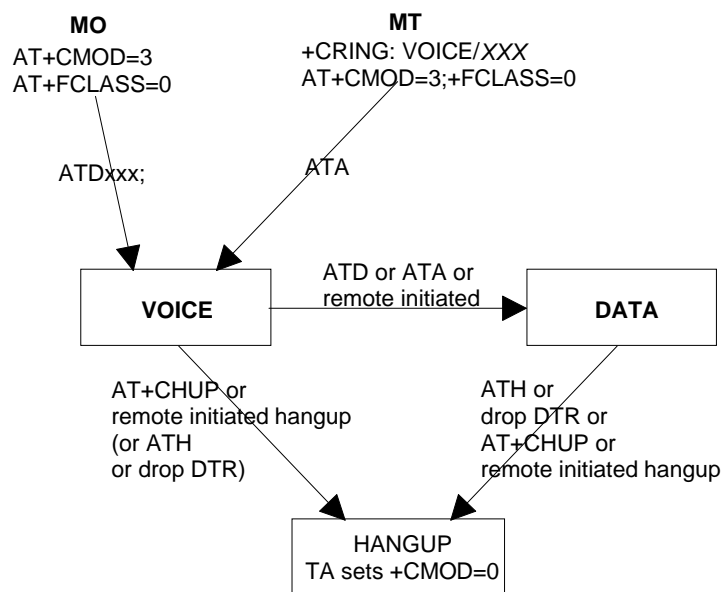

Figure 4: Voice followed by data call

### Voice/ data call (bearer service number 61)

Figure 5 shows the commands to start the call, to switch between modes (In-Call Modification) and to hang up the call. +CMOD and +FCLASS commands indicate the current settings before dialling or answering command, not that they shall be given just before D or A command. Refer subclause "Cellular result codes +CRC" for possible +CRING result code values. Refer Annex E for a detailed example.

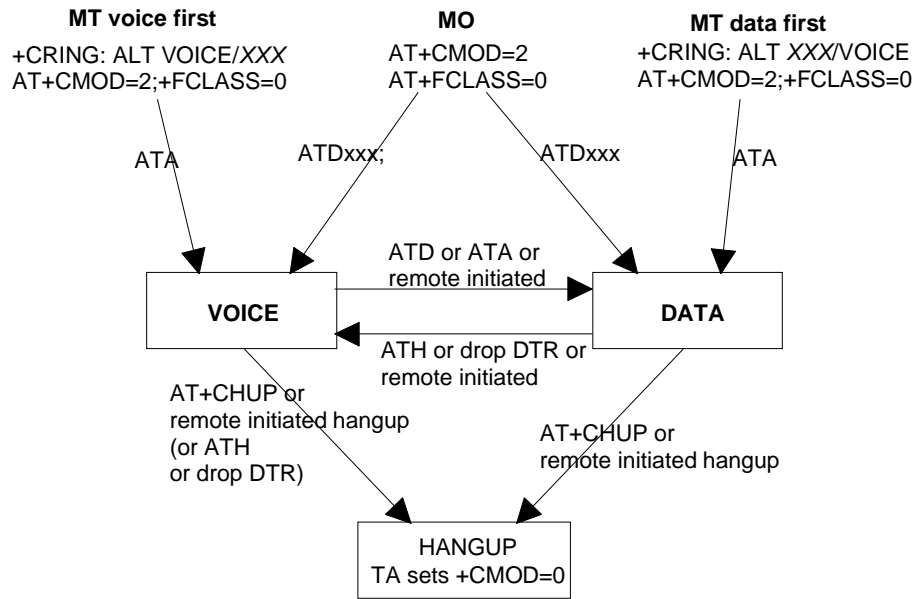

Figure 5: Alternating voice and data call

**Voice/ fax call (teleservice number 61)**

Figure 6 shows the commands to start the call, to switch between modes (In-Call Modification) and to hang up the call. +CMOD and +FCLASS commands indicate the current settings before dialling or answering command, not that they shall be given just before D or A command. The parameter "x" of +FCLASS command can be 1, 1.0, 2 or 2.0.

NOTE: The transition from fax mode to voice mode is for further study.

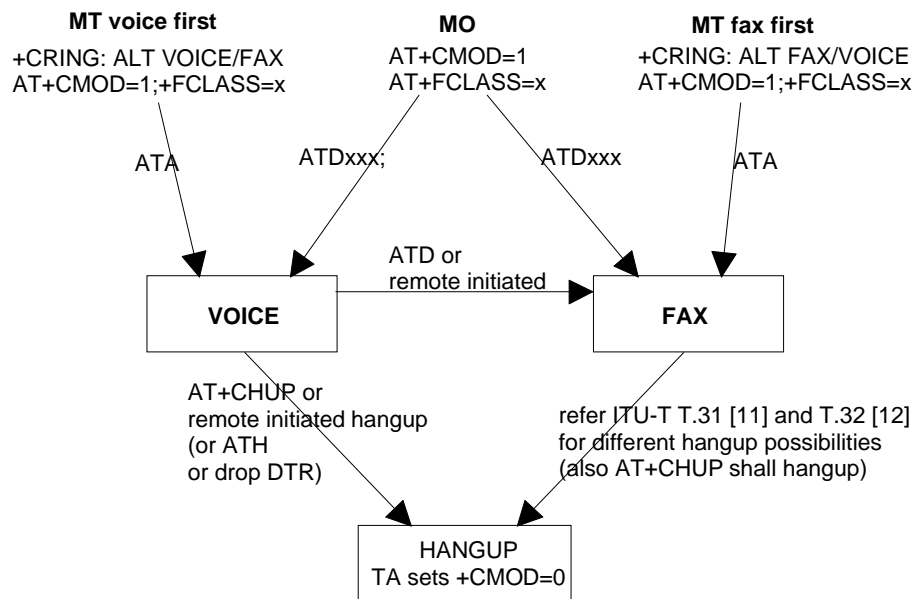

Figure 6: Alternating voice and fax call

## 6.7 Select bearer service type +CBST

**Table 14: +CBST parameter command syntax**

Command	Possible response(s)
+CBST=[ <speed> [ , <name> [ , <ce> ] ] ]	
+CBST?	+CBST: <speed> , <name> , <ce>
+CBST=?	+CBST: (list of supported <speed>s) , (list of supported <name>s) , (list of supported <ce>s)

### Description

Set command selects the bearer service <name> with data rate <speed>, and the connection element <ce> to be used when data calls are originated (refer 3G TS 22.002 [1]). Values may also be used during mobile terminated data call setup, especially in case of single numbering scheme calls (refer +CSNS).

Test command returns values supported by the TA as compound values.

### Defined values

NOTE: The default values of the subparameters are manufacturer specific since they depend on the purpose of the device and data services provided by it. Not all combinations of these subparameters are supported by GSM/UMTS (refer 3G TS 22.002 [1]).

<speed>:

0	autobauding (automatic selection of the speed; this setting is possible in case of 3.1 kHz modem and non-transparent service)
1	300 bps (V.21)
2	1200 bps (V.22)
3	1200/75 bps (V.23)
4	2400 bps (V.22bis)
5	2400 bps (V.26ter)
6	4800 bps (V.32)
7	9600 bps (V.32)
12	9600 bps (V.34)
14	14400 bps (V.34)
15	19200 bps (V.34)
16	28800 bps (V.34)
17	33600 bps (V.34)
34	1200 bps (V.120)
36	2400 bps (V.120)
38	4800 bps (V.120)
39	9600 bps (V.120)
43	14400 bps (V.120)
47	19200 bps (V.120)
48	28800 bps (V.120)
49	38400 bps (V.120)
50	48000 bps (V.120)
51	56000 bps (V.120)
65	300 bps (V.110)
66	1200 bps (V.110)
68	2400 bps (V.110 or X.31 flag stuffing)
70	4800 bps (V.110 or X.31 flag stuffing)
71	9600 bps (V.110 or X.31 flag stuffing)
75	14400 bps (V.110 or X.31 flag stuffing)
79	19200 bps (V.110 or X.31 flag stuffing)
80	28800 bps (V.110 or X.31 flag stuffing)
81	38400 bps (V.110 or X.31 flag stuffing)
82	48000 bps (V.110 or X.31 flag stuffing)

- 83 56000 bps (V.110 or X.31 flag stuffing; this setting can be used in conjunction with asynchronous non-transparent UDI or RDI service in order to get FTM)
- 84 64000 bps (X.31 flag stuffing; this setting can be used in conjunction with asynchronous non-transparent UDI service in order to get FTM)
- 115 56000 bps (bit transparent)
- 116 64000 bps (bit transparent)
- 120 32000 bps (PIAFS32k)
- 121 64000 bps (PIAFS64k)

also all other values below 128 are reserved by the present document.

<name>:

- 0 data circuit asynchronous (UDI or 3.1 kHz modem)
- 1 data circuit synchronous (UDI or 3.1 kHz modem)
- 2 PAD Access (asynchronous) (UDI)
- 3 Packet Access (synchronous) (UDI)
- 4 data circuit asynchronous (RDI)
- 5 data circuit synchronous (RDI)
- 6 PAD Access (asynchronous) (RDI)
- 7 Packet Access (synchronous) (RDI)

also all other values below 128 are reserved by the present document.

<ce>:

- 0 transparent
- 1 non-transparent
- 2 both, transparent preferred
- 3 both, non-transparent preferred

**Implementation**

Mandatory when data calls implemented.

## 6.8 Radio link protocol +CRLP

**Table 15: +CRLP parameter command syntax**

Command	Possible response(s)
+CRLP=[<iws>[ ,<mws>[ ,<T1>[ ,<N2>[ ,<ver>[ ,<T4>]]]]]]	
+CRLP?	+CRLP: <iws> ,<mws> ,<T1> ,<N2>[ ,<ver1>[ ,<T4>]] [<CR><LF>+CRLP: <iws> ,<mws> ,<T1> ,<N2>[ ,<ver2>[ ,<T4>]] [...]]
+CRLP=?	+CRLP: (list of supported <iws>s) ,(list of supported <mws>s) , (list of supported <T1>s) ,(list of supported <N2>s) [ ,<ver1> [ , (list of supported <T4>s) ] ] [<CR><LF>+CRLP: (list of supported <iws>s) ,(list of supported <mws>s) ,(list of supported <T1>s) ,(list of supported <N2>s) [ ,<ver1>[ , (list of supported <T4>s) ] ] [...]]

**Description**

Radio link protocol (RLP) parameters used when non-transparent data calls are originated may be altered with set command. Available command subparameters depend on the RLP versions implemented by the device (e.g. <ver> may not be available if device supports only versions 0 and 1).

NOTE 1: If radio link protocol is not used, but some other error correcting protocol (for transparent data calls), V.25ter [14] Error Control Selection test command +ES=? may be used to indicate the presence of the protocol.

Read command returns current settings for each supported RLP version <verx>. Only RLP parameters applicable to the corresponding <verx> are returned.

Test command returns values supported by the TA as a compound value. If ME/TA supports several RLP versions <verx>, the RLP parameter value ranges for each <verx> are returned in a separate line.

#### Defined values

<ver>, <verx>: RLP version number in integer format; when version indication is not present it shall equal 0

NOTE 2: Versions 0 and 1 share the same parameter set. Read and test commands shall return only one line for this set (where <verx> is not present).

<iws>, <mws>, <T1>, <N2>, <T4>: IWF to MS window size, MS to IWF window size, acknowledgement timer T1, retransmission attempts N2, re-sequencing period T4 in integer format (default values and value ranges depend on RLP version; refer 3G TS 24.022 [18]): T1 and T4 are in units of 10 ms.

#### Implementation

Mandatory when RLP implemented.

## 6.9 Service reporting control +CR

Table 16: +CR parameter command syntax

Command	Possible response(s)
+CR=[ <mode> ]	
+CR?	+CR: <mode>
+CR=?	+CR: (list of supported <mode>s)

#### Description

Set command controls whether or not intermediate result code +CR: <serv> is returned from the TA to the TE. If enabled, the intermediate result code is transmitted at the point during connect negotiation at which the TA has determined which speed and quality of service will be used, before any error control or data compression reports are transmitted, and before the intermediate result code CONNECT is transmitted.

NOTE: This command replaces V.25ter [14] command Modulation Reporting Control +MR, which is not appropriate for use in the GSM/UMTS network. Possible error control (other than radio link protocol) and data compression reporting can be enabled with V.25ter commands Error Control Reporting +ER and Data Compression Reporting +DR.

Test command returns values supported by the TA as a compound value.

#### Defined values

<mode>:

0 disables reporting

1 enables reporting

<serv>:

ASYNCR asynchronous transparent

SYNCR synchronous transparent

REL ASYNC asynchronous non-transparent

REL SYNC synchronous non-transparent

GPRS [ <L2P> ] GPRS

The optional <L2P> proposes a layer 2 protocol to use between the MT and the TE. It is defined in the Enter GPRS Data Mode (+CGDATA) command.

### Implementation

Mandatory when data calls implemented.

## 6.10 Extended error report +CEER

**Table 17: +CEER action command syntax**

Command	Possible response(s)
+CEER	+CEER: <report>
+CEER=?	

### Description

Execution command causes the TA to return one or more lines of information text <report>, determined by the ME manufacturer, which should offer the user of the TA an extended report of the reason for

- the failure in the last unsuccessful call setup (originating or answering) or in-call modification;
- the last call release;
- the last unsuccessful GPRS attach or unsuccessful PDP context activation;
- the last GPRS detach or PDP context deactivation.

Typically, the text will consist of a single line containing the cause information given by GSM/UMTS network in textual format.

### Defined values

<report>: the total number of characters, including line terminators, in the information text shall not exceed 2041 characters.

Text shall not contain the sequence 0<CR> or OK<CR>.

### Implementation

Optional.

## 6.11 Cellular result codes +CRC

**Table 18: +CRC parameter command syntax**

Command	Possible response(s)
+CRC=[ <mode> ]	
+CRC?	+CRC: <mode>
+CRC=?	+CRC: (list of supported <mode>s)

## Description

Set command controls whether or not the extended format of incoming call indication or GPRS network request for PDP context activation is used. When enabled, an incoming call is indicated to the TE with unsolicited result code +CRING: <type> instead of the normal RING.

Test command returns values supported by the TA as a compound value.

NOTE: Similar command may be found in TIA IS-99 [15] and TIA IS-135 [16].

## Defined values

<mode>:

0 disables extended format

1 enables extended format

<type>:

ASYNC [ ,<priority>[ ,<subaddr> ,<satype> ] ]	asynchronous transparent
SYNC [ ,<priority>[ ,<subaddr> ,<satype> ] ]	synchronous transparent
REL ASYNC [ ,<priority>[ ,<subaddr> ,<satype> ] ]	asynchronous non-transparent
REL SYNC [ ,<priority>[ ,<subaddr> ,<satype> ] ]	synchronous non-transparent
FAX [ ,<priority>[ ,<subaddr> ,<satype> ] ]	facsimile (TS 62)
VOICE [ ,<priority>[ ,<subaddr> ,<satype> ] ]	normal voice (TS 11)
VOICE/XXX [ ,<priority>[ ,<subaddr> ,<satype> ] ] ASYNC, SYNC, REL ASYNC or REL SYNC	voice followed by data (BS 81) (XXX is
ALT VOICE/XXX [ ,<priority>[ ,<subaddr> ,<satype> ] ]	alternating voice/data, voice first (BS 61)
ALT XXX/VOICE [ ,<priority>[ ,<subaddr> ,<satype> ] ]	alternating voice/data, data first (BS 61)
ALT VOICE/FAX [ ,<priority>[ ,<subaddr> ,<satype> ] ]	alternating voice/fax, voice first (TS 61)
ALT FAX/VOICE [ ,<priority>[ ,<subaddr> ,<satype> ] ]	alternating voice/fax, fax first (TS 61)
GPRS <PDP_type> , <PDP_addr>[ , <L2P> ]	GPRS network request for PDP context activation
VGC <GCA> , <GId> , <ackflag> [ ,<priority> ]	voice group call (TS 91)
VBC <GCA> , <GId> , <ackflag> [ ,<priority> ]	voice broadcast call (TS 92)

The optional <priority> indicates the eMLPP priority level of the incoming call by paging, notification or setup message. The priority level values are as defined in eMLPP specification 3G TS 22.067 [57].

<subaddr>: string type subaddress of format specified by <satype>

<satype>: type of subaddress octet in integer format (refer 3G TS 24.008 [57] subclause 10.5.4.8)

<PDP\_type> and <PDP\_addr> are as defined in the Define PDP Context (+CGDCONT) command. The optional <L2P> proposes a layer 2 protocol to use between the MT and the TE. It is defined in the Enter GPRS Data Mode (+CGDATA) command. If the MT is unable to announce to the TE the network's request (for example it is in V.25ter online data state) the MT shall reject the request. No corresponding unsolicited result code shall be issued when the MT returns to a command state.

<GCA> is a part of the group call reference as specified in 3G TS 23.003 [7] and indicates group call area.



<GId> is a part of the group call reference as specified in 3G TS 23.003 [7] and indicates group call identification. The <ackflag>=1 proposes that a predefined confirmation procedure is to be used after the call is ended. For <ackflag>=0 no confirmation procedure is required.

### Implementation

Mandatory when data or fax circuit mode calls implemented or for a ME supporting AT commands only and eMLPP or VGCS or VBS is implemented.

## 6.12 HSCSD device parameters +CHSD

**Table 19: +CHSD action command syntax**

Command	Possible response(s)
+CHSD	+CHSD: <mclass> , <maxRx> , <maxTx> , <sum> , <codings> +CME ERROR: <err>
+CHSD=?	

### Description

Execution command returns information about HSCSD features (refer 3G TS 22.034 [29]) supported by the ME/TA. Refer subclause 9.2 for possible <err> values.

### Defined values

<mclass>: integer type; multislot class

<maxRx>: integer type; maximum number of receive timeslots that ME can use

<maxTx>: integer type; maximum number of transmit timeslots that ME can use

<sum>: integer type; total number of receive and transmit timeslots that ME can use at the same time (per TDMA frame). The following applies in a HSCSD call:  $1 \leq (\text{receive slots}) + (\text{transmit slots}) \leq \text{<sum>}$

<codings> is a sum of integers each representing a supported channel coding (e.g. value 5 indicates that 4,8k and 9,6k channel codings are supported):

1 4,8k full rate data traffic channel

4 9,6k full rate data traffic channel

8 14,4k full rate data traffic channel

16 28,8k full rate data traffic channel (only possible when 14.4k is supported)

32 32,0k full rate data traffic channel (only possible in a two-timeslot configuration)

64 43,2k full rate data traffic channel (only possible when 14.4k is supported)

### Implementation

Mandatory when HSCSD implemented.

## 6.13 HSCSD transparent call configuration +CHST

**Table 20: +CHST parameter command syntax**

Command	Possible response(s)
+CHST=[ <wRx> [ , <codings> ] ]	
+CHST?	+CHST: <wRx> , <codings>
+CHST=?	

**Description**

Set command controls parameters for transparent HSCSD calls. Changing them during a call does not affect the current call.

**Defined values**

<wRx>: integer type; wanted amount of receive timeslots. Default value 0 indicates that TA shall calculate a proper value from currently selected fixed network user rate (<speed> subparameter from +CBST command) and <codings>

<codings>: a sum of integers each representing a channel coding that is accepted for transparent HSCSD calls. Default value 0 indicates that all supported codings are accepted (refer +CHSD command for other values)

**Implementation**

Mandatory when transparent HSCSD implemented.

## 6.14 HSCSD non-transparent call configuration +CHSN

**Table 21: +CHSN parameter command syntax**

Command	Possible response(s)
+CHSN=[<wAiur>[,<wRx>[,<topRx>[,<codings>]]]]	
+CHSN?	+CHSN: <wAiur>,<wRx>,<topRx>,<codings>
+CHSN=?	+CHSN: (list of supported <wAiur>s), (list of supported <wRx>s), (list of supported <topRx>), (list of supported <codings>s)

**Description**

Set command controls parameters for non-transparent HSCSD calls. Changing <topRx> or <codings> value during a call does not affect the current call. Changing of <wAiur> or <wRx> affects the current call only if <topRx> was non-zero when call was established.

**Defined values**

<wAiur>: integer type; wanted air interface user rate. Default value 0 indicates that TA shall calculate a proper value from currently selected fixed network user rate (<speed> subparameter from +CBST command), <codings>, and <wRx> (or <maxRx> from +CHSD command if <wRx>=0). Other values:

- 1 9600 bps
- 2 14400 bps
- 3 19200 bps
- 4 28800 bps
- 5 38400 bps
- 6 43200 bps
- 7 57600 bps

<wRx>: integer type; wanted amount of receive timeslots. Default value 0 indicates that TA shall calculate a proper value from currently selected <wAiur> and <codings>

<topRx>: integer type; top value for <wRx> that user is going to request during the next established non-transparent HSCSD call. Default value 0 indicates that user is not going to change <wAiur>/<wRx> during the next call

<codings>: a sum of integers each representing a channel coding that is accepted for non-transparent HSCSD calls. Default value 0 indicates that all supported codings are accepted (refer +CHSD command for other values)

### Implementation

Mandatory when non-transparent HSCSD implemented.

## 6.15 HSCSD current call parameters +CHSC

**Table 22: +CHSC action command syntax**

Command	Possible response(s)
+CHSC	+CHSC: <rx>, <tx>, <aiur>, <coding>
+CHSC=?	

### Description

Execution command returns information about current HSCSD call. If no HSCSD call is active, all parameters returned shall equal zero. (It is manufacturer specific whether non-zero information is returned in case of an active normal single-slot data call.)

### Defined values

<rx>: integer type; number of receive timeslots currently in use

<tx>: integer type; number of transmit timeslots currently in use

<aiur>: integer type; current air interface user rate (in case of transparent service this equals fixed network user rate) (refer +CHSN command for possible values). For the two-timeslot ECSD bit transparent configuration the following additional values apply:

8 56000 bps

9 64000 bps

<coding>: current channel coding (refer +CHSD command for possible values)

### Implementation

Optional.

## 6.16 HSCSD parameters report +CHSR

**Table 23: +CHSR action command syntax**

Command	Possible response(s)
+CHSR=[ <mode> ]	
+CHSR?	+CHSR: <mode>
+CHSR=?	+CHSR: (list of supported <mode>s)

**Description**

Enabled command returns intermediate result code +CHSR: <type> from the TA to the TE when an HSCSD call is being set up. The result code represents the current (negotiated or renegotiated) HSCSD parameters. If enabled, the intermediate result code is transmitted at the point of the call setup negotiation where the TA has determined what type of an HSCSD connection will be used. Result code transmission is done after possible service (+CR), error control (+ER), and/or compression (+DR) reporting but before possible TE-TA rate (+ILRR) reporting and before the intermediate result code CONNECT is transmitted. The format of the intermediate result code is:

+CHSR: <rx>, <tx>, <aiur>, <coding>

For the value definitions, refer to +CHSN and +CHSC commands. For instance, for a non-transparent HSCSD call, result code '+CHSR: 2, 2, 4, 8' means that the call has two timeslots in both up- and downlink, the air interface user rate is 28800 bps, and the used channel coding TCH/F14.4.

**Defined values**

<mode>:

0 disables reporting

1 enables reporting

**Implementation**

Mandatory when HSCSD implemented

## 6.17 HSCSD automatic user initiated upgrading + CHSU

**Table 24: +CHSU parameter command syntax**

Command	Possible response(s)
+CHSU=<mode>	
+CHSU?	+CHSU: <mode>
+CHSU=?	+CHSU: (list of supported <mode>s)

**Description**

Set command controls whether or not automatic user initiated service level upgrading shall be used for non-transparent HSCSD calls. "Automatic" means that, if enabled, the ME/TA shall use the UP bit in the received RLP frames to determine when to initiate user initiated service level upgrading (i.e. when to modify the +CHSN parameters <wAiur> and/or <wRx> for the current call). Refer to 3G TS 27.001 for details on the interpretation of the UP bit(s).

NOTE: The validity of the UP bit in the RLP frames depends on the result of the RLP negotiations. The UP bit shall only be used if the result of the RLP negotiations were successful with respect to the UP bit.

**Defined values**

<mode>:

0 disables use of UP bit for upgrading

1 enables use of UP bit for upgrading

**Implementation**

Optional

## 6.18 HSCSD non-transparent asymmetry configuration +CHSA

**Table 25: +CHSA parameter command syntax**

Command	Possible response(s)
+CHSA=<mode>	
+CHSA?	+CHSA: <mode>
+CHSA=?	+CHSA: (list of supported <mode>s)

### Description

Set command controls the preferred asymmetry bias for non-transparent ECSD calls. Downlink biased asymmetry means that 8-PSK modulation is preferred downlink and GMSK modulation uplink. Uplink based asymmetry means that 8-PSK modulation is preferred uplink and GMSK downlink. Changing of <mode> affects the current call only if <topRx> (refer +CHSN) was non-zero when call was established.

Test command returns values supported by the ME/TA as compound values. The <mode> subparameter range indirectly indicates the MS Type; range (0-1) indicates MS Type A and range (0-2) indicates MS Type B.

NOTE: ECSD is also controlled by +CHSD, +CHSN and +CHST.

### Defined values

<mode>:

- 0 No preference
- 1 Downlink biased asymmetry
- 2 Uplink biased asymmetry

### Implementation

Mandatory when non-transparent ECSD is implemented.

## 6.19 Single numbering scheme +CSNS

**Table 26: +CSNS parameter command syntax**

Command	Possible response(s)
+CSNS= [ <mode> ]	
+CSNS?	+CSNS: <mode>
+CSNS=?	+CSNS: (list of supported <mode>s)

### Description

Set command selects the bearer or teleservice to be used when mobile terminated single numbering scheme call is established. Parameter values set with +CBST command shall be used when <mode> equals to a data service. If +CBST parameter is set to a value that is not applicable to single numbering calls, ME/TA shall map the value to the closest valid one. E.g. if user has set <speed>=71, <name>=2 and <ce>=1 (non-transparent asynchronous 9600 bps V.110 ISDN connection) for mobile originated calls, ME/TA shall map the values into non-transparent asynchronous 9600 bps V.32 modem connection when single numbering scheme call is answered.

Test command returns values supported by the TA as compound values.

### Defined values

<mode>:

- 0 voice

- 1 alternating voice/fax, voice first (TS 61)
- 2 fax (TS 62)
- 3 alternating voice/data, voice first (BS 61)
- 4 data
- 5 alternating voice/fax, fax first (TS 61)
- 6 alternating voice/data, data first (BS 61)
- 7 voice followed by data (BS 81)

### Implementation

Optional.

## 6.20 Voice Hangup Control +CVHU

**Table 27: +CVHU parameter command syntax**

Command	Possible response(s)
+CVHU=[ <mode> ]	
+CVHU?	+CVHU: <mode>
+CVHU=?	+CVHU: (list of supported <mode>s)

### Description

Set command selects whether ATH or "drop DTR" shall cause a voice connection to be disconnected or not. By voice connection is also meant alternating mode calls that are currently in voice mode. (See subclause 6.6).

NOTE: When <mode> = 2, this command must be seen in conjunction with the V.25ter [14] command &D. Else &D shall be ignored.

### Defined values

<mode>:

- 0 "Drop DTR" ignored but OK response given. ATH disconnects.
- 1 "Drop DTR" and ATH ignored but OK response given.
- 2 "Drop DTR" behaviour according to &D setting. ATH disconnects.

### Implementation

Optional

## 6.21 V.120 rate adaption protocol +CV120

**Table 28: +CV120 parameter command syntax**

Command	Possible response(s)
+CV120=[<rah>[,<mfm>[,<mode>[,<llineg>[,<assign>[,<negtype>]]]]]]	
+CV120?	+CV120: <rah>, <mfm>, <mode>, <llineg>, <assign>, <negtype>
+CV120=?	+CV120: (list of supported <rah>s), (list of supported <mfm>s), (list of supported <mode>s), (list of supported <llineg>s), (list of supported <assign>s), (list of supported <negtype>s)

### Description

Set command sets the values of the V.120 protocol parameters (defined in CCITT V.120) that are carried in the GSM BC and/or LLC information elements.

Read command returns current settings for the V.120 parameters.

Test command returns values supported by the TA as a compound value.

### Defined values

<rah>

0 rate adaption header not included

1 rate adaption header included (mandatory for protocol sensitive modes).

<mfm>

0 multiple frame establishment not supported, only UI frames allowed

1 multiple frame establishment supported, both I and UI frames allowed.

<mode>

0 bit transparent mode of operation

1 protocol sensitive mode of operation.

<llineg>

0 no negotiation, LLI = 256 only

1 negotiation allowed. Note - <negtype> indicates the connection over which the negotiation is performed.

<assign>

0 message originator is "default assignee"

1 message originator is "assignor only".

<negtype>

0 negotiation is done using logical link zero

1 negotiation is done with USER INFORMATION messages on a temporary signalling connection.

GSM/UMTS does not support all the possible modes of V.120 operation. However, in order to accommodate possible future additions, the complete set of parameters is included in the command.

The permitted values are: 1, 1 or 0, 1, 0, 0, 0.

A recommended set of default values is: 1, 1, 1, 0, 0, 0.

### Implementation

Mandatory, if the ME supports V.120 interworking.

## 6.22 Settings date format +CSDF

**Table 29: +CSDF parameter command syntax**

Command	Possible response(s)
+CSDF=[ <mode> ]	+CME ERROR: <err>
+CSDF?	+CSDF: <mode> +CME ERROR: <err>
+CSDF=?	+CSDF: (list of supported <mode>s) +CME ERROR: <err>

### Description

This command sets the date format of the date information presented to the user.

### Defined values

<mode>:

NOTE: It is manufacturer specific which modes that are supported.

1 DD-MMM-YYYY

NOTE: Presentation of MMM is language dependent.

2 DD-MM-YY

3 MM/DD/YY

4 DD/MM/YY

5 DD.MM.YY

6 YYMMDD

7 YY-MM-DD

8-255 Manufacturer specific

### Implementation

Optional

## 6.23 Silence Command +CSIL

**Table 30: +CSIL parameter command syntax**

Command	Possible response(s)
+CSIL=[ <mode> ]	+CME ERROR: <err>
+CSIL?	+CSIL: <mode> +CME ERROR: <err>
+CSIL=?	+CSIL: (list of supported <mode>s) +CME ERROR: <err>



**Description**

Set command enables/disables the silent mode. When the phone is in silent mode, all sounds from MS are suppressed except voice.

Read command reads the current setting.

Test command lists the supported modes.

**Defined values**

<mode>:

0 Silent mode off

1 Silent mode on

**Implementation**

Optional

## 6.24 Settings time format +CSTF

**Table 31: +CSTF parameter command syntax**

Command	Possible response(s)
+CSTF=[ <mode> ]	+CME ERROR: <err>
+CSTF?	+CSTF:<mode> +CME ERROR: <err>
+CSTF=?	+CSTF:(list of supported <mode>s) +CME ERROR: <err>

**Description**

Set command sets the time format of the time information presented to the user.

Read commands reads the current setting.

Test commands reads the supported <modes>s.

**Defined values**

<mode>:

1 HH:MM (24 hour clock)

2 HH:MM a.m./p.m.

3-7 Manufacturer specific

**Implementation**

Optional

## 6.25 ITU-T V.25ter [14] call control commands

Table 32: V.25ter call control commands

Command	Subclause	Impl.	Use in GSM/UMTS
D[ <dial_string> ] [ ; ]	6.3.1	mand.	originates a call
T	6.3.2	mand.	ignored (select tone dialling)
P	6.3.3	mand.	ignored (select pulse dialling)
A	6.3.5	mand.	answer a call
H[ <value> ]	6.3.6	mand.	hang-up a single mode call; for alternate mode call refer subclause "Hangup call +CHUP" (only value equal to zero needed)
O[ <value> ]	6.3.7	mand.	returns TA to online data state from online command mode (only value equal to zero needed)
S0= [ <value> ]	6.3.8	mand.	sets the number of call indications (rings) before automatically answering the call; value equalling zero disables automatic answering and is the default
S6= [ <value> ]	6.3.9	mand.	ignored (pause before blind dialling)
S7= [ <value> ]	6.3.10	mand.	sets number of seconds to wait for completion of call answering or originating procedure before giving up and disconnecting
S8= [ <value> ]	6.3.11	mand.	sets number of seconds to wait when comma dial modifier encountered in dial string of D command (default is 2 seconds)
S10= [ <value> ]	6.3.12	mand.	sets number of tenths of seconds to wait before disconnecting after TA has indicated the absence of received line signal
L[ <value> ]	6.3.13	mand.	ignored (monitor speaker loudness)
M[ <value> ]	6.3.14	mand.	ignored (monitor speaker mode)

## 6.26 ITU-T V.25ter [14] data compression commands

Table 33: V.25ter data compression commands

Command	Subclause	Impl.	Use in GSM/UMTS
+DS= [ <dir> [ , <neg> [ , <P1> [ , <P2> ] ] ] ]	6.6.1	mand. when V.42bis	controls ITU-T Recommendation V.42bis data compression functions; for subparameter defaults in GSM/UMTS refer 3G TS 24.022 [18]
+DR= [ <value> ]	6.6.2	mand. when V.42bis	determines whether the use of V.42bis is informed using intermediate result code +DR: <type> before going online data state after call answering or originating

## 6.27 Informative examples

The alternating mode call handling (voice and fax, or voice and data) and the data call setup commands are defined such that the dialling command of V.25ter [14] (D) still always originates a call. The purpose is to support all current TE applications using the dialling command as default. Fax calls are controlled following the rules of ITU-T T.31 [11] and T.32 [12] standards.

An example where a voice call is originated:

```
ATD+1 812 5556731; (type of address defaults to 145, CLI presentation is restricted for this call)
OK (call setup was successful)
```

An example where a voice call is attempted from a phonebook:

```
ATD>"Doe Joe"G; (enable CUG control for this call)
+CME ERROR: 22 (entry "Doe Joe" is not found)
```

Also supplementary services may be controlled using dial command according to 3G TS 22.030 [19]. An example of call forwarding on no reply for telephony with the adjustment of the no reply condition timer on 25 seconds:

```
ATD**61*+1812555673*11*25#
OK                (modification was successful)
```

Two new commands are created for controlling the alternating mode calls. First one, Call Mode (+CMOD), selects between single and alternating mode. Because this is a crucial command, it is defined that the value is set back to zero (single mode) after every successfully originated alternating mode call. Also on power-up and factory or user resets, the value is set to zero. The second new command, Hangup Call (+CHUP), is not a replacement of V.25ter [14] command H, but a command which reliably disconnects the call in GSM/UMTS network. This is defined because the H command is used to switch from fax or data mode to voice mode.

The setting of GSM/UMTS bearer service (data circuit duplex asynchronous and synchronous, PAD access circuit asynchronous, or data packet duplex synchronous), is done with Select Bearer Service Type (+CBST). It chooses one of the four mentioned bearer services, the data rate of the service (or actually the modulation when modem IWFs are used), and enables or disables RLP. Command Radio Link Protocol (+CRLP) is used to set the RLP parameters in the radio path.

Service Reporting Control command (+CR) is defined similarly as the reporting of modulation, V.18, error control, and data compression which are V.25ter [14] features used to show information about the type of the established connection before the CONNECT intermediate result code. +CR command has one subparameter which specifies whether the intermediate result code +CR: <serv> is returned or not. The result code should be returned before any V.25ter [14] reporting result codes. An example of setting up an asynchronous 9600 bit/s modem connection with service reporting:

```
AT+CBST=7,0,1    (asynchronous modem 9600 bit/s and RLP)
OK
AT+CR=1          (enable reporting)
OK
ATD1234567890
+CR: REL ASYNC
CONNECT 9600
```

As GSM/UMTS network offers more information about the reason of the failure in call originating and answering than normal PSTN, it is useful to add an extra command to return this information to the TE. This information should not be returned always after unsuccessful call originating or answering, because many TE applications look for just the regular NO CARRIER, BUSY, NO ANSWER and CONNECT messages. Action command Extended Error Report (+CEER) does not have any subparameters, and it returns the cause of the latest call setup failure. This information may be the textual presentation of the GSM/UMTS network failure code (refer GSM specification 04.08 [8] Annex H), or some other information defined by the TA manufacturer.

## 7 Network service related commands

This clause describes GSM/UMTS network related commands, which are not covered in call control clause of the present document. Commands include GSM/UMTS supplementary service handling, MSISDN query, ME and network facility locking, and network registration information query.

### 7.1 Subscriber number +CNUM

**Table 34: +CNUM action command syntax**

Command	Possible response(s)
+CNUM	+CNUM: [<alpha1>], <number1>, <type1>[ , <speed>, <service>[ , <itc>]] [<CR><LF>+CNUM: [<alpha2>], <number2>, <type2>[ , <speed>, <service> [ , <itc>]] [...]] +CME ERROR: <err>
+CNUM=?	

#### Description

Action command returns the MSISDNs related to the subscriber (this information can be stored in the SIM or in the ME). If subscriber has different MSISDN for different services, each MSISDN is returned in a separate line. Refer subclause 9.2 for possible <err> values.

### Defined values

<alpha>: optional alphanumeric string associated with <number>; used character set should be the one selected with command Select TE Character Set +CSCS

<number>: string type phone number of format specified by <type>

<type>: type of address octet in integer format (refer GSM 04.08 [8] subclause 10.5.4.7)

<speed>: as defined in subclause 6.7

<service> (service related to the phone number):

- 0 asynchronous modem
- 1 synchronous modem
- 2 PAD Access (asynchronous)
- 3 Packet Access (synchronous)
- 4 voice
- 5 fax

also all other values below 128 are reserved by the present document

<itc> (information transfer capability):

- 0 3,1 kHz
- 1 UDI

### Implementation

Optional.

## 7.2 Network registration +CREG

**Table 35: +CREG parameter command syntax**

Command	Possible response(s)
+CREG=[ <n> ]	
+CREG?	+CREG: <n>, <stat>[ , <lac>, <ci> ] +CME ERROR: <err>
+CREG=?	+CREG: (list of supported <n>s)

### Description

Set command controls the presentation of an unsolicited result code +CREG: <stat> when <n>=1 and there is a change in the ME network registration status, or code +CREG: <stat>[ , <lac>, <ci> ] when <n>=2 and there is a change of the network cell.

Read command returns the status of result code presentation and an integer <stat> which shows whether the network has currently indicated the registration of the ME. Location information elements <lac> and <ci> are returned only when <n>=2 and ME is registered in the network. Refer subclause 9.2 for possible <err> values.

**Defined values**

<n>:

- 0 disable network registration unsolicited result code
- 1 enable network registration unsolicited result code +CREG: <stat>
- 2 enable network registration and location information unsolicited result code +CREG: <stat>[ ,<lac> ,<ci> ]

<stat>:

- 0 not registered, ME is not currently searching a new operator to register to
- 1 registered, home network
- 2 not registered, but ME is currently searching a new operator to register to
- 3 registration denied
- 4 unknown
- 5 registered, roaming

<lac>: string type; two byte location area code in hexadecimal format (e.g. "00C3" equals 195 in decimal)

<ci>: string type; two byte cell ID in hexadecimal format

**Implementation**

Optional.

## 7.3 Operator selection +COPS

**Table 36: +COPS parameter command syntax**

Command	Possible response(s)
+COPS=[<mode>[ ,<format> [ ,<oper> ] ] ]	+CME ERROR: <err>
+COPS?	+COPS: <mode>[ ,<format> ,<oper> ] +CME ERROR: <err>
+COPS=?	+COPS: [ list of supported ( <stat> , long alphanumeric <oper> , short alphanumeric <oper> , numeric <oper> ) s ] [ , , ( list of supported <mode> s ) , ( list of supported <format> s ) ] +CME ERROR: <err>

**Description**

Set command forces an attempt to select and register the GSM/UMTS network operator. <mode> is used to select whether the selection is done automatically by the ME or is forced by this command to operator <oper> (it shall be given in format <format>). If the selected operator is not available, no other operator shall be selected (except <mode>=4). The selected operator name format shall apply to further read commands (+COPS?) also. <mode>=2 forces an attempt to deregister from the network. The selected mode affects to all further network registration (e.g. after <mode>=2, ME shall be unregistered until <mode>=0 or 1 is selected). Refer subclause 9.2 for possible <err> values. This command should be abortable when registration/deregistration attempt is made.

Read command returns the current mode and the currently selected operator. If no operator is selected, <format> and <oper> are omitted.

Test command returns a list of quadruplets, each representing an operator present in the network. Quadruplet consists of an integer indicating the availability of the operator <stat>, long and short alphanumeric format of the name of the operator, and numeric format representation of the operator. Any of the formats may be unavailable and should then be an empty field. The list of operators shall be in order: home network, networks referenced in SIM, and other networks.

It is recommended (although optional) that after the operator list TA returns lists of supported <mode>s and <format>s. These lists shall be delimited from the operator list by two commas.

#### Defined values

<mode>:

- 0 automatic (<oper> field is ignored)
- 1 manual (<oper> field shall be present)
- 2 deregister from network
- 3 set only <format> (for read command +COPS?), do not attempt registration/deregistration (<oper> field is ignored); this value is not applicable in read command response
- 4 manual/automatic (<oper> field shall be present); if manual selection fails, automatic mode (<mode>=0) is entered

<format>:

- 0 long format alphanumeric <oper>
- 1 short format alphanumeric <oper>
- 2 numeric <oper>

<oper>: string type; <format> indicates if the format is alphanumeric or numeric; long alphanumeric format can be upto 16 characters long and short format up to 8 characters (refer GSM MoU SE.13 [9]); numeric format is the GSM Location Area Identification number (refer GSM 04.08 [8] subclause 10.5.1.3) which consists of a three BCD digit country code coded as in ITU-T E.212 Annex A [10], plus a two BCD digit network code, which is administration specific; returned <oper> shall not be in BCD format, but in IRA characters converted from BCD; hence the number has structure: (country code digit 3)(country code digit 2)(country code digit 1)(network code digit 2)(network code digit 1)

<stat>:

- 0 unknown
- 1 available
- 2 current
- 3 forbidden

#### Implementation

Optional.

## 7.4 Facility lock +CLCK

**Table 37: +CLCK action command syntax**

Command	Possible response(s)
+CLCK=<fac> , <mode> [ , <passwd> [ , <class> ] ]	+CME ERROR: <err> <b>when &lt;mode&gt;=2 and command successful:</b> +CLCK: <status> [ , <class1> [ <CR><LF>+CLCK: <status> , <class2> [ . . . ] ]
+CLCK=?	+CLCK: (list of supported <fac>s) +CME ERROR: <err>

### Description

Execute command is used to lock, unlock or interrogate a ME or a network facility <fac>. Password is normally needed to do such actions. When querying the status of a network service (<mode>=2) the response line for 'not active' case (<status>=0) should be returned only if service is not active for any <class>. Refer subclause 9.2 for possible <err> values. This command should be abortable when network facilities are set or interrogated.

Call barring facilities are based on GSM/UMTS supplementary services (refer 3G TS 22.088 [6]). The interaction of these with other commands based on other GSM/UMTS supplementary services is described in the GSM/UMTS standard.

Test command returns facility values supported by the TA as a compound value.

### Defined values

<fac> values reserved by the present document:

- "CS" CNTRL (lock CoNTRoL surface (e.g. phone keyboard))
- "PS" PH-SIM (lock PHone to SIM card) (ME asks password when other than current SIM card inserted; ME may remember certain amount of previously used cards thus not requiring password when they are inserted)
- "PF" lock Phone to the very First inserted SIM card (also referred in the present document as PH-FSIM) (ME asks password when other than the first SIM card is inserted)
- "SC" SIM (lock SIM card) (SIM asks password in ME power-up and when this lock command issued)
- "AO" BAO (Barr All Outgoing Calls) (refer 3G TS 22.088 [6] clause 1)
- "OI" BOIC (Barr Outgoing International Calls) (refer 3G TS 22.088 [6] clause 1)
- "OX" BOIC-exHC (Barr Outgoing International Calls except to Home Country) (refer 3G TS 22.088 [6] clause 1)
- "AI" BAIC (Barr All Incoming Calls) (refer 3G TS 22.088 [6] clause 2)
- "IR" BIC-Roam (Barr Incoming Calls when Roaming outside the home country) (refer 3G TS 22.088 [6] clause 2)
- "NT" barr incoming calls from numbers Not stored to TA memory
- "NM" barr incoming calls from numbers Not stored to ME memory
- "NS" barr incoming calls from numbers Not stored to SIM memory
- "NA" barr incoming calls from numbers Not stored in Any memory
- "AB" All Barring services (refer 3G TS 22.030 [19]) (applicable only for <mode>=0)
- "AG" All outGoing barring services (refer 3G TS 22.030 [19]) (applicable only for <mode>=0)
- "AC" All inComing barring services (refer 3G TS 22.030 [19]) (applicable only for <mode>=0)

- "FD" SIM fixed dialling memory feature (if PIN2 authentication has not been done during the current session, PIN2 is required as <passwd>)
- "PN" Network Personalisation (refer 3G TS 22.022 [33])
- "PU" network sUbset Personalisation (refer 3G TS 22.022 [33])
- "PP" service Provider Personalisation (refer 3G TS 22.022 [33])
- "PC" Corporate Personalisation (refer 3G TS 22.022 [33])

<mode>:

- 0 unlock
- 1 lock
- 2 query status

<status>:

- 0 not active
- 1 active

<passwd>: string type; shall be the same as password specified for the facility from the ME user interface or with command Change Password +CPWD

<classx> is a sum of integers each representing a class of information (default 7):

- 1 voice (telephony)
- 2 data (refers to all bearer services; with <mode>=2 this may refer only to some bearer service if TA does not support values 16, 32, 64 and 128)
- 4 fax (facsimile services)
- 8 short message service
- 16 data circuit sync
- 32 data circuit async
- 64 dedicated packet access
- 128 dedicated PAD access

### Implementation

The call barring supplementary service control is mandatory for ME supporting AT commands only and not supporting the control through dial command D.

## 7.5 Change password +CPWD

**Table 38: +CPWD action command syntax**

Command	Possible response(s)
+CPWD=<fac>, <oldpwd>, <newpwd>	+CME ERROR: <err>
+CPWD=?	+CPWD: list of supported (<fac>, <pwdlength>)s +CME ERROR: <err>



**Description**

Action command sets a new password for the facility lock function defined by command Facility Lock +CLCK. Refer subclause 9.2 for possible <err> values.

Test command returns a list of pairs which present the available facilities and the maximum length of their password.

**Defined values**

<fac>:

"P2" SIM PIN2

refer Facility Lock +CLCK for other values

<oldpwd>, <newpwd>: string type; <oldpwd> shall be the same as password specified for the facility from the ME user interface or with command Change Password +CPWD and <newpwd> is the new password; maximum length of password can be determined with <pwdlength>

<pwdlength>: integer type maximum length of the password for the facility

**Implementation**

Optional.

## 7.6 Calling line identification presentation +CLIP

**Table 39: +CLIP parameter command syntax**

Command	Possible response(s)
+CLIP=[ <n> ]	
+CLIP?	+CLIP: <n> , <m>
+CLIP=?	+CLIP: (list of supported <n>s)

**Description**

This command refers to the GSM/UMTS supplementary service CLIP (Calling Line Identification Presentation) that enables a called subscriber to get the calling line identity (CLI) of the calling party when receiving a mobile terminated call. Set command enables or disables the presentation of the CLI at the TE. It has no effect on the execution of the supplementary service CLIP in the network.

When the presentation of the CLI at the TE is enabled (and calling subscriber allows), +CLIP:

<number>, <type>[ , <subaddr> , <satype>[ , [ <alpha> ] [ , <CLI validity> ] ] ] response is returned after every RING (or +CRING: <type>; refer subclause "Cellular result codes +CRC") result code sent from TA to TE. It is manufacturer specific if this response is used when normal voice call is answered.

Read command gives the status of <n>, and also triggers an interrogation of the provision status of the CLIP service according 3G TS 22.081 [3] (given in <m>). Test command returns values supported by the TA as a compound value.

**Defined values**

<n> (parameter sets/shows the result code presentation status in the TA):

0 disable

1 enable

<m> (parameter shows the subscriber CLIP service status in the network):

0 CLIP not provisioned

1 CLIP provisioned

2 unknown (e.g. no network, etc.)

<number>: string type phone number of format specified by <type>

<type>: type of address octet in integer format (refer GSM 04.08 [8] subclause 10.5.4.7)

<subaddr>: string type subaddress of format specified by <satype>

<satype>: type of subaddress octet in integer format (refer GSM 04.08 [8] subclause 10.5.4.8)

<alpha>: optional string type alphanumeric representation of <number> corresponding to the entry found in phonebook; used character set should be the one selected with command Select TE Character Set +CSCS

<CLI validity>:

- 0 CLI valid
- 1 CLI has been withheld by the originator.
- 2 CLI is not available due to interworking problems or limitations of originating network.

When CLI is not available ( <CLI validity>=2), <number> shall be an empty string ("") and <type> value will not be significant. Nevertheless, TA may return the recommended value **128** for <type> ((TON/NPI unknown in accordance with GSM 04.08 [8] subclause 10.5.4.7).

When CLI has been withheld by the originator, (<CLI validity>=1) and the CLIP is provisioned with the "override category" option (refer 3G TS 22.081[3] and 3G TS 23.081[40]), <number> and <type> is provided. Otherwise, TA shall return the same setting for <number> and <type> as if the CLI was not available.

### Implementation

Optional.

## 7.7 Calling line identification restriction +CLIR

**Table 40: +CLIR parameter command syntax**

Command	Possible response(s)
+CLIR=[ <n> ]	
+CLIR?	+CLIR: <n> , <m>
+CLIR=?	+CLIR: (list of supported <n>s)

### Description

This command refers to CLIR-service according to 3G TS 22.081 [3] that allows a calling subscriber to enable or disable the presentation of the CLI to the called party when originating a call.

Set command overrides the CLIR subscription (default is restricted or allowed) when temporary mode is provisioned as a default adjustment for all following outgoing calls. This adjustment can be revoked by using the opposite command.. If this command is used by a subscriber without provision of CLIR in permanent mode the network will act according 3G TS 22.081 [3].

Read command gives the default adjustment for all outgoing calls (given in <n>), and also triggers an interrogation of the provision status of the CLIR service (given in <m>). Test command returns values supported by the TA as a compound value.

NOTE: On a per call base CLIR functionality is explained in subclause "ITU-T V.25ter [14] dial command".

### Defined values

<n> (parameter sets the adjustment for outgoing calls):

- 0 presentation indicator is used according to the subscription of the CLIR service

- 1 CLIR invocation
- 2 CLIR suppression

<m> (parameter shows the subscriber CLIR service status in the network):

- 0 CLIR not provisioned
- 1 CLIR provisioned in permanent mode
- 2 unknown (e.g. no network, etc.)
- 3 CLIR temporary mode presentation restricted
- 4 CLIR temporary mode presentation allowed

### Implementation

Optional.

## 7.8 Connected line identification presentation +COLP

**Table 41: +COLP parameter command syntax**

Command	Possible response(s)
+COLP=[ <n> ]	
+COLP?	+COLP: <n> , <m>
+COLP=?	+COLP: (list of supported <n>s)

### Description

This command refers to the GSM/UMTS supplementary service COLP (Connected Line Identification Presentation) that enables a calling subscriber to get the connected line identity (COL) of the called party after setting up a mobile originated call. The command enables or disables the presentation of the COL at the TE. It has no effect on the execution of the supplementary service COLR in the network.

When enabled (and called subscriber allows), +COLP :

<number> , <type> [ , <subaddr> , <satype> [ , <alpha> ] ] intermediate result code is returned from TA to TE before any +CR or V.25ter [14] responses. It is manufacturer specific if this response is used when normal voice call is established.

Read command gives the status of <n>, and also triggers an interrogation of the provision status of the COLP service according 3G TS 22.081 [3] (given in <m>).

Test command returns values supported by the TA as a compound value.

### Defined values

<n> (parameter sets/shows the result code presentation status in the TA):

- 0 disable
- 1 enable

<m> (parameter shows the subscriber COLP service status in the network):

- 0 COLP not provisioned
- 1 COLP provisioned
- 2 unknown (e.g. no network, etc.)

<number>, <type>, <subaddr>, <satype>, <alpha>: refer +CLIP

**Implementation**

Optional.

**7.9 Called line identification presentation +CDIP****Table 42: +CDIP parameter command syntax**

Command	Possible response(s)
+CDIP=[ <n> ]	
+CDIP?	+CDIP: <n>, <m>
+CDIP=?	+CDIP: (list of supported <n>s)

**Description**

This command related to a network service that provides "multiple called numbers (called line identifications) service" to an MT. This command enables a called subscriber to get the called line identification of the called party when receiving a mobile terminated call. Set command enables or disables the presentation of the called line identifications at the TE.

When the presentation of the called line identification at the TE is enabled, +CDIP: <number>, <type>[ , <subaddr>, <satype> ] response is returned after every RING (or +CRING: <type>); refer subclause "Cellular result codes +CRC") result code sent from TA to TE. It is manufacturer specific if this response is used when normal voice call is answered.

Read command gives the status of <n>, and also triggers an interrogation of the provision status of the "multiple called numbers" service. Test command returns values supported by the TA as a compound value.

**Defined values**

<n> (parameter sets/shows the result code presentation status in the TA):

0 disable

1 enable

<m> (parameter shows the subscriber "multiple called numbers" service status in the network):

0 "multiple called numbers service" is not provisioned

1 "multiple called numbers service" is provisioned

2 unknown (e.g. no network, etc.)

<number>: string type phone number of format specified by <type>

<type>: type of address octet in integer format (refer GSM 04.08 [8] subclause 10.5.4.7)

<subaddr>: string type subaddress of format specified by <satype>

<satype>: type of subaddress octet in integer format (refer GSM 04.08 [8] subclause 10.5.4.8)

**Implementation**

Optional.

## 7.10 Closed user group +CCUG

Table 43: +CCUG parameter command syntax

Command	Possible response(s)
+CCUG=[<n>[ ,<index>[ ,<info>]]]	
+CCUG?	+CCUG: <n>,<index>,<info>
+CCUG=?	

### Description

This command allows control of the Closed User Group supplementary service (refer 3G TS 22.085 [21]). Set command enables the served subscriber to select a CUG index, to suppress the Outgoing Access (OA), and to suppress the preferential CUG.

Set command with <n>=1 enables to control the CUG information on the air interface as a default adjustment for all following outgoing calls. The interaction of this command with other commands based on other GSM/UMTS supplementary services is described in the GSM/UMTS standard.

NOTE: On a per call base CUG functionality is explained in subclause "ITU-T V.25ter [14] dial command".

### Defined values

<n>:

0 disable CUG temporary mode

1 enable CUG temporary mode

<index>:

0..9 CUG index

10 no index (preferred CUG taken from subscriber data)

<info>:

0 no information

1 suppress OA

2 suppress preferential CUG

3 suppress OA and preferential CUG

### Implementation

Optional.

## 7.11 Call forwarding number and conditions +CCFC

Table 44: +CCFC action command syntax

Command	Possible response(s)
+CCFC=<reason>,<mode> [ ,<number>[ ,<type> [ ,<class> [ ,<subaddr>[ ,<satype> [ ,<time>]]]]]]]	+CME ERROR: <err> <b>when &lt;mode&gt;=2 and command successful:</b> +CCFC: <status>,<class1>[ ,<number>,<type> [ ,<subaddr>,<satype>[ ,<time>]]][ <CR><LF>+CCFC: <status>,<class2>[ ,<number>,<type> [ ,<subaddr>,<satype>[ ,<time>]] [...]]

+CCFC=?	+CCFC: (list of supported <reason>s)
---------	--------------------------------------

### Description

This command allows control of the call forwarding supplementary service according to 3G TS 22.082 [4]. Registration, erasure, activation, deactivation, and status query are supported. When querying the status of a network service (<mode>=2) the response line for 'not active' case (<status>=0) should be returned only if service is not active for any <class>.

Test command returns reason values supported by the TA as a compound value.

### Defined values

<reason>:

- 0 unconditional
- 1 mobile busy
- 2 no reply
- 3 not reachable
- 4 all call forwarding (refer 3G TS 22.030 [19])
- 5 all conditional call forwarding (refer 3G TS 22.030 [19])

<mode>:

- 0 disable
- 1 enable
- 2 query status
- 3 registration
- 4 erasure

<number>: string type phone number of forwarding address in format specified by <type>

<type>: type of address octet in integer format (refer GSM 04.08 [8] subclause 10.5.4.7); default 145 when dialling string includes international access code character "+", otherwise 129

<subaddr>: string type subaddress of format specified by <satype>

<satype>: type of subaddress octet in integer format (refer GSM 04.08 [8] subclause 10.5.4.8); default 128

<classx> is a sum of integers each representing a class of information (default 7):

- 1 voice (telephony)
- 2 data (refers to all bearer services; with <mode>=2 this may refer only to some bearer service if TA does not support values 16, 32, 64 and 128)
- 4 fax (facsimile services)
- 8 short message service
- 16 data circuit sync
- 32 data circuit async
- 64 dedicated packet access
- 128 dedicated PAD access

<time>:

1...30 when "no reply" is enabled or queried, this gives the time in seconds to wait before call is forwarded, default value 20

<status>:

0 not active

1 active

### Implementation

Mandatory for ME supporting AT commands only and not supporting the control through dial command D.

## 7.12 Call waiting +CCWA

Table 45: +CCWA parameter command syntax

Command	Possible response(s)
+CCWA=[<n>[,<mode>[,<class>]]]	+CME ERROR: <err> <b>when &lt;mode&gt;=2 and command successful</b> +CCWA: <status>,<class1> [<CR><LF>+CCWA: <status>,<class2> [...]]
+CCWA?	+CCWA: <n>
+CCWA=?	+CCWA: (list of supported <n>s)

### Description

This command allows control of the Call Waiting supplementary service according to 3G TS 22.083 [5]. Activation, deactivation and status query are supported. When querying the status of a network service (<mode>=2) the response line for 'not active' case (<status>=0) should be returned only if service is not active for any <class>. Parameter <n> is used to disable/enable the presentation of an unsolicited result code +CCWA: <number>,<type>,<class>,[<alpha>][,<CLI validity>] to the TE when call waiting service is enabled. Command should be abortable when network is interrogated.

The interaction of this command with other commands based on other GSM/UMTS supplementary services is described in the GSM/UMTS standards.

Test command returns values supported by the TA as a compound value.

### Defined values

<n> (sets/shows the result code presentation status in the TA):

0 disable

1 enable

<mode> (when <mode> parameter is not given, network is not interrogated):

0 disable

1 enable

2 query status

<classx> is a sum of integers each representing a class of information (default 7):

1 voice (telephony)

- 2 data (refers to all bearer services; with <mode>=2 this may refer only to some bearer service if TA does not support values 16, 32, 64 and 128)
- 4 fax (facsimile services)
- 8 short message service
- 16 data circuit sync
- 32 data circuit async
- 64 dedicated packet access
- 128 dedicated PAD access

<status>:

0 not active

1 active

<number>: string type phone number of calling address in format specified by <type>

<type>: type of address octet in integer format (refer GSM 04.08 [8] subclause 10.5.4.7)

<alpha>: optional string type alphanumeric representation of <number> corresponding to the entry found in phonebook; used character set should be the one selected with command Select TE Character Set +CSCS

<CLI validity>:

0 CLI valid

1 CLI has been withheld by the originator.

2 CLI is not available due to interworking problems or limitations of originating network.

When CLI is not available (<CLI validity>=2), <number> shall be an empty string ("") and <type> value will not be significant. Nevertheless, TA may return the recommended value **128** for <type> ((TON/NPI unknown in accordance with GSM 04.08 [8] subclause 10.5.4.7).

When CLI has been withheld by the originator, (<CLI validity>=1) and the CLIP is provisioned with the "override category" option (refer 3G TS 22.081[3] and 3G TS 23.081[40]), <number> and <type> is provided. Otherwise, TA shall return the same setting for <number> and <type> as if the CLI was not available.

### Implementation

Optional.

## 7.13 Call related supplementary services +CHLD

**Table 46: +CHLD action command syntax**

Command	Possible response(s)
+CHLD=[ <n> ]	+CME ERROR: <err>
+CHLD=?	[ +CHLD: (list of supported <n>s) ]

### Description

This command allows the control of the following call related services:

- a call can be temporarily disconnected from the ME but the connection is retained by the network;
- multiparty conversation (conference calls);



- the served subscriber who has two calls (one held and the other either active or alerting) can connect the other parties and release the served subscriber's own connection.

Calls can be put on hold, recovered, released, added to conversation, and transferred similarly as defined in 3G TS 22.030 [19]. Refer subclause 9.2 for possible <err> values.

This is based on the GSM/UMTS supplementary services HOLD (Call Hold; refer 3G TS 22.083 [5] clause 2), MPTY (MultiParty; refer 3G TS 22.084 [22]) and ECT (Explicit Call Transfer; refer 3G TS 22.091 [29]). The interaction of this command with other commands based on other GSM/UMTS supplementary services is described in the GSM/UMTS standards.

NOTE: Call Hold, MultiParty and Explicit Call Transfer are only applicable to teleservice 11.

It is recommended (although optional) that test command returns a list of operations which are supported. The call number required by some operations shall be denoted by "x" (e.g. +CHLD: ( 0 , 1 , 1x , 2 , 2x , 3 )).

#### Defined values

<n>: integer type; equals to numbers entered before SEND button in 3G TS 22.030 [19] subclause 4.5.5.1

NOTE: The "directory number" case shall be handled with dial command D, and the END case with hangup command H (or +CHUP). The 4\*"directory number" case is handled with +CTFR command.

#### Implementation

Optional.

## 7.14 Call deflection +CTFR

Table 47: +CTFR action command syntax

Command	Possible response(s)
+CTFR=<number>[ , <type>[ , <subaddr>[ , <satype> ] ] ]	+CME ERROR: <err>
+CTFR=?	

#### Description

This refers to a service that causes an incoming alerting call to be forwarded to a specified number. Action command does this. Refer subclause 9.2 for possible <err> values.

This is based on the GSM/UMTS supplementary service CD (Call Deflection; refer 3G TS 22.072 [30]). The interaction of this command with other commands based on other GSM/UMTS supplementary services is described in the GSM/UMTS standards.

NOTE: Call Deflection is only applicable to teleservice 11.

#### Defined values

<number>: string type phone number of format specified by <type>

<type>: type of address octet in integer format (refer GSM 04.08 [8] subclause 10.5.4.7); default 145 when dialling string includes international access code character "+", otherwise 129

<subaddr>: string type subaddress of format specified by <satype>

<satype>: type of subaddress octet in integer format (refer GSM 04.08 [8] subclause 10.5.4.8); default 128

#### Implementation

Optional.

## 7.15 Unstructured supplementary service data +CUSD

**Table 48: +CUSD parameter command syntax**

Command	Possible response(s)
+CUSD=[<n>[ ,<str>[ ,<dcs>]]]	+CME ERROR: <err>
+CUSD?	+CUSD: <n>
+CUSD=?	+CUSD: (list of supported <n>s)

### Description

This command allows control of the Unstructured Supplementary Service Data (USSD) according to 3G TS 22.090 [23]. Both network and mobile initiated operations are supported. Parameter <n> is used to disable/enable the presentation of an unsolicited result code (USSD response from the network, or network initiated operation) +CUSD: <m>[ ,<str> ,<dcs>] to the TE. In addition, value <n>=2 is used to cancel an ongoing USSD session.

When <str> is given, a mobile initiated USSD-string or a response USSD-string to a network initiated operation is sent to the network. The response USSD-string from the network is returned in a subsequent unsolicited +CUSD result code.

**NOTE:** In case of successful mobile initiated operation, TA implemented according to a version prior to 6 of this standard, waits the USSD response from the network and sends it to the TE before the final result code. This will block the AT command interface for the period of the operation. Such TA does not support <n> value 2.

The interaction of this command with other commands based on other GSM/UMTS supplementary services is described in the GSM/UMTS standards.

Test command returns values supported by the TA as a compound value.

### Defined values

<n>:

- 0 disable the result code presentation in the TA
- 1 enable the result code presentation in the TA
- 2 cancel session (not applicable to read command response)

<str>: string type USSD-string (when <str> parameter is not given, network is not interrogated):

- if <dcs> indicates that 3G TS 23.038 [25] 7 bit default alphabet is used:
  - if TE character set other than "HEX" (refer command Select TE Character Set +CSCS): ME/TA converts GSM alphabet into current TE character set according to rules of 3G TS 27.005 [24] Annex A
  - if TE character set is "HEX": ME/TA converts each 7-bit character of GSM alphabet into two IRA character long hexadecimal number (e.g. character II (GSM 23) is presented as 17 (IRA 49 and 55))
- if <dcs> indicates that 8-bit data coding scheme is used: ME/TA converts each 8-bit octet into two IRA character long hexadecimal number (e.g. octet with integer value 42 is presented to TE as two characters 2A (IRA 50 and 65))

<dcs>: 3G TS 23.038 [25] Cell Broadcast Data Coding Scheme in integer format (default 0)

<m>:

- 0 no further user action required (network initiated USSD-Notify, or no further information needed after mobile initiated operation)
- 1 further user action required (network initiated USSD-Request, or further information needed after mobile initiated operation)
- 2 USSD terminated by network
- 3 other local client has responded
- 4 operation not supported
- 5 network time out

### Implementation

Optional.

## 7.16 Advice of Charge +CAOC

**Table 49: +CAOC parameter command syntax**

Command	Possible response(s)
+CAOC[=<mode>]	[+CAOC: <ccm>] +CME ERROR: <err>
+CAOC?	+CAOC: <mode>
+CAOC=?	[+CAOC: (list of supported <mode>s)]

### Description

This refers to Advice of Charge supplementary service (3G TS 22.024 [26] and 3G TS 22.086 [27]) that enables subscriber to get information about the cost of calls. With <mode>=0, the execute command returns the current call meter value from the ME.

The command also includes the possibility to enable an unsolicited event reporting of the CCM information. The unsolicited result code +CCCM: <ccm> is sent when the CCM value changes, but not more that every 10 seconds. Deactivation of the unsolicited event reporting is made with the same command.

Refer subclause 9.2 for possible <err> values.

NOTE: Advice of Charge values stored in the SIM (ACM, ACMmax, PUCT) can be accessed with generic or restricted SIM access command (+CSIM or +CRSM)). Those values can be more readily accessed with commands +CACM, +CMM and +CPUC.

The Read command indicates whether the unsolicited reporting is activated or not. Read command is available when the unsolicited result code is supported.

It is recommended (although optional) that the test command returns the supported mode values.

### Defined values

<mode>:

- 0 query CCM value
- 1 deactivate the unsolicited reporting of CCM value
- 2 activate the unsolicited reporting of CCM value

<ccm>: string type; three bytes of the current call meter value in hexadecimal format (e.g. "00001E" indicates decimal value 30); value is in home units and bytes are similarly coded as ACMmax value in the SIM

## Implementation

Optional.

## 7.17 Supplementary service notifications +CSSN

**Table 50: +CSSN parameter command syntax**

Command	Possible response(s)
+CSSN=[ <n>[ , <m> ] ]	
+CSSN?	+CSSN: <n> , <m>
+CSSN=?	+CSSN: (list of supported <n>s) , (list of supported <m>s)

### Description

This command refers to supplementary service related network initiated notifications. The set command enables/disables the presentation of notification result codes from TA to TE.

When <n>=1 and a supplementary service notification is received after a mobile originated call setup, intermediate result code +CSSI: <code1>[ , <index> ] is sent to TE before any other MO call setup result codes presented in the present document or in V.25ter [14]. When several different <code1>s are received from the network, each of them shall have its own +CSSI result code.

When <m>=1 and a supplementary service notification is received during a mobile terminated call setup or during a call, or when a forward check supplementary service notification is received, unsolicited result code +CSSU: <code2>[ , <index>[ , <number> , <type>[ , <subaddr> , <satype> ] ] ] is sent to TE. In case of MT call setup, result code is sent after every +CLIP result code (refer command "Calling line identification presentation +CLIP") and when several different <code2>s are received from the network, each of them shall have its own +CSSU result code.

Test command returns values supported by the TA as a compound value.

### Defined values

<n> (parameter sets/shows the +CSSI result code presentation status in the TA):

0 disable

1 enable

<m> (parameter sets/shows the +CSSU result code presentation status in the TA):

0 disable

1 enable

<code1> (it is manufacturer specific, which of these codes are supported):

0 unconditional call forwarding is active

1 some of the conditional call forwardings are active

2 call has been forwarded

3 call is waiting

4 this is a CUG call (also <index> present)

5 outgoing calls are barred

6 incoming calls are barred

7 CLIR suppression rejected

8 call has been deflected

<index>: refer "Closed user group +CCUG"

<code2> (it is manufacturer specific, which of these codes are supported):

0 this is a forwarded call (MT call setup)

1 this is a CUG call (also <index> present) (MT call setup)

2 call has been put on hold (during a voice call)

3 call has been retrieved (during a voice call)

4 multiparty call entered (during a voice call)

5 call on hold has been released (this is not a SS notification) (during a voice call)

6 forward check SS message received (can be received whenever)

7 call is being connected (alerting) with the remote party in alerting state in explicit call transfer operation (during a voice call)

8 call has been connected with the other remote party in explicit call transfer operation (also number and subaddress parameters may be present) (during a voice call or MT call setup)

9 this is a deflected call (MT call setup)

10 additional incoming call forwarded

<number>: string type phone number of format specified by <type>

<type>: type of address octet in integer format (refer GSM 04.08 [8] subclause 10.5.4.7)

<subaddr>: string type subaddress of format specified by <satype>

<satype>: type of subaddress octet in integer format (refer GSM 04.08 [8] subclause 10.5.4.8)

### Implementation

Optional.

## 7.18 List current calls +CLCC

**Table 51: +CLCC action command syntax**

Command	Possible response(s)
+CLCC	[+CLCC: <id1>,<dir>,<stat>,<mode>,<mpty>[ ,<number>,<type>[,<alpha>[,<priority>]]] [<CR><LF>+CLCC: <id2>,<dir>,<stat>,<mode>,<mpty>[ ,<number>,<type>[,<alpha>[,<priority>]]] [...]] +CME ERROR: <err>
+CLCC=?	

### Description

Returns list of current calls of ME. If command succeeds but no calls are available, no information response is sent to TE. Refer subclause 9.2 for possible <err> values.

**Defined values**

<id<sub>x</sub>>: integer type; call identification number as described in 3G TS 22.030 [19] subclause 4.5.5.1; this number can be used in +CHLD command operations

<dir>:

0 mobile originated (MO) call

1 mobile terminated (MT) call

<stat> (state of the call):

0 active

1 held

2 dialing (MO call)

3 alerting (MO call)

4 incoming (MT call)

5 waiting (MT call)

<mode> (bearer/teleservice):

0 voice

1 data

2 fax

3 voice followed by data, voice mode

4 alternating voice/data, voice mode

5 alternating voice/fax, voice mode

6 voice followed by data, data mode

7 alternating voice/data, data mode

8 alternating voice/fax, fax mode

9 unknown

<mpty>:

0 call is not one of multiparty (conference) call parties

1 call is one of multiparty (conference) call parties

<number>: string type phone number in format specified by <type>

<type>: type of address octet in integer format (refer GSM 04.08 [8] subclause 10.5.4.7)

<alpha>: string type alphanumeric representation of <number> corresponding to the entry found in phonebook; used character set should be the one selected with command Select TE Character Set +CSCS

<priority>: optional digit type parameter indicating the eMLPP priority level of the call, values specified in 3G TS 22.067 [54]

**Implementation**

Optional. Recommended when +CHLD command is implemented.

## 7.19 Preferred operator list +CPOL

**Table 52: +CPOL parameter command syntax**

Command	Possible response(s)
+CPOL=[<index>][, <format>[, <oper>]]	+CME ERROR: <err>
+CPOL?	+CPOL: <index1>, <format>, <oper1> [<CR><LF>+CPOL: <index2>, <format>, <oper2> [...]] +CME ERROR: <err>
+CPOL=?	+CPOL: (list of supported <index>s), (list of supported <format>s)+CME ERROR: <err>

### Description

This command is used to edit the SIM preferred list of networks. Execute command writes an entry in the SIM list of preferred operators (EF<sub>PLMNsel</sub>). If <index> is given but <oper> is left out, entry is deleted. If <oper> is given but <index> is left out, <oper> is put in the next free location. If only <format> is given, the format of the <oper> in the read command is changed. Refer subclause 9.2 for possible <err> values.

NOTE: ME may also update this list automatically when new networks are selected.

Read command returns all used entries from the SIM list of preferred operators.

Test command returns the whole index range supported by the SIM.

### Defined values

<indexn>: integer type; the order number of operator in the SIM preferred operator list

<format>:

0 long format alphanumeric <oper>

1 short format alphanumeric <oper>

2 numeric <oper>

<opern>: string type; <format> indicates if the format is alphanumeric or numeric (see +COPS)

### Implementation

Optional.

## 7.20 Read operator names +COPN

**Table 53: +COPN action command syntax**

Command	Possible response(s)
+COPN	+COPN: <numeric1>, <alpha1> [<CR><LF>+COPN: <numeric2>, <alpha2> [...]] +CME ERROR: <err>
+COPN=?	

### Description

Execute command returns the list of operator names from the ME. Each operator code <numericn> that has an alphanumeric equivalent <alphan> in the ME memory shall be returned. Refer subclause 9.2 for possible <err> values.

#### Defined values

<numericn>: string type; operator in numeric format (see +COPS)

<alphan>: string type; operator in long alphanumeric format (see +COPS)

#### Implementation

Optional.

## 7.21 eMLPP Priority Registration and Interrogation +CAEMLPP

**Table 54: CAEMLPP parameter command syntax**

Command	Possible Response(s)
+CAEMLPP=<priority>	+CME ERROR: <err>
+CAEMLPP?	+CAEMLPP: <default_priority>, <max_priority> +CME ERROR: <err>
+CAEMLPP=?	

#### Description

The execute command is used to change the default priority level of the user in the network. The requested priority level is checked against the eMLPP subscription of the user stored on the SIM EF<sub>eMLPP</sub>. If the user doesn't have subscription for the requested priority level an ERROR or +CME ERROR result code is returned.

The read command triggers an interrogation of the provision of the maximum priority level which the service subscriber is allowed to use and default priority level activated by the user.

If the service is not provisioned, a result code including the SS-Status (?) parameter is returned.

#### Defined Values

<priority>: integer type parameter which identifies the default priority level to be activated in the network, values specified in 3G TS 22.067 [54]

<default\_priority>: integer type parameter which identifies the default priority level which is activated in the network, values specified in 3G TS 22.067 [54]

<max\_priority>: integer type parameter which identifies the maximum priority level for which the service subscriber has a subscription in the network, values specified in 3G TS 22.067 [54]

#### Implementation

Mandatory for a ME supporting AT commands only and supplementary service eMLPP is implemented.

## 7.22 Informative examples

This subclause includes all the GSM/UMTS supplementary service related commands, additional commands to lock ME and SIM capabilities, and commands to check the network registration status.

An example where MSISDNs of a ME are queried, calls are forwarded to different numbers when mobile is busy (CFB) or when it does not answer (CFNRy). The status of CFNRy is read:

```
AT+CNUM
+CNUM: "+358501234567",145,,4      (voice number)
```



```

OK
AT+CCFC=1,1,"931123456"           (enable CFB)
OK
AT+CCFC=2,1,"921654321"           (enable CFNRy)
OK
AT+CCFC=1,2                         (query CFNRy)
+CCFC: 1,7,"+35821654321",145,,20 (forward after 20 seconds)
OK

```

An example of Call Waiting (+CCWA), Call Related Supplementary Services (+CHLD), and Connected Line Identification Presentation (+COLP) usage:

```

AT+CCWA=1,1;+COLP=1                (enable call waiting and COLP result codes)
OK
ATD9311234567;                       (originate a voice call)
+COLP: "+358311234567",145
OK
...conversation...
+CCWA: "+358317654321",145          (another call is waiting)
AT+CHLD=2                             (put first call on hold and answer the second one)
OK
...conversation...
AT+CHLD=1                             (release the second (active) call and recover the first (held) call)
OK
ATH                                    (release the first call)
OK

```

Call barring supplementary services are combined in one command, Facility Lock (+CLCK), which is also used to restrict ME and SIM functionality. Some of the facilities require a password when enabled or disabled. An additional command, Change Password (+CPWD), is defined for changing the password of different barring and restriction facilities. An example where locking status of outgoing international calls is interrogated and then barred, and the password of the SIM card lock (Personal Identity Number, PIN) is changed:

```

AT+CLCK="OI",2
+CLCK: 0,7
OK
AT+CLCK="OI",1,"1234"
OK
AT+CPWD="SC","4321","1234"
OK

```

Operator Selection (+COPS) command is used for querying the status of all GSM/UMTS operators detected in the area, and switching between operators.

Following example illustrates a network selection sequence in Finland. Two operators are found, the status of Tele is unknown and Radiolinja is currently selected. Read command shows that automatic selection mode is on and that Radiolinja is selected. Then an attempt is made to access Tele, but it is denied (shown by +CME ERROR).

```

AT+COPS=?
+COPS: (2,"RADIOLINJA","RL","24405"),(0,"TELE","TELE","24491")
OK
AT+COPS?
+COPS: 0,0,"RADIOLINJA"
OK
AT+COPS=1,0,"TELE"
+CME ERROR: 3

```

When a terminal wanders between countries (i.e. networks), an application may follow this e.g. with the following scenario:

```

AT+CREG=1                             (enable +CREG: <stat> unsolicited result code)
OK
AT+CREG?
+CREG: 1,1                             (ME is registered in home PLMN)
OK
AT+COPS=3,2;+COPS?;+COPS=3,0;+COPS?
+COPS: 0,2,"24405"                     (get the country...
+COPS: 0,0,"RADIOLINJA"                 ...and operator name)
OK
...user wanders to another PLMN...
+CREG: 2                                 (deregistered, roaming ongoing)
+CREG: 5                                 (registered again, not home PLMN)
AT+COPS=3,2;+COPS?;+COPS=3,0;+COPS?

```

```
+COPS: 0,2,"24001"           (get the country...
+COPS: 0,0,"TELIA MOBITELE"  ...and operator name)
OK
...user loses connection, no other PLMNs around...
+CREG: 0
```

An example of eMLPP Supplementary Service usage for a ptp voice call:

```
ATD*752#+436644101453;      (originate a voice call with the priority level 2, see for priority level definitions GSM 02.30)
OK                           (call setup was successful)
```

---

## 8 Mobile Equipment control and status commands

This clause includes commands for ME power, keypad, display and indicator handling. Also commands for selecting, reading and writing of phonebooks, and setting real-time clock facilities are specified. Two commands are specified for accessing SIM database records in a general way.

Figure 7 illustrates the effect of these commands. Command Phone Activity Status +CPAS indicates the current general activity status of the ME. Command Set Phone Functionality +CFUN is used to set the ME to different power consumption states. Command Enter PIN +CPIN is used to enter ME passwords which are needed before any other functionality of the ME can be used (e.g. SIM PIN, PUK). Commands Generic SIM Access +CSIM and Restricted SIM Access +CRSM can be used to access all data in SIM. Commands Battery Charge +CBC and Signal Quality +CSQ are same as in TIA IS-135 [16] and they are used to query the battery charge of the ME and the current RSSI of the ME. Command Mobile Equipment Control Mode +CMEC is used to select the controlling unit of ME keypad, display and indicators. Controlling commands for the TE are Keypad Emulation +CKPD, Display Control +CDIS and Indicator Control +CIND. If corresponding event reporting is enabled with command Mobile Equipment Event Reporting +CMER, +CKEV is the result code of a keypad event, +CDEV is the result code of a display event, and +CIEV is the result code of an indicator event. Phonebook commands are Select Phonebook Memory Storage +CPBS, Read Phonebook Entries +CPBR, Find Phonebook Entries +CPBF and Write Phonebook Entry +CPBW. Additional command Clock +CCLK can be used to control the real-time clock of the ME if available. Command Alarm +CALA sets possible alarm clock facilities of the ME.

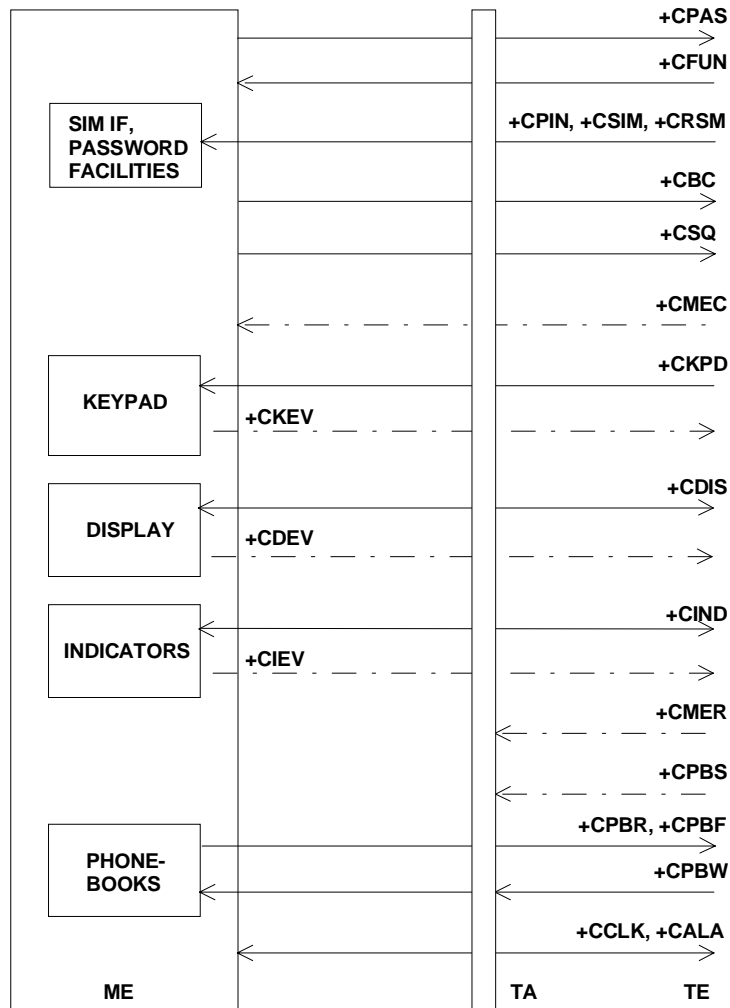

Figure 7: Mobile equipment control and status commands

## 8.1 Phone activity status +CPAS

Table 55: +CPAS action command syntax

Command	Possible response(s)
+CPAS	+CPAS: <pas> +CME ERROR: <err>
+CPAS=?	+CPAS: (list of supported <pas>s) +CME ERROR: <err>

### Description

Execution command returns the activity status <pas> of the ME. It can be used to interrogate the ME before requesting action from the phone. Refer subclause 9.2 for possible <err> values.

Test command returns values supported by the ME as a compound value.

### Defined values

<pas>:

- 0 ready (ME allows commands from TA/TE)
- 1 unavailable (ME does not allow commands from TA/TE)

- 2 unknown (ME is not guaranteed to respond to instructions)
  - 3 ringing (ME is ready for commands from TA/TE, but the ringer is active)
  - 4 call in progress (ME is ready for commands from TA/TE, but a call is in progress)
  - 5 asleep (ME is unable to process commands from TA/TE because it is in a low functionality state)
- also all other values below 128 are reserved by the present document.

### Implementation

Mandatory when ME can be operated from TE (refer subclause "Mobile Equipment control mode +CMEC").

## 8.2 Set phone functionality +CFUN

**Table 56: +CFUN parameter command syntax**

Command	Possible response(s)
+CFUN=[<fun>[,<rst>]]	+CME ERROR: <err>
+CFUN?	+CFUN: <fun> +CME ERROR: <err>
+CFUN=?	+CFUN: (list of supported <fun>s) , (list of supported <rst>s) +CME ERROR: <err>

### Description

Set command selects the level of functionality <fun> in the ME. Level "full functionality" is where the highest level of power is drawn. "Minimum functionality" is where minimum power is drawn. Level of functionality between these may also be specified by manufacturers. When supported by manufacturers, ME resetting with <rst> parameter may be utilized. Refer subclause 9.2 for possible <err> values.

NOTE: It is manufacturer specific does this command affect network registration. Command Operator Selection +COPS is used to force registration/deregistration.

Test command returns values supported by the ME as a compound value.

### Defined values

<fun>:

- 0 minimum functionality
- 1 full functionality
- 2 disable phone transmit RF circuits only
- 3 disable phone receive RF circuits only
- 4 disable phone both transmit and receive RF circuits
- 5...127 reserved for manufacturers as intermediate states between full and minimum functionality

<rst>:

- 0 do not reset the ME before setting it to <fun> power level

NOTE: This shall be always default when <rst> is not given.

- 1 reset the ME before setting it to <fun> power level

## Implementation

Optional.

## 8.3 Enter PIN +CPIN

**Table 57: +CPIN parameter command syntax**

Command	Possible response(s)
+CPIN=<pin>[, <newpin>]	+CME ERROR: <err>
+CPIN?	+CPIN: <code> +CME ERROR: <err>
+CPIN=?	

### Description

Set command sends to the ME a password which is necessary before it can be operated (SIM PIN, SIM PUK, PH-SIM PIN, etc.). If the PIN is to be entered twice, the TA shall automatically repeat the PIN. If no PIN request is pending, no action is taken towards ME and an error message, +CME ERROR, is returned to TE. Refer subclause 9.2 for possible <err> values.

If the PIN required is SIM PUK or SIM PUK2, the second pin is required. This second pin, <newpin>, is used to replace the old pin in the SIM.

NOTE: Commands which interact with ME that are accepted when ME is pending SIM PIN, SIM PUK, or PH-SIM are: +CGMI, +CGMM, +CGMR, +CGSN, D112; (emergency call), +CPAS, +CFUN, +CPIN, +CDIS (read and test command only), and +CIND (read and test command only).

Read command returns an alphanumeric string indicating whether some password is required or not.

### Defined values

<pin>, <newpin>: string type values

<code> values reserved by the present document:

READY	ME is not pending for any password
SIM PIN	ME is waiting SIM PIN to be given
SIM PUK	ME is waiting SIM PUK to be given
PH-SIM PIN	ME is waiting phone-to-SIM card password to be given
PH-FSIM PIN	ME is waiting phone-to-very first SIM card password to be given
PH-FSIM PUK	ME is waiting phone-to-very first SIM card unblocking password to be given
SIM PIN2	ME is waiting SIM PIN2 to be given (this <code> is recommended to be returned only when the last executed command resulted in PIN2 authentication failure (i.e. +CME ERROR: 17); if PIN2 is not entered right after the failure, it is recommended that ME does not block its operation)
SIM PUK2	ME is waiting SIM PUK2 to be given (this <code> is recommended to be returned only when the last executed command resulted in PUK2 authentication failure (i.e. +CME ERROR: 18); if PUK2 and new PIN2 are not entered right after the failure, it is recommended that ME does not block its operation)
PH-NET PIN	ME is waiting network personalisation password to be given
PH-NET PUK	ME is waiting network personalisation unblocking password to be given
PH-NETSUB PIN	ME is waiting network subset personalisation password to be given

PH-NETSUB PUK ME is waiting network subset personalisation unblocking password to be given

PH-SP PIN ME is waiting service provider personalisation password to be given

PH-SP PUK ME is waiting service provider personalisation unblocking password to be given

PH-CORP PIN ME is waiting corporate personalisation password to be given

PH-CORP PUK ME is waiting corporate personalisation unblocking password to be given

### Implementation

Mandatory for ME not supporting the +CKPD command and supporting AT commands only.

## 8.4 Battery charge +CBC

**Table 58: +CBC action command syntax**

Command	Possible response(s)
+CBC	+CBC: <bc>, <bc1> +CME ERROR: <err>
+CBC=?	+CBC: (list of supported <bc>s) , (list of supported <bc1>s)

### Description

Execution command returns battery connection status <bc> and battery charge level <bc1> of the ME. Refer subclause 9.2 for possible <err> values.

Test command returns values supported by the TA as compound values.

### Defined values

<bc>:

- 0 ME is powered by the battery
- 1 ME has a battery connected, but is not powered by it
- 2 ME does not have a battery connected
- 3 Recognized power fault, calls inhibited

<bc1>:

- 0 battery is exhausted, or ME does not have a battery connected
- 1...100 battery has 1-100 percent of capacity remaining

### Implementation

Optional.

## 8.5 Signal quality +CSQ

**Table 59: +CSQ action command syntax**

Command	Possible response(s)
+CSQ	+CSQ: <rs>, <ber> +CME ERROR: <err>
+CSQ=?	+CSQ: (list of supported <rs>s) , (list of supported <ber>s)

**Description**

Execution command returns received signal strength indication <rssi> and channel bit error rate <ber> from the ME. Refer subclause 9.2 for possible <err> values.

Test command returns values supported by the TA as compound values.

**Defined values**

<rssi>:

0 -113 dBm or less

1 -111 dBm

2...30 -109... -53 dBm

31 -51 dBm or greater

99 not known or not detectable

<ber> (in percent):

0...7 as RXQUAL values in the table in GSM 05.08 [20] subclause 8.2.4

99 not known or not detectable

**Implementation**

Optional.

## 8.6 Mobile Equipment control mode +CMEC

**Table 60: +CMEC parameter command syntax**

Command	Possible response(s)
+CMEC=[<keyp>[ ,<disp>[ ,<ind>]]]	+CME ERROR: <err>
+CMEC?	+CMEC: <keyp> , <disp> , <ind>
+CMEC=?	+CMEC: (list of supported <keyp>s) , (list of supported <disp>s) , (list of supported <ind>s)

**Description**

Set command selects the equipment, which operates ME keypad, writes to ME display and sets ME indicators. If operation mode is not allowed by the ME, +CME ERROR: <err> is returned. Refer subclause 9.2 for <err> values.

Test command returns the modes supported by the TA as compound values.

**Defined values**

<keyp>:

0 ME can be operated only through its keypad (execute command of +CKPD cannot be used)

1 ME can be operated only from TE (with command +CKPD)

2 ME can be operated from both ME keypad and TE

<disp>:

0 only ME can write to its display (command +CDIS can only be used to read the display)

1 only TE can write to ME display (with command +CDIS)

2 ME display can be written by both ME and TE

<ind>:

0 only ME can set the status of its indicators (command +CIND can only be used to read the indicators)

1 only TE can set the status of ME indicators (with command +CIND)

2 ME indicators can be set by both ME and TE

### Implementation

Mandatory when any of keypad, display or indicator commands is implemented.

## 8.7 Keypad control +CKPD

**Table 61: +CKPD action command syntax**

Command	Possible response(s)
+CKPD=<keys>[, <time>[, <pause>]]	+CME ERROR: <err>
+CKPD=?	

### Description

Execution command emulates ME keypad by giving each keystroke as a character in a string <keys>. <time>\*0.1 seconds is the time to stroke each key and <pause>\*0.1 seconds is the length of pause between two strokes. If emulating fails in an ME error, +CME ERROR: <err> is returned. Refer subclause 9.2 for <err> values. This command should be accepted (OK returned) before actually starting to press the keys. Thus unsolicited result codes of key pressings and display events can be returned (refer subclause "Mobile Equipment event reporting +CMER").

### Defined values

<keys>: string of characters representing keys as listed in the following table (based on PCCA STD-101 Annex table I-3). Colon character (IRA 58) followed by one character can be used to indicate a manufacturer specific key not listed here. All characters from a semicolon character (IRA 59) to the next single semicolon character are treated as alpha entries and are not converted to key equivalents. All semicolon characters inside alpha entries should be duplicated in the TE and stripped to one before entering to the ME. Pause character (IRA 87 or 119) can be used to pause between key pressings for a time specified by <pause>. All IRA values not listed here are reserved.

**Table 62: Character codes**

Char	IRA (dec)	Comment (+ some known key symbols)
#	35	hash (number sign)
%	37	percent sign (P)
*	42	star (*)
0... 9	48... 57	number keys
:	58	escape character for manufacturer specific keys
;	59	escape character for string entering
<	60	left arrow
>	62	right arrow
@	64	alpha key (α/ABC)
A/a	65/97	channel A (A)
B/b	66/98	channel B (B)
C/c	67/99	clear display (C/CLR)
D/d	68/100	volume down
E/e	69/101	connection end (END)
F/f	70/102	function (FCN)



Char	IRA (dec)	Comment (+ some known key symbols)
L/l	76/108	phone lock (LOCK)
M/m	77/109	menu (MENU)
P/p	80/112	power (PWR)
Q/q	81/113	quiet/mute (MUTE)
R/r	82/114	recall last number (R/RCL/MR)
S/s	83/115	connection start (SEND)
T/t	84/116	store/ memory (STO/M/M+)
U/u	85/117	volume up
V/v	86/118	down arrow
W/w	87/119	pause character
X/x	88/120	auxiliary (AUX)
Y/y	89/121	delete last character (C)
[	91	soft key 1
]	93	soft key 2
^	94	up arrow

<time>, <pause>:

0...255      0... 25.5 seconds (default values are manufacturer specific, but should be so long that a normal ME can handle keystrokes correctly)

### Implementation

Mandatory for ME not supporting the +CPIN command and supporting AT commands only.

## 8.8 Display control +CDIS

**Table 63: +CDIS parameter command syntax**

Command	Possible response(s)
+CDIS=[<text>[,<text>[,...]]]	+CME ERROR: <err>
+CDIS?	+CDIS: <text>[,<text>[,...]] +CME ERROR: <err>
+CDIS=?	+CDIS: <length>[,<length>[,...]] +CME ERROR: <err>

### Description

Set command is used to write the contents of ME text type display elements. An element can consist of one character or several characters. The order of element parameters <text> should follow the rule: first is the element in upper left corner, second is the next element to the right and so on. The last element is the element in lower right corner. The number of elements is ME specific. If ME does not allow writing to its display or ME is not currently reachable, +CME ERROR: <err> is returned. Refer subclause 9.2 for <err> values. If certain element is not writable, setting of it should be ignored. If element parameter is empty field, element shall remain in the previous value.

NOTE 1: This command cannot be used to write to a display which sum of element lengths exceed the length of the command line buffer of the TA.

Read command returns the contents of ME display elements. If <text> field is empty (not empty string), ME does not allow the reading of corresponding element. If ME is not currently reachable, +CME ERROR: <err> is returned. Refer subclause 9.2 for <err> values.

Test command returns maximum length of each display element. If ME does not offer the length of elements, <length> fields should be empty. If ME is not currently reachable, +CME ERROR: <err> is returned. Refer subclause 9.2 for <err> values.

NOTE 2: ME manufacturer should offer the order and maximum length of elements.

**Defined values**

<text>: string type parameter using character set specified by command Select TE Character Set +CSCS

<length>: integer type parameter giving the maximum length of corresponding <text> parameter

**Implementation**

Optional.

## 8.9 Indicator control +CIND

**Table 64: +CIND parameter command syntax**

Command	Possible response(s)
+CIND=[<ind>[,<ind>[,...]]]	+CME ERROR: <err>
+CIND?	+CIND: <ind>[,<ind>[,...]] +CME ERROR: <err>
+CIND=?	+CIND: (<descr>,(list of supported <ind>s)) [,<descr>,(list of supported <ind>s)][,...] +CME ERROR: <err>

**Description**

Set command is used to set the values of ME indicators. <ind> value 0 means that the indicator is off (or in state which can be identified as "off"-state), 1 means that indicator is on (or in a state which is more substantial than "off"-state), 2 is more substantial than 1, and so on. If the indicator is a simple on/off style element, it has values 0 and 1. The number of elements is ME specific. If ME does not allow setting of indicators or ME is not currently reachable, +CME ERROR: <err> is returned. Refer subclause 9.2 for <err> values. If certain indicator is not writable, setting of it should be ignored. If parameter is empty field, indicator shall remain in the previous value.

Read command returns the status of ME indicators. If ME is not currently reachable, +CME ERROR: <err> is returned. Refer subclause 9.2 for <err> values.

Test command returns pairs, where string value <descr> is a maximum 16 character description of the indicator and compound value is the allowed values for the indicator. If ME is not currently reachable, +CME ERROR: <err> is returned. Refer subclause 9.2 for <err> values.

NOTE: ME manufacturer should offer the description of supported indicators not listed here and their value ranges and default values.

**Defined values**

<ind>: integer type value, which shall be in range of corresponding <descr>

<descr> values reserved by the present document and their <ind> ranges:

"battchg"	battery charge level (0-5)
"signal"	signal quality (0-5)
"service"	service availability (0-1)
"sounder"	sounder activity (0-1)
"message"	message received (0-1)
"call"	call in progress (0-1)
"vox"	transmit activated by voice activity (0-1)

"roam"	roaming indicator (0-1)
"smsfull"	a short message memory storage in the MT has become full (1), or memory locations are available (0); i.e. the range is (0-1)

### Implementation

Optional.

## 8.10 Mobile Equipment event reporting +CMER

**Table 65: +CMER parameter command syntax**

Command	Possible response(s)
+CMER=[<mode>[ ,<keyp>[ ,<disp>[ ,<ind>[ ,<bfr>]]]]]	+CME ERROR: <err>
+CMER?	+CMER: <mode> , <keyp> , <disp> , <ind> , <bfr>
+CMER=?	+CMER: ( list of supported <mode>s ) , ( list of supported <keyp>s ) , ( list of supported <disp>s ) , ( list of supported <ind>s ) , ( list of supported <bfr>s )

### Description

Set command enables or disables sending of unsolicited result codes from TA to TE in the case of key pressings, display changes, and indicator state changes. <mode> controls the processing of unsolicited result codes specified within this command. <bfr> controls the effect on buffered codes when <mode> 1, 2 or 3 is entered. If setting is not supported by the ME, +CME ERROR: <err> is returned. Refer subclause 9.2 for <err> values.

Test command returns the modes supported by the TA as compound values.

### Defined values

<mode>:

- 0 buffer unsolicited result codes in the TA; if TA result code buffer is full, codes can be buffered in some other place or the oldest ones can be discarded
- 1 discard unsolicited result codes when TA-TE link is reserved (e.g. in on-line data mode); otherwise forward them directly to the TE
- 2 buffer unsolicited result codes in the TA when TA-TE link is reserved (e.g. in on-line data mode) and flush them to the TE after reservation; otherwise forward them directly to the TE
- 3 forward unsolicited result codes directly to the TE; TA-TE link specific inband technique used to embed result codes and data when TA is in on-line data mode

<keyp>:

- 0 no keypad event reporting
- 1 keypad event reporting using result code +CKEV: <key> , <press>. <key> indicates the key (refer IRA values defined in table in subclause "Keypad control +CKPD") and <press> if the key is pressed or released (1 for pressing and 0 for releasing). Only those key pressings, which are not caused by +CKPD shall be indicated by the TA to the TE.

NOTE 1: When this mode is enabled, corresponding result codes of all keys currently pressed should be flushed to the TA regardless of <bfr> setting.

- 2 keypad event reporting using result code +CKEV: <key> , <press>. All key pressings shall be directed from TA to TE.

NOTE 2: When this mode is enabled, corresponding result codes of all keys currently pressed should be flushed to the TA regardless of <bfr> setting.

<disp>:

0 no display event reporting

- 1 display event reporting using result code +CDEV: <elem>, <text>. <elem> indicates the element order number (as specified for +CDIS) and <text> is the new value of text element. Only those display events, which are not caused by +CDIS shall be indicated by the TA to the TE. Character set used in <text> is as specified by command Select TE Character Set +CSCS
- 2 display event reporting using result code +CDEV: <elem>, <text>. All display events shall be directed from TA to TE. Character set used in <text> is as specified by command Select TE Character Set +CSCS

<ind>:

0 no indicator event reporting

- 1 indicator event reporting using result code +CIEV: <ind>, <value>. <ind> indicates the indicator order number (as specified for +CIND) and <value> is the new value of indicator. Only those indicator events, which are not caused by +CIND shall be indicated by the TA to the TE
- 2 indicator event reporting using result code +CIEV: <ind>, <value>. All indicator events shall be directed from TA to TE

<bfr>:

0 TA buffer of unsolicited result codes defined within this command is cleared when <mode> 1...3 is entered

- 1 TA buffer of unsolicited result codes defined within this command is flushed to the TE when <mode> 1...3 is entered (OK response shall be given before flushing the codes)

### Implementation

Mandatory when any of the keypad, display, or indicator result codes is implemented.

## 8.11 Select phonebook memory storage +CPBS

Table 66: +CPBS parameter command syntax

Command	Possible response(s)
+CPBS=<storage> [ , <password> ]	+CME ERROR: <err>
+CPBS?	+CPBS: <storage> [ , <used> , <total> ] +CME ERROR: <err>
+CPBS=?	+CPBS: (list of supported <storage>s)

### Description

Set command selects phonebook memory storage <storage>, which is used by other phonebook commands. If setting fails in an ME error, +CME ERROR: <err> is returned. Refer subclause 9.2 for <err> values.

Read command returns currently selected memory, and when supported by manufacturer, number of used locations and total number of locations in the memory.

Test command returns supported storages as compound value.

### Defined values

<storage> values reserved by the present document:

"DC"	ME dialled calls list (+CPBW may not be applicable for this storage)
"EN"	SIM (or ME) emergency number (+CPBW is not be applicable for this storage)
"FD"	SIM fixdialling-phonebook
"LD"	SIM last-dialling-phonebook
"MC"	ME missed (unanswered received) calls list (+CPBW may not be applicable for this storage)
"ME"	ME phonebook
"MT"	combined ME and SIM phonebook
"ON"	SIM (or ME) own numbers (MSISDNs) list (reading of this storage may be available through +CNUM also)
"RC"	ME received calls list (+CPBW may not be applicable for this storage)
"SM"	SIM phonebook
"TA"	TA phonebook

<password>: string type value representing the PIN2-code required when selecting PIN2-code locked  
<storage>s above, e.g. "FD".

<used>: integer type value indicating the number of used locations in selected memory

<total>: integer type value indicating the total number of locations in selected memory

### Implementation

Mandatory when phonebook read, find or write command, or direct dialling (refer subclause "Direct dialling from phonebooks") is implemented.

## 8.12 Read phonebook entries +CPBR

**Table 67: +CPBR action command syntax**

Command	Possible response(s)
+CPBR=<index1> [, <index2>]	[+CPBR: <index1>, <number>, <type>, <text>[[...] <CR><LF>+CPBR: <index2>, <number>, <type>, <text>]] +CME ERROR: <err>
+CPBR=?	+CPBR: (list of supported <index>s), [<nlength>], [<tlength>] +CME ERROR: <err>

### Description

Execution command returns phonebook entries in location number range <index1>... <index2> from the current phonebook memory storage selected with +CPBS. If <index2> is left out, only location <index1> is returned. Entry fields returned are location number <indexn>, phone number stored there <number> (of format <type>) and text <text> associated with the number. If all queried locations are empty (but available), no information text lines may be returned. If listing fails in an ME error, +CME ERROR: <err> is returned. Refer subclause 9.2 for <err> values.

Test command returns location range supported by the current storage as a compound value and the maximum lengths of <number> and <text> fields. In case of SIM storage, the lengths may not be available. If ME is not currently reachable, +CME ERROR: <err> is returned. Refer subclause 9.2 for <err> values.

### Defined values

<index1>, <index2>, <index>: integer type values in the range of location numbers of phonebook memory

<number>: string type phone number of format <type>

<type>: type of address octet in integer format (refer GSM 04.08 [8] subclause 10.5.4.7)

<text>: string type field of maximum length <tlength>; character set as specified by command Select TE Character Set +CSCS

<nlength>: integer type value indicating the maximum length of field <number>

<tlength>: integer type value indicating the maximum length of field <text>

### Implementation

Optional.

## 8.13 Find phonebook entries +CPBF

**Table 68: +CPBF action command syntax**

Command	Possible response(s)
+CPBF=<findtext>	[+CPBF: <index1>, <number>, <type>, <text>[[...] <CR><LF>+CBPF: <index2>, <number>, <type>, <text>]] +CME ERROR: <err>
+CPBF=?	+CPBF: [<nlength>], [<tlength>] +CME ERROR: <err>

### Description

Execution command returns phonebook entries (from the current phonebook memory storage selected with +CPBS) which alphanumeric field start with string <findtext>. Entry fields returned are location number <indexn>, phone number stored there <number> (of format <type>) and text <text> associated with the number. If listing fails in an ME error, +CME ERROR: <err> is returned. Refer subclause 9.2 for <err> values.

Test command returns the maximum lengths of <number> and <text> fields. In case of SIM storage, the lengths may not be available. If ME is not currently reachable, +CME ERROR: <err> is returned. Refer subclause 9.2 for <err> values.

### Defined values

<index1>, <index2>: integer type values in the range of location numbers of phonebook memory

<number>: string type phone number of format <type>

<type>: type of address octet in integer format (refer GSM 04.08 [8] subclause 10.5.4.7)

<findtext>, <text>: string type field of maximum length <tlength>; character set as specified by command Select TE Character Set +CSCS

<nlength>: integer type value indicating the maximum length of field <number>

<tlength>: integer type value indicating the maximum length of field <text>

### Implementation

Optional.

## 8.14 Write phonebook entry +CPBW

**Table 69: +CPBW action command syntax**

Command	Possible response(s)
+CPBW=[<index>][,<number>[,<type>[,<text>]]]	+CME ERROR: <err>
+CPBW=?	+CPBW: (list of supported <index>s),[<nlength>], (list of supported <type>s),[<tlength>] +CME ERROR: <err>

### Description

Execution command writes phonebook entry in location number <index> in the current phonebook memory storage selected with +CPBS. Entry fields written are phone number <number> (in the format <type>) and text <text> associated with the number. If those fields are omitted, phonebook entry is deleted. If <index> is left out, but <number> is given, entry is written to the first free location in the phonebook (the implementation of this feature is manufacturer specific). If writing fails in an ME error, +CME ERROR: <err> is returned. Refer subclause 9.2 for <err> values.

Test command returns location range supported by the current storage as a compound value, the maximum length of <number> field, supported number formats of the storage, and the maximum length of <text> field. In case of SIM storage, the lengths may not be available. If ME is not currently reachable, +CME ERROR: <err> is returned. Refer subclause 9.2 for <err> values. If storage does not offer format information, the format list should be empty parenthesis

### Defined values

<index>: integer type values in the range of location numbers of phonebook memory

<number>: string type phone number of format <type>

<type>: type of address octet in integer format (refer GSM 04.08 [8] subclause 10.5.4.7) ; default 145 when dialling string includes international access code character "+", otherwise 129

<text>: string type field of maximum length <tlength>; character set as specified by command Select TE Character Set +CSCS

<nlength>: integer type value indicating the maximum length of field <number>

<tlength>: integer type value indicating the maximum length of field <text>

### Implementation

Optional.

## 8.15 Clock +CCLK

**Table 70: +CCLK parameter command syntax**

Command	Possible response(s)
+CCLK=<time>	+CME ERROR: <err>
+CCLK?	+CCLK: <time> +CME ERROR: <err>
+CCLK=?	

**Description**

Set command sets the real-time clock of the ME. If setting fails in an ME error, +CME ERROR: <err> is returned. Refer subclause 9.2 for <err> values.

Read command returns the current setting of the clock.

**Defined values**

<time>: string type value; format is "yy/MM/dd,hh:mm:ss±zz", where characters indicate year (two last digits), month, day, hour, minutes, seconds and time zone (indicates the difference, expressed in quarters of an hour, between the local time and GMT; range -47...+48). E.g. 6th of May 1994, 22:10:00 GMT+2 hours equals to "94/05/06,22:10:00+08"

NOTE: If ME does not support time zone information then the three last characters of <time> are not returned by +CCLK?

**Implementation**

Optional.

## 8.16 Alarm +CALA

**Table 71: +CALA parameter command syntax**

Command	Possible response(s)
+CALA=<time>[,<n>[,<type>[,<text>[,<recurr>[,<silent>]]]]]	+CME ERROR: <err>
+CALA?	[+CALA: <time>,<n1>,<type>,[<text>],[<recurr>],<silent> > [<CR><LF>+CALA: <time>,<n2>,<type>,[<text>],[<recurr>],<silent> > [...]]] +CME ERROR: <err>
+CALA=?	+CALA: (list of supported <n>s), (list of supported <type>s), <tlength>, <rlength>, (list of supported <silent>s) +CME ERROR: <err>

**Description**

Set command sets an alarm time in the ME. There can be an array of different types of alarms, and each alarm may cause different text to be displayed in the ME display. If setting fails in an ME error, +CME ERROR: <err> is returned. Refer subclause 9.2 for <err> values.

To set up a recurrent alarm for one or more days in the week, the <recurr>-parameter may be used.

When an alarm is timed out and executed, the unsolicited result code +CALV: <n> is always returned, even if the alarm is set up to be silent.

Read command returns the list of current active alarm settings in the ME.

Test command returns supported array index values, alarm types, and maximum length of the text to be displayed.

**Defined values**

<time>: refer +CCLK



NOTE: If the <recurr>-parameter is used, the <time>-parameter must not contain a date.

<n>, <n1>, <n2>: integer type value indicating the index of the alarm; default is manufacturer specific

<type>: integer type value indicating the type of the alarm (e.g. sound, volume, LED); values and default are manufacturer specific

<text>: string type value indicating the text to be displayed when alarm time is reached; maximum length <tlength>

<tlength>: integer type value indicating the maximum length of <text>

<recurr>: string type value indicating day of week for the alarm in one of the following formats:

"<1..7>[,<1..7>[...]]" – Sets a recurrent alarm for one or more days in the week. The digits 1 to 7 corresponds to the days in the week, Monday (1), ..., Sunday (7).

Example: The string "1,2,3,4,5" may be used to set an alarm for all weekdays.

"0" – Sets a recurrent alarm for all days in the week.

<rlength>: integer type value indicating the maximum length of <recurr>

<silent>: Integer type value indicating if the alarm is silent or not. If set to 1 the alarm will be silent and the only result from the alarm is the unsolicited result code +CALV. If set to 0 the alarm will not be silent.

## Implementation

Optional.

## 8.17 Generic SIM access +CSIM

**Table 72: +CSIM action command syntax**

Command	Possible response(s)
+CSIM=<length>,<command>	+CSIM: <length>,<response> +CME ERROR: <err>
+CSIM=?	

### Description

Set command transmits to the ME the <command> it then shall send as it is to the SIM. In the same manner the SIM <response> shall be sent back by the ME to the TA as it is. Refer subclause 9.2 for <err> values.

This command allows a direct control of the SIM by an distant application on the TE. The TE shall then take care of processing SIM information within the frame specified by GSM/UMTS.

NOTE: Compared to Restricted SIM Access command +CRSM, the definition of +CSIM allows TE to take more control over the SIM-ME interface. The locking and unlocking of the interface may be done by a special <command> value or automatically by TA/ME (by interpreting <command> parameter). In case that TE application does not use the unlock command (or does not send a <command> causing automatic unlock) in a certain timeout value, ME may release the locking.

### Defined values

<length> : integer type; length of the characters that are sent to TE in <command> or <response> (two times the actual length of the command or response)

<command> : command passed on by the ME to the SIM in the format as described in GSM 11.11 [28] (hexadecimal character format; refer +CSCS)

<response> : response to the command passed on by the SIM to the ME in the format as described in GSM 11.11 [28] (hexadecimal character format; refer +CSCS)

## Implementation

Optional.

## 8.18 Restricted SIM access +CRSM

**Table 73: +CRSM action command syntax**

Command	Possible response(s)
+CRSM=<command>[, <fileid>[, <P1>, <P2>, <P3>[, <data>]]]	+CRSM: <sw1>, <sw2>[, <response>] +CME ERROR: <err>
+CRSM=?	

### Description

By using this command instead of Generic SIM Access +CSIM TE application has easier but more limited access to the SIM database. Set command transmits to the ME the SIM <command> and its required parameters. ME handles internally all SIM-ME interface locking and file selection routines. As response to the command, ME sends the actual SIM information parameters and response data. ME error result code +CME ERROR may be returned when the command cannot be passed to the SIM, but failure in the execution of the command in the SIM is reported in <sw1> and <sw2> parameters. Refer to subclause 9.2 for <err> values.

Coordination of command requests to SIM and the ones issued by GSM/UMTS application inside the ME is implementation dependent. However the TE should be aware of the precedence of the GSM/UMTS application commands to the TE commands.

### Defined values

<command> (command passed on by the ME to the SIM; refer GSM 11.11 [28]):

- 176 READ BINARY
- 178 READ RECORD
- 192 GET RESPONSE
- 214 UPDATE BINARY
- 220 UPDATE RECORD
- 242 STATUS

all other values are reserved

NOTE 1: The ME internally executes all commands necessary for selecting the desired file, before performing the actual command.

<fileid>: integer type; this is the identifier of a elementary datafile on SIM. Mandatory for every command except STATUS

NOTE 2: The range of valid file identifiers depends on the actual SIM and is defined in GSM 11.11 [28]. Optional files may not be present at all.

<P1>, <P2>, <P3>: integer type; parameters passed on by the ME to the SIM. These parameters are mandatory for every command, except GET RESPONSE and STATUS. The values are described in GSM 11.11 [28]

<data>: information which shall be written to the SIM (hexadecimal character format; refer +CSCS)

<sw1>, <sw2>: integer type; information from the SIM about the execution of the actual command. These parameters are delivered to the TE in both cases, on successful or failed execution of the command

<response>: response of a successful completion of the command previously issued (hexadecimal character format; refer +CSCS). STATUS and GET RESPONSE return data, which gives information about the current

elementary datafield. This information includes the type of file and its size (refer GSM 11.11 [28]). After READ BINARY or READ RECORD command the requested data will be returned. <response> is not returned after a successful UPDATE BINARY or UPDATE RECORD command

### Implementation

Optional.

## 8.19 Secure control command +CSCC

**Table 74: +CSCC parameter command syntax**

Command	Possible response(s)
+CSCC=<mode>[,<cmd_set>[,<token>]]	+CSCC: <challenge> +CME ERROR: <err>
+CSCC?	+CSCC: <mode>,<cmd_set1> [<CR><LF>+CSCC: <mode>,<cmd_set2> [...]] +CME ERROR: <err>
+CSCC=?	+CSCC: (list of supported <mode>s) , (list of supported <cmd_set>s)

### Description

This command is used to enable/disable access to commands protected by security mechanism. This enables/disables access to command sets designated as "secure" such as programming of ME. Refer subclause 9.2 for possible <err> values.

The TE asks for a <challenge> with <mode>=1 and one specific command set (<cmd\_set>), the ME replies with the <challenge>, which should be inserted into the identification algorithm in both entities (TE and ME). The algorithm output <token> is sent to the ME with <mode>=2 to enable the specified command set. <mode>=3 is used to disable the command set.

The read command returns the status (<mode> 2 or 3) of each supported command set.

### Defined values

<mode>:

- 1 request challenge token to enable access to specified command set
- 2 enable access to specified command set (<token> required)
- 3 disable access to specified command set

<cmd\_set>, <cmd\_set1>, <cmd\_set2>:

- 0 MS code re-programming command set.

other values below 128 are reserved by the present document

<token>: string type; a variable length bit string represented with IRA characters 0 - 9 and A - F, each character representing a nibble; e.g. bit string "0110 1100 1001 1010" is represented by the IRA string "6C9A". The length of the required bit string varies depending on the value of <cmd\_set>.

<challenge>: same format as token

### Implementation

Optional.

## 8.20 Alert sound mode +CALM

**Table 75: +CALM parameter command syntax**

Command	Possible response(s)
+CALM=<mode>	+CME ERROR: <err>
+CALM?	+CALM: <mode> +CME ERROR: <err>
+CALM=?	+CALM: (list of supported <mode>s) +CME ERROR: <err>

### Description

This command is used to select the general alert sound mode of the ME. Refer subclause 9.2 for possible <err> values.

Test command returns supported values as compound value.

### Defined values

<mode>:

- 0 normal mode
- 1 silent mode (all sounds from ME are prevented)
- 2... manufacturer specific

### Implementation

Optional.

## 8.21 Ringer sound level +CRSL

**Table 76: +CRSL parameter command syntax**

Command	Possible response(s)
+CRSL=<level>	+CME ERROR: <err>
+CRSL?	+CRSL: <level> +CME ERROR: <err>
+CRSL=?	+CRSL: (list of supported <level>s) +CME ERROR: <err>

### Description

This command is used to select the incoming call ringer sound level of the ME. Refer subclause 9.2 for possible <err> values.

Test command returns supported values as compound value.

### Defined values

<level>: integer type value with manufacturer specific range (smallest value represents the lowest sound level)

### Implementation

Optional.

## 8.22 Vibrator mode +CVIB

**Table 77: +CVIB parameter command syntax**

Command	Possible response(s)
+CVIB=<mode>	+CME ERROR: <err>
+CVIB?	+CVIB: <mode> +CME ERROR: <err>
+CVIB=?	+CVIB: (list of supported <mode>s) +CME ERROR: <err>

### Description

This command is used to enable and disable the vibrator alert feature of the ME. It is manufacturer specific how this interacts with +CALM command. Refer subclause 9.2 for possible <err> values.

Test command returns supported values as compound value.

### Defined values

<mode>:

0 disable

1 enable

...15 reserved by the present document

16... manufacturer specific

### Implementation

Optional.

## 8.23 Loudspeaker volume level +CLVL

**Table 78: +CLVL parameter command syntax**

Command	Possible response(s)
+CLVL=<level>	+CME ERROR: <err>
+CLVL?	+CLVL: <level> +CME ERROR: <err>
+CLVL=?	+CLVL: (list of supported <level>s) +CME ERROR: <err>

### Description

This command is used to select the volume of the internal loudspeaker of the ME. Refer subclause 9.2 for possible <err> values.

Test command returns supported values as compound value.

### Defined values

<level>: integer type value with manufacturer specific range (smallest value represents the lowest sound level)

### Implementation

Optional.

## 8.24 Mute control +CMUT

**Table 79: +CMUT parameter command syntax**

Command	Possible response(s)
+CMUT=<n>	+CME ERROR: <err>
+CMUT?	+CMUT: <n> +CME ERROR: <err>
+CMUT=?	+CMUT: (list of supported <n>s)

### Description

This command is used to enable and disable the uplink voice muting during a voice call. Refer subclause 9.2 for possible <err> values.

Test command returns supported values as compound value.

### Defined values

<n>:

0 mute off

1 mute on

### Implementation

Optional.

## 8.25 Accumulated call meter +CACM

**Table 80: +CACM parameter command syntax**

Command	Possible response(s)
+CACM=[<passwd>]	+CME ERROR: <err>
+CACM?	+CACM: <acm> +CME ERROR: <err>
+CACM=?	

### Description

Set command resets the Advice of Charge related accumulated call meter value in SIM file EF<sub>ACM</sub>. ACM contains the total number of home units for both the current and preceding calls. SIM PIN2 is usually required to reset the value. If setting fails in an ME error, +CME ERROR: <err> is returned. Refer subclause 9.2 for <err> values.

Read command returns the current value of ACM.

### Defined values

<passwd>: string type; SIM PIN2

<acm>: string type; accumulated call meter value similarly coded as <ccm> under +CAOC

### Implementation

Optional.

## 8.26 Accumulated call meter maximum +CAMM

**Table 81: +CAMM parameter command syntax**

Command	Possible response(s)
+CAMM=[ <acmmax> [ , <passwd> ] ]	+CME ERROR: <err>
+CAMM?	+CAMM: <acmmax> +CME ERROR: <err>
+CAMM=?	

### Description

Set command sets the Advice of Charge related accumulated call meter maximum value in SIM file EF<sub>ACMmax</sub>. ACMmax contains the maximum number of home units allowed to be consumed by the subscriber. When ACM (refer +CACM) reaches ACMmax calls are prohibited (see also 3G TS 22.024 [26]). SIM PIN2 is usually required to set the value. If setting fails in an ME error, +CME ERROR: <err> is returned. Refer subclause 9.2 for <err> values.

Read command returns the current value of ACMmax.

### Defined values

<acmmax>: string type; accumulated call meter maximum value similarly coded as <ccm> under +CAOC; value zero disables ACMmax feature

<passwd>: string type; SIM PIN2

### Implementation

Optional.

## 8.27 Price per unit and currency table +CPUC

**Table 82: +CPUC parameter command syntax**

Command	Possible response(s)
+CPUC=<currency> , <ppu> [ , <passwd> ]	+CME ERROR: <err>
+CPUC?	+CPUC: <currency> , <ppu> +CME ERROR: <err>
+CPUC=?	

### Description

Set command sets the parameters of Advice of Charge related price per unit and currency table in SIM file EF<sub>PUCT</sub>. PUCT information can be used to convert the home units (as used in +CAOC, +CACM and +CAMM) into currency units. SIM PIN2 is usually required to set the parameters. If setting fails in an ME error, +CME ERROR: <err> is returned. Refer subclause 9.2 for <err> values.

Read command returns the current parameters of PUCT.

### Defined values

<currency>: string type; three-character currency code (e.g. "GBP", "DEM"); character set as specified by command Select TE Character Set +CSCS

<ppu>: string type; price per unit; dot is used as a decimal separator (e.g. "2.66")

<passwd>: string type; SIM PIN2

**Implementation**

Optional.

**8.28 Call Meter maximum event +CCWE****Table 83: +CCWE parameter command syntax**

Command	Possible response(s)
+CCWE=<mode>	+CME ERROR: <err>
+CCWE?	+CCWE: <mode> +CME ERROR: <err>
+CCWE=?	+CCWE: (list of supported <mode>s) +CME ERROR: <err>

**Description**

Shortly before the ACM (Accumulated Call Meter) maximum value is reached, an unsolicited result code +CCWV will be sent, if enabled by this command. The warning is issued approximately when 30 seconds call time remains. It is also issued when starting a call if less than 30 s call time remains. If setting fails in an ME error, +CME ERROR: <err> is returned. Refer subclause 9.2 for <err> values.

Read command returns the current setting.

Test command returns supported settings.

**Defined values**

<mode>:

0 Disable the call meter warning event

1 Enable the call meter warning event

**Implementation**

Optional.

**8.29 Power class +CPWC****Table 84: +CPWC parameter command syntax**

Command	Possible response(s)
+CPWC=[<class>[,<band>]]	+CME ERROR: <err>
+CPWC?	+CPWC: <curr_class1>,<def_class1>,<band1> [,<curr_class2>,<def_class2>,<band2>[...]] +CME ERROR: <err>
+CPWC=?	+CPWC: list of supported (<band>,(list of <class>s)) pairs +CME ERROR: <err>

**Description**

This command is used to set the preferred ME power class for each GSM frequency band supported. The interaction of this setting with the selected bearer service (+CBST and HSCSD commands) is manufacturer specific (for example, selecting a multislot operation might reduce the power class automatically). If setting fails in an ME error, +CME ERROR: <err> is returned. Refer subclause 9.2 for <err> values.



Read command returns the currently selected output power class and default output power class for each supported frequency band (as defined by ME manufacturer). Parameter <band1> and its associated power class parameters refer to the currently used frequency band. For example, +CPWC: 2,1,1,5,4,0 in case of a dual-band ME currently using band GSM1800, for which the power class is currently set to 2, the default being class 1, and for which the currently set power class value for GSM900 is class 5 the default being class 4.

Test command returns supported bands and their power classes. For example,

+CPWC: (0,(0,4,5)),(1,(0-2)) in case of a dual-band handheld ME.

#### Defined values

<class>, <curr\_class>s, <def\_class>s:

0 default (not applicable to <curr\_class>s or <def\_class>s)

1... MS output power class as in GSM 05.05 [38]

<band>, <bandn>s:

0 GSM900

1 GSM1800

2 reserved for GSM1900

3 GSM 400

#### Implementation

Optional.

## 8.30 Set Language +CLAN

Table 85: +CLAN parameter command syntax

Command	Possible response(s)
+CLAN=<code>	+CME ERROR: <err>
+CLAN?	+CLAN: <code> +CME ERROR: <err>
+CLAN=?	+CLAN:(list of supported <code>s) +CME ERROR: <err>

#### Description

This command sets the language in the ME. The set-command must confirm the selected language with the MMI-module in the ME. If setting fails, a ME error, +CME ERROR: <err> is returned. Refer subclause 9.2 for <err> values.

The <code>-parameter is a two-letter abbreviation of the language. The language codes, as defined in ISO 639, consists of two characters, e.g. "sv", "en" etc.

The complete set of language codes to be used are manufacturer specific and should all be possible to use with the command. Some examples are described under <code>. For a complete list see ISO 639.

The read command gives the current language as output. If the language has been set to "AUTO", the read command returns the current language set from the SIM-card. Hence, the "AUTO"-code is never returned by the read-command.

Test command returns supported <code>s.

#### Defined values

<code>: (not all language codes are present in this list)

"AUTO"	Read language from SIM. "Auto" is not returned by the read-command.
"sw"	Swedish
"fi"	Finnish
"da"	Danish
"no"	Norwegian
"de"	German
"fr"	French
"es"	Spanish
"it"	Italian
"en"	English

### Implementation

Optional.

## 8.31 Language Event +CLAE

**Table 86: +CLAE parameter command syntax**

Command	Possible response(s)
+CLAE=<mode>	+CME ERROR: <err>
+CLAE?	+CLAE: <mode> +CME ERROR: <err>
+CLAE=?	+CLAE: (list of supported <mode>s) +CME ERROR: <err>

### Description

This command is used to enable/disable unsolicited result code +CLAV: <code>. If <mode>=1, +CLAV: <code> is sent from the ME when the language in the ME is changed. If setting fails, a ME error, +CME ERROR: <err> is returned. Refer subclause 9.2 for <err> values.

Read command returns the current status for <mode>.

Test command returns supported <mode>s.

### Defined values

<mode>:

0 Disable unsolicited result code +CLAE

1 Enable unsolicited result code +CLAE

<code>: For description see +CLAN.

### Implementation

Optional.

## 8.32 Set Greeting Text +CSGT

**Table 87: +CSGT parameter command syntax**

Command	Possible response(s)
+CSGT=<mode>[ ,<text>]	+CME ERROR: <err>
+CSGT?	+CSGT: <text>, <mode> +CME ERROR: <err>
+CSGT=?	+CSGT: (list of supported <mode>s), <lt;text> +CME ERROR: <err>

### Description

This command sets and activates the greeting text in the ME. The greeting text is shown in the ME display when the ME is turned on. The command can also be used to deactivate a text. If setting fails in an ME error, +CME ERROR: <err> is returned. Refer subclause 9.2 for <err> values.

The read command queries the current <text> and the status of the <mode> parameter

**Test command returns supported <mode>s and the maximum number of characters in <text>. For example,**

+CSGT: (0-1),20

### Defined values

<text>: string type; A free text that shall be displayed. The text can not include <CR>

**<mode>:**

**0 Turn off greeting text.**

**1 Turn on greeting text**

### Implementation

Optional.

## 8.33 Set Voice Mail Number +CSVM

**Table 88: +CSVM parameter command syntax**

Command	Possible response(s)
+CSVM=<mode>[ ,<number>[ ,<type>]]	+CME ERROR: <err>
+CSVM?	+CSVM: <mode>, <number>, <type> +CME ERROR: <err>
+CSVM=?	+CSVM: (list of supported <mode>s), (list of supported <type>s) +CME ERROR: <err>

### Description

The number to the voice mail server is set with this command. The parameters <number> and <type> can be left out if the parameter <mode> is set to 0. If setting fails, an ME error, +CME ERROR: <err> is returned. Refer subclause 9.2 for <err> values.

Read command returns the currently selected voice mail number and the status (i.e. enabled/disabled).

Test command returns supported <mode>s and <type>s.

**Defined values**

<mode>:

- 0 Disable the voice mail number.
- 1 Enable the voice mail number.

<number>: string type; Character string <0..9,+>

<type>: integer type; Type of address octet. (refer GSM 04.08 subclause 10.5.4.7)

- 129 ISDN / telephony numbering plan, national / international unknown
- 145 ISDN / telephony numbering plan, international number
- 161 ISDN / telephony numbering plan, national number
- 128 - 255 Other values refer GSM 04.08 section 10.5.4.7

<type>: type of address octet in integer format (refer GSM 04.08 [8] subclause 10.5.4.7); default 145 when dialling string includes international access code character "+", otherwise 129

**Implementation**

Optional.

## 8.34 Ring Melody Playback +CRMP

**Table 89: +CRMP action command syntax**

Command	Possible response(s)
+CRMP=<call type>[,<volume>[,<type>,<index>]]	+CME ERROR: <err>
+CRMP=?	+CRMP: (list of supported <call type>s),(list of supported <volume>s),( <type0>),(list of supported <index>s)[<CR><LF> +CRMP: (list of supported <call type>s),(list of supported <volume>s),( <type1>),(list of supported <index>s)  +CME ERROR: <err>

**Description**

Execution command causes the ME to playback a specific ring type. The default values for the optional parameters are the current selected in the ME.

Test command returns the available ring melodies.

Defined values:

<call type>: integer type; manufacturer specific

<volume>: integer type value with manufacturer specific range (smallest value represents the lowest sound level)

<type>:

- 0 Manufacturer defined

1 User defined

<index>: integer type;

### Implementation

Optional.

## 8.35 Master Reset +CMAR

**Table 90: +CMAR action command syntax**

Command	Possible response(s)
+CMAR=<phone lock code>	+CME ERROR: <err>
+CMAR=?	+CME ERROR: <err>

### Description

This command requests the ME to reset user data. The user data in the phone will be reset to default values. If setting fails, a ME error, +CME ERROR: <err>, is returned. Refer subclause 9.2 for <err> values.

If the ME is locked and this command is used, then the ME will be unlocked after the master reset.

Test command returns OK

### Defined values

<phone lock code > string type; Security code (Phone Lock code) must be verified before performing the master reset.

### Implementation

Optional.

## 8.36 List all available AT commands +CLAC

**Table 91: +C action command syntax**

Command	Possible response(s)
+CLAC	<AT Command1> [<CR> <LF> <AT Command2>[...]] +CME ERROR: <err>
+CLAC=?	+CME ERROR: <err>

### Description

Execution command causes the ME to return one or more lines of AT Commands.

Note: This command only returns the AT commands that are available for the user.

### Defined values

<AT Command >:

Defines the AT command including the prefix AT. Text shall not contain the sequence 0<CR> or OK<CR>

### Implementation

Optional.

## 8.37 Delete alarm +CALD

**Table 92: +CALD action command syntax**

Command	Possible response(s)
+CALD=<n>	+CME ERROR: <err>
+CALD=?	+CALD: (list of supported <n>s) +CME ERROR: <err>

### Description

Action command deletes an alarm in the ME. If the command fails in an ME error, +CME ERROR: <err> is returned. Refer subclause 9.2 for <err> values.

Test command returns supported array index values.

### Defined values

<n>: integer type value indicating the index of the alarm; default is manufacturer specific

### Implementation

Optional.

## 8.38 Postpone or dismiss an alarm +CAPD

**Table 93: +CAPD action command syntax**

Command	Possible response(s)
+CAPD=[<sec>]	+CME ERROR: <err>
+CAPD=?	+CAPD: (list of supported <sec>s) +CME ERROR: <err>

### Description

Set command postpones or dismisses a currently active alarm. If the command fails in an ME error, +CME ERROR: <err> is returned. Refer subclause 9.2 for <err> values.

Test command returns supported <sec>-parameter values.

### Defined values

<sec>: integer type value indicating the number of seconds to postpone the alarm. If <sec> is set to 0 (default), the alarm is dismissed.

### Implementation

Optional.

## 8.39 Automatic Time Zone Update +CTZU

**Table 94: +CTZU parameter command syntax**

Command	Possible response(s)
+CTZU=<onoff>	+CME ERROR: <err>
+CTZU?	+CTZU: <onoff> +CME ERROR: <err>
+CTZU=?	+CTZU: (list of supported <onoff>s) +CME ERROR: <err>

### Description

Set command enables and disables automatic time zone update via NITZ. If setting fails in an ME error, +CME ERROR: <err> is returned. Refer subclause 9.2 for <err> values.

Read command returns the current settings in the ME.

Test command returns supported on- and off-values.

### Defined values

<onoff>: integer type value indicating:

- 0 – Disable automatic time zone update via NITZ (default).
- 1 – Enable automatic time zone update via NITZ.

### Implementation

Optional.

## 8.40 Time Zone Reporting +CTZR

**Table 95: +CTZR parameter command syntax**

Command	Possible response(s)
+CTZR=<onoff>	+CME ERROR: <err>
+CTZR?	+CTZR: <onoff> +CME ERROR: <err>
+CTZR=?	+CTZR: (list of supported <onoff>s) +CME ERROR: <err>

### Description

This set command enables and disables the time zone change event reporting. If the reporting is enabled the ME returns the unsolicited result code +CTZV: <tz> whenever the time zone is changed. If setting fails in an ME error, +CME ERROR: <err> is returned. Refer subclause 9.2 for <err> values.

Read command returns the current reporting settings in the ME.

Test command returns supported <onoff>-values.

NOTE: The Time Zone reporting is not affected by the Automatic Time Zone setting command, +CTZU.

### Defined values

<onoff>: integer type value indicating:

- 0 – disable time zone change event reporting (default).

- 1 – Enable time zone change event reporting.

## Implementation

Optional.

## 8.41 Enter protocol mode+CPROT

**Table 96: +CPROT parameter command syntax**

Command	Possible response(s)
+CPROT=<proto>[,<version>[,<lsap1>[,...[,<lsapN>]]]]	CONNECT NO CARRIER OK ERROR +CME ERROR: <err>
+CPROT=?	+CPROT: <proto1>[(list of supported <version>s)[,(list of supported <lsap1>s)[,...[(list of supported <lsapN>s)]]]] [<CR><LF> +CPROT : <proto2>[(list of supported <version>s)[,(list of supported <lsap1>s)[,...[(list of supported <lsapN>s)]]]] [...]]]]]

### Description

Set command informs TA that TE wants to establish a peer-to-peer protocol <proto> or upper layer connection (indicating by the <lsap>s setting) with the ME on the link from which the command was received. This command can be used in case the link between TE and ME does not provide itself such a mechanism.

If ME has succeeded in establishing a logical link between application protocols and external interface, it will send CONNECT message to the TE. Otherwise, the NO CARRIER response will be returned.

If the CONNECT response is received, TE can start sending <proto> or upper layer frames.

The connection shall always return for <proto> mode when the protocol session is ended. When the ME receives a disconnect request from its peer entity, it will process it and send OK response to the TE indicating its capability for receiving new AT commands. Since <proto> or upper layers can be accessed in other ways, TA must have pre-knowledge of the fact that connection is initiated with AT+CPROT command. This means that switch to <proto> mode must include some sort of notification to the protocol entity.

This command can be aborted by sending a <proto> or upper layer disconnection frame. In that case, ME will return in command mode by sending the OK response.

Refer subclause 9.2 for possible <err> values.

Test command returns values supported by the TA as a compound value.

### Defined values

<proto>

0 OBEX (refer.[44])

...15 reserved by the present document

16... manufacturer specific

<version>: version number of <proto>: string type



<lsap1>: defines a level of service or application protocol on the top of <proto> layer. It may refer to services or protocols defined in other standards development organisations (SDOs).

- 1 IrMC level 1 (Minimum Level) Only .(refer [43] subclause 2.9.4)
- 2 IrMC level 1 and 2 (Minimum and Access Levels) Only. .(refer [43] subclause 2.9.4)
- 4 IrMC level 1, 2 and 3 (Minimum, Access, Index Levels) Only- implies static index support. .(refer [43] subclause 2.9.4)
- 8 IrMC level 1, 2 and 4 (Minimum, Access and Sync Levels) Only-implies unique index support. .(refer [43] subclause 2.9.4)
- 10 IrMC level 1, 2, 3 and 4 (Minimum, Access, Index and Sync Levels)-implies support of static and unique index. .(refer [43] subclause 2.9.4)
- ...15 reserved by the present document
- 16... manufacturer specific

<lsap2> . . . <lsapN>

In case <lsapN>, <lsapN+1> received in the +CPROT command identifies protocol layers, the protocol identified by N+1 shall be on the top of the protocol identified by N on a framework point of view.

- 0...15 reserved by the present document
- 16... manufacturer specific

### Implementation

Optional.

## 8.42 Informative examples

Phone Activity Status (+CPAS) is a general command used to detect the presence of the ME, if there is an incoming call, or if there is a call in progress. This command should be used before trying to operate the ME from the TE. Note that the activity status may change at any time after the execution of +CPAS, and hence the returned value may be obsolete. Detachment of the ME from the TA is indicated with a special final result code that indicates all errors related to the operation of the ME. Result code is +CME ERROR: <err>, where <err> is an integer or verbose value giving useful information about the reason for the command failure (refer subclause "Mobile Equipment error result code +CME ERROR").

Set Phone Functionality (+CFUN) can be used to reset the ME or set the power consumption level of the ME by disabling certain parts of the ME (e.g. the transmit and receive RF circuits). Mobile Equipment Control Mode (+CMEC) is a command which manages access sharing between the ME and the TE to operate the user interface of the ME. It has three subparameters which describe the access to keypad, display and indicators. Each subparameter has values for restricting the operation of the corresponding user interface part only to the ME or only to the TE, or to give the access for both of them.

Keypad Control command (+CKPD) is used to operate the keypad of the ME. Here lies the problem of different keypad types between manufacturers, and also between their ME models. The keypresses are sent to the ME as a string type subparameter of this command. Each character in that string represents a key which will be logically pressed. A special character (colon) followed by any character can be used by manufacturers (or TE application programmers) to represent a key which is not defined in this profile. An escape character (semicolon) for direct string entering is also defined. All text between single semicolon characters is treated as an alphanumeric entry and is not converted to keypressings. All semicolon characters inside the text shall be duplicated in the TE and stripped back to one before entering them to the ME. Command has also optional second and third parameters which can be used to alter the time to strike each key, and the pause to wait between keystrokes (in tenths of a second). A special pause character (W or w) may be added in the string type subparameter for an extra pause of the same length as given by the third subparameter. In the following example alphanumeric mode is entered and a person predefined in the ME phonebook, "Iikka", is called; each key is struck for half a second and pauses between strokes are a tenth of a second:

```
AT+CKPD="@:Iikka:S",5,1
```

OK

Display Control command (+CDIS) is used both for writing to the display text fields and for reading the current status of the fields. Mobile equipment usually have a character set of their own, so the TA shall be able to do a conversion between the TE and the ME character sets. TE can have several character sets and the TA must be informed of the character set in use before starting to write or read the display. Character set is set with general command Select TE Character Set +CSCS. The +CDIS=? query command is a way to get information about the length of the fields. In the following example an ME is first queried about the supported conversions and the lengths of the fields. The response shows there are three ten character long and two six character long fields. Then the TE character set is set to be IRA and the current status of the display is read. The last command writes the text "Hello, I'm writing to display" in the three fields, and keeps the contents of the two other fields same (the last two commas could also be left out).

```
AT+CSCS=?;+CDIS=?
+CSCS: ("IRA","PCCP850","8859-1")
+CDIS: 10,10,10,6,6
OK
AT+CSCS="IRA"
OK
AT+CDIS?
+CDIS: "RADIOLINJA","","","Menu","Memory"
OK
AT+CDIS="IRA","Hello, I'm","writing to","display",,
OK
```

The writing is possible only when it is permitted by the Mobile Equipment Control Mode command (and by the manufacturer). If a certain field is not writable (but is readable), writing to it should be ignored. The order of the text fields should be determined by manufacturers and follow the rule: first field is in the upper left corner, second in the next field to the right, and so on, until to the last field in the lower right corner.

Indicators can be handled with Indicator Control command (+CIND). Its query command returns a short description (abbreviation) of the purpose of the indicators and the supported values for each indicator. The setting and reading is done similarly as with Display Control command. In the following example the indicators of a phone are queried, their current value is read, and the value of message indicator is tried to set (but it is forbidden):

```
AT+CIND=?
+CIND: ("memory",(0-2)),("call",(0,1)),("data",(0,1)),("roam",(0,1)),
("alpha",(0,1)),("message",(0,1)),("index1",(0-11)),("index2",(0-11)),
("index3",(0-11)),("signal",(0-5)),("service",(0,1)),("sel1",(0,1)),
("sel2",(0,1)),("sel3",(0,1)),("battchg",(0-5))
OK
AT+CIND?
+CIND: 1,0,0,0,0,1,0,0,0,3,1,0,0,0,5
OK
AT+CIND=,,,,,0
+CME ERROR: 10
```

The subparameter order in the command is defined by the query command order, not by the actual display order. The zero value of an indicator means that it is off (or in state which can be identified as "off"-state), value one means that the indicator is on (or in a state which is more substantial than "off"-state), value two is more substantial than one, and so on.

To this point, only operating through the TE is covered. But when ME can be operated also through its keypad, or there are changes in the status of the display elements, the information about these actions shall be given to the TE also. This can be solved only with unsolicited result codes which return keypad, display text and indicator events. Each event group has a result code of its own: +CKEV returns the key code and if the key pressed (1) or released (0), +CDEV returns the display text field running number (as specified by command +CDIS) and the new status of the field, and +CIEV returns the running number of the indicator (refer +CIND) and the new value of it. In the following example number key 1 is pressed, updated on the display, released, and signal strength changes its state to five:

```
+CKEV: 49,1
+CDEV: 1,"1"
+CKEV: 49,0
+CIND: 10,5
```

Mobile Equipment Event Reporting command (+CMER) has been specified for the purpose of controlling the sending of these unsolicited result codes to the TE. Four ways are provided to handle the buffering of the result codes (see figure 8). The first is to buffer them always. The second possibility is to discard them when in on-line data mode and otherwise forward them directly to the TE. The third possibility is to buffer them in data mode and otherwise forward them to the TE. The last possibility is to send them always to the TE (some inband technique - e.g. V.80 - shall be used in data mode to send the result codes within the data). This is the first subparameter of +CMER command. Next three subparameters are used to enable or disable each of the keypad, text field and indicator result codes. Sending codes can be enabled either so that only events generated from the ME user interface are returned, or so that also events caused by Keypad, Display and Indicator Control commands are returned. The fifth subparameter controls the flushing of the buffer when the value of the first subparameter is changed to a value from one to three.

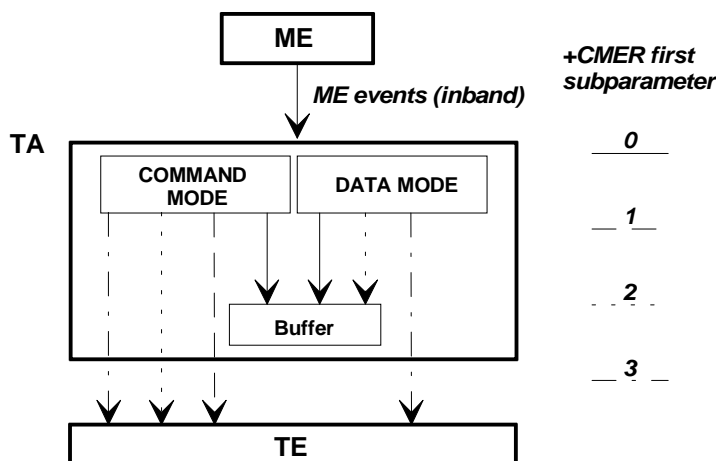

Figure 8: Mobile equipment event reporting

An example of complete setup of the TA where TE takes the control of keypad, but does not want to write to display nor control the indicators (in the start ME is powered off):

```

AT+CMEE=2;+CREG=1          (use verbose <err> values; report registration)
OK
AT+CPAS                    (query ME status)
+CPAS: 5                   (ME is asleep)
OK
AT+CFUN=1                 (set ME to full functionality state)
+CME ERROR: SIM PIN required (SIM requests PIN)
AT+CPIN="1234"
+CME ERROR: incorrect password (user entered wrong PIN)
AT+CPIN="4321"
OK                          (correct PIN)
AT+COPS=0,0               (ask for automatic operator selection and registration)
OK
+CREG: 1                   (registered in the network)
AT+COPS?
+COPS: 0,0,"RADIOLINJA"   (get the operator name)
OK
AT+CMEC=1,0,0             (take over the keypad, leave display to ME)
OK
AT+CDIS=?;+CIND=?        (query display text and indicator formats)
+CDIS: 10,10,10,6,6
+CIND: ("memory",(0-2)),("call",(0,1)),("data",(0,1)),("roam",(0,1)),
("alpha",(0,1)),("message",(0,1)),("index1",(0-11)),("index2",(0-11)),
("index3",(0-11)),("signal",(0-5)),("service",(0,1)),("sel1",(0,1)),
("sel2",(0,1)),("sel3",(0,1)),("battchg",(0-5))
OK
AT+CSCS="IRA"             (set TE character set for display text results)
OK
AT+CMER=1,0,2,2,0        (return display text and indicator result codes when
OK                          in command state, in data mode discard them)
AT+CDIS?;+CIND?          (read current state of display texts and indicators)
+CDIS: " ", " ", " ", " 12345", "Menu", "Memory" (user had pressed number buttons before

```

```
+CIND: 1,0,0,0,0,1,0,0,0,3,1,0,0,0,5      TE took control with +CMEC)
OK
AT+CKPD="C",20                             (clear main display text '12345' by holding the
OK                                           'clear' button down two seconds)
+CDEV: 3,"1234"                             (first only one character deleted)
+CDEV: 3,""                                 (while holding continues, whole display is cleared)
+CDEV: 1,"RADIOLINJA"                       (operator name comes to the display)
```

The start of the previous example could go as follows when ME has already been powered on but is waiting for the PIN:

```
AT+CMEE=2;+CREG=1                          (use verbose <err> values; report registration)
OK
AT+CPAS                                     (query ME status)
+CPAS: 0                                    (ME is ready to receive commands)
OK
AT+CPIN?                                    (is ME asking passwords?)
+CPIN: SIM PIN                              (yes, SIM PIN required)
AT+CPIN="4321"
OK                                           (correct PIN)
```

One of the most regular operations done through the ME user interface is phonebook control. To lessen the workload of the TE, some direct commands for phonebook reading and writing are practical. Command Select Phonebook Memory Storage +CPBS query version returns supported phonebook memories, read version returns current settings, and set version selects the memory. For GSM, the normal storages are SIM, ME and TA.

Read Phonebook Entries (+CPBR) can be used to read either one or many phonebook locations at the same time. A regular phonebook entry consists of three elements: memory index number, the phone number and its alphanumeric equivalent given by the user. Query version of this returns supported index values of the selected memory, and the maximum lengths of the number and alphanumeric elements. The query version of the Write Phonebook Entry command (+CPBW) is similar, but the action version sets or clears an entry in the phonebook. Find Phonebook Entries (+CPBF) may be used to search alphanumeric entries starting with specific string. An example where the whole phonebook of the ME is read, index number four is cleared, and number three is written:

```
AT+CPBS=?
+CPBS: ("ME","SIM")                         (ME and SIM have phonebooks)
OK
AT+CPBS="ME"                                (select ME memory)
OK
AT+CPBR=?                                    (read index range and element lengths)
+CPBR: (1-99),30,30
OK
AT+CPBR=1,99                                (read all entries but only the ones set are returned)
+CPBR: 1,"931123456",129,"Ilkka"
+CPBR: 2,"9501234567",129,""
+CPBR: 4,"901234567",129,"Hesari"
OK
AT+CPBW=4;+CPBW=3,"921123456",,"TS"       (clear index 4 and write index 3)
OK
```

## 9 Mobile Equipment errors

### 9.1 Report Mobile Equipment error +CMEE

**Table 97: +CMEE parameter command syntax**

Command	Possible response(s)
+CMEE=[ <n> ]	
+CMEE?	+CMEE: <n>
+CMEE=?	+CMEE: (list of supported <n>s)

## Description

Set command disables or enables the use of result code +CME ERROR: <err> as an indication of an error relating to the functionality of the ME. When enabled, ME related errors cause +CME ERROR: <err> final result code instead of the regular ERROR final result code. ERROR is returned normally when error is related to syntax, invalid parameters, or TA functionality.

Test command returns values supported by the TA as a compound value.

## Defined values

<n>:

- 0 disable +CME ERROR: <err> result code and use ERROR instead
- 1 enable +CME ERROR: <err> result code and use numeric <err> values (refer next subclause)
- 2 enable +CME ERROR: <err> result code and use verbose <err> values (refer next subclause)

## Implementation

Mandatory for <n> values 0 and 1.

## 9.2 Mobile Equipment error result code +CME ERROR

The operation of +CME ERROR: <err> result code is similar to the regular ERROR result code: if +CME ERROR: <err> is the result code for any of the commands in a command line, none of the following commands in the same command line is executed (neither ERROR nor OK result code shall be returned as a result of a completed command line execution). The format of <err> can be either numeric or verbose. This is set with command +CMEE (refer previous subclause).

NOTE: ITU-T V.25ter [14] command V does not affect the format of this result code.

<err> values (numeric format followed by verbose format):

### 9.2.1 General errors

- 0 phone failure
- 1 no connection to phone
- 2 phone-adaptor link reserved
- 3 operation not allowed
- 4 operation not supported
- 5 PH-SIM PIN required
- 6 PH-FSIM PIN required
- 7 PH-FSIM PUK required
- 10 SIM not inserted
- 11 SIM PIN required
- 12 SIM PUK required
- 13 SIM failure
- 14 SIM busy
- 15 SIM wrong

- 16 incorrect password
- 17 SIM PIN2 required
- 18 SIM PUK2 required
- 20 memory full
- 21 invalid index
- 22 not found
- 23 memory failure
- 24 text string too long
- 25 invalid characters in text string
- 26 dial string too long
- 27 invalid characters in dial string
- 30 no network service
- 31 network timeout
- 32 network not allowed - emergency calls only
- 40 network personalisation PIN required
- 41 network personalisation PUK required
- 42 network subset personalisation PIN required
- 43 network subset personalisation PUK required
- 44 service provider personalisation PIN required
- 45 service provider personalisation PUK required
- 46 corporate personalisation PIN required
- 47 corporate personalisation PUK required
- 100 unknown

## 9.2.2 GPRS-related errors

### 9.2.2.1 Errors related to a failure to perform an Attach

Numeric	Text
103	Illegal MS (#3)
106	Illegal ME (#6)
107	GPRS services not allowed (#7)
111	PLMN not allowed (#11)
112	Location area not allowed (#12)
113	Roaming not allowed in this location area (#13)

(Values in parentheses are GSM 04.08 cause codes.)

### 9.2.2.2 Errors related to a failure to Activate a Context

Numeric	Text
132	service option not supported (#32)
133	requested service option not subscribed (#33)
134	service option temporarily out of order (#34)
149	PDP authentication failure

(Values in parentheses are GSM 04.08 cause codes.)

### 9.2.2.3 Other GPRS errors

Numeric	Text
150	invalid mobile class
148	unspecified GPRS error

Other values in the range 101 - 150 are reserved for use by GPRS

Also all other values below 256 are reserved

#### Implementation

Mandatory for numeric format codes applicable to implemented command set.

## 9.3 Informative examples

An example of TA responses with all three +CMEE values when ME manufacturer identification is requested but ME is not connected to the TA:

```
AT+CMEE=0   (+CME ERROR shall not be used)
OK
AT+CGMI
ERROR
AT+CMEE=1   (use numeric <err>)
OK
AT+CGMI
+CME ERROR: 1
AT+CMEE=2   (use verbose <err>)
OK
AT+CGMI
+CME ERROR: no connection to phone
```

---

## 10 Commands for UMTS Packet Domain

This clause defines commands that a TE may use to control a MT supporting packet switched services. Other aspects of a Packet Domain MT are described in 3G TS 27.060 [34].

It is anticipated that Packet Domain MTs will vary widely in functionality. At one extreme, a MT supporting CS/PS or class-A mode of operation might support multiple PDP types as well as circuit switched data, and use multiple external networks and QoS profiles. At the other extreme a MT supporting only PS or class-C mode of operation might support only a single PDP type using a single external network, and rely on the HLR to contain the PDP context definition.

A comprehensive set of Packet Domain-specific commands is defined in clause 10.1 to provide the flexibility needed by the more complex MT. The commands are designed to be expandable to accommodate new PDP types and interface protocols, merely by defining new values for many of the parameters. Multiple contexts may be activated if the interface link-layer protocol is able to support them. The commands use the extended information and error message capabilities described in this specification.

For MTs of intermediate complexity, most commands have simplified forms where certain parameters may be omitted.

For the simplest MTs, and for backwards compatibility with existing communications software, it is possible to control access to the Packet Domain using existing modem-compatible commands. A special dial-string syntax is defined for use with the D command. This "modem compatible" mode of operation is described in subclause 10.2.

A discussion on the interaction of the AT commands, Packet Domain Management and Packet Data Protocols, together with examples of command sequences for a number of applications may be found in 3G TS 27.060 [34].

## 10.1 Commands specific to MTs supporting the Packet Domain

### 10.1.1 Define PDP Context +CGDCONT

**Table 98: +CGDCONT parameter command syntax**

Command	Possible response(s)
+CGDCONT=[<cid> [ ,<PDP_type> [ ,<APN> [ ,<PDP_addr> [ ,<d_comp> [ ,<h_comp> [ ,<pd1> [ ,...[ ,pdN]]]]]]]]]]	OK ERROR
+CGDCONT?	+CGDCONT: <cid>, <PDP_type>, <APN>, <PDP_addr>, <data_comp>, <head_comp>[ ,<pd1>[ ,...[ ,pdN]]] [<CR><LF>+CGDCONT: <cid>, <PDP_type>, <APN>, <PDP_addr>, <data_comp>, <head_comp>[ ,<pd1>[ ,...[ ,pdN]]] [ . . . ]]
+CGDCONT=?	+CGDCONT: (range of supported <cid>s) , <PDP_type> , , (list of supported <d_comp>s) , (list of supported <h_comp>s) [ , (list of supported <pd1>s) [ ,...[ , (list of supported <pdN>s) ] ] ] [<CR><LF>+CGDCONT: (range of supported <cid>s) , <PDP_type> , , (list of supported <d_comp>s) , (list of supported <h_comp>s) [ , (list of supported <pd1>s) [ ,...[ , (list of supported <pdN>s) ] ] ] [ . . . ]]

#### Description

The set command specifies PDP context parameter values for a PDP context identified by the (local) context identification parameter, <cid>. The number of PDP contexts that may be in a defined state at the same time is given by the range returned by the test command.

A special form of the set command, +CGDCONT= <cid> causes the values for context number <cid> to become undefined.

The read command returns the current settings for each defined context.

The test command returns values supported as a compound value. If the MT supports several PDP types, <PDP\_type>, the parameter value ranges for each <PDP\_type> are returned on a separate line.

#### Defined values

<cid>: (PDP Context Identifier) a numeric parameter which specifies a particular PDP context definition. The parameter is local to the TE-MT interface and is used in other PDP context-related commands. The range of permitted values (minimum value = 1) is returned by the test form of the command.

<PDP\_type>: (Packet Data Protocol type) a string parameter which specifies the type of packet data protocol

X25	ITU-T/CCITT X.25 layer 3
IP	Internet Protocol (IETF STD 5)
OSPIH	Internet Hosted Octet Stream Protocol



PPP Point to Point Protocol (IETF STD 51)

<APN>: (Access Point Name) a string parameter which is a logical name that is used to select the GGSN or the external packet data network.

If the value is null or omitted, then the subscription value will be requested.

<PDP\_address>: a string parameter that identifies the MT in the address space applicable to the PDP.

If the value is null or omitted, then a value may be provided by the TE during the PDP startup procedure or, failing that, a dynamic address will be requested.

The read form of the command will continue to return the null string even if an address has been allocated during the PDP startup procedure. The allocated address may be read using the +CGPADDR command.

<d\_comp>: a numeric parameter that controls PDP data compression

0 - off (default if value is omitted)

1 - on

Other values are reserved.

<h\_comp>: a numeric parameter that controls PDP header compression

0 - off (default if value is omitted)

1 - on

Other values are reserved.

NOTE: At present only one data compression algorithm (V.42bis) is provided in SDCP. If and when other algorithms become available, a command will be provided to select one or more of these.

<pd1>, ... <pdN>: zero to N string parameters whose meanings are specific to the <PDP\_type>

For PDP type OSP:IHOSS the following parameters are defined:

<pd1> = <host> the fully formed domain name extended hostname of the Internet host

<pd2> = <port > the TCP or UDP port on the Internet host

<pd3> = <protocol> the protocol to be used over IP on the Internet - "TCP" or "UDP"

**Implementation**

Mandatory unless only a single subscribed context is supported.

**10.1.2 Define Secondary PDP Context +CGDSCONT**

**Table 99: +CGDSCONT parameter command syntax**

Command	Possible response(s)
+CGDSCONT=[<cid> ,<p_cid> [,<d_comp> [,<h_comp>]]]	OK ERROR
+CGDSCONT?	+CGDSCONT: <cid>, <p_cid>, <data_comp>, <head_comp> [<CR><LF>+CGDSCONT: <cid>, <p_cid>, <data_comp>, <head_comp> [...]]
+CGDSCONT=?	+CGDSCONT: (range of supported <cid>s), (list of <cid>s for active primary contexts), <PDP_type>,,, (list of supported <d_comp>s), (list of supported <h_comp>s) [<CR><LF>+CGDSCONT: (range of supported <cid>s), (list of <cid>s for active primary contexts), <PDP_type>,,, (list of supported <d_comp>s), (list of supported <h_comp>s) [...]]

## Description

The set command specifies PDP context parameter values for a Secondary PDP context identified by the (local) context identification parameter, <cid>. The number of PDP contexts that may be in a defined state at the same time is given by the range returned by the test command.

A special form of the set command, +CGDSCONT= <cid> causes the values for context number <cid> to become undefined.

The read command returns the current settings for each defined context.

The test command returns values supported as a compound value. If the MT supports several PDP types, <PDP\_type>, the parameter value ranges for each <PDP\_type> are returned on a separate line.

## Defined values

<cid>: (PDP Context Identifier) a numeric parameter which specifies a particular PDP context definition. The parameter is local to the TE-MT interface and is used in other PDP context-related commands. The range of permitted values (minimum value = 1) is returned by the test form of the command.

<p\_cid>: (Primary PDP Context Identifier) a numeric parameter which specifies a particular PDP context definition which has been specified by use of the +CGDCONT command. The parameter is local to the TE-MT interface. The list of permitted values is returned by the test form of the command.

<PDP\_type>: (Packet Data Protocol type) a string parameter which specifies the type of packet data protocol

X25	ITU-T/CCITT X.25 layer 3
IP	Internet Protocol (IETF STD 5)
OSPIH	Internet Hosted Octet Stream Protocol
PPP	Point to Point Protocol (IETF STD 51)

<d\_comp>: a numeric parameter that controls PDP data compression (applicable to GPRS only)  
 0 - off (default if value is omitted)  
 1 - on  
 Other values are reserved.

<h\_comp>: a numeric parameter that controls PDP header compression  
 0 - off (default if value is omitted)  
 1 - on  
 Other values are reserved.

NOTE. At present only one data compression algorithm (V.42bis) is provided in SNDSCP. If and when other algorithms become available, a command will be provided to select one or more of these. (GPRS only)

## Implementation

Optional.

### 10.1.3 Traffic Flow Template +CGTFT

**Table 100: +CGTFT parameter command syntax**

Command	Possible Response(s)
+CGTFT=[<cid>, [<packet filter identifier>, <evaluation precedence index> [,<source address and subnet mask> [,<protocol number (ipv4) / next header (ipv6)> [,<destination port range> [,<source port range> [,<ipsec security parameter index (spi)> [,<type of service (tos) (ipv4) and mask / traffic class (ipv6) and mask> [,<flow label (ipv6)> ]]]]]]]]]	OK  ERROR
+CGTFT?	+CGTFT: <cid>, <packet filter identifier>, <evaluation precedence index>, <source address and subnet mask>, <protocol number (ipv4) / next header (ipv6)>, <destination port range>, <source port range>, <ipsec security parameter index (spi)>, <type of service (tos) (ipv4) and mask / traffic class (ipv6) and mask>, <flow label (ipv6)>  [ <cr&gt;&lt;lf&gt;+cgtft: &lt;cid&gt;,="" &lt;destination="" &lt;evaluation="" &lt;flow="" &lt;ipsec="" &lt;packet="" &lt;protocol="" &lt;source="" &lt;type="" (ipv4)="" (ipv6)="" (ipv6)&gt;,="" (ipv6)&gt;<br="" (spi)&gt;,="" (tos)="" address="" and="" class="" filter="" header="" identifier&gt;,="" index="" index&gt;,="" label="" mask="" mask&gt;,="" next="" number="" of="" parameter="" port="" precedence="" range&gt;,="" security="" service="" subnet="" traffic=""></cr&gt;&lt;lf&gt;+cgtft:> [...]]

Command	Possible Response(s)
+CGTFT=?	<p>+CGTFT: &lt;PDP_type&gt;, (list of supported &lt;packet filter identifier&gt;s), (list of supported &lt;evaluation precedence index&gt;s), (list of supported &lt;source address and subnet mask&gt;s), (list of supported &lt;protocol number (ipv4) / next header (ipv6)&gt;s), (list of supported &lt;destination port range&gt;s), (list of supported &lt;source port range&gt;s), (list of supported &lt;ipsec security parameter index (spi)&gt;s), (list of supported &lt;type of service (tos) (ipv4) and mask / traffic class (ipv6) and mask&gt;s), (list of supported &lt;flow label (ipv6)&gt;s)</p> <p>[&lt;CR&gt;&lt;LF&gt;+CGTFT: &lt;PDP_type&gt;, (list of supported &lt;packet filter identifier&gt;s), (list of supported &lt;evaluation precedence index&gt;s), (list of supported &lt;source address and subnet mask&gt;s), (list of supported &lt;protocol number (ipv4) / next header (ipv6)&gt;s), (list of supported &lt;destination port range&gt;s), (list of supported &lt;source port range&gt;s), (list of supported &lt;ipsec security parameter index (spi)&gt;s), (list of supported &lt;type of service (tos) (ipv4) and mask / traffic class (ipv6) and mask&gt;s), (list of supported &lt;flow label (ipv6)&gt;s)</p> <p>[...]</p>

## Description

This command allows the TE to specify a Packet Filter - PF for a Traffic Flow Template - TFT that is used in the GGSN for routing of down-link packets onto different QoS flows towards the TE. The concept is further described in the 3G TS 23.060[47]. A TFT consists of from one and up to eight Packet Filters, each identified by a unique <packet filter identifier>. A Packet Filter also has an <evaluation precedence index> that is unique within all TFTs associated with all PDP contexts that are associated with the same PDP address.

The set command specifies a Packet Filters that is to be added to the TFT stored in the MT and used for the context identified by the (local) context identification parameter, <cid>. The specified TFT will be stored in the GGSN only at activation or MS-initiated modification of the related context. Since this is the same parameter that is used in the +CGDCONT and +CGDSCONT commands, the +CGTFT command is effectively an extension to these commands. The Packet Filters consist of a number of parameters, each of which may be set to a separate value.

A special form of the set command, +CGTFT= <cid> causes all of the Packet Filters in the TFT for context number <cid> to become undefined. At any time there may exist only one PDP context with no associated TFT amongst all PDP contexts associated to one PDP address. At an attempt to delete a TFT, which would violate this rule, an ERROR or +CME ERROR response is returned. Extended error responses are enabled by the +CMEE command.

The read command returns the current settings for all Packet Filters for each defined context.

The test command returns values supported as a compound value. If the MT supports several PDP types, the parameter value ranges for each PDP type are returned on a separate line. TFTs shall be used for PDP-type IP and PPP only. For PDP-type PPP a TFT is applicable only when IP traffic is carried over PPP. If PPP carries header-compressed IP packets, then a TFT cannot be used.

**Defined values**

<cid>: a numeric parameter which specifies a particular PDP context definition (see the +CGDCONT and +CGDSCONT commands).

The following parameters are defined in 3G TS 23.060[47] -

<packet filter identifier>: Numeric parameter, value range from 1 to 8.

<source address and subnet mask>: Consists of dot-separated numeric (0-255) parameters on the form 'a1.a2.a3.a4.m1.m2.m3.m4', for IPv4 and 'a1.a2.a3.a4.a5.a6.a7.a8.a9.a10.a11.a12.a13.a14.a15.a16.m1.m2.m3.m4.m5.m6.m7.m8.m9.m10.m11.m12.m13.m14.m15.m16', for IPv6.

<protocol number (ipv4) / next header (ipv6)>: Numeric parameter, value range from 0 to 255.

<destination port range>: Consists of dot-separated numeric (0-65535) parameters on the form 'f.t'.

<source port range>: Consists of dot-separated numeric (0-65535) parameters on the form 'f.t'.

<ipsec security parameter index (spi)>: Hexadecimal parameter, value range from 00000000 to FFFFFFFF.

<type of service (tos) (ipv4) and mask / traffic class (ipv6) and mask>: Dot-separated numeric (0-255) parameters on the form 't.m'.

<flow label (ipv6)>: Hexadecimal parameter, value range from 00000 to FFFFF. Valid for IPv6 only.

<evaluation precedence index>: Numeric parameter, value range from 0 to 255.

Some of the above listed attributes may coexist in a Packet Filter while others mutually exclude each other, the possible combinations are shown in 3G TS 23.060[47].

**Implementation**

Optional.

**10.1.4 Quality of Service Profile (Requested) +CGQREQ****Table 101: +CGQREQ parameter command syntax**

Command	Possible Response(s)
+CGQREQ=[<cid> [,<precedence> [,<delay> [,<reliability> [,<peak> [,<mean>]]]]]]	OK ERROR
+CGQREQ?	+CGQREQ: <cid>, <precedence>, <delay>, <reliability>, <peak>, <mean> [<CR><LF>+CGQREQ: <cid>, <precedence>, <delay>, <reliability>, <peak>, <mean> [...]]
+CGQREQ=?	+CGQREQ: <PDP_type>, (list of supported <precedence>s), (list of supported <delay>s), (list of supported <reliability>s), (list of supported <peak>s), (list of supported <mean>s) [<CR><LF>+CGQREQ: <PDP_type>, (list of supported <precedence>s), (list of supported <delay>s), (list of supported <reliability>s), (list of supported <peak>s), (list of supported <mean>s) [...]]

## Description

This command allows the TE to specify a Quality of Service Profile that is used when the MT sends an Activate PDP Context Request message to the network.

The set command specifies a profile for the context identified by the (local) context identification parameter, <cid>. Since this is the same parameter that is used in the +CGDCONT and +CGDSCONT commands, the +CGQREQ command is effectively an extension to these commands. The QoS profile consists of a number of parameters, each of which may be set to a separate value.

A special form of the set command, +CGQREQ= <cid> causes the requested profile for context number <cid> to become undefined.

The read command returns the current settings for each defined context.

The test command returns values supported as a compound value. If the MT supports several PDP types, the parameter value ranges for each PDP type are returned on a separate line.

## Defined values

<cid>: a numeric parameter which specifies a particular PDP context definition (see the +CGDCONT and +CGDSCONT commands).

The following parameters are defined in GSM 03.60 -

<precedence>: a numeric parameter which specifies the precedence class

<delay>: a numeric parameter which specifies the delay class

<reliability>: a numeric parameter which specifies the reliability class

<peak>: a numeric parameter which specifies the peak throughput class

<mean>: a numeric parameter which specifies the mean throughput class

If a value is omitted for a particular class then the value is considered to be unspecified.

## Implementation

Optional. If the command is not implemented then all the values are considered to be unspecified.

## 10.1.5 Quality of Service Profile (Minimum acceptable) +CGQMIN

**Table 102: +CGQMIN parameter command syntax**

Command	Possible Response(s)
+CGQMIN=[<cid> [,<precedence > [,<delay> [,<reliability.> [,<peak> [,<mean>]]]]]]	OK ERROR
+CGQMIN?	+CGQMIN: <cid>, <precedence >, <delay>, <reliability>, <peak>, <mean> [<CR><LF>+CGQMIN: <cid>, <precedence >, <delay>, <reliability.>, <peak>, <mean> [...]]
+CGQMIN=?	+CGQMIN: <PDP_type>, (list of supported <precedence>s), (list of supported <delay>s), (list of supported <reliability>s) , (list of supported <peak>s), (list of supported <mean>s) [<CR><LF>+CGQMIN: <PDP_type>, (list of supported <precedence>s), (list of supported <delay>s), (list of supported <reliability>s) , (list of supported <peak>s), (list of supported <mean>s) [...]]

### Description

This command allows the TE to specify a minimum acceptable profile which is checked by the MT against the negotiated profile returned in the Activate PDP Context Accept message.

The set command specifies a profile for the context identified by the (local) context identification parameter, <cid>. Since this is the same parameter that is used in the +CGDCONT and +CGDSCONT commands, the +CGQMIN command is effectively an extension to these commands. The QoS profile consists of a number of parameters, each of which may be set to a separate value.

A special form of the set command, +CGQMIN= <cid> causes the minimum acceptable profile for context number <cid> to become undefined. In this case no check is made against the negotiated profile.

The read command returns the current settings for each defined context.

The test command returns values supported as a compound value. If the MT supports several PDP types, the parameter value ranges for each PDP type are returned on a separate line.

### Defined values

<cid>: a numeric parameter which specifies a particular PDP context definition (see the +CGDCONT and +CGDSCONT commands).

The following parameters are defined in GSM 03.60 -

<precedence>: a numeric parameter which specifies the precedence class

<delay>: a numeric parameter which specifies the delay class

<reliability>: a numeric parameter which specifies the reliability class

<peak>: a numeric parameter which specifies the peak throughput class

<mean>: a numeric parameter which specifies the mean throughput class

If a value is omitted for a particular class then this class is not checked.





Command	Possible Response(s)
	of supported <Maximum SDU size>s) ,(list of supported <SDU format information>s) ,(list of supported <SDU error ratio>s) ,(list of supported <Residual bit error ratio>s) ,(list of supported <Delivery of erroneous SDUs>s) ,(list of supported <Transfer delay>s) ,(list of supported <Traffic handling priority>s) ,(list of supported <Allocation/Retention Priority>s)  [...]]

### Description

This command allows the TE to specify a UMTS Quality of Service Profile that is used when the MT sends an Activate PDP Context Request message to the network.

The set command specifies a profile for the context identified by the (local) context identification parameter, <cid>. The specified profile will be stored in the MT and sent to the network only at activation or MS-initiated modification of the related context. Since this is the same parameter that is used in the +CGDCONT and +CGDSCONT commands, the +CGEQREQ command is effectively an extension to these commands. The QoS profile consists of a number of parameters, each of which may be set to a separate value.

A special form of the set command, +CGEQREQ= <cid> causes the requested profile for context number <cid> to become undefined.

The read command returns the current settings for each defined context.

The test command returns values supported as a compound value. If the MT supports several PDP types, the parameter value ranges for each PDP type are returned on a separate line.

### Defined values

<cid>: a numeric parameter which specifies a particular PDP context definition (see +CGDCONT and +CGDSCONT commands).

The following parameters are defined in 3G TS 23.107 [46] -

<Traffic class>: Indicates the type of application for which the UMTS bearer service is optimised.  
conversational  
streaming  
interactive  
background

<Maximum bitrate>: Indicates the maximum number of bits delivered by UMTS at a SAP within a period of time, divided by the duration of the period.

<Guaranteed bitrate>: Indicates the guaranteed number of bits delivered by UMTS at a SAP within a period of time (provided that there is data to deliver), divided by the duration of the period.

<Delivery order>: Indicates whether the UMTS bearer shall provide in-sequence SDU delivery or not.  
0 - no (default if value is omitted)  
1 - yes  
Other values are reserved.

<Maximum SDU size>: Indicates the maximum allowed SDU size in bits.

<SDU format information>: List of possible exact sizes of SDUs in bits. If the list contains more than one value, colons separate the values.

<SDU error ratio>: Indicates the target value for the fraction of SDUs lost or detected as erroneous. SDU error ratio is defined only for conforming traffic. The value is specified as 'mEe'. As an example a target SDU error ratio of  $5 \cdot 10^{-3}$  would be specified as '5E3'.

<Residual bit error ratio>: Indicates the target value for the undetected bit error ratio in the delivered SDUs. If no error detection is requested, Residual bit error ratio indicates the bit error ratio in the delivered SDUs. The value is specified as 'mEe'. As an example a target residual bit error ratio of  $5 \cdot 10^{-3}$  would be specified as '5E3'.

<Delivery of erroneous SDUs>: Indicates whether SDUs detected as erroneous shall be delivered or not.  
0 - no (default if value is omitted)  
1 - yes  
Other values are reserved.

<Transfer delay>: Indicates the targeted time between request to transfer an SDU at one SAP to its delivery at the other SAP, in milliseconds. Transfer delay is specified for one or more fixed SDU sizes. If transfer delay values are specified for more than one fixed SDU size the values shall be separated by commas and be in the same order as the corresponding fixed SDU sizes specified in the <SDU format information> parameter.

<Traffic handling priority>: Numeric parameter (1,2,3,...) that specifies the relative importance for handling of all SDUs belonging to the UMTS bearer compared to the SDUs of other bearers.

<Allocation/Retention Priority>: Numeric parameter (1,2,3,...) that specifies the relative importance compared to other UMTS bearers for allocation and retention of the UMTS bearer.

If a value is omitted for a particular class then the value is considered to be unspecified.

### Implementation

Optional. If the command is not implemented then all the values are considered to be unspecified.

## 10.1.7 3G Quality of Service Profile (Minimum acceptable) +CGEQMIN

**Table 104: +CGEQMIN parameter command syntax**

Command	Possible Response(s)
+CGEQMIN=[<cid> [,<Traffic class> [,<Maximum bitrate> [,<Guaranteed bitrate> [,<Delivery order> [,<Maximum SDU size> [,<SDU format information> [,<SDU error ratio> [,<Residual bit error ratio> [,<Delivery of erroneous SDUs> [,<Transfer delay> [,<Traffic handling priority> [,<Allocation/Retention Priority>]]]]]]]]]]]]]]]]	OK ERROR
+CGEQMIN?	+CGEQMIN: <cid>, <Traffic class> ,<Maximum bitrate> ,<Guaranteed bitrate> ,<Delivery order> ,<Maximum SDU size> ,<SDU format information> ,<SDU error ratio> ,<Residual bit error ratio> ,<Delivery of erroneous SDUs> ,<Transfer delay> ,<Traffic handling priority> ,<Allocation/Retention Priority>  [<CR><LF>+CGEQMIN: <cid>, <Traffic class> ,<Maximum bitrate> ,<Guaranteed bitrate> ,<Delivery order> ,<Maximum SDU size> ,<SDU format information> ,<SDU error ratio> ,<Residual bit error ratio> ,<Delivery of erroneous SDUs> ,<Transfer delay> ,<Traffic handling

Command	Possible Response(s)
	priority> ,<Allocation/Retention Priority>  [...]
+CGEQMIN=?	+CGEQMIN: <PDP_type>, (list of supported <Traffic class>s) ,(list of supported <Maximum bitrate>s) ,(list of supported <Guaranteed bitrate>s) ,(list of supported <Delivery order>s) ,(list of supported <Maximum SDU size>s) ,(list of supported <SDU format information>s) ,(list of supported <SDU error ratio>s) ,(list of supported <Residual bit error ratio>s) ,(list of supported <Delivery of erroneous SDUs>s) ,(list of supported <Transfer delay>s) ,(list of supported <Traffic handling priority>s) ,(list of supported <Allocation/Retention Priority>s)  [<CR><LF>+CGEQMIN: <PDP_type>, (list of supported <Traffic class>s) ,(list of supported <Maximum bitrate>s) ,(list of supported <Guaranteed bitrate>s) ,(list of supported <Delivery order>s) ,(list of supported <Maximum SDU size>s) ,(list of supported <SDU format information>s) ,(list of supported <SDU error ratio>s) ,(list of supported <Residual bit error ratio>s) ,(list of supported <Delivery of erroneous SDUs>s) ,(list of supported <Transfer delay>s) ,(list of supported <Traffic handling priority>s) ,(list of supported <Allocation/Retention Priority>s)  [...]

### Description

This command allows the TE to specify a minimum acceptable profile, which is checked by the MT against the negotiated profile returned in the Activate/Modify PDP Context Accept message.

The set command specifies a profile for the context identified by the (local) context identification parameter, <cid>. The specified profile will be stored in the MT and checked against the negotiated profile only at activation or MS-initiated modification of the related context. Since this is the same parameter that is used in the +CGDCONT and +CGDSCONT commands, the +CGEQMIN command is effectively an extension to these commands. The QoS profile consists of a number of parameters, each of which may be set to a separate value.

A special form of the set command, +CGEQMIN= <cid> causes the minimum acceptable profile for context number <cid> to become undefined. In this case no check is made against the negotiated profile.

The read command returns the current settings for each defined context.

The test command returns values supported as a compound value. If the MT supports several PDP types, the parameter value ranges for each PDP type are returned on a separate line.

### Defined values

<cid>: a numeric parameter which specifies a particular PDP context definition (see +CGDCONT and +CGDSCONT commands).

The following parameters are defined in 3G TS 23.107 [46] -

<Traffic class>: Indicates the type of application for which the UMTS bearer service is optimised.  
conversational  
streaming  
interactive  
background

<Maximum bitrate>: Indicates the maximum number of bits delivered by UMTS at a SAP within a period of time, divided by the duration of the period.

<Guaranteed bitrate>: Indicates the guaranteed number of bits delivered by UMTS at a SAP within a period of time (provided that there is data to deliver), divided by the duration of the period.

<Delivery order>: Indicates whether the UMTS bearer shall provide in-sequence SDU delivery or not.  
0 - no (default if value is omitted)  
1 - yes  
Other values are reserved.

<Maximum SDU size>: Indicates the maximum allowed SDU size in bits.

<SDU format information>: List of possible exact sizes of SDUs in bits. If the list contains more than one value, the values shall be separated by colons.

<SDU error ratio>: Indicates the target value for the fraction of SDUs lost or detected as erroneous. SDU error ratio is defined only for conforming traffic. The value is specified as 'mEe'. As an example a target SDU error ratio of  $5 \cdot 10^{-3}$  would be specified as '5E3'.

<Residual bit error ratio>: Indicates the target value for the undetected bit error ratio in the delivered SDUs. If no error detection is requested, Residual bit error ratio indicates the bit error ratio in the delivered SDUs. The value is specified as 'mEe'. As an example a target residual bit error ratio of  $5 \cdot 10^{-3}$  would be specified as '5E3'.

<Delivery of erroneous SDUs>: Indicates whether SDUs detected as erroneous shall be delivered or not.  
0 - no (default if value is omitted)  
1 - yes  
Other values are reserved.

<Transfer delay>: Indicates the targeted time between request to transfer an SDU at one SAP to its delivery at the other SAP, in milliseconds. Transfer delay is specified for one or more fixed SDU sizes. If transfer delay values are specified for more than one fixed SDU size the values shall be separated by commas and be in the same order as the corresponding fixed SDU sizes specified in the <SDU format information> parameter.

<Traffic handling priority>: Numeric parameter (1,2,3,...) that specifies the relative importance for handling of all SDUs belonging to the UMTS bearer compared to the SDUs of other bearers.

<Allocation/Retention Priority>: Numeric parameter (1,2,3,...) that specifies the relative importance compared to other UMTS bearers for allocation and retention of the UMTS bearer.

If a value is omitted for a particular class then the value is considered to be unspecified.

### Implementation

Optional. If the command is not implemented then no check is made against the negotiated profile.

## 10.1.8 3G Quality of Service Profile (Negotiated) +CGEQNEG

**Table 105: +CGEQNEG action command syntax**

Command	Possible Response(s)
+CGEQNEG = [<cid>[, <cid>[, ...]]]	<p>+CGEQNEG: &lt;cid&gt;, &lt;Traffic class&gt; ,&lt;Maximum bitrate&gt; ,&lt;Guaranteed bitrate&gt; ,&lt;Delivery order&gt; ,&lt;Maximum SDU size&gt; ,&lt;SDU format information&gt; ,&lt;SDU error ratio&gt; ,&lt;Residual bit error ratio&gt; ,&lt;Delivery of erroneous SDUs&gt; ,&lt;Transfer delay&gt; ,&lt;Traffic handling priority&gt; ,&lt;Allocation/Retention Priority&gt;</p> <p>[&lt;CR&gt;&lt;LF&gt;+CGEQNEG: &lt;cid&gt;, &lt;Traffic class&gt; ,&lt;Maximum bitrate&gt; ,&lt;Guaranteed bitrate&gt; ,&lt;Delivery order&gt; ,&lt;Maximum SDU size&gt; ,&lt;SDU format information&gt; ,&lt;SDU error ratio&gt; ,&lt;Residual bit error ratio&gt; ,&lt;Delivery of erroneous SDUs&gt; ,&lt;Transfer delay&gt; ,&lt;Traffic handling priority&gt; ,&lt;Allocation/Retention Priority&gt;</p> <p>[...]</p>
+CGEQNEG=?	+CGEQNEG: (list of <cid>s associated with active contexts)

### Description

This command allows the TE to retrieve the negotiated QoS profiles returned in the Activate PDP Context Accept message.

The execution command returns the negotiated QoS profile for the specified context identifiers, <cid>s. The QoS profile consists of a number of parameters, each of which may have a separate value.

The test command returns a list of <cid>s associated with active contexts.

### Defined values

<cid>: a numeric parameter which specifies a particular PDP context definition (see +CGDCONT and +CGDSCONT commands).

The following parameters are defined in 3G TS 23.107 [46] -

<Traffic class>: Indicates the type of application for which the UMTS bearer service is optimised.  
 conversational  
 streaming  
 interactive  
 background

<Maximum bitrate>: Indicates the maximum number of bits delivered by UMTS at a SAP within a period of time, divided by the duration of the period.

<Guaranteed bitrate>: Indicates the guaranteed number of bits delivered by UMTS at a SAP within a period of time (provided that there is data to deliver), divided by the duration of the period.

<Delivery order>: Indicates whether the UMTS bearer shall provide in-sequence SDU delivery or not.  
 0 - no (default if value is omitted)

1 - yes

Other values are reserved.

<Maximum SDU size>: Indicates the maximum allowed SDU size in bits.

<SDU format information>: List of possible exact sizes of SDUs in bits. If the list contains more than one value, colons separate the values.

<SDU error ratio>: Indicates the target value for the fraction of SDUs lost or detected as erroneous. SDU error ratio is defined only for conforming traffic. The value is specified as 'mEe'. As an example a target SDU error ratio of  $5 \cdot 10^{-3}$  would be specified as '5E3'.

<Residual bit error ratio>: Indicates the target value for the undetected bit error ratio in the delivered SDUs. If no error detection is requested, Residual bit error ratio indicates the bit error ratio in the delivered SDUs. The value is specified as 'mEe'. As an example a target residual bit error ratio of  $5 \cdot 10^{-3}$  would be specified as '5E3'.

<Delivery of erroneous SDUs>: Indicates whether SDUs detected as erroneous shall be delivered or not.  
0 - no (default if value is omitted)  
1 - yes  
Other values are reserved.

<Transfer delay>: Indicates the targeted time between request to transfer an SDU at one SAP to its delivery at the other SAP, in milliseconds. Transfer delay is specified for one or more fixed SDU sizes. If transfer delay values are specified for more than one fixed SDU size the values shall be separated by commas and be in the same order as the corresponding fixed SDU sizes specified in the <SDU format information> parameter.

<Traffic handling priority>: Numeric parameter (1,2,3,...) that specifies the relative importance for handling of all SDUs belonging to the UMTS bearer compared to the SDUs of other bearers.

<Allocation/Retention Priority>: Numeric parameter (1,2,3,...) that specifies the relative importance compared to other UMTS bearers for allocation and retention of the UMTS bearer.

If a value is omitted for a particular class then the value is considered to be unspecified.

### Implementation

Optional.

## 10.1.9 PS attach or detach +CGATT

**Table 106: CGATT action command syntax**

Command	Possible Response(s)
+CGATT=[<state>]	OK ERROR
+CGATT?	+CGATT: <state>
+CGATT=?	+CGATT: (list of supported <state>s)

### Description

The execution command is used to attach the MT to, or detach the MT from, the Packet Domain service. After the command has completed, the MT remains in V.25ter command state. If the MT is already in the requested state, the command is ignored and the OK response is returned. If the requested state cannot be achieved, an ERROR or +CME ERROR response is returned. Extended error responses are enabled by the +CMEE command.

Any active PDP contexts will be automatically deactivated when the attachment state changes to detached.

The read command returns the current Packet Domain service state.

The test command is used for requesting information on the supported Packet Domain service states.

NOTE: This command has the characteristics of both the V.25ter action and parameter commands. Hence it has the read form in addition to the execution/set and test forms.

### Defined Values

<state>: indicates the state of PS attachment

0 - detached

1 - attached

Other values are reserved and will result in an ERROR response to the execution command.

### Implementation

Optional.

## 10.1.10 PDP context activate or deactivate +CGACT

Table 107: CGACT action command syntax

Command	Possible Response(s)
+CGACT=[<state> [, <cid>[, <cid>[, ...]]]]	OK ERROR
+CGACT?	+CGACT: <cid>, <state> [<CR><LF>+CGACT: <cid>, <state> [...]]
+CGACT=?	+CGACT: (list of supported <state>s)

### Description

The execution command is used to activate or deactivate the specified PDP context (s). After the command has completed, the MT remains in V.25ter command state. If any PDP context is already in the requested state, the state for that context remains unchanged. If the requested state for any specified context cannot be achieved, an ERROR or +CME ERROR response is returned. Extended error responses are enabled by the +CMEE command. If the MT is not PS attached when the activation form of the command is executed, the MT first performs a PS attach and then attempts to activate the specified contexts. If the attach fails then the MT responds with ERROR or, if extended error responses are enabled, with the appropriate failure-to-attach error message.

If no <cid>s are specified the activation form of the command activates all defined contexts.

If no <cid>s are specified the deactivation form of the command deactivates all active contexts.

An active secondary context can exist if and only if the corresponding active primary context exists. If the primary PDP context associated with a PDP address is deactivated, all the associated secondary contexts are deactivated too and the data transfer for that PDP address is disabled.

The read command returns the current activation states for all the defined PDP contexts.

The test command is used for requesting information on the supported PDP context activation states.

NOTE: This command has the characteristics of both the V.25ter action and parameter commands. Hence it has the read form in addition to the execution/set and test forms.

### Defined Values

<state>: indicates the state of PDP context activation

0 - deactivated

1 - activated

Other values are reserved and will result in an ERROR response to the execution command.

<cid>: a numeric parameter which specifies a particular PDP context definition (see the +CGDCONT and +CGDSCONT commands).

**Implementation**

Optional.

**10.1.11 PDP Context Modify +CGCMOD****Table 108: CGCMOD action command syntax**

Command	Possible Response(s)
+CGCMOD=[<cid>[,<cid>[,...]]]	OK ERROR
+CGCMOD=?	+CGCMOD: (list of <cid>s associated with active contexts)

**Description**

The execution command is used to modify the specified PDP context (s) with respect to QoS profiles and TFTs. After the command has completed, the MT returns to V.25ter online data state. If the requested modification for any specified context cannot be achieved, an ERROR or +CME ERROR response is returned. Extended error responses are enabled by the +CMEE command.

If no <cid>s are specified the activation form of the command modifies all active contexts.

The test command returns a list of <cid>s associated with active contexts.

**Defined Values**

<cid>: a numeric parameter which specifies a particular PDP context definition (see the +CGDCONT and +CGDSCONT commands).

**Implementation**

Optional.

**10.1.12 Enter data state +CGDATA****Table 109: +CGDATA action command syntax**

Command	Possible Response(s)
+CGDATA=[<L2P> , [<cid> [, <cid> [, ...]]]]	CONNECT ERROR
+CGDATA=?	+CGDATA: (list of supported <L2P>s)

**Description**

The execution command causes the MT to perform whatever actions are necessary to establish communication between the TE and the network using one or more Packet Domain PDP types. This may include performing a PS attach and one or more PDP context activations. If the <L2P> parameter value is unacceptable to the MT, the MT shall return an ERROR or +CME ERROR response. Otherwise, the MT issues the intermediate result code CONNECT and enters V.25ter online data state.

Commands following +CGDATA command in the AT command line shall not be processed by the MT.

The detailed behaviour after the online data state has been entered is dependent on the PDP type. It is described briefly in 3G TS 27.060[34] and in more detail in 3G TS 29.061[39] and the specifications for the relevant PDPs. PS attachment and PDP context activation procedures may take place prior to or during the PDP startup if they have not already been performed using the +CGATT and +CGACT commands.

If context activation takes place during the PDP startup, one or more <cid>s may be specified in order to provide the information needed for the context activation request(s).



During each PDP startup procedure the MT may have access to some or all of the following information -

The MT may have a priori knowledge, for example, it may implement only one PDP type.

The command may have provided an <L2P> parameter value.

The TE may provide a PDP type and/or PDP address to the MT during in the PDP startup procedure.

If any of this information is in conflict, the command will fail.

Any PDP type and/or PDP address present in the above information shall be compared with the PDP type and/or PDP address in any context definitions specified in the command in the order in which their <cid>s appear. For a context definition to match -

The PDP type must match exactly.

The PDP addresses are considered to match if they are identical or if either or both addresses are unspecified. For example, a PPP NCP request specifying PDP type = IP and no PDP address would cause the MT to search through the specified context definitions for one with PDP type = IP and any PDP address.

The context shall be activated using the matched value for PDP type and a static PDP address if available, together with the other information found in the PDP context definition. If a static PDP address is not available then a dynamic address is requested.

If no <cid> is given or if there is no matching context definition, the MT shall attempt to activate the context with whatever information is available to the MT. The other context parameters shall be set to their default values.

If the activation is successful, data transfer may proceed.

After data transfer is complete, and the layer 2 protocol termination procedure has completed successfully, the V.25ter command state is re-entered and the MT returns the final result code OK.

In the event of an erroneous termination or a failure to start up, the V.25ter command state is re-entered and the MT returns the final result code NO CARRIER or, if enabled, +CME ERROR. Attach, activate and other errors may be reported.

The test command is used for requesting information on the supported layer 2 protocols.

This command may be used in both normal and modem compatibility modes.

### Defined Values

<L2P>: a string parameter that indicates the layer 2 protocol to be used between the TE and MT

NULL	none, for PDP type OSP:IHOSS
PPP	Point-to-point protocol for a PDP such as IP
PAD	character stream for X.25 character (triple X PAD) mode
X25	X.25 L2 (LAPB) for X.25 packet mode
M-xxxx	manufacturer-specific protocol (xxxx is an alphanumeric string)

If the value is omitted, the layer 2 protocol is unspecified. Other values are reserved and will result in an ERROR response.

<cid>: a numeric parameter which specifies a particular PDP context definition (see the +CGDCONT and +CGDSCONT commands).

### Implementation

Optional if the D (dial) command can be used to specify Packet Domain operation.

### 10.1.13 Configure local Octet Stream PAD parameters +CGCLOSP

**Table 110: CGCLOSP parameter command syntax**

Command	Possible Response(s)
+CGCLOSP=[<parm>, <value>]	OK ERROR
+CGCLOSP?	+CGCLOSP: <parm>, <value> [<CR><LF>+CGCLOSP: <parm>, <value><> [...]]
+CGCLOSP=?	+CGCLOSP: <parm>, (list of supported <value>s) [<CR><LF>+CGCLOSP: <parm>, (list of supported <value>s) [...]]

#### Description

The set command sets the value of a specified OSP PAD parameter in the local PAD. The set of parameters to be supported is listed in the OSP protocol specification.

Setting the maximum sizes for the local Packet Assembly and Disassembly buffers will cause corresponding values for the GGSN relay buffers to be negotiated.

The read command returns, one per line, the value of each of the supported parameters.

The test command returns, one per line, the permitted range of values for each of the supported parameters.

#### Defined values

<parm>: a numeric parameter which specifies the PAD parameter to be configured

<value>: a numeric parameter which specifies the value to which PAD parameter is to be set

If <value> is omitted for a particular parameter then <parm> is set to the OSP-defined default, if any.

#### Implementation

Optional.

### 10.1.14 Show PDP address +CGPADDR

**Table 111: +CGPADDR action command syntax**

Command	Possible response(s)
+CGPADDR=[<c id> [, <cid> [, ...]]]	+CGPADDR: <cid>, <PDP_addr> [<CR><LF>+CGPADDR: <cid>, <PDP_addr> [...]]
+CGPADDR=?	+CGPADDR: (list of defined <cid>s)

#### Description

The execution command returns a list of PDP addresses for the specified context identifiers.

The test command returns a list of defined <cid>s.

## Defined values

<cid>: a numeric parameter which specifies a particular PDP context definition (see the +CGDCONT and +CGDSCONT commands). If no <cid> is specified, the addresses for all defined contexts are returned.

<PDP\_address>: a string that identifies the MT in the address space applicable to the PDP. The address may be static or dynamic. For a static address, it will be the one set by the +CGDCONT and +CGDSCONT commands when the context was defined. For a dynamic address it will be the one assigned during the last PDP context activation that used the context definition referred to by <cid>. <PDP\_address> is omitted if none is available.

## Implementation

Optional.

### 10.1.15 Automatic response to a network request for PDP context activation +CGAUTO

**Table 112: CGAUTO parameter command syntax**

Command	Possible response(s)
+CGAUTO=[<n>]	OK ERROR
+CGAUTO?	+CGAUTO: <n>
+CGAUTO=?	+CGAUTO: (list of supported <n>s)

## Description

The set command disables or enables an automatic positive response (auto-answer) to the receipt of a Request PDP Context Activation message from the network. It also provides control over the use of the V.25ter basic commands 'S0', 'A' and 'H' for handling network requests for PDP context activation. The setting does not affect the issuing of the unsolicited result code RING or +CRING.

The test command returns the values of <n> supported by the MT as a compound value.

When the +CGAUTO=0 command is received, the MT shall not perform a PS detach if it is attached. Subsequently, when the MT announces a network request for PDP context activation by issuing the unsolicited result code RING or +CRING, the TE may manually accept or reject the request by issuing the +CGANS command or may simply ignore the network request.

When the +CGAUTO=1 command is received, the MT shall attempt to perform a PS attach if it is not already attached. Failure will result in ERROR or, if enabled, +CME ERROR being returned to the TE. Subsequently, when the MT announces a network request for PDP context activation by issuing the unsolicited result code RING or +CRING to the TE, this is followed by the intermediate result code CONNECT. The MT then enters V.25ter online data state and follows the same procedure as it would after having received a +CGANS=1 with no <L2P> or <cid> values specified.

## Defined values

<n>:

- 0 turn off automatic response for Packet Domain only
- 1 turn on automatic response for Packet Domain only
- 2 modem compatibility mode, Packet Domain only
- 3 modem compatibility mode, Packet Domain and circuit switched calls (default)

For <n> = 0 Packet DomainS network requests are manually accepted or rejected by the +CGANS command.

For <n> = 1 Packet Domain network requests are automatically accepted according to the description above.

For <n> = 2, automatic acceptance of Packet Domain network requests is controlled by the 'S0' command. Manual control uses the 'A' and 'H' commands, respectively, to accept and reject Packet Domain requests. (+CGANS may also be used.) Incoming circuit switched calls can be neither manually nor automatically answered.

For  $\langle n \rangle = 3$ , automatic acceptance of both Packet Domain network requests and incoming circuit switched calls is controlled by the 'S0' command. Manual control uses the 'A' and 'H' commands, respectively, to accept and reject Packet Domain requests. (+CGANS may also be used.) Circuit switched calls are handled as described elsewhere in this specification.

### Implementation

Optional. If not implemented, the MT shall behave according to the case of  $\langle n \rangle = 3$ .

## 10.1.16 Manual response to a network request for PDP context activation +CGANS

**Table 113: CGANS action command syntax**

Command	Possible response(s)
+CGANS=[ $\langle response \rangle$ , [ $\langle L2P \rangle$ ,[ $\langle cid \rangle$ ]]]	OK ERROR
+CGANS=?	+CGANS: (list of supported $\langle response \rangle$ s), (list of supported $\langle L2P \rangle$ s)

### Description

The execution command requests the MT to respond to a network request for Packet Domain PDP context activation which has been signalled to the TE by the RING or +CRING: unsolicited result code. The  $\langle response \rangle$  parameter allows the TE to accept or reject the request.

If  $\langle response \rangle$  is 0, the request is rejected and the MT returns OK to the TE.

If  $\langle response \rangle$  is 1, the following procedure is followed by the MT.

Commands following the +CGANS command in the AT command line shall not be processed by the MT.

If the  $\langle L2P \rangle$  parameter value is unacceptable to the MT, the MT shall return an ERROR or +CME ERROR response. Otherwise, the MT issues the intermediate result code CONNECT and enters V.25ter online data state.

The detailed behaviour after the online data state has been entered is dependent on the PDP type. It is described briefly in 3G TS 27.060[34] and in more detail in 3G TS 29.061[39] and the specifications for the relevant PDPs. PDP context activation procedures shall take place prior to or during the PDP startup.

One or more  $\langle cid \rangle$ s may be specified in order to provide the values needed for the context activation request.

During the PDP startup procedure the MT has the PDP type and the PDP address provided by the network in the Request PDP Context Activation message. The MT may also have some or all of the following information -

The MT may have a priori knowledge, for example, it may implement only one PDP type.

The command may have provided an  $\langle L2P \rangle$  parameter value.

The TE may provide one or both of PDP type and PDP address to the MT in the PDP startup.

If any of this information is in conflict, the command will fail.

If one or more  $\langle cid \rangle$  is given then an attempt shall be made to identify an appropriate context definition by matching the PDP type and PDP address in the network request with the PDP type and PDP address in each of the specified context definitions (in the order in which their  $\langle cid \rangle$ s appear in the command) as follows -

The PDP type must match exactly.

The PDP addresses are considered to match if they are identical or if the address in the context definition is unspecified.

The context shall be activated using the values for PDP type and PDP address provided by the network, together with the other information found in the PDP context definition. An APN may or may not be required, depending on the application.

If no <cid> is given or if there is no matching context definition, the MT will attempt to activate the context using the values for PDP type and PDP address provided by the network, together with any other relevant information known to the MT. The other context parameters will be set to their default values.

If the activation is successful, data transfer may proceed.

After data transfer is complete, and the layer 2 protocol termination procedure has completed successfully, the V.25ter command state is re-entered and the MT returns the final result code OK.

In the event of an erroneous termination or a failure to startup, the V.25ter command state is re-entered and the MT returns the final result code NO CARRIER or, if enabled, +CME ERROR. Attach, activate and other errors may be reported. It is also an error to issue the +CGANS command when there is no outstanding network request.

**NOTE:** This is not the same as if the MT issues a +CGDATA (or +CGACT) command after receiving a +CRING unsolicited result code. A +CGDATA (or +CGACT) does not command the MT to acknowledge the network request but rather to make a new request for context activation. The network request would be ignored.

The test command returns the values of <response> and <L2P> supported by the MT as compound values.

This command may be used in both normal and modem compatibility modes.

#### Defined values

<response>: is a numeric parameter which specifies how the request should be responded to.

- 0 reject the request
- 1 accept and request that the PDP context be activated

If <response> is omitted it is assumed to be 0. Other values are reserved and will result in the ERROR response.

<L2P>: a string parameter which indicates the layer 2 protocol to be used (see +CGDATA command).

<cid>: a numeric parameter which specifies a particular PDP context definition (see the +CGDCONT and +CGDSCONT commands).

#### Implementation

Optional.

### 10.1.17 GPRS mobile station class +CGCLASS (GPRS only)

**Table 114: CGCLASS parameter command syntax**

Command	Possible Response(s)
+CGCLASS=[<class>]	OK ERROR
+CGCLASS?	+CGCLASS: <class>
+CGCLASS=?	+CGCLASS: (list of supported <class>s)

#### Description

The set command is used to set the MT to operate according to the specified GPRS mobile class. If the requested class is not supported, an ERROR or +CME ERROR response is returned. Extended error responses are enabled by the +CMEE command.

The read command returns the current GPRS mobile class.

The test command is used for requesting information on the supported GPRS mobile classes.

### Defined Values

<class>: a string parameter which indicates the GPRS mobile class (in descending order of functionality)

A	class A (highest)
B	class B
C	class C in GPRS and circuit switched alternate mode
CG	class C in GPRS only mode
CC	class C in circuit switched only mode (lowest)

Other values are reserved and will result in an ERROR response to the set command.

If the MT is GPRS attached when the set command is issued with a <class> = CC specified, a detach request shall be sent to the network.

### Implementation

Optional.

## 10.1.12 Configure local triple-X PAD parameters +CGCLPAD (GPRS only)

**Table 115: CGCLPAD parameter command syntax**

Command	Possible Response(s)
+CGCLPAD=[<parm>, <value>]	OK ERROR
+CGCLPAD?	+CGCLPAD: <parm>, <value> [<CR><LF>+CGCLPAD: <parm>, <value>> [...]]
+CGCLPAD=?	+CGCLPAD: <parm>, (list of supported <value>s) [<CR><LF>+CGCLPAD: <parm>, (list of supported <value>s) [...]]

### Description

The set command sets the value of a specified X.3 PAD parameter in the local PAD. A minimum set of parameters to be supported is listed in 3G TS 27.060[34].

The read command returns, one per line, the value of each of the supported parameters.

The test command returns, one per line, the permitted range of values for each of the supported parameters.

### Defined values

<parm>: a numeric parameter which specifies the X.3 parameter to be configured

<value>: a numeric parameter which specifies the value to which the X.3 parameter is to be set

If <value> is omitted for a particular class then <parm> is set to the X.3-defined default, if any.

### Implementation

Optional.

## 10.1.18 Packet Domain event reporting +CGEREP

**Table 116: CGEREP parameter command syntax**

Command	Possible response(s)
+CGEREP=[ <mode>[ , <bfr> ] ]	OK ERROR
+CGEREP?	+CGEREP: <mode> , <bfr>
+CGEREP=?	+CGEREP: ( list of supported <mode>s ) , ( list of supported <bfr>s )

### Description

Set command enables or disables sending of unsolicited result codes, +CGEV: XXX from MT to TE in the case of certain events occurring in the Packet Domain MT or the network. <mode> controls the processing of unsolicited result codes specified within this command. <bfr> controls the effect on buffered codes when <mode> 1 or 2 is entered. If a setting is not supported by the MT, ERROR or +CME ERROR: is returned.

Read command returns the current mode and buffer settings

Test command returns the modes and buffer settings supported by the MT as compound values.

### Defined values

<mode>:

- 0 buffer unsolicited result codes in the MT; if MT result code buffer is full, the oldest ones can be discarded. No codes are forwarded to the TE.
- 1 discard unsolicited result codes when MT-TE link is reserved (e.g. in on-line data mode); otherwise forward them directly to the TE
- 2 buffer unsolicited result codes in the MT when MT-TE link is reserved (e.g. in on-line data mode) and flush them to the TE when MT-TE link becomes available; otherwise forward them directly to the TE

<bfr>:

- 0 MT buffer of unsolicited result codes defined within this command is cleared when <mode> 1 or 2 is entered
- 1 MT buffer of unsolicited result codes defined within this command is flushed to the TE when <mode> 1 or 2 is entered (OK response shall be given before flushing the codes)

### Defined events

The following unsolicited result codes and the corresponding events are defined -

+CGEV: REJECT <PDP\_type> , <PDP\_addr>

A network request for PDP context activation occurred when the MT was unable to report it to the TE with a +CRING unsolicited result code and was automatically rejected.

+CGEV: NW REACT <PDP\_type> , <PDP\_addr> , [<cid>]

The network has requested a context reactivation. The <cid> that was used to reactivate the context is provided if known to the MT.

+CGEV: NW DEACT <PDP\_type> , <PDP\_addr> , [<cid>]

The network has forced a context deactivation. The <cid> that was used to activate the context is provided if known to the MT.

+CGEV: ME DEACT <PDP\_type>, <PDP\_addr>, [<cid>]

The mobile equipment has forced a context deactivation. The <cid> that was used to activate the context is provided if known to the MT.

+CGEV: NW DETACH

The network has forced a PS detach. This implies that all active contexts have been deactivated. These are not reported separately.

+CGEV: ME DETACH

The mobile equipment has forced a PS detach. This implies that all active contexts have been deactivated. These are not reported separately.

+CGEV: NW CLASS <class>

The network has forced a change of MS class. The highest available class is reported (see +CGCLASS).

+CGEV: ME CLASS <class>

The mobile equipment has forced a change of MS class. The highest available class is reported (see +CGCLASS).

### Implementation

Optional.

## 10.1.19 GPRS network registration status +CGREG

**Table 117: CGREG parameter command syntax**

Command	Possible response(s)
+CGREG=[<n>]	
+CGREG?	+CGREG: <n>, <stat>[, <lac>, <ci>] +CME ERROR: <err>
+CGREG=?	+CGREG: (list of supported <n>s)

### Description

The set command controls the presentation of an unsolicited result code +CGREG: <stat> when <n>=1 and there is a change in the MT's GPRS network registration status, or code +CGREG: <stat>[, <lac>, <ci>] when <n>=2 and there is a change of the network cell.

NOTE. If the GPRS MT also supports circuit mode services, the +CREG command and +CREG: result code apply to the registration status and location information for those services.

The read command returns the status of result code presentation and an integer <stat> which shows whether the network has currently indicated the registration of the MT. Location information elements <lac> and <ci> are returned only when <n>=2 and MT is registered in the network.



**Defined values**

<n>:

- 0 disable network registration unsolicited result code
- 1 enable network registration unsolicited result code +CGREG: <stat>
- 2 enable network registration and location information unsolicited result code +CGREG: <stat>[ , <lac> , <ci> ]

<stat>:

- 0 not registered, ME is not currently searching a new operator to register to
- 1 registered, home network
- 2 not registered, but ME is currently searching a new operator to register to
- 3 registration denied
- 4 unknown
- 5 registered, roaming

<lac>: string type; two byte location area code in hexadecimal format (e.g. "00C3" equals 195 in decimal)

<ci>: string type; two byte cell ID in hexadecimal format

**Implementation**

Optional.

**10.1.20 Select service for MO SMS messages +CGSMS****Table 118: CGSMS parameter command syntax**

Command	Possible Response(s)
+CGSMS=[<service>]	OK ERROR
+CGSMS?	+CGSMS: <service>
+CGSMS=?	+CGSMS: (list of currently available <service>s)

**Description**

The set command is used to specify the service or service preference that the MT will use to send MO SMS messages.

The read command returns the currently selected service or service preference.

The test command is used for requesting information on the currently available services and service preferences.

**Defined Values**

- <service>: a numeric parameter which indicates the service or service preference to be used
- 0 Packet Domain
  - 1 circuit switched
  - 2 Packet Domain preferred (use circuit switched if GPRS not available)
  - 3 circuit switched preferred (use Packet Domain if circuit switched not available)

Other values are reserved and will result in an ERROR response to the set command.

## Implementation

Optional.

## 10.2 Modem compatibility commands

This subclause describes how existing AT commands, designed for use with a modem, may be used to control a Packet Domain MT. This is to provide backwards compatibility with existing communications software. For new applications it is recommended that the Packet Domain-specific commands, described in previous subclauses, be used.

### 10.2.1 MT originated PDP context activation

In this mode of operation, the MT behaves like an originating modem and accepts the normal V.25ter commands associated with placing and clearing a call. If Packet Domain-specific configuration commands are required, they may be sent to the MT as part of the modem initialisation commands.

#### 10.2.1.1 Request Packet Domain service 'D'

**Table 119: D command syntax**

Command	Possible Response(s)
D* <code>&lt;GPRS_SC&gt;</code> [* <code>&lt;called_address&gt;</code> ] [* <code>&lt;L2P&gt;</code> ][* <code>&lt;cid&gt;</code> ]]#	CONNECT ERROR

#### Description

This command causes the MT to perform whatever actions are necessary to establish communication between the TE and the external PDN.

The V.25ter 'D' (Dial) command causes the MT to enter the V.25ter online data state and, with the TE, to start the specified layer 2 protocol. The MT shall return CONNECT to confirm acceptance of the command prior to entering the V.25ter online data state. No further commands may follow on the AT command line.

The detailed behaviour after the online data state has been entered is dependent on the PDP type. It is described briefly in clauses 8 (for X.25) and 9 (for IP) of 3G TS 27.060[34]. PS attachment and PDP context activation procedures may take place prior to or during the PDP startup if they have not already been performed using the +CGATT and +CGACT commands.

When the layer 2 protocol has terminated, either as a result of an orderly shut down of the PDP or an error, the MT shall enter V.25ter command state and return the NO CARRIER final result code.

If `<called address>` is supported and provided, the MT shall automatically set up a virtual call to the specified address after the PDP context has been activated.

If `<L2P>` and `<cid>` are supported, their usage shall be the same as in the +CGDATA command. The +CGDCONT, +CGQREQ, etc. commands may be used in the modem initialisation AT command string to set values for for PDP type, APN, QoS etc..

If `<L2P>` is not supported or is supported but omitted, the MT shall use a layer 2 protocol appropriate to the PDP type.

If `<cid>` is not supported or is supported but omitted, the MT shall attempt to activate the context using:

- (a) any information provided by the TE during the PDP startup procedure, e.g. the TE may provide a PDP type and/or PDP address to the MT,

or, (b) a priori knowledge, e.g. the MT may implement only one PDP type,

or, (c) using the 'Empty PDP type' (GSM 04.08). (No PDP address or APN shall be sent in this case and only one PDP context subscription record shall be present in the HLR for this subscriber.)

This command may be used in both normal and modem compatibility modes.

NOTE: The dial string conforms to the syntax specified in 3G TS 22.030 [19].

### Defined Values

<GPRS\_SC>: (GPRS Service Code) a digit string (value 99) which identifies a request to use the Packet Domain service

<called\_address>: a string that identifies the called party in the address space applicable to the PDP. For communications software that does not support arbitrary characters in the dial string, a numeric equivalent may be used. Also, the character comma ',' may be used as a substitute for the character period '.'.

For PDP type OSP:IHOSS, the following syntax may be used for <called\_address>:

[<host>][@[<port>][@[<protocol>]]]

where <host>, <port> and <protocol> are defined in the +CGDCONT description. For communications software that does not support arbitrary characters in the dial string, a numeric equivalent to the hostname may be used. However, this should be avoided if at all possible.

<L2P>: a string which indicates the layer 2 protocol to be used (see +CGDATA command). For communications software that does not support arbitrary characters in the dial string, the following numeric equivalents shall be used:

0 NULL

1 PPP

2 PAD

3 X25

9yyyy M-xxxx

Other values are reserved and will result in an ERROR response

<cid>: a digit string which specifies a particular PDP context definition (see the +CGDCONT and +CGDSCONT commands).

### Implementation

Optional if the +CGDATA command is supported. If the D command is provided, then support for <called\_address>, <L2P> and <cid> are optional. If they are not supported but values are provided by the TE, the values shall be ignored and this shall not constitute an error.

#### 10.2.1.2 Request Packet Domain IP service 'D'

**Table 120: D command syntax**

Command	Possible Response(s)
D*<GPRS_SC_IP>[*<cid>]#	CONNECT ERROR

### Description

This command causes the MT to perform whatever actions are necessary to establish communication between the TE and the external PDN.

The V.25ter 'D' (Dial) command causes the MT to enter the V.25ter online data state and, with the TE, to start the specified layer 2 protocol. The MT shall return CONNECT to confirm acceptance of the command prior to entering the V.25ter online data state. No further commands may follow on the AT command line.

The detailed behaviour after the online data state has been entered is described briefly in clause 9, for IP, of 3G TS 27.060[34]. GPRS attachment and PDP context activation procedures may take place prior to or during the PDP startup if they have not already been performed using the +CGATT and +CGACT commands.

When the layer 2 protocol has terminated, either as a result of an orderly shut down of the PDP or an error, the MT shall enter V.25ter command state and return the NO CARRIER final result code.

If <cid> is supported, its usage shall be the same as in the +CGDATA command. The +CGDCONT, +CGQREQ, etc. commands may be used in the modem initialisation AT command string to set values for for PDP type, APN, QoS etc.

If <cid> is not supported or is supported but omitted, the MT shall attempt to activate the context using:

(a) any information provided by the TE during the PDP startup procedure, e.g. the TE may provide a PDP type and/or PDP address to the MT,

or, (b) a priori knowledge, e.g. the MT may implement only one PDP type,

or, (c) using the 'Empty PDP type' (GSM 04.08). (No PDP address or APN shall be sent in this case and only one PDP context subscription record shall be present in the HLR for this subscriber.)

This command may be used in both normal and modem compatibility modes.

NOTE. The dial string conforms to the syntax specified in 3G TS 22.030[19].

#### Defined Values

<GPRS\_SC\_IP>: (GPRS Service Code for IP) a digit string (value 98) which identifies a request to use the GPRS with IP (PDP types IP and PPP)

<cid>: a digit string which specifies a particular PDP context definition (see +CGDCONT command).

#### Implementation

Optional if the +CGDATA command is supported. If the D command is provided, then support for <cid> is optional. If it is not supported but a value is provided by the TE, the value shall be ignored and this shall not constitute an error.

## 10.2.2 Network requested PDP context activation

In this mode of operation, the MT behaves like an answering modem and accepts the normal V.25ter commands associated with answering a call. If Packet Domain-specific configuration commands are required, they may be sent to the MT as part of the modem initialisation commands.

The +CGAUTO command is used to select modem compatibility mode.

### 10.2.2.1 Automatic response to a network request for PDP context activation 'S0'

The V.25ter 'S0=n' (Automatic answer) command may be used to turn off (n=0) and on (n>0) the automatic response to a network request for a PDP context activation.

When the 'S0=n' (n>0) command is received, the MT shall attempt to perform a PS attach if it is not already attached. Failure will result in ERROR being returned to the TE. Subsequently, the MT will announce a network request for PDP context activation by issuing the unsolicited result code RING to the TE, followed by the intermediate result code CONNECT. The MT then enters V.25ter online data state and follows the same procedure as it would after having received a +CGANS=1 with no <L2P> or <cid> values specified.

NOTE: The 'S0=n' (n=0) command does not perform an automatic PS detach.

#### Implementation

Optional.

### 10.2.2.2 Manual acceptance of a network request for PDP context activation 'A'

The V.25ter 'A' (Answer) command may be used to accept a network request for a PDP context activation announced by the unsolicited result code RING. The MT responds with CONNECT, enters V.25ter online data state and follows the same procedure as it would after having received a +CGANS=1 with no <L2P> or <cid> values specified. It is an error to issue the 'A' command when there is no outstanding network request.

#### Implementation

Optional.

### 10.2.2.3 Manual rejection of a network request for PDP context activation 'H'

The V.25ter 'H' or 'H0' (On-hook) command may be used to reject a network request for PDP context activation announced by the unsolicited result code RING. The MT responds with OK. It is an error to issue the 'H' command when there is no outstanding network request.

NOTE: This is an extension to the usage of the 'H' command that is described in ITU-T V.25ter.

#### Implementation

Optional.

---

## 11 Commands for VGCS and VBS

This clause defines commands that a TE may use to control a VGCS or VBS supporting MT. The requirements for the VGCS and VBS are included in the following specifications:

- Voice Group Call service (VGCS): GSM 02.68 [55], GSM 03.68 [49], GSM 04.68 [52];
- Voice Broadcast Service (VBS): GSM 02.69 [56], GSM 03.69 [50], GSM 04.69 [53].

It is anticipated that VGCS or VBS supporting MTs will vary widely in functionality.

A comprehensive set of VGCS and VBS-specific commands is defined in clause 11.1 to provide the flexibility needed by the more complex MT. The commands use the extended information and error message capabilities described in this specification.

For the simplest MTs, and for backwards compatibility with existing communications software, it is possible to control access to the VGCS and VBS using existing modem-compatible commands. A special dial-string syntax is defined for use with the D command. This "modem compatible" mode of operation is described in subclause 11.2.

### 11.1 Commands specific to MTs supporting the VGCS and VBS

#### 11.1.1 Accept an incoming Voice Group or Voice Broadcast Call +CAJOIN

**Table 121: CAJOIN parameter command syntax**

Command	Possible Response(s)
+CAJOIN=<service>, <GId> ,<GCA>	+CME ERROR: <err>
CAJOIN=?	

#### Description

The execute command accepts an incoming voice group or voice broadcast call indicated by RING or +CRING, the command is applicable as long as the indication is pending.

See command +CALCC to get a list of current voice group or voice broadcast calls.

#### Defined Values

<GId>: a digit string that specifies the group identification for the incoming voice group or voice broadcast call.

<GCA>: a digit string that specifies the group call area identification for the incoming voice group or voice broadcast call.

<service> (tele-service):

17 voice group call

18 voice broadcast call

**Implementation**

Mandatory for a ME supporting AT commands only and VGCS or VBS is implemented.

**11.1.2 Reject an incoming Voice Group or Voice Broadcast Call +CAREJ****Table 122: CAREJ parameter command syntax**

Command	Possible Response(s)
+CAREJ=<service>, <Gid>, <GCA>	+CME ERROR: <err>
+CAREJ=?	

**Description**

The execute command rejects an incoming voice group or voice broadcast call indicated by RING or +CRING, the command is applicable as long as the indication is pending.

If the call is once rejected the RING or +CRING indication is not repeated to TE although the call is still running and notifications for the call are received.

See command +CALCC to get a list of current voice group or voice broadcast calls.

**Defined Values**

<Gid>: a digit string that specifies the group identification for the incoming voice group or voice broadcast call.

<GCA>: a digit string that specifies the group call area identification for the incoming voice group or voice broadcast call.

<service> (tele-service):

17 voice group call

18 voice broadcast call

**Implementation**

Mandatory for a ME supporting AT commands only and VGCS or VBS is implemented.

**11.1.3 Leave an ongoing Voice Group or Voice Broadcast Call +CAHLD****Table 123: CAHLD parameter command syntax**

Command	Possible Response(s)
+CAHLD	+CME ERROR: <err>
+CAHLD=?	

**Description**

The execute command forces the MT to leave the active voice group or voice broadcast call without terminating it. The command is only applicable if the MT is in group receive mode. The MT returns to idle mode.

**Implementation**

Mandatory for a ME supporting AT commands only and VGCS or VBS is implemented.

## 11.1.4 Talker Access for Voice Group Call +CAPTT

**Table 124: CAPTT parameter command syntax**

Command	Possible Response(s)
+CAPTT=[<mode> [,<time>]]	+CME ERROR: <err>
+CAPTT?	+CAPTT: <mode> +CME ERROR: <err>
+CAPTT=?	+CAPTT: (list of supported <mode>s) , (list of supported <time>s)

### Description

The execute command emulates the Push To Talk function for VGCS talker access.

If the parameter <mode> is set to value "0" i.e. "RELEASED" the PTT key is assumed to be released immediately.

If the parameter <mode> is set to value "1" i.e. "PUSHED" the PTT key is assumed to be pushed immediately for the period of <time> in seconds. If the command execution is repeated before the <time> expires the PTT timer will be loaded with the new <time> value and the PTT key remains "PUSHED" for the period of new <time> in seconds.

If the parameter <mode> is set to value "2" i.e. "PUSHED" the PTT key is assumed to be pushed immediately for an infinite period of time and can be released by <mode> value 0.

For <mode>=0 if the parameter <time> is issued it is ignored.

If the PTT timer expires after <time> seconds during <mode> "PUSHED" an unsolicited result code +CAPTT: 0 is issued to the TE.

The read command returns the current <mode>.

The test command returns values supported as a compound value.

### Defined Values

<mode> :

0 status of the PTT key is RELEASED (default value)

1 status of the PTT key is PUSHED for a limited time by <time> in seconds

2 status of the PTT key is PUSHED for an infinite time

<time> :

3..255 this gives the time in seconds to wait before the PTT key is released, default value 10

### Implementation

Mandatory for a ME supporting AT commands only and VGCS is implemented.

## 11.1.5 Voice Group Call Uplink Status Presentation +CAULEV

**Table 125: CAULEV parameter command syntax**

Command	Possible Response(s)
+CAULEV=[<mode> ]	+CME ERROR: <err>
+CAULEV?	+CAULEV: <mode>,<status> +CME ERROR: <err>
+CAULEV=?	+CAULEV: (list of supported <mode>s)

**Description**

The set command enables or disables the presentation of uplink access status for an active VGCS call. When enabled the unsolicited response +CAULEV: <status> is returned from MT to TE after every UPLINK\_FREE or UPLINK\_BUSY message received from the network.

Read command returns the current uplink <status> and the selected <mode>.

The test command returns values supported as a compound value.

**Defined Values**

<mode>: status of unsolicited result response presentation

0 disabled (default)

1 enabled

<status>: network uplink access status

0 uplink free

1 uplink busy

**Implementation**

Mandatory for a ME supporting AT commands only and VGCS is implemented.

**11.1.6 List current Voice Group and Voice Broadcast Calls +CALCC****Table 126: +CALCC action command syntax**

Command	Possible response(s)
+CALCC=<mode>	+CALCC: <GId>, <GCA>, <service>, <stat>, <dir>, <ack_flag>[, <priority>] [<CR><LF>+CALCC: <GId>, <GCA>, <service>, <stat>, <dir>, <ack_flag>[, <priority>] [...]] +CME ERROR: <err>
+CALCC=?	+CALCC: (list of supported <mode>s)

**Description**

The set command returns

for <mode>=1 the active voice group or voice broadcast call and

for <mode>=0 a list of all current running voice group and voice broadcast calls for which the user has a subscription and the GId is activated on the SIM. If the command succeeds but no calls are available, OK response is returned.

**Defined values**

<GId>: a digit string that specifies the group identification of the voice group or voice broadcast call.

<GCA>: a digit string that specifies the group call area of the voice group or voice broadcast call.

<service> (tele-service):

17 voice group call

18 voice broadcast call

<stat> (state of the call):

0 active, i.e. user participating at the call as talker or listener



- 1 held, the call is running but put to background, notifications ignored
- 2 incoming (MT call), the user doesn't respond to notifications of this call yet

<dir>:

- 0 mobile originated (MO) call, the user is the originator of the call
- 1 mobile terminated (MT) call, the user is not the originator of the call

<ack\_flag>: proposes that a predefined confirmation procedure is to be used after the call is ended

- 0 confirmation procedure is not required
- 1 confirmation procedure is required

<priority>: optional integer type parameter which identifies the priority level of the voice group or voice broadcast call, values specified in 3G TS 22.067 [45].

### Implementation

Optional. Recommended for a ME supporting AT commands only and VGCS or VBS is implemented.

## 11.1.7 Voice Group or Voice Broadcast Call State Attribute Presentation +CACSP

**Table 127: CACCS parameter command syntax**

Command	Possible Response(s)
+CACSP=[ <mode> ]	+CME ERROR: <err>
+CACSP?	+CACSP: <mode> [ , <da> , <ua> , <comm> , <oi> ] +CME ERROR: <err>
+CACSP=?	+CACSP: (list of supported <mode>s)

### Description

The set command enables or disables the presentation of unsolicited result response +CACSP : <da> , <ua> , <comm> , <oi> from MT to TE if the call control state attributes of the active voice group or voice broadcast call changes.

Read command returns the current call control state attributes <da> , <ua> , <comm> , <oi> and selected <mode>.

The test command returns values supported as a compound value.

### Defined Values

<mode> : status of unsolicited result response presentation

0 disabled (default)

1 enabled

<da> : User connection in the downlink

0 not attached

1 attached

<ua> : User connection in the uplink

0 not attached

1 attached

<comm>: The MT assumes that communication with its peer entity is

0 not enabled in both directions

1 enabled in both directions

<oi>: The MS assumes to be

0 not the originator of the call

1 the originator of the call

### Implementation

Optional. Recommended for a ME supporting AT commands only and VGCS or VBS is implemented.

## 11.1.8 NCH Support Indication +CANCHEV

**Table 128: CAULEV parameter command syntax**

Command	Possible Response(s)
+CANCHEV=[ <mode> ]	+CME ERROR: <err>
+CANCHEV?	+CANCHEV: <status>, <mode> +CME ERROR: <err>
+CANCHEV=?	+CANCHEV: (list of supported <mode>s)

### Description

The set command enables or disables the presentation of unsolicited result response +CANCHEV: <status> from MT to TE if the status of the network NCH support information changes.

Read command returns in parameter <status> the network NCH support information in the selected cell and the selected <mode>.

The test command returns values supported as a compound value.

### Defined Values

<mode>: status of unsolicited result response presentation

0 disabled (default)

1 enabled

<status>: network NCH support information

0 NCH not available

1 NCH available

### Implementation

Optional. Recommended for a ME supporting AT commands only and VGCS or VBS is implemented.

## 11.2 Modem compatibility commands

This sub-clause describes how existing AT commands, designed for use with a modem, may be used to control a VGCS or VBS supporting MT. This is to provide backwards compatibility with existing communications software.

## 11.2.1 Request VGCS or VBS service 'D'

Table 129: D command syntax

Command	Possible Response(s)
D* <i>&lt;SC<sub>1</sub>&gt;</i> [ * <i>&lt;SC<sub>2</sub>&gt;</i> ]# <i>&lt;GId&gt;</i> ;	+CME ERROR: <i>&lt;err&gt;</i>

### Description

This Dial command extension is a service request application according to 3G TS 22.030 [19]. No further commands may follow on the AT command line. The requested service, GId and priority level are checked against the subscriptions of the user and the status of the GId stored on the SIM. In case if no subscription is available for this service, GId or priority level or the GId is deactivated an ERROR or +CMEE ERROR result code is returned. See +CMEE ERROR extensions for VGCS, VBS and eMLPP in subclause 9.2.

NOTE. The dial string conforms to the syntax specified in 3G TS 22.030 [19].

### Defined Values

*<SC<sub>1</sub>>*: Service Code is a digit string which identifies a request to use

- value 17 Voice Group Call Service
- value 18 Voice Broadcast Service

*<SC<sub>2</sub>>*: Service Code is a digit string which identifies a request to use eMLPP priority . Service Code values for different priority levels are specified in 3G TS 22.030 [19]

*<GId>*: a digit string that specifies the group identification of a called party.

### Implementation

Mandatory for a ME supporting AT commands only and VGCS or VBS is implemented.

## 11.2.2 Termination of an Voice Group or Voice Broadcast Call 'H'

The V.25ter 'H' or 'H0' (On-hook) command may be used to terminate an ongoing voice group or voice broadcast call. The MT responds with OK. It is an error to issue the 'H' command when there is no outstanding network request.

It is an error to issue the 'H' command if the user is in group receive mode or the user is not the originator of the call and a ERROR or +CME ERROR result code is returned to the TE.

NOTE: This is an extension to the usage of the 'H' command that is described in ITU-T V.25ter.

### Implementation

Mandatory for a ME supporting AT commands only and VGCS or VBS is implemented.

## 11.3 Informative examples

As supplementary services may be invoked and controlled using dial command according to 3G TS 22.030 [19].

An example of voice group call service request usage:

```
ATD*17*753#500 ;           (originate voice group call with the priority level 3)
OK                          (voice group call setup was successful)
```

## Annex A (normative): Summary of commands from other standards

Summary of ITU-T Recommendation V.25ter [14] commands applicable to GSM/UMTS:

**Table A.1: V.25ter commands applicable to GSM/UMTS**

Name	V.25ter subclause	Description	Subclauses in the present document
&C	6.2.8	Circuit 109 (Received line signal detector) Behaviour	4.3
&D	6.2.9	Circuit 108 (Data terminal ready) Behaviour	4.3
&F	6.1.2	Set to Factory-defined Configuration	5.8/ 3
+DR	6.6.2	Data Compression Reporting	6.20
+DS	6.6.1	Data Compression	6.20
+GCAP	6.1.9	Request Complete Capabilities List	5.8
+GCI	6.1.10	Country of Installation	5.8
+GMI	6.1.4	Request Manufacturer Identification	5.8/ 5.1
+GMM	6.1.5	Request Model Identification	5.8/ 5.2
+GMR	6.1.6	Request Revision Identification	5.8/ 5.3
+GOI	6.1.8	Request Global Object Identification	5.8
+GSN	6.1.7	Request Product Serial Number Identification	5.8/ 5.4
+ICF	6.2.11	DTE-DCE Character Framing	4.3
+IFC	6.2.12	DTE-DCE Local Flow Control	4.3
+ILRR	6.2.13	DTE-DCE Local Rate Reporting	4.3
+IPR	6.2.10	Fixed DTE Rate	4.3
A	6.3.5	Answer	6.19/ 6.6
D	6.3.1	Dial	6.1-6.4/ 6.6
E	6.2.4	Command Echo	4.3
H	6.3.6	Hook Control	6.19/ 6.5/ 6.6
I	6.1.3	Request Identification Information	5.8
L	6.3.13	Monitor Speaker Loudness	6.19
M	6.3.14	Monitor Speaker Mode	6.19
O	6.3.7	Return to Online Data State	6.19
P	6.3.3	Select Pulse Dialling	6.19
Q	6.2.5	Result Code Suppression	4.3
S0	6.3.8	Automatic Answer	6.19
S10	6.3.12	Automatic Disconnect Delay	6.19
S3	6.2.1	Command Line Termination Character	4.3
S4	6.2.2	Response Formatting Character	4.3
S5	6.2.3	Command Line Editing Character	4.3
S6	6.3.9	Pause Before Blind Dialling	6.19
S7	6.3.10	Connection Completion Timeout	6.19
S8	6.3.11	Comma Dial Modifier Time	6.19
T	6.3.2	Select Tone Dialling	6.19
V	6.2.6	DCE Response Format	4.3/ 3/ 4.1/ 4.2
X	6.2.7	Result Code Selection and Call Progress Monitoring Control	4.3
Z	6.1.1	Reset To Default Configuration	5.8

The use of ITU-T Recommendation V.42 error control protocol is not specified for GSM/UMTS, but if a manufacturer chooses to implement it over transparent data service, +E prefixed commands of V.25ter [14] shall be used.

ITU-T T.31 [11] and T.32 [12] may be used as facsimile TA-TE protocols without deletions or additions to the command set.

TIA IS-99 [15] commands referenced in the present document:

**Table A.2: TIA IS-99 commands in the present document**

<b>Command</b>	<b>IS-99 subclause</b>	<b>Description</b>	<b>Subclause in the present document</b>
+CBC	5.6.5	Battery Charge	8.4
+CGMI	5.6.10	Request Manufacturer Identification	5.1
+CGMM	5.6.10	Request Model Identification	5.2
+CGMR	5.6.10	Request Revision Identification	5.3
+CGSN	5.6.10	Request Product Serial Number Identification	5.4
+CRC	5.6.7	Cellular Result Codes	6.11

TIA IS-135 [16] commands referenced in the present document:

**Table A.3: TIA IS-135 commands in the present document**

<b>Command</b>	<b>IS-135 subclause</b>	<b>Description</b>	<b>Subclause in the present document</b>
+CBC	4.1.24	Battery Charge	8.4
+CRC	4.1.29	Cellular Result Codes	6.11
+CSQ	4.1.31	Signal Quality	8.5

PCCA STD-101[17] commands referenced in the present document:

**Table A.4: PCCA STD-101 commands in the present document**

<b>Command</b>	<b>STD-101 subclause</b>	<b>Description</b>	<b>Subclause in the present document</b>
+WS46	5.2.4.6	WDS-side Stack Selection	5.9

## Annex B (normative): Summary of result codes

V.25ter [14] result codes which can be used in GSM/UMTS and codes defined in the present document:

**Table B.1: Result codes**

Verbose result code (V.25ter command V1 set)	Numeric (V0 set)	Type	Description
+CALV	as verbose	unsolicited	refer subclause 8.16
+CCCM: <ccm>	as verbose	unsolicited	refer subclause 7.16
+CCWA: <number>, <type> , <class>[, <alpha>]	as verbose	unsolicited	refer subclause 7.12
+CCWV	as verbose	unsolicited	refer subclause 8.28
+CDEV: <elem>, <text>	as verbose	unsolicited	refer subclause 8.10
+CDIP: <number>, <type>[, < subaddr>, <satype>]	as verbose	unsolicited	refer subclause 7.9
+CIEV: <ind>, <value>	as verbose	unsolicited	refer subclause 8.10
+CKEV: <key>, <press>	as verbose	unsolicited	refer subclause 8.10
+CLAV: <code>	as verbose	unsolicited	refer subclause 8.
+CLIP: <number> , <type>[, <subaddr> , <satype>[, <alpha>]]	as verbose	unsolicited	refer subclause 7.6
+CME ERROR: <err>	as verbose	final	refer subclause 9.2
+COLP: <number> , <type>[, <subaddr> , <satype>[, <alpha>]]	as verbose	intermediate	refer subclause 7.8
+CR: <type>	as verbose	intermediate	refer subclause 6.9
+CREG: <stat>[, <lac> , <ci>]	as verbose	unsolicited	refer subclause 7.2
+CRING: <type>	as verbose	unsolicited	refer subclause 6.11
+CSSI: <code1> , <index>]	as verbose	intermediate	refer subclause 7.17
+CSSU: <code2> , <index>[, <number>, <type>[, <subaddr>, <satype>]]]	as verbose	unsolicited	refer subclause 7.17
+CTZV: <tz>	as verbose	unsolicited	refer subclause 8.40
+CUSD: <m>[, <str>, <dcs>]	as verbose	unsolicited	refer subclause 7.15
+DR: <type>	as verbose	intermediate	refer subclause 6.13
+ILRR: <rate>	as verbose	intermediate	refer subclause 4.3
BUSY	6	final	busy signal detected
CONNECT	1	intermediate	connection has been established
CONNECT <text>	manufacturer specific	intermediate	as CONNECT but manufacturer specific <text> gives additional information (e.g. connection data rate)
ERROR	4	final	command not accepted
NO ANSWER	7	final	connection completion timeout
NO CARRIER	3	final	connection terminated
NO DIALTONE	5	final	no dialtone detected
OK	0	final	acknowledges execution of a command line
RING	2	unsolicited	incoming call signal from network

## Annex C (informative): Commands from TIA IS-101

### C.1 Introduction

The "Voice Control Interim Standard for Asynchronous DCE", TIA IS-101, contains some commands that are useful when passing audio "data" (that is, data which represents audio information) between the computer and the TA.

Some of the following subclauses describe commands from IS-101 which are central to this TA application. However, with the exception of necessary extensions, these descriptions are not intended to replace the definitions found in IS-101. Other novel commands from the interim standard are not included because they are peripheral to TA operation.

NOTE 1: IS-101 also uses V.25ter [14] AT commands, but these are not mentioned here.

The standard specifies the following modes:

- command mode, where there is no transfer of audio "data" between the TA and the computer. In command mode, the computer is neither sending audio data to the TA nor receiving audio data from the TA.
- transmit mode, where audio "data" is being transferred from the computer to the TA. No audio "data" is transferred from the TA to the computer in this state. A transition back to command mode occurs when an embedded command indicates "end of play" or "flush data", or an inactivity timer times out.
- receive mode, where audio "data" is being transferred from the TA to the computer. No audio "data" is transferred from the computer to the TA in this state. A transition back to command mode occurs when any command is sent from the computer, or an inactivity timer times out. During the receive mode, the TA embeds result codes into the audio "data". These result codes indicate pertinent events such as "silence detected", "busy detected", and so on.

Strictly, the standard specifies another mode (translation), but this is not directly of interest here.

NOTE 2: The TA "knows" the type of an incoming call (whether it is voice, data, fax, whatever), and certain POTS events cannot occur. Hence some standard result codes for indication of events and discrimination of call type are unnecessary.

There are three possible levels of service:

- a TA supporting level A performs the following operations and detects the following events: audio transmit, audio receive, DTMF detection, DTMF generation and single tone generation. The following indications are supported:

<u>Event</u>	<u>Description</u>	<u>Handset state</u>
3	ring	idle
4	DTMF received	idle
5	receive buffer overrun	receive
6	unsolicited fax request	idle
8	phone on/off hook	idle
9	presumed hangup	receive
10	presumed end of message	receive
18	ringback	idle
19	busy	idle
23	playback buffer underrun	transmit

25 fax or data request acknowledged          idle

- a TA supporting level B performs the operations and events of level A, and also supports DTMF detection while in the transmit state.
- a TA supporting level C performs the operations and events of level B, and also supports double DTMF tone generation.

Since DTMF detection and generation cannot be guaranteed over current digital networks, it follows that none of the three levels of service can be supported.

## C.2 Commands

### C.2.1 Select mode +FCLASS

This command puts the TA into a particular mode of operation (data, fax, voice etc.). This causes the TA to process information in a manner suitable for that type of information (rather than for other types of information). The values and meanings of parameter <n> are specified in the following table.

<n>	Mode
0	data
1	fax class 1 (TIA-578-A)
1.0	fax class 1 (ITU-T T.31 [11])
2	fax (manufacturer specific)
2.0	fax class 2 (ITU-T T.32 [12] and TIA-592)
3..7	reserved for other fax modes
8	voice
9..15	reserved for other voice modes
16..79	reserved
80	VoiceView (Radish)
81..255	reserved

**Table C.1: +FCLASS**

Command	Return
+FCLASS=<n>	
+FCLASS?	<n>
+FCLASS=?	(list of supported <n>s)

Voice mode is of particular interest here, and has an additional result code +VCON. Specifically, +VCON indicates that the TA is entering the voice command mode and there is a voice connection to at least one audio input or output. This presupposes that some mechanism has previously initiated a connection to that audio I/O.

### C.2.2 Buffer threshold setting +VBT

This refers to integers <lo> and <hi> that indicate levels within the TA transmit buffer at which flow control is asserted and deasserted. The buffer is used for averaging out the irregular timing of data from the computer, so that the data becomes synchronous and may be sent to some audio device.



**Table C.2: +VBT**

Command	Return
+VBT=<lo>,<hi>	
+VBT?	<lo>,<hi>
+VBT=?	(list of supported <lo>s), (list of supported <hi>s), (buffer size)

### C.2.3 Calling number ID presentation +VCID

The command refers to an integer that allows a called party to enable or disable (<n>=0) the reporting of the ID of calling parties, and specifies the method of presentation of the ID. This is basically the same as GSM/UMTS supplementary service CLIP (Calling Line Identification Presentation). The presentation may be either formatted (<n>=1) or unformatted (<n>=2):

- Formatted presentation : data items are reported in the form of <tag>=<value> pairs.

<u>&lt;tag&gt;</u>	<u>&lt;value&gt;</u>
DATE	MMDD (month, day)
TIME	HHMM (hour, minute)
NMBR	calling number or P or O (P = number is private, O = number is unavailable)
NAME	subscription listing name
MESG	data from other (unknown) tags

- Unformatted presentation : here the data is presented in ASCII hex as printable numbers.

**Table C.3: +VCID**

Command	Return
+VCID=<n>	
+VCID?	<n>
+VCID=?	(0-2)

### C.2.4 Receive gain selection +VGR

This refers to the amplification by the TA of audio samples sent from the TA to the computer. The command operates on an integer <n>, range 0...255. Values larger than 128 indicate a larger gain than nominal. Values less than 128 indicate a smaller gain than nominal. The entire range of 0...255 does not have to be provided. A value of zero implies the use of automatic gain control by the TA.

**Table C.4: +VGR**

Command	Return
+VGR=<n>	
+VGR?	<n>
+VGR=?	(list of supported <n>s)

### C.2.5 Transmit gain selection +VGT

This refers to the amplification by the TA of audio samples sent from the computer to the TA. The command operates on an integer <n>, range 0...255. Values larger than 128 indicate a larger gain than nominal. Values less than 128 indicate a smaller gain than nominal. The entire range of 0...255 does not have to be provided. A value of zero implies the uses of automatic gain control by the TA.

**Table C.5: +VGT**

Command	Return
+VGT=<n>	
+VGT?	<n>
+VGT=?	( list of supported <n>s )

## C.2.6 Initialise voice parameters +VIP

This recalls manufacturer determined settings <n> of voice parameters. The command is write only. The effect of the command is manufacturer specific.

**Table C.6: +VIP**

Command	Return
+VIP=<n>	
+VIP=?	( list of supported <n>s )

## C.2.7 Inactivity timer +VIT

This refers to the value of the inactivity timer in the TA. It is used to monitor activity on the connection between the computer and the TA when the computer is in "transmit" mode and sending audio data to the TA. When the connection has been inactive for the time set by this command, the TA leaves "transmit" mode and reverts to command mode. An integer <n> different than zero implies a time of <n>/10 seconds. A value of zero disables the timer.

**Table C.7: +VIT**

Command	Return
+VIT=<n>	
+VIT?	<n>
+VIT=?	( list of supported <n>s )

## C.2.8 Line selection +VLS

This determines the selection of sources and destinations of audio samples. An integer is used to label a particular combination of sources and destinations. The integer is defined in an entry in IS-101 which assumes as a model a TA, a local phone and a phone line. Two additional "manufacturer specific" configurations (16,17) are defined.

- label=0: this is the idle state - the phone is not connected to the radio network and no audio paths are used.
- label=1: the phone is connected to the radio network and no audio paths involving the internal microphone or internal loudspeaker are selected. This allows the computer to transmit audio data over the radio transmitter by selecting "transmit mode":

**Table C.8: +VLS label 1a**

	loudspeaker	computer i/p	transmit stage
microphone -->			
computer o/p -->			*
receiver stage -->			

This also allows the computer to receive audio data from the radio receiver by selecting "receive mode":

**Table C.9: +VLS label 1b**

	loudspeaker	computer i/p	transmit stage
microphone -->			
computer o/p -->			
receiver stage -->		*	

- label=4: the phone is not connected to the radio network but there is an audio path to the internal speaker. This allows the computer to play sound by selecting "transmit mode".

**Table C.10: +VLS label 4**

	loudspeaker	computer i/p	transmit stage
microphone -->			
computer o/p -->	*		
receiver stage -->			

- label=6: the phone is not connected to the radio network but there is an audio path to the internal microphone. This allows the computer to record sound by selecting "receive mode".

**Table C.11: +VLS label 6**

	loudspeaker	computer i/p	transmit stage
microphone -->		*	
computer o/p -->			
receiver stage -->			

- label=7: the phone is connected to the radio network. The internal microphone is connected to the radio transmitter. The radio receiver is connected to the internal loudspeaker. This allows the computer to enable normal phone operation (a human holding a conversation) by selecting command mode.

**Table C.12: +VLS label 7**

	loudspeaker	computer i/p	transmit stage
microphone -->			*
computer o/p -->			
receiver stage -->	*		

**Table C.13: +VLS**

Command	Return
+VLS=<n>	+VCON
+VLS?	<n>
+VLS=?	<i>complex; refer IS-101</i>

+VCON is returned if an audio path is established or if a connection is made to the radio network.

#### Manufacturer specific extension (reserved as such by IS-101)

- label=16: the phone is connected to the radio network. There is a path to the internal microphone, which is also connected to the radio transmitter. There is a path to the radio receiver, which is also connected to the internal loudspeaker. This allows the computer to record the sum of transmitted and received audio by selecting "receive mode".

**Table C.14: +VLS label 16**

	loudspeaker	computer i/p	transmit stage
microphone -->		*	*

computer o/p -->			
receiver stage -->	*	*	

- label=17: the phone is connected to the radio system and there is a path to the internal loudspeaker and to the radio transmitter. This allows the computer to simultaneously play sound and send audio over the radio by selecting "transmit mode".

Table C.15: +VLS label 17

	loudspeaker	computer i/p	transmit stage
microphone -->			
computer o/p -->	*		*
receiver stage -->			

## C.2.9 Receive data state +VRX

This action command causes the TA to get audio data from a source determined by the +VLS command, and send it to the computer. Once the datastream has started, any result codes will be embedded in the data and shielded using the normal <DLE> methods. The receive process is terminated when the computer sends any command to the TA, or by time-out of the inactivity timer. The command is write only.

Table C.16: +VRX

Command	Return
+VRX	CONNECT

## C.2.10 Select compression method +VSM

This selects the voice compression method <n1>, the voice sampling rate <n2>, the silence compression sensitivity <n3>, and a parameter related to silence expansion <n4>. There are several choices of compression method. IS-101 does not specify methods, but here is a list of some usual compression methods:

Name	Communications system
GSM/full-rate	GSM
GSM/half-rate	GSM
ADPCM/G.721	DECT, CT2
ADPCM/G.723	DECT, CT2
ADPCM/G.726	DECT, CT2
ADPCM/G.727	DECT, CT2
SIGNED PCM	POTS

Table C.17: +VSM

Command	Return
+VSM=<n1>, <n2>, <n3>, <n4>	
+VSM?	<n1>, <n2>, <n3>, <n4>
+VSM=?	<i>complex; refer IS-101</i>

NOTE: A value of <n3>=0 implies no silence compression sensitivity. A value of <n4>=0 implies no silence expansion.

## C.2.11 DTMF and tone generation +VTS

This command allows the transmission of DTMF tones and arbitrary tones (see note). These tones may be used (for example) when announcing the start of a recording period. The command is write only. In this profile of commands, this command does not operate in data or fax modes of operation (+FCLASS=0,1,2-7).

NOTE 1: D is used only for dialling.

The string parameter of the command consists of combinations of the following separated by commas:

1. <DTMF>. A single ASCII character in the set 0-9, #, \*, A-D. This is interpreted as a single ASCII character whose duration is set by the +VTD command.

NOTE 2: In GSM this operates only in voice mode.

2. [<tone1>, <tone2>, <duration>]. This is interpreted as a dual tone of frequencies <tone1> and <tone2>, lasting for a time <duration> (in 10 ms multiples).

NOTE 3: This does not operate in GSM.

3. {<DTMF>, <duration>}. This is interpreted as a DTMF tone of different duration from that mandated by the +VTD command.

NOTE 4: In GSM this operates only in voice mode.

**Table C.18: +VTS**

Command	Return
+VTS= <i>as above</i>	
+VTS=?	(list of supported <tone1>s) , (list of supported <tone2>s) , (list of supported <duration>s)

## C.2.12 Tone duration +VTD

This refers to an integer <n> that defines the length of tones emitted as a result of the +VTS command. This does not affect the D command. A value different than zero causes a tone of duration <n>/10 seconds. The value zero causes a "manufacturer specific" value.

**Table C.19: +VTD**

Command	Return
+VTD=<n>	
+VTD?	<n>
+VTD=?	(list of supported <n>s)

NOTE: In GSM/UMTS the value of tone duration is preset and cannot be altered.

## C.2.13 Transmit data state +VTX

This action command causes the TA to receive audio data from the computer and send it to a destination determined by the +VLS command. Once the audio datastream has started, commands to the TA shall be embedded in the data stream, and shielded using the normal <DLE> methods. The transmit process is terminated by the use of embedded commands or by the time-out of an inactivity timer. It is recommended that the TA has a buffer to allow the TA to convert potentially bursty data from the computer into synchronous data for "transmission". The command is write only.

**Table C.20: +VTX**

Command	Return
+VTX	CONNECT

---

## Annex D (informative): Bibliography

### Informative references:

- 1) IrDA Serial Infrared Physical Layer Specification.  
IrDA Serial Infrared MAC and Link Protocol.  
IrDA Serial Infrared Link Access Protocol.
- 2) PCCA STD-101 Annex I: Data Transmission Systems and Equipment - Serial Asynchronous Automatic Dialling and Control for Character Mode DCE on Wireless Data Services - Annex I: Command Extensions for Analog Cellular Data Modems.
- 3) TIA IS-101 Facsimile Digital Interfaces - Voice Control Interim Standard for Asynchronous DCE.
- 4) TIA-578-A Facsimile Digital Interfaces - Asynchronous Facsimile DCE Control Standard, Service Class 1.
- 5) TIA-592 Facsimile Digital Interfaces - Asynchronous Facsimile DCE Control Standard, Service Class 2.
- 6) TIA-617 Data Transmission Systems and Equipment - In-Band DCE Control.
- 7) ITU-T Recommendation V.80: In-band DCE control and synchronous data modes for asynchronous DTE.

# Annex E (informative): Mobile originated alternating voice/data call example

Figure E.1 illustrates the possible transitions in MO BS 61 call. Responses and result codes generated by TA are in bold face. In this example, data part of the call is asynchronous non-transparent 9600 bps service.

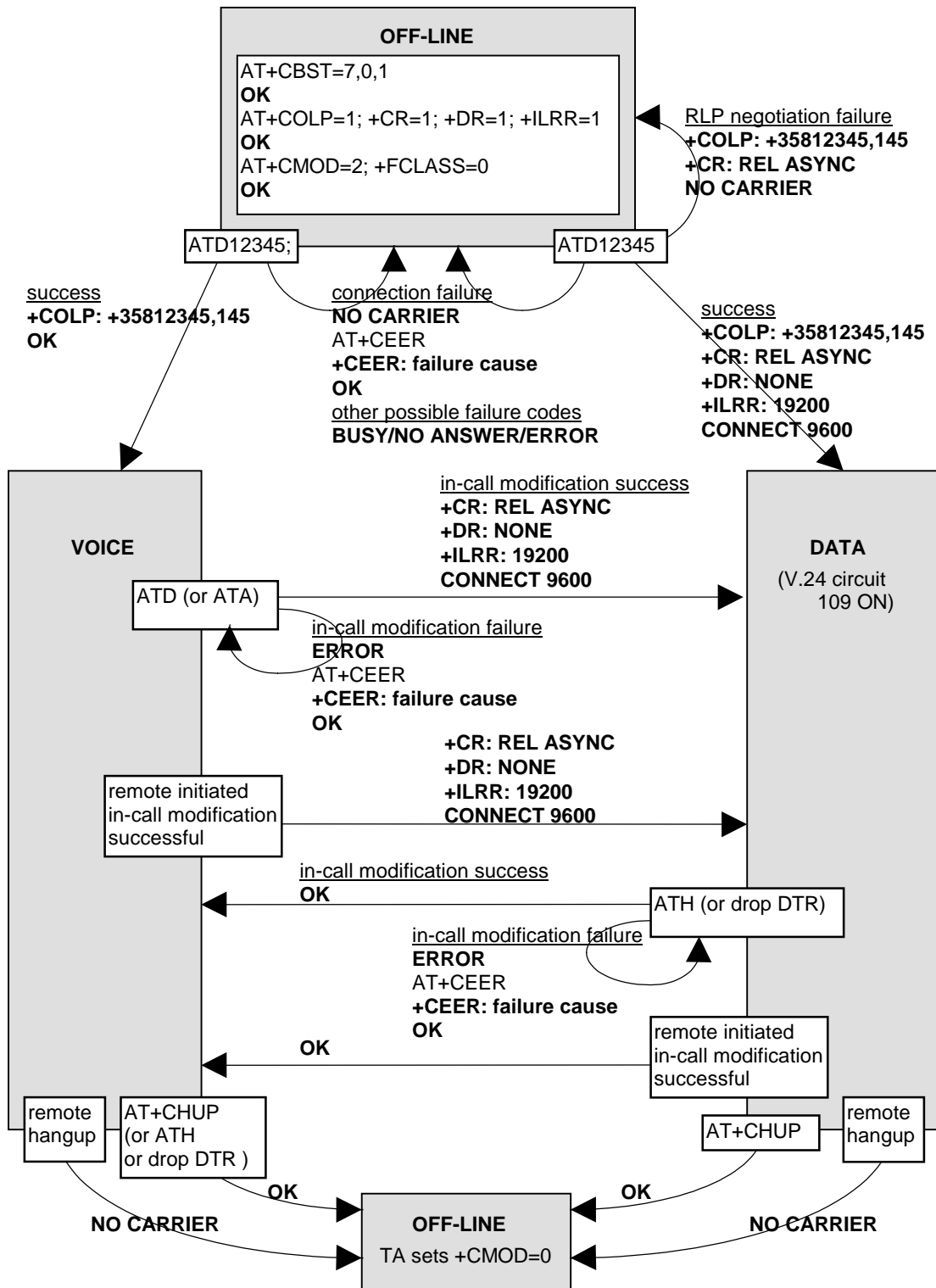

Figure E.1: MO BS 61 call



# Annex F (informative): Mobile terminated voice followed by data call example

Figure F.1 illustrates the possible transitions in MT BS 81 call. Responses and result codes generated by TA are in bold face. In this example, data part of the call is asynchronous non-transparent 9600 bps service.

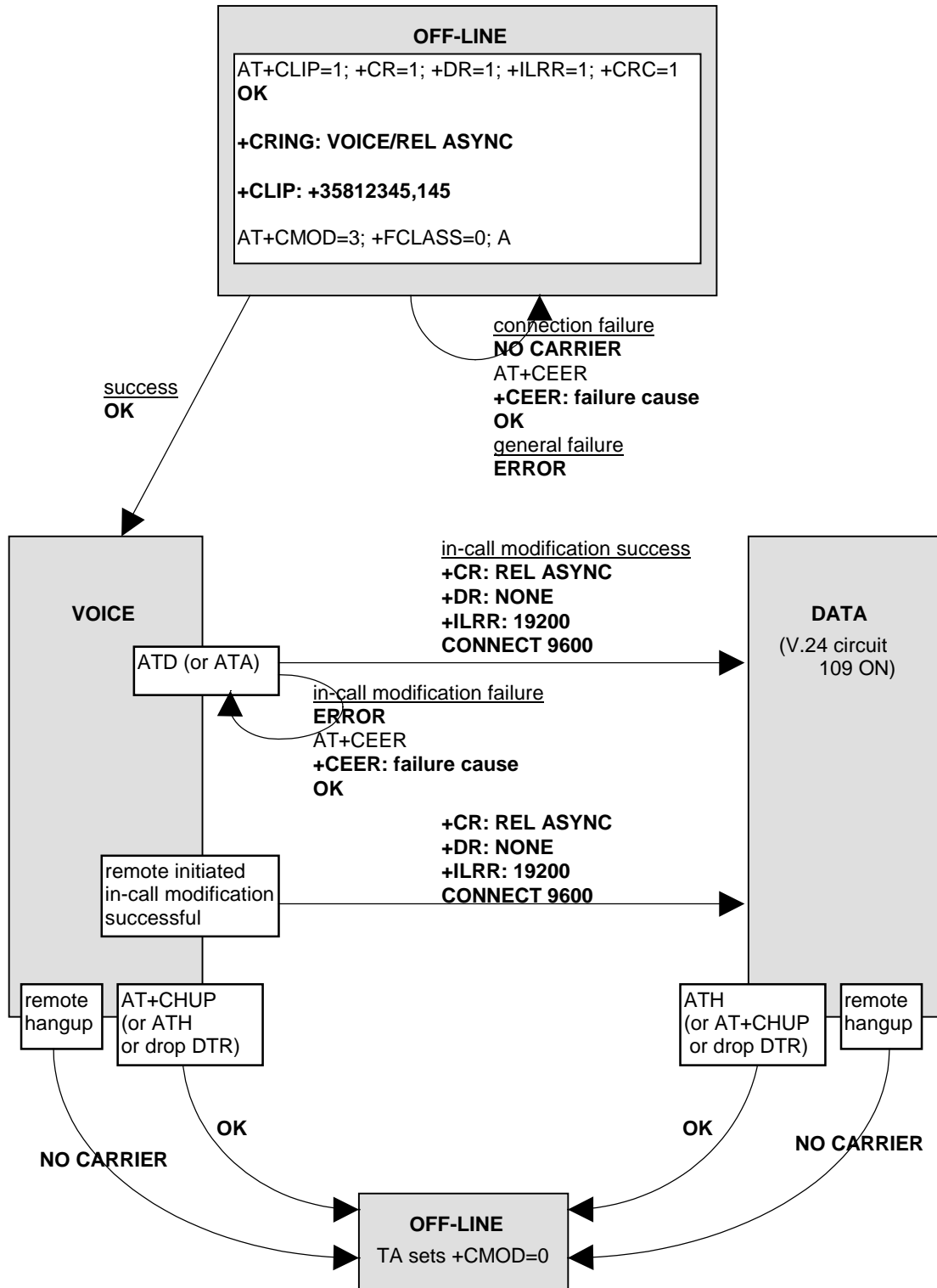

Figure F.1: MT BS 81 call

# Annex G (informative): Voice call example

Figure G.1 illustrates the possible transitions in both MT and MO TS 11 calls. Responses and result codes generated by TA are in bold face.

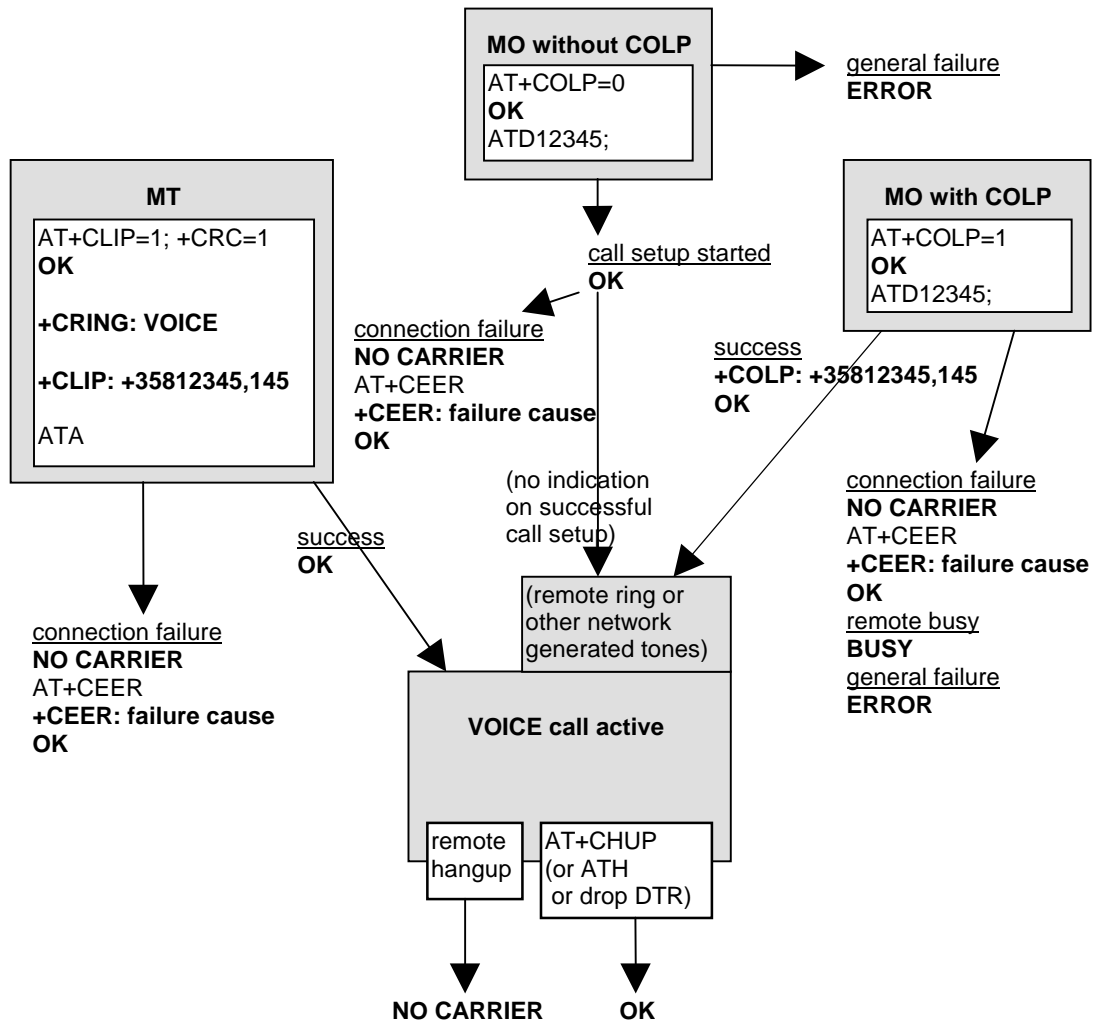

Figure G.1: TS 11 calls

## Annex H (informative): Change History

TSG	TDoc	CR	R E V	PH	CAT	SUBJECT	WORKITEM	NEW VERS
T#4	TP-99118	New				Creation of 3GPP 27.007 v3.0.0 out of GSM 07.07 v7.2.0		3.0.0
T#4	TP-99124	001		R99	A	Additional result codes for +CLIP +CCWA	TEI	3.1.0
T#4	TP-99124	002		R99	B	ECSD additions	EDGE	3.1.0
T#4	TP-99124	003		R99	B	ECSD asymmetry (new command +CHSA)	EDGE	3.1.0
T#4	TP-99146	004		R99	A	Syntax error in +CHSN command	TEI	3.1.0
T#4	TP-99146	005		R99	A	Moving AT commands to 07.07 for 07.60 handover to SMG3 / 3GPP TSG CN WG3	GPRS	3.1.0
T#5	TP-99177	006		R99	D	ECSD AT command correction	EDGE	3.2.0
T#5	TP-99177	007		R99	B	Alarm functionality	TEI	3.2.0
T#5	TP-99177	008		R99	B	Phonebook storage	TEI	3.2.0
T#5	TP-99177	009		R99	B	Time Zone	TEI	3.2.0
T#5	TP-99177	010		R99	B	Additional result code for +CSSN	TEI	3.2.0
T#5	TP-99177	011		R99	B	New command for setting of Date format	TEI	3.2.0
T#5	TP-99177	012		R99	B	New command for Silent mode	TEI	3.2.0
T#5	TP-99177	013		R99	B	New command for setting of Time format	TEI	3.2.0
T#5	TP-99177	014		R99	B	GSM 400 Spectrum update	GSM 400	3.2.0
T#5	TP-99177	015		R99	A	AT command - Request GPRS service 'D'	GPRS	3.2.0
T#6	TP-99237	016		R99	F	Clarification to result codes for +CLIP +CCWA	TEI	3.3.0
T#6	TP-99237	017		R99	B	AT command for Frame Tunnelling Mode (FTM)	Frame Tunnelling Mode	3.3.0
T#6	TP-99237	018		R99	B	New AT command for application protocols activation	TEI	3.3.0
T#6	TP-99237	022		R99	B	Add new AT command (+CDIP) to inform the called line identification	TEI	3.3.0
T#6	TP-99237	020		R99	C	Packet Domain ATD command syntax	GPRS	3.3.0
T#6	TP-99237	021		R99	B	Additional parameter for +CBST	TEI	3.3.0
T#6	TP-99237	019		R99	B	AT-commands for Enhanced QoS Support management	Enhanced QoS Support in GPRS	3.3.0
T#7	TP-000024	024		R99	F	Deletion of the AT+CPROT? read command	TEI	3.4.0
T#7	TP-000024	025		R99	F	Adaptations for UMTS	TEI	3.4.0
T#7	TP-000024	026		R99	D	References to ASCII Specifications	ASCII	3.4.0
T#7	TP-000024	027		R99	D	Abbreviations related to ASCII	ASCII	3.4.0
T#7	TP-000024	028		R99	B	Priority indication in +CLCC, List Current Calls	ASCII	3.4.0
T#7	TP-000024	029		R99	B	Indication of priority, sub-address, sub-address type and TS 91/TS92 in +CRC, Cellular Result Codes	ASCII	3.4.0
T#7	TP-000024	030		R99	B	Commands for ASCII	ASCII	3.4.0
T#7	TP-000024	031		R99	B	Commands for eMLPP	eMLPP	3.4.0
T#7	TP-000024	032		R99	B	Example for usage of priority	eMLPP	3.4.0

---

# History

<b>Document history</b>		
V3.4.0	March 2000	Publication