

ETSI TS 127 005 V4.2.1 (2005-01)

Technical Specification

**Digital cellular telecommunications system (Phase 2+);
Universal Mobile Telecommunications System (UMTS);
Use of Data Terminal Equipment -
Data Circuit terminating Equipment (DTE-DCE)
interface for Short Message Service (SMS)
and Cell Broadcast Service (CBS)
(3GPP TS 27.005 version 4.2.1 Release 4)**



Reference

RTS/TSGT-0227005v421

Keywords

GSM, UMTS

ETSI

650 Route des Lucioles
F-06921 Sophia Antipolis Cedex - FRANCE

Tel.: +33 4 92 94 42 00 Fax: +33 4 93 65 47 16

Siret N° 348 623 562 00017 - NAF 742 C
Association à but non lucratif enregistrée à la
Sous-Préfecture de Grasse (06) N° 7803/88

Important notice

Individual copies of the present document can be downloaded from:

<http://www.etsi.org>

The present document may be made available in more than one electronic version or in print. In any case of existing or perceived difference in contents between such versions, the reference version is the Portable Document Format (PDF). In case of dispute, the reference shall be the printing on ETSI printers of the PDF version kept on a specific network drive within ETSI Secretariat.

Users of the present document should be aware that the document may be subject to revision or change of status. Information on the current status of this and other ETSI documents is available at

<http://portal.etsi.org/tb/status/status.asp>

If you find errors in the present document, please send your comment to one of the following services:

http://portal.etsi.org/chaicor/ETSI_support.asp

Copyright Notification

No part may be reproduced except as authorized by written permission.
The copyright and the foregoing restriction extend to reproduction in all media.

© European Telecommunications Standards Institute 2005.
All rights reserved.

DECTTM, **PLUGTESTS**TM and **UMTS**TM are Trade Marks of ETSI registered for the benefit of its Members.
TIPHONTM and the **TIPHON logo** are Trade Marks currently being registered by ETSI for the benefit of its Members.
3GPPTM is a Trade Mark of ETSI registered for the benefit of its Members and of the 3GPP Organizational Partners.

Intellectual Property Rights

IPRs essential or potentially essential to the present document may have been declared to ETSI. The information pertaining to these essential IPRs, if any, is publicly available for **ETSI members and non-members**, and can be found in ETSI SR 000 314: *"Intellectual Property Rights (IPRs); Essential, or potentially Essential, IPRs notified to ETSI in respect of ETSI standards"*, which is available from the ETSI Secretariat. Latest updates are available on the ETSI Web server (<http://webapp.etsi.org/IPR/home.asp>).

Pursuant to the ETSI IPR Policy, no investigation, including IPR searches, has been carried out by ETSI. No guarantee can be given as to the existence of other IPRs not referenced in ETSI SR 000 314 (or the updates on the ETSI Web server) which are, or may be, or may become, essential to the present document.

Foreword

This Technical Specification (TS) has been produced by ETSI 3rd Generation Partnership Project (3GPP).

The present document may refer to technical specifications or reports using their 3GPP identities, UMTS identities or GSM identities. These should be interpreted as being references to the corresponding ETSI deliverables.

The cross reference between GSM, UMTS, 3GPP and ETSI identities can be found under <http://webapp.etsi.org/key/queryform.asp>.

Contents

Intellectual Property Rights	2
Foreword.....	2
Foreword.....	6
0 Scope	7
0.1 References	8
0.2 Abbreviations	8
1 Reference configuration	9
1.1 V.24 Interface Circuits	9
1.1.1 Circuit definitions for the SMS Block mode	9
1.1.2 Circuit definitions for the SMS Text and PDU modes	10
2 SMS Block Mode	10
2.1 Beginning and ending of SMS/CBS Block Mode	10
2.1.1 Beginning SMS/CBS Block Mode	10
2.1.2 Returning from SMS/CBS Block Mode To Default Mode.....	11
2.2 Protocol description.....	11
2.3 Requesting messages already held in the Mobile Termination	12
2.3.1 Requesting List Of Messages.....	13
2.3.2 Requesting Transfer Of Messages	13
2.3.2.1 Requesting Transfer Of A Specific Message	13
2.3.2.2 Requesting Transfer Of All Messages.....	13
2.3.3 Requesting Diversion Of Incoming Messages.....	14
2.3.3.1 Requesting SMS Messages	14
2.3.3.2 Requesting CBS Messages.....	14
2.3.3.3 Requesting indication of message arrival.....	14
2.3.4 Requesting Transfer Into Mobile Termination	15
2.3.5 Requesting Deletion Of Messages	15
2.4 Message functional definitions and contents	16
2.4.1 Commands Issued By The Terminal Equipment	16
2.4.1.1 List Request.....	17
2.4.1.2 Get Message	17
2.4.1.3 Get First Message.....	17
2.4.1.4 Get Next Message	17
2.4.1.5 Transfer Inc SMS	17
2.4.1.6 Indicate Inc SMS	17
2.4.1.7 Transfer Inc CBS	18
2.4.1.8 Insert SMS.....	18
2.4.1.9 Delete message.....	18
2.4.1.10 Unable to process	18
2.4.1.11 End SMS Mode	18
2.4.1.12 Acknowledge Message.....	19
2.4.2 Responses/Indications Issued By The MT	19
2.4.2.1 Message List	19
2.4.2.2 Message.....	19
2.4.2.3 Get Message Failure.....	20
2.4.2.4 Inc Message.....	20
2.4.2.5 Message Arrived	20
2.4.2.6 Insert SMS Complete	20
2.4.2.7 Insert SMS Failure	20
2.4.2.8 Delete Message Complete.....	21
2.4.2.9 Delete Message Failure	21
2.4.2.10 Unable To Process	21
2.4.2.11 End SMS Mode	21
2.4.2.12 Request Confirmed.....	21
2.5 General message format and information elements coding.....	21

2.5.1	Message Type	21
2.5.2	Other Information Elements	22
2.5.2.1	Short Message Reference	22
2.5.2.2	SMS Transfer Type	23
2.5.2.3	Indication Type	23
2.5.2.4	Insert Type	24
2.5.2.5	Short Message Index	25
2.5.2.6	Short Message Data	26
2.5.2.7	Cause	28
2.5.2.8	Index Count	29
2.5.2.9	CBS Transfer Type	29
2.5.2.10	Page Index	29
2.5.2.11	Last Short Message	30
2.5.2.12	Confirm Type	30
2.5.2.13	TP-Failure Cause	31
2.5.2.14	SM-Deliver-Ack	31
2.5.2.15	SM-Submit-Ack	32
3	Text Mode	32
3.1	Parameter Definitions	32
3.2	General Configuration Commands	35
3.2.1	Select Message Service +CSMS	35
3.2.2	Preferred Message Storage +CPMS	36
3.2.3	Message Format +CMGF	36
3.2.4	Enter SMS Block Mode Protocol +CESP	37
3.2.5	Message Service Failure Result Code +CMS ERROR	37
3.2.6	Informative Examples	38
3.3	Message Configuration Commands	38
3.3.1	Service Centre Address +CSCA	38
3.3.2	Set Text Mode Parameters +CSMP	38
3.3.3	Show Text Mode Parameters +CSDH	39
3.3.4	Select Cell Broadcast Message Types +CSCB	39
3.3.5	Save Settings +CSAS	40
3.3.6	Restore Settings +CRES	40
3.3.7	Informative Examples	41
3.4	Message Receiving and Reading Commands	41
3.4.1	New Message Indications to TE +CNMI	41
3.4.2	List Messages +CMGL	46
3.4.3	Read Message +CMGR	47
3.4.4	New Message Acknowledgement to ME/TA +CNMA	47
3.4.5	Informative Examples	48
3.5	Message Sending and Writing Commands	49
3.5.1	Send Message +CMGS	49
3.5.2	Send Message from Storage +CMSS	50
3.5.3	Write Message to Memory +CMGW	50
3.5.4	Delete Message +CMGD	51
3.5.5	Send Command +CMGC	52
3.5.6	More Messages to Send +CMMS	52
3.5.7	Informative Examples	53
4	PDU Mode	53
4.1	List Messages +CMGL	54
4.2	Read Message +CMGR	54
4.3	Send Message +CMGS	54
4.4	Write Message to Memory +CMGW	55
4.5	Send Command +CMGC	56
4.6	New Message Acknowledgement to ME/TA +CNMA	56
4.7	Send Message from Storage +CMSS	57
Annex A (normative):	Character Set Conversions for SMS Text Mode	58
Annex B (informative):	Example of processing a data block	61

B.1 Example state diagrams for the block receiver.....61

B.2 Example of coding and decoding a data block.....61

Annex C (informative): Change History68

History69

Foreword

This Technical Specification has been produced by the 3rd Generation Partnership Project (3GPP).

The contents of the present document are subject to continuing work within the TSG and may change following formal TSG approval. Should the TSG modify the contents of the present document, it will be re-released by the TSG with an identifying change of release date and an increase in version number as follows:

Version x.y.z

where:

- x the first digit:
 - 1 presented to TSG for information;
 - 2 presented to TSG for approval;
 - 3 Indicates TSG approved document under change control.
- y the second digit is incremented for all changes of substance, i.e. technical enhancements, corrections, updates, etc.
- z the third digit is incremented when editorial only changes have been incorporated in the specification;

0 Scope

The present document defines three interface protocols for control of SMS functions within a GSM/UMTS mobile telephone from a remote terminal via an asynchronous interface.

Clause 2 defines a binary protocol ("Block Mode"). The protocol includes error protection and is suitable for use where the link may not be completely reliable. It will be of particular use where control of remote devices is required. Efficient transfer of binary encoded user data is possible.

Clause 3 defines a character-based interfaced based on "AT" commands ("Text Mode"). This mode is suitable for unintelligent terminals or terminal emulators, and for application software built on command structures like those defined in V.25ter. Some of the commands defined in clause 3 will also be useful for implementations of clause 2 and/or clause 4, for example enabling an indication of incoming SMS messages.

Clause 4 defines a character-based interface with hex-encoded binary transfer of message blocks ("PDU Mode"). This mode is suitable for software drivers based on AT command structures which do not understand the content of the message blocks and can only pass them between the MT and "upper level" software resident in the TE.

In all three modes, the terminal is considered to be in control for SMS/CBS transactions.

The present document considers the mobile termination to be a single entity. Other 3GPP/GSM Technical Specifications describe the split of functionality between the mobile equipment and (U)SIM.

The three "modes" referred to above, are represented in figure 0.1.

The "Block mode" is a self contained mode in its own right, and when entered, control will remain within that mode until the procedures to exit the mode are executed, after which control is returned to the V.25ter "command" state or "on-line command" state.

The "Text" and "PDU" modes are not in themselves V.25ter states but are simply sets of commands which will operate in either the V.25ter "command" state or "on-line command" state. The "Text" and "PDU" modes are transitory states and after each operation, control is automatically returned to the V.25ter "command" state or "on-line command" state. Whilst in the V.25ter command state, the MS is available to handle incoming and outgoing calls such as Data or Facsimile.

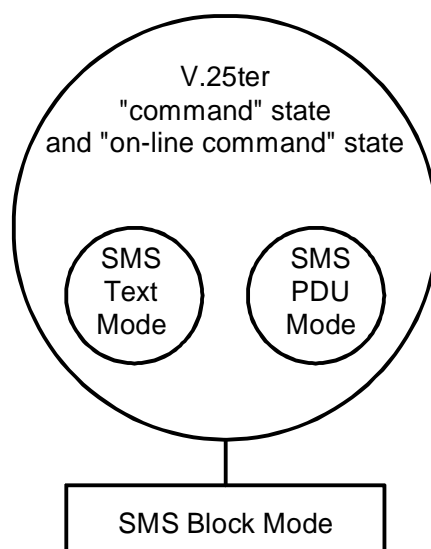

Figure 0.1: Block, Text and PDU modes

In the "Block mode" and "PDU" mode a mobile is not permitted to modify any component of an SMS/CBS message received from the air interface or an SMS message received from a TE, before passing it on, except where 3GPP TS 23.040 [3] or 3GPP TS 23.041 [4] defines a "component modification facility" and where this "component modification facility" is supported by the mobile. In the Text Mode the mobile may be unable to display characters coded in particular coding schemes. In this case, the mobile shall behave as described in 3GPP TS 23.038 [2] and assume the coding scheme to be the GSM 7 bit default alphabet.

0.1 References

The following documents contain provisions which, through reference in this text, constitute provisions of the present document.

- References are either specific (identified by date of publication, edition number, version number, etc.) or non-specific.
- For a specific reference, subsequent revisions do not apply.
- For a non-specific reference, the latest version applies. In the case of a reference to a 3GPP document (including a GSM document), a non-specific reference implicitly refers to the latest version of that document *in the same Release as the present document*.

- [1] Void.
- [2] 3GPP TS 23.038: "Alphabets and language-specific information".
- [3] 3GPP TS 23.040: "Technical realization of the Short Message Service (SMS)".
- [4] 3GPP TS 23.041: "Technical realization of the Cell Broadcast Service (CBS)".
- [5] 3GPP TS 24.008: "Mobile Radio Interface Layer 3 specification; Core Network Protocols; Stage 3".
- [6] 3GPP TS 24.011: "Short Message Service (SMS) support on mobile radio interface".
- [7] 3GPP TS 24.012: "Cell Broadcast Service (CBS) support on the mobile radio interface".
- [8] 3GPP TS 27.001: "General on Terminal Adaptation Functions (TAF) for Mobile Stations (MS)".
- [9] 3GPP TS 27.007: "AT command set for User Equipment (UE)".
- [10] 3GPP TS 51.011: "Specification of the Subscriber Identity Module - Mobile Equipment (SIM - ME) interface".
- [11] ITU-T Recommendation V.25ter: "Serial asynchronous automatic dialling and control".
- [12] ITU-T Recommendation V.24: "List of definitions for interchange circuits between data terminal equipment (DTE) and data circuit-terminating equipment (DCE)".
- [13] ITU-T Recommendation E.164: "The international public telecommunication numbering plan".
- [14] ITU-T Recommendation E.163: "Numbering plan for the international telephone service".
- [15] 3GPP TR 21.905: "Vocabulary for 3GPP Specifications".
- [16] 3GPP TS 31.102: "Characteristics of the USIM application".

0.2 Abbreviations

For the purposes of the present document, the abbreviations given in 3GPP TR 21.905 [15] and the following apply.

EVPPF Enhanced Validity Period Format

1 Reference configuration

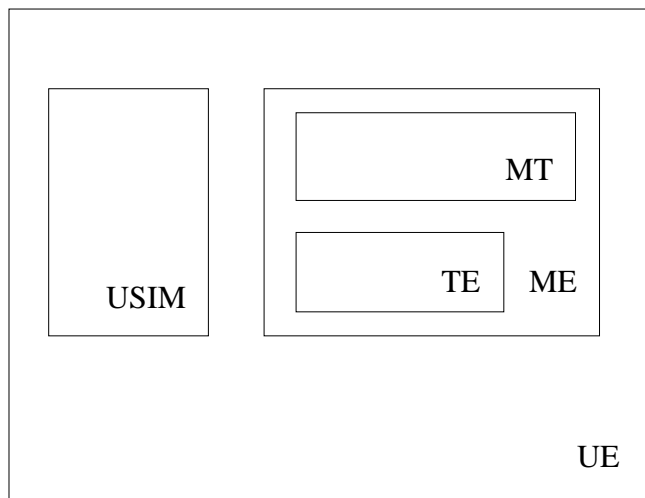

Figure 1: Reference configuration

The User Equipment (UE) consists of the mobile equipment (ME) and the (U)SIM. Messages may be stored in either, but the present document does not distinguish between messages stored in the (U)SIM or in the ME. The management of message storage in the two parts of the UE is a matter for the UE implementation.

1.1 V.24 Interface Circuits

The operation of the ITU-T Recommendation V.24 blue book interface circuits for SMS is shown in table 1.1.

Table 1.1: Use of V.24 interface circuits

V.24 CIRCUIT	DESCRIPTION	TE to MT	MT to TE
CT102	signal ground	x	x
CT103	TXD	x	
CT104	RXD		x
CT105	RTS	x	
CT106	CTS		x
CT107	DSR		x
CT108.2	DTR	x	
CT109	DCD		x

NOTE: CT105 at the TE is connected to CT133 at the MT.

1.1.1 Circuit definitions for the SMS Block mode

CT103

All commands from the TE to the MT are transferred across this circuit. Inband flow control is not permitted during Block Mode.

CT104

All responses/indications from the MT to the TE are transferred across this circuit. Inband flow control is not permitted during Block Mode.

CT105

This circuit allows the TE to flow control the MT when in the Block Mode and at other times if hardware flow control is enabled.

CT106

This circuit allows the MT to flow control the TE when in the Block Mode and at other times if hardware flow control is enabled.

CT107

This circuit shall be set to the ON condition before entry into the Block Mode, and shall remain in the ON condition during Block Mode. If the TE detects that this circuit returns to the OFF condition during the block mode then the TE shall return CT108.2 to the OFF condition and exit the Block Mode.

CT108.2

This circuit shall be set in the ON condition before the AT+CESP command is sent from the TE to begin the Block Mode, and shall be maintained in the ON condition during the Block Mode. It shall be returned to the OFF condition after the command 'END SMS MODE' has been accepted and acknowledged by the MT. If the MT detects that this circuit returns to the OFF condition during the Block Mode then the MT shall exit the Block Mode.

CT109

This circuit shall be set to the ON condition before entry into the Block Mode and remain in the ON condition during the Block Mode. If the TE detects that this circuit returns to the OFF condition during the Block Mode then the TE shall return CT108.2 to the OFF condition and shall exit the Block Mode.

1.1.2 Circuit definitions for the SMS Text and PDU modes

Only circuits CT102, CT103 and CT104 are mandatory for the Text and PDU modes. The functionality and operation of other circuits shall be in accordance with V.25ter.

2 SMS Block Mode

2.1 Beginning and ending of SMS/CBS Block Mode

2.1.1 Beginning SMS/CBS Block Mode

As described in 3GPP TS 27.001 [8], the DTE/DCE interface is normally associated with the terminal adaptation function (TAF), if such a function is available. When no data connection is in progress, and the terminal equipment wishes to enter SMS/CBS mode, the command 'AT+CESP' shall be issued by the TE through the DTE/DCE interface requesting that the Block mode protocol described in the present document is to be used. The syntax of this command is further described in clause 3.2.4 later. The syntax for these commands is derived from ITU-T Recommendation V.25ter, i.e. the command is encoded as an IA5 character string together with delimiters as described in ITU-T Recommendation V.25ter.

Upon receipt of this command, the mobile termination shall respond as follows:

- If the mobile termination supports SMS/CBS block mode commands, responses and indications as described in the present document, it shall respond with 'OK' (or 0) and enter the SMS/CBS mode.
- If the mobile termination does not support SMS/CBS block mode commands, responses and indications as described in the present document, it shall respond with 'ERROR' (or 4) and remain in the current mode.

- Terminal software shall wait a short time (e.g. 5 seconds) for the 'OK' (0) or 'ERROR' (4) response. If neither response is received before the timeout then the terminal software shall assume that the block mode has been entered. The terminal software may then submit its first block mode command. If no response is received to this command then the terminal software shall proceed as described below in clause 2.2 (i.e. repeat the command 3 times and then exit the block mode).

If the SMS/CBS block mode command is accepted by the mobile termination, then all further commands, responses and indications shall be as defined in clause 2 of the present document. These SMS/CBS mode commands, responses and indications use 8-bit encoded data and not IA5 characters.

2.1.2 Returning from SMS/CBS Block Mode To Default Mode

When the terminal equipment wishes to return to default mode from SMS/CBS mode, it shall issue the command 'END SMS MODE', described in clause 2.4.1.11. The mobile termination shall respond with 'OK' (or 0) to indicate that the DTE/DCE interface has returned to default mode. The TE shall change back to default mode whether or not such a response is received.

The TE may also indicate that it has exit from the SMS/CBS mode through the use of CT 108/2 (see clause 1.1)

If an incoming data call arrives while the DTE/DCE interface is set to SMS/CBS mode, then the mobile termination may autonomously issue the 'END SMS MODE' indication (clause 2.4.2.11) and revert to default mode in order to connect the data call through the TAF.

The MT may exit from SMS/CBS mode autonomously if the power to the MT is switched off and then on again. In addition, the MT manufacturer may provide MMI to change the mode back to the default mode. In the latter case, the MT shall issue the 'END SMS MODE' indication (clause 2.4.2.11) and exit the SMS/CBS mode immediately.

The MT may also indicate that it has exit from the SMS/CBS mode through the use of CT 107 and CT 109 (see clause 1.1).

A BREAK condition in either direction at the DTE/DCE interface shall cause the TE and the MT to exit from the SMS/CBS block mode and return to the default mode.

In the event where the TE or the MT find themselves unable to recover from a protocol error then either entity may exit the SMS/CBS mode using any of the mechanisms described above. Confirmation of default mode operation will be achieved through the use of AT commands and responses.

2.2 Protocol description

The communication path between the MT and the TE across the DTE/DCE interface should be quite reliable if it uses a short wire link. However, to ensure that the low error rate does not cause malfunction, the following error protection scheme is provided.

Each message sent from the MT to the TE or vice-versa consists of a data block (DATA) and block check sum (BCS, see figure 2.2.1). In the following description the notation DLE, STX, NUL and ETX refer to control characters having the values 10 02 00 and 03 hexadecimal respectively.

<-----DATA-----> <- BCS ->

DLE 10H	STX 02H	Message content	DLE 10H	ETX 03H	BCS MSB	BCS LSB
------------	------------	-----------------	------------	------------	------------	------------

Figure 2.2.1: Format of DTE/DCE interface messages

The data block consists of a start transmission sequence, set to 00010000 00000010 (10 02 hex), the message content as defined below and an end transmission sequence, set to 00010000 00000011 (10 03 hex). The least significant bit of each octet is always transmitted first.

The block check sum is calculated at the transmitter by adding all of the octets in the message content modulo 65536. Each bit of the 16-bit result is then inverted, and 1 is added to the answer.

During transmission of the message content and the BCS octets, any occurrence of the value 10 hex (DLE) shall result in an additional 'stuffing' octet of value 00 hex (NUL) being transmitted immediately following the octet containing 10

hex. This is to ensure that the start and end markers are unambiguous. The receiver shall remove stuffing octets by discarding any octet of value 00 hex (NUL) which immediately follows an octet of value 10 hex (DLE).

After removal of any stuffing octets, the receiver can check the BCS by adding all of the octets in the message content and the 16-bit BCS modulo 65536. The correct result is 0000 hex. If any message is received with an incorrect BCS, then the message is discarded. No response is sent over the DTE/DCE interface, but an indication may be provided to higher layers within the receiving entity.

The transmitter shall only send DLE when it is followed by STX, NUL or ETX. Therefore, if the receiver sees a DLE followed by anything else then the receiver shall assume that some data has been lost, and shall start to search for the start marker. An unexpected end marker at the receiver shall also result in a search for a start marker. A start marker shall always be treated as the start of a new block, regardless of which state the receiver is in.

Examples of state diagrams for a block receiver to implement this procedure are given in Annex B, together with an example of coding and decoding a message.

Only one Command/Response transaction shall be permitted at any one time from any sending or receiving entity. It shall however be possible for a Command/Response transaction from one entity to be initiated even if there is a Command/Response transaction in progress from the other entity.

If an immediate response is expected to a message sent over the DTE/DCE interface, then the sending entity shall wait 10 s. If no response is received within this time, the sending entity shall repeat the message. The message shall be repeated a maximum of 3 times, after which the sending entity shall exit from the SMS/CBS mode and provide an error indication to the user.

If a message cannot be understood by the receiving entity even though it has a correct BCS, then it shall return an UNABLE TO PROCESS message with cause value 'Command not understood'. The receipt of an UNABLE TO PROCESS message should not in itself initiate re-transmission although re-transmission may take place due to the timeout mechanism described earlier since an UNABLE TO PROCESS is deemed to be an invalid response. The 'Cause' may however be referred to a higher layer. An UNABLE TO PROCESS shall not be sent as the result of an incorrect BCS.

2.3 Requesting messages already held in the Mobile Termination

The TE may request the MT to provide SMS or CBS messages already stored. The TE will either request all messages, or request a list of messages and subsequently ask for specific messages.

At the start of the SMS/CBS mode session, the MT shall number all messages contiguously, starting with message number 1. These "Short Message References" are only valid for a single SMS/CBS MODE session and should not be confused with the 3GPP TS 23.040 [3] TP-Message-Reference. Each message retains its Short Message Reference for the duration of the SMS/CBS mode session. New messages will normally be given the lowest previously-unused Short Message Reference. However, if all Short Message References have been used then the MT may reallocate Short Message References previously allocated to now-deleted messages.

Short Message Reference 0 signifies that there are no messages in the MT. The value of 0 is used under the following conditions:

- When an INSERT SMS command is used to transfer an SM over the air interface and not store it in the MT then the MT will return a Short Message Reference of 0 in the REQUEST CONFIRMED response and the ensuing INSERT SMS COMPLETE / INSERT SMS FAILURE indications.
- For Class 0 SM's which are not stored in the MT.
- For TE specific SM's which are not stored in the MT.

If Message number 0 is requested by the TE, the MT will always return an error cause, but will also include the highest valid Short Message Reference (see clause 2.3.2.1).

2.3.1 Requesting List Of Messages

The TE may request the MT to provide a list of SMS and CBS messages currently stored in the mobile termination. This is achieved by the LIST REQUEST command (clause 2.4.1.1). The MT divides the messages stored into groups of 5 (called pages) and transfers the first 5 in a MESSAGE LIST response (clause 2.4.2.1) containing message references allocated by the MT, plus the relevant header information described in 3GPP TS 23.040 [3] and 3GPP TS 24.011 [6] and 3GPP TS 23.041 [4] and 3GPP TS 24.012 [7].

If there are no messages stored in the MT, then the MESSAGE LIST response shall be empty.

The TE may then request further groups of up to 5 messages by repeating the LIST REQUEST command for pages 2, 3, and so on. The MT will indicate that there are no more pages by responding with an empty MESSAGE LIST response.

2.3.2 Requesting Transfer Of Messages

The TE may request the transfer of one or more messages by means of the commands described below. The MT does not delete messages which have been transferred. Messages can only be deleted by the DELETE MESSAGE command (clause 2.4.1.9).

2.3.2.1 Requesting Transfer Of A Specific Message

The TE may request the MT to transfer a specific message by sending the GET MESSAGE command (clause 2.4.1.2), including the appropriate message reference. The MT will provide the full message including header in a MESSAGE response (clause 2.4.2.2). If the message reference is unallocated, then the GET MESSAGE FAILURE response is returned with cause 'No such message' and the highest valid Message Reference (clause 2.4.2.3).

2.3.2.2 Requesting Transfer Of All Messages

The TE may request the MT to transfer all messages by sending the GET FIRST MESSAGE command (clause 2.4.1.3), followed by the appropriate number of GET NEXT MESSAGE commands (clause 2.4.1.4).

The MT shall be able to transfer all messages one-by-one, starting with the 'first' and continuing with the 'next'. The precise ordering of the messages is left to the MT implementation.

If the MT exits from SMS/CBS mode for any reason, then this information need not be retained.

On receipt of the GET FIRST MESSAGE command, the MT shall set a pointer to the first message, and transfer this message using the MESSAGE response as described in clause 2.3.2.1.

On receipt of the GET NEXT MESSAGE command, the MT shall move the pointer to the first available message after the last message transferred (using either GET FIRST MESSAGE, GET MESSAGE or GET NEXT MESSAGE), and transfer this message using the MESSAGE response as described in clause 2.3.2.1.

If the MT receives a GET NEXT MESSAGE command when all messages have been transferred to the TE, or there are no messages stored in the MT, then the GET MESSAGE FAILURE response shall be provided with the cause 'No such message' (see clause 2.4.2.3).

If the TE receives an out of sequence message then it shall attempt to transfer the missing message using the GET MESSAGE command before continuing with GET NEXT MESSAGE. If this attempt fails with the cause 'no such message', it means that the message has been deleted, or it has been lost due to a failure at the MT.

The MT includes a LAST SHORT MESSAGE REFERENCE in the GET MESSAGE FAILURE response. This is so that the TE can detect whether or not the last short message was received in error.

If the MT receives a GET NEXT MESSAGE command prior to receiving a GET FIRST MESSAGE or GET MESSAGE command, then it shall continue as if the command had been GET FIRST MESSAGE (i.e. provide the 'first' message and continue with the 'next' on receipt of the subsequent GET NEXT MESSAGE command).

2.3.3 Requesting Diversion Of Incoming Messages

The TE may request the MT to transfer SMS or CBS messages directly from the air interface to the DTE/DCE interface, by the following procedures. If messages are diverted then they are not stored in the MT. If messages are diverted and there is no communication path to the TE (e.g. because it has been disconnected), the diversion shall be cancelled.

2.3.3.1 Requesting SMS Messages

The TE may request an indication of arrival of incoming SMS messages, or the direct transfer of incoming SMS messages.

The TE requests new SMS messages by the TRANSFER INC SMS command (clause 2.4.1.5). This command will be sent with parameters indicating whether all incoming SMS messages are to be transferred, or only those indicated as being for the TE.

The MT shall confirm receipt of this command with a REQUEST CONFIRMED message provided there is memory available to store SM's in the ME or the (U)SIM. If there is no memory available, the MT shall respond with 'unable to process' with a cause value No memory.

The MT shall transfer incoming messages by the INC MESSAGE indication (clause 2.4.2.4).

For an INC MESSAGE which contains a Short Message (SMS) info element id, the TE shall acknowledge receipt of the INC MESSAGE with an ACKNOWLEDGE MESSAGE (clause 2.4.1.12). The MT should not send another INC MESSAGE which contains a Short Message (SMS) info element id to the TE whilst it is waiting for an ACKNOWLEDGE MESSAGE.

In the event of the MT not receiving an ACKNOWLEDGE MESSAGE within a time specified by the MT manufacturer the MT shall exit the SMS mode automatically after 'n' attempts to send the INC MESSAGE (where n is a number specified by the MT manufacturer). The MT should attempt to store the unacknowledged SM or Status Report (contained in the INC MESSAGE) in the MT or on the (U)SIM as appropriate.

The ACKNOWLEDGE MESSAGE sent from the TE to the MT must not delay the MT sending the RP-ACK defined in 3GPP TS 23.040 [3] (to the SC) for longer than the RP-ACK timeout specified in 3GPP TS 24.011 [6].

The TE requests the cessation of incoming message transfer by the same command, indicating no incoming messages. The transfer of messages will automatically cease on exit of the SMS/CBS mode. Transfer shall not recommence until a new request is issued by the TE.

2.3.3.2 Requesting CBS Messages

The TE may request the transfer of all cell broadcast messages directly from the air interface to the DTE/DCE interface. This is achieved by the use of the TRANSFER INC CBS message (clause 2.4.1.7).

The MT shall confirm receipt of this command with a REQUEST CONFIRMED message.

After receipt of this command, the MT shall transfer all CBS pages as they arrive on the air interface, using the INC MESSAGE indication (clause 2.4.2.4).

While the CBS pages are being transferred, any other indication or response required to be sent to the TE will take precedence over the CBS pages. However, the MT shall not interrupt the transfer of a page to send other information within the SMS/CBS mode (ie. the MT shall wait until a page boundary).

The transfer of messages will automatically cease on exit of the SMS/CBS mode. Transfer shall not recommence until a new request is issued by the TE.

2.3.3.3 Requesting indication of message arrival

If the TE requires an indication of incoming message arrival, the INDICATE INC SMS command (clause 2.4.1.6) shall be used.

The MT shall confirm receipt of this command with a REQUEST CONFIRMED message.

After receipt of this command, the MT shall indicate all incoming messages in the specified categories (unless they are directly transferred) with the MESSAGE ARRIVED indication (clause 2.4.2.5). This indication shall be of the same format as the MESSAGE LIST response described in clause 2.3.1.

The TE shall acknowledge receipt of the MESSAGE ARRIVED with an ACKNOWLEDGE MESSAGE (clause 2.4.1.12). The MT should not send another MESSAGE ARRIVED to the TE whilst it is waiting for an ACKNOWLEDGE MESSAGE.

In the event of the MT not receiving an ACKNOWLEDGE MESSAGE within a time specified by the MT manufacturer the MT shall exit the SMS mode automatically after 'n' attempts to send the MESSAGE ARRIVED (where n is a number specified by the MT manufacturer). The MT should attempt to store the unacknowledged SM or Status Report in the MT or on the (U)SIM as appropriate.

The ACKNOWLEDGE MESSAGE sent from the TE to the MT must not delay the MT sending the RP-ACK defined in 3GPP TS 23.040 [3] (to the SC) for longer than the RP-ACK timeout specified in the 3GPP TS 24.011 [6].

The TE requests the cessation of incoming message indication by the INDICATE INC SMS command, with the 'no incoming messages' parameter.

2.3.4 Requesting Transfer Into Mobile Termination

The TE may request transfer of SMS messages into the mobile termination. Cell broadcast messages cannot be transferred in this direction.

The TE shall use the INSERT SMS command (clause 2.4.1.8) to transfer the message. This command shall indicate whether the message is to be stored in the MT, sent over the air interface or both. The command shall include the full SMS message and header as described in 3GPP TS 23.040 [3], except for the message reference and message type indication (which are allocated by the MT).

Only one INSERT SMS command may be outstanding at any given instant. An INSERT SMS is deemed complete when an INSERT SMS COMPLETE or an INSERT SMS FAILURE indication has been received irrespective of whether an intermediate REQUEST CONFIRMED has been received.

Upon receipt of an INSERT SMS command, the MT shall act in the following way:

If the TE requested the MT to store the message, the MT shall attempt to store the message. If the attempt is successful, the MT shall return an INSERT SMS COMPLETE indication (clause 2.4.2.6), including the message reference allocated by the MT. If the attempt fails (eg. due to lack of memory), the MT shall return an INSERT SMS FAILURE indication (clause 2.4.2.7), providing a cause for the failure.

If the TE requested the MT to send the message, the MT shall respond immediately with a REQUEST CONFIRMED message, and attempt to send the message. If the send attempt subsequently succeeds, the MT shall send an INSERT SMS COMPLETE indication, including the message references allocated by the MT. If the send attempt subsequently fails, the MT shall return an INSERT SMS FAILURE indication, providing a cause for the failure.

If the TE requested the MT to store and send the message, the MT shall first attempt to store the message. If no storage is available, the MT shall return an INSERT SMS FAILURE indication (clause 2.4.2.7) and shall not attempt to send the message. If storage is available, the MT shall store the message and then respond with a REQUEST CONFIRMED message. If the send attempt is successful, the MT shall return an INSERT SMS COMPLETE indication (clause 2.4.2.6), including the message references allocated by the MT. If the transmission of the message fails, then the MT shall return an INSERT SMS FAILURE indication (clause 2.4.2.7). This will show that the send attempt failed and provide a cause. After that the MT shall delete the stored message.

2.3.5 Requesting Deletion Of Messages

The TE may request deletion of SMS or CBS messages from the store in the MT. This is achieved by the DELETE MESSAGE command (clause 2.4.1.9). The command will include a message reference, as defined by the MT and provided in the message list.

Upon receipt of this command, the MT shall attempt to delete the message. If successful, the MT shall return a DELETE MESSAGE COMPLETE indication (clause 2.4.2.8). If not successful, the MT shall return a DELETE MESSAGE FAILURE indication (clause 2.4.2.9).

On successful deletion of an SM or CBS message the Page Index (see clause 2.5.2.10) and the Index Count (see clause 2.5.2.8) shall be re-assigned so that their values are contiguous (i.e. there are no gaps in either parameter). The original short message Reference values remain unchanged.

2.4 Message functional definitions and contents

This clause provides an overview of the message structure to be used over the DTE/DCE interface in SMS/CBS block mode. Each message definition includes a brief description of the use of the message, and a table showing all the information elements which may be included in the message. If an entity receives a message containing more information elements than expected then the receiving entity shall ignore the additional information elements. For each information element the following data are provided.

Reference - this indicates where the detailed description of each element can be found.

Presence:

M	Mandatory	must always be present receiver: If not present, consider message erroneous
C	Conditional	presence depending on e.g. a) value of other element b) presence of optional element receiver: If not present when condition met, consider message erroneous
O	Optional	presence is a choice of the sender receiver: present or not, accept message

Format:

T	Type only, fixed length, only IEI
V	Value only, fixed length, no IEI included
TV	Type and value, fixed length, IEI included
LV	Length and value, variable length, no IEI included and Length indicator included
TLV	Type, Length and Value, variable length, IEI and length indicator included

Length - this indicates the length of the information element in octets.

2.4.1 Commands Issued By The Terminal Equipment

Table 2.4.1 summarises the commands which may be issued by the TE.

Table 2.4.1: Commands which may be issued by the TE

	Reference
LIST REQUEST	2.4.1.1
GET MESSAGE	2.4.1.2
GET FIRST MESSAGE	2.4.1.3
GET NEXT MESSAGE	2.4.1.4
TRANSFER INC SMS	2.4.1.5
INDICATE INC SMS	2.4.1.6
TRANSFER INC CBS	2.4.1.7
INSERT SMS	2.4.1.8
DELETE MESSAGE	2.4.1.9
UNABLE TO PROCESS	2.4.1.10
END SMS MODE	2.4.1.11
ACKNOWLEDGE MESSAGE	2.4.1.12

2.4.1.1 List Request

This message is sent by the TE to the MT to request a list of messages stored in the MT.

Information element	Reference	Presence	Format	Length
Message Type	2.5.1	M	V	1
Page Index	2.5.2.10	M	V	1

2.4.1.2 Get Message

This message is sent by the TE to the MT to request transfer of a specific SMS or CBS message stored in the MT.

Information element	Reference	Presence	Format	Length
Message Type	2.5.1	M	V	1
Short Message Reference	2.5.2.1	M	V	1

2.4.1.3 Get First Message

This message is sent by the TE to the MT to request transfer of the first available SMS or CBS message stored in the MT.

Information element	Reference	Presence	Format	Length
Message Type	2.5.1	M	V	1

2.4.1.4 Get Next Message

This message is sent by the TE to the MT to request transfer of the next available SMS or CBS message stored in the MT.

Information element	Reference	Presence	Format	Length
Message Type	2.5.1	M	V	1

2.4.1.5 Transfer Inc SMS

This message is sent by the TE to the MT to request the direct transfer of incoming messages from the air interface to the TE.

Information element	Reference	Presence	Format	Length
Message Type	2.5.1	M	V	1
SMS Transfer Type	2.5.2.2	M	V	1

2.4.1.6 Indicate Inc SMS

This message is sent by the TE to the MT to request that the MT indicates when an incoming message arrives.

Information element	Reference	Presence	Format	Length
Message Type	2.5.1	M	V	1
Indication Type	2.5.2.3	M	V	1

2.4.1.7 Transfer Inc CBS

This message is sent by the TE to the MT to request transfer of all cell broadcast messages directly from the air interface to the DTE/DCE interface.

Information element	Reference	Presence	Format	Length
Message Type	2.5.1	M	V	1
CBS Transfer Type	2.5.2.9	M	V	1

2.4.1.8 Insert SMS

This message is sent by the TE to the MT to request the transfer of an SMS TPU to the MT memory or across the air interface. The TPDU is formatted in exactly the same way as described in 3GPP TS 23.040 [3]. Where the TPDU includes a TP-Message-Reference which is to be incremented by the MT for every outgoing message, the TP-Message-Reference provided by the TE will be overwritten by the MT before transmission of the message. The value provided by the TE is discarded by the MT and has no significance.

Information element	Reference	Presence	Format	Length
Message Type	2.5.1	M	V	1
Insert Type	2.5.2.4	M	V	1
RP-Destination-Address	3GPP TS 24.011 [6]	M	LV	1-12 a)
SMS-TPDU	3GPP TS 23.040 [3]	M	V	max 164
a)	If no RP-Destination-Address is to be transferred then the length is set to 0. In this case, the MT inserts the default SC address.			

2.4.1.9 Delete message

This message is sent from the TE to the MT to request deletion of a specific SMS or CBS message held in the MT.

Information element	Reference	Presence	Format	Length
Message Type	2.5.1	M	V	1
Short Message Reference	2.5.2.1	M	V	1

2.4.1.10 Unable to process

This response is sent from the TE to the MT to indicate that the MT's message could not be processed.

Information element	Reference	Presence	Format	Length
Message Type	2.5.1	M	V	1
Cause	2.5.2.7	M	V	1

2.4.1.11 End SMS Mode

This message is sent from the TE to the MT to terminate the SMS/CBS mode of the DTE/DCE interface.

Information element	Reference	Presence	Format	Length
Message Type	2.5.1	M	V	1

2.4.1.12 Acknowledge Message

This message is sent from the TE to the MT to acknowledge receipt of a INC MESSAGE or MESSAGE ARRIVED which contains a Short Message (SMS) info element id, (e.g. a Short Message or a Status Report but not a CBS message).

Information element	Reference	Presence	Format	Length
Message Type	2.5.1	M	V	1
SM-Deliver-Ack	2.5.2.14	O	TLV	2 to 160

2.4.2 Responses/Indications Issued By The MT

Table 2.4.2 summarises the responses/indications which may be issued by the MT.

Table 2.4.2: Responses/Indications which may be issued by the MT

	Reference
MESSAGE LIST	2.4.2.1
MESSAGE	2.4.2.2
GET MESSAGE FAILURE	2.4.2.3
INC MESSAGE	2.4.2.4
MESSAGE ARRIVED	2.4.2.5
INSERT SMS COMPLETE	2.4.2.6
INSERT SMS FAILURE	2.4.2.7
DELETE MESSAGE COMPLETE	2.4.2.8
DELETE MESSAGE FAILURE	2.4.2.9
UNABLE TO PROCESS	2.4.2.10
END SMS MODE	2.4.2.11
REQUEST CONFIRMED	2.4.2.12

2.4.2.1 Message List

This response is sent from the MT to the TE on receipt of a LIST REQUEST from the TE.

Information element	Reference	Presence	Format	Length
Message Type	2.5.1	M	V	1
Page Index	2.5.2.10	M	V	1
Index Count	2.5.2.8	M	V	1
Short Message Index (1)	2.5.2.5	O	TLV	8-48
Short Message Index (2)	2.5.2.5	O	TLV	8-48
:	:	:	:	:
Short Message Index (n)	2.5.2.5	O	TLV	8-48

The number of Short Message Indices included in the message may be 0, 1, 2, 3, 4 or 5.

2.4.2.2 Message

This response is sent from the MT to the TE when a short message has been requested.

Information element	Reference	Presence	Format	Length
Message Type	2.5.1	M	V	1
Short Message Data	2.5.2.6	M	TLV	28-181

2.4.2.3 Get Message Failure

This response is sent from the MT to the TE when a request for a short message cannot be fulfilled.

Information element	Reference	Presence	Format	Length
Message Type	2.5.1	M	V	1
Last Short Message	2.5.2.11	M	V	1
Cause	2.5.2.7	M	V	1

2.4.2.4 Inc Message

This indication is sent from the MT to the TE after the MT has been requested to transfer messages of certain categories immediately upon receipt.

Information element	Reference	Presence	Format	Length
Message Type	2.5.1	M	V	1
Short Message Data	2.5.2.6	M	TLV	28-181

2.4.2.5 Message Arrived

This indication is sent from the MT to the TE after the MT has been requested to provide an indication of the receipt of certain categories of incoming message.

Information element	Reference	Presence	Format	Length
Message Type	2.5.1	M	V	1
Short Message Index	2.5.2.5	M	TLV	8-48

2.4.2.6 Insert SMS Complete

This response is sent by the MT to the TE to indicate that the TE's request to insert a message has been completed.

Information element	Reference	Presence	Format	Length
Message Type	2.5.1	M	V	1
Short Message Reference	2.5.2.1	M	V	1
TP-Message Reference	3GPP TS 23.040 [3]	C a)	V	1
SM-Submit-Ack	2.5.2.15	O	TLV	2 to 160
a)	The TP-Message Reference is only included if the message had been requested to be transferred over the air interface.			

2.4.2.7 Insert SMS Failure

This response is sent from the MT to the TE to indicate that the attempt to insert an SMS message failed.

Information element	Reference	Presence	Format	Length
Message Type	2.5.1	M	V	1
Cause	2.5.2.7	M	V	1-2
TP-Failure Cause	2.5.2.13	O	TLV	4
Short Message Reference	2.5.2.1	O	TV	2

2.4.2.8 Delete Message Complete

This response is sent from the MT to the TE to indicate that the request to delete a message from the MT store has been completed.

Information element	Reference	Presence	Format	Length
Message Type	2.5.1	M	V	1
Short Message Reference	2.5.2.1	M	V	1

2.4.2.9 Delete Message Failure

This response is sent from the MT to the TE to indicate that the request to delete a message from the MT store failed.

Information element	Reference	Presence	Format	Length
Message Type	2.5.1	M	V	1
Short Message Reference	2.5.2.1	M	V	1
Cause	2.5.2.7	M	V	1

2.4.2.10 Unable To Process

This response is sent from the MT to the TE to indicate that the TE's request could not be processed.

Information element	Reference	Presence	Format	Length
Message Type	2.5.1	M	V	1
Cause	2.5.2.7	M	V	1

2.4.2.11 End SMS Mode

This indication is sent from the MT to the TE when the MT autonomously exits from SMS/CBS mode.

Information element	Reference	Presence	Format	Length
Message Type	2.5.1	M	V	1
Cause	2.5.2.7	M	V	1

2.4.2.12 Request Confirmed

This indication is sent from the MT to the TE to indicate that the MT has received the request from the TE and will perform the requested function.

Information element	Reference	Presence	Format	Length
Message Type	2.5.1	M	V	1
Confirm Type	2.5.2.12	M	V	1
Short Message Reference	2.5.2.1	O	TV	2

2.5 General message format and information elements coding

This clause describes the content of messages for the SMS/CBS mode of the DTE/DCE interface. Within the figures in this clause, the bit designated "bit 1" is transmitted first, followed by bits 2, 3, 4, etc. Similarly, the octet shown at the top of each figure is sent first.

2.5.1 Message Type

The purpose of the message type is to identify the function of the message being sent. The message type is coded as shown in figure 2.5.1 and table 2.5.1.

Bit 8 is reserved for possible future use as an extension bit.

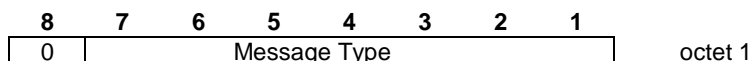

Figure 2.5.1: Message Type

Table 2.5.1: Message Types

8	7	6	5	4	3	2	1	
0	0	0	-	-	-	-	-	Commands/ Responses issued by TE
0	0	0	0	0	0	0	0	LIST REQUEST
0	0	0	0	0	0	0	1	GET MESSAGE
0	0	0	0	0	0	1	0	GET FIRST MESSAGE
0	0	0	0	0	0	1	1	GET NEXT MESSAGE
0	0	0	0	0	1	0	0	TRANSFER INC SMS
0	0	0	0	0	1	0	1	INDICATE INC SMS
0	0	0	0	0	1	1	0	TRANSFER INC CBS
0	0	0	0	0	1	1	1	INSERT SMS
0	0	0	0	1	0	0	0	DELETE MESSAGE
0	0	0	0	1	0	0	1	UNABLE TO PROCESS
0	0	0	1	1	1	1	0	END SMS MODE
0	0	0	1	1	1	1	1	ACKNOWLEDGE MESSAGE
0	0	1	-	-	-	-	-	Responses/Indications issued by MT
0	0	1	0	0	0	0	0	MESSAGE LIST
0	0	1	0	0	0	0	1	MESSAGE
0	0	1	0	0	0	1	0	GET MESSAGE FAILURE
0	0	1	0	0	0	1	1	INC MESSAGE
0	0	1	0	0	1	0	0	MESSAGE ARRIVED
0	0	1	0	0	1	0	1	INSERT SMS COMPLETE
0	0	1	0	0	1	1	0	INSERT SMS FAILURE
0	0	1	0	0	1	1	1	DELETE MESSAGE COMPLETE
0	0	1	0	1	0	0	0	DELETE MESSAGE FAILURE
0	0	1	0	1	0	0	1	UNABLE TO PROCESS
0	0	1	0	1	0	1	0	REQUEST CONFIRMED
0	0	1	1	1	1	1	1	END SMS MODE

All other values are reserved. If a reserved Message Type is received then the receiving entity shall return "Unable to Process" with Cause "Command not understood".

2.5.2 Other Information Elements

Other information elements follow the general coding principles specified in 3GPP TS 24.008 [5], and are described in the following clauses.

2.5.2.1 Short Message Reference

The Short Message Reference uniquely identifies a short message stored in the MT. It is an 8 bit number and is allocated by the MT.

The Short Message Reference information element is coded as shown in figure 2.5.2 and table 2.5.2.

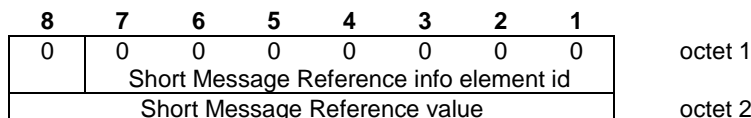

Figure 2.5.2: Short Message Reference information element

Table 2.5.2: Short Message Reference information element

<p>Short Message Reference value (octet 2).</p> <p>In the Short Message Reference value field bit 8 of octet 2 is the most significant bit and bit 1 of octet 2 is the least significant bit.</p> <p>Short Message Reference values are allocated by the MT.</p>
--

2.5.2.2 SMS Transfer Type

The SMS Transfer Type indicates to the MT which SMS messages are required to be transferred to the TE.

The SMS Transfer Type information element is coded as shown in figure 2.5.3 and table 2.5.3.

8	7	6	5	4	3	2	1	
0	0	0	0	0	0	0	1	octet 1
SMS Transfer Type info element ident								
0	0	0	0	0	SMS Txfr Type value			octet 2
Reserved								

Figure 2.5.3: SMS Transfer Type information element

Table 2.5.3: SMS Transfer Type information element

<p>SMS Txfr Type value (octet 2).</p> <p>The SMS txfr type is coded as follows:</p> <table style="margin-left: 40px;"> <tr> <td style="padding-right: 20px;">bit 2</td> <td style="padding-right: 20px;">bit 1</td> <td></td> </tr> <tr> <td>0</td> <td>0</td> <td>Transfer no SMS messages</td> </tr> <tr> <td>0</td> <td>1</td> <td>Transfer SMS messages marked as TE-specific</td> </tr> <tr> <td>1</td> <td>0</td> <td>Reserved</td> </tr> <tr> <td>1</td> <td>1</td> <td>Transfer all SMS messages</td> </tr> </table> <p>Bit 3 shows whether to transfer SMS-STATUS-REPORTS</p> <table style="margin-left: 40px;"> <tr> <td style="padding-right: 20px;">Bit 3</td> <td></td> </tr> <tr> <td>0</td> <td>Do not transfer SMS-STATUS-REPORTS</td> </tr> <tr> <td>1</td> <td>Transfer SMS-STATUS-REPORTS</td> </tr> </table> <p>A receiving entity shall ignore the setting of bits 8-4. If bit 2 is set to 1 and bit 1 is set to 0 then the receiving entity shall return "Unable to Process" with cause "Command Not Understood"</p>	bit 2	bit 1		0	0	Transfer no SMS messages	0	1	Transfer SMS messages marked as TE-specific	1	0	Reserved	1	1	Transfer all SMS messages	Bit 3		0	Do not transfer SMS-STATUS-REPORTS	1	Transfer SMS-STATUS-REPORTS
bit 2	bit 1																				
0	0	Transfer no SMS messages																			
0	1	Transfer SMS messages marked as TE-specific																			
1	0	Reserved																			
1	1	Transfer all SMS messages																			
Bit 3																					
0	Do not transfer SMS-STATUS-REPORTS																				
1	Transfer SMS-STATUS-REPORTS																				

2.5.2.3 Indication Type

The Indication Type tells the MT when to notify the TE that an incoming message has been received.

The Indication Type information element is coded as shown in figure 2.5.4 and table 2.5.4.

8	7	6	5	4	3	2	1	
0	0	0	0	0	0	1	0	octet 1
Indication Type info element identifier								
0	0	0	0	Indication Type value				octet 2
Reserved								

Figure 2.5.4: Indication Type information element

Table 2.5.4: Indication Type information element

Indication Type value (octet 2).

The indication type is coded as follows:

bit 3	bit 2	bit 1	
0	0	0	Indicate no messages
0	0	1	Reserved
0	1	0	Indicate all SMS messages
0	1	1	Indicate SMS messages marked as TE-specific
1	0	0	Indicate all CBS messages
1	0	1	Indicate CBS messages marked as TE-specific
1	1	0	Indicate all CBS and SMS messages
1	1	1	Indicate SMS and CBS messages marked as TE-specific

Bit 4 shows whether or not to indicate SMS reports:

bit 4	
0	Do not indicate SMS reports
1	Indicate SMS reports

A receiving entity shall ignore the setting of bits 8-5. If bits 3 and 2 are set to 0 and bit 1 is set to 1 then the receiving entity shall return "Unable to Process" with cause "Command Not Understood".

2.5.2.4 Insert Type

The Insert Type tells the MT what to do with the short message arriving from the TE.

The Insert Type information element is coded as shown in figure 2.5.5 and table 2.5.5

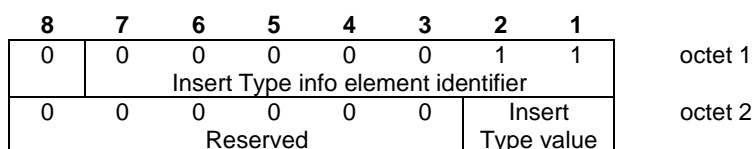

Figure 2.5.5: Insert Type information element

Table 2.5.5: Insert Type information element

Insert Type value (octet 2).

The insert type is coded as follows:

bit 2	bit 1	
0	0	Reserved
0	1	Store the short message in the MT
1	0	Send the short message over the air
1	1	Store the short message in the MT and send it over the air

A receiving entity shall ignore the setting of bits 8-3. If bits 2 and 1 are set to 0 then the receiving entity shall return "Unable to Process" with cause "Command Not Understood"

2.5.2.5 Short Message Index

The Short Message Index provides information about each individual short message currently stored in the MT. Two types of Short Message index are provided; one for SMS and one for CBS.

The Short Message Index (SMS) information element is coded as shown in figure 2.5.6 and table 2.5.6. A Short Message Index may be an SMS-SUBMIT, an SMS-DELIVER or an SMS-STATUS-REPORT.

The Short Message Index (CBS) information element is coded as shown in figure 2.5.7 and table 2.5.7.

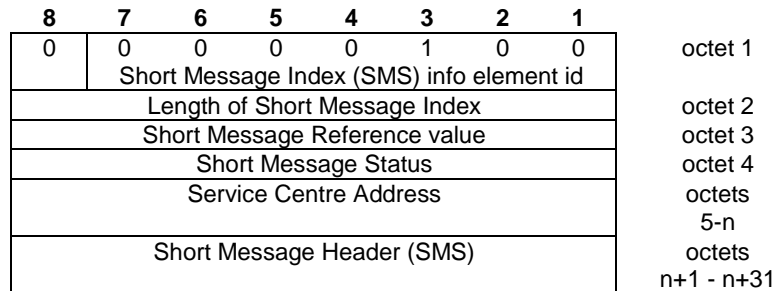

Figure 2.5.6: Short Message Index (SMS) information element

NOTE: n can take a value between 5 and 18 (inclusive).

Table 2.5.6: Short Message Index (SMS) information element

<p>Short Message Reference value (octet 3).</p> <p>The Short Message Reference value is coded as specified in table 2.5.2.</p> <p>Short Message Status (octet 4).</p> <p>The Short Message Status is coded as follows:</p> <table border="0"> <tr> <td style="text-align: center;">8</td> <td style="text-align: center;">7</td> <td style="text-align: center;">6</td> <td style="text-align: center;">5</td> <td style="text-align: center;">4</td> <td style="text-align: center;">3</td> <td style="text-align: center;">2</td> <td style="text-align: center;">1</td> <td></td> </tr> <tr> <td style="text-align: center;">0</td> <td style="text-align: center;">0</td> <td style="text-align: center;">0</td> <td style="text-align: center;">0</td> <td style="text-align: center;">0</td> <td style="text-align: center;">0</td> <td style="text-align: center;">0</td> <td style="text-align: center;">0</td> <td>Not read/not sent</td> </tr> <tr> <td style="text-align: center;">0</td> <td style="text-align: center;">0</td> <td style="text-align: center;">0</td> <td style="text-align: center;">0</td> <td style="text-align: center;">0</td> <td style="text-align: center;">0</td> <td style="text-align: center;">0</td> <td style="text-align: center;">1</td> <td>Read/Sent</td> </tr> <tr> <td style="text-align: center;">0</td> <td style="text-align: center;">0</td> <td style="text-align: center;">0</td> <td style="text-align: center;">0</td> <td style="text-align: center;">0</td> <td style="text-align: center;">1</td> <td style="text-align: center;">0</td> <td style="text-align: center;">0</td> <td>Not Read</td> </tr> <tr> <td style="text-align: center;">0</td> <td style="text-align: center;">0</td> <td style="text-align: center;">0</td> <td style="text-align: center;">0</td> <td style="text-align: center;">0</td> <td style="text-align: center;">1</td> <td style="text-align: center;">0</td> <td style="text-align: center;">1</td> <td>Read</td> </tr> <tr> <td style="text-align: center;">0</td> <td style="text-align: center;">0</td> <td style="text-align: center;">0</td> <td style="text-align: center;">0</td> <td style="text-align: center;">0</td> <td style="text-align: center;">1</td> <td style="text-align: center;">1</td> <td style="text-align: center;">0</td> <td>Not Sent</td> </tr> <tr> <td style="text-align: center;">0</td> <td style="text-align: center;">0</td> <td style="text-align: center;">0</td> <td style="text-align: center;">0</td> <td style="text-align: center;">0</td> <td style="text-align: center;">1</td> <td style="text-align: center;">1</td> <td style="text-align: center;">1</td> <td>Sent</td> </tr> </table> <p>All other values are reserved.</p> <p>The receiving entity shall ignore the setting of bits 8-4.</p> <p>In addition, if bit 3 is set to 0 then a receiving entity shall ignore the setting of bit 2. Where bit 3 is set to 0, if the message is mobile originated then bit 1 indicates whether the message has been sent to the network. If the message is mobile terminated then bit 1 indicates whether the message has been read.</p> <p>Service Centre Address (Octets 5-n).</p> <p>The Service Centre Address is coded as the RP-Origination or RP-Destination address specified in 3 TS 24.011 [6]. If the short message is mobile originated, the address will be the RP-Destination address. If the short message is mobile terminated, the address will be the RP-Origination address. The address is of variable length, 1-12 octets.</p> <p>Short Message Header (SMS) (Octets n+1 - n+31).</p> <p>The Short Message Header (SMS) is coded as a TPDU as described in 3GPP TS 23.040 [3]. In the case of SMS-DELIVER or SMS-SUBMIT, the TP-User-Data is not included, but the TP-User-Data-Length is included. The Short Message Header is of variable length, 6-31 octets.</p>	8	7	6	5	4	3	2	1		0	0	0	0	0	0	0	0	Not read/not sent	0	0	0	0	0	0	0	1	Read/Sent	0	0	0	0	0	1	0	0	Not Read	0	0	0	0	0	1	0	1	Read	0	0	0	0	0	1	1	0	Not Sent	0	0	0	0	0	1	1	1	Sent
8	7	6	5	4	3	2	1																																																								
0	0	0	0	0	0	0	0	Not read/not sent																																																							
0	0	0	0	0	0	0	1	Read/Sent																																																							
0	0	0	0	0	1	0	0	Not Read																																																							
0	0	0	0	0	1	0	1	Read																																																							
0	0	0	0	0	1	1	0	Not Sent																																																							
0	0	0	0	0	1	1	1	Sent																																																							

8	7	6	5	4	3	2	1	
0	0	0	0	0	1	0	1	octet 1
Short Message Index (CBS) info element id								
Short Message Reference value								octet 2
Short Message Header (CBS)								octets 3-8

Figure 2.5.7: Short Message Index (CBS) information element

Table 2.5.7: Short Message Index (CBS) information element

<p>Short Message Reference value (octet 2).</p> <p>The Short Message Reference value is coded as specified in table 2.5.2.</p> <p>Short Message Header (CBS) (Octets 3-8).</p> <p>The Short Message Header (CBS) is coded as described in 3GPP TS 23.041. [4], including SEQUENCE NUMBER, MESSAGE IDENTIFIER, ALPHABET IDENTIFIER and PAGE PARAMETER, but excluding the characters of the message.</p>
--

2.5.2.6 Short Message Data

The Short Message Data information element is a copy of a short message currently stored in the MT. Two types of Short Message Data information element are provided; one for SMS and one for CBS.

The Short Message Data (SMS) information element is coded as shown in figure 2.5.8 and table 2.5.8. Short Message Data may be an SMS-SUBMIT, an SMS-DELIVER or an SMS-STATUS-REPORT.

The Short Message Data (CBS) information element is coded as shown in figure 2.5.9 and table 2.5.9.

8	7	6	5	4	3	2	1	
0	0	0	0	0	1	1	0	octet 1
Short Message Data (SMS) info element id								
Length of Short Message Data								octet 2
Short Message Reference value								octet 3
Short Message Status								octet 4
Service Centre Address								octets 5-n
Short Message (SMS)								octets n+1-n+164

Figure 2.5.8: Short Message Data (SMS) information element

NOTE: n can take a value between 5 and 18 (inclusive).

Table 2.5.8: Short Message (SMS) information element

Short Message Reference value (octet 3).

The Short Message Reference value is coded as specified in table 2.5.2.

Short Message Status (octet 4).

The Short Message Status is coded as follows:

8	7	6	5	4	3	2	1	
0	0	0	0	0	0	0	0	Not read/not sent
0	0	0	0	0	0	0	1	Read/Sent
0	0	0	0	0	1	0	0	Not Read
0	0	0	0	0	1	0	1	Read
0	0	0	0	0	1	1	0	Not Sent
0	0	0	0	0	1	1	1	Sent

All other values are reserved.

The receiving entity shall ignore the setting of bits 8-4.
In addition, if bit 3 is set to 0 then a receiving entity shall ignore the setting of bit 2.

Where bit 3 is set to 0, if the message is mobile originated then bit 1 indicates whether the message has been sent to the network. If the message is mobile terminated then bit 1 indicates whether the message has been read.

Service Centre Address (Octets 5-n).

The Service Centre Address is coded as the RP-Origination-Address or RP-Destination Address specified in 3GPP TS 23.040 [3].
If the short message is mobile originated, the address will be the RP-Destination address. If the short message is mobile terminated, the address will be the RP-Origination Address. The address is of variable length, 1-12 octets.

Short Message (SMS) (Octets n+1 - n+164).

The Short Message (SMS) is coded as a TPDU as described in 3GPP TS 23.040 [3].
The Short Message is of variable length, 6-164 octets.

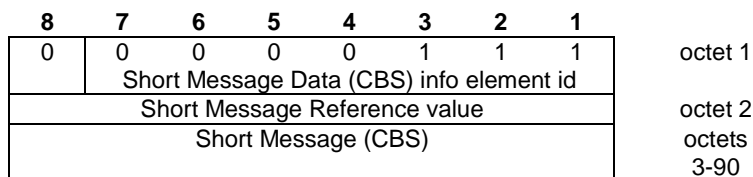

Figure 2.5.9: Short Message Data (CBS) information element

Table 2.5.9: Short Message Data (CBS) information element

Short Message Reference value (octet 2).

The Short Message Reference value is coded as specified in table 2.5.2.

Short Message (CBS) (Octets 3-90).

The Short Message (CBS) is coded as described in 3GPP TS 23.041 [4], including SEQUENCE NUMBER, MESSAGE IDENTIFIER, ALPHABET IDENTIFIER, PAGE PARAMETER and CHARACTERS OF THE MESSAGE.

2.5.2.7 Cause

The Cause information element provides more detail as to why an error has occurred. The Cause information element is coded as shown in figure 2.5.10 and table 2.5.10.

8	7	6	5	4	3	2	1	
0	0	0	0	1	0	0	0	octet 1
Cause information element identifier								
0								octet 2
ext	Cause value							
3GPP TS 24.011 [6] RP-Cause value								octet 3

Figure 2.5.10: Cause information element

Table 2.5.10: Cause information element

Cause value (octet 2).								
The cause is coded as follows:								
8	7	6	5	4	3	2	1	
0	0	0	0	0	0	0	0	No such message - no short message exists with the provided shortmessage reference
0	0	0	0	0	0	0	1	No memory - the short message cannot be stored due to lack of memory
0	0	0	0	0	0	1	0	No air interface - submission of the short message cannot be attempted because the mobile is out of coverage
0	0	0	0	0	0	1	1	Receiving entity busy - the request was not fulfilled because the Receiving entity is busy on another task
0	0	0	0	0	1	0	0	Command not understood - error in the coding of the command, or command belongs to higher version of protocol of protocol than that implemented
0	0	0	0	0	1	0	1	Incoming data call - Incoming data call forces MT to exit from SMS mode
0	0	0	0	0	1	1	0	User-invoked exit - User has taken MT out of SMS by MMI
0	0	0	0	0	1	1	1	Other error - Any other error not covered here 1 0 0 0 0 1 1 1
Message Transfer failed								- The SMS transfer to the SC failed and the 3GPP TS 24.011 [6] error cause is provided in octet 3
All other values are reserved. A receiving entity shall treat any reserved codings as "other error".								
3GPP TS 24.011 [6] RP-Cause value (octet 3)								
If this element is included then bit 8 of octet 2 is set to '1'. The error cause included in the RP-Cause over the air interface is directly mapped into this element. This element is only included if the MT attempts to send a short message to the network and that send attempt fails.								

2.5.2.8 Index Count

The Index Count identifies the number of short message indices contained in a MESSAGE LIST response from the MT to the TE. It is an 8 bit number.

The Index Count information element is coded as shown in figure 2.5.11 and table 2.5.11.

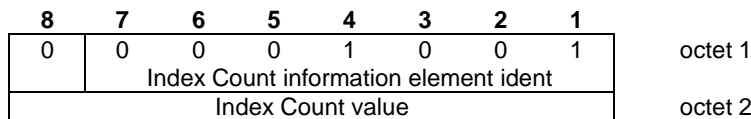

Figure 2.5.11: Index Count information element

Table 2.5.11: Index Count information element

Index Count value (octet 2).

In the Index Count field bit 8 of octet 2 is the most significant bit and bit 1 of octet 2 is the least significant bit.

2.5.2.9 CBS Transfer Type

The CBS Transfer Type indicates to the MT which CBS messages are required to be transferred to the TE.

The CBS Transfer Type information element is coded as shown in figure 2.5.12 and table 2.5.12.

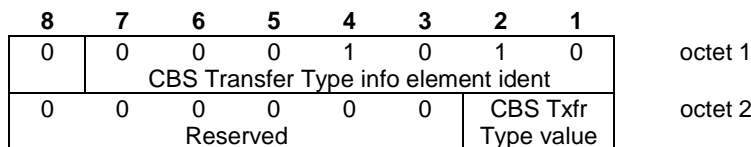

Figure 2.5.12: CBS Transfer Type information element

Table 2.5.12: CBS Transfer Type information element

CBS Txfr Type value (octet 2).

The CBS txfr type is coded as follows:

bit 2	bit 1	
0	0	Transfer no CBS messages
0	1	Transfer CBS messages marked as TE-specific
1	0	Reserved
1	1	Transfer all CBS messages

A receiving entity shall ignore the setting of bits 8-3. If bit 2 is set to 1 and bit 1 is set to 0 then the receiving entity shall return "Unable to Process" with cause "Command Not Understood"

2.5.2.10 Page Index

The Page Index indicates to the MT which Page of SMS Indices is required to be transferred. It also indicates to the TE which Page of SMS Indices is being transferred.

The Page Index information element is coded as shown in figure 2.5.13 and table 2.5.13.

8	7	6	5	4	3	2	1	
0	0	0	0	1	0	1	1	octet 1
Page Index info element ident								
0	0							octet 2
Reserved		Page Index value						

Figure 2.5.13: Page Index information element

Table 2.5.13: Page Index information element

Page Index value (octet 2).

In the Page Index field bit 6 of octet 2 is the most significant bit and bit 1 of octet 2 is the least significant bit. The Page Index can have a value from 1 to 51.

A receiving entity shall ignore the setting of bits 8 and 7. If the Page Index field has a value of 0 or a value greater than 51 then the receiving entity shall return "Unable to Process" with cause "Command Not Understood"

2.5.2.11 Last Short Message

The Last Short Message field indicates to the TE the highest value of Short Message Reference which points to a valid message stored in the MT. The value 0 signifies that there are no short messages stored in the MT.

The Last Short Message information element is coded as shown in figure 2.5.14 and table 2.5.14.

8	7	6	5	4	3	2	1	
0	0	0	0	1	1	0	0	octet 1
Last Short Message info element ident								
Last Short Message value								octet 2

Figure 2.5.14: Last Short Message information element

Table 2.5.14: Last Short Message information element

Last Short Message value (octet 2).

In the Last Short Message field bit 8 of octet 2 is the most significant bit and bit 1 of octet 2 is the least significant bit. The Last Short Message can have a value from 0 to 255.

2.5.2.12 Confirm Type

The Confirm Type field indicates the message to which the REQUEST CONFIRM is a response.

The Confirm Type information element is coded as shown in figure 2.5.15 and table 2.5.15.

8	7	6	5	4	3	2	1	
0	0	0	0	1	1	0	1	octet 1
Confirm Type info element ident								
Confirm Type value								octet 2

Figure 2.5.15: Confirm Type information element

Table 2.5.15: Confirm Type information element

Confirm Type value (octet 2).

The Confirm Type is coded as follows:

8	7	6	5	4	3	2	1	
0	0	0	0	0	0	0	0	Reserved
0	0	0	0	0	0	0	1	Confirm request to transfer incoming SMS messages
0	0	0	0	0	0	1	0	Confirm request to transfer incoming CBS messages
0	0	0	0	0	0	1	1	Confirm request to indicate arrival of messages in MT
0	0	0	0	0	1	0	0	Confirm request to attempt to send short message (actual send is confirmed later: see clause 3.3)

All other values are reserved. If any reserved value is received then the receiving entity shall return "Unable to Process" with cause value "Command Not Understood".

2.5.2.13 TP-Failure Cause

This optional field is present if provided by the Relay Layer. The TP-Failure Cause is provided from the Service Centre and indicates to the TE the reason why the delivery of the message was unsuccessful. The TP-Failure cause information element is coded as shown in figure 2.5.16 and table 2.5.16.

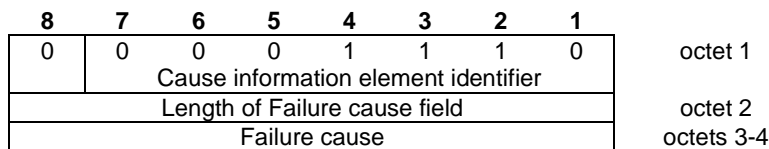

Figure 2.5.16: TP-Failure Cause information element

Table 2.5.16: TP-Failure Cause information element

Failure cause (octet 3-4)

The failure cause contained in this field is directly mapped from the TP-Failure Cause (TP-FCS) field of the SMS-SUBMIT-REPORT message defined in 3GPP TS 23.040 [3].

2.5.2.14 SM-Deliver-Ack

This optional field is sent from the TE to the MT to convey the information to be inserted into the SMS-DELIVER-REPORT RP-ACK TPDU sent by the MT to the SC as defined in 3GPP TS 23.040 [3].

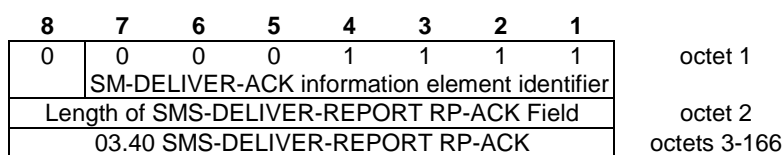

2.5.2.15 SM-Submit-Ack

This optional field is sent from the MT to the TE to convey the information to be inserted into the SMS-SUBMIT-REPORT RP-ACK TPDU sent by the SC to the MT as defined in 3GPP TS 23.040 [3].

8	7	6	5	4	3	2	1	
0	0	0	1	0	0	0	0	octet 1
SM-SUBMIT-ACK information element identifier								
Length of SMS-SUBMIT-REPORT RP-ACK Field								octet 2
03.40 SMS-SUBMIT-REPORT RP-ACK								octets 3-166

3 Text Mode

3.1 Parameter Definitions

The following parameters are used in the subsequent clauses which describe all commands. The formats of integer and string types referenced here are defined in V.25ter. The default values are for command parameters, not for result code parameters.

Message Storage Parameters

- <index> integer type; value in the range of location numbers supported by the associated memory
- <mem1> string type; memory from which messages are read and deleted (commands List Messages +CMGL, Read Message +CMGR and Delete Message +CMGD); defined values (others are manufacturer specific):
- "BM" broadcast message storage
 - "ME" ME message storage
 - "MT" any of the storages associated with ME
 - "SM" (U)SIM message storage
 - "TA" TA message storage
 - "SR" status report storage
- <mem2> string type; memory to which writing and sending operations are made (commands Send Message from Storage +CMSS and Write Message to Memory +CMGW); refer <mem1> for defined values
- <mem3> string type; memory to which received SMs are preferred to be stored (unless forwarded directly to TE; refer command New Message Indications +CNMI); refer <mem1> for defined values; received CBMs are always stored in "BM" (or some manufacturer specific storage) unless directly forwarded to TE; received status reports are always stored in "SR" (or some manufacturer specific storage) unless directly forwarded to TE
- <stat> integer type in PDU mode (default 0), or string type in text mode (default "REC UNREAD"); indicates the status of message in memory; defined values:
- 0 "REC UNREAD" received unread message (i.e. new message)
 - 1 "REC READ" received read message
 - 2 "STO UNSENT" stored unsent message (only applicable to SMs)
 - 3 "STO SENT" stored sent message (only applicable to SMs)
 - 4 "ALL" all messages (only applicable to +CMGL command)

<total1> integer type; total number of message locations in <mem1>

<total2> integer type; total number of message locations in <mem2>

<total3> integer type; total number of message locations in <mem3>

<used1> integer type; number of messages currently in <mem1>

<used2> integer type; number of messages currently in <mem2>

<used3> integer type; number of messages currently in <mem3>

Message Data Parameters

<ackpdu> 3GPP TS 23.040 [3] RP-User-Data element of RP-ACK PDU; format is same as for <pdu> in case of SMS, but without 3GPP TS 24.011 [6] SC address field and parameter shall be bounded by double quote characters like a normal string type parameter

<alpha> string type alphanumeric representation of <da> or <oa> corresponding to the entry found in MT phonebook; implementation of this feature is manufacturer specific; used character set should be the one selected with command Select TE Character Set +CSCS (see definition of this command in 3GPP TS 27.007 [9])

<cdata> 3GPP TS 23.040 [3] TP-Command-Data in text mode responses; ME/TA converts each 8-bit octet into two IRA character long hexadecimal number (e.g. octet with integer value 42 is presented to TE as two characters 2A (IRA 50 and 65))

<ct> 3GPP TS 23.040 [3] TP-Command-Type in integer format (default 0)

<da> 3GPP TS 23.040 [3] TP-Destination-Address Address-Value field in string format; BCD numbers (or GSM 7 bit default alphabet characters) are converted to characters of the currently selected TE character set (refer command +CSCS in 3GPP TS 27.007 [9]); type of address given by <to da>

<data> In the case of SMS: 3GPP TS 23.040 [3] TP-User-Data in text mode responses; format:

- if <dcs> indicates that 3GPP TS 23.038 [2] GSM 7 bit default alphabet is used and <fo> indicates that 3GPP TS 23.040 [3] TP-User-Data-Header-Indication is not set:
 - if TE character set other than "HEX" (refer command Select TE Character Set +CSCS in 3GPP TS 27.007 [9]): ME/TA converts GSM alphabet into current TE character set according to rules of Annex A
 - if TE character set is "HEX": ME/TA converts each 7-bit character of GSM 7 bit default alphabet into two IRA character long hexadecimal number (e.g. character Π (GSM 7 bit default alphabet 23) is presented as 17 (IRA 49 and 55))
- if <dcs> indicates that 8-bit or UCS2 data coding scheme is used, or <fo> indicates that 3GPP TS 23.040 [3] TP-User-Data-Header-Indication is set: ME/TA converts each 8-bit octet into two IRA character long hexadecimal number (e.g. octet with integer value 42 is presented to TE as two characters 2A (IRA 50 and 65))

In the case of CBS: 3GPP TS 23.041 [4] CBM Content of Message in text mode responses; format:

- if <dcs> indicates that 3GPP TS 23.038 [2] GSM 7 bit default alphabet is used:
 - if TE character set other than "HEX" (refer command +CSCS in 3GPP TS 27.007 [9]): ME/TA converts GSM alphabet into current TE character set according to rules of Annex A
 - if TE character set is "HEX": ME/TA converts each 7-bit character of the GSM 7 bit default alphabet into two IRA character long hexadecimal number

- if <dcS> indicates that 8-bit or UCS2 data coding scheme is used: ME/TA converts each 8-bit octet into two IRA character long hexadecimal number

<dcS>	depending on the command or result code: 3GPP TS 23.038 [2] SMS Data Coding Scheme (default 0), or Cell Broadcast Data Coding Scheme in integer format
<dt>	3GPP TS 23.040 [3] TP-Discharge-Time in time-string format: "yy/MM/dd,hh:mm:ss±zz", where characters indicate year (two last digits), month, day, hour, minutes, seconds and time zone. E.g. 6th of May 1994, 22:10:00 GMT+2 hours equals to "94/05/06,22:10:00+08"
<fo>	depending on the command or result code: first octet of 3GPP TS 23.040 [3] SMS-DELIVER, SMS-SUBMIT (default 17), SMS-STATUS-REPORT, or SMS-COMMAND (default 2) in integer format
<length>	integer type value indicating in the text mode (+CMGF=1) the length of the message body <data> > (or <cdata>) in characters; or in PDU mode (+CMGF=0), the length of the actual TP data unit in octets (i.e. the RP layer SMSC address octets are not counted in the length)
<mid>	3GPP TS 23.041 [4] CBM Message Identifier in integer format
<mn>	3GPP TS 23.040 [3] TP-Message-Number in integer format
<mr>	3GPP TS 23.040 [3] TP-Message-Reference in integer format
<oa>	3GPP TS 23.040 [3] TP-Originating-Address Address-Value field in string format; BCD numbers (or GSM 7 bit default alphabet characters) are converted to characters of the currently selected TE character set (refer command +CSCS in TS 07.07); type of address given by <tooa>
<page>	3GPP TS 23.041 [4] CBM Page Parameter bits 4-7 in integer format
<pages>	3GPP TS 23.041 [4] CBM Page Parameter bits 0-3 in integer format
<pdu>	In the case of SMS: 3GPP TS 24.011 [6] SC address followed by 3GPP TS 23.040 [3] TPDU in hexadecimal format: ME/TA converts each octet of TP data unit into two IRA character long hexadecimal number (e.g. octet with integer value 42 is presented to TE as two characters 2A (IRA 50 and 65)) In the case of CBS: 3GPP TS 23.041 [4] TPDU in hexadecimal format
<pid>	3GPP TS 23.040 [3] TP-Protocol-Identifier in integer format (default 0)
<ra>	3GPP TS 23.040 [3] TP-Recipient-Address Address-Value field in string format; BCD numbers (or GSM 7 bit default alphabet characters) are converted to characters of the currently selected TE character set (refer command +CSCS in 3GPP TS 27.007 [9]); type of address given by <tora>
<sca>	3GPP TS 24.011 [6] RP SC address Address-Value field in string format; BCD numbers (or GSM 7 bit default alphabet characters) are converted to characters of the currently selected TE character set (refer command +CSCS in 3GPP TS 27.007 [9]); type of address given by <tosca>
<scts>	3GPP TS 23.040 [3] TP-Service-Centre-Time-Stamp in time-string format (refer <dt>)
<sn>	3GPP TS 23.041 [4] CBM Serial Number in integer format
<st>	3GPP TS 23.040 [3] TP-Status in integer format
<toda>	3GPP TS 24.011 [6] TP-Destination-Address Type-of-Address octet in integer format (when first character of <da> is + (IRA 43) default is 145, otherwise default is 129)
<tooa>	3GPP TS 24.011 [6] TP-Originating-Address Type-of-Address octet in integer format (default refer <toda>)
<tora>	3GPP TS 24.011 [6] TP-Recipient-Address Type-of-Address octet in integer format (default refer <toda>)

- <tosca> 3GPP TS 24.011 [6] RP SC address Type-of-Address octet in integer format (default refer <toda>)
- <vp> depending on SMS-SUBMIT <fo> setting: 3GPP TS 23.040 [3] TP-Validity-Period either in integer format (default 167) or in time-string format (refer <dt>)
- <vp> depending on SMS-SUBMIT <fo> setting: 3GPP TS 23.040 [3] TP-Validity-Period either in integer format (default 167), in time-string format (refer <dt>), or if EVPF is supported, in enhanced format (hexadecimal coded string with double quotes)

3.2 General Configuration Commands

3.2.1 Select Message Service +CSMS

Parameter Command Syntax

Command	Possible response(s)
+CSMS=<service>	+CSMS: <mt>, <mo>, <bm> +CMS ERROR: <err>
+CSMS?	+CSMS: <service>, <mt>, <mo>, <bm>
+CSMS=?	+CSMS: (list of supported <service>s)

Description

Set command selects messaging service <service>. It returns the types of messages supported by the ME: <mt> for mobile terminated messages, <mo> for mobile originated messages and <bm> for broadcast type messages. If chosen service is not supported by the ME (but is supported by the TA), final result code +CMS ERROR: <err> shall be returned. See chapter Message Service Failure Result Code for a list of <err> values.

Also read command returns supported message types along the current service setting.

Test command returns a list of all services supported by the TA.

Defined Values

<service>:

- 0 3GPP TS 23.040 [3] and 3GPP TS 23.041 [4]
- 1 3GPP TS 23.040 [3] and 3GPP TS 23.041 [4]the requirement of <service> setting 1 is mentioned under corresponding command descriptions)
- 2...127 reserved
- 128... manufacturer specific
- <mt>, <mo>, <bm>:
- 0 type not supported
- 1 type supported

Implementation

Mandatory.

3.2.2 Preferred Message Storage +CPMS

Parameter Command Syntax

Command	Possible response(s)
+CPMS=<mem1>[, <mem2>[, <mem3>]]	+CPMS: <used1>,<total1>,<used2>,<total2>,<used3>,<total3> +CMS ERROR: <err>
+CPMS?	+CPMS: <mem1>,<used1>,<total1>,<mem2>,<used2>,<total2> , <mem3>,<used3>,<total3> +CMS ERROR: <err>
+CPMS=?	+CPMS: (list of supported <mem1>s) , (list of supported <mem2>s) , (list of supported <mem3>s)

Description

Set command selects memory storages <mem1>, <mem2> and <mem3> to be used for reading, writing, etc. If chosen storage is not appropriate for the ME (but is supported by the TA), final result code +CMS ERROR: <err> shall be returned. See chapter Message Service Failure Result Code for a list of possible <err> values.

Test command returns lists of memory storages supported by the TA.

Implementation

Mandatory.

3.2.3 Message Format +CMGF

Parameter Command Syntax

Command	Possible response(s)
+CMGF=[<mode>]	
+CMGF?	+CMGF: <mode>
+CMGF=?	+CMGF: (list of supported <mode>s)

Description

Set command tells the TA, which input and output format of messages to use. <mode> indicates the format of messages used with send, list, read and write commands and unsolicited result codes resulting from received messages. Mode can be either PDU mode (entire TP data units used) or text mode (headers and body of the messages given as separate parameters). Text mode uses the value of parameter <chset> specified by command Select TE Character Set +CSCS to inform the character set to be used in the message body in the TA-TE interface.

Test command returns supported modes as a compound value.

Defined Values

<mode>:

0 PDU mode (default when implemented)

1 text mode

Implementation

Mandatory also when only one mode implemented.

3.2.4 Enter SMS Block Mode Protocol +CESP

Action Command Syntax

Command	Possible response(s)
+CESP	
+CESP=?	

Description

Execution command sets the TA in SMS block protocol mode. The TA shall return OK (or 0) to confirm acceptance of the command prior to entering the block mode (see clause 2.1.1). The final result code OK (or 0) shall be returned when the block mode is exited.

NOTE: Commands following +CESP in the AT command line must not be processed by the TA.

Implementation

Mandatory when block mode implemented.

3.2.5 Message Service Failure Result Code +CMS ERROR

Final result code +CMS ERROR: <err> indicates an error related to mobile equipment or network. The operation is similar to ERROR result code. None of the following commands in the same command line is executed. Neither ERROR nor OK result code shall be returned. ERROR is returned normally when error is related to syntax or invalid parameters.

Defined Values

<err> values used by common messaging commands:

0...127	3GPP TS 24.011 [6] clause E.2 values
128...255	3GPP TS 23.040 [3] clause 9.2.3.22 values.
300	ME failure
301	SMS service of ME reserved
302	operation not allowed
303	operation not supported
304	invalid PDU mode parameter
305	invalid text mode parameter
310	(U)SIM not inserted
311	(U)SIM PIN required
312	PH-(U)SIM PIN required
313	(U)SIM failure
314	(U)SIM busy
315	(U)SIM wrong
316	(U)SIM PUK required
317	(U)SIM PIN2 required
318	(U)SIM PUK2 required
320	memory failure
321	invalid memory index
322	memory full
330	SMSC address unknown
331	no network service
332	network timeout
340	no +CNMA acknowledgement expected
500	unknown error
...511	other values in range 256...511 are reserved
512...	manufacturer specific

Implementation

Mandatory.

3.2.6 Informative Examples

Setting up a TA supporting SMS:

```

AT+CSMS=?                (inquiry of available services in TA)
+CSMS: (0)              OK
AT+CSMS=0;+CPMS=?      (set SMS; query available memories)
+CSMS: 1,1,1           (all MT, MO and CBM supported)
+CPMS: ("BM","ME","SM"),("ME","SM"),("ME","SM") (CBM, ME and (U)SIM memories
OK                       for reading, ME and (U)SIM memories for writing)
AT+CPMS="ME","ME","ME";+CMGF=? (set ME memory; query available message formats)
+CPMS: "ME",5,99,"ME",5,99,"ME",5,99 (five messages in ME, 99 total space)
+CMGF: (0,1)           (both text and PDU mode implemented)
OK
AT+CMGF=1;+CSCS=?      (select text mode; query available TE character sets)
+CSCS: ("IRA","PCCP437","8859-1")
OK
AT+CSCS="PCCP437"      (select PC code page 437)
OK

```

3.3 Message Configuration Commands

3.3.1 Service Centre Address +CSCA

Parameter Command Syntax

Command	Possible response(s)
+CSCA=<sca>[,<tosca>]	
+CSCA?	+CSCA: <sca>,<tosca>
+CSCA=?	

Description

Set command updates the SMSC address, through which mobile originated SMs are transmitted. In text mode, setting is used by send and write commands. In PDU mode, setting is used by the same commands, but only when the length of the SMSC address coded into <pdu> parameter equals zero.

Implementation

Mandatory.

3.3.2 Set Text Mode Parameters +CSMP

Parameter Command Syntax

Command	Possible response(s)
+CSMP=[<fo>[,<vp>[,<pid>[,<dcs>]]]]	
+CSMP?	+CSMP: <fo>,<vp>,<pid>,<dcs>
+CSMP=?	

Description

Set command is used to select values for additional parameters needed when SM is sent to the network or placed in a storage when text format message mode is selected. It is possible to set the validity period starting from when the SM is received by the SMSC (<vp> is in range 0... 255) or define the absolute time of the validity period termination (<vp> is a string). The format of <vp> is given by <fo>. If TA supports the EVPF, see 3GPP TS 23.040 [3], it shall be given as a hexadecimal coded string (refer e.g. <pdu>) with double quotes.

NOTE: When storing a SMS-DELIVER from the TE to the preferred memory storage in text mode (refer command Write Message to Memory +CMGW), <vp> field can be used for <scts>.

Implementation

Mandatory when text mode implemented.

3.3.3 Show Text Mode Parameters +CSDH**Parameter Command Syntax**

Command	Possible response(s)
+CSDH=[<show>]	
+CSDH?	+CSDH: <show>
+CSDH=?	+CSDH: (list of supported <show>s)

Description

Set command controls whether detailed header information is shown in text mode result codes.

Test command returns supported values as a compound value.

Defined Values

<show>:

0 do not show header values defined in commands +CSCA and +CSMP (<sca>, <tosca>, <fo>, <vp>, <pid> and <dcss>) nor <length>, <toda> or <tooa> in +CMT, +CMGL, +CMGR result codes for SMS-DELIVERs and SMS-SUBMITs in text mode; for SMS-COMMANDs in +CMGR result code, do not show <pid>, <mn>, <da>, <toda>, <length> or <cdata>

1 show the values in result codes

Implementation

Mandatory when text mode implemented.

3.3.4 Select Cell Broadcast Message Types +CSCB**Parameter Command Syntax**

Command	Possible response(s)
+CSCB=[<mode>[, <mids>[, <dcss>]]]	
+CSCB?	+CSCB: <mode>, <mids>, <dcss>
+CSCB=?	+CSCB: (list of supported <mode>s)

Description

Set command selects which types of CBMs are to be received by the ME.

Test command returns supported modes as a compound value.

Defined Values

<mode>:

0 message types specified in <mids> and <dcss> are accepted

1 message types specified in <mids> and <dcss> are not accepted

<mids>: string type; all different possible combinations of CBM message identifiers (refer <mid>) (default is empty string); e.g. "0,1,5,320-478,922"

<dcss>: string type; all different possible combinations of CBM data coding schemes (refer <dc>) (default is empty string); e.g. "0-3,5"

Implementation

Optional.

3.3.5 Save Settings +CSAS**Action Command Syntax**

Command	Possible response(s)
+CSAS[=<profile>]	+CMS ERROR: <err>
+CSAS=?	+CSAS: (list of supported <profile>s)

Description

Execution command saves active message service settings to a non-volatile memory. A TA can contain several profiles of settings. Settings specified in commands Service Centre Address +CSCA, Set Message Parameters +CSMP and Select Cell Broadcast Message Types +CSCB (if implemented) are saved. Certain settings may not be supported by the storage (e.g. (U)SIM SMS parameters) and therefore can not be saved. See chapter Message Service Failure Result Code for <err> values.

Test command shall display the supported profile numbers for reading and writing of settings.

Defined Values

<profile>:

0...255 manufacturer specific profile number where settings are to be stored

Implementation

Optional.

3.3.6 Restore Settings +CRES**Action Command Syntax**

Command	Possible response(s)
+CRES[=<profile>]	+CMS ERROR: <err>
+CRES=?	+CRES: (list of supported <profile>s)

Description

Execution command restores message service settings from non-volatile memory to active memory. A TA can contain several profiles of settings. Settings specified in commands Service Centre Address +CSCA, Set Message Parameters +CSMP and Select Cell Broadcast Message Types +CSCB (if implemented) are restored. Certain settings may not be supported by the storage (e.g. (U)SIM SMS parameters) and therefore can not be restored. See chapter Message Service Failure Result Code for <err> values.

Defined Values

<profile>:

0...255 manufacturer specific profile number from where settings are to be restored

Implementation

Optional.

3.3.7 Informative Examples

Figure 1 illustrates an example setup of a TE-TA-ME system for SMS. Location of volatile and non-volatile parameter memories, and the operations to change the parameter values are shown. +CSMP is used to set the text mode header values of SMS-SUBMIT (or SMS-DELIVER when received message is written from TE to a storage). The volatile memory may as well be in the ME, or when no volatile memory is used, +CSMP, +CSCA and +CSCB settings are stored directly to non-volatile memory of ME.

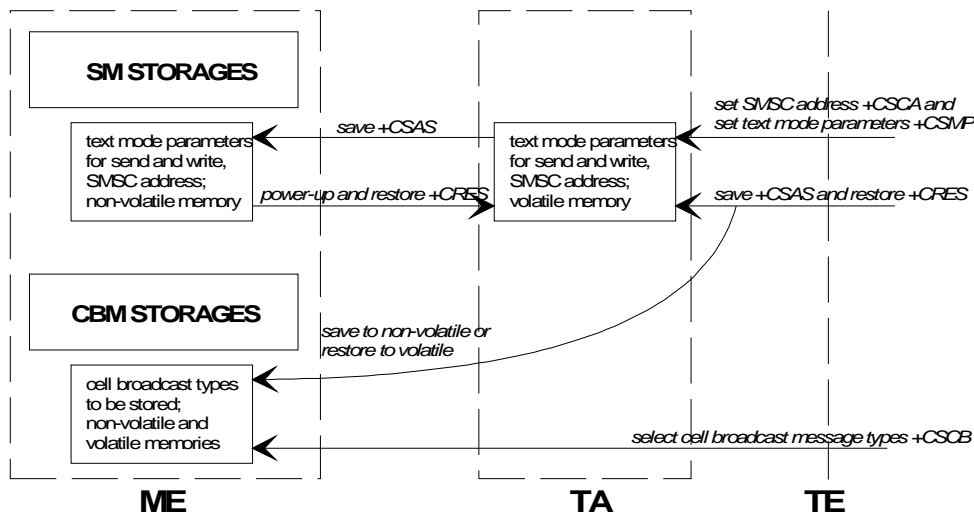

Figure 1: Message service parameter procedures

In this example, the volatile parameter settings of TA are used to construct messages in text mode. SMSC address setting is used also in PDU mode. The next example illustrates a session to restore the message parameters from the ME to the TA, and to set up the CBM identifiers (and languages) which are wanted to be received:

```

AT+CRES                (restore settings from non-volatile memory to volatile memory)
OK
AT+CSMP?;+CSCA?       (query SM parameters)
+CSMP: 17,167,0,0     (default values for SMS-SUBMIT)
+CSCA: "+358501234567",145 (SMSC address)
OK
AT+CSDH=1             (show all headers in text mode)
OK
AT+CSCB=1             (all CBMs are accepted)
OK
    
```

3.4 Message Receiving and Reading Commands

3.4.1 New Message Indications to TE +CNMI

Parameter Command Syntax

Command	Possible response(s)
+CNMI=[<mode>[,<mt>[,<bm>[,<ds>[,<bfr>]]]]]	+CMS ERROR: <err>
+CNMI?	+CNMI: <mode> ,<mt> ,<bm> ,<ds> ,<bfr>
+CNMI=?	+CNMI: (list of supported <mode>s) , (list of supported <mt>s) , (list of supported <bm>s) , (list of supported <ds>s) , (list of supported <bfr>s)

Description

Set command selects the procedure, how receiving of new messages from the network is indicated to the TE when TE is active, e.g. DTR signal is ON. If TE is inactive (e.g. DTR signal is OFF), message receiving should be done as specified in 3GPP TS 23.038 [2].

NOTE 1: When DTR signal is not available or the state of the signal is ignored (V.25ter command &D0), reliable message transfer can be assured by using +CNMA acknowledgement procedure.

<mode> controls the processing of unsolicited result codes specified within this command, <mt> sets the result code indication routing for SMS-DELIVERs, <bm> for CBMs and <ds> for SMS-STATUS-REPORTs. <bfr> defines the handling method for buffered result codes when <mode> 1, 2 or 3 is enabled. If ME does not support requested item (although TA does), final result code +CMS ERROR: <err> is returned. See chapter Message Service Failure Result Code for a list of <err> values.

Test command gives the settings supported by the TA as compound values.

NOTE 2: Command Select Message Service +CSMS should be used to detect ME support of mobile terminated SMs and CBMs, and to define whether a message routed directly to TE should be acknowledged or not (refer command +CNMA).

Defined Values

<mode> (refer figure 2;

NOTE 3: The buffering mechanism may as well be located in the ME; the setting affects only to unsolicited result codes specified within this command):

- 0 Buffer unsolicited result codes in the TA. If TA result code buffer is full, indications can be buffered in some other place or the oldest indications may be discarded and replaced with the new received indications.
- 1 Discard indication and reject new received message unsolicited result codes when TA-TE link is reserved (e.g. in on-line data mode). Otherwise forward them directly to the TE.
- 2 Buffer unsolicited result codes in the TA when TA-TE link is reserved (e.g. in on-line data mode) and flush them to the TE after reservation. Otherwise forward them directly to the TE.
- 3 Forward unsolicited result codes directly to the TE. TA-TE link specific inband technique used to embed result codes and data when TA is in on-line data mode.

NOTE 4: It is possible that ME/TA result code buffer is in volatile memory. In this case messages may get lost if the power of ME/TA is switched off before codes are sent to TE. Thus, it is not recommended to use direct message routing (<mt>=2 or 3, <bm>=2 or 3, or <ds>=1) with <mode> value 0 or 2.

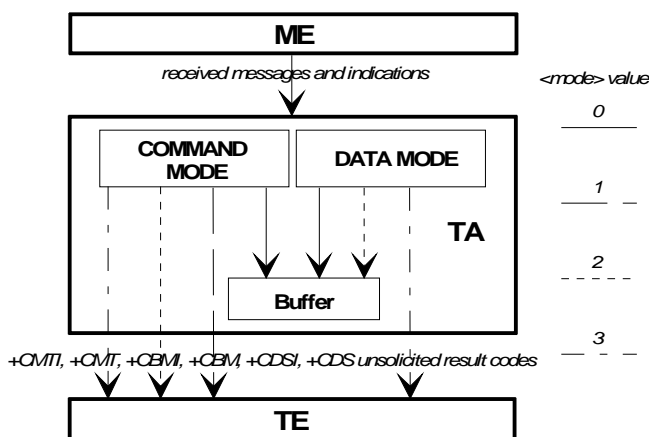

Figure 2: <mode> parameter

<mt> (the rules for storing received SMs depend on its data coding scheme (refer 3GPP TS 23.038 [2]), preferred memory storage (+CPMS) setting and this value; refer table 1;

NOTE 5: If AT command interface is acting as the only display device, the ME must support storing of class 0 messages and messages in the message waiting indication group (discard message); refer table 2):

- 0 No SMS-DELIVER indications are routed to the TE.

- 1 If SMS-DELIVER is stored into ME/TA, indication of the memory location is routed to the TE using unsolicited result code:

+CMTI: <mem>, <index>

- 2 SMS-DELIVERs (except class 2 messages and messages in the message waiting indication group (store message)) are routed directly to the TE using unsolicited result code:

+CMT: [<alpha>], <length><CR><LF><pdu> (PDU mode enabled); or

+CMT: <oa>, [<alpha>], <scts>[, <toa>, <fo>, <pid>, <dc>, <sca>, <tosca>, <length>]<CR><LF><data> (text mode enabled; about parameters in italics, refer command Show Text Mode Parameters +CSDH)

If ME has its own display device then class 0 messages and messages in the message waiting indication group (discard message) may be copied to both ME display and to TE. In this case, ME shall send the acknowledgement to the network (refer table 2).

Class 2 messages and messages in the message waiting indication group (store message) result in indication as defined in <mt>=1.

- 3 Class 3 SMS-DELIVERs are routed directly to TE using unsolicited result codes defined in <mt>=2. Messages of other data coding schemes result in indication as defined in <mt>=1.

Table 1: <mt> parameter

<mt>	Receiving procedure for different message data coding schemes (refer 3GPP TS 23.038 [2])
0	no class: as in 3GPP TS 23.038 [2], but use <mem3> as preferred memory class 0: as in 3GPP TS 23.038 [2], but use <mem3> as preferred memory if message is tried to be stored class 1: as in 3GPP TS 23.038 [2], but use <mem3> as preferred memory class 2: as in 3GPP TS 23.038 [2] class 3: as in 3GPP TS 23.038 [2], but use <mem3> as preferred memory message waiting indication group (discard message): as in 3GPP TS 23.038 [2], but use <mem3> as preferred memory if message is tried to be stored message waiting indication group (store message): as in 3GPP TS 23.038 [2], but use <mem3> as preferred memory
1	as <mt>=0 but send indication if message stored successfully
2	no class: route message to TE class 0: as in 3GPP TS 23.038 [2], but also route message to TE and do not try to store it in memory class 1: route message to TE class 2: as <mt>=1 class 3: route message to TE message waiting indication group (discard message): as in 3GPP TS 23.038 [2], but also route message to TE and do not try to store it in memory message waiting indication group (store message): as <mt>=1
3	class 3: route message to TE others: as <mt>=1

Table 2: SMS-DELIVER result code and acknowledgement summary

<mt>	no class or class 1	class 0 or message waiting indication group (discard)	class 2 or message waiting indication group (store)	class 3
1	+CMTI	[+CMTI ¹⁾]	+CMTI	+CMTI
2	+CMT & +CNMA ³⁾	+CMT [& +CNMA ²⁾]	+CMTI	+CMT & +CNMA ³⁾
3	+CMTI	[+CMTI ¹⁾]	+CMTI	+CMT & +CNMA ³⁾
1) result code is sent when ME does not have other display device than AT interface. 2) acknowledgement command must be sent when +CSMS <service> value equals 1 and ME does not have other display device than AT interface. 3) acknowledgement command must be sent when +CSMS <service> value equals 1.				

<bm> (the rules for storing received CBMs depend on its data coding scheme (refer 3GPP TS 23.038 [2]), the setting of Select CBM Types (+CSCB) and this value; refer table 3):

0 No CBM indications are routed to the TE.

1 If CBM is stored into ME/TA, indication of the memory location is routed to the TE using unsolicited result code:

+CBMI: <mem>, <index>

2 New CBMs are routed directly to the TE using unsolicited result code:

+CBM: <length><CR><LF><pdu> (PDU mode enabled); or

+CBM: <sn>, <mid>, <dcs>, <page>, <pages><CR><LF><data> (text mode enabled)

If ME supports data coding groups which define special routing also for messages other than class 3 (e.g. (U)SIM specific messages), ME may choose not to route messages of such data coding schemes into TE (indication of a stored CBM may be given as defined in <bm>=1).

3 Class 3 CBMs are routed directly to TE using unsolicited result codes defined in <bm>=2. If CBM storage is supported, messages of other classes result in indication as defined in <bm>=1.

Table 3: <bm> parameter

<bm>	Receiving procedure for different message data coding schemes (refer 3GPP TS 23.038 [2])
0	all schemes: as in 3GPP TS 23.038 [2]; if CBM storage is supported, store message to "BM" (or some manufacturer or data coding scheme specific memory)
1	all schemes: as <bm>=0 but send indication if message stored successfully
2	all schemes: route message to TE unless ME has detected a special routing to somewhere else (e.g. to (U)SIM; an indication may be sent if message stored successfully)
3	class 3: route message to TE others: as <bm>=1 (if CBM memory storage is supported)

<ds>:

0 No SMS-STATUS-REPORTs are routed to the TE.

1 SMS-STATUS-REPORTs are routed to the TE using unsolicited result code:

+CDS: <length><CR><LF><pdu> (PDU mode enabled); or

+CDS: <fo>, <mr>, [<ra>], [<tora>], <scts>, <dt>, <st> (text mode enabled)

2 If SMS-STATUS-REPORT is stored into ME/TA, indication of the memory location is routed to the TE using unsolicited result code:

+CDSI: <mem>, <index>

Table 4: SMS-STATUS-REPORT result code and acknowledgement summary

<ds>	result codes and commands
1	+CDS & +CNMA ¹⁾
2	+CDSI
¹⁾ acknowledgement command must be sent when +CSMS <service> value equals 1	

<bfr>:

0 TA buffer of unsolicited result codes defined within this command is flushed to the TE when <mode> 1...3 is entered (OK response shall be given before flushing the codes).

1 TA buffer of unsolicited result codes defined within this command is cleared when <mode> 1...3 is entered.

Implementation

Mandatory when any of the new message indications implemented.

3.4.2 List Messages +CMGL

Action Command Syntax

Command	Possible response(s)
+CMGL[=<stat>]	<p>if text mode (+CMGF=1), command successful and SMS-SUBMITs and/or SMS-DELIVERs: +CMGL: <index>, <stat>, <oa/da>, [<i><alpha></i>], [<i><scts></i>][, <tooa/toda>, <length>]<CR><LF><data>[<CR><LF> +CMGL: <index>, <stat>, <da/oa>, [<i><alpha></i>], [<i><scts></i>][, <tooa/toda>, <length>]<CR><LF><data>[...]]</p> <p>if text mode (+CMGF=1), command successful and SMS-STATUS-REPORTs: +CMGL: <index>, <stat>, <fo>, <mr>, [<i><ra></i>], [<i><tora></i>], <scts>, <dt>, <st> [<CR><LF> +CMGL: <index>, <stat>, <fo>, <mr>, [<i><ra></i>], [<i><tora></i>], <scts>, <dt>, <st> [...]]</p> <p>if text mode (+CMGF=1), command successful and SMS-COMMANDs: +CMGL: <index>, <stat>, <fo>, <ct>[<CR><LF> +CMGL: <index>, <stat>, <fo>, <ct>[...]]</p> <p>if text mode (+CMGF=1), command successful and CBM storage: +CMGL: <index>, <stat>, <sn>, <mid>, <page>, <pages> <CR><LF><data>[<CR><LF> +CMGL: <index>, <stat>, <sn>, <mid>, <page>, <pages> <CR><LF><data>[...]]</p> <p>otherwise: +CMS ERROR: <err></p>
+CMGL=?	+CMGL: (list of supported <stat>s)

Description

Execution command returns messages with status value <stat> from message storage <mem1> to the TE. About text mode parameters in italics, refer command Show Text Mode Parameters +CSDH. If status of the message is 'received unread', status in the storage changes to 'received read'. If listing fails, final result code +CMS ERROR: <err> is returned. See chapter Message Service Failure Result Code for <err> values.

NOTE: If the selected <mem1> can contain different types of SMs (e.g. SMS-DELIVERs, SMS-SUBMITs, SMS-STATUS-REPORTs and SMS-COMMANDs), the response may be a mix of the responses of different SM types. TE application can recognize the response format by examining the third response parameter.

Test command shall give a list of all status values supported by the TA.

Implementation

Optional.

3.4.3 Read Message +CMGR

Action Command Syntax

Command	Possible response(s)
+CMGR=<index>	<p>if text mode (+CMGF=1), command successful and SMS-DELIVER: +CMGR: <stat>, <oa>, [<i><alpha></i>], <scts>[<i>, <tooa></i>, <fo>, <pid>, <dcsc>, <sca>, <tosca>, <length>]<CR><LF><data></p> <p>if text mode (+CMGF=1), command successful and SMS-SUBMIT: +CMGR: <stat>, <da>, [<i><alpha></i>][<i>, <toda></i>, <fo>, <pid>, <dcsc>, [<i><vp></i>], <sca>, <tosca>, <length>]<CR><LF><data></p> <p>if text mode (+CMGF=1), command successful and SMS-STATUS-REPORT: +CMGR: <stat>, <fo>, <mr>, [<i><ra></i>], [<i><tora></i>], <scts>, <dt>, <st></p> <p>if text mode (+CMGF=1), command successful and SMS-COMMAND: +CMGR: <stat>, <fo>, <ct>[<i>, <pid></i>, [<i><mn></i>], [<i><da></i>], [<i><toda></i>], <length> <CR><LF><data>]</p> <p>if text mode (+CMGF=1), command successful and CBM storage: +CMGR: <stat>, <sn>, <mid>, <dcsc>, <page>, <pages><CR><LF><data></p> <p>otherwise: +CMS ERROR: <err></p>
+CMGR=?	

Description

Execution command returns message with location value <index> from message storage <mem1> to the TE. About text mode parameters in italics, refer command Show Text Mode Parameters +CSDH. If status of the message is 'received unread', status in the storage changes to 'received read'. If reading fails, final result code +CMS ERROR: <err> is returned. See chapter Message Service Failure Result Code for <err> values.

Implementation

Optional.

3.4.4 New Message Acknowledgement to ME/TA +CNMA

Action Command Syntax

Command	Possible response(s)
if text mode (+CMGF=1): +CNMA	+CMS ERROR: <err>
+CNMA=?	

Description

Execution command confirms correct reception of a new message (SMS-DELIVER or SMS-STATUS-REPORT) which is routed directly to the TE (refer command +CNMI tables 2 and 4). This acknowledgement command (causing ME to send RP-ACK to the network) shall be used when +CSMS parameter <service> equals 1. TA shall not send another +CMT or +CDS result code to TE before previous one is acknowledged.

If ME does not get acknowledgement within required time (network timeout), ME should respond as specified in 3GPP TS 24.011 [6] to the network. ME/TA shall automatically disable routing to TE by setting both <mt> and <ds> values of +CNMI to zero.

If command is executed, but no acknowledgement is expected, or some other ME related error occurs, final result code +CMS ERROR: <err> is returned. See chapter Message Service Failure Result Code for a list of <err> values.

NOTE: In case that a directly routed message must be buffered in ME/TA (possible when +CNMI parameter <mode> equals 0 or 2) or AT interpreter remains too long in a state where result codes cannot be sent to TE (e.g. user is entering a message using +CMGS), acknowledgement (RP-ACK) must be sent to the network without waiting +CNMA command from TE. Later, when buffered result codes are flushed to TE, TE must send +CNMA acknowledgement for each result code. In this way, ME/TA can determine if message should be placed in non-volatile memory and routing to TE disabled (+CNMA not received). Refer command +CNMI for more details how to use <mode> parameter reliably.

Implementation

Mandatory when <service> value 1 of command Select Message Service +CSMS is supported.

3.4.5 Informative Examples

Message forwarding is done as illustrated in figure 3. Optional +CNMA acknowledgement procedure is not presented. In this example, there is no TA memory for messages and result code buffer is situated in TA. The routing of message waiting indication group (discard message) SMS-DELIVERs equal to class 0 messages, and the routing of message waiting indication group (store message) SMS-DELIVERs equal to class 2 messages.

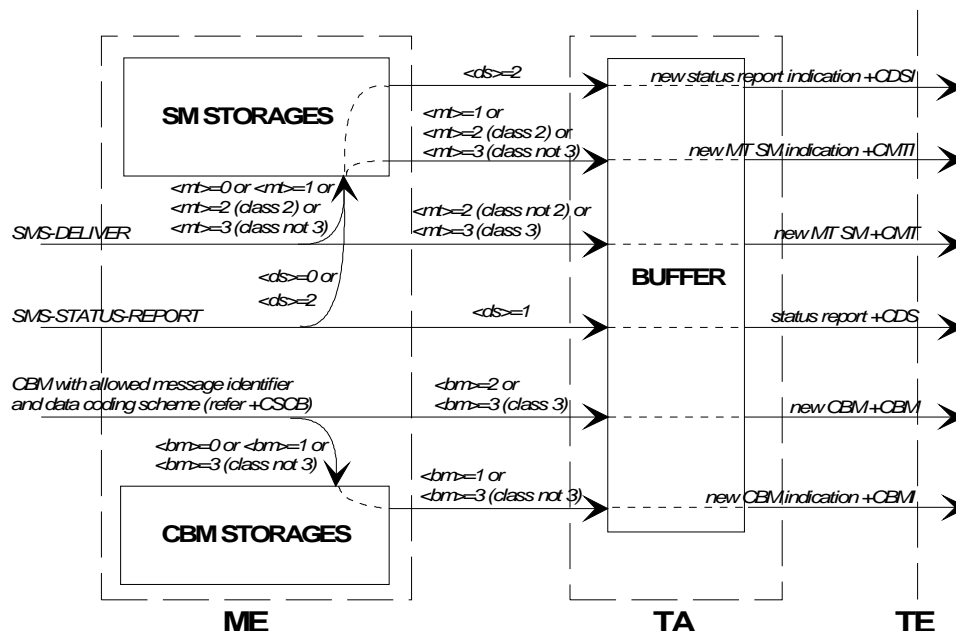

Figure 3: Message receiving procedures

Setting new message indications:

```
AT+CNMI=?                (query new message unsolicited result code modes)
+CNMI: (0-2),(0-3),(0-3),(0,1),(0,1)
OK
AT+CNMI=2,1,0,1,0      (send SM and status report indications to TE
OK                       when TA in command mode, otherwise buffer)
```

In this example, the TA is set so that it should send an unsolicited result code +CMTI: <mem>, <index> to the TE when a new SMS-DELIVER is received from the network and stored successfully to storage <mem>, and an unsolicited result code +CDS: . . . when a SMS-STATUS-REPORT is received. These result codes are routed to the TE when TA is in command mode, but buffered when in on-line data mode. Now, if new SM is received, it can be read as follows (text mode with no detailed header information; GSM 7 bit default alphabet used in message body):

```
+CMTI: "ME",2           (new message received in index 2)
AT+CMGR=2              (read the message)
+CMGR: "REC UNREAD","+358507654321","Mr. Jones","95/07/03,17:38:15+04"
This is the Mr. Jones testing
OK
```

In the next example all messages of storage <mem1> are listed (text mode with no detailed header information; GSM 7 bit default alphabet used in message bodies):

```

AT+CMGL="ALL"           (read all SMs)
+CMGL: 1,"REC READ", "+358501234567", "Mr. Smith", "95/07/03,17:45:03+04"
This is the body of the message.
+CMGL: 2,"STO UNSENT", "+358501234567", "Mr. Smith",
This is the body of the reply.
OK

```

The next example shows a method to read new CBMs received from the network (text mode; GSM 7 bit default alphabet used in message bodies):

```

AT+CNMI=2,,2,,0           (CBMs will be sent to the TE)
OK
AT+CPMS="BM";+CMGL       (select CBM memory for reading; list all unread CBMs)
+CMGL: 1,"REC UNREAD",100,40,1,3   (first page of three page weather information)
Weather in Finland 3rd of July 1995
+CMGL: 2,"REC UNREAD",100,40,2,3   (second page of three page weather information)
Helsinki: cloudy, snow storms, -20 degrees Celsius, wind -14 m/s NE
+CMGL: 3,"REC UNREAD",100,40,3,3   (third page of three page weather information)
Tampere: sunny, 40 degrees Celsius, wind 1 m/s SW
OK

```

3.5 Message Sending and Writing Commands

3.5.1 Send Message +CMGS

Action Command Syntax

Command	Possible response(s)
if text mode (+CMGF=1): +CMGS=<da>[,<todo>]<CR> text is entered <ctrl-Z/ESC>	if text mode (+CMGF=1) and sending successful: +CMGS: <mr>[,<scts>] if sending fails: +CMS ERROR: <err>
+CMGS=?	

Description

Execution command sends message from a TE to the network (SMS-SUBMIT). Message reference value <mr> is returned to the TE on successful message delivery. Optionally (when +CSMS <service> value is 1 and network supports) <scts> is returned. Values can be used to identify message upon unsolicited delivery status report result code. If sending fails in a network or an ME error, final result code +CMS ERROR: <err> is returned. See chapter Message Service Failure Result Code for a list of <err> values. This command should be abortable.

Description

Execution command sends message from a TE to the network (SMS-SUBMIT). Message reference value <mr> is returned to the TE on successful message delivery. Value can be used to identify message upon unsolicited delivery status report result code. If sending fails in a network or an ME error, final result code +CMS ERROR: <err> is returned. See chapter Message Service Failure Result Code for a list of <err> values. This command should be abortable.

- entered text (3GPP TS 23.040 [3] TP-Data-Unit) is sent to address <da> and all current settings (refer Set Text Mode Parameters +CSMP and Service Centre Address +CSCA) are used to construct the actual PDU in ME/TA.
- the TA shall send a four character sequence <CR><LF><greater_than><space> (IRA 13, 10, 62, 32) after command line is terminated with <CR>; after that text can be entered from TE to ME/TA.
- the DCD signal shall be in ON state while text is entered.
- the echoing of entered characters back from the TA is controlled by V.25ter echo command E.
- the entered text should be formatted as follows:
 - if <dcs> (set with +CSMP) indicates that 3GPP TS 23.038 [2] GSM 7 bit default alphabet is used and <fo> indicates that 3GPP TS 23.040 [3] TP-User-Data-Header-Indication is not set:

- if TE character set other than "HEX" (refer command Select TE Character Set +CSCS in 3GPP TS 27.007 [9]): ME/TA converts the entered text into the GSM 7 bit default alphabet according to rules of Annex A; backspace can be used to delete last character and carriage returns can be used (previously mentioned four character sequence shall be sent to the TE after every carriage return entered by the user);
- if TE character set is "HEX": the entered text should consist of two IRA character long hexadecimal numbers which ME/TA converts into the GSM 7 bit default alphabet characters. (e.g. 17 (IRA 49 and 55) will be converted to character Π (GSM 7 bit default alphabet 23)).
- if <dcS> indicates that 8-bit or UCS2 data coding scheme is used or <fo> indicates that 3GPP TS 23.040 [3] TP-User-Data-Header-Indication is set: the entered text should consist of two IRA character long hexadecimal numbers which ME/TA converts into 8-bit octet (e.g. two characters 2A (IRA 50 and 65) will be converted to an octet with integer value 42).
- sending can be cancelled by giving <ESC> character (IRA 27).
- <ctrl-Z> (IRA 26) must be used to indicate the ending of the message body.

Implementation

Optional.

3.5.2 Send Message from Storage +CMSS

Action Command Syntax

Command	Possible response(s)
+CMSS=<index>[, <da>[, <toda>]]	if text mode (+CMGF=1) and sending successful: +CMSS: <mr>[, <scts>] if sending fails: +CMS ERROR: <err>
+CMSS=?	

Description

Execution command sends message with location value <index> from preferred message storage <mem2> to the network (SMS-SUBMIT or SMS-COMMAND). If new recipient address <da> is given given for SMS-SUBMIT, it shall be used instead of the one stored with the message. Reference value <mr> is returned to the TE on successful message delivery. Optionally (when +CSMS <service> value is 1 and network supports) <scts> is returned. Values can be used to identify message upon unsolicited delivery status report result code. If sending fails in a network or an ME error, final result code +CMS ERROR: <err> is returned. See chapter Message Service Failure Result Code for a list of <err> values. This command should be abortable.

Implementation

Optional.

3.5.3 Write Message to Memory +CMGW

Action Command Syntax

Command	Possible response(s)
if text mode (+CMGF=1): +CMGW[=<oa/da>[, <tooa/toda>[, <stat>]]]<CR> text is entered <ctrl-Z/ESC>	+CMGW: <index> +CMS ERROR: <err>
+CMGW=?	

Description

Execution command stores message (either SMS-DELIVER or SMS-SUBMIT) to memory storage <mem2>. Memory location <index> of the stored message is returned. By default message status will be set to 'stored unsent', but parameter <stat> allows also other status values to be given. The entering of text is done similarly as specified in command Send Message +CMGS. If writing fails, final result code +CMS ERROR: <err> is returned. See chapter Message Service Failure Result Code for <err> values.

NOTE: SMS-COMMANDs and SMS-STATUS-REPORTs can not be stored in text mode.

Implementation

Optional.

3.5.4 Delete Message +CMGD**Action Command Syntax**

Command	Possible response(s)
+CMGD=<index> [, <delflag>]	+CMS ERROR: <err>
+CMGD=?	+CMGD: (list of supported <index>s)[, (list of supported <delflag>s)]

Description

Execution command deletes message from preferred message storage <mem1> location <index>. If <delflag> is present and not set to 0 then the ME shall ignore <index> and follow the rules for <delflag> shown below. If deleting fails, final result code +CMS ERROR: <err> is returned. See chapter Message Service Failure Result Code for <err> values.

Test command shows the valid memory locations and optionally the supported values of <delflag>.

<delflag>: an integer indicating multiple message deletion request as follows:

- 0 (or omitted) Delete the message specified in <index>
- 1 Delete all read messages from preferred message storage, leaving unread messages and stored mobile originated messages (whether sent or not) untouched
- 2 Delete all read messages from preferred message storage and sent mobile originated messages, leaving unread messages and unsent mobile originated messages untouched
- 3 Delete all read messages from preferred message storage, sent and unsent mobile originated messages leaving unread messages untouched.
- 4 Delete all messages from preferred message storage including unread messages.

Implementation

Optional.

3.5.5 Send Command +CMGC

Action Command Syntax

Command	Possible response(s)
if text mode (+CMGF=1): +CMGC=<fo>,<ct>[,<pid>[,<mn>[,<da>[,<toda>]]]]<CR> text is entered <ctrl-Z/ESC>	if text mode (+CMGF=1) and sending successful: +CMGC: <mr>[,<scts>] if sending fails: +CMS ERROR: <err>
+CMGC=?	

Description

Execution command sends a command message from a TE to the network (SMS-COMMAND). The entering of text (3GPP TS 23.040 [3] TP-Command-Data) is done similarly as specified in command Send Message +CMGS, but the format is fixed to be a sequence of two IRA character long hexadecimal numbers which ME/TA converts into 8-bit octets (refer +CMGS). Message reference value <mr> is returned to the TE on successful message delivery. Optionally (when +CSMS <service> value is 1 and network supports) <scts> is returned. Values can be used to identify message upon unsolicited delivery status report result code. If sending fails in a network or an ME error, final result code +CMS ERROR: <err> is returned. See chapter Message Service Failure Result Code for a list of <err> values. This command should be abortable.

Implementation

Optional.

3.5.6 More Messages to Send +CMMS

Parameter Command Syntax

Command	Possible response(s)
+CMMS=[<n>]	
+CMMS?	+CMMS: <n>
+CMMS=?	+CMMS: (list of supported <n>s)

Description

Set command controls the continuity of SMS relay protocol link. When feature is enabled (and supported by network) multiple messages can be sent much faster as link is kept open.

Test command returns supported values as a compound value.

Defined Values

<n>:

0 disable

- keep enabled until the time between the response of the latest message send command (+CMGS, +CMSS, etc.) and the next send command exceeds 1-5 seconds (the exact value is up to ME implementation), then ME shall close the link and TA switches <n> automatically back to 0
- enable (if the time between the response of the latest message send command and the next send command exceeds 1-5 seconds (the exact value is up to ME implementation), ME shall close the link but TA shall not switch automatically back to <n>=0)

Implementation

Optional.

3.5.7 Informative Examples

Figure 4 is an example of a TE-TA-ME setup when messages are sent to network or stored to ME. The volatile memory may as well be in the ME, or a non-volatile memory may be used instead when constructing messages.

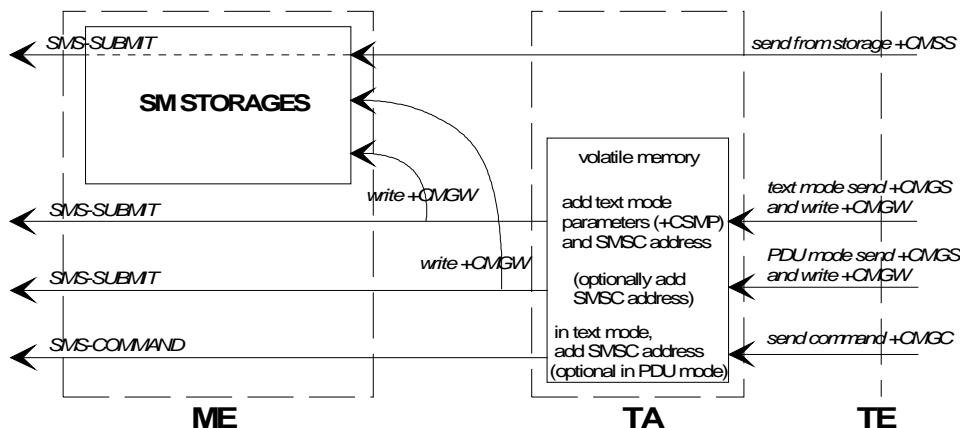

Figure 4: Message service send and write procedures

An example of sending a GSM 7 bit default alphabet message in text mode and a SMS-STATUS-REPORT is wanted:

```

AT+CNMI?                (check that status reports are routed to TE)
+CNMI: 2,1,0,1,0
OK
AT+CSMP=32,167,0,0     (status report wanted; otherwise default settings)
OK
AT+CMGS="+358501234567" (start editing a message)
> This the first line. (edit first line and press carriage return)
> This is the last line.^Z (edit second line and send message by pressing control-Z)
+CMGS: 10              (success: message reference 10 returned from SMSC)
OK
+CDS: 2,10,"+358501234567",145,"95/07/04/13:12:14+04",
"95/07/04/13:12:20+04",0 (status report of successful message delivery received)
    
```

Storing an unsent message in memory, sending it from there, and deleting it:

```

AT+CPMS?                (check memory settings)
+CPMS: "ME",4,10,"ME",4,10,"ME",4,10
OK
AT+CMGW="9501231234"   (write message)
> This is the message body^Z
+CMGW: 7               (index number in storage returned)
OK
AT+CMSS=7              (send from storage)
+CMSS: 12              (success: reference value 12 sent from SC)
OK
AT+CMGD=7              (delete message)
OK
    
```

4 PDU Mode

The PDU mode uses the same commands and responses as the Text Mode described in clause 3. However, the following commands and responses have a different format. In the PDU mode, a complete SMS Message including all header information is passed as a binary string. This binary string is composed of hexadecimal IA5 characters as defined in clause 3 above under "Message Data Parameters".

4.1 List Messages +CMGL

Action Command Syntax

Command	Possible response(s)
+CMGL[=<stat>]	if PDU mode (+CMGF=0) and command successful: +CMGL: <index>, <stat>, [<alpha>], <length><CR><LF><pdu> [<CR><LF>+CMGL:<index>, <stat>, [<alpha>], <length><CR><LF><pdu> [...]] otherwise: +CMS ERROR: <err>
+CMGL=?	+CMGL: (list of supported <stat>s)

Description

Execution command returns messages with status value <stat> from preferred message storage <mem1> to the TE. Entire data units <pdu> are returned. If status of the message is 'received unread', status in the storage changes to 'received read'. If listing fails, final result code +CMS ERROR: <err> is returned. See chapter Message Service Failure Result Code for <err> values.

Test command shall give a list of all status values supported by the TA.

Implementation

Optional.

4.2 Read Message +CMGR

Action Command Syntax

Command	Possible response(s)
+CMGR=<index>	if PDU mode (+CMGF=0) and command successful: +CMGR: <stat>, [<alpha>], <length><CR><LF><pdu> otherwise: +CMS ERROR: <err>
+CMGR=?	

Description

Execution command returns message with location value <index> from preferred message storage <mem1> to the TE. Status of the message and entire message data unit <pdu> is returned. If status of the message is 'received unread', status in the storage changes to 'received read'. If reading fails, final result code +CMS ERROR: <err> is returned. See chapter Message Service Failure Result Code for <err> values.

Implementation

Optional.

4.3 Send Message +CMGS

Action Command Syntax

Command	Possible response(s)
if PDU mode (+CMGF=0): +CMGS=<length><CR> PDU is given <ctrl-Z/ESC>	if PDU mode (+CMGF=0) and sending successful: +CMGS: <mr>[, <ackpdu>] if sending fails: +CMS ERROR: <err>
+CMGS=?	

Description

Execution command sends message from a TE to the network (SMS-SUBMIT). Message reference value <mr> is returned to the TE on successful message delivery. Optionally (when +CSMS <service> value is 1 and network supports) <ackpdu> is returned. Values can be used to identify message upon unsolicited delivery status report result code. If sending fails in a network or an ME error, final result code +CMS ERROR: <err> is returned. See chapter Message Service Failure Result Code for a list of <err> values. This command should be abortable.

- <length> must indicate the number of octets coded in the TP layer data unit to be given (i.e. SMSC address octets are excluded).
- the TA shall send a four character sequence <CR><LF><greater_than><space> (IRA 13, 10, 62, 32) after command line is terminated with <CR>; after that PDU can be given from TE to ME/TA.
- the DCD signal shall be in ON state while PDU is given.
- the echoing of given characters back from the TA is controlled by V.25ter echo command E.
- the PDU shall be hexadecimal format (similarly as specified for <pdu>) and given in one line; ME/TA converts this coding into the actual octets of PDU.
- when the length octet of the SMSC address (given in the PDU) equals zero, the SMSC address set with command Service Centre Address +CSCA is used; in this case the SMSC Type-of-Address octet shall not be present in the PDU, i.e. TPDU starts right after SMSC length octet.
- sending can be cancelled by giving <ESC> character (IRA 27).
- <ctrl-z> (IRA 26) must be used to indicate the ending of PDU.

Implementation

Optional.

4.4 Write Message to Memory +CMGW

Action Command Syntax

Command	Possible response(s)
if PDU mode (+CMGF=0):	+CMGW: <index>
+CMGW=<length>[, <stat>]<CR> PDU is given <ctrl-Z/ESC>	+CMS ERROR: <err>
+CMGW=?	

Description

Execution command stores a message to memory storage <mem2>. Memory location <index> of the stored message is returned. By default message status will be set to 'stored unsent', but parameter <stat> allows also other status values to be given. (ME/TA manufacturer may choose to use different default <stat> values for different message types.) The entering of PDU is done similarly as specified in command Send Message +CMGS. If writing fails, final result code +CMS ERROR: <err> is returned. See chapter Message Service Failure Result Code for <err> values.

Implementation

Optional.

4.5 Send Command +CMGC

Action Command Syntax

Command	Possible response(s)
if PDU mode (+CMGF=0): +CMGC=<length><CR> <i>PDU is given</i> <ctrl-Z/ESC>	if PDU mode (+CMGF=0) and sending successful: +CMGC: <mr>[, <ackpdu>] if sending fails: +CMS ERROR: <err>
+CMGC=?	

Description

Execution command sends a command message from a TE to the network (SMS-COMMAND). The entering of PDU is done similarly as specified in command Send Message +CMGS. Message reference value <mr> is returned to the TE on successful message delivery. Optionally (when +CSMS <service> value is 1 and network supports) <ackpdu> is returned. Values can be used to identify message upon unsolicited delivery status report result code. If sending fails in a network or an ME error, final result code +CMS ERROR: <err> is returned. See chapter Message Service Failure Result Code for a list of <err> values. This command should be abortable.

Implementation

Optional.

4.6 New Message Acknowledgement to ME/TA +CNMA

Action Command Syntax

Command	Possible response(s)
if PDU mode (+CMGF=0): +CNMA [=<n>[, <length>[<CR> <i>PDU is given</i> <ctrl-Z/ESC>]]]	+CMS ERROR: <err>
+CNMA=?	if PDU mode (+CMGF=0): +CNMA: (list of supported <n>s)

Description

Execution command confirms reception of a new message (SMS-DELIVER or SMS-STATUS-REPORT) which is routed directly to the TE (refer command +CNMI tables 2 and 4). This acknowledgement command shall be used when +CSMS parameter <service> equals 1. In PDU mode, it is possible to send either positive (RP-ACK) or negative (RP-ERROR) acknowledgement to the network. Parameter <n> defines which one will be sent. Optionally (when <length> is greater than zero) an acknowledgement TPDU (SMS-DELIVER-REPORT for RP-ACK or RP-ERROR) may be sent to the network. The entering of PDU is done similarly as specified in command Send Message +CMGS, except that the format of <ackpdu> is used instead of <pdu> (i.e. SMSC address field is not present). PDU shall not be bounded by double quotes. TA shall not send another +CMT or +CDS result code to TE before previous one is acknowledged.

If ME does not get acknowledgement within required time (network timeout), ME should respond as specified in 3GPP TS 24.011 [6] to the network. ME/TA shall automatically disable routing to TE by setting both <mt> and <ds> values of +CNMI to zero.

If command is executed, but no acknowledgement is expected, or some other ME related error occurs, final result code +CMS ERROR: <err> is returned. See chapter Message Service Failure Result Code for a list of <err> values.

NOTE: In case that a directly routed message must be buffered in ME/TA (possible when +CNMI parameter <mode> equals 0 or 2) or AT interpreter remains too long in a state where result codes cannot be sent to TE (e.g. user is entering a message using +CMGS), acknowledgement (RP-ACK) must be sent to the network without waiting +CNMA command from TE. Later, when buffered result codes are flushed to TE, TE must send +CNMA [=0] acknowledgement for each result code. In this way, ME/TA can determine if message should be placed in non-volatile memory and routing to TE disabled (+CNMA [=0] not received). Refer command +CNMI for more details how to use <mode> parameter reliably.

Test command returns a list of supported <n> values. If the only value supported is 0, the device does not support sending of TPDU.

Defined Values

<n>:

- 0 command operates similarly as defined for the text mode
- 1 send RP-ACK (or buffered result code received correctly)
- 2 send RP-ERROR (if PDU is not given, ME/TA shall send SMS-DELIVER-REPORT with 3GPP TS 23.040 [3] TP-FCS value set to 'FF' (unspecified error cause))

Implementation

Mandatory when <service> value 1 of command Select Message Service +CSMS is supported.

4.7 Send Message from Storage +CMSS

Action Command Syntax

Command	Possible response(s)
+CMSS=<index>[, <da>[, <toda>]]	if PDU mode (+CMGF=0) and sending successful: +CMSS: <mr> [, <ackpdu>] if sending fails: +CMS ERROR: <err>
+CMSS=?	

Description

Execution command sends message with location value <index> from message storage <mem2> to the network (SMS-SUBMIT or SMS-COMMAND). If new recipient address <da> is given for SMS-SUBMIT, it shall be used instead of the one stored with the message. Reference value <mr> is returned to the TE on successful message delivery. Optionally (when +CSMS <service> value is 1 and network supports) <ackpdu> is returned. Values can be used to identify message upon unsolicited delivery status report result code. If sending fails in a network or an ME error, final result code +CMS ERROR: <err> is returned. See chapter Message Service Failure Result Code for a list of <err> values. This command should be abortable.

Implementation

Optional.

Annex A (normative): Character Set Conversions for SMS Text Mode

The following conversions to and from 3GPP TS 23.038 [2] GSM 7 bit default alphabet are defined:

TE char set	bits/char	Commands
PC Code Page 437	8	+CMGF=1 ; +CSCS="PCCP437"
PC Danish/Norwegian	8	+CMGF=1 ; +CSCS="PCDN"
ISO 8859 Latin 1	8	+CMGF=1 ; +CSCS="8859-1"
IRA	7	+CMGF=1 ; +CSCS="IRA"
GSM 7 bit default alphabet	7	+CMGF=1 ; +CSCS="GSM"

The tables below show which GSM 7 bit default alphabet value corresponds to the 7 or 8 bit value of external character set. The TE character set value is computed by adding column value, 00H through F0H (70H for 7 bits/char), with the row value (00H through 0FH). All values are in hexadecimal, but the H suffix is not used. When text mode is implemented, it is mandatory for a TA to have at least one conversion which include the conversion table of IRA (e.g. PC Code Page 437 does). Additional conversions can be defined by manufacturers. It is manufacturer specific if the TE set is actually converted to GSM 7 bit default alphabet set in the TA or in the ME, and if the TE set is converted to a ME specific set in the TA before converting it to GSM 7 bit default alphabet set when message is sent to the network. It is recommended that characters which cannot be converted to GSM 7 bit default alphabet set are deleted.

Conversion from IRA to GSM 7 bit default alphabet:

	00	10	20	30	40	50	60	70
00	-	-	20	30	00	50	-	70
01	-	-	21	31	41	51	61	71
02	-	-	22	32	42	52	62	72
03	-	-	23	33	43	53	63	73
04	-	-	02	34	44	54	64	74
05	-	-	25	35	45	55	65	75
06	-	-	26	36	46	56	66	76
07	-	-	27	37	47	57	67	77
08	-	-	28	38	48	58	68	78
09	-	-	29	39	49	59	69	79
0A	LF	-	2A	3A	4A	5A	6A	7A
0B	-	-	2B	3B	4B	-	6B	-
0C	-	-	2C	3C	4C	-	6C	-
0D	CR-	-	2D	3D	4D	-	6D	-
0E	-	-	2E	3E	4E	-	6E	-
0F	-	-	2F	3F	4F	11	6F	-

Conversion from PCCP437 (PC-8 Code Page 437) to GSM 7 bit default alphabet:

	00	10	20	30	40	50	60	70	80	90	A0	B0	C0	D0	E0	F0
00	-	-	20	30	00	50	-	70	09	1F	61 ¹⁰	-	-	-	-	-
01	-	-	21	31	41	51	61	71	7E	1D	69 ¹¹	-	-	-	1E	-
02	-	-	22	32	42	52	62	72	05	1C	6F ¹²	-	-	-	13	-
03	-	-	23	33	43	53	63	73	61 ¹	6F ⁷	75 ¹³	-	-	-	-	-
04	-	-	02	34	44	54	64	74	7B	7C	7D	-	-	-	18	-
05	-	5F	25	35	45	55	65	75	7F	08	5D	-	-	-	-	-
06	-	-	26	36	46	56	66	76	0F	75 ⁸	-	-	-	-	-	-
07	-	-	27	37	47	57	67	77	09 ²	06	-	-	-	-	-	-
08	-	-	28	38	48	58	68	78	65 ³	79 ⁹	60	-	-	-	12	-
09	-	-	29	39	49	59	69	79	65 ⁴	5C	-	-	-	-	19	-
0A	LF	-	2A	3A	4A	5A	6A	7A	04	5E	-	-	-	-	15	-
0B	-	-	2B	3B	4B	-	6B	-	69 ⁵	-	-	-	-	-	-	-
0C	-	-	2C	3C	4C	-	6C	-	69 ⁶	01	-	-	-	-	-	-
0D	CR	-	2D	3D	4D	-	6D	-	07	03	40	-	-	-	-	-
0E	-	-	2E	3E	4E	-	6E	-	5B	-	-	-	-	-	-	-
0F	-	-	2F	3F	4F	11	6F	-	0E	-	-	-	-	-	-	-

- 1 : â ⇒ a 2 : ç ⇒ Ç 3 : ê ⇒ e 4 : ë ⇒ e 5 : ï ⇒ i
- 6 : î ⇒ i 7 : ô ⇒ o 8 : û ⇒ u 9 : ÿ ⇒ y 10 : á ⇒ a
- 11 : í ⇒ i 12 : ó ⇒ o 13: ú ⇒ u

Conversion from PCDN (PC-8 Danish/ Norwegian) to GSM 7 bit default alphabet:

	00	10	20	30	40	50	60	70	80	90	A0	B0	C0	D0	E0	F0
00	-	-	20	30	00	50	-	70	09	1F	61 ¹⁰	-	-	-	-	-
01	-	-	21	31	41	51	61	71	7E	1D	69 ¹¹	-	-	-	1E	-
02	-	-	22	32	42	52	62	72	05	1C	6F ¹²	-	-	-	13	-
03	-	-	23	33	43	53	63	73	61 ¹	6F ⁷	75 ¹³	-	-	-	-	-
04	-	-	02	34	44	54	64	74	7B	7C	7D	-	-	-	18	-
05	-	5F	25	35	45	55	65	75	7F	08	5D	-	-	-	-	-
06	-	-	26	36	46	56	66	76	0F	75 ⁸	-	-	-	-	-	-
07	-	-	27	37	47	57	67	77	09 ²	06	-	-	-	-	-	-
08	-	-	28	38	48	58	68	78	65 ³	79 ⁹	60	-	-	-	12	-
09	-	-	29	39	49	59	69	79	65 ⁴	5C	-	-	-	-	19	-
0A	LF	-	2A	3A	4A	5A	6A	7A	04	5E	-	-	-	-	15	-
0B	-	-	2B	3B	4B	-	6B	-	69 ⁵	0C	-	-	-	-	-	-
0C	-	-	2C	3C	4C	-	6C	-	69 ⁶	01	-	-	-	-	-	-
0D	CR	-	2D	3D	4D	-	6D	-	07	0B	40	-	-	-	-	-
0E	-	-	2E	3E	4E	-	6E	-	5B	-	-	-	-	-	-	-
0F	-	-	2F	3F	4F	11	6F	-	0E	-	-	-	-	-	-	-

- 1 : â ⇒ a 2 : ç ⇒ Ç 3 : ê ⇒ e 4 : ë ⇒ e 5 : ï ⇒ i
- 6 : î ⇒ i 7 : ô ⇒ o 8 : û ⇒ u 9 : ÿ ⇒ y 10 : á ⇒ a
- 11 : í ⇒ i 12 : ó ⇒ o 13 : ú ⇒ u

Conversion from 8859-1 (ISO 8859 Latin 1) to GSM 7 bit default alphabet:

	00	10	20	30	40	50	60	70	80	90	A0	B0	C0	D0	E0	F0
00	-	-	20	30	00	50	-	70	-	-	-	-	41 ¹	-	7F	-
01	-	-	21	31	41	51	61	71	-	-	40	-	41 ²	5D	61 ²⁰	7D
02	-	-	22	32	42	52	62	72	-	-	-	-	41 ³	4F ¹²	61 ²¹	08
03	-	-	23	33	43	53	63	73	-	-	01	-	41 ⁴	4F ¹³	61 ²²	6F ²⁹
04	-	-	02	34	44	54	64	74	-	-	24	-	5B	4F ¹⁴	7B	6F ³⁰
05	-	-	25	35	45	55	65	75	-	-	03	-	0E	4F ¹⁵	0F	6F ³¹
06	-	-	26	36	46	56	66	76	-	-	-	-	1C	5C	1D	7C
07	-	-	27	37	47	57	67	77	-	-	5F	-	09	-	09 ²³	-
08	-	-	28	38	48	58	68	78	-	-	-	-	45 ⁵	0B	04	0C
09	-	-	29	39	49	59	69	79	-	-	-	-	1F	55 ¹⁶	05	06
0A	LF	-	2A	3A	4A	5A	6A	7A	-	-	-	-	45 ⁶	55 ¹⁷	65 ²⁴	75 ³²
0B	-	-	2B	3B	4B	-	6B	-	-	-	-	-	45 ⁷	55 ¹⁸	65 ²⁵	75 ³³
0C	-	-	2C	3C	4C	-	6C	-	-	-	-	-	49 ⁸	5E	07	7E
0D	CR	-	2D	3D	4D	-	6D	-	-	-	-	-	49 ⁹	59 ¹⁹	69 ²⁶	79 ³⁴
0E	-	-	2E	3E	4E	-	6E	-	-	-	-	-	49 ¹⁰	-	69 ²⁷	-
0F	-	-	2F	3F	4F	11	6F	-	-	-	-	60	49 ¹¹	1E	69 ²⁸	79 ³⁵

1 : À ⇒ A	2 : Á ⇒ A	3 : Â ⇒ A	4 : Ã ⇒ A	5 : È ⇒ E
6 : Ê ⇒ E	7 : Ë ⇒ E	8 : Ì ⇒ I	9 : Í ⇒ I	10 : Î ⇒ I
11 : Ï ⇒ I	12 : Ò ⇒ O	13 : Ó ⇒ O	14 : Ô ⇒ O	15 : Õ ⇒ O
16 : Ù ⇒ U	17 : Ú ⇒ U	18 : Û ⇒ U	19 : Ý ⇒ Y	20 : á ⇒ a
21 : â ⇒ a	22 : ã ⇒ a	23 : ç ⇒ Ç	24 : ê ⇒ e	25 : ë ⇒ e
26 : í ⇒ i	27 : î ⇒ i	28 : ï ⇒ i	29 : ó ⇒ o	30 : ô ⇒ o
31 : õ ⇒ o	32 : ú ⇒ u	33 : û ⇒ u	34 : ý ⇒ y	35 : ÿ ⇒ y

Conversions from GSM 7 bit default alphabet to above character sets are otherwise straightforward, but no conversions of the characters listed below tables are applied.

Annex B (informative): Example of processing a data block

B.1 Example state diagrams for the block receiver

The state diagrams on the following two pages show how the receiver component at the block level could work. In this example the received octets are processed in two stages.

Stage 1 is a low level function which detects the unique start and end markers, and removes any stuffing octets. The results of this stage are passed to stage 2. Any unexpected octet value after a DLE will be indicated as 'abort'.

Stage 2 assembles the message content and the BCS octets, using octets passed from stage 1 and the 'start' and 'end' indications. A 'start' will always reset the process to state 1 from any state. An 'abort' will always cause a return to state 0 where a 'start' will be awaited. When an 'end' is received in state 1, the following two octets are checked as the BCS. If the BCS is correct, the message content is passed to another stage of the receiver for processing of the message content.

B.2 Example of coding and decoding a data block

The last page of this annex shows the coding of an example message at a transmitter, and the decoding stages at a receiver which has the two stages of processing as described above.

In this example, the message content and the BCS both contain an octet with a value of 10 hex. Therefore the message as transmitted over the interface has additional stuffing octets (00 hex) inserted after these octets. The receiver first detects the start and end markers, and removes the stuffing octets. Finally the BCS is checked.

EXAMPLE STATE DIAGRAMS FOR THE BLOCK RECEIVER

The block receiver can be considered as two stages. Stage 1 detects start and end markers, and removes stuffing characters. Stage 2 assembles the received message and checks the BCS.

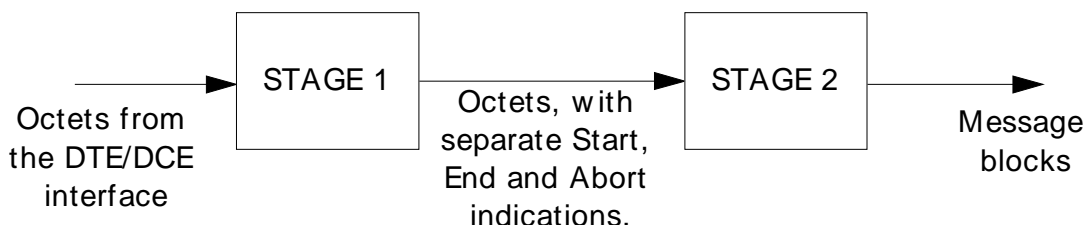

STATE TRANSITIONS IN STAGE 1

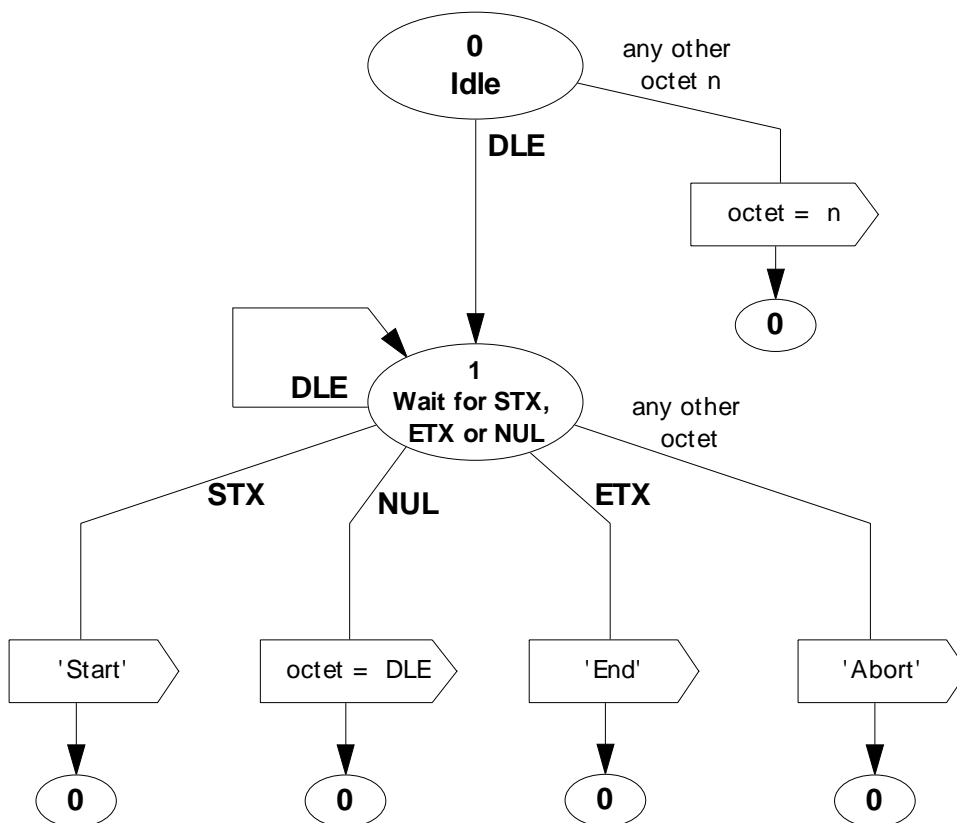

Figure B.1

STATE TRANSITIONS IN STAGE 2

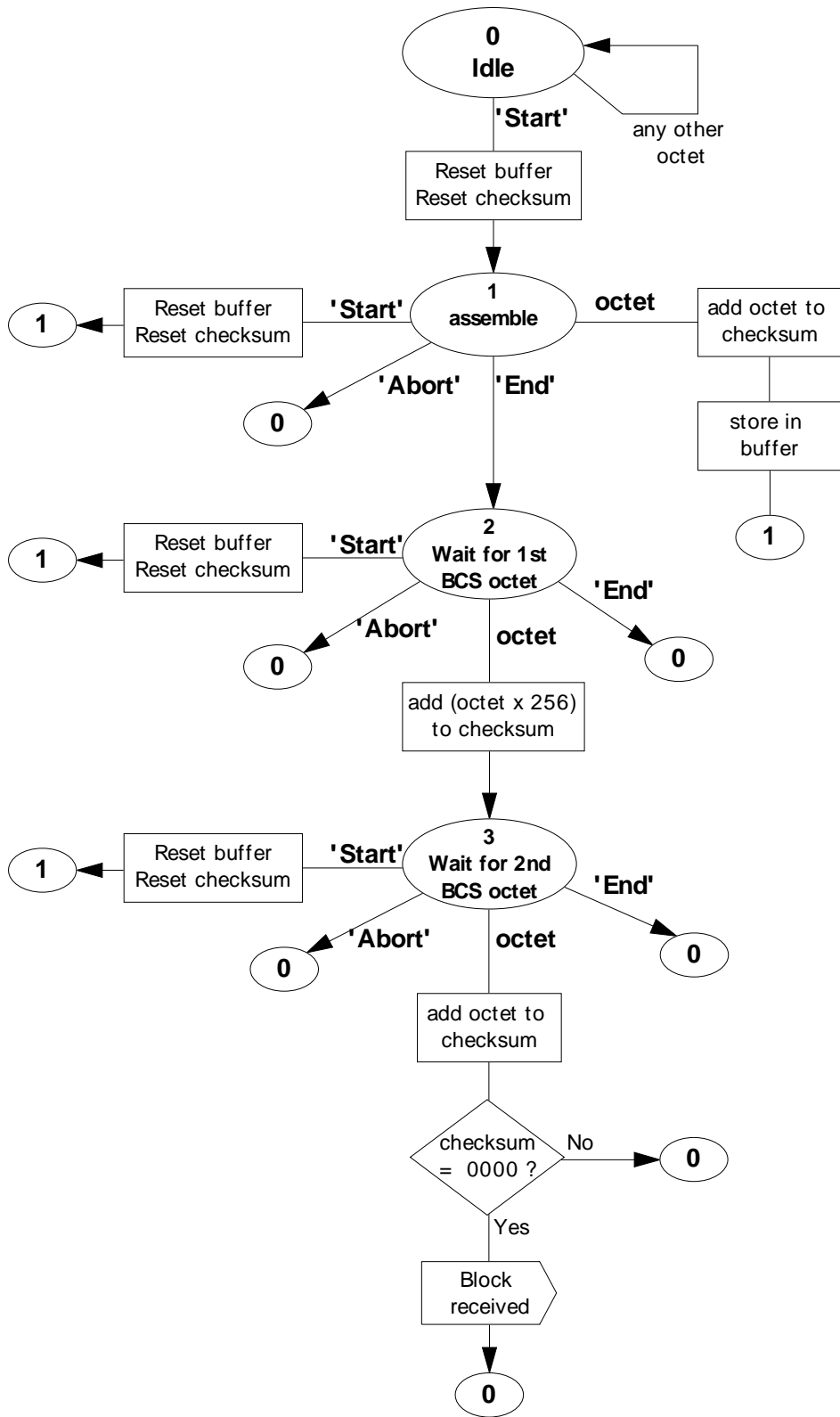

Figure B.2

Example of coding / decoding a message at the DTE/DCE interface

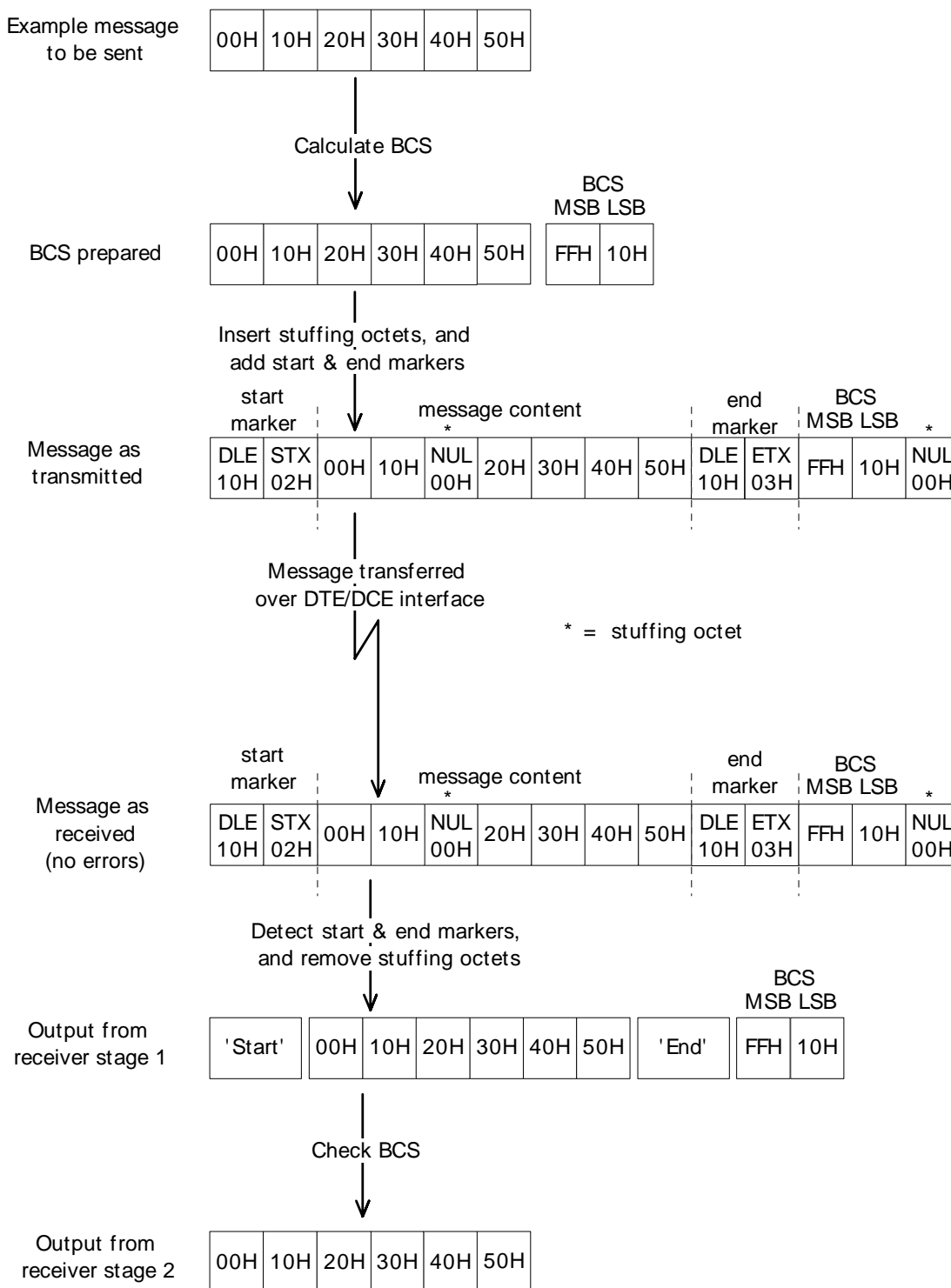
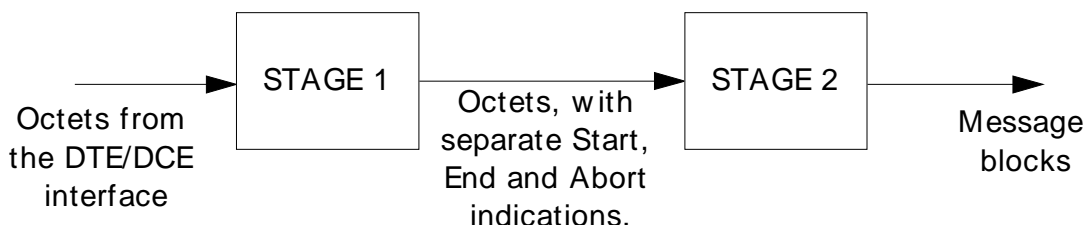

Figure B.3

EXAMPLE STATE DIAGRAMS FOR THE BLOCK RECEIVER

The block receiver can be considered as two stages. Stage 1 detects start and end markers, and removes stuffing characters. Stage 2 assembles the received message and checks the BCS.



STATE TRANSITIONS IN STAGE 1

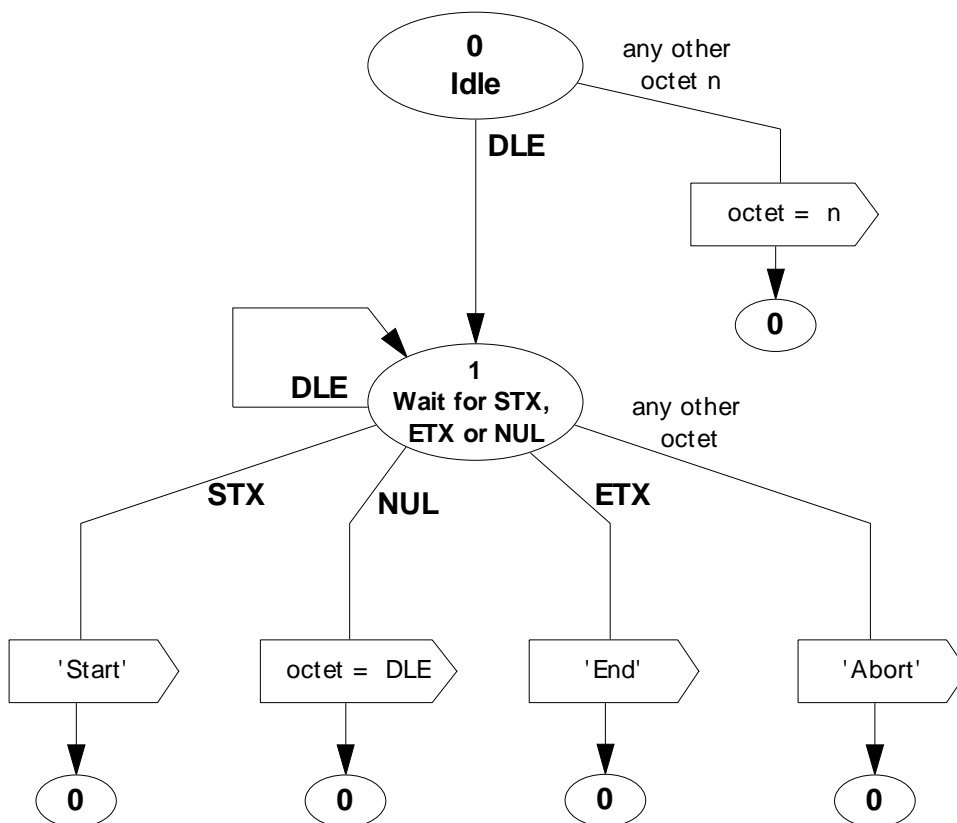

Figure B.4

STATE TRANSITIONS IN STAGE 2

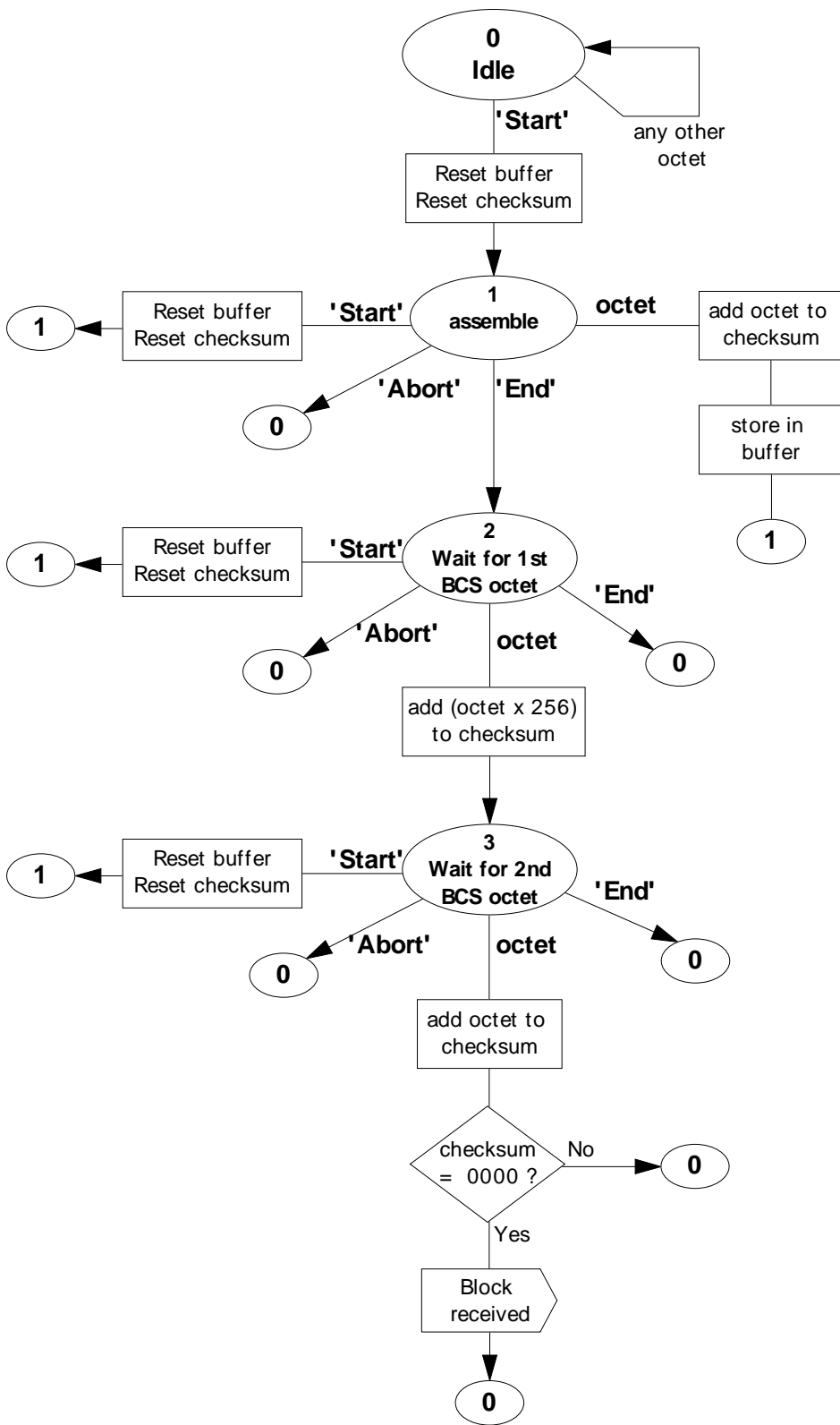

Figure B.5

Example of coding / decoding a message at the DTE/DCE interface

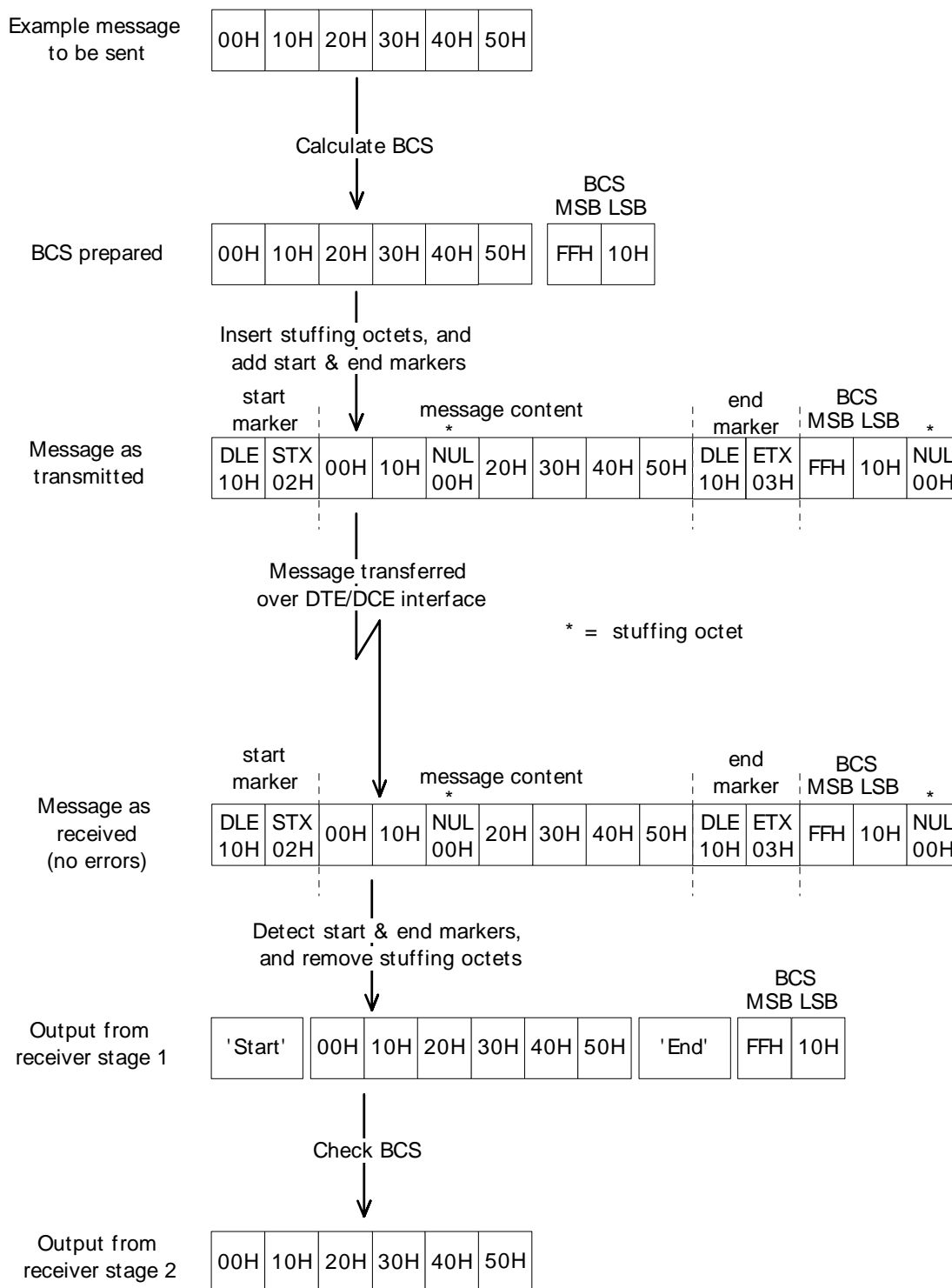

Figure B.6

Annex C (informative): Change History

TSG-T#	TDoc	VER	CR	REV	REL	CAT	WORKITEM	SUBJECT	NEW_ VER
T#3			New					Creation of 3GPP 27.005 v1.0.0 out of GSM 07.05 v7.0.0	3.0.0
T#6	TP-99237	3.0.0	001		R99	F	TEI	Adaptations for UMTS	3.1.0
T#11	-	3.1.0	-		Rel-4			Upgrade to Rel-4	4.0.0
T#13	TP-010221	4.0.0	002		Rel-4	F	TEI4	Conversion of GSM to 3GPP references	4.1.0
T#16	TP-020103	4.1.0	004		Rel-4	F	TI-ATC	Correction in description of +CNMA	4.2.0
		4.2.0						Make figure 0.1 visible	4.2.1

History

Document history		
V4.0.0	March 2001	Publication
V4.1.0	September 2001	Publication
V4.2.0	June 2002	Publication (Withdrawn)
V4.2.1	January 2005	Publication