

# ETSI TS 127 001 V5.10.0 (2006-12)

---

*Technical Specification*

**Digital cellular telecommunications system (Phase 2+);  
Universal Mobile Telecommunications System (UMTS);  
General on Terminal Adaptation Functions (TAF)  
for Mobile Stations (MS)  
(3GPP TS 27.001 version 5.10.0 Release 5)**

---



---

Reference

RTS/TSGC-0327001v5a0

---

Keywords

GSM, UMTS

**ETSI**

650 Route des Lucioles  
F-06921 Sophia Antipolis Cedex - FRANCE

Tel.: +33 4 92 94 42 00 Fax: +33 4 93 65 47 16

Siret N° 348 623 562 00017 - NAF 742 C  
Association à but non lucratif enregistrée à la  
Sous-Préfecture de Grasse (06) N° 7803/88

---

**Important notice**

Individual copies of the present document can be downloaded from:

<http://www.etsi.org>

The present document may be made available in more than one electronic version or in print. In any case of existing or perceived difference in contents between such versions, the reference version is the Portable Document Format (PDF). In case of dispute, the reference shall be the printing on ETSI printers of the PDF version kept on a specific network drive within ETSI Secretariat.

Users of the present document should be aware that the document may be subject to revision or change of status. Information on the current status of this and other ETSI documents is available at

<http://portal.etsi.org/tb/status/status.asp>

If you find errors in the present document, please send your comment to one of the following services:

[http://portal.etsi.org/chaicor/ETSI\\_support.asp](http://portal.etsi.org/chaicor/ETSI_support.asp)

---

**Copyright Notification**

No part may be reproduced except as authorized by written permission.  
The copyright and the foregoing restriction extend to reproduction in all media.

© European Telecommunications Standards Institute 2006.  
All rights reserved.

**DECT**<sup>TM</sup>, **PLUGTESTS**<sup>TM</sup> and **UMTS**<sup>TM</sup> are Trade Marks of ETSI registered for the benefit of its Members.  
**TIPHON**<sup>TM</sup> and the **TIPHON logo** are Trade Marks currently being registered by ETSI for the benefit of its Members.  
**3GPP**<sup>TM</sup> is a Trade Mark of ETSI registered for the benefit of its Members and of the 3GPP Organizational Partners.

---

## Intellectual Property Rights

IPRs essential or potentially essential to the present document may have been declared to ETSI. The information pertaining to these essential IPRs, if any, is publicly available for **ETSI members and non-members**, and can be found in ETSI SR 000 314: "*Intellectual Property Rights (IPRs); Essential, or potentially Essential, IPRs notified to ETSI in respect of ETSI standards*", which is available from the ETSI Secretariat. Latest updates are available on the ETSI Web server (<http://webapp.etsi.org/IPR/home.asp>).

Pursuant to the ETSI IPR Policy, no investigation, including IPR searches, has been carried out by ETSI. No guarantee can be given as to the existence of other IPRs not referenced in ETSI SR 000 314 (or the updates on the ETSI Web server) which are, or may be, or may become, essential to the present document.

---

## Foreword

This Technical Specification (TS) has been produced by ETSI 3rd Generation Partnership Project (3GPP).

The present document may refer to technical specifications or reports using their 3GPP identities, UMTS identities or GSM identities. These should be interpreted as being references to the corresponding ETSI deliverables.

The cross reference between GSM, UMTS, 3GPP and ETSI identities can be found under <http://webapp.etsi.org/key/queryform.asp>.

# Contents

Intellectual Property Rights .....	2
Foreword.....	2
Foreword.....	6
1 Scope .....	7
2 References .....	7
3 Definitions and abbreviations.....	11
3.1 Definitions .....	11
3.2 Abbreviations .....	11
4 Access reference configuration .....	12
5 Functions to support data services.....	13
6 Support of non transparent Bearer Services .....	13
6.1 Functions of the Layer 2 Relay .....	13
6.1.1 Layer 2 Relay in Frame Tunneling Mode .....	14
6.2 Radio Link Services Used .....	15
6.3 Flow Control - General Description .....	15
6.3.1 End to End Flow Control .....	15
6.3.2 Back Pressure.....	15
6.3.3 Receive not Ready .....	15
6.4 User initiated service level up and down grading (applies to A/Gb and GERAN Iu mode only) .....	15
6.5 Asymmetry preference indication (applies to A/Gb and GERAN Iu mode only) .....	16
7 Structure of the 3GPP TS 27-series of Specifications.....	16
8 Functions common to all interfaces.....	17
8.1 Synchronization of the Traffic Channel .....	17
8.1.1 Transparent services .....	17
8.1.1.1 Initial procedure for traffic channel types TCH/F4.8 and TCH/F9.6.....	17
8.1.1.2 Initial procedure for traffic channel types TCH/F14.4 and TCH/F28.8 .....	18
8.1.1.3 Subsequent procedures for traffic channel types TCH/F4.8, TCH/F9.6, TCH/F14.4, and TCH/F28.8 .....	18
8.1.1.3.1 V.-series interface .....	18
8.1.1.3.2 X.-series interface .....	18
8.1.1.3.3 S interface (I.420).....	18
8.1.1.4 Procedures for RLC .....	18
8.1.1.4.1 V.-series interface .....	18
8.1.2 Non-transparent services.....	19
8.1.2.1 V.-series interface .....	19
8.1.2.2 X.-series interface .....	19
8.1.2.3 S interface (I.420) (does not apply to UTRAN Iu mode).....	19
8.1.3 Action on loss of synchronization.....	19
8.1.3.1 Loss at the TAF-radio interface .....	19
8.1.3.2 Loss at the TAF-terminal interface .....	19
8.2 Filtering of Channel Control Information (A/Gb or GERAN Iu mode transparent mode only) .....	19
8.2.1 General.....	19
8.2.2 Filtering process to be applied .....	20
8.2.2.1 V.-series interface .....	20
8.2.2.2 X.-series interface .....	20
8.2.2.3 Filtering mechanism.....	21
8.2.2.3.1 Traffic channel types TCH/F4.8 and TCH/F9.6.....	21
8.2.2.3.2 Traffic channel type TCH/F14.4 .....	21
8.3 Terminal Compatibility Decision .....	21
8.3.1 Compatibility Check .....	21
8.3.2 Selection of Appropriate Terminal Function .....	21

8.3.3	Indication of Compatibility Requirements to the PLMN.....	21
8.3.3.1	Indication in case of Mobile terminating calls .....	21
8.3.3.2	Indication in case of Mobile originating calls .....	24
8.3.3.3	Differences in validity of BC parameter values in A/Gb mode, GERAN Iu mode and UTRAN Iu mode.....	26
8.4	Test Loops .....	26
8.5	Alternate speech/facsimile group 3 .....	26
8.5.1	In case of A/Gb mode .....	26
8.5.2	In case of UTRAN Iu mode .....	26
8.6	Multislot configuration split/combine function.....	27
8.6.1	Non-transparent data.....	27
8.6.2	Transparent data.....	27
8.7	EDGE multiplexing function.....	27
8.8	Seamless data rate change .....	27
<b>Annex A (informative):</b>	<b>List of Bearer Capability Elements .....</b>	<b>28</b>
<b>Annex B (normative):</b>	<b>Setting of Bearer Capability, Low Layer Compatibility and High Layer Compatibility Information Element for PLMN Bearer Services and PLMN TeleServices .....</b>	<b>35</b>
B.0	Scope .....	35
B.1	Bearer Capability Information Element .....	35
B.1.1	Introduction .....	35
B.1.1.1	General Consideration .....	35
B.1.1.2	Interpretation of the Diagrams .....	36
B.1.2	Bearer Service 20, Data Circuit Duplex Asynchronous .....	48
B.1.2.1	Unrestricted / restricted digital information transfer capability .....	48
B.1.2.2	3,1 kHz audio ex-PLMN information transfer capability .....	50
B.1.2.3	Frame Tunnelling Mode .....	52
B.1.2.4	PIAFS .....	53
B.1.3	Bearer Service 30, Data Circuit Duplex Synchronous .....	54
B.1.3.1	Unrestricted/restricted digital information transfer capability .....	54
B.1.3.1.1	Transparent FNUR <= 48 kbit/s (TCH/F4.8, TCH/F9.6, TCH/14.4, TCH/F28.8) .....	54
B.1.3.1.2	X.32 Case .....	55
B.1.3.1.3	Transparent FNUR=56 kbit/s, including 3G-H.324/M, (TCH/F9.6, TCH/F32.0, UTRAN Iu mode) .....	56
B.1.3.1.4	Transparent FNUR = 56kbit/s, including 3G-H.324/M (TCH/F14.4).....	58
B.1.3.1.5	Transparent FNUR = 64kbit/s, including 3G-H.324/M (TCH/F9.6, TCH/F14.4, TCH/F32.0, UTRAN Iu mode)) .....	59
B.1.3.1.6	3G-H.324/M, FNUR=32.0 kbit/s (TCH/F32.0, UTRAN Iu mode).....	60
B.1.3.1.7	Synchronous transparent 56 kbit/s (RDI) and 64kbit/s (UDI) (UTRAN Iu mode) .....	62
B.1.3.2	3,1 kHz audio ex-PLMN information transfer capability .....	63
B.1.3.2.1	Non-X.32 Cases .....	63
B.1.3.2.2	X.32 Case .....	64
B.1.3.2.3	3G-H.324/M Case .....	65
B.1.4	Bearer Service 40 ... 46, PAD Access Asynchronous .....	66
B.1.5	Bearer Service 50 ... 53 ,Data Packet Duplex Synchronous, Unrestricted digital information transfer capability .....	66
B.1.6	Bearer Service 61, Alternate Speech/Data .....	66
B.1.7	Bearer Service 81, Speech followed by Data .....	66
B.1.8	Teleservice 11 ... 12, Speech .....	67
B.1.9	Teleservice 21 ... 23, Short Message .....	68
B.1.10	Teleservice 61, Alternate Speech and Facsimile group 3 .....	68
B.1.10.1	Teleservice 61, Speech .....	68
B.1.10.2	Teleservice 61, Facsimile group 3 in A/Gb mode.....	69
B.1.10.3	Teleservice 61, Facsimile group 3 in UTRAN Iu mode .....	70
B.1.11	Teleservice 62, Automatic Facsimile group 3 .....	71
B.1.12	Valid combinations of FNUR, WAIUR, ACC, mTCH .....	71
B.1.12.1	Transparent Services .....	71
B.1.12.2	..... Non-transparent services	72

B.1.13	Assignment of radio access bearer parameters depending on FNUR and WAIUR.....	73
B.1.13.1	Transparent Services.....	73
B.1.13.2	Non-transparent services for UTRAN Iu mode .....	74
B.1.13.3	Non-transparent services for GERAN Iu mode .....	74
B.2	Low Layer/High Layer Compatibility Information Element .....	76
B.2.1	Introduction .....	76
B.2.1.1	General Consideration .....	76
B.2.1.2	Interpretation of the Tables.....	77
B.2.2	LLC Bearer Service 20.....	77
B.2.2.1	Unrestricted / restricted digital information transfer capability .....	77
B.2.2.2	3,1 kHz audio ex-PLMN information transfer capability .....	77
B.2.3	LLC Bearer Service 30.....	78
B.2.3.1	Unrestricted / restricted digital information transfer capability .....	78
B.2.3.2	3,1 kHz audio ex-PLMN information transfer capability .....	78
B.2.4	LLC Bearer Services 41 ... 46 .....	79
B.2.5	LLC Bearer Services 51 ... 53 .....	79
B.2.6	LLC Bearer Service 61 .....	79
B.2.7	LLC Bearer Service 81 .....	79
B.2.8	HLC Teleservices 11 ... 12 .....	79
B.2.9	HLC Teleservices 21 ... 23 .....	79
B.2.10	HLC Teleservice 61.....	79
B.2.11	HLC Teleservice 62.....	80
<b>Annex C (informative):</b>	<b>Change history .....</b>	<b>81</b>
History .....	History .....	83

---

# Foreword

This Technical Specification has been produced by the 3<sup>rd</sup> Generation Partnership Project (3GPP).

The present document specifies the functions needed for terminal adaptation within the 3GPP system.

The contents of the present document are subject to continuing work within the TSG and may change following formal TSG approval. Should the TSG modify the contents of the present document, it will be re-released by the TSG with an identifying change of release date and an increase in version number as follows:

Version x.y.z

where:

- x the first digit:
  - 1 presented to TSG for information;
  - 2 presented to TSG for approval;
  - 3 or greater indicates TSG approved document under change control.
- y the second digit is incremented for all changes of substance, i.e. technical enhancements, corrections, updates, etc.
- z the third digit is incremented when editorial only changes have been incorporated in the document.

---

# 1 Scope

The present document is based on the principles of terminal adaptor functions presented in the ITU-T I-series of Recommendations (I.460 to I.463).

The PLMN supports a wide range of voice and non-voice services in the same network. In order to enable non-voice traffic in the PLMN there is a need to connect various kinds of terminal equipment to the Mobile Termination (MT). The target of the present document is to outline the functions needed for the terminal adaptation.

The bearer services are described in 3GPP TS 22.002 and the general network configuration is described in 3GPP TS 23.002. The PLMN access reference configuration is defined in 3GPP TS 24.002. The various connection types used in the A/Gb mode or GERAN Iu mode PLMN are presented in 3GPP TS 43.010. Terminology used in the present document is presented in 3GPP TR 21.905 and 3GPP TS 29.990. For support of data services between a PLMN and other networks see 3GPP TS 29.007.

The present document is valid for a 2<sup>nd</sup> generation PLMN (A/Gb mode) as well as for a 3<sup>rd</sup> generation PLMN (Iu mode). If text applies only for one of these systems it is explicitly mentioned by using the terms "A/Gb mode" and "UTRAN Iu mode". If text applies to both of the systems, but a distinction between the ISDN/PSTN and the PLMN is necessary, the term "PLMN" is used.

NOTE 1: From R99 onwards the following services are no longer required by a PLMN:

- the dual Bearer Services "alternate speech/data" and "speech followed by data";
- the dedicated services for PAD and Packet access;
- BS 21 ... 26 and BS 31 ... 34.

From REL-4 onwards the following service is no longer required by a PLMN:

- the synchronous Bearer Service non-transparent (BS 30 NT).
- Non-transparent facsimile (TS 61/62 NT) for the A/Gb mode and GERAN Iu mode.

The support of these services is still optional. The specification of these services is not within the scope of the present document. For that, the reader is referred to former releases.

NOTE2 : Please note that the Gb interface does not play any role in the scope of the present document although the term "A/Gb mode" is used.

---

# 2 References

The following documents contain provisions which, through reference in this text, constitute provisions of the present document.

- References are either specific (identified by date of publication, edition number, version number, etc.) or non-specific.
- For a specific reference, subsequent revisions do not apply.
- For a non-specific reference, the latest version applies. In the case of a reference to a 3GPP document (including a GSM document), a non-specific reference implicitly refers to the latest version of that document *in the same Release as the present document*.

[1] Void.

[2] 3GPP TS 22.002: "Circuit Bearer Services (BS) supported by a Public Land Mobile Network (PLMN)".

[3] 3GPP TS 22.003: "Circuit Teleservices supported by a Public Land Mobile Network (PLMN)".



- [4] 3GPP TS 23.002: "Network architecture".
- [5] 3GPP TS 43.010: "GSM Public Land Mobile Network (PLMN) connection types".
- [6] 3GPP TS 24.002: "GSM - UMTS Public Land Mobile Network (PLMN) access reference configuration".
- [7] 3GPP TS 24.008: "Mobile radio interface layer 3 specification; Core network protocols -Stage 3".
- [8] 3GPP TS 44.021: "Rate adaption on the Mobile Station - Base Station System (MS - BSS) interface".
- [9] 3GPP TS 24.022: "Radio Link Protocol (RLP) for circuit switched bearer and teleservices".
- [10] 3GPP TS 45.005: " Radio transmission and reception".
- [11] 3GPP TS 27.002: "Terminal Adaptation Functions (TAF) for services using Asynchronous bearer capabilities".
- [12] 3GPP TS 27.003: "Terminal Adaptation Functions (TAF) for services using Synchronous bearer capabilities".
- [13] Void.
- [14] Void.
- [15] Void.
- [16] Void.
- [17] Void.
- [18] Void.
- [19] Void.
- [20] Void.
- [21] 3GPP TS 29.007: "General requirements on interworking between the Public Land Mobile Network (PLMN) and the Integrated Services Digital Network (ISDN) or Public Switched Telephone Network (PSTN)".
- [22] Void.
- [23] Void.
- [24] Void.
- [25] Void.
- [26] ITU-T V-series Recommendations: "Data communication over the telephone network".
- [27] Void.
- [28] ITU-T X-series Recommendations: "Data networks and open system communication".
- [29] Void
- [30] ITU-T Recommendation X.150: "Data Communication Networks: Transmission, Signalling and Switching, Network Aspects, Maintenance and Administrative Arrangements".
- [31] Void.
- [32] ITU-T Recommendation V.250: "Serial asynchronous automatic dialling and control".
- [33] ITU-T Recommendation V.54: "Loop test devices for modems".

- [34] ITU-T Recommendation V.110: "Support by an ISDN of data terminal equipments with V-Series type interfaces".
- [35] ITU-T Recommendation I.460-I.463: "ISDN Overall Network Aspects and Functions, User Network Interfaces".
- [36] ITU-T Recommendation Q.931 (1998): " ISDN user network interface layer 3 specification for basic call control".
- [37] ETSI ETR 018: "Integrated Services Digital Network (ISDN), Application of the Bearer Capability (BC), High Layer Compatibility (HLC) and Low Layer Compatibility (LLC) information elements by terminals supporting ISDN services ".
- [38] ISO/IEC 6429: "Information technology - Control functions for coded character sets".
- [39] Void.
- [40] Void.
- [41] Void.
- [42] ITU-T Recommendation V.120: "Support by an ISDN of data terminal equipment with V-Series type interfaces with provision for statistical multiplexing".
- [43] 3GPP TS 23.034:"High Speed Circuit Switched Data (HSCSD) - Stage 2 "..
- [44] ISO/IEC 3309: "Telecommunications and information exchange between systems - High-level data link control (HDLC) procedures - Frame structure"
- [45] Void.
- [46] 3GPP TR 21.905: "Vocabulary for 3GPP Specifications ".
- [47] 3GPP TR 25.990: "Vocabulary for UTRAN".
- [48] 3GPP TS 25.322: "Radio Link Control (RLC) protocol specification".
- [49] Void.
- [50] Mobile Internet Access Forum: "PIAFS Specification Ver. 1.1, 2.1".
- [51] ITU-T Recommendation V.80: "In-band DCE control and synchronous data modes for asynchronous DTE".
- [52] 3GPP TS 43.045: "Technical realization of facsimile group 3 service - transparent".
- [53] 3GPP TS 45.001: "Physical layer on the radio path; General description".
- [54] 3GPP TS 22.034: "High Speed Circuit Switched Data (HSCSD); Stage 1".
- [55] 3GPP TS 23.107: "Quality of Service QoS concept and architecture".
- [56] 3GPP TS 48.020: "Rate adaption on the Base Station System - Mobile-services Switching Centre (BSS - MSC) interface".
- [57] 3GPP TS 22.001: "Principles of circuit telecommunication services supported by a Public Land Mobile Network (PLMN) ".
- [58] ITU-T Recommendation I.440: "(see ITU-T Recommendation Q.920) ".
- [59] ITU-T Recommendation: I.450: "(see ITU-T Recommendation Q.930) ".
- [60] ITU-T Recommendation H.223: "Multiplexing protocol for low bit rate multimedia communication".
- [61] ITU-T Recommendation H.245: "Control protocol for multimedia communication".

- [62] ITU-T Recommendation V.21: "300 bits per second duplex modem standardized for use in the general switched telephone network".
- [63] ITU-T Recommendation V.22: "1200 bits per second duplex modem standardized for use in the general switched telephone network and on point-to-point 2-wire leased telephone-type circuits".
- [64] ITU-T Recommendation V.22bis: "2400 bits per second duplex modem using the frequency division technique standardized for use on the general switched telephone network and on point-to-point 2-wire leased telephone-type circuits".
- [65] ITU-T Recommendation V.26ter: "2400 bits per second duplex modem using the echo cancellation technique standardized for use on the general switched telephone network and on point-to-point 2-wire leased telephone-type circuits".
- [66] ITU-T Recommendation V.31: "Electrical characteristics for single-current interchange circuits using optocouplers".
- [67] ITU-T Recommendation V.32: "A family of 2-wire, duplex modems operating at data signalling rates of up to 9600 bit/s for use on the general switched telephone network and on leased telephone-type circuits".
- [68] ITU-T Recommendation V.34: "A modem operating at data signalling rates of up to 33 600 bit/s for use on the general switched telephone network and on leased point-to-point 2-wire telephone-type circuits".
- [69] ITU-T Recommendation V.42: "Error-correcting procedures for DCEs using asynchronous-to-synchronous conversion".
- [70] ITU-T Recommendation X.30: "Support of X.21, X.21 bis and X.20 bis based Data Terminal Equipments (DTEs) by an Integrated Services Digital Network (ISDN)".
- [71] ITU-T Recommendation Q.920: "ISDN user-network interface data link layer - General aspects".
- [72] ITU-T Recommendation Q.930: "ISDN user-network interface layer 3 - General aspects".
- [74] 3GPP TS 23.146: "Technical realisation of facsimile Group 3 service - non-transparent".

---

## 3 Definitions and abbreviations

### 3.1 Definitions

The term 'Mobile Station' ( MS ) in the present document is synonymous with the term 'User Equipment' ( UE ) as defined in 3GPP TR 21.905.

The term 'TE2' in the present document is synonymous with the term 'TE' as defined in 3GPP TR 21.905.

The term 'MT2' in the present document is synonymous with the term 'MT' as defined in 3GPP TR 21.905.

For the purposes of the present document the following terms and definitions given in 3GPP TS 21.905 and the following apply:

**A/Gb mode:** indicates that the text applies only to a system or sub-system which operate in A/Gb mode of operation, i.e. with a functional division that is in accordance with the use of an A or a Gb interface between the radio access network and the core network

**Iu mode:** indicates that the text applies only to a system or a sub-system which operates in Iu mode of operation, i.e. with a functional division that is in accordance with the use of an Iu-CS or Iu-PS interface between the radio access network and the core network

### 3.2 Abbreviations

For the purposes of the present document, the abbreviations given in 3GPP TR 21.905 and 3GPP TR 25.990 and the following apply:

CALL PROC	CALL PROCEEDING
CALL CONF	CALL CONFIRMED
CONNACK	CONNECT ACKNOWLEDGEMENT
EDGE channel	A general term referring to channels based on 8PSK modulation; i.e. TCH/F28.8, TCH/F32.0, and TCH/F43.2.
FTM	Frame Tunnelling Mode
PIAFS	PHS Internet Access Forum Standard
PHS	Personal Handyphone System

## 4 Access reference configuration

Figure 1 presents the reference configuration for access to an A/Gb mode PLMN and GERAN Iu mode (see 3GPP TS 24.002).

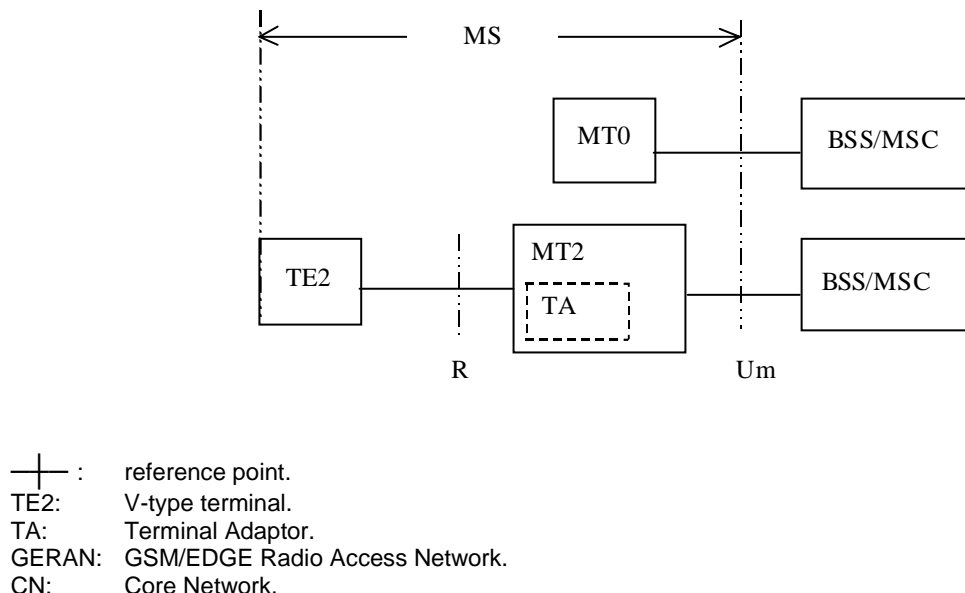

**Figure 1: PLMN Access Reference Configuration (in A/Gb mode and GERAN Iu mode)**

Within the scope of the present document the Mobile Termination MT0 means a fully integrated MS including data terminal and its adaptation functions. MT2 includes ITU-T V-series terminal adaptation functions among other MT functions.

Figure 2 presents the access reference configuration for UTRAN Iu mode. There is no reference point identified for the TAF. The TAF is considered as a part of the Mobile Termination.

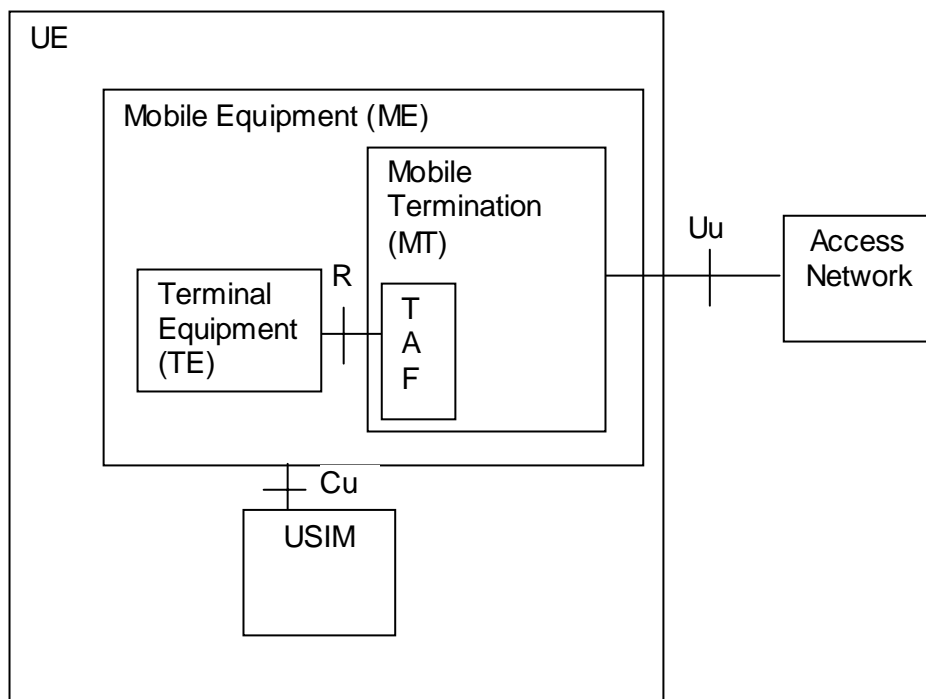

**Figure 2: UTRAN Iu mode PLMN Access Reference Configuration**

---

## 5 Functions to support data services

The main functions of the MT to support data services are:

- functions to ensure conformity of terminal service requests to network capability;
- physical connection of the R reference point;
- flow control of signalling and mapping of user signalling to/from the PLMN access signalling;
- rate adaptation of user data (see 3GPP TS 44.021) and data formatting for the transmission SAP (3GPP TS 25.322);
- flow control of non-transparent user data and mapping of flow control for asynchronous data services;
- support of data integrity between the MS and the interworking function in the PLMN;
- end-to-end synchronization between terminals;
- filtering of status information;
- functions to support non-transparent bearer services e.g. termination of the Radio Link Protocol (RLP) and the Layer 2 Relay function (L2R) including optional data compression function (where applicable);
- terminal compatibility checking;
- optional support of local test loops.

In addition, functions to support autocalling and autoanswering are optionally specified in accordance with ITU-T Recommendation V.250 (although the use of other autocalling/auto-answering procedures are not prohibited provided that mapping in a functionally equivalent way to 3GPP TS 24.008 call control is also provided).

Other functional entities may be envisaged apart from the TAF. One of the physical interface to all these functions is the DTE/DCE interface to the MT. Normally, this DTE/DCE interface is associated with the TAF, if available. Therefore the access to any of these other functional entities, if implemented, via the DCE/DTE interface, are triggered by appropriate command sequences which are described in the applicable specifications (although the use of other procedures is not prohibited provided that mapping in a functionally equivalent way is also provided). These command sequences shall be issued by the DTE only when the MT is in the appropriate command status and there is no data connection pending. They are interpreted by an MT internal control function and result in an association of the DTE/DCE interface with the addressed function, if available.

---

## 6 Support of non transparent Bearer Services

In order to support asynchronous non transparent bearer services a Layer 2 Relay (L2R) function is included in the mobile termination. The details of the particular L2R function for the different asynchronous non transparent bearer services are contained in the appropriate 3GPP 27-series Specification. This clause describes the general aspects of the L2R function.

The Layer 2 Relay (L2R) function provides for the reliable transportation of known, i.e. asynchronous non transparent, user protocols across the radio interface of a PLMN. The L2R functions are located in the Mobile Termination (MT) and the Interworking Function (IWF) associated with a Mobile Switching Centre (MSC). The L2R uses the services provided by the Radio Link Protocol (RLP) to transport the asynchronous non transparent protocol information between the MS and the IWF.

### 6.1 Functions of the Layer 2 Relay

The complete protocol reference models for data and telematic services are described in 3GPP TS 43.010. The subset of those protocol reference models relating to the L2R function is reproduced in figure 2A.

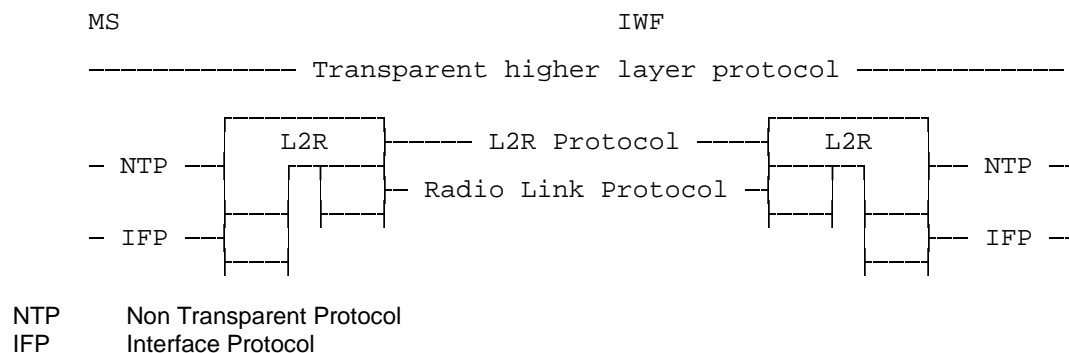

Figure 2A

The Non Transparent Protocol (NTP) is normally a layer 2 protocol for OSI conformant protocols or an equivalent in the case of non OSI protocols. The Interface Protocol (IFP) is normally a layer 1 protocol for OSI conformant systems or equivalent for non OSI systems.

The L2R can be considered to consist of 3 sub-functions, see figure 3.

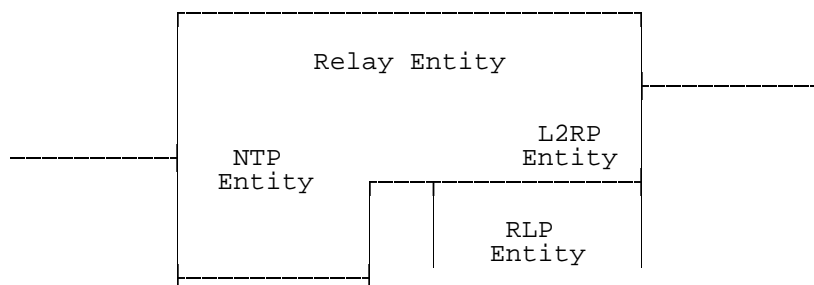

Figure 3

The 3 sub-functions are:

- a Non Transparent Protocol Entity;
- a L2R Protocol Entity;
- a Relay Entity.

The NTP-entity interfaces the L2R to the IFP-entity and provides an interface to the particular NTP.

The L2RP-entity interfaces the L2R to the RLP-entity and provides an interface to the appropriate L2R protocol.

The Relay-entity provides the mapping between the NTP-entity and the L2R-entity. If applicable, it contains the data compression function. The negotiable parameters are exchanged with the remote Relay-entity by means of the RLP XID frame.

It should be noted that the inter-layer interfaces within the MS and the IWF and within the L2R is not specified by 3GPP, The description given is for explanatory purposes only and is not intended to indicate a method of implementation. Therefore, the specification of the L2R is in terms of the peer-peer protocols. Generally, the non transparent and interface protocols are specified elsewhere, e.g. ITU-T Recommendations V.110 or V.120. Thus the main specification for the L2R consists of the L2R peer-peer protocols.

### 6.1.1 Layer 2 Relay in Frame Tunneling Mode

L2R is used in FTM to transport asynchronous HDLC (see [44]) frames between the MS and the IWF. In this case there is no NTP entity on the IWF side. Instead, the L2R entity interfaces a conversion function that performs a mapping between asynchronous and synchronous HDLC frames, which are transported on a UDI or RDI bearer with X.31 flag stuffing as rate adaptation. Consequently there is no error correction or flow control on the fixed network leg. (The HDLC FCS is used by the higher layer protocol, and error correction and flow control are performed end-to-end between the two DTEs.)

## 6.2 Radio Link Services Used

The L2R function uses services defined in 3GPP TS 24.022.

## 6.3 Flow Control - General Description

A flow control active condition may take place under a number of circumstances:

- end-to-end flow control (DTE to DTE matter);
- backpressure (buffers filling);
- receive not ready (RLP condition).

It is possible that there may be an interaction between flow control active and inactive conditions in each circumstance.

### 6.3.1 End to End Flow Control

A DTE may wish to send a flow control active condition to another DTE.

Provisions exist in the L2R entity to transfer a flow control active condition (sent by its associated DTE) to the other L2R entity as soon as possible. This mechanism in the L2R entities allows such a flow control condition to be put ahead of any queuing which exists in the L2R entities.

Such a mechanism avoids undesirable build up of data buffers.

The L2R entity, receiving a flow control active condition from its associated DTE, stops sending data to that associated DTE immediately.

### 6.3.2 Back Pressure

The L2R and RLP entities have buffers which may become full to a predetermined threshold for a number of reasons, e.g. severe radio fading, failure or slowness of DTE to react to end to end flow control, certain RNR conditions. When this predetermined threshold is reached, a flow control active condition is sent to the associated DTE which is then prevented from sending any data. Subsequently, the flow control inactive condition is sent to the associated DTE when the L2R or RLP entities have indicated that there is sufficient free capacity in their buffers for data flow from the associated DTE to proceed.

The corresponding peer-layer procedure to assess the respective buffer conditions is a layer management matter and is not dealt with here. It is also considered an implementation matter to ensure that such procedure do not result in loss of data or considerable reduction in throughput.

In FTM, back pressure is not applicable towards the DTE on the fixed network side, because there is no flow control mechanism on the fixed network leg. Consequently buffer overflow may occur leading to loss of data, which is left to the higher layer protocol to handle.

### 6.3.3 Receive not Ready

When the RNR condition arises, an RLP indication is sent to the other RLP entity which in turn shall send a flow control active condition to its associated L2R entity. That L2R entity shall then send a flow control active condition to its associated DTE.

An RNR condition may result in the Execution of "back pressure" as mentioned under subclause 6.3.2.

## 6.4 User initiated service level up and down grading (applies to A/Gb and GERAN lu mode only)

When the value of the negotiated UIMI parameter is greater than 0, the MS may at any time during the call, control, to some extent, the number of traffic channels to be used. This is done by signalling a higher or lower value for the Wanted Air Interface User Rate (WAIUR) and maximum number of traffic channels (mTCH). The network may assign



an AIUR matching the WAIUR using up to mTCH traffic channels, provided that the resources are available (3GPP TS 22.034, 3GPP TS 23.034 and 3GPP TS 24.008).

If the value of the RLP optional feature 'Up signalling' is negotiated to 1, the MS may receive a suggestion from the network to initiate an upgrading. This occurs when the following condition holds:

The IWF:

- 1) is receiving user data from the fixed network side at a higher rate than the current AIUR; or
- 2) in symmetrical calls only, can send user data towards the fixed network side at a higher rate than the current AIUR.

The MS can detect the condition stated in 1) and 2) above by examining the value of the UP bit in the received RLP S and I+S frames. When the condition does not hold, the value of the UP bit is continuously 0. If the condition does hold, the number of 1s between two consecutive 0s indicates the number of traffic channels to upgrade by. There is no need to repeat this indication since the FCS protects it. For instance, if the UP bit sequence is ...01100... and the current number of assigned traffic channels is 2, then an upgrading 4 traffic channels is suggested.

NOTE: From MSC/IWF's perspective a TCH/F28.8 or TCH/F43.2 EDGE configuration is identical to a multislot 2×TCH/F14.4 or 3×TCH/F14.4 configuration. Therefore, a factor of 1/2 or 1/3 has to be applied to the suggested increase when the assigned up link channel is TCH/F28.8 or TCH/F43.2 respectively.

The MS may use the information signalled in the UP bit to find out when a service level upgrading may increase the data throughput. In order to initiate a service level upgrading, the value of UIMI shall be greater than the number of currently assigned channels.

In order to determine when to downgrade, the MS may compare the rate of received and sent information in the RLP frames to the AIUR. If the rate of received and sent information is less than the current AIUR the MS may initiate a downgrading.

User initiated service level up and down grading mechanism may also be used to modify the asymmetry preference, see subclause 6.5. This is achieved by sending a new value of the asymmetry preference in the BC-IE.

## 6.5 Asymmetry preference indication (applies to A/Gb and GERAN Iu mode only)

The MS's classmark may restrict the possible number of channels or modulation that may be assigned by the network in one of the directions. This may result in an asymmetric transmission, i.e., different numbers of channels or modulations are assigned in each direction.

Asymmetric transmission may also result from a preference indication. At call set up, the MS may send an asymmetry preference indication in the BC-IE (see 3GPP TS 24.008). There are three options:

- 1) no preference;
- 2) up link biased asymmetry preferred;
- 3) down link biased asymmetry preferred.

If down or up link asymmetry preference is indicated, the network shall not assign EDGE channels on the unbiased link. If the network assigns EDGE channels on the biased link, it shall assign TCH/F14.4 on the unbiased link. The WAIUR shall then apply to the biased link.

---

# 7 Structure of the 3GPP TS 27-series of Specifications

The structure of the Specifications is as follows:

3GPP TS 27.001 General on Terminal Adaptation Functions for Mobile Stations.

3GPP TS 27.002 Terminal Adaptation Functions for Services using Asynchronous Bearer Capabilities.

This document defines the interfaces and terminal adaptation functions integral to a MT which enable the attachment of Asynchronous Terminals to a MT.

3GPP TS 27.003 Terminal Adaptation Functions for Services using Synchronous Bearer Capabilities.

This document defines the interfaces and terminal adaptation functions integral to a MT which enable the attachment of Synchronous Terminals to a MT.

---

## 8 Functions common to all interfaces

### 8.1 Synchronization of the Traffic Channel

As long as there is no connection between the traffic channel and the interface to the TE this interface shall be terminated in the appropriate way.

Prior to exposing the traffic channel of a PLMN connection to transmission of user data, the controlling entities of the connection shall assure the availability of the traffic channel(s). This is done by the so called synchronization process:

- starting on the indication of "physical connection established" resulting from the PLMN inherent outband signalling procedure. This indication is given:
  - for MO calls: on reception of the CONNECT message;
  - for MT calls: on reception of the CONNECT ACKNOWLEDGE message;
  - for mobile initiated in-call modification: on reception of the MODIFY COMPLETE message; and
  - for network initiated in-call modification: on sending the RR/RRC message confirming the reconfiguration of the traffic channel (in A/Gb mode: ASSIGNMENT COMPLETE, HANDOVER COMPLETE, or CHANNEL MODE MODIFY ACKNOWLEDGE; in Iu mode: RADIO BEARER RECONFIGURATION COMPLETE, TRANSPORT CHANNEL RECONFIGURATION COMPLETE, or PHYSICAL CHANNEL RECONFIGURATION COMPLETE);
- ending by indicating the successful execution of this process to the controlling entity, which then takes care of the further use of the inband information (data, status).

During the call control phases (set-up and clear), the procedures at the V.-series DTE interfaces may be mapped completely to the out-of-band signalling procedure. The state of the S-bits and X-bits during the call control phases are in this case irrelevant to the DTE interface procedures. However, the "ready for data" condition (i.e. CTs 106 and 109) is derived from the status bits received by the TAF once synchronization is complete. Since half duplex operation is not supported by a PLMN, status bit SB is not needed to signal the turn around of the connection.

#### 8.1.1 Transparent services

##### 8.1.1.1 Initial procedure for traffic channel types TCH/F4.8 and TCH/F9.6

With respect to the TAF, for the transparent bearer capability support the synchronization procedure with the channel codings 2.4 kbit/s, 4.8 kbit/s and 9.6 kbit/s is as follows:

- sending of synchronization pattern 1/OFF (all data bits "1" / all status bits "OFF", all E-bits "1") to the IWF. In multislot transparent operation, the synchronisation pattern sent is 1/OFF with the exception of the bit positions S1, first X, S3, and S4 which contain the substream number and multiframe alignment pattern (see 3GPP TS 44.021);
- searching for detection of the synchronization pattern received from the IWF, and in multislot operation, also searching for the multiframe alignment pattern "0000 1001 0110 0111 1100 0110 1110 101" (see 3GPP TS 44.021) in bit position S4 and substream numbers in bit positions S1, first X, and S3. The value of the bits E4-E7 shall not be checked.

### 8.1.1.2 Initial procedure for traffic channel types TCH/F14.4 and TCH/F28.8

With respect to the TAF, for the transparent bearer capability support, the procedure with the TCH/F14.4 or TCH/F28.8 is as follows:

- sending of synchronization pattern 1/OFF (all data bits "1" / status bits in M2 "OFF") to the network in the multiframe structure with the multiframe alignment pattern "0000 1001 0110 0111 1100 0110 1110 101" in the M1 (see 3GPP TS 44.021) and, in a multislot or TCH/F28.8 case, sending substream numbers in the bit M2;
- searching for the detection of the multiframe alignment pattern "0000 1001 0110 0111 1100 0110 1110 101" (see 3GPP TS 44.021) in the bit M1 originating from the network, and, in a multislot or TCH/F28.8 case, searching for substream numbers in the bit M2. (Any 5 bits sequence in the multiframe alignment pattern is unique, i.e. the multiframe alignment can take place by the recognition of five successive S1 bits).

### 8.1.1.3 Subsequent procedures for traffic channel types TCH/F4.8, TCH/F9.6, TCH/F14.4, and TCH/F28.8

When the synchronisation pattern and, in case of multislot, TCH/F14.4 or TCH/F28.8 operation the multiframe alignment pattern from the IWF have been recognized as a steady state (see note) the TAF continues sending the synchronization patterns to the IWF until a timer T (= 500 ms) expires.

NOTE: An idle frame sent by the BSS and received by the MS has the same pattern as the synchronization pattern 1/OFF.

At the moment when the message CONNECT (MO) or CONNACK (MT) is received at the MS, it is guaranteed that this pattern is received from the MSC/IWF with the exception of a loss of frame synchronization on the Abis interface.

The handling of frame stealing in case of 2400 bit/s full rate data channels is implementation dependent.

#### 8.1.1.3.1 V.-series interface

During the synchronization process described above, i.e. while the synchronization pattern is being sent by the MT, CT106, 107 and 109 remain in the OFF condition.

After the expiration of the timer T of each allocated traffic channel for the call, the X and SB bits received from the IWF are mapped on to CT 106 and CT 109, respectively, at the MT/DTE interface according to the filtering process described in subclause 8.2. The received SA bit, if available, is ignored. The condition on CT107 is changed from "OFF" to "ON", the data bits received from the IWF are mapped to CT104, and CT103 is mapped to the data bits sent towards the IWF. The transmitted SA (if available), SB and X bits shall be set to "ON".

#### 8.1.1.3.2 X.-series interface

Void.

#### 8.1.1.3.3 S interface (I.420)

Void.

#### 8.1.1.4 Procedures for RLC

With respect to the TAF for T bearer support, the procedure is as follows:

- no access stratum SDUs are transmitted until an access stratum SDU is received.

#### 8.1.1.4.1 V-series interface

Until the first access stratum SDU is received at the transmission SAP, CT 106, 107 and 109 remain in the OFF condition. At the reception of the first SDU, CT 106, CT 107 and CT 109 are changed from OFF to ON at the DCE/DTE (TE/TAF) interface. The data received in each SDU are mapped to CT 104 and data on CT 103 are mapped to SDUs sent toward the RNC.

## 8.1.2 Non-transparent services

With respect to the TAF, for non-transparent bearer capability support, the synchronization procedure in A/Gb and GERAN Iu mode is as follows:

- firstly, receiving frames on all allocated traffic channels for the call;
- secondly, initiating the RLP link establishment by sending a RLP-SABM across the radio interface.

In UTRAN Iu mode, the TAF shall initiate the RLP after the physical connection has been established.

### 8.1.2.1 V.-series interface

During the synchronization process described above, i.e. while the synchronization pattern is being sent by the MT, CT106, 107 and 109 remain in the OFF condition.

When the RLP link has been established, CT107 shall be changed from "OFF" to "ON". From this time the information from/to the RLP, including status changes, shall be mapped by the L2R entity applicable to the particular bearer capability (3GPP TS 27.002 "L2R functionality").

### 8.1.2.2 X.-series interface

Void.

### 8.1.2.3 S interface (I.420) (does not apply to UTRAN Iu mode)

Void.

## 8.1.3 Action on loss of synchronization

### 8.1.3.1 Loss at the TAF-radio interface

In A/Gb and GERAN Iu mode, if the TAF detects a loss of synchronisation on one or more channels, it initiates the re-synchronisation process. The TAF searches for the data frame structure in those channels in which the synchronisation has been lost according to the initial procedures described in subclauses 8.1.1 and 8.1.2. The information received from the channels shall continue to be processed as if the synchronisation had not been lost, i.e. corrupted data is forwarded towards RLP entity or TE during the re-synchronisation process. No action shall be taken on the frames being transmitted towards the MSC, other than to continue sending them normally.

In UTRAN Iu mode, no action shall be taken.

### 8.1.3.2 Loss at the TAF-terminal interface

Void.

## 8.2 Filtering of Channel Control Information (A/Gb or GERAN Iu mode transparent mode only)

### 8.2.1 General

The DTEs used at the MS side of the PLMN conforms to ITU-T's DTE/DCE interface specifications, which assume basically an error-free environment, i.e.:

- limited distance, point-to-point local interconnection of the interface circuits for data and status;
- steady state signalling.

The envisaged use of these DTEs in the PLMN environment leads to the exposure of these "interconnections" to the PLMN radio channel. To assure proper operation even under these conditions appropriate measures have to be taken. In the non transparent case the RLP satisfies the requirement for both data and status lines.

In the transparent case the:

- data line aspects have to be dealt with end-to-end by the users; while
- status line aspects are of concern to the network, and are dealt with in the following.

## 8.2.2 Filtering process to be applied

Filtering of channel control information is relevant only at the MS side and in the transparent mode of operation. By applying filtering measures the condition of a DTE/DCE control interchange circuit, for which the DTE constitutes the information sink, is preserved until another condition is signalled for an "integration time" period by the channel control information (status bits) of the rate adaptation scheme.

The filtering mechanism is understood to reside between the rate adaptation function (information source) and the DTE (information sink). It receives the unfiltered condition of the respective control interchange circuit set according to the actual sequential appearance of the individual associated status bits and forwards the filtered condition to the DTE.

The filtering process starts when the traffic channel synchronization ends with the expiry of timer T.

### 8.2.2.1 V.-series interface

#### CT 106

In the transparent mode the remote inband control of this circuit is needed to support a modem retrain procedure.

OFF-ON transition at the MS authorizes the DTE to send data; if wrongly set, loss of data may occur.

ON-OFF transition at the MS causes the DTE to cease transmitting data; set wrongly may impair the performance in connection usage.

#### CT 109

In the transparent mode the remote inband control of this circuit is needed to:

- trigger the interpretation of received data;
- indicate to the DTE the state of the connection.

OFF-ON transition at the MS authorizes the DTE to rely on the condition of the received data interchange circuit, set wrongly may cause receipt of wrong data, while setting late may cause loss of data.

ON-OFF transition at the MS:

- causes the DTE to cease receiving data;
- may initiate release of the connection during a data phase by the DTE giving an ON-OFF transition on circuit 108/2.

Setting this condition wrongly may cause loss of data and potentially release the connection.

### 8.2.2.2 X.-series interface

Void.

### 8.2.2.3 Filtering mechanism

#### 8.2.2.3.1 Traffic channel types TCH/F4.8 and TCH/F9.6

A filtering mechanism shall be provided by an integration process on those SB and X bits carrying status information in the V.110 frame or in the multiframe structure. The integration periods applied are:

V-series	Transition	Integration period	Status stream
CT 106	Off-On	1 s	X
CT 106	On-Off	1 s	X
CT 109	Off-On	200 ms	SB
CT 109	On-Off	5 s	SB

The integration process shall ensure that the interchange circuits do not change state in response to spurious transitions of the status bits during the integration period.

The integration process shall operate reliably with error characteristics as specified in 3GPP TS 45.005.

#### 8.2.2.3.2 Traffic channel type TCH/F14.4

To change the state of CT 109 or CT 106, it is required that at least two consecutive SB-bits or X-bits, respectively, carry the same value.

## 8.3 Terminal Compatibility Decision

The establishment of a mobile terminated connection depends on a positive decision on the terminal compatibility. The Mobile Station (MS) contributes to this process by performing (depending on the individual call set-up condition):

- a compatibility check;
- the selection of the appropriate terminal function; and
- the indication of compatibility requirements to the PLMN;

initiated by a call set-up request from the PLMN. The aforementioned functions shall be carried out as follows.

### 8.3.1 Compatibility Check

Annex B of 3GPP TS 24.008 applies, particularly clause B.3, subclauses B.3.1 and B.3.2. As regards the therein mentioned user-to-user compatibility checking the following applies:

When the calling user requests a service with user-to-user compatibility significance indicated by the presence of HLC and LLC information element in the call set-up request, the MS shall check that the service supported by the called user matches concerning the contents of the HLC/LLC information element. If a mismatch is detected, then the MS shall reject the offered call using the cause No.88 "Incompatible Destination".

### 8.3.2 Selection of Appropriate Terminal Function

The MS shall select the appropriate terminal functions following a positive result of the compatibility check and/or forwarding the indication of compatibility requirements to the PLMN.

### 8.3.3 Indication of Compatibility Requirements to the PLMN

#### 8.3.3.1 Indication in case of Mobile terminating calls

In support of:

- PSTN originated calls; and

- ISDN originated calls using 3,1 kHz audio Bearer Capability (BC); as well as
- ISDN originated calls using unrestricted digital Bearer Capability but not specifying all parameters for deducing a Bearer Service.

Mobile specific requirements to be dealt with in the Bearer Capability information element the call confirmed message has been introduced in the call control protocol (3GPP TS 24.008). This also allows for re-negotiation of specific parameters at the beginning of the connection set-up process. The specific parameters are:

- a) mobile specific requirements:
- Connection element (transparent/non transparent);
  - Structure (note 1);
  - Synchronous/Asynchronous (note 8);
  - Rate adaptation/other rate adaptation (note 9);
  - User information layer 2 protocol (note 1);
  - Intermediate rate (note 2), (note 3);
  - Modem Type (note 1), (note 3);
  - User Rate (note 3);
  - Compression ,
  - Fixed network user rate, (note 3) (note 4);
  - Other modem type, (note 3) (note 4);
  - User initiated modification indication (note 4).

The following parameters are indicated by the MS to the network, only:

- Radio Channel Requirement;
- Acceptable channel codings (note 5);
- Maximum number of traffic channels, (note 5);
- Wanted air interface user rate (note 6) (note 7);
- Asymmetry preference indication (note 7).

NOTE 1: This parameter is correlated with the value of the parameter connection element.

NOTE 2: For non-transparent services this parameter is correlated with the value of the parameter negotiation of intermediate rate requested.

NOTE 3: Modification of these parameters may be proposed by the MS. The Network may accept it or not.

NOTE 4: This parameter shall be included by the MS only if it was received from the network.

NOTE 5: This parameter shall be included only if the parameter 'fixed network user rate' is included.

NOTE 6: This parameter shall be included only for non-transparent services and if the parameter 'fixed network user rate' is included.

NOTE 7: This parameter has to be included if EDGE channel coding(s) are included in Acceptable channel codings. In cases where this parameter would not otherwise be included, the value is set to 'Air interface user rate not applicable' or 'User initiated modification not requested' or "No preference".

NOTE 8: For FTM and PIAFS, this parameter may be negotiated as in table B.4e. How the subscription for BS20 is assured, is an operator matter.

NOTE 9: For FTM, PIAFS or Multimedia, this parameter may be negotiated as in table B.4f.

b) requirements with effects at the partner terminal:

- Number of data bits;
- Number of stop bits;
- Parity.

The MS indicates the radio channel requirement in the call confirmed message. If the MS indicates the support of "dual" (HR and FR channels) the final decision, which radio channel is chosen, is done by the network in an RR message. The radio channel requirement is ignored in UTRAN Iu mode, see table B.5a in Annex B.

If the network proposes optional support of both transparent and non transparent connection elements, but does not indicate a user information layer 2 protocol, the MS shall set the appropriate value, if choosing non transparent in the call confirmed message and out-band flow control is not requested, see B.1.1.2.

Additionally the values of the parameters structure, modem type and intermediate rate have to be set in conformance with the values of the parameters radio channel requirements, negotiation of intermediate rate requested and connection element.

Subclause B.1.1.2 and table B.1 in the annex B describe the negotiation procedure. Annex B table B.4 describes the selection of the modem type and the dependence on the value of the parameter connection element. Annex B table B.4 describes the selection of the intermediate rate and user rate and their dependence upon the value of the NIRR parameter and the equipment capabilities.

The following MT cases can be deduced from the individual call set-up request conditions:

- a) If the set-up does not contain a BC information element, the MS in the call confirmed message shall include any BC information (single or multiple BC-IE). The MS may use the information provided in the BACKUP BC information element (see 3GPP TS 29.007 and 3GPP TS 24.008) to deduce the requested service. Note, that the presence of the BACKUP BC-IE does not change the condition of "no BC-IE received", that means in particular that the MS shall include any BC-IE (as mentioned before) and shall not negotiate parameter values where the MSC has to offer a value in the BC-IE first, as e.g., for the parameter "compression". If multiple BC-IEs are present, one BC-IE shall indicate the information transfer capability "speech". A 3,1 kHz multimedia BC-IE together with a speech BC-IE indicates the support of a fallback to speech. A UDI/RDI multimedia BC-IE together with a speech BC-IE indicates the support of service change and fallback (see 3GPP TS 29.007 and 3GPP TS 24.008).
- b) If the set-up message contains a single BC-IE, the MS in the call confirmed message shall use either a single BC-IE, if it wants to negotiate mobile specific parameter values or, unless otherwise specified, no BC-IE, if it agrees with the requested ones.
- c) If the set-up contains a multiple BC-IE, the MS in the call confirmed message shall use either a multiple BC-IE, if it wants to negotiate mobile specific parameter values or, unless otherwise specified, no BC-IE, if it agrees with the requested ones.
  - For a 3,1kHz multimedia setup the MS may either accept the possibility of a fallback to speech by responding with two BC-IEs, or turn the call to a speech call by sending only a speech BC-IE in the call confirmed message or turn the call to a multimedia only call (i.e. no fallback to speech allowed) by sending only a multimedia BC-IE, in the call confirmed message.
  - For a UDI/RDI multimedia setup, the MS may either accept the possibility of service change by responding with two BC-IEs, or turn the call to a speech call by sending only a speech BC-IE in the call confirmed message, or turn the call to a multimedia call by sending only a multimedia BC-IE in the call confirmed message.
  - For facsimile, a single BC-IE, containing fax group 3 only, shall be used if a multiple BC-IE requesting speech alternate fax group 3 is received and the MS is not able to support the speech capability. Annex B, table B.7, describes the negotiation rules.

If the BC-IE contains 3,1 kHz ex PLMN, the MS is allowed to negotiate all mobile specific parameter values listed above. If the BC-IE contains facsimile group 3, the MS is not allowed to negotiate any mobile specific parameter value.



In any case, if the set-up message requests a "single service", the MS shall not answer in the call confirmed message requesting a "dual service".

However, for dual services with repeat indicator set to "circular (alternate)" or to "service change and fallback" the MS may change the sequence of dual BC-IEs within the call confirmed message (preceded by the same value of the repeat indicator), if it wants to start with a different Bearer Capability than proposed by the network as the initial one.

In addition, the MS may propose to the network to modify User Rate, Modem Type and Intermediate Rate in the CALL CONFIRMED message. The network may accept or release the call.

If the BC-IE received from the network contains the parameters 'fixed network user rate', 'other modem type' and possibly the 'user initiated modification', the MS shall either:

- a) include no BC-IE or a BC-IE without these parameters in the call confirmed message, i.e. the MS discards these parameters (only allowed in A/Gb mode); or
- b) include the possibly modified values for the 'fixed network user rate' and 'other modem type' in the BC-IE of the call confirmed message. The network might accept or reject the modified values. In this case the MS shall also include the parameters 'maximum number of traffic channels' and 'acceptable channel codings'. Additionally for non-transparent services, the MS shall also include the parameters 'wanted air interface user rate' and the 'user initiated modification indication'. The parameters 'acceptable channel codings extended' and 'asymmetry indication' may also be included.

In case a), the MS shall use the fall-back bearer service indicated by the remaining parameters of the BC-IE on a single slot configuration (reference 3GPP TS 44.021).

In case b), the MS shall use in A/Gb or GERAN Iu mode a singleslot or multislot configuration according to the rules defined in 3GPP TS 44.021, 3GPP TS 48.020 and 3GPP TS 24.022.

If the 'acceptable channel codings' is indicated by the MS, the decision which channel coding is used is done by the network and indicated to the mobile station with a RR message. This RR message may also assign an asymmetric channel coding. The 'acceptable channel codings' parameter takes precedence over the 'negotiation of intermediate rate requested' parameter for non-transparent services. Also the intermediate rate and user rate per traffic channel in a multislot configuration are not indicated by the 'intermediate rate' and 'user rate' parameters of the BC-IE, but depend on the chosen channel coding only.

If no BC-IE is received in the SETUP message, the MS may include the parameters 'fixed network user rate', 'other modem type' etc. (i.e. octets 6d, 6e, 6f, and 6g, see 3GPP TS 24.008) in the BC-IE of the CALL CONFIRMED message. However, in this case, the network may release the call if it does not support these parameters.

If FNUR = 33.6 kbit/s is agreed on in the setup of a 3.1 kHz multimedia call, the modems may handshake to 31.2 kbit/s or 28.8 kbit/s. In this case the MS receives a MODIFY message from the MSC to indicate the new data rate, and shall respond with a MODIFY COMPLETE message (see 3GPP TS 24.008), if it supports the requested modification. If the MS does not support the requested modification, it shall respond with a MODIFY REJECT message. The MT shall indicate the new data rate to the TE (e.g. using the ITU-T Recommendation V.80 inband signalling) in order to cause the TE to use stuffing to adapt the 31.2 or 28.8 kbit/s data rate to the 33.6 kbit/s traffic channel between the TE and IWF.

### 8.3.3.2 Indication in case of Mobile originating calls

In support of mobile originating calls the values of BC-IE parameters are requested in the set-up message from the MS. If the MS indicates the support of both transparent and non transparent connection elements the network shall return its choice in the call proceeding message. The MS is not allowed to indicate support of both transparent and non transparent, if the MS also requests out-band flow control, i.e. it does not indicate a layer 2 protocol.

Additionally the value of the parameter modem type has to be set depending on the value of the parameter connection element as described in annex B, table B.4a.

The set-up message contains a single or multiple BC-IE. If multiple BC-IEs are present, one BC-IE shall indicate the information transfer capability "speech".

For a 3,1 kHz multimedia call, the setup message contains either a multimedia BC-IE indicating a multimedia only call request (i.e. no fallback to speech allowed) or both a 3,1 kHz multimedia BC-IE and a speech BC-IE to indicate the support of a fallback to speech (see 3GPP TS 29.007 and 3GPP TS 24.008).

For a UDI/RDI multimedia call, the setup message contains either a multimedia BC-IE indicating a multimedia only call request, or both a multimedia BC-IE and a speech BC-IE (in any order) to indicate the support of service change and fallback (see 3GPP TS 29.007 and 3GPP TS 24.008). The latter is not applicable to multimedia calls with FNUR=32.0 kbit/s.

If the set-up message requests a "single service", the network shall not answer in the call proceeding message requesting a "dual service". Alternatively the network shall answer with a single BC-IE containing fax group 3 if a multiple BC-IE requesting speech alternate fax group 3 is received but the network does not allow the use of this alternate service. Annex B, table B.7, describes the negotiation rules.

If the MS requests a "dual service" the network is not allowed to change the sequence of the service, a change may however occur due to the called user and this may then be relayed back to the originating MS by the network.

If the setup message requests a 3.1 kHz multimedia service with fallback, the network may return both BC-IEs in the same order to accept the request, or a single BC-IE if fallback or one of the requested services are not allowed.

If the setup message requests a UDI/RDI multimedia service with fallback, the network may return both BC-IEs in the same order to accept the request, both BC-IEs in the reverse order (relayed from terminating User), or a single BC-IE if fallback, service change or one of the requested services are not allowed.

If the set-up message indicates that negotiation of intermediate rate is requested then the network shall behave as described in annex B, table B.4b.

Unless otherwise specified, if no BC-IE parameter needs negotiation it is up to the network if it sends a CALL PROCEEDING message (with or without a BC-IE) towards the MS or not.

For MS to network direction, octet 6e shall be included whenever octet 6d is included (see 3GPP TS 24.008).

For multislot, TCH/F14.4, and EDGE operations and in Iu mode the MS shall include an appropriate set of the parameters 'fixed network user rate', 'other modem type', 'maximum number of TCH' and 'acceptable channel codings' in the BC-IE of the SETUP message. If EDGE channel coding(s) are included in ACC for transparent calls, the 'Wanted air interface user rate'-parameter shall be set to 'Air interface user rate not applicable' and the 'User initiated modification indication'-parameter to 'User initiated modification not requested'. In a non-transparent multislot operation, the MS shall also include the parameters 'wanted air interface user rate' and 'user initiated modification indication' in the BC-IE of the SETUP message. In a non-transparent TCH/F14.4 or EDGE operation or in Iu mode the MS shall also include the parameter 'wanted air interface user rate'. In non-transparent EDGE operation the MS shall also include the parameter 'asymmetry preference indication'. It shall also set the other parameters of the BC-IE (i.e. 'user rate') to values identifying fall-back values. Depending on the network two situations can be distinguished:

a) The network supports the requested operation:

- in this case the network shall include the parameter 'fixed network user rate', 'other modem type' and possibly 'user initiated modification' in the BC-IE(s) of the CALL PROCEEDING message, irrespective whether or not they contain modified values or just a copy of the received ones;
- the 'acceptable channel codings' indicated by the MS in the SETUP message takes precedence over the 'negotiation of intermediate rate requested' parameter for non-transparent services. The intermediate rate per traffic channel and the user rate per traffic channel is dependent on the chosen channel coding only. The chosen channel coding is indicated to the mobile station by the network with an RR message.

b) The network does not support the requested operation:

- in this case, in A/Gb mode, the BC-IE of the CALL PROCEEDING message does not contain the parameters 'fixed network user rate' and 'other modem type' or no BC-IE is included in the CALL PROCEEDING message at all. The mobile station shall then discard the parameters 'fixed network user rate', 'other modem type', 'maximum number of TCH', 'acceptable channel codings', 'wanted air interface user rate' and 'user initiated modification indication' sent with the SETUP message and apply the fall-back bearer service;
- in Iu mode the network shall release the call.

In case a), the MS shall use in A/Gb and GERAN Iu mode a singleslot or multislot configuration according to the rules defined in 3GPP TS 44.021, 3GPP TS 48.020 and 3GPP TS 24.022.

In case b), the MS shall use in A/Gb mode the fall-back bearer service indicated by the remaining parameters of the BC-IE on a single slot configuration (reference 3GPP TS 44.021).

If FNUR = 33.6 kbit/s is agreed on in the setup of a 3.1 kHz multimedia call, the modems may handshake to 31.2 kbit/s or 28.8 kbit/s. In this case the MS receives a MODIFY message from the MSC to indicate the new data rate, and shall respond with a MODIFY COMPLETE message (see 3GPP TS 24.008), if it supports the requested modification. If the MS does not support the requested modification, it shall respond with a MODIFY REJECT message. The MT shall indicate the new data rate to the TE (e.g. using the ITU-T Recommendation V.80 inband signalling) in order to cause the TE to use stuffing to adapt the 31.2 kbit/s or 28.8 kbit/s data rate to the 33.6 kbit/s traffic channel between the TE and IWF.

### 8.3.3.3 Differences in validity of BC parameter values in A/Gb mode, GERAN Iu mode and UTRAN Iu mode

The validity of a BC parameter value, either in the SETUP or CALL CONFIRMED message, may differ from A/Gb mode to GERAN Iu mode and to UTRAN Iu mode. Certain parameters are irrelevant in UTRAN or GERAN Iu mode and any value given is valid and ignored. These parameters may be available in the BC IE. For those parameters that are relevant in UTRAN Iu mode, GERAN Iu mode and A/Gb mode, certain values may be invalid in one of the systems. Invalid parameter values may cause rejection of the BC and subsequent release of the call.

Parameters that are ignored in UTRAN or GERAN Iu mode may be set to default values, or to specific values in view of an eventual handover to A/Gb mode. Parameter values that are invalid in one system may result in unsuccessful handover from the other system.

Table B.5a in annex B lists parameters that are ignored in UTRAN or GERAN Iu mode and parameter values which validity is different in A/Gb mode, GERAN Iu mode and UTRAN Iu mode.

## 8.4 Test Loops

In principle, both V-series and X-series interfaces allow for an activation of local or remote test loops by the terminal (see ITU-T Recommendations V.54/X.150). A comprehensive solution of such test loops in a PLMN system has to consider the special conditions of the interface between the terminal (part of the MS) and the transmission equipment (part of the modem pool of a particular IWF within the MSC). In addition, the impact of the radiolink is to be taken into account with respect to the test objectives. Due to those special conditions a PLMN system is not capable to support remote test loops. It is an implementation choice to what extent the activation of local test loops by the terminal is supported in the MT.

## 8.5 Alternate speech/facsimile group 3

### 8.5.1 In case of A/Gb mode

This alternate service may be initiated by a manual procedure where CT106, CT107, CT108.2 and CT109 are set in the OFF condition.

Selection of the data phase (from the speech phase) may be by manual intervention via the MS causing ICM by means of CT108.2 going to ON condition, refer to 3GPP TS 03.45. The ensuing data phase shall follow all the operational procedures as described in 3GPP 27-series.

Selection of the speech phase (from the data phase) may be by manual intervention via the MS causing ICM (phone off-hook condition at the MT and data call end condition at the TE).

During the ensuing speech phases, CT107, CT106 and CT109 shall be maintained in the OFF condition.

Subsequent re-selection of the data phase may be by manual intervention via the MS causing CT108.2 going to ON condition initiating ICM. At this point, re-synchronization shall take place as described in subclause 8.1.

### 8.5.2 In case of UTRAN Iu mode

Refer to subclauses 9.2.1.1 and 9.2.2.1 in 3GPP TS 23.146.

## 8.6 Multislot configuration split/combine function

In multislot configurations using multiple parallel channels the data flow is split into substreams between the Split/Combine-function in the TAF and the network.

### 8.6.1 Non-transparent data

In non-transparent data operations the N(S)-numbering in the RLP-header is used for controlling the order of the data in the substreams (reference 3GPP TS 24.022).

### 8.6.2 Transparent data

In transparent multislot configurations (TCH/F9.6 or TCH/F4.8) status bits S1, S3 and the X-bit between the D12 and D13 are used for transferring substream numbering information. This S4-bit is used for frame synchronization between the parallel substreams (reference 3GPP TS 44.021).

In case of a transparent multislot configuration using TCH/F14.4 channel coding, bit M1 in the 290-bit radio interface block is used for frame synchronization between the parallel substreams, whereas bit M2 carries status information, NIC codes and substream numbering as described in 3GPP TS 44.021.

In transparent TCH/F28.8 channels, bits M1 and M2 are used as described above for transparent TCH/F14.4 channels.

## 8.7 EDGE multiplexing function

In EDGE configurations the number of channels across the air interface and that of substreams between BTS and MSC do not necessarily match. In such cases a multiplexing function is included at MS and BTS (3GPP TS 44.021 and 3GPP TS 48.020). These functions distribute data between the substreams and radio channels.

## 8.8 Seamless data rate change

If the modems change the data rate during an ongoing multimedia call (using the ITU-T Recommendation V.34 seamless data rate change mechanism), the MSC initiates a MODIFY message (see 3GPP TS 24.008) to indicate the new data rate to the MS. The MT shall indicate the new data rate to the TE (e.g. using the ITU-T Recommendation V.80 inband signaling) in order to cause the TE to use stuffing to adapt the 31.2 kbit/s or 28.8 kbit/s data rate to the 33.6 kbit/s traffic channel between the TE and IWF.

---

## Annex A (informative): List of Bearer Capability Elements

This annex lists the PLMN Bearer Capability Elements which need to be provided to support Terminal adaptation function to Interworking control procedures. Some parameters are ignored in GERAN or UTRAN Iu mode although present in the BC-IE. The validity of parameter values may also differ from A/Gb mode to GERAN Iu mode and to UTRAN Iu mode. The ignored parameters and the difference of parameter value validity in A/Gb mode, GERAN Iu mode and UTRAN Iu mode are listed in table B.5a in annex B.

### Elements and their Values:

#### Information Transfer Capability:

This element is relevant between the IWF and the fixed network.

Values:

- Speech:
- Unrestricted Digital:
- Group 3 Facsimile (note 1):
- 3,1 kHz Ex PLMN (note 2):
- Restricted Digital (note 3):

NOTE 1: Used for facsimile transmission, unrestricted digital between MT and IWF and 3,1 kHz audio from IWF towards the fixed network.

NOTE 2: Unrestricted digital between MT and IWF and 3,1 kHz audio from IWF towards the fixed network.

NOTE 3: Unrestricted digital between MT and IWF and restricted digital information from IWF towards the fixed network; this value is signalled in the "Other ITC" element, due to a lack of further code points in the "ITC" element.

#### Transfer Mode:

This element is relevant between MT and IWF

Values: - Circuit

#### Structure:

This element is relevant between MT and IWF.

Values: - Service Data Unit Integrity (note 4)  
- Unstructured (note 5)

NOTE 4: Applicable for connection element "non transparent".

NOTE 5: Applicable for connection element "transparent".

#### Configuration:

This element is relevant for a PLMN connection.

Values: - Point to point

#### Establishment:

This element is relevant for a PLMN connection.

Values: - Demand

**Sync/Async:**

This element is relevant between TE/TA and MT and between IWF and the fixed network.

Values: - Synchronous  
- Asynchronous

**Negotiation:**

This element is relevant between MT and IWF.

Values: - In band negotiation not possible

**User Rate:**

This element is relevant between TE/TA and MT and between IWF and the fixed network, except in case the parameter FNUR is present.

Values: - 0.3 kbit/s  
- 1.2 kbit/s  
- 2.4 kbit/s  
- 4.8 kbit/s  
- 9.6 kbit/s  
- 19.2 kbit/s (see note 6)

NOTE 6: This value cannot be signalled between MT and IWF, but it can be used according to the rules in 3GPP TS 29.007 (tables 7A and 7B) for such connections.

**Intermediate Rate:**

This element is relevant between MT and BSS and BSS and IWF

Values: - 8 kbit/s  
- 16 kbit/s

**Network Independent Clock on Tx:**

This element is relevant between TE/TA and MT in the transmit direction.

Values: - Not required  
- Required

**Network Independent Clock on Rx:**

This element is relevant between TE/TA and MT in the receive direction.

Values: - Not accepted  
- accepted

**Number of Stop Bits:**

This element is relevant between the TE/TA and MT and between IWF and fixed network in case of asynchronous transmission.

Values: - 1 bit  
- 2 bit

**Number of Data Bits Excluding Parity If Present:**

This element is relevant between TE/TA and MT and between IWF and the fixed network in case of a character oriented mode of transmission.

Values:                   - 7 bit  
                              - 8 bit

**Parity Information:**

This element is relevant between TE/TA and MT and between IWF and the fixed network for a character oriented mode of transmission.

Values:                   - Odd  
                              - Even  
                              - None  
                              - Forced to 0  
                              - Forced to 1

**Duplex Mode:**

This element is relevant between MT and IWF.

Values:                   - Full Duplex

**Modem Type:**

This element is relevant between the IWF and the fixed network in case of 3,1 kHz audio ex-PLMN information transfer capability.

Values:                   - V.21  
                              - V.22  
                              - V.22 bis  
                              - V.26 ter  
                              - V.32  
                              - autobaoding type 1  
                              - none

**Radio Channel Requirement:**

This element is relevant between MT and BSS

Values:                   - Full Rate support only Mobile Station  
                              - Dual Rate support Mobile Station/Half Rate preferred  
                              - Dual Rate support Mobile Station/Full Rate preferred

**Connection Element:**

This element is relevant between MT and IWF

Values:                   - Transparent  
                              - Non Transparent  
                              - both, Transparent preferred  
                              - both, Non transparent preferred

**User Information Layer 2 Protocol:**

This element is relevant between TE/TA and MT and between IWF and the fixed network.

Values:                   - ISO/IEC 6429  
                              - Character oriented Protocol with no Flow Control mechanism

**Signalling Access Protocol:**

This element is relevant between TE/TA and MT.

Values: - I.440/450

**Rate Adaptation:**

This element is relevant between IWF and the fixed network.

Values: - V.110/X.30  
- X.31 flagstuffing  
- no rate adaptation  
- V.120 (note 7)  
- PIAFS (note 7)  
- H.223 and H.245 (note 7)

NOTE 7: This value is signalled in the "Other Rate Adaption" element, due to a lack of further code points in the "Rate Adaption" element.

**Coding Standard:**

This element refers to the structure of the BC-IE defined in 3GPP TS 24.008.

Values: - GSM

**User Information Layer 1 Protocol:**

This element characterizes the layer 1 protocol to be used between MT and BSS (Um interface) according to 3GPP TS 45.001, or between the MT and the RNC (Uu interface).

Values: - default

**Negotiation of Intermediate Rate requested:**

This element is relevant between MT and BSS and BSS and IWF.

Values: - no meaning associated  
- 6 kbit/s radio interface is requested for a full rate channel with a user rate up to and including 4,8 kbit/s, non transparent service

**Compression:**

This element is relevant between MT and IWF.

Values: - compression possible/allowed  
- compression not possible/allowed

**Rate adaption header / no header:**

This element is relevant between IWF and the fixed network. It is only applicable for ITU-T V.120 rate adaptation.

Values: - Rate adaption header not included  
- Rate adaption header included

**Multiple frame establishment support in data link:**

This element is relevant between IWF and the fixed network. It is only applicable for ITU-T V.120 rate adaptation.

Values: - Multiple frame establishment not supported. Only UI frames allowed.  
- Multiple frame establishment supported.

**Mode of operation:**

This element is relevant between IWF and the fixed network. It is only applicable for ITU-T V.120 rate adaptation.

Values: - Bit transparent mode of operation  
- Protocol sensitive mode of operation



**Logical link identifier negotiation:**

This element is relevant between IWF and the fixed network. It is only applicable for ITU-T V.120 rate adaptation.

Values:                   - Default, LLI=256 only  
                          - Full protocol negotiation (note 8)

NOTE 8: A connection over which protocol negotiation is executed as indicated in the "In-band / out-band negotiation" parameter.

**Assignor / assignee:**

This element is relevant between IWF and the fixed network. It is only applicable for ITU-T V.120 rate adaptation.

Values:                   - Message originator is „default assignee"  
                          - Message originator is „assignor only"

**In-band / out-band negotiation:**

This element is relevant between IWF and the fixed network. It is only applicable for ITU-T Recommendation V.120 rate adaptation.

Values:                   - Negotiation is done with USER INFORMATION messages on a temporary signalling connection  
                          - Negotiation is done in-band using logical link zero.

**Fixed network user rate, FNUR (note 12)**

This element is relevant between the IWF and the fixed network.

Values                   - Fixed network user rate not applicable (note 9)  
                          - 9,6 kbit/s  
                          - 14,4 kbit/s  
                          - 19,2 kbit/s  
                          - 28,8 kbit/s  
                          - 32,0 kbit/s  
                          - 38,4 kbit/s  
                          - 48,0 kbit/s  
                          - 56,0 kbit/s  
                          - 64,0 kbit/s

NOTE 9: Not used by currently specified services.

**Wanted air interface user rate, WAIUR (note 12)**

This element is relevant between the MT and the IWF

Values                   - Air interface user rate not applicable  
                          - 9,6 kbit/s  
                          - 14,4 kbit/s  
                          - 19,2 kbit/s  
                          - 28,8 kbit/s  
                          - 38,4 kbit/s  
                          - 43,2 kbit/s  
                          - 57,6 kbit/s  
                          - interpreted by the network as 38,4 kbit/s (note 10)

NOTE 10: Certain code points, if used, are interpreted by the network as 38.4 kbit/s in this version of the protocol, ref 3GPP TS 24.008.

**Acceptable channel codings, ACC (note 12)**

This element is relevant between the MT and the IWF.

- Value:
- TCH/F4.8 acceptable
  - TCH/F9.6 acceptable
  - TCH/F14.4 acceptable
  - TCH/F28.8 acceptable
  - TCH/F32.0 acceptable (Applicable to multimedia 32 kbit/s, 56 kbit/s and 64 kbit/s and synchronous transparent 56 kbit/s and 64 kbit/s services only)
  - TCH/F43.2 acceptable (Applicable to non-transparent services only.)
  - none (note 10a)

NOTE10a: No channel coding (defined by selecting none of the above).

#### Maximum number of traffic channels, MaxNumTCH (note 12)

This element is relevant between the MT and the IWF.

- Value:
- 1 TCH
  - 2 TCH
  - 3 TCH
  - 4 TCH
  - 5 TCH
  - 6 TCH
  - 7 TCH (note 11)
  - 8 TCH (note 11)

NOTE11: Not used by currently specified services.

#### Other modem type, OMT (Note 12)

This element is relevant between the IWF and the fixed network in case of 3,1 kHz audio ex-PLMN

- Values:
- no other modem type specified in this field
  - V.34

#### User initiated modification indication, UIMI (Note 12)

This element is relevant between the MT and the IWF.

- Values:
- user initiated modification not requested
  - user initiated modification upto 1 TCH requested
  - user initiated modification upto 2 TCH requested
  - user initiated modification upto 3 TCH requested
  - user initiated modification upto 4 TCH requested

#### Asymmetry preference indication (note 12)

This element is relevant between the MT and the BSS.

- Value:
- no preference
  - up link biased asymmetry preference
  - down link biased asymmetry preference

NOTE 12: These GBS-related parameters are optional.

For a configuration with data rates 9.6kbit/s or higher, the following applies to the parameters contained in the BC-IE:

- Half rate channels are not supported. The MS shall code the radio channel requirement as "Full rate support only MS" or "Dual rate support MS, full rate preferred". In the second case, the network shall assign full rate channel(s) only.
- The 'fixed network user rate' and 'other modem type' takes precedence over the 'user rate' and 'modem type', unless the 'modem type' indicates "autobauding".
- The ACC indicates which channel coding is acceptable and supported by the MS. In case of CE:NT the TCH/F4.8 and TCH/F9.6 acceptable is equivalent to the support of NIRR. If TCH/F4.8 acceptable only or

TCH/F9.6 acceptable only or TCH/F14.4 acceptable only is indicated, the assigned channel type which can be chosen by the network is TCH/F4.8 or TCH/F9.6 or TCH/F14.4, respectively.

- The 'intermediate rate' parameter is overridden. The intermediate rate used per each TCH/F is derived from the chosen channel type:

<b>channel type</b>	<b>IR per TCH/F</b>
TCH/F4.8	8 kbit/s
TCH/F9.6	16 kbit/s
TCH/F14.4	intermediate rate is to be defined

- The user rate per TCH is derived from the chosen channel type:

<b>channel type</b>	<b>user rate per TCH</b>
TCH/F4.8	4.8 kbit/s
TCH/F9.6	9.6 kbit/s

For CE:T, the padding procedure described in 3GPP TS 44.021 can be applied.

---

## Annex B (normative): Setting of Bearer Capability, Low Layer Compatibility and High Layer Compatibility Information Element for PLMN Bearer Services and PLMN TeleServices

### B.0 Scope

This annex describes the relationship between the various parameters of the PLMN Bearer Capability Information Element (BC-IE), their validity and the possible settings with reference to each PLMN Bearer service/Teleservice defined in 3GPP TS 22.002 and 3GPP TS 22.003 and various occurrences during the connection control (clause B.1). Furthermore, the contents of the Low Layer (LLC) and the High Layer (HLC) Compatibility Information Elements are described (clause B.2).

---

### B.1 Bearer Capability Information Element

#### B.1.1 Introduction

##### B.1.1.1 General Consideration

In general, the purpose of the Bearer Capability Information Element (BC-IE) is to request a particular bearer service to be provided by the network. This indication is carried by certain connection control messages which for the subject matter of the present document may be categorized into those messages:

- related to the call set-up phase; and
- those used during the established connection.

During the call set-up phase the PLMN BC-IE (single or multiple) is included in:

- the SETUP message generated by the requesting entity (either MS or MSC) to establish a mobile-originated or mobile-terminated call, respectively, and in
  - the CALL CONFIRMED or CALL PROCEEDING messages, respectively, generated by the responding entity (either MS or MSC) in order to negotiate certain parameter values. If no BC-IE is contained in the SETUP message (a mobile terminated call with the single-numbering scheme) the CALL CONFIRMED message indicates the complete applicable BC-IE. The network may release the call if it does not support the service indicated by the BC-IE. Also, if the service does not match with the service requested from the fixed network terminal the MSC/IWF may release the call.

NOTE: In the latter case also the fixed network terminal may release the call.

During the established connection the PLMN BC-IE is included in the MODIFY, MODIFY COMPLETE, and MODIFY REJECT messages in order to change the service (bearer capability) or to change the maximum number of traffic channels and/or wanted air interface user rate when a non-transparent multislot data service is in use.

If the maximum number of traffic channels and/or wanted air interface user rate is to be changed, the BC-IE included in the MODIFY message shall not indicate a different bearer service than the one used at this stage of the connection - the values of the parameters 'maximum number of traffic channels' and/or 'wanted air interface user rate' may be changed, only.

The subsequent tables and subclauses of clause B.1 deal with the representation of the individual contents of the PLMN BC-IE during the call set-up phase. For the use during the established connection refer to 3GPP TS 24.008.

With respect to the individual parameter settings at the MS the following cases may be distinguished (see 3GPP TS 27.002 and 3GPP TS 27.003):

- Mobile-originated call set up by a MS:
  - The setting results from respective MMI actions and/or MT internal settings.
- Mobile-terminated call set up to a MS:
  - The BC related part of the compatibility check is carried out according to the knowledge of the MT concerning its implemented functions (i.e. answering the call). The requested field values of the non-negotiable parameters and the selected field values of the negotiable parameters determine the selection of the terminal function to be used for the intended connection.

### B.1.1.2 Interpretation of the Diagrams

The purpose of the subsequent diagrams is to achieve unambiguous representation of the individual contents of the PLMN BC-IE for the various occurrences during the call set-up phase, covering all bearer services and teleservices according to 3GPP TS 22.002 and 3GPP TS 22.003.

The basic principle adopted is a graphic scheme, or mask, wherein the ordinate designates the individual parameters of the PLMN BC-IE and the abscissa gives the possible field values of these parameters. The abbreviations used in these sections are defined in table B.5. The allowed content of any PLMN BC-IE is represented by a number of graphs connecting parameter values (abscissa points) of all parameters (ordinate points). Each graphic scheme is subdivided into two independent parts:

- "Layer/Protocol related" part; and
- "Radio Channel related" part.

The generation of all PLMN BC-IEs in all call set-up messages shall be in accordance with these graphs. Subclauses B.1.2 through B.1.11 show individual sets of graphs for each service group (BS/TS) and for each type of applicable Information Transfer Capability.

In addition, the following rules apply:

- Those parameters which have only one possible field value for all recognized services are shown in table B.5, where they are marked accordingly in the column "common setting of field values". They are not represented in the graphic scheme.
- Not all parameters of the PLMN BC-IE are relevant for each service (BS/TS). This is represented by specific abscissa points with a value of "NA" (Not Applicable) allocated to these parameters. The graphs pass through these points for each such parameter. The actual field value to be used in the PLMN BC-IE is marked in the column "default setting of field values (NA)" of table B.5. An abscissa point with a value of "NAV" (Not Available) indicates that the entire octet carrying this parameter (see table B.2 "General Structure of the PLMN BC-Information Element") shall be omitted.
- Unless FTM is applied, there is a particular dependency of the parameters "User Information Layer 2 Protocol (UIL2P)" and "Connection Element (CE)":
  - If the MS sends a PLMN BC-IE with a CE value other than "Transparent (T)", the parameter UIL2P is essential. Its field value must be set as indicated in the applicable graph.
  - If the MSC sends a PLMN BC-IE in the SETUP message, the parameter UIL2P may also be absent in the case of the CE parameter value being other than "Transparent (T)".
- In case FTM is applied, the PLMN BC-IE shows a CE value "non-transparent", SA value "asynchronous", and RA value X.31 flag stuffing. The UIL2P is not available.
- Certain parameters of the PLMN BC-IE may be negotiated during the connection establishment phase. Table B.1 shows these parameters and the relations of their values in the SETUP message and in the CALL CONFIRMED/CALL PROCEEDING message, respectively, both for the mobile-originated and mobile-terminated case. A parameter may indicate a field value of one of the following types:
  - "requested value" indicating a request which cannot be changed by the responding entity;

- "offered value" indicating a proposal which may be changed by the responding entity;
- a particular choice value leaving it up to the responding entity which value ultimately applies;
- "as requested" indicating that the requested value applies and is confirmed (by returning it);
- "selected value" indicating that a particular value applies either out of the offered set or as a free choice out of the defined set of values;
- "supported value" indicating a value supported by the responding entity.

**Table B.1: BC-Parameters subject to negotiation procedure**

Mobile Originated Call:

BC-parameter	Message	
	SETUP	CALL PROC
NDB	Requested value	as requested
NPB	Requested value	as requested
NSB	Requested value	as requested
CE	Requested value (T/NT)	as requested
	"both" with the preferred value indicated (e.g. both NT)	selected value (T/NT)
UIL2P	Requested value <sup>9)</sup> or NAV <sup>1)</sup>	as requested or NAV <sup>4)</sup>
User Rate	Requested value	as requested
DC	Requested value <sup>2)</sup>	as requested or "NO" <sup>7)</sup>
FNUR	Requested value	supported value
Other MT	Requested value	supported value
UIMI	Requested value	supported value

Mobile Terminated Call:

BC-parameter	Message	
	SETUP	CALL CONF
NDB	Offered value	selected value (free choice)
NPB	offered value	selected value (free choice)
NSB	offered value	selected value (free choice)
CE	requested value (T/NT)	as requested or selected value (T/NT) (free choice) <sup>3)</sup>
	"both" with the preferred value indicated (e.g. both NT)	selected value (T/NT)
Sync/ Asynchronous	requested value	as requested or selected value <sup>10)</sup>
Rate adaptation/Other rate adaptation	requested value	as requested or selected value <sup>11)</sup>
UIL2P	offered value <sup>2)</sup> or NAV <sup>4)</sup>	selected or NAV <sup>1)</sup>
User Rate	offered value	selected value <sup>5)</sup>
DC	requested value <sup>2)</sup>	as requested or "NO" <sup>7)</sup>
FNUR	offered value	selected value <sup>6)</sup>
Other MT	offered value	selected value <sup>6)</sup>
UIMI	offered value	selected value <sup>8)</sup>

- 1) For CE:T only, out-band flow control, or RA:X.31 flag stuffing requested by the MS.
- 2) Not for CE:T.
- 3) When the SETUP message contains no BC-IE (single numbering scheme).
- 4) "NAV" shall not be interpreted as an out-band flow control request by the MS.
- 5) The modification of User Rate shall be in conjunction with Modem Type and Intermediate Rate.
- 6) The modification of the Fixed Network User Rate shall be in conjunction with the Modem Type and/or Other Modem Type.
- 7) In case of a Mobile Terminated Call, if the SETUP message does not contain a BC-IE, the MS shall behave as if the DC is set to "data compression not possible".  
If a sending entity, based on an earlier version of the protocol, sends a SETUP message containing "DC.. compression possible/ allowed" instead of the default value "NO.. compression not possible/allowed" as defined in Table B.5 then the receiving MS or the receiving network may ignore the DC value and may return either "NO.. compression not possible/allowed" or "DC.. compression possible/allowed" in the CALL CONF/CALL PROC message.  
In case of a MO CALL or a MT CALL where no BC-IE is included in the CALL PROCEEDING or CALL CONFIRMED message, respectively, the MS or the network shall behave as if the DC was set to "data compression not possible" or "data compression not allowed", respectively.
- 8) Less or equal to the offered value.
- 9) Not for CT:T or FTM (i.e., CE:NT, SA:A, RA:X.31 flag stuffing).
- 10) For FTM and PIAFS, this parameter may be negotiated. See Table B.4e for details.
- 11) For FTM, PIAFS and Multimedia, this parameter may be negotiated. See Table B.4f for details.

**Table B.2: General Structure of the BC-Information Element**

OCTET	INFORMATION ELEMENT FIELD
3	Radio channel requirements Coding standard Transfer mode Information Transfer Capability
4	Structure <sup>2)</sup> Duplex mode Configuration Establishment Negotiation of Intermediate Rate Requested Compression
5	Rate adaption <sup>2)</sup> Signalling access protocol
5a	Other ITC <sup>2) 7)</sup> Other rate adaption

OCTET	INFORMATION ELEMENT FIELD
5b	Rate adaption header / no header 2) 3) Multiple frame establishment support in data link Mode of operation Logical link identifier negotiation Assignor / assignee In-band / out-band negotiation
6	User information layer 1 protocol 2) Synchronous / asynchronous
6a	Number of stop bits 2) Negotiation Number of data bits User rate
6b	Intermediate rate 2) NIC on transmission NIC on reception Parity information
6c	Connection element 2) Modem type
6d	Fixed network user rate 4) Other modem type
6e	Maximum number of traffic channels 4) Acceptable channel codings
6f	Wanted air interface user rate 4) User initiated modification indication
6g	Acceptable Channel codings 5) Asymmetry preference indication 6)
7	User information layer 2 protocol 1) 2)
1)	Octets optional.
2)	Octets only available if the parameter "Information Transfer Capability" does not indicate "Speech".
3)	For ITU-T V.120 rate adaption only.
4)	Optional octets available only if the parameter "Information Transfer Capability" does not indicate "Speech".
5)	Extension of the 'Acceptable channel codings' field in octet 6e in case EDGE channel codings are supported.
6)	Only used if EDGE channels are among the 'Acceptable channel codings'. The value shall be set to 'no preference' in case the connection element is T.
7)	For ITC=RDI or UIL1P=V.120, PIAFS, and 'H.223 and H.245' only.

Table B.3a: Selection of flow control method (for CE:NT with SA:A only)

information element	flow control method		
	in-band	out-band (3)	none
number of data bits	7 or 8	7 or 8	7 or 8
user information layer 2 protocol	ISO 6429 (1)	NAV	COPnoFICt (2)
1)	ISO6429 stands for "ISO 6429, codeset 0, DC1/DC3" and is applicable for 7 and 8 bit codes.		
2)	COPnoFICt stands for a character oriented protocol with no flow control mechanism (no reserved characters for flow control).		
3)	"out-band" flow control requires ITU-T V.42 in case of PSTN or ITU-T V.110 in case of ISDN. If the ITU-T V.110 flow control mechanism is not supported, where required, the call pending shall be terminated. If the ITU-T V.42 functionality is not supported by the modem in the IWF or in the fixed network, the call shall be supported with a fallback to the non- ITU-T V.42 mode. In this case the IWF shall release the call if due to temporary throughput problems on the radio interface or initiation of flow control by the MS and the inability to flow control the fixed network modem an overflow of the L2R buffers occurs. Note that a phase 1 network may release the call, if the ITU-T V.42 functionality is not provided by the IWF or the fixed network modem. As ITU-T V.42 does not apply to ITU-T V.21 modems, outband flow control can not be supported for these modem types.		



**Table B.4a: Modem Type subject to negotiation procedure**

Mobile Originated Call:

BC-parameter CE	BC-parameter MT and OMT <sup>6)</sup>	
	Message SETUP	Message CALL PROC
T	V-series	V-series
NT	V-series	V-series
	autobauding type 1	autobauding type 1 or V-series <sup>1)</sup>
bothT or bothNT	V-series	V-series
	autobauding type 1	autobauding type 1 or V-series <sup>1)2)</sup>

Mobile Terminated Call:

BC-parameter CE	BC-parameter MT and OMT <sup>6)</sup>	
	Message SETUP	Message CALL CONF
T	V-series	V-series
NT	V-series	V-series or autobauding type <sup>13)</sup>
	autobauding type 1	autobauding type 1 or V-series <sup>4)</sup>
bothT or bothNT	V-series	V-series
	autobauding type 1	autobauding type 1 or V-series <sup>4)5)</sup>

- 1) No autobauding capability in the IWF:MSC.
- 2) CE:T selected by IWF/MSC.
- 3) Free choice if the SETUP contains no BC-IE (single numbering scheme).  
If the IWF/MSC has no autobauding capability, a V-series modem type is used.
- 4) When the MS does not allow the use of autobauding capability.
- 5) CE:T selected by the MS.
- 6) When the MT indicates "autobauding", "modem for undefined interface" or "none", the OMT shall be set to "no other modem type". Any other values of the MT is overridden by the OMT value.

**Table B.4b: Intermediate Rate negotiation procedure**

If the user rate is 9.6 kbit/s the intermediate rate negotiation procedure is not applicable and NIRR shall be set to "No meaning".

Recipient of SETUP supports full rate, non transparent, 6 kbit/s radio interface rate and the user rate is up to/equal 4,8 kbit/s:

BC-parameter	Message SETUP	Message CALL CONF or CALL PROC
NIRR	6 kbit/s	6 kbit/s
IR	16 kbit/s	8 kbit/s
User Rate	up to/equal 4,8 kbit/s	as requested

NOTE 1: In case of a Mobile Terminated Call, if the SETUP message does not contain a BC-IE, the MS shall behave as if NIRR set to "No meaning".

In case of a MO CALL or a MT CALL where no BC-IE is included in the CALL PROCEEDING or CALL CONFIRMED message, respectively, the MS or the network shall behave as if the NIRR was set to "No meaning".

Recipient of SETUP does support full rate, non transparent, but not in connection with 6 kbit/s radio interface rate:

BC-parameter	Message SETUP	Message CALL CONF or CALL PROC
NIRR	6 kbit/s	No meaning
IR	16 kbit/s	16 kbit/s
User Rate	up to/equal 4,8 kbit/s	as requested

NOTE 2: If no other parameter needs negotiation, the CALL CONF/PROC message need not contain any BC-IE.

In case of a MO CALL or a MT CALL where no BC-IE is included in the CALL PROCEEDING or CALL CONFIRMED message, respectively, the MS or the network shall behave as if the NIRR was set to "No meaning".

NOTE 3: In case a GBS-operation is requested and acknowledged, the MS indicates the acceptable channel codings. The indicated acceptance of TCH/F4.8 is equivalent to the support of 6 kbit/s radio interface rate per TCH/F and therefore overrides the NIRR parameter.

**Table B.4c Negotiation of fixed network user rate**

BC-parameter	Message SETUP	Message CALL PROC/CONFIRMED
FNUR	requested value	equal or lower than the requested value

The network might accept the modified value or reject the call.

**Table B.4d Negotiation of user initiated modification indication**

BC-parameter	Message SETUP	Message CALL PROC/CONFIRMED
UIMI	offered value	equal to or a value indicating a request for modification to a lower number of traffic channels than offered

**Table B.4e: Negotiation of Synchronous/Asynchronous**

Mobile Terminated Call:

	BC-parameter Synchronous/Asynchronous	
Bearer type	Message SETUP	Message CALL CONF
FTM <sup>1)</sup>	Synchronous	Asynchronous
PIAFS <sup>2)</sup>	Synchronous	Asynchronous

- 1) This negotiation is possible, only if ITC=UDI or RDI, FNUR=64 or 56 kbit/s and CE=NT or "both" is signalled in the SETUP message. The MS shall signal FTM as specified in B.1.2.3 .
- 2) This negotiation is possible, only if ITC=UDI, FNUR=32 kbit/s and CE= "both" is signalled in the SETUP message. The UE shall signal PIAFS as specified in B.1.2.4

**Table B.4f: Negotiation of Rate adaptation/Other rate adaptation**

Mobile Terminated Call:

	BC-parameter Rate adaptation/Other rate adaptation	
Bearer type	Message SETUP	Message CALL CONF
FTM <sup>1)</sup>	V.110, I.460 and X.30	X.31 flag stuffing
PIAFS <sup>2)</sup>	V.110, I.460 and X.30	PIAFS
Multimedia	V.110, I.460 and X.30 <sup>3)</sup>	H.223 and H.245
	No rate adaptation <sup>5) 6)</sup>	H.223 and H.245

- 1) This negotiation is possible, only if ITC=UDI or RDI, FNUR=64 or 56 kbit/s and CE=NT or "both" is signalled in the SETUP message. The MS shall signal FTM as specified in B.1.2.3.
- 2) This negotiation is possible, only if ITC=UDI, FNUR=32 kbit/s and CE= "both" is signalled in the SETUP message. The UE shall signal PIAFS as specified in B.1.2.4.

- 3) This negotiation is possible, only if ITC=UDI or RDI, FNUR=32 or 56 kbit/s and CE=T or "both" is signalled in the SETUP message. The MS shall signal 3G-H.324/M as specified in B.1.3.1.3, B.1.3.1.4 and B.1.3.1.6.
- 4) Void.
- 5) This negotiation is possible, if ITC=3,1 kHz, FNUR=28.8 kbit/s, MT=V.34 and CE=T or "both" is signalled in the SETUP message. The MS shall signal 3G-H.324/M as specified in B.1.3.2.3.
- 6) This negotiation is possible, if ITC=UDI or RDI, FNUR=64 or 56 kbit/s and CE=T is signalled in the SETUP message. The MS shall signal 3G-H.324/M as specified in B.1.3.1.3, B.1.3.1.4, and B.1.3.1.5

**Table B.5: BC parameter setting (part 1)**

Abbreviations for Parameters and Values:		common setting of field values	
		default setting of field values (NA)	
ITC...Information Transfer Capability:	- Speech - UDI..Unrestricted Digital - FAX3..Group 3 Facsimile - 3,1 kHz..3,1 kHz Ex PLMN - RDI..Restricted Digital		v
TM....Transfer Mode:	- ci..Circuit	X	X
S.....Structure:	- SDU..Service Data Unit Integrity - Unstructured	X	
C.....Configuration:	- pp..Point to point	X	X
E.....Establishment:	- de..Demand	X	X
SA....Sync/Async:	- S..Synchronous - A..Asynchronous		
N.....Negotiation	- ibn..in band negotiation not possible	X	X
UR....User Rate:	- 0.3..0.3 kbit/s - 1.2..1.2 kbit/s - 2.4..2.4 kbit/s - 4.8..4.8 kbit/s - 9.6..9.6 kbit/s	X	
IR....Intermediate Rate:	- 8.. 8 kbit/s - 16.. 16 kbit/s	X	
NICT..Network Independent Clock on Tx:	- not_required.. Not required - required	X	X
NICR..Network Independent Clock on Rx:	- not_accepted..not accepted - accepted	X	X
NSB...Number of Stop Bits:	- 1..1 bit - 2..2 bit	X	
NDB...Number of Data Bits Excluding Parity If Present:	- 7.. 7 bit - 8.. 8 bit	X	
NPB...Parity Information:	- Odd - Even - None - 0.. Forced to 0 - 1.. Forced to 1	X	
UILIP..User Information Layer 1 Protocol	- def..default layer 1 protocol	X	X

**Table B.5: BC parameter setting (part 2)**

Abbreviations for Parameters and Values		common setting of field values	
		default setting of field values (NA)	
DM....Duplex Mode:	- - fd.. Full Duplex	X	X
MT....Modem Type:	- V.21 - V.22 - V.22 bis - V.26 ter - V.32 - autol.. autobauding type 1 - none	X	
RCR...Radio Channel Requirement:	- FR Full Rate support only Mobile Station - dual HR Dual Rate support Mobile Station/ Half Rate preferred - dual FR Dual Rate support Mobile Station/ Full Rate preferred		
CE....Connection Element:	- T.. Transparent - NT.. Non Transparent - bothT both transparent preferred - bothNT both non Transparent preferred		
UIL2P.User Information Layer 2 Protocol:	- ISO6429..ISO6429, codeset 0, DC1/DC3  - COPnoFlCt..Character oriented protocol with no flow control mechanism		
SAP...Signalling Access Protocol:	- I.440.. I.440/450	X	
RA....Rate Adaptation:	- V.110.. V.110/X.30 - X.31Flag.. X.31 flagstuffing - NO.. no rate adaptation - V.120 - PIAFS - H.223 and H.245	X	
CS....Coding Standard:	- GSM	X	X
NIRR..Negotiation of Intermediate Rate Requested:	NM..No Meaning associated with this value 6kbit/s..6kbit/s radio interface rate requested	X	
DC....Data Compression	- DC.. compression possible/allowed - NO.. compression not possible/allowed	X	

**Table B.5: BC parameter setting (part 3)**

Abbreviations for Parameters and Values		common setting of field values	
		default setting of field values (NA)	
FNUR...Fixed Network User Rate	<ul style="list-style-type: none"> <li>- FNUR not applicable</li> <li>- 9.6.. 9.6 kbit/s</li> <li>- 14.4.. 14.4 kbit/s</li> <li>- 19.2.. 19.2 kbit/s</li> <li>- 28.8.. 28.8 kbit/s</li> <li>- 32.0.. 32.0 kbit/s</li> <li>- 33.6.. 33.6 kbit/s</li> <li>- 38.4.. 38.4 kbit/s</li> <li>- 48.0.. 48.0 kbit/s</li> <li>- 56.0.. 56.0 kbit/s</li> <li>- 64.0.. 64.0 kbit/s</li> </ul>	V	V
WAIUR...Wanted Air Interface User Rate	<ul style="list-style-type: none"> <li>- WAIUR not applicable</li> <li>- 9.6.. 9.6 kbit/s</li> <li>- 14.4.. 14.4 kbit/s</li> <li>- 19.2.. 19.2 kbit/s</li> <li>- 28.8.. 28.8 kbit/s</li> <li>- 38.4.. 38.4 kbit/s</li> <li>- 43.2.. 43.2 kbit/s</li> <li>- 57.6.. 57.6 kbit/s</li> <li>- int 38.4.. interpreted by the network as 38.4 kbit/s</li> </ul>	X	
ACC.....Acceptable channel codings	<ul style="list-style-type: none"> <li>- 4.8.. TCH/F4.8 acceptable</li> <li>- 9.6.. TCH/F9.6 acceptable</li> <li>- 14.4..TCH/F14.4 acceptable</li> <li>- 28.8..TCH/F28.8 acceptable</li> <li>- 32.0..TCH/F32.0 acceptable</li> <li>- 43.2..TCH/F43.2 acceptable</li> <li>- none..No channel coding (defined by selecting none of the above</li> </ul>		
MaxNumTCH...Maximum Number of Traffic Channels	<ul style="list-style-type: none"> <li>- 1.. 1 TCH</li> <li>- 2.. 2 TCH</li> <li>- 3.. 3 TCH</li> <li>- 4.. 4 TCH</li> <li>- 5.. 5 TCH</li> <li>- 6.. 6 TCH</li> <li>- 7.. 7 TCH</li> <li>- 8.. 8 TCH</li> </ul>		
OMT...Other modem type	<ul style="list-style-type: none"> <li>- no other MT.. no other modem type</li> <li>- V.34.. V.34</li> </ul>		
User initiated modification indication	<ul style="list-style-type: none"> <li>- not req.. user initiated modification not required</li> <li>- upto 1 TCH.. user initiated modification upto 1 TCH may be requested</li> <li>- upto 2 TCH.. user initiated modification upto 2 TCH may be requested</li> <li>- upto 3 TCH.. user initiated modification upto 3 TCH may be requested</li> <li>- upto 4 TCH.. user initiated modification upto 4 TCH may be requested</li> </ul>	X	
Asymmetry preference indication	<ul style="list-style-type: none"> <li>- 00 no preference</li> <li>- 01 up link biased asymmetry preferred</li> <li>- 10 down link biased asymmetry preferred</li> </ul>		

Table B.5a: Differences in parameter value validity in A/Gb mode and UTRAN Iu mode

Parameter / value	A/Gb mode	GERAN Iu mode	UTRAN Iu mode
Radio Channel Requirements / any	valid	valid	ignored
User rate / any	valid	ignored	ignored
Intermediate Rate / any	valid	valid	ignored
NIC on transmission / any	valid	ignored	ignored
NIC on reception / any	valid	ignored	ignored
Negotiation of IR requested / any	valid	ignored	ignored
Acceptable Channel Codings / any	valid	valid	ignored
Maximum number of traffic channels / any	valid	valid	ignored (Note 1)
User initiated modification indication / any	valid	valid	ignored (Note 1)
Asymmetry preference indication / any	valid	valid	ignored
Modem type /			
V.21, V.22, V.22bis, V.26ter	valid	invalid	invalid
V.32	valid	valid	invalid for CE=T
Fixed Network User Rate /			
32 kbit/s	Invalid for CE = NT	Invalid for CE = NT	valid
33.6 kbit/s	invalid	invalid	valid
9.6, 14.4, 19.2, 38.4, 48.0	valid	invalid for CE=T	invalid for CE=T
28.8	valid	invalid for CE=T in the case of ITC=UDI	invalid for CE=T in the case of ITC=UDI
Other Rate adaptation /			
PIAFS	invalid	invalid	valid

NOTE: Although a parameter value is marked as "valid", the validity may be restricted by rules given elsewhere in the present document.

NOTE 1: This parameter is relevant in UTRAN Iu mode for NT calls, in conjunction with WAIUR, for deciding which RLP version to negotiate in order to avoid renegotiation of RLP version in case of handover, see 3GPP TS 24.022 [9]. It is otherwise irrelevant for specifying the UTRAN Iu mode radio access bearer.

**Table B.6: Channel combinations**

Single Bearer and Teleservices

MS indication BC	Network selection CT
FR dual FR dual HR	FR FR or HR HR or FR

Alternate services

MS indication		Network selection				
BC(1)	BC(2)	CT(1)	CT(2)	Or	CT(1)	CT(2)
FR	FR	FR	FR			
FR	dual Rate	FR	FR			
dual Rate	dual Rate	FR	FR	Or	HR	HR
dual Rate	FR	FR	FR			

Followed-by services

MS indication		Network selection							
BC(1)	BC(2)	CT(1)	CT(2)	or	CT(1)	CT(2)	or	CT(1)	CT(2)
FR	FR	FR	FR						
FR	dual Rate	FR	FR						
dual Rate	dual Rate	FR	FR	or	HR	HR	or	FR	HR
dual Rate	FR	FR	FR						

BC Bearer Capability  
 CT Channel Type  
 dual Rate {dual FR | dual HR}

**Table B.7: TS61/TS62 Negotiation rules**

Mobile Originating Call

Subscription	SETUP	CALL PROCEED
TS61	TS61 s/f	TS61 s/f or TS62
	TS61 f/s	TS61 f/s or TS62
	TS62	TS62
TS62	TS61 s/f	TS62
	TS61 f/s	TS62
	TS62	TS62

Mobile Terminating Call

Subscription	SETUP	CALL CONFIRMED
TS61	TS61 s/f	TS61 s/f or TS61 f/s or TS62
	TS61 f/s	TS61 s/f or TS61 f/s or TS62
	TS62	TS62
	no BC	TS61 s/f or TS61 f/s or TS62
TS62	TS62	TS62
	no BC	TS62 (note)

s/f = speech then fax  
 f/s = fax then speech

NOTE: TS61 is also accepted if the VMSC supports TS61 and does not perform subscription checking on a CALL CONFIRMED message (see 3GPP TS 22.001 and 3GPP TS 29.007).



## B.1.2 Bearer Service 20, Data Circuit Duplex Asynchronous

### B.1.2.1 Unrestricted / restricted digital information transfer capability

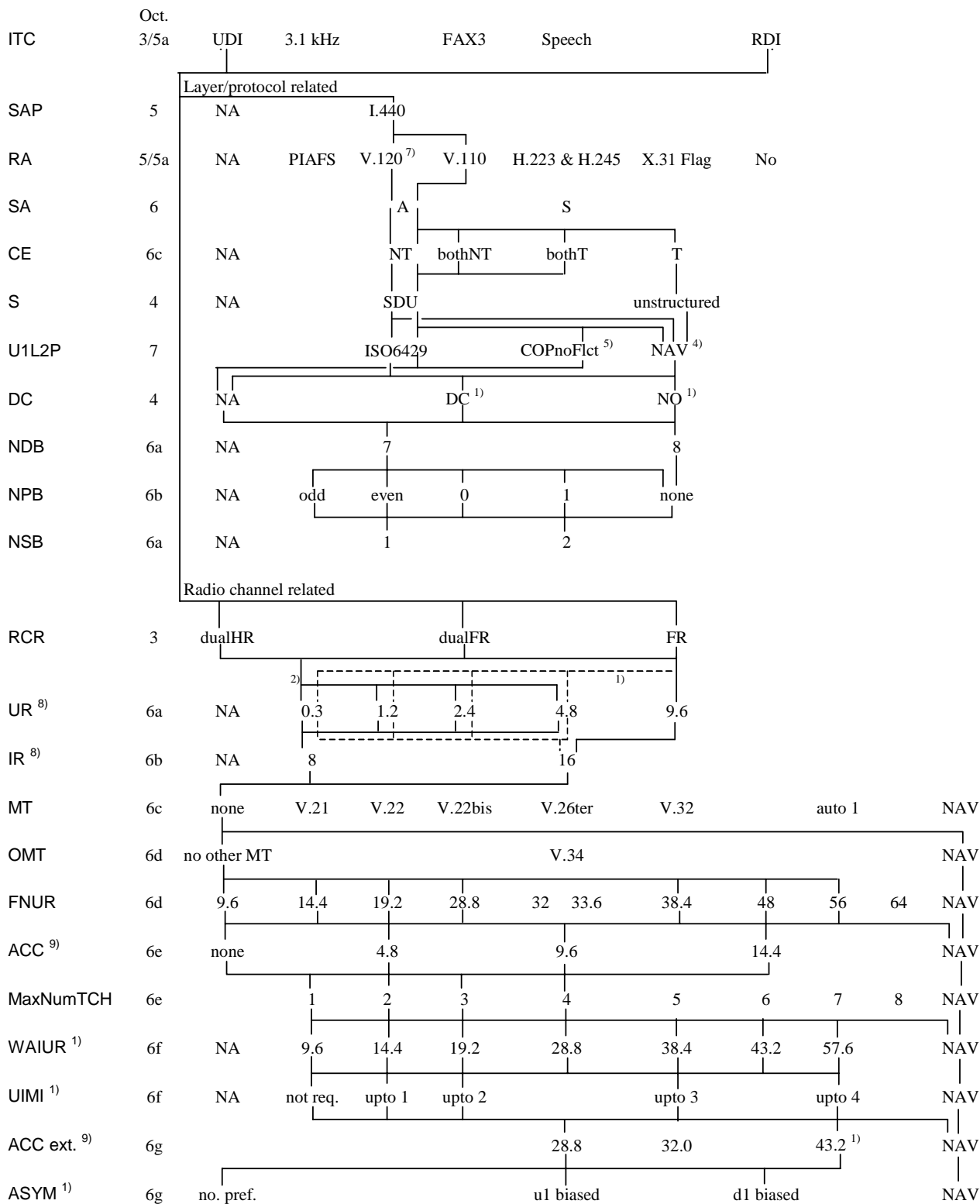

- 1) for CE:NT or "both";
- 2) for CE:T only or CE:NT and NIRR:6kb/s (not for the SETUP message);
- 3) Void;
- 4) for MT CALLS in the SETUP message or MO/MT CALLS with "out-band" flow control requested;
- 5) for MO/MT CALLS with no flow control requested;

- 6) Void;
- 7) the V.120 relevant BC parameters (octet 5b) shall be set according to the LLC (see clause B.2);
- 8) IR and UR are overridden by FNUR, ACC and MaxNumTCH;
- 9) ACC may have several values simultaneously (bit map coding).

### B.1.2.2 3,1 kHz audio ex-PLMN information transfer capability

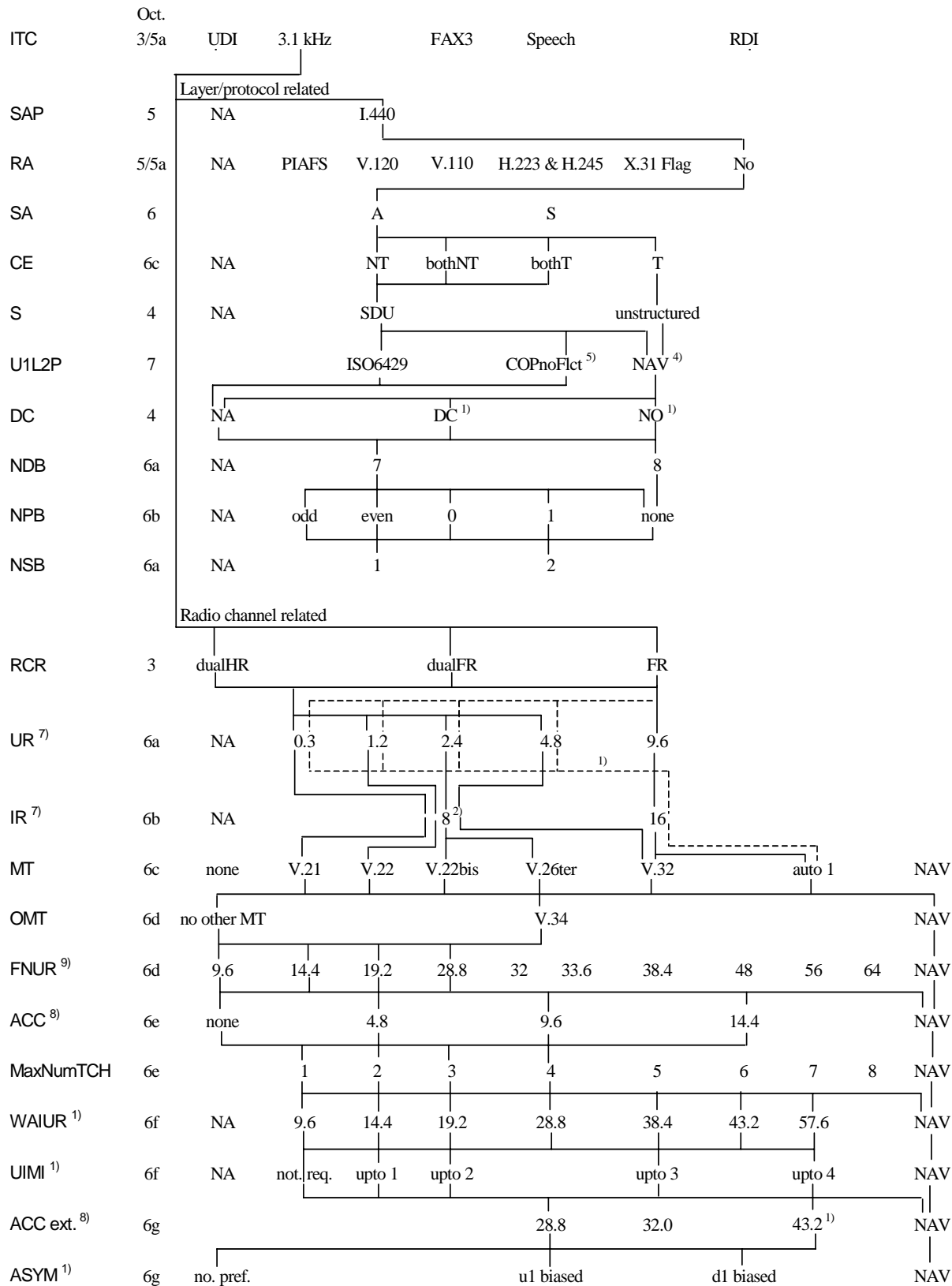

- 1) for CE:NT or "both";
- 2) for CE:T only or CE:NT and NIRR:6kb/s (not for the SETUP message);
- 3) Void;
- 4) for MT CALLS in the SETUP message or MO/MT CALLS with "out-band" flow control requested (not for V.21 modem type);

- 5) for MO/MT CALLS with no flow control requested;
- 6) Void;
- 7) IR and UR are overridden by FNUR, ACC and MaxNumTCH.
- 8) ACC may have several values simultaneously (bit map coding).
- 9) in case of MT = auto1 the value of FNUR has no meaning.

### B.1.2.3 Frame Tunnelling Mode

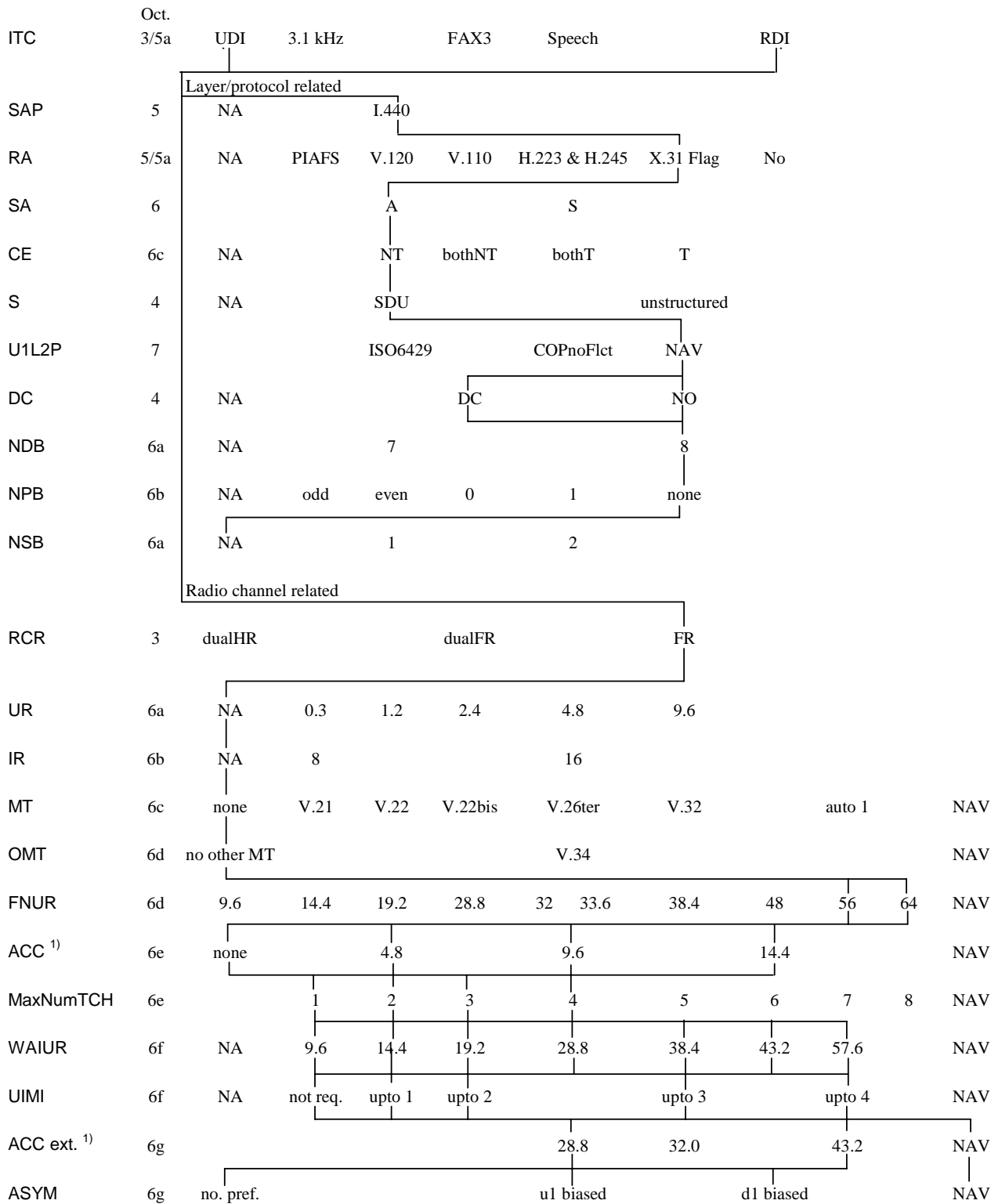

1) ACC may have several values simultaneously (bit map coding).

### B.1.2.4 PIAFS

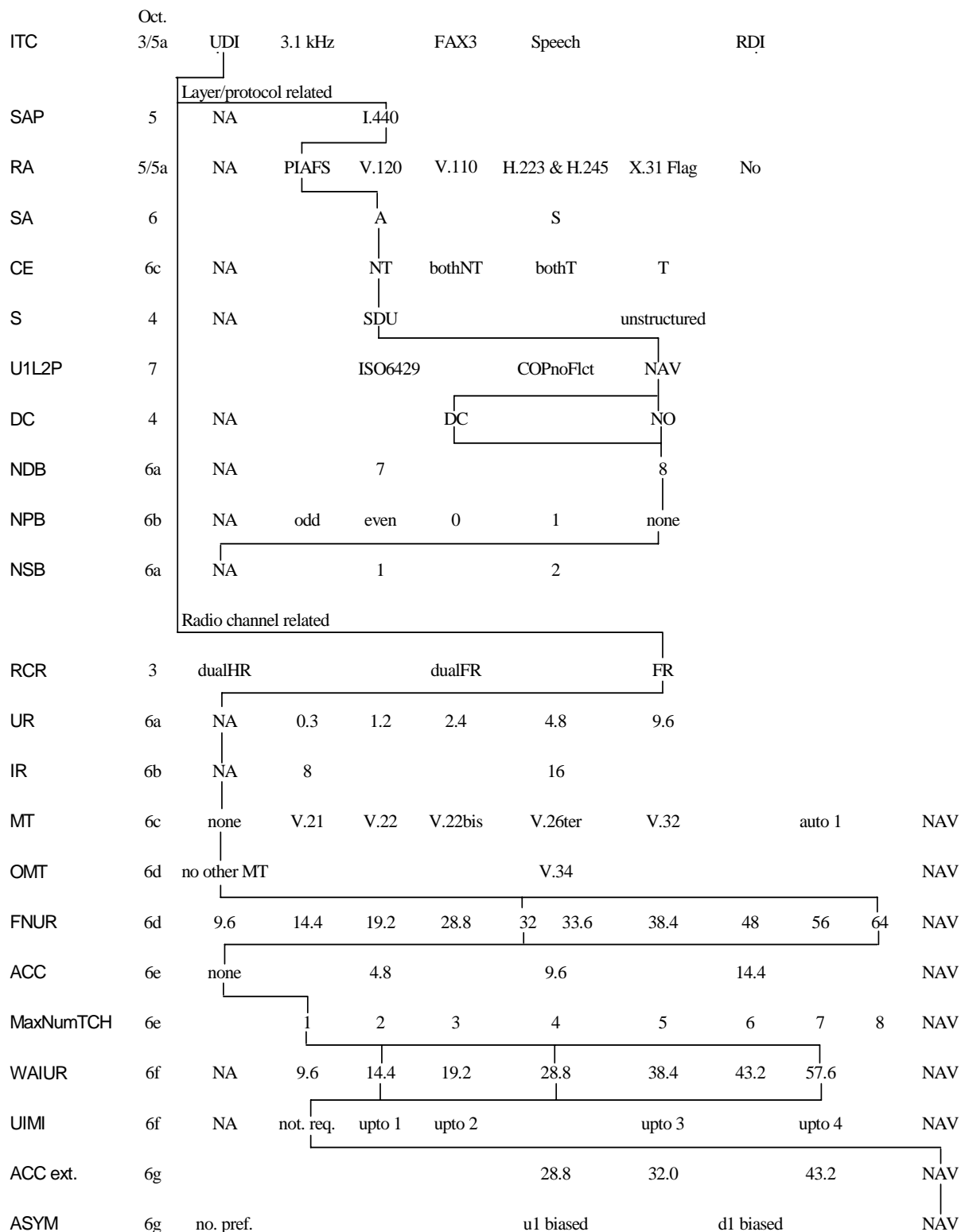

## B.1.3 Bearer Service 30, Data Circuit Duplex Synchronous

### B.1.3.1 Unrestricted/restricted digital information transfer capability

#### B.1.3.1.1 Transparent FNUR $\leq 48$ kbit/s (TCH/F4.8, TCH/F9.6, TCH/14.4, TCH/F28.8)

Applies to A/Gb mode only. No HO to/from UTRAN Iu mode.

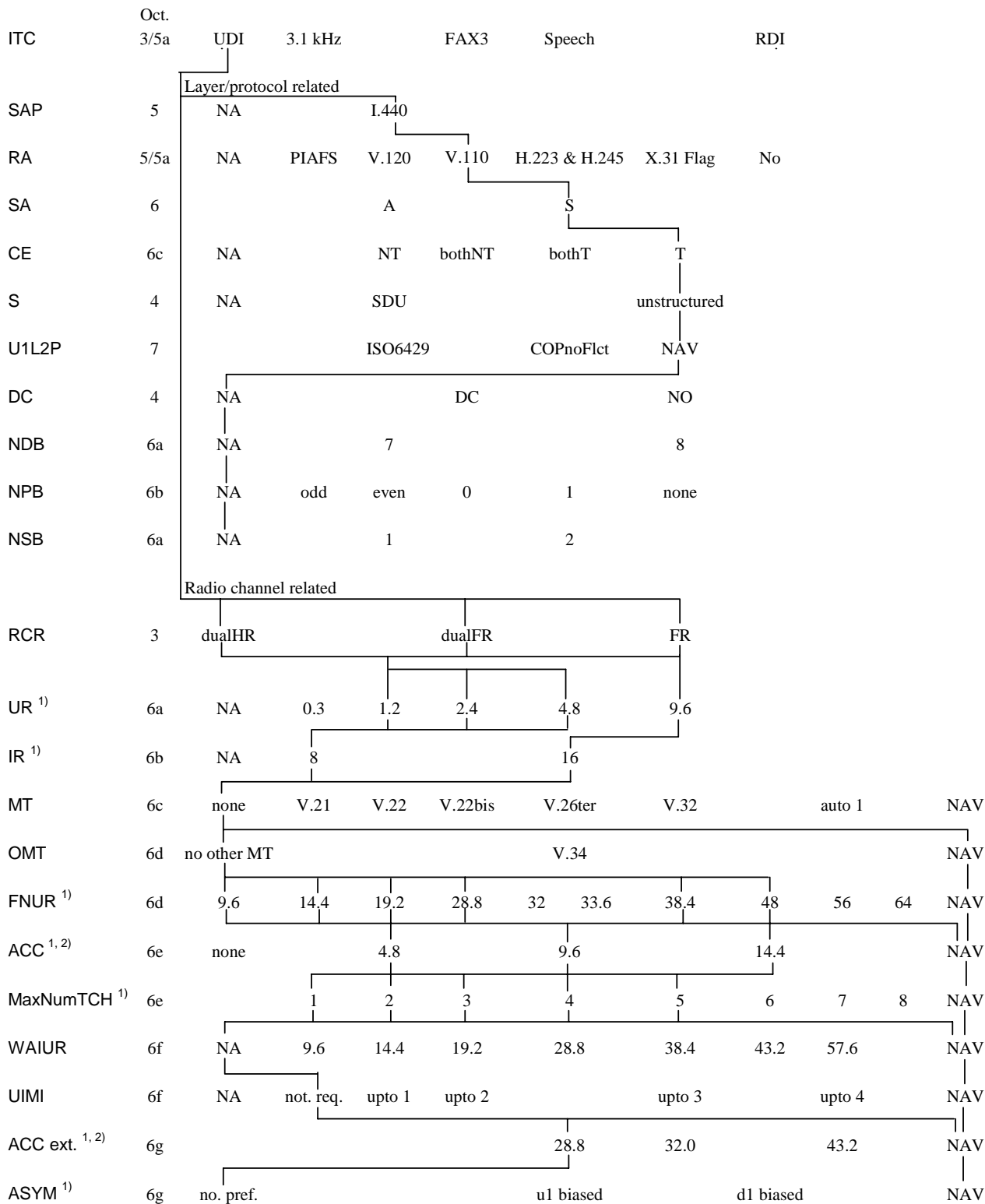

1) IR and UR are overridden by FNUR, ACC and MaxNumTCH.

2) ACC may have several values simultaneously (bit map coding).

**B.1.3.1.2 X.32 Case**

Void.



B.1.3.1.3 Transparent FNUR=56 kbit/s, including 3G-H.324/M, (TCH/F9.6, TCH/F32.0, UTRAN Iu mode)

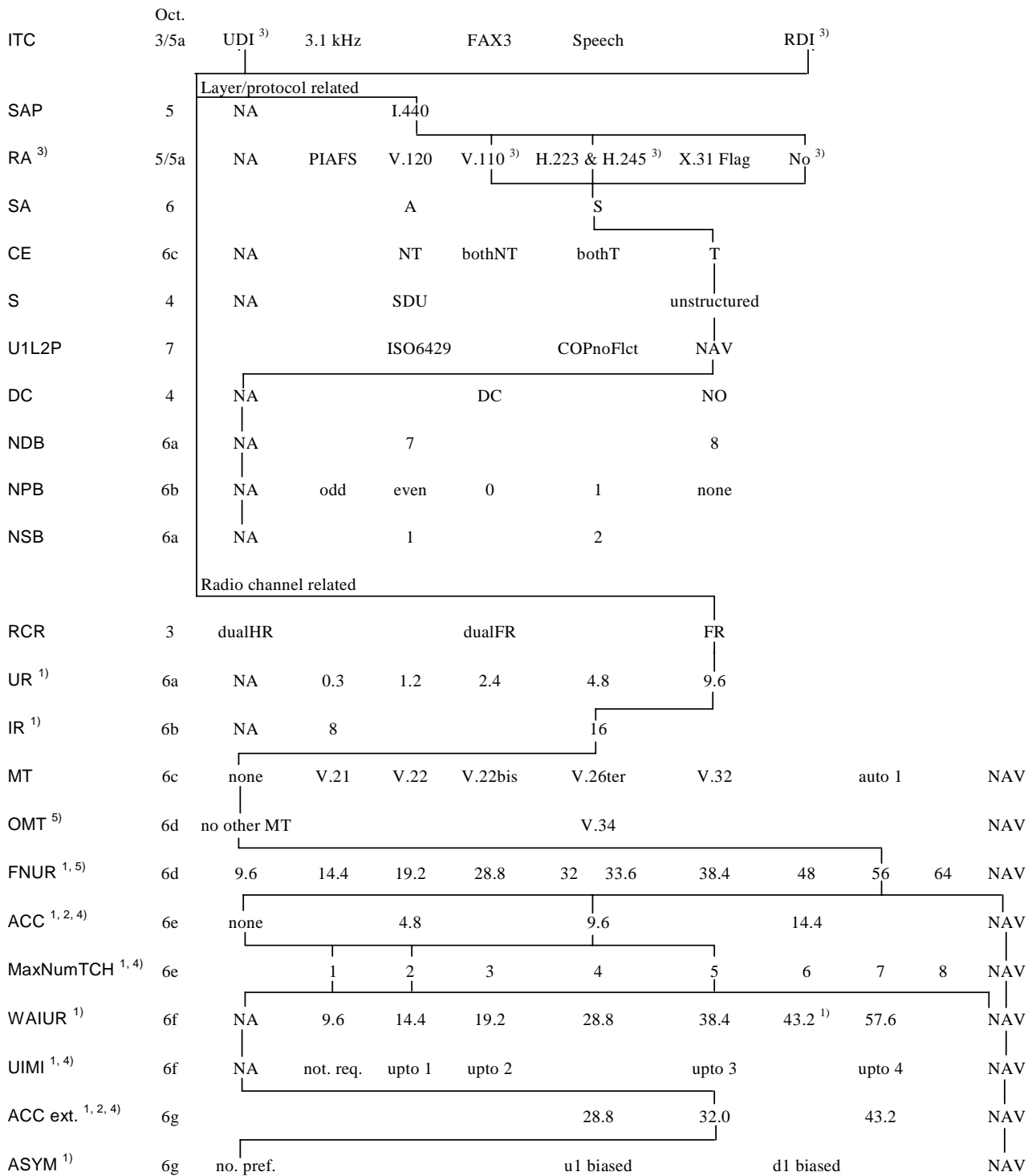

- 1) IR and UR are overridden by FNUR, ACC and MaxNumTCH. IR and UR are not applicable to UTRAN Iu mode.
- 2) ACC may have several values simultaneously (bit map coding). However, handover to/from UTRAN is not possible if the network assigns other traffic channels than TCH/F9.6 or TCH/F32.0.
- 3) In case ITC=UDI, RA shall be set to V.110. In case ITC=RDI, RA shall be set to H.223 & H.245 or No.

- 4) An MS not supporting GERAN A/Gb and GERAN Iu mode sets ACC to "none" and MaxNumTCH is set to "1 TCH". An MS not supporting GERAN A/Gb and GERAN Iu mode also sets ACCext (i.e. the extension bits of ACC parameter, see 3GPP TS 24.008 for its definition and values) and UIMI to zero if they are included in the PLMN BC-IE, i.e. UIMI is set to "NA" and the ACC parameter (including the ACCext bits) is set to the value "none" (all zeros).
- 5) The parameters FNUR and OMT are mandatory for this service.

B.1.3.1.4 Transparent FNUR = 56kbit/s, including 3G-H.324/M (TCH/F14.4)

Applies to A/Gb mode only, no HO to/from UTRAN Iu mode

ITC	Oct. 3/5a	UDI <sup>3)</sup>	3.1 kHz	FAX3	Speech	RDI <sup>3)</sup>						
SAP	5	NA	I.440	Layer/protocol related								
RA <sup>3)</sup>	5/5a	NA	PIAFS	V.120	V.110 <sup>3)</sup>	H.223 & H.245 <sup>3)</sup>	X.31 Flag	No <sup>3)</sup>				
SA	6		A		S							
CE	6c	NA	NT	bothNT	bothT	T						
S	4	NA	SDU		unstructured							
U1L2P	7		ISO6429		COPnoFlct	NAV						
DC	4	NA		DC		NO						
NDB	6a	NA	7			8						
NPB	6b	NA	odd	even	0	1	none					
NSB	6a	NA	1			2						
Radio channel related												
RCR	3	dualHR		dualFR		FR						
UR <sup>1)</sup>	6a	NA	0.3	1.2	2.4	4.8	9.6					
IR <sup>1)</sup>	6b	NA	8			16						
MT	6c	none	V.21	V.22	V.22bis	V.26ter	V.32	auto 1	NAV			
OMT <sup>4)</sup>	6d	no other MT				V.34		NAV				
FNUR <sup>1,4)</sup>	6d	9.6	14.4	19.2	28.8	32	33.6	38.4	48	56	64	NAV
ACC <sup>1,2,4)</sup>	6e	none		4.8		9.6			14.4		NAV	
MaxNumTCH <sup>1,4)</sup>	6e		1	2	3	4 <sup>1)</sup>	5	6	7	8	NAV	
WAIUR	6f	NA	9.6	14.4	19.2	28.8	38.4	43.2	57.6		NAV	
UIMI	6f	NA	not. req.	upto 1	upto 2		upto 3		upto 4		NAV	
ACC ext.	6g					28.8	32.0		43.2		NAV	
ASYM	6g	no. pref.				u1 biased		d1 biased			NAV	

- 1) IR and UR are overridden by FNUR, ACC and MaxNumTCH.
- 2) ACC may have several values simultaneously (bit map coding).
- 3) In case ITC=UDI, RA shall be set to V.110. In case ITC=RDI, RA shall be set to H.223 & H.245 or No.
- 4) The parameters FNUR, OMT, ACC and MaxNumTCH are mandatory for this service.

B.1.3.1.5 Transparent FNUR = 64kbit/s, including 3G-H.324/M (TCH/F9.6, TCH/F14.4, TCH/F32.0, UTRAN Iu mode))

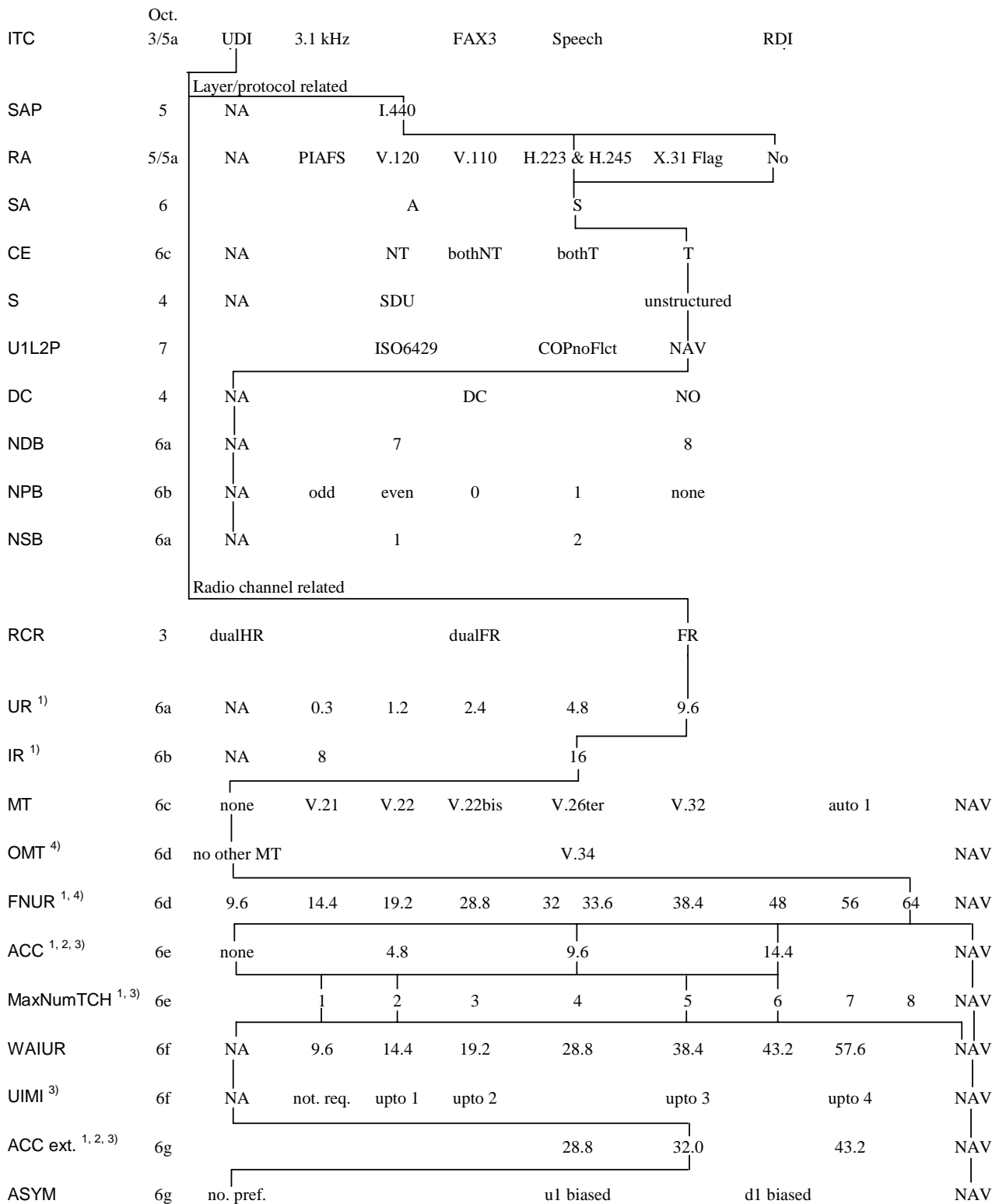

- 1) IR and UR are overridden by FNUR, ACC and MaxNumTCH. IR and UR are not applicable to UTRAN Iu mode.
- 2) ACC may have several values simultaneously (bit map coding).

- 3) An MS not supporting GERAN A/Gb and GERAN Iu mode sets ACC to "none" and MaxNumTCH is set to "1 TCH". An MS not supporting GERAN A/Gb and GERAN Iu mode also sets ACCext (i.e. the extension bits of ACC parameter, see 3GPP TS 24.008 for its definition and values) and UIMI to zero if they are included in the PLMN BC-IE, i.e. UIMI is set to "NA" and the ACC parameter (including the ACCext bits) is set to the value "none" (all zeros).
- 4) The parameters FNUR and OMT are mandatory for this service.

**B.1.3.1.6 3G-H.324/M, FNUR=32.0 kbit/s (TCH/F32.0, UTRAN Iu mode)**

	Oct.	UDI	3.1 kHz	FAX3	Speech	RDI						
ITC	3/5a											
Layer/protocol related												
SAP	5	NA	I.440									
RA	5/5a	NA	PIAFS	V.120	V.110	H.223 & H.245	X.31 Flag	No				
SA	6	A			S							
CE	6c	NA	NT	bothNT	bothT		T					
S	4	NA	SDU	unstructured								
U1L2P	7	ISO6429			COPnoFlct		NAV					
Radio channel related												
DC	4	NA	DC				NO					
NDB	6a	NA	7	8								
NPB	6b	NA	odd	even	0	1	none					
NSB	6a	NA	1	2								
RCR	3	dualHR	dualFR			FR						
UR <sup>3)</sup>	6a	NA	0.3	1.2	2.4	4.8	9.6					
IR <sup>3)</sup>	6b	NA	8	16								
MT	6c	none	V.21	V.22	V.22bis	V.26ter	V.32	auto 1	NAV			
OMT	6d	no other MT	V.34							NAV		
FNUR	6d	9.6	14.4	19.2	28.8	32	33.6	38.4	48	56	64	NAV
ACC <sup>1,2)</sup>	6e	none	4.8			9.6			14.4		NAV <sup>2)</sup>	
MaxNumTCH <sup>2)</sup>	6e	NA	2	3	4	5	6	7	8	NAV <sup>2)</sup>		
WAIUR	6f	NA	9.6	14.4	19.2	28.8	38.4	43.2	57.6	NAV		
UIMI <sup>2)</sup>	6f	NA	not req.	upto 1	upto 2	upto 3			upto 4	NAV <sup>2)</sup>		
ACC ext. <sup>1,2)</sup>	6g	not accept.	28.8			32.0			43.2	NAV <sup>2)</sup>		
ASYM <sup>2)</sup>	6g	no. pref.	u1 biased				d1 biased			NAV <sup>2)</sup>		

1) ACC may have several values simultaneously (bit map coding).

- 2) If ACC, UIMI, MaxNumTCH and ASYM are not available operation is restricted to UTRAN.
- 3) IR and UR are overridden by FNUR, ACC and MaxNumTCH. IR and UR are not applicable to UTRAN Iu mode.

B.1.3.1.7 Synchronous transparent 56 kbit/s (RDI) and 64kbit/s (UDI) (UTRAN lu mode)

See B.1.3.1.3 and B.1.3.1.5.

### B.1.3.2 3,1 kHz audio ex-PLMN information transfer capability

#### B.1.3.2.1 Non-X.32 Cases

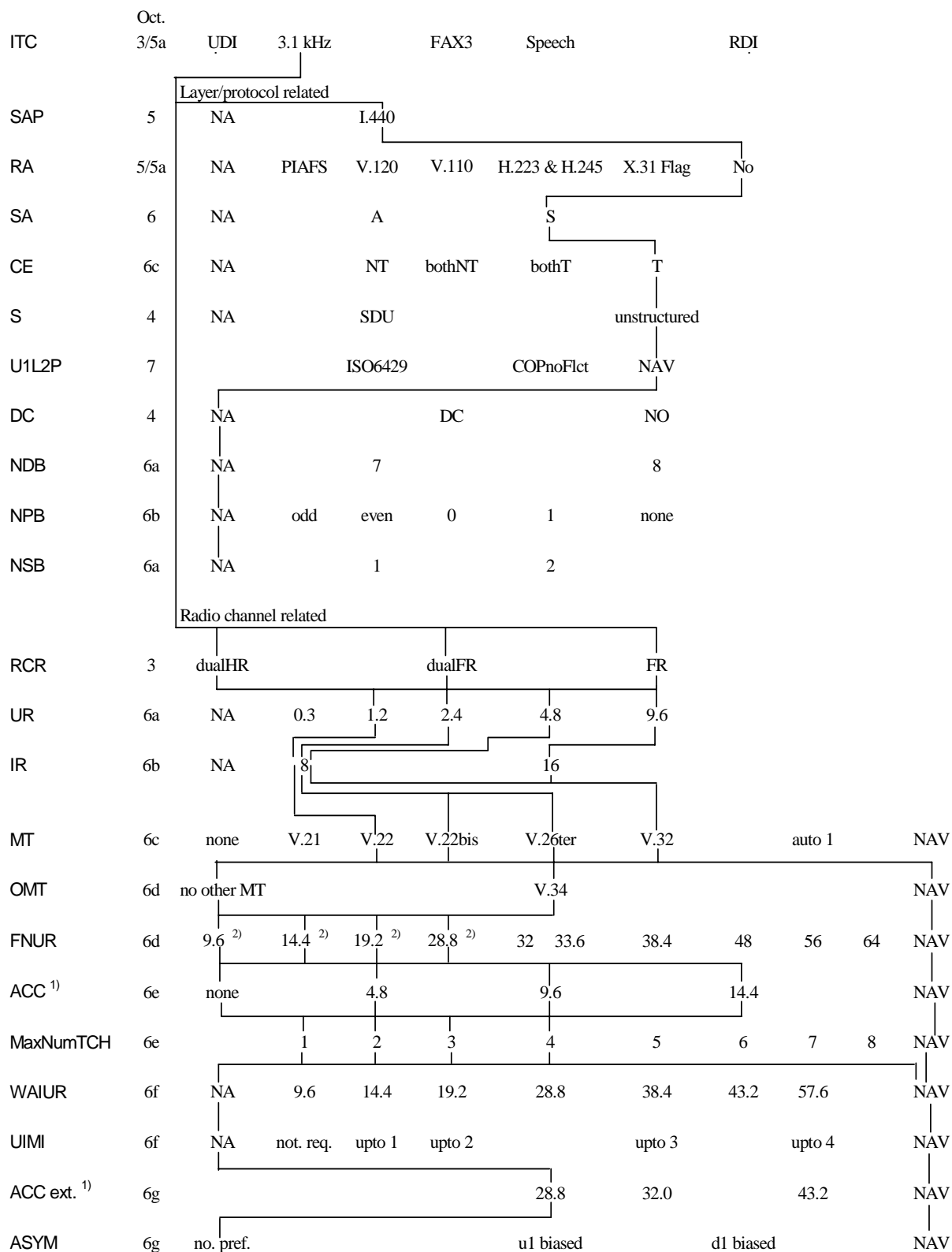

1) ACC may have several values simultaneously (bit map coding).



B.1.3.2.2 X.32 Case

Void.

B.1.3.2.3 3G-H.324/M Case

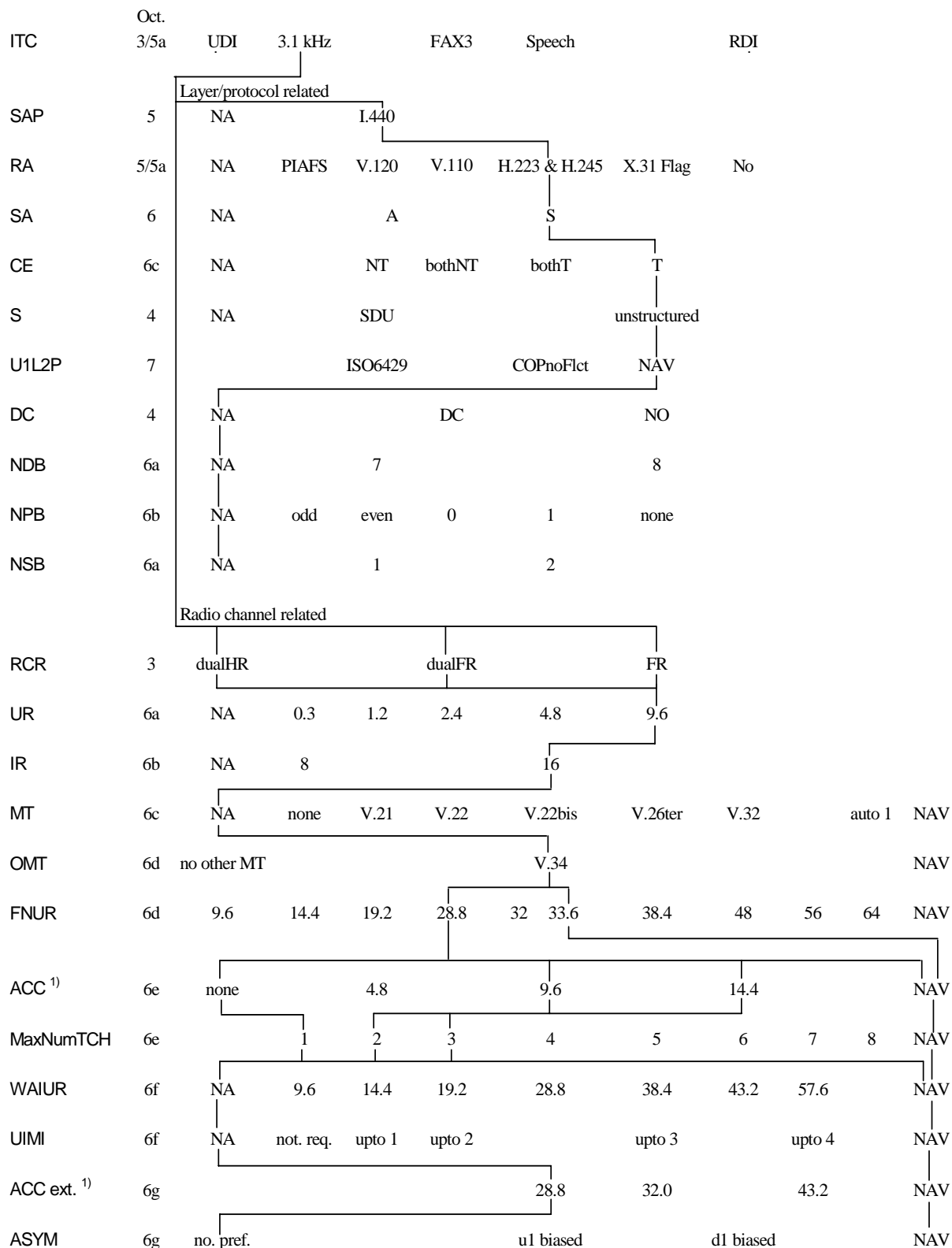

1) ACC may have several values simultaneously (bit map coding).

2) FNUR 33.6 kbit/s applies to UTRAN Iu mode only.

**B.1.4 Bearer Service 40 ... 46, PAD Access Asynchronous**

Void.

**B.1.5 Bearer Service 50 ... 53 ,Data Packet Duplex Synchronous,  
Unrestricted digital information transfer capability**

Void.

**B.1.6 Bearer Service 61, Alternate Speech/Data**

Void.

**B.1.7 Bearer Service 81, Speech followed by Data**

Void.

### B.1.8 Teleservice 11 ... 12, Speech

ITC	Oct.	UDI	3.1 kHz	FAX3	Speech	RDI						
Layer/protocol related												
SAP	5	NA	I.440			NAV						
RA	5/5a	NA	PIAFS	V.120	V.110	H.223 & H.245	X.31 Flag	No	NAV			
SA	6	NA	A		S				NAV			
CE	6c	NA	NT	bothNT	bothT	T			NAV			
S	4	NA	SDU			unstructured			NAV			
U1L2P	7		ISO6429		COPnoFlct				NAV			
DC	4	NA		DC			NO		NAV			
NDB	6a	NA	7				8		NAV			
NPB	6b	NA	odd	even	0	1	none		NAV			
NSB	6a	NA	1		2				NAV			
Radio channel related												
RCR	3	dualHR		dualFR		FR						
UR	6a	NA	0.3	1.2	2.4	4.8	9.6		NAV			
IR	6b	NA	8			16			NAV			
MT	6c	none	V.21	V.22	V.22bis	V.26ter	V.32	auto 1	NAV			
OMT	6d	no other MT				V.34			NAV			
FNUR	6d	9.6	14.4	19.2	28.8	32	33.6	38.4	48	56	64	NAV
ACC	6e	none		4.8		9.6		14.4			NAV	
MaxNumTCH	6e		1	2	3	4	5	6	7	8	NAV	
WAIUR	6f	NA	9.6	14.4	19.2	28.8	38.4	43.2	57.6		NAV	
UIMI	6f	NA	not. req.	upto 1	upto 2		upto 3		upto 4		NAV	
ACC ext.	6g					28.8	32.0		43.2		NAV	
ASYM	6g	no. pref.				u1 biased		d1 biased			NAV	

## B.1.9 Teleservice 21 ... 23, Short Message

Not applicable.

## B.1.10 Teleservice 61, Alternate Speech and Facsimile group 3

The information element of the "repeat indicator" is set to the value "circular for successive selection (alternate)".

### B.1.10.1 Teleservice 61, Speech

See subclause B.1.8.

### B.1.10.2 Teleservice 61, Facsimile group 3 in A/Gb mode

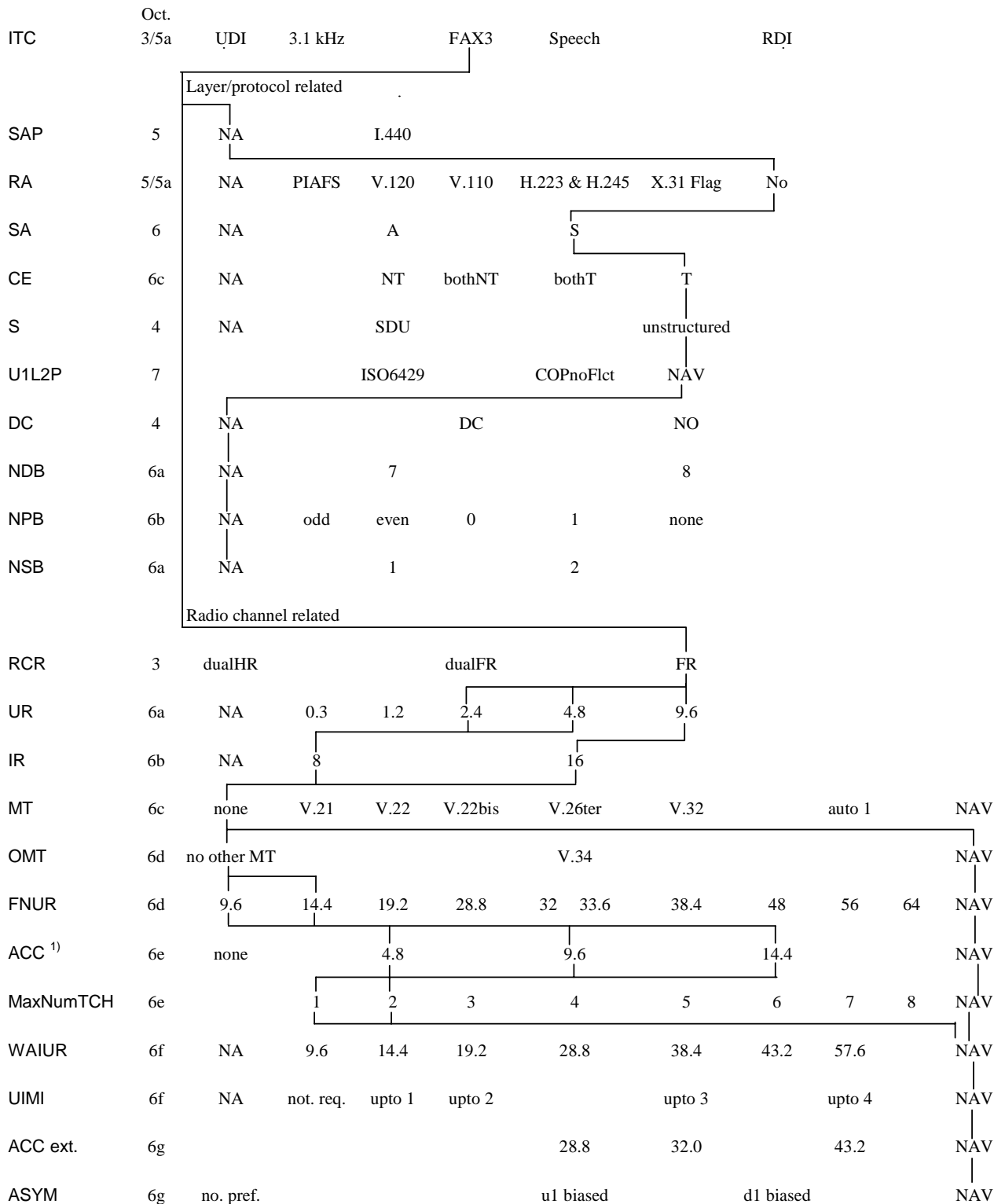

1) ACC may have several values simultaneously (bit map coding).

### B.1.10.3 Teleservice 61, Facsimile group 3 in UTRAN Iu mode

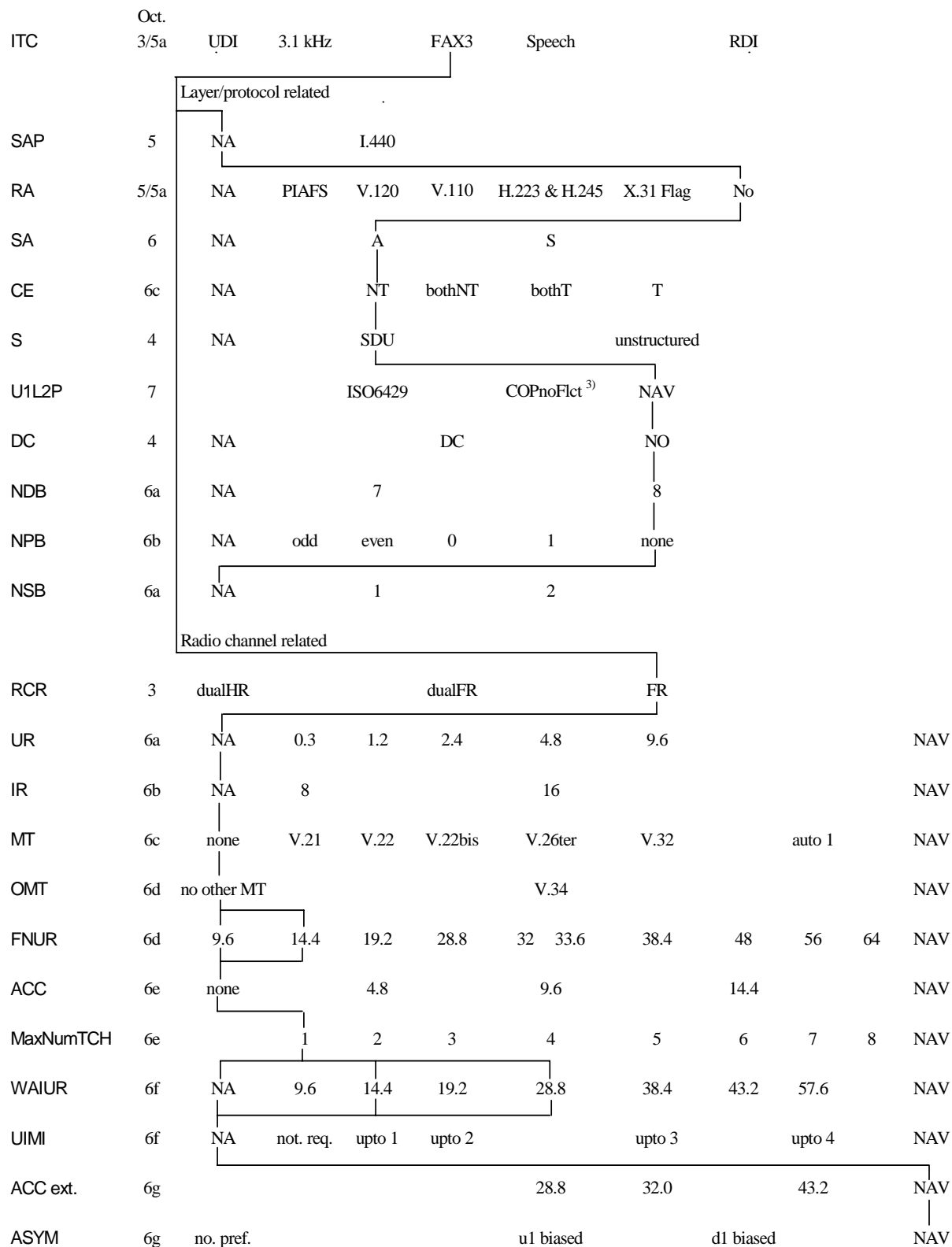

## B.1.11 Teleservice 62, Automatic Facsimile group 3

Ref. subclause B.1.10, the information element "repeat indicator" is not available/valid.

## B.1.12 Valid combinations of FNUR, WAIUR, ACC, mTCH

### B.1.12.1 Transparent Services

The MS is allowed to signal any combination of FNUR, ACC and mTCH compliant to the following table. The network is allowed to assign any Channel Mode compliant to the following table.

FNUR	mTCH (Note 7)	ACC (Note 1,6)					Channel Mode (Note 4,5)				
		TCH/F4.8	TCH/F9.6	TCH/F14.4	TCH/F28.8	TCH/F32.0	TCH/F4.8	TCH/F9.6	TCH/F14.4	TCH/F28.8	TCH/F32.0
9.6 kbit/s	1	*	+	*	*	*	-	1	-	-	-
	2	+	*	*	*	*	2	1	-	-	-
14.4 kbit/s	1	*	*	+	*	*	-	-	1	-	-
	2	*	+	*	*	*	-	2 (N2)	1	-	-
	3	+	*	*	*	*	3	2 (N2)	1	-	-
19.2 kbit/s	2	*	+	*	*	*	-	2	-	-	-
	4	+	*	*	*	*	4	2	-	-	-
28.8 kbit/s	1	*	*	*	+	*	-	-	-	1	-
	2	*	*	+	*	*	-	-	2	1	-
	3	*	+	*	*	*	-	3	2	1	-
32.0 kbit/s	1	*	*	*	*	+	-	-	-	-	1
38.4 kbit/s	3	*	*	+	*	*	-	-	3 (N2)	-	-
	4	*	+	*	*	*	-	4	3 (N2)	-	-
48.0 kbit/s	4	*	*	+	*	*	-	-	4 (N2)	-	-
	5	*	+	*	*	*	-	5	4 (N2)	-	-
56.0 kbit/s	2	*	*	*	*	+	-	-	-	-	2(N8)
	4	*	*	+	*	*	-	-	4 (N2)	-	2(N8)
	5	*	+	*	*	*	-	5 (N3)	4 (N2)	-	2(N8)
64.0 kbit/s	2	*	*	*	*	+	-	-	-	-	2(N8)
	5	*	*	+	*	*	-	-	5 (N2)	-	2(N8)
	6	*	+	*	*	*	-	6 (N2,3)	5 (N2)	-	2(N8)

**NB:** N in the table stands for NOTE.

NOTE 1: A '+' indicates that a certain channel coding shall be included in the ACC and a '\*' indicates that it may or may not be included.

NOTE 2: Padding Required, ref 3GPP TS 44.021.

NOTE 3: Air interface user rate 11,2 kbit/s, ref. 3GPP TS 44.021.

NOTE 4: A '-' indicates that this channel coding cannot be assigned for this FNUR.

NOTE 5: A certain channel coding may only be assigned if indicated as acceptable in the ACC.

NOTE 6: In case the MS signals an ACC containing TCH/F4.8 only and the network does not support TCH/F4.8 channel coding, then the network may act as if TCH/F9.6 were included in the ACC.

NOTE 7: The MS is allowed to signal higher values for mTCH than indicated in the table for the signalled FNUR and ACC. Before initiating the assignment procedure, the MSC, if necessary, shall lower the value of the mTCH to the highest value applicable for the signalled FNUR and ACC.

NOTE 8: Can only be used for bit transparent 56 (RDI) and 64 (UDI) kbit/s connections in 56 kbit/s and 64 kbit/s environments, respectively.

The final decision about the radio interface configuration is taken by the BSS during the Assignment procedure subject to the restrictions that the number of assigned TCH/F may not exceed the mTCH, that the channel coding is among the ACC and that the AIUR equals the FNUR.

The radio interface configuration may be changed by the BSS during the call as long as the channel coding used is among the ACC, the mTCH is not exceeded and the AIUR is kept constant (ref. 3GPP TS 22.034).



## B.1.12.2 Non-transparent services

The MS is allowed to signal any combination of WAIUR, ACC and mTCH compliant to the following table. A combination is compliant to the table, if there exists at least one row that it is compliant to. A combination is compliant to a row if each parameter value meets the conditions given in that row. When a WAIUR, ACC, mTCH combination is compliant to a row, the network is allowed to assign any Channel Mode compliant to that row. The notes of the table provide further details on the compliance conditions.

WAIUR (Note 7)	mTCH (Note 5)	ACC (Note 1,4)					Channel Mode (Note 2,3,6)				
		TCH/F4.8	TCH/F9.6	TCH/F14.4	TCH/F28.8	TCH/F43.2	TCH/F4.8	TCH/F9.6	TCH/F14.4	TCH/F28.8	TCH/F43.2
9.6 kbit/s	1	*	+	*	*	*	1	1	-	-	-
	2	+	*	*	*	*	1-2	1	-	-	-
14.4 kbit/s	1	*	*	+	*	*	1	1	1	-	-
	3	+	*	*	*	*	1-3	1-2	1	-	-
19.2 kbit/s	2	*	+	*	*	*	1-2	1-2	1	1	-
	4	+	*	*	*	*	1-4	1-2	1	1	-
28.8 kbit/s	1	*	*	*	+	*	1	1	1	1	-
	2	*	*	+	*	*	1-2	1-2	1-2	1	-
	3	*	+	*	*	*	1-3	1-3	1-2	1	-
38.4 kbit/s	4	*	+	*	*	*	1-4	1-4	1-3	1-2	1
43.2 kbit/s	1	*	*	*	*	+	1	1	1	1	1
	3	*	*	+	*	*	1-3	1-3	1-3	1-2	1
57.6 kbit/s	2	*	*	*	+	*	1-2	1-2	1-2	1-2	1
	4	*	*	+	*	*	1-4	1-4	1-4	1-2	1

NOTE 1: A '+' indicates that a certain channel coding shall be included in the ACC and a '\*' indicates that it may or may not be included.

NOTE 2: A '-' indicates that this channel coding cannot be used for this WAIUR.

NOTE 3: A certain channel coding may only be assigned if indicated as acceptable in the ACC.

NOTE 4: In case the MS signals an ACC containing TCH/F4.8 only and the network does not support TCH/F4.8 channel coding, then the network may act as if TCH/F9.6 were included in the ACC.

NOTE 5: The MS is allowed to signal higher values for mTCH than indicated in the table for the signalled WAIUR and ACC. Before initiating the assignment procedure, the MSC, if necessary, shall lower the value of the mTCH to the highest value applicable for the signalled WAIUR and ACC.

NOTE 6: Unless an EDGE channel is assigned in one direction at least, the same channel coding is assigned in both directions, and an equal or lesser number of channels is assigned in the up link direction than in the down link direction. If an EDGE channel is assigned in one direction, TCH/F14.4 or an EDGE channel is assigned in the other direction. If the user has indicated up or down link biased asymmetry preference, TCH/F14.4 is assigned in the unbiased direction. The number of channels assigned is the same in each direction unless restricted by the mobile classmark, and is always within the limits given in the corresponding column.

NOTE 7: The MS is allowed to signal higher values for WAIUR than indicated in the table for the signalled mTCH and ACC. Before initiating the assignment procedure, the MSC, if necessary, shall lower the value of the WAIUR to the highest value applicable for the signalled mTCH and ACC.

The final decision about the radio interface configuration is taken by the BSS during the Assignment procedure. The BSS may assign any number of TCH/F ranging from 1 to mTCH and use any of the channel codings among the ACC. The BSS shall try to reach the WAIUR if the resource situation allows it. The maximum possible AIUR shall not exceed the WAIUR unless the higher AIUR can be reached with a smaller number of TCH/F (ref. 3GPP TS 22.034).

The radio interface configuration may be changed by the BSS during the call as long as the channel coding used is among the ACC and the mTCH is not exceeded.

## B.1.13 Assignment of radio access bearer parameters depending on FNUR and WAIUR

### B.1.13.1 Transparent Services

Depending on the FNUR negotiated between the network and the MS, the network is allowed to assign any radio resources with a radio access bearer parameter indicating a Quality of Service specifying

QoS Parameter	Value	Comments
<b>Traffic Class</b>	Conversational	Subject to operator tuning (Note 2)
<b>RAB Asymmetry Indicator</b>	Symmetric	
<b>Maximum bit rate</b>	= guaranteed bit rate	
<b>Guaranteed bit rate</b>	FNUR = 64 .. 28,8 kbit/s	GBR for FNUR=56 kbit/s is 64 kbit/s (Note 1)
<b>Delivery Order</b>	Yes	
<b>Maximum SDU size</b>	640bits for FNUR = 32, 56 and 64 kbit/s 576 bits for FNUR = 28.8 kbit/s 672 bits for FNUR = 33.6 kbit/s	
<b>Transfer Delay</b>	< 200 ms	Subject to operator tuning
<b>Traffic Handling Priority</b>	-	Not applicable for the conversational traffic class
<b>Source statistics descriptor</b>	Unknown	
<b>SDU Parameters</b>		
<b>SDU error ratio</b>	-	Not applicable
<b>Residual bit error ratio</b>	$10^{-4}$	Subject to operator tuning according to 3GPP TS 23.107. Operator may also choose different value for Multimedia and other transparent data services.
<b>Delivery of erroneous SDUs</b>	-	No error detection in the core network
NOTE 1: In case the FNUR = 56 kbit/s, the GBR is set to 64 kbit/s. Last bit in each data octet is set to 1		
NOTE 2: Only traffic Classes "Streaming" and "Conversational" shall be used for Cs data service RABs. The operator tuning is restricted to a choice between them.		

The final decision about the radio interface configuration is taken by the RNC during the Assignment procedure.

### B.1.13.2 Non-transparent services for UTRAN Iu mode

Depending on the WAIUR signalled by the MS, the network is allowed to assign any radio resources with a radio access bearer parameter indicating a Quality of Service\_specifying

QoS Parameter	Value	Comments
<b>Traffic Class</b>	Streaming	Subject to operator tuning (Note 3)
<b>RAB Asymmetry Indicator</b>	Symmetric	
<b>Maximum bit rate</b>	14.4, 28.8, 57.6 kbit/s	Maximum bit rate is set to the highest value $\leq$ WAIUR (Note 1)
<b>Guaranteed bit rate</b>	14.4, 28.8, 57.6 kbit/s	Operator may choose any of the possible values less or equal to WAIUR. (Note 1).
<b>Delivery Order</b>	Yes	
<b>Maximum SDU size</b>	576 bits	
<b>Transfer Delay</b>	250 ms	Subject to operator tuning
<b>Traffic Handling Priority</b>	-	Not applicable to the streaming traffic class
<b>Source statistics descriptor</b>	Unknown	
<b>SDU Parameters</b>		
	<b>Residual bit error ratio</b>	$10^{-3}$ Subject to operator tuning.
	<b>Delivery of erroneous SDUs</b>	No error detection consideration
	<b>SDU format information</b>	
	<b>RAB Subflow Combination bit rate</b>	57.6 kbit/s (Note 2)
	<b>RAB Subflow Combination bit rate</b>	28.8 kbit/s (Note 2)
	<b>RAB Subflow Combination bit rate</b>	14.4 kbit/s
	<b>RAB Subflow Combination bit rate</b>	0 kbit/s indicates DTX, RFCI is not assigned
<p>NOTE 1: If WAIUR is less or equal to 14.4 kbit/s then GBR and MBR shall be set to 14.4 kbit/s.</p> <p>NOTE 2: Only RAB subflow combination bit rates <math>\leq</math> maximum bit rate shall be specified.</p> <p>NOTE 3: Only traffic Classes "Streaming" and "Conversational" shall be used for Cs data service RABs. The operator tuning is restricted to a choice between them.</p>		

The final decision about the radio interface configuration is taken by the RNC during the Assignment procedure.

### B.1.13.3 Non-transparent services for GERAN Iu mode

Depending on the WAIUR signalled by the MS, the network is allowed to assign any radio resources with a radio access bearer parameter indicating a Quality of Service\_specifying

QoS Parameter	Value	Comments
Traffic Class	Streaming	Subject to operator tuning (Note 8)
RAB Asymmetry Indicator	Symmetric	
Maximum bit rate	12 kbit/s, 14,4 kbit/s, 24 kbit/s, 28,8 kbit/s, 36 kbit/s, 43,2 kbit/s, 48 kbit/s, 57.6 kbit/s	Maximum bit rate is set to the highest value $\leq$ WAIUR (Note 1, 3, 4, 5 and 6)
Guaranteed bit rate	12 kbit/s, 14,4 kbit/s, 24 kbit/s, 28,8 kbit/s, 36 kbit/s, 43,2 kbit/s, 48 kbit/s, 57.6 kbit/s	Operator may choose any of the possible values less or equal to WAIUR. (Note 1)
Delivery Order	Yes	
Maximum SDU size	480 bits if only RAB Subflow Combination bit rates of multiples of 12 kbit/s are possible, 576 bits in all other cases	
Transfer Delay	230 ms if only RAB Subflow Combination bit rates of multiples of 12 kbit/s are possible, 250 ms in all other cases	Subject to operator tuning
Traffic Handling Priority	-	Not applicable to the streaming traffic class
Source statistics descriptor	Unknown	
SDU Parameters		
Residual bit error ratio	$10^{-3}$	Subject to operator tuning.
Delivery of erroneous SDUs	No error detection consideration	
SDU format information		
Subflow SDU size	576 bit	(Note 7)
RAB Subflow Combination bit rate	57,6 kbit/s	(Note 2)
Subflow SDU size	480 bit	(Note 7)
RAB Subflow Combination bit rate	48 kbit/s	(Note 2 and 3)
Subflow SDU size	576 bit	(Note 7)
RAB Subflow Combination bit rate	43,2 kbit/s	(Note 2)
Subflow SDU size	480 bit	(Note 7)
RAB Subflow Combination bit rate	36 kbit/s	(Note 2 and 4)
Subflow SDU size	576 bit	(Note 7)
RAB Subflow Combination bit rate	28,8 kbit/s	(Note 2)
Subflow SDU size	480 bit	(Note 7)
RAB Subflow Combination bit rate	24 kbit/s	(Note 2 and 5)
Subflow SDU size	576 bit	(Note 7)
RAB Subflow Combination bit rate	14,4 kbit/s	(Note 2)
Subflow SDU size	480 bit	(Note 7)
RAB Subflow Combination bit rate	12 kbit/s	(Note 2 and 6)
RAB Subflow Combination bit rate	0 kbit/s	indicates DTX, RFCI is not assigned

NOTE 1: If WAIUR is less or equal to 14.4 kbit/s then GBR and MBR shall be set to 14.4 kbit/s for TCH/F14.4. If WAIUR is less or equal to 9.6 kbit/s then GBR and MBR shall be set to 12 kbit/s for TCH/F9.6. The maximum values for GBR and MBR shall not exceed the WAIUR unless the higher GBR and MBR can be reached with a smaller number of TCH/F (ref. subclause B.1.12.2). This means, that e.g., a GBR and MBR of 24 kbit/s (2 x TCH/F9.6) can be selected for a WAIUR of 19,2 kbit/s.

NOTE 2: Only RAB subflow combination bit rates  $\leq$  maximum bit rate shall be specified.

NOTE 3: If the WAIUR is 38,4 kbit/s, a GBR and MBR of 48 kbit/s is possible for 4 x TCH/F9.6.

NOTE 4: If the WAIUR is 28,8 kbit/s, a GBR and MBR of 36 kbit/s is possible for 3 x TCH/F9.6.

NOTE 5: If the WAIUR is 19,2 kbit/s, a GBR and MBR of 24 kbit/s is possible for 2 x TCH/F9.6.

NOTE 6: If the WAIUR is 9,6 kbit/s, a GBR and MBR of 12 kbit/s is possible for 1 x TCH/F9.6.

NOTE 7: The Subflow SDU size should only be present when the individual Subflows have different sizes.

NOTE 8: Only traffic Classes "Streaming" and "Conversational" shall be used for Cs data service RABs. The operator tuning is restricted to a choice between them.

The final decision about the radio interface configuration is taken by the BSS during the Assignment procedure.

---

## B.2 Low Layer/High Layer Compatibility Information Element

### B.2.1 Introduction

#### B.2.1.1 General Consideration

The purpose of the Low Layer/High Layer Compatibility Information Element (LLC/HLC-IE) is to provide a means for additional end-to-end compatibility checking by an addressed entity (e.g. a remote user, an interworking unit or a high layer function network node). The LLC/HLC-IE may be manipulated by the PLMN to maintain consistency with the setup parameter negotiation between the mobile station and the network (ref. to 3GPP TS 29.007). The LLC/HLC-IE is transferred transparently by the ISDN between the call originating PLMN and the addressed entity.

With respect to the individual parameter settings at the MS the following cases may be distinguished (see 3GPP TS 27.002 and 3GPP TS 27.003):

- Mobile-originated call set up by a MS consisting of a MT with R interface:
  - The setting results from respective MMI actions and/or MT internal settings.
- Mobile-originated call set up by a MS consisting of a MT with S interface:
  - The LLC/HLC-IEs which are contained in the ISDN SETUP message received from the terminal are passed unchanged to the MSC.
- Mobile-terminated call set up to a MS consisting of a MT with R interface:
  - The LLC/HLC related part of the compatibility check is carried out according to the knowledge of the MT concerning its implemented functions (i.e. answering the call). The offered field values determine the selection of the terminal function for the intended connection.
- Mobile-terminated call set up to a MS consisting of a MT with S interface:
  - The LLC/HLC received from the MSC is passed to the terminal by the MT. The LLC/HLC related part of the compatibility check is up to the terminal connected to the S interface of the MT, as is the selection of the terminal function (i.e. answering the call).

Where applicable, the same settings and rules concerning LLC and/or HLC apply as for ISDN use (ref. ITU-T Recommendation Q.931 and ETR 018). However, considering that PLMN data transmission is based on ITU-T V.110

rate adaptation, the MS shall provide the LLC-IE for mobile-originated calls when using unrestricted or restricted digital information transfer capability. This is to assure the conveyance of the e.g. "ITU-T V.110" indication towards the called entity, as the comparable indication in the ISDN BC-IE may be lost. It shall also be possible to choose whether or not the LLC-IE is provided for the case of an information transfer capability "3,1 kHz audio ex PLMN".

There shall be no contradiction of the information between the BC-IE and LLC-IE at the originating side. However, as some parts of the bearer capability may be modified during the transport of the call, there should be minimum duplication of this information between the BC-IE and the LLC-IE.

If as a result of duplication, a contradiction occurs between the BC-IE and the LLC-IE at the terminating side, the receiving entity shall ignore the conflicting information in the LLC-IE.

### B.2.1.2 Interpretation of the Tables

The individual contents of the LLC/HLC-IE are represented in the following tables. The indication of the applicable service group defines the link between the PLMN BC-IE and its associated LLC/HLC-IEs.

If the appropriate message includes multiple BC-IEs and if LLC and/or HLC information is available, multiple LLCs and HLCs shall be included in the message. The LLC/HLC associated with the BC-IE indicating speech shall be marked as "not applicable" (3GPP TS 24.008).

Legend:                    { xxxx | yyyy }                    choice of values  
                               ----    not relevant for this service (set to appropriate value)  
                               [ zzzz ]    optional

## B.2.2 LLC Bearer Service 20

### B.2.2.1 Unrestricted / restricted digital information transfer capability

Low layer compatibility information element:

Octet	Information element field	field value
3	Coding standard Information transfer capability	ITU-T { unrestricted digital   restricted digital }
4	Transfer mode Information transfer rate	circuit mode 64 kbit/s
5	User information layer 1 protocol	{ V.110/X.30   V.120 }
5a	Synchronous / asynchronous Negotiation User rate	asynchronous in-band not possible { 0.3   1.2   2.4   4.8   9.6   14.4   19.2   28.8   38.4   48   56 } kbit/s
5b 2)	Intermediate rate NIC on Tx NIC on Rx Flow control on Tx Flow control on Rx	{ 8   16 } kbit/s ---- { not required 1   required } { not accepted 1   accepted }
5b 3)	Rate adaption header / no header Multiple frame establishment support Mode of operation Assignor / assignee In-band / out-band negotiation	Rate adaption header included Multiple frame establishment supported Protocol sensitive mode of operation ----
5c	Number of stop bits Number of data bits Parity	{ 1   2 } bits { 7   8 } bits { odd   even   none   forced to 0   forced to 1 }
5d	Duplex mode Modem type	á[ duplex ] ----

- 1) only these values are applicable to Mobile Originated Calls.
- 2) octet 5b for V.110/X.30.
- 3) octet 5b for V.120.

### B.2.2.2 3,1 kHz audio ex-PLMN information transfer capability

Low layer compatibility information element:

Octet	Information element field	field value
3	Coding standard Information transfer capability	ITU-T 3.1kHz audio
4	Transfer mode Information transfer rate	circuit mode 64 kbit/s
5	User information layer 1 protocol	{G.711 A-law   G.711 u-law (PCS-1900)}
5a	Synchronous / asynchronous Negotiation User rate	(may be set depending on user's requirement)
5b	Intermediate rate NIC on Tx NIC on Rx Flow control on Tx Flow control on Rx	not relevant but cannot be omitted in order to have octet 5d
5c	Number of stop bits Number of data bits Parity	(may be set depending on the user's requirement)
5d	Duplex mode Modem type	[ duplex ] [ {V.21 V.22 V.22bis  V.26ter V.32 V.34} ]

NOTE: If octet 5d is not specified, the whole LLC is not required.

## B.2.3 LLC Bearer Service 30

### B.2.3.1 Unrestricted / restricted digital information transfer capability

Low layer compatibility information element:

Octet	Information element field	field value
3	Coding standard Information transfer capability	ITU-T { digital unrestricted   restricted digital }
4	Transfer mode Information transfer rate	circuit mode 64 kbit/s
5	User information layer 1 protocol	{ V.110/X.30   X.31 flag stuffing   V.120   H.223 and H.245 }
5a	Synchronous / asynchronous Negotiation User rate	synchronous in-band not possible { 0.3   1.2   2.4   4.8   9.6   1.2/0.075   14.4   19.2   28.8   32.0   38.4   48   56 } kbit/s
5b 2)	Intermediate rate NIC on Tx NIC on Rx Flow control on Tx Flow control on Rx	{ 8   16 } kbit/s { not required   required } { not accepted   accepted } -----
5b 3)	Rate adaption header / no header Multiple frame establishment support Mode of operation Assignor / assignee In-band / out-band negotiation	Rate adaption header included Multiple frame establishment supported Protocol sensitive mode of operation -----
5c 1)	Number of stop bits Number of data bits Parity	not relevant but cannot be omitted in order to have octet 5d
5d 1)	Duplex mode Modem type	[ duplex ] -----

- 1) If octet 5d is not specified, octet 5c may be omitted.
- 2) octet 5b for V.110/X.30.
- 3) octet 5b for V.120.

### B.2.3.2 3,1 kHz audio ex-PLMN information transfer capability

Low layer compatibility information element:

Octet	Information element field	field value
3	Coding standard Information transfer capability	ITU-T 3.1kHz audio
4	Transfer mode Information transfer rate	circuit mode 64 kbit/s
5	User information layer 1 protocol	{G.711 A-law   G.711 u-law   PCS-1900}
5a	Synchronous / asynchronous Negotiation User rate	(may be set depending on the user's requirement)
5b	Intermediate rate NIC on Tx NIC on Rx Flow control on Tx Flow control on Rx	not relevant but cannot be omitted in order to have octet 5d
5c	Number of stop bits Number of data bits Parity	(may be set depending on the user's requirement)
5d	Duplex mode Modem type	[ duplex ] [ { V.22   V.22bis   V.26ter   V.32   V.34 } ]

NOTE: If octet 5d is not specified, octets 5a..5d may be omitted.

## B.2.4 LLC Bearer Services 41 ... 46

Void.

## B.2.5 LLC Bearer Services 51 ... 53

Void.

## B.2.6 LLC Bearer Service 61

Void.

## B.2.7 LLC Bearer Service 81

Void.

## B.2.8 HLC Teleservices 11 ... 12

High layer compatibility information element:

Octet	Information element field	Field value
3	Coding standard Interpretation Presentation method of protocol profile	ITU-T first high layer characteristic identification to be used in the call high layer protocol profile
4	High layer characteristics identific.	Telephony

## B.2.9 HLC Teleservices 21 ... 23

Not applicable.

## B.2.10 HLC Teleservice 61

High layer compatibility information element:



Octet	Information element field	Field value
3	Coding standard Interpretation Presentation method of protocol profile	ITU-T first high layer characteristic identification to be used in the call high layer protocol profile
4	High layer characteristics identific.	Facsimile G2/G3

## B.2.11 HLC Teleservice 62

High layer compatibility information element:

Octet	Information element field	Field value
3	Coding standard Interpretation Presentation method of protocol profile	ITU-T first high layer characteristic identification to be used in the call high layer protocol profile
4	High layer characteristics identific.	Facsimile G2/G3

## Annex C (informative): Change history

Change history							
Date	TSG #	TSG Doc.	CR	Rev	Subject/Comment	Old	New
	Apr 1999				Transferred to 3GPP CN1	7.1.0	
03-1999	CN#03				Approved at CN#03		3.0.0
06-1999	CN#04		001		Introduction of EDGE channel codings into the specifications	3.0.0	3.1.0
09-1999	CN#05		002		Asymmetry in EDGE	3.1.0	3.2.0
09-1999	CN#05		003		EDGE related correction	3.1.0	3.2.0
12-1999	CN#06		004		Introduction of FTM	3.2.0	3.3.0
12-1999	CN#06		005		Introduction of UMTS	3.2.0	3.3.0
12-1999	CN#06		006		Introduction of PIAFS and enhancement of processing at mobile terminated call	3.2.0	3.3.0
12-1999	CN#06		007		Introduction of multi media	3.2.0	3.3.0
12-1999	CN#06		008		Service clean-up for Release 99	3.2.0	3.3.0
12-1999	CN#06		009		BC-IE setting for Real-time non-transparent FAX	3.2.0	3.3.0
03-2000	CN#07		010		FALLBACK TO SPEECH IN A CS MULTIMEDIA CALL SETUP	3.3.0	3.4.0
03-2000	CN#07		011		Bit transparent services RDI and UDI	3.3.0	3.4.0
03-2000	CN#07		012		FTM corrections	3.3.0	3.4.0
03-2000	CN#07		013		Alignment to RANAP and other clarifications	3.3.0	3.4.0
03-2000	CN#07		014		Corrections related to MULTIMEDIA	3.3.0	3.4.0
06-2000	CN#08		015		Missing Asymmetry preference indication in Table B. 5.a	3.4.0	3.5.0
06-2000	CN#08		016		Residual bit error ratio in Transparent Data	3.4.0	3.5.0
06-2000	CN#08		017		Adding the value of GBR of NT services	3.4.0	3.5.0
06-2000	CN#08		018		Application of multi media in GSM	3.4.0	3.5.0
06-2000	CN#08		019		Removal of packet access service	3.4.0	3.5.0
06-2000	CN#08		020		WAIUR in case of HO between UMTS and GSM	3.4.0	3.5.0
06-2000	CN#08		021		Adaptations for UMTS	3.4.0	3.5.0
06-2000	CN#08		022		Indication of discontinuous transfer for NT data	3.4.0	3.5.0
06-2000	CN#08		022		Indication of discontinuous transfer for NT data	3.4.0	3.5.0
06-2000	CN#08		023	1	Indication of WAIUR 14.4kbit/s in case of UMTS FAX	3.4.0	4.0.0
09-2000	CN#09		024	1	UMTS clean-up	4.0.0	4.1.0
09-2000	CN#09		027		Cleanup of RAB parameter setting	4.0.0	4.1.0
09-2000	CN#09		028		Relevance of GSM specific BC-IE parameters for negotiating RLP version in UMTS	4.0.0	4.1.0
09-2000	CN#09		032		32 kbit/s UDI/RDI multimedia in GSM	4.0.0	4.1.0
09-2000	CN#09		034		3.1 kHz multimedia calls at 33.6 kbit/s data rate	4.0.0	4.1.0
09-2000	CN#09		036		RCR is not indicated from the network to the MS	4.0.0	4.1.0
09-2000	CN#09		038		Modification from V.25bis to V.250	4.0.0	4.1.0
09-2000	CN#09		040		Delivery of erroneous SDUs parameter value	4.0.0	4.1.0
12-2000	CN#10		042		Correction for 32 kbit/s UDI/RDI	4.1.0	4.2.0

12-2000	CN#10		043		Removal of Bearer Service 30 Non-transparent	4.1.0	4.2.0
12-2000	CN#10		044		Handover for 56 kbit/s	4.1.0	4.2.0
03-2001	CN#11	NP-010042	047	1	Removal of blocking of higher modem speeds	4.2.0	4.3.0
03-2001	CN#11	NP-010046	048	1	Deletion of NT Fax in GSM from Release 4.	4.2.0	4.3.0
03-2001	CN#11	NP-010042	050		RAB- assignment request (RAB parameter)	4.2.0	4.3.0
03-2001	CN#11	NP-010042	052		Handover for 56 kbit/s [Removal of flow diagram B.1.3.1.7]	4.2.0	4.3.0
03-2001	CN#11	NP-010047	053		Editorial modifications of flow diagrams	4.2.0	4.3.0
03-2001	CN#11	NP-010043	055		Correction of service's scope	4.2.0	4.3.0
03-2001	CN#11	NP-010202	057	2	Corrections for a mobile terminated call using the single numbering scheme	4.2.0	4.3.0
03-2001	CN#11	NP-010047	058		Clarification of allowed combinations of FNUR and ACC values for the V.34 modem based 3G-H.324/M service	4.2.0	4.3.0
06-2001	CN#12	NP-010255	060		Corrections of PLMN BC attributes	4.3.0	4.4.0
09-2001	CN#13	NP-010438	062	1	Removal of erroneous IR value	4.4.0	4.5.0
09-2001	CN#13	NP-010438	063	1	Removal of erroneous information in B.1.3.1.6.	4.4.0	4.5.0
09-2001	CN#13	NP-010438	066	1	Negotiation of Rate adaptation/Other rate adaptation	4.4.0	4.5.0
12-2001	CN#14	NP-010574	069		SDU size for transparent data at 33.6 kbit/s	4.5.0	4.6.0
12-2001	CN#14	NP-010604	070	3	Terminology clarifications as requested by TSG GERAN	4.6.0	5.0.0
03-2002	CN#15	NP-020081	074	1	Negotiation of parameter values for facsimile	5.0.0	5.1.0
03-2002	CN#15	NP-020084	075	1	Mobile terminated call with single numbering scheme	5.0.0	5.1.0
06-2002	CN#16	NP-020169	071	7	Service change and fallback for UDI/RDI multimedia calls	5.1.0	5.2.0
06-2002	CN#16	NP-020172	077	1	Multislot clarification	5.1.0	5.2.0
09-2002	CN#17	NP-020404	080	-	Removal of SDU error ratio for NT services	5.2.0	5.3.0
12-2002	CN#18	NP-020617	081	1	CS Data Services (including HSCSD and EDGE) for GERAN lu mode	5.3.0	5.4.0
12-2002	CN#18	NP-020619	082	4	Mobile originating BC handling for SCUDIF calls	5.3.0	5.4.0
03-2003	CN#19	NP-030075	084	1	Removal of S reference point within the MS and introduction of GERAN lu mode	5.4.0	5.5.0
06-2003	CN#20	NP-030201	088		Negotiation of fixed network user rate (FNUR)	5.5.0	5.6.0
06-2003	CN#20	NP-030202	091	1	Removal of S interface in the MS	5.5.0	5.6.0
06-2003	CN#20	NP-030260	096	1	BC-IE alignment with 24.008.	5.5.0	5.6.0
06-2003	CN#20	NP-030201	099	1	Use of single or multislot configurations	5.5.0	5.6.0
09-2003	CN#21	NP-030327	100	3	Interpretation of 'no BC-IE in CALL PROC/CONF messages'	5.6.0	5.7.0
06-2004	CN#24	NP-040239	107	1	Interpretation of 'no BC-IE in CALL PROC/CONF messages'	5.7.0	5.8.0
06-2005	CT#28	CP-050242	113	2	Alignment to R99 correction of NA value for Data Compression	5.8.0	5.9.0
12-2006	CT#34	CP-060618	117		RAB traffic class	5.9.0	5.10.0

---

## History

<b>Document history</b>		
V5.1.0	March 2002	Publication
V5.2.0	June 2002	Publication
V5.3.0	September 2002	Publication
V5.4.0	December 2002	Publication
V5.5.0	March 2003	Publication
V5.6.0	June 2003	Publication
V5.7.0	September 2003	Publication
V5.8.0	June 2004	Publication
V5.9.0	June 2005	Publication
V5.10.0	December 2006	Publication