

# ETSI TS 126 093 V6.1.0 (2006-06)

---

*Technical Specification*

**Digital cellular telecommunications system (Phase 2+);  
Universal Mobile Telecommunications System (UMTS);  
AMR speech Codec;  
Source Controlled Rate operation  
(3GPP TS 26.093 version 6.1.0 Release 6)**

---



---

Reference

RTS/TSGS-0426093v610

---

Keywords

GSM, UMTS

**ETSI**

650 Route des Lucioles  
F-06921 Sophia Antipolis Cedex - FRANCE

Tel.: +33 4 92 94 42 00 Fax: +33 4 93 65 47 16

Siret N° 348 623 562 00017 - NAF 742 C  
Association à but non lucratif enregistrée à la  
Sous-Préfecture de Grasse (06) N° 7803/88

---

**Important notice**

Individual copies of the present document can be downloaded from:

<http://www.etsi.org>

The present document may be made available in more than one electronic version or in print. In any case of existing or perceived difference in contents between such versions, the reference version is the Portable Document Format (PDF). In case of dispute, the reference shall be the printing on ETSI printers of the PDF version kept on a specific network drive within ETSI Secretariat.

Users of the present document should be aware that the document may be subject to revision or change of status. Information on the current status of this and other ETSI documents is available at

<http://portal.etsi.org/tb/status/status.asp>

If you find errors in the present document, please send your comment to one of the following services:

[http://portal.etsi.org/chaicor/ETSI\\_support.asp](http://portal.etsi.org/chaicor/ETSI_support.asp)

---

**Copyright Notification**

No part may be reproduced except as authorized by written permission.  
The copyright and the foregoing restriction extend to reproduction in all media.

© European Telecommunications Standards Institute 2006.  
All rights reserved.

**DECT**<sup>TM</sup>, **PLUGTESTS**<sup>TM</sup> and **UMTS**<sup>TM</sup> are Trade Marks of ETSI registered for the benefit of its Members.  
**TIPHON**<sup>TM</sup> and the **TIPHON logo** are Trade Marks currently being registered by ETSI for the benefit of its Members.  
**3GPP**<sup>TM</sup> is a Trade Mark of ETSI registered for the benefit of its Members and of the 3GPP Organizational Partners.

---

## Intellectual Property Rights

IPRs essential or potentially essential to the present document may have been declared to ETSI. The information pertaining to these essential IPRs, if any, is publicly available for **ETSI members and non-members**, and can be found in ETSI SR 000 314: *"Intellectual Property Rights (IPRs); Essential, or potentially Essential, IPRs notified to ETSI in respect of ETSI standards"*, which is available from the ETSI Secretariat. Latest updates are available on the ETSI Web server (<http://webapp.etsi.org/IPR/home.asp>).

Pursuant to the ETSI IPR Policy, no investigation, including IPR searches, has been carried out by ETSI. No guarantee can be given as to the existence of other IPRs not referenced in ETSI SR 000 314 (or the updates on the ETSI Web server) which are, or may be, or may become, essential to the present document.

---

## Foreword

This Technical Specification (TS) has been produced by ETSI 3rd Generation Partnership Project (3GPP).

The present document may refer to technical specifications or reports using their 3GPP identities, UMTS identities or GSM identities. These should be interpreted as being references to the corresponding ETSI deliverables.

The cross reference between GSM, UMTS, 3GPP and ETSI identities can be found under <http://webapp.etsi.org/key/queryform.asp>.

# Contents

Intellectual Property Rights .....	2
Foreword.....	2
Foreword.....	5
1 Scope .....	6
2 References .....	6
3 Definitions, symbols and abbreviations .....	6
3.1 Definitions .....	6
3.2 Symbols.....	7
3.3 Abbreviations .....	7
4 General .....	7
4.1 General organisation.....	7
5 AMR SCR operation .....	8
5.1 Transmit (TX) side .....	8
5.1.1 General operation.....	8
5.1.2 Functions of the TX SCR handler.....	9
5.1.2.1 AMR SCR Timing procedures.....	9
5.1.3 The TX part of the AN.....	10
5.2 Receive (RX) side .....	11
5.2.1 General operation.....	11
5.2.3 Demands on the RX SCR handler .....	11
5.3 AMR SID Information format.....	12
<b>Annex A (normative): AMR DTX handler for the GSM system (corresponding to GSM 06.93).....</b>	<b>13</b>
A.1 Scope .....	13
A.2 References .....	13
A.3 Definitions, symbols and abbreviations .....	14
A.3.1 Definitions .....	14
A.3.2 Symbols.....	14
A.3.3 Abbreviations .....	15
A.4 General .....	15
A.4.1 General organisation.....	15
A.5 Transmit (TX) side .....	16
A.5.1 General operation .....	16
A.5.1.1 Functions of the TX DTX handler.....	17
A.5.1.2 Functions of the TX Radio Subsystem .....	18
A.5.1.2.1 Functions of the TX Radio Subsystem for TCH/AFS.....	18
A.5.1.2.2 Functions of the TX Radio Subsystem for TCH/AHS .....	18
A.5.1.2.3 Functions of the Downlink TX Radio Subsystem for TFO.....	20
A.5.1.2.4 Functions of the TX Radio Subsystem for RATSCCH.....	20
A.6 Receive (RX) side .....	20
A.6.1 General operation .....	20
A.6.1.1 Functions of the RX radio subsystem .....	21
A.6.1.2 Functions of the RX DTX handler.....	21
<b>Annex B (normative): ETSI GSM-EFR SCR handler.....</b>	<b>23</b>
Transmit (TX) side.....	23
General operation .....	23
Functions of the TX SCR handler .....	23

GSM-EFR SCR Timing procedures .....	23
The TX part of the AN .....	23
Demands on the TX part of the Access Network .....	23
Receive (RX) side .....	24
SID Information format.....	24
<b>Annex C (normative): TIA IS-641 SCR Handler .....</b>	<b>25</b>
TX-side 25	
RX-side 25	
SID Information format.....	25
<b>Annex D (normative): TIA TDMA-US1 SCR Handler .....</b>	<b>26</b>
TX-side 26	
RX-side 26	
SID Information format.....	26
<b>Annex E (normative): ARIB PDC-EFR SCR Handler.....</b>	<b>27</b>
Transmit (TX) side.....	27
General operation .....	27
Functions of the TX SCR handler .....	27
PDC_EFR SCR Timing procedures .....	27
The TX part of the AN .....	28
Demands on the TX part of the Access Network .....	28
Receive (RX) side .....	28
SID information format.....	28
<b>Annex F (informative): Change history .....</b>	<b>29</b>
History .....	30

---

# Foreword

This Technical Specification has been produced by the 3GPP.

The present document describes the operation of the Adaptive Multi Rate speech codec during Source Controlled Rate (SCR) operation within the 3GPP system.

The contents of the present document are subject to continuing work within the TSG and may change following formal TSG approval. Should the TSG modify the contents of this TS, it will be re-released by the TSG with an identifying change of release date and an increase in version number as follows:

Version x.y.z

where:

- x the first digit:
  - 1 presented to TSG for information;
  - 2 presented to TSG for approval;
  - 3 or greater indicates TSG approved document under change control.
- y the second digit is incremented for all changes of substance, i.e. technical enhancements, corrections, updates, etc.
- z the third digit is incremented when editorial only changes have been incorporated in the specification;

---

# 1 Scope

This document describes the Source Controlled Rate (SCR) operation of the Adaptive Multi-Rate speech Codec in Codec Types UMTS\_AMR and UMTS\_AMR2 for the UMTS system. The implementation of this SCR operation is mandatory in all UMTS equipment.

The description is structured according to the block diagram in figure 1. This structure of distributing the various functions between system entities is not mandatory for implementation, as long as the operation on the speech decoder output remains the same.

Annex A describes the Discontinuous Transmission (DTX) operation of the Adaptive Multi-Rate speech Codec in Codec Types FR\_AMR, HR\_AMR and OHR\_AMR for GERAN. This annex is the former GSM 06.93 (release 98).

Annexes B to E describe the SCR operation of the Adaptive Multi-Rate speech Codec in Codec Types GSM\_EFR, TDMA\_EFR, TDMA\_US1 and PDC\_EFR for the UMTS system.

---

# 2 References

The following documents contain provisions which, through reference in this text, constitute provisions of the present document.

- References are either specific (identified by date of publication, edition number, version number, etc.) or non-specific.
- For a specific reference, subsequent revisions do not apply.
- For a non-specific reference, the latest version applies. In the case of a reference to a 3GPP document (including a GSM document), a non-specific reference implicitly refers to the latest version of that document *in the same Release as the present document*.

- [1] 3GPP TS 26.071 : "AMR Speech Codec; General description".
- [2] 3GPP TS 26.073 : "AMR Speech Codec; ANSI-C code".
- [3] 3GPP TS 26.074 : "AMR Speech Codec; Test sequences".
- [4] 3GPP TS 26.090 : "AMR Speech Codec; Transcoding functions".
- [5] 3GPP TS 26.091 : "AMR Speech Codec; Error concealment of lost frames".
- [6] 3GPP TS 26.092 : "AMR Speech Codec; Comfort noise aspects".
- [7] 3GPP TS 26.094 : "AMR Speech Codec; Voice Activity Detector (VAD)".
- [8] 3GPP TS 26.101 : "AMR Speech Codec; Frame structure".

---

# 3 Definitions, symbols and abbreviations

## 3.1 Definitions

For the purpose of this document, the following definitions apply.

**frame:** Time interval of 20 ms, corresponding to the time segmentation of the Adaptive Multi Rate speech Codec, also used as a short term for a traffic frame.

**traffic frame:** Block of 95..244 information bits transmitted on the speech traffic channels.

**SID frame:** Frame that conveys information about the acoustic background noise.

**speech frame:** Traffic frame that has been classified as SPEECH\_GOOD or SPEECH\_BAD frame.

**VAD flag:** Boolean flag, generated by the VAD algorithm indicating the presence ("1") or the absence ("0") of a speech frame.

**RX\_TYPE:** classifies the received frame.

**TX\_TYPE:** classifies the frame to be transmitted.**hangover period:** A period of frames added at the end of a speech burst in which VAD flag ="0" and TX\_TYPE is ="SPEECH\_GOOD", this period provides the encoder with an extra window to derive the Comfort Noise parameters .

## 3.2 Symbols

For the purpose of this document, the following symbols apply.

$N_{\text{elapsed}}$  Number of elapsed frames since the last updated SID frame.

## 3.3 Abbreviations

For the purpose of this document , the following abbreviations apply.

AN	Access Network
SCR	Source Controlled Rate operation
TS	Telecommunication Standard, Technical Specification
GSM	Global System for Mobile Telecommunication
GSM-EFR	GSM Enhanced Full Rate speech Codec
UE	User Equipment
PDC-EFR	ARIB PDC-EFR 6.7 kBit/s speech Codec
RAN	Radio Access Network
RX	Receive
SID	Silence Descriptor
TDMA-EFR	TIA IS-641 Enhanced speech Codec
TDMA-US1	TIA TDMA-US1 (12.2 kBit/s Codec, similar to GSM-EFR)
TX	Transmit
VAD	Voice Activity Detector

---

## 4 General

Source Controlled Rate operation (SCR) is a mechanism for the AMR Speech Codec, which allows to encode the input signal at a lower average rate by taking speech inactivity into account. The SCR scheme may be used for the following purposes:

- to save power in the User Equipment;
- to reduce the overall interference and load in the networks.

SCR in the transmitting path (uplink) shall be in operation in UEs, if commanded so by the network. Note that for UMTS AMR and UMTS AMR2 codec types, the uplink SCR operation shall always be activated. The UE shall handle SCR in the receiving path (downlink) at any time, regardless, whether SCR in the transmitting path is enabled or not.

### 4.1 General organisation

The default SCR mechanism described in this document requires the following functions:

- a Voice Activity Detector (VAD) on the transmit (TX) side;
- evaluation of the background acoustic noise on the transmit (TX) side, in order to transmit characteristic parameters to the receive (RX) side;



-generation on the receive (RX) side of a similar noise, called comfort noise, during periods where the transmission is switched off.

The Voice Activity Detector (VAD) is defined in [7] and the AMR-mode comfort noise functions in [6]. Both are based partly on the speech Codec and its internal variables, defined in [4].

In addition to these functions, if the parameters arriving at the RX side are detected to be seriously corrupted by errors, the speech or comfort noise must be generated from substituted data in order to avoid seriously annoying effects for the listener. These functions are defined in [5].

An overall description of the speech processing parts can be found in [1]. An overview of one link SCR operation is shown in Figure 1.

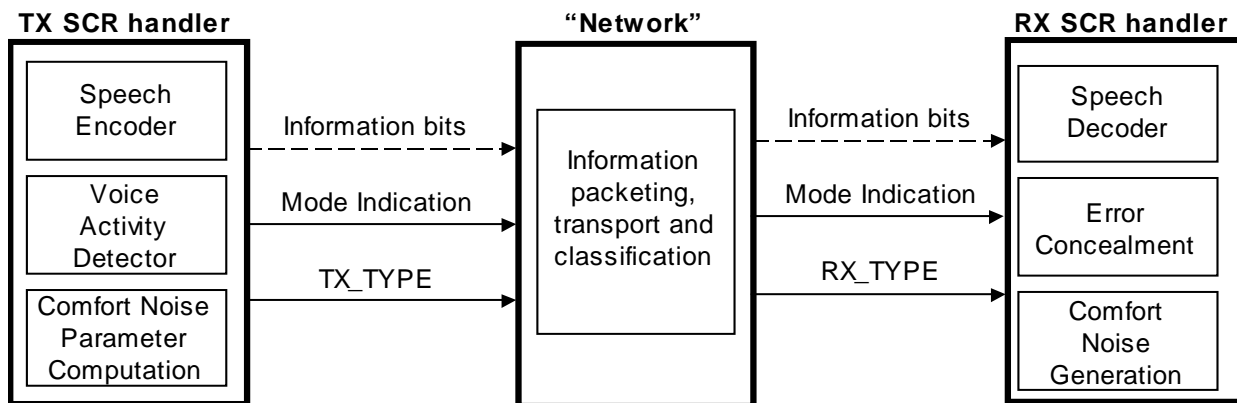

Figure 1: Block diagram of one link SCR operation

## 5 AMR SCR operation

### 5.1 Transmit (TX) side

A block diagram of the transmit side SCR functions is shown in Figure 2.

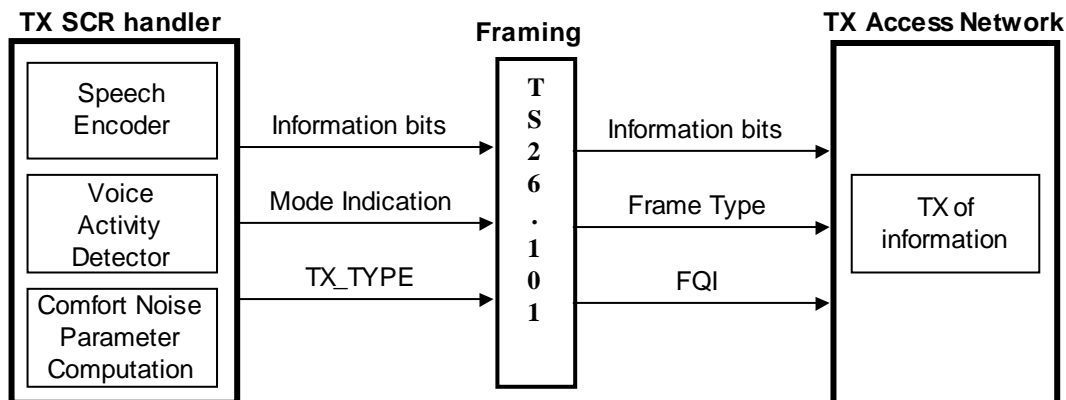

Figure 2: Block diagram of SCR functions at the TX side

#### 5.1.1 General operation

The TX SCR handler passes traffic frames, individually marked by TX\_TYPE, to the Framing unit. Each frame consists of bit fields containing the information bits, the codec mode indication, and the TX\_TYPE. TX\_TYPE shall be used to specify the contents of the frame. The table below provides an overview of the different TX\_TYPES used and explains the required contents in the information bit and the mode indication bit fields.

Table 1: SCR TX\_TYPE identifiers for UMTS\_AMR and UMTS\_AMR2

TX_TYPE	Information Bits	Mode Indication
SPEECH_GOOD	Speech frame, size 95..244 bits, depending on codec mode	Current codec mode
SPEECH_BAD	Corrupt speech frame (bad CRC), size 95..244 bits, depending on codec mode	Current codec mode
SID_FIRST	Marker for the end of talkspurt, no further information, all 35 comfort noise bits set to '0'	The codec mode that would have been used if TX_TYPE had been 'SPEECH_GOOD'
SID_UPDATE	35 comfort noise bits	The codec mode that would have been used if TX_TYPE had been 'SPEECH_GOOD'
SID_BAD	Corrupt SID update frame (bad CRC)	The codec mode that would have been used if TX_TYPE had been 'SPEECH_GOOD'
NO_DATA	No useful information, nothing to be transmitted	No useful information

TX\_TYPE = 'NO\_DATA' indicates that the Information Bit and Codec Mode fields do not contain any useful data (and should not be transmitted over AN). The purpose of this TX\_TYPE is to provide the option to save network transmission between the transcoder and AN. Note, the TX\_TYPEs 'SPEECH\_BAD' and 'SID\_BAD' may occur in TFO and TrFO situations.

The scheduling of the frames for transmission on the Access Network is controlled by the TX SCR handler by the use of the TX\_TYPE field.

## 5.1.2 Functions of the TX SCR handler

If TX SCR operation is disabled, the TX SCR handler continuously generates speech frames, i.e. frames marked with TX\_TYPE='SPEECH\_GOOD'.

If the TX SCR operation is enabled, the VAD flag controls the TX SCR handler operation as described in the following paragraphs.

Note that the TX SCR operation is always enabled on the UE side for UMTS AMR and UMTS AMR2 codec types.

### 5.1.2.1 AMR SCR Timing procedures

To allow an exact verification of the TX SCR handler functions, all frames before the reset of the system are treated as if there were speech frames of an infinitely long time. Therefore, and in order to ensure the correct estimation of comfort noise parameters at RX SCR side, the first 7 frames after the reset or after enabling the SCR operation shall always be marked with TX\_TYPE= "SPEECH\_GOOD", even if VAD flag ="0" (hangover period, see figure 3).

The Voice Activity Detector (VAD) shall operate all the time in order to assess whether the input signal contains speech or not. The output is a binary flag (VAD flag ="1" or VAD flag ="0", respectively) on a frame by frame basis (see [7]).

The VAD flag controls indirectly, via the TX SCR handler operations described below, the overall SCR operation on the transmit side.

Whenever VAD flag ="1", the speech encoder output frame along with mode information shall be passed directly to the AN, marked with TX\_TYPE = " SPEECH\_GOOD "

At the end of a speech burst (transition VAD flag = "1" to VAD flag = "0"), it takes eight consecutive frames to make a new updated SID analysis available (see [6]). Normally, the first seven speech encoder output frames after the end of the speech burst shall therefore be passed directly to the AN, marked with TX\_TYPE = " SPEECH\_GOOD " ("hangover period").

The end of the speech is then indicated by passing frame eight after the end of the speech burst to the AN, marked with TX\_TYPE = 'SID\_FIRST' (see figure 3). SID\_FIRST frames do not contain data.

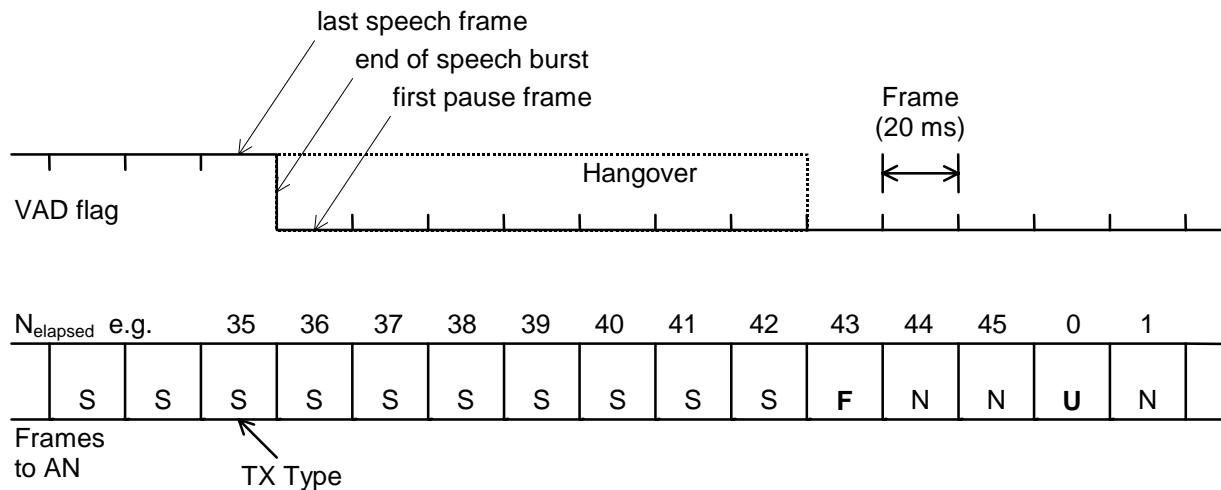

TX Types: "S" = SPEECH; "F" = SID\_FIRST; "U" = "SID\_UPDATE"; "N" = NO DATA  
 $N_{elapsed}$ : No. of elapsed frames since last SID\_UPDATE

**Figure 3: Normal hangover procedure for AMR ( $N_{elapsed} > 23$ )**

If, however, at the end of the speech burst, less than 24 frames have elapsed since the last SID\_UPDATE frame was computed, then this last analysed SID\_UPDATE frame should be passed to the AN whenever a SID\_UPDATE frame is to be produced, until a new updated SID analysis is available (8 consecutive frames marked with VAD flag = "0"). This reduces the load on the network in cases where short background noise spikes are taken for speech, by avoiding the "hangover" waiting for the SID frame computation.

Once the SID\_FIRST frame has been passed to the AN, the TX SCR handler shall at regular intervals compute and pass updated SID\_UPDATE (Comfort Noise) frames to the AN as long as VAD flag = "0". SID\_UPDATE frames shall be generated every 8<sup>th</sup> frame. The first SID\_UPDATE shall be sent as the third frame after the SID\_FIRST frame.

The speech encoder is operated in full speech modality if TX\_TYPE = " SPEECH\_GOOD " and otherwise in a simplified mode, because not all encoder functions are required for the evaluation of comfort noise parameters and because comfort noise parameters are only to be generated at certain times.

### 5.1.3 The TX part of the AN

The TX part of the AN has the following overall functionality. The transmission is cut after the transmission of a SID\_FIRST frame when the speaker stops talking. During speech pauses the transmission is resumed at regular intervals for transmission of one SID\_UPDATE frame, in order to update the generated comfort noise on the RX side. The operation of

the TX part of the AN is controlled by the TX SCR handler via the TX\_TYPE.

All frames, marked with SPEECH\_GOOD, SID\_FIRST or SID\_UPDATE shall be transmitted by the TX part of the AN.

## 5.2 Receive (RX) side

A block diagram of the receive side SCR functions is shown in Figure 4 below.

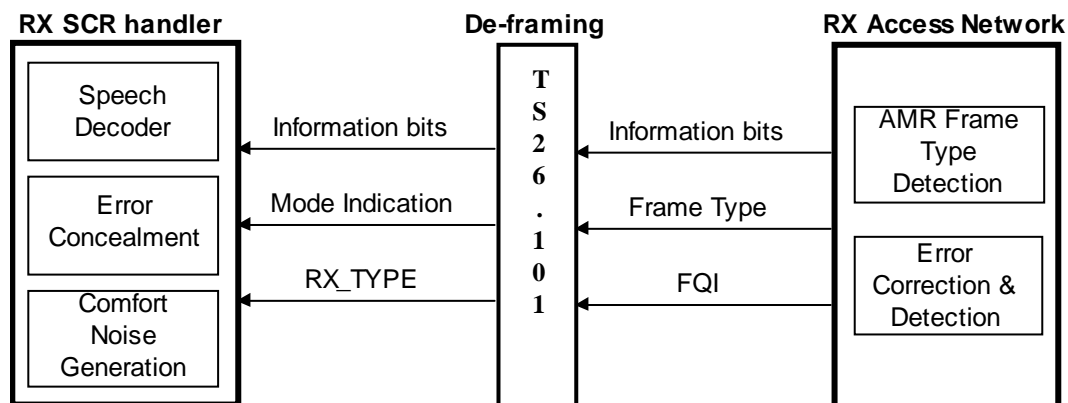

Figure 4: Block diagram of the receive side SCR functions

### 5.2.1 General operation

The AN passes all the received traffic frames to the RX SCR handler, classified with RX\_TYPE, as described in Table 2 (see TS 26.102). The RX SCR handles the frame accordingly.

Table 2: RX\_TYPE identifiers for UMTS\_AMR and UMTS\_AMR2

RX_TYPE	Information Bits
SPEECH_GOOD	Speech frame without detected errors.
SPEECH_BAD	(likely) speech frame with bad CRC (or estimated to be very bad by the RX part of the AN)
SID_FIRST	This SID-frame marks the beginning of a comfort noise period.
SID_UPDATE	Correct SID update frame
SID_BAD	Corrupt SID update frame (bad CRC; applicable only for SID_UPDATE frames)
NO_DATA	Nothing useable was received. The synthesis mode of the previous frame type is used.

### 5.2.3 Demands on the RX SCR handler

The RX SCR handler is responsible for the overall SCR operation on the RX side. It consists of two main modes: SPEECH and COMFORT\_NOISE. The initial mode shall be SPEECH.

The SCR operation on the RX side shall be as follows:

- The RX SCR handler shall enter mode SPEECH, when a frame classified as SPEECH\_GOOD is received.

whenever a frame classified as SPEECH\_GOOD is received the RX SCR handler shall pass it directly on to the speech decoder;

- if the RX SCR handler is in mode SPEECH, then frames classified as SPEECH\_BAD or NO\_DATA shall be substituted and muted as defined in [5]. Frames classified as NO\_DATA shall be handled like SPEECH\_BAD frames without valid speech information;
- frames classified as SID\_FIRST, SID\_UPDATE or SID\_BAD shall bring the RX SCR handler into mode COMFORT\_NOISE and shall result in comfort noise generation, as defined in [6]. SID\_BAD frames shall be substituted and muted as defined in [5];;
- in mode COMFORT\_NOISE the RX SCR handler shall ignore all unusable frames (NO\_DATA, SPEECH\_BAD); comfort noise generation shall continue, until timeout may apply ([5]).

### 5.3 AMR SID Information format

The SID\_UPDATE frame format is according to [5]. This is the default and only mandatory operating mode of the SCR handler.

---

# Annex A: (normative)

## AMR DTX handler for the GSM system (corresponding to GSM 06.93)

### A.1 Scope

The present document gives a description of the general baseband operation of Adaptive Multi-Rate speech traffic channels in the transmitter and in the receiver of GSM Mobile Stations (MS)s and Base Station Systems (BSS)s during Discontinuous Transmission (DTX).

For clarity, the description is structured according to the block diagrams in figures 1 and 3. Except in the case described next, this structure of distributing the various functions between system entities is not mandatory for implementation, as long as the operation on the air interface and on the speech decoder output remains the same.

In the case of BSSs where the speech transcoder is located remote from the Base Transceiver Station (BTS), the implementation of the interfaces between the DTX handlers and the Radio Sub System (RSS) as described in the present document together with all their flags is mandatory, being part of the A-bis interface as described in GSM 08.60 and GSM 08.61.

The DTX functions described in this technical specification are mandatory for implementation in the GSM MSs. The receiver requirements are mandatory for implementation in all GSM BSSs, the transmitter requirements only for those where downlink DTX or Tandem Free Operation will be used.

---

### A.2 References

The following documents contain provisions which, through reference in this text, constitute provisions of the present document.

- References are either specific (identified by date of publication, edition number, version number, etc.) or non-specific.
- For a specific reference, subsequent revisions do not apply.
- For a non-specific reference, the latest version applies. In the case of a reference to a 3GPP document (including a GSM document), a non-specific reference implicitly refers to the latest version of that document *in the same Release as the present document*.

- [1] 3GPP TR 21.905: 'Vocabulary for 3GPP Specifications'.
- [2] 3GPP TS 24.008: "Digital cellular telecommunication system (Phase 2+); Mobile radio interface layer 3 specification".
- [3] 3GPP TS 45.003: "Digital cellular telecommunication system (Phase 2+); Channel coding".
- [4] 3GPP TS 45.005: "Digital cellular telecommunication system (Phase 2+); Radio transmission and reception".
- [5] 3GPP TS 45.008: "Digital cellular telecommunication system (Phase 2+); Radio subsystem link control".
- [6] 3GPP TS 45.009: "Digital cellular telecommunication system (Phase 2+); Link adaptation".
- [7] 3GPP TS 26.071: "Digital cellular telecommunications system (Phase 2+); Adaptive Multi-Rate (AMR) speech processing functions; General description".
- [8] 3GPP TS 26.073: "Digital cellular telecommunications system (Phase 2+); ANSI-C code for the GSM Adaptive Multi-Rate speech codec".

- [9] 3GPP TS 26.074: "Digital cellular telecommunications system (Phase 2); Test vectors for the GSM Adaptive Multi-Rate speech codec".
- [10] 3GPP TS 26.090: "Digital cellular telecommunications system (Phase 2+); Adaptive Multi-Rate speech transcoding".
- [11] 3GPP TS 26.091: "Digital cellular telecommunications system (Phase 2+); Substitution and muting of lost frame for Adaptive Multi-Rate speech traffic channels".
- [12] 3GPP TS 26.092: "Digital cellular telecommunications system (Phase 2+); Comfort noise aspects for Adaptive Multi-Rate speech traffic channels".
- [13] 3GPP TS 26.094: "Digital cellular telecommunications system (Phase 2+); Voice Activity Detector (VAD) for Adaptive Multi-Rate speech traffic channels".
- [14] 3GPP TS 28.060: "Digital cellular telecommunication system (Phase 2+); Inband control of remote transcoders and rate adaptors for Full Rate traffic channels".
- [15] 3GPP TS 28.061: "Digital cellular telecommunication system (Phase 2+); Inband Control of Remote Transcoders and Rate Adaptors for Half Rate traffic channels".
- [16] 3GPP TS 28.062: " Digital cellular telecommunications system; Inband Tandem Free Operation (TFO) of Speech Codecs".

---

## A.3 Definitions, symbols and abbreviations

### A.3.1 Definitions

For the purpose of the present document, the following definitions apply.

**frame:** Time interval of 20 ms, corresponding to the time segmentation of the Adaptive Multi Rate speech transcoder (3GPP TS 26.090 [9]), also used as a short term for a traffic frame.

**traffic frame:** Block of 95..244 information bits transmitted on the TCH/AFS or TCH/AHS speech traffic channels.

**SID frame:** Frame characterised by the SID (Silence Descriptor) gross bit patterns. It may convey information on the acoustic background noise.

**speech frame:** Traffic frame that has been classified as a SPEECH frame.

**VAD flag:** Boolean flag, generated by the VAD algorithm defined in 3GPP TS 26.094 indicating the presence ("1") or the absence ("0") of a speech frame.

**RX\_TYPE:** flag with eight values, generated by the RX radio subsystem, indicating to the RX DTX handler the type of data in the current frame. Refer to Table 2.

**TX\_TYPE:** flag with eight values, generated by the TX DTX handler, indicating to the TX radio subsystem the type of data in the current frame. Refer to Table 1.

**hangover period:** A period of 7 frames added at the end of a speech burst in which VAD flag = "0" and TX\_TYPE is "SPEECH".

### A.3.2 Symbols

For the purpose of the present document, the following symbols apply.

$N_{\text{elapsed}}$  Number of elapsed frames since the last updated SID frame.

### A.3.3 Abbreviations

For the purpose of the present document, the following abbreviations apply.

BSC	Base Station Controller
BSS	Base Station System
BTS	Base Transceiver Station
CHD	Channel Decoder
CHE	Channel Encoder
DTX	Discontinuous Transmission
ETS	European Telecommunication Standard
FACCH	Fast Associated Control CHannel
GSM	Global System for Mobile Telecommunications
MS	Mobile Station
RATSCCH	Robust Amr Traffic Synchronised Control CHannel
RSS	Radio Sub System
RX	Receive
SACCH	Slow Associated Control CHannel
SID	SIlence Descriptor
TX	Transmit
VAD	Voice Activity Detector

For abbreviations not given in this subclause, see 3GPP TS 21.004.

---

## A.4 General

Discontinuous Transmission (DTX) is a mechanism, which allows the radio transmitter to be switched off most of the time during speech pauses for the following two purposes:

- to save power in the Mobile Station (MS);
- to reduce the overall interference level over the air interface.

DTX in uplink shall be in operation within the GSM MS, if commanded so by the network, see 3GPP TS 204.08. The MS shall handle DTX in downlink at any time, regardless, whether DTX in uplink is commanded or not.

### A.4.1 General organisation

The overall DTX mechanism described in the present document requires the following functions:

- a Voice Activity Detector (VAD) on the transmit (TX) side;
- evaluation of the background acoustic noise on the transmit (TX) side, in order to transmit characteristic parameters to the receive (RX) side;
- generation on the receive (RX) side of a similar noise, called comfort noise, during periods where the radio transmission is switched off.

The Voice Activity Detector (VAD) is defined in 3GPP TS 26.094 and the comfort noise functions in 3GPP TS 26.092. Both are based partly on the speech transcoder and its internal variables, defined in 3GPP TS 26.090.

In addition to these functions, if the parameters arriving at the RX side are detected to be seriously corrupted by errors, the speech or comfort noise must be generated from substituted data in order to avoid seriously annoying effects for the listener. This function is defined in 3GPP TS 26.091.

An overall description of the speech processing parts can be found in 3GPP TS 26.071.

The description for Tandem Free Operation is given in 3GPP TS 28.062.



## A.5 Transmit (TX) side

A block diagram of the transmit side DTX functions is shown in figure 5.

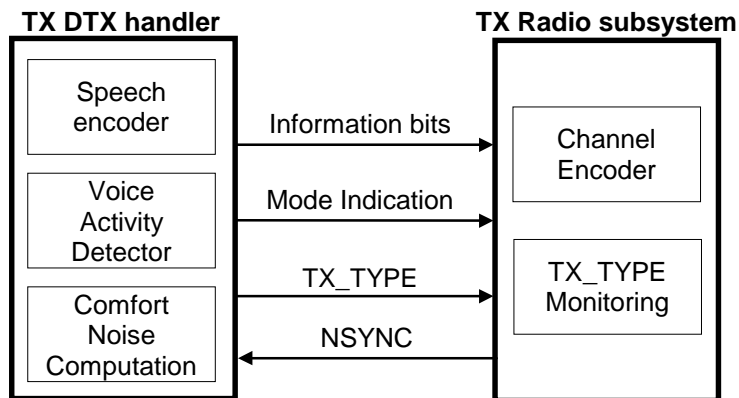

Figure 5: Block diagram of the transmit side DTX functions

### A.5.1 General operation

The TX DTX handler passes traffic frames, individually marked by TX\_TYPE, to the Radio Subsystem (RSS). Each frame passed to the RSS consists of bit fields containing the information bits, the codec mode indication, and the TX\_TYPE. TX\_TYPE is used to specify the contents of the frame. The table below provides an overview of the different TX\_TYPES used and explains the required contents in the information bit and the mode indication bit fields. In case of ongoing Tandem Free Operation (see 3GPP TS 28.062) frames with errors may arrive in downlink in the BTS.

Table 3: TX TYPE identifiers

TX_TYPE Legend	Information Bits	Mode Indication
<b>SPEECH_GOOD</b>	speech frame, size 95..244 bits depending on codec mode; no errors known.	current code mode
<b>SPEECH_DEGRADED</b> (only in downlink in TFO)	Speech frame, size 95..244 bits, depending on codec mode; there might be errors in class 2 bits.	current codec mode
<b>SPEECH_BAD</b> (only in downlink in TFO)	Speech frame, size 95..244 bits, depending on codec mode; there are errors in class 1 bits.	current codec mode
<b>SID_FIRST</b>	marks the end of a talkspurt, respectively the beginning of a speech pause; does not contain information bits.	the codec mode that would have been used if TX_TYPE had been SPEECH
<b>SID_UPDATE</b>	comfort noise, 35 bits; no errors known	the codec mode that would have been used if TX_TYPE had been SPEECH
<b>SID_BAD</b> (only in downlink in TFO)	comfort noise, 35 bits; errors detected, parameters unusable	the codec mode that would have been used if TX_TYPE had been SPEECH
<b>ONSET</b> (only in downlink in TFO)	announces the beginning of a speech burst; does not contain information bits	the codec mode of the following speech frame
<b>NO_DATA</b>	no useful information	no useful information

TX\_TYPE = 'NO\_DATA' indicates that the Information Bit and Codec Mode fields do not contain any useful data (and shall not be transmitted over the air interface). The purpose of this TX\_TYPE is to provide the option to save transmission between the transcoder and the radio base station if a packet oriented transmission is used.

The scheduling of the frames for transmission on the air interface is controlled by the TX DTX handler by the use of the TX\_TYPE field.

### A.5.1.1 Functions of the TX DTX handler

To allow an exact verification of the TX DTX handler functions, all frames before the reset of the system are treated as if there were speech frames of an infinitely long time. Therefore, and in order to ensure the correct estimation of comfort noise parameters at RX DTX side, the first 7 frames after the reset or after enabling the DTX operation shall always be marked with TX\_TYPE= " SPEECH\_GOOD ", even if VAD flag ="0" (hangover period, see figure 2).

The Voice Activity Detector (VAD) shall operate all the time in order to assess whether the input signal contains speech or not. The output is a binary flag (VAD flag ="1" or VAD flag ="0", respectively) on a frame by frame basis (see 3GPP TS 26.094).

The VAD flag controls indirectly, via the TX DTX handler operations described below, the overall DTX operation on the transmit side.

Whenever VAD flag ="1", the speech encoder output frame along with mode information shall be passed directly to the radio subsystem (RSS), marked with TX\_TYPE=" SPEECH\_GOOD "

At the end of a speech burst (transition VAD flag ="1" to VAD flag ="0"), it takes 8 consecutive frames to make a new updated SID analysis available at receiver side (see 3GPP TS 26.092). Normally, the first 7 speech encoder output frames after the end of the speech burst shall therefore be passed directly to the RSS, marked with TX\_TYPE =" SPEECH\_GOOD " ("hangover period"). The end of the speech is then indicated by passing frame 8 after the end of the speech burst to the RSS, marked with TX\_TYPE = 'SID\_FIRST' (see figure 2).

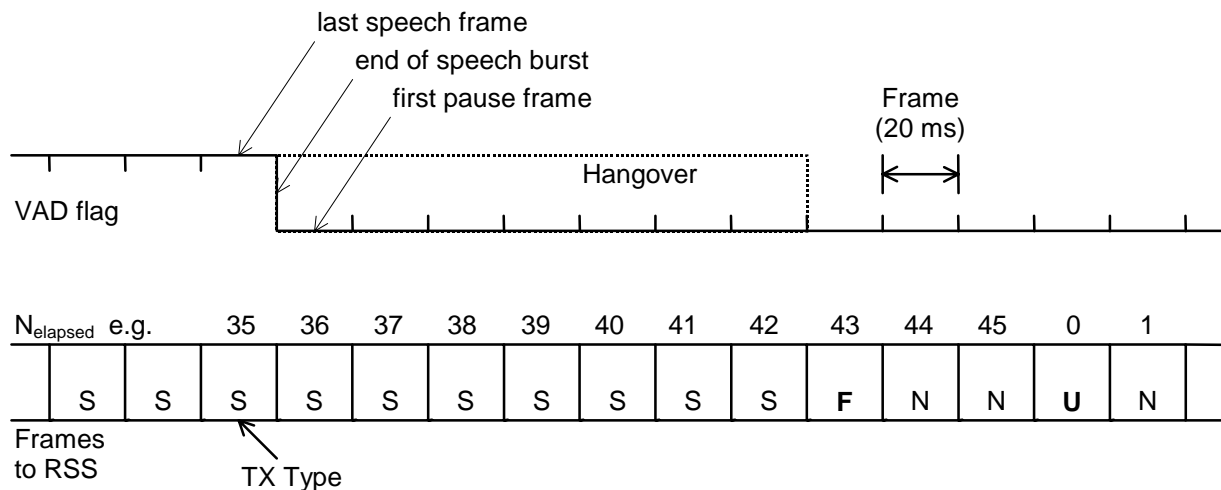

TX Types: "S" = SPEECH; "F" = SID\_FIRST; "U" = "SID\_UPDATE; "N" = NO DATA  
 $N_{elapsed}$ : No. of elapsed frames since last SID\_UPDATE

**Figure 6: Normal hangover procedure ( $N_{elapsed} > 23$ )**

If, however, at the end of the speech burst, less than 24 frames have elapsed since the last SID\_UPDATE frame was computed and passed to the RSS, then this last analysed SID\_UPDATE frame shall repeatedly be passed to the RSS whenever a SID\_UPDATE frame is to be produced, until a new updated SID analysis is available (8 consecutive frames marked with VAD flag ="0"). This reduces the activity on the air in cases where short background noise spikes are taken for speech, by avoiding the "hangover" waiting for the SID frame computation.

Once the first SID analysis after the end of a speech burst has been computed and the SID\_FIRST frame has been passed to the Radio Subsystem, the TX DTX handler shall at regular intervals compute and pass updated SID\_UPDATE (Comfort Noise) frames to the Radio Subsystem (RSS) as long as VAD flag ="0". SID\_UPDATE frames shall be generated every 8<sup>th</sup> frame. The first SID\_UPDATE shall be sent as the third frame after the SID\_FIRST frame.

The speech encoder is operated in full speech modality if TX\_TYPE = " SPEECH\_GOOD " and otherwise in a simplified mode, because not all encoder functions are required for the evaluation of comfort noise parameters and because comfort noise parameters are only to be generated at certain times.

In order to ensure TX/RX DTX handler synchronisation at handover, the uplink TX DTX handler in the MS shall accept messages from TX RSS with control parameter NSYNC, resulting in the following operation during a period of the next NSYNC frames:

- The TX DTX handler shall send SID\_UPDATE instead of NO\_DATA frames to the TX RSS.
- If, however, during this period of NSYNC frames, VAD flag is equal to 1 at least for one speech frame, TX DTX handler shall send SPEECH frames for the rest of the period of the NSYNC frames. Note the TX DTX handler shall send SPEECH frames at least for the duration of the hangover period.

### A.5.1.2 Functions of the TX Radio Subsystem

The TX Radio Subsystem has the following overall functionality. The radio transmission is cut after the transmission of a SID\_FIRST frame when the speaker stops talking. During speech pauses the transmission is resumed at regular intervals for transmission of one SID\_UPDATE frame, in order to update the generated comfort noise on the RX side (and to improve the measurement of the link quality by the RSS). Note that the transcoder knows what frames to send. In the case when nothing is to be transmitted it outputs frames marked with TX\_TYPE = 'NO\_DATA'.

Within the TX Radio Subsystem the TX\_TYPE Monitoring unit controls the operation of the Channel Encoder (as specified in 3GPP TS 25.003) and the Transmission of the frame. Control input to the TX\_TYPE Monitoring unit is the TX\_TYPE. Control output and input to the Channel Encoder are indicators specifying the frame format. These frame format indicators are defined in 3GPP TS 25.003, they are different for TCH/AFS and TCH/AHS.

#### A.5.1.2.1 Functions of the TX Radio Subsystem for TCH/AFS

The TX Radio Subsystem operates in the following way regarding DTX (without TFO):

all frames marked with TX\_TYPE = " SPEECH\_GOOD " are scheduled for normal channel coding and transmission. The frame format for CHE operation shall be SPEECH. If, however, the previous frame was not of TX\_TYPE = 'SPEECH\_GOOD', an ONSET frame format followed by SPEECH\_GOOD shall be signalled to the CHE;

for frames marked with TX\_TYPE = 'SID\_FIRST' a SID\_FIRST frame format is signalled to the CHE;

frames marked with TX\_TYPE = 'SID\_UPDATE' are scheduled for SID\_UPDATE frame channel coding and transmission. The frame format signalled to CHE is SID\_UPDATE;

for frames marked with TX\_TYPE = 'NO\_DATA' no processing or transmission is carried out.

If a FACCH needs to be sent during a speech pause, and:

if the frame preceding the FACCH is not of TX\_TYPE='SPEECH\_GOOD', then an ONSET frame shall be signalled to the CHE, followed by the FACCH frame(s);

if the frame following the FACCH frame is not of TX\_TYPE='SPEECH\_GOOD', then a SID\_FIRST shall be signalled to the CHE.

A stolen SID\_UPDATE should be rescheduled on the frame subsequent to the SID\_FIRST marker that follows the FACCH frame(s) (when that marker exists), unless that rescheduling would steal a frame of TX\_TYPE="SPEECH\_GOOD", or if a frame of TX\_TYPE="SID\_UPDATE" has been received before the rescheduling could take place. This rescheduling shall not affect the timing of subsequent SID\_UPDATE frames.

Note: a SID\_UPDATE frame is considered as stolen when this frame must be replaced by a FACCH frame.

At handover, TX/RX DTX handler synchronisation shall be initiated. At the time instant before the MS starts sending to the new base station, a message shall be sent to the uplink TX DTX handler with the parameter NSYNC = 12.

#### A.5.1.2.2 Functions of the TX Radio Subsystem for TCH/AHS

The TX Radio Subsystem operates in the following way regarding DTX:

all frames marked with TX\_TYPE = " SPEECH\_GOOD " are scheduled for normal channel coding and transmission. The frame format for CHE operation shall be SPEECH. However, if the previous frame was of

TX\_TYPE = 'SID\_FIRST', a SID\_FIRST\_INH frame format followed by SPEECH\_GOOD shall be signalled to the CHE. If the previous frame was of TX\_TYPE = 'SID\_UPDATE', a SID\_UPDATE\_INH frame format followed by SPEECH\_GOOD shall be signalled to the CHE. If the previous frame was of TX\_TYPE 'NO\_DATA', an ONSET frame format followed by SPEECH\_GOOD shall be signalled to the CHE;

for frames marked with TX\_TYPE = 'SID\_FIRST' a SID\_FIRST\_P1 frame format is signalled to the CHE. Note: All 4 TDMA frames carrying the bits of this frame shall be transmitted. The Mode Indication received with the frame is stored for potential use in the next frame;

for frames marked with TX\_TYPE = 'SID\_UPDATE' a SID\_UPDATE frame format is signalled to the CHE. All 4 TDMA frames carrying the bits of this frame shall be transmitted;

for frames marked with TX\_TYPE = 'NO\_DATA', no processing or transmission is carried out. However, if the preceding frame was marked with TX\_TYPE = 'SID\_FIRST', a SID\_FIRST\_P2 frame format is signalled to CHE. Note: The 2 TDMA frames carrying bits of this frame shall be transmitted. If, depending on the current frame number, the Mode Indication is to be transmitted with these TDMA frames, the Mode Indication shall be used that was stored during the processing of the preceding SID\_FIRST frame.

If a FACCH needs to be sent during a speech pause, and:

if the frame preceding the FACCH is of TX\_TYPE='SID\_FIRST', then a SID\_FIRST\_INH frame format followed by the FACCH shall be signalled to the CHE;

if the frame preceding the FACCH is of TX\_TYPE='SID\_UPDATE', then a SID\_UPDATE\_INH frame format followed by the FACCH shall be signalled to the CHE;

if the frame preceding the FACCH is of TX\_TYPE='NO\_DATA', then an ONSET frame format followed by the FACCH shall be signalled to the CHE;

if the frame following the FACCH is not of TX\_TYPE='SPEECH\_GOOD', then a SID\_FIRST shall be signalled to the CHE. Both SID\_FIRST\_P1 and SID\_FIRST\_P2 frame formats shall be consecutively signalled to CHE.

A stolen SID\_UPDATE should be rescheduled on the frame subsequent to the SID\_FIRST\_P1 and SID\_FIRST\_P2 markers that follow the FACCH frame(s) (when these markers exist), unless that rescheduling would steal a frame of TX\_TYPE="SPEECH\_GOOD", or if a frame of TX\_TYPE="SID\_UPDATE" has been received before the rescheduling could take place. This rescheduling shall not affect the timing of subsequent SID\_UPDATE frames.

Note: a SID\_UPDATE frame is considered as stolen when this frame must be replaced by a FACCH frame.

At handover, TX/RX DTX handler synchronisation shall be initiated. At the time instant before the MS starts sending to the new base station, a message shall be sent to the uplink TX DTX handler with the parameter NSYNC = 12.

### A.5.1.2.3 Functions of the Downlink TX Radio Subsystem for TFO

The TX Radio Subsystem in the BTS shall in addition operate in the following way regarding DTX, if TFO is ongoing (see 3GPP TS 28.062):

- Frames with TX\_TYPE = SPEECH\_GOOD, SID\_FIRST and SID\_UPDATE shall be handled as usual in DTX, regardless whether DTX in downlink is requested or not. Also NO\_DATA shall be handled as usual, if DTX is requested.
- Frames with TX\_TYPE = NO\_DATA shall be replaced by SID\_FILLER frames, if DTX in downlink is not requested. By this the radio transmission continues in downlink, although no parameters are transmitted in speech pauses on the Abis interface. The MS generates Comfort Noise in these speech pauses.
- Frames with TX\_TYPE = SPEECH\_DEGRADED shall be handled exactly like SPEECH\_GOOD frames.
- For frame with TX\_TYPE = SPEECH\_BAD and SID\_BAD the CHE shall perform its regular processing, but then shall invert the six, respectively 14 CRC bits before convolutional encoding and transmitting the frames on the air interface. By this the error concealment mechanism in the MS is triggered to handle these corrupted frames.
- ONSET frames may be ignored by the TX Radio Subsystem and need not to be processed.

**Definition:** SID\_FILLER frames are like SID\_BAD frames, but with all information bits set to '1'. The 14 CRC bits shall artificially be inverted by the CHE before convolutional encoding and transmission.

### A.5.1.2.4 Functions of the TX Radio Subsystem for RATSCCH

During regular speech transmission (in the middle of a speech burst) RATSCCH replaces (steals) one (TCH/AFS) respectively two (TCH/AHS) speech frames (see 3GPP TS 25.009). Also in all non speech cases the RATSCCH shall be handled like speech. The respective RATSCCH frame formats (RATSCCH in case of TCH/AFS, respectively RATSCCH\_MARKER and RATSCCH\_DATA in case of TCH/AHS) shall be signalled to the CHE.

RATSCCH should be handled in the same way as a FACCH.

## A.6 Receive (RX) side

A block diagram of the receive side DTX functions is shown in figure 7.

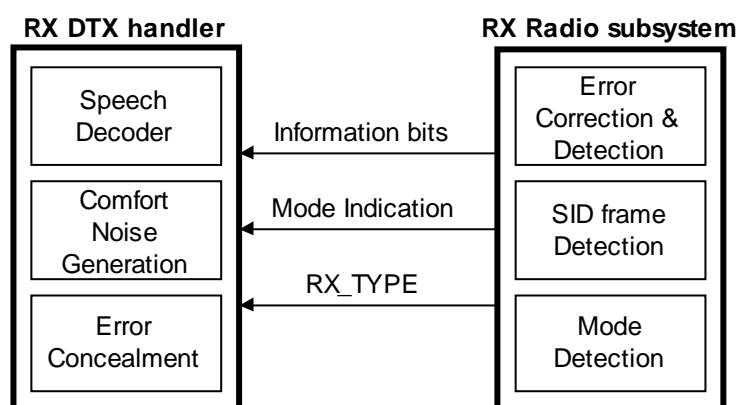

Figure 7: Block diagram of the receive side DTX functions

### A.6.1 General operation

Whatever their context (speech, SID, FACCH or none), the RSS continuously passes the received traffic frames to the RX DTX handler, individually marked by various pre-processing functions with RX\_TYPE as described in subclause 6.1.1 and table 2, which serves to classify the traffic frame. This classification allows the RX DTX handler to determine in a simple way how the received frame is to be handled.

Table 4: RX\_TYPE identifiers

RX_TYPE Legend	Description
<b>SPEECH_GOOD</b>	Speech frame with CRC OK, Channel Decoder soft values also OK
<b>SPEECH_DEGRADED</b>	Speech frame with CRC OK, but 1B bits and class2 bits may be corrupted
<b>SPEECH_BAD</b>	(likely) speech frame, bad CRC (or very bad Channel Decoder measures)
<b>SID_FIRST</b>	first SID marks the beginning of a comfort noise period
<b>SID_UPDATE</b>	SID update frame (with correct CRC)
<b>SID_BAD</b>	Corrupt SID update frame (bad CRC; applicable only for SID_UPDATE frames)
<b>ONSET</b>	ONSET frames precede the first speech frame of a speech burst
<b>NO_DATA</b>	Nothing useable (for the speech decoder) was received. This applies for the cases of no received frames (DTX) or received FACCH or RATSCCH or SID_FILLER signalling frames.

### A.6.1.1 Functions of the RX radio subsystem

The RX radio subsystem uses a combination of gross-bit markers, receiver measurements, and CRC checks to classify each received frame. The basic operation for each frame is outlined below:

the receiver first searches for the RATSCCH, SID\_UPDATE, SID\_FIRST or ONSET gross bit markers.

If the RATSCCH signalling is detected, then the RATSCCH frame (TCH/AFS) respectively the RATSCCH\_MARKER and RATSCCH\_DATA frames (TCH/AHS) shall be decoded and handled as described in 3GPP TS 25.009. They shall be passed to the RX DTX handler as a NO\_DATA frame(s).

If the SID\_FIRST marker is detected the frame is passed to the RX DTX handler as a SID\_FIRST frame.

If the SID\_UPDATE marker is detected, then the frame shall be decoded and passed to the RX DTX handler as a SID\_UPDATE or a SID\_BAD or a NO\_DATA frame, depending on the CRC and the information bits, along with the comfort noise parameters, if applicable. A NO\_DATA frame shall be passed on, if all information bits of a SID\_UPDATE frame are set to '1' and the CRC is bad (see SID\_FILLER in subclause 5.1.2.3).

- If the ONSET marker is detected, then an ONSET frame shall be passed to the RX DTX handler.

if neither SID\_UPDATE nor SID\_FIRST markers are detected, the frame shall be channel decoded assuming it to be a speech frame. Depending on the CRC for speech frame channel decoding along with other receiver measurements the frame shall then be passed to the RX DTX handler marked as either SPEECH\_GOOD, SPEECH\_DEGRADED, SPEECH\_BAD or NO\_DATA frame.

### A.6.1.2 Functions of the RX DTX handler

The RX DTX handler is responsible for the overall DTX operation on the RX side. It consists of two main modes: SPEECH and COMFORT\_NOISE. The initial mode shall be SPEECH.

The DTX operation on the RX side shall be as follows:

The RX DTX handler shall enter mode SPEECH, when a frame classified as SPEECH\_GOOD or SPEECH\_DEGRADED is received. ONSET frames may be taken into account to identify the beginning of a speech burst;

whenever a frame classified as SPEECH\_GOOD is received the RX DTX handler shall pass it directly on to the speech decoder;

if the RX DTX handler is in mode SPEECH, then frames classified as SPEECH\_DEGRADED, SPEECH\_BAD or NO\_DATA shall be substituted and muted as defined in 3GPP TS 26.091. Frames classified as NO\_DATA shall be handled like SPEECH\_BAD frames without valid speech information;

frames classified as SID\_FIRST, SID\_UPDATE or SID\_BAD shall bring the RX DTX handler into mode COMFORT\_NOISE and shall result in comfort noise generation, as defined in 3GPP TS 26.092. SID\_BAD frames

shall be substituted and muted as defined in 3GPP TS 26.091. In mode COMFORT\_NOISE the RX DTX handler shall ignore all unusable frames (NO\_DATA, SPEECH\_BAD) delivered by the RSS; comfort noise generation shall continue, until timeout may apply (see 3GPP TS 26.091).

## Annex B: (normative)

### ETSI GSM-EFR SCR handler

The interworking operation of AMR (only 12.2 kbit/s mode) with GSM-EFR is F.F.S. This annex provides the basis for the AMR operation under this condition.

## Transmit (TX) side

Speech coding interworking aspects with ETSI-EFR are described in [TBD].

## General operation

The TX SCR handler passes traffic frames, individually marked by TX\_TYPE, to the TX Framing Unit part of the Access Network. Each frame passed to the AN consists of bit fields containing the information bits, the codec mode indication, and the TX\_TYPE. TX\_TYPE shall be used to specify the contents of the frame. The table below provides an overview of the different TX\_TYPES used and explains the required contents in the information bit and the mode indication bit fields.

**Table 5: TX TYPE identifiers for GSM-EFR**

<b>TX_TYPE</b>	<b>Legend</b>	<b>Information Bits</b>	<b>Mode Indication</b>
00	SPEECH	speech frame, size depending on codec mode	current codec mode
10	SID_UPDATE	comfort noise information , information bits	the codec mode that would have been used if TX_TYPE had been 00 (SPEECH)
11	NO_DATA	no useful information	no useful information

TX\_TYPE = 'NO\_DATA' indicates that the Information Bit and Codec Mode fields do not contain any useful data (and should not be transmitted over AN). The purpose of this TX\_TYPE is to provide the option to save network transmission between the transcoder and AN.

The scheduling of the frames for transmission on the Access Network is controlled by the TX SCR handler by the use of the TX\_TYPE field and the given SCR operation mode.

## Functions of the TX SCR handler

### GSM-EFR SCR Timing procedures

To allow an exact verification of the TX SCR handler functions, all frames before the reset of the system are treated as if there were speech frames of an infinitely long time.

The SID\_UPDATE timing is according to ETSI GSM 06.81.

## The TX part of the AN

### Demands on the TX part of the Access Network

The TX part of the AN operates in the following way regarding SCR:

- frames marked with TX\_TYPE = (SPEECH) are scheduled for transmission.
- frames marked with TX\_TYPE = (SID\_UPDATE) are scheduled for transmission



- for frames marked with TX\_TYPE = (NO\_DATA) no processing or transmission is carried out.

SPEECH frames shall override other frames in these exceptional cases.

## Receive (RX) side

Whatever their context (speech, SID, or none), the deframing unit after AN continuously passes the received traffic frames to the RX SCR handler, individually marked by various pre-processing functions with a 3 bit type indicator RX\_TYPE described in Table 4, which serve to classify the traffic frame. This classification allows the RX SCR handler to determine in a simple way how the received frame is to be handled.

**Table 6: RX\_TYPE identifiers for GSM-EFR**

<b>RX_TYPE</b>	<b>Legend</b>	<b>Description</b>
000	<b>SPEECH_GOOD</b>	Speech frame with CRC OK, soft values in the RX part of AN also OK
001	<b>SPARE</b>	Spare
010	<b>SPEECH_BAD</b>	(likely) speech frame, bad CRC (or estimated to be very bad by the RX part of the AN )
011	<b>SPARE</b>	Spare
100	<b>SPARE</b>	Spare
101	<b>SID_UPDATE</b>	Correct SID update frame
110	<b>SID_BAD</b>	Corrupt SID update frame (bad CRC ; applicable only for SID_UPDATE frames)
111	<b>NO_DATA</b>	Nothing useable was received. The synthesis mode of the previous frame type is used.

## SID Information format

When the TX SCR handler is ordered by the network to operate in ETSI GSM-EFR mode with SCR operation turned on the SID\_UPDATE frame format is according to ETSI GSM 06.62. (38 +5 bits ).

---

## Annex C: (normative)

### TIA IS-641 SCR Handler

The interworking operation of AMR (only 7.4 kbit/s mode) with IS-641 (TDMA-EFR) is F.F.S. This annex provides the basis for the AMR operation under this condition.

#### TX-side

F.F.S

#### RX-side

F.F.S

#### SID Information format

When the TX SCR handler is ordered by the network to operate in IS-641 mode with SCR operation turned on the SID\_UPDATE frame format is according to IS-641-A Chapter 6 The SID\_UPDATE timing is according to IS 641-A.

Speech coding interworking aspects with IS-641 are described in [TBD].

---

## Annex D: (normative) : TIA TDMA-US1 SCR Handler

The interworking operation of AMR (only 12.2 kbit/s mode) with TDMA-US1 is F.F.S. This annex provides the basis for the AMR operation under this condition.

### TX-side

F.F.S

### RX-side

F.F.S

### SID Information format

F.F.S.

## Annex E: (normative)

### ARIB PDC-EFR SCR Handler

The interworking operation of AMR (only 6.7 kbit/s mode) with PDC-EFR-6.7 is F.F.S. This annex provides the basis for the AMR operation under this condition.

## Transmit (TX) side

### General operation

The TX SCR handler passes traffic frames, individually marked by TX\_TYPE, to the TX Framing Unit part of the Access Network. Each frame passed to the AN consists of bit fields containing the information bits, the codec mode indication, and the TX\_TYPE. TX\_TYPE shall be used to specify the contents of the frame. The table below provides an overview of the different TX\_TYPEs used and explains the required contents in the information bit and the mode indication bit fields.

**Table 7: TX TYPE identifiers for PDC\_EFR**

<b>TX_TYPE</b>	<b>Legend</b>	<b>Information Bits</b>	<b>Mode Indication</b>
000	SPEECH	speech frame, size depending on codec mode	current code mode
010	POST1	comfort noise information , information bits	the codec mode that would have been used if TX_TYPE had been 00 (SPEECH)
011	NO_DATA	no useful information	no useful information
001	POST0 (end of speech marker, start of CN generation )	no useful information,	the codec mode that would have been used if TX_TYPE had been 00 (SPEECH)
100	PRE (end of CN marker, start of speech generation )	no useful information,	the codec mode that would have been used if TX_TYPE had been 00 (SPEECH)

TX\_TYPE = 'NO\_DATA' indicates that the Information Bit and Codec Mode fields do not contain any useful data (and should not be transmitted over AN). The purpose of this TX\_TYPE is to provide the option to save network transmission between the transcoder and AN.

The scheduling of the frames for transmission on the Access Network is controlled by the TX SCR handler by the use of the TX\_TYPE field and the given SCR operation mode.

Speech coding interworking aspects with PDC-EFR are described in XX.YY.D.[TBD]

## Functions of the TX SCR handler

### PDC\_EFR SCR Timing procedures

To allow an exact verification of the TX SCR handler functions, all frames before the reset of the system are treated as if there were speech frames of an infinitely long time.

SID-frame timing is according to ARIB XXX.

## The TX part of the AN

### Demands on the TX part of the Access Network

The TX part of the AN operates in the following way regarding SCR:

- frames marked with TX\_TYPE = (SPEECH) are scheduled for transmission.
- frames marked with TX\_TYPE = (POST0) are scheduled for transmission.
- frames marked with TX\_TYPE = (POST1) are scheduled for transmission
- frames marked with TX\_TYPE = (PRE) are scheduled for transmission
- for frames marked with TX\_TYPE = (NO\_DATA) no processing or transmission is carried out.

SPEECH frames shall override other frames in these exceptional cases.

## Receive (RX) side

Whatever their context (speech, SID, or none), the deframing unit after AN continuously passes the received traffic frames to the RX SCR handler, individually marked by various pre-processing functions with a 3 bit type indicator RX\_TYPE described in Table 6, which serve to classify the traffic frame. This classification allows the RX SCR handler to determine in a simple way how the received frame is to be handled.

**Table 8: RX\_TYPE identifiers for PDC\_EFR**

<b>RX_TYPE</b>	<b>Legend</b>	<b>Description</b>
000	<b>SPEECH_GOOD</b>	Speech frame with CRC OK, soft values in the RX part of AN also OK
001	<b>PRE</b>	Next frame should be a Speech frame
010	<b>SPEECH_BAD</b>	(likely) speech frame, bad CRC (or estimated to be very bad by the RX part of the AN )
011	<b>SPARE</b>	Spare
100	<b>POST0</b>	This SID-frame marks the beginning of a comfort noise period.
101	<b>POST1</b>	Correct SID update frame
110	<b>POST1_BAD</b>	Corrupt SID update frame (bad CRC; applicable only for POST1 frames)
111	<b>NO_DATA</b>	Nothing useable was received. The synthesis mode of the previous frame type is used.

## SID information format

When the TX SCR Handler is ordered by the network to operate in PDC-EFR mode with SCR turned on the SID\_UPDATE frame format is according to ARIB TBD (134 bits).

## Annex F: (informative)

### Change history

V. 3.0.0	June 22, 1999	Approved at S#4 Plenary
V. 3.0.1	August 22, 1999	Reformatted in 3GPP style

<b>Tdoc</b>	<b>SPEC</b>	<b>CR</b>	<b>RE</b>	<b>VER</b>	<b>SUBJECT</b>	<b>CAT</b>	<b>NEW</b>
SP-99570	26.093	001	2	3.0.1	Alignment to GSM 06.93	F	3.1.0
SP-00262	26.093	002		3.1.0	Re-scheduling of stolen SID_UPDATE Frames for AMR	A	3.2.0
SP-000574	26.093	003	1	3.2.0	Re-scheduling of stolen SID_UPDATE frames for AMR (Part 2)	A	3.3.0
SP-000574	26.093	005		3.2.0	Re-scheduling of stolen SID_UPDATE frames by SID_FIRST frames for AMR Clarification of Hangover period after Handover	A	3.3.0
SP-000574	26.093	004		3.2.0	Re-scheduling of stolen SID_UPDATE frames for AMR (Part 2)	A	4.0.0
SP-000574	26.093	006		3.2.0	Re-scheduling of stolen SID_UPDATE frames by SID_FIRST frames for AMR Clarification of Hangover period after Handover	A	4.0.0
					Version for Release 5		5.0.0
SP-020436	26.093	009		5.0.0	Correction of Codec Type Names	A	5.1.0
SP-020688	26.093	010	3	5.1.0	Correction of uplink SCR operation activation for UMTS AMR	F	5.2.0
SP-030086	26.093	011		5.2.0	Handling of FACCH and RATSCCH during AMR DTX	F	6.0.0
SP-060356	26.093	0012	2	6.0.0	Correction of references	F	6.1.0

---

## History

<b>Document history</b>		
V6.0.0	January 2005	Publication
V6.1.0	June 2006	Publication