

ETSI TS 125 435 V7.6.0 (2007-10)

Technical Specification

**Universal Mobile Telecommunications System (UMTS);
UTRAN Iub interface user plane protocols for Common
Transport Channel data streams
(3GPP TS 25.435 version 7.6.0 Release 7)**



Reference

RTS/TSGR-0325435v760

Keywords

UMTS

ETSI

650 Route des Lucioles
F-06921 Sophia Antipolis Cedex - FRANCE

Tel.: +33 4 92 94 42 00 Fax: +33 4 93 65 47 16

Siret N° 348 623 562 00017 - NAF 742 C
Association à but non lucratif enregistrée à la
Sous-Préfecture de Grasse (06) N° 7803/88

Important notice

Individual copies of the present document can be downloaded from:

<http://www.etsi.org>

The present document may be made available in more than one electronic version or in print. In any case of existing or perceived difference in contents between such versions, the reference version is the Portable Document Format (PDF). In case of dispute, the reference shall be the printing on ETSI printers of the PDF version kept on a specific network drive within ETSI Secretariat.

Users of the present document should be aware that the document may be subject to revision or change of status. Information on the current status of this and other ETSI documents is available at

<http://portal.etsi.org/tb/status/status.asp>

If you find errors in the present document, please send your comment to one of the following services:

http://portal.etsi.org/chaicor/ETSI_support.asp

Copyright Notification

No part may be reproduced except as authorized by written permission.
The copyright and the foregoing restriction extend to reproduction in all media.

© European Telecommunications Standards Institute 2007.
All rights reserved.

DECTTM, **PLUGTESTS**TM and **UMTS**TM are Trade Marks of ETSI registered for the benefit of its Members.
TIPHONTM and the **TIPHON logo** are Trade Marks currently being registered by ETSI for the benefit of its Members.
3GPPTM is a Trade Mark of ETSI registered for the benefit of its Members and of the 3GPP Organizational Partners.

Intellectual Property Rights

IPRs essential or potentially essential to the present document may have been declared to ETSI. The information pertaining to these essential IPRs, if any, is publicly available for **ETSI members and non-members**, and can be found in ETSI SR 000 314: "*Intellectual Property Rights (IPRs); Essential, or potentially Essential, IPRs notified to ETSI in respect of ETSI standards*", which is available from the ETSI Secretariat. Latest updates are available on the ETSI Web server (<http://webapp.etsi.org/IPR/home.asp>).

Pursuant to the ETSI IPR Policy, no investigation, including IPR searches, has been carried out by ETSI. No guarantee can be given as to the existence of other IPRs not referenced in ETSI SR 000 314 (or the updates on the ETSI Web server) which are, or may be, or may become, essential to the present document.

Foreword

This Technical Specification (TS) has been produced by ETSI 3rd Generation Partnership Project (3GPP).

The present document may refer to technical specifications or reports using their 3GPP identities, UMTS identities or GSM identities. These should be interpreted as being references to the corresponding ETSI deliverables.

The cross reference between GSM, UMTS, 3GPP and ETSI identities can be found under <http://webapp.etsi.org/key/queryform.asp>.

Contents

Intellectual Property Rights	2
Foreword.....	2
Foreword.....	6
1 Scope	7
2 References	7
3 Definitions and abbreviations.....	7
3.1 Definitions	7
3.2 Abbreviations	8
3.3 Specification Notations	8
4 General aspects.....	9
4.1 Common Transport Channel Data Stream User Plane Protocol Services	9
4.2 Services expected from the Data Transport Network layer	9
4.3 Protocol Version.....	10
5 Data Streams User Plane Procedures	10
5.1 Data Transfer.....	10
5.1.1 RACH Channels	10
5.1.2 CPCH Channels [FDD]	10
5.1.3 Secondary-CCPCH related transport Channels	10
5.1.4 Downlink Shared Channels [TDD].....	11
5.1.5 Uplink Shared Channels [TDD].....	12
5.1.6 High Speed Downlink Shared Channels	12
5.2 Node Synchronisation	14
5.3 DL Transport Channels Synchronisation	14
5.4 DL Timing Adjustment	14
5.5 Dynamic PUSCH Assignment [TDD].....	15
5.6 DSCH TFCI Signalling [FDD].....	16
5.7 Timing Advance [3.84 Mcps and 7.68Mcps TDD].....	16
5.7A Outer Loop PC Information Transfer [1.28 Mcps TDD].....	16
5.8 General	17
5.8.1 Association between transport bearer and data/control frames.....	17
5.8.2 DSCH / USCH transport bearer replacement [TDD].....	17
5.9 HS-DSCH Capacity Request	18
5.10 HS-DSCH Capacity Allocation.....	18
6 Frame Structure and Coding.....	19
6.1 General	19
6.2 Data frame structure	20
6.2.1 RACH Channels	20
6.2.2 CPCH Channels [FDD]	22
6.2.3 FACH Channels.....	22
6.2.4 PCH Channels.....	23
6.2.5 Downlink Shared Channels [TDD].....	24
6.2.6 Uplink Shared Channels [TDD].....	25
6.2.6A HS-DSCH Channels	26
6.2.7 Coding of information elements in data frames	30
6.2.7.1 Header CRC	30
6.2.7.2 Frame Type	30
6.2.7.3 Connection Frame Number (CFN).....	30
6.2.7.4 Transport Format Indicator	30
6.2.7.5 Propagation Delay [FDD]	30
6.2.7.5A Ext Propagation Delay [FDD].....	30
6.2.7.6 Rx Timing Deviation [3.84Mcps TDD].....	31
6.2.7.6A Received SYNC UL Timing Deviation [1.28Mcps TDD].....	31

6.2.7.6B	Rx Timing Deviation [7.68Mcps TDD]	31
6.2.7.7	Transport Block	31
6.2.7.8	CRC Indicator	32
6.2.7.9	Payload CRC	32
6.2.7.10	Transmit Power Level	32
6.2.7.11	Paging Indication (PI)	32
6.2.7.12	Paging Indication bitmap (PI-bitmap)	32
6.2.7.13	Rx Timing Deviation on RACH [3.84Mcps TDD]	33
6.2.7.14	PDSCH Set Id [TDD]	33
6.2.7.15	Code Number [FDD]	33
6.2.7.16	Spreading Factor (SF) [FDD]	33
6.2.7.17	Power Offset [FDD]	33
6.2.7.18	MC Info [FDD]	33
6.2.7.19	Spare Extension	33
6.2.7.20	Quality Estimate (QE) [TDD]	33
6.2.7.21	Common Transport Channel Priority Indicator (CmCH-PI)	34
6.2.7.22	User Buffer Size	34
6.2.7.23	MAC-d PDU Length	34
6.2.7.24	NumOfPDU	34
6.2.7.25	MAC-d PDU	34
6.2.7.26	Cell Portion ID [FDD]	34
6.2.7.27	New IE Flags	34
6.2.7.28	Flush	35
6.2.7.29	DRT (Delay Reference Time)	35
6.2.7.30	Frame Sequence Number	35
6.2.7.31	Logical Channel ID in block n	35
6.2.7.32	Total Number of PDU blocks	35
6.2.7.33	MAC-d/c PDU Length in block n	36
6.2.7.34	Number of MAC-d/c PDUs in block n (#PDUs in block n)	36
6.2.7.35	DRT Indicator	36
6.2.7.36	FACH Indicator (FI) [FDD]	36
6.2.7.37	H-RNTI [FDD]	36
6.2.7.38	RACH Measurement Result [FDD]	36
6.2.7.39	H-RNTI Indicator (HI) [FDD]	36
6.2.7.40	FSN/DRT Reset	37
6.2.7.41	MAC-d/c PDU	37
6.2.7.42	AOA (Angle of Arrival) [1.28Mcps TDD]	37
6.2.7.43	Ext Received SYNC UL Timing Deviation [1.28Mcps TDD]	37
6.3	Control frame structure	37
6.3.1	Introduction	37
6.3.2	Coding of information elements of the Control frame header	38
6.3.2.1	Frame CRC	38
6.3.2.2	Frame Type (FT)	38
6.3.2.3	Control Frame Type	38
6.3.3	Payload structure and information elements	39
6.3.3.1	TIMING ADJUSTMENT	39
6.3.3.1.1	Payload Structure	39
6.3.3.1.2	CFN	39
6.3.3.1.3	Time of arrival (ToA)	40
6.3.3.1.4	Spare Extension	40
6.3.3.2	DL SYNCHRONISATION	40
6.3.3.2.1	Payload Structure	40
6.3.3.2.2	CFN	41
6.3.3.2.3	Spare Extension	41
6.3.3.3	UL SYNCHRONISATION	41
6.3.3.3.1	Payload Structure	41
6.3.3.3.2	CFN	41
6.3.3.3.3	Time of Arrival (TOA)	42
6.3.3.3.4	Spare Extension	42
6.3.3.4	DL NODE SYNCHRONISATION	42
6.3.3.4.1	Payload Structure	42
6.3.3.4.2	T1	42

6.3.3.4.3	Spare Extension	42
6.3.3.5	UL NODE SYNCHRONISATION	42
6.3.3.5.1	Payload Structure.....	42
6.3.3.5.2	T1	43
6.3.3.5.3	T2	43
6.3.3.5.4	T3	43
6.3.3.5.5	Spare Extension	44
6.3.3.6	DYNAMIC PUSCH ASSIGNMENT [TDD]	44
6.3.3.6.1	Payload structure	44
6.3.3.6.2	PUSCH Set Id.....	44
6.3.3.6.3	Activation CFN	44
6.3.3.6.4	Duration.....	44
6.3.3.7	DSCH TFCI SIGNALLING [FDD].....	44
6.3.3.7.1	Payload structure	44
6.3.3.7.2	TFCI (field 2)	44
6.3.3.7.3	Spare Extension	45
6.3.3.8	TIMING ADVANCE [3.84Mcps and 7.68Mcps TDD].....	45
6.3.3.8.1	Payload structure	45
6.3.3.8.2	CFN	45
6.3.3.8.3	TA [3.84 Mcps]	45
6.3.3.8.3A	TA [7.68 Mcps]	45
6.3.3.8.4	Spare Extension	45
6.3.3.9	OUTER LOOP POWER CONTROL [1.28 Mcps TDD].....	45
6.3.3.9.1	Payload structure	45
6.3.3.9.2	SIR Target	46
6.3.3.9.3	Spare Extension	46
6.3.3.10	HS-DSCH CAPACITY REQUEST	46
6.3.3.10.1	Common Transport Channel Priority Indicator (CmCH-PI)	47
6.3.3.10.2	User Buffer Size	47
6.3.3.10.3	Spare Extension	47
6.3.3.11	HS-DSCH CAPACITY ALLOCATION	47
6.3.3.11.1	Common Transport Channel Priority Indicator (CmCH-PI)	48
6.3.3.11.2	Maximum MAC-d PDU Length.....	48
6.3.3.11.3	HS-DSCH Credits	48
6.3.3.11.4	HS-DSCH Interval.....	49
6.3.3.11.5	HS-DSCH Repetition Period	49
6.3.3.11.6	Spare Extension	49
6.3.3.11.7	Congestion Status	49
6.3.3.11.8	Maximum MAC-d/c PDU Length.....	49
7	Frame protocol error handling.....	50
7.1	Error detection	50
7.1.1	CRC Calculation.....	50
7.1.1.1	Relation between input and output of the Cyclic Redundancy Check	50
Annex A (informative): Change History		51
History		53

Foreword

This Technical Specification (TS) has been produced by the 3rd Generation Partnership Project (3GPP).

The contents of the present document are subject to continuing work within the TSG and may change following formal TSG approval. Should the TSG modify the contents of the present document, it will be re-released by the TSG with an identifying change of release date and an increase in version number as follows:

Version x.y.z

where:

- x the first digit:
 - 1 presented to TSG for information;
 - 2 presented to TSG for approval;
 - 3 or greater indicates TSG approved document under change control.
- y the second digit is incremented for all changes of substance, i.e. technical enhancements, corrections, updates, etc.
- z the third digit is incremented when editorial only changes have been incorporated in the document.

1 Scope

The present document provides a description of the UTRAN RNC-Node B (Iub) interface user plane protocols for Common Transport Channel data streams as agreed within the TSG-RAN working group 3.

NOTE: By Common Transport Channel one must understand RACH, FACH/PCH, DSCH, USCH and HS-DSCH.

2 References

The following documents contain provisions which, through reference in this text, constitute provisions of the present document.

- References are either specific (identified by date of publication, edition number, version number, etc.) or non-specific.
- For a specific reference, subsequent revisions do not apply.
- For a non-specific reference, the latest version applies. In the case of a reference to a 3GPP document (including a GSM document), a non-specific reference implicitly refers to the latest version of that document *in the same Release as the present document*.

- [1] 3GPP TS 25.301: "Radio Interface Protocol Architecture".
- [2] 3GPP TS 25.402: "Synchronisation in UTRAN, Stage 2".
- [3] 3GPP TS 25.302: "Services provided by the Physical Layer".
- [4] 3GPP TS 25.221: "Physical channels and mapping of transport channels to physical channels (TDD)".
- [5] 3GPP TS 25.211: "Physical channels and mapping of transport channels onto physical channels (FDD)".
- [6] 3GPP TS 25.433: "UTRAN Iub interface NBAP signalling".
- [7] 3GPP TS 25.225: "Physical layer – Measurements (TDD)".
- [8] 3GPP TS 25.331: "Radio Ressource Control (RRC) protocol specification".
- [9] 3GPP TS 25.321: "Medium Access Control (MAC) protocol specification".
- [10] 3GPP TS 25.214: " Physical layer procedures".
- [11] 3GPP TS 25.401: "UTRAN overall description".

3 Definitions and abbreviations

3.1 Definitions

For the purposes of the present document, the terms and definitions in [2] and the following apply:

Transport Connection: service provided by the transport layer and used by Frame Protocol for the delivery of FP PDU

3.2 Abbreviations

For the purposes of the present document, the abbreviations in [2] and the following apply:

CFN	Connection Frame Number
CRC	Cyclic Redundancy Checksum
CRCI	CRC Indicator
DCH	Dedicated Transport Channel
DL	Downlink
DRT	Delay Reference Time
DSCH	Downlink Shared Channel
FP	Frame Protocol
FSN	Frame Sequence Number
FT	Frame Type
HSDPA	High Speed Downlink Packet Access
HS-DSCH	High Speed Downlink Shared Channel
LTOA	Latest Time of Arrival
PC	Power Control
PDSCH	Physical Downlink Shared Channel
PUSCH	Physical Uplink Shared Channel
QE	Quality Estimate
TB	Transport Block
TBS	Transport Block Set
TFI	Transport Format Indicator
TNL	Transport Network Layer
ToA	Time of Arrival
ToAWE	Time of Arrival Window Endpoint
ToAWS	Time of Arrival Window Startpoint
TTI	Transmission Time Interval
UL	Uplink
USCH	Uplink Shared Channel

3.3 Specification Notations

For the purposes of the present document, the following notations apply:

- [FDD] This tagging of a word indicates that the word preceding the tag "[FDD]" applies only to FDD. This tagging of a heading indicates that the heading preceding the tag "[FDD]" and the section following the heading applies only to FDD.
- [TDD] This tagging of a word indicates that the word preceding the tag "[TDD]" applies only to TDD, including 7.68Mcps TDD, 3.84Mcps TDD and 1.28Mcps TDD. This tagging of a heading indicates that the heading preceding the tag "[TDD]" and the section following the heading applies only to TDD, including 7.68Mcps TDD, 3.84Mcps TDD and 1.28Mcps TDD.
- [7.68Mcps TDD] This tagging of a word indicates that the word preceding the tag '[7.68Mcps TDD]' applies only to 7.68Mcps TDD. This tagging of a heading indicates that the heading preceding the tag '[7.68Mcps TDD]' and the section following the heading applies only to 7.68Mcps TDD.
- [3.84Mcps TDD] This tagging of a word indicates that the word preceding the tag '[3.84Mcps TDD]' applies only to 3.84Mcps TDD. This tagging of a heading indicates that the heading preceding the tag '[3.84Mcps TDD]' and the section following the heading applies only to 3.84Mcps TDD.
- [1.28Mcps TDD] This tagging of a word indicates that the word preceding the tag "[1.28Mcps TDD]" applies only to 1.28Mcps TDD. This tagging of a heading indicates that the heading preceding the tag "[1.28Mcps TDD]" and the section following the heading applies only to 1.28Mcps TDD.
- [FDD - ...] This tagging indicates that the enclosed text following the "[FDD - " applies only to FDD. Multiple sequential paragraphs applying only to FDD are enclosed separately to enable insertion of TDD specific (or common) paragraphs between the FDD specific paragraphs.

[TDD - ...]	This tagging indicates that the enclosed text following the "[TDD - " applies only to TDD, including 7.68Mcps TDD, 3.84Mcps TDD and 1.28Mcps TDD. Multiple sequential paragraphs applying only to TDD are enclosed separately to enable insertion of FDD specific (or common) paragraphs between the TDD specific paragraphs.
[7.68Mcps TDD - ...]	This tagging indicates that the enclosed text following the "[7.68Mcps TDD - " applies only to 7.68Mcps TDD. Multiple sequential paragraphs applying only to 7.68Mcps TDD are enclosed separately to enable insertion of FDD and TDD specific (or common) paragraphs between the 7.68Mcps TDD specific paragraphs.
[3.84Mcps TDD - ...]	This tagging indicates that the enclosed text following the "[3.84Mcps TDD - " applies only to 3.84Mcps TDD. Multiple sequential paragraphs applying only to 1.28Mcps TDD are enclosed separately to enable insertion of FDD and TDD specific (or common) paragraphs between the 3.84Mcps TDD specific paragraphs.
[1.28Mcps TDD - ...]	This tagging indicates that the enclosed text following the "[1.28Mcps TDD - " applies only to 1.28Mcps TDD. Multiple sequential paragraphs applying only to 1.28Mcps TDD are enclosed separately to enable insertion of FDD and TDD specific (or common) paragraphs between the 1.28Mcps TDD specific paragraphs.
Procedure	When referring to a procedure in the specification the Procedure Name is written with the first letters in each word in upper case characters followed by the word "procedure", e.g. Node Synchronisation procedure.
Frame	When referring to a control or data frame in the specification the CONTROL/DATA FRAME NAME is written with all letters in upper case characters followed by the words "control/data frame", e.g. TIMING ADJUSTMENT control frame.
IE	When referring to an information element (IE) in the specification the <i>Information Element Name</i> is written with the first letters in each word in upper case characters and all letters in Italic font followed by the abbreviation "IE", e.g. <i>Frame Type IE</i> .
Value of an IE	When referring to the value of an information element (IE) in the specification the "Value" is written as it is specified in subclause 6.2.7 or 6.3.3 enclosed by quotation marks, e.g. "0" or "255".

4 General aspects

4.1 Common Transport Channel Data Stream User Plane Protocol Services

Common transport channel provides the following services:

- Transport of TBS between the Node B and the CRNC for common transport channels.
- Support of transport channel synchronisation mechanism.
- Support of Node Synchronisation mechanism.

4.2 Services expected from the Data Transport Network layer

The following services are expected from the transport layer:

- Delivery of Frame Protocol PDUs.

In sequence delivery is not required. However, frequent out-of-sequence delivery may impact the performance and should be avoided.

4.3 Protocol Version

This revision of the specification specifies version 1 of the protocols.

5 Data Streams User Plane Procedures

5.1 Data Transfer

5.1.1 RACH Channels

Data Transfer procedure is used to transfer data received from Uu interface from Node B to CRNC. Data Transfer procedure consists of a transmission of Data Frame from Node B to CRNC.

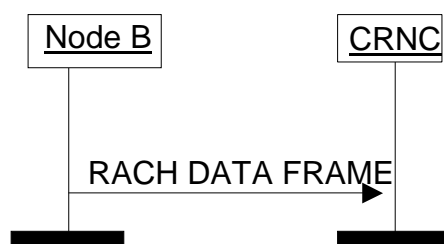

Figure 1: RACH Data Transfer procedure

5.1.2 CPCH Channels [FDD]

Void.

5.1.3 Secondary-CCPCH related transport Channels

For the FACH transport channel, a Data Transfer procedure is used to transfer data from CRNC to Node B. Data Transfer procedure consists of a transmission of Data Frame from CRNC to Node B.

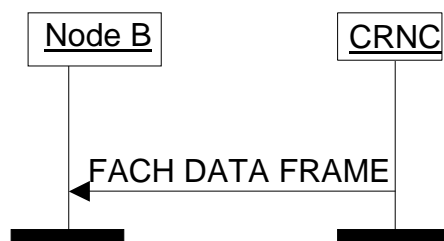

Figure 3: FACH Data Transfer procedure

For the PCH transport channel, a Data Transfer procedure is used to transfer data from CRNC to Node B. Data Transfer procedure consists of a transmission of Data Frame from CRNC to Node B.

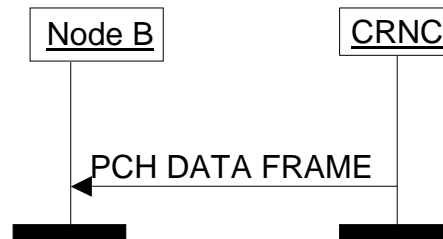

Figure 4: PCH Data Transfer procedure

In this case the PCH DATA FRAME may also transport information related to the PICH channel.

If the Node B does not receive a valid FP frame in a TTI, it assumes that there is no data to be transmitted in that TTI for this transport channel. For the FACH and PCH transport channels, the TFS shall never define a Transport Block Size of zero bits.

If the Node B is aware of a TFI value corresponding to zero bits for this transport channel, this TFI is assumed. When combining the TFI's of the different transport channels, a valid TFCI might result and in this case data shall be transmitted on the Uu.

If the Node B is not aware of a TFI value corresponding to zero bits for this transport channel or if combining the TFI corresponding to zero bits with other TFI's results in an unknown TFI combination, the handling as described in the following paragraph shall be applied.

At each frame, the Node B shall build the TFCI value of each secondary-CCPCH according to the TFIs of the transport channels multiplexed on this secondary-CCPCH and scheduled for that frame. [FDD - In case the Node B receives an unknown TFI combination, no pilot bits, TFCI bits or Data bits shall be transmitted.] [TDD - In case the Node B receives an unknown TFI combination, it shall apply DTX, i.e. suspend transmission on the corresponding S-CCPCH - except if this S-CCPCH provides the "beacon function", in which case the Node B shall maintain the physical layer transmission as specified in TS 25.221].

If the Node B does not receive a valid FP frame in a TTI or a frame without paging indication information, it assumes that no UE's have to be paged on the Uu in this TTI. In this case the default PICH bit pattern of all zeros shall be transmitted.

Data Frames sent on Iub for different transport channels multiplexed on one secondary-CCPCH might indicate different transmission power levels to be used in a certain Uu frame. Node-B shall determine the highest DL power level required for any of the transport channels multiplexed in a certain Uu frame and use this power level as the desired output level for the data.

In the case there is no data (i.e. no TB in the FP frame or no FP frame) in any transport channel for a given TTI and a TFCI is defined for no transmission on all transport channels multiplexed on the S-CCPCH, the TFCI transmit power is unspecified.

Note: It can be for example 0 or determined by the Node B relatively to $P_{\text{ref-nodata}} = \text{Min}(\text{PCH Power, Max FACH1 Power, Max FACH2 Power, ..., Max FACHn Power})$ where PCH, FACH1, FACH2, ..., FACHn are the transport channels of the S-CCPCH [FDD, using the respective PO1 and PO3 offsets specified in [10]].

5.1.4 Downlink Shared Channels [TDD]

The Data Transfer procedure is used to transfer a DSCH DATA FRAME from the CRNC to a Node B.

If the Node B does not receive a valid DSCH DATA FRAME for transmission in a given TTI, it assumes that there is no data to be transmitted in that TTI for this transport channel. For the DSCH transport channel, the TFS shall never define a Transport Block Size of zero bits.

The Node B shall use the header information in the DSCH DATA FRAME to determine which PDSCH Set [3.84Mcps and 7.68 Mcps TDD - and Transmit Power Level if no closed loop TPC power control is used] should be used in the PDSCH Uu frames associated to the specified CFN. The specified PDSCH Set [3.84Mcps and 7.68 Mcps TDD - and Transmit Power Level if no closed loop TPC power control is used] shall then be used for DSCH transmission for as

long as there is data to transmit or until a new DSCH DATA FRAME arrives that specifies that a different PDSCH Set [3.84Mcps and 7.68 Mcps TDD - and/or Transmit Power Level if no closed loop TPC power control is used] should be used. This feature enables multiple DSCH's with different TTI to be supported.

The Node B may receive a DSCH data frame which contains a TFI value corresponding to there being no data to transmit, such a DSCH DATA FRAME will have no transport blocks. On receiving such a DATA FRAME the Node B shall apply the specified PDSCH Set [3.84Mcps and 7.68 Mcps TDD - and Transmit Power Level if no closed loop TPC power control is used] as described above starting in the PDSCH Uu frame associated to the specified CFN. This feature enables multiple DSCH's with different TTI to be supported, the use of such a zero payload DSCH DATA FRAME solves the problem of how the Node B should determine what PDSCH Set [3.84Mcps and 7.68 Mcps TDD - and Transmit Power Level if no closed loop TPC power control is used] should be used in the event that transmission of a transport block set being transmitted with a short TTI comes to an end, whilst the transmission of a TBS with a long TTI continues.

Data Frames sent on Iub for different DSCH transport channels multiplexed on one CCTrCH might indicate different transmission power levels to be used in a certain Uu frame. Node-B shall determine the highest DL power level required for any of the transport channels multiplexed in a certain Uu frame and use this power level as the desired output level.

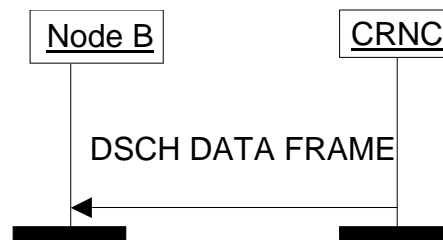

Figure 5: DSCH Data Transfer procedure

5.1.5 Uplink Shared Channels [TDD]

Data Transfer procedure is used to transfer data received from Uu interface from Node B to CRNC. Data Transfer procedure consists of a transmission of Data Frame from Node B to CRNC.

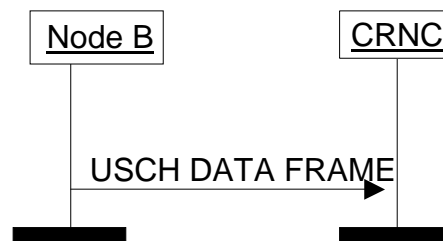

Figure 6: USCH Data Transfer procedure

Node B shall always send an USCH DATA FRAME to the CRNC provided the Transport Format addressed by the TFI indicates that the number of Transport Blocks is greater than 0.

When UL synchronisation is lost or not yet achieved on the Uu, USCH DATA FRAMEs shall not be sent to the CRNC.

When Node B receives an invalid TFCI in the PUSCH, USCH DATA FRAMEs shall not be sent to the CRNC.

5.1.6 High Speed Downlink Shared Channels

The Data Transfer procedure is used to transfer a HS-DSCH DATA FRAME (TYPE 1, TYPE 2 [FDD - or TYPE3]) from the CRNC to a Node B. HS-DSCH DATA FRAME TYPE 2 is selected if the IE *HS-DSCH MAC-d PDU Size Format* in NBAP [6] is present and set to "Flexible MAC-d PDU Size" [FDD - or if the IE *HS-DSCH Common System Information* is present. HS-DSCH DATA FRAME TYPE 3 is selected if the IE *HS-DSCH Paging System Information* in NBAP [6] is present]. HS-DSCH DATA FRAME TYPE 1 is selected in any other case.

[FDD – Three types of HS-DSCH Frame Protocols exist for HS-DSCH data transfer procedure, i.e., HS-DSCH Frame Protocol TYPE 1 (including HS-DSCH DATA FRAME TYPE 1 and HS-DSCH CAPACITY ALLOCATION TYPE 1 Control Frame), HS-DSCH Frame Protocol TYPE 2 (including HS-DSCH DATA FRAME TYPE 2 and HS-DSCH CAPACITY ALLOCATION TYPE 2 Control Frame) and HS-DSCH Frame Protocol TYPE 3 (including HS-DSCH DATA FRAME TYPE 3).]

[TDD – Two types of HS-DSCH Frame Protocols exist for HS-DSCH data transfer procedure, i.e., HS-DSCH Frame Protocol TYPE 1 (including HS-DSCH DATA FRAME TYPE 1 and HS-DSCH CAPACITY ALLOCATION TYPE 1 Control Frame) and HS-DSCH Frame Protocol TYPE 2 (including HS-DSCH DATA FRAME TYPE 2 and HS-DSCH CAPACITY ALLOCATION TYPE 2 Control Frame).]

HS-DSCH CAPACITY ALLOCATION TYPE 1 Control Frame shall be associated only with HS-DSCH DATA FRAME TYPE 1 while HS-DSCH CAPACITY ALLOCATION TYPE 2 Control Frame shall be associated only with HS-DSCH DATA FRAME TYPE 2. HS-DSCH CAPACITY REQUEST Control Frame shall be used for both of HS-DSCH Frame Protocols. HS-DSCH Frame Protocol TYPE 2 is used for Flexible MAC-d PDU Size [FDD - and Enhanced Cell_FACH Operation] as described in NBAP [6].

When the CRNC has been granted capacity by the Node B via the HS-DSCH CAPACITY ALLOCATION (TYPE 1 or TYPE 2) Control Frame or via the HS-DSCH initial capacity allocation as described in [6] and the CRNC has data waiting to be sent, then the HS-DSCH DATA FRAME (TYPE 1 or TYPE 2) is used to transfer the data. If the CRNC has been granted capacity by the Node B via the HS-DSCH initial capacity allocation as described in [6], this capacity is valid for only the first HS-DSCH DATA FRAME (TYPE 1 or TYPE 2) transmission. If the HS-DSCH Frame Protocol TYPE 2 has been selected by the Node B, the granted capacity shall be interpreted as the total number of octets which is retrieved by multiplying the maximum MAC-d PDU [FDD - or MAC-c PDU] length (indicated by the *Maximum MAC-d/c PDU Length* IE) with the number of MAC-d PDUs [FDD - or MAC-c PDUs] (indicated by the *HS-DSCH Credits* IE). When data is waiting to be transferred, and a CAPACITY ALLOCATION (TYPE 1 or TYPE 2) is received, a DATA FRAME (TYPE 1 or TYPE 2) will be transmitted immediately according to allocation received.

In case of HS-DSCH Frame Protocol TYPE 1, multiple MAC-d PDUs of same length and same priority level (CmCH-PI) may be transmitted in one MAC-d flow in the same HS-DSCH DATA FRAME TYPE 1.

In case of HS-DSCH Frame Protocol TYPE 2, MAC-d PDUs [FDD - or MAC-c PDUs] with the same logical channel ID shall be associated to one unique priority level (CmCH-PI).

The HS-DSCH DATA FRAME (TYPE 1 and TYPE 2) includes a *User Buffer Size* IE to indicate the amount of data pending for the respective MAC-d flow for the indicated priority level. [FDD - The HS-DSCH DATA FRAME TYPE 2 includes PDUs for UE in Cell_FACH includes a *User Buffer Size* IE to indicate the amount of data pending for the respective Common MAC flow for the indicated priority level.] Within one priority level (CmCH-PI) and size the MAC-d PDUs [FDD - or MAC-c PDUs] shall be transmitted by the Node B on the Uu interface in the same order as they were received from the CRNC.

If the *Flush* IE in the HS-DSCH DATA FRAME (TYPE 1 and TYPE 2) is set to "flush" the Node B should remove all MAC-d PDUs [FDD - or MAC-c PDUs] from the corresponding MAC-hs Priority Queue that have been received prior to this data frame on the same transport bearer.

For the purpose of TNL Congestion Control on HSDPA, the *Frame Sequence Number* and the *DRT* IEs may be included by the CRNC.

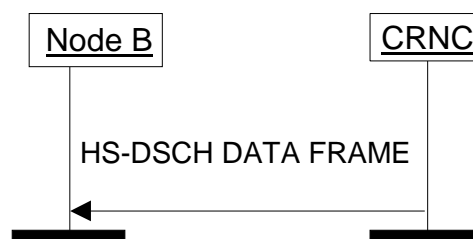

Figure 6A: HS-DSCH Data Transfer procedure

5.2 Node Synchronisation

In the Node Synchronisation procedure, the RNC sends a DL NODE SYNCHRONISATION control frame to Node B containing the parameter T1. Upon reception of a DL NODE SYNCHRONISATION control frame, the Node B shall respond with UL NODE SYNCHRONISATION control frame, indicating T2 and T3, as well as T1 which was indicated in the initiating DL NODE SYNCHRONISATION control frame.

The T1, T2, T3 parameters are defined as:

T1: RNC specific frame number (RFN) that indicates the time when RNC sends the frame through the SAP to the transport layer.

T2: Node B specific frame number (BFN) that indicates the time when Node B receives the correspondent DL NODE SYNCHRONISATION control frame through the SAP from the transport layer.

T3: Node B specific frame number (BFN) that indicates the time when Node B sends the frame through the SAP to the transport layer.

The general overview on the Node Synchronisation procedure is reported in [2].

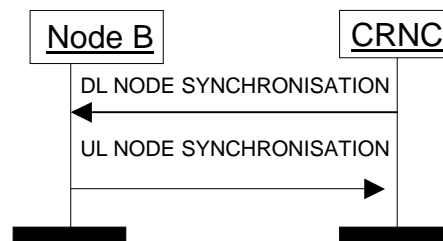

Figure 7: Node Synchronisation procedure

5.3 DL Transport Channels Synchronisation

CRNC sends a DL SYNCHRONISATION control frame to Node B. This message indicates the target CFN.

Upon reception of the DL SYNCHRONISATION control frame Node B shall immediately respond with UL SYNCHRONISATION control frame indicating the ToA for the DL SYNCHRONISATION control frame and the CFN indicated in the received message.

The procedure shall not be applied on transport bearers transporting UL traffic channels RACH or USCH.

In case a transport bearer is used by several FACH channels, the procedure shall take place for all these FACH channels.

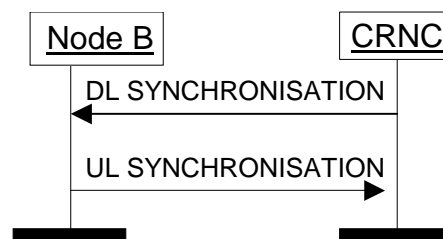

Figure 8: Transport Channels Synchronisation procedure

5.4 DL Timing Adjustment

Timing Adjustment procedure is used to indicate for the CRNC the incorrect arrival time of downlink data to Node B.

Timing Adjustment procedure is initiated by the Node B if a DL frame arrives outside of the defined arrival window.

If the DL frame has arrived before the ToAWS or after the ToAWE Node B includes the ToA and the target CFN as message parameters for TIMING ADJUSTMENT control frame.

In case a transport bearer is used by several FACH channels, the procedure shall take place for all these FACH channels.

The arrival window and the time of arrival are defined as follows:

- **Time of Arrival Window Endpoint (ToAWE):** ToAWE represents the time point by which the DL data shall arrive to the Node B from Iub. The ToAWE is defined as the amount of milliseconds before the last time point from which a timely DL transmission for the identified CFN would still be possible taking into account the Node B internal delays. ToAWE is set via control plane. If data does not arrive before ToAWE a TIMING ADJUSTMENT control frame shall be sent by Node B.
- **Time of Arrival Window Startpoint (ToAWS):** ToAWS represents the time after which the DL data shall arrive to the Node B from Iub. The ToAWS is defined as the amount of milliseconds from the ToAWE. ToAWS is set via control plane. If data arrives before ToAWS a TIMING ADJUSTMENT control frame shall be sent by Node B.
- **Time of Arrival (ToA):** ToA is the time difference between the end point of the DL arrival window (ToAWE) and the actual arrival time of DL frame for a specific CFN. A positive ToA means that the frame is received before the ToAWE, a negative ToA means that the frame is received after the ToAWE.

The general overview on the timing adjustment procedure is reported in [2].

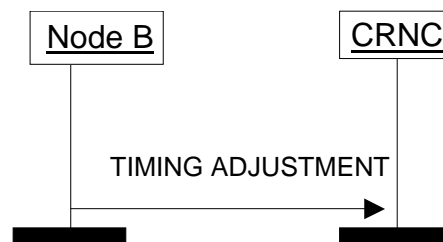

Figure 9: Timing Adjustment procedure

5.5 Dynamic PUSCH Assignment [TDD]

Procedure for dynamic allocation of physical resources to uplink shared channels (USCH) in the Node B. The control frame includes a parameter "PUSCH Set Id" which is a pointer to a pre-configured table of PUSCH Sets in the Node B.

When this control frame is sent via a certain Iub USCH data port, then it applies to that USCH and in addition to any other USCH channel which is multiplexed into the same CCTrCH in the Node B.

The time limitation of the PUSCH allocation is expressed with the parameters "Activation CFN" and "Duration".

Node B behaviour: When the Node B receives the "DYNAMIC PUSCH ASSIGNMENT" from the CRNC in the USCH frame protocol over an Iub USCH data port within a Traffic Termination Point, it shall behave as follows:

- 1) The Node B shall extract the PUSCH Set Id.
- 2) It shall extract the parameters "Activation CFN" and "Duration" which identify the allocation period of that physical channel.
- 3) It shall retrieve the PUSCH Set which is referred to by the PUSCH Set Id.
- 4) It shall identify the CCTrCH to which the USCH is multiplexed, and hence the TFCS which is applicable for the USCH.
- 5) Within the time interval indicated by Activation CFN and Duration, the Node B shall make the specified PUSCH Set available to the CCTrCH.

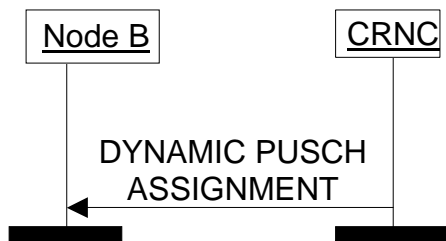

Figure 10: Dynamic PUSCH Assignment procedure

5.6 DSCH TFCI Signalling [FDD]

Void.

5.7 Timing Advance [3.84 Mcps and 7.68Mcps TDD]

This procedure is used in order to signal to the Node B the adjustment to be performed by the UE in the uplink timing.

The Node B shall use the CFN and timing adjustment values to adjust its layer 1 to allow for accurate impulse averaging.

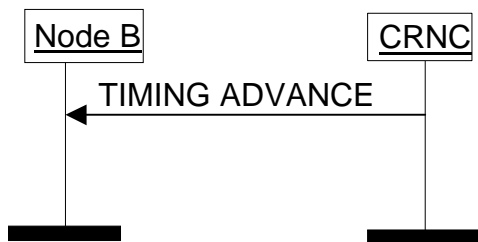

Figure 12: Timing Advance procedure

5.7A Outer Loop PC Information Transfer [1.28 Mcps TDD]

Based, for example, on the CRCI values and on the quality estimate in the USCH data frames, CRNC modifies the SIR target of the associated CCTrCH by including the absolute value of the new SIR target in the OUTER LOOP PC control frame sent to the Node B.

At the reception of the OUTER LOOP PC control frame from the CRNC via a Transport Bearer used for an USCH, the Node B shall immediately update the SIR target used for the inner loop power control for the respective CCTrCH with the specified value.

The OUTER LOOP PC control frame can be sent via any of the transport bearers carrying USCHs which belong to the CCTrCH for which the UL SIR Target shall be adjusted.

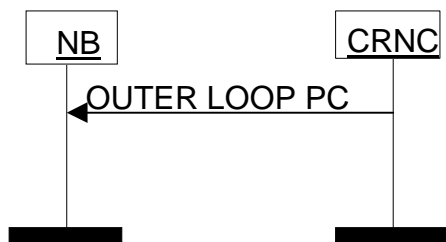

Figure 12A: Outer Loop Power Control Information Transfer procedure

5.8 General

5.8.1 Association between transport bearer and data/control frames

Table 1 shows how the data and control frames are associated to the transport bearers. 'yes' indicates that the control frame is applicable to the transport bearer, 'no' indicates that the control frame is not applicable to the transport bearer.

Table 1

Transport bearer used for	Associated data frame	Associated control frames								
		Timing Adjustment	DL Transport Channels Synchronisation	Node Synchronisation	Dynamic PUSCH Assignment	Timing Advance	Outer Loop PC Info Transfer	HS-DSCH Capacity Request	HS-DSCH Capacity Allocation TYPE 1	HS-DSC Capacity Allocation TYPE 2
RACH	RACH DATA FRAME	no	no	no	no	no	no	no	no	no
FACH	FACH DATA FRAME	yes	yes	yes	no	no	no	no	no	no
PCH	PCH DATA FRAME	yes	yes	yes	no	no	no	no	no	no
DSCH	DSCH DATA FRAME	yes	yes	yes	no	no	no	no	no	no
USCH	USCH DATA FRAME	no	no	no	yes	yes	yes	no	no	no
HS-DSCH	HS-DSCH DATA FRAME TYPE 1	no	no	no	no	no	no	yes	yes	no
HS-DSCH	HS-DSCH DATA FRAME TYPE 2	no	no	no	no	no	no	yes	no	yes
HS-DSCH	HS-DSCH DATA FRAME TYPE 3	no	no	no	no	no	no	no	no	no

5.8.2 DSCH / USCH transport bearer replacement [TDD]

As described in NBAP [6], transport bearer replacement can be achieved for a DSCH or USCH by using the Synchronised Radio Link Reconfiguration Preparation procedure in combination with the Synchronised Radio Link Reconfiguration Commit procedure. The following steps can be discerned:

- 1) The new transport bearer is established after which 2 transport bearers exist in parallel.
- 2) The transport channel(s) is/are switched to the new transport bearer.
- 3) The old transport bearer is released.

DSCH transport bearer replacement, step 1:

Communication on the old transport bearer continues as normal. In addition, the Node B shall support DSCH DATA FRAMES, the DL Transport Channel Synchronisation procedure (see sub-clause 5.3) and the DL Timing Adjustment procedure (see sub-clause 5.4) on the new bearer. This enables the CRNC to determine the timing on the new transport bearer. DSCH DATA FRAMES transported on the new transport bearer shall not be transmitted on the Uu Interface before the CFN indicated in the RADIO LINK RECONFIGURATION COMMIT message.

USCH transport bearer replacement, step 1:

Communication on the old transport bearer continues as normal.

DSCH / USCH Transport Bearer Replacement step 2:

Regarding step 2), the moment of switching is determined as follows:

- The DSCH DATA FRAMES or USCH DATA FRAMES shall be transported on the new transport bearer from the CFN indicated in the RADIO LINK RECONFIGURATION COMMIT message.

Starting from this CFN the Node B shall support all applicable Common Transport Channels frame protocol procedures on the new transport bearer and no requirements exist regarding support of Common Transport Channels frame protocol procedures on the old transport bearer.

DSCH / USCH Transport Bearer Replacement step 3:

Finally in step 3), the old transport bearer is released.

5.9 HS-DSCH Capacity Request

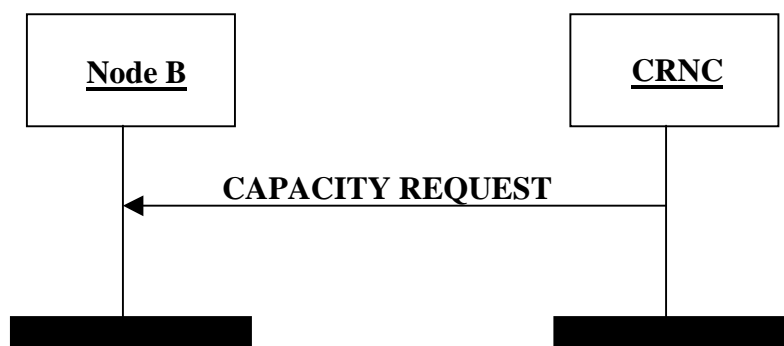

Figure 12B: HS-DSCH Capacity Request procedure

The HS-DSCH Capacity Request procedure provides means for the CRNC to request HS-DSCH capacity by indicating the user buffer size in the CRNC for a given priority level.

The CRNC is allowed to reissue the HS-DSCH Capacity Request if no CAPACITY ALLOCATION (TYPE 1 or TYPE 2) has been received within an appropriate time threshold.

5.10 HS-DSCH Capacity Allocation

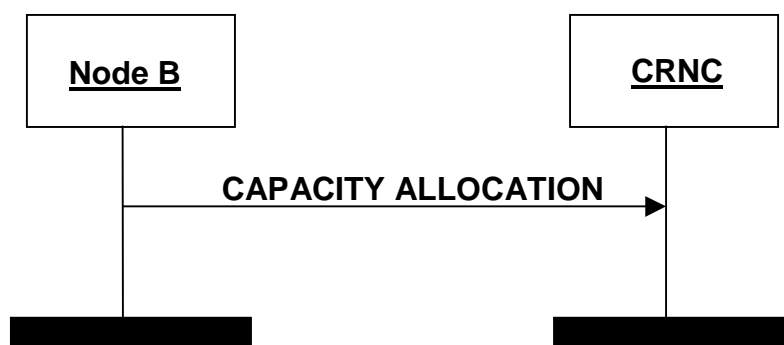

Figure 12C: HS-DSCH Capacity Allocation procedure

HS-DSCH Capacity Allocation procedure is generated within the Node B. It may be generated either in response to a HS-DSCH Capacity Request or at any other time.

The Node B may use this message to modify the capacity at any time, irrespective of the reported user buffer status.

The HS-DSCH CAPACITY ALLOCATION (TYPE 1 and TYPE 2) Control Frame is used by the Node B to control the user data flow. In case of HS-DSCH Frame Protocol TYPE 1, the *HS-DSCH Credits* IE indicates the number of MAC-d PDUs that the CRNC is allowed to transmit for the MAC-d flow and the associated priority level indicated by the *Common Transport Channel Priority Indicator* IE. In case of HS-DSCH Frame Protocol TYPE 2, the *HS-DSCH Credits* IE indicates the number of MAC-d PDU [FDD – or MAC-c PDU] octets that the CRNC is allowed to transmit for the MAC-d flow [FDD - or Common MAC flow] and the associated priority level indicated by the *Common Transport Channel Priority Indicator* IE. The number of MAC-d PDU [FDD - or MAC-c PDU] octets is retrieved by multiplying the maximum MAC-d PDU [FDD - or MAC-c PDU] length (indicated by the *Maximum MAC- d/c PDU Length* IE) with the number of MAC-d PDUs [FDD - or MAC-c PDUs] (indicated by the *HS-DSCH Credits* IE).

The *Maximum MAC-d PDU Length* (in case of HS-DSCH Frame Protocol TYPE 1) or *Maximum MAC- d/c PDU Length* (in case of HS-DSCH Frame Protocol TYPE 2), *HS-DSCH Credits*, *HS-DSCH Interval* and *HS-DSCH Repetition Period* IEs indicates the total amount of capacity granted. Any capacity previously granted is replaced.

If *HS-DSCH Credits* IE = 0 (e.g. due to congestion in the Node B), the CRNC shall immediately stop transmission of MAC-d PDUs [FDD – or MAC-c PDUs]. If *HS-DSCH Credits* IE = 2047 in case of HS-DSCH CAPACITY ALLOCATION TYPE 1 Control Frame or 65535 in case of HS-DSCH CAPACITY ALLOCATION TYPE 2 Control Frame, the CRNC can transmit MAC-d PDUs [FDD – or MAC-c PDUs] with unlimited capacity.

The IEs used in the HS-DSCH CAPACITY ALLOCATION Control Frame (TYPE 1 and TYPE 2) are the *Common Transport Channel Priority Indicator*, *HS-DSCH Credits*, *Maximum MAC- d PDU Length* (in case of HS-DSCH Frame Protocol TYPE 1) or *Maximum MAC- d/c PDU Length* (in case of HS-DSCH Frame Protocol TYPE 2), *HS-DSCH Interval* and the *HS-DSCH Repetition Period*.

If the *HS-DSCH Repetition Period* IE = "unlimited repetition period" it indicates that the CRNC may transmit the amount of granted capacity for an unlimited period according to the bounds of *Maximum MAC-d PDU Length* IE (TYPE 1) or *Maximum MAC- d/c PDU length* IE (TYPE 2), *HS-DSCH Credits* IE and *HS-DSCH Interval* IE.

6 Frame Structure and Coding

6.1 General

The general structure of a Common Transport Channel frame consists of a header and a payload. This structure is depicted in figure 13.

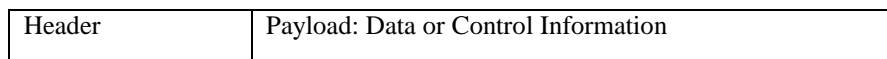

Figure 13: General Frame Structure

The header shall contain the Frame Type field and information related to the frame type.

There are two types of frames (indicated by the Frame Type field).

- Data frame.
- Control frame.

In the present document the structure of frames will be specified by using pictures similar to figure 14.

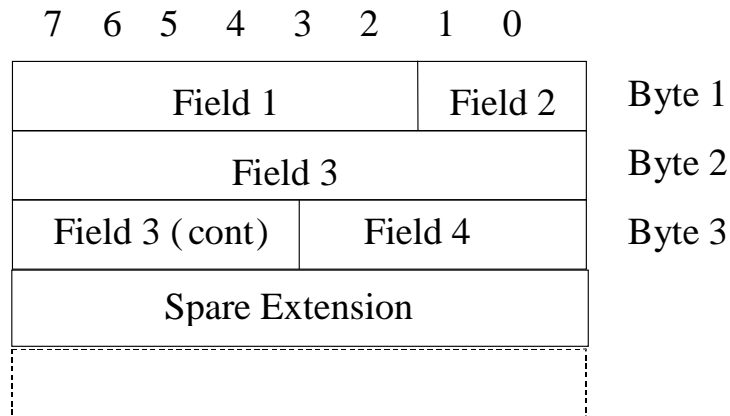

Figure 14: Example frame structure

Unless otherwise indicated, fields which consist of multiple bits within a byte will have the more significant bit located at the higher bit position (indicated above frame in figure 14). In addition, if a field spans several bytes, more significant bits will be located in lower numbered bytes (right of frame in figure 14).

On the Iub interface, the frame will be transmitted starting from the lowest numbered byte. Within each byte, the bits are sent according decreasing bit position (bit position 7 first).

The parameters are specified giving the value range and the step (if not 1). The coding is done as follows (unless otherwise specified):

- Unsigned values are binary coded.
- Signed values are 2's complement binary coded.

The Spare Extension indicates the location where new IEs can in the future be added in a backward compatible way. The Spare Extension shall not be used by the transmitter and shall be ignored by the receiver.

Bits labelled "Spare" shall be set to zero by the transmitter and shall be ignored by the receiver.

6.2 Data frame structure

6.2.1 RACH Channels

The RACH DATA FRAME includes the CFN corresponding to the SFN of the frame in which the payload was received. If the payload was received in several frames, the CFN corresponding to the first Uu frame in which the information was received shall be indicated.

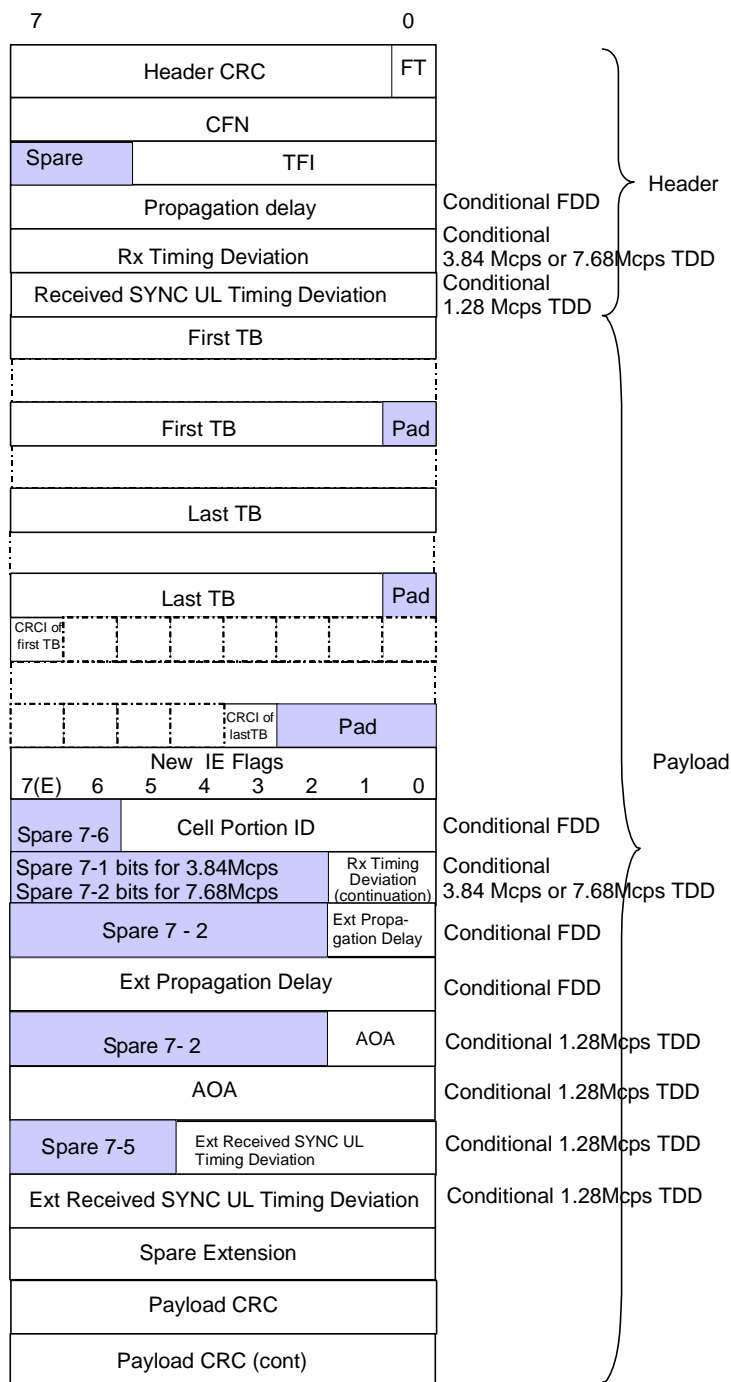

Figure 15: RACH DATA FRAME structure

Propagation Delay is a conditional Information Element which is only present when the Cell supporting the RACH Transport Channel is a FDD Cell.

Rx Timing Deviation is a conditional Information Element which is only present when the Cell supporting the RACH Transport Channel is a 3.84 Mcps or 7.68 Mcps TDD Cell.

Received SYNC UL Timing Deviation is a conditional Information Element which is only present when the Cell supporting the RACH Transport Channel is a 1.28 Mcps TDD Cell. The RNC shall ignore this IE if the measured Received SYNC UL Timing Deviation is sent in Ext Received SYNC UL Timing Deviation IE

With respect to new IEs, for which the presence is indicated by the *New IE Flags* IE, the Figure 15 is an example of how a frame is structured when all such new IEs are present. Note that non-presence of such a new IE changes the position of all subsequent IEs on octet level.

[FDD- Bit 0 of New IE Flags in RACH DATA FRAME indicates if a Cell Portion ID is present (1) or not present (0) in the byte (bits 0-5) following the *New IE Flags* IE.]

[FDD - Bit 1 of New IE Flags in RACH DATA FRAME indicates if *Ext Propagation Delay* IE is present (1) or not present (0)]

[FDD - Bits 2 through 6 of New IE Flags in RACH DATA FRAME shall be set to 0.]

[FDD - Field length of *Spare Extension* IE in RACH DATA FRAME is 0-28 octets.]

[3.84 Mcps and 7.68 Mcps TDD - Bit 0 of New IE Flags in RACH DATA FRAME indicates if the extended bits of the Rx Timing Deviation are present (1) or not present (0) in the byte (bit 0 for 3.84 Mcps TDD, bits 0 and 1 for 7.68 Mcps TDD) following the *New IE Flags* IE. Bits 1 through 6 of New IE Flags in RACH DATA FRAME shall be set to 0. Field length of *Spare Extension* IE in RACH DATA FRAME is 0-30 octets.]

[1.28Mcps TDD - Bit 0 of New IE Flags in RACH DATA FRAME indicates if the *AOA* IE is present (1) or not present (0).]

[1.28Mcps TDD - Bit 1 of New IE Flags in RACH DATA FRAME indicates if *Ext Received SYNC UL Timing Deviation* IE is present (1) or not present (0)]

[1.28Mcps TDD – Bits 2 through 6 of New IE Flags in RACH DATA FRAME shall be set to 0.]

[1.28Mcps TDD – Field length of Spare Extension IE in RACH DATA FRAME is 0-27 octets.]

6.2.2 CPCH Channels [FDD]

Void.

6.2.3 FACH Channels

FACH DATA FRAME includes the CFN corresponding to the Uu frame at which this data in which the payload (FACH TBS) has to be transmitted. If the payload is to be sent in several frames, the CFN corresponding to the first frame shall be indicated. In case a transport bearer is used by several FACH channels, the CFN and Transmit power level are valid for all these FACH channels.

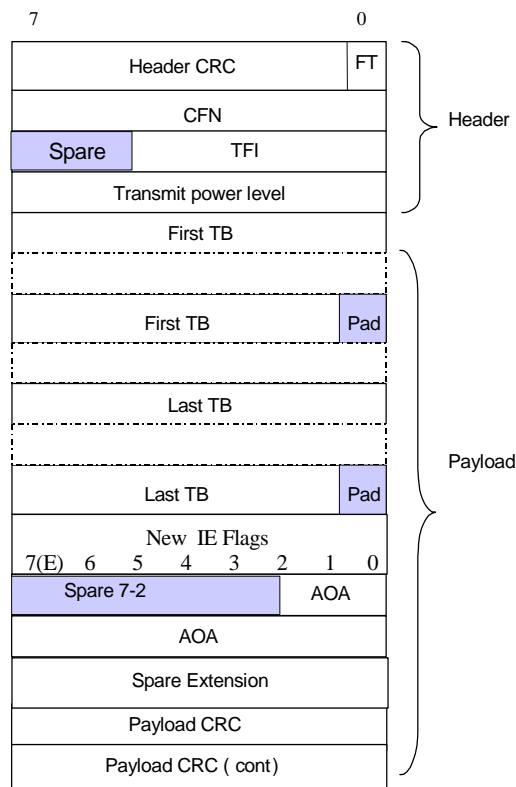

Figure 17: FACH DATA FRAME structure

[1.28Mcps TDD - Bit 0 of New IE Flags in FACH DATA FRAME indicates if the AOA IE is present (1) or not present (0).]

6.2.4 PCH Channels

The PCH DATA FRAME includes the paging indication information and paging messages [FDD - To page one User Equipment, two consecutive PCH DATA FRAMEs with consecutive CFN numbers are transmitted, the first frame contains the Paging Indication Information and the second contains the Paging Message.] [TDD – To page one User Equipment, one or more PCH DATA FRAMEs are transmitted.]

[TDD - If two or more consecutive frames are used, the first frame contains the Paging Indication Information and the rest contain the Paging Messages. If PI-bitmap and PCH TBS are both transmitted within the PCH DATA FRAME, the CFN is related to the PCH TBS only. The PI bitmap is mapped to the PICH frames, transmitted at the beginning of the paging block.]

The paging messages are transmitted in S-CCPCH frames. The CFN in the PCH DATA FRAME header corresponds to the Cell SFN of the frame in which the start of the S-CCPCH frame is located. [TDD - If the paging messages are to be sent in several frames, the CFN corresponding to the first frame shall be indicated.]

[FDD - The timing of the PICH frame (containing the paging indication information) is τ_{PICH} prior to the S-CCPCH frame timing [5]].

In contrast to all other Common Transport Channel data frames, which use a CFN of length 8, the PCH DATA FRAME includes a CFN of length 12.

The Node B has no responsibility to ensure the consistency between the paging indication information and the corresponding paging messages. E.g. if the paging indication information is lost over the Iub, the paging messages might be sent over the Uu while no UE is actually listening.

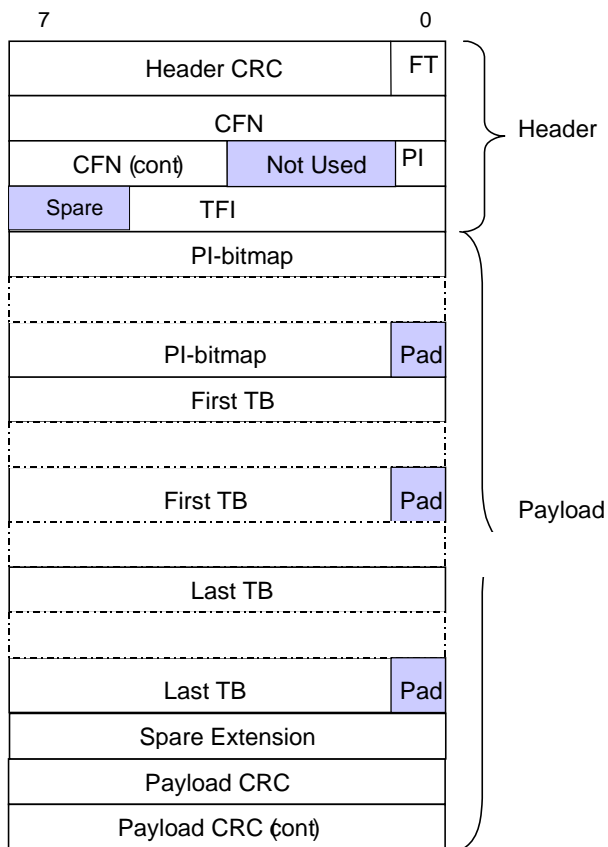

Figure 18: PCH DATA FRAME structure

"Not Used" bits shall be set to 0 by the RNC and ignored by the Node B.

6.2.5 Downlink Shared Channels [TDD]

DSCH DATA FRAME includes a CFN indicating the SFN of the PDSCH in which the payload shall be sent. If the payload is to be sent over several frames, the CFN corresponding to the first frame shall be indicated.

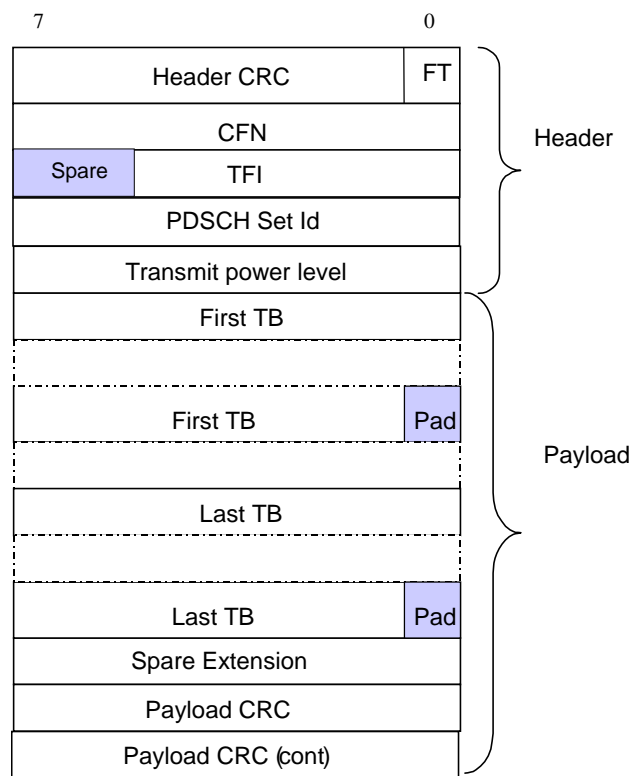

Figure 20: DSCH DATA FRAME structure

6.2.6 Uplink Shared Channels [TDD]

USCH DATA FRAME includes the CFN in which the payload was received. If the payload was received in several frames, the CFN corresponding to the first frame will be indicated.

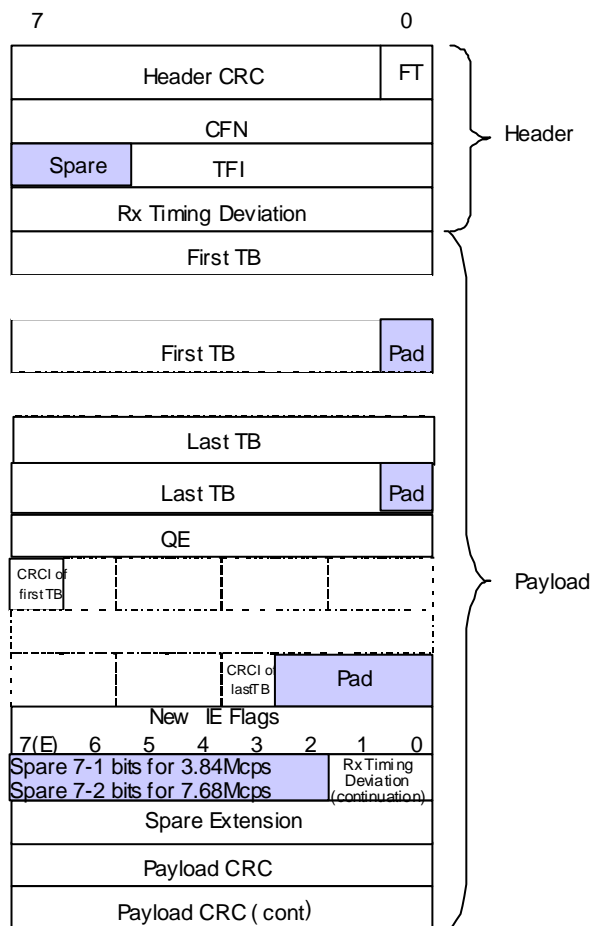

Figure 21: USCH DATA FRAME structure

[3.84 Mcps and 7.68 Mcps TDD - Field length of *Spare Extension* IE in USCH DATA FRAME is 0-30 octets.

Bit 0 of New IE Flags in USCH DATA FRAME indicates if the extended bits of the Rx Timing Deviation are present (1) or not present (0) in the byte (bit 0 for 3.84 Mcps TDD, bits 0 and 1 for 7.68 Mcps TDD) following the *New IE Flags* IE. Bits 1 through 6 of New IE Flags in USCH DATA FRAME shall be set to 0.]

6.2.6A HS-DSCH Channels

[FDD - Three types of HS-DSCH DATA FRAME exist for the HS-DSCH data transfer, i.e. HS-DSCH DATA FRAME TYPE 1, HS-DSCH DATA FRAME TYPE 2 and HS-DSCH DATA FRAME TYPE 3.]

[TDD - Two types of HS-DSCH DATA FRAME exist for the HS-DSCH data transfer, i.e. HS-DSCH DATA FRAME TYPE 1 and HS-DSCH DATA FRAME TYPE 2.]

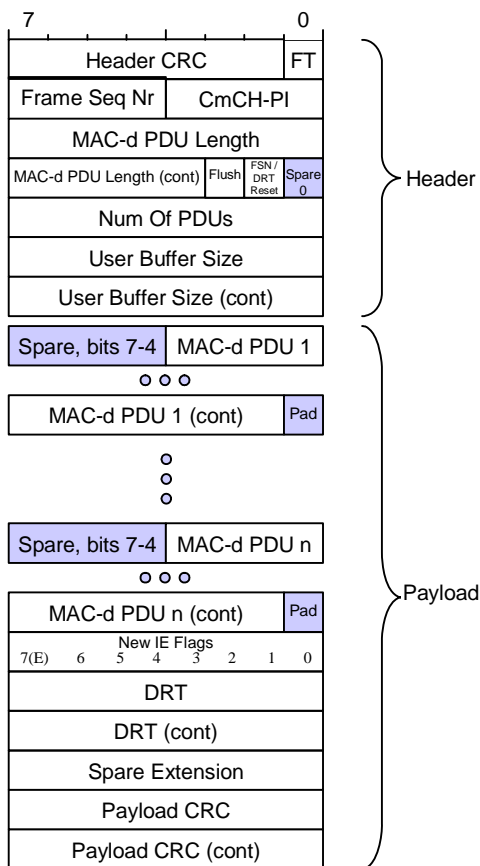

Figure 21A: HS-DSCH DATA FRAME TYPE 1 structure

Bit 0 of New IE Flags in HS-DSCH DATA FRAME TYPE 1 indicates if a DRT is present (1) or not (0) in the 2 octets following the *New IE Flags* IE. Bits 1 through 6 of New IE Flags in HS-DSCH DATA FRAME TYPE 1 shall be set to 0.

Field length of *Spare Extension* IE in HS-DSCH DATA FRAME TYPE 1 is 0-29 octets.

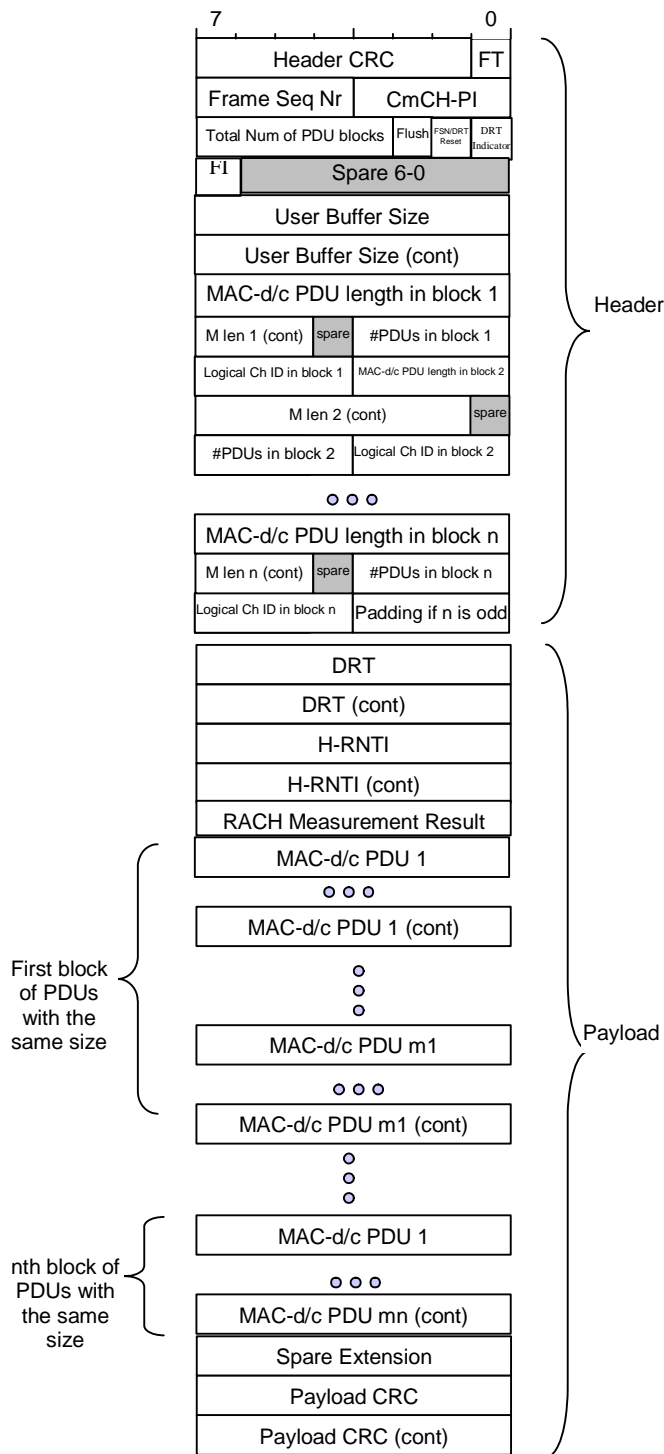

Figure 21B: HS-DSCH DATA FRAME TYPE 2 structure

[FDD – If the received *H-RNTI* IE sets to same value as the *BCCH Specific HS-DSCH RNTI* IE configured in NBAP[6], the Node B shall ignore *RACH Measurement Result* IE in the frame.]

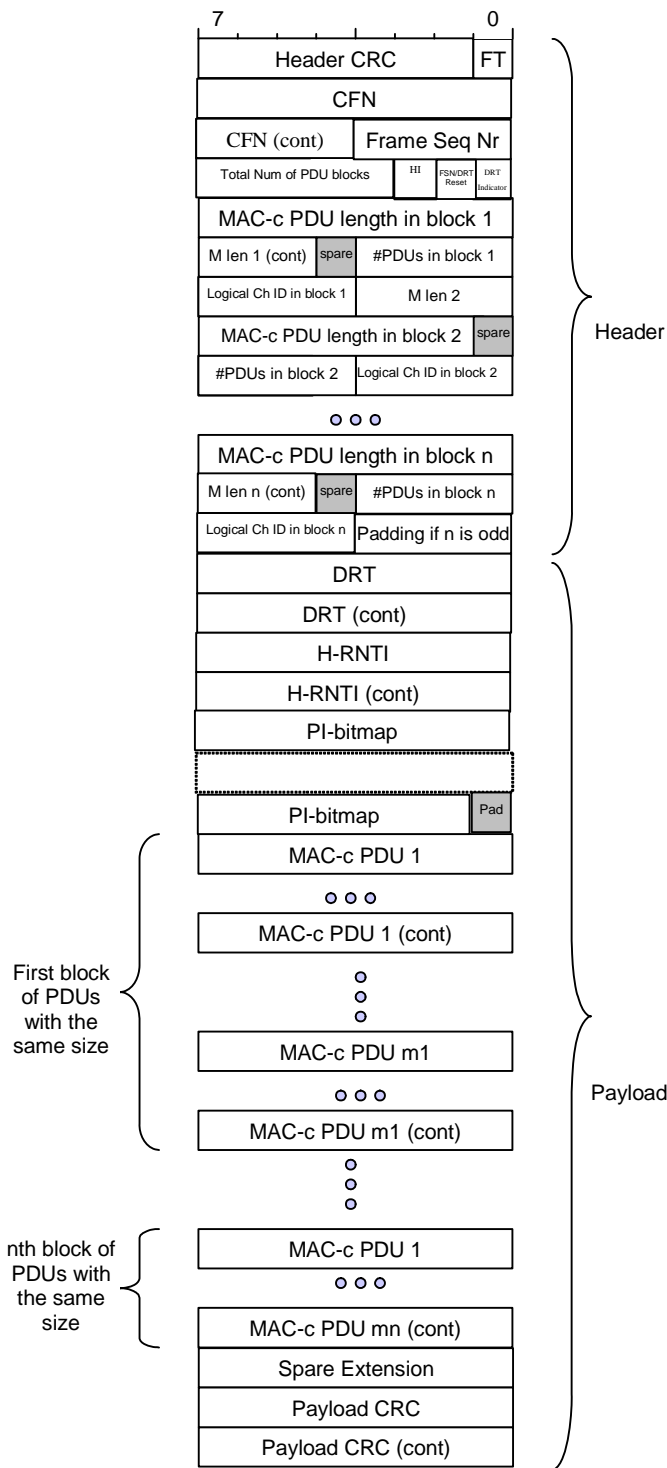

Figure 21C: HS-DSCH DATA FRAME TYPE 3 structure [FDD only]

[FDD - The CFN in the HS-DSCH DATA FRAME TYPE 3 header corresponds to the Cell SFN of the frame in which the start of the HS-SCCH frame is located. The timing of the PICH frame (containing the paging indication information) is τ_{PICH} prior to the HS-SCCH frame timing [5]].

[FDD - Note: The HS-SCCH frame is not sent if HI IE is set to 0, i.e. H-RNTI not present.]

6.2.7 Coding of information elements in data frames

6.2.7.1 Header CRC

Description: Cyclic Redundancy Checksum calculated on the header of a data frame with polynomial: $X^7+X^6+X^2+1$.

The CRC calculation shall cover all bits in the header, starting from bit 0 in the first byte (FT field) up to the end of the header. See subclause 7.1.

Value range: {0..127}.

Field length: 7 bits.

6.2.7.2 Frame Type

Description: Describes if it is a control frame or a data frame.

Value range: {0=data, 1=control}.

Field Length: 1 bit.

6.2.7.3 Connection Frame Number (CFN)

Description: Indicator as to which radio frame the first data was received on uplink or shall be transmitted on downlink. The value range and field length depend on the transport channel for which the CFN is used.

Value range (PCH): {0..4095}.

Value range (other): {0..255}.

Field length (PCH): 12 bits.

Field length (other): 8 bits.

6.2.7.4 Transport Format Indicator

Description: TFI is the local number of the transport format used for the transmission time interval. For information about what the transport format includes see [3].

Value range: {0..31}.

Field length: 5 bits.

6.2.7.5 Propagation Delay [FDD]

Description: One-way radio interface delay as measured during RACH access. If the measured value exceeds the range of this information element, the information element shall be set to its maximum value, and the *Ext Propagation Delay* IE shall be used to represent the measured value, see subclause 6.2.7.5A.

Value range: {0..765 chips}.

Granularity: 3 chips.

Field length: 8 bits.

6.2.7.5A Ext Propagation Delay [FDD]

Description: One-way radio interface delay as measured during RACH access, extended value part. This IE shall be present only if the range of the *Propagation Delay* IE is insufficient to represent the measured value.

Value range: {0 - 3069 chips}.

Granularity: 3 chips.

Field length: 10 bits.

6.2.7.6 Rx Timing Deviation [3.84Mcps TDD]

Description: Measured Rx Timing Deviation as a basis for timing advance. This value should consider measurements made in all frames and all timeslots that contain the transport blocks in the payload. In case the *Timing Advance Applied* IE indicates "No" (see [6]) in a cell, the Rx Timing Deviation field shall be set to $N = 0$.

Value range: $\{-1024 .. +1023 \text{ chips}\}$.

$$\{N*4 - 256\} \text{ chips} \leq \text{RxTiming Deviation} < \{(N+1)*4 - 256\} \text{ chips.}$$

With $N = 0, 1, \dots, 127$.

$$\{(N-128)*4 - 1024\} \text{ chips} \leq \text{Rx Timing Deviation} < \{(N-127)*4 - 1024\} \text{ chips}$$

With $N = 128, 129, \dots, 319$

$$\{N*4 - 1024\} \text{ chips} \leq \text{Rx Timing Deviation} < \{(N+1)*4 - 1024\} \text{ chips}$$

With $N = 320, 321, \dots, 511$

Granularity: 4 chips.

Field length: 9 bits. The least significant 8 bits are contained in the RX timing deviation field and the most significant bit is contained in the RX timing deviation (continuation) field.

6.2.7.6A Received SYNC UL Timing Deviation [1.28Mcps TDD]

Description: Measured Received SYNC UL Timing Deviation as a basis for propagation delay.

Value range: $\{0, \dots, +255\} \text{ chips}$

Granularity: 1 chip.

Field length: 8 bits.

6.2.7.6B Rx Timing Deviation [7.68Mcps TDD]

Description: Measured Rx Timing Deviation as a basis for timing advance. This value should consider measurements made in all frames and all timeslots that contain the transport blocks in the payload. In case the *Timing Advance Applied* IE indicates "No" (see [6]) in a cell, the Rx Timing Deviation field shall be set to $N = 0$.

Value range: $\{-2056, \dots, +2055\} \text{ chips}$

$$\{N*4 - 2056\} \text{ chips} \leq \text{RxTiming Deviation} < \{(N+1)*4 - 2056\} \text{ chips}$$

With $N = 0, 1, \dots, 1027$

Granularity: 4 chips.

Field length: 10 bits. The least significant 8 bits are contained in the RX timing deviation field and the most significant 2 bits are contained in the RX timing deviation (continuation) field.

6.2.7.7 Transport Block

Description: A block of data to be transmitted or have been received over the radio interface. The transport format indicated by the TFI describes the transport block length and transport block set size. See [3].

6.2.7.8 CRC Indicator

Description: Shows if the transport block has a correct CRC. The UL Outer Loop Power Control may use the CRC indication.

Value range: {0=Correct, 1=Not Correct}.

Field length: 1 bit.

6.2.7.9 Payload CRC

Description: Cyclic Redundancy Checksum calculated on the payload of a data frame with polynom $X^{16}+X^{15}+X^2+1$.

The CRC calculation shall cover all bits in the data frame payload, starting from bit 7 in the first byte up to bit 0 in the byte before the payload CRC. See subclause 7.1.

Field length: 16 bits.

6.2.7.10 Transmit Power Level

Description: Preferred transmission power level during this TTI for the corresponding transport channel. The indicated value is the negative offset relative to the maximum power configured for the physical channel(s) used for the respective transport channel. [1.28Mcps TDD - The Node B shall ignore the Transmit Power Level in the TDD DSCH DATA FRAME.] [3.84Mcps and 7.68Mcps TDD - The Node B shall ignore the Transmit Power Level in the TDD DSCH DATA FRAME if closed loop TPC power control is used.]

Value range: {0 .. 25.5 dB}.

Granularity: 0,1 dB.

Field length: 8 bits.

6.2.7.11 Paging Indication (PI)

Description: Describes if the PI Bitmap is present in the payload.

Value range: {0=no PI-bitmap in payload, 1=PI-bitmap in payload}.

Field length: 1 bit.

6.2.7.12 Paging Indication bitmap (PI-bitmap)

Description: Bitmap of Paging Indications $PI_0..PI_{N-1}$. Bit 7 of the first byte contains PI_0 , Bit 6 of the first byte contains PI_1, \dots , Bit 7 of the second byte contains PI_8 and so on.

Value range: [FDD - {18, 36, 72 or 144 Paging Indications}.]

[3.84Mcps TDD – {30, 34, 60, 68, 120 and 136} Paging Indications for 2 PICH frames,
{60, 68, 120, 136, 240 and 272} Paging Indications for 4 PICH frames].

[1.28Mcps TDD – {44, 88 and 176} Paging Indications for 2 PICH frames,
{88, 176 and 352} Paging Indications for 4 PICH frames].

[7.68Mcps TDD – {30, 34, 60, 68, 120 and 136} Paging Indications for 2 PICH frames,
{60, 68, 120, 136, 240 and 272} Paging Indications for 4 PICH frames,
..... {120, 136, 240, 272, 480 and 544} Paging Indications for 8 PICH frames].

Field length: [FDD - 3, 5, 9 or 18 bytes (the PI-bitmap field is padded at the end up to an octet boundary)].

[3.84Mcps TDD – 4, 5, 8, 9, 15, 17, 30 or 34 bytes (the PI-bitmap field is padded at the end up to an octet boundary)].

[1.28Mcps TDD – 6, 11, 22 or 44 bytes (the PI-bitmap field is padded at the end up to an octet boundary)].

[7.68Mcps TDD – 4, 5, 8, 9, 15, 17, 30, 34, 60 or 68 bytes (the PI-bitmap field is padded at the end up to an octet boundary)].

6.2.7.13 Rx Timing Deviation on RACH [3.84Mcps TDD]

Void.

6.2.7.14 PDSCH Set Id [TDD]

Description: A pointer to the PDSCH Set which shall be used to transmit the DSCH DATA FRAME over the radio interface.

Value range: {0..255}.

Field length: 8 bits.

6.2.7.15 Code Number [FDD]

Void.

6.2.7.16 Spreading Factor (SF) [FDD]

Void.

6.2.7.17 Power Offset [FDD]

Void.

6.2.7.18 MC Info [FDD]

Void.

6.2.7.19 Spare Extension

Description: Indicates the location where new IEs can in the future be added in a backward compatible way.

Field length: 0-32 octets.

6.2.7.20 Quality Estimate (QE) [TDD]

Description: The quality estimate is derived from the Transport channel BER.

If the USCH FP frame includes TB's for the USCH then the QE is the Transport channel BER for the selected USCH. If no Transport channel BER is available the QE shall be set to 0.

The quality estimate shall be set to the Transport channel BER and be measured in the units TrCH_BER_LOG respectively (see [6]). The UL Outer Loop Power Control may use the quality estimate.

Value range: {0..255}.

Granularity: 1.

Field length: 8 bits.

6.2.7.21 Common Transport Channel Priority Indicator (CmCH-PI)

Description: CmCH-PI, configured via the Scheduling Priority Indicator in NBAP [6], is the relative priority of the data frame and the SDUs included.

Value range: {0-15, where 0=lowest priority, 15=highest priority}.

Field length: 4 bits.

6.2.7.22 User Buffer Size

Description: Indicates the users' buffer size (i.e. the amount of data in the buffer) in octets for a given Common Transport Channel Priority Indicator level.

Value range: {0-65535}.

Field length: 16 bits.

6.2.7.23 MAC-d PDU Length

Description: The value of that field indicates the length of every MAC-d PDU in the payload of the HS-DSCH DATA FRAME in number of bits.

Value range: {0-5000}.

Field Length: 13 bits.

6.2.7.24 NumOfPDU

Description: Indicates the number of MAC-d PDUs in the payload.

Value range: {1-255}.

Field Length: 8 bits.

6.2.7.25 MAC-d PDU

Description: A MAC-d PDU contains the MAC-d PDU as defined in [9].

Field length: See the value of the *MAC-d PDU Length* IE.

6.2.7.26 Cell Portion ID [FDD]

Description: Cell Portion ID indicates the cell portion with highest SIR during RACH access. Cell Portion ID is configured by O&M.

Value range: {0-63}.

Field Length: 6 bits.

6.2.7.27 New IE Flags

Description: The *New IE Flags* IE is only present if at least one new IE is present. The *New IE Flags* IE contains flags indicating which new IEs that are present following the *New IE Flags* IE. The last bit position of the *New IE Flags* IE is used as the Extension Flag to allow the extension of the *New IE Flags* IE in the future. Extension octets of the *New IE Flags* IE shall follow directly after the first octet of the *New IE Flags* IE. When an extension octet of the *New IE Flags* IE is present, then all previous extension octets of the *New IE Flags* IE and the *New IE Flags* IE shall also be present, even if they have all their flag bits indicating no presence of their respective new IEs.

Value range:

Bit 0-6 of each octet: Indicates if a new IE is present (1) or not present (0) in the bytes following the *New IE Flags* IE. The meaning of each bit is explained in the corresponding DATA FRAME subclause;

Bit 7 of each octet: Indicates if an extension octet of the *New IE Flags* IE follows (1) or not (0).

Field length: 1 – 31 octets.

6.2.7.28 Flush

Description: Indicates whether the DRNS should remove (1) or not (0) all the MAC-d PDUs from the corresponding MAC-hs Priority Queue that have been received prior to this data frame HS-DSCH DATA FRAME on the same transport bearer.

Value range: {0 = no flush, 1 = flush}.

Field Length: 1 bit.

6.2.7.29 DRT (Delay Reference Time)

Description: *DRT* is a 16-bit *Delay Reference Time*. *DRT* can be used for dynamic delay measurements. The *DRT* counter bridges the same time span as RFN and BFN. *DRT* is locked to RFN in SRNC and is a 40960 counter with 1 ms resolution.

Value range: {0..40959_{DEC} ms (0..9FFF_{HEX} ms)}.

Granularity: 1 ms.

Field length: 16 bits.

6.2.7.30 Frame Sequence Number

Description: The 4-bit *Frame Sequence Number* is incremented for each transmitted HS-DSCH data frame belonging to one MAC-d flow. At wraparound of the Frame Sequence Number, the value "0" shall not be used. Each flow generates its own Frame Sequence.

Value range:

0 is a special value and indicates that the *Frame Sequence Number* IE shall be treated as spare.

1 – 15 indicates the Frame Sequence Number.

Granularity: 1.

Field length: 4 bits.

6.2.7.31 Logical Channel ID in block n

Description: This field provides identification of the logical channel instance associated with the PDUs of the n-th block of PDUs with the same size in the HS-DSCH DATA FRAME TYPE 2 [FDD – and TYPE 3]. Multiple logical channels may be carried on the same MAC-d flow [FDD – , Common MAC flow or Paging MAC flow].

Value range: {0-15}, where 0-14 identifies logical channels 1-15, 15 reserved.

Field length: 4 bits.

6.2.7.32 Total Number of PDU blocks

Description: The field indicates the number of blocks of PDUs with the same size in this HS-DSCH DATA FRAME.

Value range: {0-31}, 0 – not used.

Field length: 5 bits.

6.2.7.33 MAC-d/c PDU Length in block n

Description: The value of this field indicates the length of every MAC-d PDU [FDD - or MAC-c PDU] in the n-th block of PDUs with the same size in number of octets.

Value range: {0-1504}, 0 – not used.

Field length: 11 bits.

6.2.7.34 Number of MAC-d/c PDUs in block n (#PDUs in block n)

Description: Indicates the number of MAC-d PDUs [FDD - or MAC-c PDUs] in the n-th block of PDUs with the same size.

Value range: {0-15}, 0 – not used.

Field length: 4 bits.

6.2.7.35 DRT Indicator

Description: Indicates whether a DRT is present.

Value range: {0 = DRT not present, 1= DRT present}.

Field length: 1 bit.

6.2.7.36 FACH Indicator (FI) [FDD]

Description: Indicates whether an H-RNTI and a RACH Measurement Result are present (i.e. whether UE in CELL_FACH).

Value range: {0 = H-RNTI and RACH Measurement Result not present, 1= H-RNTI and RACH Measurement Result present}.

Field length: 1 bit.

6.2.7.37 H-RNTI [FDD]

Description: H-RNTI is defined in [11]. The field identifies an UE having a HS-PDSCH assignment within a cell.

Value range: {0-65535}, 0 – not used.

Field length: 16 bits.

6.2.7.38 RACH Measurement Result [FDD]

Description: This field indicates the values received in RACH Measurement. The type of the measured value in the field is configured via NBAP [6].

Value range: {0-158}

Field length: 8 bits.

6.2.7.39 H-RNTI Indicator (HI) [FDD]

Description: Indicates whether an H-RNTI is present.

Value range: {0 = H-RNTI not present, 1= H-RNTI present}.

Field length: 1 bit.

6.2.7.40 FSN/DRT Reset

Description: When the Node B receives a HS-DSCH DATA FRAME where the 1-bit *FSN/DRT Reset* IE is set to 1, the Node B should reset any state of congestion estimation based on previously received FSN and DRT values. Node B may instead decide to start a new estimation of congestion detection initiated with the FSN and DRT values included in this HS-DSCH data frame. *FSN/DRT Reset* IE set to 1 may indicate a discontinuity in the sequence of the transmitted DRT and FSN values in the transmitted HS-DSCH data frames belonging to the associated MAC-d flow.

If the 1-bit *FSN/DRT Reset* IE is set to 0, Node B may use the included DRT and FSN values for congestion detection.

Value range:

- 0 Node B may use the included DRT and FSN values for congestion detection.
- 1 Node B should not use previously received FSN and DRT values for congestion detection.

Field length: 1 bit.

6.2.7.41 MAC-d/c PDU

Description: A MAC-d/c PDU contains the MAC-ehs SDU as defined in [9].

Field length: For length of MAC-d/c PDU of block n, see the value of the *MAC-d/c PDU length in block n* IE.

6.2.7.42 AOA (Angle of Arrival) [1.28Mcps TDD]

Description: This field indicates the angle of arrival information of UE measured by Node B.

Value range: {0-719}

Field length: 10 bit.

6.2.7.43 Ext Received SYNC UL Timing Deviation [1.28Mcps TDD]

Description: Measured Received SYNC UL Timing Deviation as a basis for propagation delay.

Value range: {0, .., +1023} chips

Granularity: 1/8 chip.

Field length: 13 bits.

6.3 Control frame structure

6.3.1 Introduction

The Common Control Channel control frames are used to transport control information between the CRNC and the Node B. Figure 22 defines the Control Frame structure for common transport channels.

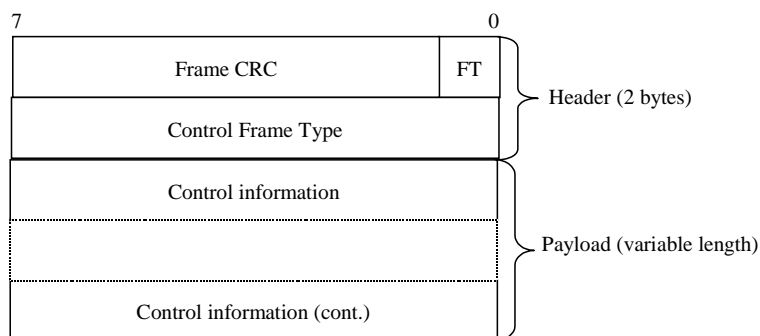

Figure 22: lub Common Transport Channel Control Frame Format

The structure of the header and the payload of the control frames is defined in the following subclauses.

6.3.2 Coding of information elements of the Control frame header

6.3.2.1 Frame CRC

Description: Cyclic Redundancy Checksum calculated on a control frame with polynom: $X^7+X^6+X^2+1$.

The CRC calculation shall cover all bits in the control frame, starting from bit 0 in the first byte (FT field) up to the end of the control frame. See subclause 7.1.

Value range: {0..127}.

Field length: 7 bits.

6.3.2.2 Frame Type (FT)

Refer to subclause 6.2.7.2.

6.3.2.3 Control Frame Type

Description: Indicates the type of the control information (information elements and length) contained in the payload.

Value: Values of the Control Frame Type parameter are defined in table 2.

Table 2

Type of control frame	Value
OUTER LOOP POWER CONTROL	0000 0001
TIMING ADJUSTMENT	0000 0010
DL SYNCHRONISATION	0000 0011
UL SYNCHRONISATION	0000 0100
Reserved Value	0000 0101
DL NODE SYNCHRONISATION	0000 0110
UL NODE SYNCHRONISATION	0000 0111
DYNAMIC PUSCH ASSIGNMENT	0000 1000
TIMING ADVANCE	0000 1001
HS-DSCH Capacity Request	0000 1010
HS-DSCH Capacity Allocation TYPE 1	0000 1011
HS-DSCH Capacity Allocation TYPE 2	0000 1100

Field Length: 8 bits.

The "Reserved Value" for the *Control Frame Type IE* shall not be used by the SRNC. A control frame whose *Control Frame Type IE* is set to the "Reserved Value" shall be ignored by the Node B.

6.3.3 Payload structure and information elements

6.3.3.1 TIMING ADJUSTMENT

6.3.3.1.1 Payload Structure

Figures 23 and 24 shows the structure of the payload when control frame is used for the timing adjustment.

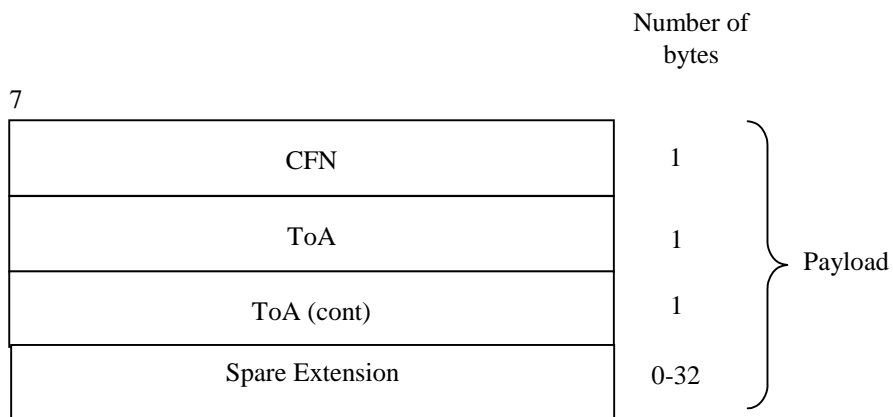

Figure 23: TIMING ADJUSTMENT payload structure (non-PCH transport bearers)

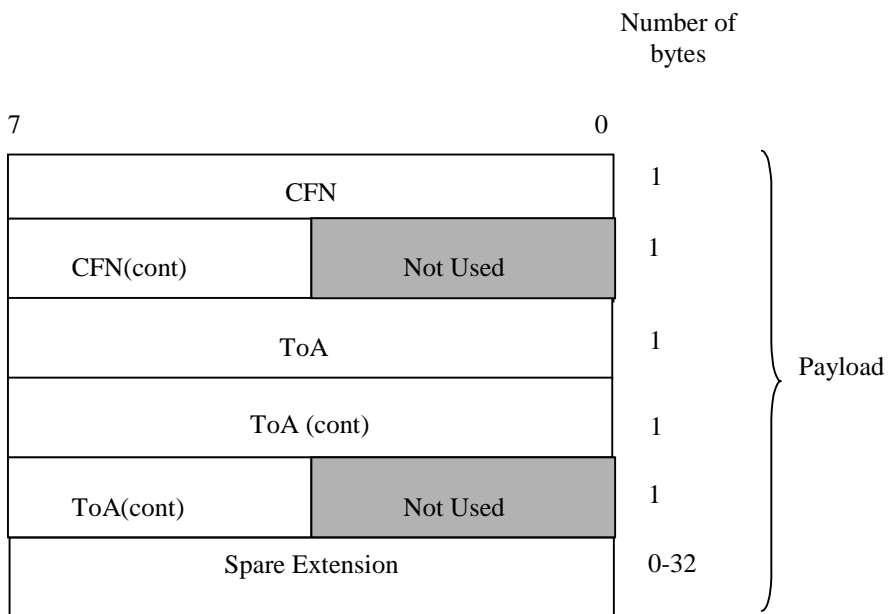

Figure 24: TIMING ADJUSTMENT payload structure (PCH transport bearer)

6.3.3.1.2 CFN

Refer to subclause 6.2.7.3.

6.3.3.1.3 Time of arrival (ToA)

Description: Time difference between the arrival of the DL frame with respect to TOAWE (based on the CFN in the frame). The value range and field length depend on the transport channel for which the CFN is used.

Value range (PCH): {-20480ms, +20479.875ms}.

Value range (other): {-1280ms, +1279.875ms}.

Granularity: 125µs.

Field length (PCH): 20 bits.

Field length (other): 16 bits.

6.3.3.1.4 Spare Extension

Description: Indicates the location where new IEs can in the future be added in a backward compatible way.

Field length: 0-32 octets.

6.3.3.2 DL SYNCHRONISATION

6.3.3.2.1 Payload Structure

Figures 25 and 26 shows the structure of the payload when control frame is used for the user plane synchronisation.

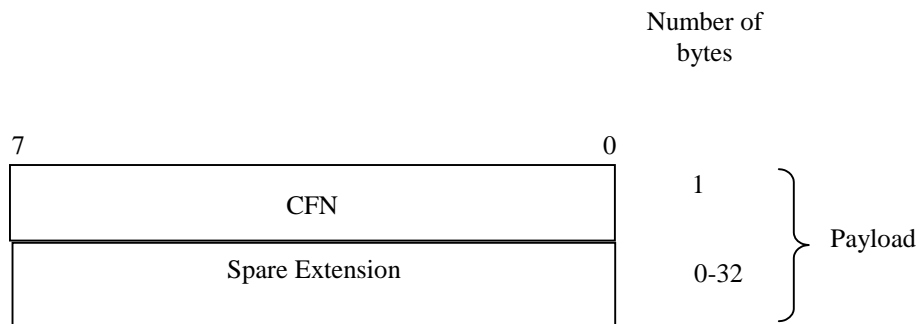

Figure 25: DL SYNCHRONISATION payload structure (non-PCH transport bearers)

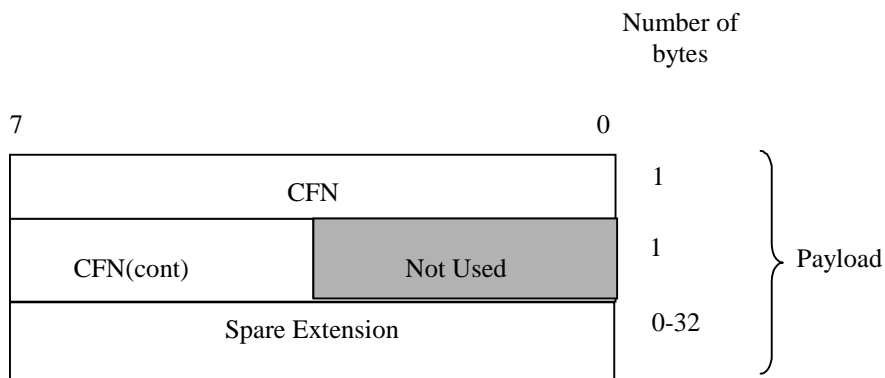

Figure 26: DL SYNCHRONISATION payload structure (PCH transport bearers)

6.3.3.2.2 CFN

Refer to subclause 6.2.7.3.

6.3.3.2.3 Spare Extension

Refer to subclause 6.3.3.1.4.

6.3.3.3 UL SYNCHRONISATION

6.3.3.3.1 Payload Structure

Figures 27 and 28 shows the structure of the payload when the control frame is used for the user plane synchronisation (UL).

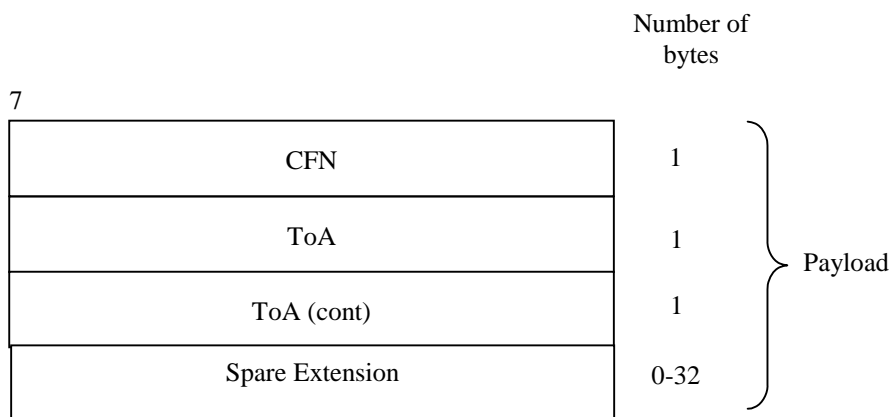

Figure 27: UL SYNCHRONISATION payload structure (non-PCH transport bearers)

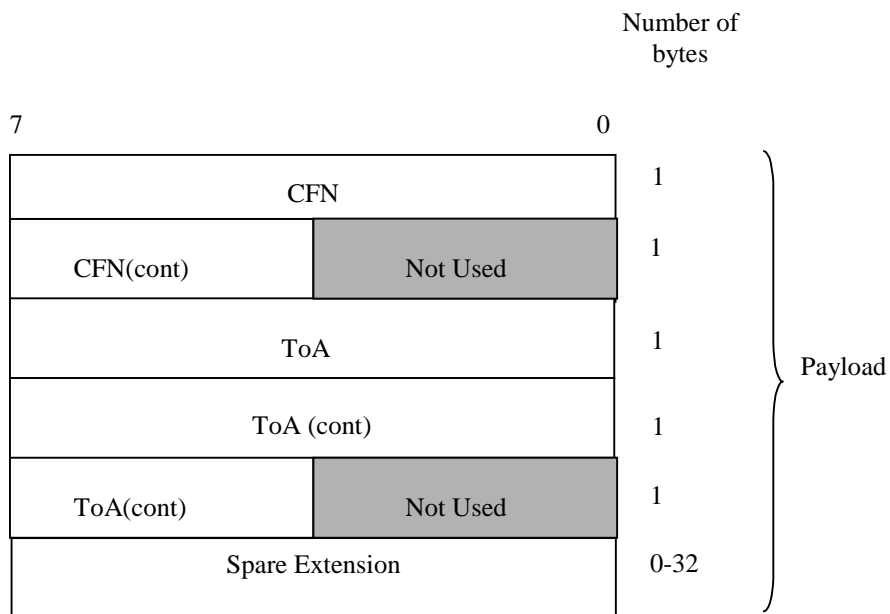

Figure 28: UL SYNCHRONISATION payload structure (PCH transport bearers)

6.3.3.3.2 CFN

Refer to subclause 6.2.7.3.

6.3.3.3.3 Time of Arrival (TOA)

Refer to subclause 6.3.3.1.3.

6.3.3.3.4 Spare Extension

Refer to subclause 6.3.3.1.4.

6.3.3.4 DL NODE SYNCHRONISATION

6.3.3.4.1 Payload Structure

The payload of the DL Node synchronisation control frames is shown in figure 29.

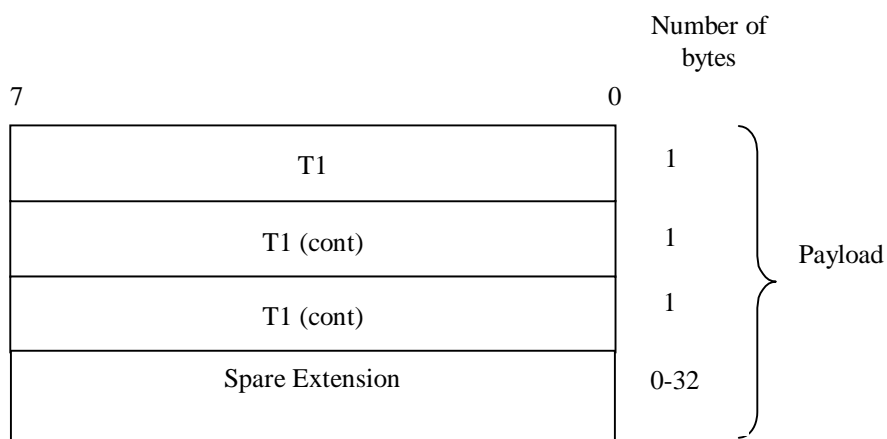

Figure 29: DL NODE SYNCHRONISATION payload structure

6.3.3.4.2 T1

Description: RNC specific frame number (RFN) that indicates the time when RNC sends the frame through the SAP to the transport layer.

Value range: {0 .. 40959.875 ms}.

Granularity: 0.125ms.

Field length: 24 bits.

6.3.3.4.3 Spare Extension

Refer to subclause 6.3.3.1.4.

6.3.3.5 UL NODE SYNCHRONISATION

6.3.3.5.1 Payload Structure

The payload of the UL Node synchronisation control frames is shown in figure 30.

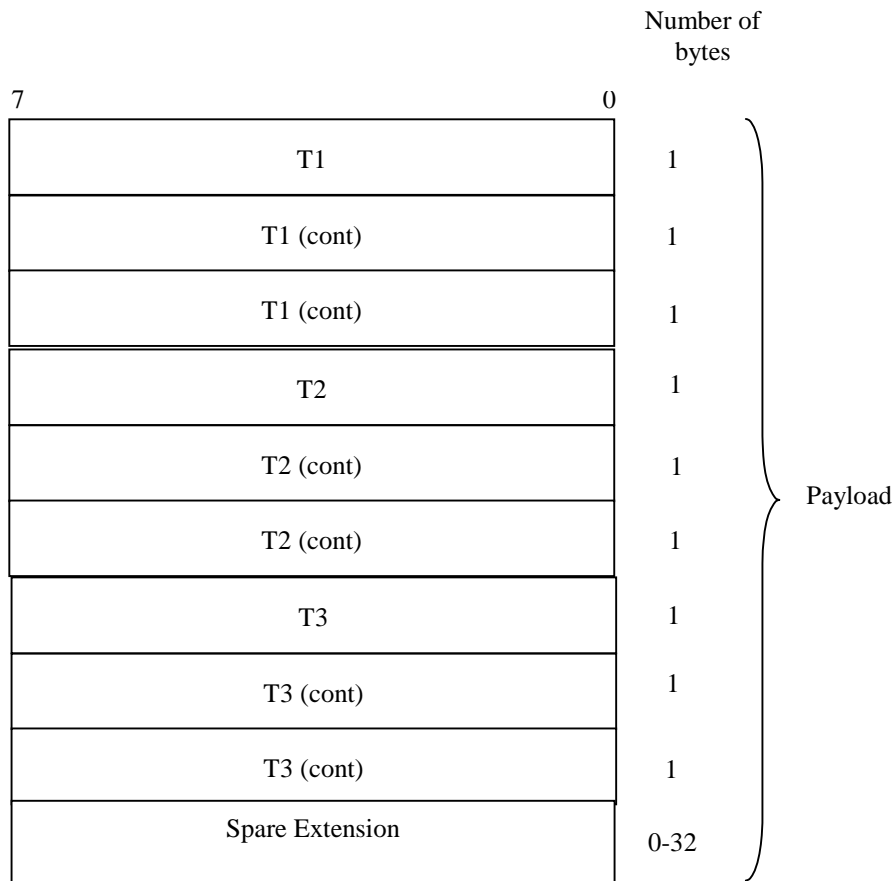

Figure 30: UL NODE SYNCHRONISATION payload structure

6.3.3.5.2 T1

Description: T1 timer is extracted from the correspondent DL Node synchronisation control frame.

Value range: {0 .. 40959.875 ms.}

Granularity: 0.125ms.

Field length: 24 bits.

6.3.3.5.3 T2

Description: Node B specific frame number (BFN) that indicates the time when Node B received the correspondent DL synchronisation frame through the SAP from the transport layer.

Value range: {0 .. 40959.875 ms}.

Granularity: 0.125ms.

Field length: 24 bits.

6.3.3.5.4 T3

Description: Node B specific frame number (BFN) that indicates the time when Node B sends the frame through the SAP to the transport layer.

Value range: {0 .. 40959.875 ms}.

Granularity: 0.125ms.

Field length: 24 bits.

6.3.3.5.5 Spare Extension

Refer to subclause 6.3.3.1.4.

6.3.3.6 DYNAMIC PUSCH ASSIGNMENT [TDD]

6.3.3.6.1 Payload structure

The payload of the Dynamic PUSCH Assignment control frames is shown in figure 31.

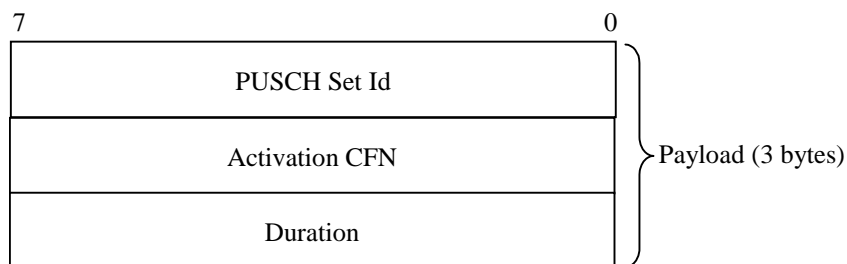

Figure 31: DYNAMIC PUSCH ASSIGNMENT payload structure

6.3.3.6.2 PUSCH Set Id

Description: Identifies a PUSCH Set from the collection of PUSCH Sets which have been pre-configured in the Node B, for the respective cell in which the USCH exists. The PUSCH Set Id is unique within a cell.

Value range: {0..255}.

Field length: 8 bits.

6.3.3.6.3 Activation CFN

Description: Activation CFN, specifies the Connection Frame Number where the allocation period of that PUSCH Set starts.

Value range: Integer {0..255}.

Field length: 8 bits.

6.3.3.6.4 Duration

Description: Indicates the duration of the activation period of the PUSCH Set, in radio frames.

Value range: 0..255 means: 0 to 255 radio frames, i.e. 0 to 2550 msec.

Field length: 8 bits.

6.3.3.7 DSCH TFCI SIGNALLING [FDD]

6.3.3.7.1 Payload structure

Void.

6.3.3.7.2 TFCI (field 2)

Void.

6.3.3.7.3 Spare Extension

Void.

6.3.3.8 TIMING ADVANCE [3.84Mcps and 7.68Mcps TDD]

6.3.3.8.1 Payload structure

Figure 33 shows the structure of the payload when the control frame is used for timing advance.

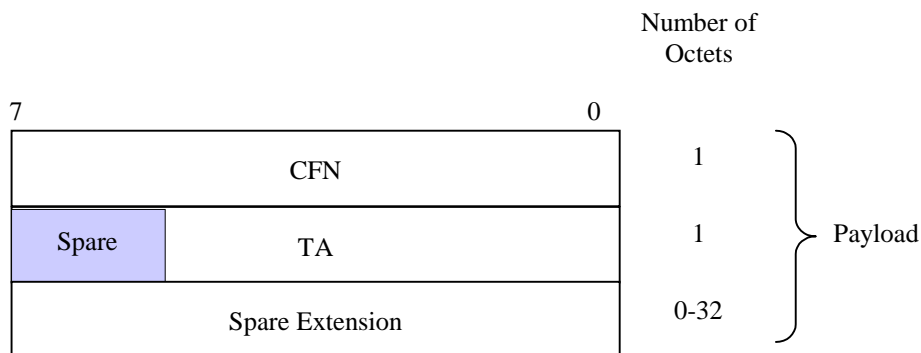

Figure 33: TIMING ADVANCE payload structure

6.3.3.8.2 CFN

Refer to subclause 6.2.7.3.

6.3.3.8.3 TA [3.84 Mcps]

Description: UE applied UL timing advance adjustment.

Value range: {0 .. 252 chips}.

Granularity: 4 chips.

Field length: 6 bits.

6.3.3.8.3A TA [7.68 Mcps]

Description: UE applied UL timing advance adjustment.

Value range: {0 .. 508 chips}.

Granularity: 4 chips.

Field length: 7 bits.

6.3.3.8.4 Spare Extension

Refer to subclause 6.3.3.1.4.

6.3.3.9 OUTER LOOP POWER CONTROL [1.28 Mcps TDD]

6.3.3.9.1 Payload structure

Figure 34 shows the structure of the payload when control frame is used for the UL outer loop power control.

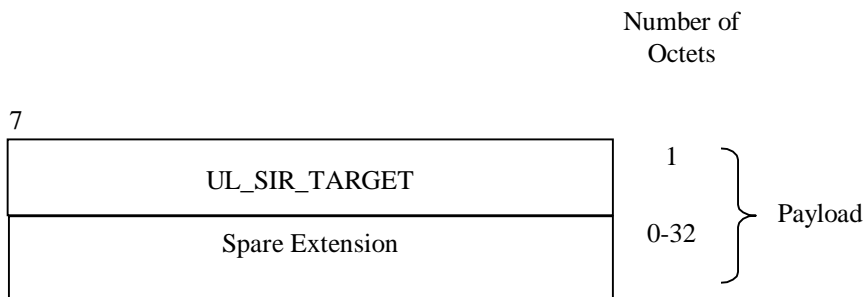

Figure 34: Structure of the payload for OUTER LOOP PC control frame

6.3.3.9.2 SIR Target

Description: Value (in dB) of the SIR target to be used by the UL inner loop power control.

SIR Target is given in the unit UL_SIR_TARGET where:

UL_SIR_TARGET = 000	SIR Target = -8.2 dB
UL_SIR_TARGET = 001	SIR Target = -8.1 dB
UL_SIR_TARGET = 002	SIR Target = -8.0 dB
...	
UL_SIR_TARGET = 254	SIR Target = 17.2 dB
UL_SIR_TARGET = 255	SIR Target = 17.3 dB

Value range: {-8.2 .. 17.3 dB}.

Granularity: 0.1 dB.

Field length: 8 bits.

6.3.3.9.3 Spare Extension

Refer to subclause 6.3.3.1.4.

6.3.3.10 HS-DSCH CAPACITY REQUEST

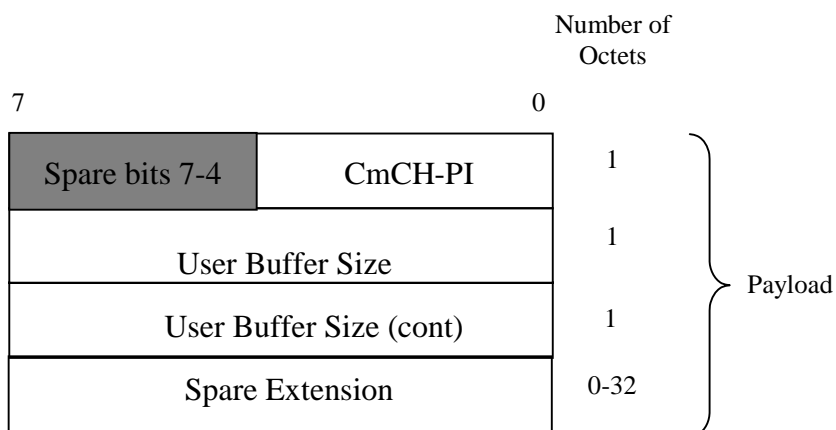

Figure 35: CAPACITY REQUEST payload structure

The HS-DSCH CAPACITY REQUEST control frame is sent for each priority group to indicate the user buffer size. The control frame is sent by the CRNC when the CRNC considers the user buffer status needs an increased buffer reporting frequency. This may be sent to signal an event, such as, data arrival or user-buffer discard. This control frame

is used to improve user-buffer reporting above the level produced by the user-buffer reporting associated with the HS-DSCH DATA FRAMEs.

6.3.3.10.1 Common Transport Channel Priority Indicator (CmCH-PI)

Refer to subclause 6.2.7.21.

6.3.3.10.2 User Buffer Size

Refer to subclause 6.2.7.22.

6.3.3.10.3 Spare Extension

Refer to subclause 6.3.3.1.4.

6.3.3.11 HS-DSCH CAPACITY ALLOCATION

Two types of HS-DSCH CAPACITY ALLOCATION exist for the HS-DSCH capacity allocation, i.e. HS-DSCH CAPACITY ALLOCATION TYPE 1 Control Frame and HS-DSCH CAPACITY ALLOCATION TYPE 2 Control Frame.

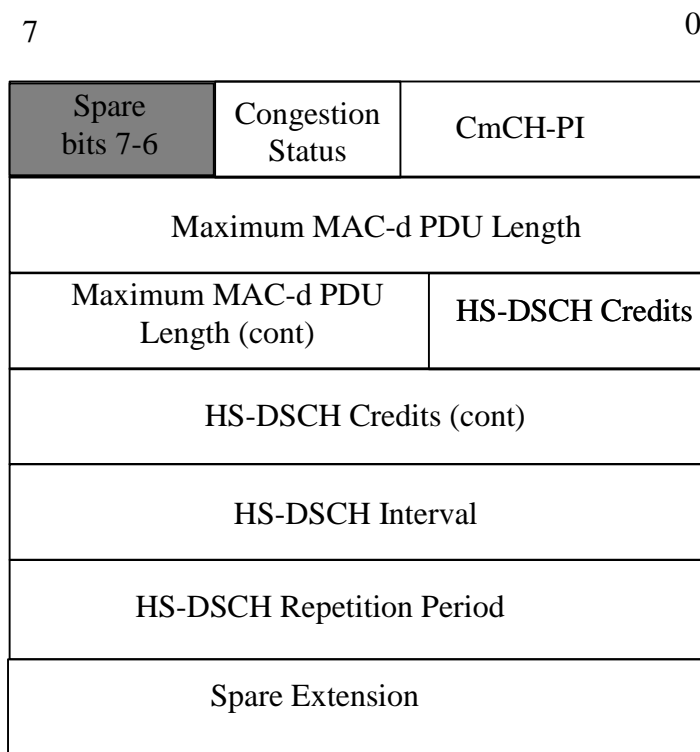

Figure 36: CAPACITY ALLOCATION TYPE 1 payload structure

The CAPACITY ALLOCATION TYPE 1 Control Frame describes an allocation that the CRNC may use. When the *HS-DSCH Credits* IE has a value of 0 it signifies that there is no resources allocated for transmission and to thus stop transmission. When the *HS-DSCH Credits* IE has a value of 2047, it signifies unlimited capacity for transmission of PDUs. When the *HS-DSCH Repetition Period* IE has a value of 0, it signifies that the allocation (*Maximum MAC-d PDU Length*, *HS-DSCH Credits* and *HS-DSCH Interval* IEs) can be repeated without limit. In addition to this the CAPACITY ALLOCATION TYPE 1 Control Frame informs the CRNC about the detection of congestion in the DL transport network layer with the *Congestion Status* Bits.

7	0
Spare bits 7-6	Congestion Status
Spare bits 7-3	
Max. MAC-d/c PDU Length	
Maximum MAC-d/c PDU Length (cont)	
HS-DSCH Credits	
HS-DSCH Credits (cont)	
HS-DSCH Interval	
HS-DSCH Repetition Period	
Spare Extension	

Figure 37: CAPACITY ALLOCATION TYPE 2 payload structure

The CAPACITY ALLOCATION TYPE 2 Control Frame describes an allocation that the CRNC may use. When the *HS-DSCH Credits* IE has a value of 0 it signifies that there is no resources allocated for transmission and to thus stop transmission. When the *HS-DSCH Credits* IE has a value of 65535, it signifies unlimited capacity for transmission of PDUs. When the *HS-DSCH Repetition Period* IE has a value of 0, it signifies that the allocation (*Maximum MAC-d/c PDU Length*, *HS-DSCH Credits* and *HS-DSCH Interval* IEs) can be repeated without limit. In addition to this the CAPACITY ALLOCATION TYPE 2 Control Frame informs the CRNC about the detection of congestion in the DL transport network layer with the *Congestion Status* Bits.

6.3.3.11.1 Common Transport Channel Priority Indicator (CmCH-PI)

Refer to subclause 6.2.7.21.

6.3.3.11.2 Maximum MAC-d PDU Length

Description: The *Maximum MAC-d PDU Length* IE is used in HS-DSCH CAPACITY ALLOCATION TYPE 1 Control Frame. The value indicates the maximum allowable PDU size among the MAC-d PDU sizes configured via NBAP [6].

Value range: Refer to subclause 6.2.7.23.

Field length: Refer to subclause 6.2.7.23.

6.3.3.11.3 HS-DSCH Credits

Description: The *HS-DSCH Credits* IE is used in HS-DSCH CAPACITY ALLOCATION (TYPE 1 and TYPE 2) Control Frame. In case of HS-DSCH CAPACITY ALLOCATION TYPE 1 Control Frame, it indicates the number of MAC-d PDUs that a CRNC may transmit during one HS-DSCH Interval granted in the HS-DSCH CAPACITY ALLOCATION TYPE 1 Control Frame. In case of HS-DSCH CAPACITY ALLOCATION TYPE 2 Control Frame, it indicates the number of MAC-d PDU [FDD – or MAC-c PDU] octets that the CRNC may transmit during one HS-DSCH Interval granted in the HS-DSCH CAPACITY ALLOCATION TYPE 2 Control Frame. The number of MAC-d PDU [FDD – or MAC-c PDU] octets is retrieved by multiplying the maximum MAC-d PDU length [FDD – or the

maximum MAC-c PDU length] (indicated by the *Maximum MAC-d/c PDU Length* IE) with the number of MAC-d PDUs [FDD – or MAC-c PDUs] (indicated by the *HS-DSCH Credits* IE).

Value range: {0-2047, where 0=stop transmission, 2047=unlimited} in case of HS-DSCH CAPACITY ALLOCATION TYPE 1 Control Frame, {0-65535, where 0=stop transmission, 65535=unlimited} in case of HS-DSCH CAPACITY ALLOCATION TYPE 2 Control Frame.

Field length: 11 bits in case of HS-DSCH CAPACITY ALLOCATION TYPE 1 Control Frame, 16 bits in case of HS-DSCH CAPACITY ALLOCATION TYPE 2 Control Frame.

6.3.3.11.4 HS-DSCH Interval

Description: The value of this field indicates the time interval during which the *HS-DSCH Credits* granted in the HS-DSCH CAPACITY ALLOCATION (TYPE 1 or TYPE 2) Control Frame may be used. The first interval starts immediately after reception of the HS-DSCH CAPACITY ALLOCATION (TYPE 1 or TYPE 2) Control Frame, subsequent intervals start immediately after the previous interval has elapsed. This value is only applied to the HS-DSCH transport channel.

Value range: {0-2550 ms}. Value 0 shall be interpreted that none of the credits shall be used.

Granularity: 10ms.

Field Length: 8 bits.

6.3.3.11.5 HS-DSCH Repetition Period

Description: The value of this field indicates the number of subsequent intervals that the *HS-DSCH Credits* IE granted in the HS-DSCH CAPACITY ALLOCATION (TYPE 1 or TYPE 2) Control Frame may be used. These values represent an integer number of Intervals (see subclause 6.3.3.11.4). This field is only applied to the HS-DSCH transport channel.

Value range: {0-255, where 0= unlimited repetition period}.

Field Length: 8 bits.

6.3.3.11.6 Spare Extension

Refer to subclause 6.3.3.1.4.

6.3.3.11.7 Congestion Status

Description: The *Congestion Status* Bits are used by the Node B to indicate whether a congestion situation is detected in a DL transport network layer or not. The Node B provides the congestion status in every HS-DSCH CAPACITY ALLOCATION (TYPE 1 or TYPE 2) Control Frame, which the CRNC may use.

Value range:

- 0 No TNL Congestion
- 1 Reserved for future use
- 2 TNL Congestion – detected by delay build-up
- 3 TNL Congestion – detected by frame loss

Field Length: 2 bits.

6.3.3.11.8 Maximum MAC-d/c PDU Length

Description: The *Maximum MAC-d/c PDU Length* IE is used in HS-DSCH CAPACITY ALLOCATION TYPE 2 Control Frame. The value indicates the maximum allowable PDU size in number of octets among the MAC-d PDU [FDD - or MAC-c PDU] sizes configured via NBAP [6].

Value range: {0-1504}, 0 – not used.

Field length: 11 bits.

7 Frame protocol error handling

A received frame protocol frame with unknown Information element or with illegal Information element value shall be ignored. Frame protocol frames sent with a CFN in which the radio resources assigned to the associated Iub data port are not available, shall be ignored.

7.1 Error detection

Error detection is provided on frames through a Cyclic Redundancy Check. The CRC for the payload is 16 and for the header and control frames is 7 bits.

7.1.1 CRC Calculation

The parity bits are generated by one of the following cyclic generator polynomials:

$$g_{\text{CRC16}}(D) = D^{16} + D^{15} + D^2 + 1.$$

$$g_{\text{CRC7}}(D) = D^7 + D^6 + D^2 + 1.$$

Denote the bits in a frame by $a_1, a_2, a_3, \dots, a_{A_i}$, and the parity bits by $p_1, p_2, p_3, \dots, p_{L_i}$. A_i is the length of a protected data and L_i is 16 or 7 depending on the CRC length.

The encoding is performed in a systematic form, which means that in GF (2), the polynomial for the payload.

$$a_1 D^{A_i+15} + a_2 D^{A_i+14} + \dots + a_{A_i} D^{16} + p_1 D^{15} + p_2 D^{14} + \dots + p_{15} D^1 + p_{16}$$

yields a remainder equal to 0 when divided by $g_{\text{CRC16}}(D)$, the polynomial for the header and control frames.

$$a_1 D^{A_i+6} + a_2 D^{A_i+5} + \dots + a_{A_i} D^7 + p_1 D^6 + p_2 D^5 + \dots + p_6 D^1 + p_7$$

yields a remainder equal to 0 when divided by $g_{\text{CRC7}}(D)$.

7.1.1.1 Relation between input and output of the Cyclic Redundancy Check

The bits after CRC attachment are denoted by $b_1, b_2, b_3, \dots, b_{B_i}$, where $B_i = A_i + L_i$.

The parity bits for the payload are attached at the end of the frame:

$$b_k = a_k \quad k = 1, 2, 3, \dots, A_i$$

$$b_k = p_{(k-A_i)} \quad k = A_i + 1, A_i + 2, A_i + 3, \dots, A_i + L_i$$

The parity bits for the frame header and the control frames are attached at the beginning of the frame:

$$b_k = p_k \quad k = 1, 2, 3, \dots, L_i$$

$$b_k = a_{(k-L_i)} \quad k = L_i + 1, L_i + 2, L_i + 3, \dots, L_i + A_i$$

Annex A (informative): Change History

Change history					
TSG RAN#	Version	CR	Tdoc RAN	New Version	Subject/Comment
RAN_05	-	-	-	3.0.0	Approved at TSG RAN #5 and placed under Change Control
RAN_06	3.0.0	001	RP-99765	3.1.0	Approved at TSG RAN #6
RAN_06	3.0.0	002	RP-99766	3.1.0	Approved at TSG RAN #6
RAN_07	3.1.0	-	-	3.2.0	Approved at TSG RAN #7
RAN_08	3.2.0	-	RP-000254	3.3.0	Approved at TSG RAN #8
RAN_09	3.3.0	022 026 027 028 029 030	RP-000391	3.4.0	Approved at TSG RAN #9
RAN_10	3.4.0	032 033 035 036	RP-000632	3.5.0	Approved at TSG RAN #10
RAN_11	3.5.0	038 039	RP-010128	3.6.0	Approved at TSG RAN #11

Change history							
Date	TSG #	TSG Doc.	CR	Rev	Subject/Comment	Old	New
March 01	11	RP-010164	037		Approved at TSG RAN #11 and placed under Change Control	-	4.0.0
06/2001	12	RP-010386	041		Approved at TSG RAN #12	4.0.0	4.1.0
06/2001	12	RP-010398	042		Approved at TSG RAN #12	4.0.0	4.1.0
09/2001	13	RP-010589	047		Addition of missing control frame type	4.1.0	4.2.0
09/2001	13	RP-010589	052	1	Applicability of the control frames on transport bearers	4.1.0	4.2.0
09/2001	13	RP-010589	056		General Corrections to TS 25.435	4.1.0	4.2.0
09/2001	13	RP-010589	058	1	General Corrections on CTrCH Data Stream	4.1.0	4.2.0
09/2001	13	RP-010600	048	1	Uplink power control for LCR TDD	4.1.0	4.2.0
09/2001	13	RP-010600	049		Correction on RACH data frame in Iub interface	4.1.0	4.2.0
09/2001	13	RP-010600	059	1	Uplink Power Control for TDD	4.1.0	4.2.0
12/2001	14	RP-010865	063	1	PCH Frame Clarification	4.2.0	4.3.0
12/2001	14	RP-010865	065		Description of CRC calculation	4.2.0	4.3.0
12/2001	14	RP-010865	067		Specification Notations	4.2.0	4.3.0
12/2001	14	RP-010865	072	2	Transport Bearer replacement for the DSCH	4.2.0	4.3.0
03/2002	15	RP-020223	077	2	Transport Bearer replacement for the USCH	4.3.0	4.4.0
03/2002	15	RP-020190	075	1	HSDPA Frame Protocol-25.435	4.4.0	5.0.0
06/2002	16	RP-020422	080		HSDPA Correction	5.0.0	5.1.0
06/2002	16	RP-020422	082	1	HS-DSCH Initial credits	5.0.0	5.1.0
06/2002	16	RP-020422	083	1	Maximum number of credits	5.0.0	5.1.0
09/2002	17	RP-020610	086		Correction on Paging Indication bitmap	5.1.0	5.2.0
12/2002	18	RP-020770	089	1	Clarification for the initial capacity allocation of HS-DSCH	5.2.0	5.3.0
12/2002	18	RP-020771	091	1	Clarification for the Maximum MAC-d PDU Length	5.2.0	5.3.0
03/2003	19	RP-030075	096		Clarification for the flow control	5.3.0	5.4.0
06/2003	20	RP-030331	099	2	Correction for the HS-DSCH frame structure	5.4.0	5.5.0
06/2003	20	RP-030321	100		Power setting for multiplexed DSCH data frames	5.4.0	5.5.0
06/2003	20	RP-030327	101	1	Clarification of Capacity Allocation Interval Definition	5.4.0	5.5.0
06/2003	20	RP-030321	102	1	S-CCPCH power settings in case of no data transmission	5.4.0	5.5.0
12/2003	22	RP-030680	105	1	Power control correction for DSCH for TDD	5.5.0	5.6.0
12/2003	22	RP-030682	109	1	Spare Extension in Data frame	5.5.0	5.6.0
12/2003	22	RP-030726	106	1	Signalling Support for Beamforming Enhancement	5.6.0	6.0.0
03/2004	23	RP-040073	111		Common Transport Channel Priority Indicator for HSDPA	6.0.0	6.1.0
06/2005	28	RP-050234	136		Correction to the range of TDD parameter in RACH DATA FRAME	6.1.0	6.2.0
06/2005	28	RP-050225	138		Feature Cleanup: Removal of CPCH	6.1.0	6.2.0
06/2005	28	RP-050222	140	1	Feature clean-up: Removal of DSCH (FDD mode)	6.1.0	6.2.0
06/2005	28	RP-050235	141	1	Iub/Iur Enhancement for HS-DSCH Related to RLC Reset	6.1.0	6.2.0
06/2005	28	RP-050235	142	1	Transport Network Congestion Detection and Control	6.1.0	6.2.0
09/2005	29	RP-050444	143	1	Congestion Indication for HSDPA	6.2.0	6.3.0
09/2005	29	RP-050445	144	1	Optional presence of new IE Flags IE and new IEs in spare extension	6.2.0	6.3.0
03/2006	31	RP-060073	145		Introduction of 7.68Mcps TDD option	6.3.0	7.0.0
04/2006	-	-	-		editorial correction in specification header	7.0.0	7.0.1
06/2006	32	RP-060290	148	1	Release 7 Timing Advance (3.84 Mcps and 7.68 Mcps TDD)	7.0.1	7.1.0
09/2006	33	RP-060498	151	1	Leftover from FDD DSCH	7.1.0	7.2.0
09/2006	33	RP-060509	152	1	Extended WCDMA Cell Range	7.1.0	7.2.0
12/2006	34	RP-060708	156	1	Capacity request correction	7.2.0	7.3.0
12/2006	34	RP-060837	159	1	Consistency of Specification Notations	7.2.0	7.3.0
03/2007	35	RP-070065	165		Iub transport efficiency improvement for MBMS	7.3.0	7.4.0
06/2007	36	RP-070330	170		Support of higher bitrates and Flexible RLC PDU size on HS-DSCH and introduction of FSN/DRT Reset	7.4.0	7.5.0
09/2007	37	RP-070650	172		Introduction of multi-frequency for 1.28Mcps TDD in 25.435	7.5.0	7.6.0
09/2007	37	RP-070573	174	2	Corrections related to changes for Improved L2 and enhanced FACH	7.5.0	7.6.0
09/2007	37	RP-070573	175	1	Corrections/Small Improvements for Enhanced Cell_FACH	7.5.0	7.6.0

History

Document history		
V7.0.1	April 2006	Publication
V7.1.0	June 2006	Publication
V7.2.0	September 2006	Publication
V7.3.0	December 2006	Publication
V7.4.0	March 2007	Publication
V7.5.0	June 2007	Publication
V7.6.0	October 2007	Publication