

# ETSI TS 125 425 V3.3.0 (2000-12)

---

*Technical Specification*

## **Universal Mobile Telecommunications System (UMTS); UTRAN I<sub>ur</sub> Interface User Plane Protocols for Common Transport Channel Data Streams (3GPP TS 25.425 version 3.3.0 Release 1999)**



---

**Reference**

RTS/TSGR-0325425UR3

---

**Keywords**

UMTS

**ETSI**

650 Route des Lucioles  
F-06921 Sophia Antipolis Cedex - FRANCE

---

Tel.: +33 4 92 94 42 00 Fax: +33 4 93 65 47 16

Siret N° 348 623 562 00017 - NAF 742 C  
Association à but non lucratif enregistrée à la  
Sous-Préfecture de Grasse (06) N° 7803/88

---

**Important notice**

---

Individual copies of the present document can be downloaded from:

<http://www.etsi.org>

The present document may be made available in more than one electronic version or in print. In any case of existing or perceived difference in contents between such versions, the reference version is the Portable Document Format (PDF). In case of dispute, the reference shall be the printing on ETSI printers of the PDF version kept on a specific network drive within ETSI Secretariat.

Users of the present document should be aware that the document may be subject to revision or change of status. Information on the current status of this and other ETSI documents is available at <http://www.etsi.org/tb/status/>

If you find errors in the present document, send your comment to:  
editor@etsi.fr

---

**Copyright Notification**

---

No part may be reproduced except as authorized by written permission.  
The copyright and the foregoing restriction extend to reproduction in all media.

© European Telecommunications Standards Institute 2000.

All rights reserved.

---

## Intellectual Property Rights

IPRs essential or potentially essential to the present document may have been declared to ETSI. The information pertaining to these essential IPRs, if any, is publicly available for **ETSI members and non-members**, and can be found in ETSI SR 000 314: "*Intellectual Property Rights (IPRs); Essential, or potentially Essential, IPRs notified to ETSI in respect of ETSI standards*", which is available from the ETSI Secretariat. Latest updates are available on the ETSI Web server (<http://www.etsi.org/ipr>).

Pursuant to the ETSI IPR Policy, no investigation, including IPR searches, has been carried out by ETSI. No guarantee can be given as to the existence of other IPRs not referenced in ETSI SR 000 314 (or the updates on the ETSI Web server) which are, or may be, or may become, essential to the present document.

---

## Foreword

This Technical Specification (TS) has been produced by the ETSI 3<sup>rd</sup> Generation Partnership Project (3GPP).

The present document may refer to technical specifications or reports using their 3GPP identities, UMTS identities or GSM identities. These should be interpreted as being references to the corresponding ETSI deliverables.

The cross reference between GSM, UMTS, 3GPP and ETSI identities can be found under [www.etsi.org/key](http://www.etsi.org/key).

# Contents

Foreword.....	5
1 Scope .....	6
2 References .....	6
3 Definitions, symbols and abbreviations .....	6
3.1 Definitions .....	6
3.2 Symbols.....	6
3.3 Abbreviations .....	7
4 General Aspects.....	7
4.1 Common Transport Channel Data Streams User Plane Protocol Services .....	7
4.1.1 RACH/CPCH[FDD] Data Streams User Plane Protocol Services.....	7
4.1.2 FACH Data Streams User Plane Protocol Services .....	7
4.1.3 [TDD USCH]/DSCH Data Streams User Plane Protocol Services.....	8
4.2 Services expected from data transport.....	8
4.3 Protocol Version.....	8
5 Common Transport Channel Data Streams User Plane Procedures.....	8
5.1 Data Transfer.....	8
5.1.1 RACH/CPCH[FDD] Data Transfer .....	8
5.1.2 FACH data transfer.....	9
5.1.3 USCH Data Transfer [TDD].....	9
5.1.4 DSCH Data Transfer.....	9
5.2 Flow Control.....	10
5.2.1 FACH Flow Control .....	10
5.2.2 DSCH Capacity Request.....	10
5.2.3 DSCH Capacity Allocation.....	10
5.2.4 FACH Capacity Request.....	11
6 Frame Structure and Coding.....	11
6.1 General .....	11
6.2 Data frame structure .....	12
6.2.1 RACH/CPCH[FDD] Channels .....	12
6.2.2 FACH Channels.....	14
6.2.3 USCH Data Frames [TDD].....	15
6.2.4 DSCH Data Frames .....	16
6.2.5 Coding of information elements in data frames.....	16
6.2.5.1 Header CRC .....	16
6.2.5.2 Frame Type (FT).....	17
6.2.5.3 DRNTI .....	17
6.2.5.4 S-RNTI.....	17
6.2.5.5 UE-ID Type Indicator (UE-ID Type).....	17
6.2.5.6 S-CCPCH Indicator (S-CI).....	17
6.2.5.7 Common Transport Channel Priority Indicator (CmCH-PI) .....	17
6.2.5.8 MAC-c/sh SDU Length.....	17
6.2.5.9 NumOfSDU.....	17
6.2.5.10 [FDD - Propagation delay].....	18
6.2.5.11 [TDD - Rx Timing Deviation].....	18
6.2.5.12 User Buffer Size .....	18
6.2.5.13 MAC-c/sh SDU.....	18
6.2.5.14 Payload CRC.....	18
6.2.5.15 Spare Extension.....	18
6.3 Control frame structure.....	18
6.3.1 Introduction.....	18
6.3.2 Header structure of the control frames.....	19
6.3.2.1 Control frame CRC .....	19
6.3.2.2 Frame type (FT) .....	19
6.3.2.3 Control Frame Type .....	19
6.3.3 Payload structure and information elements.....	20

6.3.3.1	FACH Flow Control.....	20
6.3.3.1.1	S-RNTI .....	20
6.3.3.1.2	Common Transport Channel Priority Indicator (CmCH-PI) .....	20
6.3.3.1.3	Credits .....	20
6.3.3.1.4	Spare Extension .....	20
6.3.3.2	DSCH Capacity Request .....	20
6.3.3.2.1	Common Transport Channel Priority Indicator (CmCH-PI) .....	21
6.3.3.2.2	User Buffer Size .....	21
6.3.3.3	DSCH Capacity Allocation .....	21
6.3.3.3.1	Common Transport Channel Priority Indicator (CmCH-PI) .....	21
6.3.3.3.2	Maximum MAC-c/sh SDU Length.....	21
6.3.3.3.3	Credits .....	21
6.3.3.3.4	Interval.....	21
6.3.3.3.5	Repetition Period .....	22
6.3.3.4	FACH Capacity Request .....	22
6.3.3.4.1	DRNTI.....	22
6.3.3.4.2	Common Transport Channel Priority Indicator (CmCH-PI) .....	22
6.3.3.4.3	User Buffer Size .....	22
6.3.3.4.4	Spare extension.....	22
7	Handling of Unknown, Unforeseen and Erroneous Protocol Data.....	22
7.1	General .....	22
<b>Annex A (informative):</b>	<b>Change history .....</b>	<b>23</b>

---

# Foreword

This Technical Specification (TS) has been produced by the 3<sup>rd</sup> Generation Partnership Project (3GPP).

The contents of the present document are subject to continuing work within the TSG and may change following formal TSG approval. Should the TSG modify the contents of the present document, it will be re-released by the TSG with an identifying change of release date and an increase in version number as follows:

Version x.y.z

where:

- x the first digit:
  - 1 presented to TSG for information;
  - 2 presented to TSG for approval;
  - 3 or greater indicates TSG approved document under change control.
- y the second digit is incremented for all changes of substance, i.e. technical enhancements, corrections, updates, etc.
- z the third digit is incremented when editorial only changes have been incorporated in the document.

---

# 1 Scope

The present document shall provide a description of the UTRAN RNS-RNS (Iur) interface user plane protocols for Common Transport Channel data streams as agreed within the TSG-RAN working group 3.

---

## 2 References

The following documents contain provisions which, through reference in this text, constitute provisions of the present document.

- References are either specific (identified by date of publication, edition number, version number, etc.) or non-specific.
- For a specific reference, subsequent revisions do not apply.
- For a non-specific reference, the latest version applies.

- [1] ITU-T Recommendation I.361 (11/95): "B-ISDN ATM Layer Specification".
  - [2] ITU-T Recommendation I.363.2 (9/97): "B-ISDN ATM Adaptation Layer type 2".
  - [3] ITU-T Recommendation I.366.1 (6/98): "Segmentation and Reassembly Service Specific Convergence Sublayer for the AAL type 2".
  - [4] 3G TS 25.427: "Iub/Iur User Plane Protocols for DCH Data Streams".
  - [5] 3G TS 25.401: "UTRAN overall description".
  - [6] 3G TS 25.990: "UTRAN vocabulary".
- 

## 3 Definitions, symbols and abbreviations

### 3.1 Definitions

For the purposes of the present document, the following terms and definitions apply:

**Common Transport Channel:** it is defined as a transport channel that is shared by several users i.e. DSCH, USCH [TDD], CPCH [FDD], RACH, FACH.

**Transport Connection:** service provided by the transport layer and used by Frame Protocol for the delivery of FP PDU.

For other definitions, please refer to [5].

### 3.2 Symbols

No special symbols are defined in the present document.

## 3.3 Abbreviations

For the purposes of the present document, the following abbreviations apply:

AAL2	ATM Adaptation Layer type 2
ATM	Asynchronous Transfer Mode
CFN	Connection Frame Number
CmCH	CoMmon transport Channel
CPCH	Common Packet Channel
CPS	Common Part Sublayer
C-RNC	Controlling Radio Network Controller
CRC	Cyclic Redundancy Checksum
DCH	Dedicated Transport Channel
DL	Downlink
D-RNTI	Drift RNTI
DSCH	Downlink Shared Channel
FACH	Forward Access CHannel
FP	Frame Protocol
FT	Frame Type
PC	Power Control
RACH	Random Access CHannel
RNC	Radio Network Controller
RNTI	Radio Network Temporary Identity
SRNC	Serving Radio Network Controller
S-RNTI	Serving RNTI
SSCS	Service Specific Convergence Sublayer
SSSAR	Service Specific Segmentation and Reassembly sublayer
TB	Transport Block
TBS	Transport Block Set
TFI	Transport Format Indicator
ToA	Time of arrival
TTI	Transmission Time Interval
UE	User Equipment
UL	Uplink
U-RNTI	UTRAN RNTI
USCH	Uplink Shared Channel

---

## 4 General Aspects

### 4.1 Common Transport Channel Data Streams User Plane Protocol Services

*This chapter describes the services that the User Plane Protocols provide such as data transfer, flow control.*

#### 4.1.1 RACH/CPCH[FDD] Data Streams User Plane Protocol Services

RACH/CPCH[FDD] frame protocol provides the following services:

- Transport of MAC-c/sh SDUs from the DRNC to the SRNC for RACH/CPCH[FDD] common transport channels.

#### 4.1.2 FACH Data Streams User Plane Protocol Services

FACH frame protocol provides the following services:

- Transport of MAC-c SDUs from the SRNC to the DRNC for FACH common transport channel.
- Flow Control between MAC-d and MAC-c.



### 4.1.3 [TDD USCH]/DSCH Data Streams User Plane Protocol Services

[TDD USCH]/DSCH frame protocol provides the following services:

- Transport of MAC-c/sh SDUs between the SRNC and the DRNC for [TDD USCH] and DSCH common transport channels.
- Flow Control between MAC-d and MAC-c/sh.

## 4.2 Services expected from data transport

The following services are expected from the transport layer:

- In sequence delivery of Frame Protocol PDUs.

## 4.3 Protocol Version

This revision of the specification specifies version 1 of the protocols.

# 5 Common Transport Channel Data Streams User Plane Procedures

**This chapter specifies the user plane procedures for Common Transport Channels data streams. Typical related scenarios at Iur interface should be described.**

For the user plane of the radio network layer there are four Common Transport Channel frame handling protocols:

1. Random Access Channel/Common Packet Channel [FDD] Frame Protocol (RACH/CPCH[FDD] FP) for transport of Iur data streams carried on RACH/CPCH[FDD] on the Uu-interface.
2. Forward Access Channel Frame Protocol (FACH FP) for transport of Iur data streams carried on FACH on the Uu-interface.
3. Downlink Shared Channel Frame Protocol (DSCH FP) for transport of Iur data streams carried on DSCH on the Uu-interface.
4. Uplink Shared Channel Frame Protocol ([TDD USCH] FP) for transport of Iur data streams carried on USCH on the Uu-interface.

## 5.1 Data Transfer

### 5.1.1 RACH/CPCH[FDD] Data Transfer

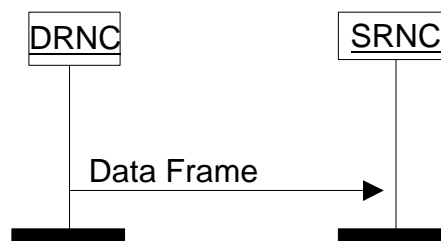

**Figure 1: RACH/CPCH[FDD] data transfer**

Data received on the RACH/CPCH[FDD] transport channel is transmitted from the DRNC to the SRNC using RACH/CPCH[FDD] data frames. The data is protected by a mandatory payload CRC. Multiple MAC-c/sh SDUs of same length may be transmitted in the same RACH/CPCH[FDD] data frame.

### 5.1.2 FACH data transfer

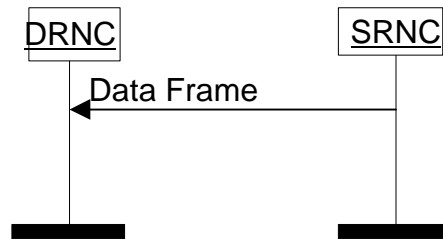

Figure 2: FACH data transfer

Data to be transmitted on the FACH transport channel is transmitted from the SRNC to the DRNC using FACH data frames. Multiple MAC-c/sh SDUs of same length and same priority (CmCH-PI) may be transmitted in the same FACH data frame. Within one priority and size the SDUs shall be transmitted by the DRNS on the Uu interface in the same order as they were received from the SRNC.

The *UE-ID Type Indicator* IE indicates which UE-ID type MAC-c/sh shall include in the MAC header.

### 5.1.3 USCH Data Transfer [TDD]

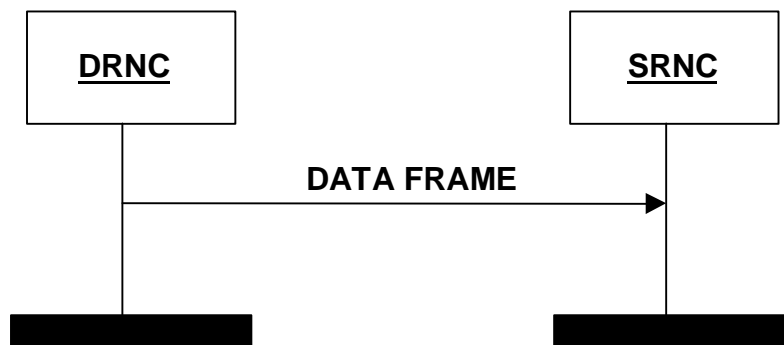

Figure 3: USCH Data transfer

Whenever there is USCH data in the DRNC, transfer is done immediately to the SRNC via the USCH Data Port using USCH Data Frames.

Data received on the USCH transport channel is transmitted from the DRNC to the SRNC using USCH data frames. The data is protected by a mandatory payload CRC. Multiple MAC-c/sh SDUs of same length may be transmitted in the same USCH data frame.

### 5.1.4 DSCH Data Transfer

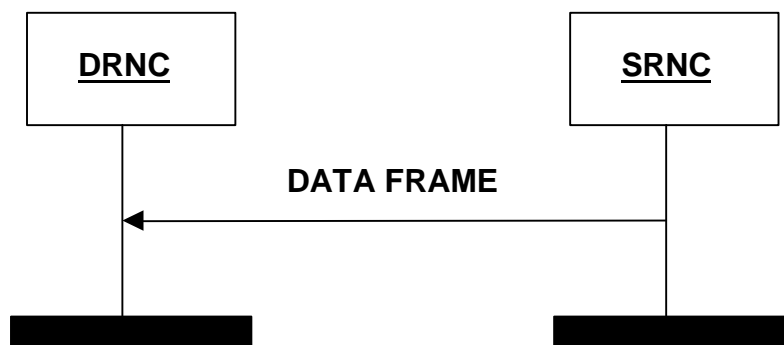

Figure 4: DSCH Data Transfer

When the SRNC has been granted capacity by the DRNC and the SRNC has data waiting to be sent, then the DSCH data frame is used to transfer the data. When data is waiting to be transferred, and a capacity allocation is received, a data frame will be transmitted immediately according to allocation received.

Multiple MAC-c/sh SDUs of same length and same priority (CmCH-PI) may be transmitted in the same DSCH data frame.

The DSCH data frame includes a user buffer size indication to indicate the amount of data pending for the respective UE and for the indicated priority level. Within one priority and size the SDUs shall be transmitted by the DRNS on the Uu interface in the same order as they were received from the SRNC.

## 5.2 Flow Control

### 5.2.1 FACH Flow Control

The FACH flow control frame is used by the DRNC to control the user data flow. It may be generated in response to a FACH Capacity Request or at any other time. The *Credits* IE indicates the number of MAC-c/sh SDUs the SRNC is allowed to transmit for the UE identified by the *SRNTI* IE and the associated priority class indicated by the *Common Transport Channel Priority Indicator* IE.

The *Credits* IE indicates the total amount of credits granted. Any credits previously granted are withdrawn.

If *Credits* IE = 0 (e.g. due to congestion in the DRNC), the SRNC shall immediately stop transmission of MAC-c/sh SDUs.

*Credits* IE = 'unlimited' indicates that the SRNC may transmit an unlimited number of MAC-c/sh SDUs.

### 5.2.2 DSCH Capacity Request

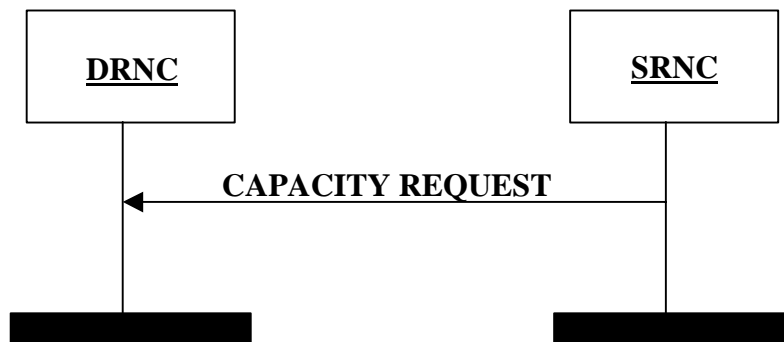

Figure 5: DSCH Capacity Request

The DSCH Capacity Request provides means for the SRNC to request DSCH capacity by indicating the user buffer size for a given priority level.

The SRNC is allowed to reissue the capacity request if no allocation has been received within an appropriate time threshold.

### 5.2.3 DSCH Capacity Allocation

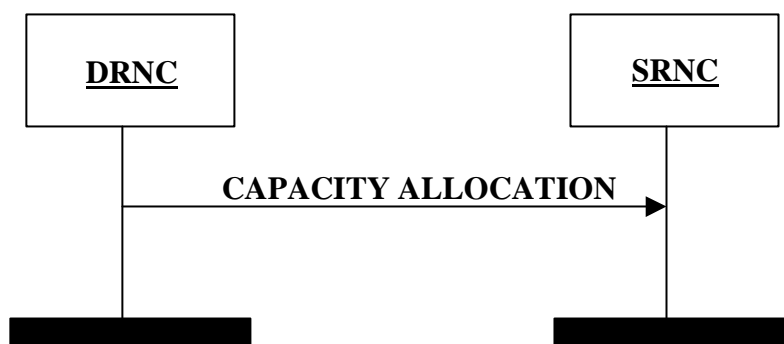

Figure 6: DSCH Capacity Allocation

DSCH Capacity Allocation is generated within the DRNC. It may be generated either in response to a capacity request or at any other time.

The DRNC may use this message to modify the capacity at any time, irrespective of the reported user buffer status.

The DSCH flow control frame is used by the DRNC to control the user data flow. It indicates the number of MAC-c/sh SDUs the SRNC is allowed to transmit for the UE and the associated priority class indicated by the *Common Transport Channel Priority Indicator IE*.

The Max. *MAC c/sh SDU length*, *Credits*, *Interval* and *Repetition Period* IEs indicates the total amount of capacity granted. Any capacity previously granted is replaced.

If *credits* = 0 (e.g. due to congestion in the DRNC), the SRNC shall immediately stop transmission of MAC-c/sh SDUs. If *credits* = 255, the SRNC can transmit MAC-c/sh SDUs with unlimited capacity.

The IEs used are the *Common Channel Priority Indicator*, *Credits*, Max. *MAC c/sh SDU Length*, *Interval* and the *Repetition Count*.

If the '*Repetition Period*' = '*unlimited*' it indicates that the SRNC may transmit the specified number of MAC-c/sh SDUs for an unlimited period according to the bounds of *Maximum MAC-c/sh SDU length*, *Credits* and *Interval* IEs.

## 5.2.4 FACH Capacity Request

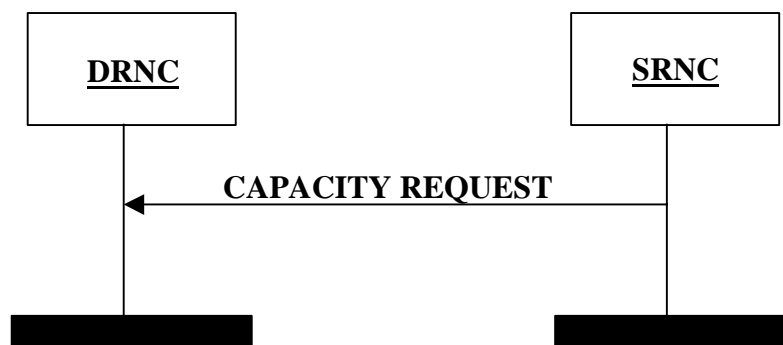

Figure 6A: FACH Capacity Request

The FACH Capacity Request provides the means for the SRNC to notify the DRNC about the user buffer size for a given priority class. It may be sent if no FACH Flow Control frame has been received within an appropriate time threshold, or to signal an event such as data arrival or user buffer discard.

# 6 Frame Structure and Coding

## 6.1 General

The general structure of a Common Transport Channel frame consists of a header and a payload. This structure is depicted in the figure 7:

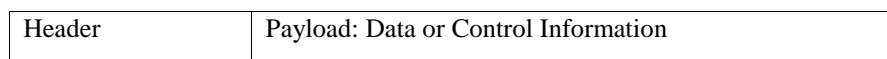

Figure 7: General Frame Structure

The header shall contain the frame type field and information related to the frame type.

There are two types of frames (indicated by the Frame Type field).

1. Data frame
2. Control frame

In this specification the structure of frames will be specified by using pictures similar to the following figure 8:

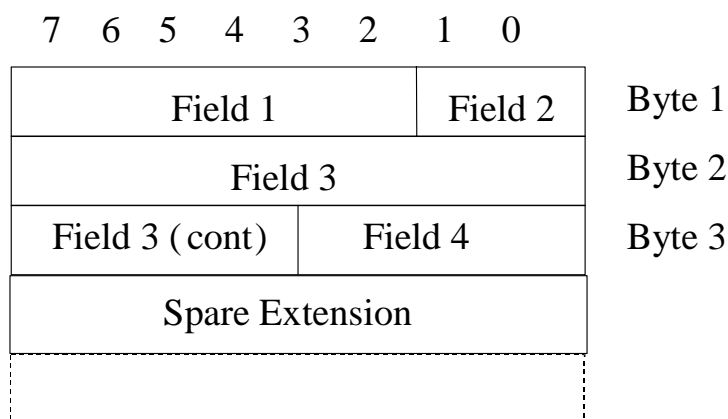

**Figure 8: Example frame structure**

Unless otherwise indicated, fields which consist of multiple bits within a byte will have the more significant bit located at the higher bit position (indicated above frame in picture 1). In addition, if a field spans several bytes, more significant bits will be located in lower numbered bytes (right of frame in picture 1).

On the Iur interface, the frame will be transmitted starting from the lowest numbered byte. Within each byte, the bits are sent according decreasing bit position (bit position 7 first).

The Spare Extension indicates the location where new IEs can in the future be added in a backward compatible way.

The Spare Extension shall not be used by the transmitter and shall be ignored by the receiver.

The parameters are specified giving the value range and the step (if not 1). The coding is done as follows (unless otherwise specified):

- Lowest value (in the range) coded as a sequence of 0's;
- Highest value in the range coded as a sequence of 1's.

## 6.2 Data frame structure

### 6.2.1 RACH/CPCH[FDD] Channels

RACH/CPCH[FDD] Iur data stream corresponds to the data stream of one specific UE. The used transport bearer for the transport of FACH/RACH or FACH/CPCH[FDD] is bi-directional.

The RACH/CPCH[FDD]/FACH FP does not facilitate multiplexing of data streams from different UEs onto the same data frame, but does allow multiple UEs to share the same transport bearer.

The RACH Data frame structure is defined as common for FDD and TDD with conditional fields, and CPCH[FDD] Data frame structure is defined as common for FDD only.

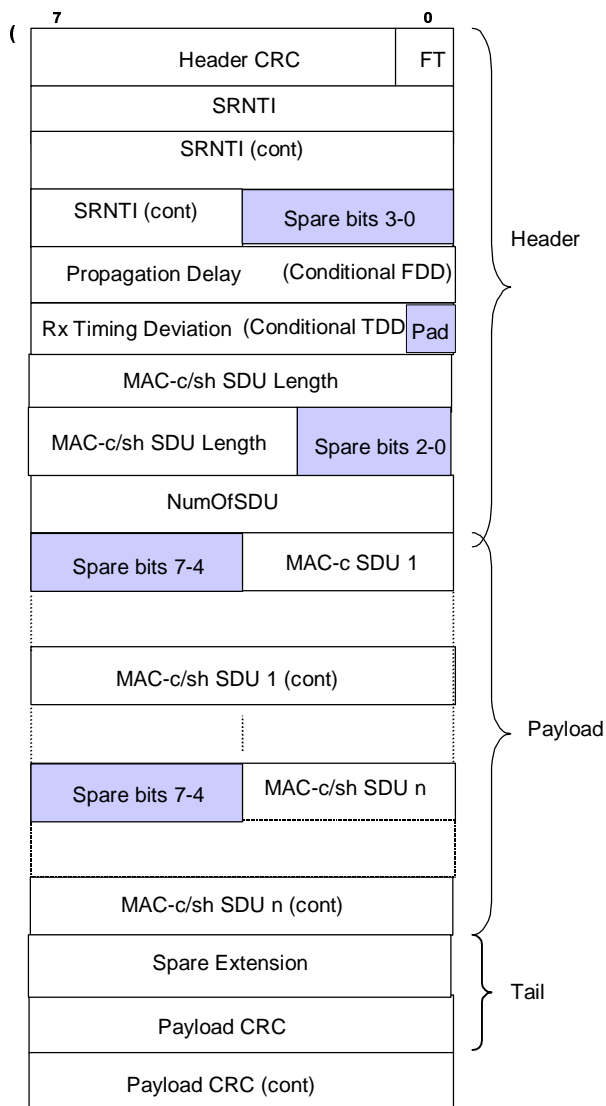

**Figure 9: RACH/CPCH[FDD] Data Frame structure**

Propagation delay is a conditional Information Element which is only present when the Cell supporting the RACH/CPCH[FDD] Transport Channel is a FDD Cell.

Rx Timing Deviation is a conditional Information Element which is only present when the Cell supporting the RACH Transport Channel is a TDD Cell.

Spare bits shall be set to 0 and ignored by the receiver.

### 6.2.2 FACH Channels

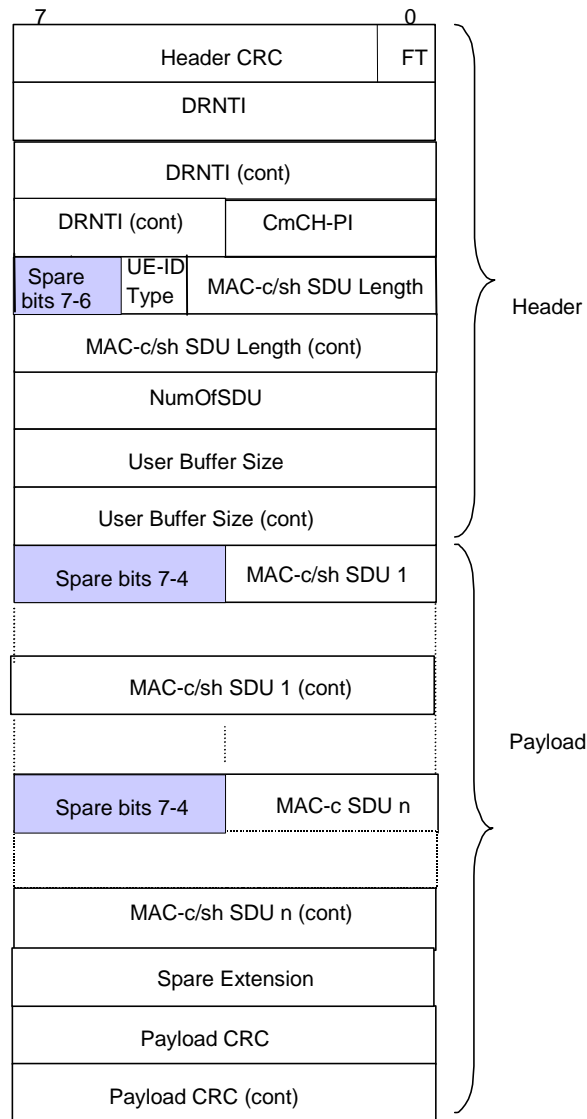

**Figure 10: FACH Data Frame structure**

Spare bits shall be set to 0 and ignored by the receiver.

### 6.2.3 USCH Data Frames [TDD]

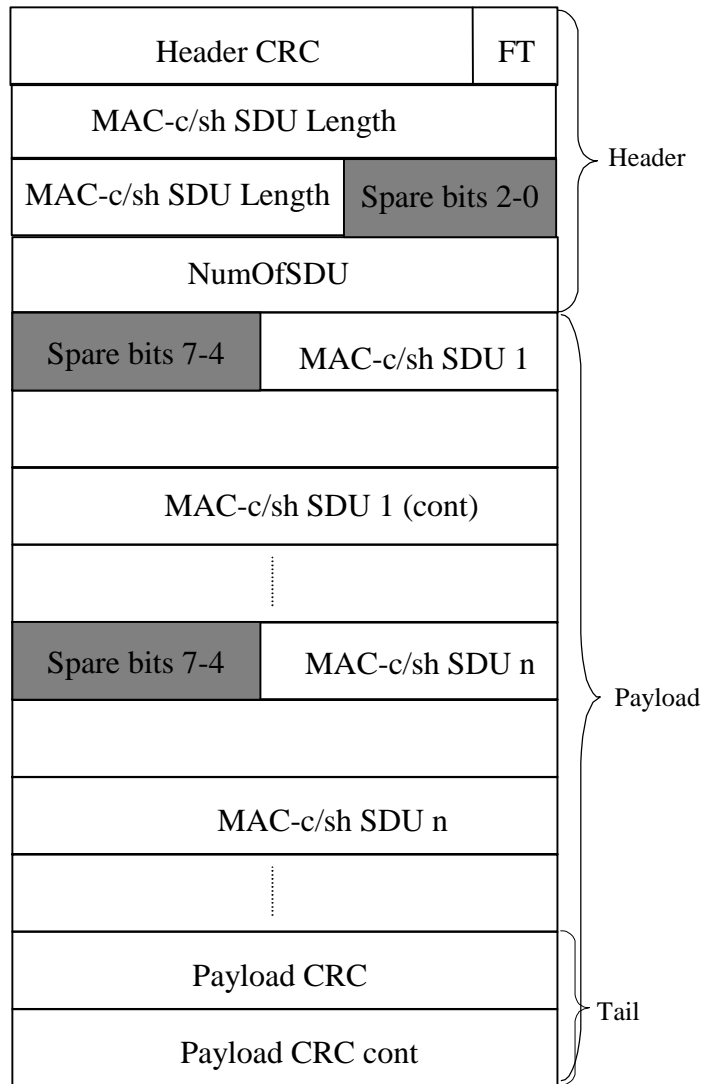

Figure 11: USCH Data Frame on the lur



## 6.2.4 DSCH Data Frames

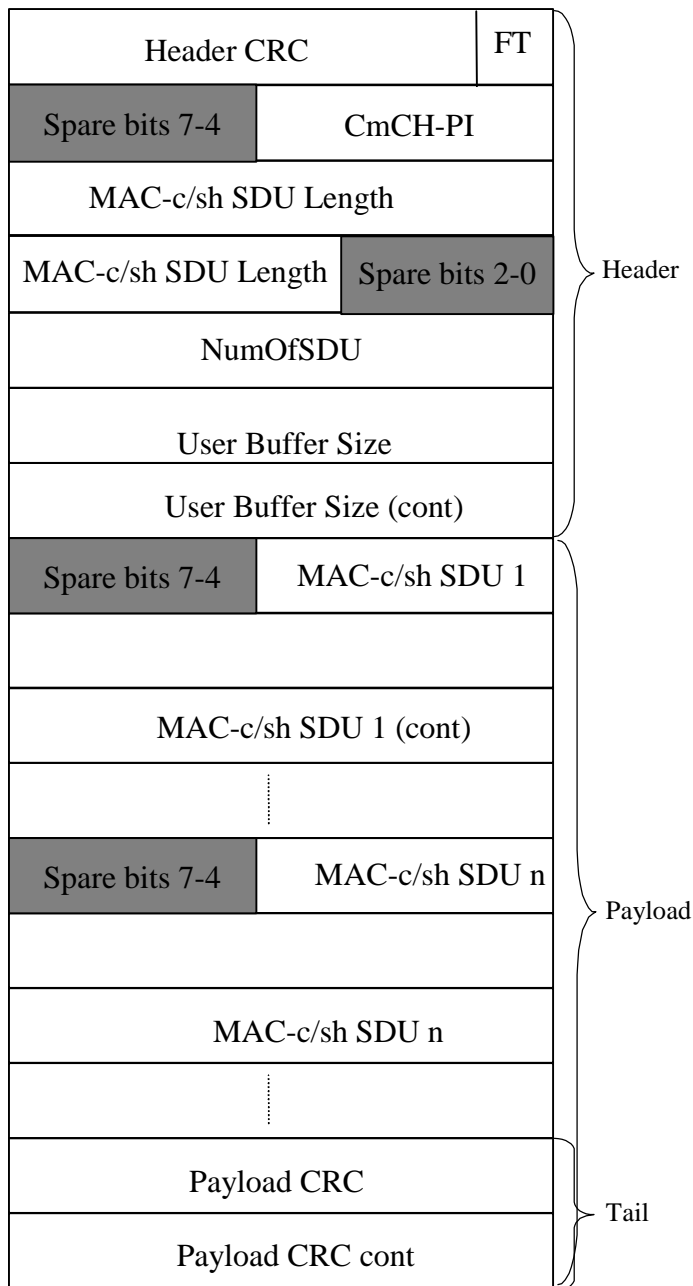

Figure 12: DSCH Iur Data Frame Structure

## 6.2.5 Coding of information elements in data frames

### 6.2.5.1 Header CRC

**Description:** Cyclic Redundancy Polynomial calculated on the header of a data frame with polynomial  $X^7+X^6+X^2+1$ . The CRC calculation shall cover all bits in the header, starting from bit 0 in the first byte (FT field) up to the end of the header.

**Value range:** {0-127}.

**Field length:** 7 bits.

### 6.2.5.2 Frame Type (FT)

**Description:** describes if it is a control frame or a data frame.

**Value range:** {0=data, 1=control}.

**Field Length:** 1 bit.

### 6.2.5.3 DRNTI

**Description:** Identifies the UE in the DRNC.

**Value range:** {0-1048575}.

**Field length:** 20 bits.

### 6.2.5.4 S-RNTI

**Description:** S-RNTI is defined in [5]. S-RNTI is used in UL control frames to identify the UE context in the SRNC.

**Value range:** {0-1048575}.

**Field length:** 20 bits.

### 6.2.5.5 UE-ID Type Indicator (UE-ID Type)

**Description:** Indicates the UE Identifier Type to be included by MAC-c/sh in the MAC header.

**Value range:** {0=U-RNTI, 1=C-RNTI}.

**Field Length:** 1 bit.

### 6.2.5.6 S-CCPCH Indicator (S-CI)

Void.

### 6.2.5.7 Common Transport Channel Priority Indicator (CmCH-PI)

**Description:** CmCH-PI is the relative priority of the data frame and the SDUs included.

**Value range:** {0-15, where 0=lowest priority, 15=highest priority}.

**Field length:** 4 bits.

### 6.2.5.8 MAC-c/sh SDU Length

**Description:** The value of that field indicates the length of every MAC-c/sh SDU in the payload of the FACH, DSCH and [TDD USCH] data frame in number of bits.

**Value range:** {0-5000}.

**Field Length:** 13 bits.

### 6.2.5.9 NumOfSDU

**Description:** Indicates the number of MAC-c SDUs in the payload.

**Value range:** {1-255}.

**Field Length:** 8 bits.

### 6.2.5.10 [FDD - Propagation delay]

**Description:** One-way air interface delay as measured during RACH access.

**Value range:** {0 - 765 chips}.

**Granularity:** 3 chips.

**Field length:** 8 bits.

### 6.2.5.11 [TDD - Rx Timing Deviation]

**Description:** Measured Rx Timing Deviation as a basis for timing advance.

**Value range:** {-256, ..., +256} chips

$$\{N*4 - 256\} \text{ chips} \leq \text{RxTiming Deviation} < \{(N+1)*4 - 256\} \text{ chips}$$

With  $N = 0, 1, \dots, 127$

**Granularity:** 4 chips.

**Field length:** 7 bits.

### 6.2.5.12 User Buffer Size

**Description:** Indicates the users' buffer size (i.e. the amount of data in the buffer) in octets for a given Common Transport Channel Priority.

**Value range:** {0-65535}.

**Field length:** 16 bits.

### 6.2.5.13 MAC-c/sh SDU

**Description:** A MAC-c/sh SDU contains the C/T field of the MAC header followed by one RLC PDU. Field length: See the value of the MAC-c/sh SDU Length IE.

### 6.2.3.14 Payload CRC

**Description:** Cyclic Redundancy Polynomial calculated on the payload of a data frame with polynomial  $X^{16}+X^{15}+X^2+1$ . The CRC calculation shall cover all bits in the data frame payload, starting from bit 7 in the first byte up to bit 0 in the byte before the payload CRC.

**Field length:** 16 bits.

### 6.2.5.15 Spare Extension

**Description:** Indicates the location where new IEs can in the future be added in a backward compatible way.

**Field length:** 0-2 octets.

## 6.3 Control frame structure

### 6.3.1 Introduction

Control Frames are used to transport control information between SRNC and DRNC.

The figure below defines the Control Frame structure for common transport channels.

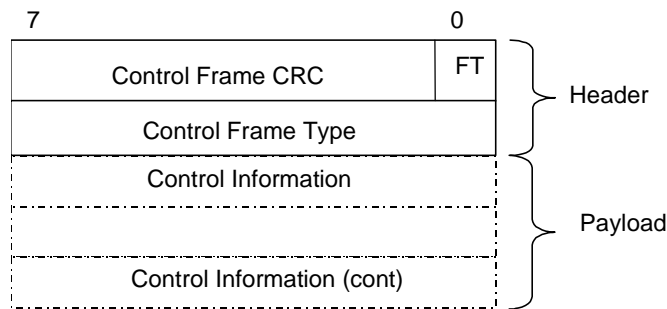

**Figure 13: Iur Common Transport Channel Control Frame Format**

The *Control Frame Type* IE defines the type of the control frames.

The length of the payload is variable accordingly to the control frame type.

The structure of the header and the payload of the control frames is defined in the following subclauses.

## 6.3.2 Header structure of the control frames

### 6.3.2.1 Control frame CRC

**Description:** Cyclic Redundancy Polynomial calculated on a control frame with polynomial  $X^7+X^6+X^2+1$ . The CRC calculation shall cover all bits in the control frame, starting from bit 0 in the first byte (FT field) up to the end of the control frame.

**Value range:** {0-127}.

**Field length:** 7 bits.

### 6.3.2.2 Frame type (FT)

Refer to subclause 6.2.3.2.

### 6.3.2.3 Control Frame Type

**Description:** Indicates the type of the control information (information elements and length) contained in the payload (=type of control frame).

**Value:** values of the *Control Frame Type* IE parameter are defined in the following table 1:

**Table 1: Control Frame Type**

Type of control frame	Value
FACH Flow Control	0000 0010
FACH Capacity Request	0000 0011
DSCH Capacity Request	0000 0100
DSCH Capacity Allocation	0000 0101

### 6.3.3 Payload structure and information elements

#### 6.3.3.1 FACH Flow Control

Figure 14 shows the payload structure when the control frame is used for the above mentioned purpose. This control information is sent in the UL only.

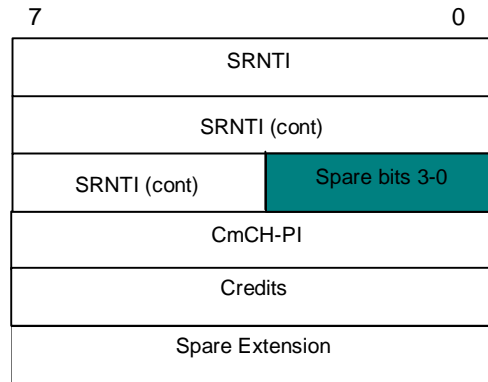

**Figure 14: FACH Flow Control Payload structure**

##### 6.3.3.1.1 S-RNTI

Refer to subclause 6.2.3.4.

##### 6.3.3.1.2 Common Transport Channel Priority Indicator (CmCH-PI)

Refer to subclause 6.2.3.6.

##### 6.3.3.1.3 Credits

**Description:** The Credits IE indicates the number of MAC-c/sh SDUs that a user may transmit.

**Value range:** {0-255, where 0=stop transmission, 255=unlimited}.

**Field length:** 8 bits.

##### 6.3.3.1.4 Spare Extension

**Description:** Indicates the location where new IEs can in the future be added in a backward compatible way.

**Field length:** 0-32 octets.

#### 6.3.3.2 DSCH Capacity Request

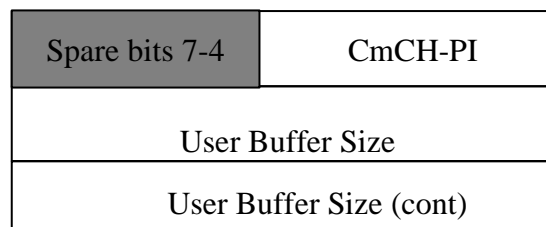

**Figure 15: Capacity Request Control Frame**

DSCH Capacity Request is sent for each priority group to indicate the user buffer size. The control frame is sent by the SRNC when the SRNC considers the user buffer status needs an increased buffer reporting frequency. This may be sent to signal an event, such as, data arrival or user-buffer discard. This control frame is used to improve user-buffer reporting above the level produced by the user-buffer reporting associated with the DSCH data frames.

6.3.3.2.1 Common Transport Channel Priority Indicator (CmCH-PI)

Refer to subclause 6.2.3.6.

6.3.3.2.2 User Buffer Size

Refer to subclause 6.2.3.11.

6.3.3.3 DSCH Capacity Allocation

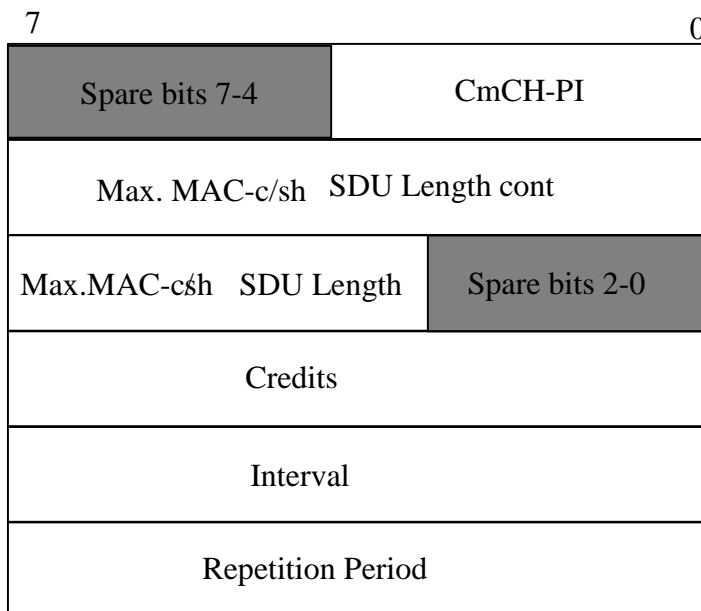

**Figure 16: Capacity Allocation Control Frame**

This message describes an allocation that the SRNC may use. When the credits has a value of 0 it signifies that there is no resources allocated. When the credits has a value of 255, it signifies unlimited capacity. When the repetition period has a value of 0, it signifies that the allocation (Max. MAC-c/sh SDU Length, Credits and Interval) can be repeated without limit.

6.3.3.3.1 Common Transport Channel Priority Indicator (CmCH-PI)

Refer to subclause 6.2.3.6.

6.3.3.3.2 Maximum MAC-c/sh SDU Length

**Description:** The values indicated the maximum allowable SDU size. MAC-c/sh SDU contains the C/T field of the MAC header followed by one RLC PDU. Field length: See the value of the MAC-c/sh SDU Length IE.

6.3.3.3.3 Credits

Refer to subclause 6.3.3.1.3.

6.3.3.3.4 Interval

**Description:** The value of this field indicates the time interval during which the (Credits) granted in the DSCH Capacity Allocation frame may be transmitted. This value is only applied to the DSCH channel.

**Value range:** {0-2550 ms}.

**Granularity:** 10ms.

**Field Length:** 8 bits.

### 6.3.3.3.5 Repetition Period

**Description:** The value of this field indicates the number of subsequent intervals that the (Credits) granted in the DSCH capacity allocation may be transmitted. These values represent an integer number of Intervals (see 6.3.3.3.4). This field is only applied to the DSCH channel.

**Value range:** {0-255, where 0= unlimited repetition period}.

**Field Length:** 8 bits.

### 6.3.3.4 FACH Capacity Request

Figure 17 shows the payload structure when the control frame is used for the above mentioned purpose. This control information is sent in the DL only.

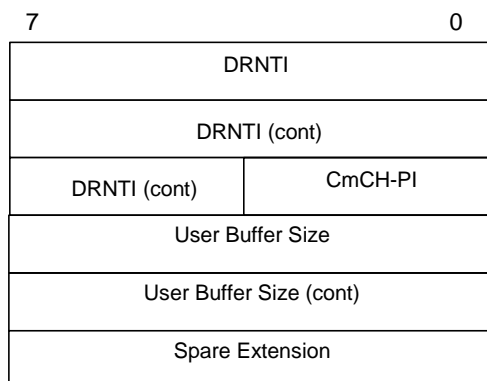

**Figure 17: FACH Capacity Request Control Frame**

#### 6.3.3.4.1 DRNTI

Refer to subclause 6.2.5.3.

#### 6.3.3.4.2 Common Transport Channel Priority Indicator (CmCH-PI)

Refer to subclause 6.2.5.7.

#### 6.3.3.4.3 User Buffer Size

Refer to subclause 6.2.5.12.

#### 6.3.3.4.4 Spare extension

Refer to subclause 6.3.3.14.

## 7 Handling of Unknown, Unforeseen and Erroneous Protocol Data

### 7.1 General

A Frame Protocol frame with an unknown IE or an illegal IE value shall be ignored.

---

## Annex A (informative): Change history

Change history					
TSG RAN#	Version	CR	Tdoc RAN	New Version	Subject/Comment
RAN_06	-	-	RP-99757	3.0.0	Approved at TSG RAN #6 and placed under Change Control
RAN_07	3.0.0	-	-	3.1.0	Approved at TSG RAN #7
RAN_08	3.1.0	-	RP-000246	3.2.0	Approved at TSG RAN #8
RAN_10	3.2.0	018 019 021	RP-000623	3.3.0	Approved at TSG RAN #10



---

## History

<b>Document history</b>		
V3.0.0	January 2000	Publication
V3.1.0	March 2000	Publication
V3.2.0	June 2000	Publication
V3.3.0	December 2000	Publication