

# ETSI TS 125 321 V7.2.0 (2006-09)

---

*Technical Specification*

## **Universal Mobile Telecommunications System (UMTS); Medium Access Control (MAC) protocol specification (3GPP TS 25.321 version 7.2.0 Release 7)**

---



---

**Reference**

RTS/TSGR-0225321v720

---

**Keywords**

UMTS

**ETSI**

650 Route des Lucioles  
F-06921 Sophia Antipolis Cedex - FRANCE

---

Tel.: +33 4 92 94 42 00 Fax: +33 4 93 65 47 16

Siret N° 348 623 562 00017 - NAF 742 C  
Association à but non lucratif enregistrée à la  
Sous-Préfecture de Grasse (06) N° 7803/88

---

**Important notice**

---

Individual copies of the present document can be downloaded from:

<http://www.etsi.org>

The present document may be made available in more than one electronic version or in print. In any case of existing or perceived difference in contents between such versions, the reference version is the Portable Document Format (PDF). In case of dispute, the reference shall be the printing on ETSI printers of the PDF version kept on a specific network drive within ETSI Secretariat.

Users of the present document should be aware that the document may be subject to revision or change of status. Information on the current status of this and other ETSI documents is available at

<http://portal.etsi.org/tb/status/status.asp>

If you find errors in the present document, please send your comment to one of the following services:

[http://portal.etsi.org/chaicor/ETSI\\_support.asp](http://portal.etsi.org/chaicor/ETSI_support.asp)

---

**Copyright Notification**

---

No part may be reproduced except as authorized by written permission.  
The copyright and the foregoing restriction extend to reproduction in all media.

© European Telecommunications Standards Institute 2006.  
All rights reserved.

**DECT**<sup>TM</sup>, **PLUGTESTS**<sup>TM</sup> and **UMTS**<sup>TM</sup> are Trade Marks of ETSI registered for the benefit of its Members.  
**TIPHON**<sup>TM</sup> and the **TIPHON logo** are Trade Marks currently being registered by ETSI for the benefit of its Members.  
**3GPP**<sup>TM</sup> is a Trade Mark of ETSI registered for the benefit of its Members and of the 3GPP Organizational Partners.

---

## Intellectual Property Rights

IPRs essential or potentially essential to the present document may have been declared to ETSI. The information pertaining to these essential IPRs, if any, is publicly available for **ETSI members and non-members**, and can be found in ETSI SR 000 314: "*Intellectual Property Rights (IPRs); Essential, or potentially Essential, IPRs notified to ETSI in respect of ETSI standards*", which is available from the ETSI Secretariat. Latest updates are available on the ETSI Web server (<http://webapp.etsi.org/IPR/home.asp>).

Pursuant to the ETSI IPR Policy, no investigation, including IPR searches, has been carried out by ETSI. No guarantee can be given as to the existence of other IPRs not referenced in ETSI SR 000 314 (or the updates on the ETSI Web server) which are, or may be, or may become, essential to the present document.

---

## Foreword

This Technical Specification (TS) has been produced by ETSI 3rd Generation Partnership Project (3GPP).

The present document may refer to technical specifications or reports using their 3GPP identities, UMTS identities or GSM identities. These should be interpreted as being references to the corresponding ETSI deliverables.

The cross reference between GSM, UMTS, 3GPP and ETSI identities can be found under <http://webapp.etsi.org/key/queryform.asp>.

# Contents

Intellectual Property Rights .....	2
Foreword.....	2
Foreword.....	7
1 Scope .....	8
2 References .....	8
3 Definitions and abbreviations.....	9
3.1 Definitions .....	9
3.1.1 HS-DSCH Specific Definitions .....	9
3.1.2 E-DCH Specific Definitions .....	9
3.1.2.1 General .....	9
3.1.2.2 FDD.....	10
3.2 Abbreviations .....	10
4 General .....	12
4.1 Objective .....	12
4.2 MAC architecture .....	12
4.2.1 MAC Entities .....	12
4.2.2 MAC-b.....	12
4.2.3 Traffic Related Architecture - UE Side.....	13
4.2.3.1 MAC-c/sh/m entity – UE Side .....	14
4.2.3.2 MAC-d entity – UE Side.....	16
4.2.3.3 MAC-hs entity – UE Side .....	17
4.2.3.4 MAC-e/es entity – UE Side.....	18
4.2.4 Traffic Related Architecture - UTRAN Side .....	20
4.2.4.1 MAC-c/sh/m entity – UTRAN Side.....	20
4.2.4.2 MAC-d entity – UTRAN Side .....	22
4.2.4.3 MAC-hs entity – UTRAN Side.....	23
4.2.4.4 MAC-es entity – UTRAN Side .....	24
4.2.4.5 MAC-e entity – UTRAN Side.....	26
4.3 Channel structure.....	27
4.3.1 Transport channels .....	28
4.3.2 Logical Channels .....	28
4.3.2.1 Logical channel structure .....	28
4.3.2.2 Control Channels.....	28
4.3.2.3 Traffic Channels.....	29
5 Services provided to upper layers .....	29
5.1 Description of Services provided to upper layers.....	29
6 Functions .....	29
6.1 Description of the MAC functions .....	29
6.2 Relation between MAC Functions and Transport Channels .....	31
6.2.1 Relation between MAC Functions and Transport Channels in UTRAN .....	31
6.2.2 Relation of MAC Functions and Transport Channels in UE .....	32
7 Services expected from physical layer .....	32
8 Elements for layer-to-layer communication.....	32
8.1 Primitives between layers 1 and 2.....	33
8.1.1 Primitives.....	33
8.1.2 Parameters.....	33
8.2 Primitives between MAC and RLC.....	33
8.2.1 Primitives.....	33
8.2.2 Parameters.....	34
8.3 Primitives between MAC and RRC .....	35
8.3.1 Primitives.....	35

8.3.2	Parameters.....	36
9	Elements for peer-to-peer communication .....	37
9.1	Protocol data units .....	37
9.1.1	General.....	37
9.1.2	MAC PDU (not HS-DSCH or E-DCH) .....	37
9.1.3	MAC-d PDU (HS-DSCH) .....	38
9.1.4	MAC PDU (HS-DSCH).....	38
9.1.5	MAC PDU (E-DCH) .....	38
9.2	Formats and parameters.....	39
9.2.1	MAC PDU: Parameters of the MAC PDU header (not HS-DSCH or E-DCH) and MAC-d PDU header (HS-DSCH and E-DCH) .....	39
9.2.1.1	MAC header for DTCH and DCCH (not mapped on HS-DSCH or E-DCH) .....	42
9.2.1.1a	MAC-d Header for DTCH and DCCH (mapped on HS-DSCH) .....	43
9.2.1.1b	MAC-d Header for DTCH and DCCH (mapped on E-DCH) .....	43
9.2.1.2	MAC header for BCCH .....	43
9.2.1.3	MAC header for PCCH .....	44
9.2.1.4	MAC header for CCCH .....	44
9.2.1.5	MAC Header for CTCH.....	44
9.2.1.6	MAC Header for SHCCH .....	44
9.2.2	MAC PDU: Parameters of the MAC header (HS-DSCH) .....	45
9.2.2.1	MAC header for DTCH and DCCH.....	46
9.2.3	Signalling of Transport Block size for HS-DSCH .....	46
9.2.3.1	Transport block size for FDD.....	46
9.2.3.2	Transport block size for 3.84 Mcps TDD.....	47
9.2.3.2a	Transport block size for 7.68 Mcps TDD.....	50
9.2.3.3	Transport block size for 1.28 Mcps TDD.....	53
9.2.4	MAC PDU: Parameters of the MAC header (E-DCH) .....	55
9.2.4.1	MAC-es header parameters .....	55
9.2.4.2	MAC-e header parameters .....	55
9.2.5	Signaling of control information for FDD E-DCH .....	56
9.2.5.1	HARQ information.....	56
9.2.5.2	DL Scheduling information.....	56
9.2.5.2.1	Relative Grants .....	56
9.2.5.2.2	Absolute Grant .....	58
9.2.5.3	UL Scheduling information.....	58
9.2.5.3.1	Happy Bit .....	58
9.2.5.3.2	Scheduling Information .....	58
9.2.5.4	Transport block size .....	61
9.2.6	Signaling of control information for 3.84/7.68 Mcps TDD E-DCH .....	62
9.2.6.1	HARQ information.....	62
9.2.6.2	DL Scheduling information.....	62
9.2.6.2.1	Absolute Grant .....	63
9.2.6.3	UL Scheduling Information .....	64
9.2.6.4	Transport block size .....	64
9.2.6.4.1	3.84 Mcps TDD Transport Block Size .....	64
9.2.6.4.2	7.68 Mcps TDD Transport Block Size .....	65
10	Handling of unknown, unforeseen and erroneous protocol data .....	65
11	Specific functions .....	66
11.1	Traffic volume measurement for dynamic radio bearer control .....	66
11.2	Control of RACH transmissions.....	67
11.2.1	Access Service Class selection .....	67
11.2.2	Control of RACH transmissions for FDD mode.....	67
11.2.3	Control of RACH transmissions for TDD .....	70
11.2.3.1	Control of RACH transmissions for 3.84 Mcps TDD and 7.68 Mcps TDD .....	70
11.2.3.2	Control of RACH Transmissions for 1.28 Mcps TDD.....	71
11.3	Void.....	73
11.4	Transport format combination selection in UE (non E-DCH).....	73
11.5	Ciphering .....	75
11.6	Control of HS-DSCH transmission and reception.....	75
11.6.1	Network operation .....	75

11.6.1.1	Scheduler.....	76
11.6.1.2	HARQ entity .....	76
11.6.1.3	HARQ process .....	76
11.6.2	UE operation.....	77
11.6.2.1	HARQ Entity.....	77
11.6.2.2	HARQ process .....	77
11.6.2.3	Reordering entity.....	78
11.6.2.3.1	Definitions .....	78
11.6.2.3.2	Reordering functionality.....	79
11.6.2.4	Disassembly entity .....	80
11.6.2.5	MAC-hs Reset.....	80
11.6.2.6	Reconfiguration of MAC-hs parameters .....	81
11.7	HS-DSCH Provided Bit Rate measurement .....	81
11.8	Control of E-DCH transmission and reception (FDD) .....	82
11.8.1	UE operation.....	82
11.8.1.1	HARQ Operation.....	82
11.8.1.1.1	HARQ entity.....	82
11.8.1.1.2	HARQ process.....	82
11.8.1.2	Multiplexing and TSN setting entity.....	83
11.8.1.2.1	TSN setting process operation.....	83
11.8.1.3	Serving Grant Update.....	84
11.8.1.3.1	Baseline Procedure .....	84
11.8.1.3.2	Handling at start of E-DCH transmission .....	85
11.8.1.3.3	Handling at serving cell change.....	86
11.8.1.3.4	Handling at TTI change.....	86
11.8.1.3.5	Higher Layer Signalling .....	86
11.8.1.4	E-TFC Selection.....	86
11.8.1.5	Happy Bit Setting.....	88
11.8.1.6	Scheduling Information reporting .....	89
11.8.1.6.1	Report Triggering when SG = 'Zero_Grant' or all processes are deactivated.....	89
11.8.1.6.2	Report Triggering when SG <> 'Zero_Grant' and at least one process is activated.....	90
11.8.1.7	MAC-es/e Reset .....	90
11.8.2	Node B operation.....	90
11.8.2.1	HARQ Operation .....	90
11.8.2.1.1	HARQ entity.....	90
11.8.2.1.2	HARQ process.....	90
11.8.2.2	De-multiplexing .....	91
11.8.2.3	Scheduler.....	91
11.8.2.4	E-DCH Provided Bit Rate measurement.....	91
11.8.3	RNC operation .....	91
11.8.3.1	Re-ordering entity .....	91
11.9	Control of E-DCH transmission and reception (3.84/7.68 Mcps TDD).....	92
11.9.1	UE operation.....	92
11.9.1.1	HARQ Operation .....	92
11.9.1.1.1	HARQ entity.....	93
11.9.1.1.2	HARQ process.....	93
11.9.1.2	Multiplexing and TSN setting entity.....	94
11.9.1.3	Receiving a Grant.....	94
11.9.1.4	E-TFC Selection.....	94
11.9.2	Node B operation.....	96
11.9.2.1	HARQ Operation .....	96
11.9.2.1.1	HARQ entity.....	96
11.9.2.1.2	HARQ process.....	96
11.9.2.2	De-multiplexing .....	96
11.9.2.3	Scheduler.....	96
11.9.2.4	E-DCH Provided Bit Rate measurement.....	96
11.9.3	RNC operation .....	97
11.9.3.1	Re-ordering entity .....	97
<b>Annex A (normative):</b>	<b>HS-DSCH Transport Block Size Table for FDD .....</b>	<b>98</b>
<b>Annex B (normative):</b>	<b>E-DCH Transport Block Size Tables for FDD.....</b>	<b>100</b>

B.1	2ms TTI E-DCH Transport Block Size Table 0 .....	100
B.2	2ms TTI E-DCH Transport Block Size Table 1 .....	100
B.3	10ms TTI E-DCH Transport Block Size Table 0 .....	101
B.4	10ms TTI E-DCH Transport Block Size Table 1 .....	102
<b>Annex BA (normative): E-DCH Transport Block Size Tables for 3.84 Mcps TDD .....</b>		<b>104</b>
BA.1	10ms TTI E-DCH Transport Block Size Table 0 .....	104
<b>Annex BB (normative): E-DCH Transport Block Size Tables for 7.68 Mcps TDD .....</b>		<b>107</b>
BB.1	10ms TTI E-DCH Transport Block Size Table 0 .....	107
<b>Annex C (informative): Pseudo-Code for E-TFC Selection (FDD).....</b>		<b>110</b>
<b>Annex CA (informative): Pseudo-Code for E-TFC Selection (TDD).....</b>		<b>112</b>
<b>Annex D (informative): Change history .....</b>		<b>114</b>
History .....		118

---

# Foreword

This Technical Specification (TS) has been produced by the 3<sup>rd</sup> Generation Partnership Project (3GPP).

The contents of the present document are subject to continuing work within the TSG and may change following formal TSG approval. Should the TSG modify the contents of the present document, it will be re-released by the TSG with an identifying change of release date and an increase in version number as follows:

Version x.y.z

where:

- x the first digit:
  - 1 presented to TSG for information;
  - 2 presented to TSG for approval;
  - 3 or greater indicates TSG approved document under change control.
- y the second digit is incremented for all changes of substance, i.e. technical enhancements, corrections, updates, etc.
- z the third digit is incremented when editorial only changes have been incorporated in the document.



---

# 1 Scope

The present document specifies the MAC protocol.

The specification describes:

- MAC architecture;
- MAC entities;
- channel structure;
- services provided to upper layers;
- MAC functions;
- services expected from the physical layer;
- elements for layer-to-layer communication including primitives between MAC and RLC;
- elements for peer-to-peer communication;
- protocol data units, formats and parameters;
- elementary procedures.

---

# 2 References

The following documents contain provisions which, through reference in this text, constitute provisions of the present document.

- References are either specific (identified by date of publication, edition number, version number, etc.) or non-specific.
- For a specific reference, subsequent revisions do not apply.
- For a non-specific reference, the latest version applies. In the case of a reference to a 3GPP document (including a GSM document), a non-specific reference implicitly refers to the latest version of that document *in the same Release as the present document*.

- [1] 3GPP TR 21.905: "Vocabulary for 3GPP Specifications".
- [2] 3GPP TS 25.301: "Radio Interface Protocol Architecture".
- [3] 3GPP TS 25.302: "Services provided by the Physical Layer".
- [4] 3GPP TS 25.303: "Interlayer Procedures in Connected Mode".
- [5] 3GPP TS 25.304: "UE Procedures in Idle Mode and Procedures for Cell Reselection in Connected Mode".
- [6] 3GPP TS 25.322: "RLC Protocol Specification".
- [7] 3GPP TS 25.331: "Radio Resource Control (RRC); protocol specification".
- [8] 3GPP TR 25.921: "Guidelines and Principles for Protocol Description and Error Handling".
- [9] 3GPP TR 25.990: "Vocabulary for the UTRAN".
- [10] 3GPP TS 33.102: "Security architecture".
- [11] 3GPP TS 25.425: "UTRAN Iur Interface User Plane Protocols for Common Transport Channel Data Streams".

- [12] 3GPP TS 25.133: "Requirements for support of radio resource management (FDD)".
- [13] 3GPP TS 25.214: "Physical layer procedures (FDD)".
- [14] 3GPP TS 25.123: "Requirements for support of radio resource management (TDD)".
- [15] 3GPP TS 33.105: "Cryptographic Algorithm Requirements".
- [16] 3GPP TS 25.212: "Multiplexing and Channel Coding (FDD)".
- [17] 3GPP TS 25.215: "Physical layer - Measurements (FDD)".
- [18] 3GPP TS 25.224: "Physical layer procedures (TDD)".
- [19] 3GPP TS 25.222: "Multiplexing and Channel Coding (TDD)".
- [20] 3GPP TS 25.225: "Physical layer – Measurements (TDD)".
- [21] 3GPP TS 25.221 'Physical Channels and Mapping of Transport Channels onto Physical Channels (TDD)'

---

## 3 Definitions and abbreviations

### 3.1 Definitions

For the purposes of the present document, the terms and definitions given below and in [9] and [1] apply.

#### 3.1.1 HS-DSCH Specific Definitions

#### 3.1.2 E-DCH Specific Definitions

##### 3.1.2.1 General

**E-DCH:** The Enhanced Dedicated Channel (E-DCH) is an uplink transport channel.

**HARQ profile:** One HARQ profile consists of a power offset attribute and maximum number of transmissions.

**Power offset attribute (FDD):** This represents the power offset between E-DPDCH(s) and reference E-DPDCH power level for a given E-TFC. This power offset attribute is set to achieve the required QoS in this MAC-d flow when carried alone in a MAC-e PDU and subsequently in the corresponding CCTrCh of E-DCH type. Details on the mapping on Beta factors can be found in [13]. The reference E-DPDCH power offset is signalled to the UE for one (or several) reference E-TFC(s) (see details in subclause 11.1).

**Power offset attribute (TDD):** This represents the power offset between E-PUCH and reference E-PUCH power level  $P_{e-base}$  for a given E-TFC. This power offset attribute is set to achieve the required QoS in this MAC-d flow when carried alone in a MAC-e PDU and subsequently in the corresponding CCTrCh of E-DCH type. Details on the power offset can be found in [18]. The reference beta value is signalled to the UE for one (or several) reference code rate(s).

**Primary Absolute Grant:** Absolute Grant received with the primary E-RNTI. Note that the primary E-RNTI is the only E-RNTI for TDD.

**Serving E-DCH cell:** Cell from which the UE receives Absolute Grants from the Node-B scheduler. A UE has one Serving E-DCH cell.

**Serving Grant (FDD):** The state variable `Serving_Grant` indicates the maximum E-DPDCH to DPCCCH power ratio that the UE is allowed to use for scheduled data in the following transmission. The value in the appropriate state variable will be provided to the E-TFC selection function to help in selecting the best format for the upcoming transmission. Possible values are: "Zero\_Grant" and numerical values.

**Serving\_Grant (TDD):** The state variable `Serving_Grant` indicates the maximum E-PUCH to reference power level  $P_{e\_base}$  power ratio that the UE is allowed to use for scheduled data on the physical resources associated with the E-AGCH grant. The value in the appropriate state variable will be provided to the E-TFC selection function to help in selecting the best format for the upcoming transmission. Possible values are: "Zero\_Grant" and numerical values.

### 3.1.2.2 FDD

**Active Process:** HARQ process for which Scheduling Grant are applicable, i.e. scheduled data can be sent.

**AG\_Timer:** This timer is set to one HARQ RTT (40ms in the case of 10ms TTI, 16ms in the case of 2ms TTI).

**E-DCH active set:** The set of cells which carry the E-DCH for one UE.

**Inactive Process:** HARQ process for which Scheduling Grants are not applicable, i.e. scheduled data cannot be sent.

**INACTIVE:** Absolute Grant value that can be sent by the serving cell's scheduler on the E-AGCH to deactivate a process or to switch the UE to its secondary E-RNTI.

**Maximum\_Serving\_Grant:** The variable `Maximum_Serving_Grant` indicates the maximum E-DPDCH to DPCCH power ratio that the UE is allowed to use for scheduled data while the timer `Non_Serving_RG_Timer` has not expired.

**Maximum number of re-transmissions, Maximum number of transmissions:** Maximum number of re-transmissions = maximum number of transmissions - 1. Both these notations are used.

**Minimum\_Grant:** The value `Minimum_Grant` corresponds to the minimum E-DPDCH to DPCCH power ratio that the UE considers. This value is  $(5/15)^2$ .

**Non-serving E-DCH RL or Non-serving RL:** Cell which belongs to the E-DCH active set but does not belong to the Serving E-DCH RLS and from which the UE can receive one Relative Grant. The UE can have zero, one or several Non-serving E-DCH RL(s).

**Non\_Serving\_RG\_Timer:** This timer is set to one HARQ RTT (40ms in the case of 10ms TTI, 16ms in the case of 2ms TTI).

**Primary Absolute Grant:** Absolute Grant received with the primary E-RNTI.

**Primary\_Grant\_Available:** This state variable is a Boolean, indicating whether the UE's serving grant is only affected by Primary Absolute Grants and Relative Grants (i.e. not by Secondary Absolute Grants).

**reference\_ETPR:** The state variable `reference_ETPR` holds the E-DPDCH to DPCCH power ratio used as reference for relative grant commands. This variable is set to the E-DPDCH to DPCCH power ratio used for the E-TFC selected for the previous TTI on this HARQ process, calculated using the amplitude ratios prior to the quantization according to subclause 5.1.2.5B.2.3 of [13], excluding non-scheduled transmissions, excluding any scaling applied according to subclause 5.1.2.6 of [13] and is obtained from the physical layer. In case no scheduled transmission took place on a HARQ process in the previous TTI, `reference_ETPR` shall be set to `Minimum_Grant` for this HARQ process.

**Secondary Absolute Grant:** Absolute Grant received with the secondary E-RNTI.

**Serving E-DCH RLS or Serving RLS:** Set of cells which contains at least the Serving E-DCH cell and from which the UE can receive and combine one Relative Grant. The UE has only one Serving E-DCH RLS.

**Stored\_Secondary\_Grant:** This state variable is used to store the last received Secondary Absolute Grant Value. Possible values are: "Zero\_Grant" and numerical values.

## 3.2 Abbreviations

For the purposes of the present document, the following abbreviations apply:

AG	Absolute Grant
ASC	Access Service Class
BCCH	Broadcast Control Channel
BCH	Broadcast Channel
C-	Control-
CCCH	Common Control Channel

DCCH	Dedicated Control Channel
DCH	Dedicated Channel
DL	Downlink
DSCH	Downlink Shared Channel
DTCH	Dedicated Traffic Channel
E-AGCH	E-DCH Absolute Grant Channel
E-DCH	Enhanced Dedicated Transport Channel
E-DPCCH	E-DCH Dedicated Physical Control Channel (FDD only)
E-HICH	E-DCH HARQ Acknowledgement Indicator Channel
E-PUCH	Enhanced Uplink Physical Channel (3.84/7.68 Mcps TDD only)
E-RGCH	E-DCH Relative Grant Channel
E-RGCH	E-DCH Relative Grant Channel (FDD only)
E-RNTI	E-DCH Radio Network Temporary Identifier
E-RUCCH	E-DCH Random Access Uplink Control Channel (3.84/7.68 Mcps TDD only)
E-TFC	E-DCH Transport Format Combination
E-TFCI	E-DCH Transport Format Combination Indicator
E-UCCH	E-DCH Uplink Control Channel (3.84/7.68 Mcps TDD only)
FACH	Forward Link Access Channel
FDD	Frequency Division Duplex
HARQ	Hybrid Automatic Repeat Request
HCSN	HS-SCCH Cyclic Sequence Number
HSDPA	High Speed Downlink Packet Access
HS-DSCH	High Speed Downlink Shared Channel
L1	Layer 1 (physical layer)
L2	Layer 2 (data link layer)
L3	Layer 3 (network layer)
MAC	Medium Access Control
MBMS	Multimedia Broadcast Multicast Service
MCCH	MBMS point-to-multipoint Control Channel
MTCH	MBMS point-to-multipoint Traffic Channel
MSCH	MBMS point-to-multipoint Scheduling Channel
PCCH	Paging Control Channel
PCH	Paging Channel
PDU	Protocol Data Unit
PHY	Physical layer
PhyCH	Physical Channels
RACH	Random Access Channel
RG	Relative Grant
RLC	Radio Link Control
RLS	Radio Link Set
RNC	Radio Network Controller
RNS	Radio Network Subsystem
RNTI	Radio Network Temporary Identity
RRC	Radio Resource Control
RSN	Retransmission Sequence Number
SAP	Service Access Point
SDU	Service Data Unit
SHCCH	Shared Channel Control Channel
SRNC	Serving Radio Network Controller
SRNS	Serving Radio Network Subsystem
TDD	Time Division Duplex
TFCI	Transport Format Combination Indicator
TFI	Transport Format Indicator
TSN	Transmission Sequence Number
U-	User-
UE	User Equipment
UL	Uplink
UMTS	Universal Mobile Telecommunications System
USCH	Uplink Shared Channel
UTRA	UMTS Terrestrial Radio Access
UTRAN	UMTS Terrestrial Radio Access Network

---

## 4 General

### 4.1 Objective

The objective is to describe the MAC architecture and the different MAC entities from a functional point of view.

### 4.2 MAC architecture

The description in this subclause is a model and does not specify or restrict implementations.

According to the RRC functions the RRC is generally in control of the internal configuration of the MAC.

#### 4.2.1 MAC Entities

The diagrams that describe the MAC architecture are constructed from MAC entities.

The entities are assigned the following names.

- MAC-b is the MAC entity that handles the following transport channels:
  - broadcast channel (BCH)
- MAC-c/sh/m, is the MAC entity that handles the following transport channels:
  - paging channel (PCH)
  - forward access channel (FACH)
  - random access channel (RACH)
  - downlink shared channel (DSCH). The DSCH exists only in TDD mode.
  - uplink shared channel (USCH). The USCH exists only in TDD mode.
- MAC-d is the MAC entity that handles the following transport channels:
  - dedicated transport channel (DCH)
- MAC-hs is the MAC entity that handles the following transport channels:
  - high speed downlink shared channel (HS-DSCH)
- MAC-m is the MAC entity that handles the following transport channels:
  - forward access channel (FACH).
- MAC-e/es are the MAC entities that handle the following transport channels:
  - enhanced dedicated transport channel (E-DCH).

The exact functions completed by the entities are different in the UE from those completed in the UTRAN.

**NOTE:** When a UE is allocated resources for exclusive use by the bearers that it supports the MAC-d entities dynamically share the resources between the bearers and are responsible for selecting the TFI/ TFCI that is to be used in each transmission time interval.

#### 4.2.2 MAC-b

The following diagram illustrates the connectivity of the MAC-b entity in a UE and in each cell of the UTRAN.

MAC-b represents the control entity for the broadcast channel (BCH).

There is one (current cell) or multiple (current and neighbour cells) MAC-b entities in each UE and one MAC-b in the UTRAN for each cell.

The MAC Control SAP is used to transfer Control information to MAC-b.

The MAC-b entity is located in the Node B.

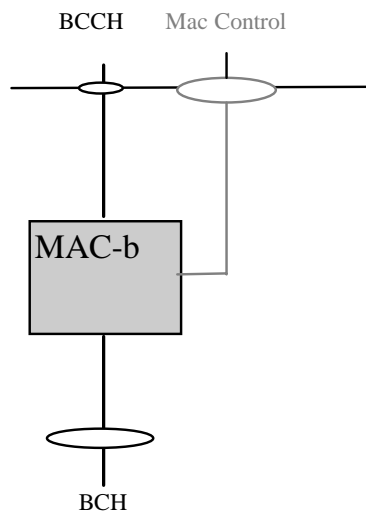

**Figure 4.2.2.1: UE side and UTRAN side architecture**

### 4.2.3 Traffic Related Architecture - UE Side

Figure 4.2.3.1 illustrates the connectivity of MAC entities.

The MAC-c/sh/m controls access to all common transport channels, except the HS-DSCH transport channel.

The MAC-d controls access to all dedicated transport channels, to MAC-c/sh/m and MAC-hs.

The MAC-hs controls access to the HS-DSCH transport channel.

The MAC-e/es controls access to the E-DCH transport channel.

In case of selective combining of MTCH channels from multiple cells, the MAC-m controls access to the FACH transport channels used to carry MTCH and MSCH.

In the downlink, if logical channels of dedicated type are mapped to common transport channels then MAC-d receives the data from MAC-c/sh/m or MAC-hs via the illustrated connection between the functional entities.

In the uplink, if logical channels of dedicated type are mapped to common transport channels then MAC-d submits the data to MAC-c/sh/m via the illustrated connection between the functional entities.

The mapping of logical channels on transport channels depends on the multiplexing that is configured by RRC.

The MAC Control SAP is used to transfer Control information to each MAC entity.

The associated signalling shown in the figure illustrates the exchange of information between layer 1 and layer 2 provided by primitives shown in [3].

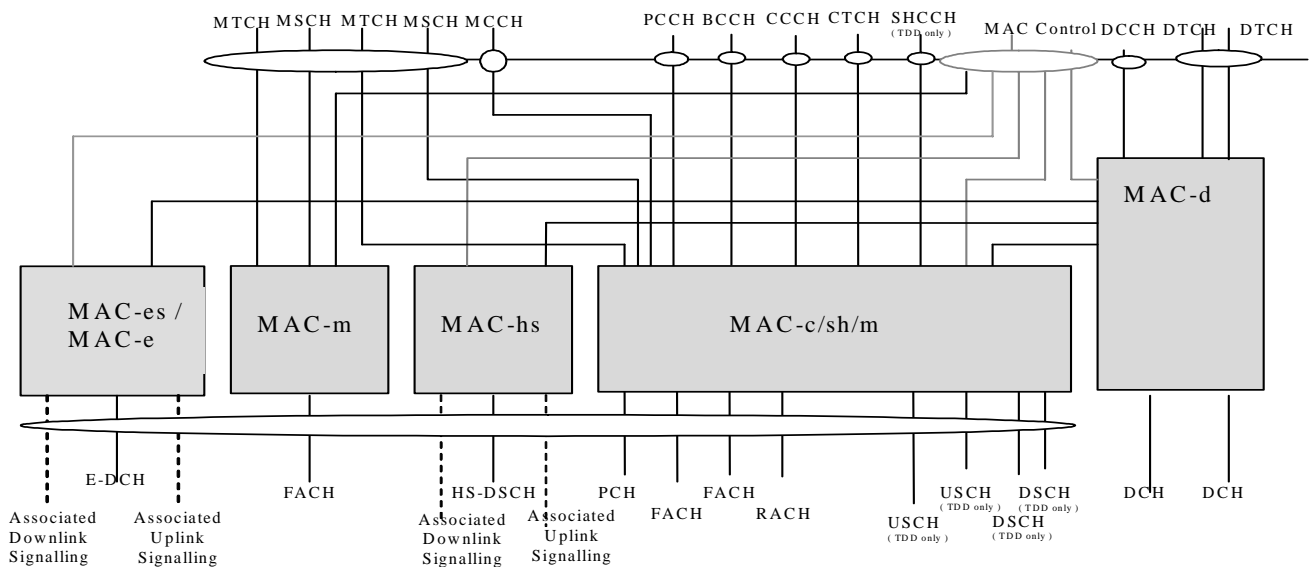

Figure 4.2.3.1: UE side MAC architecture

### 4.2.3.1 MAC-c/sh/m entity – UE Side

Figure 4.2.3.1.1 shows the UE side MAC-c/sh/m entity.

The following functionality is covered:

- TCTF MUX:
  - this function represents the handling (insertion for uplink channels and detection and deletion for downlink channels) of the TCTF field in the MAC header, and the respective mapping between logical and transport channels.  
The TCTF field indicates the common logical channel type, or if a dedicated logical channel is used;
- add/read UE Id:
  - the UE Id is added for RACH transmissions;
  - the UE Id, when present, identifies data to this UE.
- read MBMS Id:
  - the MBMS Id is read in case of MTCH reception;
  - the MBMS Id identifies received data to an MBMS service.
- UL: TF selection:
  - in the uplink, the possibility of transport format selection exists.
- ASC selection:
  - For RACH, MAC indicates the ASC associated with the PDU to the physical layer. This is to ensure that RACH messages associated with a given Access Service Class (ASC) are sent on the appropriate signature(s) and time slot(s). MAC also applies the appropriate back-off parameter(s) associated with the given ASC. When sending an RRC CONNECTION REQUEST message, RRC will determine the ASC; in all other cases MAC selects the ASC;
- scheduling /priority handling

- this functionality is used to transmit the information received from MAC-d on RACH based on logical channel priorities. This function is related to TF selection.
- TFC selection
- transport format and transport format combination selection according to the transport format combination set (or transport format combination subset) configured by RRC is performed,

The RLC provides RLC-PDUs to the MAC, which fit into the available transport blocks on the transport channels.

There is one MAC-c/sh/m entity in each UE.

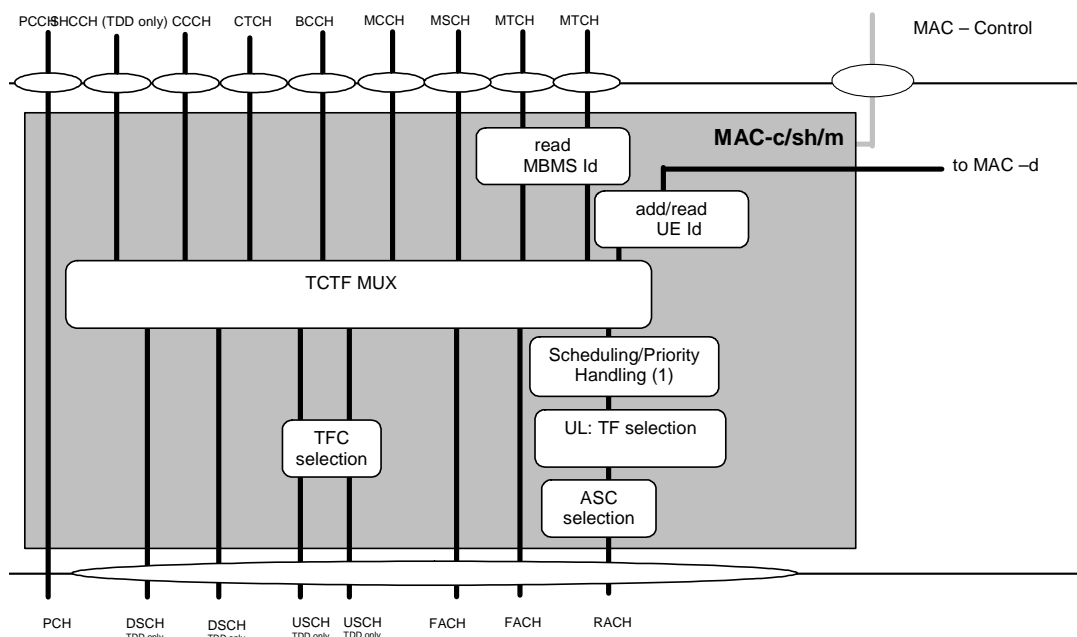

**Figure 4.2.3.1.1: UE side MAC architecture / MAC-c/sh/m details**

#### 4.2.3.1b MAC-m entity – UE Side

Figure 4.2.3.1b.1 shows the UE side MAC-m entity.

The following functionality is covered:

- TCTF DEMUX:
  - this function represents the handling (detection and deletion for downlink channels) of the TCTF field in the MAC header, and the respective mapping between logical and transport channels. The TCTF field indicates the common logical channel type;
- read MBMS Id
  - the MBMS Id is read in case of MTCH reception;
  - the MBMS Id identifies received data to an MBMS service.

The MAC Control SAP is used to transfer control information to MAC-m.



If MTCH channels are selectively combined, the MAC-m entity exists in the UE. Otherwise, the MAC-m entity does not exist.

In case of selective combining of MTCH channels from multiple cells, there are one MAC-c/sh/m for the current cell and one MAC-m entity for each neighboring cell in the UE.

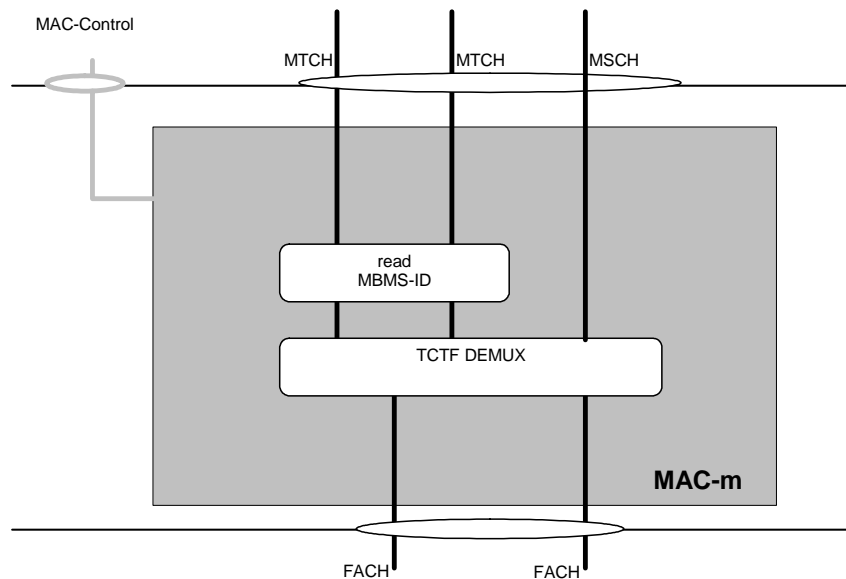

Figure 4.2.3.1b.1: UE side MAC architecture / MAC-m details

#### 4.2.3.2 MAC-d entity – UE Side

Figure 4.2.3.2.1 shows the UE side MAC-d entity.

The following functionality is covered:

- Transport Channel type switching
  - Transport Channel type switching is performed by this entity, based on decision taken by RRC. This is related to a change of radio resources. If requested by RRC, MAC shall switch the mapping of one designated logical channel between common and dedicated transport channels.
- C/T MUX:
  - The C/T MUX is used when multiplexing of several dedicated logical channels onto one transport channel (other than HS-DSCH) or one MAC-d flow (HS-DSCH) is used. An unambiguous identification of the logical channel is included.
- Ciphering:
  - Ciphering for transparent mode data to be ciphered is performed in MAC-d. Details about ciphering can be found in [10].
- Deciphering:
  - Deciphering for ciphered transparent mode data is performed in MAC-d. Details about ciphering can be found in [10].
- UL TFC selection:
  - Transport format and transport format combination selection according to the transport format combination set (or transport format combination subset) configured by RRC is performed.

The MAC-d entity is responsible for mapping dedicated logical channels for the uplink either onto dedicated transport channels or to transfer data to MAC-c/sh/m to be transmitted via common channels.

One dedicated logical channel can be mapped simultaneously onto DCH and DSCH in TDD mode.

One dedicated logical channel can be simultaneously mapped onto DCH and HS-DSCH.

The MAC-d entity has a connection to the MAC-c/sh/m entity. This connection is used to transfer data to the MAC-c/sh/m to transmit data on transport channels that are handled by MAC-c/sh/m (uplink) or to receive data from transport channels that are handled by MAC-c/sh/m (downlink).

The MAC-d entity has a connection to the MAC-hs entity. This connection is used to receive data from the HS-DSCH transport channel which is handled by MAC-hs (downlink).

The MAC-d entity has a connection to the MAC-e/es entity. This connection is used to transmit data on the E-DCH transport channel which is handled by the MAC-e/es (uplink).

There is one MAC-d entity in the UE.

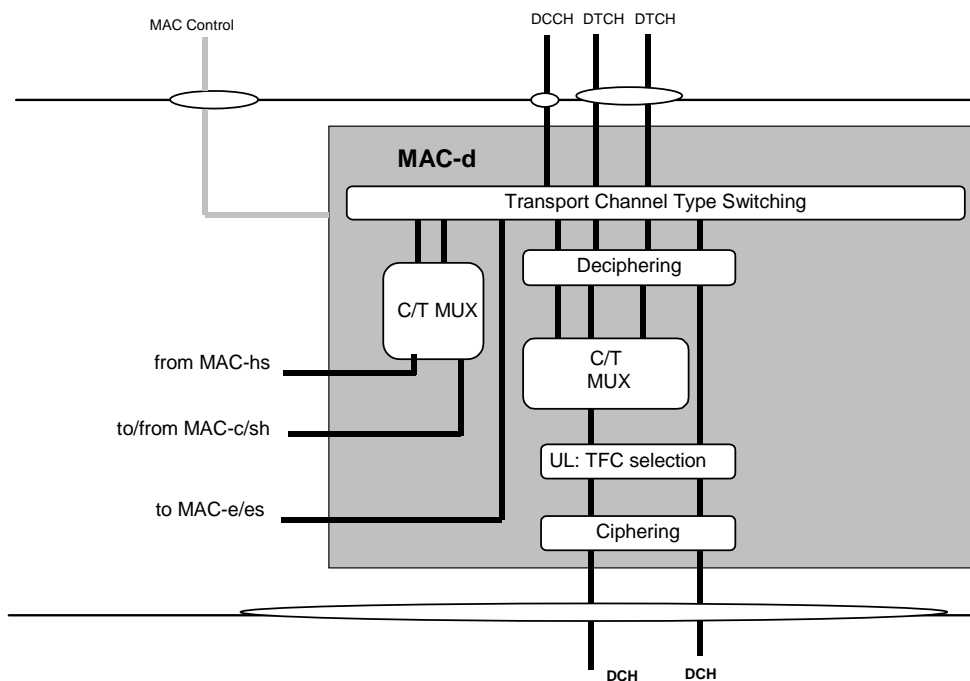

Figure 4.2.3.2.1: UE side MAC architecture / MAC-d details

#### 4.2.3.3 MAC-hs entity – UE Side

The MAC-hs handles the HSDPA specific functions. In the model below the MAC-hs comprises the following entities:

- HARQ:  
The HARQ entity is responsible for handling the MAC functions relating to the HARQ protocol. The HARQ functional entity handles all the tasks that are required for hybrid ARQ. It is responsible for generating ACKs or NACKs. The detailed configuration of the hybrid ARQ protocol is provided by RRC over the MAC-Control SAP.
- Reordering Queue distribution:  
The reordering queue distribution function routes the MAC-hs PDUs to the correct reordering buffer based on the Queue ID.
- Reordering:  
The reordering entity reorders received MAC-hs PDUs according to the received TSN. MAC-hs PDUs with consecutive TSNs are delivered to the disassembly function upon reception. MAC-hs PDUs are not delivered to the disassembly function if MAC-hs PDUs with lower TSN are missing. There is one reordering entity for each Queue ID configured at the UE.
- Disassembly:  
The disassembly entity is responsible for the disassembly of MAC-hs PDUs. When a MAC-hs PDU is

disassembled the MAC-hs header is removed, the MAC-d PDUs are extracted and any present padding bits are removed. Then the MAC-d PDUs are delivered to higher layer.

The associated signalling shown in the figure illustrates the exchange of information between layer 1 and layer 2 provided by primitives shown in [3].

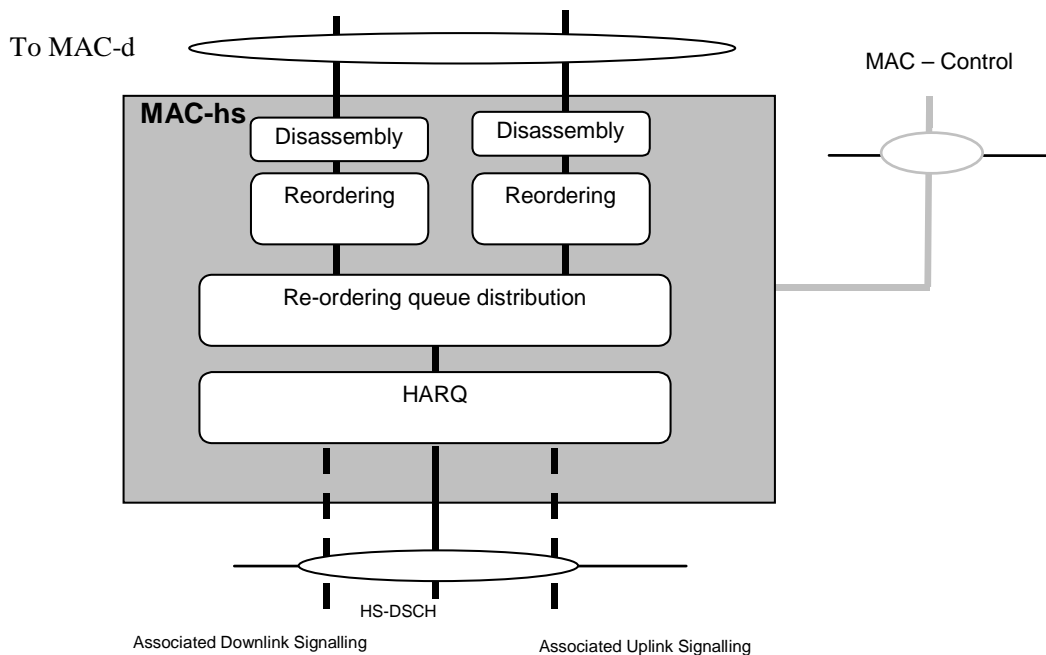

**Figure 4.2.3.3.1: UE side MAC architecture / MAC-hs details**

#### 4.2.3.4 MAC-e/es entity – UE Side

The MAC-es/e handles the E-DCH specific functions. The split between MAC-e and MAC-es in the UE is not detailed. In the model below the MAC-e/es comprises the following entities:

- HARQ:
 

The HARQ entity is responsible for handling the MAC functions relating to the HARQ protocol. It is responsible for storing MAC-e payloads and re-transmitting them. The detailed configuration of the hybrid ARQ protocol is provided by RRC over the MAC-Control SAP.
- For FDD: The HARQ entity provides the E-TFC, the retransmission sequence number (RSN), and the power offset to be used by L1. Redundancy version (RV) of the HARQ transmission is derived by L1 from RSN, CFN and in case of 2 ms TTI from the sub-frame number.
- For 3.84/7.68 Mcps TDD: The HARQ entity provides the HARQ process identity, the E-TFC, the retransmission sequence number (RSN) and an indication of the power offset to be used by L1. The redundancy version (RV) of the HARQ transmission is derived by L1 from RSN. RRC signalling can also configure the L1 to use RV=0 for every transmission.
- Multiplexing and TSN setting:
 

The multiplexing and TSN setting entity is responsible for concatenating multiple MAC-d PDUs into MAC-es PDUs, and to multiplex one or multiple MAC-es PDUs into a single MAC-e PDU, to be transmitted in the next TTI, as instructed by the E-TFC selection function. It is also responsible for managing and setting the TSN per logical channel for each MAC-es PDU.
- E-TFC selection:
 

This entity is responsible for E-TFC selection according to the scheduling information, Relative Grants (FDD only) and Absolute Grants, received from UTRAN via L1 and Serving Grant value signalled through RRC, and for arbitration among the different flows mapped on the E-DCH. The detailed configuration of the E-TFC entity is provided by RRC over the MAC-Control SAP. The E-TFC selection function controls the multiplexing function.

- Scheduling Access Control (3.84/7.68 Mcps TDD only):  
 The Scheduling Access Control entity is responsible for routing associated uplink signalling via E-UCCH (in the case that E-DCH resources are assigned) or via E-RUCCH (in the case that no E-DCH resources are assigned). It is also responsible for obtaining and formatting the appropriate information to be carried on E-UCCH/E-RUCCH.

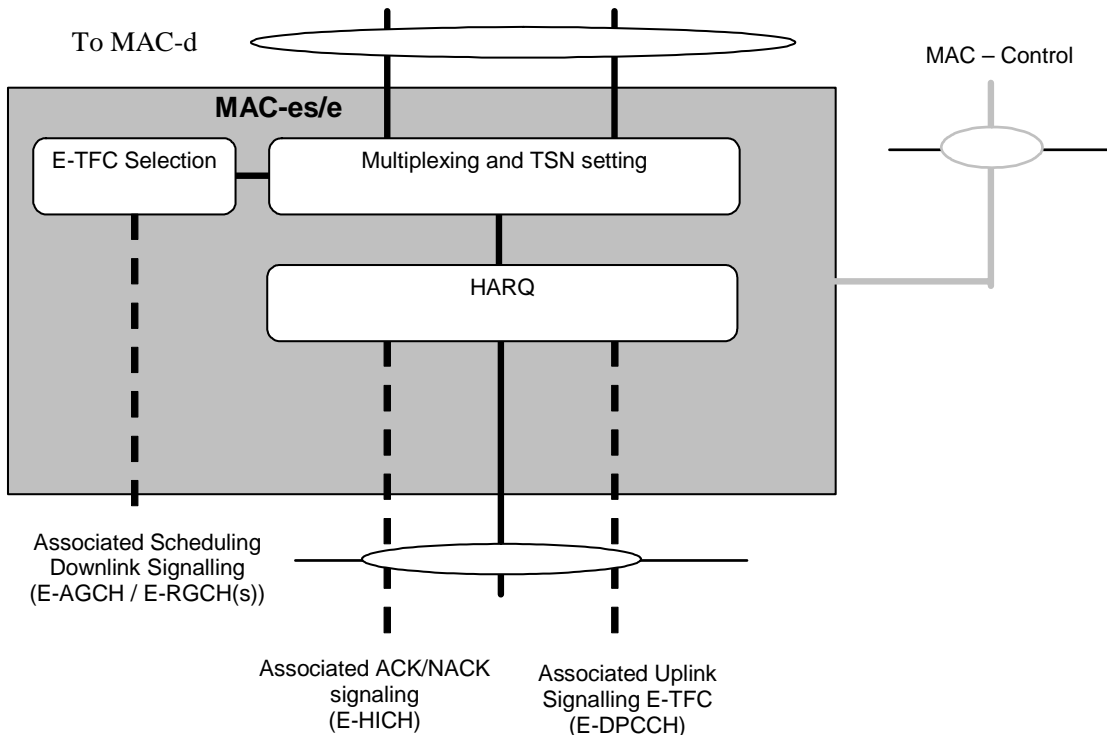

Figure 4.2.3.4.1a: UE side MAC architecture / MAC-e/es details (FDD)

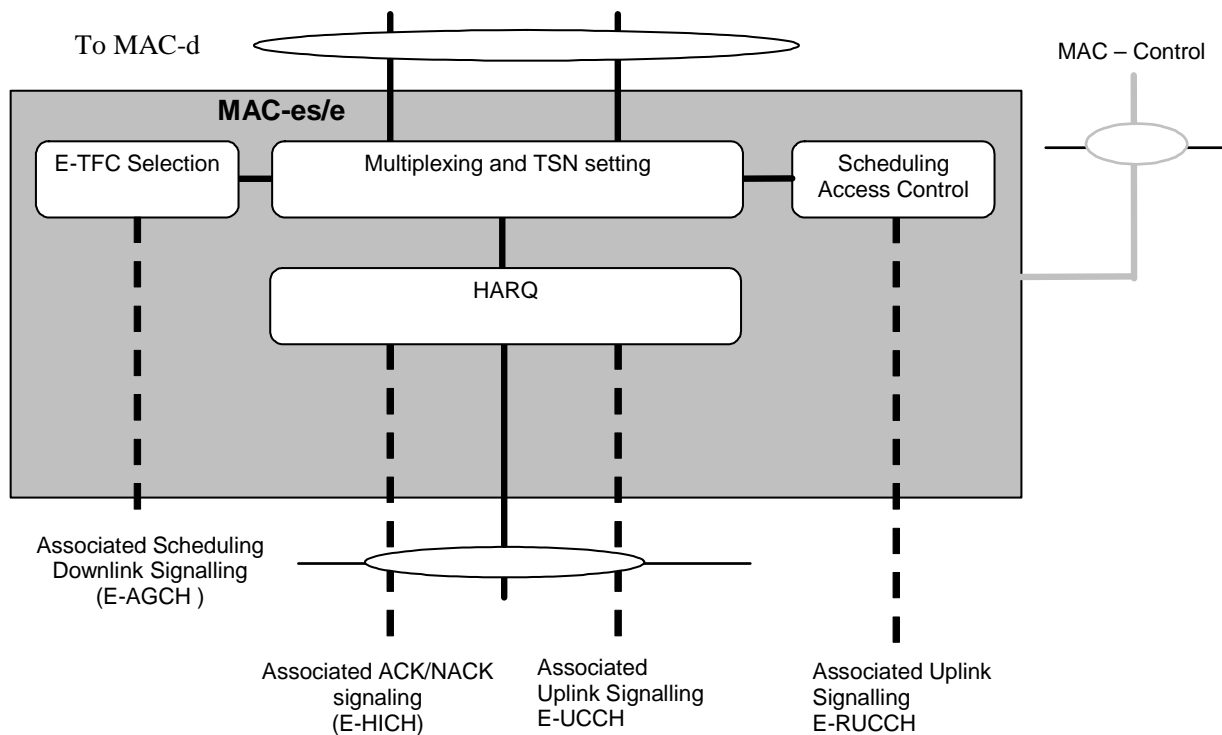

Figure 4.2.3.4.1b: UE side MAC architecture / MAC-e/es details (TDD)

## 4.2.4 Traffic Related Architecture - UTRAN Side

Figure 4.2.4.1 illustrates the connectivity between the MAC entities from the UTRAN side.

It is similar to the UE case with the exception that there will be one MAC-d for each UE and each UE (MAC-d) that is associated with a particular cell may be associated with that cell's MAC-c/sh/m.

MAC-c/sh/m is located in the controlling RNC while MAC-d is located in the serving RNC. MAC-hs is located in the Node B. The MAC-d PDUs to be transmitted are transferred from MAC-c/sh/m to the MAC-hs via the Iub interface in case of configuration with MAC-c/sh/m, or from the MAC-d via Iur/Iub in case of configuration without MAC-c/sh/m.

For each UE that uses E-DCH, one MAC-e entity per Node-B and one MAC-es entity in the SRNC are configured. MAC-e, located in the Node B, controls access to the E-DCH and is connected to MAC-es, located in the SRNC. MAC-es is further connected to MAC-d. There is one transport bearer set up per E-DCH MAC-d flow.

The MAC Control SAP is used to transfer Control information to each MAC entity belonging to one UE.

The associated signalling shown in the figure illustrates the exchange of information between layer 1 and layer 2 provided by primitives shown in [3].

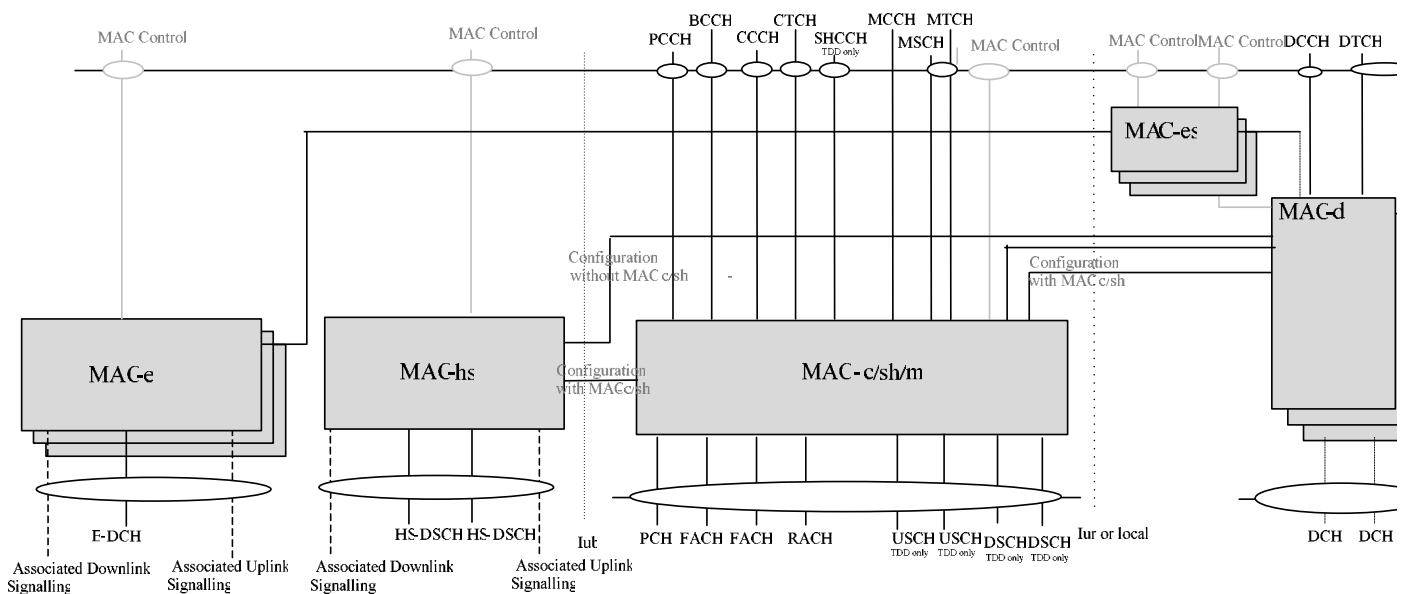

Figure 4.2.4.1: UTRAN side MAC architecture

### 4.2.4.1 MAC-c/sh/m entity – UTRAN Side

Figure 4.2.4.1.1 shows the UTRAN side MAC-c/sh/m entity. The following functionality is covered:

- Scheduling – Buffering – Priority Handling;
  - this function manages FACH and for TDD DSCH resources between the UEs and between data flows according to their priority and delay requirements set by higher layers.
- TCTF MUX
  - this function represents the handling (insertion for downlink channels and detection and deletion for uplink channels) of the TCTF field in the MAC header, and the respective mapping between logical and transport channels. The TCTF field indicates the common logical channel type, or if a dedicated logical channel is used;

- UE Id Mux;
  - for dedicated type logical channels, the UE Id field in the MAC header is used to distinguish between UEs;
- MBMS Id Mux;
  - for MTCH channels, the MBMS Id field in the MAC header is used to distinguish between MBMS services;
- TFC selection:
  - in the downlink, transport format combination selection is done for FACH and PCH and for TDD DSCHs;
- Demultiplex;
  - for TDD operation the demultiplex function is used to separate USCH data from different UEs, i.e. to be transferred to different MAC-d entities;
- DL code allocation;
  - for TDD this function is used to indicate the code used on the DSCH;
- Flow control;
  - a flow control function exists toward MAC-d to limit buffering between MAC-d and MAC-c/sh/m entities. a flow control function also exists towards MAC-hs in case of configuration with MAC-c/sh/m.

The RLC provides RLC-PDUs to the MAC, which fit into the available transport blocks on the transport channels.

There is one MAC-c/sh/m entity in the UTRAN for each cell;

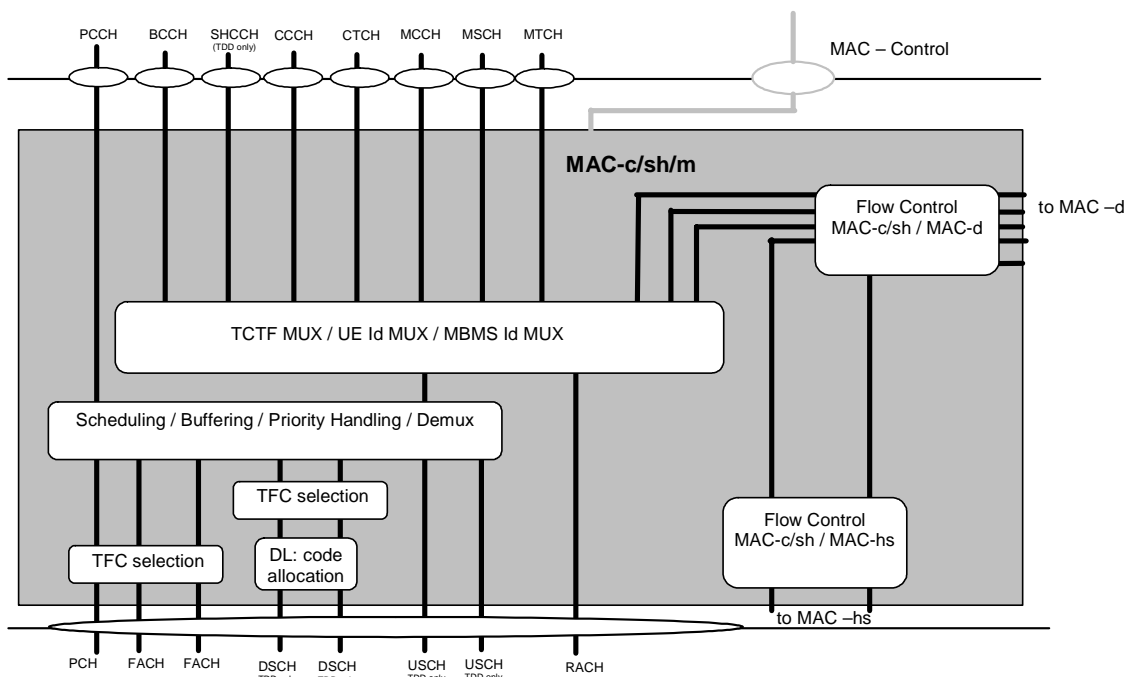

Figure 4.2.4.1.1: UTRAN side MAC architecture / MAC-c/sh/m details

#### 4.2.4.2 MAC-d entity – UTRAN Side

Figure 4.2.4.2.1 shows the UTRAN side MAC-d entity.

The following functionality is covered:

- Transport Channel type switching:
  - Transport Channel type switching is performed by this entity, based on decision taken by RRC; this is related to a change of radio resources. If requested by RRC, MAC shall switch the mapping of one designated logical channel between common and dedicated transport channels.
- C/T MUX box;
  - the function includes the C/T field when multiplexing of several dedicated logical channels onto one transport channel (other than HS-DSCH) or one MAC-d flow (HS-DSCH) is used.
- Priority setting;
  - This function is responsible for priority setting on data received from DCCH / DTCH;
- Cipherring;
  - Cipherring for transparent mode data to be cipherrered is performed in MAC-d. Details about cipherring can be found in [10].
- Decipherring;
  - Decipherring for cipherrered transparent mode data is performed in MAC-d. Details about cipherring can be found in [10].
- DL Scheduling/Priority handling;
  - in the downlink, scheduling and priority handling of transport channels is performed within the allowed transport format combinations of the TFCS assigned by the RRC.
- Flow Control;
  - a flow control function exists toward MAC-c/sh/m to limit buffering between MAC-d and MAC-c/sh/m entities. This function is intended to limit layer 2 signalling latency and reduce discarded and retransmitted data as a result of FACH or for TDD DSCH congestion. For the Iur interface this is specified in [11]. A flow control function also exists towards MAC-hs in case of configuration without MAC-c/sh/m, see subclause 4.2.4.2.

A MAC-d entity using common channels other than the high speed downlink shared channel is connected to a MAC-c/sh/m entity that handles the scheduling of the common channels to which the UE is assigned and DL (FACH) priority identification to MAC-c/sh/m;

A MAC-d entity using downlink shared channel is connected to a MAC-c/sh/m entity that handles the shared channels to which the UE is assigned and indicates the level of priority of each PDU to MAC-c/sh/m;

A MAC-d entity using the high speed downlink shared channel may be connected to a MAC-c/sh/m entity that in turn is connected to the MAC-hs entity in the Node B (configuration with MAC-c/sh/m); alternately, a MAC-d entity using the high speed downlink shared channel may be connected to the MAC-hs entity in the Node B in case of configuration without MAC-c/sh/m.

A MAC-d entity using the enhanced dedicated transport channel (Uplink only) is connected to a MAC-es entity that handles the re-ordering and combining of data received from different Node Bs. Given that the MAC-es is collocated in the SRNC, it is not necessary to flow control this connection. The MAC-es indicates the logical channel for which the data is intended, to allow the MAC-d to route it appropriately.

A MAC-d entity is responsible for mapping dedicated logical channels onto the available dedicated transport channels or routing the data received on a DCCH or DTCH to MAC-c/sh/m or to MAC-hs.

One dedicated logical channel can be mapped simultaneously on DCH and DSCH in TDD mode. Different scheduling mechanisms apply for DCH and DSCH. One dedicated logical channel can be mapped simultaneously on DCH and HS-DSCH.

There is one MAC-d entity in the UTRAN for each UE that has one or more dedicated logical channels to or from the UTRAN.

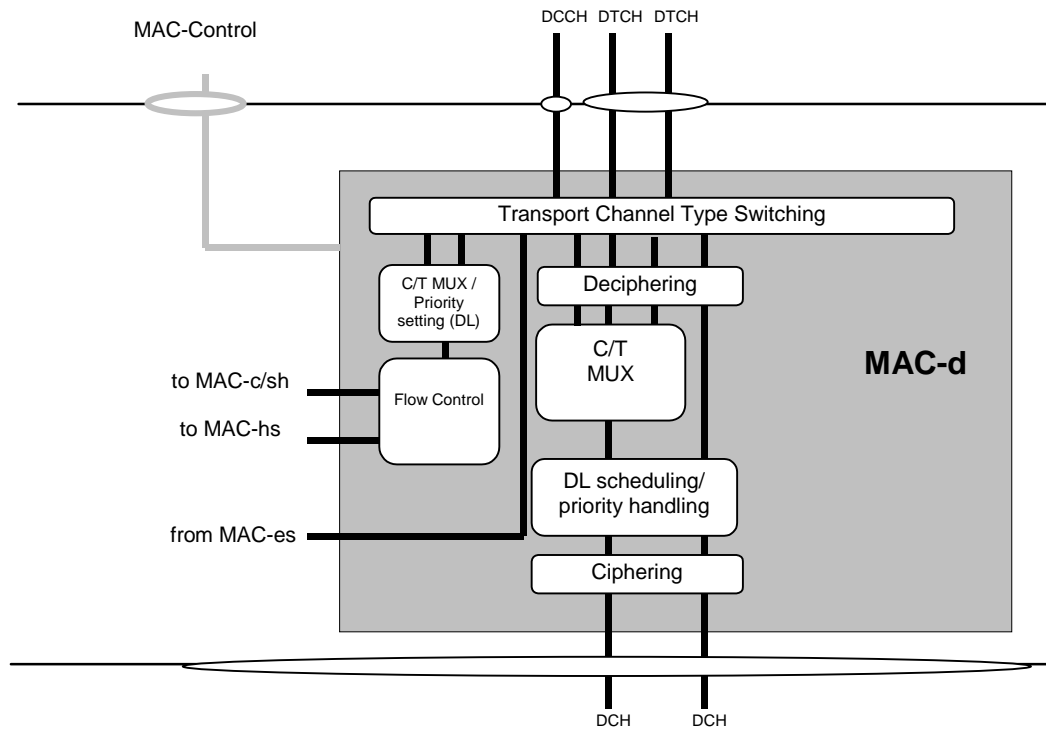

Figure 4.2.4.2.1: UTRAN side MAC architecture / MAC-d details

#### 4.2.4.3 MAC-hs entity – UTRAN Side

There is one MAC-hs entity in the UTRAN for each cell that supports HS-DSCH transmission. The MAC-hs is responsible for handling the data transmitted on the HS-DSCH. Furthermore it is responsible for the management of the physical resources allocated to HSDPA. MAC-hs receives configuration parameters from the RRC layer via the MAC-Control SAP. There should be priority handling per MAC-d PDU in the MAC-hs. The MAC-hs is comprised of four different functional entities:

- Flow Control:
 

This is the companion flow control function to the flow control function in the MAC-c/sh/m in case of configuration with MAC-c/sh/m and MAC-d in case of configuration without MAC-c/sh/m. Both entities together provide a controlled data flow between the MAC-c/sh/m and the MAC-hs (Configuration with MAC-c/sh/m) or the MAC-d and MAC-hs (Configuration without MAC-c/sh/m) taking the transmission capabilities of the air interface into account in a dynamic manner. This function is intended to limit layer 2 signalling latency and reduce discarded and retransmitted data as a result of HS-DSCH congestion. Flow control is provided independently by MAC-d flow for a given MAC-hs entity.
- Scheduling/Priority Handling:
 

This function manages HS-DSCH resources between HARQ entities and data flows according to their priority. Based on status reports from associated uplink signalling either new transmission or retransmission is determined. Further it determines the Queue ID and TSN for each new MAC-hs PDU being serviced, and in the case of TDD the HCSN is determined. A new transmission can be initiated instead of a pending retransmission at any time to support the priority handling.



- HARQ:  
One HARQ entity handles the hybrid ARQ functionality for one user. One HARQ entity is capable of supporting multiple instances (HARQ process) of stop and wait HARQ protocols. There shall be one HARQ process per HS-DSCH per TTI.
- TFRC selection:  
Selection of an appropriate transport format and resource for the data to be transmitted on HS-DSCH.

The associated signalling shown in the figure illustrates the exchange of information between layer 1 and layer 2 provided by primitives shown in [3].

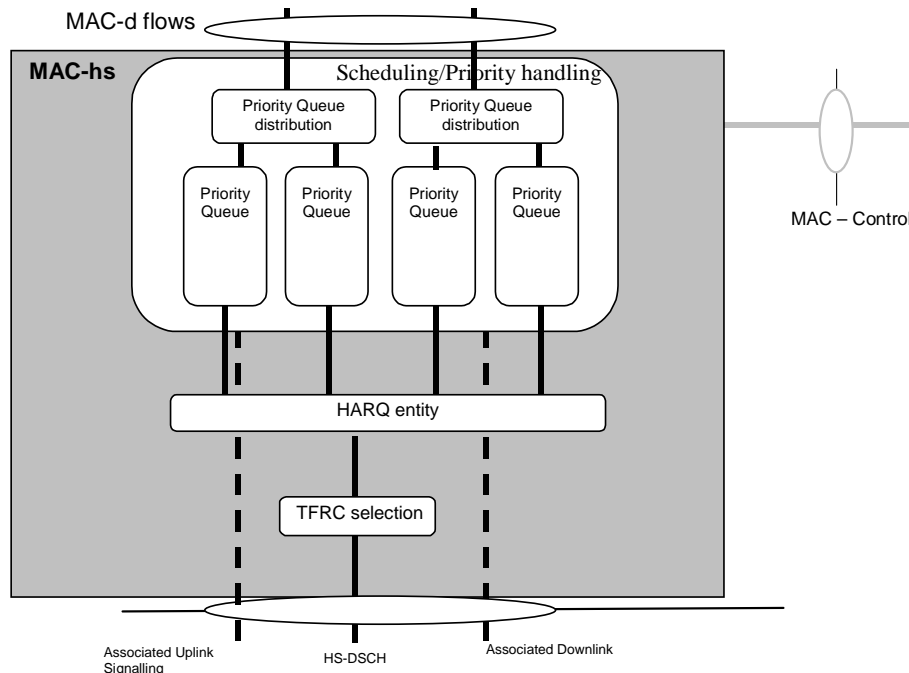

Figure 4.2.4.3.1: UTRAN side MAC architecture / MAC-hs details

#### 4.2.4.4 MAC-es entity – UTRAN Side

For each UE, there is one MAC-es entity in the SRNC. The MAC-es sublayer handles E-DCH specific functionality, which is not covered in the MAC-e entity in Node B. In the model below, the MAC-es comprises the following entities:

- Reordering Queue Distribution:  
The reordering queue distribution function routes the MAC-es PDUs to the correct reordering buffer based on the SRNC configuration.
- Reordering:  
This function reorders received MAC-es PDUs according to the received TSN and Node-B tagging i.e. (CFN, subframe number). MAC-es PDUs with consecutive TSNs are delivered to the disassembly function upon reception. Mechanisms for reordering MAC-es PDUs received out-of-order are left up to the implementation. There is one Re-ordering Process per logical channel.
- Macro diversity selection (FDD only):  
The function is performed in the MAC-es, in case of soft handover with multiple Node-Bs (The soft combining for all the cells of a Node-B takes place in the Node-B). This means that the reordering function receives MAC-es PDUs from each Node-B in the E-DCH active set. The exact implementation is not specified. However the model below is based on one Reordering Queue Distribution entity receiving all the MAC-d flow from all the Node-Bs, and one MAC-es entity per UE.
- Disassembly:  
The disassembly function is responsible for disassembly of MAC-es PDUs. When a MAC-es PDU is disassembled the MAC-es header is removed, the MAC-d PDU's are extracted and delivered to MAC-d.

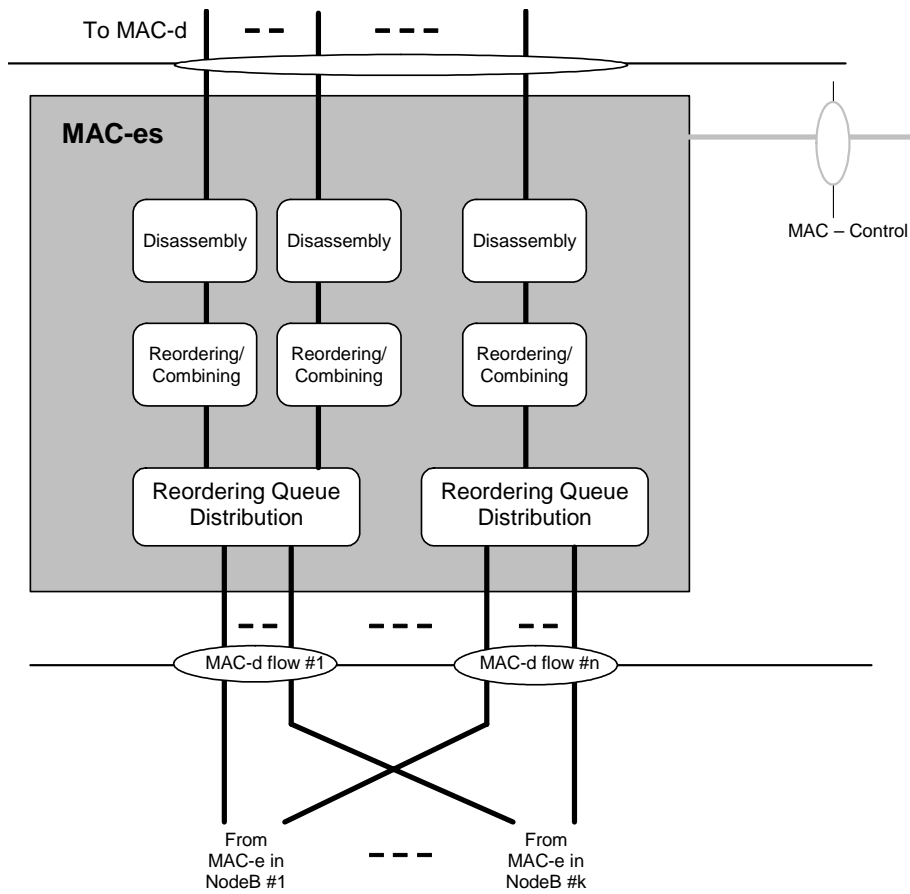
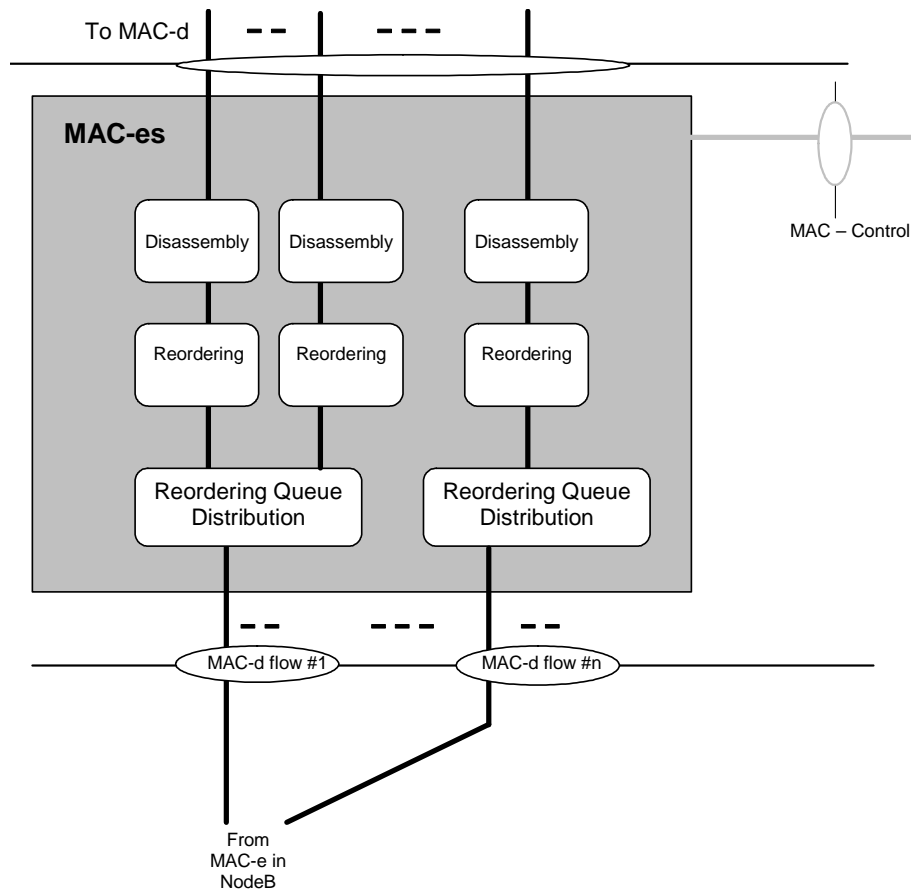

Figure 4.2.4.4-1: UTRAN side MAC architecture / MAC-es details (SHO case, FDD only)



**Figure 4.2.4.4-1b: UTRAN side MAC architecture / MAC-es details (TDD)**

#### 4.2.4.5 MAC-e entity – UTRAN Side

There is one MAC-e entity in the Node B for each UE and one E-DCH scheduler function in the Node-B. The MAC-e and E-DCH scheduler handle HSUPA specific functions in the Node B. In the model below, the MAC-e and E-DCH scheduler comprises the following entities:

- E-DCH Scheduling:  
This function manages E-DCH cell resources between UEs. Based on scheduling requests, Scheduling Grants are determined and transmitted. The general principles of the E-DCH scheduling are described in subclauses 11.8.2.3 and 11.9.2.3 below. However implementation is not specified (i.e. depends on RRM strategy).
- E-DCH Control:  
The E-DCH control entity is responsible for reception of scheduling requests and transmission of Scheduling Grants. The general principles of the E-DCH scheduling are described in subclauses 11.8.2.3 and 11.9.2.3 below.
- De-multiplexing:  
This function provides de-multiplexing of MAC-e PDUs. MAC-es PDUs are forwarded to the associated MAC-d flow.
- HARQ:  
One HARQ entity is capable of supporting multiple instances (HARQ processes) of stop and wait HARQ protocols. Each process is responsible for generating ACKs or NACKs indicating delivery status of E-DCH transmissions. The HARQ entity handles all tasks that are required for the HARQ protocol.

The associated signalling shown in the figures illustrates the exchange of information between layer 1 and layer 2 provided by primitives.

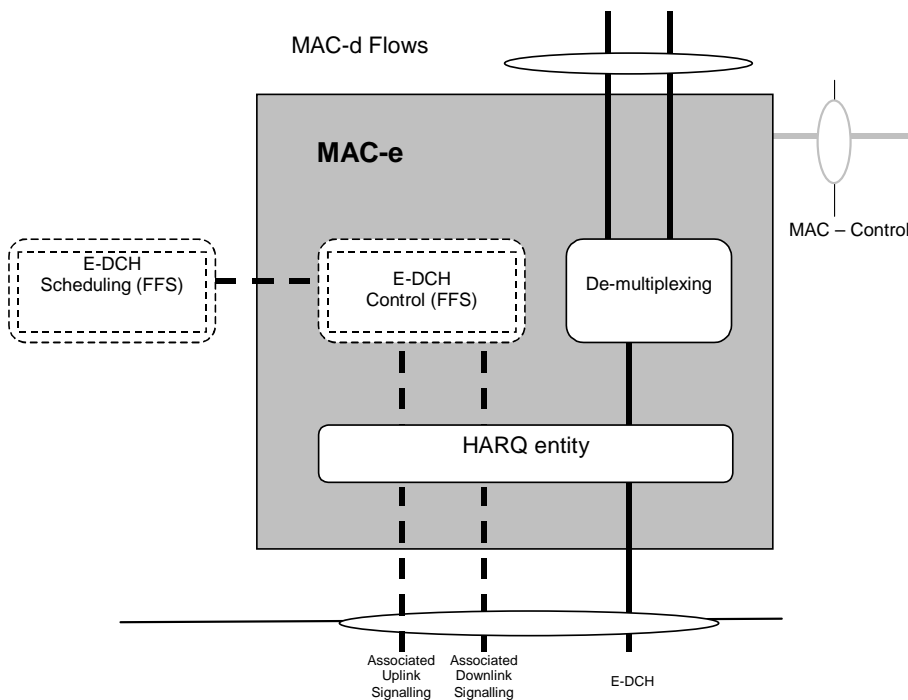

Figure 4.2.4.5-1a: UTRAN side MAC architecture / MAC-e details (FDD)

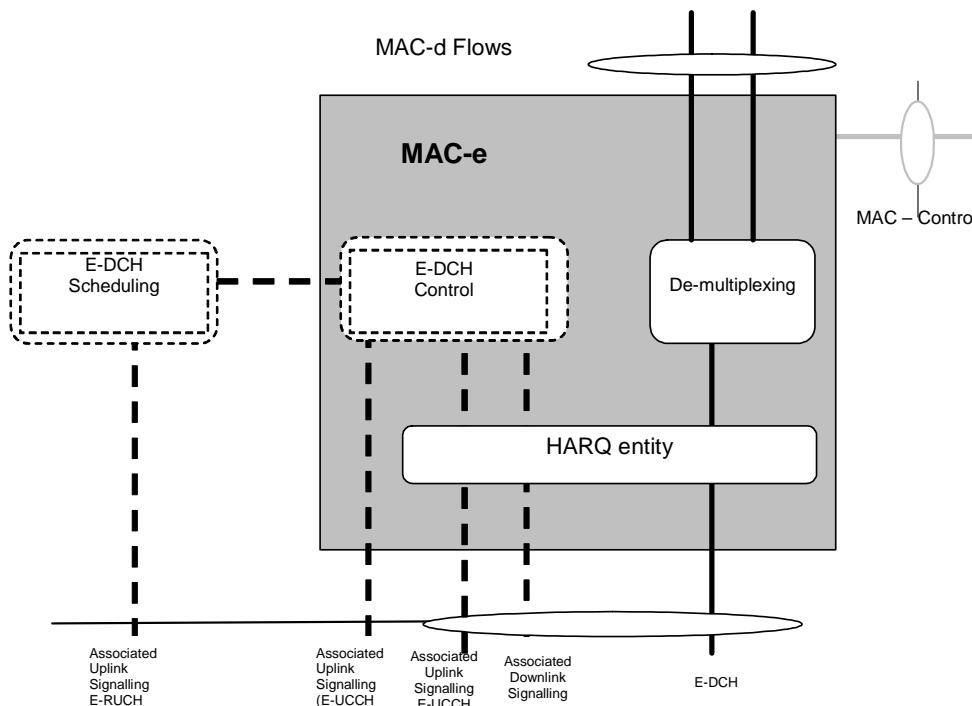

Figure 4.2.4.5-1b: UTRAN side MAC architecture / MAC-e details (TDD)

### 4.3 Channel structure

The MAC operates on the channels defined below; the transport channels are described between MAC and Layer 1, the logical channels are described between MAC and RLC.

The following subclauses provide an overview, the normative description can be found in [2] and [3] respectively.

### 4.3.1 Transport channels

Common transport channel types are:

- Random Access Channel(s) (RACH);
- Forward Access Channel(s) (FACH);
- Downlink Shared Channel(s) (DSCH), for TDD operation only;
- High Speed Downlink Shared Channel(s) (HS-DSCH);
- Uplink Shared Channel(s) (USCH), for TDD operation only;
- Broadcast Channel (BCH);
- Paging Channel (PCH).

Dedicated transport channel types are:

- Dedicated Channel (DCH);
- Enhanced Dedicated Channel (E-DCH) for UL FDD and 3.84/7.68 Mcps TDD operation only.

### 4.3.2 Logical Channels

The MAC layer provides data transfer services on logical channels. A set of logical channel types is defined for different kinds of data transfer services as offered by MAC.

Each logical channel type is defined by what type of information is transferred.

#### 4.3.2.1 Logical channel structure

The configuration of logical channel types is depicted in figure 4.3.2.1.

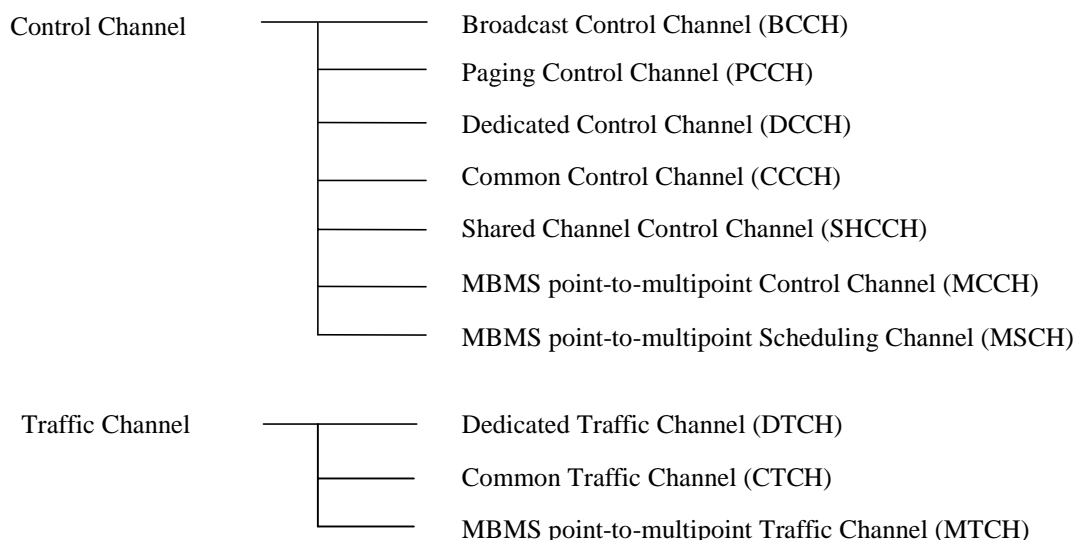

**Figure 4.3.2.1: Logical channel structure**

#### 4.3.2.2 Control Channels

Following control channels are used for transfer of control plane information only:

- Broadcast Control Channel (BCCH);
- Paging Control Channel (PCCH);
- Common Control Channel (CCCH);
- Dedicated Control Channel (DCCH);
- Shared Channel Control Channel (SHCCH);
- MBMS point-to-multipoint Control Channel (MCCH);
- MBMS point-to-multipoint Scheduling Channel (MSCH)

#### 4.3.2.3 Traffic Channels

Following traffic channels are used for the transfer of user plane information only:

- Dedicated Traffic Channel (DTCH);
- Common Traffic Channel (CTCH);
- MBMS point-to-multipoint Traffic Channel (MTCH).

---

## 5 Services provided to upper layers

This clause describes the different services provided by the MAC to higher layers. For a detailed description of the following functions see [2].

### 5.1 Description of Services provided to upper layers

- Data transfer: This service provides unacknowledged transfer of MAC SDUs between peer MAC entities without data segmentation.
- Reallocation of radio resources and MAC parameters: This service performs on request of RRC execution of radio resource reallocation and change of MAC parameters.
- Reporting of measurements: Local measurements are reported to RRC.

---

## 6 Functions

### 6.1 Description of the MAC functions

The functions of MAC include:

- mapping between logical channels and transport channels;
- selection of appropriate Transport Format for each Transport Channel depending on instantaneous source rate;
- priority handling between data flows of one UE;
- priority handling between UEs by means of dynamic scheduling;
- identification of UEs on common transport channels;
- identification of MBMS services on common transport channels;
- multiplexing/demultiplexing of upper layer PDUs into/from transport blocks delivered to/from the physical layer on common transport channels;

- multiplexing/demultiplexing of upper layer PDUs into/from transport block sets delivered to/from the physical layer on dedicated transport channels;
- traffic volume measurement;
- Transport Channel type switching;
- ciphering for transparent mode RLC;
- Access Service Class selection for RACH transmission;
- control of HS-DSCH transmission and reception including support of HARQ;
- HS-DSCH Provided Bit Rate measurement;
- control of E-DCH transmission and reception including support of HARQ;
- generation of uplink scheduling information to assist with E-DCH resource allocation;
- E-DCH Provided Bit-rate measurement.

## 6.2 Relation between MAC Functions and Transport Channels

### 6.2.1 Relation between MAC Functions and Transport Channels in UTRAN

Table 6.2.1.1: UTRAN MAC functions corresponding to the transport channel

Associated MAC Functions	Logical Ch	Transport Ch	TF Selection	Priority handling between UEs	Priority handling (one UE)	Scheduling	Identification of UEs or MBMS services	Mux/Demux on common transport channels	Mux/Demux on dedicated transport channels	HARQ support
Uplink (Rx)	CCCH	RACH						X		
	DCCH	RACH					X	X		
	DCCH	DCH							X	
	DTCH	RACH					X	X		
	DTCH	DCH							X	
	SHCCH	RACH					X	X		
	SHCCH	USCH						X		
	DTCH	USCH						X		
	DCCH	USCH						X		
	DTCH	E-DCH				X			X	X
	DCCH	E-DCH				X			X	X
Downlink (Tx)	BCCH	BCH				X				
	BCCH	FACH	X			X		X		
	PCCH	PCH	X			X				
	CCCH	FACH	X	X		X		X		
	CTCH	FACH	X			X		X		
	MCCH	FACH	X			X		X		
	MSCH	FACH	X			X		X		
	MTCH	FACH	X			X	X	X		
	CTCH	FACH	X			X		X		
	DCCH	FACH	X	X		X	X	X		
	DCCH	DSCH	X	X			X	X		
	DCCH	DCH	X		X				X	
	DCCH	HS-DSCH	X (1)	X	X	X	X	X	X	X
	DTCH	FACH	X	X		X	X	X		
	DTCH	DSCH	X	X			X	X		
	DTCH	DCH	X		X				X	
	DTCH	HS-DSCH	X (1)	X	X	X	X	X		X
SHCCH	FACH	X	X		X		X			
SHCCH	DSCH	X	X				X			

NOTE 1: In case of HS-DSCH the TF selection is replaced by TFRC selection.



## 6.2.2 Relation of MAC Functions and Transport Channels in UE

Table 6.2.2.1: UE MAC functions corresponding to the transport channel

Associated MAC Functions	Logical Ch	Transport Ch	TF Selection	Priority handling (one UE)	Identification	Mux/Demux on common transport channels	Mux/Demux on dedicated transport channels	HARQ support
Uplink (Tx)	CCCH	RACH				X		
	DCCH	RACH	X	X	X	X		
	DCCH	DCH	X	X			X	
	DTCH	RACH	X	X	X	X		
	DTCH	DCH	X	X			X	
	SHCCH	RACH				X		
	SHCCH	USCH	X	X		X		
	DCCH	USCH	X	X		X		
	DTCH	USCH	X	X		X		
	DCCH	E-DCH	X	X				X
DTCH	E-DCH	X	X				X	X
Downlink (Rx)	BCCH	BCH						
	BCCH	FACH				X		
	PCCH	PCH						
	CCCH	FACH				X		
	CTCH	FACH				X		
	MCCH	FACH				X		
	MSCH	FACH				X		
	MTCH	FACH			X	X		
	DCCH	FACH			X	X		
	DCCH	DSCH				X		
	DCCH	DCH					X	
	DCCH	HS-DSCH			X	X		X
	DTCH	FACH			X	X		
	DTCH	DSCH				X		
	DTCH	DCH					X	
DTCH	HS-DSCH			X	X		X	
SHCCH	FACH				X			
SHCCH	DSCH				X			

---

## 7 Services expected from physical layer

The physical layer offers information transfer services to MAC. For detailed description, see [3].

---

## 8 Elements for layer-to-layer communication

The interaction between the MAC layer and other layers are described in terms of primitives where the primitives represent the logical exchange of information and control between the MAC layer and other layers. The primitives shall not specify or constrain implementations. The MAC is connected to layer 1, RLC and RRC. The following subclauses describe the primitives between these layers.

## 8.1 Primitives between layers 1 and 2

### 8.1.1 Primitives

The primitives are described in [3].

### 8.1.2 Parameters

a) Transport Format Resource Indicator (TFRI) for HS-DSCH:

- For HS-DSCH the Transport Block size is derived from the TFRI value signalled on the HS-SCCH. The mapping between TFRI value and Transport Block size is specified in subclause 9.2.3.

b) HARQ information for E-DCH:

- ACK/NACK information (details specified in subclause 9.2.5.1).
- RSN information (details specified in subclause 9.2.5.1).
- Power offset (details specified in subclauses 11.8.1.4 and 11.9.1.4).
- E-TFCI (details specified in subclauses 11.8.1.4 and 11.9.1.4).

c) Relative Grant information for E-DCH (FDD only):

- Serving Relative Grant information (details specified in subclause 9.2.5.2.1).
- Non-serving Relative Grant information (details specified in subclause 9.2.5.2.1).

d) Absolute Grant information for E-DCH (details specified in subclause 9.2.5.2.2 for FDD and in 9.2.6.2.1 for 3.84/7.68 Mcps TDD).

- Identity Type for E-DCH (FDD only).
- Absolute Grant Value.
- Absolute Grant Scope (FDD only).
- Absolute Grant Code Resource (3.84/7.68 Mcps TDD only)
- Absolute Grant Timeslot Resource (3.84/7.68 Mcps TDD only)
- Absolute Grant Resource Duration (3.84/7.68 Mcps TDD only)

e) Happy Bit (FDD only, details specified in subclause 9.2.5.2.2).

## 8.2 Primitives between MAC and RLC

### 8.2.1 Primitives

The primitives between MAC layer and RLC layer are shown in table 8.2.1.1.

**Table 8.2.1.1: Primitives between MAC layer and RLC layer**

Generic Name	Parameter			
	Request	Indication	Response	Confirm
<b>MAC-DATA</b>	Data, BO, UE-ID type indicator, RLC Entity Info	Data, No_TB, TD (note), Error indication		
<b>MAC-STATUS</b>		No_PDU, PDU_Size, TX status, Status_Report_REQ	BO, RLC Entity Info	

NOTE: TDD only.

**MAC-DATA-Req/Ind:**

- MAC-DATA-Req primitive is used to request that an upper layer PDU be sent using the procedures for the information transfer service;
- MAC-DATA-Ind primitive indicates the arrival of upper layer PDUs received within one transmission time interval by means of the information transfer service.

**MAC-STATUS-Ind/Resp:**

- MAC-STATUS-Ind primitive indicates to RLC for each logical channel the rate at which it may transfer data to MAC. Parameters are the number of PDUs that can be transferred in each transmission time interval and the PDU size; it is possible that MAC would use this primitive to indicate that it expects the current buffer occupancy of the addressed logical channel in order to provide for optimised TFC selection on transport channels with long transmission time interval. At the UE, MAC-STATUS-Ind primitive is also used to indicate from MAC to RLC that MAC has requested data transmission by PHY (i.e. PHY-DATA-REQ has been submitted, see Fig. 11.2.2.1), or that transmission of an RLC PDU on RACH has failed due to exceeded preamble ramping cycle counter.
- MAC-STATUS-Resp primitive enables RLC to acknowledge a MAC-STATUS-Ind. It is possible that RLC would use this primitive to indicate that it has nothing to send or that it is in a suspended state or to indicate the current buffer occupancy to MAC.

## 8.2.2 Parameters

## a) Data:

- it contains the RLC layer messages (RLC-PDU) to be transmitted, or the RLC layer messages that have been received by the MAC sub-layer.

## b) Number of transmitted transport blocks (No\_TB) :

- indicates the number of transport blocks transmitted by the peer entity within the transmission time interval, based on the TFI value.

## c) Buffer Occupancy (BO):

- the parameter Buffer Occupancy (BO) indicates for each logical channel the amount of data in number of bytes that is available for transmission and retransmission in RLC layer. When MAC is connected to an AM RLC entity, control PDUs to be transmitted and RLC PDUs outside the RLC Tx window shall also be included in the BO. RLC PDUs that have been transmitted but not negatively acknowledged by the peer entity shall not be included in the BO.

## d) RX Timing Deviation (TD), TDD only:

- it contains the RX Timing Deviation as measured by the physical layer for the physical resources carrying the data of the Message Unit. This parameter is optional and only for Indication. It is needed for the transfer of the RX Timing Deviation measurement of RACH transmissions carrying CCCH data to RRC.

## e) Number of PDU (No\_PDU):

- specifies the number of PDUs that the RLC is permitted to transfer to MAC within a transmission time interval.
- f) PDU Size (PDU\_Size):
- specifies the size of PDU that can be transferred to MAC within a transmission time interval.
- g) UE-ID Type Indicator:
- indicates the UE-ID type to be included in MAC for a DCCH and DTCH when they are mapped onto a common transport channel (i.e. FACH, RACH in FDD). On the UE side UE-ID Type Indicator shall always be set to C-RNTI.
- h) TX status:
- when set to value "transmission unsuccessful" this parameter indicates to RLC that transmission of an RLC PDU failed in the previous Transmission Time Interval, when set to value "transmission successful" this parameter indicates to RLC that the requested RLC PDU(s) has been submitted for transmission by the physical layer.
- i) RLC Entity Info
- indicates to MAC the configuration parameters that are critical to TFC selection depending on its mode and the amount of data that could be transmitted at the next TTI. This primitive is meant to insure that MAC can perform TFC selection (see subclause 11.4).
- j) Error indication
- When a MAC SDU is delivered to upper layer, an error indication is given for the SDU to upper layer if an error indication for the SDU has been received from lower layer.
- k) Status\_Report\_REQ
- indicates to all AM RLC entities mapped on HS-DSCH to generate a status report when the MAC-hs resets.

## 8.3 Primitives between MAC and RRC

### 8.3.1 Primitives

The primitives between MAC and RRC are shown in table 8.3.1.1.

**Table 8.3.1.1: Primitives between MAC sub-layer and RRC**

Generic Name	Parameter			
	Request	Indication	Response	Confirm
<b>CMAC-CONFIG</b>	UE information elements, RB information elements, TrCH information elements, RACH transmission control elements, Ciphering elements, MBMS information elements, E-DCH configuration elements			
<b>CMAC-MEASUREMENT</b>	Measurement information elements	Measurement result		
<b>CMAC-STATUS</b>		Status info		

#### **CMAC-CONFIG-Req:**

- CMAC-CONFIG-Req is used to request for setup, release and configuration of a logical channel, e.g. RNTI allocation, switching the connection between logical channels and transport channels, TFCS update or scheduling priority of logical channel.

#### **CMAC-MEASUREMENT-Req/Ind:**

- CMAC-MEASUREMENT-Req is used by RRC to request MAC to perform measurements, e.g. traffic volume measurements;
- CMAC-MEASUREMENT-Ind is used to notify RRC of the measurement result.

#### CMAC-STATUS-Ind:

- CMAC-STATUS-Ind primitive notifies RRC of status information.

## 8.3.2 Parameters

See [7] for a detailed description of the UE, RB and TrCH information elements.

- a) UE information elements
  - S-RNTI
  - SRNC identity
  - C-RNTI
  - Activation time
  - Primary E-RNTI configured
  - Secondary E-RNTI configured
- b) RB information elements
  - RB multiplexing info (Transport channel identity, Logical channel identity, MAC logical channel priority)
  - DDI mapping table for E-DCH transmission
  - Indication whether the Logical channel is considered when the Scheduling Information is generated
- c) TrCH information elements
  - Transport Format Combination Set
  - MAC-hs reset indicator
  - MAC-es/e reset indicator
  - Re-ordering release timer (T1)
  - HARQ Profile parameters (power offset, maximum number of re-transmissions)
  - E-DCH TTI duration (FDD only)
  - Allowed combinations for multiplexing of MAC-d flows into MAC-e PDUs
  - E-DCH grant type of MAC-d flows (scheduled or non-scheduled)
  - List of HARQ processes on which non-scheduled grants are allowed (for FDD only, this is if the grant type is non-scheduled and the E-DCH TTI duration is 2ms)
- d) Measurement information elements
  - Reporting Quantity identifiers
  - Time interval to take an average or a variance (applicable when Average or Variance is Reporting Quantity)
- e) Measurement result
  - Reporting Quantity
- f) Status info
  - when set to value "transmission unsuccessful" this parameter indicates to RRC that transmission of a TM RLC PDU failed (due to e.g. Maximum number of preamble ramping cycles reached for RACH in FDD), when set to value "transmission successful" this parameter indicates to RRC that the requested TM RLC PDU(s) has been submitted for transmission by the physical layer.
- g) RACH transmission control elements
  - Set of ASC parameters (identifier for PRACH partitions, persistence values)
  - Maximum number of preamble ramping cycles (FDD) or synchronisation attempts (1.28 Mcps TDD)  $M_{\max}$
  - Minimum and maximum number of time units between two preamble ramping cycles,  $N_{\text{BO1min}}$  and  $N_{\text{BO1max}}$  (FDD only)
  - ASC for RRC CONNECTION REQUEST message
- h) Ciphering elements
  - Ciphering mode
  - Ciphering key
  - Ciphering sequence number
- i) (Void)

- j) MBMS information elements
  - MBMS Id
- k) E-DCH configuration elements
  - E-DPCCH to DPCCH power offset (FDD only)
  - Happy bit delay condition (FDD only)
  - E-TFCI table index
  - minimum set E-TFCI (FDD only)
  - Reference E-TFCI (FDD only)
  - Periodicities for Scheduling Information with and without grant (FDD only)
  - The code, timeslots and maximum power available per TDD resource unit per slot in TTIs designated for non-scheduled use by a given UE (3.84/7.68 Mcps TDD only)
  - The frames designated for non-scheduled use by a given UE (specified by means of a start frame number, repetition period and repetition length) (3.84/7.68 Mcps TDD only)
  - Scheduling Information power offset
  - List of HARQ processes on which scheduled grants are allowed (for FDD only, this is if the E-DCH TTI duration is 2ms)
  - Initial Serving Grant value and type (FDD only)
  - E-DCH maximum and minimum allowed coderates (3.84/7.68 Mcps TDD only)
  - A table of paired values, each pair consists of code rate and  $\beta$  normative value (3.84/7.68 Mcps TDD only).

## 9 Elements for peer-to-peer communication

### 9.1 Protocol data units

#### 9.1.1 General

A MAC PDU is a bit string, with a length not necessarily a multiple of 8 bits. In the drawings in clause 9.1, bit strings are represented by tables in which the first bit is the leftmost one on the first line of the table, the last bit is the rightmost on the last line of the table, and more generally the bit string is to be read from left to right and then in the reading order of the lines.

Depending on the provided service, MAC SDUs are bit strings with any non-null length, or bit strings with an integer number of octets in length. An SDU is included into a MAC PDU from first bit onward.

In the UE for the uplink, all MAC PDUs delivered to the physical layer within one TTI are defined as Transport Block Set (TBS). It consists of one or several Transport Blocks, each containing one MAC PDU. The Transport Blocks, shall be transmitted in the order as delivered from RLC. When multiplexing of RLC PDUs from different logical channels is performed on MAC, the order of all Transport Blocks originating from the same logical channel shall be the same as the order of the sequence delivered from RLC. The order of the different logical channels in a TBS is set by the MAC protocol.

#### 9.1.2 MAC PDU (not HS-DSCH or E-DCH)

A MAC PDU consists of an optional MAC header and a MAC Service Data Unit (MAC SDU), see figure 9.1.2.1. Both the MAC header and the MAC SDU are of variable size.

The content and the size of the MAC header depends on the type of the logical channel, and in some cases none of the parameters in the MAC header are needed.

The size of the MAC-SDU depends on the size of the RLC-PDU, which is defined during the setup procedure.

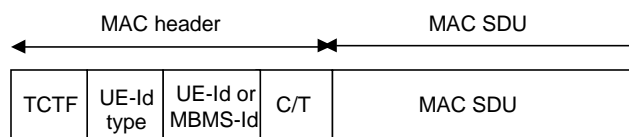

Figure 9.1.2.1: MAC PDU

### 9.1.3 MAC-d PDU (HS-DSCH)

For HS-DSCH the MAC-d PDU format equals the MAC PDU format for the non HS-DSCH case.

### 9.1.4 MAC PDU (HS-DSCH)

In case of HS-DSCH a MAC PDU consists of one MAC-hs header and one or more MAC-hs SDUs where each MAC-hs SDU equals a MAC-d PDU. A maximum of one MAC-hs PDU can be transmitted in a TTI per UE. The MAC-hs header is of variable size. The MAC-hs SDUs in one TTI belongs to the same reordering queue.

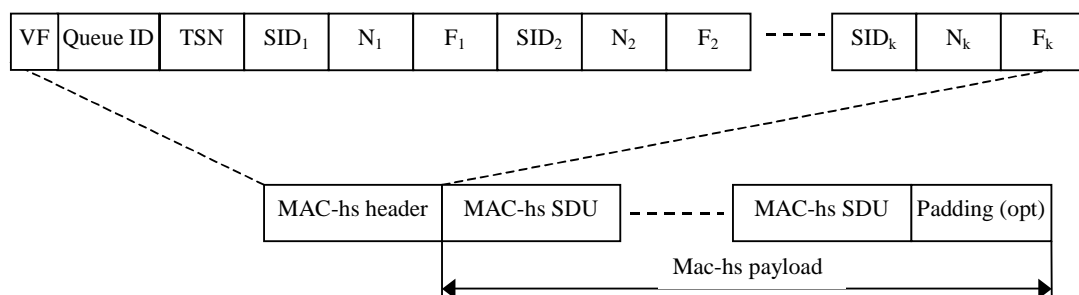

Figure 9.1.4.1: MAC-hs PDU

### 9.1.5 MAC PDU (E-DCH)

In the case of E-DCH there are two MAC sublayers, MAC-e and MAC-es. MAC-es sits on top of MAC-e and receives PDUs directly from MAC-d. MAC-es SDUs (i.e. MAC-d PDUs) of the same size, coming from a particular logical channel are multiplexed together into a single MAC-es payload. There is one and only one MAC-es PDU per logical channel per TTI (since only one MAC-d PDU size is allowed per logical channel per TTI). To this payload is prepended the MAC-es header (see subclause 9.2.4.1). The number of PDUs, as well as the one DDI identifying the logical channel, the MAC-d flow and the MAC-es SDU size are included as part of the MAC-e header. In case sufficient space is left in the E-DCH transport block or if Scheduling Information needs to be transmitted, an SI will be included at the end of the MAC-e PDU (see subclause 9.2.4.2). Multiple MAC-es PDUs from multiple logical channels, but only one MAC-e PDU can be transmitted in a TTI.

In the example MAC-e PDU shown in figure 9.1.5.2a, the field  $DDI_0$  is referring to the specific DDI value that indicates that there is an SI included in the MAC-e PDU (see subclause 9.2.4.2). This header will not be associated with a new MAC-es payload. Figure 9.1.5.2b shows the MAC-e PDU format when SI is sent alone. In this case  $DDI_0$  is not included in the MAC-e PDU and E-TFCI value 0 is used.

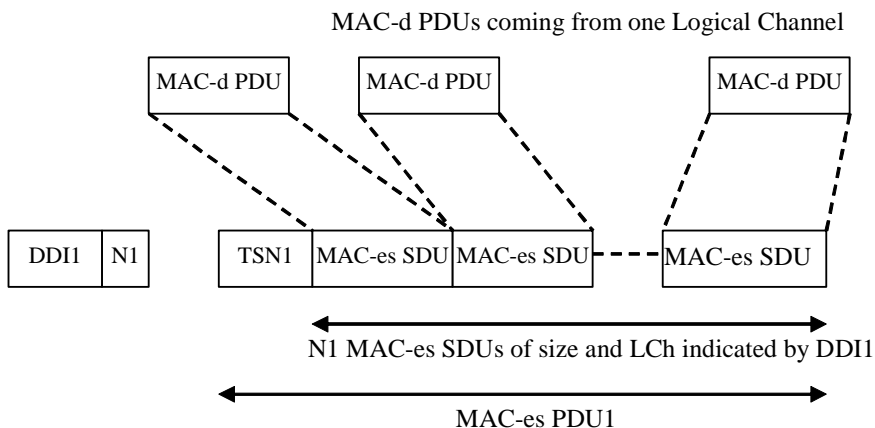

Figure 9.1.5.1 MAC-es PDU

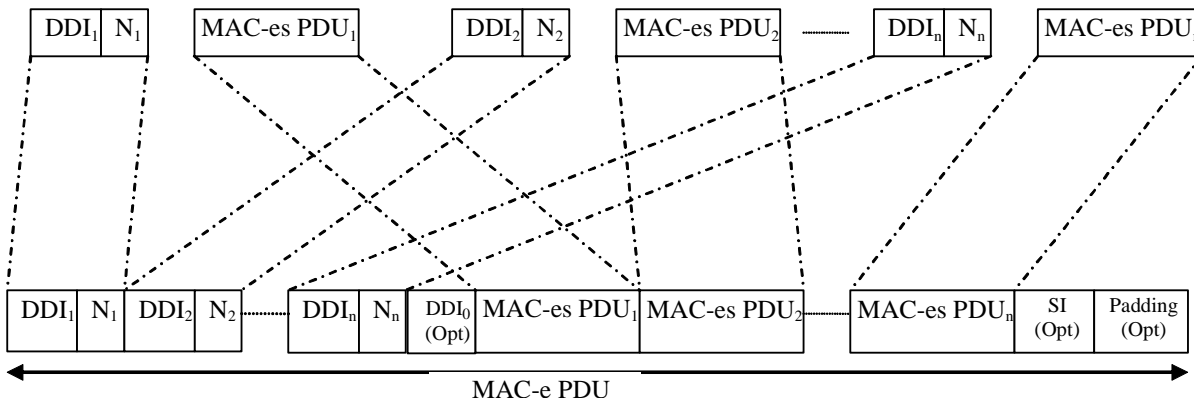

Figure 9.1.5.2a: MAC-e PDU

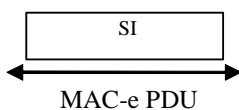

Figure 9.1.5.2b: MAC-e PDU (SI is sent alone)

## 9.2 Formats and parameters

NOTE: MAC header field encodings as specified in this clause with designation "Reserved" are forbidden to be used by a sender in this version of the protocol.

### 9.2.1 MAC PDU: Parameters of the MAC PDU header (not HS-DSCH or E-DCH) and MAC-d PDU header (HS-DSCH and E-DCH)

The following fields are defined for the MAC header for transport channels other than HS-DSCH and for the MAC-d PDU header for HS-DSCH:



- Target Channel Type Field

The TCTF field is a flag that provides identification of the logical channel class on FACH, USCH (TDD only), DSCH (TDD only) and RACH transport channels, i.e. whether it carries BCCH, CCCH, CTCH, SHCCH, MCCH, MTCH, MSCH or dedicated logical channel information. The size and coding of TCTF for FDD and TDD are shown in tables 9.2.1.1, 9.2.1.2, 9.2.1.3, 9.2.1.4 and 9.2.1.5. Note that the size of the TCTF field of FACH for FDD is 2,4 or 8 bits and for TDD is either 3 or 5 bits depending on the value of the 3 most significant bits. The TCTF of the RACH for TDD is either 2 or 4 bits depending on the value of the 2 most significant bits.

**Table 9.2.1.1: Coding of the Target Channel Type Field on FACH for TDD**

TCTF	Designation
000	BCCH
001	CCCH
010	CTCH
01100	DCCH or DTCH over FACH
01101	MCCH
01110	MTCH
01111	MSCH
100	SHCCH
101-111	Reserved (PDUs with this coding will be discarded by this version of the protocol)

**Table 9.2.1.2: Coding of the Target Channel Type Field on FACH for FDD**

TCTF	Designation
00	BCCH
01000000	CCCH
01000001- 01001111	Reserved (PDUs with this coding will be discarded by this version of the protocol)
01010000	MCCH
01010001- 01011110	Reserved (PDUs with this coding will be discarded by this version of the protocol)
01011111	MSCH
0110	MTCH
0111	Reserved (PDUs with this coding will be discarded by this version of the protocol)
10000000	CTCH
10000001- 10111111	Reserved (PDUs with this coding will be discarded by this version of the protocol)
11	DCCH or DTCH over FACH

**Table 9.2.1.3: Coding of the Target Channel Type Field on USCH or DSCH (TDD only)**

TCTF	Designation
0	SHCCH
1	DCCH or DTCH over USCH or DSCH

**Table 9.2.1.4: Coding of the Target Channel Type Field on RACH for FDD**

TCTF	Designation
00	CCCH
01	DCCH or DTCH over RACH
10-11	Reserved (PDUs with this coding will be discarded by this version of the protocol)

**Table 9.2.1.5: Coding of the Target Channel Type Field on RACH for TDD**

TCTF	Designation
00	CCCH
0100	DCCH or DTCH Over RACH
0101- 0111	Reserved (PDUs with this coding will be discarded by this version of the protocol)
10	SHCCH
11	Reserved (PDUs with this coding will be discarded by this version of the protocol)

- C/T field

The C/T field provides identification of the logical channel instance when multiple logical channels are carried on the same transport channel (other than HS-DSCH) or same MAC-d flow (HS-DSCH). The C/T field is used also to provide identification of the logical channel type on dedicated transport channels and on FACH and RACH when used for user data transmission. The size of the C/T field is fixed to 4 bits for both common transport channels and dedicated transport channels. Table 9.2.1.5a shows the 4-bit C/T field.

**Table 9.2.1.5a: Structure of the C/T field**

C/T field	Designation
0000	Logical channel 1
0001	Logical channel 2
...	...
1110	Logical channel 15
1111	Reserved (PDUs with this coding will be discarded by this version of the protocol)

- UE-Id

The UE-Id field provides an identifier of the UE on common transport channels. The following types of UE-Id used on MAC are defined:

- UTRAN Radio Network Temporary Identity (U-RNTI) may be used in the MAC header of DCCH using RLC UM (SRB1), when mapped onto common transport channels in downlink direction; the U-RNTI is never used in uplink direction;
- Cell Radio Network Temporary Identity (C-RNTI) is used on DTCH and DCCH in uplink, and may be used on DCCH in downlink and is used on DTCH in downlink when mapped onto common transport channels, except when mapped onto DSCH transport channel in TDD;

**Table 9.2.1.6: Lengths of UE Id field**

UE Id type	Length of UE Id field
U-RNTI	32 bits
C-RNTI	16 bits

- UE-Id Type

The UE-Id Type field is needed to ensure correct decoding of the UE-Id field in MAC Headers.

**Table 9.2.1.7: UE-Id Type field definition**

UE-Id Type field 2 bits	UE-Id Type
00	U-RNTI
01	C-RNTI
10	Reserved (PDUs with this coding will be discarded by this version of the protocol)
11	Reserved (PDUs with this coding will be discarded by this version of the protocol)

- MBMS-Id

The MBMS-Id field provides an identifier of MTCH for an MBMS service carried on FACH. The MBMS-Id is used in the MAC header of MTCH mapped onto FACH in downlink direction; the MBMS-Id is never used in uplink direction. The MBMS Id to be used by MAC is configured through the MAC control SAP. The length of the MBMS-Id field is 4 bits. Table 9.2.1.7a shows the 4-bit MBMS-Id field.

**Table 9.2.1.8: Structure of the MBMS-Id field**

MBMS-Id field	MBMS logical channel identity [7]
0000	1
0001	2
...	...
1110	15
1111	Reserved (PDUs with this coding will be discarded by this version of the protocol)

### 9.2.1.1 MAC header for DTCH and DCCH (not mapped on HS-DSCH or E-DCH)

a) DTCH or DCCH mapped to DCH, no multiplexing of dedicated channels on MAC:

- no MAC header is required.

b) DTCH or DCCH mapped to DCH, with multiplexing of dedicated channels on MAC:

- C/T field is included in MAC header.

c) DTCH or DCCH mapped to RACH/FACH:

- TCTF field, C/T field, UE-Id type field and UE-Id are included in the MAC header. For FACH, the UE-Id type field used is the C-RNTI or U-RNTI. For RACH, the UE-Id type field used is the C-RNTI.

d) DTCH or DCCH mapped to DSCH or USCH:

- the TCTF field is included in the MAC header. The C/T field is included if multiplexing on MAC is applied.

e) DTCH or DCCH mapped to DSCH or USCH where DTCH or DCCH are the only logical channels:

- The C/T field is included in the MAC header if multiplexing on MAC is applied.

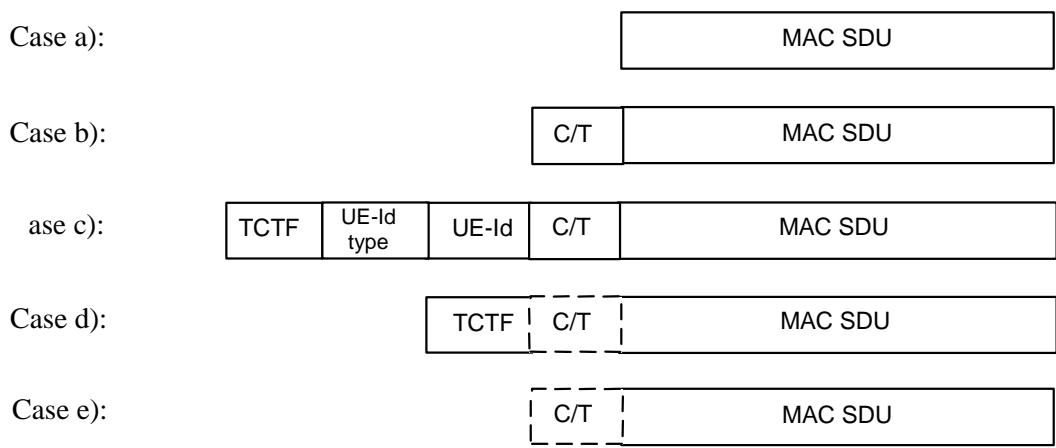
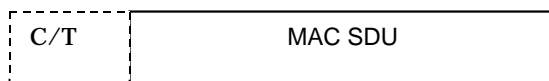

**Figure 9.2.1.1.1: MAC PDU formats for DTCH and DCCH**

**9.2.1.1a MAC-d Header for DTCH and DCCH (mapped on HS-DSCH)**

The MAC-d PDU header for DTCH and DCCH mapped on HS-DSCH is as shown in figure 9.2.1.1a.1.

- C/T field is included in the MAC-d PDU header if multiplexing on MAC is applied.



**Figure 9.2.1.1a.1 MAC-d PDU format for DTCH and DCCH mapped on HS-DSCH**

**9.2.1.1b MAC-d Header for DTCH and DCCH (mapped on E-DCH)**

For DTCH and DCCH mapped on E-DCH there is no need for a MAC-d header. Therefore, the MAC-d PDU is as shown in figure 9.2.1.1b.1.



**Figure 9.2.1.1b.1 MAC-d PDU format for DTCH and DCCH mapped on E-DCH**

**9.2.1.2 MAC header for BCCH**

- a) BCCH mapped to BCH:
  - no MAC header is included.
- b) BCCH mapped to FACH:
  - the TCTF field is included in MAC header.

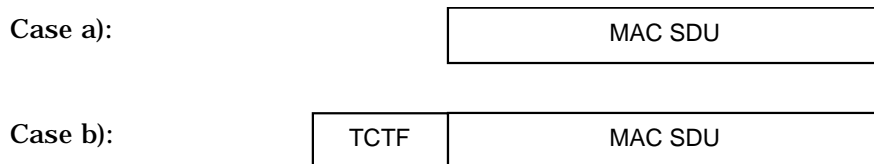

**Figure 9.2.1.2.1: MAC PDU formats for BCCH**

### 9.2.1.3 MAC header for PCCH

There is no MAC header for PCCH.

### 9.2.1.4 MAC header for CCCH

CCCH mapped to RACH/FACH:

- TCTF field is included in MAC header.

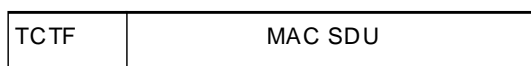

**Figure 9.2.1.4.1: MAC PDU formats for CCCH**

### 9.2.1.5 MAC Header for CTCH

The TCTF field is included as MAC header for CTCH as shown in figure 9.2.1.5.1.

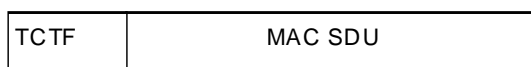
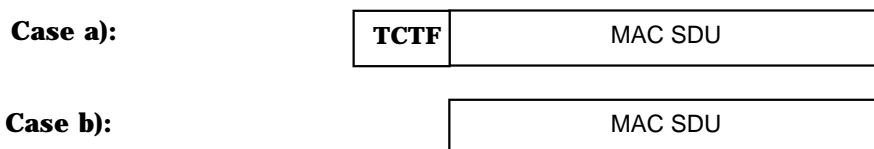

**Figure 9.2.1.5.1: MAC PDU format for CTCH**

### 9.2.1.6 MAC Header for SHCCH

The MAC header for SHCCH is as shown in figure 9.2.1.6.1.

- a) SHCCH mapped to RACH and USCH/FACH and DSCH:
  - TCTF has to be included.
- b) SHCCH mapped to RACH and USCH/FACH and DSCH, where SHCCH is the only channel.



**Figure 9.2.1.6.1: MAC PDU format for SHCCH**

### 9.2.1.7 MAC Header for MCCH

The MAC PDU format for MCCH is as shown in figure 9.2.1.7.1.

- a) If the MAC header for MCCH is not configured through the MAC control SAP:
  - there is no MAC header for MCCH.
- b) If the MAC header for MCCH is configured through the MAC control SAP:

- TCTF field is included in the MAC header for MCCH.

NOTE: If MCCH is not the only channel on the FACH, the MAC header shall be configured for the MCCH.

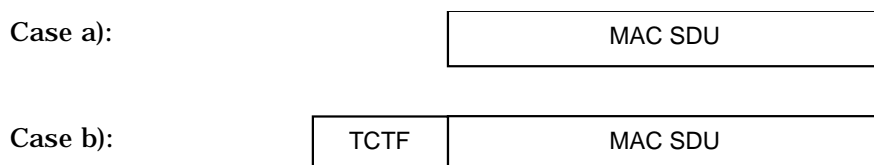

**Figure 9.2.1.7.1: MAC PDU format for MCCH**

### 9.2.1.8 MAC Header for MTCH

The TCTF field and MBMS-Id field are included in the MAC header for MTCH as shown in figure 9.2.1.8.1.

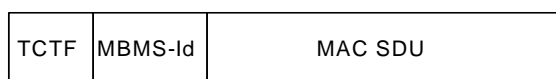

**Figure 9.2.1.8.1: MAC PDU format for MTCH**

### 9.2.1.9 MAC Header for MSCH

The MAC PDU format for MSCH is as shown in figure 9.2.1.9.1.

- If the MAC header for MSCH is not configured through the MAC control SAP:
  - there is no MAC header for MSCH.
- If the MAC header for MSCH is configured through the MAC control SAP:
  - TCTF field is included in the MAC header for MSCH.

NOTE: If MSCH is not the only channel on the FACH, the MAC header shall be configured for the MSCH.

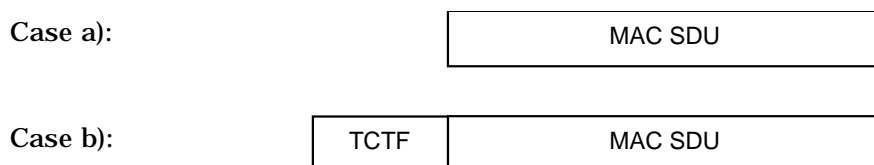

**Figure 9.2.1.9.1: MAC PDU format for MSCH**

## 9.2.2 MAC PDU: Parameters of the MAC header (HS-DSCH)

- Version Flag (VF):  
The VF field is a one bit flag providing extension capabilities of the MAC-hs PDU format. The VF field shall be set to zero and the value one is reserved in this version of the protocol.
- Queue identifier (Queue ID):  
The Queue ID field provides identification of the reordering queue in the receiver, in order to support independent buffer handling of data belonging to different reordering queues. The length of the Queue ID field is 3 bit.
- Transmission Sequence Number (TSN):  
The TSN field provides an identifier for the transmission sequence number on the HS-DSCH. The TSN field is

used for reordering purposes to support in-sequence delivery to higher layers. The length of the TSN field is 6 bit.

- Size index identifier (SID):  
The SID fields identifies the size of a set of consecutive MAC-d PDUs. The MAC-d PDU size for a given SID is configured by higher layers and is independent for each Queue ID. The length of the SID field is 3 bit.
- Number of MAC-D PDUs (N):  
The number of consecutive MAC-d PDUs with equal size is identified with the N field. The length of the N field is 7 bits. In FDD mode, the maximum number of PDUs transmitted in a single TTI shall be assumed to be 70. In 1.28 Mcps TDD mode, the maximum number of PDUs transmitted in a single TTI shall be assumed to be 45. In 3.84 Mcps TDD mode, the maximum number of PDUs transmitted in a single TTI shall be assumed to be 318. In 7.68 Mcps TDD mode, the maximum number of PDUs transmitted in a single TTI shall be assumed to be 636. If more PDUs than the defined maximum number of PDUs for the corresponding mode are received, the UE behaviour is unspecified.
- Flag (F):  
The F field is a flag indicating if more fields are present in the MAC-hs header or not. If the F field is set to "0" the F field is followed by an additional set of SID, N and F fields. If the F field is set to "1" the F field is followed by a MAC-d PDU. The maximum number of MAC-hs header extensions, i.e. number of fields F set to "0", in a single TTI shall be assumed to be 7. If more extensions than the maximum defined for the corresponding mode are included in a TTI, the UE behaviour is unspecified.

### 9.2.2.1 MAC header for DTCH and DCCH

a) DTCH or DCCH mapped to HS-DSCH:

- The Queue ID field and TSN field are always included in the MAC-hs header. One SID field, N field and F field is included for each MAC-d PDU size included in the MAC-hs PDU. Padding is not explicitly indicated but is included in the end of the MAC-hs PDU if the total size of the MAC-hs payload plus the MAC-hs header is smaller than the transport block set size.

## 9.2.3 Signalling of Transport Block size for HS-DSCH

For HS-DSCH the transport block size is derived from the TFRI value signalled on the HS-SCCH. The mapping between the TFRI value and the transport block size for each mode is specified below:

### 9.2.3.1 Transport block size for FDD

For all transmissions of a transport block, the transport block size is derived from the TFRI value as specified below, except only in those cases of retransmissions where the Node-B selects a combination for which no mapping exists between the original transport block size and the selected combination of channelisation Code set and modulation type. In such cases, the transport block size index value signalled to the UE shall be set to 111111, i.e.,  $k_i=63$ .

Let  $k_i$  be the TFRI signalled on the HS-SCCH value and let  $k_{0,i}$  be the value in the table 9.2.3.1 corresponding to the modulation and the number of codes signalled on the HS-SCCH. Let  $K_i$  be the sum of the two values:  $K_i = k_i + k_{0,i}$ . The transport block size  $L(k_i)$  can be obtained by accessing the position  $K_i$  in the table in Annex A (normative) or by using the formula below (informative):

If  $k_i < 40$

$$L(k_i) = 125 + 12 \cdot k_i$$

else

$$L(k_i) = \left\lfloor L_{\min} p^{k_i} \right\rfloor$$

$$p = 2085 / 2048$$

$$L_{\min} = 296$$

end

**Table 9.2.3.1: Values of  $k_{0,i}$  for different numbers of channelization codes and modulation schemes**

Combination $i$	Modulation scheme	Number of channelization codes	$k_{0,i}$
0	QPSK	1	1
1		2	40
2		3	63
3		4	79
4		5	92
5		6	102
6		7	111
7		8	118
8		9	125
9		10	131
10		11	136
11		12	141
12		13	145
13		14	150
14		15	153
15	16QAM	1	40
16		2	79
17		3	102
18		4	118
19		5	131
20		6	141
21		7	150
22		8	157
23		9	164
24		10	169
25		11	175
26		12	180
27		13	184
28		14	188
29		15	192

### 9.2.3.2 Transport block size for 3.84 Mcps TDD

Let  $k$  be the signalled TFRI value, then the corresponding HS-DSCH transport block size  $L_k$  is given by :

If  $k=1..510$

$$L_k = \lfloor L_{\min} p^k \rfloor$$

$$p = \frac{8313}{8192}$$

$$L_{\min} = 57$$

If  $k = 511$

$$L_k = 102000$$



If  $k=0$ ,  $L_k$  indicates NULL and shall not be used to signal a transport block size in the TFRI.

Transport block sizes calculated by this formula shall equal the values indicated in Table 9.2.3.2.1

**Table 9.2.3.2.1: HSDPA Transport Block Sizes for 3.84 Mcps TDD**

TB index (k)	TB size [bits]	TB index (k)	TB size [bits]	TB index (k)	TB size [bits]	TB index (k)	TB size [bits]
0	NULL	128	372	256	2432	384	15890
1	57	129	377	257	2468	385	16124
2	58	130	383	258	2504	386	16362
3	59	131	389	259	2541	387	16604
4	60	132	394	260	2579	388	16849
5	61	133	400	261	2617	389	17098
6	62	134	406	262	2656	390	17351
7	63	135	412	263	2695	391	17607
8	64	136	418	264	2735	392	17867
9	65	137	424	265	2775	393	18131
10	66	138	431	266	2816	394	18399
11	66	139	437	267	2858	395	18671
12	67	140	443	268	2900	396	18946
13	68	141	450	269	2943	397	19226
14	69	142	457	270	2986	398	19510
15	71	143	463	271	3030	399	19798
16	72	144	470	272	3075	400	20091
17	73	145	477	273	3121	401	20388
18	74	146	484	274	3167	402	20689
19	75	147	491	275	3213	403	20994
20	76	148	499	276	3261	404	21304
21	77	149	506	277	3309	405	21619
22	78	150	514	278	3358	406	21938
23	79	151	521	279	3408	407	22263
24	81	152	529	280	3458	408	22591
25	82	153	537	281	3509	409	22925
26	83	154	545	282	3561	410	23264
27	84	155	553	283	3613	411	23607
28	85	156	561	284	3667	412	23956
29	87	157	569	285	3721	413	24310
30	88	158	578	286	3776	414	24669
31	89	159	586	287	3832	415	25033
32	91	160	595	288	3888	416	25403
33	92	161	604	289	3946	417	25778
34	93	162	613	290	4004	418	26159
35	95	163	622	291	4063	419	26545
36	96	164	631	292	4123	420	26938
37	98	165	640	293	4184	421	27335
38	99	166	650	294	4246	422	27739
39	100	167	659	295	4309	423	28149
40	102	168	669	296	4372	424	28565
41	103	169	679	297	4437	425	28987
42	105	170	689	298	4502	426	29415

43	107	171	699	299	4569	427	29849
44	108	172	709	300	4636	428	30290
45	110	173	720	301	4705	429	30738
46	111	174	730	302	4774	430	31192
47	113	175	741	303	4845	431	31652
48	115	176	752	304	4916	432	32120
49	116	177	763	305	4989	433	32594
50	118	178	775	306	5063	434	33076
51	120	179	786	307	5138	435	33564
52	122	180	798	308	5213	436	34060
53	123	181	809	309	5290	437	34563
54	125	182	821	310	5369	438	35074
55	127	183	834	311	5448	439	35592
56	129	184	846	312	5528	440	36117
57	131	185	858	313	5610	441	36651
58	133	186	871	314	5693	442	37192
59	135	187	884	315	5777	443	37742
60	137	188	897	316	5862	444	38299
61	139	189	910	317	5949	445	38865
62	141	190	924	318	6037	446	39439
63	143	191	937	319	6126	447	40021
64	145	192	951	320	6217	448	40613
65	147	193	965	321	6308	449	41212
66	150	194	980	322	6402	450	41821
67	152	195	994	323	6496	451	42439
68	154	196	1009	324	6592	452	43066
69	156	197	1024	325	6689	453	43702
70	159	198	1039	326	6788	454	44347
71	161	199	1054	327	6889	455	45002
72	163	200	1070	328	6990	456	45667
73	166	201	1085	329	7094	457	46342
74	168	202	1101	330	7198	458	47026
75	171	203	1118	331	7305	459	47721
76	173	204	1134	332	7413	460	48426
77	176	205	1151	333	7522	461	49141
78	178	206	1168	334	7633	462	49867
79	181	207	1185	335	7746	463	50603
80	184	208	1203	336	7860	464	51351
81	186	209	1221	337	7976	465	52109
82	189	210	1239	338	8094	466	52879
83	192	211	1257	339	8214	467	53660
84	195	212	1276	340	8335	468	54453
85	198	213	1294	341	8458	469	55257
86	201	214	1313	342	8583	470	56073
87	204	215	1333	343	8710	471	56901
88	207	216	1353	344	8839	472	57742
89	210	217	1373	345	8969	473	58595
90	213	218	1393	346	9102	474	59460
91	216	219	1413	347	9236	475	60338
92	219	220	1434	348	9373	476	61230

93	222	221	1456	349	9511	477	62134
94	226	222	1477	350	9652	478	63052
95	229	223	1499	351	9794	479	63983
96	232	224	1521	352	9939	480	64928
97	236	225	1543	353	10086	481	65887
98	239	226	1566	354	10235	482	66860
99	243	227	1589	355	10386	483	67848
100	246	228	1613	356	10539	484	68850
101	250	229	1637	357	10695	485	69867
102	254	230	1661	358	10853	486	70899
103	258	231	1685	359	11013	487	71946
104	261	232	1710	360	11176	488	73009
105	265	233	1736	361	11341	489	74087
106	269	234	1761	362	11508	490	75182
107	273	235	1787	363	11678	491	76292
108	277	236	1814	364	11851	492	77419
109	281	237	1840	365	12026	493	78563
110	285	238	1868	366	12204	494	79723
111	290	239	1895	367	12384	495	80901
112	294	240	1923	368	12567	496	82095
113	298	241	1952	369	12752	497	83308
114	303	242	1981	370	12941	498	84539
115	307	243	2010	371	13132	499	85787
116	312	244	2039	372	13326	500	87054
117	316	245	2070	373	13523	501	88340
118	321	246	2100	374	13722	502	89645
119	326	247	2131	375	13925	503	90969
120	331	248	2163	376	14131	504	92313
121	336	249	2195	377	14340	505	93676
122	340	250	2227	378	14551	506	95060
123	346	251	2260	379	14766	507	96464
124	351	252	2293	380	14984	508	97889
125	356	253	2327	381	15206	509	99335
126	361	254	2362	382	15430	510	100802
127	366	255	2397	383	15658	511	102000

### 9.2.3.2a Transport block size for 7.68 Mcps TDD

Let  $k$  be the signalled TFRI value, then the corresponding HS-DSCH transport block size  $L_k$  is given by :

If  $k=1..510$

$$L_k = \lfloor L_{\min} P^k \rfloor$$

$$P = \frac{33297}{32768}$$

$$L_{\min} = 57$$

If  $k = 511$

$$L_k = 204000$$

If  $k=0$ ,  $L_k$  indicates NULL and shall not be used to signal a transport block size in the TFRI.

Transport block sizes calculated by this formula shall equal the values indicated in Table 9.2.3.2.1

**Table 9.2.3.2a.1: HSDPA Transport Block Sizes for 7.68 Mcps TDD**

TB index (k)	TB size [bits]	TB index (k)	TB size [bits]	TB index (k)	TB size [bits]	TB index (k)	TB size [bits]
0	NULL	128	442	256	3438	384	26709
1	57	129	449	257	3494	385	27140
2	58	130	457	258	3550	386	27578
3	59	131	464	259	3607	387	28023
4	60	132	472	260	3666	388	28476
5	61	133	479	261	3725	389	28935
6	62	134	487	262	3785	390	29402
7	63	135	495	263	3846	391	29877
8	64	136	503	264	3908	392	30360
9	65	137	511	265	3971	393	30850
10	66	138	519	266	4035	394	31348
11	67	139	528	267	4101	395	31854
12	69	140	536	268	4167	396	32368
13	70	141	545	269	4234	397	32891
14	71	142	553	270	4302	398	33422
15	72	143	562	271	4372	399	33961
16	73	144	572	272	4443	400	34509
17	74	145	581	273	4514	401	35066
18	76	146	590	274	4587	402	35633
19	77	147	600	275	4661	403	36208
20	78	148	609	276	4736	404	36792
21	79	149	619	277	4813	405	37386
22	81	150	629	278	4891	406	37990
23	82	151	639	279	4970	407	38603
24	83	152	650	280	5050	408	39226
25	85	153	660	281	5131	409	39860
26	86	154	671	282	5214	410	40503
27	87	155	682	283	5298	411	41157
28	89	156	693	284	5384	412	41822
29	90	157	704	285	5471	413	42497
30	92	158	715	286	5559	414	43183
31	93	159	727	287	5649	415	43880
32	95	160	739	288	5740	416	44588
33	96	161	751	289	5833	417	45308
34	98	162	763	290	5927	418	46040
35	99	163	775	291	6023	419	46783
36	101	164	787	292	6120	420	47538
37	103	165	800	293	6219	421	48306
38	104	166	813	294	6319	422	49085
39	106	167	826	295	6421	423	49878
40	108	168	840	296	6525	424	50683
41	109	169	853	297	6630	425	51501
42	111	170	867	298	6737	426	52333

43	113	171	881	299	6846	427	53178
44	115	172	895	300	6957	428	54036
45	117	173	910	301	7069	429	54908
46	119	174	924	302	7183	430	55795
47	120	175	939	303	7299	431	56696
48	122	176	954	304	7417	432	57611
49	124	177	970	305	7537	433	58541
50	126	178	986	306	7658	434	59486
51	128	179	1001	307	7782	435	60446
52	131	180	1018	308	7908	436	61422
53	133	181	1034	309	8035	437	62414
54	135	182	1051	310	8165	438	63421
55	137	183	1068	311	8297	439	64445
56	139	184	1085	312	8431	440	65486
57	142	185	1103	313	8567	441	66543
58	144	186	1120	314	8705	442	67617
59	146	187	1138	315	8846	443	68709
60	148	188	1157	316	8988	444	69818
61	151	189	1175	317	9134	445	70945
62	153	190	1194	318	9281	446	72091
63	156	191	1214	319	9431	447	73254
64	158	192	1233	320	9583	448	74437
65	161	193	1253	321	9738	449	75639
66	164	194	1274	322	9895	450	76860
67	166	195	1294	323	10055	451	78101
68	169	196	1315	324	10217	452	79361
69	172	197	1336	325	10382	453	80643
70	174	198	1358	326	10550	454	81945
71	177	199	1380	327	10720	455	83267
72	180	200	1402	328	10893	456	84612
73	183	201	1425	329	11069	457	85978
74	186	202	1448	330	11248	458	87366
75	189	203	1471	331	11429	459	88776
76	192	204	1495	332	11614	460	90209
77	195	205	1519	333	11801	461	91666
78	198	206	1543	334	11992	462	93145
79	201	207	1568	335	12185	463	94649
80	205	208	1594	336	12382	464	96177
81	208	209	1619	337	12582	465	97730
82	211	210	1646	338	12785	466	99308
83	215	211	1672	339	12992	467	100911
84	218	212	1699	340	13201	468	102540
85	222	213	1727	341	13414	469	104195
86	225	214	1755	342	13631	470	105877
87	229	215	1783	343	13851	471	107587
88	233	216	1812	344	14075	472	109324
89	237	217	1841	345	14302	473	111088
90	240	218	1871	346	14533	474	112882
91	244	219	1901	347	14767	475	114704
92	248	220	1932	348	15006	476	116556

93	252	221	1963	349	15248	477	118438
94	256	222	1994	350	15494	478	120350
95	260	223	2027	351	15744	479	122293
96	265	224	2059	352	15999	480	124267
97	269	225	2093	353	16257	481	126273
98	273	226	2126	354	16519	482	128312
99	278	227	2161	355	16786	483	130383
100	282	228	2196	356	17057	484	132488
101	287	229	2231	357	17332	485	134627
102	291	230	2267	358	17612	486	136800
103	296	231	2304	359	17897	487	139009
104	301	232	2341	360	18185	488	141253
105	306	233	2379	361	18479	489	143533
106	311	234	2417	362	18777	490	145850
107	316	235	2456	363	19081	491	148205
108	321	236	2496	364	19389	492	150597
109	326	237	2536	365	19702	493	153029
110	331	238	2577	366	20020	494	155499
111	337	239	2619	367	20343	495	158010
112	342	240	2661	368	20671	496	160560
113	348	241	2704	369	21005	497	163152
114	353	242	2748	370	21344	498	165786
115	359	243	2792	371	21689	499	168463
116	365	244	2837	372	22039	500	171182
117	371	245	2883	373	22395	501	173946
118	377	246	2929	374	22756	502	176754
119	383	247	2977	375	23124	503	179608
120	389	248	3025	376	23497	504	182507
121	395	249	3074	377	23876	505	185454
122	402	250	3123	378	24262	506	188447
123	408	251	3174	379	24653	507	191490
124	415	252	3225	380	25051	508	194581
125	421	253	3277	381	25456	509	197722
126	428	254	3330	382	25867	510	200914
127	435	255	3384	383	26284	511	204000

### 9.2.3.3 Transport block size for 1.28 Mcps TDD

The mapping of transport block size, in bits, to TFRI value is dependent upon the UE's HS-DSCH capability class.

If  $k$  is the signalled TFRI value then the corresponding HS-DSCH transport block size  $L_k$  is given by:

If  $k = 1..62$

$$L_k = \lfloor L_{\min} p^{k-1} \rfloor$$

where

$$p = \frac{1340}{1269} \text{ if the HS-DSCH physical layer category is between 1 and 6 inclusively,}$$

$$p = \frac{1755}{1652} \text{ if the HS-DSCH physical layer category is between 7 and 12 inclusively,}$$

$$p = \frac{2345}{2196} \text{ if the HS-DSCH physical layer category is between 13 and 15 inclusively,}$$

and

$$L_{\min} = 240$$

If  $k = 63$  then,

$L_k = 7008$  if the HS-DSCH physical layer category is between 1 and 6 inclusively,

10204 if the HS-DSCH physical layer category is between 7 and 12 inclusively,

14043 if the HS-DSCH physical layer category is between 13 and 15 inclusively.

If  $k=0$ ,  $L_k$  indicates NULL and shall not be used to signal a transport block size in the TFRI.

Transport block sizes calculated by this formula shall equal the values indicated in the following tables: –

**Table 9.2.3.3.1: HSDPA Transport Block Sizes for 1.28 Mcps TDD, for HS-DSCH physical layer category [1,6]**

TB index (k)	TB size [bits]	TB index (k)	TB size [bits]	TB index (k)	TB size [bits]	TB index (k)	TB size [bits]
0	NULL	16	543	32	1297	48	3100
1	240	17	573	33	1370	49	3274
2	253	18	605	34	1446	50	3457
3	267	19	639	35	1527	51	3650
4	282	20	675	36	1613	52	3854
5	298	21	712	37	1703	53	4070
6	315	22	752	38	1798	54	4298
7	332	23	794	39	1899	55	4538
8	351	24	839	40	2005	56	4792
9	370	25	886	41	2118	57	5060
10	391	26	936	42	2236	58	5344
11	413	27	988	43	2361	59	5643
12	436	28	1043	44	2493	60	5958
13	461	29	1102	45	2633	61	6292
14	487	30	1163	46	2780	62	6644
15	514	31	1228	47	2936	63	7008

**Table 9.2.3.3.2: HSDPA Transport Block Sizes for 1.28 Mcps TDD, for HS-DSCH physical layer category [7,12]**

TB index (k)	TB size [bits]	TB index (k)	TB size [bits]	TB index (k)	TB size [bits]	TB index (k)	TB size [bits]
0	NULL	16	594	32	1564	48	4118
1	240	17	631	33	1662	49	4375
2	254	18	671	34	1766	50	4648
3	270	19	712	35	1876	51	4938
4	287	20	757	36	1993	52	5246
5	305	21	804	37	2117	53	5573
6	324	22	854	38	2249	54	5920
7	344	23	908	39	2389	55	6289
8	366	24	964	40	2538	56	6681
9	389	25	1024	41	2697	57	7098
10	413	26	1088	42	2865	58	7541
11	439	27	1156	43	3043	59	8011
12	466	28	1228	44	3233	60	8510
13	495	29	1305	45	3435	61	9041
14	526	30	1386	46	3649	62	9605
15	559	31	1473	47	3877	63	10204

**Table 9.2.3.3.3 : HSDPA Transport Block Sizes for 1.28 Mcps TDD, for HS-DSCH physical layer category [13,15]**

TB index (k)	TB size [bits]	TB index (k)	TB size [bits]	TB index (k)	TB size [bits]	TB index (k)	TB size [bits]
0	NULL	16	642	32	1836	48	5250
1	240	17	686	33	1961	49	5606
2	256	18	732	34	2094	50	5987
3	273	19	782	35	2236	51	6393
4	292	20	835	36	2388	52	6827
5	312	21	892	37	2550	53	7290
6	333	22	952	38	2723	54	7785
7	355	23	1017	39	2908	55	8313
8	380	24	1086	40	3105	56	8877
9	405	25	1160	41	3316	57	9479
10	433	26	1238	42	3541	58	10123
11	462	27	1322	43	3781	59	10809
12	494	28	1412	44	4037	60	11543
13	527	29	1508	45	4311	61	12326
14	563	30	1610	46	4604	62	13162
15	601	31	1719	47	4916	63	14043

## 9.2.4 MAC PDU: Parameters of the MAC header (E-DCH)

### 9.2.4.1 MAC-es header parameters

- Transmission Sequence Number (TSN):  
The TSN field provides the transmission sequence number for the MAC-es PDU. This information is used for reordering purposes to support in-sequence delivery to higher layers. The length of the TSN field is 6 bits.

### 9.2.4.2 MAC-e header parameters

- Data description indicator (DDI):  
The DDI field identifies the logical channel, MAC-d flow and size of the MAC-d PDUs concatenated into the



associated MAC-es PDU. The mapping between the DDI values and the logical channel ID, MAC-d flow and PDU size is provided by higher layers. The length of the DDI field is 6 bits.

- For FDD: When, due to the quantization in the transport block sizes that can be supported or triggering of the Scheduling Information, the size of the data plus header is less than or equal to the TB size of the E-TFC selected by the UE minus 24 bits, the DDI value [111111] shall be appended at the end of the MAC-e header and a Scheduling Information shall be concatenated into this MAC-e PDU, where DDI value [111111] indicates that there is a Scheduling Information concatenated in this MAC-e PDU. Otherwise, if the size of the data plus header is less than or equal to the TB size of the E-TFC selected by the UE minus 18 bits, a Scheduling Information shall be concatenated into this MAC-e PDU. In any other case it is understood that another MAC-es PDU or Scheduling Information does not fit and it is therefore not necessary to reserve room in the transport block for an additional DDI field.
- For 3.84/7.68 Mcps TDD: When, due to the quantization in the transport block sizes that can be supported or triggering of the Scheduling Information, the size of the data plus header is less than or equal to the TB size of the E-TFC selected by the UE minus 29bits, the DDI value [111111] shall be appended at the end of the MAC-e header and a Scheduling Information shall be concatenated into this MAC-e PDU, where DDI value [111111] indicates that there is a Scheduling Information concatenated in this MAC-e PDU. Otherwise, if the size of the data plus header is less than or equal to the TB size of the E-TFC selected by the UE minus 23 bits, a Scheduling Information shall be concatenated into this MAC-e PDU. In any other case it is understood that another MAC-es PDU or Scheduling Information does not fit and it is therefore not necessary to reserve room in the transport block for an additional DDI field.
- Number of MAC-d PDUs (N):  
The number of consecutive MAC-d PDUs corresponding to the same DDI value. The length of the N field is 6 bits.

## 9.2.5 Signaling of control information for FDD E-DCH

### 9.2.5.1 HARQ information

This control information is used in support of the uplink hybrid ARQ functionality.

- ACK/NACK information:  
Transmitted on downlink on the E-HICH from each cell in the E-DCH active set, the ACK/NACK information indicates the successful or un-successful decoding of the corresponding uplink transmission. This information allows the UE to know whether to make another transmission for the same MAC-e PDU or to start the transmission of a new one. The length of the ACK/NACK field is 1 bit.
- RSN:  
Transmitted on the E-DPCCH, the RSN is used to convey the uplink HARQ transmission number. Because of the limitation in the field size, the RSN saturates to the maximum value once that is reached. The combination of the RSN and the transmission timing allows the receiver to determine the exact transmission number (see [16]). The length of the RSN field is 2 bits.

### 9.2.5.2 DL Scheduling information

This control information is used by Node-Bs in a UE's E-DCH active set in order to control its use of E-DCH system resources.

#### 9.2.5.2.1 Relative Grants

- Serving Relative Grant:  
Transmitted on downlink on the E-RGCH from all cells in the serving E-DCH RLS, the serving relative grant allows the Node B scheduler to incrementally adjust the serving grant of UEs under its control. By definition, there can only be one serving relative grant command received at any one time. This indication can take three different values, "UP", "DOWN" or "HOLD".
- Non-serving Relative Grant:  
Transmitted on downlink on the E-RGCH from a non-serving E-DCH RL, the non-serving relative grant allows neighboring Node Bs to adjust the transmitted rate of UEs that are not under their control in order to avoid

overload situations. By definition, there could be multiple non-serving relative grant commands received by MAC at any time. This indication can take two different values, "DOWN" or "HOLD".

The handling of the Relative Grant signalling is based on the Scheduling Grant table shown in Table 9.2.5.2.1.1.

**Table 9.2.5.2.1.1: Scheduling Grant Table (SG-table)**

Index	Scheduled Grant
37	$(168/15)^{2*6}$
36	$(150/15)^{2*6}$
35	$(168/15)^{2*4}$
34	$(150/15)^{2*4}$
33	$(134/15)^{2*4}$
32	$(119/15)^{2*4}$
31	$(150/15)^{2*2}$
30	$(95/15)^{2*4}$
29	$(168/15)^2$
28	$(150/15)^2$
27	$(134/15)^2$
26	$(119/15)^2$
25	$(106/15)^2$
24	$(95/15)^2$
23	$(84/15)^2$
22	$(75/15)^2$
21	$(67/15)^2$
20	$(60/15)^2$
19	$(53/15)^2$
18	$(47/15)^2$
17	$(42/15)^2$
16	$(38/15)^2$
15	$(34/15)^2$
14	$(30/15)^2$
13	$(27/15)^2$
12	$(24/15)^2$
11	$(21/15)^2$
10	$(19/15)^2$
9	$(17/15)^2$
8	$(15/15)^2$
7	$(13/15)^2$
6	$(12/15)^2$
5	$(11/15)^2$
4	$(9/15)^2$
3	$(8/15)^2$
2	$(7/15)^2$
1	$(6/15)^2$
0	$(5/15)^2$

When the Serving\_Grant needs to be determined due to E-RGCH signalling (see subclause 11.8.1.3.2), the UE shall:

- Determine the lowest power ratio in the SG-table (table 9.2.5.2.1.1) that is equal or higher to the reference\_ETPR, and determine the corresponding index in the SG-table:  $SG_{LUPR}$ ;
- If the UE received a Serving Relative Grant "UP", based on the thresholds "3-index-step threshold" and "2-index-step threshold" configured by higher layers, determine the Serving\_Grant as follows:
  - if  $SG_{LUPR} < \text{"3-index-step threshold"}$ :
    - $Serving\_Grant = SG[\text{MIN}(SG_{LUPR} + 3, 37)]$ .

- if "3-index-step threshold"  $\leq$   $SG_{LUPR} <$  "2-index-step threshold":
  - $Serving\_Grant = SG[\text{MIN}(SG_{LUPR} + 2, 37)]$ .
- if "2-index-step threshold"  $\leq$   $SG_{LUPR}$ :
  - $Serving\_Grant = SG[\text{MIN}(SG_{LUPR} + 1, 37)]$ .
- If the UE received a Serving Relative Grant "DOWN", determine the  $Serving\_Grant$ :
  - $Serving\_Grant = SG[\text{MAX}(SG_{LUPR} - 1, 0)]$ .
- If the UE received a Non-serving Relative Grant "DOWN", determine the  $Serving\_Grant$ :
  - $Serving\_Grant = SG[\text{MAX}(SG_{LUPR} - 1, 0)]$ .

#### 9.2.5.2.2 Absolute Grant

The absolute grant message is sent on downlink, on the configured E-AGCH, from the serving E-DCH cell and allows the Node B scheduler to directly adjust the granted rate of UEs under its control.

The E-AGCH is a shared channel that uses an E-RNTI specific CRC in order to address messages to specific users (see [16]). The RRC may configure the MAC-e with two different E-RNTIs, one primary and one secondary. Based on the identity that is used, the following information will be conveyed implicitly when an absolute grant message is received:

- Identity Type:  
This variable will take the value "Primary" or "Secondary" respectively based on whether the message was addressed to the primary or the secondary E-RNTI.

The absolute grant message itself includes multiple fields that are multiplexed together into 6 bits inside the MAC-e of the Node B and then submitted to the physical layer for transmission on the E-AGCH. These fields are:

- Absolute Grant Value:  
This field indicates the maximum E-DCH traffic to pilot ratio (E-DPDCH/DPCCH) that the UE is allowed to use in the next transmission. The length of the Absolute Grant Value field is 5 bits.
- Absolute Grant Scope:  
This field indicates the applicability of the Absolute Grant. It can take two different values, "Per HARQ process" or "All HARQ processes", allowing to indicate whether the HARQ process activation/de-activation will affect one or all processes. The Absolute Grant Scope is encoded in 1 bit. When the E-DCH is configured with 10ms TTI, only the value "All HARQ processes" is valid (see subclause 10). In case Identity Type is "Secondary", only the value "All HARQ processes" is valid in this version of the protocol.

#### 9.2.5.3 UL Scheduling information

This control information is used by UEs to indicate to their serving E-DCH Node-B the amount of resources they require.

##### 9.2.5.3.1 Happy Bit

The happy bit is a single bit field that is passed from MAC to the physical layer for inclusion on the E-DPCCH. This field takes two values, "Not Happy" and "Happy" indicating respectively whether the UE could use more resources or not. The setting of the Happy Bit is defined in subclause 11.8.1.5.

##### 9.2.5.3.2 Scheduling Information

The Scheduling Information is located at the end of the MAC-e PDU and is used to provide the serving Node B with a better view of the amount of system resources needed by the UE and the amount of resources it can actually make use of. The transmission of this information will be initiated due to the quantization of the transport block sizes that can be supported or based on the triggers defined in subclause 11.8.1.6. When a Scheduling Information is transmitted, its contents shall always be updated in new transmissions with the buffer status after application of the E-TFC selection procedure described in subclause 11.8.1.4. The logical channels for which a non-scheduled grant is configured shall

never be taken into account when putting together this information. In addition, the RRC may restrict applicability for logical channels for which no non-scheduled grant was configured.

This information includes the following fields:

- Highest priority Logical channel ID (HLID):  
The HLID field identifies unambiguously the highest priority logical channel with available data. If multiple logical channels exist with the highest priority, the one corresponding to the highest buffer occupancy will be reported. The length of the HLID is 4 bits. In case the TEBS is indicating index 0 (0 byte), the HLID shall indicate the value "0000".
- Fields related to amount of available data:
- Total E-DCH Buffer Status (TEBS):  
The TEBS field identifies the total amount of data available across all logical channels for which reporting has been requested by the RRC and indicates the amount of data in number of bytes that is available for transmission and retransmission in RLC layer. When MAC is connected to an AM RLC entity, control PDUs to be transmitted and RLC PDUs outside the RLC Tx window shall also be included in the TEBS. RLC PDUs that have been transmitted but not negatively acknowledged by the peer entity shall not be included in the TEBS.

The length of this field is 5 bits. The values taken by TEBS are shown in Table 9.2.5.3.2.1.

**Table 9.2.5.3.2-1: TEBS Values**

Index	TEBS Value (bytes)
-------	--------------------

0	TEBS = 0
1	$0 < \text{TEBS} \leq 10$
2	$10 < \text{TEBS} \leq 14$
3	$14 < \text{TEBS} \leq 18$
4	$18 < \text{TEBS} \leq 24$
5	$24 < \text{TEBS} \leq 32$
6	$32 < \text{TEBS} \leq 42$
7	$42 < \text{TEBS} \leq 55$
8	$55 < \text{TEBS} \leq 73$
9	$73 < \text{TEBS} \leq 97$
10	$97 < \text{TEBS} \leq 129$
11	$129 < \text{TEBS} \leq 171$
12	$171 < \text{TEBS} \leq 228$
13	$228 < \text{TEBS} \leq 302$
14	$302 < \text{TEBS} \leq 401$
15	$401 < \text{TEBS} \leq 533$
16	$533 < \text{TEBS} \leq 708$
17	$708 < \text{TEBS} \leq 940$
18	$940 < \text{TEBS} \leq 1248$
19	$1248 < \text{TEBS} \leq 1658$
20	$1658 < \text{TEBS} \leq 2202$
21	$2202 < \text{TEBS} \leq 2925$
22	$2925 < \text{TEBS} \leq 3884$
23	$3884 < \text{TEBS} \leq 5160$
24	$5160 < \text{TEBS} \leq 6853$
25	$6853 < \text{TEBS} \leq 9103$
26	$9103 < \text{TEBS} \leq 12092$
27	$12092 < \text{TEBS} \leq 16062$
28	$16062 < \text{TEBS} \leq 21335$
29	$21335 < \text{TEBS} \leq 28339$
30	$28339 < \text{TEBS} \leq 37642$
31	$37642 < \text{TEBS}$

- Highest priority Logical channel Buffer Status (HLBS):  
The HLBS field indicates the amount of data available from the logical channel identified by HLID, relative to the highest value of the buffer size range reported by TEBS when the reported TEBS index is not 31, and relative to 50000 bytes when the reported TEBS index is 31. The length of HLBS is 4 bits. The values taken by HLBS are shown in table 9.2.5.3.2.2. In case the TEBS field is indicating index 0 (0 byte), the HLBS field shall indicate index 0.

**Table 9.2.5.3.2-2: HLBS Values**

Index	HLBS values (%)
-------	-----------------

0	$0 < \text{HLBS} \leq 4$
1	$4 < \text{HLBS} \leq 6$
2	$6 < \text{HLBS} \leq 8$
3	$8 < \text{HLBS} \leq 10$
4	$10 < \text{HLBS} \leq 12$
5	$12 < \text{HLBS} \leq 14$
6	$14 < \text{HLBS} \leq 17$
7	$17 < \text{HLBS} \leq 21$
8	$21 < \text{HLBS} \leq 25$
9	$25 < \text{HLBS} \leq 31$
10	$31 < \text{HLBS} \leq 37$
11	$37 < \text{HLBS} \leq 45$
12	$45 < \text{HLBS} \leq 55$
13	$55 < \text{HLBS} \leq 68$
14	$68 < \text{HLBS} \leq 82$
15	$82 < \text{HLBS}$

- UE Power Headroom (UPH):

The UPH field indicates the ratio of the maximum UE transmission power and the corresponding DPCCH code power defined in [17]. The length of UPH is 5 bits.

The Scheduling Information message is represented in figure 9.2.5.3.2-1 where for each field, the LSB is the rightmost bit in the figure and the MSB is the leftmost bit.

UPH (5bits)	TEBS (5bits)	HLBS (4bits)	HLID (4bits)
----------------	-----------------	-----------------	-----------------

**Figure 9.2.5.3.2-1: Scheduling Information format**

#### 9.2.5.4 Transport block size

RRC can configure the MAC-e to use one of two Transport block size sets for each TTI duration. The normative description of the mapping between the E-TFCI and the corresponding transport block size is provided in Annex B:

- If the UE is configured with E-TFCI table 0 (see [7]) and 2ms TTI, it shall use the mapping defined in Annex B.1
- If the UE is configured with E-TFCI table 1 (see [7]) and 2ms TTI, it shall use the mapping defined in Annex B.2
- If the UE is configured with E-TFCI table 0 (see [7]) and 10ms TTI, it shall use the mapping defined in Annex B.3
- If the UE is configured with E-TFCI table 1 (see [7]) and 10ms TTI, it shall use the mapping defined in Annex B.4

The mapping in Transport block size table 0 for 2ms TTI (see table in Annex B.1) can also be obtained using the formula below.

Let  $k$  be the chosen E-TFCI, then the corresponding E-DCH transport block size  $L_k$  is given by the following formula (informative):

$$L_0 = 18$$

$$\text{if } k = 0..126$$

$$L_{k+1} = \lfloor 120 * (\rho)^k \rfloor$$

where

$$\rho = \left( \frac{11484}{120} \right)^{\frac{1}{127-1}}$$

The mapping in Transport block size table 0 for 10ms TTI (see table in Annex B.3) can also be obtained using the formula below.

Let  $k$  be the chosen E-TFCI, then the corresponding E-DCH transport block size  $L_k$  is given by the following formula (informative):

$$L_0 = 18$$

$$\text{if } k = 0..126$$

$$L_{k+1} = \lfloor 120 * (\rho)^k \rfloor$$

where

$$\rho = \left( \frac{20000}{120} \right)^{\frac{1}{127-1}}$$

## 9.2.6 Signaling of control information for 3.84/7.68 Mcps TDD E-DCH

### 9.2.6.1 HARQ information

This control information is used in support of the uplink hybrid ARQ functionality.

- ACK/NACK information:  
Transmitted on the E-HICH in the serving E-DCH cell, the ACK/NACK information indicates the successful or unsuccessful decoding of the corresponding uplink transmission. If NACK is received then the UE may retransmit if appropriate physical resources are available, otherwise it must receive a further Grant before it can retransmit the MAC-e PDU. The length of the ACK/NACK field is 1 bit.
- RSN:  
Transmitted on the E-UCCH, the RSN is used to convey the uplink HARQ transmission number. Because of the limitation in the field size, the maximum value that the RSN can represent is equal to 3. Once the RSN reaches this value, the RSN shall alternate between the values of 2 and 3 for any subsequent consecutive retransmissions. Thus, the RSN sequence follows the pattern 0,1,2,3,2,3,2,3,...(see subclause 11.9.1.1.2). The length of the RSN field is 2 bits.
- HARQ Process Identifier  
Transmitted on the E-UCCH, the HARQ process identifier is selected by the UE and identifies the HARQ process for which the MAC-e PDU is being transmitted/retransmitted. The length of the HARQ process identifier field is 3 bits. The MSB of the HARQ Process Identifier is not transmitted by the physical layer but may be inferred by the Node-B according to the nature of the physical resources used (scheduled or unscheduled). HARQ processes associated with scheduled transmission utilise HARQ Process Identifiers 0 to 3.

### 9.2.6.2 DL Scheduling information

This control information is used by a Node-B in order to control its use of E-DCH system resources.

### 9.2.6.2.1 Absolute Grant

The Absolute Grant is sent on downlink on a set of configured E-AGCHs from the serving E-DCH cell and allows the Node B scheduler to directly adjust the granted rate and assigned physical resources for UEs under its control. The physical resource assignment indicates to the UE the maximum amount of uplink resources that it may use for a scheduled transmission.

The E-AGCH is a shared channel that uses an E-RNTI specific CRC in order to address messages to specific UEs (see [19]). For TDD, the RRC shall configure the MAC with a primary E-RNTI only.

A UE is required to monitor a set of E-AGCHs. The RRC signals to the UE details of the set of E-AGCHs that are to be monitored. The UE decodes an Absolute Grant intended for it on the basis of the E-RNTI sent to it by the Node B via the SRNC and by RRC. The following information will be conveyed in an absolute grant message:

- Absolute Grant Value – maximum power granted per resource unit (per slot)
- The physical resources to be used for transmission
  - Channelisation Code
  - Timeslots
  - Resource Duration (optional)

The absolute grant message itself includes multiple fields that are multiplexed together into between 14 and 28 bits (depending on the system configuration) inside the MAC-e of the Node B and then submitted to the physical layer for transmission on the E-AGCH. These fields are:

- Absolute Grant Value:  
For TDD, this field indicates the maximum E-DCH traffic to reference power ratio ( $E\text{-P}_{\text{UCH}}/P_{\text{e-base}}$ ) per TDD resource unit that the UE is allowed to use on the E-DCH resources associated with the Absolute Grant. A TDD resource unit is defined as one sixteenth of the OVFSF codespace in one timeslot. The length of the Absolute Grant Value field for TDD is 5 bits.
- Channelisation Code:  
This field describes the code component of the physical resource grant. For 3.84 Mcps TDD it comprises an enumerated value of length 5 bits indicating which node on the OVFSF code tree has been allocated. For 7.68 Mcps TDD it comprises an enumerated value of length 6 bits indicating which node on the OVFSF tree has been allocated. The mapping between the allocated OVFSF and the enumerated node 0...30 for 3.84 Mcps and 0...62 for 7.68 Mcps is as given in [19].
- Timeslot Resource Related Information:  
This field describes the timeslot component of the physical resource grant and comprises a bitmap of length  $n_{\text{TRRI}}$  indicating which of the timeslots configured for E-DCH use by RRC have been allocated with the LSB corresponding to the lowest numbered E-DCH timeslot and the MSB corresponding to the highest numbered timeslot. The length of the TRRI field ( $n_{\text{TRRI}}$ ) is configurable by RRC on a per-cell basis between 1 and 12 bits.
- Resource Duration Indicator:  
Optionally, RRC may configure, on a per-cell basis the presence of a resource duration indicator field on E-AGCH for TDD. If configured as present in a cell, 3 bits are used to indicate the number of TTI's allocated and the spacing between the allocated TTIs via a single grant according to table 9.2.6.2.1-2. If the field is configured as not present on E-AGCH in the cell, a value of 0 is implicitly assumed by the UE corresponding to 1 TTI.

**Table 9.2.6.2.1-2 – Resource Duration Indicator (RDI) interpretation**

Resource Duration Indicator (3 bits)	TTIs allocated	TTI spacing
0	1	1
1	2	1
2	2	2
3	2	4
4	4	1
5	4	2
6	4	4
7	8	1



- E-AGCH Cyclic Sequence Number (ECSN):  
The ECSN is a 3-bit field used to assist the UE with outer-loop power control of E-AGCH (cf. HCSN for HS-SCCH).

### 9.2.6.3 UL Scheduling Information

This control information is used by UEs to indicate to the Node B the amount of resources they require. Scheduling Information is sent via the E-PUCH in the MAC-e header when the UE is granted resource and by the E-RUCCH when no resource has been granted. Scheduling Information consists of three components as defined in subclause 9.2.6.3.3 -

- Buffer Information: This consists of:
  - Highest priority Logical Channel (HLID)
  - Total E-DCH Buffer Status (TEBS)
  - Highest priority Logical channel Buffer Status (HLBS)
- UE Power Headroom (UPH): The UPH field indicates the ratio of the maximum UE transmission power and the  $P_{e-base}$  power defined in [20]. The length of UPH is 5 bits.
- Serving and Neighbour Cell Pathloss (SNPL): This may be used by the Node-B to assist with its estimation of the degree of intercell interference each UE will generate and hence the absolute grant power value and physical resources to assign . The length of SNPL is 5 bits.

The Scheduling Information message is represented in figure 9.2.6.3-1.

SNPL	UPH	TEBS	HLBS	HLID
(5 bits)	(5 bits)	(5 bits)	(4 bits)	(4 bits)

**Figure 9.2.6.3-1: Scheduling Information format**

If Scheduling Information is sent via the E-RUCCH then the E-RNTI is also sent via the E-RUCCH, as shown by Figure 9.2.6.3-2:

Scheduling Information (23 bits)	E-RNTI (16 bits)
----------------------------------	------------------

**Figure 9.2.6.3-2: Format of information sent on E-RUCCH**

### 9.2.6.4 Transport block size

For 3.84 Mcps TDD, the normative description of the mapping between the E-TFC index and the corresponding transport block size is provided in Annex BA.

For 7.68 Mcps TDD, the normative description of the mapping between the E-TFC index and the corresponding transport block size is provided in Annex BB.

#### 9.2.6.4.1 3.84 Mcps TDD Transport Block Size

For 3.84 Mcps TDD, the mapping of transport block size  $L$  to signalled index  $k_i = \{0,1,\dots,127\}$  (see Annex BA.1) is given by the formula:

$$L = \left\lfloor 60 \times \rho^{k_n + k_i} \right\rfloor$$

In the above formula  $\rho = 128^{\frac{1}{127}}$ ,  $k_i$  is the TBS index (0...127) and  $k_n$  is an integer selected based upon the number of timeslots allocated ( $n$ ). Values for  $k_n$  are tabulated in Table 9.2.6.4.1.

Table 9.2.6.4.1:  $k_n$  tabulated as a function of the number of timeslots ( $n$ )

$n$	$k_n$
1	0
2	18
3	28
4	36
5	42
6	46
7	50
8	54
9	57
10	60
11	62
12	65

#### 9.2.6.4.2 7.68 Mcps TDD Transport Block Size

For 7.68 Mcps TDD, the mapping of transport block size  $L$  to signalled index  $k_i = \{0, 1, \dots, 127\}$  (see Annex BB.1) is given by the formula:

$$L = \left\lfloor 60 \times \rho^{k_n + k_i} \right\rfloor$$

In the above formula,  $\rho = 256^{\frac{1}{127}}$   $k_i$  is the TBS index (0...127) and  $k_n$  is an integer selected based upon the number of timeslots allocated ( $n$ ). Values for  $k_n$  are tabulated in Table 9.2.6.4.2.

Table 9.2.6.4.2:  $k_n$  tabulated as a function of the number of timeslots ( $n$ )

$n$	$k_n$
1	0
2	15
3	25
4	31
5	36
6	41
7	44
8	47
9	50
10	52
11	54
12	56

---

## 10 Handling of unknown, unforeseen and erroneous protocol data

The list of error cases is reported below:

- a) Use of reserved coding in the MAC header

If the MAC entity receives a MAC PDU with a header field using a value marked as reserved for this version of the protocol, it shall discard the PDU, unless explicitly mentioned otherwise.

b) Inconsistent MAC header

If the MAC entity receives a MAC PDU with a header inconsistent with the configuration received from RRC, it shall discard the PDU. E.g.: In case DTCH is mapped to RACH/FACH, the MAC entity shall discard a PDU with a C/T field indicating a logical channel number that is not configured.

c) Erroneous MAC header fields

The MAC PDU shall be discarded if the lower layer gives an error indication for a MAC PDU and a MAC header is included in the MAC PDU.

d) Inconsistent information received on MAC control channels

If the MAC entity receives inconsistent information on the E-AGCH, it shall ignore the entire message. The following conditions constitute inconsistent information:

- The Absolute Grant Scope is "Per HARQ process" and the E-DCH TTI is configured to 10ms.
- The Identity Type is "Secondary" and the Absolute Grant Value is "INACTIVE".
- The Identity Type is "Secondary" and the Absolute Grant Scope is "Per HARQ process" in this version of the protocol.
- The Identity type is "Primary", the Absolute Grant value is "INACTIVE", the Absolute Grant Scope is "All HARQ processes", the E-DCH TTI is configured to 10ms and a secondary E-RNTI was not configured.

---

## 11 Specific functions

### 11.1 Traffic volume measurement for dynamic radio bearer control

Dynamic radio bearer control is performed by RRC, based on the traffic volume measurements reported by MAC. Traffic volume information is measured in MAC layer and the results are reported from MAC layer to RRC layer.

At least every TTI, the MAC layer shall receive from each RLC entity the value of its Buffer Occupancy (BO), expressed in bytes. RRC can configure MAC to keep track of statistics (i.e. raw BO, average of BO and variance of BO) on the BO (see [7]) values of all Radio Bearers mapped onto a given transport channel. When the average or variance are requested, an averaging interval duration will also be provided.

Every time the BO values are reported to MAC, the UE shall verify whether an event was triggered or if a periodic report is required (see [7]). If reporting is required (multiple reports may be triggered in a single TTI), the MAC shall deliver to RRC the reporting quantities required for the corresponding RBs. In the case of average and variance of BO, the averaging should be performed for the interval with the configured duration ending at the time when the event was triggered.

RRC requests MAC measurement report with the primitive CMAC-Measure-REQ including following parameters.

Measurement information elements.

- Reporting Quantity identifiers  
Indicates what should be reported to RRC layer  
For each RB, BO (optional), Average of BO (optional), or Variance of BO(optional)
- Time interval to take an average or a variance (applicable when Average or Variance is Reporting Quantity)  
Indicates time interval to take an average or a variance of BO  
The calculation of average and variance of BO shall be based on one sample of BO per 10ms during the time interval given in this information element. All samples taken in the time interval shall have equal weight in the calculation.

MAC receives RLC PDUs with the primitive MAC-Data-REQ including following parameters.

- Buffer Occupancy (BO)  
The parameter Buffer Occupancy (BO) indicates for each logical channel the amount of data in number of bytes that is available for transmission and retransmission in RLC layer. When MAC is connected to an AM RLC entity, control PDUs to be transmitted and RLC PDUs outside the RLC Tx window shall also be included in the BO. RLC PDUs that have been transmitted but not negatively acknowledged by the peer entity shall not be included in the BO.

## 11.2 Control of RACH transmissions

The MAC sublayer is in charge of controlling the timing of RACH transmissions on transmission time interval level (the timing on access slot level is controlled by L1). Note that retransmissions in case of erroneously received RACH message part are under control of higher layers, i.e. RLC, or RRC for CCCH (and SHCCH for TDD).

### 11.2.1 Access Service Class selection

The physical RACH resources (i.e. access slots and preamble signatures for FDD, timeslot and channelisation code for 3.84 Mcps TDD and 7.68 Mcps TDD, SYNC1 code for 1.28 Mcps TDD) may be divided between different Access Service Classes in order to provide different priorities of RACH usage. It is possible for more than one ASC or for all ASCs to be assigned to the same access slot/signature space or SYNC1 code.

Access Service Classes are numbered in the range  $0 \leq i \leq \text{NumASC} \leq 7$  (i.e. the maximum number of ASCs is 8). An ASC is defined by an identifier  $i$  that defines a certain partition of the PRACH resources and an associated persistence value  $P_i$ . A set of ASC parameters consists of  $\text{NumASC}+1$  such parameters  $(i, P_i)$ ,  $i = 0, \dots, \text{NumASC}$ . The PRACH partitions and the persistence values  $P_i$  are derived by the RRC protocol from system information (see [7]). The set of ASC parameters is provided to MAC with the CMAC-Config-REQ primitive. The ASC enumeration is such that it corresponds to the order of priority (ASC 0 = highest priority, ASC 7 = lowest priority). ASC 0 shall be used in case of Emergency Call or for reasons with equivalent priority.

At radio bearer setup/reconfiguration each involved logical channel is assigned a MAC Logical channel Priority (MLP) in the range 1, ..., 8. When the MAC sublayer is configured for RACH transmission in the UE, these MLP levels shall be employed for ASC selection on MAC.

The following ASC selection scheme shall be applied, where NumASC is the highest available ASC number and MinMLP the highest logical channel priority assigned to one logical channel:

- in case all TBs in the TB set have the same MLP, select  $\text{ASC} = \min(\text{NumASC}, \text{MLP})$ ;
- in case TBs in a TB set have different priority, determine the highest priority level MinMLP and select  $\text{ASC} = \min(\text{NumASC}, \text{MinMLP})$ .

When an RRC CONNECTION REQUEST message is sent RRC determines ASC by means of the access class [7]. The ASC to be used in these circumstances is signalled to MAC by means of the CMAC-CONFIG-REQ message.

If MAC has knowledge of a U-RNTI then the ASC is determined in the MAC entity. If no U-RNTI has been indicated to MAC then MAC will use the ASC indicated in the CMAC-CONFIG-REQ primitive.

### 11.2.2 Control of RACH transmissions for FDD mode

The RACH transmissions are controlled by the UE MAC sublayer as outlined in figure 11.2.2.1.

**NOTE:** The figure shall illustrate the operation of the transmission control procedure as specified below. It shall not impose restrictions on implementation. MAC controls the timing of each initial preamble ramping cycle as well as successive preamble ramping cycles in case that none or a negative acknowledgement is received on AICH.

**NOTE:** In Cell-FACH state, the UE should co-ordinate the UL transmission schedule with the measurement schedule in FACH measurement occasions so as to minimise any delays associated with inter-frequency measurements.

MAC receives the following RACH transmission control parameters from RRC with the CMAC-CONFIG-Req primitive:

- a set of Access Service Class (ASC) parameters, which includes for each ASC,  $i=0, \dots, \text{NumASC}$  an identification of a PRACH partition and a persistence value  $P_i$  (transmission probability);
- maximum number of preamble ramping cycles  $M_{\text{max}}$ ;
- range of backoff interval for timer  $T_{\text{BO1}}$ , given in terms of numbers of transmission 10 ms time intervals  $N_{\text{BO1max}}$  and  $N_{\text{BO1min}}$ , applicable when negative acknowledgement on AICH is received.

When there is data to be transmitted, MAC selects the ASC from the available set of ASCs, which consists of an identifier  $i$  of a certain PRACH partition and an associated persistence value  $P_i$ . The procedure to be applied for ASC selection is described in subclause 11.2.1.

Based on the persistence value  $P_i$ , the UE decides whether to start the L1 PRACH transmission procedure (see [13]) in the present transmission time interval or not. If transmission is allowed, the PRACH transmission procedure (starting with a preamble power ramping cycle) is initiated by sending of a PHY-ACCESS-REQ primitive. MAC then waits for access information from L1 via PHY-ACCESS-CNF primitive. If transmission is not allowed, a new persistency check is performed in the next transmission time interval. The persistency check is repeated until transmission is permitted.

When the preamble has been acknowledged on AICH, L1 access information with parameter value "ready for data transmission" is indicated to MAC with PHY-ACCESS-CNF primitive. Then data transmission is requested with PHY-DATA-REQ primitive, and the PRACH transmission procedure shall be completed with transmission of the PRACH message part according to L1 specifications. Successful completion (TX status) of the MAC transmission control procedure shall be indicated to higher layer.

When PHY indicates that no acknowledgement on AICH is received while the maximum number of preamble retransmissions is reached (defined by parameter Preamble\_Retrans\_Max on L1), a new persistency test is performed in the next transmission time interval. The timer  $T_2$  ensures that two successive persistency tests are separated by at least one 10 ms time interval.

In case that a negative acknowledgement has been received on AICH a backoff timer  $T_{\text{BO1}}$  is started. After expiry of the timer, persistence check is performed again. Backoff timer  $T_{\text{BO1}}$  is set to an integer number  $N_{\text{BO1}}$  of 10 ms time intervals, randomly drawn within an interval  $0 \leq N_{\text{BO1min}} \leq N_{\text{BO1}} \leq N_{\text{BO1max}}$  (with uniform distribution).  $N_{\text{BO1min}}$  and  $N_{\text{BO1max}}$  may be set equal when a fixed delay is desired, and even to zero when no delay other than the one due to persistency is desired.

Before a persistency test is performed it shall be checked whether any new RACH transmission control parameters have been received from RRC with CMAC-CONFIG-Req primitive. The latest set of RACH transmission control parameters shall be applied.

If the maximum number of preamble ramping cycles  $M_{\text{max}}$  is exceeded, failure of RACH transmission shall be reported to higher layer.

Both, transmission failure and successful completion of the MAC transmission control procedure, shall be indicated individually for each logical channel of which data was included in the transport block set of that access attempt. When transparent mode RLC is employed (i.e. for CCCH), transmission status is reported to RRC with CMAC-STATUS-Ind primitive. For logical channels employing acknowledged or unacknowledged mode RLC, transmission status is reported to RLC with MAC-STATUS-Ind primitive.

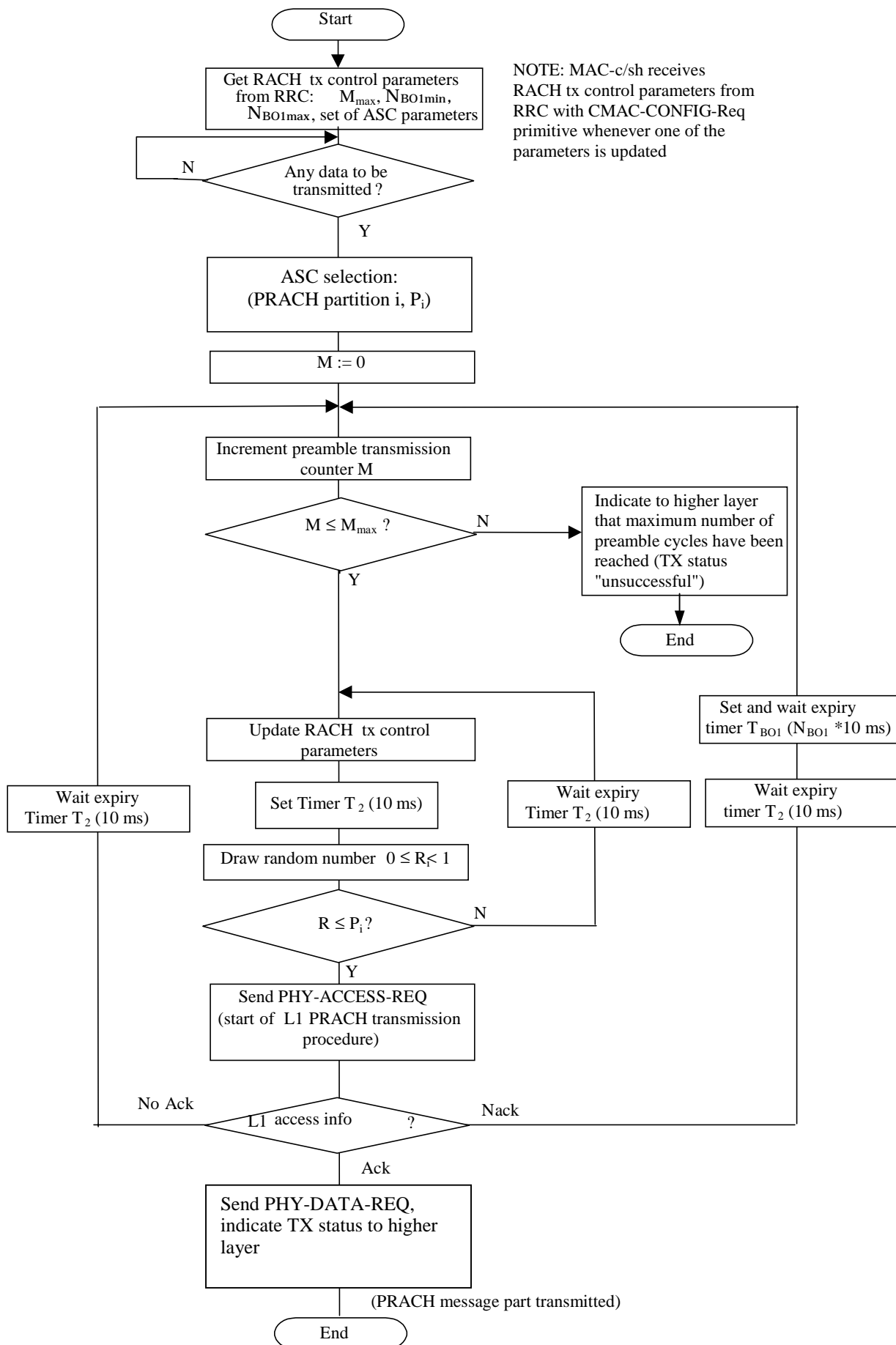

Figure 11.2.2.1: RACH transmission control procedure (UE side, informative)

## 11.2.3 Control of RACH transmissions for TDD

### 11.2.3.1 Control of RACH transmissions for 3.84 Mcps TDD and 7.68 Mcps TDD

The RACH transmissions are performed by the UE as shown in figure 11.2.3.2.

NOTE: The figure shall illustrate the operation of the transmission control procedure as specified below. It shall not impose restrictions on implementation.

MAC receives the following RACH transmission control parameters from RRC with the CMAC-Config-REQ primitive:

- a set of Access Service Class (ASC) parameters, which includes for each ASC,  $i=0, \dots, \text{NumASC}$  an identification of a PRACH partition and a persistence value  $P_i$  (transmission probability).

When there is data to be transmitted, MAC selects the ASC from the available set of ASCs, which consists of an identifier  $i$  of a certain PRACH partition and an associated persistence value  $P_i$ . The procedure to be applied for ASC selection is described in subclause 11.2.1.

In order to separate different ASCs each PRACH has  $N$  sub-channels associated with it (numbered from 0 to  $N-1$ ).  $N$  may be assigned the value 1,2,4, or 8 by higher layer signalling. Sub-channel  $i$  for a PRACH defined in timeslot  $k$  is defined as the  $k$ :th slot in the frames where  $\text{SFN mod } N = i$ . Therefore follows the definition:

- Sub-channel  $i$  associated to a PRACH defined in timeslot  $k$  is defined as the  $k$ :th timeslot in the frames where  $\text{SFN mod } N = i$ .

Figure 11.2.3.1 illustrates the eight possible subchannels for the case,  $N=8$ . For illustration, the figure assumes that the PRACH is assigned timeslot 3.

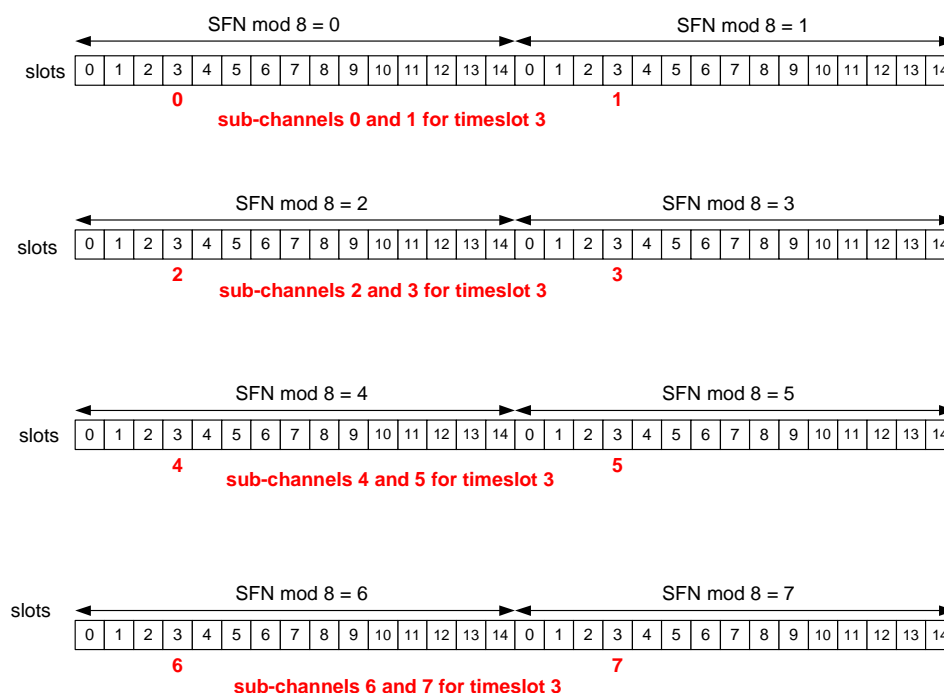

Figure 11.2.3.1 Eight sub-channels for timeslot 3

Based on the persistence value  $P$ , the UE decides whether to send the message on the RACH. If transmission is not allowed, a new persistency check is performed in the next transmission time interval. The persistency check is repeated until transmission is permitted. If transmission is allowed, a subchannel is randomly selected from the set of available subchannels for this ASC. The random subchannel selection shall be such that each of the allowed selections is chosen with equal probability. If an available subchannel is not found, the persistency check and subchannel assignment is repeated for the next subchannel period. If an available subchannel is found the PRACH transmission procedure is initiated by sending of a PHY-Data-REQ primitive.

Successful completion (TX status) of the MAC transmission control procedure shall be indicated to higher layer individually for each logical channel of which data was included in the transport block set of that access attempt. When transparent mode RLC is employed (i.e. for CCCH), transmission status is reported to RRC with CMAC-STATUS-Ind primitive. For logical channels employing acknowledged or unacknowledged mode RLC, transmission status is reported to RLC with MAC-STATUS-Ind primitive.

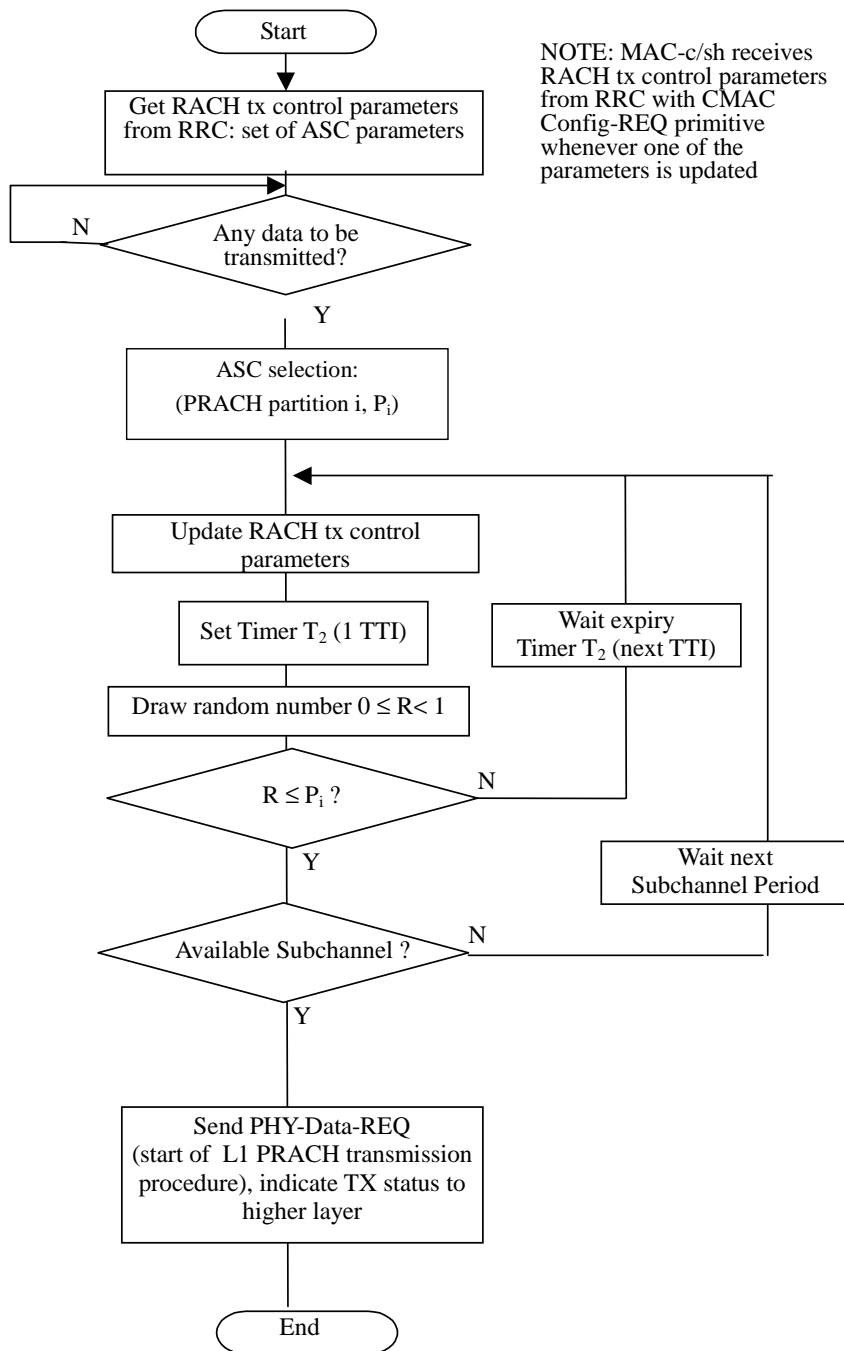

Figure 11.2.3.2: RACH transmission control procedure for TDD (UE side, informative)

### 11.2.3.2 Control of RACH Transmissions for 1.28 Mcps TDD

The RACH transmissions are performed by the UE as shown in figure 11.2.3.3.

NOTE: The figure shall illustrate the operation of the transmission control procedure as specified below. It shall not impose restrictions on implementation.

UE MAC receives the following RACH transmission control parameters from RRC with the CMAC-Config-REQ primitive:



- a set of Access Service Class (ASC) parameters, which includes for each ASC,  $i=0, \dots, \text{NumASC}$  an identification of a PRACH partition and a persistence value  $P_i$  (transmission probability),
- maximum number of synchronisation attempts  $M_{\max}$ .

When there is data to be transmitted, MAC selects the ASC from the available set of ASCs, which consists of an identifier  $i$  of a certain PRACH partition and an associated persistence value  $P_i$ .

Based on the persistence value  $P_i$ , MAC decides whether to start the L1 PRACH procedure in the present transmission time interval or not. If transmission is allowed, the PRACH transmission procedure (starting with the SYNC\_UL/FPACH power ramping sequence) is initiated by the sending of a PHY-ACCESS-REQ primitive. MAC then waits for access information from L1 via the PHY-ACCESS-CNF primitive. If transmission is not allowed, a new persistency check is performed in the next transmission time interval. The persistency check is repeated until transmission is permitted.

If a synchronisation burst has been acknowledged on its associated FPACH, PHY will inform MAC by a PHY-ACCESS-CNF primitive indicating "ready for RACH data transmission". Then MAC requests data transmission with a PHY-DATA-REQ primitive, and the PRACH transmission procedure will be completed with transmission on the PRACH resources associated with the FPACH.

Successful completion of the MAC procedure is indicated to higher layer individually for each logical channel of which data was included in the transport block set of that access attempt. When transparent mode RLC is employed (i.e. for CCCH), transmission status is reported to RRC with CMAC-STATUS-Ind primitive. For logical channels employing acknowledged or unacknowledged mode RLC, transmission status is reported to RLC with MAC-STATUS-Ind primitive.

If no synchronisation burst received an acknowledgement on the FPACH within the maximum number of transmissions permitted in a power ramping cycle, PHY will inform MAC by a PHY-ACCESS-CNF primitive indicating "no response received on FPACH". If the maximum number of synchronisation attempts permitted,  $M_{\max}$ , has not been exceeded, then MAC commences a new persistency test sequence in the next transmission time interval and the PHY-ACCESS-REQ procedure is repeated. The timer  $T_2$  ensures that two successive persistency tests are separated by at least one transmission time interval. If the maximum number of synchronisation attempts is exceeded then MAC abandons the RACH procedure. Failure to complete the MAC procedure is indicated to higher layer by the CMAC-STATUS-Ind or MAC-STATUS-Ind primitives.

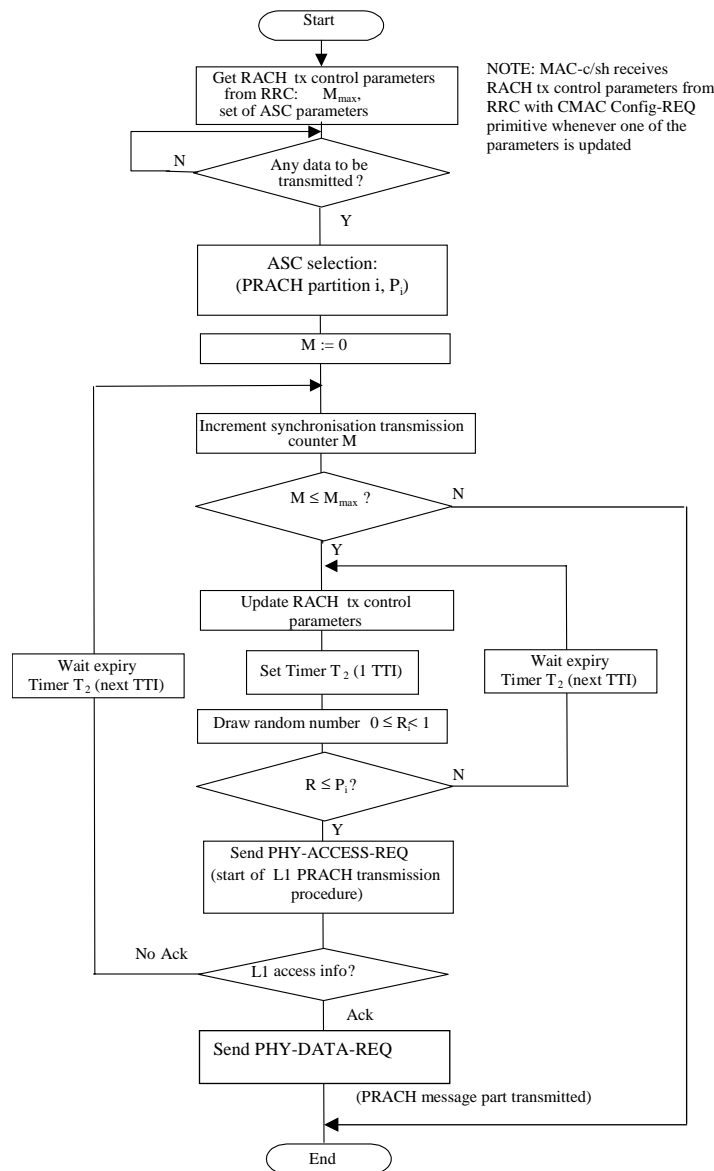

Figure 11.2.3.3: RACH transmission control procedure for 1.28 Mcps TDD (UE side, informative)

### 11.3 Void

### 11.4 Transport format combination selection in UE (non E-DCH)

RRC can control the scheduling of uplink data by giving each logical channel a priority between 1 and 8, where 1 is the highest priority and 8 the lowest. TFC selection in the UE shall be done in accordance with the priorities indicated by RRC. Logical channels have absolute priority, i.e. the UE shall maximise the transmission of higher priority data.

If the uplink TFCS or TFC Subset configured by UTRAN follows the guidelines described in [7] the UE shall perform the TFC selection according to the rules specified below. If these guidelines are not followed then the UE behaviour is not specified.

A given TFC can be in any of the following states:

- Supported state;

- Excess-power state;
- Blocked state.

TDD mode UEs in CELL\_FACH state using the USCH transport channel and UEs in CELL\_DCH state using a DCH shall continuously monitor the state of each TFC based on its required transmit power versus the maximum UE transmit power (see [7]). The state transition criteria and the associated requirements are described in [12, 14]. The UE shall consider that the Blocking criterion is never met for TFCs included in the minimum set of TFCs (see [7]).

The following diagram illustrates the state transitions for the state of a given TFC:

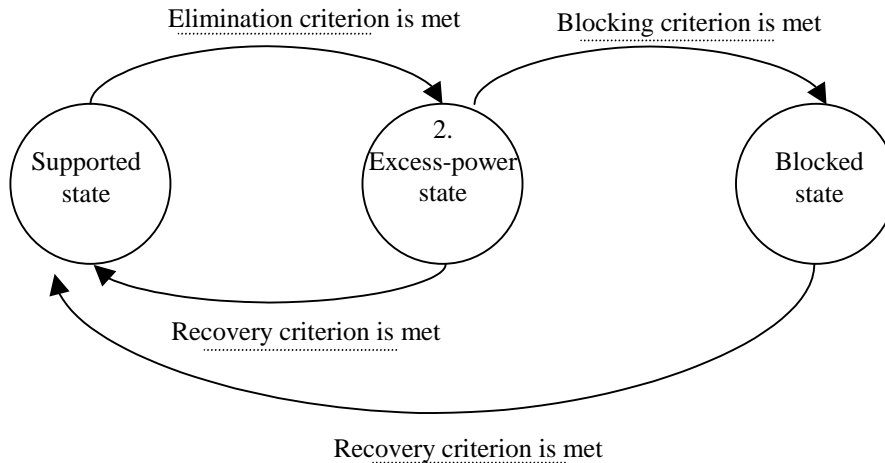

**Figure 11.4.1: State transitions for the state of a given TFC**

FDD Mode UEs in CELL\_FACH state may estimate the channel path loss and set to excess power state all the TFCs requiring more power than the Maximum UE transmitter power (see [7]). All other TFCs shall be set to Supported state.

Every time the set of supported TFCs changes, the available bitrate shall be indicated to upper layers for each logical channel in order to facilitate the adaptation of codec data rates when codecs supporting variable-rate operation are used. The details of the computation of the available bitrate and the interaction with the application layer are not further specified.

Before selecting a TFC, i.e. at every boundary of the shortest TTI, or prior to each transmission on PRACH the set of valid TFCs shall be established. All TFCs in the set of valid TFCs shall:

1. belong to the TFCS.
  - 1a. not be restricted by higher layer signalling (e.g. TFC Control, see [7]).
2. not be in the Blocked state.
3. be compatible with the RLC configuration.
4. not require RLC to produce padding PDUs (see [6] for definition).
5. not carry more bits than can be transmitted in a TTI (e.g. when compressed mode by higher layer scheduling is used and the presence of compressed frames reduces the number of bits that can be transmitted in a TTI using the Minimum SF configured).

The UE may remove from the set of valid TFCs, TFCs in Excess-power state in order to maintain the quality of service for sensitive applications (e.g. speech). However, this shall not apply to TFCs included in the minimum set of TFCs (see [7]). Additionally, if compressed frames are present within the longest configured TTI to which the next transmission belongs, the UE may remove TFCs from the set of valid TFCs in order to account for the higher power requirements.

The chosen TFC shall be selected from within the set of valid TFCs and shall satisfy the following criteria in the order in which they are listed below:

1. No other TFC shall allow the transmission of more highest priority data than the chosen TFC.

2. No other TFC shall allow the transmission of more data from the next lower priority logical channels. Apply this criterion recursively for the remaining priority levels.
3. No other TFC shall have a lower bit rate than the chosen TFC.

In FDD mode the above rules for TFC selection in the UE shall apply to DCH, and the same rules shall apply for TF selection on RACH.

In 3.84 Mcps TDD mode and in 7.68 Mcps TDD mode the above rules for TFC selection in the UE shall apply to DCH and USCH.

## 11.5 Ciphering

The ciphering function is performed in MAC (i.e. only in MAC-d) if a radio bearer is using the transparent RLC mode. The part of the MAC PDU that is ciphered is the MAC SDU and this is shown in Figure 11.5.1 below.

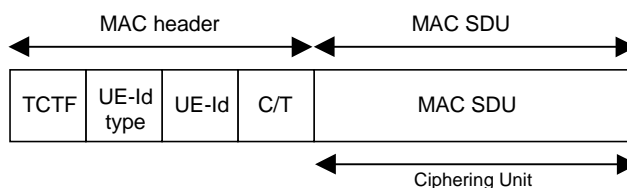

**Figure 11.5.1: Ciphered part unit for a MAC PDU**

In case a TTI contains multiple MAC PDUs for a given Transparent mode RB, the ciphering unit for this RB is the bitstring concatenation of all the MAC SDUs, resulting in the PLAINTEXT BLOCK, as defined in [15]. In case there is only one MAC PDU for a given Transparent mode RB, the ciphering unit is the MAC SDU, resulting in the PLAINTEXT BLOCK. The concatenation order is the same as the order of transmission of the Transport Blocks between MAC and Physical layer.

The KEYSTREAM BLOCK as defined in [10] is applied to the PLAINTEXT BLOCK, and the end result, CIPHERTEXT BLOCK, becomes the ciphered part for the MAC PDU, in case there is only one MAC PDU per RB. In case there is more than one MAC PDU per RB, the CIPHERTEXT BLOCK is split into the corresponding ciphered parts for each MAC PDU. The split order is the same as the order of transmission of the Transport Blocks between MAC and Physical layer.

The ciphering algorithm and key to be used are configured by upper layers [7] and the ciphering method shall be applied as specified in [10].

The parameters that are required by MAC for ciphering are defined in [10] and are input to the ciphering algorithm. The parameters required by MAC which are provided by upper layers [7] are listed below:

- MAC-d HFN (Hyper frame number for radio bearers that are mapped onto transparent mode RLC)
- BEARER defined as the radio bearer identifier in [10]. It will use the value RB identity -1 as in [7])
- CK (Ciphering Key)

If the TTI consists of more than one 10 ms radio frame, the CFN of the first radio frame in the TTI shall be used as input to the ciphering algorithm for all the data in the TTI.

## 11.6 Control of HS-DSCH transmission and reception

### 11.6.1 Network operation

The following are the functions of the various functional entities at the network in support of the HARQ protocol used on HS-DSCH.

### 11.6.1.1 Scheduler

The scheduler performs the following functions:

- Schedules all UEs within a cell;
- Services priority queues:
  - The scheduler schedules MAC-hs SDUs based on information from upper layers. One UE may be associated with one or more MAC-d flows. Each MAC-d flow contains HS-DSCH MAC-d PDUs for one or more priority queues.
- Determines the HARQ Entity and the queue to be serviced;
- Sets the TSN for new data blocks being transferred from the selected queue;
  - set the TSN to value 0 for the first MAC-hs PDU transmitted for each Queue ID within an HS-DSCH;
  - increment the TSN with one for each transmitted MAC-hs PDU on each Queue ID within an HS-DSCH.

NOTE: The scheduler may re-use TSNs by toggling the NDI bit in order to resume pre-empted transmissions or to force the UE to flush the soft buffer. In this case the content of the payload may be changed but care should be taken to preserve the higher layer data order.

- Indicates the Queue ID and TSN to the HARQ entity for each MAC-hs PDU to be transmitted;
- Schedules new transmissions and retransmissions:
  - Based on the status reports from HARQ Processes the scheduler determines if either a new transmission or a retransmission should be made. A new transmission can however be initiated on a HARQ process at any time. Based on a delay attribute provided by upper layers, the scheduler may decide to discard any 'out-of-date' MAC-hs SDU.
- Determines the redundancy version:
  - The scheduler determines a suitable redundancy version for each transmitted and retransmitted MAC-hs PDU and indicates the redundancy version to lower layer.
- Determines the TDD HCSN;
  - Increment UE specific HCSN for each HS-SCCH transmission.

### 11.6.1.2 HARQ entity

- There is one HARQ entity per UE in UTRAN.
- The HARQ entity sets the Queue ID in transmitted MAC-hs PDUs to the value indicated by the UTRAN scheduler.
- The HARQ entity sets the transmission sequence number (TSN) in transmitted MAC-hs PDUs to the value indicated by the UTRAN scheduler.
- The HARQ entity sets the HARQ process identifier in transmitted MAC-hs PDUs. UTRAN should:
  - determine a suitable HARQ process to service the MAC-hs PDU and set the HARQ process identifier accordingly.

### 11.6.1.3 HARQ process

- The HARQ process sets the New data indicator in transmitted MAC-hs PDUs. UTRAN should:
  - set the New Data Indicator to the value "0" for the first MAC-hs PDU transmitted by a HARQ process;

- not increment the New Data Indicator for retransmissions of a MAC-hs PDU;
- increment the New Data Indicator with one for each transmitted MAC-hs PDU containing new data.
- The HARQ process processes received status messages. UTRAN should:
  - deliver received status messages to the scheduler.

## 11.6.2 UE operation

The UE operation in support of the HARQ protocol used on HS-DSCH is split among the following four functional units with their associated functions.

### 11.6.2.1 HARQ Entity

There is one HARQ entity at the UE which processes the HARQ process identifiers received on the HS-SCCH transmissions associated with MAC-hs PDUs received on the HS-DSCH.

A number of parallel HARQ processes are used in the UE to support the HARQ entity. The number of HARQ processes is configured by upper layers:

- Each received MAC-hs PDU shall be allocated to the HARQ process indicated by the HARQ process identifier of the MAC-hs PDU.

### 11.6.2.2 HARQ process

The HARQ process processes the New Data Indicator indicated by lower layers for each received MAC-hs PDU.

The UE may:

- for FDD, if the MAC-hs PDU is received within 5 sub-frames from the reception of the previous MAC-hs PDU intended for this HARQ process; or
- for TDD, if the MAC-hs PDU is received before generation of feedback resulting from reception of a previous MAC-hs PDU for the same HARQ process:
  - discard the MAC-hs PDU.

The UE shall:

- if the New Data Indicator has been incremented compared to the value in the previous received transmission in this HARQ process or this is the first received transmission in the HARQ process:
  - replace the data currently in the soft buffer for this HARQ process with the received data.
- if the Transport Block Size index value is equal to 111111 (FDD only):
  - generate a positive acknowledgement (ACK) of the data in this HARQ process;
  - discard the received data;
  - assume that the data has been successfully decoded.
- if the New Data Indicator is identical to the value used in the previous received transmission in the HARQ process:
  - if the Transport Block Size index value is equal to 111111 (FDD only):
    - assume that the transport block size is identical to the last valid transport block size signalled for this HARQ process.
  - if the data has not yet been successfully decoded:
    - combine the received data with the data currently in the soft buffer for this HARQ process.

- if the transport block size is different from the last valid transport block size signalled for this HARQ process:
  - the UE may replace the data currently in the soft buffer for this HARQ process with the received data.
- if the data in the soft buffer has been successfully decoded and no error was detected:
  - deliver the decoded MAC-hs PDU to the reordering entity;
  - generate a positive acknowledgement (ACK) of the data in this HARQ process.
- else:
  - generate a negative acknowledgement (NAK) of the data in this HARQ process;
- schedule the generated positive or negative acknowledgement for transmission and the time of transmission relative to the reception of data in a HARQ process is configured by upper layer.

The HARQ process processes the Queue ID in the received MAC-hs PDUs. The UE shall:

- arrange the received MAC-hs PDUs in queues based on the Queue ID.

### 11.6.2.3 Reordering entity

#### 11.6.2.3.1 Definitions

In the functions described in this section the following definitions apply:

##### Parameters

- Transmitter window size (TRANSMIT\_WINDOW\_SIZE)  
TRANSMIT\_WINDOW\_SIZE is the size of the transmitter window according to the definition below. This is a parameter in the Node B and the value of the parameter is configured by higher layers.
- Receiver window size (RECEIVE\_WINDOW\_SIZE)  
RECEIVE\_WINDOW\_SIZE is the size of the receiver window according to the definition below. This is a parameter in the UE and the value of the parameter is configured by higher layers.

##### State variables

All state variables are non-negative integers. MAC-hs PDUs are numbered by modulo integer Transmission sequence numbers (TSN) cycling through the field 0 to 63. All arithmetic operations contained in the present document on next\_expected\_TSN, RcvWindow\_UpperEdge, T1\_TSN and TSN\_flush are affected by the 64 modulus. When performing arithmetic comparisons of state variables or Transmission sequence number values a 64 modulus base shall be used. This modulus base is subtracted (within the appropriate field) from all the values involved and then an absolute comparison is performed.  $RcvWindow\_UpperEdge - RECEIVE\_WINDOW\_SIZE + 1$  shall be assumed to be the modulus base.

- next\_expected\_TSN:  
The next\_expected\_TSN is the Transmission sequence number (TSN) following the TSN of the last in-sequence MAC-hs PDU received. It shall be updated according to the procedures given in subclauses 11.6.2.3.2, 11.6.2.5 and 11.6.2.6. The initial value of next\_expected\_TSN = 0.
- RcvWindow\_UpperEdge:  
The RcvWindow\_UpperEdge represents the TSN, which is at the upper edge of the receiver window. After the first MAC-hs PDU has been received successfully, it also corresponds to the MAC-hs PDU with the highest TSN of all received MAC-hs PDUs. The initial RcvWindow\_UpperEdge equals 63. RcvWindow\_UpperEdge is updated based on the reception of new MAC-hs PDU according to the procedure given below.
- T1\_TSN:  
The TSN of the latest MAC-hs PDU that cannot be delivered to the disassembly entity, when the timer T1 is started.

## Timers

- Re-ordering release timer (T1):  
The Re-ordering release timer T1 controls the stall avoidance in the UE reordering buffer as described below.  
The value of T1 is configured by upper layers.

## Other definitions

- Receiver window:  
The receiver window defines TSNs of those MAC-hs PDUs that can be received in the receiver without causing an advancement of the receiver window according to the procedure below. The size of the receiver window equals RECEIVE\_WINDOW\_SIZE and spans TSNs going from RcvWindow\_UpperEdge – RECEIVE\_WINDOW\_SIZE + 1 to RcvWindow\_UpperEdge included.

### 11.6.2.3.2 Reordering functionality

If no timer T1 is active:

- the timer T1 shall be started when a MAC-hs PDU with TSN > next\_expected\_TSN is correctly received.
- T1\_TSN shall be set to the TSN of this MAC-hs PDU.

If a timer T1 is already active:

- no additional timer shall be started, i.e. only one timer T1 may be active at a given time.

The timer T1 shall be stopped if:

- the MAC-hs PDU with TSN = T1\_TSN can be delivered to the disassembly entity before the timer expires.

When the timer T1 expires and T1\_TSN > next\_expected\_TSN:

- all correctly received MAC-hs PDUs with TSN > next\_expected\_TSN up to and including T1\_TSN-1 shall be delivered to the disassembly entity;
- all correctly received MAC-hs PDUs up to the next not received MAC-hs PDU shall be delivered to the disassembly entity.
- next\_expected\_TSN shall be set to the TSN of the next not received MAC-hs PDU.

When the timer T1 is stopped or expires, and there still exist some received MAC-hs PDUs that can not be delivered to higher layer:

- timer T1 is started
- set T1\_TSN to the highest TSN among those of the MAC-hs PDUs that can not be delivered.

### Transmitter operation:

After the transmitter has transmitted a MAC-hs PDU with TSN=SN, any MAC-hs PDU with TSN ≤ SN – TRANSMIT\_WINDOW\_SIZE should not be retransmitted to avoid sequence number ambiguity in the receiver.

### Receiver operation:

When a MAC-hs PDU with TSN = SN is received:

- if SN is within the receiver window:
  - if SN < next\_expected\_TSN, or this MAC-hs PDU has previously been received:
    - the MAC-hs PDU shall be discarded;



- else:
  - the MAC-hs PDU shall be placed in the reordering buffer at the place indicated by the TSN.
  
- if SN is outside the receiver window:
  - the received MAC-hs PDU shall be placed above the highest received TSN in the reordering buffer, at the position indicated by SN;
  - RcvWindow\_UpperEdge shall be set to SN thus advancing the receiver window;
  - any MAC-hs PDUs with  $TSN \leq RcvWindow\_UpperEdge - RECEIVE\_WINDOW\_SIZE$ , i.e. outside the receiver window after its position is updated, shall be removed from the reordering buffer and be delivered to the disassembly entity;
  - if next\_expected\_TSN is below the updated receiver window:
    - next\_expected\_TSN shall be set to  $RcvWindow\_UpperEdge - RECEIVE\_WINDOW\_SIZE + 1$ ;
- if the MAC-hs PDU with  $TSN = next\_expected\_TSN$  is stored in the reordering buffer:
  - all received MAC-hs PDUs with consecutive TSNs from next\_expected\_TSN (included) up to the first not received MAC-hs PDU shall be delivered to the disassembly entity;
  - next\_expected\_TSN shall be advanced to the TSN of this first not received MAC-hs PDU.

In case a UE has insufficient memory to process a received MAC-hs PDU, it shall perform the following set of operations:

- select TSN\_flush such that:  $next\_expected\_TSN < TSN\_flush \leq RcvWindow\_UpperEdge + 1$ ;
- deliver all correctly received MAC-hs PDUs with  $TSN < TSN\_flush$  to the disassembly entity;
- if the MAC-hs PDU with  $TSN=TSN\_flush$  has previously been received:
  - deliver all received MAC-hs PDUs with consecutive TSNs from TSN\_flush (included) up to the first not received MAC-hs PDU to the disassembly entity;
  - advance next\_expected\_TSN to the TSN of this first not received MAC-hs PDU.
- else:
  - set next\_expected\_TSN to TSN\_flush.

#### 11.6.2.4 Disassembly entity

For each MAC-hs PDU that is delivered to the disassembly entity, the UE shall:

- remove any padding bits if present;
- remove the MAC-hs header;
- deliver the MAC-d PDUs in the MAC-hs PDU to MAC-d.

#### 11.6.2.5 MAC-hs Reset

If a reset of the MAC-hs entity is requested by upper layers, the UE shall at the activation time indicated by higher layers:

- flush soft buffer for all configured HARQ processes;
- stop all active re-ordering release timer (T1) and set all timer T1 to their initial value;
- start TSN with value 0 for the next transmission on every configured HARQ process;

- initialise the variables RcvWindow\_UpperEdge and next\_expected\_TSN to their initial values;
- disassemble all MAC-hs PDUs in the re-ordering buffer and deliver all MAC-d PDUs to the MAC-d entity;
- flush the re-ordering buffer.

and then:

if the MAC-hs reset was initiated due to reception of the IE "MAC-hs reset indicator" by the upper layers [7]:

- indicate to all AM RLC entities mapped on HS-DSCH to generate a status report.

### 11.6.2.6 Reconfiguration of MAC-hs parameters

The parameters for a MAC-hs entity may be reconfigured (modified) by upper layers.

When a parameter is reconfigured by the upper layer, the UE shall:

- start using the reconfigured value of the parameter at the activation time indicated by higher layers.

If the parameter T1 is reconfigured for an already existing re-ordering queue, the UE shall:

- start to use the new value of T1 the next time T1 is started.

If the MAC-d PDU size info (i.e. mapping of MAC-d PDU size index to MAC-d PDU size) is reconfigured for an already existing re-ordering queue, at the activation time indicated by higher layers, the UE shall:

- stop timer T1 if running;
- set next\_expected\_TSN to (highest TSN of received MAC-hs PDU of this re-ordering queue + 1);
- deliver all correctly received MAC-hs PDUs in this re-ordering queue to the disassembly entity and use the old MAC-d PDU size info for these MAC-hs PDUs.

If the parameter RECEIVE\_WINDOW\_SIZE is reconfigured for a re-ordering queue, the UE shall:

- set RECEIVE\_WINDOW\_SIZE to the new value;
- remove any MAC-hs PDUs in this re-ordering queue with  $TSN \leq RcvWindow\_UpperEdge - RECEIVE\_WINDOW\_SIZE$  (i.e. outside the receiver window after its size is updated) from the reordering buffer and deliver these MAC-hs PDUs to the disassembly entity;
- if next\_expected\_TSN is below the receiver window after its size is updated:
  - set next\_expected\_TSN to  $RcvWindow\_UpperEdge - RECEIVE\_WINDOW\_SIZE + 1$ ;
  - deliver all received MAC-hs PDUs in this re-ordering queue with consecutive TSNs from next\_expected\_TSN (included) up to the first not received MAC-hs PDU to the disassembly entity;
  - advance next\_expected\_TSN to the TSN of this first not received MAC-hs PDU.

If the "Memory Partitioning" (see [7]) for soft buffer is reconfigured, the UE shall:

- flush soft buffer for all configured HARQ processes.

## 11.7 HS-DSCH Provided Bit Rate measurement

The HS-DSCH Provided Bit Rate measurements is defined as follows:

- for each priority class the MAC-hs entity measures the total number of MAC-d PDU bits whose transmission over the radio interface has been considered successful by MAC-hs in Node-B during the last measurement period, divided by the duration of the measurement period;
- the values reported by MAC-hs shall be raw samples;
- the measurement period shall be [100 ms];

- when the cell portions are defined in a cell, the HS-DSCH Provided Bit Rate shall be measured for each cell portion.

## 11.8 Control of E-DCH transmission and reception (FDD)

### 11.8.1 UE operation

#### 11.8.1.1 HARQ Operation

##### 11.8.1.1.1 HARQ entity

There is one HARQ entity at the UE. A number of parallel HARQ processes are used in the UE to support the HARQ entity, allowing transmissions to take place continuously while waiting for the feedback on the successful or unsuccessful reception of previous transmissions.

At a given TTI, the HARQ entity identifies the HARQ process for which a transmission should take place. Also, based on the timing, it routes the receiver feedback (ACK/NACK information), relayed by the physical layer, to the appropriate HARQ process.

The number of HARQ processes is equal to the HARQ round-trip-time (HARQ\_RTT). The HARQ\_RTT is equal to 4 for 10ms TTI and 8 for 2ms TTI. The TTI duration shall be configured by the higher layers. Each process is associated with a number from 0 to HARQ\_RTT-1.

After each TTI, the HARQ entity shall:

- if the buffer of the HARQ process corresponding to the next TTI is empty:
  - notify the E-TFC selection entity that the next TTI is available for a new transmission;
  - if the "E-TFC Selection" entity indicates the need for a new transmission:
    - obtain the transmission information (i.e. HARQ profile, whether triggered Scheduling Information is included and whether it is sent alone) from the "E-TFC Selection" entity;
    - obtain the MAC-e PDU to transmit from the "Multiplexing and TSN setting" entity;
    - instruct the HARQ process corresponding to this TTI to trigger the transmission of this new payload using the identified HARQ profile parameters.
- else:
  - instruct the HARQ process to generate a re-transmission.

##### 11.8.1.1.2 HARQ process

Each HARQ process is associated with a physical buffer (HARQ buffer).

Each HARQ process maintains the state variable CURRENT\_TX\_NB, which indicates the number of transmissions that have taken place for the MAC-e PDU currently in the buffer. When the HARQ process is established, CURRENT\_TX\_NB shall be initialized to 0.

At the time of a new transmission, the HARQ entity provides the HARQ profile to use for all transmissions and re-transmissions of this MAC-e PDU. This HARQ profile includes information on the maximum number of transmissions to perform, and the power offset with which to configure the physical layer.

If the HARQ entity provides a new PDU, the HARQ process shall:

- set CURRENT\_TX\_NB to 0;
- set CURRENT\_RSN to 0;
- store the MAC-e PDU in the associated HARQ buffer;

- generate a transmission as described below.

If the HARQ entity requests a re-transmission, the HARQ process shall:

- generate a transmission as described below.

To generate a transmission, the HARQ process shall, regardless of any overlapping with a compressed mode gap:

- instruct the physical layer to set the RSN field on the E-DPCCH to CURRENT\_RSN;
- instruct the physical layer to generate a transmission with the power offset corresponding to the HARQ profile and the redundancy version corresponding to the RSN value and the transmission timing (i.e. the CFN and in the case of 2ms TTI, sub-frame number as described in [16]);
- if CURRENT\_RSN < 3:
  - increment CURRENT\_RSN by 1;
  - increment CURRENT\_TX\_NB by 1;

The HARQ process shall:

- if an ACK is received from the RLS containing the serving cell; or
- if an ACK is received from any RLS and the transmission included higher layer data (i.e. not only included Scheduling Information); or
- if CURRENT\_TX\_NB  $\geq$  maximum number of transmissions indicated in the transmission HARQ profile:
  - flush the HARQ buffer;
  - if the transmission included Scheduling Information which was triggered per subclause 11.8.1.6 and if no ACK for that transmission was received from the RLS containing the serving cell:
    - notify the Scheduling Information Reporting function that the HARQ process failed to deliver the triggered Scheduling Information to the RLS containing the serving cell (see subclause 11.8.1.6.3).

**NOTE:** In the case where the Scheduling Information is transmitted alone, without any higher layer data the UE will keep re-transmitting the Scheduling Information until an ACK is received from the RLS containing the serving cell or the maximum number of re-transmissions is reached. In the latter case, periodic triggering will be relied upon for reliability.

### 11.8.1.2 Multiplexing and TSN setting entity

There is one Multiplexing and TSN setting entity at the UE. A number of TSN setting processes are used to support independent numbering of transmissions from different logical channels.

#### 11.8.1.2.1 TSN setting process operation

There is one TSN setting process at the UE for each logical channel. When a MAC-es PDU is transmitted, the UE operation in support of the re-ordering functionality consists in generating an explicit sequence number (TSN) for the MAC-es PDU intended for the associated re-ordering queue. In one TTI, there is only one TSN per logical channel: one for the MAC-es PDU that is transmitted.

Each TSN setting process maintains the state variable CURRENT\_TSN, which indicates the sequence number to be included in the header of the following MAC-es PDU to be generated. When the TSN setting process is established, CURRENT\_TSN shall be initialized to 0.

When a new payload needs to be generated for the associated re-ordering queue, the Multiplexing and TSN setting entity shall:

- set the TSN of the transmission to CURRENT\_TSN;

After each MAC-es PDU is multiplexed:

- increment CURRENT\_TSN by 1;

- if CURRENT\_TSN > 63:
- set CURRENT\_TSN = 0.

### 11.8.1.3 Serving Grant Update

UEs in CELL\_DCH state, configured with an E-DCH transport channel shall maintain a Serving Grant and the list of active HARQ processes based on the absolute and relative grant commands decoded on the configured E-AGCH and E-RGCH(s).

Each Absolute Grant or Relative Grant command is applied at a specific TTI. This association is implicit based on the timing of the E-AGCH and E-RGCH (see [13]). The timing is tight enough that this relationship is un-ambiguous.

The activation/deactivation of one or all processes is only applicable to processes for which transmission of scheduled data is allowed according to RRC signalling

Process activation of an active process does not result in any action taken by the UE.

#### 11.8.1.3.1 Baseline Procedure

The Serving Grant Update procedure shall be applied at every TTI boundary and shall take into account the Absolute Grant message, Serving Relative Grant and non-serving Relative Grants that apply to the TTI.

The UE shall:

- 1> set reference\_ETPR to the E-DPDCH to DPCCH power ratio as defined in subclause 3.1.2;
- 1> if an Absolute Grant was received for this TTI:
  - 2> if the Identity type is "Primary", and the Absolute Grant value is set to "INACTIVE":
    - 3> if Absolute Grant Scope indicates "Per HARQ process" and a 2ms TTI is configured:
      - 4> de-activate the process given by the value of CURRENT\_HARQ\_PROCESS.
    - 3> if Absolute Grant Scope indicates "All HARQ processes" and a secondary E-RNTI was configured by higher layers:
      - 4> activate all HARQ processes;
      - 4> set Serving\_Grant = Stored\_Secondary\_Grant;
      - 4> set Primary\_Grant\_Available to "False".
    - 3> if Absolute Grant Scope indicates "All HARQ processes", a 2ms TTI is configured and a secondary E-RNTI was not configured by higher layers:
      - 4> deactivate all HARQ processes (if a process was inactive it remains inactive, if a process was active it becomes inactive).
  - 2> else if the Absolute Grant Value is different from "INACTIVE":
    - 3> if the Identity Type is "Secondary":
      - 4> set Stored\_Secondary\_Grant = Absolute Grant Value.
    - 3> if the Identity Type is "Primary" or Primary\_Grant\_Available is set to "False":
      - 4> set Serving\_Grant = Absolute Grant Value.
      - 4> if the Identity Type is "Primary":
        - 5> set Primary\_Grant\_Available to "True";
        - 5> if Absolute Grant Scope indicates "Per HARQ process":
          - 6> activate the process given by the value of CURRENT\_HARQ\_PROCESS.

- 5> if Absolute Grant Scope indicates "All HARQ processes":
  - 6> activate all HARQ processes.
  - 5> if AG\_Timer is not active, it shall be started, otherwise it shall be restarted.
- 1> else (no Absolute Grant received):
  - 2> if the HARQ process given by the value of CURRENT\_HARQ\_PROCESS is active; and
  - 2> if Primary\_Grant\_Available is equal to "True"; and
  - 2> if Serving\_Grant <> "Zero\_Grant" ; and
  - 2> if AG\_Timer has expired; and
  - 2> if there was a scheduled transmission (see NOTE) in the previous TTI of the HARQ process given by the value of CURRENT\_HARQ\_PROCESS:
    - 3> if the Serving Relative Grant indicates "UP":
      - 4> determine the Serving\_Grant in accordance with subclause 9.2.5.2.1.
    - 3> else, if the Serving Relative Grant indicates "DOWN":
      - 4> determine the Serving\_Grant in accordance with subclause 9.2.5.2.1.
  - 1> if any Non-Serving Relative Grants indicate "DOWN" for this TTI and Serving\_Grant <> "Zero\_Grant":
    - 2> Serving\_Grant = MIN(Serving\_Grant, Serving\_Grant determined in accordance with subclause 9.2.5.2.1);
    - 2> Maximum\_Serving\_Grant = Serving\_Grant.
    - 2> if Non\_Serving\_RG\_Timer is not active it shall be started, otherwise it shall be restarted;
  - 1> else if no Non-Serving Relative Grants indicate "DOWN" for this TTI:
    - 2> if Non\_Serving\_RG\_Timer has not expired:
      - 3> Serving\_Grant = MIN(Maximum\_Serving\_Grant, Serving\_Grant).

NOTE 1: MIN("Zero\_Grant", any numerical value) = "Zero\_Grant".

NOTE 2: Scheduling Information sent alone is not considered as a scheduled transmission.

#### 11.8.1.3.2 Handling at start of E-DCH transmission

When E-DCH transmission is started (i.e. the RRC variable E\_DCH\_TRANSMISSION is changed from "false" to "true"), the UE shall:

- activate all HARQ processes;
- if the IE's "Serving Grant value" and "Primary/Secondary Grant Selector" are provided by higher layers:
  - update the state variables and timers according to subclause 11.8.1.3.5.
- else:
  - initialise the state variable Serving\_Grant to Zero\_Grant;
  - initialise the state variable Primary\_Grant\_Available to "False";
  - initialise the state variable Stored\_Secondary\_Grant to "Zero\_Grant".
- initialise the state variables reference\_ETPR to "Minimum\_Grant".

### 11.8.1.3.3 Handling at serving cell change

At E-DCH serving cell change, the UTRAN may configure the UE with the grant value to use in the new cell and shall indicate whether the UE should monitor Absolute Grant Messages with the secondary E-RNTI.

The UE shall:

- activate all HARQ processes;
- if the IE's "Serving Grant value" and "Primary/Secondary Grant Selector" are provided by higher layers:
  - update the state variables and timers according to subclause 11.8.1.3.5.
- else:
  - continue to use the current values of state variables `Serving_Grant` and `Primary_Grant_Available`;
  - initialise the state variable `Stored_Secondary_Grant` to "Zero\_Grant".

### 11.8.1.3.4 Handling at TTI change

At E-DCH TTI change, the UE shall:

- activate all HARQ processes;
- initialise the state variables `reference_ETPR` to "Minimum\_Grant";
- reset `Non_Serving_RG_Timer` and `AG_Timer`;
- if the IE's "Serving Grant value" and "Primary/Secondary Grant Selector" are provided by higher layers:
  - update the state variables and timers according to subclause 11.8.1.3.5.
- else:
  - continue to use the current values of state variables `Serving_Grant` and `Primary_Grant_Available`;
  - initialise the state variable `Stored_Secondary_Grant` to "Zero\_Grant".

### 11.8.1.3.5 Higher Layer Signalling

When the IE's "Serving Grant value" and "Primary/Secondary Grant Selector" are provided by higher layers:

- set the state variable `Serving_Grant` to the value of the IE's "Serving Grant value" provided by higher layers;
- if the IE's "Primary/Secondary Grant Selector" is provided by higher layers as "Primary":
  - if `AG_Timer` is not active, it shall be started, otherwise it shall be restarted;
  - set the state variable `Primary_Grant_Available` to "True";
  - set the state variable `Stored_Secondary_Grant` to "Zero\_Grant".
- if the IE's "Primary/Secondary Grant Selector" is provided by higher layers as "Secondary":
  - set the state variable `Primary_Grant_Available` to "False";
  - set the state variable `Stored_Secondary_Grant` to the value of the IE's "Serving Grant value" provided by higher layers.

### 11.8.1.4 E-TFC Selection

In FDD mode, the rules for E-TFC selection provided below shall apply to UEs in `CELL_DCH` state with an E-DCH transport channel configured. These UEs shall apply the E-TFC selection procedure when invoked by the HARQ entity (see subclause 11.8.1.1.1). In the case where a 2ms TTI is configured, E-TFC selection shall not be performed for TTIs that overlap with an uplink compressed mode gap. The E-TFC restriction procedure described in [12] shall always be

applied before the E-TFC selection process below. Furthermore, for UEs that are also configured with a DCH transport channel on uplink, the TFC selection procedure shall be applied before either of these.

For each MAC-d flow, RRC configures MAC with a HARQ profile and a multiplexing list. Additionally, RRC configures MAC with a power offset for "Control-only" transmissions. This power offset and a maximum number of HARQ transmissions of 8 will be used to define a HARQ profile for "Control-only" transmissions which will be used, in case the Scheduling Information needs to be transmitted without any higher-layer data. The HARQ profile includes the power offset and maximum number of HARQ transmissions to use for this MAC-d flow. The multiplexing list identifies for each MAC-d flow(s), the other MAC-d flows from which data can be multiplexed in a transmission that uses the power offset included in its HARQ profile.

RRC can control the scheduling of uplink data by giving each logical channel a priority between 1 and 8, where 1 is the highest priority and 8 the lowest. E-TFC selection in the UE shall be done in accordance with the priorities indicated by RRC. Logical channels have absolute priority, i.e. the UE shall maximise the transmission of higher priority data.

RRC can allocate non-scheduled transmission grants to individual MAC-d flows in order to reduce the transmission delays. When a 2ms TTI is configured each non-scheduled grant is applicable to the specific set of HARQ processes indicated by RRC. The applicability of scheduled grants can be also restricted to a specific set of HARQ processes when a 2ms TTI is configured. HARQ process restriction and reservation is under the control of the serving cell Node B and indicated to the UE by RRC.

For each configured MAC-d flow, a given E-TFC can be in any of the following states:

- Supported state;
- Blocked state.

At each TTI boundary, UEs in CELL\_DCH state with an E-DCH transport channel configured shall determine the state of each E-TFC for every MAC-d flow configured based on its required transmit power versus the maximum UE transmit power (see [7] and [12]). If no DCH transport channel is configured or if a DCH transport channel is configured and the selected TFC is "empty" (see [3]), the UE shall consider that E-TFCs included in the minimum set of E-TFCs are always in supported state (see [7]).

At every TTI boundary for which a new transmission is requested by the HARQ entity (see subclause 11.8.1.1.1), the UE shall perform the operations described below. UEs configured both with DCH and E-DCH transport channels shall perform TFC selection before performing E-TFC selection.

The Serving Grant Update function provides the E-TFC selection function with the maximum E-DPDCH to DPCCH power ratio that the UE is allowed to allocate for the upcoming transmission for scheduled data (held in the Serving Grant state variable – see subclause 11.8.1.3).

The HARQ process ID for the upcoming transmission is determined using the following formulae:

- For 2ms TTI:  $CURRENT\_HARQ\_PROCESS\_ID = [5 * CFN + \text{subframe number}] \bmod HARQ\_RTT$
- For 10ms TTI:  $CURRENT\_HARQ\_PROCESS\_ID = [CFN] \bmod HARQ\_RTT$

Based on this current HARQ process ID and the RRC configuration, the UE shall determine whether to take the scheduled and non-scheduled grants into account in the upcoming transmission. If they are not supposed to be taken into account, then the corresponding grant shall be assumed to not exist. If the variable `Serving_Grant` has the value "Zero\_Grant" after the Serving Grant Update, then the Serving Grant shall not be taken into account in the upcoming transmission.

When Scheduling Information is triggered per subclause 11.8.1.6, the E-TFC selection and data-allocation process shall assume that a non-scheduled grant is available for its transmission and that Scheduling Information has a priority higher than any other logical channel. Furthermore the HARQ process used for the upcoming transmission shall be assumed to be active and not L3 restricted for the transmission of the Scheduling Information, i.e. transmission of Scheduling Information can take place on this process.

The transmission format and data allocation shall follow the requirements below:

- Only E-TFCs from the configured E-TFCS shall be considered for the transmission;



- For all logical channels, if the logical channel belongs to a non-scheduled MAC-d flow, its data shall be considered as available up to the corresponding non-scheduled grant, if the logical channel does not belong to a non-scheduled MAC-d flow, its data shall be considered as available up to the Serving Grant;
- The power offset for the transmission is the one from the HARQ profile of the MAC-d flow that allows highest-priority data to be transmitted. If more than one MAC-d flow allows data of the same highest priority to be transmitted, it is left to implementation to select which MAC-d flow to prefer);
- In case the variable `Serving_Grant` has the value "Zero\_Grant" after the Serving Grant Update function and there is no data available for MAC-d flows for which non-scheduled grants were configured and the transmission of Scheduling Information has been triggered, the 'Control-only' HARQ profile configured by the higher layers shall be used.
- The Nominal Power Offset shall be set to the power offset included in the transmission HARQ profile;
- The data allocation shall maximize the transmission of higher priority data;
- The amount of data from MAC-d flows for which non-scheduled grants were configured shall not exceed the value of the non-scheduled grant;
- If a 10ms TTI is configured and the TTI for the upcoming transmission overlaps with a compressed mode gap, the `Serving_Grant` provided by the Serving Grant Update function shall be scaled back as follows:

$$SG' = SG * \left(\frac{N_C}{15}\right)$$

where  $SG'$  represents the modified serving grant considered by the E-TFC selection algorithm and  $N_C$  represents the number of non DTX slots in the compressed TTI;

- When not in a power limited condition the maximum amount of data from MAC-d flows for which no non-scheduled grants were configured shall be quantized to the next smaller supported E-TFC based on amplitude ratios prior to the quantization according to subclause 5.1.2.5B.2.3 of [13], the Serving Grant (after adjustment for compressed frames), the power offset from the selected HARQ profile, the non-scheduled grants (if any) and Scheduling Information (if any); In the case a 2ms TTI is configured and the HARQ process is inactive, the UE shall not include any such data in the transmission;
- The Scheduling Information is always sent when triggered (see subclause 11.8.1.6);
- Only E-TFCs in supported state shall be considered;
- The E-TFC resulting in the smallest amount of padding for the selected MAC-es PDUs and corresponding MAC-e/es headers, shall be selected including the case when the Scheduling Information needs to be transmitted.

Once an appropriate E-TFC and data allocation are found according to the rules above, the 'Multiplexing and TSN Setting' entity shall generate the corresponding MAC-e PDU.

The E-TFC selection function shall provide this MAC-e PDU and transmission HARQ profile to the HARQ entity. The maximum number of HARQ transmissions and the power offset in this profile, shall be set respectively to the maximum of the Max Number of HARQ Transmissions of the HARQ profiles from all the MAC-d flows from which data is multiplexed into the transmission and to the Nominal Power Offset. The HARQ entity shall also be informed of whether the transmission includes Scheduling Information and whether this information is sent by itself or with higher-layer data. The E-TFC selection function shall provide the E-TFCI for the selected E-TFC to the HARQ entity.

### 11.8.1.5 Happy Bit Setting

The Happy Bit is included on the E-DPCCH for every E-DCH transmission. E-DCH transmissions shall not be triggered specifically to allow the transmission of the happy bit.

RRC configures MAC with the duration `Happy_Bit_Delay_Condition`, over which to evaluate the current grant relative to the TEBS after application of the E-TFC selection procedure described in subclause 11.8.1.4.

For every E-DCH transmission, the Happy Bit shall be set to "unhappy" if the three following criteria are met:

- 1) UE is transmitting as much scheduled data as allowed by the current `Serving_Grant` in E-TFC selection; and
- 2) UE has enough power available to transmit at higher data rate; and
- 3) Based on the same power offset as the one selected in E-TFC selection to transmit data in the same TTI as the Happy Bit, TEBS would require more than `Happy_Bit_Delay_Condition` ms to be transmitted with the current `Serving_Grant`  $\times$  the ratio of active processes to the total number of processes.

The first criteria is always true for a deactivated process and the ratio of the third criteria is always 1 for 10ms TTI..

Otherwise, the Happy Bit shall be set to "happy".

In order to assess if it has enough power available to transmit at higher data rate the UE shall:

- 1) Identify the E-TFC that has a transport block size at least  $x$  bits larger than the transport block size of the E-TFC selected for transmission in the same TTI as the Happy Bit, where  $x$  is the smallest RLC PDU size configured among all the logical channels that do not belong to non-scheduled MAC-d flows and which have data in the buffer; and
- 2) Based on the same power offset as the one selected in E-TFC selection to transmit data in the same TTI as the Happy Bit, check that the identified E-TFC is supported i.e. not blocked.

### 11.8.1.6 Scheduling Information reporting

Scheduling information reports will be triggered differently depending on the value of the variable `Serving_Grant` after the `Serving Grant Update` function. The triggering of a report shall be indicated to the E-TFC selection function at the first new transmission opportunity (this process may be delayed in case the HARQ processes are occupied with re-transmissions).

Even if multiple events are triggered by the time a new transmission can take place, only a single scheduling information header will be included in the payload.

The Scheduling Information shall not be transmitted if the TEBS is zero, even if it was triggered by one of the configured triggering mechanisms. If the Scheduling Information needs to be included in the MAC-e PDU according to subclause 9.2.4.2, it shall be transmitted regardless of TEBS status.

The transmission of Scheduling Information can take place on every HARQ process, even on those processes for which transmission is restricted according to RRC or deactivated by absolute grants, i.e. processes on which scheduled and/or non-scheduled transmission can not take place.

The description of the behaviour in the two cases is provided below.

#### 11.8.1.6.1 Report Triggering when `SG = 'Zero_Grant'` or all processes are deactivated

If the `Serving_Grant` has the value "Zero\_Grant" or all processes are deactivated, and the TEBS becomes larger than zero, the transmission of Scheduling Information shall be triggered.

If data with higher priority than the data already in the transmission buffer arrives, the transmission of a Scheduling Information shall be triggered.

RRC can also configure MAC with periodic Scheduling Information triggering. The periodic trigger timer `T_SING` (Timer Scheduling Information – "Zero\_Grant") shall be started once the `Serving_Grant` variable becomes "Zero\_Grant" or all processes are deactivated and TEBS is larger than zero.

When `T_SING` expires, the transmission of a Scheduling Information shall be triggered.

`T_SING` shall be restarted when the transmission of a Scheduling Information is triggered.

`T_SING` shall be stopped and reset once the `Serving_Grant` variable in the `Serving Grant Update` function takes a value other than "Zero\_Grant" and at least one process is activated.

#### 11.8.1.6.2 Report Triggering when SG $\leftrightarrow$ 'Zero\_Grant' and at least one process is activated

If an E-DCH serving cell change occurs and if the new E-DCH serving cell was not part of the previous Serving E-DCH RLS, the transmission of a Scheduling Information shall be triggered.

RRC can configure MAC with periodic triggering also for the case when the variable Serving\_Grant  $\leftrightarrow$  "Zero\_Grant" and at least one process is activated. The periodic trigger timer T\_SIG (Timer Scheduling Information – different from "Zero\_Grant") can be configured to a different value than T\_SING.

T\_SIG shall be started once the Serving\_Grant variable becomes  $\leftrightarrow$  "Zero\_Grant" and at least one process is activated.

When T\_SIG expires, the transmission of a new Scheduling Information shall be triggered.

T\_SIG shall be stopped and reset once the Serving\_Grant variable in the Serving Grant Update function becomes equal to "Zero\_Grant" or all processes are deactivated.

T\_SIG shall be restarted when the transmission of a Scheduling Information is triggered.

Once the Serving\_Grant variable in the Serving Grant Update function becomes equal to "Zero\_Grant" or all processes are deactivated and TEBS is larger than zero, the transmission of a Scheduling Information shall be triggered.

#### 11.8.1.6.3 HARQ delivery failure for triggered Scheduling Information

If the HARQ process fails to deliver a MAC-e PDU containing a triggered Scheduling Information to the RLS containing the serving cell:

- if the Scheduling Information was transmitted without any higher layer data multiplexed in the same MAC-e PDU:
  - no further action is required (rely on periodic triggering).
- else (Scheduling Information was transmitted together with higher layer data multiplexed in the same MAC-e PDU):
  - the transmission of a new Scheduling Information shall be triggered.

#### 11.8.1.7 MAC-es/e Reset

If a reset of the MAC-es/e entity is requested by upper layers, the UE shall at the activation time indicated by higher layers:

- flush all HARQ processes;
- set CURRENT\_TSN to 0 for all the logical channels mapped to E-DCH.

NOTE: In this case, the HARQ entity will not notify the Scheduling Information Reporting function if a flushed MAC-e PDU contained a triggered Scheduling Information (rely on periodic triggering).

### 11.8.2 Node B operation

#### 11.8.2.1 HARQ Operation

##### 11.8.2.1.1 HARQ entity

There is one HARQ entity per UE in each Node-B in its E-DCH active set. The HARQ entity routes the payload and the associated RSN value to the appropriate HARQ process based on the transmission timing. Based on the outcome of the decoding, the HARQ entity transmits an ACK or a NACK in return.

##### 11.8.2.1.2 HARQ process

The HARQ process uses the RSN and the transmission timing (CFN, sub-frame) to establish the transmission number. Based on this it identifies the transmission redundancy version and attempts to decode the transmission. The outcome of the decoding is reported to the HARQ entity, so that it may be fed back to the UE.

### 11.8.2.2 De-multiplexing

There is one de-multiplexing entity per UE in the Node B. The SRNC configures the Node B with the mapping between the active DDI values and the corresponding MAC-d flow and PDU size. Also, it provides it with the mapping between MAC-d flow IDs and the corresponding Iub bearer.

The de-multiplexing entity uses the MAC-e header information (DDI, N) to determine the size of each MAC-es PDU and based on this it segments the MAC-e payload into MAC-es PDUs. These are then routed onto the Iub bearer indicated by the DDI value.

With each MAC-es PDU, the Node B will send to the SRNC:

- the associated DDI and N values;
- the CFN and sub-frame number when the payload including the MAC-es PDU was decoded correctly;
- the total number of transmissions that were needed for the MAC-e PDU to be decoded correctly.

### 11.8.2.3 Scheduler

There is one E-DCH Node B scheduler per Node B. The Node B scheduler is responsible for the following functions:

- Allocating uplink resources to UEs for which it acts as the serving Node B;
- Monitoring other-cell interference and accordingly sending relative grants to UEs for which it does not act as the serving Node B;
- Reporting to the SRNC on the lack of processing resources;

### 11.8.2.4 E-DCH Provided Bit Rate measurement

The E-DCH Provided Bit Rate measurement is defined as follows:

- for each priority class the MAC-e function in the Node B measures the total number of MAC-d PDU bits whose transmission over the radio interface has been considered successful by MAC-e in Node-B during the last measurement period, divided by the duration of the measurement period;
- the number of MAC-d PDU bits from UEs in softer handover shall be considered after soft combining;
- the Node-B shall allocate the bit rate received over an RLS equally divided among all cells in the RLS regardless of whether the RLS contains the E-DCH serving cell or not;
- the values reported shall be raw samples;
- the measurement period shall be 100 ms.

## 11.8.3 RNC operation

### 11.8.3.1 Re-ordering entity

The re-ordering entity is part of the MAC-es sublayer in the SRNC. There is one re-ordering entity per UE. Each re-ordering entity will support one re-ordering process per logical channel. The DDI value is used to determine the logical channel for which each MAC-es PDU is meant. Based on this information, the MAC-es PDUs are routed to the proper re-ordering process. The re-ordering process may use the explicit TSN indication as well as the timing information provided by the Node B in order to eliminate duplicates and deliver the packets in order to RLC. The details of the re-ordering mechanism are left up to the implementation.

## 11.9 Control of E-DCH transmission and reception (3.84/7.68 Mcps TDD)

### 11.9.1 UE operation

#### 11.9.1.1 HARQ Operation

The TDD HARQ protocol is a stop and wait protocol based on synchronous downlink ACK/NACKs with asynchronous retransmissions in the uplink. If NACK is received then the UE may only retransmit the previously transmitted MAC-e PDU if suitable physical resources are available, otherwise it must wait until it receives an appropriate Absolute Grant (or in the case of non-scheduled transmission, the UE must wait until resource is next designated as available for non-scheduled transmission/retransmission). There are a maximum of 8 HARQ processes (instances of the HARQ entity). Operation of the HARQ protocol is as follows:

- If an Absolute Grant is received in Frame (i) then the UE transmits a data block (MAC-e PDU) in Frame (i+T1)
- For a MAC-e PDU transmitted in Frame (i+T1) the UE receives an ACK/NACK in Frame (i+T1+T2)
- If NACK is received in Frame (i+T1+T2) then the UE cannot retransmit the MAC-e PDU previously transmitted in Frame (i+T1) (now stored for potential retransmission) until suitable physical resources are available (e.g. until Absolute Grant received)
- The interval T3 between reception of NACK and the availability of suitable resources via reception of a Grant for a subsequent retransmission is variable and depends on Node B scheduling decisions
- If an ACK is received in Frame (i+T1+T2) then the MAC-e PDUs previously transmitted in Frame (i+T1) (stored for potential retransmission) are discarded and the HARQ process identity associated with the previously transmitted data blocks can now be reassigned.

T1 and T2 may be derived from the physical layer timings given in [21].

Operation of the TDD HARQ protocol is illustrated by Figure 11.9.1.1.

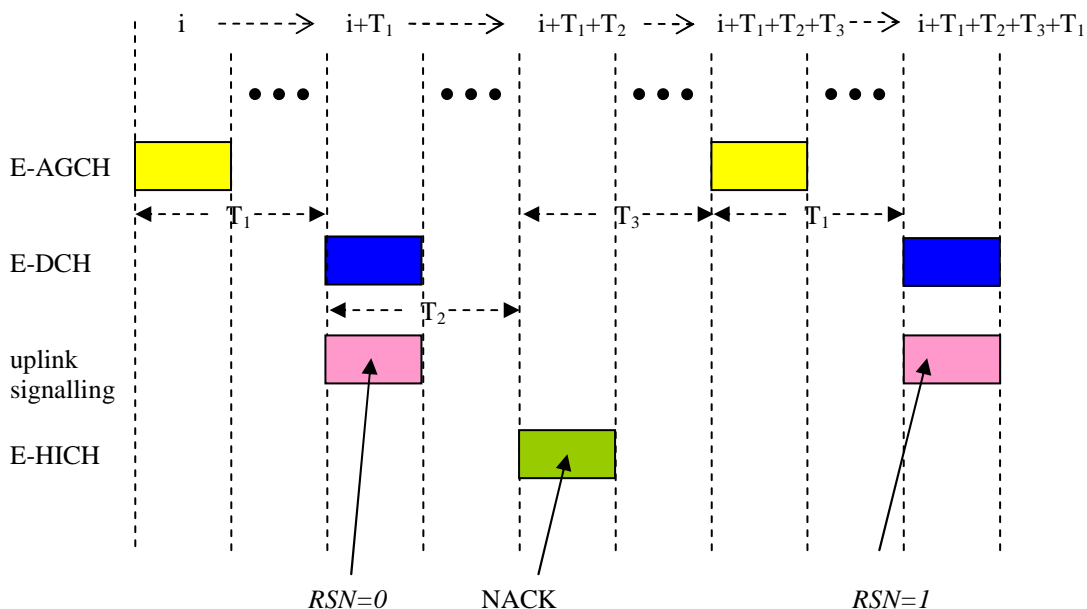

Figure 11.9.1.1: TDD E-DCH HARQ Operation

#### 11.9.1.1.1 HARQ entity

There is one HARQ entity in the UE. A number of parallel HARQ processes (identified by a HARQ process identifier) are used in the UE to support the HARQ entity, allowing transmissions to take place continuously while the UE is granted resources. The HARQ entity identifies the HARQ process for which transmission should take place if resources are available. Also, based on timing with respect to a previously-transmitted MAC-e PDU it routes the receiver feedback (ACK/NACK information), relayed by the physical layer, to the appropriate HARQ process.

The minimum number of HARQ processes is a function of T1 and T2 (see subclause 11.9.1.1). The maximum number of HARQ process identifiers is 8. Each process is associated with a HARQ process identifier numbered from 0 to 7.

The HARQ entity is responsible for determining which HARQ process will use the assigned resources in a given TTI (for both scheduled and non-scheduled resource types). It is further responsible for determining for each HARQ process whether new data or existing data should be transmitted from the HARQ process buffer, including the case in which new data is transmitted before successful delivery of the exiting data.

For transmission in a given TTI, the HARQ entity shall only consider those HARQ processes associated with the resource grant type (scheduled / non-scheduled). HARQ processes 0 to 3 are associated with scheduled transmission whilst HARQ processes 4 to 7 are associated with non-scheduled transmission. In the following, the set of HARQ processes associated with the resource grant type is denoted the "associated set".

The following rules control the operation of the HARQ entity:

- If retransmissions are pending for any of the HARQ processes of the associated set:
  - the HARQ entity shall determine for each HARQ process of the associated set whether the current resource grant is sufficient to allow retransmission of the data. The grant is deemed to be sufficient if the corresponding transport block size is supportable within the allocated resources as determined by the E-TFC selection entity (see subclause 11.9.1.4);
  - if the grant is sufficient for retransmission by at least one of the HARQ processes of the associated set, select the HARQ process containing the oldest MAC-e PDU for retransmission and notify the E-TFC selection entity that the TTI shall be used for retransmission;
  - if the grant is not sufficient for retransmission by any of the HARQ processes of the associated set, the HARQ entity shall select an available HARQ process from the associated set for transmission of new data. In the case that none of the HARQ processes in the associated set are available (all contain data for retransmission) the HARQ entity shall discard the data from the HARQ process in the associated set containing the oldest MAC-e PDU and shall select that HARQ process for transmission of new data. In either case, the HARQ entity shall notify the E-TFC selection entity that the TTI shall be used for a new transmission.
- else:
  - the HARQ entity shall select an available HARQ process from the associated set for transmission of new data and shall notify the E-TFC selection entity that the TTI shall be used for a new transmission of scheduled data.

#### 11.9.1.1.2 HARQ process

Each HARQ process is associated with a physical buffer (HARQ buffer).

Each HARQ process maintains the state variable CURRENT\_TX\_NB, which indicates the number of transmissions that have taken place for the MAC-e PDU currently in the buffer. When the HARQ process is established, CURRENT\_TX\_NB shall be initialized to 0.

At the time of a new transmission, the HARQ entity provides the HARQ profile to use for all transmissions and re-transmissions of this MAC-e PDU. This HARQ profile includes information on the maximum number of transmissions to perform, and the power offset with which to configure the physical layer.

If the HARQ entity provides a new PDU, the HARQ process shall:

- set CURRENT\_TX\_NB to 0;
- set CURRENT\_RSN to 0;

- store the MAC-e PDU in the associated HARQ buffer;
- generate a transmission as described below.

If the HARQ entity requests a re-transmission, the HARQ process shall:

- generate a transmission as described below.

To generate a transmission, the HARQ process shall:

- instruct the physical layer to set the RSN field on the E-UCCH to CURRENT\_RSN;
- instruct the physical layer to generate a transmission with the power offset corresponding to the HARQ profile and the redundancy version corresponding to the RSN value
- if  $CURRENT\_RSN < 3$ 
  - increment CURRENT\_RSN by 1;
- else
  - decrement CURRENT\_RSN by 1;
- increment CURRENT\_TX\_NB by 1;
- if  $CURRENT\_TX\_NB \geq$  maximum number of transmissions indicated in the transmission HARQ profile:
  - flush the HARQ buffer;

If an ACK is received, the HARQ process shall:

- flush the HARQ buffer;
- set CURRENT\_TX\_NB to 0;
- set CURRENT\_RSN to 0.

### 11.9.1.2 Multiplexing and TSN setting entity

As subclause 11.8.1.2.

### 11.9.1.3 Receiving a Grant

The UE determines whether each TTI is available for scheduled or non-scheduled transmissions.

The parameters applicable to a transmission are timeslots, code and maximum power. In the case of non-scheduled transmission, these parameters are set by RRC and retransmissions and/or new transmissions may occur in frames at intervals set by RRC. For scheduled transmission, the parameters are received via the E-AGCH.

For given grant, the HARQ entity determines which HARQ process to use in the TTI (see subclause 11.9.1.1.1).

### 11.9.1.4 E-TFC Selection

In TDD, rules for E-TFC selection shall be applied as provided below.

UEs shall apply E-TFC selection when invoked by the HARQ entity (see subclause 11.9.1.1.1).

For each MAC-d flow, RRC configures MAC-e with a HARQ profile and multiplexing list. The HARQ profile includes the power offset and maximum number of HARQ transmissions to use for this MAC-d flow. The multiplexing list identifies for each MAC-d flow(s), the other MAC-d flows for which data can be multiplexed in a transmission that uses the power offset included in its HARQ profile.

RRC can control the scheduling of uplink data by giving each logical channel a priority between 1 and 8, where 1 is the highest priority and 8 the lowest. E-TFC selection in the UE shall be done in accordance with the priorities indicated by RRC. Logical channels have absolute priority, i.e. the UE shall maximise the transmission of higher priority data.

RRC can allocate non-scheduled transmission grants to individual MAC-d flows in order to reduce the transmission delays.

The UE shall determine whether to take scheduled or non-scheduled grants into account in the upcoming transmission. If neither are supposed to be taken into account (i.e. the TTI is not available for non-scheduled transmission and no Grant for scheduled transmission has been received) then no grant shall be assumed to exist. If a grant exists then the transmission format and data allocation shall follow the requirements below.

For each configured MAC-d flow, a given E-TFC can be in any of the following states:

- Supported state;
- Blocked state.

The E-TFC states are derived according to the following:

- If the transmission is a retransmission then only the E-TFC with the same block size as the original transmission may be in the supported state.
- Only E-TFCs from the E-TFCS (the table of TB sizes) which can be supported by (exactly) the number of slots assigned by the grant shall be considered for the transmission;
- Only E-TFCs which result (for the granted timeslot and code physical resources) in a coderate lying between the maximum and minimum (inclusive) allowable coderates set by RRC [7] shall be considered for the transmission {note: the definition of the term 'coderate' as used here is the same as that provided by [18]}. This shall be evaluated for both QPSK and 16-QAM modulation;
- $P_{\text{HARQ}}$ , the HARQ profile power offset is selected (the HARQ profile for the transmission shall be selected among the HARQ profiles of MAC-d flows on which the highest priority logical channels with available data are mapped)
- Only E-TFCs whose calculated transmission power requirement  $P_{\text{E-PUCH}}$  (see [18]) is less than or equal to the available or granted power shall be considered for the transmission (note: this requirement does not apply in the case of a retransmission on non-scheduled resources).

From those E-TFCs in the supported state the UE determines the largest block size that it is permitted to transmit within the given constraints.

The UE shall select the modulation type associated with the determined E-TFC (note: if an E-TFC is supported by both QPSK and 16-QAM then 16-QAM modulation shall be used if its power requirement ( $P_{\text{E-PUCH}}$ ) is lower than the power requirement for QPSK, otherwise QPSK modulation shall be used).

Data allocation shall then be performed in accordance with the following:

- For all logical channels, if the logical channel belongs to a non-scheduled MAC-d flow, its data shall be considered as available up to the largest block size determined for the corresponding non-scheduled grant. If the logical channel does not belong to a non-scheduled MAC-d flow, its data shall be considered as available up to the largest block size determined for the Serving Grant;
- The data allocation shall maximise the transmission of higher priority data;
- The UE shall select the E-TFC, SF and modulation which minimises the power used;

Once an appropriate E-TFC and data allocation are found according to the rules above, the "Multiplexing and TSN Setting" entity shall generate the corresponding MAC-e PDU.

The E-TFC selection function shall provide this MAC-e PDU and transmission HARQ profile to the HARQ entity. The maximum number of HARQ transmissions and the power offset in this profile shall be set respectively to the maximum of both the Max Number of HARQ Transmissions and of the power offset of the HARQ profiles from all the MAC-d flows from which data is multiplexed into the transmission. Each HARQ process which is associated with a buffer holding a MAC-e PDU for potential retransmission shall maintain the HARQ profile and the number of re-transmissions that have occurred.

Further information on E-TFC selection is provided in Annex CA.



## 11.9.2 Node B operation

### 11.9.2.1 HARQ Operation

#### 11.9.2.1.1 HARQ entity

There is one HARQ entity per UE in the Node-B. The HARQ entity routes the payload and the associated RSN value to the indicated HARQ process (the HARQ process identifier is signalled to the Node B via the E-UCCH). Based on the outcome of the decoding, the HARQ entity transmits an ACK or a NACK in return.

#### 11.9.2.1.2 HARQ process

The HARQ process uses the RSN to identify the redundancy version, The Node B uses the identified redundancy version to attempt to decode the transmission. The outcome of the decoding is reported to the HARQ entity, so that it may be fed back to the UE as ACK or NACK.

### 11.9.2.2 De-multiplexing

There is one de-multiplexing entity per UE in the Node B. The SRNC configures the Node B with the mapping between the active DDI values and the corresponding MAC-d flow and PDU size. Also, it provides it with the mapping between MAC-d flow IDs and the corresponding Iub bearer.

The de-multiplexing entity uses the MAC-e header information (DDI, N) to determine the size of each MAC-es PDU and based on this it segments the MAC-e payload into MAC-es PDUs. These are then routed onto the Iub bearer indicated by the DDI value.

With each MAC-es PDU, the Node B will send to the SRNC:

- the associated DDI and N values;
- the CFN when the payload including the MAC-es PDU was decoded correctly;
- the total number of transmissions that were needed for the MAC-e PDU to be decoded correctly.

### 11.9.2.3 Scheduler

There is one E-DCH Node B scheduler per Node B. The Node B scheduler is responsible for the following functions:

- Allocating uplink resources to UEs and signalling these to UEs via Absolute Grants;
- Reporting uplink interference measurements to the SRNC
- Reporting to the SRNC on the lack of processing resources
- Determining the TDD ECSN (the UE specific ECSN is incremented for each E-AGCH transmission)

### 11.9.2.4 E-DCH Provided Bit Rate measurement

The E-DCH Provided Bit Rate measurement is defined as follows:

- for each priority class the MAC-e function in the Node B measures the total number of MAC-d PDU bits whose transmission over the radio interface has been considered successful by MAC-e in Node-B during the last measurement period, divided by the duration of the measurement period;
- the measurement period shall be [100 ms].

## 11.9.3 RNC operation

### 11.9.3.1 Re-ordering entity

The re-ordering entity is part of the MAC-es sublayer in the SRNC. There is one re-ordering entity per UE. Each re-ordering entity will support one re-ordering process per logical channel. The DDI value is used to determine the logical channel for which each MAC-es PDU is meant. Based on this information, the MAC-es PDUs are routed to the proper re-ordering process. The re-ordering process may use the explicit TSN indication as well as the timing information provided by the Node B in order to eliminate duplicates and deliver the packets in order to RLC. The details of the re-ordering mechanism are left up to the implementation.

## Annex A (normative): HS-DSCH Transport Block Size Table for FDD

The following table provides the mapping between  $k_t$  (as per the definition in subclause 9.2.3.1) and the HS-DSCH Transport Block Size ( $L(k_t)$ ):

Index	TB Size	Index	TB Size	Index	TB Size
1	137	86	1380	171	6324
2	149	87	1405	172	6438
3	161	88	1430	173	6554
4	173	89	1456	174	6673
5	185	90	1483	175	6793
6	197	91	1509	176	6916
7	209	92	1537	177	7041
8	221	93	1564	178	7168
9	233	94	1593	179	7298
10	245	95	1621	180	7430
11	257	96	1651	181	7564
12	269	97	1681	182	7700
13	281	98	1711	183	7840
14	293	99	1742	184	7981
15	305	100	1773	185	8125
16	317	101	1805	186	8272
17	329	102	1838	187	8422
18	341	103	1871	188	8574
19	353	104	1905	189	8729
20	365	105	1939	190	8886
21	377	106	1974	191	9047
22	389	107	2010	192	9210
23	401	108	2046	193	9377
24	413	109	2083	194	9546
25	425	110	2121	195	9719
26	437	111	2159	196	9894
27	449	112	2198	197	10073
28	461	113	2238	198	10255
29	473	114	2279	199	10440
30	485	115	2320	200	10629
31	497	116	2362	201	10821
32	509	117	2404	202	11017
33	521	118	2448	203	11216
34	533	119	2492	204	11418
35	545	120	2537	205	11625
36	557	121	2583	206	11835
37	569	122	2630	207	12048
38	581	123	2677	208	12266
39	593	124	2726	209	12488
40	605	125	2775	210	12713
41	616	126	2825	211	12943
42	627	127	2876	212	13177
43	639	128	2928	213	13415
44	650	129	2981	214	13657
45	662	130	3035	215	13904

46	674	131	3090	216	14155
47	686	132	3145	217	14411
48	699	133	3202	218	14671
49	711	134	3260	219	14936
50	724	135	3319	220	15206
51	737	136	3379	221	15481
52	751	137	3440	222	15761
53	764	138	3502	223	16045
54	778	139	3565	224	16335
55	792	140	3630	225	16630
56	806	141	3695	226	16931
57	821	142	3762	227	17237
58	836	143	3830	228	17548
59	851	144	3899	229	17865
60	866	145	3970	230	18188
61	882	146	4042	231	18517
62	898	147	4115	232	18851
63	914	148	4189	233	19192
64	931	149	4265	234	19538
65	947	150	4342	235	19891
66	964	151	4420	236	20251
67	982	152	4500	237	20617
68	1000	153	4581	238	20989
69	1018	154	4664	239	21368
70	1036	155	4748	240	21754
71	1055	156	4834	241	22147
72	1074	157	4921	242	22548
73	1093	158	5010	243	22955
74	1113	159	5101	244	23370
75	1133	160	5193	245	23792
76	1154	161	5287	246	24222
77	1175	162	5382	247	24659
78	1196	163	5480	248	25105
79	1217	164	5579	249	25558
80	1239	165	5680	250	26020
81	1262	166	5782	251	26490
82	1285	167	5887	252	26969
83	1308	168	5993	253	27456
84	1331	169	6101	254	27952
85	1356	170	6211		

## Annex B (normative): E-DCH Transport Block Size Tables for FDD

The mapping between the chosen E-TFCI and the corresponding E-DCH transport block size is given in the following tables:

### B.1 2ms TTI E-DCH Transport Block Size Table 0

E-TFCI	TB Size (bits)	E-TFCI	TB Size (bits)	E-TFCI	TB Size (bits)	E-TFCI	TB Size (bits)	E-TFCI	TB Size (bits)
0	18	30	342	60	1015	90	3008	120	8913
1	120	31	355	61	1053	91	3119	121	9241
2	124	32	368	62	1091	92	3234	122	9582
3	129	33	382	63	1132	93	3353	123	9935
4	133	34	396	64	1173	94	3477	124	10302
5	138	35	410	65	1217	95	3605	125	10681
6	143	36	426	66	1262	96	3738	126	11075
7	149	37	441	67	1308	97	3876	127	11484
8	154	38	458	68	1356	98	4019		
9	160	39	474	69	1406	99	4167		
10	166	40	492	70	1458	100	4321		
11	172	41	510	71	1512	101	4480		
12	178	42	529	72	1568	102	4645		
13	185	43	548	73	1626	103	4816		
14	192	44	569	74	1685	104	4994		
15	199	45	590	75	1748	105	5178		
16	206	46	611	76	1812	106	5369		
17	214	47	634	77	1879	107	5567		
18	222	48	657	78	1948	108	5772		
19	230	49	682	79	2020	109	5985		
20	238	50	707	80	2094	110	6206		
21	247	51	733	81	2172	111	6435		
22	256	52	760	82	2252	112	6672		
23	266	53	788	83	2335	113	6918		
24	275	54	817	84	2421	114	7173		
25	286	55	847	85	2510	115	7437		
26	296	56	878	86	2603	116	7711		
27	307	57	911	87	2699	117	7996		
28	318	58	944	88	2798	118	8290		
29	330	59	979	89	2901	119	8596		

### B.2 2ms TTI E-DCH Transport Block Size Table 1

E-TFCI	TB Size (bits)	E-TFCI	TB Size (bits)	E-TFCI	TB Size (bits)
0	18	43	2724	86	7252
1	186	44	2742	87	7288
2	204	45	3042	88	7428
3	354	46	3060	89	7464

4	372	47	3078	90	7764
5	522	48	3298	91	7800
6	540	49	3316	92	7908
7	674	50	3334	93	7944
8	690	51	3378	94	8100
9	708	52	3396	95	8136
10	726	53	3414	96	8436
11	858	54	3732	97	8472
12	876	55	3750	98	8564
13	1026	56	3972	99	8600
14	1044	57	3990	100	8772
15	1062	58	4068	101	8808
16	1194	59	4086	102	9108
17	1212	60	4404	103	9144
18	1330	61	4422	104	9220
19	1348	62	4628	105	9256
20	1362	63	4646	106	9444
21	1380	64	4740	107	9480
22	1398	65	4758	108	9780
23	1530	66	5076	109	9816
24	1548	67	5094	110	9876
25	1698	68	5284	111	9912
26	1716	69	5302	112	10116
27	1734	70	5412	113	10152
28	1866	71	5430	114	10452
29	1884	72	5748	115	10488
30	1986	73	5766	116	10532
31	2004	74	5940	117	10568
32	2022	75	5958	118	10788
33	2034	76	6084	119	10824
34	2052	77	6102	120	11124
35	2070	78	6420	121	11178
36	2370	79	6438	122	11188
37	2388	80	6596	123	11242
38	2406	81	6614	124	11460
39	2642	82	6756	125	11478
40	2660	83	6774		
41	2678	84	7092		
42	2706	85	7110		

### B.3 10ms TTI E-DCH Transport Block Size Table 0

E-TFCI	TB Size (bits)	E-TFCI	TB Size (bits)	E-TFCI	TB Size (bits)	E-TFCI	TB Size (bits)	E-TFCI	TB Size (bits)
0	18	30	389	60	1316	90	4452	120	15051
1	120	31	405	61	1371	91	4636	121	15675
2	124	32	422	62	1428	92	4828	122	16325
3	130	33	440	63	1487	93	5029	123	17001
4	135	34	458	64	1549	94	5237	124	17706
5	141	35	477	65	1613	95	5454	125	18440
6	147	36	497	66	1680	96	5680	126	19204
7	153	37	517	67	1749	97	5915	127	20000
8	159	38	539	68	1822	98	6161		
9	166	39	561	69	1897	99	6416		

10	172	40	584	70	1976	100	6682
11	180	41	608	71	2058	101	6959
12	187	42	634	72	2143	102	7247
13	195	43	660	73	2232	103	7547
14	203	44	687	74	2325	104	7860
15	211	45	716	75	2421	105	8186
16	220	46	745	76	2521	106	8525
17	229	47	776	77	2626	107	8878
18	239	48	809	78	2735	108	9246
19	249	49	842	79	2848	109	9629
20	259	50	877	80	2966	110	10028
21	270	51	913	81	3089	111	10444
22	281	52	951	82	3217	112	10877
23	293	53	991	83	3350	113	11328
24	305	54	1032	84	3489	114	11797
25	317	55	1074	85	3634	115	12286
26	331	56	1119	86	3784	116	12795
27	344	57	1165	87	3941	117	13325
28	359	58	1214	88	4105	118	13877
29	374	59	1264	89	4275	119	14453

#### B.4 10ms TTI E-DCH Transport Block Size Table 1

E-TFCI	TB Size (bits)	E-TFCI	TB Size (bits)	E-TFCI	TB Size (bits)
0	18	41	5076	82	11850
1	186	42	5094	83	12132
2	204	43	5412	84	12186
3	354	44	5430	85	12468
4	372	45	5748	86	12522
5	522	46	5766	87	12804
6	540	47	6084	88	12858
7	690	48	6102	89	13140
8	708	49	6420	90	13194
9	858	50	6438	91	13476
10	876	51	6756	92	13530
11	1026	52	6774	93	13812
12	1044	53	7092	94	13866
13	1194	54	7110	95	14148
14	1212	55	7428	96	14202
15	1362	56	7464	97	14484
16	1380	57	7764	98	14556
17	1530	58	7800	99	14820
18	1548	59	8100	100	14892
19	1698	60	8136	101	15156
20	1716	61	8436	102	15228
21	1866	62	8472	103	15492
22	1884	63	8772	104	15564
23	2034	64	8808	105	15828
24	2052	65	9108	106	15900
25	2370	66	9144	107	16164
26	2388	67	9444	108	16236
27	2706	68	9480	109	16500
28	2724	69	9780	110	16572

29	3042	70	9816	111	17172
30	3060	71	10116	112	17244
31	3378	72	10152	113	17844
32	3396	73	10452	114	17916
33	3732	74	10488	115	18516
34	3750	75	10788	116	18606
35	4068	76	10824	117	19188
36	4086	77	11124	118	19278
37	4404	78	11178	119	19860
38	4422	79	11460	120	19950
39	4740	80	11514		
40	4758	81	11796		



## Annex BA (normative): E-DCH Transport Block Size Tables for 3.84 Mcps TDD

The mapping between the chosen E-TFC index and the corresponding E-DCH transport block size is given in the following tables:

### BA.1 10ms TTI E-DCH Transport Block Size Table 0

$N_{slots}$	1	2	3	4	5	6	7	8	9	10	11	12
$K_n$	0	18	28	36	42	46	50	54	57	60	62	65
TBS index												
0	60	119	174	237	298	347	405	472	529	593	641	718
1	62	123	181	246	310	361	421	490	550	616	665	746
2	64	128	188	256	322	375	437	509	571	641	691	775
3	67	133	196	266	334	390	454	529	593	665	718	806
4	69	139	203	276	347	405	472	550	616	691	746	837
5	72	144	211	287	361	421	490	571	641	718	775	870
6	75	150	219	298	375	437	509	593	665	746	806	904
7	78	155	228	310	390	454	529	616	691	775	837	939
8	81	162	237	322	405	472	550	641	718	806	870	975
9	84	168	246	334	421	490	571	665	746	837	904	1013
10	87	174	256	347	437	509	593	691	775	870	939	1053
11	91	181	266	361	454	529	616	718	806	904	975	1094
12	94	188	276	375	472	550	641	746	837	939	1013	1136
13	98	196	287	390	490	571	665	775	870	975	1053	1181
14	102	203	298	405	509	593	691	806	904	1013	1094	1227
15	106	211	310	421	529	616	718	837	939	1053	1136	1275
16	110	219	322	437	550	641	746	870	975	1094	1181	1324
17	114	228	334	454	571	665	775	904	1013	1136	1227	1376
18	119	237	347	472	593	691	806	939	1053	1181	1275	1429
19	123	246	361	490	616	718	837	975	1094	1227	1324	1485
20	128	256	375	509	641	746	870	1013	1136	1275	1376	1543
21	133	266	390	529	665	775	904	1053	1181	1324	1429	1603
22	139	276	405	550	691	806	939	1094	1227	1376	1485	1665
23	144	287	421	571	718	837	975	1136	1275	1429	1543	1730
24	150	298	437	593	746	870	1013	1181	1324	1485	1603	1798
25	155	310	454	616	775	904	1053	1227	1376	1543	1665	1868
26	162	322	472	641	806	939	1094	1275	1429	1603	1730	1941
27	168	334	490	665	837	975	1136	1324	1485	1665	1798	2016
28	174	347	509	691	870	1013	1181	1376	1543	1730	1868	2095
29	181	361	529	718	904	1053	1227	1429	1603	1798	1941	2176
30	188	375	550	746	939	1094	1275	1485	1665	1868	2016	2261
31	196	390	571	775	975	1136	1324	1543	1730	1941	2095	2349
32	203	405	593	806	1013	1181	1376	1603	1798	2016	2176	2441
33	211	421	616	837	1053	1227	1429	1665	1868	2095	2261	2536
34	219	437	641	870	1094	1275	1485	1730	1941	2176	2349	2634
35	228	454	665	904	1136	1324	1543	1798	2016	2261	2441	2737
36	237	472	691	939	1181	1376	1603	1868	2095	2349	2536	2844
37	246	490	718	975	1227	1429	1665	1941	2176	2441	2634	2954
38	256	509	746	1013	1275	1485	1730	2016	2261	2536	2737	3070
39	266	529	775	1053	1324	1543	1798	2095	2349	2634	2844	3189

40	276	550	806	1094	1376	1603	1868	2176	2441	2737	2954	3313
41	287	571	837	1136	1429	1665	1941	2261	2536	2844	3070	3442
42	298	593	870	1181	1485	1730	2016	2349	2634	2954	3189	3576
43	310	616	904	1227	1543	1798	2095	2441	2737	3070	3313	3716
44	322	641	939	1275	1603	1868	2176	2536	2844	3189	3442	3861
45	334	665	975	1324	1665	1941	2261	2634	2954	3313	3576	4011
46	347	691	1013	1376	1730	2016	2349	2737	3070	3442	3716	4167
47	361	718	1053	1429	1798	2095	2441	2844	3189	3576	3861	4329
48	375	746	1094	1485	1868	2176	2536	2954	3313	3716	4011	4498
49	390	775	1136	1543	1941	2261	2634	3070	3442	3861	4167	4673
50	405	806	1181	1603	2016	2349	2737	3189	3576	4011	4329	4855
51	421	837	1227	1665	2095	2441	2844	3313	3716	4167	4498	5044
52	437	870	1275	1730	2176	2536	2954	3442	3861	4329	4673	5241
53	454	904	1324	1798	2261	2634	3070	3576	4011	4498	4855	5445
54	472	939	1376	1868	2349	2737	3189	3716	4167	4673	5044	5657
55	490	975	1429	1941	2441	2844	3313	3861	4329	4855	5241	5877
56	509	1013	1485	2016	2536	2954	3442	4011	4498	5044	5445	6106
57	529	1053	1543	2095	2634	3070	3576	4167	4673	5241	5657	6344
58	550	1094	1603	2176	2737	3189	3716	4329	4855	5445	5877	6591
59	571	1136	1665	2261	2844	3313	3861	4498	5044	5657	6106	6848
60	593	1181	1730	2349	2954	3442	4011	4673	5241	5877	6344	7115
61	616	1227	1798	2441	3070	3576	4167	4855	5445	6106	6591	7392
62	641	1275	1868	2536	3189	3716	4329	5044	5657	6344	6848	7680
63	665	1324	1941	2634	3313	3861	4498	5241	5877	6591	7115	7979
64	691	1376	2016	2737	3442	4011	4673	5445	6106	6848	7392	8289
65	718	1429	2095	2844	3576	4167	4855	5657	6344	7115	7680	8612
66	746	1485	2176	2954	3716	4329	5044	5877	6591	7392	7979	8948
67	775	1543	2261	3070	3861	4498	5241	6106	6848	7680	8289	9296
68	806	1603	2349	3189	4011	4673	5445	6344	7115	7979	8612	9658
69	837	1665	2441	3313	4167	4855	5657	6591	7392	8289	8948	10034
70	870	1730	2536	3442	4329	5044	5877	6848	7680	8612	9296	10425
71	904	1798	2634	3576	4498	5241	6106	7115	7979	8948	9658	10831
72	939	1868	2737	3716	4673	5445	6344	7392	8289	9296	10034	11253
73	975	1941	2844	3861	4855	5657	6591	7680	8612	9658	10425	11691
74	1013	2016	2954	4011	5044	5877	6848	7979	8948	10034	10831	12146
75	1053	2095	3070	4167	5241	6106	7115	8289	9296	10425	11253	12620
76	1094	2176	3189	4329	5445	6344	7392	8612	9658	10831	11691	13111
77	1136	2261	3313	4498	5657	6591	7680	8948	10034	11253	12146	13622
78	1181	2349	3442	4673	5877	6848	7979	9296	10425	11691	12620	14152
79	1227	2441	3576	4855	6106	7115	8289	9658	10831	12146	13111	14703
80	1275	2536	3716	5044	6344	7392	8612	10034	11253	12620	13622	15276
81	1324	2634	3861	5241	6591	7680	8948	10425	11691	13111	14152	15871
82	1376	2737	4011	5445	6848	7979	9296	10831	12146	13622	14703	16489
83	1429	2844	4167	5657	7115	8289	9658	11253	12620	14152	15276	17131
84	1485	2954	4329	5877	7392	8612	10034	11691	13111	14703	15871	17798
85	1543	3070	4498	6106	7680	8948	10425	12146	13622	15276	16489	18491
86	1603	3189	4673	6344	7979	9296	10831	12620	14152	15871	17131	19212
87	1665	3313	4855	6591	8289	9658	11253	13111	14703	16489	17798	19960
88	1730	3442	5044	6848	8612	10034	11691	13622	15276	17131	18491	20737
89	1798	3576	5241	7115	8948	10425	12146	14152	15871	17798	19212	21545
90	1868	3716	5445	7392	9296	10831	12620	14703	16489	18491	19960	22384
91	1941	3861	5657	7680	9658	11253	13111	15276	17131	19212	20737	23256
92	2016	4011	5877	7979	10034	11691	13622	15871	17798	19960	21545	24161

93	2095	4167	6106	8289	10425	12146	14152	16489	18491	20737	22384	25102
94	2176	4329	6344	8612	10831	12620	14703	17131	19212	21545	23256	26080
95	2261	4498	6591	8948	11253	13111	15276	17798	19960	22384	24161	27095
96	2349	4673	6848	9296	11691	13622	15871	18491	20737	23256	25102	28151
97	2441	4855	7115	9658	12146	14152	16489	19212	21545	24161	26080	29247
98	2536	5044	7392	10034	12620	14703	17131	19960	22384	25102	27095	30386
99	2634	5241	7680	10425	13111	15276	17798	20737	23256	26080	28151	31569
100	2737	5445	7979	10831	13622	15871	18491	21545	24161	27095	29247	32799
101	2844	5657	8289	11253	14152	16489	19212	22384	25102	28151	30386	34076
102	2954	5877	8612	11691	14703	17131	19960	23256	26080	29247	31569	35403
103	3070	6106	8948	12146	15276	17798	20737	24161	27095	30386	32799	36782
104	3189	6344	9296	12620	15871	18491	21545	25102	28151	31569	34076	38214
105	3313	6591	9658	13111	16489	19212	22384	26080	29247	32799	35403	39703
106	3442	6848	10034	13622	17131	19960	23256	27095	30386	34076	36782	41249
107	3576	7115	10425	14152	17798	20737	24161	28151	31569	35403	38214	42855
108	3716	7392	10831	14703	18491	21545	25102	29247	32799	36782	39703	44524
109	3861	7680	11253	15276	19212	22384	26080	30386	34076	38214	41249	46258
110	4011	7979	11691	15871	19960	23256	27095	31569	35403	39703	42855	48060
111	4167	8289	12146	16489	20737	24161	28151	32799	36782	41249	44524	49932
112	4329	8612	12620	17131	21545	25102	29247	34076	38214	42855	46258	51876
113	4498	8948	13111	17798	22384	26080	30386	35403	39703	44524	48060	53896
114	4673	9296	13622	18491	23256	27095	31569	36782	41249	46258	49932	55995
115	4855	9658	14152	19212	24161	28151	32799	38214	42855	48060	51876	58176
116	5044	10034	14703	19960	25102	29247	34076	39703	44524	49932	53896	60442
117	5241	10425	15276	20737	26080	30386	35403	41249	46258	51876	55995	62796
118	5445	10831	15871	21545	27095	31569	36782	42855	48060	53896	58176	65241
119	5657	11253	16489	22384	28151	32799	38214	44524	49932	55995	60442	67782
120	5877	11691	17131	23256	29247	34076	39703	46258	51876	58176	62796	70422
121	6106	12146	17798	24161	30386	35403	41249	48060	53896	60442	65241	73164
122	6344	12620	18491	25102	31569	36782	42855	49932	55995	62796	67782	76013
123	6591	13111	19212	26080	32799	38214	44524	51876	58176	65241	70422	78974
124	6848	13622	19960	27095	34076	39703	46258	53896	60442	67782	73164	82049
125	7115	14152	20737	28151	35403	41249	48060	55995	62796	70422	76013	85245
126	7392	14703	21545	29247	36782	42855	49932	58176	65241	73164	78974	88565
127	7680	15276	22384	30386	38214	44524	51876	60442	67782	76013	82049	92014

## Annex BB (normative): E-DCH Transport Block Size Tables for 7.68 Mcps TDD

The mapping between the chosen E-TFC index and the corresponding E-DCH transport block size is given in the following tables:

### BB.1 10ms TTI E-DCH Transport Block Size Table 0

Nslots	1	2	3	4	5	6	7	8	9	10	11	12
kn	0	15	25	31	36	41	44	47	50	52	54	56
TBS index												
0	60	115	178	232	288	359	409	467	532	581	634	691
1	62	120	186	242	301	375	428	487	556	606	662	722
2	65	126	195	253	315	392	447	509	581	634	691	755
3	68	131	203	264	329	409	467	532	606	662	722	788
4	71	137	212	276	344	428	487	556	634	691	755	823
5	74	143	222	288	359	447	509	581	662	722	788	860
6	77	150	232	301	375	467	532	606	691	755	823	899
7	81	156	242	315	392	487	556	634	722	788	860	939
8	85	163	253	329	409	509	581	662	755	823	899	981
9	88	171	264	344	428	532	606	691	788	860	939	1024
10	92	178	276	359	447	556	634	722	823	899	981	1070
11	96	186	288	375	467	581	662	755	860	939	1024	1118
12	101	195	301	392	487	606	691	788	899	981	1070	1168
13	105	203	315	409	509	634	722	823	939	1024	1118	1220
14	110	212	329	428	532	662	755	860	981	1070	1168	1275
15	115	222	344	447	556	691	788	899	1024	1118	1220	1331
16	120	232	359	467	581	722	823	939	1070	1168	1275	1391
17	126	242	375	487	606	755	860	981	1118	1220	1331	1453
18	131	253	392	509	634	788	899	1024	1168	1275	1391	1518
19	137	264	409	532	662	823	939	1070	1220	1331	1453	1586
20	143	276	428	556	691	860	981	1118	1275	1391	1518	1656
21	150	288	447	581	722	899	1024	1168	1331	1453	1586	1730
22	156	301	467	606	755	939	1070	1220	1391	1518	1656	1808
23	163	315	487	634	788	981	1118	1275	1453	1586	1730	1888
24	171	329	509	662	823	1024	1168	1331	1518	1656	1808	1973
25	178	344	532	691	860	1070	1220	1391	1586	1730	1888	2061
26	186	359	556	722	899	1118	1275	1453	1656	1808	1973	2153
27	195	375	581	755	939	1168	1331	1518	1730	1888	2061	2249
28	203	392	606	788	981	1220	1391	1586	1808	1973	2153	2349
29	212	409	634	823	1024	1275	1453	1656	1888	2061	2249	2454
30	222	428	662	860	1070	1331	1518	1730	1973	2153	2349	2564
31	232	447	691	899	1118	1391	1586	1808	2061	2249	2454	2678
32	242	467	722	939	1168	1453	1656	1888	2153	2349	2564	2798
33	253	487	755	981	1220	1518	1730	1973	2249	2454	2678	2922
34	264	509	788	1024	1275	1586	1808	2061	2349	2564	2798	3053
35	276	532	823	1070	1331	1656	1888	2153	2454	2678	2922	3189
36	288	556	860	1118	1391	1730	1973	2249	2564	2798	3053	3331
37	301	581	899	1168	1453	1808	2061	2349	2678	2922	3189	3480
38	315	606	939	1220	1518	1888	2153	2454	2798	3053	3331	3636

39	329	634	981	1275	1586	1973	2249	2564	2922	3189	3480	3798
40	344	662	1024	1331	1656	2061	2349	2678	3053	3331	3636	3967
41	359	691	1070	1391	1730	2153	2454	2798	3189	3480	3798	4144
42	375	722	1118	1453	1808	2249	2564	2922	3331	3636	3967	4329
43	392	755	1168	1518	1888	2349	2678	3053	3480	3798	4144	4523
44	409	788	1220	1586	1973	2454	2798	3189	3636	3967	4329	4725
45	428	823	1275	1656	2061	2564	2922	3331	3798	4144	4523	4935
46	447	860	1331	1730	2153	2678	3053	3480	3967	4329	4725	5156
47	467	899	1391	1808	2249	2798	3189	3636	4144	4523	4935	5386
48	487	939	1453	1888	2349	2922	3331	3798	4329	4725	5156	5626
49	509	981	1518	1973	2454	3053	3480	3967	4523	4935	5386	5877
50	532	1024	1586	2061	2564	3189	3636	4144	4725	5156	5626	6140
51	556	1070	1656	2153	2678	3331	3798	4329	4935	5386	5877	6414
52	581	1118	1730	2249	2798	3480	3967	4523	5156	5626	6140	6700
53	606	1168	1808	2349	2922	3636	4144	4725	5386	5877	6414	6999
54	634	1220	1888	2454	3053	3798	4329	4935	5626	6140	6700	7311
55	662	1275	1973	2564	3189	3967	4523	5156	5877	6414	6999	7638
56	691	1331	2061	2678	3331	4144	4725	5386	6140	6700	7311	7979
57	722	1391	2153	2798	3480	4329	4935	5626	6414	6999	7638	8335
58	755	1453	2249	2922	3636	4523	5156	5877	6700	7311	7979	8707
59	788	1518	2349	3053	3798	4725	5386	6140	6999	7638	8335	9095
60	823	1586	2454	3189	3967	4935	5626	6414	7311	7979	8707	9501
61	860	1656	2564	3331	4144	5156	5877	6700	7638	8335	9095	9925
62	899	1730	2678	3480	4329	5386	6140	6999	7979	8707	9501	10368
63	939	1808	2798	3636	4523	5626	6414	7311	8335	9095	9925	10831
64	981	1888	2922	3798	4725	5877	6700	7638	8707	9501	10368	11314
65	1024	1973	3053	3967	4935	6140	6999	7979	9095	9925	10831	11819
66	1070	2061	3189	4144	5156	6414	7311	8335	9501	10368	11314	12347
67	1118	2153	3331	4329	5386	6700	7638	8707	9925	10831	11819	12898
68	1168	2249	3480	4523	5626	6999	7979	9095	10368	11314	12347	13474
69	1220	2349	3636	4725	5877	7311	8335	9501	10831	11819	12898	14075
70	1275	2454	3798	4935	6140	7638	8707	9925	11314	12347	13474	14703
71	1331	2564	3967	5156	6414	7979	9095	10368	11819	12898	14075	15360
72	1391	2678	4144	5386	6700	8335	9501	10831	12347	13474	14703	16045
73	1453	2798	4329	5626	6999	8707	9925	11314	12898	14075	15360	16761
74	1518	2922	4523	5877	7311	9095	10368	11819	13474	14703	16045	17509
75	1586	3053	4725	6140	7638	9501	10831	12347	14075	15360	16761	18291
76	1656	3189	4935	6414	7979	9925	11314	12898	14703	16045	17509	19107
77	1730	3331	5156	6700	8335	10368	11819	13474	15360	16761	18291	19960
78	1808	3480	5386	6999	8707	10831	12347	14075	16045	17509	19107	20851
79	1888	3636	5626	7311	9095	11314	12898	14703	16761	18291	19960	21781
80	1973	3798	5877	7638	9501	11819	13474	15360	17509	19107	20851	22753
81	2061	3967	6140	7979	9925	12347	14075	16045	18291	19960	21781	23769
82	2153	4144	6414	8335	10368	12898	14703	16761	19107	20851	22753	24830
83	2249	4329	6700	8707	10831	13474	15360	17509	19960	21781	23769	25938
84	2349	4523	6999	9095	11314	14075	16045	18291	20851	22753	24830	27095
85	2454	4725	7311	9501	11819	14703	16761	19107	21781	23769	25938	28305
86	2564	4935	7638	9925	12347	15360	17509	19960	22753	24830	27095	29568
87	2678	5156	7979	10368	12898	16045	18291	20851	23769	25938	28305	30888
88	2798	5386	8335	10831	13474	16761	19107	21781	24830	27095	29568	32266
89	2922	5626	8707	11314	14075	17509	19960	22753	25938	28305	30888	33706
90	3053	5877	9095	11819	14703	18291	20851	23769	27095	29568	32266	35211
91	3189	6140	9501	12347	15360	19107	21781	24830	28305	30888	33706	36782
92	3331	6414	9925	12898	16045	19960	22753	25938	29568	32266	35211	38424
93	3480	6700	10368	13474	16761	20851	23769	27095	30888	33706	36782	40139

94	3636	6999	10831	14075	17509	21781	24830	28305	32266	35211	38424	41930
95	3798	7311	11314	14703	18291	22753	25938	29568	33706	36782	40139	43801
96	3967	7638	11819	15360	19107	23769	27095	30888	35211	38424	41930	45756
97	4144	7979	12347	16045	19960	24830	28305	32266	36782	40139	43801	47798
98	4329	8335	12898	16761	20851	25938	29568	33706	38424	41930	45756	49932
99	4523	8707	13474	17509	21781	27095	30888	35211	40139	43801	47798	52160
100	4725	9095	14075	18291	22753	28305	32266	36782	41930	45756	49932	54488
101	4935	9501	14703	19107	23769	29568	33706	38424	43801	47798	52160	56920
102	5156	9925	15360	19960	24830	30888	35211	40139	45756	49932	54488	59460
103	5386	10368	16045	20851	25938	32266	36782	41930	47798	52160	56920	62114
104	5626	10831	16761	21781	27095	33706	38424	43801	49932	54488	59460	64886
105	5877	11314	17509	22753	28305	35211	40139	45756	52160	56920	62114	67782
106	6140	11819	18291	23769	29568	36782	41930	47798	54488	59460	64886	70807
107	6414	12347	19107	24830	30888	38424	43801	49932	56920	62114	67782	73967
108	6700	12898	19960	25938	32266	40139	45756	52160	59460	64886	70807	77268
109	6999	13474	20851	27095	33706	41930	47798	54488	62114	67782	73967	80717
110	7311	14075	21781	28305	35211	43801	49932	56920	64886	70807	77268	84319
111	7638	14703	22753	29568	36782	45756	52160	59460	67782	73967	80717	88082
112	7979	15360	23769	30888	38424	47798	54488	62114	70807	77268	84319	92014
113	8335	16045	24830	32266	40139	49932	56920	64886	73967	80717	88082	96120
114	8707	16761	25938	33706	41930	52160	59460	67782	77268	84319	92014	100410
115	9095	17509	27095	35211	43801	54488	62114	70807	80717	88082	96120	104891
116	9501	18291	28305	36782	45756	56920	64886	73967	84319	92014	100410	109573
117	9925	19107	29568	38424	47798	59460	67782	77268	88082	96120	104891	114463
118	10368	19960	30888	40139	49932	62114	70807	80717	92014	100410	109573	119572
119	10831	20851	32266	41930	52160	64886	73967	84319	96120	104891	114463	124908
120	11314	21781	33706	43801	54488	67782	77268	88082	100410	109573	119572	130483
121	11819	22753	35211	45756	56920	70807	80717	92014	104891	114463	124908	136306
122	12347	23769	36782	47798	59460	73967	84319	96120	109573	119572	130483	142390
123	12898	24830	38424	49932	62114	77268	88082	100410	114463	124908	136306	148744
124	13474	25938	40139	52160	64886	80717	92014	104891	119572	130483	142390	155383
125	14075	27095	41930	54488	67782	84319	96120	109573	124908	136306	148744	162318
126	14703	28305	43801	56920	70807	88082	100410	114463	130483	142390	155383	169562
127	15360	29568	45756	59460	73967	92014	104891	119572	136306	148744	162318	177130

---

## Annex C (informative): Pseudo-Code for E-TFC Selection (FDD)

The pseudo-code below describes one possible implementation of the E-TFC Selection as described in subclause 11.8.1.4:

- 1> determine whether to take the scheduled and non-scheduled grants into account in the upcoming transmission.
- 1> if scheduled and/or non-scheduled data can be transmitted:
  - 2> select a MAC-d flow that allows highest-priority data to be transmitted (when more than one MAC-d flow allows data of the same highest priority to be transmitted, it is left to implementation to select which MAC-d flow to prefer);
  - 2> based on this MAC-d flow, identify the MAC-d flow(s) that can be sent according to their multiplexing list and ignore the one(s) that cannot.
  - 2> based on the HARQ profile of this MAC-d flow, identify the power offset to use;
  - 2> based on this power offset and the E-TFC restriction procedure, determine the maximum supported payload (i.e. maximum MAC-e PDU size or E-TFC) that can be sent by the UE during the upcoming transmission;
  - 2> set "Remaining Available Payload" to the maximum supported payload;
  - 2> if the upcoming transmission overlaps with a compressed mode gap on 10ms TTI, scale down the current serving grant (SG);
  - 2> set "Scheduled Grant Payload" to the highest payload that could be transmitted according to SG and selected power offset;
  - 2> for each MAC-d flow with a non-scheduled grant, set the "Remaining Non-scheduled Payload" to the value of the grant;
  - 2> set "Non scheduled Payload" to sum of MIN ("Remaining Non-scheduled Payload", non-scheduled available payload) for all non scheduled MAC-d flow(s);
  - 2> if Scheduling Information needs to be transmitted:
    - 3> if "Remaining Available Payload" > "Scheduled Grant Payload" + "Non-scheduled Payload" + size of the Scheduling Information:
      - 4> quantize the sum of the "Scheduled Grant Payload" + "Non-scheduled Payload" + size of the Scheduling Information to the next smaller supported E-TFC;
      - 4> set the "Scheduled Grant Payload" to the quantized sum minus "Non-scheduled Payload" + size of the Scheduling Information.
    - 3> subtract the size of the Scheduling Information from "Remaining Available Payload".
  - 2> else:
    - 3> if "Remaining Available Payload" > "Scheduled Grant Payload" + "Non-scheduled Payload":
      - 4> quantize the sum of the "Scheduled Grant Payload" + "Non-scheduled Payload" to the next smaller supported E-TFC;
      - 4> set the "Scheduled Grant Payload" to the quantized sum minus "Non-scheduled Payload".
  - 2> perform the following loop for each logical channel, in the order of their priorities:
    - 3> if this logical channel belongs to a MAC-d flow with a non-scheduled grant, then:
      - 4> consider the "Remaining Non-scheduled Payload" corresponding to the MAC-d flow on which this logical channel is mapped;

- 4> fill the MAC-e PDU with SDU(s) from this logical channel up to MIN("Remaining Non-scheduled Payload", Available Data for this logical channel, "Remaining Available Payload");
- 4> subtract the corresponding bits if any from "Remaining Available Payload" and "Remaining Non-scheduled Payload" taking into account the MAC-e headers.
- 3> else:
  - 4> fill the MACe PDU with SDU(s) from this logical channel up to MIN("Scheduled Grant Payload", Available Data for this logical channel, "Remaining Available Payload");
  - 4> subtract the corresponding bits if any from "Remaining Available Payload" and "Scheduled Grant Payload" taking into account the MAC-e headers.
- 2> if Scheduling Information needs to be transmitted:
  - 3> add Scheduling Information to the MAC-e PDU;
  - 3> determine the smallest E-TFC that can carry the resulting MAC-e PDU;
- 2> else:
  - 3> determine the smallest E-TFC that can carry the resulting MAC-e PDU;
  - 3> if the padding allows a Scheduling Information to be sent, add it to the MAC-e PDU;
- 2> set the maximum number of HARQ transmissions to the maximum among the maximum number of HARQ transmissions of the HARQ profiles of the MAC-d flows selected for transmissions.
- 1> else if Scheduling Information needs to be transmitted:
  - 2> select the "control-only" HARQ profile;
  - 2> fill the MAC-e PDU with the scheduling information;
  - 2> select the smallest E-TFC.



## Annex CA (informative): Pseudo-Code for E-TFC Selection (TDD)

The pseudo-code below describes one possible implementation of UE E-TFC Selection as described in subclause 11.9.1.4. It consists of three separate procedures which are normally executed Procedure 1, 2 and then 3:

### Procedure 1:

- 1> Determine set B, the set of logical channels which consist of a) the highest priority logical channel which has data buffered for transmission b) the set of logical channels which have data buffered for transmission and which may be multiplexed with the highest priority channel. The detailed steps involved are as follows:
  - 2> Determine whether or not a TTI is designated for scheduled or non scheduled transmission.
  - 2> Determine the set A of logical channels which have data buffered for transmission and which are consistent with the TTI designation (scheduled or non-scheduled).
  - 2> Determine X, the highest priority logical channel in set A.
  - 2> Select the HARQ profile of the MAC-d flow, flow Y, to which logical channel X belongs. (*Note: A logical channel can only belong to one MAC-d flow and can therefore only have one HARQ profile*)
  - 2> Determine set B, the set of logical channels which are in set A and which belong to flow Y or to a flow which may be multiplexed with flow Y

### Procedure 2:

- 1> Generate the largest block size that can be supported by the resources granted. The detailed steps involved are as follows:
  - 2> Determine the sets of TFCs  $C_1$  (QPSK) and  $C_2$  (16-QAM) whose code rates fall within the allowed maximum and minimum (inclusive) coderates specified by RRC for the assigned number of time slots and the assigned channelisation code (the UE is not allowed to use more or less slots than are assigned nor to use a code associated with a lower spreading factor).
  - 2> Determine the subsets  $D_1$  and  $D_2$  of  $C_1$  and  $C_2$  respectively which require transmit power that is less than or equal to the power available taking into account of the power offset of the HARQ profile of flow y,  $P_{e-base}$  and beta values associated with TFCs for QPSK and 16QAM.
  - 2> Determine k, the largest MAC-e PDU block size that can be supported, from the sets  $D_1$  and  $D_2$
  - 2> If k belongs exclusively to set  $D_1$ , select QPSK modulation. If k belongs exclusively to set  $D_2$ , select 16-QAM modulation. If k appears in both sets  $D_1$  and  $D_2$ , select 16-QAM modulation only if it offers a lower power requirement than QPSK, otherwise select QPSK modulation.

### Procedure 3:

- 1> Generate the largest MAC-e PDU, having a size  $\leq k$ , by taking MAC-d PDUs from logical channels in set B (in order of priority) and select SF and modulation so as to minimise the power used. The detailed steps are as follows:
  - 2> Generate the largest MAC-e PDU  $\leq k$ , taking MAC-d PDUs from logical channels belonging to set B (in priority order);
  - 2> If this is successful (i.e. sufficient resources granted):
    - 3> select the SF and modulation to use in order to minimise the power used to transmit the MAC-e PDU;
    - 3> transmit the MAC-e PDU.
  - 2> If this is not successful (i.e. the MAC-e PDU is empty due to insufficient resources granted):
    - 3>  $A := A - B$ ;

- 3> if A is not empty (i.e. other logical channels have data buffered for transmission):
  - 4> determine a new set B (repeat Procedure 1 and then Procedure 3).
- 3> if A is empty (i.e. no other logical channels have data buffered for transmission):
  - 4> transmit scheduling information only in the MAC-e PDU.

## Annex D (informative): Change history

Change history								
Date	TSG #	TSG Doc.	CR	Rev	Subject/Comment	Old	New	
06/1999	RP-04	RP-99312	-		Approved at TSG-RAN #4 and placed under Change Control	-	3.0.0	
10/1999	RP-05	RP-99463	001	1	Modified MAC handling of PCH and FACH	3.0.0	3.1.0	
	RP-05	RP-99463	002		Modifications of MAC primitives	3.0.0	3.1.0	
	RP-05	RP-99463	003	2	RACH/FACH MAC header – Channel type identification	3.0.0	3.1.0	
	RP-05	RP-99463	004		Support for USCH/DSCH signalling in TDD	3.0.0	3.1.0	
	RP-05	RP-99463	006		Clarification on RACH partitioning and prioritization via access service class (ASC) and relation to back-off algorithm	3.0.0	3.1.0	
	RP-05	RP-99463	010	1	Modifications on UE-Id formats	3.0.0	3.1.0	
	RP-05	RP-99463	011		CPCH primitives	3.0.0	3.1.0	
	RP-05	RP-99463	012		Timing advance for TDD	3.0.0	3.1.0	
	RP-05	RP-99463	013	1	Traffic volume measurement report procedure	3.0.0	3.1.0	
	RP-05	RP-99463	014		Mapping of BCCH logical channel onto FACH transport channel	3.0.0	3.1.0	
	RP-05	RP-99463	015	1	MAC PDU formats for DCCH/DTCH on DSCH and for PCCH	3.0.0	3.1.0	
	RP-05	RP-99463	016	1	Informative parts that shall not specify or constrain implementations	3.0.0	3.1.0	
	RP-05	RP-99463	017	1	Modification of RACH transmission control procedure	3.0.0	3.1.0	
	RP-05	RP-99463	018		Removal of MAC function for system information and paging scheduling	3.0.0	3.1.0	
	RP-05	RP-99463	019	1	RACH transmission control procedure on MAC for TDD mod	3.0.0	3.1.0	
	RP-05	RP-99463	021	1	Removal of Annex A and B of TS 25.321	3.0.0	3.1.0	
	12/1999	RP-06	RP-99638	022	3	Modified MAC header field sizes	3.1.0	3.2.0
		RP-06	RP-99638	023		MAC: Multiple shared channels (DSCH/USCH)	3.1.0	3.2.0
RP-06		RP-99638	024		Parameters for Status Primitive	3.1.0	3.2.0	
RP-06		RP-99638	025	1	Support of shared channel operation in TDD	3.1.0	3.2.0	
RP-06		RP-99638	028		Modification of Cell Broadcast Service (CBS)	3.1.0	3.2.0	
RP-06		RP-99637	030	1	Editorial changes	3.1.0	3.2.0	
RP-06		RP-99638	031	1	Simultaneous mapping of logical channels on	3.1.0	3.2.0	
03/2000	RP-07	RP-000039	032		Bit Aligned TDD MAC Headers	3.2.0	3.3.0	
	RP-07	RP-000039	035	2	CPCH including Channel Assignment	3.2.0	3.3.0	
	RP-07	RP-000039	036		UE-ID type indication	3.2.0	3.3.0	
	RP-07	RP-000039	037	1	RACH transmission control procedure	3.2.0	3.3.0	
	RP-07	RP-000039	039		CPCH start of message indication	3.2.0	3.3.0	
	RP-07	RP-000039	040		Removal of SCH and SCCH	3.2.0	3.3.0	
	RP-07	RP-000039	041	1	Clarification of bit order	3.2.0	3.3.0	
06/2000	RP-08	RP-000219	042		CPCH correction	3.3.0	3.4.0	
	RP-08	RP-000219	043	1	End of CPCH transmission	3.3.0	3.4.0	
	RP-08	RP-000219	044	2	Clarification of prioritisation of logical channels in UE	3.3.0	3.4.0	
	RP-08	RP-000219	045	1	CPCH MAC procedures	3.3.0	3.4.0	
	RP-08	RP-000219	046		Traffic Volume Measurement for dynamic radio bearer control	3.3.0	3.4.0	
	RP-08	RP-000219	046		Traffic Volume Measurement for dynamic radio bearer control	3.3.0	3.4.0	
09/2000	RP-09	RP-000357	047		Movement of primitives text to the correct section	3.4.0	3.5.0	
	RP-09	RP-000357	048		Corrections to RACH procedure	3.4.0	3.5.0	
	RP-09	RP-000357	049		Clarification on the parameters of the MAC-RLC primitives	3.4.0	3.5.0	
	RP-09	RP-000357	051	1	Editorial Cleanup	3.4.0	3.5.0	
12/2000	RP-10	RP-000567	053	2	Corrections to logical channel priorities in MAC Protocol	3.5.0	3.6.0	
	RP-10	RP-000567	055	1	Removal of FAUSCH	3.5.0	3.6.0	
	RP-10	RP-000567	056	2	General MAC clarification	3.5.0	3.6.0	
	RP-10	RP-000567	057	1	Error Handling in MAC	3.5.0	3.6.0	
	RP-10	RP-000567	058	1	Error handling for MAC RACH and CPCH transmission control procedure	3.5.0	3.6.0	
	RP-10	RP-000567	059		Inclusion of stage 3 for ciphering	3.5.0	3.6.0	
03/2001	RP-11	RP-010025	061		Removal of FAUSCH	3.6.0	3.7.0	
	RP-11	RP-010025	066	3	TFC selection algorithm correction	3.6.0	3.7.0	
	RP-11	RP-010025	067	3	Miscellaneous corrections	3.6.0	3.7.0	
	RP-11	RP-010025	068	2	Clarification on Traffic Volume Measurement Procedure	3.6.0	3.7.0	
	RP-11	RP-010025	070	1	Clarification on parameters of the primitives	3.6.0	3.7.0	
	RP-11	RP-010037	064		1.28Mcps TDD	3.7.0	4.0.0	
06/2001	RP-12	RP-010308	074		RLC Tr Discard	4.0.0	4.1.0	
	RP-12	RP-010308	076		Clarification on compressed mode	4.0.0	4.1.0	
	RP-12	RP-010308	078		Correction of relation between MAC functions and transport channels	4.0.0	4.1.0	
	RP-12	RP-010308	080		Rate adaptation	4.0.0	4.1.0	
	RP-12	RP-010308	082		Cleanup of MAC services and functions	4.0.0	4.1.0	
	RP-12	RP-010322	083		Correction to control of RACH Transmissions for 1.28Mcps TDD	4.0.0	4.1.0	

Change history							
Date	TSG #	TSG Doc.	CR	Rev	Subject/Comment	Old	New
09/2001	RP-13	RP-010541	085		Setting of UE Id in MAC	4.1.0	4.2.0
	RP-13	RP-010541	087		MAC ASC selection operation when access class is used to determine ASC	4.1.0	4.2.0
	RP-13	RP-010541	089		Addition of neighbour cell BCH to MAC-b model for the UE	4.1.0	4.2.0
	RP-13	RP-010541	093	1	Clarification on TFC selection	4.1.0	4.2.0
12/2001	RP-14	RP-010760	091	1	Cautionary Note for Interfrequency Measurements in Cell-FACH	4.2.0	4.3.0
	RP-14	RP-010760	095		Correction on Control of RACH Transmissions	4.2.0	4.3.0
	RP-14	RP-010760	097		Correction on Traffic Volume Control	4.2.0	4.3.0
	RP-14	RP-010760	099		General correction on Access Service Class selection	4.2.0	4.3.0
	RP-14	RP-010760	101		TFC selection in compressed mode	4.2.0	4.3.0
03/2002	RP-15	RP-020067	103		Clarification on ciphering	4.3.0	4.4.0
	RP-15	RP-020067	106		TDD MAC Layer Subchannel Assignment	4.3.0	4.4.0
	RP-15	RP-020067	110		Missing DTCH channel type in UE-ID Type Indicator	4.3.0	4.4.0
	RP-15	RP-020067	112		Correction on UE Id for DSCH	4.3.0	4.4.0
	RP-15	RP-020067	114		UE undefined behaviour when padding is required	4.3.0	4.4.0
	RP-15	RP-020094	104	2	Introduction of HSDPA	4.4.0	5.0.0
06/2002	RP-16	RP-020326	117		Update References to include 25.123 (TDD)	5.0.0	5.1.0
	RP-16	RP-020326	120		TFCS selection guideline correction	5.0.0	5.1.0
	RP-16	RP-020341	121		HSDPA related MAC corrections	5.0.0	5.1.0
	RP-16	RP-020341	122		Description for MAC-hs reset	5.0.0	5.1.0
09/2002	RP-17	RP-020538	130		MAC TVM Corrections	5.1.0	5.2.0
	RP-17	RP-020538	133		MAC header for DTCH and DCCH	5.1.0	5.2.0
	RP-17	RP-020556	123		Optional use of a maximum transmission delay for MAC-hs SDUs	5.1.0	5.2.0
	RP-17	RP-020556	124		MAC-hs: Scheduler and HARQ entity functions for TSN	5.1.0	5.2.0
	RP-17	RP-020556	125		Correction on C/T field definition for HS-DSCH	5.1.0	5.2.0
	RP-17	RP-020556	126		Corrections to re-ordering protocol description	5.1.0	5.2.0
	RP-17	RP-020556	127		Limiting of number of PDUs per TTI	5.1.0	5.2.0
	RP-17	RP-020556	134		Signaling of Transport Block Sizes for HS-DSCH	5.1.0	5.2.0
	RP-17	RP-020556	135		Transport block size signalling 3.84 Mcps TDD	5.1.0	5.2.0
	RP-17	RP-020556	136		Static HSDPA Transport Block Sizes for 1.28 Mcps TDD	5.1.0	5.2.0
12/2002	RP-18	RP-020718	142	1	TFC selection for RACH transmissions	5.2.0	5.3.0
	RP-18	RP-020718	145		RB id in ciphering	5.2.0	5.3.0
	RP-18	RP-020718	148		Correction to TFC selection for TDD	5.2.0	5.3.0
	RP-18	RP-020718	151		Unblockable TFCs in excess power state	5.2.0	5.3.0
	RP-18	RP-020735	137		Generation of RLC Status Reports to coordinate with MAC-hs reset	5.2.0	5.3.0
	RP-18	RP-020735	138		Re-ordering Mechanism	5.2.0	5.3.0
	RP-18	RP-020735	139		Transport Block Size Signalling for 1.28Mcps TDD	5.2.0	5.3.0
	RP-18	RP-020735	153		Limitation on number of PDUs per single TTI for 1.28 Mcps TDD	5.2.0	5.3.0
	RP-18	RP-020735	154		The Number of mac-d pdu's in a single mac-hs PDU for TDD	5.2.0	5.3.0
	RP-18	RP-020851	155		HSDPA Retransmission block Size	5.2.0	5.3.0
	RP-18	RP-020874	158		Ciphering of multiple PDUs per TTI	5.2.0	5.3.0
	RP-19	RP-030100	166		Setting of ciphering activation time for TM bearers	5.3.0	5.4.0
	RP-19	RP-030100	169	1	TFC Control Implementation	5.3.0	5.4.0
	RP-19	RP-030115	159		TDD HCSN determination in MAC-hs	5.3.0	5.4.0
	RP-19	RP-030115	160		Correction to the use of Transport Block Size index equal to 111111 for TDD	5.3.0	5.4.0
	RP-19	RP-030115	163		Editorial changes to MAC-hs	5.3.0	5.4.0
	RP-19	RP-030115	170		Re-ordering entity corrections	5.3.0	5.4.0
06/2003	RP-20	RP-030302	171		Text clean up of the description of the reordering entity	5.4.0	5.5.0
	RP-20	RP-030302	172		MAC header for DTCH and DCCH mapped to HS-DSCH	5.4.0	5.5.0
09/2003	RP-21	RP-030501	178		TFCS selection guidelines for TFC Subset	5.5.0	5.6.0
	RP-21	RP-030536	174	2	MAC-hs Re-ordering Protocol Correction & MAC-hs window re-ordering	5.5.0	5.6.0
	RP-21	RP-030494	175		Addition of HS-DSCH Provided Bit Rate measurement	5.5.0	5.6.0
12/2003	RP-22	RP-030624	179		Corrections Relating to HSDPA TB Sizes for 1.28Mcps TDD	5.6.0	5.7.0
	RP-22	RP-030624	180		HSDPA Transport block size table for 3.84Mcps TDD	5.6.0	5.7.0
	RP-22	RP-030624	181		HSDPA TB size table	5.6.0	5.7.0
	RP-22	RP-030624	182		Unwarranted HARQ re-transmissions	5.6.0	5.7.0
	RP-22	RP-030624	183		MAC-hs Re-ordering Protocol Flushing correction	5.6.0	5.7.0
	RP-22	RP-030624	184		Correction to window based stall avoidance mechanism	5.6.0	5.7.0
	RP-22	-	-		Upgrade to Release 6 - no technical change	5.7.0	6.0.0
03/2004	RP-23	RP-040104	186	1	UE handling of NDI and TBS for HSDPA	6.0.0	6.1.0
	RP-23	RP-040104	188		HSDPA related corrections on MAC-hs reconfiguration	6.0.0	6.1.0
	RP-23	RP-040104	190		Reconfiguration of soft memory buffer partitioning	6.0.0	6.1.0
06/2004	RP-24	RP-040200	194		Use of U-RNTI in downlink	6.1.0	6.2.0
	RP-24	RP-040234	196		State variables arithmetic comparison	6.1.0	6.2.0
12/2004	RP-26	RP-040480	198		MAC-hs header extension	6.2.0	6.3.0
	RP-26	RP-040480	200		Clarification on the C/T field use in the HSDPA Mac-d header	6.2.0	6.3.0
	RP-26	RP-040489	201	1	Introduction of MBMS MAC header	6.2.0	6.3.0

Change history							
Date	TSG #	TSG Doc.	CR	Rev	Subject/Comment	Old	New
	RP-26	RP-040489	202		Introduction of MBMS	6.2.0	6.3.0
	RP-26	RP-040497	203		Introduction of EUL in MAC specification	6.2.0	6.3.0
03/2005	RP-27	RP-050078	204		Correction to MBMS header for MBMS	6.3.0	6.4.0
06/2005	RP-28	RP-050301	0207		Correction of HSDPA state variable	6.4.0	6.5.0
	RP-28	RP-050319	0208		Corrections to the description of TCTF field	6.4.0	6.5.0
	RP-28	RP-050301	0210		Reconfiguration of MAC-hs parameters	6.4.0	6.5.0
	RP-28	RP-050308	0212		Feature Clean-up: Removal of DSCH (FDD)	6.4.0	6.5.0
	RP-28	RP-050309	0214		Feature Clean Up: Removal of CPCH	6.4.0	6.5.0
	RP-28	RP-050323	0215		HS-DSCH Provided Bit Rate measurement per Cell Portion	6.4.0	6.5.0
	RP-28	RP-050375	0216	2	Additional text on EUL in MAC specification	6.4.0	6.5.0
09/2005	RP-29	RP-050462	0218		Correction of TB size for 1.28 Mcps TDD	6.5.0	6.6.0
	RP-29	RP-050602	0219	5	Additional text on EUL in MAC specification	6.5.0	6.6.0
	RP-29	RP-050452	0220		Definition of UE power Headroom	6.5.0	6.6.0
	RP-29	RP-050457	0222		Feature Clean Up: Removal of CPCH	6.5.0	6.6.0
12/2005	RP-30	RP-050791	0223		Multi-step handling for E-RGCH	6.6.0	6.7.0
	RP-30	RP-050791	0224		Clarifications and Corrections of E-TFC Selection	6.6.0	6.7.0
	RP-30	RP-050791	0225	1	Criteria for the Happy Bit	6.6.0	6.7.0
	RP-30	RP-050791	0226	1	Correction to definition of reference_ETPR	6.6.0	6.7.0
	RP-30	RP-050791	0227		TEBS and HLBS Coding	6.6.0	6.7.0
	RP-30	RP-050791	0228		Correction on MAC-e PDU format	6.6.0	6.7.0
	RP-30	RP-050791	0229		SI Triggering Timer	6.6.0	6.7.0
	RP-30	RP-050791	0230		Maximum number of transmissions for control-only information	6.6.0	6.7.0
	RP-30	RP-050791	0231		Additional error case on the Absolute Grant channel	6.6.0	6.7.0
	RP-30	RP-050791	0232		HARQ process restriction/reservation	6.6.0	6.7.0
	RP-30	RP-050791	0233		Behavior at E-DCH TTI change	6.6.0	6.7.0
	RP-30	RP-050792	0234		Buffer status for Scheduling Information	6.6.0	6.7.0
	RP-30	RP-050792	0235		Buffer definition for Happy Bit setting	6.6.0	6.7.0
	RP-30	RP-050792	0236		Specification of rate control combining rules in baseline procedure for Serving Grant update	6.6.0	6.7.0
	RP-30	RP-050792	0237		Definition of sample for E-DCH bit rate measurement	6.6.0	6.7.0
	RP-30	RP-050792	0238		Size of Absolute Grant field	6.6.0	6.7.0
	RP-30	RP-050792	0239		Transmission of Scheduling Information without higher layer data	6.6.0	6.7.0
	RP-30	RP-050792	0241		Size of UPH field and assembly of Scheduling Information message	6.6.0	6.7.0
	RP-30	RP-050792	0242		E-DCH SI MAC-e PDU and SI timers	6.6.0	6.7.0
	RP-30	RP-050792	0243		MAC es/e reset indicator	6.6.0	6.7.0
	RP-30	RP-050792	0244		E-DCH handling at serving cell change	6.6.0	6.7.0
	RP-30	RP-050792	0245		RSN sequence in the presence of compressed mode transmission gaps	6.6.0	6.7.0
03/2006	RP-31	RP-060085	0246		Definition of reference_ETPR	6.7.0	6.8.0
	RP-31	RP-060085	0247	1	AG_Timer for IE 'Serving Grant'	6.7.0	6.8.0
	RP-31	RP-060085	0248		TEBS and HLBS Coding	6.7.0	6.8.0
	RP-31	RP-060194	0249	1	Correction related to automatic triggering of SI retransmissions	6.7.0	6.8.0
	RP-31	RP-060085	0250		Clarifications at TTI Change	6.7.0	6.8.0
	RP-31	RP-060085	0251	2	MAC-es/e and MAC-hs reset procedure	6.7.0	6.8.0
	RP-31	RP-060085	0254		Enhanced Uplink Corrections	6.7.0	6.8.0
	RP-31	RP-060085	0255		E-TFC Selection Pseudo Code Correction	6.7.0	6.8.0
	RP-31	RP-060088	0256		Correction of MBMS-Id field (MAC header of MTCH)	6.7.0	6.8.0
	RP-31	RP-060085	0257		E-DCH Serving Grant Update	6.7.0	6.8.0
	RP-31	RP-060085	0258		One PDU size per logical channel per TTI	6.7.0	6.8.0
	RP-31	RP-060098	0253		7.68 Mcps TDD Option (Release 7)	6.8.0	7.0.0
06/2006	RP-32	RP-060352	0260		Buffer Status for the Happy Bit and Scheduling Information Reporting	7.0.0	7.1.0
	RP-32	RP-060352	0262		Serving RG and Scheduling Information	7.0.0	7.1.0
	RP-32	RP-060352	0264		Definition of RG_step_size	7.0.0	7.1.0
	RP-32	RP-060352	0266		Correction to AG_Timer Start	7.0.0	7.1.0
	RP-32	RP-060352	0268		Miscellaneous corrections for E-DCH	7.0.0	7.1.0
	RP-32	RP-060353	0270		Correction to Notification of SI transmission failure and variable resets	7.0.0	7.1.0
	RP-32	RP-060353	0272		Correction to Handling at Start of E-DCH Transmission	7.0.0	7.1.0
	RP-32	RP-060353	0274		Additional inconsistent information on E-AGCH	7.0.0	7.1.0
	RP-32	RP-060370	0276		Clarifications on E-TFCI	7.0.0	7.1.0
	RP-32	RP-060353	0282		Transmission of SI if TEBS is zero	7.0.0	7.1.0
	RP-32	RP-060419	0284	1	Serving_Grant and Unquantized E-DPDCH to DPCCH power ratios	7.0.0	7.1.0
09/2006	RP-33	RP-060625	0286	2	Maximum number of transmissions	7.1.0	7.2.0
	RP-33	RP-060574	0289		HLBS values in Scheduling Information message	7.1.0	7.2.0
	RP-33	RP-060580	0290	1	Note on Serving Grant Update with Zero Grant	7.1.0	7.2.0
	RP-33	RP-060586	0291		Introduction of 3.84 Mcps and 7.68 Mcps TDD E-DCH	7.1.0	7.2.0

Change history							
Date	TSG #	TSG Doc.	CR	Rev	Subject/Comment	Old	New
	RP-33	RP-060578	0293		MAC-hs reset	7.1.0	7.2.0

---

## History

<b>Document history</b>		
V7.0.0	March 2006	Publication
V7.1.0	June 2006	Publication
V7.2.0	September 2006	Publication