

ETSI TS 125 221 V3.6.0 (2001-03)

Technical Specification

Universal Mobile Telecommunications System (UMTS); Physical channels and mapping of transport channels onto physical channels (TDD) (3GPP TS 25.221 version 3.6.0 Release 1999)



Reference

RTS/TSGR-0125221UR5

Keywords

UMTS

ETSI

650 Route des Lucioles
F-06921 Sophia Antipolis Cedex - FRANCE

Tel.: +33 4 92 94 42 00 Fax: +33 4 93 65 47 16

Siret N° 348 623 562 00017 - NAF 742 C
Association à but non lucratif enregistrée à la
Sous-Préfecture de Grasse (06) N° 7803/88

Important notice

Individual copies of the present document can be downloaded from:

<http://www.etsi.org>

The present document may be made available in more than one electronic version or in print. In any case of existing or perceived difference in contents between such versions, the reference version is the Portable Document Format (PDF). In case of dispute, the reference shall be the printing on ETSI printers of the PDF version kept on a specific network drive within ETSI Secretariat.

Users of the present document should be aware that the document may be subject to revision or change of status. Information on the current status of this and other ETSI documents is available at <http://www.etsi.org/tb/status/>

If you find errors in the present document, send your comment to:
editor@etsi.fr

Copyright Notification

No part may be reproduced except as authorized by written permission.
The copyright and the foregoing restriction extend to reproduction in all media.

© European Telecommunications Standards Institute 2001.

All rights reserved.

Intellectual Property Rights

IPRs essential or potentially essential to the present document may have been declared to ETSI. The information pertaining to these essential IPRs, if any, is publicly available for **ETSI members and non-members**, and can be found in ETSI SR 000 314: "*Intellectual Property Rights (IPRs); Essential, or potentially Essential, IPRs notified to ETSI in respect of ETSI standards*", which is available from the ETSI Secretariat. Latest updates are available on the ETSI Web server (<http://www.etsi.org/ipr>).

Pursuant to the ETSI IPR Policy, no investigation, including IPR searches, has been carried out by ETSI. No guarantee can be given as to the existence of other IPRs not referenced in ETSI SR 000 314 (or the updates on the ETSI Web server) which are, or may be, or may become, essential to the present document.

Foreword

This Technical Specification (TS) has been produced by the ETSI 3rd Generation Partnership Project (3GPP).

The present document may refer to technical specifications or reports using their 3GPP identities, UMTS identities or GSM identities. These should be interpreted as being references to the corresponding ETSI deliverables.

The cross reference between GSM, UMTS, 3GPP and ETSI identities can be found under www.etsi.org/key.

Contents

Foreword.....	5
1 Scope	6
2 References	6
3 Abbreviations	6
4 Services offered to higher layers	7
4.1 Transport channels	7
4.1.1 Dedicated transport channels	7
4.1.2 Common transport channels	7
4.1.2.1 BCH - Broadcast Channel	8
4.1.2.2 FACH – Forward Access Channel	8
4.1.2.3 PCH – Paging Channel	8
4.1.2.4 RACH – Random Access Channel	8
4.1.2.5 USCH – Uplink Shared Channel	8
4.1.2.6 DSCH – Downlink Shared Channel	8
4.2 Indicators.....	8
5 Physical channels.....	8
5.1 Frame structure.....	9
5.2 Dedicated physical channel (DPCH).....	10
5.2.1 Spreading.....	10
5.2.1.1 Spreading for Downlink Physical Channels	10
5.2.1.2 Spreading for Uplink Physical Channels	10
5.2.2 Burst Types.....	11
5.2.2.1 Burst Type 1	11
5.2.2.2 Burst Type 2	11
5.2.2.3 Burst Type 3	12
5.2.2.4 Transmission of TFCI.....	12
5.2.2.5 Transmission of TPC	14
5.2.2.6 Timeslot formats.....	14
5.2.2.6.1 Downlink timeslot formats.....	14
5.2.2.6.2 Uplink timeslot formats	15
5.2.3 Training sequences for spread bursts.....	17
5.2.4 Beamforming.....	19
5.3 Common physical channels.....	19
5.3.1 Primary common control physical channel (P-CCPCH)	19
5.3.1.1 P-CCPCH Spreading	20
5.3.1.2 P-CCPCH Burst Types	20
5.3.1.3 P-CCPCH Training sequences.....	20
5.3.2 Secondary common control physical channel (S-CCPCH)	20
5.3.2.1 S-CCPCH Spreading	20
5.3.2.2 S-CCPCH Burst Types	20
5.3.2.3 S-CCPCH Training sequences.....	20
5.3.3 The physical random access channel (PRACH).....	20
5.3.3.1 PRACH Spreading.....	20
5.3.3.2 PRACH Burst Type	20
5.3.3.3 PRACH Training sequences.....	20
5.3.3.4 PRACH timeslot formats.....	21
5.3.3.5 Association between Training Sequences and Channelisation Codes	21
5.3.4 The synchronisation channel (SCH).....	22
5.3.5 Physical Uplink Shared Channel (PUSCH).....	23
5.3.5.1 PUSCH Spreading	23
5.3.5.2 PUSCH Burst Types.....	24
5.3.5.3 PUSCH Training Sequences.....	24
5.3.5.4 UE Selection.....	24
5.3.6 Physical Downlink Shared Channel (PDSCH).....	24

5.3.6.1	PDSCH Spreading	24
5.3.6.2	PDSCH Burst Types	24
5.3.6.3	PDSCH Training Sequences	24
5.3.6.4	UE Selection	24
5.3.7	The Paging Indicator Channel (PICH)	24
5.3.7.1	Mapping of Paging Indicators to the PICH bits	24
5.3.7.2	Structure of the PICH over multiple radio frames	25
5.4	Transmit Diversity for DL Physical Channels	26
5.5	Beacon characteristics of physical channels	26
5.5.1	Location of beacon channels	26
5.5.2	Physical characteristics of beacon channels	26
5.6	Midamble Allocation for Physical Channels	27
5.6.1	Midamble Allocation for DL Physical Channels	27
5.6.1.1	Midamble Allocation by signalling from higher layers	27
5.6.1.2	Midamble Allocation by layer 1	27
5.6.1.2.1	Default midamble	27
5.6.1.2.2	Common Midamble	28
5.6.2	Midamble Allocation for UL Physical Channels	28
5.7	Midamble Transmit Power	28
6	Mapping of transport channels to physical channels	29
6.1	Dedicated Transport Channels	30
6.2	Common Transport Channels	30
6.2.1	The Broadcast Channel (BCH)	30
6.2.2	The Paging Channel (PCH)	30
6.2.2.1	PCH/PICH Association	31
6.2.3	The Forward Channel (FACH)	31
6.2.4	The Random Access Channel (RACH)	31
6.2.5	The Uplink Shared Channel (USCH)	31
6.2.6	The Downlink Shared Channel (DSCH)	31
Annex A (normative):	Basic Midamble Codes	32
A.1	Basic Midamble Codes for Burst Type 1 and 3	32
A.2	Basic Midamble Codes for Burst Type 2	37
A.3	Association between Midambles and Channelisation Codes	42
A.3.1	Association for Burst Type 1/3 and K=16 Midambles	42
A.3.2	Association for Burst Type 1/3 and K=8 Midambles	43
A.3.3	Association for Burst Type 1/3 and K=4 Midambles	43
A.3.4	Association for Burst Type 2 and K=6 Midambles	44
A.3.5	Association for Burst Type 2 and K=3 Midambles	45
Annex B (normative):	Signalling of the number of channelisation codes for the DL common midamble case	46
B.1	Mapping scheme for Burst Type 1 and K=16 Midambles	46
B.2	Mapping scheme for Burst Type 1 and K=8 Midambles	46
B.3	Mapping scheme for Burst Type 1 and K=4 Midambles	46
B.4	Mapping scheme for beacon timeslots and K=16 Midambles	47
B.5	Mapping scheme for beacon timeslots and K=8 Midambles	47
B.6	Mapping scheme for beacon timeslots and K=4 Midambles	47
B.7	Mapping scheme for Burst Type 2 and K=6 Midambles	47
B.8	Mapping scheme for Burst Type 2 and K=3 Midambles	47
Annex C (informative):	CCPCH Multiframe Structure	48
Annex D (informative):	Change history	50

Foreword

This Technical Specification (TS) has been produced by the 3rd Generation Partnership Project (3GPP).

The contents of the present document are subject to continuing work within the TSG and may change following formal TSG approval. Should the TSG modify the contents of the present document, it will be re-released by the TSG with an identifying change of release date and an increase in version number as follows:

Version x.y.z

where:

- x the first digit:
 - 1 presented to TSG for information;
 - 2 presented to TSG for approval;
 - 3 or greater indicates TSG approved document under change control.
- y the second digit is incremented for all changes of substance, i.e. technical enhancements, corrections, updates, etc.
- z the third digit is incremented when editorial only changes have been incorporated in the document.

1 Scope

The present document describes the characteristics of the physical channels and the mapping of the transport channels to physical channels in the TDD mode of UTRA.

2 References

The following documents contain provisions which, through reference in this text, constitute provisions of the present document.

- References are either specific (identified by date of publication, edition number, version number, etc.) or non-specific.
- For a specific reference, subsequent revisions do not apply.
- For a non-specific reference, the latest version applies. In the case of a reference to a 3GPP document (including a GSM document), a non-specific reference implicitly refers to the latest version of that document *in the same Release as the present document*.

- [1] 3GPP TS 25.201: "Physical layer - general description".
- [2] 3GPP TS 25.211: "Physical channels and mapping of transport channels onto physical channels (FDD)".
- [3] 3GPP TS 25.212: "Multiplexing and channel coding (FDD)".
- [4] 3GPP TS 25.213: "Spreading and modulation (FDD)".
- [5] 3GPP TS 25.214: "Physical layer procedures (FDD)".
- [6] 3GPP TS 25.215: "Physical layer – Measurements (FDD)".
- [7] 3GPP TS 25.222: "Multiplexing and channel coding (TDD)".
- [8] 3GPP TS 25.223: "Spreading and modulation (TDD)".
- [9] 3GPP TS 25.224: "Physical layer procedures (TDD)".
- [10] 3GPP TS 25.225: "Physical layer – Measurements (TDD)".
- [11] 3GPP TS 25.301: "Radio Interface Protocol Architecture".
- [12] 3GPP TS 25.302: "Services Provided by the Physical Layer".
- [13] 3GPP TS 25.401: "UTRAN Overall Description".
- [14] 3GPP TS 25.402: "Synchronisation in UTRAN, Stage 2".
- [15] 3GPP TS 25.304: " UE Procedures in Idle Mode and Procedures for Cell Reselection in Connected Mode".
- [16] 3GPP TS 25.427: "UTRAN Iur and Iub interface user plane protocols for DCH data streams".

3 Abbreviations

For the purposes of the present document, the following abbreviations apply:

BCH	Broadcast Channel
CCPCH	Common Control Physical Channel
CCTrCH	Coded Composite Transport Channel

CDMA	Code Division Multiple Access
DPCH	Dedicated Physical Channel
DRX	Discontinuous Reception
DSCH	Downlink Shared Channel
FACH	Forward Access Channel
FDD	Frequency Division Duplex
FEC	Forward Error Correction
GP	Guard Period
GSM	Global System for Mobile Communication
NRT	Non-Real Time
OVSF	Orthogonal Variable Spreading Factor
P-CCPCH	Primary CCPCH
PCH	Paging Channel
PDSCH	Physical Downlink Shared Channel
PI	Paging Indicator (value calculated by higher layers)
PICH	Page Indicator Channel
P_q	Paging Indicator (indicator set by physical layer)
PRACH	Physical Random Access Channel
PUSCH	Physical Uplink Shared Channel
RACH	Random Access Channel
RF	Radio Frame
RT	Real Time
S-CCPCH	Secondary CCPCH
SCH	Synchronisation Channel
SFN	Cell System Frame Number
TCH	Traffic Channel
TDD	Time Division Duplex
TDMA	Time Division Multiple Access
TrCH	Transport Channel
UE	User Equipment
USCH	Uplink Shared Channel

4 Services offered to higher layers

4.1 Transport channels

Transport channels are the services offered by layer 1 to the higher layers. A transport channel is defined by how and with what characteristics data is transferred over the air interface. A general classification of transport channels is into two groups:

- Dedicated Channels, using inherent addressing of UE
- Common Channels, using explicit addressing of UE if addressing is needed

General concepts about transport channels are described in [12].

4.1.1 Dedicated transport channels

The Dedicated Channel (DCH) is an up- or downlink transport channel that is used to carry user or control information between the UTRAN and a UE.

4.1.2 Common transport channels

There are six types of transport channels: BCH, FACH, PCH, RACH, USCH, DSCH

4.1.2.1 BCH - Broadcast Channel

The Broadcast Channel (BCH) is a downlink transport channel that is used to broadcast system- and cell-specific information.

4.1.2.2 FACH – Forward Access Channel

The Forward Access Channel (FACH) is a downlink transport channel that is used to carry control information to a mobile station when the system knows the location cell of the mobile station. The FACH may also carry short user packets.

4.1.2.3 PCH – Paging Channel

The Paging Channel (PCH) is a downlink transport channel that is used to carry control information to a mobile station when the system does not know the location cell of the mobile station.

4.1.2.4 RACH – Random Access Channel

The Random Access Channel (RACH) is an up link transport channel that is used to carry control information from mobile station. The RACH may also carry short user packets.

4.1.2.5 USCH – Uplink Shared Channel

The uplink shared channel (USCH) is an uplink transport channel shared by several UEs carrying dedicated control or traffic data.

4.1.2.6 DSCH – Downlink Shared Channel

The downlink shared channel (DSCH) is a downlink transport channel shared by several UEs carrying dedicated control or traffic data.

4.2 Indicators

Indicators are means of fast low-level signalling entities which are transmitted without using information blocks sent over transport channels. The meaning of indicators is implicit to the receiver.

The indicator(s) defined in the current version of the specifications are: Paging Indicator.

5 Physical channels

All physical channels take three-layer structure with respect to timeslots, radio frames and system frame numbering (SFN), see [14]. Depending on the resource allocation, the configuration of radio frames or timeslots becomes different. All physical channels need a guard period in every timeslot. The time slots are used in the sense of a TDMA component to separate different user signals in the time domain. The physical channel signal format is presented in figure 1.

A physical channel in TDD is a burst, which is transmitted in a particular timeslot within allocated Radio Frames. The allocation can be continuous, i.e. the time slot in every frame is allocated to the physical channel or discontinuous, i.e. the time slot in a subset of all frames is allocated only. A burst is the combination of two data parts, a midamble part and a guard period. The duration of a burst is one time slot. Several bursts can be transmitted at the same time from one transmitter. In this case, the data parts must use different OVVSF channelisation codes, but the same scrambling code. The midamble parts are either identically or differently shifted versions of a cell-specific basic midamble code, see section 5.2.3.

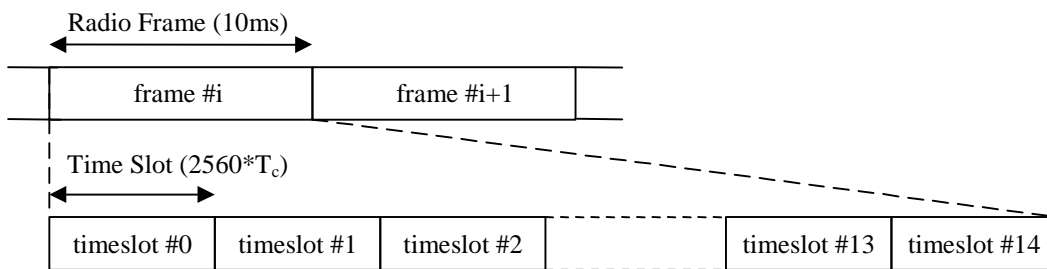

Figure 1: Physical channel signal format

The data part of the burst is spread with a combination of channelisation code and scrambling code. The channelisation code is a OVSF code, that can have a spreading factor of 1, 2, 4, 8, or 16. The data rate of the physical channel is depending on the used spreading factor of the used OVSF code.

The midamble part of the burst can contain two different types of midambles: a short one of length 256 chips, or a long one of 512 chips. The data rate of the physical channel is depending on the used midamble length.

So a physical channel is defined by frequency, timeslot, channelisation code, burst type and Radio Frame allocation. The scrambling code and the basic midamble code are broadcast and may be constant within a cell. When a physical channel is established, a start frame is given. The physical channels can either be of infinite duration, or a duration for the allocation can be defined.

5.1 Frame structure

The TDMA frame has a duration of 10 ms and is subdivided into 15 time slots (TS) of $2560 \cdot T_c$ duration each. A time slot corresponds to 2560 chips. The physical content of the time slots are the bursts of corresponding length as described in subclause 5.2.2.

Each 10 ms frame consists of 15 time slots, each allocated to either the uplink or the downlink (figure 2). With such a flexibility, the TDD mode can be adapted to different environments and deployment scenarios. In any configuration at least one time slot has to be allocated for the downlink and at least one time slot has to be allocated for the uplink.

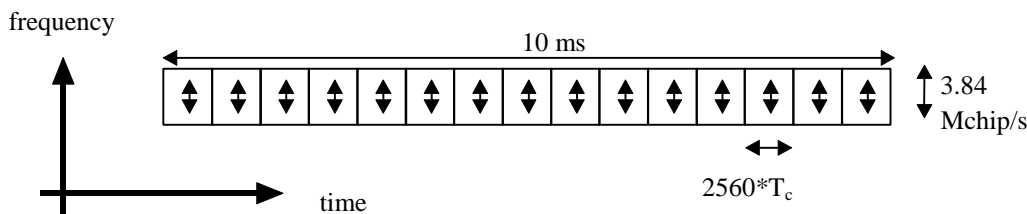

Figure 2: The TDD frame structure

Examples for multiple and single switching point configurations as well as for symmetric and asymmetric UL/DL allocations are given in figure 3.

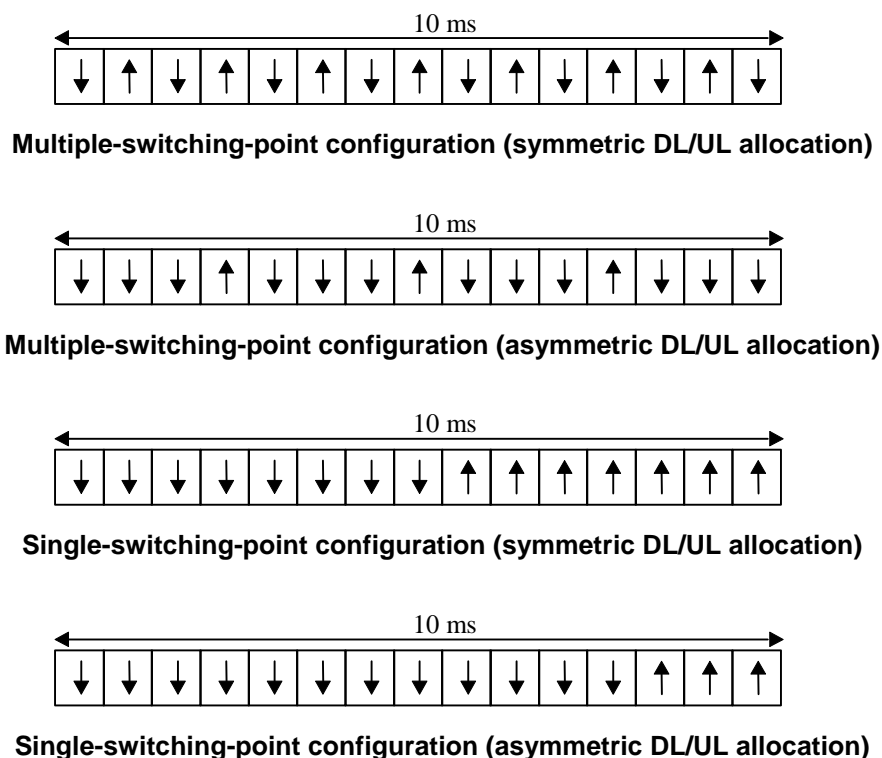

Figure 3: TDD frame structure examples

5.2 Dedicated physical channel (DPCH)

The DCH as described in subclause 4.1.1 is mapped onto the dedicated physical channel.

5.2.1 Spreading

Spreading is applied to the data part of the physical channels and consists of two operations. The first is the channelisation operation, which transforms every data symbol into a number of chips, thus increasing the bandwidth of the signal. The number of chips per data symbol is called the Spreading Factor (SF). The second operation is the scrambling operation, where a scrambling code is applied to the spread signal. Details on channelisation and scrambling operation can be found in [8].

5.2.1.1 Spreading for Downlink Physical Channels

Downlink physical channels shall use $SF = 16$. Multiple parallel physical channels can be used to support higher data rates. These parallel physical channels shall be transmitted using different channelisation codes, see [8]. These codes with $SF = 16$ are generated as described in [8].

Operation with a single code with spreading factor 1 is possible for the downlink physical channels.

5.2.1.2 Spreading for Uplink Physical Channels

The range of spreading factor that may be used for uplink physical channels shall range from 16 down to 1. For each physical channel an individual minimum spreading factor SF_{min} is transmitted by means of the higher layers. There are two options that are indicated by UTRAN:

1. The UE shall use the spreading factor SF_{min} , independent of the current TFC.
2. The UE shall autonomously increase the spreading factor depending on the current TFC.

If the UE autonomously changes the SF, it shall always vary the channelisation code along the lower branch of the allowed OVFS sub tree, as depicted in [8].

For multicode transmission a UE shall use a maximum of two physical channels per timeslot simultaneously. These two parallel physical channels shall be transmitted using different channelisation codes, see [8].

5.2.2 Burst Types

Three types of bursts for dedicated physical channels are defined. All of them consist of two data symbol fields, a midamble and a guard period, the lengths of which are different for the individual burst types. Thus, the number of data symbols in a burst depends on the SF and the burst type, as depicted in table 1.

Table 1: Number of data symbols (N) for burst type 1, 2, and 3

Spreading factor (SF)	Burst Type 1	Burst Type 2	Burst Type 3
1	1952	2208	1856
2	976	1104	928
4	488	552	464
8	244	276	232
16	122	138	116

The support of all three burst types is mandatory for the UE. The three different bursts defined here are well suited for different applications, as described in the following sections.

5.2.2.1 Burst Type 1

The burst type 1 can be used for uplink and downlink. Due to its longer midamble field this burst type supports the construction of a larger number of training sequences, see 5.2.3. The maximum number of training sequences depend on the cell configuration, see annex A. For the burst type 1 this number may be 4, 8, or 16.

The data fields of the burst type 1 are 976 chips long. The corresponding number of symbols depends on the spreading factor, as indicated in table 1 above. The midamble of burst type 1 has a length of 512 chips. The guard period for the burst type 1 is 96 chip periods long. The burst type 1 is shown in Figure 4. The contents of the burst fields are described in table 2.

Table 2: The contents of the burst type 1 fields

Chip number (CN)	Length of field in chips	Length of field in symbols	Contents of field
0-975	976	Cf table 1	Data symbols
976-1487	512	-	Midamble
1488-2463	976	Cf table 1	Data symbols
2464-2559	96	-	Guard period

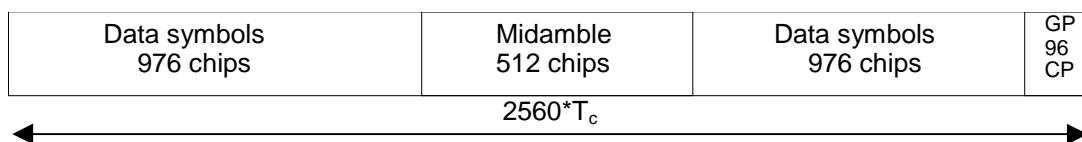

Figure 4: Burst structure of the burst type 1. GP denotes the guard period and CP the chip periods

5.2.2.2 Burst Type 2

The burst type 2 can be used for uplink and downlink. It offers a longer data field than burst type 1 on the cost of a shorter midamble. Due to the shorter midamble field the burst type 2 supports a maximum number of training sequences of 3 or 6 only, depending on the cell configuration, see annex A.

The data fields of the burst type 2 are 1104 chips long. The corresponding number of symbols depends on the spreading factor, as indicated in table 1 above. The guard period for the burst type 2 is 96 chip periods long. The burst type 2 is shown in Figure 5. The contents of the burst fields are described in table 3.

Table 3: The contents of the burst type 2 fields

Chip number (CN)	Length of field in chips	Length of field in symbols		Contents of field
0-1103	1104	cf table 1		Data symbols
1104-1359	256	-		Midamble
1360-2463	1104	cf table 1		Data symbols
2464-2559	96	-		Guard period

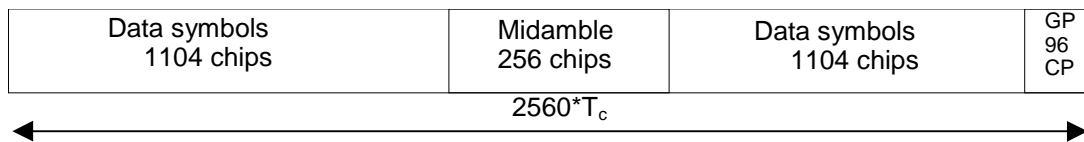

Figure 5: Burst structure of the burst type 2. GP denotes the guard period and CP the chip periods

5.2.2.3 Burst Type 3

The burst type 3 is used for uplink only. Due to the longer guard period it is suitable for initial access or access to a new cell after handover. It offers the same number of training sequences as burst type 1.

The data fields of the burst type 3 have a length of 976 chips and 880 chips, respectively. The corresponding number of symbols depends on the spreading factor, as indicated in table 1 above. The midamble of burst type 3 has a length of 512 chips. The guard period for the burst type 3 is 192 chip periods long. The burst type 3 is shown in Figure 6. The contents of the burst fields are described in table 4.

Table 4: The contents of the burst type 3 fields

Chip number (CN)	Length of field in chips	Length of field in symbols		Contents of field
0-975	976	Cf table 1		Data symbols
976-1487	512	-		Midamble
1488-2367	880	Cf table 1		Data symbols
2368-2559	192	-		Guard period

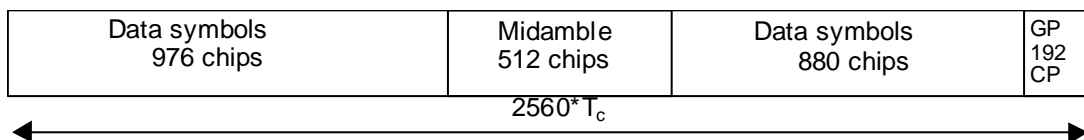

Figure 6: Burst structure of the burst type 3. GP denotes the guard period and CP the chip periods

5.2.2.4 Transmission of TFCI

All burst types 1, 2 and 3 provide the possibility for transmission of TFCI.

The transmission of TFCI is negotiated at call setup and can be re-negotiated during the call. For each CCTrCH it is indicated by higher layer signalling, which TFCI format is applied. Additionally for each allocated timeslot it is signalled individually whether that timeslot carries the TFCI or not. The TFCI is always present in the first timeslot in a radio frame for each CCTrCH. If a time slot contains the TFCI, then it is always transmitted using the first allocated channelisation code in the timeslot, according to the order in the higher layer allocation message.

The transmission of TFCI is done in the data parts of the respective physical channel. In DL the TFCI and data bits are subject to the same spreading procedure as depicted in [8]. In UL, independent of the SF that is applied to the data symbols in the burst, the data in the TFCI field are always spread with SF=16 using the channelisation code in the lowest branch of the allowed OVSF sub tree, as depicted in [8]. Hence the midamble structure and length is not changed. The TFCI information is to be transmitted directly adjacent to the midamble, possibly after the TPC. Figure 6 shows the position of the TFCI in a traffic burst in downlink. Figure 7 shows the position of the TFCI in a traffic burst in uplink.

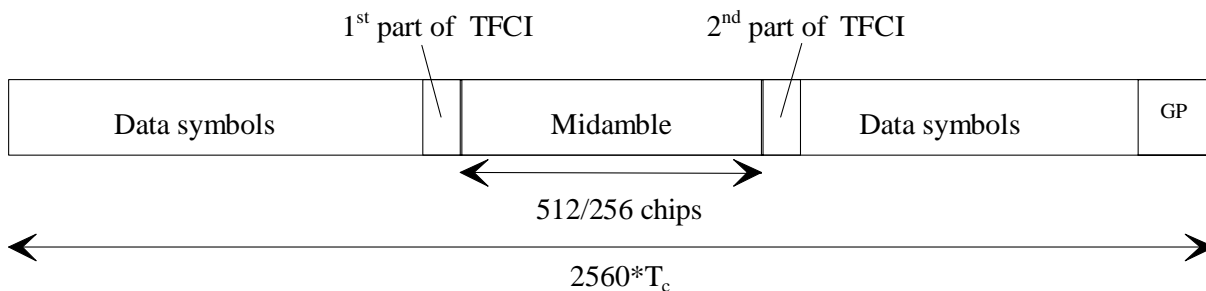

Figure 7: Position of TFCI information in the traffic burst in case of downlink

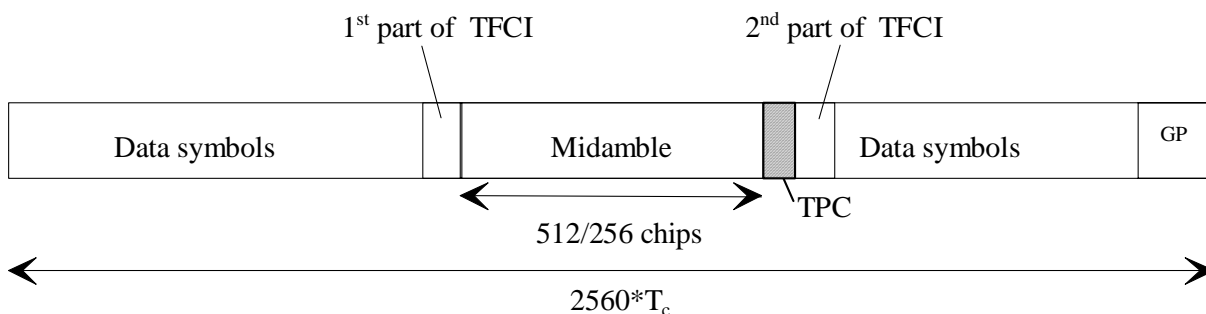

Figure 8: Position of TFCI information in the traffic burst in case of uplink

Two examples of TFCI transmission in the case of multiple DPCHs used for a connection are given in the Figure 8 and Figure 9 below. Combinations of the two schemes shown are also applicable.

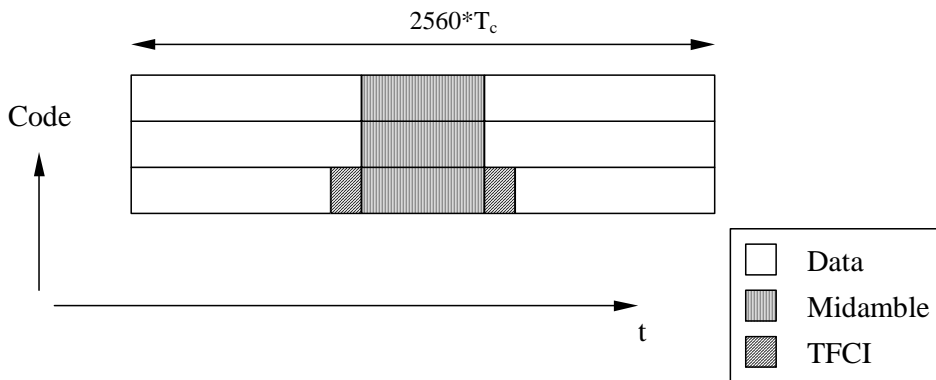

Figure 9: Example of TFCI transmission with physical channels multiplexed in code domain

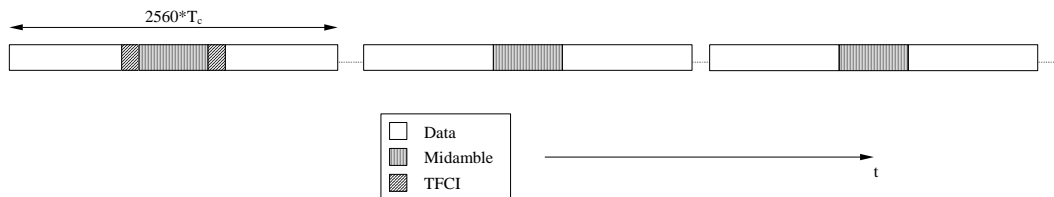

Figure 10: Example of TFCI transmission with physical channels multiplexed in time domain

In case the Node B receives an invalid TFI combination on the DCHs mapped to one CCTrCH the procedure described in [16] shall be applied. According to this procedure DTX shall be applied to all DPCHs to which the CCTrCH is mapped to.

5.2.2.5 Transmission of TPC

All burst types 1, 2 and 3 for dedicated channels provide the possibility for transmission of TPC in uplink.

The transmission of TPC is done in the data parts of the traffic burst. Independent of the SF that is applied to the data symbols in the burst, the data in the TPC field are always spread with SF=16 using the channelisation code in the lowest branch of the allowed OVSF sub tree, as depicted in [8]. Hence the midamble structure and length is not changed. The TPC information is to be transmitted directly after the midamble. Figure 10 shows the position of the TPC in a traffic burst.

For every user the TPC information shall be transmitted at least once per transmitted frame. If TFCI is applied for a CCTrCH, TPC shall be transmitted with the same channelization codes and in the same timeslots as TFCI. If no TFCI is applied for a CCTrCH, TPC shall be transmitted using the first allocated channelisation code and the first allocated timeslot, according to the order in the higher layer allocation message.

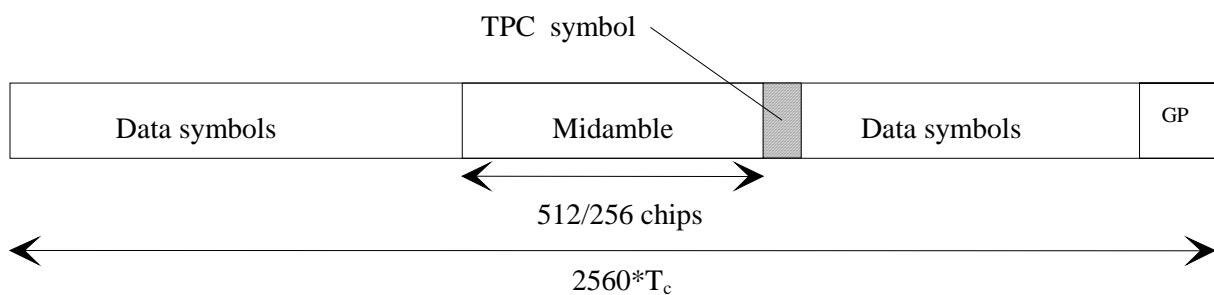

Figure 11: Position of TPC information in the traffic burst

The length of the TPC command is one symbol. The relationship between the TPC symbol and the TPC command is shown in table 4a.

Table 4a: TPC bit pattern

TPC Bits	TPC command	Meaning
00	'Down'	Decrease Tx Power
11	'Up'	Increase Tx Power

5.2.2.6 Timeslot formats

5.2.2.6.1 Downlink timeslot formats

The downlink timeslot format depends on the spreading factor, midamble length and on the number of the TFCI bits, as depicted in the table 4a.

Table 5a: Time slot formats for the Downlink

Slot Format #	Spreading Factor	Midamble length (chips)	N _{TFCI} (bits)	Bits/slot	N _{Data/Slot} (bits)	N _{data/data field} (bits)
0	16	512	0	244	244	122
1	16	512	4	244	240	120
2	16	512	8	244	236	118
3	16	512	16	244	228	114
4	16	512	32	244	212	106
5	16	256	0	276	276	138
6	16	256	4	276	272	136
7	16	256	8	276	268	134
8	16	256	16	276	260	130
9	16	256	32	276	244	122
10	1	512	0	3904	3904	1952
11	1	512	4	3904	3900	1950
12	1	512	8	3904	3896	1948
13	1	512	16	3904	3888	1944
14	1	512	32	3904	3872	1936
15	1	256	0	4416	4416	2208
16	1	256	4	4416	4412	2206
17	1	256	8	4416	4408	2204
18	1	256	16	4416	4400	2200
19	1	256	32	4416	4384	2192

5.2.2.6.2 Uplink timeslot formats

The uplink timeslot format depends on the spreading factor, midamble length, guard period length and on the number of the TFCI bits. Due to TPC, different amount of bits are mapped to the two data fields. The timeslot formats are depicted in the table 4b.

Table 5b: Timeslot formats for the Uplink

Slot Format #	Spreading Factor	Midamble length (chips)	Guard Period (chips)	N _{TF} CI (bits)	N _{TPC} (bits)	Bits/slot	N _{Data/Slot} (bits)	N _{data/data field(1)} (bits)	N _{data/data field(2)} (bits)
0	16	512	96	0	0	244	244	122	122
1	16	512	96	0	2	244	242	122	120
2	16	512	96	4	2	244	238	120	118
3	16	512	96	8	2	244	234	118	116
4	16	512	96	16	2	244	226	114	112
5	16	512	96	32	2	244	210	106	104
6	16	256	96	0	0	276	276	138	138
7	16	256	96	0	2	276	274	138	136
8	16	256	96	4	2	276	270	136	134
9	16	256	96	8	2	276	266	134	132
10	16	256	96	16	2	276	258	130	128
11	16	256	96	32	2	276	242	122	120
12	8	512	96	0	0	488	488	244	244
13	8	512	96	0	2	486	484	244	240
14	8	512	96	4	2	482	476	240	236
15	8	512	96	8	2	478	468	236	232
16	8	512	96	16	2	470	452	228	224
17	8	512	96	32	2	454	420	212	208
18	8	256	96	0	0	552	552	276	276
19	8	256	96	0	2	550	548	276	272
20	8	256	96	4	2	546	540	272	268
21	8	256	96	8	2	542	532	268	264
22	8	256	96	16	2	534	516	260	256
23	8	256	96	32	2	518	484	244	240
24	4	512	96	0	0	976	976	488	488
25	4	512	96	0	2	970	968	488	480
26	4	512	96	4	2	958	952	480	472
27	4	512	96	8	2	946	936	472	464
28	4	512	96	16	2	922	904	456	448
29	4	512	96	32	2	874	840	424	416
30	4	256	96	0	0	1104	1104	552	552
31	4	256	96	0	2	1098	1096	552	544
32	4	256	96	4	2	1086	1080	544	536
33	4	256	96	8	2	1074	1064	536	528
34	4	256	96	16	2	1050	1032	520	512
35	4	256	96	32	2	1002	968	488	480
36	2	512	96	0	0	1952	1952	976	976
37	2	512	96	0	2	1938	1936	976	960
38	2	512	96	4	2	1910	1904	960	944
39	2	512	96	8	2	1882	1872	944	928
40	2	512	96	16	2	1826	1808	912	896
41	2	512	96	32	2	1714	1680	848	832
42	2	256	96	0	0	2208	2208	1104	1104
43	2	256	96	0	2	2194	2192	1104	1088
44	2	256	96	4	2	2166	2160	1088	1072
45	2	256	96	8	2	2138	2128	1072	1056
46	2	256	96	16	2	2082	2064	1040	1024
47	2	256	96	32	2	1970	1936	976	960

Slot Format #	Spreading Factor	Midamble length (chips)	Guard Period (chips)	N _{TFCI} (bits)	N _{TPC} (bits)	Bits/slot	N _{Data/Slot} (bits)	N _{data/data field(1)} (bits)	N _{data/data field(2)} (bits)
48	1	512	96	0	0	3904	3904	1952	1952
49	1	512	96	0	2	3874	3872	1952	1920
50	1	512	96	4	2	3814	3808	1920	1888
51	1	512	96	8	2	3754	3744	1888	1856
52	1	512	96	16	2	3634	3616	1824	1792
53	1	512	96	32	2	3394	3360	1696	1664
54	1	256	96	0	0	4416	4416	2208	2208
55	1	256	96	0	2	4386	4384	2208	2176
56	1	256	96	4	2	4326	4320	2176	2144
57	1	256	96	8	2	4266	4256	2144	2112
58	1	256	96	16	2	4146	4128	2080	2048
59	1	256	96	32	2	3906	3872	1952	1920
60	16	512	192	0	0	232	232	122	110
61	16	512	192	0	2	232	230	122	108
62	16	512	192	4	2	232	226	120	106
63	16	512	192	8	2	232	222	118	104
64	16	512	192	16	2	232	214	114	100
65	16	512	192	32	2	232	198	106	92
66	8	512	192	0	0	464	464	244	220
67	8	512	192	0	2	462	460	244	216
68	8	512	192	4	2	458	452	240	212
69	8	512	192	8	2	454	444	236	208
70	8	512	192	16	2	446	428	228	200
71	8	512	192	32	2	430	396	212	184
72	4	512	192	0	0	928	928	488	440
73	4	512	192	0	2	922	920	488	432
74	4	512	192	4	2	910	904	480	424
75	4	512	192	8	2	898	888	472	416
76	4	512	192	16	2	874	856	456	400
77	4	512	192	32	2	826	792	424	368
78	2	512	192	0	0	1856	1856	976	880
79	2	512	192	0	2	1842	1840	976	864
80	2	512	192	4	2	1814	1808	960	848
81	2	512	192	8	2	1786	1776	944	832
82	2	512	192	16	2	1730	1712	912	800
83	2	512	192	32	2	1618	1584	848	736
84	1	512	192	0	0	3712	3712	1952	1760
85	1	512	192	0	2	3682	3680	1952	1728
86	1	512	192	4	2	3622	3616	1920	1696
87	1	512	192	8	2	3562	3552	1888	1664
88	1	512	192	16	2	3442	3424	1824	1600
89	1	512	192	32	2	3202	3168	1696	1472

5.2.3 Training sequences for spread bursts

In this subclause, the training sequences for usage as midambles in burst type 1, 2 and 3 (see subclause 5.2.2) are defined. The training sequences, i.e. midambles, of different users active in the same cell and same time slot are cyclically shifted versions of one cell-specific single basic midamble code. The applicable basic midamble codes are

given in Annex A.1 and A.2. As different basic midamble codes are required for different burst formats, the Annex A.1 shows the basic midamble codes \mathbf{m}_{pL} for burst type 1 and 3, and Annex and A.2 shows \mathbf{m}_{pS} for burst type 2. It should be noted that burst type 2 must not be mixed with burst type 1 or 3 in the same timeslot of one cell.

The basic midamble codes in Annex A.1 and A.2 are listed in hexadecimal notation. The binary form of the basic midamble code shall be derived according to table 6 below.

Table 6: Mapping of 4 binary elements m_i on a single hexadecimal digit

4 binary elements m_i	Mapped on hexadecimal digit
-1 -1 -1 -1	0
-1 -1 -1 1	1
-1 -1 1 -1	2
-1 -1 1 1	3
-1 1 -1 -1	4
-1 1 -1 1	5
-1 1 1 -1	6
-1 1 1 1	7
1 -1 -1 -1	8
1 -1 -1 1	9
1 -1 1 -1	A
1 -1 1 1	B
1 1 -1 -1	C
1 1 -1 1	D
1 1 1 -1	E
1 1 1 1	F

For each particular basic midamble code, its binary representation can be written as a vector \mathbf{m}_p :

$$\mathbf{m}_p = (m_1, m_2, \dots, m_p) \quad (1)$$

According to Annex A.1, the size of this vector \mathbf{m}_p is $P=456$ for burst type 1 and 3. Annex A.2 is setting $P=192$ for burst type 2. As QPSK modulation is used, the training sequences are transformed into a complex form, denoted as the complex vector $\underline{\mathbf{m}}_p$:

$$\underline{\mathbf{m}}_p = (\underline{m}_1, \underline{m}_2, \dots, \underline{m}_p) \quad (2)$$

The elements \underline{m}_i of $\underline{\mathbf{m}}_p$ are derived from elements m_i of \mathbf{m}_p using equation (3):

$$\underline{m}_i = (j)^i \cdot m_i \text{ for all } i = 1, \dots, P \quad (3)$$

Hence, the elements \underline{m}_i of the complex basic midamble code are alternating real and imaginary.

To derive the required training sequences (different shifts), this vector $\underline{\mathbf{m}}_p$ is periodically extended to the size:

$$i_{\max} = L_m + (K'-1)W + \lfloor P/K \rfloor \quad (4)$$

Notes on equation (4):

- L_m : Midamble length
- K' : Maximum number of different midamble shifts in a cell, when no intermediate shifts are used. This value depends on the midamble length.
- K : Maximum number of different midamble shifts in a cell, when intermediate shifts are used, $K=2K'$. This value depends on the midamble length.
- W : Shift between the midambles, when the number of midambles is K' .

- $\lfloor x \rfloor$ denotes the largest integer smaller or equal to x

Allowed values for L_m , K' and W are given in Annex A.1 and A.2.

So we obtain a new vector $\underline{\mathbf{m}}$ containing the periodic basic midamble sequence:

$$\underline{\mathbf{m}} = (m_1, m_2, \dots, m_{i_{\max}}) = (m_1, m_2, \dots, m_{L_m + (K'-1)W + \lfloor P/K \rfloor}) \quad (5)$$

The first P elements of this vector $\underline{\mathbf{m}}$ are the same ones as in vector $\underline{\mathbf{m}}_p$, the following elements repeat the beginning:

$$m_i = m_{i-P} \text{ for the subset } i = (P+1), \dots, i_{\max} \quad (6)$$

Using this periodic basic midamble sequence $\underline{\mathbf{m}}$ for each shift k a midamble $\underline{\mathbf{m}}^{(k)}$ of length L_m is derived, which can be written as a shift specific vector:

$$\underline{\mathbf{m}}^{(k)} = (m_1^{(k)}, m_2^{(k)}, \dots, m_{L_m}^{(k)}) \quad (7)$$

The L_m midamble elements $m_i^{(k)}$ are generated for each midamble of the first K' shift ($k = 1, \dots, K'$) based on:

$$m_i^{(k)} = m_{i+(K'-k)W} \text{ with } i = 1, \dots, L_m \text{ and } k = 1, \dots, K' \quad (8)$$

The elements of midambles for the second K' shift ($k = (K'+1), \dots, K = (K'+1), \dots, 2K'$) are generated based on a slight modification of this formula introducing intermediate shifts:

$$m_i^{(k)} = m_{i+(K-k-1)W + \lfloor P/K \rfloor} \text{ with } i = 1, \dots, L_m \text{ and } k = K'+1, \dots, K-1 \quad (9)$$

$$m_i^{(k)} = m_{i+(K'-1)W + \lfloor P/K \rfloor} \text{ with } i = 1, \dots, L_m \text{ and } k = K \quad (10)$$

Whether intermediate shifts are allowed in a cell is signalled by higher layers.

The midamble sequences derived according to equations (7) to (10) have complex values and are not subject to channelisation or scrambling process, i.e. the elements $m_i^{(k)}$ represent complex chips for usage in the pulse shaping process at modulation.

The term 'a midamble code set' or 'a midamble code family' denotes K specific midamble codes $\underline{\mathbf{m}}^{(k)}$; $k=1, \dots, K$, based on a single basic midamble code $\underline{\mathbf{m}}_p$ according to (1).

5.2.4 Beamforming

When DL beamforming is used, at least that user to which beamforming is applied and which has a dedicated channel shall get one individual midamble according to subclause 5.2.3, even in DL.

5.3 Common physical channels

5.3.1 Primary common control physical channel (P-CCPCH)

The BCH as described in subclause 4.1.2 is mapped onto the Primary Common Control Physical Channel (P-CCPCH). The position (time slot / code) of the P-CCPCH is known from the Physical Synchronisation Channel (PSCH), see subclause 5.3.4.

5.3.1.1 P-CCPCH Spreading

The P-CCPCH uses fixed spreading with a spreading factor $SF = 16$ as described in subclause 5.2.1.1. The P-CCPCH always uses channelisation code $C_{Q=16}^{(k=1)}$.

5.3.1.2 P-CCPCH Burst Types

The burst type 1 as described in subclause 5.2.2 is used for the P-CCPCH. No TFCI is applied for the P-CCPCH.

5.3.1.3 P-CCPCH Training sequences

The training sequences, i.e. midambles, as described in subclause 5.2.3 are used for the P-CCPCH. For those timeslots in which the P-CCPCH is transmitted, the midambles $m^{(1)}$ and $m^{(2)}$ are reserved for P-CCPCH in order to support Block STTD antenna diversity and the beacon function, see 5.4 and 5.5. The use of midambles depends on whether Block STTD is applied to the P-CCPCH:

- If no antenna diversity is applied to P-CCPCH, $m^{(1)}$ is used and $m^{(2)}$ is left unused. The maximum number K of midambles in a cell may be 4, 8 or 16.
- If Block STTD antenna diversity is applied to P-CCPCH, $m^{(1)}$ is used for the first antenna and $m^{(2)}$ is used for the diversity antenna. The maximum number K of midambles in a cell may be 8 or 16. The case of 4 midambles is not allowed for Block STTD.

5.3.2 Secondary common control physical channel (S-CCPCH)

PCH and FACH as described in subclause 4.1.2 are mapped onto one or more secondary common control physical channels (S-CCPCH). In this way the capacity of PCH and FACH can be adapted to the different requirements.

5.3.2.1 S-CCPCH Spreading

The S-CCPCH uses fixed spreading with a spreading factor $SF = 16$ as described in subclause 5.2.1.1.

5.3.2.2 S-CCPCH Burst Types

The burst types 1 or 2 as described in subclause 5.2.2 are used for the S-CCPCHs. TFCI may be applied for S-CCPCHs.

5.3.2.3 S-CCPCH Training sequences

The training sequences, i.e. midambles, as described in subclause 5.2.3 are used for the S-CCPCH.

5.3.3 The physical random access channel (PRACH)

The RACH as described in subclause 4.1.2 is mapped onto one uplink physical random access channel (PRACH).

5.3.3.1 PRACH Spreading

The uplink PRACH uses either spreading factor $SF=16$ or $SF=8$ as described in subclause 5.2.1.2. The set of admissible spreading codes for use on the PRACH and the associated spreading factors are broadcast on the BCH (within the RACH configuration parameters on the BCH).

5.3.3.2 PRACH Burst Type

The UEs send uplink access bursts of type 3 randomly in the PRACH. TFCI and TPC are not applied for the PRACH.

5.3.3.3 PRACH Training sequences

The training sequences, i.e. midambles, of different users active in the same time slot are time shifted versions of a single periodic basic code. The basic midamble codes for burst type 3 are shown in Annex A. The necessary time shifts

are obtained by choosing either *all* $k=1,2,3,\dots,K'$ (for cells with small radius) or *uneven* $k=1,3,5,\dots\leq K'$ (for cells with large radius). Different cells use different periodic basic codes, i.e. different midamble sets.

For cells with large radius additional midambles may be derived from the time-inverted Basic Midamble Sequence. Thus, the second Basic Midamble Code m_2 is the time inverted version of Basic Midamble Code m_1 .

In this way, a joint channel estimation for the channel impulse responses of all active users within one time slot can be performed by a maximum of two cyclic correlations (in cells with small radius, a single cyclic correlator suffices). The different user specific channel impulse response estimates are obtained sequentially in time at the output of the cyclic correlators.

5.3.3.4 PRACH timeslot formats

For the PRACH the timeslot format is only spreading factor dependent. The timeslot formats 60 and 66 of table 5b are applicable for the PRACH.

5.3.3.5 Association between Training Sequences and Channelisation Codes

For the PRACH there exists a fixed association between the training sequence and the channelisation code. The generic rule to define this association is based on the order of the channelisation codes $c_Q^{(k)}$ given by k and the order of the midambles $m_j^{(k)}$ given by k , firstly, and j , secondly, with the constraint that the midamble for a spreading factor Q is the same as in the upper branch for the spreading factor $2Q$. The index $j=1$ or 2 indicates whether the original Basic Midamble Sequence ($j=1$) or the time-inverted Basic Midamble Sequence is used ($j=2$).

- For the case that all k are allowed and only one periodic basic code m_1 is available for the RACH, the association depicted in figure 12 is straightforward.
- For the case that only odd k are allowed the principle of the association is shown in figure 13. This association is applied for one and two basic periodic codes.

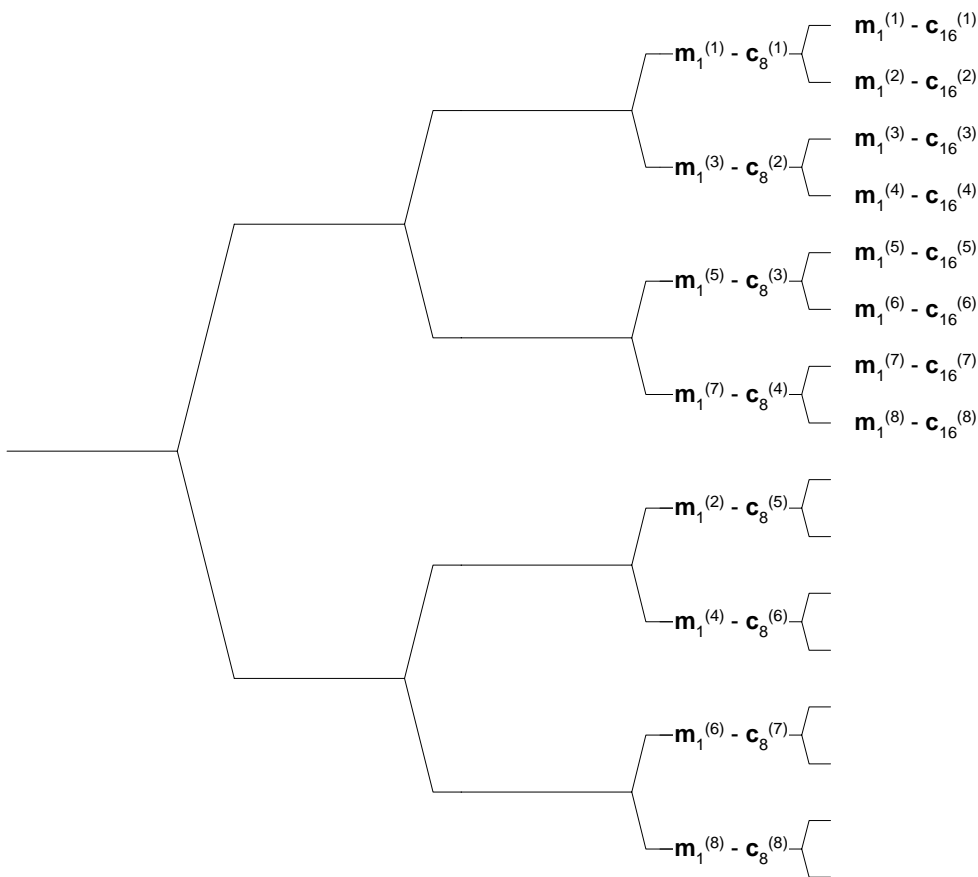

Figure 12: Association of Midambles to Channelisation Codes in the OVSF tree for all k

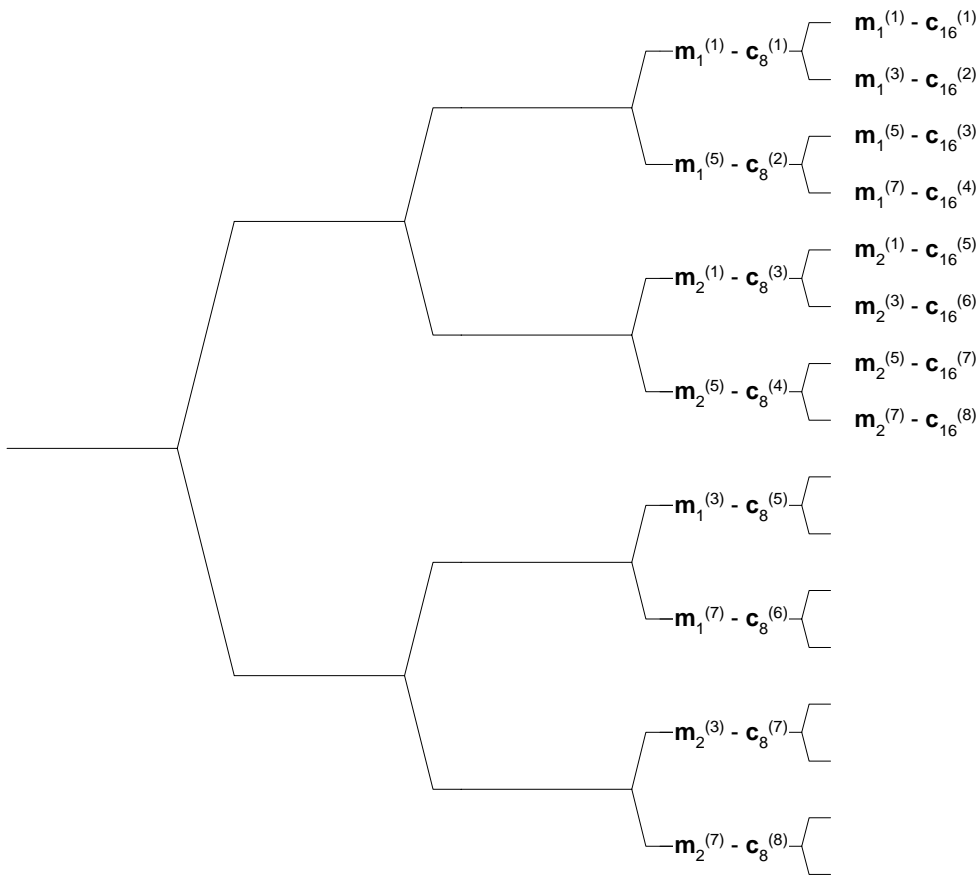

Figure 13: Association of Midambles to Channelisation Codes in the OVSF tree for odd k

5.3.4 The synchronisation channel (SCH)

In TDD mode code group of a cell can be derived from the synchronisation channel. In order not to limit the uplink/downlink asymmetry the SCH is mapped on one or two downlink slots per frame only.

There are two cases of SCH and P-CCPCH allocation as follows:

- Case 1) SCH and P-CCPCH allocated in TS# k , $k=0\dots14$
- Case 2) SCH allocated in two TS: TS# k and TS# $k+8$, $k=0\dots6$; P-CCPCH allocated in TS# k .

The position of SCH (value of k) in frame can change on a long term basis in any case.

Due to this SCH scheme, the position of P-CCPCH is known from the SCH.

Figure 14 is an example for transmission of SCH, $k=0$, of Case 2.

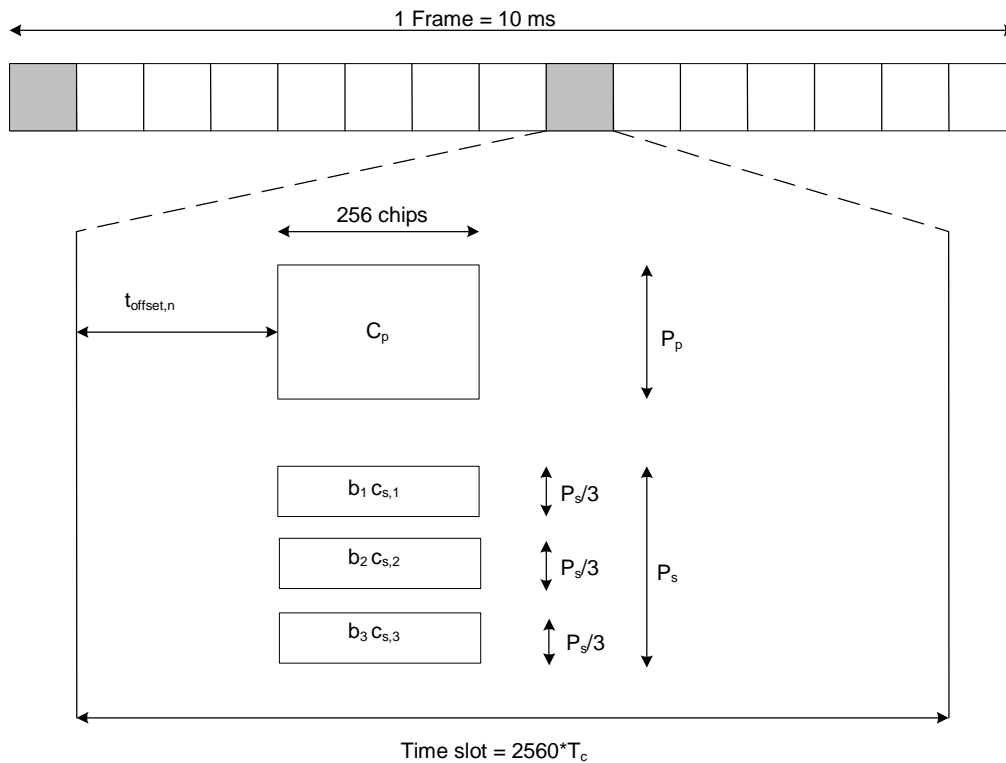

$$b_i \in \{ \pm 1, \pm j \}, C_{s,i} \in \{ C_0, C_1, C_3, C_4, C_5, C_6, C_8, C_{10}, C_{12}, C_{13}, C_{14}, C_{15} \}, i=1,2,3; \text{ see [8]}$$

Figure 14: Scheme for Synchronisation channel SCH consisting of one primary sequence Cp and 3 parallel secondary sequences Cs,i in slot k and k+8 (example for k=0 in Case 2)

As depicted in figure 14, the SCH consists of a primary and three secondary code sequences each 256 chips long. The primary and secondary code sequences are defined in [8] clause 7 ‘Synchronisation codes’.

Due to mobile to mobile interference, it is mandatory for public TDD systems to keep synchronisation between base stations. As a consequence of this, a capture effect concerning SCH can arise. The time offset $t_{offset,n}$ enables the system to overcome the capture effect.

The time offset $t_{offset,n}$ is one of 32 values, depending on the code group of the cell, n, cf. ‘table 6 Mapping scheme for Cell Parameters, Code Groups, Scrambling Codes, Midambles and t_{offset} ’ in [8]. Note that the cell parameter will change from frame to frame, cf. ‘Table 7 Alignment of cell parameter cycling and system frame number’ in [8], but the cell will belong to only one code group and thus have one time offset $t_{offset,n}$. The exact value for $t_{offset,n}$, regarding column ‘Associated t_{offset} ’ in table 6 in [8] is given by:

$$t_{offset,n} = \begin{cases} n \cdot 48 \cdot T_c & n < 16 \\ (720 + n \cdot 48) T_c & n \geq 16 \end{cases}; \quad n = 0, \dots, 31$$

5.3.5 Physical Uplink Shared Channel (PUSCH)

The USCH as described in subclause 4.1.2 is mapped onto one or more physical uplink shared channels (PUSCH). Timing advance, as described in [9], subclause 4.3, is applied to the PUSCH.

5.3.5.1 PUSCH Spreading

The spreading factors that can be applied to the PUSCH are SF = 1, 2, 4, 8, 16 as described in subclause 5.2.1.2.

5.3.5.2 PUSCH Burst Types

Burst types 1, 2 or 3 as described in subclause 5.2.2 can be used for PUSCH. TFCI and TPC can be transmitted on the PUSCH.

5.3.5.3 PUSCH Training Sequences

The training sequences as described in subclause 5.2.3 are used for the PUSCH.

5.3.5.4 UE Selection

The UE that shall transmit on the PUSCH is selected by higher layer signalling.

5.3.6 Physical Downlink Shared Channel (PDSCH)

The DSCH as described in subclause 4.1.2 is mapped onto one or more physical downlink shared channels (PDSCH).

5.3.6.1 PDSCH Spreading

The PDSCH uses either spreading factor $SF = 16$ or $SF = 1$ as described in subclause 5.2.1.1.

5.3.6.2 PDSCH Burst Types

Burst types 1 or 2 as described in subclause 5.2.2 can be used for PDSCH. TFCI can be transmitted on the PDSCH.

5.3.6.3 PDSCH Training Sequences

The training sequences as described in subclause 5.2.3 are used for the PDSCH.

5.3.6.4 UE Selection

To indicate to the UE that there is data to decode on the DSCH, three signalling methods are available:

- 1) using the TFCI field of the associated channel or PDSCH;
- 2) using on the DSCH user specific midamble derived from the set of midambles used for that cell;
- 3) using higher layer signalling.

When the midamble based method is used, the UE specific midamble allocation method shall be employed (see subclause 5.6), and the UE shall decode the PDSCH if the PDSCH was transmitted with the midamble assigned to the UE by UTRAN. For this method no other physical channels may use the same time slot as the PDSCH and only one UE may share the PDSCH time slot within one TTI.

Note: From the above mentioned signalling methods, only the higher layer signalling method is supported by higher layers in R99.

5.3.7 The Paging Indicator Channel (PICH)

The Paging Indicator Channel (PICH) is a physical channel used to carry the paging indicators.

5.3.7.1 Mapping of Paging Indicators to the PICH bits

Figure 15 depicts the structure of a PICH burst and the numbering of the bits within the burst. The same burst type is used for the PICH in every cell. N_{PIB} bits in a normal burst of type 1 or 2 are used to carry the paging indicators, where N_{PIB} depends on the burst type: $N_{PIB}=240$ for burst type 1 and $N_{PIB}=272$ for burst type 2. The bits $s_{N_{PIB}+1}, \dots, s_{N_{PIB}+4}$ adjacent to the midamble are reserved for possible future use.

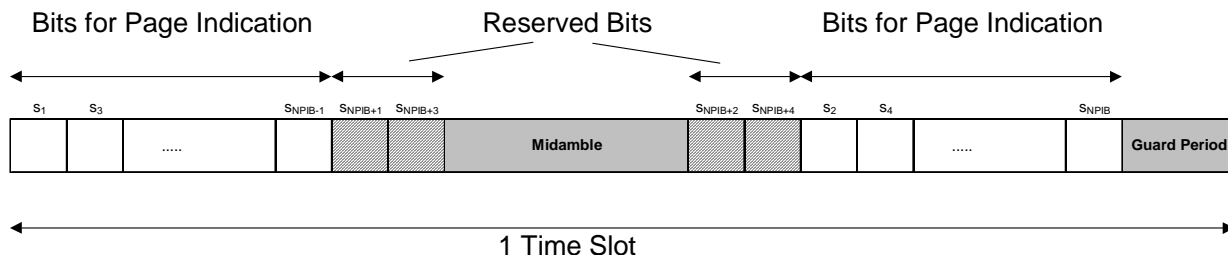

Figure 15: Transmission and numbering of paging indicator carrying bits in a PICH burst

Each paging indicator P_q in one time slot is mapped to the bits $\{s_{2L_{PI} \cdot q+1}, \dots, s_{2L_{PI} \cdot (q+1)}\}$ within this time slot. Thus, due to the interleaved transmission of the bits half of the symbols used for each paging indicator are transmitted in the first data part, and the other half of the symbols are transmitted in the second data part, as exemplary shown in figure 16 for a paging indicator length L_{PI} of 4 symbols.

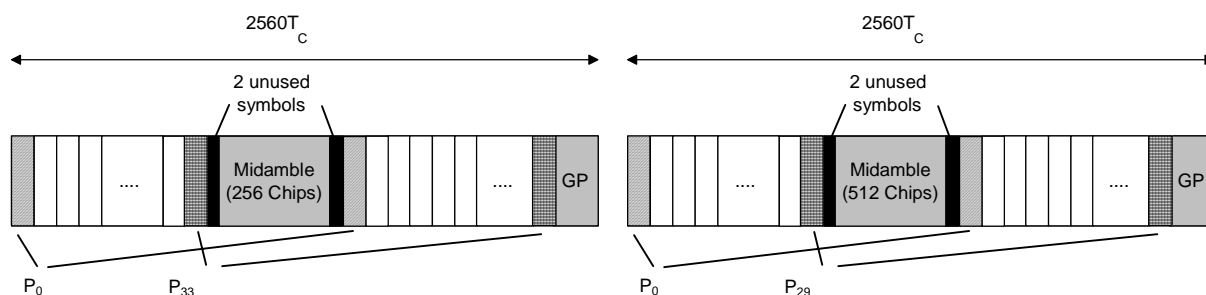

Figure 16: Example of mapping of paging indicators on PICH bits for $L_{PI}=4$

The setting of the paging indicators and the corresponding PICH bits (including the reserved ones) is described in [7].

In each radio frame, N_{PI} paging indicators are transmitted, using $L_{PI}=2$, $L_{PI}=4$ or $L_{PI}=8$ symbols. The number of paging indicators N_{PI} per radio frame is given by the paging indicator length and the burst type, which are both known by higher layer signalling. In table 7 this number is shown for the different possibilities of burst types and paging indicator lengths.

Table 7: Number N_{PI} of paging indicators per time slot for the different burst types and paging indicator lengths L_{PI}

	$L_{PI}=2$	$L_{PI}=4$	$L_{PI}=8$
Burst Type 1	$N_{PI}=60$	$N_{PI}=30$	$N_{PI}=15$
Burst Type 2	$N_{PI}=68$	$N_{PI}=34$	$N_{PI}=17$

5.3.7.2 Structure of the PICH over multiple radio frames

As shown in figure 17, the paging indicators of N_{PICH} consecutive frames form a PICH block, N_{PICH} is configured by higher layers. Thus, $N_P=N_{PICH} \cdot N_{PI}$ paging indicators are transmitted in each PICH block.

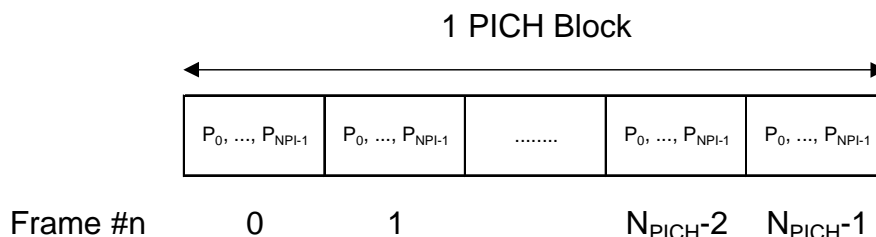

Figure 17: Structure of a PICH block

The value PI (PI = 0, ..., N_P-1) calculated by higher layers for use for a certain UE, see [15], is associated to the paging indicator P_q in the n th frame of one PICH block, where q is given by

$$q = \text{PI mod } N_{PI}$$

and n is given by

$$n = \text{PI div } N_{PI}$$

The PI bitmap in the PCH data frames over I_{ub} contains indication values for all possible higher layer PI values, see [16]. Each bit in the bitmap indicates if the paging indicator P_q associated with that particular PI shall be set to 0 or 1. Hence, the calculation in the formulas above is to be performed in Node B to make the association between PI and P_q .

5.4 Transmit Diversity for DL Physical Channels

Table 8 summarizes the different transmit diversity schemes for different downlink physical channel types that are described in [9].

Table 8: Application of Tx diversity schemes on downlink physical channel types
"X" – can be applied, "-" – must not be applied

Physical channel type	Open loop Tx Diversity		Closed loop Tx Diversity
	TSTD	Block STTD	
P-CCPCH	–	X	–
SCH	X	–	–
DPCH	–	–	X
PDSCH	–	–	X

5.5 Beacon characteristics of physical channels

For the purpose of measurements, physical channels at particular locations (time slot, code) shall have particular physical characteristics, called beacon characteristics. Physical channels with beacon characteristics are called beacon channels. The locations of the beacon channels are called beacon locations. The ensemble of beacon channels shall provide the beacon function, i.e. a reference power level at the beacon locations, regularly existing in each radio frame. Thus, beacon channels must be present in each radio frame.

5.5.1 Location of beacon channels

The beacon locations are determined by the SCH and depend on the SCH allocation case, see subclause 5.3.4:

Case 1) The beacon function shall be provided by the physical channels that are allocated to channelisation code $c_{Q=16}^{(k=1)}$ and to TS#k, $k=0, \dots, 14$.

Case 2) The beacon function shall be provided by the physical channels that are allocated to channelisation code $c_{Q=16}^{(k=1)}$ and to TS#k and TS#k+8, $k=0, \dots, 6$.

Note that by this definition the P-CCPCH always has beacon characteristics.

5.5.2 Physical characteristics of beacon channels

The beacon channels shall have the following physical characteristics. They:

- are transmitted with reference power;
- are transmitted without beamforming;
- use burst type 1;
- use midamble $m^{(1)}$ and $m^{(2)}$ exclusively in this time slot; and
- midambles $m^{(9)}$ and $m^{(10)}$ are always left unused in this time slot, if 16 midambles are allowed in that cell.

Note that in the time slot where the P-CCPCH is transmitted only the midambles $m^{(1)}$ to $m^{(8)}$ shall be used, see 5.6.1. Thus, midambles $m^{(9)}$ and $m^{(10)}$ are always left unused in this time slot.

The reference power corresponds to the sum of the power allocated to both midambles $m^{(1)}$ and $m^{(2)}$. Two possibilities exist:

- If no Block STTD antenna diversity is applied to P-CCPCH, all the reference power of any beacon channel is allocated to $m^{(1)}$.
- If Block STTD antenna diversity is applied to P-CCPCH, for any beacon channel midambles $m^{(1)}$ and $m^{(2)}$ are each allocated half of the reference power. Midamble $m^{(1)}$ is used for the first antenna and $m^{(2)}$ is used for the diversity antenna. Block STTD encoding is used for the data in P-CCPCH, see [9]; for all other beacon channels identical data sequences are transmitted on both antennas.

5.6 Midamble Allocation for Physical Channels

Midambles are part of the physical channel configuration which is performed by higher layers. Three different midamble allocation schemes exist:

- UE specific midamble allocation: A UE specific midamble for DL or UL is explicitly assigned by higher layers.
- Default midamble allocation: The midamble for DL or UL is allocated by layer 1 depending on the associated channelisation code.
- Common midamble allocation: The midamble for the DL is allocated by layer 1 depending on the number of channelisation codes currently being present in the DL time slot.

If a midamble is not explicitly assigned and the use of the common midamble allocation scheme is not signalled by higher layers, the midamble shall be allocated by layer 1, based on the default midamble allocation scheme. This default midamble allocation scheme is given by a fixed association between midambles and channelisation codes, see clause A.3, and shall be applied individually to all channelisation codes within one time slot. Different associations apply for different burst types and cell configurations with respect to the maximum number of midambles.

5.6.1 Midamble Allocation for DL Physical Channels

Beacon channels shall always use the reserved midambles $m^{(1)}$ and $m^{(2)}$, see 5.5. For DL physical channels that are located in the same time slot as the P-CCPCH, midambles shall be allocated based on the default midamble allocation scheme, using the association for burst type 1 and $K=8$ midambles. For all other DL physical channels, the midamble is explicitly assigned by higher layers or allocated by layer 1.

5.6.1.1 Midamble Allocation by signalling from higher layers

UE specific midambles may be signalled by higher layers to UE's as a part of the physical channel configuration, if:

- multiple UEs use the physical channels in one DL time slot; and
- beamforming is applied to all of these DL physical channels; and
- no closed loop Tx Diversity is applied to any of these DL physical channels;

or

- PDSCH physical layer signalling based on the midamble is used.

5.6.1.2 Midamble Allocation by layer 1

5.6.1.2.1 Default midamble

If a midamble is not explicitly assigned and the use of the common midamble allocation scheme is not signalled by higher layers, the UE shall derive the midamble from the associated channelisation code and shall use an individual midamble for each channelisation code. For each association between midambles and channelisation codes in annex A.3, there is one primary channelisation code associated to each midamble. A set of secondary channelisation codes is

associated to each primary channelisation code. All the secondary channelisation codes within a set use the same midamble as the primary channelisation code to which they are associated.

Higher layers shall allocate the channelisation codes in a particular order. Primary channelisation codes shall be allocated prior to associated secondary channelisation codes. If midambles are reserved for the beacon channels, all primary and secondary channelisation codes that are associated with the reserved midambles shall not be used.

Primary and its associated secondary channelisation codes shall not be allocated to different UE's.

In the case that secondary channelisation codes are used, secondary channelisation codes of one set shall be allocated in ascending order, with respect to their numbering.

5.6.1.2.2 Common Midamble

The use of the common midamble allocation scheme is signalled to the UE by higher layers as a part of the physical channel configuration. A common midamble may be assigned by layer 1 to all physical channels in one DL time slot, if:

- a single UE uses all physical channels in one DL time slot (as in the case of high rate service);

or

- multiple UEs use the physical channels in one DL time slot; and
- no beamforming is applied to any of these DL physical channels; and
- no closed loop TxDiversity is applied to any of these DL physical channels; and
- midambles are not used for PDSCH physical layer signalling.

The number of channelisation codes currently employed in the DL time slot is associated with the use of a particular common midamble. Different associations apply for different burst types and cell configurations with respect to the maximum number of midambles, see annex B.

5.6.2 Midamble Allocation for UL Physical Channels

If the midamble is explicitly assigned by higher layers, an individual midamble shall be assigned to all UE's in one UL time slot.

If no midamble is explicitly assigned by higher layers, the UE shall derive the midamble from the channelisation code that is used for the data part (except for TFCI/TPC) of the burst. The associations between midamble and channelisation code are the same as for DL physical channels.

5.7 Midamble Transmit Power

There shall be no offset between the sum of the powers allocated to all midambles in a timeslot and the sum of the powers allocated to the data symbol fields. The transmit power within a timeslot is hence constant.

The midamble transmit power of beacon channels is equal to the reference power. If Block STTD is used for the P-CCPCH, the reference power is equally divided between the midambles $m^{(1)}$ and $m^{(2)}$.

The midamble transmit power of all other physical channels depends on the midamble allocation scheme used. The following rules apply

- In case of Default Midamble Allocation, every midamble is transmitted with the same power as the associated codes.
- In case of Common Midamble Allocation in the downlink, the transmit power of this common midamble is such that there is no power offset between the data parts and the midamble part of the overall transmit signal within one time slot.
- In case of UE Specific Midamble Allocation, the transmit power of the UE specific midamble is such that there is no power offset between the data parts and the midamble part of every user within one time slot.

The following figure depicts the midamble powers for the different channel types and midamble allocation schemes. For the UE Specific Midamble Allocation, as an example, code 1 and code 2 are both assigned to UE 1, whereas to UE m is assigned only the code n.

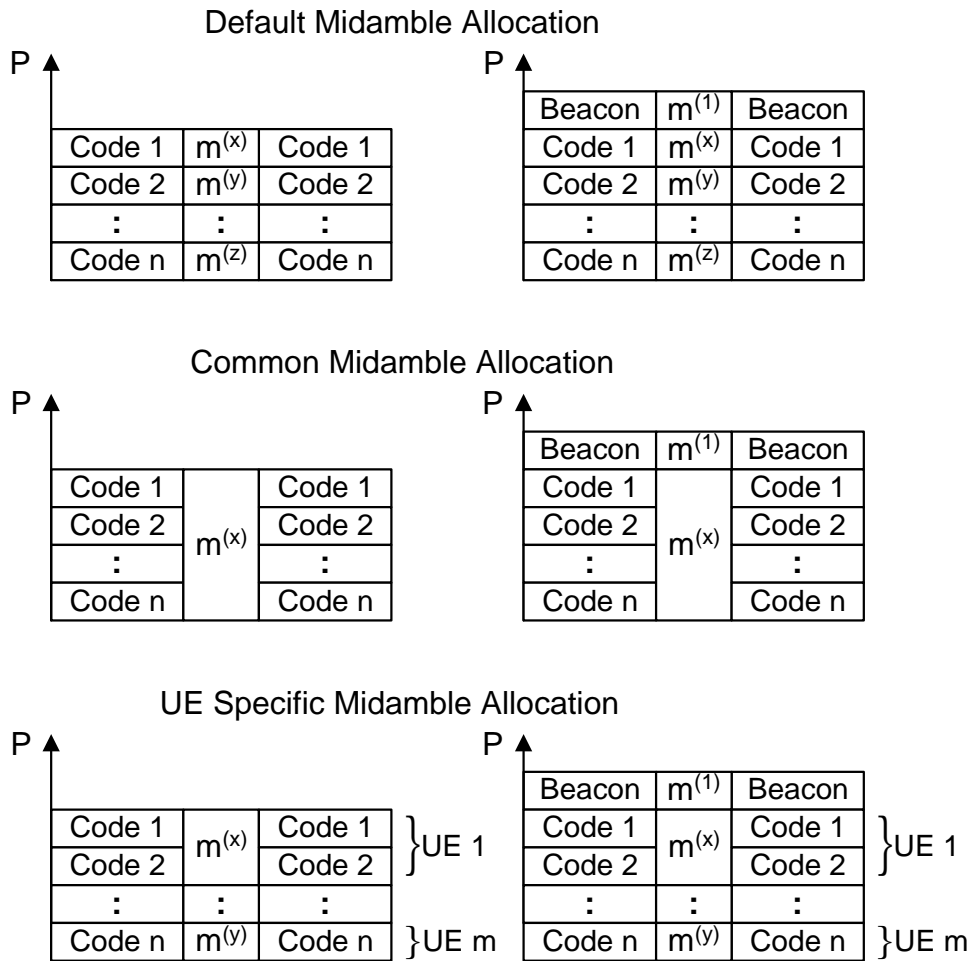

Figure 18: Midamble powers for the different midamble allocation schemes

6 Mapping of transport channels to physical channels

This clause describes the way in which transport channels are mapped onto physical resources, see figure 19.

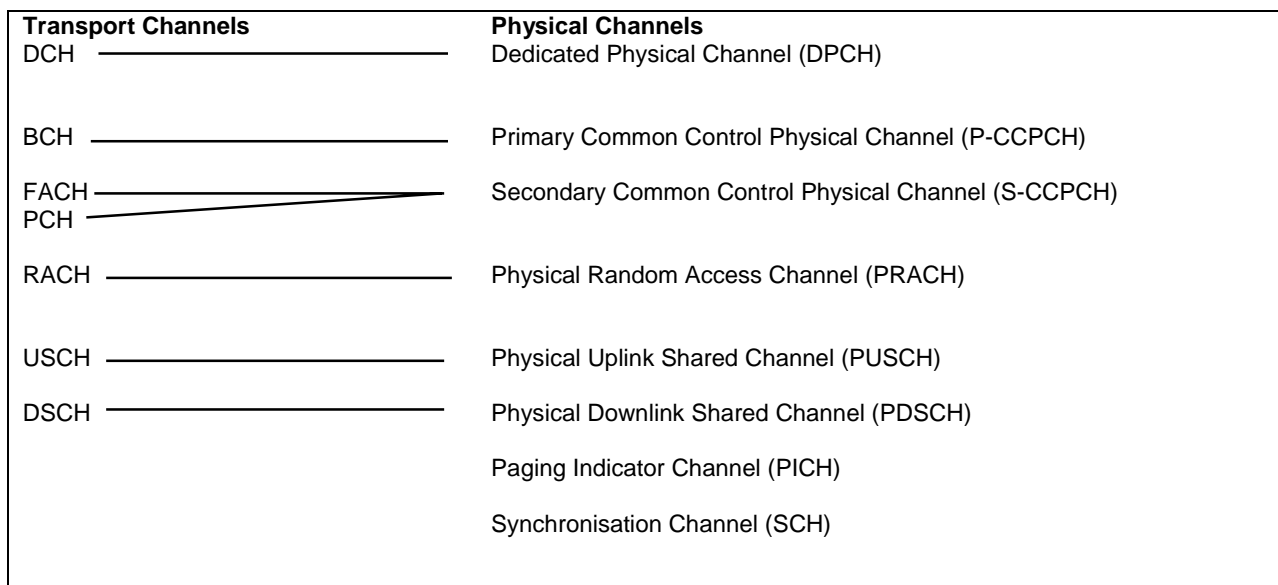

Figure 19: Transport channel to physical channel mapping

6.1 Dedicated Transport Channels

A dedicated transport channel is mapped onto one or more physical channels. An interleaving period is associated with each allocation. The frame is subdivided into slots that are available for uplink and downlink information transfer. The mapping of transport blocks on physical channels is described in TS 25.222 ("multiplexing and channel coding").

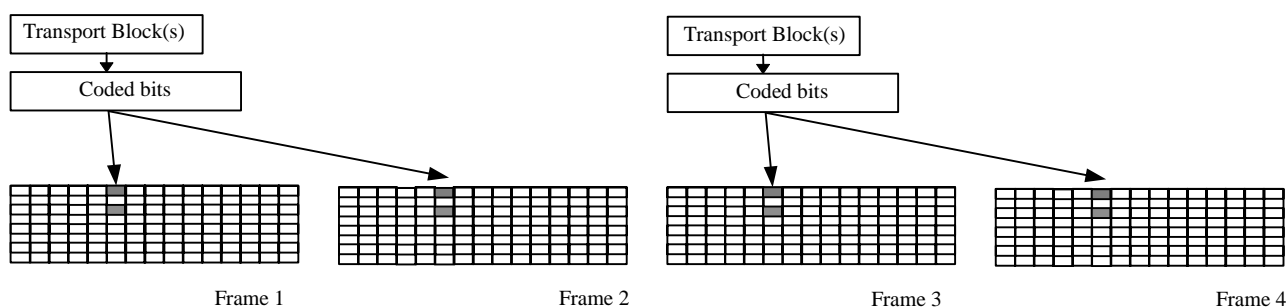

Figure 20: Mapping of Transport Blocks onto the physical bearer

For NRT packet data services, shared channels (USCH and DSCH) can be used to allow efficient allocations for a short period of time.

6.2 Common Transport Channels

6.2.1 The Broadcast Channel (BCH)

The BCH is mapped onto the P-CCPCH. The secondary SCH codes indicate in which timeslot a mobile can find the P-CCPCH containing BCH.

6.2.2 The Paging Channel (PCH)

The PCH is mapped onto one or several S-CCPCHs so that capacity can be matched to requirements. The location of the PCH is indicated on the BCH. It is always transmitted at a reference power level.

To allow an efficient DRX, the PCH is divided into PCH blocks, each of which comprising N_{PCH} paging sub-channels. N_{PCH} is configured by higher layers. Each paging sub-channel is mapped onto 2 consecutive PCH frames within one PCH block. Layer 3 information to a particular UE is transmitted only in the paging sub-channel, that is assigned to the

UE by higher layers, see [15]. The assignment of UEs to paging sub-channels is independent of the assignment of UEs to page indicators.

6.2.2.1 PCH/PICH Association

As depicted in figure 21, a paging block consists of one PICH block and one PCH block. If a paging indicator in a certain PICH block is set to '1' it is an indication that UEs associated with this paging indicator shall read their corresponding paging sub-channel within the same paging block. The value $N_{GAP} > 0$ of frames between the end of the PICH block and the beginning of the PCH block is configured by higher layers.

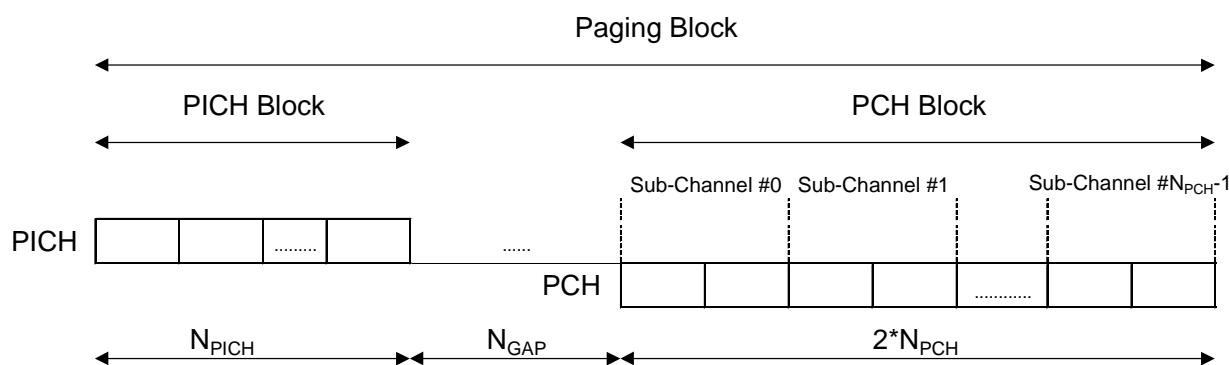

Figure 21: Paging Sub-Channels and Association of PICH and PCH blocks

6.2.3 The Forward Channel (FACH)

The FACH is mapped onto one or several S-CCPCHs. The location of the FACH is indicated on the BCH and both, capacity and location can be changed, if required. FACH may or may not be power controlled.

6.2.4 The Random Access Channel (RACH)

The RACH has intraslot interleaving only and is mapped onto PRACH. The same slot may be used for PRACH by more than one cell. Multiple transmissions using different spreading codes may be received in parallel. More than one slot per frame may be administered for the PRACH. The location of slots allocated to PRACH is broadcast on the BCH. The PRACH uses open loop power control. The details of the employed open loop power control algorithm may be different from the corresponding algorithm on other channels.

6.2.5 The Uplink Shared Channel (USCH)

The uplink shared channel is mapped on one or several PUSCH, see subclause 5.5.

6.2.6 The Downlink Shared Channel (DSCH)

The downlink shared channel is mapped on one or several PDSCH, see subclause 5.6.

Annex A (normative): Basic Midamble Codes

A.1 Basic Midamble Codes for Burst Type 1 and 3

In the case of burst type 1 or 3 (see subclause 5.2.2) the midamble has a length of $L_m=512$, which is corresponding to:

$K'=8$; $W=57$; $P=456$.

Depending on the possible delay spread cells are configured to use midambles which are generated from the Basic Midamble Codes (see table A-1)

- for all $k=1,2,\dots,K$; $K=2K'$ or
- for $k=1,2,\dots,K'$, only, or
- for odd $k=1,3,5,\dots,\leq K'$, only.

Depending on the cell size midambles for PRACH are generated from the Basic Midamble Codes (see table A-1)

- for $k=1,2,\dots,K'$ or
- for odd $k=1,3,5,\dots,\leq K'$, only.

The cell configuration is broadcast on BCH.

The mapping of these Basic Midamble Codes to Cell Parameters is shown in TS 25.223.

Table A-1: Basic Midamble Codes m_P according to equation (5) from subclause 5.2.3 for case of burst type 1 and 3

Code ID	Basic Midamble Codes m_{PL} of length $P=456$
m_{PL0}	8DF65B01E4650910A4BF89992E48F43860B07FE55FA0028E454EDCD1F0A09A6F029668F55427253FB8A71E5EF2EF360E539C489584413C6DC4
m_{PL1}	4C63F9BC3FD7B655D5401653BE75E1018DC26D271AADA1CF13FD348386759506270F2F953E93A44468E0A76605EAE8526225903B1201077602
m_{PL2}	8522611FFCAEB55A5F07D966036C852E7B15B893B3ABA9672C327380283D168564B8E1200F0E2205AF1BB23A58679899785CFA2A6C131CFDC4
m_{PL3}	F58107E6B777C221999BDE9340E192DC6C31AB8AE85E70AA9BBEB39727435412A5A27C0EF73AB453ED0D28E5B032B94306EC1304736C91E922
m_{PL4}	89670985013DFD2223164B68A63BD58C7867E97316742D3ABD6CDBA4FC4E08C0B0CBE44451575C72F887507956BD1F27C466681800B4B016EE
m_{PL5}	FCDEF63500D6745CDB962594AF171740241E982E9210FC238C4DD85541F08C1A010F7B3161A7F4DF19BAD916FD308AB1CED2A32538C184E92C
m_{PL6}	DB04CE77A5BA7C0E09B6D3551072B11A7A43B6A355C1D6FDCF725D587874999895748DD09832ABC35CEC3008338249612E6FE5005E13B03103
m_{PL7}	D2F61A622D0BA9E448CD29587D398EF8CDC3B6582B6CDD50E9E20BF5FE2B3258041E14D60821DC6725132C22D787CD5D497780D4241E3B420D
m_{PL8}	7318524E62D806FA149ECC5435058A2B74111524B84727FE9A7923B4A1F0D8FCD89208F34BE E5CADEB90130F9954BB30605A98C11045FF173D
m_{PL9}	8E832B4FA1A11E0BF318E84F54725C8052E0D099EF0AF54BC342BEE44976C9F38DE701623C7BF6474DF90D2E222A4915C8080E7CD3EC84DAC
m_{PL10}	CFA5BAC90780876C417933C43103B55699A8AD51164E590AF9DA6AF0C18804E1F74862F00CE7ECC899C85B6ABB0CAD5E50836AD7A39878FE2F
m_{PL11}	AD539094A19858A75458F1B98E286A4F7DC3A117083D04724CBE83F34102817C5531329CDB437FFF712241B644BDF0C1FEC8598A63C2F21BD7
m_{PL12}	BEB8483139529BDE23E42DA6AB8170DD0BFBB30CE28A4502FAF3C8EDA219B9A6D5B849D9C9E4451F74E2408EA046061201E0C1D69CF48F3A94
m_{PL13}	C482462CA7846266060D21688BA00B72E1EC84A3D5B7194C8DA39E21A3CE12BF512C8AAB6A7079F73C0D3E4F40AC555A4BCC453F1DFE3F6C82
m_{PL14}	9663373935FD5C213AC58C0670206683D579D2526C05B0A81030DDF61A221D8A68EAD8D6F7AA0D662C07C6DCD0115A54D39F03F7122B0675AC
m_{PL15}	387397AE5CD3F2B3912C26B8F87CE82CEFEC55507DB08FB0C4CF2FD6858896201ACA7264281D0298440DD3481E5E9DDB24C16F30EB7A22948A
m_{PL16}	AFE9266843C892571B6230D808788C63B9065EA3BDF687B92B8734A8D7099559FEA22C9416576D0C087EB4503E87E356471B330182A24A3E6
m_{PL17}	6E6C550A4CB74010F6C3E0328651DF421C456D9A5E8AE9D3946C10189D72B579184552EE3E799970969C870FE8A37B6C4BA890992103486DC0
m_{PL18}	D803CA71B6F99CFB3105D40F4695D61EB0B62E803F79302EE3D2A6BF12EA70D304B181E8B38B3B74F5022B67EB8109808C62532688C563D4BE
m_{PL19}	E599ED48D01772055DBE9D343A4EA5EABE643DA38F06904FC7523B08C4101F021B199AF759A00D9AC298881D79413A77470992A75C771492D0
m_{PL20}	9F30AC4162CE5D185953705F3D45F026F38E9B5721AEFE07370214D526A2C4B344B508B57BF B2492320C05903C79CBEE08C6E7F218B57E14D6
m_{PL21}	B5971060DA84685B4D042ED0189FAF13C961B2EF61CC164E363B22AAB14AC8AF607906C1C6E04F2054C687AA6741A9E70639857DA002B6FFFA
m_{PL22}	97135FC2226C4B4A5CBA5FCA3732763B87455F73A1148006F3DF214BD4C936D061E04045160E2CE33B9CD09D08FDE2A37F4E998322B4401D27
m_{PL23}	4D256D57C861B9791151A78D5299C56D116B6178B2A2D04BB95FB76540AF28341DC6EC4E7E D3BF9E508478D9C8F44914805DA82429E1CF320E
m_{PL24}	858EF5C84CE32D18D9ABA110EEA7474CF0CD70254D2928C3F4DFF6BB3A518587CADA19029078AC90A8336C8178203BE3289E601F07D089CB64
m_{PL25}	920A8796A511650AEF32F93DD3C39C624E07AE03CE8C96139973F54DCB9803C5164ADB502D4FF561564D607037FCD172921F1982B102C3312C
m_{PL26}	485C5DAE76B360A9C56E20B8422EA3E6ACF07CB093B5587CB0E6A5498A4714081EA98DBCD B0482B26E0D097C03444473D233BEF3C8E440DEBF
m_{PL27}	565A9D54EA789892B024F97E728E8EE112411942C48BD0C5BC8AA457D8DC9941F0F7424B38643FFFE6521CD306FBC56FE10F1428D4C245B5606
m_{PL28}	5AEF2C0C2C378179A1AC36242E6B3EDB72C42D3624437674F8D51260C0898C201837CBA14E9E23D1EF6451C4ACF27AB031F457A8A1BFD148AE
m_{PL29}	87D8FE685417822A23D925307E6C11081ADAC4702BCCD9BE448E78984D109B50DEF5B7C58B C71EA1F0A6826BA8AD1978843E7697F3E416AADA

Code ID	Basic Midamble Codes m_{PL} of length $P=456$
m _{PL30}	84802B72AF27B5BE724D1FB629E0E627BDB0D9061292562F98350C1D0C9D4B9D8E2BF71123C82EBB161003AE9829E07244D78F19926F8847A2
m _{PL31}	8CCB5128238BCB088E30972D62792AEF02B9BBDDCAD68C9916C00BF91CBE788B0F03851FAAF88605534FD73436C259D270B1013CB14226F658
m _{PL32}	62F4E6FAC2BF1979CE6854AA2D33534BFB2F946519101A6589131C3640707D40E67ED804AF8736AD213CAF5935741900061967E8285C27E34C
m _{PL33}	4095E5B4EEAFCD68A34B267EEA28D8444FA533900F41499E260D2E65C256A52E1DD5861F5227C98E00687D107233F51A1167BCF72FB184654
m _{PL34}	5630E9A79FCAD303404D9E5A802299162657AAC734761C6E90DA8BCE4F61A763E0BB48D3FEB3F78468C828ABA4828DAD06E0F904CFD40421DC
m _{PL35}	CD12B24C0BCA8AAC1FCBF0500A3BC684A180E863D888F2506B48C68ECF17F76CB285991FBA18EB6397211FAD002F482D57A258CD45DE3FF1A6
m _{PL36}	AFCF2A50877286CD3405442730C45514F082D9EC296B367C0F64F04C4E0007DCA9E50BEED5C102126E319ACBC64F1729272F2F72C9397029FE
m _{PL37}	18F89EE8589D20882A72A44DCDF0050F0A3D88DBA6531614973D26905FDF41E3F779FF0648E8AF1540928511BCF4C25D9C64AF34AC31B8965
m _{PL38}	F890D550F33F032ECDA3A51FED427D634F64EB29AF1332A23CD961258E4BAED040E7B336918E250EC272A12816B9EBFFA1E0AE401185F08C10
m _{PL39}	ACE5DD61506047E80FB7D41BD3992DF4D7F18EB46CC145C0E9105428C2F8F299141F5D66691904A7DC2513A3B83994ACB1292246B32818FE9D
m _{PL40}	150680FF900C9B46E1E24D54BE2238CB950A934E5CCDE9BC3939EB51CB0AE202B7D339EEC2018B33A0AB9B63DA5D512D64FB58C0E51A1C82C2
m _{PL41}	51A579EED2663A002D32D10A0753173612F4D5BA167D1807C61F25C4D42C063682E8E9DD019F79D446A046EB3F75E50FEB228DC52F08E694B6
m _{PL42}	CDC644FE4C0C6897604F9D14D714123BF16FFF0E49F35F674908CA60653702FE27BCCA2A47098453AF8661055C8C549EB6A951A8396AD4B94D
m _{PL43}	750A10366C595373C5001CA3E4239764B1409D602CF6052B39BC6A3255A15FE06C782C4C5F847026A7E79838A2933A61C77BB6CBF5915B2DA5
m _{PL44}	B7490686D78E409082C4C48FE18D4C35429C20AADF96076B92FC4E85490664753DB0891A0B27FD849BB7FCA99E3B38F22F8C662852C0D35AA6
m _{PL45}	D86E1B575B47D23DA811806A54C231281F03317830E7BD305D3CAA7D6382A5233104CFD54D22DF9F34535E5B390D9040CF1375FEA44CEC29E2
m _{PL46}	828655960C026EC67B683480992AC2ED2C43ABC606F5220C2945F373470BE7ED5BCCF7C1AA0986BBCC84F11F1658AA568FAA0A60C5F0B5BFA
m _{PL47}	D76230E02C8533653AAB99B288AA2ADE25A1C1BF28516C04239240EAF1EFC0B98974B51F886861D8A1E9F5D62CFFEC309F071A9716B325101B
m _{PL48}	EA207662865B8A07D69648964DED818EE474A90B94473408871880E63EF0596B9FCFEC3C06B86EA6AD2B06C91672EFB33C70241A5450B59B8A
m _{PL49}	9CB5459549909835FAB22F0D99298C120ACF479F814CCE749079D40688F28101037762F125C776DA9C5FA1FCE0E76E452F8185354FDCDE94E2
m _{PL50}	227506304AEC1D6F93569B51FDC3405A0F38194F65BE17163A3CB9827A35AECEA757D020FE249377ECD561428A38FEED004EC859C272563185
m _{PL51}	96B9AEC9938910F0E533422A3977519B05CD4AD3909BC15A7502D48D49C124FA192A8E57027CFEB11DF542010603CE5C9FDF8E626D4FBF8CF4
m _{PL52}	A6AAD06E095A9BE0BD9F8A2ED40C3CBDBAE91C700CBB778C8696CC06F3A675C16BDB2918E5F2111005A8727206DC6A9684E05655185C398EEB
m _{PL53}	CD168D384A78DA172991AD333EE2A9880905AFE59E2A2A4AC4414C40F82874F98A3CBE7B44F4C7F4710B35FD88AFC0399FAEB070EB9CA4D30A
m _{PL54}	22016CA87AD1549174A8699DD65599697871091457E83E0912E7E77A06531C209394D283D18A38662B73681DD9C5BF330FED978BDA7D487CA8
m _{PL55}	B9401B0843AA6F7827A13BD66C922287E8886C31EB5B90B82B472CCD6DA3D8D4FBF78B8F8496DFA8252B06429D5DD17142F1C908ACCD70EAOC
m _{PL56}	E42B9EFDC5D09AC27B3C7DA28D02493A70521223B9D7A76A9D13E9C171017964D16A70C08EAD02C3DC948889C23E365AFCF01BF20B89B0BF5C
m _{PL57}	9DA0180168DB915E9F3597B59312198E1B5CC00D743C2ECB0DBAADA3E35A2465ED1EAA9D74734D49A313CE4DFF020D0760E3153DC485603943
m _{PL58}	B6C966619ECB98191D719C187C07BD503425650CAA3A2D1F2DF5212B1441D7A0C1D36A4C9C2550240AD17CA43BB3943DFFFBF1E283D81299CC
m _{PL59}	DB0E8C41F08A03D477C1AA548799274C4BF3EB68F2636166FDC8D4B1E7132539930297E228BA232BB5C279FA5ECA3AC10E24361AF050A453B8
m _{PL60}	89BCE2DE2974EEBA833CF32F224C85A2891484478527DB48FA6ECEA84C5E288CC3914CB54ADA0476278750187F68FBEA41017E1E58DF1A5A3D
m _{PL61}	70A457D1314A278625443EEB52520815EC92CEF17417B97440DCB531BC1CE83212F63270418D0FBDE71F6DB9E0EA88772E1E4535B6633E4425

Code ID	Basic Midamble Codes m_{PL} of length $P=456$
m _{PL62}	C388460AD54B36C4452CF0433BD347100ACCC24C79C535AD3E1F23FE0425E93A044C553BFA116E09AA4BB32F13CFA76FBA1BC17520F45EFD44
m _{PL63}	0BAFCADCDF9AA2846681782CD3B90CA036A863C78EE1507620BC394D0C6804B4C97A15BC9C0D7B79E6892EA1BFF1A0DD9573A9213AB140D0D2
m _{PL64}	833B0226789A62882FCD27A30885E67872B1A1C2FA484AD498011599DD57E8E2A07A560B47167AA5F60EF47177DBB1632D5387A2896348640B
m _{PL65}	8F52820323ABA5E6C6B465821B621600B980E59F53A599DA5646BA103214336836CF17E3386CE4FB2BC5F25CCB30CF7F500546828EC8786B8E
m _{PL66}	E2E9A29C3C8207B9A4508FD2F667A159F068EEE8D00686F46EA904C3692C1D79DFF1B32E5103720D47B4B58AC35384A26087027E141B3126A8
m _{PL67}	70E7C39FD2D3AE1DCE341699A544D801A8688A6EE47C5CB3630022147DDC06241FC5337A348A462B2472DEC5E104DD520ADA5114DB065D4B0D
m _{PL68}	9E3483CAB164BD053C4971D4D87494CC689033D589EF80E5453376E4A8DCC02183B98C36B0FF7DDC0AD07FCE8B4D5164371BD03A2110AD1247
m _{PL69}	04DA1C649B0608938DAADD3FE920A4F681690C54505429DBDCDCF10067AB5714BCDDFE1F28692710F794765781C1D233344E119BEE8A8416DC
m _{PL70}	7A18D6D30BDF44410714C3DCA27D8F9EA8A542D87122205640B98313C91AD9A0B993A5A7BC3E035F93B88BBE6D4204BC82A9FA8D4C1A7618CF
m _{PL71}	EB9525E10265A48733C8E0E77E459310112A71DCA680F68AC044B64BC0A31D02EEA0F7ACAAAB7F1E574E94FEA2D1301CB14B03263DA8122B76
m _{PL72}	E706C6ED2D6F89153835079BE0C6D45310845EF2F9F6C6AE91B7419810508BA501C0148BF09955BAD90D6391BA8EBA5CEFB23221CC75143D7
m _{PL73}	DF071A10AC4120CD1431590BEDCFF9483CA7047B19590D035D309240BDB4264E9A3A2761402EC97FD8BC51B4AF32E37FBC47162A2357D18751
m _{PL74}	F0F952B2238139F46D8254D1A2C1C22A16BA71EC0C0C900ED1442452D7F44C798BC65FF40671B88074BA0B74C6510996EEAC495C5B49C37DEB
m _{PL75}	1C86BD82EDA81FD65418D3837B5552A853791456D93B06C62C650D86CFBEC269AFFD772763064062C03751B9428C6DA2E60383025F9E404B70
m _{PL76}	B390978DD2552C88AABA7838489A6F5A8E9C41E95FFA2215819BF8A5BFE39C8A706CC658E549E966611B843A1468406C41C09D1560BEDA4F1B
m _{PL77}	1A69EC9D053C7E84BAE7A48CCC71857D0C6B06D1065E3EA4633B133AA022B8104F6EE7C69B6184B746C8822958B0A16686F27C8A0E3B4FEAD
m _{PL78}	C95B2070816DC97C6D8DD2583263E73F9AAAFD13F0548D2EBD835824418F11E54111005FB713AB234BE412347358281C7DE331EDD21B8BEA52
m _{PL79}	56D6408399F23C2ED85EE0F68111D69A91A3AD9A732AC57CA08F86CC28B3CF4E4B02EBBA0BCE5CAE5BACC4D52004070797C04093A84BB18DBA
m _{PL80}	E662E7043867BE250764DA0596D34A582A619B408B505E6211DD6286E93A37F95B1EA680C0C5F3E777E3F71E8D75495D59043217FC0E222E16
m _{PL81}	27D5E681C222297AD478A079EF12F1A98F744B66335303322EF8880B931FEBF8322F4302944E80BED468A0A516D410B183D863795992DA7DDB
m _{PL82}	5100336C05F9E5BF35201906C1C588858E0DAF56130DF5554B9AB21CA15311A90290624CD63E03F5EDA49DB7A0C32AB5F1CA427A2D5635FDA5
m _{PL83}	C696DC993BFAEA9A61B781B9C5C3F5CFAA4C8339D8B03A9B0387883D0482A41AC78D6522425959846E561D26A30FF79A205C801A85889736B2
m _{PL84}	D562297561AFF42D3168296C1153E4E39BE7B2EB0348BC704625AA08391235075EE0DE0A79AB03222FEDB27218C56F96EAC2F91CC8FCE64B12
m _{PL85}	DD0B6768FC01CC0A551F8ACC36907129623E975AB8B3FF58037F1859E2FA8C62C2D9D1E8506916029A2C3F8CAD9A26AE2CC652F48800859F5C
m _{PL86}	923920696EB3AB413786C41854822282BB83F6900D33A232D470BE198BBF086067B72613300C593B74251E2F079857ADBBCD86583A9DCAA6DC
m _{PL87}	B8EF30C797D8D2C4EF11244F137D806E556A436626D0115A621C92C34D166A68BCEDFA0040DA8FD6F987B1CD5C2AA1C1B045E64475F0F8DABD
m _{PL88}	E1887001D414405ED6419E9EE1D1D346D924ED57ADF04B31B7948099976B2D1501A60DFFB287AD44C8783DF0C1EA5AA5D273D1389C8EA22DCC
m _{PL89}	8C2E379A58AA96748141CA84C35987905F984A49D3AD9BFF7807AC244C16C1DF74343C2E1F25514F5A0954CFBB3C92E25EF783136844998AC5
m _{PL90}	78F8A99E0A54E27F51C0726FE7A11EB26B1E29FE65F55AC8AC58011465900B958488A90F6DF614A58431DC8B6C6B9A6F032EE0E0B1306EC4B4
m _{PL91}	88F7A31B7B20E0F05CA26E729B4F8A1933962D7BD7BE3E1EB130B28C794C0B4D01CADE09006FF97E80117509733F3A9DC225413A0AE08CA662
m _{PL92}	BE4DFCEAC18905AC8D5DA27A794F88A4D3058D2EFA3B075A819DEAE688EAF8940A653ED7104E7B403D490F0A9030264E1F12B8922C75775E61
m _{PL93}	5BA4B79FC4550234D8922963BF3537485E3C8745A5DB90D3E2E454B30FF61112F508155B7C2B3C4C628AF846240C2021ACDE547E5A41F666B8

Code ID	Basic Midamble Codes m_{PL} of length $P=456$
m_{PL94}	00556D35649F7610AB24A43C4F16D6AC0571FD126F11880C5CD72100D730E4E4D6BB73C33F837FAF1072743B249ADA2E09598B1EB23F1180A7
m_{PL95}	7A0CC9F21BD69CF3023E944545C2176EF0D4F450B765C28359FB8A32137D043D0E5713E67B3F61320985D2C6106605081F87D2296321468A2F
m_{PL96}	DA669880995B0671201172BABFF141D5854A245E211879EF3038A7C84170DADBD368455F24653161E7886E15B253F93E3A3C568EFB17CDEB1A
m_{PL97}	4E294E53D1661C1F6F748302A7723DA951C00FDB8BEBBF67A68710BA0F1A255DFB1627059D41A23D3961726DE6FEB10E5D209CC4505B209812
m_{PL98}	73385DF701414E144768A67EF72924B1653479E962FB1554B7E54BC5284D9B3E41C0C133F878972230721918AA425501B920B204FECE0C7F8A
m_{PL99}	F4492160805F258CE592DF4D1200566F81D173458D78EA3ABED79A14AF88170DB1D4A9A5931D2B80C58C27FE17D806E3E6A66CDAAD09F118D4
m_{PL100}	44D562D9012D8B07B8F44596467C11A163982BB7EAEAC184078B6B8CE46B5D7E17C39CEF576A025491183017FA09931D070B307B86524B03FF
m_{PL101}	FCAAEFFC49A13B4FFA12C0CC6A2B90CF4F57D78B1E98294B04675C2F0991661FDC61A452A247F8C29E0284AA21026F368307375AA2C3F1E12C
m_{PL102}	C486DF0510DCAD5AB86E178A686D398E11A0ECFAC5A326C10129257E5456B22FB8E147E9190D9929A5DFFE44715FA47D62F04CFC9B1C201414
m_{PL103}	C10AF383DC708E257E15A8AB337BCE684A2F4AC7A22DC2C25C277F8E8D0858E79317CDDD9AA2EA6CBE604D24AC0945026103E7B4126FD361A4
m_{PL104}	A5C60A181148D9A931B2DDDB9D169648BA54F366B4EFAE88F6861909EE0F07C037EE349D0EC59A823286E366CA3943589EEA7F828C3728085F
m_{PL105}	96136AEBD5E28462B0421DF292BA899FFA660D80EA01620D2C7490E5347127884AA3C3D1FF44BCEEF6C29EC589CDEF200C5742C5964F8B2B52
m_{PL106}	40F63C04ACAD986255D1E16B769A6D4C11A1D075E804BDC0AC61923E9A67F5D7417756328072455F6E22B1C64E06F367D1B0808295C2D90E22
m_{PL107}	F4B82D413578C4888C5F002CF6D0E03778134A860436551FD57537E4CED334B3C9CEBACE615238271717AA762448B86FA53D2074BCE35658A7
m_{PL108}	BCCC92D72C920E685530591FC351743D1E23DE044BF81D32650406113E23ECC757FDE4E386B6E2E7195EE4969717A7BD0812AC312B33A54308
m_{PL109}	6ED59DE0D44370A861CE2B42CF5E578E764A682AB5777905EE027D7160490EDC6C28989B23805AA697FCD215CB401BC5E4D430624C01B16192
m_{PL110}	DE80C0E273B92CC3C5034F7A20DB3914643C430B425C8B9249EAF73ACE8C3BCF17957242CF534D87A67D4DC0252275262E737F4095450CFA14
m_{PL111}	9505C4FEF2A397D5059F4729D013292A8321FFFA929ACB0A210D0A13E13061227C44A68FBD8CE6B66CE3D783363CD039AB35EE52603E09B758
m_{PL112}	E8BE90D7F954B14D8002A4CAC20765ABEED80634498C836D79B0F9338DBC17B28F05CF4E79136779E1C55AA30B6215F890882887B3B53C23E2
m_{PL113}	9F4B622C1358AE5468DC31E4B2CA320E5E20458C1DE5405BF4F9AD7D45A5BCAA39EC0626FFFC698C16A009CCCB7A18A64E85E70BA71731BA24
m_{PL114}	B91B2624843CF48299AFC2B1442570B41F28F578530D1E322E0B54282372131C71ACB924E70768A243EEC3200E7A5EBFA77111D9FB07FEA8AE
m_{PL115}	965F42DDA3A4650FE2F5103932B68F166FA424B9F0F7045311D962C2A9F66B9BC6C66FB480F9800354E0C54A72251071422CF1DFC44F94C00C
m_{PL116}	08ADCE48699FC30FA0788073BDAADB9177BBB4C1CED41F93085218364B8BAD8488561EF0FE1B0DDAA403C602494CB35697D62AA0A2B93A64CF
m_{PL117}	9A313BED80B1220D77C8ADA4B2E0B3D284A5120A94B741380923C78D3AD32BC3E71EC6EEA520E9D447D8727697598BB987F17506F482003ABD
m_{PL118}	24C9AD4C14EFEC002A3473FCAB04E492F2E269161A2960BA8AF09FD710B444A40C4E8B138418E62301E91FBA97AFDC58759A76D00F676736C7
m_{PL119}	6514C7733711CE4942CD2123AB37186EB7FECB7E78ABB28744864942FCF4C0F810054AF55B1042EB53064F0857C61D85B2CF0D2DC5826AF22F
m_{PL120}	B2C80CDC83E48C36BC6FDAB8661208EAD392F3A0571BE41DFAD765E744932ADEA50061E66C05498A5381B2A1F1B446587089DC4E4A2DF03D82
m_{PL121}	639368BA75CC709A3D9F28EDA237E32C2017A9BF1E382045B9426AEE0A4049DCB4E1D7EBE4647B855212824557497CFA039885A3BA42F98F63
m_{PL122}	6A70DDC17D0C8024B1C853F0C1948561EF32510151BE0C63BCA9171F20217891D1021EE72586CAFF557F8973336913A9A2A699B8740B054B8
m_{PL123}	2E32E3A35CCD001172CE310B63B4E406126045A0FA3795BE3E3D9B56F72405FC94FD89946818BAECD24A61BABBBE2D23052AB01EF73CA0CF4A
m_{PL124}	829395C35205A480AC1351C25E234BF52D384A3DE1C5138A650A6F82F739757D812D9C38231AB9FD81AA0648B11F6F6113F9312C57624FC746
m_{PL125}	D98FFE19C0AAAAB0571A9075ECDFD3E7373F5255DC669116A8C6913F0123E598F930934C5F6A601C37C529C371A0C391B59AC5A9E286D04011

Code ID	Basic Midamble Codes m_{PL} of length $P=456$
m_{PL126}	C1A108192BCE96C2430A63C189BB33856BE6B8B524703FCB205DAEF37EF544CD43CA09B618 1B417398083FF2F781BA4AE89A5CA291DB928D71
m_{PL127}	42568DF9F61849BF9E7DEE750604BE2E0BC16CC464B1CDE15015E01D6498E9F3E6D6950E58 24651F212BA0057CE9529B9CCAB88D8136B8545E

A.2 Basic Midamble Codes for Burst Type 2

In the case of burst type 2 (see subclause 5.2.2) the midamble has a length of $L_m=256$, which is corresponding to:

$K'=3$; $W=64$; $P=192$.

Depending on the possible delay spread cells are configured to use midambles which are generated from the Basic Midamble Codes (see table A-2)

- for all $k=1,2,\dots,K$; $K=2K'$ or
- for $k=1,2,\dots,K'$, only.

The cell configuration is broadcast on BCH.

The mapping of these Basic Midamble Codes to Cell Parameters is shown in TS 25.223.

Table A-2: Basic Midamble Codes m_P according to equation (5) from subclause 6.2.3 for case of burst type 2

Code ID	Basic Midamble Codes m_{PS} of length $P=192$
m_{PS0}	5D253744435A24EF0ECC21F43AA5B8144FBDB348C746080C
m_{PS1}	9D7174187201B5CE0136B7A6D85D39A9DD8D4B00E23835E4
m_{PS2}	AE90B477C294E55D28467476C6011029CDE29B7325DF0683
m_{PS3}	BC8A44125F823E51E568641EC12A6C68EAFDFA2350E3233C
m_{PS4}	898B7317B830D207C9BC7B521D5715680824DC08347B2943
m_{PS5}	466C7482C8827655BC13F479C7C1417290679A9841297C4A
m_{PS6}	AC0734C27C7DC1B818A8492744290DFE866B0EBA62B0B56E
m_{PS7}	0A92106325B15A8C15FC3764724CE67A5056D50A77F9360E
m_{PS8}	AE69F62E23035083E6094B89493D33E06FDB6532D473A280
m_{PS9}	B485D4E3614C9C373EA1365FA6FA890E9844084EBA90EB0C
m_{PS10}	66182885E2D28360D2FEAB842C65304FFC956CE8DC8A90C7
m_{PS11}	CC30A9B0A742FCC1E9A408415368391F1299AEA3CB6509FE
m_{PS12}	673928915886947F464FDDAAD29A07D182328EBC5839089A
m_{PS13}	4418861C14D62B46EE6D70D4BF05A3ED801A01BD6CDC5235
m_{PS14}	DAD62DC88F52F2D140062C2330BE6540E6F86192322AFB04
m_{PS15}	A2122BAF24529CEA9855FB43CE40923E7CA7B30D92E40702
m_{PS16}	6C44AB41E11F54B0929DF65673BD231F92A380132D9F1712
m_{PS17}	1DC2742E756CDA6421340D0087DD087A615E4B8688CB2F75
m_{PS18}	2E0105328B56E9E07D9B5A62F38B08AF8D8C2817B54F3302
m_{PS19}	88315EC30A94CA4EDB2C77079D9BD810A2E280B50DABB213
m_{PS20}	440E0093D28CB2B2B0A95D18CEB4AB934C33FA45C1CFC7B0
m_{PS21}	CC9BF85D41A96A6EC314F9611D5E1C0672556C8850801BB4
m_{PS22}	1ABEA04C99BC26972715F01957C0B6B959CC71CD88120817
m_{PS23}	EC5A33DA0BA4470442C5CB324A8E47B0A9F7968FC8108EE8
m_{PS24}	F82086290271DB446B5B1DC15D9BE96414B19B3D5E0F540C
m_{PS25}	11A1A790D6958FD3A9157DF1E05D1378248CA201EBCC7592
m_{PS26}	AA8564882231907BCE78092DC6C9DD4F5A0E4A34AFCFB809
m_{PS27}	912EE2238212F87BC7CDA7F30441ED184A6AA954EC4D20C8
m_{PS28}	2D200D8B8891B804673E380A1AF5AB875986E29D37D3FDC9
m_{PS29}	75E086B6C818423491BF9D6365C52FD1C5E42A576E268170
m_{PS30}	50ADB727DA2A3701470186B699118E16DDB0D10F705607B1
m_{PS31}	656C0692B4E22023590A906D2A74DFD471C883A7B1E0B3A2
m_{PS32}	C21FDACD09A3CDCE74C4794010A3E45769B142505C56A0E6
m_{PS33}	CD9392A87C2D4D7CE5801CDDA8A76339B6F900F008B290E2
m_{PS34}	956426FEFD8B8D52073E87984E10C4D255064E1372C04A24
m_{PS35}	C4F4D6DF1B754AD6063FD10C331C1428ABB27B0700134B94
m_{PS36}	B65548082B34E9FAF43F33C4070F79099758CFD41B491A11
m_{PS37}	C8317EA111A82B04E78B88B864B1EF5D711BBEB4A0527036
m_{PS38}	8FB7AD1188E8D1A5219845013672560FD38904E70537403B
m_{PS39}	B41A324E0D80AA0598A8D391C1D7FFC82B4A075218E98EC3
m_{PS40}	49A6350A62E208B011E86528B9A481A0E76D723F6675FF82

Code ID	Basic Midamble Codes m_{PS} of length $P=192$
m_{PS41}	C344C8C23C42A7B7442E6022E95AE4B08A4BFA786F35F911
m_{PS42}	28F430CF67D69C9DF60E25656413BC5F932A022DB1406C44
m_{PS43}	2FA5D70CF0FED4213F32116051450391C2A627D9B670C428
m_{PS44}	959537D988FDD4F1360B4E84701AE5409229C30EDF8BC404
m_{PS45}	CDD2E0450F9EC12F81391AD4633CB29F315B4A0A890A9A22
m_{PS46}	158776A20B4B82C563EC08F086830EA66DBD2DCCB4DF6026
m_{PS47}	431FCACBE48208975950342709D11F19AD5FB047F3B440C9
m_{PS48}	86B141AC571BA6B42653B12FF04D4F0E6C81F3EB608660A2
m_{PS49}	86D297ABD34E8510F6CDB0EA617F1F1051C8799117B02211
m_{PS50}	80B2D9530B34E781311D95CFA3857F277CC07014D324AF5A
m_{PS51}	2B607B93FD8B45601C1E574E14CFC6912C22AEC1045ADC49
m_{PS52}	D234C5C45E105A837E6DD74BC4E534523A20317BA0625A29
m_{PS53}	768CCDB3E2A7A2B863128382590946B25472BE2BFFC40641
m_{PS54}	3DA38212E0A987EE1F665D4E13C2AA4446E00A76C948A073
m_{PS55}	09173135E4A2CFC8F2678750AB5257110906F013587BDE82
m_{PS56}	522E070B266F35E99C1F3C42D2017F8E415550492B72F086
m_{PS57}	D63E4BD805262A3DEF05C7D86C422E5048921E5531784132
m_{PS58}	564AF806E28131611E5F884229265D446A50E1E488EAFBBA
m_{PS59}	A2603E009D3D30147727B750C35C62299AF754D3E4A54E1C
m_{PS60}	938504B02599D33E28246E4271C375AE81A3BBE8D3F8A920
m_{PS61}	461516B2CAC6FC42A4B707CC6073BBE573C014892C811776
m_{PS62}	29186DE4CCAAB2CD0100BB19EA595879D63F0F0CFA881AA5
m_{PS63}	A064B449CB784A91B803369CDC5EF61A670AAAC044BA3E68
m_{PS64}	8719C454D88FF5149DB943CB6CADA01D0B9664B357A18203
m_{PS65}	A27EC68720F00A714AA2C45A7EF232286984D7B193F5C916
m_{PS66}	AC8361676AB424E48F0789082B0CD2EFB8D2E627D041DD66
m_{PS67}	ABA1BEB0064733A0620906BF2B29C95883F069D7E4C35D39
m_{PS68}	9E22EDED47D92CA1D0B7530EC6062287BD83A04874AE00C
m_{PS69}	0BADEF288B20F5686C5DE3A71219AC2172054326BE831696
m_{PS70}	953801EB2AF58C2F80E49A6CC46085CB554243E3B3BBEC8C
m_{PS71}	333A504C51C8FAC5025994565C3F600F154F64FAEF4EA484
m_{PS72}	A6583E19647662005474153A6F8DD88A473853E94B720CE7
m_{PS73}	90ACAF707D18AF34F5848C58166830AF620ACDC1B2DFDDA8
m_{PS74}	39C5C598A374EA82F3F83378258248DAD3808812DD0E74BB
m_{PS75}	F79525DE694629346D73F6256CC0F140F82603197AAA1844
m_{PS76}	B8C2A8F139097699A693022E78588D4058DB0A65FF52F813
m_{PS77}	449B50C2A52996FA5A828A907F30F9F460EE3D99930DF890
m_{PS78}	62CEC9574D30184BCB4F94EECF0CC23D2D2A8D0003F0AA33
m_{PS79}	B56D258889703F76A0738EE3A7D355994159A4851833E198
m_{PS80}	65894AA54C0F6C9A206521C9FC379A8AAF6E621C03CF849C
m_{PS81}	2D47F3414E30CC02C6835D95C9BA204488F0FFCB4852677D
m_{PS82}	12BE4DD8B906B584010F8A330AB67B278E8642FA33D51B68
m_{PS83}	BC928A90A4B10906CAEE638BF768E08542F48F1676006DF0

Code ID	Basic Midamble Codes m_{PS} of length $P=192$
m_{PS84}	30C544E437C8ADA143566CD1BC4E9E7BA84139A08505C2F4
m_{PS85}	84FD5B05506192B753FBA2C719B584E0EDA01814999867D2
m_{PS86}	191F14DD00034E03AB5BB4342F1138B2CD33784E60CFD75A
m_{PS87}	B8ACE7990B6A98A80A61162C4D2D5F88F24E8F7DE4207590
m_{PS88}	EC1DBE72E8EED0C61054FC2695422AC0AD2D888265B21AB0
m_{PS89}	9A1B4CA467AB7E082AF4278E44D177EA78424508C23E8B08
m_{PS90}	999EE541C608164AC975214F3A37A677FC2CA03E2C2A4B20
m_{PS91}	1BDCC20265031432917A2EB828FB356A22DF9CB609C0F8F3
m_{PS92}	EB4A81859C93338B8A1B87C02C815AE09D765F6F2249B958
m_{PS93}	E6A5D1629F4CF09A1F280DE0C480D4C73B26ADE321A50AEE
m_{PS94}	BAAB7286DD24C80B15A7958039B904F1CA83C310C8C7AFF2
m_{PS95}	12220F72619E983717C68FFE1C4148F2354B7B1955B65620
m_{PS96}	A198706E24FAA08BD09EE392414816038E667BB34307D6B2
m_{PS97}	30B3493B4C035881A7A722E4546527AAE787FA2C0893AC46
m_{PS98}	5A7318126522843DCB7F00A2D9F9BA8F88963E4152BC923C
m_{PS99}	844844B0CACAB702C332CE2692B4166F4B0C63E62BF151BF
m_{PS100}	B8297389526410313692F861DC60DA86A23607F7DDE24755
m_{PS101}	6C1144CF8BC01538D655D29ED62DE6E74A3180EC905BF1E0
m_{PS102}	E9DB3221FACFC5C88691A7013EF09672A130D52C3413AAE2
m_{PS103}	2FD0508615EC4CD4BF18ADD46D777078869130C8921A4F0E
m_{PS104}	40911B4E0525AC874228F6EF642E59154730CB187C7E417A
m_{PS105}	2034C6A027D4D850F5184AA64C3153231F4651B616BBFCF9
m_{PS106}	57833235451525A1DFA213FCE0B419B6494BC7B99F488410
m_{PS107}	6DC3D57F2E39158D036825F8804810D77CA1ECA610ECD894
m_{PS108}	F5C50DE43AA7B731CAB7683524021701F97650499A7070E4
m_{PS109}	F2184D2699785442E09FA22CC2D60A5A13FFF22AE660A470
m_{PS110}	EF0029DE0D79207205458CF4D7328E81A93518D93C9A74BD
m_{PS111}	9D6D8992482FB885AA5E878C3BA2045538B09886C23CDC2D
m_{PS112}	C0A5AB67D1CEA126F6476C75443F0A11CBE749412EF03104
m_{PS113}	1853A5C20CDF968C5A180D8EB5E72BF15517D06680D98412
m_{PS114}	8CEA1223227ADF37D0DAAB320906E1C79029F480D25181A7
m_{PS115}	5561038E96A658EF3EC665612FF92B064065D1ACC1F54812
m_{PS116}	C55A6263F08D664A1E53584560DF5E611640D8281D9A843
m_{PS117}	4386A8EA59124D043F29056A4598735A4FC7BC11119B90C1
m_{PS118}	D6571B20668BED50BD7C80388C162632BCB069AA67C7FC22
m_{PS119}	4F9F09ABBC1391EC2CCA5359FB52250E533BF04324154106
m_{PS120}	662659F42188C9453F6E6DF00C579627045DA1461A3A0EA5
m_{PS121}	8DCC9274C0C2A9BA6096BF27FACA542CD01CA8653D60A80F
m_{PS122}	5C1210A1E50E505F6B73C90156C9D9F19AE2310BBD820DF0
m_{PS123}	B1E0A7CE26202E223D4FC06D5C9BBA4E5F6D98204D2D5286
m_{PS124}	DB506776958E34552F7E60E4B400D836153218F918E22FA6
m_{PS125}	ECAA60300439B2360B2AC3C43FB6241ACDE5055B295FA71C
m_{PS126}	BF1E6D9AA9CA4AC092BE60500C77D0DC7A6A236520F86722

Code ID	Basic Midamble Codes m_{PS} of length $P=192$
m_{PS127}	051C5FA122845A30B4EC306B38016B45667C7754F92F13A0

A.3 Association between Midambles and Channelisation Codes

The following mapping schemes apply for the association between midambles and channelisation codes if no midamble is allocated by higher layers. Secondary channelisation codes are marked with a (*). These associations apply both for UL and DL.

A.3.1 Association for Burst Type 1/3 and K=16 Midambles

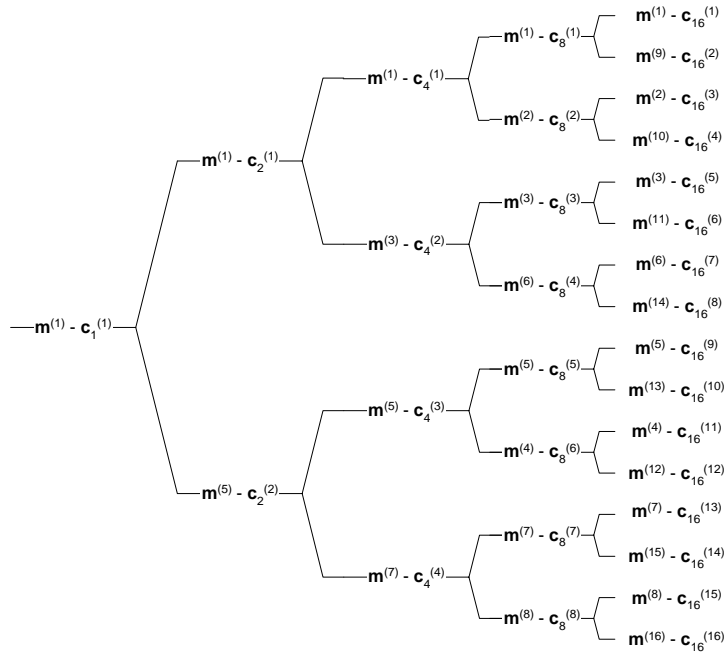

Figure A-1: Association of Midambles to Spreading Codes for Burst Type 1/3 and K=16

A.3.2 Association for Burst Type 1/3 and K=8 Midambles

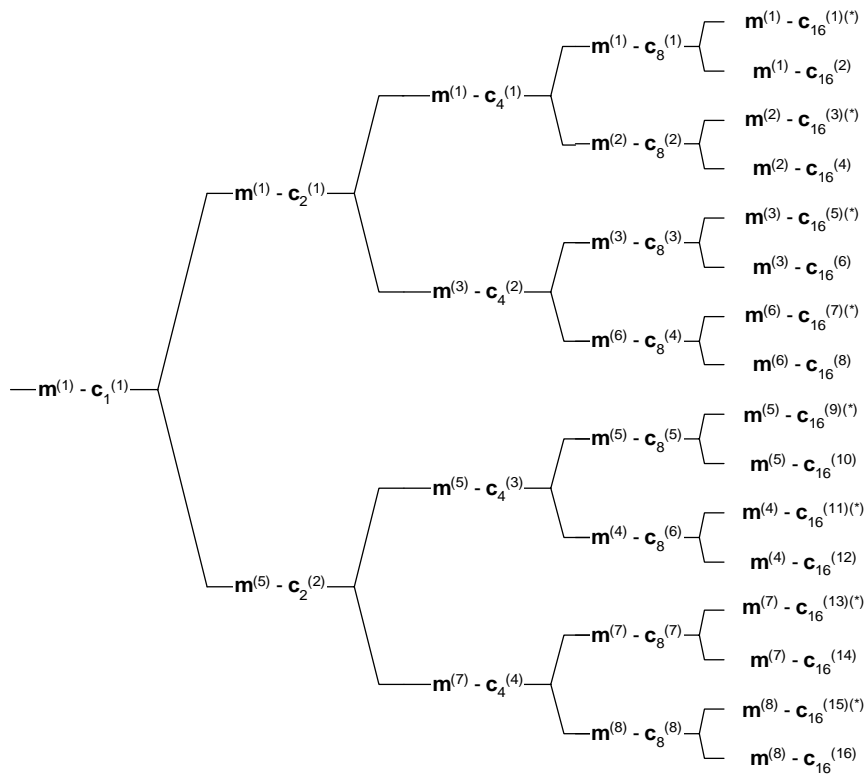

Figure A-2: Association of Midambles to Spreading Codes for Burst Type 1/3 and K=8

A.3.3 Association for Burst Type 1/3 and K=4 Midambles

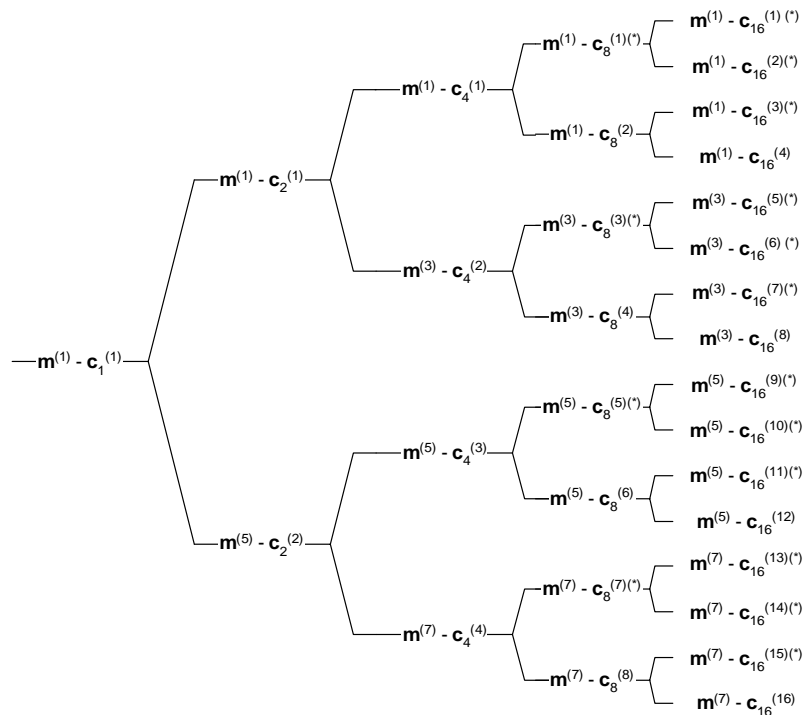

Figure A-3: Association of Midambles to Spreading Codes for Burst Type 1/3 and K=4

A.3.4 Association for Burst Type 2 and K=6 Midambles

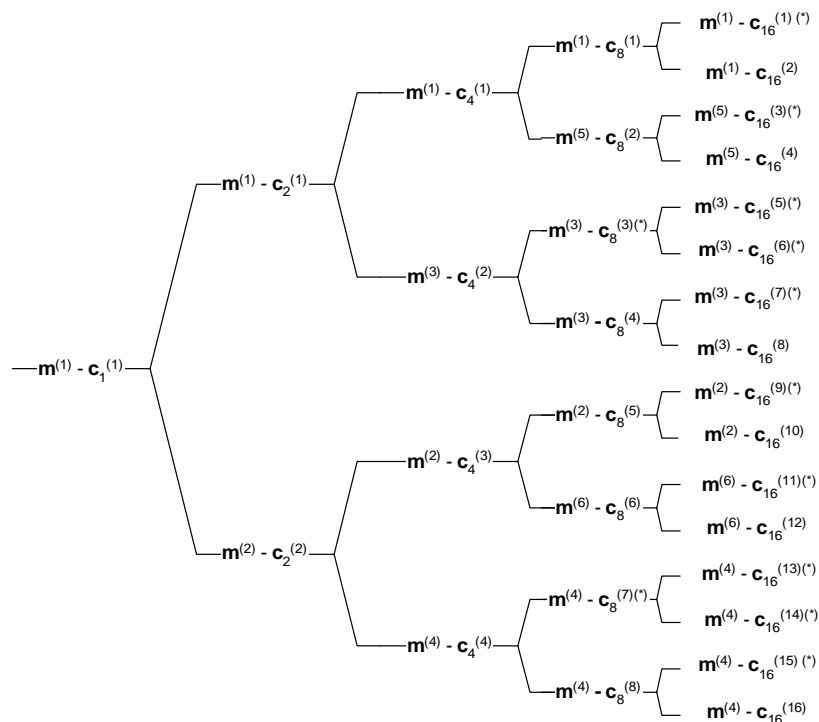

Figure A-4: Association of Midambles to Spreading Codes for Burst Type 2 and K=6

A.3.5 Association for Burst Type 2 and K=3 Midambles

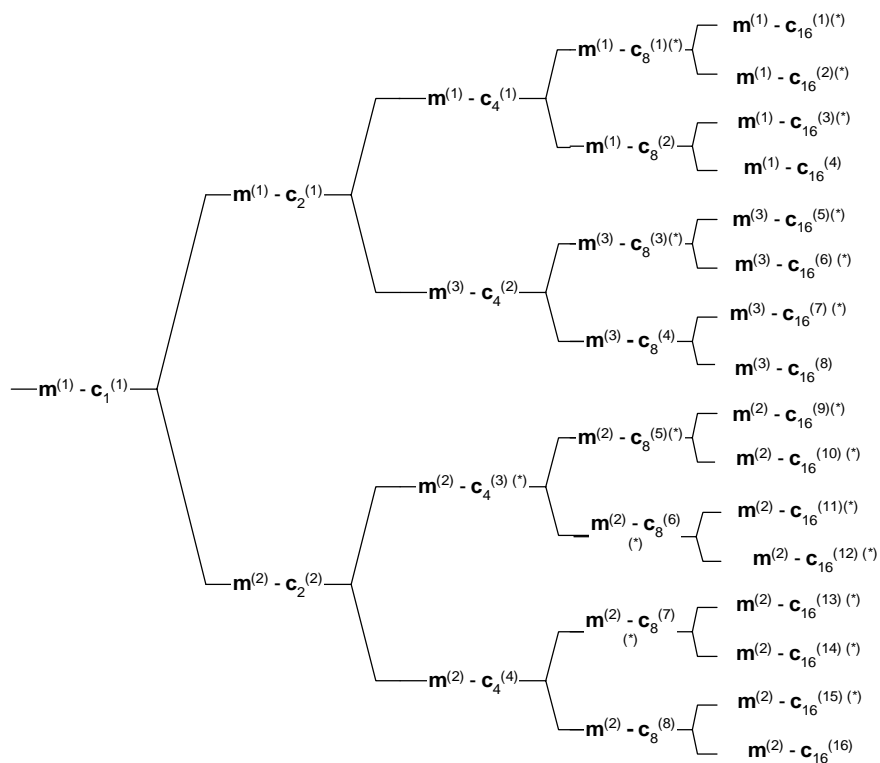

Figure A-5: Association of Midambles to Spreading Codes for Burst Type 2 and K=3

Note that the association for burst type 2 can be derived from the association for burst type 1 and 3, using the following table:

Burst Type 1/3	m(1)	m(2)	m(3)	m(4)	m(5)	m(6)	m(7)	m(8)
Burst Type 2	m(1)	m(5)	m(3)	m(6)	m(2)	m(4)	-	-

Annex B (normative): Signalling of the number of channelisation codes for the DL common midamble case

The following mapping schemes shall apply for the association between the number of channelisation codes employed in a timeslot and the use of a particular midamble shift in the DL common midamble case. In the following tables the presence of a particular midamble shift is indicated by '1'. Midamble shifts marked with '0' are left unused. Mapping schemes B.3 and B.4 are not applicable to beacon timeslots where a P-CCPCH is present, because the default midamble allocation scheme is applied to these timeslots. Note that in mapping schemes B.3 and B.4, the fixed and pre-allocated channelisation code for the beacon channel is included into the number of indicated channelisation codes.

B.1 Mapping scheme for Burst Type 1 and K=16 Midambles.

m1	m2	m3	m4	m5	m6	m7	M8	m9	m10	m11	m12	m13	m14	m15	m16	
1	0	0	0	0	0	0	0	0	0	0	0	0	0	0	0	1 code
0	1	0	0	0	0	0	0	0	0	0	0	0	0	0	0	2 codes
0	0	1	0	0	0	0	0	0	0	0	0	0	0	0	0	3 codes
0	0	0	1	0	0	0	0	0	0	0	0	0	0	0	0	4 codes
0	0	0	0	1	0	0	0	0	0	0	0	0	0	0	0	5 codes
0	0	0	0	0	1	0	0	0	0	0	0	0	0	0	0	6 codes
0	0	0	0	0	0	1	0	0	0	0	0	0	0	0	0	7 codes
0	0	0	0	0	0	0	1	0	0	0	0	0	0	0	0	8 codes
0	0	0	0	0	0	0	0	1	0	0	0	0	0	0	0	9 codes
0	0	0	0	0	0	0	0	0	1	0	0	0	0	0	0	10 codes
0	0	0	0	0	0	0	0	0	0	1	0	0	0	0	0	11 codes
0	0	0	0	0	0	0	0	0	0	0	1	0	0	0	0	12 codes
0	0	0	0	0	0	0	0	0	0	0	0	1	0	0	0	13 codes
0	0	0	0	0	0	0	0	0	0	0	0	0	1	0	0	14 codes
0	0	0	0	0	0	0	0	0	0	0	0	0	0	1	0	15 codes
0	0	0	0	0	0	0	0	0	0	0	0	0	0	0	1	16 codes

B.2 Mapping scheme for Burst Type 1 and K=8 Midambles.

M1	m2	m3	m4	m5	m6	m7	m8	
1	0	0	0	0	0	0	0	1 code or 9 codes
0	1	0	0	0	0	0	0	2 codes or 10 codes
0	0	1	0	0	0	0	0	3 codes or 11 codes
0	0	0	1	0	0	0	0	4 codes or 12 codes
0	0	0	0	1	0	0	0	5 codes or 13 codes
0	0	0	0	0	1	0	0	6 codes or 14 codes
0	0	0	0	0	0	1	0	7 codes or 15 codes
0	0	0	0	0	0	0	1	8 codes or 16 codes

B.3 Mapping scheme for Burst Type 1 and K=4 Midambles.

m1	m3	m5	m7	
1	0	0	0	1 or 5 or 9 or 13 codes
0	1	0	0	2 or 6 or 10 or 14 codes
0	0	1	0	3 or 7 or 11 or 15 codes
0	0	0	1	4 or 8 or 12 or 16 codes

B.4 Mapping scheme for beacon timeslots and K=16 Midambles.

m1	m2	m3	M4	m5	m6	m7	M8	m9	m10	m11	M12	m13	m14	m15	m16	
1	$x^{(1)}$	1	0	0	0	0	0	0	0	0	0	0	0	0	0	1 codes or 13 codes
1	$x^{(2)}$	0	1	0	0	0	0	0	0	0	0	0	0	0	0	2 codes or 14 codes
1	$x^{(3)}$	0	0	1	0	0	0	0	0	0	0	0	0	0	0	3 codes or 15 codes
1	$x^{(4)}$	0	0	0	1	0	0	0	0	0	0	0	0	0	0	4 codes or 16 codes
1	$x^{(5)}$	0	0	0	0	1	0	0	0	0	0	0	0	0	0	5 codes
1	$x^{(6)}$	0	0	0	0	0	1	0	0	0	0	0	0	0	0	6 codes
1	$x^{(7)}$	0	0	0	0	0	0	0	1	0	0	0	0	0	0	7 codes
1	$x^{(8)}$	0	0	0	0	0	0	0	0	0	1	0	0	0	0	8 codes
1	$x^{(9)}$	0	0	0	0	0	0	0	0	0	0	1	0	0	0	9 codes
1	$x^{(10)}$	0	0	0	0	0	0	0	0	0	0	0	1	0	0	10 codes
1	$x^{(11)}$	0	0	0	0	0	0	0	0	0	0	0	0	1	0	11 codes
1	$x^{(12)}$	0	0	0	0	0	0	0	0	0	0	0	0	0	1	12 codes

(*) In case of Block-STTD encoding for the P-CCPCH, midamble shift 2 is used by the diversity antenna

B.5 Mapping scheme for beacon timeslots and K=8 Midambles.

m1	m2	m3	m4	m5	m6	m7	M8	
1	$x^{(1)}$	1	0	0	0	0	0	1 or 7 or 13 codes
1	$x^{(2)}$	0	1	0	0	0	0	2 or 8 or 14 codes
1	$x^{(3)}$	0	0	1	0	0	0	3 or 9 or 15 codes
1	$x^{(4)}$	0	0	0	1	0	0	4 or 10 or 16 codes
1	$x^{(5)}$	0	0	0	0	1	0	5 codes or 11 codes
1	$x^{(6)}$	0	0	0	0	0	1	6 codes or 12 codes

(*) In case of Block-STTD encoding for the P-CCPCH, midamble shift 2 is used by the diversity antenna

B.6 Mapping scheme for beacon timeslots and K=4 Midambles.

m1	m3	m5	m7	
1	1	0	0	1 or 4 or 7 or 10 or 13 or 16 codes
1	0	1	0	2 or 5 or 8 or 11 or 14 codes
1	0	0	1	3 or 6 or 9 or 12 or 15 codes

B.7 Mapping scheme for Burst Type 2 and K=6 Midambles.

m1	m2	m3	m4	m5	m6	
1	0	0	0	0	0	1 or 7 or 13 codes
0	1	0	0	0	0	2 or 8 or 14 codes
0	0	1	0	0	0	3 or 9 or 15 codes
0	0	0	1	0	0	4 or 10 or 16 codes
0	0	0	0	1	0	5 or 11 codes
0	0	0	0	0	1	6 or 12 codes

B.8 Mapping scheme for Burst Type 2 and K=3 Midambles.

m1	m2	m3	
1	0	0	1 or 4 or 7 or 10 or 13 or 16 codes
0	1	0	2 or 5 or 8 or 11 or 14 codes
0	0	1	3 or 6 or 9 or 12 or 15 codes

Annex C (informative): CCPCH Multiframe Structure

In the following figures B.1 to B.3 some examples for Multiframe Structures on Primary and Secondary CCPCH are given. The figures show the placement of Common Transport Channels on the Common Control Physical Channels. Additional S-CCPCH capacity can be allocated on other codes and timeslots of course, e.g. FACH capacity is related to overall cell capacity and can be configured according to the actual needs. Channel capacities in the annex are derived using bursts with long midambles (Burst format 1). Every TrCH-box in the figures is assumed to be valid for two frames (see row 'Frame #'), i.e. the transport channels in CCPCHs have an interleaving time of 20msec.

The actual CCPCH Multiframe Scheme used in the cell is described and broadcast on BCH. Thus the system information structure has its roots in this particular transport channel and allocations of other Common Channels can be handled this way, i.e. by pointing from BCH.

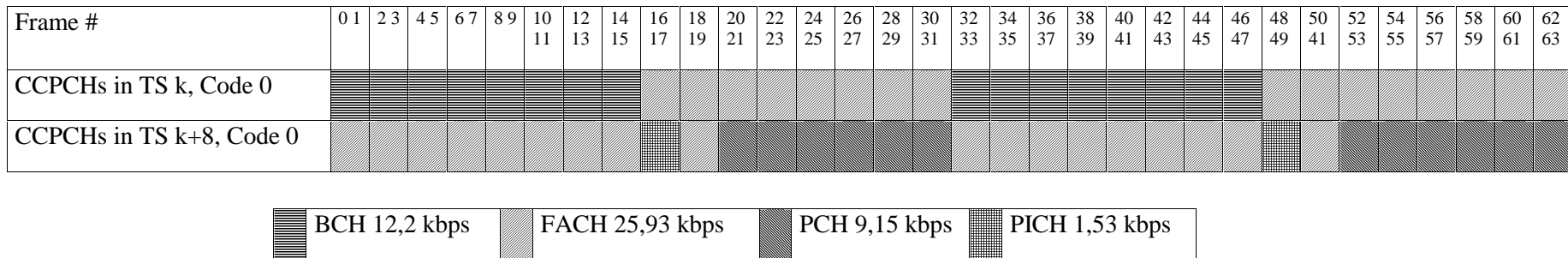

Figure C.1: Example for a multiframe structure for CCPCHs and PICH that is repeated every 64th frame

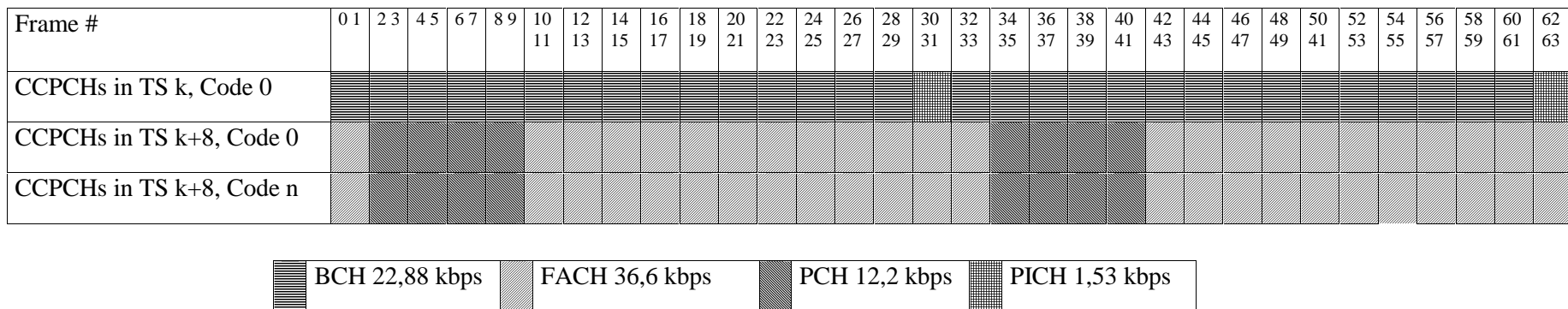

Figure C.2: Example for a multiframe structure for CCPCHs and PICH that is repeated every 64th frame, n=1...7

History

Document history		
V3.1.1	January 2000	Publication
V3.2.0	March 2000	Publication
V3.3.0	June 2000	Publication
V3.4.0	September 2000	Publication
V3.5.0	December 2000	Publication
V3.6.0	March 2001	Publication