

# ETSI TS 125 212 V11.7.0 (2014-03)



## **Universal Mobile Telecommunications System (UMTS); Multiplexing and channel coding (FDD) (3GPP TS 25.212 version 11.7.0 Release 11)**



---

**Reference**

RTS/TSGR-0125212vb70

---

**Keywords**

UMTS

**ETSI**

---

650 Route des Lucioles  
F-06921 Sophia Antipolis Cedex - FRANCE

Tel.: +33 4 92 94 42 00 Fax: +33 4 93 65 47 16

Siret N° 348 623 562 00017 - NAF 742 C  
Association à but non lucratif enregistrée à la  
Sous-Préfecture de Grasse (06) N° 7803/88

---

**Important notice**

The present document can be downloaded from:

<http://www.etsi.org>

The present document may be made available in electronic versions and/or in print. The content of any electronic and/or print versions of the present document shall not be modified without the prior written authorization of ETSI. In case of any existing or perceived difference in contents between such versions and/or in print, the only prevailing document is the print of the Portable Document Format (PDF) version kept on a specific network drive within ETSI Secretariat.

Users of the present document should be aware that the document may be subject to revision or change of status. Information on the current status of this and other ETSI documents is available at

<http://portal.etsi.org/tb/status/status.asp>

If you find errors in the present document, please send your comment to one of the following services:

[http://portal.etsi.org/chaicor/ETSI\\_support.asp](http://portal.etsi.org/chaicor/ETSI_support.asp)

---

**Copyright Notification**

No part may be reproduced or utilized in any form or by any means, electronic or mechanical, including photocopying and microfilm except as authorized by written permission of ETSI.

The content of the PDF version shall not be modified without the written authorization of ETSI.

The copyright and the foregoing restriction extend to reproduction in all media.

© European Telecommunications Standards Institute 2014.

All rights reserved.

**DECT™**, **PLUGTESTS™**, **UMTS™** and the ETSI logo are Trade Marks of ETSI registered for the benefit of its Members. **3GPP™** and **LTE™** are Trade Marks of ETSI registered for the benefit of its Members and of the 3GPP Organizational Partners.

**GSM®** and the GSM logo are Trade Marks registered and owned by the GSM Association.

---

## Intellectual Property Rights

IPRs essential or potentially essential to the present document may have been declared to ETSI. The information pertaining to these essential IPRs, if any, is publicly available for **ETSI members and non-members**, and can be found in ETSI SR 000 314: *"Intellectual Property Rights (IPRs); Essential, or potentially Essential, IPRs notified to ETSI in respect of ETSI standards"*, which is available from the ETSI Secretariat. Latest updates are available on the ETSI Web server (<http://ipr.etsi.org>).

Pursuant to the ETSI IPR Policy, no investigation, including IPR searches, has been carried out by ETSI. No guarantee can be given as to the existence of other IPRs not referenced in ETSI SR 000 314 (or the updates on the ETSI Web server) which are, or may be, or may become, essential to the present document.

---

## Foreword

This Technical Specification (TS) has been produced by ETSI 3rd Generation Partnership Project (3GPP).

The present document may refer to technical specifications or reports using their 3GPP identities, UMTS identities or GSM identities. These should be interpreted as being references to the corresponding ETSI deliverables.

The cross reference between GSM, UMTS, 3GPP and ETSI identities can be found under <http://webapp.etsi.org/key/queryform.asp>.

# Contents

Intellectual Property Rights .....	2
Foreword.....	2
Foreword.....	9
1 Scope .....	10
2 References .....	10
3 Definitions, symbols and abbreviations .....	10
3.1 Definitions .....	10
3.2 Symbols.....	12
3.3 Abbreviations .....	12
4 Multiplexing, channel coding and interleaving .....	14
4.1 General .....	14
4.2 General coding/multiplexing of TrCHs.....	14
4.2.1 CRC attachment.....	17
4.2.1.1 CRC Calculation .....	17
4.2.1.2 Relation between input and output of the CRC attachment block.....	17
4.2.2 Transport block concatenation and code block segmentation.....	18
4.2.2.1 Concatenation of transport blocks.....	18
4.2.2.2 Code block segmentation .....	18
4.2.3 Channel coding .....	19
4.2.3.1 Convolutional coding.....	19
4.2.3.2 Turbo coding.....	20
4.2.3.2.1 Turbo coder .....	20
4.2.3.2.2 Trellis termination for Turbo coder .....	21
4.2.3.2.3 Turbo code internal interleaver.....	21
4.2.3.3 Concatenation of encoded blocks.....	25
4.2.4 Radio frame size equalisation .....	25
4.2.5 1 <sup>st</sup> interleaving .....	25
4.2.5.1 Void.....	25
4.2.5.2 1 <sup>st</sup> interleaver operation.....	25
4.2.5.3 Relation between input and output of 1 <sup>st</sup> interleaving in uplink.....	26
4.2.5.4 Relation between input and output of 1 <sup>st</sup> interleaving in downlink.....	27
4.2.6 Radio frame segmentation .....	27
4.2.6.1 Relation between input and output of the radio frame segmentation block in uplink .....	27
4.2.6.2 Relation between input and output of the radio frame segmentation block in downlink .....	27
4.2.7 Rate matching .....	27
4.2.7.1 Determination of rate matching parameters in uplink .....	29
4.2.7.1.1 Determination of SF and number of PhCHs needed.....	29
4.2.7.2 Determination of rate matching parameters in downlink .....	32
4.2.7.2.1 Determination of rate matching parameters for fixed positions of TrCHs .....	32
4.2.7.2.2 Determination of rate matching parameters for flexible positions of TrCHs .....	34
4.2.7.3 Bit separation and collection in uplink.....	36
4.2.7.3.1 Bit separation.....	38
4.2.7.3.2 Bit collection .....	38
4.2.7.4 Bit separation and collection in downlink .....	39
4.2.7.4.1 Bit separation.....	40
4.2.7.4.2 Bit collection .....	40
4.2.7.5 Rate matching pattern determination .....	41
4.2.8 TrCH multiplexing.....	42
4.2.9 Insertion of discontinuous transmission (DTX) indication bits .....	42
4.2.9.1 1 <sup>st</sup> insertion of DTX indication bits.....	42
4.2.9.2 2 <sup>nd</sup> insertion of DTX indication bits .....	43
4.2.10 Physical channel segmentation .....	44
4.2.10.1 Relation between input and output of the physical segmentation block in uplink .....	44

4.2.10.2	Relation between input and output of the physical segmentation block in downlink .....	44
4.2.11	2 <sup>nd</sup> interleaving.....	44
4.2.11.1	2 <sup>nd</sup> interleaving for Secondary CCPCH with 16QAM .....	45
4.2.12	Physical channel mapping .....	46
4.2.12.1	Uplink .....	46
4.2.12.2	Downlink.....	46
4.2.13	Restrictions on different types of CCTrCHs.....	47
4.2.13.1	Uplink Dedicated channel (DCH) .....	47
4.2.13.2	Random Access Channel (RACH).....	47
4.2.13.3	Void.....	47
4.2.13.4	Downlink Dedicated Channel (DCH) .....	47
4.2.13.5	Void.....	47
4.2.13.6	Broadcast channel (BCH) .....	47
4.2.13.7	Forward access and paging channels (FACH and PCH).....	48
4.2.13.8	High Speed Downlink Shared Channel (HS-DSCH) associated with a DCH.....	48
4.2.13.9	Enhanced Dedicated Channel (E-DCH).....	48
4.2.14	Multiplexing of different transport channels into one CCTrCH, and mapping of one CCTrCH onto physical channels .....	48
4.2.14.1	Allowed CCTrCH combinations for one UE .....	49
4.2.14.1.1	Allowed CCTrCH combinations on the uplink .....	49
4.2.14.1.2	Allowed CCTrCH combinations on the downlink .....	49
4.3	Transport format detection .....	49
4.3.1	Blind transport format detection .....	50
4.3.1a	Single transport format detection.....	50
4.3.2	Transport format detection based on TFCI.....	51
4.3.3	Coding of Transport-Format-Combination Indicator (TFCI) .....	51
4.3.4	Void.....	52
4.3.5	Mapping of TFCI words .....	53
4.3.5.1	Mapping of TFCI word in normal mode.....	53
4.3.5.1.1	Mapping of TFCI bits for Secondary CCPCH with 16QAM .....	53
4.3.5.2	Mapping of TFCI word in compressed mode .....	53
4.3.5.2.1	Uplink compressed mode .....	53
4.3.5.2.2	Downlink compressed mode .....	54
4.4	Compressed mode .....	54
4.4.1	Frame structure in the uplink .....	55
4.4.2	Frame structure types in the downlink.....	55
4.4.2A	Frame structure in the downlink for F-DPCH .....	55
4.4.2B	Frame structure in the downlink for F-TPICH.....	56
4.4.3	Transmission time reduction method.....	56
4.4.3.1	Void.....	56
4.4.3.2	Compressed mode by reducing the spreading factor by 2.....	56
4.4.3.3	Compressed mode by higher layer scheduling.....	56
4.4.4	Transmission gap position .....	56
4.4.5	Transmission gap position for E-DCH .....	58
4.4.5.1	E-DPDCH Transmission Gap Position during Initial Transmissions.....	58
4.4.5.2	E-DPDCH Transmission Gap Position during Retransmissions.....	59
4.4.5.3	E-DPCCH Transmission Gap Position.....	59
4.5	Coding for HS-DSCH .....	59
4.5.1	CRC attachment for HS-DSCH .....	60
4.5.1.1	CRC attachment method 1 for HS-DSCH.....	60
4.5.1.2	CRC attachment method 2 for HS-DSCH.....	61
4.5.1a	Bit scrambling for HS-DSCH .....	61
4.5.2	Code block segmentation for HS-DSCH .....	61
4.5.3	Channel coding for HS-DSCH.....	62
4.5.4	Hybrid ARQ for HS-DSCH .....	62
4.5.4.1	HARQ bit separation.....	62
4.5.4.2	HARQ First Rate Matching Stage.....	62
4.5.4.3	HARQ Second Rate Matching Stage .....	63
4.5.4.4	HARQ bit collection .....	64
4.5.5	Physical channel segmentation for HS-DSCH.....	64
4.5.6	Interleaving for HS-DSCH .....	65
4.5.7	Constellation re-arrangement for 16 QAM and 64QAM.....	65

4.5.8	Physical channel mapping for HS-DSCH.....	66
4.6	Coding for HS-SCCH type 1.....	66
4.6.1	Overview.....	66
4.6.2	HS-SCCH information field mapping.....	68
4.6.2.1	Redundancy and constellation version coding.....	68
4.6.2.2	Modulation scheme mapping.....	69
4.6.2.3	Channelization code-set mapping.....	69
4.6.2.4	UE identity mapping.....	70
4.6.2.5	HARQ process identifier mapping.....	70
4.6.2.6	Transport block size index mapping.....	70
4.6.3	Multiplexing of HS-SCCH information.....	70
4.6.4	CRC attachment for HS-SCCH.....	70
4.6.5	Channel coding for HS-SCCH.....	71
4.6.6	Rate matching for HS-SCCH.....	71
4.6.7	UE specific masking for HS-SCCH.....	71
4.6.8	Physical channel mapping for HS-SCCH.....	71
4.6A	Coding for HS-SCCH type 2.....	71
4.6A.1	Overview.....	71
4.6A.2	HS-SCCH Type 2 information field mapping.....	72
4.6A.2.1	The first transmission.....	72
4.6A.2.2	The second and the third transmissions.....	73
4.6A.2.2.1	Special Information mapping.....	73
4.6A.2.2.1.1	Transport-block size information mapping.....	73
4.6A.2.2.1.2	Pointer to the previous transmission mapping.....	73
4.6A.2.2.1.3	Second or third transmission mapping.....	73
4.6A.2.2.2	Redundancy and Constellation Version mapping.....	74
4.6A.2.2.3	Modulation scheme mapping.....	74
4.6A.2.2.4	Channelization code-set mapping.....	74
4.6A.2.2.5	UE identity mapping.....	74
4.6A.3	Multiplexing of HS-SCCH Type 2 information.....	74
4.6A.4	CRC attachment for HS-SCCH Type 2.....	74
4.6A.5	Channel coding for HS-SCCH Type 2.....	74
4.6A.6	Rate matching for HS-SCCH Type 2.....	74
4.6A.7	UE specific masking for HS-SCCH Type 2.....	74
4.6A.8	Physical channel mapping for HS-SCCH Type 2.....	74
4.6B	Coding for HS-SCCH type 3.....	75
4.6B.1	Overview.....	75
4.6B.2	HS-SCCH type 3 information field mapping.....	76
4.6B.2.1	Redundancy and constellation version coding.....	76
4.6B.2.2	Modulation scheme and number of transport blocks mapping.....	77
4.6B.2.3	Channelization code-set mapping.....	77
4.6B.2.4	UE identity mapping.....	78
4.6B.2.5	HARQ process identifier mapping.....	78
4.6B.2.6	Transport block size index mapping.....	78
4.6B.2.7	Precoding Weight Information mapping.....	78
4.6B.3	Multiplexing of HS-SCCH type 3 information.....	79
4.6B.4	CRC attachment for HS-SCCH type 3.....	79
4.6B.5	Channel coding for HS-SCCH type 3.....	80
4.6B.6	Rate matching for HS-SCCH type 3.....	80
4.6B.7	UE specific masking for HS-SCCH type 3.....	80
4.6B.8	Physical channel mapping for HS-SCCH type 3.....	80
4.6C	Coding for HS-SCCH orders.....	81
4.6C.1	Overview.....	81
4.6C.2	HS-SCCH Order information field mapping in the CELL_DCH state.....	81
4.6C.2.1	Order type mapping.....	81
4.6C.2.2	Order mapping.....	81
4.6C.2.2.1	Orders for activation and deactivation of DTX, DRX and HS-SCCH-less operation and for HS-DSCH serving cell change.....	81
4.6C.2.2.2	Orders for activation and deactivation of Secondary serving HS-DSCH cells and Secondary uplink frequency.....	82
4.6C.2.2.3	Orders for Switching between Uplink Closed Loop Transmit Diversity Activation states.....	89

4.6C.2.2.4	Orders for activating and de-activating demodulation common pilots (D-CPICH) when the UE is configured in MIMO mode with four transmit antennas .....	90
4.6C.2.3	UE identity mapping .....	90
4.6C.3	HS-SCCH Order information field mapping in the CELL_FACH and CELL_PCH states.....	90
4.6C.3.1	Order type mapping.....	90
4.6C.3.2	Order mapping .....	90
4.6C.3.2.1	Orders for Network Triggered HS-DPCCH Transmission .....	90
4.6D	Coding for HS-SCCH type 4.....	91
4.6D.1	Overview .....	91
4.6D.2	HS-SCCH type 4 information field mapping.....	91
4.6D.2.1	Redundancy and constellation version coding .....	91
4.6D.2.2	Modulation scheme and number of transport blocks mapping.....	92
4.6D.2.3	Channelization code-set mapping .....	93
4.6D.2.4	UE identity mapping .....	94
4.6D.2.5	HARQ process identifier mapping.....	94
4.6D.2.6	Transport block size index mapping .....	94
4.6D.2.7	Precoding Weight Information mapping.....	95
4.6D.3	Multiplexing of HS-SCCH type 4 information.....	96
4.6D.4	CRC attachment for HS-SCCH type 4.....	97
4.6D.5	Channel coding for HS-SCCH type 4.....	98
4.6D.6	Rate matching for HS-SCCH type 4.....	98
4.6D.7	UE specific masking for HS-SCCH type 4.....	98
4.6D.8	Physical channel mapping for HS-SCCH type 4 .....	98
4.7	Coding for HS-DPCCH.....	99
4.7.1	Overview .....	99
4.7.2	Channel coding for HS-DPCCH when the UE is not configured in MIMO mode and not configured in MIMO mode with four transmit antennas in the serving HS-DSCH cell and Secondary_Cell_Enabled is 0 or 1 and Secondary_Cell_Active is 0.....	104
4.7.2.1	Channel coding for HS-DPCCH HARQ-ACK .....	104
4.7.2.2	Channel coding for HS-DPCCH channel quality indication .....	104
4.7.3	Channel coding for HS-DPCCH when the UE is configured in MIMO mode in the serving HS-DSCH cell and Secondary_Cell_Enabled is 0 .....	105
4.7.3.1	Channel coding for HS-DPCCH HARQ-ACK .....	105
4.7.3.2	Channel coding for HS-DPCCH composite precoding control indication and channel quality indication.....	106
4.7.3.2.1	Bit mapping of Type A channel quality indication .....	106
4.7.3.2.2	Bit mapping of Type B channel quality indication .....	106
4.7.3.2.3	Bit mapping of precoding control indication .....	106
4.7.3.2.4	Composite precoding control indication and channel quality indication bits.....	106
4.7.3.2.5	Block encoding of composite precoding control indication and channel quality indication bits .....	107
4.7.3A	Channel coding for HS-DPCCH when the UE is not configured in MIMO mode in any cell and Secondary_Cell_Enabled is 1 and Secondary_Cell_Active is 1 .....	108
4.7.3A.1	Channel coding for the composite HS-DPCCH HARQ-ACK .....	108
4.7.3A.2	Channel coding for HS-DPCCH composite channel quality indication.....	109
4.7.3A.2.1	Composite channel quality indication bits .....	109
4.7.3A.2.2	Block encoding of composite channel quality indication bits.....	110
4.7.3B	Channel coding for HS-DPCCH when Secondary_Cell_Enabled is at least 3 or when the UE is configured in MIMO mode in at least one cell and Secondary_Cell_Enabled is greater than 0.....	110
4.7.3B.1	Channel coding for the composite HS-DPCCH HARQ-ACK .....	110
4.7.3B.2	Channel coding for HS-DPCCH composite precoding control indication and channel quality indication.....	112
4.7.3C	Channel coding for HS-DPCCH when the UE is not configured in MIMO mode in any cell and Secondary_Cell_Enabled is 2 .....	112
4.7.3C.1	Channel coding for the composite HS-DPCCH HARQ-ACK .....	112
4.7.3C.2	Channel coding for HS-DPCCH channel quality indication .....	113
4.7.3D	Channel coding for HS-DPCCH when the UE is configured in Multiflow mode .....	113
4.7.3D.1	Channel coding for the composite HS-DPCCH HARQ-ACK .....	113
4.7.3D.2	Channel coding for HS-DPCCH channel quality indication .....	114
4.7.3E	Channel coding for HS-DPCCH when the UE is configured in MIMO mode with 4 transmit antennas .....	114
4.7.3E1	Channel coding for HS-DPCCH when the UE is configured in MIMO mode with four transmit antennas and Secondary_Cell_Enabled is 0.....	114

4.7.3E1.1	Channel coding for HS-DPCCH HARQ-ACK .....	114
4.7.3E1.2	Channel coding for HS-DPCCH composite number of transport blocks preferred, precoding control indication and channel quality indication .....	116
4.7.3E1.2.1	Bit mapping of Type A channel quality indication .....	116
4.7.3E1.2.2	Bit mapping of Type B channel quality indication .....	116
4.7.3E1.2.3	Bit mapping of number of transport blocks preferred .....	116
4.7.3E1.2.4	Bit mapping of precoding control indication .....	117
4.7.3E1.2.5	Composite number of transport blocks preferred, precoding control indication and channel quality indication bits .....	117
4.7.3E1.2.6	Channel coding for composite number of transport blocks preferred, precoding control indication and channel quality indication bits .....	118
4.7.3E1.2.7	Rate matching for composite number of transport blocks preferred, precoding control indication and channel quality indication bits .....	118
4.7.3E2	Channel coding for HS-DPCCH when the UE is configured in MIMO mode with four transmit antennas in any cell and Secondary_Cell_Enabled is 1 .....	118
4.7.3E2.1	Channel coding for the composite HS-DPCCH HARQ-ACK .....	118
4.7.3E2.2	Channel coding for HS-DPCCH composite number of transport blocks preferred, precoding control indication and channel quality indication .....	119
4.7.3E3	Channel coding for HS-DPCCH when the UE is configured in MIMO mode with four transmit antennas in any cell and Secondary_Cell_Enabled is 2 .....	119
4.7.3E3.1	Channel coding for the composite HS-DPCCH HARQ-ACK .....	119
4.7.3E3.2	Channel coding for HS-DPCCH composite number of transport blocks preferred, precoding control indication and channel quality indication .....	119
4.7.3E4	Channel coding for HS-DPCCH when the UE is configured in MIMO mode with four transmit antennas in any cell and Secondary_Cell_Enabled is 3 .....	119
4.7.3E4.1	Channel coding for the composite HS-DPCCH HARQ-ACK .....	120
4.7.3E4.2	Channel coding for HS-DPCCH composite number of transport blocks preferred, precoding control indication and channel quality indication .....	120
4.7.4	Physical channel mapping for HS-DPCCH .....	120
4.7.4.1	Physical Channel mapping for HS-DPCCH HARQ-ACK .....	120
4.7.4.2	Physical Channel mapping for HS-DPCCH PCI/CQI .....	123
4.7.4.3	Physical Channel mapping for HS-DPCCH HARQ-ACK and PCI/CQI when the UE is configured in Multiflow mode .....	129
4.7.4.3.1	Physical Channel mapping for HS-DPCCH HARQ-ACK and PCI/CQI when the UE is configured with one serving and one assisting serving HS-DSCH cell .....	129
4.7.4.3.2	Physical Channel mapping for HS-DPCCH HARQ-ACK and PCI/CQI when the UE is configured with two serving and one assisting serving or one serving and two assisting serving HS-DSCH cells .....	130
4.7.4.3.3	Physical Channel mapping for HS-DPCCH HARQ-ACK and PCI/CQI when the UE is configured with two serving and two assisting serving HS-DSCH cells .....	131
4.7.4.4	Physical Channel mapping for HS-DPCCH when the UE is configured in MIMO mode with four transmit antennas in at least one cell .....	132
4.7.4.4.1	Physical Channel mapping for HS-DPCCH HARQ-ACK .....	132
4.7.4.4.2	Physical Channel mapping for HS-DPCCH NTBP/PCI/CQI .....	133
4.8	Coding for E-DCH .....	135
4.8.1	CRC attachment for E-DCH .....	137
4.8.2	Code block segmentation for E-DCH .....	137
4.8.3	Channel coding for E-DCH .....	137
4.8.4	Physical layer HARQ functionality and rate matching for E-DCH .....	137
4.8.4.1	Determination of SF, modulation scheme and number of E-DPDCH PhCHs needed .....	137
4.8.4.1A	Determination of SF, modulation scheme and number of S-E-DPDCH PhCHs needed .....	139
4.8.4.2	HARQ bit separation .....	140
4.8.4.3	HARQ Rate Matching Stage .....	140
4.8.4.4	HARQ bit collection .....	141
4.8.5	Physical channel segmentation for E-DCH .....	141
4.8.6	Interleaving for E-DCH .....	141
4.8.7	Physical channel mapping for E-DCH .....	142
4.9	Coding for E-DPCCH .....	142
4.9.1	Overview .....	143
4.9.2	E-DPCCH information field mapping .....	143
4.9.2.1	Information field mapping of E-TFCl .....	143
4.9.2.2	Information field mapping of retransmission sequence number .....	143



4.9.2.3	Information field mapping of the "Happy" bit .....	144
4.9.3	Multiplexing of E-DPCCH information .....	144
4.9.4	Channel coding for E-DPCCH.....	144
4.9.5	Physical channel mapping for E-DPCCH.....	144
4.9A	Coding for S-E-DPCCH .....	145
4.9A.1	Overview .....	145
4.9A.2	S-E-DPCCH information field mapping.....	145
4.9A.2.1	Information field mapping of E-TFCI.....	145
4.9A.2.2	Information field mapping of retransmission sequence number .....	145
4.9A.2.3	Information field mapping of the Spare bit .....	145
4.9A.3	Multiplexing of S-E-DPCCH information.....	145
4.9A.4	Channel coding for S-E-DPCCH .....	145
4.9A.5	Physical channel mapping for S-E-DPCCH .....	145
4.10	Coding for E-AGCH .....	145
4.10.1	Overview .....	145
4.10.1A	E-AGCH information field mapping .....	146
4.10.1A.1	Information field mapping of the Absolute Grant Value .....	146
4.10.1A.2	Information field mapping of the Absolute Grant Scope .....	148
4.10.1B	Multiplexing of E-AGCH information .....	148
4.10.2	CRC attachment for E-AGCH .....	149
4.10.3	Channel coding for E-AGCH.....	149
4.10.4	Rate matching for E-AGCH.....	149
4.10.5	Physical channel mapping for E-AGCH.....	149
4.10A	Coding for E-ROCH.....	149
4.10A.1	Overview .....	149
4.10A.2	E-ROCH information field mapping .....	150
4.10A.2.1	Information field mapping of the S-ETFC Offset .....	150
4.10A.2.2	Information field mapping of the Rank Indication.....	151
4.10A.3	Multiplexing of E-ROCH information.....	151
4.10A.4	CRC attachment for E-ROCH .....	151
4.10A.5	Channel coding for E-ROCH.....	152
4.10A.6	Rate matching for E-ROCH.....	152
4.10A.7	Physical channel mapping for E-ROCH.....	152
4.11	Mapping for E-RGCH Relative Grant.....	152
4.11.1	Overview .....	152
4.11.2	Relative Grant mapping .....	152
4.12	Mapping for E-HICH ACK/NACK.....	152
4.12.1	Overview .....	152
4.12.2	ACK/NACK mapping.....	152
<b>Annex A (informative): Blind transport format detection.....</b>		<b>154</b>
A.1	Blind transport format detection using fixed positions .....	154
A.1.1	Blind transport format detection using received power ratio.....	154
A.1.2	Blind transport format detection using CRC .....	154
<b>Annex B (informative): Compressed mode idle lengths.....</b>		<b>157</b>
B.1	Idle lengths for DL, UL and DL+UL compressed mode for DPCH .....	157
<b>Annex C (informative): Change history .....</b>		<b>159</b>
History .....		164

---

# Foreword

This Technical Specification (TS) has been produced by the 3<sup>rd</sup> Generation Partnership Project (3GPP).

The contents of the present document are subject to continuing work within the TSG and may change following formal TSG approval. Should the TSG modify the contents of the present document, it will be re-released by the TSG with an identifying change of release date and an increase in version number as follows:

Version x.y.z

where:

- x the first digit:
  - 1 presented to TSG for information;
  - 2 presented to TSG for approval;
  - 3 or greater indicates TSG approved document under change control.
- y the second digit is incremented for all changes of substance, i.e. technical enhancements, corrections, updates, etc.
- z the third digit is incremented when editorial only changes have been incorporated in the document.

---

# 1 Scope

The present document describes the characteristics of the Layer 1 multiplexing and channel coding in the FDD mode of UTRA.

---

## 2 References

The following documents contain provisions which, through reference in this text, constitute provisions of the present document.

- References are either specific (identified by date of publication, edition number, version number, etc.) or non-specific.
- For a specific reference, subsequent revisions do not apply.
- For a non-specific reference, the latest version applies.

- [1] 3GPP TS 25.201: "Physical layer - General Description".
- [2] 3GPP TS 25.211: "Physical channels and mapping of transport channels onto physical channels (FDD)".
- [3] 3GPP TS 25.213: "Spreading and modulation (FDD)".
- [4] 3GPP TS 25.214: "Physical layer procedures (FDD)".
- [5] 3GPP TS 25.215: "Physical layer – Measurements (FDD)".
- [6] 3GPP TS 25.221: "Physical channels and mapping of transport channels onto physical channels (TDD)".
- [7] 3GPP TS 25.222: "Multiplexing and channel coding (TDD)".
- [8] 3GPP TS 25.223: "Spreading and modulation (TDD)".
- [9] 3GPP TS 25.224: "Physical layer procedures (TDD)".
- [10] 3GPP TS 25.225: "Physical layer – Measurements (TDD)".
- [11] 3GPP TS 25.302: "Services Provided by the Physical Layer".
- [12] 3GPP TS 25.402: "Synchronization in UTRAN, Stage 2".
- [13] 3GPP TS 25.331: "Radio Resource Control (RRC); Protocol Specification".
- [14] ITU-T Recommendation X.691 (12/97) "Information technology - ASN.1 encoding rules: Specification of Packed Encoding Rules (PER)"
- [15] 3GPP TS 25.306: "UE Radio Access capabilities".
- [16] 3GPP TS 25.321: "Medium Access Control (MAC) protocol specification".

---

## 3 Definitions, symbols and abbreviations

### 3.1 Definitions

For the purposes of the present document, the following terms and definitions apply:

**Assisting secondary serving HS-DSCH Cell:** In addition to the serving HS-DSCH cell, a cell in the secondary downlink frequency, where the UE is configured to simultaneously monitor a HS-SCCH set and receive HS-DSCH if it is scheduled in that cell.

**Assisting serving HS-DSCH Cell:** In addition to the serving HS-DSCH cell, a cell in the same frequency, where the UE is configured to simultaneously monitor a HS-SCCH set and receive HS-DSCH if it is scheduled in that cell.

**Cell group:** A group of (one or two) Multiflow mode cells that have the same CPICH timing. The CQI reports for all the cells in a cell group are reported together in the same sub frame. The cells that belong to a cell group are indicated by higher layers.

**MIMO mode:** This term refers to the downlink MIMO configuration with two transmit antennas

**MIMO mode with four transmit antennas:** This term refers to the downlink MIMO configuration with four transmit antennas

**Multiflow mode:** The UE is configured in Multiflow mode when it is configured with assisting serving HS-DSCH cell.

**Primary uplink frequency:** If a single uplink frequency is configured for the UE, then it is the primary uplink frequency. In case more than one uplink frequency is configured for the UE, then the primary uplink frequency is the frequency on which the E-DCH corresponding to the serving E-DCH cell associated with the serving HS-DSCH cell is transmitted. The association between a pair of uplink and downlink frequencies is indicated by higher layers.

**Secondary uplink frequency:** A secondary uplink frequency is a frequency on which an E-DCH corresponding to a serving E-DCH cell associated with a secondary serving HS-DSCH cell is transmitted. The association between a pair of uplink and downlink frequencies is indicated by higher layers.

**TG:** Transmission Gap is consecutive empty slots that have been obtained with a transmission time reduction method. The transmission gap can be contained in one or two consecutive radio frames.

**TGL:** Transmission Gap Length is the number of consecutive empty slots that have been obtained with a transmission time reduction method.  $0 \leq TGL \leq 14$ . The CFNs of the radio frames containing the first empty slot of the transmission gaps, the CFNs of the radio frames containing the last empty slot, the respective positions  $N_{\text{first}}$  and  $N_{\text{last}}$  within these frames of the first and last empty slots of the transmission gaps, and the transmission gap lengths can be calculated with the compressed mode parameters described in [5].

**TrCH number:** The transport channel number identifies a TrCH in the context of L1. The L3 transport channel identity (TrCH ID) maps onto the L1 transport channel number. The mapping between the transport channel number and the TrCH ID is as follows: TrCH 1 corresponds to the TrCH with the lowest TrCH ID, TrCH 2 corresponds to the TrCH with the next lowest TrCH ID and so on.

**1<sup>st</sup> secondary serving HS-DSCH cell:** If the UE is configured with two uplink frequencies, the 1<sup>st</sup> secondary serving HS-DSCH cell is the secondary serving HS-DSCH cell that is associated with the secondary uplink frequency. If the UE is configured with a single uplink frequency, the 1<sup>st</sup> secondary serving HS-DSCH cell is a secondary serving HS-DSCH cell whose index is indicated by higher layers.

**2<sup>nd</sup> secondary serving HS-DSCH cell:** If the UE is configured with more than two serving HS-DSCH cells, the 2<sup>nd</sup> secondary serving HS-DSCH cell is a secondary serving HS-DSCH cell whose index is indicated by higher layers.

**3<sup>rd</sup> secondary serving HS-DSCH cell:** If the UE is configured with more than three serving HS-DSCH cells, the 3<sup>rd</sup> secondary serving HS-DSCH cell is a secondary serving HS-DSCH cell whose index is indicated by higher layers.

**4<sup>th</sup> secondary serving HS-DSCH cell:** If the UE is configured with more than four serving HS-DSCH cells, the 4<sup>th</sup> secondary serving HS-DSCH cell is a secondary serving HS-DSCH cell whose index is indicated by higher layers.

**5<sup>th</sup> secondary serving HS-DSCH cell:** If the UE is configured with more than five serving HS-DSCH cells, the 5<sup>th</sup> secondary serving HS-DSCH cell is a secondary serving HS-DSCH cell whose index is indicated by higher layers.

**6<sup>th</sup> secondary serving HS-DSCH cell:** If the UE is configured with more than six serving HS-DSCH cells, the 6<sup>th</sup> secondary serving HS-DSCH cell is a secondary serving HS-DSCH cell whose index is indicated by higher layers.

**7<sup>th</sup> secondary serving HS-DSCH cell:** If the UE is configured with eight serving HS-DSCH cells, the 7<sup>th</sup> secondary serving HS-DSCH cell is a secondary serving HS-DSCH cell whose index is indicated by higher layers.

## 3.2 Symbols

For the purposes of the present document, the following symbols apply:

$\lceil x \rceil$	round towards $\infty$ , i.e. integer such that $x \leq \lceil x \rceil < x+1$
$\lfloor x \rfloor$	round towards $-\infty$ , i.e. integer such that $x-1 < \lfloor x \rfloor \leq x$
$ x $	absolute value of $x$
$\text{sgn}(x)$	signum function, i.e. $\text{sgn}(x) = \begin{cases} 1; & x \geq 0 \\ -1; & x < 0 \end{cases}$
$N_{first}$	The first slot in the <i>TG</i> , located in the first compressed radio frame if the <i>TG</i> spans two frames.
$N_{last}$	The last slot in the <i>TG</i> , located in the second compressed radio frame if the <i>TG</i> spans two frames.
$N_{tr}$	Number of transmitted slots in a radio frame.

Unless otherwise is explicitly stated when the symbol is used, the meaning of the following symbols is:

$i$	TrCH number
$j$	TFC number
$k$	Bit number
$l$	TF number
$m$	Transport block number
$n_i$	Radio frame number of TrCH $i$ .
$p$	PhCH number
$r$	Code block number
$I$	Number of TrCHs in a CCTrCH.
$C_i$	Number of code blocks in one TTI of TrCH $i$ .
$F_i$	Number of radio frames in one TTI of TrCH $i$ .
$M_i$	Number of transport blocks in one TTI of TrCH $i$ .
$N_{data,j}$	Number of data bits that are available for the CCTrCH in a radio frame with TFC $j$ .
$N_{data,j}^{cm}$	Number of data bits that are available for the CCTrCH in a compressed radio frame with TFC $j$ .
$P$	Number of PhCHs used for one CCTrCH.
$PL$	Puncturing Limit for the uplink. Signalled from higher layers
$RM_i$	Rate Matching attribute for TrCH $i$ . Signalled from higher layers.

Temporary variables, i.e. variables used in several (sub)clauses with different meaning.

$x, X$   
 $y, Y$   
 $z, Z$

## 3.3 Abbreviations

For the purposes of the present document, the following abbreviations apply:

ARQ	Automatic Repeat Request
BCH	Broadcast Channel
BER	Bit Error Rate
BLER	Block Error Rate
BS	Base Station
CCPCH	Common Control Physical Channel
CCTrCH	Coded Composite Transport Channel
CFN	Connection Frame Number
CLTD	Closed Loop Transmit Diversity
CRC	Cyclic Redundancy Check
DCH	Dedicated Channel
DL	Downlink (Forward link)
DPCCCH	Dedicated Physical Control Channel
DPCH	Dedicated Physical Channel
DPDCH	Dedicated Physical Data Channel
DS-CDMA	Direct-Sequence Code Division Multiple Access
DTX	Discontinuous Transmission

FACH	Forward Access Channel
E-AGCH	E-DCH Absolute Grant Channel
E-DCH	Enhanced Dedicated Channel
E-DPCCH	E-DCH Dedicated Physical Control Channel
E-DPDCH	E-DCH Dedicated Physical Data Channel
E-HICH	E-DCH Hybrid ARQ Indicator Channel
E-RGCH	E-DCH Relative Grant Channel
E-RNTI	E-DCH Radio Network Temporary Identifier
E-ROCH	E-DCH Rank and Offset Channel
FDD	Frequency Division Duplex
F-DPCH	Fractional Dedicated Physical Channel
F-TPICH	Fractional Transmitted Precoding Indicator Channel
FER	Frame Error Rate
GF	Galois Field
HARQ	Hybrid Automatic Repeat reQuest
HS-DPCCH	Dedicated Physical Control Channel (uplink) for HS-DSCH
HS-DPCCH <sub>2</sub>	Secondary Dedicated Physical Control Channel (uplink) for HS-DSCH, when Secondary_Cell_Enabled is greater than 3
HS-DSCH	High Speed Downlink Shared Channel
HS-PDSCH	High Speed Physical Downlink Shared Channel
HS-SCCH	Shared Control Channel for HS-DSCH
MAC	Medium Access Control
MBSFN	MBMS over a Single Frequency Network
Mcps	Mega Chip Per Second
MIMO	Multiple Input Multiple Output
MS	Mobile Station
OVSF	Orthogonal Variable Spreading Factor (codes)
PCCC	Parallel Concatenated Convolutional Code
PCH	Paging Channel
PhCH	Physical Channel
PRACH	Physical Random Access Channel
RACH	Random Access Channel
RSC	Recursive Systematic Convolutional Coder
RV	Redundancy Version
RX	Receive
SCH	Synchronization Channel
SF	Spreading Factor
SFN	System Frame Number
SIR	Signal-to-Interference Ratio
SNR	Signal to Noise Ratio
S-DPCCH	Secondary Dedicated Physical Control Channel
S-E-DPCCH	Secondary Dedicated Physical Control Channel for E-DCH
S-E-DPDCH	Secondary Dedicated Physical Data Channel for E-DCH
S-E-RNTI	Secondary E-RNTI
TF	Transport Format
TFC	Transport Format Combination
TFCI	Transport Format Combination Indicator
TPC	Transmit Power Control
TPI	Transmitted Precoding Indicator
TrCH	Transport Channel
TTI	Transmission Time Interval
TX	Transmit
UL	Uplink (Reverse link)

---

## 4 Multiplexing, channel coding and interleaving

### 4.1 General

Data stream from/to MAC and higher layers (Transport block / Transport block set) is encoded/decoded to offer transport services over the radio transmission link. Channel coding scheme is a combination of error detection, error correcting, rate matching, interleaving and transport channels mapping onto/splitting from physical channels.

### 4.2 General coding/multiplexing of TrCHs

This section only applies to the transport channels: DCH, RACH, BCH, FACH and PCH. Other transport channels which do not use the general method are described separately below.

Data arrives to the coding/multiplexing unit in form of transport block sets once every transmission time interval. The transmission time interval is transport-channel specific from the set {10 ms, 20 ms, 40 ms, 80 ms}, where 80 ms TTI for DCH shall not be used unless SF=512.

The following coding/multiplexing steps can be identified:

- add CRC to each transport block (see subclause 4.2.1);
- transport block concatenation and code block segmentation (see subclause 4.2.2);
- channel coding (see subclause 4.2.3);
- radio frame equalisation (see subclause 4.2.4);
- rate matching (see subclause 4.2.7);
- insertion of discontinuous transmission (DTX) indication bits (see subclause 4.2.9);
- interleaving (two steps, see subclauses 4.2.5 and 4.2.11);
- radio frame segmentation (see subclause 4.2.6);
- multiplexing of transport channels (see subclause 4.2.8);
- physical channel segmentation (see subclause 4.2.10);
- mapping to physical channels (see subclause 4.2.12).

The coding/multiplexing steps for uplink and downlink are shown in figure 1 and figure 2 respectively.

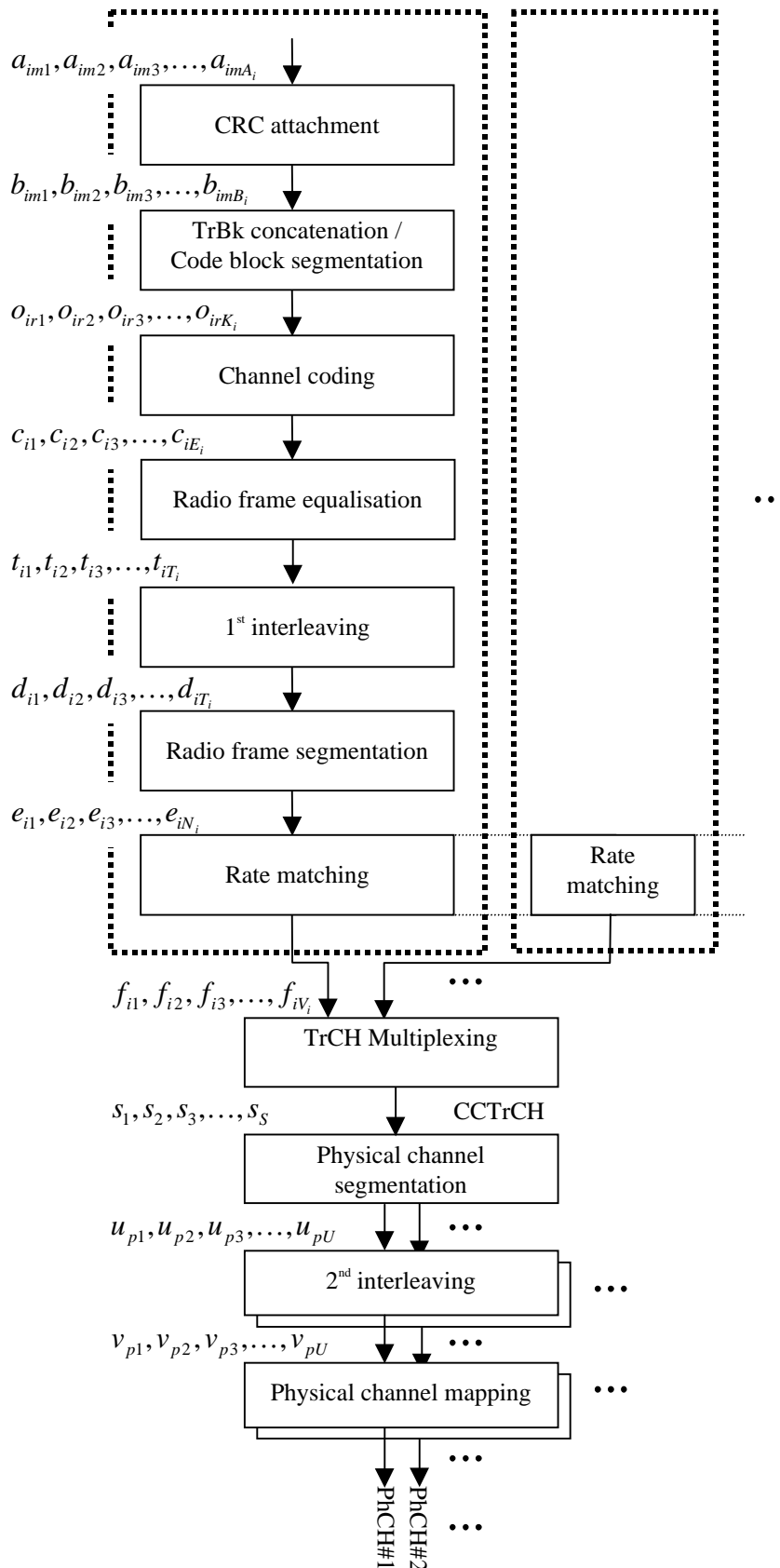
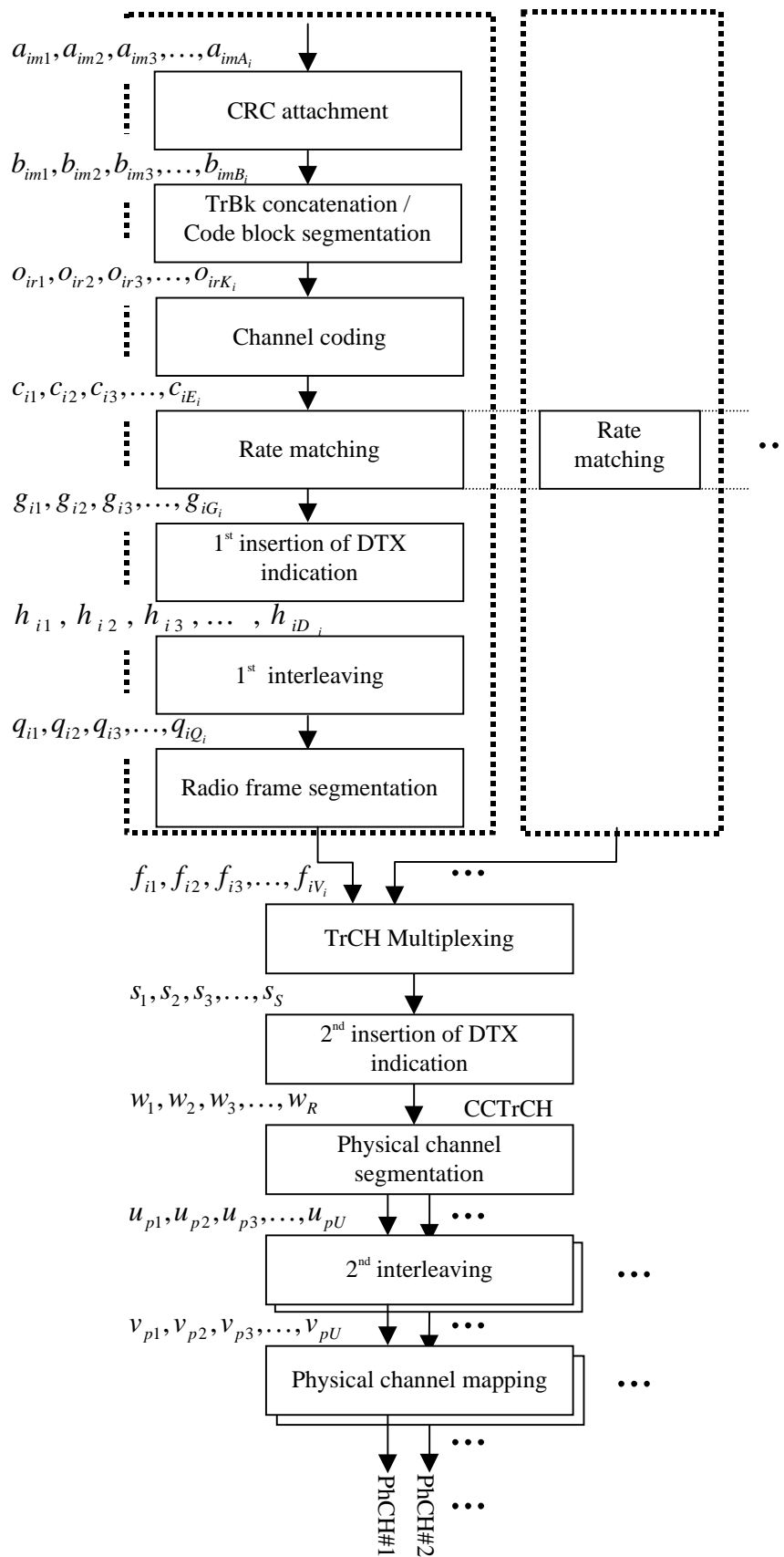

Figure 1: Transport channel multiplexing structure for uplink





**Figure 2: Transport channel multiplexing structure for downlink**

The single output data stream from the TrCH multiplexing, including DTX indication bits in downlink, is denoted *Coded Composite Transport Channel (CCTrCH)*. A CCTrCH can be mapped to one or several physical channels.

## 4.2.1 CRC attachment

Error detection is provided on transport blocks through a Cyclic Redundancy Check (CRC). The size of the CRC is 24, 16, 12, 8 or 0 bits and it is signalled from higher layers what CRC size that should be used for each TrCH.

### 4.2.1.1 CRC Calculation

The entire transport block is used to calculate the CRC parity bits for each transport block. The parity bits are generated by one of the following cyclic generator polynomials:

- $g_{\text{CRC24}}(D) = D^{24} + D^{23} + D^6 + D^5 + D + 1$ ;
- $g_{\text{CRC16}}(D) = D^{16} + D^{12} + D^5 + 1$ ;
- $g_{\text{CRC12}}(D) = D^{12} + D^{11} + D^3 + D^2 + D + 1$ ;
- $g_{\text{CRC8}}(D) = D^8 + D^7 + D^4 + D^3 + D + 1$ .

Denote the bits in a transport block delivered to layer 1 by  $a_{im1}, a_{im2}, a_{im3}, \dots, a_{imA_i}$ , and the parity bits by  $p_{im1}, p_{im2}, p_{im3}, \dots, p_{imL_i}$ .  $A_i$  is the size of a transport block of TrCH  $i$ ,  $m$  is the transport block number, and  $L_i$  is the number of parity bits.  $L_i$  can take the values 24, 16, 12, 8, or 0 depending on what is signalled from higher layers.

The encoding is performed in a systematic form, which means that in GF(2), the polynomial:

$$a_{im1}D^{A_i+23} + a_{im2}D^{A_i+22} + \dots + a_{imA_i}D^{24} + p_{im1}D^{23} + p_{im2}D^{22} + \dots + p_{im23}D^1 + p_{im24}$$

yields a remainder equal to 0 when divided by  $g_{\text{CRC24}}(D)$ , polynomial:

$$a_{im1}D^{A_i+15} + a_{im2}D^{A_i+14} + \dots + a_{imA_i}D^{16} + p_{im1}D^{15} + p_{im2}D^{14} + \dots + p_{im15}D^1 + p_{im16}$$

yields a remainder equal to 0 when divided by  $g_{\text{CRC16}}(D)$ , polynomial:

$$a_{im1}D^{A_i+11} + a_{im2}D^{A_i+10} + \dots + a_{imA_i}D^{12} + p_{im1}D^{11} + p_{im2}D^{10} + \dots + p_{im11}D^1 + p_{im12}$$

yields a remainder equal to 0 when divided by  $g_{\text{CRC12}}(D)$  and polynomial:

$$a_{im1}D^{A_i+7} + a_{im2}D^{A_i+6} + \dots + a_{imA_i}D^8 + p_{im1}D^7 + p_{im2}D^6 + \dots + p_{im7}D^1 + p_{im8}$$

yields a remainder equal to 0 when divided by  $g_{\text{CRC8}}(D)$ .

If no transport blocks are input to the CRC calculation ( $M_i = 0$ ), no CRC attachment shall be done. If transport blocks are input to the CRC calculation ( $M_i \neq 0$ ) and the size of a transport block is zero ( $A_i = 0$ ), CRC shall be attached, i.e. all parity bits equal to zero.

### 4.2.1.2 Relation between input and output of the CRC attachment block

The bits after CRC attachment are denoted by  $b_{im1}, b_{im2}, b_{im3}, \dots, b_{imB_i}$ , where  $B_i = A_i + L_i$ . The relation between  $a_{imk}$  and  $b_{imk}$  is:

$$b_{imk} = a_{imk} \quad k = 1, 2, 3, \dots, A_i$$

$$b_{imk} = p_{im(L_i+1-(k-A_i))} \quad k = A_i + 1, A_i + 2, A_i + 3, \dots, A_i + L_i$$

## 4.2.2 Transport block concatenation and code block segmentation

All transport blocks in a TTI are serially concatenated. If the number of bits in a TTI is larger than  $Z$ , the maximum size of a code block in question, then code block segmentation is performed after the concatenation of the transport blocks. The maximum size of the code blocks depends on whether convolutional coding or turbo coding is used for the TrCH.

### 4.2.2.1 Concatenation of transport blocks

The bits input to the transport block concatenation are denoted by  $b_{im1}, b_{im2}, b_{im3}, \dots, b_{imB_i}$  where  $i$  is the TrCH number,  $m$  is the transport block number, and  $B_i$  is the number of bits in each block (including CRC). The number of transport blocks on TrCH  $i$  is denoted by  $M_i$ . The bits after concatenation are denoted by  $x_{i1}, x_{i2}, x_{i3}, \dots, x_{iX_i}$ , where  $i$  is the TrCH number and  $X_i = M_i B_i$ . They are defined by the following relations:

$$x_{ik} = b_{i1k} \quad k = 1, 2, \dots, B_i$$

$$x_{ik} = b_{i,2,(k-B_i)} \quad k = B_i + 1, B_i + 2, \dots, 2B_i$$

$$x_{ik} = b_{i,3,(k-2B_i)} \quad k = 2B_i + 1, 2B_i + 2, \dots, 3B_i$$

...

$$x_{ik} = b_{i,M_i,(k-(M_i-1)B_i)} \quad k = (M_i - 1)B_i + 1, (M_i - 1)B_i + 2, \dots, M_i B_i$$

### 4.2.2.2 Code block segmentation

Segmentation of the bit sequence from transport block concatenation is performed if  $X_i > Z$ . The code blocks after segmentation are of the same size. The number of code blocks on TrCH  $i$  is denoted by  $C_i$ . If the number of bits input to the segmentation,  $X_i$ , is not a multiple of  $C_i$ , filler bits are added to the beginning of the first block. If turbo coding is selected and  $X_i < 40$ , filler bits are added to the beginning of the code block. The filler bits are transmitted and they are always set to 0. The maximum code block sizes are:

- convolutional coding:  $Z = 504$ ;
- turbo coding:  $Z = 5114$ .

The bits output from code block segmentation, for  $C_i \neq 0$ , are denoted by  $o_{ir1}, o_{ir2}, o_{ir3}, \dots, o_{irK_i}$ , where  $i$  is the TrCH number,  $r$  is the code block number, and  $K_i$  is the number of bits per code block.

Number of code blocks:

$$C_i = \lceil X_i / Z \rceil$$

Number of bits in each code block (applicable for  $C_i \neq 0$  only):

if  $X_i < 40$  and Turbo coding is used, then

$$K_i = 40$$

else

$$K_i = \lceil X_i / C_i \rceil$$

end if

Number of filler bits:  $Y_i = C_i K_i - X_i$

for  $k = 1$  to  $Y_i$                       -- Insertion of filler bits

$$o_{ik} = 0$$

```

end for
for  $k = Y_i + 1$  to  $K_i$ 
     $O_{ik} = x_{i,(k-Y_i)}$ 
end for
 $r = 2$                                 -- Segmentation
while  $r \leq C_i$ 
    for  $k = 1$  to  $K_i$ 
         $O_{irk} = x_{i,(k+(r-1)K_i-Y_i)}^I$ 
    end for
     $r = r + 1$ 
end while

```

### 4.2.3 Channel coding

Code blocks are delivered to the channel coding block. They are denoted by  $O_{ir1}, O_{ir2}, O_{ir3}, \dots, O_{irK_i}$ , where  $i$  is the TrCH number,  $r$  is the code block number, and  $K_i$  is the number of bits in each code block. The number of code blocks on TrCH  $i$  is denoted by  $C_i$ . After encoding the bits are denoted by  $y_{ir1}, y_{ir2}, y_{ir3}, \dots, y_{irY_i}$ , where  $Y_i$  is the number of encoded bits. The relation between  $O_{irk}$  and  $y_{irk}$  and between  $K_i$  and  $Y_i$  is dependent on the channel coding scheme.

The following channel coding schemes can be applied to TrCHs:

- convolutional coding;
- turbo coding.

Usage of coding scheme and coding rate for the different types of TrCH is shown in table 1.

The values of  $Y_i$  in connection with each coding scheme:

- convolutional coding with rate 1/2:  $Y_i = 2 * K_i + 16$ ; rate 1/3:  $Y_i = 3 * K_i + 24$ ;
- turbo coding with rate 1/3:  $Y_i = 3 * K_i + 12$ .

**Table 1: Usage of channel coding scheme and coding rate**

Type of TrCH	Coding scheme	Coding rate
BCH	Convolutional coding	1/2
PCH		
RACH		
DCH, FACH	Turbo coding	1/3

#### 4.2.3.1 Convolutional coding

Convolutional codes with constraint length 9 and coding rates 1/3 and 1/2 are defined.

The configuration of the convolutional coder is presented in figure 3.

Output from the rate 1/3 convolutional coder shall be done in the order output0, output1, output2, output0, output1, output 2, output 0, ..., output2. Output from the rate 1/2 convolutional coder shall be done in the order output 0, output 1, output 0, output 1, output 0, ..., output 1.

8 tail bits with binary value 0 shall be added to the end of the code block before encoding.

The initial value of the shift register of the coder shall be "all 0" when starting to encode the input bits.

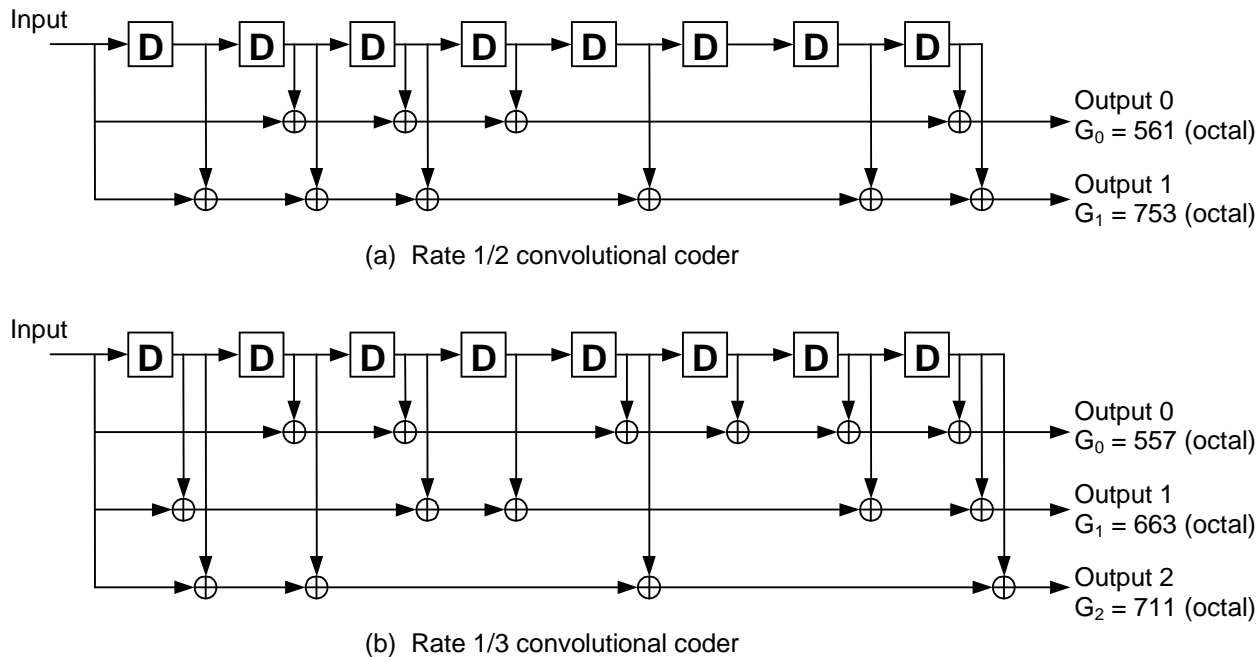

Figure 3: Rate 1/2 and rate 1/3 convolutional coders

4.2.3.2 Turbo coding

4.2.3.2.1 Turbo coder

The scheme of Turbo coder is a Parallel Concatenated Convolutional Code (PCCC) with two 8-state constituent encoders and one Turbo code internal interleaver. The coding rate of Turbo coder is 1/3. The structure of Turbo coder is illustrated in figure 4.

The transfer function of the 8-state constituent code for PCCC is:

$$G(D) = \left[ 1, \frac{g_1(D)}{g_0(D)} \right],$$

where

$$g_0(D) = 1 + D^2 + D^3,$$

$$g_1(D) = 1 + D + D^3.$$

The initial value of the shift registers of the 8-state constituent encoders shall be all zeros when starting to encode the input bits.

Output from the Turbo coder is

$$x_1, z_1, z'_1, x_2, z_2, z'_2, \dots, x_K, z_K, z'_K,$$

where  $x_1, x_2, \dots, x_K$  are the bits input to the Turbo coder i.e. both first 8-state constituent encoder and Turbo code internal interleaver, and  $K$  is the number of bits, and  $z_1, z_2, \dots, z_K$  and  $z'_1, z'_2, \dots, z'_K$  are the bits output from first and second 8-state constituent encoders, respectively.

The bits output from Turbo code internal interleaver are denoted by  $x'_1, x'_2, \dots, x'_K$ , and these bits are to be input to the second 8-state constituent encoder.

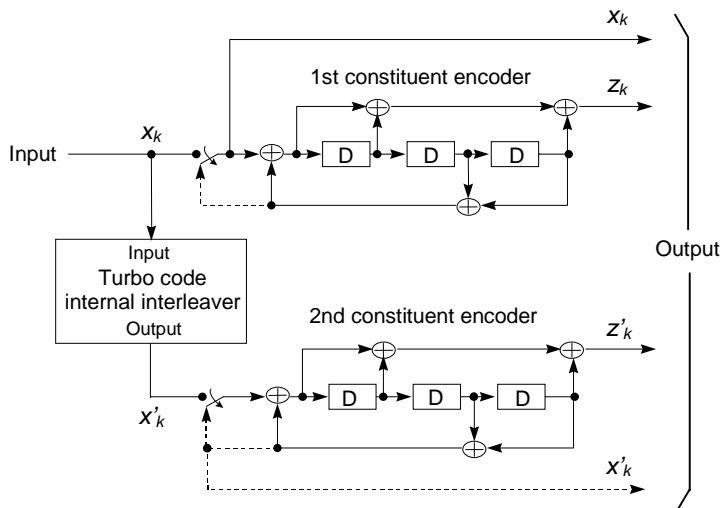

Figure 4: Structure of rate 1/3 Turbo coder (dotted lines apply for trellis termination only)

4.2.3.2.2 Trellis termination for Turbo coder

Trellis termination is performed by taking the tail bits from the shift register feedback after all information bits are encoded. Tail bits are padded after the encoding of information bits.

The first three tail bits shall be used to terminate the first constituent encoder (upper switch of figure 4 in lower position) while the second constituent encoder is disabled. The last three tail bits shall be used to terminate the second constituent encoder (lower switch of figure 4 in lower position) while the first constituent encoder is disabled.

The transmitted bits for trellis termination shall then be:

$$x_{K+1}, z_{K+1}, x_{K+2}, z_{K+2}, x_{K+3}, z_{K+3}, x'_{K+1}, z'_{K+1}, x'_{K+2}, z'_{K+2}, x'_{K+3}, z'_{K+3}.$$

4.2.3.2.3 Turbo code internal interleaver

The Turbo code internal interleaver consists of bits-input to a rectangular matrix with padding, intra-row and inter-row permutations of the rectangular matrix, and bits-output from the rectangular matrix with pruning. The bits input to the Turbo code internal interleaver are denoted by  $x_1, x_2, x_3, \dots, x_K$ , where  $K$  is the integer number of the bits and takes one value of  $40 \leq K \leq 5114$ . The relation between the bits input to the Turbo code internal interleaver and the bits input to the channel coding is defined by  $x_k = o_{irk}$  and  $K = K_i$ .

The following subclause specific symbols are used in subclauses 4.2.3.2.3.1 to 4.2.3.2.3.3:

- $K$  Number of bits input to Turbo code internal interleaver
- $R$  Number of rows of rectangular matrix
- $C$  Number of columns of rectangular matrix
- $p$  Prime number
- $v$  Primitive root
- $\langle s(j) \rangle_{j \in \{0,1,\dots,p-2\}}$  Base sequence for intra-row permutation
- $q_i$  Minimum prime integers
- $r_i$  Permuted prime integers

$\langle T(i) \rangle_{i \in \{0,1,\dots,R-1\}}$  Inter-row permutation pattern

$\langle U_i(j) \rangle_{j \in \{0,1,\dots,C-1\}}$  Intra-row permutation pattern of  $i$ -th row

$i$  Index of row number of rectangular matrix

$j$  Index of column number of rectangular matrix

$k$  Index of bit sequence

#### 4.2.3.2.3.1 Bits-input to rectangular matrix with padding

The bit sequence  $x_1, x_2, x_3, \dots, x_K$  input to the Turbo code internal interleaver is written into the rectangular matrix as follows.

(1) Determine the number of rows of the rectangular matrix,  $R$ , such that:

$$R = \begin{cases} 5, & \text{if } (40 \leq K \leq 159) \\ 10, & \text{if } ((160 \leq K \leq 200) \text{ or } (481 \leq K \leq 530)) \\ 20, & \text{if } (K = \text{any other value}) \end{cases} .$$

The rows of rectangular matrix are numbered  $0, 1, \dots, R - 1$  from top to bottom.

(2) Determine the prime number to be used in the intra-permutation,  $p$ , and the number of columns of rectangular matrix,  $C$ , such that:

if  $(481 \leq K \leq 530)$  then

$$p = 53 \text{ and } C = p.$$

else

Find minimum prime number  $p$  from table 2 such that

$$K \leq R \times (p + 1),$$

and determine  $C$  such that

$$C = \begin{cases} p - 1 & \text{if } K \leq R \times (p - 1) \\ p & \text{if } R \times (p - 1) < K \leq R \times p \\ p + 1 & \text{if } R \times p < K \end{cases} .$$

end if

The columns of rectangular matrix are numbered  $0, 1, \dots, C - 1$  from left to right.

**Table 2: List of prime number  $p$  and associated primitive root  $v$** 

$p$	$v$	$p$	$v$	$p$	$v$	$p$	$v$	$p$	$v$
7	3	47	5	101	2	157	5	223	3
11	2	53	2	103	5	163	2	227	2
13	2	59	2	107	2	167	5	229	6
17	3	61	2	109	6	173	2	233	3
19	2	67	2	113	3	179	2	239	7
23	5	71	7	127	3	181	2	241	7
29	2	73	5	131	2	191	19	251	6
31	3	79	3	137	3	193	5	257	3
37	2	83	2	139	2	197	2		
41	6	89	3	149	2	199	3		
43	3	97	5	151	6	211	2		

- (3) Write the input bit sequence  $x_1, x_2, x_3, \dots, x_K$  into the  $R \times C$  rectangular matrix row by row starting with bit  $y_1$  in column 0 of row 0:

$$\begin{bmatrix} y_1 & y_2 & y_3 & \dots & y_C \\ y_{(C+1)} & y_{(C+2)} & y_{(C+3)} & \dots & y_{2C} \\ \vdots & \vdots & \vdots & \dots & \vdots \\ y_{((R-1)C+1)} & y_{((R-1)C+2)} & y_{((R-1)C+3)} & \dots & y_{R \times C} \end{bmatrix}$$

where  $y_k = x_k$  for  $k = 1, 2, \dots, K$  and if  $R \times C > K$ , the dummy bits are padded such that  $y_k = 0$  or  $1$  for  $k = K + 1, K + 2, \dots, R \times C$ . These dummy bits are pruned away from the output of the rectangular matrix after intra-row and inter-row permutations.

#### 4.2.3.2.3.2 Intra-row and inter-row permutations

After the bits-input to the  $R \times C$  rectangular matrix, the intra-row and inter-row permutations for the  $R \times C$  rectangular matrix are performed stepwise by using the following algorithm with steps (1) – (6):

- (1) Select a primitive root  $v$  from table 2 in clause 4.2.3.2.3.1, which is indicated on the right side of the prime number  $p$ .

- (2) Construct the base sequence  $\langle s(j) \rangle_{j \in \{0, 1, \dots, p-2\}}$  for intra-row permutation as:

$$s(j) = (v \times s(j-1)) \bmod p, \quad j = 1, 2, \dots, (p-2), \text{ and } s(0) = 1.$$

- (3) Assign  $q_0 = 1$  to be the first prime integer in the sequence  $\langle q_i \rangle_{i \in \{0, 1, \dots, R-1\}}$ , and determine the prime integer  $q_i$  in the sequence  $\langle q_i \rangle_{i \in \{0, 1, \dots, R-1\}}$  to be a least prime integer such that  $\text{g.c.d}(q_i, p-1) = 1$ ,  $q_i > 6$ , and  $q_i > q_{(i-1)}$  for each  $i = 1, 2, \dots, R-1$ . Here g.c.d. is greatest common divisor.

- (4) Permute the sequence  $\langle q_i \rangle_{i \in \{0, 1, \dots, R-1\}}$  to make the sequence  $\langle r_i \rangle_{i \in \{0, 1, \dots, R-1\}}$  such that

$$r_{T(i)} = q_i, \quad i = 0, 1, \dots, R-1,$$

where  $\langle T(i) \rangle_{i \in \{0, 1, \dots, R-1\}}$  is the inter-row permutation pattern defined as the one of the four kind of patterns, which are shown in table 3, depending on the number of input bits  $K$ .



Table 3: Inter-row permutation patterns for Turbo code internal interleaver

Number of input bits $K$	Number of rows $R$	Inter-row permutation patterns $\langle T(0), T(1), \dots, T(R-1) \rangle$
$(40 \leq K \leq 159)$	5	$\langle 4, 3, 2, 1, 0 \rangle$
$(160 \leq K \leq 200)$ or $(481 \leq K \leq 530)$	10	$\langle 9, 8, 7, 6, 5, 4, 3, 2, 1, 0 \rangle$
$(2281 \leq K \leq 2480)$ or $(3161 \leq K \leq 3210)$	20	$\langle 19, 9, 14, 4, 0, 2, 5, 7, 12, 18, 16, 13, 17, 15, 3, 1, 6, 11, 8, 10 \rangle$
$K = \text{any other value}$	20	$\langle 19, 9, 14, 4, 0, 2, 5, 7, 12, 18, 10, 8, 13, 17, 3, 1, 16, 6, 15, 11 \rangle$

(5) Perform the  $i$ -th ( $i = 0, 1, \dots, R - 1$ ) intra-row permutation as:

if ( $C = p$ ) then

$$U_i(j) = s((j \times r_i) \bmod (p - 1)), \quad j = 0, 1, \dots, (p - 2), \text{ and } U_i(p - 1) = 0,$$

where  $U_i(j)$  is the original bit position of  $j$ -th permuted bit of  $i$ -th row.

end if

if ( $C = p + 1$ ) then

$$U_i(j) = s((j \times r_i) \bmod (p - 1)), \quad j = 0, 1, \dots, (p - 2). \quad U_i(p - 1) = 0, \text{ and } U_i(p) = p,$$

where  $U_i(j)$  is the original bit position of  $j$ -th permuted bit of  $i$ -th row, and

if ( $K = R \times C$ ) then

Exchange  $U_{R-1}(p)$  with  $U_{R-1}(0)$ .

end if

end if

if ( $C = p - 1$ ) then

$$U_i(j) = s((j \times r_i) \bmod (p - 1)) - 1, \quad j = 0, 1, \dots, (p - 2),$$

where  $U_i(j)$  is the original bit position of  $j$ -th permuted bit of  $i$ -th row.

end if

(6) Perform the inter-row permutation for the rectangular matrix based on the pattern  $\langle T(i) \rangle_{i \in \{0, 1, \dots, R-1\}}$ ,

where  $T(i)$  is the original row position of the  $i$ -th permuted row.

#### 4.2.3.2.3.3 Bits-output from rectangular matrix with pruning

After intra-row and inter-row permutations, the bits of the permuted rectangular matrix are denoted by  $y'_k$ :

$$\begin{bmatrix} y'_1 & y'_{(R+1)} & y'_{(2R+1)} & \cdots & y'_{((C-1)R+1)} \\ y'_2 & y'_{(R+2)} & y'_{(2R+2)} & \cdots & y'_{((C-1)R+2)} \\ \vdots & \vdots & \vdots & \cdots & \vdots \\ y'_R & y'_{2R} & y'_{3R} & \cdots & y'_{C \times R} \end{bmatrix}$$

The output of the Turbo code internal interleaver is the bit sequence read out column by column from the intra-row and inter-row permuted  $R \times C$  rectangular matrix starting with bit  $y'_1$  in row 0 of column 0 and ending with bit  $y'_{CR}$  in row  $R - 1$  of column  $C - 1$ . The output is pruned by deleting dummy bits that were padded to the input of the rectangular matrix before intra-row and inter row permutations, i.e. bits  $y'_k$  that corresponds to bits  $y_k$  with  $k > K$  are removed from the output. The bits output from Turbo code internal interleaver are denoted by  $x'_1, x'_2, \dots, x'_K$ , where  $x'_1$  corresponds to the bit  $y'_k$  with smallest index  $k$  after pruning,  $x'_2$  to the bit  $y'_k$  with second smallest index  $k$  after pruning, and so on. The number of bits output from Turbo code internal interleaver is  $K$  and the total number of pruned bits is:

$$R \times C - K.$$

### 4.2.3.3 Concatenation of encoded blocks

After the channel coding for each code block, if  $C_i$  is greater than 1, the encoded blocks are serially concatenated so that the block with lowest index  $r$  is output first from the channel coding block, otherwise the encoded block is output from channel coding block as it is. The bits output are denoted by  $c_{i1}, c_{i2}, c_{i3}, \dots, c_{iE_i}$ , where  $i$  is the TrCH number and  $E_i = C_i Y_i$ . The output bits are defined by the following relations:

$$c_{ik} = y_{i1k} \quad k = 1, 2, \dots, Y_i$$

$$c_{ik} = y_{i,2,(k-Y_i)} \quad k = Y_i + 1, Y_i + 2, \dots, 2Y_i$$

$$c_{ik} = y_{i,3,(k-2Y_i)} \quad k = 2Y_i + 1, 2Y_i + 2, \dots, 3Y_i$$

...

$$c_{ik} = y_{i,C_i,(k-(C_i-1)Y_i)} \quad k = (C_i - 1)Y_i + 1, (C_i - 1)Y_i + 2, \dots, C_i Y_i$$

If no code blocks are input to the channel coding ( $C_i = 0$ ), no bits shall be output from the channel coding, i.e.  $E_i = 0$ .

## 4.2.4 Radio frame size equalisation

Radio frame size equalisation is padding the input bit sequence in order to ensure that the output can be segmented in  $F_i$  data segments of same size as described in subclause 4.2.7. Radio frame size equalisation is only performed in the UL.

The input bit sequence to the radio frame size equalisation is denoted by  $c_{i1}, c_{i2}, c_{i3}, \dots, c_{iE_i}$ , where  $i$  is TrCH number and  $E_i$  the number of bits. The output bit sequence is denoted by  $t_{i1}, t_{i2}, t_{i3}, \dots, t_{iT_i}$ , where  $T_i$  is the number of bits. The output bit sequence is derived as follows:

- $t_{ik} = c_{ik}$ , for  $k = 1 \dots E_i$ ; and
- $t_{ik} = \{0, 1\}$  for  $k = E_i + 1 \dots T_i$ , if  $E_i < T_i$ ;

where

- $T_i = F_i * N_i$ ; and
- $N_i = \lceil E_i / F_i \rceil$  is the number of bits per segment after size equalisation.

## 4.2.5 1<sup>st</sup> interleaving

### 4.2.5.1 Void

### 4.2.5.2 1<sup>st</sup> interleaver operation

The 1<sup>st</sup> interleaving is a block interleaver with inter-column permutations. The input bit sequence to the block interleaver is denoted by  $x_{i,1}, x_{i,2}, x_{i,3}, \dots, x_{i,X_i}$ , where  $i$  is TrCH number and  $X_i$  the number of bits. Here  $X_i$  is

guaranteed to be an integer multiple of the number of radio frames in the TTI. The output bit sequence from the block interleaver is derived as follows:

- (1) Select the number of columns  $C1$  from table 4 depending on the TTI. The columns are numbered  $0, 1, \dots, C1 - 1$  from left to right.
- (2) Determine the number of rows of the matrix,  $R1$  defined as

$$R1 = X_i / C1.$$

The rows of the matrix are numbered  $0, 1, \dots, R1 - 1$  from top to bottom.

- (3) Write the input bit sequence into the  $R1 \times C1$  matrix row by row starting with bit  $x_{i,1}$  in column 0 of row 0 and ending with bit  $x_{i,(R1 \times C1)}$  in column  $C1 - 1$  of row  $R1 - 1$ :

$$\begin{bmatrix} x_{i,1} & x_{i,2} & x_{i,3} & \dots & x_{i,C1} \\ x_{i,(C1+1)} & x_{i,(C1+2)} & x_{i,(C1+3)} & \dots & x_{i,(2 \times C1)} \\ \vdots & \vdots & \vdots & \dots & \vdots \\ x_{i,((R1-1) \times C1+1)} & x_{i,((R1-1) \times C1+2)} & x_{i,((R1-1) \times C1+3)} & \dots & x_{i,(R1 \times C1)} \end{bmatrix}$$

- (4) Perform the inter-column permutation for the matrix based on the pattern  $\langle P1_{C1}(j) \rangle_{j \in \{0,1,\dots,C1-1\}}$  shown in table 4, where  $P1_{C1}(j)$  is the original column position of the  $j$ -th permuted column. After permutation of the columns, the bits are denoted by  $y_{ik}$ :

$$\begin{bmatrix} y_{i,1} & y_{i,(R1+1)} & y_{i,(2 \times R1+1)} & \dots & y_{i,((C1-1) \times R1+1)} \\ y_{i,2} & y_{i,(R1+2)} & y_{i,(2 \times R1+2)} & \dots & y_{i,((C1-1) \times R1+2)} \\ \vdots & \vdots & \vdots & \dots & \vdots \\ y_{i,R1} & y_{i,(2 \times R1)} & y_{i,(3 \times R1)} & \dots & y_{i,(C1 \times R1)} \end{bmatrix}$$

- (5) Read the output bit sequence  $y_{i,1}, y_{i,2}, y_{i,3}, \dots, y_{i,(C1 \times R1)}$  of the block interleaver column by column from the inter-column permuted  $R1 \times C1$  matrix. Bit  $y_{i,1}$  corresponds to row 0 of column 0 and bit  $y_{i,(R1 \times C1)}$  corresponds to row  $R1 - 1$  of column  $C1 - 1$ .

**Table 4 Inter-column permutation patterns for 1st interleaving**

TTI	Number of columns $C1$	Inter-column permutation patterns $\langle P1_{C1}(0), P1_{C1}(1), \dots, P1_{C1}(C1-1) \rangle$
10 ms	1	$\langle 0 \rangle$
20 ms	2	$\langle 0, 1 \rangle$
40 ms	4	$\langle 0, 2, 1, 3 \rangle$
80 ms	8	$\langle 0, 4, 2, 6, 1, 5, 3, 7 \rangle$

#### 4.2.5.3 Relation between input and output of 1<sup>st</sup> interleaving in uplink

The bits input to the 1<sup>st</sup> interleaving are denoted by  $t_{i,1}, t_{i,2}, t_{i,3}, \dots, t_{i,T_i}$ , where  $i$  is the TrCH number and  $T_i$  the number of bits. Hence,  $x_{i,k} = t_{i,k}$  and  $X_i = T_i$ .

The bits output from the 1<sup>st</sup> interleaving are denoted by  $d_{i,1}, d_{i,2}, d_{i,3}, \dots, d_{i,T_i}$ , and  $d_{i,k} = y_{i,k}$ .

#### 4.2.5.4 Relation between input and output of 1<sup>st</sup> interleaving in downlink

If fixed positions of the TrCHs in a radio frame is used then the bits input to the 1<sup>st</sup> interleaving are denoted by  $h_{i1}, h_{i2}, h_{i3}, \dots, h_{iD_i}$ , where  $i$  is the TrCH number. Hence,  $x_{ik} = h_{ik}$  and  $X_i = D_i$ .

If flexible positions of the TrCHs in a radio frame is used then the bits input to the 1<sup>st</sup> interleaving are denoted by  $g_{i1}, g_{i2}, g_{i3}, \dots, g_{iG_i}$ , where  $i$  is the TrCH number. Hence,  $x_{ik} = g_{ik}$  and  $X_i = G_i$ .

The bits output from the 1<sup>st</sup> interleaving are denoted by  $q_{i1}, q_{i2}, q_{i3}, \dots, q_{iQ_i}$ , where  $i$  is the TrCH number and  $Q_i$  is the number of bits. Hence,  $q_{ik} = y_{ik}$ ,  $Q_i = F_i H_i$  if fixed positions are used, and  $Q_i = G_i$  if flexible positions are used.

### 4.2.6 Radio frame segmentation

When the transmission time interval is longer than 10 ms, the input bit sequence is segmented and mapped onto consecutive  $F_i$  radio frames. Following rate matching in the DL and radio frame size equalisation in the UL the input bit sequence length is guaranteed to be an integer multiple of  $F_i$ .

The input bit sequence is denoted by  $x_{i1}, x_{i2}, x_{i3}, \dots, x_{iX_i}$  where  $i$  is the TrCH number and  $X_i$  is the number bits. The  $F_i$  output bit sequences per TTI are denoted by  $y_{i,n_1}, y_{i,n_2}, y_{i,n_3}, \dots, y_{i,n_{Y_i}}$  where  $n_i$  is the radio frame number in current TTI and  $Y_i$  is the number of bits per radio frame for TrCH  $i$ . The output sequences are defined as follows:

$$y_{i,n,k} = x_{i,((n-1)Y_i)+k}, n_i = 1 \dots F_i, k = 1 \dots Y_i$$

where

$$Y_i = (X_i / F_i) \text{ is the number of bits per segment.}$$

The  $n_i$ -th segment is mapped to the  $n_i$ -th radio frame of the transmission time interval.

#### 4.2.6.1 Relation between input and output of the radio frame segmentation block in uplink

The input bit sequence to the radio frame segmentation is denoted by  $d_{i1}, d_{i2}, d_{i3}, \dots, d_{iT_i}$ , where  $i$  is the TrCH number and  $T_i$  the number of bits. Hence,  $x_{ik} = d_{ik}$  and  $X_i = T_i$ .

The output bit sequence corresponding to radio frame  $n_i$  is denoted by  $e_{i1}, e_{i2}, e_{i3}, \dots, e_{iN_i}$ , where  $i$  is the TrCH number and  $N_i$  is the number of bits. Hence,  $e_{i,k} = y_{i,n_i,k}$  and  $N_i = Y_i$ .

#### 4.2.6.2 Relation between input and output of the radio frame segmentation block in downlink

The bits input to the radio frame segmentation are denoted by  $q_{i1}, q_{i2}, q_{i3}, \dots, q_{iQ_i}$ , where  $i$  is the TrCH number and  $Q_i$  the number of bits. Hence,  $x_{ik} = q_{ik}$  and  $X_i = Q_i$ .

The output bit sequence corresponding to radio frame  $n_i$  is denoted by  $f_{i1}, f_{i2}, f_{i3}, \dots, f_{iV_i}$ , where  $i$  is the TrCH number and  $V_i$  is the number of bits. Hence,  $f_{i,k} = y_{i,n_i,k}$  and  $V_i = Y_i$ .

### 4.2.7 Rate matching

Rate matching means that bits on a transport channel are repeated or punctured. Higher layers assign a rate-matching attribute for each transport channel. This attribute is semi-static and can only be changed through higher layer signalling. The rate-matching attribute is used when the number of bits to be repeated or punctured is calculated.

The number of bits on a transport channel can vary between different transmission time intervals. In the downlink the transmission is interrupted if the number of bits is lower than maximum. When the number of bits between different transmission time intervals in uplink is changed, bits are repeated or punctured to ensure that the total bit rate after TrCH multiplexing is identical to the total channel bit rate of the allocated dedicated physical channels.

If no bits are input to the rate matching for all TrCHs within a CCTrCH, the rate matching shall output no bits for all TrCHs within the CCTrCH and no uplink DPDCH will be selected in the case of uplink rate matching.

**Notation used in subclause 4.2.7 and subclauses:**

- $N_{i,j}$ : For uplink: Number of bits in a radio frame before rate matching on TrCH  $i$  with transport format combination  $j$ .  
For downlink: An intermediate calculation variable (not an integer but a multiple of 1/8).
- $N_{i,l}^{TTI}$ : Number of bits in a transmission time interval before rate matching on TrCH  $i$  with transport format  $l$ .  
Used in downlink only.
- $\Delta N_{i,j}$ : For uplink: If positive - number of bits that should be repeated in each radio frame on TrCH  $i$  with transport format combination  $j$ .  
If negative - number of bits that should be punctured in each radio frame on TrCH  $i$  with transport format combination  $j$ .  
For downlink : An intermediate calculation variable (not an integer but a multiple of 1/8).
- $\Delta N_{i,l}^{TTI}$ : If positive - number of bits to be repeated in each transmission time interval on TrCH  $i$  with transport format  $l$ .  
If negative - number of bits to be punctured in each transmission time interval on TrCH  $i$  with transport format  $l$ .  
Used in downlink only.
- $N_{TGL}$ : Positive or null: number of bits in the radio frame corresponding to the gap for compressed mode for the CCTrCH.
- $RM_i$ : Semi-static rate matching attribute for transport channel  $i$ .  $RM_i$  is provided by higher layers or takes a value as indicated in clause 4.2.13.
- $PL$ : Puncturing limit for uplink. This value limits the amount of puncturing that can be applied in order to avoid multicode or to enable the use of a higher spreading factor. Signalled from higher layers. The allowed puncturing in % is actually equal to  $(1-PL)*100$ .
- $N_{data,j}$ : Total number of bits that are available for the CCTrCH in a radio frame with transport format combination  $j$ .
- $I$ : Number of TrCHs in the CCTrCH.
- $Z_{i,j}$ : Intermediate calculation variable.
- $F_i$ : Number of radio frames in the transmission time interval of TrCH  $i$ .
- $n_i$ : Radio frame number in the transmission time interval of TrCH  $i$  ( $0 \leq n_i < F_i$ ).
- $q$ : Average puncturing or repetition distance (normalised to only show the remaining rate matching on top of an integer number of repetitions). Used in uplink only.
- $P1_F(n_i)$ : The column permutation function of the 1<sup>st</sup> interleaver,  $P1_F(x)$  is the original position of column with number  $x$  after permutation.  $P1$  is defined on table 4 of clause 4.2.5.2 (note that the  $P1_F$  is self-inverse). Used for rate matching in uplink only.
- $S[n]$ : The shift of the puncturing or repetition pattern for radio frame  $n_i$  when  $n = P1_{F_i}(n_i)$ . Used in uplink only.

- $TF_i(j)$ : Transport format of TrCH  $i$  for the transport format combination  $j$ .
- $TFS(i)$ : The set of transport format indexes  $l$  for TrCH  $i$ .
- $TFCS$ : The set of transport format combination indexes  $j$ .
- $e_{ini}$ : Initial value of variable  $e$  in the rate matching pattern determination algorithm of subclause 4.2.7.5.
- $e_{plus}$ : Increment of variable  $e$  in the rate matching pattern determination algorithm of subclause 4.2.7.5.
- $e_{minus}$ : Decrement of variable  $e$  in the rate matching pattern determination algorithm of subclause 4.2.7.5.
- $b$ : Indicates systematic and parity bits
- $b=1$ : Systematic bit.  $x_k$  in subclause 4.2.3.2.1.
- $b=2$ : 1<sup>st</sup> parity bit (from the upper Turbo constituent encoder).  $z_k$  in subclause 4.2.3.2.1.
- $b=3$ : 2<sup>nd</sup> parity bit (from the lower Turbo constituent encoder).  $z'_k$  in subclause 4.2.3.2.1.

The \* (star) notation is used to replace an index  $x$  when the indexed variable  $X_x$  does not depend on the index  $x$ . In the left wing of an assignment the meaning is that " $X_* = Y$ " is equivalent to "**for all  $x$  do  $X_x = Y$** ". In the right wing of an assignment, the meaning is that " $Y = X_*$ " is equivalent to "**take any  $x$  and do  $Y = X_x$** ".

The following relations, defined for all TFC  $j$ , are used when calculating the rate matching parameters:

$$Z_{0,j} = 0$$

$$Z_{i,j} = \left[ \frac{\left( \left( \sum_{m=1}^i RM_m \times N_{m,j} \right) \times N_{data,j} \right)}{\sum_{m=1}^I RM_m \times N_{m,j}} \right] \text{ for all } i = 1 \dots I \quad (1)$$

$$\Delta N_{i,j} = Z_{i,j} - Z_{i-1,j} - N_{i,j} \text{ for all } i = 1 \dots I$$

#### 4.2.7.1 Determination of rate matching parameters in uplink

##### 4.2.7.1.1 Determination of SF and number of PhCHs needed

In uplink, puncturing can be applied to match the CCTrCH bit rate to the PhCH bit rate. The bit rate of the PhCH(s) is limited by the UE capability and restrictions imposed by UTRAN, through limitations on the PhCH spreading factor. The maximum amount of puncturing that can be applied is 1-PL, PL is signalled from higher layers. The number of available bits in the radio frames of one PhCH for all possible spreading factors is given in [2]. Denote these values by  $N_{256}$ ,  $N_{128}$ ,  $N_{64}$ ,  $N_{32}$ ,  $N_{16}$ ,  $N_8$ , and  $N_4$ , where the index refers to the spreading factor. The possible number of bits available to the CCTrCH on all PhCHs,  $N_{data}$ , then are  $\{ N_{256}, N_{128}, N_{64}, N_{32}, N_{16}, N_8, N_4, 2 \times N_4, 3 \times N_4, 4 \times N_4, 5 \times N_4, 6 \times N_4 \}$ .

For a RACH CCTrCH SET0 represents the set of  $N_{data}$  values allowed by the UTRAN, as set by the minimum SF provided by higher layers. SET0 may be a sub-set of  $\{ N_{256}, N_{128}, N_{64}, N_{32} \}$ . SET0 does not take into account the UE's capability.

For other CCTrCHs, SET0 denotes the set of  $N_{data}$  values allowed by the UTRAN and supported by the UE, as part of the UE's capability. SET0 can be a subset of  $\{ N_{256}, N_{128}, N_{64}, N_{32}, N_{16}, N_8, N_4, 2 \times N_4, 3 \times N_4, 4 \times N_4, 5 \times N_4, 6 \times N_4 \}$ .  $N_{data,j}$  for the transport format combination  $j$  is determined by executing the following algorithm:

$$SET1 = \{ N_{data} \text{ in SET0 such that } \left( \min_{1 \leq y \leq I} \{ RM_y \} \right) \times N_{data} - \sum_{x=1}^I RM_x \times N_{x,j} \text{ is non negative} \}$$

If SET1 is not empty and the smallest element of SET1 requires just one PhCH then

$$N_{data,j} = \min SET1$$

else

$$\text{SET2} = \{ N_{data} \text{ in SET0 such that } \left( \min_{1 \leq y \leq I} \{ RM_y \} \right) \times N_{data} - PL \times \sum_{x=1}^I RM_x \times N_{x,j} \text{ is non negative} \}$$

Sort SET2 in ascending order

$$N_{data} = \min \text{ SET2}$$

While  $N_{data}$  is not the max of SET2 and the follower of  $N_{data}$  requires no additional PhCH do

$$N_{data} = \text{follower of } N_{data} \text{ in SET2}$$

End while

$$N_{data,j} = N_{data}$$

End if

For a RACH CCTrCH, if  $N_{data,j}$  is not part of the UE's capability then the TFC  $j$  cannot be used.

#### 4.2.7.1.2 Determination of parameters needed for calculating the rate matching pattern

The number of bits to be repeated or punctured,  $\Delta N_{i,j}$ , within one radio frame for each TrCH  $i$  is calculated with equation 1 for all possible transport format combinations  $j$  and selected every radio frame.  $N_{data,j}$  is given from subclause 4.2.7.1.1.

In a compressed radio frame,  $N_{data,j}$  is replaced by  $N_{data,j}^{cm}$  in Equation 1.  $N_{data,j}^{cm}$  is given as follows:

In a radio frame compressed by higher layer scheduling,  $N_{data,j}^{cm}$  is obtained by executing the algorithm in subclause

4.2.7.1.1 but with the number of bits in one radio frame of one PhCH reduced to  $\frac{N_{tr}}{15}$  of the value in normal mode.

$N_{tr}$  is the number of transmitted slots in a compressed radio frame and is defined by the following relation:

$$N_{tr} = \begin{cases} 15 - TGL, & \text{if } N_{first} + TGL \leq 15 \\ N_{first}, & \text{in first frame if } N_{first} + TGL > 15 \\ 30 - TGL - N_{first}, & \text{in second frame if } N_{first} + TGL > 15 \end{cases}$$

$N_{first}$  and  $TGL$  are defined in subclause 4.4.

In a radio frame compressed by spreading factor reduction,  $N_{data,j}^{cm} = 2 \times (N_{data,j} - N_{TGL})$ , where

$$N_{TGL} = \frac{15 - N_{tr}}{15} \times N_{data,j}$$

If  $\Delta N_{i,j} = 0$  then the output data of the rate matching is the same as the input data and the rate matching algorithm of subclause 4.2.7.5 does not need to be executed.

If  $\Delta N_{i,j} \neq 0$  the parameters listed in subclauses 4.2.7.1.2.1 and 4.2.7.1.2.2 shall be used for determining  $e_{minus}$ ,  $e_{plus}$ , and  $e_{minus}$  (regardless if the radio frame is compressed or not).

#### 4.2.7.1.2.1 Convolutionally encoded TrCHs

$R = \Delta N_{i,j} \bmod N_{i,j}$  -- note: in this context  $\Delta N_{i,j} \bmod N_{i,j}$  is in the range of 0 to  $N_{i,j}-1$  i.e.  $-1 \bmod 10 = 9$ .

if  $R \neq 0$  and  $2 \times R \leq N_{ij}$

then  $q = \lceil N_{ij} / R \rceil$

else

$q = \lceil N_{ij} / (R - N_{ij}) \rceil$

endif

-- note:  $q$  is a signed quantity.

if  $q$  is even

then  $q' = q + \gcd(|q|, F_i) / F_i$  -- where  $\gcd(|q|, F_i)$  means greatest common divisor of  $|q|$  and  $F_i$

-- note that  $q'$  is not an integer, but a multiple of  $1/8$

else

$q' = q$

endif

for  $x = 0$  to  $F_i - 1$

$S[\lfloor x \times q' \rfloor \bmod F_i] = (\lfloor x \times q' \rfloor \div F_i)$

end for

$\Delta N_i = \Delta N_{ij}$

$a = 2$

For each radio frame, the rate-matching pattern is calculated with the algorithm in subclause 4.2.7.5, where :

$X_i = N_{ij}$ , and

$e_{mi} = (a \times S[\text{PI}_{F_i}(n_i)] \times |\Delta N_i| + 1) \bmod (a \cdot N_{ij})$ .

$e_{plus} = a \times N_{ij}$

$e_{minus} = a \times |\Delta N_i|$

puncturing for  $\Delta N < 0$ , repetition otherwise.

#### 4.2.7.1.2.2 Turbo encoded TrCHs

If repetition is to be performed on turbo encoded TrCHs, i.e.  $\Delta N_{ij} > 0$ , the parameters in subclause 4.2.7.1.2.1 are used.

If puncturing is to be performed, the parameters below shall be used. Index  $b$  is used to indicate systematic ( $b=1$ ), 1<sup>st</sup> parity ( $b=2$ ), and 2<sup>nd</sup> parity bit ( $b=3$ ).

$a=2$  when  $b=2$

$a=1$  when  $b=3$

$$\Delta N_i = \begin{cases} \lfloor \Delta N_{i,j} / 2 \rfloor, & b = 2 \\ \lfloor \Delta N_{i,j} / 2 \rfloor, & b = 3 \end{cases}$$

If  $\Delta N_i$  is calculated as 0 for  $b=2$  or  $b=3$ , then the following procedure and the rate matching algorithm of subclause 4.2.7.5 don't need to be performed for the corresponding parity bit stream.

$X_i = \lfloor N_{ij} / 3 \rfloor$ ,

$q = \lfloor X_i / |\Delta N_i| \rfloor$



```

if(q ≤ 2)
    for r=0 to Fi-1
        S[(3×r+b-1) mod Fi] = r mod 2;
    end for
else
    if q is even
        then q' = q - gcd(q, Fi) / Fi -- where gcd(q, Fi) means greatest common divisor of q and Fi
            -- note that q' is not an integer, but a multiple of 1/8
        else q' = q
    endif
    for x=0 to Fi - 1
        r = ⌈x×q'⌉ mod Fi;
        S[(3×r+b-1) mod Fi] = ⌈x×q'⌉ div Fi;
    endfor
endif

```

For each radio frame, the rate-matching pattern is calculated with the algorithm in subclause 4.2.7.5, where:

$X_i$  is as above:

$$e_{\text{ini}} = (a \times S[P1_{F_i}(n_i)] \times |\Delta N_i| + X_i) \bmod (a \times X_i), \quad \text{if } e_{\text{ini}} = 0 \text{ then } e_{\text{ini}} = a \times X_i$$

$$e_{\text{plus}} = a \times X_i$$

$$e_{\text{minus}} = a \times |\Delta N_i|$$

#### 4.2.7.2 Determination of rate matching parameters in downlink

For downlink channels,  $N_{\text{data},j}$  does not depend on the transport format combination  $j$ .  $N_{\text{data},*}$  is given by the channelization code(s) assigned by higher layers.

Denote the number of physical channels used for the CCTrCH by  $P$ .  $N_{\text{data},*}$  is the number of bits available to the CCTrCH in one radio frame and defined as  $N_{\text{data},*} = P \times 15 \times (N_{\text{data}1} + N_{\text{data}2})$ , where  $N_{\text{data}1}$  and  $N_{\text{data}2}$  are defined in [2]. Note that contrary to the uplink, the same rate matching patterns are used in TTIs containing no compressed radio frames and in TTIs containing radio frames compressed by spreading factor reduction or higher layer scheduling.

##### 4.2.7.2.1 Determination of rate matching parameters for fixed positions of TrCHs

###### 4.2.7.2.1.1 Calculation of $\Delta N_{i,\text{max}}$ for normal mode and compressed mode by spreading factor reduction

First an intermediate calculation variable  $N_{i,*}$  is calculated for all transport channels  $i$  by the following formula:

$$N_{i,*} = \frac{1}{F_i} \times \left( \max_{l \in \text{TFS}(i)} N_{i,l}^{\text{TTI}} \right)$$

In order to compute the  $\Delta N_{i,l}^{\text{TTI}}$  parameters for all TrCH  $i$  and all TF  $l$ , we first compute an intermediate parameter  $\Delta N_{i,\text{max}}$  by the following formula, where  $\Delta N_{i,*}$  is derived from  $N_{i,*}$  by the formula given at subclause 4.2.7:

$$\Delta N_{i,max} = F_i \times \Delta N_{i,*}$$

If  $\Delta N_{i,max} = 0$  then, for TrCH  $i$ , the output data of the rate matching is the same as the input data and the rate matching algorithm of subclause 4.2.7.5 does not need to be executed. In this case we have :

$$\forall l \in TFS(i) \Delta N_{i,l}^{TTI} = 0$$

If  $\Delta N_{i,max} \neq 0$  the parameters listed in subclauses 4.2.7.2.1.3 and 4.2.7.2.1.4 shall be used for determining  $e_{ini}$ ,  $e_{plus}$ , and  $e_{minus}$ , and  $\Delta N_{i,l}^{TTI}$ .

4.2.7.2.1.2 Void

4.2.7.2.1.3 Determination of rate matching parameters for convolutionally encoded TrCHs

$$\Delta N_i = \Delta N_{i,max}$$

$$a=2$$

$$N_{max} = \max_{l \in TFS(i)} N_{il}^{TTI}$$

For each transmission time interval of TrCH  $i$  with TF  $l$ , the rate-matching pattern is calculated with the algorithm in subclause 4.2.7.5. The following parameters are used as input:

$$X_i = N_{il}^{TTI}$$

$$e_{ini} = 1$$

$$e_{plus} = a \times N_{max}$$

$$e_{minus} = a \times |\Delta N_i|$$

Puncturing if  $\Delta N_i < 0$ , repetition otherwise. The values of  $\Delta N_{i,l}^{TTI}$  may be computed by counting repetitions or puncturing when the algorithm of subclause 4.2.7.5 is run. The resulting values of  $\Delta N_{i,l}^{TTI}$  can be represented with following expression.

$$\Delta N_{i,l}^{TTI} = \left\lfloor \frac{|\Delta N_i| \times X_i}{N_{max}} \right\rfloor \times \text{sgn}(\Delta N_i)$$

4.2.7.2.1.4 Determination of rate matching parameters for Turbo encoded TrCHs

If repetition is to be performed on turbo encoded TrCHs, i.e.  $\Delta N_{i,max} > 0$ , the parameters in subclause 4.2.7.2.1.3 are used.

If puncturing is to be performed, the parameters below shall be used. Index  $b$  is used to indicate systematic ( $b=1$ ), 1<sup>st</sup> parity ( $b=2$ ), and 2<sup>nd</sup> parity bit ( $b=3$ ).

$$a=2 \text{ when } b=2$$

$$a=1 \text{ when } b=3$$

The bits indicated by  $b=1$  shall not be punctured.

$$\Delta N_i^b = \begin{cases} \left\lfloor \frac{\Delta N_{i,max}}{2} \right\rfloor, & \text{for } b = 2 \\ \left\lceil \frac{\Delta N_{i,max}}{2} \right\rceil, & \text{for } b = 3 \end{cases}$$

$$N_{max} = \max_{l \in TFS(i)} (N_{il}^{TTI} / 3)$$

For each transmission time interval of TrCH  $i$  with TF  $l$ , the rate-matching pattern is calculated with the algorithm in subclause 4.2.7.5. The following parameters are used as input:

$$X_i = N_{il}^{TTI} / 3$$

$$e_{ini} = N_{max}$$

$$e_{plus} = a \times N_{max}$$

$$e_{minus} = a \times \left| \Delta N_i^b \right|$$

The values of  $\Delta N_{i,l}^{TTI}$  may be computed by counting puncturing when the algorithm of subclause 4.2.7.5 is run. The resulting values of  $\Delta N_{i,l}^{TTI}$  can be represented with following expression.

$$\Delta N_{i,l}^{TTI} = - \left\lfloor \frac{\left| \Delta N_i^2 \right| \times X_i}{N_{max}} + 0.5 \right\rfloor - \left\lfloor \frac{\left| \Delta N_i^3 \right| \times X_i}{N_{max}} \right\rfloor$$

In the above equation, the first term of the right hand side represents the amount of puncturing for  $b=2$  and the second term represents the amount of puncturing for  $b=3$ .

#### 4.2.7.2.2 Determination of rate matching parameters for flexible positions of TrCHs

##### 4.2.7.2.2.1 Calculations for normal mode, compressed mode by higher layer scheduling, and compressed mode by spreading factor reduction

First an intermediate calculation variable  $N_{ij}$  is calculated for all transport channels  $i$  and all transport format combinations  $j$  by the following formula:

$$N_{i,j} = \frac{1}{F_i} \times N_{i,TF_i(j)}^{TTI}$$

Then rate matching ratios  $RF_i$  are calculated for each the transport channel  $i$  in order to minimise the number of DTX bits when the bit rate of the CCTrCH is maximum. The  $RF_i$  ratios are defined by the following formula:

$$RF_i = \frac{N_{data,*}}{\max_{j \in TFCs} \sum_{i=1}^{i=I} (RM_i \times N_{i,j})} \times RM_i$$

The computation of  $\Delta N_{i,l}^{TTI}$  parameters is then performed in two phases. In a first phase, tentative temporary values of  $\Delta N_{i,l}^{TTI}$  are computed, and in the second phase they are checked and corrected. The first phase, by use of the  $RF_i$  ratios, ensures that the number of DTX indication bits inserted is minimum when the CCTrCH bit rate is maximum, but it does not ensure that the maximum CCTrCH bit rate is not greater than  $N_{data,*}$  per 10ms. The latter condition is ensured through the checking and possible corrections carried out in the second phase.

At the end of the second phase, the latest value of  $\Delta N_{i,l}^{TTI}$  is the definitive value.

The first phase defines the tentative temporary  $\Delta N_{i,l}^{TTI}$  for all transport channel  $i$  and any of its transport format  $l$  by use of the following formula:

$$\Delta N_{i,l}^{TTI} = F_i \times \left\lfloor \frac{RF_i \times N_{i,l}^{TTI}}{F_i} \right\rfloor - N_{i,l}^{TTI} = F_i \times \left\lfloor \frac{N_{data,*} \times RM_i \times N_{i,l}^{TTI}}{F_i \times \max_{j \in TFCS} \sum_{i=1}^I (RM_i \times N_{i,j})} \right\rfloor - N_{i,l}^{TTI}$$

The second phase is defined by the following algorithm:

for all  $j$  in  $TFCS$  in ascending order of TFCI do -- for all TFC

$$D = \sum_{i=1}^{i=I} \frac{N_{i,TF_i(j)}^{TTI} + \Delta N_{i,TF_i(j)}^{TTI}}{F_i} \quad \text{-- CCTrCH bit rate (bits per 10ms) for TFC } j$$

if  $D > N_{data,*}$  then

for  $i = 1$  to  $I$  do -- for all TrCH

$$\Delta N = F_i \times \Delta N_{i,j} \quad \text{-- } \Delta N_{i,j} \text{ is derived from } N_{i,j} \text{ by the formula given at subclause 4.2.7.}$$

if  $\Delta N_{i,TF_i(j)}^{TTI} > \Delta N$  then

$$\Delta N_{i,TF_i(j)}^{TTI} = \Delta N$$

end-if

end-for

end-if

end-for

If  $\Delta N_{i,l}^{TTI} = 0$  then, for TrCH  $i$  at TF  $l$ , the output data of the rate matching is the same as the input data and the rate matching algorithm of subclause 4.2.7.5 does not need to be executed.

If  $\Delta N_{i,l}^{TTI} \neq 0$  the parameters listed in subclauses 4.2.7.2.2.2 and 4.2.7.2.2.3 shall be used for determining  $e_{ini}$ ,  $e_{plus}$ , and  $e_{minus}$ .

#### 4.2.7.2.2.2 Determination of rate matching parameters for convolutionally encoded TrCHs

$$\Delta N_i = \Delta N_{il}^{TTI}$$

$$a=2$$

For each transmission time interval of TrCH  $i$  with TF  $l$ , the rate-matching pattern is calculated with the algorithm in subclause 4.2.7.5. The following parameters are used as input:

$$X_i = N_{il}^{TTI}$$

$$e_{ini} = 1$$

$$e_{plus} = a \times N_{il}^{TTI}$$

$$e_{minus} = a \times |\Delta N_i|$$

puncturing for  $\Delta N_i < 0$ , repetition otherwise.

#### 4.2.7.2.2.3 Determination of rate matching parameters for Turbo encoded TrCHs

If repetition is to be performed on turbo encoded TrCHs, i.e.  $\Delta N_{il}^{TTI} > 0$ , the parameters in subclause 4.2.7.2.2 are used.

If puncturing is to be performed, the parameters below shall be used. Index  $b$  is used to indicate systematic ( $b=1$ ), 1<sup>st</sup> parity ( $b=2$ ), and 2<sup>nd</sup> parity bit ( $b=3$ ).

$$a=2 \text{ when } b=2$$

$$a=1 \text{ when } b=3$$

The bits indicated by  $b=1$  shall not be punctured.

$$\Delta N_i = \begin{cases} \left\lfloor \frac{\Delta N_{il}^{TTI}}{2} \right\rfloor, & b = 2 \\ \left\lceil \frac{\Delta N_{il}^{TTI}}{2} \right\rceil, & b = 3 \end{cases}$$

For each transmission time interval of TrCH  $i$  with TF  $l$ , the rate-matching pattern is calculated with the algorithm in subclause 4.2.7.5. The following parameters are used as input:

$$X_i = N_{il}^{TTI} / 3,$$

$$e_{ini} = X_i,$$

$$e_{plus} = a \times X_i$$

$$e_{minus} = a \times |\Delta N_i|$$

#### 4.2.7.3 Bit separation and collection in uplink

The systematic bits of turbo encoded TrCHs shall not be punctured, the other bits may be punctured. The systematic bits, first parity bits, and second parity bits in the bit sequence input to the rate matching block are therefore separated into three sequences.

The first sequence contains:

- All of the systematic bits that are from turbo encoded TrCHs.
- From 0 to 2 first and/or second parity bits that are from turbo encoded TrCHs. These bits come into the first sequence when the total number of bits in a block after radio frame segmentation is not a multiple of three.
- Some of the systematic, first parity and second parity bits that are for trellis termination.

The second sequence contains:

- All of the first parity bits that are from turbo encoded TrCHs, except those that go into the first sequence when the total number of bits is not a multiple of three.
- Some of the systematic, first parity and second parity bits that are for trellis termination.

The third sequence contains:

- All of the second parity bits that are from turbo encoded TrCHs, except those that go into the first sequence when the total number of bits is not a multiple of three.
- Some of the systematic, first parity and second parity bits that are for trellis termination.

The second and third sequences shall be of equal length, whereas the first sequence can contain from 0 to 2 more bits. Puncturing is applied only to the second and third sequences. The bit separation function is transparent for

convolutionally encoded TrCHs and for turbo encoded TrCHs with repetition. The bit separation and bit collection are illustrated in figures 5 and 6.

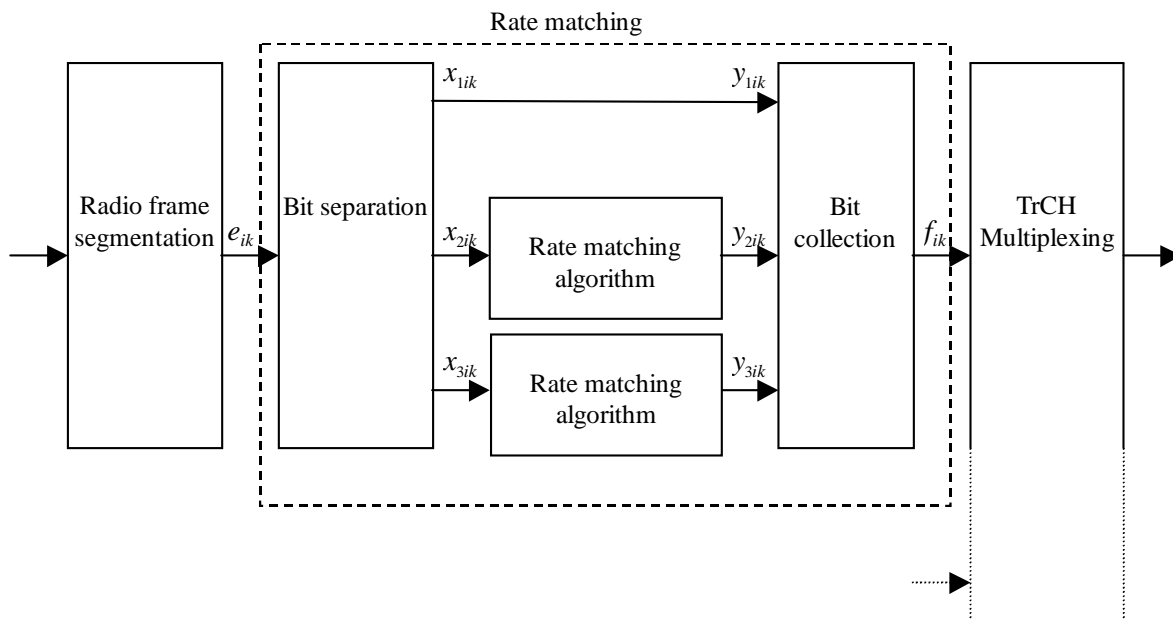

Figure 5: Puncturing of turbo encoded TrCHs in uplink

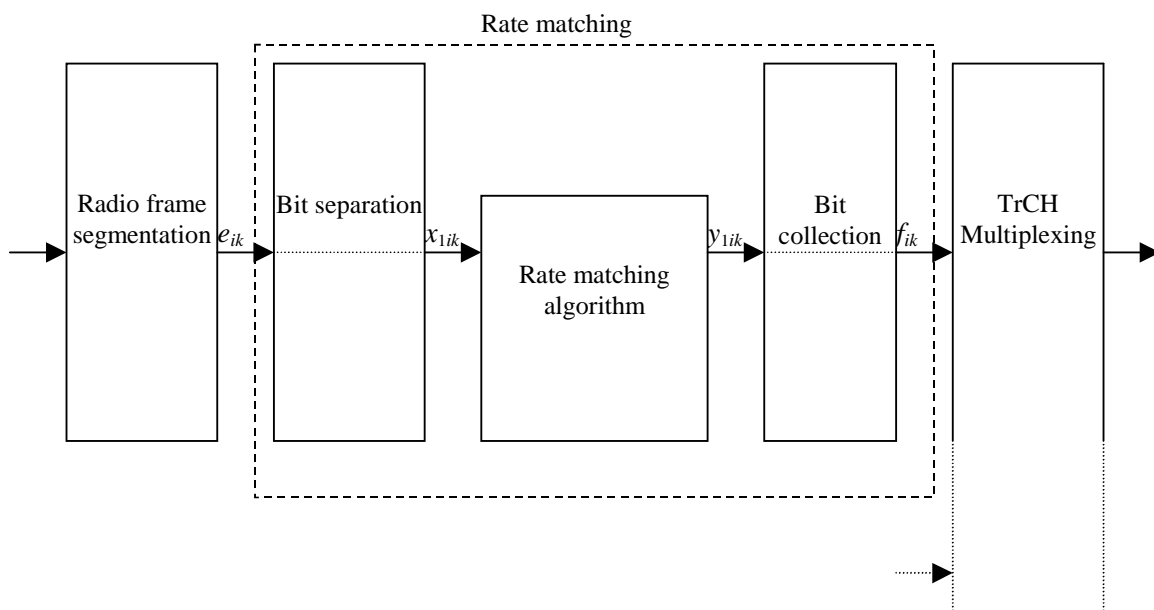

Figure 6: Rate matching for convolutionally encoded TrCHs and for turbo encoded TrCHs with repetition in uplink

The bit separation is dependent on the 1<sup>st</sup> interleaving and offsets are used to define the separation for different TTIs. *b* indicates the three sequences defined in this section, with *b*=1 indicating the first sequence, *b* = 2 the second one, and *b* = 3 the third one. The offsets  $\alpha_b$  for these sequences are listed in table 5.

Table 5: TTI dependent offset needed for bit separation

TTI (ms)	$\alpha_1$	$\alpha_2$	$\alpha_3$
10, 40	0	1	2
20, 80	0	2	1

The bit separation is different for different radio frames in the TTI. A second offset is therefore needed. The radio frame number for TrCH  $i$  is denoted by  $n_i$ , and the offset by  $\beta_{n_i}$ .

**Table 6: Radio frame dependent offset needed for bit separation**

TTI (ms)	$\beta_0$	$\beta_1$	$\beta_2$	$\beta_3$	$\beta_4$	$\beta_5$	$\beta_6$	$\beta_7$
10	0	NA	NA	NA	NA	NA	NA	NA
20	0	1	NA	NA	NA	NA	NA	NA
40	0	1	2	0	NA	NA	NA	NA
80	0	1	2	0	1	2	0	1

#### 4.2.7.3.1 Bit separation

The bits input to the rate matching are denoted by  $e_{i1}, e_{i2}, e_{i3}, \dots, e_{iN_i}$ , where  $i$  is the TrCH number and  $N_i$  is the number of bits input to the rate matching block. Note that the transport format combination number  $j$  for simplicity has been left out in the bit numbering, i.e.  $N_i = N_{ij}$ . The bits after separation are denoted by  $x_{bi1}, x_{bi2}, x_{bi3}, \dots, x_{biX_i}$ . For turbo encoded TrCHs with puncturing,  $b$  indicates the three sequences defined in clause 4.2.7.3, with  $b=1$  indicating the first sequence, and so forth. For all other cases  $b$  is defined to be 1.  $X_i$  is the number of bits in each separated bit sequence. The relation between  $e_{ik}$  and  $x_{bik}$  is given below.

For turbo encoded TrCHs with puncturing:

$$x_{1,i,k} = e_{i,3(k-1)+1+(\alpha_1+\beta_{n_i}) \bmod 3} \quad k = 1, 2, 3, \dots, X_i \quad X_i = \lfloor N_i/3 \rfloor$$

$$x_{1,i,\lfloor N_i/3 \rfloor+k} = e_{i,3\lfloor N_i/3 \rfloor+k} \quad k = 1, \dots, N_i \bmod 3 \quad \text{Note: When } (N_i \bmod 3) = 0 \text{ this row is not needed.}$$

$$x_{2,i,k} = e_{i,3(k-1)+1+(\alpha_2+\beta_{n_i}) \bmod 3} \quad k = 1, 2, 3, \dots, X_i \quad X_i = \lfloor N_i/3 \rfloor$$

$$x_{3,i,k} = e_{i,3(k-1)+1+(\alpha_3+\beta_{n_i}) \bmod 3} \quad k = 1, 2, 3, \dots, X_i \quad X_i = \lfloor N_i/3 \rfloor$$

For convolutionally encoded TrCHs and turbo encoded TrCHs with repetition:

$$x_{1,i,k} = e_{i,k} \quad k = 1, 2, 3, \dots, X_i \quad X_i = N_i$$

#### 4.2.7.3.2 Bit collection

The bits  $x_{bik}$  are input to the rate matching algorithm described in subclause 4.2.7.5. The bits output from the rate matching algorithm are denoted  $y_{bi1}, y_{bi2}, y_{bi3}, \dots, y_{biY_i}$ .

Bit collection is the inverse function of the separation. The bits after collection are denoted by  $z_{bi1}, z_{bi2}, z_{bi3}, \dots, z_{biY_i}$ .

After bit collection, the bits indicated as punctured are removed and the bits are then denoted by  $f_{i1}, f_{i2}, f_{i3}, \dots, f_{iV_i}$ , where  $i$  is the TrCH number and  $V_i = N_{ij} + \Delta N_{ij}$ . The relations between  $y_{bik}$ ,  $z_{bik}$ , and  $f_{ik}$  are given below.

For turbo encoded TrCHs with puncturing ( $Y_i = X_i$ ):

$$z_{i,3(k-1)+1+(\alpha_1+\beta_{n_i}) \bmod 3} = y_{1,i,k} \quad k = 1, 2, 3, \dots, Y_i$$

$$z_{i,3\lfloor N_i/3 \rfloor+k} = y_{1,i,\lfloor N_i/3 \rfloor+k} \quad k = 1, \dots, N_i \bmod 3 \quad \text{Note: When } (N_i \bmod 3) = 0 \text{ this row is not needed.}$$

$$z_{i,3(k-1)+1+(\alpha_2+\beta_{n_i}) \bmod 3} = y_{2,i,k} \quad k = 1, 2, 3, \dots, Y_i$$

$$z_{i,3(k-1)+1+(\alpha_3+\beta_{n_i}) \bmod 3} = y_{3,i,k} \quad k = 1, 2, 3, \dots, Y_i$$

After the bit collection, bits  $z_{i,k}$  with value  $\delta$ , where  $\delta \in \{0, 1\}$ , are removed from the bit sequence. Bit  $f_{i,1}$  corresponds to the bit  $z_{i,k}$  with smallest index  $k$  after puncturing, bit  $f_{i,2}$  corresponds to the bit  $z_{i,k}$  with second smallest index  $k$  after puncturing, and so on.

For convolutionally encoded TrCHs and turbo encoded TrCHs with repetition:

$$z_{i,k} = y_{1,i,k} \quad k = 1, 2, 3, \dots, Y_i$$

When repetition is used,  $f_{i,k} = z_{i,k}$  and  $Y_i = V_i$ .

When puncturing is used,  $Y_i = X_i$  and bits  $z_{i,k}$  with value  $\delta$ , where  $\delta \in \{0, 1\}$ , are removed from the bit sequence. Bit  $f_{i,1}$  corresponds to the bit  $z_{i,k}$  with smallest index  $k$  after puncturing, bit  $f_{i,2}$  corresponds to the bit  $z_{i,k}$  with second smallest index  $k$  after puncturing, and so on.

#### 4.2.7.4 Bit separation and collection in downlink

The systematic bits of turbo encoded TrCHs shall not be punctured, the other bits may be punctured.

The systematic bits, first parity bits and second parity bits in the bit sequence input to the rate matching block are therefore separated into three sequences of equal lengths.

The first sequence contains :

- All of the systematic bits that are from turbo encoded TrCHs.
- Some of the systematic, first parity and second parity bits that are for trellis termination.

The second sequence contains:

- All of the first parity bits that are from turbo encoded TrCHs.
- Some of the systematic, first parity and second parity bits that are for trellis termination.

The third sequence contains:

- All of the second parity bits that are from turbo encoded TrCHs.
- Some of the systematic, first parity and second parity bits that are for trellis termination.

Puncturing is applied only to the second and third sequences.

The bit separation function is transparent for convolutionally encoded TrCHs and for turbo encoded TrCHs with repetition. The bit separation and bit collection are illustrated in figures 7 and 8.

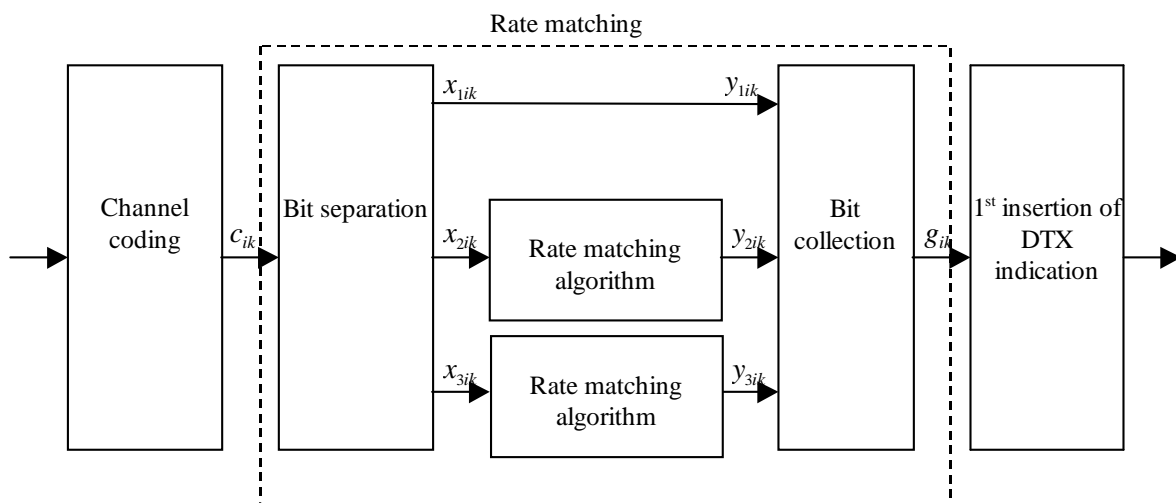
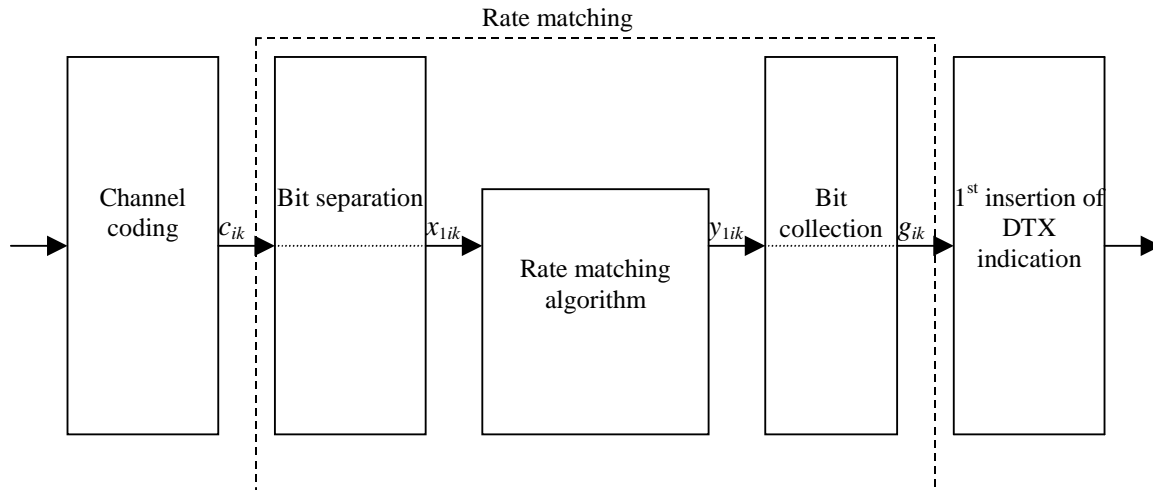

Figure 7: Puncturing of turbo encoded TrCHs in downlink





**Figure 8: Rate matching for convolutionally encoded TrCHs and for turbo encoded TrCHs with repetition in downlink**

#### 4.2.7.4.1 Bit separation

The bits input to the rate matching are denoted by  $c_{i1}, c_{i2}, c_{i3}, \dots, c_{iE_i}$ , where  $i$  is the TrCH number and  $E_i$  is the number of bits input to the rate matching block. Note that  $E_i$  is a multiple of 3 for turbo encoded TrCHs and that the transport format  $l$  for simplicity has been left out in the bit numbering, i.e.  $E_i = N_{il}^{TTI}$ . The bits after separation are denoted by  $x_{bi1}, x_{bi2}, x_{bi3}, \dots, x_{biX_i}$ . For turbo encoded TrCHs with puncturing,  $b$  indicates the three sequences defined in clause 4.2.7.4, with  $b=1$  indicating the first sequence, and so forth. For all other cases  $b$  is defined to be 1.  $X_i$  is the number of bits in each separated bit sequence. The relation between  $c_{ik}$  and  $x_{bik}$  is given below.

For turbo encoded TrCHs with puncturing:

$$x_{1,i,k} = c_{i,3(k-1)+1} \quad k = 1, 2, 3, \dots, X_i \quad X_i = E_i / 3$$

$$x_{2,i,k} = c_{i,3(k-1)+2} \quad k = 1, 2, 3, \dots, X_i \quad X_i = E_i / 3$$

$$x_{3,i,k} = c_{i,3(k-1)+3} \quad k = 1, 2, 3, \dots, X_i \quad X_i = E_i / 3$$

For convolutionally encoded TrCHs and turbo encoded TrCHs with repetition:

$$x_{1,i,k} = c_{i,k} \quad k = 1, 2, 3, \dots, X_i \quad X_i = E_i$$

#### 4.2.7.4.2 Bit collection

The bits  $x_{bik}$  are input to the rate matching algorithm described in subclause 4.2.7.5. The bits output from the rate matching algorithm are denoted  $y_{bi1}, y_{bi2}, y_{bi3}, \dots, y_{biY_i}$ .

Bit collection is the inverse function of the separation. The bits after collection are denoted by  $z_{bi1}, z_{bi2}, z_{bi3}, \dots, z_{biY_i}$ .

After bit collection, the bits indicated as punctured are removed and the bits are then denoted by  $g_{i1}, g_{i2}, g_{i3}, \dots, g_{iG_i}$ , where  $i$  is the TrCH number and  $G_i = N_{il}^{TTI} + \Delta N_{il}^{TTI}$ . The relations between  $y_{bik}$ ,  $z_{bik}$ , and  $g_{ik}$  are given below.

For turbo encoded TrCHs with puncturing ( $Y_i = X_i$ ):

$$z_{i,3(k-1)+1} = y_{1,i,k} \quad k = 1, 2, 3, \dots, Y_i$$

$$z_{i,3(k-1)+2} = y_{2,i,k} \quad k = 1, 2, 3, \dots, Y_i$$

$$z_{i,3(k-1)+3} = y_{3,i,k} \quad k = 1, 2, 3, \dots, Y_i$$

After the bit collection, bits  $z_{i,k}$  with value  $\delta$ , where  $\delta \notin \{0, 1\}$ , are removed from the bit sequence. Bit  $g_{i,1}$  corresponds to the bit  $z_{i,k}$  with smallest index  $k$  after puncturing, bit  $g_{i,2}$  corresponds to the bit  $z_{i,k}$  with second smallest index  $k$  after puncturing, and so on.

For convolutionally encoded TrCHs and turbo encoded TrCHs with repetition:

$$z_{i,k} = y_{1,i,k} \quad k = 1, 2, 3, \dots, Y_i$$

When repetition is used,  $g_{i,k}=z_{i,k}$  and  $Y_i=G_i$ .

When puncturing is used,  $Y_i=X_i$  and bits  $z_{i,k}$  with value  $\delta$ , where  $\delta \notin \{0, 1\}$ , are removed from the bit sequence. Bit  $g_{i,1}$  corresponds to the bit  $z_{i,k}$  with smallest index  $k$  after puncturing, bit  $g_{i,2}$  corresponds to the bit  $z_{i,k}$  with second smallest index  $k$  after puncturing, and so on.

#### 4.2.7.5 Rate matching pattern determination

Denote the bits before rate matching by:

$x_{i1}, x_{i2}, x_{i3}, \dots, x_{iX_i}$ , where  $i$  is the TrCH number and the sequence is defined in 4.2.7.3 for uplink or in 4.2.7.4 for downlink. Parameters  $X_i$ ,  $e_{ini}$ ,  $e_{plus}$ , and  $e_{minus}$  are given in 4.2.7.1 for uplink or in 4.2.7.2 for downlink.

The rate matching rule is as follows:

if puncturing is to be performed

$e = e_{ini}$       -- initial error between current and desired puncturing ratio

$m = 1$       -- index of current bit

do while  $m \leq X_i$

$e = e - e_{minus}$       -- update error

if  $e \leq 0$  then      -- check if bit number  $m$  should be punctured

    set bit  $x_{i,m}$  to  $\delta$  where  $\delta \notin \{0, 1\}$

$e = e + e_{plus}$       -- update error

end if

$m = m + 1$       -- next bit

end do

else

$e = e_{ini}$       -- initial error between current and desired puncturing ratio

$m = 1$       -- index of current bit

do while  $m \leq X_i$

$e = e - e_{minus}$       -- update error

do while  $e \leq 0$       -- check if bit number  $m$  should be repeated

    repeat bit  $x_{i,m}$

$e = e + e_{plus}$  -- update error

```

    end do
    m = m + 1      -- next bit
  end do
end if

```

A repeated bit is placed directly after the original one.

## 4.2.8 TrCH multiplexing

Every 10 ms, one radio frame from each TrCH is delivered to the TrCH multiplexing. These radio frames are serially multiplexed into a coded composite transport channel (CCTrCH).

The bits input to the TrCH multiplexing are denoted by  $f_{i1}, f_{i2}, f_{i3}, \dots, f_{iV_i}$ , where  $i$  is the TrCH number and  $V_i$  is the number of bits in the radio frame of TrCH  $i$ . The number of TrCHs is denoted by  $I$ . The bits output from TrCH multiplexing are denoted by  $s_1, s_2, s_3, \dots, s_S$ , where  $S$  is the number of bits, i.e.  $S = \sum_i V_i$ . The TrCH multiplexing is defined by the following relations:

$$s_k = f_{1k} \quad k = 1, 2, \dots, V_1$$

$$s_k = f_{2,(k-V_1)} \quad k = V_1+1, V_1+2, \dots, V_1+V_2$$

$$s_k = f_{3,(k-(V_1+V_2))} \quad k = (V_1+V_2)+1, (V_1+V_2)+2, \dots, (V_1+V_2)+V_3$$

...

$$s_k = f_{I,(k-(V_1+V_2+\dots+V_{I-1}))} \quad k = (V_1+V_2+\dots+V_{I-1})+1, (V_1+V_2+\dots+V_{I-1})+2, \dots, (V_1+V_2+\dots+V_{I-1})+V_I$$

## 4.2.9 Insertion of discontinuous transmission (DTX) indication bits

In the downlink, DTX is used to fill up the radio frame with bits. The insertion point of DTX indication bits depends on whether fixed or flexible positions of the TrCHs in the radio frame are used. It is up to the UTRAN to decide for each CCTrCH whether fixed or flexible positions are used during the connection. DTX indication bits only indicate when the transmission should be turned off, they are not transmitted.

### 4.2.9.1 1<sup>st</sup> insertion of DTX indication bits

This step of inserting DTX indication bits is used only if the positions of the TrCHs in the radio frame are fixed. With fixed position scheme a fixed number of bits is reserved for each TrCH in the radio frame.

The bits from rate matching are denoted by  $g_{i1}, g_{i2}, g_{i3}, \dots, g_{iG_i}$ , where  $G_i$  is the number of bits in one TTI of TrCH  $i$ . Denote the number of bits in one radio frame of TrCH  $i$  by  $H_i$ . Denote  $D_i$  the number of bits output of the first DTX insertion block.

In TTIs containing no compressed frames or frames compressed by spreading factor reduction,  $H_i$  is constant and corresponds to the maximum number of bits from TrCH  $i$  in one radio frame for any transport format of TrCH  $i$  and  $D_i = F_i \times H_i$ .

The bits output from the DTX insertion are denoted by  $h_{i1}, h_{i2}, h_{i3}, \dots, h_{iD_i}$ . Note that these bits are three valued. They are defined by the following relations:

$$h_{ik} = g_{ik} \quad k = 1, 2, 3, \dots, G_i$$

$$h_{ik} = \delta \quad k = G_i+1, G_i+2, G_i+3, \dots, D_i$$

where DTX indication bits are denoted by  $\delta$ . Here  $g_{ik} \in \{0, 1\}$  and  $\delta \notin \{0, 1\}$ .

#### 4.2.9.2 2<sup>nd</sup> insertion of DTX indication bits

The DTX indication bits inserted in this step shall be placed at the end of the radio frame. Note that the DTX will be distributed over all slots after 2<sup>nd</sup> interleaving.

The bits input to the DTX insertion block are denoted by  $s_1, s_2, s_3, \dots, s_S$ , where  $S$  is the number of bits from TrCH multiplexing. The number of PhCHs is denoted by  $P$  and the number of bits in one radio frame, including DTX indication bits, for each PhCH by  $R$ .

In non-compressed frames,  $R = \frac{N_{data,*}}{P} = 15 \times (N_{data1} + N_{data2})$ , where  $N_{data1}$  and  $N_{data2}$  are defined in [2].

For compressed frames,  $N'_{data,*}$  is defined as  $N'_{data,*} = P \times 15 \times (N'_{data1} + N'_{data2})$ .  $N'_{data1}$  and  $N'_{data2}$  are the number of bits in the data fields of the slot format used for the current compressed frame, i.e. slot format A or B as defined in [2] corresponding to the spreading factor and the number of transmitted slots in use.

In frames compressed by higher layer scheduling, additional DTX with respect to normal mode shall be inserted if the transmission time reduction does not exactly create a transmission gap of the desired  $TGL$ .

The number of bits available to the CCTrCH in one radio frame compressed by spreading factor reduction or by higher layer scheduling is denoted by  $N_{data,*}^{cm}$  and  $R = \frac{N_{data,*}^{cm}}{P}$ .

For frames compressed by spreading factor reduction  $N_{data,*}^{cm} = \frac{N'_{data,*}}{2}$ .

For frames compressed by higher layer scheduling the exact value of  $N_{data,*}^{cm}$  is dependent on the  $TGL$  which is signalled from higher layers. It can be calculated as  $N_{data,*}^{cm} = N'_{data,*} - N_{TGL}$ .

$N_{TGL}$  is the number of bits that are located within the transmission gap and defined as:

$$N_{TGL} = \begin{cases} \frac{TGL}{15} \times N'_{data,*}, & \text{if } N_{first} + TGL \leq 15 \\ \frac{15 - N_{first}}{15} \times N'_{data,*}, & \text{in first frame if } N_{first} + TGL > 15 \\ \frac{TGL - (15 - N_{first})}{15} \times N'_{data,*}, & \text{in second frame if } N_{first} + TGL > 15 \end{cases}$$

$N_{first}$  and  $TGL$  are defined in subclause 4.4.

The bits output from the DTX insertion block are denoted by  $w_1, w_2, w_3, \dots, w_{(PR)}$ . Note that these bits are three valued. They are defined by the following relations:

$$w_k = s_k \quad k = 1, 2, 3, \dots, S$$

$$w_k = \delta \quad k = S+1, S+2, S+3, \dots, P \cdot R$$

where DTX indication bits are denoted by  $\delta$ . Here  $s_k \in \{0, 1, p\}$  and  $\delta \notin \{0, 1\}$ .

## 4.2.10 Physical channel segmentation

When more than one PhCH is used, physical channel segmentation divides the bits among the different PhCHs. The bits input to the physical channel segmentation are denoted by  $x_1, x_2, x_3, \dots, x_X$ , where  $X$  is the number of bits input to the physical channel segmentation block. The number of PhCHs is denoted by  $P$ .

The bits after physical channel segmentation are denoted  $u_{p,1}, u_{p,2}, u_{p,3}, \dots, u_{p,U}$ , where  $p$  is PhCH number and  $U$  is the number of bits in one radio frame for each PhCH, i.e.  $U = \frac{X}{P}$ . The relation between  $x_k$  and  $u_{p,k}$  is given below.

For all modes, some bits of the input flow are mapped to each code until the number of bits on the code is  $U$ . All bits of the input flow are taken to be mapped to the codes.

Bits on first PhCH after physical channel segmentation:

$$u_{1,k} = x_k \quad k = 1, 2, \dots, U$$

Bits on second PhCH after physical channel segmentation:

$$u_{2,k} = x_{k+U} \quad k = 1, 2, \dots, U$$

...

Bits on the  $P^{\text{th}}$  PhCH after physical channel segmentation:

$$u_{p,k} = x_{k+(P-1) \times U} \quad k = 1, 2, \dots, U$$

### 4.2.10.1 Relation between input and output of the physical segmentation block in uplink

The bits input to the physical segmentation are denoted by  $s_1, s_2, s_3, \dots, s_S$ . Hence,  $x_k = s_k$  and  $Y = S$ .

### 4.2.10.2 Relation between input and output of the physical segmentation block in downlink

The bits input to the physical segmentation are denoted by  $w_1, w_2, w_3, \dots, w_{(PU)}$ . Hence,  $x_k = w_k$  and  $Y = PU$ .

## 4.2.11 2<sup>nd</sup> interleaving

The 2<sup>nd</sup> interleaving is a block interleaver and consists of bits input to a matrix with padding, the inter-column permutation for the matrix and bits output from the matrix with pruning. The bits input to the block interleaver are denoted by  $u_{p,1}, u_{p,2}, u_{p,3}, \dots, u_{p,U}$ , where  $p$  is PhCH number and  $U$  is the number of bits in one radio frame for one PhCH. The output bit sequence from the block interleaver is derived as follows:

(1) Assign  $C2 = 30$  to be the number of columns of the matrix. The columns of the matrix are numbered  $0, 1, 2, \dots, C2 - 1$  from left to right.

(2) Determine the number of rows of the matrix,  $R2$ , by finding minimum integer  $R2$  such that:

$$U \leq R2 \times C2.$$

The rows of rectangular matrix are numbered  $0, 1, 2, \dots, R2 - 1$  from top to bottom.

(3) Write the input bit sequence  $u_{p,1}, u_{p,2}, u_{p,3}, \dots, u_{p,U}$  into the  $R2 \times C2$  matrix row by row starting with bit  $y_{p,1}$  in column 0 of row 0:

$$\begin{bmatrix} y_{p,1} & y_{p,2} & y_{p,3} & \cdots & y_{p,C2} \\ y_{p,(C2+1)} & y_{p,(C2+2)} & y_{p,(C2+3)} & \cdots & y_{p,(2 \times C2)} \\ \vdots & \vdots & \vdots & \dots & \vdots \\ y_{p,((R2-1) \times C2+1)} & y_{p,((R2-1) \times C2+2)} & y_{p,((R2-1) \times C2+3)} & \cdots & y_{p,(R2 \times C2)} \end{bmatrix}$$

where  $y_{p,k} = u_{p,k}$  for  $k = 1, 2, \dots, U$  and if  $R2 \times C2 > U$ , the dummy bits are padded such that  $y_{p,k} = 0$  or 1 for  $k = U + 1, U + 2, \dots, R2 \times C2$ . These dummy bits are pruned away from the output of the matrix after the inter-column permutation.

- (4) Perform the inter-column permutation for the matrix based on the pattern  $\langle P2(j) \rangle_{j \in \{0,1,\dots,C2-1\}}$  that is shown in table 7, where  $P2(j)$  is the original column position of the  $j$ -th permuted column. After permutation of the columns, the bits are denoted by  $y'_{p,k}$ .

$$\begin{bmatrix} y'_{p,1} & y'_{p,(R2+1)} & y'_{p,(2 \times R2+1)} & \cdots & y'_{p,((C2-1) \times R2+1)} \\ y'_{p,2} & y'_{p,(R2+2)} & y'_{p,(2 \times R2+2)} & \cdots & y'_{p,((C2-1) \times R2+2)} \\ \vdots & \vdots & \vdots & \dots & \vdots \\ y'_{p,R2} & y'_{p,(2 \times R2)} & y'_{p,(3 \times R2)} & \cdots & y'_{p,(C2 \times R2)} \end{bmatrix}$$

- (5) The output of the block interleaver is the bit sequence read out column by column from the inter-column permuted  $R2 \times C2$  matrix. The output is pruned by deleting dummy bits that were padded to the input of the matrix before the inter-column permutation, i.e. bits  $y'_{p,k}$  that corresponds to bits  $y_{p,k}$  with  $k > U$  are removed from the output. The bits after 2<sup>nd</sup> interleaving are denoted by  $v_{p,1}, v_{p,2}, \dots, v_{p,U}$ , where  $v_{p,1}$  corresponds to the bit  $y'_{p,k}$  with smallest index  $k$  after pruning,  $v_{p,2}$  to the bit  $y'_{p,k}$  with second smallest index  $k$  after pruning, and so on.

**Table 7 Inter-column permutation pattern for 2nd interleaving**

Number of columns C2	Inter-column permutation pattern $\langle P2(0), P2(1), \dots, P2(C2-1) \rangle$
30	$\langle 0, 20, 10, 5, 15, 25, 3, 13, 23, 8, 18, 28, 1, 11, 21, 6, 16, 26, 4, 14, 24, 19, 9, 29, 12, 2, 7, 22, 27, 17 \rangle$

#### 4.2.11.1 2<sup>nd</sup> interleaving for Secondary CCPCH with 16QAM

For MBSFN transmissions with 16QAM, the 2<sup>nd</sup> interleaving for Secondary CCPCH is done as illustrated in figure 8a below. The basic block interleaver is as described in Clause 4.2.11. For 16QAM modulated bits, there are two identical basic block interleavers of size  $R2 \times 30$ , where  $R2$  is the minimum integer fulfilling

$$\lceil U/2 \rceil \leq R2 \times 30,$$

The output bits from the physical channel segmentation are divided two by two between the interleavers: bits  $u_{p,k}$  and  $u_{p,k+1}$  go to the first interleaver and bits  $u_{p,k+2}$  and  $u_{p,k+3}$  go to the second interleaver. Bits are collected two by two from the interleavers: bits  $v_{p,k}$  and  $v_{p,k+1}$  are obtained from the first interleaver and bits  $v_{p,k+2}$  and  $v_{p,k+3}$  are obtained from the second interleaver, where  $k \bmod 4 = 1$ .

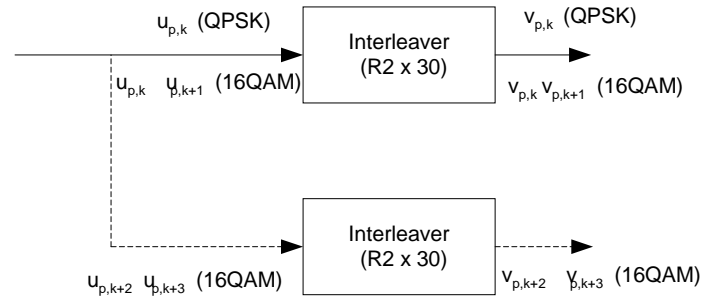

**Figure 8a: Interleaver structure for Secondary CCPCH**

## 4.2.12 Physical channel mapping

The PhCH for both uplink and downlink is defined in [2]. The bits input to the physical channel mapping are denoted by  $v_{p,1}, v_{p,2}, \dots, v_{p,U}$ , where  $p$  is the PhCH number and  $U$  is the number of bits in one radio frame for one PhCH. The bits  $v_{p,k}$  are mapped to the PhCHs so that the bits for each PhCH are transmitted over the air in ascending order with respect to  $k$ .

In compressed mode, no bits are mapped to certain slots of the PhCH(s). If  $N_{first} + TGL \leq 15$ , no bits are mapped to slots  $N_{first}$  to  $N_{last}$ . If  $N_{first} + TGL > 15$ , i.e. the transmission gap spans two consecutive radio frames, the mapping is as follows:

- In the first radio frame, no bits are mapped to slots  $N_{first}, N_{first}+1, N_{first}+2, \dots, 14$ .
- In the second radio frame, no bits are mapped to the slots  $0, 1, 2, \dots, N_{last}$ .

$TGL$ ,  $N_{first}$ , and  $N_{last}$  are defined in subclause 4.4.

### 4.2.12.1 Uplink

In uplink, the PhCHs used during a radio frame are either completely filled with bits that are transmitted over the air or not used at all. The only exception is when the UE is in compressed mode. The transmission can then be turned off during consecutive slots of the radio frame.

### 4.2.12.2 Downlink

In downlink, the PhCHs do not need to be completely filled with bits that are transmitted over the air. Values  $v_{p,k} \notin \{0, 1\}$  correspond to DTX indicators, which are mapped to the DPCCH/DPDCH fields but are not transmitted over the air.

During compressed mode by reducing the spreading factor by 2, the data bits are always mapped into 7.5 slots within a compressed frame. No bits are mapped to the DPDCH field as follows:

If  $N_{first} + TGL \leq 15$ , i.e. the transmission gap spans one radio frame,

if  $N_{first} + 7 \leq 14$

no bits are mapped to slots  $N_{first}, N_{first} + 1, N_{first} + 2, \dots, N_{first} + 6$

no bits are mapped to the first  $(N_{Data1} + N_{Data2})/2$  bit positions of slot  $N_{first} + 7$

else

no bits are mapped to slots  $N_{first}, N_{first} + 1, N_{first} + 2, \dots, 14$

no bits are mapped to slots  $N_{first} - 1, N_{first} - 2, N_{first} - 3, \dots, 8$

no bits are mapped to the last  $(N_{Data1} + N_{Data2})/2$  bit positions of slot 7

end if

If  $N_{first} + TGL > 15$ , i.e. the transmission gap spans two consecutive radio frames,

In the first radio frame, no bits are mapped to last  $(N_{Data1} + N_{Data2})/2$  bit positions in slot 7 as well as to slots 8, 9, 10, ..., 14.

In the second radio frame, no bits are mapped to slots 0, 1, 2, ..., 6 as well as to first  $(N_{Data1} + N_{Data2})/2$  bit positions in slot 7.

$N_{Data1}$  and  $N_{Data2}$  are defined in [2].

## 4.2.13 Restrictions on different types of CCTrCHs

Restrictions on the different types of CCTrCHs are described in general terms in TS 25.302[11]. In this subclause those restrictions are given with layer 1 notation.

### 4.2.13.1 Uplink Dedicated channel (DCH)

The maximum value of the number of TrCHs  $I$  in a CCTrCH, the maximum value of the number of transport blocks  $M_i$  on each transport channel, and the maximum value of the number of DPDCHs  $P$  are given from the UE capability class.

### 4.2.13.2 Random Access Channel (RACH)

- There can only be one TrCH in each RACH CCTrCH, i.e.  $I=1$ ,  $s_k = f_{1k}$  and  $S = V_1$ .
- The maximum value of the number of transport blocks  $M_i$  on the transport channel is given from the UE capability class.
- The transmission time interval is either 10 ms or 20 ms.
- Only one PRACH is used, i.e.  $P=1$ ,  $u_{1k} = s_k$ , and  $U = S$ .
- The Static rate matching parameter  $RM_1$  is not provided by higher layer signalling on the System information as the other transport channel parameters. Any value may be used as there is one transport channel in the CCTrCH, hence one transport channel per Transport Format Combination and no need to do any balancing between multiple transport channels.

### 4.2.13.3 Void

### 4.2.13.4 Downlink Dedicated Channel (DCH)

The maximum value of the number of TrCHs  $I$  in a CCTrCH, the maximum value of the number of transport blocks  $M_i$  on each transport channel, and the maximum value of the number of DPDCHs  $P$  are given from the UE capability class.

### 4.2.13.5 Void

### 4.2.13.6 Broadcast channel (BCH)

- There can only be one TrCH in the BCH CCTrCH, i.e.  $I=1$ ,  $s_k = f_{1k}$ , and  $S = V_1$ .
- There can only be one transport block in each transmission time interval, i.e.  $M_1 = 1$ .
- All transport format attributes have predefined values which are provided in [11] apart from the rate matching  $RM_1$ .
- The Static rate matching parameter  $RM_1$  is not provided by higher layer signalling neither fixed. Any value may be used as there is one transport channel in the CCTrCH, hence one transport channel per Transport Format Combination and no need to do any balancing between multiple transport channels.
- Only one primary CCPCH is used, i.e.  $P=1$ .



#### 4.2.13.7 Forward access and paging channels (FACH and PCH)

- The maximum value of the number of TrCHs  $I$  in a CCTrCH and the maximum value of the number of transport blocks  $M_i$  on each transport channel are given from the UE capability class.
- The transmission time interval for TrCHs of PCH type is always 10 ms.
- Only one secondary CCPCH is used per CCTrCH, i.e.  $P=1$ .

#### 4.2.13.8 High Speed Downlink Shared Channel (HS-DSCH) associated with a DCH

- There can be only one TrCH in an HS-DSCH CCTrCH, i.e.  $I = 1$ ,
- In case the UE is not configured in MIMO mode and not in MIMO mode with four transmit antennas or the UE is configured in MIMO mode and single-stream restriction is configured, there can only be one transport block in each transmission time interval, i.e.  $M_i = 1$ . In case the UE is configured in MIMO mode, there can be one or two transport blocks in each transmission time interval and in case the UE is configured in MIMO mode with four transmit antennas, there can be up to four transport blocks in each transmission time interval.
- The transmission time interval for TrCHs of HS-DSCH type is always 2 ms.
- The maximum value of the number of HS-PDSCHs  $P$  are given from the UE capability class.

#### 4.2.13.9 Enhanced Dedicated Channel (E-DCH)

- There can be only one TrCH in the E-DCH CCTrCH, i.e.  $I = 1$ .
- If the UL\_MIMO\_Enabled is not set to TRUE, there can only be one transport block in each transmission time interval, i.e.  $M_i = 1$ . If the UL\_MIMO\_Enabled is set to TRUE, there can be one or two transport blocks in each transmission time interval.
- The transmission time interval for TrCHs of E-DCH type is 2 ms or 10 ms. If the UL\_MIMO\_Enabled is set to TRUE, the transmission time interval for TrCHs of E-DCH type is always set to 2 ms.
- The maximum value of the number of E-DPDCHs  $P$  are given from the UE capabilities.

### 4.2.14 Multiplexing of different transport channels into one CCTrCH, and mapping of one CCTrCH onto physical channels

The following rules shall apply to the different transport channels which are part of the same CCTrCH:

- 1) Transport channels multiplexed into one CCTrCH shall have co-ordinated timings. When the TFCS of a CCTrCH is changed because one or more transport channels are added to the CCTrCH or reconfigured within the CCTrCH, or removed from the CCTrCH, the change may only be made at the start of a radio frame with CFN fulfilling the relation

$$\text{CFN} \bmod F_{\max} = 0,$$

where  $F_{\max}$  denotes the maximum number of radio frames within the transmission time intervals of all transport channels which are multiplexed into the same CCTrCH, including any transport channels  $i$  which are added, reconfigured or have been removed, and CFN denotes the connection frame number of the first radio frame of the changed CCTrCH.

After addition or reconfiguration of a transport channel  $i$  within a CCTrCH, the TTI of transport channel  $i$  may only start in radio frames with CFN fulfilling the relation:

$$\text{CFN} \bmod F_i = 0.$$

- 2) Only transport channels with the same active set can be mapped onto the same CCTrCH.
- 3) Different CCTrCHs cannot be mapped onto the same PhCH.
- 4) One CCTrCH shall be mapped onto one or several PhCHs. These physical channels shall all have the same SF, except for the case of four E-DPDCHs, where two E-DPDCHs have spreading factor 2 and the other two E-

DPDCHs have spreading factor 4, and for the case of four S-E-DPDCHs, where two S-E-DPDCHs have spreading factor 2 and the other two S-E-DPDCHs have spreading factor 4.

All physical channels belonging to the same CCTrCH shall use the same modulation scheme with the exception that, when transmitted, the modulation scheme used by the four S-E-DPDCHs may be different from that used by the four E-DPDCHs.

The 4PAM modulation shall only be used for orthogonal PhCH pairs which are orthogonal in phase and use the same OVSF code.

The 8PAM modulation shall only be used for orthogonal PhCH pairs which are orthogonal in phase and use the same OVSF code.

- 5) Dedicated Transport channels and common transport channels cannot be multiplexed into the same CCTrCH.
- 6) For the common transport channels, only the FACH and PCH may belong to the same CCTrCH.

There are hence two types of CCTrCH:

- 1) CCTrCH of dedicated type, corresponding to the result of coding and multiplexing of one or several DCHs or one E-DCH.
- 2) CCTrCH of common type, corresponding to the result of the coding and multiplexing of a common channel, RACH in the uplink, HS-DSCH, BCH, or FACH/PCH for the downlink.

#### 4.2.14.1 Allowed CCTrCH combinations for one UE

##### 4.2.14.1.1 Allowed CCTrCH combinations on the uplink

The following CCTrCH combinations for one UE are allowed:

- 1) one CCTrCH of dedicated type or
  - 1a) two CCTrCHs of dedicated type, one being of DCH type and the other one of E-DCH type or
- 2) one CCTrCH of common type.

##### 4.2.14.1.2 Allowed CCTrCH combinations on the downlink

The following CCTrCH combinations for one UE are allowed:

- $x$  CCTrCH of dedicated type +  $y$  CCTrCH of common type. The allowed combination of CCTrCHs of dedicated and common type are given from UE radio access capabilities. There can be a maximum of one CCTrCH of common type for HS-DSCH. The maximum number of CCTrCHs of common type for FACH is determined from UE capabilities. With one CCTrCH of common type for HS-DSCH, there shall be only one CCTrCH of dedicated type.

NOTE 1: There is only one DPCCH in the uplink, hence one TPC bits flow on the uplink to control possibly the different DPDCHs on the downlink, part of the same or several CCTrCHs.

NOTE 2: There is only one DPCCH in the downlink, even with multiple CCTrCHs. With multiple CCTrCHs, the DPCCH is transmitted on one of the physical channels of that CCTrCH which has the smallest SF among the multiple CCTrCHs. Thus there is only one TPC command flow and only one TFCI word in downlink even with multiple CCTrCHs.

NOTE 3: in the current release, only 1 CCTrCH of dedicated type is supported.

## 4.3 Transport format detection

If the transport format set of a TrCH  $i$  contains more than one transport format, the transport format can be detected according to one of the following methods:

- TFCI based detection: This method is applicable when the transport format combination is signalled using the TFCI field;
- explicit blind detection: This method typically consists of detecting the TF of TrCH  $i$  by use of channel decoding and CRC check;
- guided detection: This method is applicable when there is at least one other TrCH  $i'$ , hereafter called guiding TrCH, such that:
  - the guiding TrCH has the same TTI duration as the TrCH under consideration, i.e.  $F_T = F_i$ ;
  - different TFs of the TrCH under consideration correspond to different TFs of the guiding TrCH;
  - explicit blind detection is used on the guiding TrCH.

If the transport format set for a TrCH  $i$  does not contain more than one transport format with more than zero transport blocks, no explicit blind transport format detection needs to be performed for this TrCH. The UE can use guided detection for this TrCH or single transport format detection, where the UE always assumes the transport format corresponding to more than zero transport blocks for decoding.

For uplink, blind transport format detection is a network controlled option. For downlink, the UE shall be capable of performing blind transport format detection, if certain restrictions on the configured transport channels are fulfilled.

### 4.3.1 Blind transport format detection

When no TFCI is available then explicit blind detection or guided detection shall be performed on all TrCHs within the CCTrCH that have more than one transport format and that do not use single transport format detection. The UE shall only be required to support blind transport format detection if all of the following restrictions are fulfilled:

1. either only one CCTrCH is received, or one CCTrCH of dedicated type and one CCTrCH of common type for HS-DSCH are received by the UE;

If only one CCTrCH is received by the UE, the following conditions apply to that CCTrCH and those TrCHs that are multiplexed on the CCTrCH. If one CCTrCH of dedicated type and one CCTrCH of common type for HS-DSCH are received by the UE, the following conditions apply to the dedicated type CCTrCH and the TrCHs that are multiplexed on the dedicated type CCTrCH.

2. the number of CCTrCH bits received per radio frame is 600 or less;
3. the number of transport format combinations of the CCTrCH is 64 or less;
4. fixed positions of the transport channels is used on the CCTrCH to be detectable;
5. convolutional coding is used on all explicitly detectable TrCHs;
6. CRC with non-zero length is appended to all transport blocks on all explicitly detectable TrCHs;
7. at least one transport block shall be transmitted per TTI on each explicitly detectable TrCH;
8. the number of explicitly detectable TrCHs is 3 or less;
9. for all explicitly detectable TrCHs  $i$ , the number of code blocks in one TTI ( $C_i$ ) shall not exceed 1;
10. the sum of the transport format set sizes of all explicitly detectable TrCHs, is 16 or less. The transport format set size is defined as the number of transport formats within the transport format set;
11. there is at least one TrCH that can be used as the guiding transport channel for all transport channels using guided detection.

Examples of blind transport format detection methods are given in annex A.

#### 4.3.1a Single transport format detection

When no TFCI is available, then single transport format detection shall be applied on all TrCHs within the CCTrCH that have a transport format set not containing more than one transport format with more than zero transport blocks and

that do not use guided detection. The UE shall only be required to support single transport format detection if the following restrictions are fulfilled:

1. For each transport channel that is single transport format detected, CRC with non-zero length is appended to all transport blocks within the non-zero transport block transport format;
2. fixed positions of the transport channels is used on the CCTrCH to be detectable.

### 4.3.2 Transport format detection based on TFCI

If a TFCI is available, then TFCI based detection shall be applicable to all TrCHs within the CCTrCH. The TFCI informs the receiver about the transport format combination of the CCTrCHs. As soon as the TFCI is detected, the transport format combination, and hence the transport formats of the individual transport channels are known.

If higher layers indicate that S-CCPCHs can be soft combined during a period of consecutive TTIs, then the same TFCI is used on those S-CCPCHs for each combinable TTI. The UE may therefore detect TFCI on one S-CCPCH to determine the TFC on all S-CCPCHs that can be soft combined. (S-CCPCH soft combining is further specified in [4]).

### 4.3.3 Coding of Transport-Format-Combination Indicator (TFCI)

The TFCI is encoded using a (32, 10) sub-code of the second order Reed-Muller code. The coding procedure is as shown in figure 9.

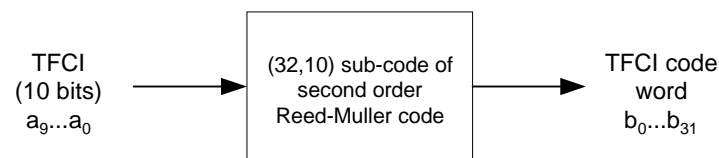

**Figure 9: Channel coding of TFCI information bits**

If the TFCI consist of less than 10 bits, it is padded with zeros to 10 bits, by setting the most significant bits to zero. The length of the TFCI code word is 32 bits.

The code words of the (32,10) sub-code of second order Reed-Muller code are linear combination of 10 basis sequences. The basis sequences are as in the following table 8.

Table 8: Basis sequences for (32,10) TFCI code

<i>i</i>	$M_{i,0}$	$M_{i,1}$	$M_{i,2}$	$M_{i,3}$	$M_{i,4}$	$M_{i,5}$	$M_{i,6}$	$M_{i,7}$	$M_{i,8}$	$M_{i,9}$
0	1	0	0	0	0	1	0	0	0	0
1	0	1	0	0	0	1	1	0	0	0
2	1	1	0	0	0	1	0	0	0	1
3	0	0	1	0	0	1	1	0	1	1
4	1	0	1	0	0	1	0	0	0	1
5	0	1	1	0	0	1	0	0	1	0
6	1	1	1	0	0	1	0	1	0	0
7	0	0	0	1	0	1	0	1	1	0
8	1	0	0	1	0	1	1	1	1	0
9	0	1	0	1	0	1	1	0	1	1
10	1	1	0	1	0	1	0	0	1	1
11	0	0	1	1	0	1	0	1	1	0
12	1	0	1	1	0	1	0	1	0	1
13	0	1	1	1	0	1	1	0	0	1
14	1	1	1	1	0	1	1	1	1	1
15	1	0	0	0	1	1	1	1	0	0
16	0	1	0	0	1	1	1	1	0	1
17	1	1	0	0	1	1	1	0	1	0
18	0	0	1	0	1	1	0	1	1	1
19	1	0	1	0	1	1	0	1	0	1
20	0	1	1	0	1	1	0	0	1	1
21	1	1	1	0	1	1	0	1	1	1
22	0	0	0	1	1	1	0	1	0	0
23	1	0	0	1	1	1	1	1	0	1
24	0	1	0	1	1	1	1	0	1	0
25	1	1	0	1	1	1	1	0	0	1
26	0	0	1	1	1	1	0	0	1	0
27	1	0	1	1	1	1	1	1	0	0
28	0	1	1	1	1	1	1	1	1	0
29	1	1	1	1	1	1	1	1	1	1
30	0	0	0	0	0	1	0	0	0	0
31	0	0	0	0	1	1	1	0	0	0

The TFCI information bits  $a_0, a_1, a_2, a_3, a_4, a_5, a_6, a_7, a_8, a_9$  (where  $a_0$  is LSB and  $a_9$  is MSB) shall correspond to the TFC index (expressed in unsigned binary form) defined by the RRC layer to reference the TFC of the CCTrCH in the associated DPCH radio frame.

The output code word bits  $b_i$  are given by:

$$b_i = \sum_{n=0}^9 (a_n \times M_{i,n}) \bmod 2$$

where  $i = 0, \dots, 31$ .

The output bits are denoted by  $b_k, k = 0, 1, 2, \dots, 31$ .

In downlink, when the SF < 128 the encoded TFCI code words are repeated yielding 8 encoded TFCI bits per slot in normal mode and 16 encoded TFCI bits per slot in compressed mode. Mapping of repeated bits to slots is explained in subclause 4.3.5.

#### 4.3.4 Void

## 4.3.5 Mapping of TFCI words

### 4.3.5.1 Mapping of TFCI word in normal mode

The bits of the code word are directly mapped to the slots of the radio frame. Within a slot the bit with lower index is transmitted before the bit with higher index. The coded bits  $b_k$ , are mapped to the transmitted TFCI bits  $d_k$ , according to the following formula:

$$d_k = b_{k \bmod 32}$$

For uplink physical channels regardless of the SF and downlink physical channels, if  $SF \geq 128$ ,  $k = 0, 1, 2, \dots, 29$ . Note that this means that bits  $b_{30}$  and  $b_{31}$  are not transmitted.

For downlink physical channels whose  $SF < 128$ ,  $k = 0, 1, 2, \dots, 119$ . Note that this means that bits  $b_0$  to  $b_{23}$  are transmitted four times and bits  $b_{24}$  to  $b_{31}$  are transmitted three times.

#### 4.3.5.1.1 Mapping of TFCI bits for Secondary CCPCH with 16QAM

For MBSFN transmissions with 16QAM, the coded bits  $b_k$ , are mapped to the transmitted TFCI bits according to the following formulas:

$$d_{4k} = b_{2k \bmod 32} ,$$

$$d_{4k+1} = b_{2k+1 \bmod 32} ,$$

$$d_{4k+2} = (d_{4k} + d_{4k+1}) \bmod 2,$$

$$d_{4k+3} = (1 + d_{4k} + d_{4k+1}) \bmod 2,$$

where  $k = 0, 1, 2, \dots, 59$  for  $SF < 128$  and  $k = 0, 1, 2, \dots, 14$  for  $SF \geq 128$ .

### 4.3.5.2 Mapping of TFCI word in compressed mode

The mapping of the TFCI bits in compressed mode is different for uplink, downlink with  $SF \geq 128$  and downlink with  $SF < 128$ .

#### 4.3.5.2.1 Uplink compressed mode

For uplink compressed mode, the slot format is changed so that no TFCI coded bits are lost. The different slot formats in compressed mode do not match the exact number of TFCI coded bits for all possible TGLs. Repetition of the TFCI bits is therefore used.

Denote the number of bits available in the TFCI fields of one compressed radio frame by  $D$  and the number of bits in the TFCI field in a slot by  $N_{\text{TFCI}}$ . The parameter  $E$  is used to determine the number of the first TFCI bit to be repeated.

$E = N_{\text{first}} N_{\text{TFCI}}$ , if the start of the transmission gap is allocated to the current frame.

$E = 0$ , if the start of the transmission gap is allocated to the previous frame and the end of the transmission gap is allocated to the current frame.

The TFCI coded bits  $b_k$  are mapped to the bits in the TFCI fields  $d_k$ . The following relations define the mapping for each compressed frame.

$$d_k = b_k$$

where  $k = 0, 1, 2, \dots, \min(31, D-1)$ .

If  $D > 32$ , the remaining positions are filled by repetition (in reversed order):

$$d_{D-k-1} = b_{(E+k) \bmod 32}$$

where  $k = 0, \dots, D-33$ .

#### 4.3.5.2.2 Downlink compressed mode

For downlink compressed mode, the slot format is changed so that no TFCI coded bits are lost. The different slot formats in compressed mode do not match the exact number of TFCI bits for all possible TGLs. DTX is therefore used if the number of bits available in the TFCI fields in one compressed frame exceeds the number of TFCI bits given from the slot format. The block of bits in the TFCI fields where DTX is used starts on the first TFCI field after the transmission gap. If there are more bits available in the TFCI fields before the transmission gap than TFCI bits, DTX is also used on the bits in the last TFCI fields before the transmission gap.

Denote the number of bits available in the TFCI fields of one compressed radio frame by  $D$  and the number of bits in the TFCI field in a slot by  $N_{\text{TFCI}}$ . The parameter  $E$  is used to determine the position of the first bit in the TFCI field on which DTX is used.

$E = N_{\text{first}} N_{\text{TFCI}}$ , if the start of the transmission gap is allocated to the current frame.

$E = 0$ , if the start of the transmission gap is allocated to the previous frame and the end of the transmission gap is allocated to the current frame.

Denote the total number of TFCI bits to be transmitted by  $F$ .  $F = 32$  for slot formats  $nA$  or  $nB$ , where  $n = 0, 1, \dots, 11$  (see table 11 in [2]). Otherwise,  $F = 128$ . The TFCI coded bits  $b_k$  are mapped to the bits in the TFCI fields  $d_k$ . The following relations define the mapping for each compressed frame.

If  $E > 0$ ,

$$d_k = b_{k \bmod 32}$$

where  $k = 0, 1, 2, \dots, \min(E, F) - 1$ .

If  $E < F$ ,

$$d_{k+D-F} = b_{k \bmod 32}$$

where  $k = E, \dots, F - 1$ .

DTX is used on  $d_k$  where  $k = \min(E, F), \dots, \min(E, F) + D - F - 1$ .

## 4.4 Compressed mode

In compressed frames, TGL slots from  $N_{\text{first}}$  to  $N_{\text{last}}$  are not used for transmission of data. As illustrated in figure 11, the instantaneous transmit power is increased in the compressed frame in order to keep the quality (BER, FER, etc.) unaffected by the reduced processing gain. The amount of power increase depends on the transmission time reduction method (see subclause 4.4.3). What frames are compressed, are decided by the network. When in compressed mode, compressed frames can occur periodically, as illustrated in figure 11, or requested on demand. The rate and type of compressed frames is variable and depends on the environment and the measurement requirements.

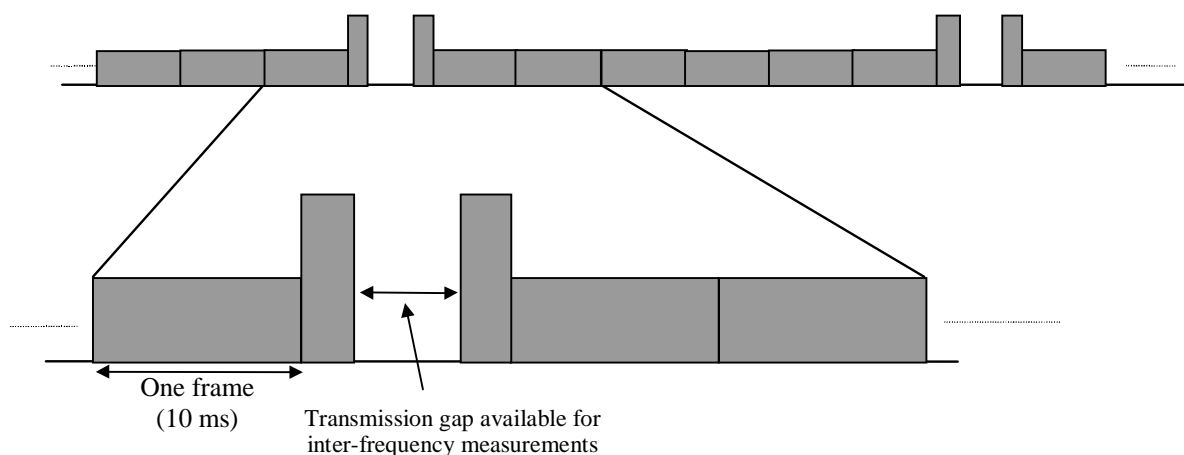

Figure 11: Compressed mode transmission

### 4.4.1 Frame structure in the uplink

The frame structure for uplink compressed frames is illustrated in figure 12.

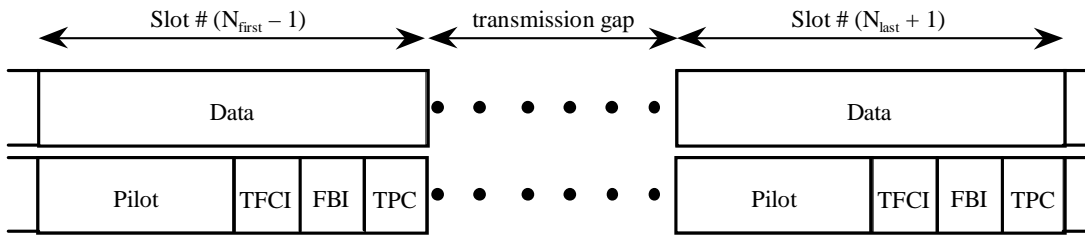
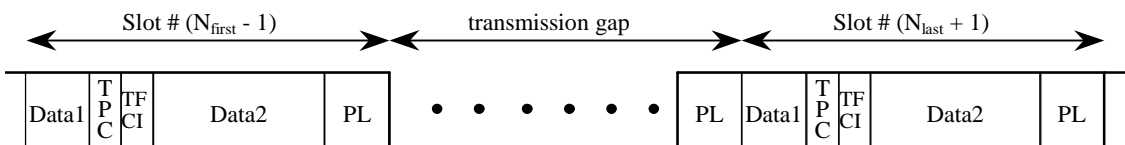

Figure 12: Frame structure in uplink compressed transmission

### 4.4.2 Frame structure types in the downlink

There are two different types of frame structures defined for downlink compressed frames. Type A maximises the transmission gap length and type B is optimised for power control. The frame structure type A or B is set by higher layers independent from the downlink slot format type A or B.

- With frame structure of type A, the pilot field of the last slot in the transmission gap is transmitted. Transmission is turned off during the rest of the transmission gap (figure 13(a)). In case the length of the pilot field is 2 bits and STTD is used on the radio link, the pilot bits in the last slot of the transmission gap shall be STTD encoded assuming DTX indicators as the two last bits in the Data2 field.
- With frame structure of type B, the TPC field of the first slot in the transmission gap and the pilot field of the last slot in the transmission gap is transmitted. Transmission is turned off during the rest of the transmission gap (figure 13(b)). In case the length of the pilot field is 2 bits and STTD is used on the radio link, the pilot bits in the last slot of the transmission gap shall be STTD encoded assuming DTX indicators as the two last bits of the Data2 field. Similarly, the TPC bits in the first slot of the transmission gap shall be STTD encoded assuming DTX indicators as the two last bits in the Data1 field.



(a) Frame structure type A

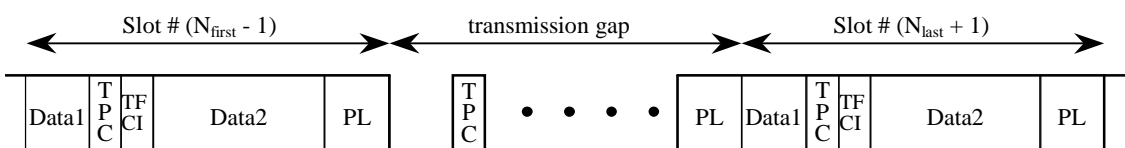

(b) Frame structure type B

Figure 13: Frame structure types in downlink compressed transmission

#### 4.4.2A Frame structure in the downlink for F-DPCH

There is only one type of frame structure defined for downlink F-DPCH compressed frames: transmission is turned off during the whole transmission gap i.e. in slots  $N_{\text{first}}$  to  $N_{\text{last}}$ .



## 4.4.2B Frame structure in the downlink for F-TPICH

There is only one type of frame structure defined for downlink F-TPICH compressed frames: transmission is turned off during the whole transmission gap i.e. in slots  $N_{\text{first}}$  to  $N_{\text{last}}$ . TPI will not be transmitted in either of the both slots in the case where only one of the two slots carrying the TPI information overlaps with the transmission gap.

## 4.4.3 Transmission time reduction method

When in compressed mode, the information normally transmitted during a 10 ms frame is compressed in time. The mechanisms provided for achieving this are reduction of the spreading factor by a factor of two, and higher layer scheduling. In the downlink and the uplink, all methods are supported. The maximum idle length is defined to be 7 slots per one 10 ms frame. The slot formats that are used in compressed frames are listed in [2].

In case F-DPCH is configured in the downlink, no transmission time reduction method is needed during compressed frames. The same slot format is used in compressed frames and normal frames.

### 4.4.3.1 Void

### 4.4.3.2 Compressed mode by reducing the spreading factor by 2

The spreading factor (SF) can be reduced by 2 during one compressed radio frame to enable the transmission of the information bits in the remaining time slots of the compressed frame. This method is not supported for SF=4.

On the downlink, UTRAN can also order the UE to use a different scrambling code in a compressed frame than in a non-compressed frame. If the UE is ordered to use a different scrambling code in a compressed frame, then there is a one-to-one mapping between the scrambling code used in the non-compressed frame and the one used in the compressed frame, as described in [3] subclause 5.2.1.

### 4.4.3.3 Compressed mode by higher layer scheduling

Compressed frames can be obtained by higher layer scheduling. Higher layers then set restrictions so that only a subset of the allowed TFCs are used in a compressed frame. The maximum number of bits that will be delivered to the physical layer during the compressed radio frame is then known and a transmission gap can be generated. Note that in the downlink, the TFCI field is expanded on the expense of the data fields and this shall be taken into account by higher layers when setting the restrictions on the TFCs. Compressed mode by higher layer scheduling shall not be used with fixed starting positions of the TrCHs in the radio frame.

## 4.4.4 Transmission gap position

Transmission gaps can be placed at different positions as shown in figures 14 and 15 for each purpose such as interfrequency power measurement, acquisition of control channel of other system/carrier, and actual handover operation.

The restrictions listed below apply to DPCCH/ S-DPCCH/DPDCH in the uplink and DPCH or F-DPCH in the downlink.

When using single frame method, the transmission gap is located within the compressed frame depending on the transmission gap length (TGL) as shown in figure 14 (1). When using double frame method, the transmission gap is located on the center of two connected frames as shown in figure 14 (2).

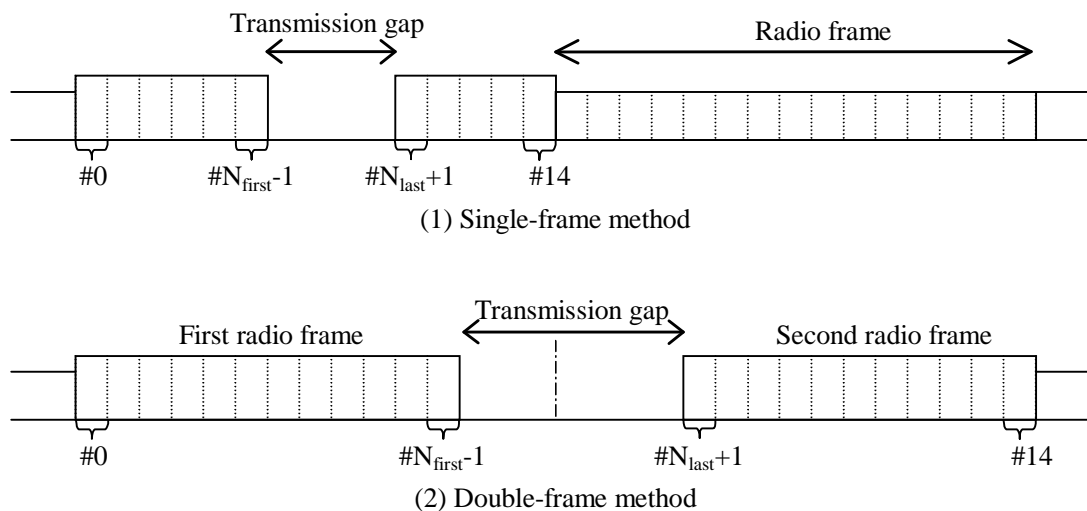

**Figure 14: Transmission gap position**

Parameters of the transmission gap positions are calculated as follows.

TGL is the number of consecutive idle slots during the compressed mode transmission gap:

$$\text{TGL} = 3, 4, 5, 7, 10, 14$$

$N_{\text{first}}$  specifies the starting slot of the consecutive idle slots,

$$N_{\text{first}} = 0, 1, 2, 3, \dots, 14.$$

$N_{\text{last}}$  shows the number of the final idle slot and is calculated as follows;

$$\text{If } N_{\text{first}} + \text{TGL} \leq 15, \text{ then } N_{\text{last}} = N_{\text{first}} + \text{TGL} - 1 \text{ ( in the same frame )},$$

$$\text{If } N_{\text{first}} + \text{TGL} > 15, \text{ then } N_{\text{last}} = (N_{\text{first}} + \text{TGL} - 1) \bmod 15 \text{ ( in the next frame )}.$$

When the transmission gap spans two consecutive radio frames,  $N_{\text{first}}$  and TGL must be chosen so that at least 8 slots in each radio frame are transmitted.

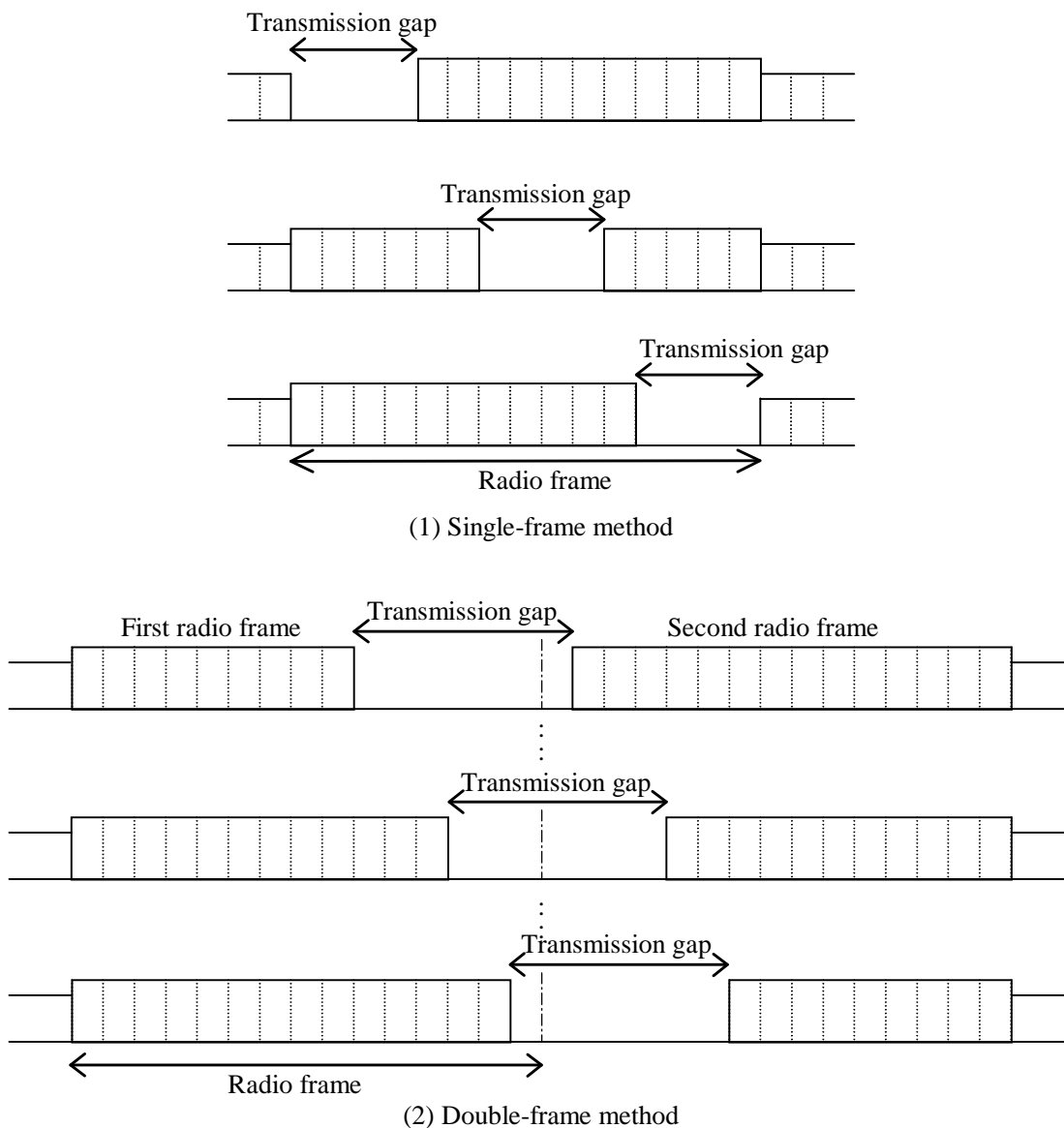

Figure 15: Transmission gap positions with different Nfirst

### 4.4.5 Transmission gap position for E-DCH

In the following, the transmission gap position for E-DCH during compressed frames is specified for the case when E-DCH TTI length is 10 ms. Slots that are not idle due to uplink compressed mode are termed "available".

The parameter  $n_{first}$  and  $n_{last}$  are used to determine the transmission gap position due to uplink compressed mode in the current radio frame. If the start of the transmission gap is allocated in the current frame  $n_{first}=N_{first}$  else  $n_{first}=0$ . If the end of a transmission gap is allocated in the current frame  $n_{last}=N_{last}$  else  $n_{last}=14$ .

#### 4.4.5.1 E-DPDCH Transmission Gap Position during Initial Transmissions

If an initial transmission overlaps with a compressed frame the starting slot of the consecutive E-DPDCH idle slots within the E-DCH TTI is  $n_{first}$ , and  $n_{last}$  is the final idle slot within the 10 ms E-DCH TTI. The number of transmitted slots  $n_{tx}$  is given by  $n_{tx}=14+n_{first}-n_{last}$ .

If the initial transmission occurs in a non-compressed uplink frame,  $n_{tx}=15$ .

#### 4.4.5.2 E-DPDCH Transmission Gap Position during Retransmissions

If the current retransmission occurs in a compressed frame the maximum number of slots available for the retransmission is given by  $n_{max}=14+n_{first}-n_{last}$ . Else the maximum number of slots available for the retransmission  $n_{max}$  is 15.

If the initial transmission was compressed and in the retransmission more than  $n_{txl}$  slots are available for transmission ( $n_{max}>n_{txl}$ ), the last  $n_{dtx}=n_{max}-n_{txl}$  available slots of the E-DPDCH frame are E-DPDCH idle slots. The parameter  $n_{txl}$  refers to the number of transmitted slots calculated as defined in 4.4.5.1 for the corresponding initial transmission.

The E-DPDCH transmission gap in case a retransmission occurs in a compressed frame or a retransmission occurs in a non-compressed frame for which initial transmission was compressed is defined as follows:

If  $n_{max} \leq n_{txl}$

E-DPDCH idle slots are slots  $n_{first}, n_{first}+1, \dots, n_{last}$

Else

If a retransmission occurs in a compressed frame and  $n_{first} < n_{txl}$

E-DPDCH idle slots are the slots  $n_{first}, n_{first}+1, \dots, n_{last}$  and  $15-n_{dtx}, 15-n_{dtx}+1, \dots, 14$

Else

E-DPDCH idle slots are the slots  $n_{txl}, n_{txl}+1, \dots, 14$

#### 4.4.5.3 E-DPCCH Transmission Gap Position

If a transmission overlaps with an uplink compressed frame the starting slot of the compressed mode gap within the E-DCH TTI is  $n_{first}$ , and  $n_{last}$  is the final E-DPCCH idle slot within the 10 ms E-DCH TTI.

## 4.5 Coding for HS-DSCH

Data arrives to the coding unit in form of a maximum of one transport block once every transmission time interval. The transmission time interval is 2 ms which is mapped to a radio sub-frame of 3 slots.

The following coding steps can be identified:

- add CRC to each transport block (see subclause 4.5.1);
- bit scrambling (see subclause 4.5.1a);
- code block segmentation (see subclause 4.5.2);
- channel coding (see subclause 4.5.3);
- hybrid ARQ (see subclause 4.5.4);
- physical channel segmentation (see subclause 4.5.5);
- interleaving for HS-DSCH (see subclause 4.5.6);
- constellation re-arrangement for 16QAM and 64QAM (see subclause 4.5.7);
- mapping to physical channels (see subclause 4.5.8).

The coding steps for HS-DSCH are shown in the figure below.

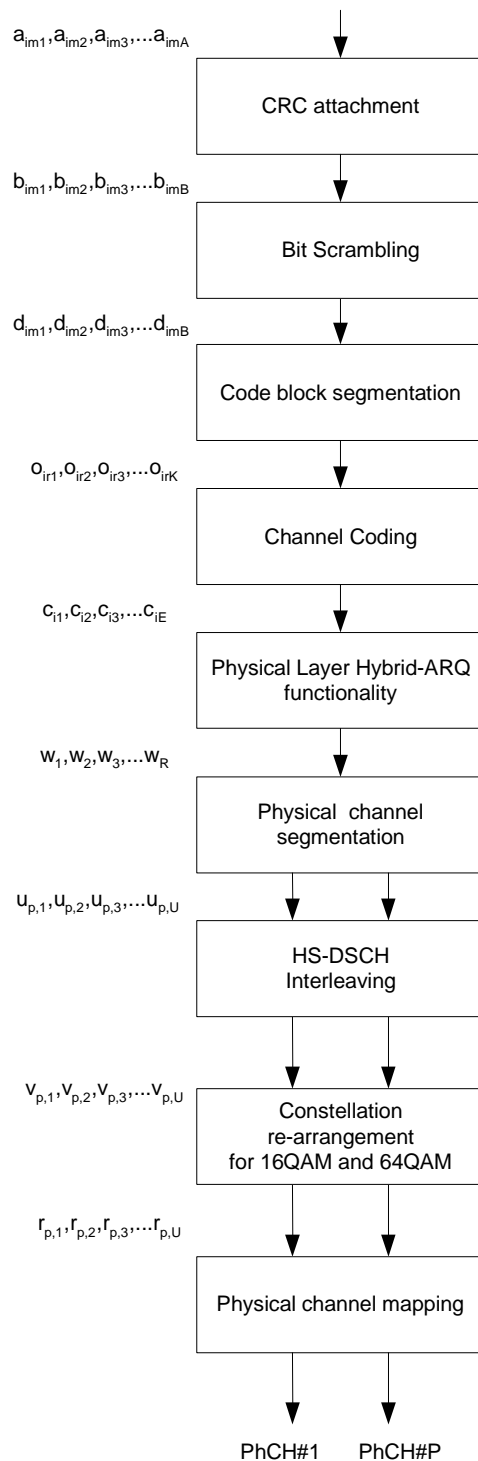

**Figure 16: Coding chain for HS-DSCH**

In the following the number of transport blocks and the number of transport channels is always one i.e.  $m=1, i=1$ . When referencing non HS-DSCH formulae which are used in correspondence with HS-DSCH formulae the convention is used that transport block subscripts may be omitted (e.g.  $X_1$  may be written  $X$ ).

## 4.5.1 CRC attachment for HS-DSCH

### 4.5.1.1 CRC attachment method 1 for HS-DSCH

CRC attachment method 1 for the HS-DSCH transport channel shall be done using the general method described in 4.2.1 above with the following specific parameters.

The CRC length shall always be  $L_1 = 24$  bits.

#### 4.5.1.2 CRC attachment method 2 for HS-DSCH

CRC attachment method 2 for the HS-DSCH transport channel shall be done according to the following method.

From the sequence of bits  $a_1, a_2, a_3, \dots, a_A$ , where  $A$  is the size of the HS-DSCH transport block, a CRC of length  $L_1 = 24$  bits is calculated according to Clause 4.2.1.1 above. This gives a sequence of bits  $c_{im1}, c_{im2}, c_{im3}, \dots, c_{im24}$  where

$$c_k = P_{im(25-k)} \quad k=1,2,\dots,24$$

This sequence of bits is then masked with the UE Identity  $x_{ue,1}, x_{ue,2}, \dots, x_{ue,16}$  and then appended to the sequence of bits  $a_1, a_2, a_3, \dots, a_A$  to form the sequence of bits  $b_1, b_2, b_3, \dots, b_B$ , where  $B = A + 24$ , and

$$b_k = a_k \quad k=1,2,\dots,A$$

$$b_k = c_{k-A} \quad k=A+1,\dots,A+8$$

$$b_k = (c_{k-A} + x_{ue,k-A-8}) \bmod 2 \quad k=A+9, \dots, A+24$$

#### 4.5.1a Bit scrambling for HS-DSCH

The bits output from the HS-DSCH CRC attachment are scrambled in the bit scrambler. The bits input to the bit scrambler are denoted by  $b_{im,1}, b_{im,2}, b_{im,3}, \dots, b_{im,B}$ , where  $B$  is the number of bits input to the HS-DSCH bit scrambler. The bits after bit scrambling are denoted  $d_{im,1}, d_{im,2}, d_{im,3}, \dots, d_{im,B}$ .

Bit scrambling is defined by the following relation:

$$d_{im,k} = (b_{im,k} + y_k) \bmod 2 \quad k = 1, 2, \dots, B$$

and  $y_k$  results from the following operation:

$$y'_\gamma = 0 \quad -15 < \gamma < 1$$

$$y'_\gamma = 1 \quad \gamma = 1$$

$$y'_\gamma = \left( \sum_{x=1}^{16} g_x \cdot y'_{\gamma-x} \right) \bmod 2 \quad 1 < \gamma \leq B,$$

where  $g = \{g_1, g_2, \dots, g_{16}\} = \{0, 0, 0, 0, 0, 0, 0, 0, 0, 0, 1, 0, 1, 1, 0, 1\}$ ,

$$y_k = y'_k \quad k = 1, 2, \dots, B.$$

#### 4.5.2 Code block segmentation for HS-DSCH

Code block segmentation for the HS-DSCH transport channel shall be done with the general method described in 4.2.2.2 above with the following specific parameters.

There will be a maximum of one transport block,  $i=1$ . The bits  $d_{im1}, d_{im2}, d_{im3}, \dots, d_{imB}$  input to the block are mapped to the bits  $x_{i1}, x_{i2}, x_{i3}, \dots, x_{iX_i}$  directly. It follows that  $X_1 = B$ . Note that the bits  $x$  referenced here refer only to the internals of the code block segmentation function. The output bits from the code block segmentation function are  $o_{ir1}, o_{ir2}, o_{ir3}, \dots, o_{irK}$ .

The value of  $Z = 5114$  for turbo coding shall be used.

### 4.5.3 Channel coding for HS-DSCH

Channel coding for the HS-DSCH transport channel shall be done with the general method described in 4.2.3 above with the following specific parameters.

There will be a maximum of one transport block,  $i=1$ . The rate 1/3 turbo coding shall be used.

### 4.5.4 Hybrid ARQ for HS-DSCH

The hybrid ARQ functionality matches the number of bits at the output of the channel coder to the total number of bits of the HS-PDSCH set to which the HS-DSCH is mapped. The hybrid ARQ functionality is controlled by the redundancy version (RV) parameters. The exact set of bits at the output of the hybrid ARQ functionality depends on the number of input bits, the number of output bits, and the RV parameters.

The hybrid ARQ functionality consists of two rate-matching stages and a virtual buffer as shown in the figure below.

The first rate matching stage matches the number of input bits to the virtual IR buffer, information about which is provided by higher layers. Note that, if the number of input bits does not exceed the virtual IR buffering capability, the first rate-matching stage is transparent.

The second rate matching stage matches the number of bits after first rate matching stage to the number of physical channel bits available in the HS-PDSCH set in the TTI.

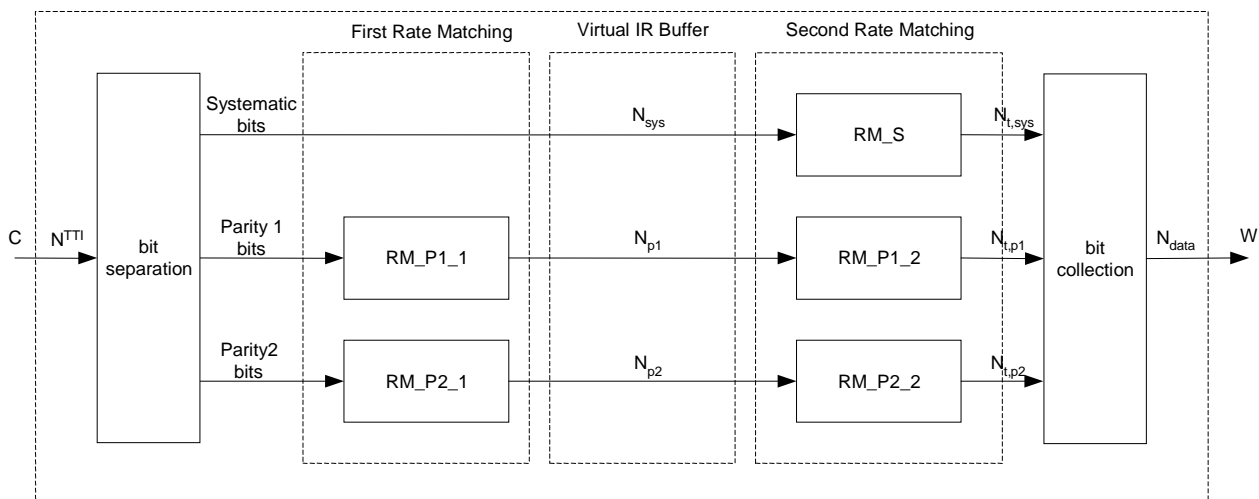

Figure 17: HS-DSCH hybrid ARQ functionality

#### 4.5.4.1 HARQ bit separation

The HARQ bit separation function shall be performed in the same way as bit separation for turbo encoded TrCHs with puncturing in 4.2.7.4.1 above.

#### 4.5.4.2 HARQ First Rate Matching Stage

HARQ first stage rate matching for the HS-DSCH transport channel shall be done with the general method described in 4.2.7.2.2.3 above with the following specific parameters.

The maximum number of soft channel bits available in the virtual IR buffer is  $N_{IR}$  which is signalled from higher layers for each HARQ process. The number of coded bits in a TTI before rate matching is  $N^{TTI}$  this is deduced from information signalled from higher layers and parameters signalled on the HS-SCCH for each TTI. Note that HARQ processing and physical layer storage occurs independently for each HARQ process currently active.

If  $N_{IR}$  is greater than or equal to  $N^{TTI}$  (i.e. all coded bits of the corresponding TTI can be stored) the first rate matching stage shall be transparent. This can, for example, be achieved by setting  $e_{minus} = 0$ . Note that no repetition is performed.

If  $N_{IR}$  is smaller than  $N^{TTI}$  the parity bit streams are punctured as in 4.2.7.2.2.3 above by setting the rate matching parameter  $\Delta N_{il}^{TTI} = N_{IR} - N^{TTI}$  where the subscripts  $i$  and  $l$  refer to transport channel and transport format in the referenced sub-clause. Note the negative value is expected when the rate matching implements puncturing. Bits selected for puncturing which appear as  $\delta$  in the algorithm in 4.2.7 above shall be discarded and not counted in the totals for the streams through the virtual IR buffer.

#### 4.5.4.3 HARQ Second Rate Matching Stage

HARQ second stage rate matching for the HS-DSCH transport channel shall be done with the general method described in 4.2.7.5 above with the following specific parameters. Bits selected for puncturing which appear as  $\delta$  in the algorithm in 4.2.7.5 above shall be discarded and are not counted in the streams towards the bit collection.

The parameters of the second rate matching stage depend on the value of the RV parameters  $s$  and  $r$ . The parameter  $s$  can take the value 0 or 1 to distinguish between transmissions that prioritise systematic bits ( $s = 1$ ) and non systematic bits ( $s = 0$ ). The parameter  $r$  (range 0 to  $r_{max}-1$ ) changes the initial error variable  $e_{ini}$  in the case of puncturing. In case of repetition both parameters  $r$  and  $s$  change the initial error variable  $e_{ini}$ . The parameters  $X_i$ ,  $e_{plus}$  and  $e_{minus}$  are calculated as per table 10 below.

Denote the number of bits before second rate matching as  $N_{sys}$  for the systematic bits,  $N_{p1}$  for the parity 1 bits, and  $N_{p2}$  for the parity 2 bits, respectively. Denote the number of physical channels used for the HS-DSCH by  $P$ .  $N_{data}$  is the number of bits available to the HS-DSCH in one TTI and defined as  $N_{data} = P \times 3 \times N_{data1}$ , where  $N_{data1}$  is defined in [2]. The rate matching parameters are determined as follows.

For  $N_{data} \leq N_{sys} + N_{p1} + N_{p2}$ , puncturing is performed in the second rate matching stage. The number of transmitted systematic bits in a transmission is  $N_{t,sys} = \min\{N_{sys}, N_{data}\}$  for a transmission that prioritises systematic bits and  $N_{t,sys} = \max\{N_{data} - (N_{p1} + N_{p2}), 0\}$  for a transmission that prioritises non systematic bits.

For  $N_{data} > N_{sys} + N_{p1} + N_{p2}$  repetition is performed in the second rate matching stage. A similar repetition rate in

all bit streams is achieved by setting the number of transmitted systematic bits to  $N_{t,sys} = \left\lfloor N_{sys} \cdot \frac{N_{data}}{N_{sys} + 2N_{p1}} \right\rfloor$ .

The number of parity bits in a transmission is:  $N_{t,p1} = \left\lfloor \frac{N_{data} - N_{t,sys}}{2} \right\rfloor$  and  $N_{t,p2} = \left\lfloor \frac{N_{data} - N_{t,sys}}{2} \right\rfloor$  for

the parity 1 and parity 2 bits, respectively.

Table 10 below summarizes the resulting parameter choice for the second rate matching stage.

**Table 10: Parameters for HARQ second rate matching**

	$X_i$	$e_{plus}$	$e_{minus}$
Systematic RM S	$N_{sys}$	$N_{sys}$	$ N_{sys} - N_{t,sys} $
Parity 1 RM P1_2	$N_{p1}$	$2 \cdot N_{p1}$	$2 \cdot  N_{p1} - N_{t,p1} $
Parity 2 RM P2_2	$N_{p2}$	$N_{p2}$	$ N_{p2} - N_{t,p2} $

The rate matching parameter  $e_{ini}$  is calculated for each bit stream according to the RV parameters  $r$  and  $s$  using

$e_{ini}(r) = \left\{ \left( X_i - \left\lfloor \frac{r \cdot e_{plus}}{r_{max}} \right\rfloor - 1 \right) \bmod e_{plus} \right\} + 1$  in the case of puncturing, i.e.,  $N_{data} \leq N_{sys} + N_{p1} + N_{p2}$ , and

$e_{ini}(r) = \left\{ \left( X_i - \left\lfloor \frac{(s + 2 \cdot r) \cdot e_{plus}}{(2 \cdot r_{max})} \right\rfloor - 1 \right) \bmod e_{plus} \right\} + 1$  for repetition, i.e.,

$N_{data} > N_{sys} + N_{p1} + N_{p2}$ . Where  $r \in \{0, 1, \dots, r_{max} - 1\}$  and  $r_{max}$  is the total number of redundancy versions



allowed by varying  $r$  as defined in 4.6.2. Note that  $r_{\max}$  varies depending on the modulation mode, i.e. for 16QAM and 64QAM,  $r_{\max} = 2$  and for QPSK  $r_{\max} = 4$ .

Note: For the modulo operation the following clarification is used: the value of  $(x \bmod y)$  is strictly in the range of 0 to  $y-1$  (i.e.  $-1 \bmod 10 = 9$ ).

#### 4.5.4.4 HARQ bit collection

The HARQ bit collection is achieved using a rectangular interleaver of size  $N_{\text{row}} \times N_{\text{col}}$ .

The number of rows and columns are determined from:

$$N_{\text{row}} = 6 \text{ for 64QAM, } N_{\text{row}} = 4 \text{ for 16QAM and } N_{\text{row}} = 2 \text{ for QPSK}$$

$$N_{\text{col}} = N_{\text{data}} / N_{\text{row}}$$

where  $N_{\text{data}}$  is used as defined in 4.5.4.3.

Data is written into the interleaver column by column, and read out of the interleaver column by column starting from the first column.

$N_{t,\text{sys}}$  is the number of transmitted systematic bits. Intermediate values  $N_r$  and  $N_c$  are calculated using:

$$N_r = \left\lfloor \frac{N_{t,\text{sys}}}{N_{\text{col}}} \right\rfloor \text{ and } N_c = N_{t,\text{sys}} - N_r \cdot N_{\text{col}}.$$

If  $N_c=0$  and  $N_r > 0$ , the systematic bits are written into rows  $1 \dots N_r$ .

Otherwise systematic bits are written into rows  $1 \dots N_r+1$  in the first  $N_c$  columns and, if  $N_r > 0$ , also into rows  $1 \dots N_r$  in the remaining  $N_{\text{col}}-N_c$  columns.

The remaining space is filled with parity bits. The parity bits are written column wise into the remaining rows of the respective columns. Parity 1 and 2 bits are written in alternating order, starting with a parity 2 bit in the first available column with the lowest index number.

In the case of 64QAM for each column the bits are read out of the interleaver in the order row 1, row 2, row 3, row 4, row 5, row 6. In the case of 16QAM for each column the bits are read out of the interleaver in the order row 1, row 2, row 3, row 4. In the case of QPSK for each column the bits are read out of the interleaver in the order row1, row2.

#### 4.5.5 Physical channel segmentation for HS-DSCH

When more than one HS-PDSCH is used, physical channel segmentation divides the bits among the different physical channels. The bits input to the physical channel segmentation are denoted by  $w_1, w_2, w_3, \dots, w_R$ , where  $R$  is the number of bits input to the physical channel segmentation block. The number of PhCHs is denoted by  $P$ .

The bits after physical channel segmentation are denoted  $u_{p1}, u_{p2}, u_{p3}, \dots, u_{pU}$ , where  $p$  is PhCH number and  $U$  is the

number of bits in one radio sub-frame for each HS-PDSCH, i.e.  $U = \frac{R}{P}$ . The relation between  $w_k$  and  $u_{p,k}$  is given below.

For all modes, some bits of the input flow are mapped to each code until the number of bits on the code is  $U$ .

Bits on first PhCH after physical channel segmentation:

$$u_{1,k} = w_k \quad k = 1, 2, \dots, U$$

Bits on second PhCH after physical channel segmentation:

$$u_{2,k} = w_{k+U} \quad k = 1, 2, \dots, U$$

...

Bits on the  $P^{th}$  PhCH after physical channel segmentation:

$$u_{p,k} = w_{k+(P-1) \times U} \quad k = 1, 2, \dots, U$$

### 4.5.6 Interleaving for HS-DSCH

The interleaving for FDD is done as shown in figure 18 below, separately for each physical channel. The bits input to the block interleaver are denoted by  $u_{p,1}, u_{p,2}, u_{p,3}, \dots, u_{p,U}$ , where  $p$  is PhCH number and  $U$  is the number of bits in one TTI for one PhCH. For QPSK  $U = 960$ , for 16QAM  $U = 1920$  and for 64QAM  $U = 2880$ . The basic interleaver is as the 2<sup>nd</sup> interleaver described in Clause 4.2.11. The interleaver is of fixed size: R2=32 rows and C2=30 columns.

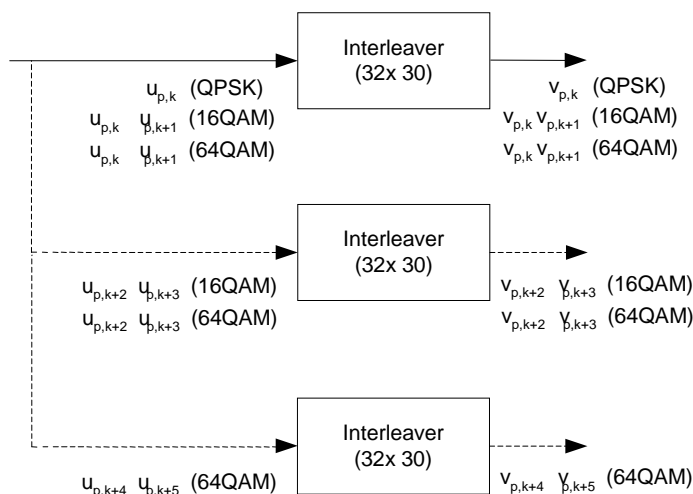

Figure 18: Interleaver structure for HS-DSCH

For 16QAM, there are two identical interleavers of the same fixed size  $R2 \times C2 = 32 \times 30$ . The output bits from the physical channel segmentation are divided two by two between the interleavers: bits  $u_{p,k}$  and  $u_{p,k+1}$  go to the first interleaver and bits  $u_{p,k+2}$  and  $u_{p,k+3}$  go to the second interleaver. Bits are collected two by two from the interleavers: bits  $v_{p,k}$  and  $v_{p,k+1}$  are obtained from the first interleaver and bits  $v_{p,k+2}$  and  $v_{p,k+3}$  are obtained from the second interleaver, where  $k \bmod 4 = 1$ .

For 64QAM, there are three identical interleavers of the same fixed size  $R2 \times C2 = 32 \times 30$ . The output bits from the physical channel segmentation are divided two by two between the interleavers: bits  $u_{p,k}$  and  $u_{p,k+1}$  go to the first interleaver, bits  $u_{p,k+2}$  and  $u_{p,k+3}$  go to the second interleaver and bits  $u_{p,k+4}$  and  $u_{p,k+5}$  go to the third interleaver. Bits are collected two by two from the interleavers: bits  $v_{p,k}$  and  $v_{p,k+1}$  are obtained from the first interleaver, bits  $v_{p,k+2}$  and  $v_{p,k+3}$  are obtained from the second interleaver and bits  $v_{p,k+4}$  and  $v_{p,k+5}$  are obtained from the third interleaver, where  $k \bmod 6 = 1$ .

### 4.5.7 Constellation re-arrangement for 16 QAM and 64QAM

This function only applies to 16QAM and 64QAM modulated bits. In case of QPSK it is transparent.

Table 11 describes the operations that produce the different rearrangements for 16QAM. The bits of the input sequence are mapped in groups of 4 so that  $v_{p,k}, v_{p,k+1}, v_{p,k+2}, v_{p,k+3}$  are used, where  $k \bmod 4 = 1$ . The output bit sequences map to the output bits in groups of 4, i.e.  $r_{p,k}, r_{p,k+1}, r_{p,k+2}, r_{p,k+3}$ , where  $k \bmod 4 = 1$ .

**Table 11: Constellation re-arrangement for 16QAM**

constellation version parameter $b$	Output bit sequence	Operation
0	$V_{p,k}V_{p,k+1}V_{p,k+2}V_{p,k+3}$	None
1	$V_{p,k+2}V_{p,k+3}V_{p,k}V_{p,k+1}$	Swapping MSBs with LSBs
2	$V_{p,k}V_{p,k+1}V_{p,k+2}V_{p,k+3}$	Inversion of the logical values of LSBs
3	$V_{p,k+2}V_{p,k+3}V_{p,k}V_{p,k+1}$	Swapping MSBs with LSBs and inversion of logical values of LSBs

Table 11A describes the operations that produce the different rearrangements for 64QAM. The bits of the input sequence are mapped in groups of 6 so that  $v_{p,k}, v_{p,k+1}, v_{p,k+2}, v_{p,k+3}, v_{p,k+4}, v_{p,k+5}$  are used, where  $k \bmod 6 = 1$ . The output bit sequences map to the output bits in groups of 6, i.e.  $r_{p,k}, r_{p,k+1}, r_{p,k+2}, r_{p,k+3}, r_{p,k+4}, r_{p,k+5}$ , where  $k \bmod 6 = 1$ .

**Table 11A: Constellation re-arrangement for 64QAM**

constellation version parameter $b$	Output bit sequence	Operation
0	$V_{p,k}V_{p,k+1}V_{p,k+2}V_{p,k+3}V_{p,k+4}V_{p,k+5}$	None
1	$V_{p,k+4}V_{p,k+5}V_{p,k+2}V_{p,k+3}V_{p,k}V_{p,k+1}$	Swapping MSBs and LSBs. Inversion of Middle SBs
2	$V_{p,k+2}V_{p,k+3}V_{p,k+4}V_{p,k+5}V_{p,k}V_{p,k+1}$	Left circular shift of pair of SBs. Inversion of Middle SBs
3	$V_{p,k}V_{p,k+1}V_{p,k+2}V_{p,k+3}V_{p,k+4}V_{p,k+5}$	Inversion of Middle SBs

## 4.5.8 Physical channel mapping for HS-DSCH

The HS-PDSCH is defined in [2]. The bits input to the physical channel mapping are denoted by  $r_{p,1}, r_{p,2}, \dots, r_{p,U}$ , where  $p$  is the physical channel number and  $U$  is the number of bits in one radio sub-frame for one HS-PDSCH. The bits  $r_{p,k}$  are mapped to the PhCHs so that the bits for each PhCH are transmitted over the air in ascending order with respect to  $k$ .

## 4.6 Coding for HS-SCCH type 1

### 4.6.1 Overview

HS-SCCH shall be of type 1 when the following two conditions are both true:

- the UE is not configured in MIMO mode and not in MIMO mode with four transmit antennas, and
- the conditions for usage of HS-SCCH type 2 are not met.

In this section, the terms 'HS-SCCH' and 'HS-SCCH type 1' are used interchangeably.

The following information is transmitted by means of the HS-SCCH type 1 physical channel.

- Channelization-code-set information (7 bits):  $x_{ccs,1}, x_{ccs,2}, \dots, x_{ccs,7}$
- Modulation scheme information (1 bit):  $x_{ms,1}$
- Transport-block size information (6 bits):  $x_{tbs,1}, x_{tbs,2}, \dots, x_{tbs,6}$
- Hybrid-ARQ process information (3 bits):  $x_{hap,1}, x_{hap,2}, x_{hap,3}$

- Redundancy and constellation version (3 bits):  $x_{rv,1}, x_{rv,2}, x_{rv,3}$
- New data indicator (1 bit):  $x_{nd,1}$
- UE identity (16 bits):  $x_{ue,1}, x_{ue,2}, \dots, x_{ue,16}$

For an HS-SCCH order,

- $x_{ccs,1}, x_{ccs,2}, \dots, x_{ccs,7}, x_{ms,1}$  shall be set to "11100000"
- $x_{tbs,1}, x_{tbs,2}, \dots, x_{tbs,4}$  shall be set to "1111"
- $x_{tbs,5}, x_{tbs,6}$  shall be set to  $x_{eodt,1}, x_{eodt,2}$
- $x_{hap,1}, x_{hap,2}, x_{hap,3}, x_{rv,1}, x_{rv,2}, x_{rv,3}$  shall be set to  $x_{odt,1}, x_{odt,2}, x_{odt,3}, x_{ord,1}, x_{ord,2}, x_{ord,3}$
- $x_{nd,1}$  is reserved

where  $x_{eodt,1}, x_{eodt,2}, x_{odt,1}, x_{odt,2}, x_{odt,3}, x_{ord,1}, x_{ord,2}, x_{ord,3}$  are defined in subclause 4.6C.

Figure 19 below illustrates the overall coding chain for HS-SCCH type 1.

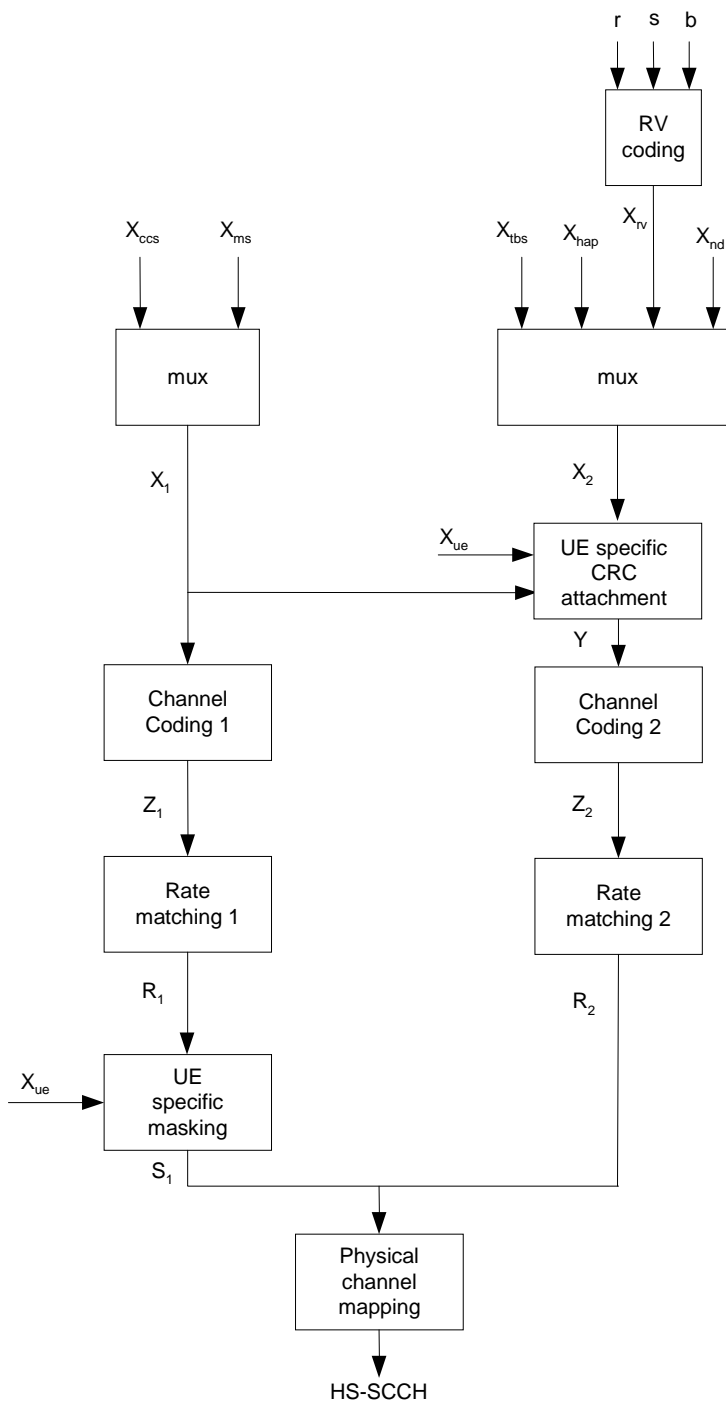

Figure 19: Coding chain for HS-SCCH type 1

## 4.6.2 HS-SCCH information field mapping

### 4.6.2.1 Redundancy and constellation version coding

The redundancy version (RV) parameters  $r$ ,  $s$  and constellation version parameter  $b$  are coded jointly to produce the value  $X_{rv}$ .  $X_{rv}$  is alternatively represented as the sequence  $x_{rv,1}$ ,  $x_{rv,2}$ ,  $x_{rv,3}$  where  $x_{rv,1}$  is the MSB. This is done according to tables 12 and 13 according to the modulation mode used:

Table 12: RV coding for 16QAM and 64QAM

$X_{rv}$ (value)	<b>s</b>	<b>R</b>	<b>b</b>
0	1	0	0
1	0	0	0
2	1	1	1
3	0	1	1
4	1	0	1
5	1	0	2
6	1	0	3
7	1	1	0

Table 13: RV coding for QPSK

$X_{rv}$ (value)	<b>s</b>	<b>r</b>
0	1	0
1	0	0
2	1	1
3	0	1
4	1	2
5	0	2
6	1	3
7	0	3

#### 4.6.2.2 Modulation scheme mapping

The value of  $x_{ms,1}$  is derived from the modulation and given by the following:

$$x_{ms,1} = \begin{cases} 0 & \text{if } QPSK \\ 1 & \text{otherwise} \end{cases}$$

#### 4.6.2.3 Channelization code-set mapping

The channelization code-set bits  $x_{ccs,1}, x_{ccs,2}, \dots, x_{ccs,7}$  are coded according to the following:

Given  $P$  (multi-)codes starting at code  $O$ , and given the HS-SCCH number if 64QAM is configured for the UE and  $x_{ms,1}=1$ , calculate the information-field using the unsigned binary representation of integers calculated by the expressions,

for the first three bits (code group indicator) of which  $x_{ccs,1}$  is the MSB:

$$x_{ccs,1}, x_{ccs,2}, x_{ccs,3} = \min(P-1, 15-P)$$

If 64QAM is not configured for the UE, or if 64QAM is configured and  $x_{ms,1}=0$ , then

for the last four bits (code offset indicator) of which  $x_{ccs,4}$  is the MSB:

$$x_{ccs,4}, x_{ccs,5}, x_{ccs,6}, x_{ccs,7} = |O-1-\lfloor P/8 \rfloor * 15|$$

Otherwise (i.e. if 64QAM is configured for the UE and  $x_{ms,1}=1$ ),

$P$  and  $O$  shall fulfil  $|O-1-\lfloor P/8 \rfloor * 15| \bmod 2 = (\text{HS-SCCH number}) \bmod 2$ , and then

$$x_{ccs,4}, x_{ccs,5}, x_{ccs,6}, x_{ccs,dummy} = |O-1-\lfloor P/8 \rfloor * 15|, \text{ where } x_{ccs,dummy} \text{ is a dummy bit that is not transmitted on HS-SCCH.}$$

Furthermore,

$$x_{ccs,7} = \begin{cases} 0 & \text{if } 16QAM \\ 1 & \text{if } 64QAM \end{cases}$$

The definitions of P and O are given in [3]. The HS-SCCH number is given by the position in the list of HS-SCCH Channelisation Code Informations signalled by higher layers. The HS-SCCH number is associated with the code offset indicator and code group indicator as described above if 64QAM is configured for the UE and  $x_{ms,1}=1$ .

#### 4.6.2.4 UE identity mapping

The UE identity is the HS-DSCH Radio Network Identifier (H-RNTI) defined in [13]. This is mapped such that  $x_{ue,1}$  corresponds to the MSB and  $x_{ue,16}$  to the LSB, cf. [14].

#### 4.6.2.5 HARQ process identifier mapping

Hybrid-ARQ process information (3 bits)  $x_{hap,1}, x_{hap,2}, x_{hap,3}$  is the unsigned binary representation of the HARQ process identifier where  $x_{hap,1}$  is MSB.

#### 4.6.2.6 Transport block size index mapping

Transport-block size information (6 bits)  $x_{tbs,1}, x_{tbs,2}, \dots, x_{tbs,6}$  is unsigned binary representation of the transport block size index where  $x_{tbs,1}$  is MSB.

### 4.6.3 Multiplexing of HS-SCCH information

The channelization-code-set information  $x_{ccs,1}, x_{ccs,2}, \dots, x_{ccs,7}$  and modulation-scheme information  $x_{ms,1}$  are multiplexed together. This gives a sequence of bits  $x_{1,1}, x_{1,2}, \dots, x_{1,8}$  where

$$x_{1,i} = x_{ccs,i} \quad i=1,2,\dots,7$$

$$x_{1,i} = x_{ms,i-7} \quad i=8$$

The transport-block-size information  $x_{tbs,1}, x_{tbs,2}, \dots, x_{tbs,6}$ , Hybrid-ARQ-process information  $x_{hap,1}, x_{hap,2}, x_{hap,3}$ , redundancy-version information  $x_{rv,1}, x_{rv,2}, x_{rv,3}$  and new-data indicator  $x_{nd,1}$  are multiplexed together. This gives a sequence of bits  $x_{2,1}, x_{2,2}, \dots, x_{2,13}$  where

$$x_{2,i} = x_{tbs,i} \quad i=1,2,\dots,6$$

$$x_{2,i} = x_{hap,i-6} \quad i=7,8,9$$

$$x_{2,i} = x_{rv,i-9} \quad i=10,11,12$$

$$x_{2,i} = x_{nd,i-12} \quad i=13$$

#### 4.6.4 CRC attachment for HS-SCCH

From the sequence of bits  $x_{1,1}, x_{1,2}, \dots, x_{1,8}, x_{2,1}, x_{2,2}, \dots, x_{2,13}$  a 16 bits CRC is calculated according to Clause 4.2.1.1. This gives a sequence of bits  $c_1, c_2, \dots, c_{16}$  where

$$c_k = p_{im(17-k)} \quad k=1,2,\dots,16$$

This sequence of bits is then masked with the UE Identity  $x_{ue,1}, x_{ue,2}, \dots, x_{ue,16}$  and then appended to the sequence of bits  $x_{2,1}, x_{2,2}, \dots, x_{2,13}$  to form the sequence of bits  $y_1, y_2, \dots, y_{29}$ , where

$$y_i = x_{2,i} \quad i=1,2,\dots,13$$

$$y_i = (c_{i-13} + x_{ue,i-13}) \bmod 2 \quad i=14,15,\dots,29$$

## 4.6.5 Channel coding for HS-SCCH

Rate 1/3 convolutional coding, as described in Clause 4.2.3.1, is applied to the sequence of bits  $x_{1,1}, x_{1,2}, \dots, x_{1,8}$ . This gives a sequence of bits  $z_{1,1}, z_{1,2}, \dots, z_{1,48}$ .

Rate 1/3 convolutional coding, as described in Clause 4.2.3.1, is applied to the sequence of bits  $y_1, y_2, \dots, y_{29}$ . This gives a sequence of bits  $z_{2,1}, z_{2,2}, \dots, z_{2,111}$ .

Note that the coded sequence lengths result from the termination of K=9 convolutional coding being fully applied.

## 4.6.6 Rate matching for HS-SCCH

From the input sequence  $z_{1,1}, z_{1,2}, \dots, z_{1,48}$  the bits  $z_{1,1}, z_{1,2}, z_{1,4}, z_{1,8}, z_{1,42}, z_{1,45}, z_{1,47}, z_{1,48}$  are punctured to obtain the output sequence  $r_{1,1}, r_{1,2}, \dots, r_{1,40}$ .

From the input sequence  $z_{2,1}, z_{2,2}, \dots, z_{2,111}$  the bits  $z_{2,1}, z_{2,2}, z_{2,3}, z_{2,4}, z_{2,5}, z_{2,6}, z_{2,7}, z_{2,8}, z_{2,12}, z_{2,14}, z_{2,15}, z_{2,24}, z_{2,42}, z_{2,48}, z_{2,54}, z_{2,57}, z_{2,60}, z_{2,66}, z_{2,69}, z_{2,96}, z_{2,99}, z_{2,101}, z_{2,102}, z_{2,104}, z_{2,105}, z_{2,106}, z_{2,107}, z_{2,108}, z_{2,109}, z_{2,110}, z_{2,111}$  are punctured to obtain the output sequence  $r_{2,1}, r_{2,2}, \dots, r_{2,80}$ .

## 4.6.7 UE specific masking for HS-SCCH

The rate matched bits  $r_{1,1}, r_{1,2}, \dots, r_{1,40}$  shall be masked in an UE specific way using the UE identity  $x_{ue,1}, x_{ue,2}, \dots, x_{ue,16}$ , to produce the bits  $s_{1,1}, s_{1,2}, \dots, s_{1,40}$ .

Intermediate code word bits  $b_i, i=1,2,\dots,48$ , are defined by encoding the UE identity bits using the rate 1/2 convolutional coding described in Clause 4.2.3.1. Eight bits out of the resulting 48 convolutionally encoded bits are punctured using the rate matching rule of Clause 4.6.6 for the HS-SCCH part 1 sequence, that is, the intermediate code word bits  $b_1, b_2, b_4, b_8, b_{42}, b_{45}, b_{47}, b_{48}$ , are punctured to obtain the 40 bit UE specific scrambling sequence  $c_1, c_2, \dots, c_{40}$ .

The mask output bits  $s_{1,1}, s_{1,2}, \dots, s_{1,40}$  are calculated as follows:

$$s_{1,k} = (r_{1,k} + c_k) \bmod 2 \quad \text{for } k = 1, 2, \dots, 40$$

## 4.6.8 Physical channel mapping for HS-SCCH

The HS-SCCH sub-frame is described in [2].

The sequence of bits  $s_{1,1}, s_{1,2}, \dots, s_{1,40}$  is mapped to the first slot of the HS-SCCH sub frame. The bits  $s_{1,k}$  are mapped to the PhCHs so that the bits for each PhCH are transmitted over the air in ascending order with respect to  $k$ .

The sequence of bits  $r_{2,1}, r_{2,2}, \dots, r_{2,80}$  is mapped to the second and third slot of the HS-SCCH sub frame. The bits  $r_{2,k}$  are mapped to the PhCHs so that the bits for each PhCH are transmitted over the air in ascending order with respect to  $k$ .

## 4.6A Coding for HS-SCCH type 2

### 4.6A.1 Overview

HS-SCCH type 2 is used for HS-SCCH-less operation. HS-SCCH type 2 is not used when the UE is configured in MIMO mode or in MIMO mode with four transmit antennas. During second and third transmission, the following information is transmitted by means of the HS-SCCH type 2 physical channel.

- Channelization-code-set information (7 bits):  $x_{ccs,1}, x_{ccs,2}, \dots, x_{ccs,7}$
- Modulation scheme information (1 bit):  $x_{ms,1}$
- Special Information type (6 bits):  $x_{type,1}, x_{type,2}, \dots, x_{type,6}$
- Special Information (7 bits):  $x_{info,1}, x_{info,2}, x_{info,3}, x_{info,4}, x_{info,5}, x_{info,6}, x_{info,7}$
- UE identity (16 bits):  $x_{ue,1}, x_{ue,2}, \dots, x_{ue,16}$



Figure 19A below illustrates the overall coding chain for HS-SCCH type 2.

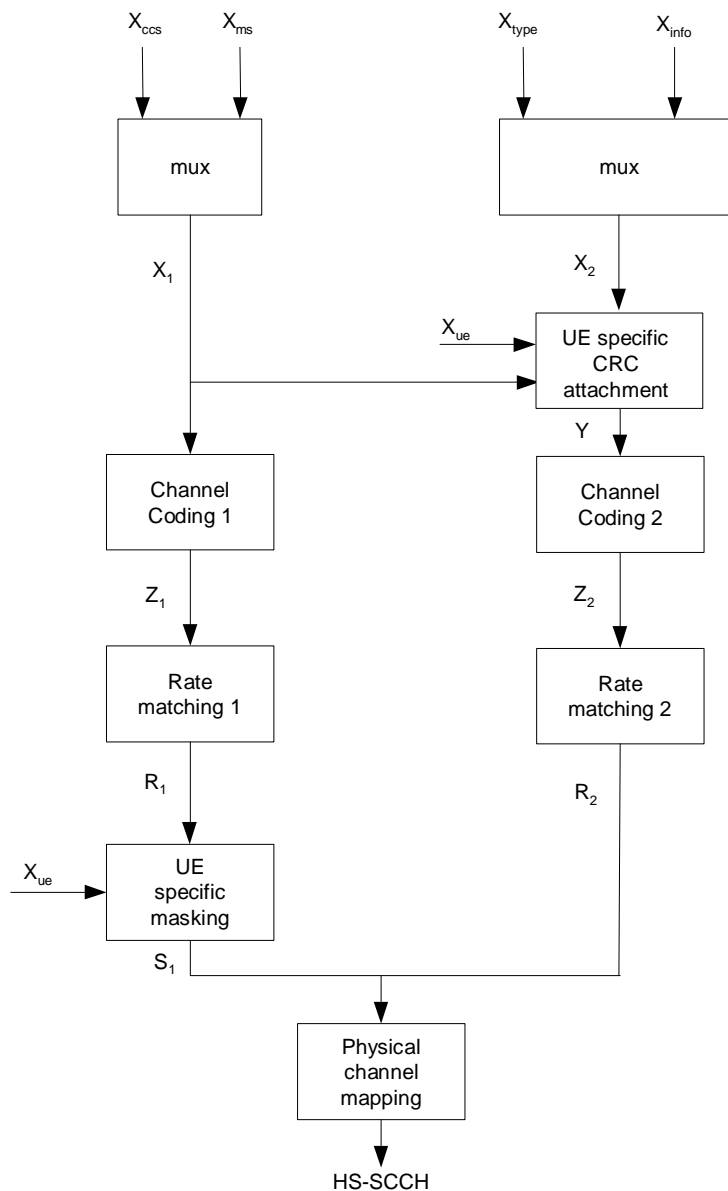

Figure 19A: Coding chain for HS-SCCH type 2

## 4.6A.2 HS-SCCH Type 2 information field mapping

### 4.6A.2.1 The first transmission

When HS-SCCH\_less\_mode=1 for a UE (as defined in [4]), the first transmission of an HS-DSCH transport block using CRC attachment method 2 shall be sent without an associated HS-SCCH. In this case, the UE shall use the following signalling values in order to attempt to decode the transport block:

- Channelization-code-set information: *Configured by higher layers*

- Modulation scheme information: *QPSK*
- Transport-block size information: *Each of four possible sizes configured by higher layers*
- Redundancy and constellation version:  $X_{rv} = 0$  (see 4.6.2.1)
- UE identity: *Configured by higher layers*

#### 4.6A.2.2 The second and the third transmissions

For HS-SCCH\_less\_mode=1 there are at maximum 3 transmissions for a HS-DSCH transport block using CRC attachment method 2. The 2<sup>nd</sup> and 3<sup>rd</sup> transmissions of a transport block that was sent without an associated HS-SCCH in the first transmission, as described in subclause 4.6A.2.1.1, are associated with an HS-SCCH of type 2.

##### 4.6A.2.2.1 Special Information mapping

The Special Information type  $x_{type,1}, x_{type,2}, \dots, x_{type,6}$  shall be set to "111110" to indicate HS-SCCH less operation.

The Special Information bits  $x_{info,1}, x_{info,2}, \dots, x_{info,7}$  are comprised of:

- Transport-block size information (2 bits):  $x_{info,1}, x_{info,2} = x_{tbs,1}, x_{tbs,2}$
- Pointer to the previous transmission (3 bits):  $x_{info,3}, x_{info,4}, x_{info,5} = x_{ptr,1}, x_{ptr,2}, x_{ptr,3}$
- Second or third transmission (1 bit):  $x_{info,6} = x_{sec,1}$
- Reserved (1 bit):  $x_{info,7} = x_{res,1}$

##### 4.6A.2.2.1.1 Transport-block size information mapping

The Transport-block size information (2 bits)  $x_{tbs,1}, x_{tbs,2}$  is the unsigned binary representation of a reference to one of the four Transport-block sizes and the associated number of HS-PDSCH codes for the first transmission configured by higher layers.

$x_{tbs,1}, x_{tbs,2}$	Entry in 'Transport Block size list' as signalled in the HS-SCCH-less Information of HS_SCCH_LESS_PARAMS [13]
"00"	1 <sup>st</sup> entry
"01"	2 <sup>nd</sup> entry
"10"	3 <sup>rd</sup> entry
"11"	4 <sup>th</sup> entry

##### 4.6A.2.2.1.2 Pointer to the previous transmission mapping

Pointer to the previous transmission (3 bits)  $x_{ptr,1}, x_{ptr,2}, x_{ptr,3}$  is the unsigned binary representation of  $s$ , such that the previous transmission of the same transport block started  $(6+s)$  subframes before the start of this transmission.

##### 4.6A.2.2.1.3 Second or third transmission mapping

Second or Third transmission (1 bit) indicates whether this is the second or third transmission.

If  $x_{sec,I} = "0"$ , this is a second transmission.

If  $x_{sec,I} = "1"$ , this is a third transmission.

#### 4.6A.2.2.2 Redundancy and Constellation Version mapping

The redundancy version  $X_{rv}$  for the second and third transmissions shall be equal to 3 and 4 respectively, as defined in Table 13.

#### 4.6A.2.2.3 Modulation scheme mapping

The value of  $x_{ms,1}$  shall be set to "0" (QPSK).

#### 4.6A.2.2.4 Channelization code-set mapping

The channelization code-set bits  $x_{ccs,1}, x_{ccs,2}, \dots, x_{ccs,7}$  are coded as per clause 4.6.2.3 where the value of P shall be set to either 1 or 2.

#### 4.6A.2.2.5 UE identity mapping

The UE identity is encoded as per clause 4.6.2.4.

### 4.6A.3 Multiplexing of HS-SCCH Type 2 information

The channelization-code-set information  $x_{ccs,1}, x_{ccs,2}, \dots, x_{ccs,7}$  and modulation-scheme information  $x_{ms,1}$  are multiplexed together. This gives a sequence of bits  $x_{1,1}, x_{1,2}, \dots, x_{1,8}$  where

$$x_{1,i} = x_{ccs,i} \quad i=1,2,\dots,7$$

$$x_{1,i} = x_{ms,i-7} \quad i=8$$

The Special Information type  $x_{type,1}, x_{type,2}, \dots, x_{type,6}$ , and Special Information  $x_{info,1}, x_{info,2}, x_{info,3}, x_{info,4}, x_{info,5}, x_{info,6}, x_{info,7}$  are multiplexed together. This gives a sequence of bits  $x_{2,1}, x_{2,2}, \dots, x_{2,13}$  where

$$x_{2,i} = x_{type,i} \quad i=1,2,\dots,6$$

$$x_{2,i} = x_{info,i-6} \quad i=7,8,\dots,13$$

#### 4.6A.4 CRC attachment for HS-SCCH Type 2

The sequence of bits  $y_1, y_2, \dots, y_{29}$ , is calculated according to Clause 4.6.4.

#### 4.6A.5 Channel coding for HS-SCCH Type 2

Channel coding is performed according to Clause 4.6.5.

#### 4.6A.6 Rate matching for HS-SCCH Type 2

Rate matching is performed according to Clause 4.6.6.

#### 4.6A.7 UE specific masking for HS-SCCH Type 2

The mask output bits  $s_{1,1}, s_{1,2}, \dots, s_{1,40}$  are calculated according to Clause 4.6.7.

#### 4.6A.8 Physical channel mapping for HS-SCCH Type 2

Physical channel mapping is performed according to Clause 4.6.8.

## 4.6B Coding for HS-SCCH type 3

### 4.6B.1 Overview

HS-SCCH type 3 is used when the UE is configured in MIMO mode. If one transport block is transmitted on the associated HS-PDSCH(s) or an HS-SCCH order is transmitted, the following information is transmitted by means of the HS-SCCH type 3 physical channel:

- Channelization-code-set information (7 bits):  $x_{ccs,1}, x_{ccs,2}, \dots, x_{ccs,7}$
- Modulation scheme and number of transport blocks information (3 bits):  $x_{ms,1}, x_{ms,2}, x_{ms,3}$
- Precoding weight information (2 bits):  $x_{pwipb,1}, x_{pwipb,2}$
- Transport-block size information (6 bits):  $x_{tbspb,1}, x_{tbspb,2}, \dots, x_{tbspb,6}$
- Hybrid-ARQ process information (4 bits):  $x_{hap,1}, x_{hap,2}, \dots, x_{hap,4}$
- Redundancy and constellation version (2 bits):  $x_{rvpb,1}, x_{rvpb,2}$
- UE identity (16 bits):  $x_{ue,1}, x_{ue,2}, \dots, x_{ue,16}$

For an HS-SCCH order,

- $x_{ccs,1}, x_{ccs,2}, \dots, x_{ccs,7}, x_{ms,1}, x_{ms,2}, x_{ms,3}, x_{pwipb,1}, x_{pwipb,2}$  shall be set to "111000000000"
- $x_{tbspb,1}, x_{tbspb,2}, \dots, x_{tbspb,4}$  shall be set to "1111"
- $x_{tbspb,5}, x_{tbspb,6}$  shall be set to  $x_{eodt,1}, x_{eodt,2}$
- $x_{hap,1}, x_{hap,2}, x_{hap,3}, x_{hap,4}, x_{rvpb,1}, x_{rvpb,2}$  shall be set to  $x_{odt,1}, x_{odt,2}, x_{odt,3}, x_{ord,1}, x_{ord,2}, x_{ord,3}$

where  $x_{eodt,1}, x_{eodt,2}, x_{odt,1}, x_{odt,2}, x_{odt,3}, x_{ord,1}, x_{ord,2}, x_{ord,3}$  are defined in subclause 4.6C.

If two transport blocks are transmitted on the associated HS-PDSCHs (not applicable when single-stream restriction is configured), the following information is transmitted by means of the HS-SCCH type 3 physical channel:

- Channelization-code-set information (7 bits):  $x_{ccs,1}, x_{ccs,2}, \dots, x_{ccs,7}$
- Modulation scheme and number of transport blocks information (3 bits):  $x_{ms,1}, x_{ms,2}, x_{ms,3}$
- Precoding weight information for the primary transport block (2 bits):  $x_{pwipb,1}, x_{pwipb,2}$
- Transport-block size information for the primary transport block (6 bits):  $x_{tbspb,1}, x_{tbspb,2}, \dots, x_{tbspb,6}$
- Transport-block size information for the secondary transport block (6 bits):  $x_{tbssb,1}, x_{tbssb,2}, \dots, x_{tbssb,6}$
- Hybrid-ARQ process information (4 bits):  $x_{hap,1}, x_{hap,2}, \dots, x_{hap,4}$
- Redundancy and constellation version for the primary transport block (2 bits):  $x_{rvpb,1}, x_{rvpb,2}$
- Redundancy and constellation version for the secondary transport block (2 bits):  $x_{rvsb,1}, x_{rvsb,2}$
- UE identity (16 bits):  $x_{ue,1}, x_{ue,2}, \dots, x_{ue,16}$

Figure 19B below illustrates the overall coding chain for HS-SCCH type 3. Note that some information shown is not present if only one transport block is transmitted on the associated HS-PDSCH(s).

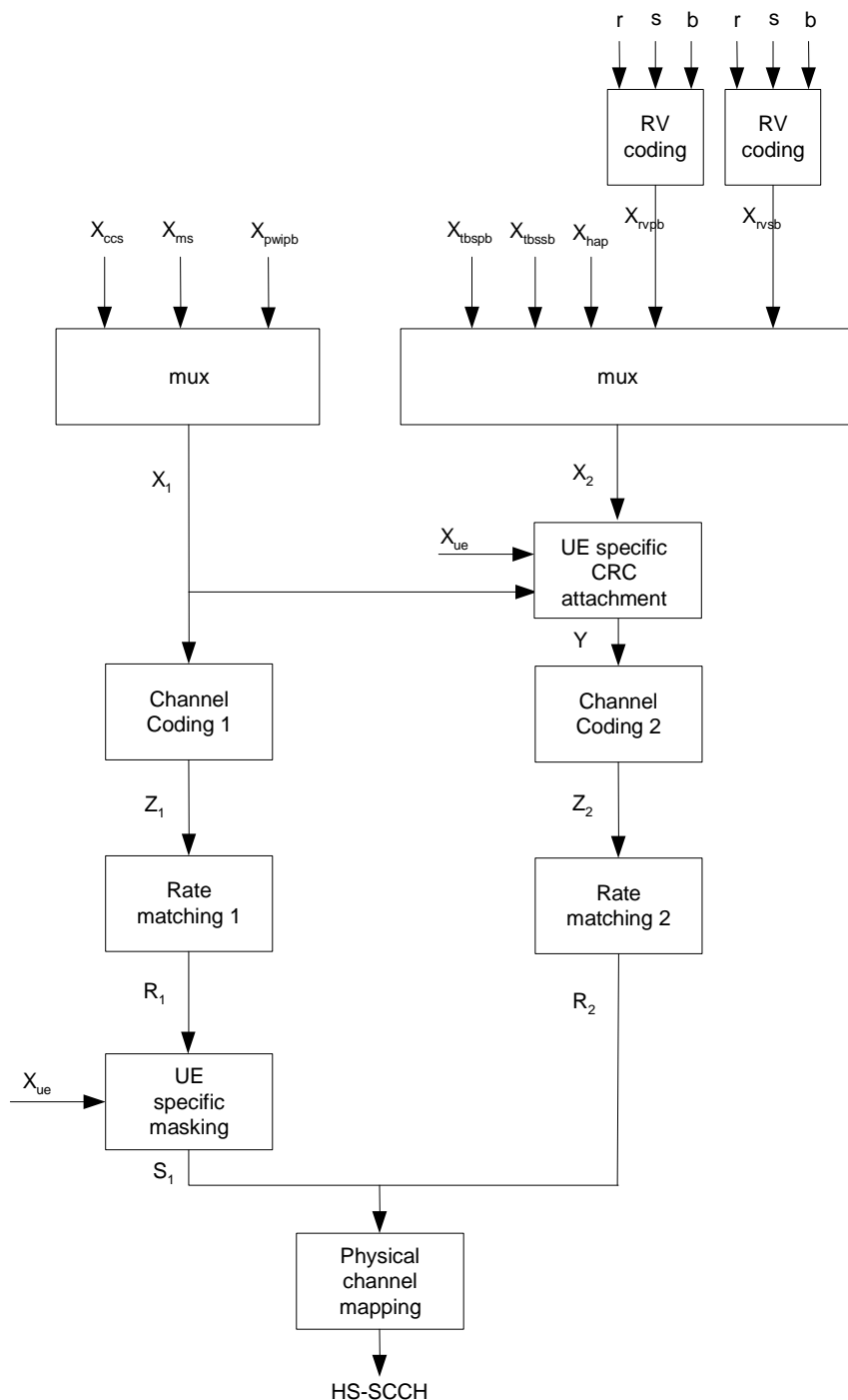

Figure 19B: Coding chain for HS-SCCH type 3

## 4.6B.2 HS-SCCH type 3 information field mapping

### 4.6B.2.1 Redundancy and constellation version coding

For each of the primary transport block and a secondary transport block if two transport blocks are transmitted on the associated HS-PDSCH(s), the redundancy version (RV) parameters  $r$ ,  $s$  and constellation version parameter  $b$  are coded jointly to produce the values  $X_{rvpb}$  and  $X_{rvsb}$  respectively. The transmitted sequences  $x_{rvpb,1}$ ,  $x_{rvpb,2}$  and  $x_{rvsb,1}$ ,  $x_{rvsb,2}$  are the binary representations of  $X_{rvpb}$  and  $X_{rvsb}$ , respectively, where  $x_{rvpb,1}$  and  $x_{rvsb,1}$  are the MSBs.

For the primary transport block if only one transport block is transmitted on the associated HS-PDSCH(s), the redundancy version (RV) parameters  $r$ ,  $s$  and constellation version parameter  $b$  are coded jointly to produce the value  $X_{rvpb}$ . The transmitted sequence  $x_{rvpb,1}$ ,  $x_{rvpb,2}$  is the binary representation of  $X_{rvpb}$ , where  $x_{rvpb,1}$  is the MSB.

Joint coding of parameters  $r$ ,  $s$  and constellation version parameter  $b$  is done according to tables 13A and 13B according to the modulation mode used. If  $X_{rvpb} = 0$  or  $X_{rvsb} = 0$ , the UE shall treat the corresponding transport block as an initial transmission.

**Table 13A: RV coding for 16QAM and 64QAM for HS-SCCH type 3**

$X_{rvpb}$ or $X_{rvsb}$ (value)	$N_{sys} / N_{data} < 1/2$			$N_{sys} / N_{data} \geq 1/2$		
	s	r	b	s	r	b
0	1	0	0	1	0	0
1	1	1	1	0	1	1
2	1	0	2	0	0	0
3	1	0	3	1	0	2

**Table 13B: RV coding for QPSK for HS-SCCH type 3**

$X_{rvpb}$ or $X_{rvsb}$ (value)	$N_{sys} / N_{data} < 1/2$		$N_{sys} / N_{data} \geq 1/2$	
	s	r	s	r
0	1	0	1	0
1	1	1	0	1
2	1	2	0	3
3	1	3	1	2

#### 4.6B.2.2 Modulation scheme and number of transport blocks mapping

The number of transport blocks transmitted on the associated HS-PDSCH(s) and the modulation scheme information are jointly coded as shown in Table 14:

**Table 14: Mapping of  $x_{ms}$**

$x_{ms,1}, x_{ms,2},$ $x_{ms,3}$	Modulation for primary transport block	Modulation for secondary transport block	Number of transport blocks
111	16QAM	16QAM	2
110	16QAM	QPSK	2
101	64QAM	Indicated by $x_{ccs,7}$	Indicated by $x_{ccs,7}$
100	16QAM	n/a	1
011	QPSK	QPSK	2
010	64QAM	64QAM	2
001	64QAM	16QAM	2
000	QPSK	n/a	1

In case  $x_{ms,1}, x_{ms,2}, x_{ms,3}$  equals '101'  $x_{ccs,7}$  is used as an extra bit in modulation scheme information.

#### 4.6B.2.3 Channelization code-set mapping

The channelization code-set bits  $x_{ccs,1}, x_{ccs,2}, \dots, x_{ccs,7}$  are coded according to the following:

Given P (multi-)codes starting at code O, and given the HS-SCCH number if 64QAM is configured for the UE and  $x_{ms,1}, x_{ms,2}, x_{ms,3}$  is equal to '101', calculate the information-field using the unsigned binary representation of integers calculated by the expressions,

for the first three bits (code group indicator) of which  $x_{ccs,1}$  is the MSB:

$$x_{ccs,1}, x_{ccs,2}, x_{ccs,3} = \min(P-1, 15-P)$$

If 64QAM is not configured for the UE, or if 64QAM is configured and  $x_{ms,1}, x_{ms,2}, x_{ms,3}$  is not equal to '101', then

for the last four bits (code offset indicator) of which  $x_{ccs,4}$  is the MSB:

$$x_{ccs,4}, x_{ccs,5}, x_{ccs,6}, x_{ccs,7} = \lfloor \text{O-1} \lfloor \text{P}/8 \rfloor * 15 \rfloor$$

Otherwise (i.e. if 64QAM is configured for the UE and  $x_{ms,1}, x_{ms,2}, x_{ms,3}$  is equal to '101'),

$P$  and  $O$  shall fulfil  $\lfloor \text{O-1} \lfloor \text{P}/8 \rfloor * 15 \rfloor \bmod 2 = (\text{HS-SCCH number}) \bmod 2$ , and then

$x_{ccs,4}, x_{ccs,5}, x_{ccs,6}, x_{ccs,dummy} = \lfloor \text{O-1} \lfloor \text{P}/8 \rfloor * 15 \rfloor$ , where  $x_{ccs,dummy}$  is a dummy bit that is not transmitted on HS-SCCH.

Furthermore,

$x_{ccs,7} = 0$  if the modulation for the secondary transport block is QPSK, and

$x_{ccs,7} = 1$  if the number of transport blocks = 1.

The definitions of  $P$  and  $O$  are given in [3]. The HS-SCCH number is given by the position in the list of HS-SCCH Channelisation Code Informations signalled by higher layers. The HS-SCCH number is associated with the code offset indicator and code group indicator as described above if 64QAM is configured for the UE and  $x_{ms,1}, x_{ms,2}, x_{ms,3}$  is equal to '101'.

If two transport blocks are transmitted on the associated HS-PDSCH(s), the same set of channelization codes shall be used for both transport blocks.

#### 4.6B.2.4 UE identity mapping

The UE identity is the HS-DSCH Radio Network Identifier (H-RNTI) defined in [13]. This is mapped such that  $x_{ue,1}$  corresponds to the MSB and  $x_{ue,16}$  to the LSB, cf. [14].

#### 4.6B.2.5 HARQ process identifier mapping

If two transport blocks are transmitted on the associated HS-PDSCH(s), the mapping relationship between the hybrid-ARQ processes and the transport blocks is such that when the HARQ-process with identifier  $HAP_{pb}$  is mapped to the primary transport block, the HARQ-process with the identifier given by  $(HAP_{pb} + N_{proc} / 2) \bmod (N_{proc})$  shall be mapped to the secondary transport block, where  $N_{proc}$  is the number of HARQ processes configured by higher layers. The combination of HARQ-processes is indicated by the hybrid-ARQ process information (4 bits)  $x_{hap,1}, x_{hap,2}, x_{hap,3}, x_{hap,4}$  which are the unsigned binary representation of  $HAP_{pb}$  where  $x_{hap,1}$  is MSB.

If only one transport block is transmitted on the associated HS-PDSCH(s), the above mapping is ignored and the hybrid-ARQ process information  $x_{hap,1}, x_{hap,2}, x_{hap,3}, x_{hap,4}$  is the unsigned binary representation of the HARQ process identifier where  $x_{hap,1}$  is MSB.

#### 4.6B.2.6 Transport block size index mapping

The transport-block size information  $x_{tbsp,1}, x_{tbsp,2}, \dots, x_{tbsp,6}$  is the unsigned binary representation of the transport block size index for the primary transport block, where  $x_{tbsp,1}$  is the MSB.

If two transport blocks are transmitted on the associated HS-PDSCH(s), the transport-block size information  $x_{tssb,1}, x_{tssb,2}, \dots, x_{tssb,6}$  is the unsigned binary representation of the transport block size index for the secondary transport block, where  $x_{tssb,1}$  is the MSB.

#### 4.6B.2.7 Precoding Weight Information mapping

The precoding weight information for the primary transport block  $x_{pwipb,1}, x_{pwipb,2}$  is derived from the precoding weight factor  $w_2$  as defined in [4], according to Table 14A.

Table 14A: Mapping of precoding weight information for primary transport block

$W_2$	$X_{pwipb,1}, X_{pwipb,2}$
$\frac{1+j}{2}$	00
$\frac{1-j}{2}$	01
$\frac{-1+j}{2}$	10
$\frac{-1-j}{2}$	11

### 4.6B.3 Multiplexing of HS-SCCH type 3 information

The channelization-code-set information  $x_{ccs,1}, x_{ccs,2}, \dots, x_{ccs,7}$ , modulation-scheme and number of transport blocks information  $x_{ms,1}, x_{ms,2}, x_{ms,3}$  and precoding weight information  $x_{pwipb,1}, x_{pwipb,2}$  are multiplexed together. This gives a sequence of bits  $x_{1,1}, x_{1,2}, \dots, x_{1,12}$ , where

$$x_{1,i} = x_{ccs,i} \quad i=1,2,\dots,7$$

$$x_{1,i} = x_{ms,i-7} \quad i=8,9,10$$

$$x_{1,i} = x_{pwipb,i-10} \quad i=11,12$$

If one transport block is transmitted on the associated HS-PDSCH(s), the transport-block-size information  $x_{tbsp,1}, x_{tbsp,2}, \dots, x_{tbsp,6}$ , Hybrid-ARQ-process information  $x_{hap,1}, x_{hap,2}, \dots, x_{hap,4}$  and redundancy-version information  $x_{rvpb,1}, x_{rvpb,2}$  are multiplexed together. This gives a sequence of bits  $x_{2,1}, x_{2,2}, \dots, x_{2,12}$  where

$$x_{2,i} = x_{tbs,i} \quad i=1,2,\dots,6$$

$$x_{2,i} = x_{hap,i-6} \quad i=7,8,\dots,10$$

$$x_{2,i} = x_{rv,i-10} \quad i=11,12$$

If two transport blocks are transmitted on the associated HS-PDSCHs, the transport-block-size information for the primary transport block  $x_{tbsp,1}, x_{tbsp,2}, \dots, x_{tbsp,6}$ , transport-block-size information for the secondary transport block  $x_{tbssb,1}, x_{tbssb,2}, \dots, x_{tbssb,6}$ , Hybrid-ARQ-process information  $x_{hap,1}, x_{hap,2}, \dots, x_{hap,4}$ , redundancy-version information for the primary transport block  $x_{rvpb,1}, x_{rvpb,2}$ , and redundancy-version information for the secondary transport block  $x_{rvsb,1}, x_{rvsb,2}$  are multiplexed together. This gives a sequence of bits  $x_{2,1}, x_{2,2}, \dots, x_{2,20}$  where

$$x_{2,i} = x_{tbsp,i} \quad i=1,2,\dots,6$$

$$x_{2,i} = x_{tbssb,i-6} \quad i=7,8,\dots,12$$

$$x_{2,i} = x_{hap,i-12} \quad i=13,14,\dots,16$$

$$x_{2,i} = x_{rvpb,i-16} \quad i=17,18$$

$$x_{2,i} = x_{rvsb,i-18} \quad i=19,20$$

### 4.6B.4 CRC attachment for HS-SCCH type 3

If one transport block is transmitted on the associated HS-PDSCH(s), from the sequence of bits  $x_{1,1}, x_{1,2}, \dots, x_{1,12}, x_{2,1}, x_{2,2}, \dots, x_{2,12}$  a 16-bit CRC is calculated according to Clause 4.2.1.1. This gives a sequence of bits  $c_1, c_2, \dots, c_{16}$  where

$$c_k = p_{im(17-k)} \quad k=1,2,\dots,16$$



This sequence of bits is then masked with the UE Identity  $x_{ue,1}, x_{ue,2}, \dots, x_{ue,16}$  and then appended to the sequence of bits  $x_{2,1}, x_{2,2}, \dots, x_{2,12}$  to form the sequence of bits  $y_1, y_2, \dots, y_{28}$ , where

$$y_i = x_{2,i} \quad i=1,2,\dots,12$$

$$y_i = (c_{i-12} + x_{ue,i-12}) \bmod 2 \quad i=13,14,\dots,28$$

If two transport blocks are transmitted on the associated HS-PDSCHs, from the sequence of bits  $x_{1,1}, x_{1,2}, \dots, x_{1,12}, x_{2,1}, x_{2,2}, \dots, x_{2,20}$  a 16-bit CRC is calculated according to Clause 4.2.1.1. This gives a sequence of bits  $c_1, c_2, \dots, c_{16}$  where

$$c_k = p_{im(17-k)} \quad k=1,2,\dots,16$$

This sequence of bits is then masked with the UE Identity  $x_{ue,1}, x_{ue,2}, \dots, x_{ue,16}$  and then appended to the sequence of bits  $x_{2,1}, x_{2,2}, \dots, x_{2,20}$  to form the sequence of bits  $y_1, y_2, \dots, y_{36}$ , where

$$y_i = x_{2,i} \quad i=1,2,\dots,20$$

$$y_i = (c_{i-20} + x_{ue,i-20}) \bmod 2 \quad i=21,22,\dots,36$$

#### 4.6B.5 Channel coding for HS-SCCH type 3

Rate 1/3 convolutional coding, as described in Clause 4.2.3.1, is applied to the sequence of bits  $x_{1,1}, x_{1,2}, \dots, x_{1,12}$ . This gives a sequence of bits  $z_{1,1}, z_{1,2}, \dots, z_{1,60}$ .

If one transport block is transmitted on the associated HS-PDSCH(s), rate 1/3 convolutional coding, as described in Clause 4.2.3.1, is applied to the sequence of bits  $y_1, y_2, \dots, y_{28}$ . This gives a sequence of bits  $z_{2,1}, z_{2,2}, \dots, z_{2,108}$ .

If two transport blocks are transmitted on the associated HS-PDSCHs, rate 1/3 convolutional coding, as described in Clause 4.2.3.1, is applied to the sequence of bits  $y_1, y_2, \dots, y_{36}$ . This gives a sequence of bits  $z_{2,1}, z_{2,2}, \dots, z_{2,132}$ .

Note that the coded sequence lengths result from the termination of K=9 convolutional coding being fully applied.

#### 4.6B.6 Rate matching for HS-SCCH type 3

From the input sequence  $z_{1,1}, z_{1,2}, \dots, z_{1,60}$  the bits  $z_{1,1}, z_{1,2}, z_{1,4}, z_{1,6}, z_{1,8}, z_{1,12}, z_{1,15}, z_{1,18}, z_{1,21}, z_{1,24}, z_{1,37}, z_{1,40}, z_{1,43}, z_{1,46}, z_{1,49}, z_{1,53}, z_{1,55}, z_{1,57}, z_{1,59}, z_{1,60}$  are punctured to obtain the output sequence  $r_{1,1}, r_{1,2}, \dots, r_{1,40}$ .

If one transport block is transmitted on the associated HS-PDSCH(s), from the input sequence  $z_{2,1}, z_{2,2}, \dots, z_{2,108}$  the bits  $z_{2,1}, z_{2,2}, z_{2,3}, z_{2,4}, z_{2,5}, z_{2,6}, z_{2,7}, z_{2,8}, z_{2,12}, z_{2,14}, z_{2,15}, z_{2,24}, z_{2,42}, z_{2,48}, z_{2,63}, z_{2,66}, z_{2,93}, z_{2,96}, z_{2,98}, z_{2,99}, z_{2,101}, z_{2,102}, z_{2,103}, z_{2,104}, z_{2,105}, z_{2,106}, z_{2,107}, z_{2,108}$  are punctured to obtain the output sequence  $r_{2,1}, r_{2,2}, \dots, r_{2,80}$ .

If two transport blocks are transmitted on the associated HS-PDSCHs, from the input sequence  $z_{2,1}, z_{2,2}, \dots, z_{2,132}$  the bits  $z_{2,1}, z_{2,2}, z_{2,3}, z_{2,4}, z_{2,5}, z_{2,6}, z_{2,7}, z_{2,8}, z_{2,10}, z_{2,11}, z_{2,13}, z_{2,14}, z_{2,16}, z_{2,19}, z_{2,22}, z_{2,25}, z_{2,28}, z_{2,31}, z_{2,34}, z_{2,37}, z_{2,40}, z_{2,43}, z_{2,46}, z_{2,49}, z_{2,55}, z_{2,61}, z_{2,72}, z_{2,78}, z_{2,84}, z_{2,87}, z_{2,90}, z_{2,93}, z_{2,96}, z_{2,99}, z_{2,102}, z_{2,105}, z_{2,108}, z_{2,111}, z_{2,114}, z_{2,117}, z_{2,119}, z_{2,120}, z_{2,122}, z_{2,123}, z_{2,125}, z_{2,126}, z_{2,127}, z_{2,128}, z_{2,129}, z_{2,130}, z_{2,131}, z_{2,132}$  are punctured to obtain the output sequence  $r_{2,1}, r_{2,2}, \dots, r_{2,80}$ .

#### 4.6B.7 UE specific masking for HS-SCCH type 3

The output bits  $s_{1,1}, s_{1,2}, \dots, s_{1,40}$  are calculated as described in subclause 4.6.7.

#### 4.6B.8 Physical channel mapping for HS-SCCH type 3

The HS-SCCH sub-frame is described in [2]. The physical channel mapping is carried out as described in subclause 4.6.8.

## 4.6C Coding for HS-SCCH orders

### 4.6C.1 Overview

HS-SCCH orders are commands sent to the UE using HS-SCCH. No HS-PDSCH is associated with HS-SCCH orders.

The following information is transmitted by means of the HS-SCCH order physical channel.

- Extended order type (2bits)  $x_{eodt,1}, x_{eodt,2}$
- Order type (3 bits):  $x_{odt,1}, x_{odt,2}, x_{odt,3}$
- Order (3 bits):  $x_{ord,1}, x_{ord,2}, x_{ord,3}$
- UE identity (16 bits):  $x_{ue,1}, x_{ue,2}, \dots, x_{ue,16}$

The coding for HS-SCCH orders is specified in subclause 4.6.1 for a cell where the UE is not configured in MIMO mode and not configured in MIMO mode with four transmit antennas or if the UE is in CELL\_FACH state and in subclause 4.6B.1 for a cell where the UE is configured in MIMO mode, in subclause 4.6D.1 for a cell where the UE is configured in MIMO mode with four transmit antennas with the exception of HS-DSCH serving cell change order, which is always transmitted using HS-SCCH type 1 specified in subclause 4.6.1.

### 4.6C.2 HS-SCCH Order information field mapping in the CELL\_DCH state

#### 4.6C.2.1 Order type mapping

If the extended Order type  $x_{eodt,1}, x_{eodt,2} = "01"$  and the Order type  $x_{odt,1}, x_{odt,2}, x_{odt,3} = "000"$ , then the mapping for  $x_{ord,1}, x_{ord,2}, x_{ord,3}$  is according to subclause 4.6C.2.2.1.

If the extended Order type  $x_{eodt,1}, x_{eodt,2} = "01"$  and the Order type  $x_{odt,1}, x_{odt,2}, x_{odt,3} = "011"$ , then the mapping for  $x_{ord,1}, x_{ord,2}, x_{ord,3}$  is according to subclause 4.6C.2.2.3.

If the extended Order type  $x_{eodt,1}, x_{eodt,2} = "11"$  and the Order type  $x_{odt,1}, x_{odt,2}, x_{odt,3} = "010"$ , then the mapping for  $x_{ord,1}, x_{ord,2}, x_{ord,3}$  is according to subclause 4.6C.2.2.4.

Otherwise the mapping for  $x_{eodt,1}, x_{eodt,2}, x_{odt,1}, x_{odt,2}, x_{odt,3}, x_{ord,1}, x_{ord,2}, x_{ord,3}$  is according to subclause 4.6C.2.2.2.

#### 4.6C.2.2 Order mapping

##### 4.6C.2.2.1 Orders for activation and deactivation of DTX, DRX and HS-SCCH-less operation and for HS-DSCH serving cell change

If the order is transmitted from the serving HS-DSCH cell or a secondary serving HS-DSCH cell, for this Order type,  $x_{ord,1}, x_{ord,2}, x_{ord,3}$  is comprised of:

- DRX activation (1 bit):  $x_{ord,1} = x_{drx,1}$
- DTX activation (1 bit):  $x_{ord,2} = x_{dtx,1}$
- HS-SCCH-less operation activation (1 bit):  $x_{ord,3} = x_{hs-sch-less,1}$

If  $x_{drx,1} = "0"$ , then the HS-SCCH order is a DRX De-activation order.

If  $x_{drx,1} = "1"$ , then the HS-SCCH order is a DRX Activation order.

If  $x_{dtx,1} = "0"$ , then the HS-SCCH order is a DTX De-activation order.

If  $x_{dtx,1} = "1"$ , then the HS-SCCH order is a DTX Activation order.

If  $x_{hs-sch-less,1} = "0"$ , then the HS-SCCH order is a HS-SCCH-less operation De-activation order.

If  $x_{hs-sch-less,1} = "1"$ , then the HS-SCCH order is a HS-SCCH-less operation Activation order.

If the order is transmitted from a non-serving cell using HS-SCCH type 1 specified in subclause 4.6.1 and  $x_{ord,1}, x_{ord,2}, x_{ord,3} = "000"$ , then it is an HS-DSCH serving cell change order .

$x_{drx,1}, x_{dtx,1} = "10"$  is a reserved combination (not used in this release).

**4.6C.2.2.2 Orders for activation and deactivation of Secondary serving HS-DSCH cells and Secondary uplink frequency**

For these Extended Order types and Order types, the meaning of the orders is listed in Table 14B for the case where Secondary\_Cell\_Enabled is less than 4. For the case where Secondary\_Cell\_Enabled is greater than 3 the meaning of the orders is listed in Table 14B.1.

When Secondary\_Cell\_Enabled is 1,

- the order type  $x_{odt,1}, x_{odt,2}, x_{odt,3} = '010'$  is unused;
- regardless of the signaled value of  $x_{ord,1}$  the UE shall assume  $x_{ord,1} = '0'$ ;
- $x_{ord,2}, x_{ord,3} = "10"$  is an unused combination.

When the UE is configured in Multiflow mode the following exceptions to the definitions in table 14B apply:

- For the orders received from the Serving or the Secondary Serving HS-DSCH cell, the UE shall consider the 1<sup>st</sup> Secondary Serving cell to refer to the Secondary Serving HS-DSCH cell and apply the received order to that cell. The activation status of all other cells shall remain unchanged.
- For the orders received from the Assisting Serving or Assisting Secondary Serving HS-DSCH cell the UE shall consider the 1<sup>st</sup> Secondary Serving cell to refer to the Assisting Secondary Serving HS-DSCH cell and apply the received order to that cell. The activation status of all other cells shall remain unchanged.
- For the orders received from the Assisting Serving or Assisting Secondary Serving HS-DSCH cell the UE shall ignore activation status related to the Secondary Uplink Frequency and maintain the activation status of the Secondary Uplink Frequency unchanged.
- The order contents related to the 2<sup>nd</sup> and 3<sup>rd</sup> Secondary Serving HS-DSCH cells shall be ignored.

**Table 14B: Orders for activation and deactivation of Secondary serving HS-DSCH cells and Secondary uplink frequency when Secondary\_Cell\_Enabled is less than 4, or when the UE is configured in Multiflow mode.**

Extended Order Type	Order Type	Order Mapping			Activation Status of Secondary Serving HS-DSCH cells and Secondary Uplink Frequency A= Activate; D = De-activate			
		$x_{ord,1}$	$x_{ord,2}$	$x_{ord,3}$	1 <sup>st</sup> Secondary Serving HS-DSCH cell	2 <sup>nd</sup> Secondary Serving HS-DSCH cell	3 <sup>rd</sup> Secondary Serving HS-DSCH cell	Secondary Uplink Frequency
$x_{eodt,1}, x_{eodt,2}$	$x_{odt,1}, x_{odt,2}, x_{odt,3}$	$x_{ord,1}$	$x_{ord,2}$	$x_{ord,3}$				
	001	0	0	0	D	D	D	D
		0	0	1	A	D	D	D
		0	1	1	A	D	D	A
		0	1	0	D	A	D	D
		1	0	0	A	A	D	D
		1	0	1	A	A	D	A
		1	1	0	D	D	A	D
		1	1	1	A	D	A	D

01	010	0	0	0	A	D	A	A	
		0	0	1	D	A	A	D	
		0	1	0	A	A	A	D	
		0	1	1	A	A	A	A	
		1	0	0	Unused (Reserved)				
		1	0	1	Unused (Reserved)				
		1	1	0	Unused (Reserved)				
		1	1	1	Unused (Reserved)				

**Table 14B.1: Orders for activation and deactivation of Secondary serving HS-DSCH cells and Secondary uplink frequency when Secondary\_Cell\_Enabled is greater than 3.**

Extended Order Type		Order Type	Order Mapping			Activation Status of Secondary Serving HS-DSCH cells and Secondary Uplink Frequency A= Activate; D = De-activate							
X <sub>eodt,,1</sub>	X <sub>eodt,,2</sub>	X <sub>odt,1</sub> , X <sub>odt,2</sub> , X <sub>odt,3</sub>	X <sub>ord,1</sub>	X <sub>ord,2</sub>	X <sub>ord,3</sub>	1 <sup>st</sup> Sec Serving HS-DSCH cell	2 <sup>nd</sup> Sec Serving HS-DSCH cell	3 <sup>rd</sup> Sec Serving HS-DSCH cell	4 <sup>th</sup> Sec Serving HS-DSCH cell	5 <sup>th</sup> Sec Serving HS-DSCH cell	6 <sup>th</sup> Sec Serving HS-DSCH cell	7 <sup>th</sup> Sec Serving HS-DSCH cell	Sec Uplink Freq
00		000	0	0	0	A	D	A	D	A	D	A	A
			0	0	1	D	A	A	D	A	D	A	D
			0	1	1	A	A	A	D	A	D	A	A
			0	1	0	A	A	A	D	A	D	A	D
			1	0	0	D	D	D	A	A	D	A	D
			1	0	1	A	D	D	A	A	D	A	D
			1	1	0	D	A	D	A	A	D	A	D
			1	1	1	A	D	D	A	A	D	A	A
00		001	0	0	0	A	A	D	A	A	D	A	D
			0	0	1	A	A	D	A	A	D	A	A
			0	1	1	A	D	A	A	A	D	A	D
			0	1	0	D	D	A	A	A	D	A	D
			1	0	0	A	D	A	A	A	D	A	A
			1	0	1	D	A	A	A	A	D	A	D
			1	1	0	A	A	A	A	A	D	A	D
			1	1	1	A	A	A	A	A	D	A	A
00		010	0	0	0	D	D	D	D	D	A	A	D
			0	0	1	A	D	D	D	D	A	A	D

		0	1	1	A	D	D	D	D	A	A	A
		0	1	0	D	A	D	D	D	A	A	D
		1	0	0	A	A	D	D	D	A	A	D
		1	0	1	A	A	D	D	D	A	A	A
		1	1	0	D	D	A	D	D	A	A	D
		1	1	1	A	D	A	D	D	A	A	D
00	011	0	0	0	A	D	A	D	D	A	A	A
		0	0	1	D	A	A	D	D	A	A	D
		0	1	1	A	A	A	D	D	A	A	A
		0	1	0	A	A	A	D	D	A	A	D
		1	0	0	D	D	D	A	D	A	A	D
		1	0	1	A	D	D	A	D	A	A	D
		1	1	0	D	A	D	A	D	A	A	D
		1	1	1	A	D	D	A	D	A	A	A
00	100	0	0	0	A	A	D	A	D	A	A	D
		0	0	1	A	A	D	A	D	A	A	A
		0	1	1	A	D	A	A	D	A	A	D
		0	1	0	D	D	A	A	D	A	A	D
		1	0	0	A	D	A	A	D	A	A	A
		1	0	1	D	A	A	A	D	A	A	D
		1	1	0	A	A	A	A	D	A	A	D
		1	1	1	A	A	A	A	D	A	A	A
00	101	0	0	0	D	D	D	D	A	A	A	D
		0	0	1	A	D	D	D	A	A	A	D
		0	1	1	A	D	D	D	A	A	A	A
		0	1	0	D	A	D	D	A	A	A	D
		1	0	0	A	A	D	D	A	A	A	D
		1	0	1	A	A	D	D	A	A	A	A
		1	1	0	D	D	A	D	A	A	A	D
		1	1	1	A	D	A	D	A	A	A	D
00	110	0	0	0	A	D	A	D	A	A	A	A
		0	0	1	D	A	A	D	A	A	A	D
		0	1	1	A	A	A	D	A	A	A	A

		0	1	0	A	A	A	D	A	A	A	D
		1	0	0	D	D	D	A	A	A	A	D
		1	0	1	A	D	D	A	A	A	A	D
		1	1	0	D	A	D	A	A	A	A	D
		1	1	1	A	D	D	A	A	A	A	A
00	111	0	0	0	A	A	D	A	A	A	A	D
		0	0	1	A	A	D	A	A	A	A	A
		0	1	1	A	D	A	A	A	A	A	D
		0	1	0	D	D	A	A	A	A	A	D
		1	0	0	A	D	A	A	A	A	A	A
		1	0	1	D	A	A	A	A	A	A	D
		1	1	0	A	A	A	A	A	A	A	D
		1	1	1	A	A	A	A	A	A	A	A
01	001	0	0	0	D	D	D	D	D	D	D	D
		0	0	1	A	D	D	D	D	D	D	D
		0	1	1	A	D	D	D	D	D	D	A
		0	1	0	D	A	D	D	D	D	D	D
		1	0	0	A	A	D	D	D	D	D	D
		1	0	1	A	A	D	D	D	D	D	A
		1	1	0	D	D	A	D	D	D	D	D
		1	1	1	A	D	A	D	D	D	D	D
01	010	0	0	0	A	D	A	D	D	D	D	A
		0	0	1	D	A	A	D	D	D	D	D
		0	1	1	A	A	A	D	D	D	D	A
		0	1	0	A	A	A	D	D	D	D	D
		1	0	0	D	D	D	A	D	D	D	D
		1	0	1	A	D	D	A	D	D	D	D
		1	1	0	D	A	D	A	D	D	D	D
		1	1	1	A	D	D	A	D	D	D	A
01	100	0	0	0	D	D	D	D	A	D	D	D
		0	0	1	A	D	D	D	A	D	D	D
		0	1	1	A	D	D	D	A	D	D	A
		0	1	0	D	A	D	D	A	D	D	D

		1	0	0	A	A	D	D	A	D	D	D
		1	0	1	A	A	D	D	A	D	D	A
		1	1	0	D	D	A	D	A	D	D	D
		1	1	1	A	D	A	D	A	D	D	D
01	101	0	0	0	A	D	A	D	A	D	D	A
		0	0	1	D	A	A	D	A	D	D	D
		0	1	1	A	A	A	D	A	D	D	A
		0	1	0	A	A	A	D	A	D	D	D
		1	0	0	D	D	D	A	A	D	D	D
		1	0	1	A	D	D	A	A	D	D	D
		1	1	0	D	A	D	A	A	D	D	D
		1	1	1	A	D	D	A	A	D	D	A
01	110	0	0	0	A	A	D	A	A	D	D	D
		0	0	1	A	A	D	A	A	D	D	A
		0	1	1	A	D	A	A	A	D	D	D
		0	1	0	D	D	A	A	A	D	D	D
		1	0	0	A	D	A	A	A	D	D	A
		1	0	1	D	A	A	A	A	D	D	D
		1	1	0	A	A	A	A	A	D	D	D
		1	1	1	A	A	A	A	A	D	D	A
01	111	0	0	0	D	D	D	D	D	A	D	D
		0	0	1	A	D	D	D	D	A	D	D
		0	1	1	A	D	D	D	D	A	D	A
		0	1	0	D	A	D	D	D	A	D	D
		1	0	0	A	A	D	D	D	A	D	D
		1	0	1	A	A	D	D	D	A	D	A
		1	1	0	D	D	A	D	D	A	D	D
		1	1	1	A	D	A	D	D	A	D	D
10	000	0	0	0	A	D	A	D	D	A	D	A
		0	0	1	D	A	A	D	D	A	D	D
		0	1	1	A	A	A	D	D	A	D	A
		0	1	0	A	A	A	D	D	A	D	D
		1	0	0	D	D	D	A	D	A	D	D

		1	0	1	A	D	D	A	D	A	D	D
		1	1	0	D	A	D	A	D	A	D	D
		1	1	1	A	D	D	A	D	A	D	A
10	001	0	0	0	A	A	D	A	D	A	D	D
		0	0	1	A	A	D	A	D	A	D	A
		0	1	1	A	D	A	A	D	A	D	D
		0	1	0	D	D	A	A	D	A	D	D
		1	0	0	A	D	A	A	D	A	D	A
		1	0	1	D	A	A	A	D	A	D	D
		1	1	0	A	A	A	A	D	A	D	D
		1	1	1	A	A	A	A	D	A	D	A
10	010	0	0	0	D	D	D	D	A	A	D	D
		0	0	1	A	D	D	D	A	A	D	D
		0	1	1	A	D	D	D	A	A	D	A
		0	1	0	D	A	D	D	A	A	D	D
		1	0	0	A	A	D	D	A	A	D	D
		1	0	1	A	A	D	D	A	A	D	A
		1	1	0	D	D	A	D	A	A	D	D
		1	1	1	A	D	A	D	A	A	D	D
10	011	0	0	0	A	D	A	D	A	A	D	A
		0	0	1	D	A	A	D	A	A	D	D
		0	1	1	A	A	A	D	A	A	D	A
		0	1	0	A	A	A	D	A	A	D	D
		1	0	0	D	D	D	A	A	A	D	D
		1	0	1	A	D	D	A	A	A	D	D
		1	1	0	D	A	D	A	A	A	D	D
		1	1	1	A	D	D	A	A	A	D	A
10	100	0	0	0	A	A	D	A	A	A	D	D
		0	0	1	A	A	D	A	A	A	D	A
		0	1	1	A	D	A	A	A	A	D	D
		0	1	0	D	D	A	A	A	A	D	D
		1	0	0	A	D	A	A	A	A	D	A
		1	0	1	D	A	A	A	A	A	D	D



		1	1	0	A	A	A	A	A	A	D	D
		1	1	1	A	A	A	A	A	A	D	A
10	101	0	0	0	D	D	D	D	D	D	A	D
		0	0	1	A	D	D	D	D	D	A	D
		0	1	1	A	D	D	D	D	D	A	A
		0	1	0	D	A	D	D	D	D	A	D
		1	0	0	A	A	D	D	D	D	A	D
		1	0	1	A	A	D	D	D	D	A	A
		1	1	0	D	D	A	D	D	D	A	D
		1	1	1	A	D	A	D	D	D	A	D
10	110	0	0	0	A	D	A	D	D	D	A	A
		0	0	1	D	A	A	D	D	D	A	D
		0	1	1	A	A	A	D	D	D	A	A
		0	1	0	A	A	A	D	D	D	A	D
		1	0	0	D	D	D	A	D	D	A	D
		1	0	1	A	D	D	A	D	D	A	D
		1	1	0	D	A	D	A	D	D	A	D
		1	1	1	A	D	D	A	D	D	A	A
10	111	0	0	0	A	A	D	A	D	D	A	D
		0	0	1	A	A	D	A	D	D	A	A
		0	1	1	A	D	A	A	D	D	A	D
		0	1	0	D	D	A	A	D	D	A	D
		1	0	0	A	D	A	A	D	D	A	A
		1	0	1	D	A	A	A	D	D	A	D
		1	1	0	A	A	A	A	D	D	A	D
		1	1	1	A	A	A	A	D	D	A	A
11	000	0	0	0	D	D	D	D	A	D	A	D
		0	0	1	A	D	D	D	A	D	A	D
		0	1	1	A	D	D	D	A	D	A	A
		0	1	0	D	A	D	D	A	D	A	D
		1	0	0	A	A	D	D	A	D	A	D
		1	0	1	A	A	D	D	A	D	A	A
		1	1	0	D	D	A	D	A	D	A	D

		1	1	1	A	D	A	D	A	D	A	D
11	001	0	0	0	A	A	D	A	D	D	D	D
		0	0	1	A	A	D	A	D	D	D	A
		0	1	1	A	D	A	A	D	D	D	D
		0	1	0	D	D	A	A	D	D	D	D
		1	0	0	A	D	A	A	D	D	D	A
		1	0	1	D	A	A	A	D	D	D	D
		1	1	0	A	A	A	A	D	D	D	D
		1	1	1	A	A	A	A	D	D	D	A

4.6C.2.2.3 Orders for Switching between Uplink Closed Loop Transmit Diversity Activation states

For this Order type, the meaning of the orders is listed in Table 14B.2.

When the UE is configured in Multiflow mode, if any of the orders related to uplink CLTD activation states as defined in Table 14B.2 are received from the Assisting Serving or Assisting Secondary Serving HS-DSCH cell, then the UE shall ignore the orders and maintain the uplink CLTD activation state unchanged.

Table 14B.2: Orders for UE when UL\_CLTD\_Enabled is TRUE

Extended Order Type	Order Type	Order Mapping			Activation States A= Activate; D = De-activate		
		$X_{ord,1}$	$X_{ord,2}$	$X_{ord,3}$	1	2	3
$X_{eodt,1}, X_{eodt,2}$	$X_{odt,1}, X_{odt,2}, X_{odt,3}$				<b>Tx on Antenna 1 and Antenna 2 with Beamforming (Note 1)</b>	<b>Single Tx on Antenna 1 with no S-DPCCH</b>	<b>Single Tx on Antenna 2 with no S-DPCCH</b>
01	011	1	1	1	A	D	D
		0	0	1	D	A	D
		0	1	0	D	D	A
		1	0	1	Unused (Reserved)		
		1	1	0	Unused (Reserved)		
		0	0	0	Unused (Reserved)		
		0	1	1	Unused (Reserved)		
		1	0	0	Unused (Reserved)		

Note 1: The precoding weights for beamforming are defined in [4].

#### 4.6C.2.2.4 Orders for activating and de-activating demodulation common pilots (D-CPICH) when the UE is configured in MIMO mode with four transmit antennas

For this Order type, the meaning of the orders is listed in Table 14B.3.

**Table 14B.3: Orders when the UE is configured in MIMO mode with four transmit antennas**

Extended Order Type	Order Type	Order Mapping			D-CPICH Activation States A= Activate; D = De-activate
		$x_{ord,1}$	$x_{ord,2}$	$x_{ord,3}$	
$x_{eodt,1}, x_{eodt,2}$	$x_{odt,1}, x_{odt,2}, x_{odt,3}$	$x_{ord,1}$	$x_{ord,2}$	$x_{ord,3}$	
11	010	1	1	1	A
		0	0	0	D
		0	0	1	Unused (Reserved)
		0	1	0	Unused (Reserved)
		0	1	1	Unused (Reserved)
		1	0	0	Unused (Reserved)
		1	0	1	Unused (Reserved)
		1	1	0	Unused (Reserved)

Note 1: The activation and de-activation status corresponds to individual HS-DSCH cell.

Note 2: Activation and de-activation indication applies for all the demodulation common pilots configured in the cell.

#### 4.6C.2.3 UE identity mapping

The UE identity is the HS-DSCH Radio Network Identifier (H-RNTI) defined in [13]. This is mapped such that  $x_{ue,1}$  corresponds to the MSB and  $x_{ue,16}$  to the LSB, cf. [14].

### 4.6C.3 HS-SCCH Order information field mapping in the CELL\_FACH and CELL\_PCH states

#### 4.6C.3.1 Order type mapping

If the extended Order type  $x_{eodt,1}, x_{eodt,2} = "01"$  and the Order type  $x_{odt,1}, x_{odt,2}, x_{odt,3} = "000"$ , then the mapping for  $x_{ord,1}, x_{ord,2}, x_{ord,3}$  is according to subclause 4.6C.3.2.1.

#### 4.6C.3.2 Order mapping

##### 4.6C.3.2.1 Orders for Network Triggered HS-DPCCH Transmission

For this Order type, the Order mapping  $x_{ord,1}, x_{ord,2}, x_{ord,3}$  and the associated meaning is as follows:

If  $x_{ord,1}, x_{ord,2}, x_{ord,3} = "001"$ , then the HS-SCCH order is an order for triggering the random access procedure in CELL\_FACH as specified in subclause 6.1A in [4].

## 4.6D Coding for HS-SCCH type 4

### 4.6D.1 Overview

HS-SCCH type 4 is used when the UE is configured in MIMO mode with four transmit antennas. If one transport block is transmitted on the associated HS-PDSCH(s) or an HS-SCCH order is transmitted, the following information is transmitted by means of the HS-SCCH type 4 physical channel:

- Channelization-code-set information (7 bits):  $x_{ccs,1}, x_{ccs,2}, \dots, x_{ccs,7}$
- Modulation scheme and number of transport blocks information (5 bits):  $x_{ms,1}, x_{ms,2}, x_{ms,3}, x_{ms,4}, x_{ms,5}$
- Precoding weight information (4 bits):  $x_{pwipb,1}, x_{pwipb,2}, x_{pwipb,3}, x_{pwipb,4}$
- Transport-block size information (6 bits):  $x_{tbspb,1}, x_{tbspb,2}, \dots, x_{tbspb,6}$
- Hybrid-ARQ process information (4 bits):  $x_{hap,1}, x_{hap,2}, \dots, x_{hap,4}$
- Redundancy and constellation version (2 bits):  $x_{rvpb,1}, x_{rvpb,2}$
- UE identity (16 bits):  $x_{ue,1}, x_{ue,2}, \dots, x_{ue,16}$

For an HS-SCCH order,

- $x_{ccs,1}, x_{ccs,2}, \dots, x_{ccs,7}, x_{ms,1}, x_{ms,2}, x_{ms,3}, x_{ms,4}, x_{ms,5}, x_{pwipb,1}, x_{pwipb,2}, x_{pwipb,3}, x_{pwipb,4}$  shall be set to "1110000000000000"
- $x_{tbspb,1}, x_{tbspb,2}, \dots, x_{tbspb,4}$  shall be set to "1111"
- $x_{tbspb,5}, x_{tbspb,6}$  shall be set to  $x_{eodt,1}, x_{eodt,2}$
- $x_{hap,1}, x_{hap,2}, x_{hap,3}, x_{hap,4}, x_{rvpb,1}, x_{rvpb,2}$  shall be set to  $x_{odt,1}, x_{odt,2}, x_{odt,3}, x_{ord,1}, x_{ord,2}, x_{ord,3}$

where  $x_{eodt,1}, x_{eodt,2}, x_{odt,1}, x_{odt,2}, x_{odt,3}, x_{ord,1}, x_{ord,2}, x_{ord,3}$  are defined in subclause 4.6C.

If more than one transport block is transmitted on the associated HS-PDSCHs, the following information is transmitted by means of the HS-SCCH type 4 physical channel:

- Channelization-code-set information (7 bits):  $x_{ccs,1}, x_{ccs,2}, \dots, x_{ccs,7}$
- Modulation scheme and number of transport blocks information (5 bits):  $x_{ms,1}, x_{ms,2}, x_{ms,3}, x_{ms,4}, x_{ms,5}$
- Precoding weight information (4 bits):  $x_{pwipb,1}, x_{pwipb,2}, x_{pwipb,3}, x_{pwipb,4}$
- Transport-block size information for the primary or/and fourth transport block (6 bits):  $x_{tbspb,1}, x_{tbspb,2}, \dots, x_{tbspb,6}$
- Transport-block size information for the second or/and third transport block (6 bits):  $x_{tbssb,1}, x_{tbssb,2}, \dots, x_{tbssb,6}$
- Hybrid-ARQ process information (4 bits):  $x_{hap,1}, x_{hap,2}, \dots, x_{hap,4}$
- Redundancy and constellation version for the primary or/and fourth transport block (2 bits):  $x_{rvpb,1}, x_{rvpb,2}$
- Redundancy and constellation version for the second or/and third transport block (2 bits):  $x_{rvsb,1}, x_{rvsb,2}$
- UE identity (16 bits):  $x_{ue,1}, x_{ue,2}, \dots, x_{ue,16}$

The overall coding chain for HS-SCCH type 4 is same as that of HS-SCCH type 3 as shown in Figure 19 B.

### 4.6D.2 HS-SCCH type 4 information field mapping

#### 4.6D.2.1 Redundancy and constellation version coding

If four transport blocks are transmitted on the associated HS-PDSCH(s), the redundancy version (RV) parameters  $r$ ,  $s$  and constellation version parameter  $b$  are coded jointly to produce the values  $X_{rvpb}$  for the primary and the fourth

transport blocks and  $X_{rvsb}$  for the second and the third transport blocks respectively. The transmitted sequences  $x_{rvpb,1}$ ,  $x_{rvpb,2}$  and  $x_{rvsb,1}$ ,  $x_{rvsb,2}$  are the binary representations of  $X_{rvpb}$  and  $X_{rvsb}$ , respectively, where  $x_{rvpb,1}$  and  $x_{rvsb,1}$  are the MSBs.

If three transport blocks are transmitted on the associated HS-PDSCH(s), the redundancy version (RV) parameters  $r$ ,  $s$  and constellation version parameter  $b$  are coded jointly to produce the values  $X_{rvpb}$  for the primary transport block and  $X_{rvsb}$  for the second and the third transport blocks respectively. The transmitted sequences  $x_{rvpb,1}$ ,  $x_{rvpb,2}$  and  $x_{rvsb,1}$ ,  $x_{rvsb,2}$  are the binary representations of  $X_{rvpb}$  and  $X_{rvsb}$ , respectively, where  $x_{rvpb,1}$  and  $x_{rvsb,1}$  are the MSBs.

For each of the primary transport block and a second transport block if two transport blocks are transmitted on the associated HS-PDSCH(s), the redundancy version (RV) parameters  $r$ ,  $s$  and constellation version parameter  $b$  are coded jointly to produce the values  $X_{rvpb}$  and  $X_{rvsb}$  respectively. The transmitted sequences  $x_{rvpb,1}$ ,  $x_{rvpb,2}$  and  $x_{rvsb,1}$ ,  $x_{rvsb,2}$  are the binary representations of  $X_{rvpb}$  and  $X_{rvsb}$ , respectively, where  $x_{rvpb,1}$  and  $x_{rvsb,1}$  are the MSBs.

For the primary transport block if only one transport block is transmitted on the associated HS-PDSCH(s), the redundancy version (RV) parameters  $r$ ,  $s$  and constellation version parameter  $b$  are coded jointly to produce the value  $X_{rvpb}$ . The transmitted sequence  $x_{rvpb,1}$ ,  $x_{rvpb,2}$  is the binary representation of  $X_{rvpb}$ , where  $x_{rvpb,1}$  is the MSB.

Joint coding of parameters  $r$ ,  $s$  and constellation version parameter  $b$  is done according to tables 14B.4 and 14B.5 according to the modulation mode used. If  $X_{rvpb} = 0$  or  $X_{rvsb} = 0$ , the UE shall treat the corresponding transport block as an initial transmission.

**Table 14B.4: RV coding for 16QAM and 64QAM for HS-SCCH type 4**

$X_{rvpb}$ or $X_{rvsb}$ (value)	$N_{sys} / N_{data} < 1/2$			$N_{sys} / N_{data} \geq 1/2$		
	s	r	b	s	r	b
0	1	0	0	1	0	0
1	1	1	1	0	1	1
2	1	0	2	0	0	0
3	1	0	3	1	0	2

**Table 14B.5: RV coding for QPSK for HS-SCCH type 4**

$X_{rvpb}$ or $X_{rvsb}$ (value)	$N_{sys} / N_{data} < 1/2$		$N_{sys} / N_{data} \geq 1/2$	
	s	r	s	r
0	1	0	1	0
1	1	1	0	1
2	1	2	0	3
3	1	3	1	2

#### 4.6D.2.2 Modulation scheme and number of transport blocks mapping

The number of transport blocks transmitted on the associated HS-PDSCH(s) and the modulation scheme information are jointly coded as shown in Table 14B.6:

**Table 14B.6: Mapping of  $x_{ms}$**

$x_{ms,1}$ , $x_{ms,2}$ , $x_{ms,3}$ , $x_{ms,4}$ , $x_{ms,5}$	Modulation for primary transport block	Modulation for second transport block	Modulation for third transport block	Modulation for fourth transport block	Number of transport blocks
00000	QPSK	Unused	Unused	Unused	1
00001	16QAM	Unused	Unused	Unused	1
00010	64 QAM	Unused	Unused	Unused	1

00011	QPSK	QPSK	Unused	Unused	2
00100	QPSK	16QAM	Unused	Unused	2
00101	QPSK	64QAM	Unused	Unused	2
00110	16QAM	QPSK	Unused	Unused	2
00111	16QAM	16QAM	Unused	Unused	2
1000	16QAM	64QAM	Unused	Unused	2
01001	64QAM	QPSK	Unused	Unused	2
01010	64QAM	16QAM	Unused	Unused	2
01011	64QAM	64QAM	Unused	Unused	2
01100	QPSK	QPSK	QPSK	Unused	3
01101	QPSK	16QAM	16QAM	Unused	3
01110	QPSK	64QAM	64QAM	Unused	3
01111	16QAM	QPSK	QPSK	Unused	3
10000	16QAM	16QAM	16QAM	Unused	3
10001	16QAM	64QAM	64QAM	Unused	3
10010	64QAM	QPSK	QPSK	Unused	3
10011	64QAM	16QAM	16QAM	Unused	3
10100	64QAM	64QAM	64QAM	Unused	3
10101	QPSK	QPSK	QPSK	QPSK	4
10110	QPSK	16QAM	16QAM	QPSK	4
10111	QPSK	64QAM	64QAM	QPSK	4
11000	16QAM	QPSK	QPSK	16QAM	4
11001	16QAM	16QAM	16QAM	16QAM	4
11010	16QAM	64QAM	64QAM	16QAM	4
11011	64QAM	QPSK	QPSK	64QAM	4
11100	64QAM	16QAM	16QAM	64QAM	4
11101	64 QAM	64QAM	64QAM	64 QAM	4
11110	Unused (Reserved)				
11111	Unused (Reserved)				

#### 4.6D.2.3 Channelization code-set mapping

The channelization code-set bits  $x_{ccs,1}, x_{ccs,2}, \dots, x_{ccs,7}$  are coded according to the following:

Given P (multi-)codes starting at code O calculate the information-field using the unsigned binary representation of integers calculated by the expressions,

for the first three bits (code group indicator) of which  $x_{ccs,1}$  is the MSB:

$$x_{ccs,1}, x_{ccs,2}, x_{ccs,3} = \min(P-1, 15-P)$$

for the last four bits (code offset indicator) of which  $x_{ccs,4}$  is the MSB:

$$x_{ccs,4}, x_{ccs,5}, x_{ccs,6}, x_{ccs,7} = \lfloor O - 1 - \lfloor P/8 \rfloor * 15 \rfloor$$

The definitions of P and O are given in [3].

If more than one transport blocks are transmitted on the associated HS-PDSCH(s), the same set of channelization codes shall be used for all transport blocks.

#### 4.6D.2.4 UE identity mapping

The UE identity is the HS-DSCH Radio Network Identifier (H-RNTI) defined in [13]. This is mapped such that  $x_{ue,1}$  corresponds to the MSB and  $x_{ue,16}$  to the LSB, cf. [14].

#### 4.6D.2.5 HARQ process identifier mapping

If four transport blocks are transmitted on the associated HS-PDSCH(s), the mapping relationship between the hybrid-ARQ processes and the transport blocks is such that when the HARQ-process with identifier  $HAP_{pb}$  is mapped to the primary and the fourth transport block, the HARQ-process with the identifier given by  $(HAP_{pb} + N_{proc}/2) \bmod(N_{proc})$  shall be mapped to the second and the third transport block, where  $N_{proc}$  is the number of HARQ processes configured by higher layers. The combination of HARQ-processes is indicated by the hybrid-ARQ process information (4 bits)  $x_{hap,1}, x_{hap,2}, x_{hap,3}, x_{hap,4}$  which are the unsigned binary representation of  $HAP_{pb}$  where  $x_{hap,1}$  is MSB.

If three transport blocks are transmitted on the associated HS-PDSCH(s), the mapping relationship between the hybrid-ARQ processes and the transport blocks is such that when the HARQ-process with identifier  $HAP_{pb}$  is mapped to the primary transport block, the HARQ-process with the identifier given by  $(HAP_{pb} + N_{proc}/2) \bmod(N_{proc})$  shall be mapped to the second and the third transport block, where  $N_{proc}$  is the number of HARQ processes configured by higher layers. The combination of HARQ-processes is indicated by the hybrid-ARQ process information (4 bits)  $x_{hap,1}, x_{hap,2}, x_{hap,3}, x_{hap,4}$  which are the unsigned binary representation of  $HAP_{pb}$  where  $x_{hap,1}$  is MSB.

If two transport blocks are transmitted on the associated HS-PDSCH(s), the mapping relationship between the hybrid-ARQ processes and the transport blocks is such that when the HARQ-process with identifier  $HAP_{pb}$  is mapped to the primary transport block, the HARQ-process with the identifier given by  $(HAP_{pb} + N_{proc}/2) \bmod(N_{proc})$  shall be mapped to the second transport block, where  $N_{proc}$  is the number of HARQ processes configured by higher layers. The combination of HARQ-processes is indicated by the hybrid-ARQ process information (4 bits)  $x_{hap,1}, x_{hap,2}, x_{hap,3}, x_{hap,4}$  which are the unsigned binary representation of  $HAP_{pb}$  where  $x_{hap,1}$  is MSB.

If only one transport block is transmitted on the associated HS-PDSCH(s), the above mapping is ignored and the hybrid-ARQ process information  $x_{hap,1}, x_{hap,2}, x_{hap,3}, x_{hap,4}$  is the unsigned binary representation of the HARQ process identifier where  $x_{hap,1}$  is MSB.

#### 4.6D.2.6 Transport block size index mapping

The transport-block size information  $x_{tbsp,1}, x_{tbsp,2}, \dots, x_{tbsp,6}$  is the unsigned binary representation of the transport block size index for the primary transport block, where  $x_{tbsp,1}$  is the MSB.

If two transport blocks are transmitted on the associated HS-PDSCH(s), the transport-block size information  $x_{tbssb,1}, x_{tbssb,2}, \dots, x_{tbssb,6}$  is the unsigned binary representation of the transport block size index for the second transport block, where  $x_{tbssb,1}$  is the MSB. If the number of transport blocks indicated is equal to 2, if  $X_{rvpb} = 0$  and if the transport-block size information  $x_{tbsp,1}, x_{tbsp,2}, \dots, x_{tbsp,6}$  is set to "11111", then the primary transport block is not transmitted. If the number of transport blocks indicated is equal to 2, if  $X_{rvsb} = 0$  and if the transport-block size information  $x_{tbssb,1}, x_{tbssb,2}, \dots, x_{tbssb,6}$  is set to "11111", then the second transport block is not transmitted.

If three transport blocks are transmitted on the associated HS-PDSCH(s), the transport-block size information  $x_{tbsp,1}, x_{tbsp,2}, \dots, x_{tbsp,6}$  is the unsigned binary representation of the transport block size index for the primary transport block, where  $x_{tbsp,1}$  is the MSB and the transport-block size information  $x_{tbssb,1}, x_{tbssb,2}, \dots, x_{tbssb,6}$  is the unsigned binary representation of the transport block size index for the second and the third transport blocks, where  $x_{tbssb,1}$  is the MSB. If the number of transport blocks indicated is equal to 3, if  $X_{rvpb} = 0$  and if the transport-block size information  $x_{tbsp,1}, x_{tbsp,2}, \dots, x_{tbsp,6}$  is set to "11111", then the primary transport block is not transmitted. If the number of transport blocks indicated is equal to 3, if  $X_{rvsb} = 0$  and if the transport-block size information  $x_{tbssb,1}, x_{tbssb,2}, \dots, x_{tbssb,6}$  is set to "11111", then the second and the third transport blocks are not transmitted.

If four transport blocks are transmitted on the associated HS-PDSCH(s), the transport-block size information  $x_{tbspb,1}$ ,  $x_{tbspb,2}$ , ...,  $x_{tbspb,6}$  is the unsigned binary representation of the transport block size index for the primary and the fourth transport blocks, where  $x_{tbspb,1}$  is the MSB and the transport-block size information  $x_{tbssb,1}$ ,  $x_{tbssb,2}$ , ...,  $x_{tbssb,6}$  is the unsigned binary representation of the transport block size index for the second and the third transport blocks, where  $x_{tbssb,1}$  is the MSB. If the number of transport blocks indicated is equal to 4 if  $X_{rvpb} = 0$  and if the transport-block size information  $x_{tbspb,1}$ ,  $x_{tbspb,2}$ , ...,  $x_{tbspb,6}$  is set to "111111", then the primary and fourth transport blocks are not transmitted. If the number of transport blocks indicated is equal to 4 if  $X_{rvsb} = 0$  and if the transport-block size information  $x_{tbssb,1}$ ,  $x_{tbssb,2}$ , ...,  $x_{tbssb,6}$  is set to "111111", then the second and the third transport blocks are not transmitted.

#### 4.6D.2.7 Precoding Weight Information mapping

The precoding weight information  $x_{pwipb,1}$ ,  $x_{pwipb,2}$ ,  $x_{pwipb,3}$ ,  $x_{pwipb,4}$  is mapped according to Table 14B.7. The quantity  $W_n^{\{s\}}$  denotes the matrix defined by the columns given by the set  $\{s\}$  from the expression  $W_n = I - 2u_n u_n^H / u_n^H u_n$  where  $I$  is the  $4 \times 4$  identity matrix and the vector  $u_n$  is given by Table 14B.7.



Table 14B.7: precoding weight information

$x_{pwipb,1}$ , $x_{pwipb,2}$ , $x_{pwipb,3}$ , $x_{pwipb,4}$	$u_n$	Number of transport blocks			
		1	2	3	4
0000	$u_0 = [1 \ -1 \ -1 \ -1]^T$	$W_0^{(1)}$	$W_0^{(14)} / \sqrt{2}$	$W_0^{(124)} / \sqrt{3}$	$W_0^{(1234)} / 2$
0001	$u_1 = [1 \ -j \ 1 \ j]^T$	$W_1^{(1)}$	$W_1^{(12)} / \sqrt{2}$	$W_1^{(123)} / \sqrt{3}$	$W_1^{(1234)} / 2$
0010	$u_2 = [1 \ 1 \ -1 \ 1]^T$	$W_2^{(1)}$	$W_2^{(12)} / \sqrt{2}$	$W_2^{(123)} / \sqrt{3}$	$W_2^{(3214)} / 2$
0011	$u_3 = [1 \ j \ 1 \ -j]^T$	$W_3^{(1)}$	$W_3^{(12)} / \sqrt{2}$	$W_3^{(123)} / \sqrt{3}$	$W_3^{(3214)} / 2$
0100	$u_4 = [1 \ (-1-j)/\sqrt{2} \ -j \ (1-j)/\sqrt{2}]^T$	$W_4^{(1)}$	$W_4^{(14)} / \sqrt{2}$	$W_4^{(124)} / \sqrt{3}$	$W_4^{(1234)} / 2$
0101	$u_5 = [1 \ (1-j)/\sqrt{2} \ j \ (-1-j)/\sqrt{2}]^T$	$W_5^{(1)}$	$W_5^{(14)} / \sqrt{2}$	$W_5^{(124)} / \sqrt{3}$	$W_5^{(1234)} / 2$
0110	$u_6 = [1 \ (1+j)/\sqrt{2} \ -j \ (-1+j)/\sqrt{2}]^T$	$W_6^{(1)}$	$W_6^{(13)} / \sqrt{2}$	$W_6^{(134)} / \sqrt{3}$	$W_6^{(1324)} / 2$
0111	$u_7 = [1 \ (-1+j)/\sqrt{2} \ j \ (1+j)/\sqrt{2}]^T$	$W_7^{(1)}$	$W_7^{(13)} / \sqrt{2}$	$W_7^{(134)} / \sqrt{3}$	$W_7^{(1324)} / 2$
1000	$u_8 = [1 \ -1 \ 1 \ 1]^T$	$W_8^{(1)}$	$W_8^{(12)} / \sqrt{2}$	$W_8^{(124)} / \sqrt{3}$	$W_8^{(1234)} / 2$
1001	$u_9 = [1 \ -j \ -1 \ -j]^T$	$W_9^{(1)}$	$W_9^{(14)} / \sqrt{2}$	$W_9^{(134)} / \sqrt{3}$	$W_9^{(1234)} / 2$
1010	$u_{10} = [1 \ 1 \ 1 \ -1]^T$	$W_{10}^{(1)}$	$W_{10}^{(13)} / \sqrt{2}$	$W_{10}^{(123)} / \sqrt{3}$	$W_{10}^{(1324)} / 2$
1011	$u_{11} = [1 \ j \ -1 \ j]^T$	$W_{11}^{(1)}$	$W_{11}^{(13)} / \sqrt{2}$	$W_{11}^{(134)} / \sqrt{3}$	$W_{11}^{(1324)} / 2$
1100	$u_{12} = [1 \ -1 \ -1 \ 1]^T$	$W_{12}^{(1)}$	$W_{12}^{(12)} / \sqrt{2}$	$W_{12}^{(123)} / \sqrt{3}$	$W_{12}^{(1234)} / 2$
1101	$u_{13} = [1 \ -1 \ 1 \ -1]^T$	$W_{13}^{(1)}$	$W_{13}^{(13)} / \sqrt{2}$	$W_{13}^{(123)} / \sqrt{3}$	$W_{13}^{(1324)} / 2$
1110	$u_{14} = [1 \ 1 \ -1 \ -1]^T$	$W_{14}^{(1)}$	$W_{14}^{(13)} / \sqrt{2}$	$W_{14}^{(123)} / \sqrt{3}$	$W_{14}^{(3214)} / 2$
1111	$u_{15} = [1 \ 1 \ 1 \ 1]^T$	$W_{15}^{(1)}$	$W_{15}^{(12)} / \sqrt{2}$	$W_{15}^{(123)} / \sqrt{3}$	$W_{15}^{(1234)} / 2$

#### 4.6D.3 Multiplexing of HS-SCCH type 4 information

The channelization-code-set information  $x_{ccs,1}, x_{ccs,2}, \dots, x_{ccs,7}$ , modulation-scheme and number of transport blocks information  $x_{ms,1}, x_{ms,2}, x_{ms,3}, x_{ms,4}, x_{ms,5}$  and precoding weight information  $x_{pwipb,1}, x_{pwipb,2}, x_{pwipb,3}, x_{pwipb,4}$  are multiplexed together. This gives a sequence of bits  $x_{1,1}, x_{1,2}, \dots, x_{1,16}$ , where

$$x_{1,i} = x_{ccs,i} \quad i=1,2,\dots,7$$

$$x_{1,i} = x_{ms,i-7} \quad i=8,9,10,11,12$$

$$x_{1,i} = x_{pwipb,i-12} \quad i=13,14,15,16$$

If one transport block is transmitted on the associated HS-PDSCH(s), the transport-block-size information  $x_{tbspb,1}, x_{tbspb,2}, \dots, x_{tbspb,6}$ , Hybrid-ARQ-process information  $x_{hap,1}, x_{hap,2}, \dots, x_{hap,4}$  and redundancy-version information  $x_{rvpb,1}, x_{rvpb,2}$  are multiplexed together. This gives a sequence of bits  $x_{2,1}, x_{2,2}, \dots, x_{2,12}$  where

$$x_{2,i} = x_{tbs,i} \quad i=1,2,\dots,6$$

$$x_{2,i} = x_{hap,i-6} \quad i=7,8,\dots,10$$

$$x_{2,i} = x_{rv,i-10} \quad i=11,12$$

If two transport blocks are transmitted on the associated HS-PDSCHs, the transport-block-size information for the primary transport block  $x_{tbspb,1}, x_{tbspb,2}, \dots, x_{tbspb,6}$ , transport-block-size information for the second transport block  $x_{tbssb,1}, x_{tbssb,2}, \dots, x_{tbssb,6}$ , Hybrid-ARQ-process information  $x_{hap,1}, x_{hap,2}, \dots, x_{hap,4}$ , redundancy-version information for the primary transport block  $x_{rvpb,1}, x_{rvpb,2}$ , and redundancy-version information for the second transport block  $x_{rvsb,1}, x_{rvsb,2}$  are multiplexed together. This gives a sequence of bits  $x_{2,1}, x_{2,2}, \dots, x_{2,20}$  where

$$x_{2,i} = x_{tbspb,i} \quad i=1,2,\dots,6$$

$$x_{2,i} = x_{tbssb,i-6} \quad i=7,8,\dots,12$$

$$x_{2,i} = x_{hap,i-12} \quad i=13,14,\dots,16$$

$$x_{2,i} = x_{rvpb,i-16} \quad i=17,18$$

$$x_{2,i} = x_{rvsb,i-18} \quad i=19,20$$

If three transport blocks are transmitted on the associated HS-PDSCHs, the transport-block-size information for the primary transport block  $x_{tbspb,1}, x_{tbspb,2}, \dots, x_{tbspb,6}$ , transport-block-size information for the second and the third transport blocks  $x_{tbssb,1}, x_{tbssb,2}, \dots, x_{tbssb,6}$ , Hybrid-ARQ-process information  $x_{hap,1}, x_{hap,2}, \dots, x_{hap,4}$ , redundancy-version information for the primary transport block  $x_{rvpb,1}, x_{rvpb,2}$ , and redundancy-version information for the second and the third transport blocks  $x_{rvsb,1}, x_{rvsb,2}$  are multiplexed together. This gives a sequence of bits  $x_{2,1}, x_{2,2}, \dots, x_{2,20}$  where

$$x_{2,i} = x_{tbspb,i} \quad i=1,2,\dots,6$$

$$x_{2,i} = x_{tbssb,i-6} \quad i=7,8,\dots,12$$

$$x_{2,i} = x_{hap,i-12} \quad i=13,14,\dots,16$$

$$x_{2,i} = x_{rvpb,i-16} \quad i=17,18$$

$$x_{2,i} = x_{rvsb,i-18} \quad i=19,20$$

If four transport blocks are transmitted on the associated HS-PDSCHs, the transport-block-size information for the primary and the fourth transport blocks  $x_{tbspb,1}, x_{tbspb,2}, \dots, x_{tbspb,6}$ , transport-block-size information for the second and the third transport blocks  $x_{tbssb,1}, x_{tbssb,2}, \dots, x_{tbssb,6}$ , Hybrid-ARQ-process information  $x_{hap,1}, x_{hap,2}, \dots, x_{hap,4}$ , redundancy-version information for the primary and the fourth transport blocks  $x_{rvpb,1}, x_{rvpb,2}$ , and redundancy-version information for the second and the third transport blocks  $x_{rvsb,1}, x_{rvsb,2}$  are multiplexed together. This gives a sequence of bits  $x_{2,1}, x_{2,2}, \dots, x_{2,20}$  where

$$x_{2,i} = x_{tbspb,i} \quad i=1,2,\dots,6$$

$$x_{2,i} = x_{tbssb,i-6} \quad i=7,8,\dots,12$$

$$x_{2,i} = x_{hap,i-12} \quad i=13,14,\dots,16$$

$$x_{2,i} = x_{rvpb,i-16} \quad i=17,18$$

$$x_{2,i} = x_{rvsb,i-18} \quad i=19,20$$

#### 4.6D.4 CRC attachment for HS-SCCH type 4

If one transport block is transmitted on the associated HS-PDSCH(s), from the sequence of bits  $x_{1,1}, x_{1,2}, \dots, x_{1,16}, x_{2,1}, x_{2,2}, \dots, x_{2,12}$  a 16-bit CRC is calculated according to Clause 4.2.1.1. This gives a sequence of bits  $c_1, c_2, \dots, c_{16}$  where

$$c_k = p_{im(17-k)} \quad k=1,2,\dots,16$$

This sequence of bits is then masked with the UE Identity  $x_{ue,1}, x_{ue,2}, \dots, x_{ue,16}$  and then appended to the sequence of bits  $x_{2,1}, x_{2,2}, \dots, x_{2,12}$  to form the sequence of bits  $y_1, y_2, \dots, y_{28}$ , where

$$y_i = x_{2,i} \quad i=1,2,\dots,12$$

$$y_i = (c_{i-12} + x_{ue,i-12}) \bmod 2 \quad i=13,14,\dots,28$$

If more than one transport blocks are transmitted on the associated HS-PDSCHs, from the sequence of bits  $x_{1,1}, x_{1,2}, \dots, x_{1,16}, x_{2,1}, x_{2,2}, \dots, x_{2,20}$  a 16-bit CRC is calculated according to Clause 4.2.1.1. This gives a sequence of bits  $c_1, c_2, \dots, c_{16}$  where

$$c_k = p_{im(17-k)} \quad k=1,2,\dots,16$$

This sequence of bits is then masked with the UE Identity  $x_{ue,1}, x_{ue,2}, \dots, x_{ue,16}$  and then appended to the sequence of bits  $x_{2,1}, x_{2,2}, \dots, x_{2,20}$  to form the sequence of bits  $y_1, y_2, \dots, y_{36}$ , where

$$y_i = x_{2,i} \quad i=1,2,\dots,20$$

$$y_i = (c_{i-20} + x_{ue,i-20}) \bmod 2 \quad i=21,22,\dots,36$$

#### 4.6D.5 Channel coding for HS-SCCH type 4

Rate 1/2 convolutional coding, as described in Clause 4.2.3.1, is applied to the sequence of bits  $x_{1,1}, x_{1,2}, \dots, x_{1,16}$ . This gives a sequence of bits  $z_{1,1}, z_{1,2}, \dots, z_{1,48}$ .

If one transport block is transmitted on the associated HS-PDSCH(s), rate 1/3 convolutional coding, as described in Clause 4.2.3.1, is applied to the sequence of bits  $y_1, y_2, \dots, y_{28}$ . This gives a sequence of bits  $z_{2,1}, z_{2,2}, \dots, z_{2,108}$ .

If more than one transport blocks are transmitted on the associated HS-PDSCHs, rate 1/3 convolutional coding, as described in Clause 4.2.3.1, is applied to the sequence of bits  $y_1, y_2, \dots, y_{36}$ . This gives a sequence of bits  $z_{2,1}, z_{2,2}, \dots, z_{2,132}$ .

Note that the coded sequence lengths result from the termination of K=9 convolutional coding being fully applied.

#### 4.6D.6 Rate matching for HS-SCCH type 4

From the input sequence  $z_{1,1}, z_{1,2}, \dots, z_{1,48}$  the bits  $z_{1,1}, z_{1,2}, z_{1,4}, z_{1,8}, z_{1,12}, z_{1,16}, z_{1,20}, z_{1,24}, z_{1,28}, z_{1,32}, z_{1,36}, z_{1,40}, z_{1,44}, z_{1,48}$  are punctured to obtain the output sequence  $r_{1,1}, r_{1,2}, \dots, r_{1,40}$ .

If one transport block is transmitted on the associated HS-PDSCH(s), from the input sequence  $z_{2,1}, z_{2,2}, \dots, z_{2,108}$  the bits  $z_{2,1}, z_{2,2}, z_{2,3}, z_{2,4}, z_{2,5}, z_{2,6}, z_{2,7}, z_{2,8}, z_{2,12}, z_{2,14}, z_{2,15}, z_{2,24}, z_{2,42}, z_{2,48}, z_{2,63}, z_{2,66}, z_{2,93}, z_{2,96}, z_{2,98}, z_{2,99}, z_{2,101}, z_{2,102}, z_{2,103}, z_{2,104}, z_{2,105}, z_{2,106}, z_{2,107}, z_{2,108}$  are punctured to obtain the output sequence  $r_{2,1}, r_{2,2}, \dots, r_{2,80}$ .

If more than one transport blocks are transmitted on the associated HS-PDSCHs, from the input sequence  $z_{2,1}, z_{2,2}, \dots, z_{2,132}$  the bits  $z_{2,1}, z_{2,2}, z_{2,3}, z_{2,4}, z_{2,5}, z_{2,6}, z_{2,7}, z_{2,8}, z_{2,10}, z_{2,11}, z_{2,13}, z_{2,14}, z_{2,16}, z_{2,19}, z_{2,22}, z_{2,25}, z_{2,28}, z_{2,31}, z_{2,34}, z_{2,37}, z_{2,40}, z_{2,43}, z_{2,46}, z_{2,49}, z_{2,55}, z_{2,61}, z_{2,72}, z_{2,78}, z_{2,84}, z_{2,87}, z_{2,90}, z_{2,93}, z_{2,96}, z_{2,99}, z_{2,102}, z_{2,105}, z_{2,108}, z_{2,111}, z_{2,114}, z_{2,117}, z_{2,119}, z_{2,120}, z_{2,122}, z_{2,123}, z_{2,125}, z_{2,126}, z_{2,127}, z_{2,128}, z_{2,129}, z_{2,130}, z_{2,131}, z_{2,132}$  are punctured to obtain the output sequence  $r_{2,1}, r_{2,2}, \dots, r_{2,80}$ .

#### 4.6D.7 UE specific masking for HS-SCCH type 4

The output bits  $s_{1,1}, s_{1,2}, \dots, s_{1,40}$  are calculated as described in subclause 4.6.7.

#### 4.6D.8 Physical channel mapping for HS-SCCH type 4

The HS-SCCH sub-frame is described in [2]. The physical channel mapping is carried out as described in subclause 4.6.8.

## 4.7 Coding for HS-DPCCH

### 4.7.1 Overview

Data arrives to the coding unit in form of indicators for measurement indication and HARQ acknowledgement.

The following coding/multiplexing steps can be identified:

- channel coding (see subclauses 4.7.2, 4.7.3, 4.7.3A, 4.7.3B, 4.7.3C, 4.7.3D and 4.7.3E);
- mapping to physical channels (see subclause 4.7.4).

The coding/multiplexing for HS-DPCCH is defined separately for the following cases:

- when the UE is not configured in MIMO mode and not configured in MIMO mode with four transmit antennas in the serving HS-DSCH cell, and Secondary\_Cell\_Enabled is 0 or 1 and Secondary\_Cell\_Active is 0 (see subclause 4.7.2);
- when the UE is configured in MIMO mode in the serving HS-DSCH cell and Secondary\_Cell\_Enabled is 0 (see subclause 4.7.3);
- when the UE is configured in MIMO mode in at least the serving HS-DSCH cell, and Secondary\_Cell\_Enabled is 1 and Secondary\_Cell\_Active is 0 (see subclause 4.7.3B);
- when the UE is not configured in MIMO mode in any cell and Secondary\_Cell\_Enabled is 1 and Secondary\_Cell\_Active is 1 (see subclause 4.7.3A);
- when the UE is configured in MIMO mode in at least one cell and Secondary\_Cell\_Enabled is 1 and Secondary\_Cell\_Active is 1 (see subclause 4.7.3B);
- when Secondary\_Cell\_Enabled is equal to 2 or 3 (see applicable subclauses in Table 14C and 14D)
- when Secondary\_Cell\_Enabled is more than 3 (see applicable subclauses in Table 14C.1 and 14D.1)
- when the UE is configured in Multiflow mode, see subclause 4.7.3D
- when the UE is configured in MIMO mode with four transmit antennas at least in one cell, see subclause 4.7.3E

where Secondary\_Cell\_Enabled and Secondary\_Cell\_Active are defined in [4].

**Table 14C: Coding for HARQ-ACK when Secondary\_Cell\_Enabled is 2 or 3**

		Secondary Cell Enabled is 2 UE is configured with two secondary serving HS-DSCH cells			
Secondary_Cell_Active	Condition	Serving HS-DSCH cell	1 <sup>st</sup> Secondary Serving HS-DSCH cell	2 <sup>nd</sup> Secondary Serving HS-DSCH cell	3 <sup>rd</sup> Secondary Serving HS-DSCH cell
0, 1, 2	MIMO mode and MIMO mode with four transmit antennas is not configured in any cell	4.7.3C.1 (Note 1)			N/A
0	MIMO mode is configured in at least one cell	4.7.3B.1 (Note 3)			N/A
1	MIMO mode is configured in at least one cell	4.7.3B.1 (Note 2)			N/A
2	MIMO mode is configured in at least one cell	4.7.3B.1	4.7.3B.1 (Note 4)		N/A

Secondary Cell Enabled is 3 UE is configured with three secondary serving HS-DSCH cells					
Secondary_Cell_Active	Condition	Serving HS-DSCH cell	1 <sup>st</sup> Secondary Serving HS-DSCH cell	2 <sup>nd</sup> Secondary Serving HS-DSCH cell	3 <sup>rd</sup> Secondary Serving HS-DSCH cell
0	-	4.7.3B.1 (Note 3)			
1	-	4.7.3B.1 (Note 2)			
2, 3	-	4.7.3B.1 (Note 1)		4.7.3B.1 (Note 1)	

Note 1: When a cell is deactivated, DTX message is indicated for that cell.

Note 2: HARQ-ACK information is jointly encoded for the pair of serving HS-DSCH cell and the active secondary serving HS-DSCH cell and repeated to fill the whole HARQ-ACK slot in the HS-DPCCH sub-frame as described in subclause 4.7.4.1.

Note 3: HARQ-ACK information for the serving HS-DSCH cell is repeated to fill the whole HARQ-ACK slot in the HS-DPCCH sub-frame as described in subclause 4.7.4.1.

Note 4: HARQ-ACK information for the 2<sup>nd</sup> secondary serving HS-DSCH cell is jointly encoded with a DTX message in place of the 3<sup>rd</sup> secondary serving HS-DSCH cell as described in subclause 4.7.3B.1.

**Table 14C.1: Coding for HARQ-ACK of HS-DPCCH when Secondary\_Cell\_Enabled is more than 3**

Secondary Cell Enabled is more than 3 UE is configured with more than 3 secondary serving HS-DSCH cells				
Number of active cells mapped to the HS-DPCCH	Serving HS-DSCH cell	1 <sup>st</sup> Secondary Serving HS-DSCH cell	2 <sup>nd</sup> Secondary Serving HS-DSCH cell	3 <sup>rd</sup> Secondary Serving HS-DSCH cell
1	4.7.3B.1 (Note 1)			
2	4.7.3B.1 (Note 2)			
3	4.7.3B.1 (Note 3)		4.7.3B.1 (Note 3)	
4	4.7.3B.1		4.7.3B.1	

Note 1: The HARQ-ACK information is repeated to fill the whole HARQ-ACK slot of HS-DPCCH sub-frame as described in subclause 4.7.4.1.

Note 2: HARQ-ACK information is jointly encoded for the pair of serving HS-DSCH cell and the active secondary serving HS-DSCH cell and repeated to fill the whole HARQ-ACK slot in the HS-DPCCH sub-frame as described in subclause 4.7.4.1.

Note 3: If one of the 1<sup>st</sup>, 2<sup>nd</sup>, or 3<sup>rd</sup> secondary serving HS-DSCH cells is deactivated a DTX message is indicated for the deactivated cell.

**Table 14C.2: Coding for HARQ-ACK transmitted on HS-DPCCH<sub>2</sub> when Secondary\_Cell\_Enabled is more than 3**

Secondary Cell Enabled is more than 3 UE is configured with more than 3 secondary serving HS-DSCH cells	

Number of active cells mapped to the HS-DPCCH <sub>2</sub>	4 <sup>th</sup> secondary serving HS-DSCH cell	5 <sup>th</sup> Secondary Serving HS-DSCH cell	6 <sup>th</sup> Secondary Serving HS-DSCH cell	7 <sup>th</sup> Secondary Serving HS-DSCH cell
1	4.7.3B.1 (Note 1)			
2	4.7.3B.1 (Note 2)			
3	4.7.3B.1 (Note 3)		4.7.3B.1 (Note 3)	
4	4.7.3B.1		4.7.3B.1	

Note 1: The HARQ-ACK information is repeated to fill the whole HARQ-ACK slot of HS-DPCCH<sub>2</sub> sub-frame as described in subclause 4.7.4.1.

Note 2: The HARQ-ACK information for the two activated secondary serving HS-DSCH cells are jointly encoded and repeated to fill the whole HARQ-ACK slot in the HS-DPCCH<sub>2</sub> sub-frame as described in subclause 4.7.4.1.

Note 3: If one of the 4<sup>th</sup>, 5<sup>th</sup>, 6<sup>th</sup>, and 7<sup>th</sup> secondary serving HS-DSCH cells is deactivated a DTX message is indicated for the deactivated cell.

The order of the cells in HARQ-ACK joint encoding is specified in detail in subclause 4.7.4.1.

**Table 14D: Coding for PCI/CQI when Secondary\_Cell\_Enabled is 2 or 3**

Secondary Cell Enabled is 2 UE is configured with two secondary serving HS-DSCH cells				
Secondary_Cell_Active	Serving HS-DSCH cell	1 <sup>st</sup> Secondary Serving HS-DSCH cell	2 <sup>nd</sup> Secondary Serving HS-DSCH cell	3 <sup>rd</sup> Secondary Serving HS-DSCH cell
0, 1	The CQI information for a cell not configured in MIMO mode and not configured in MIMO mode with four transmit antennas is encoded according to subclause 4.7.2.2(Note 1)The composite PCI/CQI information for a cell configured with MIMO mode is encoded according to subclause 4.7.3.2 (Note 3)			N/A
2 MIMO is not configured in any cell	The CQI information for the serving HS-DSCH cell is encoded using subclause 4.7.2.2	The CQI information for the 1 <sup>st</sup> secondary serving HS-DSCH cell and the 2 <sup>nd</sup> secondary serving HS-DSCH cell is encoded according to subclause 4.7.3A.2		N/A
2 (Otherwise) Note 4	The CQI information for a cell not configured in MIMO mode and not configured in MIMO mode with four transmit antennas is encoded according to subclause 4.7.2.2. The composite PCI/CQI information for a cell configured with MIMO mode is encoded according to subclause 4.7.3.2			N/A
Secondary Cell Enabled is 3 UE is configured with three secondary serving HS-DSCH cells				
Secondary_Cell_Active	Serving HS-DSCH cell	1 <sup>st</sup> Secondary Serving HS-DSCH cell	2 <sup>nd</sup> Secondary Serving HS-DSCH cell	3 <sup>rd</sup> Secondary Serving HS-DSCH cell
0, 1 Note 3	The CQI information for a cell not configured in MIMO mode and not configured in MIMO mode with four transmit antennas is encoded according to subclause 4.7.2.2.			

2, 3 Note 2	The composite PCI/CQI information for a cell configured with MIMO mode is encoded according to subclause 4.7.3.2
----------------	------------------------------------------------------------------------------------------------------------------

Note 1: If the UE is configured with MIMO mode in at least one cell, the CQI field for each active cell is repeated to fill the two slot CQI field in the HS-DPCCH sub-frame as described in subclause 4.7.4.2.

Note 2: In the deactivated cell, the PCI/CQI field is DTXed.

Note 3: The CQI or PCI/CQI for each active cell is repeated to fill the two slot CQI or PCI/CQI field in the HS-DPCCH sub-frame as described in subclause 4.7.4.2.

Note 4: The PCI/CQI field for the 3rd secondary serving HS-DSCH cell is DTXed.

**Table 14D.1: Coding for PCI/CQI transmitted on HS-DPCCH when Secondary\_Cell\_Enabled is more than 3**

Number of active cells mapped to the HS-DPCCH	Secondary Cell Enabled more than 3 UE is configured with more than 3 secondary serving HS-DSCH cells			
	Serving HS-DSCH cell	1 <sup>st</sup> Secondary Serving HS-DSCH cell	2 <sup>nd</sup> Secondary Serving HS-DSCH cell	3 <sup>rd</sup> Secondary Serving HS-DSCH cell
1, 2 Note 1	The CQI information for a cell not configured in MIMO mode and not configured in MIMO mode with four transmit antennas is encoded according to subclause 4.7.2.2. The composite PCI/CQI information for a cell configured with MIMO mode is encoded according to subclause 4.7.3.2.			
3, 4 Note 2				

Note 1: The CQI or PCI/CQI for each active cell is repeated to fill the two slot CQI or PCI/CQI field in the corresponding HS-DPCCH sub-frame as described in subclause 4.7.4.2.

Note 2: In the deactivated cell, the PCI/CQI field is DTXed.

**Table 14D.2: Coding for PCI/CQI transmitted on HS-DPCCH<sub>2</sub> when Secondary\_Cell\_Enabled is more than 3**

Number of active cells mapped to the HS-DPCCH <sub>2</sub>	Secondary Cell Enabled more than 3 UE is configured with more than 3 secondary serving HS-DSCH cells			
	4 <sup>th</sup> Secondary serving HS-DSCH cell	5 <sup>th</sup> Secondary Serving HS-DSCH cell	6 <sup>th</sup> Secondary Serving HS-DSCH cell	7 <sup>th</sup> Secondary Serving HS-DSCH cell
1, 2 Note 1	The CQI information for a cell not configured in MIMO mode and not configured in MIMO mode with four transmit antennas is encoded according to subclause 4.7.2.2. The composite PCI/CQI information for a cell configured with MIMO mode is encoded according to subclause 4.7.3.2.			
3, 4 Note 2				

Note 1: The CQI or PCI/CQI for each active cell is repeated to fill the two slot CQI or PCI/CQI field in the corresponding HS-DPCCH sub-frame as described in subclause 4.7.4.2.

Note 2: In the deactivated cell, the PCI/CQI field is DTXed.

For each HS-DPCCH the general coding flow when the UE is not configured in MIMO mode and not configured in MIMO mode with four transmit antennas is shown in the figure 20. This is done in parallel for the HARQ-ACK and CQI as the flows are not directly multiplexed but are transmitted at different times.

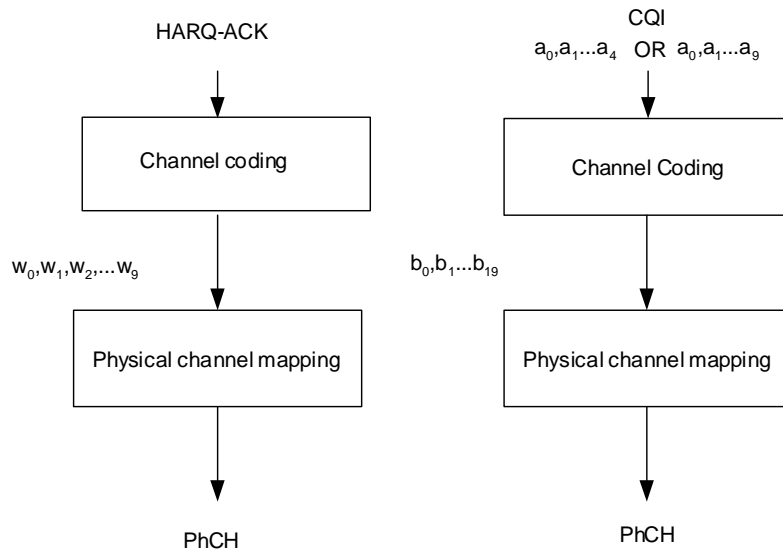

**Figure 20: Coding for each HS-DPCCH when the UE is not configured in MIMO mode and not configured in MIMO mode with four transmit antennas**

In case the UE is configured in MIMO mode, the measurement indication consists of precoding control indication (PCI) and channel quality indication (CQI). For each HS-DPCCH the general coding flow when the UE is configured in MIMO mode is shown in the figure 20A. This is done in parallel for the flow of HARQ-ACK and for the flow of composite PCI/CQI reports as the two flows are not directly multiplexed but are transmitted at different times

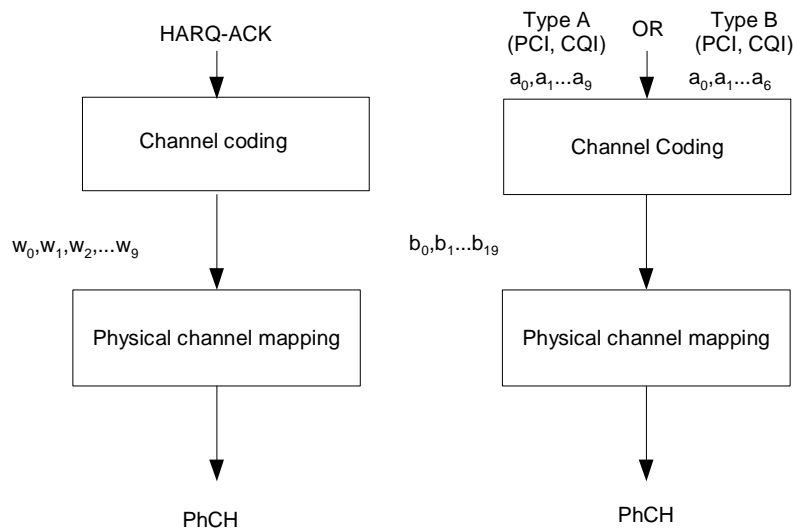

**Figure 20A: Coding for each HS-DPCCH when the UE is configured in MIMO mode**

In case the UE is configured in MIMO mode with four transmit antennas, the measurement indication consists of number of transport blocks preferred (NTBP), precoding control indication (PCI) and channel quality indication (CQI). For each HS-DPCCH the general coding flow when the UE is configured in MIMO mode with four transmit antennas is shown in the figure 20A.1. This is done in parallel for the flow of HARQ-ACK and for the flow of composite NTBP/PCI/CQI reports as the two flows are not directly multiplexed but are transmitted at different times



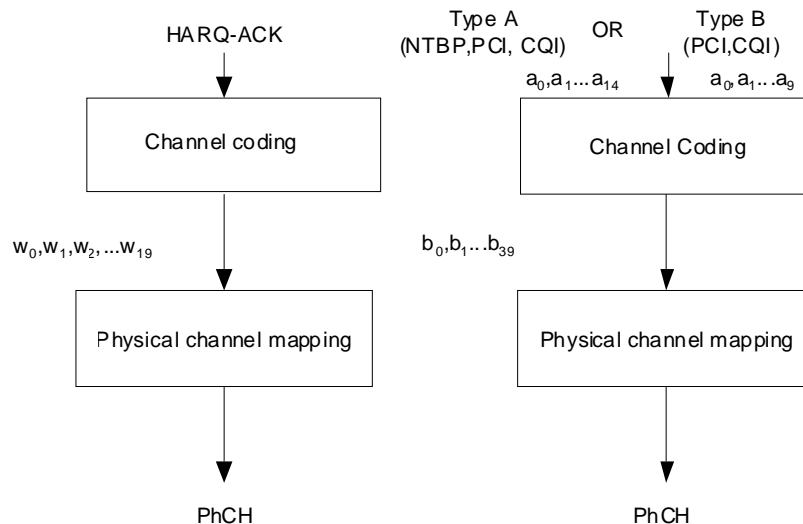

Figure 20A.1: Coding for each HS-DPCCH when the UE is configured in MIMO mode with four transmit antennas

4.7.2 Channel coding for HS-DPCCH when the UE is not configured in MIMO mode and not configured in MIMO mode with four transmit antennas in the serving HS-DSCH cell and Secondary\_Cell\_Enabled is 0 or 1 and Secondary\_Cell\_Active is 0

Two forms of channel coding are used, one for the channel quality indication (CQI) and another for HARQ-ACK (acknowledgement).

4.7.2.1 Channel coding for HS-DPCCH HARQ-ACK

The HARQ acknowledgement message to be transmitted, as defined in [4], shall be coded to 10 bits as shown in Table 15. The output is denoted  $w_0, w_1, \dots, w_9$ .

Table 15: Channel coding of HARQ-ACK when the UE is not configured in MIMO mode and not configured in MIMO mode with four transmit antennas in the serving HS-DSCH cell and Secondary\_Cell\_Enabled is 0 or 1 and Secondary\_Cell\_Active is 0

HARQ-ACK message to be transmitted	$w_0$	$w_1$	$w_2$	$w_3$	$w_4$	$w_5$	$w_6$	$w_7$	$w_8$	$w_9$
ACK	1	1	1	1	1	1	1	1	1	1
NACK	0	0	0	0	0	0	0	0	0	0
PRE	0	0	1	0	0	1	0	0	1	0
POST	0	1	0	0	1	0	0	1	0	0

4.7.2.2 Channel coding for HS-DPCCH channel quality indication

The channel quality indication is coded using a (20,5) code. The code words of the (20,5) code are a linear combination of the 5 basis sequences denoted  $M_{i,n}$  defined in the table below.

**Table 15A: Basis sequences for (20,5) code**

<i>i</i>	$M_{i,0}$	$M_{i,1}$	$M_{i,2}$	$M_{i,3}$	$M_{i,4}$
0	1	0	0	0	1
1	0	1	0	0	1
2	1	1	0	0	1
3	0	0	1	0	1
4	1	0	1	0	1
5	0	1	1	0	1
6	1	1	1	0	1
7	0	0	0	1	1
8	1	0	0	1	1
9	0	1	0	1	1
10	1	1	0	1	1
11	0	0	1	1	1
12	1	0	1	1	1
13	0	1	1	1	1
14	1	1	1	1	1
15	0	0	0	0	1
16	0	0	0	0	1
17	0	0	0	0	1
18	0	0	0	0	1
19	0	0	0	0	1

The CQI values 0 ... 30 as defined in [4] are converted from decimal to binary to map them to the channel quality indication bits (1 0 0 0 0) to (1 1 1 1 1) respectively. The information bit pattern (0 0 0 0 0) shall not be used in this release. The channel quality indication bits are  $a_0, a_1, a_2, a_3, a_4$  (where  $a_0$  is LSB and  $a_4$  is MSB). The output code word bits  $b_i$  are given by:

$$b_i = \sum_{n=0}^4 (a_n \times M_{i,n}) \bmod 2$$

where  $i = 0, \dots, 19$ .

### 4.7.3 Channel coding for HS-DPCCH when the UE is configured in MIMO mode in the serving HS-DSCH cell and Secondary\_Cell\_Enabled is 0

Two forms of channel coding are used, one for the composite precoding control indication (PCI) and channel quality indication (CQI) and another for HARQ-ACK (acknowledgement).

#### 4.7.3.1 Channel coding for HS-DPCCH HARQ-ACK

The HARQ acknowledgement message to be transmitted, as defined in [4], shall be coded to 10 bits as shown in Table 15B. The output is denoted  $w_0, w_1, \dots, w_9$ .

**Table 15B: Channel coding of HARQ-ACK when the UE is configured in MIMO mode in the serving HS-DSCH cell and Secondary\_Cell\_Enabled is 0**

HARQ-ACK message to be transmitted		$w_0$	$w_1$	$w_2$	$w_3$	$w_4$	$w_5$	$w_6$	$w_7$	$w_8$	$w_9$
HARQ-ACK in response to a single scheduled transport block											
ACK		1	1	1	1	1	1	1	1	1	1
NACK		0	0	0	0	0	0	0	0	0	0
HARQ-ACK in response to two scheduled transport blocks											
Response to primary	Response to secondary										

transport block	transport block										
ACK	ACK	1	0	1	0	1	1	1	1	0	1
ACK	NACK	1	1	0	1	0	1	0	1	1	1
NACK	ACK	0	1	1	1	1	0	1	0	1	1
NACK	NACK	1	0	0	1	0	0	1	0	0	0
PRE/POST indication											
PRE		0	0	1	0	0	1	0	0	1	0
POST		0	1	0	0	1	0	0	1	0	0

#### 4.7.3.2 Channel coding for HS-DPCCH composite precoding control indication and channel quality indication

When the UE is configured in MIMO mode and single-stream restriction is not configured, two types of CQI reports shall be supported by the UE. According to the definition of the CQI reporting procedure in [4], type A CQI reports use values 0 ... 255 and type B CQI reports use values 0 ... 30, respectively. When the UE is configured in MIMO mode and single-stream restriction is configured, only type B shall be supported by the UE.

##### 4.7.3.2.1 Bit mapping of Type A channel quality indication

In case a type A CQI shall be reported, the CQI values 0 ... 255 as defined in [4] are converted from decimal to binary to map them to the channel quality indication bits (0 0 0 0 0 0 0) to (1 1 1 1 1 1 1), respectively. The channel quality indication bits are  $cqi_0$ ,  $cqi_1$ ,  $cqi_2$ ,  $cqi_3$ ,  $cqi_4$ ,  $cqi_5$ ,  $cqi_6$ ,  $cqi_7$  (where  $cqi_0$  is LSB and  $cqi_7$  is MSB).

##### 4.7.3.2.2 Bit mapping of Type B channel quality indication

In case a type B CQI shall be reported, the CQI values 0 ... 30 as defined in [4] are converted from decimal to binary to map them to the channel quality indication bits (1 0 0 0 0) to (1 1 1 1 1), respectively. The information bit pattern (0 0 0 0 0) shall not be used in this release. The channel quality indication bits are  $cqi_0$ ,  $cqi_1$ ,  $cqi_2$ ,  $cqi_3$ ,  $cqi_4$  (where  $cqi_0$  is LSB and  $cqi_4$  is MSB).

##### 4.7.3.2.3 Bit mapping of precoding control indication

According to the PCI definition in [4], the range of possible PCI values is 0 ... 3. The PCI values 0 ... 3 as defined in [4] are converted from decimal to binary to map them to the precoding control indication bits (0 0) to (1 1) respectively. The precoding control indication bits are  $pci_0$ ,  $pci_1$  (where  $pci_0$  is LSB and  $pci_1$  is MSB).

##### 4.7.3.2.4 Composite precoding control indication and channel quality indication bits

Two formats for composite PCI/CQI information words are possible depending on the type of the reported CQI value. The two formats shall be constructed according to the scheme depicted in Figure 20B.

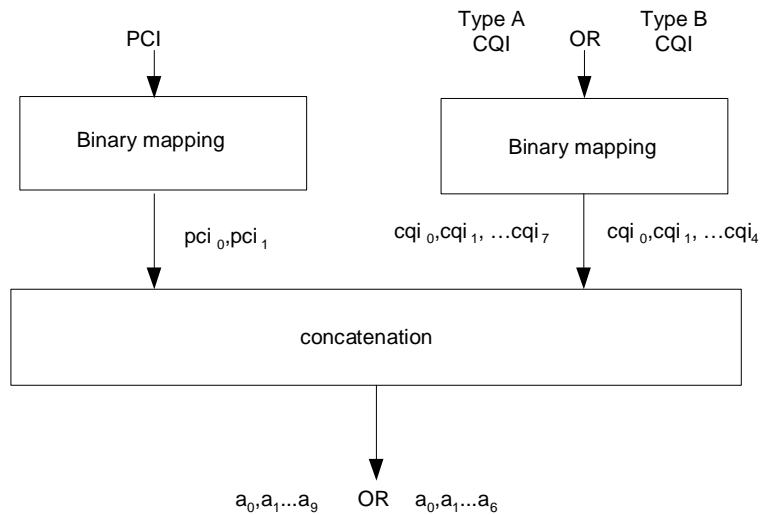

• **Figure 20B: Construction of composite PCI/CQI report**

In case a type A CQI shall be reported, the precoding control indication bits  $pci_0$ ,  $pci_1$ , and the channel quality indication bits  $cqi_0$ ,  $cqi_1$ ,  $cqi_2$ ,  $cqi_3$ ,  $cqi_4$ ,  $cqi_5$ ,  $cqi_6$ ,  $cqi_7$  are concatenated to the composite precoding control indication and channel quality indication bits according to the relation

$$(a_0 a_1 a_2 a_3 a_4 a_5 a_6 a_7 a_8 a_9) = (pci_0 pci_1 cqi_0 cqi_1 cqi_2 cqi_3 cqi_4 cqi_5 cqi_6 cqi_7)$$

In case a type B CQI shall be reported, the precoding control indication bits  $pci_0$ ,  $pci_1$ , and the channel quality indication bits  $cqi_0$ ,  $cqi_1$ ,  $cqi_2$ ,  $cqi_3$ ,  $cqi_4$  are concatenated to the composite precoding control indication and channel quality indication bits according to the relation

$$(a_0 a_1 a_2 a_3 a_4 a_5 a_6) = (pci_0 pci_1 cqi_0 cqi_1 cqi_2 cqi_3 cqi_4)$$

#### 4.7.3.2.5 Block encoding of composite precoding control indication and channel quality indication bits

In case a type A CQI needs to be reported, the composite precoding control indication and channel quality indication is coded using a (20,10) code. The code words of the (20,10) code are a linear combination of the 10 basis sequences denoted  $M_{i,n}$  defined in the table 15C below.

Table 15C: Basis sequences for channel encoding of composite PCI/CQI reports

$i$	$M_{i,0}$	$M_{i,1}$	$M_{i,2}$	$M_{i,3}$	$M_{i,4}$	$M_{i,5}$	$M_{i,6}$	$M_{i,7}$	$M_{i,8}$	$M_{i,9}$	$M_{i,10}$
0	1	0	0	0	0	0	0	0	0	0	0
1	0	1	0	0	0	0	0	0	0	0	0
2	0	0	0	1	0	0	0	0	0	0	0
3	0	0	0	0	1	0	0	0	0	0	0
4	0	0	0	0	0	1	0	0	0	0	0
5	0	0	0	0	0	0	0	1	0	0	0
6	0	0	0	0	0	0	0	0	1	0	1
7	0	0	0	0	0	0	0	0	0	1	1
8	1	0	1	0	0	0	1	1	1	0	1
9	1	1	0	1	0	0	0	1	1	1	1
10	0	1	1	0	1	0	0	0	1	1	1
11	1	0	1	1	0	1	0	0	0	1	0
12	1	1	0	1	1	0	1	0	0	0	0
13	1	1	1	0	1	1	0	1	0	0	0
14	0	1	1	1	0	1	1	0	1	0	1
15	0	0	1	1	1	0	1	1	0	1	0
16	0	0	0	1	1	1	0	1	1	0	1
17	1	0	0	0	1	1	1	0	1	1	1
18	0	1	0	0	0	1	1	1	0	1	0
19	1	1	1	1	1	1	1	1	1	1	1

The output code word bits  $b_i$  are given by:

$$b_i = \sum_{n=0}^9 (a_n \times M_{i,n}) \bmod 2$$

where  $i = 0, \dots, 19$ .

In case a type B CQI needs to be reported, the composite precoding control indication and channel quality indication is coded using a (20,7) code. The code words of the (20,7) code are a linear combination of the basis sequences denoted  $M_{i,n}$  defined in the table 15C for  $n \in \{0,1,3,4,5,7,10\}$ .

The output code word bits  $b_i$  are given by:

$$b_i = \left( \sum_{n=0}^1 (a_n \times M_{i,n}) + \sum_{n=2}^4 (a_n \times M_{i,n+1}) + a_5 \times M_{i,7} + a_6 \times M_{i,10} \right) \bmod 2$$

where  $i = 0, \dots, 19$ .

#### 4.7.3A Channel coding for HS-DPCCH when the UE is not configured in MIMO mode in any cell and Secondary\_Cell\_Enabled is 1 and Secondary\_Cell\_Active is 1

Two forms of channel coding are used, one for the composite channel quality indication (CQI) and another for the composite HARQ-ACK (acknowledgement).

##### 4.7.3A.1 Channel coding for the composite HS-DPCCH HARQ-ACK

The composite HARQ acknowledgement message to be transmitted, as defined in [4], shall be coded to 10 bits as shown in Table 15C.1. The output is denoted  $w_0, w_1, \dots, w_9$ .

**Table 15C.1: Channel coding of HARQ-ACK when the UE is not configured in MIMO mode in a pair of serving HS-DSCH cells and Secondary\_Cell\_Enabled is 1 and Secondary\_Cell\_Active is 1**

HARQ-ACK message to be transmitted		w <sub>0</sub>	w <sub>1</sub>	w <sub>2</sub>	w <sub>3</sub>	w <sub>4</sub>	w <sub>5</sub>	w <sub>6</sub>	w <sub>7</sub>	w <sub>8</sub>	w <sub>9</sub>
HARQ-ACK when UE detects a single scheduled transport block on the serving HS-DSCH cell											
ACK		1	1	1	1	1	1	1	1	1	1
NACK		0	0	0	0	0	0	0	0	0	0
HARQ-ACK when UE detects a single scheduled transport block on the secondary serving HS-DSCH cell											
ACK		1	1	1	1	1	0	0	0	0	0
NACK		0	0	0	0	0	1	1	1	1	1
HARQ-ACK when UE detects a single scheduled transport block on each of the serving and secondary serving HS-DSCH cells											
Response to transport block from serving HS-DSCH cell	Response to transport block from secondary serving HS-DSCH cell										
ACK	ACK	1	0	1	0	1	0	1	0	1	0
ACK	NACK	1	1	0	0	1	1	0	0	1	1
NACK	ACK	0	0	1	1	0	0	1	1	0	0
NACK	NACK	0	1	0	1	0	1	0	1	0	1
PRE/POST indication											
PRE		0	0	1	0	0	1	0	0	1	0
POST		0	1	0	0	1	0	0	1	0	0

#### 4.7.3A.2 Channel coding for HS-DPCCH composite channel quality indication

##### 4.7.3A.2.1 Composite channel quality indication bits

The composite CQI report is constructed from two individual CQI reports that are represented by CQI1 and CQI2. CQI1 corresponds to the serving HS-DSCH cell and CQI2 corresponds to the secondary serving HS-DSCH cell.

Each constituent CQI report uses values 0 ... 30 in accordance with the definition of the CQI reporting procedure in [4]. The individual CQI values are converted from decimal to binary to map them to the channel quality indication bits (1 0 0 0 0) to (1 1 1 1 1) respectively. The information bit pattern (0 0 0 0 0) shall not be used in this release.

The channel quality indication bits corresponding to CQI1 are  $cqi1_0, cqi1_1, cqi1_2, cqi1_3, cqi1_4$  (where  $cqi1_0$  is LSB and  $cqi1_4$  is MSB) and those corresponding to CQI2 are  $cqi2_0, cqi2_1, cqi2_2, cqi2_3, cqi2_4$  (where  $cqi2_0$  is LSB and  $cqi2_4$  is MSB).

The composite CQI report is constructed according to the scheme depicted in Figure 20C

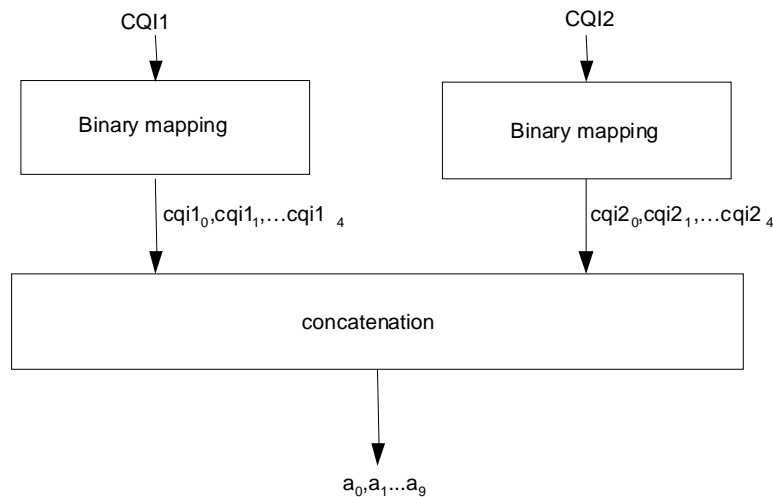

**Figure 20C: Construction of composite CQI report**

The two individual CQI reports are concatenated to form the composite channel quality indication according to the relation

$$(a_0 a_1 a_2 a_3 a_4 a_5 a_6 a_7 a_8 a_9) = (cqi1_0 cqi1_1 cqi1_2 cqi1_3 cqi1_4 cqi2_0 cqi2_1 cqi2_2 cqi2_3 cqi2_4)$$

#### 4.7.3A.2.2 Block encoding of composite channel quality indication bits

The composite channel quality indication is coded using a (20,10) code. The code words of the (20,10) code are a linear combination of the 10 basis sequences denoted  $M_{i,n}$  defined in Table 15C.

The output code word bits  $b_i$  are given by:

$$b_i = \sum_{n=0}^9 (a_n \times M_{i,n}) \bmod 2$$

where  $i = 0, \dots, 19$  and  $a_0, \dots, a_9$  are defined in the previous subclause.

#### 4.7.3B Channel coding for HS-DPCCH when Secondary\_Cell\_Enabled is at least 3 or when the UE is configured in MIMO mode in at least one cell and Secondary\_Cell\_Enabled is greater than 0

Two forms of channel coding are used, one for the composite precoding control indication (PCI) and channel quality indication (CQI) and another for the composite HARQ-ACK (acknowledgement).

##### 4.7.3B.1 Channel coding for the composite HS-DPCCH HARQ-ACK

The composite HARQ acknowledgement message to be transmitted, as defined in [4], shall be coded to 10 bits as shown in Table 15C.2. The feedback related to the first cell is given before the divider sign and the feedback related to the second cell is given after the divider sign. "A" means "ACK", "N" means "NACK" and "D" means "no transmission" ("DTX"). "AA", "AN", "NA" and "NN" refer to feedback for dual-stream transmission in a cell. For example, "AN" means ACK on the primary stream and NACK on the secondary stream. The output is denoted  $w_0, w_1, \dots, w_9$ .

When Secondary\_Cell\_Enabled is 2, and when Secondary\_Cell\_Active is 2, HARQ-ACK information for the 2<sup>nd</sup> secondary serving HS-DSCH cell is jointly encoded with a DTX message in place of the 3<sup>rd</sup> secondary serving HS-DSCH cell.

When Secondary\_Cell\_Enabled is 4, and when Secondary\_Cell\_Active is 4, HARQ-ACK information for the 4<sup>th</sup> secondary serving HS-DSCH cell is jointly encoded with a DTX message in place of the 5<sup>th</sup> secondary serving HS-DSCH cell.

When Secondary\_Cell\_Enabled is 6, and when Secondary\_Cell\_Active is 6, HARQ-ACK information for the 6<sup>th</sup> secondary serving HS-DSCH cell is jointly encoded with a DTX message in place of the 7<sup>th</sup> secondary serving HS-DSCH cell.

**Table 15C.2: Channel coding of HARQ-ACK when Secondary\_Cell\_Enabled is at least 3 or the UE is configured in MIMO mode in at least one cell and Secondary\_Cell\_Enabled is greater than 0**

HARQ-ACK message to be transmitted	w <sub>0</sub>	w <sub>1</sub>	w <sub>2</sub>	w <sub>3</sub>	w <sub>4</sub>	w <sub>5</sub>	w <sub>6</sub>	w <sub>7</sub>	w <sub>8</sub>	w <sub>9</sub>	HARQ-ACK message to be transmitted	w <sub>0</sub>	w <sub>1</sub>	w <sub>2</sub>	w <sub>3</sub>	w <sub>4</sub>	w <sub>5</sub>	w <sub>6</sub>	w <sub>7</sub>	w <sub>8</sub>	w <sub>9</sub>
A/D	1	1	1	1	1	1	1	1	1	1	AA/A	0	1	1	0	0	0	0	1	0	0
N/D	0	0	0	0	0	0	0	0	0	0	AA/N	1	1	1	0	0	1	1	0	1	0
AA/D	1	0	1	0	1	1	1	1	0	1	AN/A	1	0	1	1	1	0	0	1	1	0
AN/D	1	1	0	1	0	1	0	1	1	1	AN/N	0	0	1	1	0	1	0	0	0	1
NA/D	0	1	1	1	1	0	1	0	1	1	NA/A	0	1	0	1	1	1	1	1	0	0
NN/D	1	0	0	1	0	0	1	0	0	0	NA/N	1	1	0	0	1	0	0	0	0	1
D/A	0	0	0	0	0	0	1	1	1	1	NN/A	0	0	0	0	1	1	0	0	1	0
D/N	1	1	1	1	1	1	0	0	0	0	NN/N	0	1	0	0	0	1	1	0	0	1
D/AA	1	0	0	0	1	0	0	0	1	1	AA/AA	0	1	1	0	1	1	0	1	1	1
D/AN	0	1	0	0	0	0	1	1	0	1	AA/AN	1	0	1	1	0	0	1	1	1	1
D/NA	0	0	0	1	1	1	1	1	1	0	AA/NA	1	1	0	1	1	1	1	0	0	1
D/NN	1	1	1	1	1	0	0	1	0	0	AA/NN	0	1	1	1	0	1	1	1	0	0
A/A	1	1	0	1	0	0	0	0	1	1	AN/AA	0	0	0	1	1	0	0	1	0	1
A/N	0	0	1	1	1	0	1	0	0	1	AN/AN	1	1	1	0	0	0	0	0	0	1
N/A	1	0	0	1	0	1	1	1	0	0	AN/NA	1	0	0	0	0	1	0	1	0	0
N/N	0	1	1	0	0	1	0	1	0	1	AN/NN	0	0	1	1	0	1	0	0	0	1
A/AA	1	0	1	0	0	1	1	0	0	0	NA/AA	1	1	0	0	1	0	1	1	1	0
A/AN	1	0	0	1	0	1	0	1	0	1	NA/AN	0	0	1	0	1	0	1	0	0	0
A/NA	0	0	1	1	1	0	1	0	0	1	NA/NA	1	0	1	1	1	1	0	0	1	0
A/NN	0	1	1	1	0	1	0	0	1	1	NA/NN	1	1	1	0	0	1	1	0	1	0
N/AA	1	1	0	1	0	0	1	0	1	0	NN/AA	0	1	0	1	0	0	0	0	1	0
N/AN	1	1	0	0	0	1	0	1	1	0	NN/AN	0	0	1	0	0	0	0	1	1	0
N/NA	0	1	1	0	1	0	1	0	1	0	NN/NA	0	1	0	0	1	1	0	0	0	0
N/NN	0	0	1	0	1	1	0	1	0	1	NN/NN	0	0	0	0	0	1	1	0	1	1
PRE/POST																					
PRE	0	0	1	0	0	1	0	0	1	0	POST	0	1	0	0	1	0	0	1	0	0

When Secondary\_Cell\_Active is 2 or 3, and when DTX message is indicated for a cell pair, whose HARQ-ACK information is jointly encoded, the specific DTX code word as defined in Table 15C.2A is transmitted for that cell pair except for the case when DTX message is indicated for all active cells, in which case the HARQ-ACK slot is DTXed. The slot containing HARQ-ACK information is either transmitted or DTXed. If Secondary\_Cell\_Active is larger than 3 and when DTX message is indicated for both cell pairs transmitted on one of the two HS-DPCCHs and there is at least one HARQ-ACK message associated with the other HS-DPCCH that does not correspond to DTX message, then the specific DTX code word as defined in Table 15C.2A is transmitted for all cell pairs for which a DTX message is indicated. If the DTX message is indicated for all active cell pairs then the slot on each respective HS-DPCCH containing the HARQ-ACK information is DTXed.



**Table 15C.2A: Channel coding of HARQ-ACK for a pair of DTX messages when Secondary\_Cell\_Active is greater than 2**

HARQ-ACK message to be transmitted	$w_0$	$w_1$	$w_2$	$w_3$	$w_4$	$w_5$	$w_6$	$w_7$	$w_8$	$w_9$
D/D	0	0	1	1	0	1	1	0	1	0

#### 4.7.3B.2 Channel coding for HS-DPCCH composite precoding control indication and channel quality indication

The channel coding for CQI associated with a cell for which the UE is not configured in MIMO mode is specified in subclause 4.7.2.2.

The channel coding for PCI and CQI associated with a cell for which the UE is configured in MIMO mode is specified in subclause 4.7.3.2.

#### 4.7.3C Channel coding for HS-DPCCH when the UE is not configured in MIMO mode in any cell and Secondary\_Cell\_Enabled is 2

Two forms of channel coding are used, one for the composite channel quality indication (CQI) and another for the composite HARQ-ACK (acknowledgement).

##### 4.7.3C.1 Channel coding for the composite HS-DPCCH HARQ-ACK

**Table 15C.3: Channel coding of HARQ-ACK when the UE is not configured in MIMO mode in any cell and Secondary\_Cell\_Enabled is 2**

HARQ-ACK message to be transmitted	$w_0$	$w_1$	$w_2$	$w_3$	$w_4$	$w_5$	$w_6$	$w_7$	$w_8$	$w_9$
A/D/D	1	1	1	1	1	1	1	1	1	1
N/D/D	0	0	0	0	0	0	0	0	0	0
D/A/D	1	1	1	1	1	0	0	0	0	0
D/N/D	0	0	0	0	0	1	1	1	1	1
D/D/A	1	1	0	0	0	1	1	0	0	0
D/D/N	0	0	1	1	1	0	0	1	1	1
A/A/D	1	0	1	0	1	0	1	0	1	0
A/N/D	1	1	0	0	1	1	0	0	1	1
N/A/D	0	0	1	1	0	0	1	1	0	0
N/N/D	0	1	0	1	0	1	0	1	0	1
A/D/A	1	0	1	1	0	1	1	0	0	1
A/D/N	0	1	0	1	1	0	1	0	0	1
N/D/A	0	0	0	1	1	1	1	0	1	0
N/D/N	1	0	0	1	1	1	0	1	0	0
D/A/A	0	1	1	1	0	1	0	0	1	0
D/A/N	1	0	1	0	0	1	0	1	1	0
D/N/A	0	1	1	0	0	0	1	0	1	1
D/N/N	0	0	0	0	1	0	1	0	1	1
A/A/A	1	1	0	1	0	0	1	1	1	0
A/A/N	0	1	1	0	1	1	1	1	0	0
A/N/A	1	0	0	1	0	0	0	0	1	1

A/N/N	0	0	1	0	1	1	0	0	0	1											
N/A/A	1	1	1	0	0	0	0	1	0	1											
N/A/N	0	1	0	0	1	0	0	1	1	0											
N/N/A	1	0	0	0	1	0	1	1	0	1											
N/N/N	1	1	1	1	0	1	0	1	0	0											
PRE/POST																					
PRE	0	0	1	0	0	1	0	0	1	0	POST	0	1	0	0	1	0	0	1	0	0

4.7.3C.2 Channel coding for HS-DPCCH channel quality indication

The channel coding for CQI is specified in subclause 4.7.2.2 for the serving HS-DSCH cell, and in subclause 4.7.3A.2 for the 1<sup>st</sup> and 2<sup>nd</sup> secondary serving HS-DSCH cells.

4.7.3D Channel coding for HS-DPCCH when the UE is configured in Multiflow mode

4.7.3D.1 Channel coding for the composite HS-DPCCH HARQ-ACK

Subclause 4.7.4.3 defines the applicable HARQ-ACK encoding to be used with the following exception

- When the UE is configured with one serving and one assisting HS-DSCH cell and at least one of the two cells is configured in MIMO mode the HARQ-ACK encoding is defined in Table 15C.3A.

**Table 15C.3A: Channel coding of HARQ-ACK when the UE is configured with one serving and one assisting HS-DSCH cell and at least one cell is configured in MIMO mode**

HARQ-ACK message to be transmitted	w <sub>0</sub>	w <sub>1</sub>	w <sub>2</sub>	w <sub>3</sub>	w <sub>4</sub>	w <sub>5</sub>	w <sub>6</sub>	w <sub>7</sub>	w <sub>8</sub>	w <sub>9</sub>	HARQ-ACK message to be transmitted	w <sub>0</sub>	w <sub>1</sub>	w <sub>2</sub>	w <sub>3</sub>	w <sub>4</sub>	w <sub>5</sub>	w <sub>6</sub>	w <sub>7</sub>	w <sub>8</sub>	w <sub>9</sub>
A/D	1	1	1	0	0	0	0	1	0	1	AA/A	1	0	0	1	0	1	0	1	1	0
N/D	1	1	0	0	1	0	1	0	0	1	AA/N	1	0	1	0	0	1	1	0	0	1
AA/D	1	1	1	0	0	0	0	1	0	1	AN/A	1	1	0	1	0	0	1	0	1	0
AN/D	1	0	1	1	0	0	0	0	0	0	AN/N	0	1	1	0	0	0	1	0	0	0
NA/D	0	0	0	1	0	1	1	0	1	1	NA/A	0	0	1	0	1	0	1	1	1	0
NN/D	1	1	0	0	1	0	1	0	0	1	NA/N	0	1	0	0	1	1	0	0	1	1
D/A	0	1	1	1	1	0	1	0	1	1	NN/A	0	0	0	1	1	0	1	1	0	1
D/N	0	0	1	0	1	0	0	0	0	1	NN/N	0	1	1	1	1	1	0	0	0	0
D/AA	0	1	1	1	1	0	1	0	1	1	AA/AA	1	0	0	1	0	1	0	1	1	0
D/AN	1	1	1	1	1	0	1	1	0	0	AA/AN	1	0	0	0	0	0	0	0	1	1
D/NA	0	1	0	0	0	0	1	1	1	1	AA/NA	1	1	1	0	0	1	1	1	1	0
D/NN	0	0	1	0	1	0	0	0	0	1	AA/NN	1	0	1	0	0	1	1	0	0	1
A/A	1	0	0	1	0	1	0	1	1	0	AN/AA	1	1	0	1	0	0	1	0	1	0
A/N	1	0	1	0	0	1	1	0	0	1	AN/AN	1	1	1	1	0	1	0	0	1	1
N/A	0	0	0	1	1	0	1	1	0	1	AN/NA	1	0	0	0	0	0	1	1	0	0
N/N	0	1	1	1	1	1	0	0	0	0	AN/NN	0	1	1	0	0	0	1	0	0	0
A/AA	1	0	0	1	0	1	0	1	1	0	NA/AA	0	0	1	0	1	0	1	1	1	0
A/AN	1	0	0	0	0	0	0	0	1	1	NA/AN	0	1	1	0	1	1	1	1	0	1
A/NA	1	1	1	0	0	1	1	1	1	0	NA/NA	0	0	0	1	1	0	0	0	1	0

A/NN	1	0	1	0	0	1	1	0	0	1	NA/NN	0	1	0	0	1	1	0	0	1	1
N/AA	0	0	0	1	1	0	1	1	0	1	NN/AA	0	0	0	1	1	0	1	1	0	1
N/AN	0	1	0	1	0	0	0	0	0	1	NN/AN	0	1	0	1	0	0	0	0	0	1
N/NA	1	1	1	0	1	0	0	0	1	0	NN/NA	1	1	1	0	1	0	0	0	1	0
N/NN	0	1	1	1	1	1	0	0	0	0	NN/NN	0	1	1	1	1	1	0	0	0	0
PRE/POST																					
PRE	0	0	1	0	0	1	0	0	1	0	POST	0	1	0	0	1	0	0	1	0	0

#### 4.7.3D.2 Channel coding for HS-DPCCH channel quality indication

Subclause 4.7.4.3 defines the applicable CQI encoding to be used with different Multiflow configurations.

#### 4.7.3E Channel coding for HS-DPCCH when the UE is configured in MIMO mode with 4 transmit antennas

The coding for HS-DPCCH is defined separately for the following cases:

- when the UE is configured in MIMO mode with four transmit antennas and Secondary\_Cell\_Enabled is 0 (see subclause 4.7.3E1);
- when the UE is configured in MIMO mode with four transmit antennas in any cell, and Secondary\_Cell\_Enabled is 1 (see subclause 4.7.3E2);
- when the UE is configured in MIMO mode with four transmit antennas in any cell, and Secondary\_Cell\_Enabled is 2 (see subclause 4.7.3E3);
- when the UE is configured in MIMO mode with four transmit antennas in any cell, and Secondary\_Cell\_Enabled is 3 (see subclause 4.7.3E4);

##### 4.7.3E1 Channel coding for HS-DPCCH when the UE is configured in MIMO mode with four transmit antennas and Secondary\_Cell\_Enabled is 0

Two forms of channel coding are used, one for the composite number of transport blocks preferred (NTBP), precoding control indication (PCI) and channel quality indication (CQI) and another for HARQ-ACK (acknowledgement).

##### 4.7.3E1.1 Channel coding for HS-DPCCH HARQ-ACK

The HARQ acknowledgement message to be transmitted, as defined in [4], shall be coded to 10 bits as shown in Table 15C.3B. The output is denoted  $g_0, g_1, \dots, g_9$ .

When three or four transport blocks are received, the second and the third transport blocks are positively acknowledged (ACK) only if both transport blocks are received correctly. Otherwise both the second and the third transport blocks are negatively acknowledged (NACK).

When four transport blocks are received, the first and the fourth transport blocks are positively acknowledged (ACK) only if both transport blocks are received correctly. Otherwise both the first and the fourth transport blocks are negatively acknowledged (NACK).

**Table 15C.3B: Channel coding of HARQ-ACK when the UE is configured in MIMO mode with four transmit antennas in the serving HS-DSCH cell and Secondary\_Cell\_Enabled is 0**

HARQ-ACK message to be transmitted	$g_0$	$g_1$	$g_2$	$g_3$	$g_4$	$g_5$	$g_6$	$g_7$	$g_8$	$g_9$
HARQ-ACK in response to a single scheduled transport block										
ACK	1	1	1	1	1	1	1	1	1	1

NACK		0	0	0	0	0	0	0	0	0	0
HARQ-ACK in response to two scheduled transport blocks											
Response to primary transport block	Response to second transport block										
ACK	ACK	1	0	1	0	1	1	1	1	0	1
ACK	NACK	1	1	0	1	0	1	0	1	1	1
NACK	ACK	0	1	1	1	1	0	1	0	1	1
NACK	NACK	1	0	0	1	0	0	1	0	0	0
HARQ-ACK in response to three scheduled transport blocks											
Response to primary transport block	Response to second and third transport blocks										
ACK	ACK	1	0	1	0	1	1	1	1	0	1
ACK	NACK	1	1	0	1	0	1	0	1	1	1
NACK	ACK	0	1	1	1	1	0	1	0	1	1
NACK	NACK	1	0	0	1	0	0	1	0	0	0
HARQ-ACK in response to four scheduled transport blocks											
Response to primary and fourth transport blocks	Response to second and third transport blocks										
ACK	ACK	1	0	1	0	1	1	1	1	0	1
ACK	NACK	1	1	0	1	0	1	0	1	1	1
NACK	ACK	0	1	1	1	1	0	1	0	1	1
NACK	NACK	1	0	0	1	0	0	1	0	0	0
PRE/POST indication											
PRE		0	0	1	0	0	1	0	0	1	0
POST		0	1	0	0	1	0	0	1	0	0

The output bits  $g_0, g_1, \dots, g_9$  are repeated as shown in Figure 20C.0

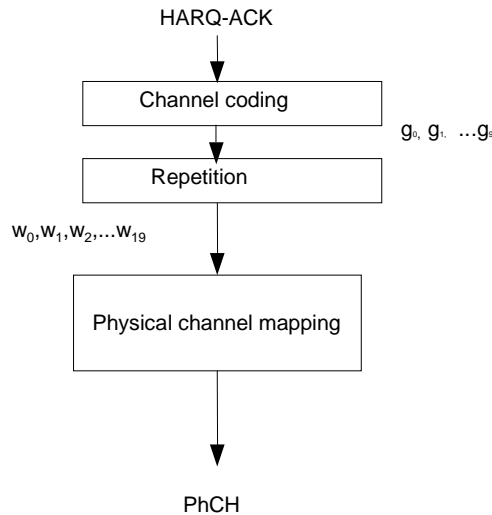

**Figure 20C.0: Repetition of HARQ-ACK message**

In Figure 20C.0, the repetition is according to the relation:

$$(w_0 \ w_1 \ \dots \ w_9 \ w_{10} \ w_{11} \ \dots \ w_{19}) = (g_0 \ g_1 \ \dots \ g_9 \ g_0 \ g_1 \ \dots \ g_9)$$

#### 4.7.3E1.2 Channel coding for HS-DPCCH composite number of transport blocks preferred, precoding control indication and channel quality indication

When the UE is configured in MIMO mode with four transmit antennas two types of CQI reports shall be supported by the UE. According to the definition of the CQI reporting procedure in [4], in type A CQI reporting the number of transport blocks preferred is up to four and in type B CQI reporting the number of transport blocks preferred is one.

##### 4.7.3E1.2.1 Bit mapping of Type A channel quality indication

In case a type A CQI shall be reported, the CQI values 0 ... 255 as defined in [4] are converted from decimal to binary to map them to the channel quality indication bits (0 0 0 0 0 0 0) to (1 1 1 1 1 1 1), respectively. The channel quality indication bits are  $cqi_0, cqi_1, cqi_2, cqi_3, cqi_4, cqi_5, cqi_6, cqi_7$  (where  $cqi_0$  is LSB and  $cqi_7$  is MSB).

In case the number of transport blocks preferred is one, the CQI values 0 ... 30 as defined in [4] are converted from decimal to binary to map them to the channel quality indication bits (1 0 0 0 0) to (1 1 1 1 1), respectively. The information bit pattern (0 0 0 0 0) shall not be used in this release. The channel quality indication bits are  $cqi_0, cqi_1, cqi_2, cqi_3, cqi_4$  (where  $cqi_0$  is LSB and  $cqi_4$  is MSB) and (0 0 0) is used for indicating  $cqi_5, cqi_6, cqi_7$  (where  $cqi_5$  is LSB and  $cqi_7$  is MSB).

##### 4.7.3E1.2.2 Bit mapping of Type B channel quality indication

In case a type B CQI shall be reported, the CQI values 0 ... 30 as defined in [4] are converted from decimal to binary to map them to the channel quality indication bits (1 0 0 0 0) to (1 1 1 1 1), respectively. The information bit pattern (0 0 0 0 0) shall not be used in this release. The channel quality indication bits are  $cqi_0, cqi_1, cqi_2, cqi_3, cqi_4$  (where  $cqi_0$  is LSB and  $cqi_4$  is MSB).

##### 4.7.3E1.2.3 Bit mapping of number of transport blocks preferred

According to the number of transport blocks preferred definition in [4], the range of possible values is 0 ... 3. The number of transport blocks preferred values 0 ... 3 as defined in [4] are converted from decimal to binary to map them to the number of transport blocks preferred bits (0 0) to (1 1) respectively. The number of transport blocks preferred bits are  $ri_0, ri_1$  (where  $ri_0$  is LSB and  $ri_1$  is MSB).

4.7.3E1.2.4 Bit mapping of precoding control indication

According to the PCI definition in [4], the range of possible PCI values is 0 ... 15. The PCI values 0 ... 15 as defined in [4] are converted from decimal to binary to map them to the precoding control indication bits (0 0,0,0) to (1 1,1,1) respectively. The precoding control indication bits are  $pci_0, pci_1, pci_2, pci_3$  (where  $pci_0$  is LSB and  $pci_3$  is MSB).

4.7.3E1.2.5 Composite number of transport blocks preferred , precoding control indication and channel quality indication bits

For type A CQI report the composite NTBP/PCI/CQI shall be constructed according to the scheme depicted in Figure 20C.1.

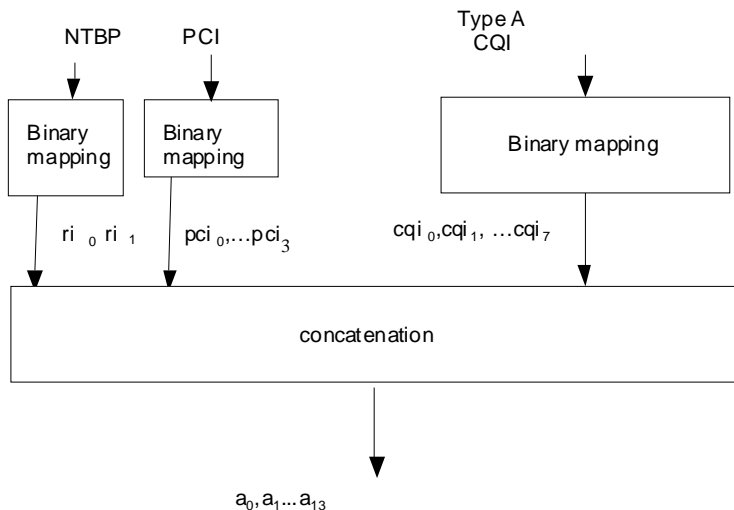
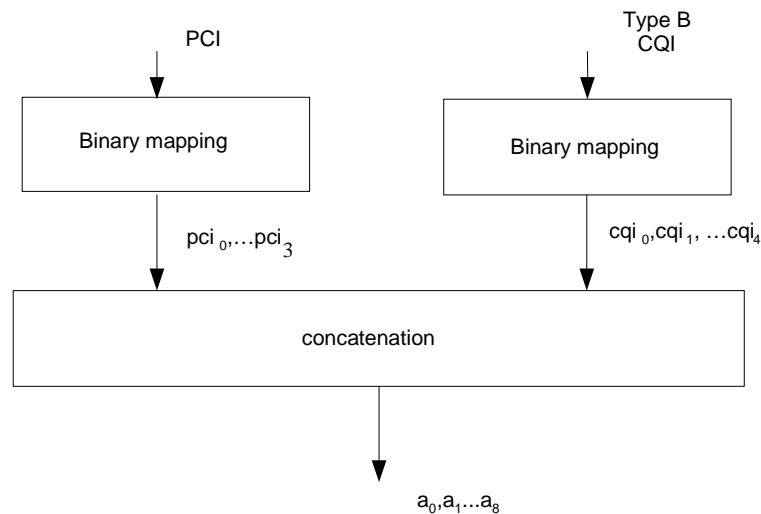

Figure 20C.1: Construction of composite NTBP/PCI/CQI for Type A CQI report

In case a type A CQI shall be reported, the number of transport blocks preferred bits  $ri_0, ri_1$ , precoding control indication bits  $pci_0, pci_1, pci_2, pci_3$ , and the channel quality indication bits  $cqi_0, cqi_1, cqi_2, cqi_3, cqi_4, cqi_5, cqi_6, cqi_7$  are concatenated to the composite number of transport blocks preferred, precoding control indication and channel quality indication bits according to the relation

$$(a_0 a_1 a_2 a_3 a_4 a_5 a_6 a_7 a_8 a_9 a_{10} a_{11} a_{12} a_{13}) = (ri_0 ri_1 pci_0 pci_1 pci_2 pci_3 cqi_0 cqi_1 cqi_2 cqi_3 cqi_4 cqi_5 cqi_6 cqi_7)$$

For type B CQI report the composite PCI/CQI shall be constructed according to the scheme depicted in Figure 20C.2.



**Figure 20C.2: Construction of composite NTBP/PCI/CQI for Type B CQI report**

In case a type B CQI shall be reported, the precoding control indication bits  $pci_0$ ,  $pci_1$ ,  $pci_2$ ,  $pci_3$ , and the channel quality indication bits  $cqi_0$ ,  $cqi_1$ ,  $cqi_2$ ,  $cqi_3$ ,  $cqi_4$  are concatenated to the composite precoding control indication and channel quality indication bits according to the relation

$$(a_0 \ a_1 \ a_2 \ a_3 \ a_4 \ a_5 \ a_6 \ a_7 \ a_8) = (pci_0 \ pci_1 \ pci_2 \ pci_3 \ cqi_0 \ cqi_1 \ cqi_2 \ cqi_3 \ cqi_4)$$

#### 4.7.3E1.2.6 Channel coding for composite number of transport blocks preferred, precoding control indication and channel quality indication bits

In case a type A CQI needs to be reported, rate 1/2 convolutional coding, as described in Clause 4.2.3.1 is applied to the sequence of bits  $a_0, a_1, \dots, a_{13}$ , resulting in the sequence of bits  $d_0, d_1, \dots, d_{43}$ .

Note that the coded sequence lengths result from the termination of K=9 convolutional coding being fully applied.

In case a type B CQI needs to be reported, rate 1/3 convolutional coding, as described in Clause 4.2.3.1 is applied to the sequence of bits  $a_0, a_1, \dots, a_8$ , resulting in the sequence of bits  $d_0, d_1, \dots, d_{50}$ .

Note that the coded sequence lengths result from the termination of K=9 convolutional coding being fully applied.

#### 4.7.3E1.2.7 Rate matching for composite number of transport blocks preferred, precoding control indication and channel quality indication bits

In case a type A CQI needs to be reported, from the input sequence  $d_0, d_1, \dots, d_{43}$  the bits  $d_0, d_2, d_{41}, d_{43}$  are punctured to obtain the output sequence  $b_0, b_1, \dots, b_{39}$ .

In case a type B CQI needs to be reported, from the input sequence  $d_0, d_1, \dots, d_{50}$  the bits  $d_0, d_2, d_3, d_4, d_6, d_{44}, d_{45}, d_{46}, d_{47}, d_{48}, d_{50}$  are punctured to obtain the output sequence  $b_0, b_1, \dots, b_{39}$ .

#### 4.7.3E2 Channel coding for HS-DPCCH when the UE is configured in MIMO mode with four transmit antennas in any cell and Secondary\_Cell\_Enabled is 1

Two forms of channel coding are used, one for the composite number of transport blocks preferred (NTBP), precoding control indication (PCI) and channel quality indication (CQI) and another for HARQ-ACK (acknowledgement).

##### 4.7.3E2.1 Channel coding for the composite HS-DPCCH HARQ-ACK

The HARQ acknowledgement message associated with a cell for which the UE is configured in MIMO mode with four transmit antennas shall be coded to 10 bits as in Table 15C.3B in subclause 4.7.3E1.1.

The HARQ acknowledgement message associated with a cell for which the UE is configured in MIMO mode shall be coded to 10 bits as in Table 15B in subclause 4.7.3.1.

The HARQ acknowledgement message associated with a cell for which the UE is configured not in MIMO mode and not in MIMO mode with four transmit antennas shall be coded to 10 bits as specified in Table 15 in subclause 4.7.2.

The HARQ acknowledgement messages corresponding to the serving HS-DSCH cell and secondary serving HS-DSCH cell in that order are encoded and concatenated into the same slot according to Figure 20D in clause 4.7.4.1.

#### 4.7.3E2.2 Channel coding for HS-DPCCH composite number of transport blocks preferred, precoding control indication and channel quality indication

The channel coding for NTBP, PCI and CQI associated with a cell for which the UE is configured in MIMO mode with four transmit antennas is specified in subclause 4.7.3E1.2.

The channel coding for PCI and CQI associated with a cell for which the UE is configured in MIMO mode is specified in subclause 4.7.3.2.

The channel coding for CQI associated with a cell for which the UE is configured not in MIMO mode and not in MIMO mode with four transmit antennas is specified in subclause 4.7.2.2.

#### 4.7.3E3 Channel coding for HS-DPCCH when the UE is configured in MIMO mode with four transmit antennas in any cell and Secondary\_Cell\_Enabled is 2

Two forms of channel coding are used, one for the composite number of transport blocks preferred (NTBP), precoding control indication (PCI) and channel quality indication (CQI) and another for HARQ-ACK (acknowledgement).

##### 4.7.3E3.1 Channel coding for the composite HS-DPCCH HARQ-ACK

The HARQ acknowledgement message associated with a cell for which the UE is configured in MIMO mode with four transmit antennas shall be coded to 10 bits as in Table 15C.3B in subclause 4.7.3E1.1.

The HARQ acknowledgement message associated with a cell for which the UE is configured in MIMO mode shall be coded to 10 bits as in Table 15B in subclause 4.7.3.1.

The HARQ acknowledgement message associated with a cell for which the UE is not configured in MIMO mode and not configured in MIMO mode with four transmit antennas shall be coded to 10 bits as specified in Table 15 in subclause 4.7.2.

The HARQ acknowledgement messages corresponding to the serving HS-DSCH cell and 1<sup>st</sup> secondary serving HS-DSCH cell in that order are encoded and concatenated into the same slot according to Figure 20D in clause 4.7.4.1.

##### 4.7.3E3.2 Channel coding for HS-DPCCH composite number of transport blocks preferred, precoding control indication and channel quality indication

The channel coding for NTBP, PCI and CQI associated with a cell for which the UE is configured in MIMO mode with four transmit antennas is specified in subclause 4.7.3E1.2.

The channel coding for PCI and CQI associated with a cell for which the UE is configured in MIMO mode is specified in subclause 4.7.3.2.

The channel coding for PCI and CQI associated with a cell for which the UE is configured not in MIMO mode and not in MIMO mode with four transmit antennas is specified in subclause 4.7.2.2.

#### 4.7.3E4 Channel coding for HS-DPCCH when the UE is configured in MIMO mode with four transmit antennas in any cell and Secondary\_Cell\_Enabled is 3

Two forms of channel coding are used, one for the composite number of transport blocks preferred (NTBP), precoding control indication (PCI) and channel quality indication (CQI) and another for HARQ-ACK (acknowledgement).



#### 4.7.3E4.1 Channel coding for the composite HS-DPCCH HARQ-ACK

The HARQ acknowledgement message associated with a cell for which the UE is configured in MIMO mode with four transmit antennas shall be coded to 10 bits as in Table 15C.3B in subclause 4.7.3E1.1.

The HARQ acknowledgement message associated with a cell for which the UE is configured in MIMO mode shall be coded to 10 bits as in Table 15B in subclause 4.7.3.1.

The HARQ acknowledgement message associated with a cell for which the UE is configured not in MIMO mode and not in MIMO mode with four transmit antennas shall be coded to 10 bits as specified in Table 15 in subclause 4.7.2.

The HARQ acknowledgement messages corresponding to the serving HS-DSCH cell and 1<sup>st</sup> secondary serving HS-DSCH cell in that order are encoded and concatenated into the same slot according to Figure 20D in clause 4.7.4.1.

The HARQ acknowledgement messages corresponding to the 2<sup>nd</sup> secondary serving HS-DSCH cell and the 3<sup>rd</sup> secondary serving HS-DSCH cell in that order are encoded and concatenated into the same slot according to Figure 20D.1 in clause 4.7.4.1.

#### 4.7.3E4.2 Channel coding for HS-DPCCH composite number of transport blocks preferred, precoding control indication and channel quality indication

The channel coding for NTBP, PCI and CQI associated with a cell for which the UE is configured in MIMO mode with four transmit antennas is specified in subclause 4.7.3E1.2.

The channel coding for PCI and CQI associated with a cell for which the UE is configured in MIMO mode is specified in subclause 4.7.3.2.

The channel coding for PCI and CQI associated with a cell for which the UE is configured not in MIMO mode and not in MIMO mode with four transmit antennas is specified in subclause 4.7.2.2.

### 4.7.4 Physical channel mapping for HS-DPCCH

#### 4.7.4.1 Physical Channel mapping for HS-DPCCH HARQ-ACK

This section is not applicable when the UE is configured in MIMO mode with four transmit antennas in at least one cell.

If the HS-DPCCH slot format 0 as defined in [2] is used, the HS-DPCCH physical channel mapping function shall map the input bits  $w_k$  directly to physical channel so that bits are transmitted over the air in ascending order with respect to  $k$ .

If the HS-DPCCH slot format 1 as defined in [2], is used, the HS-DPCCH physical channel mapping function shall map the input bits  $w_k$  to the physical channel so that bits are transmitted over the air in ascending order with respect to  $k$  as follows:

- If Secondary\_Cell\_Enabled is equal to 7 and Secondary\_Cell\_Active is equal to 7
  - The following two HARQ-ACK messages are transmitted on HS-DPCCH according to Figure 20D:
    - HARQ-ACK1 comprising the HARQ acknowledgement messages for the pair of serving HS-DSCH cell and 1<sup>st</sup> secondary serving HS-DSCH cell in that order and
    - HARQ-ACK2 comprising the HARQ acknowledgement messages for the pair of the 2<sup>nd</sup> secondary serving HS-DSCH cell and the 3<sup>rd</sup> secondary serving HS-DSCH cell in that order
  - The following two HARQ-ACK messages are transmitted on HS-DPCCH<sub>2</sub> according to Figure 20D.1:
    - HARQ-ACK3 comprising the HARQ acknowledgement messages for the pair of the 4<sup>th</sup> secondary serving HS-DSCH cell and the 5<sup>th</sup> secondary serving HS-DSCH cell in that order

- HARQ-ACK4 comprising the HARQ acknowledgement messages for the pair of the 6<sup>th</sup> secondary serving HS-DSCH cell and the 7<sup>th</sup> secondary serving HS-DSCH cell in that order
- If Secondary\_Cell\_Enabled is equal to 6 and Secondary\_Cell\_Active is equal to 6
  - The following two HARQ-ACK messages are transmitted on HS-DPCCH according to Figure 20D:
    - HARQ-ACK1 comprising the HARQ acknowledgement messages for the pair of serving HS-DSCH cell and 1<sup>st</sup> secondary serving HS-DSCH cell in that order and
    - HARQ-ACK2 comprising the HARQ acknowledgement messages for the pair of the 2<sup>nd</sup> secondary serving HS-DSCH cell and the 3<sup>rd</sup> secondary serving HS-DSCH cell in that order
  - The following two HARQ-ACK messages are transmitted on HS-DPCCH<sub>2</sub> according to Figure 20D.1:
    - HARQ-ACK3 comprising the HARQ acknowledgement messages for the pair of the 4<sup>th</sup> secondary serving HS-DSCH cell and the 5<sup>th</sup> secondary serving HS-DSCH cell in that order
    - HARQ-ACK4 comprising the HARQ acknowledgement messages for the 6<sup>th</sup> secondary serving HS-DSCH cell and a DTX message in that order
- If Secondary\_Cell\_Enabled is equal to 5 and Secondary\_Cell\_Active is equal to 5
  - The following two HARQ-ACK messages are transmitted on HS-DPCCH according to Figure 20D:
    - HARQ-ACK1 comprising the HARQ acknowledgement messages for the pair of serving HS-DSCH cell and 1<sup>st</sup> secondary serving HS-DSCH cell in that order and
    - HARQ-ACK2 comprising the HARQ acknowledgement messages for the pair of the 2<sup>nd</sup> secondary serving HS-DSCH cell and the 3<sup>rd</sup> secondary serving HS-DSCH cell in that order
  - The following HARQ-ACK message is transmitted on HS-DPCCH<sub>2</sub>:
    - The HARQ acknowledgement messages for the pair of the 4<sup>th</sup> secondary serving HS-DSCH cell and the 5<sup>th</sup> secondary serving HS-DSCH cell are repeated according to Figure 20E.
- If Secondary\_Cell\_Enabled is equal to 4 and Secondary\_Cell\_Active is equal to 4
  - The following two HARQ-ACK messages are transmitted on HS-DPCCH according to Figure 20D:
    - HARQ-ACK1 comprising the HARQ acknowledgement messages for the pair of serving HS-DSCH cell and 1<sup>st</sup> secondary serving HS-DSCH cell in that order and
    - HARQ-ACK2 comprising the HARQ acknowledgement messages for the pair of the 2<sup>nd</sup> secondary serving HS-DSCH cell and the 3<sup>rd</sup> secondary serving HS-DSCH cell in that order
  - The following two HARQ-ACK messages are transmitted on HS-DPCCH<sub>2</sub>:
    - The HARQ-ACK comprising the HARQ acknowledgement the 4<sup>th</sup> secondary serving HS-DSCH cell and a DTX message in that order and it is repeated according to Figure 20E.
- If Secondary\_Cell\_Enabled is greater than 3 and Secondary\_Cell\_Active is less than Secondary\_Cell\_Enabled:

- If none of the 4<sup>th</sup>, 5<sup>th</sup>, 6<sup>th</sup>, or 7<sup>th</sup> secondary serving HS-DSCH cell is activated the HARQ-ACK transmissions on HS-DPCCH<sub>2</sub> are DTXed
  - If at most one of the 1<sup>st</sup>, 2<sup>nd</sup>, or 3<sup>rd</sup> secondary serving HS-DSCH cell is activated the HARQ-ACK message is repeated according to Figure 20E
  - If one of the 4<sup>th</sup>, 5<sup>th</sup>, 6<sup>th</sup>, and 7<sup>th</sup> secondary serving HS-DSCH cell is activated the HARQ-ACK message is repeated according to Figure 20E.
  - If two of the 4<sup>th</sup>, 5<sup>th</sup>, 6<sup>th</sup> and 7<sup>th</sup> secondary serving HS-DSCH cell are active the HARQ-ACK comprises the HARQ acknowledgement messages for the pair of the secondary serving HS-DSCH cell with lowest index as indicated by higher layers and the other activated secondary serving HS-DSCH cell in that order. The HARQ-ACK message is repeated according to Figure 20E.
  - Otherwise the transmissions of the HARQ-ACK messages is the same as if Secondary\_Cell\_Active was equal to Secondary\_Cell\_Enabled but where DTX message(s) is transmitted in place of deactivated secondary serving HS-DSCH cells.
- If Secondary\_Cell\_Enabled is 3 and Secondary\_Cell\_Active is 2 or 3 then the following two HARQ-ACK messages are encoded and concatenated into the same slot according to Figure 20D :
    - HARQ-ACK1 comprising the HARQ acknowledgement messages for the pair of serving HS-DSCH cell and 1<sup>st</sup> secondary serving HS-DSCH cell in that order and
    - HARQ-ACK2 comprising the HARQ acknowledgement messages for the pair of 2<sup>nd</sup> secondary serving HS-DSCH cell and the 3<sup>rd</sup> secondary serving HS-DSCH cell in that order
  - If Secondary\_Cell\_Enabled is 2 with MIMO configured in at least one of the cells and Secondary\_Cell\_Active is 2 then the following two HARQ-ACK messages, are encoded and concatenated into the same slot according to Figure 20D:
    - HARQ-ACK1 comprising the HARQ acknowledgement messages for the pair of serving HS-DSCH cell and 1<sup>st</sup> secondary serving HS-DSCH cell in that order and
    - HARQ-ACK2 comprising the HARQ acknowledgement messages for the 2<sup>nd</sup> secondary serving HS-DSCH cell and a DTX message in that order
  - If Secondary\_Cell\_Enabled is more than 1 and Secondary\_Cell\_Active is 0 or 1 then the transmission of the HARQ-ACK message is repeated according to Figure 20E.

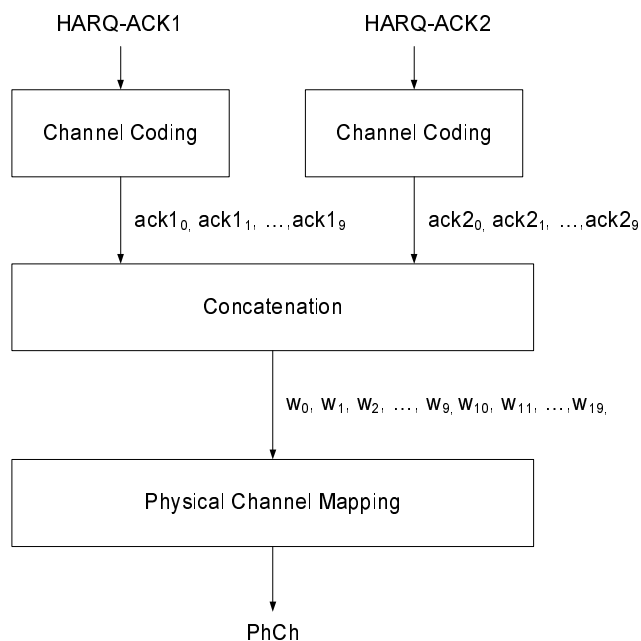

**Figure 20D: Concatenation of 2 HARQ-ACK messages**

In Figure 20D, the concatenation of the 2 HARQ-ACK messages is according to the relation:

$$(w_0 w_1 \dots w_9 w_{10} w_{11} \dots w_{19}) = (ack1_0 ack1_1 \dots ack1_9 ack2_0 ack2_1 \dots ack2_9)$$

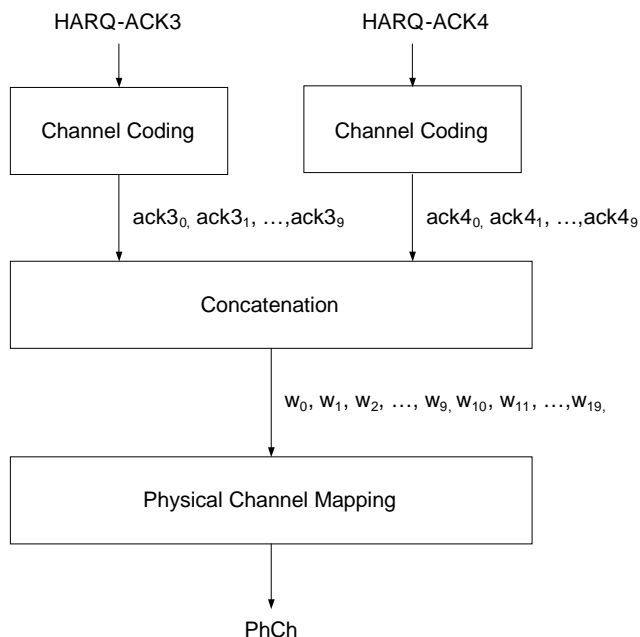

Figure 20D.1: Concatenation of 2 HARQ-ACK messages on HS-DPCCH<sub>2</sub>

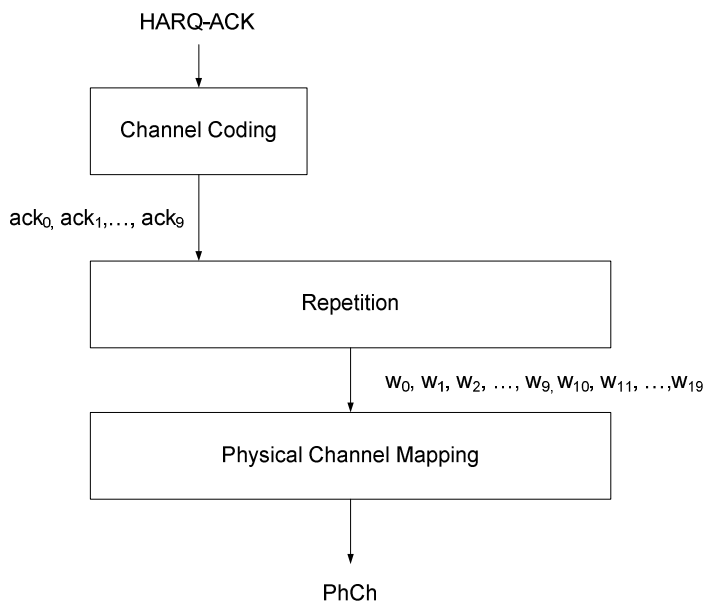

Figure 20E: Repetition of HARQ-ACK message

In Figure 20E, the repetition of the HARQ-ACK message is according to the relation:

$$(w_0 w_1 \dots w_9 w_{10} w_{11} \dots w_{19}) = (ack_0 ack_1 \dots ack_9 ack_0 ack_1 \dots ack_9)$$

#### 4.7.4.2 Physical Channel mapping for HS-DPCCH PCI/CQI

Table 15C.4 lists the CQI and PCI/CQI report mapping scenarios when Secondary\_Cell\_Enabled is less than 4. Tables 15C.5 and 15C.6 list the CQI and PCI/CQI report mapping scenarios when Secondary\_Cell\_Enabled is greater than 3. The transmission timing and repetition of the 1<sup>st</sup> and the 2<sup>nd</sup> CQI and PCI/CQI report is defined in [4].

**Table 15C.4: The CQI and PCI/CQI report mapping scenarios when Secondary\_Cell\_Enabled is less than 4**

Case	Secondary_Cell_Enabled	MIMO configured in any cell	HS-DPCCH slot format	Secondary_Cell_Active	1 <sup>st</sup> CQI or PCI/CQI report		2 <sup>nd</sup> CQI or PCI/CQI report	
					CQI or PCI/CQI Type A/B		CQI or PCI/CQI Type A/B	
1	0	No	0	0	CQI		Not applicable	
2		Yes	0	0	PCI/CQI		Not applicable	
3	1 Note 2	No	0	1	CQI <sub>0</sub> & CQI <sub>1</sub> Note 5		Not applicable	
4				0	CQI <sub>0</sub>		Not applicable	
5		Yes Note 1	0	1	PCI/CQI <sub>0</sub>		PCI/CQI <sub>1</sub>	
6	0			PCI/CQI <sub>0</sub>		DTX		
7	2 Note 2	No	0	2	CQI <sub>0</sub>		CQI <sub>1</sub> & CQI <sub>2</sub> Note 5	
8				1	CQI <sub>0</sub>		CQI <sub>n</sub> Note 4	
9				0	CQI <sub>0</sub>		DTX	
					CQI 1 or PCI/CQI 1 Type A/B	CQI 2 or PCI/CQI 2 Type A/B	CQI 1 or PCI/CQI 1 Type A/B	CQI 2 or PCI/CQI 2 Type A/B
10	2 Note 2	Yes Note 1	1	2	PCI/CQI <sub>0</sub>	PCI/CQI <sub>2</sub>	PCI/CQI <sub>1</sub>	DTX
11				1	PCI/CQI <sub>0</sub>	PCI/CQI <sub>0</sub>	PCI/CQI <sub>n</sub> Note 4	PCI/CQI <sub>n</sub> Note 4
12				0	PCI/CQI <sub>0</sub>	PCI/CQI <sub>0</sub>	DTX	
13	3 Note 2	No	1	3	CQI <sub>0</sub>	CQI <sub>2</sub>	CQI <sub>1</sub>	CQI <sub>3</sub>
14				2	CQI <sub>0</sub>	CQI <sub>2</sub> Note 3	CQI <sub>1</sub> Note 3	CQI <sub>3</sub> Note 3
15				1	CQI <sub>0</sub>	CQI <sub>0</sub>	CQI <sub>n</sub> Note 4	CQI <sub>n</sub> Note 4
16				0	CQI <sub>0</sub>	CQI <sub>0</sub>	DTX	
17		Yes Note 1	1	3	PCI/CQI <sub>0</sub>	PCI/CQI <sub>2</sub>	PCI/CQI <sub>1</sub>	PCI/CQI <sub>3</sub>
18				2	PCI/CQI <sub>0</sub>	PCI/CQI <sub>2</sub> Note 3	PCI/CQI <sub>1</sub> Note 3	PCI/CQI <sub>3</sub> Note 3
19	1	PCI/CQI <sub>0</sub>	PCI/CQI <sub>0</sub>	PCI/CQI <sub>n</sub> Note 4	PCI/CQI <sub>n</sub> Note 4			
20	0	PCI/CQI <sub>0</sub>	PCI/CQI <sub>0</sub>	DTX				

Note 1: If the UE is configured in MIMO mode in at least one cell, but not in all cells, a CQI value is reported instead of PCI/CQI value for the non-MIMO cell(s).

Note 2: The CQI<sub>0</sub> and PCI/CQI<sub>0</sub> refer to the serving HS-DSCH cell's CQI and PCI/CQI reports respectively, the CQI<sub>n</sub> and PCI/CQI<sub>n</sub> refer to the n<sup>th</sup> secondary serving HS-DSCH cell's reports.

Note 3: The deactivated secondary cell's CQI or PCI/CQI is not transmitted (DTX"d).

Note 4: The CQI or the PCI/CQI of the single active secondary cell is transmitted.

Note 5: The two CQI values are jointly encoded.

**Table 15C.5: The CQI and PCI/CQI report mapping for HS-DPCCH when Secondary\_Cell\_Enabled is greater than 3.**

Case	Secondary_Cell_Enabled	MIMO configured in any cell	HS-DPCCH slot format	Active secondary cells out of 1 <sup>st</sup> , 2 <sup>nd</sup> , 3 <sup>rd</sup> secondary cell	1 <sup>st</sup> CQI or PCI/CQI report		2 <sup>nd</sup> CQI or PCI/CQI report	
					CQI 1 or PCI/CQI 1 Type A/B	CQI 2 or PCI/CQI 2 Type A/B	CQI 1 or PCI/CQI 1 Type A/B	CQI 2 or PCI/CQI 2 Type A/B
21a	4-7 Note 2	No	1	3	CQI <sub>0</sub>	CQI <sub>2</sub>	CQI <sub>1</sub>	CQI <sub>3</sub>
22a				2	CQI <sub>0</sub>	CQI <sub>2</sub> Note 3	CQI <sub>1</sub> Note 3	CQI <sub>3</sub> Note 3
23a				1	CQI <sub>0</sub>	CQI <sub>0</sub>	CQI <sub>n</sub> Note 4	CQI <sub>n</sub> Note 4

24a	Yes Note 1	1	0	CQI <sub>0</sub>	CQI <sub>0</sub>	DTX	
25a			3	PCI/CQI <sub>0</sub>	PCI/CQI <sub>2</sub>	PCI/CQI <sub>1</sub>	PCI/CQI <sub>3</sub>
26a			2	PCI/CQI <sub>0</sub>	PCI/CQI <sub>2</sub> Note 3	PCI/CQI <sub>1</sub> Note 3	PCI/CQI <sub>3</sub> Note 3
27a			1	PCI/CQI <sub>0</sub>	PCI/CQI <sub>0</sub>	PCI/CQI <sub>n</sub> Note 4	PCI/CQI <sub>n</sub> Note 4
28a			0	PCI/CQI <sub>0</sub>	PCI/CQI <sub>0</sub>	DTX	

- Note 1: If the UE is configured in MIMO mode in at least one cell, but not in all cells, a CQI value is reported instead of PCI/CQI value for the non-MIMO cell(s).
- Note 2: The CQI<sub>0</sub> and PCI/CQI<sub>0</sub> refer to the serving HS-DSCH cell's CQI and PCI/CQI reports respectively, the CQI<sub>n</sub> and PCI/CQI<sub>n</sub> refer to the n<sup>th</sup> secondary serving HS-DSCH cell's reports, and  $n \in \{1,2,3\}$ .
- Note 3: The deactivated secondary cell's CQI or PCI/CQI is not transmitted (DTX"d).
- Note 4: The CQI or the PCI/CQI of the single active secondary cell is transmitted.

**Table 15C.6: The CQI and PCI/CQI report mapping for HS-DPCCH2 when Secondary\_Cell\_Enabled is greater than 3.**

Case	Secondary_Cell_Enabled	MIMO configured in any cell	HS-DPCCH slot format	Active secondary cells out of 4 <sup>th</sup> , 5 <sup>th</sup> , 6 <sup>th</sup> and 7 <sup>th</sup> secondary cell	3 <sup>rd</sup> CQI or PCI/CQI report		4 <sup>th</sup> CQI or PCI/CQI report	
					CQI 3 or PCI/CQI 3 Type A/B	CQI 4 or PCI/CQI 4 Type A/B	CQI 3 or PCI/CQI 3 Type A/B	CQI 4 or PCI/CQI 4 Type A/B
21b	4-7 Note 2	No	1	4	CQI <sub>4</sub>	CQI <sub>6</sub>	CQI <sub>5</sub>	CQI <sub>7</sub>
22b				3	CQI <sub>4</sub> Note 3	CQI <sub>6</sub> Note 3	CQI <sub>5</sub> Note 3	CQI <sub>7</sub> Note 3
23b				2	CQI <sub>n</sub> Note 2	CQI <sub>n</sub> Note 2	CQI <sub>m</sub> Note 2	CQI <sub>m</sub> Note 2
24b				1	CQI <sub>n</sub> Note 4	CQI <sub>n</sub> Note 4	DTX	
25b				0	DTX		DTX	
26b		Yes Note 1	1	4	PCI/CQI <sub>4</sub>	PCI/CQI <sub>6</sub>	PCI/CQI <sub>5</sub>	PCI/CQI <sub>7</sub>
27b				3	PCI/CQI <sub>4</sub> Note 3	PCI/CQI <sub>6</sub> Note 3	PCI/CQI <sub>5</sub> Note 3	PCI/CQI <sub>7</sub> Note 3
28b				2	PCI/CQI <sub>n</sub> Note 2	PCI/CQI <sub>n</sub> Note 2	PCI/CQI <sub>m</sub> Note 2	PCI/CQI <sub>m</sub> Note 2
29b				1	PCI/CQI <sub>n</sub> Note 4	PCI/CQI <sub>n</sub> Note 4	DTX	
30b				0	DTX		DTX	

- Note 1: If the UE is configured in MIMO mode in at least one cell, but not in all cells, a CQI value is reported instead of PCI/CQI value for the non-MIMO cell(s).
- Note 2: The CQI<sub>n</sub> and PCI/CQI<sub>n</sub> refer to the n<sup>th</sup> secondary serving HS-DSCH cell's reports, and the CQI<sub>m</sub> and PCI/CQI<sub>m</sub> refer to the m<sup>th</sup> secondary serving HS-DSCH cell's reports, where  $n < m$  and  $\{n, m\} \in \{4,5,6,7\}$ .
- Note 3: The deactivated secondary cells' CQI or PCI/CQI is not transmitted (DTX"d).
- Note 4: The CQI or the PCI/CQI of the single active secondary cell out of the 4<sup>th</sup>, 5<sup>th</sup>, 6<sup>th</sup> and 7<sup>th</sup> secondary cells is transmitted.

If the HS-DPCCH slot format 0 as defined in [2] is used, the HS-DPCCH physical channel mapping function shall map the input bits  $b_k$  directly to physical channel so that bits are transmitted over the air in ascending order with respect to k. When Secondary\_Cell\_Active is 2, the CQI reports for each of the following groups are mapped to separate subframes as specified in [4]:

- The report for the serving HS-DSCH cell (CQI) is mapped according to the physical channel mapping of CQI in Figure 20.
- The report for the 1<sup>st</sup> secondary serving HS-DSCH cell (CQI 1) and the 2<sup>nd</sup> secondary serving HS-DSCH cell (CQI 2) are mapped according to Figure 20C and according to the physical channel mapping of CQI in Figure 20.

If the HS-DPCCH slot format 1 as defined in [2] is used and Secondary\_Cell\_Enabled is less than 4, the HS-DPCCH physical channel mapping function shall map the input bits  $b_k$  to the physical channel so that bits are transmitted over the air in ascending order with respect to  $k$  as follows:

- When Secondary\_Cell\_Active is 3, the CQI or PCI/CQI reports for each of the following pairs are mapped to separate subframes as specified in [4]:
  - The report for the serving HS-DSCH cell (CQI 1 or PCI/CQI 1) and the 2<sup>nd</sup> secondary serving HS-DSCH cell (CQI 2 or PCI/CQI 2) are mapped according to Figure 20F.
  - The report for the 1<sup>st</sup> secondary serving HS-DSCH cell (CQI 1 or PCI/CQI 1) and the 3<sup>rd</sup> secondary serving HS-DSCH cell (CQI 2 or PCI/CQI 2) are mapped according to Figure 20F.
- When Secondary\_Cell\_Active is 2, the mapping of the CQI or PCI/CQI reports is the same as the case when Secondary\_Cell\_Active is 3 with the following exception: In the subframe in which only one active cell is mapped, the HS-DPCCH physical channel mapping function shall map the input bits  $b_k$  directly to the physical channel in the corresponding slot of the CQI (or PCI/CQI) field of that subframe while the other slot of the CQI (or PCI/CQI) field is DTXed.
- When Secondary\_Cell\_Active is 0 or 1, the CQI or PCI/CQI report for each active cell is mapped to a separate subframe as specified in [4]. In each subframe, the HS-DPCCH physical channel mapping function shall map the input bits to the physical channel according to Figure 20G.

If the HS-DPCCH slot format 1 as defined in [2] is used and Secondary\_Cell\_Enabled is greater than 3, the HS-DPCCH physical channel mapping function shall map the input bits  $b_k$  to the physical channel so that bits are transmitted over the air in ascending order with respect to  $k$  as follows:

- When Secondary\_Cell\_Active is 7, the CQI or PCI/CQI reports for each of the following pairs are mapped to separate subframes as specified in [4]:
  - The following is transmitted on HS-DPCCH<sub>1</sub>:
    - The report for the serving HS-DSCH cell (CQI1 or PCI/CQI1) and the 2<sup>nd</sup> secondary serving HS-DSCH cell (CQI2 or PCI/CQI2) are mapped according to Figure 20F.
    - The report for the 1<sup>st</sup> secondary serving HS-DSCH cell (CQI1 or PCI/CQI1) and the 3<sup>rd</sup> secondary serving HS-DSCH cell (CQI2 or PCI/CQI2) are mapped according to Figure 20F.
  - The following is transmitted on HS-DPCCH<sub>2</sub>:
    - The report for the 4<sup>th</sup> secondary serving HS-DSCH cell (CQI3 or PCI/CQI3) and the 6<sup>th</sup> secondary serving HS-DSCH cell (CQI4 or PCI/CQI4) are mapped according to Figure 20F.1.
    - The report for the 5<sup>th</sup> secondary serving HS-DSCH cell (CQI3 or PCI/CQI3) and the 7<sup>th</sup> secondary serving HS-DSCH cell (CQI4 or PCI/CQI4) are mapped according to Figure 20F.1.
- When Secondary\_Cell\_Active is less than 7 the mapping of the CQI or PCI/CQI reports is the same as the case when Secondary\_Cell\_Active is 7 with the following exceptions:
  - When one of the 1<sup>st</sup>, 2<sup>nd</sup> or 3<sup>rd</sup> secondary serving HS-DSCH cell is deactivated the HS-DPCCH physical channel mapping function shall map the input bits  $b_k$  directly to the physical channel in the corresponding slot of the CQI (or PCI/CQI) field of that subframe while the other slot of the CQI (or PCI/CQI) field is DTXed in the subframe in which only one active cell is mapped.
  - When one of the 4<sup>th</sup>, 5<sup>th</sup>, 6<sup>th</sup> or 7<sup>th</sup> secondary serving HS-DSCH cell is deactivated the HS-DPCCH physical channel mapping function shall map the input bits  $b_k$  directly to the physical channel in the corresponding slot of the CQI (or PCI/CQI) field of that subframe while the other slot of the CQI (or PCI/CQI) field is DTXed in the subframe in which only one active cell is mapped.
  - If at most one of the 1<sup>st</sup>, 2<sup>nd</sup>, or 3<sup>rd</sup> secondary serving HS-DSCH cell is activated the CQI or PCI/CQI report for each active cell is mapped to a separate subframe as specified in [4]. In each

subframe, the HS-DPCCH physical channel mapping function shall map the input bits to the physical channel according to Figure 20G.

- If at most two of the 4<sup>th</sup>, 5<sup>th</sup>, 6<sup>th</sup> or 7<sup>th</sup> secondary serving HS-DSCH cell is activated the CQI or PCI/CQI report for each active cell is mapped to a separate subframe as specified in [4]. In each subframe, the HS-DPCCH physical channel mapping function shall map the input bits to the physical channel according to Figure 20G.

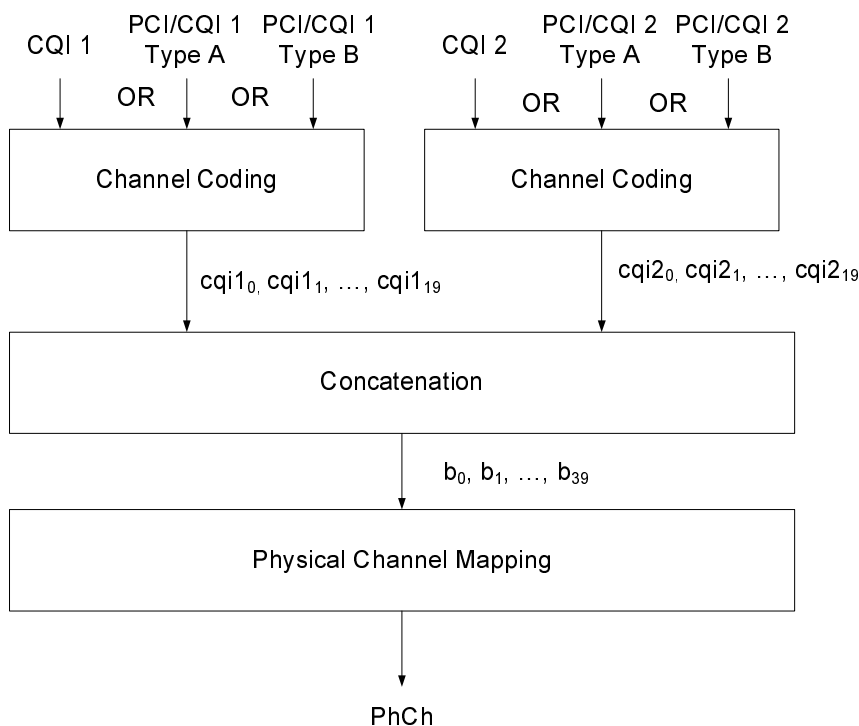
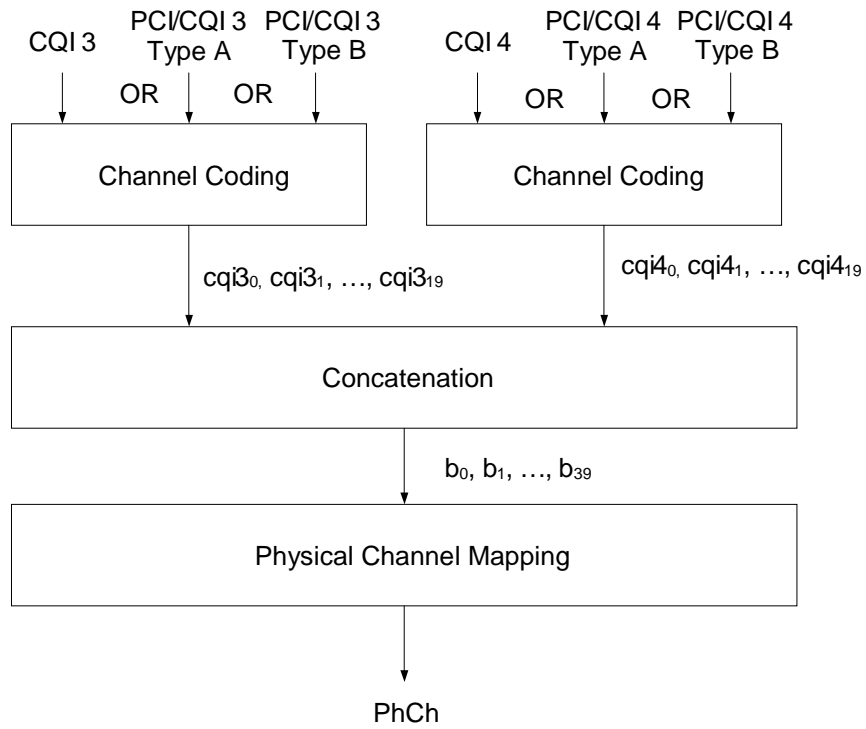

**Figure 20F: Concatenation of CQI (or PCI/CQI) reports in the CQI (or PCI/CQI) field of a sub-frame**

In Figure 20F, the two individual CQI (or PCI/CQI) reports are concatenated to form the composite channel quality indication according to the relation

$$(b_0 b_1 \dots b_{19} b_{20} b_{21} \dots b_{39}) = (cqi1_0 cqi1_1 \dots cqi1_{19} cqi2_0 cqi2_1 \dots cqi2_{19})$$





**Figure 20F.1: Concatenation of CQI (or PCI/CQI) reports in the CQI (or PCI/CQI) field of a sub-frame on HS-DPCCH<sub>2</sub>.**

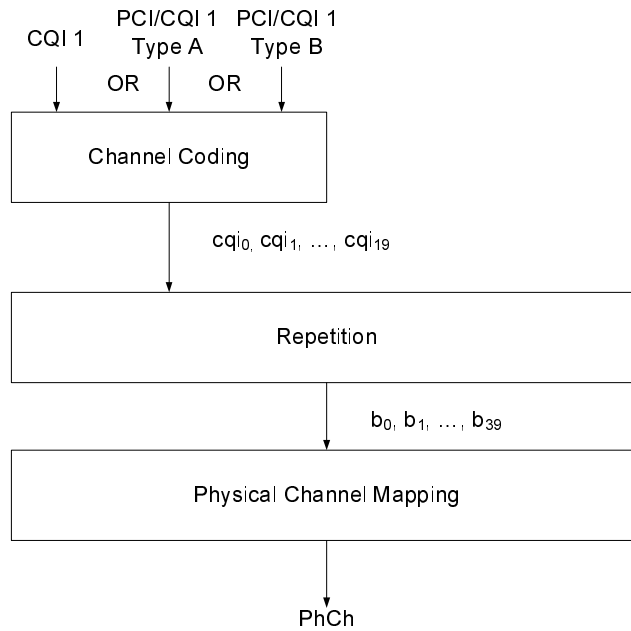

**Figure 20G: Repetition of CQI or PCI/CQI reports**

In Figure 20G, the CQI (or PCI/CQI) report is repeated according to the relation

$$(b_0 b_1 \dots b_{19} b_{20} b_{21} \dots b_{39}) = (cqi1_0 cqi1_1 \dots cqi1_{19} cqi1_0 cqi1_1 \dots cqi1_{19})$$

#### 4.7.4.3 Physical Channel mapping for HS-DPCCH HARQ-ACK and PCI/CQI when the UE is configured in Multiflow mode

The notation used in the following subclauses is as defined below:

Cell activation status "A": Indicates a cell that is active (not deactivated by an HS-SCCH order).

Cell activation status "-": Indicates a cell that is inactive (deactivated by an HS-SCCH order).

Cell group n: A group of (one or two) cells that have the same CPICH timing. The CQI reports for all the cells in a cell group are reported together in one HS-DPCCH subframe. The cells that belong to a cell group are indicated by higher layers.

$A_i$  &  $A_j$ : HARQ-ACK field for jointly encoded HARQ-ACK information of cell  $i$  and cell  $j$ .

$A_i$  &  $A_j$  &  $A_k$ : HARQ-ACK field for jointly encoded HARQ-ACK information of cell  $i$ , cell  $j$  and cell  $k$ .

$A_i$  & D: HARQ-ACK field for jointly encoded HARQ-ACK information of cell  $i$  and DTX indication.

$A_i$  &  $A_j$  & D: HARQ-ACK field for jointly encoded HARQ-ACK information of cell  $i$ , cell  $j$  and DTX indication.

$A_i$  & D &  $A_j$ : HARQ-ACK field for jointly encoded HARQ-ACK information of cell  $i$ , DTX indication, and HARQ-ACK information of cell  $j$ .

CQI $_i$ : CQI field for CQI information of cell  $i$ .

PCI/CQI $_i$ : PCI/CQI field for jointly encoded PCI and CQI information of cell  $i$ .

CQI $_i$  & CQI $_j$ : Jointly encoded CQI field for CQI information of cell  $i$  and cell  $j$ .

##### 4.7.4.3.1 Physical Channel mapping for HS-DPCCH HARQ-ACK and PCI/CQI when the UE is configured with one serving and one assisting serving HS-DSCH cell

When MIMO is not configured in any cell;

- The HS-DPCCH mapping follows the table 15C.8.
- The HARQ-ACK and CQI encoding follow the definition in subclause 4.7.3A.
- HS-DPCCH is transmitted using slot format #0.

**Table 15C.8: The UE is configured with one serving and one assisting serving HS-DSCH cell and no cells are in MIMO mode**

MF case	Cell activation status		HS-DPCCH subframe		
	Cell group 1	Cell group 2	Slot 0	Slot 1	Slot 2
	Cell0	Cell1			
1	A	A	A0 & A1	CQI0 & CQI1	

In this table cell 0 refers to the serving HS-DSCH cell, and cell 1 refers to the assisting serving HS-DSCH cell.

When MIMO is configured in at least one cell;

- The HS-DPCCH mapping follows the table 15C.9.
- The HARQ-ACK encoding follows the subclause 4.7.3D.1.
- The channel coding for CQI associated with a cell for which the UE is not configured in MIMO mode is specified in subclause 4.7.2.2.
- The channel coding for PCI and CQI associated with a cell for which the UE is configured in MIMO mode is specified in subclause 4.7.3.2.
- HS-DPCCH is transmitted using slot format #0.

**Table 15C.9: The UE is configured with one serving and one assisting serving HS-DSCH cell and at least one cell is configured in MIMO mode**

MF case	Cell activation status			HS-DPCCH subframe #1			HS-DPCCH subframe #2		
	Cell group 1		Cell group 2	Slot 0	Slot 1	Slot 2	Slot 0	Slot 1	Slot 2
	Cell0	Cell1	Cell1						
2	A	A	A	A0 & A1	PCI/CQI0		A0 & A1	PCI/CQI1	

In this table cell 0 refers to the serving HS-DSCH cell, and cell 1 refers to the assisting serving HS-DSCH cell.

#### 4.7.4.3.2 Physical Channel mapping for HS-DPCCH HARQ-ACK and PCI/CQI when the UE is configured with two serving and one assisting serving or one serving and two assisting serving HS-DSCH cells

When MIMO is not configured in any cell;

- If the UE is configured with two serving and one assisting serving HS-DSCH cells the HS-DPCCH mapping follows the table 15C.10
- If the UE is configured with one serving and two assisting serving HS-DSCH cells the HS-DPCCH mapping follows the table 15C.11.
- The HARQ-ACK encoding follow the definition in subclause 4.7.3C.1.
- The CQI encoding for composite CQI reports containing channel quality indication for two cells follows the definition in subclause 4.7.3A.2
- The CQI encoding for the separately encoded CQI reports follows the definition in subclause 4.7.2.2.
- HS-DPCCH is transmitted using slot format #0.

**Table 15C.10: The UE is configured with two serving and one assisting serving HS-DSCH cells and no cells are in MIMO mode**

MF case	Cell activation status			HS-DPCCH subframe #1			HS-DPCCH subframe #2		
	Cell group 1		Cell group 2	Slot 0	Slot 1	Slot 2	Slot 0	Slot 1	Slot 2
	Cell0	Cell1	Cell2						
3	A	A	A	A0&A1&A2	CQI0 & CQI1		A0&A1&A2	CQI2	
4	A	-	A	A0&D&A2	CQI0		A0&D&A2	CQI2	

In this table cell 0 refers to the serving HS-DSCH cell, cell 1 refers to the secondary serving HS-DSCH cell and cell 2 refers to the assisting serving HS-DSCH cell.

**Table 15C.11: The UE is configured with one serving and two assisting serving HS-DSCH cells and no cells are in MIMO mode**

MF case	Cell activation status			HS-DPCCH subframe #1			HS-DPCCH subframe #2		
	Cell group 1	Cell group 2		Slot 0	Slot 1	Slot 2	Slot 0	Slot 1	Slot 2
	Cell0	Cell1	Cell2						
5	A	A	A	A0&A1&A2	CQI0		A0&A1&A2	CQI1 & CQI2	
6	A	A	-	A0&A1&D	CQI0		A0&A1&D	CQI1	

In this table cell 0 refers to the serving HS-DSCH cell, cell 1 refers to the assisting serving HS-DSCH cell and cell 2 refers to the assisting secondary serving HS-DSCH cell.

When MIMO is configured in at least one cell;

- If the UE is configured with two serving and one assisting serving HS-DSCH cells the HS-DPCCH mapping follows the table 15C.12
- If the UE is configured with one serving and two assisting serving HS-DSCH cells the HS-DPCCH mapping follows the table 15C.13.
- The channel coding for HARQ-ACK for all cells is specified in subclause 4.7.3B.1.
- The channel coding for CQI associated with a cell for which the UE is not configured in MIMO mode is specified in subclause 4.7.2.2.
- The channel coding for PCI and CQI associated with a cell for which the UE is configured in MIMO mode is specified in subclause 4.7.3.2.

- HS-DPCCH is transmitted using slot format #1.

**Table 15C.12: The UE is configured with two serving and one assisting serving HS-DSCH cells and at least one cell is configured in MIMO mode**

MF case	Cell activation status			HS-DPCCH subframe #1				HS-DPCCH subframe #2			
	Cell group 1		Cell group 2	Slot 0		Slot 1	Slot 2	Slot 0		Slot 1	Slot 2
	Cell0	Cell1		Cell2	A0&A1	A2&D	PCI/CQI0	PCI/CQI1	A0&A1	A2&D	PCI/CQI2
7	A	A	A	A0&A1	A2&D	PCI/CQI0	PCI/CQI1	A0&A1	A2&D	PCI/CQI2	PCI/CQI2
8	A	-	A	A0&D	A2&D	PCI/CQI0	PCI/CQI0	A0&D	A2&D	PCI/CQI2	PCI/CQI2

In this table cell 0 refers to the serving HS-DSCH cell, cell 1 refers to the secondary serving HS-DSCH cell and cell 2 refers to the assisting serving HS-DSCH cell.

**Table 15C.13: The UE is configured with one serving and two assisting serving HS-DSCH cells and at least one cell is configured in MIMO mode**

MF case	Cell activation status			HS-DPCCH subframe #1				HS-DPCCH subframe #2			
	Cell group 1	Cell group 2		Slot 0		Slot 1	Slot 2	Slot 0		Slot 1	Slot 2
		Cell0	Cell1	Cell2	A0&D	A1&A2	PCI/CQI0	PCI/CQI0	A0&D	A1&A2	PCI/CQI1
9	A	A	A	A0&D	A1&A2	PCI/CQI0	PCI/CQI0	A0&D	A1&A2	PCI/CQI1	PCI/CQI2
10	A	A	-	A0&D	A1&D	PCI/CQI0	PCI/CQI0	A0&D	A1&D	PCI/CQI1	PCI/CQI1

In this table cell 0 refers to the serving HS-DSCH cell, cell 1 refers to the assisting serving HS-DSCH cell and cell 2 refers to the assisting secondary serving HS-DSCH cell.

#### 4.7.4.3.3 Physical Channel mapping for HS-DPCCH HARQ-ACK and PCI/CQI when the UE is configured with two serving and two assisting serving HS-DSCH cells

When MIMO is not configured in any cell;

- The HS-DPCCH mapping follows the table 15C.14
- The channel coding for HARQ-ACK is specified in subclause 4.7.3B.1.
- The channel coding for CQI is specified in subclause 4.7.2.2.
- HS-DPCCH is transmitted using slot format #1.

**Table 15C.14: The UE is configured with two serving and two assisting serving HS-DSCH cells and no cells are in MIMO mode**

MF case	Cell activation status				HS-DPCCH subframe #1				HS-DPCCH subframe #2			
	Cell group 1		Cell group 2		Slot 0		Slot 1	Slot 2	Slot 0		Slot 1	Slot 2
	Cell0	Cell1	Cell2	Cell3	A0&A1	A2&A3	CQI0	CQI1	A0&A1	A2&A3	CQI2	CQI3
11	A	A	A	A	A0&A1	A2&A3	CQI0	CQI1	A0&A1	A2&A3	CQI2	CQI3
12	A	A	A	-	A0&A1	A2&D	CQI0	CQI1	A0&A1	A2&D	CQI2	CQI2
13	A	-	A	A	A0&D	A2&A3	CQI0	CQI0	A0&D	A2&A3	CQI2	CQI3
14	A	-	A	-	A0&D	A2&D	CQI0	CQI0	A0&D	A2&D	CQI2	CQI2

In this table cell 0 refers to the serving HS-DSCH cell, cell 1 refers to the secondary serving HS-DSCH cell, cell 2 refers to the assisting serving HS-DSCH cell and cell 3 refers to the assisting secondary serving HS-DSCH cell.

When MIMO is configured in at least one cell;

- The HS-DPCCH mapping follows the table 15C.15
- The channel coding for HARQ-ACK for all cells is specified in subclause 4.7.3B.1.
- The channel coding for CQI associated with a cell for which the UE is not configured in MIMO mode is specified in subclause 4.7.2.2.
- The channel coding for PCI and CQI associated with a cell for which the UE is configured in MIMO mode is specified in subclause 4.7.3.2.
- HS-DPCCH is transmitted using slot format #1.

**Table 15C.15: The UE is configured with two serving and two assisting serving HS-DSCH cells and at least one cell is configured in MIMO mode**

MF case	Cell activation status				HS-DPCCH subframe #1				HS-DPCCH subframe #2					
	Cell group 1		Cell group 2		Slot 0		Slot 1		Slot 0		Slot 1		Slot 2	
	Cell0	Cell1	Cell2	Cell3										
15	A	A	A	A	A0&A1	A2&A3	PCI/CQI0	PCI/CQI1	A0&A1	A2&A3	PCI/CQI2	PCI/CQI3		
16	A	A	A	-	A0&A1	A2&D	PCI/CQI0	PCI/CQI1	A0&A1	A2&D	PCI/CQI2	PCI/CQI2		
17	A	-	A	A	A0&D	A2&A3	PCI/CQI0	PCI/CQI0	A0&D	A2&A3	PCI/CQI2	PCI/CQI3		
18	A	-	A	-	A0&D	A2&D	PCI/CQI0	PCI/CQI0	A0&D	A2&D	PCI/CQI2	PCI/CQI2		

In this table cell 0 refers to the serving HS-DSCH cell, cell 1 refers to the secondary serving HS-DSCH cell, cell 2 refers to the assisting serving HS-DSCH cell and cell 3 refers to the assisting secondary serving HS-DSCH cell.

#### 4.7.4.4 Physical Channel mapping for HS-DPCCH when the UE is configured in MIMO mode with four transmit antennas in at least one cell

##### 4.7.4.4.1 Physical Channel mapping for HS-DPCCH HARQ-ACK

If the HS-DPCCH slot format 0 as defined in [2], is used, the HS-DPCCH physical channel mapping function shall map the input bits  $w_k$  directly to physical channel so that bits are transmitted over the air in ascending order with respect to  $k$ .

If the HS-DPCCH slot format 1 as defined in [2], is used, the HS-DPCCH physical channel mapping function shall map the input bits  $w_k$  to the physical channel so that bits are transmitted over the air in ascending order with respect to  $k$  as follows:

- If Secondary\_Cell\_Enabled is equal to 3 and Secondary\_Cell\_Active is equal to 3
  - The following HARQ-ACK messages are transmitted on HS-DPCCH:
    - HARQ-ACK comprising the HARQ acknowledgement messages for the pair of serving HS-DSCH cell and 1<sup>st</sup> secondary serving HS-DSCH cell in that order
  - The following HARQ-ACK messages are transmitted on HS-DPCCH<sub>2</sub>:
    - HARQ-ACK comprising the HARQ acknowledgement messages for the pair of the 2<sup>nd</sup> secondary serving HS-DSCH cell and the 3<sup>rd</sup> secondary serving HS-DSCH cell in that order
- If Secondary\_Cell\_Enabled is equal to 2 and Secondary\_Cell\_Active is equal to 2
  - The following HARQ-ACK messages are transmitted on HS-DPCCH:
    - HARQ-ACK comprising the HARQ acknowledgement messages for the pair of serving HS-DSCH cell and 1<sup>st</sup> secondary serving HS-DSCH cell in that order
  - The following HARQ-ACK messages are transmitted on HS-DPCCH<sub>2</sub>:
    - HARQ-ACK comprising the HARQ acknowledgement message for the 2<sup>nd</sup> secondary serving HS-DSCH cell
- If Secondary\_Cell\_Enabled is equal to 1 and Secondary\_Cell\_Active is equal to 1
  - The following two HARQ-ACK messages are transmitted on HS-DPCCH
    - HARQ-ACK comprising the HARQ acknowledgement messages for the pair of serving HS-DSCH cell and 1<sup>st</sup> secondary serving HS-DSCH cell in that order
- If Secondary\_Cell\_Enabled is equal to 3 and Secondary\_Cell\_Active is less than Secondary\_Cell\_Enabled:
  - If none of the 2<sup>nd</sup> or 3<sup>rd</sup> secondary serving HS-DSCH cell is activated HS-DPCCH<sub>2</sub> is not transmitted

- If only one of the 2<sup>nd</sup> or 3<sup>rd</sup> secondary serving HS-DSCH cell is activated the HARQ-ACK is repeated according to the Figure 20E
- If the 1<sup>st</sup> secondary serving HS-DSCH cell is not activated the HARQ-ACK is repeated according to the Figure 20E
- Otherwise the transmissions of the HARQ-ACK messages are the same as if Secondary\_Cell\_Active was equal to Secondary\_Cell\_Enabled.
- If Secondary\_Cell\_Enabled is equal to 2 and Secondary\_Cell\_Active is less than Secondary\_Cell\_Enabled:
  - If the 2<sup>nd</sup> secondary serving HS-DSCH cell is not activated the HARQ-ACK transmissions on HS-DPCCH<sub>2</sub> are DTXed
  - If the 1<sup>st</sup> secondary serving HS-DSCH cell is not activated the HARQ-ACK is repeated according to the Figure 20E
  - Otherwise the transmissions of the HARQ-ACK messages are the same as if Secondary\_Cell\_Active was equal to Secondary\_Cell\_Enabled.
- If Secondary\_Cell\_Enabled is equal to 1 and Secondary\_Cell\_Active is 0 then the transmission of the HARQ-ACK message is repeated according to Figure 20E.

#### 4.7.4.4.2 Physical Channel mapping for HS-DPCCH NTBP/PCI/CQI

If the HS-DPCCH slot format 0 as defined in [2] is used, the HS-DPCCH physical channel mapping function shall map the input bits  $b_k$  directly to physical channel so that bits are transmitted over the air in ascending order with respect to  $k$ .

If the HS-DPCCH slot format 1 as defined in [2] is used, the HS-DPCCH physical channel mapping function shall map the input bits  $b_k$  directly to physical channel so that bits are transmitted over the air in ascending order with respect to  $k$ .

- If Secondary\_Cell\_Enabled is equal to 3 and Secondary\_Cell\_Active is equal to 3
  - The following is transmitted on HS-DPCCH:
    - The report for the serving HS-DSCH cell (CQI1 or PCI/CQI1 or NTBP/PCI/CQI1) and the 1<sup>st</sup> secondary serving HS-DSCH cell (CQI2 or PCI/CQI2 or NTBP/PCI/CQI2) are mapped to a separate subframe as specified in [4].
    - If the serving cell is configured in MIMO mode with four transmit antennas and the 1<sup>st</sup> secondary serving cell is not configured in MIMO mode with four transmit antennas, the CQI2 or PCI/CQI2 of the 1<sup>st</sup> secondary serving cell is repeated.
    - If the serving cell is not configured in MIMO mode with four transmit antennas and the 1<sup>st</sup> secondary serving cell is configured in MIMO mode with four transmit antennas, the CQI1 or PCI/CQI1 of the serving cell is repeated.
    - If both the serving cell and 1<sup>st</sup> secondary serving cell are not configured in MIMO mode with four transmit antennas the CQI1 or PCI/CQI1 and CQI2 or PCI/CQI2 are mapped to a separate subframe as specified in [4].
  - The following is transmitted on HS-DPCCH<sub>2</sub>:
    - The report for the 2<sup>nd</sup> secondary HS-DSCH cell (CQI3 or PCI/CQI3 or NTBP/PCI/CQI3) and the 3<sup>rd</sup> secondary HS-DSCH cell (CQI4 or PCI/CQI4 or NTBP/PCI/CQI4) are mapped to a separate subframe as specified in [4].
    - If the 2<sup>nd</sup> serving cell is configured in MIMO mode with four transmit antennas and the 3<sup>rd</sup> secondary serving cell is not configured in MIMO mode with four transmit antennas, the CQI4 or PCI/CQI4 of the 3<sup>rd</sup> secondary serving cell is repeated.
    - If the 2<sup>nd</sup> serving cell is not configured in MIMO mode with four transmit antennas and the 3<sup>rd</sup> secondary serving cell is configured in MIMO mode with four transmit antennas, the CQI3 or PCI/CQI3 of the 2<sup>nd</sup> serving cell is repeated.

- If both the 2<sup>nd</sup> serving cell and 3<sup>rd</sup> secondary serving cell are not configured in MIMO mode with four transmit antennas the CQI3 or PCI/CQI3 and CQI4 or PCI/CQI4 are mapped to a separate subframe as specified in [4].
- If Secondary\_Cell\_Enabled is equal to 2 and Secondary\_Cell\_Active is equal to 2
  - The following is transmitted on HS-DPCCH:
    - The report for the serving HS-DSCH cell (CQI1 or PCI/CQI1 or NTBP/PCI/CQI1) and the 1<sup>st</sup> secondary serving HS-DSCH cell (CQI2 or PCI/CQI2 or NTBP/PCI/CQI2) are mapped to a separate subframe as specified in [4].
    - If the serving cell is configured in MIMO mode with four transmit antennas and the 1<sup>st</sup> secondary serving cell is not configured in MIMO mode with four transmit antennas, the CQI2 or PCI/CQI2 of the 1<sup>st</sup> secondary serving cell is repeated.
    - If the serving cell is not configured in MIMO mode with four transmit antennas and the 1<sup>st</sup> secondary serving cell is configured in MIMO mode with four transmit antennas, the CQI1 or PCI/CQI1 of the serving cell is repeated.
    - If both the serving cell and 1<sup>st</sup> secondary serving cell are not configured in MIMO mode with four transmit antennas the CQI1 or PCI/CQI1 and CQI2 or PCI/CQI2 are mapped to a separate subframe as specified in [4].
  - The following is transmitted on HS-DPCCH<sub>2</sub>:
    - If the 2<sup>nd</sup> serving cell is configured in MIMO mode with four transmit antennas the HS-DPCCH<sub>2</sub> physical channel mapping function shall map NTBP/ PCI/CQI3 to the physical channel.
    - If the 2<sup>nd</sup> serving cell is not configured in MIMO mode with four transmit antennas the HS-DPCCH<sub>2</sub> physical channel mapping function shall map CQI3 or PCI/CQI3 to the physical channel.
- If Secondary\_Cell\_Enabled is equal to 1 and Secondary\_Cell\_Active is equal to 1
  - The following is transmitted on HS-DPCCH:
    - The report for the serving HS-DSCH cell (CQI1 or PCI/CQI1 or NTBP/PCI/CQI1) and the 1<sup>st</sup> secondary serving HS-DSCH cell (CQI2 or PCI/CQI2 or NTBP/PCI/CQI2) are mapped to a separate subframe as specified in [4].
    - If the serving cell is configured in MIMO mode with four transmit antennas and the 1<sup>st</sup> secondary serving cell is not configured in MIMO mode with four transmit antennas, the CQI2 or PCI/CQI2 of the 1<sup>st</sup> secondary serving cell is repeated.
    - If the serving cell is not configured in MIMO mode with four transmit antennas and the 1<sup>st</sup> secondary serving cell is configured in MIMO mode with four transmit antennas, the CQI1 or PCI/CQI1 of the serving cell is repeated.
- If Secondary\_Cell\_Enabled is equal to 1 and Secondary\_Cell\_Active is less than Secondary\_Cell\_Enabled:
  - The following is transmitted on HS-DPCCH:
    - The report for the serving HS-DSCH cell (CQI1 or PCI/CQI1 or NTBP/PCI/CQI1) and the 1<sup>st</sup> secondary serving HS-DSCH cell (CQI2 or PCI/CQI2 or NTBP/PCI/CQI2) are mapped to a separate subframe as specified in [4]. The slots corresponding to the (CQI2 or PCI/CQI2 or NTBP/PCI/CQI2) are DTXed.
- If Secondary\_Cell\_Enabled is equal to 2 and Secondary\_Cell\_Active is less than Secondary\_Cell\_Enabled:
  - If the 2<sup>nd</sup> serving cell is not activated HS-DPCCH<sub>2</sub> is not transmitted.
  - The following is transmitted on HS-DPCCH:

- The report for the serving HS-DSCH cell (CQI1 or PCI/CQI1 or NTBP/PCI/CQI1) and the 1st secondary serving HS-DSCH cell (CQI2 or PCI/CQI2 or NTBP/PCI/CQI2) are mapped to a separate subframe as specified in [4]. The slots corresponding to the (CQI2 or PCI/CQI2 or NTBP/PCI/CQI2) are DTXed.
- The following is transmitted on HS-DPCCH<sub>2</sub>:
  - If the 2<sup>nd</sup> serving cell is configured in MIMO mode with four transmit antennas the HS-DPCCH<sub>2</sub> physical channel mapping function shall map NTBP/ PCI/CQI3 to the physical channel
  - If the 2<sup>nd</sup> serving cell is not configured in MIMO mode with four transmit antennas the HS-DPCCH<sub>2</sub> physical channel mapping function shall map CQI3 or PCI/CQI3 to the physical channel.
- If Secondary\_Cell\_Enabled is equal to 3 and Secondary\_Cell\_Active is less than Secondary\_Cell\_Enabled:
  - If none of the 2<sup>nd</sup> or 3<sup>rd</sup> secondary serving HS-DSCH cell is activated HS-DPCCH<sub>2</sub> is not transmitted and the rules in case Secondary\_Cell\_Enabled is equal to 1 and Secondary\_Cell\_Active is equal to 1 are followed for HS-DPCCH
  - The following is transmitted on HS-DPCCH:
    - The report for the serving HS-DSCH cell (CQI1 or PCI/CQI1 or NTBP/PCI/CQI1) and the 1st secondary serving HS-DSCH cell (CQI2 or PCI/CQI2 or NTBP/PCI/CQI2) are mapped to a separate subframe as specified in [4]. The slots corresponding to the (CQI2 or PCI/CQI2 or NTBP/PCI/CQI2) are DTXed.
- The following is transmitted on HS-DPCCH<sub>2</sub>:
  - If the 3<sup>rd</sup> secondary serving HS-DSCH cell is not activated, the report for the 2<sup>nd</sup> secondary HS-DSCH cell (CQI3 or PCI/CQI3 or NTBP/PCI/CQI3) and the 3<sup>rd</sup> secondary serving HS-DSCH cell (CQI4 or PCI/CQI4 or NTBP/PCI/CQI4) are mapped to a separate subframe as specified in [4]. The slots corresponding to the (CQI4 or PCI/CQI4 or NTBP/PCI/CQI4) are DTXed.
  - If the 2<sup>nd</sup> secondary serving HS-DSCH cell is not activated, the report for the 3<sup>rd</sup> secondary HS-DSCH cell (CQI4 or PCI/CQI4 or NTBP/PCI/CQI4) and the 2<sup>nd</sup> secondary serving HS-DSCH cell (CQI3 or PCI/CQI3 or NTBP/PCI/CQI3) are mapped to a separate subframe as specified in [4]. The slots corresponding to the (CQI3 or PCI/CQI3 or NTBP/PCI/CQI3) are DTXed.
- If Secondary\_Cell\_Enabled is equal to 0
  - The following is transmitted on HS-DPCCH:
    - The physical channel mapping function shall map NTBP/ PCI/CQI1 to the physical channel.

## 4.8 Coding for E-DCH

Figure 21 shows the processing structure for the E-DCH transport channel mapped onto a separate CCTrCH.

If UL\_MIMO\_Enabled is not set to TRUE, or UL\_MIMO\_Enabled is set to TRUE and UL\_CLTD\_Active is not 1, data arrives to the coding unit in form of a maximum of one transport block once every transmission time interval (TTI).

If UL\_MIMO\_Enabled is set to TRUE and UL\_CLTD\_Active = 1, data arrives to the coding unit in form of a maximum of two transport blocks once every TTI.

- If a single transport block arrives to the coding unit in a TTI, the transport block is processed as when UL\_MIMO\_Enabled is not set to TRUE.
- If two transport blocks arrive to the coding unit in a TTI, each transport block is separately processed as when UL\_MIMO\_Enabled is not set to TRUE, with the exception of the rank-dependent determinations of SF, modulation, number of E-DPDCHs and S-E-DPDCHs, and the physical channel mapping.



The following coding steps can be identified:

- Add CRC to the transport block
- Code block segmentation
- Channel coding
- Physical layer hybrid ARQ and rate matching
- Physical channel segmentation
- Interleaving
- Physical channel mapping

The coding steps for E-DCH transport channel are shown in the figure below.

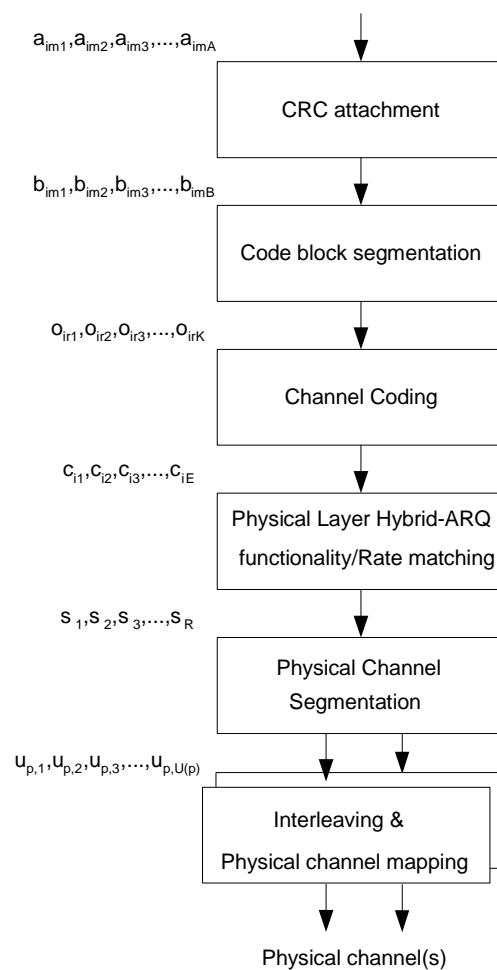

**Figure 21: Transport channel processing for E-DCH**

In the following the number of transport blocks per TTI and the number of transport channels is always one i.e.  $m=1$  and  $i=1$ . When referencing non E-DCH formulae which are used in correspondence with E-DCH formulae the convention is used that transport block subscripts may be omitted (e.g.  $X_l$  may be written  $X$ ).

### 4.8.1 CRC attachment for E-DCH

CRC attachment for the E-DCH transport channel shall be performed according to the general method described in 4.2.1 above with the following specific parameters.

The CRC length shall always be  $L_c=24$  bits.

### 4.8.2 Code block segmentation for E-DCH

Code block segmentation for the E-DCH transport channel shall be performed according to the general method described in 4.2.2.2 with the following specific parameters.

There is a maximum of one transport block. The bits  $b_{im1}, b_{im2}, b_{im3}, \dots, b_{imB_i}$  input to the block are mapped to the bits  $x_{i1}, x_{i2}, x_{i3}, \dots, x_{iX_i}$  directly. It follows that  $X_i = B_i$ . Note that the bits  $x$  referenced here refer only to the internals of the code block segmentation function. The output bits from the code block segmentation function are  $o_{ir1}, o_{ir2}, o_{ir3}, \dots, o_{irK}$ .

The value of  $Z = 5114$  for turbo coding shall be used.

### 4.8.3 Channel coding for E-DCH

Channel coding for the E-DCH transport channel shall be performed according to the general method described in clause 4.2.3 above with the following specific parameters.

There is a maximum of one transport block,  $i=1$ . The rate 1/3 turbo coding shall be used.

### 4.8.4 Physical layer HARQ functionality and rate matching for E-DCH

The hybrid ARQ functionality matches the number of bits at the output of the channel coder to the total number of bits of the E-DPDCH or S-E-DPDCH set to which the E-DCH transport channel is mapped. The hybrid ARQ functionality is controlled by the redundancy version (RV) parameters.

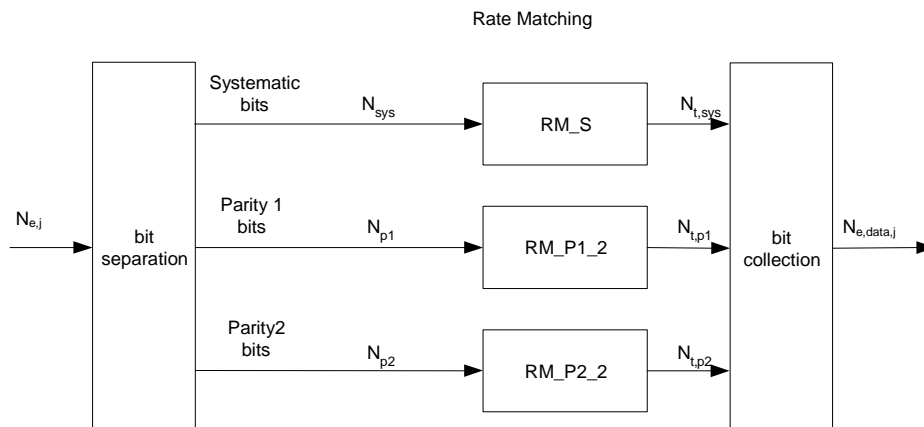

Figure 22: E-DCH hybrid ARQ functionality

#### 4.8.4.1 Determination of SF, modulation scheme and number of E-DPDCH PhCHs needed

The maximum amount of puncturing that can be applied is

- $1-PL_{non-max}$  if the modulation scheme or the number of code channels is less than the maximum allowed by the UE capability and restrictions imposed by UTRAN.

- $1-PL_{mod-switch}$  if the modulation scheme is BPSK, the number of E-DPDCH code channels equals to 4 and the usage of 4PAM is allowed by the UE capability and restrictions imposed by UTRAN.
- $1-PL_{mod-switch_2}$  if the modulation scheme is 4PAM, the number of E-DPDCH code channels equals to 4 and the usage of 8PAM is allowed by the UE capability and restrictions imposed by UTRAN.
- $1-PL_{max}$  if the modulation scheme and the number of code channels equals to the maximum allowed by the UE capability and restrictions imposed by UTRAN.

The number of available bits per TTI of one E-DPDCH for all possible spreading factors and modulation schemes is denoted by  $N_{256}, N_{128}, N_{64}, N_{32}, N_{16}, N_8, N_4, N_2, M_4, M_2, L_4$  and  $L_2$  where the index refers to the spreading factor.  $N$  refers to BPSK modulation,  $M$  to 4PAM modulation and  $L$  to 8PAM modulation.

The possible number of bits available to the CCTrCH of E-DCH type on all E-DPDCHs,  $N_{e,data}$ , then are  $\{N_{256}, N_{128}, N_{64}, N_{32}, N_{16}, N_8, N_4, 2 \times N_4, 2 \times N_2, 2 \times N_2 + 2 \times N_4, 2 \times M_2 + 2 \times M_4, 2 \times L_2 + 2 \times L_4\}$ .

SET0 denotes the set of  $N_{e,data}$  values allowed by the UTRAN and supported by the UE, as part of the UE's capability. SET0 can be a subset of  $\{N_{256}, N_{128}, N_{64}, N_{32}, N_{16}, N_8, N_4, 2 \times N_4, 2 \times N_2, 2 \times N_2 + 2 \times N_4, 2 \times M_2 + 2 \times M_4, 2 \times L_2 + 2 \times L_4\}$ .

The total number of bits in a TTI on all E-DPDCHs before rate matching with transport format  $j$  is  $N_{e,j}$ . The total number of bits available for the E-DCH transmission per TTI on all E-DPDCHs with transport format  $j$ ,  $N_{e,data,j}$ , is determined by executing the following algorithm, where

- $PL_{non-max}$  is signalled from higher layers,
- $PL_{mod-switch}$  is equal to 0.468,
- $PL_{mod-switch_2}$  is equal to 0.4,
- $PL_{max}$  is equal to 0.44, except when the  $N_{e,data} = 2 \times N_2 + 2 \times N_4, 2 \times M_2 + 2 \times M_4$  or  $2 \times L_2 + 2 \times L_4$  is allowed by the UTRAN and supported by the UE, in which case  $PL_{max}$  is equal to 0.33:

If the UE transmits only one transport block:

$$SET1 = \{ N_{e,data} \text{ in SET0 such that } N_{e,data} - N_{e,j} \text{ is non negative} \}$$

If SET1 is not empty and the smallest element of SET1 requires just one E-DPDCH then

$$N_{e,data,j} = \min SET1$$

Else

$$SET2 = \{ N_{e,data} \text{ in SET0 without } 2 \times N_2 + 2 \times N_4, 2 \times M_2 + 2 \times M_4 \text{ and } 2 \times L_2 + 2 \times L_4 \text{ such that } N_{e,data} - PL_{non-max} \times N_{e,j} \text{ is non negative} \}$$

If SET2 is not empty then

Sort SET2 in ascending order

$$N_{e,data} = \min SET2$$

While  $N_{e,data}$  is not the max of SET2 and the follower of  $N_{e,data}$  requires only one E-DPDCH do

$$N_{e,data} = \text{follower of } N_{e,data} \text{ in SET2}$$

End while

$$N_{e,data,j} = N_{e,data}$$

Else

If SET0 includes  $2 \times N_2 + 2 \times N_4$

$$N_{e,data} = 2 \times N_2 + 2 \times N_4$$

If  $N_{e,data} / N_{e,j} < PL_{mod\_switch}$  and SET0 includes  $2 \times M_2 + 2 \times M_4$

$$N_{e,data} = 2 \times M_2 + 2 \times M_4$$

End if

If  $N_{e,data}$  is equal to  $2 \times M_2 + 2 \times M_4$  and  $N_{e,data} / N_{e,j} < PL_{mod\_switch\_2}$  and SET0 includes  $2 \times L_2 + 2 \times L_4$

$$N_{e,data} = 2 \times L_2 + 2 \times L_4$$

End if

$N_{e,data,j} = N_{e,data}$  provided that  $N_{e,data,j} - PL_{max} \times N_{e,j}$  is non negative

Else

$N_{e,data,j} = \max \text{ SET0}$  provided that  $N_{e,data,j} - PL_{max} \times N_{e,j}$  is non negative

End if

End if

End if

Else (when UE transmits two transport blocks)

$$N_{e,data} = 2 \times N_2 + 2 \times N_4$$

If  $N_{e,data} / N_{e,j} < PL_{mod\_switch}$  and SET0 includes  $2 \times M_2 + 2 \times M_4$

$$N_{e,data} = 2 \times M_2 + 2 \times M_4$$

End if

If  $N_{e,data}$  is equal to  $2 \times M_2 + 2 \times M_4$ ,  $N_{e,data} / N_{e,j} < PL_{mod\_switch\_2}$  and SET0 includes  $2 \times L_2 + 2 \times L_4$

$$N_{e,data} = 2 \times L_2 + 2 \times L_4$$

End if

$N_{e,data,j} = N_{e,data}$  provided that  $N_{e,data} - PL_{max} \times N_{e,j}$  is non negative

End if

While E-DCH TTI length is 10 ms, if an initial transmission occurs in a compressed frame, or a retransmission occurs in a compressed frame, or a retransmission occurs in a non-compressed frame for which initial transmission was compressed, the number of available bits per TTI of one E-DPDCH for all possible spreading factors denoted by  $N_{256}$ ,  $N_{128}$ ,  $N_{64}$ ,  $N_{32}$ ,  $N_{16}$ ,  $N_8$ ,  $N_4$  and  $N_2$  used in the algorithm above is replaced by  $k \times N_{256}$ ,  $k \times N_{128}$ ,  $k \times N_{64}$ ,  $k \times N_{32}$ ,  $k \times N_{16}$ ,  $k \times N_8$ ,  $k \times N_4$  and  $k \times N_2$ . The parameter  $k$  is equal to  $n_{tx1}/15$  and  $n_{tx1}$  is defined in 4.4.5.1.

#### 4.8.4.1A Determination of SF, modulation scheme and number of S-E-DPDCH PhCHs needed

S-E-DPDCHs are only present when the UE transmits two transport blocks. When present, the number of S-E-DPDCHs is always 4.

The maximum amount of puncturing that can be applied is

- $1 - PL_{non-max}$  if the modulation scheme is less than the maximum allowed by the UE capability and restrictions imposed by UTRAN.
- $1 - PL_{mod\_switch}$  if the modulation scheme is BPSK and the usage of 4PAM is allowed by the UE capability and restrictions imposed by UTRAN.

- $1-PL_{mod\_switch\_2}$  if the modulation scheme is 4PAM and the usage of 8PAM is allowed by the UE capability and restrictions imposed by UTRAN.
- $1-PL_{max}$  if the modulation scheme equals to the maximum allowed by the UE capability and restrictions imposed by UTRAN.

The number of available bits per TTI of one S-E-DPDCH for all possible spreading factors and modulation schemes is denoted by  $N_4$ ,  $N_2$ ,  $M_4$ ,  $M_2$ ,  $L_4$  and  $L_2$ , where the index refers to the spreading factor.  $N$  refers to BPSK modulation,  $M$  to 4PAM modulation and  $L$  to 8PAM modulation.

The possible number of bits available to the CCTrCH of E-DCH type on all S-E-DPDCHs,  $N_{e,data}$ , then are  $\{2 \times N_2 + 2 \times N_4, 2 \times M_2 + 2 \times M_4, 2 \times L_2 + 2 \times L_4\}$ .

SET0 denotes the set of  $N_{e,data}$  values allowed by the UTRAN and supported by the UE, as part of the UE's capability. SET0 can be a subset of  $\{2 \times N_2 + 2 \times N_4, 2 \times M_2 + 2 \times M_4, 2 \times L_2 + 2 \times L_4\}$ .

The total number of bits in a TTI on all S-E-DPDCHs before rate matching with transport format  $j$  is  $N_{e,j}$ . The total number of bits available for the E-DCH transmission per TTI on all S-E-DPDCHs with transport format  $j$ ,  $N_{e,data,j}$ , is determined by executing the following algorithm, where

- $PL_{mod\_switch}$  is equal to 0.468,
- $PL_{mod\_switch\_2}$  is equal to 0.4,
- $PL_{max}$  is equal to 0.33:

$$N_{e,data} = 2 \times N_2 + 2 \times N_4$$

If  $N_{e,data} / N_{e,j} < PL_{mod\_switch}$  and SET0 includes  $2 \times M_2 + 2 \times M_4$

$$N_{e,data} = 2 \times M_2 + 2 \times M_4$$

End if

If  $N_{e,data}$  is equal to  $2 \times M_2 + 2 \times M_4$ ,  $N_{e,data} / N_{e,j} < PL_{mod\_switch\_2}$  and SET0 includes  $2 \times L_2 + 2 \times L_4$

$$N_{e,data} = 2 \times L_2 + 2 \times L_4$$

End if

$N_{e,data,j} = N_{e,data}$  provided that  $N_{e,data} - PL_{max} \times N_{e,j}$  is non negative

#### 4.8.4.2 HARQ bit separation

The HARQ bit separation function shall be performed in the same way as bit separation for turbo encoded TrCHs with puncturing in 4.2.7.4.1 above.

#### 4.8.4.3 HARQ Rate Matching Stage

The hybrid ARQ rate matching for the E-DCH transport channel shall be done with the general method described in 4.2.7.5 with the following specific parameters.

The parameters of the rate matching stage depend on the value of the RV parameters  $s$  and  $r$ . The  $s$  and  $r$  combinations corresponding to each RV allowed for the E-DCH are listed in the table below.

**Table 15D: RV for E-DCH**

E-DCH RV Index	$s$	$r$
0	1	0
1	0	0
2	1	1
3	0	1

The parameter  $e_{plus}$ ,  $e_{minus}$  and  $e_{ini}$  are calculated with the general method for QPSK as described in 4.5.4.3 above. The following parameters are used as input:

$$N_{sys} = N_{p1} = N_{p2} = N_{e,j}/3$$

$$N_{data} = N_{e,data,j}$$

$$r_{max} = 2$$

During uplink compressed frames while E-DCH TTI length is 10 ms and if  $N_{data} > N_{e,j}$ :

- If  $N_{data} \bmod 3 = 1$ , one  $\delta$  bit is added to the  $N_{t,sys}$  bits as the last systematic bit and another  $\delta$  bit is added to the  $N_{t,p1}$  bits as the last  $N_{t,p1}$  bit.
- If  $N_{data} \bmod 3 = 2$ , one  $\delta$  bit is added to the  $N_{t,sys}$  bits as the last systematic bit.

#### 4.8.4.4 HARQ bit collection

The HARQ bit collection shall be performed according to the general method for bit collection for turbo encoded TrCHs with puncturing as specified in 4.2.7.4.2 including the removal of the bits with value  $\delta$ .

### 4.8.5 Physical channel segmentation for E-DCH

When more than one E-DPDCH or S-E-DPDCH is used, physical channel segmentation distributes the bits among the different physical channels. The bits input to the physical channel segmentation are denoted by  $s_1, s_2, s_3, \dots, s_R$ , where  $R$  is the number of bits input to the physical channel segmentation block. The number of PhCHs is denoted by  $P$ .

The bits after physical channel segmentation are denoted  $u_{p,k}$  where  $p$  is the PhCH number.  $U(p)$  is the number of physical channel bits in one E-DCH TTI for the  $p^{\text{th}}$  E-DPDCH or S-E-DPDCH. The relation between  $s_k$  and  $u_{p,k}$  is given below.

Bits on first PhCH after physical channel segmentation:

$$u_{1,k} = s_k \quad k = 1, 2, \dots, U(1)$$

Bits on  $p^{\text{th}}$  PhCH after physical channel segmentation:

$$u_{p,k} = s_{k + \sum_{q=1}^{p-1} U(q)} \quad k = 1, 2, \dots, U(p)$$

### 4.8.6 Interleaving for E-DCH

The interleaving is done as shown in figure 22A below, separately for each physical channel. The bits input to the block interleaver are denoted by  $u_{p,1}, u_{p,2}, u_{p,3}, \dots, u_{p,U}$ , where  $p$  is PhCH number and  $U=U(p)$  is the number of bits in one TTI for one PhCH.

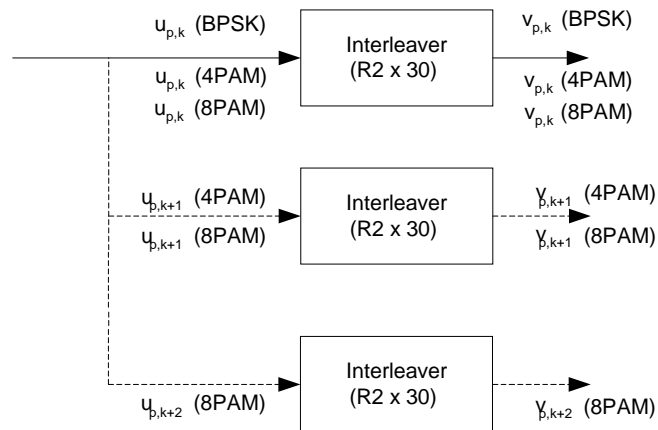

**Figure 22A: Interleaver structure for E-DCH**

The basic interleaver is as the 2<sup>nd</sup> interleaver described in Clause 4.2.11.

For 4PAM, there are two identical interleavers of the same size  $R2 \times 30$ , where  $R2$  is the minimum integer fulfilling  $\lceil U/2 \rceil \leq R2 \times 30$ . The output bits from the physical channel segmentation are divided one by one between the interleavers: bit  $u_{p,k}$  goes to the first interleaver and bit  $u_{p,k+1}$  goes to the second interleaver. Bits are collected one by one from the interleavers: bit  $v_{p,k}$  is obtained from the first interleaver and bit  $v_{p,k+1}$  is obtained from the second interleaver, where  $k \bmod 2 = 1$ .

For 8PAM, there are three identical interleavers of the same size  $R2 \times 30$ , where  $R2$  is the minimum integer fulfilling  $\lceil U/3 \rceil \leq R2 \times 30$ . The output bits from the physical channel segmentation are divided one by one between the interleavers: bit  $u_{p,k}$  goes to the first interleaver, bit  $u_{p,k+1}$  goes to the second interleaver and bit  $u_{p,k+2}$  goes to the third interleaver. Bits are collected one by one from the interleavers: bit  $v_{p,k}$  is obtained from the first interleaver, bit  $v_{p,k+1}$  is obtained from the second interleaver and bit  $v_{p,k+2}$  is obtained from the third interleaver, where  $k \bmod 3 = 1$ .

#### 4.8.7 Physical channel mapping for E-DCH

The E-DCH structure is described in [2]. The bits input to the physical channel mapping are denoted  $v_{p,1}, v_{p,2}, \dots, v_{p,U(p)}$ . The bits  $v_{p,k}$  are mapped to the PhCHs such that the bits for each PhCH are transmitted over the air in ascending order with respect to  $k$ .

During compressed frames in the uplink and when E-DCH TTI is 10 ms:

- For the initial transmission the bits shall be consecutively mapped to the non-idle slots. The UE shall not map any bit to the E-DPDCH idle slots specified in 4.4.5.1.
- In case a retransmission occurs in a compressed frame or a retransmission occurs in a non-compressed frame for which initial transmission was compressed:
  - If  $n_{txl} > n_{max}$ : The bits shall be consecutively mapped to the  $n_{max}$  available slots. The remaining bits are not transmitted.
  - If  $n_{txl} \leq n_{max}$ : The bits shall be consecutively mapped to the  $n_{txl}$  non-idle slots, whilst no bits are mapped to the idle slots.
  - The transmission gap position and the parameters  $n_{txl}$  and  $n_{max}$  are specified in 4.4.5.2.

### 4.9 Coding for E-DPCCH

The following information is transmitted by means of the E-DPCCH:

- Retransmission sequence number (RSN):  $x_{rsn,1}, x_{rsn,2}$
- E-TFCI:  $x_{tfc,1}, x_{tfc,2}, \dots, x_{tfc,7}$
- "Happy" bit:  $x_{h,1}$

## 4.9.1 Overview

The figure below illustrates the overall coding chain for E-DPCCH.

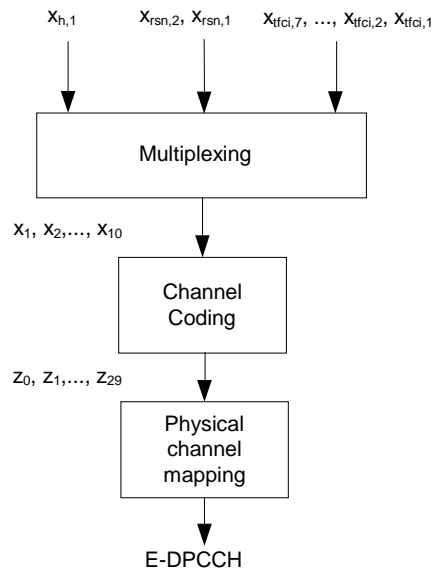

**Figure 23: Coding chain for E-DPCCH**

## 4.9.2 E-DPCCH information field mapping

### 4.9.2.1 Information field mapping of E-TFCI

The E-TFCI is mapped such that  $x_{tfc,1}$  corresponds to the MSB.

### 4.9.2.2 Information field mapping of retransmission sequence number

To indicate the redundancy version (RV) of each HARQ transmission and to assist the Node B soft buffer management a two bit retransmission sequence number (RSN) is signalled from the UE to the Node B. The Node B can avoid soft buffer corruption by flushing the soft buffer associated to one HARQ process in case more than 3 consecutive E-DPCCH transmissions on that HARQ process can not be decoded or the last received RSN is incompatible with the current one.

The RSN is set by higher layers as described in [16]. The RSN is mapped such that  $x_{rsn,1}$  corresponds to the MSB.

The applied E-DCH RV index specifying the used RV ( $s$  and  $r$  parameter) depends on the RSN, on  $N_{sys} / N_{e,data,j}$  and if RSN=3 also on the TTIN (TTI number). For 10 ms TTI the TTI number is equal to the CFN, for 2 ms TTI

$$TTIN = 5 * CFN + \text{subframe number}$$

where the subframe number counts the five TTIs which are within a given CFN, starting from 0 for the first TTI to 4 for the last TTI.  $N_{ARQ}$  is the number of Hybrid ARQ processes.



**Table 16: Relation between RSN value and E-DCH RV Index**

RSN Value	$N_{\text{sys}} / N_{e,\text{data},j} < 1/2$	$1/2 \leq N_{\text{sys}} / N_{e,\text{data},j}$
	E-DCH RV Index	E-DCH RV Index
0	0	0
1	2	3
2	0	2
3	$\lfloor \lfloor \text{TTI} / N_{\text{ARQ}} \rfloor \bmod 2 \rfloor \times 2$	$\lfloor \text{TTI} / N_{\text{ARQ}} \rfloor \bmod 4$

The UE shall use either

- an RV index as indicated in Table 16 and according to the RSN
- or, if signalled by higher layers only E-DCH RV index 0 independently of the RSN.

#### 4.9.2.3 Information field mapping of the "Happy" bit

The UE shall set  $x_{h,1}$  as specified in Table 16A.

**Table 16A: Mapping of "Happy" bit**

"Happy" bit	$x_{h,1}$
Happy	1
Not happy	0

### 4.9.3 Multiplexing of E-DPCCH information

The E-TFCI  $x_{\text{tfc},1}, x_{\text{tfc},2}, \dots, x_{\text{tfc},7}$ , the retransmission sequence number  $x_{\text{rsn},1}, x_{\text{rsn},2}$  and the "happy" bit  $x_{h,1}$  are multiplexed together. This gives a sequence of bits  $x_1, x_2, \dots, x_{10}$  where

$$x_k = x_{h,1} \quad k=1$$

$$x_k = x_{\text{rsn},4-k} \quad k=2,3$$

$$x_k = x_{\text{tfc},11-k} \quad k=4,5,\dots,10$$

### 4.9.4 Channel coding for E-DPCCH

Channel coding of the E-DPCCH is done using a sub-code of the second order Reed-Muller code. Coding is applied to the output  $x_1, x_2, \dots, x_{10}$  from the E-DPCCH multiplexing, resulting in:

$$z_i = \sum_{n=0}^9 (x_{n+1} \times M_{i,n}) \bmod 2 \quad i=0, 1, \dots, 29$$

The basis sequences are as described in 4.3.3 for  $i=0, 1, \dots, 29$ .

### 4.9.5 Physical channel mapping for E-DPCCH

The E-DPCCH is described in [2]. The sequence of bits  $z_0, z_1, \dots, z_{29}$  output from the E-DPCCH channel coding is mapped to the corresponding E-DPCCH sub frame. The bits are mapped so that they are transmitted over the air in ascending order with respect to  $i$ . If the E-DCH TTI is equal to 10 ms the sequence of bits is transmitted in all the E-DPCCH sub frames of the E-DPCCH radio frame.

For compressed frames in the uplink and the case when E-DCH TTI length is 10 ms, the bits mapped to the E-DPCCH idle slots specified in 4.4.5.3 shall not be transmitted.

## 4.9A Coding for S-E-DPCCH

The following information related to the transport block transmitted on the secondary stream is transmitted by means of the S-E-DPCCH:

- Retransmission sequence number (RSN):  $x_{rsn,1}, x_{rsn,2}$
- E-TFCI:  $x_{tfc,1}, x_{tfc,2}, \dots, x_{tfc,7}$
- Spare:  $x_{h,1}$

### 4.9A.1 Overview

Overall coding chain for S-E-DPCCH follows that of the E-DPCCH described in clause 4.9.1.

### 4.9A.2 S-E-DPCCH information field mapping

#### 4.9A.2.1 Information field mapping of E-TFCI

The E-TFCI mapping for S-E-DPCCH follows that of the E-DPCCH described in clause 4.9.2.1.

#### 4.9A.2.2 Information field mapping of retransmission sequence number

The RSN mapping for S-E-DPCCH follows that of the E-DPCCH described in clause 4.9.2.2.

#### 4.9A.2.3 Information field mapping of the Spare bit

This bit is fixed to "0" in this release of the specifications.

### 4.9A.3 Multiplexing of S-E-DPCCH information

The S-E-DPCCH multiplexing follows that of the E-DPCCH multiplexing described in clause 4.9.3.

### 4.9A.4 Channel coding for S-E-DPCCH

Channel coding for S-E-DPCCH follows the channel coding for E-DPCCH described in clause 4.9.4.

### 4.9A.5 Physical channel mapping for S-E-DPCCH

Physical channel mapping for S-E-DPCCH follows the physical channel mapping for E-DPCCH described in clause 4.9.5.

## 4.10 Coding for E-AGCH

The following information is transmitted by means of the absolute grant channel (E-AGCH):

- Absolute Grant Value:  $x_{agv,1}, x_{agv,2}, \dots, x_{agv,5}$
- Absolute Grant Scope:  $x_{ags,1}$

### 4.10.1 Overview

Figure 24 below illustrates the overall coding chain for the E-AGCH.

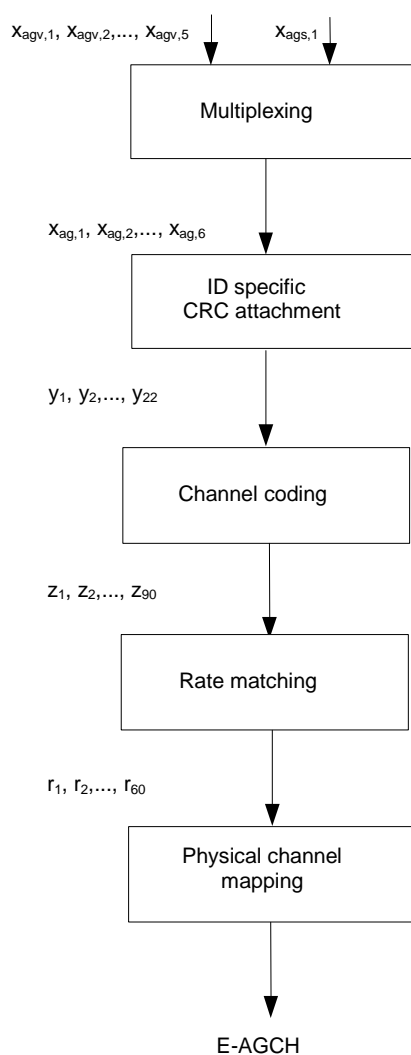

**Figure 24: Coding for E-AGCH**

## 4.10.1A E-AGCH information field mapping

### 4.10.1A.1 Information field mapping of the Absolute Grant Value

The Absolute Grant Value information is specified in Table 16B and Table 16.B.1. The values are mapped such that  $x_{agv,1}$  corresponds to the MSB of the index.

Based on higher layer signalling, either Table 16B or Table 16.B.1 is selected.

**Table 16B: Mapping of Absolute Grant Value**

Absolute Grant Value	Index
$(168/15)^2 \times 6$	31
$(150/15)^2 \times 6$	30
$(168/15)^2 \times 4$	29
$(150/15)^2 \times 4$	28
$(134/15)^2 \times 4$	27
$(119/15)^2 \times 4$	26
$(150/15)^2 \times 2$	25
$(95/15)^2 \times 4$	24
$(168/15)^2$	23
$(150/15)^2$	22
$(134/15)^2$	21
$(119/15)^2$	20
$(106/15)^2$	19
$(95/15)^2$	18
$(84/15)^2$	17
$(75/15)^2$	16
$(67/15)^2$	15
$(60/15)^2$	14
$(53/15)^2$	13
$(47/15)^2$	12
$(42/15)^2$	11
$(38/15)^2$	10
$(34/15)^2$	9
$(30/15)^2$	8
$(27/15)^2$	7
$(24/15)^2$	6
$(19/15)^2$	5
$(15/15)^2$	4
$(11/15)^2$	3
$(7/15)^2$	2
ZERO_GRANT*	1
INACTIVE*	0

NOTE \*: These values are specified in [16].

**Table 16B.1: Alternative Mapping of Absolute Grant Value**

Absolute Grant Value	Index
$(377/15)^2 \times 4$	31
$(237/15)^2 \times 6$	30
$(168/15)^2 \times 6$	29
$(150/15)^2 \times 6$	28
$(168/15)^2 \times 4$	27
$(150/15)^2 \times 4$	26
$(134/15)^2 \times 4$	25
$(119/15)^2 \times 4$	24
$(150/15)^2 \times 2$	23
$(95/15)^2 \times 4$	22
$(168/15)^2$	21
$(150/15)^2$	20
$(134/15)^2$	19
$(119/15)^2$	18
$(106/15)^2$	17
$(95/15)^2$	16
$(84/15)^2$	15
$(75/15)^2$	14
$(67/15)^2$	13
$(60/15)^2$	12
$(53/15)^2$	11
$(47/15)^2$	10
$(42/15)^2$	9
$(38/15)^2$	8
$(34/15)^2$	7
$(30/15)^2$	6
$(27/15)^2$	5
$(24/15)^2$	4
$(19/15)^2$	3
$(15/15)^2$	2
ZERO_GRANT*	1
INACTIVE*	0

NOTE \*: These values are specified in [16].

#### 4.10.1A.2 Information field mapping of the Absolute Grant Scope

The value of  $x_{ags,1}$  is set as specified in Table 16C.

**Table 16C: Mapping of Absolute Grant Scope**

Absolute Grant Scope	$x_{ags,1}$
"Per HARQ process"	1
"All HARQ processes"	0

#### 4.10.1B Multiplexing of E-AGCH information

The Absolute Grant Value information  $x_{agv,1}, x_{agv,2}, \dots, x_{agv,5}$  and the Absolute Grant Scope information  $x_{ags,1}$  are multiplexed together. This gives a sequence of bits  $x_{ag,1}, x_{ag,2}, \dots, x_{ag,6}$  where

$$x_{ag,k} = x_{agv,k} \quad k=1,2,\dots,5$$

$$x_{ag,k} = x_{ags,7-k} \quad k=6$$

## 4.10.2 CRC attachment for E-AGCH

The E-RNTI is the E-DCH Radio Network Identifier defined in [13]. It is mapped such that  $x_{id,1}$  corresponds to the MSB.

From the sequence of bits  $x_{ag,1}, x_{ag,2}, \dots, x_{ag,6}$  a 16 bit CRC is calculated according to clause 4.2.1.1. That gives the sequence of bits  $c_1, c_2, \dots, c_{16}$  where

$$c_k = P_{im(17-k)} \quad k=1,2,\dots,16$$

This sequence of bits is then masked with  $x_{id,1}, x_{id,2}, \dots, x_{id,16}$  and appended to the sequence of bits  $x_{ag,1}, x_{ag,2}, \dots, x_{ag,6}$  to form the sequence of bits  $y_1, y_2, \dots, y_{22}$  where

$$y_i = x_{ag,i} \quad i=1,2,\dots,6$$

$$y_i = (c_{i-6} + x_{id,i-6}) \bmod 2 \quad i=7,\dots,22$$

## 4.10.3 Channel coding for E-AGCH

Rate 1/3 convolutional coding, as described in Clause 4.2.3.1 is applied to the sequence of bits  $y_1, y_2, \dots, y_{22}$ , resulting in the sequence of bits  $z_1, z_2, \dots, z_{90}$ .

## 4.10.4 Rate matching for E-AGCH

From the input sequence  $z_1, z_2, \dots, z_{90}$  the bits  $z_1, z_2, z_5, z_6, z_7, z_{11}, z_{12}, z_{14}, z_{15}, z_{17}, z_{23}, z_{24}, z_{31}, z_{37}, z_{44}, z_{47}, z_{61}, z_{63}, z_{64}, z_{71}, z_{72}, z_{75}, z_{77}, z_{80}, z_{83}, z_{84}, z_{85}, z_{87}, z_{88}, z_{90}$  are punctured to obtain the output sequence  $r_1, r_2, \dots, r_{60}$ .

## 4.10.5 Physical channel mapping for E-AGCH

The E-AGCH sub frame is described in [2]. The sequence of bits  $r_1, r_2, \dots, r_{60}$  is mapped to the corresponding E-AGCH sub frame. The bits  $r_k$  are mapped so that they are transmitted over the air in ascending order with respect to  $k$ . If the E-DCH TTI is equal to 10 ms the same sequence of bits is transmitted in all the E-AGCH sub frames of the E-AGCH radio frame.

## 4.10A Coding for E-ROCH

The following information is transmitted by means of the E-DCH rank and offset channel (E-ROCH):

- S-ETFC Offset:  $x_{seo,1}, x_{seo,2}, \dots, x_{seo,5}$
- Rank Indication:  $x_{ri,1}$

### 4.10A.1 Overview

The E-ROCH coding chain uses the same coding chain as the E-AGCH. Figure 24B below illustrates the overall coding chain for the E-ROCH.

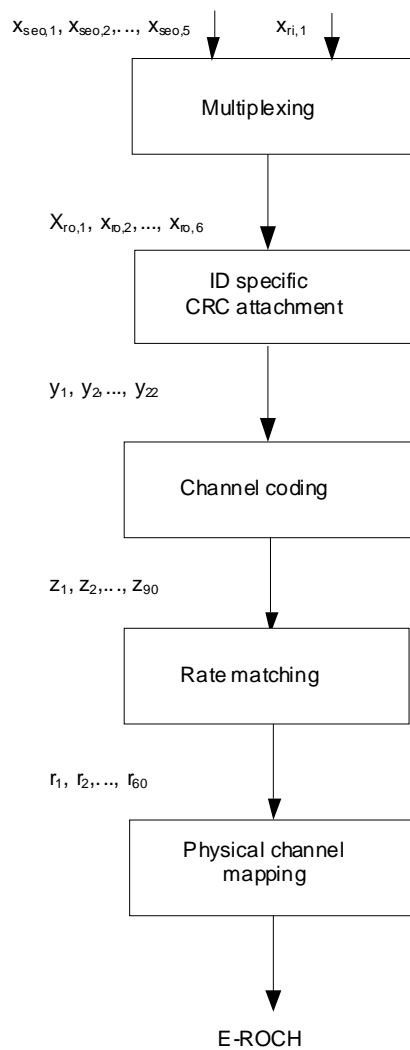

**Figure 24B: Coding for E-ROCH**

## 4.10A.2 E-ROCH information field mapping

### 4.10A.2.1 Information field mapping of the S-ETFC Offset

The S-ETFC Offset information is specified in Table 16D. The values are mapped such that  $x_{seq,1}$  corresponds to the MSB of the index.

**Table 16D: Mapping of S-ETFC Offset value**

S-ETFC Offset Value	Index
60/30	31
55/30	30
50/30	29
45/30	28
40/30	27
35/30	26
30/30	25
28/30	24
26/30	23
24/30	22
22/30	21
21/30	20
20/30	19
19/30	18
18/30	17
17/30	16
16/30	15
15/30	14
14/30	13
13/30	12
12/30	11
11/30	10
10/30	9
9/30	8
8/30	7
7/30	6
6/30	5
5/30	4
4/30	3
3/30	2
2/30	1
1/30	0

#### 4.10A.2.2 Information field mapping of the Rank Indication

The value of  $x_{ri,1}$  is set as specified in Table 16E.

**Table 16E: Mapping of Rank Indication**

Rank Indication	$x_{ri,1}$
"Rank 2 allowed"	1
"Rank 2 not allowed"	0

#### 4.10A.3 Multiplexing of E-ROCH information

The S-ETFC Offset information  $x_{seo,1}, x_{seo,2}, \dots, x_{seo,5}$  and the Rank Indication information  $x_{ri,1}$  are multiplexed together. This gives a sequence of bits  $x_{ro,1}, x_{ro,2}, \dots, x_{ro,6}$  where

$$x_{ro,k} = x_{seo,k} \quad k=1,2,\dots,5$$

$$x_{ro,6} = x_{ri,1}$$

#### 4.10A.4 CRC attachment for E-ROCH

The S-E-RNTI is the E-DCH Radio Network Identifier specific to E-ROCH defined in [13]. It is mapped such that  $x_{id,1}$  corresponds to the MSB.



From the sequence of bits  $x_{ro,1}, x_{ro,2}, \dots, x_{ro,6}$  a 16 bit CRC is calculated according to clause 4.2.1.1. That gives the sequence of bits  $c_1, c_2, \dots, c_{16}$  where

$$c_k = p_{im(17-k)} \quad k=1,2,\dots,16$$

This sequence of bits is then masked with  $x_{id,1}, x_{id,2}, \dots, x_{id,16}$  and appended to the sequence of bits  $x_{ro,1}, x_{ro,2}, \dots, x_{ro,6}$  to form the sequence of bits  $y_1, y_2, \dots, y_{22}$  where

$$y_i = x_{ro,i} \quad i=1,2,\dots,6$$

$$y_i = (c_{i-6} + x_{id,i-6}) \bmod 2 \quad i=7,\dots,22$$

#### 4.10A.5 Channel coding for E-ROCH

Rate 1/3 convolutional coding, as described in Clause 4.2.3.1 is applied to the sequence of bits  $y_1, y_2, \dots, y_{22}$ , resulting in the sequence of bits  $z_1, z_2, \dots, z_{90}$ .

#### 4.10A.6 Rate matching for E-ROCH

From the input sequence  $z_1, z_2, \dots, z_{90}$  the bits  $z_1, z_2, z_5, z_6, z_7, z_{11}, z_{12}, z_{14}, z_{15}, z_{17}, z_{23}, z_{24}, z_{31}, z_{37}, z_{44}, z_{47}, z_{61}, z_{63}, z_{64}, z_{71}, z_{72}, z_{75}, z_{77}, z_{80}, z_{83}, z_{84}, z_{85}, z_{87}, z_{88}, z_{90}$  are punctured to obtain the output sequence  $r_1, r_2, \dots, r_{60}$ .

#### 4.10A.7 Physical channel mapping for E-ROCH

The E-ROCH sub frame is described in [2]. The sequence of bits  $r_1, r_2, \dots, r_{60}$  is mapped to the corresponding E-ROCH sub frame. The bits  $r_k$  are mapped so that they are transmitted over the air in ascending order with respect to k.

### 4.11 Mapping for E-RGCH Relative Grant

#### 4.11.1 Overview

The relative grant is transmitted on the E-RGCH as described in [2].

#### 4.11.2 Relative Grant mapping

The relative grant (RG) command is mapped to the relative grant value as described in the table below.

**Table 17: Mapping of RG value**

Command	RG Value (serving E-DCH RLS)	RG Value (other radio links)
UP	+1	not allowed
HOLD	0	0
DOWN	-1	-1

### 4.12 Mapping for E-HICH ACK/NACK

#### 4.12.1 Overview

The ACK/NACK is transmitted on the E-HICH as described in [2].

#### 4.12.2 ACK/NACK mapping

The ACK/NACK command is mapped to the HARQ acknowledgement indicator as described in the table below.

**Table 18: Mapping of HARQ Acknowledgement**

Command	HARQ acknowledgement indicator
ACK	+1
NACK (RLSs not containing the serving E-DCH cell)	0
NACK (RLS containing the serving E-DCH cell)	-1

## Annex A (informative): Blind transport format detection

### A.1 Blind transport format detection using fixed positions

#### A.1.1 Blind transport format detection using received power ratio

For the dual transport format case (the possible data rates are 0 and full rate, and CRC is only transmitted for full rate), blind transport format detection using received power ratio can be used.

The transport format detection is then done using average received power ratio of DPDCH to DPCCH. Define the following:

- $P_c$ : Received power per bit of DPCCH calculated from all pilot and TPC bits per slot over a radio frame;
- $P_d$ : Received power per bit of DPDCH calculated from  $X$  bits per slot over a radio frame;
- $X$ : the number of DPDCH bits per slot when transport format corresponds to full rate;
- $T$ : Threshold of average received power ratio of DPDCH to DPCCH for transport format detection.

The decision rule can then be formulated as:

If  $P_d/P_c > T$  then:

- full rate transport format detected;

else

- zero rate transport format detected.

#### A.1.2 Blind transport format detection using CRC

For the multiple transport format case (the possible data rates are 0, ..., (full rate)/ $r$ , ..., full rate, and CRC is transmitted for all transport formats), blind transport format detection using CRC can be used.

At the transmitter, the data stream with variable number of bits from higher layers is block-encoded using a cyclic redundancy check (CRC) and then convolutionally encoded. CRC parity bits are attached just after the data stream with variable number of bits as shown in figure A.1.

The receiver knows only the possible transport formats (or the possible end bit position  $\{n_{\text{end}}\}$ ) by Layer-3 negotiation. The receiver performs Viterbi-decoding on the soft decision sample sequence. The correct trellis path of the Viterbi-decoder ends at the zero state at the correct end bit position.

The blind transport format detection method using CRC traces back the surviving trellis path ending at the zero state (hypothetical trellis path) at each possible end bit position to recover the data sequence. For each recovered data sequence error-detection is performed by checking the CRC, and if there is no error, the recovered sequence is declared to be correct.

The following variable is defined:

$$s(n_{\text{end}}) = -10 \log \left( (a_0(n_{\text{end}}) - a_{\min}(n_{\text{end}})) / (a_{\max}(n_{\text{end}}) - a_{\min}(n_{\text{end}})) \right) \text{ [dB]} \quad (\text{Eq. 1})$$

where  $a_{\max}(n_{\text{end}})$  and  $a_{\min}(n_{\text{end}})$  are the maximum and minimum path-metric values among all survivors at end bit position  $n_{\text{end}}$ , and  $a_0(n_{\text{end}})$  is the path-metric value at zero state.

In order to reduce the probability of false detection (this happens if the selected path is wrong but the CRC misses the error detection), a path selection threshold  $D$  is introduced. The threshold  $D$  determines whether the hypothetical trellis path connected to the zero state should be traced back or not at each end bit position  $n_{\text{end}}$ . If the hypothetical trellis path connected to the zero state that satisfies:

$$s(n_{\text{end}}) \leq D \quad (\text{Eq. 2})$$

is found, the path is traced back to recover the frame data, where  $D$  is the path selection threshold and a design parameter.

If more than one end bit positions satisfying Eq. 2 is found, the end bit position which has minimum value of  $s(n_{\text{end}})$  is declared to be correct. If no path satisfying Eq. 2 is found even after all possible end bit positions have been exhausted, the received frame data is declared to be in error.

Figure A-2 shows the procedure of blind transport format detection using CRC.

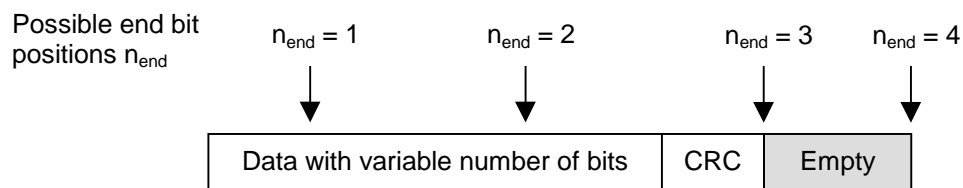

**Figure A.1: An example of data with variable number of bits. Four possible transport formats, and transmitted end bit position  $n_{\text{end}} = 3$**

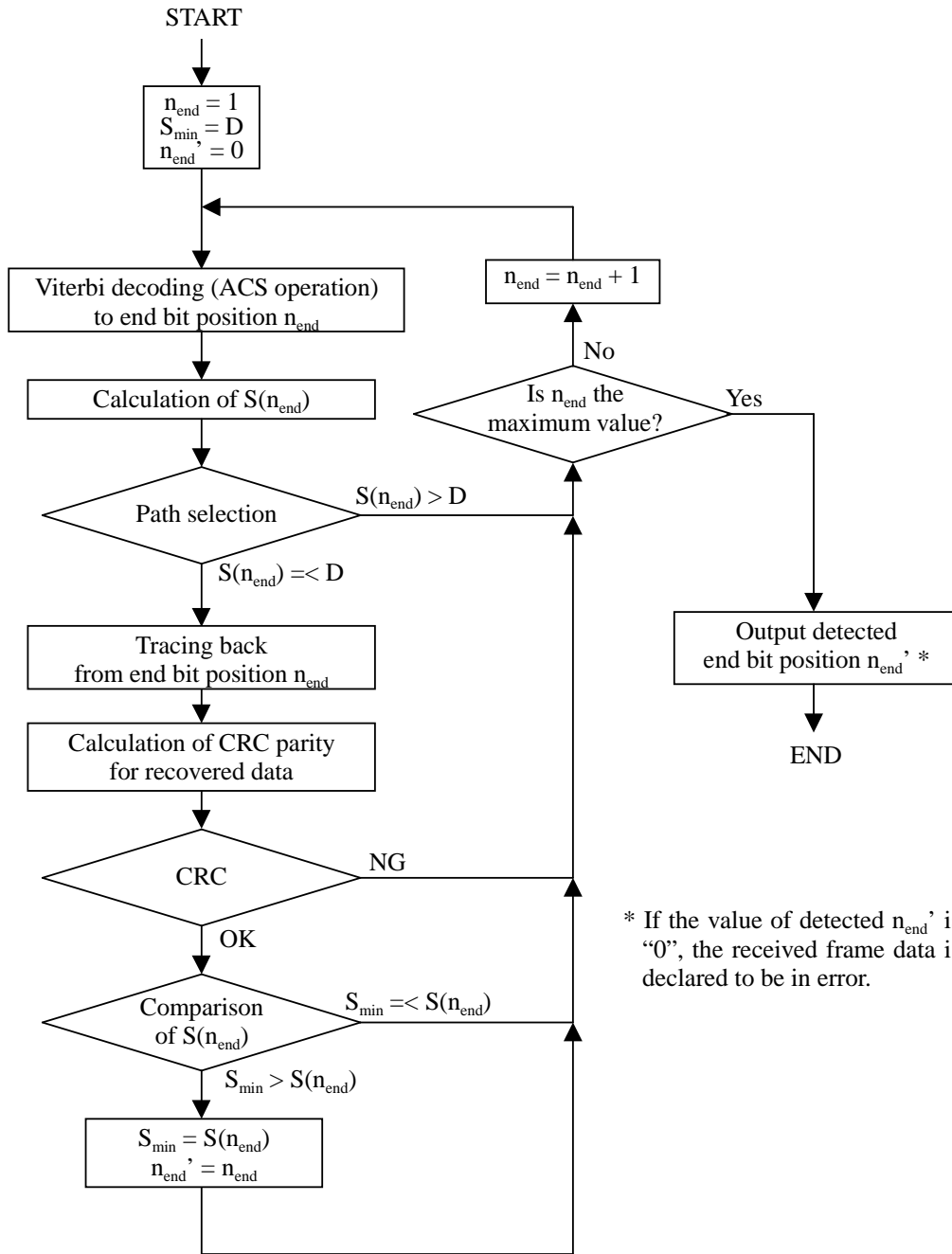

\* If the value of detected  $n_{end}'$  is "0", the received frame data is declared to be in error.

Figure A.2: Basic processing flow of blind transport format detection

## Annex B (informative): Compressed mode idle lengths

The tables B.1-B.3 show the resulting idle lengths for different transmission gap lengths, UL/DL modes and DL frame types when DPCCH/DPDCH are used in the uplink and DPCH in the downlink. The idle lengths given are calculated purely from the slot and frame structures and the UL/DL offset. They do not contain margins for e.g. synthesizer switching.

### B.1 Idle lengths for DL, UL and DL+UL compressed mode for DPCH

Table B.1: Parameters for DL compressed mode

TGL	DL Frame Type	Spreading Factor	Idle length [ms]	Transmission time Reduction method	Idle frame Combining
3	A	512 – 4	1.73 – 1.99	Spreading factor division by 2 or Higher layer scheduling	(S) (D) =(1,2) or (2,1)
	B		1.60 – 1.86		(S) (D) =(1,3), (2,2) or (3,1)
4	A		2.40 – 2.66		(S) (D) = (1,4), (2,3), (3, 2) or (4,1)
	B		2.27 – 2.53		(S) (D)= (1,6), (2,5), (3,4), (4,3), (5,2) or (6,1)
5	A		3.07 – 3.33		(D)=(3,7), (4,6), (5,5), (6,4) or (7,3)
	B		2.93 – 3.19		(D) =(7,7)
7	A		4.40 – 4.66		
	B		4.27 – 4.53		
10	A		6.40 – 6.66		
	B		6.27 – 6.53		
14	A		9.07 – 9.33		
	B		8.93 – 9.19		

Table B.2: Parameters for UL compressed mode

TGL	Spreading Factor	Idle length [ms]	Transmission time Reduction method	Idle frame Combining
3	256 – 4	2.00	Spreading factor division by 2 or Higher layer scheduling	(S) (D) =(1,2) or (2,1)
4		2.67		(S) (D) =(1,3), (2,2) or (3,1)
5		3.33		(S) (D) = (1,4), (2,3), (3, 2) or (4,1)
7		4.67		(S) (D)= (1,6), (2,5), (3,4), (4,3), (5,2) or (6,1)
10		6.67		(D)=(3,7), (4,6), (5,5), (6,4) or (7,3)
14		9.33		(D) =(7,7)

Table B.3: Parameters for combined UL/DL compressed mode

TGL	DL Frame Type	Spreading Factor	Idle length [ms]	Transmission time Reduction method	Idle frame Combining
3	A or B	DL: 512 – 4	1.47 – 1.73	Spreading factor division by 2 or Higher layer scheduling	(S) (D) = (1,2) or (2,1)
4			2.13 – 2.39		(S) (D) = (1,3), (2,2) or (3,1)
5		UL: 256 – 4	2.80 – 3.06		(S) (D) = (1,4), (2,3), (3, 2) or (4,1)
7			4.13 – 4.39		(S) (D) = (1,6), (2,5), (3,4), (4,3), (5,2) or (6,1)
10			6.13 – 6.39		(D) = (3,7), (4,6), (5,5), (6,4) or (7,3)
14			8.80 – 9.06		(D) = (7,7)

(S): Single-frame method as shown in figure 14 (1).

(D): Double-frame method as shown in figure 14 (2). (x,y) indicates x: the number of idle slots in the first frame, y: the number of idle slots in the second frame.

NOTE: Compressed mode by spreading factor reduction is not supported when SF=4 is used in normal mode

## Annex C (informative): Change history

Change history							
Date	TSG #	TSG Doc.	CR	Rev	Subject/Comment	Old	New
	RP_05	RP-99588	-		Approved at TSG RAN #5 and placed under Change Control	-	3.0.0
14/01/00	RP_06	RP-99680	001	3	Correction of rate matching parameters for repetition after 1st interleaving in 25.212	3.0.0	3.1.0
14/01/00	RP_06	RP-99680	004	-	Changing the initial offset value for convolutional code rate matching	3.0.0	3.1.0
14/01/00	RP_06	RP-99681	005	1	Introduction of compressed mode by higher layer scheduling	3.0.0	3.1.0
14/01/00	RP_06	RP-99679	008	-	Editorial corrections to TS 25.212	3.0.0	3.1.0
14/01/00	RP_06	RP-99680	009	-	Removal of SFN multiplexing	3.0.0	3.1.0
14/01/00	RP_06	RP-99680	010	1	Clarification of bit separation and collection	3.0.0	3.1.0
14/01/00	RP_06	RP-99680	011	2	Connection between TTI and CFN	3.0.0	3.1.0
14/01/00	RP_06	RP-99680	012	2	Zero length transport blocks	3.0.0	3.1.0
14/01/00	RP_06	RP-99679	014	-	Update of channel coding sections	3.0.0	3.1.0
14/01/00	RP_06	RP-99680	016	-	Removal of TrCH restriction in DSCH CTrCH	3.0.0	3.1.0
14/01/00	RP_06	RP-99681	017	-	20 ms RACH message length	3.0.0	3.1.0
14/01/00	RP_06	RP-99680	018	-	Minimum SF in UL	3.0.0	3.1.0
14/01/00	RP_06	RP-99680	024	-	Rate matching parameter determination in DL and fixed positions	3.0.0	3.1.0
14/01/00	RP_06	RP-99680	026	1	Corrections to TS 25.212	3.0.0	3.1.0
14/01/00	RP_06	RP-99679	027	-	Modification of BTFD description in 25.212 Annex	3.0.0	3.1.0
14/01/00	RP_06	RP-99681	028	-	TFCI coding and mapping including compressed mode	3.0.0	3.1.0
14/01/00	-	-	-	-	Change history was added by the editor	3.1.0	3.1.1
31/03/00	RP_07	RP-000061	025	2	CR for parity bit attachment to 0 bit transport block	3.1.1	3.2.0
31/03/00	RP_07	RP-000061	029	1	Limitations of blind transport format detection	3.1.1	3.2.0
31/03/00	RP_07	RP-000061	034	1	Clarification of fixed position rate matching	3.1.1	3.2.0
31/03/00	RP_07	RP-000061	035	1	Clarification of DL compressed mode	3.1.1	3.2.0
31/03/00	RP_07	RP-000061	036	-	Reconfiguration of TFCS	3.1.1	3.2.0
31/03/00	RP_07	RP-000061	037	1	Removal of fixed gap position in 25.212	3.1.1	3.2.0
31/03/00	RP_07	RP-000061	038	2	Definition clarification for TS 25.212	3.1.1	3.2.0
31/03/00	RP_07	RP-000061	039	1	Clarification on TFCI coding input	3.1.1	3.2.0
31/03/00	RP_07	RP-000061	041	2	Correction of UL compressed mode by higher layer scheduling	3.1.1	3.2.0
31/03/00	RP_07	RP-000061	042	5	Downlink Compressed Mode by puncturing	3.1.1	3.2.0
31/03/00	RP_07	RP-000061	044	-	Modification of Turbo code internal interleaver	3.1.1	3.2.0
31/03/00	RP_07	RP-000061	045	-	Editorial corrections	3.1.1	3.2.0
31/03/00	RP_07	RP-000061	046	-	SF/2 method: DTX insertion after 2nd interleaver	3.1.1	3.2.0
31/03/00	RP_07	RP-000061	047	1	TFCI coding for FDD	3.1.1	3.2.0
31/03/00	RP_07	RP-000061	048	-	Mapping of TFCI in downlink compressed mode	3.1.1	3.2.0
31/03/00	RP_07	RP-000061	049	-	Editorial changes to Annex A	3.1.1	3.2.0
31/03/00	RP_07	RP-000061	050	-	Removal of rate matching attribute setting for RACH	3.1.1	3.2.0
31/03/00	RP_07	RP-000061	052	-	Padding Function for Turbo coding of small blocks	3.1.1	3.2.0
31/03/00	RP_07	RP-000061	055	2	Clarifications relating to DSCH	3.1.1	3.2.0
31/03/00	RP_07	RP-000061	056	-	Editorial modification of uplink shifting parameter calculation for turbo code puncturing	3.1.1	3.2.0
31/03/00	RP_07	RP-000062	059	1	Revision: Editorial correction to the calculation of Rate Matching parameters	3.1.1	3.2.0
31/03/00	RP_07	RP-000062	060	1	Editorial changes of channel coding section	3.1.1	3.2.0
31/03/00	RP_07	RP-000062	061	-	Removal of DL compressed mode by higher layer scheduling with fixed positions	3.1.1	3.2.0
26/06/00	RP_08	RP-000266	066	1	Clause 4.4.5 and table 9 is moved to informative annex	3.2.0	3.3.0
26/06/00	RP_08	RP-000266	068	-	Editorial modifications of 25.212	3.2.0	3.3.0
26/06/00	RP_08	RP-000266	069	-	Removal of BTFD for flexible positions in Release 99	3.2.0	3.3.0
26/06/00	RP_08	RP-000266	070	1	Editorial modifications	3.2.0	3.3.0
26/06/00	RP_08	RP-000266	071	1	Corrections and editorial modifications of 25.212 for 2nd insertion of DTX bits for CM	3.2.0	3.3.0
26/06/00	RP_08	RP-000266	072	4	Corrections to 25.212 (Rate Matching, p-bit insertion, PhCH segmentation)	3.2.0	3.3.0
26/06/00	RP_08	RP-000266	073	-	Editorial correction in 25.212 coding/multiplexing	3.2.0	3.3.0
26/06/00	RP_08	RP-000266	074	2	Bit separation of the Turbo encoded data	3.2.0	3.3.0
26/06/00	RP_08	RP-000266	076	1	Revision of code block segmentation description	3.2.0	3.3.0
26/06/00	RP_08	RP-000266	077	-	Clarifications for TFCI coding	3.2.0	3.3.0
26/06/00	RP_08	RP-000266	078	2	Clarifying the rate matching parameter setting for the RACH and BCH	3.2.0	3.3.0
26/06/00	RP_08	RP-000266	080	-	Clarification on BTFD utilisation (single CTrCH)	3.2.0	3.3.0



Change history							
Date	TSG #	TSG Doc.	CR	Rev	Subject/Comment	Old	New
26/06/00	RP_08	RP-000266	081	-	Correction of order of checking TFC during flexible position RM parameter determination	3.2.0	3.3.0
26/06/00	RP_08	RP-000266	082	-	Editorial corrections in channel coding section	3.2.0	3.3.0
26/06/00	RP_08	RP-000266	083	-	Correction for bit separation and bit collection	3.2.0	3.3.0
26/06/00	RP_08	RP-000266	084	1	Correction on the spreading factor selection for the RACH	3.2.0	3.3.0
23/09/00	RP_09	RP-000341	079	-	Clarification of compressed mode terminology	3.3.0	3.4.0
23/09/00	RP_09	RP-000341	085	1	Editorial corrections in Turbo code internal interleaver section	3.3.0	3.4.0
23/09/00	RP_09	RP-000341	086	1	Clarification on DL slot format for compressed mode by SF/2	3.3.0	3.4.0
23/09/00	RP_09	RP-000341	087	-	Corrections	3.3.0	3.4.0
23/09/00	RP_09	RP-000341	088	1	Clarifications to TS 25.212	3.3.0	3.4.0
23/09/00	RP_09	RP-000341	089	-	Correction regarding DSCH	3.3.0	3.4.0
23/09/00	RP_09	RP-000341	090	-	Correction regarding CPCH	3.3.0	3.4.0
23/09/00	RP_09	RP-000341	092	1	Bit separation and collection for rate matching	3.3.0	3.4.0
23/09/00	RP_09	RP-000341	093	-	Puncturing Limit definition in WG1 specification	3.3.0	3.4.0
15/12/00	RP_10	RP-000538	094	2	Correction of BTFD limitations	3.4.0	3.5.0
15/12/00	RP_10	RP-000538	096	-	Compressed mode by puncturing	3.4.0	3.5.0
15/12/00	RP_10	RP-000538	097	-	Clarification on the Ci formula	3.4.0	3.5.0
15/12/00	RP_10	RP-000538	099	-	Editorial modification in RM section	3.4.0	3.5.0
15/12/00	RP_10	RP-000538	100	1	Editorial corrections in TS 25.212	3.4.0	3.5.0
15/12/00	RP_10	RP-000538	101	-	Correction to code block segmentation	3.4.0	3.5.0

Change history							
Date	TSG #	TSG Doc.	CR	Rev	Subject/Comment	Old	New
16/03/01	RP_11	-	-	-	Approved as Release 4 specification (v4.0.0) at TSG RAN #11	3.5.0	4.0.0
15/06/01	RP_12	RP-010332	106	-	Correction of compressed mode by puncturing	4.0.0	4.1.0
15/06/01	RP_12	RP-010332	108	1	Dual transport format detection	4.0.0	4.1.0
15/06/01	RP_12	RP-010332	112	1	Correction for downlink rate matching for the DSCH	4.0.0	4.1.0
21/09/01	RP_13	RP-010519	115	-	Correction of PDSCH spreading factor signalling	4.1.0	4.2.0
14/12/01	RP_14	RP-010737	118	-	Clarification of compressed mode	4.2.0	4.3.0
14/12/01	RP_14	RP-010737	122	-	Support of multiple CCTrChs of dedicated type	4.2.0	4.3.0
08/03/02	RP_15	RP-020231	128	2	Removal of channel coding option 'no coding' for FDD	4.3.0	4.4.0
08/03/02	RP_15	RP-020054	123	4	Inclusion of flexible hard split mode TFCI operation	4.3.0	5.0.0
08/03/02	RP_15	RP-020058	126	1	Changes to 25.212 for HSDPA work item	4.3.0	5.0.0
07/06/02	RP_16	RP-020308	136	-	Downlink bit mapping	5.0.0	5.1.0
07/06/02	RP_16	RP-020316	130	5	Correction of Errata noted by RAN1 delegates	5.0.0	5.1.0
07/06/02	RP_16	RP-020316	131	2	Removal of inconsistencies and ambiguities in the HARQ description	5.0.0	5.1.0
07/06/02	RP_16	RP-020316	132	-	Rate Matching and Channel Coding for HS-SCCH	5.0.0	5.1.0
07/06/02	RP_16	RP-020316	137	-	Basis sequences for HS-DPCCH Channel Quality information code	5.0.0	5.1.0
07/06/02	RP_16	RP-020316	145	5	UE specific masking for HS-SCCH part1	5.0.0	5.1.0
14/09/02	RP_17	RP-020582	141	1	Bit scrambling for HS-DSCH	5.1.0	5.2.0
15/09/02	RP_17	RP-020582	148		Physical channel mapping for HS-DPCCH	5.1.0	5.2.0
15/09/02	RP_17	RP-020582	149		HARQ bit collection	5.1.0	5.2.0
15/09/02	RP_17	RP-020582	150	1	Coding for HS-SCCH	5.1.0	5.2.0
15/09/02	RP_17	RP-020582	151		Correction to UE specific masking for HS-SCCH part1	5.1.0	5.2.0
15/09/02	RP_17	RP-020568	155	2	Clarification of the definition of layer 1 transport channel numbers	5.1.0	5.2.0
15/09/02	RP_17	RP-020573	157		Numbering Corrections	5.1.0	5.2.0
15/09/02	RP_17	RP-020645	158	1	Specification of H-RNTI to UE identity mapping	5.1.0	5.2.0
20/12/02	RP_18	RP-020846	163	-	Correction of CQI index to bit mapping	5.2.0	5.3.0
20/12/02	RP_18	RP-020846	164	-	Correction of mapping of HARQ-ACK	5.2.0	5.3.0
26/03/03	RP_19	RP-030134	165	1	Correction of CQI index to bit mapping	5.3.0	5.4.0
26/03/03	RP_19	RP-030134	166	3	Correction of bit scrambling of HS-DSCH	5.3.0	5.4.0
26/03/03	RP_19	RP-030134			Correction of subscript for modulation scheme information	5.3.0	5.4.0
23/06/03	RP_20	RP-030272	172	1	Clarification of TPC and Pilot transmission with STTD in compressed mode	5.4.0	5.5.0
23/06/03	RP_20	RP-030272	173	2	Correction on the flexible TFCI coding in the DSCH hard split mode for Rel5	5.4.0	5.5.0
21/09/03	RP_21	RP-030456	178	4	Clarification on Single Transport Format Detection	5.5.0	5.6.0
21/09/03	RP_21	RP-030456	179	-	Correction on table number in first interleave description	5.5.0	5.6.0
21/09/03	RP_21	RP-030456	180	3	Broadening the conditions that require UEs to perform BTDF for the case of HS-DSCH reception	5.5.0	5.6.0
06/01/04	RP_22	RP-030647	183	-	Clarification of the CRC attachment procedure for HS-SCCH	5.6.0	5.7.0
06/01/04	RP_22	RP-030647	184	1	Correction of UE identity notation	5.6.0	5.7.0
06/01/04	RP_22	RP-030644	185	-	HARQ process identifier mapping	5.6.0	5.7.0
06/01/04	RP_22	RP-030712	186		Alignment of terminology across 3GPP documentation	5.6.0	5.7.0
13/01/04	RP_22	-	-	-	Created for M.1457 update	5.7.0	6.0.0
23/03/04	RP_23	RP-040085	187	1	CCTrCH definition extension to HS-DSCH	6.0.0	6.1.0
09/06/04	RP_24	RP-040230	191	1	Clarification of Channelization Code-Set Mapping	6.1.0	6.2.0
13/12/04	RP_26	RP-040446	192	2	Introduction of MBMS Soft Combining	6.2.0	6.3.0
13/12/04	RP_26	RP-040527	195	-	Preamble and Postamble to reduce HS-DPCCH transmit power	6.2.0	6.3.0
13/12/04	RP_26	RP-040449	196	2	Introduction of E-DCH	6.2.0	6.3.0
14/03/05	RP_27	RP-050088	193	1	Introduction of F-DPCH	6.3.0	6.4.0
14/03/05	RP_27	RP-050044	198	1	PLnon-max and PLmax	6.3.0	6.4.0
14/03/05	RP_27	RP-050045	199	-	HARQ bit collection for E-DCH	6.3.0	6.4.0
16/06/05	RP_28	RP-050241	203	-	Correction of HSDPA Bit Separation	6.4.0	6.5.0
16/06/05	RP_28	RP-050252	204	2	E-DCH Corrections	6.4.0	6.5.0
16/06/05	RP_28	RP-050252	205	1	Compressed mode operation for the Enhanced Uplink	6.4.0	6.5.0
16/06/05	RP_28	RP-050357	206	1	E-HICH and E-RGCH serving/non-serving definition clarification	6.4.0	6.5.0
16/06/05	RP_28	RP-050250	208	1	Feature Clean Up: Removal of 'CPCH'	6.4.0	6.5.0
16/06/05	RP_28	RP-050248	210	-	Feature Clean Up: Removal of DSCH (FDD mode)	6.4.0	6.5.0
16/06/05	RP_28	RP-050243	212	1	Feature Clean-Up: Removal of 80 ms TTI for DCH for all other cases but when the UE supports SF512	6.4.0	6.5.0
16/06/05	RP_28	RP-050252	215	-	Clarification on E-AGCH bit mapping	6.4.0	6.5.0
16/06/05	RP_28	RP-050252	216	-	Determination of SF and number of PhCHs considering SF2	6.4.0	6.5.0
16/06/05	RP_28	RP-050251	217	1	MBMS related corrections	6.4.0	6.5.0
16/06/05	RP_28	RP-050249	218	1	Feature clean up: Removal of the 'compressed mode by puncturing'	6.4.0	6.5.0
16/06/05	RP_28	RP-050252	219	-	Re-ordering of the E-DPCCH bit mapping	6.4.0	6.5.0
16/06/05	RP_28	RP-050252	220	-	Coding for E-AGCH	6.4.0	6.5.0
26/09/05	RP_29	RP-050450	0222	-	SF max for E-DPDCH	6.5.0	6.6.0
26/09/05	RP_29	RP-050450	0223	1	Compressed mode operation for the Enhanced Uplink	6.5.0	6.6.0
26/09/05	RP_29	RP-050450	0225	1	Absolute grant values	6.5.0	6.6.0
26/09/05	RP_29	RP-050450	0227	-	Removal of description on RSN setting	6.5.0	6.6.0

Change history							
Date	TSG #	TSG Doc.	CR	Rev	Subject/Comment	Old	New
12/12/05	RP_30	RP-050727	0228	-	PLmax alignment over all UE categories	6.6.0	6.7.0
12/12/05	RP_30	RP-050727	0229	-	Correction of SF when a CCTrCH is mapped onto four E-DPDCHs	6.6.0	6.7.0
12/12/05	RP_30	RP-050727	0231	1	Usage of 2xSF4 with puncturing	6.6.0	6.7.0
20/03/06	RP_31	-	-	-	Creation of Release 7 specification (v.7.0.0) at RAN#31	6.7.0	7.0.0
12/06/06	RP_32	RP-060370	0236	-	Clarification of E-TFCI terminology	7.0.0	7.1.0
29/09/06	RP_33	RP-060490	0240	-	Correction to the E-DCH HARQ rate matching for compressed mode	7.1.0	7.2.0
11/12/06	RP_34	RP-060727	0244	1	Clarification on the number of physical channels, transmission gap positioning and physical channel mapping for E-DCH in relation to compressed mode	7.2.0	7.3.0
07/03/07	RP_35	RP-070115	0238	5	Support of CPC feature	7.3.0	7.4.0
07/03/07	RP_35	RP-070114	0241	4	Coding of HS-SCCH to support FDD MIMO	7.3.0	7.4.0
07/03/07	RP_35	RP-070114	0242	7	Coding of HS-DPCCH to support operation of FDD MIMO	7.3.0	7.4.0
07/03/07	RP_35	RP-070116	0245	4	Introduction of 64QAM for HSDPA	7.3.0	7.4.0
30/05/07	RP_36	RP-070387	0249	-	MIMO HS-SCCH rate matching	7.4.0	7.5.0
30/05/07	RP_36	RP-070387	0248	1	Correction to coding of HS-SCCH to support FDD MIMO	7.4.0	7.5.0
30/05/07	RP_36	RP-070387	0251	1	HS-SCCH orders in MIMO mode	7.4.0	7.5.0
30/05/07	RP_36	RP-070388	0246	5	Introduction of 16QAM for HSUPA	7.4.0	7.5.0
30/05/07	RP_36	RP-070384	0247	1	Support for DL only SFN operation for MBMS FDD	7.4.0	7.5.0
11/09/07	RP_37	RP-070644	0252	-	16QAM modulation selection for HSUPA	7.5.0	7.6.0
11/09/07	RP_37	RP-070642	0253	-	Clarifications of MIMO	7.5.0	7.6.0
11/09/07	RP_37	RP-070641	0254	-	Clarifications of CPC and MIMO	7.5.0	7.6.0
27/11/07	RP_38	RP-070941	0257	-	Correction of decimal to binary mapping in case of type B CQI	7.6.0	7.7.0
27/11/07	RP_38	RP-070941	0259	-	Correction of number of TBs in a TTI in case of MIMO	7.6.0	7.7.0
28/11/07	RP_38	RP-070950	0256	-	HS-SCCH information field mapping for 64QAM MIMO	7.7.0	8.0.0
05/04/08	RP_39	RP-080146	0261	-	Correction to RV-coding in case of simultaneous usage of 64QAM and MIMO	8.0.0	8.1.0
28/05/08	RP_40	RP-080440	0262	1	HS-SCCH orders for HS-SCCH-less operation	8.1.0	8.2.0
28/05/08	RP_40	RP-080349	0264	2	Clarification to number of HS-PDSCH codes in HS-SCCH less operations	8.1.0	8.2.0
09/09/08	RP_41	RP-080673	270	2	Introduction of HS-PDSCH Serving Cell Change Enhancements	8.2.0	8.3.0
09/09/08	RP_41	RP-080665	272	-	Correction to the table name and the quoted name	8.2.0	8.3.0
03/12/08	RP_42	RP-080989	267	5	Introduction of Dual-Cell HSDPA Operation on Adjacent Carriers	8.3.0	8.4.0
03/12/08	RP_42	RP-080988	270	3	Introduction of HS-PDSCH Serving Cell Change Enhancements	8.3.0	8.4.0
03/03/09	RP_43	RP-090228	274	1	Correction to the puncturing limit allowed when UL 4PAM modulation is allowed	8.4.0	8.5.0
15/09/09	RP_45	RP-090885	278	1	Reservation of HS-SCCH order combination not used by CPC	8.5.0	8.6.0
15/09/09	RP_45	RP-090889	280	1	Alignment with RAN2 decisions on HS-SCCH orders for activation and deactivation of DTX and DRX operation	8.5.0	8.6.0
18/09/09	RP_45	RP-090975	276	4	Introduction of TxAA extension for non-MIMO UEs	8.6.0	9.0.0
18/09/09	RP_45	RP-090974	282	1	Combination of DC-HSDPA with MIMO	8.6.0	9.0.0
01/12/09	RP_46	RP-091170	281	2	Introduction of DC-HSUPA	9.0.0	9.1.0
01/12/09	RP_46	RP-091171	283	3	MIMO configuration per downlink frequency in DC-MIMO operation	9.0.0	9.1.0
16/03/10	RP_47	RP-100206	286	1	Clarification of MIMO configuration per downlink frequency in DC-MIMO operation	9.1.0	9.2.0
14/09/10	RP_49	RP-100897	287	1	Clarification of uplink frequencies	9.2.0	9.3.0
16/09/10	RP_49	RP-100902	288	3	Release 10 created with the introduction of 4C-HSDPA	9.3.0	10.0.0
07/12/10	RP_50	RP-101318	290	3	Clarification of 4C-HSDPA	10.0.0	10.1.0
07/12/10	RP_50	RP-101318	295	-	4C-HSDPA summary of CQI reporting configurations	10.0.0	10.1.0
05/12/11	RP_54	RP-111671	296	8	Introduction of 8C-HSDPA	10.1.0	11.0.0
05/12/11	RP_54	RP-111672	297	1	Introduction of Uplink Closed Loop Transmit Diversity for HSPA	10.1.0	11.0.0
28/02/12	RP_55	RP-120280	301	-	Clarification to Target cell HS-SCCH order type	11.0.0	11.1.0
28/02/12	RP_55	RP-120284	303	-	Correction to 4C-HSDPA CQI report mapping scenarios table	11.0.0	11.1.0
28/02/12	RP_55	RP-120287	304	1	Introduction of 8C-HSDPA CQI report mapping scenarios table	11.0.0	11.1.0
28/02/12	RP_55	RP-120288	305	-	Corrections to Uplink Closed Loop Transmit Diversity	11.0.0	11.1.0
13/06/12	RP_56	RP-120740	307	1	Addition of missing 8C-HSDPA CQI reporting case indices	11.1.0	11.2.0
13/06/12	RP_56	RP-120741	306	-	Clarification of CLTD Features	11.1.0	11.2.0
04/09/12	RP_57	RP-121271	308	2	Introduction of Multiflow	11.2.0	11.3.0
04/09/12	RP_57	RP-121267	310	1	Correction of the number of CQI information bits for MC-HSDPA	11.2.0	11.3.0
04/09/12	RP_57	RP-121268	311	-	Correction of HS-SCCH order information	11.2.0	11.3.0
04/09/12	RP_57	RP-121270	314	-	Introduction of Further Enhancements to CELL_FACH	11.2.0	11.3.0
04/12/12	RP_58	RP-121845	312	5	Introduction of uplink MIMO and 64QAM	11.3.0	11.4.0
04/12/12	RP_58	RP-121843	313	5	Introduction of 4Tx_HSDPA in 25.212	11.3.0	11.4.0
04/12/12	RP_58	RP-121840	316	1	Clarification of HS-SCCH order for MC-HSPA	11.3.0	11.4.0
04/12/12	RP_58	RP-121844	317	1	Clarifications and corrections to HSDPA Multiflow	11.3.0	11.4.0
04/12/12	RP_58	RP-121842	318	1	Clarification of HS-SCCH order information	11.3.0	11.4.0
11/06/13	RP_60	RP-130745	319	2	Correction to the HS-SCCH Type 4 Structure	11.4.0	11.5.0
11/06/13	RP_60	RP-130748	320	1	Clarification of HS-SCCH orders with the UE is configured in Multiflow and CLTD	11.4.0	11.5.0
03/09/13	RP_61	RP-131245	321	-	Correction of HS-SCCH type 4 order	11.5.0	11.6.0

Change history							
Date	TSG #	TSG Doc.	CR	Rev	Subject/Comment	Old	New
03/03/14	RP_63	RP-140285	326	-	Correction of HS-SCCH type 4 order Correction to HS-SCCH special information mapping for HS-SCCH less HSDPA	11.6.0	11.7.0

---

## History

<b>Document history</b>		
V11.3.0	September 2012	Publication
V11.4.0	January 2013	Publication
V11.5.0	July 2013	Publication
V11.6.0	October 2013	Publication
V11.7.0	March 2014	Publication