

# ETSI TS 125 212 V5.5.0 (2003-06)

---

*Technical Specification*

**Universal Mobile Telecommunications System (UMTS);  
Multiplexing and channel coding (FDD)  
(3GPP TS 25.212 version 5.5.0 Release 5)**

---



---

Reference

RTS/TSGR-0125212v550

---

Keywords

UMTS

**ETSI**

650 Route des Lucioles  
F-06921 Sophia Antipolis Cedex - FRANCE

Tel.: +33 4 92 94 42 00 Fax: +33 4 93 65 47 16

Siret N° 348 623 562 00017 - NAF 742 C  
Association à but non lucratif enregistrée à la  
Sous-Préfecture de Grasse (06) N° 7803/88

---

**Important notice**

Individual copies of the present document can be downloaded from:

<http://www.etsi.org>

The present document may be made available in more than one electronic version or in print. In any case of existing or perceived difference in contents between such versions, the reference version is the Portable Document Format (PDF). In case of dispute, the reference shall be the printing on ETSI printers of the PDF version kept on a specific network drive within ETSI Secretariat.

Users of the present document should be aware that the document may be subject to revision or change of status. Information on the current status of this and other ETSI documents is available at

<http://portal.etsi.org/tb/status/status.asp>

If you find errors in the present document, send your comment to:

[editor@etsi.org](mailto:editor@etsi.org)

---

**Copyright Notification**

No part may be reproduced except as authorized by written permission.  
The copyright and the foregoing restriction extend to reproduction in all media.

© European Telecommunications Standards Institute 2003.  
All rights reserved.

**DECT**<sup>TM</sup>, **PLUGTESTS**<sup>TM</sup> and **UMTS**<sup>TM</sup> are Trade Marks of ETSI registered for the benefit of its Members.  
**TIPHON**<sup>TM</sup> and the **TIPHON logo** are Trade Marks currently being registered by ETSI for the benefit of its Members.  
**3GPP**<sup>TM</sup> is a Trade Mark of ETSI registered for the benefit of its Members and of the 3GPP Organizational Partners.

---

## Intellectual Property Rights

IPRs essential or potentially essential to the present document may have been declared to ETSI. The information pertaining to these essential IPRs, if any, is publicly available for **ETSI members and non-members**, and can be found in ETSI SR 000 314: "*Intellectual Property Rights (IPRs); Essential, or potentially Essential, IPRs notified to ETSI in respect of ETSI standards*", which is available from the ETSI Secretariat. Latest updates are available on the ETSI Web server (<http://webapp.etsi.org/IPR/home.asp>).

Pursuant to the ETSI IPR Policy, no investigation, including IPR searches, has been carried out by ETSI. No guarantee can be given as to the existence of other IPRs not referenced in ETSI SR 000 314 (or the updates on the ETSI Web server) which are, or may be, or may become, essential to the present document.

---

## Foreword

This Technical Specification (TS) has been produced by ETSI 3rd Generation Partnership Project (3GPP).

The present document may refer to technical specifications or reports using their 3GPP identities, UMTS identities or GSM identities. These should be interpreted as being references to the corresponding ETSI deliverables.

The cross reference between GSM, UMTS, 3GPP and ETSI identities can be found under <http://webapp.etsi.org/key/queryform.asp>.

# Contents

Intellectual Property Rights .....	2
Foreword.....	2
Foreword.....	6
1 Scope .....	7
2 References .....	7
3 Definitions, symbols and abbreviations .....	7
3.1 Definitions .....	7
3.2 Symbols.....	8
3.3 Abbreviations .....	8
4 Multiplexing, channel coding and interleaving.....	9
4.1 General .....	9
4.2 General coding/multiplexing of TrCHs.....	9
4.2.1 CRC attachment.....	13
4.2.1.1 CRC Calculation .....	13
4.2.1.2 Relation between input and output of the CRC attachment block.....	13
4.2.2 Transport block concatenation and code block segmentation.....	14
4.2.2.1 Concatenation of transport blocks.....	14
4.2.2.2 Code block segmentation .....	14
4.2.3 Channel coding .....	15
4.2.3.1 Convolutional coding .....	15
4.2.3.2 Turbo coding.....	16
4.2.3.2.1 Turbo coder .....	16
4.2.3.2.2 Trellis termination for Turbo coder .....	17
4.2.3.2.3 Turbo code internal interleaver.....	17
4.2.3.3 Concatenation of encoded blocks.....	21
4.2.4 Radio frame size equalisation .....	21
4.2.5 1 <sup>st</sup> interleaving .....	21
4.2.5.1 Insertion of marked bits in the sequence to be input in first interleaver.....	21
4.2.5.2 1 <sup>st</sup> interleaver operation.....	22
4.2.5.3 Relation between input and output of 1 <sup>st</sup> interleaving in uplink.....	23
4.2.5.4 Relation between input and output of 1 <sup>st</sup> interleaving in downlink.....	23
4.2.6 Radio frame segmentation .....	24
4.2.6.1 Relation between input and output of the radio frame segmentation block in uplink .....	24
4.2.6.2 Relation between input and output of the radio frame segmentation block in downlink .....	24
4.2.7 Rate matching .....	24
4.2.7.1 Determination of rate matching parameters in uplink .....	26
4.2.7.1.1 Determination of SF and number of PhCHs needed.....	26
4.2.7.2 Determination of rate matching parameters in downlink .....	29
4.2.7.2.1 Determination of rate matching parameters for fixed positions of TrCHs .....	30
4.2.7.2.2 Determination of rate matching parameters for flexible positions of TrCHs .....	33
4.2.7.3 Bit separation and collection in uplink.....	35
4.2.7.3.1 Bit separation.....	37
4.2.7.3.2 Bit collection .....	38
4.2.7.4 Bit separation and collection in downlink .....	38
4.2.7.4.1 Bit separation.....	39
4.2.7.4.2 Bit collection .....	40
4.2.7.5 Rate matching pattern determination .....	40
4.2.8 TrCH multiplexing.....	41
4.2.9 Insertion of discontinuous transmission (DTX) indication bits .....	42
4.2.9.1 1 <sup>st</sup> insertion of DTX indication bits.....	42
4.2.9.2 2 <sup>nd</sup> insertion of DTX indication bits.....	42
4.2.10 Physical channel segmentation .....	43
4.2.10.1 Relation between input and output of the physical segmentation block in uplink .....	44

4.2.10.2	Relation between input and output of the physical segmentation block in downlink .....	44
4.2.11	2 <sup>nd</sup> interleaving.....	44
4.2.12	Physical channel mapping .....	45
4.2.12.1	Uplink .....	45
4.2.12.2	Downlink.....	45
4.2.13	Restrictions on different types of CCTrCHs.....	46
4.2.13.1	Uplink Dedicated channel (DCH) .....	46
4.2.13.2	Random Access Channel (RACH).....	46
4.2.13.3	Common Packet Channel (CPCH).....	46
4.2.13.4	Downlink Dedicated Channel (DCH) .....	47
4.2.13.5	Downlink Shared Channel (DSCH) associated with a DCH.....	47
4.2.13.6	Broadcast channel (BCH) .....	47
4.2.13.7	Forward access and paging channels (FACH and PCH).....	47
4.2.14	Multiplexing of different transport channels into one CCTrCH, and mapping of one CCTrCH onto physical channels .....	47
4.2.14.1	Allowed CCTrCH combinations for one UE .....	48
4.2.14.1.1	Allowed CCTrCH combinations on the uplink .....	48
4.2.14.1.2	Allowed CCTrCH combinations on the downlink .....	48
4.3	Transport format detection .....	48
4.3.1	Blind transport format detection .....	49
4.3.2	Transport format detection based on TFCI.....	49
4.3.3	Coding of Transport-Format-Combination Indicator (TFCI) .....	49
4.3.4	Operation of TFCI in Hard Split Mode.....	51
4.3.5	Mapping of TFCI words .....	52
4.3.5.1	Mapping of TFCI word in normal mode .....	52
4.3.5.2	Mapping of TFCI word in compressed mode .....	52
4.3.5.2.1	Uplink compressed mode .....	52
4.3.5.2.2	Downlink compressed mode .....	52
4.4	Compressed mode .....	53
4.4.1	Frame structure in the uplink .....	53
4.4.2	Frame structure types in the downlink.....	54
4.4.3	Transmission time reduction method.....	54
4.4.3.1	Compressed mode by puncturing .....	54
4.4.3.2	Compressed mode by reducing the spreading factor by 2.....	55
4.4.3.3	Compressed mode by higher layer scheduling.....	55
4.4.4	Transmission gap position .....	55
4.5	Coding for HS-DSCH .....	56
4.5.1	CRC attachment for HS-DSCH .....	58
4.5.1a	Bit scrambling for HS-DSCH .....	58
4.5.2	Code block segmentation for HS-DSCH .....	58
4.5.3	Channel coding for HS-DSCH.....	58
4.5.4	Hybrid ARQ for HS-DSCH.....	59
4.5.4.1	HARQ bit separation.....	59
4.5.4.2	HARQ First Rate Matching Stage.....	59
4.5.4.3	HARQ Second Rate Matching Stage .....	60
4.5.4.4	HARQ bit collection .....	61
4.5.5	Physical channel segmentation for HS-DSCH.....	61
4.5.6	Interleaving for HS-DSCH .....	62
4.5.7	Constellation re-arrangement for 16 QAM.....	62
4.5.8	Physical channel mapping for HS-DSCH.....	62
4.6	Coding for HS-SCCH.....	63
4.6.1	Overview .....	63
4.6.2	HS-SCCH information field mapping .....	64
4.6.2.1	Redundancy and constellation version coding .....	64
4.6.2.2	Modulation scheme mapping .....	65
4.6.2.3	Channelization code-set mapping .....	65
4.6.2.4	UE identity mapping .....	65
4.6.3	Multiplexing of HS-SCCH information.....	65
4.6.4	CRC attachment for HS-SCCH .....	66
4.6.5	Channel coding for HS-SCCH.....	66
4.6.6	Rate matching for HS-SCCH.....	66
4.6.7	UE specific masking for HS-SCCH.....	66

4.6.8	Physical channel mapping for HS-SCCH .....	67
4.7	Coding for HS-DPCCH.....	67
4.7.1	Channel coding for HS-DPCCH.....	67
4.7.1.1	Channel coding for HS-DPCCH HARQ-ACK .....	67
4.7.1.2	Channel coding for HS-DPCCH channel quality information .....	68
4.7.2	Physical channel mapping for HS-DPCCH .....	68
<b>Annex A (informative): Blind transport format detection.....</b>		<b>69</b>
A.1	Blind transport format detection using fixed positions .....	69
A.1.1	Blind transport format detection using received power ratio.....	69
A.1.2	Blind transport format detection using CRC .....	69
<b>Annex B (informative): Compressed mode idle lengths.....</b>		<b>72</b>
B.1	Idle lengths for DL, UL and DL+UL compressed mode.....	72
<b>Annex C (informative): Change history .....</b>		<b>74</b>
History .....		76

---

## Foreword

This Technical Specification (TS) has been produced by the 3<sup>rd</sup> Generation Partnership Project (3GPP).

The contents of the present document are subject to continuing work within the TSG and may change following formal TSG approval. Should the TSG modify the contents of the present document, it will be re-released by the TSG with an identifying change of release date and an increase in version number as follows:

Version x.y.z

where:

- x the first digit:
  - 1 presented to TSG for information;
  - 2 presented to TSG for approval;
  - 3 or greater indicates TSG approved document under change control.
- y the second digit is incremented for all changes of substance, i.e. technical enhancements, corrections, updates, etc.
- z the third digit is incremented when editorial only changes have been incorporated in the document.

---

# 1 Scope

The present document describes the characteristics of the Layer 1 multiplexing and channel coding in the FDD mode of UTRA.

---

## 2 References

The following documents contain provisions which, through reference in this text, constitute provisions of the present document.

- References are either specific (identified by date of publication, edition number, version number, etc.) or non-specific.
- For a specific reference, subsequent revisions do not apply.
- For a non-specific reference, the latest version applies.

- [1] 3GPP TS 25.201: "Physical layer - General Description".
- [2] 3GPP TS 25.211: "Physical channels and mapping of transport channels onto physical channels (FDD)".
- [3] 3GPP TS 25.213: "Spreading and modulation (FDD)".
- [4] 3GPP TS 25.214: "Physical layer procedures (FDD)".
- [5] 3GPP TS 25.215: "Physical layer – Measurements (FDD)".
- [6] 3GPP TS 25.221: "Physical channels and mapping of transport channels onto physical channels (TDD)".
- [7] 3GPP TS 25.222: "Multiplexing and channel coding (TDD)".
- [8] 3GPP TS 25.223: "Spreading and modulation (TDD)".
- [9] 3GPP TS 25.224: "Physical layer procedures (TDD)".
- [10] 3GPP TS 25.225: "Physical layer – Measurements (TDD)".
- [11] 3GPP TS 25.302: "Services Provided by the Physical Layer".
- [12] 3GPP TS 25.402: "Synchronisation in UTRAN, Stage 2".
- [13] 3GPP TS 25.331: "Radio Resource Control (RRC); Protocol Specification".
- [14] ITU-T Recommendation X.691 (12/97) "Information technology - ASN.1 encoding rules: Specification of Packed Encoding Rules (PER)"

---

## 3 Definitions, symbols and abbreviations

### 3.1 Definitions

For the purposes of the present document, the following terms and definitions apply:

**TG:** Transmission Gap is consecutive empty slots that have been obtained with a transmission time reduction method. The transmission gap can be contained in one or two consecutive radio frames.

**TGL:** Transmission Gap Length is the number of consecutive empty slots that have been obtained with a transmission time reduction method.  $0 \leq TGL \leq 14$ . The CFNs of the radio frames containing the first empty slot of the transmission



gaps, the CFNs of the radio frames containing the last empty slot, the respective positions  $N_{\text{first}}$  and  $N_{\text{last}}$  within these frames of the first and last empty slots of the transmission gaps, and the transmission gap lengths can be calculated with the compressed mode parameters described in [5].

**TrCH number:** The transport channel number identifies a TrCH in the context of L1. The L3 transport channel identity (TrCH ID) maps onto the L1 transport channel number. The mapping between the transport channel number and the TrCH ID is as follows: TrCH 1 corresponds to the TrCH with the lowest TrCH ID, TrCH 2 corresponds to the TrCH with the next lowest TrCH ID and so on.

## 3.2 Symbols

For the purposes of the present document, the following symbols apply:

$\lceil x \rceil$	round towards $\infty$ , i.e. integer such that $x \leq \lceil x \rceil < x+1$
$\lfloor x \rfloor$	round towards $-\infty$ , i.e. integer such that $x-1 < \lfloor x \rfloor \leq x$
$ x $	absolute value of $x$
$\text{sgn}(x)$	signum function, i.e. $\text{sgn}(x) = \begin{cases} 1; & x \geq 0 \\ -1; & x < 0 \end{cases}$
$N_{\text{first}}$	The first slot in the <i>TG</i> , located in the first compressed radio frame if the <i>TG</i> spans two frames.
$N_{\text{last}}$	The last slot in the <i>TG</i> , located in the second compressed radio frame if the <i>TG</i> spans two frames.
$N_{\text{tr}}$	Number of transmitted slots in a radio frame.

Unless otherwise is explicitly stated when the symbol is used, the meaning of the following symbols is:

$i$	TrCH number
$j$	TFC number
$k$	Bit number
$l$	TF number
$m$	Transport block number
$n_i$	Radio frame number of TrCH $i$ .
$p$	PhCH number
$r$	Code block number
$I$	Number of TrCHs in a CCTrCH.
$C_i$	Number of code blocks in one TTI of TrCH $i$ .
$F_i$	Number of radio frames in one TTI of TrCH $i$ .
$M_i$	Number of transport blocks in one TTI of TrCH $i$ .
$N_{\text{data},j}$	Number of data bits that are available for the CCTrCH in a radio frame with TFC $j$ .
$N_{\text{data},j}^{\text{cm}}$	Number of data bits that are available for the CCTrCH in a compressed radio frame with TFC $j$ .
$P$	Number of PhCHs used for one CCTrCH.
$PL$	Puncturing Limit for the uplink. Signalled from higher layers
$RM_i$	Rate Matching attribute for TrCH $i$ . Signalled from higher layers.

Temporary variables, i.e. variables used in several (sub)clauses with different meaning.

$x, X$   
 $y, Y$   
 $z, Z$

## 3.3 Abbreviations

For the purposes of the present document, the following abbreviations apply:

ARQ	Automatic Repeat Request
BCH	Broadcast Channel
BER	Bit Error Rate
BLER	Block Error Rate
BS	Base Station
CCPCH	Common Control Physical Channel
CCTrCH	Coded Composite Transport Channel

CFN	Connection Frame Number
CRC	Cyclic Redundancy Check
DCH	Dedicated Channel
DL	Downlink (Forward link)
DPCCH	Dedicated Physical Control Channel
DPCH	Dedicated Physical Channel
DPDCH	Dedicated Physical Data Channel
DS-CDMA	Direct-Sequence Code Division Multiple Access
DSCH	Downlink Shared Channel
DTX	Discontinuous Transmission
FACH	Forward Access Channel
FDD	Frequency Division Duplex
FER	Frame Error Rate
GF	Galois Field
HARQ	Hybrid Automatic Repeat reQuest
HS-DPCCH	Dedicated Physical Control Channel (uplink) for HS-DSCH
HS-DSCH	High Speed Downlink Shared Channel
HS-PDSCH	High Speed Physical Downlink Shared Channel
HS-SCCH	Shared Control Channel for HS-DSCH
MAC	Medium Access Control
Mcps	Mega Chip Per Second
MS	Mobile Station
OVSF	Orthogonal Variable Spreading Factor (codes)
PCCC	Parallel Concatenated Convolutional Code
PCH	Paging Channel
PhCH	Physical Channel
PRACH	Physical Random Access Channel
RACH	Random Access Channel
RSC	Recursive Systematic Convolutional Coder
RV	Redundancy Version
RX	Receive
SCH	Synchronisation Channel
SF	Spreading Factor
SFN	System Frame Number
SIR	Signal-to-Interference Ratio
SNR	Signal to Noise Ratio
TF	Transport Format
TFC	Transport Format Combination
TFCI	Transport Format Combination Indicator
TPC	Transmit Power Control
TrCH	Transport Channel
TTI	Transmission Time Interval
TX	Transmit
UL	Uplink (Reverse link)

---

## 4 Multiplexing, channel coding and interleaving

### 4.1 General

Data stream from/to MAC and higher layers (Transport block / Transport block set) is encoded/decoded to offer transport services over the radio transmission link. Channel coding scheme is a combination of error detection, error correcting, rate matching, interleaving and transport channels mapping onto/splitting from physical channels.

### 4.2 General coding/multiplexing of TrCHs

This section only applies to the transport channels: DCH, RACH, CPCH, DSCH, BCH, FACH and PCH. Other transport channels which do not use the general method are described separately below.

Data arrives to the coding/multiplexing unit in form of transport block sets once every transmission time interval. The transmission time interval is transport-channel specific from the set {10 ms, 20 ms, 40 ms, 80 ms}.

The following coding/multiplexing steps can be identified:

- add CRC to each transport block (see subclause 4.2.1);
- transport block concatenation and code block segmentation (see subclause 4.2.2);
- channel coding (see subclause 4.2.3);
- radio frame equalisation (see subclause 4.2.4);
- rate matching (see subclause 4.2.7);
- insertion of discontinuous transmission (DTX) indication bits (see subclause 4.2.9);
- interleaving (two steps, see subclauses 4.2.5 and 4.2.11);
- radio frame segmentation (see subclause 4.2.6);
- multiplexing of transport channels (see subclause 4.2.8);
- physical channel segmentation (see subclause 4.2.10);
- mapping to physical channels (see subclause 4.2.12).

The coding/multiplexing steps for uplink and downlink are shown in figure 1 and figure 2 respectively.

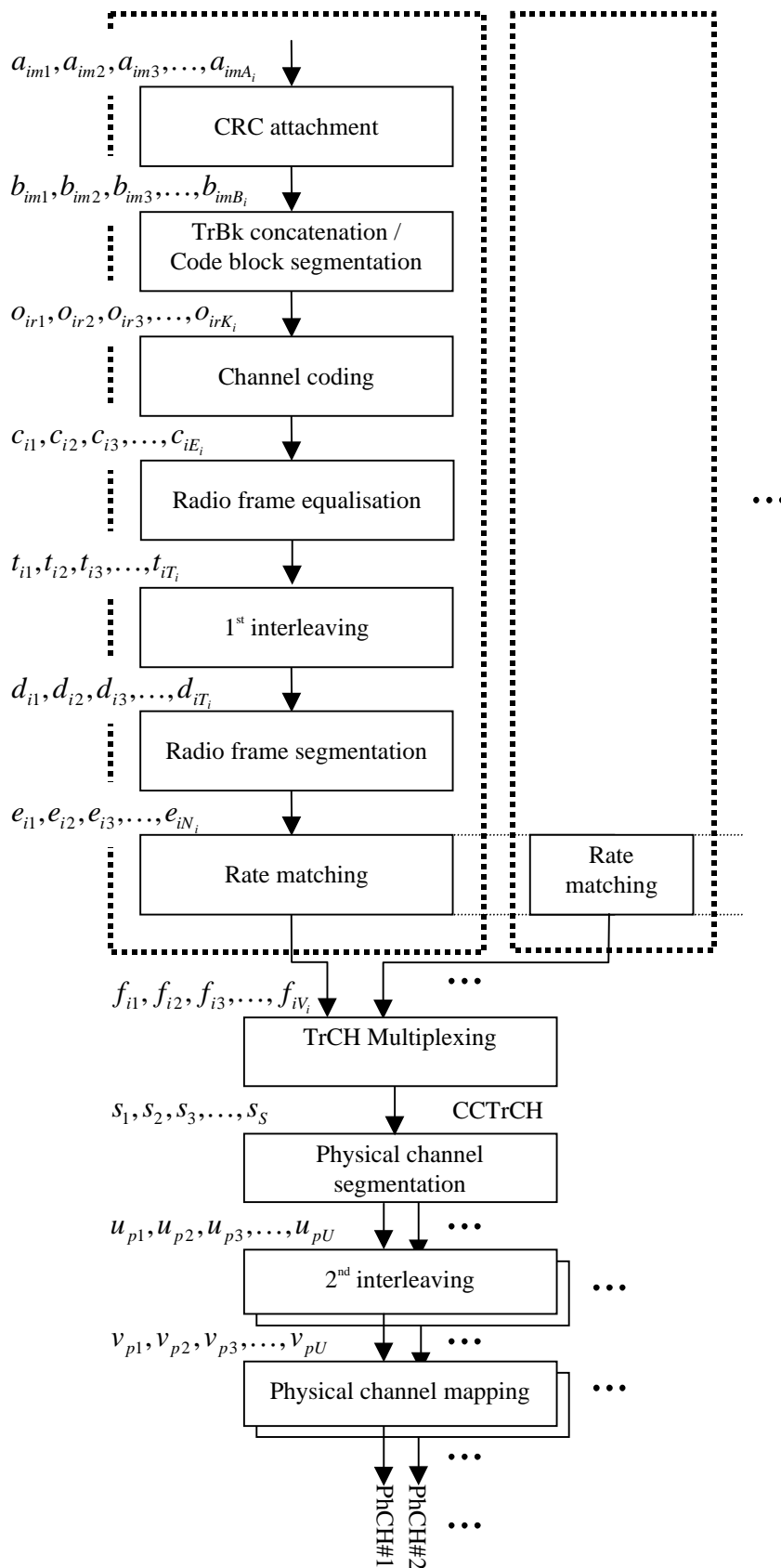
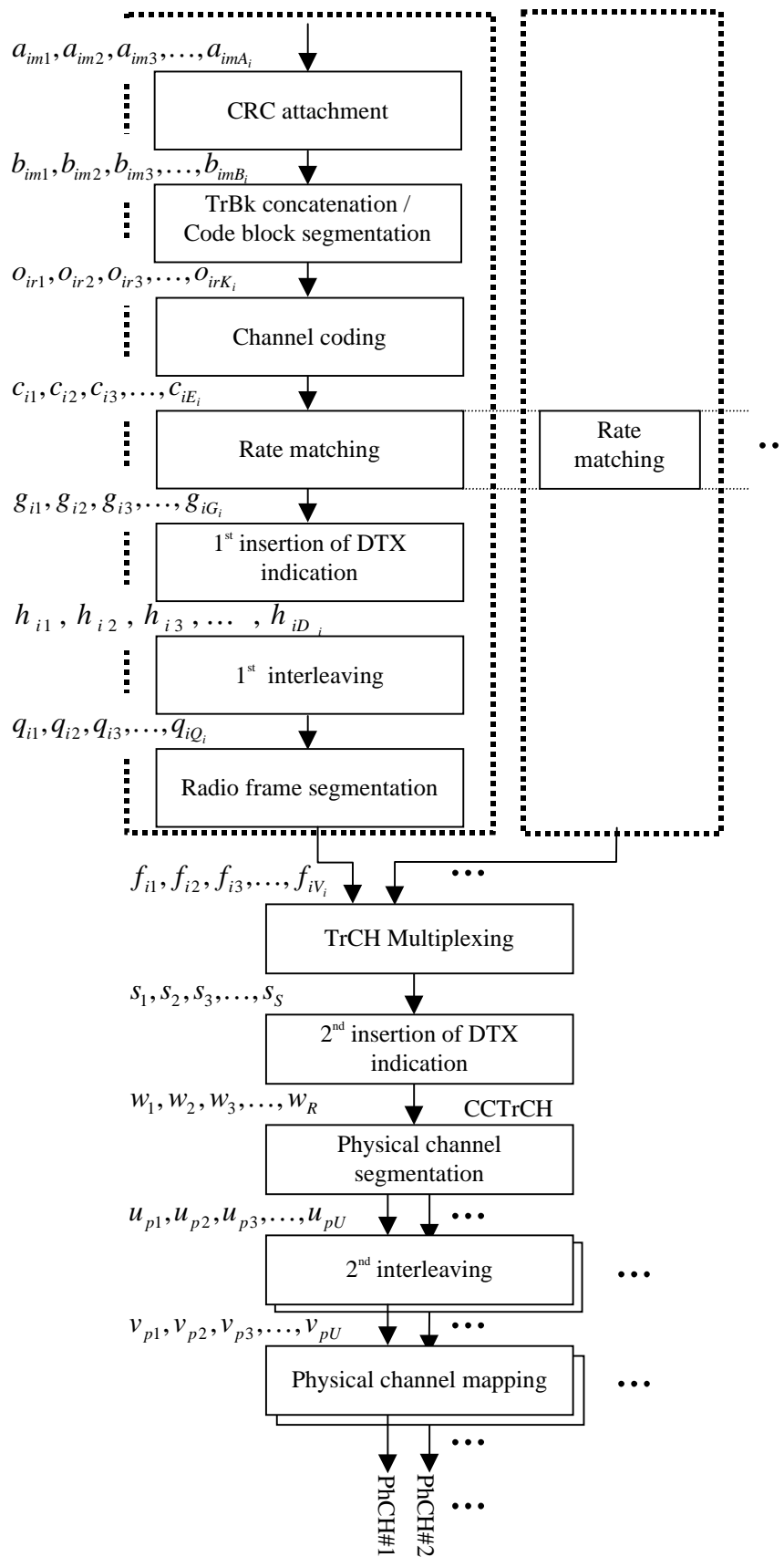

Figure 1: Transport channel multiplexing structure for uplink



**Figure 2: Transport channel multiplexing structure for downlink**

The single output data stream from the TrCH multiplexing, including DTX indication bits in downlink, is denoted *Coded Composite Transport Channel (CCTrCH)*. A CCTrCH can be mapped to one or several physical channels.

## 4.2.1 CRC attachment

Error detection is provided on transport blocks through a Cyclic Redundancy Check (CRC). The size of the CRC is 24, 16, 12, 8 or 0 bits and it is signalled from higher layers what CRC size that should be used for each TrCH.

### 4.2.1.1 CRC Calculation

The entire transport block is used to calculate the CRC parity bits for each transport block. The parity bits are generated by one of the following cyclic generator polynomials:

- $g_{\text{CRC24}}(D) = D^{24} + D^{23} + D^6 + D^5 + D + 1$ ;
- $g_{\text{CRC16}}(D) = D^{16} + D^{12} + D^5 + 1$ ;
- $g_{\text{CRC12}}(D) = D^{12} + D^{11} + D^3 + D^2 + D + 1$ ;
- $g_{\text{CRC8}}(D) = D^8 + D^7 + D^4 + D^3 + D + 1$ .

Denote the bits in a transport block delivered to layer 1 by  $a_{im1}, a_{im2}, a_{im3}, \dots, a_{imA_i}$ , and the parity bits by  $p_{im1}, p_{im2}, p_{im3}, \dots, p_{imL_i}$ .  $A_i$  is the size of a transport block of TrCH  $i$ ,  $m$  is the transport block number, and  $L_i$  is the number of parity bits.  $L_i$  can take the values 24, 16, 12, 8, or 0 depending on what is signalled from higher layers.

The encoding is performed in a systematic form, which means that in GF(2), the polynomial:

$$a_{im1}D^{A_i+23} + a_{im2}D^{A_i+22} + \dots + a_{imA_i}D^{24} + p_{im1}D^{23} + p_{im2}D^{22} + \dots + p_{im23}D^1 + p_{im24}$$

yields a remainder equal to 0 when divided by  $g_{\text{CRC24}}(D)$ , polynomial:

$$a_{im1}D^{A_i+15} + a_{im2}D^{A_i+14} + \dots + a_{imA_i}D^{16} + p_{im1}D^{15} + p_{im2}D^{14} + \dots + p_{im15}D^1 + p_{im16}$$

yields a remainder equal to 0 when divided by  $g_{\text{CRC16}}(D)$ , polynomial:

$$a_{im1}D^{A_i+11} + a_{im2}D^{A_i+10} + \dots + a_{imA_i}D^{12} + p_{im1}D^{11} + p_{im2}D^{10} + \dots + p_{im11}D^1 + p_{im12}$$

yields a remainder equal to 0 when divided by  $g_{\text{CRC12}}(D)$  and polynomial:

$$a_{im1}D^{A_i+7} + a_{im2}D^{A_i+6} + \dots + a_{imA_i}D^8 + p_{im1}D^7 + p_{im2}D^6 + \dots + p_{im7}D^1 + p_{im8}$$

yields a remainder equal to 0 when divided by  $g_{\text{CRC8}}(D)$ .

If no transport blocks are input to the CRC calculation ( $M_i = 0$ ), no CRC attachment shall be done. If transport blocks are input to the CRC calculation ( $M_i \neq 0$ ) and the size of a transport block is zero ( $A_i = 0$ ), CRC shall be attached, i.e. all parity bits equal to zero.

### 4.2.1.2 Relation between input and output of the CRC attachment block

The bits after CRC attachment are denoted by  $b_{im1}, b_{im2}, b_{im3}, \dots, b_{imB_i}$ , where  $B_i = A_i + L_i$ . The relation between  $a_{imk}$  and  $b_{imk}$  is:

$$b_{imk} = a_{imk} \quad k = 1, 2, 3, \dots, A_i$$

$$b_{imk} = p_{im(L_i+1-(k-A_i))} \quad k = A_i + 1, A_i + 2, A_i + 3, \dots, A_i + L_i$$

## 4.2.2 Transport block concatenation and code block segmentation

All transport blocks in a TTI are serially concatenated. If the number of bits in a TTI is larger than  $Z$ , the maximum size of a code block in question, then code block segmentation is performed after the concatenation of the transport blocks. The maximum size of the code blocks depends on whether convolutional coding or turbo coding is used for the TrCH.

### 4.2.2.1 Concatenation of transport blocks

The bits input to the transport block concatenation are denoted by  $b_{im1}, b_{im2}, b_{im3}, \dots, b_{imB_i}$  where  $i$  is the TrCH number,  $m$  is the transport block number, and  $B_i$  is the number of bits in each block (including CRC). The number of transport blocks on TrCH  $i$  is denoted by  $M_i$ . The bits after concatenation are denoted by  $x_{i1}, x_{i2}, x_{i3}, \dots, x_{iX_i}$ , where  $i$  is the TrCH number and  $X_i = M_i B_i$ . They are defined by the following relations:

$$x_{ik} = b_{i1k} \quad k = 1, 2, \dots, B_i$$

$$x_{ik} = b_{i,2,(k-B_i)} \quad k = B_i + 1, B_i + 2, \dots, 2B_i$$

$$x_{ik} = b_{i,3,(k-2B_i)} \quad k = 2B_i + 1, 2B_i + 2, \dots, 3B_i$$

...

$$x_{ik} = b_{i,M_i,(k-(M_i-1)B_i)} \quad k = (M_i - 1)B_i + 1, (M_i - 1)B_i + 2, \dots, M_i B_i$$

### 4.2.2.2 Code block segmentation

Segmentation of the bit sequence from transport block concatenation is performed if  $X_i > Z$ . The code blocks after segmentation are of the same size. The number of code blocks on TrCH  $i$  is denoted by  $C_i$ . If the number of bits input to the segmentation,  $X_i$ , is not a multiple of  $C_i$ , filler bits are added to the beginning of the first block. If turbo coding is selected and  $X_i < 40$ , filler bits are added to the beginning of the code block. The filler bits are transmitted and they are always set to 0. The maximum code block sizes are:

- convolutional coding:  $Z = 504$ ;
- turbo coding:  $Z = 5114$ .

The bits output from code block segmentation, for  $C_i \neq 0$ , are denoted by  $o_{ir1}, o_{ir2}, o_{ir3}, \dots, o_{irK_i}$ , where  $i$  is the TrCH number,  $r$  is the code block number, and  $K_i$  is the number of bits per code block.

Number of code blocks:

$$C_i = \lceil X_i / Z \rceil$$

Number of bits in each code block (applicable for  $C_i \neq 0$  only):

if  $X_i < 40$  and Turbo coding is used, then

$$K_i = 40$$

else

$$K_i = \lceil X_i / C_i \rceil$$

end if

Number of filler bits:  $Y_i = C_i K_i - X_i$

for  $k = 1$  to  $Y_i$                       -- Insertion of filler bits

$$o_{ik} = 0$$

```

end for
for  $k = Y_i + 1$  to  $K_i$ 
     $O_{ik} = x_{i,(k-Y_i)}$ 
end for
 $r = 2$                                 -- Segmentation
while  $r \leq C_i$ 
    for  $k = 1$  to  $K_i$ 
         $O_{irk} = x_{i,(k+(r-1)K_i-Y_i)}^I$ 
    end for
     $r = r + 1$ 
end while

```

### 4.2.3 Channel coding

Code blocks are delivered to the channel coding block. They are denoted by  $O_{ir1}, O_{ir2}, O_{ir3}, \dots, O_{irK_i}$ , where  $i$  is the TrCH number,  $r$  is the code block number, and  $K_i$  is the number of bits in each code block. The number of code blocks on TrCH  $i$  is denoted by  $C_i$ . After encoding the bits are denoted by  $y_{ir1}, y_{ir2}, y_{ir3}, \dots, y_{irY_i}$ , where  $Y_i$  is the number of encoded bits. The relation between  $O_{irk}$  and  $y_{irk}$  and between  $K_i$  and  $Y_i$  is dependent on the channel coding scheme.

The following channel coding schemes can be applied to TrCHs:

- convolutional coding;
- turbo coding.

Usage of coding scheme and coding rate for the different types of TrCH is shown in table 1.

The values of  $Y_i$  in connection with each coding scheme:

- convolutional coding with rate 1/2:  $Y_i = 2 * K_i + 16$ ; rate 1/3:  $Y_i = 3 * K_i + 24$ ;
- turbo coding with rate 1/3:  $Y_i = 3 * K_i + 12$ .

**Table 1: Usage of channel coding scheme and coding rate**

Type of TrCH	Coding scheme	Coding rate
BCH	Convolutional coding	1/2
PCH		
RACH		
CPCH, DCH, DSCH, FACH	Turbo coding	1/3, 1/2 1/3

#### 4.2.3.1 Convolutional coding

Convolutional codes with constraint length 9 and coding rates 1/3 and 1/2 are defined.

The configuration of the convolutional coder is presented in figure 3.

Output from the rate 1/3 convolutional coder shall be done in the order output0, output1, output2, output0, output1, output 2, output 0, ..., output2. Output from the rate 1/2 convolutional coder shall be done in the order output 0, output 1, output 0, output 1, output 0, ..., output 1.



8 tail bits with binary value 0 shall be added to the end of the code block before encoding.

The initial value of the shift register of the coder shall be "all 0" when starting to encode the input bits.

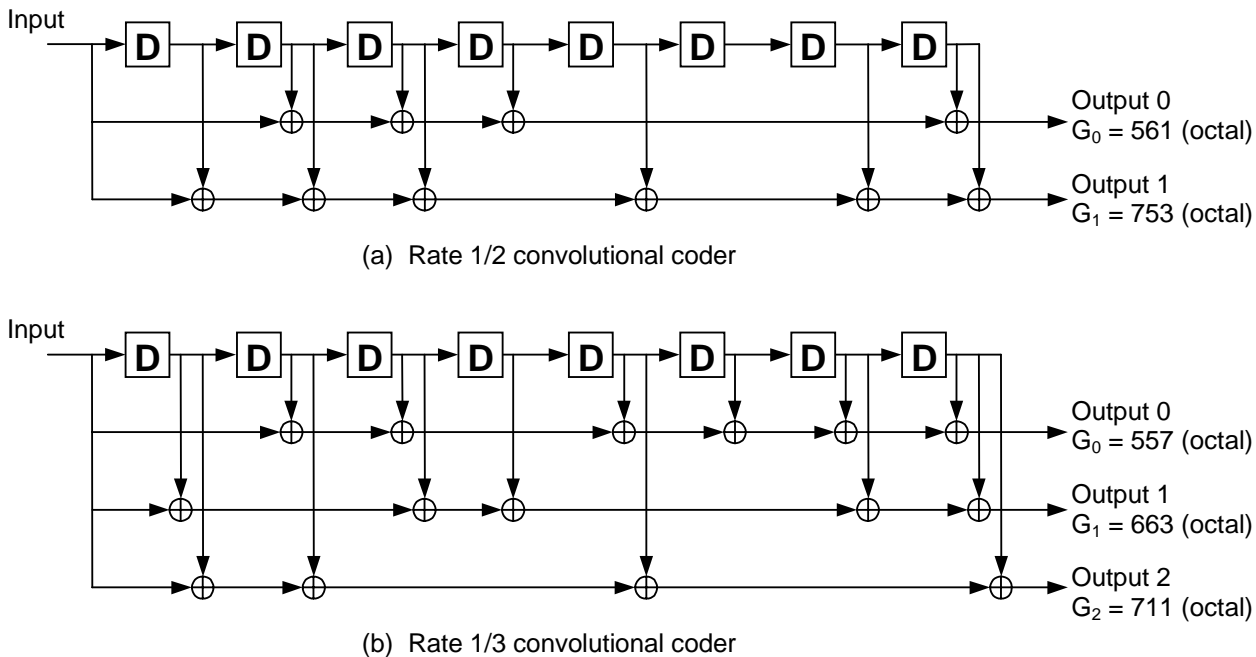

Figure 3: Rate 1/2 and rate 1/3 convolutional coders

### 4.2.3.2 Turbo coding

#### 4.2.3.2.1 Turbo coder

The scheme of Turbo coder is a Parallel Concatenated Convolutional Code (PCCC) with two 8-state constituent encoders and one Turbo code internal interleaver. The coding rate of Turbo coder is 1/3. The structure of Turbo coder is illustrated in figure 4.

The transfer function of the 8-state constituent code for PCCC is:

$$G(D) = \left[ 1, \frac{g_1(D)}{g_0(D)} \right],$$

where

$$g_0(D) = 1 + D^2 + D^3,$$

$$g_1(D) = 1 + D + D^3.$$

The initial value of the shift registers of the 8-state constituent encoders shall be all zeros when starting to encode the input bits.

Output from the Turbo coder is

$$x_1, z_1, z'_1, x_2, z_2, z'_2, \dots, x_K, z_K, z'_K,$$

where  $x_1, x_2, \dots, x_K$  are the bits input to the Turbo coder i.e. both first 8-state constituent encoder and Turbo code internal interleaver, and  $K$  is the number of bits, and  $z_1, z_2, \dots, z_K$  and  $z'_1, z'_2, \dots, z'_K$  are the bits output from first and second 8-state constituent encoders, respectively.

The bits output from Turbo code internal interleaver are denoted by  $x'_1, x'_2, \dots, x'_K$ , and these bits are to be input to the second 8-state constituent encoder.

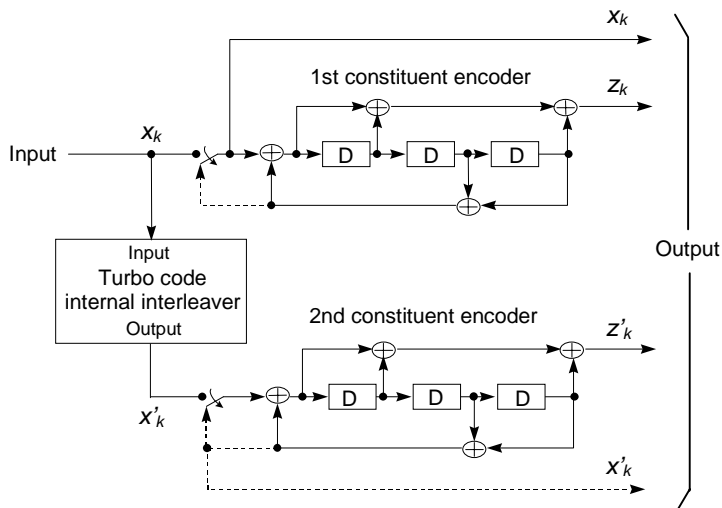

Figure 4: Structure of rate 1/3 Turbo coder (dotted lines apply for trellis termination only)

4.2.3.2.2 Trellis termination for Turbo coder

Trellis termination is performed by taking the tail bits from the shift register feedback after all information bits are encoded. Tail bits are padded after the encoding of information bits.

The first three tail bits shall be used to terminate the first constituent encoder (upper switch of figure 4 in lower position) while the second constituent encoder is disabled. The last three tail bits shall be used to terminate the second constituent encoder (lower switch of figure 4 in lower position) while the first constituent encoder is disabled.

The transmitted bits for trellis termination shall then be:

$$x_{K+1}, z_{K+1}, x_{K+2}, z_{K+2}, x_{K+3}, z_{K+3}, x'_{K+1}, z'_{K+1}, x'_{K+2}, z'_{K+2}, x'_{K+3}, z'_{K+3}.$$

4.2.3.2.3 Turbo code internal interleaver

The Turbo code internal interleaver consists of bits-input to a rectangular matrix with padding, intra-row and inter-row permutations of the rectangular matrix, and bits-output from the rectangular matrix with pruning. The bits input to the Turbo code internal interleaver are denoted by  $x_1, x_2, x_3, \dots, x_K$ , where  $K$  is the integer number of the bits and takes one value of  $40 \leq K \leq 5114$ . The relation between the bits input to the Turbo code internal interleaver and the bits input to the channel coding is defined by  $x_k = o_{irk}$  and  $K = K_i$ .

The following subclause specific symbols are used in subclauses 4.2.3.2.3.1 to 4.2.3.2.3.3:

- $K$  Number of bits input to Turbo code internal interleaver
- $R$  Number of rows of rectangular matrix
- $C$  Number of columns of rectangular matrix
- $p$  Prime number
- $v$  Primitive root
- $\langle s(j) \rangle_{j \in \{0,1,\dots,p-2\}}$  Base sequence for intra-row permutation
- $q_i$  Minimum prime integers
- $r_i$  Permuted prime integers

$\langle T(i) \rangle_{i \in \{0,1,\dots,R-1\}}$  Inter-row permutation pattern

$\langle U_i(j) \rangle_{j \in \{0,1,\dots,C-1\}}$  Intra-row permutation pattern of  $i$ -th row

$i$  Index of row number of rectangular matrix

$j$  Index of column number of rectangular matrix

$k$  Index of bit sequence

#### 4.2.3.2.3.1 Bits-input to rectangular matrix with padding

The bit sequence  $x_1, x_2, x_3, \dots, x_K$  input to the Turbo code internal interleaver is written into the rectangular matrix as follows.

(1) Determine the number of rows of the rectangular matrix,  $R$ , such that:

$$R = \begin{cases} 5, & \text{if } (40 \leq K \leq 159) \\ 10, & \text{if } ((160 \leq K \leq 200) \text{ or } (481 \leq K \leq 530)) \\ 20, & \text{if } (K = \text{any other value}) \end{cases} .$$

The rows of rectangular matrix are numbered  $0, 1, \dots, R - 1$  from top to bottom.

(2) Determine the prime number to be used in the intra-permutation,  $p$ , and the number of columns of rectangular matrix,  $C$ , such that:

if  $(481 \leq K \leq 530)$  then

$$p = 53 \text{ and } C = p.$$

else

Find minimum prime number  $p$  from table 2 such that

$$K \leq R \times (p + 1),$$

and determine  $C$  such that

$$C = \begin{cases} p - 1 & \text{if } K \leq R \times (p - 1) \\ p & \text{if } R \times (p - 1) < K \leq R \times p \\ p + 1 & \text{if } R \times p < K \end{cases}$$

end if

The columns of rectangular matrix are numbered  $0, 1, \dots, C - 1$  from left to right.

**Table 2: List of prime number  $p$  and associated primitive root  $v$**

$p$	$v$	$p$	$v$	$p$	$v$	$p$	$v$	$p$	$v$
7	3	47	5	101	2	157	5	223	3
11	2	53	2	103	5	163	2	227	2
13	2	59	2	107	2	167	5	229	6
17	3	61	2	109	6	173	2	233	3
19	2	67	2	113	3	179	2	239	7
23	5	71	7	127	3	181	2	241	7
29	2	73	5	131	2	191	19	251	6
31	3	79	3	137	3	193	5	257	3
37	2	83	2	139	2	197	2		
41	6	89	3	149	2	199	3		
43	3	97	5	151	6	211	2		

(3) Write the input bit sequence  $x_1, x_2, x_3, \dots, x_K$  into the  $R \times C$  rectangular matrix row by row starting with bit  $y_1$  in column 0 of row 0:

$$\begin{bmatrix} y_1 & y_2 & y_3 & \dots & y_C \\ y_{(C+1)} & y_{(C+2)} & y_{(C+3)} & \dots & y_{2C} \\ \vdots & \vdots & \vdots & \dots & \vdots \\ y_{((R-1)C+1)} & y_{((R-1)C+2)} & y_{((R-1)C+3)} & \dots & y_{R \times C} \end{bmatrix}$$

where  $y_k = x_k$  for  $k = 1, 2, \dots, K$  and if  $R \times C > K$ , the dummy bits are padded such that  $y_k = 0$  or  $1$  for  $k = K + 1, K + 2, \dots, R \times C$ . These dummy bits are pruned away from the output of the rectangular matrix after intra-row and inter-row permutations.

**4.2.3.2.3.2 Intra-row and inter-row permutations**

After the bits-input to the  $R \times C$  rectangular matrix, the intra-row and inter-row permutations for the  $R \times C$  rectangular matrix are performed stepwise by using the following algorithm with steps (1) – (6):

(1) Select a primitive root  $v$  from table 2 in section 4.2.3.2.3.1, which is indicated on the right side of the prime number  $p$ .

(2) Construct the base sequence  $\langle s(j) \rangle_{j \in \{0,1,\dots,p-2\}}$  for intra-row permutation as:

$$s(j) = (v \times s(j-1)) \bmod p, \quad j = 1, 2, \dots, (p-2), \text{ and } s(0) = 1.$$

(3) Assign  $q_0 = 1$  to be the first prime integer in the sequence  $\langle q_i \rangle_{i \in \{0,1,\dots,R-1\}}$ , and determine the prime integer  $q_i$  in the sequence  $\langle q_i \rangle_{i \in \{0,1,\dots,R-1\}}$  to be a least prime integer such that  $\text{g.c.d}(q_i, p-1) = 1$ ,  $q_i > 6$ , and  $q_i > q_{(i-1)}$  for each  $i = 1, 2, \dots, R-1$ . Here g.c.d. is greatest common divisor.

(4) Permute the sequence  $\langle q_i \rangle_{i \in \{0,1,\dots,R-1\}}$  to make the sequence  $\langle r_i \rangle_{i \in \{0,1,\dots,R-1\}}$  such that

$$r_{T(i)} = q_i, \quad i = 0, 1, \dots, R-1,$$

where  $\langle T(i) \rangle_{i \in \{0,1,\dots,R-1\}}$  is the inter-row permutation pattern defined as the one of the four kind of patterns, which are shown in table 3, depending on the number of input bits  $K$ .

**Table 3: Inter-row permutation patterns for Turbo code internal interleaver**

Number of input bits $K$	Number of rows $R$	Inter-row permutation patterns $\langle T(0), T(1), \dots, T(R-1) \rangle$
$(40 \leq K \leq 159)$	5	$\langle 4, 3, 2, 1, 0 \rangle$
$(160 \leq K \leq 200)$ or $(481 \leq K \leq 530)$	10	$\langle 9, 8, 7, 6, 5, 4, 3, 2, 1, 0 \rangle$

$(2281 \leq K \leq 2480)$ or $(3161 \leq K \leq 3210)$	20	<19, 9, 14, 4, 0, 2, 5, 7, 12, 18, 16, 13, 17, 15, 3, 1, 6, 11, 8, 10>
$K = \text{any other value}$	20	<19, 9, 14, 4, 0, 2, 5, 7, 12, 18, 10, 8, 13, 17, 3, 1, 16, 6, 15, 11>

(5) Perform the  $i$ -th ( $i = 0, 1, \dots, R - 1$ ) intra-row permutation as:

if ( $C = p$ ) then

$$U_i(j) = s((j \times r_i) \bmod (p - 1)), \quad j = 0, 1, \dots, (p - 2), \text{ and } U_i(p - 1) = 0,$$

where  $U_i(j)$  is the original bit position of  $j$ -th permuted bit of  $i$ -th row.

end if

if ( $C = p + 1$ ) then

$$U_i(j) = s((j \times r_i) \bmod (p - 1)), \quad j = 0, 1, \dots, (p - 2). \quad U_i(p - 1) = 0, \text{ and } U_i(p) = p,$$

where  $U_i(j)$  is the original bit position of  $j$ -th permuted bit of  $i$ -th row, and

if ( $K = R \times C$ ) then

Exchange  $U_{R-1}(p)$  with  $U_{R-1}(0)$ .

end if

end if

if ( $C = p - 1$ ) then

$$U_i(j) = s((j \times r_i) \bmod (p - 1)) - 1, \quad j = 0, 1, \dots, (p - 2),$$

where  $U_i(j)$  is the original bit position of  $j$ -th permuted bit of  $i$ -th row.

end if

(6) Perform the inter-row permutation for the rectangular matrix based on the pattern  $\langle T(i) \rangle_{i \in \{0, 1, \dots, R-1\}}$ ,

where  $T(i)$  is the original row position of the  $i$ -th permuted row.

#### 4.2.3.2.3.3 Bits-output from rectangular matrix with pruning

After intra-row and inter-row permutations, the bits of the permuted rectangular matrix are denoted by  $y'_k$ :

$$\begin{bmatrix} y'_1 & y'_{(R+1)} & y'_{(2R+1)} & \cdots & y'_{((C-1)R+1)} \\ y'_2 & y'_{(R+2)} & y'_{(2R+2)} & \cdots & y'_{((C-1)R+2)} \\ \vdots & \vdots & \vdots & \cdots & \vdots \\ y'_R & y'_{2R} & y'_{3R} & \cdots & y'_{C \times R} \end{bmatrix}$$

The output of the Turbo code internal interleaver is the bit sequence read out column by column from the intra-row and inter-row permuted  $R \times C$  rectangular matrix starting with bit  $y'_1$  in row 0 of column 0 and ending with bit  $y'_{CR}$  in row  $R - 1$  of column  $C - 1$ . The output is pruned by deleting dummy bits that were padded to the input of the rectangular matrix before intra-row and inter row permutations, i.e. bits  $y'_k$  that corresponds to bits  $y_k$  with  $k > K$  are removed from the output. The bits output from Turbo code internal interleaver are denoted by  $x'_1, x'_2, \dots, x'_K$ , where  $x'_1$  corresponds to the bit  $y'_k$  with smallest index  $k$  after pruning,  $x'_2$  to the bit  $y'_k$  with second smallest index  $k$  after pruning, and so on. The number of bits output from Turbo code internal interleaver is  $K$  and the total number of pruned bits is:

$$R \times C - K.$$

### 4.2.3.3 Concatenation of encoded blocks

After the channel coding for each code block, if  $C_i$  is greater than 1, the encoded blocks are serially concatenated so that the block with lowest index  $r$  is output first from the channel coding block, otherwise the encoded block is output from channel coding block as it is. The bits output are denoted by  $c_{i1}, c_{i2}, c_{i3}, \dots, c_{iE_i}$ , where  $i$  is the TrCH number and  $E_i = C_i Y_i$ . The output bits are defined by the following relations:

$$c_{ik} = y_{i1k} \quad k = 1, 2, \dots, Y_i$$

$$c_{ik} = y_{i,2,(k-Y_i)} \quad k = Y_i + 1, Y_i + 2, \dots, 2Y_i$$

$$c_{ik} = y_{i,3,(k-2Y_i)} \quad k = 2Y_i + 1, 2Y_i + 2, \dots, 3Y_i$$

...

$$c_{ik} = y_{i,C_i,(k-(C_i-1)Y_i)} \quad k = (C_i - 1)Y_i + 1, (C_i - 1)Y_i + 2, \dots, C_i Y_i$$

If no code blocks are input to the channel coding ( $C_i = 0$ ), no bits shall be output from the channel coding, i.e.  $E_i = 0$ .

### 4.2.4 Radio frame size equalisation

Radio frame size equalisation is padding the input bit sequence in order to ensure that the output can be segmented in  $F_i$  data segments of same size as described in subclause 4.2.7. Radio frame size equalisation is only performed in the UL.

The input bit sequence to the radio frame size equalisation is denoted by  $c_{i1}, c_{i2}, c_{i3}, \dots, c_{iE_i}$ , where  $i$  is TrCH number and  $E_i$  the number of bits. The output bit sequence is denoted by  $t_{i1}, t_{i2}, t_{i3}, \dots, t_{iT_i}$ , where  $T_i$  is the number of bits. The output bit sequence is derived as follows:

- $t_{ik} = c_{ik}$ , for  $k = 1 \dots E_i$ ; and
- $t_{ik} = \{0, 1\}$  for  $k = E_i + 1 \dots T_i$ , if  $E_i < T_i$ ;

where

- $T_i = F_i * N_i$ ; and
- $N_i = \lceil E_i / F_i \rceil$  is the number of bits per segment after size equalisation.

### 4.2.5 1<sup>st</sup> interleaving

In Compressed Mode by puncturing, bits marked with a fourth value on top of  $\{0, 1, \delta\}$  and noted p, are introduced in the radio frames to be compressed, in positions corresponding to the first bits of the radio frames. They will be removed in a later stage of the multiplexing chain to create the actual gap. Additional puncturing has been performed in the rate matching step, over the TTI containing the compressed radio frame, to create room for these p-bits. The following subclause describes this feature.

#### 4.2.5.1 Insertion of marked bits in the sequence to be input in first interleaver

In normal mode, compressed mode by higher layer scheduling, and compressed mode by spreading factor reduction:

$$x_{i,k} = z_{i,k} \text{ and } X_i = Z_i$$

In case the TTI contains a radio frame that is compressed by puncturing and fixed positions are used, sequence  $x_{i,k}$  which will be input to first interleaver for TrCH  $i$  and TTI  $m$  within largest TTI, is built from bits  $z_{i,k}$ ,  $k = 1, \dots, Z_i$ , plus  $Np_{i,\max}^{TTI,m}$  bits marked p and  $X_i = Z_i + Np_{i,\max}^{TTI,m}$ , as is described thereafter.

$Np_{i,\max}^{TTI,m}$  is defined in the Rate Matching subclause 4.2.7.



- (3) Write the input bit sequence into the  $R1 \times C1$  matrix row by row starting with bit  $x_{i,1}$  in column 0 of row 0 and ending with bit  $x_{i,(R1 \times C1)}$  in column  $C1 - 1$  of row  $R1 - 1$ :

$$\begin{bmatrix} x_{i,1} & x_{i,2} & x_{i,3} & \cdots & x_{i,C1} \\ x_{i,(C1+1)} & x_{i,(C1+2)} & x_{i,(C1+3)} & \cdots & x_{i,(2 \times C1)} \\ \vdots & \vdots & \vdots & \cdots & \vdots \\ x_{i,((R1-1) \times C1+1)} & x_{i,((R1-1) \times C1+2)} & x_{i,((R1-1) \times C1+3)} & \cdots & x_{i,(R1 \times C1)} \end{bmatrix}$$

- (4) Perform the inter-column permutation for the matrix based on the pattern  $\langle P1_{C1}(j) \rangle_{j \in \{0,1,\dots,C1-1\}}$  shown in table 4, where  $P1_{C1}(j)$  is the original column position of the  $j$ -th permuted column. After permutation of the columns, the bits are denoted by  $y_{ik}$ :

$$\begin{bmatrix} y_{i,1} & y_{i,(R1+1)} & y_{i,(2 \times R1+1)} & \cdots & y_{i,((C1-1) \times R1+1)} \\ y_{i,2} & y_{i,(R1+2)} & y_{i,(2 \times R1+2)} & \cdots & y_{i,((C1-1) \times R1+2)} \\ \vdots & \vdots & \vdots & \cdots & \vdots \\ y_{i,R1} & y_{i,(2 \times R1)} & y_{i,(3 \times R1)} & \cdots & y_{i,(C1 \times R1)} \end{bmatrix}$$

- (5) Read the output bit sequence  $y_{i,1}, y_{i,2}, y_{i,3}, \dots, y_{i,(C1 \times R1)}$  of the block interleaver column by column from the inter-column permuted  $R1 \times C1$  matrix. Bit  $y_{i,1}$  corresponds to row 0 of column 0 and bit  $y_{i,(R1 \times C1)}$  corresponds to row  $R1 - 1$  of column  $C1 - 1$ .

**Table 4 Inter-column permutation patterns for 1st interleaving**

TTI	Number of columns C1	Inter-column permutation patterns $\langle P1_{C1}(0), P1_{C1}(1), \dots, P1_{C1}(C1-1) \rangle$
10 ms	1	$\langle 0 \rangle$
20 ms	2	$\langle 0, 1 \rangle$
40 ms	4	$\langle 0, 2, 1, 3 \rangle$
80 ms	8	$\langle 0, 4, 2, 6, 1, 5, 3, 7 \rangle$

#### 4.2.5.3 Relation between input and output of 1<sup>st</sup> interleaving in uplink

The bits input to the 1<sup>st</sup> interleaving are denoted by  $t_{i,1}, t_{i,2}, t_{i,3}, \dots, t_{i,T_i}$ , where  $i$  is the TrCH number and  $T_i$  the number of bits. Hence,  $z_{i,k} = t_{i,k}$  and  $Z_i = T_i$ .

The bits output from the 1<sup>st</sup> interleaving are denoted by  $d_{i,1}, d_{i,2}, d_{i,3}, \dots, d_{i,T_i}$ , and  $d_{i,k} = y_{i,k}$ .

#### 4.2.5.4 Relation between input and output of 1<sup>st</sup> interleaving in downlink

If fixed positions of the TrCHs in a radio frame is used then the bits input to the 1<sup>st</sup> interleaving are denoted by  $h_{i,1}, h_{i,2}, h_{i,3}, \dots, h_{i,D_i}$ , where  $i$  is the TrCH number. Hence,  $z_{i,k} = h_{i,k}$  and  $Z_i = D_i$ .

If flexible positions of the TrCHs in a radio frame is used then the bits input to the 1<sup>st</sup> interleaving are denoted by  $g_{i,1}, g_{i,2}, g_{i,3}, \dots, g_{i,G_i}$ , where  $i$  is the TrCH number. Hence,  $z_{i,k} = g_{i,k}$  and  $Z_i = G_i$ .

The bits output from the 1<sup>st</sup> interleaving are denoted by  $q_{i,1}, q_{i,2}, q_{i,3}, \dots, q_{i,Q_i}$ , where  $i$  is the TrCH number and  $Q_i$  is the number of bits. Hence,  $q_{i,k} = y_{i,k}$ ,  $Q_i = F_i H_i$  if fixed positions are used, and  $Q_i = G_i$  if flexible positions are used.



## 4.2.6 Radio frame segmentation

When the transmission time interval is longer than 10 ms, the input bit sequence is segmented and mapped onto consecutive  $F_i$  radio frames. Following rate matching in the DL and radio frame size equalisation in the UL the input bit sequence length is guaranteed to be an integer multiple of  $F_i$ .

The input bit sequence is denoted by  $x_{i1}, x_{i2}, x_{i3}, \dots, x_{iX_i}$  where  $i$  is the TrCH number and  $X_i$  is the number bits. The  $F_i$  output bit sequences per TTI are denoted by  $y_{i,n_i1}, y_{i,n_i2}, y_{i,n_i3}, \dots, y_{i,n_iY_i}$  where  $n_i$  is the radio frame number in current TTI and  $Y_i$  is the number of bits per radio frame for TrCH  $i$ . The output sequences are defined as follows:

$$y_{i,n_i,k} = x_{i,((n_i-1)Y_i)+k}, n_i = 1 \dots F_i, k = 1 \dots Y_i$$

where

$$Y_i = (X_i / F_i) \text{ is the number of bits per segment.}$$

The  $n_i$ -th segment is mapped to the  $n_i$ -th radio frame of the transmission time interval.

### 4.2.6.1 Relation between input and output of the radio frame segmentation block in uplink

The input bit sequence to the radio frame segmentation is denoted by  $d_{i1}, d_{i2}, d_{i3}, \dots, d_{iT_i}$ , where  $i$  is the TrCH number and  $T_i$  the number of bits. Hence,  $x_{ik} = d_{ik}$  and  $X_i = T_i$ .

The output bit sequence corresponding to radio frame  $n_i$  is denoted by  $e_{i1}, e_{i2}, e_{i3}, \dots, e_{iN_i}$ , where  $i$  is the TrCH number and  $N_i$  is the number of bits. Hence,  $e_{i,k} = y_{i,n_i,k}$  and  $N_i = Y_i$ .

### 4.2.6.2 Relation between input and output of the radio frame segmentation block in downlink

The bits input to the radio frame segmentation are denoted by  $q_{i1}, q_{i2}, q_{i3}, \dots, q_{iQ_i}$ , where  $i$  is the TrCH number and  $Q_i$  the number of bits. Hence,  $x_{ik} = q_{ik}$  and  $X_i = Q_i$ .

The output bit sequence corresponding to radio frame  $n_i$  is denoted by  $f_{i1}, f_{i2}, f_{i3}, \dots, f_{iV_i}$ , where  $i$  is the TrCH number and  $V_i$  is the number of bits. Hence,  $f_{i,k} = y_{i,n_i,k}$  and  $V_i = Y_i$ .

## 4.2.7 Rate matching

Rate matching means that bits on a transport channel are repeated or punctured. Higher layers assign a rate-matching attribute for each transport channel. This attribute is semi-static and can only be changed through higher layer signalling. The rate-matching attribute is used when the number of bits to be repeated or punctured is calculated.

The number of bits on a transport channel can vary between different transmission time intervals. In the downlink the transmission is interrupted if the number of bits is lower than maximum. When the number of bits between different transmission time intervals in uplink is changed, bits are repeated or punctured to ensure that the total bit rate after TrCH multiplexing is identical to the total channel bit rate of the allocated dedicated physical channels.

If no bits are input to the rate matching for all TrCHs within a CCTrCH, the rate matching shall output no bits for all TrCHs within the CCTrCH and no uplink DPDCH will be selected in the case of uplink rate matching.

### Notation used in subclause 4.2.7 and subclauses:

$N_{i,j}$ : For uplink: Number of bits in a radio frame before rate matching on TrCH  $i$  with transport format combination  $j$ .

For downlink: An intermediate calculation variable (not an integer but a multiple of 1/8).

- $N_{i,l}^{TTI}$ : Number of bits in a transmission time interval before rate matching on TrCH  $i$  with transport format  $l$ .  
Used in downlink only.
- $\Delta N_{i,j}$ : For uplink: If positive - number of bits that should be repeated in each radio frame on TrCH  $i$  with transport format combination  $j$ .  
  
If negative - number of bits that should be punctured in each radio frame on TrCH  $i$  with transport format combination  $j$ .  
  
For downlink : An intermediate calculation variable (not an integer but a multiple of 1/8).
- $\Delta N_{i,l}^{TTI}$ : If positive - number of bits to be repeated in each transmission time interval on TrCH  $i$  with transport format  $l$ .  
  
If negative - number of bits to be punctured in each transmission time interval on TrCH  $i$  with transport format  $l$ .  
  
Used in downlink only.
- $Np_{i,l}^{TTI,m}$ ,  $m=0$  to  $(F_{max}/F_i) - 1$ : Positive or null: number of bits to be removed in TTI number  $m$  within the largest TTI, to create the required gaps in the compressed radio frames of this TTI, in case of compressed mode by puncturing, for TrCH  $i$  with transport format  $l$ . In case of fixed positions and compressed mode by puncturing, this value is noted  $Np_{i,max}^{TTI,m}$  since it is calculated for all TrCH with their maximum number of bits; thus it is the same for all TFCs  
  
Used in downlink only.
- $Np_{i,l}^n$ ,  $n=0$  to  $F_{max}-1$ : Positive or null: number of bits, in radio frame number  $n$  within the largest TTI, corresponding to the gap for compressed mode in this radio frame, for TrCH  $i$  with transport format  $l$ . The value will be null for the radio frames not overlapping with a transmission gap. In case of fixed positions and compressed mode by puncturing, this value is noted  $Np_{i,max}^n$  since it is calculated for all TrCHs with their maximum number of bits; thus it is the same for all TFCs  
  
Used in downlink only.
- $N_{TGL}[k]$ ,  $k=0$  to  $F_{max}-1$ : Positive or null: number of bits in each radio frame corresponding to the gap for compressed mode for the CCTrCH.
- $RM_i$ : Semi-static rate matching attribute for transport channel  $i$ .  $RM_i$  is provided by higher layers or takes a value as indicated in section 4.2.13.
- $PL$ : Puncturing limit for uplink. This value limits the amount of puncturing that can be applied in order to avoid multicode or to enable the use of a higher spreading factor. Signalled from higher layers. The allowed puncturing in % is actually equal to  $(1-PL)*100$ .
- $N_{data,j}$ : Total number of bits that are available for the CCTrCH in a radio frame with transport format combination  $j$ .
- $I$ : Number of TrCHs in the CCTrCH.
- $Z_{i,j}$ : Intermediate calculation variable.
- $F_i$ : Number of radio frames in the transmission time interval of TrCH  $i$ .
- $F_{max}$ : Maximum number of radio frames in a transmission time interval used in the CCTrCH :
- $$F_{max} = \max_{1 \leq i \leq I} F_i$$
- $n_i$ : Radio frame number in the transmission time interval of TrCH  $i$  ( $0 \leq n_i < F_i$ ).

- $q$ : Average puncturing or repetition distance (normalised to only show the remaining rate matching on top of an integer number of repetitions). Used in uplink only.
- $P1_F(n_i)$ : The column permutation function of the 1<sup>st</sup> interleaver,  $P1_F(x)$  is the original position of column with number  $x$  after permutation.  $P1$  is defined on table 4 of section 4.2.5.2 (note that the  $P1_F$  is self-inverse). Used for rate matching in uplink only.
- $S[n]$ : The shift of the puncturing or repetition pattern for radio frame  $n_i$  when  $n = P1_F(n_i)$ . Used in uplink only.
- $TF_i(j)$ : Transport format of TrCH  $i$  for the transport format combination  $j$ .
- $TFS(i)$ : The set of transport format indexes  $l$  for TrCH  $i$ .
- $TFCS$ : The set of transport format combination indexes  $j$ .
- $e_{ini}$ : Initial value of variable  $e$  in the rate matching pattern determination algorithm of subclause 4.2.7.5.
- $e_{plus}$ : Increment of variable  $e$  in the rate matching pattern determination algorithm of subclause 4.2.7.5.
- $e_{minus}$ : Decrement of variable  $e$  in the rate matching pattern determination algorithm of subclause 4.2.7.5.
- $b$ : Indicates systematic and parity bits
- $b=1$ : Systematic bit.  $x_k$  in subclause 4.2.3.2.1.
- $b=2$ : 1<sup>st</sup> parity bit (from the upper Turbo constituent encoder).  $z_k$  in subclause 4.2.3.2.1.
- $b=3$ : 2<sup>nd</sup> parity bit (from the lower Turbo constituent encoder).  $z'_k$  in subclause 4.2.3.2.1.

The \* (star) notation is used to replace an index  $x$  when the indexed variable  $X_x$  does not depend on the index  $x$ . In the left wing of an assignment the meaning is that " $X_* = Y$ " is equivalent to "**for all  $x$  do  $X_x = Y$** ". In the right wing of an assignment, the meaning is that " $Y = X_*$ " is equivalent to "**take any  $x$  and do  $Y = X_x$** ".

The following relations, defined for all TFC  $j$ , are used when calculating the rate matching parameters:

$$Z_{0,j} = 0$$

$$Z_{i,j} = \left\lfloor \frac{\left( \left( \sum_{m=1}^i RM_m \times N_{m,j} \right) \times N_{data,j} \right)}{\sum_{m=1}^I RM_m \times N_{m,j}} \right\rfloor \text{ for all } i = 1 \dots I \quad (1)$$

$$\Delta N_{i,j} = Z_{i,j} - Z_{i-1,j} - N_{i,j} \text{ for all } i = 1 \dots I$$

## 4.2.7.1 Determination of rate matching parameters in uplink

### 4.2.7.1.1 Determination of SF and number of PhCHs needed

In uplink, puncturing can be applied to match the CCTrCH bit rate to the PhCH bit rate. The bit rate of the PhCH(s) is limited by the UE capability and restrictions imposed by UTRAN, through limitations on the PhCH spreading factor. The maximum amount of puncturing that can be applied is 1-PL, PL is signalled from higher layers. The number of available bits in the radio frames of one PhCH for all possible spreading factors is given in [2]. Denote these values by  $N_{256}$ ,  $N_{128}$ ,  $N_{64}$ ,  $N_{32}$ ,  $N_{16}$ ,  $N_8$ , and  $N_4$ , where the index refers to the spreading factor. The possible number of bits available to the CCTrCH on all PhCHs,  $N_{data}$ , then are  $\{ N_{256}, N_{128}, N_{64}, N_{32}, N_{16}, N_8, N_4, 2 \times N_4, 3 \times N_4, 4 \times N_4, 5 \times N_4, 6 \times N_4 \}$ .

For a RACH CCTrCH SET0 represents the set of  $N_{data}$  values allowed by the UTRAN, as set by the minimum SF provided by higher layers. SET0 may be a sub-set of  $\{ N_{256}, N_{128}, N_{64}, N_{32} \}$ . SET0 does not take into account the UE's capability.

For other CCTrCHs, SET0 denotes the set of  $N_{data}$  values allowed by the UTRAN and supported by the UE, as part of the UE's capability. SET0 can be a subset of  $\{N_{256}, N_{128}, N_{64}, N_{32}, N_{16}, N_8, N_4, 2 \times N_4, 3 \times N_4, 4 \times N_4, 5 \times N_4, 6 \times N_4\}$ .  $N_{data,j}$  for the transport format combination  $j$  is determined by executing the following algorithm:

$$\text{SET1} = \{ N_{data} \text{ in SET0 such that } \left( \min_{1 \leq y \leq I} \{ RM_y \} \right) \times N_{data} - \sum_{x=1}^I RM_x \times N_{x,j} \text{ is non negative} \}$$

If SET1 is not empty and the smallest element of SET1 requires just one PhCH then

$$N_{data,j} = \min \text{SET1}$$

else

$$\text{SET2} = \{ N_{data} \text{ in SET0 such that } \left( \min_{1 \leq y \leq I} \{ RM_y \} \right) \times N_{data} - PL \times \sum_{x=1}^I RM_x \times N_{x,j} \text{ is non negative} \}$$

Sort SET2 in ascending order

$$N_{data} = \min \text{SET2}$$

While  $N_{data}$  is not the max of SET2 and the follower of  $N_{data}$  requires no additional PhCH do

$$N_{data} = \text{follower of } N_{data} \text{ in SET2}$$

End while

$$N_{data,j} = N_{data}$$

End if

For a RACH CCTrCH, if  $N_{data,j}$  is not part of the UE's capability then the TFC  $j$  cannot be used.

#### 4.2.7.1.2 Determination of parameters needed for calculating the rate matching pattern

The number of bits to be repeated or punctured,  $\Delta N_{i,j}$ , within one radio frame for each TrCH  $i$  is calculated with equation 1 for all possible transport format combinations  $j$  and selected every radio frame.  $N_{data,j}$  is given from subclause 4.2.7.1.1.

In a compressed radio frame,  $N_{data,j}$  is replaced by  $N_{data,j}^{cm}$  in Equation 1.  $N_{data,j}^{cm}$  is given as follows:

In a radio frame compressed by higher layer scheduling,  $N_{data,j}^{cm}$  is obtained by executing the algorithm in subclause

4.2.7.1.1 but with the number of bits in one radio frame of one PhCH reduced to  $\frac{N_{tr}}{15}$  of the value in normal mode.

$N_{tr}$  is the number of transmitted slots in a compressed radio frame and is defined by the following relation:

$$N_{tr} = \begin{cases} 15 - TGL, & \text{if } N_{first} + TGL \leq 15 \\ N_{first}, & \text{in first frame if } N_{first} + TGL > 15 \\ 30 - TGL - N_{first}, & \text{in second frame if } N_{first} + TGL > 15 \end{cases}$$

$N_{first}$  and  $TGL$  are defined in subclause 4.4.

In a radio frame compressed by spreading factor reduction,  $N_{data,j}^{cm} = 2 \times (N_{data,j} - N_{TGL})$ , where

$$N_{TGL} = \frac{15 - N_{tr}}{15} \times N_{data,j}$$

If  $\Delta N_{i,j} = 0$  then the output data of the rate matching is the same as the input data and the rate matching algorithm of subclause 4.2.7.5 does not need to be executed.

If  $\Delta N_{i,j} \neq 0$  the parameters listed in subclauses 4.2.7.1.2.1 and 4.2.7.1.2.2 shall be used for determining  $e_{\text{minus}}$ ,  $e_{\text{plus}}$ , and  $e_{\text{minus}}$  (regardless if the radio frame is compressed or not).

#### 4.2.7.1.2.1 Convolutionally encoded TrCHs

$R = \Delta N_{i,j} \bmod N_{i,j}$  -- note: in this context  $\Delta N_{i,j} \bmod N_{i,j}$  is in the range of 0 to  $N_{i,j}-1$  i.e.  $-1 \bmod 10 = 9$ .

if  $R \neq 0$  and  $2 \times R \leq N_{i,j}$

then  $q = \lceil N_{i,j} / R \rceil$

else

$q = \lceil N_{i,j} / (R - N_{i,j}) \rceil$

endif

-- note:  $q$  is a signed quantity.

if  $q$  is even

then  $q' = q + \text{gcd}(|q|, F_i) / F_i$  -- where  $\text{gcd}(|q|, F_i)$  means greatest common divisor of  $|q|$  and  $F_i$

-- note that  $q'$  is not an integer, but a multiple of 1/8

else

$q' = q$

endif

for  $x = 0$  to  $F_i - 1$

$S[\lfloor x \times q' \rfloor \bmod F_i] = (\lfloor x \times q' \rfloor \text{ div } F_i)$

end for

$\Delta N_i = \Delta N_{i,j}$

$a = 2$

For each radio frame, the rate-matching pattern is calculated with the algorithm in subclause 4.2.7.5, where :

$X_i = N_{i,j}$ , and

$e_{\text{minus}} = (a \times S[\text{P1}_{F_i}(n_i)] \times |\Delta N_i| + 1) \bmod (a \cdot N_{i,j})$ .

$e_{\text{plus}} = a \times N_{i,j}$

$e_{\text{minus}} = a \times |\Delta N_i|$

puncturing for  $\Delta N < 0$ , repetition otherwise.

#### 4.2.7.1.2.2 Turbo encoded TrCHs

If repetition is to be performed on turbo encoded TrCHs, i.e.  $\Delta N_{i,j} > 0$ , the parameters in subclause 4.2.7.1.2.1 are used.

If puncturing is to be performed, the parameters below shall be used. Index  $b$  is used to indicate systematic ( $b=1$ ), 1<sup>st</sup> parity ( $b=2$ ), and 2<sup>nd</sup> parity bit ( $b=3$ ).

$a=2$  when  $b=2$

$a=1$  when  $b=3$

$$\Delta N_i = \begin{cases} \lfloor \Delta N_{i,j} / 2 \rfloor, & b = 2 \\ \lfloor \Delta N_{i,j} / 2 \rfloor, & b = 3 \end{cases}$$

If  $\Delta N_i$  is calculated as 0 for  $b=2$  or  $b=3$ , then the following procedure and the rate matching algorithm of subclause 4.2.7.5 don't need to be performed for the corresponding parity bit stream.

$$X_i = \lfloor N_{i,j} / 3 \rfloor,$$

$$q = \lfloor X_i / |\Delta N_i| \rfloor$$

if( $q \leq 2$ )

for  $r=0$  to  $F_i-1$

$$S[(3 \times r + b - 1) \bmod F_i] = r \bmod 2;$$

end for

else

if  $q$  is even

then  $q' = q - \text{gcd}(q, F_i) / F_i$  -- where  $\text{gcd}(q, F_i)$  means greatest common divisor of  $q$  and  $F_i$   
 -- note that  $q'$  is not an integer, but a multiple of  $1/8$

else  $q' = q$

endif

for  $x=0$  to  $F_i - 1$

$$r = \lceil x \times q' \rceil \bmod F_i;$$

$$S[(3 \times r + b - 1) \bmod F_i] = \lceil x \times q' \rceil \text{ div } F_i;$$

endfor

endif

For each radio frame, the rate-matching pattern is calculated with the algorithm in subclause 4.2.7.5, where:

$X_i$  is as above:

$$e_{\text{ini}} = (a \times S[P1_{F_i}(n_i)] \times |\Delta N_i| + X_i) \bmod (a \times X_i), \text{ if } e_{\text{ini}} = 0 \text{ then } e_{\text{ini}} = a \times X_i$$

$$e_{\text{plus}} = a \times X_i$$

$$e_{\text{minus}} = a \times |\Delta N_i|$$

#### 4.2.7.2 Determination of rate matching parameters in downlink

For downlink channels other than the downlink shared channel(s) (DSCH),  $N_{\text{data},j}$  does not depend on the transport format combination  $j$ .  $N_{\text{data},*}$  is given by the channelization code(s) assigned by higher layers.

Denote the number of physical channels used for the CCTrCH by  $P$ .  $N_{\text{data},*}$  is the number of bits available to the CCTrCH in one radio frame and defined as  $N_{\text{data},*} = P \times 15 \times (N_{\text{data}1} + N_{\text{data}2})$ , where  $N_{\text{data}1}$  and  $N_{\text{data}2}$  are defined in [2]. Note that contrary to the uplink, the same rate matching patterns are used in TTIs containing no compressed radio frames and in TTIs containing radio frames compressed by spreading factor reduction or higher layer scheduling.

For a DSCH CCTrCH, different sets of channelisation codes may be configured by higher layers resulting in possibly multiple  $N_{\text{data},*}$  values, where  $N_{\text{data},*}$  is the number of bits available to the CCTrCH in one radio frame and is given by  $N_{\text{data},*} = P \times 15 \times (N_{\text{data}1} + N_{\text{data}2})$ , where  $N_{\text{data}1}$  and  $N_{\text{data}2}$  are defined in [2]. Each  $N_{\text{data},*}$  corresponds to a sub-set of the Transport format combinations configured as part of the TFCS. For a DSCH CCTrCH only flexible positions apply. The rate matching calculations as specified in section 4.2.7.2.2 shall be performed for each  $N_{\text{data},*}$ , where the TFCS

taken into account in the calculations is restricted to the set of TFCs associated with  $N_{data,*}$ , as configured by higher layers. Therefore the amount of rate matching for a transport channel  $i$  for a TTI interval is a function of the  $N_{data,*}$  value which shall be constant over the entire TTI as specified in section 4.2.14.

In the following, the total amount of puncturing or repetition for the TTI is calculated.

Additional calculations for TTIs containing radio frames compressed by puncturing in case fixed positions are used, are performed to determine this total amount of rate matching needed.

For compressed mode by puncturing, in TTIs where some compressed radio frames occur, the puncturing is increased or the repetition is decreased compared to what is calculated according to the rate matching parameters provided by higher layers. This allows to cope with reduction of available data bits on the physical channel(s) if the slot format for the compressed frame(s) contains fewer data bits than for the normal frames(s), and to create room for later insertion of marked bits, noted p-bits, which will identify the positions of the gaps in the compressed radio frames.

The amount of additional puncturing corresponds to the number of bits to create the gap in the TTI for TrCH  $i$ , plus the difference between the number of data bits available in normal frames and in compressed frames, due to slot format change. In case of fixed positions, it is calculated in addition to the amount of rate matching indicated by higher layers.

It is noted  $Np_{i,max}^{TTI,m}$ .

In fixed positions case, to obtain the total rate matching  $\Delta N_{i,max}^{TTI,cm,m}$  to be performed on the TTI  $m$ ,  $Np_{i,max}^{TTI,m}$  is subtracted from  $\Delta N_{i,max}^{TTI,m}$  (calculated based on higher layers RM parameters as for normal rate matching). This allows to create room for the  $Np_{i,max}^{TTI,m}$  bits p to be inserted later. If the result is null, i.e. the amount of repetition matches exactly the amount of additional puncturing needed, then no rate matching is necessary.

In case of compressed mode by puncturing and fixed positions, for some calculations,  $N'_{data,*}$  is used for radio frames with gap instead of  $N_{data,*}$ , where  $N'_{data,*} = P \times 15 \times (N'_{data1} + N'_{data2})$ .  $N'_{data1}$  and  $N'_{data2}$  are the number of bits in the data fields of the slot format used for the frames compressed by puncturing.

#### 4.2.7.2.1 Determination of rate matching parameters for fixed positions of TrCHs

##### 4.2.7.2.1.1 Calculation of $\Delta N_{i,max}$ for normal mode and compressed mode by spreading factor reduction

First an intermediate calculation variable  $N_{i,*}$  is calculated for all transport channels  $i$  by the following formula:

$$N_{i,*} = \frac{1}{F_i} \times \left( \max_{l \in TFS(i)} N_{i,l}^{TTI} \right)$$

In order to compute the  $\Delta N_{i,l}^{TTI}$  parameters for all TrCH  $i$  and all TF  $l$ , we first compute an intermediate parameter  $\Delta N_{i,max}$  by the following formula, where  $\Delta N_{i,*}$  is derived from  $N_{i,*}$  by the formula given at subclause 4.2.7:

$$\Delta N_{i,max} = F_i \times \Delta N_{i,*}$$

If  $\Delta N_{i,max} = 0$  then, for TrCH  $i$ , the output data of the rate matching is the same as the input data and the rate matching algorithm of subclause 4.2.7.5 does not need to be executed. In this case we have :

$$\forall l \in TFS(i) \Delta N_{i,l}^{TTI} = 0$$

If  $\Delta N_{i,max} \neq 0$  the parameters listed in subclauses 4.2.7.2.1.3 and 4.2.7.2.1.4 shall be used for determining  $e_{ini}$ ,  $e_{plus}$ , and  $e_{minus}$  and  $\Delta N_{i,l}^{TTI}$ .

## 4.2.7.2.1.2 Calculations for compressed mode by puncturing

Calculations of  $\Delta N_{i,\max}^{TTI,m}$  for all TTI  $m$  within largest TTI, for all TrCH  $i$

First an intermediate calculation variable  $N_{i,*}$  is calculated for all transport channels  $i$  by the following formula:

$$N_{i,*} = \frac{1}{F_i} \times \left( \max_{l \in TFS(i)} N_{i,l}^{TTI} \right)$$

Then an intermediate calculation variable  $\Delta N_{i,*}$  is derived from  $N_{i,*}$  by the formula given at subclause 4.2.7, for all TrCH  $i$ .

In order to compute the  $\Delta N_{i,l}^{TTI,m}$  parameters for all TrCH  $i$ , all TF  $l$  and all TTI with number  $m$  in the largest TTI, we first compute an intermediate parameter  $\Delta N_{i,\max}^m$  by the following formula :

$$\Delta N_{i,\max}^m = F_i \times \Delta N_{i,*}$$

Calculations of  $Np_{i,\max}^n$  and  $Np_{i,\max}^{TTI,m}$

Let  $Np_{i,\max}^n$  be the number of bits to eliminate on TrCH  $i$  to create the gap for compressed mode and to cope for the reduction of the number of available data bits in the compressed frame if the changed slot format contains fewer data bits than for normal frame, in each radio frame  $n$  of the TTI, calculated for the Transport Format Combination of TrCH  $i$ , in which the number of bits of TrCH  $i$  is at its maximum.

$Np_{i,\max}^n$  is calculated for each radio frame  $n$  of the TTI in the following way.

Intermediate variables  $Z_i$  for  $i = 1$  to  $I$  are calculated using the formula (1) in 4.2.7, by replacing  $N_{data,j}$  in the frames compressed by puncturing with  $(N_{TGL}[n] + (N_{data,*} - N'_{data,*}))$ .

The number of bits corresponding to the gap for TrCH  $i$ , in each radio frame of its TTI is calculated using the number of bits to remove on all Physical Channels  $N_{TGL}[k]$ , where  $k$  is the radio frame number in the largest TTI.

For each radio frame  $k$  of the largest TTI that is overlapping with a transmission gap,  $N_{TGL}[k]$  is given by the relation:

$$N_{TGL} = \begin{cases} \frac{TGL}{15} \times N'_{data,*} & , \text{ if } N_{first} + TGL \leq 15 \\ \frac{15 - N_{first}}{15} \times N'_{data,*} & , \text{ in first radio frame of the gap if } N_{first} + TGL > 15 \\ \frac{TGL - (15 - N_{first})}{15} \times N'_{data,*} & , \text{ in second radio frame of the gap if } N_{first} + TGL > 15 \end{cases}$$

$N_{first}$  and  $TGL$  are defined in subclause 4.4.

Note that  $N_{TGL}[k] = 0$  if radio frame  $k$  is not overlapping with a transmission gap.

Then  $Np_{i,\max}^n = (Z_i - Z_{i-1})$  for  $i = 1$  to  $I$

The total number of bits  $Np_{i,\max}^{TTI,m}$  corresponding to the gaps for compressed mode for TrCH  $i$  in the TTI is calculated as:



$$Np_{i,max}^{TTI,m} = \sum_{n=m \times F_i}^{n=(m+1) \times F_i - 1} Np_{i,max}^n$$

The amount of rate matching  $\Delta N_{i,max}^{TTI,cm,m}$  for the highest TrCH bit rate is then computed by the following formula :

$$\Delta N_{i,max}^{TTI,cm,m} = \Delta N_{i,max}^m - Np_{i,max}^{TTI,m}$$

If  $\Delta N_{i,max}^{TTI,cm,m} = 0$ , then, for TrCH  $i$ , the output data of the rate matching is the same as the input data and the rate matching algorithm of subclause 4.2.7.5 does not need to be executed.

If  $\Delta N_{i,max}^{TTI,cm,m} \neq 0$ , then, for TrCH  $i$ , the rate matching algorithm of subclause 4.2.7.5 needs to be executed, and the parameters listed in subclauses 4.2.7.2.1.3 and 4.2.7.2.1.4 shall be used for determining  $e_{ini}$ ,  $e_{plus}$ , and  $e_{minus}$ , and  $\Delta N_{i,l}^{TTI,m}$ .

#### 4.2.7.2.1.3 Determination of rate matching parameters for convolutionally encoded TrCHs

$$\Delta N_i = \Delta N_{i,max}$$

For compressed mode by puncturing,  $\Delta N_i$  is defined as:  $\Delta N_i = \Delta N_{i,max}^{TTI,cm,m}$ , instead of the previous relation.

$$a=2$$

$$N_{max} = \max_{l \in TFS(i)} N_{il}^{TTI}$$

For each transmission time interval of TrCH  $i$  with TF  $l$ , the rate-matching pattern is calculated with the algorithm in subclause 4.2.7.5. The following parameters are used as input:

$$X_i = N_{il}^{TTI}$$

$$e_{ini} = 1$$

$$e_{plus} = a \times N_{max}$$

$$e_{minus} = a \times |\Delta N_i|$$

Puncturing if  $\Delta N_i < 0$ , repetition otherwise. The values of  $\Delta N_{i,l}^{TTI}$  may be computed by counting repetitions or puncturing when the algorithm of subclause 4.2.7.5 is run. The resulting values of  $\Delta N_{i,l}^{TTI}$  can be represented with following expression.

$$\Delta N_{i,l}^{TTI} = \left\lceil \frac{|\Delta N_i| \times X_i}{N_{max}} \right\rceil \times \text{sgn}(\Delta N_i)$$

For compressed mode by puncturing, the above formula produces  $\Delta N_{i,l}^{TTI,m}$  instead of  $\Delta N_{i,l}^{TTI}$ .

#### 4.2.7.2.1.4 Determination of rate matching parameters for Turbo encoded TrCHs

If repetition is to be performed on turbo encoded TrCHs, i.e.  $\Delta N_{i,max} > 0$ , the parameters in subclause 4.2.7.2.1.3 are used.

If puncturing is to be performed, the parameters below shall be used. Index  $b$  is used to indicate systematic ( $b=1$ ), 1<sup>st</sup> parity ( $b=2$ ), and 2<sup>nd</sup> parity bit ( $b=3$ ).

$$a=2 \text{ when } b=2$$

$$a=1 \text{ when } b=3$$

The bits indicated by  $b=1$  shall not be punctured.

$$\Delta N_i^b = \begin{cases} \left\lfloor \frac{\Delta N_{i,max}}{2} \right\rfloor, & \text{for } b=2 \\ \left\lceil \frac{\Delta N_{i,max}}{2} \right\rceil, & \text{for } b=3 \end{cases}$$

In Compressed Mode by puncturing, the following relations are used instead of the previous ones:

$$\Delta N_i^b = \left\lfloor \frac{\Delta N_{i,max}^{TTI,cm,m}}{2} \right\rfloor, \text{ for } b=2$$

$$\Delta N_i^b = \left\lceil \frac{\Delta N_{i,max}^{TTI,cm,m}}{2} \right\rceil, \text{ for } b=3$$

$$N_{max} = \max_{l \in TFS(i)} (N_{il}^{TTI} / 3)$$

For each transmission time interval of TrCH  $i$  with TF  $l$ , the rate-matching pattern is calculated with the algorithm in subclause 4.2.7.5. The following parameters are used as input:

$$X_i = N_{il}^{TTI} / 3$$

$$e_{ini} = N_{max}$$

$$e_{plus} = a \times N_{max}$$

$$e_{minus} = a \times |\Delta N_i^b|$$

The values of  $\Delta N_{i,l}^{TTI}$  may be computed by counting puncturing when the algorithm of subclause 4.2.7.5 is run. The resulting values of  $\Delta N_{i,l}^{TTI}$  can be represented with following expression.

$$\Delta N_{i,l}^{TTI} = - \left\lfloor \frac{|\Delta N_i^2| \times X_i}{N_{max}} + 0.5 \right\rfloor - \left\lfloor \frac{|\Delta N_i^3| \times X_i}{N_{max}} \right\rfloor$$

In the above equation, the first term of the right hand side represents the amount of puncturing for  $b=2$  and the second term represents the amount of puncturing for  $b=3$ .

For compressed mode by puncturing, the above formula produces  $\Delta N_{i,l}^{TTI,m}$  instead of  $\Delta N_{i,l}^{TTI}$ .

#### 4.2.7.2.2 Determination of rate matching parameters for flexible positions of TrCHs

##### 4.2.7.2.2.1 Calculations for normal mode, compressed mode by higher layer scheduling, and compressed mode by spreading factor reduction

First an intermediate calculation variable  $N_{ij}$  is calculated for all transport channels  $i$  and all transport format combinations  $j$  by the following formula:

$$N_{i,j} = \frac{1}{F_i} \times N_{i,TF_i(j)}^{TTI}$$

Then rate matching ratios  $RF_i$  are calculated for each the transport channel  $i$  in order to minimise the number of DTX bits when the bit rate of the CCTrCH is maximum. The  $RF_i$  ratios are defined by the following formula:

$$RF_i = \frac{N_{data,*}}{\max_{j \in TFCS} \sum_{i=1}^{i=I} (RM_i \times N_{i,j})} \times RM_i$$

The computation of  $\Delta N_{i,l}^{TTI}$  parameters is then performed in two phases. In a first phase, tentative temporary values of  $\Delta N_{i,l}^{TTI}$  are computed, and in the second phase they are checked and corrected. The first phase, by use of the  $RF_i$  ratios, ensures that the number of DTX indication bits inserted is minimum when the CCTrCH bit rate is maximum, but it does not ensure that the maximum CCTrCH bit rate is not greater than  $N_{data,*}$  per 10ms. The latter condition is ensured through the checking and possible corrections carried out in the second phase.

At the end of the second phase, the latest value of  $\Delta N_{i,l}^{TTI}$  is the definitive value.

The first phase defines the tentative temporary  $\Delta N_{i,l}^{TTI}$  for all transport channel  $i$  and any of its transport format  $l$  by use of the following formula:

$$\Delta N_{i,l}^{TTI} = F_i \times \left[ \frac{RF_i \times N_{i,l}^{TTI}}{F_i} \right] - N_{i,l}^{TTI} = F_i \times \left[ \frac{N_{data,*} \times RM_i \times N_{i,l}^{TTI}}{F_i \times \max_{j \in TFCS} \sum_{i=1}^I (RM_i \times N_{i,j})} \right] - N_{i,l}^{TTI}$$

The second phase is defined by the following algorithm:

for all  $j$  in  $TFCS$  in ascending order of TFCI do      -- for all TFC

$$D = \sum_{i=1}^{i=I} \frac{N_{i,TF_i(j)}^{TTI} + \Delta N_{i,TF_i(j)}^{TTI}}{F_i} \quad \text{-- CCTrCH bit rate (bits per 10ms) for TFC } j$$

if  $D > N_{data,*}$  then

for  $i = 1$  to  $I$  do      -- for all TrCH

$$\Delta N = F_i \times \Delta N_{i,j} \quad \text{-- } \Delta N_{i,j} \text{ is derived from } N_{i,j} \text{ by the formula given at subclause 4.2.7.}$$

if  $\Delta N_{i,TF_i(j)}^{TTI} > \Delta N$  then

$$\Delta N_{i,TF_i(j)}^{TTI} = \Delta N$$

end-if

end-for

end-if

end-for

If  $\Delta N_{i,l}^{TTI} = 0$  then, for TrCH  $i$  at TF  $l$ , the output data of the rate matching is the same as the input data and the rate matching algorithm of subclause 4.2.7.5 does not need to be executed.

If  $\Delta N_{i,l}^{TTI} \neq 0$  the parameters listed in subclauses 4.2.7.2.2.2 and 4.2.7.2.2.3 shall be used for determining  $e_{\text{minus}}$ ,  $e_{\text{plus}}$ , and  $e_{\text{minus}}$ .

#### 4.2.7.2.2.2 Determination of rate matching parameters for convolutionally encoded TrCHs

$$\Delta N_i = \Delta N_{il}^{TTI}$$

$$a=2$$

For each transmission time interval of TrCH  $i$  with TF  $l$ , the rate-matching pattern is calculated with the algorithm in subclause 4.2.7.5. The following parameters are used as input:

$$X_i = N_{il}^{TTI}$$

$$e_{ini} = 1$$

$$e_{plus} = a \times N_{il}^{TTI}$$

$$e_{minus} = a \times |\Delta N_i|$$

puncturing for  $\Delta N_i < 0$ , repetition otherwise.

#### 4.2.7.2.2.3 Determination of rate matching parameters for Turbo encoded TrCHs

If repetition is to be performed on turbo encoded TrCHs, i.e.  $\Delta N_{il}^{TTI} > 0$ , the parameters in subclause 4.2.7.2.2 are used.

If puncturing is to be performed, the parameters below shall be used. Index  $b$  is used to indicate systematic ( $b=1$ ), 1<sup>st</sup> parity ( $b=2$ ), and 2<sup>nd</sup> parity bit ( $b=3$ ).

$$a=2 \text{ when } b=2$$

$$a=1 \text{ when } b=3$$

The bits indicated by  $b=1$  shall not be punctured.

$$\Delta N_i = \begin{cases} \lfloor \Delta N_{il}^{TTI} / 2 \rfloor, & b = 2 \\ \lfloor \Delta N_{il}^{TTI} / 2 \rfloor, & b = 3 \end{cases}$$

For each transmission time interval of TrCH  $i$  with TF  $l$ , the rate-matching pattern is calculated with the algorithm in subclause 4.2.7.5. The following parameters are used as input:

$$X_i = N_{il}^{TTI} / 3,$$

$$e_{ini} = X_i,$$

$$e_{plus} = a \times X_i$$

$$e_{minus} = a \times |\Delta N_i|$$

#### 4.2.7.3 Bit separation and collection in uplink

The systematic bits of turbo encoded TrCHs shall not be punctured, the other bits may be punctured. The systematic bits, first parity bits, and second parity bits in the bit sequence input to the rate matching block are therefore separated into three sequences.

The first sequence contains:

- All of the systematic bits that are from turbo encoded TrCHs.

- From 0 to 2 first and/or second parity bits that are from turbo encoded TrCHs. These bits come into the first sequence when the total number of bits in a block after radio frame segmentation is not a multiple of three.
- Some of the systematic, first parity and second parity bits that are for trellis termination.

The second sequence contains:

- All of the first parity bits that are from turbo encoded TrCHs, except those that go into the first sequence when the total number of bits is not a multiple of three.
- Some of the systematic, first parity and second parity bits that are for trellis termination.

The third sequence contains:

- All of the second parity bits that are from turbo encoded TrCHs, except those that go into the first sequence when the total number of bits is not a multiple of three.
- Some of the systematic, first parity and second parity bits that are for trellis termination.

The second and third sequences shall be of equal length, whereas the first sequence can contain from 0 to 2 more bits. Puncturing is applied only to the second and third sequences. The bit separation function is transparent for convolutionally encoded TrCHs and for turbo encoded TrCHs with repetition. The bit separation and bit collection are illustrated in figures 5 and 6.

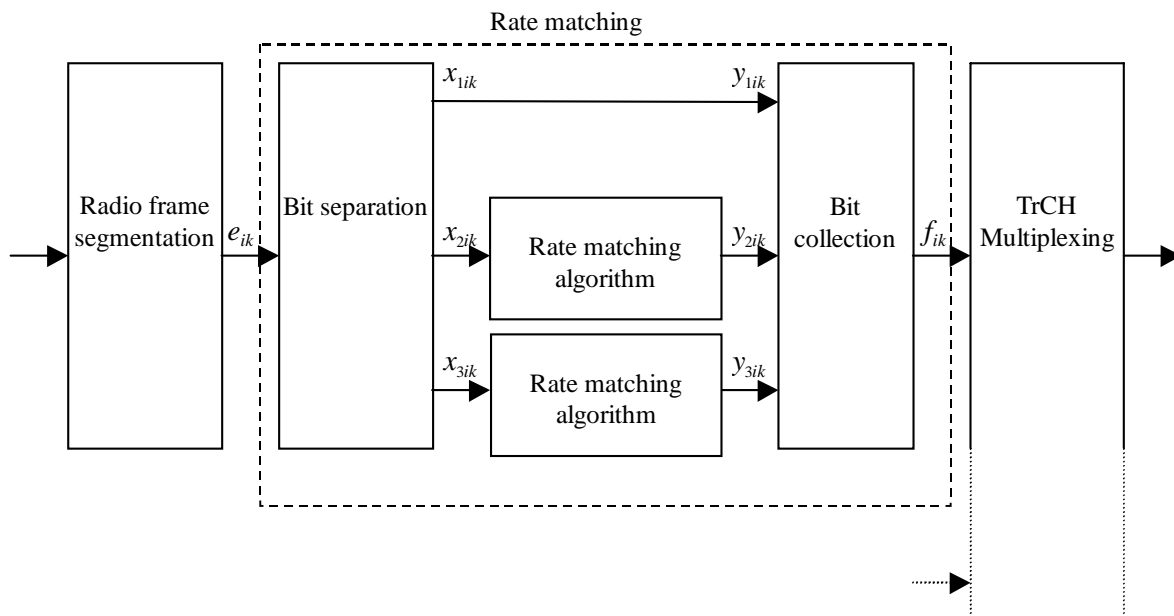
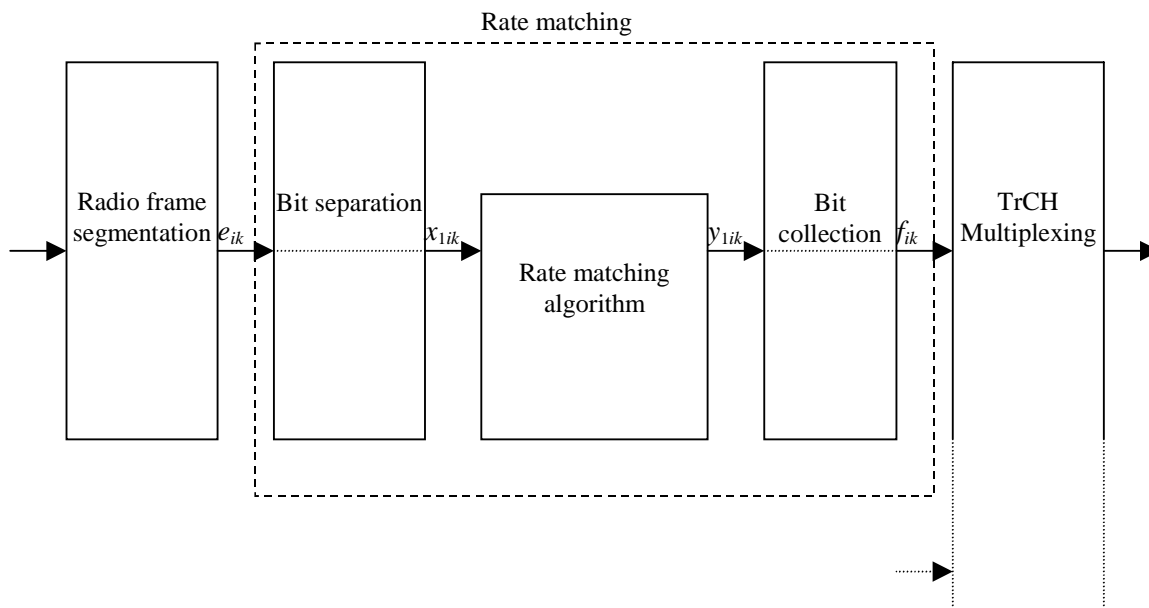

Figure 5: Puncturing of turbo encoded TrCHs in uplink



**Figure 6: Rate matching for convolutionally encoded TrCHs and for turbo encoded TrCHs with repetition in uplink**

The bit separation is dependent on the 1<sup>st</sup> interleaving and offsets are used to define the separation for different TTIs. *b* indicates the three sequences defined in this section, with *b*=1 indicating the first sequence, *b* = 2 the second one, and *b* = 3 the third one. The offsets  $\alpha_b$  for these sequences are listed in table 5.

**Table 5: TTI dependent offset needed for bit separation**

TTI (ms)	$\alpha_1$	$\alpha_2$	$\alpha_3$
10, 40	0	1	2
20, 80	0	2	1

The bit separation is different for different radio frames in the TTI. A second offset is therefore needed. The radio frame number for TrCH *i* is denoted by  $n_i$ . and the offset by  $\beta_{n_i}$ .

**Table 6: Radio frame dependent offset needed for bit separation**

TTI (ms)	$\beta_0$	$\beta_1$	$\beta_2$	$\beta_3$	$\beta_4$	$\beta_5$	$\beta_6$	$\beta_7$
10	0	NA	NA	NA	NA	NA	NA	NA
20	0	1	NA	NA	NA	NA	NA	NA
40	0	1	2	0	NA	NA	NA	NA
80	0	1	2	0	1	2	0	1

4.2.7.3.1 Bit separation

The bits input to the rate matching are denoted by  $e_{i1}, e_{i2}, e_{i3}, \dots, e_{iN_i}$ , where *i* is the TrCH number and  $N_i$  is the number of bits input to the rate matching block. Note that the transport format combination number *j* for simplicity has been left out in the bit numbering, i.e.  $N_i=N_{ij}$ . The bits after separation are denoted by  $x_{bi1}, x_{bi2}, x_{bi3}, \dots, x_{biX_i}$ . For turbo encoded TrCHs with puncturing, *b* indicates the three sequences defined in section 4.2.7.3, with *b*=1 indicating the first sequence, and so forth. For all other cases *b* is defined to be 1.  $X_i$  is the number of bits in each separated bit sequence. The relation between  $e_{ik}$  and  $x_{bik}$  is given below.

For turbo encoded TrCHs with puncturing:

$$x_{1,i,k} = e_{i,3(k-1)+1+(\alpha_1+\beta_{n_i}) \bmod 3} \quad k = 1, 2, 3, \dots, X_i \quad X_i = \lfloor N_i / 3 \rfloor$$

$$x_{1,i,\lfloor N_i/3 \rfloor+k} = e_{i,3\lfloor N_i/3 \rfloor+k} \quad k = 1, \dots, N_i \bmod 3 \quad \text{Note: When } (N_i \bmod 3) = 0 \text{ this row is not needed.}$$

$$x_{2,i,k} = e_{i,3(k-1)+1+(\alpha_2+\beta_{n_i}) \bmod 3} \quad k = 1, 2, 3, \dots, X_i \quad X_i = \lfloor N_i/3 \rfloor$$

$$x_{3,i,k} = e_{i,3(k-1)+1+(\alpha_3+\beta_{n_i}) \bmod 3} \quad k = 1, 2, 3, \dots, X_i \quad X_i = \lfloor N_i/3 \rfloor$$

For convolutionally encoded TrCHs and turbo encoded TrCHs with repetition:

$$x_{1,i,k} = e_{i,k} \quad k = 1, 2, 3, \dots, X_i \quad X_i = N_i$$

#### 4.2.7.3.2 Bit collection

The bits  $x_{bik}$  are input to the rate matching algorithm described in subclause 4.2.7.5. The bits output from the rate matching algorithm are denoted  $y_{bi1}, y_{bi2}, y_{bi3}, \dots, y_{biY_i}$ .

Bit collection is the inverse function of the separation. The bits after collection are denoted by  $z_{bi1}, z_{bi2}, z_{bi3}, \dots, z_{biY_i}$ . After bit collection, the bits indicated as punctured are removed and the bits are then denoted by  $f_{i1}, f_{i2}, f_{i3}, \dots, f_{iV_i}$ , where  $i$  is the TrCH number and  $V_i = N_i + \Delta N_{ij}$ . The relations between  $y_{bik}$ ,  $z_{bik}$ , and  $f_{ik}$  are given below.

For turbo encoded TrCHs with puncturing ( $Y_i = X_i$ ):

$$z_{i,3(k-1)+1+(\alpha_1+\beta_{n_i}) \bmod 3} = y_{1,i,k} \quad k = 1, 2, 3, \dots, Y_i$$

$$z_{i,3\lfloor N_i/3 \rfloor+k} = y_{1,i,\lfloor N_i/3 \rfloor+k} \quad k = 1, \dots, N_i \bmod 3 \quad \text{Note: When } (N_i \bmod 3) = 0 \text{ this row is not needed.}$$

$$z_{i,3(k-1)+1+(\alpha_2+\beta_{n_i}) \bmod 3} = y_{2,i,k} \quad k = 1, 2, 3, \dots, Y_i$$

$$z_{i,3(k-1)+1+(\alpha_3+\beta_{n_i}) \bmod 3} = y_{3,i,k} \quad k = 1, 2, 3, \dots, Y_i$$

After the bit collection, bits  $z_{i,k}$  with value  $\delta$ , where  $\delta \notin \{0, 1\}$ , are removed from the bit sequence. Bit  $f_{i,1}$  corresponds to the bit  $z_{i,k}$  with smallest index  $k$  after puncturing, bit  $f_{i,2}$  corresponds to the bit  $z_{i,k}$  with second smallest index  $k$  after puncturing, and so on.

For convolutionally encoded TrCHs and turbo encoded TrCHs with repetition:

$$z_{i,k} = y_{1,i,k} \quad k = 1, 2, 3, \dots, Y_i$$

When repetition is used,  $f_{i,k} = z_{i,k}$  and  $Y_i = V_i$ .

When puncturing is used,  $Y_i = X_i$  and bits  $z_{i,k}$  with value  $\delta$ , where  $\delta \notin \{0, 1\}$ , are removed from the bit sequence. Bit  $f_{i,1}$  corresponds to the bit  $z_{i,k}$  with smallest index  $k$  after puncturing, bit  $f_{i,2}$  corresponds to the bit  $z_{i,k}$  with second smallest index  $k$  after puncturing, and so on.

#### 4.2.7.4 Bit separation and collection in downlink

The systematic bits of turbo encoded TrCHs shall not be punctured, the other bits may be punctured.

The systematic bits, first parity bits and second parity bits in the bit sequence input to the rate matching block are therefore separated into three sequences of equal lengths.

The first sequence contains :

- All of the systematic bits that are from turbo encoded TrCHs.
- Some of the systematic, first parity and second parity bits that are for trellis termination.

The second sequence contains:

- All of the first parity bits that are from turbo encoded TrCHs.
- Some of the systematic, first parity and second parity bits that are for trellis termination.

The third sequence contains:

- All of the second parity bits that are from turbo encoded TrCHs.
- Some of the systematic, first parity and second parity bits that are for trellis termination.

Puncturing is applied only to the second and third sequences.

The bit separation function is transparent for convolutionally encoded TrCHs and for turbo encoded TrCHs with repetition. The bit separation and bit collection are illustrated in figures 7 and 8.

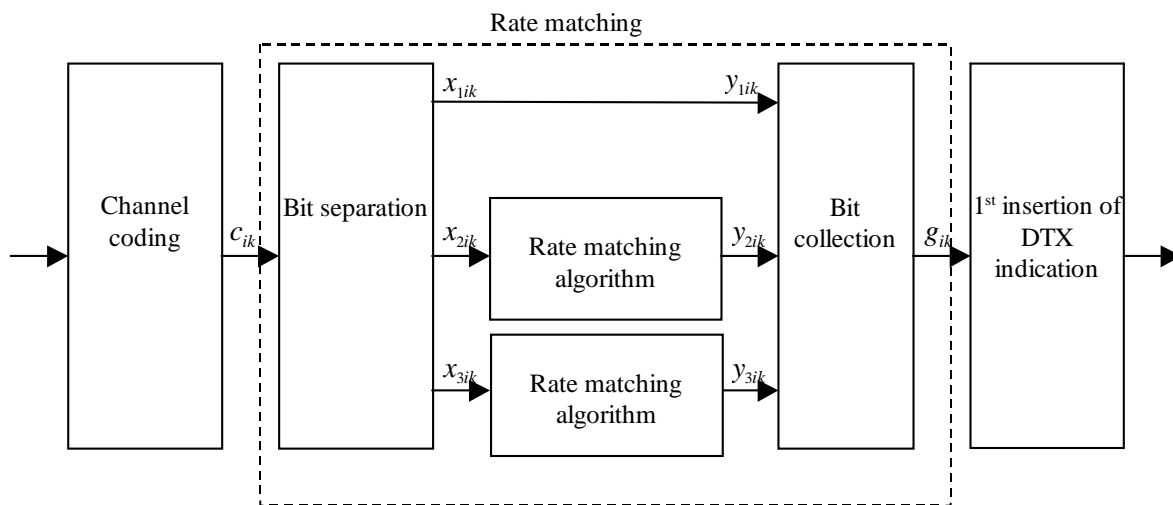

Figure 7: Puncturing of turbo encoded TrCHs in downlink

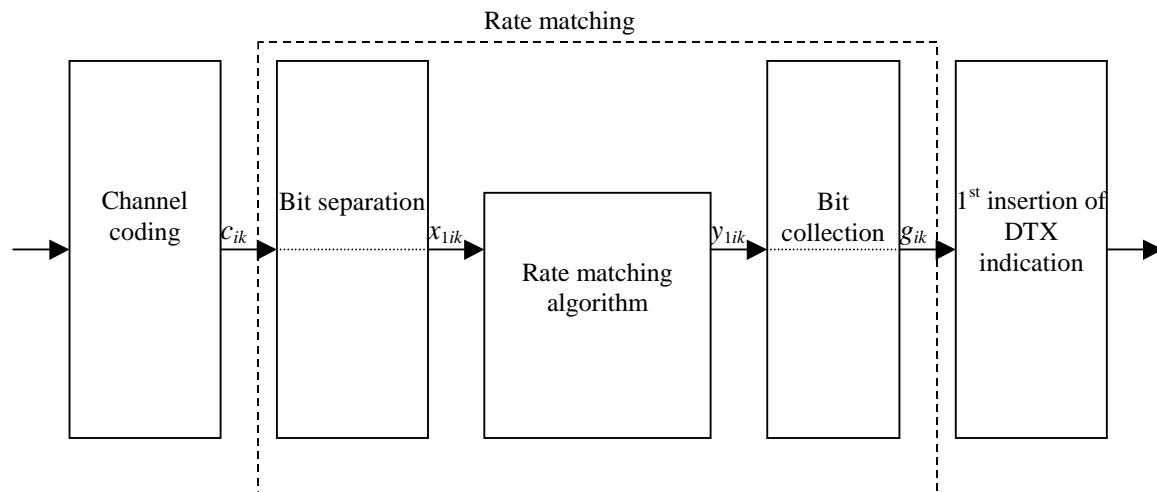

Figure 8: Rate matching for convolutionally encoded TrCHs and for turbo encoded TrCHs with repetition in downlink

4.2.7.4.1 Bit separation

The bits input to the rate matching are denoted by  $c_{i1}, c_{i2}, c_{i3}, \dots, c_{iE_i}$ , where  $i$  is the TrCH number and  $E_i$  is the number of bits input to the rate matching block. Note that  $E_i$  is a multiple of 3 for turbo encoded TrCHs and that the transport format  $l$  for simplicity has been left out in the bit numbering, i.e.  $E_i = N_{il}^{TTI}$ . The bits after separation are



denoted by  $x_{bi1}, x_{bi2}, x_{bi3}, \dots, x_{biX_i}$ . For turbo encoded TrCHs with puncturing,  $b$  indicates the three sequences defined in section 4.2.7.4, with  $b=1$  indicating the first sequence, and so forth. For all other cases  $b$  is defined to be 1.  $X_i$  is the number of bits in each separated bit sequence. The relation between  $c_{ik}$  and  $x_{bik}$  is given below.

For turbo encoded TrCHs with puncturing:

$$x_{1,i,k} = c_{i,3(k-1)+1} \quad k = 1, 2, 3, \dots, X_i \quad X_i = E_i/3$$

$$x_{2,i,k} = c_{i,3(k-1)+2} \quad k = 1, 2, 3, \dots, X_i \quad X_i = E_i/3$$

$$x_{3,i,k} = c_{i,3(k-1)+3} \quad k = 1, 2, 3, \dots, X_i \quad X_i = E_i/3$$

For convolutionally encoded TrCHs and turbo encoded TrCHs with repetition:

$$x_{1,i,k} = c_{i,k} \quad k = 1, 2, 3, \dots, X_i \quad X_i = E_i$$

#### 4.2.7.4.2 Bit collection

The bits  $x_{bik}$  are input to the rate matching algorithm described in subclause 4.2.7.5. The bits output from the rate matching algorithm are denoted  $y_{bi1}, y_{bi2}, y_{bi3}, \dots, y_{biY_i}$ .

Bit collection is the inverse function of the separation. The bits after collection are denoted by  $z_{bi1}, z_{bi2}, z_{bi3}, \dots, z_{biY_i}$ .

After bit collection, the bits indicated as punctured are removed and the bits are then denoted by  $g_{i1}, g_{i2}, g_{i3}, \dots, g_{iG_i}$ ,

where  $i$  is the TrCH number and  $G_i = N_{il}^{TTI} + \Delta N_{il}^{TTI}$ . The relations between  $y_{bik}$ ,  $z_{bik}$ , and  $g_{ik}$  are given below.

For turbo encoded TrCHs with puncturing ( $Y_i=X_i$ ):

$$z_{i,3(k-1)+1} = y_{1,i,k} \quad k = 1, 2, 3, \dots, Y_i$$

$$z_{i,3(k-1)+2} = y_{2,i,k} \quad k = 1, 2, 3, \dots, Y_i$$

$$z_{i,3(k-1)+3} = y_{3,i,k} \quad k = 1, 2, 3, \dots, Y_i$$

After the bit collection, bits  $z_{i,k}$  with value  $\delta$ , where  $\delta \notin \{0, 1\}$ , are removed from the bit sequence. Bit  $g_{i,1}$  corresponds to the bit  $z_{i,k}$  with smallest index  $k$  after puncturing, bit  $g_{i,2}$  corresponds to the bit  $z_{i,k}$  with second smallest index  $k$  after puncturing, and so on.

For convolutionally encoded TrCHs and turbo encoded TrCHs with repetition:

$$z_{i,k} = y_{1,i,k} \quad k = 1, 2, 3, \dots, Y_i$$

When repetition is used,  $g_{i,k}=z_{i,k}$  and  $Y_i=G_i$ .

When puncturing is used,  $Y_i=X_i$  and bits  $z_{i,k}$  with value  $\delta$ , where  $\delta \notin \{0, 1\}$ , are removed from the bit sequence. Bit  $g_{i,1}$  corresponds to the bit  $z_{i,k}$  with smallest index  $k$  after puncturing, bit  $g_{i,2}$  corresponds to the bit  $z_{i,k}$  with second smallest index  $k$  after puncturing, and so on.

#### 4.2.7.5 Rate matching pattern determination

Denote the bits before rate matching by:

$x_{i1}, x_{i2}, x_{i3}, \dots, x_{iX_i}$ , where  $i$  is the TrCH number and the sequence is defined in 4.2.7.3 for uplink or in 4.2.7.4 for downlink. Parameters  $X_i$ ,  $e_{ini}$ ,  $e_{plus}$ , and  $e_{minus}$  are given in 4.2.7.1 for uplink or in 4.2.7.2 for downlink.

The rate matching rule is as follows:

if puncturing is to be performed

$e = e_{ini}$       -- initial error between current and desired puncturing ratio

$m = 1$       -- index of current bit

do while  $m \leq X_i$

$e = e - e_{minus}$       -- update error

if  $e \leq 0$  then      -- check if bit number  $m$  should be punctured

set bit  $x_{i,m}$  to  $\delta$  where  $\delta \in \{0, 1\}$

$e = e + e_{plus}$       -- update error

end if

$m = m + 1$       -- next bit

end do

else

$e = e_{ini}$       -- initial error between current and desired puncturing ratio

$m = 1$       -- index of current bit

do while  $m \leq X_i$

$e = e - e_{minus}$       -- update error

do while  $e \leq 0$       -- check if bit number  $m$  should be repeated

repeat bit  $x_{i,m}$

$e = e + e_{plus}$       -- update error

end do

$m = m + 1$       -- next bit

end do

end if

A repeated bit is placed directly after the original one.

## 4.2.8 TrCH multiplexing

Every 10 ms, one radio frame from each TrCH is delivered to the TrCH multiplexing. These radio frames are serially multiplexed into a coded composite transport channel (CCTrCH).

The bits input to the TrCH multiplexing are denoted by  $f_{i1}, f_{i2}, f_{i3}, \dots, f_{iV_i}$ , where  $i$  is the TrCH number and  $V_i$  is the number of bits in the radio frame of TrCH  $i$ . The number of TrCHs is denoted by  $I$ . The bits output from TrCH multiplexing are denoted by  $s_1, s_2, s_3, \dots, s_S$ , where  $S$  is the number of bits, i.e.  $S = \sum_i V_i$ . The TrCH multiplexing is defined by the following relations:

$$s_k = f_{1k} \quad k = 1, 2, \dots, V_1$$

$$s_k = f_{2,(k-V_1)} \quad k = V_1+1, V_1+2, \dots, V_1+V_2$$

$$s_k = f_{3,(k-(V_1+V_2))} \quad k = (V_1+V_2)+1, (V_1+V_2)+2, \dots, (V_1+V_2)+V_3$$

...

$$s_k = f_{I,(k-(V_1+V_2+\dots+V_{I-1}))} \quad k = (V_1+V_2+\dots+V_{I-1})+1, (V_1+V_2+\dots+V_{I-1})+2, \dots, (V_1+V_2+\dots+V_{I-1})+V_I$$

## 4.2.9 Insertion of discontinuous transmission (DTX) indication bits

In the downlink, DTX is used to fill up the radio frame with bits. The insertion point of DTX indication bits depends on whether fixed or flexible positions of the TrCHs in the radio frame are used. It is up to the UTRAN to decide for each CCTrCH whether fixed or flexible positions are used during the connection. DTX indication bits only indicate when the transmission should be turned off, they are not transmitted.

### 4.2.9.1 1<sup>st</sup> insertion of DTX indication bits

This step of inserting DTX indication bits is used only if the positions of the TrCHs in the radio frame are fixed. With fixed position scheme a fixed number of bits is reserved for each TrCH in the radio frame.

The bits from rate matching are denoted by  $g_{i1}, g_{i2}, g_{i3}, \dots, g_{iG_i}$ , where  $G_i$  is the number of bits in one TTI of TrCH  $i$ . Denote the number of bits in one radio frame of TrCH  $i$  by  $H_i$ . Denote  $D_i$  the number of bits output of the first DTX insertion block.

In TTIs containing no compressed frames or frames compressed by spreading factor reduction,  $H_i$  is constant and corresponds to the maximum number of bits from TrCH  $i$  in one radio frame for any transport format of TrCH  $i$  and  $D_i = F_i \times H_i$ .

In TTIs containing frames compressed by puncturing, additional puncturing is performed in the rate matching block. The empty positions resulting from the additional puncturing are used to insert p-bits in the first interleaving block, the DTX insertion is therefore limited to allow for later insertion of p-bits. Thus DTX bits are inserted until the total number of bits is  $D_i$  where  $D_i = F_i \times H_i - Np^{TTI, m}_{i, max}$ , and  $H_i = N_{i,*} + \Delta N_{i,*}$ .

The bits output from the DTX insertion are denoted by  $h_{i1}, h_{i2}, h_{i3}, \dots, h_{iD_i}$ . Note that these bits are three valued. They are defined by the following relations:

$$h_{ik} = g_{ik} \quad k = 1, 2, 3, \dots, G_i$$

$$h_{ik} = \delta \quad k = G_i+1, G_i+2, G_i+3, \dots, D_i$$

where DTX indication bits are denoted by  $\delta$ . Here  $g_{ik} \in \{0, 1\}$  and  $\delta \notin \{0, 1\}$ .

### 4.2.9.2 2<sup>nd</sup> insertion of DTX indication bits

The DTX indication bits inserted in this step shall be placed at the end of the radio frame. Note that the DTX will be distributed over all slots after 2<sup>nd</sup> interleaving.

The bits input to the DTX insertion block are denoted by  $s_1, s_2, s_3, \dots, s_S$ , where  $S$  is the number of bits from TrCH multiplexing. The number of PhCHs is denoted by  $P$  and the number of bits in one radio frame, including DTX indication bits, for each PhCH by  $R$ .

In non-compressed frames,  $R = \frac{N_{data,*}}{P} = 15 \times (N_{data1} + N_{data2})$ , where  $N_{data1}$  and  $N_{data2}$  are defined in [2].

For compressed frames,  $N'_{data,*}$  is defined as  $N'_{data,*} = P \times 15 \times (N'_{data1} + N'_{data2})$ .  $N'_{data1}$  and  $N'_{data2}$  are the number of bits in the data fields of the slot format used for the current compressed frame, i.e. slot format A or B as defined in [2] corresponding to the spreading factor and the number of transmitted slots in use.

In frames compressed by puncturing and when fixed positions are used, no DTX shall be inserted, since the exact room for the gap is already reserved thanks to the earlier insertion of the p-bits.

In frames compressed by higher layer scheduling, additional DTX with respect to normal mode shall be inserted if the transmission time reduction does not exactly create a transmission gap of the desired  $TGL$ .

The number of bits available to the CCTrCH in one radio frame compressed by spreading factor reduction or by higher layer scheduling is denoted by  $N_{data,*}^{cm}$  and  $R = \frac{N_{data,*}^{cm}}{P}$ .

For frames compressed by spreading factor reduction  $N_{data,*}^{cm} = \frac{N'_{data,*}}{2}$ .

For frames compressed by higher layer scheduling the exact value of  $N_{data,*}^{cm}$  is dependent on the  $TGL$  which is signalled from higher layers. It can be calculated as  $N_{data,*}^{cm} = N'_{data,*} - N_{TGL}$ .

$N_{TGL}$  is the number of bits that are located within the transmission gap and defined as:

$$N_{TGL} = \begin{cases} \frac{TGL}{15} \times N'_{data,*}, & \text{if } N_{first} + TGL \leq 15 \\ \frac{15 - N_{first}}{15} \times N'_{data,*}, & \text{in first frame if } N_{first} + TGL > 15 \\ \frac{TGL - (15 - N_{first})}{15} \times N'_{data,*}, & \text{in second frame if } N_{first} + TGL > 15 \end{cases}$$

$N_{first}$  and  $TGL$  are defined in subclause 4.4.

The bits output from the DTX insertion block are denoted by  $w_1, w_2, w_3, \dots, w_{(PR)}$ . Note that these bits are four valued in case of compressed mode by puncturing, and three valued otherwise. They are defined by the following relations:

$$w_k = s_k \quad k = 1, 2, 3, \dots, S$$

$$w_k = \delta \quad k = S+1, S+2, S+3, \dots, P \cdot R$$

where DTX indication bits are denoted by  $\delta$ . Here  $s_k \in \{0, 1, p\}$  and  $\delta \notin \{0, 1\}$ .

#### 4.2.10 Physical channel segmentation

When more than one PhCH is used, physical channel segmentation divides the bits among the different PhCHs. The bits input to the physical channel segmentation are denoted by  $x_1, x_2, x_3, \dots, x_X$ , where  $X$  is the number of bits input to the physical channel segmentation block. The number of PhCHs is denoted by  $P$ .

The bits after physical channel segmentation are denoted  $u_{p,1}, u_{p,2}, u_{p,3}, \dots, u_{p,U}$ , where  $p$  is PhCH number and  $U$  is the number of bits in one radio frame for each PhCH, i.e.  $U = (X - N_{TGL} - (N_{data,*} - N'_{data,*})) / P$  for compressed mode by puncturing, and  $U = \frac{X}{P}$  otherwise. The relation between  $x_k$  and  $u_{p,k}$  is given below.

For all modes, some bits of the input flow are mapped to each code until the number of bits on the code is  $U$ . For modes other than compressed mode by puncturing, all bits of the input flow are taken to be mapped to the codes. For compressed mode by puncturing, only the bits of the input flow not corresponding to bits  $p$  are taken to be mapped to the codes, each bit  $p$  is removed to ensure creation the gap required by the compressed mode, as described below.

Bits on first PhCH after physical channel segmentation:

$$u_{1,k} = x_{f(k)} \quad k = 1, 2, \dots, U$$

Bits on second PhCH after physical channel segmentation:

$$u_{2,k} = x_{f(k+U)} \quad k = 1, 2, \dots, U$$

...

Bits on the  $P^{\text{th}}$  PhCH after physical channel segmentation:

$$u_{p,k} = x_{f(k+(P-1) \times U)} \quad k = 1, 2, \dots, U$$

where  $f$  is such that :

- for modes other than compressed mode by puncturing,  $x_{f(k)} = x_k$ , i.e.  $f(k) = k$ , for all  $k$ .
- for compressed mode by puncturing, bit  $u_{1,1}$  corresponds to the bit  $x_k$  with smallest index  $k$  when the bits  $p$  are not counted, bit  $u_{1,2}$  corresponds to the bit  $x_k$  with second smallest index  $k$  when the bits  $p$  are not counted, and so on for bits  $u_{1,3}, \dots, u_{1,U}, u_{2,1}, u_{2,2}, \dots, u_{2,U}, \dots, u_{p,1}, u_{p,2}, \dots, u_{p,U}$ .

#### 4.2.10.1 Relation between input and output of the physical segmentation block in uplink

The bits input to the physical segmentation are denoted by  $s_1, s_2, s_3, \dots, s_S$ . Hence,  $x_k = s_k$  and  $Y = S$ .

#### 4.2.10.2 Relation between input and output of the physical segmentation block in downlink

The bits input to the physical segmentation are denoted by  $w_1, w_2, w_3, \dots, w_{(PU)}$ . Hence,  $x_k = w_k$  and  $Y = PU$ .

### 4.2.11 2<sup>nd</sup> interleaving

The 2<sup>nd</sup> interleaving is a block interleaver and consists of bits input to a matrix with padding, the inter-column permutation for the matrix and bits output from the matrix with pruning. The bits input to the block interleaver are denoted by  $u_{p,1}, u_{p,2}, u_{p,3}, \dots, u_{p,U}$ , where  $p$  is PhCH number and  $U$  is the number of bits in one radio frame for one PhCH. The output bit sequence from the block interleaver is derived as follows:

- (1) Assign  $C2 = 30$  to be the number of columns of the matrix. The columns of the matrix are numbered 0, 1, 2, ...,  $C2 - 1$  from left to right.
- (2) Determine the number of rows of the matrix,  $R2$ , by finding minimum integer  $R2$  such that:

$$U \leq R2 \times C2.$$

The rows of rectangular matrix are numbered 0, 1, 2, ...,  $R2 - 1$  from top to bottom.

- (3) Write the input bit sequence  $u_{p,1}, u_{p,2}, u_{p,3}, \dots, u_{p,U}$  into the  $R2 \times C2$  matrix row by row starting with bit  $y_{p,1}$  in column 0 of row 0:

$$\begin{bmatrix} y_{p,1} & y_{p,2} & y_{p,3} & \dots & y_{p,C2} \\ y_{p,(C2+1)} & y_{p,(C2+2)} & y_{p,(C2+3)} & \dots & y_{p,(2 \times C2)} \\ \vdots & \vdots & \vdots & \dots & \vdots \\ y_{p,((R2-1) \times C2+1)} & y_{p,((R2-1) \times C2+2)} & y_{p,((R2-1) \times C2+3)} & \dots & y_{p,(R2 \times C2)} \end{bmatrix}$$

where  $y_{p,k} = u_{p,k}$  for  $k = 1, 2, \dots, U$  and if  $R2 \times C2 > U$ , the dummy bits are padded such that  $y_{p,k} = 0$  or 1 for  $k = U + 1, U + 2, \dots, R2 \times C2$ . These dummy bits are pruned away from the output of the matrix after the inter-column permutation.

- (4) Perform the inter-column permutation for the matrix based on the pattern  $\langle P2(j) \rangle_{j \in \{0,1,\dots,C2-1\}}$  that is shown in table 7, where  $P2(j)$  is the original column position of the  $j$ -th permuted column. After permutation of the columns, the bits are denoted by  $y'_{p,k}$ .

$$\begin{bmatrix} y'_{p,1} & y'_{p,(R2+1)} & y'_{p,(2 \times R2+1)} & \cdots & y'_{p,((C2-1) \times R2+1)} \\ y'_{p,2} & y'_{p,(R2+2)} & y'_{p,(2 \times R2+2)} & \cdots & y'_{p,((C2-1) \times R2+2)} \\ \vdots & \vdots & \vdots & \cdots & \vdots \\ y'_{p,R2} & y'_{p,(2 \times R2)} & y'_{p,(3 \times R2)} & \cdots & y'_{p,(C2 \times R2)} \end{bmatrix}$$

- (5) The output of the block interleaver is the bit sequence read out column by column from the inter-column permuted  $R2 \times C2$  matrix. The output is pruned by deleting dummy bits that were padded to the input of the matrix before the inter-column permutation, i.e. bits  $y'_{p,k}$  that corresponds to bits  $y_{p,k}$  with  $k > U$  are removed from the output. The bits after 2<sup>nd</sup> interleaving are denoted by  $v_{p,1}, v_{p,2}, \dots, v_{p,U}$ , where  $v_{p,1}$  corresponds to the bit  $y'_{p,k}$  with smallest index  $k$  after pruning,  $v_{p,2}$  to the bit  $y'_{p,k}$  with second smallest index  $k$  after pruning, and so on.

**Table 7 Inter-column permutation pattern for 2nd interleaving**

Number of columns C2	Inter-column permutation pattern < P2(0), P2(1), ..., P2(C2-1) >
30	<0, 20, 10, 5, 15, 25, 3, 13, 23, 8, 18, 28, 1, 11, 21, 6, 16, 26, 4, 14, 24, 19, 9, 29, 12, 2, 7, 22, 27, 17>

## 4.2.12 Physical channel mapping

The PhCH for both uplink and downlink is defined in [2]. The bits input to the physical channel mapping are denoted by  $v_{p,1}, v_{p,2}, \dots, v_{p,U}$ , where  $p$  is the PhCH number and  $U$  is the number of bits in one radio frame for one PhCH. The bits  $v_{p,k}$  are mapped to the PhCHs so that the bits for each PhCH are transmitted over the air in ascending order with respect to  $k$ .

In compressed mode, no bits are mapped to certain slots of the PhCH(s). If  $N_{first} + TGL \leq 15$ , no bits are mapped to slots  $N_{first}$  to  $N_{last}$ . If  $N_{first} + TGL > 15$ , i.e. the transmission gap spans two consecutive radio frames, the mapping is as follows:

- In the first radio frame, no bits are mapped to slots  $N_{first}, N_{first}+1, N_{first}+2, \dots, 14$ .
- In the second radio frame, no bits are mapped to the slots  $0, 1, 2, \dots, N_{last}$ .

$TGL$ ,  $N_{first}$ , and  $N_{last}$  are defined in subclause 4.4.

### 4.2.12.1 Uplink

In uplink, the PhCHs used during a radio frame are either completely filled with bits that are transmitted over the air or not used at all. The only exception is when the UE is in compressed mode. The transmission can then be turned off during consecutive slots of the radio frame.

### 4.2.12.2 Downlink

In downlink, the PhCHs do not need to be completely filled with bits that are transmitted over the air. Values  $v_{p,k} \in \{0, 1\}$  correspond to DTX indicators, which are mapped to the DPCCH/DPDCH fields but are not transmitted over the air.

During compressed mode by reducing the spreading factor by 2, the data bits are always mapped into 7.5 slots within a compressed frame. No bits are mapped to the DPDCH field as follows:

If  $N_{first} + TGL \leq 15$ , i.e. the transmission gap spans one radio frame,

if  $N_{first} + 7 \leq 14$

no bits are mapped to slots  $N_{first}, N_{first} + 1, N_{first} + 2, \dots, N_{first} + 6$

no bits are mapped to the first  $(N_{Data1} + N_{Data2})/2$  bit positions of slot  $N_{first} + 7$

else

no bits are mapped to slots  $N_{first}, N_{first} + 1, N_{first} + 2, \dots, 14$

no bits are mapped to slots  $N_{first} - 1, N_{first} - 2, N_{first} - 3, \dots, 8$

no bits are mapped to the last  $(N_{Data1} + N_{Data2})/2$  bit positions of slot 7

end if

If  $N_{first} + TGL > 15$ , i.e. the transmission gap spans two consecutive radio frames,

In the first radio frame, no bits are mapped to last  $(N_{Data1} + N_{Data2})/2$  bit positions in slot 7 as well as to slots 8, 9, 10, ..., 14.

In the second radio frame, no bits are mapped to slots 0, 1, 2, ..., 6 as well as to first  $(N_{Data1} + N_{Data2})/2$  bit positions in slot 7.

$N_{Data1}$  and  $N_{Data2}$  are defined in [2].

## 4.2.13 Restrictions on different types of CCTrCHs

Restrictions on the different types of CCTrCHs are described in general terms in TS 25.302[11]. In this subclause those restrictions are given with layer 1 notation.

### 4.2.13.1 Uplink Dedicated channel (DCH)

The maximum value of the number of TrCHs  $I$  in a CCTrCH, the maximum value of the number of transport blocks  $M_i$  on each transport channel, and the maximum value of the number of DPDCHs  $P$  are given from the UE capability class.

### 4.2.13.2 Random Access Channel (RACH)

- There can only be one TrCH in each RACH CCTrCH, i.e.  $I=1$ ,  $s_k = f_{1k}$  and  $S = V_1$ .
- The maximum value of the number of transport blocks  $M_1$  on the transport channel is given from the UE capability class.
- The transmission time interval is either 10 ms or 20 ms.
- Only one PRACH is used, i.e.  $P=1$ ,  $u_{1k} = s_k$ , and  $U = S$ .
- The Static rate matching parameter  $RM_1$  is not provided by higher layer signalling on the System information as the other transport channel parameters. Any value may be used as there is one transport channel in the CCTrCH, hence one transport channel per Transport Format Combination and no need to do any balancing between multiple transport channels.

### 4.2.13.3 Common Packet Channel (CPCH)

- There can only be one TrCH in each CPCH CCTrCH, i.e.  $I=1$ ,  $s_k = f_{1k}$  and  $S = V_1$ .
- The maximum value of the number of transport blocks  $M_1$  on the transport channel is given from the UE capability class.
- Only one PCPCH is used, i.e.  $P=1$ ,  $u_{1k} = s_k$ , and  $U = S$ .

#### 4.2.13.4 Downlink Dedicated Channel (DCH)

The maximum value of the number of TrCHs  $I$  in a CCTrCH, the maximum value of the number of transport blocks  $M_i$  on each transport channel, and the maximum value of the number of DPDCs  $P$  are given from the UE capability class.

#### 4.2.13.5 Downlink Shared Channel (DSCH) associated with a DCH

- The spreading factor is indicated with the TFCI of the associated DPCH.
- The maximum value of the number of TrCHs  $I$  in a CCTrCH, the maximum value of the number of transport blocks  $M_i$  on the transport channel and the maximum value of the number of PDSCHs  $P$  are given from the UE capability class.

#### 4.2.13.6 Broadcast channel (BCH)

- There can only be one TrCH in the BCH CCTrCH, i.e.  $I=1$ ,  $S_k = f_{1k}$ , and  $S = V_1$ .
- There can only be one transport block in each transmission time interval, i.e.  $M_1 = 1$ .
- All transport format attributes have predefined values which are provided in [11] apart from the rate matching  $RM_1$ .
- The Static rate matching parameter  $RM_1$  is not provided by higher layer signalling neither fixed. Any value may be used as there is one transport channel in the CCTrCH, hence one transport channel per Transport Format Combination and no need to do any balancing between multiple transport channels.
- Only one primary CCPCH is used, i.e.  $P=1$ .

#### 4.2.13.7 Forward access and paging channels (FACH and PCH)

- The maximum value of the number of TrCHs  $I$  in a CCTrCH and the maximum value of the number of transport blocks  $M_i$  on each transport channel are given from the UE capability class.
- The transmission time interval for TrCHs of PCH type is always 10 ms.
- Only one secondary CCPCH is used per CCTrCH, i.e.  $P=1$ .

### 4.2.14 Multiplexing of different transport channels into one CCTrCH, and mapping of one CCTrCH onto physical channels

The following rules shall apply to the different transport channels which are part of the same CCTrCH:

- 1) Transport channels multiplexed into one CCTrCh shall have co-ordinated timings. When the TFCS of a CCTrCH is changed because one or more transport channels are added to the CCTrCH or reconfigured within the CCTrCH, or removed from the CCTrCH, the change may only be made at the start of a radio frame with CFN fulfilling the relation

$$\text{CFN mod } F_{\max} = 0,$$

where  $F_{\max}$  denotes the maximum number of radio frames within the transmission time intervals of all transport channels which are multiplexed into the same CCTrCH, including any transport channels  $i$  which are added, reconfigured or have been removed, and CFN denotes the connection frame number of the first radio frame of the changed CCTrCH.

After addition or reconfiguration of a transport channel  $i$  within a CCTrCH, the TTI of transport channel  $i$  may only start in radio frames with CFN fulfilling the relation:

$$\text{CFN mod } F_i = 0.$$

For a CCTrCH of DSCH type, a modification of number of bits  $N_{data,*}$  allocated on a radio frame is allowed if the CFN verifies  $\text{CFN mod } F_{\max} = 0$ , where  $F_{\max}$  denotes the maximum number of radio frames within the transmission time intervals of all the transport channels with a non zero transport block transport format multiplexed into the CCTrCH in the previous radio frame.



- 2) Only transport channels with the same active set can be mapped onto the same CCTrCH.
- 3) Different CCTrCHs cannot be mapped onto the same PhCH.
- 4) One CCTrCH shall be mapped onto one or several PhCHs. These physical channels shall all have the same SF.
- 5) Dedicated Transport channels and common transport channels cannot be multiplexed into the same CCTrCH.
- 6) For the common transport channels, only the FACH and PCH may belong to the same CCTrCH.

There are hence two types of CCTrCH:

- 1) CCTrCH of dedicated type, corresponding to the result of coding and multiplexing of one or several DCHs.
- 2) CCTrCH of common type, corresponding to the result of the coding and multiplexing of a common channel, RACH in the uplink, DSCH, BCH, or FACH/PCH for the downlink.

#### 4.2.14.1 Allowed CCTrCH combinations for one UE

##### 4.2.14.1.1 Allowed CCTrCH combinations on the uplink

A maximum of one CCTrCH is allowed for one UE on the uplink. It can be either:

- 1) one CCTrCH of dedicated type;
- 2) one CCTrCH of common type.

##### 4.2.14.1.2 Allowed CCTrCH combinations on the downlink

The following CCTrCH combinations for one UE are allowed:

- $x$  CCTrCH of dedicated type +  $y$  CCTrCH of common type. The allowed combination of CCTrCHs of dedicated and common type are given from UE radio access capabilities. There can be a maximum on one CCTrCH of common type for DSCH and a maximum of one CCTrCH of common type for FACH. With one CCTrCH of common type for DSCH, there shall be only one CCTrCH of dedicated type.

NOTE 1: There is only one DPCCCH in the uplink, hence one TPC bits flow on the uplink to control possibly the different DPDCHs on the downlink, part of the same or several CCTrCHs.

NOTE 2: There is only one DPCCCH in the downlink, even with multiple CCTrCHs. With multiple CCTrCHs, the DPCCCH is transmitted on one of the physical channels of that CCTrCH which has the smallest SF among the multiple CCTrCHs. Thus there is only one TPC command flow and only one TFCI word in downlink even with multiple CCTrCHs.

NOTE 3: in the current release, only 1 CCTrCH of dedicated type is supported.

## 4.3 Transport format detection

If the transport format set of a TrCH  $i$  contains more than one transport format, the transport format can be detected according to one of the following methods:

- TFCI based detection: This method is applicable when the transport format combination is signalled using the TFCI field;
- explicit blind detection: This method typically consists of detecting the TF of TrCH  $i$  by use of channel decoding and CRC check;
- guided detection: This method is applicable when there is at least one other TrCH  $i'$ , hereafter called guiding TrCH, such that:
  - the guiding TrCH has the same TTI duration as the TrCH under consideration, i.e.  $F_T = F_i$ ;
  - different TFs of the TrCH under consideration correspond to different TFs of the guiding TrCH;

- explicit blind detection is used on the guiding TrCH.

If the transport format set for a TrCH  $i$  does not contain more than one transport format with more than zero transport blocks, no explicit blind transport format detection needs to be performed for this TrCH. The UE can use guided detection for this TrCH or single transport format detection, where the UE always assumes the transport format corresponding to more than zero transport blocks for decoding.

For uplink, blind transport format detection is a network controlled option. For downlink, the UE shall be capable of performing blind transport format detection, if certain restrictions on the configured transport channels are fulfilled.

For a DPCH associated with a PDSCH, the DPCCH shall include TFCI.

### 4.3.1 Blind transport format detection

When no TFCI is available then explicit blind detection or guided detection shall be performed on all TrCHs within the CCTrCH that have more than one transport format and that do not use single transport format detection. The UE shall only be required to support blind transport format detection if all of the following restrictions are fulfilled:

1. only one CCTrCH is received by the UE;
2. the number of CCTrCH bits received per radio frame is 600 or less;
3. the number of transport format combinations of the CCTrCH is 64 or less;
4. fixed positions of the transport channels is used on the CCTrCH to be detectable;
5. convolutional coding is used on all explicitly detectable TrCHs;
6. CRC with non-zero length is appended to all transport blocks on all explicitly detectable TrCHs;
7. at least one transport block shall be transmitted per TTI on each explicitly detectable TrCH;
8. the number of explicitly detectable TrCHs is 3 or less;
9. for all explicitly detectable TrCHs  $i$ , the number of code blocks in one TTI ( $C_i$ ) shall not exceed 1;
10. the sum of the transport format set sizes of all explicitly detectable TrCHs, is 16 or less. The transport format set size is defined as the number of transport formats within the transport format set;
11. there is at least one TrCH that can be used as the guiding transport channel for all transport channels using guided detection.

Examples of blind transport format detection methods are given in annex A.

### 4.3.2 Transport format detection based on TFCI

If a TFCI is available, then TFCI based detection shall be applicable to all TrCHs within the CCTrCH. The TFCI informs the receiver about the transport format combination of the CCTrCHs. As soon as the TFCI is detected, the transport format combination, and hence the transport formats of the individual transport channels are known.

### 4.3.3 Coding of Transport-Format-Combination Indicator (TFCI)

The TFCI is encoded using a (32, 10) sub-code of the second order Reed-Muller code. The coding procedure is as shown in figure 9.

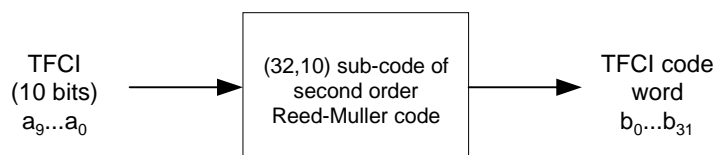

Figure 9: Channel coding of TFCI information bits

If the TFCI consist of less than 10 bits, it is padded with zeros to 10 bits, by setting the most significant bits to zero. The length of the TFCI code word is 32 bits.

The code words of the (32,10) sub-code of second order Reed-Muller code are linear combination of 10 basis sequences. The basis sequences are as in the following table 8.

**Table 8: Basis sequences for (32,10) TFCI code**

<i>i</i>	$M_{i,0}$	$M_{i,1}$	$M_{i,2}$	$M_{i,3}$	$M_{i,4}$	$M_{i,5}$	$M_{i,6}$	$M_{i,7}$	$M_{i,8}$	$M_{i,9}$
0	1	0	0	0	0	1	0	0	0	0
1	0	1	0	0	0	1	1	0	0	0
2	1	1	0	0	0	1	0	0	0	1
3	0	0	1	0	0	1	1	0	1	1
4	1	0	1	0	0	1	0	0	0	1
5	0	1	1	0	0	1	0	0	1	0
6	1	1	1	0	0	1	0	1	0	0
7	0	0	0	1	0	1	0	1	1	0
8	1	0	0	1	0	1	1	1	1	0
9	0	1	0	1	0	1	1	0	1	1
10	1	1	0	1	0	1	0	0	1	1
11	0	0	1	1	0	1	0	1	1	0
12	1	0	1	1	0	1	0	1	0	1
13	0	1	1	1	0	1	1	0	0	1
14	1	1	1	1	0	1	1	1	1	1
15	1	0	0	0	1	1	1	1	0	0
16	0	1	0	0	1	1	1	1	0	1
17	1	1	0	0	1	1	1	0	1	0
18	0	0	1	0	1	1	0	1	1	1
19	1	0	1	0	1	1	0	1	0	1
20	0	1	1	0	1	1	0	0	1	1
21	1	1	1	0	1	1	0	1	1	1
22	0	0	0	1	1	1	0	1	0	0
23	1	0	0	1	1	1	1	1	0	1
24	0	1	0	1	1	1	1	0	1	0
25	1	1	0	1	1	1	1	0	0	1
26	0	0	1	1	1	1	0	0	1	0
27	1	0	1	1	1	1	1	1	0	0
28	0	1	1	1	1	1	1	1	1	0
29	1	1	1	1	1	1	1	1	1	1
30	0	0	0	0	0	1	0	0	0	0
31	0	0	0	0	1	1	1	0	0	0

The TFCI information bits  $a_0, a_1, a_2, a_3, a_4, a_5, a_6, a_7, a_8, a_9$  (where  $a_0$  is LSB and  $a_9$  is MSB) shall correspond to the TFC index (expressed in unsigned binary form) defined by the RRC layer to reference the TFC of the CCTrCH in the associated DPCH radio frame.

The output code word bits  $b_i$  are given by:

$$b_i = \sum_{n=0}^9 (a_n \times M_{i,n}) \text{ mod } 2$$

where  $i = 0, \dots, 31$ .

The output bits are denoted by  $b_k, k = 0, 1, 2, \dots, 31$ .

In downlink, when the  $SF < 128$  the encoded TFCI code words are repeated yielding 8 encoded TFCI bits per slot in normal mode and 16 encoded TFCI bits per slot in compressed mode. Mapping of repeated bits to slots is explained in subclause 4.3.5.

#### 4.3.4 Operation of TFCI in Hard Split Mode

If one of the DCH is associated with a DSCH, the TFCI code word may be split in such a way that the code word relevant for TFCI activity indication is not transmitted from every cell. The use of such a functionality shall be indicated by higher layer signalling.

The TFCI is encoded by using punctured code of (32,10) sub-code of second order Reed-Muller code. The coding procedure is as shown in figure 10.

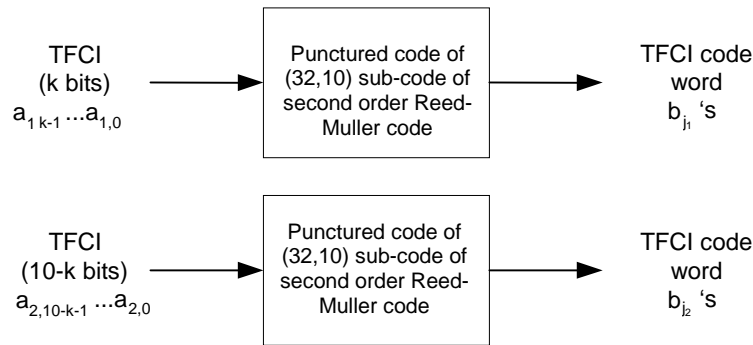

**Figure 10: Channel coding of flexible hard split mode TFCI information bits**

The code words of the punctured code of (32,10) sub-code of second order Reed-Muller code are linear combinations of basis sequences generated by puncturing 10 basis sequences defined in table 8 in section 4.3.3.

The first set of TFCI information bits ( $a_{1,0}, a_{1,1}, a_{1,2}, a_{1,3}, \dots, a_{1,k-1}$  where  $a_{1,0}$  is LSB and  $a_{1,k-1}$  is MSB) shall correspond to the TFC index (expressed in unsigned binary form) defined by the RRC layer to reference the TFC of the DCH CCTrCH in the associated DPCH radio frame.

The second set of TFCI information bits ( $a_{2,0}, a_{2,1}, a_{2,2}, a_{2,3}, \dots, a_{2,10-k-1}$  where  $a_{2,0}$  is LSB and  $a_{2,10-k-1}$  is MSB) shall correspond to the TFC index (expressed in unsigned binary form) defined by the RRC layer to reference the TFC of the associated DSCH CCTrCH in the corresponding PDSCH radio frame.

The output code word bits are given by :

$$b_{j_1} = \sum_{n=0}^{k-1} (a_{1,n} \times M_{\pi_1(k,i_1), \pi_2(k,n)}) \bmod 2; \quad b_{j_2} = \sum_{n=0}^{10-k-1} (a_{2,n} \times M_{\pi_1(10-k,i_2), \pi_2(10-k,n)}) \bmod 2$$

where  $i_1 = 0, \dots, 3 \times k$  and  $i_2 = 0, \dots, 30 - 3 \times k$ .

Then, the relation between  $j_1$  (or  $j_2$ ) and  $i_1$  (or  $i_2$ ) is as follows:

$$j_1 = \left\lfloor \frac{32}{3 \times k + 1} \times \left( i_1 + 1 - \frac{1}{2} \left\lfloor \frac{k}{5} \right\rfloor \right) + \frac{1}{2} \right\rfloor - 1; \quad j_2 = \left\lfloor \frac{32}{32 - (3 \times k + 1)} \times \left( i_2 + \frac{1}{2} \left( 1 + \left\lfloor \frac{k}{5} \right\rfloor \right) \right) + \frac{1}{2} \right\rfloor - 1.$$

The functions  $\pi_1, \pi_2$  are defined as shown in the following table 9.

Table 9.  $\pi_1, \pi_2$  functions

m	$\pi_1(m, i)$ for $i = 0, \dots, 3 \times m$	$\pi_2(m, n)$ for $n = 0, \dots, m-1$
3	0, 1, 2, 3, 4, 5, 6, 8, 9, 11	0, 1, 2
4	3, 4, 5, 6, 7, 8, 9, 10, 11, 12, 13, 14, 15	0, 1, 2, 3
5	0, 1, 2, 3, 4, 5, 6, 7, 8, 9, 10, 11, 12, 13, 14, 30	0, 1, 2, 3, 5
6	0, 1, 2, 3, 4, 5, 7, 8, 9, 12, 15, 18, 21, 23, 25, 27, 28, 29, 30	0, 1, 2, 3, 4, 5
7	0, 1, 2, 3, 4, 5, 6, 7, 9, 10, 11, 13, 14, 15, 17, 20, 21, 22, 24, 25, 28, 29	0, 1, 2, 3, 4, 6, 7

## 4.3.5 Mapping of TFCI words

### 4.3.5.1 Mapping of TFCI word in normal mode

The bits of the code word are directly mapped to the slots of the radio frame. Within a slot the bit with lower index is transmitted before the bit with higher index. The coded bits  $b_k$ , are mapped to the transmitted TFCI bits  $d_k$ , according to the following formula:

$$d_k = b_{k \bmod 32}$$

For uplink physical channels regardless of the SF and downlink physical channels, if  $SF \geq 128$ ,  $k = 0, 1, 2, \dots, 29$ . Note that this means that bits  $b_{30}$  and  $b_{31}$  are not transmitted.

For downlink physical channels whose  $SF < 128$ ,  $k = 0, 1, 2, \dots, 119$ . Note that this means that bits  $b_0$  to  $b_{23}$  are transmitted four times and bits  $b_{24}$  to  $b_{31}$  are transmitted three times.

### 4.3.5.2 Mapping of TFCI word in compressed mode

The mapping of the TFCI bits in compressed mode is different for uplink, downlink with  $SF \geq 128$  and downlink with  $SF < 128$ .

#### 4.3.5.2.1 Uplink compressed mode

For uplink compressed mode, the slot format is changed so that no TFCI coded bits are lost. The different slot formats in compressed mode do not match the exact number of TFCI coded bits for all possible TGLs. Repetition of the TFCI bits is therefore used.

Denote the number of bits available in the TFCI fields of one compressed radio frame by  $D$  and the number of bits in the TFCI field in a slot by  $N_{\text{TFCI}}$ . The parameter  $E$  is used to determine the number of the first TFCI bit to be repeated.

$E = N_{\text{first}} N_{\text{TFCI}}$ , if the start of the transmission gap is allocated to the current frame.

$E = 0$ , if the start of the transmission gap is allocated to the previous frame and the end of the transmission gap is allocated to the current frame.

The TFCI coded bits  $b_k$  are mapped to the bits in the TFCI fields  $d_k$ . The following relations define the mapping for each compressed frame.

$$d_k = b_k$$

where  $k = 0, 1, 2, \dots, \min(31, D-1)$ .

If  $D > 32$ , the remaining positions are filled by repetition (in reversed order):

$$d_{D-k-1} = b_{(E+k) \bmod 32}$$

where  $k = 0, \dots, D-33$ .

#### 4.3.5.2.2 Downlink compressed mode

For downlink compressed mode, the slot format is changed so that no TFCI coded bits are lost. The different slot formats in compressed mode do not match the exact number of TFCI bits for all possible TGLs. DTX is therefore used

if the number of bits available in the TFCI fields in one compressed frame exceeds the number of TFCI bits given from the slot format. The block of bits in the TFCI fields where DTX is used starts on the first TFCI field after the transmission gap. If there are more bits available in the TFCI fields before the transmission gap than TFCI bits, DTX is also used on the bits in the last TFCI fields before the transmission gap.

Denote the number of bits available in the TFCI fields of one compressed radio frame by  $D$  and the number of bits in the TFCI field in a slot by  $N_{TFCI}$ . The parameter  $E$  is used to determine the position of the first bit in the TFCI field on which DTX is used.

$E = N_{first} N_{TFCI}$ , if the start of the transmission gap is allocated to the current frame.  
 $E = 0$ , if the start of the transmission gap is allocated to the previous frame and the end of the transmission gap is allocated to the current frame.

Denote the total number of TFCI bits to be transmitted by  $F$ .  $F = 32$  for slot formats  $nA$  or  $nB$ , where  $n = 0, 1, \dots, 11$  (see table 11 in [2]). Otherwise,  $F = 128$ . The TFCI coded bits  $b_k$  are mapped to the bits in the TFCI fields  $d_k$ . The following relations define the mapping for each compressed frame.

If  $E > 0$ ,

$$d_k = b_{k \bmod 32}$$

where  $k = 0, 1, 2, \dots, \min(E, F)-1$ .

If  $E < F$ ,

$$d_{k+D-F} = b_{k \bmod 32}$$

where  $k = E, \dots, F - 1$ .

DTX is used on  $d_k$  where  $k = \min(E, F), \dots, \min(E, F) + D - F - 1$ .

## 4.4 Compressed mode

In compressed frames, TGL slots from  $N_{first}$  to  $N_{last}$  are not used for transmission of data. As illustrated in figure 11, the instantaneous transmit power is increased in the compressed frame in order to keep the quality (BER, FER, etc.) unaffected by the reduced processing gain. The amount of power increase depends on the transmission time reduction method (see subclause 4.4.3). What frames are compressed, are decided by the network. When in compressed mode, compressed frames can occur periodically, as illustrated in figure 11, or requested on demand. The rate and type of compressed frames is variable and depends on the environment and the measurement requirements.

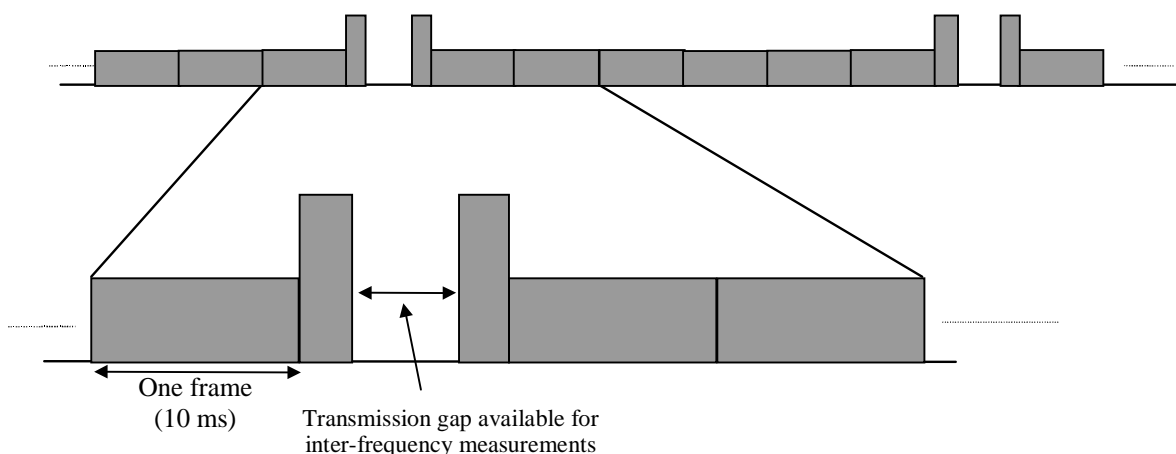

Figure 11: Compressed mode transmission

### 4.4.1 Frame structure in the uplink

The frame structure for uplink compressed frames is illustrated in figure 12.

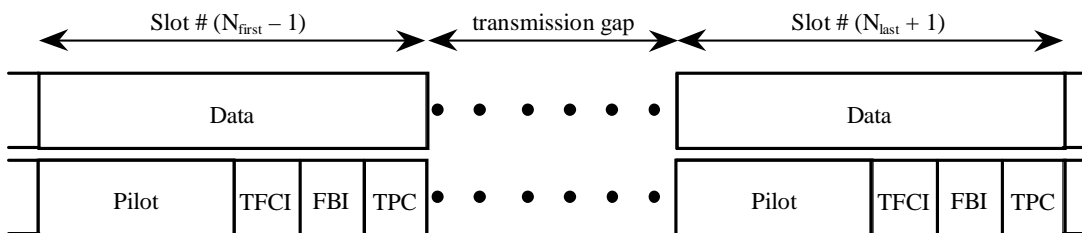
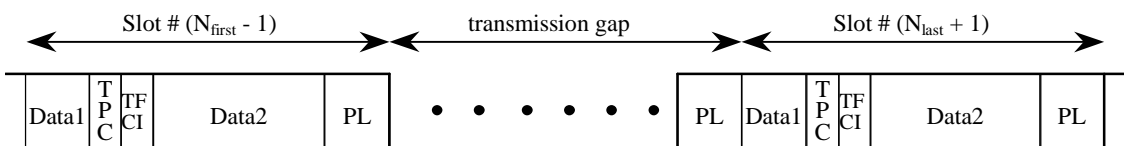

Figure 12: Frame structure in uplink compressed transmission

### 4.4.2 Frame structure types in the downlink

There are two different types of frame structures defined for downlink compressed frames. Type A maximises the transmission gap length and type B is optimised for power control. The frame structure type A or B is set by higher layers independent from the downlink slot format type A or B.

- With frame structure of type A, the pilot field of the last slot in the transmission gap is transmitted. Transmission is turned off during the rest of the transmission gap (figure 13(a)). In case the length of the pilot field is 2 bits and STTD is used on the radio link, the pilot bits in the last slot of the transmission gap shall be STTD encoded assuming DTX indicators as the two last bits in the Data2 field.
- With frame structure of type B, the TPC field of the first slot in the transmission gap and the pilot field of the last slot in the transmission gap is transmitted. Transmission is turned off during the rest of the transmission gap (figure 13(b)). In case the length of the pilot field is 2 bits and STTD is used on the radio link, the pilot bits in the last slot of the transmission gap shall be STTD encoded assuming DTX indicators as the two last bits of the Data2 field. Similarly, the TPC bits in the first slot of the transmission gap shall be STTD encoded assuming DTX indicators as the two last bits in the Data1 field.



(a) Frame structure type A

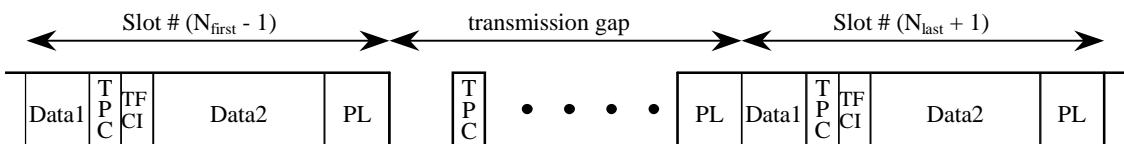

(b) Frame structure type B

Figure 13: Frame structure types in downlink compressed transmission

### 4.4.3 Transmission time reduction method

When in compressed mode, the information normally transmitted during a 10 ms frame is compressed in time. The mechanisms provided for achieving this are puncturing, reduction of the spreading factor by a factor of two, and higher layer scheduling. In the downlink, all methods are supported while compressed mode by puncturing is not used in the uplink. The maximum idle length is defined to be 7 slots per one 10 ms frame. The slot formats that are used in compressed frames are listed in [2].

#### 4.4.3.1 Compressed mode by puncturing

Rate matching is applied for creating a transmission gap in one or two frames. The algorithm for rate matching as described in subclause 4.2.7 is used.

#### 4.4.3.2 Compressed mode by reducing the spreading factor by 2

The spreading factor (SF) can be reduced by 2 during one compressed radio frame to enable the transmission of the information bits in the remaining time slots of the compressed frame. This method is not supported for SF=4.

On the downlink, UTRAN can also order the UE to use a different scrambling code in a compressed frame than in a non-compressed frame. If the UE is ordered to use a different scrambling code in a compressed frame, then there is a one-to-one mapping between the scrambling code used in the non-compressed frame and the one used in the compressed frame, as described in [3] subclause 5.2.1.

#### 4.4.3.3 Compressed mode by higher layer scheduling

Compressed frames can be obtained by higher layer scheduling. Higher layers then set restrictions so that only a subset of the allowed TFCs are used in a compressed frame. The maximum number of bits that will be delivered to the physical layer during the compressed radio frame is then known and a transmission gap can be generated. Note that in the downlink, the TFCI field is expanded on the expense of the data fields and this shall be taken into account by higher layers when setting the restrictions on the TFCs. Compressed mode by higher layer scheduling shall not be used with fixed starting positions of the TrCHs in the radio frame.

#### 4.4.4 Transmission gap position

Transmission gaps can be placed at different positions as shown in figures 14 and 15 for each purpose such as interfrequency power measurement, acquisition of control channel of other system/carrier, and actual handover operation.

When using single frame method, the transmission gap is located within the compressed frame depending on the transmission gap length (TGL) as shown in figure 14 (1). When using double frame method, the transmission gap is located on the center of two connected frames as shown in figure 14 (2).

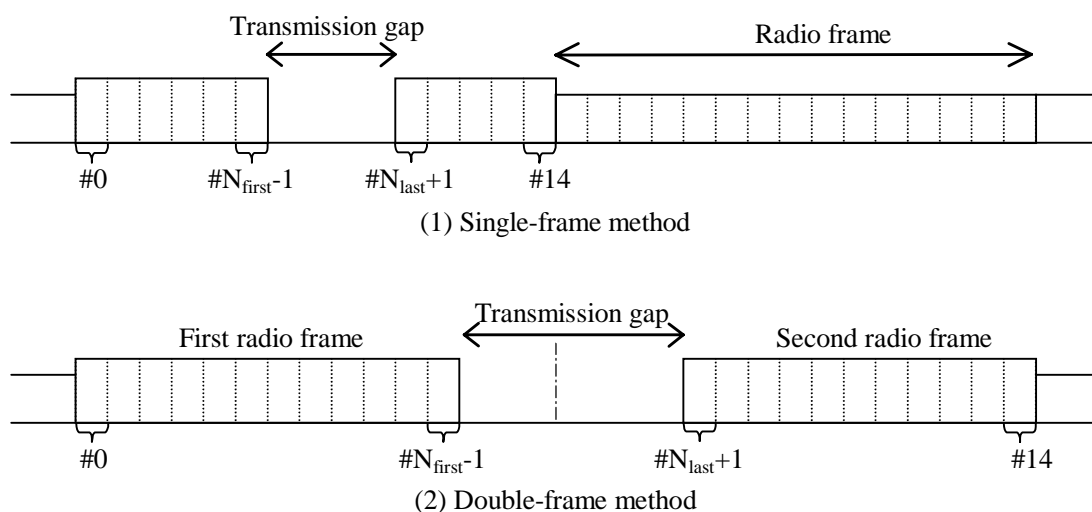

**Figure 14: Transmission gap position**

Parameters of the transmission gap positions are calculated as follows.

TGL is the number of consecutive idle slots during the compressed mode transmission gap:

$$\text{TGL} = 3, 4, 5, 7, 10, 14$$

$N_{\text{first}}$  specifies the starting slot of the consecutive idle slots,

$$N_{\text{first}} = 0, 1, 2, 3, \dots, 14.$$

$N_{\text{last}}$  shows the number of the final idle slot and is calculated as follows;

$$\text{If } N_{\text{first}} + \text{TGL} \leq 15, \text{ then } N_{\text{last}} = N_{\text{first}} + \text{TGL} - 1 \text{ ( in the same frame ),}$$



If  $N_{first} + TGL > 15$ , then  $N_{last} = (N_{first} + TGL - 1) \bmod 15$  ( in the next frame ).

When the transmission gap spans two consecutive radio frames,  $N_{first}$  and TGL must be chosen so that at least 8 slots in each radio frame are transmitted.

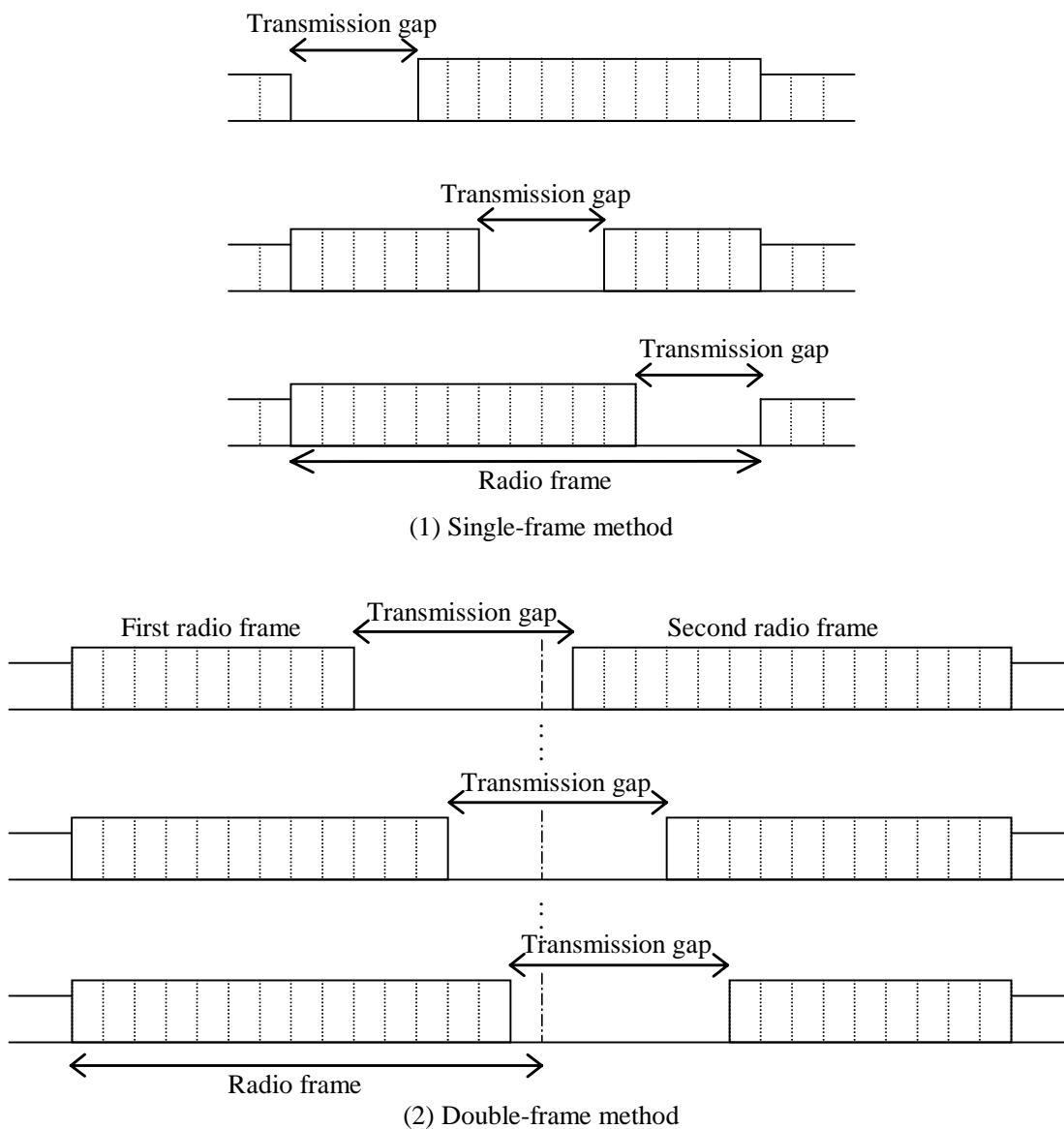

Figure 15: Transmission gap positions with different  $N_{first}$

## 4.5 Coding for HS-DSCH

Data arrives to the coding unit in form of a maximum of one transport block once every transmission time interval. The transmission time interval is 2 ms which is mapped to a radio sub-frame of 3 slots.

The following coding steps can be identified:

- add CRC to each transport block (see subclause 4.5.1);
- bit scrambling (see subclause 4.5.1a);
- code block segmentation (see subclause 4.5.2);
- channel coding (see subclause 4.5.3);
- hybrid ARQ (see subclause 4.5.4);

- physical channel segmentation (see subclause 4.5.5);
- interleaving for HS-DSCH (see subclause 4.5.6);
- constellation re-arrangement for 16 QAM (see subclause 4.5.7);
- mapping to physical channels (see subclause 4.5.8).

The coding steps for HS-DSCH are shown in the figure below.

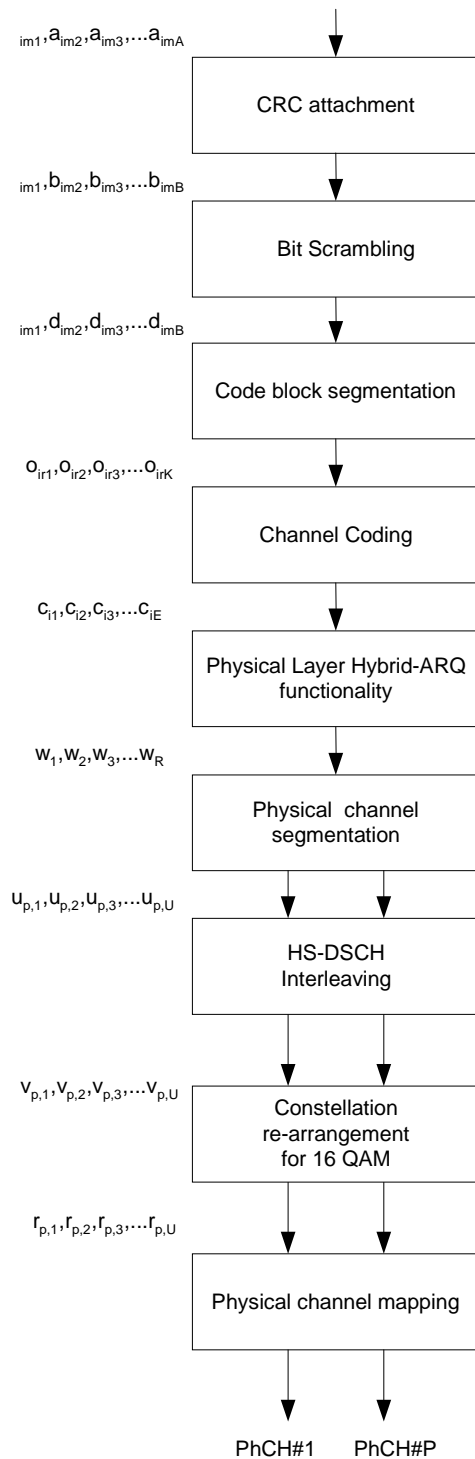

Figure 16: Coding chain for HS-DSCH

In the following the number of transport blocks and the number of transport channels is always one i.e.  $m=1, i=1$ . When referencing non HS-DSCH formulae which are used in correspondence with HS-DSCH formulae the convention is used that transport block subscripts may be omitted (e.g.  $X_1$  may be written  $X$ ).

#### 4.5.1 CRC attachment for HS-DSCH

CRC attachment for the HS-DSCH transport channel shall be done using the general method described in 4.2.1 above with the following specific parameters.

The CRC length shall always be  $L_1 = 24$  bits.

##### 4.5.1a Bit scrambling for HS-DSCH

The bits output from the HS-DSCH CRC attachment are scrambled in the bit scrambler. The bits input to the bit scrambler are denoted by  $b_{im,1}, b_{im,2}, b_{im,3}, \dots, b_{im,B}$ , where  $B$  is the number of bits input to the HS-DSCH bit scrambler

The bits after bit scrambling are denoted  $d_{im,1}, d_{im,2}, d_{im,3}, \dots, d_{im,B}$ .

Bit scrambling is defined by the following relation:

$$d_{im,k} = (b_{im,k} + y_k) \bmod 2 \quad k = 1, 2, \dots, B$$

and  $y_k$  results from the following operation:

$$y'_\gamma = 0 \quad -15 < \gamma < 1$$

$$y'_\gamma = 1 \quad \gamma = 1$$

$$y'_\gamma = \left( \sum_{x=1}^{16} g_x \cdot y'_{\gamma-x} \right) \bmod 2 \quad 1 < \gamma \leq B,$$

where  $g = \{g_1, g_2, \dots, g_{16}\} = \{0, 0, 0, 0, 0, 0, 0, 0, 0, 0, 1, 0, 1, 1, 0, 1\}$ ,

$$y_k = y'_k \quad k = 1, 2, \dots, B.$$

#### 4.5.2 Code block segmentation for HS-DSCH

Code block segmentation for the HS-DSCH transport channel shall be done with the general method described in 4.2.2.2 above with the following specific parameters.

There will be a maximum of one transport block,  $i=1$ . The bits  $d_{im1}, d_{im2}, d_{im3}, \dots, d_{imB}$  input to the block are mapped to the bits  $x_{i1}, x_{i2}, x_{i3}, \dots, x_{iX_i}$  directly. It follows that  $X_1 = B$ . Note that the bits  $x$  referenced here refer only to the internals of the code block segmentation function. The output bits from the code block segmentation function are  $o_{ir1}, o_{ir2}, o_{ir3}, \dots, o_{irK}$ .

The value of  $Z = 5114$  for turbo coding shall be used.

#### 4.5.3 Channel coding for HS-DSCH

Channel coding for the HS-DSCH transport channel shall be done with the general method described in 4.2.3 above with the following specific parameters.

There will be a maximum of one transport block,  $i=1$ . The rate 1/3 turbo coding shall be used.

## 4.5.4 Hybrid ARQ for HS-DSCH

The hybrid ARQ functionality matches the number of bits at the output of the channel coder to the total number of bits of the HS-PDSCH set to which the HS-DSCH is mapped. The hybrid ARQ functionality is controlled by the redundancy version (RV) parameters. The exact set of bits at the output of the hybrid ARQ functionality depends on the number of input bits, the number of output bits, and the RV parameters.

The hybrid ARQ functionality consists of two rate-matching stages and a virtual buffer as shown in the figure below.

The first rate matching stage matches the number of input bits to the virtual IR buffer, information about which is provided by higher layers. Note that, if the number of input bits does not exceed the virtual IR buffering capability, the first rate-matching stage is transparent.

The second rate matching stage matches the number of bits after first rate matching stage to the number of physical channel bits available in the HS-PDSCH set in the TTI.

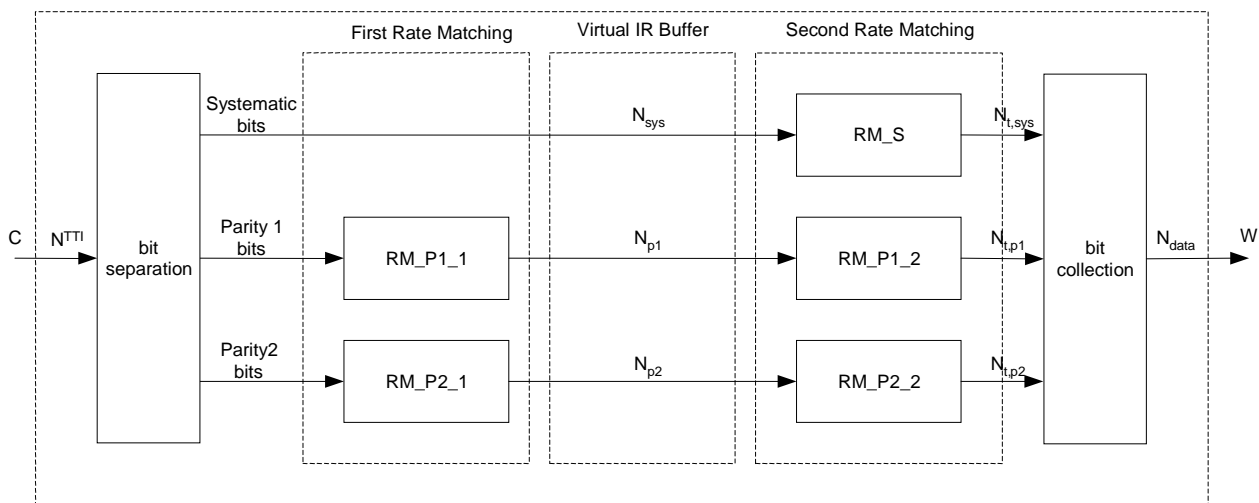

Figure 17: HS-DSCH hybrid ARQ functionality

### 4.5.4.1 HARQ bit separation

The HARQ bit separation function shall be performed in the same way as bit separation for turbo encoded TrCHs in 4.2.7.4 above.

### 4.5.4.2 HARQ First Rate Matching Stage

HARQ first stage rate matching for the HS-DSCH transport channel shall be done with the general method described in 4.2.7.2.2.3 above with the following specific parameters.

The maximum number of soft bits available in the virtual IR buffer is  $N_{IR}$  which is signalled from higher layers for each HARQ process. The number of coded bits in a TTI before rate matching is  $N^{TTI}$  this is deduced from information signalled from higher layers and parameters signalled on the HS-SCCH for each TTI. Note that HARQ processing and physical layer storage occurs independently for each HARQ process currently active.

If  $N_{IR}$  is greater than or equal to  $N^{TTI}$  (i.e. all coded bits of the corresponding TTI can be stored) the first rate matching stage shall be transparent. This can, for example, be achieved by setting  $e_{minus} = 0$ . Note that no repetition is performed.

If  $N_{IR}$  is smaller than  $N^{TTI}$  the parity bit streams are punctured as in 4.2.7.2.2.3 above by setting the rate matching parameter  $\Delta N_{il}^{TTI} = N_{IR} - N^{TTI}$  where the subscripts  $i$  and  $l$  refer to transport channel and transport format in the referenced sub-clause. Note the negative value is expected when the rate matching implements puncturing. Bits selected for puncturing which appear as  $\delta$  in the algorithm in 4.2.7 above shall be discarded and not counted in the totals for the streams through the virtual IR buffer.

#### 4.5.4.3 HARQ Second Rate Matching Stage

HARQ second stage rate matching for the HS-DSCH transport channel shall be done with the general method described in 4.2.7.5 above with the following specific parameters. Bits selected for puncturing which appear as  $\delta$  in the algorithm in 4.2.7.5 above shall be discarded and are not counted in the streams towards the bit collection.

The parameters of the second rate matching stage depend on the value of the RV parameters  $s$  and  $r$ . The parameter  $s$  can take the value 0 or 1 to distinguish between transmissions that prioritise systematic bits ( $s = 1$ ) and non systematic bits ( $s = 0$ ). The parameter  $r$  (range 0 to  $r_{max}-1$ ) changes the initial error variable  $e_{ini}$  in the case of puncturing. In case of repetition both parameters  $r$  and  $s$  change the initial error variable  $e_{ini}$ . The parameters  $X_i$ ,  $e_{plus}$  and  $e_{minus}$  are calculated as per table 10 below.

Denote the number of bits before second rate matching as  $N_{sys}$  for the systematic bits,  $N_{p1}$  for the parity 1 bits, and  $N_{p2}$  for the parity 2 bits, respectively. Denote the number of physical channels used for the HS-DSCH by  $P$ .  $N_{data}$  is the number of bits available to the HS-DSCH in one TTI and defined as  $N_{data} = P \times 3 \times N_{data1}$ , where  $N_{data1}$  is defined in [2]. The rate matching parameters are determined as follows.

For  $N_{data} \leq N_{sys} + N_{p1} + N_{p2}$ , puncturing is performed in the second rate matching stage. The number of transmitted systematic bits in a transmission is  $N_{t,sys} = \min\{N_{sys}, N_{data}\}$  for a transmission that prioritises systematic bits and  $N_{t,sys} = \max\{N_{data} - (N_{p1} + N_{p2}), 0\}$  for a transmission that prioritises non systematic bits.

For  $N_{data} > N_{sys} + N_{p1} + N_{p2}$  repetition is performed in the second rate matching stage. A similar repetition rate in

all bit streams is achieved by setting the number of transmitted systematic bits to  $N_{t,sys} = \left\lfloor N_{sys} \cdot \frac{N_{data}}{N_{sys} + 2N_{p1}} \right\rfloor$ .

The number of parity bits in a transmission is:  $N_{t,p1} = \left\lfloor \frac{N_{data} - N_{t,sys}}{2} \right\rfloor$  and  $N_{t,p2} = \left\lfloor \frac{N_{data} - N_{t,sys}}{2} \right\rfloor$  for the parity 1 and parity 2 bits, respectively.

Table 10 below summarizes the resulting parameter choice for the second rate matching stage.

**Table 10: Parameters for HARQ second rate matching**

	$X_i$	$e_{plus}$	$e_{minus}$
Systematic RM S	$N_{sys}$	$N_{sys}$	$ N_{sys} - N_{t,sys} $
Parity 1 RM P1_2	$N_{p1}$	$2 \cdot N_{p1}$	$2 \cdot  N_{p1} - N_{t,p1} $
Parity 2 RM P2_2	$N_{p2}$	$N_{p2}$	$ N_{p2} - N_{t,p2} $

The rate matching parameter  $e_{ini}$  is calculated for each bit stream according to the RV parameters  $r$  and  $s$  using

$e_{ini}(r) = \left\{ \left( X_i - \left\lfloor r \cdot e_{plus} / r_{max} \right\rfloor - 1 \right) \bmod e_{plus} \right\} + 1$  in the case of puncturing, i.e.,  $N_{data} \leq N_{sys} + N_{p1} + N_{p2}$ , and

$e_{ini}(r) = \left\{ \left( X_i - \left\lfloor (s + 2 \cdot r) \cdot e_{plus} / (2 \cdot r_{max}) \right\rfloor - 1 \right) \bmod e_{plus} \right\} + 1$  for repetition, i.e.,  $N_{data} > N_{sys} + N_{p1} + N_{p2}$ .

Where  $r \in \{0, 1, \dots, r_{max} - 1\}$  and  $r_{max}$  is the total number of redundancy versions allowed by varying  $r$  as defined in 4.6.2. Note that  $r_{max}$  varies depending on the modulation mode, i.e. for 16QAM  $r_{max} = 2$  and for QPSK  $r_{max} = 4$ .

Note: For the modulo operation the following clarification is used: the value of  $(x \bmod y)$  is strictly in the range of 0 to  $y-1$  (i.e.  $-1 \bmod 10 = 9$ ).

#### 4.5.4.4 HARQ bit collection

The HARQ bit collection is achieved using a rectangular interleaver of size  $N_{row} \times N_{col}$ .

The number of rows and columns are determined from:

$$N_{row} = 4 \text{ for 16QAM and } N_{row} = 2 \text{ for QPSK}$$

$$N_{col} = N_{data} / N_{row}$$

where  $N_{data}$  is used as defined in 4.5.4.3.

Data is written into the interleaver column by column, and read out of the interleaver column by column starting from the first column.

$N_{t,sys}$  is the number of transmitted systematic bits. Intermediate values  $N_r$  and  $N_c$  are calculated using:

$$N_r = \left\lfloor \frac{N_{t,sys}}{N_{col}} \right\rfloor \text{ and } N_c = N_{t,sys} - N_r \cdot N_{col}.$$

If  $N_c=0$  and  $N_r > 0$ , the systematic bits are written into rows  $1 \dots N_r$ .

Otherwise systematic bits are written into rows  $1 \dots N_r + 1$  in the first  $N_c$  columns and, if  $N_r > 0$ , also into rows  $1 \dots N_r$  in the remaining  $N_{col} - N_c$  columns.

The remaining space is filled with parity bits. The parity bits are written column wise into the remaining rows of the respective columns. Parity 1 and 2 bits are written in alternating order, starting with a parity 2 bit in the first available column with the lowest index number.

In the case of 16QAM for each column the bits are read out of the interleaver in the order row 1, row 2, row 3, row 4. In the case of QPSK for each column the bits are read out of the interleaver in the order row1, row2.

#### 4.5.5 Physical channel segmentation for HS-DSCH

When more than one HS-PDSCH is used, physical channel segmentation divides the bits among the different physical channels. The bits input to the physical channel segmentation are denoted by  $w_1, w_2, w_3, \dots, w_R$ , where  $R$  is the number of bits input to the physical channel segmentation block. The number of PhCHs is denoted by  $P$ .

The bits after physical channel segmentation are denoted  $u_{p1}, u_{p2}, u_{p3}, \dots, u_{pU}$ , where  $p$  is PhCH number and  $U$  is the

number of bits in one radio sub-frame for each HS-PDSCH, i.e.  $U = \frac{R}{P}$ . The relation between  $w_k$  and  $u_{p,k}$  is given below.

For all modes, some bits of the input flow are mapped to each code until the number of bits on the code is  $U$ .

Bits on first PhCH after physical channel segmentation:

$$u_{1,k} = w_k \quad k = 1, 2, \dots, U$$

Bits on second PhCH after physical channel segmentation:

$$u_{2,k} = w_{k+U} \quad k = 1, 2, \dots, U$$

...

Bits on the  $P^{th}$  PhCH after physical channel segmentation:

$$u_{P,k} = w_{k+(P-1) \times U} \quad k = 1, 2, \dots, U$$

### 4.5.6 Interleaving for HS-DSCH

The interleaving for FDD is done as shown in figure 18 below, separately for each physical channel. The bits input to the block interleaver are denoted by  $u_{p,1}, u_{p,2}, u_{p,3}, \dots, u_{p,U}$ , where  $p$  is PhCH number and  $U$  is the number of bits in one TTI for one PhCH. For QPSK  $U = 960$  and for 16QAM  $U = 1920$ . The basic interleaver is as the 2<sup>nd</sup> interleaver described in Section 4.2.11. The interleaver is of fixed size:  $R2=32$  rows and  $C2=30$  columns.

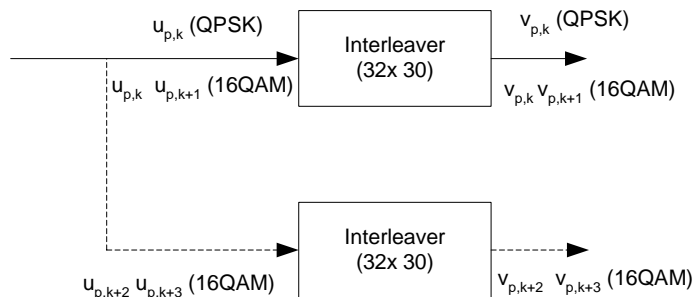

Figure 18: Interleaver structure for HS-DSCH

For 16QAM, there are two identical interleavers of the same fixed size  $R2 \times C2 = 32 \times 30$ . The output bits from the physical channel segmentation are divided two by two between the interleavers: bits  $u_{p,k}$  and  $u_{p,k+1}$  go to the first interleaver and bits  $u_{p,k+2}$  and  $u_{p,k+3}$  go to the second interleaver. Bits are collected two by two from the interleavers: bits  $v_{p,k}$  and  $v_{p,k+1}$  are obtained from the first interleaver and bits  $v_{p,k+2}$  and  $v_{p,k+3}$  are obtained from the second interleaver, where  $k \bmod 4 = 1$ .

### 4.5.7 Constellation re-arrangement for 16 QAM

This function only applies to 16 QAM modulated bits. In case of QPSK it is transparent.

The following table describes the operations that produce the different rearrangements.

The bits of the input sequence are mapped in groups of 4 so that  $v_{p,k}, v_{p,k+1}, v_{p,k+2}, v_{p,k+3}$  are used, where  $k \bmod 4 = 1$ .

Table 11: Constellation re-arrangement for 16 QAM

constellation version parameter $b$	Output bit sequence	Operation
0	$v_{p,k} v_{p,k+1} v_{p,k+2} v_{p,k+3}$	None
1	$v_{p,k+2} v_{p,k+3} v_{p,k} v_{p,k+1}$	Swapping MSBs with LSBs
2	$v_{p,k} v_{p,k+1} v_{p,k+2} v_{p,k+3}$	Inversion of the logical values of LSBs
3	$v_{p,k+2} v_{p,k+3} v_{p,k} v_{p,k+1}$	Swapping MSBs with LSBs and inversion of logical values of LSBs

The output bit sequences from the table above map to the output bits in groups of 4, i.e.  $r_{p,k}, r_{p,k+1}, r_{p,k+2}, r_{p,k+3}$ , where  $k \bmod 4 = 1$ .

### 4.5.8 Physical channel mapping for HS-DSCH

The HS-PDSCH is defined in [2]. The bits input to the physical channel mapping are denoted by  $r_{p,1}, r_{p,2}, \dots, r_{p,U}$ , where  $p$  is the physical channel number and  $U$  is the number of bits in one radio sub-frame for one HS-PDSCH. The bits  $r_{p,k}$  are mapped to the PhCHs so that the bits for each PhCH are transmitted over the air in ascending order with respect to  $k$ .

## 4.6 Coding for HS-SCCH

The following information is transmitted by means of the HS-SCCH physical channel.

- Channelization-code-set information (7 bits):  $x_{ccs,1}, x_{ccs,2}, \dots, x_{ccs,7}$
- Modulation scheme information (1 bit):  $x_{ms,1}$
- Transport-block size information (6 bits):  $x_{tbs,1}, x_{tbs,2}, \dots, x_{tbs,6}$
- Hybrid-ARQ process information (3 bits):  $x_{hap,1}, x_{hap,2}, x_{hap,3}$
- Redundancy and constellation version (3 bits):  $x_{rv,1}, x_{rv,2}, x_{rv,3}$
- New data indicator (1 bit):  $x_{nd,1}$
- UE identity (16 bits):  $x_{ue,1}, x_{ue,2}, \dots, x_{ue,16}$

### 4.6.1 Overview

Figure 19 below illustrates the overall coding chain for HS-SCCH.



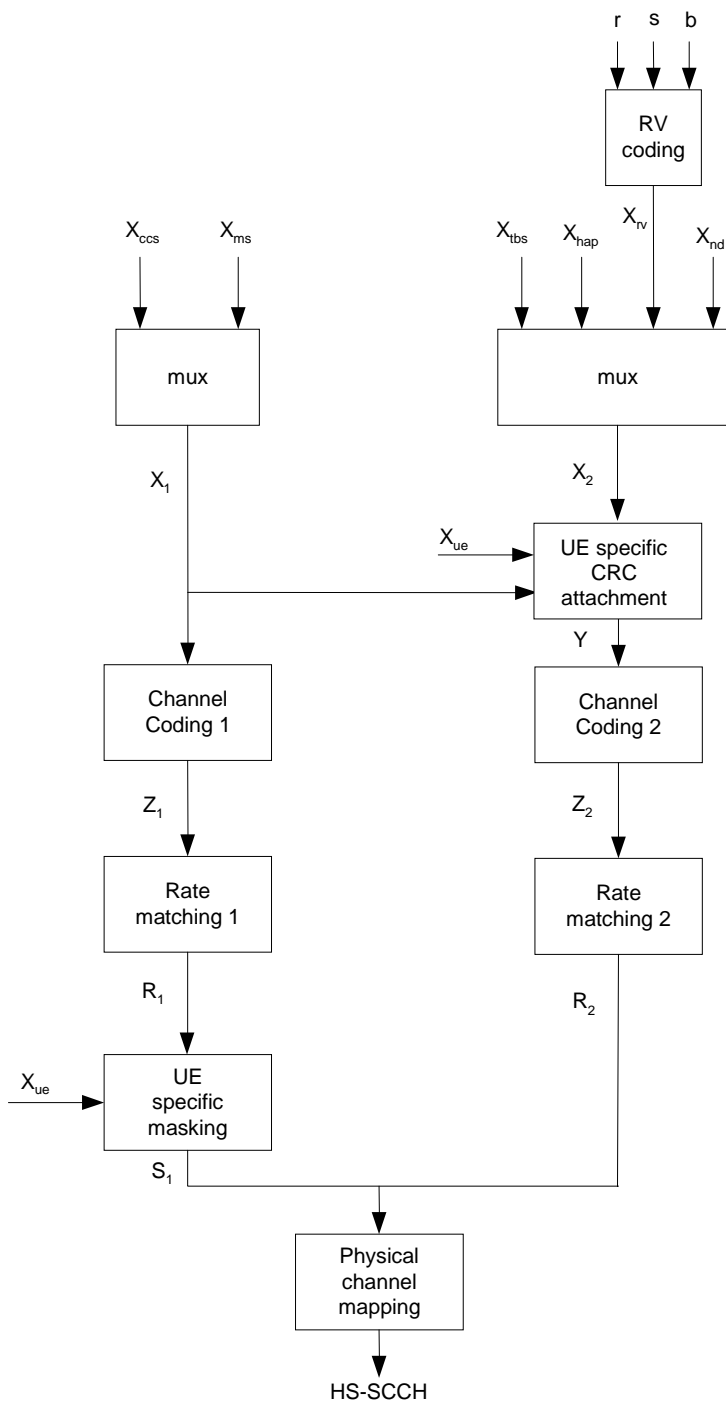

Figure 19: Coding chain for HS-SCCH

## 4.6.2 HS-SCCH information field mapping

### 4.6.2.1 Redundancy and constellation version coding

The redundancy version (RV) parameters  $r$ ,  $s$  and constellation version parameter  $b$  are coded jointly to produce the value  $X_{rv}$ .  $X_{rv}$  is alternatively represented as the sequence  $x_{rv,1}$ ,  $x_{rv,2}$ ,  $x_{rv,3}$  where  $x_{rv,1}$  is the MSB. This is done according to the following tables according to the modulation mode used:

Table 12: RV coding for 16 QAM

$X_{rv}$ (value)	<b>s</b>	<b>r</b>	<b>b</b>
0	1	0	0
1	0	0	0
2	1	1	1
3	0	1	1
4	1	0	1
5	1	0	2
6	1	0	3
7	1	1	0

Table 13: RV coding for QPSK

$X_{rv}$ (value)	<b>s</b>	<b>r</b>
0	1	0
1	0	0
2	1	1
3	0	1
4	1	2
5	0	2
6	1	3
7	0	3

#### 4.6.2.2 Modulation scheme mapping

The value of  $x_{ms,i}$  is derived from the modulation and given by the following:

$$x_{ms,1} = \begin{cases} 0 & \text{if } QPSK \\ 1 & \text{if } 16QAM \end{cases}$$

#### 4.6.2.3 Channelization code-set mapping

The channelization code-set bits  $x_{ccs,1}, x_{ccs,2}, \dots, x_{ccs,7}$  are coded according to the following:

Given P (multi-)codes starting at code O calculate the information-field using the unsigned binary representation of integers calculated by the expressions,

for the first three bits (code group indicator):

$$x_{ccs,1}, x_{ccs,2}, x_{ccs,3} = \min(P-1, 15-P)$$

for the last four bits (code offset indicator):

$$x_{ccs,4}, x_{ccs,5}, x_{ccs,6}, x_{ccs,7} = |O-1-\lfloor P/8 \rfloor * 15|$$

The definitions of P and O are given in [3].

#### 4.6.2.4 UE identity mapping

The UE identity is the HS-DSCH Radio Network Identifier (H-RNTI) defined in [13]. This is mapped such that  $x_{ue,1}$  corresponds to the MSB and  $x_{ue,16}$  to the LSB, cf. [14].

### 4.6.3 Multiplexing of HS-SCCH information

The channelization-code-set information  $x_{ccs,1}, x_{ccs,2}, \dots, x_{ccs,7}$  and modulation-scheme information  $x_{ms,i}$  are multiplexed together. This gives a sequence of bits  $x_{I,1}, x_{I,2}, \dots, x_{I,8}$  where

$$x_{I,i} = x_{ccs,i} \quad i=1,2,\dots,7$$

$$x_{1,i} = x_{ms,i-7} \quad i=8$$

The transport-block-size information  $x_{tbs,1}, x_{tbs,2}, \dots, x_{tbs,6}$ , Hybrid-ARQ-process information  $x_{hap,1}, x_{hap,2}, x_{hap,3}$ , redundancy-version information  $x_{rv,1}, x_{rv,2}, x_{rv,3}$  and new-data indicator  $x_{nd,1}$  are multiplexed together. This gives a sequence of bits  $x_{2,1}, x_{2,2}, \dots, x_{2,13}$  where

$$x_{2,i} = x_{tbs,i} \quad i=1,2,\dots,6$$

$$x_{2,i} = x_{hap,i-6} \quad i=7,8,9$$

$$x_{2,i} = x_{rv,i-9} \quad i=10,11,12$$

$$x_{2,i} = x_{nd,i-12} \quad i=13$$

#### 4.6.4 CRC attachment for HS-SCCH

From the sequence of bits  $x_{1,1}, x_{1,2}, \dots, x_{1,8}, x_{2,1}, x_{2,2}, \dots, x_{2,13}$  a 16 bits CRC is calculated according to Section 4.2.1.1. This gives a sequence of bits  $c_1, c_2, \dots, c_{16}$ . This sequence of bits is then masked with the UE Identity  $x_{ue,1}, x_{ue,2}, \dots, x_{ue,16}$  and then appended to the sequence of bits  $x_{2,1}, x_{2,2}, \dots, x_{2,13}$  to form the sequence of bits  $y_1, y_2, \dots, y_{29}$ , where

$$y_i = x_{2,i} \quad i=1,2,\dots,13$$

$$y_i = (c_{i-13} + x_{ue,i-13}) \bmod 2 \quad i=14,15,\dots,29$$

#### 4.6.5 Channel coding for HS-SCCH

Rate 1/3 convolutional coding, as described in Section 4.2.3.1, is applied to the sequence of bits  $x_{1,1}, x_{1,2}, \dots, x_{1,8}$ . This gives a sequence of bits  $z_{1,1}, z_{1,2}, \dots, z_{1,48}$ .

Rate 1/3 convolutional coding, as described in Section 4.2.3.1, is applied to the sequence of bits  $y_1, y_2, \dots, y_{29}$ . This gives a sequence of bits  $z_{2,1}, z_{2,2}, \dots, z_{2,111}$ .

Note that the coded sequence lengths result from the termination of K=9 convolutional coding being fully applied.

#### 4.6.6 Rate matching for HS-SCCH

From the input sequence  $z_{1,1}, z_{1,2}, \dots, z_{1,48}$  the bits  $z_{1,1}, z_{1,2}, z_{1,4}, z_{1,8}, z_{1,42}, z_{1,45}, z_{1,47}, z_{1,48}$  are punctured to obtain the output sequence  $r_{1,1}, r_{1,2}, \dots, r_{1,40}$ .

From the input sequence  $z_{2,1}, z_{2,2}, \dots, z_{2,111}$  the bits  $z_{2,1}, z_{2,2}, z_{2,3}, z_{2,4}, z_{2,5}, z_{2,6}, z_{2,7}, z_{2,8}, z_{2,12}, z_{2,14}, z_{2,15}, z_{2,24}, z_{2,42}, z_{2,48}, z_{2,54}, z_{2,57}, z_{2,60}, z_{2,66}, z_{2,69}, z_{2,96}, z_{2,99}, z_{2,101}, z_{2,102}, z_{2,104}, z_{2,105}, z_{2,106}, z_{2,107}, z_{2,108}, z_{2,109}, z_{2,110}, z_{2,111}$  are punctured to obtain the output sequence  $r_{2,1}, r_{2,2}, \dots, r_{2,80}$ .

#### 4.6.7 UE specific masking for HS-SCCH

The rate matched bits  $r_{1,1}, r_{1,2}, \dots, r_{1,40}$  shall be masked in an UE specific way using the UE identity  $x_{ue,1}, x_{ue,2}, \dots, x_{ue,16}$ , to produce the bits  $s_{1,1}, s_{1,2}, \dots, s_{1,40}$ .

Intermediate code word bits  $b_i, i=1,2,\dots,48$ , are defined by encoding the UE identity bits using the rate 1/2 convolutional coding described in Section 4.2.3.1. Eight bits out of the resulting 48 convolutionally encoded bits are punctured using the rate matching rule of Section 4.6.6 for the HS-SCCH part 1 sequence, that is, the intermediate code word bits  $b_1, b_2, b_4, b_8, b_{42}, b_{45}, b_{47}, b_{48}$ , are punctured to obtain the 40 bit UE specific scrambling sequence  $c_1, c_2, \dots, c_{40}$ .

The mask output bits  $s_{1,1}, s_{1,2}, \dots, s_{1,40}$  are calculated as follows:

$$s_{1,k} = (r_{1,k} + c_k) \bmod 2 \quad \text{for } k = 1,2,\dots,40$$

### 4.6.8 Physical channel mapping for HS-SCCH

The HS-SCCH sub-frame is described in[2].

The sequence of bits  $s_{1,1}, s_{1,2}, \dots, s_{1,40}$  is mapped to the first slot of the HS-SCCH sub frame. The bits  $s_{1,k}$  are mapped to the PhCHs so that the bits for each PhCH are transmitted over the air in ascending order with respect to  $k$ .

The sequence of bits  $r_{2,1}, r_{2,2}, \dots, r_{2,80}$  is mapped to the second and third slot of the HS-SCCH sub frame. The bits  $r_{2,k}$  are mapped to the PhCHs so that the bits for each PhCH are transmitted over the air in ascending order with respect to  $k$ .

## 4.7 Coding for HS-DPCCH

Data arrives to the coding unit in form of indicators for measurement indication and HARQ acknowledgement.

The following coding/multiplexing steps can be identified:

- channel coding (see subclause 4.7.1);
- mapping to physical channels (see subclause 4.7.2).

The general coding flow is shown in the figure below. This is done in parallel for the HARQ-ACK and CQI as the flows are not directly multiplexed but are transmitted at different times.

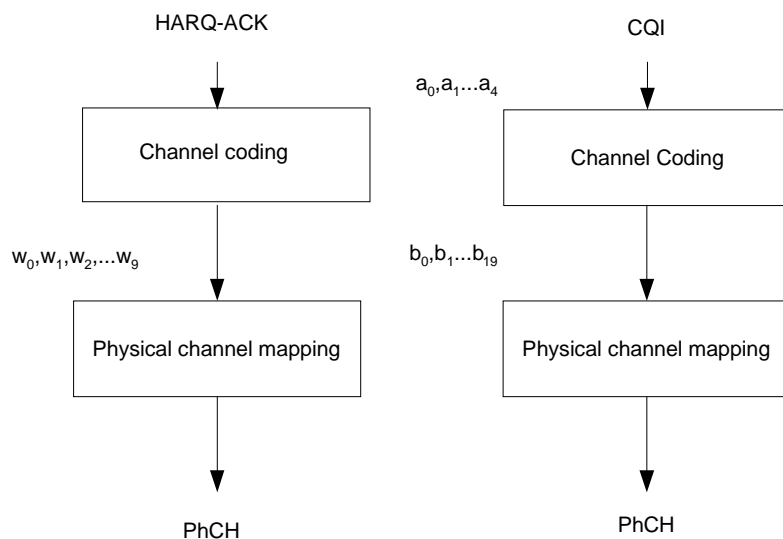

Figure 20: Coding for HS-DPCCH

### 4.7.1 Channel coding for HS-DPCCH

Two forms of channel coding are used, one for the channel quality information (CQI) and another for HARQ-ACK (acknowledgement).

#### 4.7.1.1 Channel coding for HS-DPCCH HARQ-ACK

The HARQ acknowledgement message to be transmitted, as defined in [4], shall be coded to 10 bits as shown in Table 13A. The output is denoted  $w_0, w_1, \dots, w_9$ .

Table 13A: Channel coding of HARQ-ACK

HARQ-ACK message to be transmitted	$w_0$	$w_1$	$w_2$	$w_3$	$w_4$	$w_5$	$w_6$	$w_7$	$w_8$	$w_9$
------------------------------------	-------	-------	-------	-------	-------	-------	-------	-------	-------	-------

ACK	1	1	1	1	1	1	1	1	1	1
NACK	0	0	0	0	0	0	0	0	0	0

#### 4.7.1.2 Channel coding for HS-DPCCH channel quality information

The channel quality information is coded using a (20,5) code. The code words of the (20,5) code are a linear combination of the 5 basis sequences denoted  $M_{i,n}$  defined in the table below.

**Table 14: Basis sequences for (20,5) code**

$i$	$M_{i,0}$	$M_{i,1}$	$M_{i,2}$	$M_{i,3}$	$M_{i,4}$
0	1	0	0	0	1
1	0	1	0	0	1
2	1	1	0	0	1
3	0	0	1	0	1
4	1	0	1	0	1
5	0	1	1	0	1
6	1	1	1	0	1
7	0	0	0	1	1
8	1	0	0	1	1
9	0	1	0	1	1
10	1	1	0	1	1
11	0	0	1	1	1
12	1	0	1	1	1
13	0	1	1	1	1
14	1	1	1	1	1
15	0	0	0	0	1
16	0	0	0	0	1
17	0	0	0	0	1
18	0	0	0	0	1
19	0	0	0	0	1

The CQI values 0 .. 30 as defined in [4] are converted from decimal to binary to map them to the channel quality information bits (1 0 0 0 0) to (1 1 1 1 1) respectively. The information bit pattern (0 0 0 0 0) shall not be used in this release. The channel quality information bits are  $a_0, a_1, a_2, a_3, a_4$  (where  $a_0$  is LSB and  $a_4$  is MSB). The output code word bits  $b_i$  are given by:

$$b_i = \sum_{n=0}^4 (a_n \times M_{i,n}) \bmod 2$$

where  $i = 0, \dots, 19$ .

#### 4.7.2 Physical channel mapping for HS-DPCCH

The HS-DPCCH physical channel mapping function shall map the input bits  $w_k$  directly to physical channel so that bits are transmitted over the air in ascending order with respect to  $k$ .

The HS-DPCCH physical channel mapping function shall map the input bits  $b_k$  directly to physical channel so that bits are transmitted over the air in ascending order with respect to  $k$ .

## Annex A (informative): Blind transport format detection

### A.1 Blind transport format detection using fixed positions

#### A.1.1 Blind transport format detection using received power ratio

For the dual transport format case (the possible data rates are 0 and full rate, and CRC is only transmitted for full rate), blind transport format detection using received power ratio can be used.

The transport format detection is then done using average received power ratio of DPDCH to DPCCH. Define the following:

- $P_c$ : Received power per bit of DPCCH calculated from all pilot and TPC bits per slot over a radio frame;
- $P_d$ : Received power per bit of DPDCH calculated from  $X$  bits per slot over a radio frame;
- $X$ : the number of DPDCH bits per slot when transport format corresponds to full rate;
- $T$ : Threshold of average received power ratio of DPDCH to DPCCH for transport format detection.

The decision rule can then be formulated as:

If  $P_d/P_c > T$  then:

- full rate transport format detected;

else

- zero rate transport format detected.

#### A.1.2 Blind transport format detection using CRC

For the multiple transport format case (the possible data rates are 0, ..., (full rate)/ $r$ , ..., full rate, and CRC is transmitted for all transport formats), blind transport format detection using CRC can be used.

At the transmitter, the data stream with variable number of bits from higher layers is block-encoded using a cyclic redundancy check (CRC) and then convolutionally encoded. CRC parity bits are attached just after the data stream with variable number of bits as shown in figure A.1.

The receiver knows only the possible transport formats (or the possible end bit position  $\{n_{\text{end}}\}$ ) by Layer-3 negotiation. The receiver performs Viterbi-decoding on the soft decision sample sequence. The correct trellis path of the Viterbi-decoder ends at the zero state at the correct end bit position.

The blind transport format detection method using CRC traces back the surviving trellis path ending at the zero state (hypothetical trellis path) at each possible end bit position to recover the data sequence. For each recovered data sequence error-detection is performed by checking the CRC, and if there is no error, the recovered sequence is declared to be correct.

The following variable is defined:

$$s(n_{\text{end}}) = -10 \log \left( (a_0(n_{\text{end}}) - a_{\text{min}}(n_{\text{end}})) / (a_{\text{max}}(n_{\text{end}}) - a_{\text{min}}(n_{\text{end}})) \right) \text{ [dB]} \quad (\text{Eq. 1})$$

where  $a_{\text{max}}(n_{\text{end}})$  and  $a_{\text{min}}(n_{\text{end}})$  are the maximum and minimum path-metric values among all survivors at end bit position  $n_{\text{end}}$ , and  $a_0(n_{\text{end}})$  is the path-metric value at zero state.

In order to reduce the probability of false detection (this happens if the selected path is wrong but the CRC misses the error detection), a path selection threshold  $D$  is introduced. The threshold  $D$  determines whether the hypothetical trellis path connected to the zero state should be traced back or not at each end bit position  $n_{\text{end}}$ . If the hypothetical trellis path connected to the zero state that satisfies:

$$s(n_{\text{end}}) \leq D \quad (\text{Eq. 2})$$

is found, the path is traced back to recover the frame data, where  $D$  is the path selection threshold and a design parameter.

If more than one end bit positions satisfying Eq. 2 is found, the end bit position which has minimum value of  $s(n_{\text{end}})$  is declared to be correct. If no path satisfying Eq. 2 is found even after all possible end bit positions have been exhausted, the received frame data is declared to be in error.

Figure A-2 shows the procedure of blind transport format detection using CRC.

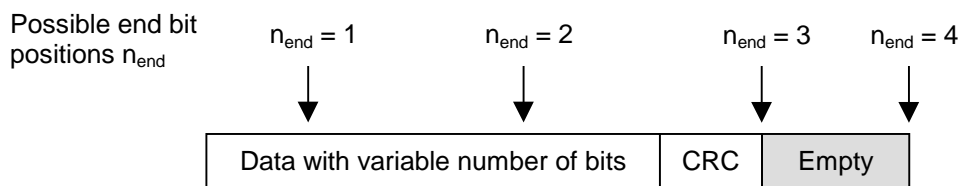

**Figure A.1: An example of data with variable number of bits.  
Four possible transport formats, and transmitted end bit position  $n_{\text{end}} = 3$**

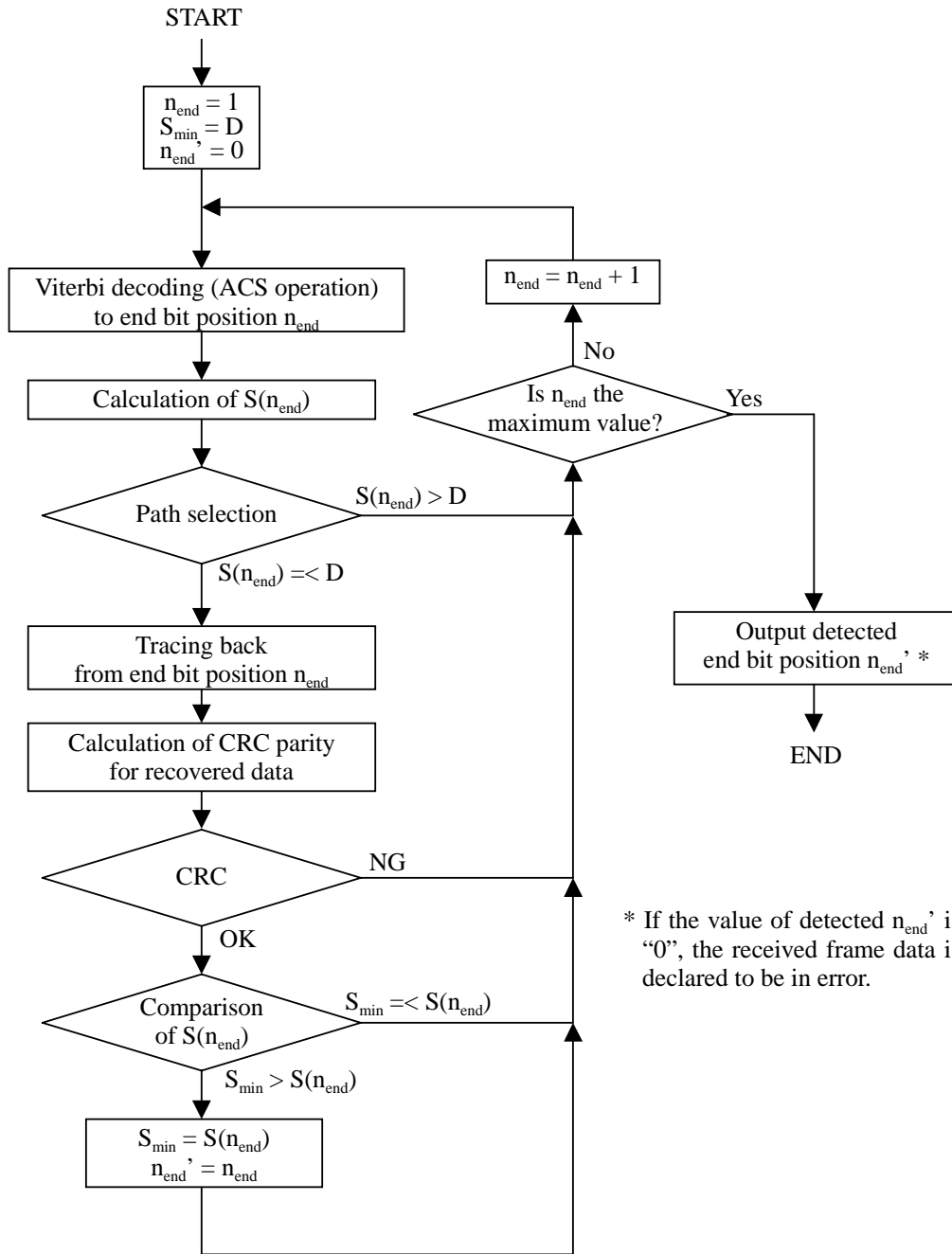

\* If the value of detected  $n_{end}'$  is "0", the received frame data is declared to be in error.

Figure A.2: Basic processing flow of blind transport format detection



## Annex B (informative): Compressed mode idle lengths

The tables B.1-B.3 show the resulting idle lengths for different transmission gap lengths, UL/DL modes and DL frame types. The idle lengths given are calculated purely from the slot and frame structures and the UL/DL offset. They do not contain margins for e.g. synthesizer switching.

### B.1 Idle lengths for DL, UL and DL+UL compressed mode

**Table B.1: Parameters for DL compressed mode**

TGL	DL Frame Type	Spreading Factor	Idle length [ms]	Transmission time Reduction method	Idle frame Combining
3	A	512 – 4	1.73 – 1.99	Puncturing, Spreading factor division by 2 or Higher layer scheduling	(S) (D) =(1,2) or (2,1)
	B		1.60 – 1.86		(S) (D) =(1,3), (2,2) or (3,1)
4	A		2.40 – 2.66		(S) (D) = (1,4), (2,3), (3, 2) or (4,1)
	B		2.27 – 2.53		(S) (D)=(1,6), (2,5), (3,4), (4,3), (5,2) or (6,1)
5	A		3.07 – 3.33		(D)=(3,7), (4,6), (5,5), (6,4) or (7,3)
	B		2.93 – 3.19		(D) =(7,7)
7	A		4.40 – 4.66		
	B		4.27 – 4.53		
10	A		6.40 – 6.66		
	B		6.27 – 6.53		
14	A		9.07 – 9.33		
	B		8.93 – 9.19		

**Table B.2: Parameters for UL compressed mode**

TGL	Spreading Factor	Idle length [ms]	Transmission time Reduction method	Idle frame Combining
3	256 – 4	2.00	Spreading factor division by 2 or Higher layer scheduling	(S) (D) =(1,2) or (2,1)
4		2.67		(S) (D) =(1,3), (2,2) or (3,1)
5		3.33		(S) (D) = (1,4), (2,3), (3, 2) or (4,1)
7		4.67		(S) (D)=(1,6), (2,5), (3,4), (4,3), (5,2) or (6,1)
10		6.67		(D)=(3,7), (4,6), (5,5), (6,4) or (7,3)
14		9.33		(D) =(7,7)

Table B.3: Parameters for combined UL/DL compressed mode

TGL	DL Frame Type	Spreading Factor	Idle length [ms]	Transmission time Reduction method	Idle frame Combining
3	A or B	DL: 512 – 4	1.47 – 1.73	DL: Puncturing, Spreading factor division by 2 or Higher layer scheduling  UL: Spreading factor division by 2 or Higher layer scheduling	(S) (D) =(1,2) or (2,1)
4			2.13 – 2.39		(S) (D) =(1,3), (2,2) or (3,1)
5		UL: 256 – 4	2.80 – 3.06		(S) (D) = (1,4), (2,3), (3, 2) or (4,1)
7			4.13 – 4.39		(S) (D)=(1,6), (2,5), (3,4), (4,3), (5,2) or (6,1)
10			6.13 – 6.39		(D)=(3,7), (4,6), (5,5), (6,4) or (7,3)
14			8.80 – 9.06		(D) =(7,7)

(S): Single-frame method as shown in figure 14 (1).

(D): Double-frame method as shown in figure 14 (2). (x,y) indicates x: the number of idle slots in the first frame, y: the number of idle slots in the second frame.

NOTE: Compressed mode by spreading factor reduction is not supported when SF=4 is used in normal mode

## Annex C (informative): Change history

Change history							
Date	TSG #	TSG Doc.	CR	Rev	Subject/Comment	Old	New
	RAN_05	RP-99588	-		Approved at TSG RAN #5 and placed under Change Control	-	3.0.0
14/01/00	RAN_06	RP-99680	001	3	Correction of rate matching parameters for repetition after 1st interleaving in 25.212	3.0.0	3.1.0
14/01/00	RAN_06	RP-99680	004	-	Changing the initial offset value for convolutional code rate matching	3.0.0	3.1.0
14/01/00	RAN_06	RP-99681	005	1	Introduction of compressed mode by higher layer scheduling	3.0.0	3.1.0
14/01/00	RAN_06	RP-99679	008	-	Editorial corrections to TS 25.212	3.0.0	3.1.0
14/01/00	RAN_06	RP-99680	009	-	Removal of SFN multiplexing	3.0.0	3.1.0
14/01/00	RAN_06	RP-99680	010	1	Clarification of bit separation and collection	3.0.0	3.1.0
14/01/00	RAN_06	RP-99680	011	2	Connection between TTI and CFN	3.0.0	3.1.0
14/01/00	RAN_06	RP-99680	012	2	Zero length transport blocks	3.0.0	3.1.0
14/01/00	RAN_06	RP-99679	014	-	Update of channel coding sections	3.0.0	3.1.0
14/01/00	RAN_06	RP-99680	016	-	Removal of TrCH restriction in DSCH CCH	3.0.0	3.1.0
14/01/00	RAN_06	RP-99681	017	-	20 ms RACH message length	3.0.0	3.1.0
14/01/00	RAN_06	RP-99680	018	-	Minimum SF in UL	3.0.0	3.1.0
14/01/00	RAN_06	RP-99680	024	-	Rate matching parameter determination in DL and fixed positions	3.0.0	3.1.0
14/01/00	RAN_06	RP-99680	026	1	Corrections to TS 25.212	3.0.0	3.1.0
14/01/00	RAN_06	RP-99679	027	-	Modification of BTFD description in 25.212 Annex	3.0.0	3.1.0
14/01/00	RAN_06	RP-99681	028	-	TFCI coding and mapping including compressed mode	3.0.0	3.1.0
14/01/00	-	-	-	-	Change history was added by the editor	3.1.0	3.1.1
31/03/00	RAN_07	RP-000061	025	2	CR for parity bit attachment to 0 bit transport block	3.1.1	3.2.0
31/03/00	RAN_07	RP-000061	029	1	Limitations of blind transport format detection	3.1.1	3.2.0
31/03/00	RAN_07	RP-000061	034	1	Clarification of fixed position rate matching	3.1.1	3.2.0
31/03/00	RAN_07	RP-000061	035	1	Clarification of DL compressed mode	3.1.1	3.2.0
31/03/00	RAN_07	RP-000061	036	-	Reconfiguration of TFCS	3.1.1	3.2.0
31/03/00	RAN_07	RP-000061	037	1	Removal of fixed gap position in 25.212	3.1.1	3.2.0
31/03/00	RAN_07	RP-000061	038	2	Definition clarification for TS 25.212	3.1.1	3.2.0
31/03/00	RAN_07	RP-000061	039	1	Clarification on TFCI coding input	3.1.1	3.2.0
31/03/00	RAN_07	RP-000061	041	2	Correction of UL compressed mode by higher layer scheduling	3.1.1	3.2.0
31/03/00	RAN_07	RP-000061	042	5	Downlink Compressed Mode by puncturing	3.1.1	3.2.0
31/03/00	RAN_07	RP-000061	044	-	Modification of Turbo code internal interleaver	3.1.1	3.2.0
31/03/00	RAN_07	RP-000061	045	-	Editorial corrections	3.1.1	3.2.0
31/03/00	RAN_07	RP-000061	046	-	SF/2 method: DTX insertion after 2nd interleaver	3.1.1	3.2.0
31/03/00	RAN_07	RP-000061	047	1	TFCI coding for FDD	3.1.1	3.2.0
31/03/00	RAN_07	RP-000061	048	-	Mapping of TFCI in downlink compressed mode	3.1.1	3.2.0
31/03/00	RAN_07	RP-000061	049	-	Editorial changes to Annex A	3.1.1	3.2.0
31/03/00	RAN_07	RP-000061	050	-	Removal of rate matching attribute setting for RACH	3.1.1	3.2.0
31/03/00	RAN_07	RP-000061	052	-	Padding Function for Turbo coding of small blocks	3.1.1	3.2.0
31/03/00	RAN_07	RP-000061	055	2	Clarifications relating to DSCH	3.1.1	3.2.0
31/03/00	RAN_07	RP-000061	056	-	Editorial modification of uplink shifting parameter calculation for turbo code puncturing	3.1.1	3.2.0
31/03/00	RAN_07	RP-000062	059	1	Revision: Editorial correction to the calculation of Rate Matching parameters	3.1.1	3.2.0
31/03/00	RAN_07	RP-000062	060	1	Editorial changes of channel coding section	3.1.1	3.2.0
31/03/00	RAN_07	RP-000062	061	-	Removal of DL compressed mode by higher layer scheduling with fixed positions	3.1.1	3.2.0
26/06/00	RAN_08	RP-000266	066	1	Section 4.4.5 and table 9 is moved to informative annex	3.2.0	3.3.0
26/06/00	RAN_08	RP-000266	068	-	Editorial modifications of 25.212	3.2.0	3.3.0
26/06/00	RAN_08	RP-000266	069	-	Removal of BTFD for flexible positions in Release 99	3.2.0	3.3.0
26/06/00	RAN_08	RP-000266	070	1	Editorial modifications	3.2.0	3.3.0
26/06/00	RAN_08	RP-000266	071	1	Corrections and editorial modifications of 25.212 for 2nd insertion of DTX bits for CM	3.2.0	3.3.0
26/06/00	RAN_08	RP-000266	072	4	Corrections to 25.212 (Rate Matching, p-bit insertion, PhCH segmentation)	3.2.0	3.3.0
26/06/00	RAN_08	RP-000266	073	-	Editorial correction in 25.212 coding/multiplexing	3.2.0	3.3.0
26/06/00	RAN_08	RP-000266	074	2	Bit separation of the Turbo encoded data	3.2.0	3.3.0
26/06/00	RAN_08	RP-000266	076	1	Revision of code block segmentation description	3.2.0	3.3.0
26/06/00	RAN_08	RP-000266	077	-	Clarifications for TFCI coding	3.2.0	3.3.0
26/06/00	RAN_08	RP-000266	078	2	Clarifying the rate matching parameter setting for the RACH and BCH	3.2.0	3.3.0
26/06/00	RAN_08	RP-000266	080	-	Clarification on BTFD utilisation (single CCH)	3.2.0	3.3.0

Change history							
Date	TSG #	TSG Doc.	CR	Rev	Subject/Comment	Old	New
26/06/00	RAN_08	RP-000266	081	-	Correction of order of checking TFC during flexible position RM parameter determination	3.2.0	3.3.0
26/06/00	RAN_08	RP-000266	082	-	Editorial corrections in channel coding section	3.2.0	3.3.0
26/06/00	RAN_08	RP-000266	083	-	Correction for bit separation and bit collection	3.2.0	3.3.0
26/06/00	RAN_08	RP-000266	084	1	Correction on the spreading factor selection for the RACH	3.2.0	3.3.0
23/09/00	RAN_09	RP-000341	079	-	Clarification of compressed mode terminology	3.3.0	3.4.0
23/09/00	RAN_09	RP-000341	085	1	Editorial corrections in Turbo code internal interleaver section	3.3.0	3.4.0
23/09/00	RAN_09	RP-000341	086	1	Clarification on DL slot format for compressed mode by SF/2	3.3.0	3.4.0
23/09/00	RAN_09	RP-000341	087	-	Corrections	3.3.0	3.4.0
23/09/00	RAN_09	RP-000341	088	1	Clarifications to TS 25.212	3.3.0	3.4.0
23/09/00	RAN_09	RP-000341	089	-	Correction regarding DSCH	3.3.0	3.4.0
23/09/00	RAN_09	RP-000341	090	-	Correction regarding CPCH	3.3.0	3.4.0
23/09/00	RAN_09	RP-000341	092	1	Bit separation and collection for rate matching	3.3.0	3.4.0
23/09/00	RAN_09	RP-000341	093	-	Puncturing Limit definition in WG1 specification	3.3.0	3.4.0
15/12/00	RAN_10	RP-000538	094	2	Correction of BTFD limitations	3.4.0	3.5.0
15/12/00	RAN_10	RP-000538	096	-	Compressed mode by puncturing	3.4.0	3.5.0
15/12/00	RAN_10	RP-000538	097	-	Clarification on the Ci formula	3.4.0	3.5.0
15/12/00	RAN_10	RP-000538	099	-	Editorial modification in RM section	3.4.0	3.5.0
15/12/00	RAN_10	RP-000538	100	1	Editorial corrections in TS 25.212	3.4.0	3.5.0
15/12/00	RAN_10	RP-000538	101	-	Correction to code block segmentation	3.4.0	3.5.0
16/03/01	RAN_11	-	-	-	Approved as Release 4 specification (v4.0.0) at TSG RAN #11	3.5.0	4.0.0
15/06/01	RAN_12	RP-010332	106	-	Correction of compressed mode by puncturing	4.0.0	4.1.0
15/06/01	RAN_12	RP-010332	108	1	Dual transport format detection	4.0.0	4.1.0
15/06/01	RAN_12	RP-010332	112	1	Correction for downlink rate matching for the DSCH	4.0.0	4.1.0
21/09/01	RAN_13	RP-010519	115	-	Correction of PDSCH spreading factor signalling	4.1.0	4.2.0
14/12/01	RAN_14	RP-010737	118	-	Clarification of compressed mode	4.2.0	4.3.0
14/12/01	RAN_14	RP-010737	122	-	Support of multiple CCTrChs of dedicated type	4.2.0	4.3.0
08/03/02	RAN_15	RP-020231	128	2	Removal of channel coding option "no coding" for FDD	4.3.0	4.4.0
08/03/02	RAN_15	RP-020054	123	4	Inclusion of flexible hard split mode TFCl operation	4.3.0	5.0.0
08/03/02	RAN_15	RP-020058	126	1	Changes to 25.212 for HSDPA work item	4.3.0	5.0.0
07/06/02	RAN_16	RP-020308	136	-	Downlink bit mapping	5.0.0	5.1.0
07/06/02	RAN_16	RP-020316	130	5	Correction of Errata noted by RAN1 delegates	5.0.0	5.1.0
07/06/02	RAN_16	RP-020316	131	2	Removal of inconsistencies and ambiguities in the HARQ description	5.0.0	5.1.0
07/06/02	RAN_16	RP-020316	132	-	Rate Matching and Channel Coding for HS-SCCH	5.0.0	5.1.0
07/06/02	RAN_16	RP-020316	137	-	Basis sequences for HS-DPCCH Channel Quality information code	5.0.0	5.1.0
07/06/02	RAN_16	RP-020316	145	5	UE specific masking for HS-SCCH part1	5.0.0	5.1.0
14/09/02	RAN_17	RP-020582	141	1	Bit scrambling for HS-DSCH	5.1.0	5.2.0
15/09/02	RAN_17	RP-020582	148	-	Physical channel mapping for HS-DPCCH	5.1.0	5.2.0
15/09/02	RAN_17	RP-020582	149	-	HARQ bit collection	5.1.0	5.2.0
15/09/02	RAN_17	RP-020582	150	1	Coding for HS-SCCH	5.1.0	5.2.0
15/09/02	RAN_17	RP-020582	151	-	Correction to UE specific masking for HS-SCCH part1	5.1.0	5.2.0
15/09/02	RAN_17	RP-020568	155	2	Clarification of the definition of layer 1 transport channel numbers	5.1.0	5.2.0
15/09/02	RAN_17	RP-020573	157	-	Numbering Corrections	5.1.0	5.2.0
15/09/02	RAN_17	RP-020645	158	1	Specification of H-RNTI to UE identity mapping	5.1.0	5.2.0
20/12/02	RAN_18	RP-020846	163	-	Correction of CQI index to bit mapping	5.2.0	5.3.0
20/12/02	RAN_18	RP-020846	164	-	Correction of mapping of HARQ-ACK	5.2.0	5.3.0
26/03/03	RAN_19	RP-030134	165	1	Correction of CQI index to bit mapping	5.3.0	5.4.0
26/03/03	RAN_19	RP-030134	166	3	Correction of bit scrambling of HS-DSCH	5.3.0	5.4.0
26/03/03	RAN_19	RP-030134			Correction of subscript for modulation scheme information	5.3.0	5.4.0
23/06/03	RAN_20	RP-030272	172	1	Clarification of TPC and Pilot transmission with STTD in compressed mode	5.4.0	5.5.0
23/06/03	RAN_20	RP-030272	173	2	Correction on the flexible TFCl coding in the DSCH hard split mode for Rel5	5.4.0	5.5.0

---

## History

<b>Document history</b>		
V5.0.0	March 2002	Publication
V5.1.0	June 2002	Publication
V5.2.0	September 2002	Publication
V5.3.0	December 2002	Publication
V5.4.0	March 2003	Publication
V5.5.0	June 2003	Publication