

# ETSI TS 124 135 V11.0.0 (2012-10)



**Universal Mobile Telecommunications System (UMTS);  
LTE;  
Multicall supplementary service;  
Stage 3  
(3GPP TS 24.135 version 11.0.0 Release 11)**



---

**Reference**

RTS/TSGC-0424135vb00

---

**Keywords**

LTE,UMTS

**ETSI**

650 Route des Lucioles  
F-06921 Sophia Antipolis Cedex - FRANCE

---

Tel.: +33 4 92 94 42 00 Fax: +33 4 93 65 47 16

Siret N° 348 623 562 00017 - NAF 742 C  
Association à but non lucratif enregistrée à la  
Sous-Préfecture de Grasse (06) N° 7803/88

---

**Important notice**

---

Individual copies of the present document can be downloaded from:

<http://www.etsi.org>

The present document may be made available in more than one electronic version or in print. In any case of existing or perceived difference in contents between such versions, the reference version is the Portable Document Format (PDF). In case of dispute, the reference shall be the printing on ETSI printers of the PDF version kept on a specific network drive within ETSI Secretariat.

Users of the present document should be aware that the document may be subject to revision or change of status. Information on the current status of this and other ETSI documents is available at

<http://portal.etsi.org/tb/status/status.asp>

If you find errors in the present document, please send your comment to one of the following services:

[http://portal.etsi.org/chaicor/ETSI\\_support.asp](http://portal.etsi.org/chaicor/ETSI_support.asp)

---

**Copyright Notification**

---

No part may be reproduced except as authorized by written permission.  
The copyright and the foregoing restriction extend to reproduction in all media.

© European Telecommunications Standards Institute 2012.  
All rights reserved.

**DECT™**, **PLUGTESTS™**, **UMTS™** and the ETSI logo are Trade Marks of ETSI registered for the benefit of its Members.  
**3GPP™** and **LTE™** are Trade Marks of ETSI registered for the benefit of its Members and  
of the 3GPP Organizational Partners.  
**GSM®** and the GSM logo are Trade Marks registered and owned by the GSM Association.

---

## Intellectual Property Rights

IPRs essential or potentially essential to the present document may have been declared to ETSI. The information pertaining to these essential IPRs, if any, is publicly available for **ETSI members and non-members**, and can be found in ETSI SR 000 314: *"Intellectual Property Rights (IPRs); Essential, or potentially Essential, IPRs notified to ETSI in respect of ETSI standards"*, which is available from the ETSI Secretariat. Latest updates are available on the ETSI Web server (<http://ipr.etsi.org>).

Pursuant to the ETSI IPR Policy, no investigation, including IPR searches, has been carried out by ETSI. No guarantee can be given as to the existence of other IPRs not referenced in ETSI SR 000 314 (or the updates on the ETSI Web server) which are, or may be, or may become, essential to the present document.

---

## Foreword

This Technical Specification (TS) has been produced by ETSI 3rd Generation Partnership Project (3GPP).

The present document may refer to technical specifications or reports using their 3GPP identities, UMTS identities or GSM identities. These should be interpreted as being references to the corresponding ETSI deliverables.

The cross reference between GSM, UMTS, 3GPP and ETSI identities can be found under <http://webapp.etsi.org/key/queryform.asp>.

---

# Contents

Intellectual Property Rights .....	2
Foreword.....	2
Foreword.....	4
1 Scope .....	5
2 References .....	5
3 Definitions and abbreviations.....	6
3.1 Abbreviations .....	6
4 Multicall (MC) .....	6
4.1 Normal operation.....	6
4.1.1 Mobile originating call (request a new traffic channel) .....	6
4.1.2 Mobile originating call (reuse an existing traffic channel) .....	7
4.1.3 Mobile terminating call (request a new traffic channel) .....	8
4.1.4 Mobile terminating call (reuse an existing traffic channel) .....	10
4.1.5 Mobile terminating call (unsuccessful simultaneous Call in Setup case) .....	11
4.2 Registration .....	11
4.2.1 Registration by the served mobile subscriber .....	11
4.3 Interrogation .....	12
<b>Annex A (informative): Change history .....</b>	<b>14</b>
History .....	15

---

# Foreword

This Technical Specification (TS) has been produced by the 3<sup>rd</sup> Generation Partnership Project (3GPP).

The present document gives the stage 3 description of the Multicall (MC) supplementary service within the 3GPP system.

The contents of the present document are subject to continuing work within the TSG and may change following formal TSG approval. Should the TSG modify the contents of the present document, it will be re-released by the TSG with an identifying change of release date and an increase in version number as follows:

Version x.y.z

where:

- x the first digit:
  - 1 presented to TSG for information;
  - 2 presented to TSG for approval;
  - 3 or greater indicates TSG approved document under change control.
- y the second digit is incremented for all changes of substance, i.e. technical enhancements, corrections, updates, etc.
- z the third digit is incremented when editorial only changes have been incorporated in the document.

---

# 1 Scope

The present document gives the stage 3 description of the Multicall (MC) supplementary service. The present document specifies the procedures used by the radio interface for normal operation, registration and interrogation of the Multicall supplementary service. Provision, withdrawal, erasure, activation and deactivation of supplementary services is an administrative matter between the mobile subscriber and the service provider and causes no signalling on the radio interface.

3GPP TS 24.010 describes the general aspects of the specification of supplementary services at the layer 3 radio interface.

3GPP TS 24.080 specifies the formats and coding for the supplementary services.

Definitions and descriptions of supplementary services are given in 3GPP TS 22.004, 3GPP TS 22.072, 3GPP TS 22.08x, 3GPP TS 22.09x-series and 3GPP TS 22.135. 3GPP TS 22.135 is related specifically to the Multicall supplementary service.

The technical realisation of supplementary services are described in 3GPP TS 23.011, 3GPP TS 23.072, 3GPP TS 23.08x, 23.09x-series and 3GPP TS 23.135. 3GPP TS 23.135 is related specifically to the Multicall supplementary service.

The procedures for Call Control and Mobility Management at the layer 3 radio interface are defined in 3GPP TS 24.007 and 3GPP TS 24.008.

The following supplementary services are described in the present document:

- Multicall (MC) (see clause 4).

---

# 2 References

The following documents contain provisions which, through reference in this text, constitute provisions of the present document.

- References are either specific (identified by date of publication, edition number, version number, etc.) or non-specific.
- For a specific reference, subsequent revisions do not apply.
- For a non-specific reference, the latest version applies. In the case of a reference to a 3GPP document (including a GSM document), a non-specific reference implicitly refers to the latest version of that document *in the same Release as the present document*.

- [1] 3GPP TR 21.905: "3GPP Vocabulary".
- [2] 3GPP TS 22.004: "General on supplementary services".
- [3] 3GPP TS 22.030: "Man-Machine Interface (MMI) of the Mobile Station (MS)".
- [4] 3GPP TS 22.135: "Multicall Stage1".
- [5] 3GPP TS 23.011: "Technical realization of supplementary services".
- [6] 3GPP TS 23.135: "Multicall supplementary service – stage 2".
- [7] 3GPP TS 24.007: "Mobile radio interface signalling layer 3 General aspects".
- [8] 3GPP TS 24.008: "Mobile radio interface layer 3 specification Core Network Protocol – Stage 3".
- [9] 3GPP TS 24.010: "Mobile radio interface layer 3 Supplementary services specification General aspects".

- [10] 3GPP TS 24.080: "Mobile radio interface layer 3 Supplementary services specification Formats and coding".
- [11] 3GPP TS 24.083: "Call Waiting (CW) and Call Hold (HOLD) supplementary services - Stage 3".

## 3 Definitions and abbreviations

### 3.1 Abbreviations

For the purposes of the present document, the terms and definitions given in 3GPP TS 22.135 apply.

Further related abbreviations are given in 3GPP TR 21.905.

## 4 Multicall (MC)

### 4.1 Normal operation

All of the radio signalling specific to Multicall is at the served mobile subscriber side. The radio signalling on the other side uses basic call signalling procedures only.

The mobile subscriber supporting Multicall shall include the stream identifier (SI) information element. The purpose of the stream identifier (SI) information element is to associate a particular call with a Radio Access Bearer (RAB), and to identify whether a new traffic channel is requested for the call. Refer to TS 24.008 for the rules on allocating stream identifiers.

#### 4.1.1 Mobile originating call (request a new traffic channel)

If the served mobile subscriber initiates an outgoing call (A-B), the mobile subscriber shall include the stream identifier (SI) information element in the SETUP message. When there are no other ongoing calls, the following rules apply:

- The stream identifier value shall be equal to 1.
- CC capabilities that indicate  $N_{br\_UE}$  shall be included in the SETUP message.
- NW CC capabilities that indicate the network supports Multicall shall be included in the CALL PROCEEDING message.
- If the NW CC capabilities is not sent from the network, the mobile station shall assume that the network does not support Multicall, and shall not initiate an additional mobile originating call via a new bearer.
- If the network receives the SETUP message with a stream identifier including an invalid content (SI value indicates other than 1 for the first call), the network shall initiate call clearing with cause #95 "semantically incorrect message".

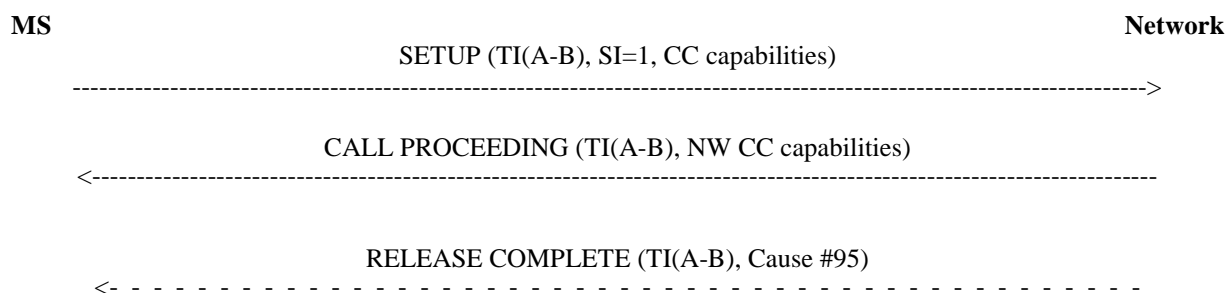

**Figure 1: The first mobile originating call**

When there are one or more ongoing call(s) and the served mobile subscriber B wants to initiate another call (B-C) via a new bearer, the mobile station B shall include a stream identifier (B-C) in the SETUP message. If there are several active calls and the mobile subscriber B wants to initiate another call via a new bearer, the mobile station B shall include a stream identifier that is not used for the active calls.

- If the network receives a SETUP message with a stream identifier including an invalid content (SI = no bearer), the network shall initiate call clearing with cause #95 "semantically incorrect message".
- If the network receives a SETUP message with a stream identifier including the requesting entity cannot be provided (SI value is already used by other active call), the network shall initiate call clearing with cause #44 "requested circuit/channel not available".
- If the network can not permit the call because the mobile subscriber is not provisioned with the Multicall supplementary service, the network shall initiate call clearing with cause #50 "requested facility not subscribed".
- If the network can not permit the call because the Multicall limit ( $N_{br\_SN}$  or  $N_{br\_User}$ ) is exceeded, the network shall initiate call clearing with cause #63 "service or option not available". In this case, a NotifySS operation containing the Multicall-indicator that indicates the number of active bearers in use would exceed the maximum value will be sent to the served mobile subscriber B in a clearing message. Multicall-indicator includes:
  - $N_{br\_SN}$  exceeded.
  - $N_{br\_User}$  exceeded.

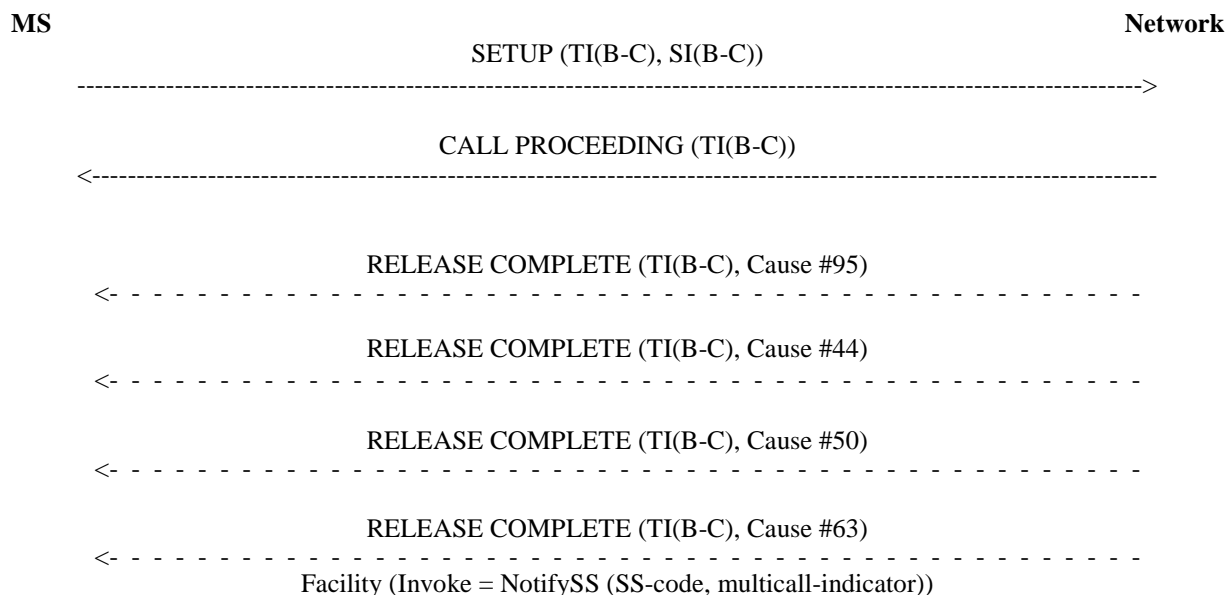

**Figure 2: The additional mobile originating call**

#### 4.1.2 Mobile originating call (reuse an existing traffic channel)

When there are one or more ongoing calls and the served mobile subscriber B wants to initiate another call (B-C) via the existing bearer, the subscriber will put one of the active calls (A-B) on hold first, and initiate the additional mobile originating call (B-C).

The hold function shall be initiated by the mobile subscriber B and the transaction identifier (TI) shall have the same value as the transaction identifier (A-B) of the existing call.

For the initiation of another call (B-C), the mobile station B shall include the stream identifier (SI) in the SETUP message and the stream identifier shall have the same value as the stream identifier (A-B) of the existing call.

- If the network receives a SETUP message with a stream identifier including an invalid content (SI value indicates 'no bearer'), the network shall initiate call clearing with cause #95 "semantically incorrect message".



- If the network receives a SETUP message with a stream identifier including the requesting entity cannot be provided (SI value indicates 'used for other active call(s) except held call' or 'SI element is missing'), the network shall initiate call clearing with cause #44 "requested circuit/channel not available".

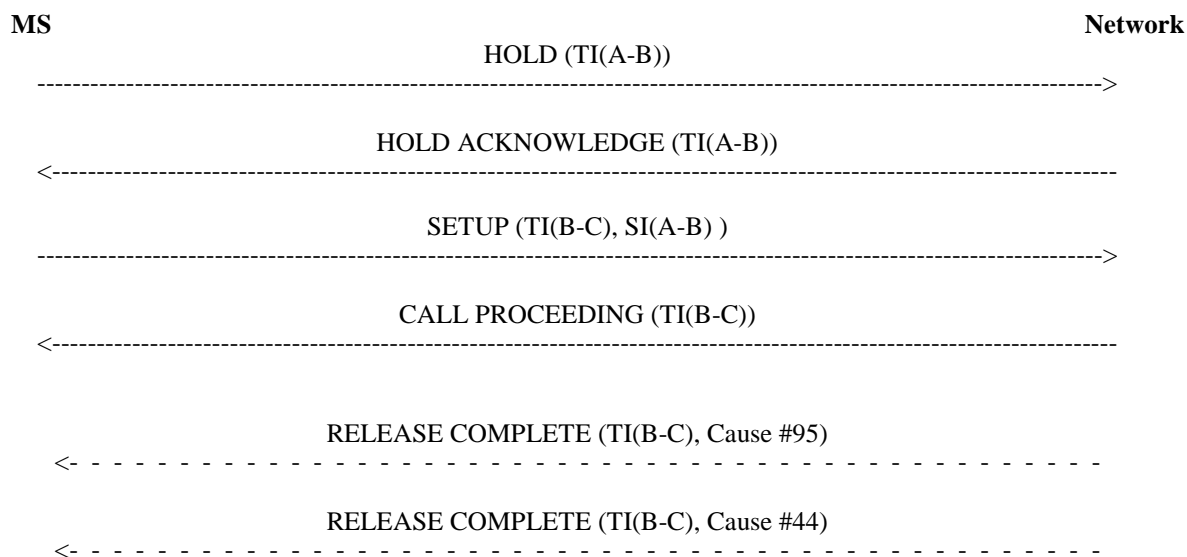
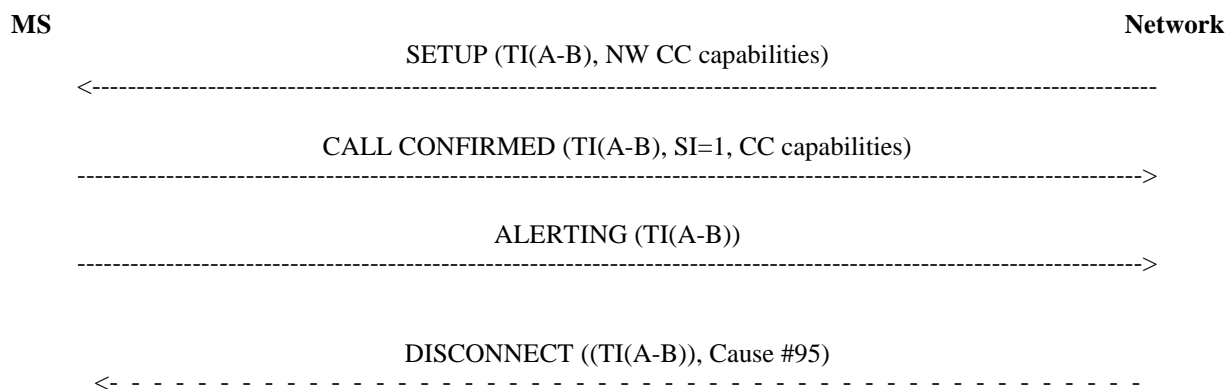

**Figure 3: The mobile originating call via an existing traffic channel**

#### 4.1.3 Mobile terminating call (request a new traffic channel)

If the served mobile subscriber accepts the arrival of an incoming call (A-B), the mobile station shall include the stream identifier (SI) information element in the CALL CONFIRMED message. When there are no other ongoing calls, the following rules apply:

- NW CC capabilities that indicate the network supports Multicall shall be included in the SETUP message.
- The stream identifier value shall be equal to 1.
- CC capabilities that indicate  $N_{br\_UE}$  shall be included in the CALL CONFIRMED message.
- If the NW CC capabilities is not sent from the network, the mobile station shall assume that the network does not support Multicall, and shall not initiate a mobile originating call via a new bearer.
- If the network receives a CALL CONFIRMED message with a stream identifier including an invalid content (SI value indicates other than 1 for the first call), the network shall initiate call clearing with cause #95 "semantically incorrect message".



**Figure 4: The first mobile terminating call**

- When there are one or more ongoing calls and the served mobile subscriber B wants to accept another incoming call (B-C) via a new bearer, the mobile station B shall include the stream identifier with either of the following value in the CALL CONFIRMED message:

- SI = new value (not used for any of the active calls) (Case1).
- SI = 'No Bearer' (Case2).

If the mobile station B includes the stream identifier with 'No Bearer' in the CALL CONFIRMED message, the mobile station B shall include the stream identifier with a new value in the CONNECT message.

If the network receives a CALL CONFIRMED message with a stream identifier including the request entity cannot be provided (SI value is already in use), the network shall initiate call clearing with cause #44 "requested circuit/channel not available".

- If the network receives a CONNECT message with a stream identifier after receiving a CALL CONFIRMED message with an indicator to initiate a new bearer (Case 1), the network shall initiate call clearing with cause #95 "semantically incorrect message".
- If the network receives a CONNECT message with a stream identifier including an invalid content ( SI = no bearer) after receiving CALL CONFIRMED message with SI = no bearer (Case 2), the network shall initiate call clearing with cause #95 "semantically incorrect message".
- If the network receives a CONNECT message with a stream identifier including the requested entity cannot be provided (SI value is used for other active call(s) except held call) after receiving CALL CONFIRMED message with SI = no bearer (Case 2), the network shall initiate call clearing with cause #44 "requested circuit/channel not available".

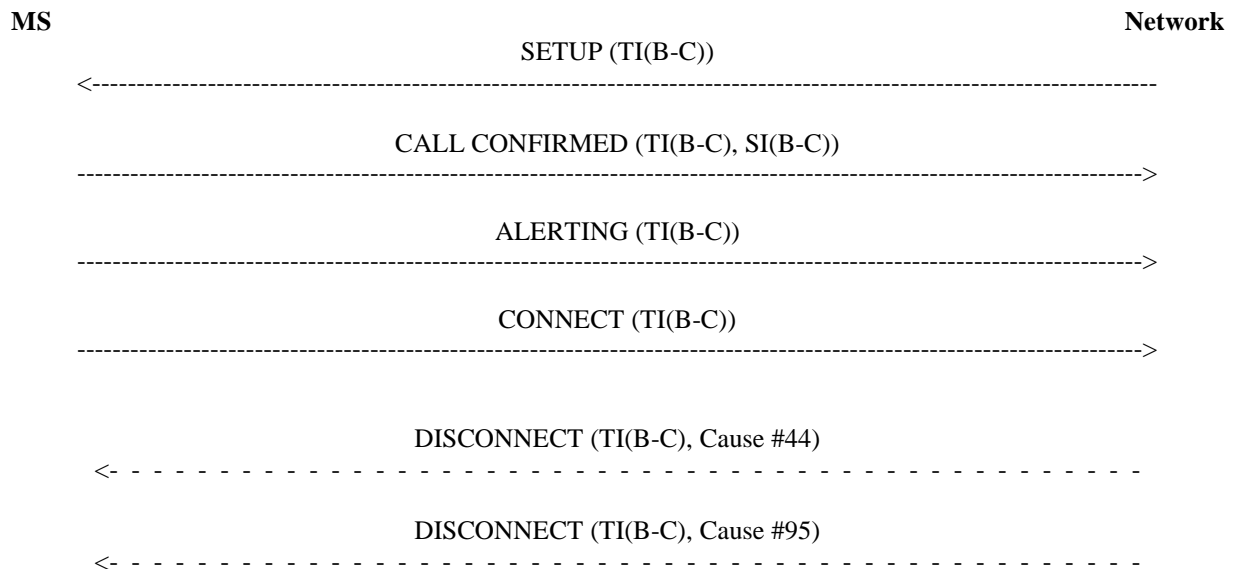
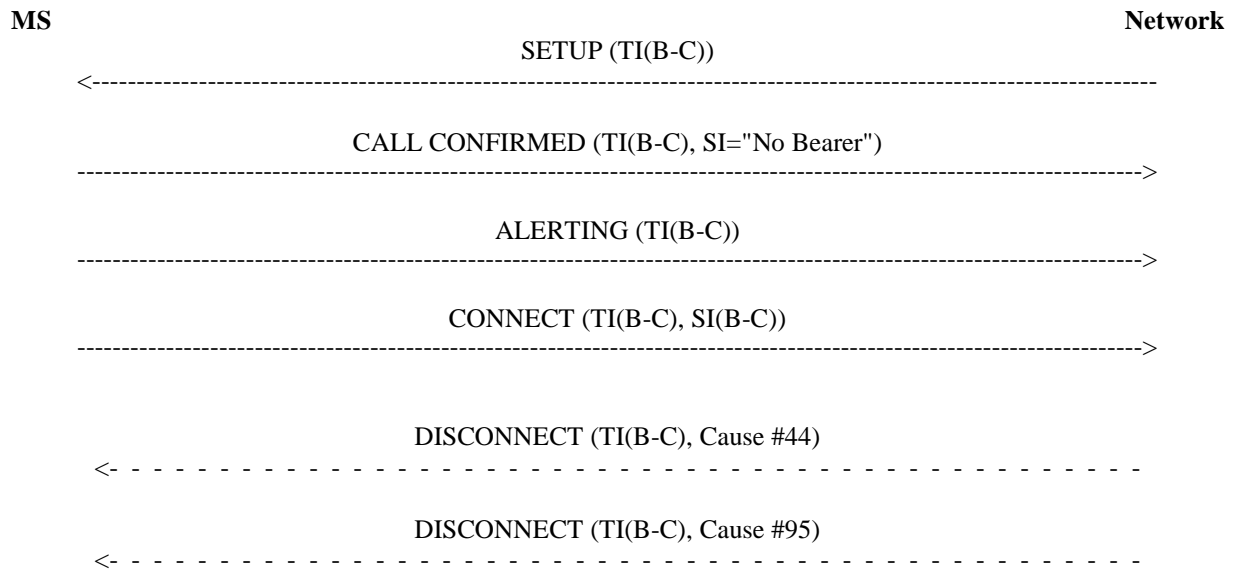

Figure 5: The additional mobile terminating call (Case1)



**Figure 6: The additional mobile terminating call (Case2)**

#### 4.1.4 Mobile terminating call (reuse an existing traffic channel)

When there are one or more active calls and the served mobile subscriber B wants to accept another incoming call (B-C) via the existing bearer, the subscriber will put one of the active calls (A-B) on hold first, and accept the additional mobile terminating call (B-C).

The hold function shall be initiated by the mobile subscriber B and the transaction identifier (TI) shall be the transaction identifier (A-B) of the existing call.

To accept the other incoming call (B-C), the mobile station B shall include the stream identifier (SI) with value "No bearer" in the CALL CONFIRMED message. Mobile station B shall include the stream identifier (A-B) in the CONNECT message. (See Figure 7). If the mobile station B is located in the network not supporting multicall, it shall include the SI with value 1 in the CALL CONFIRMED message.

If the Call waiting SS is invoked and the mobile subscriber B wants to accept the waiting call, the mobile subscriber B can put an existing call on hold and then accept the waiting call. In this case the mobile station B shall include the stream identifier (SI) with value "No bearer" in the CALL CONFIRMED message, and include the stream identifier value which is used for the held call in the CONNECT message.

- If the network receives a CALL CONFIRMED message with a stream identifier including the request entity cannot be provided (SI value is already in use) the network shall initiate call clearing with cause #44 "requested circuit/channel not available".
- If the network receives a CONNECT message with a stream identifier including an invalid content (SI = no bearer) after receiving CALL CONFIRMED message with SI = no bearer, the network shall initiate call clearing with cause #95 "semantically incorrect message".
- If the network receives a CONNECT message with a stream identifier including the requested entity cannot be provided (SI value is used for other active call(s) except held call) after receiving CALL CONFIRMED message with SI = no bearer (Case 2), the network shall initiate call clearing with cause #44 "requested circuit/channel not available".

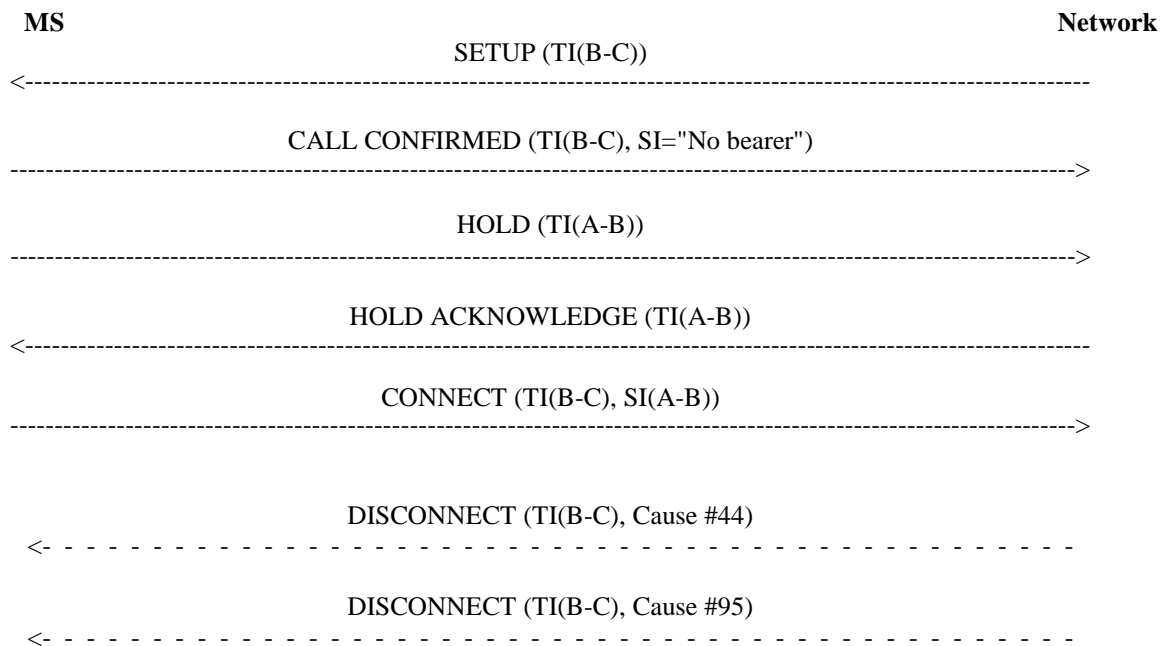

**Figure 7: The mobile terminating call via an existing traffic channel**

#### 4.1.5 Mobile terminating call (unsuccessful simultaneous Call in Setup case)

If there is one call (A-B) that has not reached the established phase and the served mobile station B receives another incoming call (B-C), the served mobile subscriber B may not be able to accept the additional incoming call (B-C). In this case, the mobile subscriber B can initiate call clearing with cause #47 "no resources available, unspecified".

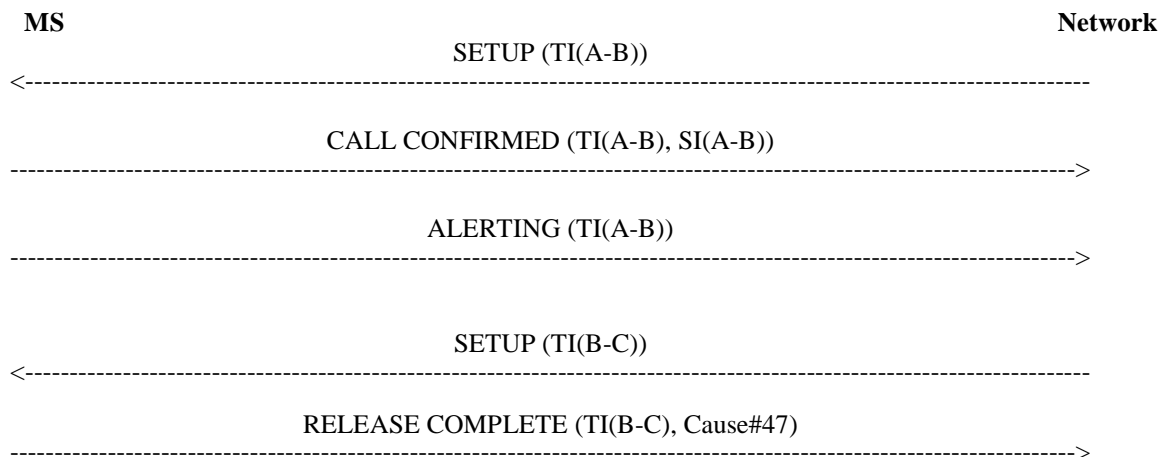

**Figure 8: The mobile terminating call in the unsuccessful case of simultaneous Call in Setup**

## 4.2 Registration

The following information has to be registered in the network:

- The maximum number of bearers chosen by the user,  $N_{br\_User}$ .

### 4.2.1 Registration by the served mobile subscriber

A Multicall registration request from a mobile user shall include the SS-Code of Multicall. The request applies to all basic services.

If the registration is successful, the Multicall service will be registered. The network will then send a return result indicating acceptance of the request including the value of  $N_{br\_User}$ .

If the MS does not send an SS Version Indicator in the invocation request then the network shall send an SS-Status in the result.

If the MS does send an SS Version Indicator in the invocation request then the inclusion of SS-Status in the result is optional. If the SS-Status is included the network shall set it to reflect the state of the service. The MS shall ignore the contents of the SS-Status parameter if one is received. See figure 9.

If the system cannot accept a registration request, a corresponding error indication is returned to the served mobile subscriber that Multicall registration was not successful. Error values are specified in 3GPP TS 24.080.

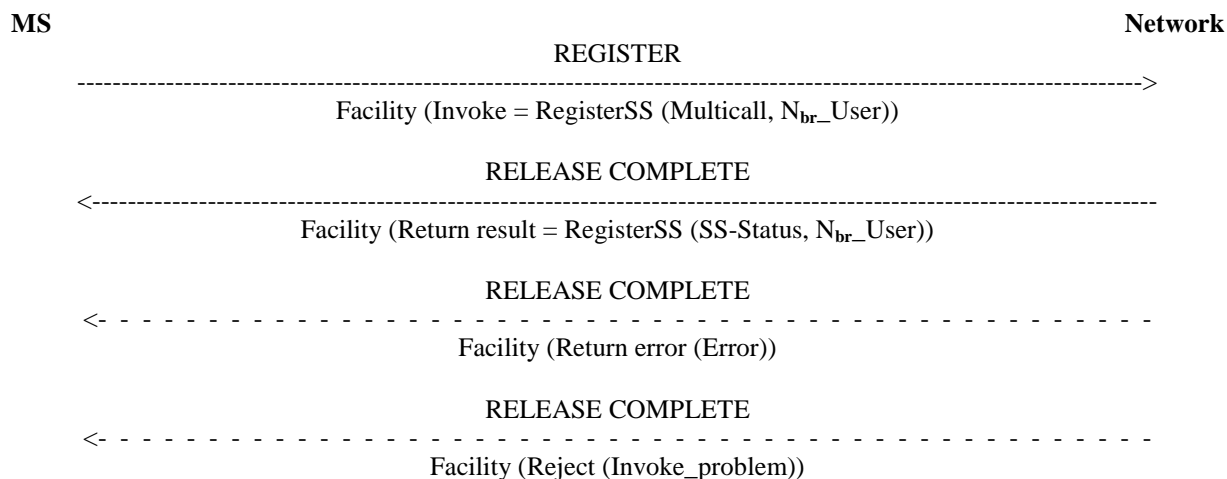

**Figure 9: Registration of Multicall**

## 4.3 Interrogation

The interrogation procedure enables the mobile subscriber to obtain information about the data stored in the PLMN. The network shall return the following information:

- The maximum number of bearers set by the user,  $N_{br\_User}$ .
- The maximum number of bearers defined by Multicall subscription,  $N_{br\_SB}$ .
- The maximum number of bearers supported by serving network,  $N_{br\_SN}$ .

See figure 10.

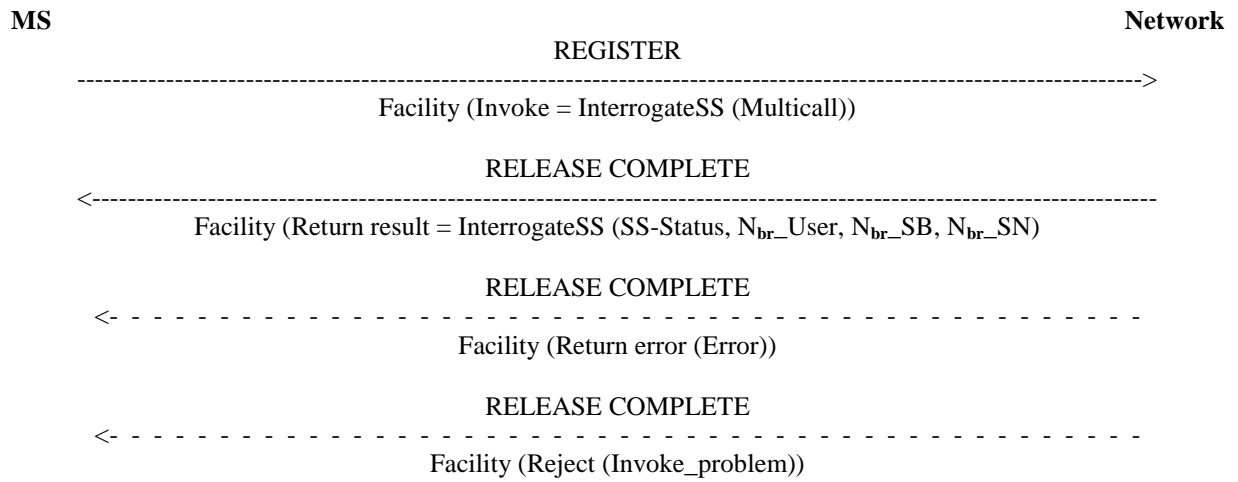

**Figure 10: Interrogation of Multicall**

## Annex A (informative): Change history

Change history						
TSG CN#	Spec	Version	CR	<Phase>	New Version	Subject/Comment
CN#07	24.135	1.0.0		R99	3.0.0	Approved in TSGN#07
CN#08	24.135	3.0.0	001r2	R99	3.1.0	Clarifications of the Multicall procedures
CN#11	24.135	3.1.0		Rel-4	4.0.0	Approved at CN#11
CN#14	24.135	4.0.0	003r1	Rel-4	4.1.0	Clarification on SI value for Mobile terminating call (reuse an existing traffic channel)
CN#16	24.135	4.1.0		Rel-4	4.1.1	References updated
CN#16	24.135	4.1.1		Rel-5	5.0.0	Rel-5 created after CN#16
CN#26	24.135	5.0.0		Rel-6	6.0.0	Rel-6 created after CN#26
CT#36	24.135	6.0.0		Rel-7	7.0.0	Upgraded unchanged from Rel-6
CT#42	24.135	7.0.0		Rel-8	8.0.0	Upgraded unchanged from Rel-7
2009-12	24.135	8.0.0	-	Rel-9	9.0.0	Update to Rel-9 version (MCC)
2011-03	24.135	9.0.0	-	Rel-10	10.0.0	Update to Rel-10 version (MCC)
2012-09	24.135	10.0.0	-	Rel-11	11.0.0	Update to Rel-11 version (MCC)

---

# History

<b>Document history</b>		
V11.0.0	October 2012	Publication