

ETSI TS 124 008 V16.7.0 (2021-04)



**Digital cellular telecommunications system (Phase 2+) (GSM);
Universal Mobile Telecommunications System (UMTS);
LTE;
5G;
Mobile radio interface Layer 3 specification;
Core network protocols;
Stage 3
(3GPP TS 24.008 version 16.7.0 Release 16)**



Reference

RTS/TSGC-0124008vg70

Keywords

5G,GSM,LTE,UMTS

ETSI

650 Route des Lucioles
F-06921 Sophia Antipolis Cedex - FRANCE

Tel.: +33 4 92 94 42 00 Fax: +33 4 93 65 47 16

Siret N° 348 623 562 00017 - APE 7112B
Association à but non lucratif enregistrée à la
Sous-Préfecture de Grasse (06) N° w061004871

Important notice

The present document can be downloaded from:

<http://www.etsi.org/standards-search>

The present document may be made available in electronic versions and/or in print. The content of any electronic and/or print versions of the present document shall not be modified without the prior written authorization of ETSI. In case of any existing or perceived difference in contents between such versions and/or in print, the prevailing version of an ETSI deliverable is the one made publicly available in PDF format at www.etsi.org/deliver.

Users of the present document should be aware that the document may be subject to revision or change of status.

Information on the current status of this and other ETSI documents is available at

<https://portal.etsi.org/TB/ETSIDeliverableStatus.aspx>

If you find errors in the present document, please send your comment to one of the following services:

<https://portal.etsi.org/People/CommitteeSupportStaff.aspx>

Notice of disclaimer & limitation of liability

The information provided in the present deliverable is directed solely to professionals who have the appropriate degree of experience to understand and interpret its content in accordance with generally accepted engineering or other professional standard and applicable regulations.

No recommendation as to products and services or vendors is made or should be implied.

No representation or warranty is made that this deliverable is technically accurate or sufficient or conforms to any law and/or governmental rule and/or regulation and further, no representation or warranty is made of merchantability or fitness for any particular purpose or against infringement of intellectual property rights.

In no event shall ETSI be held liable for loss of profits or any other incidental or consequential damages.

Any software contained in this deliverable is provided "AS IS" with no warranties, express or implied, including but not limited to, the warranties of merchantability, fitness for a particular purpose and non-infringement of intellectual property rights and ETSI shall not be held liable in any event for any damages whatsoever (including, without limitation, damages for loss of profits, business interruption, loss of information, or any other pecuniary loss) arising out of or related to the use of or inability to use the software.

Copyright Notification

No part may be reproduced or utilized in any form or by any means, electronic or mechanical, including photocopying and microfilm except as authorized by written permission of ETSI.

The content of the PDF version shall not be modified without the written authorization of ETSI.

The copyright and the foregoing restriction extend to reproduction in all media.

© ETSI 2021.
All rights reserved.

Intellectual Property Rights

Essential patents

IPRs essential or potentially essential to normative deliverables may have been declared to ETSI. The declarations pertaining to these essential IPRs, if any, are publicly available for **ETSI members and non-members**, and can be found in ETSI SR 000 314: "*Intellectual Property Rights (IPRs); Essential, or potentially Essential, IPRs notified to ETSI in respect of ETSI standards*", which is available from the ETSI Secretariat. Latest updates are available on the ETSI Web server (<https://ipr.etsi.org/>).

Pursuant to the ETSI Directives including the ETSI IPR Policy, no investigation regarding the essentiality of IPRs, including IPR searches, has been carried out by ETSI. No guarantee can be given as to the existence of other IPRs not referenced in ETSI SR 000 314 (or the updates on the ETSI Web server) which are, or may be, or may become, essential to the present document.

Trademarks

The present document may include trademarks and/or tradenames which are asserted and/or registered by their owners. ETSI claims no ownership of these except for any which are indicated as being the property of ETSI, and conveys no right to use or reproduce any trademark and/or tradename. Mention of those trademarks in the present document does not constitute an endorsement by ETSI of products, services or organizations associated with those trademarks.

DECT™, **PLUGTESTS™**, **UMTS™** and the ETSI logo are trademarks of ETSI registered for the benefit of its Members. **3GPP™** and **LTE™** are trademarks of ETSI registered for the benefit of its Members and of the 3GPP Organizational Partners. **oneM2M™** logo is a trademark of ETSI registered for the benefit of its Members and of the oneM2M Partners. **GSM®** and the GSM logo are trademarks registered and owned by the GSM Association.

Legal Notice

This Technical Specification (TS) has been produced by ETSI 3rd Generation Partnership Project (3GPP).

The present document may refer to technical specifications or reports using their 3GPP identities. These shall be interpreted as being references to the corresponding ETSI deliverables.

The cross reference between 3GPP and ETSI identities can be found under <http://webapp.etsi.org/key/queryform.asp>.

Modal verbs terminology

In the present document "**shall**", "**shall not**", "**should**", "**should not**", "**may**", "**need not**", "**will**", "**will not**", "**can**" and "**cannot**" are to be interpreted as described in clause 3.2 of the [ETSI Drafting Rules](#) (Verbal forms for the expression of provisions).

"**must**" and "**must not**" are **NOT** allowed in ETSI deliverables except when used in direct citation.

Contents

Intellectual Property Rights	2
Legal Notice	2
Modal verbs terminology.....	2
Foreword.....	28
Introduction	28
1 Scope	29
1.1 Scope of the Technical Specification	29
1.2 Application to the interface structures.....	29
1.3 Structure of layer 3 procedures.....	29
1.4 Test procedures	30
1.5 Use of logical channels in A/Gb mode.....	30
1.6 Overview of control procedures	30
1.6.1 List of procedures	30
1.7 Applicability of implementations	32
1.7.1 Voice Group Call Service (VGCS) and Voice Broadcast Service (VBS).....	32
1.7.2 General Packet Radio Service (GPRS)	32
1.7.2.1 Packet services in GSM (A/Gb mode only)	32
1.7.2.2 Packet services in Iu mode (Iu mode only)	33
1.8 Handling of NAS signalling low priority indication	33
1.9 Restrictions.....	34
2 References	34
2.1 Definitions and abbreviations.....	41
2.1.1 Random values.....	42
2.1.2 Vocabulary.....	42
3 Radio Resource management procedures.....	47
4 Elementary procedures for Mobility Management.....	47
4.1 General	47
4.1.1 MM and GMM procedures	48
4.1.1.1 Types of MM and GMM procedures	48
4.1.1.1.1 Integrity Checking of Signalling Messages in the Mobile Station (Iu mode only).....	49
4.1.1.1.1a Integrity protection for emergency call (Iu mode only).....	51
4.1.1.2 MM-GMM co-ordination for GPRS MS's	52
4.1.1.2.1 GPRS MS operating in mode A or B in a network that operates in mode I	52
4.1.1.2.2 GPRS MS operating in mode A or B in a network that operates in mode II.....	53
4.1.1.2A Coordination between GMM and EMM	54
4.1.1.2B Coordination between GMM and 5GMM.....	54
4.1.1.3 Core Network System Information for MM (Iu mode only).....	54
4.1.1.4 Core Network System Information for GMM (Iu mode only).....	54
4.1.1.4.1 General	54
4.1.1.4.2 Control of Network Mode of Operation I.....	54
4.1.1.5 Access class control	54
4.1.1.6 Specific requirements for MS configured to use timer T3245	55
4.1.1.6A Specific requirements for the MS when receiving non-integrity protected reject messages	56
4.1.1.7 Handling of NAS level mobility management congestion control.....	61
4.1.1.8 Handling of security related parameters at switch on and switch off.....	62
4.1.1.9 Equivalent PLMNs list.....	63
4.1.1.10 Dedicated core network.....	63
4.1.2 MM sublayer states	63
4.1.2.1 MM sublayer states in the mobile station.....	63
4.1.2.1.1 Main states.....	63
4.1.2.1.2 Substates of the MM IDLE state	67
4.1.2.2 The update Status	69
4.1.2.3 MM sublayer states on the network side	69

4.1.3	GPRS mobility management (GMM) sublayer states.....	71
4.1.3.1	GMM states in the MS	71
4.1.3.1.1	Main states.....	71
4.1.3.1.2	Substates of state GMM-DEREGISTERED.....	72
4.1.3.1.3	Substates of state GMM-REGISTERED.....	72
4.1.3.2	GPRS update status	75
4.1.3.3	GMM mobility management states on the network side.....	75
4.1.3.3.1	Main States	76
4.1.3.3.2	Substates of state GMM-REGISTERED.....	76
4.2	Behaviour of the MS in MM Idle state, GMM-DEREGISTERED state and GMM-REGISTERED state	77
4.2.1	Primary Service State selection	77
4.2.1.1	Selection of the Service State after Power On.....	77
4.2.1.2	Other Cases	78
4.2.2	Detailed Description of the MS behaviour in MM IDLE State.	78
4.2.2.1	Service State, NORMAL SERVICE	78
4.2.2.2	Service State, ATTEMPTING TO UPDATE	79
4.2.2.3	Service State, LIMITED SERVICE.....	79
4.2.2.4	Service State, NO IMSI.....	80
4.2.2.5	Service State, SEARCH FOR PLMN, NORMAL SERVICE.....	80
4.2.2.6	Service State, SEARCH FOR PLMN	81
4.2.2.7	Service State, RECEIVING GROUP CALL (NORMAL SERVICE)	81
4.2.2.8	Service State, RECEIVING GROUP CALL (LIMITED SERVICE).....	81
4.2.2.9	Service State, eCALL INACTIVE.....	82
4.2.3	Service state when back to state MM IDLE from another state.....	82
4.2.4	Behaviour in state GMM-DEREGISTERED.....	83
4.2.4.1	Primary substate selection.....	83
4.2.4.1.1	Selection of the substate after power on or enabling the MS's GPRS capability.....	83
4.2.4.1.2	Other Cases.....	84
4.2.4.2	Detailed description of the MS behaviour in state GMM-DEREGISTERED.....	84
4.2.4.2.1	Substate, NORMAL-SERVICE	84
4.2.4.2.2	Substate, ATTEMPTING-TO-ATTACH	84
4.2.4.2.3	Substate, LIMITED-SERVICE	85
4.2.4.2.4	Substate, NO-IMSI	85
4.2.4.2.5	Substate, NO-CELL	85
4.2.4.2.6	Substate, PLMN-SEARCH	85
4.2.4.2.7	Substate, ATTACH-NEEDED	85
4.2.4.2.8	Substate, SUSPENDED (A/Gb mode only)	85
4.2.4.3	Substate when back to state GMM-DEREGISTERED from another GMM state	85
4.2.5	Behaviour in state GMM-REGISTERED.....	86
4.2.5.1	Detailed description of the MS behaviour in state GMM-REGISTERED.....	86
4.2.5.1.1	Substate, NORMAL-SERVICE	86
4.2.5.1.2	Substate, SUSPENDED (A/Gb mode only)	86
4.2.5.1.3	Substate, UPDATE-NEEDED.....	87
4.2.5.1.4	Substate, ATTEMPTING-TO-UPDATE	87
4.2.5.1.5	Substate, NO-CELL-AVAILABLE	88
4.2.5.1.6	Substate, LIMITED-SERVICE	88
4.2.5.1.7	Substate, ATTEMPTING-TO-UPDATE-MM	88
4.2.5.1.8	Substate, PLMN-SEARCH	88
4.3	MM common procedures	88
4.3.1	TMSI reallocation procedure	88
4.3.1.0	General	88
4.3.1.1	TMSI reallocation initiation by the network	89
4.3.1.2	TMSI reallocation completion by the mobile station	89
4.3.1.3	TMSI reallocation completion in the network.....	89
4.3.1.4	Abnormal cases in the mobile station.....	89
4.3.1.5	Abnormal cases on the network side.....	90
4.3.2	Authentication procedure.....	90
4.3.2a	Authentication procedure used for a UMTS authentication challenge.....	90
4.3.2b	Authentication Procedure used for a GSM authentication challenge.....	91
4.3.2.1	Authentication request by the network.....	91
4.3.2.2	Authentication response by the mobile station.....	91
4.3.2.3	Authentication processing in the network	92

4.3.2.3a	128-bit circuit-switched GSM ciphering key	92
4.3.2.4	Ciphering key sequence number	92
4.3.2.5	Authentication not accepted by the network	93
4.3.2.5.1	Authentication not accepted by the MS	94
4.3.2.6	Abnormal cases	95
4.3.2.6.1	MS behaviour towards a network that has failed the authentication procedure.....	97
4.3.2.7	Handling of keys at intersystem change from Iu mode to A/Gb mode	97
4.3.2.7a	Use of established security contexts.....	98
4.3.2.8	Handling of keys at intersystem change from A/Gb mode to Iu mode	99
4.3.2.9	Void.....	100
4.3.2.10	Derivation of keys at SRVCC or vSRVCC handover from S1 mode	100
4.3.2.10.0	General	100
4.3.2.10.1	PDN connection with integrity protection	100
4.3.2.10.2	PDN connection without integrity protection	100
4.3.2.11	Derivation of keys at SRVCC handover from Iu mode to Iu mode	100
4.3.2.11.1	PDN connection with integrity protection	100
4.3.2.11.2	PDN connection without integrity protection	101
4.3.2.12	Derivation of keys at SRVCC handover from Iu mode to A/Gb mode.....	102
4.3.2.12.1	PDN connection with integrity protection	102
4.3.2.12.2	PDN connection without integrity protection.....	103
4.3.2.13	Derivation of keys at CS to PS SRVCC handover from A/Gb mode to Iu mode	103
4.3.2.14	Derivation of keys at 5G-SRVCC from NG-RAN to UTRAN	105
4.3.2.14.1	PDU session with integrity protection	105
4.3.2.14.2	PDU session without integrity protection.....	105
4.3.3	Identification procedure	105
4.3.3.0	General	105
4.3.3.1	Identity request by the network.....	105
4.3.3.2	Identification response by the mobile station.....	105
4.3.3.3	Abnormal cases in the mobile station.....	106
4.3.3.4	Abnormal cases on the network side.....	106
4.3.4	IMSI detach procedure.....	106
4.3.4.0	General	106
4.3.4.1	IMSI detach initiation by the mobile station	107
4.3.4.2	IMSI detach procedure in the network	107
4.3.4.3	IMSI detach completion by the mobile station.....	107
4.3.4.4	Abnormal cases	107
4.3.5	Abort procedure	108
4.3.5.1	Abort procedure initiation by the network	108
4.3.5.2	Abort procedure in the mobile station.....	108
4.3.6	MM information procedure.....	108
4.3.6.1	MM information procedure initiation by the network.....	108
4.3.6.2	MM information procedure in the mobile station	109
4.4	MM specific procedures	109
4.4.1	Location updating procedure	109
4.4.2	Periodic updating	111
4.4.3	IMSI attach procedure	112
4.4.4	Generic Location Updating procedure.....	112
4.4.4.1	Location updating initiation by the mobile station.....	112
4.4.4.1a	Network Request for Additional mobile station Capability Information	113
4.4.4.2	Identification request from the network.....	113
4.4.4.3	Authentication by the network	113
4.4.4.4	Security mode setting by the network	113
4.4.4.5	Location Update Attempt Counter	113
4.4.4.6	Location updating accepted by the network.....	114
4.4.4.7	Location updating not accepted by the network.....	116
4.4.4.8	Release of RR connection after location updating	117
4.4.4.9	Abnormal cases on the mobile station side	118
4.4.4.10	Abnormal cases on the network side.....	120
4.4.5	Void	120
4.4.6	Void	120
4.4.7	eCall inactivity procedure.....	120
4.5	Connection management sublayer service provision	121

4.5.1	MM connection establishment.....	121
4.5.1.1	MM connection establishment initiated by the mobile station.....	121
4.5.1.2	Abnormal cases.....	125
4.5.1.3	MM connection establishment initiated by the network.....	127
4.5.1.3.1	Mobile Terminating CM Activity.....	127
4.5.1.3.2	Mobile Originating CM Activity \$(CCBS)\$.....	127
4.5.1.3.3	Paging response in Iu mode (Iu mode only).....	128
4.5.1.3.4	Paging response for CS fallback.....	129
4.5.1.4	Abnormal cases.....	129
4.5.1.5	MM connection establishment for emergency calls.....	129
4.5.1.5a	MM connection establishment for emergency calls for CS fallback.....	130
4.5.1.6	Call re-establishment.....	130
4.5.1.6.1	Call re-establishment, initiation by the mobile station.....	131
4.5.1.6.2	Abnormal cases.....	133
4.5.1.7	Forced release during MO MM connection establishment.....	133
4.5.1.8	MM connection establishment due to SRVCC or vSRVCC handover.....	134
4.5.1.9	MM connection establishment due to Dual Radio Voice Call Continuity (DRVCC) access transfer.....	134
4.5.2	MM connection information transfer phase.....	134
4.5.2.1	Sending CM messages.....	135
4.5.2.2	Receiving CM messages.....	135
4.5.2.3	Abnormal cases.....	135
4.5.3	MM connection release.....	135
4.5.3.1	Release of associated RR connection.....	135
4.5.3.2	Uplink release in a voice group call.....	136
4.6	Receiving a MM STATUS message by a MM entity.....	136
4.7	Elementary mobility management procedures for GPRS services.....	136
4.7.1	General.....	136
4.7.1.1	Lower layer failure.....	136
4.7.1.2	Ciphering of messages (A/Gb mode only).....	136
4.7.1.2a	Integrity protection of layer 3 signalling messages (A/Gb mode only and when integrity protection is required).....	137
4.7.1.2a.1	General.....	137
4.7.1.2a.2	Integrity checking of GMM signalling messages in the MS.....	137
4.7.1.2a.3	Integrity checking of layer 3 signalling messages in the network.....	137
4.7.1.2a.4	Establishment of integrity protection of layer 3 signalling messages.....	138
4.7.1.2a.5	Optional establishment of integrity protection in the user plane.....	139
4.7.1.2a.6	Change of security keys.....	139
4.7.1.3	P-TMSI signature.....	139
4.7.1.4	Radio resource sublayer address handling.....	140
4.7.1.4.1	Radio resource sublayer address handling (A/Gb mode only).....	140
4.7.1.5	P-TMSI handling.....	141
4.7.1.5.1	P-TMSI handling in A/Gb mode.....	141
4.7.1.5.2	P-TMSI handling in Iu mode.....	142
4.7.1.5.3	Void.....	142
4.7.1.5.4	Void.....	142
4.7.1.6	Change of network mode of operation.....	142
4.7.1.6.1	Change of network mode of operation in A/Gb mode (A/Gb mode only).....	142
4.7.1.6.2	Change of network mode of operation in Iu mode (Iu mode only).....	142
4.7.1.6.3	Change of network mode of operation at Iu mode to A/Gb mode inter-system change.....	143
4.7.1.6.4	Change of network mode of operation at A/Gb mode to Iu mode inter-system change.....	143
4.7.1.7	Intersystem change between A/Gb mode and Iu mode.....	144
4.7.1.7a	Intersystem change from S1 mode to A/Gb mode or S1 mode to Iu mode with ISR activated.....	145
4.7.1.7b	Intersystem change from S1 mode to A/Gb mode or S1 mode to Iu mode for eCall only MS capable of eCall over IMS.....	146
4.7.1.7c	Return to packet idle mode for eCall only MS capable of eCall over IMS.....	146
4.7.1.8	List of forbidden PLMNs for GPRS service.....	146
4.7.1.8a	Establishment of the PS signalling connection (Iu mode only).....	147
4.7.1.9	Release of the PS signalling connection (Iu mode only).....	147
4.7.1.10	Handling of 3GPP PS data off.....	148
4.7.2	GPRS Mobility management timers and UMTS PS signalling connection control.....	149
4.7.2.1	READY timer behaviour.....	149

4.7.2.1.1	READY timer behaviour (A/Gb mode only).....	149
4.7.2.1.2	Handling of READY timer in the MS in Iu mode and S1 mode	150
4.7.2.1.2a	Handling of READY timer in the network in Iu mode and S1 mode	150
4.7.2.2	Periodic routing area updating	150
4.7.2.3	PMM-IDLE mode and PMM-CONNECTED mode (Iu mode only)	153
4.7.2.4	Handling of <i>Force to standby</i> in Iu mode (Iu mode only).....	153
4.7.2.5	RA Update procedure for Signalling Connection Re-establishment (Iu mode only)	153
4.7.2.6	Cell Update triggered by low layers.....	153
4.7.2.7	Handling of timer T3302.....	154
4.7.2.8	Handling of timer T3324 (A/Gb mode, Iu mode and S1 mode).....	154
4.7.2.9	Power saving mode	155
4.7.2.10	Extended idle-mode DRX cycle.....	156
4.7.2.11	Interaction between power saving mode and extended idle mode DRX cycle	156
4.7.2.12	Extended coverage for GSM.....	156
4.7.3	GPRS attach procedure.....	157
4.7.3.1	GPRS attach procedure for GPRS services.....	159
4.7.3.1.1	GPRS attach procedure initiation	159
4.7.3.1.2	GMM common procedure initiation.....	160
4.7.3.1.3	GPRS attach accepted by the network.....	161
4.7.3.1.4	GPRS attach not accepted by the network.....	164
4.7.3.1.4a	GPRS attach for emergency bearer services not accepted by the network (UTRAN Iu mode only)	169
4.7.3.1.4b	Attach for initiating a PDN connection for emergency bearer services not accepted by the network (UTRAN Iu mode only)	170
4.7.3.1.5	Abnormal cases in the MS.....	170
4.7.3.1.6	Abnormal cases on the network side	173
4.7.3.2	Combined GPRS attach procedure for GPRS and non-GPRS services	174
4.7.3.2.1	Combined GPRS attach procedure initiation.....	175
4.7.3.2.2	GMM Common procedure initiation	175
4.7.3.2.3	Combined GPRS attach accepted by the network	175
4.7.3.2.4	Combined GPRS attach not accepted by the network	177
4.7.3.2.5	Abnormal cases in the MS.....	181
4.7.3.2.6	Abnormal cases on the network side	182
4.7.4	GPRS detach procedure	182
4.7.4.0	General	182
4.7.4.1	MS initiated GPRS detach procedure.....	183
4.7.4.1.1	MS initiated GPRS detach procedure initiation.....	183
4.7.4.1.2	MS initiated GPRS detach procedure completion for GPRS services only.....	183
4.7.4.1.3	MS initiated combined GPRS detach procedure completion.....	184
4.7.4.1.4	Abnormal cases in the MS.....	184
4.7.4.1.5	Abnormal cases on the network side	186
4.7.4.2	Network initiated GPRS detach procedure	187
4.7.4.2.1	Network initiated GPRS detach procedure initiation.....	187
4.7.4.2.2	Network initiated GPRS detach procedure completion by the MS.....	187
4.7.4.2.3	Network initiated GPRS detach procedure completion by the network	192
4.7.4.2.4	Abnormal cases on the network side	192
4.7.5	Routing area updating procedure	193
4.7.5.1	Normal and periodic routing area updating procedure	196
4.7.5.1.1	Normal and periodic routing area updating procedure initiation	197
4.7.5.1.2	GMM Common procedure initiation	198
4.7.5.1.3	Normal and periodic routing area updating procedure accepted by the network.....	199
4.7.5.1.4	Normal and periodic routing area updating procedure not accepted by the network.....	205
4.7.5.1.4a	Routing area updating procedure for initiating a PDN connection for emergency bearer services not accepted by the network (UTRAN Iu mode only).....	211
4.7.5.1.5	Abnormal cases in the MS.....	212
4.7.5.1.6	Abnormal cases on the network side	215
4.7.5.2	Combined routing area updating procedure	217
4.7.5.2.0	General	217
4.7.5.2.1	Combined routing area updating procedure initiation	217
4.7.5.2.2	GMM Common procedure initiation	219
4.7.5.2.3	Combined routing area updating procedure accepted by the network.....	219
4.7.5.2.4	Combined routing area updating not accepted by the network.....	222

4.7.5.2.5	Abnormal cases in the MS	226
4.7.5.2.6	Abnormal cases on the network side	227
4.7.6	P-TMSI reallocation procedure.....	228
4.7.6.0	General	228
4.7.6.1	P-TMSI reallocation initiation by the network.....	228
4.7.6.2	P-TMSI reallocation completion by the MS	228
4.7.6.3	P-TMSI reallocation completion by the network	228
4.7.6.3A	Abnormal cases in the MS	228
4.7.6.4	Abnormal cases on the network side.....	229
4.7.7	Authentication and ciphering procedure	230
4.7.7a	Authentication and ciphering procedure used for UMTS authentication challenge.....	230
4.7.7b	Authentication and ciphering procedure used for GSM authentication challenge	231
4.7.7c	Change of the ciphering algorithm at PS Handover	231
4.7.7.1	Authentication and ciphering initiation by the network	231
4.7.7.2	Authentication and ciphering response by the MS	233
4.7.7.3	Authentication and ciphering completion by the network.....	235
4.7.7.3a	128-bit packet-switched GSM ciphering key	236
4.7.7.3b	128-bit packet-switched GSM integrity key (in A/Gb mode and only if MS supports integrity protection)	236
4.7.7.4	GPRS ciphering key sequence number	237
4.7.7.5	Authentication not accepted by the network	238
4.7.7.5.1	Authentication not accepted by the MS	239
4.7.7.6	Abnormal cases	239
4.7.7.6.1	MS behaviour towards a network that has failed the authentication procedure.....	243
4.7.7.7	Use of established security contexts.....	244
4.7.7.8	Handling of keys at intersystem change from Iu mode to A/Gb mode	245
4.7.7.9	Handling of keys at intersystem change from A/Gb mode to Iu mode	245
4.7.7.10	Handling of keys at intersystem change from S1 mode to Iu mode or A/Gb mode.....	246
4.7.8	Identification procedure	248
4.7.8.1	Identification initiation by the network.....	248
4.7.8.2	Identification response by the MS.....	248
4.7.8.3	Identification completion by the network	248
4.7.8.3a	Abnormal cases in the MS	248
4.7.8.4	Abnormal cases on the network side.....	249
4.7.9	Paging procedure	250
4.7.9.1	Paging for GPRS services	250
4.7.9.1.1	Paging for GPRS services using P-TMSI.....	250
4.7.9.1.2	Paging for GPRS services using IMSI.....	251
4.7.9.2	Paging for non-GPRS services.....	252
4.7.10	Receiving a GMM STATUS message by a GMM entity	252
4.7.11	Void	252
4.7.12	GMM Information procedure	252
4.7.12.1	GMM information procedure initiation by the network.....	252
4.7.12.2	GMM information procedure in the mobile station	252
4.7.13	Service Request procedure (Iu mode only).....	252
4.7.13.1	Service Request procedure initiation.....	254
4.7.13.2	GMM common procedure initiation	255
4.7.13.3	Service request procedure accepted by the network.....	255
4.7.13.4	Service request procedure not accepted by the network.....	256
4.7.13.4a	Service request procedure for initiating a PDN connection for emergency bearer services not accepted by the network (UTRAN Iu mode only)	260
4.7.13.5	Abnormal cases in the MS	261
4.7.13.6	Abnormal cases on the network side.....	263
4.7.14	Void	264
4.7.15	GMM eCall inactivity procedure	264
5	Elementary procedures for circuit-switched Call Control.....	265
5.1	Overview	265
5.1.1	General.....	265
5.1.2	Call Control States	273
5.1.2.1	Call states at the mobile station side of the interface	273
5.1.2.1.1	Null (State U0)	273

5.1.2.1.2	MM Connection pending (U0.1)	273
5.1.2.1.2a	CC prompt present (U0.2) \$(CCBS)\$	273
5.1.2.1.2b	Wait for network information (U0.3) \$(CCBS)\$	273
5.1.2.1.2c	CC-Establishment present (U0.4) \$(CCBS)\$	273
5.1.2.1.2d	CC-Establishment confirmed (U0.5) \$(CCBS)\$	273
5.1.2.1.2e	Recall present (U0.6) \$(CCBS)\$	273
5.1.2.1.3	Call initiated (U1)	273
5.1.2.1.4	Mobile originating call proceeding (U3)	274
5.1.2.1.5	Call delivered (U4)	274
5.1.2.1.6	Call present (U6)	274
5.1.2.1.7	Call received (U7)	274
5.1.2.1.8	Connect Request (U8)	274
5.1.2.1.9	Mobile terminating call confirmed (U9)	274
5.1.2.1.10	Active (U10)	274
5.1.2.1.11	Disconnect request (U11)	274
5.1.2.1.12	Disconnect indication (U12)	274
5.1.2.1.13	Release request (U19)	274
5.1.2.1.14	Mobile originating modify (U26)	274
5.1.2.1.15	Mobile terminating modify (U27)	274
5.1.2.2	Network call states	275
5.1.2.2.1	Null (State N0)	275
5.1.2.2.2	MM connection pending (N0.1)	275
5.1.2.2.2a	CC connection pending (N0.2) \$(CCBS)\$	275
5.1.2.2.2b	Network answer pending (N0.3) \$(CCBS)\$	275
5.1.2.2.2c	CC-Establishment present (N0.4) \$(CCBS)\$	275
5.1.2.2.2d	CC-Establishment confirmed (N0.5) \$(CCBS)\$	275
5.1.2.2.2e	Recall present (N0.6) \$(CCBS)\$	275
5.1.2.2.3	Call initiated (N1)	275
5.1.2.2.4	Mobile originating call proceeding (N3)	275
5.1.2.2.5	Call delivered (N4)	275
5.1.2.2.6	Call present (N6)	275
5.1.2.2.7	Call received (N7)	276
5.1.2.2.8	Connect request (N8)	276
5.1.2.2.9	Mobile terminating call confirmed (N9)	276
5.1.2.2.10	Active (N10)	276
5.1.2.2.11	Not used	276
5.1.2.2.12	Disconnect indication (N12)	276
5.1.2.2.13	Release request (N19)	276
5.1.2.2.14	Mobile originating modify (N26)	276
5.1.2.2.15	Mobile terminating modify (N27)	276
5.1.2.2.16	Connect Indication (N28)	276
5.2	Call establishment procedures	276
5.2.1	Mobile originating call establishment	277
5.2.1.1	Call initiation	278
5.2.1.2	Receipt of a setup message	278
5.2.1.3	Receipt of a CALL PROCEEDING message	280
5.2.1.4	Notification of progressing mobile originated call	280
5.2.1.4.1	Notification of interworking in connection with mobile originated call establishment	280
5.2.1.4.2	Call progress in the PLMN/ISDN environment	281
5.2.1.5	Alerting	281
5.2.1.6	Call connected	281
5.2.1.7	Call rejection	282
5.2.1.8	Transit network selection	282
5.2.1.9	Traffic channel assignment at mobile originating call establishment	282
5.2.1.10	Call queuing at mobile originating call establishment	283
5.2.1.11	Speech Codec Selection	283
5.2.1.12	Cellular Text telephone Modem (CTM) selection	284
5.2.2	Mobile terminating call establishment	284
5.2.2.1	Call indication	284
5.2.2.2	Compatibility checking	285
5.2.2.3	Call confirmation	285
5.2.2.3.1	Response to SETUP	285

5.2.2.3.2	Receipt of CALL CONFIRMED and ALERTING by the network	286
5.2.2.3.3	Call failure procedures	286
5.2.2.3.4	Called mobile station clearing during mobile terminating call establishment	287
5.2.2.4	Notification of interworking in connection with mobile terminating call establishment	287
5.2.2.5	Call accept	287
5.2.2.6	Active indication	287
5.2.2.7	Traffic channel assignment at mobile terminating call establishment	288
5.2.2.8	Call queuing at mobile terminating call establishment	288
5.2.2.9	User connection attachment during a mobile terminating call	288
5.2.2.10	Speech Codec Selection	289
5.2.2.11	Cellular Text telephone Modem (CTM) selection	289
5.2.3	Network initiated MO call \$(CCBS)\$	289
5.2.3.1	Initiation	289
5.2.3.2	CC-Establishment present	289
5.2.3.2.1	Recall Alignment Procedure	290
5.2.3.3	CC-Establishment confirmation	292
5.2.3.4	Recall present	292
5.2.3.5	Traffic channel assignment during network initiated mobile originating call establishment	293
5.2.4	Call establishment for SRVCC or vSRVCC	293
5.2.4.1	General	293
5.2.4.2	Call activation for SRVCC	293
5.2.4.2a	Call activation for vSRVCC	295
5.2.4.2b	Multimedia CAT and vSRVCC handover	296
5.2.4.3	Traffic channel assignment and user connection attachment	296
5.2.4.4	State verification	296
5.3	Signalling procedures during the "active" state	296
5.3.1	User notification procedure	296
5.3.2	Call rearrangements	296
5.3.3	Codec Change Procedure	297
5.3.4	Support of Dual Services	297
5.3.4.1	Service Description	297
5.3.4.2	Call establishment	297
5.3.4.2.1	Mobile Originating Establishment	297
5.3.4.2.2	Mobile Terminating Establishment	298
5.3.4.3	Changing the Call Mode	298
5.3.4.3.1	Initiation of in-call modification	299
5.3.4.3.2	Successful completion of in-call modification	299
5.3.4.3.3	Change of the channel configuration	300
5.3.4.3.4	Failure of in-call modification	300
5.3.4.4	Abnormal procedures	301
5.3.5	User initiated service level up- and downgrading (A/Gb mode and GERAN Iu mode only)	301
5.3.5.1	Initiation of service level up- and downgrading	301
5.3.5.2	Successful completion of service level up- and downgrading	302
5.3.5.3	Rejection of service level up- and downgrading	302
5.3.5.4	Time-out recovery	302
5.3.6	Support of multimedia calls	302
5.3.6.1	Service description	302
5.3.6.2	Call establishment	303
5.3.6.2.1	Mobile originated multimedia call establishment	303
5.3.6.2.2	Mobile terminating multimedia call	304
5.3.6.2.2.1	Fallback to speech	305
5.3.6.3	In-call modification in the "active" state	305
5.3.6.3.1	Void	305
5.3.6.3.2	Void	305
5.3.6.3.3	Void	305
5.3.6.4	Multimedia CAT during the alerting phase of a mobile originated call	305
5.3.6.5	DTMF transmission during a multimedia call	306
5.3.6.6	vSRVCC handover to a circuit-switched multimedia call	306
5.4	Call clearing	306
5.4.1	Terminology	306
5.4.2	Exception conditions	307
5.4.3	Clearing initiated by the mobile station	307

5.4.3.1	Initiation of call clearing	307
5.4.3.2	Receipt of a DISCONNECT message from the mobile station.....	307
5.4.3.3	Receipt of a RELEASE message from the network.....	308
5.4.3.4	Receipt of a RELEASE COMPLETE message from the mobile station	308
5.4.3.5	Abnormal cases	308
5.4.4	Clearing initiated by the network.....	308
5.4.4.1	Clearing initiated by the network: mobile does not support "Prolonged Clearing Procedure"	308
5.4.4.1.1	Clearing when tones/announcements provided.....	308
5.4.4.1.2	Clearing when tones/announcements not provided	309
5.4.4.1.3	Completion of clearing.....	309
5.4.4.2	Clearing initiated by the network: mobile supports "Prolonged Clearing Procedure"	309
5.4.4.2.1	Clearing when tones/announcements provided and the network does not indicate that "CCBS activation is possible"	310
5.4.4.2.2	Clearing when the network indicates that "CCBS activation is possible"	310
5.4.4.2.3	Clearing when tones/announcements are not provided and the network does not indicate that "CCBS activation is possible"	311
5.4.4.2.4	Receipt of a RELEASE message from the mobile station.....	312
5.4.4.2.5	Completion of clearing	312
5.4.5	Call clearing for SRVCC from CS to PS	313
5.5	Miscellaneous procedures	313
5.5.1	In-band tones and announcements	313
5.5.2	Call collisions	313
5.5.3	Status procedures	313
5.5.3.1	Status enquiry procedure.....	313
5.5.3.2	Reception of a STATUS message by a CC entity	314
5.5.3.2.1	STATUS message with incompatible state	314
5.5.3.2.2	STATUS message with compatible state	314
5.5.4	Call re-establishment, mobile station side	314
5.5.4.1	Indication from the mobility management sublayer.....	315
5.5.4.2	Reaction of call control	315
5.5.4.3	Completion of re-establishment	315
5.5.4.4	Unsuccessful outcome.....	315
5.5.5	Call re-establishment, network side.....	315
5.5.5.1	State alignment.....	315
5.5.6	Progress	315
5.5.7	DTMF protocol control procedure.....	316
5.5.7.1	Start DTMF request by the mobile station	316
5.5.7.2	Start DTMF response by the network	316
5.5.7.3	Stop DTMF request by the mobile station	316
5.5.7.4	Stop DTMF response by the network.....	317
5.5.7.5	Sequencing of subsequent start DTMF requests by the mobile station.....	317
6	Support for packet services	318
6.1	GPRS Session management	318
6.1.1	General.....	318
6.1.2	Session management states.....	318
6.1.2.1	Session management states in the MS.....	318
6.1.2.1.1	PDP-INACTIVE.....	318
6.1.2.1.2	PDP-ACTIVE-PENDING	318
6.1.2.1.3	PDP-INACTIVE-PENDING	318
6.1.2.1.4	PDP-ACTIVE.....	319
6.1.2.1.5	PDP-MODIFY_PENDING	319
6.1.2.1.6	MBMS-ACTIVE-PENDING	319
6.1.2.1.7	MBMS-ACTIVE	319
6.1.2.2	Session management states on the network side	320
6.1.2.2.1	PDP-INACTIVE.....	320
6.1.2.2.2	PDP-ACTIVE-PENDING	320
6.1.2.2.3	PDP-INACTIVE-PENDING	320
6.1.2.2.4	PDP-ACTIVE.....	320
6.1.2.2.5	PDP-MODIFY-PENDING	320
6.1.2.2.6	MBMS-ACTIVE-PENDING	321
6.1.2.2.7	MBMS-INACTIVE-PENDING	321

6.1.2.2.8	MBMS-ACTIVE	321
6.1.2A	PDP address allocation	322
6.1.2A.1	General	322
6.1.2A.1.1	Interworking with PDN based on IP	322
6.1.2A.1.2	Interworking with PDN based on PPP	322
6.1.2A.2	IP address allocation via NAS signalling	323
6.1.3	Session Management procedures	323
6.1.3.0	General	323
6.1.3.1	PDP context activation	323
6.1.3.1.1	Successful PDP context activation initiated by the mobile station	324
6.1.3.1.2	Successful PDP context activation requested by the network	327
6.1.3.1.3	Unsuccessful PDP context activation initiated by the MS	327
6.1.3.1.3.1	General	327
6.1.3.1.3.2	Handling of network rejection due to SM cause #26	328
6.1.3.1.3.3	Handling of network rejection due to SM cause other than SM cause #26	330
6.1.3.1.3A	Void	333
6.1.3.1.4	Unsuccessful PDP context activation requested by the network	333
6.1.3.1.5	Abnormal cases	333
6.1.3.1.6	Handling Activate PDP context request for MS configured for dual priority	335
6.1.3.2	Secondary PDP Context Activation Procedure	336
6.1.3.2.1	Successful Secondary PDP Context Activation Procedure Initiated by the MS	336
6.1.3.2.1a	Successful Secondary PDP Context Activation Procedure Requested by the network	337
6.1.3.2.2	Unsuccessful Secondary PDP Context Activation Procedure initiated by the MS	338
6.1.3.2.2.1	General	338
6.1.3.2.2.2	Handling of network rejection due to SM cause #26	338
6.1.3.2.2.3	Handling of network rejection due to SM cause other than SM cause #26	340
6.1.3.2.2a	Unsuccessful secondary PDP context activation requested by the network	341
6.1.3.2.3	Abnormal cases	342
6.1.3.3	PDP context modification procedure	345
6.1.3.3.1	Network initiated PDP Context Modification	346
6.1.3.3.2	MS initiated PDP Context Modification accepted by the network	347
6.1.3.3.3	MS initiated PDP Context Modification not accepted by the network	348
6.1.3.3.3.1	General	348
6.1.3.3.3.2	Handling of network rejection due to SM cause #26	349
6.1.3.3.3.3	Handling of network rejection due to SM cause other than SM cause #26	350
6.1.3.3.3a	Network initiated PDP Context Modification not accepted by the MS	352
6.1.3.3.4	Abnormal cases	352
6.1.3.4	PDP context deactivation procedure	357
6.1.3.4.1	PDP context deactivation initiated by the MS	357
6.1.3.4.2	PDP context deactivation initiated by the network	358
6.1.3.4.3	Abnormal cases	360
6.1.3.4a	Void	361
6.1.3.5	Void	361
6.1.3.5a	Notification procedure	361
6.1.3.5a.1	General	361
6.1.3.5a.2	Notification procedure initiation by the network	361
6.1.3.5a.3	Notification procedure in the MS	362
6.1.3.6	Receiving a SM STATUS message by a SM entity	362
6.1.3.7	Protocol configuration options	363
6.1.3.8	MBMS context activation	363
6.1.3.8.1	Successful MBMS context activation	364
6.1.3.8.2	Unsuccessful MBMS context activation requested by the MS	364
6.1.3.8.2.1	General	364
6.1.3.8.2.2	Handling of network rejection due to SM cause #26	364
6.1.3.8.2.3	Handling of network rejection due to SM cause other than SM cause #26	365
6.1.3.8.3	Unsuccessful MBMS context activation requested by the network	366
6.1.3.8.4	Abnormal cases	367
6.1.3.9	MBMS context deactivation	367
6.1.3.9.1	MBMS context deactivation initiated by the network	368
6.1.3.9.2	Abnormal cases	368
6.1.3.10	MBMS protocol configuration options	368
6.1.3.11	Handling of APN based congestion control	368

6.1.3.11A	Handling of group specific session management congestion control.....	369
6.1.3.12	Handling session management request for MS configured for dual priority.....	369
6.1.3.13	Handling of network rejection not due to APN based congestion control	370
6.1.3.14	Handling of WLAN offload control.....	370
6.2	void.....	370
6.3	Coordination between SM and GMM for supporting ISR	370
6.4	MSISDN notification procedure.....	371
7	Examples of structured procedures	371
8	Handling of unknown, unforeseen, and erroneous protocol data	371
8.1	General	371
8.2	Message too short.....	372
8.3	Unknown or unforeseen transaction identifier	372
8.3.1	Call Control	372
8.3.2	Session Management	373
8.4	Unknown or unforeseen message type	374
8.5	Non-semantic mandatory information element errors	374
8.5.1	Radio resource management.....	375
8.5.2	Mobility management.....	375
8.5.3	Call control	375
8.5.4	GMM mobility management.....	375
8.5.5	Session management.....	375
8.6	Unknown and unforeseen IEs in the non-imperative message part.....	376
8.6.1	IEs unknown in the message	376
8.6.2	Out of sequence IEs	376
8.6.3	Repeated IEs	376
8.7	Non-imperative message part errors.....	376
8.7.1	Syntactically incorrect optional IEs	376
8.7.2	Conditional IE errors	376
8.8	Messages with semantically incorrect contents.....	377
9	Message functional definitions and contents.....	377
9.1	Messages for Radio Resources management.....	378
9.2	Messages for mobility management	378
9.2.1	Authentication reject.....	379
9.2.2	Authentication request	380
9.2.2.1	Authentication Parameter AUTN.....	380
9.2.3	Authentication response.....	380
9.2.3.1	Authentication Response Parameter.....	381
9.2.3.2	Authentication Response Parameter (extension).....	381
9.2.3a	Authentication Failure	381
9.2.3a.1	Authentication Failure parameter.....	381
9.2.4	CM Re-establishment request	382
9.2.4.1	Location area identification.....	382
9.2.4.2	Mobile Station Classmark	382
9.2.4.3	Device properties	382
9.2.5	CM service accept.....	382
9.2.5a	CM service prompt \$(CCBS)\$.....	383
9.2.6	CM service reject.....	383
9.2.6.1	T3246 value.....	384
9.2.7	CM service abort.....	384
9.2.8	Abort.....	384
9.2.9	CM service request	385
9.2.9.1	Mobile Station Classmark	385
9.2.9.2	Priority	385
9.2.9.3	Additional update parameters.....	385
9.2.9.4	Device properties	386
9.2.10	Identity request	386
9.2.11	Identity response.....	386
9.2.12	IMSI detach indication.....	387
9.2.12.1	Mobile Station Classmark	387
9.2.13	Location updating accept	387

9.2.13.1	Follow on proceed.....	388
9.2.13.2	CTS permission.....	388
9.2.13.3	Equivalent PLMNs.....	388
9.2.13.4	Emergency Number List.....	388
9.2.13.5	Per MS T3212.....	388
9.2.13.6	Non-3GPP NW provided policies.....	388
9.2.14	Location updating reject.....	389
9.2.14.1	T3246 value.....	389
9.2.15	Location updating request.....	389
9.2.15.1	Location area identification.....	390
9.2.15.2	Mobile Station Classmark.....	390
9.2.15.3	Mobile Station Classmark for Iu mode.....	390
9.2.15.4	Additional update parameters.....	390
9.2.15.5	Device properties.....	390
9.2.15.6	MS network feature support.....	390
9.2.15a	MM information.....	391
9.2.15a.1	Full name for network.....	391
9.2.15a.2	Short name for network.....	391
9.2.15a.3	Local time zone.....	391
9.2.15a.4	Universal time and local time zone.....	391
9.2.15a.5	LSA Identity.....	392
9.2.15a.6	Network Daylight Saving Time.....	392
9.2.16	MM Status.....	392
9.2.17	TMSI reallocation command.....	392
9.2.18	TMSI reallocation complete.....	393
9.2.19	MM Null.....	393
9.3	Messages for circuit-switched call control.....	394
9.3.1	Alerting.....	394
9.3.1.1	Alerting (network to mobile station direction).....	394
9.3.1.1.1	Facility.....	395
9.3.1.1.2	Progress indicator.....	395
9.3.1.1.3	User-user.....	395
9.3.1.2	Alerting (mobile station to network direction).....	395
9.3.1.2.1	Facility.....	396
9.3.1.2.2	User-user.....	396
9.3.1.2.3	SS version.....	396
9.3.2	Call confirmed.....	396
9.3.2.1	Repeat indicator.....	397
9.3.2.2	Bearer capability 1 and bearer capability 2.....	397
9.3.2.3	Cause.....	398
9.3.2.4	CC Capabilities.....	398
9.3.2.5	Stream Identifier.....	398
9.3.2.6	Supported Codecs.....	398
9.3.3	Call proceeding.....	398
9.3.3.1	Repeat indicator.....	398
9.3.3.2	Bearer capability 1 and bearer capability 2.....	399
9.3.3.3	Facility.....	399
9.3.3.4	Progress Indicator.....	399
9.3.3.5	Priority granted.....	399
9.3.3.6	Network Call Control Capabilities.....	399
9.3.4	Congestion control.....	399
9.3.4.1	Cause.....	400
9.3.5	Connect.....	400
9.3.5.1	Connect (network to mobile station direction).....	400
9.3.5.1.1	Facility.....	400
9.3.5.1.2	Progress indicator.....	400
9.3.5.1.3	User-user.....	400
9.3.5.2	Connect (mobile station to network direction).....	400
9.3.5.2.1	Facility.....	401
9.3.5.2.2	User-user.....	401
9.3.5.2.3	SS version.....	401
9.3.5.2.4	Stream Identifier.....	401

9.3.6	Connect acknowledge	401
9.3.7	Disconnect	402
9.3.7.1	Disconnect (network to mobile station direction)	402
9.3.7.1.1	Facility	402
9.3.7.1.2	Progress indicator	402
9.3.7.1.3	User-user	402
9.3.7.1.4	Allowed actions \$(CCBS)\$	402
9.3.7.2	Disconnect (mobile station to network direction)	403
9.3.7.2.1	Facility	403
9.3.7.2.2	User-user	403
9.3.7.2.3	SS version	403
9.3.8	Emergency setup	403
9.3.8.1	Bearer capability	404
9.3.8.2	Stream Identifier	404
9.3.8.3	Supported Codecs	404
9.3.8.4	Emergency category	404
9.3.9	Facility	404
9.3.9.1	Facility (network to mobile station direction)	404
9.3.9.2	Facility (mobile station to network direction)	405
9.3.9.2.1	SS version	405
9.3.10	Hold	406
9.3.11	Hold Acknowledge	406
9.3.12	Hold Reject	406
9.3.13	Modify	407
9.3.13.1	Low layer compatibility	407
9.3.13.2	High layer compatibility	407
9.3.13.3	Reverse call setup direction	407
9.3.13.4	Void	408
9.3.13.5	Network-initiated Service Upgrade indicator	408
9.3.14	Modify complete	408
9.3.14.1	Low layer compatibility	408
9.3.14.2	High layer compatibility	408
9.3.14.3	Reverse call setup direction	408
9.3.15	Modify reject	408
9.3.15.1	Low layer compatibility	409
9.3.15.2	High layer compatibility	409
9.3.16	Notify	409
9.3.17	Progress	409
9.3.17.1	User-user	410
9.3.17.2	Progress indicator	410
9.3.17a	CC-Establishment \$(CCBS)\$	410
9.3.17a.1	Void	411
9.3.17a.2	Setup container	411
9.3.17b	CC-Establishment confirmed \$(CCBS)\$	411
9.3.17b.1	Repeat indicator	411
9.3.17b.2	Bearer capability 1 and bearer capability 2	412
9.3.17b.3	Cause	412
9.3.17b.4	Supported Codecs	412
9.3.18	Release	412
9.3.18.1	Release (network to mobile station direction)	412
9.3.18.1.1	Cause	412
9.3.18.1.2	Second cause	412
9.3.18.1.3	Facility	413
9.3.18.1.4	User-user	413
9.3.18.2	Release (mobile station to network direction)	413
9.3.18.2.1	Cause	413
9.3.18.2.2	Second cause	413
9.3.18.2.3	Facility	413
9.3.18.2.4	User-user	414
9.3.18.2.5	SS version	414
9.3.18a	Recall \$(CCBS)\$	414
9.3.18a.1	Recall Type	414

9.3.18a.2	Facility	414
9.3.19	Release complete	414
9.3.19.1	Release complete (network to mobile station direction)	414
9.3.19.1.1	Cause	415
9.3.19.1.2	Facility	415
9.3.19.1.3	User-user	415
9.3.19.2	Release complete (mobile station to network direction)	415
9.3.19.2.1	Cause	416
9.3.19.2.2	Facility	416
9.3.19.2.3	User-user	416
9.3.19.2.4	SS version	416
9.3.20	Retrieve	416
9.3.21	Retrieve Acknowledge	417
9.3.22	Retrieve Reject	417
9.3.23	Setup	418
9.3.23.1	Setup (mobile terminated call establishment)	418
9.3.23.1.1	BC repeat indicator	419
9.3.23.1.2	Bearer capability 1 and bearer capability 2	420
9.3.23.1.3	Facility	420
9.3.23.1.4	Progress indicator	420
9.3.23.1.4a	Called party BCD number	420
9.3.23.1.5	Called party subaddress	420
9.3.23.1.6	LLC repeat indicator	420
9.3.23.1.7	Low layer compatibility I	420
9.3.23.1.8	Low layer compatibility II	420
9.3.23.1.9	HLC repeat indicator	420
9.3.23.1.10	High layer compatibility i	420
9.3.23.1.11	High layer compatibility ii	421
9.3.23.1.12	User-user	421
9.3.23.1.13	Redirecting party BCD number	421
9.3.23.1.14	Redirecting party subaddress	421
9.3.23.1.15	Priority	421
9.3.23.1.16	Alert \$(Network Indication of Alerting in the MS)\$	421
9.3.23.1.17	Network Call Control Capabilities	421
9.3.23.1.18	Cause of No CLI	421
9.3.23.1.19	Backup bearer capability	421
9.3.23.2	Setup (mobile originating call establishment)	421
9.3.23.2.1	BC repeat indicator	422
9.3.23.2.2	Facility	423
9.3.23.2.3	LLC repeat indicator	423
9.3.23.2.4	Low layer compatibility I	423
9.3.23.2.5	Low layer compatibility II	423
9.3.23.2.6	HLC repeat indicator	423
9.3.23.2.7	High layer compatibility i	423
9.3.23.2.8	High layer compatibility ii	423
9.3.23.2.9	User-user	423
9.3.23.2.10	SS version	423
9.3.23.2.11	CLIR suppression	423
9.3.23.2.12	CLIR invocation	424
9.3.23.2.13	CC Capabilities	424
9.3.23.2.14	Stream Identifier	424
9.3.23.2.15	Bearer capability 1 and bearer capability 2	424
9.3.23.2.16	Supported Codecs	424
9.3.23.2.17	Redial	424
9.3.23a	Start CC \$(CCBS)\$	424
9.3.23a.1	CC Capabilities	424
9.3.24	Start DTMF	425
9.3.25	Start DTMF Acknowledge	425
9.3.25.1	Keypad facility	425
9.3.26	Start DTMF reject	425
9.3.27	Status	426
9.3.27.1	Auxiliary states	426

9.3.28	Status enquiry	426
9.3.29	Stop DTMF.....	427
9.3.30	Stop DTMF acknowledge.....	427
9.3.31	User information.....	428
9.3.31.1	User-user	428
9.3.31.2	More data	428
9.4	GPRS Mobility Management Messages.....	428
9.4.1	Attach request	428
9.4.1.1	Old P-TMSI signature.....	430
9.4.1.2	Requested READY timer value	430
9.4.1.3	TMSI status	430
9.4.1.4	PS LCS Capability	430
9.4.1.5	UE network capability.....	430
9.4.1.6	Mobile station classmark 2.....	430
9.4.1.7	Mobile station classmark 3.....	430
9.4.1.8	Supported Codexs	430
9.4.1.9	Additional mobile identity	430
9.4.1.10	Additional old routing area identification	430
9.4.1.11	Voice domain preference and UE's usage setting.....	430
9.4.1.12	Device properties	431
9.4.1.13	P-TMSI type.....	431
9.4.1.14	MS network feature support.....	431
9.4.1.15	Old location area identification	431
9.4.1.16	Additional update type	431
9.4.1.17	TMSI based NRI container	431
9.4.1.18	T3324 value.....	431
9.4.1.19	T3312 extended value	431
9.4.1.20	Extended DRX parameters.....	431
9.4.2	Attach accept	431
9.4.2.1	P-TMSI signature.....	434
9.4.2.2	Negotiated READY timer value	434
9.4.2.3	Allocated P-TMSI.....	434
9.4.2.4	MS identity.....	434
9.4.2.5	GMM cause.....	434
9.4.2.6	T3302 value.....	434
9.4.2.7	Cell Notification (A/Gb mode only)	434
9.4.2.8	Equivalent PLMNs.....	434
9.4.2.9	Network feature support.....	434
9.4.2.10	Emergency Number List	434
9.4.2.11	Requested MS Information	434
9.4.2.12	T3319 value.....	434
9.4.2.13	T3323 value.....	434
9.4.2.14	T3312 extended value	435
9.4.2.15	Additional network feature support.....	435
9.4.2.16	T3324 value.....	435
9.4.2.17	Extended DRX parameters.....	435
9.4.2.18	User Plane integrity indicator.....	435
9.4.2.19	Replayed MS network capability	435
9.4.2.20	Replayed MS radio access capability	435
9.4.2.21	DCN-ID.....	435
9.4.2.22	PLMN identity of the CN operator	435
9.4.2.23	Non-3GPP NW provided policies	435
9.4.3	Attach complete	435
9.4.3.1	Inter RAT handover information.....	436
9.4.3.2	E-UTRAN inter RAT handover information	436
9.4.4	Attach reject.....	436
9.4.4.1	T3302 value.....	436
9.4.4.2	T3346 value.....	437
9.4.5	Detach request	437
9.4.5.1	Detach request (mobile terminated detach).....	437
9.4.5.1.1	GMM cause.....	437
9.4.5.2	Detach request (mobile originating detach)	437

9.4.5.2.1	P-TMSI.....	438
9.4.5.2.2	P-TMSI signature	438
9.4.6	Detach accept.....	438
9.4.6.1	Detach accept (mobile terminated detach)	438
9.4.6.2	Detach accept (mobile originating detach).....	438
9.4.7	P-TMSI reallocation command.....	439
9.4.7.1	P-TMSI signature.....	439
9.4.7.2	DCN-ID.....	439
9.4.8	P-TMSI reallocation complete.....	439
9.4.9	Authentication and ciphering request	440
9.4.9.1	Authentication Parameter RAND.....	440
9.4.9.2	GPRS ciphering key sequence number	441
9.4.9.3	Authentication Parameter AUTN.....	441
9.4.9.4	Replayed MS network capability	441
9.4.9.5	Integrity algorithm	441
9.4.9.6	Message authentication code.....	441
9.4.9.7	Replayed MS Radio Access Capability.....	441
9.4.10	Authentication and ciphering response	441
9.4.10.1	Authentication Response Parameter.....	442
9.4.10.2	IMEISV	442
9.4.10.3	Authentication Response Parameter (extension).....	442
9.4.10.4	Message authentication code.....	442
9.4.10a	Authentication and Ciphering Failure	442
9.4.10a.1	Authentication Failure parameter.....	443
9.4.11	Authentication and ciphering reject.....	443
9.4.12	Identity request	443
9.4.13	Identity response.....	444
9.4.14	Routing area update request.....	444
9.4.14.1	Old P-TMSI signature	447
9.4.14.2	Requested READY timer value	447
9.4.14.3	DRX parameter	447
9.4.14.4	TMSI status	447
9.4.14.5	P-TMSI (Iu mode only).....	447
9.4.14.6	MS network capability	447
9.4.14.7	PDP context status	447
9.4.14.8	PS LCS Capability	447
9.4.14.9	MBMS context status	447
9.4.14.10	Additional mobile identity	447
9.4.14.11	Additional old routing area identification	447
9.4.14.12	UE network capability.....	447
9.4.14.13	Mobile station classmark 2.....	447
9.4.14.14	Mobile station classmark 3.....	448
9.4.14.15	Supported Codecs	448
9.4.14.16	Voice domain preference and UE's usage setting.....	448
9.4.14.17	P-TMSI type.....	448
9.4.14.18	Device properties	448
9.4.14.19	MS network feature support.....	448
9.4.14.20	Old location area identification	448
9.4.14.21	Additional update type	448
9.4.14.22	TMSI based NRI container	448
9.4.14.23	T3324 value.....	448
9.4.14.24	T3312 extended value	448
9.4.14.25	Extended DRX parameters.....	448
9.4.15	Routing area update accept	449
9.4.15.1	P-TMSI signature.....	452
9.4.15.2	Allocated P-TMSI.....	452
9.4.15.3	MS identity.....	452
9.4.15.4	List of Receive N-PDU Numbers.....	452
9.4.15.5	Negotiated READY timer value	452
9.4.15.6	GMM cause.....	452
9.4.15.7	T3302 value.....	452
9.4.15.8	Cell Notification (A/Gb mode only)	452

9.4.15.9	Equivalent PLMNs.....	452
9.4.15.10	PDP context status	452
9.4.15.11	Network feature support.....	453
9.4.15.12	Emergency Number List	453
9.4.15.13	MBMS context status	453
9.4.15.14	Requested MS Information	453
9.4.15.15	T3319 value.....	453
9.4.15.16	T3323 value.....	453
9.4.15.17	T3312 extended value	453
9.4.15.18	Additional network feature support.....	453
9.4.15.19	T3324 value.....	453
9.4.15.20	Extended DRX parameters.....	453
9.4.15.21	User Plane integrity indicator.....	453
9.4.15.22	Replayed MS network capability	454
9.4.15.23	Replayed MS Radio Access Capability.....	454
9.4.15.24	DCN-ID.....	454
9.4.15.25	PLMN identity of the CN operator	454
9.4.15.26	Non-3GPP NW provided policies	454
9.4.16	Routing area update complete.....	454
9.4.16.1	List of Receive N-PDU Numbers.....	455
9.4.16.2	Inter RAT handover information.....	455
9.4.16.3	E-UTRAN inter RAT handover information	455
9.4.17	Routing area update reject	455
9.4.17.1	T3302 value.....	455
9.4.17.2	T3346 value.....	455
9.4.18	GMM Status.....	456
9.4.19	GMM Information	456
9.4.19.1	Full name for network.....	456
9.4.19.2	Short name for network.....	457
9.4.19.3	Local time zone	457
9.4.19.4	Universal time and local time zone	457
9.4.19.5	LSA Identity.....	457
9.4.19.6	Network Daylight Saving Time	457
9.4.20	Service Request (Iu mode only).....	457
9.4.20.1	PDP context status	458
9.4.20.2	MBMS context status	458
9.4.20.3	Uplink data status.....	458
9.4.20.4	Device properties	458
9.4.21	Service Accept (Iu mode only)	458
9.4.21.1	PDP context status	459
9.4.21.2	MBMS context status	459
9.4.22	Service Reject (Iu mode only)	459
9.4.22.1	T3346 value.....	459
9.5	GPRS Session Management Messages.....	459
9.5.1	Activate PDP context request	459
9.5.1.1	Access point name.....	460
9.5.1.2	Protocol configuration options	460
9.5.1.3	Request type	460
9.5.1.4	Device properties	460
9.5.1.5	NBIFOM container	461
9.5.1.6	Extended protocol configuration options	461
9.5.1.7	Extended QoS	461
9.5.2	Activate PDP context accept.....	461
9.5.2.1	PDP address	462
9.5.2.2	Protocol configuration options	462
9.5.2.3	Packet Flow Identifier	462
9.5.2.4	SM cause	463
9.5.2.5	Connectivity type	463
9.5.2.6	WLAN offload indication	463
9.5.2.7	NBIFOM container	463
9.5.2.8	Extended protocol configuration options	463
9.5.2.9	Extended QoS	463

9.5.3	Activate PDP context reject	463
9.5.3.1	Protocol configuration options	464
9.5.3.2	Back-off timer value	464
9.5.3.3	Re-attempt indicator	464
9.5.3.4	NBIFOM container	464
9.5.3.5	Extended protocol configuration options	464
9.5.4	Activate Secondary PDP Context Request	464
9.5.4.1	TFT	465
9.5.4.2	Protocol configuration options	465
9.5.4.3	Device properties	465
9.5.4.4	NBIFOM container	465
9.5.4.5	Extended protocol configuration options	465
9.5.4.6	Extended QoS	466
9.5.5	Activate Secondary PDP Context Accept	466
9.5.5.1	Packet Flow Identifier	466
9.5.5.2	Protocol configuration options	466
9.5.5.3	WLAN offload indication	467
9.5.5.4	NBIFOM container	467
9.5.5.5	Extended protocol configuration options	467
9.5.5.6	Extended QoS	467
9.5.6	Activate Secondary PDP Context Reject	467
9.5.6.1	Protocol configuration options	467
9.5.6.2	Back-off timer value	468
9.5.6.3	Re-attempt indicator	468
9.5.6.4	NBIFOM container	468
9.5.6.5	Extended protocol configuration options	468
9.5.7	Request PDP context activation	468
9.5.7.1	Protocol configuration options	468
9.5.7.2	NBIFOM container	469
9.5.7.3	Extended protocol configuration options	469
9.5.8	Request PDP context activation reject	469
9.5.8.1	Protocol configuration options	469
9.5.8.2	NBIFOM container	469
9.5.8.3	Extended protocol configuration options	469
9.5.9	Modify PDP context request (Network to MS direction)	470
9.5.9.1	PDP address	470
9.5.9.2	Packet Flow Identifier	470
9.5.9.3	Protocol configuration options	471
9.5.9.4	TFT	471
9.5.9.5	WLAN offload indication	471
9.5.9.6	NBIFOM container	471
9.5.9.7	Extended protocol configuration options	471
9.5.9.8	Extended QoS	471
9.5.10	Modify PDP context request (MS to network direction)	471
9.5.10.1	Requested LLC SAPI	472
9.5.10.2	Requested new QoS	472
9.5.10.3	New TFT	472
9.5.10.4	Protocol configuration options	472
9.5.10.5	Device properties	472
9.5.10.6	NBIFOM container	472
9.5.10.7	Extended protocol configuration options	473
9.5.10.8	Extended QoS	473
9.5.11	Modify PDP context accept (MS to network direction)	473
9.5.11.1	Protocol configuration options	473
9.5.11.2	NBIFOM container	473
9.5.11.3	Extended protocol configuration options	473
9.5.12	Modify PDP context accept (Network to MS direction)	474
9.5.12.1	Negotiated QoS	474
9.5.12.2	Negotiated LLC SAPI	474
9.5.12.3	New radio priority	474
9.5.12.4	Packet Flow Identifier	474
9.5.12.5	Protocol configuration options	475

9.5.12.6	WLAN offload indication	475
9.5.12.7	NBIFOM container	475
9.5.12.8	Extended protocol configuration options	475
9.5.12.9	Extended QoS	475
9.5.13	Modify PDP Context Reject	475
9.5.13.1	Protocol configuration options	476
9.5.13.2	Back-off timer value	476
9.5.13.3	Re-attempt indicator	476
9.5.13.4	NBIFOM container	476
9.5.13.5	Extended protocol configuration options	476
9.5.14	Deactivate PDP context request	476
9.5.14.1	Tear down indicator	477
9.5.14.2	Protocol configuration options	477
9.5.14.3	MBMS protocol configuration options	477
9.5.14.4	T3396 value	477
9.5.14.5	WLAN offload indication	477
9.5.14.6	Void	477
9.5.14.7	Extended protocol configuration options	477
9.5.15	Deactivate PDP context accept	477
9.5.15.1	Protocol configuration options	478
9.5.15.2	MBMS protocol configuration options	478
9.5.15.3	Void	478
9.5.15.4	Extended protocol configuration options	478
9.5.15a	Request Secondary PDP Context Activation	478
9.5.15a.1	TFT	479
9.5.15a.2	Protocol configuration options	479
9.5.15a.3	WLAN offload indication	479
9.5.15a.4	NBIFOM container	479
9.5.15a.5	Extended protocol configuration options	479
9.5.15a.6	Extended QoS	479
9.5.15b	Request Secondary PDP Context Activation Reject	480
9.5.15b.1	Protocol configuration options	480
9.5.15b.2	NBIFOM container	480
9.5.15b.3	Extended protocol configuration options	480
9.5.16	Void	480
9.5.16a	Notification	480
9.5.17	Void	481
9.5.18	Void	481
9.5.19	Void	481
9.5.20	Void	481
9.5.21	SM Status	481
9.5.22	Activate MBMS Context Request	481
9.5.22.1	MBMS protocol configuration options	482
9.5.22.2	Device properties	482
9.5.23	Activate MBMS Context Accept	482
9.5.23.1	MBMS protocol configuration options	483
9.5.24	Activate MBMS Context Reject	483
9.5.24.1	MBMS protocol configuration options	483
9.5.24.2	Back-off timer value	483
9.5.24.3	Re-attempt indicator	483
9.5.25	Request MBMS Context Activation	483
9.5.25.1	Linked NSAPI	484
9.5.25.2	MBMS protocol configuration options	484
9.5.26	Request MBMS Context Activation Reject	484
9.5.26.1	MBMS protocol configuration options	484
10	General message format and information elements coding	485
10.1	Overview	485
10.2	Protocol Discriminator	485
10.3	Skip indicator and transaction identifier	485
10.3.1	Skip indicator	485
10.3.2	Transaction identifier	487

10.4	Message Type.....	487
10.5	Other information elements.....	490
10.5.1	Common information elements.....	491
10.5.1.1	Cell identity.....	491
10.5.1.2	Ciphering Key Sequence Number.....	492
10.5.1.3	Location Area Identification.....	492
10.5.1.4	Mobile Identity.....	494
10.5.1.5	Mobile Station Classmark 1.....	499
10.5.1.6	Mobile Station Classmark 2.....	502
10.5.1.7	Mobile Station Classmark 3.....	505
10.5.1.8	Spare Half Octet.....	521
10.5.1.9	Descriptive group or broadcast call reference.....	521
10.5.1.10	Group Cipher Key Number.....	522
10.5.1.10a	PD and SAPI \$(CCBS)\$.....	523
10.5.1.11	Priority Level.....	524
10.5.1.12	Core Network System Information (Iu mode only).....	524
10.5.1.12.1	CN Common GSM-MAP NAS system information.....	524
10.5.1.12.2	CS domain specific system information.....	525
10.5.1.12.3	PS domain specific system information.....	525
10.5.1.13	PLMN list.....	526
10.5.1.14	NAS container for PS HO.....	527
10.5.1.15	MS network feature support.....	528
10.5.2	Radio Resource management information elements.....	529
10.5.3	Mobility management information elements.....	529
10.5.3.1	Authentication parameter RAND.....	529
10.5.3.1.1	Authentication Parameter AUTN (UMTS and EPS authentication challenge).....	529
10.5.3.2	Authentication Response parameter.....	530
10.5.3.2.1	Authentication Response Parameter (extension) (UMTS authentication challenge only).....	531
10.5.3.2.2	Authentication Failure parameter (UMTS and EPS authentication challenge).....	531
10.5.3.3	CM service type.....	532
10.5.3.4	Identity type.....	532
10.5.3.5	Location updating type.....	533
10.5.3.5a	Network Name.....	533
10.5.3.6	Reject cause.....	535
10.5.3.7	Follow-on Proceed.....	536
10.5.3.8	Time Zone.....	536
10.5.3.9	Time Zone and Time.....	537
10.5.3.10	CTS permission.....	538
10.5.3.11	LSA Identifier.....	539
10.5.3.12	Daylight Saving Time.....	539
10.5.3.13	Emergency Number List.....	540
10.5.3.14	Additional update parameters.....	541
10.5.3.15	Void.....	541
10.5.3.16	MM Timer.....	541
10.5.4	Call control information elements.....	542
10.5.4.1	Extensions of codesets.....	542
10.5.4.2	Locking shift procedure.....	543
10.5.4.3	Non-locking shift procedure.....	543
10.5.4.4	Auxiliary states.....	544
10.5.4.4a	Backup bearer capability.....	545
10.5.4.4a.1	Static conditions for the backup bearer capability IE contents.....	554
10.5.4.5	Bearer capability.....	554
10.5.4.5.1	Static conditions for the bearer capability IE contents.....	569
10.5.4.5a	Call Control Capabilities.....	569
10.5.4.6	Call state.....	570
10.5.4.7	Called party BCD number.....	571
10.5.4.8	Called party subaddress.....	573
10.5.4.9	Calling party BCD number.....	574
10.5.4.10	Calling party subaddress.....	575
10.5.4.11	Cause.....	576
10.5.4.11a	CLIR suppression.....	581
10.5.4.11b	CLIR invocation.....	582

10.5.4.12	Congestion level.....	582
10.5.4.13	Connected number	582
10.5.4.14	Connected subaddress	583
10.5.4.15	Facility	583
10.5.4.16	High layer compatibility	584
10.5.4.16.1	Static conditions for the high layer compatibility IE contents.....	585
10.5.4.17	Keypad facility	585
10.5.4.18	Low layer compatibility	585
10.5.4.19	More data	585
10.5.4.20	Notification indicator	586
10.5.4.21	Progress indicator.....	586
10.5.4.21a	Recall type \$(CCBS)\$	587
10.5.4.21b	Redirecting party BCD number.....	588
10.5.4.21c	Redirecting party subaddress.....	588
10.5.4.22	Repeat indicator	589
10.5.4.22a	Reverse call setup direction.....	589
10.5.4.22b	SETUP Container \$(CCBS)\$.....	590
10.5.4.23	Signal	590
10.5.4.24	SS Version Indicator	591
10.5.4.25	User-user	591
10.5.4.26	Alerting Pattern \$(NIA)\$	592
10.5.4.27	Allowed actions \$(CCBS)\$.....	593
10.5.4.28	Stream Identifier	594
10.5.4.29	Network Call Control Capabilities.....	594
10.5.4.30	Cause of No CLI	595
10.5.4.31	Void.....	595
10.5.4.32	Supported codec list	595
10.5.4.33	Service category	596
10.5.4.34	Redial	597
10.5.4.35	Network-initiated Service Upgrade indicator.....	597
10.5.5	GPRS mobility management information elements.....	598
10.5.5.0	Additional update type	598
10.5.5.1	Attach result	598
10.5.5.2	Attach type	598
10.5.5.3	Ciphering algorithm	599
10.5.5.3a	Integrity algorithm	600
10.5.5.4	TMSI status	600
10.5.5.5	Detach type	601
10.5.5.6	DRX parameter	601
10.5.5.7	Force to standby	603
10.5.5.8	P-TMSI signature.....	604
10.5.5.8a	P-TMSI signature 2.....	604
10.5.5.9	Identity type 2	605
10.5.5.10	IMEISV request	605
10.5.5.11	Receive N-PDU Numbers list	606
10.5.5.12	MS network capability	607
10.5.5.12a	MS Radio Access capability	612
10.5.5.13	Spare	631
10.5.5.14	GMM cause.....	631
10.5.5.15	Routing area identification	632
10.5.5.15a	Routing area identification 2	634
10.5.5.16	Spare	634
10.5.5.17	Update result	634
10.5.5.18	Update type	635
10.5.5.19	A&C reference number	636
10.5.5.20	Service type.....	636
10.5.5.21	Cell Notification.....	637
10.5.5.22	PS LCS Capability	637
10.5.5.23	Network feature support.....	639
10.5.5.23A	Additional network feature support.....	639
10.5.5.24	Inter RAT information container.....	640
10.5.5.25	Requested MS information	641

10.5.5.26	UE network capability.....	641
10.5.5.27	E-UTRAN inter RAT information container	641
10.5.5.28	Voice domain preference and UE's usage setting.....	642
10.5.5.29	P-TMSI type.....	643
10.5.5.30	Location Area Identification 2	643
10.5.5.31	Network resource identifier container	643
10.5.5.32	Extended DRX parameters.....	644
10.5.5.33	Message authentication code.....	648
10.5.5.34	User Plane integrity indicator.....	649
10.5.5.35	DCN-ID.....	649
10.5.5.36	PLMN identity of the CN operator	650
10.5.5.37	Non-3GPP NW provided policies	651
10.5.6	Session management information elements	651
10.5.6.1	Access point name.....	651
10.5.6.2	Network service access point identifier.....	652
10.5.6.3	Protocol configuration options	652
10.5.6.3.1	General	652
10.5.6.3.2	APN rate control parameters	665
10.5.6.3.3	Additional APN rate control parameters for exception data.....	666
10.5.6.3.4	Small data rate control parameters	667
10.5.6.3.5	Additional small data rate control parameters for exception data	667
10.5.6.3.6	Initial small data rate control parameters.....	667
10.5.6.3.7	Initial additional small data rate control for exception data parameters	667
10.5.6.3.8	Initial APN rate control parameters.....	667
10.5.6.3.9	Initial additional APN rate control for exception data parameters	667
10.5.6.3A	Extended protocol configuration options	667
10.5.6.4	Packet data protocol address	668
10.5.6.5	Quality of service	670
10.5.6.5A	Re-attempt indicator.....	680
10.5.6.5B	Extended quality of service	681
10.5.6.6	SM cause	681
10.5.6.6A	SM cause 2	682
10.5.6.7	Linked TI	683
10.5.6.8	Spare	683
10.5.6.9	LLC service access point identifier.....	683
10.5.6.10	Tear down indicator	684
10.5.6.11	Packet Flow Identifier	684
10.5.6.12	Traffic Flow Template	685
10.5.6.13	Temporary Mobile Group Identity (TMGI)	692
10.5.6.14	MBMS bearer capabilities.....	693
10.5.6.15	MBMS protocol configuration options	694
10.5.6.16	Enhanced network service access point identifier.....	694
10.5.6.17	Request type	695
10.5.6.18	Notification indicator	696
10.5.6.19	Connectivity type	697
10.5.6.20	WLAN offload acceptability.....	697
10.5.6.21	NBIFOM container	698
10.5.7	GPRS Common information elements.....	698
10.5.7.1	PDP context status	698
10.5.7.2	Radio priority	699
10.5.7.3	GPRS Timer	699
10.5.7.4	GPRS Timer 2.....	700
10.5.7.4a	GPRS Timer 3.....	700
10.5.7.5	Radio priority 2	701
10.5.7.6	MBMS context status.....	702
10.5.7.7	Uplink data status.....	703
10.5.7.8	Device properties	703
11	List of system parameters.....	705
11.1	Timers and counters for radio resource management.....	705
11.2	Timers of mobility management	705
11.2.1	Timer T3240 and Timer T3241	709

11.2.2	Timers of GPRS mobility management	710
11.2.3	Timers of GPRS session management	722
11.3	Timers of circuit-switched call control	728
Annex A (informative):	Example of subaddress information element coding	730
Annex B (normative):	Compatibility checking	731
B.1	Introduction	731
B.2	Calling side compatibility checking	731
B.2.1	Compatibility checking of the CM SERVICE REQUEST message	731
B.2.2	Compatibility/Subscription checking of the SETUP message	731
B.3	Called side compatibility checking	731
B.3.1	Compatibility checking with addressing information	732
B.3.2	Network-to-MS compatibility checking	732
B.3.3	User-to-User compatibility checking	732
B.4	High layer compatibility checking	732
Annex C (normative):	Low layer information coding principles	733
C.1	Purpose	733
C.2	Principles	733
C.2.1	Definition of types of information	733
C.2.2	Examination by network	733
C.2.3	Location of type I information	734
C.2.4	Location of types II and III information	734
C.2.5	Relationship between bearer capability and low layer compatibility information elements	734
Annex D (informative):	Examples of bearer capability information element coding	735
D.1	Coding for speech for a full rate support only mobile station	735
D.1.1	Mobile station to network direction	735
D.1.2	Network to mobile station direction	735
D.2	An example of a coding for modem access with V22-bis, 2,4 kbit/s, 8 bit no parity	736
D.2.1	Mobile station to network direction, data compression allowed	736
D.2.2	Network to mobile station direction, data compression possible	737
D.3	An example of a coding for group 3 facsimile (9,6 kbit/s, transparent)	738
D.3.1	Mobile station to network direction	738
D.3.2	Network to mobile station direction	739
Annex E (informative):	Comparison between call control procedures specified in 3GPP TS 24.008 and ITU-T Recommendation Q.931	740
Annex F (informative):	A/Gb mode specific cause values for radio resource management	744
Annex G (informative):	3GPP specific cause values for mobility management	745
G.1	Causes related to MS identification	745
G.2	Cause related to subscription options	745
G.3	Causes related to PLMN specific network failures and congestion/Authentication Failures	746
G.4	Causes related to nature of request	746
G.5	Causes related to invalid messages	747
G.6	Additional cause codes for GMM	747
Annex H (informative):	3GPP specific cause values for call control	749
H.1	Normal class	749
H.1.1	Cause No. 1 "unassigned (unallocated) number"	749

H.1.2	Cause No. 3 "no route to destination"	749
H.1.3	Cause No. 6 "channel unacceptable"	749
H.1.4	Cause No. 8 "operator determined barring"	749
H.1.4a	Cause No. 13 "call completed elsewhere"	749
H.1.5	Cause No.16 "normal call clearing"	749
H.1.6	Cause No.17 "user busy"	749
H.1.7	Cause No. 18 "no user responding"	749
H.1.8	Cause No. 19 "user alerting, no answer"	750
H.1.9	Cause No. 21 "call rejected"	750
H.1.10	Cause No. 22 "number changed"	750
H.1.10a	Cause No. 24 "call rejected due to feature at the destination"	750
H.1.11	Cause No. 25 "pre-emption"	750
H.1.12	Cause No. 26 "non-selected user clearing"	750
H.1.13	Cause No. 27 "destination out of order"	750
H.1.14	Cause No. 28 "invalid number format (incomplete number)"	750
H.1.15	Cause No. 29 "facility rejected"	750
H.1.16	Cause No. 30 "response to STATUS ENQUIRY"	750
H.1.17	Cause No. 31 "normal, unspecified"	751
H.2	Resource unavailable class	751
H.2.1	Cause No. 34 "no circuit/channel available"	751
H.2.2	Cause No. 38 "network out of order"	751
H.2.3	Cause No. 41 "temporary failure"	751
H.2.4	Cause No. 42 "switching equipment congestion"	751
H.2.5	Cause No. 43 "access information discarded"	751
H.2.6	Cause No. 44 "requested circuit/channel not available"	751
H.2.7	Cause No. 47 "resource unavailable, unspecified"	751
H.3	Service or option not available class	751
H.3.1	Cause No. 49 "quality of service unavailable"	751
H.3.2	Cause No. 50 "Requested facility not subscribed"	752
H.3.3	Cause No. 55 "Incoming calls barred within the CUG"	752
H.3.4	Cause No. 57 "bearer capability not authorized"	752
H.3.5	Cause No. 58 "bearer capability not presently available"	752
H.3.6	Cause No. 63 "service or option not available, unspecified"	752
H.3.7	Cause No. 68 "ACM equal to or greater than ACMmax"	752
H.4	Service or option not implemented class	752
H.4.1	Cause No. 65 "bearer service not implemented"	752
H.4.2	Cause No. 69 "Requested facility not implemented"	752
H.4.3	Cause No. 70 "only restricted digital information bearer capability is available"	752
H.4.4	Cause No. 79 "service or option not implemented, unspecified"	753
H.5	Invalid message (e.g., parameter out of range) class	753
H.5.1	Cause No. 81 "invalid transaction identifier value"	753
H.5.2	Cause No. 87 "user not member of CUG"	753
H.5.3	Cause No. 88 "incompatible destination"	753
H.5.4	Cause No. 91 "invalid transit network selection"	753
H.5.5	Cause No. 95 "semantically incorrect message"	753
H.6	Protocol error (e.g., unknown message) class	753
H.6.1	Cause No. 96 "invalid mandatory information"	753
H.6.2	Cause No. 97 "message type non-existent or not implemented"	753
H.6.3	Cause No. 98 "message type not compatible with protocol state"	754
H.6.4	Cause No. 99 "information element non-existent or not implemented"	754
H.6.5	Cause No. 100 "conditional IE error"	754
H.6.6	Cause No. 101 "message not compatible with protocol state"	754
H.6.7	Cause No. 102 "recovery on timer expiry"	754
H.6.8	Cause No. 111 "protocol error, unspecified"	754
H.7	Interworking class	754
H.7.1	Cause No. 127 "interworking, unspecified"	754
Annex I (informative): GPRS specific cause values for GPRS Session Management.....		755

I.1	Causes related to nature of request.....	755
I.2	Causes related to invalid messages	758
I.3	Void.....	758
Annex J (informative):	Algorithm to encode frequency list information elements	759
Annex K (informative):	Default Codings of Information Elements.....	760
K.1	Common information elements.....	760
K.2	Radio Resource management information elements.....	760
K.3	Mobility management information elements.....	760
K.4	Call control information elements.....	761
Annex L (normative):	Establishment cause (Iu mode only).....	763
L.1	Mapping of NAS procedure to RRC establishment cause(Iu mode only).....	763
Annex M (normative):	Additional Requirements for backward compatibility with PCS 1900 for NA revision 0 ME.....	767
Annex N (normative):	Ranking of reject causes for Location Registration (MM and GMM) in a shared network	768
Annex O (normative):	3GPP capability exchange protocol.....	770
O.1	Scope.....	770
O.2	User-user protocol contents.....	770
O.3	Information element identifier.....	770
O.4	Information elements.....	771
O.4.1	Personal ME identifier.....	771
O.4.2	Radio environment capability.....	772
O.4.3	UE capability version	772
O.4.4	IM Status	773
O.5	Handling of unknown, unforeseen, and erroneous protocol data	774
O.5.1	General	774
O.5.2	Not supported IEs, unknown IEs	774
O.5.3	Repeated IEs.....	774
O.5.4	Syntactically incorrect IEs.....	775
O.5.5	Semantically incorrect IEs.....	775
Annex P (normative):	Mobility management for IMS voice termination	776
P.1	Introduction	776
P.2	Activation of mobility management for IMS voice termination	776
P.3	Inter-system change between A/Gb mode and Iu mode.....	776
P.4	Inter-system change between A/Gb mode and S1 mode.....	777
P.5	Inter-system change between Iu mode and S1 mode	777
Annex Q (normative):	Application specific Congestion control for Data Communication (ACDC) (Iu mode only)	778
Annex R (informative):	Change History	779
History		819

Foreword

This Technical Specification has been produced by the 3rd Generation Partnership Project (3GPP).

The contents of the present document are subject to continuing work within the TSG and may change following formal TSG approval. Should the TSG modify the contents of the present document, it will be re-released by the TSG with an identifying change of release date and an increase in version number as follows:

Version x.y.z

where:

- x the first digit:
 - 1 presented to TSG for information;
 - 2 presented to TSG for approval;
 - 3 or greater indicates TSG approved document under change control.
- y the second digit is incremented for all changes of substance, i.e. technical enhancements, corrections, updates, etc.
- z the third digit is incremented when editorial only changes have been incorporated in the document.

Introduction

The present document includes references to features which are not part of the Phase 2+ Release 96 of the GSM Technical specifications. All subclauses which were changed as a result of these features contain a marker (see table below) relevant to the particular feature.

The following table lists all features that were introduced after GSM Release 96.

Feature	Designator
BA Range IE handling	\$(impr-BA-range-handling)\$
Advanced Speech Call Item	\$(ASCI)\$
Call Completion Busy Subscriber	\$(CCBS)\$
Mobile Assisted Frequency Allocation	\$(MAFA)\$
Network Indication of Alerting in MS	\$(NIA)\$

1 Scope

The present document specifies the procedures used at the radio interface core network protocols within the 3rd generation mobile telecommunications system and the digital cellular telecommunications system.

It specifies the procedures used at the radio interface (Reference Point Um or Uu, see 3GPP TS 24.002 [15] or 3GPP TS 23.002 [127]) for Call Control (CC), Mobility Management (MM), and Session Management (SM).

When the notations for "further study" or "FS" or "FFS" are present in this TS they mean that the indicated text is not a normative portion of the present document.

These procedures are defined in terms of messages exchanged over the control channels of the radio interface. The control channels are described in 3GPP TS 44.003 [16] and 3GPP TS 25.301 [128].

The structured functions and procedures of this protocol and the relationship with other layers and entities are described in general terms in 3GPP TS 24.007 [20].

The present document specifies functions, procedures and information which apply to GERAN Iu mode. However, functionality related to GERAN Iu mode is neither maintained nor enhanced.

1.1 Scope of the Technical Specification

The procedures currently described in this TS are for the call control of circuit-switched connections, session management for GPRS services, mobility management and radio resource management for circuit-switched and GPRS services.

3GPP TS 24.010 [21] contains functional procedures for support of supplementary services.

3GPP TS 24.011 [22] contains functional procedures for support of point-to-point short message services.

3GPP TS 24.012 [23] contains functional description of short message - cell broadcast.

3GPP TS 44.060 [76] contains procedures for radio link control and medium access control (RLC/MAC) of packet data physical channels.

3GPP TS 44.071 [23a] contains functional descriptions and procedures for support of location services.

NOTE: "layer 3" includes the functions and protocols described in the present document. The terms "data link layer" and "layer 2" are used interchangeably to refer to the layer immediately below layer 3.

1.2 Application to the interface structures

The procedures defined in the present document apply to the interface structures defined in 3GPP TS 44.003 [16] and 3GPP TS 25.301 [128]. They use the functions and services provided by lower layers defined in 3GPP TS 44.005 [18] and 3GPP TS 44.006 [19] or 3GPP TS 25.331 [23c], 3GPP TS 25.322 [19b] and 3GPP TS 25.321 [19a].

3GPP TS 24.007 [20] gives the general description of layer 3 (A/Gb mode) and Non Access Stratum (Iu mode and S1 mode) including procedures, messages format and error handling.

1.3 Structure of layer 3 procedures

A building block method is used to describe the layer 3 procedures.

The basic building blocks are "elementary procedures" provided by the protocol control entities of the three sublayers, i.e. radio resource management, mobility management and connection management sublayer.

Complete layer 3 transactions consist of specific sequences of elementary procedures. The term "structured procedure" is used for these sequences.

1.4 Test procedures

Test procedures of the GSM radio interface signalling are described in 3GPP TS 51.010 [39] and 3GPP TS 51.02x series.

1.5 Use of logical channels in A/Gb mode

The logical control channels are defined in 3GPP TS 45.002 [32]. In the following those control channels are considered which carry signalling information or specific types of user packet information:

- i) Broadcast Control CHannel (BCCH): downlink only, used to broadcast Cell specific information;
- ii) Synchronization CHannel (SCH): downlink only, used to broadcast synchronization and BSS identification information;
- iii) Paging CHannel (PCH): downlink only, used to send page requests to Mobile Stations (MSs);
- iv) Random Access CHannel (RACH): uplink only, used to request a Dedicated Control CHannel;
- v) Access Grant CHannel (AGCH): downlink only, used to allocate a Dedicated Control CHannel;
- vi) Standalone Dedicated Control CHannel (SDCCH): bi-directional;
- vii) Fast Associated Control CHannel (FACCH): bi-directional, associated with a Traffic CHannel;
- viii) Slow Associated Control CHannel (SACCH): bi-directional, associated with a SDCCH or a Traffic CHannel;
- ix) Cell Broadcast CHannel (CBCH): downlink only used for general (not point to point) short message information;
- x) Notification CHannel (NCH): downlink only, used to notify mobile stations of VBS (Voice Broadcast Service) calls or VGCS (Voice Group Call Service) calls.

Two service access points are defined on signalling layer 2 which are discriminated by their Service Access Point Identifiers (SAPI) (see 3GPP TS 44.006 [19]):

- i) SAPI 0: supports the transfer of signalling information including user-user information;
- ii) SAPI 3: supports the transfer of user short messages.

Layer 3 selects the service access point, the logical control channel and the mode of operation of layer 2 (acknowledged, unacknowledged or random access, see 3GPP TS 44.005 [18] and 3GPP TS 44.006 [19]) as required for each individual message.

1.6 Overview of control procedures

1.6.1 List of procedures

The following procedures are specified in the present document:

- a) Clause 4 specifies elementary procedures for Mobility Management:
 - mobility management common procedures (subclause 4.3):
 - TMSI reallocation procedure (subclause 4.3.1);
 - authentication procedure (subclause 4.3.2);
 - identification procedure (subclause 4.3.3);
 - IMSI detach procedure (subclause 4.3.4);
 - abort procedure (subclause 4.3.5);

- MM information procedure (subclause 4.3.6).
 - mobility management specific procedures (subclause 4.4):
 - location updating procedure (subclause 4.4.1);
 - periodic updating (subclause 4.4.2);
 - IMSI attach procedure (subclause 4.4.3);
 - generic location updating procedure (subclause 4.4).
 - connection management sublayer service provision:
 - mobility management connection establishment (subclause 4.5.1);
 - mobility management connection information transfer phase (subclause 4.5.2);
 - mobility management connection release (subclause 4.5.3).
 - GPRS specific mobility management procedures (subclause 4.7):
 - GPRS attach procedure (subclause 4.7.3);
 - GPRS detach procedure (subclause 4.7.4);
 - GPRS routing area updating procedure (subclause 4.7.5).
 - GPRS common mobility management procedures (subclause 4.7):
 - GPRS P-TMSI reallocation procedure (subclause 4.7.6);
 - GPRS authentication and ciphering procedure (subclause 4.7.7);
 - GPRS identification procedure (subclause 4.7.8);
 - GPRS information procedure (subclause 4.7.12).
- b) Clause 5 specifies elementary procedures for circuit switched Call Control comprising the following elementary procedures:
- mobile originating call establishment (subclause 5.2.1);
 - mobile terminating call establishment (subclause 5.2.2);
 - signalling procedures during the active state (subclause 5.3):
 - user notification procedure (subclause 5.3.1);
 - call rearrangements (subclause 5.3.2);
 - DTMF protocol control procedure (subclause 5.5.7);
 - in-call modification (subclause 5.3.4).
 - call clearing initiated by the mobile station (subclause 5.4.3);
 - call clearing initiated by the network (subclause 5.4.4);
 - miscellaneous procedures:
 - in-band tones and announcements (subclause 5.5.1);
 - status enquiry procedure (subclause 5.5.3);
 - call re-establishment procedure (subclause 5.5.4).

d) Clause 6 specifies elementary procedures for session management:

- GPRS session management procedures (subclause 6.1):
 - PDP context activation (subclauses 6.1.3.1 and 6.1.3.2);
 - PDP context modification (subclause 6.1.3.3);
 - PDP context deactivation (subclause 6.1.3.4).
 - MBMS context activation (subclause 6.1.3.8);
 - MBMS context deactivation (subclause 6.1.3.9).

The elementary procedures can be combined to form structured procedures. Examples of such structured procedures are given in clause 7. This part of the present document is only provided for guidance to assist implementations.

Clause 8 specifies actions to be taken on various error conditions and also provides rules to ensure compatibility with future enhancements of the protocol.

1.7 Applicability of implementations

The applicability of procedures of the present document for the mobile station is dependent on the services and functions which are to be supported by a mobile station.

1.7.1 Voice Group Call Service (VGCS) and Voice Broadcast Service (VBS)

Voice Group Call Service and Voice Broadcast Service are applicable in A/Gb mode only.

For mobile stations supporting the Voice Group Call Service or the Voice Broadcast Service, it is explicitly mentioned throughout the present document if a certain procedure is applicable only for such a service and, if necessary, how mobile stations not supporting such a service shall behave.

For VGCS and VBS, the following possible mobile station implementations exist:

- support of listening to voice broadcast calls (VBS listening);
- support of originating a voice broadcast call (VBS originating);
- support of listening to voice group calls (VGCS listening);
- support of talking in voice group calls (VGCS talking. This always includes the implementation for VGCS listening);
- support of originating a voice group call (VGCS originating. This always includes the implementation for VGCS talking).

Apart from the explicitly mentioned combinations, all possible combinations are optional and supported by the present document.

The related terms are used in the present document, if information on these implementation options is required.

1.7.2 General Packet Radio Service (GPRS)

1.7.2.1 Packet services in GSM (A/Gb mode only)

For mobile stations supporting the General Packet Radio Service (GPRS), it is explicitly mentioned throughout the technical specification if a certain procedure is applicable only for such a service and, if necessary, how mobile stations not supporting such a service shall behave.

A GPRS MS may operate in one of the following MS operation modes, see 3GPP TS 23.060 [74]:

- MS operation mode A;
- MS operation mode B; or
- MS operation mode C.

The MS operation mode depends on the services that the MS is attached to, i.e., only GPRS or both GPRS and non-GPRS services, and upon the MS's capabilities to operate GPRS and other GSM services simultaneously. Mobile stations that are capable to operate GPRS services are referred to as GPRS MSs.

NOTE: Other GSM technical specifications may refer to the MS operation modes A, B, and C as GPRS class-A MS, GPRS class-B MS, and GPRS class-C MS.

It should be noted that it is possible that for a GPRS MS, the GMM procedures currently described in the ETS do not support combinations of VGCS, VBS and GPRS. The possible interactions are not studied yet.

1.7.2.2 Packet services in lu mode (lu mode only)

An MS attached to packet switched domain may operate in one of the following MS operation modes, see 3GPP TS 23.060 [74]:

- CS/PS mode of operation; or
- PS mode of operation.

The terms 'CS/PS mode of operation' and 'PS mode of operation' are not used in the present document with some exceptions. Instead the terms 'MS operation mode A' and 'MS operation mode C' are used.

In network operation mode I and II (see 3GPP TS 23.060 [74]), an MS in CS/PS mode of operation shall use the same procedures as for a GPRS MS operating in MS operation mode A, unless it is explicitly stated for A/Gb mode only or Iu mode only.

In network operation mode I and II, an MS in PS mode of operation shall use the same procedures as for a GPRS MS operating in MS operation mode C, unless it is explicitly stated for A/Gb mode only or Iu mode only.

1.8 Handling of NAS signalling low priority indication

An MS configured for NAS signalling low priority (see 3GPP TS 24.368 [135], 3GPP TS 31.102 [112]) indicates this by including the Device properties IE in the appropriate NAS message and setting the low priority indicator to "MS is configured to NAS signalling low priority" except for the following cases in which the MS shall set the low priority indicator to "MS is not configured for NAS signalling low priority":

- the MS is performing an attach for emergency bearer services;
- the MS has a PDN connection for emergency bearer services established and is performing mobility management procedures, or is establishing a PDN connection for emergency bearer services;
- the MS configured for dual priority is requested by the upper layers to establish a PDN connection with the low priority indicator set to "MS is not configured for NAS signalling low priority";
- the MS configured for dual priority is performing session management procedures related to the PDN connection established with low priority indicator set to "MS is not configured for NAS signalling low priority";
- the MS configured for dual priority has a PDN connection established by setting the low priority indicator to "MS is not configured for NAS signalling low priority" and is performing mobility management procedures;
- the MS is establishing or re-establishing an MM connection for an emergency call;
- the MS is an MS configured to use AC11 – 15 in selected PLMN; or
- the MS is responding to paging.

The network may use the NAS signalling low priority indication for NAS level mobility management congestion control on a per core network node basis and APN based congestion control.

If the NAS signalling low priority indication is provided in an ACTIVATE PDP CONTEXT REQUEST message, the SGSN stores the NAS signalling low priority indication within the default PDP context activated due to this request.

1.9 Restrictions

Independently of what is stated elsewhere in this and other 3GPP specifications, mobile station support for PBCCH and PCCCH is optional for A/Gb-mode of operation. The network shall never enable PBCCH and PCCCH. This makes use of network operation mode III obsolete.

2 References

The following documents contain provisions which, through reference in this text, constitute provisions of the present document.

- References are either specific (identified by date of publication, edition number, version number, etc.) or non-specific.
- For a specific reference, subsequent revisions do not apply.
- For a non-specific reference, the latest version applies. In the case of a reference to a 3GPP document (including a GSM document), a non-specific reference implicitly refers to the latest version of that document *in the same Release as the present document*.

- [1] Void.
- [2] Void.
- [2a] 3GPP TR 21.905 "Vocabulary for 3GPP Specifications"
- [3] 3GPP TS 22.002: "Circuit Bearer Services (BS) supported by a Public Land Mobile Network (PLMN)".
- [4] 3GPP TS 22.003: "Teleservices supported by a Public Land Mobile Network (PLMN)".
- [5] 3GPP TS 42.009, Release 4: "Security aspects".
- [5a] 3GPP TS 33.102: "3G security; Security architecture".
- [6] Void.
- [7] 3GPP TS 42.017, Release 4: "Subscriber Identity Modules (SIM); Functional characteristics".
- [8] 3GPP TS 22.101: "Service aspects; Service principles".
- [8a] 3GPP TS 22.001: "Principles of circuit telecommunication services supported by a Public Land Mobile Network (PLMN)".
- [8b] 3GPP TS 23.038: "Alphabets and language-specific information".
- [9] Void.
- [9a] 3GPP TS 23.108: "Mobile radio interface layer 3 specification core network protocols; Stage 2 (structured procedures)".
- [10] 3GPP TS 23.003: "Numbering, addressing and identification".
- [11] Void.
- [12] 3GPP TS 23.014: "Support of Dual Tone Multi-Frequency (DTMF) signalling".

- [12a] ETSI ES 201 235-2, v1.2.1: "Specification of Dual Tone Multi-Frequency (DTMF); Transmitters and Receivers; Part 2: Transmitters".
- [13] 3GPP TS 43.020: "Security-related network functions".
- [14] 3GPP TS 23.122: "Non-Access-Stratum functions related to Mobile Station (MS) in idle mode".
- [15] 3GPP TS 24.002: "GSM-UMTS Public Land Mobile Network (PLMN) access reference configuration".
- [16] 3GPP TS 44.003: "Mobile Station - Base Station System (MS - BSS) interface; Channel structures and access capabilities".
- [17] Void.
- [18] 3GPP TS 44.005: "Data Link (DL) layer; General aspects".
- [19] 3GPP TS 44.006: "Mobile Station - Base Station System (MS - BSS) interface; Data Link (DL) layer specification".
- [19a] 3GPP TS 25.321: "Medium Access Control (MAC) protocol specification".
- [19b] 3GPP TS 25.322: "Radio Link Control (RLC) protocol specification".
- [19c] 3GPP TS 25.413: "UTRAN Iu interface Radio Access Network Application Part (RANAP) signalling".
- [20] 3GPP TS 24.007: "Mobile radio interface signalling layer 3; General aspects".
- [21] 3GPP TS 24.010: "Mobile radio interface layer 3; Supplementary services specification; General aspects".
- [22] 3GPP TS 24.011: "Point-to-Point (PP) Short Message Service (SMS) support on mobile radio interface".
- [23] 3GPP TS 24.012: "Short Message Service Cell Broadcast (SMSCB) support on the mobile radio interface".
- [23a] 3GPP TS 44.071: "Location Services (LCS); Mobile radio interface layer 3 specification."
- [23b] 3GPP TS 44.031 "Location Services LCS); Mobile Station (MS) - Serving Mobile Location Centre (SMLC); Radio Resource LCS Protocol (RRLP)".
- [23c] 3GPP TS 25.331: "Radio Resource Control (RRC) protocol specification"
- [24] 3GPP TS 24.080: "Mobile radio Layer 3 supplementary service specification; Formats and coding".
- [25] 3GPP TS 24.081: "Line identification supplementary services; Stage 3".
- [26] Void.
- [27] 3GPP TS 24.083: "Call Waiting (CW) and Call Hold (HOLD) supplementary services; Stage 3".
- [28] 3GPP TS 24.084: "MultiParty (MPTY) supplementary services; Stage 3".
- [29] Void.
- [30] Void.
- [31] Void.
- [32] 3GPP TS 45.002: "Multiplexing and multiple access on the radio path".
- [33] 3GPP TS 45.005: "Radio transmission and reception".
- [34] 3GPP TS 45.008: "Radio subsystem link control".

- [35] Void.
- [36] 3GPP TS 27.001: "General on Terminal Adaptation Functions (TAF) for Mobile Stations (MS)".
- [36a] 3GPP TS 27.060: "Mobile Station (MS) supporting Packet Switched Services".
- [37] 3GPP TS 29.002: "Mobile Application Part (MAP) specification".
- [38] 3GPP TS 29.007: "General requirements on interworking between the Public Land Mobile Network (PLMN) and the Integrated Services Digital Network (ISDN) or Public Switched Telephone Network (PSTN)".
- [39] 3GPP TS 51.010: "Mobile Station (MS) conformance specification".
- [40] Void.
- [41] ISO/IEC 646 (1991): "Information technology - ISO 7-bit coded character set for information interchange".
- [42] ISO/IEC 6429: "Information technology - Control functions for coded character sets".
- [43] ISO 8348 (1987): "Information technology -- Open Systems Interconnection -- Network Service Definition".
- [44] ITU-T Recommendation E.163: "Numbering plan for the international telephone service".
- [45] ITU-T Recommendation E.164: "The international public telecommunication numbering plan".
- [46] ITU-T Recommendation E.212: "The international identification plan for mobile terminals and mobile users".
- [47] ITU-T Recommendation F.69 (1993): "The international telex service - Service and operational provisions of telex destination codes and telex network identification codes".
- [48] ITU-T Recommendation I.330: "ISDN numbering and addressing principles".
- [49] ITU-T Recommendation Q.920 (1993): "ISDN user-network interface data link layer - General aspects".
- [50] ITU-T Recommendation Q.930 (1993): "ISDN user-network interface layer 3 - General aspects".
- [51] ITU-T Recommendation I.500 (1993): "General structure of the ISDN interworking recommendations".
- [52] ITU-T Recommendation T.50: "International Reference Alphabet (IRA) (Formerly International Alphabet No. 5 or IA5) - Information technology - 7-bit coded character set for information interchange".
- [53] ITU Recommendation Q.931: "ISDN user-network interface layer 3 specification for basic control".
- [54] ITU-T Recommendation V.21: "300 bits per second duplex modem standardized for use in the general switched telephone network".
- [55] ITU-T Recommendation V.22: "1200 bits per second duplex modem standardized for use in the general switched telephone network and on point-to-point 2-wire leased telephone-type circuits".
- [56] ITU-T Recommendation V.22bis: "2400 bits per second duplex modem using the frequency division technique standardized for use on the general switched telephone network and on point-to-point 2-wire leased telephone-type circuits".
- [57] Void.
- [58] ITU-T Recommendation V.26ter: "2400 bits per second duplex modem using the echo cancellation technique standardized for use on the general switched telephone network and on point-to-point 2-wire leased telephone-type circuits".

- [59] ITU-T Recommendation V.32: "A family of 2-wire, duplex modems operating at data signalling rates of up to 9600 bit/s for use on the general switched telephone network and on leased telephone-type circuits".
- [60] ITU-T Recommendation V.110: "Support by an ISDN of data terminal equipments with V-Series type interfaces".
- [61] ITU-T Recommendation V.120: "Support by an ISDN of data terminal equipment with V-Series type interfaces with provision for statistical multiplexing".
- [62] ITU-T Recommendation X.21: "Interface between Data Terminal Equipment (DTE) and Data Circuit-terminating Equipment (DCE) for synchronous operation on public data networks".
- [63] Void.
- [64] Void.
- [65] ITU-T Recommendation X.30: "Support of X.21, X.21 bis and X.20 bis based Data Terminal Equipments (DTEs) by an Integrated Services Digital Network (ISDN)".
- [66] ITU-T Recommendation X.31: "Support of packet mode terminal equipment by an ISDN".
- [67] Void.
- [68] Void.
- [69] ITU-T Recommendation X.121: "International numbering plan for public data networks".
- [70] ETSI ETS 300 102-1: "Integrated Services Digital Network (ISDN); User-network interface layer 3; Specifications for basic call control".
- [71] Void.
- [72] ISO/IEC 10646: "Information technology -- Universal Multiple-Octet Coded Character Set (UCS)".
- [73] 3GPP TS 22.060: "General Packet Radio Service (GPRS); Service Description; Stage 1".
- [74] 3GPP TS 23.060: "General Packet Radio Service (GPRS); Service Description; Stage 2".
- [75] Void.
- [75a] 3GPP TS 43.318: "Generic Access Network (GAN); Stage 2".
- [76] 3GPP TS 44.060: "General Packet Radio Service (GPRS); Mobile Station (MS) - Base Station System (BSS) interface; Radio Link Control/Medium Access Control (RLC/MAC) protocol".
- [76b] 3GPP TS 44.318: "Generic Access Network (GAN); Mobile GAN interface layer 3 specification; Stage 3".
- [77] Void.
- [78] 3GPP TS 44.065: "Mobile Station (MS) - Serving GPRS Support Node (SGSN); Subnetwork Dependent Convergence Protocol (SNDTCP)".
- [78a] 3GPP TS 44.064: "Mobile Station - Serving GPRS Support Node (MS-SGSN) Logical Link Control (LLC) Layer Specification".
- [79] ITU Recommendation I.460: "Multiplexing, rate adaption and support of existing interfaces".
- [80] 3GPP TS 26.111: "Codec for Circuit Switched Multimedia Telephony Service; Modifications to H.324".
- [81] 3GPP TS 23.107: "Quality of Service (QoS) concept and architecture".
- [82] 3GPP TS 43.022: "Functions related to Mobile Station (MS) in idle mode and group receive mode".

- [83] 3GPP TS 26.103: "Speech Codec List for GSM and UMTS".
- [84] 3GPP TS 44.018: "Mobile radio interface layer 3 specification, Radio Resource Control Protocol".
- [85] 3GPP TS 48.008: "Mobile-services Switching Centre – Base Station System (MSC – BSS) interface; layer 3 specification".
- [86] 3GPP TS 48.018: "General Packet Radio Service (GPRS); Base Station System (BSS) - Serving GPRS Support Node (SGSN); BSS GPRS Protocol (BSSGP)".
- [87] 3GPP TS 43.055: "Dual Transfer Mode (DTM); Stage 2".
- [88] 3GPP TS 23.067: "enhanced Multi-Level Precedence and Pre-emption service (eMLPP); Stage 2".
- [88a] 3GPP TS 23.093: "Technical realization of Completion of Calls to Busy Subscriber (CCBS); Stage 2".
- [89] 3GPP TS 22.042: "Network Identity and Time Zone (NITZ), Stage 1".
- [90] 3GPP TS 23.040: "Technical realization of Short Message Service (SMS)".
- [91] 3GPP TS 44.056: "GSM Cordless Telephony System (CTS), (Phase 1) CTS Radio Interface Layer 3 Specification".
- [92] 3GPP TS 23.226: "Global Text Telephony; Stage 2"
- [93] 3GPP TS 26.226: "Cellular Text Telephone Modem (CTM), General Description"
- [94] 3GPP TS 23.236: "Intra Domain Connection of RAN Nodes to Multiple CN Nodes"
- [95] 3GPP TS 24.229: "IP Multimedia Call Control Protocol based on SIP and SDP"
- [96] 3GPP TS 23.205: "Bearer-independent circuit-switched core network; Stage 2".
- [97] 3GPP TS 23.172: "UDI/RDI Fallback and Service Modification; Stage 2".
- [98] 3GPP TS 25.304: "UE Procedures in Idle Mode and Procedures for Cell Reselection in Connected Mode"
- [99] IETF RFC 4291 (February 2006): "Internet Protocol Version 6 (IPv6) Addressing Architecture".
- [100] 3GPP TS 29.207, Release 6: "Policy control over Gs interface".
- [101] 3GPP TS 21.111: "USIM and IC card requirements".
- [102] IETF RFC 1661 (July 1994): "The Point-to-Point Protocol (PPP)".
- [103] IETF RFC 3232 (January 2002): "Assigned Numbers: RFC 1700 is Replaced by an On-line Database".
- [104] 3GPP TS 23.034: "High Speed Circuit Switched Data (HSCSD) – Stage 2".
- [105] 3GPP TS 23.271: "Functional stage 2 description of Location Services (LCS)".
- [106] 3GPP TS 23.246: "Multimedia Broadcast/Multicast Service (MBMS); Architecture and Functional Description".
- [107] IETF RFC 3376 (October 2002): "Internet Group Management Protocol, Version 3".
- [108] IETF RFC 2710 (October 1999): "Multicast Listener Discovery (MLD) for IPv6".
- [109] 3GPP TS 23.251: "Network Sharing; Architecture and Functional Description".
- [110] 3GPP TS 25.346: "Introduction of the Multimedia Broadcast Multicast Service (MBMS) in the Radio Access Network"
- [111] 3GPP TS 44.118, Release 11: "Radio Resource Control (RRC) protocol; Iu mode".

- [112] 3GPP TS 31.102: "Characteristics of the USIM Application".
- [113] 3GPP TS 43.129: "Packet-switched handover for GERAN A/Gb mode; Stage 2".
- [114] 3GPP TS 23.009: "Handover procedures".
- [115] 3GPP TR 23.903: "Redial solution for voice-video switching".
- [116] 3GPP TS 24.279: "Combining Circuit Switched (CS) and IP Multimedia Subsystem (IMS) services, stage 3"
- [117] ITU-T Recommendation H.324 Amendment 1: "New Annex K "Media Oriented Negotiation Acceleration Procedure" and associated changes to Annex".
- [118] ITU-T Recommendation H.324 Amendment 2: "New Annex L on text conversation and associated changes; corrections and clarifications to Annex K".
- [119] ITU-T Recommendation H.245: "Control protocol for multimedia communication"
- [120] 3GPP TS 24.301: "Non-Access-Stratum (NAS) protocol for Evolved Packet System (EPS); Stage 3".
- [121] 3GPP TS 36.304: "Evolved Universal Terrestrial Radio Access (E-UTRA); User Equipment (UE) procedures in idle mode".
- [122] 3GPP TS 23.401: "GPRS enhancements for E-UTRAN access".
- [123] 3GPP TS 33.401: "3GPP System Architecture Evolution; Security architecture".
- [124] 3GPP TS 24.303: "Mobility management based on Dual-Stack Mobile IPv6; Stage 3".
- [125] 3GPP TS 24.327: "Mobility between 3GPP WLAN Interworking and 3GPP systems; GPRS and 3GPP I-WLAN aspects; Stage 3".
- [126] 3GPP TS 23.216: "Single Radio Voice Call Continuity (SRVCC); Stage 2".
- [127] 3GPP TS 23.002: "Network architecture".
- [128] 3GPP TS 25.301: "Radio interface protocol architecture".
- [129] 3GPP TS 36.331: "Evolved Universal Terrestrial Radio Access (E-UTRA); Radio Resource Control (RRC); Protocol specification".
- [130] 3GPP TS 29.061: "Interworking between the Public Land Mobile Network (PLMN) supporting packet based services and Packet Data Networks (PDN)".
- [131] 3GPP TS 23.221: "Architectural requirements".
- [132] 3GPP TS 23.090: "Unstructured Supplementary Service Data (USSD); Stage 2".
- [133] 3GPP TS 23.272: "Circuit Switched Fallback in Evolved Packet System; Stage 2".
- [133A] 3GPP TS 23.682: "Architecture enhancements to facilitate communications with packet data networks and applications".
- [134] 3GPP TS 24.167: "3GPP IMS Management Object (MO); Stage 3".
- [135] 3GPP TS 24.368: "Non-Access Stratum (NAS) configuration Management Object (MO)".
- [136] 3GPP TS 24.237: "IP Multimedia Subsystem (IMS) Service Continuity; Stage 3".
- [137] IETF RFC 3261 (June 2002): "SIP: Session Initiation Protocol".
- [138] 3GPP TS 22.011: "Service accessibility".
- [139] IETF RFC 3633 (December 2003): "IPv6 Prefix Options for Dynamic Host Configuration Protocol (DHCP) version 6".

- [140] 3GPP TS 23.012: "Location management procedures".
- [141] 3GPP TS 24.022: "Radio Link Protocol (RLP) for circuit switched bearer and teleservices".
- [142] ITU-T Recommendation X.1: "International user classes of service in, and categories of access to, public data networks and Integrated Services Digital Networks (ISDNs)".
- [143] ITU-T Recommendation X.25: "Interface between Data Terminal Equipment (DTE) and Data Circuit-terminating Equipment (DCE) for terminals operating in the packet mode and connected to public data networks by dedicated circuit".
- [144] ITU-T Recommendation X.213: "Information technology – Open Systems Interconnection – Network service definition".
- [145] ITU-T Recommendation I.334: "Principles relating ISDN numbers/sub-addresses to the OSI reference model network layer addresses".
- [146] ITU-T Recommendation H.223: "Multiplexing protocol for low bit rate multimedia communication".
- [147] ITU-T Recommendation V.34: "A modem operating at data signalling rates of up to 33 600 bit/s for use on the general switched telephone network and on leased point-to-point 2-wire telephone-type circuits".
- [148] IETF RFC 3810 (June 2004): "Multicast Listener Discovery Version 2 (MLDv2) for IPv6".
- [149] 3GPP TS 29.018: "General Packet Radio Service (GPRS); Serving GPRS Support Node (SGSN) - Visitors Location Register (VLR); Gs interface layer 3 specification".
- [150] 3GPP TS 29.272: "Evolved Packet System (EPS); Mobility Management Entity (MME) and Serving GPRS Support Node (SGSN) related interfaces based on Diameter protocol".
- [151] 3GPP TS 45.008: "Radio subsystem link control".
- [152] 3GPP TS 29.010: "Information element mapping between Mobile Station - Base Station System (MS - BSS) and Base Station System - Mobile-services Switching Centre (BSS - MSC); Signalling Procedures and the Mobile Application Part (MAP)".
- [153] 3GPP TS 36.306: "Evolved Universal Terrestrial Radio Access (E-UTRA); User Equipment (UE) radio access capabilities".
- [154] 3GPP TS 24.105: "Application specific Congestion control for Data Communication (ACDC) Management Object (MO)".
- [155] 3GPP TS 23.161: "Network-Based IP Flow Mobility (NBIFOM); Stage 2".
- [156] 3GPP TS 24.302: "Access to the 3GPP Evolved Packet Core (EPC) via non-3GPP access networks; Stage 3".
- [157] 3GPP TS 45.001: "Physical layer on the radio path; General description".
- [158] 3GPP TS 24.161: " Network-Based IP Flow Mobility (NBIFOM); Stage 3".
- [159] 3GPP TS 43.064: "Overall description of the GPRS Radio Interface; Stage 2".
- [160] 3GPP TS 23.167: "IP Multimedia Subsystem (IMS) emergency sessions".
- [161] 3GPP TS 26.267: "eCall Data Transfer; In-band modem solution; General description".
- [162] 3GPP TS 24.250: "Protocol for Reliable Data Service; Stage 3".
- [163] 3GPP TS 24.292: "IP Multimedia (IM) Core Network (CN) subsystem; Centralized Services (ICS); Stage 3".
- [164] 3GPP TS 29.292: "Interworking between the IP Multimedia (IM) Core Network (CN) Subsystem (IMS) and MSC Server for IMS Centralized Services (ICS)".

- [165] 3GPP TS 49.031: "Location Services (LCS); Base Station System Application Part LCS Extension (BSSAP-LE)".
- [166] 3GPP TS 23.501: "System Architecture for the 5G System; Stage 2".
- [167] 3GPP TS 24.501: "Non-Access-Stratum (NAS) protocol for 5G System (5GS); Stage 3".
- [168] IETF RFC 3629 (November 2003): "UTF-8, a transformation format of ISO 10646".
- [169] IETF RFC 5905 (June 2010): "Network Time Protocol Version 4: Protocol and Algorithms Specification".
- [170] 3GPP TS 33.501: "Security architecture and procedures for 5G System".
- [171] 3GPP TS 24.193: "Access Traffic Steering, Switching and Splitting; Stage 3".
- [172] IETF RFC 7858 (May 2016): "Specification for DNS over Transport Layer Security (TLS)".
- [173] IETF RFC 8094 (February 2017): "DNS over Datagram Transport Layer Security (DTLS)".
- [174] IETF RFC 6056 (January 2011): "Recommendations for Transport-Protocol Port Randomization".
- [175] IETF RFC 1035 (November 1987): "DOMAIN NAMES - IMPLEMENTATION AND SPECIFICATION".
- [176] IETF RFC 7469 (April 2015): "Public Key Pinning Extension for HTTP".
- [177] ITU-T Recommendation X.690 (2002) | ISO/IEC 8825-1:2002, Information technology - ASN.1 encoding rules: Specification of Basic Encoding Rules (BER), Canonical Encoding Rules (CER) and Distinguished Encoding Rules (DER).
- [178] 3GPP TS 24.502: "Access to the 3GPP 5G System (5GS) via non-3GPP access networks; Stage 3".

2.1 Definitions and abbreviations

For the purposes of the present document, the abbreviations defined in 3GPP TR 21.905 [2a] and the followings apply:

CAT	Customized Alerting Tone
DRVCC	Dual Radio Voice Call Continuity
eDRX	Extended idle-mode DRX cycle
IP-CAN	IP-Connectivity Access Network
HNB	Home Node B
IoT	Internet of Things
Kc	64-bit GSM ciphering key
Kc ₁₂₈	128-bit GSM ciphering key
Kint	128-bit GSM integrity key
L-GW	Local PDN Gateway
LHN-ID	Local Home Network Identifier
LIPA	Local IP Access
MSD	Minimum Set of emergency related Data
MTU	Maximum Transfer Unit
NB-IoT	Narrowband IoT
NR	New Radio
PSM	Power Saving Mode
SIPTO	Selected IP Traffic Offload
S-NSSAI	Single Network Slice Selection Assistance Information
SNPN	Stand-alone Non-Public Network
TMGI	Temporary Mobile Group Identity

2.1.1 Random values

In a number of places in the present document, it is mentioned that some value must take a "random" value, in a given range, or more generally with some statistical distribution. Such cases interest only the Mobile Station.

It is required that there is a low probability that two MSs in the same conditions (including the case of two MSs of the same type from the same manufacturer) will choose the same value. Moreover, it is required that, if it happens that two MSs in similar conditions choose the same value, the probability of their choices being identical at the next occasion is the same as if their first choices had been different.

The meaning of such a specification is that any statistical test for these values, done on a series of similar events, will obtain a result statistically compatible with the specified distribution. This shall hold even in the cases where the tests are conducted with a subset of possible events, with some common parameters. Moreover, basic tests of independence of the values within the series shall pass.

Data against which correlation with the values shall not be found are the protocol state, or the IMSI, or identities or other unrelated information broadcast by the network, or the current TDMA frame number.

2.1.2 Vocabulary

For the purposes of the present document, the following terms and definitions apply:

- A **GSM security context** is established and stored in the MS and the network as a result of a successful execution of a GSM authentication challenge. The GSM security context for the CS domain consists of the GSM ciphering key and the ciphering key sequence number. The GSM security context for the PS domain consists of the GPRS GSM ciphering key and the GPRS ciphering key sequence number.
- A **UMTS security context** is established and stored in the MS and the network as a result of a successful execution of a UMTS authentication challenge. The UMTS security context for the CS domain consists of the UMTS ciphering key, the UMTS integrity key, the GSM ciphering key, the ciphering key sequence number and the GSM K_{C128} (if an A5 ciphering algorithm that requires a 128-bit ciphering key is in use). The UMTS security context for the PS domain consists of the GPRS UMTS ciphering key, the GPRS UMTS integrity key, the GPRS GSM ciphering key, the GPRS ciphering key sequence number, the GPRS GSM K_{C128} (if a GEA ciphering algorithm that requires a 128-bit ciphering key is in use) and the GPRS GSM K_{int} (if a GIA integrity algorithm that requires a 128-bit integrity key is in use).
- An MS is **attached for emergency bearer services** if it has successfully completed an attach for emergency bearer services or if it has only a PDN connection for emergency bearer services established.
- **idle mode**: In this mode, the mobile station is not allocated any dedicated channel; it listens to the CCCH and the BCCH;
- **group receive mode**: (Only applicable for mobile stations supporting VGCS listening or VBS listening) In this mode, the mobile station is not allocated a dedicated channel with the network; it listens to the downlink of a voice broadcast channel or voice group call channel allocated to the cell. Occasionally, the mobile station has to listen to the BCCH of the serving cell as defined in 3GPP TS 43.022 [82] and 3GPP TS 45.008 [34];
- **dedicated mode**: In this mode, the mobile station is allocated at least two dedicated channels, only one of them being a SACCH;
- **EAB**: Extended Access Barring, see 3GPP TS 22.011 [138].
- **group transmit mode**: (Only applicable for mobile stations supporting VGCS talking) In this mode, one mobile station of a voice group call is allocated two dedicated channels, one of them being a SACCH. These channels can be allocated to one mobile station at a time but to different mobile stations during the voice group call;
- **packet idle mode**: (only applicable for mobile stations supporting GPRS) In this mode, mobile station is not allocated any radio resource on a packet data physical channel; it listens to the BCCH and the CCCH, see 3GPP TS 44.060 [76].
- **packet transfer mode**: (only applicable for mobile stations supporting GPRS) In this mode, the mobile station is allocated radio resource on one or more packet data physical channels for the transfer of LLC PDUs.

- **main DCCH:** In dedicated mode and group transmit mode, only two channels are used as DCCH, one being a SACCH, the other being a SDCCH or a FACCH; the SDCCH or FACCH is called here "the main DCCH";
- A channel is **activated** if it can be used for transmission, in particular for signalling, at least with UI frames. On the SACCH, whenever activated, it must be ensured that a contiguous stream of layer 2 frames is sent;
- A TCH is **connected** if circuit mode user data can be transferred. A TCH cannot be connected if it is not activated. A TCH which is activated but not connected is used only for signalling, i.e. as a DCCH;
- The data link of SAPI 0 on the main DCCH is called the **main signalling link**. Any message specified to be sent on the main signalling link is sent in acknowledged mode except when otherwise specified;
- The term "**to establish**" a link is a short form for "**to establish the multiframe mode**" on that data link. It is possible to send UI frames on a data link even if it is not established as soon as the corresponding channel is activated. Except when otherwise indicated, a data link layer establishment is done without an information field.
- "**channel set**" is used to identify TCHs that carry related user information flows, e.g., in a multislot configuration used to support circuit switched connection(s), which therefore need to be handled together.
- A **temporary block flow** (TBF) is a physical connection used by the two RR peer entities to support the uni-directional transfer of LLC PDUs on packet data physical channels, see 3GPP TS 44.060 [76].
- **RLC/MAC block:** A RLC/MAC block is the protocol data unit exchanged between RLC/MAC entities, see 3GPP TS 44.060 [76].
- A **GMM context** is established when a GPRS attach procedure is successfully completed.

- **Network operation mode**

The network operation modes I and II are defined in 3GPP TS 23.060 [74].

The network operation mode shall be indicated as system information. For proper operation, the network operation mode should be the same in each cell of one routing area.

- **GAN mode:** See 3GPP TS 43.318 [75a].

- **GPRS MS operation mode**

The three different GPRS MS operation modes A, B, and C are defined in 3GPP TS 23.060 [74].

- **RR connection:** A RR connection is a dedicated physical circuit switched domain connection used by the two RR or RRC peer entities to support the upper layers' exchange of information flows.
- **PS signalling connection** is a peer to peer Iu mode connection between MS and CN packet domain node.
- **Inter-system change** is a change of an MS from A/Gb mode to Iu mode of operation or vice versa, or from S1 mode to A/Gb mode or Iu mode of operation.
- **GPRS:** Packet services for systems which operate the Gb or Iu-PS interfaces.
- **GSM ciphering key:** A 64-bit CS GSM ciphering key
- **GSM K_{C128}:** A 128-bit CS GSM ciphering key
- **GPRS GSM ciphering key:** A 64-bit PS GSM ciphering key
- **GPRS GSM K_{C128}:** A 128-bit PS GSM ciphering key
- **GPRS GSM K_{int}:** A 128-bit PS GSM integrity key.
- The label (**A/Gb mode only**) indicates this section or paragraph applies only to a system which operates in A/Gb mode, i.e. with a functional division that is in accordance with the use of an A or a Gb interface between the radio access network and the core network. For multi system case this is determined by the current serving radio access network.
- The label (**Iu mode only**) indicates this section or paragraph applies only to a system which operates in UTRAN Iu mode, i.e. with a functional division that is in accordance with the use of an Iu-CS or Iu-PS interface between

the radio access network and the core network. For multi system case this is determined by the current serving radio access network.

- **In A/Gb mode,...** Indicates this paragraph applies only to a system which operates in A/Gb mode. For multi system case this is determined by the current serving radio access network.
- **In Iu mode,...** Indicates this paragraph applies only to a system which operates in UTRAN Iu mode. For multi system case this is determined by the current serving radio access network.
- **In A/Gb mode and GERAN Iu mode,...** Indicates this paragraph applies only to a system which operates in A/Gb mode or GERAN Iu mode. For multi system case this is determined by the current serving radio access network.
- **In UTRAN Iu mode,...** Indicates this paragraph applies only to a system which operates in UTRAN Iu mode. For multi system case this is determined by the current serving radio access network.
- **In a shared network,...** Indicates this paragraph applies only to a shared network. For the definition of shared network see 3GPP TS 23.122 [14].

NOTE: A shared network is applicable to GERAN and UTRAN, however, according to this definition, a multi-operator core network (MOCN) with common GERAN is not considered a shared network in 3GPP TS 23.122 [14] and in the present specification.

- **Multi-Operator Core Network (MOCN) with common GERAN:** a network in which different core network operators are connected to a shared GERAN broadcasting only a single, common PLMN identity.
- **Chosen PLMN:** The same as selected PLMN as specified in 3GPP TS 23.122 [14].
- **A default PDP context** is a PDP context activated by the PDP context activation procedure that establishes a PDN connection. The default PDP context remains active during the lifetime of the PDN connection.
- **A PDP context for emergency bearer services** is a default PDP context which was activated with request type "emergency", or any secondary PDP contexts associated to this default PDP context.
- **Non-emergency PDP context:** Any PDP context which is not a PDP context for emergency bearer services.
- **SIM**, Subscriber Identity Module (see 3GPP TS 42.017 [7]).
- **USIM**, Universal Subscriber Identity Module (see 3GPP TS 21.111 [101]).
- **MS**, Mobile Station. The present document makes no distinction between MS and UE.
- **MS configured for dual priority:** An MS which provides dual priority support is configured for NAS signalling low priority and also configured to override the NAS signalling low priority indicator (see 3GPP TS 24.368 [135], 3GPP TS 31.102 [112]).
- **Cell Notification** is an (optimised) variant of the Cell Update Procedure which uses the LLC NULL frame for cell change notification which does not trigger the restart of the READY timer
- **DTM:** Dual Transfer Mode, see 3GPP TS 44.018 [84] and 3GPP TS 43.055 [87]
- The term "**eCall only**" applies to a mobile station which is in the eCall only mode, as described in 3GPP TS 22.101 [8].
- "**removal of eCall only restriction**" means that all the limitations as described in 3GPP TS 22.101 [8] for the eCall only mode do not apply any more.
- "**SMS-only service**": A subset of services which includes only short message service. The MS can request "SMS-only service" in order to obtain SMS.
- **Access domain selection:** The process to select whether the CS domain or the IMS/IP-CAN is used to transmit the call control signalling between MS and core network. Definition derived from 3GPP TS 23.221 [131].
- **APN based congestion control:** Congestion control in session management where the network can reject session management requests from MSs or deactivate PDP contexts when the associated APN is congested.

- **NAS level mobility management congestion control:** Congestion control mechanism in the network in mobility management. "NAS level mobility management congestion control" consists of "subscribed APN based congestion control" and "general NAS level mobility management congestion control".
- **General NAS level mobility management congestion control:** The type of congestion control that is applied at a general overload or congestion situation in the network, e.g. lack of processing resources.
- **Group specific session management congestion control:** Type of congestion control at session management level that is applied to reject session management requests from MSs belonging to a particular group when one or more group congestion criteria as specified in 3GPP TS 23.060 [74] are met.
- **Subscribed APN based congestion control:** Congestion control in mobility management where the network can reject attach requests from MSs with a certain APN in the subscription.
- **Mapped P-TMSI:** A P-TMSI which is mapped from a GUTI previously allocated to the MS by an MME. Mapping rules are defined in 3GPP TS 23.003 [10]. Definition derived from 3GPP TS 23.401 [122].
- **Native P-TMSI:** A P-TMSI previously allocated by an SGSN. Definition derived from 3GPP TS 23.401 [122].
- **Valid LAI:** A LAI that is not deleted LAI.
- **EMM Combined UE Waiting Flag:** See 3GPP TS 29.018 [149].
- **Power Saving Mode:** Power saving mode allows the MS to reduce its power consumption. When power saving mode is active in the MS, the MS is registered to the network and in PMM-IDLE mode (in Iu mode), EMM-IDLE mode (in S1 mode) or the READY timer is not running (in A/Gb mode) but the AS layer is deactivated. Definition derived from 3GPP TS 23.060 [74] and 3GPP TS 23.401 [122].
- **ACDC:** Application specific Congestion control for Data Communication, see 3GPP TS 22.011 [138].
- **Highest ranked ACDC category:** The ACDC category with the lowest value as defined in 3GPP TS 24.105 [154].
- **Extended idle-mode DRX cycle:** Extended idle-mode DRX cycle allows the MS to reduce its power consumption in PMM-IDLE mode (in Iu mode) or when the READY timer is not running (in A/Gb mode) or in EMM-IDLE mode (in S1 mode). Extended idle-mode DRX cycle is associated with the eDRX cycle value. Definition derived from 3GPP TS 23.060 [74] and 3GPP TS 23.401 [122].
- **EC-GSM-IoT:** Extended coverage in GSM for IoT is a feature which enables extended coverage operation. See 3GPP TS 43.064 [159].

For the purposes of the present document, the following terms and definitions given in 3GPP TS 23.401 [122], subclause 3.2, apply:

DCN-ID
Globally Unique MME Identifier (GUMMEI)
Globally Unique Temporary Identity (GUTI)
Idle Mode Signalling Reduction (ISR)
M-Temporary Mobile Subscriber Identity (M-TMSI)
NarrowBand-IoT
PDN connection
Tracking Area Identity (TAI)
Temporary Identity used in Next update (TIN)

For the purposes of the present document, the following terms and definitions given in 3GPP TS 24.301 [120] apply:

CSG cell
CSG ID
CSG selection
EMM
EMM-IDLE mode
EPS
ESM
In NB-S1 mode
In WB-S1 mode

LIPA PDN connection
MO MMTEL voice call is started
MO MMTEL video call is started
MO SMSoIP is started
MS configured to use AC11 – 15 in selected PLMN: see UE configured to use AC11 – 15 in selected PLMN
PDN connection for emergency bearer services
S1 mode
SIPTO at the local network PDN connection
SIPTO at the local network PDN connection with collocated L-GW
SIPTO at the local network PDN connection with stand-alone GW

For the purposes of the present document, the following terms and definitions given in 3GPP TS 23.272 [133] apply:

CS fallback
SMS over SGs

For the purposes of the present document, the following terms and definitions given in 3GPP TS 33.401 [123] apply:

Current EPS security context
Mapped security context
eKSI
CK' and IK'
NAS downlink COUNT
NAS uplink COUNT

For the purposes of the present document, the following terms and definitions given in 3GPP TS 23.251 [109] apply:

Multi-Operator Core Network (MOCN)
Network Sharing non-supporting MS: see non-supporting UE.
Network Sharing supporting MS: see supporting UE.

For the purposes of the present document, the following terms and definitions given in 3GPP TS 23.122 [14] apply:

Country
EHPLMN
HPLMN
Suitable Cell
VPLMN

For the purposes of the present document, the following terms and definitions given in 3GPP TS 23.216 [126] apply:

SRVCC
vSRVCC
CS to PS SRVCC

For the purposes of the present document, the following terms and definitions given in 3GPP TS 23.251 [109] and 3GPP TS 44.018 [84] apply:

Common PLMN

For the purposes of the present document, the following terms and definitions given in 3GPP TS 44.018 [84] apply:

Additional PLMN
Network sharing

For the purposes of the present document, the following terms and definitions given in 3GPP TS 23.003 [10] apply:

Local Home Network Identifier

For the purposes of the present document, the following terms and definitions given in 3GPP TS 23.161 [155] apply:

RAN rules handling parameter

For the purposes of the present document, the following terms and definitions given in 3GPP TS 24.302 [156] apply:

move-traffic-to-WLAN indication
move-traffic-from-WLAN indication

For the purposes of the present document, the following terms and definitions given in 3GPP TS 23.060 [74] apply:

Dedicated core network

For the purposes of the present document, the following terms and definitions given in 3GPP TS 24.161 [158] apply:

**NBIFOM
multi-access PDN connection**

For the purposes of the present document, the following terms and definitions given in 3GPP TS 23.167 [160] apply:

eCall over IMS

For the purposes of the present document, the following terms and definitions given in 3GPP TS 22.101 [8] apply:

Minimum Set of Data (MSD)

For the purposes of the present document, the following terms and definitions given in 3GPP TS 23.501 [166] apply:

NG-RAN

For the purposes of the present document, the following terms and definitions given in 3GPP TS 24.501 [167] apply:

**5GCN
5GMM
5GS
5GSM
DNN
DNN based congestion control
In NB-N1 mode
In WB-N1 mode
N1 mode**

For the purposes of the present document, the following terms and definitions given in 3GPP TS 23.221 [131] apply:

Restricted local operator services

3 Radio Resource management procedures

See 3GPP TS 44.018 [84].

4 Elementary procedures for Mobility Management

4.1 General

This clause describes the procedures used for mobility management for non-GPRS services and for GPRS-services at the radio interface (Reference Point Um and Uu).

The main function of the Mobility Management sublayer is to support the mobility of user terminals, such as informing the network of its present location and providing user identity confidentiality.

A further function of the MM sublayer is to provide connection management services to the different entities of the upper Connection Management (CM) sublayer (see 3GPP TS 24.007 [20]).

There are two sets of procedures defined in this chapter:

- MM procedures for non-GPRS services (performed by the MM entity of the MM sublayer); and
- GMM procedures for GPRS services (performed by the GMM entity of the MM sublayer), see 3GPP TS 24.007 [20].

All the MM procedures described in this clause can only be performed if a RR connection has been established between the MS and the network. Else, the MM sublayer has to initiate the establishment of a RR connection (see 3GPP TS 44.018 [84] subclause 3.3 and 3GPP TS 25.331 [23c]).

In A/Gb mode, the GMM procedures described in this clause, use services provided by the RR sublayer without prior RR connection establishment.

In Iu mode: all the GMM procedures described in this clause can only be performed if a PS signalling connection has been established between the MS and the network. Else, the GMM sublayer has to initiate the establishment of a PS signalling connection (see 3GPP TS 25.331 [23c]).

GMM procedures are mandatory and applicable only for GPRS MSs and networks supporting those MSs. For GPRS MSs which are IMSI attached for both GPRS and non-GPRS services, some MM procedures are replaced by GMM combined procedures provided that the network operates in network operation mode I, i.e. is supporting combined GMM procedures. GMM combined procedures are not applicable for the GPRS MS operation mode C but are mandatory for the GPRS MS operation modes A and B and networks supporting network operation mode I, see 3GPP TS 23.060 [74].

4.1.1 MM and GMM procedures

4.1.1.1 Types of MM and GMM procedures

Depending on how they can be initiated, three types of MM procedures can be distinguished:

1) MM common procedures:

A MM common procedure can always be initiated whilst a RR connection exists. The procedures belonging to this type are:

Initiated by the network:

- TMSI reallocation procedure;
- authentication procedure;
- identification procedure;
- MM information procedure;
- abort procedure.

However, abort procedure is used only if an MM connection is being established or has already been established i.e. not during MM specific procedures or during IMSI detach procedure, see subclause 4.3.5.

Initiated by the mobile station:

- IMSI detach procedure (with the exceptions specified in subclause 4.3.4).

2) MM specific procedures:

A MM specific procedure can only be initiated if no other MM specific procedure is running or no MM connection exists. The procedures belonging to this type are:

- normal location updating procedure;
- periodic updating procedure;
- IMSI attach procedure; and
- eCall inactivity procedure.

3) MM connection management procedures:

These procedures are used to establish, maintain and release a MM connection between the mobile station and the network, over which an entity of the upper CM layer can exchange information with its peer. A MM connection

establishment can only be performed if no MM specific procedure is running. More than one MM connection may be active at the same time.

Depending on how they can be initiated, three types of GMM procedures can be distinguished:

1) GMM common procedures:

In Iu mode, a GMM common procedure can always be initiated whilst a PS signalling connection exists.

The procedures belonging to this type are:

Initiated by the network when a GMM context has been established:

- P-TMSI (re-) allocation;
- GPRS authentication and ciphering;
- GPRS identification;
- GPRS information.

2) GMM specific procedures:

Initiated by the network and used to detach the IMSI in the network for GPRS services and/or non-GPRS services and to release a GMM context:

- GPRS detach.

Initiated by the MS and used to attach or detach the IMSI in the network for GPRS services and/or non-GPRS services and to establish or release a GMM context:

- GPRS attach and combined GPRS attach;
- GPRS detach and combined GPRS detach;
- eCall inactivity procedure.

Initiated by the MS when a GMM context has been established:

- normal routing area updating and combined routing area updating;
- periodic routing area updating.

3) GMM connection management procedures (Iu mode only):

Initiated by the MS and used to establish a secure connection to the network and/or to request the resource reservation for sending data:

Service Request.

The Service Request procedure can only be initiated if no MS initiated GMM specific procedure is ongoing.

4.1.1.1.1 Integrity Checking of Signalling Messages in the Mobile Station (Iu mode only)

In Iu mode only, integrity protected signalling is mandatory with one exception regarding emergency calls (see subclause 4.1.1.1.1a). In Iu mode only, all layer 3 protocols shall use integrity protected signalling once the security mode procedure has been successfully activated in the network and the MS. Integrity protection of all layer 3 signalling messages is the responsibility of lower layers. It is the network which activates integrity protection. This is done using the security mode control procedure (3GPP TS 25.331 [23c] and 3GPP TS 44.118 [111]).

The supervision that integrity protection is activated shall be the responsibility of the MM and GMM layer in the MS (see 3GPP TS 33.102 [5a]). In order to do this, the lower layers shall provide the MM and GMM layer with an indication on when the integrity protection is activated in the MS (i.e. one indication to the MM layer when a security mode control procedure for the CS domain is processed successfully and one indication to the GMM layer when a security mode control procedure for the PS domain is processed successfully).

The CS and PS domains in the network and the MM and GMM layers in the MS, are not aware of whether integrity protection has been started in the lower layers by the other domain. It is mandatory for the network to initiate one security mode control procedure for the CS domain and one for the PS domain.

Except the messages listed below, no layer 3 signalling messages shall be processed by the receiving MM and GMM entities or forwarded to the CM entities, unless the network has activated the integrity protection for that domain.

- MM messages:
 - AUTHENTICATION REQUEST
 - AUTHENTICATION REJECT
 - IDENTITY REQUEST
 - LOCATION UPDATING ACCEPT (at periodic location update with no change of location area or temporary identity, and, any Per MS T3212 value is not changed)
 - LOCATION UPDATING REJECT (if the cause is not #25)
 - CM SERVICE ACCEPT, if the following two conditions apply:
 - no other MM connection is established; and
 - the CM SERVICE ACCEPT is the response to a CM SERVICE REQUEST with CM SERVICE TYPE IE set to 'emergency call establishment'
 - CM SERVICE REJECT (if the cause is not #25)
 - ABORT
- GMM messages:
 - AUTHENTICATION & CIPHERING REQUEST
 - AUTHENTICATION & CIPHERING REJECT
 - IDENTITY REQUEST
 - ATTACH REJECT (if the cause is not #25)
 - ROUTING AREA UPDATE ACCEPT, if any of the following conditions applies:
 - the MS performs periodic routing area updating with:
 - no change in routing area or temporary identities;
 - no change in T3312 extended value;
 - no change in Network feature support value; and
 - extended DRX parameters IE not included.
 - the GMM entity in the MS has received an ATTACH ACCEPT message with neither ciphering nor integrity protection applied in response to an ATTACH REQUEST message with attach type set to "emergency attach"; or
 - the MS has performed intersystem change from S1 mode to Iu mode with a PDN connection for emergency bearer services for which the "null integrity protection algorithm" EIA0 has been used while in S1 mode.
 - ROUTING AREA UPDATE REJECT (if the cause is not #25)
 - SERVICE REJECT (if the cause is not #25)
 - DETACH ACCEPT (for non power-off)

- ATTACH ACCEPT, if the ATTACH ACCEPT is the response to an ATTACH REQUEST with attach type set to "emergency attach".
- SERVICE ACCEPT, if any of the following conditions applies:
 - the GMM entity in the MS has received an ATTACH ACCEPT message with neither ciphering nor integrity protection applied in response to an ATTACH REQUEST message, with attach type set to "emergency attach"; or
 - the MS has performed intersystem change from S1 mode to Iu mode with a PDN connection for emergency bearer services for which the "null integrity protection algorithm" EIA0 has been used while in S1 mode.
- CC messages:
 - all CC messages, if the following two conditions apply:
 - no other MM connection is established; and
 - the MM entity in the MS has received a CM SERVICE ACCEPT message with no ciphering or integrity protection applied as response to a CM SERVICE REQUEST message, with CM SERVICE TYPE set to 'Emergency call establishment' sent to the network;
 - the MM connection was established locally due to the SRVCC handover of a PDN connection for emergency bearer services for which the "null integrity protection algorithm" EIA0 has been used while in S1 mode or for which integrity protection has not been activated while in Iu mode; or
 - the MM connection was established locally due to the 5G-SRVCC handover from NG-RAN to UTRAN of an emergency PDU session for which the "null integrity protection algorithm" 5G-IA0 has been used while in N1 mode.
- SM messages:
 - all SM messages, if any of the following conditions applies:
 - the GMM entity in the MS has received an ATTACH ACCEPT message with neither ciphering nor integrity protection applied in response to an ATTACH REQUEST message, with attach type set to "emergency attach"; or
 - the MS has performed intersystem change from S1 mode to Iu mode with a PDN connection for emergency bearer services for which the "null integrity protection algorithm" EIA0 has been used while in S1 mode.

Once integrity protection is activated, the receiving layer 3 entity in the MS shall not process any layer 3 signalling messages unless they have been successfully integrity checked by the lower layers. If any signalling messages, having not successfully passed the integrity check, are received, then the lower layers in the MS shall discard that message (see 3GPP TS 25.331 [23c] and 3GPP TS 44.118 [111]). If any layer 3 signalling message is received, in either PS or CS domains, as not integrity protected even though the integrity protection has been activated in the MS by that domain in the network, then the lower layers shall discard this message (see 3GPP TS 25.331 [23c] and 3GPP TS 44.118 [111]).

Integrity checking on the network side is performed by the RNC and is described in 3GPP TS 25.331 [23c] and 3GPP TS 44.118 [111].

4.1.1.1.1a Integrity protection for emergency call (Iu mode only)

The network should initiate the security mode procedure for an emergency call, in the same way as it would for any other call except in the cases defined in sub-clause "Security Procedures Not Applied" in 3GPP TS 33.102 [5a].

For the establishment of a MM connection for an emergency call when no other MM connection is established (e.g. for an emergency call initiated without a SIM/USIM no other MM connections can exist) the decision on whether or not to apply the security procedures shall be made by the network as defined in the subclause "Emergency Call Handling" in 3GPP TS 33.102 [5a]. If the MM connection was established locally due to the SRVCC handover of a PDN connection for emergency bearer services for which the "null integrity protection algorithm" EIA0 has been used while in S1 mode or for which integrity protection has not been activated while in Iu mode, the network need not apply the security procedures for this call. If the MM connection was established locally due to the 5G-SRVCC handover from NG-RAN

to UTRAN of an emergency PDU session for which the "null integrity protection algorithm" 5G-IA0 has been used while in N1 mode, the network need not apply the security procedures for this call.

For an attach for emergency bearer services, (e.g. initiated without a SIM/USIM) the decision on whether or not to apply the security procedures shall be made by the network as defined in the subclause "Emergency Call Handling" in 3GPP TS 33.102 [5a]. After intersystem change from S1 mode to Iu mode with a PDN connection for emergency bearer services for which the "null integrity protection algorithm" EIA0 has been used while in S1 mode, the network need not apply the security procedures for this connection.

For an initial registration for emergency services, (e.g. initiated without a SIM/USIM) the decision on whether or not to apply the security procedures shall be made by the network as defined in the clause J.2 of 3GPP TS 33.501 [170]. After 5G-SRVCC handover from NG-RAN to UTRAN with an emergency PDU session for which the "null integrity protection algorithm" 5G-IA0 has been used while in N1 mode, the network need not apply the security procedures for this connection.

4.1.1.2 MM-GMM co-ordination for GPRS MS's

4.1.1.2.1 GPRS MS operating in mode A or B in a network that operates in mode I

If the network operates in mode I, GPRS MSes that operate in mode A or B and wish to be or are simultaneously IMSI attached for GPRS and non-GPRS services, shall use the combined GPRS attach and the combined and periodic routing area updating procedures instead of the corresponding MM specific procedures IMSI attach and normal and periodic location area updating.

A GPRS MS operating in mode A or B in a network that operates in mode I, shall perform the combined GPRS attach or routing area update procedure regardless the value of the ATT flag.

If a GPRS MS is operating in mode A or B in a network that operates in mode I the IMSI detach shall be performed by the GMM using the combined GPRS detach procedure.

A GPRS MS operating in mode A or B in a network that operates in mode I, shall perform the combined GPRS detach procedure regardless the value of the ATT flag.

A GPRS MS operating in mode A or B in network that operates in mode I, shall use the combined GMM specific procedures in place of the MM specific procedures unless the re-activation of the MM specific procedures is explicitly described, so all conditions describing when to trigger an MM specific procedure listed in subclauses 4.3 and 4.4 shall not apply.

A GPRS MS operating in mode A or B in a network that operates in mode I should not use any MM timers relating to MM specific procedures, (e.g. T3210, T3211, T3212, T3213) unless the re-activation of the MM specific procedures is explicitly described. If the MM timers are already running, the MS should not react on the expiration of the timers.

NOTE 1: Whenever GMM performs a combined GMM procedure, a GPRS MS enters the MM state MM LOCATION UPDATING PENDING in order to prevent the MM from performing a location area updating procedure.

If the authentication procedure is performed by MM and the authentication is rejected by the network (i.e. upon receive of AUTHENTICATION REJECT), the MS shall in addition set the GPRS update status to GU3 ROAMING NOT ALLOWED and shall, if available, delete the P-TMSI, P-TMSI signature, RAI and GPRS ciphering key sequence number stored. The SIM/USIM shall be considered as invalid for GPRS and non-GPRS services until switching off or the SIM/USIM is removed. The MS shall abort any GMM procedure and shall enter state GMM-DEREGISTERED. If S1 mode is supported in the MS, the MS shall handle the EMM parameters EPS update status, GUTI, last visited registered TAI, TAI list and KSI as specified in 3GPP TS 24.301 [120] for the case when the EPS authentication is not accepted by the network.

If the PS or CS domain is barred because of domain specific access control, a GPRS MS operating in mode A or B in a network that operates in mode I shall act as if in network operation mode II and access to the barred domain shall be stopped entirely. If the MS detects that a domain is barred, this shall not trigger any MM or GMM specific procedure.

A GPRS MS operating in mode A or B in a network that operates in mode I shall perform a normal location updating procedure (in order to remove the Gs association in the MSC/VLR) when the following conditions are fulfilled:

- the GPRS MS has camped on a cell where the PS domain is barred and the CS domain is unbarred; and

- T3312, T3311, T3302, or T3330 expires; and
- for the last attempt to update the registration of the location area a combined GMM procedure was performed.

Additionally the MS shall treat the expiry of T3312 when the PS domain changes from barred to unbarred, analogous to the descriptions for the cases when the timer expires out of coverage or in a cell that does not support GPRS (see subclause 4.7.2.2).

If timer T3312 expires and both the PS and CS domain are barred, then a GPRS MS operating in mode A or B in a network that operates in mode I shall treat the expiry of T3312 when the GPRS MS detects that the PS or CS domain becomes unbarred, analogous to the descriptions for the cases when the timer expires out of coverage (see subclause 4.7.2.2).

If the PS domain is barred and timer T3312 expires during an ongoing CS connection, then a GPRS MS operating in mode A or B in a network that operates in mode I shall treat the expiry of T3312 when the MM state MM-IDLE is entered, analogous to the descriptions for the cases when the timer expires out of coverage or in a cell that does not support GPRS (see subclause 4.7.2.2), or in a cell where the PS domain is barred.

A GPRS MS operating in mode A or B in a network that operates in mode I shall perform a combined routing area update procedure indicating "combined RA/LA updating with IMSI attach" (in order to establish the Gs association in the MSC/VLR) when the following conditions are fulfilled:

- the GPRS MS detects that CS or PS domain or both change from barred to unbarred;
- as a result of the change of the domain specific barring status, both domains are unbarred; and
- for the last attempt to update the registration of the location area an MM specific procedure was performed (see subclause 4.7.5.2.1) or for the last attempt to update the registration of the routing area a normal routing area update was performed.

A GPRS MS operating in mode A or B on a PLMN which is part of "forbidden PLMNs for GPRS service" list in a network that is operating in mode I shall act as if in network operation mode II and proceed with appropriate MM procedures.

4.1.1.2.2 GPRS MS operating in mode A or B in a network that operates in mode II

If the network operates in mode II, a GPRS MS that operates in mode A or B and wishes to be or is simultaneously IMSI attached for GPRS and non-GPRS services, shall use the MM specific procedures listed in subclauses 4.3 and 4.4 and the GMM specific procedures listed in subclauses 4.7.3, 4.7.4 and 4.7.5. The applicability of periodic location updating is further specified in subclause 4.4.2 and the periodic routing area updating is specified in subclause 4.7.2.2. If the GPRS MS, which operates in mode A or B, wishes to be IMSI attached for GPRS and "SMS-only service" or is simultaneously IMSI attached for GPRS and non-GPRS services in order to obtain GPRS services and "SMS-only service", then the GPRS MS shall first complete the GMM specific procedure before performing the MM specific procedures. If this GPRS MS receives in the ATTACH ACCEPT or ROUTING AREA UPDATE ACCEPT message the Additional network feature support IE indicating "SMS via GPRS supported", then the GPRS MS shall not perform the MM specific procedure until a new ATTACH ACCEPT or ROUTING AREA UPDATE ACCEPT message indicating "SMS via GPRS not supported" or the GPRS MS does not wish to be IMSI attached only for GPRS and "SMS-only service".

If the authentication procedure is performed by MM and the authentication is rejected by the network (i.e upon receive of AUTHENTICATION REJECT), the MS shall in addition set the GPRS update status to GU3 ROAMING NOT ALLOWED and shall, if available, delete the P-TMSI, P-TMSI signature, RAI and GPRS ciphering key sequence number stored. The SIM/USIM shall be considered as invalid for GPRS and non-GPRS services until switching off or the SIM/USIM is removed. The MS shall abort any GMM procedure and shall enter state GMM-DEREGISTERED. If S1 mode is supported in the MS, the MS shall handle the EMM parameters EPS update status, GUTI, last visited registered TAI, TAI list and KSI as specified in 3GPP TS 24.301 [120] for the case when the EPS authentication is not accepted by the network.

If the PS or CS domain is barred because of domain specific access control, a GPRS MS operating in mode A or B in a network that operates in mode II shall use the MM specific procedures or GMM specific procedures, respectively, in the domain which is unbarred. If the MS detects that a domain changes from barred to unbarred, it shall behave as specified in subclauses 4.3.4.4, 4.4.4.9, 4.5.1.2, 4.7.3.1.5, 4.7.4.1.4, 4.7.5.1.5, and 4.7.13.5.

4.1.1.2A Coordination between GMM and EMM

See subclause 5.1.4 in 3GPP TS 24.301 [120].

4.1.1.2B Coordination between GMM and 5GMM

See subclause 5.1.5 in 3GPP TS 24.501 [167].

4.1.1.3 Core Network System Information for MM (lu mode only)

In the network broadcast system information some of the system information is used by MM.

At reception of new system information, the RRC layer in the MS delivers the contents of the CN common system information and the CS domain specific system information to the MM layer in the MS.

The Core Network system information is included in specific information elements within some RRC messages sent to MS (see 3GPP TS 25.331 [23c] and 3GPP TS 44.118 [111]). In the Core Network system information the Common system information part and the CS domain specific system information part contains settings of parameters controlling MM functionality. No MM messages contain the Core Network System Information.

4.1.1.4 Core Network System Information for GMM (lu mode only)

4.1.1.4.1 General

In the network broadcast system information some of the system information is used by GMM.

At reception of new system information, the RRC layer in the MS delivers the contents of the CN common system information and the PS domain specific system information to the GMM layer in the MS.

The Core Network system information is included in specific information elements within some RRC messages sent to MS (see 3GPP TS 25.331 [23c] and 3GPP TS 44.118 [111]). In the Core Network system information the Common system information part and the PS domain specific system information part contains settings of parameters controlling GMM functionality. No GMM messages contain the Core Network System Information.

4.1.1.4.2 Control of Network Mode of Operation I

The behaviour of the MS with respect to NMO I is determined by the combination of PS domain specific system information IE as defined in subclause 10.5.1.12.3 and the setting of the parameter "NMO_I_Behaviour" in the NAS configuration Management Object as specified in 3GPP TS 24.368 [135] or in USIM file NAS_{CONFIG} as specified in 3GPP TS 31.102 [112]:

- if the parameter "NMO_I_Behaviour" in the NAS configuration Management Object is set to the value of "1", the bit 2 "NMO I" of system information as described in figure 10.5.1.12.3/table 10.5.1.12.3 is applied; or
- if the parameter "NMO_I_Behaviour" in the NAS configuration Management Object is set to the value of zero or is not provisioned, the bit 1 "NMO" of system information as described in figure 10.5.1.12.3/table 10.5.1.12.3 is applied.

4.1.1.5 Access class control

The network can restrict the access for certain groups of mobile stations. These groups are also known as access classes.

The restriction can apply for access to both domains (common access class control or EAB, depending on EAB configuration) or to one domain only (domain specific access control) (see 3GPP TS 23.122 [14]).

Additionally, the network can alleviate the access restriction in both domains or domain specifically, and allow restricted mobile stations to respond to paging messages or to perform generic location updating, or GPRS attach or routing area updating procedure.

A network operator can also restrict some MSs to access the network for location registration, although via common access class control or domain specific access class control the MSs are permitted to access the network for other

purposes. Therefore, for each access to the network the mobile station shall determine from the information received via the system information broadcast whether access is allowed or not:

- For paging response the mobile station shall evaluate the control information for common access control (as specified in 3GPP TS 44.018 [84], 3GPP TS 44.060 [76], and 3GPP TS 25.331 [23c]), the control information for EAB (as specified in 3GPP TS 44.018 [84], and 3GPP TS 25.331 [23c]), domain specific access control (as specified in 3GPP TS 44.018 [84] and 3GPP TS 25.331 [23c]), and the specific control information for paging response (as specified in 3GPP TS 25.331 [23c]; see "Paging Permission with Access Control").
- For generic location updating, GPRS attach and routing area updating procedures the mobile station shall evaluate the control information for:
 - common access control (as specified in 3GPP TS 44.018 [84], 3GPP TS 44.060 [76], and 3GPP TS 25.331 [23c]);
 - domain specific access control (as specified in 3GPP TS 44.018 [84] and 3GPP TS 25.331 [23c]);
 - specific control information for location registration (as specified in 3GPP TS 25.331 [23c]; see "Paging Permission with Access Control"); and
 - EAB as specified for A/Gb mode in 3GPP TS 44.018 [84], and for Iu mode in 3GPP TS 25.331 [23c].

The same control information shall also be taken into account, when the present document requires the mobile station to initiate a generic location updating, or GPRS attach or routing area updating procedure when it detects that a domain changes from barred to unbarred (see e.g. subclauses 4.1.1.2.1 and 4.1.1.2.2).

- For GPRS attach and routing area updating procedures in Iu mode, the mobile station shall evaluate the control information for:
 - ACDC if the mobile station supports ACDC (as specified in 3GPP TS 25.331 [23c]).

The same control information shall also be taken into account, when the present document requires the mobile station to initiate a GPRS attach or routing area updating procedure in Iu mode when it detects that PS domain changes from barred to unbarred (see e.g. subclauses 4.1.1.2.1 and 4.1.1.2.2).

- For all other purposes the mobile station shall evaluate the control information for common access control as specified in 3GPP TS 44.018 [84], 3GPP TS 44.060 [76], and 3GPP TS 25.331 [23c], the control information for EAB (as specified in 3GPP TS 44.018 [84], and 3GPP TS 25.331 [23c]), domain specific access control (as specified in 3GPP TS 44.018 [84] and 3GPP TS 25.331 [23c]) and in Iu mode for PS domain if the mobile station supports ACDC, the control information for ACDC (as specified in 3GPP TS 25.331 [23c]).

4.1.1.6 Specific requirements for MS configured to use timer T3245

The following requirement applies for an MS that is configured to use timer T3245 (see 3GPP TS 24.368 [135] or 3GPP TS 31.102 [112]):

When the MS adds a PLMN identity to the "forbidden PLMN list" or the "forbidden PLMNs for GPRS service" list or sets the SIM/USIM as invalid for non-GPRS services or GPRS services or both, and timer T3245 is not running, the MS shall start timer T3245 with a random value, uniformly drawn from the range between 12h and 24h.

Upon expiry of the timer T3245, the MS shall erase the "forbidden PLMN list" and the "forbidden PLMNs for GPRS service" list and set the SIM/USIM to valid for non-GPRS services and GPRS services. When the lists are erased, the MS performs a cell selection according to 3GPP TS 43.022 [82] and 3GPP TS 25.304 [98].

If the MS is switched off when the timer T3245 is running, the MS shall behave as follows when the MS is switched on and the SIM/USIM in the MS remains the same:

- let t_1 be the time remaining for T3245 timeout at switch off and let t be the time elapsed between switch off and switch on. If t_1 is greater than t , then the timer shall be restarted with the value $t_1 - t$. If t_1 is equal to or less than t , then the MS will follow the behaviour as defined in the paragraph above upon expiry of the timer T3245. If the MS is not capable of determining t , then the MS shall restart the timer with the value t_1 .

4.1.1.6A Specific requirements for the MS when receiving non-integrity protected reject messages

This subclause specifies the requirements for an MS that is not configured to use timer T3245 (see 3GPP TS 24.368 [135] or 3GPP TS 31.102 [112]) and receives a LOCATION UPDATING REJECT, CM SERVICE REJECT, ABORT, ATTACH REJECT, ROUTING AREA UPDATE REJECT or SERVICE REJECT message without integrity protection with specific MM or GMM causes.

NOTE 1: Additional MS requirements for this case, requirements for other MM or GMM causes, and requirements for the case when the MS receives a successfully integrity checked reject message are specified in subclauses 4.4.4.7, 4.5.1.1, 4.7.3.1.4, 4.7.3.2.4, 4.7.5.1.4, 4.7.5.2.4 and 4.7.13.4.

The present subclause is applicable to A/Gb mode and Iu mode. In A/Gb mode,

- for the CS domain, as integrity protection is not supported, all messages received by the MS are considered to be received "before the network has activated the integrity protection"; and
- for the PS domain, if integrity protection is not required (see subclause 4.7.1.2a.), all messages received by the MS are considered to be received "before the network has activated the integrity protection".

The MS may maintain a list of PLMN-specific attempt counters and a list of PLMN-specific PS-attempt counters. The maximum number of possible entries in each list is implementation dependent.

Additionally, the MS may maintain one counter for "SIM/USIM considered invalid for non-GPRS services" events and one counter for "SIM/USIM considered invalid for GPRS services" events.

The MS may also maintain a list of "forbidden location areas for non-GPRS services" and a list of "forbidden location areas for GPRS services". If the MS is in a location area which is included in the list of "forbidden location areas for non-GPRS services", the MS shall not initiate any MM procedure. If the MS is in a location area which is included in the list of "forbidden location areas for GPRS services", the MS shall not initiate any GMM, SM, SMS or SS procedure for GPRS services.

If the MS receives a LOCATION UPDATING REJECT message without integrity protection with MM cause value #2, #3, #6, #11, #12, #13 or #15 before the network has activated the integrity protection for the CS domain, the MS shall start timer T3247 with a random value uniformly drawn from the range between 30 minutes and 60 minutes, if the timer is not running, and take the following actions:

- 1) if the MM cause value received is #3 or #6, and
 - a) if the MS maintains a counter for "SIM/USIM considered invalid for non-GPRS services" events and the counter has a value less than an MS implementation-specific maximum value, the MS shall:
 - i) delete any LAI, TMSI and ciphering key sequence number stored in the SIM/USIM, reset the location update attempt counter, and set the update status to ROAMING NOT ALLOWED (and store it in the SIM/USIM according to subclause 4.1.2.2);

delete the list of equivalent PLMNs;

in Iu mode, increment the counter for "SIM/USIM considered invalid for non-GPRS services" events, if not already incremented over the same RRC connection;

in A/Gb mode, increment the counter for "SIM/USIM considered invalid for non-GPRS services" events;

store the current LAI in the list of "forbidden location areas for roaming"; and

search for a suitable cell in another location area or a tracking area according to 3GPP TS 43.022 [82] and 3GPP TS 25.304 [98] or 3GPP TS 36.304 [121]; or
 - ii) proceed as specified in subclause 4.4.4.7 and;

in Iu mode, increment the counter for "SIM/USIM considered invalid for non-GPRS services" events, if not already incremented over the same RRC connection;

in A/Gb mode, increment the counter for "SIM/USIM considered invalid for non-GPRS services" events;

and

- b) else the MS shall proceed as specified in subclause 4.4.4.7;
- 2) if the MM cause value received is #2, and
- a) if the MS maintains a counter for "SIM/USIM considered invalid for non-GPRS services" events and the counter has a value less than an MS implementation-specific maximum value, the MS shall:
- i) delete any LAI, TMSI and ciphering key sequence number stored in the SIM/USIM, reset the location update attempt counter, and set the update status to ROAMING NOT ALLOWED (and store it in the SIM/USIM according to subclause 4.1.2.2);
- delete the list of equivalent PLMNs;
- in Iu mode, increment the counter for "SIM/USIM considered invalid for non-GPRS services" events, if not already incremented over the same RRC connection;
- in A/Gb mode, increment the counter for "SIM/USIM considered invalid for non-GPRS services" events;
- if the MS maintains a list of "forbidden location areas for non-GPRS services" and a list of "forbidden location areas for GPRS services", proceed as follows:
- if the current LAI is already included in the list of "forbidden location areas for GPRS services" or the MS is not operating in MS operation mode A or B, store the current LAI in the list of "forbidden location areas for roaming"; otherwise store the current LAI in the list of "forbidden location areas for non-GPRS services"; and
- attempt to select a suitable cell according to 3GPP TS 43.022 [82] and 3GPP TS 25.304 [98] or 3GPP TS 36.304 [121], different from the cell where the LOCATION UPDATING REJECT was received; or
- NOTE 2: The cell on which the reject was received could still be a suitable cell.
- ii) proceed as specified in subclause 4.4.4.7 and;
- in Iu mode, increment the counter for "SIM/USIM considered invalid for non-GPRS services" events, if not already incremented over the same RRC connection;
- in A/Gb mode, increment the counter for "SIM/USIM considered invalid for non-GPRS services" events; and
- b) else the MS shall proceed as specified in subclause 4.4.4.7;
- 3) if the MM cause value received is #12, #13 or #15, the MS shall additionally proceed as specified in subclause 4.4.4.7;
- 4) if the MM cause value received is #11 and the MS is in its HPLMN or in a PLMN that is within the EHPLMN list:
- the MS shall delete any LAI, TMSI and ciphering key sequence number stored in the SIM/USIM, reset the location update attempt counter, and set the update status to ROAMING NOT ALLOWED (and store it in the SIM/USIM according to subclause 4.1.2.2). Additionally, the MS shall store the current LAI in the list of "forbidden location areas for roaming"; and
- the MS shall search for a suitable cell in another location area or a tracking area according to 3GPP TS 43.022 [82] and 3GPP TS 25.304 [98] or 3GPP TS 36.304 [121]; and
- 5) if the MM cause value received is #11 and if the MS is not in its HPLMN or in a PLMN that is within the EHPLMN list, in addition to the MS requirements specified in subclause 4.4.4.7,
- if the MS maintains a list of PLMN-specific attempt counters and the PLMN-specific attempt counter for the PLMN sending the reject message has a value less than an MS implementation-specific maximum value, the MS shall increment the PLMN-specific attempt counter for the PLMN.

If the MS receives a CM SERVICE REJECT or ABORT message with MM cause value #6 without integrity protection before the network has activated the integrity protection for the CS domain, the MS shall start timer T3247 with a random value uniformly drawn from the range between 30 minutes and 60 minutes, if the timer is not running, and

- a) if the MS maintains a counter for "SIM/USIM considered invalid for non-GPRS services" events and the counter has a value less than an MS implementation-specific maximum value, the MS shall:
- i) proceed as specified in subclauses 4.5.1.1 or 4.3.5.2 respectively with the exception that the MS shall not consider the SIM/USIM as invalid for non-GPRS services and;
delete the list of equivalent PLMNs;
in Iu mode, increment the counter for "SIM/USIM considered invalid for non-GPRS services" events, if not already incremented over the same RRC connection;
in A/Gb mode, increment the counter for "SIM/USIM considered invalid for non-GPRS services" events;
reset the location update attempt counter;
store the current LAI in the list of "forbidden location areas for roaming"; and
search for a suitable cell in another location area or a tracking area according to 3GPP TS 43.022 [82] and 3GPP TS 25.304 [98] or 3GPP TS 36.304 [121]; or
 - ii) proceed as specified in subclauses 4.5.1.1 or 4.3.5.2 respectively and;
in Iu mode, increment the counter for "SIM/USIM considered invalid for non-GPRS services" events, if not already incremented over the same RRC connection;
in A/Gb mode, increment the counter for "SIM/USIM considered invalid for non-GPRS services" events; and
- b) else the MS shall proceed as specified in subclause 4.5.1.1 or 4.3.5.2 respectively.

If the MS receives an ATTACH REJECT or ROUTING AREA UPDATE REJECT message without integrity protection with GMM cause value #3, #6, #7, #8, #11, #12, #13, #14 or #15 before the network has activated the integrity protection for the PS domain, the MS shall start timer T3247 with a random value uniformly drawn from the range between 30 minutes and 60 minutes, if the timer is not running, and shall take the following actions:

- 6) if the GMM cause value received is #3, #6, or #8, and
- a) if the MS maintains a counter for "SIM/USIM considered invalid for GPRS services" events and the counter has a value less than an MS implementation-specific maximum value, the MS shall:
 - i) set the GPRS update status to GU3 ROAMING NOT ALLOWED (and shall store it according to subclause 4.1.3.2) and shall delete any RAI, P-TMSI, P-TMSI signature and GPRS ciphering key sequence number;
delete the list of equivalent PLMNs;
increment the counter for "SIM/USIM considered invalid for GPRS services" events;
if the MS maintains a counter for "SIM/USIM considered invalid for non-GPRS services" events and the counter has a value less than an MS implementation-specific maximum value, set the update status to U3 ROAMING NOT ALLOWED, delete any TMSI, LAI and ciphering key sequence number. If the MS is operating in MS operation mode A and an RR connection exists, the MS shall abort the RR connection, unless an emergency call is ongoing. In Iu mode, the MS shall increment the counter for "SIM/USIM considered invalid for non-GPRS services" events, if not already incremented over the same RRC connection. In A/Gb mode, the MS shall increment the counter for "SIM/USIM considered invalid for non-GPRS services" events;
if a GPRS attach or routing area updating procedure was performed, reset the GPRS attach attempt counter or the routing area updating attempt counter, respectively;
if S1 mode is supported by the MS, handle the EMM parameters attach attempt counter or tracking area updating attempt counter, EMM state, EPS update status, GUTI, last visited registered TAI, TAI list and KSI as specified in 3GPP TS 24.301 [120] for the case when an EPS attach or tracking area update procedure is rejected with the EMM cause of the same value in a NAS message without integrity protection;

store the current LAI in the list of "forbidden location areas for roaming" and enter the state GMM-DEREGISTERED.LIMITED-SERVICE; and

search for a suitable cell in another location area or a tracking area according to 3GPP TS 43.022 [82] and 3GPP TS 25.304 [98] or 3GPP TS 36.304 [121]; or

- ii) proceed as specified in subclauses 4.7.3.1.4, 4.7.3.2.4, 4.7.5.1.4, 4.7.5.2.4 and 4.7.13.4;

increment the counter for "SIM/USIM considered invalid for GPRS services" events; and

if the MS maintains a counter for "SIM/USIM considered invalid for non-GPRS services" events and the counter has a value less than an MS implementation-specific maximum value:

in Iu mode, increment the counter for "SIM/USIM considered invalid for non-GPRS services" events, if not already incremented over the same RRC connection

in A/Gb mode, increment the counter for "SIM/USIM considered invalid for non-GPRS services" events; and

- b) else the MS shall proceed as specified in subclause 4.7.3.1.4, 4.7.3.2.4, 4.7.5.1.4, 4.7.5.2.4 and 4.7.13.4;

- 7) if the GMM cause value received is #7, and

- a) if the MS maintains a counter for "SIM/USIM considered invalid for GPRS services" events and the counter has a value less than an MS implementation-specific maximum value, the MS shall:

- i) set the GPRS update status to GU3 ROAMING NOT ALLOWED (and shall store it according to subclause 4.1.3.2) and shall delete any RAI, P-TMSI, P-TMSI signature and GPRS ciphering key sequence number;

delete the list of equivalent PLMNs;

increment the counter for "SIM/USIM considered invalid for GPRS services" events;

- if a GPRS attach or routing area updating procedure was performed, reset the GPRS attach attempt counter or the routing area updating attempt counter, respectively;

if S1 mode is supported by the MS, handle the EMM parameters attach attempt counter or tracking area updating attempt counter, EMM state, EPS update status, GUTI, last visited registered TAI, TAI list and KSI as specified in 3GPP TS 24.301 [120] for the case when an EPS attach or tracking area update procedure is rejected with the EMM cause of the same value in a NAS message without integrity protection;

enter the state GMM-DEREGISTERED.LIMITED-SERVICE;

if the MS maintains a list of "forbidden location areas for non-GPRS services" and a list of "forbidden location areas for GPRS services", proceed as follows:

if the current LAI is already included in the list of "forbidden location areas for non-GPRS services" or the MS is operating in MS operation mode C, store the current LAI in the list of "forbidden location areas for roaming"; otherwise store the current LAI in the list of "forbidden location areas for GPRS services"; and

attempt to select a suitable cell according to 3GPP TS 43.022 [82] and 3GPP TS 25.304 [98] or 3GPP TS 36.304 [121], different from the cell where the ATTACH REJECT or ROUTING AREA UPDATING REJECT was received; or

NOTE 3: The cell on which the reject was received could still be a suitable cell.

- ii) proceed as specified in subclauses 4.7.3.1.4, 4.7.3.2.4, 4.7.5.1.4, 4.7.5.2.4 and 4.7.13.4; and

increment the counter for "SIM/USIM considered invalid for GPRS services" events; and

- b) else the MS shall proceed as specified in subclause 4.7.3.1.4, 4.7.3.2.4, 4.7.5.1.4, 4.7.5.2.4 and 4.7.13.4;

- 8) if the GMM cause value received is #12, #13 or #15, the MS shall additionally proceed as specified in subclauses 4.7.3.1.4, 4.7.3.2.4, 4.7.5.1.4, 4.7.5.2.4 and 4.7.13.4;

- 9) if the GMM cause value received is #11 or #14 and the MS is in its HPLMN or in a PLMN that is within the EHPLMN list:
- the MS shall set the GPRS update status to GU3 ROAMING NOT ALLOWED (and shall store it according to subclause 4.1.3.2) and shall delete any RAI, P-TMSI, P-TMSI signature and GPRS ciphering key sequence number. The MS shall delete the list of equivalent PLMNs. Additionally, if a GPRS attach or the routing area updating procedure was performed, the MS shall reset the GPRS attach attempt counter or the routing area updating attempt counter respectively;
 - for GMM cause value #11, the MS shall store the current LAI in the list of "forbidden location areas for roaming", and enter the state GMM-DEREGISTERED.LIMITED-SERVICE;
 - for GMM cause value #14, the MS shall enter the state GMM-DEREGISTERED.LIMITED-SERVICE. If the MS maintains a list of "forbidden location areas for non-GPRS services" and a list of "forbidden location areas for GPRS services", proceed as follows:
 - if the current LAI is already included in the list of "forbidden location areas for non-GPRS services" or the MS is operating in MS operation mode C, store the current LAI in the list of "forbidden location areas for roaming"; otherwise store the current LAI in the list of "forbidden location areas for GPRS services";
 - if S1 mode is supported in the MS, the MS shall handle the EMM parameters EMM state, EPS update status, GUTI, last visited registered TAI, TAI list, KSI and attach attempt counter or tracking area updating attempt counter as specified in 3GPP TS 24.301 [120] for the case when the procedure is rejected with the EMM cause with the same value without integrity protection; and
 - the MS shall search for a suitable cell in another location area or in another tracking area according to 3GPP TS 43.022 [82] and 3GPP TS 25.304 [98] or 3GPP TS 36.304 [121].
- 10) if the GMM cause value received is #11 and the MS is not in its HPLMN or in a PLMN that is within the EHPLMN list, the MS shall additionally proceed as specified in subclauses 4.7.3.1.4, 4.7.3.2.4, 4.7.5.1.4, 4.7.5.2.4 and 4.7.13.4:
- Furthermore, if the MS maintains a list of PLMN-specific attempt counters and the PLMN-specific attempt counter for the PLMN sending the reject message has a value less than an MS implementation-specific maximum value, the MS shall increment the PLMN-specific attempt counter for the PLMN.
- 11) if the GMM cause value received is #14 and the MS is not in its HPLMN or in a PLMN that is within the EHPLMN list, the MS shall additionally proceed as specified in subclauses 4.7.3.1.4, 4.7.3.2.4, 4.7.5.1.4, and 4.7.5.2.4:
- Furthermore, if the MS maintains a list of PLMN-specific PS-attempt counters and the PLMN-specific PS-attempt counter for the PLMN sending the reject message has a value less than an MS implementation-specific maximum value, the MS shall increment the PLMN-specific PS-attempt counter for the PLMN.
 - If the MS maintains a list of "forbidden location areas for non-GPRS services" and a list of "forbidden location areas for GPRS services", proceed as follows:
 - if the current LAI is already included in the list of "forbidden location areas for non-GPRS services" or the MS is operating in MS operation mode C, store the current LAI in the list of "forbidden location areas for roaming"; otherwise store the current LAI in the list of "forbidden location areas for GPRS services" and the MS shall enter the state GMM-DEREGISTERED.LIMITED-SERVICE.

If the MS receives a SERVICE REJECT message without integrity protection with GMM cause value #3, #6, #7, #8, #11, #12, #13 or #15 before the network has activated the integrity protection for the PS domain, the MS shall start timer T3247 with a random value uniformly drawn from the range between 30 minutes and 60 minutes, if the timer is not running, and proceed as specified under items 6, 7, 8, 9 and 10 above.

Upon expiry of timer T3247, the MS shall:

- erase the list of "forbidden location areas for regional provision of service" and the list of "forbidden location areas for roaming";
- set the SIM/USIM to valid for non-GPRS services, if
- the MS does not maintain a counter for "SIM/USIM considered invalid for non-GPRS services" events; or

- the MS maintains a counter for "SIM/USIM considered invalid for non-GPRS services" events and this counter has a value less than an MS implementation-specific maximum value.
- set the SIM/USIM to valid for GPRS services, if
 - the MS does not maintain a counter for "SIM/USIM considered invalid for GPRS services" events; or
 - the MS maintains a counter for "SIM/USIM considered invalid for GPRS services" events and this counter has a value less than an MS implementation-specific maximum value.
- erase the list of "forbidden location areas for non-GPRS services" and the list of "forbidden location areas for GPRS services", if the MS maintains these lists;
- if the MS maintains a list of PLMN-specific attempt counters, for each PLMN-specific attempt counter that has a value greater than zero and less than an MS implementation-specific maximum value, remove the respective PLMN from the forbidden PLMN list;
- if the MS maintains a list of PLMN-specific PS-attempt counters, for each PLMN-specific PS-attempt counter that has a value greater than zero and less than an MS implementation-specific maximum value, remove the respective PLMN from the "forbidden PLMNs for GPRS service" list. If the resulting "forbidden PLMNs for GPRS service" list is empty and the MS is supporting S1 mode, the MS re-enables the E-UTRA capability as specified in 3GPP TS 24.301 [120] for the case when timer T3247 expires;
- if the MS is supporting S1 mode, handle the list of "forbidden tracking areas for regional provision of service" and the list of "forbidden tracking areas for roaming" as specified in 3GPP TS 24.301 [120] for the case when timer T3247 expires; and
- initiate a location updating procedure, GPRS attach procedure or routing area updating procedure, if still needed, dependent on MM state and update status, and GMM state and GPRS update status, or perform a PLMN selection according to 3GPP TS 23.122 [14].

If the MS maintains a list of PLMN-specific attempt counters and PLMN-specific PS-attempt counters, when the MS is switched off, the MS shall, for each PLMN-specific attempt counter that has a value greater than zero and less than the MS implementation-specific maximum value, remove the respective PLMN from the forbidden PLMN list. When the SIM/USIM is removed, the MS should perform this action.

NOTE 4: If the respective PLMN was stored in the extension of the "forbidden PLMNs" list, then according to 3GPP TS 23.122 [14] the MS will delete the contents of this extension when the SIM/USIM is removed.

4.1.1.7 Handling of NAS level mobility management congestion control

The network may detect GMM or MM signalling congestion and perform NAS level mobility management congestion control. PS domain NAS level mobility management congestion control consists of general NAS level mobility management congestion control and subscribed APN based congestion control. CS domain NAS level mobility management congestion control consists of general NAS level mobility management congestion control.

Under NAS level mobility management congestion control the network may reject mobility management signalling requests from MSs as specified in 3GPP TS 23.060 [74]. The network should not reject requests for emergency bearer services.

When subscribed APN based congestion control is active for a particular APN, the network may reject attach request from MSs with subscription to this APN.

In mobility management the network may detect NAS signalling congestion. The network may start or stop performing the subscribed APN based congestion control based on mobility management level criteria such as:

- rate of mobility management NAS messages from a group of MSs with a subscription to a particular APN exceeds or falls below certain thresholds; or
- setting in network management.

When the NAS level mobility management congestion control is active, the network may include a value for the mobility management back-off timer T3246 or T3346 in the reject messages. The MS starts the mobility management back-off timer with the value received in the mobility management reject messages. To avoid that large numbers of

MSs simultaneously initiate deferred requests, the network should select the value for the mobility management back-off timer for the rejected MSs so that timeouts are not synchronised.

For subscribed APN based congestion control the value of timer T3346 for a particular APN may be APN dependent.

If the timer T3346 is running when the MS enters state GMM-DEREGISTERED, the MS remains switched on, and the SIM/USIM in the MS remains the same, then timer T3346 is kept running until it expires or it is stopped.

If the MS is switched off when the timer T3246 or T3346 is running, the MS shall behave as follows for each running timer when the MS is switched on and the SIM/USIM in the MS remains the same:

- let t_1 be the time remaining until timeout at switch off and let t be the time elapsed between switch off and switch on. If t_1 is greater than t , then the timer shall be restarted with the value $t_1 - t$. If t_1 is equal to or less than t , then the timer need not be restarted. If the MS is not capable of determining t , then the MS shall restart the timer with the value t_1 ; and
- if prior to switch off, timer T3346 was started due to a NAS request message (ATTACH REQUEST, ROUTING AREA UPDATE REQUEST or SERVICE REQUEST) which contained the low priority indicator set to "MS is configured for NAS signalling low priority", then if timer T3346 is restarted at switch on, the MS configured for low priority shall handle mobility management requests as indicated in subclauses 4.7.3.1.5, 4.7.5.1.5 and 4.7.13.5.

If the MS enters a new PLMN while timer T3246 is running, and the new PLMN is not equivalent to the PLMN where the MS started timer T3246, the MS shall stop timer T3246 when initiating mobility management procedures in the new PLMN.

If the MS enters a new PLMN while timer T3346 is running, and the new PLMN is not equivalent to the PLMN where the MS started timer T3346, the MS shall stop timer T3346 when initiating mobility management procedures in the new PLMN.

At an inter-system change from S1 mode to A/Gb mode or from Iu mode to A/Gb mode within the same RA, if the timer T3346 is running and the TIN indicates "RAT-related TMSI", the MS shall set the GPRS update status to GU2 NOT UPDATED and enter state GMM-REGISTERED.ATTEMPTING-TO-UPDATE.

After change in RAI, if the timer T3346 is running and GPRS update status is GU1 UPDATED then MS shall set the GPRS update status to GU2 NOT UPDATED and enter state GMM-REGISTERED.ATTEMPTING-TO-UPDATE.

After change in LAI, if the timer T3246 is running and MM update status is U1 UPDATED then MS shall set the MM update status to U2 NOT UPDATED and enter state MM IDLE, ATTEMPTING TO UPDATE.

4.1.1.8 Handling of security related parameters at switch on and switch off

At switch on, an ME supporting UTRAN Iu mode shall proceed as follows:

- if a USIM is inserted, the ME shall read the $START_{CS}$ and $START_{PS}$ value from the USIM. If $START_{CS}$ and/or $START_{PS}$ read from the USIM are greater than or equal to the maximum value of $START_{CS}$ and $START_{PS}$ provided on the USIM (see 3GPP TS 31.102 [112]) or the CKSN or GPRS CKSN stored on the USIM indicates "no key available", the ME shall set the START value in the volatile memory of the ME for the corresponding core network domain(s) to zero. In addition if the read $START_{CS}$ and/or $START_{PS}$ are greater than or equal to the maximum value, the ME shall delete the corresponding CKSN or GPRS CKSN from the ME and the USIM. The ME shall set the $START_{CS}$ and $START_{PS}$ value on the USIM to the maximum value of $START_{CS}$ and $START_{PS}$ provided on the USIM (see 3GPP TS 31.102 [112]); and
- if a SIM is inserted, the ME shall read the $START_{CS}$ and $START_{PS}$ value from the non-volatile memory. If $START_{CS}$ and/or $START_{PS}$ read from the non-volatile memory are greater than or equal to the default value specified in 3GPP TS 33.102 [5a], subclause 6.8.2.4 or the CKSN or GPRS CKSN stored on the SIM indicates "no key available", the ME shall set the START value in the volatile memory of the ME for the corresponding core network domain(s) to zero. In addition if the read $START_{CS}$ and/or $START_{PS}$ are greater than or equal to the default value, the ME shall delete the corresponding CKSN or GPRS CKSN from the ME. The ME shall set the $START_{CS}$ and $START_{PS}$ value in the non-volatile memory to the default value specified in 3GPP TS 33.102 [5a], subclause 6.8.2.4.

NOTE: The lower layer handles the $START_{CS}$ and $START_{PS}$ value stored in the volatile memory of the ME as specified in 3GPP TS 25.331 [23c].

Only at switch off, an ME supporting UTRAN Iu mode shall proceed for each of the two domains, CS and PS, as follows:

- if since switch on the ME performed an authentication procedure for the respective domain and stored the new security context on the USIM or SIM, and the new security context was not taken into use, the ME shall set the START value for this domain on the USIM or, if a SIM is inserted, in the non-volatile memory to zero; and
- otherwise, if a security context for the respective domain is stored on the USIM or SIM, i.e. the CKSN or GPRS CKSN stored on the USIM or SIM is different from "no key available", the ME shall store the current START value used by the lower layer for this domain on the USIM or, if a SIM is inserted, in the non-volatile memory.

4.1.1.9 Equivalent PLMNs list

The mobile equipment shall store a list of "equivalent PLMNs". These PLMNs shall be regarded by the MS as equivalent to each other for PLMN selection and cell selection/re-selection. The same list is used by EMM, GMM and MM.

The list of equivalent PLMNs is replaced or deleted at the end of each location updating procedure, routing area updating procedure and GPRS attach procedure. The stored list consists of a list of equivalent PLMNs as downloaded by the network plus the PLMN code of the registered PLMN that downloaded the list. The stored list shall not be deleted when the MS is switched off. The stored list shall be deleted if the SIM/USIM is removed or when an MS attached for emergency bearer services enters the state GMM-DEREGISTERED. The maximum number of possible entries in the stored list is 16.

4.1.1.10 Dedicated core network

The network may reject mobility management signalling requests from MSs due to dedicated core network as specified in 3GPP TS 23.060 [74]. When the network rejects mobility management signalling requests due to dedicated core network, the mechanism for general NAS level mobility management congestion control as specified in subclause 4.1.1.7 shall be followed.

4.1.2 MM sublayer states

The description of the states for the MM sublayer is organized as follows. The main states for the MS side, related to the procedures, are described in subclause 4.1.2.1.1. The MM IDLE state is subdivided in substates for the description of the behaviour in idle mode (subclause 4.1.2.1.2). This behaviour depends on an update status, described in subclause 4.1.2.2. The states for the network side are described in subclause 4.1.2.3.

4.1.2.1 MM sublayer states in the mobile station

In this subclause, the possible states for the MM sublayer in the mobile station is described. In figure 4.1 of the present document, an overview of the MM sublayer protocol is given.

4.1.2.1.1 Main states

0 NULL

The mobile station is inactive (e.g. power down). Important parameters are stored. Only manual action by the user may transfer the MM sublayer to another state.

3 LOCATION UPDATING INITIATED

A location updating procedure has been started and the MM awaits a response from the network. The timer T3210 is running.

5 WAIT FOR OUTGOING MM CONNECTION

The MM connection establishment has been started, and the MM awaits a response from the network. The timer T3230 is running.

6 MM CONNECTION ACTIVE

The MM sublayer has a RR connection to its peer entity on the network side. One or more MM connections are active.

7 IMSI DETACH INITIATED

The IMSI detach procedure has been started. The timer T3220 is running.

8 PROCESS CM SERVICE PROMPT

The MM sublayer has a RR connection to its peer entity on the network side. The Mobile Station has received a CM SERVICE PROMPT message but has not yet responded \$(CCBS)\$.

9 WAIT FOR NETWORK COMMAND

The MM sublayer has a RR connection to its peer entity in the network, but no MM connection is established. The mobile station is passive, awaiting further commands from the network. The timer T3240 may be running.

10 LOCATION UPDATE REJECTED

A location updating procedure has been rejected and RR connection release is awaited. The timer T3240 is running.

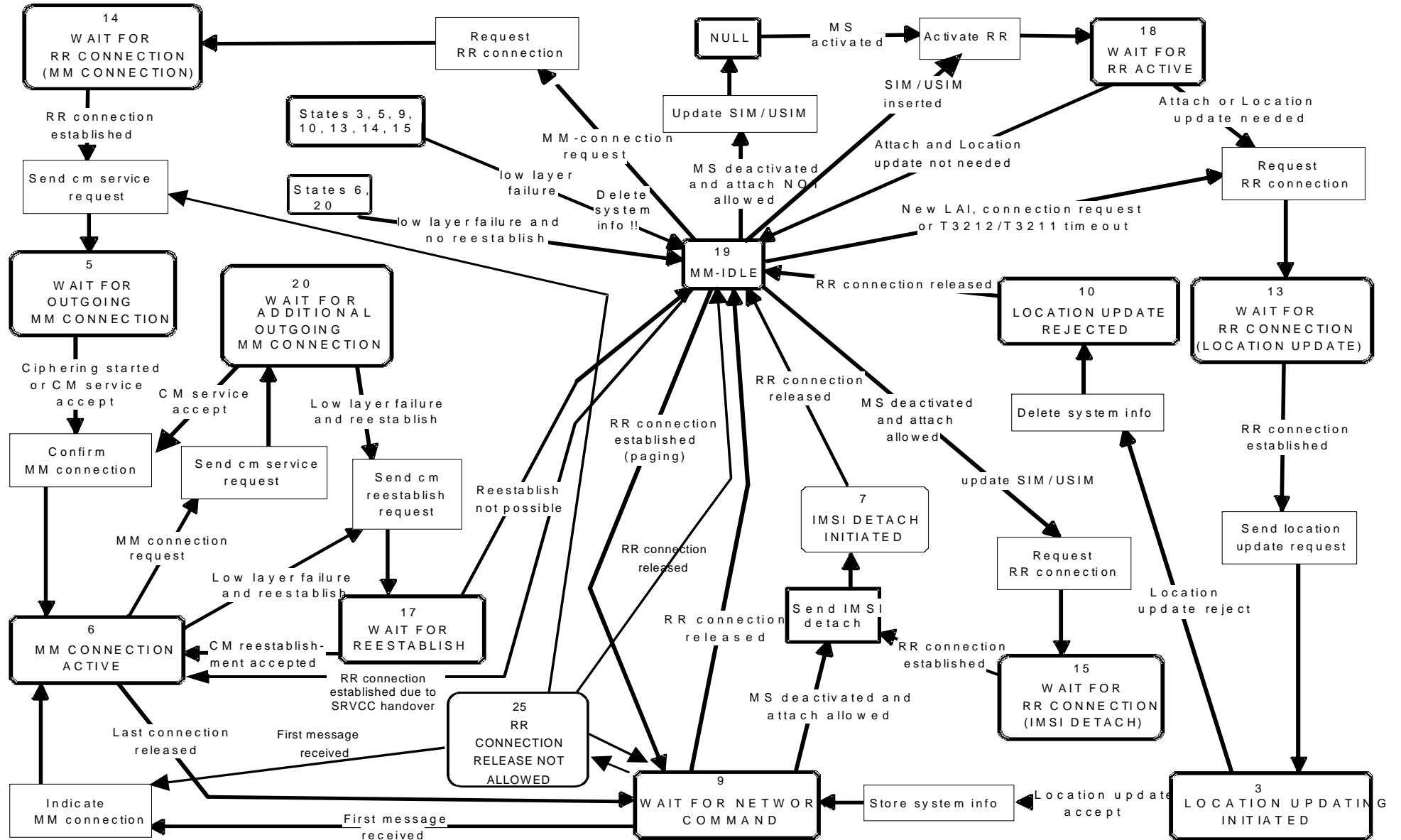
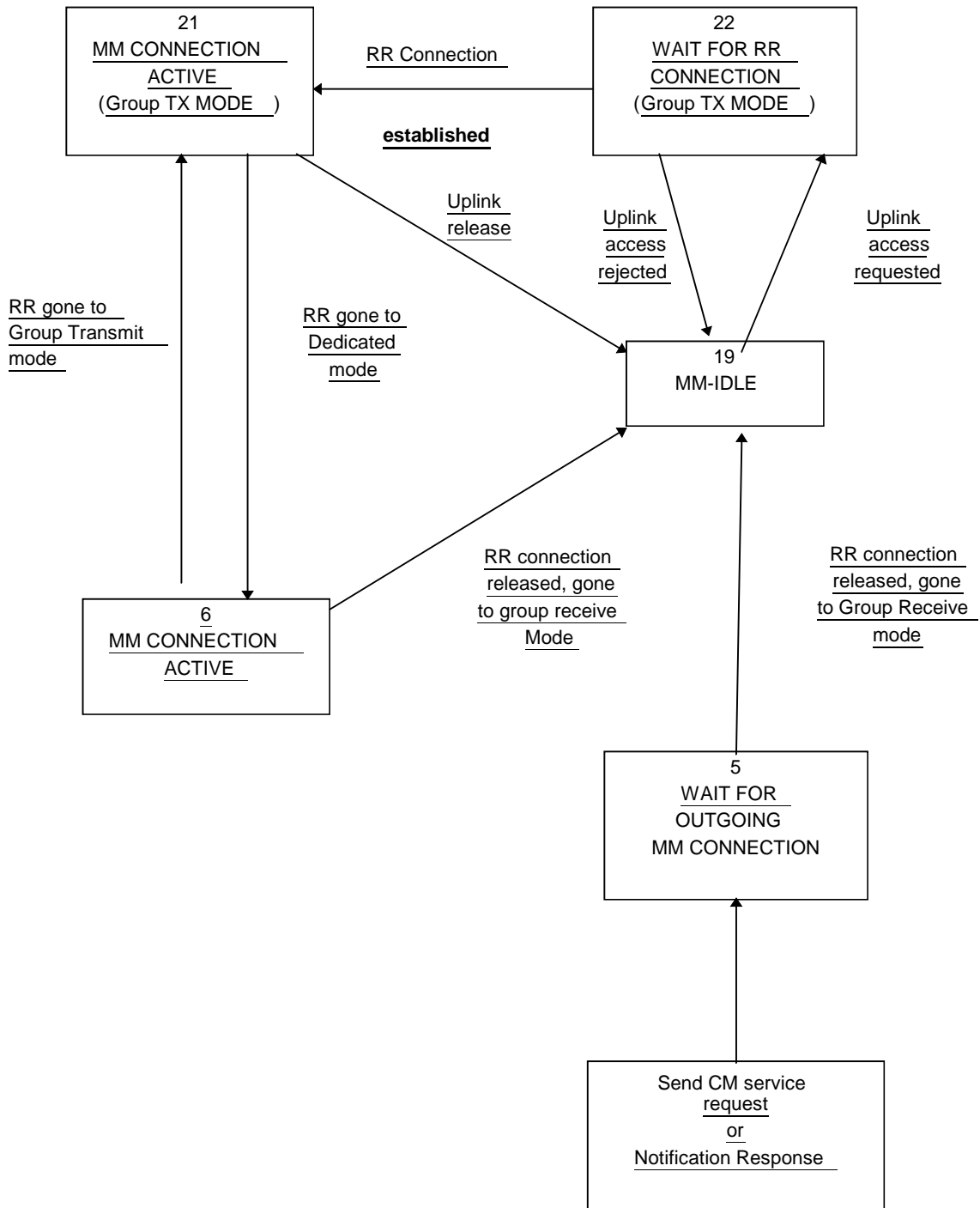

Figure 4.1a/3GPP TS 24.008: Overview mobility management protocol/MS Side



Additions to Figure 4.1a/3GPP TS 24.008

13. WAIT FOR RR CONNECTION (LOCATION UPDATING)

The MM sublayer has requested RR connection establishment for starting the location updating procedure.

14. WAIT FOR RR CONNECTION (MM CONNECTION)

The MM sublayer has requested RR connection establishment for dedicated mode for starting the MM connection establishment.

15. WAIT FOR RR CONNECTION (IMSI DETACH)

The MM sublayer has requested RR connection establishment for starting the IMSI detach procedure.

17. WAIT FOR REESTABLISH

A lower layer failure has occurred and re-establishment may be performed from the disturbed CM layer entities.

18. WAIT FOR RR ACTIVE

The MM sublayer has requested activation of the RR sublayer.

19. MM IDLE

There is no MM procedure running and no RR connection exists except that a local MM context may exist when the RR sublayer is in Group Receive mode. This is a compound state, and the actual behaviour of the mobile station to Connection Management requests is determined by the actual substate as described hereafter.

20. WAIT FOR ADDITIONAL OUTGOING MM CONNECTION.

The MM connection establishment for an additional MM connection has been started, and the MM awaits response from the network.

21. MM CONNECTION ACTIVE (GROUP TRANSMIT MODE)

(Only applicable for mobile stations supporting VGCS talking:) The MM sublayer has a RR connection on the VGCS channel to its peer entity on the network side. Only one MM connection is active.

22. WAIT FOR RR CONNECTION (GROUP TRANSMIT MODE)

(Only applicable for mobile stations supporting VGCS talking:) The MM sublayer has requested to perform an uplink access on the VGCS channel.

23. LOCATION UPDATING PENDING

(Only applicable for GPRS MS operation modes A and B; not shown in figure 4.1a) A location updating has been started using the combined GPRS attach procedure or the combined GPRS routing area updating procedure.

24. IMSI DETACH PENDING

(Only applicable for GPRS MS operation modes A and B; not shown in figure 4.1a) An IMSI detach for non-GPRS services has been started using the combined GPRS detach procedure at not switching off.

25. RR CONNECTION RELEASE NOT ALLOWED

(Only applicable for mobile stations supporting RRLP procedures (see 3GPP TS 44.031 [23b]) or LCS procedures over RRC (see 3GPP TS 25.331 [23c])). All MM connections are released by their CM entities, but the RR connection is maintained by the network due to an ongoing RRLP procedure or LCS procedure over RRC.

4.1.2.1.2 Substates of the MM IDLE state

For the description of the behaviour of the MS the MM IDLE state is subdivided in several substates, also called the service states. The service state pertains to the whole MS (ME alone if no SIM/USIM is inserted, or ME plus SIM/USIM). The service state depends on the update status (see subclause 4.1.2.2) and on the selected cell.

19.1 NORMAL SERVICE

Valid subscriber data are available, update status is U1, a cell is selected that belongs to the LA where the subscriber is registered.

In this state, all requests from the CM layers are treated normally.

19.2 ATTEMPTING TO UPDATE

Valid subscriber data are available, update status is U2 and a cell is selected. Requests from upper layers are accepted. Emergency call requests are treated normally, otherwise the request triggers first a location

updating attempt in the selected cell, and then triggers the needed procedure only in case of successful location updating, otherwise the request is rejected.

19.3 LIMITED SERVICE

Valid subscriber data are available, update status is U3, and a cell is selected, which is known not to be able to provide normal service. Only emergency services are offered.

19.4 NO IMSI

No valid subscriber data (no SIM/USIM, or the SIM/USIM is not considered valid by the ME), and a cell is selected. Only emergency services are offered.

19.5 NO CELL AVAILABLE

No cell can be selected. This state is entered after a first intensive search failed (state 19.7). Cells are searched at a low rhythm.

This state is also entered when S1 mode is activated in the MS and current cell is an E-UTRAN cell. No services, except those provided by CS fallback and SMS over SGs, are offered.

19.6 LOCATION UPDATE NEEDED

Valid subscriber data are available, and for some reason a location updating must be done as soon as possible (for instance update status is U1 but the selected cell is not in the registered LA, or the timer has expired). This state is usually of no duration, but can last, e.g. due to access class control, (see subclause 4.1.1.2.1).

19.7 PLMN SEARCH

The mobile station is searching for PLMNs, and the conditions for state 19.8 are not met. This state is ended when either a cell is selected (the new state is 19.1, 19.3 or 19.6), or when it is concluded that no cell is available for the moment (the new state is 19.5).

19.8 PLMN SEARCH, NORMAL SERVICE

Valid subscriber data are available, update status is U1, a cell is selected which belongs to the LA where the subscriber is registered, and the mobile station is searching for PLMNs. This state is ended when either a cell is selected (the new state is 19.1, 19.3 or 19.6), or when it is concluded that no cell is available for the moment (the new state is 19.5).

19.9 RECEIVING GROUP CALL (NORMAL SERVICE)

Only applicable for mobile stations supporting VGCS listening or VBS listening. Valid subscriber data are available, update status is U1, a VGCS channel or VBS channel is received in a cell that belongs to the LA where the subscriber is registered.

In this state, only requests from the GCC or BCC layers are treated.

19.10 RECEIVING GROUP CALL (LIMITED SERVICE)

Only applicable for mobile stations supporting VGCS listening or VBS listening. Valid subscriber data are available, update status is U3, a VGCS channel or VBS channel is received in a cell which is known not to be able to provide normal service.

In this state, only requests from the GCC or BCC layers for the reception of VGCS or VBS calls are treated and group call emergency services are offered.

19.11 eCALL INACTIVE

Valid subscriber data are available, update status is U4, and a cell is selected, which is expected to be able to provide normal service. Only emergency services and test/reconfiguration calls (see 3GPP TS 22.101 [8]) can be initiated by the mobile station. This state is applicable only to an eCall only mobile station (as determined by information configured in USIM). The state is entered by the mobile station in order to avoid MM activity and MM signalling in the absence of an emergency call or test/reconfiguration call. The state is ended when an emergency services or test/reconfiguration calls[8] is initiated by the mobile station, the new state depends on the result of the procedure when returning to MM-IDLE described in subclause 4.2.3.

4.1.2.2 The update Status

In parallel with the sublayer states described in subclause 4.1.2.1 and which control the MM sublayer protocol, an update status exists.

The update status pertains to a specific subscriber embodied by a SIM/USIM. This status is defined even when the subscriber is not activated (SIM/USIM removed or connected to a switched-off ME). It is stored in a non volatile memory in the SIM/USIM. The update status is changed only as a result of a location updating procedure attempt (with the exception of an authentication failure and of some cases of CM service rejection). In some cases, the update status is changed as a result of a GPRS attach, GPRS routing area update, service request network initiated GPRS detach procedure or due to change in LAI while timer T3246 running.

U1 UPDATED

The last location updating attempt was successful (correct procedure outcome, and the answer was acceptance from the network). With this status, the SIM/USIM contains also the LAI of the LA where the subscriber is registered, and possibly valid TMSI, GSM ciphering key, UMTS integrity key, UMTS ciphering key and ciphering key sequence number. Furthermore, if the ME supports any A5 ciphering algorithm that requires a 128-bit ciphering key and a USIM is in use, then the ME may contain a valid GSM K_{C128}. The "Location update status" stored on the SIM/USIM shall be "updated".

U2 NOT UPDATED

The last location updating attempt made failed procedurally (no significant answer was received from the network, including the cases of failures or congestion inside the network).

For this status, the SIM/USIM can contain a valid LAI of the location area to which the subscriber was registered, and possibly also a valid TMSI, GSM ciphering key, UMTS integrity key, UMTS ciphering key and ciphering key sequence number. For compatibility reasons, all these fields shall be set to the "deleted" value if the LAI is deleted. However the presence of other values shall not be considered an error by the mobile station. Furthermore, if the ME supports any A5 ciphering algorithm that requires a 128-bit ciphering key and a USIM is in use, then the ME shall delete the GSM K_{C128} stored if the LAI is deleted. The "Location update status" stored on the SIM/USIM shall be "not updated".

U3 ROAMING NOT ALLOWED

The last location updating attempt run correctly, but the answer from the network was negative (because of roaming or subscription restrictions).

For this status, the SIM/USIM can contain a valid LAI, TMSI, GSM ciphering key, UMTS integrity key, UMTS ciphering key or ciphering key sequence number. For compatibility reasons, all these fields shall be set to the "deleted" value if the LAI is deleted. However the presence of other values shall not be considered an error by the mobile station. Furthermore, if the ME supports any A5 ciphering algorithm that requires a 128-bit ciphering key and a USIM is in use, then the ME shall delete the GSM K_{C128} stored if the LAI is deleted. The "Location update status" stored on the SIM/USIM shall be "Location Area not allowed".

U4 UPDATING DISABLED

Location updating has been disabled.

For this status, the SIM/USIM does not contain any valid LAI, TMSI, GSM ciphering key, UMTS integrity key, UMTS ciphering key or ciphering key sequence number. For compatibility reasons, all these fields shall be set to the "deleted" value at the moment the status is set to eCALL INACTIVE. However the presence of other values shall not be considered an error by the mobile station. Furthermore, if the ME supports any A5 ciphering algorithm that requires a 128-bit ciphering key and a USIM is in use, then the ME shall delete the GSM K_{C128} stored at the moment the status is set to eCALL INACTIVE. The "Location update status" stored on the SIM/USIM shall be "not updated".

4.1.2.3 MM sublayer states on the network side

1. IDLE

The MM sublayer is not active except possibly when the RR sublayer is in Group Receive mode.

2. WAIT FOR RR CONNECTION

The MM sublayer has received a request for MM connection establishment from the CM layer. A RR connection to the mobile station is requested from the RR sublayer (i.e. paging is performed).

3. MM CONNECTION ACTIVE

The MM sublayer has a RR connection to a mobile station. One or more MM connections are active, or no MM connection is active but an RRLP procedure or LCS procedure over RRC is ongoing.

4. IDENTIFICATION INITIATED

The identification procedure has been started by the network. The timer T3270 is running.

5. AUTHENTICATION INITIATED

The authentication procedure has been started by the network. The timer T3260 is running.

6. TMSI REALLOCATION INITIATED

The TMSI reallocation procedure has been started by the network. The timer T3250 is running.

7. SECURITY MODE INITIATED

In Iu mode, the security mode setting procedure has been requested to the RR sublayer. In A/Gb mode, the cipher mode setting procedure has been requested to the RR sublayer.

8a. WAIT FOR MOBILE ORIGINATED MM CONNECTION

A CM SERVICE REQUEST message is received and processed, and the MM sublayer awaits the "opening message" of the MM connection.

8b. WAIT FOR NETWORK ORIGINATED MM CONNECTION

A CM SERVICE PROMPT message has been sent by the network and the MM sublayer awaits the "opening message" of the MM connection \$(CCBS)\$.

9. WAIT FOR REESTABLISHMENT

The RR connection to a mobile station with one or more active MM connection has been lost. The network awaits a possible re-establishment request from the mobile station.

10. WAIT OF A GROUP CALL

Only applicable in case for mobile station supporting VGCS talking. The MM sublayer has received a request for establishing a VGCS from the GCC sublayer. The request for establishing a VGCS channels is given to the RR sublayer.

11. GROUP CALL ACTIVE

Only applicable in case of mobile station supporting VGCS talking. A VGCS channel is established by the RR sublayer. An RR connection to the talking mobile station can be established by the RR sublayer on the VGCS channel. The MM sublayer is active but no sending of MM message between the network and the mobile station has occurred.

12. MM CONNECTION ACTIVE (GROUP CALL)

Only applicable in case of mobile station supporting VGCS talking. The MM sublayer has a RR connection to the talking mobile station on the VGCS channel. Only one MM connection is active.

13. WAIT FOR BROADCAST CALL

Only applicable in case of VBS. The MM sublayer has received a request for a VBS establishment from the BCC sublayer. The request for establishment of VBS channels is given to the RR sublayer.

14. BROADCAST CALL ACTIVE

Only applicable in case of VBS. A VBS channel is established by the RR sublayer. The MM sublayer is active but no explicit MM establishment between the Network and the mobile station has occurred.

4.1.3 GPRS mobility management (GMM) sublayer states

In this subclause, the GMM protocol of the MS and the network are described by means of two different state machines. In subclause 4.1.3.1, the states of the GMM entity in the MS are introduced. The behaviour of the MS depends on a GPRS update status that is described in subclause 4.1.3.2. The states for the network side are described in subclause 4.1.3.3.

4.1.3.1 GMM states in the MS

In this subclause, the possible GMM states are described of a GMM entity in the mobile station. subclause 4.1.3.1.1 summarises the main states of a GMM entity, see figure 4.1b of the present document. The substates that have been defined are described in subclause 4.1.3.1.2 and subclause 4.1.3.1.3.

However, it should be noted that this subclause does not include a description of the detailed behaviour of the MS in the single states and does not cover abnormal cases. Thus, figure 4.1b of the present document is rather intended to give an overview of the state transitions than to be a complete state transition diagram. A detailed description of the behaviour of the MS is given in subclause 4.2. Especially, with respect to the behaviour of the MS in abnormal cases it is referred to subclause 4.7.

4.1.3.1.1 Main states

4.1.3.1.1.1 GMM-NULL

The GPRS capability is disabled in the MS. No GPRS mobility management function shall be performed in this state.

4.1.3.1.1.2 GMM-DEREGISTERED

The GPRS capability has been enabled in the MS, but no GMM context has been established. In this state, the MS may establish a GMM context by starting the GPRS attach or combined GPRS attach procedure.

4.1.3.1.1.3 GMM-REGISTERED-INITIATED

A GPRS attach or combined GPRS attach procedure has been started and the MS is awaiting a response from the network.

4.1.3.1.1.4 GMM-REGISTERED

A GMM context has been established, i.e. the GPRS attach or combined GPRS attach procedure has been successfully performed. In this state, the MS may activate PDP contexts, MBMS contexts, may send and receive user data and signalling information and may reply to a page request. Furthermore, cell and routing area updating are performed.

4.1.3.1.1.5 GMM-DEREGISTERED-INITIATED

The MS has requested release of the GMM context by starting the GPRS detach or combined GPRS detach procedure. This state is only entered if the MS is not being switched off at detach request.

4.1.3.1.1.6 GMM-ROUTING-AREA-UPDATING-INITIATED

A routing area updating procedure has been started and the MS is awaiting a response from the network.

4.1.3.1.1.7 GMM-SERVICE-REQUEST-INITIATED (lu mode only)

A service request procedure has been started and the MS is awaiting a response from the network.

4.1.3.1.2 Substates of state GMM-DEREGISTERED

The GMM-DEREGISTERED state is subdivided into several substates as explained below. The substates pertain to the whole MS (ME alone if no SIM/USIM is inserted, or ME plus SIM/USIM). The selection of the appropriate substate depends on the GPRS update status, see subclause 4.1.3.2, and on the selected cell.

4.1.3.1.2.1 GMM-DEREGISTERED.NORMAL-SERVICE

Valid subscriber data is available, a suitable cell has been found and the PLMN or LA is not in the forbidden list. In this state, a request for GPRS attach is performed using the stored temporary mobile subscriber identity for GPRS (P-TMSI), routing area identification (RAI) and GPRS ciphering key sequence number in case of GU1. If the GPRS update status is GU2, the IMSI shall be used to attach for GPRS services.

4.1.3.1.2.2 GMM-DEREGISTERED.LIMITED-SERVICE

Valid subscriber data is available, and a cell is selected, which is known not to be able to provide normal service.

4.1.3.1.2.3 GMM-DEREGISTERED.ATTACH-NEEDED

Valid subscriber data is available and for some reason a GPRS attach must be performed as soon as possible. This state is usually of no duration, but can last, e.g. due to access class control (see subclause 4.1.1.2.1).

4.1.3.1.2.4 GMM-DEREGISTERED.ATTEMPTING-TO-ATTACH

A cell is selected, a previous GPRS attach was rejected or failed due to a missing response from the network. The execution of further attach procedures depends on the GPRS attach attempt counter. No GMM procedure except GPRS attach shall be initiated by the MS in this substate.

4.1.3.1.2.5 GMM-DEREGISTERED.NO-IMSI

No valid subscriber data is available (no SIM/USIM, or the SIM/USIM is not considered valid by the ME) and a cell has been selected.

4.1.3.1.2.6 GMM-DEREGISTERED.NO-CELL-AVAILABLE

No cell can be selected. This substate is entered after a first intensive search failed (substate PLMN SEARCH). Cells are searched for at a low rhythm. No services are offered.

4.1.3.1.2.7 GMM-DEREGISTERED.PLMN-SEARCH

The mobile station is searching for PLMNs. This substate is left either when a cell has been selected (the new substate is NORMAL-SERVICE or LIMITED-SERVICE) or when it has been concluded that no cell is available at the moment (the new substate is NO-CELL-AVAILABLE).

4.1.3.1.2.8 GMM-DEREGISTERED.SUSPENDED (A/Gb mode only)

The MS shall enter this substate when entering dedicated mode and the MS limitations make it unable to communicate on GPRS channels. The MS shall leave this substate when leaving dedicated mode.

4.1.3.1.3 Substates of state GMM-REGISTERED

The state GMM-REGISTERED is subdivided into several substate as explained below. The substates pertain to the whole MS (ME alone if no SIM/USIM is inserted, or ME plus SIM/USIM).

4.1.3.1.3.1 GMM-REGISTERED.NORMAL-SERVICE

User data and signalling information may be sent and received.

4.1.3.1.3.2 GMM-REGISTERED.SUSPENDED (A/Gb mode only)

The MS shall enter this substate when entering dedicated mode and when the MS limitations makes it unable to communicate on GPRS channels. In this substate, no user data should be sent and no signalling information shall be sent. The MS shall leave this substate when leaving dedicated mode.

4.1.3.1.3.3 GMM-REGISTERED.UPDATE-NEEDED

The MS has to perform a routing area updating procedure, but its access class is not allowed in the cell due to access class control (see subclause 4.1.1.2.1). The procedure will be initiated as soon as access is granted (this might be due to a cell-reselection or due to change of the access classes allowed in the current cell). No GMM procedure except routing area updating shall be initiated by the MS in this substate. In this substate, no user data and no signalling information shall be sent.

4.1.3.1.3.4 GMM-REGISTERED.ATTEMPTING-TO-UPDATE

A routing area updating procedure failed due to a missing response from the network. The MS retries the procedure controlled by timers and a GPRS attempt counter. No GMM procedure except routing area updating shall be initiated by the MS in this substate. No data shall be sent or received.

4.1.3.1.3.5 GMM-REGISTERED.NO-CELL-AVAILABLE

GPRS coverage has been lost or PSM is active in the MS. If PSM is active, the MS can deactivate PSM at any time by activating the AS layer when the MS needs to send mobile originated signalling or user data. Otherwise, the MS shall not initiate any GMM procedures except of cell (and PLMN) reselection.

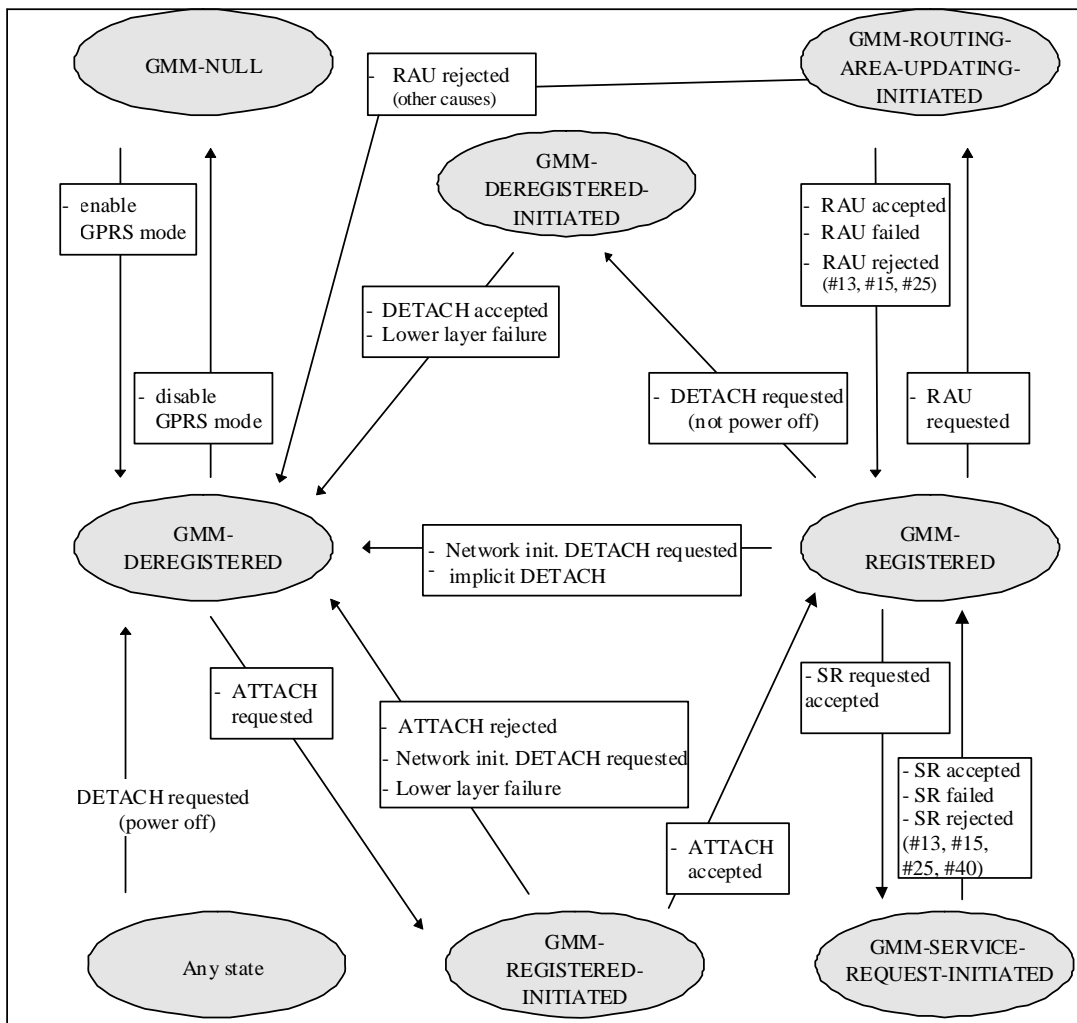

Figure 4.1b/3GPP TS 24.008:GMM main states in the MS

4.1.3.1.3.6 GMM-REGISTERED.LIMITED-SERVICE

A cell is selected, which is known not to be able to provide normal service. The MS will remain in this sub-state until a cell is selected which is able to provide normal service.

4.1.3.1.3.7 GMM-REGISTERED.ATTEMPTING-TO-UPDATE-MM

A combined routing area updating procedure or a combined GPRS attach procedure was successful for GPRS services only. The MS retries the procedure controlled by timers and a GPRS attempt counter. User data and signalling information may be sent and received.

4.1.3.1.3.8 GMM-REGISTERED.IMSI-DETACH-INITIATED

The MS performs a combined GPRS detach procedure for non-GPRS services only (detach type "IMSI Detach"). This state is entered if the MS is attached for GPRS and non-GPRS services in a network that operates in network mode I and wants to detach for non-GPRS services only. User data and signalling information may be sent and received.

4.1.3.1.3.9 GMM-REGISTERED.PLMN-SEARCH

The mobile station is searching for PLMNs. This substate is left either when a cell has been selected (the new substate is NORMAL-SERVICE or LIMITED-SERVICE) or when it has been concluded that no cell is available at the moment (the new substate is NO-CELL-AVAILABLE).

4.1.3.2 GPRS update status

In addition to the GMM sublayer states described so far, a GPRS update status exists.

The GPRS update status pertains to a specific subscriber embodied by a SIM/USIM. This status is defined even when the subscriber is not activated (SIM/USIM removed or connected to a switched off ME). It is stored in a non volatile memory in the SIM/USIM. The GPRS update status is changed only after execution of a GPRS attach, combined GPRS attach, network initiated GPRS detach, authentication, service request, paging for GPRS services using IMSI, routing area updating, combined routing area updating procedure or due to change in RAI while timer T3346 running.

GU1: UPDATED

The last GPRS attach or routing area updating attempt was successful (correct procedure outcome, and the answer was accepted by the network). The SIM/USIM contains the RAI of the routing area (RA) to which the subscriber was attached, and possibly a valid P-TMSI, GPRS GSM ciphering key, GPRS UMTS ciphering key, GPRS UMTS integrity key and GPRS ciphering key sequence number. Furthermore, if the ME supports any GEA ciphering algorithm that requires a 128-bit ciphering key and a USIM is in use, then the ME may contain a valid GPRS GSM Kc_{128} . Furthermore, if the ME supports any GIA integrity algorithm that requires a 128-bit integrity key and a USIM is in use, then the ME may contain a valid GPRS GSM Kint.

GU2: NOT UPDATED

The last GPRS attach or routing area updating attempt failed procedurally, e.g. no response was received from the network. This includes the cases of failures or congestion inside the network.

In this case, the SIM/USIM can contain the RAI of the routing area (RA) to which the subscriber was attached, and possibly also a valid P-TMSI, GPRS GSM ciphering key, GPRS UMTS ciphering key, GPRS UMTS integrity key and GPRS ciphering key sequence number. For compatibility reasons, all these fields shall be set to the "deleted" value if the RAI is deleted. However, the presence of other values shall not be considered an error by the MS. Furthermore, if the ME supports any GEA ciphering algorithm that requires a 128-bit ciphering key and a USIM is in use, then the ME shall delete the GPRS GSM Kc_{128} stored if the RAI is deleted. Furthermore, if the ME supports any GIA integrity algorithm that requires a 128-bit integrity key and a USIM is in use, then the ME shall delete the GPRS GSM Kint stored if the RAI is deleted.

GU3: ROAMING NOT ALLOWED

The last GPRS attach or routing area updating attempt was correctly performed, but the answer from the network was negative (because of roaming or subscription restrictions).

In this case, the SIM/USIM can contain the RAI of the routing area (RA) to which the subscriber was attached, and possibly also a valid P-TMSI, GPRS GSM ciphering key, GPRS UMTS ciphering key, GPRS UMTS integrity key or GPRS ciphering key sequence number. For compatibility reasons, all these fields shall be set to the value "deleted" if the RAI is deleted. However, the presence of other values shall not be considered an error by the MS. Furthermore, if the ME supports any GEA ciphering algorithm that requires a 128-bit ciphering key and a USIM is in use, then the ME shall delete the GPRS GSM Kc_{128} stored if the RAI is deleted. Furthermore, if the ME supports any GIA integrity algorithm that requires a 128-bit integrity key and a USIM is in use, then the ME shall delete the GPRS GSM Kint stored if the RAI is deleted.

If the MS is attached for emergency bearer services, the MS shall not store the GMM parameters described in this subclause on the SIM/USIM or in non-volatile memory. Instead the MS shall temporarily store these parameters locally in the ME and the MS shall delete these parameters when the MS is detached.

4.1.3.3 GMM mobility management states on the network side

In this subsubclause, the possible states are described for the GMM on the network side. Subclause 4.1.3.3.1 summarises the main states. The corresponding substates are described in subclause 4.1.3.3.2.

However, it should be noted that this subclause does not include a description of the detailed behaviour of the network in the single states and does not cover abnormal cases. Thus, figure 4.1c/3GPP TS 24.008 is rather intended to give an overview of the state transitions than to be a complete state transition diagram. A detailed description of the behaviour of the MS is given in subclause 4.2. Especially, with respect to the behaviour of the MS in abnormal cases it is referred to subclause 4.7.

4.1.3.3.1 Main States

4.1.3.3.1.1 GMM-DEREGISTERED

The network has no GMM context or the GMM context is marked as detached, the MS is detached. In this state, the network may answer to a GPRS attach or combined GPRS attach procedure initiated by the MS.

4.1.3.3.1.2 GMM-COMMON-PROCEDURE-INITIATED

A common GMM procedure, as defined in subclause 4.1.1, has been started. The network is awaiting the answer from the MS.

4.1.3.3.1.3 GMM-REGISTERED

The GMM context has been established and the GPRS attach procedure has been successfully performed.

4.1.3.3.1.4 GMM-DEREGISTERED-INITIATED

The network has started a GPRS detach procedure and is awaiting the answer from the MS.

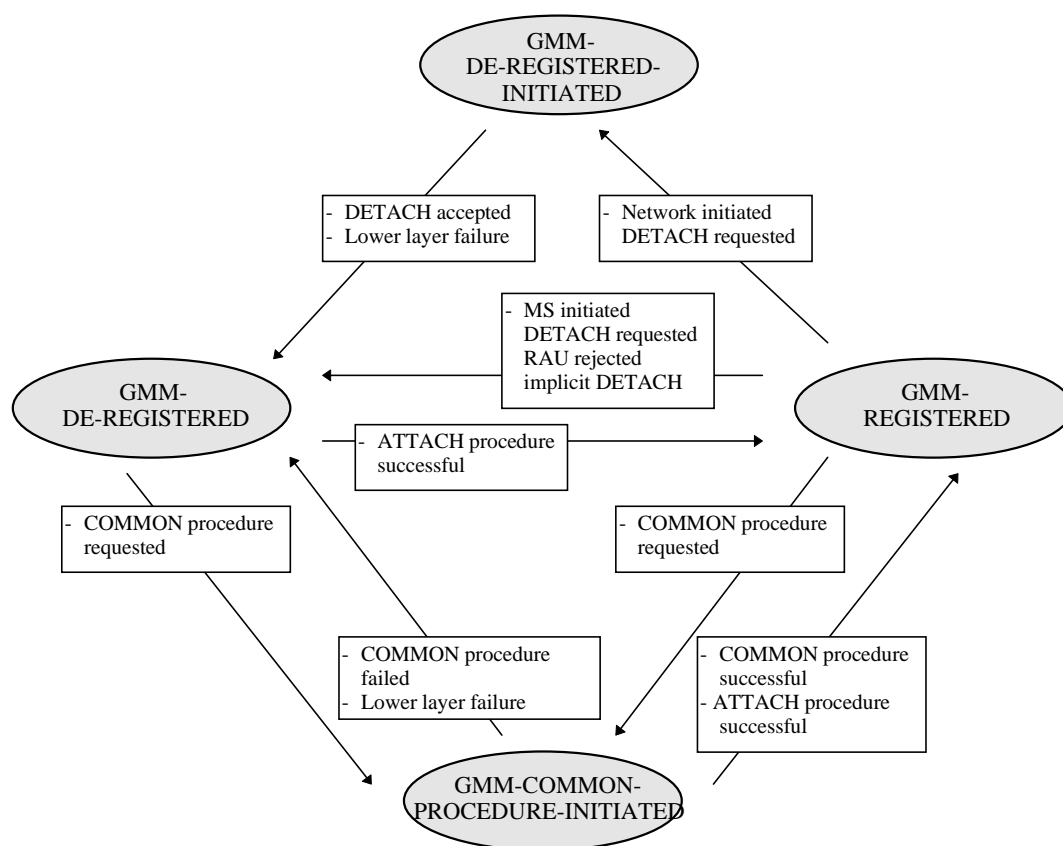

Figure 4.1c/3GPP TS 24.008: GMM main states on the network side

4.1.3.3.2 Substates of state GMM-REGISTERED

The state GMM-REGISTERED is subdivided into two substates as explained below.

4.1.3.3.2.1 GMM-REGISTERED.NORMAL-SERVICE

User data and signalling information may be sent and received.

4.1.3.3.2.2 GMM-REGISTERED.SUSPENDED (A/Gb mode only)

In this substate, the lower layers shall be prevented of sending user data or signalling information.

4.2 Behaviour of the MS in MM Idle state, GMM-DEREGISTERED state and GMM-REGISTERED state

In this subclause, the detailed behaviour of the MS in the main states MM IDLE, GMM-DEREGISTERED and GMM-REGISTERED is described. Subclauses 4.2.1 to 4.2.3 refer to the state MM IDLE, whereas subclauses 4.2.4 and 4.2.5 refer to the states GMM-DEREGISTERED and GMM-REGISTERED, respectively.

The MM IDLE state is entered when none of the MM procedures are running and no RR connection exists. It is left when one of the MM procedures are triggered or a RR connection is established.

The specific behaviour in the MM IDLE state depends on the service state of the mobile station as described in subclause 4.1.2.1.2. The service state depends in particular on the update status which is defined in subclause 4.1.2.2.

How an appropriate service state is chosen after power on is described in subclause 4.2.1, and the specific behaviour of the mobile station in MM IDLE state is described in subclause 4.2.2. The service state chosen when the MM IDLE state is returned to from any state except NULL state is described in subclause 4.2.3.

It should be noted that transitions between the various MM idle states are caused by (e.g.):

- results of procedures on RR connected mode (see subclause 4.2.3);
- insertion or removal of the SIM/USIM;
- cell selection/reselection (see also 3GPP TS 43.022 [82] and 3GPP TS 25.304 [98]);
- PLMN search;
- loss of coverage.

How various MM procedures affects the service state and the update status is described in the detailed descriptions of the procedures in subclauses 4.3 to 4.5.

4.2.1 Primary Service State selection

4.2.1.1 Selection of the Service State after Power On.

For an eCall only mobile station (as determined by information configured in the USIM), Timers T3242 and T3243 are considered to have expired at power-on. When mobility management is activated after power-on, the service state is 19.7 PLMN SEARCH. The detailed processing in this state is described in detail in 3GPP TS 23.122 [14], 3GPP TS 43.022 [82], 3GPP TS 45.008 [34] and 3GPP TS 25.304 [98], where procedures for power on and selection of PLMN is described in detail. If the "Location update status" stored on the SIM/USIM is different from "updated", then the mobile shall act as if the "Location update status" stored on the SIM/USIM is "not updated".

The service state when the PLMN SEARCH state is left depends on the outcome of the search and on the presence of the SIM/USIM:

- if no cell has been found, the state is NO CELL AVAILABLE, until a cell is found;
- if no SIM/USIM is present the state is NO IMSI;
- for an eCall only mobile station (as determined by information configured in USIM), the state is eCALL INACTIVE.
- if the mobile station has been continuously activated since losing coverage and then returns to coverage, and if the selected cell is in the location area where the mobile station is registered and the timer T3212 has not expired, then the state is NORMAL SERVICE;
- if the selected cell is in the location area where the mobile station is registered and IMSI ATTACH is not required and timer T3212 has not expired, then the state is NORMAL SERVICE;

- if the mobile station is in automatic network selection mode and the selected cell is in a forbidden PLMN, is in a forbidden LA, or is a CSG cell whose CSG ID and associated PLMN identity are not in the Allowed CSG list or in the Operator CSG list stored in the MS, then the mobile station enters the LIMITED SERVICE state;
- if the mobile station is in manual network selection mode and no cell of the selected PLMN has been found, or the cell that is found in the selected PLMN is a CSG cell whose CSG ID and associated PLMN identity are not in the Allowed CSG list or in the Operator CSG list stored in the MS, then the mobile station enters the LIMITED SERVICE state;
- otherwise, the mobile station enters the LOCATION UPDATE NEEDED state.

4.2.1.2 Other Cases

The state PLMN SEARCH is also entered in the following cases:

- in state NO IMSI, a SIM/USIM is inserted;
- in any state except NO IMSI, NO CELL AVAILABLE, NORMAL SERVICE and RECEIVING GROUP CALL (NORMAL SERVICE) after the user has asked for a PLMN selection;
- in any state except NO IMSI and NO CELL AVAILABLE, coverage is lost;
- roaming is denied;
- optionally, when the mobile station is in the ATTEMPTING TO UPDATE state and is in Automatic Network Selection mode and location update attempt counter is greater than or equal to 4.

The service state when the PLMN SEARCH is left depends on the outcome of the search and on the presence of the SIM/USIM as specified in subclause 4.2.1.1.

4.2.2 Detailed Description of the MS behaviour in MM IDLE State.

In the MM IDLE state the mobile station shall behave according to the service state. In the following subclauses the behaviour is described for the non transient service states. It should be noted that after procedures in RR connected mode, e.g. location updating procedures, subclause 4.2.3 applies which specifies the selection of the MM idle state. Furthermore when in sub-state NORMAL SERVICE, if a PLMN selection is requested, the MS enters sub-state SEARCH FOR PLMN, NORMAL SERVICE.

4.2.2.1 Service State, NORMAL SERVICE

When in state MM IDLE and service state NORMAL SERVICE, the mobile station shall:

- provided that T3246 is not running, perform normal location updating when a new location area is entered;
- perform location updating procedure at expiry of timer T3211 or T3213;
- perform periodic updating at expiration of timer T3212;
- perform IMSI detach;
- provided that T3246 is not running, support requests from the CM layer;
- support request for emergency calls;
- respond to paging; and
- for an eCall only mobile station (as determined by information configured in USIM), perform the eCall inactivity procedure at expiry of timer T3242 or timer T3243.

In addition, mobile stations supporting VGCS listening or VBS listening shall:

- indicate notifications to the GCC or BCC sublayer;
- respond to notification if the GCC or BCC sublayer requests the reception of a voice group or broadcast call for which no channel description has been received in the notification by the RR sublayer;

- request the RR sublayer to receive a voice group or broadcast call if the GCC or BCC sublayer requests the reception of a voice group or broadcast call for which a channel description has been received in the notification by the RR sublayer and then go to the service state RECEIVING GROUP CALL (NORMAL SERVICE).

4.2.2.2 Service State, ATTEMPTING TO UPDATE

When in state MM IDLE and service state ATTEMPTING TO UPDATE the mobile station shall:

- perform location updating procedure at expiry of timer T3211, T3213 or T3246;
- perform normal location updating when entering a new PLMN, if timer T3246 is running and the new PLMN is not equivalent to the PLMN where the MS started timer T3246;
- perform normal location updating when the location area identification of the serving cell changes, if timer T3246 is not running;
- if entry into this state was caused by c) or d) or f) (with cause different from "abnormal release, unspecified") or g) (with cause "retry upon entry into a new cell") of subclause 4.4.4.9, then location updating shall be performed when a new cell is entered;
- if entry into this state was caused by e) or f) (with cause "abnormal release, unspecified"), g) (with cause different from "retry upon entry into a new cell"), i) or j) of subclause 4.4.4.9, then location updating shall not be performed because a new cell is entered;
- perform normal location updating at expiry of timer T3212;
- not perform IMSI detach unless timer T3246 is running and the location area of the current cell is same as the stored location area;
- support request for emergency calls;
- use other request from CM layer as triggering of normal location updating procedure (if the location updating procedure is successful, then the request for MM connection is accepted, see subclause 4.5.1), if timer T3246 is not running;
- respond to paging, if the location area of the current cell is same as the stored location area;
- respond to paging (with IMSI) ; and
- for an eCall only mobile station (as determined by information configured in USIM), perform the eCall inactivity procedure at expiry of timer T3242 or timer T3243.

In addition, mobile stations supporting VGCS listening or VBS listening shall:

- indicate notifications to the GCC or BCC sublayer for which a channel description has been received in the notification by the RR sublayer;
- reject requests of the GCC or BCC sublayer to respond to notifications for which no channel description has been received in the notification by the RR sublayer;
- request the RR sublayer to receive a voice group or broadcast call if the GCC or BCC sublayer requests the reception of a voice group or broadcast call for which a channel description has been received in the notification by the RR sublayer and then go to the service state RECEIVING GROUP CALL (LIMITED SERVICE).

4.2.2.3 Service State, LIMITED SERVICE

When in state MM IDLE and service state LIMITED SERVICE the mobile station shall:

- not perform periodic updating;
- not perform IMSI detach;
- reject any requests from CM entities for MM connections except for emergency calls;

- perform normal location updating when a cell is entered which may provide normal service (e.g. location area not in one of the forbidden LAI lists.); and
- for an eCall only mobile station (as determined by information configured in USIM), perform the eCall inactivity procedure at expiry of timer T3242 or timer T3243.

When in state MM IDLE and service state LIMITED SERVICE the mobile station may:

- respond to paging (with IMSI);

In addition, mobile stations supporting VGCS listening or VBS listening shall:

- indicate notifications to the GCC or BCC sublayer for which a channel description has been received in the notification by the RR sublayer;
- reject requests of the GCC or BCC sublayer to respond to notifications for which no channel description has been received in the notification by the RR sublayer;
- request the RR sublayer to receive a voice group or broadcast call if the GCC or BCC sublayer requests the reception of a voice group or broadcast call for which a channel description has been received in the notification by the RR sublayer and then go to the service state RECEIVING GROUP CALL (LIMITED SERVICE).

4.2.2.4 Service State, NO IMSI

When in state MM IDLE and service state NO IMSI the mobile station shall (see subclause 3.2, 3GPP TS 43.022 [82] and 3GPP TS 45.008 [34]):

- not start any normal location updating attempt;
- not perform periodic updating;
- not perform IMSI detach if powered down;
- reject any request from CM entities for MM connections except for emergency calls;
- not respond to paging;
- only perform default cell selection.

In addition, mobile stations supporting VGCS listening or VBS listening shall:

- not indicate notifications to the GCC or BCC layer.

4.2.2.5 Service State, SEARCH FOR PLMN, NORMAL SERVICE

When in state MM IDLE and service state SEARCH FOR PLMN, NORMAL SERVICE the mobile station shall:

- if timer T3211 or T3213 expires in this state perform a location updating procedure at the latest if and when back to NORMAL SERVICE state and if the cell is not changed;
- if timer T3212 expires in this state perform a periodic location updating procedure at the latest if and when back to NORMAL SERVICE state;
- perform IMSI detach;
- support requests from the CM layer;
- listen as far as possible to paging, and respond; and
- for an eCall only mobile station (as determined by information configured in USIM), perform the eCall inactivity procedure at expiry of timer T3242 or T3243.

In addition, mobile stations supporting VGCS listening or VBS listening shall:

- listen as far as possible to notifications and indicate notifications to the GCC or BCC layer;

- respond to notification if the GCC or BCC sublayer requests the reception of a voice group or broadcast call for which no channel description has been received in the notification by the RR sublayer;
- request the RR sublayer to receive a voice group or broadcast call if the GCC or BCC sublayer requests the reception of a voice group or broadcast call for which a channel description has been received in the notification by the RR sublayer.

4.2.2.6 Service State, SEARCH FOR PLMN

When in state MM IDLE and service state SEARCH FOR PLMN the mobile station shall:

- not start any normal location updating attempt;
- not perform periodic updating;
- not perform IMSI detach if powered down;
- reject any request from CM entities for MM connections except emergency calls;
- not respond to paging.

4.2.2.7 Service State, RECEIVING GROUP CALL (NORMAL SERVICE)

Only applicable for mobile stations supporting VGCS listening or VBS listening:

When in state MM IDLE and service state RECEIVING GROUP CALL (NORMAL SERVICE), the mobile station shall:

- perform normal location updating when a new location area is entered;
- perform location updating procedure at expiry of timer T3211 or T3213;
- perform periodic updating at expiration of timer T3212;
- perform IMSI detach;
- support requests from the GCC or BCC layers;
- indicate notifications or paging information to the GCC or BCC layer;
- respond to notification if the GCC or BCC sublayer requests the reception of a voice group or broadcast call for which no channel description has been received in the notification by the RR sublayer;
- request the RR sublayer to receive another voice group or broadcast call if the GCC or BCC sublayer requests the reception of a voice group or broadcast call for which a channel description has been received in the notification by the RR sublayer.

4.2.2.8 Service State, RECEIVING GROUP CALL (LIMITED SERVICE)

Only applicable for mobile stations supporting VGCS listening or VBS listening:

When in state MM IDLE and service state RECEIVING GROUP CALL (LIMITED SERVICE), the mobile station shall:

- not perform periodic updating;
- not perform IMSI detach;
- reject any requests from CM entities for MM connections except for emergency calls;
- perform normal location updating when a cell is entered which may provide normal service (e.g. location area not in one of the forbidden LAI lists.);
- it may respond to paging (with IMSI);

- indicate notifications to the GCC or BCC sublayer for which a channel description has been received in the notification by the RR sublayer;
- reject requests of the GCC or BCC sublayer to respond to notifications for which no channel description has been received in the notification by the RR sublayer;
- request the RR sublayer to receive a voice group or broadcast call if the GCC or BCC sublayer requests the reception of a voice group or broadcast call for which a channel description has been received in the notification by the RR sublayer and then go to the service state RECEIVING GROUP CALL (LIMITED SERVICE).

4.2.2.9 Service State, eCALL INACTIVE

When in state MM IDLE and service state eCALL INACTIVE, the mobile station shall:

- not perform periodic updating;
- not perform IMSI detach;
- reject any requests from CM entities for MM connections except for emergency calls and calls to a non-emergency MSISDN for test and terminal reconfiguration services;
- not perform normal location updating; and
- not respond to paging.

4.2.3 Service state when back to state MM IDLE from another state

When returning to MM IDLE, e.g., after a location updating procedure, the mobile station selects the cell as specified in 3GPP TS 43.022 [82] and 3GPP TS 25.304 [98]. With one exception, this is a normal cell selection.

An eCall only mobile station (as determined by information configured in USIM), shall start timer T3242 if the return to MM IDLE state is the result of an emergency services call and shall start timer T3243 if the return to MM IDLE state is the result of a call to a non-emergency MSISDN for test and terminal reconfiguration services, as described in subclause 4.4.7.

If this return to idle state is not subsequent to a location updating procedure terminated with reception of cause "Roaming not allowed in this location area", the service state depends on the result of the cell selection procedure, on the update status of the mobile station, on the location data stored in the mobile station and on the presence of the SIM/USIM:

- if no cell has been found, the state is NO CELL AVAILABLE, until a cell is found;
- if no SIM/USIM is present, or if the inserted SIM/USIM is considered invalid by the MS, the state is NO IMSI;
- for an eCall only mobile station (as determined by information configured in USIM), if timer T3242 or timer T3243 has expired and service state PLMN SEARCH is not required, the state is eCALL INACTIVE and the eCall inactivity procedure is performed as described in subclause 4.4.7;
- if the selected cell is in the location area where the MS is registered, then the state is NORMAL SERVICE; it shall be noted that this also includes an abnormal case described in subclause 4.4.4.9;
- (Only applicable for mobile stations supporting VGCS listening or VBS listening.) if the mobile stations was in the service state RECEIVING GROUP CALL (NORMAL SERVICE) or RECEIVING GROUP CALL (LIMITED SERVICE) before the location updating procedure and the selected cell is in the location area where the mobile station is registered, then the state is RECEIVING GROUP CALL (NORMAL SERVICE);
- if the selected cell is in a location area where the mobile station is not registered but in which the MS is allowed to attempt a location update, then the state is LOCATION UPDATE NEEDED;
- if the selected cell is in a location area where the mobile station is not allowed to attempt a location update, then the state is LIMITED SERVICE;
- if the selected cell is a CSG cell whose CSG ID and associated PLMN identity are not in the Allowed CSG list or in the Operator CSG list stored in the MS, then the state is LIMITED SERVICE;

- (Only applicable for MSs supporting VGCS listening or VBS listening.) if the MSs was in the service state RECEIVING GROUP CALL (NORMAL SERVICE) or RECEIVING GROUP CALL (LIMITED SERVICE) before the location updating procedure and the selected cell is in the location area where the MS is not allowed to attempt a location update, then the state is RECEIVING GROUP CALL (LIMITED SERVICE);
- after some abnormal cases occurring during an unsuccessful location updating procedure, as described in subclause 4.4.4.9, the state is ATTEMPTING TO UPDATE.

In case of a return from a location updating procedure to which was answered "Roaming not allowed in this location area", the service state PLMN SEARCH is entered as specified in subclause 4.2.1.2.

4.2.4 Behaviour in state GMM-DEREGISTERED

The state GMM-DEREGISTERED is entered when:

- the MS is switched on;
- the GPRS capability has been enabled in the MS;
- a GPRS detach or combined GPRS detach procedure has been performed;
- a GMM procedure has failed (except routing area updating, see subclause 4.7.5); or
- the MS attached for emergency bearer services is in PMM-IDLE mode and its periodic routing area update timer expires (see subclause 4.7.2.2).

The selection of the appropriate substate of GMM-DEREGISTERED after switching on is described in subclause 4.2.4.1. The specific behaviour of the MS in state GMM-DEREGISTERED is described in subclause 4.2.4.2. The substate chosen when the GMM-DEREGISTERED state is returned to from another state except state GMM-NULL is described in subclause 4.2.4.3.

It should be noted that transitions between the various substates of GMM-DEREGISTERED are caused by (e.g.):

- insertion or removal of the SIM/USIM;
- cell selection/reselection (see also 3GPP TS 43.022 [82] and 3GPP TS 25.304 [98]);
- PLMN search;
- loss/regain of coverage; or
- change of RA.

How various GMM procedures affect the GMM-DEREGISTERED substates and the GPRS update status is described in the detailed description of the GMM procedures in subclause 4.7.

4.2.4.1 Primary substate selection

4.2.4.1.1 Selection of the substate after power on or enabling the MS's GPRS capability

When the MS is switched on, the substate shall be PLMN-SEARCH in case the SIM/USIM is inserted and valid. See 3GPP TS 23.122 [14] and 3GPP TS 45.008 [34] for further details.

When the GPRS capability in an activated MS has been enabled, the selection of the GMM-DEREGISTERED substate depends on the MM state and the GPRS update status.

The substate chosen after PLMN-SEARCH, in case of power on or after enabling of the GPRS capability is:

- if the cell is not supporting GPRS, the substate shall be NO-CELL-AVAILABLE;
- if no SIM/USIM is present the substate shall be NO-IMSI;
- if a suitable cell supporting GPRS has been found and the PLMN or LA is not in the forbidden list, then the substate shall be NORMAL-SERVICE;

- if the selected cell supporting GPRS is in a forbidden PLMN, is in a forbidden LA, or is a CSG cell with a CSG ID and associated PLMN identity that are not in Allowed CSG list or in the Operator CSG list stored in the MS , then the MS shall enter the substate LIMITED-SERVICE;
- if the MS is in manual network selection mode and no cell supporting GPRS of the selected PLMN has been found, the MS shall enter the substate NO-CELL-AVAILABLE.

4.2.4.1.2 Other Cases

When the MM state is IDLE, the GMM substate PLMN-SEARCH shall also be entered in the following cases:

- when a SIM/USIM is inserted in substate NO-IMSI;
- when the user has asked for a PLMN selection in any substate except NO IMSI and NO CELL AVAILABLE ;
- when coverage is lost in any substate except NO IMSI and NO CELL AVAILABLE ;
- Roaming is denied;
- optionally, when the MS is in automatic network selection mode and the maximum allowed number of consecutive unsuccessful attach attempts controlled by the GPRS attach attempt counter (subclause 4.7.3) have been performed.

4.2.4.2 Detailed description of the MS behaviour in state GMM-DEREGISTERED

In state GMM-DEREGISTERED, the MS shall behave according to the substate. In the following subclauses, the behaviour is described for the non transient substates.

4.2.4.2.1 Substate, NORMAL-SERVICE

The MS:

- shall initiate GPRS attach or combined GPRS attach procedure if timer T3346 is not running. If timer T3346 is running, then MS shall initiate an GPRS attach or combined GPRS attach procedure on the expiry of timer T3346; and
- may initiate GPRS attach for emergency bearer services (UTRAN Iu mode only) even if timer T3346 is running.

4.2.4.2.2 Substate, ATTEMPTING-TO-ATTACH

The MS:

- shall initiate GPRS attach on the expiry of timers T3311, T3302, or T3346;
- shall initiate GPRS attach when entering a new PLMN, if timer T3346 is running and the new PLMN is not equivalent to the PLMN where the MS started timer T3346, the PLMN identity of the new cell is not in one of the forbidden PLMN lists and the location area this cell is belonging to is not in one of the lists of forbidden LAs;
- may initiate GPRS attach for emergency bearer services (UTRAN Iu mode only) even if timer T3346 is running;
- shall initiate GPRS attach when the routing area of the serving cell has changed, if timer T3346 is not running, the PLMN identity of the new cell is not in one of the forbidden PLMN lists and the location area this cell is belonging to is not in one of the lists of forbidden LAs;
- shall if entry into this state was caused by b) or d) with cause "Retry upon entry into a new cell" of subclause 4.7.3.1.5, perform GPRS attach when a new cell is entered;
- shall if entry into this state was caused by c) or d) with cause different from "Retry upon entry into a new cell" of subclause 4.7.3.1.5, not perform GPRS attach when a new cell is entered;
- shall use requests for non-GPRS services from CM layers to trigger the combined GPRS attach procedure, if timer T3346 is not running and the network operates in network operation mode I. Depending on which of the

timers T3311 or T3302 is running the MS shall stop the relevant timer and act as if the stopped timer has expired; and

- may initiate GPRS attach upon request of the upper layers to establish a PDN connection for emergency bearer services (UTRAN Iu mode only).

4.2.4.2.3 Substate, LIMITED-SERVICE

The MS:

- shall initiate GPRS attach when a cell is entered which may provide normal service (e.g. location area is not in one of the forbidden lists); and
- may initiate GPRS attach for emergency bearer services (UTRAN Iu mode only).

4.2.4.2.4 Substate, NO-IMSI

The MS:

- shall perform default cell selection; and
- may initiate GPRS attach for emergency bearer services (UTRAN Iu mode only).

4.2.4.2.5 Substate, NO-CELL

The MS shall:

- perform cell selection according to 3GPP TS 43.022 [82] and 3GPP TS 25.304 [98] and shall choose an appropriate substate.

4.2.4.2.6 Substate, PLMN-SEARCH

The MS shall perform PLMN selection. If a new PLMN is selected, the MS shall reset the GPRS attach attempt counter and initiate the GPRS attach procedure (see subclause 4.7.3.1).

If the selected cell is known not to be able to provide normal service, the MS may initiate GPRS attach for emergency bearer services (UTRAN Iu mode only).

4.2.4.2.7 Substate, ATTACH-NEEDED

The MS shall start a GPRS attach procedure if still needed as soon as the access class control allows network contact in the selected cell.

The MS may initiate GPRS attach for emergency bearer services (UTRAN Iu mode only).

4.2.4.2.8 Substate, SUSPENDED (A/Gb mode only)

The MS:

- shall not send any user data; and
- shall not send any signalling information.

4.2.4.3 Substate when back to state GMM-DEREGISTERED from another GMM state

When returning to state GMM-DEREGISTERED, the MS shall select a cell as specified in 3GPP TS 43.022 [82] and 3GPP TS 25.304 [98].

The substate depends on the result of the cell selection procedure, the outcome of the previously performed GMM specific procedures, on the GPRS update status of the MS, on the location area data stored in the MS and on the presence of the SIM/USIM:

- if no cell has been found, the substate is NO-CELL-AVAILABLE, until a cell is found;
- if no SIM/USIM is present or if the inserted SIM/USIM is considered invalid by the MS, the substate shall be NO-IMSI;
- if a suitable cell supporting GPRS has been found and the PLMN or LA is not in the forbidden list, the substate shall be NORMAL-SERVICE;
- if a GPRS attach shall be performed (e.g. network requested reattach), the substate shall be ATTEMPTING-TO-ATTACH;
- if a PLMN reselection (according to 3GPP TS 23.122 [14]) is needed, the substate shall be PLMN SEARCH;
- if the selected cell is known not to be able to provide normal service, the substate shall be LIMITED-SERVICE.

4.2.5 Behaviour in state GMM-REGISTERED

The state GMM-REGISTERED is entered when:

- a GMM context is established, i.e. the MS is IMSI attached for GPRS services only or for GPRS and non-GPRS services.

The specific behaviour of the MS in state GMM-REGISTERED is described in subclause 4.2.5.1. The primary substate when entering the state GMM-REGISTERED is always NORMAL-SERVICE.

It should be noted that transitions between the various substates of GMM-REGISTERED are caused by (e.g.):

- cell selection/reselection (see also 3GPP TS 43.022 [82] and 3GPP TS 25.304 [98]);
- change of RA;
- loss/regain of coverage.

How various GMM procedures affect the GMM-REGISTERED substates is described in the detailed description of the procedures in subclause 4.7.

4.2.5.1 Detailed description of the MS behaviour in state GMM-REGISTERED

In state GMM-REGISTERED, the MS shall behave according to the substate as explained below.

4.2.5.1.1 Substate, NORMAL-SERVICE

The MS shall:

- perform cell selection/reselection according to 3GPP TS 43.022 [82] and 3GPP TS 25.304 [98];
- initiate normal routing area updating;
- perform periodic routing area updating except when attached for emergency bearer services (see subclause 4.7.2.2); and
- receive and transmit user data and signalling information.

GPRS MSs in operation modes C or A shall answer to paging requests.

GPRS MS in operation mode B may answer to paging requests.

4.2.5.1.2 Substate, SUSPENDED (A/Gb mode only)

The MS:

- shall not send any user data;
- shall not send any signalling information; and

- shall not perform cell-updates.

4.2.5.1.3 Substate, UPDATE-NEEDED

The MS shall:

- not send any user data;
- not send any signalling information, unless for a routing area update procedure upon request of the upper layers to establish a PDN connection for emergency bearer services (UTRAN Iu mode only);
- perform cell selection/reselection according to 3GPP TS 43.022 [82] and 3GPP TS 25.304 [98]; and
- choose the appropriate new substate depending on the GPRS update status as soon as the access class control allows network contact in the selected cell.

4.2.5.1.4 Substate, ATTEMPTING-TO-UPDATE

The MS:

- shall not send any user data;
- shall initiate routing area updating procedure on the expiry of timers T3311, T3302 or T3346;
- shall initiate routing area updating procedure when entering a new PLMN, if timer T3346 is running and the new PLMN is not equivalent to the PLMN where the MS started timer T3346, the PLMN identity of the new cell is not in one of the forbidden PLMN lists and the location area this cell is belonging to is not in one of the lists of forbidden LAs;
- shall initiate routing area updating procedure when the routing area of the serving cell has changed, if timer T3346 is not running, the PLMN identity of the new cell is not in one of the forbidden PLMN lists and the location area this cell is belonging to is not in one of the lists of forbidden LAs;
- shall, if entry into this state was caused by b) or d) with cause "Retry upon entry into a new cell" of subclause 4.7.5.1.5, initiate routing area updating procedure when a new cell is entered;
- shall, if entry into this state was caused by c) or d) with cause different from "Retry upon entry into a new cell" of subclause 4.7.5.1.5, not initiate routing area updating procedure when a new cell is entered;
- shall use request for non-GPRS services from CM layers to trigger the combined routing area updating procedure, if timer T3346 is not running and the network operates in network operation mode I. Depending on which of the timers T3311 or T3302 is running the MS shall stop the relevant timer and act as if the stopped timer has expired;
- may use a request for an MMTEL voice call or MMTEL video call from the upper layers to initiate routing area updating procedure (Iu mode only), if timer T3346 is not running;
- may initiate routing area updating procedure upon request of the upper layers to establish a PDN connection for emergency bearer services (UTRAN Iu mode only);
- shall initiate routing area updating procedure upon request of the upper layers to establish a PDN connection without the NAS signalling low priority indication as specified in subclause 4.7.5.1.5, item j), if timer T3346 is running due to a NAS request message (ROUTING AREA UPDATE REQUEST or SERVICE REQUEST) which contained the low priority indicator set to "MS is configured for NAS signalling low priority" and timer T3302 and timer T3311 are not running;
- may detach locally and initiate GPRS attach for emergency bearer services even if timer T3346 is running;
- shall initiate routing area updating procedure in response to paging; and
- shall not initiate the signalling procedure for GPRS detach unless timer T3346 is running and the routing area of the current cell is same as the stored routing area.

4.2.5.1.5 Substate, NO-CELL-AVAILABLE

The MS shall perform cell selection/reselection according to 3GPP TS 43.022 [82] and 3GPP TS 25.304 [98]. If PSM is active, the MS can deactivate PSM at any time by activating the AS layer when the MS needs to send mobile originated signalling or user data.

4.2.5.1.6 Substate, LIMITED-SERVICE

The MS:

- shall perform cell selection/reselection according to 3GPP TS 43.022 [82] and 3GPP TS 25.304 [98];
- may respond to paging (with IMSI); and
- may initiate GPRS attach for emergency bearer services (UTRAN Iu mode only).

4.2.5.1.7 Substate, ATTEMPTING-TO-UPDATE-MM

The MS shall:

- perform cell selection/reselection according to 3GPP TS 43.022 [82] and 3GPP TS 25.304 [98];
- receive and transmit user data and signalling information;
- initiate routing area update indicating "combined RA/LA updating with IMSI attach" on the expiry of timers T3311 or T3302;
- initiate routing area update indicating "combined RA/LA updating with IMSI attach" when the routing area of the serving cell has changed and the location area this cell is belonging to is not in the list of forbidden LAs.

GPRS MSs in operation modes C or A shall answer to paging requests.

GPRS MS in operation mode B may answer to paging requests.

4.2.5.1.8 Substate, PLMN-SEARCH

When the MM state is IDLE, the GMM substate PLMN-SEARCH may be entered if the MS is in automatic network selection mode and the maximum allowed number of consecutive unsuccessful routing area update attempts controlled by the GPRS routing area updating attempt counter (subclause 4.7.5) have been performed. If a new PLMN is selected, the MS shall reset the routing area updating attempt counter and perform the routing area updating procedure.

If the selected cell is known not to be able to provide normal service, the MS may initiate GPRS attach for emergency bearer services (UTRAN Iu mode only).

4.3 MM common procedures

As described in subclause 4.1.1, a MM common procedure can be initiated at any time whilst a RR connection exists between the network and the mobile station.

4.3.1 TMSI reallocation procedure

4.3.1.0 General

The purpose of the TMSI reallocation procedure is to provide identity confidentiality, i.e. to protect a user against being identified and located by an intruder (see 3GPP TS 42.009 [5], 3GPP TS 43.020 [13] and 3GPP TS 33.102 [5a]).

If the identity confidentiality service is applied for an IMSI, a Temporary Mobile Subscriber Identity (TMSI) is used for identification within the radio interface signalling procedures.

In a network supporting the feature 'Intra domain connection of RAN nodes to multiple CN nodes' a TMSI shall be allocated to each IMSI attached mobile station. See 3GPP TS 23.236 [94], subclause 4.3.

The structure of the TMSI is specified in 3GPP TS 23.003 [10]. The TMSI has significance only within a location area. Outside the location area it has to be combined with the Location Area Identifier (LAI) to provide for an unambiguous identity.

Usually the TMSI reallocation is performed at least at each change of a location area. (Such choices are left to the network operator).

The reallocation of a TMSI can be performed either by a unique procedure defined in this subclause or implicitly by a location updating procedure using the TMSI. The implicit reallocation of a TMSI is described together with that procedure.

If a TMSI provided by a mobile station is unknown in the network e.g. due to a data base failure, the network may require the mobile station to provide its International Mobile Subscriber Identity (IMSI). In this case the identification procedure (see subclause 4.3.3) should be used before the TMSI reallocation procedure may be initiated.

The TMSI reallocation can be initiated by the network at any time whilst a RR connection exists between the network and the mobile station.

NOTE 1: Usually the TMSI reallocation is performed in ciphered mode.

NOTE 2: Normally the TMSI reallocation will take place in conjunction with another procedure, e.g. at location updating or at call setup (see 3GPP TS 29.002 [37]).

NOTE 3: The explicit TMSI reallocation procedure is started by the network only if the mobile station is updated in the current location area or if a location updating procedure is ongoing for that particular mobile station, or if the network wishes to send a non-broadcast LAI according to 3GPP TS 23.236 [94] to the mobile station.

4.3.1.1 TMSI reallocation initiation by the network

The network initiates the TMSI reallocation procedure by sending a TMSI REALLOCATION COMMAND message to the mobile station and starts the timer T3250.

The TMSI REALLOCATION COMMAND message contains a new combination of TMSI and LAI allocated by the network or a LAI and the IMSI if the used TMSI shall be deleted. Usually the TMSI-REALLOCATION COMMAND message is sent to the mobile station using a RR connection in ciphered mode (see 3GPP TS 43.020 [13] and 3GPP TS 33.102 [5a]).

4.3.1.2 TMSI reallocation completion by the mobile station

Upon receipt of the TMSI REALLOCATION COMMAND message the mobile station:

- a) shall store the Location Area Identifier (LAI) in the SIM/USIM;
- b) shall enter the sub-state NORMAL SERVICE if the MS is in the sub-state ATTEMPTING TO UPDATE;
- c) if the received identity is the IMSI of the relevant mobile station, shall delete any TMSI;
- d) if the received identity is a TMSI, shall store the TMSI in the SIM/USIM; and
- e) shall send a TMSI REALLOCATION COMPLETE message to the network.

4.3.1.3 TMSI reallocation completion in the network.

Upon receipt of the TMSI REALLOCATION COMPLETE message, the network stops the timer T3250 and either considers the new TMSI as valid or, if an IMSI was sent to the mobile station, considers the old TMSI as deleted.

If the RR connection is no more needed, then the network will request the RR sublayer to release it (see 3GPP TS 44.018 [84] subclause 3.5 and 3GPP TS 25.331 [23c]).

4.3.1.4 Abnormal cases in the mobile station

The following abnormal cases can be identified:

a) RR connection failure:

The mobile station shall consider the new TMSI and new LAI, if any, as valid and the old TMSI and old LAI as deleted as soon as a TMSI REALLOCATION COMMAND message or another message containing a new TMSI (e.g. LOCATION UPDATING ACCEPT message) is correctly received. Any RR connection failure at a later stage shall not have any impact on the TMSI and LAI storage.

4.3.1.5 Abnormal cases on the network side

The following abnormal cases can be identified:

a) RR connection failure:

If the RR connection is lost before the TMSI REALLOCATION COMPLETE message is received, the network shall release all MM connections, if any. Furthermore, the network should consider both the old and the new TMSI as occupied for a certain recovery time.

During this period the network:

- may use the IMSI for paging or network originated transactions on the CM layer. Upon response from the mobile station the TMSI reallocation procedure shall be restarted;
- may consider the new TMSI as valid if it is used by the mobile station; or
- may use the identification procedure followed by a new TMSI reallocation procedure, if the mobile station uses the old TMSI (see subclause 4.3.3).

Other implementations are possible, e.g. the network may page with the old TMSI.

b) Expiry of timer T3250:

The TMSI reallocation procedure is supervised by the timer T3250 (see example in figure 4.1). At expiry of timer T3250 the network may release the RR connection. In this case, the network shall abort the reallocation procedure release all MM connections if any, and follow the rules for the case a as described above.

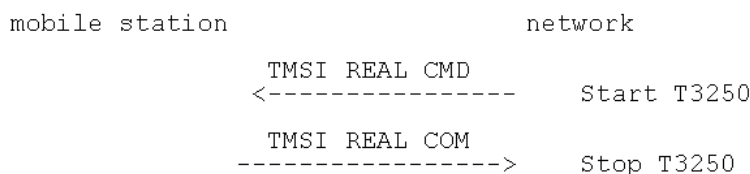

Figure 4.1/3GPP TS 24.008: TMSI reallocation sequence

4.3.2 Authentication procedure

4.3.2a Authentication procedure used for a UMTS authentication challenge

The purpose of the authentication procedure is fourfold (see 3GPP TS 33.102 [5a]):

- First to permit the network to check whether the identity provided by the mobile station is acceptable or not;
- Second to provide parameters enabling the mobile station to calculate a new UMTS ciphering key;
- Third to provide parameters enabling the mobile station to calculate a new UMTS integrity key;
- Fourth to permit the mobile station to authenticate the network.

The cases where the authentication procedure should be used are defined in 3GPP TS 33.102 [5a].

The UMTS authentication procedure is always initiated and controlled by the network. However, there is the possibility for the MS to reject the UMTS authentication challenge sent by the network.

The MS shall support the UMTS authentication challenge, if a USIM is inserted.

A UMTS security context is established in the MS and the network when a UMTS authentication challenge is performed in A/Gb mode or in Iu mode. After a successful UMTS authentication, the UMTS ciphering key, the UMTS integrity key, the GSM ciphering key and the ciphering key sequence number, are stored both in the network and the MS. Furthermore, in A/Gb mode both the ME and the network may derive and store a GSM K_{C128} as part of the UMTS security context as described in the subclause 4.3.2.3a.

4.3.2b Authentication Procedure used for a GSM authentication challenge

The purpose of the authentication procedure is twofold (see 3GPP TS 43.020 [13]):

First to permit the network to check whether the identity provided by the mobile station is acceptable or not;

Second to provide parameters enabling the mobile station to calculate a new GSM ciphering key.

The cases where the authentication procedure should be used are defined in 3GPP TS 42.009 [5].

The authentication procedure is always initiated and controlled by the network. GSM authentication challenge shall be supported by a ME supporting GERAN or UTRAN.

A GSM security context is established in the MS and the network when a GSM authentication challenge is performed in A/Gb mode or in Iu mode. However, in Iu mode the MS shall not accept a GSM authentication challenge, if a USIM is inserted. After a successful GSM authentication, the GSM ciphering key and the ciphering key sequence number, are stored both in the network and the MS.

4.3.2.1 Authentication request by the network

The network initiates the authentication procedure by transferring an AUTHENTICATION REQUEST message across the radio interface and starts the timer T3260. The AUTHENTICATION REQUEST message contains the parameters necessary to calculate the response parameters (see 3GPP TS 43.020 [13] (in case of GSM authentication challenge) and 3GPP TS 33.102 [5a] (in case of an UMTS authentication challenge)).

In a GSM authentication challenge, the AUTHENTICATION REQUEST message also contains the GSM ciphering key sequence number allocated to the key which may be computed from the given parameters.

In a UMTS authentication challenge, the AUTHENTICATION REQUEST message also contains the ciphering key sequence number allocated to the key set of UMTS ciphering key, UMTS integrity key and GSM ciphering key which may be computed from the given parameters. Furthermore, the ciphering key sequence number is also linked to a GSM K_{C128} if after the authentication procedure the network in A/Gb mode selects an A5 ciphering algorithm that requires a 128-bit ciphering key.

4.3.2.2 Authentication response by the mobile station

The mobile station shall be ready to respond upon an AUTHENTICATION REQUEST message at any time whilst a RR connection exists. With exception of the cases described in subclause 4.3.2.5.1, it shall process the challenge information and send back an AUTHENTICATION RESPONSE message to the network.

If a SIM is inserted in the MS, the MS shall ignore the Authentication Parameter AUTN IE if included in the AUTHENTICATION REQUEST message and shall proceed as in case of a GSM authentication challenge. It shall not perform the authentication of the network described in subclause 4.3.2.5.1.

In a GSM authentication challenge, the new GSM ciphering key calculated from the challenge information shall overwrite the previous GSM ciphering key and any previously stored UMTS ciphering key and UMTS integrity key shall be deleted. The new GSM ciphering key shall be stored on the SIM/USIM together with the ciphering key sequence number.

In a UMTS authentication challenge, the new UMTS ciphering key, the new GSM ciphering key and the new UMTS integrity key calculated from the challenge information shall overwrite the previous UMTS ciphering key, GSM ciphering key and UMTS integrity key. The new UMTS ciphering key, GSM ciphering key and UMTS integrity key are stored on the USIM together with the ciphering key sequence number. Furthermore, in A/Gb mode when after the authentication procedure an A5 ciphering algorithm that requires a 128-bit ciphering key is taken into use, then a new GSM K_{C128} shall also be calculated as described in the subclause 4.3.2.3a.

The SIM/USIM will provide the mobile station with the authentication response, based upon the authentication challenge given from the ME. A UMTS authentication challenge will result in the USIM passing a RES to the ME. A GSM authentication challenge will result in the SIM/USIM passing a SRES to the ME.

A ME supporting UMTS authentication challenge may support the following procedure:

In order to avoid a synchronisation failure, when the mobile station receives an AUTHENTICATION REQUEST message, the mobile station shall store the received RAND together with the RES returned from the USIM in the volatile memory and associate it with CS domain. When the MS receives a subsequent AUTHENTICATION REQUEST message, if the stored RAND value for the CS domain is equal to the new received value in the AUTHENTICATION REQUEST message, then the mobile station shall not pass the RAND to the USIM, but shall immediately send the AUTHENTICATION RESPONSE message with the stored RES for the CS domain. If, for the CS domain, there is no valid stored RAND in the mobile station or the stored RAND is different from the new received value in the AUTHENTICATION REQUEST message, the mobile station shall pass the RAND to the USIM, shall override any previously stored RAND and RES with the new ones and start, or reset and restart timer T3218.

The RAND and RES values stored in the mobile station shall be deleted and timer T3218, if running, shall be stopped:

- upon receipt of a SECURITY MODE COMMAND (Iu mode only),
CIPHERING MODE COMMAND (A/Gb mode only),
CM_SERVICE_ACCEPT,
CM_SERVICE_REJECT,
LOCATION_UPDATING_ACCEPT
or AUTHENTICATION REJECT message;
- upon expiry of timer T3218; or
- if the mobile station enters the MM state MM_IDLE or NULL.

4.3.2.3 Authentication processing in the network

Upon receipt of the AUTHENTICATION RESPONSE message, the network stops the timer T3260 and checks the validity of the response (see 3GPP TS 43.020 [13] in case of a GSM authentication challenge respective 3GPP TS 33.102 [5a] in case of an UMTS authentication challenge).

Upon receipt of the AUTHENTICATION FAILURE message, the network stops the timer T3260. In Synch failure case, the core network may renegotiate with the HLR/AuC and provide the MS with new authentication parameters.

4.3.2.3a 128-bit circuit-switched GSM ciphering key

The ME and the network may derive and store a 128-bit circuit-switched GSM ciphering key or GSM Kc_{128} from an established UMTS security context. If the GSM Kc_{128} exists, then it is also part of the UMTS security context.

The ME with a USIM in use shall compute a new GSM Kc_{128} using the UMTS ciphering key and the UMTS integrity key from an established UMTS security context as specified in 3GPP TS 33.102 [5a]. The new GSM Kc_{128} shall be stored only in the ME. The ME shall overwrite the existing GSM Kc_{128} with the new GSM Kc_{128} . The ME shall delete the GSM Kc_{128} at switch off, when the USIM is disabled as well as under the conditions identified in the subclause 4.1.2.2 and 4.3.2.4. The ME with a USIM in use shall apply the GSM Kc_{128} when in A/Gb mode an A5 ciphering algorithm that requires a 128-bit ciphering key is taken into use.

The network shall compute the GSM Kc_{128} using the UMTS integrity key and the UMTS ciphering key from an established UMTS security context as specified in 3GPP TS 33.102 [5a] only when in A/Gb mode an A5 ciphering algorithm that requires a 128-bit ciphering key is to be used.

4.3.2.4 Ciphering key sequence number

The security parameters for authentication and ciphering are tied together in sets.

In a GSM authentication challenge, from a challenge parameter RAND both the authentication response parameter SRES and the GSM ciphering key can be computed given the secret key associated to the IMSI.

In a UMTS authentication challenge, from a challenge parameter RAND, the authentication response parameter RES and the UMTS ciphering key and the UMTS integrity key can be computed given the secret key associated to the IMSI.

In addition, in the USIM a GSM ciphering key can be computed from the UMTS ciphering key and the UMTS integrity key by means of an unkeyed conversion function. Furthermore, in A/Gb mode if an A5 ciphering algorithm that requires a 128-bit ciphering key is taken into use, then a GSM K_{C128} shall also be calculated as described in the subclause 4.3.2.3a.

In order to allow start of ciphering on a RR connection without authentication, the ciphering key sequence numbers are introduced. The ciphering key sequence number is managed by the network in the way that the AUTHENTICATION REQUEST message contains the ciphering key sequence number allocated to the GSM ciphering key (in case of a GSM authentication challenge) or the UMTS ciphering key and the UMTS integrity key (in case of a UMTS authentication challenge) which may be computed from the RAND parameter carried in that message.

If an authentication procedure has been completed successfully and a ciphering key sequence number is stored in the network, the network shall include a different ciphering key sequence number in the AUTHENTICATION REQUEST message when it initiates a new authentication procedure.

The mobile station stores the ciphering key sequence number with the GSM ciphering key (in case of a GSM authentication challenge) and the UMTS ciphering key and the UMTS integrity key (in case of a UMTS authentication challenge) and indicates to the network in the first message (LOCATION UPDATING REQUEST, CM SERVICE REQUEST, PAGING RESPONSE, CM RE-ESTABLISHMENT REQUEST) which ciphering key sequence number the stored GSM ciphering key (in case of a GSM authentication challenge) or set of UMTS ciphering, UMTS integrity, derived GSM ciphering key, and potentially the derived GSM K_{C128} (in case of a UMTS authentication challenge) has.

When the deletion of the ciphering key sequence number is described this also means that the associated GSM ciphering key, the UMTS ciphering key and the UMTS integrity key shall be considered as invalid and also the GSM K_{C128} shall be deleted if any (i.e. the established GSM security context or the UMTS security context is no longer valid).

In A/Gb mode, the network may choose to start ciphering with the stored GSM ciphering key or GSM K_{C128} (under the restrictions given in 3GPP TS 42.009 [5]) if the stored ciphering key sequence number and the one given from the mobile station are equal.

NOTE 1: The decision of starting ciphering with the GSM ciphering key or the GSM K_{C128} depends on whether the network indicates in the CIPHERING MODE COMMAND message an A5 ciphering algorithm which requires a 64 or 128-bit ciphering key as specified in 3GPP TS 33.102 [5a].

In Iu mode, the network may choose to start ciphering and integrity with the stored UMTS ciphering key and UMTS integrity key (under the restrictions given in 3GPP TS 42.009 [5] and 3GPP TS 33.102 [5a]) if the stored ciphering key sequence number and the one given from the mobile station are equal.

NOTE 2: In some specifications the term KSI (Key Set Identifier) might be used instead of the term ciphering key sequence number.

4.3.2.5 Authentication not accepted by the network

If the authentication response (RES or SRES) is not valid, the network response depends upon the type of identity used by the mobile station in the first message, that is:

- the TMSI was used; or
- the IMSI was used.

If the TMSI has been used, the network may decide to initiate the identification procedure. If the IMSI given by the mobile station then differs from the one the network had associated with the TMSI, the authentication should be restarted with the correct parameters. If the IMSI provided by the MS is the expected one (i.e. authentication has really failed), the network should send an AUTHENTICATION REJECT message to the mobile station.

If the IMSI has been used, or the network decides not to try the identification procedure, an AUTHENTICATION REJECT message should be transferred to the mobile station.

After having sent this message, all MM connections in progress (if any) are released and the network should initiate the RR connection release procedure described in subclause 3.5. of 3GPP TS 44.018 [84] (A/Gb mode only), 3GPP TS 25.331 [23c] (UTRAN Iu mode only), or in 3GPP TS 44.118 [111] (GERAN Iu mode only).

Upon receipt of an AUTHENTICATION REJECT message,

- a) if the message has been successfully integrity checked by the lower layers, the mobile station shall set the update status in the SIM/USIM to U3 ROAMING NOT ALLOWED, delete from the SIM/USIM the stored TMSI, LAI and ciphering key sequence number. The SIM/USIM shall be considered as invalid until switching off or the SIM/USIM is removed. If the MS maintains a counter for "SIM/USIM considered invalid for non-GPRS services", then the MS shall set this counter to MS implementation-specific maximum value. If the MS maintains a counter for "SIM/USIM considered invalid for GPRS services", then the MS shall set this counter to MS implementation-specific maximum value.
- b) if the message is received without integrity protection, then the MS shall start timer T3247 with a random value uniformly drawn from the range between 30 minutes and 60 minutes, if the timer is not running (see subclause 4.1.1.6A). Additionally, the MS shall:
 - if the MS maintains a counter for "SIM/USIM considered invalid for non-GPRS services" events and the counter has a value less than an MS implementation-specific maximum value, proceed as specified in subclause 4.1.1.6A, list item 1.a) for the case a LOCATION UPDATING REJECT message is received without integrity protection. Additionally, if the MS maintains a counter for "SIM/USIM considered invalid for GPRS services", then the MS shall increment this counter; and
 - otherwise proceed as specified under list item a) above for the case that the message has been successfully checked by the lower layers.

List item b) above is also applicable, if the message is received in A/Gb mode.

If the AUTHENTICATION REJECT message is received in the state IMSI DETACH INITIATED the mobile station shall follow subclause 4.3.4.3.

If the AUTHENTICATION REJECT message is received in any other state the mobile station shall abort any MM specific, MM connection establishment or call re-establishment procedure, stop any of the timers T3210, T3230, T3214 or T3216 (if they were running), release all MM connections (if any), start timer T3240 and enter the state WAIT FOR NETWORK COMMAND, expecting the release of the RR connection. If the RR connection is not released within a given time controlled by the timer T3240, the mobile station shall abort the RR connection. In both cases, either after a RR connection release triggered from the network side or after a RR connection abort requested by the MS-side, the MS enters state MM IDLE, substate NO IMSI.

4.3.2.5.1 Authentication not accepted by the MS

In a UMTS authentication challenge, the authentication procedure is extended to allow the MS to check the authenticity of the core network. Thus allowing, for instance, detection of false base station.

Following a UMTS authentication challenge, the MS may reject the core network, on the grounds of an incorrect AUTN parameter (see 3GPP TS 33.102 [5a]). This parameter contains two possible causes for authentication failure:

a) MAC code failure:

If the MS considers the MAC code (supplied by the core network in the AUTN parameter) to be invalid, it shall send an AUTHENTICATION FAILURE message to the network, with the reject cause 'MAC failure'. The MS shall then follow the procedure described in subclause 4.3.2.6 (c).

b) SQN failure:

If the MS considers the SQN (supplied by the core network in the AUTN parameter) to be out of range, it shall send a AUTHENTICATION FAILURE message to the network, with the reject cause 'Synch failure' and a re-synchronization token AUTS provided by the USIM (see 3GPP TS 33.102 [5a]). The MS shall then follow the procedure described in subclause 4.3.2.6 (d).

In UMTS, an MS with a USIM inserted shall reject the authentication challenge if no Authentication Parameter AUTN IE was present in the AUTHENTICATION REQUEST message (i.e. a GSM authentication challenge has been received when the MS expects a UMTS authentication challenge). In such a case, the MS shall send the AUTHENTICATION FAILURE message to the network, with the reject cause "GSM authentication unacceptable". The MS shall then follow the procedure described in subclause 4.3.2.6 (c).

If the MS returns an AUTHENTICATION_FAILURE message to the network, the MS shall delete any previously stored RAND and RES and shall stop timer T3218, if running.

4.3.2.6 Abnormal cases

(a) RR connection failure:

Upon detection of a RR connection failure before the AUTHENTICATION RESPONSE message is received, the network shall release all MM connections (if any) and abort any ongoing MM specific procedure.

(b) Expiry of timer T3260:

The authentication procedure is supervised on the network side by the timer T3260. At expiry of this timer the network may release the RR connection. In this case the network shall abort the authentication procedure and any ongoing MM specific procedure, release all MM connections if any, and initiate the RR connection release procedure described in subclause 3.5 of 3GPP TS 44.018 [84] (A/Gb mode only), 3GPP TS 25.331 [23c] (UTRAN Iu mode only), or in 3GPP TS 44.118 [111] (GERAN Iu mode only).

(c) Authentication failure (reject cause "MAC failure" or "GSM authentication unacceptable"):

The MS shall send an AUTHENTICATION FAILURE message, with reject cause "MAC failure" or "GSM authentication unacceptable" according to subclause 4.3.2.5.1, to the network and start timer T3214. Furthermore, the MS shall stop any of the retransmission timers that are running (e.g. T3210, T3220 or T3230). Upon the first receipt of an AUTHENTICATION FAILURE message from the MS with reject cause "MAC failure" or "GSM authentication unacceptable", the network may initiate the identification procedure described in subclause 4.3.3. This is to allow the network to obtain the IMSI from the MS. The network may then check that the TMSI originally used in the authentication challenge corresponded to the correct IMSI. Upon receipt of the IDENTITY REQUEST message from the network, the MS shall send the IDENTITY RESPONSE message.

NOTE: Upon receipt of an AUTHENTICATION FAILURE message from the MS with reject cause "MAC failure" or "GSM authentication unacceptable", the network may also terminate the authentication procedure (see subclause 4.3.2.5).

If the TMSI/IMSI mapping in the network was incorrect, the network should respond by sending a new AUTHENTICATION REQUEST message to the MS. Upon receiving the new AUTHENTICATION REQUEST message from the network, the MS shall stop the timer T3214, if running, and then process the challenge information as normal. If the TMSI/IMSI mapping in the network was correct, the network should terminate the authentication procedure by sending an AUTHENTICATION REJECT message.

If the network is validated successfully (an AUTHENTICATION REQUEST message that contains a valid SQN and MAC is received), the MS shall send the AUTHENTICATION RESPONSE message to the network and shall start any retransmission timers (e.g. T3210, T3220 or T3230), if they were running and stopped when the MS received the first failed AUTHENTICATION REQUEST message.

If the MS receives the second AUTHENTICATION REQUEST message while T3214 is running, and the MAC value cannot be resolved or the message contains a GSM authentication challenge, the MS shall follow the procedure specified in this subclause (c), starting again from the beginning. If the SQN is invalid, the MS shall proceed as specified in (d).

It can be assumed that the source of the authentication challenge is not genuine (authentication not accepted by the MS) if any of the following occur:

- the timer T3214 expires;
- the MS detects any combination of the authentication failures: "MAC failure", "invalid SQN", and "GSM authentication unacceptable", during three consecutive authentication challenges. The authentication challenges shall be considered as consecutive only, if the authentication challenges causing the second and third authentication failure are received by the MS, while the timer T3214 or T3216 started after the previous authentication failure is running.

The MS shall stop timer T3214, if the timer is running and the MS detects an RR connection failure or the network releases the RR connection.

When it has been deemed by the MS that the source of the authentication challenge is not genuine (i.e. authentication not accepted by the MS), the MS shall behave as described in subclause 4.3.2.6.1.

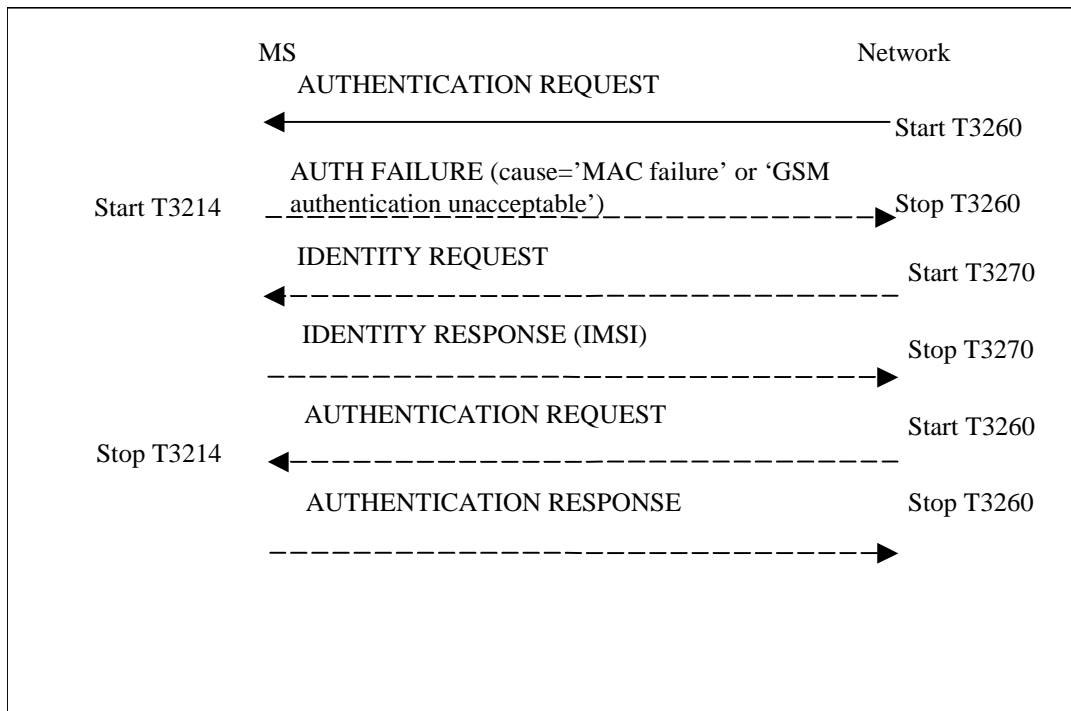

Figure 4.2/3GPP TS 24.008: Authentication Failure Procedure (reject cause "MAC failure" or "GSM authentication unacceptable")

(d) Authentication failure (reject cause "synch failure"):

The MS shall send an AUTHENTICATION FAILURE message, with reject cause "synch failure", to the network and start the timer T3216. Furthermore, the MS shall stop any of the retransmission timers that are running (e.g. T3210, T3220 or T3230). Upon the first receipt of an AUTHENTICATION FAILURE message from the MS with the reject cause "synch failure", the network shall use the returned AUTS parameter from the authentication failure parameter IE in the AUTHENTICATION FAILURE message, to re-synchronise. The re-synchronisation procedure requires the VLR/MSC to delete all unused authentication vectors for that IMSI and obtain new vectors from the HLR. When re-synchronisation is complete, the network shall initiate the authentication procedure. Upon receipt of the AUTHENTICATION REQUEST message, the MS shall stop the timer T3216, if running.

NOTE: Upon receipt of two consecutive AUTHENTICATION FAILURE messages from the MS with reject cause "synch failure", the network may terminate the authentication procedure by sending an AUTHENTICATION REJECT message.

If the network is validated successfully (a new AUTHENTICATION REQUEST message is received which contains a valid SQN and MAC) while T3216 is running, the MS shall send the AUTHENTICATION RESPONSE message to the network and shall start any retransmission timers (e.g. T3210, T3220 or T3230), if they were running and stopped when the MS received the first failed AUTHENTICATION REQUEST message.

If the MS receives the second AUTHENTICATION REQUEST message while T3216 is running, and the MAC value cannot be resolved or the message contains a GSM authentication challenge, the MS shall proceed as specified in (c); if the SQN is invalid, the MS shall follow the procedure specified in this subclause (d), starting again from the beginning.

The MS shall deem that the network has failed the authentication check and behave as described in subclause 4.3.2.6.1, if any of the following occurs:

- the timer T3216 expires;
- the MS detects any combination of the authentication failures: "MAC failure", "invalid SQN", and "GSM authentication unacceptable", during three consecutive authentication challenges. The authentication challenges shall be considered as consecutive only, if the authentication challenges causing the second and third authentication failure are received by the MS, while the timer T3214 or T3216 started after the previous authentication failure is running.

The MS shall stop timer T3216, if the timer is running and the MS detects an RR connection failure or the network releases the RR connection.

When it has been deemed by the MS that the source of the authentication challenge is not genuine (i.e. authentication not accepted by the MS), the MS shall behave as described in subclause 4.3.2.6.1.

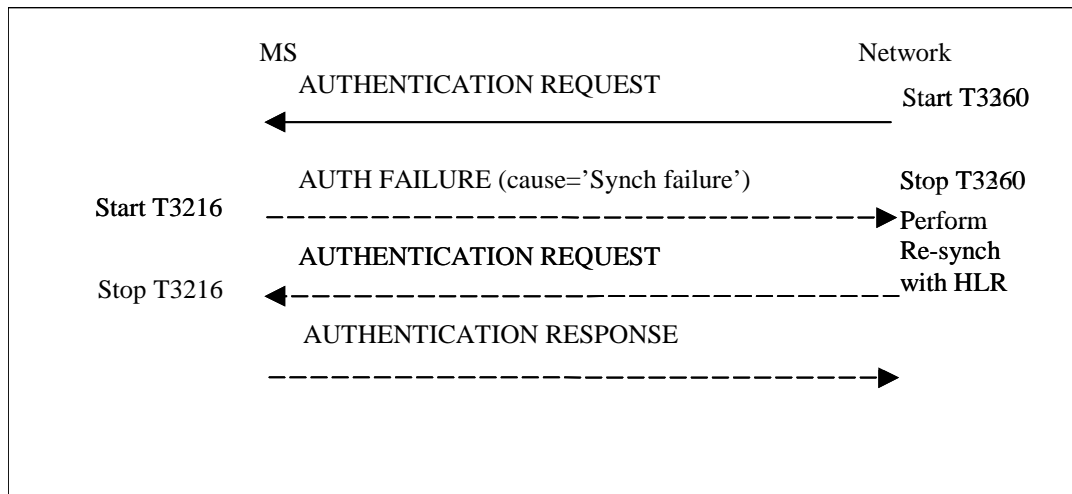

Figure 4.2a/3GPP TS 24.008: Authentication Failure Procedure (reject cause "Synch failure")

Upon receipt of an AUTHENTICATION REJECT message, the mobile station shall perform the actions as specified in subclause 4.3.2.5. If an MS has an MM connection for an emergency call established or is establishing an MM connection for an emergency call when timer T3214 or T3216 expires, the MS shall not deem that the network has failed the authentication check and not behave as described in subclause 4.3.2.6.1.

4.3.2.6.1 MS behaviour towards a network that has failed the authentication procedure

If the MS deems that the network has failed the authentication check, then it shall request RR or RRC to release the RR connection and the PS signalling connection, if any, and bar the active cell or cells (see 3GPP TS 25.331 [23c], 3GPP TS 25.304 [98] and 3GPP TS 44.018 [84]). The MS shall start any retransmission timers (e.g. T3210, T3220 or T3230), if they were running and stopped when the MS received the first AUTHENTICATION REQUEST message containing an invalid MAC or invalid SQN, or no AUTN when a UMTS authentication challenge was expected.

4.3.2.7 Handling of keys at intersystem change from Iu mode to A/Gb mode

At inter-system change from Iu mode to A/Gb mode, ciphering may be started (see 3GPP TS 44.018 [84]) without any new authentication procedure. Deduction of the appropriate security key for ciphering in A/Gb mode, depends on the current GSM/UMTS security context stored in the MS and the network.

The ME shall handle the GSM ciphering key and a potential GSM K_{C128} according to table 4.3.2.7.1.

Table 4.3.2.7.1/3GPP TS 24.008: Inter-system change from Iu mode to A/Gb mode

Security context established in MS and network in Iu mode	At inter-system change to A/Gb mode:
GSM security context	An ME shall apply the stored GSM ciphering key that was received from the GSM security context residing in the SIM/USIM during the latest successful ciphering mode setting or security mode control procedure before the inter-system change.
UMTS security context	If an A5 algorithm is taken into use that requires a 64-bit ciphering key, then an ME shall apply the stored GSM ciphering key that was derived by the USIM from the UMTS ciphering key and the UMTS integrity key and provided by the USIM during the latest successful ciphering mode setting or security mode control procedure before the inter-system change. If an A5 algorithm is taken into use that requires a 128-bit ciphering key, then an ME shall apply the GSM Kc_{128} derived by the ME from the UMTS ciphering key and the UMTS integrity key (see 3GPP TS 33.102 [5a]) provided by USIM during the latest successful ciphering mode setting or security mode control procedure before the inter-system change (see subclause 4.3.2.3a).

NOTE: A USIM with UMTS security context, passes the UMTS ciphering key, the UMTS integrity key and the derived GSM ciphering key to the ME independent on the current radio access being UTRAN or GERAN.

4.3.2.7a Use of established security contexts

In A/Gb mode, in the case of an established GSM security context, the GSM ciphering key shall be loaded from the SIM/USIM and taken into use by the ME when any valid CIPHERING MODE COMMAND is received during an RR connection (the definition of a valid CIPHERING MODE COMMAND message is given in 3GPP TS 44.018 [84] subclause 3.4.7.2).

In A/Gb mode, in the case of an established UMTS security context, the GSM ciphering key shall be loaded from the USIM and taken into use by the MS when a valid CIPHERING MODE COMMAND is received during an RR connection (the definition of a valid CIPHERING MODE COMMAND message is given in 3GPP TS 44.018 [84] subclause 3.4.7.2) which indicates an A5 ciphering algorithm that requires a 64-bit ciphering key. The network shall derive a GSM ciphering key from the UMTS ciphering key and the UMTS integrity key by using the conversion function named "c3" defined in 3GPP TS 33.102 [5a].

In A/Gb mode, in the case of an established UMTS security context, the UMTS ciphering key and the UMTS integrity key shall be loaded from the USIM in order for the ME to derive the GSM Kc_{128} (see 3GPP TS 33.102 [5a]) and shall be taken into use by the ME when a valid CIPHERING MODE COMMAND is received during an RR connection (the definition of a valid CIPHERING MODE COMMAND message is given in 3GPP TS 44.018 [84] subclause 3.4.7.2) which indicates an A5 ciphering algorithm that requires a 128-bit ciphering key. The network shall derive a GSM Kc_{128} from the UMTS ciphering key and the UMTS integrity as defined in 3GPP TS 33.102 [5a].

In Iu mode, in the case of an established GSM security context, the ME shall derive a UMTS ciphering key and a UMTS integrity key from the GSM ciphering key by using the conversion functions named "c4" and "c5" defined in 3GPP TS 33.102 [5a]. The GSM ciphering key shall be loaded from the SIM/USIM and the derived UMTS ciphering key and UMTS integrity key shall be taken into use by the MS when a valid SECURITY MODE COMMAND indicating CS domain is received during an RR connection (the definition of a valid SECURITY MODE COMMAND message is given in 3GPP TS 25.331 [23c] and 3GPP TS 44.118 [111]). The network shall derive a UMTS ciphering key and a UMTS integrity key from the GSM ciphering key by using the conversion functions named "c4" and "c5" defined in 3GPP TS 33.102 [5a].

In Iu mode, in the case of an established UMTS security context, the UMTS ciphering key and UMTS integrity key shall be loaded from the USIM and taken into use by the MS when a valid SECURITY MODE COMMAND indicating CS domain is received during a RR connection (the definition of a valid SECURITY MODE COMMAND message is given in 3GPP TS 25.331 [23c] and 3GPP TS 44.118 [111]).

In Iu mode and A/Gb mode, if the MS received a valid SECURITY MODE COMMAND indicating CS domain in Iu mode or a valid CIPHERING MODE COMMAND in A/Gb mode before the network initiates a new Authentication procedure and establishes a new GSM/UMTS security context, the new keys are taken into use in the MS when a new valid SECURITY MODE COMMAND indicating CS domain in Iu mode, or a new valid CIPHERING MODE COMMAND in A/Gb mode, is received during the RR connection. In case of Iu mode to Iu mode handover, A/Gb mode to A/Gb mode handover, or inter-system change to A/Gb mode, the MS and the network shall continue to use the key from the old key set until a new valid SECURITY MODE COMMAND indicating CS domain in Iu mode, or a new valid CIPHERING MODE COMMAND in A/Gb mode, is received during the RR connection. In case of inter-system change to Iu mode, the MS and the network shall continue to use the keys from the old key set until the second valid SECURITY MODE COMMAND indicating CS domain is received during the RR connection.

NOTE 1: If the MS received a valid SECURITY MODE COMMAND indicating CS domain in Iu mode or a valid CIPHERING MODE COMMAND in A/Gb mode before the inter-system change to Iu mode occurs, the first SECURITY MODE COMMAND message after the inter-system change, which indicates CS domain and includes only an Integrity protection mode IE, is initiated by the UTRAN without receipt of a corresponding RANAP security mode control procedure from the MSC/VLR. The only purpose of this SECURITY MODE COMMAND message is to activate the integrity protection, but not to load a new key set from the SIM/USIM (see 3GPP TS 25.331 [23c] and 3GPP TS 44.118 [111]).

NOTE 2: If the MS did not receive any valid SECURITY MODE COMMAND indicating CS domain in Iu mode or any valid CIPHERING MODE COMMAND in A/Gb mode before the inter-system change to Iu mode occurs, the first SECURITY MODE COMMAND message after the inter-system change, which indicates CS domain, is initiated by the UTRAN on receipt of a RANAP security mode control procedure from the MSC/VLR. The purpose of this SECURITY MODE COMMAND message is to load a key set from the SIM/USIM and to activate either integrity protection or ciphering and integrity protection (see 3GPP TS 25.331 [23c] and 3GPP TS 44.118 [111]).

4.3.2.8 Handling of keys at intersystem change from A/Gb mode to Iu mode

At inter-system change from A/Gb mode to Iu mode, ciphering and integrity may be started (see 3GPP TS 25.331 [23c]) without any new authentication procedure. Deduction of the appropriate security keys for ciphering and integrity check in Iu mode, depends on the current GSM/UMTS security context stored in the MS and the network.

The ME shall handle the UMTS ciphering key and the UMTS integrity key according to table 4.3.2.8.1.

Table 4.3.2.8.1/3GPP TS 24.008: Inter-system change from A/Gb mode to Iu mode

Security context established in MS and network in A/Gb mode	At inter-system change to Iu mode:
GSM security context	An ME shall derive the UMTS ciphering key and the UMTS integrity key from the stored GSM ciphering key that was provided by the SIM/USIM during the latest successful ciphering mode setting or security mode control procedure before the inter-system change. The conversion functions named "c4" and "c5" in 3GPP TS 33.102 [5a] are used for this purpose.
UMTS security context	An ME shall apply the stored UMTS ciphering key and the stored UMTS integrity key that were received from the UMTS security context residing in the USIM during the latest successful ciphering mode setting or security mode control procedure before the inter-system change.

NOTE: A USIM with UMTS security context, passes the UMTS ciphering key, the UMTS integrity key and the derived GSM ciphering key to the ME independent on the current radio access being UTRAN or GERAN.

4.3.2.9 Void

4.3.2.10 Derivation of keys at SRVCC or vSRVCC handover from S1 mode

4.3.2.10.0 General

NOTE: The keys CK_{SRVCC} and IK_{SRVCC} apply for both SRVCC and vSRVCC.

4.3.2.10.1 PDN connection with integrity protection

At PS to CS domain change from S1 mode due to SRVCC or vSRVCC handover of a PDN connection for which the "null integrity protection algorithm" EIA0 has not been used (see 3GPP TS 23.216 [126]), when the MS receives the command to perform handover, the MS shall derive a UMTS security context for the CS domain from the current EPS security context.

The MS shall set the CKSN of the derived UMTS security context to the value of the eKSI of the EPS security context and derive security keys CK_{SRVCC} and IK_{SRVCC} as specified in 3GPP TS 33.401 [123]. The ME shall also derive the security key GSM ciphering key Kc from CK_{SRVCC} and IK_{SRVCC} using the conversion function c3 as specified in 3GPP TS 33.102 [5a]. The MS shall apply these derived security keys, handle the $START_{CS}$ value as specified in 3GPP TS 25.331 [23c] and replace an already established UMTS security context for the CS domain, if any, in the USIM, when the SRVCC or vSRVCC handover from S1 mode has been completed successfully.

NOTE: Because of deriving a new UMTS security context for the CS domain, a new GSM ciphering key needs also to be derived from the new derived UMTS security keys for the CS domain (i.e. CK_{SRVCC} and IK_{SRVCC}). Note that the new GSM ciphering key is also part of the new UMTS security context for the CS domain as well, as any old GSM ciphering key stored in the USIM and in the ME, belongs to an old UMTS security context for the CS domain and can no longer be used.

The network shall replace an already established UMTS security context for the CS domain, if any, when the SRVCC or vSRVCC handover from S1 mode has been completed successfully.

If the SRVCC or vSRVCC handover from S1 mode has not been completed successfully, the MS and the network shall delete the new derived GSM or UMTS security context for the CS domain. Additionally, the network shall delete the already established GSM or UMTS security context for the CS domain, if the CKSN of the already established GSM or UMTS security context is equal to the CKSN of the new derived GSM or UMTS security context for the CS domain.

4.3.2.10.2 PDN connection without integrity protection

At PS to CS domain change from S1 mode due to SRVCC handover of a PDN connection for emergency bearer services for which the "null integrity protection algorithm" EIA0 has been used while in S1 mode, the MS and the network shall not perform key derivation.

4.3.2.11 Derivation of keys at SRVCC handover from Iu mode to Iu mode

4.3.2.11.1 PDN connection with integrity protection

At PS to CS domain change from Iu mode to Iu mode due to SRVCC handover of a PDN connection for which integrity protection has been activated, ciphering and integrity may be started (see 3GPP TS 25.331 [23c]) without any new authentication procedure. Deduction of the appropriate security keys for ciphering and integrity check in Iu mode, depends on the current GSM or UMTS security context for the PS domain stored in the MS and the network.

The ME shall handle the UMTS ciphering key and the UMTS integrity key according to table 4.3.2.11.1.

Table 4.3.2.11.1/3GPP TS 24.008: SRVCC handover from Iu mode to Iu mode

Security context for the PS domain established in MS and network in Iu mode	At inter-system change to Iu mode:
GSM security context	An ME shall derive the GSM ciphering key (Kc') from the stored GPRS GSM ciphering key, which was provided by the SIM/USIM during the latest successful authentication, and the NONCE received in the command to perform handover (see 3GPP TS 25.331 [23c]) using the key derivation function specified in 3GPP TS 33.102 [5a]. The ME shall use the derived GSM ciphering key (Kc') to derive the UMTS security keys UMTS ciphering key (CK') and UMTS integrity key (IK'). The conversion functions named "c4" and "c5" in 3GPP TS 33.102 [5a] are used for this purpose. The MS shall set the CKSN of the derived GSM security context for the CS domain to the value of the GPRS CKSN of the GSM security context for PS domain. Furthermore, the ME shall apply the new derived UMTS security keys and replace an already established GSM security context for the CS domain, if any, in the SIM/USIM, when the SRVCC handover from Iu mode has been completed successfully. Furthermore, the MS shall handle the START _{CS} value as specified in 3GPP TS 25.331 [23c]).
UMTS security context	An ME shall derive the UMTS security keys UMTS ciphering key (CK') and UMTS integrity key (IK') from the GPRS UMTS ciphering key and the GPRS UMTS integrity key, which were received from the UMTS security context for the PS domain residing in the USIM, and the NONCE received in the command to perform handover (see 3GPP TS 25.331 [23c]) as specified in 3GPP TS 33.102 [5a]. The ME shall use the derived UMTS security keys to derive the GSM ciphering key (Kc') using the "c3" conversion function as specified in 3GPP TS 33.102 [5a]. The MS shall set the CKSN of the derived UMTS security context for the CS domain to the value of the KSI of the UMTS security context for PS domain. Furthermore, the ME shall apply the derived UMTS security keys and replace an already established UMTS security context for the CS domain, if any, in the USIM, when the SRVCC handover from Iu mode has been completed successfully. Furthermore, the MS shall handle the START _{CS} value as specified in 3GPP TS 25.331 [23c]).

NOTE 1: For the case of an established UMTS security context for the PS domain, because of deriving a new UMTS security context for the CS domain, a new GSM ciphering key needs to be derived from the new derived UMTS security keys (i.e. CK' and IK'). Note that the new GSM ciphering key is also part of the new UMTS security context for the CS domain, and therefore any old GSM ciphering key stored in the USIM and in the ME belongs to an old UMTS security context for the CS domain and can no longer be taken into use.

The network shall replace an already established GSM or UMTS security context for the CS domain, if any, when the SRVCC handover from Iu mode to Iu mode has been completed successfully.

If the SRVCC handover from Iu mode to Iu mode has not been completed successfully, the MS and the network shall delete the new derived GSM or UMTS security context for the CS domain. Additionally, the network shall delete the already established GSM or UMTS security context for the CS domain, if the CKSN of the already established GSM or UMTS security context is equal to the CKSN of the new derived GSM or UMTS security context for the CS domain.

4.3.2.11.2 PDN connection without integrity protection

At PS to CS domain change from Iu mode to Iu mode due to SRVCC handover of a PDN connection for emergency bearer services for which integrity protection has not been activated before the SRVCC handover, the MS and the network shall not perform key derivation.

4.3.2.12 Derivation of keys at SRVCC handover from Iu mode to A/Gb mode

4.3.2.12.1 PDN connection with integrity protection

At PS to CS domain change from Iu mode to A/Gb mode due to SRVCC handover of a PDN connection for which integrity protection has been activated, ciphering may be started (see 3GPP TS 44.018 [84]) without any new authentication procedure. Deduction of the appropriate security key for ciphering in A/Gb mode, depends on the current GSM or UMTS security context for the PS domain stored in the MS and the network.

The ME shall handle the GSM ciphering key according to table 4.3.2.12.1.

Table 4.3.2.12.1/3GPP TS 24.008: SRVCC handover from Iu mode to A/Gb mode

Security context for the PS domain established in MS and network in Iu mode	At inter-system change to A/Gb mode:
GSM security context	An ME shall derive the GSM ciphering key (Kc') from the stored GPRS GSM ciphering key, which was provided by the SIM/USIM during the latest successful authentication, and the NONCE received in the command to perform handover (see 3GPP TS 25.331 [23c]) using the key derivation function specified in 3GPP TS 33.102 [5a]. The MS shall set the CKSN of the derived GSM security context for the CS domain to the value of the GPRS CKSN of the GSM security context for PS domain. Furthermore, the ME shall apply the new derived GSM ciphering key and replace an already established GSM security context for the CS domain, if any, in the SIM/USIM when the SRVCC handover from Iu mode has been completed successfully.
UMTS security context	An ME shall derive the UMTS security keys UMTS ciphering key (CK') and UMTS integrity key (IK') from the GPRS UMTS ciphering key and GPRS UMTS integrity key, which were received from the UMTS security context for the PS domain residing in the USIM, and the NONCE received in the command to perform handover (see 3GPP TS 25.331 [23c]) as specified in 3GPP TS 33.102 [5a]. The ME shall use the derived UMTS security keys to derive the GSM ciphering key (Kc') using the "c3" conversion function as specified in 3GPP TS 33.102 [5a]. Furthermore, the MS shall set the CKSN of the derived UMTS security context for the CS domain to the value of the KSI of the UMTS security context for PS domain. If an A5 algorithm is taken into use that requires a 64-bit long ciphering key, then the ME shall apply the new derived GSM ciphering key. If an A5 algorithm is taken into use that requires a 128-bit long ciphering key, then the ME shall use the derived UMTS security keys CK' and IK' to derive a GSM Kc ₁₂₈ (see 3GPP TS 33.102 [5a]). After that, the ME shall apply the new derived GSM Kc ₁₂₈ . Furthermore, the ME shall replace an already established UMTS security context for the CS domain, if any, in the USIM, when the SRVCC handover from Iu mode has been completed successfully.

The network shall replace an already established GSM or UMTS security context for the CS domain, if any, when the SRVCC handover from Iu mode to A/Gb mode has been completed successfully.

If the SRVCC handover from Iu mode to A/Gb mode has not been completed successfully, the MS and the network shall delete the new derived GSM or UMTS security context for the CS domain. Additionally, the network shall delete the already established GSM or UMTS security context for the CS domain, if the CKSN of the already established GSM or UMTS security context is equal to the CKSN of the new derived GSM or UMTS security context for the CS domain.

4.3.2.12.2 PDN connection without integrity protection

At PS to CS domain change from Iu mode to A/Gb mode due to SRVCC handover of a PDN connection for emergency bearer services for which integrity protection has not been activated while in Iu mode, the MS and the network shall not perform key derivation.

4.3.2.13 Derivation of keys at CS to PS SRVCC handover from A/Gb mode to Iu mode

At change from A/Gb mode to Iu mode due to CS to PS SRVCC handover (see 3GPP TS 23.216 [126]), the MS shall derive a UMTS security context for the PS domain from the current GSM or UMTS security context for the CS domain.

At change from A/Gb mode to Iu mode due to CS to PS SRVCC handover, ciphering may be started and integrity protection shall be started (see 3GPP TS 25.331 [23c]) without any new authentication procedure. Derivation of the appropriate security keys for ciphering and integrity protection for the PS domain in Iu mode depends on the current GSM or UMTS security context for the CS domain stored in the MS and the network.

The ME shall handle the PS UMTS ciphering key and the PS UMTS integrity key according to table 4.3.2.13.1.

Table 4.3.2.13.1/3GPP TS 24.008: CS to PS SRVCC handover from A/Gb mode to Iu mode

Security context for the CS domain established in MS and network in A/Gb mode	At inter-system change to Iu mode:
GSM security context	An ME shall derive the GPRS ciphering key (Kc') from the stored GSM ciphering key, which was provided by the SIM/USIM during the latest successful authentication, and the NONCE _{MSC} received in the command to perform handover (see 3GPP TS 25.331 [23c]) using the key derivation function specified in 3GPP TS 33.102 [5a]. The ME shall set the GPRS CKSN' of the derived GPRS security context (Kc') for the PS domain to the value of the GSM CKSN of the GSM security context for CS domain. The ME shall use the derived GPRS ciphering key (Kc') to derive the PS UMTS security keys PS UMTS ciphering key (CK') and PS UMTS integrity key (IK') for the PS domain. The conversion functions named "c4" and "c5" in 3GPP TS 33.102 [5a] are used for this purpose. The ME shall associate the derived keys PS UMTS ciphering key (CK') and PS UMTS integrity key (IK') for the PS domain with a KSI' which shall be set to the value of the GPRS CKSN of the derived GPRS security context (Kc') for the PS domain. Furthermore, the ME shall apply the new derived PS UMTS security keys (CK', IK') and replace an already established GPRS security context for the PS domain, if any, by overwriting the stored GPRS Kc and GPRS CKSN with the derived GPRS Kc' and GPRS CKSN' in both the ME and the SIM/USIM, when the CS to PS SRVCC handover has been completed successfully. Furthermore, the MS shall handle the START _{PS} value as specified in 3GPP TS 33.102 [5a] and 3GPP TS 25.331 [23c].
UMTS security context	An ME shall derive the PS UMTS security keys PS UMTS ciphering key (CK') and PS UMTS integrity key (IK') from the CS UMTS ciphering key and the CS UMTS integrity key, which were received from the UMTS security context for the CS domain residing in the USIM, and the NONCE _{MSC} received in the command to perform handover (see 3GPP TS 25.331 [23c]) as specified in 3GPP TS 33.102 [5a]. The ME shall set the KSI' of the derived PS UMTS security context (CK' and IK') for the PS domain to the value of the KSI of the CS UMTS security context for the CS domain. The ME shall use the derived PS UMTS security keys (CK' and IK') to derive the GPRS ciphering key (Kc') using the "c3" conversion function as specified in 3GPP TS 33.102 [5a]. The ME shall set the CKSN' associated with the derived GPRS ciphering key (Kc') to the value of the KSI of the derived PS UMTS security context (CK' and IK') for the PS domain. Furthermore, the ME shall apply the derived PS UMTS security keys (CK' and IK') and replace an already established UMTS security context for the PS domain, if any, by overwriting the stored UMTS PS CK, UMTS PS IK, UMTS PS KSI, GPRS Kc, and GPRS CKSN with the derived UMTS PS CK', UMTS PS IK', UMTS PS KSI', GPRS Kc' and GPRS CKSN', in both the ME and the USIM, when the CS to PS SRVCC handover has been completed successfully. Furthermore, the MS shall handle the START _{PS} value as specified in 3GPP TS 33.102 [5a] and 3GPP TS 25.331 [23c].

The network shall replace an already established GSM or UMTS security context for the PS domain, if any, when the CS to PS SRVCC handover from A/Gb mode to Iu mode has been completed successfully.

If the CS to PS SRVCC handover from A/Gb mode to Iu mode has not been completed successfully, the MS and the network shall delete the new derived GSM or UMTS security context for the PS domain. Additionally, the network shall delete the already established GSM or UMTS security context for the PS domain, if the GPRS CKSN of the already established GSM or UMTS security context is equal to the GPRS CKSN of the new derived GSM or UMTS security context for the PS domain.

4.3.2.14 Derivation of keys at 5G-SRVCC from NG-RAN to UTRAN

4.3.2.14.1 PDU session with integrity protection

At 5G-SRVCC from NG-RAN to UTRAN handover of a PDU session for which the "null integrity protection algorithm" 5G-IA0 has not been used (see 3GPP TS 23.216 [126]), when the MS receives the command to perform handover, the MS shall derive a new K_{ASME_SRVCC} from K_{AMF} as specified in 3GPP TS 33.501 [170].

The MS shall set the CKSN of the derived UMTS security context to the value of the eKSI associated with the new K_{ASME_SRVCC} and derive security keys CK_{SRVCC} and IK_{SRVCC} from the new K_{ASME_SRVCC} as specified in 3GPP TS 33.401 [123]. The MS shall apply these derived security keys, handle the $START_{CS}$ value as specified in 3GPP TS 25.331 [23c] and replace an already established UMTS security context for the CS domain, if any, in the USIM, when the 5G-SRVCC handover from NG-RAN to UTRAN has been completed successfully.

The network shall replace an already established UMTS security context for the CS domain, if any, when the 5G-SRVCC handover from NG-RAN to UTRAN has been completed successfully.

If the 5G-SRVCC handover from NG-RAN to UTRAN has not been completed successfully, the MS and the network shall delete the new derived UMTS security context for the CS domain. Additionally, the network shall delete the already established UMTS security context for the CS domain, if the CKSN of the already established UMTS security context is equal to the CKSN of the new derived UMTS security context for the CS domain.

4.3.2.14.2 PDU session without integrity protection

At the 5G-SRVCC from NG-RAN to UTRAN handover of an emergency PDU connection for which the "null integrity protection algorithm" 5G-IA0 has been used while in N1 mode, the MS and the network shall not perform key derivation.

4.3.3 Identification procedure

4.3.3.0 General

The identification procedure is used by the network to request a mobile station to provide specific identification parameters to the network e.g. International Mobile Subscriber Identity (IMSI), International Mobile Equipment Identity (IMEI). IMEI and IMSI definition and structure are specified in 3GPP TS 23.003 [10].

4.3.3.1 Identity request by the network

The network initiates the identification procedure by sending an IDENTITY REQUEST message to the mobile station and starting the timer T3270 (see figure 4.3). The IDENTITY REQUEST message specifies the requested identification parameters in the Identity type information element.

4.3.3.2 Identification response by the mobile station

The mobile station shall be ready to respond to an IDENTITY REQUEST message at any time whilst a RR connection exists.

Upon receipt of the IDENTITY REQUEST message the mobile station shall send an IDENTITY RESPONSE message. The IDENTITY RESPONSE message shall contain the identification parameters as requested by the network.

Upon receipt of the IDENTITY REQUEST message with the Identity type IE indicating that P-TMSI, RAI and P-TMSI signature are being requested, an MS that supports S1 mode shall handle the IDENTITY RESPONSE message as follows:

- If the TIN indicates "GUTI" and the MS holds a valid GUTI, the MS shall map the GUTI into a P-TMSI, P-TMSI signature and RAI as specified in 3GPP TS 23.003 [10]. The MS shall indicate the P-TMSI in the Mobile identity IE. In addition, the MS shall include the mapped RAI in the Routing area identification IE and the mapped P-TMSI signature in the P-TMSI signature IE. In addition, the MS shall include the P-TMSI type IE with P-TMSI type set to "mapped P-TMSI".

- If the TIN indicates "P-TMSI" or "RAT-related TMSI" and the MS holds a valid P-TMSI and RAI, the MS shall indicate the P-TMSI in the Mobile identity IE and shall indicate the RAI in the Routing area identification IE. In addition, the MS shall include the P-TMSI type IE with P-TMSI type set to "native P-TMSI". If the MS holds a valid P-TMSI signature, it shall include it in the P-TMSI signature IE.

If the MS does not support S1 mode, it shall handle the IDENTITY RESPONSE message as follows:

- If the MS holds a valid P-TMSI and RAI, the MS shall indicate the P-TMSI in the Mobile identity IE and shall indicate the RAI in the Routing area identification IE. In addition, the MS shall include the P-TMSI type IE with P-TMSI type set to "native P-TMSI". If the MS holds a valid P-TMSI signature, it shall include it in the P-TMSI signature IE.

Upon receipt of the IDENTITY RESPONSE message, the network shall stop timer T3270.

4.3.3.3 Abnormal cases in the mobile station

The following abnormal case can be identified:

- Requested identity is not available

If the MS cannot encode the requested identity in the IDENTITY RESPONSE message, e.g. because no valid SIM is available, then it shall encode the identity type as "no identity".

4.3.3.4 Abnormal cases on the network side

The following abnormal cases can be identified:

- RR connection failure:

Upon detection of a RR connection failure before the IDENTITY RESPONSE message is received, the network shall release all MM connections (if any) and abort any ongoing MM specific procedure.

- Expiry of timer T3270:

The identification procedure is supervised by the network by the timer T3270. At expiry of the timer T3270 the network may release the RR connection. In this case, the network shall abort the identification procedure and any ongoing MM specific procedure, release all MM connections if any, and initiate the RR connection release procedure as described in 3GPP TS 44.018 [84] subclause 3.5, 3GPP TS 25.331 [23c] (UTRAN Iu mode only), or in 3GPP TS 44.118 [111] (GERAN Iu mode only).

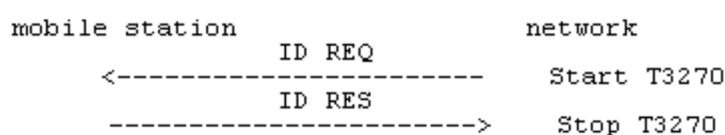

Figure 4.3/3GPP TS 24.008: Identification sequence

4.3.4 IMSI detach procedure

4.3.4.0 General

The IMSI detach procedure may be invoked by a mobile station if the mobile station is deactivated or if the Subscriber Identity Module (see 3GPP TS 42.017 [7] and 3GPP TS 31.102 [112]) is detached from the mobile station or as part of the eCall inactivity procedure defined in subclause 4.4.7.

In A/Gb mode and GERAN Iu mode, the network indicates whether the IMSI detach/attach procedures are required by using the ATT flag which is broadcast in the L3-RR SYSTEM INFORMATION TYPE 3 message on the BCCH (see 3GPP TS 44.018 [84] subclause 10.5.2.11). The mobile station shall use the value of the ATT flag that was broadcast when the mobile station was in the MM IDLE state.

In UTRAN Iu mode, the network indicates whether the IMSI detach/attach procedures are required by using the ATT flag which is included in the CS domain specific system information element (see subclause 10.5.1.12.2). The mobile station shall use the latest received value of the ATT flag.

If a RR connection exists and the ATT flag indicates that the IMSI detach/attach procedures are not required, the MM sublayer will release locally any ongoing MM connections before releasing the RR connection. If an MM specific procedure is active, the release of the RR connection may be delayed until the MM specific procedure is complete.

The IMSI detach procedure causes the mobile station to be indicated as inactive in the network.

The mobile station is allowed to initiate the IMSI detach procedure even if the timer T3246 is running.

The network proceeds with the IMSI detach procedure even if NAS level mobility management congestion control is active.

4.3.4.1 IMSI detach initiation by the mobile station

The IMSI detach procedure consists only of the IMSI DETACH INDICATION message sent from the mobile station to the network. The mobile station then starts timer T3220 and enters the MM sublayer state IMSI DETACH INITIATED.

If no RR connection exists, the MM sublayer within the mobile station will request the RR sublayer to establish a RR connection. If establishment of the RR connection is not possible because a suitable cell is not (or not yet) available then, the mobile station shall try for a period of at least 5 seconds and for not more than a period of 20 seconds to find a suitable cell. If a suitable cell is found during this time then, the mobile station shall request the RR sublayer to establish an RR connection, otherwise the IMSI detach is aborted. For:

- a shared GERAN in A/Gb mode, if the MS is a GERAN network sharing supporting MS, the chosen PLMN identity shall be indicated to the GERAN in the IMSI DETACH INDICATION message using the Skip Indicator IE as specified in subclause 10.3.1 and;
- a shared UTRAN, the chosen PLMN identity shall be indicated to the UTRAN in the RRC INITIAL DIRECT TRANSFER message (see 3GPP TS 25.331 [23c]).

If a RR connection exists, the MM sublayer will release locally any ongoing MM connections before the IMSI DETACH INDICATION message is sent.

The IMSI detach procedure may not be started if a MM specific procedure is active. If possible, the IMSI detach procedure is then delayed until the MM specific procedure is finished, else the IMSI detach is omitted.

4.3.4.2 IMSI detach procedure in the network

When receiving an IMSI DETACH INDICATION message, the network may set an inactive indication for the IMSI. No response is returned to the mobile station. After reception of the IMSI DETACH INDICATION message the network shall release locally any ongoing MM connections, and start the normal RR connection release procedure (see 3GPP TS 44.018 [84] subclause 3.5 (A/Gb mode only), 3GPP TS 25.331 [23c] (UTRAN Iu mode only), or in 3GPP TS 44.118 [111] (GERAN Iu mode only)).

Only applicable for a network supporting VGCS: If an IMSI DETACH INDICATION message is received from the talking mobile station in a group call while the network is in service state MM CONNECTION ACTIVE (GROUP TRANSMIT MODE), the network shall release locally the ongoing MM connection and then go to the service state GROUP CALL ACTIVE.

4.3.4.3 IMSI detach completion by the mobile station

Timer T3220 is stopped when the RR connection is released. The mobile station should, if possible, delay the local release of the channel to allow a normal release from the network side until T3220 timeout. If this is not possible (e.g. detach at power down) the RR sublayer on the mobile station side should be aborted.

4.3.4.4 Abnormal cases

The following abnormal cases can be identified:

- a) Lower layer failure

If the establishment of an RR connection is unsuccessful, or the RR connection is lost, the IMSI detach is aborted by the mobile station.

- b) Access barred because of access class control or EAB

The signalling procedure for IMSI detach shall not be started. The MS starts the signalling procedure as soon as possible and if still necessary, i.e. when the barred state is removed or because of a cell change, or performs a local detach immediately or after an implementation dependent time.

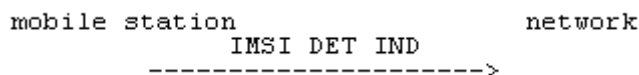

Figure 4.4/3GPP TS 24.008: IMSI detach sequence

4.3.5 Abort procedure

The abort procedure may be invoked by the network to abort any on-going MM connection establishment or already established MM connection. The mobile station shall treat ABORT message as compatible with current protocol state only if it is received when at least one MM connection exists or an MM connection is being established.

4.3.5.1 Abort procedure initiation by the network

The abort procedure consists only of the ABORT message sent from the network to the mobile station. Before the sending of the ABORT message the network shall locally release any ongoing MM connection. After the sending the network may start the normal RR connection release procedure.

The Cause information element indicates the reason for the abortion. The following cause values may apply:

- # 6: Illegal ME
- #17: Network failure

4.3.5.2 Abort procedure in the mobile station

At the receipt of the ABORT message the mobile station shall abort any MM connection establishment or call re-establishment procedure and release all MM connections (if any). If cause value #6 is received the mobile station shall delete any TMSI, LAI and ciphering key sequence number stored in the SIM/USIM, set the update status to ROAMING NOT ALLOWED (and store it in the SIM/USIM according to subclause 4.1.2.2) and consider the SIM/USIM invalid until switch off or the SIM/USIM is removed. If the message has been successfully integrity checked by the lower layers and the MS maintains a counter for "SIM/USIM considered invalid for non-GPRS services", then the MS shall set this counter to MS implementation-specific maximum value. As a consequence the mobile station enters state MM IDLE, substate NO IMSI after the release of the RR connection.

The mobile station shall then wait for the network to release the RR connection - see subclause 4.5.3.1.

4.3.6 MM information procedure

The MM information message support is optional in the network.

The MM information procedure may be invoked by the network at any time during an RR connection.

4.3.6.1 MM information procedure initiation by the network

The MM information procedure consists only of the MM INFORMATION message sent from the network to the mobile station. During an RR connection, the network shall send none, one, or more MM INFORMATION messages to the mobile station. If more than one MM INFORMATION message is sent, the messages need not have the same content.

NOTE: The network may be able to select particular instants where it can send the MM INFORMATION message without adding delay to, or interrupting, any CM layer transaction, e.g. immediately after the AUTHENTICATION REQUEST message.

4.3.6.2 MM information procedure in the mobile station

When the mobile station (supporting the MM information message) receives an MM INFORMATION message, it shall accept the message and optionally use the contents to update appropriate information stored within the mobile station.

If the mobile station does not support the MM information message the mobile station shall ignore the contents of the message and return an MM STATUS message with cause #97.

4.4 MM specific procedures

A MM specific procedure can only be started if no other MM specific procedure is running or no MM connection exists between the network and the mobile station. The end of the running MM specific procedure or the release of all MM connections have to be awaited before a new MM specific procedure can be started.

During the lifetime of a MM specific procedure, if a MM connection establishment is requested by a CM entity, this request will either be rejected or be delayed until the running MM specific procedure is terminated (this depends on the implementation).

Any MM common procedure (except IMSI detach) may be initiated during a MM specific procedure.

Unless it has specific permission from the network (follow-on proceed) the mobile station side should await the release of the RR connection used for a MM specific procedure before a new MM specific procedure or MM connection establishment is started.

NOTE: The network side may use the same RR connection for MM connection management.

4.4.1 Location updating procedure

The location updating procedure is a general procedure which is used for the following purposes:

- normal location updating (described in this subclause);
- periodic updating (see subclause 4.4.2); or
- IMSI attach (see subclause 4.4.3).

The normal location updating procedure is used to update the registration of the actual Location Area of a mobile station in the network. The location updating type information element in the LOCATION UPDATING REQUEST message shall indicate normal location updating. The conditions under which the normal location updating procedure is used by a mobile station in the MM IDLE state are defined for each service state in subclause 4.2.2.

Only applicable for mobile stations supporting VGCS listening or VBS listening: A mobile station in RR group receive mode is in the MM IDLE state, substate RECEIVING GROUP CALL (NORMAL SERVICE) or RECEIVING GROUP CALL (LIMITED SERVICE). To perform a location updating, the MS in RR group receive mode shall leave the group receive mode, establish an independent dedicated RR connection to perform the location updating as described above and return to the RR group receive mode afterwards.

The MS shall also start the normal location updating procedure:

- a) if the network indicates that the mobile station is unknown in the VLR as a response to MM connection establishment request;
- b) void
- c) when the MS, configured to use CS fallback and SMS over SGs, or SMS over SGs only, enters a GERAN or UTRAN cell in network operation mode II and timer T3423 has expired or is in the GERAN or UTRAN cell in network operation mode II when timer T3423 expires;

NOTE 1: Timer T3423 is specified in 3GPP TS 24.301 [120].

- d) when the MS, configured to use CS fallback and SMS over SGs, or SMS over SGs only, enters a GERAN or UTRAN cell after intersystem change from S1 mode to Iu or A/Gb mode, if timer T3346 is running, and the location area of the current cell is the same as the stored location area;

NOTE 2: If inter-system change is due to a mobile originating CS call, the location updating procedure can be performed after the RR connection is released unless the MS moves back to E-UTRAN.

- e) when the MS is both IMSI attached for GPRS and non-GPRS services and enters a new routing area where the network operates in network operation mode I and timer T3346 is running.
- f) when the network is operating in network operation mode I, timer T3346 is running, timer T3246 is not running, and due to manual CSG selection the MS has selected a CSG cell whose CSG identity and associated PLMN identity are not included in the Allowed CSG list or in the Operator CSG list of the MS;
- g) when due to a manual CSG selection the MS has selected a CSG cell whose CSG identity and associated PLMN identity are not included in the MS's Allowed CSG list or in the MS's Operator CSG list;
- h) when the network is operating in network operation mode I, T3346 is running, update status is not U1 UPDATED and the user manually selects the current PLMN; or
- i) when the MS is configured to use CS fallback and SMS over SGs, or SMS over SGs only, and the TIN indicates "GUTI", enters a GERAN or UTRAN cell after intersystem change from S1 mode to Iu or A/Gb mode in NMO II and timer T3412 is not running.

If the MS, configured to use CS fallback and SMS over SGs, enters a GERAN or UTRAN cell, after intersystem change from S1 mode to Iu or A/Gb mode due to CS fallback, and the location area of the current cell is not available, the MS may initiate the location updating procedure.

When the MS supporting N1 mode in MS operation modes A or B moves from NG-RAN coverage to GERAN coverage, or from NG-RAN coverage to UTRAN coverage, and the network operates in network operation mode II, the MS may initiate the normal location updating procedure.

To limit the number of consecutive unsuccessful location updating attempts made, an attempt counter is used. The detailed handling of the attempt counter is described in subclauses 4.4.4.5 to 4.4.4.9.

The mobile equipment shall contain a list of "forbidden location areas for roaming", as well as a list of "forbidden location areas for regional provision of service". These lists shall be erased when the MS is switched off or when the SIM/USIM is removed, and periodically (with period in the range 12 to 24 hours). When the lists are erased, the MS performs a cell selection according to 3GPP TS 43.022 [82] and 3GPP TS 25.304 [98]. The location area identification received on the BCCH that triggered the location updating request shall be added to the suitable list whenever a LOCATION AREA UPDATING REJECT message is received with the cause "Roaming not allowed in this location area", "Location Area not allowed", or "No suitable cells in Location Area". The lists shall accommodate each 10 or more location area identifications. When the list is full and a new entry has to be inserted, the oldest entry shall be deleted.

In a shared network, the MS shall choose one of the PLMN identities as specified in 3GPP TS 23.122 [14]. The MS shall construct the Location Area Identification of the cell from this chosen PLMN identity and the LAC received on the BCCH. If the constructed LAI is different from the stored LAI, the MS shall initiate the location updating procedure. For:

- a shared GERAN, in A/Gb mode, the chosen PLMN identity shall be indicated to the GERAN in the LOCATION UPDATING REQUEST message using the Skip Indicator IE as specified in subclause 10.3.1.
- a shared UTRAN, the chosen PLMN identity shall be indicated to the UTRAN in the RRC INITIAL DIRECT TRANSFER message (see 3GPP TS 25.331 [23c]).

For GERAN Iu mode, network sharing is not supported.

Whenever a LOCATION UPDATING REJECT message with the cause "PLMN not allowed" is received by the MS, the PLMN identity used to construct the LAI which triggered the location updating procedure shall be stored in the "forbidden PLMN list" and if the MS is configured to use timer T3245 (see 3GPP TS 24.368 [135] or 3GPP TS 31.102 [112]) then the MS shall start timer T3245 and proceed as described in subclause 4.1.1.6. Whenever a LOCATION UPDATING REJECT message is received by the MS with the cause "Roaming not allowed in this location area", "Location Area not allowed", or "No suitable cells in Location Area", the constructed LAI which triggered the location updating procedure shall be stored in the suitable list.

The cell selection processes in the different states are described in 3GPP TS 43.022 [82] and 3GPP TS 45.008 [34].

The location updating procedure is always initiated by the mobile station.

In the case that the mobile station is initiating an emergency call but, due to cell re-selection or redirection by the network, it moves to a different LAI then the mobile station may delay the location updating procedure in the new LA until after the emergency call is completed.

4.4.2 Periodic updating

Periodic updating may be used to notify periodically the availability of the mobile station to the network. Periodic updating is performed by using the location updating procedure. The location updating type information element in the LOCATION UPDATING REQUEST message shall indicate periodic updating.

The procedure is controlled by the timer T3212 in the mobile station. The MS indicates in the MS network feature support IE whether it supports the extended value for timer T3212. If the MS receives the *Per MS T3212* IE in the LOCATION UPDATING ACCEPT message, the MS shall use this IE to determine the value of T3212 instead of the value of T3212 that is broadcast. If the MS does not receive the *Per MS T3212* IE in the LOCATION UPDATING ACCEPT message, the MS shall use the value of T3212 that is broadcast. If the timer is not already started, the timer is started each time the mobile station enters the MM IDLE substate NORMAL SERVICE or ATTEMPTING TO UPDATE. When the MS leaves the MM Idle State the timer T3212 shall continue running until explicitly stopped.

The timer is stopped (shall be set to its initial value for the next start) when:

- a LOCATION UPDATING ACCEPT or LOCATION UPDATING REJECT message is received;
- an AUTHENTICATION REJECT message is received;
- the first MM message is received, or security mode setting is completed in the case of MM connection establishment, except when the most recent service state is LIMITED SERVICE;
- the mobile station has responded to paging and thereafter has received the first correct layer 3 message except RR message;
- the mobile station is deactivated (i.e. equipment powered down or SIM/USIM removed).

When the timer T3212 expires, the location updating procedure is started and the timer shall be set to its initial value for the next start. If the mobile station is in other state than MM Idle when the timer expires the location updating procedure is delayed until the MM Idle State is entered.

The conditions under which the periodic location updating procedure is used by a mobile station in the MM IDLE state are defined for each service state in subclause 4.2.2.

If the mobile station is in service state NO CELL AVAILABLE, LIMITED SERVICE, PLMN SEARCH or PLMN SEARCH-NORMAL SERVICE when the timer expires the location updating procedure is delayed until this service state is left.

In A/Gb mode and GERAN Iu mode, the (periodic) location updating procedure is not started if the BCCH information at the time the procedure is triggered indicates that periodic location shall not be used. The timeout value is broadcasted in the L3-RR SYSTEM INFORMATION TYPE 3 message on the BCCH, in the Control channel description IE, see 3GPP TS 44.018 [84] subclause 10.5.2.11.

In UTRAN Iu mode, the (periodic) location updating procedure is not started if the information on BCCH or in the last received dedicated system information at the time the procedure is triggered indicates that periodic location shall not be used. The timeout value is included in the CS domain specific system information element.

The T3212 timeout value shall not be changed in the NO CELL AVAILABLE, LIMITED SERVICE, PLMN SEARCH and PLMN SEARCH-NORMAL SERVICE states.

If the MS, configured to use CS fallback and SMS over SGs, or SMS over SGs only, enters a GERAN or UTRAN cell after intersystem change from S1 mode to Iu or A/Gb mode in NMO II, the TIN indicates "GUTI", and the location area of the current cell is the same as the stored location area, the MS shall start timer T3212, with a value set to the shorter of the values of the remaining value of timer T3412, and the broadcast T3212 timeout value.

When the MS supporting N1 mode in MS operation modes A or B moves from NG-RAN coverage to GERAN coverage, or from NG-RAN coverage to UTRAN coverage, the network operates in network operation mode II, the location area of the current cell is the same as the stored location area, the broadcast value of T3212 does not indicate "deactivated" and the T3212 has expired, the MS may initiate the periodic location updating procedure.

When a change of the broadcast T3212 timeout value has to be taken into account and the timer is running (at change of the serving cell or, change of the broadcast value of T3212), the MS shall behave as follows: let t_1 be the new T3212 timeout value and let t be the current timer value at the moment of the change to the new T3212 timeout value; then the timer shall be restarted with the value t modulo t_1 .

When the mobile station is activated, or when a change of the broadcast T3212 timeout value has to be taken into account and the timer is not running, the mobile station shall behave as follows: let t_1 be the new T3212 timeout value, the new timer shall be started at a value randomly, uniformly drawn between 0 and t_1 .

4.4.3 IMSI attach procedure

The IMSI attach procedure is the complement of the IMSI detach procedure (see subclause 4.3.4). It is used to indicate the IMSI as active in the network.

In A/Gb mode and GERAN Iu mode, the network indicates whether the IMSI attach/detach procedures are required by using the ATT flag which is broadcast in the L3-RR SYSTEM INFORMATION TYPE 3 message (see 3GPP TS 44.018 [84] subclause 10.5.2.11).

In UTRAN Iu mode, the network indicates whether the IMSI attach/detach procedures are required by using the ATT flag which is included in the CS domain specific system information element (see subclause 10.5.1.12.2).

The IMSI attach procedure is invoked if the ATT flag indicates that the IMSI detach/attach procedures are required and an IMSI is activated in a mobile station (i.e. activation of a mobile station with plug-in SIM/USIM, insertion of a card in a card-operated mobile station etc.) within coverage area from the network or a mobile station with an IMSI activated outside the coverage area enters the coverage area. The IMSI attach procedure is used only if the update status is U1 UPDATED and if the stored location area identification is the same as the one which is actually broadcasted on the BCCH of the current serving cell.

In a shared network, the MS shall choose one of the PLMN identities as specified in 3GPP TS 23.122 [14]. The MS shall use the IMSI attach procedure only if the update status is U1 UPDATED and the stored location area identification is equal to the combination of the chosen PLMN identity and the LAC received on the BCCH. Otherwise a normal location updating procedure (see subclause 4.4.1) is invoked independently of the ATT flag indication.

The IMSI attach procedure is performed by using the location updating procedure (see subclause 4.4.1). The location updating type information element in the LOCATION UPDATING REQUEST message shall in this case indicate IMSI attach.

4.4.4 Generic Location Updating procedure

4.4.4.1 Location updating initiation by the mobile station

Any timer used for triggering the location updating procedure (e.g. T3211, T3212) is stopped if running.

As no RR connection exists at the time when the location updating procedure has to be started, the MM sublayer within the mobile station will request the RR sublayer to establish a RR connection and enter state WAIT FOR RR CONNECTION (LOCATION UPDATE). The procedure for establishing an RR connection is described in 3GPP TS 44.018 [84] subclause 3.3 and 3GPP TS 25.331 [23c].

The mobile station initiates the location updating procedure by sending a LOCATION UPDATING REQUEST message to the network, starts the timer T3210 and enters state LOCATION UPDATING INITIATED. The location updating type information element shall indicate what kind of updating is requested.

If the MS is configured for "AttachWithIMSI" as specified in 3GPP TS 24.368 [135] or 3GPP TS 31.102 [112] and the selected PLMN is neither the registered PLMN nor in the list of equivalent PLMNs, the MS shall include the IMSI in the Mobile identity IE in the LOCATION UPDATING REQUEST message.

If the mobile station is configured to use CS fallback and SMS over SGs, or SMS over SGs only, and TIN indicates "RAT-related TMSI" the mobile station shall set the TIN to "P-TMSI" unless the mobile station had already received

the EMM cause #18 during a combined attach procedure (see subclause 5.5.1.3.4.3 of 3GPP TS 24.301 [120]) or a combined tracking area updating procedure (see subclause 5.5.3.3.4.3 of 3GPP TS 24.301 [120]) on the same PLMN, but not disabled the E-UTRAN capability.

4.4.4.1a Network Request for Additional mobile station Capability Information

In A/Gb mode, the network may initiate the classmark interrogation procedure, for example, to obtain further information on the mobile station's encryption capabilities.

4.4.4.2 Identification request from the network

The network may initiate the identification procedure, e.g. if the network is unable to get the IMSI based on the TMSI and LAI used as identification by the mobile station (see subclause 4.3.3).

4.4.4.3 Authentication by the network

The authentication procedure (see subclause 4.3.2) may be initiated by the network upon receipt of the LOCATION UPDATING REQUEST message from the mobile station. (See the cases defined in 3GPP TS 42.009 [5]).

4.4.4.4 Security mode setting by the network

In A/Gb mode, the security mode setting procedure (see 3GPP TS 44.018 [84] subclause 3.4.7) may be initiated by the network, e.g., if a new TMSI has to be allocated.

In Iu mode, the security mode control procedure (see 3GPP TS 25.331 [23c] and 3GPP TS 44.118 [111]) may be initiated by the network, e.g., if a new TMSI has to be allocated.

4.4.4.5 Location Update Attempt Counter

To limit the number of consecutive unsuccessful location updating attempts, an location update attempt counter is used. The location update attempt counter counts the number of consecutive unsuccessful location updating attempts.

The location update attempt counter shall be incremented as specified in subclause 4.4.4.9.

The location update attempt counter shall be reset when:

- the mobile station is powered on;
- a SIM/USIM is inserted;
- a location updating procedure is successfully completed;
- a location updating procedure is rejected with cause:
 - a) #11, #12, #13, #15 or #25 (see subclause 4.4.4.7);
 - b) #22 and T3346 value IE indicating neither zero nor deactivated (see subclause 4.4.4.7);
- a normal or periodic routing area updating procedure or combined routing updating is not accepted by the network with cause #11, #12, #13, #15 or #25 (see subclause 4.7.5.1.4 and 4.7.5.2.4);
- GPRS attach or combined GPRS attach procedure is not accepted by the network with cause #11, #12, #13, or #15 (see subclause 4.7.3.1.4 and 4.7.3.2.4);
- service request procedure is not accepted by the network with cause #12, #13, or #15 (see subclause 4.7.13.4);
- network initiated GPRS detach procedure is completed with cause #12, #13, or #15 (see subclause 4.7.4.2.2);
- combined GPRS attach or combined routing area updating procedure is successful for GPRS and non-GPRS services; or
- a new PLMN is selected.

and additionally when the mobile station is in the state MM IDLE sub-state ATTEMPTING to UPDATE:

- a new location area is entered;
- expiry of timer T3212;
- a location updating procedure is triggered by CM sublayer requests; or
- timer T3246 is started.

The location update attempt counter shall be used when deciding whether to re-attempt a location updating procedure after expiry of timer T3211 as specified in subclause 4.4.4.9.

4.4.4.6 Location updating accepted by the network

If the location updating is accepted by the network a LOCATION UPDATING ACCEPT message is transferred to the mobile station.

In case the identity confidentiality service is active (see subclauses 4.3.1 and 4.4.4.4), the TMSI reallocation may be part of the location updating procedure. The TMSI allocated is then contained in the LOCATION UPDATING ACCEPT message together with the location area identifier LAI. The network shall in this case start the supervision timer T3250 as described in subclause 4.3.1.

In a shared network, if the MS is a network sharing supporting MS, the network shall indicate in the LAI the PLMN identity of the CN operator that has accepted the location updating; if the MS is a network sharing non-supporting MS, the network shall indicate the PLMN identity of the common PLMN (see 3GPP TS 23.251 [109]).

In a multi-operator core network (MOCN) with common GERAN, the network shall indicate in the LAI the common PLMN identity (see 3GPP TS 23.251 [109]).

If the network wishes to prolong the RR connection to allow the mobile station to initiate MM connection establishment (for example if the mobile station has indicated in the LOCATION UPDATING REQUEST that it has a follow-on request pending) the network shall send "follow on proceed" in the LOCATION UPDATING ACCEPT and start timer T3255.

If the mobile station has indicated "CS fallback mobile terminating call" in the LOCATION UPDATING REQUEST message, the network shall maintain the RR connection for an implementation dependent duration to allow for mobile terminating call establishment. If the mobile station has also indicated in the LOCATION UPDATING REQUEST message that it has a follow-on request pending, it is implementation dependent whether the network proceeds with the mobile terminating call establishment or allows for a mobile initiated MM connection establishment.

The mobile station receiving a LOCATION UPDATING ACCEPT message shall store the received location area identification LAI, stop timer T3210, reset the location update attempt counter and set the update status in the SIM/USIM to UPDATED. If the message contains an IMSI, the mobile station is not allocated any TMSI, and shall delete any TMSI in the SIM/USIM accordingly. If the message contains a TMSI, the mobile station is allocated this TMSI, and shall store this TMSI in the SIM/USIM and a TMSI REALLOCATION COMPLETE shall be returned to the network. If neither IMSI nor TMSI is received in the LOCATION UPDATING ACCEPT message, the old TMSI if any available shall be kept.

If the MS has initiated the location updating procedure due to manual CSG selection and receives a LOCATION UPDATING ACCEPT message, and the MS sent the LOCATION UPDATING REQUEST message in a CSG cell, the MS shall check if the CSG ID and associated PLMN identity of the cell are contained in the Allowed CSG list. If not, the MS shall add that CSG ID and associated PLMN identity to the Allowed CSG list and the MS may add the HNB Name (if provided by lower layers) to the Allowed CSG list if the HNB Name is present in neither the Operator CSG list nor the Allowed CSG list.

If the LAI or PLMN identity contained in the LOCATION UPDATING ACCEPT message is a member of the list of "forbidden location areas for regional provision of service", the list of "forbidden location areas for roaming" or the "forbidden PLMN list" then such entries shall be deleted.

If the MS receives the LOCATION UPDATING ACCEPT message from a PLMN for which a PLMN-specific attempt counter is maintained (see subclause 4.1.1.6A), then the MS shall reset this counter. If the MS maintains a counter for "SIM/USIM considered invalid for non-GPRS services", then the MS shall reset this counter.

The network may also send a list of "equivalent PLMNs" in the LOCATION UPDATING ACCEPT message. Each entry of the list contains a PLMN code (MCC+MNC). If the location updating procedure is initiated during a CS

fallback procedure and the network is configured to support the return to the last registered E-UTRAN PLMN after CS fallback as specified in 3GPP TS 23.272 [133], and the PLMN identity which is provided as part of the RAI contained in the ROUTING AREA UPDATE ACCEPT message differs from the last registered E-UTRAN PLMN identity, the network shall include the last registered E-UTRAN PLMN identity in the list of "equivalent PLMNs" in the LOCATION UPDATING ACCEPT message.

NOTE 1: The network can determine a location updating procedure is initiated during a CS fallback procedure as specified in 3GPP TS 23.272 [133].

NOTE 2: The last registered E-UTRAN PLMN identity can be derived by the network as specified in 3GPP TS 23.272 [133].

The mobile station shall store the list, as provided by the network, except that any PLMN code that is already in the "forbidden PLMN list" shall be removed from the "equivalent PLMNs" list before it is stored by the mobile station. If the mobile station is supporting S1 mode, it shall also remove any PLMN code that is already in the list of "forbidden PLMNs for GPRS service" before storing the list. In addition the mobile station shall add to the stored list the PLMN code of the registered PLMN that sent the list. All PLMNs in the stored list shall be regarded as equivalent to each other for PLMN selection, cell selection/re-selection and handover. The stored list in the mobile station shall be replaced on each occurrence of the LOCATION UPDATING ACCEPT message. If no list is contained in the message, then the stored list in the mobile station shall be deleted. The list shall be stored in the mobile station while switched off so that it can be used for PLMN selection after switch on.

After that, the mobile station shall act according to the presence of the "Follow-on proceed" information element in the LOCATION UPDATING ACCEPT; if this element is present and the mobile station has a CM application request pending, it shall send a CM SERVICE REQUEST to the network and proceed as in subclause 4.5.1.1. Otherwise, it shall start timer T3240 and enter state WAIT FOR NETWORK COMMAND.

Furthermore, the network may grant authorisation for the mobile station to use GSM-Cordless Telephony System (CTS) in the Location Area and its immediate neighbourhood. The mobile should memorise this permission in non-volatile memory. If the "CTS permission" IE is not present in the message, the mobile is not authorised to use GSM-CTS, and shall accordingly delete any memorised permission.

NOTE 3: The interaction between CTS and GPRS procedures are not yet defined.

The network may also send a Local Emergency Numbers List with local emergency numbers in the LOCATION UPDATING ACCEPT, by including the Emergency Number List IE. The mobile equipment shall store the Local Emergency Numbers List, as provided by the network. The Local Emergency Numbers List stored in the mobile equipment shall be replaced on each receipt of the Emergency Number List IE. The received Local Emergency Numbers List shall be provided to the upper layers.

The emergency number(s) received in the Emergency Number List IE are valid only in networks in the same country as the cell on which this IE is received. If no list is contained in the LOCATION UPDATING ACCEPT message, then the stored Local Emergency Numbers List in the mobile equipment shall be kept, except if the mobile equipment has successfully registered to a PLMN in a country different from that of the PLMN that sent the Local Emergency Numbers List.

The mobile equipment shall use the stored Local Emergency Numbers List of emergency numbers received from the network in addition to the emergency numbers stored on the SIM/USIM or ME to detect that the number dialled is an emergency number.

NOTE 4: The mobile equipment may use the Local Emergency Numbers List to assist the end user in determining whether the dialled number is intended for an emergency service or for another destination, e.g. a local directory service. The possible interactions with the end user are implementation specific.

NOTE 5: An MS that supports procedures specified in 3GPP TS 24.302 [156], can get additional local emergency numbers through those procedures, which can be used based on operator policy (see 3GPP TS 24.302 [156]) to detect that the number dialled is an emergency number.

The Local Emergency Numbers List shall be deleted at switch off and removal of the SIM/USIM. The mobile equipment shall be able to store up to ten local emergency numbers received from the network.

4.4.4.7 Location updating not accepted by the network

If the location updating cannot be accepted, the network sends a LOCATION UPDATING REJECT message to the mobile station. The mobile station receiving a LOCATION UPDATING REJECT message containing a reject cause other than MM cause value #25 or the message is integrity protected, shall stop the timer T3210, store the reject cause, start the timer T3240, enter state LOCATION UPDATING REJECTED, await the release of the RR connection triggered by the network, and for all causes except #12, #15, #22 and #25 deletes the list of "equivalent PLMNs".

If the LOCATION UPDATING REJECT message containing the MM cause value #25 was received without integrity protection, then the MS shall discard the message.

If the location updating is rejected due to general NAS level mobility management congestion control, the network shall set the MM cause value to #22 "congestion" and assign a back-off timer T3246 (see 3GPP TS 23.012 [140]).

Upon the release of the RR connection, the mobile station shall take the following actions depending on the stored reject cause:

2: (IMSI unknown in HLR);

3: (Illegal MS); or

6: (Illegal ME).

The mobile station shall set the update status to ROAMING NOT ALLOWED (and store it in the SIM/USIM according to subclause 4.1.2.2), and delete any TMSI, stored LAI and ciphering key sequence number and shall consider the SIM/USIM as invalid for non-GPRS services until switch-off or the SIM/USIM is removed or the timer T3245 expires as described in subclause 4.1.1.6. If the message has been successfully integrity checked by the lower layers and the MS maintains a counter for "SIM/USIM considered invalid for non-GPRS services", then the MS shall set this counter to MS implementation-specific maximum value.

11: (PLMN not allowed);

The mobile station shall delete any LAI, TMSI and ciphering key sequence number stored in the SIM/USIM, reset the location update attempt counter, and set the update status to ROAMING NOT ALLOWED (and store it in the SIM/USIM according to subclause 4.1.2.2). The mobile station shall store the PLMN identity in the "forbidden PLMN list" and if the MS is configured to use timer T3245 (see 3GPP TS 24.368 [135] or 3GPP TS 31.102 [112]) then the MS shall start timer T3245 and proceed as described in subclause 4.1.1.6. If the message has been successfully integrity checked by the lower layers and the MS maintains a PLMN-specific attempt counter for that PLMN, then the MS shall set this counter to the MS implementation-specific maximum value.

The MS shall perform a PLMN selection when back to the MM IDLE state according to 3GPP TS 23.122 [14].

An MS in GAN mode shall request a PLMN list in GAN (see 3GPP TS 44.318 [76b]) prior to performing a PLMN selection from this list according to 3GPP TS 23.122 [14].

12: (Location Area not allowed);

The mobile station shall delete any LAI, TMSI and ciphering key sequence number stored in the SIM/USIM, reset the location update attempt counter, and set the update status to ROAMING NOT ALLOWED (and store it in the SIM/USIM according to subclause 4.1.2.2).

The mobile station shall store the LAI in the list of "forbidden location areas for regional provision of service".

The MS shall perform a cell selection when back to the MM IDLE state according to 3GPP TS 43.022 [82] and 3GPP TS 25.304 [98].

NOTE 1: The cell selection procedure is not applicable for an MS in GAN mode.

13: (Roaming not allowed in this location area).

The mobile station shall reset the location update attempt counter, and set the update status to ROAMING NOT ALLOWED (and store it in the SIM/USIM according to subclause 4.1.2.2).

The mobile station shall store the LAI in the list of "forbidden location areas for roaming".

The mobile station shall perform a PLMN selection instead of a cell selection when back to the MM IDLE state according to 3GPP TS 23.122 [14].

An MS in GAN mode shall request a PLMN list in GAN (see 3GPP TS 44.318 [76b]) prior to performing a PLMN selection from this list according to 3GPP TS 23.122 [14].

15: (No Suitable Cells In Location Area).

The mobile station shall reset the location update attempt counter, set the update status to ROAMING NOT ALLOWED (and store it in the SIM/USIM according to subclause 4.1.2.2).

The mobile station shall store the LAI in the list of "forbidden location areas for roaming".

The mobile station shall search for a suitable cell in another location area or a tracking area according to 3GPP TS 43.022 [82] and 3GPP TS 25.304 [98] or 3GPP TS 36.304 [121].

NOTE 2: The cell selection procedure is not applicable for an MS in GAN mode.

22: (Congestion).

If the T3246 value IE is present in the LOCATION UPDATING REJECT message and the value indicates that this timer is neither zero nor deactivated, the mobile station shall proceed as described below, otherwise it shall be considered as an abnormal case and the behaviour of the MS for this case is specified in subclause 4.4.4.9.

The mobile station shall abort the location updating procedure, reset the location update attempt counter, set the MM update status to U2 NOT UPDATED and change to state MM IDLE sub-state ATTEMPTING TO UPDATE.

The MS shall stop timer T3246 if it is running.

If the LOCATION UPDATING REJECT message is integrity protected, the mobile station shall start timer T3246 with the value provided in the T3246 value IE.

If the LOCATION UPDATING REJECT message is not integrity protected, the mobile station shall start timer T3246 with a random value from the default range specified in table 11.1.

The mobile station stays in the current serving cell and applies the normal cell reselection process. The MM connection establishment is started, if still necessary, when timer T3246 expires or is stopped.

25: (Not authorized for this CSG).

Cause #25 is only applicable in UTRAN Iu mode and when received from a CSG cell. Other cases are considered as abnormal cases and the specification of the mobile station behaviour is given in subclause 4.4.4.9.

The MS shall reset the location update attempt counter, and set the update status to ROAMING NOT ALLOWED (and store it in the SIM/USIM according to subclause 4.1.2.2).

If the CSG ID and associated PLMN identity of the cell where the MS has sent the LOCATION UPDATING REQUEST message are contained in the Allowed CSG list stored in the MS, the MS shall remove the entry corresponding to this CSG ID and associated PLMN identity from the Allowed CSG list.

If the CSG ID and associated PLMN identity of the cell where the MS has sent the LOCATION UPDATING REQUEST message are contained in the Operator CSG list, the MS shall proceed as specified in 3GPP TS 23.122 [14] subclause 3.1A.

The MS shall search for a suitable cell according to 3GPP TS 43.022 [82] and 3GPP TS 25.304 [98].

Other values are considered as abnormal cases and the specification of the mobile station behaviour in those cases is given in subclause 4.4.4.9.

4.4.4.8 Release of RR connection after location updating

When the Location updating procedure is finished (see subclauses 4.4.4.6 and 4.4.4.7) the mobile station shall (except in the case where the mobile has a follow-on CM application request pending and has received the follow-on proceed indication, see subclause 4.4.4.6) set timer T3240 and enter the state WAIT FOR NETWORK COMMAND, expecting

the release of the RR connection. The network may decide to keep the RR connection for network initiated establishment of a MM connection, or to allow for mobile initiated MM connection establishment.

Any release of the RR connection shall be initiated by the network according to subclause 3.5 in 3GPP TS 44.018 [84], and 3GPP TS 25.331 [23c]. If the RR connection is not released within a given time controlled by the timer T3240, the mobile station shall abort the RR connection. In both cases, either after a RR connection release triggered from the network side or after a RR connection abort requested by the MS-side, the MS shall return to state MM IDLE.

At transition to state MM IDLE, substates NORMAL SERVICE or RECEIVING GROUP CALL (NORMAL SERVICE) or ATTEMPTING TO UPDATE either timer T3212 or timer T3211 is started as described in subclause 4.4.4.9, or, timer T3246 is started as described in subclauses 4.4.4.7, 4.4.4.9 and 4.5.1.1.

If the MS receives the "Extended wait time" for CS domain from the lower layers when no location updating or CM service request procedure is ongoing, the MS shall ignore the "Extended wait time".

4.4.4.9 Abnormal cases on the mobile station side

The different abnormal cases that can be identified are the following:

- a) Access barred because of access class control or EAB

The location updating procedure is not started. The mobile station stays in the current serving cell and applies normal cell reselection process. The procedure is started as soon as possible and if still necessary (when the barred state is ended or because of a cell change).

- b) The answer to random access is an IMMEDIATE ASSIGNMENT REJECT message (A/Gb mode only)

The location updating is not started. The mobile station stays in the chosen cell and applies normal cell selection process. The waiting timer T3122 is reset when a cell change occurs. The procedure is started as soon as possible after T3122 timeout if still necessary.

- c) Random access failure (A/Gb mode only)

Timer T3213 is started. When it expires the procedure is attempted again if still necessary.

NOTE 1: As specified in 3GPP TS 45.008 [34], a cell reselection then takes place, with return to the cell inhibited for 5 seconds if there is at least one other suitable cell. Typically the selection process will take the mobile station back to the cell where the random access failed after 5 seconds.

If at the expiry of timer T3213 a new cell has not been selected due to the lack of valid information (see 3GPP TS 45.008 [34]), the mobile station may as an option delay the repeated attempt for up to 8 seconds to allow cell re-selection to take place. In this case the procedure is attempted as soon as a new cell has been selected or the mobile station has concluded that no other cell can be selected.

If random access failure occurs for two successive random access attempts for location updating the mobile station proceeds as specified below.

- d) RR connection failure

The procedure is aborted and the mobile station proceeds as specified below.

- e) T3210 timeout

The procedure is aborted, the RR connection is aborted and the MS proceeds as specified below.

- f) RR release without "Extended Wait Time" received from lower layers before the normal end of procedure

The procedure is aborted and the mobile station proceeds as specified below, except in the following implementation option case f.1.

- f.1) RR release in Iu mode (i.e. RRC connection release) with, for example, cause "Normal", "User inactivity" or "Directed signalling connection re-establishment" (see 3GPP TS 25.331 [23c] and 3GPP TS 44.118 [111])

The location updating procedure shall be initiated again, if the following conditions apply:

- i) The original location updating procedure was initiated over an existing RRC connection; and

ii) No SECURITY MODE COMMAND message and no Non-Access Stratum (NAS) messages relating to the CS signalling connection (e.g. CS authentication procedures, see subclause 4.3.2), were received after the LOCATION UPDATING REQUEST message was transmitted.

NOTE 2: The RRC connection release cause that triggers the re-initiation of the location updating procedure is implementation specific.

g) Location updating reject, other causes than those treated in subclause 4.4.4.7, and cases of MM cause values #22 and #25, if considered as abnormal cases according to subclause 4.4.4.7

Upon reception of the cause codes #22, # 95, # 96, # 97, # 99 and # 111 the MS should set the location update attempt counter to 4. The MS waits for release of the RR connection as specified in subclause 4.4.4.8.

The MS shall proceed as described below.

h) RR connection establishment failure without "Extended Wait Time" received from lower layers (Iu mode only)

The procedure is aborted and the mobile station proceeds as specified below.

NOTE 3: Case h) covers all cases when the signalling connection cannot be established, including random access failure and access reject. As the RRC protocol has error specific retransmission mechanisms (see 3GPP TS 25.331 [23c]), there is no need to distinguish between the different error cases within MM.

i) "Extended wait time" for CS domain from the lower layers

The MS shall abort the location updating procedure and stop timer T3210 if still running.

If the LOCATION UPDATING REQUEST message contained the low priority indicator set to "MS is configured for NAS signalling low priority", the MS shall start timer T3246 with the "Extended wait time" value and reset the location update attempt counter.

In other cases the MS shall ignore the "Extended wait time".

Additionally, the MS shall set the MM update status to U2 NOT UPDATED and change to state MM IDLE sub-state ATTEMPTING TO UPDATE. The MS stays in the current serving cell and applies normal cell reselection process. The location updating procedure is started, if still necessary, when timer T3246 expires or is stopped, and the MS proceeds as specified below.

j) Timer T3246 is running

The location updating procedure shall not be initiated unless the MS is establishing an emergency call or the MS is an MS configured to use AC11 – 15 in selected PLMN. The MS stays in the current serving cell and applies normal cell reselection process. The location updating procedure is started, if still necessary, when timer T3246 expires or is stopped.

In cases d) to i) (except in the case f.1 and except in the case i) when timer T3246 is started) above, and, for repeated failures as defined in c) above, the mobile station proceeds as follows. Timer T3210 is stopped if still running. The RR Connection is aborted in case of timer T3210 timeout. The location update attempt counter is incremented. The next actions depend on the Location Area Identities (stored and received from the BCCH of the current serving cell) and the value of the location update attempt counter.

- the update status is UPDATED, and the stored LAI is equal to the one received on the BCCH from the current serving cell and the location update attempt counter is smaller than 4:

The mobile station shall keep the update status to UPDATED, the MM IDLE sub-state after the RR connection release is NORMAL SERVICE. The mobile station shall memorize the location updating type used in the location updating procedure. It shall start timer T3211 when the RR connection is released. When timer T3211 or T3246 expires the location updating procedure is triggered again with the memorized location updating type;

- either the update status is different from UPDATED, or the stored LAI is different from the one received on the BCCH from the current serving cell, or the location update attempt counter is greater or equal to 4:

When the RR connection is released the mobile station shall delete any LAI, TMSI, ciphering key sequence number stored in the SIM/USIM, and set the update status to NOT UPDATED. A mobile station which is not a GPRS MS shall also delete the list of equivalent PLMNs. The mobile station shall enter the MM IDLE sub-state ATTEMPTING TO UPDATE (see subclause 4.2.2.2 for the subsequent actions) or optionally the MM IDLE

sub-state PLMN SEARCH (see subclause 4.2.1.2) in order to perform a PLMN selection according to 3GPP TS 23.122 [14]. If the location update attempt counter is smaller than 4, the mobile station shall memorize that timer T3211 is to be started when the RR connection is released, otherwise it shall memorize that timer T3212 is to be started when the RR connection is released.

4.4.4.10 Abnormal cases on the network side

a) RR connection failure

If a RR connection failure occurs during a common procedure integrated with the location updating procedure, the behaviour of the network should be according to the description of that common procedure.

If a RR connection failure occurs when a common procedure does not exist, the location updating procedure towards the mobile station should be aborted.

b) protocol error

If the LOCATION UPDATING REQUEST message is received with a protocol error, the network should, if possible, return a LOCATION UPDATING REJECT message with one of the following Reject causes:

- #96: Mandatory information element error
- #99: Information element non-existent or not implemented
- #100: Conditional IE error
- #111: Protocol error, unspecified

Having sent the response, the network should start the channel release procedure (see subclause 3.5).

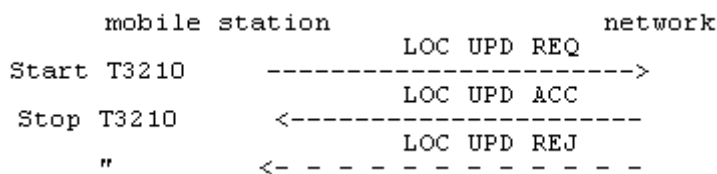

Figure 4.5/3GPP TS 24.008: Location updating sequence

4.4.5 Void

4.4.6 Void

4.4.7 eCall inactivity procedure

The eCall inactivity procedure is applicable only to an eCall only mobile station (as determined by information configured in USIM). The procedure shall be started when:

- the mobile station is in any MM Idle state except NO IMSI, NO CELL AVAILABLE or PLMN SEARCH;
- the mobile station is in GMM-NULL or GMM-DEREGISTERED state; and
- one of the following conditions applies:
 - timer T3242 expires or is found to have already expired and T3243 is not running;
 - timer T3243 expires or is found to have already expired and T3242 is not running; or
 - timer T3242 and timer T3243 expire or are found to have already expired.

The mobile station shall then stop other running timers (e.g. T3211, T3212, T3213) and shall perform the IMSI detach procedure if required by the serving network and if the update state is U1. The mobile station then enters MM Idle

eCALL INACTIVE state and the mobile station shall delete any LAI, TMSI, ciphering key sequence number stored in the SIM/USIM and set the update state to U4 Updating Disabled.

While in eCALL INACTIVE state, the mobile station maintains awareness of a potential serving cell in a potential serving network but initiates no MM signalling with the network and ignores any paging requests.

The mobile station shall leave eCALL INACTIVE state only when one of the following events occur:

- if the SIM or USIM is removed, the mobile station enters the NO IMSI state;
- if coverage is lost, the mobile station enters PLMN SEARCH state;
- if the mobile station is deactivated (e.g. powered off) by the user: the mobile station enters the NULL state;
- if there is a CM request for an emergency services call: the mobile station should follow the procedure for return to state MM-IDLE in subclause 4.2.3 and attempt a location update. The MS then uses the MM and CM procedures to establish the emergency call at the earliest opportunity; or

NOTE 1: If an eCall only device has not successfully completed a location update procedure, PSAP callback will not be possible due to its calling line identity being unavailable at the PSAP.

NOTE 2: An eCall only device uses the CS domain to originate an emergency services call when in A/Gb or Iu mode, even if the device is capable of eCall over IMS.

- if there is a CM request for a call to an HPLMN designated non-emergency MSISDN for the purpose of accessing test and terminal reconfiguration services: the mobile station follows the procedure for return to state MM-IDLE in subclause 4.2.3 and attempts a normal location update. Once this is complete, further MM and CM procedures are used to establish the non-emergency call.

NOTE 3: An eCall only device uses the CS domain to originate a call to an HPLMN designated non-emergency MSISDN for the purpose of accessing test and terminal reconfiguration services when in A/Gb or Iu mode, even if the device is capable of eCall over IMS.

4.5 Connection management sublayer service provision

The concept of MM connection is introduced in this subclause. This concept is mainly a descriptive tool: The establishment of an MM connection by the network can be local (i.e. it is achieved by the transmission of the first CM layer message and without the transmission of any MM layer messages) or can be achieved by the transmission of a CM SERVICE PROMPT message (eg. in the case of certain ring back services). The release of an MM connection by the network or by the mobile station is always local, i.e. these purposes can be achieved without sending any MM messages over the radio interface. (On the contrary, establishment of an MM connection by the mobile station requires the sending of MM messages over the radio interface. An exception is VGCS, where an MM connection will be established as result of an uplink access procedure (see subclause 3.7.2.1.1 in 3GPP TS 44.018 [84]).)

The Mobility Management (MM) sublayer is providing connection management services to the different entities of the upper Connection management (CM) sublayer (see 3GPP TS 24.007 [20]). It offers to a CM entity the possibility to use an MM connection for the exchange of information with its peer entity. An MM connection is established and released on request from a CM entity. Different CM entities communicate with their peer entity using different MM connections. Several MM connections may be active at the same time.

An MM connection requires an RR connection. All simultaneous MM connections for a given mobile station use the same RR connection.

In the following subclauses, the procedures for establishing, re-establishing, maintaining, and releasing an MM connection are described, usually separately for the mobile station and the network side.

4.5.1 MM connection establishment

4.5.1.1 MM connection establishment initiated by the mobile station

Upon request of a CM entity to establish an MM connection the MM sublayer first decides whether to accept, delay, or reject this request:

- An MM connection establishment may only be initiated by the mobile station when the following conditions are fulfilled:
 - Its update status is UPDATED.
 - The MM sublayer is in one of the states MM IDLE, RR CONNECTION RELEASE NOT ALLOWED or MM connection active but not in MM connection active (Group call).

An exception from this general rule exists for emergency calls (see subclause 4.5.1.5). A further exception is defined in the following clause.

- If an MM specific procedure is running at the time the request from the CM sublayer is received, and the LOCATION UPDATING REQUEST message has been sent, the request will either be rejected or delayed, depending on implementation, until the MM specific procedure is finished and, provided that the network has not sent a "follow-on proceed" indication, the RR connection is released. If the LOCATION UPDATING REQUEST message has not been sent, the mobile station may include a "follow-on request" indicator in the message. The mobile station shall then delay the request until the MM specific procedure is completed, when it may be given the opportunity by the network to use the RR connection: see subclause 4.4.4.6.

In order to establish an MM connection, the mobile station proceeds as follows:

- a) If no RR connection exists, the MM sublayer requests the RR sublayer to establish an RR connection and enters MM sublayer state WAIT FOR RR CONNECTION (MM CONNECTION). This request contains an establishment cause and a CM SERVICE REQUEST message. When the establishment of an RR connection is indicated by the RR sublayer, the MM sublayer of the mobile station starts timer T3230, gives an indication to the CM entity that requested the MM connection establishment, and enters MM sublayer state WAIT FOR OUTGOING MM CONNECTION.
- b) If an RR connection is available, the MM sublayer of the mobile station sends a CM SERVICE REQUEST message to the network, starts timer T3230, stops and resets timer T3241, gives an indication to the CM entity that requested the MM connection establishment, and enters:
 - MM sublayer state WAIT FOR OUTGOING MM CONNECTION, if no MM connection is active;
 - MM sublayer state WAIT FOR ADDITIONAL OUTGOING MM CONNECTION, if at least one MM connection is active;
 - If an RR connection exists but the mobile station is in the state WAIT FOR NETWORK COMMAND then any requests from the CM layer that are received will either be rejected or delayed until this state is left.
- c) Only applicable for mobile stations supporting VGCS talking:

If a mobile station which is in the MM sublayer state MM IDLE, service state RECEIVING GROUP CALL (NORMAL SERVICE), receives a request from the GCC sublayer to perform an uplink access, the MM sublayer requests the RR sublayer to perform an uplink access procedure and enters MM sublayer state WAIT FOR RR CONNECTION (GROUP TRANSMIT MODE).

When a successful uplink access is indicated by the RR sublayer, the MM sublayer of the mobile station gives an indication to the GCC sublayer and enters MM sublayer state MM CONNECTION ACTIVE (GROUP TRANSMIT MODE).

When an uplink access reject is indicated by the RR sublayer, the MM sublayer of the mobile station gives an indication to the GCC sublayer and enters the MM sublayer state MM IDLE, service state RECEIVING GROUP CALL (NORMAL SERVICE).

In the network, if an uplink access procedure is performed, the RR sublayer in the network provides an indication to the MM sublayer together with the mobile subscriber identity received in the TALKER INDICATION message. The network shall then enter the MM sublayer state MM CONNECTION ACTIVE (GROUP TRANSMIT MODE).

- d) When the MS is IMSI attached for CS services via EMM combined procedures, as described in 3GPP TS 24.301 [120], and the MS is camping on an E-UTRAN cell, and if T3246 is not running, the MM sublayer requests EMM to initiate a service request procedure for CS fallback. The MM connection establishment is delayed until the MS changes to a GERAN or UTRAN cell.

If the MS enters a GERAN or UTRAN cell, then the MS shall initiate the MM connection establishment and send a CM SERVICE REQUEST message. The MS shall include the Additional update parameters information element indicating "CS fallback mobile originating call". If the MS determines that it is in a different location area than the stored location area, the MS shall first initiate a normal location updating procedure regardless of Network Mode of Operation. If the location area of the current cell is not available, the MS may initiate a normal location updating procedure directly. The MM connection establishment is delayed until successful completion of the normal location updating procedure. Additionally the MS performs routing area updating as specified in subclause 4.7.5. If the normal location updating procedure is initiated, the MS shall indicate the "follow-on request pending", shall include the Additional update parameters information element indicating "CS fallback mobile originating call", and shall not include the MS network feature support information element in the LOCATION UPDATING REQUEST message.

In case a, b and d, the CM SERVICE REQUEST message contains the:

- mobile identity according to subclause 10.5.1.4;
- mobile station classmark 2;
- ciphering key sequence number; and
- CM service type identifying the requested type of transaction (e.g. mobile originating call establishment, emergency call establishment, short message service, supplementary service activation, location services).

A MS supporting eMLPP may optionally include a priority level in the CM SERVICE REQUEST message.

For MM connection establishment involving a shared GERAN network in A/Gb mode, if the MS is a GERAN network sharing supporting MS, the chosen PLMN identity shall be indicated to the GERAN in the CM SERVICE REQUEST message using the Skip Indicator IE as specified in subclause 10.3.1.

A collision may occur when a CM layer message is received by the mobile station in MM sublayer state WAIT FOR OUTGOING MM CONNECTION or in WAIT FOR ADDITIONAL OUTGOING MM CONNECTION. In this case the MM sublayer in the MS shall establish a new MM connection for the incoming CM message as specified in subclause 4.5.1.3.

Upon receiving a CM SERVICE REQUEST message, the network shall analyse its content. The type of semantic analysis may depend on other on going MM connection(s). Depending on the type of request and the current status of the RR connection, the network may start any of the MM common procedures and RR procedures.

In A/Gb mode, the network may initiate the classmark interrogation procedure, for example, to obtain further information on the mobile station's encryption capabilities.

The identification procedure (see subclause 4.3.3) may be invoked for instance if a TMSI provided by the mobile station is not recognized.

The network may invoke the authentication procedure (see subclause 4.3.2) depending on the CM service type.

In A/Gb mode, the network decides also if the ciphering mode setting procedure shall be invoked (see subclause 3.4.7 in 3GPP TS 44.018 [84]).

In Iu mode, the network decides also if the security mode control procedure shall be invoked (see 3GPP TS 25.331 [23c] and 3GPP TS 44.118 [111]).

NOTE 1: If the CM_SERVICE_REQUEST message contains a priority level the network may use this to perform queuing and pre-emption as defined in 3GPP TS 23.067 [88].

In A/Gb mode, the MS shall consider the MM connection establishment to be completed when:

- receiving an indication from the RR sublayer that the ciphering mode setting procedure is completed; or
- receiving a CM SERVICE ACCEPT message.

In Iu mode, the MS shall consider the MM connection establishment to be completed when

- receiving an indication from the RR sublayer that the security mode control procedure is completed, except for the case when it is the first security mode control procedure after successful inter-system change received in MM sublayer state WAIT FOR ADDITIONAL OUTGOING MM CONNECTION; or

- receiving a CM SERVICE ACCEPT message.

The procedures in subclause 4.1.1.1.1 shall always have precedence over this subclause.

In Iu mode, during a MM connection establishment for all services, except for emergency call (see subclause 4.1.1.1.1), the security mode control procedure with activation of integrity protection shall be invoked by the network unless integrity protection is already started (see subclause 4.1.1.1.1).

The MM connection establishment is completed, timer T3230 shall be stopped, the CM entity that requested the MM connection shall be informed, and MM sublayer state MM CONNECTION ACTIVE is entered. The MM connection is considered to be active.

If the service request cannot be accepted, the network returns a CM SERVICE REJECT message to the mobile station.

The reject cause information element (see subclause 10.5.3.6 and annex G) indicates the reason for rejection. The following cause values may apply:

- #4: IMSI unknown in VLR
- #6: Illegal ME
- #17: Network failure
- #22: Congestion
- #25: Not authorized for this CSG
- #32: Service option not supported
- #33: Requested service option not subscribed
- #34: Service option temporarily out of order

If the service request is rejected due to general NAS level mobility management congestion control, the network shall set the MM cause value to #22 "congestion" and assign a back-off timer T3246 (see 3GPP TS 23.012 [140]).

If no other MM connection is active, the network may start the RR connection release (see subclause 3.5 of 3GPP TS 44.018 [84] (A/Gb mode only), 3GPP TS 25.331 [23c] (UTRAN Iu mode only), or in 3GPP TS 44.118 [111] (GERAN Iu mode only) when the CM SERVICE REJECT message is sent.

If a CM SERVICE REJECT message is received by the mobile station, timer T3230 shall be stopped, the requesting CM sublayer entity informed. Then the mobile station shall proceed as follows:

- If the cause value is not #4 or #6 or #25 received from a CSG cell and the MS is in UTRAN Iu mode, the MM sublayer returns to the previous state (the state where the request was received). Other MM connections shall not be affected by the CM SERVICE REJECT message.
- If cause value #4 is received, the mobile station aborts any MM connection, deletes any TMSI, LAI and ciphering key sequence number in the SIM/USIM, changes the update status to NOT UPDATED (and stores it in the SIM/USIM according to subclause 4.1.2.2), and enters the MM sublayer state WAIT FOR NETWORK COMMAND. If subsequently the RR connection is released or aborted, this will force the mobile station to initiate a normal location updating). Whether the CM request shall be memorized during the location updating procedure, is a choice of implementation.
- If cause value #6 is received, the mobile station aborts any MM connection, deletes any TMSI, LAI and ciphering key sequence number in the SIM/USIM, changes the update status to ROAMING NOT ALLOWED (and stores it in the SIM/USIM according to subclause 4.1.2.2), and enters the MM sublayer state WAIT FOR NETWORK COMMAND. The mobile station shall consider the SIM/USIM as invalid for non-GPRS services until switch-off or the SIM/USIM is removed. If the message has been successfully integrity checked by the lower layers and the MS maintains a counter for "SIM/USIM considered invalid for non-GPRS services", then the MS shall set this counter to MS implementation-specific maximum value.
- If cause value #22 is received, the T3246 value IE is present in the CM SERVICE REJECT message and the value indicates that this timer is neither zero nor deactivated, the MS shall check whether the CM SERVICE REJECT message with cause #22 is integrity protected and shall stop timer T3246 if it is running. If the message is integrity protected, the MS shall start timer T3246 with the value provided in the T3246 value IE. Otherwise,

the MS shall start timer T3246 with a random value from the default range specified in table 11.1. The MS stays in the current serving cell and applies normal cell reselection process. The service request procedure may be started by CM layer, if it is still necessary, when timer T3246 expires or is stopped.

If cause value #22 is received, the T3246 value IE is not present in the CM SERVICE REJECT message or if the T3246 value IE the value indicates that this timer is zero or deactivated, the same actions as on timer expiry in subclause 4.5.1.2 shall be taken by the mobile station.

- If cause value #25 is received from a CSG cell and the MS is in UTRAN Iu mode, the MS shall check whether the CM SERVICE REJECT message with cause #25 is integrity protected. If the message is not integrity protected, the MS shall discard the message. Otherwise, the MS shall abort any MM connection, remove the entry corresponding to the CSG ID and associated PLMN identity of the cell where the MS has sent the CM SERVICE REQUEST message from the Allowed CSG list if the CSG ID and associated PLMN identity are contained in the Allowed CSG list, and enter the MM sublayer state WAIT FOR NETWORK COMMAND. If the CSG ID and associated PLMN identity of the cell where the MS has sent the CM SERVICE REQUEST message is contained in the Operator CSG list, the MS shall proceed as specified in 3GPP TS 23.122 [14] subclause 3.1A. Subsequently, after the RR connection is released or aborted, the MS applies normal cell reselection process.

If cause value #25 is received and the cell is not a CSG cell or the MS is not in UTRAN Iu mode, the MS shall discard the CM SERVICE REJECT message.

4.5.1.2 Abnormal cases

Mobile station side:

- a) RR connection failure without "Extended Wait Time" received from lower layers or IMSI deactivation

If an RR connection failure occurs, except in the following implementation option case a.1, or the IMSI is deactivated during the establishment of an MM connection, the MM connection establishment is aborted, timers T3230 is stopped, and an indication is given to the CM entity that requested the MM connection establishment. This shall be treated as a rejection for establishment of the new MM connection, and the MM sublayer shall release all active MM connections.

- a.1) RR connection failure in Iu mode (i.e. RRC connection release) with, for example, cause "Normal", "User inactivity" or "Directed signalling connection re-establishment" (see 3GPP TS 25.331 [23c] and 3GPP TS 44.118 [111])

The MM connection establishment procedure shall be initiated again, if the following conditions apply:

- i) The original MM connection establishment was initiated over an existing RRC connection; and
- ii) No SECURITY MODE COMMAND message and no Non-Access Stratum (NAS) messages relating to the CS signalling connection (e.g. CS authentication procedures, see subclause 4.3.2), were received after the CM SERVICE REQUEST message was transmitted.

NOTE 1: The RRC connection release cause that triggers the re-initiation of the MM connection establishment procedure is implementation specific.

- b) T3230 expiry

If T3230 expires (i.e. no response is given but a RR connection is available) the MM connection establishment is aborted and the requesting CM sublayer is informed. If no other MM connection exists then the mobile station shall proceed as described in subclause 4.5.3.1 for release of the RR connection. Otherwise the mobile station shall return to the MM sublayer state where the request of an MM connection was received, i.e. to MM sublayer state MM connection active. Other ongoing MM connections (if any) shall not be affected.

- c) Reject cause values #95, #96, #97, #99, #100, #111 received

The same actions as on timer expiry shall be taken by the mobile station.

- d) Random access failure or RR connection establishment failure without "Extended Wait Time" received from lower layers

If the mobile station detects a random access failure or RR connection establishment failure during the establishment of an MM connection, it aborts the MM connection establishment and gives an indication to the CM entity that requested the MM connection establishment.

NOTE 2: Further actions of the mobile station depend on the RR procedures and MM specific procedures during which the abnormal situation has occurred and are described together with those procedures.

e) Access barred because of access class control or EAB

The MM connection establishment shall not be initiated. The MS stays in the current serving cell and applies normal cell reselection process. The MM connection establishment may be initiated by CM layer if it is still necessary, i.e. when access is granted or because of a cell change.

f) Indication that a CS fallback to GERAN or UTRAN has failed

If EMM indicates that the CS fallback to GERAN or UTRAN failed, the MM sublayer shall abort the MM connection establishment and inform the requesting CM sublayer.

g) "Extended wait time" for CS domain from the lower layers

The MS shall abort the MM connection establishment and stop timer T3230 if still running.

If the CM SERVICE REQUEST message contained the low priority indicator set to "MS is configured for NAS signalling low priority", the MS shall start timer T3246 with the "Extended wait time" value.

In other cases the MS shall ignore the "Extended wait time".

The MM connection establishment is started, if still necessary, when timer T3246 expires or is stopped.

h) Timer T3246 is running

The MM connection establishment shall not be initiated unless the MS is establishing an emergency call or the MS is an MS configured to use AC11 – 15 in selected PLMN. The MS stays in the current serving cell and applies normal cell reselection process. The MM connection establishment is started, if still necessary, when timer T3246 expires or is stopped.

Network side:

a) RR connection failure

The actions to be taken upon RR connection failure within a MM common procedure are described together with that procedure. A RR connection failure occurring outside such MM common procedures, shall trigger the release of all active MM connections if any.

b) Invalid message or message content

Upon reception of an invalid initial message or a CM SERVICE REQUEST message with invalid content, a CM SERVICE REJECT message shall be returned with one of the following appropriate Reject cause indications:

95: Semantically incorrect message

96: Mandatory information element error

97: Message type non-existent or not implemented

99: Information element non-existent or not implemented

100: Conditional IE error

111: Protocol error, unspecified

When the CM SERVICE REJECT message has been sent, the network may start RR connection release if no other MM connections exist or if the abnormal condition also has influence on the other MM connections.

4.5.1.3 MM connection establishment initiated by the network

4.5.1.3.1 Mobile Terminating CM Activity

When a CM sublayer entity in the network requests the MM sublayer to establish a MM connection, the MM sublayer will request the establishment of an RR connection to the RR sublayer if no RR connection to the desired mobile station exists. The MM sublayer is informed when the paging procedure is finished (see 3GPP TS 44.018 [84] subclause 3.3.2 and 3GPP TS 25.331 [23c]) and the mobile station shall enter the MM state WAIT FOR NETWORK COMMAND and stop the timer T3246 if running.

In A/Gb mode, when an RR connection is established (or if it already exists at the time the request is received), the MM sublayer may initiate any of the MM common procedures (except IMSI detach); it may request the RR sublayer to perform the RR classmark interrogation procedure, and/or the security mode setting procedure.

In Iu mode, when an RR connection is established (or if it already exists at the time the request is received), the MM sublayer may initiate any of the MM common procedures (except IMSI detach); it may request the RR sublayer to perform the security mode control procedure.

When all MM and RR procedures are successfully completed which the network considers necessary, the MM sublayer will inform the requesting mobile terminating CM sublayer entity on the success of the MM connection establishment.

If an RR connection already exists and no MM specific procedure is running, the network may also establish a new mobile terminating MM connection by sending a CM message with a new PD/TI combination.

If the MS receives the first CM message in the MM states WAIT FOR NETWORK COMMAND or RR CONNECTION RELEASE NOT ALLOWED, the MS shall stop and reset the timers T3240 and T3241 and shall enter the MM state MM CONNECTION ACTIVE.

In A/Gb mode, if the establishment of an RR connection is unsuccessful, or if any of the MM common procedures or the security mode setting fail, this is indicated to the CM layer with an appropriate error cause.

In Iu mode, if the establishment of an RR connection is unsuccessful, or if any of the MM common procedures or the security mode control fail, this is indicated to the CM layer with an appropriate error cause.

If an RR connection used for a MM specific procedure exists to the mobile station, the CM request may be rejected or delayed depending on implementation. When the MM specific procedure has been completed, the network may use the same RR connection for the delayed CM request.

Only applicable in case of VGCS talking:

In the MM CONNECTION ACTIVE (GROUP TRANSMIT MODE) the mobile station is in RR Group transmit mode. There shall be only one MM connection active.

When in MM CONNECTION ACTIVE (GROUP TRANSMIT MODE) state, the MM sublayer in the network shall reject the request for the establishment of another MM connection by any CM layer.

If the RR sublayer in the network indicates a request to perform a transfer of the mobile station from RR connected mode to RR Group transmit mode which will result in a transition from MM CONNECTION ACTIVE state to MM CONNECTION ACTIVE (GROUP TRANSMIT MODE) state in the MM sublayer, the MM sublayer shall not allow the transition if more than one MM connection is active with the mobile station.

4.5.1.3.2 Mobile Originating CM Activity \$(CCBS)\$

When a CM sublayer entity in the network requests the MM sublayer to establish a MM connection, the MM sublayer will request the establishment of an RR connection to the RR sublayer if no RR connection to the desired mobile station exists. The MM sublayer is informed when the paging procedure is finished (see 3GPP TS 44.018 [84] subclause 3.3.2 and 3GPP TS 25.331 [23c]) and the mobile station shall enter the MM state WAIT FOR NETWORK COMMAND.

In A/Gb mode, when an RR connection is established (or if it already exists at the time the request is received), the MM sublayer may initiate any of the MM common procedures (except IMSI detach), it may request the RR sublayer to perform the RR classmark interrogation procedure and/or the security mode setting procedure.

In *lu* mode, when an RR connection is established (or if it already exists at the time the request is received), the MM sublayer may initiate any of the MM common procedures (except IMSI detach), it may request the RR sublayer to perform the security mode control procedure.

The network should use the information contained in *the Mobile Station Classmark Type 2 IE* on the mobile station's support for "Network Initiated MO CM Connection Request" to determine whether to:

- not start this procedure (eg if an RR connection already exists), or,
- to continue this procedure, or,
- to release the newly established RR connection.

In the case of a "Network Initiated MO CM Connection Request" the network shall use the established RR connection to send a CM SERVICE PROMPT message to the mobile station.

If the mobile station supports "Network Initiated MO CM Connection Request", the MM sublayer of the MS gives an indication to the CM entity identified by the CM SERVICE PROMPT message and enters the MM sublayer state PROCESS CM SERVICE PROMPT. In the state PROCESS CM SERVICE PROMPT the MM sublayer waits for either the rejection or confirmation of the recall by the identified CM entity. Any other requests from the CM entities shall either be rejected or delayed until this state is left.

When the identified CM entity informs the MM sublayer, that it has send the first CM message in order to start the CM recall procedure the MM sublayer enters the state MM CONNECTION ACTIVE.

If the identified CM entity indicates that it will not perform the CM recall procedure and all MM connections are released by their CM entities the MS shall proceed according to subclause 4.5.3.1.

If the CM SERVICE PROMPT message is received by the MS in MM sublayer states WAIT FOR OUTGOING MM CONNECTION or in WAIT FOR ADDITIONAL OUTGOING MM CONNECTION then the mobile station shall send an MM STATUS message with cause " Message not compatible with protocol state".

A mobile that does not support "Network Initiated MO CM Connection Request" shall return an MM STATUS message with cause #97 "message type non-existent or not implemented" to the network.

If the mobile station supports "Network Initiated MO CM Connection Request" but the identified CM entity in the mobile station does not provide the associated support, then the mobile station shall send an MM STATUS message with cause "Service option not supported". In the case of a temporary CM problem (eg lack of transaction identifiers) then the mobile station shall send an MM STATUS message with cause "Service option temporarily out of order".

If an RR connection already exists and no MM specific procedure is running, the network may use it to send the CM SERVICE PROMPT message.

In *A/Gb* mode, if the establishment of an RR connection is unsuccessful, or if any of the MM common procedures or the security mode setting fail, this is indicated to the CM layer in the network with an appropriate error cause.

In *lu* mode, if the establishment of an RR connection is unsuccessful, or if any of the MM common procedures or the security mode control fail, this is indicated to the CM layer in the network with an appropriate error cause.

If an RR connection used for a MM specific procedure exists to the mobile station, the "Network Initiated MO CM Connection Request" may be rejected or delayed depending on implementation. When the MM specific procedure has been completed, the network may use the same RR connection for the delayed "Network Initiated MO CM Connection Request".

4.5.1.3.3 Paging response in *lu* mode (*lu* mode only)

The network may initiate the paging procedure for CS services when the MS is IMSI attached for CS services. To initiate the procedure, the MM entity requests the RR sublayer to initiate paging (see 3GPP TS 25.331 [23c], 3GPP TS 25.413 [19c] and 3GPP TS 44.118 [111]) for CS services.

At reception of a paging message, the RR sublayer in the MS shall deliver a paging indication to the MM sublayer if the paging was initiated by the MM entity in the network (see 3GPP TS 25.331 [23c] and 3GPP TS 44.118 [111]) and the MS shall stop the timer T3246, if running. The MS shall respond with the PAGING RESPONSE message defined in 3GPP TS 44.018 [84], subclause 9.1.25. For reasons of backward compatibility the paging response shall use the RR protocol discriminator.

If the MS receives a paging request for CS services during an ongoing MM procedure, and the MS has already requested the establishment of a radio connection, the MS shall ignore the paging request and the MS and the network shall continue the MM procedure.

4.5.1.3.4 Paging response for CS fallback

The network may initiate the paging procedure for CS services when the MS is IMSI attached for CS services via EMM combined procedures, as described in 3GPP TS 24.301 [120].

At reception of an indication of paging for CS services from EMM, the MS shall stop timer T3246, if it is running. The MM sublayer in the MS requests EMM to perform the service request procedure for CS fallback.

After the MS changes to a GERAN or UTRAN cell, the MS shall:

- In A/Gb mode: ask for the establishment of an RR connection and proceed as if a paging has been received in the lower layers;
- In Iu mode: ask for the establishment of an RRC connection and respond with the PAGING RESPONSE message defined in 3GPP TS 44.018 [84], subclause 9.1.25. For reasons of backward compatibility the paging response shall use the RR protocol discriminator.

If the MS determines, before sending the response to paging, that it is in a different location area than the stored location area, the MS shall initiate a normal location updating procedure first, regardless of Network Mode of Operation. Additionally the MS performs routing area updating as specified in subclause 4.7.5. If the location area of the current cell is not available, the MS may initiate a normal location updating procedure directly.

When initiating the location updating procedure, the MS shall indicate "CS fallback mobile terminating call" in the Additional update parameters IE and the MS shall not include the MS network feature support IE. The MM connection establishment is delayed until successful completion of the normal location updating procedure. After the completion of the normal location updating procedure, the MS shall not send the PAGING RESPONSE message.

NOTE: For the race condition when the mobile station has a CM application request pending, the mobile station also indicates that it has a follow-on request pending.

4.5.1.4 Abnormal cases

The behaviour upon abnormal events is described together with the relevant RR procedure or MM common procedure.

In addition, the following abnormal events can be identified:

- a) Indication that a CS fallback to GERAN or UTRAN has failed

If EMM indicates that the CS fallback to GERAN or UTRAN failed, the MM sublayer shall abort the paging response procedure.

- b) Paging message for an MS which is IMSI attached for GPRS and for non-GPRS services in order to obtain GPRS services and "SMS-only service"

An MS that received the GPRS-SMS indicator set to "0" at the last combined GPRS attach or combined routing area updating procedure may ignore the paging for CS services.

An MS that requested "SMS-only service" in the combined GPRS attach procedure or combined routing area updating procedure may ignore the paging for CS services.

NOTE: A network that is compliant with the earlier versions of the protocol will implicitly indicate to the MS that the delivery of SMS via GPRS is always supported, i.e. as GPRS-SMS indicator set to "0", even if it does not provide this support to the MS. The MS can learn whether SMS over GPRS is provided by using the mechanism defined in 3GPP TS 24.011 [22], subclause 2.6. If the MS learns that SMS over GPRS is provided, the MS can ignore paging for CS services.

4.5.1.5 MM connection establishment for emergency calls

A MM connection for an emergency call may be established in all states of the mobility management sublayer which allow MM connection establishment for a normal originating call. In addition, establishment may be attempted in all

service states where a cell is selected (see subclause 4.2.2) but not in the MM CONNECTION ACTIVE state (GROUP TRANSMIT MODE) state. However, as a network dependent option, a MM connection establishment for emergency call may be rejected in some of the states.

When a user requests an emergency call establishment the mobile station will send a CM SERVICE REQUEST message to the network with a CM service type information element indicating emergency call establishment. If the network does not accept the emergency call request, e.g., because IMEI was used as identification and this capability is not supported by the network, the network will reject the request by returning a CM SERVICE REJECT message to the mobile station.

The reject cause information element indicates the reason for rejection. The following cause values may apply:

- #3 "Illegal MS"
- #4 "IMSI unknown in VLR"
- #5 "IMEI not accepted"
- #6 " Illegal ME"
- #17 "Network failure"
- #22 "Congestion"
- #25 "Not authorized for this CSG"
- #32 "Service option not supported"
- #34 "Service option temporarily out of order"

With the above defined exceptions, the procedures described for MM connection establishment in subclauses 4.5.1.1 and 4.5.1.2 shall be followed.

NOTE: Normally, the mobile station will be identified by an IMSI or a TMSI. However, if none of these identifiers is available in the mobile station, then the mobile station shall use the IMEI for identification purposes. The network may in that case reject the request by returning a CM SERVICE REJECT message with reject cause: #5 "IMEI not accepted".

4.5.1.5a MM connection establishment for emergency calls for CS fallback

When the MS is in NO CELL AVAILABLE state, camped on an E-UTRAN cell, and IMSI attached for CS services via EMM combined procedures, as described in 3GPP TS 24.301 [120], the MM sublayer requests EMM to initiate a service request procedure for mobile originating CS fallback emergency call, irrespective of whether timer T3246 is running. The MM connection establishment is delayed until the mobile station changes to a GERAN or UTRAN cell. After this point, the behaviour specified in subclause 4.5.1.5 applies.

When the MS is not IMSI attached for CS services via EMM combined procedures, as described in 3GPP TS 24.301 [120], and the MS is camping on an E-UTRAN cell, the MS shall perform any cell selection to GERAN or UTRAN (see 3GPP TS 43.022 [82] and 3GPP TS 25.304 [98]). The MM connection establishment is delayed until the MS changes to a GERAN or UTRAN cell. After this point, the behaviour specified in subclause 4.5.1.5 applies.

4.5.1.6 Call re-establishment

The re-establishment procedure allows a MS to resume a connection in progress after a radio link failure, possibly in a new cell and possibly in a new location area. The conditions in which to attempt call re-establishment or not depend on the call control state, see subclause 5.5.4 and, whether or not a cell allowing call re-establishment has been found (as described in 3GPP TS 45.008 [34]). MM connections are identified by their protocol discriminators and transaction identifiers: these shall not be changed during call re-establishment.

The re-establishment takes place when a lower layer failure occurs and at least one MM connection is active (i.e. the mobile station's MM sublayer is either in state 6 "MM CONNECTION ACTIVE" or state 20 "WAIT FOR ADDITIONAL OUTGOING MM CONNECTION").

NOTE: During a re-establishment attempt the mobile station does not return to the MM IDLE state; thus no location updating is performed even if the mobile is not updated in the location area of the selected cell.

No call re-establishment shall be performed for voice group and broadcast calls.

4.5.1.6.1 Call re-establishment, initiation by the mobile station

NOTE: The network is unable to initiate call re-establishment.

If at least one request to re-establish an MM connection is received from a CM entity as a response to the indication that the MM connection is interrupted (see subclause 4.5.2.3.) the mobile station initiates the call re-establishment procedure. If several CM entities request re-establishment only one re-establishment procedure is initiated. If any CM entity requests re-establishment, then re-establishment of all transactions belonging to all Protocol Discriminators that permit Call Re-establishment shall be attempted.

Upon request of a CM entity to re-establish an MM connection the MM sublayer requests the RR sublayer to establish an RR connection and enters MM sublayer state WAIT FOR REESTABLISH. This request contains an establishment cause and a CM RE-ESTABLISHMENT REQUEST message. When the establishment of an RR connection is indicated by the RR sublayer, the MM sublayer of the mobile station starts timer T3230, gives an indication to all CM entities that are being re-established, and remains in the MM sublayer state WAIT FOR REESTABLISH.

The CM RE-ESTABLISHMENT REQUEST message contains the

- mobile identity according to subclause 10.5.1.4;
- mobile station classmark 2;
- ciphering key sequence number.

NOTE: Whether or not a CM entity can request re-establishment depends upon the Protocol Discriminator. The specifications for Short Message Service (3GPP TS 24.011 [22]), Call Independent Supplementary Services (3GPP TS 24.010 [21]) and Location Services (3GPP TS 44.071 [23a]) do not currently specify any re-establishment procedures.

For a shared GERAN in A/Gb mode, if the MS is a GERAN network sharing supporting MS, the chosen PLMN identity shall be indicated to the GERAN in the CM RE-ESTABLISHMENT REQUEST message using the Skip Indicator IE as specified in subclause 10.3.1.

Upon receiving a CM RE-ESTABLISHMENT REQUEST message, the network shall analyse its content. Depending on the type of request, the network may start any of the MM common procedures and RR procedures.

The network may initiate the classmark interrogation procedure, for example, to obtain further information on the mobile station's encryption capabilities.

The identification procedure (see subclause 4.3.3) may be invoked.

The network may invoke the authentication procedure (see subclause 4.3.2).

In A/Gb mode, the network decides if the security mode setting procedure shall be invoked (see 3GPP TS 44.018 [84] subclause 3.4.7).

An indication from the RR sublayer that the security mode setting procedure is completed, or reception of a CM SERVICE ACCEPT message, shall be treated as a service acceptance indication by the mobile station.

In Iu mode, the network decides if the security mode control procedure shall be invoked (see 3GPP TS 25.331 [23c] and 3GPP TS 44.118 [111]). An indication from the RR sublayer that the security mode control procedure is completed, or reception of a CM SERVICE ACCEPT message, shall be treated as a service acceptance indication by the mobile station.

The MM connection re-establishment is completed, timer T3230 shall be stopped, all CM entities associated with the re-establishment shall be informed, and MM sublayer state MM CONNECTION ACTIVE is re-entered. All the MM connections are considered to be active.

If the network cannot associate the re-establishment request with any existing call for that mobile station, a CM SERVICE REJECT message is returned with the reject cause:

#38 "call cannot be identified"

If call re-establishment cannot be performed for other reasons, a CM SERVICE REJECT is returned, the appropriate reject cause may be any of the following (see annex G):

4 "IMSI unknown in VLR";

6 "illegal ME";

#17 "network failure";

#22 "congestion";

#25 "not authorized for this CSG";

#32 "service option not supported";

#34 "service option temporarily out of order".

If the service request is rejected due to general NAS level mobility management congestion control, the network shall set the MM cause value to #22 "congestion" and assign a back-off timer T3246 (see 3GPP TS 23.012 [140]).

Whatever the reject cause a mobile station receiving a CM SERVICE REJECT as a response to the CM RE-ESTABLISHMENT REQUEST shall stop T3230, release all MM connections and proceed as described in subclause 4.5.3.1. In addition:

- if cause value #4 is received, the mobile station deletes any TMSI, LAI and ciphering key sequence number in the SIM/USIM, changes the update status to NOT UPDATED (and stores it in the SIM/USIM according to subclause 4.1.2.2), and enters the MM sublayer state WAIT FOR NETWORK COMMAND. If subsequently the RR connection is released or aborted, this will force the mobile station to initiate a normal location updating. The CM re-establishment request shall not be memorized during the location updating procedure.
- if cause value #6 is received, the mobile station deletes any TMSI, LAI and ciphering key sequence number in the SIM/USIM, changes the update status to ROAMING NOT ALLOWED (and stores it in the SIM/USIM according to subclause 4.1.2.2), and enters the MM sublayer state WAIT FOR NETWORK COMMAND. The MS shall consider the SIM/USIM as invalid for non-GPRS services until switch-off or the SIM/USIM is removed.
- If cause value # 22 is received, the T3246 value IE is present in the CM SERVICE REJECT message and the value indicates that this timer is neither zero nor deactivated, the MS shall abort the re-establishment, release any MM connections, and proceed as specified in subclause 4.5.3.1. The MS shall stop timer T3246 if it is running. If the CM SERVICE REJECT message is integrity protected, the MS shall start timer T3246 with the value provided in the T3246 value IE. If the CM SERVICE REJECT message is not integrity protected, the MS shall start timer T3246 with a random value from the default range specified in table 11.1. The MS stays in the current serving cell and applies the normal cell reselection process. The CM RE-ESTABLISHMENT REQUEST procedure should not be restarted when timer T3246 expires or is stopped.

If cause value #22 is received, the T3246 value IE is not present in the CM SERVICE REJECT message or if the value provided in the T3246 value IE indicates that this timer is zero or deactivated, the MS shall abort the re-establishment, release any MM connections, and proceed as specified in subclause 4.5.3.1.

- if cause value #25 is received from a CSG cell and the mobile station is in UTRAN Iu mode, the MS shall check whether the CM SERVICE REJECT message with cause #25 is integrity protected. If the message is not integrity protected, the MS shall discard the message. Otherwise, the MS shall remove the entry corresponding to the CSG ID and associated PLMN identity of the cell where the MS has sent the CM SERVICE REQUEST message from the Allowed CSG list if the CSG ID and associated PLMN identity are contained in the Allowed CSG list, and enter the MM sublayer state WAIT FOR NETWORK COMMAND. If the CSG ID and associated PLMN identity of the cell where the MS has sent the CM SERVICE REQUEST message is contained in the Operator CSG list, the MS shall proceed as specified in 3GPP TS 23.122 [14] subclause 3.1A.

If cause value #25 is received and the cell is not a CSG cell or the MS is not in UTRAN Iu mode, the MS shall discard the CM SERVICE REJECT message.

4.5.1.6.2 Abnormal cases

Mobile station side:

- a) Random access failure or RR connection establishment failure

If the mobile station detects a random access failure or RR connection establishment failure during the re-establishment of an MM connection, the re-establishment is aborted and all MM connections are released.

- b) RR connection failure

If a RR connection failure occurs, timer T3230 is stopped, the re-establishment is aborted and all active MM connections are released.

- c) IMSI deactivation

If the IMSI deactivated during the re-establishment attempt then timer T3230 is stopped, the re-establishment is aborted and all MM connections are released.

- d) T3230 expires

If T3230 expires (i.e. no response is given but a RR connection is available) the re-establishment is aborted, all active MM connections are released and the mobile station proceeds as described in subclause 4.5.3.1.

- e) Reject causes #96, #97, #99, #100, #111 received

The mobile station shall perform the same actions as if timer T3230 had expired.

Network side:

- a) RR connection failure

If a RR connection failure occurs after receipt of the CM RE-ESTABLISHMENT REQUEST the network shall release all MM connections.

- b) Invalid message content

Upon reception an invalid initial of message or a CM RE-ESTABLISHMENT REQUEST message with invalid content, a CM SERVICE REJECT message shall be returned with one of the following appropriate Reject cause indications:

#96: Mandatory information element error

#99: Information element non-existent or not implemented

#100: Conditional IE error

#111: Protocol error, unspecified

When the CM SERVICE REJECT message has been sent, the network shall release the RR connection.

4.5.1.7 Forced release during MO MM connection establishment

If the mobile station's CM layer initiated the MM connection establishment but the CM layer wishes to abort the establishment prior to the completion of the establishment phase, the mobile station shall send a CM SERVICE ABORT message any time after the completion of the RR connection and not after the first CM message (e.g. SETUP) is sent.

If the first CM message has already been sent, the normal release procedure defined by the appropriate CM protocol applies and the CM SERVICE ABORT shall not be sent.

Sending of the CM SERVICE ABORT message is only allowed during the establishment of the first MM connection, where no other MM connection exists in parallel. If parallel MM connections exist already, a new connection establishment cannot be aborted and normal MM connection release according to subclause 4.5.3 applies after MM connection establishment.

Upon transmission of the CM SERVICE ABORT message the mobile station shall stop timer T3230 and shall follow the procedures specified in subclause 4.5.3.1.

Upon receipt of the CM SERVICE ABORT message the network shall abort ongoing processes, release the appropriate resources, and unless another MM connection establishment is pending or an RRLP procedure (see 3GPP TS 44.031 [23b]) or LCS procedure over RRC (see 3GPP TS 25.331 [23c]) is ongoing, initiate a normal release of the RR connection.

4.5.1.8 MM connection establishment due to SRVCC or vSRVCC handover

An MM connection can be established locally in the MS due to an SRVCC or vSRVCC handover (see 3GPP TS 23.216 [126]), i.e. without dedicated MM signalling. That is the case when the MS has:

- a voice media stream carried over the PS domain that is handed over to the CS domain in A/Gb mode or Iu mode via SRVCC;
- a voice media stream and a video media stream of a single session carried over the PS domain in S1 mode that is handed over to the CS domain in Iu mode via vSRVCC;
- a voice media stream and a video media stream of a single session carried over the PS domain in S1 mode but only the voice media stream is handed over to the CS domain in A/Gb mode via SRVCC; or
- a voice media stream carried over the PS domain in N1 mode that is handed over to the CS domain in Iu mode via 5G-SRVCC handover from NG-RAN to UTRAN.

An MS in MM state MM IDLE shall establish the MM connection locally when it receives an indication from lower layers that either a voice only SRVCC handover or a voice and video SRVCC handover was completed successfully.

After completing MM connection establishment, the MM layer shall indicate "MM connection establishment due to SRVCC handover" or "MM connection establishment due to vSRVCC handover" to the upper layer and shall enter state MM CONNECTION ACTIVE.

4.5.1.9 MM connection establishment due to Dual Radio Voice Call Continuity (DRVCC) access transfer

The MM Connection establishment procedures for a dual radio voice call continuity (DRVCC) access transfer follow the procedures described in subclause 4.5.1.1 with the following additions:

Upon request from the upper layers to set up a DRVCC call, the MS shall initiate the MM connection establishment and send a CM SERVICE REQUEST message. The MS shall include the Additional update parameters information element indicating "DRVCC call". If the MS determines that it is in a different location area than the stored location area, the MS shall first initiate a normal location updating procedure regardless of Network Mode of Operation. The MS shall indicate "follow-on request pending", shall include the Additional update parameters information element indicating "DRVCC call", and shall not include the MS network feature support information element in the LOCATION UPDATING REQUEST message.

The network may use the "DRVCC call" indication to decide whether to initiate any of the MM common procedures.

If the MS and the network have an established GSM security context or UMTS security context, the MS and the network may take the key(s) of the established security context into use as specified in subclause 4.3.2.7a.

4.5.2 MM connection information transfer phase

After the MM connection has been established, it can be used by the CM sublayer entity for information transfer. According to the protocol architecture described in 3GPP TS 24.007 [20], each CM entity will have its own MM connection. These different MM connections are identified by the protocol discriminator PD and, additionally, by the transaction identifier TI.

All MM common procedures may be initiated at any time while MM connections are active. Except for Short Message Control which uses a separate layer 2 low priority data link, no priority mechanism is defined between the CM, MM and RR sublayer messages.

4.5.2.1 Sending CM messages

A CM sublayer entity, after having been advised that a MM connection has been established, can request the transfer of CM messages. The CM messages passed to the MM sublayer are then sent to the other side of the interface with the PD and TI set according to the source entity.

4.5.2.2 Receiving CM messages

Upon receiving a CM message, the MM sublayer will distribute it to the relevant CM entity according to the PD value and TI value. However, if the received CM message is the first for the MM connection (identified by PD and TI), the MM sublayer will in addition indicate to the CM entity that a new MM connection has been established.

4.5.2.3 Abnormal cases

RR connection failure:

If the RR connection failure occurs during a RR or MM common procedure, the consequent actions are described together with that procedure.

In other cases, the following applies:

- Mobile station:

The MM sublayer shall indicate to all CM entities associated with active MM connections that the MM connection is interrupted, the subsequent action of the MM sublayer (call re-establishment, see 4.5.1.6, or local release) will then depend on the decisions by the CM entities.

- Network:

The MM sublayer shall locally release all active MM connections. As an option the network may delay the release of all or some of the MM connections to allow the mobile station to initiate call re-establishment.

4.5.3 MM connection release

An established MM connection can be released by the local CM entity. The release of the CM connection will then be done locally in the MM sublayer, i.e. no MM message are sent over the radio interface for this purpose.

4.5.3.1 Release of associated RR connection

If all MM connections are released by their CM entities, and no RRLP procedure (see 3GPP TS 44.031 [23b]) and no LCS procedure over RRC (see 3GPP TS 25.331 [23c]) is ongoing, the mobile station shall set timer T3240 and enter the state WAIT FOR NETWORK COMMAND, expecting the release of the RR connection.

If all MM connections are released by their CM entities and an RRLP procedure or LCS procedure over RRC is ongoing, the MS shall start the timer T3241 and enter the state RR CONNECTION RELEASE NOT ALLOWED.

If the MS is expecting the release of the RR connection in MM state WAIT FOR NETWORK COMMAND and an RRLP procedure or LCS procedure over RRC is started, the MS shall stop the timer T3240, start the timer T3241 and enter the state RR CONNECTION RELEASE NOT ALLOWED.

If the MS is in MM state RR CONNECTION RELEASE NOT ALLOWED and the ongoing RRLP procedure or LCS procedure over RRC is finished, the MS shall stop the timer T3241, reset and start the timer T3240 and shall enter the state WAIT FOR NETWORK COMMAND.

If the MS receives the "Extended wait time" for CS domain from the lower layers when no location updating or CM service request procedure is ongoing, the MS shall ignore the "Extended wait time".

In the network, if the last MM connection is released by its user, the MM sublayer may decide to release the RR connection. The RR connection may be maintained by the network, e.g. in order to establish another MM connection.

If the RR connection is not released within a given time controlled by the timer T3240 or T3241, the mobile station shall abort the RR connection. In both cases, either after a RR connection release triggered from the network side or

after a RR connection abort requested by the MS-side, the MS shall return to MM IDLE state; the service state depending upon the current update status as specified in subclause 4.2.3.

4.5.3.2 Uplink release in a voice group call

(Only applicable for mobile stations supporting VGCS talking:)

If a mobile station which is in the MM sublayer state MM CONNECTION ACTIVE (GROUP TRANSMIT MODE) receives a request from the GCC sublayer to perform an uplink release, the MM sublayer requests the RR sublayer to perform an uplink release procedure and enters the MM sublayer state RECEIVING GROUP CALL (NORMAL SERVICE).

4.6 Receiving a MM STATUS message by a MM entity.

If the MM entity of the mobile station receives a MM STATUS message no state transition and no specific action shall be taken as seen from the radio interface, i.e. local actions are possible.

With the exceptions described for the responses to the CM SERVICE PROMPT message, the actions to be taken on receiving a MM STATUS message in the network are an implementation dependent option.

4.7 Elementary mobility management procedures for GPRS services

4.7.1 General

This subclause describes the basic functions offered by the mobility management (GMM) sublayer at the radio interface (reference point U_m/U_{ij}). The functionality is described in terms of timers and procedures. During GMM procedures, procedures of CM layer services via the PS domain, e.g. SM, SMS, and SS, are suspended.

4.7.1.1 Lower layer failure

The lower layers shall indicate a logical link failure or an RR sublayer failure or an RRC sublayer failure to the GMM sublayer. The failure indicates an error that cannot be corrected by the lower layers.

4.7.1.2 Ciphering of messages (A/Gb mode only)

If ciphering is to be applied on a GMM context, all GMM messages shall be ciphered except the following messages:

- ATTACH REQUEST;
- ATTACH REJECT;
- AUTHENTICATION AND CIPHERING REQUEST;
- AUTHENTICATION AND CIPHERING RESPONSE;
- AUTHENTICATION AND CIPHERING FAILURE;
- AUTHENTICATION AND CIPHERING REJECT;
- IDENTITY REQUEST;
- IDENTITY RESPONSE;
- ROUTING AREA UPDATE REQUEST; and
- ROUTING AREA UPDATE REJECT.

4.7.1.2a Integrity protection of layer 3 signalling messages (A/Gb mode only and when integrity protection is required)

4.7.1.2a.1 General

The requirements in subclause 4.7.1.2a are only applicable for MSs and networks supporting EC-GSM-IoT (see 3GPP TS 43.064 [159]).

For the MS, integrity protected signalling is mandatory for the GMM messages and SM messages once a valid UMTS security context exists and has been taken into use. For the network, integrity protected signalling is mandatory for the GMM messages and SM messages once authentication and ciphering procedure is initiated by the network. Integrity protection of all GMM signalling messages and SM messages is the responsibility of the LLC layer. In addition, the GMM layer protects the AUTHENTICATION AND CIPHERING REQUEST message and the AUTHENTICATION AND CIPHERING RESPONSE message by a message authentication code (MAC) calculated at the GMM layer when an authentication takes place in the Authentication and Ciphering procedure. This message authentication code is included in the AUTHENTICATION AND CIPHERING REQUEST message and the AUTHENTICATION AND CIPHERING RESPONSE message. The GMM layer is always using the new UMTS security context derived from the AKA taking place in the Authentication and Ciphering procedure when calculating the message authentication code (MAC) at GMM layer.

The GMM layer activates integrity protection in the LLC layer by providing an indication when integrity protection shall be started.

Integrity protection is initiated in the MS upon request from the network. This is done using the authentication and ciphering procedure at the GMM layer (3GPP TS 43.020 [13] and 3GPP TS 44.064 [78a]).

Details of the integrity protection and verification of GMM signalling messages are specified in 3GPP TS 43.020 [13].

4.7.1.2a.2 Integrity checking of GMM signalling messages in the MS

Except the messages listed below, no GMM signalling messages shall be processed by the receiving GMM entity in the MS or forwarded to the SM entity, unless the use of integrity protection has been successfully negotiated:

- GMM messages:
 - IDENTITY REQUEST (only if the requested identification parameter is IMSI)
 - ATTACH REJECT (if the cause is not #25)
 - AUTHENTICATION AND CIPHERING REJECT
 - ROUTING AREA UPDATE REJECT (if the cause is not #25)
 - DETACH ACCEPT (for non power-off)

NOTE: These messages are accepted by the MS without integrity protection, as in certain situations they are sent by the network before integrity protection can be activated.

All SM messages shall be integrity protected.

Once the integrity protection has been successfully negotiated, the receiving GMM or SM entity in the MS shall not process any GMM signalling messages unless they have been successfully integrity checked by the LLC layer. If GMM signalling messages, having not successfully passed the integrity check, are received, then the LLC layer in the MS discards that message. The processing of the AUTHENTICATION AND CIPHERING REQUEST message, at authentication, that has not successfully passed the integrity check at GMM layer is specified in subclause 4.7.7.2. If any GMM or SM signalling message is received without integrity protection even though integrity protection has been successfully negotiated, then the GMM layer shall discard this message.

4.7.1.2a.3 Integrity checking of layer 3 signalling messages in the network

Except the messages listed below, no GMM signalling messages shall be processed by the receiving GMM entity in the network or forwarded to the SM entity, unless integrity protection has been successfully negotiated:

- GMM messages:

- ATTACH REQUEST;
- IDENTITY RESPONSE (if requested identification parameter is IMSI);
- AUTHENTICATION AND CIPHERING FAILURE;
- DETACH REQUEST;
- DETACH ACCEPT.

All SM messages are integrity protected.

Once a valid UMTS security context exists, until integrity protection has been successfully negotiated, the receiving GMM entity in the network shall process the following GMM signalling messages, even if the MAC included in the LLC frame carrying the GMM message fails the integrity check or cannot be verified in the LLC layer, as the UMTS security context is not available in the network:

- ATTACH REQUEST;
- IDENTITY RESPONSE (if requested identification parameter is IMSI);
- AUTHENTICATION AND CIPHERING FAILURE;
- DETACH REQUEST (if sent before integrity protection has been activated);
- DETACH ACCEPT;
- ROUTING AREA UPDATE REQUEST;

NOTE: These messages are processed by the GMM layer even when the MAC fails the integrity check or cannot be verified, as in certain situations they can be sent by the MS protected with an UMTS security context that is no longer available in the network.

If an ATTACH REQUEST message fails the integrity check, the network shall authenticate the subscriber before processing the attach request any further.

If a ROUTING AREA UPDATE REQUEST message fails the integrity check, the network shall initiate an re-authentication of the subscriber by initiating an authentication and ciphering procedure.

Once integrity protection has been successfully negotiated, the receiving GMM or SM entity in the network shall not process any GMM or SM signalling messages unless they have been successfully integrity checked by the LLC layer. If any GMM or SM signalling message, having not successfully passed the integrity check, is received, then the LLC layer in the network discards that message. The processing of the AUTHENTICATION AND CIPHERING RESPONSE message when authentication is taking place, that has not successfully passed the integrity check at GMM layer is specified in subclause 4.7.7.3. If any GMM or SM signalling message is received, as not integrity protected even though integrity protection has been successfully negotiated, then the GMM layer shall discard this message.

4.7.1.2a.4 Establishment of integrity protection of layer 3 signalling messages

Establishment of integrity protection of layer 3 signalling messages and optionally user plane data is done during the attach procedure. The MS shall indicate support for integrity protection in the MS network capability IE included in the ATTACH REQUEST message and the ROUTING AREA UPDATE REQUEST message to the network.

When an MS sends an ATTACH REQUEST message or a ROUTING AREA UPDATE REQUEST message, then if the MS has no UMTS security context, it shall send the ATTACH REQUEST or the ROUTING AREA UPDATE REQUEST message without integrity protection to the network. If the network supports integrity protection, then the network activates integrity protection by initiating an authentication and ciphering procedure. The network selects an integrity algorithm among the supported integrity algorithms indicated by the MS in the MS network capability IE. After successful completion of the authentication and ciphering procedure, all layer 3 signalling messages sent between the MS and network are integrity protected in the LLC layer using the new UMTS security context.

When an MS sends an ATTACH REQUEST message or a ROUTING AREA UPDATE REQUEST message, then if the MS has a UMTS security context, it shall send the ATTACH REQUEST or the ROUTING AREA UPDATE REQUEST message integrity protected with the current UMTS security context to the network. The MS shall include the CKSN indicating the current UMTS security context value in the initial ATTACH REQUEST message or a

ROUTING AREA UPDATE REQUEST message. The MS shall use the integrity algorithm identified by the stored integrity algorithm identifier. The network shall check whether the CKSN included in the initial ATTACH REQUEST message or the ROUTING AREA UPDATE REQUEST message belongs to an UMTS security context available in the network, and if yes, then the network re-establishes integrity protection of layer 3 signalling messages in the LLC layer:

- by replying with a GMM message (ATTACH ACCEPT or ROUTING AREA UPDATE ACCEPT) that is integrity protected in LLC layer by using the current UMTS security context. From this time onward, all layer 3 signalling messages exchanged between the MS and the network are sent integrity protected, except for the messages specified in subclause 4.7.1.2a; or
- by initiating an authentication and ciphering procedure. This procedure can be used by the network to select a new integrity algorithm different from the one currently used by the MS.

NOTE: Even if the message authentication code protecting the ATTACH REQUEST or the ROUTING AREA UPDATE message in the LLC layer cannot be verified in the network due to the integrity key and the integrity algorithm in the LLC layer at the network not having been configured yet for this MS, the network progresses the attach procedure and the routing area updating procedure at the GMM layer anyway without having to run a new authentication and ciphering procedure if the network decides to re-use the same encryption- and integrity keys and the same ciphering and integrity algorithms and not run a re-authentication.

4.7.1.2a.5 Optional establishment of integrity protection in the user plane

If an MS supports integrity protection of user plane data, then the MS shall indicate in the MS network capability IE to the network that it supports integrity protection of user plane data when it sends an ATTACH REQUEST message or a ROUTING AREA UPDATE REQUEST message. If the network supports integrity protection of the user plane data, then the network shall indicate in the ATTACH ACCEPT message or the ROUTING AREA UPDATE ACCEPT message to the MS that integrity protection of user plane data shall be used.

4.7.1.2a.6 Change of security keys

When the network initiates a re-authentication to create a new UMTS security context, the AUTHENTICATION AND CIPHERING REQUEST message and AUTHENTICATION AND CIPHERING RESPONSE message exchanged during the authentication and ciphering procedure are integrity protected with the new UMTS security context at GMM layer by including a MAC. The AUTHENTICATION AND CIPHERING REQUEST message and AUTHENTICATION AND CIPHERING RESPONSE message may be also integrity protected at the LLC layer using the current UMTS security context, if any. Both UE and network shall continue to use the current UMTS security context, until the network initiates a re-authentication in the authentication and ciphering procedure. The AUTHENTICATION AND CIPHERING REQUEST message sent by the network includes the CKSN of the new UMTS security context to be used. The SGSN shall send the AUTHENTICATION AND CIPHERING REQUEST message integrity protected with the new UMTS security context at GMM layer by including a MAC, but unciphered. When the UE responds with an AUTHENTICATION AND CIPHERING RESPONSE message, it shall send the message integrity protected with the new UMTS security context at GMM layer by including a MAC, but unciphered.

The UE shall take the new UMTS security context and the indicated integrity algorithm and encryption algorithm received in the AUTHENTICATION AND CIPHERING REQUEST message, into use in the LLC layer after sending the AUTHENTICATION AND CIPHERING RESPONSE message. The network shall take the new UMTS security context and the indicated integrity algorithm and encryption algorithm sent in the AUTHENTICATION AND CIPHERING REQUEST message, into use in the LLC layer in the network after receiving the AUTHENTICATION AND CIPHERING RESPONSE message and a successful check of the RES.

4.7.1.3 P-TMSI signature

The network may assign a P-TMSI signature to an MS in an attach, routing area update, or P-TMSI reallocation procedure. Only in combination with a valid P-TMSI, this P-TMSI signature is used by the MS for authentication and identification purposes in the subsequent attach, routing area update or detach procedure. If the MS has no valid P-TMSI it shall not use the P-TMSI signature in the subsequent attach, routing area update or detach procedure. Upon successful completion of the subsequent attach or routing area update procedure, the used P-TMSI signature shall be deleted. Upon completion of an MS initiated detach procedure, the used P-TMSI signature shall be deleted. Upon completion of a network initiated detach procedure the P-TMSI signature shall be kept, unless explicitly specified otherwise in subclause 4.7.4.2.2.

4.7.1.4 Radio resource sublayer address handling

In A/Gb mode, while a packet TMSI (P-TMSI) is used in the GMM sublayer for identification of an MS, a temporary logical link identity (TLLI) is used for addressing purposes at the RR sublayer.

In Iu mode a Radio Network Temporary Identity (RNTI) identifies a user between the MS and the UTRAN or GERAN. The relationship between RNTI and IMSI is known only in the MS and in the UTRAN, see 3GPP TS 25.301 [128].

4.7.1.4.1 Radio resource sublayer address handling (A/Gb mode only)

This subclause describes how the RR addressing is managed by GMM. For the detailed coding of the different TLLI types and how a TLLI can be derived from a P-TMSI, see 3GPP TS 23.003 [10].

If the MS is configured for "AttachWithIMSI" as specified in 3GPP TS 24.368 [135] or 3GPP TS 31.102 [112] and is entering a new PLMN which is neither the registered PLMN nor in the list of equivalent PLMNs, the MS should proceed as specified for case ii) below and use a randomly selected random TLLI for the transmission of the ATTACH REQUEST message.

For all other cases, the MS shall determine the TLLI as follows:

For an MS not supporting S1 mode, two cases can be distinguished:

- a valid P-TMSI is available in the MS; or
 - no valid P-TMSI is available in the MS.
- i) valid P-TMSI available

If the MS has stored a valid P-TMSI, the MS shall derive a foreign TLLI from that P-TMSI and shall use it for transmission of the:

- ATTACH REQUEST message of any GPRS combined/non-combined attach procedure; other GMM messages sent during this procedure shall be transmitted using the same foreign TLLI until the ATTACH ACCEPT message or the ATTACH REJECT message is received; and
- ROUTING AREA UPDATE REQUEST message of a combined/non-combined RAU procedure if the MS has entered a new routing area, or if the GPRS update status is not equal to GU1 UPDATED. Other GMM messages sent during this procedure shall be transmitted using the same foreign TLLI, until the ROUTING AREA UPDATE ACCEPT message or the ROUTING AREA UPDATE REJECT message is received.

After a successful GPRS attach or routing area update procedure, independent of whether a new P-TMSI is assigned, if the MS has stored a valid P-TMSI then the MS shall derive a local TLLI from the stored P-TMSI and shall use it for addressing at lower layers.

NOTE 1: Although the MS derives a local TLLI for addressing at lower layers, the network should not assume that it will receive only LLC frames using a local TLLI. Immediately after the successful GPRS attach or routing area update procedure, the network must be prepared to continue accepting LLC frames from the MS still using the foreign TLLI.

- ii) no valid P-TMSI available

When the MS has not stored a valid P-TMSI, i.e. the MS is not attached to GPRS, the MS shall use a randomly selected random TLLI for transmission of the:

- ATTACH REQUEST message of any combined/non-combined GPRS attach procedure.

The same randomly selected random TLLI value shall be used for all message retransmission attempts and for the cell updates within one attach attempt.

Upon receipt of an ATTACH REQUEST message, the network shall assign a P-TMSI to the MS. The network derives a local TLLI from the assigned P-TMSI, and transmits the assigned P-TMSI to the MS.

Upon receipt of the assigned P-TMSI, the MS shall derive the local TLLI from this P-TMSI and shall use it for addressing at lower layers.

NOTE 2: Although the MS derives a local TLLI for addressing at lower layers, the network should not assume that it will receive only LLC frames using a local TLLI. Immediately after the successful GPRS attach, the network must be prepared to continue accepting LLC frames from the MS still using the random TLLI.

In both cases the MS shall acknowledge the reception of the assigned P-TMSI to the network. After receipt of the acknowledgement, the network shall use the local TLLI for addressing at lower layers.

For an MS supporting S1 mode, the following five cases can be distinguished:

- a) the TIN indicates "P-TMSI" or "RAT-related TMSI" and the MS holds a valid P-TMSI and a RAI;
- b) the TIN indicates "GUTI" and the MS holds a valid GUTI;
- c) the TIN is deleted and the MS holds a valid P-TMSI and RAI;
- d) the TIN is deleted and the MS holds a valid GUTI, but no valid P-TMSI and RAI; or
- e) none of the previous cases is fulfilled.

In case a) the MS shall derive a foreign TLLI from the P-TMSI and proceed as specified for case i) above.

In case b), the MS shall derive a P-TMSI from the GUTI and then a foreign TLLI from this P-TMSI and proceed as specified for case i) above.

NOTE 3: The mapping of the GUTI to the P-TMSI is specified in 3GPP TS 23.003 [10].

In case c) the MS shall derive a foreign TLLI from the P-TMSI and proceed as specified for case i) above.

In case d) the MS shall derive a P-TMSI from the GUTI and then a foreign TLLI from this P-TMSI and proceed as specified for case i) above.

In case e) the MS shall proceed as as specified for case ii) above.

For transmission of an ATTACH REQUEST message, or a ROUTING AREA UPDATE REQUEST message after a routing area change, the MS also provides the lower layers with the DCN-ID according to the following rules:

- a) if a DCN-ID for the PLMN code of the selected PLMN is available in the MS, the MS shall provide this DCN-ID to the lower layers; or
- b) if no DCN-ID for the PLMN code of the selected PLMN is available but a Default_DCN_ID value is available in the MS, as specified in 3GPP TS 24.368 [135] or in USIM file NAS_{CONFIG} as specified in 3GPP TS 31.102 [112], the MS shall provide the Default_DCN_ID value to the lower layers.

4.7.1.5 P-TMSI handling

4.7.1.5.1 P-TMSI handling in A/Gb mode

If a new P-TMSI is assigned by the network the MS and the network shall handle the old and the new P-TMSI as follows:

Upon receipt of a GMM message containing a new P-TMSI the MS shall consider the new P-TMSI and new RAI and also the old P-TMSI and old RAI as valid in order to react to paging requests and downlink transmission of LLC frames. For uplink transmission of LLC frames the new P-TMSI shall be used.

NOTE: For the case of multiple consecutive P-TMSI REALLOCATION COMMAND messages, the old P-TMSI is the latest P-TMSI included by the network in a previous message different from the multiple consecutive P-TMSI REALLOCATION COMMAND messages.

The MS shall consider the old P-TMSI and old RAI as invalid as soon as an LLC frame is received with the local TLLI derived from the new P-TMSI.

Upon the transmission of a GMM message containing a new P-TMSI the network shall consider the new P-TMSI and new RAI and also the old P-TMSI and old RAI as valid in order to be able to receive LLC frames from the MS.

The network shall consider the old P-TMSI and old RAI as invalid as soon as an LLC frame is received with the local TLLI derived from the new P-TMSI.

4.7.1.5.2 P-TMSI handling in lu mode

If a new P-TMSI is assigned by the network the MS and the network shall handle the old and the new P-TMSI as follows:

Upon receipt of a GMM message containing a new P-TMSI the MS shall consider the new P-TMSI and new RAI as valid. Old P-TMSI and old RAI are regarded as invalid.

The network shall consider the old P-TMSI and old RAI as invalid as soon as an acknowledge message (e.g. ATTACH COMPLETE, ROUTING AREA UPDATE COMPLETE and P-TMSI REALLOCATION COMPLETE) is received.

4.7.1.5.3 Void

4.7.1.5.4 Void

4.7.1.6 Change of network mode of operation

In the following tables below the abbreviations 'A/Gb mode I' and 'A/Gb mode II' are used for network operation mode I and II in A/Gb mode.

In the following tables below the abbreviations 'lu mode I' and 'lu mode II' are used for network operation modes I and II in lu mode.

4.7.1.6.1 Change of network mode of operation in A/Gb mode (A/Gb mode only)

Whenever an MS moves to a new RA, the procedures executed by the MS depend on the network mode of operation in the old and new routing area.

In case the MS is in state GMM REGISTERED or GMM ROUTING AREA UPDATING INITIATED and is in operation mode A or B, the MS shall execute according to table 4.7.1.6.1-1:

Table 4.7.1.6.1-1/3GPP TS 24.008: Mode A or B

Network operation mode change	Procedure to execute
I → II (***)	Normal Location Update(*), followed by a Normal Routing Area Update
II → I	Combined Routing Area Update with IMSI attach(**)

(*) Intended to remove the Gs association in the MSC/VLR.

(**) Intended to establish the Gs association in the MSC/VLR.

(***) If the MS that needs only GPRS services and "SMS-only service" moves to a new routing area, see subclause 4.1.1.2.2.

Further details are implementation issues.

4.7.1.6.2 Change of network mode of operation in lu mode (lu mode only)

Whenever an MS moves to a new RA, the procedures executed by the MS depend on the network mode of operation in the old and new routing area.

In case the MS is in state GMM-REGISTERED or GMM-ROUTING-AREA-UPDATING-INITIATED and is in operation mode A, the MS shall execute:

Table 4.7.1.6.4/3GPP TS 24.008: Mode A

Network operation mode change	Procedure to execute
I → II (***)	Normal Location Update(*), followed by a Normal Routing Area Update
II → I	Combined Routing Area Update with IMSI attach(**)

(*) Intended to remove the Gs association in the MSC/VLR.

(**) Intended to establish the Gs association in the MSC/VLR.

(***) If the MS that needs only GPRS services and "SMS-only service" moves to a new routing area, see subclause 4.1.1.2.2.

Further details are implementation issues.

4.7.1.6.3 Change of network mode of operation at Iu mode to A/Gb mode inter-system change

Whenever an MS moves to a new RA supporting the A/Gb mode radio interface, the procedures executed by the MS depend on the network mode of operation in the old and new routing area.

In case the MS is in state GMM-REGISTERED or GMM-ROUTING-AREA-UPDATING-INITIATED and is in operation mode:

- a) A in Iu mode, an MS that changes to GPRS operation mode A or B in A/Gb mode shall execute:

Table 4.7.1.6.5/3GPP TS 24.008: Mode A in Iu mode changing to GPRS mode A or B in A/Gb mode

Network operation mode change	Procedure to execute
Iu mode I → A/Gb mode I	Combined Routing Area Update
Iu mode II → A/Gb mode I	Combined Routing Area Update with IMSI attach(**)
Iu mode I → A/Gb mode II (***)	Normal Location Update(*), followed by a Normal Routing Area Update

- b) C in Iu mode, the MS shall change to GPRS operation mode C in A/Gb mode and shall execute the normal Routing Area Update procedure.

- c) CS in Iu mode, the MS shall execute the normal Location Update procedure.

(*) Intended to remove the Gs association in the MSC/VLR.

(**) Intended to establish the Gs association in the MSC/VLR.

(***) If the MS that needs only GPRS services and "SMS-only service" moves to a new routing area, see subclause 4.1.1.2.2.

Further details are implementation issues.

4.7.1.6.4 Change of network mode of operation at A/Gb mode to Iu mode inter-system change

Whenever an MS moves to a new RA supporting the Iu mode radio interface, the procedures executed by the MS depend on the network mode of operation in the old and new routing area.

In case the MS is in state GMM-REGISTERED or GMM-ROUTING-AREA-UPDATING-INITIATED and is in operation mode:

- a) A or B in A/Gb mode, the MS shall change to operation mode A in Iu mode and shall execute:

Table 4.7.1.6.8/3GPP TS 24.008: Mode A or B in A/Gb mode changing to mode A in Iu mode

Network operation mode change	Procedure to execute
A/Gb mode I → Iu mode I	Combined Routing Area Update
A/Gb mode II → Iu mode I	Combined Routing Area Update with IMSI attach(**)
A/Gb mode I → Iu mode II (***)	Normal Location Update(*), followed by a Normal Routing Area Update
A/Gb mode II → Iu mode II (***)	Normal Location Update if a new LA is entered, followed by a Normal Routing Area Update

- b) C in A/Gb mode, an MS that changes to operation mode C in Iu mode shall execute a Normal Routing Area Update.

(*) Intended to remove the Gs association in the MSC/VLR.

(**) Intended to establish the Gs association in the MSC/VLR.

(***) If the MS that needs only GPRS services and "SMS-only service" moves to a new routing area, see subclause 4.1.1.2.2.

Further details are implementation issues.

4.7.1.7 Intersystem change between A/Gb mode and Iu mode

For the Iu mode to A/Gb mode and A/Gb mode to Iu mode intersystem change the following cases can be distinguished:

- a) Intersystem change between cells belonging to different RA's:

The procedures executed by the MS depends on the network mode of operation in the old and new RA. If a change of the network operation mode has occurred in the new RA, then the MS shall behave as specified in subclause 4.7.1.6. If no change of the network operation mode has occurred in the new RA, then the MS shall initiate the normal or combined routing area updating procedure depending on the network operation mode in the current RA.

- b) Intersystem change between cells belonging to the same RA:

- 1) If the READY timer is running in the MS in A/Gb mode before or after the inter-system change occurs, or the MS is in PMM-CONNECTED mode in Iu mode, before the inter-system change occurs then the MS shall perform a normal or combined routing area updating procedure depending on the network mode of operation in the current RA.
- 2) If the READY timer is not running in the MS in A/Gb mode before the inter-system change occurs, or the MS is in PMM-IDLE mode in Iu mode before the inter-system change and the READY timer is not running in the MS in A/Gb mode after the intersystem change, then, unless a routing area updating procedure is required according to case c) or case b) 3) below or according to subclause 4.7.5.1 and 4.7.5.2.1, the MS shall not perform a routing area updating procedure until uplink user data or signalling information needs to be sent from the MS to the network.
 - If the MS is in the same access network (i.e. A/Gb mode or Iu mode), as when it last sent user data or signalling messages, the procedures defined for that access system shall be followed. This shall be sending of an LLC PDU in an A/Gb mode cell or initiating the service request procedure in an Iu mode cell.
 - If the MS is in a different access network (i.e. A/Gb mode or Iu mode), as when it last sent user data or signalling messages, the normal or combined routing area updating procedure shall be performed depending on the network operation mode in the current RA, before the sending of user data or signalling

messages. If the signalling message is a DETACH REQUEST indicating "power off", the routing area updating procedure need not to be performed.

- If the periodic routing area update timer expires the MS shall initiate the periodic routing area updating procedure.
- 3) If the READY timer is not running in the MS in A/Gb mode or the MS is in PMM-IDLE mode in Iu mode, then the MS shall perform a normal or combined routing area updating procedure depending on the network mode of operation in the current RA if the MS is required to perform routing area updating for IMS voice termination as specified in annex P.3.
 - 4) If the READY timer is not running in the network in A/Gb mode or the network is in PMM-IDLE mode in Iu mode, then the network shall page the MS if downlink user data or signalling information needs to be sent from the network to the MS. This shall include both A/Gb mode and Iu mode cells.
 - If the MS receives the paging indication in the same access network (i.e. A/Gb mode or Iu mode), as when it last sent user data or signalling information, the MS shall send any LLC PDU in a A/Gb mode cell or shall initiate the service request procedure indicating service type "paging response" in an Iu mode cell.
 - If the MS receives the paging indication in a different access network (i.e. A/Gb mode or Iu mode), as when it last sent user data or signalling information, the MS shall perform a normal or combined routing area updating procedure depending on the network operation mode in the current RA.
- c) Intersystem handover from A/Gb mode to Iu mode during a CS connection:

After the successful completion of the handover from an A/Gb mode cell to an Iu mode cell, an MS which has performed the GPRS suspension procedure in Gb mode (see 3GPP TS 44.018 [84]) (i.e. an MS in MS operation mode B or an DTM MS in a A/Gb mode cell that does not support DTM) shall perform a normal routing area updating procedure in the Iu mode cell in order to resume the GPRS services in the network, before sending any other signalling messages or user data.

4.7.1.7a Intersystem change from S1 mode to A/Gb mode or S1 mode to Iu mode with ISR activated

If ISR is activated and the MS returns from S1 mode to a cell belonging to a RA which is different from the RA where the MS is registered, the MS initiates a normal or combined routing area updating procedure depending on the network operation mode in the current RA.

If ISR is activated and the MS returns from S1 mode to a cell belonging to the RA where the MS is registered, the following cases can be distinguished:

- a) Inter-system change due to PS handover:

If the PS handover is to A/Gb mode, the MS initiates a normal or combined routing area updating procedure depending on the network operation mode in the current RA.
- b) Inter-system change not due to PS handover:
 - 1) If the READY timer is running in the MS after the intersystem change occurs, then the MS shall perform a normal or combined routing area updating procedure depending on the network mode of operation in the current RA.
 - 2) If the READY timer is not running in the MS in A/Gb mode or the MS is in PMM-IDLE mode in Iu mode after the intersystem change occurs, unless a routing area updating procedure is required according to subclause 4.7.5.1 and 4.7.5.2.1, the MS shall not perform a routing area updating procedure until uplink user data or signalling information needs to be sent from the MS to the network.
 - If the MS is in the same access network, (i.e. A/Gb mode or Iu mode), as when it last sent user data or signalling messages in a cell belonging to the RA where the MS is registered, the procedures defined for that access system shall be followed. This shall be sending of an LLC PDU in a A/Gb mode cell or initiating the SERVICE REQUEST procedure in an Iu mode cell.

- If the MS is in a different access network (i.e. A/Gb mode or Iu mode), as when it last sent user data or signalling messages in a cell belonging to the RA where the MS is registered, the normal or combined RA update procedure shall be performed depending on the network operation mode in the current RA, before the sending of user data or signalling messages. If the signalling message is a DETACH REQUEST indicating "power off", the routing area updating procedure need not be performed.
 - If the periodic routing area update timer expires the MS shall initiate the periodic RA update procedure.
- 3) If the READY timer is not running in the network in A/Gb mode or the network is in PMM-IDLE mode in Iu mode, then the network shall page the MS if downlink user data or signalling information needs to be sent from the network to the MS. This shall include both A/Gb mode and Iu mode cells.
- If the MS receives the paging indication in the same access network (i.e. A/Gb mode or Iu mode), as when it last sent user data or signalling information in a cell belonging to the RA where the MS is registered, the MS shall send any LLC PDU in a A/Gb mode cell or shall initiate the service request procedure indicating service type "paging response" in an Iu mode cell.
 - If the MS receives the paging indication in a different access network (i.e. A/Gb mode or Iu mode), as when it last sent user data or signalling information in a cell belonging to the RA where the MS is registered, the MS shall perform normal or combined routing area updating procedure shall be performed depending on the network operation mode in the current RA.

4.7.1.7b Intersystem change from S1 mode to A/Gb mode or S1 mode to Iu mode for eCall only MS capable of eCall over IMS

If an eCall only MS (as determined by information configured in USIM) capable of eCall over IMS returns from S1 mode to A/Gb or Iu mode, the MS shall:

- a) if timer T3444 is running, start timer T3242 with the time left on timer T3444, and stop timer T3444;
- b) if timer T3445 is running, start timer T3243 with the time left on timer T3445, and stop timer T3445;
- c) if the MS is attached for GPRS services only and timer T3444 or timer T3445 is running:
 - perform a combined routing area updating procedure with IMSI attach if the network operates in network operation mode I; and
 - perform a routing area updating procedure and a location area updating procedure if the network operates in network operation mode II; and
- d) if the MS is attached for both GPRS services and non-GPRS services and timer T3444 or timer T3445 is running:
 - perform a combined routing area updating procedure if the network operates in network operation mode I; and
 - perform a routing area updating procedure and a location are updating procedure if the network operates in network operation mode II.

NOTE: Timers T3444 and T3445 are specified in 3GPP TS 24.301 [120].

4.7.1.7c Return to packet idle mode for eCall only MS capable of eCall over IMS

If an eCall only MS (as determined by information configured in USIM) capable of eCall over IMS returns to packet idle mode following the release of a call to an HPLMN designated non-emergency MSISDN or URI for test or terminal reconfiguration service which was handed over from S1 mode and timer T3243 is not running, the MS shall start timer T3243.

4.7.1.8 List of forbidden PLMNs for GPRS service

The Mobile Equipment shall contain a list of "forbidden PLMNs for GPRS service". This lists shall be erased when the MS is switched off or when the SIM/USIM is removed or upon the expiry of the timer T3245 as described in subclause 4.1.1.6. The PLMN identification received on the BCCH shall be added to the list whenever a GPRS attach or

routing area update is rejected by the network with the cause "GPRS services not allowed in this PLMN" or whenever a GPRS detach is initiated by the network with the cause "GPRS services not allowed in this PLMN".

In a shared network, the MS shall choose one of the PLMN identities as specified in 3GPP TS 23.122 [14]. The PLMN identity selected for a GPRS attach procedure, or the PLMN identity used to construct the RAI that triggered the routing area updating procedure shall be added to the list of "forbidden PLMNs for GPRS service" whenever such a procedure is rejected by the network with the cause "GPRS services not allowed in this PLMN". Whenever a GPRS detach is initiated by the network with the cause "GPRS services not allowed in this PLMN", the PLMN identity that was selected for GPRS attach procedure or routing area update procedure shall be added to the list of "forbidden PLMNs for GPRS service".

The maximum number of possible entries in this list is implementation dependent, but must be at least one entry. When the list is full and a new entry has to be inserted, the oldest entry shall be deleted.

4.7.1.8a Establishment of the PS signalling connection (lu mode only)

In order to route the NAS message to an appropriate SGSN, the MS NAS provides the lower layers with the routing parameter according to the following rules:

- a) if the TIN indicates "P-TMSI" or "RAT-related TMSI", and the MS holds a valid P-TMSI, the MS NAS shall provide the lower layers with the P-TMSI;
- b) if the TIN indicates "GUTI" and the MS holds a valid GUTI, the MS NAS shall provide the lower layers with the P-TMSI mapped from the GUTI (see 3GPP TS 23.003 [10]);
- c) if the TIN is not available and the MS holds a valid P-TMSI, the MS NAS shall provide the lower layers with the P-TMSI; or
- d) if the TIN is not available and the MS holds a valid GUTI, but no valid P-TMSI, the MS NAS shall provide the lower layers with the P-TMSI mapped from the GUTI (see 3GPP TS 23.003 [10]).

When an ATTACH REQUEST message, or a ROUTING AREA UPDATE REQUEST message after a routing area change, is sent to establish a PS signalling connection, the MS NAS also provides the lower layers with the DCN-ID according to the following rules:

- a) if a DCN-ID for the PLMN code of the selected PLMN is available in the MS, this DCN-ID the MS NAS shall provide this DCN-ID to the lower layers; or
- b) if no DCN-ID for the PLMN code of the selected PLMN is available but a Default_DCN_ID value is available in the MS, as specified in 3GPP TS 24.368 [135] or in USIM file NAS_{CONFIG} as specified in 3GPP TS 31.102 [112], the Default_DCN_ID value MS NAS shall provide the Default_DCN_ID value to the lower layers.

4.7.1.9 Release of the PS signalling connection (lu mode only)

In lu mode, to allow the network to release the PS signalling connection (see 3GPP TS 25.331 [23c] and 3GPP TS 44.118 [111]) the MS:

- a) shall start the timer T3340 if the MS receives any of the reject cause values #11, #12, #13, #15 or #25;
- b) shall start the timer T3340 if the network indicates "no follow-on proceed" in the ROUTING AREA UPDATE ACCEPT or ATTACH ACCEPT message and user plane radio access bearers have not been setup;
- c) shall start the timer T3340 if the MS receives a DETACH ACCEPT message and the MS has set the detach type to "IMSI detach" in the DETACH REQUEST message and user plane radio access bearers have not been set up; or
- d) may start the timer T3340 if the MS receives any of the reject cause values #3, #6, #7 or #8 or if it receives an AUTHENTICATION AND CIPHERING REJECT message.

Upon expiry of T3340, the MS shall release the established PS signalling connection (see 3GPP TS 25.331 [23c] and 3GPP TS 44.118 [111]).

Upon release of the established PS signalling connection, if timer T3243 is not running, the MS shall start timer T3243 when:

- the MS is an eCall only MS (as determined by information configured in USIM);
- the MS is capable of eCall over IMS; and
- the PS signalling connection that was released had been established for a call to an HPLMN designated non-emergency MSISDN or URI for test or terminal reconfiguration service which was handed over from S1 mode.

In case b, if the MS has signalling pending, then it shall request a new PS signalling connection for further signalling.

In case b and c,

- upon an indication from the lower layers that radio access bearer(s) is set up, the MS shall stop timer T3340 and may send uplink signalling via the existing PS signalling connection or user data via radio access bearer(s). If the MS is establishing a PDN connection for emergency bearer services or the MS is initiating a service request procedure to send user data for emergency bearer services, the MS shall send the uplink signalling via the existing PS signalling connection;
- upon receipt of a REQUEST PDP CONTEXT ACTIVATION message, MODIFY PDP CONTEXT REQUEST message, DEACTIVATE PDP CONTEXT REQUEST message, REQUEST SECONDARY PDP CONTEXT ACTIVATION message or REQUEST MBMS CONTEXT ACTIVATION message, the MS shall stop timer T3340 and may send uplink signalling via the existing PS signalling connection. If the MS is establishing a PDN connection for emergency bearer services or the MS is initiating a service request procedure to send user data for emergency bearer services, the MS shall send the uplink signalling via the existing PS signalling connection; or
- upon receipt of a DETACH REQUEST message, the MS shall stop timer T3340 and respond to the network initiated GPRS detach as specified in subclause 4.7.4.2.

If the MS receives the "Extended wait time" for PS domain from the lower layers when no attach, routing area updating or service request procedure is ongoing, the MS shall ignore the "Extended wait time".

If the MS needs to perform PLMN selection, the MS may release the established PS signalling connection (see 3GPP TS 25.331 [23c] and 3GPP TS 44.118 [111]).

4.7.1.10 Handling of 3GPP PS data off

An MS, which supports 3GPP PS data off (see 3GPP TS 23.060 [74]), can be configured with up to two lists of 3GPP PS data off exempt services as specified in 3GPP TS 24.368 [135] or in the EF_{3GPPPSDATAOFF} USIM file as specified in 3GPP TS 31.102 [112]:

- a list of 3GPP PS data off exempt services to be used in the HPLMN or EHPLMN; and
- a list of 3GPP PS data off exempt services to be used in the VPLMN.

If only the list of 3GPP PS data off exempt services to be used in the HPLMN or EHPLMN is configured at the MS, this list shall be also used in the VPLMN.

If the MS supports 3GPP PS data off, the MS shall provide the 3GPP PS data off UE status in the protocol configuration options IE during PDP context activation procedure (see subclause 6.1.3.1).

The network informs the MS about the support of 3GPP PS data off during PDP context activation procedure as specified in subclause 6.1.3.1. If 3GPP data off support is not indicated in the protocol configuration options IE in the ACTIVATE PDP CONTEXT ACCEPT message, the MS shall not indicate any change of 3GPP PS data off UE status for the PDN connection established by the PDP context activation procedure; otherwise the MS shall indicate change of the 3GPP PS data off UE status for the PDN connection by using the PDP context modification procedure as specified in subclause 6.1.3.3. If the network does not provide indication of support of 3GPP PS data off during PDP context activation procedure, the MS behaviour for non-exempt service requests from the network is implementation dependent.

When the 3GPP PS data off UE status is "activated":

- a) the MS does not send uplink IP packets except:
 - for those services indicated in the list of 3GPP PS data off exempt services to be used in the HPLMN or EHPLMN as specified in 3GPP TS 24.368 [135] when the MS is in its HPLMN or EHPLMN;

- for those services indicated in the list of 3GPP PS data off exempt services to be used in the HPLMN or EHPLMN when the MS is in the VPLMN, if only the list of 3GPP PS data off exempt services to be used in the HPLMN or EHPLMN is configured to the MS as specified in 3GPP TS 24.368 [135];
- for those services indicated in the list of 3GPP PS data off exempt services to be used in the VPLMN when the MS is in the VPLMN, if the list of 3GPP PS data off exempt services to be used in the VPLMN is configured to the MS as specified in 3GPP TS 24.368 [135];
- for those services indicated in the EF_{3GPPSDATAOFF} USIM file as specified in 3GPP TS 31.102 [112]; and
- any uplink traffic due to procedures specified in 3GPP TS 24.229 [13D]; and

b) the MS does not send uplink non-IP user data packets.

Otherwise the MS sends uplink user data packets without restriction.

NOTE: If the MS supports 3GPP PS data off, uplink IP packets are filtered as specified in 3GPP TS 24.229 [13D] in subclause B.3.1.5.

4.7.2 GPRS Mobility management timers and UMTS PS signalling connection control

4.7.2.1 READY timer behaviour

4.7.2.1.1 READY timer behaviour (A/Gb mode only)

The READY timer, T3314 is used in the MS and in the network per each assigned P-TMSI to control the cell updating procedure.

When the READY timer is running or has been deactivated the MS shall perform cell update each time a new cell is selected (see 3GPP TS 43.022 [82]). If a routing area border is crossed, a routing area updating procedure shall be performed instead of a cell update.

When the READY timer has expired:

- the MS shall perform the routing area updating procedure when a routing area border is crossed;
- the MS shall not perform a cell update when a new cell is selected.
- the network shall page the MS if down-link user data or signalling information needs to be sent to the MS.

All other GMM procedures are not affected by the READY timer.

The READY timer is started:

- in the MS when the GMM entity receives an indication from lower layers that an LLC frame other than LLC NULL frame has been transmitted on the radio interface; and
- in the network when the GMM entity receives an indication from lower layers that an LLC frame other than LLC NULL frame has been successfully received by the network.

Within GMM signalling procedures the network includes a "force to standby" information element, in order to indicate whether or not the READY timer shall be stopped when returning to the GMM-REGISTERED state. If the "force to standby" information element is received within more than one message during a ongoing GMM specific procedure, the last one received shall apply. If the READY timer is deactivated and the network indicates "force to standby" with the "force to standby" information element, this shall not cause a modification of the READY timer.

The READY timer is not affected by state transitions to and from the GMM-REGISTERED.SUSPENDED sub-state.

The value of the READY timer may be negotiated between the MS and the network using the GPRS attach or GPRS routing area updating procedure.

- If the MS wishes to indicate its preference for a READY timer value it shall include the preferred values into the ATTACH REQUEST and/or ROUTING AREA UPDATE REQUEST messages. The preferred values may be

smaller, equal to or greater than the default values or may be equal to the value requesting the READY Timer function to be deactivated.

- Regardless of whether or not a timer value has been received by the network in the ATTACH REQUEST or ROUTING AREA UPDATE REQUEST messages, the network may include a timer value for the READY timer (different or not from the default value) into the ATTACH ACCEPT or ROUTING AREA UPDATE ACCEPT messages, respectively. If the READY Timer value was included, it shall be applied for the GMM context by the network and by the MS.
- When the MS proposes a READY Timer value and the Network does not include any READY Timer Value in its answer, then the value proposed by the MS shall be applied for the GMM context by the Network and by the MS.
- When neither the MS nor the Network proposes a READY Timer value into the ATTACH REQUEST/ATTACH ACCEPT or ROUTING AREA UPDATE REQUEST/ROUTING AREA UPDATE ACCEPT message, then the default value shall be used.

If the negotiated READY timer value indicates that the ready timer function is deactivated, the READY timer shall always run without expiry. If the negotiated READY timer value indicates that the ready timer function is deactivated, and within the same procedure the network indicates "force to standby" with the "force to standby" information element, the READY timer shall always run without expiry. If the negotiated READY timer value is set to zero, the READY timer shall be stopped immediately.

To account for the LLC frame uplink transmission delay, the READY timer value should be slightly shorter in the network than in the MS. This is a network implementation issue.

If a new READY timer value is negotiated, the MS shall upon the reception of the ATTACH ACCEPT or ROUTING AREA UPDATE ACCEPT message perform an initial cell update (either by transmitting a LLC frame or, if required, a ATTACH COMPLETE or ROUTING AREA UPDATE COMPLETE message), in order to apply the new READY timer value immediately. If both the network and the MS support the Cell Notification, the initial cell update shall use any LLC frame except the LLC NULL frame. If the new READY timer value is set to zero or if the network indicates "force to standby" with the "force to standby" IE, the initial cell update should not be done.

4.7.2.1.2 Handling of READY timer in the MS in Iu mode and S1 mode

The READY timer is not applicable for Iu mode in S1 mode.

Upon completion of a successful GPRS attach or routing area updating procedure in Iu mode, the MS shall stop the READY timer, if running.

Upon completion of a successful EPS attach or tracking area updating procedure, the MS shall stop the READY timer, if running.

In Iu mode, an MS may indicate a READY timer value to the network in the ATTACH REQUEST and the ROUTING AREA UPDATE REQUEST messages.

If a READY timer value is received by an MS capable of both Iu mode and A/Gb mode in the ATTACH ACCEPT or the ROUTING AREA UPDATE ACCEPT message, then the MS shall store the received value in order to use it at an intersystem change from Iu mode to A/Gb mode.

4.7.2.1.2a Handling of READY timer in the network in Iu mode and S1 mode

The READY timer is not applicable for Iu mode in S1 mode.

Upon completion of a successful GPRS attach or routing area updating procedure, the network shall stop the READY timer, if running.

When the SGSN is informed by the HLR/HSS that the MS performed an EPS attach or by the MME that the UE is performing a tracking area updating procedure, the SGSN shall stop the READY timer, if running.

4.7.2.2 Periodic routing area updating

The periodic routing area updating procedure is used to periodically notify the availability of the MS to the network. The procedure is controlled in the MS by timer T3312. The value of timer T3312 is sent by the network to the MS in the

messages ATTACH ACCEPT and ROUTING AREA UPDATE ACCEPT. The value of timer T3312 shall be unique within a RA.

If the value of timer T3312 received by the MS in A/Gb mode or received in Iu mode in a message with integrity protection contains an indication that the timer is deactivated or the timer value is zero, then timer T3312 is deactivated and the MS shall not perform the periodic routing area updating procedure.

In Iu mode, if the value of timer T3312 is received in a message without integrity protection and the indicated value is larger than the last received value, or the indicated value is "deactivated" or zero, the MS shall use the last received value. If there is no last received value, then the MS shall use the default value.

In A/Gb mode, the timer T3312 is reset and started with its initial value, when the READY timer is stopped or expires. Timer T3312 is stopped and shall be set to its initial value for the next start when the READY timer is started. If after a READY timer negotiation the READY timer value is set to zero, timer T3312 is reset and started with its initial value. If the initial READY timer value is zero, the timer T3312 is reset and started with its initial value, when the ROUTING AREA UPDATE REQUEST message is transmitted.

In Iu mode, timer T3312 is reset and started with its initial value, when the MS changes from PMM-CONNECTED to PMM-IDLE mode. Timer T3312 is stopped when the MS enters PMM-CONNECTED mode.

If the MS is attached for emergency bearer services, when timer T3312 expires, the MS shall not initiate a periodic routing area updating procedure, but shall locally detach from the network. When the MS is camping on a suitable cell, it may re-attach to regain normal service.

If the MS is not attached for emergency bearer services, when timer T3312 expires, the periodic routing area updating procedure shall be started and timer T3312 shall be set to its initial value for the next start.

If the MS is in a state other than GMM-REGISTERED.NORMAL-SERVICE when timer T3312 expires, the periodic routing area updating procedure is delayed until the MS returns to GMM-REGISTERED.NORMAL-SERVICE.

In A/Gb mode, if the MS in MS operation mode B is in the state GMM-REGISTERED.SUSPENDED when timer T3312 expires the periodic routing area updating procedure is delayed until the state is left.

If ISR is activated, the MS shall keep both timer T3412 and timer T3312. The two separate timers run in the MS for updating the MME and the SGSN independently. The MS shall start timer T3323 if timer T3312 expires, and timer T3346 is running or the MS is in one of the following states:

- GMM-REGISTERED.NO-CELL-AVAILABLE;
- GMM-REGISTERED.PLMN-SEARCH;
- GMM-REGISTERED.UPDATE-NEEDED; or
- GMM-REGISTERED.LIMITED-SERVICE.

The MS shall initiate the routing area updating procedure and stop timer T3323 when the MS enters the state GMM-REGISTERED.NORMAL-SERVICE before timer T3323 expires. After expiry of timer T3323 the MS shall deactivate ISR by setting its TIN to "GUTI".

If timer T3323 expires, the MS shall memorize that it has to initiate a routing area updating procedure when it returns to state GMM-REGISTERED.NORMAL-SERVICE.

The network supervises the periodic routing area updating procedure by means of the mobile reachable timer.

If the MS is not attached for emergency bearer services, the mobile reachable timer shall be longer than timer T3312. In this case, by default, the mobile reachable timer is 4 minutes greater than timer T3312.

NOTE 1: According to subclause 4.7.5.1.5, if a periodic routing area updating procedure fails repeatedly, it can take more than 7 minutes before the MS starts using MM specific procedures.

The network may include timer T3312 extended value IE in the ATTACH ACCEPT message or ROUTING AREA UPDATE ACCEPT message only if the MS indicates support of the timer T3312 extended value in the MS network feature support IE.

If the network includes the timer T3312 extended value IE in the ATTACH ACCEPT message or ROUTING AREA UPDATE ACCEPT message, the network shall use the timer T3312 extended value IE as the value of timer T3312.

If ISR is not activated, when the mobile reachable timer expires, typically the network stops sending paging messages to the mobile and may take other appropriate actions.

If the MS is attached for emergency bearer services, the SGSN shall set the mobile reachable timer with a value equal to timer T3312. When the mobile reachable timer expires, the SGSN shall locally detach the MS.

In A/Gb mode, the mobile reachable timer is reset and started with the value as indicated above, when the READY timer is stopped or expires. The mobile reachable timer is stopped when the READY timer is started.

In A/Gb mode, if after a READY timer negotiation the READY timer value is set to zero, the mobile reachable timer is reset and started with its initial value. If the initial READY timer value is zero, the mobile reachable timer is reset and started with its initial value, when the ROUTING AREA UPDATE REQUEST message is received.

In Iu mode, the mobile reachable timer is reset and started with the value as indicated above, when the MS changes from PMM-CONNECTED to PMM-IDLE mode. The mobile reachable timer is stopped when the MS enters PMM-CONNECTED mode.

If ISR is activated, upon expiry of the mobile reachable timer the network shall start the implicit detach timer. By default, the implicit detach timer is 4 minutes greater than timer T3323. If the implicit detach timer expires before the MS contacts the network, the network shall implicitly detach the MS and deactivate ISR.

If ISR is not activated, upon expiry of the mobile reachable timer the network may start the implicit detach timer. The value of the implicit detach timer is network dependent. If the implicit detach timer expires before the MS contacts the network, the network shall implicitly detach the MS.

If the network includes the T3324 value IE in the ATTACH ACCEPT message or ROUTING AREA UPDATE ACCEPT message and if the MS is not attached for emergency bearer services and has no PDN connection for emergency bearer services, the network shall set the active timer to a value equal to the value of timer T3324.

If the MS has established a PDN connection for emergency bearer services after receiving the timer T3324 value IE in the ATTACH ACCEPT message or ROUTING AREA UPDATE ACCEPT message, the active timer shall not be started.

When the active timer expires, typically the network stops sending paging messages to the mobile and may take other appropriate actions.

In A/Gb mode, the active timer is reset and started with the value as indicated above, when the READY timer is stopped or expires. The active timer is stopped when the READY timer is started.

In Iu mode, the active timer is reset and started with the value as indicated above, when the MS changes from PMM-CONNECTED to PMM-IDLE mode. The active timer is stopped when the MS enters PMM-CONNECTED mode.

NOTE 2: ISR is not activated when the network includes the T3324 value IE in the ATTACH ACCEPT message or ROUTING AREA UPDATE ACCEPT message.

If the SGSN includes timer T3346 in the ROUTING AREA UPDATE REJECT message or the SERVICE REJECT message and timer T3346 is greater than timer T3312, the SGSN sets the mobile reachable timer and the implicit detach timer such that the sum of the timer values is greater than timer T3346.

NOTE 3: According to subclause 4.7.5.1.5, if a periodic routing area updating procedure fails repeatedly, it can take more than 7 minutes before the MS starts using MM specific procedures.

If the MS is both IMSI attached for GPRS and non-GPRS services, and if the MS lost coverage of the registered PLMN and timer T3312 expires or timer T3323 expires, then:

- a) if the MS returns to coverage in a cell that supports GPRS and that indicates that the network is in network operation mode I, then the MS shall either perform the combined routing area update procedure indicating "combined RA/LA updating with IMSI attach"; or
- b) if the MS returns to coverage in a cell in the same RA that supports GPRS and that indicates that the network is in network operation mode II, then the MS shall perform the periodic routing area updating procedure indicating "Periodic updating"; or

- c) if the MS was both IMSI attached for GPRS and non-GPRS services in network operation mode I and the MS returns to coverage in a cell in the same LA that does not support GPRS, then the MS shall perform the periodic location updating procedure. In addition, the MS shall perform a combined routing area update procedure indicating "combined RA/LA updating with IMSI attach" when the MS enters a cell that supports GPRS and that indicates that the network is in network operation mode I; or
- d) if the MS returns to coverage in a new RA, the description given in subclause 4.7.5 applies.

If this subclause specifies that the MS shall perform a periodic routing area updating procedure, but subclause 4.7.5 specifies the MS shall perform a normal or combined routing area updating procedure, the description in subclause 4.7.5 takes precedence.

If the MS is both IMSI attached for GPRS and non-GPRS services in a network that operates in network operation mode I, and if the MS has camped on a cell that does not support GPRS, and timer T3312 expires or timer T3323 expires, then the MS shall start an MM location updating procedure. In addition, the MS shall perform a combined routing area update procedure indicating "combined RA/LA updating with IMSI attach" when the MS enters a cell that supports GPRS and indicates that the network is in operation mode I.

If timer T3312 expires or timer T3323 expires during an ongoing CS connection, then a MS operating in MS operation mode B shall treat the expiry of T3312 when the MM state MM-IDLE is entered, analogous to the descriptions for the cases when the timer expires out of coverage or in a cell that does not support GPRS.

In A/Gb mode, timer T3312 and timer T3323 shall not be stopped when a GPRS MS enters state GMM-REGISTERED.SUSPENDED.

4.7.2.3 PMM-IDLE mode and PMM-CONNECTED mode (lu mode only)

An MS shall enter PMM-CONNECTED mode when a PS signalling connection for packet switched domain is established between the MS and the network. The MS shall not perform periodic routing area update in PMM-CONNECTED mode.

An MS shall enter PMM-IDLE mode when the PS signalling connection for packet switched domain between the MS and the network has been released. The MS shall perform periodic routing area update in PMM-IDLE mode.

4.7.2.4 Handling of *Force to standby* in lu mode (lu mode only)

Force to standby is not applicable for lu mode.

The network shall always indicate *Force to standby not indicated* in the *Force to standby* information element.

The *Force to standby* information element shall be ignored by the MS.

4.7.2.5 RA Update procedure for Signalling Connection Re-establishment (lu mode only)

When the MS receives an indication from the lower layers that the RRC connection has been released with cause "Directed signalling connection re-establishment", see 3GPP TS 25.331 [23c] and 3GPP TS 44.118 [111], then the MS shall enter PMM-IDLE mode and initiate immediately a normal routing area update procedure (the use of normal or combined procedure depends on the network operation mode in the current serving cell) regardless whether the routing area has been changed since the last update or not. This routing area update procedure shall also be performed or continued if the MS has performed an inter-system change towards GSM, irrespective whether the READY timer is running or the MS is in PMM-IDLE or PMM-CONNECTED mode.

4.7.2.6 Cell Update triggered by low layers

A Cell Update may be requested by the low layers, see 3GPP TS 44.060 [76]. In this case the Cell Update shall be performed even if the READY timer is not running. If both the network and the MS support the Cell Notification, then the MS shall use the LLC NULL frame to perform the Cell Update.

4.7.2.7 Handling of timer T3302

The value of timer T3302 can be sent by the network to the MS in the ATTACH ACCEPT message, ROUTING AREA UPDATE ACCEPT message, ATTACH REJECT message, and ROUTING AREA UPDATE REJECT message. The MS shall apply this value, if the value is different from "deactivated" in the routing area registered by the MS, until a new value is received. The default value of this timer is used in the following cases:

- ATTACH ACCEPT message, ROUTING AREA UPDATE ACCEPT message, ATTACH REJECT message, or ROUTING AREA UPDATE REJECT message is received without a value specified;
- In Iu mode, if the network provides a value in a non-integrity protected Iu mode GMM message and the MS is not attaching for emergency services or not attached for emergency services;
- In A/Gb mode and if the MS supports integrity protection, if the network provides a value in a non-integrity protected GMM message;
- the network indicates that the timer is "deactivated";
- the MS does not have a stored value for this timer;
- a new PLMN which is not in the list of equivalent PLMNs has been entered, the routing area updating fails and the routing area updating attempt counter is equal to 5; or
- a new PLMN which is not in the list of equivalent PLMNs has been entered, the attach procedure fails, and the attach attempt counter is equal to 5.

4.7.2.8 Handling of timer T3324 (A/Gb mode, Iu mode and S1 mode)

An MS supporting PSM may request the network to assign a value for T3324 by including a requested timer value in:

- the ATTACH REQUEST or ROUTING AREA UPDATE REQUEST message (in A/Gb mode and Iu mode); or
- the ATTACH REQUEST or TRACKING AREA UPDATE REQUEST message (in S1 mode).

The value of timer T3324 can be sent by the network to the MS in:

- the ATTACH ACCEPT or ROUTING AREA UPDATE ACCEPT message (in A/Gb mode and Iu mode); and
- the ATTACH ACCEPT or TRACKING AREA UPDATE ACCEPT message (in S1 mode).

NOTE: Besides the value requested by the MS, the network can take local configuration into account when selecting a value for T3324 (see 3GPP TS 23.682 [133A], subclause 4.5.4).

In A/Gb mode and Iu mode, the MS shall apply the received T3324 value in the RA identified by the RAI contained in the ATTACH ACCEPT or ROUTING AREA UPDATE ACCEPT message, until a new value is received, T3324 is deactivated or a new PLMN is selected. The timer T3324 is deactivated if:

- the last attach or routing area updating attempt was not completed successfully;
- the network does not include a value for timer T3324 in the last ATTACH ACCEPT or ROUTING AREA UPDATE ACCEPT message received by the MS; or
- the indicated value of the timer is "deactivated".

In A/Gb mode and Iu mode, timer T3324 is reset and started with its initial value, when the MS changes from PMM-CONNECTED mode to PMM-IDLE mode (in Iu mode) or when the READY timer is stopped or expires (in A/Gb mode). Timer T3324 is stopped when the MS enters PMM-CONNECTED mode or GMM-DEREGISTERED state or the READY timer is started.

In S1 mode, the MS shall apply the received T3324 value in all tracking areas of the list of tracking areas assigned to the MS, until a new value is received, T3324 is deactivated or a new PLMN is selected. The timer T3324 is deactivated if:

- the last attach or tracking area updating attempt was not completed successfully;

- the network does not include a value for timer T3324 in the last ATTACH ACCEPT or TRACKING AREA UPDATE ACCEPT message received by the MS; or
- the indicated value of the timer is "deactivated".

In S1 mode, timer T3324 is reset and started with its initial value, when the MS changes from EMM-CONNECTED mode to EMM-IDLE mode. Timer T3324 is stopped when the MS enters EMM-CONNECTED mode or EMM-DEREGISTERED state. In A/Gb mode and Iu mode, when timer T3324 expires the MS may activate PSM as specified in subclause 4.7.2.9.

In S1 mode, when timer T3324 expires the MS may activate PSM as specified in 3GPP TS 24.301 [120], subclause 5.3.11.

In A/Gb mode and Iu mode, if timer T3324 expires during an ongoing CS connection, the MS shall take action on the expiry of timer T3324 as described in subclause 4.7.2.9 when the MM state MM-IDLE is entered.

4.7.2.9 Power saving mode

The MS can request the use of power saving mode (PSM) during an attach or routing area updating procedures (see 3GPP TS 23.682 [133A] and 3GPP TS 23.060 [74]). The MS shall not request the use of PSM during:

- an attach for emergency bearer services procedure;
- a routing area updating procedure for initiating a PDN connection for emergency bearer services; or
- a routing area updating procedure when the MS has a PDN connection established for emergency bearer services.

The network accepts the use of PSM by providing a specific value for timer T3324 when accepting the attach or routing area updating procedure. The MS may use PSM only if the network has provided the T3324 value IE during the last attach or routing area updating procedure with a value different from "deactivated".

Upon expiry of the timer T3324 or if the T3324 value provided by the network is zero, the MS may deactivate the AS layer and activate PSM by entering the state GMM-REGISTERED.NO-CELL-AVAILABLE if:

- a) the MS is not attached for emergency bearer services;
- b) the MS has no PDN connection for emergency bearer services;
- c) the MS is in PMM-IDLE mode (in Iu mode) or the READY timer is not running (in A/Gb mode);
- d) the MS is in the GMM-REGISTERED.NORMAL-SERVICE state; and
- e) no RR connection exists.

If conditions a, b, c and e are fulfilled, but the MS is in a state other than GMM-REGISTERED.NORMAL-SERVICE when timer T3324 expires, the MS may activate PSM when the MS returns to state GMM-REGISTERED.NORMAL-SERVICE.

If conditions a, b, c and d are fulfilled, but an RR connection exists, the MS may activate PSM when the RR connection has been released.

An MS that has already been allocated timer T3324 with a value different from "deactivated" and the timer T3324 has expired, may activate PSM if it receives an "Extended wait time" from lower layers.

When PSM is activated all NAS timers are stopped and associated procedures aborted except for timers T3312, T3346, T3396, any backoff timers, and the timer T controlling the periodic search for HPLMN or EHPLMN or higher prioritized PLMNs (see 3GPP TS 23.122 [14]).

If the MS is attached for emergency bearer services or has a PDN connection for emergency bearer services, the MS shall not activate PSM.

The MS may deactivate PSM at any time (e.g. for transfer of mobile originated signalling or user data, or to initiate a mobile originated circuit-switched transaction), by activating the AS layer before initiating the necessary GMM or MM procedures (if any).

4.7.2.10 Extended idle-mode DRX cycle

The MS can request the use of extended idle mode DRX cycle (eDRX) during an attach or routing area updating procedure by including the extended DRX parameters IE (see 3GPP TS 23.682 [11A] and 3GPP TS 23.060 [74]). The MS shall not request the use of eDRX during:

- an attach for emergency bearer services procedure; or
- a routing area updating procedure for the MS attached for emergency bearer services.

The MS and the network may negotiate eDRX parameters during a routing area updating procedure when the MS has a PDP context for emergency bearer services.

The network accepts the request to use eDRX by providing the extended DRX parameters IE when accepting the attach or the routing area updating procedure. The MS shall use extended idle mode DRX cycle only if it received the extended DRX parameters IE during the last attach or routing area updating procedure and the MS does not have a PDP context for emergency bearer services.

NOTE: If the MS wants to keep using eDRX, the MS includes the extended DRX parameters IE in each attach or routing area updating procedure.

If the MS received the extended DRX parameters IE during the last attach or routing area updating procedure, upon the successful completion of the PDP context deactivation procedure for a PDP context for emergency bearer services, the MS shall resume eDRX.

If the network has provided the extended DRX parameters IE during the last attach or routing area updating procedure, upon the successful completion of the PDP context deactivation procedure for a PDP context for emergency bearer services, the network shall resume eDRX.

If the MS or the network locally deactivates the PDP context for emergency bearer service, the MS or the network shall not use eDRX until the MS receives eDRX parameters during a routing area updating procedure with PDP context synchronization or upon successful completion of a service request procedure.

If the MS did not receive the extended DRX parameters IE, or if the MS has a PDP context for emergency bearer services, the MS shall use the stored DRX parameters, if available.

If the network did not accept the request to use eDRX, or if the MS has a PDP context for emergency bearer services, the network shall use the stored DRX parameters, if available.

4.7.2.11 Interaction between power saving mode and extended idle mode DRX cycle

The MS can request the use of both PSM and eDRX during an attach or routing area update procedure but it is up to the network to decide to enable none, one of them or both (see 3GPP TS 23.682 [133A] and 3GPP TS 23.060 [74]).

If the network accepts the use of both PSM (see subclause 4.7.2.9) and eDRX (see subclause 4.7.2.10), the extended DRX parameters IE provided to the MS should allow for multiple paging occasions before the active timer expires.

4.7.2.12 Extended coverage for GSM

The MS can support and use the extended coverage in GSM for IoT (EC-GSM-IoT) feature (see 3GPP TS 43.064 [159]). A GPRS MS using EC-GSM-IoT may operate in MS operation mode C only. If the MS uses one of the four coverage classes of EC-GSM-IoT as defined in 3GPP TS 43.064 [159], the MS shall calculate the value of the applicable NAS timers as indicated in tables 11.3, 11.3A and 11.2c using a multiplier of 3, unless the timer is deactivated. The NAS timer value obtained is used as described in the appropriate procedure subclause of this specification. The NAS timer value shall be calculated at start of a NAS procedure and shall not be re-calculated until the NAS procedure is completed, restarted or aborted.

The usage of one of the four coverage classes of EC-GSM-IoT by an MS is indicated to the SGSN by lower layers. When a SGSN that supports EC-GSM-IoT performs NAS signaling with an MS that is using EC-GSM-IoT, the SGSN shall calculate the value of the applicable NAS timers as indicated in tables 11.4, 11.4a and 11.2d using a multiplier of 3. The NAS timer value shall be calculated at start of a NAS procedure and shall not be re-calculated until the NAS procedure is completed, restarted or aborted.

In order to deal with use of extensive resources from the network, the operator may prevent specific subscribers from using enhanced coverage (see 3GPP TS 23.060 [74]). When in A/Gb mode, the MS supporting EC-GSM-IoT shall indicate support for restriction on use of enhanced coverage. The MS supporting restriction on use of enhanced coverage indicates "Mobile station supports restriction on use of enhanced coverage" in the MS network capability information element in the ATTACH REQUEST and ROUTING AREA UPDATE REQUEST message. If the MS supports restriction on use of enhanced coverage, the SGSN indicates whether the use of enhanced coverage is restricted or not in the ATTACH ACCEPT message and ROUTING AREA UPDATE ACCEPT message (see subclause 4.7.3.1 and subclause 4.7.5.1). If the use of enhanced coverage is restricted the MS shall not use enhanced coverage in the registered PLMN and in any PLMN which is in the list of equivalent PLMNs.

4.7.3 GPRS attach procedure

The GPRS attach procedure is used for the following purposes:

- normal GPRS attach, performed by the MS to IMSI attach for GPRS services only. The normal GPRS attach procedure shall be used:
 - by GPRS MSs in MS operation mode C, independent of the network operation mode;
 - by GPRS MSs in MS operation modes A or B if the network operates in network operation mode II; and
 - by GPRS MSs in MS operation mode A, independent of the network operation mode, if a circuit-switched transaction is ongoing;
- combined GPRS attach procedure, used by GPRS MSs in MS operation modes A or B to attach the IMSI for GPRS and non-GPRS services provided that the network operates in network operation mode I.
- GPRS attach for emergency bearer services, performed by the MS to IMSI or IMEI attach to emergency bearer services.

The lower layers indicate to NAS that the network does not support emergency bearer services for the MS in limited service state (see 3GPP TS 25.331 [23c]). This information is taken into account when deciding whether to initiate attach for emergency bearer services.

With a successful GPRS attach procedure a GMM context is established.

When the timer T3346 is running, MS is allowed to initiate an attach procedure if:

- the MS is an MS configured to use AC11 – 15 in selected PLMN;
- the MS is attaching for emergency bearer services; or
- the MS has timer T3346 running because a request from an MS with the low priority indicator set to "MS is configured for NAS signalling low priority" was rejected, and the MS needs to attach without the low priority indicator, or with the low priority indicator set to "MS is not configured for NAS signalling low priority".

An eCall only mobile station that is not capable of eCall over IMS shall not perform a normal or combined GPRS attach procedure.

An eCall only mobile station that is capable of eCall over IMS may perform a normal or combined GPRS attach procedure only upon failure of a routing area updating procedure following intersystem change from S1 mode to A/Gb or Iu mode.

When the MS moves from NG-RAN coverage to GERAN coverage, or from NG-RAN coverage to UTRAN coverage, the MS shall perform a normal or combined GPRS attach procedure, if the following applies:

- the MS initiated a registration procedure while in N1 mode; and
- since then the MS did not perform a successful EPS attach or tracking area updating procedure in S1 mode or GPRS attach or routing area updating procedure in A/Gb mode or Iu mode.

Subclause 4.7.3.1 describes the GPRS attach procedure to attach the IMSI only for GPRS services. The combined GPRS attach procedure used to attach the IMSI for both GPRS and non-GPRS services is described in subclause 4.7.3.2. GPRS attach for emergency bearer services is described as part of subclause 4.7.3.1.

If an IMSI attach for non-GPRS services is requested and a GMM context exists, the routing area updating procedure shall be used as described in subclause 4.7.5.2.

To limit the number of consecutive rejected attach attempts, a GPRS attach attempt counter is introduced. The GPRS attach attempt counter shall be incremented as specified in subclause 4.7.3.1.5. Depending on the value of the GPRS attach attempt counter, specific actions shall be performed. The GPRS attach attempt counter shall be reset when:

- the MS is powered on;
- a SIM/USIM is inserted;
- a GPRS attach or combined GPRS attach procedure is successfully completed;
- an attach or combined attach procedure is successfully completed in S1 mode;
- a combined GPRS attach procedure is completed for GPRS services only with cause #2, #16, #17, #22 or #28;
- a GPRS attach or combined GPRS attach procedure is rejected with cause #11, #12, #13, #14, #15 or #25;
- a network initiated detach procedure is completed with cause #11, #12, #13, #14, #15 or #25; or
- a new PLMN is selected;

and additionally when the MS is in substate ATTEMPTING-TO-ATTACH:

- expiry of timer T3302;
- a new routing area is entered;
- an attach is triggered by CM sublayer requests;
- timer T3346 is started.

The mobile equipment shall contain a list of "forbidden location areas for roaming", as well as a list of "forbidden location areas for regional provision of service". The handling of these lists is described in subclause 4.4.1; the same lists are used by GMM and MM procedures.

In a shared network, the MS shall choose one of the PLMN identities as specified in 3GPP TS 23.122 [14]. The MS shall construct the Routing Area Identification of the cell from this chosen PLMN identity, and the LAC and the RAC received on the BCCH. For:

- a shared GERAN, in A/Gb mode, the chosen PLMN identity is indicated to the GERAN in the first RLC data block of an upper layer PDU (see 3GPP TS 44.060 [76]) when a foreign TLLI or a random TLLI is used by the network sharing supporting MS for the transmission.
- a shared UTRAN, the chosen PLMN identity shall be indicated to the UTRAN in the RRC INITIAL DIRECT TRANSFER message (see 3GPP TS 25.331 [23c]).

For GERAN Iu mode, network sharing is not supported.

Whenever an ATTACH REJECT message with the cause "PLMN not allowed" is received by the MS, the chosen PLMN identity shall be stored in the "forbidden PLMN list" and if the MS is configured to use timer T3245 (see 3GPP TS 24.368 [135] or 3GPP TS 31.102 [112]) then the MS shall start timer T3245 and proceed as described in subclause 4.1.1.6. Whenever an ATTACH REJECT message is received by the MS with the cause "Roaming not allowed in this location area", "Location Area not allowed", or "No suitable cells in Location Area", the LAI that is part of the constructed RAI shall be stored in the suitable list.

The network informs the MS about the support of specific features, such as LCS-MOLR, MBMS, IMS voice over PS session, emergency bearer services in Iu mode in the Network feature support information element. The information is either explicitly given by sending the Network feature support IE or implicitly by not sending it. The handling in the network is described in subclause 9.4.2.9. The network can also use the Additional network feature support IE in order to inform the MS about the support of specific features such as the delivery of SMS via GPRS (GPRS-SMS) or implicitly by not sending it. The MS may use the support indications for LCS-MOLR, MBMS and GPRS-SMS to inform the user about the availability of the appropriate services. The MS shall not request the LCS-MOLR or MBMS services, if the service has not been indicated as available. The indication for MBMS is defined in subclause "MBMS feature support indication" in 3GPP TS 23.246 [106]. In an MS with IMS voice over PS capability, the IMS voice over

PS session indicator and the emergency bearer services indicator shall be provided to the upper layers. The upper layers take the IMS voice over PS session indicator into account as specified in 3GPP TS 23.221 [131], subclause 7.2a and subclause 7.2b, when selecting the access domain for voice sessions or calls in Iu mode. When initiating an emergency call in Iu mode, the upper layers also take the emergency bearer services indicator into account for the access domain selection. The MS may use the GPRS-SMS indication in order to obtain SMS.

4.7.3.1 GPRS attach procedure for GPRS services

The GPRS attach procedure is a GMM procedure used by GPRS MSs to IMSI attach for GPRS services. The procedure is also used by GPRS MSs to IMSI or IMEI attach for emergency bearer services.

The attach type information element shall indicate "GPRS attach". For an MS attaching for emergency bearer services the attach type information element shall indicate "Emergency attach".

4.7.3.1.1 GPRS attach procedure initiation

In state GMM-DEREGISTERED, the MS initiates the GPRS attach procedure by sending an ATTACH REQUEST message to the network, starts timer T3310 and enters state GMM-REGISTERED-INITIATED. If timer T3302 is currently running, the MS shall stop timer T3302. If timer T3311 is currently running, the MS shall stop timer T3311.

If the MS is configured for "AttachWithIMSI" as specified in 3GPP TS 24.368 [135] or 3GPP TS 31.102 [112] and the selected PLMN is neither the registered PLMN nor in the list of equivalent PLMNs, the MS shall include the IMSI in the Mobile identity IE in the ATTACH REQUEST message.

For all other cases:

If the MS does not support S1 mode:

- the MS capable of both Iu mode and A/Gb mode or only of A/Gb mode shall include a valid P-TMSI, if any is available, the P-TMSI signature associated with the P-TMSI and the routing area identity associated with the P-TMSI in the ATTACH REQUEST message. In addition, the MS shall include P-TMSI type IE with P-TMSI type set to "native P-TMSI". If there is no valid P-TMSI available, the IMSI shall be included instead of the P-TMSI and P-TMSI signature.

If the MS supports S1 mode:

- if the TIN indicates "GUTI" and the MS holds a valid GUTI, the MS shall map the GUTI into the Mobile identity IE, P-TMSI signature IE and Old routing area identification IE. The MS shall also include P-TMSI type IE with P-TMSI type set to "mapped P-TMSI". Additionally, if the MS holds a valid P-TMSI and RAI, the MS shall indicate the P-TMSI in the Additional mobile identity IE and the RAI in the Additional old routing area identification IE.

NOTE: The mapping of the GUTI to the P-TMSI, P-TMSI signature and RAI is specified in 3GPP TS 23.003 [10].

- If the TIN indicates "P-TMSI" or "RAT-related TMSI" and the MS holds a valid P-TMSI and a RAI, the MS shall indicate the P-TMSI in the Mobile identity IE and the RAI in the Old routing area identification IE. The MS shall also include P-TMSI type IE with P-TMSI type set to "native P-TMSI". If a P-TMSI signature is associated with the P-TMSI, the MS shall include it in the Old P-TMSI signature IE.
- If the TIN is deleted and
 - the MS holds a valid P-TMSI and a RAI, the MS shall indicate the P-TMSI in the Mobile identity IE and the RAI in the Old routing area identification IE. The MS shall also include P-TMSI type IE with P-TMSI type set to "native P-TMSI". If a P-TMSI signature is associated with the P-TMSI, the MS shall include it in the Old P-TMSI signature IE; or
 - the MS does not hold a valid P-TMSI and RAI, but holds a valid GUTI, the MS shall map the GUTI into the Mobile identity IE, P-TMSI signature IE and Old routing area identification IE. The MS shall also include P-TMSI type IE with P-TMSI type set to "mapped P-TMSI"; or
 - the MS does not hold a valid P-TMSI, RAI or GUTI, the MS shall include the IMSI in the Mobile identity IE.
- Otherwise the MS shall include the IMSI in the Mobile identity IE.

In the cases when the MS maps a GUTI into the Mobile identity IE, P-TMSI signature IE and Old routing area identification IE, then:

- If a current EPS security exists, the P-TMSI signature shall include a truncated NAS token as specified in 3GPP TS 33.401 [123]. In the GPRS ciphering key sequence number IE, the MS shall indicate the value of the eKSI associated with the current EPS security context. The MS shall derive CK' and IK' from the K_{ASME} and the NAS uplink COUNT value corresponding to the NAS token derived and handle the START value as specified in 3GPP TS 25.331 [23c]. Then, the MS shall store the mapped UMTS security context replacing the established UMTS security context for the PS domain.
- If a current EPS security does not exist, the MS shall set the truncated NAS token included in the P-TMSI signature to all zeros and the GPRS ciphering key sequence number to "No key is available".

If the MS is attaching for emergency bearer services and does not hold a valid GUTI, P-TMSI or IMSI as described above, the IMEI shall be included in the Mobile identity IE.

The MS shall also indicate within the DRX parameters whether it supports the split pg cycle option on CCCH. The optional support of the split pg cycle on CCCH by the network is indicated in SI13 or PSII. Split pg cycle on CCCH is applied by both the network and the MS when the split pg cycle option is supported by both (see 3GPP TS 45.002 [32]).

If the MS supports eDRX and requests the use of eDRX, the MS shall include the extended DRX parameters IE in the ATTACH REQUEST message.

In Iu mode, if the MS wishes to prolong the established PS signalling connection after the GPRS attach procedure (for example, the MS has any CM application request pending), it may set a follow-on request pending indicator on (see subclause 4.7.13).

An MS attaching for emergency bearer services shall set the follow-on request pending indicator.

If the MS supports PSM and requests the use of PSM, then the MS shall include the T3324 value IE with a requested timer value in the ATTACH REQUEST message. When the MS includes the T3324 value IE and the MS indicates support for extended periodic timer value in the MS network feature support IE, it may also include the T3312 extended value IE to request a particular T3312 value to be allocated.

In A/Gb mode, if the MS supports the restriction on use of enhanced coverage, then the MS shall set the Restriction on use of enhanced coverage capability bit to "Mobile station supports restriction of use of enhanced coverage" in the MS network capability IE of the ATTACH REQUEST message.

If the MS supports dual connectivity of E-UTRA with New Radio (NR), then the MS shall set the Dual connectivity of E-UTRA with NR capability bit to "Mobile station supports dual connectivity of E-UTRA with NR" in the MS network capability IE of the ATTACH REQUEST message.

In A/Gb mode, if a UMTS security context is available and if the MS indicates support of integrity protection in the MS network capability IE included in the ATTACH REQUEST message, then the MS shall derive a GPRS GSM Kint key as described in subclause 4.7.7.3b and a GPRS GSM K_{C128} key as described in subclause 4.7.7.3a. The MS shall then assign the GPRS GSM Kint key, the GPRS GSM K_{C128} key, the GPRS GSM integrity algorithm and the GPRS GSM ciphering algorithm (identified by the information in the Ciphering Algorithm IE and Integrity Algorithm IE stored in the non-volatile ME memory) to the LLC layer, and indicate to the LLC layer that it shall start integrity protection. This shall be done so that the LLC layer can integrity protect, but not cipher, the ATTACH REQUEST message. The MS shall include the CKSN in the CKSN IE in the ATTACH REQUEST message. If the MS has no UMTS security context available, then the MS shall not integrity protect the ATTACH REQUEST message in the LLC layer. In this case the MS shall set the CKSN IE to the value "no key is available" and send the ATTACH REQUEST unprotected.

4.7.3.1.2 GMM common procedure initiation

If the network receives an ATTACH REQUEST message containing the P-TMSI type IE and the Mobile identity IE with type of identity indicating "TMSI/P-TMSI/M-TMSI", and the network does not follow the use of the most significant bit of the LAC as specified in 3GPP TS 23.003 [10] subclause 2.8.2.2.2, the network shall use the P-TMSI type IE to determine whether the mobile identity included in the Mobile identity IE is a native P-TMSI or a mapped P-TMSI.

The network may initiate GMM common procedures, e.g. the GMM identification and GMM authentication and ciphering procedure, depending on the received information such as IMSI, CKSN, old RAI, P-TMSI and P-TMSI signature.

4.7.3.1.3 GPRS attach accepted by the network

During an attach for emergency bearer services, if not restricted by local regulations, the network shall not check for mobility and access restrictions, regional restrictions, subscription restrictions, or perform CSG access control when processing the ATTACH REQUEST message. The network shall not apply subscribed APN based congestion control during an attach procedure for emergency bearer services.

If the GPRS attach request is accepted by the network, an ATTACH ACCEPT message is sent to the MS.

In A/Gb mode, if the MS indicates support of integrity protection in the MS network capability IE in the ATTACH REQUEST message, and if the network supports integrity protection, then the network shall store all octets received from the MS in the MS network capability IE and in the MS Radio Access Capability IE, up to the maximum length defined for the respective information element.

NOTE 1: The network needs to store the MS network capability IE and the MS Radio Access Capability IE exactly as received from the MS and network is not allowed to ignore the "higher" octets sent by the MS even if the network does not support any features indicated in the higher octets. Otherwise the replay check of the MS network capability and the MS Radio Access Capability will fail in the MS.

In A/Gb mode, if a UMTS security context is available in the network and if the MS indicates support of integrity protection in the ATTACH REQUEST message and the network supports integrity protection, and if integrity protection of the ATTACH REQUEST message is successfully verified in the LLC layer in the network, then if the network decides to re-authenticate the MS or select a new integrity algorithm or ciphering algorithm, the network shall initiate an authentication and ciphering procedure.

In A/Gb mode, if a UMTS security context is available in the network and if the MS indicates support of integrity protection in the ATTACH REQUEST message and the network supports integrity protection if integrity protection of the ATTACH REQUEST message is successfully verified in the LLC layer in the network, the network may decide to continue using the stored: GPRS GSM Kint integrity key, the GPRS GSM Kc₁₂₈ ciphering key, the GPRS GSM ciphering algorithm and the GPRS GSM integrity algorithm in the LLC layer without initiating an authentication and ciphering procedure. If the MS and network continue to use the same ciphering mode as when the MS was previously attached to the network, ciphering or no ciphering, the ciphering mode is re-established without the need to run an authentication and ciphering procedure. The network shall replay the MS network capability IE and the MS radio access capability IE received from the MS in the ATTACH REQUEST message, by including the MS network capability IE and the MS radio access capability IE in the ATTACH ACCEPT message to the MS. The GMM layer in the network shall assign the stored GPRS GSM Kint key, the GPRS GSM Kc₁₂₈ key, the GPRS GSM integrity algorithm and the GPRS GSM ciphering algorithm to the LLC layer. The GMM layer in the network shall then indicate to the LLC layer that it shall start integrity protection and ciphering in the LLC layer before sending the ATTACH ACCEPT message to the MS. If the integrity protection of the ATTACH REQUEST message is not successfully verified in the LLC layer or if the ATTACH REQUEST message is received without integrity protection, then the network shall progress the ATTACH REQUEST message and initiate an authentication and ciphering procedure in order to authenticate the MS and activate integrity protection and ciphering in the MS.

In A/Gb mode, if a UMTS security context is available in the network and if the MS indicates support of integrity protection in the ATTACH REQUEST message and the network supports integrity protection, and if the network is not able to verify the message authentication code in the LLC layer protecting the ATTACH REQUEST message, due to the LLC layer at the network not having been configured yet with the integrity key and integrity algorithm for this MS, then the network shall progress the ATTACH REQUEST message at GMM layer anyway. If the CKSN included in the ATTACH REQUEST message belongs to an UMTS security context available in the network, then the network may re-establish integrity protection and ciphering of layer 3 signalling messages in the LLC layer without initiating an authentication and ciphering procedure.

In A/Gb mode, if the MS indicates support of integrity protection of user plane data in the MS network capability IE in the ATTACH REQUEST message, and if the network supports and accepts integrity protection of user plane data, then the network shall indicate integrity protection of user plane data to the MS in the ATTACH ACCEPT message. The MS shall indicate to the LLC layer to start integrity protection of user plane data after the reception of the ATTACH ACCEPT message. The same GPRS GSM Kint key and the same GPRS GSM integrity algorithm used for integrity protection of layer 3 signalling messages shall be used for integrity protection of user plane data in the LLC layer. The network shall indicate to the LLC layer to start integrity protection of user plane data after sending off the ATTACH ACCEPT message to the MS. If the network does not indicate to the MS in the ATTACH ACCEPT message that it accepts the use of integrity protection of user plane, and if the MS does not accept such a network, then the MS shall detach from the network.

The P-TMSI reallocation may be part of the GPRS attach procedure. When the ATTACH REQUEST includes the IMSI or IMEI, the SGSN shall allocate the P-TMSI. The P-TMSI that shall be allocated is then included in the ATTACH ACCEPT message together with the routing area identifier. The network shall, in this case, change to state GMM-COMMON-PROCEDURE-INITIATED and shall start timer T3350 as described in subclause 4.7.6. Furthermore, the network may assign a P-TMSI signature for the GMM context which is then also included in the ATTACH ACCEPT message. If the LAI or PLMN identity that has been transmitted in the ATTACH ACCEPT message is a member of any of the "forbidden" lists, any such entry shall be deleted. If the attach procedure is for emergency bearer services, the "forbidden" lists shall remain unchanged. Additionally, the network shall include the radio priority level to be used by the MS for mobile originated SMS transfer in the ATTACH ACCEPT message.

In a shared network, if the MS is a network sharing supporting MS, the network shall indicate the PLMN identity of the CN operator that has accepted the GPRS attach request in the RAI contained in the ATTACH ACCEPT message; if the MS is a network sharing non-supporting MS, the network shall indicate the PLMN identity of the common PLMN (see 3GPP TS 23.251 [109]). If the PLMN identity of the common PLMN included in the RAI does not identify the CN operator that has accepted the GPRS attach request, the network may include the PLMN identity of the CN operator that has accepted the GPRS attach request in the ATTACH ACCEPT message.

In a multi-operator core network (MOCN) with common GERAN, the network shall indicate in the RAI the common PLMN identity (see 3GPP TS 23.251 [109]).

If the common PLMN identity included in the RAI does not identify the CN operator that has accepted the GPRS attach request, the network may include the PLMN identity of the CN operator that has accepted the GPRS attach request in the ATTACH ACCEPT message.

If the MS has indicated in the ATTACH REQUEST message that it supports PS inter-RAT handover from GERAN to UTRAN Iu mode, the network may include in the ATTACH ACCEPT message a request to provide the Inter RAT information container.

If the MS has included the MS network capability IE or the UE network capability IE or both in the ATTACH REQUEST message, the network shall store all octets received from the MS, up to the maximum length defined for the respective information element.

NOTE 2: This information is forwarded to the new SGSN during inter-SGSN handover or to the new MME during intersystem handover to S1 mode.

If the DRX parameter was included in the DRX Parameter IE in the ATTACH REQUEST message, the network shall replace any stored DRX parameter with the received parameter and use it for the downlink transfer of signalling and user data.

The network shall include the extended DRX parameters IE in the ATTACH ACCEPT message only if the extended DRX parameters IE was included in the ATTACH REQUEST message, and the network supports and accepts the use of eDRX.

In A/Gb mode, the Cell Notification information element shall be included in the ATTACH ACCEPT message by the network which indicates that the Cell Notification is supported by the network.

In Iu mode, the network should prolong the PS signalling connection if the mobile station has indicated a follow-on request pending in ATTACH REQUEST. The network may also prolong the PS signalling connection without any indication from the mobile terminal.

The MS, receiving an ATTACH ACCEPT message, stores the received routing area identification, stops timer T3310, resets the GPRS attach attempt counter, resets the routing area updating attempt counter, resets the service request attempt counter, enters state GMM-REGISTERED and sets the GPRS update status to GU1 UPDATED.

If the message contains a P-TMSI, the MS shall use this P-TMSI as the new temporary identity for GPRS services. In this case, an ATTACH COMPLETE message is returned to the network. The MS shall delete its old P-TMSI and shall store the new one. If no P-TMSI has been included by the network in the ATTACH ACCEPT message, the old P-TMSI, if any available, shall be kept.

If the message contains a P-TMSI signature, the MS shall use this P-TMSI signature as the new temporary signature for the GMM context. The MS shall delete its old P-TMSI signature, if any is available, and shall store the new one. If the message contains no P-TMSI signature, the old P-TMSI signature, if available, shall be deleted.

If the network supports delivery of SMS via GPRS (3GPP TS 23.060 [74]) and this delivery is enabled (see 3GPP TS 29.272 [150]), then the network shall include the Additional network feature support IE in the ATTACH ACCEPT message and set the GPRS-SMS indicator.

If the network supports the extended protocol configuration options IE and the MS indicated support of the extended protocol configuration options IE, then the network shall include the Additional network feature support IE in the ATTACH ACCEPT message and set the ePCO IE indicator to "extended protocol configuration options IE supported".

Upon receiving the ATTACH ACCEPT message an MS supporting S1 mode shall set the TIN to "P-TMSI".

If the network has requested the provision of Inter RAT handover information, the MS shall return an ATTACH COMPLETE message including the Inter RAT handover information IE to the network.

The network may also send a list of "equivalent PLMNs" in the ATTACH ACCEPT message. Each entry of the list contains a PLMN code (MCC+MNC). The mobile station shall store the list, as provided by the network, and if the GPRS attach procedure is not for emergency bearer services, any PLMN code that is already in the "forbidden PLMN" list shall be removed from the "equivalent PLMNs" list before it is stored by the mobile station. If the mobile station is operating in MS operation mode C or the mobile station is supporting S1 mode, it shall also remove any PLMN code that is already in the list of "forbidden PLMNs for GPRS service" before storing the list. In addition the mobile station shall add to the stored list the PLMN code of the registered PLMN that sent the list. All PLMNs in the stored list shall be regarded as equivalent to each other for PLMN selection, cell selection/re-selection and handover. The stored list in the mobile station shall be replaced on each occurrence of the ATTACH ACCEPT message. If no list is contained in the message, then the stored list in the mobile station shall be deleted. An MS attached for emergency bearer services shall delete the stored list when the MS enters the state GMM-DEREGISTERED. The list shall be stored in the mobile station while switched off so that it can be used for PLMN selection after switch on.

The network shall include the T3324 value IE in the ATTACH ACCEPT message only if the T3324 value IE was included in the ATTACH REQUEST message, and the network supports and accepts the use of PSM.

If the network supports and accepts the use of PSM, and the MS included the T3312 extended value IE in the ATTACH REQUEST message, then the network shall take into account the T3312 value requested when providing the Periodic RA update timer IE and the T3312 extended value IE in the ATTACH ACCEPT message.

NOTE 3: Besides the value requested by the MS, the network can take local configuration into account when selecting a value for T3312 (see 3GPP TS 23.060 [74] subclause 5.3.13.54).

In A/Gb mode, if the MS indicates support for restriction on use of enhanced coverage in the ATTACH REQUEST message, and the network restricts enhanced coverage for the MS, then the network shall set the RestrictEC bit to "Enhanced coverage restricted" in the Additional network feature support IE of the ATTACH ACCEPT message.

In Iu mode, if the network wishes to prolong the PS signalling connection (for example, if the mobile station has indicated "follow-on request pending" in ATTACH REQUEST message) the network shall indicate the "follow-on proceed" in the ATTACH ACCEPT message. If the network wishes to release the PS signalling connection, the network shall indicate "no follow-on proceed" in the ATTACH ACCEPT message.

After that in Iu mode, the mobile station shall act according to the follow-on proceed flag included in the Attach result information element in the ATTACH ACCEPT message (see subclause 4.7.13).

In A/Gb mode, if the ATTACH ACCEPT message contains the Cell Notification information element, then the MS shall start to use the LLC NULL frame to perform cell updates. The network receiving an ATTACH COMPLETE message stops timer T3350, changes to GMM-REGISTERED state and considers the P-TMSI sent in the ATTACH ACCEPT message as valid.

If the ATTACH ACCEPT message contains the T3312 extended value IE, then the MS shall use the value in T3312 extended value IE as periodic routing area update timer (T3312). If the ATTACH ACCEPT message does not contain T3312 extended value IE, then the MS shall use the value in the Periodic RA update timer IE as periodic routing area update timer (T3312).

If the ATTACH ACCEPT message contains the T3324 value IE, then the MS shall use the included timer value for T3324 as specified in subclause 4.7.2.8.

If the ATTACH ACCEPT message contains the DCN-ID IE, then the MS shall store the included DCN-ID value together with the PLMN code of the registered PLMN in a DCN-ID list in a non-volatile memory in the ME as described in 3GPP TS 24.301 [120], annex C.

In a shared network or in a multi-operator core network (MOCN) with common GERAN, if the ATTACH ACCEPT message contains the DCN-ID IE and the PLMN identity of the CN operator IE, the MS shall store the included DCN-ID value with the PLMN identity indicated in the PLMN identity of the CN operator IE, and the included DCN-ID value with the PLMN identity indicated in the RAI in a DCN-ID list in a non-volatile memory in the ME as described in 3GPP TS 24.301 [120], annex C.

If the MS receives the ATTACH ACCEPT message from a PLMN for which a PLMN-specific attempt counter or PLMN-specific PS-attempt counter is maintained (see subclause 4.1.1.6A), then the MS shall reset these counters. If the MS maintains a counter for "SIM/USIM considered invalid for GPRS services", then the MS shall reset this counter.

The network may also send a Local Emergency Numbers List with local emergency numbers in the ATTACH ACCEPT, by including the Emergency Number List IE. The mobile equipment shall store the Local Emergency Numbers List, as provided by the network. The Local Emergency Numbers List stored in the mobile equipment shall be replaced on each receipt of the Emergency Number List IE. The received Local Emergency Numbers List shall be provided to the upper layers.

The emergency number(s) received in the Emergency Number List IE are valid only in networks in the same country as the cell on which this IE is received. If no list is contained in the ATTACH ACCEPT message, then the stored Local Emergency Numbers List in the mobile equipment shall be kept, except if the mobile equipment has successfully registered to a PLMN in a country different from that of the PLMN that sent the Local Emergency Numbers List.

The mobile equipment shall use the stored Local Emergency Numbers List of emergency numbers received from the network in addition to the emergency numbers stored on the SIM/USIM or ME to detect that the number dialled is an emergency number.

NOTE 4: The mobile equipment may use the Local Emergency Numbers List to assist the end user in determining whether the dialled number is intended for an emergency service or for another destination, e.g. a local directory service. The possible interactions with the end user are implementation specific.

NOTE 5: An MS that supports procedures specified in 3GPP TS 24.302 [156], can get additional local emergency numbers through those procedures, which can be used based on operator policy (see 3GPP TS 24.302 [156]) to detect that the number dialled is an emergency number.

The Local Emergency Numbers List shall be deleted at switch off and removal of the SIM/USIM. The mobile equipment shall be able to store up to ten local emergency numbers received from the network.

If the MS has initiated the attach procedure due to manual CSG selection and receives an ATTACH ACCEPT message, and the MS sent the ATTACH REQUEST message in a CSG cell, the MS shall check if the CSG ID and associated PLMN identity of the cell are contained in the Allowed CSG list. If not, the MS shall add that CSG ID and associated PLMN identity to the Allowed CSG list and the MS may add the HNB Name (if provided by lower layers) to the Allowed CSG list if the HNB Name is present in neither the Operator CSG list nor the Allowed CSG list.

In A/Gb mode, if a UMTS security context is available, if the MS indicates support of integrity protection in the ATTACH REQUEST message and the network supports integrity protection, then if the MS receives replayed capabilities IE's in ATTACH ACCEPT, then the MS shall check if the replayed MS network capability IE and replayed MS Radio Access Capability IE received in the ATTACH ACCEPT message has not been altered compared to the MS network capability IE and the MS Radio Access Capability IE that the MS sent to the network in ATTACH REQUEST message. If the replayed MS network capability IE and the replayed MS Radio Access Capability IE are not the same, then the MS shall ignore the ATTACH ACCEPT message.

4.7.3.1.4 GPRS attach not accepted by the network

If the attach request cannot be accepted by the network, an ATTACH REJECT message is transferred to the MS. The MS receiving the ATTACH REJECT message containing a reject cause other than GMM cause value #25 or the message is integrity protected, shall stop the timer T3310 and for all causes except #7, #12, #14, #15, #22 and #25 deletes the list of "equivalent PLMNs".

If the ATTACH REJECT message containing GMM cause value cause #25 was received without integrity protection, then the MS shall discard the message.

If the attach request is rejected due to NAS level mobility management congestion control, the network shall set the GMM cause value to #22 "congestion" and assign a back-off timer T3346.

The MS shall then take one of the following actions depending upon the reject cause:

3 (Illegal MS);

6 (Illegal ME);

The MS shall set the GPRS update status to GU3 ROAMING NOT ALLOWED (and shall store it according to subclause 4.1.3.2) and shall delete any P-TMSI, P-TMSI signature, RAI and GPRS ciphering key sequence number. The new GMM state is GMM-DEREGISTERED.NO-IMSI. The SIM/USIM shall be considered as invalid for GPRS services until switching off or the SIM/USIM is removed or the timer T3245 expires as described in subclause 4.1.1.6. If the message has been successfully integrity checked by the lower layers and the MS maintains a counter for "SIM/USIM considered invalid for GPRS services", then the MS shall set this counter to MS implementation-specific maximum value.

If the MS is IMSI attached, the MS shall in addition set the update status to U3 ROAMING NOT ALLOWED, shall delete any TMSI, LAI and ciphering key sequence number. If the MS is operating in MS operation mode A and an RR connection exists, the MS shall abort the RR connection, unless an emergency call is ongoing. The SIM/USIM shall be considered as invalid also for non-GPRS services until switching off or the SIM/USIM is removed. If the message has been successfully integrity checked by the lower layers and the MS maintains a counter for "SIM/USIM considered invalid for non-GPRS services", then the MS shall set this counter to MS implementation-specific maximum value.

If S1 mode is supported in the MS, the MS shall handle the EMM parameters EMM state, EPS update status, GUTI, last visited registered TAI, TAI list and KSI as specified in 3GPP TS 24.301 [120] for the case when the attach procedure is rejected with the EMM cause with the same value.

7 (GPRS services not allowed);

The MS shall set the GPRS update status to GU3 ROAMING NOT ALLOWED (and shall store it according to subclause 4.1.3.2) and shall delete any P-TMSI, P-TMSI signature, RAI and GPRS ciphering key sequence number. The SIM/USIM shall be considered as invalid for GPRS services until switching off or the SIM/USIM is removed. The new state is GMM-DEREGISTERED. If the message has been successfully integrity checked by the lower layers and the MS maintains a counter for "SIM/USIM considered invalid for GPRS services", then the MS shall set this counter to MS implementation-specific maximum value.

NOTE 1: Optionally the MS starts the timer T3340 as described in subclause 4.7.1.9

If S1 mode is supported in the MS, the MS shall handle the EMM parameters EMM state, EPS update status, GUTI, last visited registered TAI, TAI list and KSI as specified in 3GPP TS 24.301 [120] for the case when the attach procedure is rejected with the EMM cause with the same value.

8 (GPRS services and non-GPRS services not allowed);

The MS shall set the GPRS update status to GU3 ROAMING NOT ALLOWED (and shall store it according to subclause 4.1.3.2) and shall delete any P-TMSI, P-TMSI signature, RAI and GPRS ciphering key sequence number. The new GMM state is GMM-DEREGISTERED.NO-IMSI.

NOTE 2: Optionally the MS starts the timer T3340 as described in subclause 4.7.1.9.

The MS shall set the update status to U3 ROAMING NOT ALLOWED, shall delete any TMSI, LAI and ciphering key sequence number. If the MS is operating in MS operation mode A and an RR connection exists, the MS shall abort the RR connection, unless an emergency call is ongoing. The SIM/USIM shall be considered as invalid for GPRS and non-GPRS services until switching off or the SIM/USIM is removed. If the message has been successfully integrity checked by the lower layers and the MS maintains a counter for "SIM/USIM considered invalid for GPRS services", then the MS shall set this counter to MS implementation-specific maximum value. If the message has been successfully integrity checked by the lower layers and the MS maintains a counter for "SIM/USIM considered invalid for non-GPRS services", then the MS shall set this counter to MS implementation-specific maximum value.

If S1 mode is supported in the MS, the MS shall handle the EMM parameters EMM state, EPS update status, GUTI, last visited registered TAI, TAI list and KSI as specified in 3GPP TS 24.301 [120] for the case when the attach procedure is rejected with the EMM cause with the same value.

11 (PLMN not allowed);

The MS shall delete any RAI, P-TMSI, P-TMSI signature, and GPRS ciphering key sequence number stored, shall set the GPRS update status to GU3 ROAMING NOT ALLOWED (and shall store it according to

subclause 4.1.3.2), shall reset the GPRS attach attempt counter and shall change to state GMM-DEREGISTERED.

The MS shall store the PLMN identity in the "forbidden PLMN list" and if the MS is configured to use timer T3245 (see 3GPP TS 24.368 [135] or 3GPP TS 31.102 [112]) then the MS shall start timer T3245 and proceed as described in subclause 4.1.1.6. If the message has been successfully integrity checked by the lower layers and the MS maintains a PLMN-specific attempt counter for that PLMN, then the MS shall set this counter to the MS implementation-specific maximum value.

The MS shall start timer T3340 as described in subclause 4.7.1.9.

If no RR connection exists, the MS shall perform the following additional actions immediately. If the MS is operating in MS operation mode A and an RR connection exists, the MS shall perform these actions when the RR connection is subsequently released:

- If the MS is IMSI attached, the MS shall set the update status to U3 ROAMING NOT ALLOWED, shall delete any TMSI, LAI and ciphering key sequence number and shall reset the location update attempt counter. The new MM state is MM IDLE.
- The MS shall perform a PLMN selection according to 3GPP TS 23.122 [14].

An MS in GAN mode shall request a PLMN list in GAN (see 3GPP TS 44.318 [76b]) prior to perform a PLMN selection from this list according to 3GPP TS 23.122 [14].

If S1 mode is supported in the MS, the MS shall handle the EMM parameters EMM state, EPS update status, GUTI, last visited registered TAI, TAI list, KSI and attach attempt counter as specified in 3GPP TS 24.301 [120] for the case when attach procedure is rejected with the EMM cause with the same value.

12 (Location area not allowed);

The MS shall delete any RAI, P-TMSI, P-TMSI signature and GPRS ciphering key sequence number, shall set the GPRS update status to GU3 ROAMING NOT ALLOWED (and shall store it according to clause 4.1.3.2) and shall reset the GPRS attach attempt counter. The state is changed to GMM-DEREGISTERED.LIMITED-SERVICE.

The mobile station shall store the LAI in the list of "forbidden location areas for regional provision of service".

The MS shall start timer T3340 as described in subclause 4.7.1.9.

If no RR connection exists, the MS shall perform the following additional actions immediately. If the MS is operating in MS operation mode A and an RR connection exists, the MS shall perform these actions when the RR connection is subsequently released:

- If the MS is IMSI attached, the MS shall set the update status to U3 ROAMING NOT ALLOWED, shall delete any TMSI, LAI and ciphering key sequence number and shall reset the location update attempt counter. The new MM state is MM IDLE.
- The MS shall perform a cell selection according to 3GPP TS 43.022 [82] and 3GPP TS 25.304 [98].

NOTE 3: The cell selection procedure is not applicable for an MS in GAN mode.

If S1 mode is supported in the MS, the MS shall handle the EMM parameters EMM state, EPS update status, GUTI, last visited registered TAI, TAI list, KSI and attach attempt counter as specified in 3GPP TS 24.301 [120] for the case when the attach procedure is rejected with the EMM cause with the same value.

13 (Roaming not allowed in this location area);

The MS shall delete any RAI, P-TMSI, P-TMSI signature and GPRS ciphering key sequence number, shall set the GPRS update status to GU3 ROAMING NOT ALLOWED (and shall store it according to clause 4.1.3.2) and shall reset the GPRS attach attempt counter. The state is changed to GMM-DEREGISTERED.LIMITED-SERVICE or optionally to GMM-DEREGISTERED.PLMN-SEARCH.

The MS shall store the LAI in the list of "forbidden location areas for roaming".

The MS shall start timer T3340 as described in subclause 4.7.1.9.

If no RR connection exists, the MS shall perform the following additional actions immediately. If the MS is operating in MS operation mode A and an RR connection exists, the MS shall perform these actions when the RR connection is subsequently released:

- If the MS is IMSI attached, the MS shall set the update status to U3 ROAMING NOT ALLOWED, shall delete any TMSI, LAI and ciphering key sequence number and shall reset the location update attempt counter. The new MM state is MM IDLE.
- The MS shall perform a PLMN selection according to 3GPP TS 23.122 [14].

An MS in GAN mode shall request a PLMN list in GAN (see 3GPP TS 44.318 [76b]) prior to perform a PLMN selection from this list according to 3GPP TS 23.122 [14].

If S1 mode is supported in the MS, the MS shall handle the EMM parameters EMM state, EPS update status, GUTI, last visited registered TAI, TAI list, KSI and attach attempt counter as specified in 3GPP TS 24.301 [120] for the case when the attach procedure is rejected with the EMM cause with the same value.

14 (GPRS services not allowed in this PLMN);

The MS shall delete any RAI, P-TMSI, P-TMSI signature, and GPRS ciphering key sequence number stored, shall set the GPRS update status to GU3 ROAMING NOT ALLOWED (and shall store it according to subclause 4.1.3.2), shall reset the GPRS attach attempt counter and shall change to state GMM-DEREGISTERED.

The MS shall store the PLMN identity in the "forbidden PLMNs for GPRS service" list and if the MS is configured to use timer T3245 (see 3GPP TS 24.368 [135] or 3GPP TS 31.102 [112]) then the MS shall start timer T3245 and proceed as described in subclause 4.1.1.6. A GPRS MS operating in MS operation mode C shall perform a PLMN selection instead of a cell selection. If the message has been successfully integrity checked by the lower layers and the MS maintains a PLMN-specific PS-attempt counter for that PLMN, then the MS shall set this counter to the MS implementation-specific maximum value.

A GPRS MS operating in MS operation mode A or B in network operation mode II, is still IMSI attached for CS services in the network.

As an implementation option, a GPRS MS operating in operation mode A or B may perform the following additional action. If no RR connection exists the MS may perform the action immediately. If the MS is operating in MS operation mode A and an RR connection exists, the MS may only perform the action when the RR connection is subsequently released:

- The MS may perform a PLMN selection according to 3GPP TS 23.122 [14].

If an MS in GAN mode performs a PLMN selection, it shall request a PLMN list in GAN (see 3GPP TS 44.318 [76b]) prior to perform a PLMN selection from this list according to 3GPP TS 23.122 [14].

The MS shall not perform the optional PLMN selection in the case where the PLMN providing this reject cause is:

- On the "User Controlled PLMN Selector with Access Technology" list;
- On the "Operator Controlled PLMN Selector with Access Technology" list;
- On the "PLMN Selector" list for an MS using a SIM/USIM without access technology information storage (i.e. the "User Controlled PLMN Selector with Access Technology" and the "Operator Controlled PLMN Selector with Access Technology" data files are not present); or
- A PLMN identified as equivalent to any PLMN, within the same country, contained in the lists above.

If S1 mode is supported in the MS, the MS shall handle the EMM parameters EMM state, EPS update status, GUTI, last visited registered TAI, TAI list, KSI and attach attempt counter as specified in 3GPP TS 24.301 [120] for the case when the attach procedure is rejected with the EMM cause with the same value.

15 (No Suitable Cells In Location Area);

The MS shall delete any RAI, P-TMSI, P-TMSI signature and GPRS ciphering key sequence number, shall set the GPRS update status to GU3 ROAMING NOT ALLOWED (and shall store it according to clause 4.1.3.2) and

shall reset the GPRS attach attempt counter. The state is changed to GMM-DEREGISTERED.LIMITED-SERVICE.

The MS shall store the LAI in the list of "forbidden location areas for roaming".

The MS shall start timer T3340 as described in subclause 4.7.1.9.

If no RR connection exists, the MS shall perform the following additional actions immediately. If the MS is operating in MS operation mode A and an RR connection exists, the MS shall perform these actions when the RR connection is subsequently released:

- If the MS is IMSI attached, the MS shall set the update status to U3 ROAMING NOT ALLOWED, shall delete any TMSI, LAI and ciphering key sequence number and shall reset the location update attempt counter. The new MM state is MM IDLE.
- The MS shall search for a suitable cell in another location area or a tracking area according to 3GPP TS 43.022 [82] and 3GPP TS 25.304 [98] or 3GPP TS 36.304 [121].

NOTE 4: The cell selection procedure is not applicable for an MS in GAN mode.

If S1 mode is supported in the MS, the MS shall handle the EMM parameters EMM state, EPS update status, GUTI, last visited registered TAI, TAI list, KSI and attach attempt counter as specified in 3GPP TS 24.301 [120] for the case when the attach procedure is rejected with the EMM cause with the same value.

22 (Congestion);

If the T3346 value IE is present in the ATTACH REJECT message and the value indicates that this timer is neither zero nor deactivated, the MS shall proceed as described below, otherwise it shall be considered as an abnormal case and the behaviour of the MS for this case is specified in subclause 4.7.3.1.5.

The MS shall abort the attach procedure, reset the GPRS attach attempt counter, set the GPRS update status to GU2 NOT UPDATED and enter state GMM-DEREGISTERED.ATTEMPTING-TO-ATTACH.

The MS shall stop timer T3346 if it is running.

If the ATTACH REJECT message is integrity protected, the MS shall start timer T3346 with the value provided in the T3346 value IE.

If the ATTACH REJECT message is not integrity protected, the MS shall start timer T3346 with a random value from the default range specified in table 11.3a.

The MS stays in the current serving cell and applies the normal cell reselection process. The attach procedure is started if still needed when timer T3346 expires or is stopped.

If S1 mode is supported in the MS, the MS shall handle the EMM parameters EMM state, EPS update status, and attach attempt counter as specified in 3GPP TS 24.301 [120] for the case when the attach procedure is rejected with the EMM cause with the same value.

25 (Not authorized for this CSG);

Cause #25 is only applicable in UTRAN Iu mode and when received from a CSG cell. Other cases are considered as abnormal cases and the specification of the mobile station behaviour is given in subclause 4.7.3.1.5.

The MS shall set the GPRS update status to GU3 ROAMING NOT ALLOWED (and shall store it according to subclause 4.1.3.2), reset the GPRS attach attempt counter and enter the state GMM-DEREGISTERED.LIMITED-SERVICE.

If the CSG ID and associated PLMN identity of the cell where the MS has sent the ATTACH REQUEST message are contained in the Allowed CSG list stored in the MS, the MS shall remove the entry corresponding to this CSG ID and associated PLMN identity from the Allowed CSG list.

If the CSG ID and associated PLMN identity of the cell where the MS has sent the ATTACH REQUEST message are contained in the Operator CSG list stored in the MS, the MS shall proceed as specified in 3GPP TS 23.122 [14] subclause 3.1A.

The MS shall start timer T3340 as described in subclause 4.7.1.9.

The MS shall search for a suitable cell according to 3GPP TS 43.022 [82] and 3GPP TS 25.304 [98].

If S1 mode is supported in the MS, the MS shall handle the EMM parameters EMM state, EPS update status, GUTI, last visited registered TAI, TAI list, KSI and attach attempt counter as specified in 3GPP TS 24.301 [120] for the case when the attach procedure is rejected with the EMM cause with the same value.

Other values are considered as abnormal cases. The specification of the MS behaviour in those cases is specified in subclause 4.7.3.1.5.

4.7.3.1.4a GPRS attach for emergency bearer services not accepted by the network (UTRAN lu mode only)

If the attach request for emergency bearer services cannot be accepted by the network, an ATTACH REJECT message is transferred to the MS. The ATTACH REJECT message includes GMM cause #5 "IMEI not accepted" or one of the GMM cause values as described in subclause 4.7.3.1.4.

NOTE 1: If GMM cause #11 is sent to a MS of a roaming subscriber attaching for emergency bearer services and the MS is in automatic network selection mode, it cannot obtain normal service provided by this PLMN.

Upon receiving the ATTACH REJECT message including GMM cause #5, the MS shall enter the state GMM-DEREGISTERED.NO-IMSI.

Upon receiving the ATTACH REJECT message including one of the other GMM cause values, the MS shall perform the actions as described in subclause 4.7.3.1.4 with the following addition: the MS shall inform the upper layers of the failure of the procedure.

NOTE 2: This can result in the upper layers requesting establishment of a CS emergency call (if not already attempted in the CS domain), or other implementation specific mechanisms, e.g. procedures specified in 3GPP TS 24.229 [13D] can result in the emergency call being attempted to another IP-CAN.

If the attach request for emergency bearer services fails due to abnormal case a) in subclause 4.7.3.1.5, the MS shall perform the actions as described in subclause 4.7.3.1.5 and inform the upper layers of the failure to access the network.

NOTE 3: This can result in the upper layers requesting establishment of a CS emergency call (if not already attempted in the CS domain), or other implementation specific mechanisms, e.g. procedures specified in 3GPP TS 24.229 [13D] can result in the emergency call being attempted to another IP-CAN.

If the attach request for emergency bearer services fails due to abnormal cases b), c) or d) in subclause 4.7.3.1.5, the MS shall perform the actions as described in subclause 4.7.3.1.5 with the following addition: the MS shall inform the upper layers of the failure of the procedure.

NOTE 4: This can result in the upper layers requesting establishment of a CS emergency call (if not already attempted in the CS domain), or other implementation specific mechanisms, e.g. procedures specified in 3GPP TS 24.229 [13D] can result in the emergency call being attempted to another IP-CAN.

In a shared network, upon receiving the ATTACH REJECT message, the MS shall perform the actions as described in subclause 4.7.3.1.4, and shall:

a) inform the upper layers of the failure of the procedure; or

NOTE 5: This can result in the upper layers requesting establishment of a CS emergency call (if not already attempted in the CS domain), or other implementation specific mechanisms, e.g. procedures specified in 3GPP TS 24.229 [13D] can result in the emergency call being attempted to another IP-CAN.

b) attempt the attach for emergency bearer services to another PLMN in the shared network.

In a shared network, if the attach request for emergency bearer services fails due to abnormal case a) in subclause 4.7.3.1.5, the MS shall perform the actions as described in subclause 4.7.3.1.5 and shall:

a) inform the upper layers of the failure to access the network; or

NOTE 6: This can result in the upper layers requesting establishment of a CS emergency call (if not already attempted in the CS domain), or other implementation specific mechanisms, e.g. procedures specified in 3GPP TS 24.229 [13D] can result in the emergency call being attempted to another IP-CAN.

b) attempt the attach for emergency bearer services to another PLMN in the shared network.

In a shared network, if the attach request for emergency bearer services fails due to abnormal cases b), c) or d) in subclause 4.7.3.1.5, the MS shall perform the actions as described in subclause 4.7.3.1.5, and shall:

a) inform the upper layers of the failure of the procedure; or

NOTE 7: This can result in the upper layers requesting establishment of a CS emergency call (if not already attempted in the CS domain), or other implementation specific mechanisms, e.g. procedures specified in 3GPP TS 24.229 [13D] can result in the emergency call being attempted to another IP-CAN.

b) attempt the attach for emergency bearer services to another PLMN in the shared network.

4.7.3.1.4b Attach for initiating a PDN connection for emergency bearer services not accepted by the network (UTRAN Iu mode only)

If the network cannot accept the attach request for initiating a PDN connection for emergency bearer services with attach type not set to "emergency attach", the MS shall perform the procedures as described in subclause 4.7.3.1.4. Then if the MS is in the same selected PLMN where the last attach request was attempted, the MS shall:

a) inform the upper layers of the failure of the procedure; or

NOTE 1: This can result in the upper layers requesting establishment of a CS emergency call (if not already attempted in the CS domain) or other implementation specific mechanisms, e.g. procedures specified in 3GPP TS 24.229 [95] that can result in the emergency call being attempted to another IP-CAN.

b) attempt GPRS attach for emergency bearer services.

If the attach request for initiating a PDN connection for emergency bearer services with attach type not set to "emergency attach" fails due to abnormal case a) in subclause 4.7.3.1.5, the MS shall perform the procedures as described in subclause 4.7.3.1.5 and inform the upper layers of the failure to access the network.

NOTE 2: This can result in the MS attempting a CS emergency call (if not already attempted in the CS domain) or other implementation specific mechanisms, e.g. procedures specified in 3GPP TS 24.229 [95] that can result in the emergency call being attempted to another IP-CAN.

If the attach request for initiating a PDN connection for emergency bearer services with attach type not set to "emergency attach" fails due to abnormal cases b), c) or d) in subclause 4.7.3.1.5, the MS shall perform the procedures as described in subclause 4.7.3.1.5. Then if the MS is in the same selected PLMN where the last attach request was attempted, the MS shall:

a) inform the upper layers; or

NOTE 3: This can result in the MS attempting a CS emergency call (if not already attempted in the CS domain) or other implementation specific mechanisms, e.g. procedures specified in 3GPP TS 24.229 [95] that can result in the emergency call being attempted to another IP-CAN.

b) attempt GPRS attach for emergency bearer services.

4.7.3.1.5 Abnormal cases in the MS

The following abnormal cases can be identified:

a) Access barred because of access class control, EAB or ACDC

The GPRS attach procedure shall not be started. The MS stays in the current serving cell and applies normal cell reselection process. The GPRS attach procedure is started as soon as possible, i.e. when access is granted or because of a cell change.

If access is barred because of access class control, ACDC is applicable to the request from the upper layers and the MS supports ACDC, then the GPRS attach procedure shall be started.

If access is barred for a certain ACDC category, a request with a higher ACDC category is received from the upper layers and the MS supports ACDC, then the GPRS attach procedure shall be started.

If an access request for an uncategorized application is barred due to ACDC, a request with a certain ACDC category is received from the upper layers and the MS supports ACDC, then the GPRS attach procedure shall be started.

- b) Lower layer failure without "Extended Wait Time" received from lower layers before the ATTACH ACCEPT or ATTACH REJECT message is received

The procedure shall be aborted and the MS shall proceed as described below, except in the following implementation option cases b.1 and b.2.

- b.1) Release of PS signalling connection in Iu mode before the completion of the GPRS attach procedure

If the release of the PS signalling connection occurs before completion of the GPRS attach procedure, then the GPRS attach procedure shall be initiated again, if the following conditions apply:

- i) The original GPRS attach procedure was initiated over an existing PS signalling connection; and
- ii) The GPRS attach procedure was not due to timer T3310 expiry; and
- iii) No SECURITY MODE COMMAND message and no Non-Access Stratum (NAS) messages relating to the PS signalling connection (e.g. PS authentication procedure, see subclause 4.7.7) were received after the ATTACH REQUEST message was transmitted.

- b.2) RR release in Iu mode (i.e. RRC connection release) with, for example, cause "Normal", or "User inactivity" (see 3GPP TS 25.331 [23c] and 3GPP TS 44.118 [111])

The GPRS attach procedure shall be initiated again, if the following conditions apply:

- i) The original GPRS attach procedure was initiated over an existing RRC connection; and
- ii) The GPRS attach procedure was not due to timer T3310 expiry; and
- iii) No SECURITY MODE COMMAND message and no Non-Access Stratum (NAS) messages relating to the PS signalling connection (e.g. PS authentication procedure, see subclause 4.7.7) were received after the ATTACH REQUEST message was transmitted.

NOTE 1: The RRC connection release cause that triggers the re-initiation of the GPRS attach procedure is implementation specific.

- c) T3310 time-out

On the first expiry of the timer, the MS shall reset and restart timer T3310 and shall retransmit the ATTACH REQUEST message. This retransmission is repeated four times, i.e. on the fifth expiry of timer T3310, the MS shall abort the GPRS attach procedure and, in Iu mode, release the PS signalling connection (see 3GPP TS 25.331 [23c]). The MS shall proceed as described below.

- d) ATTACH REJECT, other causes than those treated in subclause 4.7.3.1.4, and cases of GMM cause values #22 and #25, if considered as abnormal cases according to subclause 4.7.3.1.4

If the attach request is neither for emergency bearer services nor for initiating a PDN connection for emergency bearer services with attach type not set to "emergency attach", upon reception of the cause codes # 95, # 96, # 97, # 99 and # 111 the MS should set the GPRS attach attempt counter to 5.

The MS shall proceed as described below.

- e) Change of cell within the same RA (A/Gb mode only)

If a cell change occurs within the same RA when the MS is in state GMM-REGISTERED-INITIATED, then the cell update procedure shall be performed before completion of the attach procedure.

f) Change of cell into a new routing area

If a cell change into a new routing area occurs before an ATTACH ACCEPT or ATTACH REJECT message has been received, the GPRS attach procedure shall be aborted and re-initiated immediately. If a routing area border is crossed when the ATTACH ACCEPT message is received but before an ATTACH COMPLETE message is sent, the GPRS attach procedure shall be aborted and the routing area updating procedure shall be initiated. If a P-TMSI was allocated during the GPRS attach procedure, this P-TMSI shall be used in the routing area updating procedure. If a P-TMSI signature was allocated together with the P-TMSI during the GPRS attach procedure, this P-TMSI signature shall be used in the routing area updating procedure.

g) Mobile originated detach required

If the MS is in state GMM-REGISTERED-INITIATED, the GPRS attach procedure shall be aborted and the GPRS detach procedure shall be performed (see subclause 4.7.4.1).

h) Detach procedure collision

If the MS receives a DETACH REQUEST message from the network in state GMM-REGISTERED-INITIATED with detach type "re-attach not required" and no cause code, or "re-attach not required" and the cause code is not #2 "IMSI unknown in HLR", the GPRS detach procedure shall be progressed and the GPRS attach procedure shall be aborted. Otherwise the GPRS attach procedure shall be progressed and the DETACH REQUEST message shall be ignored.

i) "Extended wait time" for PS domain from the lower layers

If the ATTACH REQUEST message contained the low priority indicator set to "MS is configured for NAS signalling low priority", the MS shall start timer T3346 with the "Extended wait time" value and reset the attach attempt counter.

In other cases the MS shall ignore the "Extended wait time".

The MS shall abort the attach procedure, stay in the current serving cell, change the state to GMM-DEREGISTERED.ATTEMPTING-TO-ATTACH and apply the normal cell reselection process.

j) Timer T3346 is running

The MS shall not start the GPRS attach procedure unless the MS needs to attach for emergency bearer services or the MS is an MS configured to use AC11 – 15 in selected PLMN or the MS needs to attach without the NAS signalling low priority indication and if the timer T3346 was started due to rejection of a NAS request message (e.g. ATTACH REQUEST, ROUTING AREA UPDATE REQUEST or SERVICE REQUEST) which contained the low priority indicator set to "MS is configured for NAS signalling low priority". The MS stays in the current serving cell and applies normal cell reselection process.

NOTE 2: It is considered an abnormal case if the MS needs to initiate an attach procedure while timer T3346 is running independent on whether timer T3346 was started due to an abnormal case or a non successful case.

In cases b, c, d, i and j, the MS shall proceed as follows:

- Timer T3310 shall be stopped if still running.
- For the cases b, c, d, and i when the "Extended wait time" is ignored, if the attach request is neither for emergency bearer services nor for initiating a PDN connection for emergency bearer services with attach type not set to "emergency attach", the GPRS attach attempt counter shall be incremented.
- If the GPRS attach attempt counter is less than 5:
 - for the cases i and j, the GPRS attach procedure is started, if still necessary, when timer T3346 expires or is stopped.
 - for the cases b, c, d, and i when the "Extended wait time" is ignored, if the attach request is neither for emergency bearer services nor for initiating a PDN connection for emergency bearer services with attach type not set to "emergency attach", timer T3311 is started and the state is changed to GMM-DEREGISTERED.ATTEMPTING-TO-ATTACH.
- If the GPRS attach attempt counter is greater than or equal to 5:

- the MS shall delete any RAI, P-TMSI, P-TMSI signature, list of equivalent PLMNs, and GPRS ciphering key sequence number, shall set the GPRS update status to GU2 NOT UPDATED, shall start timer T3302. The state is changed to GMM-DEREGISTERED. ATTEMPTING-TO-ATTACH or optionally to GMM-DEREGISTERED.PLMN-SEARCH (see subclause 4.2.4.1.2) in order to perform a PLMN selection according to 3GPP TS 23.122 [14].
- If S1 mode is supported by the MS, the MS shall in addition handle the EMM parameters EMM state, EPS update status, GUTI, last visited registered TAI, TAI list and KSI as specified in 3GPP TS 24.301 [120] for the abnormal case when a normal attach procedure fails and the attach attempt counter is equal to 5.

4.7.3.1.6 Abnormal cases on the network side

The following abnormal cases can be identified:

a) Lower layer failure

If a low layer failure occurs before the message ATTACH COMPLETE has been received from the MS and a new P-TMSI (or a new P-TMSI and a new P-TMSI signature) has been assigned, the network shall consider both the old and new P-TMSI each with its corresponding P-TMSI-signature as valid until the old P-TMSI can be considered as invalid by the network (see subclause 4.7.1.5) or the GMM context which has been marked as detached in the network is released, and shall not resent the message ATTACH ACCEPT. During this period the network may:

- use the identification procedure followed by a P-TMSI reallocation procedure if the old P-TMSI is used by the MS in a subsequent message.

b) Protocol error

If the ATTACH REQUEST message is received with a protocol error, the network shall return an ATTACH REJECT message with one of the following reject causes:

- #96: Mandatory information element error;
- #99: Information element non-existent or not implemented;
- #100: Conditional IE error;
- #111: Protocol error, unspecified.

c) T3350 time-out

On the first expiry of the timer, the network shall retransmit the ATTACH ACCEPT message and shall reset and restart timer T3350.

This retransmission is repeated four times, i.e. on the fifth expiry of timer T3350, the GPRS attach procedure shall be aborted. If a new P-TMSI or a new P-TMSI together with a new P-TMSI signature were allocated in the ATTACH ACCEPT message, the network shall consider both the old and new P-TMSI each together with the corresponding P-TMSI signatures as valid until the old P-TMSI can be considered as invalid by the network (see subclause 4.7.1.5) or the GMM context which has been marked as detached in the network is released. During this period the network acts as specified for case a.

d.1) ATTACH REQUEST received after the ATTACH ACCEPT message has been sent and before the ATTACH COMPLETE message is received

- If one or more of the information elements in the ATTACH REQUEST message differ from the ones received within the previous ATTACH REQUEST message, the previously initiated GPRS attach procedure shall be aborted if the ATTACH COMPLETE message has not been received and the new GPRS attach procedure shall be progressed, or
- If the information elements do not differ, then the ATTACH ACCEPT message shall be resent and the timer T3350 shall be restarted if an ATTACH COMPLETE message is expected. In that case, the retransmission counter related to T3350 is not incremented.

d.2) More than one ATTACH REQUEST received and no ATTACH ACCEPT or ATTACH REJECT message has been sent

- If one or more of the information elements in the ATTACH REQUEST message differs from the ones received within the previous ATTACH REQUEST message, the previously initiated GPRS attach procedure shall be aborted and the new GPRS attach procedure shall be progressed;
- If the information elements do not differ, then the network shall continue with the previous attach procedure and shall not treat any further this ATTACH REQUEST message.

e) ATTACH REQUEST received in state GMM-REGISTERED

If an ATTACH REQUEST message is received in state GMM-REGISTERED the network may initiate the GMM common procedures; if it turned out that the ATTACH REQUEST message was send by an MS that has already been attached, the GMM context, PDP contexts and MBMS contexts, if any, are deleted and the new ATTACH REQUEST is progressed.

f) ROUTING AREA UPDATE REQUEST message received before ATTACH COMPLETE message.

Timer T3350 shall be stopped. The allocated P-TMSI shall be considered as valid and the routing area updating procedure shall be progressed as described in subclause 4.7.5.

g) DETACH REQUEST message received before ATTACH COMPLETE message.

The network shall abort the attach procedure and shall progress the detach procedure as described in subclause 4.7.4.1.

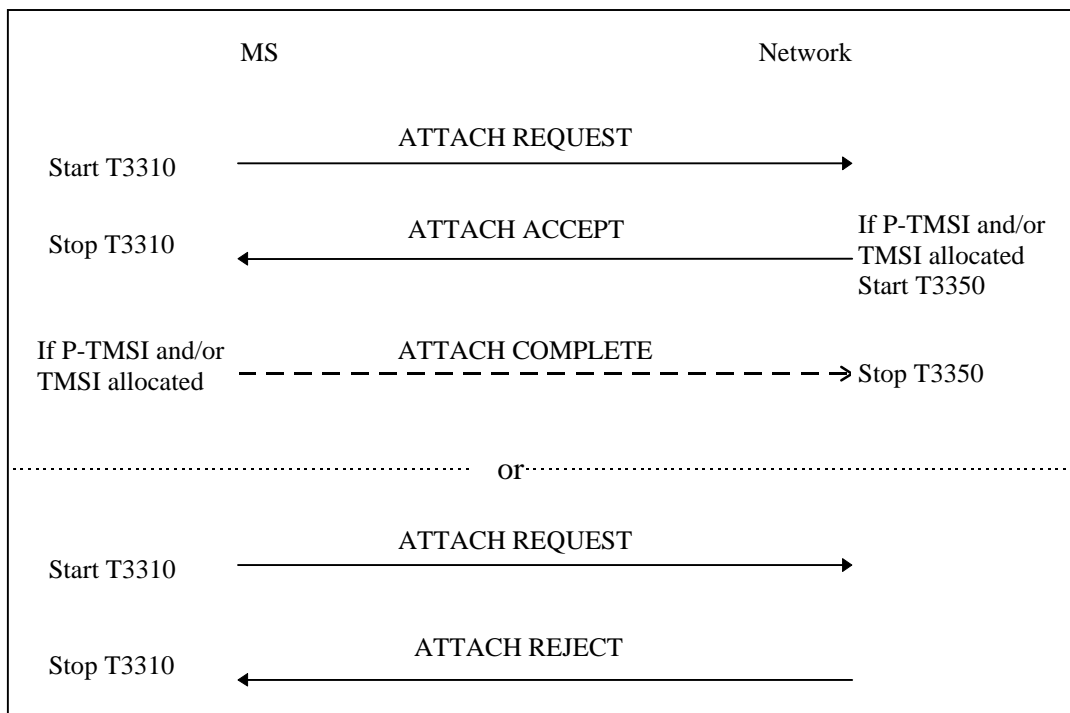

Figure 4.7.3/1 3GPP TS 24.008: GPRS attach procedure and combined GPRS attach procedure

4.7.3.2 Combined GPRS attach procedure for GPRS and non-GPRS services

The combined GPRS attach procedure is a GMM procedure used by a GPRS MS operating in MS operation modes A or B for IMSI attach for GPRS and non-GPRS services if the network operates in network operation mode I.

If a GPRS MS operating in MS operation modes A or B is already attached for non-GPRS services by use of the MM specific IMSI attach procedure, but additionally wishes to perform an IMSI attach for GPRS services, the combined GPRS attach procedure shall also be used.

The attach type information element shall indicate "combined GPRS/IMSI attach". In this case, the messages ATTACH ACCEPT, ATTACH COMPLETE, and ATTACH REJECT used by the combined GPRS attach procedure carry information for both the GPRS and the non-GPRS services.

A GPRS MS in MS operation mode A shall perform the normal GPRS/IMSI attach procedure during an ongoing circuit-switched transaction.

4.7.3.2.1 Combined GPRS attach procedure initiation

If the MS is in GMM state GMM-DEREGISTERED and in MM state MM IDLE, the MS initiates the combined GPRS attach procedure by sending an ATTACH REQUEST message to the network, starts timer T3310 and enters state GMM-REGISTERED-INITIATED and MM LOCATION UPDATING PENDING. If timer T3302 is currently running, the MS shall stop timer T3302. If timer T3311 is currently running, the MS shall stop timer T3311.

The MS shall set the Mobile identity IE, old RAI and P-TMSI signature in the ATTACH REQUEST message as specified in subclause 4.7.3.1.1. Furthermore the MS shall include the TMSI status IE if no valid TMSI is available.

If the MS initiates a combined GPRS attach procedure for GPRS services and "SMS-only service", the MS shall indicate "SMS only" in the Additional update type IE.

If the MS has stored a valid LAI and the MS supports EMM combined procedures, the MS shall include it in the Old location area identification IE in the ATTACH REQUEST message.

If the MS has stored a valid TMSI, the MS shall include the TMSI based NRI container IE in the ATTACH REQUEST message.

In Iu mode, if the MS wishes to prolong the established PS signalling connection after the GPRS attach (for example, the MS has any CM application request pending), it may set a follow-on request pending indicator on (see subclause 4.7.13).

4.7.3.2.2 GMM Common procedure initiation

The network may initiate GMM common procedures, e.g. the GMM identification and GMM authentication and ciphering procedure, depending on the received information such as IMSI, CKSN, old RAI, P-TMSI and P-TMSI signature.

4.7.3.2.3 Combined GPRS attach accepted by the network

Depending on the value of the attach result IE received in the ATTACH ACCEPT message, two different cases can be distinguished:

- Case 1) The attach result IE value indicates "combined GPRS attach": IMSI attach for GPRS and non-GPRS services have been successful.
- Case 2) The attach result IE value indicates "GPRS only": IMSI attach for GPRS services has been successful but IMSI attach for non-GPRS services has not been successful.

In Iu mode, if the network wishes to prolong the PS signalling connection (for example, if the mobile station has indicated "follow-on request pending" in ATTACH REQUEST message) the network shall indicate the "follow-on proceed" in the ATTACH ACCEPT message. If the network wishes to release the PS signalling connection, the network shall indicate "no follow-on proceed" in the ATTACH ACCEPT message.

After that in Iu mode, the mobile station shall act according to the follow-on proceed flag included in the Attach result information element in the ATTACH ACCEPT message (see subclause 4.7.13).

4.7.3.2.3.1 Combined attach successful for GPRS and non-GPRS services

The description for IMSI attach for GPRS services as specified in subclause 4.7.3.1.3 shall be followed. In addition, the following description for IMSI attach for non-GPRS services applies.

The TMSI reallocation may be part of the combined GPRS attach procedure. The TMSI allocated is then included in the ATTACH ACCEPT message together with the location area identification (LAI). The network shall, in this case, change to state GMM-COMMON-PROCEDURE-INITIATED and shall start timer T3350 as described in subclause 4.7.6.

The MS, receiving an ATTACH ACCEPT message, stores the received location area identification, stops timer T3310, reset the location update attempt counter and sets the update status to U1 UPDATED. If the message contains an IMSI, the mobile station is not allocated any TMSI, and shall delete any TMSI accordingly. If the message contains a TMSI, the MS shall use this TMSI as the new temporary identity. The MS shall delete its old TMSI and shall store the new TMSI. In this case, an ATTACH COMPLETE message is returned to the network. If neither a TMSI nor an IMSI has been included by the network in the ATTACH ACCEPT message, the old TMSI, if any available, shall be kept. The new MM state is MM IDLE, the new GMM state is GMM-REGISTERED.

If the MS maintains a counter for "SIM/USIM considered invalid for non-GPRS services" events (see subclause 4.1.1.6A), then the MS shall reset this counter.

If the network has requested the provision of Inter RAT handover information, the MS shall return an ATTACH COMPLETE message including the Inter RAT handover information IE to the network.

If the MS is not configured for NAS signalling low priority then the MS may stop timer T3246 if running.

Any timer used for triggering the location update procedure (e.g T3211, T3212) shall be stopped if running.

The network receiving an ATTACH COMPLETE message stops timer T3350, changes to state GMM-REGISTERED.

NOTE: Upon receiving an ATTACH COMPLETE message, the SGSN sends a BSSAP+-TMSI-REALLOCATION-COMplete message as specified in 3GPP TS 29.018 [149].

4.7.3.2.3.2 Combined attach successful for GPRS services only

Apart from the actions on the routing area updating attempt counter, the description for IMSI attach for GPRS services as specified in subclause 4.7.3.1.3 shall be followed. In addition, the following description for IMSI attach for non-GPRS services applies.

The SGSN shall use GMM cause #28 "SMS provided via GPRS in this routing area" in the ATTACH ACCEPT message only if the MS requested "SMS-only service" by including the Additional update type IE in the ATTACH REQUEST message.

The MS receiving the ATTACH ACCEPT message takes one of the following actions depending on the GMM cause:

2 (IMSI unknown in HLR)

The MS shall stop timer T3310 if still running and shall reset the routing area updating attempt counter. The MS shall set the update status to U3 ROAMING NOT ALLOWED and shall delete any TMSI, LAI and ciphering key sequence number. The MS shall enter state GMM-REGISTERED.NORMAL-SERVICE. The new MM state is MM IDLE. The SIM/USIM shall be considered as invalid for non-GPRS services until switching off or the SIM/USIM is removed. If the message has been successfully integrity checked by the lower layers and the MS maintains a counter for "SIM/USIM considered invalid for non-GPRS services", then the MS shall set this counter to MS implementation-specific maximum value.

16 (MSC temporarily not reachable); or

17 (Network failure)

The MS shall stop timer T3310 if still running, and shall enter state MM-IDLE. The routing area updating attempt counter shall be incremented.

If the routing area updating attempt counter is less than 5, and the stored RAI is equal to the RAI of the current serving cell and the GMM update status is equal to GU1 UPDATED:

- the MS shall keep the GMM update status GU1 UPDATED and changes state to GMM-REGISTERED.ATTEMPTING-TO-UPDATE-MM. The MS shall start timer T3311. When timer T3311 expires the combined routing area update procedure indicating "combined RA/LA updating with IMSI attach" is triggered again.

If the routing area updating attempt counter is greater than or equal to 5:

- the MS shall start timer T3302 and shall change to state GMM-REGISTERED.ATTEMPTING-TO-UPDATE-MM;
- a GPRS MS operating in MS operation mode A shall then proceed with appropriate MM specific procedure; a GPRS MS operating in MS operation mode B may then proceed with appropriate MM specific procedures. The MM sublayer shall act as in network operation mode II as long as the combined GMM procedures are not successful and no new RA is entered.

22 (Congestion)

The MS shall change to state GMM-REGISTERED.ATTEMPTING-TO-UPDATE-MM, shall stop timer T3310 if still running, and shall enter state MM-IDLE. The MS shall set the routing area updating attempt counter to 5 and shall start the timer T3302.

28 (SMS provided via GPRS in this routing area);

The MS shall stop timer T3310 if still running and shall reset the routing area updating attempt counter. The MS shall set the update status to U3 ROAMING NOT ALLOWED and shall delete any TMSI, LAI and ciphering key sequence number. The MS shall enter state GMM-REGISTERED.NORMAL-SERVICE. The new MM state is MM IDLE.

The MS stays in the current serving cell and applies the normal cell reselection process.

Other GMM causevalues and the case that no GMM cause IE was received are considered as abnormal cases. The combined attach procedure shall be considered as failed for non-GPRS services. The behaviour of the MS in those cases is specified in subclause 4.7.3.2.5.

4.7.3.2.4 Combined GPRS attach not accepted by the network

If the attach request can neither be accepted by the network for GPRS nor for non-GPRS services, an ATTACH REJECT message is transferred to the MS. The MS receiving the ATTACH REJECT message containing a reject cause other than GMM cause value #25 or the message is integrity protected, shall stop the timer T3310, and for all causes except #7, #12, #14, #15, #22 and #25 deletes the list of "equivalent PLMNs".

If the ATTACH REJECT message containing GMM cause value #25 was received without integrity protection, then the MS shall discard the message.

If the attach request is rejected due to NAS level mobility management congestion control, the network shall set the GMM cause value to #22 "congestion" and assign a back-off timer T3346.

The MS shall then take one of the following actions depending upon the reject cause:

- # 3 (Illegal MS);
- # 6 (Illegal ME), or
- # 8 (GPRS services and non-GPRS services not allowed);

The MS shall set the GPRS update status to GU3 ROAMING NOT ALLOWED (shall store it according to subclause 4.1.3.2) and shall delete any P-TMSI, P-TMSI signature, RAI and GPRS ciphering key sequence number. The new GMM state is GMM-DEREGISTERED.NO-IMSI. The new MM state is MM IDLE.

The MS shall set the update status to U3 ROAMING NOT ALLOWED, shall delete any TMSI, LAI and ciphering key sequence number. The SIM/USIM shall be considered as invalid for GPRS and non-GPRS services until switching off or the SIM/USIM is removed or the timer T3245 expires as described in subclause 4.1.1.6.

If the message has been successfully integrity checked by the lower layers and the MS maintains a counter for "SIM/USIM considered invalid for GPRS services", then the MS shall set this counter to MS implementation-specific maximum value. If the message has been successfully integrity checked by the lower layers and the MS

maintains a counter for "SIM/USIM considered invalid for non-GPRS services", then the MS shall set this counter to MS implementation-specific maximum value.

NOTE 1: Optionally the MS starts the timer T3340 as described in subclause 4.7.1.9 for reject cause #8

If S1 mode is supported in the MS, the MS shall handle the EMM parameters EMM state, EPS update status, GUTI, last visited registered TAI, TAI list and KSI as specified in 3GPP TS 24.301 [120] for the case when the combined attach procedure is rejected with the EMM cause with the same value.

7 (GPRS services not allowed);

The MS shall set the GPRS update status to GU3 ROAMING NOT ALLOWED (and shall store it according to subclause 4.1.3.2) and shall delete any P-TMSI, P-TMSI signature, RAI and GPRS ciphering key sequence number. The SIM/USIM shall be considered as invalid for GPRS services until switching off or the SIM/USIM is removed. The new GMM state is GMM-DEREGISTERED; the MM state is MM IDLE.

If the message has been successfully integrity checked by the lower layers and the MS maintains a counter for "SIM/USIM considered invalid for GPRS services", then the MS shall set this counter to MS implementation-specific maximum value.

NOTE 2: Optionally the MS starts the timer T3340 as described in subclause 4.7.1.9.

A GPRS MS operating in MS operation mode A or B which is already IMSI attached for CS services in the network is still IMSI attached for CS services in the network.

A GPRS MS operating in MS operation mode A or B shall proceed with the appropriate MM specific procedure according to the MM service state.

If S1 mode is supported in the MS, the MS shall handle the EMM parameters EMM state, EPS update status, GUTI, last visited registered TAI, TAI list and KSI as specified in 3GPP TS 24.301 [120] for the case when the combined attach procedure is rejected with the EMM cause with the same value.

11 (PLMN not allowed);

The MS shall delete any RAI, P-TMSI, P-TMSI signature and GPRS ciphering key sequence number stored, shall set the GPRS update status to GU3 ROAMING NOT ALLOWED (and shall store it according to subclause 4.1.3.2), shall reset the GPRS attach attempt counter and changes to state GMM-DEREGISTERED.

The MS shall set the update status to U3 ROAMING NOT ALLOWED, reset the location update attempt counter and shall delete any TMSI, LAI and ciphering key sequence number. The new MM state is MM IDLE.

The MS shall store the PLMN identity in the "forbidden PLMN list" and if the MS is configured to use timer T3245 (see 3GPP TS 24.368 [135] or 3GPP TS 31.102 [112]) then the MS shall start timer T3245 and proceed as described in subclause 4.1.1.6. If the message has been successfully integrity checked by the lower layers and the MS maintains a PLMN-specific attempt counter for that PLMN, then the MS shall set this counter to the MS implementation-specific maximum value.

The MS shall start timer T3340 as described in subclause 4.7.1.9.

The MS shall perform a PLMN selection according to 3GPP TS 23.122 [14].

An MS in GAN mode shall request a PLMN list in GAN (see 3GPP TS 44.318 [76b]) prior to perform a PLMN selection from this list according to 3GPP TS 23.122 [14].

If S1 mode is supported in the MS, the MS shall handle the EMM parameters EMM state, EPS update status, GUTI, last visited registered TAI, TAI list, KSI and attach attempt counter as specified in 3GPP TS 24.301 [120] for the case when the combined attach procedure is rejected with the EMM cause with the same value.

12 (Location area not allowed);

The MS shall delete any RAI, P-TMSI, P-TMSI signature GPRS ciphering key sequence number, shall set the GPRS update status to GU3 ROAMING NOT ALLOWED (and shall store it according to clause 4.1.3.2) and shall reset the GPRS attach attempt counter. The state is changed to GMM-DEREGISTERED.LIMITED-SERVICE.

The MS shall set the update status to U3 ROAMING NOT ALLOWED, reset the location update attempt counter and shall delete any TMSI, LAI and ciphering key sequence number. The new MM state is MM IDLE.

The MS shall store the LAI in the list of "forbidden location areas for regional provision of service".

The MS shall start timer T3340 as described in subclause 4.7.1.9.

The MS shall perform a cell selection according to 3GPP TS 43.022 [82] and 3GPP TS 25.304 [98].

NOTE 3: The cell selection procedure is not applicable for an MS in GAN mode.

If S1 mode is supported in the MS, the MS shall handle the EMM parameters EMM state, EPS update status, GUTI, last visited registered TAI, TAI list, KSI and attach attempt counter as specified in 3GPP TS 24.301 [120] for the case when the combined attach procedure is rejected with the EMM cause with the same value.

13 (Roaming not allowed in this location area);

The MS shall delete any RAI, P-TMSI, P-TMSI signature and GPRS ciphering key sequence number, shall set the GPRS update status to GU3 ROAMING NOT ALLOWED (and shall store it according to clause 4.1.3.2) and shall reset the GPRS attach attempt counter. The state is changed to GMM-DEREGISTERED.LIMITED-SERVICE or optionally to GMM-DEREGISTERED.PLMN-SEARCH.

The MS shall set the update status to U3 ROAMING NOT ALLOWED, reset the location update attempt counter and shall delete any TMSI, LAI and ciphering key sequence number. The new MM state is MM IDLE.

The mobile station shall store the LAI in the list of "forbidden location areas for roaming".

The MS shall start timer T3340 as described in subclause 4.7.1.9.

The MS shall perform a PLMN selection according to 3GPP TS 23.122 [14].

An MS in GAN mode shall request a PLMN list in GAN (see 3GPP TS 44.318 [76b]) prior to perform a PLMN selection from this list according to 3GPP TS 23.122 [14].

If S1 mode is supported in the MS, the MS shall handle the EMM parameters EMM state, EPS update status, GUTI, last visited registered TAI, TAI list, KSI and attach attempt counter as specified in 3GPP TS 24.301 [120] for the case when the combined attach procedure is rejected with the EMM cause with the same value.

14 (GPRS services not allowed in this PLMN);

The MS shall delete any RAI, P-TMSI, P-TMSI signature, and GPRS ciphering key sequence number stored, shall set the GPRS update status to GU3 ROAMING NOT ALLOWED (and shall store it according to subclause 4.1.3.2), shall reset the GPRS attach attempt counter and shall change to state GMM-DEREGISTERED.

The MS shall store the PLMN identity in the "forbidden PLMNs for GPRS service" list and if the MS is configured to use timer T3245 (see 3GPP TS 24.368 [135] or 3GPP TS 31.102 [112]) then the MS shall start timer T3245 and proceed as described in subclause 4.1.1.6. If the message has been successfully integrity checked by the lower layers and the MS maintains a PLMN-specific PS-attempt counter for that PLMN, then the MS shall set this counter to the MS implementation-specific maximum value.

As an implementation option, a GPRS MS operating in operation mode A or B may perform a PLMN selection according to 3GPP TS 23.122 [14].

If an MS in GAN mode performs a PLMN selection, it shall request a PLMN list in GAN (see 3GPP TS 44.318 [76b]) prior to perform a PLMN selection from this list according to 3GPP TS 23.122 [14].

The MS shall not perform the optional PLMN selection in the case where the PLMN providing this reject cause is:

- On the "User Controlled PLMN Selector with Access Technology";
- On the "Operator Controlled PLMN Selector with Access Technology" list;

- On the "PLMN Selector" list for an MS using a SIM/USIM without access technology information storage (i.e. the "User Controlled PLMN Selector with Access Technology" and the "Operator Controlled PLMN Selector with Access Technology" data files are not present); or
- A PLMN identified as equivalent to any PLMN, within the same country, contained in the lists above.

If the MS does not perform a PLMN selection then a GPRS MS operating in MS operation mode A or B which is not yet IMSI attached for CS services in the network shall then perform an IMSI attach for non-GPRS services according to the conditions for the MM IMSI attach procedure (see subclause 4.4.3).

A GPRS MS operating in MS operation mode A or B which is already IMSI attached for CS services in the network is still IMSI attached for CS services in the network.

A GPRS MS operating in MS operation mode A or B shall proceed with the appropriate MM specific procedure according to the MM service state.

If S1 mode is supported in the MS, the MS shall handle the EMM parameters EMM state, EPS update status, GUTI, last visited registered TAI, TAI list, KSI and attach attempt counter as specified in 3GPP TS 24.301 [120] for the case when the combined attach procedure is rejected with the EMM cause with the same value.

15 (No Suitable Cells In Location Area);

The MS shall delete any RAI, P-TMSI, P-TMSI signature and GPRS ciphering key sequence number, shall set the GPRS update status to GU3 ROAMING NOT ALLOWED (and shall store it according to clause 4.1.3.2) and shall reset the GPRS attach attempt counter. The state is changed to GMM-DEREGISTERED.LIMITED-SERVICE.

The MS shall set the update status to U3 ROAMING NOT ALLOWED, reset the location update attempt counter and shall delete any TMSI, LAI and ciphering key sequence number. The new MM state is MM IDLE.

The MS shall store the LAI in the list of "forbidden location areas for roaming".

The MS shall start timer T3340 as described in subclause 4.7.1.9.

The MS shall search for a suitable cell in another location area or a tracking area according to 3GPP TS 43.022 [82] and 3GPP TS 25.304 [98] or 3GPP TS 36.304 [121].

NOTE 4: The cell selection procedure is not applicable for an MS in GAN mode.

If S1 mode is supported in the MS, the MS shall handle the EMM parameters EMM state, EPS update status, GUTI, last visited registered TAI, TAI list, KSI and attach attempt counter as specified in 3GPP TS 24.301 [120] for the case when the combined attach procedure is rejected with the EMM cause with the same value.

22 (Congestion);

If the T3346 value IE is present in the ATTACH REJECT message and the value indicates that this timer is neither zero nor deactivated, the MS shall proceed as described below, otherwise it shall be considered as an abnormal case and the behaviour of the MS for this case is specified in subclause 4.7.3.1.5.

The MS shall abort the attach procedure, reset the GPRS attach attempt counter, set the GPRS update status to GU2 NOT UPDATED and enter state GMM-DEREGISTERED.ATTEMPTING-TO-ATTACH.

The MS shall stop timer T3346 if it is running.

If the ATTACH REJECT message is integrity protected, the MS shall start timer T3346 with the value provided in the T3346 value IE.

If the ATTACH REJECT message is not integrity protected, the MS shall start timer T3346 with a random value from the default range specified in table 11.3a.

The MS stays in the current serving cell and applies the normal cell reselection process. The attach procedure is started, if still necessary, when timer T3346 expires or is stopped.

A GPRS MS operating in MS operation mode A or B which is already IMSI attached for CS services in the network is still IMSI attached for CS services in the network.

If S1 mode is supported in the MS, the MS shall handle the EMM parameters EMM state, EPS update status, and attach attempt counter as specified in 3GPP TS 24.301 [120] for the case when the attach procedure is rejected with the EMM cause with the same value.

25 (Not authorized for this CSG)

Cause #25 is only applicable in UTRAN Iu mode and when received from a CSG cell. Other cases are considered as abnormal cases and the specification of the mobile station behaviour is given in subclause 4.7.3.2.5.

The MS shall set the GPRS update status to GU3 ROAMING NOT ALLOWED (and shall store it according to subclause 4.1.3.2) and shall reset the GPRS attach attempt counter. The state is changed to GMM-DEREGISTERED.LIMITED-SERVICE.

If the CSG ID and associated PLMN identity of the cell where the MS has sent the ATTACH REQUEST message are contained in the Allowed CSG list stored in the MS, the MS shall remove the entry corresponding to this CSG ID and associated PLMN identity from the Allowed CSG list.

If the CSG ID and associated PLMN identity of the cell where the MS has sent the ATTACH REQUEST message are contained in the Operator CSG list, the MS shall proceed as specified in 3GPP TS 23.122 [14] subclause 3.1A.

The MS shall start timer T3340 as described in subclause 4.7.1.9.

If the MS is IMSI attached for non-GPRS services, the MS shall set the update status to U3 ROAMING NOT ALLOWED and shall reset the location update attempt counter. The new MM state is MM IDLE.

The MS shall search for a suitable cell according to 3GPP TS 43.022 [82] and 3GPP TS 25.304 [98].

If S1 mode is supported in the MS, the MS shall handle the EMM parameters EMM state, EPS update status, GUTI, last visited registered TAI, TAI list, KSI and attach attempt counter as specified in 3GPP TS 24.301 [120] for the case when the combined attach procedure is rejected with the EMM cause with the same value.

Other values are considered as abnormal cases. The specification of the MS behaviour in those cases is specified in subclause 4.7.3.2.5.

4.7.3.2.5 Abnormal cases in the MS

The MS shall proceed as follows:

- 1) If the combined attach was successful for GPRS services only and the ATTACH ACCEPT message contained a cause value not treated in subclause 4.7.3.2.3.2 or the GMM Cause IE is not included in the message, the MS shall proceed as follows:
 - a) The MS shall stop timer T3310 if still running, and shall enter state MM IDLE. The routing area updating attempt counter shall be incremented;
 - b) If the routing area updating attempt counter is less than 5, and the stored RAI is equal to the RAI of the current serving cell and the GMM update status is equal to GU1 UPDATED:
 - the MS shall keep the GMM update status GU1 UPDATED and changes state to GMM-REGISTERED.ATTEMPTING-TO-UPDATE-MM. The MS shall start timer T3311. When timer T3311 expires the combined routing area update procedure indicating "combined RA/LA updating with IMSI attach" is triggered again; and
 - c) If the routing area updating attempt counter is greater than or equal to 5:
 - the MS shall start timer T3302 and shall change to state GMM-REGISTERED.ATTEMPTING-TO-UPDATE-MM; and
 - a GPRS MS operating in MS operation mode A shall then proceed with appropriate MM specific procedure; a GPRS MS operating in MS operation mode B may then proceed with appropriate MM specific procedures. The MM sublayer shall act as in network operation mode II as long as the combined GMM procedures are not successful and no new RA is entered; and

2) Otherwise, the abnormal cases specified in subclause 4.7.3.1.5 apply with the following modification.

If the GPRS attach attempt counter is incremented according to subclause 4.7.3.1.5 the next actions depend on the Location Area Identities (stored on SIM/USIM and the one of the current serving cell) and the value of the attach attempt counter:

- if the update status is U1 UPDATED, and the stored LAI is equal to the one of the current serving cell and the attach attempt counter is smaller than 5, then the mobile station shall keep the update status to U1 UPDATED, the new MM state is MM IDLE substate NORMAL SERVICE;
- if the attach attempt counter is smaller than 5 and, additionally, the update status is different from U1 UPDATED or the stored LAI is different from the one of the current serving cell, then the mobile station shall delete any LAI, TMSI, ciphering key sequence number stored in the SIM/USIM and list of equivalent PLMNs and set the update status to U2 NOT UPDATED. The MM state remains MM LOCATION UPDATING PENDING; or
- if the attach attempt counter is greater or equal to 5, then the mobile station shall delete any LAI, TMSI, ciphering key sequence number stored in the SIM/USIM and list of equivalent PLMNs and set the update status to U2 NOT UPDATED.
A GPRS MS operating in MS operation mode A shall then proceed with appropriate MM specific procedure; a GPRS MS operating in MS operation mode B may then proceed with appropriate MM specific procedures. The MM sublayer shall act as in network operation mode II as long as the combined GMM procedures are not successful and no new RA is entered. The new MM state is MM IDLE substate ATTEMPTING TO UPDATE or optionally MM IDLE substate PLMN SEARCH in order to perform a PLMN selection according to 3GPP TS 23.122 [14].

4.7.3.2.6 Abnormal cases on the network side

The abnormal cases specified in subclause 4.7.3.1.6 apply.

4.7.4 GPRS detach procedure

4.7.4.0 General

The GPRS detach procedure is used:

- to detach the IMSI for GPRS services only. Independent of the network operation mode, this procedure is used by all kind of GPRS MSs;
- as a combined GPRS detach procedure used by GPRS MSs operating in MS operation mode A or B to detach the IMSI for GPRS and non-GPRS services or for non-GPRS services only, if the network operates in network operation mode I and no circuit-switched transaction is ongoing;
- in the case of a network failure condition to indicate to the MS that a re-attach with successive activation of previously active PDP contexts shall be performed. In this case, the MS may also perform the procedures needed in order to activate any previously active multicast service(s); or
- to detach the IMSI or IMEI for emergency bearer services.

After completion of a GPRS detach procedure or combined GPRS detach procedure for GPRS and non-GPRS services the GMM context is released.

An eCall only mobile station that is not capable of eCall over IMS shall not perform any kind of GPRS detach procedure.

The GPRS detach procedure shall be invoked by the MS if the MS is switched off, the SIM/USIM card is removed from the MS or if the GPRS or non-GPRS capability of the MS is disabled. The procedure may be invoked by the network to detach the IMSI for GPRS services. The GPRS detach procedure causes the MS to be marked as inactive in the network for GPRS services, non-GPRS services or both services.

If the detach procedure is triggered due to SIM/USIM removal, the MS shall indicate "switch off" in the detach type IE.

If a detach is requested by the HLR for an MS that has a PDP context for emergency services, the SGSN shall not send a DETACH REQUEST message to the MS, and shall follow the procedure described in subclause 6.1.3.4.2 for an MS that has PDP contexts for emergency bearer services.

When upper layers indicates that emergency bearer services are no longer required, the MS if still attached for emergency bearer services, may perform a detach followed by a re-attach to regain normal services, if the MS is in or moves to a suitable cell.

In A/Gb mode, if the GPRS detach procedure is performed, the PDP contexts and the MBMS contexts, if any, are deactivated locally without peer to peer signalling between the SM and LLC entities in the MS and the network.

In Iu mode, if the GPRS detach procedure is performed, the PDP contexts and the MBMS contexts, if any, are deactivated locally without peer to peer signalling between the SM entities in the MS and the network.

If the MS supports S1 mode, the MS shall store the TIN in the non-volatile memory in the ME, as described in 3GPP TS 24.301 [120], annex C, for a subsequent attach procedure.

The MS is allowed to initiate the GPRS detach procedure even if the timer T3346 is running.

The network proceeds with the GPRS detach procedure even if NAS level mobility management congestion control is active.

4.7.4.1 MS initiated GPRS detach procedure

4.7.4.1.1 MS initiated GPRS detach procedure initiation

The GPRS detach procedure is initiated by the MS by sending a DETACH REQUEST message. The detach type information element may indicate "GPRS detach with switching off", "GPRS detach without switching off", "IMSI detach", "GPRS/IMSI detach with switching off" or "GPRS/IMSI detach without switching off".

If the MS has a valid P-TMSI, the MS shall include the P-TMSI in the DETACH REQUEST message. The MS shall also include a valid P-TMSI signature, if available.

If the MS is not switched off and the MS is in the state GMM_REGISTERED, timer T3321 shall be started after the DETACH REQUEST message has been sent. If the detach type information element value indicates "IMSI Detach" the MS shall enter GMM-REGISTERED.IMSI-DETACH_INITIATED, otherwise the MS shall enter the state GMM-DEREGISTERED-INITIATED. If the detach type information element value indicates "IMSI Detach" or "GPRS/IMSI Detach", state MM IMSI DETACH PENDING is entered. If the MS to be switched off is not a MS using any of the coverage classes of EC-GSM-IoT, the MS shall try for a period of 5 seconds to send the DETACH REQUEST message. If the MS to be switched off is a MS using any of the coverage classes of EC-GSM-IoT, that MS should try for at least a period of 10 seconds to send the DETACH REQUEST message. If the MS is able to send the DETACH REQUEST message during this time the MS may be switched off.

If the detach type information element value indicates "GPRS detach without switching off" and the MS is attached for GPRS and non-GPRS services and the network operates in network operation mode I, then if in the MS the timer T3212 is not already running, the timer T3212 shall be set to its initial value and restarted after the DETACH REQUEST message has been sent.

4.7.4.1.2 MS initiated GPRS detach procedure completion for GPRS services only

When the DETACH REQUEST message is received by the network, the network shall send a DETACH ACCEPT message to the MS, if the detach type IE value indicates that the detach request has not been sent due to switching off. If switching off was indicated, the procedure is completed when the network receives the DETACH REQUEST message. The network and the MS shall deactivate the PDP contexts, the MBMS contexts and deactivate the logical link(s), if any.

The MS is marked as inactive in the network for GPRS services; state GMM-DEREGISTERED is entered in the MS and the network.

In Iu mode, if the detach has been sent due to switching off, then the network shall release the resources in the lower layers for this MS (see 3GPP TS 25.331 [23c]).

NOTE: When the DETACH REQUEST message is received by the network, and if the detach type IE value indicates that the detach is not due to power off, the authentication and ciphering procedure as well as the identification procedure may be performed.

If the MS supports S1 mode and operates in MS operation mode A or B, the MS shall disable the E-UTRA capability (see 3GPP TS 24.301 [120]).

4.7.4.1.3 MS initiated combined GPRS detach procedure completion

When the DETACH REQUEST message is received by the network, a DETACH ACCEPT message shall be sent to the MS, if the detach type IE value indicates that the detach request has not been sent due to switching off. Depending on the value of the detach type IE the following applies:

GPRS/IMSI detach:

The MS is marked as inactive in the network for GPRS and for non-GPRS services. The network and the MS shall deactivate the PDP contexts, the MBMS contexts and deactivate the logical link(s), if any. The States GMM-DEREGISTERED and MM NULL are entered in both the MS and the network.

In Iu mode, if the detach has been sent due to switching off, then the network shall release the resources in the lower layers for this MS (see 3GPP TS 25.331 [23c]).

IMSI detach:

The MS is marked as inactive in the network for non-GPRS services. State MM NULL is entered in the MS and the network.

4.7.4.1.4 Abnormal cases in the MS

The following abnormal cases can be identified:

a) T3321 time-out

On the first expiry of the timer, the MS shall retransmit the DETACH REQUEST message and shall reset and restart timer T3321. This retransmission is repeated four times, i.e. on the fifth expiry of timer T3321, the GPRS detach procedure shall be aborted, the MS shall change to state:

- MM-NULL if "IMSI detach" was requested;
- GMM-REGISTERED.NORMAL-SERVICE if "IMSI Detach" was requested;
- GMM-DEREGISTERED if "GPRS detach" was requested;
- GMM-DEREGISTERED and MM-NULL if "GPRS/IMSI" detach was requested.

b) Lower layer failure before reception of DETACH ACCEPT message

The detach procedure is aborted and the MS shall change to one of the following states, except in the following implementation option cases b.1, b.2 and b3:

- MM-NULL if "IMSI detach" was requested;
- GMM-REGISTERED.NORMAL-SERVICE if "IMSI Detach" was requested;
- GMM-DEREGISTERED if "GPRS detach" was requested;
- GMM-DEREGISTERED and MM-NULL if "IMSI/GPRS" detach was requested.

b.1) Release of PS signalling connection before the completion of the GPRS detach procedure

The release of the PS signalling connection before completion of the GPRS detach procedure shall result in the GPRS detach procedure being initiated again, if the following conditions apply:

- i) The original GPRS detach procedure was initiated over an existing PS signalling connection; and
- ii) No SECURITY MODE COMMAND message and no Non-Access Stratum (NAS) messages relating to the PS signalling connection (e.g. PS authentication procedure, see subclause 4.7.7) were received after the DETACH REQUEST message was transmitted.

- b.2) RR release in Iu mode (i.e. RRC connection release) with cause different than "Directed signalling connection re-establishment", for example, "Normal", or "User inactivity" (see 3GPP TS 25.331 [23c] and 3GPP TS 44.118 [111])

The GPRS detach procedure shall be initiated again, if the following conditions apply:

- i) The original GPRS detach procedure was initiated over an existing RRC connection; and
- ii) No SECURITY MODE COMMAND message and no Non-Access Stratum (NAS) messages relating to the PS signalling connection (e.g. PS authentication procedure, see subclause 4.7.7) were received after the DETACH REQUEST message was transmitted.

NOTE: The RRC connection release cause different than "Directed signalling connection re-establishment" that triggers the re-initiation of the GPRS detach procedure is implementation specific.

- b.3) RR release in Iu mode (i.e. RRC connection release) with cause "Directed signalling connection re-establishment" (see 3GPP TS 25.331 [23c] and 3GPP TS 44.118 [111])

The routing area updating procedure shall be initiated followed by completion of the GPRS detach procedure if the following conditions apply:

- i) The original GPRS detach procedure was not due to SIM removal; and
- ii) The original GPRS detach procedure was not due to a rerun of the procedure due to "Directed signalling connection reestablishment".

c) Detach procedure collision

GPRS detach containing cause "power off":

- If the MS receives a DETACH REQUEST message before the MS initiated GPRS detach procedure has been completed, this message shall be ignored and the MS initiated GPRS detach procedure shall continue.

GPRS detach containing other causes than "power off":

- If the MS receives a DETACH REQUEST message before the MS initiated GPRS detach procedure has been completed, the MS shall treat the message as specified in subclause 4.7.4.2.2 with the following modifications:
 - If the DETACH REQUEST message received by the MS contains detach type "re-attach required", and the MS initiated detach procedure is with detach type "GPRS detach" or "Combined GPRS/IMSI detach", the MS need not initiate the GPRS attach or combined GPRS attach procedure.
 - If the DETACH REQUEST message received by the MS contains detach type "IMSI detach", and the MS initiated detach procedure is with detach type "IMSI detach", the MS in operation mode A or B in network operation mode I need not re-attach to non-GPRS services.
 - If the DETACH REQUEST message received by the MS contains detach type "IMSI detach", and the MS initiated detach procedure is with detach type "GPRS detach" or "combined GPRS/IMSI detach", the MS shall progress both procedures. The MS in operation mode A or B in network operation mode I need not re-attach to non-GPRS services.

d) Detach and GMM common procedure collision

GPRS detach containing cause "power off":

- If the MS receives a message used in a GMM common procedure before the GPRS detach procedure has been completed, this message shall be ignored and the GPRS detach procedure shall continue.

GPRS detach containing other causes than "power off" and containing detach type "IMSI detach":

- If the MS receives a message used in a GMM common procedure before the GPRS detach procedure has been completed, both the GMM common procedure and the GPRS detach procedure shall continue.

GPRS detach containing other causes than "power off" and containing other detach types than "IMSI detach":

- If the MS receives a P-TMSI REALLOCATION COMMAND, a GMM STATUS, or a GMM INFORMATION message before the GPRS detach procedure has been completed, this message shall be ignored and the GPRS detach procedure shall continue.
- If the MS receives an AUTHENTICATION AND CIPHERING REQUEST or IDENTITY REQUEST message, before the GPRS detach procedure has been completed, the MS shall respond to it as described in subclauses 4.7.7 and 4.7.8 respectively.

e) Change of cell within the same RA (A/Gb mode only)

If a cell change occurs within the same RA before a DETACH ACCEPT message has been received, then the cell update procedure shall be performed before completion of the detach procedure.

f) Change of cell into a new routing area

If a cell change into a new routing area occurs before a DETACH ACCEPT message has been received, the GPRS detach procedure shall be aborted and re-initiated after successfully performing a routing area updating procedure. If the detach procedure is performed due to the removal of the SIM/USIM or the MS is to be switched off, the MS shall abort the detach procedure and enter the state GMM-DEREGISTERED.

g) Access barred because of access class control or EAB

The signalling procedure for GPRS detach shall not be started. The MS starts the signalling procedure as soon as possible and if still necessary, i.e. when the barred state is removed or because of a cell change, or performs a local detach immediately or after an implementation dependent time.

h) Detach and paging for non-GPRS services procedure collision

If the MS receives a paging for non-GPRS services before the MS initiated combined GPRS detach procedure with detach type "IMSI detach" or "GPRS/IMSI detach" has been completed, then the paging for non-GPRS services shall be ignored and the MS initiated combined GPRS detach procedure shall continue.

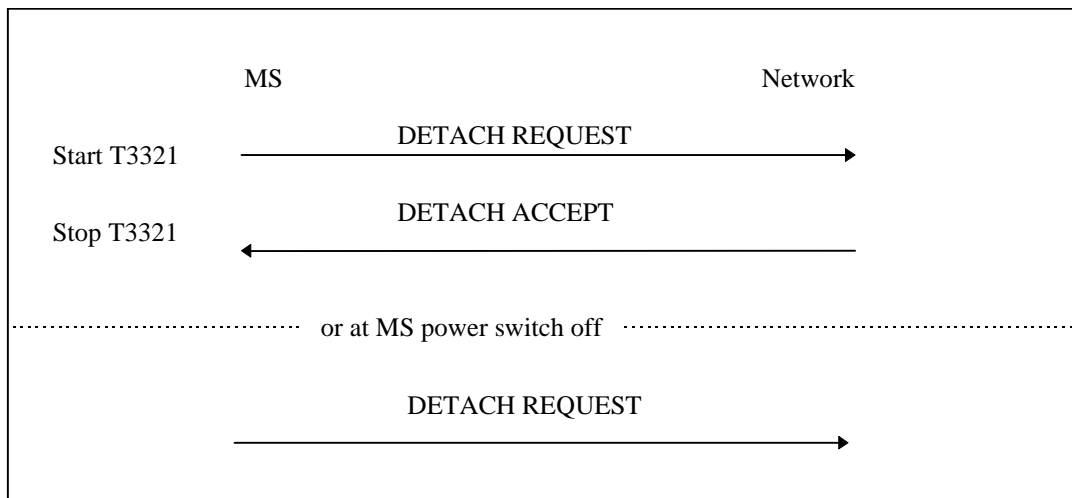

Figure 4.7.4/1 3GPP TS 24.008: MS initiated GPRS detach procedure

For the cases b and f:

- Timer T3321 shall be stopped if still running.

4.7.4.1.5 Abnormal cases on the network side

The following abnormal cases can be identified:

a) Detach request received in a CSG cell for which the MS has no valid CSG subscription

If the MS initiates a detach procedure in a CSG cell the CSG ID of which is not valid for the MS and the detach procedure is not due to "switch off", the network shall proceed as follows:

- if the detach type is "IMSI detach" and the MS has a PDN connection for emergency bearer services active, the SGSN shall send a DETACH ACCEPT message and deactivate all non-emergency PDP contexts, if any, by initiating a PDP context deactivation procedure;
- otherwise, the network shall initiate the detach procedure. The network shall send a DETACH REQUEST message including the GMM cause value #25 "not authorized for this CSG".

4.7.4.2 Network initiated GPRS detach procedure

4.7.4.2.1 Network initiated GPRS detach procedure initiation

The network initiates the GPRS detach procedure by sending a DETACH REQUEST message to the MS. The DETACH REQUEST message shall include a detach type IE. In addition, the network may include a cause IE to specify the reason for the detach request. The network shall start timer T3322. If the detach type IE indicates "re-attach required", or "re-attach not required" and the cause code is not #2 "IMSI unknown in HLR", the network shall deactivate the PDP contexts, the MBMS contexts and deactivate the logical link(s), if any, and shall change to state GMM-DEREGISTERED-INITIATED.

4.7.4.2.2 Network initiated GPRS detach procedure completion by the MS

When receiving the DETACH REQUEST message and the detach type indicates "re-attach required", the MS shall deactivate the PDP context(s), the MBMS context(s) and deactivate the logical link(s), if any. The MS shall stop the timer T3346, if it is running. The MS shall also stop timer(s) T3396, if it is running. The MS shall send a DETACH ACCEPT message to the network and shall enter the state GMM-DEREGISTERED. The MS shall, after the completion of the GPRS detach procedure, initiate a GPRS attach procedure. The MS should also activate PDP context(s) that were originally activated by the MS to replace any previously MS activated PDP context(s). The MS should also perform the procedures needed in order to activate any previously active multicast service(s).

NOTE 1: When the detach type indicates "re-attach required", user interaction is necessary in some cases when the MS cannot re-activate the PDP/MBMS context(s) automatically.

A GPRS MS operating in MS operation mode A or B in network operation mode I, which receives an DETACH REQUEST message with detach type indicating "re-attach required" or "re-attach not required" and no cause code, is only detached for GPRS services in the network.

When receiving the DETACH REQUEST message and the detach type IE indicates "IMSI detach", the MS shall not deactivate the PDP/MBMS contexts. The MS shall set the MM update status to U2 NOT UPDATED. An MS in operation mode A or B in network operation mode I may send a DETACH ACCEPT message to the network, and shall re-attach to non-GPRS service by performing the combined routing area updating procedure according to subclause 4.7.5.2, sending a ROUTING AREA UPDATE REQUEST message with Update type IE indicating "combined RA/LA updating with IMSI attach". An MS in operation mode A that is in an ongoing circuit-switched transaction shall initiate the combined routing area updating after the circuit-switched transaction has been released. An MS in operation mode C, or in MS operation mode A or B in network operation mode II, shall send a DETACH ACCEPT message to the network.

If the detach type IE indicates "IMSI detach", or "re-attach required" then the MS shall ignore the cause code if received.

If the MS is attached for GPRS and non-GPRS services and the network operates in network operation mode I, then if in the MS the timer T3212 is not already running, the timer T3212 shall be set to its initial value and restarted if:

- the detach type IE indicates "re-attach required"; or
- the detach type IE indicates "re-attach not required" and no cause code is included.

When receiving the DETACH REQUEST message and the detach type IE indicates "re-attach not required" and no cause code, or "re-attach not required" and the cause code is not #2 "IMSI unknown in HLR", the MS shall deactivate the PDP contexts, the MBMS contexts and deactivate the logical link(s), if any. The MS shall then send a DETACH ACCEPT message to the network and shall change state to GMM-DEREGISTERED.

If the detach type IE indicates "re-attach not required" and no cause code is included,

- the MS shall set the GPRS update status to GU2 NOT UPDATED, delete the GMM parameters P-TMSI, P-TMSI signature, RAI, and GPRS ciphering key sequence number, and start timer T3302. If the MS is operating in MS operation mode C, it may enter the state GMM-DEREGISTERED.PLMN-SEARCH in order to perform a PLMN selection according to 3GPP TS 23.122 [6]; otherwise the MS shall enter the state GMM-DEREGISTERED.ATTEMPTING-TO-ATTACH; and
- if S1 mode is supported in the MS, the MS shall handle the EMM parameters EMM state, EPS update status, GUTI, last visited registered TAI, TAI list and KSI, as specified in 3GPP TS 24.301 [120] for the case when a DETACH REQUEST is received with the no EMM cause included and with detach type set to "re-attach not required".

If the detach type IE indicates "re-attach not required" and a cause code is included, then, depending on the received cause code, the MS shall act as follows:

2 (IMSI unknown in HLR);

The MS shall set the update status to U3 ROAMING NOT ALLOWED and shall delete any TMSI, LAI and ciphering key sequence number. The new MM state is MM IDLE. The SIM/USIM shall be considered as invalid for non-GPRS services until switching off or the SIM/USIM is removed. If the message has been successfully integrity checked by the lower layers and the MS maintains a counter for "SIM/USIM considered invalid for non-GPRS services", then the MS shall set this counter to MS implementation-specific maximum value.

A GPRS MS operating in MS operation mode A or B in network operation mode I, is still IMSI attached for GPRS services in the network.

3 (Illegal MS);

6 (Illegal ME);

The MS shall set the GPRS update status to GU3 ROAMING NOT ALLOWED (and shall store it according to subclause 4.1.3.2) and shall delete any P-TMSI, P-TMSI signature, RAI and GPRS ciphering key sequence number. The MS shall delete the list of equivalent PLMNs. The new GMM state is GMM-DEREGISTERED.NO-IMSI. The SIM/USIM shall be considered as invalid for GPRS services until switching off or the SIM/USIM is removed. If the message has been successfully integrity checked by the lower layers and the MS maintains a counter for "SIM/USIM considered invalid for GPRS services", then the MS shall set this counter to MS implementation-specific maximum value.

A GPRS MS operating in MS operation mode A or B shall in addition set the update status to U3 ROAMING NOT ALLOWED, shall delete any TMSI, LAI and ciphering key sequence number. If the MS is operating in MS operation mode A and an RR connection exists, the MS shall abort the RR connection, unless an emergency call is ongoing. The SIM/USIM shall be considered as invalid also for non-GPRS services until switching off or the SIM/USIM is removed. If the message has been successfully integrity checked by the lower layers and the MS maintains a counter for "SIM/USIM considered invalid for non-GPRS services", then the MS shall set this counter to MS implementation-specific maximum value.

If S1 mode is supported in the MS, the MS shall handle the EMM parameters EMM state, EPS update status, GUTI, last visited registered TAI, TAI list and KSI as specified in 3GPP TS 24.301 [120] for the case when a DETACH REQUEST is received with the EMM cause with the same value and with detach type set to "re-attach not required".

NOTE 2: The possibility to configure an MS so that the radio transceiver for a specific radio access technology is not active, although it is implemented in the MS, is out of scope of the present specification.

7 (GPRS services not allowed);

The MS shall set the GPRS update status to GU3 ROAMING NOT ALLOWED (and shall store it according to subclause 4.1.3.2) and shall delete any P-TMSI, P-TMSI signature, RAI and GPRS ciphering key sequence number. The SIM/USIM shall be considered as invalid for GPRS services until switching off or the SIM/USIM is removed. The new state is GMM-DEREGISTERED. If the message has been successfully integrity checked by the lower layers and the MS maintains a counter for "SIM/USIM considered invalid for GPRS services", then the MS shall set this counter to MS implementation-specific maximum value.

A GPRS MS operating in MS operation mode A or B which is already IMSI attached for CS services is still IMSI attached for CS services in the network.

A GPRS MS operating in MS operation mode A or B in network operation mode I shall then proceed with the appropriate MM specific procedure.

NOTE 3: Optionally the MS starts the timer T3340 as described in subclause 4.7.1.9.

If S1 mode is supported in the MS, the MS shall handle the EMM parameters EMM state, EPS update status, GUTI, last visited registered TAI, TAI list and KSI as specified in 3GPP TS 24.301 [120] for the case when a DETACH REQUEST is received with the EMM cause with the same value and with detach type set to "re-attach not required".

8 (GPRS services and non-GPRS services not allowed);

The MS shall set the GPRS update status to GU3 ROAMING NOT ALLOWED (and shall store it according to subclause 4.1.3.2) and shall delete any P-TMSI, P-TMSI signature, RAI and GPRS ciphering key sequence number. The MS shall delete the list of equivalent PLMNs. The new GMM state is GMM-DEREGISTERED.NO-IMSI.

The MS shall set the update status to U3 ROAMING NOT ALLOWED, shall delete any TMSI, LAI and ciphering key sequence number. If the MS is operating in MS operation mode A and an RR connection exists, the MS shall abort the RR connection, unless an emergency call is ongoing. The SIM/USIM shall be considered as invalid for GPRS and non-GPRS services until switching off or the SIM/USIM is removed. If the message has been successfully integrity checked by the lower layers and the MS maintains a counter for "SIM/USIM considered invalid for GPRS services", then the MS shall set this counter to MS implementation-specific maximum value. If the message has been successfully integrity checked by the lower layers and the MS maintains a counter for "SIM/USIM considered invalid for non-GPRS services", then the MS shall set this counter to MS implementation-specific maximum value.

NOTE 4: Optionally the MS starts the timer T3340 as described in subclause 4.7.1.9.

If S1 mode is supported in the MS, the MS shall handle the EMM parameters EMM state, EPS update status, GUTI, last visited registered TAI, TAI list and KSI as specified in 3GPP TS 24.301 [120] for the case when a DETACH REQUEST is received with the EMM cause with the same value and with detach type set to "re-attach not required".

11 (PLMN not allowed);

The MS shall delete any RAI or LAI, P-TMSI, P-TMSI signature and GPRS ciphering key sequence number, shall set the GPRS update status to GU3 ROAMING NOT ALLOWED (and shall store it according to subclause 4.1.3.2) and shall reset the GPRS attach attempt counter. The MS shall delete the list of equivalent PLMNs. The new GMM state is GMM-DEREGISTERED.

The MS shall store the PLMN identity in the "forbidden PLMN list" and if the MS is configured to use timer T3245 (see 3GPP TS 24.368 [135] or 3GPP TS 31.102 [112]) then the MS shall start timer T3245 and proceed as described in subclause 4.1.1.6. If the message has been successfully integrity checked by the lower layers and the MS maintains a PLMN-specific attempt counter for that PLMN, then the MS shall set this counter to the MS implementation-specific maximum value.

The MS shall start timer T3340 as described in subclause 4.7.1.9.

If no RR connection exists, the MS shall perform the following additional actions immediately. If the MS is operating in MS operation mode A and an RR connection exists, the MS shall perform these actions when the RR connection is subsequently released:

- A GPRS MS operating in MS operation mode A or B shall set the update status to U3 ROAMING NOT ALLOWED and shall delete any TMSI, LAI and ciphering key sequence number. The new MM state is MM IDLE.
- The MS shall perform a PLMN selection according to 3GPP TS 23.122 [14].

An MS in GAN mode shall request a PLMN list in GAN (see 3GPP TS 44.318 [76b]) prior to perform a PLMN selection from this list according to 3GPP TS 23.122 [14].

If S1 mode is supported in the MS, the MS shall handle the EMM parameters EMM state, EPS update status, GUTI, last visited registered TAI, TAI list, KSI and attach attempt counter as specified in 3GPP TS 24.301 [120]

for the case when a DETACH REQUEST is received with the EMM cause with the same value and with detach type set to "re-attach not required".

12 (Location area not allowed);

The MS shall delete any RAI, P-TMSI, P-TMSI signature GPRS ciphering key sequence number, shall set the GPRS update status to GU3 ROAMING NOT ALLOWED (and shall store it according to clause 4.1.3.2) and shall reset the GPRS attach attempt counter. The state is changed to GMM-DEREGISTERED.LIMITED-SERVICE.

The MS shall store the LAI in the list of "forbidden location areas for regional provision of service".

The MS shall start timer T3340 as described in subclause 4.7.1.9.

If no RR connection exists, the MS shall perform the following additional actions immediately. If the MS is operating in MS operation mode A and an RR connection exists, the MS shall perform these actions when the RR connection is subsequently released:

- If the MS is IMSI attached, the MS shall set the update status to U3 ROAMING NOT ALLOWED, shall delete any TMSI, LAI and ciphering key sequence number and shall reset the location update attempt counter. The new MM state is MM IDLE.
- The MS shall perform a cell selection according to 3GPP TS 43.022 [82] and 3GPP TS 25.304 [98].

NOTE 5: The cell selection procedure is not applicable for an MS in GAN mode.

If S1 mode is supported in the MS, the MS shall handle the EMM parameters EMM state, EPS update status, GUTI, last visited registered TAI, TAI list, KSI and attach attempt counter as specified in 3GPP TS 24.301 [120] for the case when a DETACH REQUEST is received with the EMM cause with the same value and with detach type set to "re-attach not required".

13 (Roaming not allowed in this location area);

The MS shall delete any RAI, P-TMSI, P-TMSI signature and GPRS ciphering key sequence number, shall set the GPRS update status to GU3 ROAMING NOT ALLOWED (and shall store it according to clause 4.1.3.2) and shall reset the GPRS attach attempt counter. The MS shall delete the list of equivalent PLMNs. The state is changed to GMM-DEREGISTERED.LIMITED-SERVICE or optionally to GMM-DEREGISTERED.PLMN-SEARCH.

The MS shall store the LAI in the list of "forbidden location areas for roaming".

The MS shall start timer T3340 as described in subclause 4.7.1.9.

If no RR connection exists, the MS shall perform the following additional actions immediately. If the MS is operating in MS operation mode A and an RR connection exists, the MS shall perform these actions when the RR connection is subsequently released:

- If the MS is IMSI attached, the MS shall set the update status to U3 ROAMING NOT ALLOWED, shall delete any TMSI, LAI and ciphering key sequence number and shall reset the location update attempt counter. The new MM state is MM IDLE.
- The MS shall perform a PLMN selection according to 3GPP TS 23.122 [14].

An MS in GAN mode shall request a PLMN list in GAN (see 3GPP TS 44.318 [76b]) prior to perform a PLMN selection from this list according to 3GPP TS 23.122 [14].

If S1 mode is supported in the MS, the MS shall handle the EMM parameters EMM state, EPS update status, GUTI, last visited registered TAI, TAI list, KSI and attach attempt counter as specified in 3GPP TS 24.301 [120] for the case when a DETACH REQUEST is received with the EMM cause with the same value and with detach type set to "re-attach not required".

14 (GPRS services not allowed in this PLMN);

The MS shall delete any RAI, P-TMSI, P-TMSI signature, and GPRS ciphering key sequence number stored, shall set the GPRS update status to GU3 ROAMING NOT ALLOWED (and shall store it according to

subclause 4.1.3.2), shall reset the GPRS attach attempt counter and shall change to state GMM-DEREGISTERED.

The MS shall store the PLMN identity in the "forbidden PLMNs for GPRS service" list and if the MS is configured to use timer T3245 (see 3GPP TS 24.368 [135] or 3GPP TS 31.102 [112]) then the MS shall start timer T3245 and proceed as described in subclause 4.1.1.6. If the message has been successfully integrity checked by the lower layers and the MS maintains a PLMN-specific PS-attempt counter for that PLMN, then the MS shall set this counter to the MS implementation-specific maximum value.

A GPRS MS operating in MS operation mode C shall delete the list of equivalent PLMNs and perform a PLMN selection according to 3GPP TS 23.122 [14].

A GPRS MS operating in MS operation mode A or B which is already IMSI attached for CS services is still IMSI attached for CS services in the network.

A GPRS MS operating in MS operation mode A or B in network operation mode I shall then proceed with the appropriate MM specific procedure.

If S1 mode is supported in the MS, the MS shall handle the EMM parameters EMM state, EPS update status, GUTI, last visited registered TAI, TAI list, KSI and attach attempt counter as specified in 3GPP TS 24.301 [120] for the case when a DETACH REQUEST is received with the EMM cause with the same value and with detach type set to "re-attach not required".

15 (No Suitable Cells In Location Area);

The MS shall delete any RAI, P-TMSI, P-TMSI signature and GPRS ciphering key sequence number, shall set the GPRS update status to GU3 ROAMING NOT ALLOWED (and shall store it according to clause 4.1.3.2) and shall reset the GPRS attach attempt counter. The state is changed to GMM-DEREGISTERED.LIMITED-SERVICE.

The MS shall store the LAI in the list of "forbidden location areas for roaming".

The MS shall start timer T3340 as described in subclause 4.7.1.9.

If no RR connection exists, the MS shall perform the following additional actions immediately. If the MS is operating in MS operation mode A and an RR connection exists, the MS shall perform these actions when the RR connection is subsequently released:

- If the MS is IMSI attached, the MS shall set the update status to U3 ROAMING NOT ALLOWED, shall delete any TMSI, LAI and ciphering key sequence number and shall reset the location update attempt counter. The new MM state is MM IDLE.
- The MS shall search for a suitable cell in another location area or a tracking area according to 3GPP TS 43.022 [82] and 3GPP TS 25.304 [98] or 3GPP TS 36.304 [121].

NOTE 6: The cell selection procedure is not applicable for an MS in GAN mode.

If S1 mode is supported in the MS, the MS shall handle the EMM parameters EMM state and EPS update status, GUTI, last visited registered TAI, TAI list, KSI and attach attempt counter as specified in 3GPP TS 24.301 [120] for the case when a DETACH REQUEST is received with the EMM cause with the same value and with detach type set to "re-attach not required".

25 (Not authorized for this CSG)

The MS shall set the GPRS update status to GU3 ROAMING NOT ALLOWED (and store it according to subclause 4.1.3.2) and shall reset the GPRS attach attempt counter. The state is changed to GMM-DEREGISTERED.LIMITED-SERVICE.

If the cell where the MS has received the DETACH REQUEST message is a CSG cell and the CSG ID and associated PLMN identity of the cell are contained in the Allowed CSG list stored in the MS, the MS shall remove the CSG ID and associated PLMN identity from the Allowed CSG list.

If the cell where the MS has received the DETACH REQUEST message is a CSG cell and the CSG ID and associated PLMN identity of the cell are contained in the Operator CSG list, the MS shall proceed as specified in 3GPP TS 23.122 [14] subclause 3.1A.

The MS shall start timer T3340 as described in subclause 4.7.1.9.

If the MS is IMSI attached for non-GPRS services, the MS shall set the update status to U3 ROAMING NOT ALLOWED and shall reset the location update attempt counter. The new MM state is MM IDLE.

The MS shall search for a suitable cell according to 3GPP TS 43.022 [82] and 3GPP TS 25.304 [98].

If S1 mode is supported in the MS, the MS shall handle the EMM parameters EMM state and EPS update status, GUTI, last visited registered TAI, TAI list, KSI and attach attempt counter as specified in 3GPP TS 24.301 [120] for the case when a DETACH REQUEST is received with the EMM cause with the same value and with detach type set to "re-attach not required".

NOTE 7: CSG is applicable only for UMTS.

Other cause values shall not impact the update status. Further actions of the MS are implementation dependent.

4.7.4.2.3 Network initiated GPRS detach procedure completion by the network

The network shall, upon receipt of the DETACH ACCEPT message, stop timer T3322. If the detach type IE included in the DETACH REQUEST message indicates "IMSI detach", or "re-attach not required" and the cause code is #2 "IMSI unknown in HLR", the network shall not change the current GMM state; otherwise the network shall change state to GMM-DEREGISTERED.

4.7.4.2.4 Abnormal cases on the network side

The following abnormal cases can be identified:

a) T3322 time-out

On the first expiry of the timer, the network shall retransmit the DETACH REQUEST message and shall start timer T3322. This retransmission is repeated four times, i.e. on the fifth expiry of timer T3322, the GPRS detach procedure shall be aborted. If the detach type indicates "IMSI detach", or "re-attach not required" and the cause code is #2 "IMSI unknown in HLR", the network shall not change the current GMM state; otherwise the network shall change state to GMM-DEREGISTERED.

b) Low layer failure

The GPRS detach procedure is aborted. If the detach type indicates "IMSI detach", or "re-attach not required" and the cause code is #2 "IMSI unknown in HLR", the network shall not change the current GMM state; otherwise the network shall change state to GMM-DEREGISTERED.

c) GPRS detach procedure collision

If the network receives a DETACH REQUEST message with "switching off" indicated, before the network initiated GPRS detach procedure has been completed, both procedures shall be considered completed.

If the network receives a DETACH REQUEST message without "switching off" indicated, before the network initiated GPRS detach procedure has been completed, the network shall send a DETACH ACCEPT message to the MS.

d) GPRS detach and GPRS attach procedure collision

If the network receives an ATTACH REQUEST message before the network initiated GPRS detach procedure with type of detach 're-attach not required' has been completed, the network shall ignore the ATTACH REQUEST message. If the detach type IE value, sent in the DETACH REQUEST message, indicates "re-attach required" the detach procedure is aborted and the GPRS attach procedure shall be progressed after the PDP contexts and MBMS contexts, if any, have been deleted. If the detach type IE value, sent in the DETACH REQUEST message, indicates "IMSI detach" the detach procedure is aborted and the GPRS attach procedure shall be progressed.

e) GPRS detach and routing area updating procedure collision

GPRS detach containing detach type "re-attach required" or "re-attach not required":

If the network receives a ROUTING AREA UPDATE REQUEST message before the network initiated GPRS detach procedure has been completed, the detach procedure shall be progressed, i.e. the ROUTING AREA UPDATE REQUEST message shall be ignored. If the DETACH REQUEST message contains detach type "re-attach not required" and GMM cause #2 "IMSI unknown in HLR", the network will follow the procedure as described below for the detach type "IMSI detach".

GPRS detach containing detach type "IMSI detach":

If the network receives a ROUTING AREA UPDATE REQUEST message before the network initiated GPRS detach procedure has been completed, the network shall abort the detach procedure, shall stop T3322 and shall progress the routing area update procedure.

f) GPRS detach and service request procedure collision

GPRS detach containing detach type "re-attach required" or "re-attach not required":

If the network receives a SERVICE REQUEST message before the network initiated GPRS detach procedure has been completed, the network shall progress the detach procedure. If the GPRS Detach Request message contains detach type "re-attach not required" and GMM cause #2 "IMSI unknown in HLR", the network will follow the procedure as described below for the detach type "IMSI detach".

GPRS detach containing detach type "IMSI detach":

If the network receives a SERVICE REQUEST message before the network initiated GPRS detach procedure has been completed, the network shall progress both procedures.

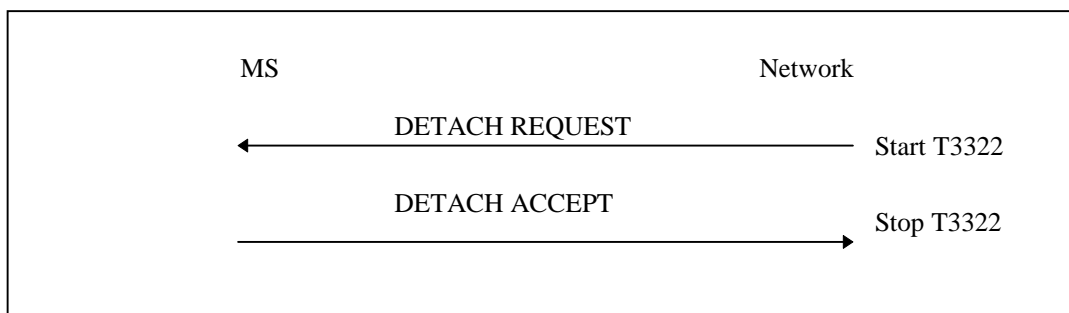

Figure 4.7.4/2 3GPP TS 24.008: Network initiated GPRS detach procedure

4.7.5 Routing area updating procedure

This procedure is used for:

- normal routing area updating to update the registration of the actual routing area of an MS in the network. This procedure is used by GPRS MSs in MS operation mode C and by GPRS MSs in MS operation modes A or B that are IMSI attached for GPRS and non-GPRS services if the network operates in network operation mode II;
- combined routing area updating to update the registration of the actual routing and location area of an MS in the network. This procedure is used by GPRS MSs in MS operation modes A or B that are IMSI attached for GPRS and non-GPRS services provided that the network operates in network operation mode I;
- periodic routing area updating. This procedure is used by GPRS MSs in MS operation mode C and by GPRS MSs in MS operation modes A or B that are IMSI attached for GPRS or for GPRS and non-GPRS services independent of the network operation mode;
- IMSI attach for non-GPRS services when the MS is IMSI attached for GPRS services. This procedure is used by GPRS MSs in MS operation modes A or B, if the network operates in network operation mode I;
- in A/Gb mode, resuming GPRS services when the RR sublayer indicated a resumption failure after dedicated mode was left, see 3GPP TS 44.018 [84];
- in A/Gb mode, updating the network with the new MS Radio Access Capability IE when the content of the IE has changed;

- updating the network with the new DRX parameter IE when the content of the IE has changed;

NOTE 1: Such changes can be used e.g. when the MS activates a PDP context with service requirements that cannot be met with the current DRX parameter. As PDP context(s) are activated and deactivated, the GMM context will be updated with an appropriate DRX parameter;

- re-negotiation of the READY timer value;
- Iu mode to A/Gb mode and for A/Gb mode to Iu mode intersystem change, see subclause 4.7.1.7;
- in Iu mode, re-synchronizing the PMM mode of MS and network after RRC connection release with cause "Directed signalling connection re-establishment", see subclause 4.7.2.5;
- in Iu mode and A/Gb mode after intersystem change from S1 mode, and the GMM receives an indication of "RRC connection failure" from lower layers due to lower layer failure while in S1 mode;
- S1 mode to Iu mode or S1 mode to A/Gb mode intersystem change and ISR is not activated;
- S1 mode to Iu mode or S1 mode to A/Gb mode intersystem change and ISR is activated, but the MS changes to a routing area it has not previously registered with the network;
- indicating to the network that due to a manual CSG selection the MS has selected a CSG cell whose CSG identity and associated PLMN identity are not included in the MS's Allowed CSG list or in the MS's Operator CSG list;
- indicating to the network that the mobile station classmark 2, mobile station classmark 3 or the supported codecs have changed for a MS supporting SRVCC; or
- indicating the current radio access technology to the network for the support of terminating access domain selection for voice calls or voice sessions (for details see subclause 4.7.5.1 and subclause 4.7.5.2.1).

While an MS has a PDN connection for emergency bearer services, the MS shall not perform manual CSG selection.

The routing area updating procedure shall also be used by a MS which is attached for GPRS services if a new PLMN is entered (see 3GPP TS 23.122 [14]), unless the MS is configured for "AttachWithIMSI" as specified in 3GPP TS 24.368 [135] or 3GPP TS 31.102 [112] and the new PLMN is neither the registered PLMN nor in the list of equivalent PLMNs.

An eCall only mobile station that is not capable of eCall over IMS shall not perform a normal or combined routing area updating procedure.

Subclause 4.7.5.1 describes the routing area updating procedures for updating the routing area only. The combined routing area updating procedure used to update both the routing and location area is described in subclause 4.7.5.2.

The routing area updating procedure is always initiated by the MS. It is only invoked in state GMM-REGISTERED.

To limit the number of consecutive rejected routing area update attempts, a routing area updating attempt counter is introduced. The routing area updating attempt counter shall be incremented as specified in subclause 4.7.5.1.5.

Depending on the value of the routing area updating attempt counter, specific actions shall be performed. The routing area updating attempt counter shall be reset when:

- a GPRS attach or combined GPRS attach procedure is successfully completed;
- a normal or periodic routing area updating or combined routing area updating procedure is successfully completed;
- a combined GPRS attach procedure or a combined routing area updating procedure is completed for GPRS services only with cause #2 or #28;
- a normal or periodic routing area updating or combined routing updating procedure is rejected with cause #11, #12, #13, #14, #15 or #25;
- a new PLMN is selected.

and additionally when the MS is in substate ATTEMPTING-TO-UPDATE:

- a new routing area is entered;

- expiry of timer T3302;
- at request from registration function; or
- timer T3346 is started.

The mobile equipment shall contain a list of "forbidden location areas for roaming", as well as a list of "forbidden location areas for regional provision of service". The handling of these lists is described in subclause 4.4.1.

In a shared network, the MS shall choose one of the PLMN identities as specified in 3GPP TS 23.122 [14]. The MS shall construct the Routing Area Identification of the cell from this chosen PLMN identity, and the LAC and the RAC received on the BCCH. If the constructed RAI is different from the stored RAI, the MS shall initiate the routing area updating procedure. For:

- a shared GERAN, in A/Gb mode, the chosen PLMN identity is indicated to the GERAN in the first RLC data block of an upper layer PDU (see 3GPP TS 44.060 [76]) when a foreign TLLI is used by the network sharing supporting MS for the transmission.
- a shared UTRAN, the chosen PLMN identity shall be indicated to the UTRAN in the RRC INITIAL DIRECT TRANSFER message (see 3GPP TS 25.331 [23c]).

For GERAN Iu mode, network sharing is not supported.

Whenever a ROUTING AREA UPDATE REJECT message with the cause "PLMN not allowed" is received by the MS, the chosen PLMN identity shall be stored in the "forbidden PLMN list" and if the MS is configured to use timer T3245 (see 3GPP TS 24.368 [135] or 3GPP TS 31.102 [112]) then the MS shall start timer T3245 and proceed as described in subclause 4.1.1.6. Whenever a ROUTING AREA UPDATE REJECT message is received by the MS with the cause "Roaming not allowed in this location area", "Location Area not allowed", or "No suitable cells in Location Area", the LAI that is part of the constructed RAI which triggered the routing area updating procedure shall be stored in the suitable list.

In A/Gb mode, user data transmission in the MS shall be suspended during the routing area updating procedure, except if the routing area updating procedure is triggered by a PS handover procedure as described in 3GPP TS 43.129 [113]; user data reception shall be possible. User data transmission in the network may be suspended during the routing area updating procedure.

In Iu mode, user data transmission and reception in the MS shall not be suspended during the routing area updating procedure. User data transmission in the network shall not be suspended during the routing area updating procedure.

In Iu mode, when a ROUTING AREA UPDATE REQUEST is received by the SGSN over a new PS signalling connection while there is an ongoing PS signalling connection (network is already in mode PMM-CONNECTED) for this MS, the network shall progress the routing area updating procedure as normal and release the previous PS signalling connection when the routing area updating procedure has been accepted by the network.

NOTE 2: The re-establishment of the radio bearers of active PDP contexts is done as described in subclause "Service Request procedure".

The network informs the MS about the support of specific features, such as LCS-MOLR, MBMS, IMS voice over PS session, emergency bearer services in Iu mode in the Network feature support information element. The information is either explicitly given by sending the Network feature support IE or implicitly by not sending it. The handling in the network is described in subclause 9.4.15.11. The network can also use the Additional network feature support IE in order to inform the MS about the support of specific features such as the delivery of SMS via GPRS (GPRS-SMS) or implicitly by not sending it. The MS may use the support indications for LCS-MOLR, MBMS and GPRS-SMS to inform the user about the availability of the appropriate services. The MS shall not request the LCS-MOLR or MBMS services, if the service has not been indicated as available. The indication for MBMS is defined in subclause "MBMS feature support indication" in 3GPP TS 23.246 [106]. In an MS with IMS voice over PS capability, the IMS voice over PS session indicator and the emergency bearer services indicator shall be provided to the upper layers. The upper layers take the IMS voice over PS session indicator into account as specified in 3GPP TS 23.221 [131], subclause 7.2a and subclause 7.2b, when selecting the access domain for voice sessions or calls in Iu mode. When initiating an emergency call in Iu mode, the upper layers also take the emergency bearer services indicator into account for the access domain selection. The MS may use the GPRS-SMS indication in order to obtain SMS.

4.7.5.1 Normal and periodic routing area updating procedure

Periodic routing area updating is used to periodically notify the availability of the MS to the network. The value of the update type IE in the ROUTING AREA UPDATE REQUEST message shall indicate "periodic updating". The procedure is controlled in the MS by timer T3312. When timer T3312 expires, the periodic routing area updating procedure is started. Start and reset of timer T3312 is described in subclause 4.7.2.2.

The normal routing area updating procedure is initiated:

- when the MS detects a change of the routing area in state GMM-REGISTERED;
- when the MS determines that GPRS resumption shall be performed;
- when the MS needs to update the network with the new MS Radio Access Capability IE;
- when the MS needs to update the network with the new DRX parameter IE;
- in Iu mode, to re-synchronize the PMM mode of MS and network after RRC connection release with cause "Directed signalling connection re-establishment", see subclause 4.7.2.5;
- in Iu mode, to re-synchronize the PMM mode of MS and network after inter-system change not due to PS handover from PMM-CONNECTED mode in Iu mode to A/Gb mode or S1 mode, if the MS performs an inter-system change back to Iu mode without sending a ROUTING AREA UPDATE REQUEST message while in A/Gb mode or a TRACKING AREA UPDATE REQUEST message while in S1 mode;
- in Iu mode and A/Gb mode, after intersystem change from S1 mode, and the GMM receives an indication of "RRC connection failure" from lower layers due to lower layer failure while in S1 mode. In this case, if the TIN indicates "RAT-related TMSI", the MS shall set the TIN to "GUTI" before initiating the routing area updating procedure;
- in A/Gb mode, after intersystem change from S1 mode if the TIN indicates "RAT-related TMSI", but the MS is required to perform routing area updating for IMS voice termination as specified in annex P.4;
- when the MS enters GMM-REGISTERED.NORMAL-SERVICE and the TIN indicates "GUTI";
- when the MS has selected a CSG cell whose CSG identity and associated PLMN identity are not included in the Allowed CSG list; or in the Operator CSG list;
- when the MS supports SRVCC and changes the mobile station classmark 2, mobile station classmark 3 or the supported codecs;
- when the MS changes the MS network capability information;
- when the UE's usage setting or the voice domain preference for E-UTRAN change in the MS;
- when the MS activates mobility management for IMS voice termination as specified in annex P.2 and the TIN indicates "RAT-related TMSI";
- upon reception of a paging indication, using P-TMSI, if the timer T3346 is running and the MS is in state GMM-REGISTERED.ATTEMPTING-TO-UPDATE and the RAI of the current cell is same as the stored RAI;
- in A/Gb mode, after intersystem change from S1 mode via cell change order procedure not due to CS fallback, if the TIN indicates "RAT-related TMSI"; in this case the MS shall set the TIN to "GUTI" before initiating the routing area updating procedure;
- in A/Gb or Iu mode in NMO I, after intersystem change from S1 mode due to CS fallback, if the TIN indicates "GUTI" or if the routing area the MS is in is different from the registered routing area;
- in A/Gb mode, after Inter RAT handover from S1 mode or Iu mode;
- when the MS needs to request the use of PSM or needs to stop the use of PSM;
- when the MS needs to request the use of eDRX or needs to stop the use of eDRX;
- when a change in the PSM usage conditions at the MS requires a different timer T3312 value or different timer T3324 value;

- when a change in the eDRX usage conditions at the MS requires different extended DRX parameters; or

NOTE 1: A change in the PSM or eDRX usage conditions at the MS can include e.g. a change in the MS configuration, a change in requirements from upper layers or the battery running low at the MS.

- when the Default_DCN_ID value changes, as specified in 3GPP TS 24.368 [135] or in USIM file NAS_{CONFIG} as specified in 3GPP TS 31.102 [112].

NOTE 2: The routing area updating procedure is initiated after deleting the DCN-ID list as specified in 3GPP TS 24.301 [120], annex C.

The ROUTING AREA UPDATE REQUEST message shall always be the first data sent by the MS when a routing area border is crossed. The routing area identification is broadcast on the broadcast channel(s).

A normal routing area updating shall abort any ongoing GMM procedure. Aborted GMM procedures may be repeated after the normal routing area updating procedure has been successfully performed. The value of the update type IE included in the message shall indicate "RA updating".

If the normal routing area updating procedure is initiated due to the reception of the paging indication while timer T3346 is running, the "follow-on request pending" indication shall be set to 1.

4.7.5.1.1 Normal and periodic routing area updating procedure initiation

To initiate the normal routing area updating procedure, the MS sends the message ROUTING AREA UPDATE REQUEST to the network, starts timer T3330 and changes to state GMM-ROUTING-AREA-UPDATING-INITIATED. If timer T3302 is currently running, the MS shall stop timer T3302. If timer T3311 is currently running, the MS shall stop timer T3311.

If the MS supports S1 mode, the MS shall handle the P-TMSI IE as follows:

- If the TIN indicates "GUTI" and the MS holds a valid GUTI, the MS shall map the GUTI into a P-TMSI, P-TMSI signature and RAI as specified in 3GPP TS 23.003 [10]. The MS shall include the mapped RAI in the Old routing area identification IE and the mapped P-TMSI signature in the P-TMSI signature IE. In addition, the MS shall include the P-TMSI type IE with P-TMSI type set to "mapped P-TMSI". When the routing area updating procedure is initiated in Iu mode, the MS shall also include the mapped P-TMSI in the P-TMSI IE. Additionally, in Iu mode and A/Gb mode, if the MS holds a valid P-TMSI and RAI, the MS shall indicate the P-TMSI in the Additional mobile identity IE and the RAI in the Additional old routing area identification IE.
- If the TIN indicates "P-TMSI" or "RAT-related TMSI" and the MS holds a valid P-TMSI and RAI, the MS shall indicate the RAI in the Old routing area identification IE. In addition, the MS shall include the P-TMSI type IE with P-TMSI type set to "native P-TMSI". When the routing area updating procedure is initiated in Iu mode, the MS shall also include the P-TMSI in the P-TMSI IE.

If the MS does not support S1 mode, the MS shall include the P-TMSI type IE with P-TMSI type set to "native P-TMSI".

If the MS supports PSM and requests the use of PSM, the MS shall include the T3324 value IE with a requested timer value in the ROUTING AREA UPDATE REQUEST message. When the MS includes the T3324 value IE and the MS indicates support for extended periodic timer value in the MS network feature support IE, it may also include the T3312 extended value IE to request a particular T3312 value to be allocated.

If the routing area updating procedure is not initiated by the MS due to an S1 mode to Iu mode or S1 mode to A/Gb mode intersystem change, or if it is initiated due to such an intersystem change and the TIN indicates "RAT-related TMSI", the MS shall use the existing UMTS security context for the PS domain. The ROUTING AREA UPDATE REQUEST message shall contain the P-TMSI signature when received in a previous ATTACH ACCEPT or ROUTING AREA UPDATE ACCEPT message. If the MS has a valid UMTS security context, the MS shall indicate it in the GPRS ciphering key sequence number IE.

If the routing area updating procedure is initiated by the MS due to an S1 mode to Iu mode or S1 mode to A/Gb mode inter-system change in idle mode, or if it is initiated by the MS due to PS to CS domain change from S1 mode due to SRVCC or vSRVCC handover, and the TIN indicates "GUTI", the MS shall derive a UMTS security context for the PS domain from the current EPS security context as described in the subclause 4.7.7.10. The ROUTING AREA UPDATE REQUEST message shall include a P-TMSI signature filled with a NAS token as specified in 3GPP TS 33.401 [123]. Furthermore, the MS shall indicate the eKSI value, which is associated with the derived UMTS security keys, in the CKSN field of the GPRS GSM ciphering key sequence number IE in the ROUTING AREA UPDATE REQUEST message.

NOTE: When the MS includes a P-TMSI signature filled with a NAS token, 8 bits of the NAS token will be filled with bits from the M-TMSI (see 3GPP TS 23.003 [10]).

If the routing area updating procedure is initiated by the MS due to the S1 mode to Iu mode or S1 mode to A/Gb mode inter-system change in connected mode, the MS shall derive a UMTS security context for the PS domain from the current EPS security context as described in the subclause 4.7.7.10. Furthermore, the MS shall indicate the eKSI value, which is associated with the derived UMTS security keys, in the CKSN field of the GPRS GSM ciphering key sequence number IE in the ROUTING AREA UPDATE REQUEST message.

In Iu mode, if the MS wishes to prolong the established PS signalling connection after the normal routing area updating procedure (for example, the MS has any CM application request pending), it may set a follow-on request pending indicator on (see subclause 4.7.13).

In order to indicate the new DRX parameter while in GERAN or UTRAN coverage, the MS shall send the ROUTING AREA UPDATE REQUEST message containing the DRX parameter in the DRX parameter IE to the network, with the exception of the case if the MS had indicated its MS specific DRX parameter (3GPP TS 24.301 [120]) to the network while in E-UTRAN coverage. In this case, when the MS enters GERAN or UTRAN coverage and initiates a routing area updating procedure, the MS shall not include the DRX parameter in the DRX parameter IE in the ROUTING AREA UPDATE REQUEST message.

If the MS supports eDRX and requests the use of eDRX, the MS shall include the extended DRX parameters IE in the ROUTING AREA UPDATE REQUEST message.

In A/Gb mode, if the MS supports the restriction on use of enhanced coverage, then the MS shall set the Restriction on use of enhanced coverage capability bit to "Mobile station supports restriction on use of enhanced coverage" in the MS network capability IE of the ROUTING AREA UPDATE REQUEST message

If the MS supports dual connectivity of E-UTRA with NR, then the MS shall set the Dual connectivity of E-UTRA with NR capability bit to "Mobile station supports dual connectivity of E-UTRA with NR" in the MS network capability IE of the ROUTING AREA UPDATE REQUEST message.

In A/Gb mode, if a UMTS security context is available and if the MS indicates support of integrity protection in the MS network capability IE included in the ROUTING AREA UPDATE REQUEST message, then the MS shall use the current GPRS GSM Kint key and the current GPRS GSM integrity algorithm to integrity protect the ROUTING AREA UPDATE REQUEST message in the LLC layer. If LLC layer has not yet been configured, then the GMM layer in the MS shall assign the GPRS GSM Kint key, the GPRS GSM Kc₁₂₈ key, the GPRS GSM integrity algorithm and the GPRS GSM ciphering algorithm to the LLC layer, and indicates to the LLC layer that it shall start integrity protection. This shall be done so that the LLC layer can integrity protect, but not cipher, the ROUTING AREA UPDATE REQUEST message. The MS shall include the CKSN in the CKSN IE in the ROUTING AREA UPDATE REQUEST message. If the MS has no UMTS security context available, then the MS shall not integrity protect the ROUTING AREA UPDATE REQUEST message in the LLC layer. The MS shall in this case set the CKSN IE to the value "no key is available" and send the ROUTING AREA UPDATE REQUEST message unprotected.

4.7.5.1.2 GMM Common procedure initiation

If the network receives a ROUTING AREA UPDATE REQUEST message containing the P-TMSI type IE, and the network does not follow the use of the most significant bit of the <LAC> to distinguish the node type as specified in 3GPP TS 23.003 [10] subclause 2.8.2.2.2, the network shall use the P-TMSI type IE to determine whether the mobile identity included in the P-TMSI IE, if any, or the mobile identity used by the MS to derive a foreign TLLI (see subclause 4.7.1.4.1) is a native P-TMSI or a mapped P-TMSI.

The network may initiate GMM common procedures, e.g. the GMM authentication and ciphering procedure.

4.7.5.1.3 Normal and periodic routing area updating procedure accepted by the network

If the routing area updating request has been accepted by the network, a ROUTING AREA UPDATE ACCEPT message shall be sent to the MS. The network may assign a new P-TMSI and/or a new P-TMSI signature for the MS. If a new P-TMSI and/or P-TMSI signature have been assigned to the MS, it/they shall be included in the ROUTING AREA UPDATE ACCEPT message together with the routing area identification.

In a shared network, if the MS is a network sharing supporting MS, the network shall indicate the PLMN identity of the CN operator that has accepted the routing area updating request in the RAI contained in the ROUTING AREA UPDATE ACCEPT message; if the MS is a network sharing non-supporting MS, the network shall indicate the PLMN identity of the common PLMN (see 3GPP TS 23.251 [109]). If the PLMN identity of the common PLMN included in the RAI does not identify the CN operator that has accepted the routing area updating request, the network may include the PLMN identity of the CN operator that has accepted the routing area updating request in the ROUTING AREA UPDATE ACCEPT message.

In a multi-operator core network (MOCN) with common GERAN, the network shall indicate in the RAI the common PLMN identity (see 3GPP TS 23.251 [109]). If the common PLMN identity included in the RAI does not identify the CN operator that has accepted the routing area updating request, the network may include the PLMN identity of the CN operator that has accepted the routing area updating request in the ROUTING AREA UPDATE ACCEPT message.

In A/Gb mode, if the MS indicates support of integrity protection in the MS network capability IE in the ROUTING AREA UPDATE REQUEST message, and if the network supports integrity protection, then the network shall store all octets received from the MS in the MS network capability IE and in the MS Radio Access Capability IE, up to the maximum length defined for the respective information element.

NOTE 1: The network needs to store the MS network capability and MS Radio Access Capability exactly as received from the MS and network is not allowed to ignore the "higher" octets sent by the MS even if the network does not support any features indicated in the higher octets. Otherwise the replay check of the MS network capability and MS Radio Access Capability will fail in the MS.

In A/Gb mode, if a UMTS security context is available in the network and if the MS indicates support of integrity protection in the ROUTING AREA UPDATE REQUEST message and the network supports integrity protection, and if integrity protection of the ROUTING AREA UPDATE REQUEST message is successfully verified in the LLC layer in the network, then if the network decides to re-authenticate the MS or select a new integrity algorithm or ciphering algorithm, the network shall initiate an authentication and ciphering procedure.

In A/Gb mode, if a UMTS security context is available in the network and if the MS indicates support of integrity protection in the ROUTING AREA UPDATE REQUEST message and the network supports integrity protection if integrity protection of the ROUTING AREA UPDATE REQUEST message is successfully verified in the LLC layer in the network, the network may decide to continue using the stored GPRS GSM Kint integrity key, GPRS GSM Kc₁₂₈ encryption key, GPRS GSM ciphering algorithm and GPRS GSM integrity algorithm in the LLC layer without initiating an authentication and ciphering procedure. If the MS and network continue to use the same ciphering mode, ciphering or no ciphering, the ciphering mode is re-established without the need to run an authentication and ciphering procedure. The network shall replay the MS network capability IE and the MS radio access capability IE received from the MS in the ROUTING AREA UPDATE REQUEST message, by including the MS network capability IE and the MS radio access capability IE in the ROUTING AREA UPDATE ACCEPT message to the MS. The GMM layer in the network shall assign the stored GPRS GSM Kint key, the GPRS GSM Kc₁₂₈ key, the GPRS GSM integrity algorithm and the GPRS GSM ciphering algorithm to the LLC layer. The MS shall then indicate to the LLC layer that it shall start integrity protection and ciphering in the LLC layer before sending the ROUTING AREA UPDATE ACCEPT message to the MS. If the integrity protection of the ROUTING AREA UPDATE REQUEST message is not successfully verified in the LLC layer or if the ROUTING AREA UPDATE REQUEST message is received without integrity protection, then the network shall progress the routing area updating procedure and initiate an authentication and ciphering procedure to authenticate the MS and activate integrity protection and ciphering in the MS.

In A/Gb mode, if a UMTS security context is available in the network and if the MS indicates support of integrity protection in the ROUTING AREA UPDATE REQUEST message and the network supports integrity protection, and if the network is not able to verify the message authentication code in the LLC layer protecting the ROUTING AREA UPDATE REQUEST message, due to the LLC layer at the network not having been configured yet with the integrity key and integrity algorithm for this MS, then the network shall progress the ROUTING AREA UPDATE REQUEST message at GMM layer anyway. If the CKSN included in the ROUTING AREA UPDATE REQUEST message belongs to an UMTS security context available in the network, then the network may re-establish integrity protection and ciphering of layer 3 signalling messages in the LLC layer without initiating an authentication and ciphering procedure.

In A/Gb mode, if the MS indicates support of integrity protection of user plane data in the MS network capability IE in the ROUTING AREA UPDATE REQUEST message, and if the network supports and accepts integrity protection of user plane data, then the network shall indicate integrity protection of user plane data to the MS in the ROUTING AREA UPDATE ACCEPT message. The MS shall indicate to the LLC layer to start integrity protection of user plane data after the reception of the ROUTING AREA UPDATE ACCEPT message, if indicated. The same GPRS GSM Kint key and the same GPRS GSM integrity algorithm used for integrity protection of layer 3 signalling messages shall be used for integrity protection of user plane data in the LLC layer. The network shall indicate to the LLC layer to start integrity protection of user plane data after sending the ROUTING AREA UPDATE ACCEPT message to the MS. If the network does not indicate to the MS in the ROUTING AREA UPDATE ACCEPT message that it accepts the use of integrity protection of user plane data, and if the MS does not accept such a network, then the MS shall detach from the network.

If a new DRX parameter was included in the ROUTING AREA UPDATE REQUEST message, the network shall store the new DRX parameter and use it for the downlink transfer of signalling and user data.

The network shall include the extended DRX parameters IE in the ROUTING AREA UPDATE ACCEPT message only if the extended DRX parameters IE was included in the ROUTING AREA UPDATE REQUEST message, and the network supports and accepts the use of eDRX.

If the MS has indicated in the ROUTING AREA UPDATE REQUEST message that it supports PS inter-RAT handover from GERAN to UTRAN Iu mode, the network may include in the ROUTING AREA UPDATE ACCEPT message a request to provide the Inter RAT information container.

If the MS has included the MS network capability IE or the UE network capability IE or both in the ROUTING AREA UPDATE REQUEST message, the network shall store all octets received from the MS, up to the maximum length defined for the respective information element. In case the UE network capability IE indicated new information to the network, the MS shall set the TIN to "P-TMSI".

NOTE 2: This information is forwarded to the new SGSN during inter-SGSN handover or to the new MME during intersystem handover to S1 mode.

In A/Gb mode the Cell Notification information element shall be included in the ROUTING AREA UPDATE ACCEPT message in order to indicate the ability of the network to support the Cell Notification.

The network shall change to state GMM-COMMON-PROCEDURE-INITIATED and shall start the supervision timer T3350 as described in subclause 4.7.6.

If the LAI or PLMN identity contained in the ROUTING AREA UPDATE ACCEPT message is a member of any of the "forbidden" lists and the MS is not attached for emergency bearer services, then any such entry shall be deleted.

In Iu mode, the network should prolong the PS signalling connection if the mobile station has indicated a follow-on request pending in ROUTING AREA UPDATE REQUEST. The network may also prolong the PS signalling connection without any indication from the mobile terminal (for example, if user plane radio access bearers have been established for the MS).

If the PDP context status information element is included in ROUTING AREA UPDATE REQUEST message, then the network shall deactivate all those PDP contexts locally (without peer to peer signalling between the MS and the network), which are not in SM state PDP-INACTIVE on network side but are indicated by the MS as being in state PDP-INACTIVE.

If the MBMS context status information element is included in the ROUTING AREA UPDATE REQUEST message, then the network shall deactivate all those MBMS contexts locally (without peer to peer signalling between the MS and network) which are not in SM state PDP-INACTIVE on the network side, but are indicated by the MS as being in state PDP-INACTIVE. If no MBMS context status information element is included, then the network shall deactivate all MBMS contexts locally which are not in SM state PDP-INACTIVE on the network side.

If a ROUTING AREA UPDATE REQUEST message is received from an MS with a LIPA PDN connection, and if:

- a L-GW Transport Layer Address is provided by the lower layer together with the ROUTING AREA UPDATE REQUEST message, and the GGSN address associated with the PDP context of the LIPA PDN connection is different from the provided L-GW Transport Layer Address (see 3GPP TS 25.413 [19c]); or
- no L-GW Transport Layer Address is provided together with the ROUTING AREA UPDATE REQUEST message by the lower layer,

then the SGSN locally deactivates all PDP contexts associated with the LIPA PDN connection. If the ROUTING AREA UPDATE REQUEST request message is accepted, the SGSN informs the MS via the PDP context status IE in the ROUTING AREA UPDATE ACCEPT message that PDP contexts were locally deactivated.

If a ROUTING AREA UPDATE REQUEST message is received from an MS with a SIPTO at the local network PDN connection, the following different cases can be distinguished:

- 1) If the PDN connection is a SIPTO at the local network PDN connection with collocated L-GW and if:
 - a SIPTO L-GW Transport Layer Address is provided by the lower layer together with the ROUTING AREA UPDATE REQUEST message, and the GGSN address associated with the PDP context of the SIPTO at the local network PDN connection is different from the provided SIPTO L-GW Transport Layer Address (see 3GPP TS 25.413 [19c]); or
 - no SIPTO L-GW Transport Layer Address is provided together with the ROUTING AREA UPDATE REQUEST message by the lower layer,
- 2) If the PDN connection is a SIPTO at the local network PDN connection with stand-alone GW and if:
 - a LHN-ID value is provided by the lower layer together with the ROUTING AREA UPDATE REQUEST message, and the LHN-ID stored in the PDP context of the SIPTO at the local network PDN connection is different from the provided LHN-ID value (see 3GPP TS 25.413 [19c]); or
 - no LHN-ID value is provided together with the ROUTING AREA UPDATE REQUEST message by the lower layer,

then the SGSN locally deactivates all PDP contexts associated with the SIPTO at the local network PDN connection. If the ROUTING AREA UPDATE REQUEST request message is accepted, the SGSN informs the MS via the PDP context status IE in the ROUTING AREA UPDATE ACCEPT message that PDP contexts were locally deactivated.

For a SIPTO at the local network PDN connection with stand-alone GW, the conditions to deactivate ISR are specified in 3GPP TS 23.401 [122], subclause 4.3.5.6.

If due to regional subscription restrictions or access restrictions the MS is not allowed to access the routing area, but the MS has a PDN connection for emergency bearer services established, the network may accept the ROUTING AREA UPDATE REQUEST message and deactivate all non-emergency PDP contexts by initiating a PDP context deactivation procedure when the routing area updating procedure is initiated in PMM-CONNECTED mode. When the routing area updating procedure is initiated in PMM-IDLE mode, the network locally deactivates all non-emergency PDP contexts and informs the MS via the PDP context status IE in the ROUTING AREA UPDATE ACCEPT message. The network shall not deactivate the PDP contexts for emergency bearer services. The network shall consider the MS to be attached for emergency bearer services only.

If the network supports delivery of SMS via GPRS (see 3GPP TS 23.060 [74]) and this delivery is enabled (see 3GPP TS 29.272 [150]), then the network shall include the Additional network feature support IE in the ROUTING AREA UPDATE ACCEPT message and set the GPRS-SMS indicator.

If the network supports the extended protocol configuration options IE and the MS indicated support of the extended protocol configuration options IE, then the network shall include the Additional network feature support IE in the ROUTING AREA UPDATE ACCEPT message and set the ePCO IE indicator to "extended protocol configuration options IE supported".

The network shall indicate "combined RA/LA updated" or "combined RA/LA updated and ISR activated" in the update result IE in the ROUTING AREA UPDATE ACCEPT message, if the following conditions apply:

- the update type IE included in the ROUTING AREA UPDATE REQUEST message indicates "periodic updating" and the MS was previously successfully attached for GPRS and non-GPRS services; and
- location area updating for non-GPRS services as specified in 3GPP TS 29.018 [149] is successful.

The network shall include the T3324 value IE in the ROUTING AREA UPDATE ACCEPT message only if the T3324 value IE was included in the ROUTING AREA UPDATE REQUEST message, and the network supports and accepts the use of PSM.

If the network supports and accepts the use of PSM, and the MS included the T3312 extended value IE in the ROUTING AREA UPDATE REQUEST message, then the network shall take into account the T3312 value requested

when providing the Periodic RA update timer IE and the T3312 extended value IE in the ROUTING AREA UPDATE ACCEPT message.

NOTE 3: Besides the value requested by the MS, the network can take local configuration into account when selecting a value for T3312 (see 3GPP TS 23.060 [74] subclause 5.3.13.54).

In A/Gb mode, if the MS indicates support for restriction on use of enhanced coverage in the ROUTING AREA UPDATE REQUEST message, and the network restricts enhanced coverage for the MS, then the network shall set the RestrictEC bit to "Enhanced coverage restricted" in the Additional network feature support IE of the ROUTING AREA UPDATE ACCEPT message.

If the network includes the T3324 value IE indicating a value other than deactivated in the ROUTING AREA UPDATE ACCEPT message, the network shall indicate in the Update result IE in the ROUTING AREA UPDATE ACCEPT message that ISR is not activated.

Upon receipt of a ROUTING AREA UPDATE ACCEPT message, the MS shall store the received routing area identification, stop timer T3330, reset the routing area updating attempt counter, reset the service request attempt counter and set the GPRS update status to GU1 UPDATED. If the message contains a P-TMSI, the MS shall use this P-TMSI as new temporary identity for GPRS services and shall store the new P-TMSI. If no P-TMSI was included by the network in the ROUTING AREA UPDATE ACCEPT message, the old P-TMSI shall be kept. Furthermore, the MS shall store the P-TMSI signature if received in the ROUTING AREA UPDATE ACCEPT message. If no P-TMSI signature was included in the message, the old P-TMSI signature, if available, shall be deleted.

Upon receipt of a ROUTING AREA UPDATE ACCEPT message with update result IE indicating "combined RA/LA updated" or "combined RA/LA updated and ISR activated" during the periodic routing area updating procedure, the MS shall behave as follows:

- if the ROUTING AREA UPDATE ACCEPT message contains an IMSI, the MS is not allocated any TMSI. The MS shall delete any old TMSI accordingly;
- if the ROUTING AREA UPDATE ACCEPT message contains a TMSI, the MS shall use this TMSI as new temporary identity. The MS shall delete its old TMSI and shall store the new TMSI. In this case, a ROUTING AREA UPDATE COMPLETE message is returned to the network to confirm the received TMSI; or
- if neither a TMSI nor an IMSI has been included by the network in the ROUTING AREA UPDATE ACCEPT message, the old TMSI, if any is available, shall be kept.

Upon receiving a ROUTING AREA UPDATE COMPLETE message, the SGSN shall stop timer T3350 and change to state GMM-REGISTERED. The P-TMSI, if sent in the ROUTING AREA UPDATE ACCEPT message, shall be considered as valid.

NOTE 4: Upon receiving a ROUTING AREA UPDATE COMPLETE message, if a new TMSI is included in the ROUTING AREA UPDATE ACCEPT message, the SGSN sends a BSSAP+-TMSI-REALLOCATION-COMplete message as specified in 3GPP TS 29.018 [149].

If the PDP context status information element is included in ROUTING AREA UPDATE ACCEPT message, then the MS shall deactivate all those PDP contexts locally (without peer to peer signalling between the MS and network), which are not in SM state PDP-INACTIVE in the MS but are indicated by the network as being in state PDP-INACTIVE. If there is a default PDP context among the PDP contexts to be deactivated, an MS supporting S1 mode shall locally deactivate all PDP contexts associated to the same PDP address and APN as the default PDP context without peer-to-peer SM signalling to the network; an MS not supporting S1 mode may apply the same behaviour. If only the PDN connection for emergency bearer services remains established, the MS shall consider itself attached for emergency bearer services only.

If the MBMS context status information element is included in the ROUTING AREA UPDATE ACCEPT message, then the MS shall deactivate all those MBMS contexts locally (without peer to peer signalling between the MS and network) which are not in SM state PDP-INACTIVE in the MS, but are indicated by the network as being in state PDP-INACTIVE. If no MBMS context status information element is included, then the MS shall deactivate all those MBMS contexts locally which are not in SM state PDP-INACTIVE in the MS.

If the ROUTING AREA UPDATE ACCEPT message contains the T3312 extended value IE, then the MS shall use the T3312 extended value IE as periodic routing area update timer (T3312). If the ROUTING AREA UPDATE ACCEPT message does not contain the T3312 extended value IE, then the MS shall use value in the Periodic RA update timer IE as periodic routing area update timer (T3312).

If the MS receives the ROUTING AREA UPDATE ACCEPT message from a PLMN for which a PLMN-specific attempt counter or PLMN-specific PS-attempt counter is maintained (see subclause 4.1.1.6A), then the MS shall reset these counters. If the MS maintains a counter for "SIM/USIM considered invalid for GPRS services", then the MS shall reset this counter.

If the ROUTING AREA UPDATE ACCEPT message contains the T3324 value IE, then the MS shall use the timer value for T3324 as specified in subclause 4.7.2.8.

If the ROUTING AREA UPDATE ACCEPT message contains the DCN-ID IE, then the MS shall store the included DCN-ID value together with the PLMN code of the registered PLMN in a DCN-ID list in a non-volatile memory in the ME as described in 3GPP TS 24.301 [120], annex C.

In a shared network or in a multi-operator core network (MOCN) with common GERAN, if the ROUTING AREA UPDATE ACCEPT message contains the DCN-ID IE and the PLMN identity of the CN operator IE, the MS shall store the included DCN-ID value with the PLMN identity indicated in the PLMN identity of the CN operator IE, and the included DCN-ID value with the PLMN identity indicated in the RAI in a DCN-ID list in a non-volatile memory in the ME as described in 3GPP TS 24.301 [120], annex C.

In A/Gb mode, if the ROUTING AREA UPDATE ACCEPT message contains the Cell Notification information element, then the MS shall start to use the LLC NULL frame to perform cell updates.

If the MS has initiated the routing area updating procedure due to manual CSG selection and receives a ROUTING AREA UPDATE ACCEPT message, and the MS sent the ROUTING AREA UPDATE REQUEST message in a CSG cell, the MS shall check if the CSG ID and associated PLMN identity of the cell are contained in the Allowed CSG list. If not, the MS shall add that CSG ID and associated PLMN identity to the Allowed CSG list and the MS may add the HNB Name (if provided by lower layers) to the Allowed CSG list if the HNB Name is present in neither the Operator CSG list nor the Allowed CSG list.

The network may also send a list of "equivalent PLMNs" in the ROUTING AREA UPDATE ACCEPT message. Each entry of the list contains a PLMN code (MCC+MNC). If the routing area updating procedure is initiated during a CS fallback procedure and the network is configured to support the return to the last registered E-UTRAN PLMN after CS fallback as specified in 3GPP TS 23.272 [133], and the PLMN identity which is provided as part of the RAI contained in the ROUTING AREA UPDATE ACCEPT message differs from the last registered E-UTRAN PLMN identity, the network shall include the last registered E-UTRAN PLMN identity in the list of "equivalent PLMNs" in the ROUTING AREA UPDATE ACCEPT message.

NOTE 5: The network can determine a routing area updating procedure is initiated during a CS fallback procedure as specified in 3GPP TS 23.272 [133].

NOTE 6: The last registered E-UTRAN PLMN identity can be derived by the network as specified in 3GPP TS 23.272 [133].

The mobile station shall store the list, as provided by the network, and further handle the list as follows:

- if there is no PDN connection for emergency bearers established, the mobile station shall remove from the list of "equivalent PLMNs" any PLMN code that is already in the "forbidden PLMN" list. If the mobile station is operating in MS operation mode C or the mobile station is supporting S1 mode, it shall also remove any PLMN code that is already in the list of "forbidden PLMNs for GPRS service";
- if the MS is not attached for emergency bearer services and there is a PDN connection for emergency bearer services established, the MS shall remove from the list of "equivalent PLMNs" any PLMN code present in the "forbidden PLMN" list when the PDN connection for emergency bearer services is released. If the mobile station is operating in MS operation mode C or the mobile station is supporting S1 mode, it shall also remove any PLMN code present in the list of "forbidden PLMNs for GPRS service" when the PDN connection for emergency bearer services is released; and
- in addition, for all cases the mobile station shall add to the stored list the PLMN code of the registered PLMN that sent the list.

All PLMNs in the stored list shall be regarded as equivalent to each other for PLMN selection, cell selection/re-selection and handover. The stored list in the mobile station shall be replaced on each occurrence of the ROUTING AREA UPDATE ACCEPT message. If no list is contained in the message, then the stored list in the mobile station shall be deleted. An MS attached for emergency bearer services only shall delete the stored list when the MS enters the state

GMM-DEREGISTERED. The list shall be stored in the mobile station while switched off so that it can be used for PLMN selection after switch on.

A ROUTING AREA UPDATE COMPLETE message shall be returned to the network if the ROUTING AREA UPDATE ACCEPT message contained any of:

- a P-TMSI;
- a TMSI;
- receive N-PDU Numbers (see 3GPP TS 44.065 [78] and 3GPP TS 25.322 [19b]); or
- a request for the provision of Inter RAT handover information.

If Receive N-PDU Numbers were included, the Receive N-PDU Numbers values valid in the MS, shall be included in the ROUTING AREA UPDATE COMPLETE message.

If the network has requested the provision of Inter RAT handover information, the MS shall return a ROUTING AREA UPDATE COMPLETE message including the Inter RAT handover information IE to the network.

NOTE 7: In Iu mode, after a routing area updating procedure, the mobile station can initiate Service Request procedure to request the resource reservation for the active PDP contexts if the resources have been released by the network or send upper layer message (e.g. ACTIVATE PDP CONTEXT REQUEST) to the network via the existing PS signalling connection.

In Iu mode, if the network wishes to prolong the PS signalling connection (for example, if the mobile station has indicated "follow-on request pending" in ROUTING AREA UPDATE REQUEST message or if user plane radio access bearers have been established for the MS) the network shall indicate the "follow-on proceed" in the ROUTING AREA UPDATE ACCEPT message. If the network wishes to release the PS signalling connection, the network shall indicate "no follow-on proceed" in the ROUTING AREA UPDATE ACCEPT message.

After that in Iu mode, the mobile station shall act according to the follow-on proceed flag included in the Update result information element in the ROUTING AREA UPDATE ACCEPT message (see subclause 4.7.13).

The network may also send a Local Emergency Numbers List with local emergency numbers in the ROUTING AREA UPDATE ACCEPT, by including the Emergency Number List IE. The mobile equipment shall store the Local Emergency Numbers List, as provided by the network. The Local Emergency Numbers List stored in the mobile equipment shall be replaced on each receipt of the Emergency Number List IE. The received Local Emergency Numbers List shall be provided to the upper layers.

The emergency number(s) received in the Emergency Number List IE are valid only in networks in the same country as the cell on which this IE is received. If no list is contained in the ROUTING AREA UPDATE ACCEPT message, then the stored Local Emergency Numbers List in the mobile equipment shall be kept, except if the mobile equipment has successfully registered to a PLMN in a country different from that of the PLMN that sent the Local Emergency Numbers List.

The mobile equipment shall use the stored Local Emergency Numbers List of emergency numbers received from the network in addition to the emergency numbers stored on the SIM/USIM or ME to detect that the number dialled is an emergency number.

NOTE 8: The mobile equipment may use the Local Emergency Numbers List to assist the end user in determining whether the dialled number is intended for an emergency service or for another destination, e.g. a local directory service. The possible interactions with the end user are implementation specific.

NOTE 9: An MS that supports procedures specified in 3GPP TS 24.302 [156], can get additional local emergency numbers through those procedures, which can be used based on operator policy (see 3GPP TS 24.302 [156]) to detect that the number dialled is an emergency number.

The Local Emergency Numbers List shall be deleted at switch off and removal of the SIM/USIM. The mobile equipment shall be able to store up to ten local emergency numbers received from the network.

In order to indicate to the MS that the GUTI and TAI list assigned to the MS remain registered with the network and are valid in the MS, the network shall indicate in the Update result IE in the ROUTING AREA UPDATE ACCEPT message that ISR is activated.

If the MS is attached for emergency bearer services or if the network has deactivated all non-emergency PDP contexts, the network shall indicate in the update result IE in the ROUTING AREA UPDATE ACCEPT message that ISR is not activated.

If the ROUTING AREA UPDATE ACCEPT message contains:

- i) no indication that ISR is activated, an MS supporting S1 mode shall set the TIN to "P-TMSI" and shall stop the periodic tracking area update timer T3412 or T3423, if running; or
- ii) an indication that ISR is activated, then:
 - if the MS is required to perform tracking area updating for IMS voice termination as specified in annex P.5, the MS shall set the TIN to "P-TMSI" and shall stop the periodic tracking area update timer T3412 or T3423, if running;
 - if the MS had initiated the routing area updating procedure due to a change in DRX parameters, the MS shall set the TIN to "P-TMSI" and shall stop the periodic tracking area update timer T3412 or T3423 if running;
 - if the MS had initiated the routing area updating procedure due to a change in the UE's usage setting or the voice domain preference for E-UTRAN, the MS shall set the TIN to "P-TMSI" and shall stop the periodic tracking area update timer T3412 or T3423, if running; or
 - the MS shall regard the available GUTI and TAI list as valid and registered with the network. If the TIN currently indicates "GUTI" and the periodic tracking area update timer T3412 is running or is deactivated, the MS shall set the TIN to "RAT-related TMSI". If the TIN currently indicates "GUTI" and the periodic tracking area update timer T3412 has already expired, the MS shall set the TIN to "P-TMSI".

In A/Gb mode, if a UMTS security context is available, if the MS indicates support of integrity protection in the ROUTING AREA UPDATE REQUEST message and the network supports integrity protection, then if the MS receives replayed capability IE's in ROUTING AREA UPDATE ACCEPT message, then the MS shall check if the replayed MS network capability IE and the replayed MS Radio Access Capability IE received in the ROUTING AREA UPDATE ACCEPT message has not been altered compared to the MS network capability IE and the MS Radio Access Capability IE that the MS sent to the network in ROUTING AREA UPDATE REQUEST message. If the replayed MS network capability IE and the replayed MS Radio Access Capability IE are not the same, then the MS shall ignore the ROUTING AREA UPDATE ACCEPT message.

4.7.5.1.4 Normal and periodic routing area updating procedure not accepted by the network

If the routing area updating cannot be accepted, the network sends a ROUTING AREA UPDATE REJECT message to the MS. An MS, which receives a ROUTING AREA UPDATE REJECT message with a reject cause other than GMM cause value #25 or the message is integrity protected, shall stop the timer T3330. If a ROUTING AREA UPDATE REJECT message containing a reject cause other than GMM cause value #25 is received or the message is integrity protected, the MS shall stop any ongoing transmission of user data.

If the ROUTING AREA UPDATE REJECT message containing GMM cause value cause #25 was received without integrity protection, then the MS shall discard the message.

If the routing area update request is rejected due to general NAS level mobility management congestion control, the network shall set the GMM cause value to #22 "congestion" and assign a back-off timer T3346.

The MS shall then take different actions depending on the received reject cause value:

- # 3 (Illegal MS);
- # 6 (Illegal ME);

The MS shall set the GPRS update status to GU3 ROAMING NOT ALLOWED (and shall store it according to subclause 4.1.3.2) and shall delete any P-TMSI, P-TMSI signature, RAI and GPRS ciphering key sequence number. The MS shall consider the SIM/USIM as invalid for GPRS services until switching off or the SIM/USIM is removed. If the message has been successfully integrity checked by the lower layers and the MS maintains a counter for "SIM/USIM considered invalid for GPRS services", then the MS shall set this counter to MS implementation-specific maximum value. The MS shall delete the list of equivalent PLMNs, and shall enter the state GMM-DEREGISTERED.NO-IMSI.

If the MS is IMSI attached, the MS shall in addition set the update status to U3 ROAMING NOT ALLOWED, shall delete any TMSI, LAI and ciphering key sequence number. If the MS is operating in MS operation mode A and an RR connection exists, the MS shall abort the RR connection, unless an emergency call is ongoing. The SIM/USIM shall be considered as invalid also for non-GPRS services until switching off or the SIM/USIM is removed or the timer T3245 expires as described in subclause 4.1.1.6. If the MS maintains a counter for "SIM/USIM considered invalid for non-GPRS services", then the MS shall set this counter to MS implementation-specific maximum value.

If S1 mode is supported in the MS, the MS shall handle the EMM parameters EMM state, EPS update status, GUTI, last visited registered TAI, TAI list and KSI as specified in 3GPP TS 24.301 [120] for the case when the tracking area update procedure is rejected with the EMM cause with the same value.

NOTE 1: The possibility to configure a MS so that the radio transceiver for a specific radio access technology is not active, although it is implemented in the MS, is out of scope of the present specification.

7 (GPRS services not allowed);

The MS shall set the GPRS update status to GU3 ROAMING NOT ALLOWED (and shall store it according to subclause 4.1.3.2.9) and shall delete any P-TMSI, P-TMSI signature, RAI and GPRS ciphering key sequence number. The SIM/USIM shall be considered as invalid for GPRS services until switching off or the SIM/USIM is removed. The MS shall enter the state GMM-DEREGISTERED. If the message has been successfully integrity checked by the lower layers and the MS maintains a counter for "SIM/USIM considered invalid for GPRS services", then the MS shall set this counter to MS implementation-specific maximum value.

A GPRS MS operating in MS operation mode A or B which is already IMSI attached for CS services in the network is still IMSI attached for CS services in the network.

If the update type is "periodic updating", a GPRS MS operating in MS operation mode A or B in network operation mode I shall then proceed with the appropriate MM specific procedure.

NOTE 2: Optionally the MS starts the timer T3340 as described in subclause 4.7.1.9.

If S1 mode is supported in the MS, the MS shall handle the EMM parameters EMM state, EPS update status, GUTI, last visited registered TAI, TAI list and KSI as specified in 3GPP TS 24.301 [120] for the case when the tracking area update procedure is rejected with the EMM cause with the same value.

8 (GPRS services and non-GPRS services not allowed);

The MS shall set the GPRS update status to GU3 ROAMING NOT ALLOWED (and shall store it according to subclause 4.1.3.2) and shall delete any P-TMSI, P-TMSI signature, RAI and GPRS ciphering key sequence number. The MS shall delete the list of equivalent PLMNs, and shall enter the GMM state GMM-DEREGISTERED.NO-IMSI.

The MS shall set the update status to U3 ROAMING NOT ALLOWED, shall delete any TMSI, LAI and ciphering key sequence number. If the MS is operating in MS operation mode A and an RR connection exists, the MS shall abort the RR connection, unless an emergency call is ongoing. The SIM/USIM shall be considered as invalid for GPRS and non-GPRS services until switching off or the SIM/USIM is removed. If the message has been successfully integrity checked by the lower layers and the MS maintains a counter for "SIM/USIM considered invalid for GPRS services", then the MS shall set this counter to MS implementation-specific maximum value. If the message has been successfully integrity checked by the lower layers and the MS maintains a counter for "SIM/USIM considered invalid for non-GPRS services", then the MS shall set this counter to MS implementation-specific maximum value.

NOTE 3: Optionally the MS starts the timer T3340 as described in subclause 4.7.1.9.

If S1 mode is supported in the MS, the MS shall handle the EMM parameters EMM state, EPS update status, GUTI, last visited registered TAI, TAI list and KSI as specified in 3GPP TS 24.301 [120] for the case when the tracking area procedure is rejected with the EMM cause with the same value.

9 (MS identity cannot be derived by the network);

The MS shall set the GPRS update status to GU2 NOT UPDATED (and shall store it according to subclause 4.1.3.2), enter the state GMM-DEREGISTERED.NORMAL-SERVICE, and shall delete any P-TMSI, P-TMSI signature, RAI and GPRS ciphering key sequence number.

A GPRS MS operating in MS operation mode A or B which is already IMSI attached for CS services in the network is still IMSI attached for CS services in the network.

If the rejected request was not for initiating a PDN connection for emergency bearer services, then

- a GPRS MS operating in MS operation mode A in network operation mode I shall proceed with appropriate MM specific procedures. Additionally, the MS shall initiate a normal or combined GPRS attach procedure depending on whether it is in an ongoing circuit-switched transaction. If the MS is in an ongoing circuit-switched transaction, it shall initiate the appropriate MM specific procedure after the circuit-switched transaction has been released. The MM sublayer shall act as in network operation mode II as long as the combined GMM procedures are not successful and no new RA is entered;
- if the update type is "periodic updating", a GPRS MS operating in MS operation mode B in network operation mode I shall proceed with appropriate MM specific procedures. Additionally, the MS shall initiate a combined GPRS attach procedure. The MM sublayer shall act as in network operation mode II as long as the combined GMM procedures are not successful and no new RA is entered;
- a GPRS MS operating in MS operation mode A or B in network operation mode II which is configured to use CS fallback and SMS over SGs, or SMS over SGs only, and which did not perform a successful generic location updating procedure since the last intersystem change from S1 mode to A/Gb or Iu mode shall proceed with appropriate MM specific procedures. Additionally, a GPRS MS operating in MS operation mode A or B in network operation mode II shall initiate a GPRS attach procedure; and
- a GPRS MS operating in MS operation mode A or B in network operation mode II which is not configured to use CS fallback and SMS over SGs, or SMS over SGs only, and a GPRS MS operating in MS operation mode C may subsequently, automatically initiate the GPRS attach procedure.

If S1 mode is supported in the MS, the MS shall handle the EMM parameters EMM state, EPS update status, GUTI, last visited registered TAI, TAI list and KSI as specified in 3GPP TS 24.301 [120] for the case when the tracking area update procedure is rejected with the EMM cause with the same value.

10 (Implicitly detached);

If the update type is "periodic updating", a GPRS MS operating in MS operation mode B in network operation mode I, is IMSI detached for both GPRS and CS services in the network.

A GPRS MS operating in MS operation mode A in network operation mode I is detached for GPRS services. If no RR connection exists then the MS is also IMSI detached for the CS services.

The MS shall enter the state GMM-DEREGISTERED.NORMAL-SERVICE. If the rejected request was not for initiating a PDN connection for emergency bearer services, then

- a GPRS MS operating in MS operation mode A or B in network operation mode II which is configured to use CS fallback and SMS over SGs, or SMS over SGs only, and which did not perform a successful generic location updating procedure since the last intersystem change from S1 mode to A/Gb or Iu mode shall proceed with appropriate MM specific procedures;
- regardless of the MS operation mode and the network operation mode, the MS shall then perform a new attach procedure. The MS should also activate PDP context(s) that were originally activated by the MS to replace any previously MS activated PDP context(s). The MS should also perform the procedures needed in order to activate any previously active multicast service(s); and
- additionally, a GPRS MS operating in MS operation mode A in network operation mode I which is configured to use CS fallback and SMS over SGs, or SMS over SGs only, and which is in an ongoing circuit-switched transaction shall initiate the appropriate MM specific procedure after the circuit-switched transaction has been released. The MM sublayer shall act as in network operation mode II as long as the combined GMM procedures are not successful and no new RA is entered.

If S1 mode is supported in the MS, the MS shall handle the EMM state as specified in 3GPP TS 24.301 [120] for the case when the tracking area update procedure is rejected with the EMM cause with the same value.

NOTE 4: In some cases, user interaction may be required and then the MS cannot activate the PDP and MBMS context(s) automatically.

11 (PLMN not allowed);

The MS shall delete any RAI, P-TMSI, P-TMSI signature and GPRS ciphering key sequence number, shall set the GPRS update status to GU3 ROAMING NOT ALLOWED (and shall store it according to subclause 4.1.3.2), shall reset the routing area updating attempt counter, shall delete the list of equivalent PLMNs, and enter the state GMM-DEREGISTERED.

The MS shall store the PLMN identity in the "forbidden PLMN list" and if the MS is configured to use timer T3245 (see 3GPP TS 24.368 [135] or 3GPP TS 31.102 [112]) then the MS shall start timer T3245 and proceed as described in subclause 4.1.1.6. If the message has been successfully integrity checked by the lower layers and the MS maintains a PLMN-specific attempt counter for that PLMN, then the MS shall set this counter to the MS implementation-specific maximum value.

The MS shall start timer T3340 as described in subclause 4.7.1.9.

If no RR connection exists, the MS shall perform the following additional actions immediately. If the MS is operating in MS operation mode A and an RR connection exists, the MS shall perform these actions when the RR connection is subsequently released:

- If the MS is IMSI attached, the MS shall set the update status to U3 ROAMING NOT ALLOWED and shall delete any TMSI, LAI and ciphering key sequence number and shall reset the location update attempt counter. The new MM state is MM IDLE.
- The MS shall perform a PLMN selection according to 3GPP TS 23.122 [14].

An MS in GAN mode shall request a PLMN list in GAN (see 3GPP TS 44.318 [76b]) prior to perform a PLMN selection from this list according to 3GPP TS 23.122 [14].

If S1 mode is supported in the MS, the MS shall handle the EMM parameters EMM state, EPS update status, GUTI, last visited registered TAI, TAI list, KSI and tracking area updating attempt counter as specified in 3GPP TS 24.301 [120] for the case when the tracking area update procedure is rejected with the EMM cause with the same value.

12 (Location area not allowed);

The MS shall delete any RAI, P-TMSI, P-TMSI signature and GPRS ciphering key sequence number, shall set the GPRS update status to GU3 ROAMING NOT ALLOWED (and shall store it according to clause 4.1.3.2), shall reset the routing area updating attempt counter and shall change to state GMM-DEREGISTERED.LIMITED-SERVICE.

The mobile station shall store the LAI in the list of "forbidden location areas for regional provision of service".

The MS shall start timer T3340 as described in subclause 4.7.1.9.

If no RR connection exists, the MS shall perform the following additional actions immediately. If the MS is operating in MS operation mode A and an RR connection exists, the MS shall perform these actions when the RR connection is subsequently released:

- If the MS is IMSI attached, the MS shall set the update status to U3 ROAMING NOT ALLOWED, shall delete any TMSI, LAI and ciphering key sequence number and shall reset the location update attempt counter. The new MM state is MM IDLE.
- The MS shall perform a cell selection according to 3GPP TS 43.022 [82] and 3GPP TS 25.304 [98].

NOTE 5: The cell selection procedure is not applicable for an MS in GAN mode.

If S1 mode is supported in the MS, the MS shall handle the EMM parameters EMM state, EPS update status, GUTI, last visited registered TAI, TAI list, KSI and tracking area updating attempt counter as specified in 3GPP TS 24.301 [120] for the case when the tracking area update procedure is rejected with the EMM cause with the same value.

13 (Roaming not allowed in this location area);

The MS shall set the GPRS update status to GU3 ROAMING NOT ALLOWED (and shall store it according to clause 4.1.3.2) and shall delete the list of equivalent PLMNs. The MS shall reset the routing area updating attempt counter, and shall enter the state GMM-REGISTERED.LIMITED-SERVICE.

The MS shall store the LAI in the list of "forbidden location areas for roaming".

The MS shall start timer T3340 as described in subclause 4.7.1.9.

If no RR connection exists, the MS shall perform the following additional actions immediately. If the MS is operating in MS operation mode A and an RR connection exists, the MS shall perform these actions when the RR connection is subsequently released:

- If the MS is IMSI attached, the MS shall set the update status to U3 ROAMING NOT ALLOWED and shall reset the location update attempt counter. The new MM state is MM IDLE.
- The MS shall perform a PLMN selection according to 3GPP TS 23.122 [14].

An MS in GAN mode shall request a PLMN list in GAN (see 3GPP TS 44.318 [76b]) prior to perform a PLMN selection from this list according to 3GPP TS 23.122 [14].

If S1 mode is supported in the MS, the MS shall handle the EMM parameters EMM state, EPS update status and tracking area updating attempt counter as specified in 3GPP TS 24.301 [120] for the case when the tracking area update procedure is rejected with the EMM cause with the same value.

14 (GPRS services not allowed in this PLMN);

The MS shall delete any RAI, P-TMSI, P-TMSI signature, and GPRS ciphering key sequence number stored, shall set the GPRS update status to GU3 ROAMING NOT ALLOWED (and shall store it according to subclause 4.1.3.2), shall reset the routing area updating attempt counter and shall change to state GMM-DEREGISTERED.

The MS shall store the PLMN identity in the "forbidden PLMNs for GPRS service" list and if the MS is configured to use timer T3245 (see 3GPP TS 24.368 [135] or 3GPP TS 31.102 [112]) then the MS shall start timer T3245 and proceed as described in subclause 4.1.1.6. A GPRS MS operating in MS operation mode C shall perform a PLMN selection instead of a cell selection. If the message has been successfully integrity checked by the lower layers and the MS maintains a PLMN-specific PS-attempt counter for that PLMN, then the MS shall set this counter to the MS implementation-specific maximum value.

A GPRS MS operating in MS operation mode A or B which is already IMSI attached for CS services in the network is still IMSI attached for CS services in the network.

If the update type is "periodic updating" a GPRS MS operating in MS operation mode A or B in network operation mode I shall then proceed with the appropriate MM specific procedure.

As an implementation option, a GPRS MS operating in operation mode A or B may perform the following additional action. If no RR connection exists the MS may perform the action immediately. If the MS is operating in MS operation mode A and an RR connection exists, the MS may only perform the action when the RR connection is subsequently released:

- The MS may perform a PLMN selection according to 3GPP TS 23.122 [14].

If an MS in GAN mode performs a PLMN selection, it shall request a PLMN list in GAN (see 3GPP TS 44.318 [76b]) prior to perform a PLMN selection from this list according to 3GPP TS 23.122 [14].

The MS shall not perform the optional PLMN selection in the case where the PLMN providing this reject cause is:

- On the "User Controlled PLMN Selector with Access Technology " or,
- On the "Operator Controlled PLMN Selector with Access Technology " list or,
- A PLMN identified as equivalent to any PLMN, within the same country, contained in the lists above.

If S1 mode is supported in the MS, the MS shall handle the EMM parameters EMM state, EPS update status, GUTI, last visited registered TAI, TAI list, KSI and tracking area updating attempt counter as specified in 3GPP TS 24.301 [120] for the case when the tracking area update procedure is rejected with the EMM cause with the same value.

15 (No Suitable Cells In Location Area);

The MS shall set the GPRS update status to GU3 ROAMING NOT ALLOWED (and shall store it according to subclause 4.1.3.2) shall reset the routing area updating attempt counter and shall change to state GMM-REGISTERED.LIMITED-SERVICE.

The MS shall store the LAI in the list of "forbidden location areas for roaming".

The MS shall start timer T3340 as described in subclause 4.7.1.9.

If no RR connection exists, the MS shall perform the following additional actions immediately. If the MS is operating in MS operation mode A and an RR connection exists, the MS shall perform these actions when the RR connection is subsequently released:

- If the MS is IMSI attached, the MS shall set the update status to U3 ROAMING NOT ALLOWED and shall reset the location update attempt counter. The new MM state is MM IDLE.
- The MS shall search for a suitable cell in another location area or a tracking area according to 3GPP TS 43.022 [82] and 3GPP TS 25.304 [98] or 3GPP TS 36.304 [121].

NOTE 6: The cell selection procedure is not applicable for an MS in GAN mode.

If S1 mode is supported in the MS, the MS shall handle the EMM parameters EMM state, EPS update status and tracking area updating attempt counter as specified in 3GPP TS 24.301 [120] for the case when the tracking area update procedure is rejected with the EMM cause with the same value.

#22 (Congestion);

If the T3346 value IE is present in the ROUTING AREA UPDATE REJECT message and the value indicates that this timer is neither zero nor deactivated, the MS shall proceed as described below, otherwise it shall be considered as an abnormal case and the behaviour of the MS for this case is specified in subclause 4.7.5.1.5.

The MS shall abort the routing area updating procedure, reset the routing area updating attempt counter and set the GPRS update status to GU2 NOT UPDATED. If the rejected request was not for initiating a PDN connection for emergency bearer services, the MS shall change to state GMM-REGISTERED.ATTEMPTING-TO-UPDATE.

The MS shall stop timer T3346 if it is running.

If the ROUTING AREA UPDATE REJECT message is integrity protected, the MS shall start timer T3346 with the value provided in the T3346 value IE.

If the ROUTING AREA UPDATE REJECT message is not integrity protected, the MS shall start timer T3346 with a random value from the default range specified in table 11.3a.

The MS stays in the current serving cell and applies the normal cell reselection process. The routing area updating procedure is started, if still necessary, when timer T3346 expires or is stopped.

A GPRS MS operating in MS operation mode A or B which is already IMSI attached for CS services in the network is still IMSI attached for CS services in the network.

If S1 mode is supported in the MS, the MS shall handle the EMM parameters EMM state, EPS update status, and tracking area updating attempt counter as specified in 3GPP TS 24.301 [120] for the case when the tracking area update procedure is rejected with the EMM cause with the same value.

A GPRS MS operating in MS operation mode A or B in network operation mode II which is configured to use CS fallback and SMS over SGs, or SMS over SGs only, and which did not perform a successful generic location updating procedure since the last intersystem change from S1 mode to A/Gb or Iu mode shall proceed with appropriate MM specific procedures.

25 (Not authorized for this CSG)

Cause #25 is only applicable in UTRAN Iu mode and when received from a CSG cell. Other cases are considered as abnormal cases and the specification of the mobile station behaviour is given in subclause 4.7.5.1.5.

The MS shall set the GPRS update status to GU3 ROAMING NOT ALLOWED (and store it according to subclause 4.1.3.2) and shall reset the routing area updating attempt counter. The state is changed to GMM-REGISTERED.LIMITED-SERVICE.

If the CSG ID and associated PLMN identity of the cell where the MS has sent the ROUTING AREA UPDATE REQUEST message are contained in the Allowed CSG list stored in the MS, the MS shall remove the entry corresponding to this CSG ID and associated PLMN identity from the Allowed CSG list.

If the CSG ID and associated PLMN identity of the cell where the MS has sent the ROUTING AREA UPDATE REQUEST message are contained in the Operator CSG list, the MS shall proceed as specified in 3GPP TS 23.122 [14] subclause 3.1A.

The MS shall start timer T3340 as described in subclause 4.7.1.9.

If no RR connection exists, the MS shall perform the following additional actions immediately. If the MS is operating in MS operation mode A and an RR connection exists, the MS shall perform these actions when the RR connection is subsequently released:

- If the MS is IMSI attached, the MS shall set the update status to U3 ROAMING NOT ALLOWED and shall reset the location update attempt counter. The new MM state is MM IDLE.
- The MS shall search for a suitable cell according to 3GPP TS 43.022 [82] and 3GPP TS 25.304 [98].

If S1 mode is supported in the MS, the MS shall handle the EMM parameters EMM state, EPS update status and tracking area updating attempt counter as specified in 3GPP TS 24.301 [120] for the case when the tracking area update procedure is rejected with the EMM cause with the same value.

Other values are considered as abnormal cases. The specification of the MS behaviour in those cases is described in subclause 4.7.5.1.5.

4.7.5.1.4a Routing area updating procedure for initiating a PDN connection for emergency bearer services not accepted by the network (UTRAN lu mode only)

If the routing area updating request for initiating a PDN connection for emergency bearer services cannot be accepted by the network, the MS shall perform the procedures as described in subclause 4.7.5.1.4. Then if the MS is in the same selected PLMN where the last routing area updating was attempted, the MS shall:

- a) inform the upper layers of the failure of the procedure; or

NOTE 1: This can result in the upper layers requesting establishment of a CS emergency call (if not already attempted in the CS domain) or other implementation specific mechanisms, e.g. procedures specified in 3GPP TS 24.229 [95] that can result in the emergency call being attempted to another IP-CAN.

- b) detach locally, if not detached already, attempt GPRS attach for emergency bearer services.

If the routing area updating request for initiating a PDN connection for emergency bearer services fails due to abnormal case a) in subclause 4.7.5.1.5, the MS shall perform the procedures as described in subclause 4.7.5.1.5 and inform the upper layers of the failure to access the network.

NOTE 2: This can result in the upper layers requesting establishment of a CS emergency call (if not already attempted in the CS domain) or other implementation specific mechanisms, e.g. procedures specified in 3GPP TS 24.229 [95] that can result in the emergency call being attempted to another IP-CAN.

If the routing area updating request for initiating a PDN connection for emergency bearer services fails due to abnormal cases b), c) or d) in subclause 4.7.5.1.5, the MS shall perform the procedures as described in subclause 4.7.5.1.5. Then if the MS is in the same selected PLMN where the last routing area updating was attempted, the MS shall:

- a) inform the upper layers of the failure of the procedure; or

NOTE 3: This can result in the upper layers requesting establishment of a CS emergency call (if not already attempted in the CS domain) or other implementation specific mechanisms, e.g. procedures specified in 3GPP TS 24.229 [95] that can result in the emergency call being attempted to another IP-CAN.

- b) detach locally, if not detached already, attempt GPRS attach for emergency bearer services.

4.7.5.1.5 Abnormal cases in the MS

The following abnormal cases can be identified:

- a) Access barred because of access class control, EAB or ACDC

If the routing area updating procedure is started in response to a paging request from the network, access class barring, EAB or ACDC is not applicable.

The routing area updating procedure shall not be started. The MS stays in the current serving cell and applies the normal cell reselection process. The procedure is started as soon as possible and if still necessary, i.e. when the barred state is removed or because of a cell change.

If access is barred because of access class control, the upper layers request PS signalling connection, ACDC is applicable to the request and the MS supports ACDC, then the routing area updating procedure shall be started according to subclause 4.7.5.1.1.

If access is barred for a certain ACDC category, and if the upper layers request PS signalling connection for a higher ACDC category and the MS supports ACDC, then the routing area updating procedure shall be started according to subclause 4.7.5.1.1.

If an access request for an uncategorized application is barred due to ACDC, and if the upper layers request PS signalling connection for a certain ACDC category and the MS supports ACDC, then the routing area updating procedure shall be started according to subclause 4.7.5.1.1.

- b) Lower layer failure without "Extended Wait Time" received from lower layers before the ROUTING AREA UPDATE ACCEPT or ROUTING AREA UPDATE REJECT message is received

The procedure shall be aborted and the MS shall proceed as described below, except in the following implementation option cases b.1 and b.2.

- b.1) Release of PS signalling connection before the completion of the routing area updating procedure

The routing area updating procedure shall be initiated again, if the following conditions apply:

- i) The original routing area update procedure was initiated over an existing PS signalling connection; and
- ii) The routing area update procedure was not due to timer T3330 expiry; and
- iii) No SECURITY MODE COMMAND message and no Non-Access Stratum (NAS) messages relating to the PS signalling connection were (e.g. PS authentication procedure, see subclause 4.7.7) received after the ROUTING AREA UPDATE REQUEST message was transmitted.

- b.2) RR release in Iu mode (i.e. RRC connection release) with, for example, cause "Normal", or "User inactivity" or "Direct signalling connection re-establishment" (see 3GPP TS 25.331 [23c] and 3GPP TS 44.118 [111])

The routing area updating procedure shall be initiated again, if the following conditions apply:

- i) The original routing area update procedure was initiated over an existing RRC connection; and
- ii) The routing area update procedure was not due to timer T3330 expiry; and
- iii) No SECURITY MODE COMMAND message and no Non-Access Stratum (NAS) messages relating to the PS signalling connection (e.g. PS authentication procedure, see subclause 4.7.7) were received after the ROUTING AREA UPDATE REQUEST message was transmitted.

NOTE 1: The RRC connection release cause that triggers the re-initiation of the routing area update procedure is implementation specific.

- c) T3330 time-out

The procedure is restarted four times, i.e. on the fifth expiry of timer T3330, the MS shall abort the procedure and, in Iu mode, release the PS signalling connection (see 3GPP TS 25.331 [23c]). The MS shall proceed as described below.

- d) ROUTING AREA UPDATE REJECT, other causes than those treated in subclause 4.7.5.1.4, and cases of GMM cause values #22 and #25, if considered as abnormal cases according to subclause 4.7.5.1.4

If the routing area updating request is not for initiating a PDN connection for emergency bearer services, upon reception of the cause codes # 95, # 96, # 97, # 99 and # 111 the MS should set the routing area updating attempt counter to 5.

The MS shall proceed as described below.

- e) If a routing area border is crossed, when the MS is in state GMM-ROUTING-AREA-UPDATE-INITIATED, the routing area updating procedure shall be aborted and re-initiated immediately. The MS shall set the GPRS update status to GU2 NOT UPDATED.
- f) In A/Gb mode, if a cell change occurs within the same RA, when the MS is in state GMM-ROUTING-AREA-UPDATE-INITIATED, the cell update procedure is performed, before completion of the routing area updating procedure.
- g) Routing area updating and detach procedure collision

GPRS detach containing detach type "re-attach required" or "re-attach not required":

If the MS receives a DETACH REQUEST message before the routing area updating procedure has been completed, the routing area updating procedure shall be aborted and the GPRS detach procedure shall be progressed. If the DETACH REQUEST message contains detach type "re-attach not required" and GMM cause #2 "IMSI unknown in HLR", the MS will follow the procedure as described below for the detach type "IMSI detach".

GPRS detach containing detach type "IMSI detach":

If the MS receives a DETACH REQUEST message before the routing area updating procedure has been completed, the routing area updating procedure shall be progressed, i.e. the DETACH REQUEST message shall be ignored.

The MS shall proceed as described below.

- h) Routing area updating and P-TMSI reallocation procedure collision

If the MS receives a P-TMSI REALLOCATION COMMAND message before the routing area updating procedure has been completed, the P-TMSI reallocation procedure shall be aborted and the routing area updating procedure shall be progressed.

- i) "Extended wait time" for PS domain from the lower layers

If the ROUTING AREA UPDATE REQUEST message contained the low priority indicator set to "MS is configured for NAS signalling low priority", the MS shall start timer T3346 with the "Extended wait time" value and reset the routing area updating attempt counter.

In other cases the MS shall ignore the "Extended wait time".

The MS shall abort the routing area updating procedure, stay in the current serving cell, set the GPRS update status to GU2 NOT UPDATED, change the state to GMM-REGISTERED.ATTEMPTING-TO-UPDATE and apply the normal cell reselection process.

If the MS had used eDRX before initiating routing area updating procedure, then the MS shall continue to use the eDRX with the extended DRX parameters IE received during the last attach or routing area updating procedure.

The MS shall proceed as described below.

- j) Timer T3346 is running

The MS shall not start the routing area updating procedure unless:

- the MS is an MS configured to use AC11 – 15 in selected PLMN;
- the MS is in PMM-CONNECTED mode (Iu mode);
- the MS receives a paging;
- the MS has a PDN connection for emergency bearer services established;

- the MS is establishing a PDN connection for emergency bearer services; or
- the MS has a PDN connection established without the NAS signalling low priority indication or is establishing a PDN connection without the NAS signalling low priority indication and if the timer T3346 was started due to rejection of a NAS request message (e.g. ATTACH REQUEST, ROUTING AREA UPDATE REQUEST or SERVICE REQUEST) which contained the low priority indicator set to "MS is configured for NAS signalling low priority".

The MS stays in the current serving cell and applies the normal cell reselection process.

NOTE 2: It is considered an abnormal case if the MS needs to initiate an routing area updating procedure while timer T3346 is running independent on whether timer T3346 was started due to an abnormal case or a non successful case.

If the stored RAI is different to the RAI of the current serving cell or the TIN indicates "GUTI", the MS shall set the GPRS update status to GU2 NOT UPDATED and change to state GMM-REGISTERED.ATTEMPTING-TO-UPDATE.

The MS shall proceed as described below.

k) Mobile originated detach required

GPRS detach due to removal of the USIM or due to switch off:

If the MS is in the state GMM-ROUTING-AREA-UPDATE-INITIATED, the routing area updating procedure shall be aborted and the GPRS detach procedure shall be performed (see subclause 4.7.4.1).

GPRS detach not due to removal of the USIM and not due to switch off:

The MS shall initiate the MS initiated detach procedure after successful completion of the routing area updating procedure.

l) Routing area updating and paging for non-GPRS services procedure collision

If a GPRS MS in MS operation mode B receives a paging for non-GPRS services before the normal or periodic routing area updating procedure has been completed, the MS shall progress the routing area updating procedure and respond to the paging for non-GPRS services when it has completed the routing area updating procedure or aborted the procedure for other reasons.

In cases b, c, d, e, g with detach type "re-attach required" or "re-attach not required" with GMM cause other than #2 "IMSI unknown in HLR", and i, the MS shall stop any ongoing transmission of user data.

In cases b, c, d, i and j the MS shall proceed as follows:

Timer T3330 shall be stopped if still running.

For the cases b, c, d, and i when the "Extended wait time" is ignored, if the routing area updating request is not for initiating a PDN connection for emergency bearer services, the routing area updating attempt counter shall be incremented.

If the routing area updating attempt counter is less than 5, and the stored RAI is equal to the RAI of the current serving cell and the GPRS update status is equal to GU1 UPDATED and the TIN does not indicate "GUTI":

- the MS shall keep the GPRS update status to GU1 UPDATED and changes state to GMM-REGISTERED.NORMAL-SERVICE. The MS shall start timer T3311.
- If in addition the ROUTING AREA UPDATE REQUEST message indicated "periodic updating", none of the other reasons for initiating the routing area updating procedure listed in subclause 4.7.5.1 was applicable, and the ROUTING AREA UPDATE REQUEST message did not include a Requested READY timer value IE, T3324 value IE, T3312 extended value IE or Extended DRX parameters IE,
 - in Iu mode, the timer T3311 may be stopped when the MS enters PMM-CONNECTED mode;
 - in A/Gb mode, the timer T3311 may be stopped when the READY timer is started.
- If timer T3311 expires the routing area updating procedure is triggered again.

If the routing area updating attempt counter is less than 5, and the stored RAI is different to the RAI of the current serving cell or the GPRS update status is different to GU1 UPDATED or the TIN indicates "GUTI":

- for the cases i and j, the routing area updating procedure is started, if still necessary, when timer T3346 expires or is stopped.
- for the cases b, c, d, and i when the "Extended wait time" is ignored, if the routing area updating request is not for initiating a PDN connection for emergency bearer services, the MS shall start timer T3311, shall set the GPRS update status to GU2 NOT UPDATED and changes state to GMM-REGISTERED.ATTEMPTING-TO-UPDATE.
- If S1 mode is supported by the MS, the MS shall in addition handle the EPS update status as specified in 3GPP TS 24.301 [120] for the abnormal case when a normal or periodic tracking area updating procedure fails and the tracking area updating attempt counter is less than 5 and the EPS update status is different from EU1 UPDATED.

If the routing area updating attempt counter is greater than or equal to 5:

- the MS shall start timer T3302, and shall set the GPRS update status to GU2 NOT UPDATED. An MS which is a GPRS MS in MS operation modes C shall also delete the list of equivalent PLMNs. The MS shall also enter the state GMM-REGISTERED.ATTEMPTING-TO-UPDATE or optionally the GMM-REGISTERED.PLMN-SEARCH state (see subclause 4.2.5.1.8) in order to perform a PLMN selection according to 3GPP TS 23.122 [14].
- If S1 mode is supported by the MS, the MS shall in addition handle the EPS update status as specified in 3GPP TS 24.301 [120] for the abnormal case when a normal or periodic tracking area updating procedure fails and the tracking area updating attempt counter is equal to 5.
- If the MS does not enter the state GMM-REGISTERED.PLMN-SEARCH, then
 - a GPRS MS operating in MS operation mode A in network operation mode I shall proceed with appropriate MM specific procedures. If the MS operating in MS operation mode A is in an ongoing circuit-switched transaction, it shall initiate the appropriate MM specific procedure after the circuit-switched transaction has been released. The MM sublayer of the MS operating in MS operation mode A shall act as in network operation mode II as long as the combined GMM procedures are not successful and no new RA is entered;
 - if the update type is "periodic updating", a GPRS MS operating in MS operation mode B in network operation mode I shall proceed with appropriate MM specific procedures. The MM sublayer shall act as in network operation mode II as long as the combined GMM procedures are not successful and no new RA is entered; and
 - a GPRS MS operating in MS operation mode A or B in network operation mode II which is configured to use CS fallback and SMS over SGs, or SMS over SGs only, and which did not perform a successful generic location updating procedure since the last intersystem change from S1 mode to A/Gb or Iu mode shall proceed with appropriate MM specific procedures.

4.7.5.1.6 Abnormal cases on the network side

The following abnormal cases can be identified:

- a) If a lower layer failure occurs before the message ROUTING AREA UPDATE COMPLETE has been received from the MS and a P-TMSI and/or PTMSI signature has been assigned, the network shall abort the procedure and shall consider both, the old and new P-TMSI and the corresponding P-TMSI signatures as valid until the old P-TMSI can be considered as invalid by the network (see subclause 4.7.1.5). During this period the network may use the identification procedure followed by a P-TMSI reallocation procedure if the old P-TMSI is used by the MS in a subsequent message.

NOTE 1: Optionally, paging with IMSI may be used if paging with old and new P-TMSI fails. Paging with IMSI causes the MS to re-attach as described in subclause 4.7.9.1.

- b) Protocol error

If the ROUTING AREA UPDATE REQUEST message has been received with a protocol error, the network shall return a ROUTING AREA UPDATE REJECT message with one of the following reject causes:

- #96: Mandatory information element error;
- #99: Information element non-existent or not implemented;
- #100: Conditional IE error;
- #111: Protocol error, unspecified.

c) T3350 time-out

On the first expiry of the timer, the network shall retransmit the ROUTING AREA UPDATE ACCEPT message and shall reset and restart timer T3350. The retransmission is performed four times, i.e. on the fifth expiry of timer T3350, the routing area updating procedure is aborted. Both, the old and the new P-TMSI and the corresponding P-TMSI signatures shall be considered as valid until the old P-TMSI can be considered as invalid by the network(see subclause 4.7.1.5). During this period the network acts as described for case a above.

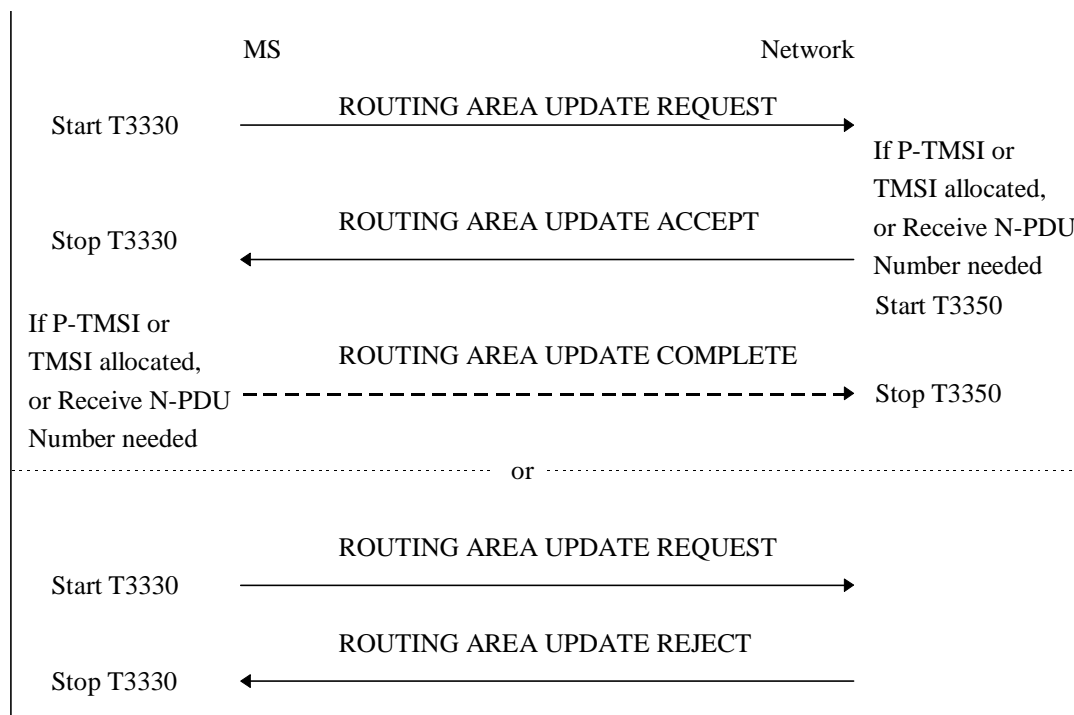

Figure 4.7.5/1 3GPP TS 24.008: Routing and combined routing area updating procedure

- d.1) ROUTING AREA UPDATE REQUEST received after the ROUTING AREA UPDATE ACCEPT message has been sent and before the ROUTING AREA UPDATE COMPLETE message is received
- If one or more of the information elements in the ROUTING AREA UPDATE REQUEST message differ from the ones received within the previous ROUTING AREA UPDATE REQUEST message, the previously initiated routing area updating procedure shall be aborted if the ROUTING AREA UPDATE COMPLETE message has not been received and the new routing area updating procedure shall be progressed, or
 - If the information elements do not differ, then the ROUTING AREA UPDATE ACCEPT message shall be resent and the timer T3350 shall be restarted if an ROUTING AREA UPDATE COMPLETE message is expected. In that case, the retransmission counter related to T3350 is not incremented.
- d.2) More than one ROUTING AREA UPDATE REQUEST received and no ROUTING AREA UPDATE ACCEPT or ROUTING AREA UPDATE REJECT message has been sent
- If one or more of the information elements in the ROUTING AREA UPDATE REQUEST message differs from the ones received within the previous ROUTING AREA UPDATE REQUEST message, the previously initiated routing area updating procedure shall be aborted and the new routing area updating procedure shall be progressed;

- If the information elements do not differ, then the network shall continue with the previous routing area updating procedure and shall not treat any further this ROUTING AREA UPDATE REQUEST message.
- e) DETACH REQUEST message received before the ROUTING AREA UPDATE ACCEPT message is sent or before the ROUTING AREA UPDATE COMPLETE message (in case of P-TMSI and/or TMSI was allocated) is received.

GPRS detach containing cause "power off":

The network shall abort the signalling for the routing area updating procedure towards the MS and shall progress the detach procedure as described in subclause 4.7.4.1.

NOTE 2: Internally in the network, before processing the detach request, the SGSN can perform the necessary signalling procedures for the routing area updating procedure before progressing the detach procedure.

GPRS detach containing other causes than "power off":

The network shall proceed with the routing area updating procedure and shall progress the detach procedure after successful completion of the routing area updating procedure.

- f) ROUTING AREA UPDATE REQUEST message with update type IE indicating "periodic updating" is received by the network, the network does not have the GMM context data related to the subscription, and the network operates in network operation mode I.

The network may send the ROUTING AREA UPDATE REJECT message with GMM cause value #10 "Implicitly detached".

4.7.5.2 Combined routing area updating procedure

4.7.5.2.0 General

Within a combined routing area updating procedure the messages ROUTING AREA UPDATE ACCEPT and ROUTING AREA UPDATE COMPLETE carry information for the routing area updating and the location area updating.

4.7.5.2.1 Combined routing area updating procedure initiation

The combined routing area updating procedure is initiated only by a GPRS MS operating in MS operation modes A or B, if the MS is in state GMM-REGISTERED and MM-IDLE, and if the network operates in network operation mode I:

- when a GPRS MS that is IMSI attached for GPRS and non-GPRS services detects a change of the routing area in state GMM-REGISTERED and MM-IDLE, unless the MS is configured for "AttachWithIMSI" as specified in 3GPP TS 24.368 [135] or 3GPP TS 31.102 [112] and is entering a routing area in a new PLMN that is neither the registered PLMN nor in the list of equivalent PLMNs;
- when a GPRS MS that is IMSI attached for GPRS services wants to perform an IMSI attach for non-GPRS services;
- after termination of a non-GPRS service via non-GPRS channels to update the association if the MS has changed the RA during that non-GPRS service transaction;
- after termination of a non-GPRS service via non-GPRS channels to update the association if GPRS services were suspended during the non-GPRS service but no resume is received. See 3GPP TS 23.060 [74] subclause 16.2.1;
- after termination of a non-GPRS service via non-GPRS channels to update the association, if the GPRS MS in MS operation mode A performed a normal GPRS attach or a normal routing area updating procedure during the circuit-switched transaction;
- after a CM SERVICE REJECT message with cause value #4 is received by the mobile station (see subclause 4.5.1.1); in this case the update type IE shall be set to "Combined RA/LA updating with IMSI attach";
- when a GPRS MS needs to update the network with the new MS Radio Access Capability IE;
- when a GPRS MS needs to update the network with a new DRX parameter IE;

- in Iu mode, to re-synchronize the PMM mode of MS and network after RRC connection release with cause "Directed signalling connection re-establishment", see subclause 4.7.2.5;
- in Iu mode, to re-synchronize the PMM mode of MS and network after inter-system change not due to PS handover from PMM-CONNECTED mode in Iu mode to A/Gb mode or S1 mode, if the MS performed an inter-system change back to Iu mode without sending a ROUTING AREA UPDATE REQUEST message while in A/Gb mode or a TRACKING AREA UPDATE REQUEST message while in S1 mode;
- in Iu mode and A/Gb mode, after intersystem change from S1 mode, and the GMM receives an indication of "RRC connection failure" from lower layers due to lower layer failure while in S1 mode. In this case, if the TIN indicates "RAT-related TMSI", the MS shall set the TIN to "GUTI" before initiating the routing area updating procedure;
- in A/Gb mode, after intersystem change from S1 mode if the TIN indicates "RAT-related TMSI", but the MS is required to perform routing area updating for IMS voice termination as specified in annex P.4;
- when the MS enters GMM-REGISTERED.NORMAL-SERVICE and the TIN indicates "GUTI";
- when the MS supports SRVCC and changes the mobile station classmark 2, mobile station classmark 3 or the supported codecs;
- when the MS which is configured to use CS fallback and SMS over SGs, or SMS over SGs only, enters a GERAN or UTRAN cell and timer T3423 has expired, or is in the GERAN or UTRAN cell when timer T3423 expires;
- when due to a manual CSG selection the GPRS MS has selected a CSG cell whose CSG identity and associated PLMN identity are not included in the MS's Allowed CSG list or in the MS's Operator CSG list;
- when the MS changes the MS network capability information;
- when the UE's usage setting or the voice domain preference for E-UTRAN change in the MS;
- when the MS activates mobility management for IMS voice termination as specified in annex P.2 and the TIN indicates "RAT-related TMSI";
- upon reception of a paging indication using P-TMSI, if the timer T3346 is running and the MS is in state GMM-REGISTERED.ATTEMPTING-TO-UPDATE and the RAI of the current cell is same as the stored RAI;
- when the MS which is configured to use CS fallback and SMS over SGs, or SMS over SGs only, enters a GERAN or UTRAN cell, after intersystem change from S1 mode to Iu or A/Gb mode not due to CS fallback, and the location area of the current cell is different from the location area stored in the MS;
- in A/Gb mode, after intersystem change from S1 mode via cell change order procedure not due to CS fallback, if the TIN indicates "RAT-related TMSI"; in this case the MS shall set the TIN to "GUTI" before initiating the combined routing area updating procedure;
- in A/Gb mode, after Inter RAT handover from S1 mode or Iu mode;
- when the MS needs to request the use of PSM or needs to stop the use of PSM;
- when the MS needs to request the use of eDRX or needs to stop the use of eDRX;
- when a change in the eDRX usage conditions at the MS requires different extended DRX parameters;
- when a change in the PSM usage conditions at the MS requires a different timer T3312 value or different timer T3324 value; or

NOTE 1: A change in the PSM or eDRX usage conditions at the MS can include e.g. a change in the MS configuration, a change in requirements from upper layers or the battery running low at the MS.

- when the Default_DCN_ID value changes, as specified in 3GPP TS 24.368 [135] or in USIM file NAS_{CONFIG} as specified in 3GPP TS 31.102 [112].

NOTE 2: The routing area updating procedure is initiated after deleting the DCN-ID list as specified in 3GPP TS 24.301 [120], annex C.

In A/Gb mode, the routing and location area identification are broadcast on the broadcast channel(s). A combined routing area updating procedure shall abort any ongoing GMM procedure. Aborted GMM procedures shall be repeated after the combined routing area updating procedure has been successfully performed. The ROUTING AREA UPDATE REQUEST message shall always be the first message sent from the MS in the new routing area after routing area change.

In Iu mode, the routing and location area identification are broadcast on the broadcast channel(s) or sent to the MS via the PS signalling connection. A combined routing area updating procedure shall abort any ongoing GMM procedure. Aborted GMM procedures may be repeated after the combined routing area updating procedure has been successfully performed. The ROUTING AREA UPDATE REQUEST message shall always be the first GMM message sent from the MS in the new routing area after routing area change.

To initiate a combined routing area updating procedure the MS sends the message ROUTING AREA UPDATE REQUEST to the network, starts timer T3330 and changes to state GMM-ROUTING-UPDATING-INITIATED and MM LOCATION UPDATING PENDING. The value of the Update type IE in the message shall indicate "combined RA/LA updating" unless explicitly specified otherwise. If for the last attempt to update the registration of the location area a MM specific procedure was performed, the value of the Update type IE in the ROUTING AREA UPDATE REQUEST message shall indicate "combined RA/LA updating with IMSI attach". Furthermore the MS shall include the TMSI status IE if no valid TMSI is available. If the MS has stored a valid LAI and the MS supports EMM combined procedures, the MS shall include it in the Old location area identification IE in the ROUTING AREA UPDATE REQUEST message. If timer T3302 is currently running, the MS shall stop timer T3302. If timer T3311 is currently running, the MS shall stop timer T3311.

If the MS has stored a valid TMSI, the MS shall include the TMSI based NRI container IE in the ROUTING AREA UPDATE REQUEST message.

A GPRS MS in MS operation modes B that is in an ongoing circuit-switched transaction, shall initiate the combined routing area updating procedure after the circuit-switched transaction has been released, if the MS has changed the RA during the circuit-switched transaction and if the network operates in network operation mode I.

A GPRS MS in MS operation mode A shall initiate the combined routing area updating procedure with IMSI attach after the circuit-switched transaction has been released, if a normal GPRS attach or a normal routing area updating procedure was performed during the circuit-switched transaction and provided that the network operates in network operation mode I.

A GPRS MS in MS operation mode A shall perform the normal routing area update procedure during an ongoing circuit-switched transaction.

If the MS initiates the combined routing area updating procedure for GPRS services and "SMS-only service", the MS shall indicate "SMS only" in the Additional update type IE.

In Iu mode, if the MS wishes to prolong the established PS signalling connection after the normal routing area updating procedure (for example, the MS has any CM application request pending), it may set a follow-on request pending indicator on (see subclause 4.7.13).

In Iu mode, when a ROUTING AREA UPDATE REQUEST is received by the SGSN over a new PS signalling connection while there is an ongoing PS signalling connection (network is already in mode PMM-CONNECTED) for this MS, the network shall progress the routing area update procedure as normal and release the previous PS signalling connection when the routing area update procedure has been accepted by the network.

NOTE 3: The re-establishment of the radio bearers of active PDP contexts is done as described in subclause "Service Request procedure".

If the combined routing area updating procedure is initiated due to the reception of the paging indication while T3346 is running, the "follow-on request pending" indication shall be set to 1.

4.7.5.2.2 GMM Common procedure initiation

The network may initiate GMM common procedures, e.g. the GMM authentication and ciphering procedure.

4.7.5.2.3 Combined routing area updating procedure accepted by the network

Depending on the value of the update result IE received in the ROUTING AREA UPDATE ACCEPT message, two different cases can be distinguished:

- Case 1) The update result IE value indicates "combined RA/LA": Routing and location area updating is successful;
- Case 2) The update result IE value indicates "RA only": Routing area updating is successful, but location area updating is not successful.

A ROUTING AREA UPDATE COMPLETE message shall be returned to the network if the ROUTING AREA UPDATE ACCEPT message contains any of:

- a P-TMSI and/or a TMSI;
- Receive N-PDU Numbers (see 3GPP TS 44.065 [78] and 3GPP TS 25.322 [19b]); or
- a request for the provision of Inter RAT handover information.

If Receive N-PDU Numbers were included, the Receive N-PDU Numbers that are valid in the MS shall be included in the ROUTING AREA UPDATE COMPLETE message.

If the network has requested the provision of Inter RAT handover information the MS shall return a ROUTING AREA UPDATE COMPLETE message including the Inter RAT handover information IE, as applicable, to the network.

In Iu mode, if the network wishes to prolong the PS signalling connection (for example, if the mobile station has indicated "follow-on request pending" in ROUTING AREA UPDATE REQUEST message) the network shall indicate the "follow-on proceed" in the ROUTING AREA UPDATE ACCEPT message. If the network wishes to release the PS signalling connection, the network shall indicate "no follow-on proceed" in the ROUTING AREA UPDATE ACCEPT message.

After that in Iu mode, the mobile station shall act according to the follow-on proceed flag included in the Update result information element in the ROUTING AREA UPDATE ACCEPT message (see subclause 4.7.13).

If the network supports CS Fallback, and the mobile station has indicated support of EMM combined procedures in MS network capability, the network shall indicate in the Update result IE in the ROUTING AREA UPDATE ACCEPT message that ISR is not activated.

4.7.5.2.3.1 Combined routing area updating successful

The description for normal routing area update as specified in subclause 4.7.5.1.3 shall be followed. In addition, the following description for location area updating applies.

The handling at the receipt of the ROUTING AREA UPDATE ACCEPT depends on the value received in the update result IE as specified below.

The TMSI reallocation may be part of the combined routing area updating procedure. The TMSI allocated is then included in the ROUTING AREA UPDATE ACCEPT message together with the location area identification (LAI). The network shall, in this case, change to state GMM-COMMON-PROCEDURE-INITIATED and shall start the timer T3350 as described in subclause 4.7.6.

The MS, receiving a ROUTING AREA UPDATE ACCEPT message, stores the received location area identification, stops timer T3330, enters state MM IDLE, reset the location update attempt counter and sets the update status to U1 UPDATED. If the ROUTING AREA UPDATE ACCEPT message contains an IMSI, the mobile station is not allocated any TMSI, and shall delete any TMSI accordingly. If the ROUTING AREA UPDATE ACCEPT message contains a TMSI, the MS shall use this TMSI as new temporary identity. The MS shall delete its old TMSI and shall store the new TMSI. In this case, a ROUTING AREA UPDATE COMPLETE message is returned to the network. If neither a TMSI nor an IMSI has been included by the network in the ROUTING AREA UPDATE ACCEPT message, the old TMSI, if any is available, shall be kept.

If the MS maintains a counter for "SIM/USIM considered invalid for non-GPRS services" events (see subclause 4.1.1.6A), then the MS shall reset this counter.

If the MS is not configured for NAS signalling low priority, and any of the following conditions is fulfilled:

- the MS initiated the combined routing area updating procedure due to a change of the registered location area;
- the value of the Update type IE in the ROUTING AREA UPDATE REQUEST message indicated "combined RA/LA updating with IMSI attach"; or

- the MS indicated support of EMM combined procedures in the MS network capability;

then the MS may stop timer T3246 if running.

Any timer used for triggering the location updating procedure (e.g. T3211, T3212) shall be stopped if running.

The network receiving a ROUTING AREA UPDATE COMPLETE message stops timer T3350, changes to GMM-REGISTERED state

NOTE: Upon receiving a ROUTING AREA UPDATE COMPLETE message, the SGSN sends a BSSAP+-TMSI-REALLOCATION-COMplete message as specified in 3GPP TS 29.018 [149].

4.7.5.2.3.2 Combined routing area updating successful for GPRS services only

Apart from the actions on the routing area updating attempt counter, the description for normal routing area update as specified in subclause 4.7.5.1.3 shall be followed. In addition, the following description for location area updating applies.

The SGSN shall use GMM cause #28 "SMS provided via GPRS in this routing area" in the ROUTING AREA UPDATE ACCEPT message only if the MS requested "SMS-only service" by including the Additional update type IE in the ROUTING AREA UPDATE REQUEST message. The SGSN may indicate in the Update result IE in the ROUTING AREA UPDATE ACCEPT message that ISR is activated.

The MS receiving the ROUTING AREA UPDATE ACCEPT message takes one of the following actions depending on the GMM cause:

#2 (IMSI unknown in HLR);

The MS shall stop timer T3330 if still running and shall reset the routing area updating attempt counter. The MS shall set the update status to U3 ROAMING NOT ALLOWED and shall delete any TMSI, LAI and ciphering key sequence number. The MS shall enter state GMM-REGISTERED.NORMAL-SERVICE. The new MM state is MM IDLE. The SIM/USIM shall be considered as invalid for non-GPRS services until switching off or the SIM/USIM is removed. If the message has been successfully integrity checked by the lower layers and the MS maintains a counter for "SIM/USIM considered invalid for non-GPRS services", then the MS shall set this counter to MS implementation-specific maximum value.

#16 (MSC temporarily not reachable); or

#17 (Network failure)

The MS shall stop timer T3330 if still running, and shall enter state MM-IDLE. The routing area updating attempt counter shall be incremented.

If the routing area updating attempt counter is less than 5, and the stored RAI is equal to the RAI of the current serving cell and the GMM update status is equal to GU1 UPDATED:

- the MS shall keep the GMM update status GU1 UPDATED and changes state to GMM-REGISTERED.ATTEMPTING-TO-UPDATE-MM. The MS shall start timer T3311. When timer T3311 expires the combined routing area update procedure indicating "combined RA/LA updating with IMSI attach" is triggered again.

If the routing area updating attempt counter is greater than or equal to 5:

- the MS shall start timer T3302 and shall change to state GMM-REGISTERED.ATTEMPTING-TO-UPDATE-MM;
- a GPRS MS operating in MS operation mode A shall then proceed with appropriate MM specific procedure; a GPRS MS operating in MS operation mode B may then proceed with appropriate MM specific procedures.

The MM sublayer shall act as in network operation mode II as long as the combined GMM procedures are not successful and no new RA is entered.

22 (Congestion);

The MS shall change to state GMM-REGISTERED.ATTEMPTING-TO-UPDATE-MM, shall stop timer T3330 if still running, and shall enter state MM-IDLE. The MS shall set the routing area updating attempt counter to 5 and shall start timer T3302.

28 (SMS provided via GPRS in this routing area);

The MS shall stop timer T3330 if still running and shall reset the routing area updating attempt counter. The MS shall set the update status to U3 ROAMING NOT ALLOWED and shall delete any TMSI, LAI and ciphering key sequence number. The MS shall enter state GMM-REGISTERED.NORMAL-SERVICE. The new MM state is MM IDLE.

The MS stays in the current serving cell and applies the normal cell reselection process.

Other GMM cause values and the case that no GMM cause IE was received are considered as abnormal cases. The combined routing area updating shall be considered as failed for non-GPRS services. The specification of the MS behaviour in those cases is specified in subclause 4.7.5.2.5.

4.7.5.2.4 Combined routing area updating not accepted by the network

If the combined routing area updating cannot be accepted, the network sends a ROUTING AREA UPDATE REJECT message to the MS. An MS that receives a ROUTING AREA UPDATE REJECT message containing a reject cause other than GMM cause value #25 or the message is integrity protected, shall stop the timer T3330, and shall enter the state MM IDLE. If a ROUTING AREA UPDATE REJECT message containing a reject cause other than GMM cause value #25 is received or the message is integrity protected, the MS shall stop any ongoing transmission of user data.

If the ROUTING AREA UPDATE REJECT message containing GMM cause value #25 was received without integrity protection, then the MS shall discard the message.

If the routing area update request is rejected due to general NAS level mobility management congestion control, the network shall set the GMM cause value to #22 "congestion" and assign a back-off timer T3346.

The MS shall then take different actions depending on the received reject cause:

3 (Illegal MS);

6 (Illegal ME), or

8 (GPRS services and non GPRS services not allowed);

The MS shall set the GPRS update status to GU3 ROAMING NOT ALLOWED and the update status to U3 ROAMING NOT ALLOWED (and shall store it according to subclause 4.1.3.2) and shall delete any P-TMSI, P-TMSI signature, TMSI, RAI, LAI, ciphering key sequence number and GPRS ciphering key sequence number. The MS shall consider the SIM/USIM as invalid for GPRS and non GPRS services until switching off or the SIM/USIM is removed or the timer T3245 expires as described in subclause 4.1.1.6. The MS shall delete the list of equivalent PLMNs, and shall enter the state GMM-DEREGISTERED.NO-IMSI.

If the message has been successfully integrity checked by the lower layers and the MS maintains a counter for "SIM/USIM considered invalid for GPRS services", then the MS shall set this counter to MS implementation-specific maximum value. If the message has been successfully integrity checked by the lower layers and the MS maintains a counter for "SIM/USIM considered invalid for non-GPRS services", then the MS shall set this counter to MS implementation-specific maximum value.

NOTE 1: Optionally the MS starts the timer T3340 as described in subclause 4.7.1.9 for reject cause #8.

If S1 mode is supported in the MS, the MS shall handle the EMM parameters EMM state, EPS update status, GUTI, last visited registered TAI, TAI list and KSI as specified in 3GPP TS 24.301 [120] for the case when the combined tracking area update procedure is rejected with the EMM cause with the same value.

7 (GPRS services not allowed);

The MS shall set the GPRS update status to GU3 ROAMING NOT ALLOWED (and shall store it according to subclause 4.1.3.2) and shall delete any P-TMSI, P-TMSI signature, RAI and GPRS ciphering key sequence number. The SIM/USIM shall be considered as invalid for GPRS services until switching off or the SIM/USIM is removed. The MS shall enter the state GMM-DEREGISTERED.

If the message has been successfully integrity checked by the lower layers and the MS maintains a counter for "SIM/USIM considered invalid for GPRS services", then the MS shall set this counter to MS implementation-specific maximum value.

A GPRS MS operating in MS operation mode A or B which is already IMSI attached for CS services is still IMSI attached for CS services in the network.

A GPRS MS operating in MS operation mode A or B in network operation mode I shall then proceed with the appropriate MM specific procedure.

NOTE 2: Optionally the MS starts the timer T3340 as described in subclause 4.7.1.9.

If S1 mode is supported in the MS, the MS shall handle the EMM parameters EMM state, EPS update status, GUTI, last visited registered TAI, TAI list and KSI as specified in 3GPP TS 24.301 [120] for the case when the combined tracking area update procedure is rejected with the EMM cause with the same value.

9 (MS identity cannot be derived by the network);

The MS shall set the GPRS update status to GU2 NOT UPDATED (and shall store it according to subclause 4.1.3.2), enter the state GMM-DEREGISTERED.NORMAL-SERVICE, and shall delete any P-TMSI, P-TMSI signature, RAI and GPRS ciphering key sequence number.

A GPRS MS operating in MS operation mode A or B in network operation mode I which is already IMSI attached for CS services in the network, is still IMSI attached for CS services in the network.

If the rejected request was not for initiating a PDN connection for emergency bearer services, then

- a GPRS MS operating in MS operation mode A or B shall proceed with appropriate MM specific procedures. The MM sublayer shall act as in network operation mode II as long as the combined GMM procedures are not successful and no new RA is entered; and
- the MS may subsequently, automatically initiate the GPRS attach procedure.

If S1 mode is supported in the MS, the MS shall handle the EMM parameters EMM state, EPS update status, GUTI, last visited registered TAI, TAI list and KSI as specified in 3GPP TS 24.301 [120] for the case when the combined tracking area update procedure is rejected with the EMM cause with the same value.

10 (Implicitly detached);

A GPRS MS operating in MS operation mode A or B in network operation mode I, is IMSI detached for both GPRS and CS services in the network.

The MS shall enter the state GMM-DEREGISTERED.NORMAL-SERVICE. If the rejected request was not for initiating a PDN connection for emergency bearer services, the MS shall then perform a new attach procedure. The MS should also activate PDP context(s) that were originally activated by the MS to replace any previously MS activated PDP context(s). The MS should also perform the procedures needed in order to activate any previously active multicast service(s).

If S1 mode is supported in the MS, the MS shall handle the EMM state as specified in 3GPP TS 24.301 [120] for the case when the combined tracking area update procedure is rejected with the EMM cause with the same value.

NOTE 3: In some cases, user interaction may be required and then the MS cannot activate the PDP/MBMS context(s) automatically.

11 (PLMN not allowed);

The MS shall set the GPRS update status to GU3 ROAMING NOT ALLOWED and the update status to U3 ROAMING NOT ALLOWED (and shall store it according to subclause 4.1.3.2) and enter the state GMM-DEREGISTERED. Furthermore, the MS shall delete any P-TMSI, P-TMSI signature, TMSI, RAI, LAI, ciphering key sequence number GPRS ciphering key sequence number, shall delete the list of equivalent PLMNs, and shall reset the routing area updating attempt counter and the location update attempt counter.

The MS shall store the PLMN identity in the "forbidden PLMN list" and if the MS is configured to use timer T3245 (see 3GPP TS 24.368 [135] or 3GPP TS 31.102 [112]) then the MS shall start timer T3245 and proceed as described in subclause 4.1.1.6. If the message has been successfully integrity checked by the lower layers and

the MS maintains a PLMN-specific attempt counter for that PLMN, then the MS shall set this counter to the MS implementation-specific maximum value.

The MS shall start timer T3340 as described in subclause 4.7.1.9.

The MS shall then perform a PLMN selection according to 3GPP TS 23.122 [14].

An MS in GAN mode shall request a PLMN list in GAN (see 3GPP TS 44.318 [76b]) prior to perform a PLMN selection from this list according to 3GPP TS 23.122 [14].

If S1 mode is supported in the MS, the MS shall handle the EMM parameters EMM state, EPS update status, GUTI, last visited registered TAI, TAI list, KSI and tracking area updating attempt counter as specified in 3GPP TS 24.301 [120] for the case when the combined tracking area update procedure is rejected with the EMM cause with the same value.

12 (Location area not allowed);

The MS shall delete any RAI, P-TMSI, P-TMSI signature and GPRS ciphering key sequence number, shall set the GPRS update status to GU3 ROAMING NOT ALLOWED (and shall store it according to subclause 4.1.3.2), shall reset the routing area updating attempt counter and shall change to state GMM-DEREGISTERED.LIMITED-SERVICE.

The MS shall in addition set the update status to U3 ROAMING NOT ALLOWED, shall delete any TMSI, LAI and ciphering key sequence number and shall reset the location update attempt counter. The new MM state is MM IDLE.

The mobile station shall store the LAI in the list of "forbidden location areas for regional provision of service".

The MS shall start timer T3340 as described in subclause 4.7.1.9.

The MS shall perform a cell selection according to 3GPP TS 43.022 [82] and 3GPP TS 25.304 [98].

NOTE 4: The cell selection procedure is not applicable for an MS in GAN mode.

If S1 mode is supported in the MS, the MS shall handle the EMM parameters EMM state, EPS update status, GUTI, last visited registered TAI, TAI list, KSI and tracking area updating attempt counter as specified in 3GPP TS 24.301 [120] for the case when the combined tracking area update procedure is rejected with the EMM cause with the same value.

13 (Roaming not allowed in this location area);

The MS shall set the GPRS update status to GU3 ROAMING NOT ALLOWED (and shall store it according to clause 4.1.3.2), and shall delete the list of equivalent PLMNs. The MS shall reset the routing area updating attempt counter, and shall enter the state GMM-REGISTERED.LIMITED-SERVICE.

The MS shall in addition set the update status to U3 ROAMING NOT ALLOWED and shall reset the location update attempt counter. The new MM state is MM IDLE.

The MS shall store the LAI in the list of "forbidden location areas for roaming".

The MS shall start timer T3340 as described in subclause 4.7.1.9.

The MS shall perform a PLMN selection according to 3GPP TS 23.122 [14].

The MS shall indicate the Update type IE "combined RA/LA updating with IMSI attach" when performing the routing area updating procedure following the PLMN selection.

An MS in GAN mode shall request a PLMN list in GAN (see 3GPP TS 44.318 [76b]) prior to perform a PLMN selection from this list according to 3GPP TS 23.122 [14].

If S1 mode is supported in the MS, the MS shall handle the EMM parameters EMM state, EPS update status and tracking area updating attempt counter as specified in 3GPP TS 24.301 [120] for the case when the combined tracking area update procedure is rejected with the EMM cause with the same value.

14 (GPRS services not allowed in this PLMN);

The MS shall delete any RAI, P-TMSI, P-TMSI signature, and GPRS ciphering key sequence number stored, shall set the GPRS update status to GU3 ROAMING NOT ALLOWED (and shall store it according to subclause 4.1.3.2), shall reset the routing area updating attempt counter and shall change to state GMM-DEREGISTERED.

The MS shall store the PLMN identity in the "forbidden PLMNs for GPRS service" list and if the MS is configured to use timer T3245 (see 3GPP TS 24.368 [135] or 3GPP TS 31.102 [112]) then the MS shall start timer T3245 and proceed as described subclause 4.1.1.6. If the message has been successfully integrity checked by the lower layers and the MS maintains a PLMN-specific PS-attempt counter for that PLMN, then the MS shall set this counter to the MS implementation-specific maximum value.

A GPRS MS operating in MS operation mode A or B which is already IMSI attached for CS services is still IMSI attached for CS services in the network.

A GPRS MS operating in MS operation mode A or B in network operation mode I shall then proceed with the appropriate MM specific procedure.

As an implementation option, a GPRS MS operating in operation mode A or B may perform a PLMN selection according to 3GPP TS 23.122 [14].

If an MS in GAN mode performs a PLMN selection, it shall request a PLMN list in GAN (see 3GPP TS 44.318 [76b]) prior to perform a PLMN selection from this list according to 3GPP TS 23.122 [14].

The MS shall not perform the optional PLMN selection in the case where the PLMN providing this reject cause is:

- On the "User Controlled PLMN Selector with Access Technology " or,
- On the "Operator Controlled PLMN Selector with Access Technology " list or,
- A PLMN identified as equivalent to any PLMN, within the same country, contained in the lists above.

If S1 mode is supported in the MS, the MS shall handle the EMM parameters EMM state, EPS update status, GUTI, last visited registered TAI, TAI list, KSI and tracking area updating attempt counter as specified in 3GPP TS 24.301 [120] for the case when the combined tracking area update procedure is rejected with the EMM cause with the same value.

15 (No Suitable Cells In Location Area);

The MS shall set the GPRS update status to GU3 ROAMING NOT ALLOWED (and shall store it according to clause 4.1.3.2), shall reset the routing area updating attempt counter and shall change to state GMM-REGISTERED.LIMITED-SERVICE.

The MS shall in addition set the update status to U3 ROAMING NOT ALLOWED and shall reset the location update attempt counter. The new MM state is MM IDLE.

The MS shall store the LAI in the list of "forbidden location areas for roaming".

The MS shall start timer T3340 as described in subclause 4.7.1.9.

The MS shall search for a suitable cell in another location area according to 3GPP TS 43.022 [82] and 3GPP TS 25.304 [98].

NOTE 5: The cell selection procedure is not applicable for an MS in GAN mode.

The MS shall indicate the Update type IE "combined RA/LA updating with IMSI attach" when performing the routing area updating procedure.

If S1 mode is supported in the MS, the MS shall handle the EMM parameters EMM state, EPS update status and tracking area updating attempt counter as specified in 3GPP TS 24.301 [120] for the case when the combined tracking area update procedure is rejected with the EMM cause with the same value.

#22 (Congestion);

If the T3346 value IE is present in the ROUTING AREA UPDATE REJECT message and the value indicates that this timer is neither zero nor deactivated, the MS shall proceed as described below, otherwise it shall be considered as an abnormal case and the behaviour of the MS for this case is specified in subclause 4.7.5.2.5.

The MS shall abort the routing area updating procedure, reset the routing area updating attempt counter and set the GPRS update status to GU2 NOT UPDATED. If the rejected request was not for initiating a PDN connection for emergency bearer services, the MS shall change to state GMM-REGISTERED.ATTEMPTING-TO-UPDATE.

The MS shall stop timer T3346 if it is running.

If the ROUTING AREA UPDATE REJECT message is integrity protected, the MS shall start timer with the value provided in the T3346 value IE.

If the ROUTING AREA UPDATE REJECT message is not integrity protected, the ME shall start timer T3346 with a random value from the default range specified in table 11.3a.

The MS stays in the current serving cell and applies the normal cell reselection process. The routing area updating procedure is started, if still necessary, when timer T3346 expires or is stopped.

If S1 mode is supported in the MS, the MS shall handle the EMM parameters EMM state, EPS update status, and tracking area updating attempt counter as specified in 3GPP TS 24.301 [120] for the case when the tracking area update procedure is rejected with the EMM cause with the same value.

#25 (Not authorized for this CSG)

Cause #25 is only applicable in UTRAN Iu mode and when received from a CSG cell. Other cases are considered as abnormal cases and the specification of the mobile station behaviour is given in subclause 4.7.5.2.5.

The MS shall set the GPRS update status to GU3 ROAMING NOT ALLOWED (and store it according to subclause 4.1.3.2) and shall reset the routing area updating attempt counter. The state is changed to GMM-REGISTERED.LIMITED-SERVICE.

If the CSG ID and associated PLMN identity of the cell where the MS has sent the ROUTING AREA UPDATE REQUEST message are contained in the Allowed CSG list stored in the MS, the MS shall remove the entry corresponding to this CSG ID and associated PLMN identity from the Allowed CSG list.

If the CSG ID and associated PLMN identity of the cell where the MS has sent the ROUTING AREA UPDATE REQUEST message are contained in the Operator CSG list, the MS shall proceed as specified in 3GPP TS 23.122 [14] subclause 3.1A.

The MS shall start timer T3340 as described in subclause 4.7.1.9.

If the MS is IMSI attached, the MS shall set the update status to U3 ROAMING NOT ALLOWED and shall reset the location update attempt counter. The new MM state is MM IDLE.

The MS shall search for a suitable cell according to 3GPP TS 43.022 [82] and 3GPP TS 25.304 [98].

If S1 mode is supported in the MS, the MS shall handle the EMM parameters EMM state, EPS update status and tracking area updating attempt counter as specified in 3GPP TS 24.301 [120] for the case when the combined tracking area update procedure is rejected with the EMM cause with the same value.

Other values are considered as abnormal cases. The specification of the MS behaviour in those cases is described in subclause 4.7.5.2.5.

4.7.5.2.5 Abnormal cases in the MS

The MS shall proceed as follows:

- 1) If the combined routing area update was successful for GPRS services only and the ROUTING AREA UPDATE ACCEPT message contained a cause value not treated in subclause 4.7.5.2.3.2 or the GMM Cause IE is not included in the message, the MS shall proceed as follows:

- a) The MS shall stop timer T3330 if still running, and shall enter state MM IDLE. The routing area updating attempt counter shall be incremented;
- b) If the routing area updating attempt counter is less than 5, and the stored RAI is equal to the RAI of the current serving cell and the GMM update status is equal to GU1 UPDATED:
 - the MS shall keep the GMM update status GU1 UPDATED and changes state to GMM-REGISTERED.ATTEMPTING-TO-UPDATE-MM. The MS shall start timer T3311. When timer T3311 expires the combined routing area update procedure indicating "combined RA/LA updating with IMSI attach" is triggered again; and
- c) If the routing area updating attempt counter is greater than or equal to 5:
 - the MS shall start timer T3302 and shall change to state GMM-REGISTERED.ATTEMPTING-TO-UPDATE-MM; and
 - a GPRS MS operating in MS operation mode A shall then proceed with appropriate MM specific procedure; a GPRS MS operating in MS operation mode B may then proceed with appropriate MM specific procedures. The MM sublayer shall act as in network operation mode II or as long as the combined GMM procedures are not successful and no new RA is entered;

2) Combined routing area updating and paging for non-GPRS services procedure collision

If the MS receives a paging for non-GPRS services before the routing area updating procedure has been completed, the MS shall progress the routing area updating procedure and respond to the paging for non-GPRS services when the MS has completed the routing area updating procedure or aborted the procedure for other reasons. The MS shall return to MM state MM IDLE and proceed with the appropriate MM specific procedures to respond to the paging for non-GPRS services; and

3) otherwise, the abnormal cases specified in subclause 4.7.5.1.5 apply with the following modification.

If the GPRS routing area updating attempt counter is incremented according to subclause 4.7.5.1.5 the next actions depend on the Location Area Identities (stored on SIM/USIM and the one of the current serving cell) and the value of the routing area updating attempt counter.

- if the update status is U1 UPDATED, and the stored LAI is equal to the one of the current serving cell and the routing area updating attempt counter is smaller than 5, then the mobile station shall keep the update status to U1 UPDATED, the new MM state is MM IDLE substate NORMAL SERVICE;
- if the routing area updating attempt counter is smaller than 5 and, additionally, the update status is different from U1 UPDATED or the stored LAI is different from the one of the current serving cell, the mobile station shall delete any LAI, TMSI, ciphering key sequence number stored in the SIM/USIM and list of equivalent PLMNs and set the update status to U2 NOT UPDATED. The MM state remains MM LOCATION UPDATING PENDING; or
- if the routing area updating attempt counter is greater or equal to 5, the mobile station shall delete any LAI, TMSI, ciphering key sequence number stored in the SIM/USIM and the list of equivalent PLMNs, and shall set the update status to U2 NOT UPDATED.

A GPRS MS operating in MS operation mode A shall then proceed with appropriate MM specific procedure; a GPRS MS operating in MS operation mode B may then proceed with appropriate MM specific procedures. The MM sublayer shall act as in network operation mode II as long as the combined GMM procedures are not successful and no new RA is entered. The new MM state is MM IDLE substate ATTEMPTING TO UPDATE or optionally MM IDLE substate PLMN SEARCH in order to perform a PLMN selection according to 3GPP TS 23.122 [14].

4.7.5.2.6 Abnormal cases on the network side

The abnormal cases specified in subclause 4.7.5.1.6 apply.

4.7.6 P-TMSI reallocation procedure

4.7.6.0 General

A temporary mobile station identity for GPRS services, the Packet-TMSI (P-TMSI), is used for identification within the radio interface signalling procedures. The structure of the P-TMSI is specified in 3GPP TS 23.003 [10]. The P-TMSI has significance only within a routing area. Outside the routing area the P-TMSI has to be combined with the routing area identification (RAI) to provide for an unambiguous identity.

The purpose of the P-TMSI reallocation procedure is to provide identity confidentiality, i.e. to protect a user against being identified and located by an intruder (see 3GPP TS 43.020 [13], 3GPP TS 23.060 [74] and 3GPP TS 33.102 [5a]).

Usually, P-TMSI reallocation is performed at least at each change of a routing area (Such choices are left to the network operator).

The reallocation of a P-TMSI is performed by the unique procedure defined in subclause 4.7.6. This procedure can only be initiated by the network in state GMM-REGISTERED.

P-TMSI can also be implicitly reallocated in the attach or routing area updating procedures (see subclauses 4.7.3.1 and 4.7.5). The implicit reallocation of a P-TMSI is described in the corresponding subclauses.

NOTE: Normally, the P-TMSI reallocation will take place in conjunction with another GMM procedure, e.g. at routing area updating (see 3GPP TS 29.002 [37]).

4.7.6.1 P-TMSI reallocation initiation by the network

The network shall initiate the P-TMSI reallocation procedure by sending a P-TMSI REALLOCATION COMMAND message to the MS and shall start the timer T3350.

The P-TMSI REALLOCATION COMMAND message shall contain a new combination of P-TMSI, RAI and optionally a P-TMSI signature or a DCN-ID or both allocated by the network.

The network may suspend the transmission of user data during the P-TMSI reallocation procedure.

4.7.6.2 P-TMSI reallocation completion by the MS

Upon receipt of the P-TMSI REALLOCATION COMMAND message, the MS shall store the routing area identifier (RAI) and the P-TMSI. Furthermore, the MS shall send a P-TMSI REALLOCATION COMPLETE message to the network.

If a P-TMSI signature is present in the P-TMSI REALLOCATION COMMAND message, the MS shall store the new P-TMSI signature and shall if available delete the old P-TMSI signature. If no P-TMSI signature is present in the P-TMSI REALLOCATION COMMAND message, the old P-TMSI signature, if available, shall be kept.

If the P-TMSI REALLOCATION COMMAND message contains the DCN-ID IE, then the MS shall store the included DCN-ID value together with the PLMN code of the registered PLMN in a DCN-ID list in a non-volatile memory in the ME as described in 3GPP TS 24.301 [120], annex C.

4.7.6.3 P-TMSI reallocation completion by the network

Upon receipt of the P-TMSI REALLOCATION COMPLETE message, the network shall stop the timer T3350 and shall consider both the old and the new P-TMSI and the corresponding P-TMSI signatures as valid until the old P-TMSI can be considered as invalid by the network (see subclause 4.7.1.5).

In A/Gb mode, the GMM layer shall notify the LLC layer that the P-TMSI has been changed (see 3GPP TS 44.064 [78a]).

4.7.6.3A Abnormal cases in the MS

The following abnormal cases can be identified:

If different new P-TMSIs are included in subsequent P-TMSI REALLOCATION COMMAND messages due to an aborted or repeated P-TMSI reallocation procedure, the MS shall behave as described in subclause 4.7.6.2. Furthermore, the MS shall take action on the P-TMSI as described in subclause 4.7.1.5.

4.7.6.4 Abnormal cases on the network side

The following abnormal cases can be identified:

a) Lower layer failure

If a lower layer failure is detected before the P-TMSI REALLOCATION COMPLETE message is received, the network shall consider both the old and the new P-TMSI as occupied until the old P-TMSI can be considered as invalid (see subclause 4.7.1.5).

During this period the network:

- may first use the old P-TMSI for paging for an implementation dependent number of paging attempts in the case of network-originated transactions. Upon response from the MS, the network may re-initiate the P-TMSI reallocation procedure. If no response is received to the paging attempts, the network may use the new P-TMSI for paging for an implementation dependent number of paging attempts. Upon response from the MS, the network shall consider the new P-TMSI as valid and the old P-TMSI as invalid. If no response is received to the paging attempts, the network may use the IMSI for paging for an implementation dependent number of paging attempts;

NOTE: Paging with IMSI causes the MS to re-attach as described in subclause 4.7.9.1.

- shall consider the new P-TMSI as valid if it is used by the MS (see subclause 4.7.1.5); or
- may use the identification procedure followed by a new P-TMSI reallocation, if the MS uses the old P-TMSI.

b) Expiry of timer T3350

The P-TMSI reallocation procedure is supervised by the timer T3350 (see example in figure 4.7.6/1). On the first expiry of timer T3350, the network shall reset and restart timer T3350 and shall retransmit the P-TMSI REALLOCATION COMMAND message. This retransmission is repeated four times, i.e. on the fifth expiry of timer T3350, the network shall abort the P-TMSI reallocation procedure and shall follow the rules for case a as described above.

c) P-TMSI reallocation and GPRS attach procedure collision

If the network receives an ATTACH REQUEST message before the ongoing P-TMSI reallocation procedure has been completed, the network shall proceed with the GPRS attach procedure after deletion of the GMM context.

d) P-TMSI reallocation and an MS initiated GPRS detach procedure collision

If the network receives a DETACH REQUEST message before the ongoing P-TMSI reallocation procedure has been completed, the network shall abort the P-TMSI reallocation procedure and shall progress the GPRS detach procedure.

e) P-TMSI reallocation and a routing area updating procedure collision

If the network receives a ROUTING AREA UPDATE REQUEST message before the ongoing P-TMSI reallocation procedure has been completed, the network shall abort the P-TMSI reallocation procedure and shall progress the routing area updating procedure. The network may then perform a new P-TMSI reallocation.

f) P-TMSI reallocation and a service request procedure collision

If the network receives a SERVICE REQUEST message before the ongoing P-TMSI reallocation procedure has been completed, the network shall progress both procedures.

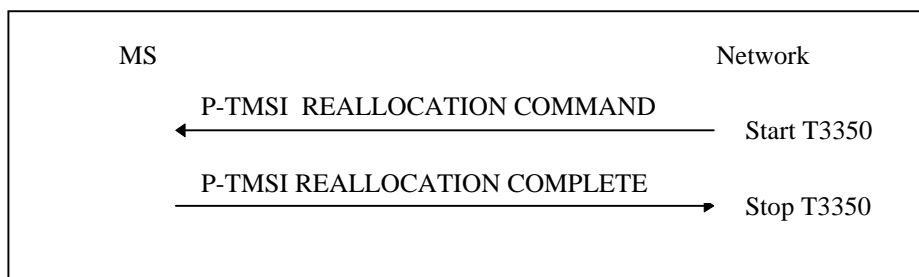

Figure 4.7.6/1 3GPP TS 24.008: P-TMSI reallocation procedure

4.7.7 Authentication and ciphering procedure

4.7.7a Authentication and ciphering procedure used for UMTS authentication challenge.

The purpose of the authentication and ciphering procedure is fivefold (see 3GPP TS 33.102 [5a] and 3GPP TS 43.020 [13]):

- to permit the network to check whether the identity provided by the MS is acceptable or not;
- to provide parameters enabling the MS to calculate a new GPRS UMTS ciphering key and a new GPRS UMTS integrity key;
- to let the network set the GSM ciphering mode (ciphering /no ciphering) and GSM ciphering algorithm;
- to permit the mobile station to authenticate the network; and
- to let the network set GSM integrity protection and GSM integrity algorithm (for control plane and optionally for user plane).

In Iu mode, and in the case of a UMTS authentication challenge, the authentication and ciphering procedure can be used for authentication only.

The cases in which the authentication and ciphering procedure shall be used are defined in 3GPP TS 33.102 [5a], 3GPP TS 43.020 [13] and 3GPP TS 42.009 [5].

The authentication and ciphering procedure is always initiated and controlled by the network. However, in the case of a UMTS authentication challenge, there is the possibility for the MS to reject the network.

The MS shall support the UMTS authentication challenge, if a USIM is inserted.

The authentication and ciphering procedure can be used for any combination of the following:

- authentication;
- setting of the GSM ciphering mode and the GSM ciphering algorithm; and
- setting of GSM integrity protection and the GSM integrity algorithm (for control plane and optionally for user plane).

NOTE: Setting of GSM integrity protection and the GSM integrity algorithm in the authentication and ciphering procedure is only applicable for an MS and a network supporting integrity protection in A/Gb mode.

In A/Gb mode, the network should not send any user data during the authentication and ciphering procedure.

A UMTS security context is established in the MS and the network when a UMTS authentication challenge is performed in A/Gb mode or in Iu mode. After a successful UMTS authentication, the GPRS UMTS ciphering key, the GPRS UMTS integrity key, the GPRS GSM ciphering key and the GPRS ciphering key sequence number, are stored both in the network and the MS. Furthermore, in A/Gb mode both the ME and the network may derive and store a GPRS GSM Kc_{128} as part of the UMTS security context as described in the subclause 4.7.7.3a. Furthermore, in A/Gb mode, if integrity protection is used, both the MS and the network shall derive and store a GPRS GSM $Kint$ as part of the UMTS security context as described in the subclause 4.7.7.3b.

4.7.7b Authentication and ciphering procedure used for GSM authentication challenge

The purpose of the authentication and ciphering procedure is threefold (see 3GPP TS 43.020 [13]):

- to permit the network to check whether the identity provided by the MS is acceptable or not;
- to provide parameters enabling the MS to calculate a new GPRS GSM ciphering key; and
- to let the network set the GSM ciphering mode (ciphering/no ciphering) and GSM ciphering algorithm.

The authentication and ciphering procedure can be used for either:

- authentication only;
- setting of the GSM ciphering mode and the GSM ciphering algorithm only; or
- authentication and the setting of the GSM ciphering mode and the GSM ciphering algorithm.

The cases in which the authentication and ciphering procedure shall be used are defined in 3GPP TS 42.009 [5].

In A/Gb mode, the authentication and ciphering procedure is always initiated and controlled by the network. It shall be performed in a non ciphered mode because of the following reasons:

- the network cannot decipher a ciphered AUTHENTICATION_AND_CIPHERING RESPONSE from an unauthorised MS and put it on the black list; and
- to be able to define a specific point in time from which on a new GPRS GSM ciphering key should be used instead of the old one.

GSM authentication challenge shall be supported by a ME supporting GERAN or UTRAN.

In A/Gb mode, the network should not send any user data during the authentication and ciphering procedure.

A GSM security context is established in the MS and the network when a GSM authentication challenge is performed in A/Gb mode or in Iu mode. However, in Iu mode the MS shall not accept a GSM authentication challenge, if a USIM is inserted. After a successful GSM authentication challenge, the GPRS GSM ciphering key and the GPRS ciphering key sequence number, are stored both in the network and the MS.

4.7.7c Change of the ciphering algorithm at PS Handover

For PS handover to A/Gb mode (see subclause 10.5.1.14 and 3GPP TS 44.060 [76]) the network shall either assign a GSM ciphering algorithm to be used in the target cell or deactivate ciphering in the target cell. The MS shall start to use the new GSM ciphering algorithm or deactivate ciphering upon an indication from the lower layers that the PS handover procedure has been successfully completed (see 3GPP TS 44.060 [76]).

After PS handover to Iu mode (see 3GPP TS 25.331 [23c] and 3GPP TS 44.118 [111]) the network shall activate integrity protection and shall either assign a ciphering algorithm to be used in the target cell or deactivate ciphering in the target cell, using the security mode control procedure (3GPP TS 25.331 [23c] and 3GPP TS 44.118 [111]).

If the GSM ciphering algorithm is changed at PS handover and the routing area updating procedure triggered by the PS handover procedure is not accepted by the network, the MS shall delete any GPRS ciphering key sequence number and proceed as specified in subclauses 4.7.5.1.4 and 4.7.5.2.4. If the routing area updating procedure fails, because the radio resources assigned in the new cell are released before the MS receives a ROUTING AREA UPDATE ACCEPT message, the MS shall delete any GPRS ciphering key sequence number and proceed as specified in subclauses 4.7.5.1.5 item b and 4.7.5.2.5, respectively.

4.7.7.1 Authentication and ciphering initiation by the network

The network initiates the authentication and ciphering procedure by transferring an AUTHENTICATION_AND_CIPHERING REQUEST message across the radio interface and starts timer T3360. The AUTHENTICATION_AND_CIPHERING REQUEST message shall contain all parameters necessary to calculate the response parameters when authentication is performed (see 3GPP TS 43.020 [13] and 3GPP TS 33.102 [5a]).

If authentication is requested, then the AUTHENTICATION_AND_CIPHERING REQUEST message shall contain either:

- In a GSM authentication challenge, the GPRS ciphering key sequence number and the RAND, or
- In a UMTS authentication challenge, the GPRS ciphering key sequence number, the RAND and the AUTN.

In A/Gb mode, if authentication is not requested, then the AUTHENTICATION_AND_CIPHERING REQUEST message shall not contain neither the GPRS ciphering key sequence number, the RAND nor the AUTN.

In A/Gb mode, if ciphering is requested, in a GSM authentication challenge or in a UMTS authentication challenge, then the AUTHENTICATION_AND_CIPHERING REQUEST message shall indicate the GPRS GSM ciphering algorithm.

In A/Gb mode, an MS supporting integrity protection shall ignore a GSM authentication challenge from the network.

In A/Gb mode, in a UMTS authentication challenge, if the MS has indicated support for integrity protection in MS network capability IE included in the ATTACH REQUEST or ROUTING AREA UPDATE REQUEST message to the network, then if the network supports integrity protection then the network shall activate integrity protection in the MS (see subclause 4.7.3.1.3 and subclause 4.7.5.1.3). If the network does not activate integrity protection in the MS, then the MS shall detach from the network.

In A/Gb mode, if no UMTS security context is available in the network or if no common UMTS security context is available in the MS and the network, and if the MS has indicated support for integrity protection in MS network capability IE to the network, then an authentication and activation of integrity protection and setting of ciphering mode (enabled or disabled), shall take place in the same authentication and ciphering procedure. The network shall replay the MS network capability IE and the MS radio access capability IE received from the MS in the latest ATTACH REQUEST message or the latest ROUTING AREA UPDATE REQUEST message, by including the MS network capability IE and the MS radio access capability IE in the AUTHENTICATION AND CIPHERING REQUEST message to the MS. The network shall select one of the GPRS GSM integrity algorithms indicated in the MS network capability IE received from the MS in the latest ATTACH REQUEST message or ROUTING AREA UPDATE REQUEST message. The selected GPRS GSM integrity algorithm shall be included in the AUTHENTICATION AND CIPHERING REQUEST message. The network shall enable or disable ciphering and include the selected GPRS GSM ciphering algorithm if ciphering is enabled. If ciphering is enabled, then the network shall select one of the GPRS GSM ciphering algorithm indicated in the MS network capability IE received from the MS in the latest ATTACH REQUEST message or ROUTING AREA UPDATE REQUEST message. The network shall calculate a message authentication code for the AUTHENTICATION AND CIPHERING REQUEST message at the GMM layer with the new integrity key, GPRS GSM Kint key, indicated by the GPRS ciphering key sequence number included in the AUTHENTICATION AND CIPHERING REQUEST message. The new GPRS GSM Kint shall be calculated from the new UMTS security context established in the same procedure as described in the subclause 4.7.7.3b. The AUTHENTICATION AND CIPHERING REQUEST message shall include the calculated message authentication code for integrity protection.

In A/Gb mode, if an established UMTS security context is available in the network and if the MS has indicated support for integrity protection in the MS network capability IE, when authentication takes place in the authentication and ciphering procedure (regardless whether a change of the integrity algorithm, ciphering algorithm or a change of ciphering mode takes place in the same procedure), then the network shall replay the MS network capability IE and the MS Radio Access Capability IE received from the MS in the latest ATTACH REQUEST message or the latest ROUTING AREA UPDATE REQUEST message, by including the MS network capability IE and the MS Radio Access Capability IE into the AUTHENTICATION AND CIPHERING REQUEST message to the MS. If a change of the GPRS GSM integrity algorithm takes place in the same procedure, then the network shall select one of the GPRS GSM integrity algorithms indicated in the MS network capability IE received from the MS in the latest ATTACH REQUEST message or ROUTING AREA UPDATE REQUEST message. The selected GPRS GSM integrity algorithm shall be included into the AUTHENTICATION AND CIPHERING REQUEST message. If the network decides to change the ciphering mode or the ciphering algorithm or both, then if ciphering is enabled the network shall select one of the GPRS GSM ciphering algorithms indicated in the MS network capability IE received from the MS in the latest ATTACH REQUEST message or ROUTING AREA UPDATE REQUEST message. The network shall also include the ciphering mode or the selected GPRS GSM ciphering algorithm or both, if ciphering is enabled (Ciphering algorithm IE) in the AUTHENTICATION AND CIPHERING REQUEST message. The network calculates a message authentication code over the parameters included in the AUTHENTICATION AND CIPHERING REQUEST message at the GMM layer with the new integrity key GPRS GSM Kint indicated by the GPRS ciphering key sequence number included by the AUTHENTICATION AND CIPHERING REQUEST message. The new GPRS GSM Kint shall be calculated from the new UMTS security context established in the same procedure as described in the

subclause 4.7.7.3b. The AUTHENTICATION AND CIPHERING REQUEST message shall include the calculated message authentication code for integrity protection.

In A/Gb mode, if an established UMTS security context context is available in the network and if the MS has indicated support for integrity protection in the MS network capability IE to the network, and if integrity protection is in use, then if only a change of the integrity algorithm or ciphering algorithm or both, or a change of the ciphering mode, is requested in the authentication and ciphering procedure, then the AUTHENTICATION AND CIPHERING REQUEST message shall include the new GPRS GSM integrity algorithm or the new setting of the ciphering mode and the new GPRS GSM ciphering algorithm; that shall be taken into use.

NOTE: The AUTHENTICATION AND CIPHERING REQUEST message is protected by a message authentication code in the LLC layer when no authentication takes place in the authentication and ciphering procedure. Therefore, no message authentication code shall be calculated and included by the GMM layer into this message when only an algorithm change takes place. In addition, there is no need to replay the MS network capability IE and the MS Radio Access Capability IE in the AUTHENTICATION AND CIPHERING REQUEST message when no authentication takes place as a valid UMTS security context is already established between the MS and network.

The network includes the A&C reference number information element in the AUTHENTICATION AND CIPHERING REQUEST message. Its value is chosen in order to link an AUTHENTICATION AND CIPHERING REQUEST in a RA with its RESPONSE. The A&C reference number value might be based on the RA Colour Code value.

Additionally, the network may request the MS to include its IMEISV in the AUTHENTICATION AND CIPHERING RESPONSE message.

4.7.7.2 Authentication and ciphering response by the MS

In A/Gb mode, an MS shall be ready to respond upon an AUTHENTICATION_AND_CIPHERING REQUEST message at any time.

In UMTS, an MS shall be ready to respond upon an AUTHENTICATION_AND_CIPHERING REQUEST message at any time whilst a PS signalling connection exists.

If a SIM is inserted in the MS, the MS shall ignore the Authentication Parameter AUTN IE if included in the AUTHENTICATION_AND_CIPHERING REQUEST message and perform the GSM authentication challenge. It shall not perform the authentication of the network described in subclause 4.7.7.5.1.

In a GSM authentication challenge, if the AUTHENTICATION_AND_CIPHERING REQUEST message includes the authentication parameters RAND and GPRS CKSN, then upon receipt of the message, the MS processes the challenge information and sends an AUTHENTICATION_AND_CIPHERING RESPONSE message to the network. The value of the received A&C reference number information element shall be copied into the A&C reference number information element in the AUTHENTICATION_AND_CIPHERING RESPONSE message. A GSM authentication challenge will result in the SIM/USIM passing a SRES and a GPRS GSM ciphering key to the ME. The new GPRS GSM ciphering key calculated from the challenge information shall overwrite the previous one and any previously stored GPRS UMTS ciphering and GPRS UMTS integrity keys shall be deleted. The calculated GSM ciphering key shall be stored on the SIM/USIM together with the GPRS ciphering key sequence number before the AUTHENTICATION_AND_CIPHERING RESPONSE message is transmitted.

In a UMTS authentication challenge, if the AUTHENTICATION_AND_CIPHERING REQUEST message includes the UMTS authentication parameters GPRS CKSN, RAND and AUTN, then upon receipt of the message, the MS verifies the AUTN parameter and if this is accepted, the MS processes the challenge information and sends an AUTHENTICATION_AND_CIPHERING RESPONSE message to the network. The value of the received A&C reference number information element shall be copied into the A&C reference number information element in the AUTHENTICATION_AND_CIPHERING RESPONSE message. A UMTS authentication challenge will result in the USIM passing a RES, a GPRS UMTS ciphering key, a GPRS UMTS integrity key and a GPRS GSM ciphering key to the ME. The new GPRS UMTS ciphering key, GPRS UMTS integrity key and GPRS GSM ciphering key calculated from the challenge information shall overwrite the previous ones. The new GPRS UMTS ciphering key, GPRS UMTS integrity key and GPRS GSM ciphering key shall be stored on the USIM together with the GPRS ciphering key sequence number before the AUTHENTICATION_AND_CIPHERING RESPONSE message is transmitted. Furthermore, in A/Gb mode if a GEA ciphering algorithm that requires a 128-bit ciphering key is taken into use, then a new GPRS GSM K_{C128} shall also be calculated as described in the subclause 4.7.7.3a.

In A/Gb mode, in a UMTS authentication challenge, if the MS supports integrity protection, then the MS shall ignore the GPRS GSM ciphering key received from the USIM and not store the GPRS GSM ciphering key in the ME or on the USIM.

In addition, in A/Gb mode, in a UMTS authentication challenge, if the MS has indicated support of integrity protection in the MS network capability IE to the network, and if an authentication takes place in the authentication and ciphering procedure, then a new GPRS GSM Kint shall also be calculated by the MS from the new UMTS security context derived from AKA as described in the subclause 4.7.7.3b. The new GPRS GSM Kint shall be used by the MS to check and verify the message authentication code received in the AUTHENTICATION AND CIPHERING REQUEST message as described in Annex H in 3GPP TS 43.020 [13]. If the integrity is successfully verified in the MS, then the MS shall check if the replayed MS network capability IE and replayed MS Radio Access Capability IE received in the AUTHENTICATION AND CIPHERING REQUEST message has not been altered compared to the latest MS network capability IE and the latest MS Radio Access Capability IE that the MS sent to the network. If the replayed MS network capability IE and the replayed MS Radio Access Capability IE received in the AUTHENTICATION AND CIPHERING REQUEST message are not the same as the latest MS network capability IE and the MS Radio Access Capability IE that the MS sent to the network, then the MS shall ignore the authentication and ciphering procedure. The network may in addition indicate a GPRS GSM integrity algorithm and a new setting of the ciphering mode and GPRS GSM ciphering algorithm, to be taken into use by the MS. If the integrity of the AUTHENTICATION AND CIPHERING REQUEST message is not successfully verified in the GMM layer, then the MS shall ignore the AUTHENTICATION AND CIPHERING REQUEST message.

In A/Gb mode, in a UMTS authentication challenge if the MS has no available UMTS security context and, if the MS has indicated support for integrity protection in MS network capability IE to the network, then if the network does not activate integrity protection by indicating a GPRS GSM integrity algorithm or does not include a message authentication code to the MS in AUTHENTICATION AND CIPHERING REQUEST message, then the MS shall ignore the AUTHENTICATION AND CIPHERING REQUEST message.

In A/Gb mode, in a UMTS authentication challenge, if the MS has indicated support for integrity protection to the network and if the integrity of the AUTHENTICATION AND CIPHERING REQUEST message is successfully verified in the MS and the MS decides to reply by sending an AUTHENTICATION AND CIPHERING RESPONSE message to the network, then the MS shall integrity protect the AUTHENTICATION AND CIPHERING RESPONSE message by calculating a message authentication code at the GMM layer using the new integrity key GPRS GSM Kint calculated by the MS from the new UMTS security context derived from AKA as described in the subclause 4.7.7.3b and as described in Annex H in 3GPP TS 43.020 [13] and include the new message authentication code into the AUTHENTICATION AND CIPHERING RESPONSE message. When a successful authentication takes place on the USIM the GMM layer in the MS shall request the LLC layer to reset the IOV_updates counter to the value zero before sending the AUTHENTICATION AND CIPHERING RESPONSE message to the network.

In Iu mode, an MS not capable of A/Gb mode shall ignore the Ciphering Algorithm IE in the AUTHENTICATION_AND_CIPHERING REQUEST message. An MS capable of both Iu mode and A/Gb mode shall store the received value in the Ciphering Algorithm IE in the AUTHENTICATION_AND_CIPHERING REQUEST message until entering state GMM-DEREGISTERED, in order to use it at an inter system change to A/Gb mode. In A/Gb mode, an MS supporting integrity protection shall store the received value in the Ciphering Algorithm IE when entering GMM-DEREGISTERED and at MS power off as described in subclause 4.7.7.3a.

If the AUTHENTICATION_AND_CIPHERING REQUEST message does not include neither the GSM authentication parameters (RAND and GPRS CKSN) nor the UMTS authentication parameters (RAND, AUTN and GPRS CKSN), then upon receipt of the message, the MS replies by sending an AUTHENTICATION_AND_CIPHERING RESPONSE message to the network.

In A/Gb mode, in the case of an established UMTS security context, if the MS has indicated support for integrity protection to the network, the network may only indicate a GPRS GSM integrity algorithm or a GPRS GSM ciphering algorithm or a change of ciphering mode setting in the AUTHENTICATION AND CIPHERING REQUEST message without re-authentication to the MS. The AUTHENTICATION AND CIPHERING REQUEST message shall include the new GPRS GSM integrity algorithm or the new GPRS GSM ciphering algorithm; or both, that shall be taken into use. When the MS receives this AUTHENTICATION AND CIPHERING REQUEST message without requiring a new authentication, then a new GPRS GSM Kint shall be calculated using the GPRS UMTS ciphering key and the GPRS UMTS integrity key from the already established UMTS security context stored in the ME as described in the subclause 4.7.7.3b and a new GPRS GSM Kc₁₂₈ shall be calculated using the GPRS UMTS ciphering key and the GPRS UMTS integrity key from the already established UMTS security context stored in the ME as described in the subclause 4.7.7.3a and the MS replies by sending an AUTHENTICATION AND CIPHERING RESPONSE message to the network.

NOTE: If only a change of GPRS GSM integrity algorithm or GPRS GSM encryption algorithm or a change of both algorithms is included in the AUTHENTICATION AND CIPHERING RESPONSE message without authentication, then the MS shall not integrity protect the AUTHENTICATION AND CIPHERING RESPONSE message at GMM layer. The MS does therefore not calculate and include a message authentication code into the AUTHENTICATION AND CIPHERING RESPONSE message at GMM layer. These GMM messages are instead integrity protected at the LLC layer with current UMTS security context.

In A/Gb mode, the GMM layer shall notify the LLC layer if ciphering shall be used or not and if yes which GSM ciphering algorithm and GPRS GSM ciphering key that shall be used (see 3GPP TS 44.064 [78a]).

In A/Gb mode, if an established UMTS security context context is available in the network, if the MS has indicated support of integrity protection to the network, then the GMM layer in the MS shall assign the GPRS GSM integrity algorithm and the GPRS GSM Kint integrity key to the LLC layer after it has sent off the AUTHENTICATION AND CIPHERING RESPONSE message to the network (see 3GPP TS 43.020 [13] and 3GPP TS 44.064 [78a]).

A ME supporting UMTS authentication challenge shall support the following procedure:

In order to avoid a synchronisation failure, when the mobile station receives an AUTHENTICATION AND CIPHERING REQUEST message, the mobile station shall store the received RAND together with the RES returned from the USIM in the volatile memory and associate it with the PS domain. When the MS receives a subsequent AUTHENTICATION AND CIPHERING REQUEST message, if the stored RAND value for the PS domain is equal to the new received value in the AUTHENTICATION AND CIPHERING REQUEST message, then the mobile station shall not pass the RAND to the USIM, but shall immediately send the AUTHENTICATION AND CIPHERING RESPONSE message with the stored RES for the PS domain. If, for the PS domain, there is no valid stored RAND in the mobile station or the stored RAND is different from the new received value in the AUTHENTICATION AND CIPHERING REQUEST message, the mobile station shall pass the RAND to the USIM, shall override any previously stored RAND and RES with the new ones and start, or reset and restart timer T3316.

The RAND and RES values stored in the mobile station shall be deleted and timer T3316, if running, shall be stopped:

- upon receipt of a SECURITY MODE COMMAND (Iu mode only),
SERVICE ACCEPT (Iu mode only),
SERVICE REJECT (Iu mode only),
ROUTING AREA UPDATE_ACCEPT
or AUTHENTICATION AND CIPHERING REJECT message;
- upon expiry of timer T3316;
- if the mobile station enters the GMM states GMM-DEREGISTERED or GMM-NULL; or
- if the mobile station enters PMM-IDLE mode (Iu mode only).

4.7.7.3 Authentication and ciphering completion by the network

Upon receipt of the AUTHENTICATION AND CIPHERING RESPONSE message, the network stops the timer T3360 and checks the validity of the response (see 3GPP TS 43.020 [13] and 3GPP TS 33.102 [5a]). For this, it may use the A&C reference number information element within the AUTHENTICATION AND CIPHERING RESPONSE message to determine whether the response is correlating to the last request that was sent.

In A/Gb mode, in a UMTS authentication challenge if the MS has indicated support of integrity protection to the network and if the AUTHENTICATION AND CIPHERING REQUEST message authentication, then the network shall check and verify the message authentication code received in the AUTHENTICATION AND CIPHERING RESPONSE message from the MS by using the new integrity key GPRS GSM Kint derived from the new UMTS security context as described in subclause 4.7.7.3b and annex H in 3GPP TS 43.020 [13]. When a successful authentication takes place after a successful verification of the RES and the message authentication code received in the AUTHENTICATION AND CIPHERING RESPONSE message from the MS, the GMM layer in the network shall indicate this successful authentication to the LLC layer. If the check and verification of the message authentication code included in the AUTHENTICATION AND CIPHERING RESPONSE message fails in the network, then the network shall ignore the GMM message. If the AUTHENTICATION AND CIPHERING RESPONSE message is received in the network without a message authentication code then the network shall silently discard the GMM message.

In A/Gb mode, in the case of an established GSM security context, the GMM layer shall notify the LLC sublayer if ciphering shall be used or not. Furthermore, if ciphering shall be used, then the GMM layer shall also notify the LLC sublayer which GEA algorithm and GPRS GSM ciphering key that shall be used (see 3GPP TS 44.064 [78a]).

In A/Gb mode, in the case of an established UMTS security context, the GMM layer shall notify the LLC sublayer if ciphering shall be used or not. Furthermore, if ciphering shall be used, then the GMM layer shall also notify the LLC sublayer which GEA algorithm and which ciphering key (i.e. GPRS GSM ciphering key or GPRS GSM K_{C128}) that shall be used (see 3GPP TS 44.064 [78a]). If the network has selected a GEA ciphering algorithm that requires a 128-bit ciphering key, then the ME shall derive a GPRS GSM K_{C128} as described in the subclause 4.7.7.3a.

In A/Gb mode, if an established UMTS security context context is available in the network, if the MS has indicated support of integrity protection to the network, the GMM layer in the network shall assign the GPRS GSM integrity algorithm and the GPRS GSM K_{int} integrity key to the LLC layer, after it has received the AUTHENTICATION AND CIPHERING RESPONSE message from the MS (see 3GPP TS 43.020 [13] and 3GPP TS 44.064[78a]).

Upon receipt of the AUTHENTICATION AND CIPHERING FAILURE message, the network stops the timer T3360. In Synch failure case, the core network may renegotiate with the HLR/AuC and provide the MS with new authentication parameters.

4.7.7.3a 128-bit packet-switched GSM ciphering key

The ME and the network may derive and store a 128-bit packet-switched GSM key or GPRS GSM K_{C128} from an established UMTS security context. If the GPRS GSM K_{C128} exists, then it is also part of the UMTS security context.

The ME with a USIM in use shall compute a new GPRS GSM K_{C128} using the GPRS UMTS ciphering key and the GPRS UMTS integrity key from an established UMTS security context as specified in 3GPP TS 33.102 [5a]. The new GPRS GSM K_{C128} shall be stored only in the ME. The ME shall overwrite the existing GPRS GSM K_{C128} with the new GPRS GSM K_{C128} . The ME shall delete the GPRS GSM K_{C128} at switch off, when the USIM is disabled as well as under the conditions identified in the subclause 4.1.3.2 and 4.7.7.4. The ME with a USIM in use shall apply the GPRS GSM K_{C128} when in A/Gb mode a GEA ciphering algorithm that requires a 128-bit ciphering key is taken into use.

The network shall compute the GPRS GSM K_{C128} using the GPRS UMTS integrity key and the GPRS UMTS ciphering key from an established UMTS security context as specified in 3GPP TS 33.102 [5a] only when in A/Gb mode a GEA ciphering algorithm that requires a 128-bit ciphering key is to be used.

In A/Gb mode, if the MS supports integrity protection, the information in the Ciphering Algorithm IE together with the IMSI from the USIM shall be stored in a non-volatile memory in the ME at MS power off. The information stored in the Ciphering Algorithm IE can only be used if the IMSI from the USIM matches the IMSI stored in the ME non-volatile memory at MS power on; otherwise the MS shall delete the Ciphering Algorithm IE.

4.7.7.3b 128-bit packet-switched GSM integrity key (in A/Gb mode and only if MS supports integrity protection)

The ME and the network may derive and store a 128-bit packet-switched GPRS GSM K_{int} from an established UMTS security context. If the GPRS GSM K_{int} exists, then it is also part of the UMTS security context.

The ME with a USIM in use shall compute a new GPRS GSM K_{int} using the GPRS UMTS ciphering key and the GPRS UMTS integrity key from an established UMTS security context as specified in 3GPP TS 43.020 [13]. The new GPRS GSM K_{int} shall be stored only in the ME. The ME shall overwrite the existing GPRS GSM K_{int} with the new GPRS GSM K_{int} . The ME shall delete the GPRS GSM K_{int} at MS switch off, when the USIM is disabled as well as under the conditions identified in the subclause 4.1.3.2 and 4.7.7.4. The ME with a USIM in use shall apply the GPRS GSM K_{int} when in A/Gb mode a GIA integrity algorithm that requires a 128-bit integrity key is taken into use.

The network shall compute the GPRS GSM K_{int} using the GPRS UMTS integrity key and the GPRS UMTS ciphering key from an established UMTS security context as specified in 3GPP TS 43.020 [13] only when in A/Gb mode a GIA integrity algorithm that requires a 128-bit integrity key is to be used.

At MS power off, the information in the Integrity Algorithm IE shall be stored in a non-volatile memory in the ME together with the IMSI from the USIM. The information stored in the Integrity Algorithm IE can only be used if the IMSI from the USIM matches the IMSI stored in the ME non-volatile memory at MS power on; otherwise the MS shall delete the Integrity Algorithm IE.

4.7.7.4 GPRS ciphering key sequence number

The security parameters for authentication and ciphering are tied together in sets.

In a GSM authentication challenge, from a challenge parameter RAND both the authentication response parameter SRES and the GPRS GSM ciphering key can be computed given the secret key associated to the IMSI.

In a UMTS authentication challenge, from a challenge parameter RAND, the authentication response parameter RES and the GPRS UMTS ciphering key and the GPRS UMTS integrity key can be computed given the secret key associated to the IMSI. Furthermore, in the USIM a GPRS GSM ciphering key can be computed from the GPRS UMTS integrity key and the GPRS UMTS ciphering key by means of an unkeyed conversion function. Furthermore, in A/Gb mode if a GEA ciphering algorithm that requires a 128-bit ciphering key is taken into use, then a GPRS GSM K_{C128} shall also be calculated as described in the subclause 4.7.7.3a. Furthermore, in A/Gb mode, if the MS and the network support integrity protection, when a GIA integrity algorithm that requires a 128-bit integrity key is taken into use, then a GPRS GSM K_{int} shall also be calculated as described in the subclause 4.7.7.3b.

In order to allow start of ciphering on a logical link without authentication, GPRS ciphering key sequence numbers are introduced.

The GPRS ciphering key sequence number is managed by the network such that the AUTHENTICATION AND CIPHERING REQUEST message contains the GPRS ciphering key sequence number allocated to the GPRS GSM ciphering key (in case of a GSM authentication challenge) or the GPRS UMTS ciphering key and the GPRS UMTS integrity key (in case of a UMTS authentication challenge) which may be computed from the RAND parameter carried in that message.

If an authentication and ciphering procedure has been completed successfully and a GPRS ciphering key sequence number is stored in the network, the network shall include a different GPRS ciphering key sequence number in the AUTHENTICATION AND CIPHERING REQUEST message when it initiates a new authentication and ciphering procedure.

If a GPRS ciphering key sequence number is contained in the first message during a GMM procedure, the network shall include a different GPRS ciphering key sequence number in the AUTHENTICATION_AND_CIPHERING REQUEST message when it initiates an authentication and ciphering procedure.

The MS stores the GPRS ciphering key sequence number with the GPRS GSM ciphering key (in case of a GSM authentication challenge) and the GPRS UMTS ciphering key and the GPRS UMTS integrity key (in case of a UMTS authentication challenge), and includes the corresponding GPRS ciphering key sequence number in the ROUTING AREA UPDATE REQUEST, SERVICE REQUEST and ATTACH REQUEST messages.

If the GPRS ciphering key sequence number is deleted, the associated GPRS GSM ciphering key, GPRS UMTS ciphering key, GPRS UMTS integrity key, GPRS GSM K_{C128} and GPRS GSM K_{int} shall be deleted if any (i.e. the established GSM security context or the UMTS security context is no longer valid).

In Iu mode, the network may choose to start ciphering and integrity checking with the stored GPRS UMTS ciphering key and the stored GPRS UMTS integrity key (under the restrictions given in 3GPP TS 42.009 [5] and 3GPP TS 33.102 [5a]) if the stored GPRS ciphering key sequence number and the one given from the MS are equal.

In A/Gb mode, the network may choose to start ciphering with the stored GPRS GSM ciphering key or GPRS GSM K_{C128} (under the restrictions given in 3GPP TS 42.009 [5]) if the stored GPRS ciphering key sequence number and the one given from the MS are equal and the previously negotiated ciphering algorithm is known and supported in the network. When ciphering is requested at GPRS attach, the authentication and ciphering procedure shall be performed since the MS does not store the ciphering algorithm after entering state GMM-DEREGISTERED.

NOTE 1: The decision of starting ciphering with the GPRS GSM ciphering key or the GPRS GSM K_{C128} depends on whether the network indicates in the AUTHENTICATION AND CIPHERING REQUEST message a GEA ciphering algorithm which requires a 64 or 128-bit ciphering key as specified in 3GPP TS 33.102 [5a].

In A/Gb mode, if MS indicates support of integrity protection in the MS network capability IE to the network, if the ME has a Integrity Algorithm IE and a Ciphering Algorithm IE stored in the ME non-volatile memory at MS power on, then the GMM layer shall calculate a GPRS GSM K_{int} key as described in subclause 4.7.7.3b and a GPRS GSM K_{C128} key as described in subclause 4.7.7.3a and indicate to the LLC layer before sending the ATTACH REQUEST message that LLC layer shall start integrity protection with the indicated GPRS GSM K_{int} key and the integrity algorithm (indicated in the stored Integrity Algorithm IE). The GMM layer shall also assign the GPRS GSM K_{C128} key and the ciphering

algorithm (indicated in the stored Ciphering Algorithm IE) to the LLC layer. The network shall start integrity protection in the LLC layer after reception of the ATTACH REQUEST message with the stored GPRS GSM Kint and the integrity algorithm identified by the stored GPRS GSM integrity algorithm used when UE was previously attached if the GPRS GSM integrity algorithm is known and supported in the network, and if the stored GPRS ciphering key sequence number and the one given from the MS are equal.

Upon GPRS attach, if ciphering is to be used, an AUTHENTICATION AND CIPHERING REQUEST message shall be sent to the MS to start ciphering. In A/Gb mode, upon GPRS attach, if the MS and network supports integrity protection, then the network may choose to start ciphering with the stored GPRS GSM ciphering key or GPRS GSM K_{C128} (under the restrictions given in 3GPP TS 42.009 [5]) if the stored GPRS ciphering key sequence number and the one given from the MS in the ATTACH REQUEST message or ROUTING AREA UPDATE REQUEST message are equal and the previously negotiated ciphering algorithm is known and supported in the network, without initiating an authentication and ciphering procedure.

If the GPRS ciphering key sequence number stored in the network does not match the GPRS ciphering key sequence number received from the MS in the ATTACH REQUEST message, then the network should authenticate the MS.

In A/Gb mode, the MS starts ciphering after sending the AUTHENTICATION AND CIPHERING RESPONSE message. The network starts ciphering when a valid AUTHENTICATION AND CIPHERING RESPONSE is received from the MS.

In Iu mode, the MS starts ciphering and integrity checking according to the conditions specified in specification 3GPP TS 25.331 [23c].

In A/Gb mode, as an option, the network may decide to continue ciphering without sending an AUTHENTICATION AND CIPHERING REQUEST message after receiving a ROUTING AREA UPDATE REQUEST message with a valid GPRS ciphering key sequence number. Both the MS and the network shall use the latest ciphering parameters. The network starts ciphering when sending the ciphered ROUTING AREA UPDATE ACCEPT message to the MS. The MS starts ciphering after receiving a valid ciphered ROUTING AREA UPDATE ACCEPT message from the network.

NOTE 2: In some specifications the term KSI (Key Set Identifier) is used instead of the term GPRS ciphering key sequence number.

4.7.7.5 Authentication not accepted by the network

If the authentication response (RES or SRES) is not valid, the network response depends upon the type of identity used by the MS in the first message:

- If the P-TMSI has been used, the network may decide to initiate the identification procedure. If the IMSI given by the MS differs from the one the network had associated with the P-TMSI, the authentication should be restarted with the correct parameters. If the IMSI provided by the MS is the expected one (i.e. authentication has really failed), the network should send an AUTHENTICATION AND CIPHERING REJECT message to the mobile station.
- If the IMSI has been used, or the network decides not to try the identification procedure, an AUTHENTICATION AND CIPHERING REJECT message should be transferred to the MS.

Upon receipt of an AUTHENTICATION AND CIPHERING REJECT message,

- a) if the message has been successfully integrity checked by the lower layers, the MS shall set the GPRS update status to GU3 ROAMING NOT ALLOWED and shall delete the P-TMSI, P-TMSI signature, RAI and GPRS ciphering key sequence number stored. If available, also the TMSI, LAI and ciphering key sequence number shall be deleted and the update status shall be set to U3 ROAMING NOT ALLOWED. The SIM/USIM shall be considered as invalid until switching off or the SIM/USIM is removed. If the MS maintains a counter for "SIM/USIM considered invalid for GPRS services", then the MS shall set this counter to MS implementation-specific maximum value. If the MS maintains a counter for "SIM/USIM considered invalid for non-GPRS services", then the MS shall set this counter to MS implementation-specific maximum value.

If S1 mode is supported by the MS, the MS shall in addition handle the EMM parameters EMM state, EPS update status, last visited registered TAI, TAI list, GUTI and KSI_{ASME} as specified in 3GPP TS 24.301 [120] for the case when an EPS authentication is not accepted by the network.

- b) if the message is received without integrity protection, then the MS shall start timer T3247 with a random value uniformly drawn from the range between 30 minutes and 60 minutes, if the timer is not running (see subclause 4.1.1.6A). Additionally, the MS shall:
- if the MS maintains a counter for "SIM/USIM considered invalid for GPRS services" events and the counter has a value less than an MS implementation-specific maximum value, proceed as specified in subclause 4.1.1.6A, list item 6.a) for the case an ATTACH REJECT or ROUTING AREA UPDATE REJECT message is received without integrity protection; and
 - otherwise proceed as specified under list item a) above for the case that the message has been successfully checked by the lower layers.

List item b) above is also applicable, if the message is received in A/Gb mode.

If the AUTHENTICATION AND CIPHERING REJECT message is received, the MS shall abort any GMM procedure, shall stop any of the retransmission timers that are running (e.g. T3310, T3317, T3330, T3321, T3318 or T3320 and shall enter state GMM-DEREGISTERED.

In UTRAN Iu mode, depending on local regulations or operator preference for emergency bearer services, if the MS has a PDN connection for emergency bearer services established or is establishing a PDN connection for emergency bearer services, the SGSN need not follow the procedures specified for the authentication failure in the present subclause, the SGSN can continue with the ongoing GMM specific procedure or Session Management procedure. Upon completion of the GMM procedure or Session management procedure, the SGSN shall deactivate all non-emergency PDP contexts, if any, by initiating a PDP context deactivation procedure. The network shall consider the MS to be attached for emergency bearer services only.

4.7.7.5.1 Authentication not accepted by the MS

In a UMTS authentication challenge, the authentication procedure is extended to allow the MS to check the authenticity of the core network. Thus allowing, for instance, detection of false base station.

Following a UMTS authentication challenge, the MS may reject the core network, on the grounds of an incorrect AUTN parameter (see 3GPP TS 33.102 [5a]). This parameter contains two possible causes for authentication failure:

a) MAC code failure

If the MS considers the MAC code (supplied by the core network in the AUTN parameter) to be invalid, it shall send a AUTHENTICATION AND CIPHERING FAILURE message to the network, with the GMM cause 'MAC failure'. The MS shall then follow the procedure described in subclause 4.7.7.6 (f).

b) SQN failure

If the MS considers the SQN (supplied by the core network in the AUTN parameter) to be out of range, it shall send a AUTHENTICATION AND CIPHERING FAILURE message to the network, with the GMM cause 'Synch failure' and the re-synchronization token AUTS provided by the USIM (see 3GPP TS 33.102 [5a]). The MS shall then follow the procedure described in subclause 4.7.7.6 (g).

In Iu mode, an MS with a USIM inserted shall reject the authentication challenge if no Authentication Parameter AUTN IE was present in the AUTHENTICATION REQUEST message (i.e. a GSM authentication challenge has been received when the MS expects a UMTS authentication challenge). In such a case, the MS shall send the AUTHENTICATION AND CIPHERING FAILURE message to the network, with the GMM cause 'GSM authentication unacceptable'. The MS shall then follow the procedure described in subclause 4.7.7.6 (f).

If the MS returns an AUTHENTICATION_AND_CIPHERING_FAILURE message to the network, the MS shall delete any previously stored RAND and RES and shall stop timer T3316, if running.

If the MS has a PDN connection for emergency bearer services established or is establishing such a PDN connection, additional MS requirements are specified in subclause 4.7.7.6, under "for items f and g".

4.7.7.6 Abnormal cases

The following abnormal cases can be identified:

a) Lower layer failure

Upon detection of a lower layer failure before the AUTHENTICATION AND CIPHERING RESPONSE message is received, the network shall abort the procedure.

b) Expiry of timer T3360

The network shall, on the first expiry of the timer T3360, retransmit the AUTHENTICATION AND CIPHERING REQUEST message and shall reset and start timer T3360. This retransmission is repeated four times, i.e. on the fifth expiry of timer T3360, the procedure shall be aborted.

c) Collision of an authentication and ciphering procedure with a GPRS attach procedure

If the network receives an ATTACH REQUEST message before the ongoing authentication procedure has been completed and no GPRS attach procedure is pending on the network (i.e. no ATTACH ACCEPT/REJECT message has to be sent as an answer to an ATTACH REQUEST message), the network shall abort the authentication and ciphering procedure and proceed with the new GPRS attach procedure.

d) Collision of an authentication and ciphering procedure with a GPRS attach procedure when the authentication and ciphering procedure has been caused by a previous GPRS attach procedure

If the network receives an ATTACH REQUEST message before the ongoing authentication procedure has been completed and a GPRS attach procedure is pending (i.e. an ATTACH ACCEPT/REJECT message has still to be sent as an answer to an earlier ATTACH REQUEST message), then:

- If one or more of the information elements in the ATTACH REQUEST message differs from the ones received within the previous ATTACH REQUEST message, the network shall not treat the authentication any further and proceed with the GPRS attach procedure; or
- If the information elements do not differ, then the network shall not treat any further this new ATTACH REQUEST message.

d1) Collision of an authentication and ciphering procedure with a GPRS detach procedure

GPRS detach containing cause "power off":

If the network receives a DETACH REQUEST message before the ongoing authentication and ciphering procedure has been completed, the network shall abort the authentication and ciphering procedure and shall progress the GPRS detach procedure.

GPRS detach containing other causes than "power off":

If the network receives a DETACH REQUEST message before the ongoing authentication and ciphering procedure has been completed, the network shall complete the authentication and ciphering procedure and shall respond to the GPRS detach procedure as described in subclause 4.7.4.

e) Collision of an authentication and ciphering procedure with a routing area updating procedure

If the network receives a ROUTING AREA UPDATE REQUEST message before the ongoing authentication procedure has been completed, the network shall progress both procedures.

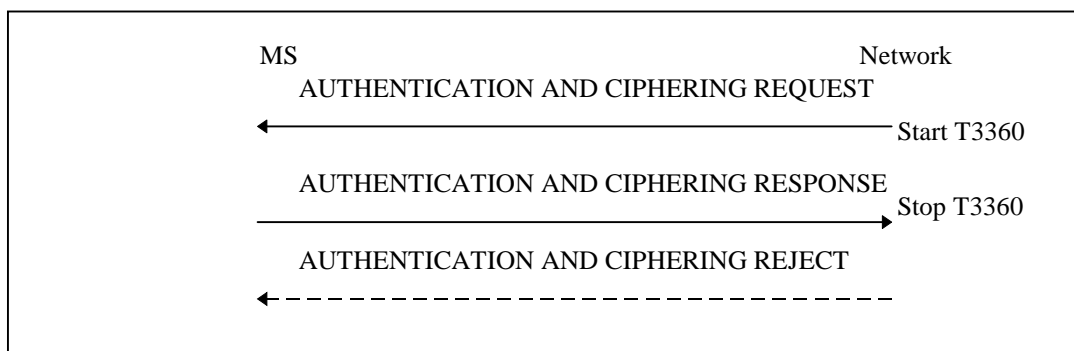

Figure 4.7.7/1 3GPP TS 24.008: Authentication and ciphering procedure

(f) Authentication failure (GMM cause #18 "MAC failure" or #21 "GSM authentication unacceptable")

The MS shall send an AUTHENTICATION AND CIPHERING FAILURE message, with GMM cause 'MAC failure' or 'GSM authentication unacceptable' according to subclause 4.7.7.5.1, to the network and start timer T3318. Furthermore, the MS shall stop any of the retransmission timers that are running (e.g. T3310, T3321, T3330 or T3317). Upon the first receipt of an AUTHENTICATION AND CIPHERING FAILURE message from the MS with GMM cause 'MAC failure' or 'GSM authentication unacceptable' the network may initiate the identification procedure described in subclause 4.7.8. This is to allow the network to obtain the IMSI from the MS. The network may then check that the P-TMSI originally used in the authentication challenge corresponded to the correct IMSI. Upon receipt of the IDENTITY REQUEST message from the network, the MS shall send the IDENTITY RESPONSE message.

NOTE: Upon receipt of an AUTHENTICATION AND CIPHERING FAILURE message from the MS with reject cause "MAC failure" or "GSM authentication unacceptable", the network may also terminate the authentication procedure (see subclause 4.7.7.5).

If the P-TMSI/IMSI mapping in the network was incorrect, the network should respond by sending a new AUTHENTICATION AND CIPHERING REQUEST message to the MS. Upon receiving the new AUTHENTICATION AND CIPHERING REQUEST message from the network, the MS shall stop timer T3318, if running, and then process the challenge information as normal. If the P-TMSI/IMSI mapping in the network was correct, the network should terminate the authentication and ciphering procedure by sending an AUTHENTICATION AND CIPHERING REJECT message.

If the network is validated successfully (an AUTHENTICATION AND CIPHERING REQUEST message that contains a valid SQN and MAC is received), the MS shall send the AUTHENTICATION AND CIPHERING RESPONSE message to the network and shall start any retransmission timers (e.g. T3310, T3321, T3330 or T3317), if they were running and stopped when the MS received the first failed AUTHENTICATION AND CIPHERING REQUEST message.

If the MS receives the second AUTHENTICATION AND CIPHERING REQUEST message while T3318 is running and

- the MAC value cannot be resolved; or
- the message was received in UMTS and contains a GSM authentication challenge,

the MS shall follow the procedure specified in this subclause (f), starting again from the beginning. If the SQN is invalid, the MS shall proceed as specified in (g).

It can be assumed that the source of the authentication challenge is not genuine (authentication not accepted by the MS) if any of the following occurs:

- the timer T3318 expires;
- the MS detects any combination of the authentication failures: "MAC failure", "invalid SQN", and "GSM authentication unacceptable", during three consecutive authentication challenges. The authentication challenges shall be considered as consecutive only, if the authentication challenges causing the second and third authentication failure are received by the MS, while the timer T3318 or T3320 started after the previous authentication failure is running.

The MS shall stop timer T3318, if the timer is running and the MS detects a lower layer failure, the network releases the PS signalling connection, the MS performs inter-system change to S1 mode, or the MS initiates a GPRS suspension procedure (see 3GPP TS 44.018 [84]).

When it has been deemed by the MS that the source of the authentication challenge is not genuine (authentication not accepted by the MS), the MS shall behave as described in subclause 4.7.7.6.1.

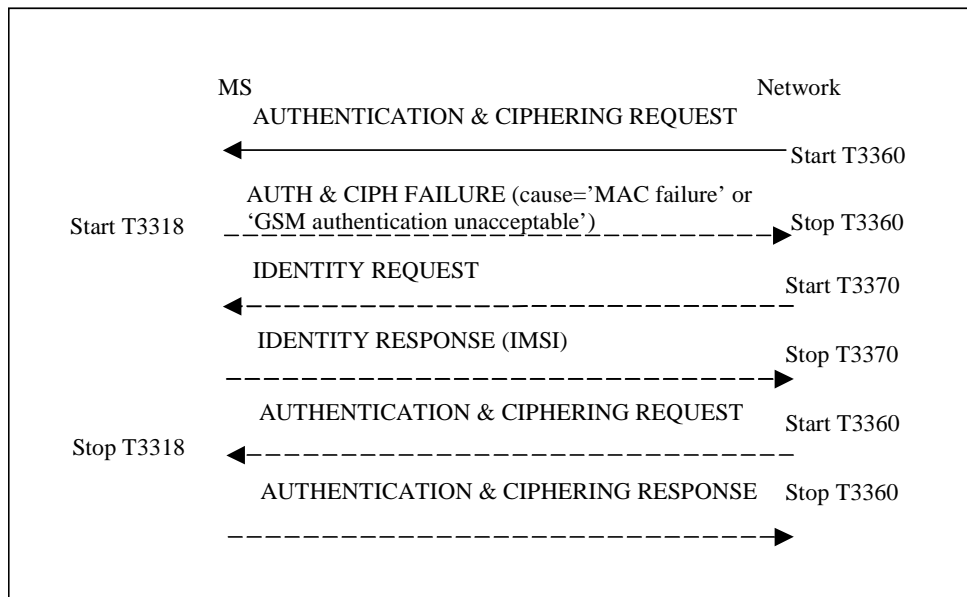

Figure 4.7.7a/1 3GPP TS 24.008: Authentication failure cause "MAC failure" or "GSM authentication unacceptable"

(g) Authentication failure (GMM cause #19 "Synch failure"):

The MS shall send an AUTHENTICATION AND CIPHERING FAILURE message, with the GMM cause "Synch failure", to the network and start the timer T3320. Furthermore, the MS shall stop any of the retransmission timers that are running (e.g. T3310, T3321, T3330 or T3317). Upon the first receipt of an AUTHENTICATION AND CIPHERING message from the MS with the GMM cause "synch failure", the network shall use the returned AUTS parameter from the authentication & ciphering failure parameter IE in the AUTHENTICATION AND CIPHERING FAILURE message, to re-synchronise. The re-synchronisation procedure requires the SGSN to delete all unused authentication vectors for that IMSI and obtain new vectors from the HLR. When re-synchronisation is complete, the network shall initiate the authentication & ciphering procedure. Upon receipt of the AUTHENTICATION AND CIPHERING REQUEST message, the MS shall stop timer T3320, if running.

NOTE: Upon receipt of two consecutive AUTHENTICATION AND CIPHERING FAILURE messages from the MS with reject cause "synch failure", the network may terminate the authentication procedure by sending an AUTHENTICATION AND CIPHERING REJECT message.

If the network is validated successfully (a new AUTHENTICATION AND CIPHERING REQUEST message is received which contains a valid SQN and MAC) while T3320 is running, the MS shall send the AUTHENTICATION AND CIPHERING RESPONSE message to the network and shall start any retransmission timers (i.e. T3310, T3321, T3330 or T3317), if they were running and stopped when the MS received the first failed AUTHENTICATION AND CIPHERING REQUEST message.

If the MS receives the second AUTHENTICATION AND CIPHERING REQUEST message while T3320 is running and

- the MAC value cannot be resolved; or
- the message was received in Iu mode and contains a GSM authentication challenge,

the MS shall proceed as specified in (f). If the SQN is invalid, the MS shall follow the procedure specified in this subclause (g), starting again from the beginning.

The MS shall deem that the network has failed the authentication check and behave as described in subclause 4.7.7.6.1, if any of the following occurs:

- the timer T3320 expires;
- the MS detects any combination of the authentication failures: "MAC failure", "invalid SQN", and "GSM authentication unacceptable", during three consecutive authentication challenges. The authentication challenges shall be considered as consecutive only, if the authentication challenges causing the second and

third authentication failure are received by the MS, while the timer T3318 or T3320 started after the previous authentication failure is running.

The MS shall stop timer T3320, if the timer is running and the MS detects a lower layer failure, the network releases the PS signalling connection, the MS performs inter-system change to S1 mode, or the MS initiates a GPRS suspension procedure (see 3GPP TS 44.018 [84]).

When it has been deemed by the MS that the source of the authentication challenge is not genuine (authentication not accepted by the MS), the MS shall behave as described in subclause 4.7.7.6.1.

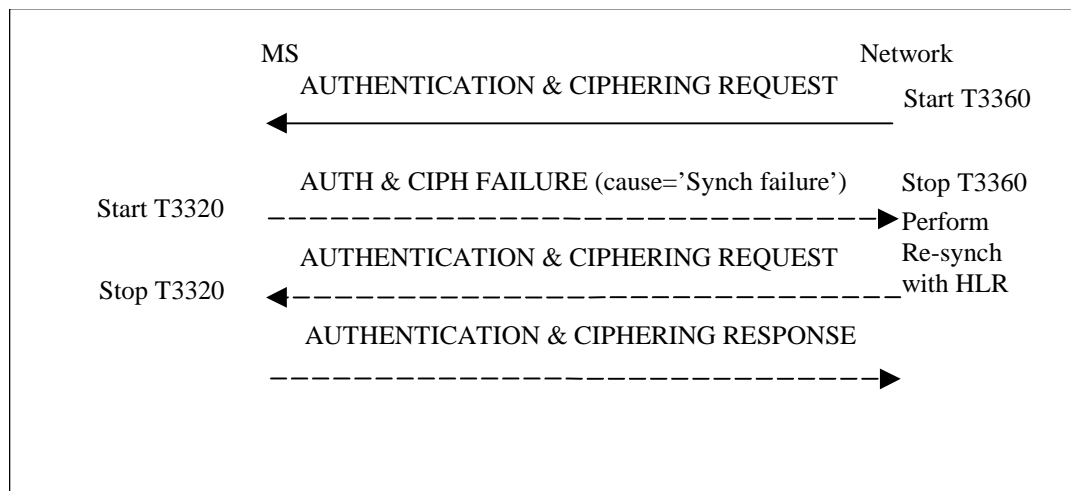

Figure 4.7.7b/1 3GPP TS 24.008: Authentication failure cause 'Synch failure'

Upon receipt of an AUTHENTICATION AND CIPHERING REJECT message, the UE shall perform the actions as specified in subclause 4.7.7.5.

For items f and g:

Depending on local requirements or operator preference for emergency bearer services, if the MS has a PDN connection for emergency bearer services established or is establishing such a PDN connection, the SGSN need not follow the procedures specified for the authentication failure specified in the present subclause and shall continue using the current security context, if any. The SGSN shall deactivate all non-emergency PDP contexts, if any, by initiating a PDP context deactivation procedure. If there is an ongoing session management procedure, the SGSN shall deactivate all non-emergency PDP contexts upon completion of the session management procedure. The network shall consider the MS to be attached for emergency bearer services only.

If an MS has a PDN connection for emergency bearer services established or is establishing such a PDN connection when timer T3318 or T3320 expires, the MS shall not deem that the network has failed the authentication check and not behave as described in subclause 4.7.7.6.1. Instead the MS shall continue using the current security context, if any. The MS shall deactivate all non-emergency PDP contexts, if any, by initiating a PDP context deactivation procedure. If there is an ongoing session management procedure, the MS shall deactivate all non-emergency PDP contexts upon completion of the session management procedure. The MS shall start any retransmission timers (e.g. T3310, T3317, T3321 or T3330) if:

- they were running and stopped when the MS received the AUTHENTICATION AND CIPHERING REJECT message and detected an authentication failure; and
- the procedures associated with these timers have not yet been completed.

The MS shall consider itself to be attached for emergency bearer services only.

4.7.7.6.1 MS behaviour towards a network that has failed the authentication procedure

If the MS deems that the network has failed the authentication check, then it shall request RR or RRC to release the RR connection and the PS signalling connection, if any, and bar the active cell or cells (see 3GPP TS 25.331 [23c] and 3GPP TS 44.018 [84]). The MS shall start any retransmission timers (i.e. T3310, T3321, T3330 or T3317), if they were

running and stopped when the MS received the first AUTHENTICATION AND CIPHERING REQUEST message containing an invalid MAC or invalid SQN, or no AUTN when a UMTS authentication challenge was expected.

4.7.7.7 Use of established security contexts

In A/Gb mode, in the case of an established GSM security context, the GPRS GSM ciphering key shall be taken into use by the MS before the AUTHENTICATION AND CIPHERING RESPONSE message is transmitted.

In A/Gb mode, in the case of an established UMTS security context, and if the network indicates in the AUTHENTICATION AND CIPHERING REQUEST message to the MS that a GEA ciphering algorithm that requires a 64-bit ciphering key shall be taken into use, then the GPRS GSM ciphering key shall be taken into use by the MS before the AUTHENTICATION AND CIPHERING RESPONSE message is transmitted. The network shall derive a GPRS GSM ciphering key from the GPRS UMTS ciphering key and the GPRS UMTS integrity key, by using the conversion function named "c3" defined in 3GPP TS 33.102 [5a].

In A/Gb mode, in the case of an established UMTS security context, and if the network indicates in the AUTHENTICATION AND CIPHERING REQUEST message to the MS that a GEA ciphering algorithm that requires a 128-bit ciphering key shall be taken into use, then the MS shall take the following actions:

- if authentication is not requested and a GEA ciphering algorithm that requires 64-bit ciphering key is in use, the MS shall take into use the GPRS GSM K_{c128} derived by the ME from the GPRS UMTS ciphering key and GPRS UMTS integrity key of the established UMTS security context in use (see 3GPP TS 33.102 [5a]) before the AUTHENTICATION AND CIPHERING RESPONSE message is transmitted;
- if authentication is not requested and a GEA ciphering algorithm that requires 128-bit ciphering key is in use, the GPRS GSM K_{c128} of the established UMTS security context in use still applies;

otherwise, the MS shall take into use the GPRS GSM K_{c128} derived by the ME from the GPRS UMTS ciphering key and the GPRS UMTS integrity key provided by the USIM during the latest successful authentication procedure (see subclause 4.7.7.3a) before the AUTHENTICATION AND CIPHERING RESPONSE message is transmitted.

In A/Gb mode, in the case of an established UMTS security context, and if the network indicates in the AUTHENTICATION AND CIPHERING REQUEST message to the MS that a GEA ciphering algorithm that requires a 128-bit ciphering key shall be taken into use, then the network shall derive a GPRS GSM K_{c128} (see subclause 4.7.7.3a).

In A/Gb mode, if an established UMTS security context context is available in the network, if the MS indicates support of integrity protection to the network and the network supports integrity protection, if the network indicates in the AUTHENTICATION AND CIPHERING REQUEST message to the MS that a new GPRS GSM integrity algorithm shall be taken into use but no authentication is requested, then the GPRS GSM K_{int} of the established UMTS security context in use still applies in the MS and network.

In A/Gb mode, in the case of an established UMTS security context, and if the network indicates in the AUTHENTICATION AND CIPHERING REQUEST message to the MS that a GIA integrity protection algorithm that requires a 128-bit integrity key shall be taken into use but no authentication is requested, then the GPRS GSM K_{int} of the established UMTS security context in use still applies in the MS.

In A/Gb mode, if during an ongoing, already ciphering protected RR connection, the network initiates a new Authentication and ciphering procedure, the new GPRS GSM ciphering key or GPRS GSM K_{c128} shall be taken into use by the MS before the AUTHENTICATION AND CIPHERING RESPONSE message is transmitted. In case of inter-system change to Iu mode after receipt of the AUTHENTICATION AND CIPHERING REQUEST message, the MS and the network shall take the new keys into use immediately after the inter-system change.

In Iu mode, in the case of an established GSM security context, the ME shall derive a GPRS UMTS ciphering key and a GPRS UMTS integrity key from the GPRS GSM ciphering key by using the conversion functions named "c4" and "c5" defined in 3GPP TS 33.102 [5a]. The derived GPRS UMTS ciphering key and GPRS UMTS integrity key shall be taken into use by the MS when a valid SECURITY MODE COMMAND message indicating PS domain is received during an RR connection (the definition of a valid SECURITY MODE COMMAND message is given in 3GPP TS 25.331 [23c]). The network shall derive a GPRS UMTS ciphering key and a GPRS UMTS integrity key from the GPRS GSM ciphering key by using the conversion functions named "c4" and "c5" defined in 3GPP TS 33.102 [5a].

In Iu mode, in the case of an established UMTS security context, the GPRS UMTS ciphering key and the GPRS UMTS integrity key shall be taken into use by the MS when a valid SECURITY MODE COMMAND message indicating PS

domain is received during a PS signalling connection (the definition of a valid SECURITY MODE COMMAND message is given in 3GPP TS 25.331 [23c]).

In Iu mode, if the MS received a valid SECURITY MODE COMMAND message indicating PS domain in Iu mode or a valid AUTHENTICATION AND CIPHERING REQUEST message in A/Gb mode before the network initiates a new authentication and ciphering procedure and establishes a new GSM/UMTS security context, the new GPRS UMTS ciphering key and GPRS UMTS integrity key are taken into use by the MS, when a new valid SECURITY MODE COMMAND message indicating PS domain is received during the PS signalling connection. In case of inter-system change to A/Gb mode, the MS and the network shall take the new keys into use immediately after the inter-system change.

4.7.7.8 Handling of keys at intersystem change from Iu mode to A/Gb mode

At an inter-system change from Iu mode to A/Gb mode, ciphering may be started (see 3GPP TS 44.064 [78a]) without any new authentication and ciphering procedure. Deduction of the appropriate security key for ciphering in A/Gb mode, depends on the current GSM/UMTS security context stored in the MS and the network.

The ME shall handle the GPRS GSM ciphering key and a potential GPRS GSM K_{C128} according to table 4.7.7.8.1.

In the case of an established GSM security context, before any initial GMM message is sent in the new cell in A/Gb mode, the GMM layer in the MS shall notify the LLC layer if ciphering shall be used or not. If ciphering shall be used, then the GPRS GSM ciphering key and the applicable GEA ciphering algorithm according to the stored *Ciphering Algorithm IE* in the MS shall also be indicated to the LLC layer (see 3GPP TS 44.064 [78a]).

In the case of an established UMTS security context, before any initial GMM message is sent in the new cell in A/Gb mode, the GMM layer in the MS shall notify the LLC layer if ciphering shall be used or not. If ciphering shall be used, then the GPRS GSM ciphering key or GPRS GSM K_{C128} and the applicable GEA ciphering algorithm according to the stored *Ciphering Algorithm IE* in the MS shall also be indicated to the LLC layer (see 3GPP TS 44.064 [78a]). If the network has selected a GEA-algorithm that requires a 128-bit ciphering key, then the ME shall apply a GPRS GSM K_{C128} derived from the GPRS UMTS ciphering key and the GPRS UMTS integrity key of the established UMTS security context as specified in 3GPP TS 33.102 [5a].

Table 4.7.7.8.1/3GPP TS 24.008: Inter-system change from Iu mode to A/Gb mode

Security context established in MS and network in Iu mode	At inter-system change to A/Gb mode:
GSM security context	An ME shall apply the GPRS GSM ciphering key that was received from the GSM security context created in the SIM/USIM during the latest successful authentication procedure.
UMTS security context	If a GEA algorithm is taken into use that requires a 64-bit long ciphering key, then an ME shall apply the GPRS GSM ciphering key that was derived by the USIM from the GPRS UMTS ciphering key and the GPRS UMTS integrity key during the latest successful authentication procedure. If a GEA algorithm is taken into use that requires a 128-bit ciphering key, then an ME shall apply the GPRS GSM K_{C128} derived by the ME from the GPRS UMTS ciphering key and the GPRS UMTS integrity key (see 3GPP TS 33.102 [5a]) provided by the USIM during the latest successful authentication procedure (see subclause 4.7.7.3a).

NOTE: A USIM with UMTS security context, passes the GPRS UMTS ciphering key, the GPRS UMTS integrity key and the derived GPRS GSM ciphering key to the ME independent on the current radio access being UTRAN or GERAN.

4.7.7.9 Handling of keys at intersystem change from A/Gb mode to Iu mode

At an inter-system change from A/Gb mode to Iu mode, ciphering and integrity may be started (see 3GPP TS 25.331 [23c]) without any new authentication and ciphering procedure. Deduction of the appropriate security keys for ciphering and integrity check in Iu mode, depends on the current GSM/UMTS security context stored in the MS and the network.

The ME shall handle the GPRS UMTS ciphering key and the GPRS UMTS integrity key according to table 4.7.7.9.1.

Table 4.7.7.9.1/3GPP TS 24.008: Inter-system change from A/Gb mode to Iu mode

Security context established in MS and network in A/Gb mode	At inter-system change to Iu mode:
GSM security context	An ME shall derive the GPRS UMTS ciphering key and the GPRS UMTS integrity key from the GPRS GSM ciphering key that was provided by the SIM/USIM during the latest successful authentication procedure. The conversion functions named "c4" and "c5" in 3GPP TS 33.102 [5a] are used for this purpose.
UMTS security context	An ME shall apply the GPRS UMTS ciphering key and the GPRS UMTS integrity key that were received from the UMTS security context created in the USIM during the latest successful authentication procedure.

NOTE: A USIM with UMTS security context, passes the GPRS UMTS ciphering key, the GPRS UMTS integrity key and the derived GPRS GSM ciphering key to the ME independent on the current radio access being UTRAN or GERAN.

4.7.7.10 Handling of keys at intersystem change from S1 mode to Iu mode or A/Gb mode

At an inter-system change from S1 mode to Iu mode, ciphering and integrity may be started (see 3GPP TS 25.331 [23c]) without any new authentication and ciphering procedure. At an inter-system change from S1 mode to A/Gb mode, ciphering may be started (see 3GPP TS 44.064 [78a]) without any new authentication and ciphering procedure. Deduction of the appropriate security keys for ciphering and integrity check in Iu mode or for ciphering in A/Gb mode, depends on the current EPS security context or the UMTS security context for the PS domain stored in the MS and the network.

The ME shall handle the GPRS UMTS ciphering key, the GPRS UMTS integrity key, the GPRS GSM ciphering key and a potential GPRS GSM K_{C128} according to table 4.7.7.10.1, table 4.7.7.10.2 and table 4.7.7.10.3.

Table 4.7.7.10.1/3GPP TS 24.008: Inter-system change from S1 mode to Iu mode or A/Gb mode in connected mode.

Security context established in MS and network	At inter-system change to Iu mode or A/Gb mode in connected mode
EPS security context	An ME shall derive the UMTS security keys GPRS UMTS ciphering key (CK') and GPRS UMTS integrity key (IK') from K_{ASME} and the NAS downlink COUNT value as specified in 3GPP TS 33.401 [123]. The ME shall use the derived UMTS security keys to derive the GPRS GSM ciphering key using the "c3" conversion function as specified in 3GPP TS 33.102 [5a]. At inter-system change from S1 mode to Iu mode, the ME shall apply the new derived GPRS UMTS integrity key and GPRS UMTS ciphering key. At inter-system change from S1 mode to A/Gb mode, the ME shall apply the new derived GPRS GSM ciphering key. Furthermore, the ME shall replace an already established UMTS security context for the PS domain, if any, in the USIM. The MS shall in addition handle the $START_{PS}$ value as specified in 3GPP TS 25.331 [23c]. At inter-system change from S1 mode to A/Gb mode, if a GEA algorithm is taken into use that requires a 64-bit long ciphering key, then an ME shall apply the derived GPRS GSM ciphering key. At inter-system change from S1 mode to A/Gb mode, if a GEA algorithm is taken into use that requires a 128-bit long ciphering key, then an ME shall apply the derived GPRS GSM K_{C128} that was derived by the ME from the derived UMTS security keys (see subclause 4.7.7.3a).

NOTE 1: For the case in table 4.7.7.10.1, because of deriving a new UMTS security context for the PS domain, a new GPRS GSM ciphering key needs to be derived from the new derived UMTS security keys (i.e. CK' and IK'). Note that the new GPRS GSM ciphering key is also part of the new UMTS security context for the PS domain, and therefore any old GPRS GSM ciphering key stored in the USIM and in the ME belongs to an old UMTS security context for the PS domain and can no longer be taken into use.

Table 4.7.7.10.2/3GPP TS 24.008: Inter-system change from S1 mode to lu mode or A/Gb mode in idle mode when the TIN indicates "GUTI".

Security context established in MS and network	At inter-system change to lu mode or A/Gb mode in idle mode when the TIN indicates "GUTI"
EPS security context	<p>An ME shall derive the UMTS security keys GPRS UMTS ciphering key (CK') and GPRS UMTS integrity key (IK') from K_{ASME} and the NAS uplink COUNT value as specified in 3GPP TS 33.401 [123]. The ME shall use the derived UMTS security keys to derive the GPRS GSM ciphering key using the "c3" conversion function as specified in 3GPP TS 33.102 [5a].</p> <p>At inter-system change from S1 mode to lu mode, the ME shall apply the new derived GPRS UMTS integrity key and GPRS UMTS ciphering key.</p> <p>At inter-system change from S1 mode to A/Gb mode, the ME shall apply the new derived GPRS GSM ciphering key.</p> <p>Furthermore, the ME shall replace an already established UMTS security context for the PS domain, if any, in the USIM. The MS shall in addition handle the $START_{PS}$ value as specified in 3GPP TS 25.331 [23c].</p> <p>At inter-system change from S1 mode to A/Gb mode, if a GEA algorithm is taken into use that requires a 64-bit long ciphering key, then an ME shall apply the derived GPRS GSM ciphering key.</p> <p>At inter-system change from S1 mode to A/Gb mode, if a GEA algorithm is taken into use that requires a 128-bit long ciphering key, then an ME shall apply the derived GPRS GSM Kc_{128} that was derived by the ME from the derived UMTS security keys (see subclause 4.7.7.3a).</p>

NOTE 2: For the case in table 4.7.7.10.2, because of deriving a new UMTS security context for the PS domain, a new GPRS GSM ciphering key needs to be derived from the new derived UMTS security keys (i.e. CK' and IK'). The new GPRS GSM ciphering key is also part of the new UMTS security context for the PS domain, and therefore any old GPRS GSM ciphering key stored in the USIM and in the ME belongs to an old UMTS security context for the PS domain and can no longer be taken into use.

Table 4.7.7.10.3/3GPP TS 24.008: Inter-system change from S1 mode to Iu mode or A/Gb mode in idle mode when the TIN indicates "RAT-related TMSI"

Security context established in MS and network	At inter-system change to Iu mode or A/Gb mode in idle mode when the TIN indicates "RAT-related TMSI"
UMTS security context	At inter-system change from S1 mode to Iu mode, the ME shall apply the GPRS UMTS ciphering key and the GPRS UMTS integrity key that were received from the UMTS security context for the PS domain created in the USIM during the latest successful authentication procedure. At inter-system change from S1 mode to A/Gb mode, if a GEA algorithm is taken into use that requires a 64-bit long ciphering key, then an ME shall apply the GPRS GSM ciphering key that was received from the GSM security context created in the SIM/USIM during the latest successful authentication procedure. At inter-system change from S1 mode to A/Gb mode, if a GEA algorithm is taken into use that requires a 128-bit long ciphering key, then an ME shall apply the GPRS GSM K _{C128} derived by the ME from the GPRS UMTS ciphering key and the GPRS UMTS integrity key (see 3GPP TS 33.102 [5a]) provided by the USIM during the latest successful authentication procedure (see subclause 4.7.7.3a).

The network shall replace an already established UMTS security context for the PS domain, if any, when a handover from S1 mode to Iu mode or from S1 mode to A/Gb mode has been completed successfully.

If the handover from S1 mode to Iu mode or S1 mode to A/Gb mode has not been completed successfully, the ME and the network shall delete the new derived UMTS security context for the PS domain. Additionally, the network shall delete the already established UMTS security context for the PS domain, if the CKSN of the already established UMTS security context is equal to the CKSN of the new derived security context for the PS domain.

4.7.8 Identification procedure

The identification procedure is used by the network to request an MS to provide specific identification parameters to the network e.g. International Mobile Subscriber Identity, International Mobile Equipment Identity (see 3GPP TS 23.003 [10]). For the presentation of the IMEI, the requirements of 3GPP TS 42.009 [5] apply.

4.7.8.1 Identification initiation by the network

The network initiates the identification procedure by transferring an IDENTITY REQUEST message to the MS and starts the timer T3370. The IDENTITY REQUEST message specifies the requested identification parameters in the identity type information element.

4.7.8.2 Identification response by the MS

An MS shall be ready to respond to an IDENTITY REQUEST message at any time.

Upon receipt of the IDENTITY REQUEST message the MS sends back an IDENTITY RESPONSE message. The IDENTITY RESPONSE message shall contain the identification parameters as requested by the network.

4.7.8.3 Identification completion by the network

Upon receipt of the IDENTITY RESPONSE the network shall stop timer T3370.

4.7.8.3a Abnormal cases in the MS

- (a) Requested identity is not available:

If the MS cannot encode the requested identity in the IDENTITY RESPONSE message, e.g. because no valid SIM is available, then it shall encode the identity type as "No identity".

4.7.8.4 Abnormal cases on the network side

The following abnormal cases can be identified:

a) Lower layer failure

Upon detection of a lower layer failure before the IDENTITY RESPONSE is received, the network shall abort any ongoing GMM procedure.

b) Expiry of timer T3370

The identification procedure is supervised by the network by the timer T3370. The network shall, on the first expiry of the timer T3370, retransmit the IDENTITY REQUEST message and reset and restart the timer T3370. This retransmission is repeated four times, i.e. on the fifth expiry of timer T3370, the network shall abort the identification procedure and any ongoing GMM procedure.

c) Collision of an identification procedure with a GPRS attach procedure

If the network receives an ATTACH REQUEST message before the ongoing identification procedure has been completed and no GPRS attach procedure is pending on the network (i.e. no ATTACH ACCEPT/REJECT message has still to be sent as an answer to an ATTACH REQUEST message), the network shall proceed with the GPRS attach procedure.

d) Collision of an identification procedure with a GPRS attach procedure when the identification procedure has been caused by a GPRS attach procedure

If the network receives an ATTACH REQUEST message before the ongoing identification procedure has been completed and a GPRS attach procedure is pending (i.e. an ATTACH ACCEPT/REJECT message has to be sent as an answer to an earlier ATTACH REQUEST message), then:

- If one or more of the information elements in the ATTACH REQUEST message differs from the ones received within the previous ATTACH REQUEST message, the network shall proceed with the GPRS attach procedure; or
- If the information elements do not differ, then the network shall not treat any further this new ATTACH REQUEST.

d1) Collision of an identification procedure with an MS initiated GPRS detach procedure

GPRS detach containing cause "power off":

If the network receives a DETACH REQUEST message before the ongoing identification procedure has been completed, the network shall abort the identification procedure and shall progress the GPRS detach procedure.

GPRS detach containing other causes than "power off":

If the network receives a DETACH REQUEST message before the ongoing identification procedure has been completed, the network shall complete the identification procedure and shall respond to the GPRS detach procedure as described in subclause 4.7.4.

e) Collision of an identification procedure with a routing area updating procedure

If the network receives a ROUTING AREA UPDATE REQUEST message before the ongoing identification procedure has been completed, the network shall progress both procedures.

f) Collision of an identification procedure with a service request procedure

If the network receives a SERVICE REQUEST message before the ongoing identification procedure has been completed, the network shall progress both procedures.

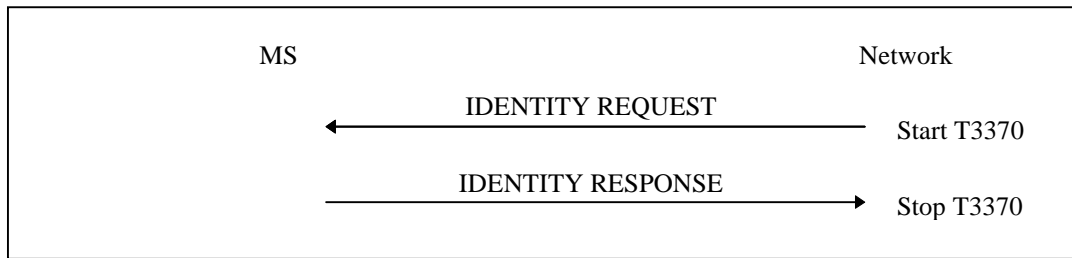

Figure 4.7.8/1 3GPP TS 24.008: Identification procedure

4.7.9 Paging procedure

4.7.9.1 Paging for GPRS services

In A/Gb mode, paging is used by the network to identify the cell the MS has currently selected, or to prompt the mobile to re-attach if necessary as a result of network failure. If the MS is not GPRS attached when it receives a paging for GPRS services, the MS shall ignore the paging.

In Iu mode, paging is used by the network to request the establishment of PS signalling connection or to prompt the mobile to re-attach if necessary as a result of network failure. If the MS is not GPRS attached when it receives a paging for GPRS services, the MS shall ignore the paging.

4.7.9.1.1 Paging for GPRS services using P-TMSI

The network shall initiate the paging procedure for GPRS services using P-TMSI when GMM signalling messages or user data is pending to be sent to the MS while the mobile reachable timer is running. The network may page only GPRS MSs which are GMM-REGISTERED and identified by a local P-TMSI.

In Iu mode, for the MS using eDRX, the network initiates the paging procedure when the paging trigger is received within the paging time window. If the paging trigger is received outside the paging time window, the network initiates the paging procedure at T time ahead of the beginning of the next paging time window.

NOTE: T time is a short time period based on implementation. The operator can take possible imperfections in the synchronization between the CN and the MS into account when choosing T time.

In Iu mode, to initiate the procedure the GMM entity in the network requests the lower layer to start paging (see 3GPP TS 25.331 [23c] and 3GPP TS 25.413 [19c]) and shall start the timer:

- T3315 for this paging procedure, if the network accepted to use eDRX for the MS.
- Otherwise T3313 for this paging procedure.

In Iu mode, if the network starts the timer T3315, the network shall set the timer T3315 to a value smaller than the value of timer T3-RESPONSE (see 3GPP TS 29.274 [16D] for further details on timer T3-RESPONSE).

In Iu mode, the GMM entity in the network may provide the lower layer with a list of CSG IDs, including the CSG IDs of both the expired and the unexpired subscriptions. If there is a PDN connection for emergency bearer services established, the GMM entity in the network shall not provide the list of CSG IDs to the lower layer.

Upon reception of a paging indication, the MS shall stop the timer T3346, if running, and:

- initiate a service request procedure to respond to the paging, the MS shall set the service type to "paging response" in the SERVICE REQUEST message (see 3GPP TS 24.007 [20], 3GPP TS 23.060 [74], 3GPP TS 25.331 [23c] and 3GPP TS 25.413 [19c]); or
- initiate a routing area update procedure as specified in subclauses 4.7.5.1 and 4.7.5.2.1.

If the paging request for GPRS services was received during an ongoing MS initiated GMM specific procedure, then the MS shall progress the GMM specific procedure, and the network shall proceed with the GMM specific procedure.

In A/Gb mode, to initiate the procedure the GMM entity requests the RR sublayer to start paging (see 3GPP TS 44.018 [84], 3GPP TS 44.060 [76]), and shall start the timer:

- T3315 for this paging procedure, if the network accepted to use eDRX for the MS.
- Otherwise T3313 for this paging procedure.

In A/Gb mode, if the network starts the timer T3315, the network shall set the timer T3315 to a value smaller than the value of timer T3-RESPONSE (see 3GPP TS 29.274 [16D] for further details on timer T3-RESPONSE).

In A/Gb mode, upon reception of a paging indication, the MS shall respond to the paging with any LLC frame (see 3GPP TS 44.064 [78a], 3GPP TS 24.007 [20], 3GPP TS 23.060 [74]).

At intersystem change, an MS not having the READY timer running in A/Gb mode or an MS in PMM-IDLE mode in Iu mode, being paged in a different access network as when it last sent user data or signalling message, uses the ROUTING AREA UPDATE REQUEST message as paging response, i.e. the routing area updating procedure shall be performed instead according to the selective routing area updating procedure.

The network shall stop the timer for the paging procedure (i.e. either timer T3313 or timer T3315) when a response is received from the MS.

Upon expiry of the timer T3313, the network may re-initiate paging.

Upon expiry of the timer T3315, the network shall abort the paging procedure and shall proceed as specified in 3GPP TS 23.060 [74].

In Iu mode, when a response is received from the MS, the network shall change from PMM-IDLE mode to PMM-CONNECTED mode.

In A/Gb mode, when a response different from an LLC NULL frame is received from the MS, the network shall start the READY timer.

4.7.9.1.2 Paging for GPRS services using IMSI

Paging for GPRS services using IMSI is an abnormal procedure used for error recovery in the network.

The network may initiate paging using IMSI if the P-TMSI is not available due to a network failure.

In Iu mode, to initiate the procedure the GMM entity in the network requests the lower layer to start paging (see 3GPP TS 25.331 [23c] and 3GPP TS 25.413 [19c]).

In A/Gb mode, to initiate the procedure the GMM entity in the network requests the RR sublayer to start paging (see 3GPP TS 44.018 [84], 3GPP TS 44.060 [76]).

Upon reception of a paging indication for GPRS services using IMSI, the MS shall stop the timer T3346, if it is running, locally deactivate any active PDP context(s), MBMS context(s) and locally detach from GPRS. The local detach includes deleting any RAI, P-TMSI, P-TMSI signature and GPRS ciphering key sequence number stored, setting the GPRS update status to GU2 NOT UPDATED and changing state to GMM-DEREGISTERED. The MS shall stop all timers T3396 that are running.

If S1 mode is supported by the MS, the MS shall in addition handle the EMM parameters EMM state, EPS update status, last visited registered TAI, TAI list, GUTI and KSI_{ASME} as specified in 3GPP TS 24.301 [120] for the case when a paging for EPS services using IMSI is received.

In Iu mode, when an MS receives a paging request for GPRS services using the IMSI from the network before an MS initiated GMM specific procedure has been completed, then the MS shall abort the GMM specific procedure, and the MS shall proceed according to the description in this clause.

After performing the local detach, the MS shall then perform a GPRS attach or combined GPRS attach procedure.

After performing the attach, the MS should activate PDP context(s) to replace any previously active PDP context(s). The MS should also perform the procedures needed in order to activate any previously active multicast service(s).

NOTE 1: In some cases, user interaction may be required and then the MS cannot activate the PDP and MBMS context(s) automatically.

NOTE 2: The MS does not respond to the paging except with the Attach Request. Hence timers T3313 and T3315 in the network are not used when paging with IMSI.

NOTE 3: Paging without DRX parameters may require a considerable extension of the paging duration.

NOTE 4: Paging without using eDRX parameters may result in the paging with IMSI not to be received by the MS for which eDRX has been negotiated or may require a considerable extension of the paging duration.

4.7.9.2 Paging for non-GPRS services

The network may initiate the paging procedure for non-GPRS services when the MS is IMSI attached for non-GPRS services.

In Iu mode, to initiate the procedure the GMM entity requests the lower layer to start paging (see 3GPP TS 25.331 [23c] and 3GPP TS 25.413 [19c]) for non-GPRS services.

In A/Gb mode, to initiate the procedure the GMM entity requests the RR sublayer to start paging (see 3GPP TS 44.018 [84] and 3GPP TS 44.060 [76] for non-GPRS services).

The MS identity used for paging shall be the allocated TMSI if acknowledged by the MS, otherwise the IMSI.

4.7.10 Receiving a GMM STATUS message by a GMM entity

If the MS receives a GMM STATUS message no state transition and no specific action shall be taken as seen from the radio interface, i.e. local actions are possible. The actions to be taken on receiving a GMM STATUS message in the network are an implementation dependent option.

4.7.11 Void

4.7.12 GMM Information procedure

The GMM information message support is optional in the network. The MM information procedure may be invoked by the network at any time during an established GMM context.

4.7.12.1 GMM information procedure initiation by the network

The GMM information procedure consists only of the GMM INFORMATION message sent from the network to the mobile station. During an established GMM context, the network may send none, one, or more GMM INFORMATION messages to the mobile station. If more than one GMM INFORMATION message is sent, the messages need not have the same content.

4.7.12.2 GMM information procedure in the mobile station

When the mobile station (supporting the GMM information message) receives an GMM INFORMATION message, it shall accept the message and optionally use the contents to update appropriate information stored within the mobile station.

If the mobile station does not support the GMM information message the mobile station shall ignore the contents of the message and return an GMM STATUS message with cause #97.

4.7.13 Service Request procedure (Iu mode only)

The purpose of this procedure is to transfer the PMM mode from PMM-IDLE to PMM-CONNECTED mode, and/or to assign radio access bearer in case of PDP contexts are activated without radio access bearer assigned. In latter case, the PMM mode may be PMM-IDLE mode or may alternatively be the PMM-CONNECTED mode if the MS requires radio access bearer re-establishment. This procedure is used for;

- the initiation of CM layer service (e.g. SM or SMS) procedure from the MS in PMM-IDLE mode,
- the network to transfer down link signalling,
- uplink (in PMM-IDLE or PMM CONNECTED) and downlink (only in PMM-IDLE) user data,
- counting the number of mobile stations in a cell which are interested in a specific MBMS service.

- requesting the establishment of a point-to-point Radio Bearer for receiving a MBMS service.

For downlink transfer of signalling or user data in PMM-IDLE mode, the trigger is given from the network by the paging request procedure, which is out of scope of the present document.

For pending downlink user data in PMM-CONNECTED mode, the re-establishment of radio access bearers for all active PDP contexts is done without paging.

For counting the number of mobile stations in PMM-IDLE mode interested in a specific MBMS service, the trigger is given from the network by the MBMS notification procedure (see 3GPP TS 25.331 [23c]).

For establishing a point-to-point radio bearer to allow MBMS service, the trigger is given from the RRC determining this need from the MBMS control parameters broadcasted by the network (see 3GPP TS 25.331 [23c]).

Service type can take either of the following values; "signalling", "data", "paging response", "MBMS multicast service reception" or "MBMS broadcast service reception". Each of the values shall be selected according to the criteria to initiate the Service request procedure.

If the MS is triggered to send a Service Request message for both MBMS multicast service and MBMS broadcast service simultaneously, the MS shall include a Service Type indicating "MBMS multicast service reception".

The criteria to invoke the Service request procedure are when:

- a) the MS has any signalling messages except GMM messages (e.g. for SM or SMS) to be sent to the network in PMM-IDLE mode (i.e., no secure PS signalling connection has been established). In this case, the service type shall be set to "signalling".
- b) the MS, either in PMM-IDLE or PMM-CONNECTED mode, has pending user data to be sent, no radio access bearer is established for the corresponding PDP context, and timer T3319 (see subclause 4.7.13.3) is not running or, optionally, if timer T3319 is running and the flag in the Uplink data status IE for this PDP context has not been set in the last Service Request. The procedure is initiated by an indication from the lower layers (see 3GPP TS 24.007 [20]). In this case, the service type shall be set to "data".
- c) the MS receives a paging request using P-TMSI for PS domain from the network in PMM-IDLE mode. In this case, the service type shall be set to "paging response".
- d) the MS is in PMM-IDLE mode or PMM-CONNECTED, receives an MBMS notification for an MBMS multicast service for which the MS has activated an MBMS context or for an MBMS broadcast service which has been selected for reception locally by upper layers in the MS, and is prompted by the contents of the notification to establish a PS signalling connection (see 3GPP TS 25.346 [110]). In this case, the service type shall be set to "MBMS multicast service reception" or "MBMS broadcast service reception", respectively.
- e) the MS in PMM-IDLE mode or PMM-CONNECTED, determines from the broadcast MBMS control parameters that there is a need to establish a point-to-point Radio Bearer to enable MBMS reception (see 3GPP TS 25.346 [110]). In this case, the service type shall be set to "MBMS multicast service reception" or "MBMS broadcast service reception", respectively.

If one of the above criteria to invoke the Service request procedure is fulfilled, then the Service request procedure may only be initiated by the MS when the following conditions are fulfilled:

- its GPRS update status is GU1 UPDATED and the stored RAI is equal to the RAI of the current serving cell; and
- no GMM specific procedure is ongoing (see subclause 4.1.1.1).

If a GMM specific procedure is ongoing at the time a request from CM sublayer, the RRC or the RABM (see 3GPP TS 24.007 [20]) is received and the ATTACH REQUEST or ROUTING AREA UPDATE REQUEST message has been sent, then, depending on implementation, the MS shall abort the received request or delay it until the GMM specific procedure is completed. If the ATTACH REQUEST or ROUTING AREA UPDATE REQUEST message has not been sent, the MS may indicate "follow-on request pending" in the message (i.e. the MS wishes to prolong the established PS signalling connection after the GMM specific procedure). Then, the MS shall delay the Service request procedure until the GMM specific procedure is completed.

If the network indicates "follow-on proceed" in the ATTACH ACCEPT or ROUTING AREA UPDATE ACCEPT message and the MS has a service request pending, the MS shall react depending on the service type. If the service type is:

- "signalling": the MS shall abort the Service request procedure and send the pending signalling messages immediately;
- "data": the MS shall immediately perform the pending Service request procedure using the current PS signalling connection;
- "paging response": the MS shall abort the Service request procedure. No further specific action is required from the MS.

If the network indicates "follow-on proceed" and the MS has no service request pending, then no specific action is required from the MS. As an implementation option, the MS may start timer T3340 as described in subclause 4.7.1.9 if no user plane radio access bearers are set up.

If the network indicates "no follow-on proceed" in the ATTACH ACCEPT or ROUTING AREA UPDATE ACCEPT message, the MS shall not initiate the pending Service request procedure until the current PS signalling connection is released.

NOTE: The "follow-on proceed" indication was not defined in earlier versions of the protocol. A network that is compliant with the earlier versions of the protocol will always encode the respective bit as zero, i.e. as "follow-on proceed", even if it does not prolong the PS signalling connection.

After completion of a Service request procedure but before re-establishment of radio access bearer, if the PDP and MBMS context status information elements are included, then the network shall deactivate all those PDP and MBMS contexts locally (without peer to peer signalling between the MS and the network), which are not in SM state PDP-INACTIVE on network side but are indicated by the MS as being in state PDP-INACTIVE.

After completion of a Service request procedure, the pending service is resumed and uses then the connection established by the procedure. If the service type is indicating "data", then the radio access bearers for all activated PDP contexts are re-established by the network, except for those activated PDP contexts having maximum bit rate value set to 0 kbit/s for both uplink and downlink and as an option those which have no pending user data. The re-establishment of radio access bearers for those PDP contexts is specified in subclause 6.1.3.3.

A service request attempt counter is used to limit the number of service request attempts and no response from the network. The service request attempt counter shall be incremented as specified in subclause 4.7.13.5.

The service request attempt counter shall be reset when:

- an attach or combined attach procedure is successfully completed;
- a normal or periodic routing area updating or a combined routing area updating procedure is successfully completed;
- a service request procedure is successfully completed ; or
- the UE moves to GMM-DEREGISTERED state.

4.7.13.1 Service Request procedure initiation

The MS initiates the Service request procedure by sending a SERVICE REQUEST message. The timer T3317 shall be started after the SERVICE REQUEST message has been sent and state GMM-SERVICE-REQUEST-INITIATED is entered. The message SERVICE REQUEST shall contain the P-TMSI and the Service type shall indicate either "data", "signalling", "paging response", "MBMS multicast service reception" or "MBMS broadcast service reception". The MS shall not issue another Service request when the MS is in state GMM-SERVICE-REQUEST-INITIATED

If the PDP context status information element is included in the SERVICE REQUEST message, then the network shall deactivate all those PDP contexts locally (without peer to peer signalling between the MS and the network) which are not in SM state PDP-INACTIVE on the network side, but are indicated by the MS as being in state PDP-INACTIVE.

If the MBMS context status information element is included in the SERVICE REQUEST message, then the network shall deactivate all those MBMS contexts locally (without peer to peer signalling between the MS and network) which are not in SM state PDP-INACTIVE on the network side, but are indicated by the MS as being in state PDP-INACTIVE. If no MBMS context status information element is included, then the network shall deactivate all MBMS contexts locally which are not in SM state PDP-INACTIVE on the network side.

For a Service Request of type "data", the MS may include the Uplink data status information element in the SERVICE REQUEST message. The Uplink data status information indicates which preserved PDP contexts have pending uplink data to be sent. If the Uplink data status information element is included in the SERVICE REQUEST message with service type "data", the network may use this information to determine which of the RABs for the preserved PDP contexts to re-establish.

4.7.13.2 GMM common procedure initiation

The network may initiate GMM common procedures, e.g. the GMM identification or the GMM authentication and ciphering procedure, depending on the received information such as GPRS ciphering key sequence number and P-TMSI.

4.7.13.3 Service request procedure accepted by the network

If the SERVICE REQUEST message was sent in PMM-IDLE mode, the indication from the lower layers that the security mode control procedure is completed shall be treated as a successful completion of the procedure. The service request attempt counter shall be reset, timer T3317 shall be stopped, and the MS enters GMM-REGISTERED state and PMM-CONNECTED mode.

If the SERVICE REQUEST message was sent in PMM-CONNECTED mode, then the reception of the SERVICE ACCEPT message shall be treated as a successful completion of the procedure. The timer T3317 shall be stopped and the MS remains in PMM-CONNECTED mode.

Upon reception of the SERVICE REQUEST message, if the EMM Combined UE Waiting Flag is 'true', the SGSN shall complete the procedure and perform a detach procedure for non-GPRS services only as described in subclause 4.7.4.2.

If the SERVICE REQUEST message was sent in a CSG cell and the CSG subscription has expired or was removed for a MS, but the MS has a PDN connection for emergency bearer services established, the network shall accept the SERVICE REQUEST message and deactivate all non-emergency PDP contexts by initiating PDP context deactivation procedure. The PDP contexts for emergency services shall not be deactivated.

At successful completion of a service request procedure with Service type "data", the MS shall start timer T3319. The timer T3319 shall be stopped when the MS returns to PMM-IDLE mode or when the network releases the radio access bearer of any active PDP context. The MS shall not issue another Service Request with service type "data" while timer T3319 is running unless the Service request is being generated from a PDP context for which the flag in the Uplink data status IE has not been set in the last Service Request.

The network may indicate a value for timer T3319 in the ATTACH ACCEPT or ROUTING AREA UPDATE ACCEPT messages. The last provided value of T3319 shall be used by the MS. If the information element T3319 value is not included in the ATTACH ACCEPT or ROUTING AREA UPDATE ACCEPT messages, the default value shall be used. If the T3319 value received by the MS contains an indication that the timer is deactivated or the timer value is zero, then the MS shall use the default value.

If the PDP context status information element is included in the Service Accept, then the MS shall deactivate locally (without peer to peer signalling between the MS and the network) all that PDP contexts which are not in SM state PDP-INACTIVE on MS side but are indicated by the Network as being in state PDP-INACTIVE. If there is a default PDP context among the PDP contexts to be deactivated, an MS supporting S1 mode shall locally deactivate all PDP contexts associated to the same PDP address and APN as the default PDP context without peer-to-peer SM signalling to the network; an MS not supporting S1 mode may apply the same behaviour.

If the MBMS context status information element is included in the SERVICE ACCEPT message, then the MS shall deactivate all those MBMS contexts locally (without peer to peer signalling between the MS and network) which are not in SM state PDP-INACTIVE in the MS, but are indicated by the network as being in state PDP-INACTIVE. If no MBMS context status information element is included, then the MS shall deactivate all those MBMS contexts locally which are not in SM state PDP-INACTIVE in the MS.

If a service request is received from an MS with a LIPA PDN connection, and if:

- a L-GW Transport Layer Address is provided by the lower layer together with the service request, and the GGSN address associated with the PDP context of the LIPA PDN connection is different from the provided L-GW Transport Layer Address (see 3GPP TS 25.413 [19c]); or
- no L-GW Transport Layer Address is provided together with the service request by the lower layer,

then the SGSN explicitly deactivates all PDP contexts associated with the LIPA PDN connection by initiating the PDP context deactivation procedure (see subclause 6.1.3.4.2).

If a service request is received from an MS with a SIPTO at the local network PDN connection, the following different cases can be distinguished:

- 1) if the PDN connection is a SIPTO at the local network PDN connection with collocated L-GW and if:
 - a SIPTO L-GW Transport Layer Address is provided by the lower layer together with the service request, and the GGSN address associated with the PDP context of the SIPTO at the local network PDN connection is different from the provided SIPTO L-GW Transport Layer Address (see 3GPP TS 25.413 [19c]); or
 - no SIPTO L-GW Transport Layer Address is provided together with the service request by the lower layer,
- 2) if the PDN connection is a SIPTO at the local network PDN connection with stand-alone GW and if:
 - a LHN-ID value is provided by the lower layer together with the service request, and the LHN-ID stored in the PDP context of the SIPTO at the local network PDN connection is different from the provided LHN-ID value (see 3GPP TS 25.413 [19c]); or
 - no LHN-ID value is provided together with the service request by the lower layer,

then the SGSN explicitly deactivates all PDP contexts associated with the SIPTO at the local network PDN connection by initiating the PDP context deactivation procedure (see subclause 6.1.3.4.2).

4.7.13.4 Service request procedure not accepted by the network

If the Service request cannot be accepted, the network returns a SERVICE REJECT message to the mobile station.

Based on local policies or configurations in the network, if the network determines to change the periodic routing area update timer (T3312), or if the network determines to change the PSM usage or the value of the timer T3324 in the MS for which PSM is allowed by the network, the network may return a SERVICE REJECT with the cause #10 "implicitly detached" to the MS.

If the service request for mobile originated services is rejected due to general NAS level mobility management congestion control, the network shall set the GMM cause value to #22 "congestion" and assign a back-off timer T3346.

An MS that receives a SERVICE REJECT message containing a reject cause other than GMM cause value #25 or the message is integrity protected, shall reset the service request attempt counter, shall stop the timer T3317.

If the SERVICE REJECT message containing GMM cause value #25 was received without integrity protection, then the MS shall discard the message.

The MS shall then take different actions depending on the received reject cause value:

- # 3 (Illegal MS); or
- # 6 (Illegal ME);
- The MS shall set the GPRS update status to GU3 ROAMING NOT ALLOWED (and shall store it according to subclause 4.1.3.2), shall delete the list of equivalent PLMNs and enter the state GMM-DEREGISTERED.NO-IMSI. Furthermore, it shall delete any P-TMSI, P-TMSI signature, RAI and GPRS ciphering key sequence number and shall consider the SIM/USIM as invalid for GPRS services until switching off or the SIM/USIM is removed. If the message has been successfully integrity checked by the lower layers and the MS maintains a counter for "SIM/USIM considered invalid for GPRS services", then the MS shall set this counter to MS implementation-specific maximum value.
- A GPRS MS operating in MS operation mode A or B shall in addition set the update status to U3 ROAMING NOT ALLOWED, shall delete any TMSI, LAI and ciphering key sequence number. If the MS is operating in MS operation mode A and an RR connection exists, the MS shall abort the RR connection, unless an emergency call is ongoing. The SIM/USIM shall be considered as invalid also for non-GPRS services until switching off or the SIM/USIM is removed or the timer T3245 expires as described in subclause 4.1.1.6. If the message has been successfully integrity checked by the lower layers and the MS maintains a counter for "SIM/USIM considered invalid for non-GPRS services", then the MS shall set this counter to MS implementation-specific maximum value.

If S1 mode is supported in the MS, the MS shall handle the EMM parameters EMM state, EPS update status, GUTI, last visited registered TAI, TAI list and KSI as specified in 3GPP TS 24.301 [120] for the case when the service request procedure is rejected with the EMM cause with the same value.

7 (GPRS services not allowed);

- The MS shall set the GPRS update status to GU3 ROAMING NOT ALLOWED (and shall store it according to subclause 4.1.3.2.9) and shall delete any P-TMSI, P-TMSI signature, RAI and GPRS ciphering key sequence number. The SIM/USIM shall be considered as invalid for GPRS services until switching off or the SIM/USIM is removed. The new state is GMM-DEREGISTERED. If the message has been successfully integrity checked by the lower layers and the MS maintains a counter for "SIM/USIM considered invalid for GPRS services", then the MS shall set this counter to MS implementation-specific maximum value.

A GPRS MS operating in MS operation mode A or B which is already IMSI attached for CS services is still IMSI attached for CS services in the network.

A GPRS MS operating in MS operation mode A or B in network operation mode I shall then proceed with the appropriate MM specific procedure.

NOTE 1: Optionally the MS starts the timer T3340 as described in subclause 4.7.1.9.

If S1 mode is supported in the MS, the MS shall handle the EMM parameters EMM state, EPS update status, GUTI, last visited registered TAI, TAI list and KSI as specified in 3GPP TS 24.301 [120] for the case when the service request procedure is rejected with the EMM cause with the same value.

8 (GPRS services and non-GPRS services not allowed);

The MS shall set the GPRS update status to GU3 ROAMING NOT ALLOWED (and shall store it according to subclause 4.1.3.2) and shall delete any P-TMSI, P-TMSI signature, RAI and GPRS ciphering key sequence number. The new GMM state is GMM-DEREGISTERED.NO-IMSI.

The MS shall set the update status to U3 ROAMING NOT ALLOWED, shall delete any TMSI, LAI and ciphering key sequence number. The MS shall delete the list of equivalent PLMNs. If the MS is operating in MS operation mode A and an RR connection exists, the MS shall abort the RR connection, unless an emergency call is ongoing. The SIM/USIM shall be considered as invalid for GPRS and non-GPRS services until switching off or the SIM/USIM is removed. If the message has been successfully integrity checked by the lower layers and the MS maintains a counter for "SIM/USIM considered invalid for GPRS services", then the MS shall set this counter to MS implementation-specific maximum value. If the message has been successfully integrity checked by the lower layers and the MS maintains a counter for "SIM/USIM considered invalid for non-GPRS services", then the MS shall set this counter to MS implementation-specific maximum value.

NOTE 2: Optionally the MS starts the timer T3340 as described in subclause 4.7.1.9.

If S1 mode is supported in the MS, the MS shall handle the EMM parameters EMM state, EPS update status, GUTI, last visited registered TAI, TAI list and KSI as specified in 3GPP TS 24.301 [120] for the case when the service request procedure is rejected with the EMM cause with the same value.

9 (MS identity cannot be derived by the network);

- The MS shall set the GPRS update status to GU2 NOT UPDATED (and shall store it according to subclause 4.1.3.2), enter the state GMM-DEREGISTERED.NORMAL-SERVICE, and shall delete any P-TMSI, P-TMSI signature, RAI and GPRS ciphering key sequence number. If the rejected request was not for initiating a PDN connection for emergency bearer services, the MS may subsequently, automatically initiate the GPRS attach procedure.

If S1 mode is supported in the MS, the MS shall handle the EMM parameters EMM state, EPS update status, GUTI, last visited registered TAI, TAI list and KSI as specified in 3GPP TS 24.301 [120] for the case when the service request procedure is rejected with the EMM cause with the same value.

10 (Implicitly detached);

- A GPRS MS operating in MS operation mode B in network operation mode I is IMSI detached for both GPRS and CS services.

A GPRS MS operating in MS operation mode A in network operation mode I is detached for GPRS services. If no RR connection exists then the MS is also IMSI detached for the CS services.

- The MS shall change to state GMM-DEREGISTERED.NORMAL-SERVICE. If the rejected request was not for initiating a PDN connection for emergency bearer services, the MS shall then perform a new attach procedure. The MS should also activate PDP context(s) that were originally activated by the MS to replace any previously MS activated PDP context(s). The MS should also perform the procedures needed in order to activate any previously active multicast service(s).

If S1 mode is supported in the MS, the MS shall handle the EMM state as specified in 3GPP TS 24.301 [120] for the case when the the service request procedure is rejected with the EMM cause with the same value.

NOTE 3: In some cases, user interaction may be required and then the MS cannot activate the PDP and MBMS context(s) automatically.

11 (PLMN not allowed);

- The MS shall delete any RAI, P-TMSI, P-TMSI signature and GPRS ciphering key sequence number, shall set the GPRS update status to GU3 ROAMING NOT ALLOWED (and shall store it according to subclause 4.1.3.2) and enter the state GMM-DEREGISTERED. The MS shall delete the list of equivalent PLMNs.
- The MS shall store the PLMN identity in the "forbidden PLMN list" and if the MS is configured to use timer T3245 (see 3GPP TS 24.368 [135] or 3GPP TS 31.102 [112]) then the MS shall start timer T3245 and proceed as described in subclause 4.1.1.6. If the message has been successfully integrity checked by the lower layers and the MS maintains a PLMN-specific attempt counter for that PLMN, then the MS shall set this counter to the MS implementation-specific maximum value.

The MS shall start timer T3340 as described in subclause 4.7.1.9.

- If no RR connection exists, the MS shall perform the following additional actions immediately. If the MS is operating in MS operation mode A and an RR connection exists, the MS shall perform these actions when the RR connection is subsequently released:
 - A GPRS MS operating in MS operation mode A shall set the update status to U3 ROAMING NOT ALLOWED and shall delete any TMSI, LAI and ciphering key sequence number. The new MM state is MM IDLE.
 - The MS shall perform a PLMN selection according to 3GPP TS 23.122 [14].

An MS in GAN mode shall request a PLMN list in GAN (see 3GPP TS 44.318 [76b]) prior to perform a PLMN selection from this list according to 3GPP TS 23.122 [14].

If S1 mode is supported in the MS, the MS shall handle the EMM parameters EMM state, EPS update status, GUTI, last visited registered TAI, TAI list and KSI as specified in 3GPP TS 24.301 [120] for the case when the service request procedure is rejected with the EMM cause with the same value.

12 (Location area not allowed);

- The MS shall delete any RAI, P-TMSI, P-TMSI signature and GPRS ciphering key sequence number, shall set the GPRS update status to GU3 ROAMING NOT ALLOWED (and shall store it according to subclause 4.1.3.2) and shall change to state GMM-DEREGISTERED.LIMITED-SERVICE.
- The mobile station shall store the LAI in the list of "forbidden location areas for regional provision of service".

The MS shall start timer T3340 as described in subclause 4.7.1.9.

- If no RR connection exists, the MS shall perform the following additional actions immediately. If the MS is operating in MS operation mode A and an RR connection exists, the MS shall perform these actions when the RR connection is subsequently released:
 - If the MS is IMSI attached, the MS shall set the update status to U3 ROAMING NOT ALLOWED, shall delete any TMSI, LAI and ciphering key sequence number and shall reset the location update attempt counter. The new MM state is MM IDLE.
 - The MS shall perform a cell selection according to 3GPP TS 43.022 [82] and 3GPP TS 25.304 [98].

NOTE 4: The cell selection procedure is not applicable for an MS in GAN mode.

If S1 mode is supported in the MS, the MS shall handle the EMM parameters EMM state, EPS update status, GUTI, last visited registered TAI, TAI list and KSI as specified in 3GPP TS 24.301 [120] for the case when the service request procedure is rejected with the EMM cause with the same value.

13 (Roaming not allowed in this location area);

- The MS shall set the GPRS update status to GU3 ROAMING NOT ALLOWED (and shall store it according to subclause 4.1.3.2) and shall change to state GMM-REGISTERED.LIMITED-SERVICE.
- The MS shall store the LAI in the list of "forbidden location areas for roaming".

The MS shall start timer T3340 as described in subclause 4.7.1.9.

- If no RR connection exists, the MS shall perform the following additional actions immediately. If the MS is operating in MS operation mode A and an RR connection exists, the MS shall perform these actions when the RR connection is subsequently released:
 - If the MS is IMSI attached, the MS shall set the update status to U3 ROAMING NOT ALLOWED and shall reset the location update attempt counter. The new MM state is MM IDLE.
 - The MS shall perform a PLMN selection according to 3GPP TS 23.122 [14].

An MS in GAN mode shall request a PLMN list in GAN (see 3GPP TS 44.318 [76b]) prior to perform a PLMN selection from this list according to 3GPP TS 23.122 [14].

If S1 mode is supported in the MS, the MS shall handle the EMM parameters EMM state and EPS update status as specified in 3GPP TS 24.301 [120] for the case when the service request procedure is rejected with the EMM cause with the same value.

15 (No Suitable Cells In Location Area);

- The MS shall set the GPRS update status to GU3 ROAMING NOT ALLOWED (and shall store it according to subclause 4.1.3.2) and shall change to state GMM-REGISTERED.LIMITED-SERVICE.
- The MS shall store the LAI in the list of "forbidden location areas for roaming".

The MS shall start timer T3340 as described in subclause 4.7.1.9.

- If no RR connection exists, the MS shall perform the following additional actions immediately. If the MS is operating in MS operation mode A and an RR connection exists, the MS shall perform these actions when the RR connection is subsequently released:
 - If the MS is IMSI attached, the MS shall set the update status to U3 ROAMING NOT ALLOWED and shall reset the location update attempt counter. The new MM state is MM IDLE.
 - The MS shall search for a suitable cell in another location area or a tracking area according to 3GPP TS 43.022 [82] and 3GPP TS 25.304 [98] or 3GPP TS 36.304 [121].

NOTE 5: The cell selection procedure is not applicable for an MS in GAN mode.

If S1 mode is supported in the MS, the MS shall handle the EMM parameters EMM state and EPS update status as specified in 3GPP TS 24.301 [120] for the case when the service request procedure is rejected with the EMM cause with the same value.

#22 (Congestion);

If the T3346 value IE is present in the SERVICE REJECT message and the value indicates that this timer is neither zero nor deactivated, the MS shall proceed as described below, otherwise it shall be considered as an abnormal case and the behaviour of the MS for this case is specified in subclause 4.7.13.5.

If the rejected request was not for initiating a PDN connection for emergency bearer services, the MS shall abort the service request procedure and enter state GMM-REGISTERED, and stop timer T3317 if still running.

The MS shall stop timer T3346 if it is running.

If the SERVICE REJECT message is integrity protected, the MS shall start timer T3346 with the value provided in the T3346 value IE.

If the SERVICE REJECT message is not integrity protected, the MS shall start timer T3346 with a random value from the default range specified in table 11.3a.

The MS stays in the current serving cell and applies normal cell reselection process. The service request procedure may be started by CM layer, if it is still necessary, when timer T3346 expires or is stopped.

A GPRS MS operating in MS operation mode A or B which is already IMSI attached for CS services in the network is still IMSI attached for CS services in the network.

If S1 mode is supported in the MS, the MS shall handle the EMM parameters EMM state and EPS update status as specified in 3GPP TS 24.301 [120] for the case when the service request procedure is rejected with the EMM cause with the same value.

25 (Not authorized for this CSG)

- Cause #25 is only applicable in UTRAN Iu mode and when received from a CSG cell. Other cases are considered as abnormal cases and the specification of the mobile station behaviour is given in subclause 4.7.13.5.
- The MS shall set the GPRS update status to GU3 ROAMING NOT ALLOWED (and shall store it according to subclause 4.1.3.2) and shall change to state GMM-REGISTERED.LIMITED-SERVICE.
- If the CSG ID and associated PLMN identity of the cell where the MS has sent the SERVICE REQUEST message are contained in the Allowed CSG list stored in the MS, the MS shall remove the entry corresponding to this CSG ID and associated PLMN identity from the Allowed CSG list.
- If the CSG ID and associated PLMN identity of the cell where the MS has sent the SERVICE REQUEST message are contained in the Operator CSG list, the MS shall proceed as specified in 3GPP TS 23.122 [14] subclause 3.1A.

The MS shall start timer T3340 as described in subclause 4.7.1.9.

If the MS is IMSI attached for non-GPRS services, the MS shall set the update status to U3 ROAMING NOT ALLOWED and shall reset the location update attempt counter. The new MM state is MM IDLE.

- The MS shall search for a suitable cell according to 3GPP TS 43.022 [82] and 3GPP TS 25.304 [98].
- If S1 mode is supported in the MS, the MS shall handle the EMM parameters EMM state and EPS update status as specified in 3GPP TS 24.301 [120] for the case when the service request procedure is rejected with the EMM cause with the same value.

40 (No PDP context activated)

- The MS shall deactivate locally all active PDP and MBMS contexts and the MS shall enter the state GMM-REGISTERED.NORMAL-SERVICE. If the rejected request was not for initiating a PDN connection for emergency bearer services, the MS may also activate PDP context(s) that were originally activated by the MS to replace any previously MS activated PDP context(s). The MS may also perform the procedures needed in order to activate any previously active multicast service(s).

NOTE 6: In some cases, user interaction may be required and then the MS cannot activate the PDP and MBMS context(s) automatically.

Other values are considered as abnormal cases. The specification of the MS behaviour in those cases is described in subclause 4.7.13.5.

4.7.13.4a Service request procedure for initiating a PDN connection for emergency bearer services not accepted by the network (UTRAN Iu mode only)

If the service request for initiating a PDN connection for emergency bearer services cannot be accepted by the network, the MS shall perform the procedures as described in subclause 4.7.13.4. Then if the MS is in the same selected PLMN where the last service request was attempted, the MS shall:

- a) inform the upper layers of the failure of the procedure; or

NOTE 1: This can result in the upper layers requesting establishment of a CS emergency call (if not already attempted in the CS domain) or other implementation specific mechanisms, e.g. procedures specified in 3GPP TS 24.229 [95] that can result in the emergency call being attempted to another IP-CAN.

- b) detach locally, if not detached already, attempt GPRS attach for emergency bearer services.

If the service request for initiating a PDN connection for emergency bearer services fails due to abnormal case a) in subclause 4.7.13.5, the MS shall perform the procedures as described in subclause 4.7.13.5 and inform the upper layers of the failure to access the network.

NOTE 2: This can result in the upper layers establishment of a CS emergency call (if not already attempted in the CS domain) or other implementation specific mechanisms, e.g. procedures specified in 3GPP TS 24.229 [95] that can result in the emergency call being attempted to another IP-CAN.

If the service request for initiating a PDN connection for emergency bearer services fails due to abnormal cases b), c) or d) in subclause 4.7.13.5, the MS shall perform the procedures as described in subclause 4.7.13.5. Then if the MS is in the same selected PLMN where the last service request was attempted, the MS shall:

- a) inform the upper layers of the failure of the procedure; or

NOTE 3: This can result in the upper layers establishment of a CS emergency call (if not already attempted in the CS domain) or other implementation specific mechanisms, e.g. procedures specified in 3GPP TS 24.229 [95] that can result in the emergency call being attempted to another IP-CAN.

- b) detach locally, if not detached already, attempt GPRS attach for emergency bearer services.

4.7.13.5 Abnormal cases in the MS

The following abnormal cases can be identified:

- a) Access barred because of access class control, EAB or ACDC

If the service request procedure is started in response to a paging request from the network, access class barring, EAB or ACDC is not applicable.

The service request procedure shall not be started. The MS stays in the current serving cell and applies normal cell reselection process. The service request procedure may be started by CM layer if it is still necessary, i.e. when access is granted or because of a cell change.

If access is barred because of access class control, the service request is initiated due to a request from upper layers for PS signalling connection, ACDC is applicable to the request and the MS supports ACDC, then the service request procedure shall be started.

If access is barred for a certain ACDC category, and if the service request is initiated due to a request from upper layers for PS signalling connection for a higher ACDC category and the MS supports ACDC, then the service request procedure shall be started.

If an access request for an uncategorized application is barred due to ACDC, and if the service request is initiated due to a request from upper layers for PS signalling connection for a certain ACDC category and the MS supports ACDC, then the service request procedure shall be started.

- b) Lower layer failure without "Extended Wait Time" received from lower layers before the security mode control procedure is completed, SERVICE ACCEPT or SERVICE REJECT message is received

The procedure shall be aborted except in the following implementation option cases b.1, b.2 and b.3.

- b.1) Release of PS signalling connection in Iu mode (i.e. RRC connection release) before the completion of the service request procedure

The service request procedure shall be initiated again, if the following conditions apply:

- i) The original service request procedure was initiated over an existing PS signalling connection; and

ii) No SECURITY MODE COMMAND message and no Non-Access Stratum (NAS) messages relating to the PS signalling connection were received after the SERVICE REQUEST message was transmitted.

- b.2) RR release in Iu mode (i.e. RRC connection release) with cause different than "Directed signalling connection re-establishment", for example, "Normal", or "User inactivity" (see 3GPP TS 25.331 [23c] and 3GPP TS 44.118 [111])

The service request procedure shall be initiated again, if the following conditions apply:

- i) The original service request procedure was initiated over an existing RRC connection and,
 ii) No SECURITY MODE COMMAND message and no Non-Access Stratum (NAS) messages relating to the PS signalling connection were received after the SERVICE REQUEST message was transmitted.

NOTE: The RRC connection release cause different than "Directed signalling connection re-establishment" that triggers the re-initiation of the service request procedure is implementation specific.

- b.3) RR release in Iu mode (i.e. RRC connection release) with cause "Directed signalling connection re-establishment" (see 3GPP TS 25.331 [23c] and 3GPP TS 44.118 [111])

The routing area updating procedure shall be initiated followed by a rerun of the service request procedure if the following condition applies:

- i) The service request procedure was not due to a rerun of the procedure due to "Directed signalling connection re-establishment".

- c) T3317 expired

The MS shall enter GMM-REGISTERED state.

If the MS is in PMM-IDLE mode then the MS shall increment the service request attempt counter, abort the procedure and release locally any resources allocated for the service request procedure. If the service request procedure is initiated to establish a PDN connection for emergency bearer services or the MS has a PDN connection for emergency bearer services established or the MS is an MS configured to use AC11 – 15 in selected PLMN, the service request counter shall not be incremented. If the service request attempt counter is greater than or equal to 5, the MS shall start timer T3325. The MS shall not attempt service request until expiry of timer T3325 unless:

- the service request is in response to paging from the network;
- the MS is an MS configured to use AC11 – 15 in selected PLMN;
- the service request is initiated to establish a PDN connection for emergency bearer services;
- the MS has a PDN connection for emergency bearer services established; or
- the MS is registered in a new PLMN.

If the MS is in PMM-CONNECTED mode, then the procedure shall be aborted.

- d) SERVICE REJECT received, other causes than those treated in subclause 4.7.13.4, and cases of GMM cause values #22 and #25, if considered as abnormal cases according to subclause 4.7.13.4

The procedure shall be aborted.

- e) Routing area update procedure is triggered

If a cell change into a new routing area occurs and the necessity of routing area update procedure is determined before the security mode control procedure is completed, a SERVICE ACCEPT or SERVICE REJECT message has been received, the Service request procedure shall be aborted and the routing area updating procedure is started immediately. Follow-on request pending may be indicated in the ROUTING AREA UPDATE REQUEST for the service, which was the trigger of the aborted Service request procedure, to restart the pending service itself or the Service request procedure after the completion of the routing area updating procedure. If the Service type of the aborted SERVICE REQUEST was indicating "data", then the routing area update procedure may be followed by a re-initiated Service request procedure indicating "data", if it is still necessary. If the

Service type was indicating "MBMS multicast service reception", or "MBMS broadcast service reception" the Service request procedure shall be aborted.

f) Power off

If the MS is in state GMM-SERVICE-REQUEST-INITIATED at power off, the GPRS detach procedure shall be performed.

g) Detach procedure collision

GPRS detach containing detach type "re-attach required" or "re-attach not required":

If the MS receives a DETACH REQUEST message from the network in state GMM-SERVICE-REQUEST-INITIATED, the GPRS detach procedure shall be progressed and the Service request procedure shall be aborted. If the GMM cause IE, in the DETACH REQUEST message, indicated a "re-attach required", the GPRS attach procedure shall be performed. If the DETACH REQUEST message contains detach type "re-attach not required" and GMM cause #2 "IMSI unknown in HLR", the MS will follow the procedure as described below for the detach type "IMSI detach".

GPRS detach containing detach type "IMSI detach":

If the MS receives a DETACH REQUEST message from the network in state GMM-SERVICE-REQUEST-INITIATED, the network and the MS shall progress both procedures.

h) "Extended wait time" for PS domain from the lower layers

The MS shall abort the service request procedure, enter state GMM-REGISTERED, and stop timer T3317 if still running.

If the SERVICE REQUEST message contained the low priority indicator set to "MS is configured for NAS signalling low priority", the MS shall start timer T3346 with the "Extended wait time" value.

In other cases the MS shall ignore the "Extended wait time".

The MS stays in the current serving cell and applies normal cell reselection process. The service request procedure is started, if still necessary, when timer T3346 expires or is stopped.

m) Timer T3346 is running

The MS shall not start the service request procedure unless:

- the MS receives a paging; or
- the MS is an MS configured to use AC11 – 15 in selected PLMN; or
- the MS has a PDN connection for emergency bearer services established; or
- the MS is establishing a PDN connection for emergency bearer services; or
- the MS has a PDN connection established without the NAS signalling low priority indication or is establishing a PDN connection without the NAS signalling low priority indication, the timer T3302 and the timer T3311 are not running and the timer T3346 was started due to rejection of a NAS request message (e.g. ATTACH REQUEST, ROUTING AREA UPDATE REQUEST or SERVICE REQUEST) which contained the low priority indicator set to "MS is configured for NAS signalling low priority".

The MS stays in the current serving cell and applies normal cell reselection process. The service request procedure is started, if still necessary, when timer T3346 expires or is stopped.

4.7.13.6 Abnormal cases on the network side

The following abnormal cases can be identified:

a) Lower layer failure

If a low layer failure occurs before the security mode control procedure is completed, a SERVICE ACCEPT or SERVICE REJECT message has been sent to the MS, the network enters/stays in PMM-IDLE.

b) Protocol error

If the SERVICE REQUEST message is received with a protocol error, the network shall return a SERVICE REJECT message with one of the following reject causes:

- #96: Mandatory information element error;
- #99: Information element non-existent or not implemented;
- #100: Conditional IE error;
- #111: Protocol error, unspecified.

The network stays in PMM-IDLE mode.

c) More than one SERVICE REQUEST received and the procedure has not been completed (i.e., the security mode control procedure has not been completed or SERVICE ACCEPT, SERVICE REJECT message has not been sent)

- If one or more of the information elements in the SERVICE REQUEST message differs from the ones received within the previous SERVICE REQUEST message, the previously initiated Service request procedure shall be aborted and the new Service request procedure shall be progressed;
- If the information elements do not differ, then the network shall continue with the previous Service request procedure and shall not treat any further this SERVICE REQUEST message.

d) ATTACH REQUEST received before the security mode control procedure has been completed or an SERVICE ACCEPT or an SERVICE REJECT message has been sent

If an ATTACH REQUEST message is received and the security mode control procedure has not been completed or an SERVICE ACCEPT or an SERVICE REJECT message has not been sent, the network may initiate the GMM common procedures, e.g. the GMM authentication and ciphering procedure. The network may e.g. after a successful GMM authentication and ciphering procedure execution, abort the Service request procedure, the GMM context, PDP contexts and MBMS contexts, if any, are deleted and the new ATTACH REQUEST is progressed.

e) ROUTING AREA UPDATE REQUEST message received before the security mode control procedure has been completed or an SERVICE ACCEPT or an SERVICE REJECT message has been sent

If an ROUTING AREA UPDATE REQUEST message is received and the security mode control procedure has not been completed or an SERVICE ACCEPT or an SERVICE REJECT message has not been sent, the network may initiate the GMM common procedures, e.g. the GMM authentication and ciphering procedure. The network may e.g. after a successful GMM authentication and ciphering procedure execution, abort the Service request procedure and progress the routing area update procedure.

f) If the Service Type indicates 'data' and the network fails to re-establish some or all RAB(s) then the SGSN may determine if PDP Context Modification or PDP Context Deactivation should be initiated. The appropriate action is an operator choice and depends on the QoS profile of the PDP Context, and the Uplink data status.

4.7.14 Void

4.7.15 GMM eCall inactivity procedure

The GMM eCall inactivity procedure is applicable only to an eCall only mobile station (as determined by information configured in USIM) that is capable of eCall over IMS and attached for GPRS services. The procedure shall be started when:

- the mobile station is in PMM-IDLE mode (Iu mode) or packet idle mode;
- the mobile station is in MM IDLE state;
- the mobile station is in any GMM-REGISTERED substate except GMM-REGISTERED.NO-CELL-AVAILABLE or GMM-REGISTERED.PLMN-SEARCH; and

- one of the following conditions applies:
 - timer T3242 expires or is found to have already expired and timer T3243 is not running;
 - timer T3243 expires or is found to have already expired and timer T3242 is not running; or
 - timers T3242 and T3243 expire or have found to have already expired.

The mobile station shall then stop other running timers (e.g. T3311, T3312) and shall:

- if the mobile station is also attached for non-GPRS services and the network operates in network operation mode I, perform a combined GPRS detach procedure for GPRS and non-GPRS services;
- if the mobile station is also attached for non-GPRS services and the network operates in network operation mode II, perform a GPRS detach procedure for GPRS services and an IMSI detach procedure; and
- if the mobile station is not attached for non-GPRS services, perform a GPRS detach procedure for GPRS services.

The mobile station shall then enter MM Idle eCALL INACTIVE state, delete any LAI, TMSI, ciphering key sequence number stored in the SIM/USIM, delete any RAI, P-TMSI, P-TMSI signature and GPRS ciphering key sequence number stored, delete any GUTI, TAI list, last visited registered TAI, list of equivalent PLMNs, KSI and set the update state to U4 Updating Disabled.

While in eCALL INACTIVE state, the mobile station shall behave as specified in subclause 4.4.7.

5 Elementary procedures for circuit-switched Call Control

5.1 Overview

5.1.1 General

This subclause describes the call control (CC) protocol, which is one of the protocols of the Connection Management (CM) sublayer (see 3GPP TS 24.007 [20]).

Every mobile station must support the call control protocol. If a mobile station does not support any bearer capability at all then it shall respond to a SETUP message with a RELEASE COMPLETE message as specified in subclause 5.2.2.2.

In Iu mode only, integrity protected signalling (see subclause 4.1.1.1.1 of the present document and in general, see 3GPP TS 33.102 [5a]) is mandatory. In Iu mode only, all protocols shall use integrity protected signalling. Integrity protection of all CC signalling messages is the responsibility of lower layers. It is the network which activates integrity protection. This is done using the security mode control procedure (3GPP TS 25.331 [23c] and 3GPP TS 44.118 [111]).

In the call control protocol, more than one CC entity are defined. Each CC entity is independent from each other and shall communicate with the correspondent peer entity using its own MM connection. Different CC entities use different transaction identifiers.

With a few exceptions the present document describes the call control protocol only with regard to two peer entities. The call control entities are described as communicating finite state machines which exchange messages across the radio interface and communicate internally with other protocol (sub)layers. This description is only normative as far as the consequential externally observable behaviour is concerned.

Certain sequences of actions of the two peer entities compose "elementary procedures" which are used as a basis for the description in this subclause. These elementary procedures may be grouped into the following classes:

- call establishment procedures;
- call clearing procedures;
- call information phase procedures;

- miscellaneous procedures.

The terms "mobile originating" or "mobile originated" (MO) are used to describe a call initiated by the mobile station. The terms "mobile terminating" or "mobile terminated" (MT) are used to describe a call initiated by the network.

Figure 5.1a/3GPP TS 24.008 gives an overview of the main states and transitions on the mobile station side.

The MS side extension figure 5.1a.1/3GPP TS 24.008 shows how for the Network Initiated MO call the MS reaches state U1.0 from state U0 (CCBS).

Figure 5.1a.2/3GPP TS 24.008 illustrates the additional state transitions possible in the MS due to SRVCC handovers from PS to CS or 5G-SRVCC handover from NG-RAN to UTRAN.

Figure 5.1a.3/3GPP TS 24.008 illustrates the additional state transitions possible in the MS due to SRVCC handovers from CS to PS.

Figure 5.1b/3GPP TS 24.008 gives an overview of the main states and transitions on the network side.

The Network side extension figure 5.1b.1/3GPP TS 24.008 shows for Network Initiated MO Calls the Network reaches state N1.0 from state N0 (CCBS). Figure 5.1b.2/3GPP TS 24.008 illustrates the additional state transitions possible in the network due to SRVCC handovers from PS to CS or 5G-SRVCC handover from NG-RAN to UTRAN.

Figure 5.1b.3/3GPP TS 24.008 illustrates the additional state transitions possible in the network due to SRVCC handovers from CS to PS.

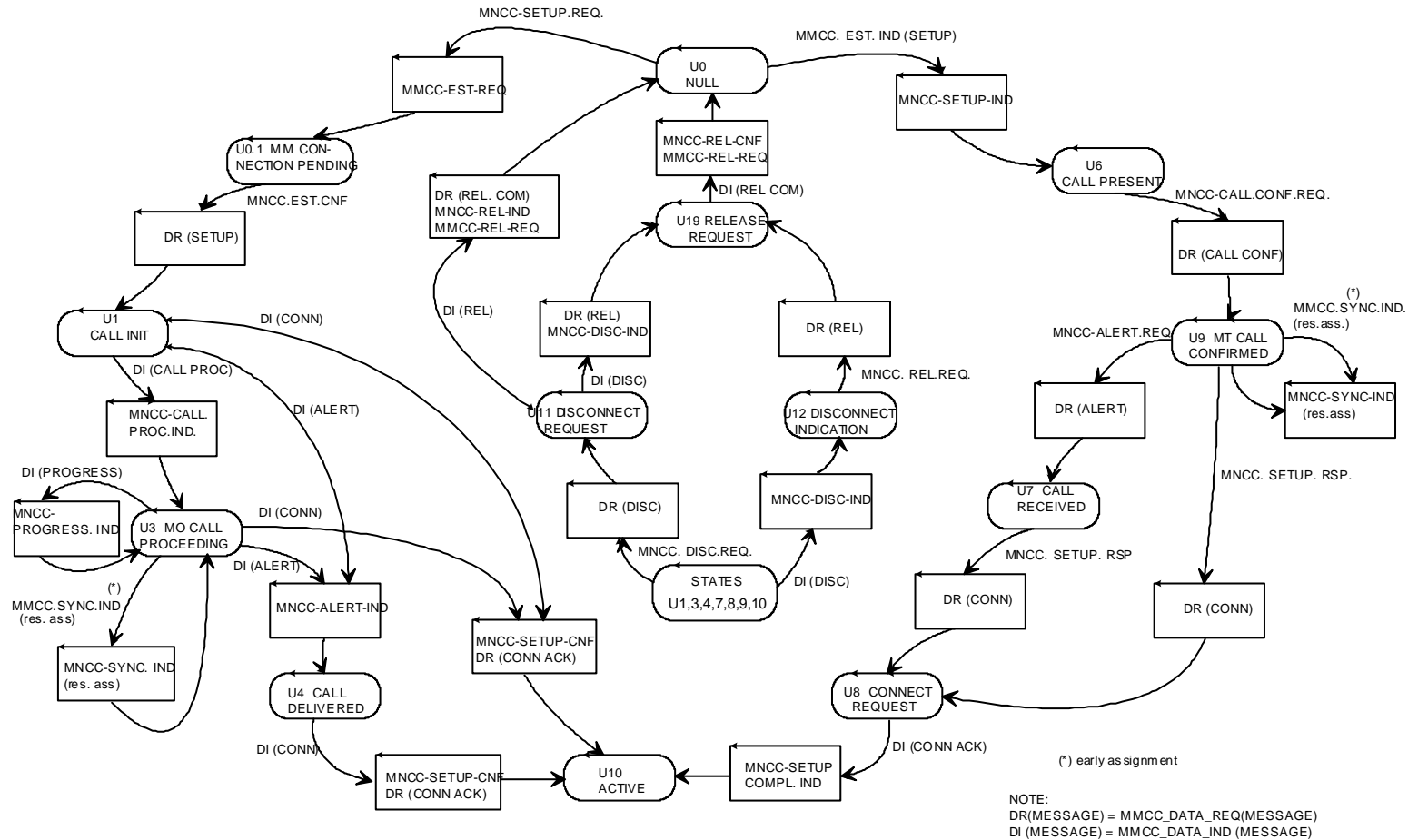

Figure 5.1a/3GPP TS 24.008: Overview call control protocol/MS side

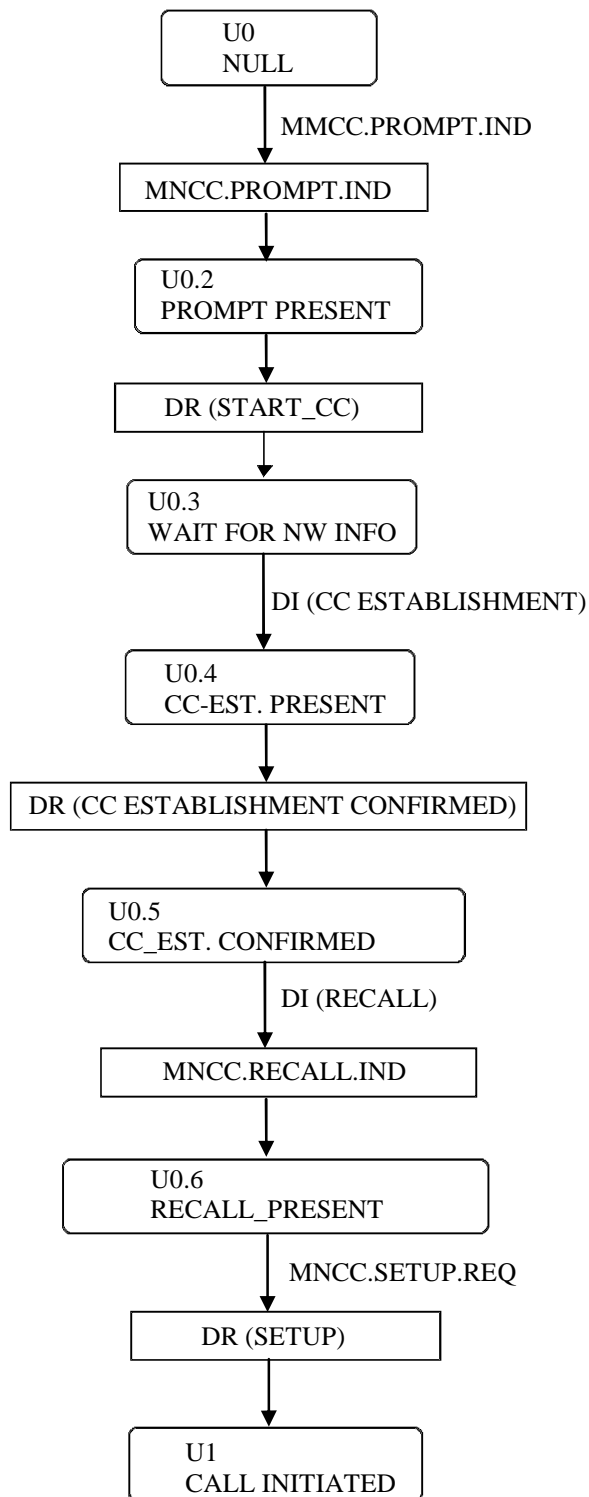

Figure 5.1a.1/3GPP TS 24.008: Overview call control protocol/MS side, extension

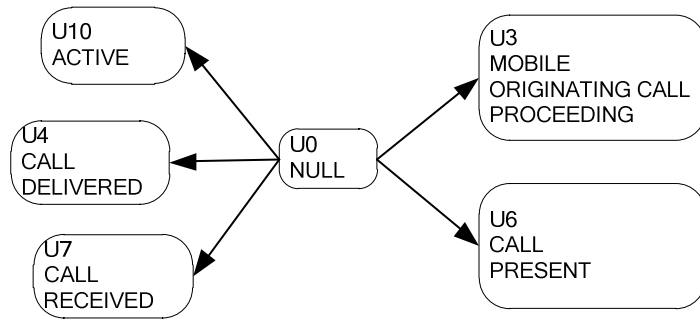

Figure 5.1a.2/3GPP TS 24.008: Overview call control protocol/MS side, extension for SRVCC from PS to CS or 5G-SRVCC handover from NG-RAN to UTRAN

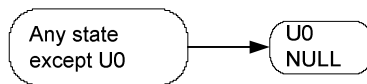

Figure 5.1a.3/3GPP TS 24.008: Overview call control protocol/MS side, extension for SRVCC from CS to PS

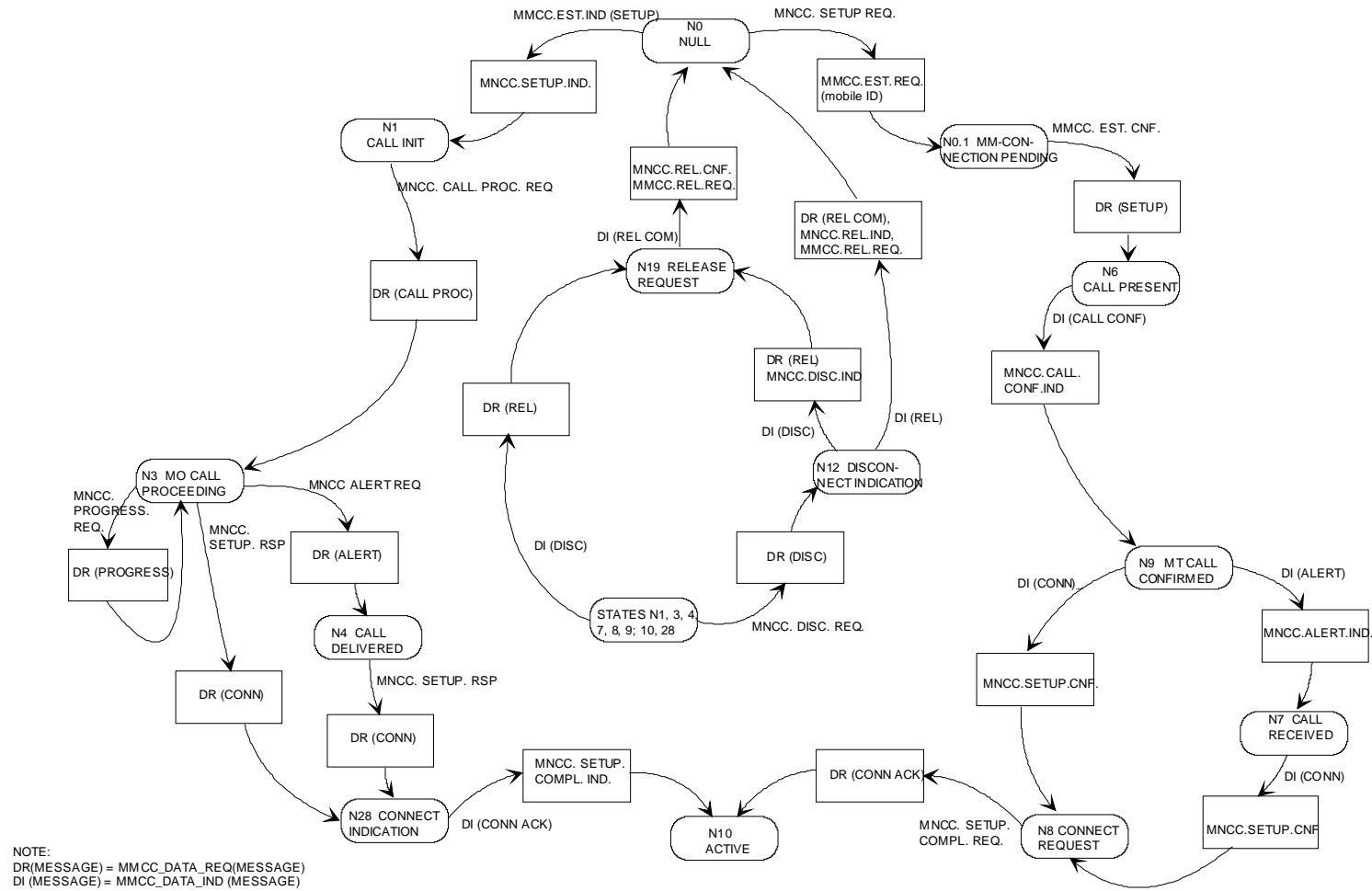

Figure 5.1b/3GPP TS 24.008 Overview call control protocol/Network side

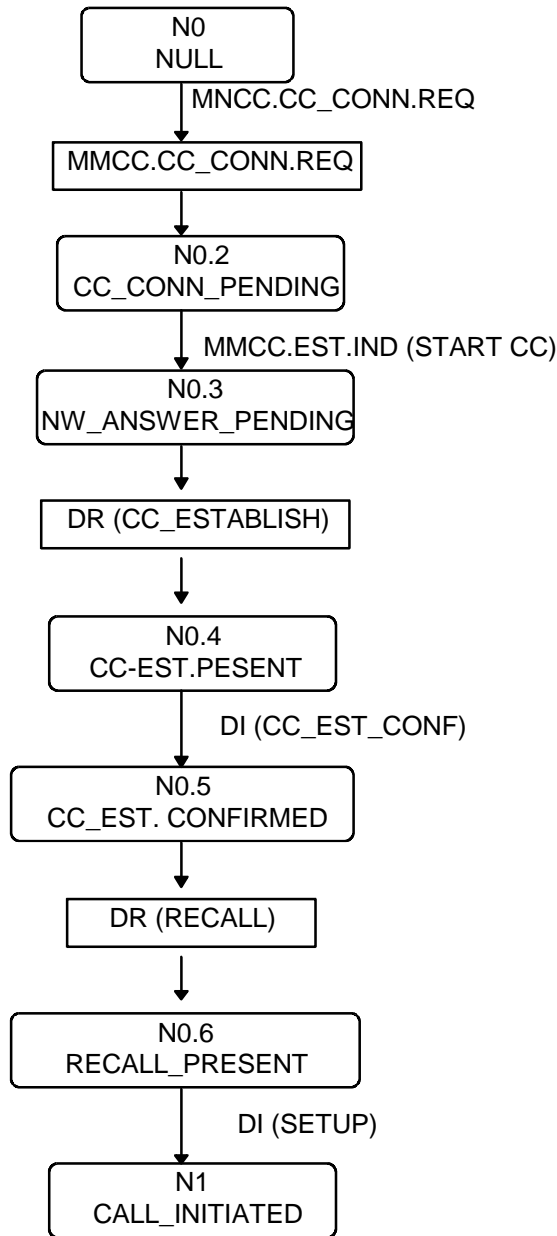

Figure 5.1b.1/3GPP TS 24.008 Overview call control protocol/Network side, extension

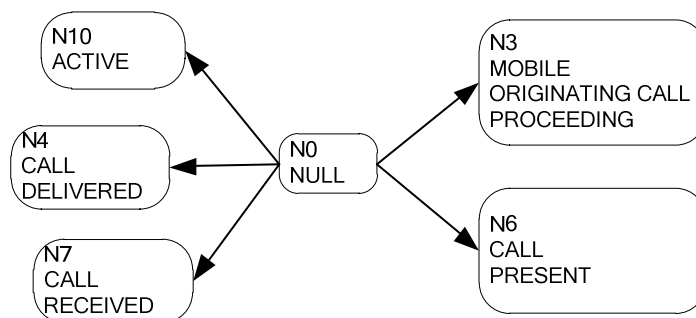

Figure 5.1b.2/3GPP TS 24.008: Overview call control protocol/Network side, extension for SRVCC from PS to CS or 5G-SRVCC handover from NG-RAN to UTRAN

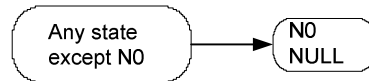

Figure 5.1b.3/3GPP TS 24.008: Overview call control protocol/Network side, extension for SRVCC from CS to PS

5.1.2 Call Control States

5.1.2.1 Call states at the mobile station side of the interface

The states which may exist on the mobile station side of the radio interface are defined in this subclause.

NOTE: States U0.1, U0.2, U0.3, U0.4, U0.5, U0.6, U26, and U27 are 3GPP specific. All other states are ITU-T defined.

5.1.2.1.1 Null (State U0)

No call exists.

5.1.2.1.2 MM Connection pending (U0.1)

This state exists for a mobile originating call, when the mobile station requests the establishment of a MM connection.

5.1.2.1.2a CC prompt present (U0.2) \$(CCBS)\$

This state exists for a mobile originating call when the network has prompted the mobile station to establish a CC connection but the mobile station has not yet responded.

NOTE: This state is transient.

5.1.2.1.2b Wait for network information (U0.3) \$(CCBS)\$

This state exists for a mobile originating call when the mobile station has responded to the prompt from the network to establish a CC connection and the mobile station is waiting for further information from the network.

5.1.2.1.2c CC-Establishment present (U0.4) \$(CCBS)\$

This state exists for a mobile originating call when the mobile station has received a CC-establishment request but has not yet responded.

NOTE: This state is transient.

5.1.2.1.2d CC-Establishment confirmed (U0.5) \$(CCBS)\$

This state exists for a mobile originating call when the mobile station has sent the acknowledgement that the mobile station has received all the CC information that is needed.

5.1.2.1.2e Recall present (U0.6) \$(CCBS)\$

This state exists for a mobile originating call when the mobile station has received a recall request but has not yet responded.

NOTE: This state is transient.

5.1.2.1.3 Call initiated (U1)

This state exists for a mobile originating call, when the MS requests call establishment from the network.

5.1.2.1.4 Mobile originating call proceeding (U3)

This state exists for a mobile originating call when the mobile station has received acknowledgement that the network has received all call information necessary to effect call establishment.

5.1.2.1.5 Call delivered (U4)

This state exists for a mobile originating call, when the calling mobile station has received an indication that remote user alerting has been initiated.

5.1.2.1.6 Call present (U6)

This state exists for a mobile terminating call when the mobile station has received a call establishment request but has not yet responded.

5.1.2.1.7 Call received (U7)

This state exists for a mobile terminating call when the mobile station has indicated alerting but has not yet answered.

5.1.2.1.8 Connect Request (U8)

This state exists for a mobile terminating call, when the mobile station has answered the call and is waiting to be awarded the call.

5.1.2.1.9 Mobile terminating call confirmed (U9)

This state exists for a mobile terminating call when the mobile station has sent acknowledgement that the mobile station has received all call information necessary to effect call establishment.

5.1.2.1.10 Active (U10)

This state exists for a mobile terminating call when the MS has answered the call. This state exists for a mobile originating call when the MS has received an indication that the remote user has answered the call..

5.1.2.1.11 Disconnect request (U11)

This state exists when the mobile station has requested the network to clear the end-to-end connection (if any) and is waiting for a response.

5.1.2.1.12 Disconnect indication (U12)

This state exists when the mobile station has received an invitation to disconnect because the network has disconnected the end-to-end connection (if any).

5.1.2.1.13 Release request (U19)

This state exists when the MS has requested the network to release and is waiting for a response.

5.1.2.1.14 Mobile originating modify (U26)

This state exists when the mobile station has sent a request to the network for a new mode but has not yet received an answer.

5.1.2.1.15 Mobile terminating modify (U27)

This state exists when the mobile station has received a request from the network for a new mode and has not yet sent a response to this request.

5.1.2.2 Network call states

NOTE: States N0.1, N0.2, N0.3, N0.4, N0.5, N0.6, N26, N27, N28, N3a, N4,a, N7a, and N9a are 3GPP specific. All other states are ITU-T defined.

The call states that may exist on the network side of the radio interface are defined in this subclause.

5.1.2.2.1 Null (State N0)

No call exists.

5.1.2.2.2 MM connection pending (N0.1)

This state exists for a mobile terminating call, when the network requests the establishment of a MM connection.

5.1.2.2.2a CC connection pending (N0.2) \$(CCBS)\$

This state exists for a mobile originating call when the network has requested the mobile station to establish a CC connection.

5.1.2.2.2b Network answer pending (N0.3) \$(CCBS)\$

This state exists for a mobile originating call when the mobile station has established a CC connection upon the request of the network, but the network has not yet informed the mobile station of the reason for the network's action.

5.1.2.2.2c CC-Establishment present (N0.4) \$(CCBS)\$

This state exists for a mobile originating call when the network has sent a CC establishment request but has not yet received a satisfactory response.

5.1.2.2.2d CC-Establishment confirmed (N0.5) \$(CCBS)\$

This state exists for a mobile originating call when the network has received acknowledgement that the mobile station has received all call information necessary to effect call establishment.

5.1.2.2.2e Recall present (N0.6) \$(CCBS)\$

This state exists for a mobile originating call when the network has sent a recall request but has not yet received a satisfactory response.

5.1.2.2.3 Call initiated (N1)

This state exists for a mobile originating call when the network has received a call establishment request but has not yet responded.

5.1.2.2.4 Mobile originating call proceeding (N3)

This state exists for a mobile originating call when the network has sent acknowledgement that the network has received all call information necessary to effect call establishment.

5.1.2.2.5 Call delivered (N4)

This state exists for a mobile originating call when the network has indicated that remote user alerting has been initiated.

5.1.2.2.6 Call present (N6)

This state exists for a mobile terminating call when the network has sent a call establishment request but has not yet received a satisfactory response.

5.1.2.2.7 Call received (N7)

This state exists for a mobile terminating call when the network has received an indication that the mobile station is alerting but has not yet received an answer.

5.1.2.2.8 Connect request (N8)

This state exists for a mobile terminating call when the network has received an answer but the network has not yet awarded the call.

5.1.2.2.9 Mobile terminating call confirmed (N9)

This state exists for a mobile terminating call when the network has received acknowledgement that the mobile station has received all call information necessary to effect call establishment.

5.1.2.2.10 Active (N10)

This state exists for a mobile terminating call when the network has awarded the call to the called mobile station. This state exists for a mobile originating call when the network has indicated that the remote user has answered the call.

5.1.2.2.11 Not used

5.1.2.2.12 Disconnect indication (N12)

This state exists when the network has disconnected the end-to-end connection (if any) and has sent an invitation to disconnect the mobile station to network connection.

5.1.2.2.13 Release request (N19)

This state exists when the network has requested the MS to release and is waiting for a response.

5.1.2.2.14 Mobile originating modify (N26)

This state exists when the network has received a request from the mobile station for a new mode but has not yet sent a response.

5.1.2.2.15 Mobile terminating modify (N27)

This state exists when the network has sent a request to the mobile station for a new mode but has not yet received an answer.

5.1.2.2.16 Connect Indication (N28)

This state exists for a mobile originating call when the network has indicated that the remote user has answered the call and the network is waiting for acknowledgement by the mobile station.

5.2 Call establishment procedures

Establishment of a call is initiated by request of upper layer in either the mobile station or the network; it consists of:

- the establishment of a CC connection between the mobile station and the network;
- the activation of the codec or interworking function.

Whenever it is specified in the present document clause 5 that the mobile station shall attach the user connection, this means that the mobile station shall activate the codec or interworking function as soon as an appropriate channel is available. The mobile station shall de-activate the codec or interworking function whenever an appropriate channel is no longer available. As soon as an appropriate channel is (again) available, the codec or interworking function shall be re-activated. If a new order to attach the user connection is received, the new order shall supersede the previous one.

A channel shall be considered as appropriate if it is consistent with the possibly negotiated bearer capability applicable for the actual phase of the call. The mobile station shall not consider a channel as not appropriate because the type of the channel (full rate/half rate) is not the preferred one. If:

- the user connection has to be attached but no appropriate channel is available for a contiguous time of 30 seconds; or if
- the codec or interworking function is de-activated for a contiguous time of 30 seconds;

then the mobile station may initiate call clearing.

Upon request of upper layers to establish a call, restricting conditions for the establishment of the call are examined. These restricting conditions concern the states of parallel CC entities and are defined elsewhere. If these restricting conditions are fulfilled, the call establishment is rejected. Otherwise a CC entity in state U0, "null", is selected to establish the call. It initiates the establishment by requesting the MM sublayer to establish an MM connection.

In lu mode, if the lower layers indicate the release of a radio access bearer, whereas the corresponding call is still active, the MS shall not automatically initiate the release of that call.

5.2.1 Mobile originating call establishment

The call control entity of the mobile station initiates establishment of a CC connection by requesting the MM sublayer to establish a mobile originating MM connection and entering the "MM connection pending" state. There are two kinds of a mobile originating call: basic call and emergency call. The request to establish an MM connection shall contain a parameter to specify whether the call is a basic or an emergency call. This information may lead to specific qualities of services to be provided by the MM sublayers. Timer T303 is started when the CM SERVICE REQUEST message is sent.

For mobile stations supporting eMLPP basic calls may optionally have an associated priority level as defined in 3GPP TS 23.067 [88]. This information may also lead to specified qualities of service to be provided by the MM sublayers.

While being in the "MM connection pending" state, the call entity of the mobile station may cancel the call prior to sending the first call control message according to the rules given in subclause 4.5.1.7.

The mobile station supporting multicall that is initiating an emergency call shall release one or more existing call to ensure the emergency call can be established if the multicall supported information stored in the mobile station described in subclauses 5.2.1.2 and 5.2.2.1 indicates the network does not support multicall and some ongoing calls exists.

Having entered the "MM connection pending" state, upon MM connection establishment, the call control entity of the mobile station sends a setup message to its peer entity. This setup message is:

- a SETUP message, if the call to be established is a basic call, and
- an EMERGENCY SETUP message, if the call to be established is an emergency call.

NOTE 1: The Extended Local Emergency Numbers List (see 3GPP TS 24.301 [120]) does not apply in this specification.

The mobile station then enters the "call initiated" state. Timer T303 is not stopped.

The setup message shall contain all the information required by the network to process the call. In particular, the:

- SETUP message shall contain the called party address information;
- EMERGENCY SETUP message shall contain the emergency category, if the emergency category is available at the MS.

If the mobile station supports multicall, it shall include the Stream Identifier (SI) information element. For the first call i.e. when there are no other ongoing calls the SI value shall be 1.

For speech calls the mobile station shall indicate all codecs that it supports for UTRAN in the *Supported Codec List* information element. Codecs for GERAN shall be indicated in the *Bearer Capability* information element, if this

information element is included. Additionally, if the mobile station supports codecs for GERAN and UTRAN, it shall indicate the codecs for GERAN also in the *Supported Codec List* information element.

If the call is a redial attempt to switch from speech to multimedia or vice-versa, the SETUP message shall include the Redial information element.

NOTE 2: Redial attempt is defined in 3GPP TR 23.903: "Redial solution for voice-video switching"[115].

If the MS supports the enhanced network-initiated in-call modification procedure as specified in subclause 5.3.4.3, the MS shall indicate this in the *Call Control Capabilities* IE in the SETUP message.

If timer T303 elapses in the "MM connection pending" state, the MM connection in progress shall be aborted and the user shall be informed about the rejection of the call.

5.2.1.1 Call initiation

The "call initiated" state is supervised by timer T303. For normal MO calls, this timer will have already been started after entering the "MM connection pending" state. For network-initiated MO calls this timer will be started in the recall present state as defined in subclause 5.2.3.4

When the call control entity of the mobile station is in the "call initiated" state and if it receives:

- i) a CALL PROCEEDING message, it shall proceed as described in subclause 5.2.1.3;
- ii) an ALERTING message, it shall proceed as described in subclause 5.2.1.5;
- iii) a CONNECT message, it shall proceed as described in subclause 5.2.1.6;
- iv) a RELEASE COMPLETE message it shall proceed as described in subclause 5.2.1.2.

Abnormal case:

- If timer T303 elapses in the "call initiated" state before any of the CALL PROCEEDING, ALERTING, CONNECT or RELEASE COMPLETE messages has been received, the clearing procedure described in subclause 5.4 is performed.

5.2.1.2 Receipt of a setup message

In the "null" or "recall present" states, upon receipt of a setup message (a SETUP message or an EMERGENCY SETUP message, see subclause 5.2.1.1), the call control entity of the network enters the "call initiated" state. It shall then analyse the call information contained in the setup message.

In Iu mode, network shall include the SI received in the SETUP message into the RABid and send it back to the mobile station. For RABid see 3GPP TS 25.413 [19c] and 3GPP TS 44.118 [111]. If the network receives the SETUP message with no SI, the network shall set the SI value to 1.

- i) If, following the receipt of the setup message, the call control entity of the network determines that the call information received from the mobile station is invalid (e.g. invalid number), then the network shall initiate call clearing as defined in subclause 5.4 with one of the following cause values:
 - # 1 "unassigned (unallocated) number",
 - # 3 "no route to destination",
 - # 22 "number changed",
 - # 28 "invalid number format (incomplete number)".
- ii) If, following the receipt of the setup message, the call control entity of the network determines that a requested service is not authorized or is not available, it shall initiate call clearing in accordance with subclause 5.4.2 with one of the following cause values:
 - # 8 "operator determined barring",
 - # 57 "bearer capability not authorized",

- # 58 "bearer capability not presently available",
- # 63 "service or option not available, unspecified", or
- # 65 "bearer service not implemented".

iii) Otherwise, the call control entity of the network shall either:

- send a CALL PROCEEDING message to its peer entity to indicate that the call is being processed; and enter the "mobile originating call proceeding" state;
- or: send an ALERTING message to its peer entity to indicate that alerting has been started at the called user side; and enter the "call received" state;
- or: send a CONNECT message to its peer entity to indicate that the call has been accepted at the called user side; and enter the "connect request" state.

The call control entity of the network may insert bearer capability information element(s) in the CALL PROCEEDING message to select options presented by the mobile station in the Bearer Capability information element(s) of the SETUP message. The bearer capability information element(s) shall contain the same parameters as received in the SETUP except those presenting a choice. Where choices were offered, appropriate parameters indicating the results of those choices shall be included.

The CALL_PROCEEDING message shall also contain the priority of the call in the case where the network supports eMLPP. Mobile stations supporting eMLPP shall indicate this priority level to higher sublayers and store this information for the duration of the call for further action. Mobile stations not supporting eMLPP shall ignore this information element if provided in a CALL_PROCEEDING message.

NOTE: If the network supports only R98 or older versions of this protocol and the priority is not included in the CALL_PROCEEDING message, this does not imply that the network does not support eMLPP.

- The CALL_PROCEEDING message shall contain the multicall supported information in the network call control capabilities in the case where the network supports multicall and there are no other ongoing calls to the MS. Mobile stations supporting multicall shall store this information until the call control state for all calls returns to null. Mobile stations not supporting multicall shall ignore this information if provided in a CALL_PROCEEDING message. If the multicall supported information is not sent in the CALL_PROCEEDING message, the mobile station supporting multicall shall regard that the network doesn't support multicall.

The call control entity of the network having entered the "mobile originating call proceeding" state, the network may initiate the assignment of a traffic channel according to subclause 5.2.1.9 (early assignment).

For speech calls, if the SETUP message or EMERGENCY SETUP message contains a *Supported Codec List* information element, the network shall use this list to select the codec for UTRAN. If no *Supported Codec List* information element is received, then for UTRAN the network shall select the default UMTS speech codec according to subclause 5.2.1.11.

Codecs for GERAN shall be selected from the codecs indicated in the *Supported Codec List* information element or in the *Bearer Capability* information element. If neither a *Supported Codec List* information element nor a *Bearer Capability* information element is received, then for GERAN the network shall select GSM full rate speech version 1.

Codec information that does not apply to the currently serving radio access shall be used by the network if an inter-system change occurs.

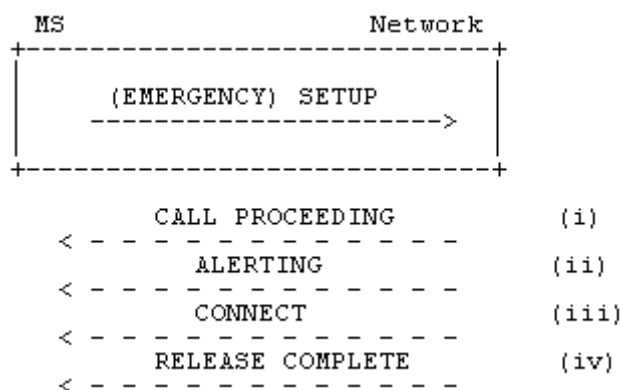

Figure 5.2/3GPP TS 24.008 Mobile originated call initiation and possible subsequent responses.

5.2.1.3 Receipt of a CALL PROCEEDING message

Having entered the "call initiated" state, when the call control entity of the mobile station receives a CALL PROCEEDING message, it shall stop timer T303; start timer T310 unless

- the CALL PROCEEDING message contains a *progress indicator* IE specifying progress description #1, #2, or #64; or
- it has received a PROGRESS message containing a *progress indicator* IE specifying progress description #1, #2, or #64 prior to the CALL PROCEEDING message

and enter the "mobile originating call proceeding" state.

Abnormal case:

If timer T310 elapses before any of the ALERTING, CONNECT or DISCONNECT messages has been received, the mobile station shall perform the clearing procedure described in subclause 5.4.

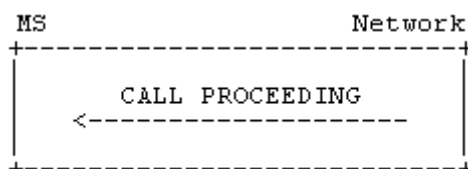

Figure 5.3/3GPP TS 24.008 Call proceeding sequence at mobile originating call establishment

5.2.1.4 Notification of progressing mobile originated call

In this subclause, the term "interworking" is used only in the meaning of interworking with a network other than PLMN or ISDN, not as interworking between PLMN and ISDN since this is the normal case. In this sense, PLMN and ISDN are seen within the same environment, called the PLMN/ISDN environment.

5.2.1.4.1 Notification of interworking in connection with mobile originated call establishment

During call establishment, the call may leave a PLMN/ISDN environment; e.g., because of interworking with another network, with a non-PLMN/ISDN user, or with non-PLMN/ISDN equipment within the called user's premises; the call may also return to a PLMN/ISDN environment. When such situations occur, the network may send a *progress indicator* information element to the calling mobile station either:

- a) in an appropriate call control message, if a state change is required (e.g. ALERTING or CONNECT); or,
- b) in the PROGRESS message, if no state change is appropriate.

This *progress indicator* information element shall contain one of the following progress description values:

- a) #1 "call is not end-to-end PLMN/ISDN; further call progress information may be available in-band".

- b) #2 "destination address is non-PLMN/ISDN".
- c) #4 "call has returned to PLMN/ISDN".

See also subclauses 5.5.1 and 5.5.6 for further reactions of the mobile station.

5.2.1.4.2 Call progress in the PLMN/ISDN environment

In order to inform the mobile station that the call is progressing in the PLMN/ISDN environment the network may send a *progress indicator* information element to the calling mobile station either:

- a) in an appropriate call control message, if a state change is required (e.g., ALERTING or CONNECT); or
- b) in the PROGRESS message, if no state change is appropriate.

This *progress indicator* information element shall contain progress description value #32 "Call is end-to-end ISDN/PLMN". See also subclause 5.5.6 for further reactions of the mobile station.

5.2.1.5 Alerting

Having entered the "mobile originating call proceeding" state, upon receiving an indication that user alerting has been initiated at the called address, the call control entity of the network shall: send an ALERTING message to its peer entity at the calling mobile station and enter the "call delivered" state.

When the call control entity of the mobile station in the "call initiated" state or "mobile originating call proceeding" state receives an ALERTING message then, the call control entity of the mobile station shall stop timer T303 and T310 (if running) and shall enter the "call delivered" state. In this state:

- for speech calls: an alerting indication should be given to the user. If the mobile station has not attached the user connection then the mobile station shall internally generate an alerting indication. If the mobile station has attached the user connection then the network is responsible for generating the alerting indication and the mobile station need not generate one; and
- for multimedia calls: if the mobile station has not attached the user connection then the mobile station may internally generate an alerting indication. If the mobile station supports multimedia CAT during the alerting phase of a mobile originated multimedia call establishment, the network may request the mobile station to attach the user connection and setup a H.324 call and generate multimedia CAT as specified in subclause 5.3.6.4, in which case the mobile station need not generate an alerting tone.

Abnormal cases:

On the mobile station side, if timer T303 or T310 expires, the call control entity of the mobile station shall initiate call clearing as described in subclause 5.4.

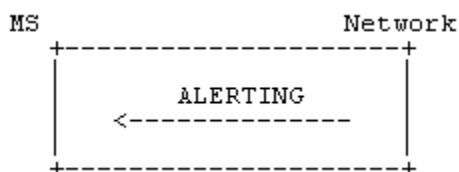

Figure 5.4/3GPP TS 24.008 Call confirmation at mobile originating call establishment

5.2.1.6 Call connected

Upon receiving an indication that the call has been accepted, the call control entity of the network shall: through connect the traffic channel (including the connection of an interworking function, if required) and send a CONNECT message to its peer entity at the calling mobile station; start timer T313 and enter the "connect indication" state.

This message indicates to the call control entity of the calling mobile station that a connection has been established through the network.

The call control entity of the mobile station in the "call initiated" state, in the "mobile originating call proceeding" state or in the "call delivered" state, shall, upon receipt of a CONNECT message:

- attach the user connection;
- return a CONNECT ACKNOWLEDGE message;
- stop any locally generated alerting indication (if applied);
- clear any H.324 call established to receive multimedia CAT during the alerting phase (if applied) , as specified in subclause 5.3.6.4
- stop timer T303 and T310 (if running);
- enter the "active" state.

Abnormal cases:

On the mobile station side, if timer T303 or T310 expires, the call control entity of the mobile station shall initiate call clearing as described in subclause 5.4.

NOTE: The mobile station may have applied an additional internal alerting supervision which causes initiation of call clearing prior to the expiry of T303 or T310.

The call control of the network in the "connect indication" state, shall, upon receipt of a CONNECT ACKNOWLEDGE message:

- stop timer T313 and enter the "active" state.

Abnormal cases:

On the network side, if timer T313 elapses before a CONNECT ACKNOWLEDGE message has been received, the network shall perform the clearing procedure as described in subclause 5.4.

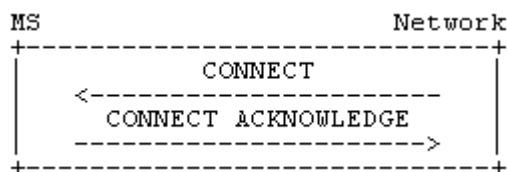

Figure 5.5/3GPP TS 24.008 Call acceptance sequence at mobile originating call establishment

5.2.1.7 Call rejection

Upon receiving an indication that the network or the called user is unable to accept the call, the network shall initiate call clearing at the radio interface to the mobile which originated the call, as described in subclause 5.4 using the cause provided by the terminating network or the called user.

5.2.1.8 Transit network selection

NOTE: For further study.

5.2.1.9 Traffic channel assignment at mobile originating call establishment

The mobile station supporting multicall includes the Stream Identifier (SI) in the SETUP message. The multicall supporting network shall interpret the SI value as follows:

- a) Mobile station generates a new SI value at the initiation of an originating call, then a new traffic channel shall be assigned to the mobile originating call.
- b) Mobile station indicates an existing SI value, then the indicated traffic channel shall be used for the mobile originating call.

Mobile station supporting multicall shall never send an additional SETUP with indication that a new traffic channel is requested to a network that does not support multicall.

It is a network dependent decision when to initiate the assignment of an appropriate traffic channel during the mobile originating call establishment phase. Initiation of a suitable RR procedure to assign an appropriate traffic channel does neither change the state of a call control entity nor affect any call control timer.

NOTE: During certain phases of such an RR procedure, transmission of CC and MM messages may be suspended, see 3GPP TS 44.018 [84], clause 3 and 3GPP TS 48.008 [85].

The assignment procedure does not affect any call control timer.

5.2.1.10 Call queuing at mobile originating call establishment

If an idle traffic channel is not available at the assignment instant, the network may place the traffic channel request in a queue. Calls arriving when all positions in the queue are occupied shall be cleared by the network using the cause #34 "no circuit/channel available".

The maximum queuing interval is supervised by the network. The limit is a network dependent choice. In case the network is not able to allocate a traffic channel within the queuing limit, the network will release the call using cause #34 "no circuit/channel available".

Optionally, e.g. if eMLPP is used, the network may decide to pre-empt existing calls or to place the traffic channel request at some preferential position within the queue.

Specific indications provided in the network to the remote user are a network dependent choice.

5.2.1.11 Speech Codec Selection

For speech calls, a mobile station implementing this version of the protocol shall indicate all codecs that it supports for UTRAN in the *Supported Codec List* information element. Codecs for GERAN shall be indicated in the *Bearer Capability* information element, if this information element is included. Additionally, if the mobile station supports codecs for GERAN and UTRAN, it shall indicate the codecs for GERAN also in the *Supported Codec List* information element.

If the network does not receive a *Supported Codec List* information element then for speech calls in UTRAN it shall select the default UMTS speech codec.

For speech calls in GERAN, if the network does not receive a *Supported Codec List* information element nor a *Bearer Capability* information element, the network shall select GSM full rate speech version 1.

The network shall determine the default UMTS speech codec by the following:

- i) If no GSM Speech Version codepoints are received in the *Supported Codec List* IE or in octet 3a etc. of the *Bearer Capabilities* IE then a "UMTS only" terminal is assumed and the default UMTS speech codec shall be UMTS_AMR.
- ii) If at least one GSM Speech Version codepoint is received in the *Supported Codec List* IE or in octet 3a etc. of the *Bearer Capabilities* IE then the ME supports GSM and UMTS and the default UMTS speech codec shall be UMTS_AMR_2.

NOTE 1: In case (ii), if the call is set up in A/Gb or GERAN Iu mode by a R99 ME, call control in the core network may treat the ME as a "GSM only" ME. The default UMTS speech codec will only become relevant when an intersystem handover to UTRAN Iu mode is initiated by the radio access network, and can be determined when this procedure is started.

If the *Supported Codec List* IE is received, then the network shall use this list to select the codec for Iu mode and indicate the selected codec to the ME via RANAP and RRC protocol in the NAS Synchronisation Indicator IE. See 3GPP TS 25.413 [19c], 3GPP TS 25.331 [23c] and 3GPP TS 44.118 [111].

The NAS Synchronisation Indicator IE shall be coded as the 4 least significant bits of the selected codec type (CoID) defined in 3GPP TS 26.103 [83], subclause 6.3.

The network shall determine the preference for the selected codec type; codec type prioritisation is not provided by the ME.

The ME shall activate the codec type received in the NAS Synchronisation Indicator IE.

If the mobile station does not receive the NAS Synchronisation Indicator IE (RRC protocol)

- during setup of a speech call;
- during inter-system handover of a speech call from A/Gb or GERAN Iu mode to UTRAN Iu mode;
- during an in-call modification from data to speech;
- during a SRVCC handover to UTRAN Iu mode; or
- during a 5G-SRVCC handover from NG-RAN to UTRAN Iu mode,

then it shall select the UMTS_AMR_2 speech codec.

NOTE 2: If the network does not support UMTS_AMR_2, it may activate the UMTS_AMR codec and indicate to the mobile station that it shall select UMTS_AMR_2. According to 3GPP TS 26.103 [83], subclause 5.4, no interworking problem will occur in this case.

If the mobile station has selected a speech codec for UTRAN Iu mode, it shall keep this codec until

- a new codec is requested by the network by sending a NAS Synchronisation Indicator IE (RRC protocol);
- a new codec is requested by the network during inter-system handover from UTRAN Iu mode to A/Gb or GERAN Iu mode; or
- an in-call modification from speech to data is performed.

For adaptive multirate codec types no indication of subsets of modes is supported in this protocol, from the mobile station or to the mobile station. It is a pre-condition that the support of such codec types by the mobile station implicitly includes all modes defined for that codec type.

5.2.1.12 Cellular Text telephone Modem (CTM) selection

The mobile station can send a CTM support indication in the *Bearer Capability* IE in call establishment messages to inform the network of the use of CTM text in the call.

When the mobile station indicates speech and support of CTM text telephony, the network shall select a speech codec and additionally CTM text telephony detection/conversion functions as specified in 3GPP TS 23.226 [92] and 3GPP TS 26.226 [93], if such functions are available.

NOTE: If CTM support is indicated by the mobile station, then it supports CTM text telephony together with any supported speech codec and for any supported radio access.

5.2.2 Mobile terminating call establishment

Before call establishment can be initiated in the mobile station, the MM connection must be established by the network.

5.2.2.1 Call indication

After the arrival of a call from a remote user, the corresponding call control entity in the network shall: initiate the MM connection establishment according to clause 4 and enter the "MM connection pending" state. The request to establish the MM connection is passed from the CM sublayer to the MM sublayer. It contains the necessary routing information derived from the SETUP message.

Upon completion of the MM connection, the call control entity of the network shall: send the SETUP message to its peer entity at the mobile station, start timer T303 and enter the "call present" state.

The SETUP message shall contain the multicall supported information in the network call control capabilities in the case where the network supports multicall and there are no other ongoing calls to the MS. Mobile stations supporting multicall shall store this information until the call control state for all calls returns to null. Mobile stations not supporting multicall shall ignore this information if provided in a SETUP message. If the multicall supported information is not sent in the SETUP message, the mobile station supporting multicall shall regard that the network does not support multicall.

Upon receipt of a SETUP message, the mobile station shall perform compatibility checking as described in subclause 5.2.2.2. If the result of the compatibility checking was compatibility, the call control entity of the mobile station shall enter the "call present" state. An incompatible mobile station shall respond with a RELEASE COMPLETE message in accordance with subclause 5.2.2.3.4.

If there are no *bearer capability* IEs in the SETUP message, the network may provide information about the requested service in the *backup bearer capability* IE.

If no response to the SETUP message is received by the call control entity of the network before the expiry of timer T303, the procedures described in subclause 5.2.2.3.3 shall apply.

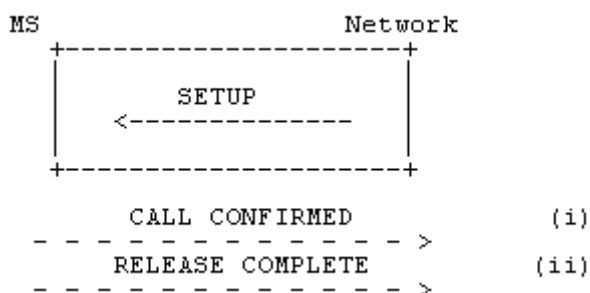

Figure 5.6/3GPP TS 24.008 Mobile terminating call initiation and possible subsequent responses.

5.2.2.2 Compatibility checking

The mobile station receiving a SETUP message shall perform compatibility checking before responding to that SETUP message. Annex B defines compatibility checking to be performed by the mobile station upon receiving a SETUP message. For a *backup bearer capability* IE received with a SETUP message the mobile station shall not perform compatibility checking as described in annex B.

5.2.2.3 Call confirmation

5.2.2.3.1 Response to SETUP

Having entered the "call present state" the call control entity of the mobile station shall - with the exception of the cases described below - acknowledge the SETUP message by a CALL CONFIRMED message, and enter the "mobile terminating call confirmed" state.

If the mobile station supports multicall, it shall include the Stream Identifier (SI) information element in the CALL CONFIRMED message.

If the mobile station is located in the network supporting multicall, it shall never include the SI that is in use and shall include with either of the following two values:

- SI="no bearer";
- SI=new value (not used by any of the existing bearers).

If the mobile station supporting multicall is located in the network not supporting multicall, it shall include the SI with value 1.

The call control entity of the mobile station may include in the CALL CONFIRMED message to the network one or two bearer capability information elements to the network, either preselected in the mobile station or corresponding to a service dependent directory number (see 3GPP TS 29.007 [38]). The mobile station may also use the *backup bearer capability* IE, if provided by the network, to deduce the requested service (see 3GPP TS 27.001 [36], subclause 8.3.3.1). The mobile station may also include one or two bearer capabilities in the CALL CONFIRMED message to define the radio channel requirements. In any case the rules specified in subclause 9.3.2.2 shall be followed.

NOTE: The possibility of alternative responses (e.g., in connection with supplementary services) is for further study.

For speech calls the mobile station shall indicate all codecs that it supports for UTRAN in the *Supported Codec List* information element. Codecs for GERAN shall be indicated in the *Bearer Capability* information element, if this information element is included. Additionally, if the mobile station supports codecs for GERAN and UTRAN, it shall indicate the codecs for GERAN also in the *Supported Codec List* information element.

If the MS supports the enhanced network-initiated in-call modification procedure as specified in subclause 5.3.4.3, the MS shall indicate this in the *Call Control Capabilities* IE in the CALL CONFIRMED message.

A busy MS which satisfies the compatibility requirements indicated in the SETUP message shall respond either with a CALL CONFIRMED message if the call setup is allowed to continue or a RELEASE COMPLETE message if the call setup is not allowed to continue, both with cause #17 "user busy".

If the mobile user wishes to refuse the call, a RELEASE COMPLETE message shall be sent with the cause #21 "call rejected".

In the cases where the mobile station responds to a SETUP message with RELEASE COMPLETE message the mobile station shall release the MM connection and enter the "null" state after sending the RELEASE COMPLETE message.

The network shall process the RELEASE COMPLETE message in accordance with subclause 5.4.

5.2.2.3.2 Receipt of CALL CONFIRMED and ALERTING by the network

The call control entity of the network in the "call present" state, shall, upon receipt of a CALL CONFIRMED message: stop timer T303, start timer T310 and enter the "mobile terminating call confirmed" state.

In lu mode, network shall include the SI received in the CALL CONFIRMED message into the RABid and send it back to the mobile station. For RABid see 3GPP TS 25.413 [19c] and 3GPP TS 44.118 [111]. If the network receives the CALL CONFIRMED message with no SI, the network shall set the SI value to 1.

For speech calls, if the CALL CONFIRMED message contains a *Supported Codec List* information element, the network shall use this list to select the codec for UTRAN. If no *Supported Codec List* information element is received, then for UTRAN the network shall select the default UMTS speech codec according to subclause 5.2.1.11.

Codecs for GERAN shall be selected from the codecs indicated in the *Supported Codec List* information element or in the *Bearer Capability* information element. If neither a *Supported Codec List* information element nor a *Bearer Capability* information element is received, then for GERAN the network shall select GSM full rate speech version 1.

Codec information that does not apply to the currently serving radio access shall be used by the network if an inter-system change occurs.

The call control entity of the mobile station having entered the "mobile terminating call confirmed" state, if the call is accepted at the called user side, the mobile station proceeds as described in subclause 5.2.2.5. Otherwise, if the signal information element was present in the SETUP message user alerting is initiated at the mobile station side; if the signal information element was not present in the SETUP message, user alerting is initiated when an appropriate channel is available.

Here, initiation of user alerting means:

- the generation of an appropriate tone or indication at the mobile station; and
- sending of an ALERTING message by the call control entity of the MS to its peer entity in the network and entering the "call received" state.

The call control entity of the network in the "mobile terminated call confirmed" state shall, upon receipt of an ALERTING message: send a corresponding ALERTING indication to the calling user; stop timer T310; start timer T301, and enter the "call received" state.

In the "mobile terminating call confirmed" state or the "call received" state, if the user of a mobile station is User Determined User Busy then a DISCONNECT message shall be sent with cause #17 "user busy". In the "mobile terminating call confirmed" state, if the user of a mobile station wishes to reject the call then a DISCONNECT message shall be sent with cause #21 "call rejected".

5.2.2.3.3 Call failure procedures

In case of abnormal behaviour the following call failure procedures apply:

- i. If the network does not receive any response to the SETUP message prior to the expiration of timer T303, then the network shall: initiate clearing procedures towards the calling user with cause #18 "no user responding"; and initiate clearing procedures towards the called mobile station in accordance with subclause 5.4.4 using cause #102 "recovery on timer expiry".
- ii. If the network has received a CALL CONFIRMED message, but does not receive an ALERTING, CONNECT or DISCONNECT message prior to the expiration of timer T310, then the network shall:
 - initiate clearing procedures towards the calling user with cause #18 "no user responding"; and
 - initiate clearing procedures towards the called MS in accordance with subclause 5.4.4 using cause #102 "recovery on timer expiry".
- iii. If the network has received an ALERTING message, but does not receive a CONNECT or DISCONNECT message prior to the expiry of timer T301 (or a corresponding internal alerting supervision timing function), then the network shall: initiate clearing procedures towards the calling user with cause #19 "user alerting, no answer"; and initiate clearing procedures towards the called mobile station in accordance with subclause 5.4.4, using cause #102 "recovery on timer expiry" or using cause #31 "normal, unspecified".

NOTE: The choice between cause #31 and cause #102 may have consequences on indications generated by the mobile station, see 3GPP TS 22.001 [8a].

5.2.2.3.4 Called mobile station clearing during mobile terminating call establishment

See subclause 5.4.2.

5.2.2.4 Notification of interworking in connection with mobile terminating call establishment

In this subclause, the term "interworking" is used only in the meaning of interworking with a network other than PLMN or ISDN, not as interworking between PLMN and ISDN since this is the normal case. In this sense, PLMN and ISDN are seen within the same environment, called the PLMN/ISDN environment.

During call establishment the call may enter an PLMN/ISDN environment, e.g., because of interworking with another network, with a non-PLMN/ISDN user, or with non-PLMN/ISDN equipment within the calling or called user's premises. When this occurs, the network may include a *progress indicator* information element to be included in the SETUP message to be sent to the called mobile station specifying progress description value:

- a) #1 "call is not end-to-end PLMN/ISDN; further call progress information may be available in-band" or
- b) #3 "origination address is non-PLMN/ISDN".

See also subclause 5.5.1 for further reactions of the mobile station.

5.2.2.5 Call accept

In the "mobile terminating call confirmed" state or the "call received" state, the call control entity in the mobile station indicates acceptance of a mobile terminating call by:

- sending a CONNECT message to its peer entity in the network;
- starting Timer T313; and
- entering the "connect request" state.

If the call control entity of the mobile station has indicated "No Bearer" as the SI value in the CALL CONFIRMED message, it shall assign the SI value and include the SI information element in the CONNECT message. Otherwise the SI information element shall not be included in the CONNECT message.

5.2.2.6 Active indication

In the "mobile terminated call confirmed" state or in the "call received" state, the call control entity of the network shall, upon receipt of a CONNECT message: through connect the traffic channel (including the connection of an interworking

function, if required), stop timers T310, T303 or T301 (if running); send a CONNECT ACKNOWLEDGE message to its peer entity at the mobile station of the called user; initiate procedures to send a CONNECT message towards the calling user and enter the "active" state.

In the "connect request" state, the call control entity of the mobile station shall, upon receipt of a CONNECT ACKNOWLEDGE message: stop timer T313 and enter the "active" state.

When timer T313 expires prior to the receipt of a CONNECT ACKNOWLEDGE message, the mobile station shall initiate clearing in accordance with subclause 5.4.3.

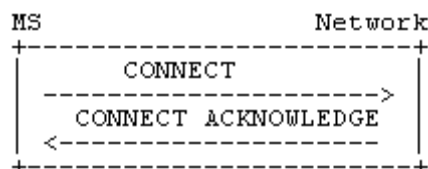

Figure 5.7/3GPP TS 24.008 Call acceptance and active indication at mobile terminating call establishment

5.2.2.7 Traffic channel assignment at mobile terminating call establishment

After receiving the SETUP message, the mobile station supporting multicall may either require a new traffic channel or reuse an existing traffic channel.

If a mobile station in the network supporting multicall requires a new traffic channel, it shall:

- send a CALL CONFIRMED message including the SI indicating a new value, not used by any of the existing traffic channels.

If a mobile station in the network supporting multicall does not require a new traffic channel, it shall:

- send a CALL CONFIRMED message including the SI equal to "no bearer".

After the mobile station has send the CALL CONFIRMED with SI="no bearer", the SI value in the CONNECT message will tell to the network if a user requests a new traffic channel or one of the existing ones will be re-uesd.

If a new traffic channel is requested by the user, the mobile station in the network supporting multicall shall:

- send a CONNECT message containing the SI with a new value, not used by any existing traffic channel.

If the user decides that an existing traffic channel will be reused, the mobile station in the network supporting multicall shall:

- send a CONNECT message with an SI indicating an existing value used by an existing traffic channel.

It is a network dependent decision when to initiate the assignment of a traffic channel during the mobile terminating call establishment phase.

Initiation of the assignment phase does not directly change the state of a CC entity nor affect any call control timer, but may have some secondary effects (see e.g. subclause 5.2.2.3.2).

5.2.2.8 Call queuing at mobile terminating call establishment

The principles described in subclause 5.2.1.10 apply accordingly.

NOTE: The interworking to the fixed network has to fulfil the network specific requirements.

5.2.2.9 User connection attachment during a mobile terminating call

For speech calls:

The mobile station shall attach the user connection at latest when sending the connect message.

For data calls:

The mobile station shall attach the user connection when receiving the CONNECT ACKNOWLEDGE message from the network.

5.2.2.10 Speech Codec Selection

The principles described in subclause 5.2.1.11 apply accordingly.

5.2.2.11 Cellular Text telephone Modem (CTM) selection

The principles described in subclause 5.2.1.12 apply accordingly.

5.2.3 Network initiated MO call \$(CCBS)\$

The procedures of subclause 5.2.3 are mandatory for mobile stations supporting "Network initiated MO call".

NOTE: The behaviour of a mobile station that does not support "Network initiated MO call" is described in clause 4.

5.2.3.1 Initiation

Before call establishment can be initiated in the mobile station, the MM connection shall be established by the network.

After the arrival of an appropriate stimulus (for example a Remote User Free Indication), the corresponding call control entity in the network shall initiate the MM connection establishment according to clause 4, enter the "CC connection pending" state and start timer T331. The request to establish the MM connection is passed from the CM sublayer to the MM sublayer. It contains the necessary routing information derived from the received stimulus.

Upon completion of the MM connection, the call control entity of the mobile station shall send a START CC message to its peer entity in the network. The mobile station shall then enter the "Wait for network information" state and start timer T332.

If the network receives a START CC message while in the "CC connection pending" state, the network stops T331, sends the CC-ESTABLISHMENT message, starts timer T333 and enters the "CC-establishment present" state.

The MM connection establishment may be unsuccessful for a variety of reasons, in which case the MM sublayer in the network will inform the CC entity in the network with an indication of the reason for the failure. The CC entity shall then stop all running timers, enter the "Null" state and inform all appropriate entities within the network.

If timer T331 expires, the network shall abort the MM connection establishment attempt, stop all running CC timers, enter the "Null" state and inform all appropriate entities within the network.

5.2.3.2 CC-Establishment present

In the "CC establishment present" state, the mobile station, upon receipt of the CC-ESTABLISHMENT message, shall stop timer T332.

The CC-ESTABLISHMENT message contains information which the mobile station shall use for the subsequent SETUP message (if any) related to this CC-ESTABLISHMENT.

The CC-ESTABLISHMENT message shall contain the *Setup Container IE*.

If no CC-ESTABLISHMENT message is received by the call control entity of the mobile station before the expiry of timer T332, then the mobile station shall initiate clearing procedures towards the network using a RELEASE COMPLETE message with cause #102 "recovery on timer expiry" and proceed in accordance with subclause 5.4.2.

Upon receipt of a CC-ESTABLISHMENT message the mobile station shall perform checks on the Setup Container IE in order to align the contained information with the mobile's present capabilities and configuration. The "recall alignment procedure" is defined later on in this subclause.

If the recall alignment procedure has succeeded, the call control entity of the Mobile Station shall:

- form and store the SETUP message for sending later in the "Recall present" state,
- acknowledge the CC-ESTABLISHMENT message with a CC-ESTABLISHMENT CONFIRMED message,
- start timer T335, and
- enter the "CC-establishment confirmed" state.

Exception:

A busy mobile station which has successfully performed the recall alignment procedure shall respond with a CC-ESTABLISHMENT CONFIRMED message with cause #17 "user busy", and proceed as stated above.

For speech calls the mobile station shall indicate all codecs that it supports for UTRAN in the *Supported Codec List* information element of the CC-ESTABLISHMENT CONFIRMED message. Codecs for GERAN shall be indicated in the *Bearer Capability* information element. Additionally, if the mobile station supports codecs for GERAN and UTRAN, it shall indicate the codecs for GERAN also in the *Supported Codec List* information element.

A mobile station, for which the recall alignment procedure failed, shall respond with a RELEASE COMPLETE message in accordance with subclause 5.4.2 with the appropriate cause code as indicated in the description of the recall alignment procedure.

The SETUP message is constructed from the *Setup Container IE* received in the CC ESTABLISHMENT MESSAGE. The mobile station shall assume that the *Setup Container IE* contains an entire SETUP message with the exception of the Protocol Discriminator, Transaction ID and Message Type elements. The mobile station may assume that the contents of the *Setup Container IE* are the same as were sent from the subscriber in a previous SETUP message of the mobile originating call establishment attempt. The mobile station shall copy the *Setup Container* to the SETUP message and not modify the contents except as defined in the recall alignment procedure and as defined in *exceptions* below. The mobile station shall not add other Information Elements to the end of the SETUP message.

Exceptions:

Bearer Capability IE(s), *HLC IE(s)* and *LLC IE(s)* (including *Repeat Indicator(s)*, if there are 2 bearer capabilities), and the *Supported Codec List IE* require handling as described in the recall alignment procedure below.

If the *CC Capabilities* in the *Setup Container IE* is different to that supported by the mobile station, the mobile station shall modify the *CC Capabilities* in the SETUP message to indicate the true capabilities of the mobile station.

Facility IE(s) and *SS Version IE(s)* require handling as described in the recall alignment procedure.

Stream Identifier IE requires handling as described in the recall alignment procedure.

If no response to the CC-ESTABLISHMENT message is received by the call control entity of the network before the expiry of timer T333, then the network shall initiate clearing procedures towards the called mobile station using a RELEASE COMPLETE message with cause #102 "recovery on timer expiry" and inform all appropriate entities within the network, proceeding in accordance with subclause 5.4.2.

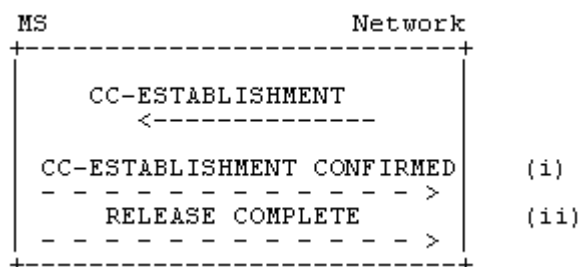

Figure 5.7a/3GPP TS 24.008 Call initiation and possible subsequent responses.

5.2.3.2.1 Recall Alignment Procedure

The recall alignment procedure consists of three parts:

- basic service group alignment,
- facility alignment, and
- stream identifier alignment.

Basic service group alignment:

The mobile station shall check that the *Bearer Capability*, *HLC* and *LLC* and *Repeat Indicator* fields, which are embedded in the *Setup Container IE*, match a basic service group supported by the mobile station.

If this check fails, then the recall alignment procedure has failed. The mobile station shall use the cause #88 "incompatible destination" afterwards.

Otherwise, the mobile station is allowed to alter the content within the *Bearer Capability*, *HLC* and *LLC* Information Elements (e.g. the speech codec version(s), the data rate, the radio channel requirement) provided that the basic service group is not changed. Furthermore, for speech calls the mobile station is allowed to add or remove the *Supported Codec List* Information Element, or to alter the contents of this information element dependent on the codecs supported by the mobile station. The result shall be that the mobile station has derived *Bearer Capability*, *HLC*, *LLC*, and *Supported Codec List* Information Elements, which it can use for a later call setup according to its configuration and capabilities.

Facility alignment:

This only applies if the *Setup Container* contains 1 or more *Facility IEs*. Each *Facility IE* within the *Setup Container* will be associated with the common *SS Version IE*, if present. The handling for each *Facility IE* is defined below. The mobile station shall align each facility IE contained in the *Setup Container*. The rules defined in 3GPP TS 24.010 [21] also apply.

The *Facility IE* is encoded as 'simple recall alignment', 'advanced recall alignment' or 'recall alignment not essential' (see 3GPP TS 24.010 [21]). If the encoding indicates, that

- a simple recall alignment is required, the mobile station shall copy the Facility IE and the common SS version IE from the *Setup Container* to the SETUP message without modifying the content.
- an advanced recall alignment is required, the mobile station must recognise and support the operation defined in the facility. If the mobile station does not recognise or support the operation, then the recall alignment procedure has failed and the mobile station shall use the cause #29 "facility rejected" in the subsequent rejection of the CC establishment request.
- the recall alignment is not essential, then the facility operation is not an essential part of the SETUP. If the MS does not recognise the operation then the SS Version IE and Facility IE are discarded, and NOT copied into the SETUP message.

NOTE: A mobile station may include a *Facility IE* without an associated *SS Version IE*. This would indicate that the SS operation is encoded using Phase 1 protocols.

Further details on Facility handling are given in 3GPP TS 24.010 [21].

Stream identifier alignment:

The mobile station shall check whether the *Stream Identifier* field is contained in the *Setup Container* or not.

If the *Stream Identifier* is contained in the *Setup Container*, the mobile station shall behave as one of the following.

- the mobile station re-assign the *Stream Identifier* value, and modify the *Stream Identifier* field.
- the mobile station remove the *Stream Identifier* field.

If the *Stream Identifier* is not contained in the *Setup Container*, the mobile station may behave as follows.

- the mobile station assign the *Stream Identifier* value, and add the *Stream Identifier IE* to the end of the SETUP message.

5.2.3.3 CC-Establishment confirmation

The call control entity of the network in the "CC-establishment present" state, shall, upon receipt of a CC-ESTABLISHMENT CONFIRMED message, stop timer T333 and enter the "CC-establishment confirmed" state.

For speech calls, if the ESTABLISHMENT CONFIRMED message contains a *Supported Codec List* information element, the network shall use this list to select the codec for UMTS. If no *Supported Codec List* information element is received, then for UMTS the network shall select the default UMTS speech codec according to subclause 5.2.1.11.

Codecs for GERAN shall be selected from the codecs indicated in the *Supported Codec List* information element or in the *Bearer Capability* information element. If neither a *Supported Codec List* information element nor a *Bearer Capability* information element is received, then for GERAN the network shall select GSM full rate speech version 1.

Codec information that does not apply to the currently serving radio access shall be used by the network if an inter-system change occurs.

In the "CC-establishment confirmed" state, the network sends a RECALL message. This message initiates user alerting and also shall include the Facility IE (providing additional information to be presented to the user for notification). The network starts timer T334 and enters the 'recall present' state.

Upon reception of the RECALL message the Mobile station stops T335 and enters the "recall present" state.

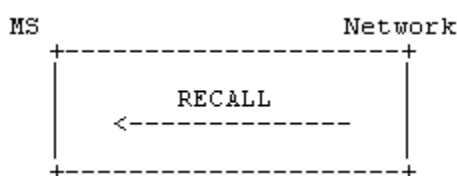

Figure 5.7b/3GPP TS 24.008 Recall

5.2.3.4 Recall present

In the "recall present" state, the call control entity in the mobile station waits for acceptance of the Recall by the user. Once confirmation is received, the mobile station indicates acceptance of a recall by

- sending a SETUP message to its peer entity in the network;
- starting Timer T303; and
- entering the "call initiated" state and proceeding as described in subclause 5.2.1.1.

The MS shall ensure that the contents of the *Bearer Capability IE(s)* and *Supported Codec List IE* sent in the SETUP message are the same as the *Bearer Capability IE(s)* and *Supported Codec List IE* in the previous CC-ESTABLISHMENT CONFIRMED message related to this Network Initiated MO Call.

In the "recall-present" state, if the user of a mobile station is User Determined User Busy then a RELEASE COMPLETE message shall be sent with cause #17 "user busy" In the "recall-present" state. If the user of a mobile station wishes to reject the recall then a RELEASE COMPLETE message shall be sent with cause #21 "call rejected".

In either case, the mobile shall release the connection in accordance with subclause 5.4.2

On receipt of the SETUP message in the "recall present" state, the network shall stop timer T334 and proceed as specified in subclause 5.2.1.2.

If the call control entity of the network does not receive a SETUP message before the expiry of timer T334, then the network shall send a RELEASE COMPLETE message to the mobile using cause #102 "recovery on timer expiry", release the MM connection, enter the "null" state and shall inform all appropriate entities within the network.

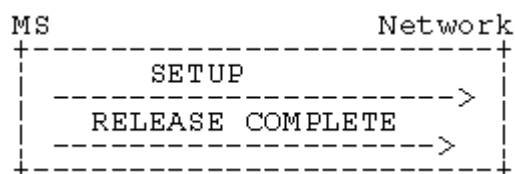

Figure 5.7b/3GPP TS 24.008 Recall acceptance or rejection by user

5.2.3.5 Traffic channel assignment during network initiated mobile originating call establishment

It is a network dependent decision whether or not to initiate the assignment of a traffic channel during the "CC-establishment confirmed" state.

5.2.4 Call establishment for SRVCC or vSRVCC

5.2.4.1 General

Before call establishment for SRVCC or vSRVCC can be initiated in the mobile station, the MM connection must be established by the network.

At PS to CS domain change from S1 mode or Iu mode due to SRVCC handover or vSRVCC handover (see 3GPP TS 23.216 [126]), the RR sublayer in the MS indicates to the MM layer if a voice only SRVCC handover or a voice and video SRVCC handover was completed successfully. At reception of this indication, the MS that supports SRVCC or vSRVCC shall establish an MM connection as specified in subclause 4.5.1.8 and either proceeds with subclause 5.2.4.2 if the indication is that voice only SRVCC was completed successfully or proceeds with subclause 5.2.4.2a if the indication is that voice and video SRVCC was completed successfully.

At 5G-SRVCC handover from NG-RAN to UTRAN (see 3GPP TS 23.216 [126]), the RR sublayer in the MS indicates to the MM layer if 5G-SRVCC handover from NG-RAN to UTRAN was completed successfully. At reception of this indication, the MS that supports 5G-SRVCC handover from NG-RAN to UTRAN shall establish an MM connection as specified in subclause 4.5.1.8 and proceeds with subclause 5.2.4.2 if the indication is that 5G-SRVCC handover from NG-RAN to UTRAN was completed successfully.

5.2.4.2 Call activation for SRVCC

If the MS

- supports SRVCC and the MS has a voice media stream previously carried over the PS domain that is handed over to the CS domain via SRVCC;
- supports SRVCC or vSRVCC and the MS has a voice media stream and a video media stream of a single session previously in S1 mode carried over the PS domain and only the voice media stream is handed over to the CS domain via SRVCC; or
- supports 5G-SRVCC handover from NG-RAN to UTRAN and the MS has a voice media stream previously in the N1 mode that is handed over to the CS domain via 5G-SRVCC handover from NG-RAN to UTRAN

and the session is in the "confirmed" state (defined in IETF RFC 3261 [137]), and the call control entity in "null" state receives indication "MM connection establishment due to SRVCC handover", the call control entity of the MS shall enter the "active" state, set the auxiliary state (defined in 3GPP TS 24.083 [27]) to "idle", set the multi party auxiliary state (defined in 3GPP TS 24.084 [28]) to "idle" and indicate the call establishment to upper layers. The MS and the network shall locally set the TI value of the call to "000" and the TI flag value as in mobile terminated call. If a single voice media stream is handed over and:

- if the session is on hold, the setting of the auxiliary state (as defined in 3GPP TS 24.083 [27]) is described in 3GPP TS 24.237 [136]; and
- if the session is a conferencing session, the setting of the multi party auxiliary state (as defined in 3GPP TS 24.084 [28]) is described in 3GPP TS 24.237 [136].

If the MS supports single radio PS to CS access transfer for calls in alerting state as specified in 3GPP TS 24.237 [136] subclause 12.2.3B, and the MS has a single voice media stream over the PS domain that is handed over to the CS domain via SRVCC, and the call control entity of the MS in the "null" state receives an indication "MM connection establishment due to SRVCC handover" then:

- the call control entity shall indicate to the upper layers that call establishment is due to SRVCC handover;
- if the upper layers indicate that the media stream(s) is/are associated with a mobile originated session in the "early" state (defined in IETF RFC 3261 [137]) according to the conditions specified in 3GPP TS 24.237 [136] subclause 12.2.3B.3.2, the call control entity of the MS shall enter the "call delivered" state for this transaction. The MS and the network shall locally set the TI value of the call to "000" and the TI flag value as in mobile terminated call; and
- if the upper layers indicate that the media stream(s) is/are associated with a mobile terminating session in the "early" state (defined in IETF RFC 3261 [137]) according to the conditions specified in 3GPP TS 24.237 [136] subclause 12.2.3B.3.1, the call control entity of the MS shall enter the "call received" state for this transaction. The MS and the network shall locally set the TI value of the call to "000" and the TI flag value as in mobile terminated call.

If the MS supports single radio PS to CS SRVCC for originating calls in pre-alerting phase as specified in 3GPP TS 24.237 [136] subclause 12.2.3B, and the MS has a single voice media stream over the PS domain that is handed over to the CS domain via SRVCC, and the call control entity of the MS in the "null" state receives an indication "MM connection establishment due to SRVCC handover" then:

- the call control entity shall indicate to the upper layers that call establishment is due to SRVCC handover; and
- if the upper layers indicate that the media stream(s) is/are associated with a mobile originated session in the "early" state (defined in IETF RFC 3261 [137]) according to the conditions specified in 3GPP TS 24.237 [136] subclause 12.2.3B.3.3, the call control entity of the MS shall enter the "mobile originating call proceeding" state for this transaction. The MS and the network shall locally set the TI value of the call to "000" and the TI flag value as in mobile terminated call.

If the MS supports single radio PS to CS SRVCC for terminating calls in pre-alerting phase as specified in 3GPP TS 24.237 [136] subclause 12.2.3B, and the MS has a single voice media stream over the PS domain that is handed over to the CS domain via SRVCC, and the call control entity of the MS in the "null" state receives an indication "MM connection establishment due to SRVCC handover" then:

- the call control entity shall indicate to the upper layers that call establishment is due to SRVCC handover; and
- if the upper layers indicate that the media stream(s) is/are associated with a mobile terminated session in the "early" state (defined in IETF RFC 3261 [137]) according to the conditions specified in 3GPP TS 24.237 [136] subclause 12.2.3B.3.2, the call control entity of the MS shall enter the "call present" state for this transaction. The MS and the network shall locally set the TI value of the call to "000" and the TI flag value as in mobile terminated call.

If the MS has additional voice media streams carried over the PS domain that are handed over to the CS domain via SRVCC, the call states for the transactions and the setting of the TI value and TI flag for these additional media streams are described in 3GPP TS 24.237 [136].

If the MS supports multicall, the MS shall locally set SI value to "1" and the MS shall assume that the network does not support multicall. The network shall also locally set SI value to "1".

If the MS has a mobile originating session in the "early" state (as defined in IETF RFC 3261 [137]) and is providing an internally generated alerting indication to the user prior to the SRVCC handover, then after transitioning from the PS domain, the MS shall continue to provide the internal alerting indication to the user. The alerting indication is stopped when the user connection is attached.

If the MS has a mobile originated session established upon a request from the upper layers to establish an eCall over IMS, then after transitioning from the PS domain, the MS shall support inband transfer of the updated MSD according to 3GPP TS 26.267 [161].

5.2.4.2a Call activation for vSRVCC

If the MS supports vSRVCC, the MS has a voice media stream and a video media stream of a single session previously in S1 mode carried over the PS domain that are handed over to the CS domain via vSRVCC, the session associated with these media streams is in the "confirmed" state (defined in IETF RFC 3261 [137]), and the call control entity in "null" state receives indication "MM connection establishment due to vSRVCC handover", then the call control entity of the MS shall enter the "active" state, set the auxiliary state (defined in 3GPP TS 24.083 [27]) to "idle", set the multi party auxiliary state (defined in 3GPP TS 24.084 [28]) to "idle" and indicate the call establishment is due to vSRVCC handover to the upper layers. The MS and the network shall locally set the TI value of the call to "000" and the TI flag value as in mobile terminated call.

If the MS supports single radio PS to CS access transfer for calls in alerting state as specified in 3GPP TS 24.237 [136] subclause 12.2.3B, and the MS has a single voice media stream and a single video media stream carried over the PS domain that is handed over to the CS domain via vSRVCC, and the call control entity of the MS in the "null" state receives indication "MM connection establishment due to vSRVCC handover" then:

- the call control entity shall indicate to the upper layers that call establishment is due to vSRVCC handover;
- if the upper layers indicate that the media stream(s) is/are associated with a mobile originated session in the "early" state (defined in IETF RFC 3261 [137]) according to the conditions specified in 3GPP TS 24.237 [136] subclause 12.2.3B.3.2, the call control entity of the MS shall enter the "call delivered" state for this transaction. The MS and the network shall locally set the TI value of the call to "000" and the TI flag value as in mobile terminated call; and
- if the upper layers indicate that the media stream(s) is/are associated with a mobile terminating session in the "early" state (defined in IETF RFC 3261 [137]) according to the conditions specified in 3GPP TS 24.237 [136] subclause 12.2.3B.3.1, the call control entity of the MS shall enter the "call received" state for this transaction. The MS and the network shall locally set the TI value of the call to "000" and the TI flag value as in mobile terminated call.

If the MS supports single radio PS to CS SRVCC for originating calls in pre-alerting phase as specified in 3GPP TS 24.237 [136] subclause 12.2.3B, and the MS has a single voice media stream and a single video media stream carried over the PS domain that is handed over to the CS domain via vSRVCC, and the call control entity of the MS in the "null" state receives indication "MM connection establishment due to vSRVCC handover" then:

- the call control entity shall indicate to the upper layers that call establishment is due to vSRVCC handover; and
- if the upper layers indicate that the media stream(s) is/are associated with a mobile originated session in the "early" state (defined in IETF RFC 3261 [137]) according to the conditions specified in 3GPP TS 24.237 [136] subclause 12.2.3B.3.3, the call control entity of the MS shall enter the "mobile originating call proceeding" state for this transaction. The MS and the network shall locally set the TI value of the call to "000" and the TI flag value as in mobile terminated call.

If the MS supports single radio PS to CS SRVCC for terminating calls in pre-alerting phase as specified in 3GPP TS 24.237 [136] subclause 12.2.3B, and the MS has a single voice media stream and a single video media stream carried over the PS domain that is handed over to the CS domain via vSRVCC, and the call control entity of the MS in the "null" state receives indication "MM connection establishment due to vSRVCC handover" then:

- the call control entity shall indicate to the upper layers that call establishment is due to vSRVCC handover; and
- if the upper layers indicate that the media stream(s) is/are associated with a mobile originated session in the "early" state (defined in IETF RFC 3261 [137]) according to the conditions specified in 3GPP TS 24.237 [136] subclause 12.2.3B.3.2, the call control entity of the MS shall enter the "call present" state for this transaction. The MS and the network shall locally set the TI value of the call to "000" and the TI flag value as in mobile terminated call.

If the MS supports multicall, the MS shall locally set SI value to "1" and the MS shall assume that the network does not support multicall. The network shall also locally set SI value to "1". If the MS has a mobile originating session in the "early" state (as defined in IETF RFC 3261 [137]) and is providing an internally generated alerting indication to the user prior to the vSRVCC handover, then after transitioning from the PS domain, the MS shall continue to provide the internal alerting indication to the user. The alerting indication is stopped when the user connection is attached.

5.2.4.2b Multimedia CAT and vSRVCC handover

If the MS has a mobile originating session in the "early" state (as defined in IETF RFC 3261 [137]) and is receiving multimedia CAT over the PS domain prior to the vSRVCC handover, then after transitioning from the PS domain, the MS stops providing the early media to the user and may internally generate an alerting indication. The alerting indication is stopped when the user connection is attached.

5.2.4.3 Traffic channel assignment and user connection attachment

An appropriate traffic channel for the call is assigned in SRVCC handover, vSRVCC handover or 5G-SRVCC handover from NG-RAN to UTRAN.

For SRVCC handover or 5G-SRVCC handover from NG-RAN to UTRAN, the mobile station shall attach the user connection:

- when the call control entity enters the "active" state or the "call received" state;
- when the call control entity enters the "call delivered" state, if prior to SRVCC the MS in the PS domain was receiving media for the session subjected to SRVCC handover or 5G-SRVCC handover from NG-RAN to UTRAN; and
- when the call control entity enters the "mobile originating call proceeding" state, if prior to SRVCC the MS in the PS domain was receiving media for the session subjected to SRVCC handover or 5G-SRVCC handover from NG-RAN to UTRAN.

NOTE: The attachment of the user connection prior to entering the "active" state allows the network to provide in-band tones and announcements to the UE.

For vSRVCC handover, the mobile station shall attach the user connection when the call control entity enters the "active" state.

For SRVCC or vSRVCC handover to a speech call, the principles of speech codec selection are described in subclause 5.2.1.11.

For vSRVCC handover to a circuit-switched multimedia call, further requirements are specified in subclause 5.3.6.6.

5.2.4.4 State verification

The network may check the call and auxiliary states of its peer entity as specified in subclause 5.5.3.1 when the PS to CS access transfer is complete.

5.3 Signalling procedures during the "active" state

5.3.1 User notification procedure

The mobile terminating user notification procedure allows the network to notify a mobile station of any appropriate call-related event during the "active" state of a call. The procedure consists in the network sending a NOTIFY message to the mobile station. No state change occurs at any of the interface sides following the sending or the receipt of this message (but an appropriate indication may optionally be generated in the mobile station).

The mobile originating notification procedure allows the mobile station to notify the remote user of any appropriate call-related event during the "active" state of a call by sending a NOTIFY message containing a notification indicator to the network; upon receipt of this message, the network sends a NOTIFY message containing the same notify indicator to the other user involved in the call. No state change occurs at any of the interface sides following the sending or the receipt of this message.

5.3.2 Call rearrangements

Call rearrangements on the radio interface are not supported by explicit messages (e.g. SUSPEND and RESUME messages as defined in ETSI ETS 300 102-1 [70]). However if a remote non-PLMN user initiates call rearrangements, the network shall inform the mobile station by means of a NOTIFY message. In a similar way the mobile station can

inform the network about rearrangements by sending a NOTIFY message (e.g. change of user equipment connected to the mobile station).

5.3.3 Codec Change Procedure

During a speech call in UMTS, if a mobile station supports more than one UMTS codec, the network can change the UMTS codec via RRC procedures. In order to request the mobile station to change the codec, the network shall send the new selected codec type in the NAS Synchronisation Indicator IE (RRC protocol), see subclause 5.2.1.11.

5.3.4 Support of Dual Services

The behaviour described in this subclause is used to realize the following required services throughout subclause 5.3.4. The mobile station is not obliged to support the network originated in-call modification procedure. In that case, the mobile station shall, when receiving a MODIFY message, treat the message as unknown and react as described in subclause 8.4. If the mobile station is already prepared to support the procedure in both directions, it shall act as described in this subclause.

Alternate Speech/Group 3 fax (Teleservice 61 according to 3GPP TS 22.003 [4]).

5.3.4.1 Service Description

This circuit switched service allows the two users on a point-to-point connection to use the connection between them for different information transfer during the same call, but not at the same time.

If the negotiation during call establishment leads to the recognition of the above mentioned services, the in-call modification procedure is allowed to be executed within the current call by changing from one call mode to the other.

In some cases the in-call modification procedure makes it necessary to change the channel configuration by allocating a new channel and in other cases to change channel configuration parameters while keeping the previously allocated channel. This change is determined by the network, which initiates either the channel assignment procedure, handover procedure or channel mode modify procedure (see clause 3).

The capability and the initial mode desired must be identified by the mobile station by identifying each mode of operation with a separate information element during call establishment. Further the type of change between the modes must be identified by means of the repeat indicator:

mode 1 "alternate" mode 2.

5.3.4.2 Call establishment

For both mobile originating and mobile terminating calls, the normal call establishment procedures apply.

5.3.4.2.1 Mobile Originating Establishment

The service is requested by the originating mobile station by transferring a SETUP message to the network containing the *BC repeat indicator* IE, the *bearer capability 1* information element, and the *bearer capability 2* information element. The first mode of operation ("call mode") shall be indicated by the *bearer capability 1* information element and the second call mode by the *bearer capability 2* information element.

A low layer compatibility may optionally be specified for each call mode in a *low layer compatibility I* and *low layer compatibility II* information element. In that case:

- the SETUP message shall contain the *LLC repeat indicator* IE and both *low layer compatibility I* and *low layer compatibility II* information elements. The *low layer compatibility I* information element then corresponds to the *bearer capability 1* information element and the *low layer compatibility II* information element to the *bearer capability 2* information element;
- if no low layer compatibility specification applies for one of the two call modes, the corresponding low layer compatibility IE (*low layer compatibility I* or *low layer compatibility II*) shall indicate "not applicable";
- the *LLC repeat indicator* shall specify the same repeat indication as the *BC repeat indicator* IE.

Similarly, a high layer compatibility may optionally be specified for each call mode in a *high layer compatibility i* and *high layer compatibility ii* information element. In that case:

- the SETUP message shall contain the *HLC repeat indicator* IE and both *high layer compatibility i* and *high layer compatibility ii* information elements. The *high layer compatibility i* information element then corresponds to the *bearer capability 1* information element and the *high layer compatibility ii* information element to the *bearer capability 2* information element;
- if no high layer compatibility specification applies for one of the two call modes, the corresponding high layer compatibility IE (*high layer compatibility i* or *high layer compatibility ii*) shall indicate "not applicable";
- the *HLC repeat indicator* shall specify the same repeat indication as the *BC repeat indicator* IE.

The receiving entity shall ignore whether the *LLC repeat indicator* IE or *HLC repeat indicator* are contained in the message or not; it shall also ignore the repeat indication of an *LLC repeat indicator* IE or *HLC repeat indicator* IE. If the *low layer compatibility II* IE is not contained in the message and the *low layer compatibility I* IE is contained in the message, the receiving entity shall relate it to a call mode indicated in the message that does not specify speech (if any). If the *high layer compatibility ii* IE is not contained in the message and the *high layer compatibility i* IE is contained in the message, the receiving entity shall relate it to a call mode indicated in the message that does not specify speech (if any).

The specific part of the network which is sensitive to the call mode shall examine each mode described in the bearer capabilities included in the SETUP message by performing compatibility checking as defined in Annex B. If as a result of this compatibility checking the network decides to reject the call, then the network shall initiate call clearing as specified in subclause 5.4 with the following causes:

- a) #57 "bearer capability not authorized";
- b) #58 "bearer capability not presently available";
- c) #65 "bearer service not implemented";
- d) #70 "only restricted digital information bearer capability is available".

5.3.4.2.2 Mobile Terminating Establishment

The service is indicated to the called mobile station by a SETUP message coded in the same manner as in the mobile originating call establishment. As specified for normal terminating call establishment, the service may be indicated by the called mobile station in the CALL CONFIRMED message.

The destination mobile station shall perform the compatibility checking as defined in Annex B for both required modes if indicated in the SETUP message. If as a result of compatibility checking the mobile station decides to reject the call, the mobile station shall initiate call clearing according to the procedures of subclause 5.4 with one of the following causes:

- a) #57 "bearer capability not authorized";
- b) #58 "bearer capability not presently available";
- c) #65 "bearer service not implemented";
- d) #88 "incompatible destination".

The mobile station may accept the call if the first mode indicated is free irrespective of whether the other mode is free or busy.

5.3.4.3 Changing the Call Mode

In order to change the call mode, the following in-call modification procedures shall be used.

Either side of the radio interface may act as the requesting user to invoke the in-call modification.

Upon each successful completion of the in-call modification procedure, the call changes to the next mode negotiated and agreed during the establishment phase of the call.

The in-call modification procedures are completely symmetrical at the radio interface.

5.3.4.3.1 Initiation of in-call modification

The procedure is initiated by the requesting originating side in the "active" state of the call. It shall send a MODIFY message including the new mode to be changed to. The requesting originating side shall also start timer T323 and enter the "mobile originating modify" state (mobile station side) or the "mobile terminating modify" state (network side). The new mode given in the MODIFY message shall be one of those already negotiated and agreed during the establishment phase of the call. If the data call direction is different from the direction of the call setup a reverse call setup direction IE shall be included in the MODIFY message; otherwise this IE shall not be included.

If the in-call modification is originated by the mobile station, the mobile station shall reserve any internal resources necessary to support the next call mode, stop sending Bm-channel information; and stop interpreting received Bm-channel information according to the old call mode.

If the in-call modification is originated by the network, the network may reserve any internal resources necessary to support the next call mode. The network shall stop sending Bm-channel information and stop interpreting received Bm-channel information according to the old call mode at the latest when it changes the channel configuration.

Upon receipt of the MODIFY message, the destination side shall check to ensure that the requested call mode can still be supported and if so, it shall initiate the reservation of any resources necessary to support the next call mode; start T324 (mobile station side only) if the in-call modification procedure is triggered as a result of a service change from speech to UDI/RDI multimedia modes; and enter the "mobile originating modify" (network side) or "mobile terminating modify" state (mobile station side).

5.3.4.3.2 Successful completion of in-call modification

If the destination network/mobile station receives a MODIFY message with a new mode which is already the actual one of the call the network/mobile station shall remain in the "active" state; send a MODIFY COMPLETE message with the actual mode; and shall not initiate anything else.

If the requested mode is speech and if during call establishment the network received a *Supported Codec List* IE, the network shall use this list to select the codec for UTRAN. If no *Supported Codec List* information element is received, then for UTRAN the network shall select the default UMTS speech codec according to subclause 5.2.1.11.

Codecs for GERAN shall be selected from the codecs indicated in the *Supported Codec List* information element or in the *Bearer Capability* information element. If neither a *Supported Codec List* information element nor a *Bearer Capability* information element is received, then for GERAN the network shall select GSM full rate speech version 1.

If the *Supported Codec List* IE is received, then the network shall indicate the codec selected for Iu mode to the mobile station via RANAP and RRC protocol in the NAS Synchronisation Indicator IE (see subclause 5.2.1.11).

If the in-call modification was originated by the mobile station, the mobile station and the network shall proceed as follows:

If the requested mode is not the actual one and can be supported by the network it shall change the channel configuration, if required, and step on to any internal resources necessary to support the next call mode. If the requested mode is a data or facsimile mode, it shall also perform the appropriate means to take the direction of the data call into account. After successful change of the channel configuration it shall start sending user information according to the next call mode and start interpreting received user channel information according to the next call mode; send a MODIFY COMPLETE message with the new call mode included and enter the "active" state (network side). If the MODIFY message had contained a *reverse call setup direction* IE, the same IE shall be included in the MODIFY COMPLETE message.

Upon receipt of the MODIFY COMPLETE message the mobile station shall: initiate the alternation to those resources necessary to support the next call mode; stop timer T323; and enter the "active" state (mobile station side).

If the in-call modification was originated by the network, the mobile station and the network shall proceed as follows:

If the requested mode is not the actual one and can be supported by the mobile station it shall reserve any internal resources necessary to support the next call mode.

NOTE: For a change from speech to a different call mode, user interaction may be required, before the mobile decides that the requested mode can be supported.

If the requested mode is a data or facsimile mode, it shall also perform the appropriate means to take the direction of the data call into account. The mobile station shall send a MODIFY COMPLETE message with the new call mode included, stop timer T324 and enter the "active" state (mobile station side). If the MODIFY message had contained a *reverse call setup direction* IE, the same IE shall be included in the MODIFY COMPLETE message. If the old call mode is speech, the mobile station shall continue sending Bm-channel information and interpreting received Bm-channel information for speech until the network modifies its channel configuration.

After receipt of the MODIFY COMPLETE message the network shall: reserve any internal resources necessary to support the next call mode, stop sending Bm-channel information, and stop interpreting received Bm-channel information according to the old call mode, unless these actions were already performed earlier. Furthermore, the network shall change the channel configuration, if required; after successful change of the channel configuration initiate the alternation to those resources necessary to support the next call mode; stop timer T323; and enter the "active" state (network side).

The mobile station shall start sending user information according to the next call mode and start interpreting received user channel information according to the next call mode as soon as a suitable channel for the new mode is available.

In both cases:

For an alternate speech/facsimile group 3 service (refer to subclause 5.3.4) the old resources may still be kept reserved.

The reaction of the originating side if it had included a reverse call setup direction IE in the MODIFY message, but the destination side did not include the IE in the MODIFY COMPLETE message is implementation dependent.

5.3.4.3.3 Change of the channel configuration

In case the requested bearer capability cannot be supported by the current channel configuration the network shall initiate the assignment procedure and change the channel configuration accordingly.

5.3.4.3.4 Failure of in-call modification

5.3.4.3.4.1 Network rejection of in-call modification

If the network cannot support the change to the requested call mode or if the change of the channel configuration fails the network shall: release the resources which had been reserved for the alternation; send a MODIFY REJECT message with the old bearer capability and with cause # 58 "bearer capability not presently available" to the initiating mobile station; and enter the "active" state. If the change of the channel configuration fails, the network shall return to the internal resources required for the old call mode.

Upon receipt of the MODIFY REJECT message with the old bearer capability the initiating mobile station shall: stop timer T323; release any resources which had been reserved for the alternation; resume sending user channel information according to the present call mode; resume interpreting received user channel information according to the present call mode; and enter the "active" state.

5.3.4.3.4.2 Mobile station rejection of in-call modification

If the mobile station cannot support the change to the requested call mode, the mobile station shall: stop timer T324; release any resources which had been reserved for the alternation; send a MODIFY REJECT message with the old bearer capability and cause # 58 "bearer capability not presently available", and enter the "active" state.

Upon receipt of the MODIFY REJECT message the network shall: stop timer T323, release any resources which had been reserved for the alternation.

5.3.4.3.4.3 Time-out recovery

Upon expiration of T323 in either the mobile station or the network the procedures for call clearing shall be initiated (see subclause 5.4) with cause # 102 "recovery on timer expiry".

Upon expiration of T324 the mobile station shall: release any resources which had been reserved for the alternation; send a MODIFY REJECT message with the old bearer capability and cause #58 "bearer capability not presently available"; and enter the "active" state.

5.3.4.4 Abnormal procedures

If a MODIFY, MODIFY COMPLETE or MODIFY REJECT message is received in the "disconnect indication", "disconnect request" (mobile station side only) or "release request" state then the received message shall be discarded and no action shall be taken.

If a MODIFY COMPLETE message indicating a call mode which does not correspond to the requested one is received or if a MODIFY REJECT message indicating a call mode which does not correspond to the actual one is received then the received message shall be discarded and no action shall be taken.

If a MODIFY message indicating a call mode which does not belong to those negotiated and agreed during the establishment phase of the call, is received, then a MODIFY REJECT message with the actual call mode and with cause # 57 "bearer capability not authorized" shall be sent back.

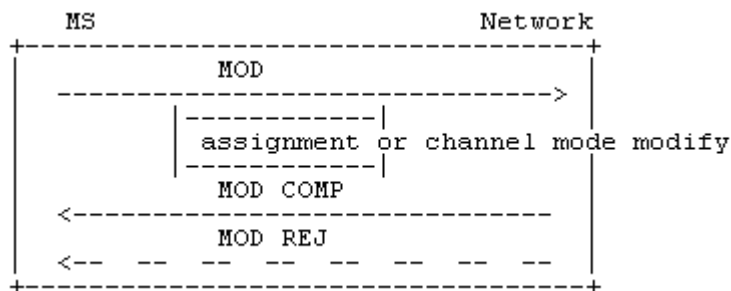

Figure 5.10a/3GPP TS 24.008 In-call modification sequence initiated by MS

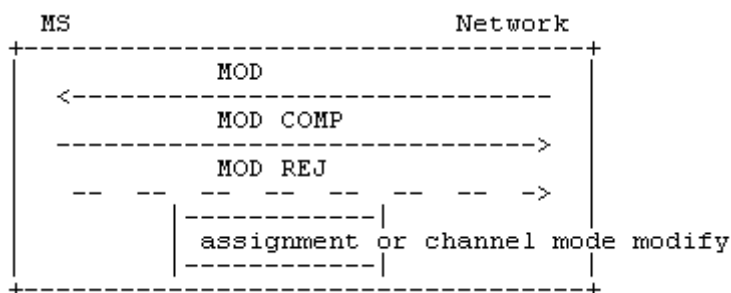

Figure 5.10b/3GPP TS 24.008 In-call modification sequence initiated by network

5.3.5 User initiated service level up- and downgrading (A/Gb mode and GERAN lu mode only)

The user initiated service level up- and downgrading is applicable for non-transparent multislot data services, only. By means of this procedure the user can request a change of the "maximum number of traffic channels" and/or "wanted air interface user rate" parameters, to be assigned by the network.

5.3.5.1 Initiation of service level up- and downgrading

The procedure is initiated by the mobile station in the "active" state of the call. It shall:

- send a MODIFY message including the wanted value of the "maximum number of traffic channels" and/or the "wanted air interface user rate" parameters;
- not change any of the other, possibly negotiated, parameters of the bearer capability information element;
- start timer T323; and
- enter the "mobile originating modify" state.

Any internal resources necessary to support the next service parameters shall be reserved. If a dual service was negotiated at call setup, the mobile station shall initiate the service level up- or down-grading only during the data phase of the dual service.

Upon receipt of the MODIFY message, the network shall check if the indicated maximum number of traffic channels can be supported and enter the "mobile originating modify" state.

5.3.5.2 Successful completion of service level up- and downgrading

The network may upon reception of the MODIFY message initiate a change of the channel configuration assigned to the mobile station.

As a response to the MODIFY message the network sends a MODIFY COMPLETE message including the bearer capability negotiated at call setup and enters the "active" state.

Upon receipt of the MODIFY COMPLETE message the mobile station shall stop timer T323 and enter the "active" state.

5.3.5.3 Rejection of service level up- and downgrading

If a change of bearer service is requested together with a change of the "maximum number of traffic channels" and/or the "wanted air interface user rate", or if the current used service is not a data service where up- and downgrading is applicable, or if the receiver chooses not to grant the request, the network shall:

- send a MODIFY REJECT message with bearer capability negotiated at call setup and with cause #58 "bearer capability not presently available";
- enter the "active" state.

Upon receipt of the MODIFY REJECT message with the bearer capability negotiated at call setup, the mobile station shall: stop timer T323 and enter the "active" state.

5.3.5.4 Time-out recovery

Upon expiration of T323 in the mobile station the procedures for call clearing shall be initiated with cause #102 "recovery on timer expiry".

5.3.6 Support of multimedia calls

5.3.6.1 Service description

The 3GPP circuit-switched multimedia call is based on the 3G-324M (see 3GPP TS 26.111 [80]), which is a 3GPP-variant of the ITU-T Recommendation H.324 [146]. CS Multimedia telephony is a Bearer Service, which utilizes the Synchronous Transparent Data service (BS30), see 3GPP TS 22.002 [3].

At the multimedia call setup the required call type, 3G-324M, is indicated, for the network to be able to invoke appropriate interworking functionality. In the peer end the H.324 information is used to invoke the terminal application. In addition to H.324 indication the terminal must select Information Transfer Capability (ITC) for the multimedia call. The 'correct' ITC depends on the peer end and the transporting networks; an all-ISDN call is a UDI/RDI call, and a call, which involves PSTN, is an analog "3.1 kHz audio" call.

For the case when the setup of a multimedia call is not successful, fallback to speech is specified.

Users may also request a service change between UDI/RDI multimedia and speech modes during a call (see 3GPP TS 23.172 [97]).

5.3.6.2 Call establishment

For both mobile originating and mobile terminating calls, the normal call establishment procedures apply, with the exceptions specified in the following subclauses.

For further description of the function of MSC/IWF in the following clauses, see 3GPP TS 29.007 [38].

5.3.6.2.1 Mobile originated multimedia call establishment

At call setup the required call type, 3G-324M, is indicated by the originating MS in the SETUP message, with the *bearer capability IE* parameter Other Rate Adaption set to "H.223 and H.245".

For analogue multimedia, the support of a fallback to speech is requested by including two *bearer capability IEs*, multimedia first and speech as the second BC in the SETUP message. The MS shall indicate fallback to speech by these two BC IEs and the associated Repeat Indicator set to "support of fallback".

For UDI/RDI multimedia, the support of a fallback and service change is requested by including two *bearer capability IEs*, with the first BC as the preferred service in the SETUP message. The MS shall indicate service change and fallback by these two BC IEs and the associated Repeat Indicator set to "support of service change and fallback".

If the *bearer capability IE* is received from the MS either in A/Gb or GERAN Iu mode and indicates no A/Gb mode support for the requested bearer service, the network shall consider it as a request to perform an inter-system handover to UTRAN Iu mode, as described in 3GPP TS 23.009 [114] subclause 14.2.

The bearer compatibility checking in the network is according to subclause 5.3.4.2.1.

If the MS requested for an analogue multimedia call with fallback to speech, or for a UDI/RDI multimedia call with fallback and service change, and the network accepts the call, the network has the following options for the inclusion of *bearer capability IEs* in the CALL PROCEEDING message:

- if the network accepts the requested analogue multimedia call and supports fallback to speech, both multimedia and speech *bearer capability IEs* shall be included;
- if the network accepts the requested UDI/RDI multimedia call and supports fallback and service change, both multimedia and speech *bearer capability IEs* shall be included. The order of the *bearer capability IEs* determines the preferred service, and the network may reverse the order of these IEs (see 3GPP TS 23.172 [97], subclause 4.2.1);
- if the network accepts a multimedia (only) call, a multimedia *bearer capability IE* shall be included;
- if the network accepts a speech (only) call, a speech *bearer capability IE* shall be included;
- for a UDI/RDI multimedia call, if the network accepts the requested speech call and supports service change, both multimedia and speech *bearer capability IEs* shall be included. The order of the *bearer capability IEs* determines the preferred service, and the network may reverse the order of these IEs (see 3GPP TS 23.172 [97], subclause 4.2.1);
- if the network received a UDI/RDI multimedia *bearer capability IE* with FNUR equal to 32kbit/s and a speech *bearer capability IE* in the SETUP message, the network shall not release the call, but shall reply with one *bearer capability IE* only, as specified in 3GPP TS 23.172 [97].

NOTE: Service change and fallback for UDI/RDI multimedia calls is not supported with Fixed Network User Rate set to 32 kbit/s (see 3GPP TS 23.172 [97]).

If the MS requested for a multimedia call only, and the network accepts the call, the network shall always include a single multimedia *bearer capability IE* in the CALL PROCEEDING message.

The originating user shall determine (possibly by pre-configuration of the terminal) whether a digital connection is required or if the call will be an analog modem call. If the call is expected to be digital the multimedia *bearer capability IE* parameter ITC is set to UDI/RDI. In an analog call the multimedia *bearer capability IE* parameter ITC is set to "3,1 kHz audio ex PLMN". Additionally required modem type is indicated (Other Modem Type = V.34).

5.3.6.2.1.1 Fallback

If the network, during the setup of an H.324-call, detects that the transit network or the called end does not support an H.324 call (*e.g.* because of a failure in the modem handshaking in case of an analogue multimedia call), then the network initiates the in-call modification procedure (see subclause 5.3.4.3) towards the MS to modify the call mode to speech, if the MS had included a speech *bearer capability IE* in the SETUP message.

In case of a UDI/RDI multimedia call with service change and fallback, if the network detects that the called end does not support speech, then it initiates an in-call modification procedure towards the MS to modify the call mode to multimedia, if the first *bearer capability IE* was for a speech call.

5.3.6.2.2 Mobile terminating multimedia call

At call setup the required call type, 3G-324M, is indicated by the network in the SETUP message, with the *bearer capability IE* parameter. Other Rate Adaption set to 'H.223 and H.245'. ITC is either '3,1 kHz audio ex PLMN' or 'UDI/RDI'.

For analogue multimedia, if the network supports fallback to speech and the subscriber has subscription to speech, two *bearer capability IEs*, multimedia first and speech as the second BC are included in the SETUP message. The network shall indicate fallback to speech by these two BC IEs and the associated Repeat Indicator set to "support of fallback".

For UDI/RDI multimedia, if the network supports fallback and service change, and the subscriber has subscription to speech, two *bearer capability IEs*, with the first BC as the preferred service are included in the SETUP message. The network shall indicate service change and fallback by these two BC IEs and the associated Repeat Indicator set to "service change and fallback".

If the *bearer capability IE* is received from the MS either in A/Gb or GERAN Iu mode and indicates no A/Gb mode support for the requested bearer service, the network shall consider it as a request to perform an inter-system handover to UTRAN Iu mode, as described in 3GPP TS 23.009 [114] subclause 14.2.

The *bearer capability IE(s)* may (in the case of the single numbering scheme) be missing from the SETUP message.

The bearer compatibility checking in the MS is according to subclause 5.3.4.2.2.

The MS shall indicate the supported call type(s) in the CALL CONFIRMED message, which is the acknowledgement to SETUP. If the network offered an analogue multimedia call with fallback to speech, or a UDI/RDI multimedia call with fallback and service change, the MS has the following options for the inclusion of *bearer capability IEs* in the CALL CONFIRMED message:

- if the MS/user accepts the offered analogue multimedia call and supports fallback to speech, both multimedia and speech *bearer capability IEs* shall be included;
- if the MS/user accepts the offered UDI/RDI multimedia call, and supports fallback and service change, both multimedia and speech *bearer capability IEs* shall be included. The order of the BC IEs determines the preferred service, and the MS/user may reverse the order of these IEs;
- if the MS/user accepts the offered multimedia call, but does not support fallback or service change, only a multimedia *bearer capability IE* shall be included;
- if the MS/user wishes a speech (only) call a speech *bearer capability IE* is included;
- for a UDI/RDI multimedia call, if the MS/user accepts the offered speech call and supports service change, both speech and multimedia *bearer capability IEs* shall be included. The order of the BC IEs determines the preferred service, and the MS/user may reverse the order of these IEs.

If the network offered a multimedia call only, and the MS/user accepts the call, the MS shall always include a single multimedia *bearer capability IE* in the CALL CONFIRMED message.

If the SETUP contained no *bearer capability IE* the network shall perform compatibility checking of the CALL CONFIRMED message in the same way as the compatibility checking of the SETUP message in the mobile originating call case, described in subclause 5.3.6.2.1.

5.3.6.2.2.1 Fallback to speech

If modem handshaking fails (in a modem call), the call mode will be modified to speech if a speech *bearer capability IE* was included. The modem signalling is inband, so the call must have reached the active state, when these conclusions about the presence of modems can be done. The call modifications are realized through the in-call modification procedure, by which the network requests the MS to modify the call mode (see subclause 5.3.4.3).

NOTE: Fallback from digital (UDI) H.324-call to speech after call setup is not a valid case at the terminating side.

5.3.6.3 In-call modification in the "active" state

The in-call modification procedure as described in subclause 5.3.4.3 shall be used to:

- trigger a service change between speech and UDI/RDI multimedia modes, when service change has been agreed at call setup;
- trigger a network-initiated service upgrade from speech to UDI/RDI multimedia modes (see 3GPP TS 23.172 [97]). The network shall initiate this procedure only if the mobile station indicated support of the enhanced network-initiated in-call modification procedure in the Call Control Capabilities IE at call establishment. In this case, the MODIFY message shall include the *Network-initiated Service Upgrade indicator IE*; or
- modify the multimedia bearer capability for an analogue multimedia call (restricted to the network initiated in-call modification only). In this case, the network shall send a MODIFY message including the new Bearer Capability to be changed to. The following bearer capability parameters can be modified with the procedure (see 3GPP TS 29.007 [38]):
 - Fixed Network User Rate (analogue multimedia calls only).

5.3.6.3.1 Void

5.3.6.3.2 Void

5.3.6.3.3 Void

5.3.6.3.3.1 Void

5.3.6.3.3.2 Void

5.3.6.4 Multimedia CAT during the alerting phase of a mobile originated call

A mobile station supporting multimedia CAT during the alerting phase of a mobile originated multimedia call establishment shall indicate support of this capability to the network in the Call Control Capabilities information element in the SETUP message.

The network may generate a multimedia CAT to such a mobile station before it has reached the "active" state of a call. To do so, the network shall through connect the traffic channel towards the source of the multimedia CAT and send a *progress indicator IE* indicating user attachment with progress description #9 "In-band multimedia CAT available" in either an ALERTING message or a PROGRESS message that is sent to the mobile station during call establishment.

On reception of an ALERTING or a PROGRESS message the mobile station shall proceed as specified elsewhere in clause 5; if the *progress indicator IE* indicated user attachment with progress description #9 "In-band multimedia CAT available", the mobile station shall:

- attach the user connection for multimedia as soon as an appropriate channel in multimedia mode is available; and
- set up an H.324 call.

It is up to the network to ensure that no undesired end-to-end through connection with the called party takes place during the establishment of a mobile terminated call.

The mobile station shall not abort the call if an error or H.324 call clearing occurs during the setup or the lifetime of the H.324 call during the alerting phase; the call control entity of the calling mobile station shall remain in its current state.

Upon reception of a new request from the network to attach the user connection with progress description #9 "In-band multimedia CAT available", the mobile station shall release any on-going H.324 call, and set up a new H.324 call.

NOTE: The network can request the mobile station to restart a new H.324 call during the alerting phase of the call e.g. during call forwarding scenarios to transmit to the calling party the multimedia CAT of the forwarded-to party.

The network may initiate the in-call modification procedure (see subclause 5.3.4.3) towards the MS in the "call delivered" state to modify the call mode to speech, if service change has been agreed at call setup.

Upon receiving an indication that the call has been accepted, the call control entity of the network shall send a CONNECT message to its peer entity at the calling mobile station; start timer T313 and enter the "connect indication" state. This message indicates to the call control entity of the calling mobile station that a connection has been established through the network.

On reception of a CONNECT message, the mobile station shall proceed as specified elsewhere in clause 5; the mobile station shall release any on-going H.324 call and set up a new H.324 call towards the called party.

Mobile stations supporting multimedia CAT during the alerting phase of a mobile originated multimedia call establishment should also support the Media Oriented Negotiation Acceleration procedures specified in ITU-T Recommendation H.324 Amendment 1 [117] and ITU-T Recommendation H.324 Amendment 2 [118].

5.3.6.5 DTMF transmission during a multimedia call

A mobile station supporting multimedia CAT during the alerting phase of a mobile originated multimedia call establishment should support transmission of DTMFs during a H.324 call using the H.245 UserInputIndication message (see ITU-T H.245 [119]) if it has attached the user connection for multimedia and an appropriate channel is available.

NOTE: DTMF can be used to convey to the network the end user request to stop or copy an on-going multimedia CAT.

5.3.6.6 vSRVCC handover to a circuit-switched multimedia call

Upon vSRVCC handover to a traffic channel suitable for a data call, the MS shall use a single bearer capability IE for multimedia with ITC set to "UDI" and FNUR set to 64 kbit/s for the call.

NOTE: After the MS has attached the user connection (see subclause 5.2.4.3), the MS initially uses predefined codecs for voice and video as specified in 3GPP TS 26.111 [80]. Additionally, the MS can perform in-band codec re-negotiation using H.245 signalling according to the procedures defined in 3GPP TS 26.111 [80].

5.4 Call clearing

5.4.1 Terminology

The following terms are used in the present document in the description of clearing procedures:

- A traffic channel (see 3GPP TS 44.003 [16]) is "connected" when the channel is part of a circuit-switched connection established according to the present document.
- A traffic channel is "disconnected" when the channel is no longer part of a circuit-switched connection, but is not yet available for use in a new connection.

5.4.2 Exception conditions

Under normal conditions, the call control entity of the mobile station or of the network initiates call clearing by sending a DISCONNECT message to its peer entity; then both entities follow the procedures defined in subclauses 5.4.3 and 5.4.4 respectively.

As an exception to the above rule, the call control entity of the mobile station or of the network, in response to a SETUP or START CC or CC-ESTABLISHMENT CC-ESTABLISHMENT CONFIRMED or RECALL message, can reject a call by stopping all running call control timers, responding with a RELEASE COMPLETE message, releasing the MM connection, and returning to the "null" state, provided no other response has previously been sent.

As a further exception, the call control entity of the network may initiate call clearing by stopping all running call control timers, sending a RELEASE message, starting timer T308, and entering the "release request" state.

NOTE: This way to initiate call clearing by sending a RELEASE message should not be used by the network:

- if in-band tones/announcements are provided and the network decides to use the procedure described in subclause 5.4.4.1.1.1 or 5.4.4.2.1;
- if the network wants to have the opportunity to respond to information sent by the mobile station during call clearing, e.g. when the network indicates that "CCBS activation is possible".

A call control entity shall accept an incoming RELEASE COMPLETE message used to initiate the call clearing even though the cause information element is not included.

A control entity shall accept an incoming RELEASE message used to initiate the call clearing even though the cause information element is not included.

Furthermore, a call control entity shall regard an incoming RELEASE COMPLETE message as consistent with any of its states; a call control entity shall regard an incoming RELEASE message as consistent with any of its states except the null state: a call control entity of the mobile station shall regard an incoming DISCONNECT message as consistent with any of its call control states except the "null" state, the "release request" state, and the "disconnect indication" state; a call control entity of the network shall regard an incoming DISCONNECT message as consistent with any of its call control states except the "null" state and the "release request" state.

NOTE: This allows the introduction of shorter call clearing procedures in the future.

5.4.3 Clearing initiated by the mobile station

5.4.3.1 Initiation of call clearing

Apart from the exceptions identified in subclause 5.4.2, the call control entity of the mobile station shall initiate clearing by: stopping all running call control timers, sending a DISCONNECT message; starting timer T305; and entering the "disconnect request" state.

5.4.3.2 Receipt of a DISCONNECT message from the mobile station.

The call control entity in the network in any state except the "null" state and the "release request" state shall, upon receipt of a DISCONNECT message:

- Stop all running call control timers;
- initiate procedures to clear the network connection and the call to the remote user;
- send a RELEASE message to its peer entity;
- start timer T308; and
- enter the "release request" state.

NOTE: The RELEASE message has only local significance and does not imply an acknowledgement of clearing from the remote user.

5.4.3.3 Receipt of a RELEASE message from the network

The call control entity of the mobile station in any state except the "null" state and the "release request" state, shall, upon receipt of a RELEASE message: stop all running call control timers; send a RELEASE COMPLETE message; release the MM connection; and return to the "null" state.

5.4.3.4 Receipt of a RELEASE COMPLETE message from the mobile station

A call control entity of the network in any call control state shall, upon receipt of a RELEASE COMPLETE message from its peer entity in the mobile station: stop all running call control timers; release the MM connection; and return to the "null" state.

5.4.3.5 Abnormal cases

The call control entity of the mobile station in the "disconnect request" state, shall upon expiry of timer T305: send a RELEASE message to the network with the cause number originally contained in the DISCONNECT message and optionally, a second cause information element with cause #102 "recovery on timer expiry", start timer T308, and enter the "release request" state.

The call control entity of the network in the "release request" state, shall, at first expiry of timer T308, retransmit the RELEASE message, start timer T308, and stay in the "release request" state. At second expiry of timer T308, the call control entity of the network shall: release the MM connection; and return to the "null" state.

5.4.4 Clearing initiated by the network

Apart from the exception conditions identified in subclause 5.4.2, the call control entity of the network shall initiate clearing by: sending a DISCONNECT message; and entering the "disconnect indication" state. The DISCONNECT message is a local invitation to clear the call.

NOTE: When the network initiates clearing by sending a RELEASE message, the procedures described in subclauses 5.4.3., 5.4.3.4 and 5.4.3.5 are followed.

A mobile station that does not support the "Prolonged Clearing Procedure" shall comply with the requirements of subclause 5.4.4.1 and shall ignore subclause 5.4.4.2. A mobile station that supports the "Prolonged Clearing Procedure" shall comply with the requirements of subclauses 5.4.4.2 and shall ignore subclause 5.4.4.1.

5.4.4.1 Clearing initiated by the network: mobile does not support "Prolonged Clearing Procedure"

Subclause 5.4.4.1 only applies to mobile stations that do not support the "Prolonged Clearing Procedure" option.

5.4.4.1.1 Clearing when tones/announcements provided

When in-band tones/announcements are provided (see subclause 5.5.1), the call control entity of the network may initiate clearing by sending a DISCONNECT message containing progress indicator #8 "in-band information or appropriate pattern now available", starting timer T306, and entering the "disconnect indication" state.

5.4.4.1.1.1 Receipt of a DISCONNECT message with progress indicator #8 from the network

The call control entity of the MS in any state except the "null" state, the "disconnect indication" state, and the "release request" state, shall, upon receipt of a DISCONNECT message with progress indicator #8:

- i) if an appropriate speech traffic channel is not connected, continue clearing as defined in subclause 5.4.4.1.2.1 without connecting to the in-band tone/announcement;
- ii) if an appropriate speech traffic channel is connected, attach the user connection for speech if it is not yet attached and enter the "disconnect indication" state. In that state, if upper layers request the clearing of the call, the call control entity of the MS shall proceed as defined in subclause 5.4.4.1.2.1.

5.4.4.1.1.2 Expiry of timer T306

The call control entity of the network, having entered the "disconnect indication" state after sending a disconnect message with the progress indicator #8, shall, upon expiry of timer T306, continue clearing by sending a RELEASE message with the cause number originally contained in the DISCONNECT message; starting timer T308; and entering the "release request" state.

5.4.4.1.2 Clearing when tones/announcements not provided

When in-band tones and announcements are not provided, the call control entity of the network shall initiate call clearing by stopping all running call control timers, sending a DISCONNECT message without progress indicator, starting timer T305 and entering the "disconnect indication" state.

5.4.4.1.2.1 Receipt of a DISCONNECT message without progress indicator or with progress indicator different from #8 from the network

The call control entity of the mobile station in any state except the "null" state, the "disconnect indication" state, and the "release request" state, shall, upon the receipt of a DISCONNECT message without progress indicator information element or with progress indicator different from #8:

- stop all running call control timers;
- send a RELEASE message;
- start timer T308; and
- enter the "release request" state.

5.4.4.1.2.2 Receipt of a RELEASE message from the mobile station

The call control entity of the network in any state except the "null" state and the "release request" state, shall, upon receipt of a RELEASE message: stop all running call control timers; send a RELEASE COMPLETE message; release the MM connection; and return to the "null" state.

5.4.4.1.2.3 Abnormal cases

The call control entity of the network, having entered the "disconnect indication" state after sending a DISCONNECT message without progress indicator or with progress indicator different from #8, shall upon expiry of timer T305: send a RELEASE message to the mobile station with the cause number originally contained in the DISCONNECT message; start timer T308; and enter the "release request" state. In addition to the original clearing cause, the RELEASE message may contain a second cause information element with cause #102 "recovery on timer expiry".

5.4.4.1.3 Completion of clearing

A call control entity of the mobile station in any call control state shall, upon receipt of a RELEASE COMPLETE message from its peer entity in the network: stop all running call control timers; release the MM connection; and return to the "null" state.

5.4.4.1.3.1 Abnormal cases

The call control entity of the mobile station in the "release request" state shall at first expiry of timer T308 retransmit the RELEASE message and restart timer T308. At second expiry of timer T308, the call control entity of the mobile station shall: release the MM connection; and return to the "null" state.

5.4.4.2 Clearing initiated by the network: mobile supports "Prolonged Clearing Procedure"

Subclause 5.4.4.2 only applies to mobile stations that support the "Prolonged Clearing Procedure" option.

5.4.4.2.1 Clearing when tones/announcements provided and the network does not indicate that "CCBS activation is possible"

When in-band tones/announcements are provided (see subclause 5.5.1) and CCBS is not applicable, the call control entity of the network may initiate clearing by sending a DISCONNECT message containing progress indicator #8 "in-band information or appropriate pattern now available", either not containing an *Allowed Actions* IE or containing an *Allowed Actions* IE indicating "CCBS activation is not possible", starting timer T306, and entering the "disconnect indication" state.

5.4.4.2.1.1 Receipt of a DISCONNECT message

The call control entity of the MS in any state except the "null" state, the "disconnect indication" state, and the "release request" state, shall, upon receipt of a DISCONNECT message with progress indicator #8 and, either not containing an *Allowed Actions* IE or containing an *Allowed Actions* IE indicating "CCBS activation is not possible":

- i) if an appropriate speech traffic channel is not connected,
 - stop all running call control timers;
 - send a RELEASE message;
 - start timer T308;
 - enter the "release request" state; and
 - not connect to the in-band tone/announcement.
- ii) if an appropriate speech traffic channel is connected, attach the user connection for speech if it is not yet attached and enter the "disconnect indication" state. In that state, if upper layers request the clearing of the call, the call control entity of the MS shall:
 - stop all running call control timers;
 - send a RELEASE message;
 - start timer T308; and
 - enter the "release request" state.

5.4.4.2.1.2 Expiry of timer T306

The call control entity of the network, having entered the "disconnect indication, shall, upon expiry of timer T306, continue clearing by sending a RELEASE message with the cause number originally contained in the DISCONNECT message; starting timer T308; and entering the "release request" state.

5.4.4.2.2 Clearing when the network indicates that "CCBS activation is possible"

When Activation of CCBS is possible, the call control entity of the network may initiate clearing by sending a DISCONNECT message containing the *Allowed Actions* IE with an indication that "Activation of CCBS is possible" and starting T338. Optionally, progress indicator #8 "in-band information or appropriate pattern now available" may also be contained in the DISCONNECT message (in which case, T338 shall not be greater than T306).

5.4.4.2.2.1 Receipt of a DISCONNECT

Relative to the current state the following procedures apply:

- The call control entity of the MS in the "null" state, the "disconnect indication" state and the "release request" state, shall, upon receipt of a DISCONNECT message react as described in clause 8.
- The call control entity of the MS in the "disconnect request" state, shall, upon receipt of a DISCONNECT message:
 - stop all running call control timers;

- send a RELEASE message;
 - start timer T308; and
 - enter the "release request" state.
- The call control entity of the MS in any other states, shall, upon receipt of a DISCONNECT message with an *Allowed Actions* IE indicating "Activation of CCBS is possible" pass the "Activation of CCBS is possible" indication to the upper layer, enter the "disconnect indication" state, stop all running call control timers and await a response from the upper layers.

If the DISCONNECT message contained the progress indicator #8 "in-band information or appropriate pattern now available" and an appropriate speech traffic channel is connected, then the MS shall attach the user connection for speech if it is not yet attached. If the DISCONNECT message did not contain the progress indicator #8 "in-band information or appropriate pattern now available" any connected speech traffic channel shall be disconnected.

Response from the upper layers:

- i) If the upper layers request the clearing of the call, the call control entity of the MS shall:
 - stop all running call control timers;
 - send a RELEASE message;
 - start timer T308; and
 - enter the "release request" state.
- ii) If the upper layers request that the "CCBS activation is to be attempted" then the MS shall
 - send a RELEASE message containing a *Facility* IE including an
 - Invoke=CCBSRequest to the network;
 - stop all running call control timers;
 - start timer T308; and
 - enter the "release request" state.

If an appropriate speech traffic channel is connected, transmission of this RELEASE message shall not cause it to be disconnected.

5.4.4.2.2.2 Expiry of timer T338

The call control entity of the network, having entered the "disconnect indication" state after sending a DISCONNECT message with an *Allowed Actions* IE indicating "Activation of CCBS is possible" shall, upon expiry of timer T338, continue clearing by sending a RELEASE message with the cause number originally contained in the DISCONNECT message; starting timer T308; and entering the "release request" state.

5.4.4.2.3 Clearing when tones/announcements are not provided and the network does not indicate that "CCBS activation is possible"

When in-band tones and announcements are not provided, and, the network does not wish to indicate in the *Allowed Actions* IE that "CCBS is possible", the call control entity of the network shall initiate call clearing by stopping all running call control timers, sending a DISCONNECT message without progress indicator, either without the *Allowed Actions* IE or with the *Allowed Actions* IE indicating that "CCBS is not possible", starting timer T305 and entering the "disconnect indication" state.

5.4.4.2.3.1 Receipt of a DISCONNECT message

The call control entity of the mobile station in any state except the "null" state, the "disconnect indication" state, and the "release request" state, shall, upon the receipt of a DISCONNECT message either without progress indicator information element or with progress indicator different from #8, and, either without the *Allowed Actions* IE or with the *Allowed Actions* IE indicating that "CCBS is not possible":

- stop all running call control timers;
- send a RELEASE message;
- start timer T308; and
- enter the "release request" state.

5.4.4.2.3.2 Abnormal cases

The call control entity of the network, having entered the "disconnect indication", shall upon expiry of timer T305: send a RELEASE message to the mobile station with the cause number originally contained in the DISCONNECT message; start timer T308; and enter the "release request" state.

5.4.4.2.4 Receipt of a RELEASE message from the mobile station

5.4.4.2.4.1 Release, CCBS not requested

For a network that does not support the "CCBS activation" option:

The call control entity of the network in any state except the "null" state and the "release request" state, shall, upon receipt of a RELEASE message: stop all running call control timers; send a RELEASE COMPLETE message; release the MM connection; and return to the "null" state.

For a network that does support the "CCBS activation" option:

The call control entity of the network in any state except the "null" state and the "release request" state, shall, upon receipt of a RELEASE message without a *Facility* IE including an Invoke=CCBSRequest: stop all running call control timers; send a RELEASE COMPLETE message; release the MM connection; and return to the "null" state.

5.4.4.2.4.2 Release, CCBS Requested

For a network that does not support the "CCBS activation" option:

The call control entity of the network in any state except the "null" state and the "release request" state, shall, upon receipt of a RELEASE message: stop all running call control timers; send a RELEASE COMPLETE message; release the MM connection; and return to the "null" state.

For a network that does support the "CCBS activation" option:

The call control entity of the network in any state except the "null" state and the "release request" state, shall, upon receipt of a RELEASE message containing a *Facility* IE including an Invoke=CCBSRequest: stop all running call control timers; then attempt to activate the recall; then send a RELEASE COMPLETE message indicating the success or failure of the recall activation attempt; release the MM connection; and return to the "null" state.

5.4.4.2.5 Completion of clearing

A call control entity of the mobile station in any call control state shall, upon receipt of a RELEASE COMPLETE message from its peer entity in the network: stop all running call control timers; release the MM connection; and return to the "null" state.

5.4.4.2.5.1 Abnormal cases

The call control entity of the mobile station in the "release request" state shall at first expiry of timer T308 retransmit the RELEASE message and restart timer T308. At second expiry of timer T308, the call control entity of the mobile station shall: release the MM connection; and return to the "null" state.

The retransmitted RELEASE message need not contain the *Facility* IE including an Invoke=CCBSRequest, even if the original RELEASE message did contain this IE.5.4.5 Clear collision

Clear collision occurs when both the mobile station and the network simultaneously transfer DISCONNECT messages specifying the same call.

The behaviour of the network call control entity receiving a DISCONNECT message whilst in the "disconnect indication" state is specified in subclause 5.4.3. The behaviour of the MS call control entity receiving a DISCONNECT message whilst in the "disconnect request" state is defined in subclause 5.4.4.

Clear collision can also occur when both sides simultaneously transfer RELEASE messages related to the same call. The entity receiving such a RELEASE message whilst within the "release request" state shall: stop timer T308; release the MM connection; and enter the "null" state (without sending a RELEASE COMPLETE message).

5.4.5 Call clearing for SRVCC from CS to PS

If the MS receives the request from upper layers to release the call locally, the call control entity of the MS shall detach the user connection, if connected, and enter the NULL state.

5.5 Miscellaneous procedures

5.5.1 In-band tones and announcements

When the network wants to make the mobile station attach the user connection (e.g. in order to provide in-band tones/announcement) before the mobile station has reached the "active" state of a call, the network may include a *progress indicator* IE indicating user attachment in a suitable CC message:

- Either it includes the IE in a SETUP, CALL PROCEEDING, ALERTING, or CONNECT message that is sent during call establishment
- it sends a PROGRESS message containing the IE.

A *progress indicator* IE indicates user attachment if it specifies a progress description in the set {1, 2, 3} or in the set {6, 7, 8, ..., 20}.

On reception of a SETUP, CALL PROCEEDING, ALERTING, CONNECT, or PROGRESS message the mobile station shall proceed as specified elsewhere in clause 5; if the *progress indicator* IE indicated user attachment and a speech mode traffic channel is appropriate for the call the mobile station shall in addition: attach the user connection for speech as soon as an appropriate channel in speech mode is available. (If a new order to attach the user connection is received before the attachment has been performed, the new order shall supersede the previous one.)

Under certain conditions the MS will have to attach the user connection before the CONNECT message. It is up to the network to ensure that no undesired end-to-end through connection takes place during the establishment of a MT call.

NOTE: This allows the use of *progress indicator* IEs independently from the channel modes appropriate for the call.

The network may generate multimedia CAT to a mobile station supporting multimedia CAT during the alerting phase of a mobile originated multimedia call establishment as specified in subclause 5.3.6.4.

5.5.2 Call collisions

Call collisions as such cannot occur at the network. Any simultaneous mobile originating or mobile terminating calls are dealt with separately assigned and different transaction identifiers.

5.5.3 Status procedures

5.5.3.1 Status enquiry procedure

Whenever a call control entity wishes to check the call state of its peer entity, it may initiate the status enquiry procedure.

NOTE: This may, in particular, apply to procedural error conditions described in clause 8.

A call control entity initiates the status enquiry procedure by sending the STATUS ENQUIRY message and starting timer T322. The value of T322 is implementation dependent in the MS and set in the network by the network operator. While timer T322 is running, the call control entity shall not send further STATUS ENQUIRY messages.

Upon receipt of a STATUS ENQUIRY message, the receiver shall respond with a STATUS message, reporting the current call state and cause value #30 "response to STATUS ENQUIRY". Receipt of the STATUS ENQUIRY shall not result in a state change relating to any protocol and connection of the receiver.

If a STATUS message is received that contains cause value #30 "response to status enquiry", timer T322 shall be stopped and further appropriate actions taken, based on the information in that STATUS message, relative to the current state of the receiver of the STATUS message. These further "appropriate actions" are implementation dependent. However, the actions prescribed in subclause 5.5.3.2 shall apply.

If a clearing message is received while timer T322 is running, timer T322 shall be stopped, and call clearing shall continue.

If timer T322 expires, the STATUS ENQUIRY message may be retransmitted maximally once. If T322 expires after the STATUS ENQUIRY has been transmitted the maximum number of times, clearing of the call shall be initiated with cause value #41, "temporary failure", in the first call clearing message.

5.5.3.2 Reception of a STATUS message by a CC entity

5.5.3.2.1 STATUS message with incompatible state

On receipt of a STATUS message reporting an incompatible call control state, the receiving entity shall clear the call by sending a RELEASE COMPLETE message with cause # 101 "message not compatible with protocol state". The reported call control state is incompatible if the combination of call control states at the sender and receiver side cannot occur, do not match or cannot be aligned by actions of the receiver; the exact definition is implementation dependent.

5.5.3.2.2 STATUS message with compatible state

A STATUS message may be received indicating a compatible call state but containing one of the following causes:

- # 95 "semantically incorrect message"; or
- # 96 "invalid mandatory information"; or
- # 97 "message type non-existent or not implemented"; or
- # 98 "message type not compatible with protocol state"; or
- # 99 "information element non-existent or not implemented"; or
- # 100 "conditional IE error".

This indicates that the transmitter of the STATUS message was unable to accept some information sent by the recipient of the STATUS message. This allow the recipient to retransmit some or all of the information. Other actions are possible and are implementation dependent; they may include releasing the call.

In the case the MS receives a STATUS message with the cause #100 due to the presence of a Repeat Indicator with the value "service change and fallback" in a SETUP message, it may then resend a new SETUP message with a single BC-IE (no Repeat Indicator is included). The actual behaviour is dependent on the implementation.

In the case the network receives a STATUS message with the cause #100 due to the presence of a Repeat Indicator with the value "service change and fallback" in a SETUP message, it shall then resend a new SETUP message, with either the BC-IE of the preferred service or the speech BC-IE (fallback to speech) as the only BC (no Repeat Indicator is included). The preferred behaviour is decided by configuration.

5.5.4 Call re-establishment, mobile station side

This subclause describes the internal handling in the mobile station as far as call control is concerned.

5.5.4.1 Indication from the mobility management sublayer

When a MM connection is active, an indication may be given by the MM sublayer to the call control entity to announce that the current MM connection has been interrupted but might be re-established on request of call control.

5.5.4.2 Reaction of call control

Depending whether call re-establishment is allowed or not and on its actual state, call control shall decide to either request re-establishment or to release the MM connection.

a) Re-establishment not required

If the call is in the call establishment or call clearing phase, i.e. any state other than the "active" state or the "mobile originating modify" state, call control shall release the MM connection

b) Re-establishment required

If the call is in the "active" state or "mobile originating modify" state, the indication from MM that re-establishment is possible shall cause call control to request re-establishment from the MM connection, suspend any further message to be sent and await the completion of the re-establishment procedure.

5.5.4.3 Completion of re-establishment

Call Control is notified when the MM connection is re-established and shall then resume the transmission of possibly suspended messages and resume user data exchange when an appropriate channel is available.

5.5.4.4 Unsuccessful outcome

If the attempt to re-establish the connection was unsuccessful, the MM connection will be released and a release indication will be given to call control, see subclause 4.5.1.6.

5.5.5 Call re-establishment, network side

This subclause describes the handling in the network as far as call control is concerned.

5.5.5.1 State alignment

After a successful call re-establishment it is a network responsibility to identify (e.g. by using the status enquiry procedure, if needed, and resolve, if possible, any call state or auxiliary state mismatch between the network and the mobile station.

5.5.6 Progress

At any time during the establishment or release of a call and during an active call the network may send a PROGRESS message to the mobile station.

On receipt of a PROGRESS message during the establishment or release of a call the mobile station shall stop all call control timers related to that call.

NOTE: If the PROGRESS has been received before the receipt of a CALL PROCEEDING message, the mobile station will not start timer T310 on receipt of a CALL PROCEEDING message, see subclause 5.2.1.1.3.

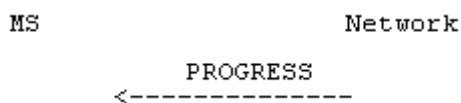

Figure 5.11/3GPP TS 24.008 Progress

5.5.7 DTMF protocol control procedure

Dual Tone Multi Frequency (DTMF) is an inband one out of four plus one out of four signalling system primarily used from terminal instruments in telecommunication networks. The support of DTMF in the network is described in 3GPP TS 23.014 [12].

The mobile station shall be capable of transmitting DTMF messages as specified in this subclause if and only if the mobile station has the user connection for speech attached and an appropriate channel is available.

The transaction identifier used by the DTMF messages shall be that of the attached speech call.

NOTE 1: The present document means that DTMF messages can generally be sent in the active state of a call in speech transmission mode or when a traffic channel is available during setup or release and the *progress indicator* IE has been received.

NOTE 2: Since the DTMF protocol messages are sent in a store and forward mode on the signalling channels the control of the device at the far end may be delayed dependent on the load or quality of the channels.

NOTE 3: The procedures described in this paragraph support DTMF only in the direction mobile station to network.

A mobile station supporting multimedia CAT during the alerting phase of a mobile originated multimedia call establishment should also be capable of transmitting DTMFs during a multimedia call as specified in subclause 5.3.6.5.

5.5.7.1 Start DTMF request by the mobile station

A user may cause a DTMF tone to be generated e.g. by depression of a key in the mobile station. The relevant action is interpreted by the mobile station as a requirement for a DTMF digit to be sent in a START DTMF message on an established FACCH. This message contains the value of the digit to be transmitted (0, 1, ..., 9, A, B, C, D, *, #).

Only a single digit will be transferred in each START DTMF message.

On sending a START DTMF message the MS shall start timer T336.

Where a previous START DTMF message has been sent, another START DTMF message shall only be sent by the MS following receipt of its STOP DTMF ACKNOWLEDGE message (see subclause 5.5.7.4) or a START DTMF REJECT message from the network (see subclause 5.5.7.2) or following the expiry of timers T336 and T337.

If timer T336 expires, the MS shall terminate the ongoing DTMF procedure without any retransmissions, and is free to begin another DTMF procedure (e.g. another START DTMF message).

5.5.7.2 Start DTMF response by the network

Upon receiving the START DTMF message the network shall either:

- convert the received digit into a DTMF tone which is applied toward the remote user, or
- send the DTMF digit as an out-of-band message (see 3GPP TS 23.205 [96])

and return a START DTMF ACKNOWLEDGE message to the mobile station. This acknowledgement may be used in the mobile station to generate an indication as a feedback for a successful transmission.

If the network cannot accept the START DTMF message a START DTMF REJECT message will be sent to the mobile station. Upon receipt of a START DTMF ACK message or a START DTMF REJECT message, the MS shall stop timer T336.

5.5.7.3 Stop DTMF request by the mobile station

When the user indicates that the DTMF sending should cease e.g. by releasing the key the mobile station will send a STOP DTMF message to the network.

On sending a STOP DTMF message the MS shall start timer T337.

The MS shall only send a STOP DTMF message if a START DTMF ACKNOWLEDGE message has been received from the network (see subclause 5.5.7.2).

If timer T337 expires, the MS shall terminate the ongoing DTMF procedure without any retransmissions, and is free to begin another DTMF procedure. (e.g. another START DTMF message).

5.5.7.4 Stop DTMF response by the network

Upon receiving the STOP DTMF message the network shall either:

- stop sending the DTMF tone if applied by the network, or
- initiate a suitable out-of-band message (see 3GPP TS 23.205 [96])

and return a STOP DTMF ACKNOWLEDGE message to the mobile station. Upon receipt of a STOP DTMF ACKNOWLEDGE message, the MS shall stop timer T337.

5.5.7.5 Sequencing of subsequent start DTMF requests by the mobile station

If the network is generating DTMF tones it shall ensure that the minimum length of tone and the minimum gap between two subsequent tones (according to ETSI ES 201 235-2 [12a]) is achieved.

NOTE 1: In ETSI ES 201 235-2 [12a] the minimum duration of a DTMF tone is 65ms.

NOTE 2: In ETSI ES 201 235-2 [12a] the minimum gap between DTMF tones is 65ms.

There is no defined maximum length to the tone, which will normally cease when a STOP DTMF message is received from the MS. However, the operator may choose to put a pre-defined time limit on the duration of tones sent.

The appropriate sequencing of DTMF control messages is shown in figures 5.8 and 5.9.

NOTE 3: The network may implement the time limit option where the DTMF tone duration is controlled by the network irrespective of the receipt of a STOP DTMF message from the mobile station.

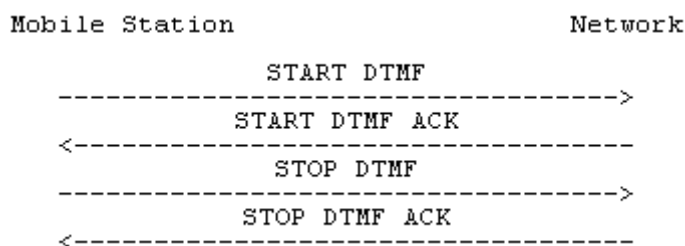

Figure 5.8/3GPP TS 24.008 Single DTMF transmission

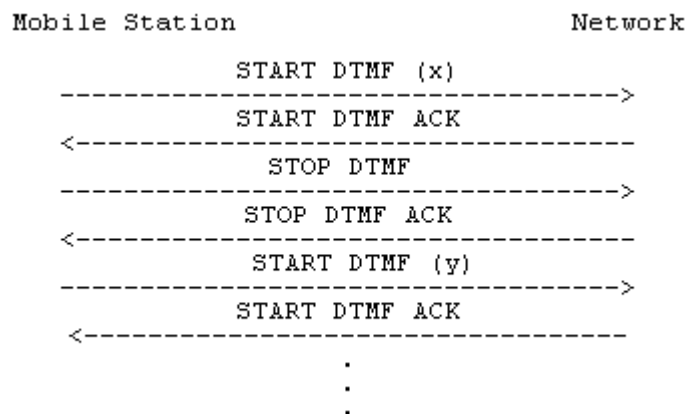

Figure 5.9/3GPP TS 24.008 Multiple DTMF transmission

6 Support for packet services

This chapter contains the description of the procedures for the session management of GPRS point-to-point data services and MBMS point-to-point and point-to-multipoint data services at the radio interface (Reference point Uu and U_m).

6.1 GPRS Session management

6.1.1 General

The main function of the session management (SM) is to support PDP context handling of the user terminal. Furthermore, the SM supports the MBMS context handling within the MS and the network, which allows the MS to receive data from a specific MBMS source.

The SM comprises procedures for

- identified PDP context activation, deactivation and modification; and
- identified MBMS context activation and deactivation.

SM procedures for identified access can only be performed if a GMM context has been established between the MS and the network. If no GMM context has been established, the MM sublayer has to initiate the establishment of a GMM context by use of the GMM procedures as described in chapter 4. After GMM context establishment, SM uses services offered by GMM (see 3GPP TS 24.007 [20]). Ongoing SM procedures are suspended during GMM procedure execution.

The SM procedures for identified MBMS context activation and deactivation can only be performed, if in addition to the GMM context the MS has a PDP context activated.

In Iu mode only, integrity protected signalling (see subclause 4.1.1.1.1 of the present document and in general, see 3GPP TS 33.102 [5a]) is mandatory. In Iu mode only, all protocols shall use integrity protected signalling. Integrity protection of all SM signalling messages is the responsibility of lower layers. It is the network which activates integrity protection. This is done using the security mode control procedure (3GPP TS 25.331 [23c] and 3GPP TS 44.118 [111]).

For the session management protocol, the extended TI mechanism may be used (see 3GPP TS 24.007 [20]).

6.1.2 Session management states

In this subclause, the SM states are described for one SM entity (see 3GPP TS 24.007 [20]). Each SM entity is associated with one PDP context or MBMS context. Subclause 6.1.2.1 describes the SM states in the MS and subclause 6.1.2.2 describes the SM states on the network side.

6.1.2.1 Session management states in the MS

In this subclause, the possible states of an SM entity in the mobile station are described. As illustrated in figure 6.1/3GPP TS 24.008 and 6.1a/3GPP TS 24.008 there are seven SM states in the MS.

6.1.2.1.1 PDP-INACTIVE

This state indicates that neither PDP context nor MBMS context exist.

6.1.2.1.2 PDP-ACTIVE-PENDING

This state exists when PDP context activation was requested by the MS.

6.1.2.1.3 PDP-INACTIVE-PENDING

This state exists when deactivation of the PDP contexts was requested by the MS.

6.1.2.1.4 PDP-ACTIVE

This state indicates that the PDP context is active.

6.1.2.1.5 PDP-MODIFY_PENDING

This state exists when modification of the PDP context was requested by the MS.

6.1.2.1.6 MBMS-ACTIVE-PENDING

This state exists when the MS has requested the network to activate an MBMS context.

6.1.2.1.7 MBMS-ACTIVE

This state indicates that the MBMS context is active.

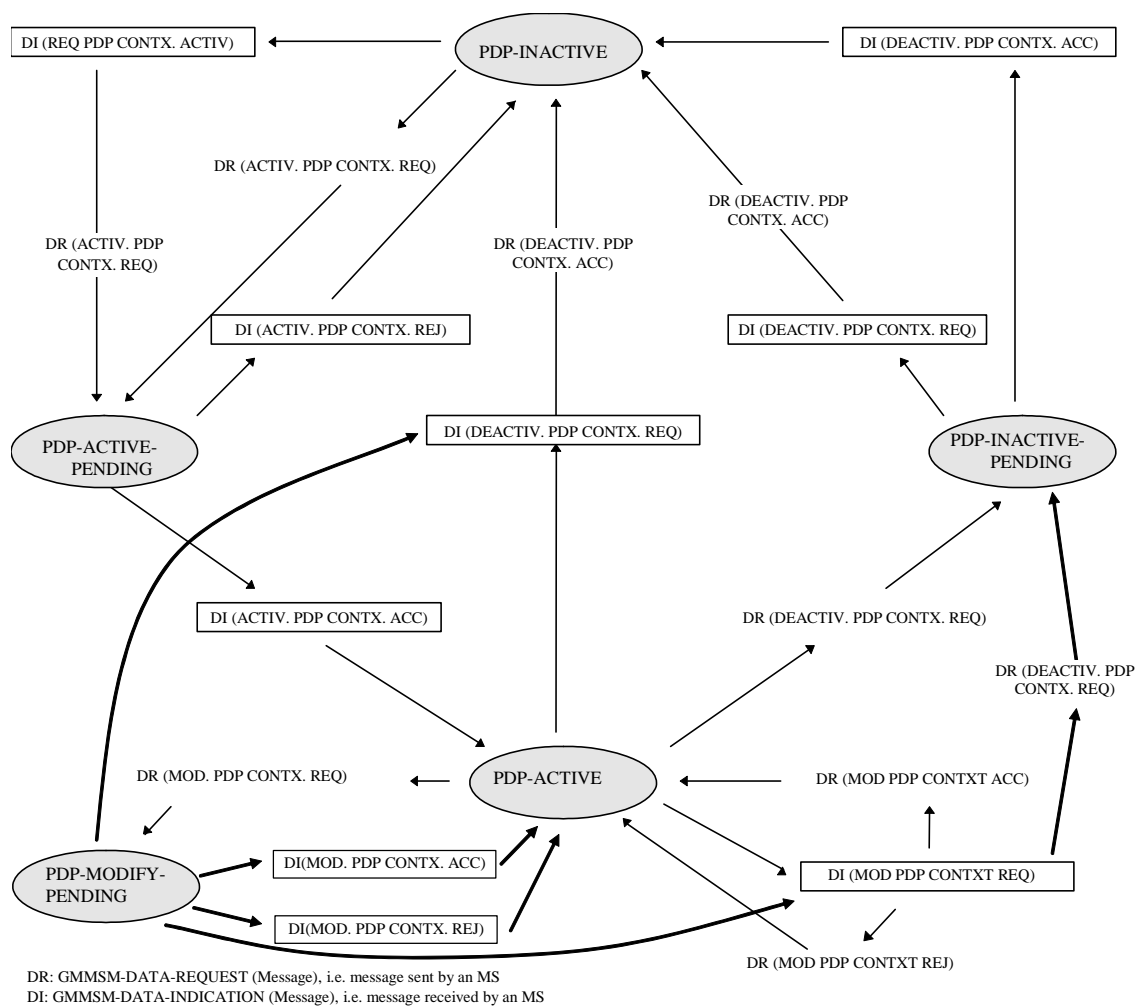

Figure 6.1/3GPP TS 24.008: Session management states for PDP context handling in the MS (overview)

It shall be noted, that Figure 6.1/3GPP TS 24.008 applies to both the PDP context activation procedure and the secondary PDP context activation procedure, though the distinction in messages regarding the activation of PDP contexts is not shown here for simplicity.

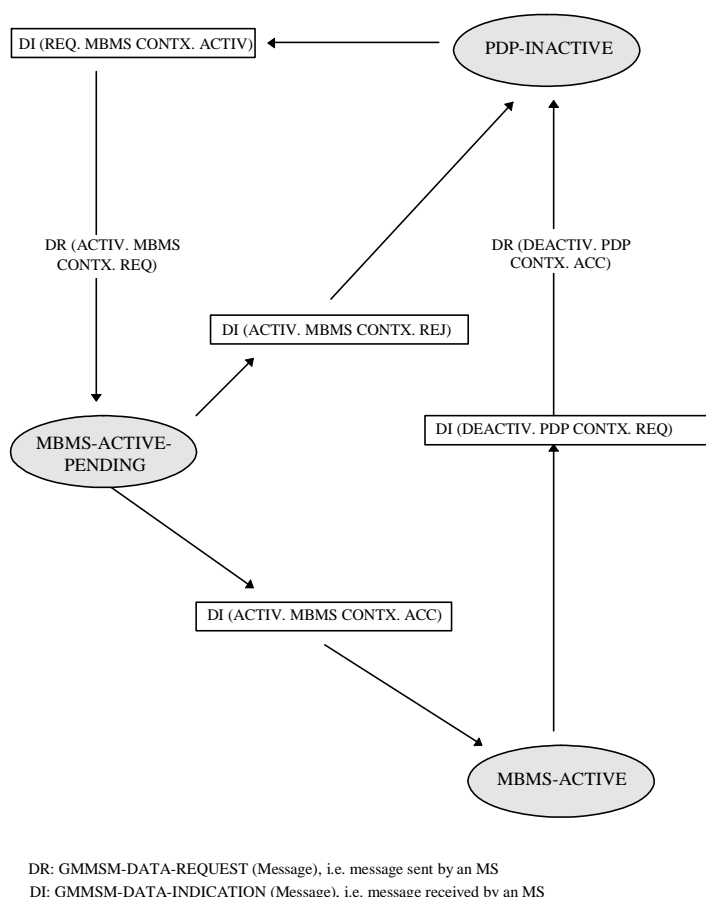

Figure 6.1a/3GPP TS 24.008: Session management states for MBMS context handling in the MS (overview)

6.1.2.2 Session management states on the network side

In this subclause, the possible states of an SM entity on the network side are described. As illustrated in figures 6.2/3GPP TS 24.008 and 6.2a/3GPP TS 24.008 there are eight SM states on the network side.

6.1.2.2.1 PDP-INACTIVE

This state indicates that the PDP context or MBMS context is not active.

6.1.2.2.2 PDP-ACTIVE-PENDING

This state exists when the PDP context activation was initiated by the network.

6.1.2.2.3 PDP-INACTIVE-PENDING

This state exists when deactivation of the PDP context was requested by the network.

6.1.2.2.4 PDP-ACTIVE

This state indicates that the PDP context is active.

6.1.2.2.5 PDP-MODIFY-PENDING

This state exists when modification of the PDP context was requested by the network.

6.1.2.2.6 MBMS-ACTIVE-PENDING

This state exists when the network has initiated MBMS context activation.

6.1.2.2.7 MBMS-INACTIVE-PENDING

This state exists when the network has requested the MS to deactivate an MBMS context.

6.1.2.2.8 MBMS-ACTIVE

This state indicates that the MBMS context is active.

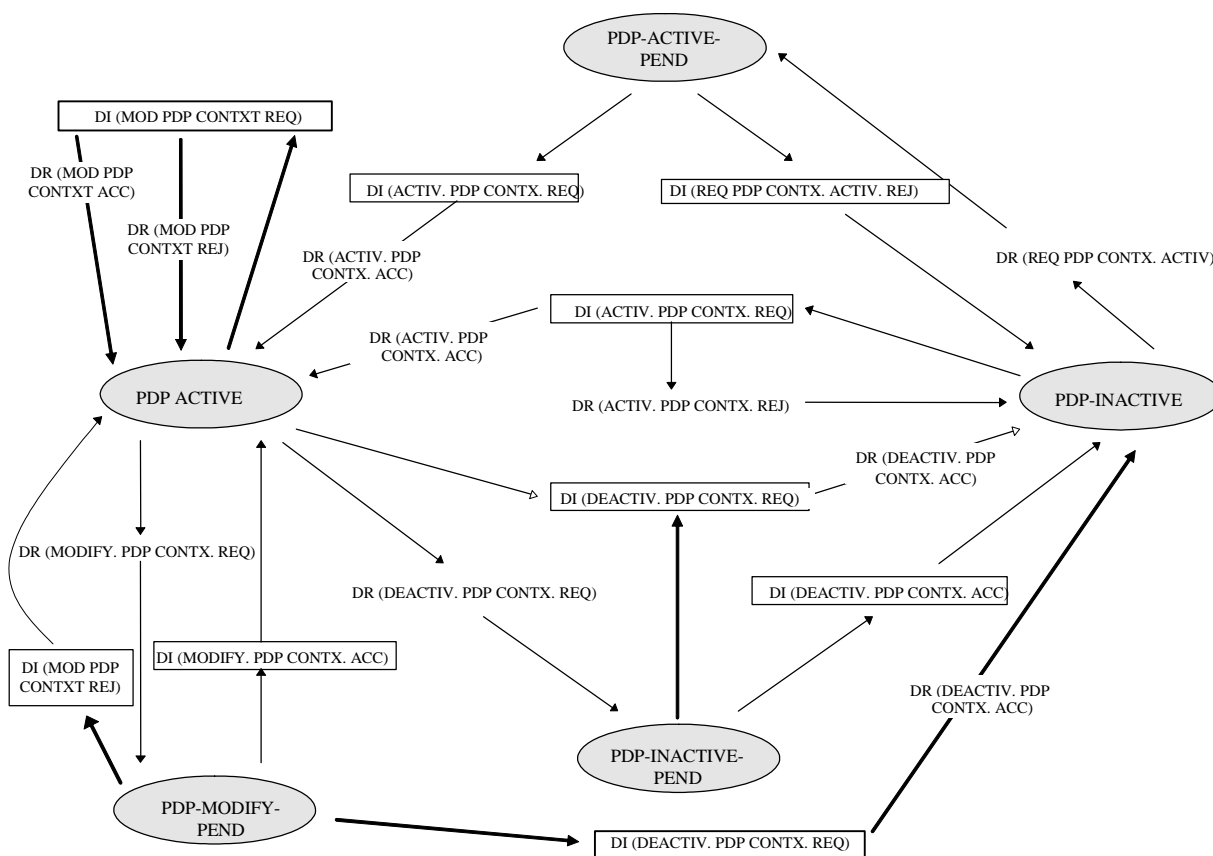

DR: GMM-SM-DATA-REQUEST (Message), i.e. message sent by network
 DI: GMM-SM-DATA-INDICATION (Message), i.e. message received by the network

Figure 6.2/3GPP TS 24.008: Session management states for PDP context handling on the network side (overview)

It shall be noted, that figure 6.2/3GPP TS 24.008 applies to both the PDP context activation procedure and the secondary PDP context activation procedure, though the distinction in messages regarding the activation of PDP contexts is not shown here for simplicity.

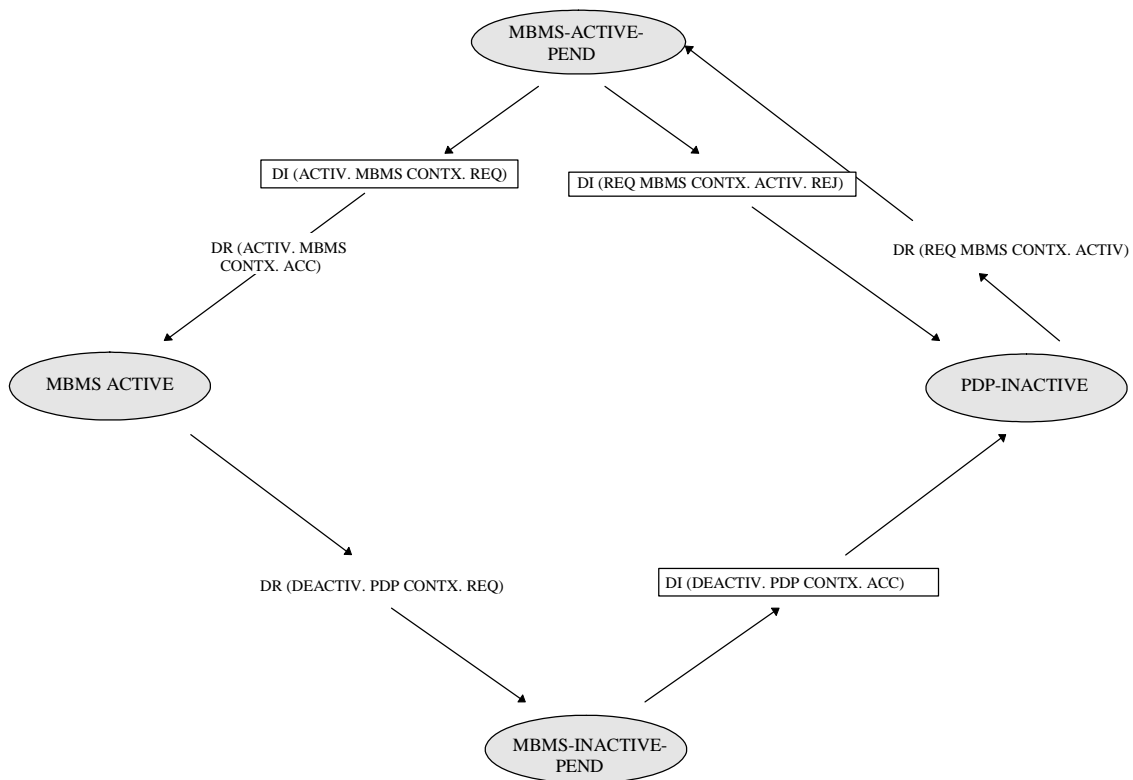

DR: GMM-SM-DATA-REQUEST (Message), i.e. message sent by network
 DI: GMM-SM-DATA-INDICATION (Message), i.e. message received by the network

Figure 6.2a/3GPP TS 24.008: Session management states for MBMS context handling on the network side (overview)

6.1.2A PDP address allocation

6.1.2A.1 General

PDP addresses are handled differently for PDN interworking of type PPP and IP (IPv4 or IPv6).

6.1.2A.1.1 Interworking with PDN based on IP

During PDP context activation (see subclause 6.1.3.1), the MS can configure an IPv4 address, or obtain an IPv6 interface identifier to be used during the IETF-based IP address allocation after PDP context establishment.

The MS can obtain an IPv4 address or an IPv6 prefix via an IETF-based IP address allocation mechanism once the PDP context is established.

The following IETF-based IP address/prefix allocation methods are specified for GPRS (the corresponding procedures are specified in 3GPP TS 29.061 [130]):

- a) /64 IPv6 default prefix allocation via IPv6 stateless address autoconfiguration. Optionally, allocation of additional IPv6 prefix(es) with length /64 or shorter via stateful DHCPv6 Prefix Delegation (see IETF RFC 3633 [139]);
- b) IPv4 address allocation and IPv4 parameter configuration via DHCPv4;

Upon deactivation of a default PDP context, the MS shall locally release any IPv4 address or IPv6 prefix allocated to the MS for the corresponding PDN connection.

6.1.2A.1.2 Interworking with PDN based on PPP

During PDP context activation no PDP address is configured. Instead, such information is negotiated and configured during the NCP phase of PPP.

6.1.2A.2 IP address allocation via NAS signalling

The MS shall set the PDP type in the PDP address IE in the ACTIVATE PDP CONTEXT REQUEST message when requesting establishment of a default PDP context; the detailed rules with regards to IP version for MS and network side are defined in subclause 6.1.3.1.

If the MS wants to use DHCPv4 for IPv4 address assignment, it shall indicate that to the network within the Protocol Configuration Options IE in the ACTIVATE PDP CONTEXT REQUEST.

If the MS requests allocation of an IPv6 address, the network constructs it of two parts: a /64 IPv6 prefix and an interface identifier of 64 bits length. The IPv6 prefix part is not used immediately by the MS; however, the network shall use the same IPv6 prefix in subsequent procedures for IETF-based IP address allocation. The interface identifier is only used for building a unique link-local IPv6 address.

6.1.3 Session Management procedures

6.1.3.0 General

The MS's maximum number of active PDP contexts in a PLMN is determined by the lowest of the maximum number of Network Service Access Point Identifiers (NSAPIs) allowed by the protocol (as specified in subclause 10.5.6.2), the PLMN's maximum number of PDP contexts in Iu or A/Gb mode and the MS's implementation-specific maximum number of PDP contexts.

NOTE: Subclauses 6.1.3.1.3 and 6.1.3.2.2 specify how the MS determines the PLMN's maximum number of PDP contexts in Iu or A/Gb mode.

6.1.3.1 PDP context activation

The purpose of this procedure is to establish a PDP context between the MS and the network for a specific QoS on a specific NSAPI. The PDP context activation may be initiated by the MS or the initiation may be requested by the network.

An MS attached for emergency bearer services shall only request a PDP context with request type set to "emergency". If there already is a PDN connection for emergency bearer services established, the MS shall not request an additional PDN connection for emergency bearer services. The MS shall not request emergency bearer services in A/Gb mode or in GERAN Iu mode.

If the MS has reached the maximum number of active PDP contexts (see subclause 6.1.3.0) and the upper layers of the MS request activation of additional PDP context, then the MS shall not send an ACTIVATE PDP CONTEXT REQUEST message or an ACTIVATE SECONDARY PDP CONTEXT REQUEST message to activate the additional PDP context. If the additional PDP context is a PDP context with type set to "emergency", then it may skip explicit deactivation to free PDP context resources and instead re-activate the necessary context(s) relying on network handling of abnormal cases as specified in subclause 6.1.3.1.5 case c). In either case it is an MS implementation option which PDP context(s) to re-use for emergency.

Each PDP address may be described by one or more PDP contexts in the MS or the network. The PDP Context Activation procedure is used to activate the default PDP context for a given PDP address and APN, i.e. a PDN connection, whereas all additional contexts associated to the same PDP address and APN are activated with the secondary PDP context activation procedure. An MS supporting S1 mode shall keep the default PDP context activated during the lifetime of the PDN connection. An MS not supporting S1 mode should apply the same behaviour (see 3GPP TS 23.060 [74]). When more than one PDP context is associated to a PDP address, there shall be a Traffic Flow Template (TFT), including one or more packet filters, for each or all but one context. The downlink and uplink packet filters are considered separately. If present, the TFT shall be sent transparently either from the MS via the SGSN to the GGSN to enable packet classification and policing for downlink data transfer in the GGSN or from the GGSN via the SGSN to the MS to be used in a network requested secondary PDP context activation procedure (see subclause 6.1.3.2) and enable packet classification and policing for uplink data transfer in the MS (see 3GPP TS 23.060 [74]).

For the purpose of requesting non-IP connectivity, the MS shall set the PDP type number in the Requested PDP address information element in the ACTIVATE PDP CONTEXT REQUEST message to "non IP". The MS supporting non-IP connectivity shall also support the extended protocol configuration options IE.

For the purpose of requesting IP address allocation the MS shall set the PDP type number in the Requested PDP address information element in the ACTIVATE PDP CONTEXT REQUEST message based on its IP stack configuration (e.g. the per APN settings specified in 3GPP TS 23.060 [74]) as follows:

- a) An MS, which is IPv6 and IPv4 capable, and
 - has not been allocated an IP address for this APN, shall set the PDP type number to "IPv4v6 address";
 - has been allocated an IPv4 address for this APN and received the SM cause #52, "single address bearers only allowed", and is requesting an IPv6 address, shall set the PDP type number to "IPv6 address";
 - has been allocated an IPv6 address for this APN and received the SM cause #52, "single address bearers only allowed", and is requesting an IPv4 address, shall set the PDP type number to "IPv4 address".
- b) An MS, which is only IPv4 capable, shall set the PDP type number to "IPv4 address".
- c) An MS, which is only IPv6 capable, shall set the PDP type number to "IPv6 address".
- d) When the IP version capability of the MS is unknown in the MS (as in the case when the MT and TE are separated and the capability of the TE is not known in the MT), the MS shall set the PDP type number to "IPv4v6 address".

On receipt of the ACTIVATE PDP CONTEXT REQUEST message sent by the MS, the network when allocating an IP address shall take into account the PDP type number, the operator policies of the home and visited network, and the user's subscription data.

- If the MS requests PDP type IPv4v6, but the network configuration dictates the use of IPv4 addressing only or IPv6 addressing only for this APN, the network shall override the PDP type requested by the MS to a single address PDP type (IPv4 or IPv6). In the ACTIVATE PDP CONTEXT ACCEPT message sent to the MS, the network sets the PDP type number to either "IPv4 address" or "IPv6 address" and the SM cause to #50 "PDP type IPv4 only allowed", or #51 "PDP type IPv6 only allowed", respectively (see subclause 6.1.3.1.1).
- If the MS requests PDP type IPv4v6, but the operator uses single addressing per PDP context due to interworking with nodes of earlier releases, the network shall override the PDP type requested by setting the PDP type in the ACTIVATE PDP CONTEXT ACCEPT message sent to the MS to a single address PDP type. In the ACTIVATE PDP CONTEXT ACCEPT message sent to the MS, the network sets the PDP type number to either "IPv4 address" or "IPv6 address" and the SM cause to #52, "single address bearers only allowed" (see subclause 6.1.3.1.1).

The MS, in a pre release 8 network not supporting IPv4/v6, could encounter other network reactions:

- If the MS requests PDP type IPv4v6, and the PDP type is changed to PDP type IPv4 and no SM cause is included, the MS should request another PDP context for PDP type IPv6 to the same APN.

NOTE: Some networks can respond with ACTIVATE PDP CONTEXT REJECT with SM cause #28 "unknown PDP address or PDP type". In that instance, the MS can attempt to establish dual-stack connectivity by performing two PDP context activation request procedures to activate an IPv4 PDP context and an IPv6 PDP context, both to the same APN.

6.1.3.1.1 Successful PDP context activation initiated by the mobile station

In order to request a PDP context activation, the MS sends an ACTIVATE PDP CONTEXT REQUEST message to the network, enters the state PDP-ACTIVE-PENDING and starts timer T3380. The message contains the selected NSAPI, PDP type number and requested QoS. The MS shall ensure that the selected NSAPI is not currently being used by another Session Management entity in the MS. The MS may indicate the support of Network Requested Bearer Control procedures, the support of local IP address in TFTs or the 3GPP PS data off UE status in the protocol configuration options information element. The MS supporting S1 mode shall indicate subscribed, interactive or background traffic class in the QoS requested. The MS not supporting S1 mode should indicate subscribed, interactive or background traffic class in the QoS requested. If there is a subscribed QoS profile available for the MS, the network may ignore the requested QoS and apply the subscribed QoS profile (see 3GPP TS 23.060 [74]).

The MS shall set the request type to "initial request" when the MS is establishing connectivity to an additional PDN for the first time, i.e. when it is an initial attach to that PDN. The MS shall set the request type to "handover" when the connectivity to a PDN is established upon handover from a non-3GPP access network and the MS was connected to that

PDN before the handover to the 3GPP access network. If the MS is establishing connectivity for emergency bearer services it shall set the request type to "emergency" and not include an APN in the ACTIVATE PDP CONTEXT REQUEST message.

Upon receipt of the ACTIVATE PDP CONTEXT REQUEST message with request type set to "emergency" the network shall use the APN or the GGSN/PDN GW configured for emergency bearer services.

Upon receipt of an ACTIVATE PDP CONTEXT REQUEST message with a PDP type number "IPv4v6 address" in the Requested PDP address information element, the network shall on sending the ACTIVATE PDP CONTEXT ACCEPT message:

- include the SM cause information element with cause #50 "PDP type IPv4 only allowed", if the requested PDN connectivity is accepted with the restriction that only PDP type IPv4 is allowed; or
- include the SM cause information element with cause #51 "PDP type IPv6 only allowed", if the requested PDN connectivity is accepted with the restriction that only PDP type IPv6 is allowed; or
- include the SM cause information element with cause #52 "single address bearers only allowed", if the requested PDN connectivity is accepted with the restriction that only single IP version bearers are allowed.

If the MS receives the SM cause value #50 "PDP type IPv4 only allowed" or #51 "PDP type IPv6 only allowed" in the ACTIVATE PDP CONTEXT ACCEPT message, the MS shall not subsequently request another PDP context to get a PDP Type different from the one allowed by the network, until:

- all PDP contexts to the given APN are deactivated either explicitly between the MS and the network, i.e. PDP context deactivation procedure, or implicitly (without peer to peer signalling between the MS and the network) as a result of:
 - i) PDP context synchronization during routing area updating or service request procedure;
 - ii) PDP context deactivation initiated by the network,
 - iii) detach from GPRS services; or;
 - iv) a service request procedure is rejected with a cause which results in the MS entering state GMM-DEREGISTERED; or
- the PDP type which is used to access to the APN is changed.

NOTE 1: Request to send another ACTIVATE PDP CONTEXT REQUEST message with a specific PDP type comes from upper layers.

If the MS receives the SM cause value #52 "single address bearers only allowed" in the ACTIVATE PDP CONTEXT ACCEPT message, the MS should subsequently request another PDP context for the other PDP type to the same APN with a single address PDP type (IPv4 or IPv6) other than the one already activated.

NOTE 2: If the MT and TE are separated, the MS might not be able to use SM cause #52 "single address bearers only allowed" as a trigger for activating a second single-IP-stack PDP context.

Upon receipt of an ACTIVATE PDP CONTEXT REQUEST message, the network selects a radio priority level based on the QoS negotiated and may reply with an ACTIVATE PDP CONTEXT ACCEPT message.

If the ACTIVATE PDP CONTEXT REQUEST message included a low priority indicator set to "MS is configured for NAS signalling low priority", the network shall store the NAS signalling low priority indication within the default PDP context.

If the network receives an ACTIVATE PDP CONTEXT REQUEST message with the same combination of APN and PDP type as an already existing PDN connection, and multiple PDN connections for a given APN are allowed, the network may retain the existing PDP contexts and proceed with the requested PDP context activation procedure.

Upon receipt of the message ACTIVATE PDP CONTEXT ACCEPT the MS shall stop timer T3380, shall enter the state PDP-ACTIVE. If the protocol configuration options information element is present, the network may indicate the Bearer Control Mode that shall be used, the network support of local IP address in TFTs, or the 3GPP PS data off support indication. If the protocol configuration options information element is not present or the Selected Bearer Control Mode parameter is not present in the protocol configuration options information element, the MS shall apply Bearer Control Mode 'MS only' for all active PDP contexts sharing the same PDP Address and APN. If the 3GPP PS

data off UE status is "activated", the MS behaves as described in subclause 4.7.1.10. If the offered QoS parameters received from the network differ from the QoS requested by the MS, the MS shall either accept the negotiated QoS or initiate the PDP context deactivation procedure. If the Request type information element is not present, the network shall assume that the request type is "initial request".

NOTE 3: If the MS requested a value for a QoS parameter that is not within the range specified by 3GPP TS 23.107 [81], the network should negotiate the parameter to a value that lies within the specified range.

If the lower layers provide a L-GW Transport Layer Address value together with the ACTIVATE PDP CONTEXT REQUEST message and a PDN connection is established as a LIPA PDN connection due to the ACTIVATE PDP CONTEXT REQUEST message, then the SGSN shall store the L-GW Transport Layer Address value as the GGSN address in the PDP context of the LIPA PDN connection. If connectivity with the requested APN is accepted and the network considers this PDN connection a LIPA PDN connection, then subject to operator policy the SGSN shall include in the ACTIVATE PDP CONTEXT ACCEPT message the Connectivity type IE indicating "the PDN connection is considered a LIPA PDN connection".

If the lower layers provide a SIPTO L-GW Transport Layer Address value identifying a L-GW together with the ACTIVATE PDP CONTEXT REQUEST message and a PDN connection is established as a SIPTO at the local network PDN connection due to the ACTIVATE PDP CONTEXT REQUEST message, then the SGSN shall store the SIPTO L-GW Transport Layer Address value as the P-GW address in the PDP context of the SIPTO at the local network PDN connection.

If the lower layers provide a LHN-ID value together with the ACTIVATE PDP CONTEXT REQUEST message and a PDN connection is established as a SIPTO at the local network PDN connection due to the ACTIVATE PDP CONTEXT REQUEST message, then the SGSN shall store the LHN-ID value in the PDP context of the SIPTO at the local network PDN connection.

NOTE 4: The receipt of a LHN-ID value during the establishment of the PDN connection, during routing area updating procedure or during inter-SGSN handover can be used as an indication by the SGSN that the SIPTO at the local network PDN connection is established to a stand-alone GW (see 3GPP TS 23.060 [74]).

In A/Gb mode, the MS shall initiate establishment of the logical link for the LLC SAPI indicated by the network with the offered QoS and selected radio priority level if no logical link has been already established for that SAPI. If the offered QoS parameters received from the network differ from the QoS requested by the MS, the MS shall either accept the negotiated QoS or initiate the PDP context deactivation procedure. If the LLC SAPI indicated by the network can not be supported by the MS, the MS shall initiate the PDP context deactivation procedure.

In Iu mode, both the network and the MS shall store the LLC SAPI and the radio priority in the PDP context. If a Iu mode to A/Gb mode system change is performed, the new SGSN shall initiate establishment of the logical link using the negotiated QoS profile, the negotiated LLC SAPI, and selected radio priority level stored in the PDP context as in a A/Gb mode to A/Gb mode Routing Area Update.

An MS, which is capable of operating in A/Gb mode, shall use a valid LLC SAPI, while an MS which is not capable of operating in A/Gb mode shall indicate the LLC SAPI value as "LLC SAPI not assigned" in order to avoid unnecessary value range checking and any other possible confusion in the network. When the MS uses a valid LLC SAPI, the network shall return a valid LLC SAPI. The network shall return the "LLC SAPI not assigned" value only when the MS uses the "LLC SAPI not assigned" value.

NOTE 5: The radio priority level and the LLC SAPI parameters, though not used in Iu mode, shall be included in the messages, in order to support handover between Iu mode and A/Gb mode networks.

If a WLAN offload indication information element is included in the ACTIVATE PDP CONTEXT ACCEPT message, the MS shall store the WLAN offload acceptability values for this PDN connection and use the UTRAN offload acceptability value to determine whether this PDN connection is offloadable to WLAN or not.

At inter-system change from Iu mode to A/Gb mode, SM shall locally deactivate the active PDP context(s) if SM does not have the following parameters:

- LLC SAPI; and
- radio priority.

Upon receipt of the ACTIVATE PDP CONTEXT ACCEPT message with the Connectivity type IE indicating "the PDN connection is considered a LIPA PDN connection", the MS provides an indication to the upper layers that the connectivity is provided by a LIPA PDN connection.

6.1.3.1.2 Successful PDP context activation requested by the network

In order to request a PDP context activation, the network sends a REQUEST PDP CONTEXT ACTIVATION message to the MS and starts timer T3385. The message contains an offered PDP address. If available, the APN shall be included in the REQUEST PDP CONTEXT ACTIVATION message.

Upon receipt of a REQUEST PDP CONTEXT ACTIVATION message if an APN is indicated in the message and the timer T3396 is running for the APN, the MS shall stop the timer T3396, and then either initiate the PDP context activation procedure as described in the previous subclause or reject the activation request by sending a REQUEST PDP CONTEXT ACTIVATION REJECT message as described in subclause 6.1.3.1.4. If the REQUEST PDP CONTEXT ACTIVATION message did not contain an APN, then the MS shall stop the timer T3396 associated with no APN. The value of the reject cause IE of the REQUEST PDP CONTEXT ACTIVATION REJECT message shall indicate the reason for rejection, e.g. "insufficient resources to activate another context".

The ACTIVATE PDP CONTEXT REQUEST message sent by the MS in order to initiate the PDP context activation procedure shall contain the PDP address, PDP Type and APN requested by the network in the REQUEST PDP CONTEXT ACTIVATION message.

Upon receipt of the ACTIVATE PDP CONTEXT REQUEST message, the network shall stop timer T3385.

The same procedures then apply as described for MS initiated PDP context activation.

6.1.3.1.3 Unsuccessful PDP context activation initiated by the MS

6.1.3.1.3.1 General

Upon receipt of an ACTIVATE PDP CONTEXT REQUEST message the network may reject the MS initiated PDP context activation by sending an ACTIVATE PDP CONTEXT REJECT message to the MS. The message shall contain a cause code that typically indicates one of the following causes:

- # 8: Operator Determined Barring;
- # 26: insufficient resources;
- # 27: missing or unknown APN;
- # 28: unknown PDP address or PDP type;
- # 29: user authentication failed;
- # 30: activation rejected by GGSN, Serving GW or PDN GW;
- # 31: activation rejected, unspecified;
- # 32: service option not supported;
- # 33: requested service option not subscribed;
- # 34: service option temporarily out of order;
- # 35: NSAPI already used. The network shall not send this cause code (see note 1);
- # 50: PDP type IPv4 only allowed;
- # 51: PDP type IPv6 only allowed;
- # 57: PDP type IPv4v6 only allowed;
- # 58: PDP type non IP only allowed;
- # 65: maximum number of PDP contexts reached;

66: requested APN not supported in current RAT and PLMN combination;

95 - 111: protocol errors;

#112: APN restriction value incompatible with active PDP context; or

#113: Multiple accesses to a PDN connection not allowed.

NOTE 1: Pre-R99 network may send this cause code.

The network may include a Back-off timer value IE in the ACTIVATE PDP CONTEXT REJECT message. If the SM cause value is #26 "insufficient resources" and if the request type in the ACTIVATE PDP CONTEXT REQUEST was set to "emergency", the network shall not include a Back-off timer value IE.

If the Back-off timer value IE is included and the SM cause value is different from #26 "insufficient resources", #50 "PDP type IPv4 only allowed", #51 "PDP type IPv6 only allowed", #57 "PDP type IPv4v6 only allowed", #58 "PDP type non IP only allowed" and #65 "maximum number of PDP contexts reached", the network may include the Re-attempt indicator IE to indicate whether the MS is allowed to attempt a PDN connectivity procedure in the PLMN for the same APN in S1 mode, and whether another attempt in A/Gb and Iu mode or in S1 mode is allowed in an equivalent PLMN.

If the SM cause value is #50 "PDP type IPv4 only allowed", #51 "PDP type IPv6 only allowed", #57 "PDP type IPv4v6 only allowed" or #58 "PDP type non IP only allowed", the network may include the Re-attempt indicator IE without Back-off timer value IE to indicate whether the MS is allowed to attempt a PDP context activation procedure in an equivalent PLMN for the same APN in A/Gb or Iu mode using the same PDP type.

If the SM cause value is #66 "requested APN not supported in current RAT and PLMN combination", the network may include the Re-attempt indicator IE without Back-off timer value IE to indicate whether the MS is allowed to attempt a PDP context activation procedure in an equivalent PLMN for the same APN in A/Gb or Iu mode.

Upon receipt of an ACTIVATE PDP CONTEXT REJECT message, the MS shall stop timer T3380 and enter/remain in state PDP-INACTIVE.

If the ACTIVATE PDP CONTEXT REQUEST message was sent with request type set to "emergency" and the MS receives an ACTIVATE PDP CONTEXT REJECT message, then the MS may inform the upper layers of the failure to establish the emergency bearer.

NOTE 2: This can result in the upper layers requesting establishment of a CS emergency call (if not already attempted in the CS domain) or initiating other implementation specific mechanisms, e.g. procedures specified in 3GPP TS 24.229 [95] can result in the emergency call being attempted to another IP-CAN.

6.1.3.1.3.2 Handling of network rejection due to SM cause #26

If the SM cause value is #26 "insufficient resources" and the Back-off timer value IE is included, the MS shall ignore the Re-attempt indicator IE provided by the network, if any, and take different actions depending on the timer value received for timer T3396 in the Back-off timer value IE (if the MS is configured for dual priority, exceptions are specified in subclause 6.1.3.12; if the MS is an MS configured to use AC11 – 15 in selected PLMN, exceptions are specified in subclause 6.1.3.11):

- i) if the timer value indicates neither zero nor deactivated and an APN was included in the ACTIVATE PDP CONTEXT REQUEST message, the MS shall stop timer T3396 associated with the corresponding APN, if it is running. If the timer value indicates neither zero nor deactivated, the request type was different from "emergency", and no APN was included in the ACTIVATE PDP CONTEXT REQUEST message, the MS shall stop timer T3396 associated with no APN if it is running. The MS shall then start timer T3396 with the value provided in the Back-off timer value IE and:
 - shall not send another ACTIVATE PDP CONTEXT REQUEST, ACTIVATE SECONDARY PDP CONTEXT REQUEST or MODIFY PDP CONTEXT REQUEST message with exception of those identified in subclause 6.1.3.3, for the same APN that was sent by the MS, until timer T3396 expires or timer T3396 is stopped; and
 - shall not send another ACTIVATE PDP CONTEXT REQUEST message without an APN and with request type different from "emergency", or another ACTIVATE SECONDARY PDP CONTEXT REQUEST or MODIFY PDP CONTEXT REQUEST message with exception of those identified in subclause 6.1.3.3, for a non-emergency PDN connection established without an APN sent by the MS, if the APN was not included in

the ACTIVATE PDP CONTEXT REQUEST message and the request type was different from "emergency", until timer T3396 expires or timer T3396 is stopped.

The MS shall not stop timer T3396 upon a PLMN change or inter-system change;

ii) if the timer value indicates that this timer is deactivated, the MS:

- shall not send another ACTIVATE PDP CONTEXT REQUEST, ACTIVATE SECONDARY PDP CONTEXT REQUEST or MODIFY PDP CONTEXT REQUEST message with exception of those identified in subclause 6.1.3.3, for the same APN that was sent by the MS, until the MS is switched off or the SIM/USIM is removed or the MS receives a REQUEST PDP CONTEXT ACTIVATION, REQUEST SECONDARY PDP CONTEXT ACTIVATION or MODIFY PDP CONTEXT REQUEST message with the same APN from the network or a DEACTIVATE PDP CONTEXT REQUEST message including SM cause #39 "reactivation requested" for a PDP context which was activated by the MS for the same APN from the network; and
- shall not send another ACTIVATE PDP CONTEXT REQUEST message without an APN and with request type different from "emergency", or another ACTIVATE SECONDARY PDP CONTEXT REQUEST or MODIFY PDP CONTEXT REQUEST message with exception of those identified in subclause 6.1.3.3, for a non-emergency PDN connection established without an APN sent by the MS, if the APN was not included in the ACTIVATE PDP CONTEXT REQUEST message and the request type was different from "emergency", until the MS is switched off or the SIM/USIM is removed or the MS receives for a non-emergency PDP context which was activated by the MS any of the following messages: a REQUEST PDP CONTEXT ACTIVATION without an APN, a REQUEST SECONDARY PDP CONTEXT ACTIVATION or MODIFY PDP CONTEXT REQUEST message for a non-emergency PDN connection established without an APN sent by the MS, or a DEACTIVATE PDP CONTEXT REQUEST message including SM cause #39 "reactivation requested" for a non-emergency PDN connection which was established without an APN sent by the MS.

The timer T3396 remains deactivated upon a PLMN change or inter-system change; and

iii) if the timer value indicates that this timer is zero, the MS:

- shall stop timer T3396 associated with the corresponding APN, if running, and may send an ACTIVATE PDP CONTEXT REQUEST, ACTIVATE SECONDARY PDP CONTEXT REQUEST or MODIFY PDP CONTEXT REQUEST message for the same APN; and
- if the APN was not included in the ACTIVATE PDP CONTEXT REQUEST message and the request type was different from "emergency", the MS shall stop timer T3396 associated with no APN, if running, and may send an ACTIVATE PDP CONTEXT REQUEST message without an APN, or another ACTIVATE SECONDARY PDP CONTEXT REQUEST or MODIFY PDP CONTEXT REQUEST message for a non-emergency PDN connection established without an APN sent by the MS.

If the Back-off timer value IE is not included, then the MS may send another ACTIVATE PDP CONTEXT REQUEST, ACTIVATE SECONDARY PDP CONTEXT REQUEST or MODIFY PDP CONTEXT REQUEST message for the same APN.

The MS may initiate a PDP context activation procedure for emergency bearer services even if the timer T3396 is running.

If the timer T3396 is running when the MS enters state GMM-DEREGISTERED, the MS remains switched on, and the SIM/USIM in the MS remains the same, then timer T3396 is kept running until it expires or it is stopped.

If the MS is switched off when the timer T3396 is running, and if the SIM/USIM in the MS remains the same when the MS is switched on, the MS shall behave as follows:

- let t_1 be the time remaining for T3396 timeout at switch off and let t be the time elapsed between switch off and switch on. If t_1 is greater than t , then the timer shall be restarted with the value $t_1 - t$. If t_1 is equal to or less than t , then the timer need not be restarted. If the MS is not capable of determining t , then the MS shall restart the timer with the value t_1 ; and
- if prior to switch off, timer T3396 was running because an ACTIVATE PDP CONTEXT REQUEST, ACTIVATE SECONDARY PDP CONTEXT REQUEST, MODIFY PDP CONTEXT REQUEST or ACTIVATE MBMS CONTEXT REQUEST message containing the low priority indicator set to "MS is configured for NAS signalling low priority" was rejected with a timer value for timer T3396, and if timer T3396

is restarted at switch on, then the MS configured for dual priority shall handle session management requests as indicated in subclause 6.1.3.12.

6.1.3.1.3.3 Handling of network rejection due to SM cause other than SM cause #26

If the SM cause value is different from #26 "insufficient resources", #50 "PDP type IPv4 only allowed", #51 "PDP type IPv6 only allowed", #57 "PDP type IPv4v6 only allowed", #58 "PDP type non IP only allowed", #65 "maximum number of PDP contexts reached", and #66 "requested APN not supported in current RAT and PLMN combination", and the Back-off timer value IE is included, the MS shall take different actions depending on the timer value received in the Back-off timer value IE (if the MS is an MS configured to use AC11 – 15 in selected PLMN, exceptions are specified in subclause 6.1.3.13):

- i) if the timer value indicates neither zero nor deactivated, the MS shall start the back-off timer with the value provided in the Back-off timer value IE for the PDP context activation procedure and PLMN and APN combination and:
 - shall not send another ACTIVATE PDP CONTEXT REQUEST message in the PLMN for the same APN that was sent by the MS, until the back-off timer expires, the MS is switched off or the SIM/USIM is removed; and
 - shall not send another ACTIVATE PDP CONTEXT REQUEST message in the PLMN without an APN if the APN was not included in the ACTIVATE PDP CONTEXT REQUEST message, until the back-off timer expires, the MS is switched off or the SIM/USIM is removed;
- ii) if the timer value indicates that this timer is deactivated, the MS:
 - shall not send another ACTIVATE PDP CONTEXT REQUEST message in the PLMN for the same APN that was sent by the MS, until the MS is switched off or the SIM/USIM is removed; and
 - shall not send another ACTIVATE PDP CONTEXT REQUEST message in the PLMN without an APN if the APN was not included in the ACTIVATE PDP CONTEXT REQUEST message, until the MS is switched off or the SIM/USIM is removed; and
- iii) if the timer value indicates that this timer is zero, the MS:
 - may send an ACTIVATE PDP CONTEXT REQUEST message in the PLMN for the same APN; and
 - may send an ACTIVATE PDP CONTEXT REQUEST message in the PLMN without an APN if the APN was not included in the ACTIVATE PDP CONTEXT REQUEST message.

If the Back-off timer value IE is not included, then the MS shall ignore the Re-attempt indicator IE provided by the network, if any.

- i) Additionally, if the SM cause value is #8 "operator determined barring", #27 "missing or unknown APN", #32 "service option not supported", or #33 "requested service option not subscribed", the MS shall proceed as follows:
 - if the MS is registered in its HPLMN or in a PLMN that is within the EHPLMN list, the MS shall behave as described above in the present subclause, using the configured SM_RetryWaitTime value as specified in 3GPP TS 24.368 [135] or in USIM file NAS_{CONFIG} as specified in 3GPP TS 31.102 [112], if available, as back-off timer value; and
 - otherwise, if the MS is not registered in its HPLMN or in a PLMN that is within the EHPLMN list, or if the SM_RetryWaitTime value is not configured, the MS shall behave as described above in the present subclause using the default value of 12 minutes for the back-off timer.
- ii) For SM cause values different from #8 "operator determined barring", #27 "missing or unknown APN", #32 "service option not supported", or #33 "requested service option not subscribed", the MS behaviour regarding the start of a back-off timer is unspecified.

The MS shall not stop any back-off timer upon a PLMN change or inter-system change. If the network indicates that a back-off timer for the PDP context activation procedure and PLMN and APN combination is deactivated, then it remains deactivated upon a PLMN change or inter-system change.

NOTE 1: This means the back-off timer can still be running or be deactivated for the given SM procedure and PLMN and APN combination when the MS returns to the PLMN or when it performs inter-system change back from S1 mode to A/Gb or Iu mode. Thus the MS can still be prevented from sending another ACTIVATE PDP CONTEXT REQUEST message in the PLMN for the same APN.

If the back-off timer is started upon receipt of an ACTIVATE PDP CONTEXT REJECT message (i.e. the timer value was provided by the network, a configured value is available or the default value is used as explained above) or the back-off timer is deactivated, the MS behaves as follows:

- i) after a PLMN change the MS may send an ACTIVATE PDP CONTEXT REQUEST message for the same APN in the new PLMN, if the back-off timer is not running and is not deactivated for the PDP context activation procedure and the combination of new PLMN and APN;

Furthermore as an implementation option, for the SM cause values #8 "operator determined barring", #27 "missing or unknown APN", #32 "service option not supported" or #33 "requested service option not subscribed", if the network does not include a Re-attempt indicator IE, the MS may decide not to automatically send another ACTIVATE PDP CONTEXT REQUEST message for the same APN, if the MS registered to a new PLMN which is in the list of equivalent PLMNs.

- ii) if the network does not include the Re-attempt indicator IE to indicate whether re-attempt in S1 mode is allowed, or the MS ignores the Re-attempt indicator IE, e.g. because the Back-off timer value IE is not included, then:

- if the MS is registered in its HPLMN or in a PLMN that is within the EHPLMN list, the MS shall apply the configured SM_RetryAtRATChange value as specified in 3GPP TS 24.368 [135] or in USIM file NAS_{CONFIG} as specified in 3GPP TS 31.102 [112], if available, to determine whether the MS may attempt a PDN connectivity procedure for the same PLMN and APN combination in S1 mode; and
- if the MS is not registered in its HPLMN or in a PLMN that is within the EHPLMN list, or if the NAS configuration MO as specified in 3GPP TS 24.368 [135] is not available and the value for inter-system change is not configured in the USIM file NAS_{CONFIG}, then the MS behaviour regarding a PDN connectivity procedure for the same PLMN and APN combination in S1 mode is unspecified; and

- iii) if the network includes the Re-attempt indicator IE indicating that re-attempt in an equivalent PLMN is not allowed, then depending on the timer value received in the Back-off timer value IE, for each combination of a PLMN from the equivalent PLMN list and the APN the MS shall start a back-off timer for the PDP context activation procedure with the value provided by the network, or deactivate the respective back-off timer as follows:

- If the Re-attempt indicator IE additionally indicates that re-attempt in S1 mode is allowed, the MS shall start or deactivate the back-off timer for A/Gb and Iu mode only; and
- otherwise the MS shall start or deactivate the back-off timer for A/Gb, Iu, and S1 mode.

If the back-off timer for a PLMN and APN combination was started or deactivated in S1 mode upon receipt of a PDN CONNECTIVITY REJECT message (see 3GPP TS 24.301 [120]) and the network indicated that re-attempt in A/Gb or Iu mode is allowed, then this back-off timer does not prevent the MS from sending an ACTIVATE PDP CONTEXT REQUEST message in this PLMN for the same APN in A/Gb or Iu mode. If the network indicated that re-attempt in A/Gb or Iu mode is not allowed, the MS shall not send any ACTIVATE PDP CONTEXT REQUEST message in this PLMN for the same APN in A/Gb or Iu mode until the back-off timer expires, the MS is switched off or the USIM is removed.

NOTE 2: The back-off timer is used to describe a logical model of the required MS behaviour. This model does not imply any specific implementation, e.g. as a timer or timestamp.

NOTE 3: Reference to back-off timer in this section can either refer to use of timer T3396 or to use of a different packet system specific timer within the MS. Whether the MS uses T3396 as a back-off timer or it uses different packet system specific timers as back-off timers is left up to MS implementation. This back-off timer is stopped when the MS is switched off or the SIM/USIM is removed.

The MS may initiate a PDP context activation procedure for emergency bearer services even if the back-off timer is running.

If the SM cause value is #50 "PDP type IPv4 only allowed", #51 "PDP type IPv6 only allowed", #57 "PDP type IPv4v6 only allowed" or #58 "PDP type non IP only allowed", the MS shall ignore the Back-off timer value IE provided by the

network, if any. The MS shall not automatically send another ACTIVATE PDP CONTEXT REQUEST message for the same APN that was sent by the MS using the same PDP type, until any of the following conditions is fulfilled:

- the MS is registered to a new PLMN, and either the network did not include a Re-attempt indicator IE in the ACTIVATE PDP CONTEXT REJECT message or the Re-attempt indicator IE included in the message indicated that re-attempt in an equivalent PLMN is allowed;
- the MS is registered to a new PLMN which was not in the list of equivalent PLMNs at the time when the ACTIVATE PDP CONTEXT REJECT message was received;
- the PDP type which is used to access to the APN is changed;
- the MS is switched off; or
- the SIM/USIM is removed.

For the SM cause values #50 "PDP type IPv4 only allowed", #51 "PDP type IPv6 only allowed", #57 "PDP type IPv4v6 only allowed" and #58 "PDP type non IP only allowed", the MS shall ignore the value of the RATC bit in the Re-attempt indicator IE provided by the network, if any.

NOTE 4: For the SM cause values #50 "PDP type IPv4 only allowed", #51 "PDP type IPv6 only allowed", #57 "PDP type IPv4v6 only allowed" and #58 "PDP type non IP only allowed", re-attempt in S1 mode for the same APN (or no APN, if no APN was indicated by the MS) using the same PDP type is not allowed.

Furthermore as an implementation option, for the SM cause values #50 "PDP type IPv4 only allowed", #51 "PDP type IPv6 only allowed", #57 "PDP type IPv4v6 only allowed" and #58 "PDP type non IP only allowed", if the network does not include a Re-attempt indicator IE the MS may decide not to automatically send another ACTIVATE PDP CONTEXT REQUEST message for the same APN that was sent by the MS using the same PDP type, if the MS registered to a new PLMN which is in the list of equivalent PLMNs.

NOTE 5: Request to send another ACTIVATE PDP CONTEXT REQUEST message with a specific PDP type has to come from upper layers.

If the SM cause value is #65 "maximum number of PDP contexts reached", the MS shall determine the PLMN's maximum number of PDP contexts in A/Gb or Iu mode (see subclause 6.1.3.0) as the number of active PDP contexts it has. The MS shall ignore the Back-off timer value IE and Re-attempt indicator IE provided by the network, if any.

NOTE 6: In some situations, when attempting to establish multiple PDP contexts, the number of active PDP contexts that the MS has when SM cause #65 is received is not equal to the maximum number of PDP contexts reached in the network.

NOTE 7: When the network supports emergency bearer services, it is not expected that SM cause #65 is returned by the network when the MS requests a PDP context for emergency bearer services.

The PLMN's maximum number of PDP contexts in A/Gb or Iu mode applies to the PLMN in which the SM cause #65 "maximum number of PDP contexts reached" is received. When the MS is switched off or when the USIM is removed, the MS shall clear all previous determinations representing any PLMN's maximum number of PDP contexts in A/Gb or Iu mode (see subclause 6.1.3.0). Upon successful registration with a new PLMN, the MS may clear previous determinations representing any PLMN's maximum number of PDP contexts in A/Gb or Iu mode.

If the SM cause value is #66 "requested APN not supported in current RAT and PLMN combination", the MS shall take different actions depending on the Back-off timer value IE and the Re-attempt indicator IE optionally included:

- i) If the Back-off timer value IE is not included, and either the Re-attempt indicator IE is not included or the Re-attempt indicator IE is included indicating that re-attempt in an equivalent PLMN is allowed, the MS shall not send an ACTIVATE PDP CONTEXT REQUEST message for the same APN in the current PLMN in A/Gb or Iu mode until the MS is switched off or the SIM/USIM is removed;
- ii) if the Back-off timer value IE is not included, and the Re-attempt indicator IE is included and indicates that re-attempt in an equivalent PLMN is not allowed, the MS shall not send an ACTIVATE PDP CONTEXT REQUEST message for the same APN in any PLMN in the list of equivalent PLMNs in A/Gb or Iu mode until the MS is switched off or the SIM/USIM is removed; and
- iii) if the Back-off timer value IE is included, the MS shall take different actions depending on the timer value received in the Back-off timer value IE:

- a) if the timer value indicates neither zero nor deactivated, the MS shall start the back-off timer with the value provided in the Back-off timer value IE for the PLMN and APN combination and shall not send another ACTIVATE PDP CONTEXT REQUEST for the same APN in the current PLMN in A/Gb or Iu mode until the back-off timer expires, the MS is switched off or the SIM/USIM is removed;
- b) if the timer value indicates that this timer is deactivated, the MS shall not send another ACTIVATE PDP CONTEXT REQUEST message for the same APN in the current PLMN in A/Gb or Iu mode until the MS is switched off or the SIM/USIM is removed; and
- c) if the timer value indicates that this timer is zero, the MS may send an ACTIVATE PDP CONTEXT REQUEST message in the PLMN for the same APN.

If the network includes the Re-attempt indicator IE indicating that re-attempt in an equivalent PLMN is not allowed, then

- for case a) the MS shall additionally start a back-off timer with the value provided in the Back-off timer value IE for the PDP context activation procedure for each combination of a PLMN from the equivalent PLMN list and the APN; and
- for case b) the MS shall deactivate the respective back-off timers for the PDP context activation procedure for each combination of a PLMN from the equivalent PLMN list and the APN.

For the SM cause value #66 "requested APN not supported in current RAT and PLMN combination" the MS shall ignore the value of the RATC bit in the Re-attempt indicator IE provided by the network, if any.

As an implementation option, for cases i), iii.a) and iii.b), if the Re-attempt indicator IE is not included, the MS may decide not to automatically send another ACTIVATE PDP CONTEXT REQUEST message for the same APN in a PLMN which is in the list of equivalent PLMNs.

6.1.3.1.3A Void

6.1.3.1.4 Unsuccessful PDP context activation requested by the network

Upon receipt of the REQUEST PDP CONTEXT ACTIVATION message, the MS may reject the network requested PDP context activation by sending the REQUEST PDP CONTEXT ACTIVATION REJECT message to the network. The message contains the same TI as included in the REQUEST PDP CONTEXT ACTIVATION and an additional cause code that typically indicates one of the following causes:

- # 26: insufficient resources;
- # 31: activation rejected, unspecified;
- # 40: feature not supported; or
- # 95 - 111: protocol errors.

The network shall stop timer T3385 and enter state PDP-INACTIVE.

6.1.3.1.5 Abnormal cases

The following abnormal cases can be identified:

- a) Expiry of timers

In the mobile station:

On the first expiry of the timer T3380, the MS shall resend the ACTIVATE PDP CONTEXT REQUEST and shall reset and restart timer T3380. This retransmission is repeated four times, i.e. on the fifth expiry of timer T3380, the MS shall release all resources possibly allocated for this invocation and shall abort the procedure; no automatic PDP context activation re-attempt shall be performed; and

- if the ACTIVATE PDP CONTEXT REQUEST message was sent with request type set to "emergency", then the MS may inform the upper layers of the failure to establish the emergency bearer.

NOTE: This can result in the upper layers requesting establishment of a CS emergency call (if not already attempted in the CS domain) or initiating other implementation specific mechanisms, e.g. procedures specified in 3GPP TS 24.229 [95] can result in the emergency call being attempted to another IP-CAN.

On the network side:

On the first expiry of the timer T3385, the network shall resend the message REQUEST PDP CONTEXT ACTIVATION and shall reset and restart timer T3385. This retransmission is repeated four times, i.e. on the fifth expiry of timer T3385, the network shall release possibly allocated resources for this activation and shall abort the procedure.

b) Collision of MS initiated and network requested PDP context activation

If the MS uses dynamic PDP addressing that turns out to collide with the network requested PDP address, then there is no detection of collision specified but left for network implementation.

c) MS initiated PDP context activation request for an already activated PDP context (on the network side)

- i) If the network receives a ACTIVATE PDP CONTEXT REQUEST message with the same combination of APN, PDP type and PDP address as an already activated PDP context, the network shall deactivate the existing PDP context and, if any, all the linked PDP contexts (matching the combination of APN, PDP type and PDP address), locally without notification to the MS and proceed with the requested PDP context activation.
- ii) Alternatively (different combination of APN, PDP type and PDP address), if the NSAPI matches that of an already activated PDP context, then the network shall deactivate only the existing PDP context locally without notification to the MS and proceed with the requested PDP context activation.

It is an implementation option if the parameters used for comparison described in clause i) and ii) are the parameters provided in the (current and previous) ACTIVATE PDP CONTEXT REQUESTs or the parameters which are the result of the application of the selection rules defined in 3GPP TS 23.060 [74] Annex A.2.

The parameter provided in the current ACTIVATE PDP CONTEXT REQUEST can not be compared to the actually used parameters (result of application of selection rules defined in 3GPP TS 23.060 [74] Annex A.2) of the previously activated PDP contexts.

If the network receives an ACTIVATE PDP CONTEXT REQUEST message with request type "emergency" and there already is a PDN connection for emergency bearer services existing, the network shall reject the request with cause code #31 "activation rejected, unspecified".

d) Network initiated PDP context activation request for an already activated PDP context (on the mobile station side)

If the MS receives a REQUEST PDP CONTEXT ACTIVATION message with the same combination of APN, PDP type and PDP address as an already activated PDP context, the MS shall deactivate the existing PDP context and, if any, all the linked PDP contexts (matching the combination of APN, PDP type and PDP address) locally without notification to the network and proceed with the requested PDP context activation.

e) Additional MS initiated PDP context activation request received from an MS that is attached for emergency bearer services:

If the MS is attached for emergency bearer services the network shall only accept the PDP context activation request for emergency services. The network shall reject any other PDP context activation request with cause code #31 "activation rejected, unspecified".

f) Reception of the ACTIVATE PDP CONTEXT ACCEPT message and Bearer Control Mode violation

If the Selected Bearer Control Mode indicates other value than 'MS only' in the ACTIVATE PDP CONTEXT ACCEPT message although the protocol configuration options information element was not present or the MS Support of Network Requested Bearer Control indicator was not present in the protocol configuration options information element of the corresponding ACTIVATE PDP CONTEXT REQUEST message, the MS shall ignore the Selected Bearer Control Mode parameter received from the network and apply Bearer Control Mode 'MS only' for all active PDP contexts sharing the same PDP Address and APN.

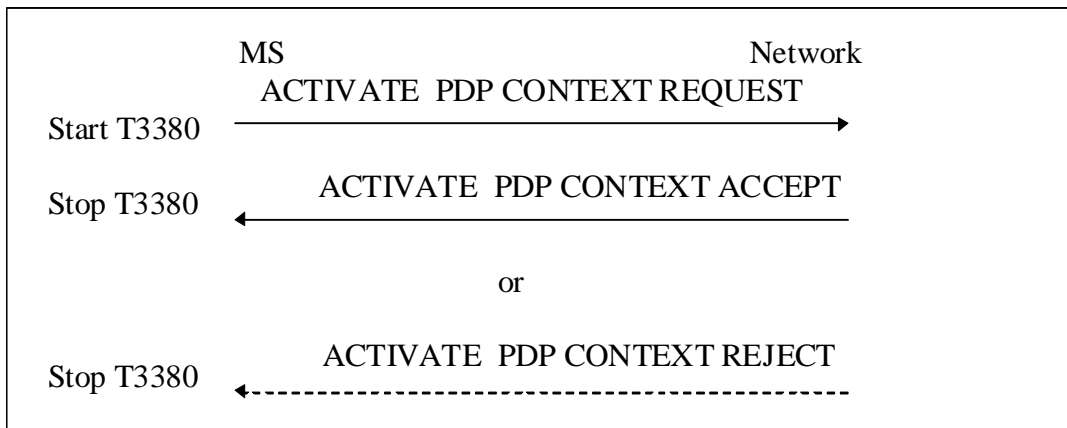

Figure 6.3/3GPP TS 24.008: MS initiated PDP context activation procedure

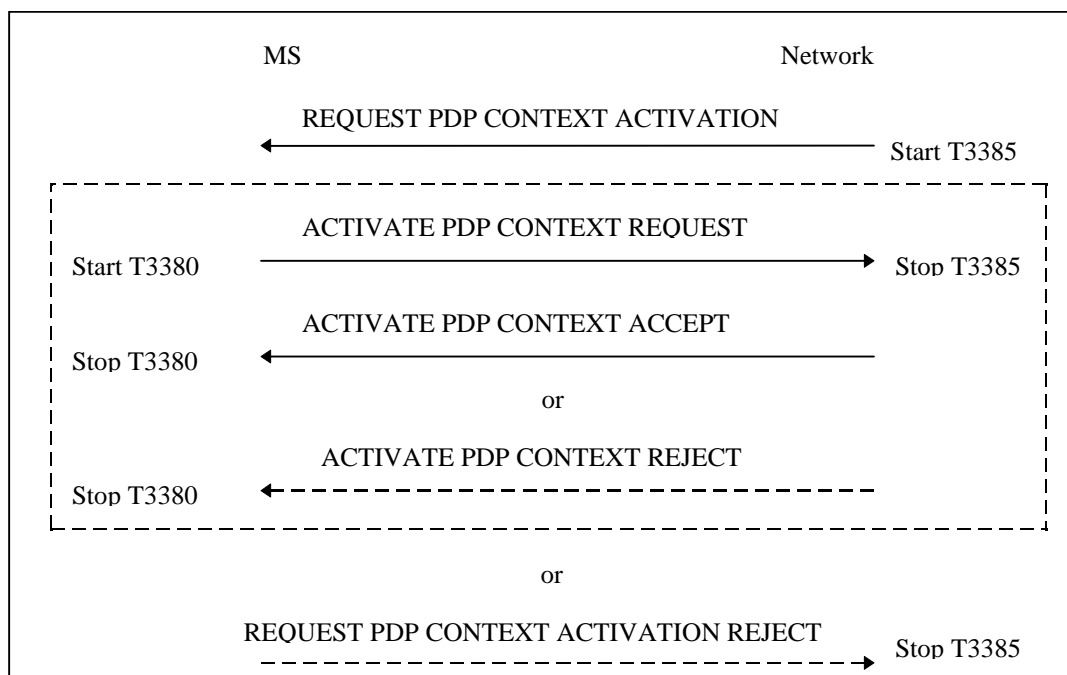

Figure 6.4/3GPP TS 24.008: Network initiated PDP context activation procedure

6.1.3.1.6 Handling Activate PDP context request for MS configured for dual priority

If a PDP context exists that was created due to a request including a low priority indicator set to "MS is configured for NAS signalling low priority" and the upper layers of the MS request to activate a PDP context with the same APN and the low priority indicator set to "MS is not configured for NAS signalling low priority", when initiating the PDP context activation procedure, the MS shall:

- send an ACTIVATE PDP CONTEXT REQUEST message with the same combination of APN, PDP type and PDP address as the existing PDP context to activate a PDP context;

NOTE 1: This option relies on the network handling of abnormal cases as specified in subclause 6.1.3.1.5 case c).

- send an ACTIVATE PDP CONTEXT REQUEST message with the same combination of APN and PDP type as the existing PDP context but with a different PDP address, or without PDP address, to activate a PDP context; or
- send an ACTIVATE PDP CONTEXT REQUEST message with the same APN after the successful deactivation of the existing PDP context.

NOTE 2: The above list of options also apply for the case when the existing PDP context was created due to a request including a low priority indicator set to "MS is not configured for NAS signalling low priority" and the new request to activate a PDP context with the same APN contains a low priority indicator set to "MS is configured for NAS signalling low priority".

As an alternative the upper layers of the MS can request to activate a PDP context with a different APN.

6.1.3.2 Secondary PDP Context Activation Procedure

The purpose of this procedure is to establish an additional PDP context between the MS and the network for a specific Traffic Flow Template (TFT) and QoS profile on a specific NSAPI, when one or more PDP contexts has/have already been established for the particular PDP address and APN. The MS shall include a request for a TFT comprising at least one packet filter applicable for the uplink direction. Depending on the selected Bearer Control Mode being 'MS only' or 'MS/NW', the secondary PDP context activation procedure may either be initiated by the MS or by either the MS or the network, respectively. However, the network and the MS shall not initiate a secondary PDP context activation procedure for established PDP context of "non IP" PDP type.

The network shall allocate packet filter identifiers and manage packet filter evaluation precedence for the packet filters added by the network. The the MS shall allocate packet filter identifiers and manage packet filter evaluation precedence for the packet filters added by the MS.

If there is a PDN connection for emergency bearer services established, the MS shall not initiate a secondary PDP context activation procedure for this connection unless triggered by the network.

NOTE: 3GPP TS 23.060 [74] subclause 9.3 specifies that a packet filter applicable for the downlink direction is not mandatory in a TFT.

6.1.3.2.1 Successful Secondary PDP Context Activation Procedure Initiated by the MS

In order to request a PDP context activation with the same PDP address and APN as an already active PDP context, the MS shall send an ACTIVATE SECONDARY PDP CONTEXT REQUEST message to the network, enter the state PDP-ACTIVE-PENDING and start timer T3380. The message shall contain the selected NSAPI. The MS shall ensure that the selected NSAPI is not currently being used by another Session Management entity in the MS. The message shall also include a QoS profile, a requested LLC SAPI and the Linked TI. The QoS profile is the requested QoS. If present, the TFT shall be sent transparently through the SGSN to the GGSN to enable packet classification and policing for downlink data transfer. If the selected Bearer Control Mode is 'MS/NW' and a TFT IE is included in the ACTIVATE SECONDARY PDP CONTEXT REQUEST message, the MS shall set the packet filter direction parameter of each packet filter in the TFT to a value different from "00". The MS shall allocate packet filter identifiers for all packet filters included in the TFT.

Upon receipt of an ACTIVATE SECONDARY PDP CONTEXT REQUEST, the network shall validate the message by verifying the TI given in the Linked TI IE to be any of the active PDP context(s). The same GGSN address shall be used by the SGSN as for the already established PDP context(s) for that PDP address. The network shall select a radio priority level based on the QoS negotiated and shall reply with an ACTIVATE SECONDARY PDP CONTEXT ACCEPT message, if the request can be accepted.

NOTE 1: If the MS requested a value for a QoS parameter that is not within the range specified by 3GPP TS 23.107 [81], the network should negotiate the parameter to a value that lies within the specified range.

Upon receipt of the message ACTIVATE SECONDARY PDP CONTEXT ACCEPT, the MS shall stop timer T3380 and enter the state PDP-ACTIVE. If the offered QoS parameters received from the network differ from the QoS requested by the MS, the MS shall either accept the negotiated QoS or initiate the PDP context deactivation procedure.

In A/Gb mode the MS shall initiate establishment of the logical link for the LLC SAPI indicated by the network with the offered QoS and selected radio priority level if no logical link has been already established for that SAPI. If the LLC SAPI indicated by the network can not be supported by the MS, the MS shall initiate the PDP context deactivation procedure.

In Iu mode, both SGSN and MS shall store the LLC SAPI and the radio priority in the PDP context. If an Iu mode to A/Gb mode Routing Area Update is performed, the new SGSN shall initiate establishment of the logical link using the negotiated LLC SAPI, the negotiated QoS profile and selected radio priority level stored in the PDP context as in an A/Gb mode to A/Gb mode Routing Area Update.

An MS, which is capable of operating in A/Gb mode, shall use a valid LLC SAPI, while an MS which is not capable of operating in A/Gb mode shall indicate the LLC SAPI value as "LLC SAPI not assigned" in order to avoid unnecessary value range checking and any other possible confusion in the network. When the MS uses a valid LLC SAPI, the network shall return a valid LLC SAPI. The network shall return the "LLC SAPI not assigned" value only when the MS uses the "LLC SAPI not assigned" value.

NOTE 2: The radio priority level and the LLC SAPI parameters, though not used in Iu mode, shall be included in the messages, in order to support handover between Iu mode and A/Gb mode networks.

At inter-system change from Iu mode to A/Gb mode, SM shall locally deactivate the active PDP context(s) if SM does not have the following parameters:

- LLC SAPI; and
- radio priority.

6.1.3.2.1a Successful Secondary PDP Context Activation Procedure Requested by the network

In order to request a PDP context activation with the same PDP address and APN as an already active PDP context, the network shall send a REQUEST SECONDARY PDP CONTEXT ACTIVATION message to the MS and start timer T3385. The message contains the required QoS, Linked TI, and optionally protocol configuration options and a TFT. The network shall always include a TFT in the REQUEST SECONDARY PDP CONTEXT ACTIVATION message. If present, the TFT shall be sent transparently through the SGSN to the MS to enable packet classification and policing for uplink and downlink data transfer. The network shall allocate packet filter identifiers for all packet filters included in the TFT.

NOTE: A network implementing an earlier release of this specification can send a REQUEST SECONDARY PDP CONTEXT ACTIVATION message without any TFT.

Upon receipt of a REQUEST SECONDARY PDP CONTEXT ACTIVATION message, if the MS sent an APN for the establishment of the PDN connection, the MS shall stop the timer T3396 if it is running for the APN sent by the MS. If the MS did not send an APN for the establishment of the PDN connection and the request type was different from "emergency", the MS shall stop the timer T3396 associated with no APN if it is running. If the REQUEST SECONDARY PDP CONTEXT ACTIVATION message was received for an emergency PDN connection, the UE shall not stop the timer T3396 associated with no APN if it is running. For any case, the MS shall then either initiate the secondary PDP context activation procedure as described in the subclause 6.1.3.2.1 or shall reject the activation request by sending a REQUEST SECONDARY PDP CONTEXT ACTIVATION REJECT message as described in subclause 6.1.3.2.2a. The value of the reject cause IE of the REQUEST SECONDARY PDP CONTEXT ACTIVATION REJECT message shall indicate the reason for rejection, e.g. "insufficient resources to activate another context".

The MS shall maintain the previously negotiated Bearer Control Mode (BCM) for all active PDP contexts sharing the same PDP Address and APN and ignore any BCM parameter, if included in the REQUEST SECONDARY PDP CONTEXT ACTIVATION message. If the previously negotiated BCM is 'MS only', the MS should reject the PDP context activation (see subclause 6.1.3.2.2a).

The ACTIVATE SECONDARY PDP CONTEXT REQUEST message sent by the MS in order to initiate the secondary PDP context activation procedure shall contain the QoS and Linked TI required in the REQUEST SECONDARY PDP CONTEXT ACTIVATION message. The MS shall also include a TFT with packet filters as specified in the REQUEST SECONDARY PDP CONTEXT ACTIVATION message.

Upon receipt of the ACTIVATE SECONDARY PDP CONTEXT REQUEST message, the network shall stop timer T3385.

The same procedures then apply as described for MS initiated secondary PDP context activation.

6.1.3.2.2 Unsuccessful Secondary PDP Context Activation Procedure initiated by the MS

6.1.3.2.2.1 General

Upon receipt of an ACTIVATE SECONDARY PDP CONTEXT REQUEST message, the network may reject the MS initiated PDP context activation by sending an ACTIVATE SECONDARY PDP CONTEXT REJECT message to the MS. The message shall contain a cause code that typically indicates one of the following:

- # 26: insufficient resources;
- # 30: activation rejected by GGSN, Serving GW or PDN GW;
- # 31: activation rejected, unspecified;
- # 32: service option not supported;
- # 33: requested service option not subscribed;
- # 34: service option temporarily out of order;
- # 41: semantic error in the TFT operation;
- # 42: syntactical error in the TFT operation;
- # 43: unknown PDP context;
- # 44: semantic errors in packet filter(s);
- # 45: syntactical errors in packet filter(s);
- # 46: PDP context without TFT already activated;
- # 48: request rejected, Bearer Control Mode violation;
- # 56: collision with network initiated request;
- # 60: bearer handling not supported;
- # 65: maximum number of PDP contexts reached; or
- # 95 - 111: protocol errors.

The network may include a Back-off timer value IE in the ACTIVATE SECONDARY PDP CONTEXT REJECT message.

If the Back-off timer value IE is included and the SM cause value is different from #26 "insufficient resources" and #65 "maximum number of PDP contexts reached", the network may include the Re-attempt indicator IE to indicate whether the MS is allowed to attempt a bearer resource allocation procedure in the PLMN for the same APN in S1 mode, and whether another attempt in A/Gb and Iu mode or in S1 mode is allowed in an equivalent PLMN.

If the ACTIVATE SECONDARY PDP CONTEXT REQUEST message is related to an already active LIPA PDN connection or SIPTO at the local network PDN connection, then the network shall reply with an ACTIVATE SECONDARY PDP CONTEXT REJECT message with cause code #60 "bearer handling not supported".

If a PDP context for the TI given in the Linked TI IE exists, then the TFT in the ACTIVATE SECONDARY PDP CONTEXT REQUEST message is checked by the network for different types of TFT IE errors as specified in subclause 6.1.3.2.3.

Upon receipt of an ACTIVATE SECONDARY PDP CONTEXT REJECT message, the MS shall stop timer T3380 and enter the state PDP-INACTIVE.

6.1.3.2.2.2 Handling of network rejection due to SM cause #26

If the SM cause value is #26 "insufficient resources" and the Back-off timer value IE is included, the MS shall ignore the Re-attempt indicator IE provided by the network, if any, and take different actions depending on the timer value received for timer T3396 in the Back-off timer value IE (if the MS is configured for dual priority, exceptions are

specified in subclause 6.1.3.12; if the MS is an MS configured to use AC11 – 15 in selected PLMN, exceptions are specified in subclause 6.1.3.11):

- i) if the timer value indicates neither zero nor deactivated, the MS shall stop timer T3396 associated with the corresponding APN, if it is running. The MS shall then start timer T3396 with the value provided in the Back-off timer value IE and not send another ACTIVATE PDP CONTEXT REQUEST, ACTIVATE SECONDARY PDP CONTEXT REQUEST or MODIFY PDP CONTEXT REQUEST message with exception of those identified in subclause 6.1.3.3, for the same APN until timer T3396 expires or timer T3396 is stopped. If the MS did not send an APN for the establishment of the PDN connection and the request type was different from "emergency", the MS shall stop timer T3396 associated with no APN, if it is running. The MS shall then start timer T3396 with the value provided in the Back-off timer value IE and not send another ACTIVATE PDP CONTEXT REQUEST without an APN and with request type different from "emergency", or another ACTIVATE SECONDARY PDP CONTEXT REQUEST or MODIFY PDP CONTEXT REQUEST message with exception of those identified in subclause 6.1.3.3, for a non-emergency PDN connection established without an APN sent by the MS, until timer T3396 expires or timer T3396 is stopped. The MS shall not stop timer T3396 upon a PLMN change or inter-system change;
- ii) if the timer value indicates that this timer is deactivated, the MS shall not send another ACTIVATE PDP CONTEXT REQUEST, ACTIVATE SECONDARY PDP CONTEXT REQUEST or MODIFY PDP CONTEXT REQUEST message with exception of those identified in subclause 6.1.3.3, for the same APN until the MS is switched off or the SIM/USIM is removed or the MS receives a REQUEST PDP CONTEXT ACTIVATION, REQUEST SECONDARY PDP CONTEXT ACTIVATION or MODIFY PDP CONTEXT REQUEST message for the same APN or a DEACTIVATE PDP CONTEXT REQUEST message including SM cause #39 "reactivation requested" for a PDP context which was activated by the MS for the same APN from the network. If the MS did not send an APN for the establishment of the PDN connection and the request type was different from "emergency", the MS shall not send another ACTIVATE PDP CONTEXT REQUEST without an APN and with request type different from "emergency", or another ACTIVATE SECONDARY PDP CONTEXT REQUEST or MODIFY PDP CONTEXT REQUEST with exception of those identified in subclause 6.1.3.3, for a non-emergency PDN connection established without an APN sent by the MS, until the MS is switched off or the SIM/USIM is removed or the MS receives any of the following messages: a REQUEST PDP CONTEXT ACTIVATION without an APN, a REQUEST SECONDARY PDP CONTEXT ACTIVATION or MODIFY PDP CONTEXT REQUEST message for a non-emergency PDN connection established without an APN sent by the MS, or a DEACTIVATE PDP CONTEXT REQUEST message including SM cause #39 "reactivation requested" for a PDP context which was activated by the MS for a non-emergency PDN connection established without an APN sent by the MS. The timer T3396 remains deactivated upon a PLMN change or inter-system change; or
- iii) if the timer value indicates that this timer is zero, the MS:
 - shall stop timer T3396 associated with the corresponding APN, if running, and may send an ACTIVATE PDP CONTEXT REQUEST, ACTIVATE SECONDARY PDP CONTEXT REQUEST or MODIFY PDP CONTEXT REQUEST message for the same APN; and
 - if the MS did not send an APN for the establishment of the PDN connection and the request type was different from "emergency", the MS shall stop timer T3396 associated with no APN, if running, and may send an ACTIVATE PDP CONTEXT REQUEST message without an APN, or another ACTIVATE SECONDARY PDP CONTEXT REQUEST or MODIFY PDP CONTEXT REQUEST message for a non-emergency PDN connection established without an APN sent by the MS.

If the Back-off timer value IE is not included, the MS may send an ACTIVATE PDP CONTEXT REQUEST, ACTIVATE SECONDARY PDP CONTEXT REQUEST or MODIFY PDP CONTEXT REQUEST message for the same APN.

If the timer T3396 is running when the MS enters state GMM-DEREGISTERED, the MS remains switched on, and the SIM/USIM in the MS remains the same, then timer T3396 is kept running until it expires or it is stopped.

If the MS is switched off when the timer T3396 is running, and if the SIM/USIM in the MS remains the same when the MS is switched on, the MS behaves as follows:

- let t_1 be the time remaining for T3396 timeout at switch off and let t be the time elapsed between switch off and switch on. If t_1 is greater than t , then the timer shall be restarted with the value $t_1 - t$. If t_1 is equal to or less than t , then the timer need not be restarted. If the MS is not capable of determining t , then the MS shall restart the timer with the value t_1 ; and

- if prior to switch off, timer T3396 was running because an ACTIVATE PDP CONTEXT REQUEST, ACTIVATE SECONDARY PDP CONTEXT REQUEST, MODIFY PDP CONTEXT REQUEST or ACTIVATE MBMS CONTEXT REQUEST message containing the low priority indicator set to "MS is configured for NAS signalling low priority" was rejected with a timer value for timer T3396, and if timer T3396 is restarted at switch on, then the MS configured for dual priority shall handle session management requests as indicated in subclause 6.1.3.12.

6.1.3.2.2.3 Handling of network rejection due to SM cause other than SM cause #26

If the SM cause value is different from #26 "insufficient resources" and #65 "maximum number of PDP contexts reached", and the Back-off timer value IE is included, the MS takes different actions depending on the timer value received in the Back-off timer value IE (if the MS is an MS configured to use AC11 – 15 in selected PLMN, exceptions are specified in subclause 6.1.3.13):

- i) if the timer value indicates neither zero nor deactivated, the MS shall start the back-off timer with the value provided in the Back-off timer value IE for the secondary PDP context activation procedure and PLMN and APN combination and not send another ACTIVATE SECONDARY PDP CONTEXT REQUEST message in the PLMN for the same APN until the back-off timer expires, the MS is switched off or the SIM/USIM is removed;
- ii) if the timer value indicates that this timer is deactivated, the MS shall not send another ACTIVATE SECONDARY PDP CONTEXT REQUEST message in the PLMN for the same APN until the MS is switched off or the SIM/USIM is removed; and
- iii) if the timer value indicates that this timer is zero, the MS may send an ACTIVATE SECONDARY PDP CONTEXT REQUEST message in the PLMN for the same APN.

If the Back-off timer value IE is not included, then the MS shall ignore the Re-attempt indicator IE provided by the network, if any.

- i) Additionally, if the SM cause value is #32 "service option not supported", or #33 "requested service option not subscribed", the MS shall proceed as follows:
 - if the MS is registered in its HPLMN or in a PLMN that is within the EHPLMN list, the MS shall behave as described above in the present subclause, using the configured SM_RetryWaitTime value as specified in 3GPP TS 24.368 [135] or in USIM file NAS_{CONFIG} as specified in 3GPP TS 31.102 [112], if available, as back-off timer value; and
 - otherwise, if the MS is not registered in its HPLMN or in a PLMN that is within the EHPLMN list, or if the SM_RetryWaitTime value is not configured, the MS shall behave as described above in the present subclause using the default value of 12 minutes for the back-off timer.
- ii) For SM cause values different from #32 "service option not supported", or #33 "requested service option not subscribed", the MS behaviour regarding the start of a back-off timer is unspecified.

The MS shall not stop any back-off timer upon a PLMN change or inter-system change. If the network indicates that a back-off timer for the secondary PDP context activation procedure and PLMN and APN combination is deactivated, then it remains deactivated upon a PLMN change or inter-system change.

NOTE 1: This means the back-off timer can still be running or be deactivated for the given SM procedure and PLMN and APN combination when the MS returns to the PLMN or when it performs inter-system change back from S1 mode to A/Gb or Iu mode. Thus the MS can still be prevented from sending another ACTIVATE SECONDARY PDP CONTEXT REQUEST message in the PLMN for the same APN.

If the back-off timer is started upon receipt of an ACTIVATE SECONDARY PDP CONTEXT REJECT message (i.e. the timer value was provided by the network, a configured value is available or the default value is used as explained above) or the back-off timer is deactivated, the MS behaves as follows:

- i) after a PLMN change the MS may send an ACTIVATE SECONDARY PDP CONTEXT REQUEST message for the same APN in the new PLMN, if the back-off timer is not running and is not deactivated for the secondary PDP context activation procedure and the combination of new PLMN and APN;

Furthermore as an implementation option, for the SM cause values #32 "service option not supported" or #33 "requested service option not subscribed", if the network does not include a Re-attempt indicator IE, the MS may

decide not to automatically send another ACTIVATE SECONDARY PDP CONTEXT REQUEST message for the same APN, if the MS registered to a new PLMN which is in the list of equivalent PLMNs.

- ii) if the network does not include the Re-attempt indicator IE to indicate whether re-attempt in S1 mode is allowed, or the MS ignores the Re-attempt indicator IE, e.g. because the Back-off timer value IE is not included, then:
 - if the MS is registered in its HPLMN or in a PLMN that is within the EHPLMN list, the MS shall apply the configured SM_RetryAtRATChange value as specified in 3GPP TS 24.368 [135] or in USIM file NAS_{CONFIG} as specified in 3GPP TS 31.102 [112], if available, to determine whether the MS may attempt a bearer resource allocation procedure for the same PLMN and APN combination in S1 mode; and
 - if the MS is not registered in its HPLMN or in a PLMN that is within the EHPLMN list, or if the NAS configuration MO as specified in 3GPP TS 24.368 [135] is not available and the value for inter-system change is not configured in the USIM file NAS_{CONFIG}, then the MS behaviour regarding a bearer resource allocation procedure for the same PLMN and APN combination in S1 mode is unspecified; and
- iii) if the network includes the Re-attempt indicator IE indicating that re-attempt in an equivalent PLMN is not allowed, then depending on the timer value received in the Back-off timer value IE, for each combination of a PLMN from the equivalent PLMN list and the APN the MS shall start a back-off timer for the secondary PDP context activation procedure with the value provided by the network, or deactivate the respective back-off timer as follows:
 - If the Re-attempt indicator IE additionally indicates that re-attempt in S1 mode is allowed, the MS shall start or deactivate the back-off timer for A/Gb and Iu mode only; and
 - otherwise the MS shall start or deactivate the back-off timer for A/Gb, Iu, and S1 mode.

If the back-off timer for a PLMN and APN combination was started or deactivated in S1 mode upon receipt of a BEARER RESOURCE ALLOCATION REJECT message (see 3GPP TS 24.301 [120]) and the network indicated that re-attempt in A/Gb or Iu mode is allowed, then this back-off timer does not prevent the MS from sending an ACTIVATE SECONDARY PDP CONTEXT REQUEST message in this PLMN for the same APN in A/Gb or Iu mode. If the network indicated that re-attempt in A/Gb or Iu mode is not allowed, the MS shall not send any ACTIVATE SECONDARY PDP CONTEXT REQUEST message in this PLMN for the same APN in A/Gb or Iu mode, until the timer expires, the MS is switched off or the USIM is removed.

NOTE 2: The back-off timer is used to describe a logical model of the required MS behaviour. This model does not imply any specific implementation, e.g. as a timer or timestamp.

NOTE 3: Reference to back-off timer in this section can either refer to use of timer T3396 or to use of a different packet system specific timer within the MS. Whether the MS uses T3396 as a back-off timer or it uses different packet system specific timers as back-off timers is left up to MS implementation. This back-off timer is stopped when the MS is switched off or the SIM/USIM is removed.

If the SM cause value is #65 "maximum number of PDP contexts reached", the MS shall determine the PLMN's maximum number of PDP contexts in A/Gb or Iu mode (see subclause 6.1.3.0) as the number of active PDP contexts it has. The MS shall ignore the Back-off timer value IE and Re-attempt indicator IE provided by the network, if any.

NOTE 4: In some situations, when attempting to establish multiple PDP contexts, the number of active PDP contexts that the MS has when cause #65 is received is not equal to the maximum number of PDP contexts reached in the network.

The PLMN's maximum number of PDP context in A/Gb or Iu mode applies to the PLMN in which the SM cause #65 "maximum number of PDP contexts reached" is received. When the MS is switched off or when the USIM is removed, the MS shall clear all previous determinations representing any PLMN's maximum number of PDP contexts in A/Gb or Iu mode (see subclause 6.1.3.0). Upon successful registration with a new PLMN, the MS may clear previous determinations representing any PLMN's maximum number of PDP contexts in A/Gb or Iu mode.

6.1.3.2.2a Unsuccessful secondary PDP context activation requested by the network

Upon receipt of the REQUEST SECONDARY PDP CONTEXT ACTIVATION message, the MS may reject the network requested secondary PDP context activation by sending the REQUEST SECONDARY PDP CONTEXT ACTIVATION REJECT message to the network. The message contains the same TI as included in the REQUEST

SECONDARY PDP CONTEXT ACTIVATION and an additional cause code that typically indicates one of the following causes:

- # 26: insufficient resources;
- # 31: activation rejected, unspecified;
- # 40: feature not supported;
- # 41: semantic error in the TFT operation;
- # 42: syntactical error in the TFT operation;
- # 43: unknown PDP context;
- # 44: semantic errors in packet filter(s);
- # 45: syntactical errors in packet filter(s);
- # 46: PDP context without TFT already activated;
- # 48: request rejected, Bearer Control Mode violation; or
- # 95 - 111: protocol errors.

The MS should reply with the REQUEST SECONDARY PDP CONTEXT ACTIVATION REJECT message with cause #48 "request rejected, Bearer Control Mode violation" if the previously negotiated Bearer Control Mode is 'MS-only'.

If a PDP context for the TI given in the Linked TI IE exists, then the TFT in the REQUEST SECONDARY PDP CONTEXT ACTIVATION message is checked by the MS for different types of TFT IE errors as specified in subclause 6.1.3.2.3.

Upon receipt of a REQUEST SECONDARY PDP CONTEXT ACTIVATION REJECT message, the network shall stop timer T3385 and enter state PDP-INACTIVE.

6.1.3.2.3 Abnormal cases

The following abnormal cases can be identified:

a) Expiry of timers

In the mobile station:

On the first expiry of the timer T3380, the MS shall resend the ACTIVATE SECONDARY PDP CONTEXT REQUEST and shall reset and restart timer T3380. This retransmission is repeated four times, i.e. on the fifth expiry of timer T3380, the MS shall release all resources possibly allocated for this invocation and shall abort the procedure; no automatic PDP context activation re-attempt shall be performed.

On the network side:

On the first expiry of the timer T3385, the network shall resend the message REQUEST SECONDARY PDP CONTEXT ACTIVATION and shall reset and restart timer T3385. This retransmission is repeated four times, i.e. on the fifth expiry of timer T3385, the network shall release possibly allocated resources for this activation and shall abort the procedure.

b) MS initiated secondary PDP context activation procedure for an already activated PDP context (On the network side)

If the NSAPI matches that of an already activated PDP context, the network shall deactivate the existing PDP context locally without notification to the MS and proceed with the requested PDP context activation. The case of a TI match is described in subclause 8.3.2.

c) no PDP context with linked TI activated (on the network side)

The network shall then check whether there is an activated PDP context for the TI given in the Linked TI IE in the ACTIVATE SECONDARY PDP CONTEXT REQUEST message. If there is no active PDP context for the specified TI, the network shall reply with an ACTIVATE SECONDARY PDP CONTEXT REJECT message, cause code indicating "unknown PDP context".

- d) no PDP context with Linked TI activated (on the mobile station side)

The MS shall check whether there is an activated PDP context for the TI given in the Linked TI IE in the REQUEST SECONDARY PDP CONTEXT ACTIVATION message. If there is no active PDP context for the specified TI, the MS shall reply with a REQUEST SECONDARY PDP CONTEXT ACTIVATION REJECT message, cause code indicating "unknown PDP context".

- e) MS initiated secondary PDP context activation procedure for a PDN connection established for emergency bearer services (on the network side)

If the MS initiated secondary PDP context activation procedure is for a PDN connection established for emergency bearer services the network shall reply with an ACTIVATE SECONDARY PDP CONTEXT REJECT message, cause code indicating "activation rejected, unspecified".

- f) no TFT IE is received in the REQUEST SECONDARY PDP CONTEXT ACTIVATION message (on the mobile station side)

The MS shall either:

- A) reply with a REQUEST SECONDARY PDP CONTEXT ACTIVATION REJECT message, cause code indicating "semantic error in the TFT operation"; or
- B) optionally, to support networks compliant with earlier versions of the protocol, accept the network requested secondary PDP context activation and proceed as specified in subclause 6.1.3.2.1a. If another PDP context with the same PDP address and APN without a TFT exists, the MS shall deactivate this old PDP context without a TFT by explicit peer-to-peer signalling between the MS and the network.

If during a previous inter-system change from S1 mode to A/Gb or Iu mode the default PDP context linked to the new PDP context was mapped from an EPS bearer context, the MS shall follow option A.

NOTE 1: A network implementing this version of the protocol will always include a request for a TFT when requesting the activation of a non-default PDP context.

If a PDP context for the TI given in the Linked TI IE exists, then the TFT in the ACTIVATE SECONDARY PDP CONTEXT REQUEST or the REQUEST SECONDARY PDP CONTEXT ACTIVATION message is checked for different types of TFT IE errors as follows:

- a) Semantic errors in TFT operations:

- 1) When the TFT operation is an operation other than "Create a new TFT".

The network shall reject the activation request with cause "semantic error in the TFT operation".

The MS shall reject the activation request with cause "semantic error in the TFT operation".

- b) Syntactical errors in TFT operations:

- 1) When the TFT operation is "Create a new TFT" and the packet filter list in the TFT IE is empty.

- 2) Void.

- 3) When there are other types of syntactical errors in the coding of the TFT IE, such as a mismatch between the number of packet filters subfield, and the number of packet filters in the packet filter list.

The network shall reject the activation request with cause "syntactical error in the TFT operation".

The MS shall reject the activation request with cause "syntactical error in the TFT operation".

- c) Semantic errors in packet filters:

- 1) When a packet filter consists of conflicting packet filter components which would render the packet filter ineffective, i.e. no IP packet will ever fit this packet filter. How the network determines a semantic error in a packet filter is outside the scope of the present document.
- 2) When the resulting TFT does not contain any packet filter applicable for the uplink direction.

NOTE 2: When BCM='MS only', the MS is allowed to include a TFT with packet filters without any explicit direction information, i.e. with value "00", and such packet filters are applicable for both uplink and downlink directions.

The network shall reject the activation request with cause "semantic errors in packet filter(s)".

The MS shall reject the activation request with cause "semantic errors in packet filter(s)".

d) Syntactical errors in packet filters:

- 1) When the TFT operation is "Create a new TFT" and two or more packet filters in the resultant TFT would have identical packet filter identifiers.
- 2) When the TFT operation is "Create a new TFT" and two or more packet filters in all TFTs associated with this PDP address and APN would have identical packet filter precedence values.
- 3) When there are other types of syntactical errors in the coding of packet filters, such as the use of a reserved value for a packet filter component identifier.

In case 2) the network shall not diagnose an error, further process the new activation request and, if it was processed successfully, delete the old packet filters which have identical filter precedence values. Furthermore, by means of explicit peer-to-peer signalling between the MS and the network, the network shall deactivate the PDP context(s) for which it has deleted the packet filters.

In cases 1) and 3) the network shall reject the activation request with cause "syntactical errors in packet filter(s)".

In case 2) the MS shall not diagnose an error, further process the new activation request and, if it was processed successfully, delete the old packet filters which have identical filter precedence values. Furthermore, by means of explicit peer-to-peer signalling between the network and the MS, the MS shall deactivate the PDP context(s) for which it has deleted the packet filters.

In cases 1) and 3) the MS shall reject the activation request with cause "syntactical errors in packet filter(s)".

Otherwise, the network shall accept the activation request by replying to the MS with an ACTIVATE SECONDARY PDP CONTEXT ACCEPT message. In case of network requested secondary PDP context activation procedure the MS shall accept the activation request by replying to the network with an ACTIVATE SECONDARY PDP CONTEXT REQUEST message.

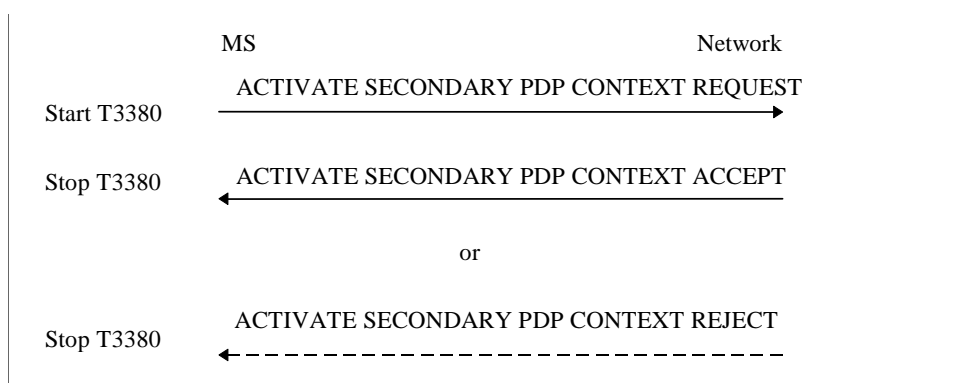

Figure 6.5/3GPP TS 24.008: MS initiated secondary PDP context activation procedure

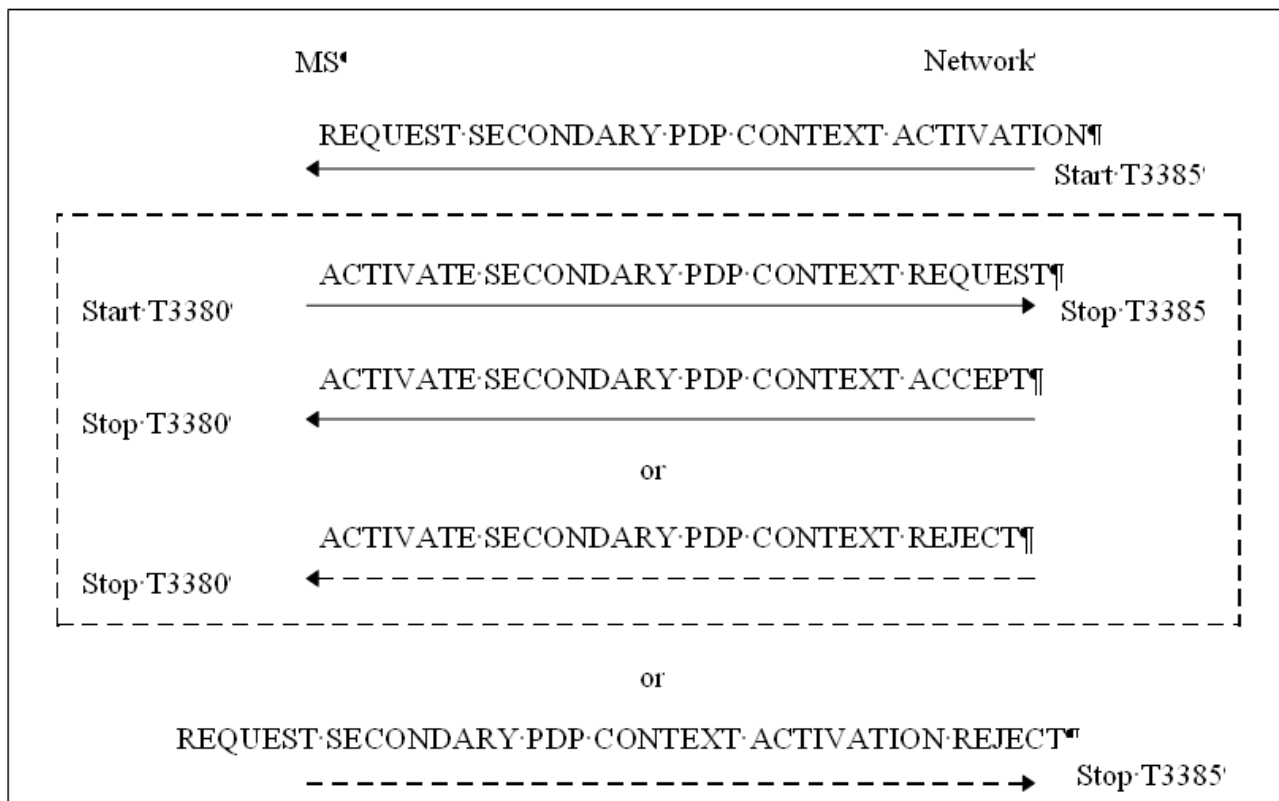

Figure 6.5a/3GPP TS 24.008: Network requested secondary PDP context activation procedure

6.1.3.3 PDP context modification procedure

The PDP context modification procedure is invoked by the network or by the MS, in order to:

- inform about the change of the 3GPP PS data off UE status for a PDN connection;
- change the QoS negotiated;
- change the Radio priority level; or
- change the TFT,

negotiated during the PDP context activation procedure, the secondary PDP context activation procedure or at previously performed PDP context modification procedures. Depending on the selected Bearer Control Mode being 'MS only' or 'MS/NW', the MS or the network respectively may also create and delete a TFT of an active default PDP context. The PDP context modification procedure can be initiated by the network or the MS at any time when a PDP context is active. The network and the MS shall manage packet filter identifiers for the packet filters each modifies or deletes. The network and the MS shall manage packet filter evaluation precedence for the packet filters each modifies. If the MS changes a TFT, which is not assigned to a default PDP context, the MS shall ensure that at least one packet filter applicable for the uplink direction remains among the packet filters created by the MS in that TFT, or no own packet filters. If the network changes a TFT, which is not assigned to a default PDP context, the network shall ensure that at least one packet filter applicable for the uplink direction remains among the TFT packet filters created by the network in that TFT, or no own packet filters. The MS supporting S1 mode shall not modify the QoS of the first PDP context that was established within the PDN connection. The MS not supporting S1 mode should not modify the QoS of the first PDP context that was established within the PDN connection (see 3GPP TS 23.060 [74]).

To indicate a change of 3GPP PS data off UE status for a PDN connection, the MS shall include the protocol configuration options IE in the MODIFY PDP CONTEXT REQUEST message and set the 3GPP PS data off UE status only if the network included the 3GPP PS data off support indication for the PDN connection established by the PDP context activation procedure. The MS behaves as described in subclause 4.7.1.10.

When the PDP context modification procedure is used to indicate a change of 3GPP PS data off UE status for a PDN connection (see subclause 4.7.1.10), the UE shall initiate the PDP context modification procedure even if the timer T3396 or the back-off timer is running or is deactivated.

The PDP context modification procedure may also be invoked by the MS, in order to upgrade the maximum bit rate and to trigger the re-establishment of the radio access bearer for an activated PDP context which is preserved in the MS with maximum bit rate values of 0kbit/s for both uplink and downlink (see 3GPP TS 23.060 [74]).

NOTE 1: As described in 3GPP TS 23.060 [74], the MS only preserves PDP contexts with a TFT including packet filter(s) set by the MS.

If

- the PDP Context Modification request is accepted by the network but the radio access bearer is not established; or
- the PDP Context Modification request is rejected with cause "insufficient resources" (see subclause 6.1.3.3.3),

then the MS is not required to start a new PDP Context Modification procedure or to start a Service Request procedure in order to trigger the re-establishment of the radio access bearer.

If there is a PDN connection for emergency bearer services established, the MS shall not request a modification of bearer resources for this PDN connection.

The network requested PDP context modification procedure may also be used to update the PDP address when external PDP address allocation is performed, in which case the MS receives the PDP address in the MODIFY PDP CONTEXT REQUEST (Network to MS direction) message.

NOTE 2: The procedure may be initiated by the network due to an inter-SGSN Routing Area Updating when a PDP context is active.

The network requested PDP context modification procedure may also be used to update the WLAN offload indication, in which case the MS receives the updated WLAN offload indication in the MODIFY PDP CONTEXT REQUEST (Network to MS direction) message.

6.1.3.3.1 Network initiated PDP Context Modification

In order to initiate the procedure, the network sends the MODIFY PDP CONTEXT REQUEST message to the MS and starts timer T3386. The message shall contain the new QoS and the radio priority level and LLC SAPI that shall be used by the MS in A/Gb mode at the lower layers for the transmission of data related to the PDP context. The MODIFY PDP CONTEXT REQUEST message may also contain packet filters in the TFT information element. If the selected Bearer Control Mode is 'MS/NW' and the TFT information element is included in the MODIFY PDP CONTEXT REQUEST message, the network shall include packet filter(s), or if no packet filters are proposed to be either added, replaced or deleted, it shall set TFT operation code to "No TFT operation" and include packet filter identifier(s) in the Packet filter identifier parameter in the parameters list to indicate which packet filter(s) in the TFT is associated with the QoS change. If the TFT information element is included in the MODIFY PDP CONTEXT REQUEST message and packet filter(s) is proposed to be added, the network shall allocate packet filter identifier(s) for all packet filters to be added to the TFT. The network shall allocate packet filter identifier value s which are currently not allocated to any existing packet filter of the same TFT.

The network informs the MS about the Bearer Control Mode to be applied for all active PDP contexts sharing the same PDP Address and APN by including the selected Bearer Control Mode parameter in the protocol configuration options information element. This information is either explicitly given in the MODIFY PDP CONTEXT REQUEST message or implicitly given by not being present. The MS shall act according to the presence of the protocol configuration options information element and the value of the selected Bearer Control Mode parameter in the MODIFY PDP CONTEXT REQUEST message:

- if the protocol configuration options information element is not present, the MS shall apply Bearer Control Mode 'MS only' for all active PDP contexts sharing the same PDP Address and APN.
- if the selected Bearer Control Mode parameter is not present in the protocol configuration options information element, the MS shall apply Bearer Control Mode 'MS only' for all active PDP contexts sharing the same PDP Address and APN.

- if the selected Bearer Control Mode parameter is present in the protocol configuration options information element, the MS shall apply Bearer Control Mode according to the value of this parameter for all active PDP contexts sharing the same PDP Address and APN.

If a WLAN offload indication information element is included in the MODIFY PDP CONTEXT REQUEST message, the MS shall replace stored WLAN offload acceptability values for this PDN connection with the newly received offload indications and use the UTRAN offload acceptability value to determine whether this PDN connection is offloadable to WLAN or not.

Upon receipt of the MODIFY PDP CONTEXT REQUEST message, if the MS sent an APN for the establishment of the PDN connection, the MS shall stop the timer T3396 if it is running for the APN sent by the MS. If the MS did not send an APN for the establishment of the PDN connection and the request type was different from "emergency", the MS shall stop the timer T3396 associated with no APN if it is running. If the MODIFY PDP CONTEXT REQUEST message was received for an emergency PDN connection, the MS shall not stop the timer T3396 associated with no APN if it is running. For any case, the MS shall then reply with the MODIFY PDP CONTEXT ACCEPT message, if the MS accepts the new QoS and the indicated LLC SAPI.

The network shall upon receipt of the MODIFY PDP CONTEXT ACCEPT message stop timer T3386.

In A/Gb mode, the network shall establish, reconfigure or continue using the logical link with the new QoS for the LLC SAPI indicated in the MODIFY PDP CONTEXT REQUEST message.

In Iu mode, if the Radio Access Bearer supporting the PDP context is active, then the network shall reconfigure and continue using the Radio Access Bearer with the new QoS indicated in the MODIFY PDP CONTEXT REQUEST message; if the PDP context is preserved, then the network may re-establish a Radio Access Bearer with the new QoS indicated in the MODIFY PDP CONTEXT REQUEST message.

6.1.3.3.2 MS initiated PDP Context Modification accepted by the network

In order to initiate the procedure, the MS sends the MODIFY PDP CONTEXT REQUEST message to the network, enters the state PDP-MODIFY-PENDING and starts timer T3381. The message may contain the requested new QoS and/or the TFT and the requested LLC SAPI (used in A/Gb mode). If the selected Bearer Control Mode is 'MS/NW' and the MS wants to modify the QoS, it shall include a TFT with packet filter(s), or if no packet filters are proposed to be either added, replaced or deleted, it shall set TFT operation code to "No TFT operation" and include packet filter identifier(s) in the Packet filter identifier parameter in the parameters list to indicate which packet filter(s) in the TFT is associated with the QoS change. If the TFT information element is included in the MODIFY PDP CONTEXT REQUEST message and packet filters are proposed to be added, the MS shall allocate packet filter identifier(s) for all packet filters to be added to the TFT. The MS shall allocate packet filter identifier value s which are currently not allocated to any existing packet filter of the TFT. If a PDP context is associated with a TFT containing packet filters established by both the MS and the network, the only parameters in the QoS profile of that PDP context the MS is allowed to modify are the bitrate parameters.

Upon receipt of the MODIFY PDP CONTEXT REQUEST message, the network may reply with the MODIFY PDP CONTEXT ACCEPT message in order to accept the context modification. The reply message may contain the negotiated QoS and the radio priority level based on the new QoS profile and the negotiated LLC SAPI that shall be used in A/Gb mode by the logical link.

Upon receipt of the MODIFY PDP CONTEXT ACCEPT message, the MS shall stop the timer T3381. If the offered QoS parameters received from the network differs from the QoS requested by the MS, the MS shall either accept the negotiated QoS or initiate the PDP context deactivation procedure.

If a modification of QoS is requested by the MS, which the network can not accept, being unable to provide the requested QoS, it should maintain the QoS negotiated as previously negotiated or propose a new QoS. That means that the network should not reject the MS initiated PDP context modification request due to the unavailability of the QoS. If the MS requested a value for a QoS parameter that is not within the range specified by 3GPP TS 23.107[81], the network should negotiate the parameter to a value that lies within the specified range.

6.1.3.3.3 MS initiated PDP Context Modification not accepted by the network

6.1.3.3.3.1 General

Upon receipt of a MODIFY PDP CONTEXT REQUEST message, the network may reject the MS initiated PDP context modification request by sending a MODIFY PDP CONTEXT REJECT message to the MS. The message shall contain a cause code that typically indicates one of the following:

- # 26: insufficient resources;
- # 30: activation rejected by GGSN, Serving GW or PDN GW;
- # 32: Service option not supported;
- # 37: QoS not accepted;
- # 41: semantic error in the TFT operation;
- # 42: syntactical error in the TFT operation;
- # 44: semantic errors in packet filter(s);
- # 45: syntactical errors in packet filter(s);
- # 48: request rejected, Bearer Control Mode violation;
- # 60: bearer handling not supported; or
- # 95 - 111: protocol errors.

If upon the reception of a MODIFY PDP CONTEXT REQUEST message the network fails to re-establish the radio access bearer for a PDP context whose maximum bit rate in uplink and downlink is set to 0kbit/s, the network shall reply with a MODIFY PDP CONTEXT REJECT message with cause #26 "insufficient resources".

If a TFT modification was requested and the requested TFT is not available, then the MODIFY PDP CONTEXT REJECT message shall be sent.

The network shall reply with a MODIFY PDP CONTEXT REJECT message with cause #48 "request rejected, Bearer Control Mode violation", if

- the selected Bearer Control Mode is 'MS/NW' and the MS requests to create a TFT for a PDP context that was established without TFT;
- the selected Bearer Control Mode is 'MS/NW' and the MS requests to upgrade the QoS of a PDP context without downlink packet filters, unless uplink packet filters already exist for the PDP context and the MS requests with the same MODIFY PDP CONTEXT REQUEST message to create downlink packet filters ;
- the selected Bearer Control Mode is 'MS/NW' and the MS requests to modify the QoS, but does not include a TFT with at least a packet filter identifiers to indicate which packet filters in the TFT that is associated with the QoS change; or
- the selected Bearer Control Mode is 'MS/NW' and the MS requests to modify the QoS for a PDP context associated with a TFT containing packet filters established by both the MS and the network and the MS tries to modify other parameters than the bitrate parameters in the QoS profile of that PDP context.

If a TFT modification was requested and the MS requests to modify or delete packet filters which were added by the network, then the MODIFY PDP CONTEXT REJECT message shall be sent.

If the MS has requested to modify the QoS of a default PDP context, the network shall reply with a MODIFY PDP CONTEXT REJECT message with cause code "QoS not accepted".

If the MS has requested to modify the PDP context of a LIPA PDN connection or SIPTO at the local network PDN connection, then the network shall reply with a MODIFY PDP CONTEXT REJECT message with cause code "bearer handling not supported".

The TFT in the request message is checked by the network for different types of TFT IE errors as specified in subclause 6.1.3.3.4.

The network may include a Back-off timer value IE in the MODIFY PDP CONTEXT REJECT message.

The network shall not include the SM cause value #26 "insufficient resources" in the MODIFY PDP CONTEXT REJECT message due to APN based congestion control being active.

If the Back-off timer value IE is included and the SM cause value is not #26 "insufficient resources", the network may include the Re-attempt indicator IE to indicate whether the MS is allowed to attempt a bearer resource modification procedure in the PLMN for the same APN in S1 mode, and whether another attempt in A/Gb and Iu mode or in S1 mode is allowed in an equivalent PLMN.

Upon receipt of a MODIFY PDP CONTEXT REJECT message, the MS shall stop timer T3381 and enter the state PDP-ACTIVE.

6.1.3.3.3.2 Handling of network rejection due to SM cause #26

If the SM cause value is #26 and the Back-off timer value IE is included, the MS shall ignore the Re-attempt indicator IE provided by the network, if any, and take different actions depending on the timer value received for timer T3396 in the Back-off timer value IE (if the MS is configured for dual priority, exceptions are specified in subclause 6.1.3.12; if the MS is an MS configured to use AC11 – 15 in selected PLMN, exceptions are specified in subclause 6.1.3.11):

- i) if the timer value indicates neither zero nor deactivated, the MS shall stop timer T3396 associated with the corresponding APN, if it is running. The MS shall then start timer T3396 with the value provided in the Back-off timer value IE and not send another ACTIVATE PDP CONTEXT REQUEST, ACTIVATE SECONDARY PDP CONTEXT REQUEST or MODIFY PDP CONTEXT REQUEST message with exception of those identified in subclause 6.1.3.3, for the same APN until timer T3396 expires or timer T3396 is stopped. If the MS did not send an APN for the establishment of the PDN connection and the request type was different from "emergency", the MS shall stop timer T3396 associated with no APN, if it is running. The MS shall then start timer T3396 with the value provided in the Back-off timer value IE and not send another ACTIVATE PDP CONTEXT REQUEST without an APN and with request type different from "emergency", or another ACTIVATE SECONDARY PDP CONTEXT REQUEST or MODIFY PDP CONTEXT REQUEST message with exception of those identified in subclause 6.1.3.3, for a non-emergency PDN connection established without an APN sent by the MS, until timer T3396 expires or timer T3396 is stopped. The MS shall not stop timer T3396 upon a PLMN change or inter-system change;
- ii) if the timer value indicates that this timer is deactivated, the MS shall not send another ACTIVATE PDP CONTEXT REQUEST, ACTIVATE SECONDARY PDP CONTEXT REQUEST or MODIFY PDP CONTEXT REQUEST message with exception of those identified in subclause 6.1.3.3, for the same APN until the MS is switched off or the SIM/USIM is removed or the MS receives REQUEST PDP CONTEXT ACTIVATION, REQUEST SECONDARY PDP CONTEXT ACTIVATION or MODIFY PDP CONTEXT REQUEST message for the same APN or a DEACTIVATE PDP CONTEXT REQUEST message including SM cause #39 "reactivation requested" for a PDP context which was activated by the MS for the same APN from the network. If the MS did not send an APN for the establishment of the PDN connection and the request type was different from "emergency", the MS shall not send another ACTIVATE PDP CONTEXT REQUEST without an APN and with request type different from "emergency", or another ACTIVATE SECONDARY PDP CONTEXT REQUEST or MODIFY PDP CONTEXT REQUEST with exception of those identified in subclause 6.1.3.3, for a non-emergency PDN connection established without APN sent by the MS, until the MS is switched off or the SIM/USIM is removed or the MS receives any of the following messages: a REQUEST PDP CONTEXT ACTIVATION without an APN, a REQUEST SECONDARY PDP CONTEXT ACTIVATION or MODIFY PDP CONTEXT REQUEST message for a non-emergency PDN connection established without an APN sent by the MS, or a DEACTIVATE PDP CONTEXT REQUEST message including SM cause #39 "reactivation requested" for a PDP context which was activated by the MS for a non-emergency PDN connection established without an APN sent by the MS. The timer T3396 remains deactivated upon a PLMN change or inter-system change; or
- iii) if the timer value indicates that this timer is zero, the MS:
 - shall stop timer T3396 associated with the corresponding APN, if running, and may send an ACTIVATE PDP CONTEXT REQUEST, ACTIVATE SECONDARY PDP CONTEXT REQUEST or MODIFY PDP CONTEXT REQUEST message for the same APN; and

- if the MS did not send an APN for the establishment of the PDN connection and the request type was different from "emergency", the MS shall stop timer T3396 associated with no APN, if running, and may send an ACTIVATE PDP CONTEXT REQUEST message without an APN, or another ACTIVATE SECONDARY PDP CONTEXT REQUEST or MODIFY PDP CONTEXT REQUEST message for a non-emergency PDN connection established without an APN sent by the MS.

If the Back-off timer value IE is not included, the MS may send an ACTIVATE PDP CONTEXT REQUEST, ACTIVATE SECONDARY PDP CONTEXT REQUEST or MODIFY PDP CONTEXT REQUEST message for the same APN.

If the timer T3396 is running when the MS enters state GMM-DEREGISTERED, the MS remains switched on, and the SIM/USIM in the MS remains the same, then timer T3396 is kept running until it expires or it is stopped.

If the MS is switched off when the timer T3396 is running, and if the SIM/USIM in the MS remains the same when the MS is switched on, the MS behaves as follows:

- let t_1 be the time remaining for T3396 timeout at switch off and let t be the time elapsed between switch off and switch on. If t_1 is greater than t , then the timer shall be restarted with the value $t_1 - t$. If t_1 is equal to or less than t , then the timer need not be restarted. If the MS is not capable of determining t , then the MS shall restart the timer with the value t_1 ; and
- if prior to switch off, timer T3396 was running because an ACTIVATE PDP CONTEXT REQUEST, ACTIVATE SECONDARY PDP CONTEXT REQUEST, MODIFY PDP CONTEXT REQUEST or ACTIVATE MBMS CONTEXT REQUEST message containing the low priority indicator set to "MS is configured for NAS signalling low priority" was rejected with a timer value for timer T3396, and if timer T3396 is restarted at switch on, then the MS configured for dual priority shall handle session management requests as indicated in subclause 6.1.3.12.

6.1.3.3.3 Handling of network rejection due to SM cause other than SM cause #26

If the SM cause value is not #26 "insufficient resources" and the Back-off timer value IE is included, the MS takes different actions depending on the timer value received in the Back-off timer value IE (if the MS is an MS configured to use AC11 – 15 in selected PLMN, exceptions are specified in subclause 6.1.3.13):

- i) if the timer value indicates neither zero nor deactivated, the MS shall start the back-off timer with the value provided in the Back-off timer value IE for the PDP context modification procedure and PLMN and APN combination and not send another MODIFY PDP CONTEXT REQUEST message with exception of those identified in subclause 6.1.3.3, in the PLMN for the same APN until the back-off timer expires, the MS is switched off or the SIM/USIM is removed;
- ii) if the timer value indicates that this timer is deactivated, the MS shall not send another MODIFY PDP CONTEXT REQUEST message with exception of those identified in subclause 6.1.3.3, in the PLMN for the same APN until the MS is switched off or the SIM/USIM is removed; or
- iii) if the timer value indicates that this timer is zero, the MS may send an MODIFY PDP CONTEXT REQUEST message in the PLMN for the same APN.

If the Back-off timer value IE is not included, then the MS shall ignore the Re-attempt indicator IE provided by the network, if any.

- i) Additionally, if the SM cause value is #32 "service option not supported", or #33 "requested service option not subscribed", the MS shall proceed as follows:
 - if the MS is registered in its HPLMN or in a PLMN that is within the EHPLMN list, the MS shall behave as described above in the present subclause, using the configured SM_RetryWaitTime value as specified in 3GPP TS 24.368 [135] or in USIM file NAS_{CONFIG} as specified in 3GPP TS 31.102 [112], if available, as back-off timer value; and
 - otherwise, if the MS is not registered in its HPLMN or in a PLMN that is within the EHPLMN list, or if the SM_RetryWaitTime value is not configured, the MS shall behave as described above in the present subclause, using the default value of 12 minutes for the back-off timer.
- ii) For SM cause values different from #32 "service option not supported", or #33 "requested service option not subscribed", the MS behaviour regarding the start of a back-off timer is unspecified.

The MS shall not stop any back-off timer upon a PLMN change or inter-system change. If the network indicates that a back-off timer for the PDP context modification procedure and PLMN and APN combination is deactivated, then it remains deactivated upon a PLMN change or inter-system change.

NOTE 1: This means the back-off timer can still be running or be deactivated for the given SM procedure and PLMN and APN combination when the MS returns to the PLMN or when it performs inter-system change back from S1 mode to A/Gb or Iu mode. Thus the MS can still be prevented from sending another MODIFY PDP CONTEXT REQUEST message with exception of those identified in subclause 6.1.3.3, in the PLMN for the same APN.

If the back-off timer is started upon receipt of a MODIFY PDP CONTEXT REQUEST message (i.e. the timer value was provided by the network, a configured value is available or the default value is used as explained above) or the back-off timer is deactivated, the MS behaves as follows:

- i) after a PLMN change the MS may send a MODIFY PDP CONTEXT REQUEST message for the same APN in the new PLMN, if the back-off timer is not running and is not deactivated for the PDP context modification procedure and the combination of new PLMN and APN;

Furthermore as an implementation option, for the SM cause values #32 "service option not supported" or #33 "requested service option not subscribed", if the network does not include a Re-attempt indicator IE, the MS may decide not to automatically send another MODIFY PDP CONTEXT REQUEST message for the same APN, if the MS registered to a new PLMN which is in the list of equivalent PLMNs.

- ii) if the network does not include the Re-attempt indicator IE to indicate whether re-attempt in S1 mode is allowed, or the MS ignores the Re-attempt indicator IE, e.g. because the Back-off timer value IE is not included, then:
 - if the MS is registered in its HPLMN or in a PLMN that is within the EHPLMN list, the MS shall apply the configured SM_RetryAtRATChange value as specified in 3GPP TS 24.368 [135] or in USIM file NAS_{CONFIG} as specified in 3GPP TS 31.102 [112], if available, to determine whether the MS may attempt a bearer resource modification procedure for the same PLMN and APN combination in S1 mode; and
 - if the MS is not registered in its HPLMN or in a PLMN that is within the EHPLMN list, or if the NAS configuration MO as specified in 3GPP TS 24.368 [135] is not available and the value for inter-system change is not configured in the USIM file NAS_{CONFIG}, then the MS behaviour regarding a bearer resource modification procedure for the same PLMN and APN combination in S1 mode is unspecified; and

- iii) if the network includes the Re-attempt indicator IE indicating that re-attempt in an equivalent PLMN is not allowed, then depending on the timer value received in the Back-off timer value IE, for each combination of a PLMN from the equivalent PLMN list and the APN the MS shall start a back-off timer for the PDP context modification procedure with the value provided by the network, or deactivate the respective back-off timer as follows:
 - If the Re-attempt indicator IE additionally indicates that re-attempt in S1 mode is allowed, the MS shall start or deactivate the back-off timer for A/Gb and Iu mode only; and
 - otherwise the MS shall start or deactivate the back-off timer for A/Gb, Iu, and S1 mode.

If the back-off timer for a PLMN and APN combination was started or deactivated in S1 mode upon receipt of a BEARER RESOURCE MODIFICATION REJECT message (see 3GPP TS 24.301 [120]) and the network indicated that re-attempt in A/Gb or Iu mode is allowed, then this back-off timer does not prevent the MS from sending a MODIFY PDP CONTEXT REQUEST message in this PLMN for the same APN in A/Gb or Iu mode. If the network indicated that re-attempt in A/Gb or Iu mode is not allowed, the MS shall not send any MODIFY PDP CONTEXT REQUEST message in this PLMN for the same APN in A/Gb or Iu mode until the timer expires, the MS is switched off or the USIM is removed.

NOTE 2: The back-off timer is used to describe a logical model of the required MS behaviour. This model does not imply any specific implementation, e.g. as a timer or timestamp.

NOTE 3: Reference to back-off timer in this section can either refer to use of timer T3396 or to use of a different packet system specific timer within the MS. Whether the MS uses T3396 as a back-off timer or it uses different packet system specific timers as back-off timers is left up to MS implementation. This back-off timer is stopped when the MS is switched off or the SIM/USIM is removed.

6.1.3.3.3a Network initiated PDP Context Modification not accepted by the MS

Upon receipt of a MODIFY PDP CONTEXT REQUEST message, if the MS does not accept the new QoS due to resource reasons or the indicated LLC SAPI, the MS shall initiate the PDP context deactivation procedure for the PDP context - the reject cause IE value of the DEACTIVATE PDP CONTEXT REQUEST message shall indicate "QoS not accepted".

The MS may reject the network initiated PDP context modification request by sending a MODIFY PDP CONTEXT REJECT message to the network. The message shall contain a cause code that typically indicates one of the following:

- # 41: semantic error in the TFT operation;
- # 42: syntactical error in the TFT operation;
- # 44: semantic errors in packet filter(s);
- # 45: syntactical errors in packet filter(s);
- # 48: request rejected, Bearer Control Mode violation; or
- # 95 - 111: protocol errors.

The MS shall reply with a MODIFY PDP CONTEXT REJECT message with cause "request rejected, Bearer Control Mode violation", if the selected Bearer Control Mode is 'MS only' and the network requests to modify or delete a TFT

If a TFT modification was requested and the network requests to modify or delete packet filters which were added by the MS, then the MODIFY PDP CONTEXT REJECT message shall be sent.

The TFT in the request message is checked by the MS for different types of TFT IE errors as specified in subclause 6.1.3.3.4.

Upon receipt of a MODIFY PDP CONTEXT REJECT message, the network shall stop timer T3386 and enter the state PDP-ACTIVE.

6.1.3.3.4 Abnormal cases

a) Expiry of timers

On the network side:

On the first expiry of timer T3386, the network shall resend the MODIFY PDP CONTEXT REQUEST message reset and restart timer T3386. This retransmission is repeated four times, i.e. on the fifth expiry of timer T3386, the network may continue to use the previously negotiated QoS and TFT, or it may initiate the PDP context deactivation procedure.

In the MS:

On the first expiry of timer T3381, the MS shall resend the MODIFY PDP CONTEXT REQUEST message reset and restart timer T3381. This retransmission is repeated four times, i.e. on the fifth expiry of timer T3381, the MS may continue to use the previously negotiated QoS and TFT, or it may initiate the PDP context deactivation procedure.

b) Collision of MS and Network initiated PDP Context Modification Procedures

A collision of a MS and network initiated PDP context modification procedures is identified by the MS if a MODIFY PDP CONTEXT REQUEST message is received from the network after the MS has sent a MODIFY PDP CONTEXT REQUEST message itself, and both messages contain the same TI and the MS has not yet received a MODIFY PDP CONTEXT ACCEPT message from the network.

A collision is detected by the network in case a MODIFY PDP CONTEXT REQUEST message is received from the MS with the same TI as the MODIFY PDP CONTEXT REQUEST message sent to the MS.

In the case of such a collision, the network initiated PDP context modification shall take precedence over the MS initiated PDP context modification. The MS shall terminate internally the MS initiated PDP context modification procedure, enter the state PDP-Active and proceed with the network initiated PDP context modification procedure by sending a MODIFY PDP CONTEXT ACCEPT message. The network shall ignore the MODIFY

PDP CONTEXT REQUEST message received in the state PDP-MODIFY-PENDING. The network shall proceed with the network initiated PDP context modification procedure as if no MODIFY PDP CONTEXT REQUEST message was received from the MS.

c) Collision of MS initiated PDP Context Modification Procedures and Network initiated Deactivate PDP Context Request Procedures

A collision of a MS initiated PDP context modification procedures and a network initiated PDP context deactivation procedures is identified by the MS if a DEACTIVATE PDP CONTEXT REQUEST message is received from the network after the MS has sent a MODIFY PDP CONTEXT REQUEST message, and the MS has not yet received a MODIFY PDP CONTEXT ACCEPT message from the network.

In the case of such a collision, the network initiated PDP context deactivation shall take precedence over the MS initiated PDP context modification. The MS shall terminate internally the MS initiated PDP context modification procedure, and proceed with the network initiated PDP context deactivation procedure by sending a DEACTIVATE PDP CONTEXT ACCEPT, enter the state PDP-INACTIVE. The network shall ignore the MODIFY PDP CONTEXT REQUEST message received in the state PDP-INACTIVE-PENDING. The network shall proceed with the network initiated PDP context deactivation procedure as if no MODIFY PDP CONTEXT REQUEST message was received from the MS.

d) MS initiated PDP context modification procedure for a PDN connection established for emergency bearer services.

The network shall reply with a MODIFY PDP CONTEXT REJECT message with a cause code indicating "activation rejected by GGSN, Serving GW or PDN GW".

The TFT in the MODIFY PDP CONTEXT REQUEST message is checked for different types of TFT IE errors as follows:

a) Semantic errors in TFT operations:

- 1) When the TFT operation is "Create a new TFT" and there is already an existing TFT for the PDP context.
- 2) When the TFT operation is an operation other than "Create a new TFT" and there is no TFT for the PDP context.
- 3) When the TFT operation is "Delete existing TFT" and the TFT includes packet filters created by the receiver of the request.
- 4) When the TFT operation is "Delete existing TFT" and there is already another PDP context with the same PDP address and APN without a TFT.
- 5) When the TFT operation is "Delete existing TFT" and the PDP context is not the default PDP context.
- 6) When the TFT operation is "Delete packet filters from existing TFT" or "Replace packet filters in existing TFT" and at least one of the packet filters to be deleted or replaced was created by the receiver of the request.
- 7) When the TFT operation is "Delete packet filters from existing TFT" and this operation would render the TFT empty.

In the above cases the network shall perform the following actions:

In case 1) the network shall further process the new activation request and, if it was processed successfully, delete the old TFT.

In case 2) the network shall:

- further process the new request and, if no error according to list items b), c), and d) was detected, consider the TFT as successfully deleted, if the TFT operation is "Delete existing TFT" or "Delete packet filters from existing TFT"; and
- process the new request as an activation request, if the TFT operation is "Add packet filters in existing TFT" or "Replace packet filters in existing TFT".

In case 3) the network shall reject the modification request with cause "semantic error in the TFT operation".

In case 4) the network shall either:

- reject the modification request with cause "semantic error in the TFT operation"; or
 - optionally, if the BCM is "MS only" and the packet filters in the TFT do not have any explicit direction information, i.e. the packet filter direction parameter is set to "00", process the new deletion request and, after successful deletion of the TFT, deactivate the old PDP context with the same PDP address and APN without a TFT by explicit peer-to-peer signalling between the MS and the network.
- In case 5) the network shall either:
- reject the modification request with cause "semantic error in the TFT operation"; or
 - optionally, if the BCM is "MS only" and the packet filters in the TFT do not have any explicit direction information, i.e. the packet filter direction parameter is set to "00", process the new deletion request.

In case 6) the network shall reject the modification request with cause "semantic error in the TFT operation".

In case 7) the network shall:

- i) if the PDP context is the default PDP context, further process the new request and, if no error according to list items b), c), and d) was detected, delete the existing TFT. After successful deletion of the TFT, if there was already another PDP context with the same PDP address and APN without a TFT, the network shall deactivate this old PDP context without a TFT by explicit peer-to-peer signalling between the MS and the network; and
- ii) if the PDP context is not the default PDP context, further process the new request and, if no error according to list items b), c), and d) was detected, delete the existing TFT. After successful deletion of the TFT, the network shall deactivate the modified PDP context by explicit peer-to-peer signalling between the MS and the network. The network need not respond with a Modify PDP Context Accept message.

In the above cases the MS shall perform the following actions:

In case 1) the MS shall further process the new activation request and, if it was processed successfully, delete the old TFT.

In case 2) the MS shall:

- further process the new request and, if no error according to list items b), c), and d) was detected, consider the TFT as successfully deleted, if the TFT operation is "Delete existing TFT" or "Delete packet filters from existing TFT"; and
- process the new request as an activation request, if the TFT operation is "Add packet filters in existing TFT" or "Replace packet filters in existing TFT".

In case 3) the MS shall reject the modification request with cause "semantic error in the TFT operation".

In case 4) the MS shall either:

- A) reject the modification request with cause "semantic error in the TFT operation"; or
- B) optionally, to support networks compliant with earlier versions of the protocol, process the new deletion request and, after successful deletion of the TFT, deactivate the old PDP context with the same PDP address and APN without a TFT by explicit peer-to-peer signalling between the MS and the network.

NOTE 1: This case is not expected to occur for a network implementing this version of the protocol, because at least one of the two PDP contexts without TFT will be a non-default PDP context. But for Bearer Control Mode 'MS/NW' such a network does not support an initial configuration where the old PDP context without TFT is a non-default PDP context, and the network will not attempt to delete the TFT of a non-default PDP context.

If during a previous inter-system change from S1 mode to A/Gb or Iu mode the default PDP context linked to the PDP context to be modified was mapped from an EPS bearer context, the MS shall follow option A.

In case 5) the MS shall either:

- A) reject the modification request with cause "semantic error in the TFT operation"; or
- B) optionally, to support networks compliant with earlier versions of the protocol, process the new deletion request.

NOTE 2: A network implementing this version of the protocol will not attempt to delete the TFT of a non-default PDP context.

If during a previous inter-system change from S1 mode to A/Gb or Iu mode the default PDP context linked to the PDP context to be modified was mapped from an EPS bearer context, the MS shall follow option A.

In case 6) the MS shall reject the modification request with cause "semantic error in the TFT operation".

In case 7) the MS shall:

- i) if the PDP context is the default PDP context, further process the new request and, if no error according to list items b), c), and d) was detected, delete the existing TFT. After successful deletion of the TFT, if there was already another PDP context with the same PDP address and APN without a TFT, the MS shall deactivate this old PDP context without a TFT by explicit peer-to-peer signalling between the MS and the network; and
- ii) if the PDP context is not the default PDP context, either
 - further process the new request and, if no error according to list items b), c), and d) was detected, delete the existing TFT. After successful deletion of the TFT, the MS shall deactivate the modified PDP context by explicit peer-to-peer signalling between the MS and the network. The MS need not send a Modify PDP Context Accept message; or
 - reject the modification request with cause "semantic error in the TFT operation".

b) Syntactical errors in TFT operations:

- 1) When the TFT operation is an operation other than "Delete existing TFT" or "No TFT operation" and the packet filter list in the TFT IE is empty.
- 2) When the TFT operation is "Delete existing TFT" or "No TFT operation" with a non-empty packet filter list in the TFT IE.
- 3) When the TFT operation is "Replace packet filters in existing TFT" and the packet filter to be replaced does not exist in the original TFT.
- 4) When the TFT operation is "Delete packet filters from existing TFT" and the packet filter to be deleted does not exist in the original TFT.
- 5) Void.
- 6) When there are other types of syntactical errors in the coding of the TFT IE, such as a mismatch between the number of packet filters subfield, and the number of packet filters in the packet filter list.
- 7) When the TFT operation is "No TFT operation" with an empty parameters list.

In case 3) the network shall not diagnose an error, further process the replace request and, if no error according to list items c) and d) was detected, include the packet filters received to the existing TFT.

In case 4) the network shall not diagnose an error, further process the deletion request and, if no error according to list items c) and d) was detected, consider the respective packet filter as successfully deleted.

Otherwise the network shall reject the modification request with cause "syntactical error in the TFT operation".

In case 3) the MS shall not diagnose an error, further process the replace request and, if no error according to list items c) and d) was detected, include the packet filters received to the existing TFT.

In case 4) the MS shall not diagnose an error, further process the deletion request and, if no error according to list items c) and d) was detected, consider the respective packet filter as successfully deleted.

Otherwise the MS shall reject the modification request with cause "syntactical error in the TFT operation".

c) Semantic errors in packet filters:

- 1) When a packet filter consists of conflicting packet filter components which would render the packet filter ineffective, i.e. no IP packet will ever fit this packet filter. How the receiver determines a semantic error in a packet filter is outside the scope of the present document.
- 2) When the resulting TFT, which is not assigned to the default PDP context, does not contain any packet filter applicable for the uplink direction.

NOTE 3: When BCM is 'MS only', the MS is allowed to include a TFT with packet filters without any explicit direction information, i.e. with value "00", and such packet filters are applicable for both uplink and downlink directions.

The network shall reject the modification request with cause "semantic errors in packet filter(s)".

The MS shall reject the modification request with cause "semantic errors in packet filter(s)".

d) Syntactical errors in packet filters:

- 1) When the TFT operation is "Create a new TFT" or "Add packet filters to existing TFT" and two or more packet filters in the resultant TFT would have identical packet filter identifiers.
- 2) When the TFT operation is "Create a new TFT" or "Add packet filters to existing TFT" or "Replace packet filters in existing TFT" and two or more packet filters in all TFTs associated with this PDP address and APN would have identical packet filter precedence values.
- 3) When there are other types of syntactical errors in the coding of packet filters, such as the use of a reserved value for a packet filter component identifier.

In case 1), if two or more packet filters with identical packet filter identifiers are contained in the new request, the network shall reject the modification request with cause "syntactical errors in packet filter(s)". Otherwise, the network shall not diagnose an error, further process the new request and, if it was processed successfully, delete the old packet filters which have the identical packet filter identifiers.

In case 2) the network shall not diagnose an error, further process the new request and, if it was processed successfully, delete the old packet filters which have identical filter precedence values. Furthermore, by means of explicit peer-to-peer signalling between the MS and the network, the network shall deactivate the PDP context(s) for which it has deleted the packet filters.

Otherwise the network shall reject the modification request with cause "syntactical errors in packet filter(s)".

In case 1), if two or more packet filters with identical packet filter identifiers are contained in the new request, the MS shall reject the modification request with cause "syntactical errors in packet filter(s)". Otherwise, the MS shall not diagnose an error, further process the new request and, if it was processed successfully, delete the old packet filters which have the identical packet filter identifiers.

In case 2) the MS shall not diagnose an error, further process the new request and, if it was processed successfully, delete the old packet filters which have identical filter precedence values. Furthermore, the MS shall deactivate the PDP context(s) for which it has deleted the packet filters by means of explicit peer-to-peer signalling between the MS and the network,.

Otherwise, the MS shall reject the modification request with cause "syntactical errors in packet filter(s)".

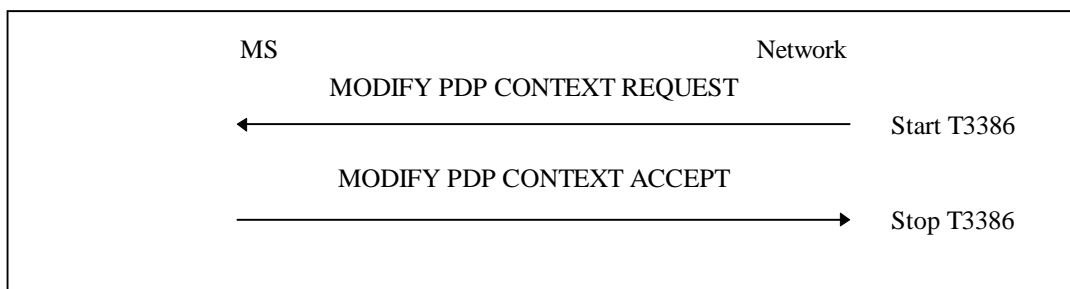

Figure 6.6/3GPP TS 24.008: Network initiated PDP context modification procedure

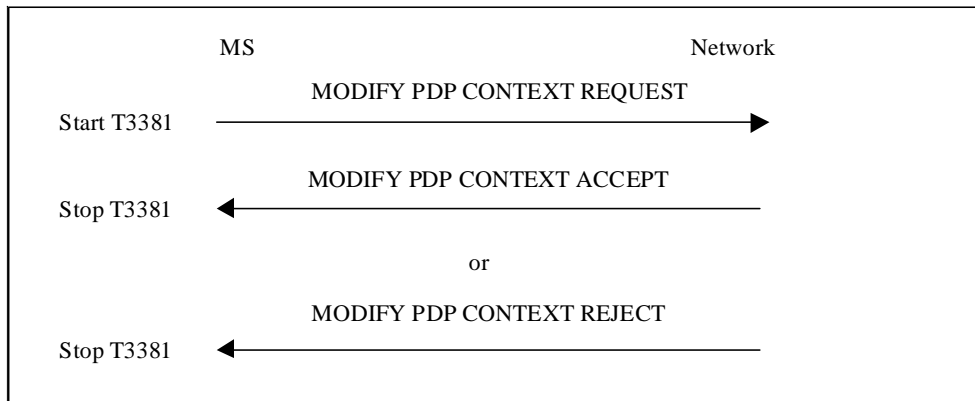

Figure 6.7/3GPP TS 24.008: MS initiated PDP context modification procedure

6.1.3.4 PDP context deactivation procedure

The purpose of this procedure is to deactivate an existing PDP context between the MS and the network. The PDP context deactivation may be initiated by the MS or by the network. The *tear down indicator* information element may be included in the DEACTIVATE PDP CONTEXT REQUEST message in order to indicate whether only the PDP context associated with this specific TI or all active PDP contexts sharing the same PDP address and APN as the PDP context associated with this specific TI shall be deactivated. If the tear down is requested, all other active PDP contexts sharing the same PDP address and APN as the PDP context associated with this specific TI shall be deactivated locally without peer-to-peer signalling. In this case, the network should not include WLAN offload indication in the DEACTIVATE PDP CONTEXT REQUEST message, and if the UE receives the WLAN offload indication, the UE shall ignore the indication. If the *tear down indicator* information element is not included in the DEACTIVATE PDP CONTEXT REQUEST message, only the PDP context associated with this specific TI shall be deactivated. For an exception when the PDP context is a default PDP context and there are other active PDP contexts sharing the same PDP address and APN, see subclause 6.1.3.4.3.

An MS supporting S1 mode shall always include the tear down indicator when deactivating the default PDP context. An MS not supporting S1 mode should apply the same behavior (see 3GPP TS 23.060 [74]).

Local deactivation of a NBIFOM multi-access PDN connection can be triggered by an NBIFOM procedure (see 3GPP TS 24.161 [158]). If such a trigger is received then the associated PDP contexts mentioned in this specification shall be deactivated locally without peer-to-peer signalling.

After successful PDP context deactivation, the associated NSAPI and TI values are released and can be reassigned to another PDP context.

If one or more MBMS contexts are linked to a PDP context that has been deactivated, the MS shall deactivate all those MBMS contexts locally (without peer to peer signalling between the MS and the network).

The MS is allowed to initiate the PDP context deactivation procedure even if the timer T3396 is running.

6.1.3.4.1 PDP context deactivation initiated by the MS

In order to deactivate a PDP context, the MS sends a DEACTIVATE PDP CONTEXT REQUEST message to the network, enters the state PDP-INACTIVE-PENDING and starts timer T3390. The message contains the transaction identifier (TI) in use for the PDP context to be deactivated and a cause code that typically indicates one of the following causes:

- # 25: LLC or SMDCP failure (A/Gb mode only);
- # 26: insufficient resources;
- # 36: regular deactivation; or
- # 37: QoS not accepted.

The network shall reply with the DEACTIVATE PDP CONTEXT ACCEPT message. Upon receipt of the DEACTIVATE PDP CONTEXT ACCEPT message, the MS shall stop timer T3390.

In A/Gb mode, both the MS and the network shall initiate local release of the logical link if it is not used by another PDP context.

In Iu mode, the network shall initiate the release of Radio Access Bearer associated with this PDP context.

If the selected Bearer Control Mode is 'MS/NW' the MS should not deactivate a PDP context, if it is the only PDP context without TFT within a group of active PDP contexts sharing the same PDP address and APN.

NOTE 1: A configuration with more than one PDP context without TFT within a group of active PDP contexts sharing the same PDP address and APN can occur during a network initiated PDP context modification due to asynchronous TFT states in the MS and in the network (see e.g. subclause 6.1.3.3.4 bullet a.3 in the description of the TFT checks).

NOTE 2: If the MS deactivates the last remaining PDP context without TFT within a group of active PDP contexts sharing the same PDP address and APN, a network implementing this version of the protocol will deactivate all other active PDP contexts sharing the same PDP address and APN by explicit peer-to-peer signalling; a network compliant with earlier versions of the protocol can initiate the re-establishment of this PDP context using the network requested secondary PDP context activation procedure.

6.1.3.4.2 PDP context deactivation initiated by the network

In order to deactivate a PDP context, the network sends a DEACTIVATE PDP CONTEXT REQUEST message to the MS and starts timer T3395. The message contains the transaction identifier in use for the PDP context to be deactivated and a cause code that typically indicates one of the following causes:

- # 8: Operator Determined Barring;
- # 25: LLC or SNDCP failure (A/Gb mode only);
- # 26: insufficient resources;
- # 36: regular deactivation;
- # 38: network failure;
- # 39: reactivation requested.
- #112: APN restriction value incompatible with active PDP context; or
- #113: Multiple accesses to a PDN connection not allowed.

The MS shall, upon receipt of this message, reply with a DEACTIVATE PDP CONTEXT ACCEPT message. Upon receipt of the DEACTIVATE PDP CONTEXT ACCEPT message, the network shall stop the timer T3395.

If the DEACTIVATE PDP CONTEXT REQUEST message includes the cause #39 "reactivation requested", the PDP context was activated by the MS, and the MS sent an APN for the establishment of the PDN connection, the MS shall stop timer T3396 if it is running for the APN sent by the MS. The MS should then re-activate the PDP context. If the MS did not send an APN for the establishment of the PDN connection and the request type was different from "emergency", the MS shall stop the timer T3396 associated with no APN if it is running, and should re-activate the PDP context without including an APN. Additionally, the MS should re-activate the PDP contexts that were originally activated by the MS and released by the network as a result of this PDP context deactivation procedure. If the DEACTIVATE PDP CONTEXT REQUEST message was received for an emergency PDN connection, the MS shall not stop the timer T3396 associated with no APN if it is running. The MS should then re-initiate the PDP context activation procedure for the emergency PDN connection.

NOTE: User interaction is necessary in some cases when the MS cannot re-activate the PDP context(s) automatically.

If a detach is requested by the HLR for an MS that has PDP contexts for emergency services, the SGSN shall send a DEACTIVATE PDP CONTEXT REQUEST message to the MS for all the PDP contexts that are not PDP contexts for emergency services.

If the network operates in network operation mode I, ISR is activated and the MS has indicated support of EMM combined procedures in MS network capability, when the SGSN receives the request from the Serving GW for deactivating the last remaining PDP context, then the SGSN shall perform a detach procedure for non-GPRS services only as described in subclause 4.7.4.2.

In A/Gb mode, both the MS and the network shall initiate local release of the logical link if it is not used by another PDP context.

In Iu mode, the network shall initiate the release of Radio Access Bearer associated with this PDP context.

If the SM cause value is #26 "insufficient resources", the network may include a value for timer T3396 in the DEACTIVATE PDP CONTEXT REQUEST message.

If the SM cause value is #26 "insufficient resources" and T3396 value IE is included:

- the MS shall take different actions depending on the timer value received for timer T3396 (if the MS is configured for dual priority, exceptions are specified in subclause 6.1.3.12; if the MS is an MS configured to use AC11 – 15 in selected PLMN, exceptions are specified in subclause 6.1.3.11):
 - i) if the timer value indicates neither zero nor deactivated, the MS shall stop the timer T3396 associated with the corresponding APN, if it is running. The MS shall start timer T3396 with received value and not send another ACTIVATE PDP CONTEXT REQUEST, ACTIVATE SECONDARY PDP CONTEXT REQUEST or MODIFY PDP CONTEXT REQUEST message with exception of those identified in subclause 6.1.3.3, for the same APN until timer T3396 expires or the timer T3396 is stopped. If the MS did not send an APN for the establishment of the PDN connection and the request type was different from "emergency", the MS shall stop timer T3396 associated with no APN, if it is running. The MS shall then start timer T3396 with the value provided in the Back-off timer value IE and not send another ACTIVATE PDP CONTEXT REQUEST without an APN and with request type different from "emergency", or another ACTIVATE SECONDARY PDP CONTEXT REQUEST or MODIFY PDP CONTEXT REQUEST message with exception of those identified in subclause 6.1.3.3, for a non-emergency PDN connection established without an APN sent by the MS, until timer T3396 expires or timer T3396 is stopped. The MS shall not stop timer T3396 upon a PLMN change or inter-system change;
 - ii) if the timer value indicates that this timer is deactivated, the MS shall not send another ACTIVATE PDP CONTEXT REQUEST, ACTIVATE SECONDARY PDP CONTEXT REQUEST or MODIFY PDP CONTEXT REQUEST message with exception of those identified in subclause 6.1.3.3, for the same APN until the MS is switched off or the SIM/USIM is removed or the MS receives a REQUEST PDP CONTEXT ACTIVATION, REQUEST SECONDARY PDP CONTEXT ACTIVATION or MODIFY PDP CONTEXT REQUEST message with exception of those identified in subclause 6.1.3.3, for the same APN from the network or a DEACTIVATE PDP CONTEXT REQUEST message including SM cause #39 "reactivation requested" for a PDP context which was activated by the MS for the same APN from the network. If the MS did not send an APN for the establishment of the PDN connection and the request type was different from "emergency", the MS shall not send another ACTIVATE PDP CONTEXT REQUEST without an APN and with request type different from "emergency", or another ACTIVATE SECONDARY PDP CONTEXT REQUEST or MODIFY PDP CONTEXT REQUEST with exception of those identified in subclause 6.1.3.3, for a non-emergency PDN connection established without an APN sent by the MS, until the MS is switched off or the SIM/USIM is removed or the MS receives any of the following messages: a REQUEST PDP CONTEXT ACTIVATION without an APN, a REQUEST SECONDARY PDP CONTEXT ACTIVATION or MODIFY PDP CONTEXT REQUEST message for a non-emergency PDN connection established without an APN sent by the MS, or a DEACTIVATE PDP CONTEXT REQUEST message including SM cause #39 "reactivation requested" for a PDP context which was activated by the MS for a non-emergency PDN connection established without APN sent by the MS. The timer T3396 remains deactivated upon a PLMN change or inter-system change; and
 - iii) if the timer value indicates that this timer is zero, the MS:
 - shall stop timer T3396 associated with the corresponding APN, if running, and may send another ACTIVATE PDP CONTEXT REQUEST, ACTIVATE SECONDARY PDP CONTEXT REQUEST or MODIFY PDP CONTEXT REQUEST message for the same APN; and
 - if the MS did not send an APN for the establishment of the PDN connection and the request type was different from "emergency", the MS shall stop timer T3396 associated with no APN, if running, and may send an ACTIVATE PDP CONTEXT REQUEST message without an APN, or another ACTIVATE

SECONDARY PDP CONTEXT REQUEST or MODIFY PDP CONTEXT REQUEST message for a non-emergency PDN connection established without an APN sent by the MS.

- If the timer T3396 is running when the MS enters state GMM-DEREGISTERED, the MS remains switched on, and the SIM/USIM in the MS remains the same, then timer T3396 is kept running until it expires or it is stopped.
- if the MS is switched off when the timer T3396 is running, the MS shall behave as follows when the MS is switched on and the SIM/USIM in the MS remains the same:
 - let t_1 be the time remaining for T3396 timeout at switch off and let t be the time elapsed between switch off and switch on. If t_1 is greater than t , then the timer shall be restarted with the value $t_1 - t$. If t_1 is equal to or less than t , then the timer need not be restarted. If the MS is not capable of determining t , then the MS shall restart the timer with the value t_1 ; and
 - if prior to switch off, timer T3396 was running because an ACTIVATE PDP CONTEXT REQUEST, ACTIVATE SECONDARY PDP CONTEXT REQUEST or MODIFY PDP CONTEXT REQUEST message containing the low priority indicator set to "MS is configured for NAS signalling low priority" was rejected with timer T3396, and if timer T3396 is restarted at switch on, then the MS configured for dual priority shall handle session management requests as indicated in subclause 6.1.3.12.

If the T3396 value IE is not included, the MS shall proceed with deactivation procedure and then send DEACTIVATE PDP CONTEXT ACCEPT message.

6.1.3.4.3 Abnormal cases

The following abnormal cases can be identified:

a) Expiry of timers

In the mobile station:

On the first expiry of timer T3390, the MS shall resent the message DEACTIVATE PDP CONTEXT REQUEST and shall reset and restart the timer T3390. This retransmission is repeated four times, i.e. on the fifth expiry of timer T3390, the MS shall release all resources allocated and shall erase the PDP context related data.

On the network side:

On the first expiry of timer T3395, the network shall resent the message DEACTIVATE PDP CONTEXT REQUEST and shall reset and restart timer T3395. This retransmission is repeated four times, i.e. on the fifth expiry of timer T3395, the network shall erase the PDP context related data for that MS.

b) Collision of MS and network initiated PDP context deactivation requests

If the MS and the network initiated PDP context deactivation requests collide, the MS and the network shall each reply with the messages DEACTIVATE PDP CONTEXT ACCEPT and shall stop timer T3390 and T3395, respectively.

c) Network initiated PDP context deactivation request without *tear down indicator* information element for a default PDP context

If an MS supporting S1 mode receives a DEACTIVATE PDP CONTEXT REQUEST message without *tear down indicator* information element, and the PDP context associated with the specific TI is a default PDP context, the MS shall deactivate the default PDP context as specified in subclause 6.1.3.4.2. Additionally the MS shall deactivate all other active PDP contexts sharing the same PDP address and APN as the default PDP context locally without peer-to-peer signalling.

An MS not supporting S1 mode may apply the same behaviour.

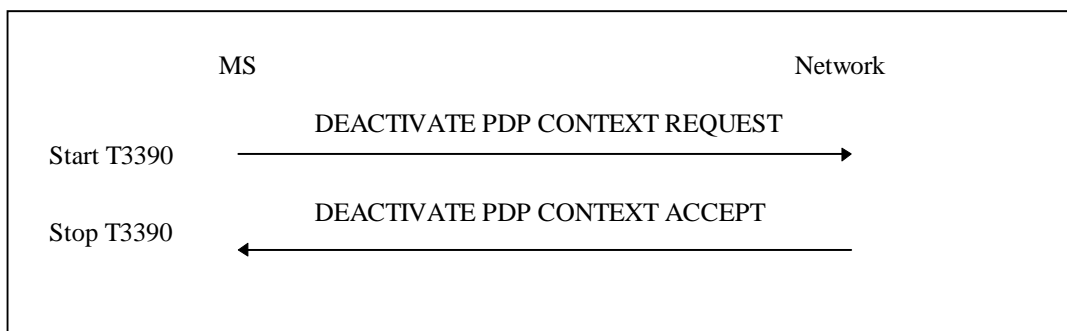

Figure 6.8/3GPP TS 24.008: MS initiated PDP context deactivation procedure

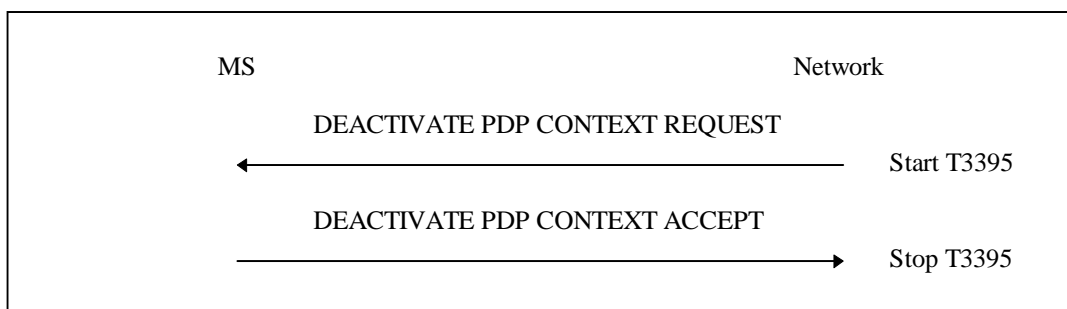

Figure 6.9/3GPP TS 24.008: Network initiated PDP context deactivation procedure

6.1.3.4a Void

6.1.3.5 Void

6.1.3.5a Notification procedure

6.1.3.5a.1 General

The network can use the notification procedure to inform the MS about events which are relevant for the upper layer which is using a PDP context or has requested a session management procedure.

If the MS has indicated that it supports the notification procedure, the network may initiate the procedure at any time while a PDP context is activated or another session management procedure is ongoing.

6.1.3.5a.2 Notification procedure initiation by the network

The network initiates the notification procedure by sending a NOTIFICATION message to the MS (see example in figure 6.9a/3GPP TS 24.008).

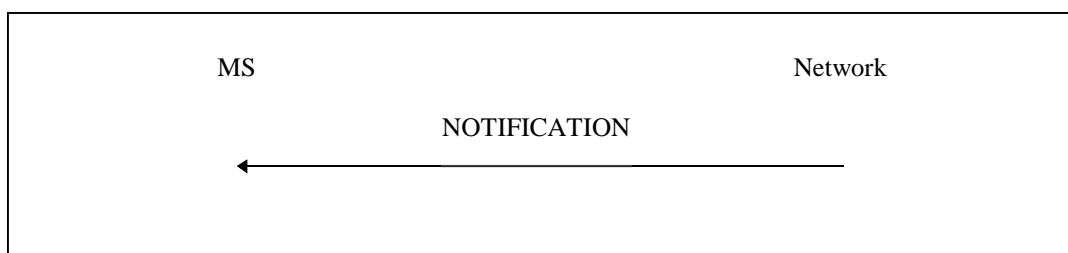

Figure 6.9a/3GPP TS 24.008: Notification procedure

6.1.3.5a.3 Notification procedure in the MS

When the MS receives a NOTIFICATION message, the SM protocol entity in the MS shall provide the notification indicator to the upper layer.

The notification indicator can have the following value:

- #1: SRVCC handover cancelled, IMS session re-establishment required.

6.1.3.6 Receiving a SM STATUS message by a SM entity

If the SM entity of the MS receives an SM STATUS message the MS shall take different actions depending on the received SM cause value:

#81 Invalid transaction identifier value

The MS shall abort any ongoing SM procedure related to the received transaction identifier value, stop any related timer, and deactivate the corresponding PDP or MBMS context locally (without peer to peer signalling between the MS and the network).

If one or more MBMS contexts are linked to a PDP context that has been deactivated, the MS shall deactivate all those MBMS Contexts locally (without peer to peer signalling between the MS and the network).

#97 Message type non-existent or not implemented

The MS shall abort any ongoing SM procedure related to the received transaction identifier value and stop any related timer.

If the SM entity of the MS receives a SM STATUS message with any other SM cause value no state transition and no specific action shall be taken as seen from the radio interface, i.e. local actions are possible.

If the SM entity of the network receives an SM STATUS message the network shall take different actions depending on the received SM cause value:

#81 Invalid transaction identifier value

The network shall abort any ongoing SM procedure related to the received transaction identifier value, stop any related timer, and deactivate the corresponding PDP or MBMS context locally (without peer to peer signalling between the MS and the network).

If one or more MBMS contexts are linked to a PDP context that has been deactivated, the MS shall deactivate all those MBMS Contexts locally (without peer to peer signalling between the MS and the network).

#97 Message type non-existent or not implemented

The network shall abort any ongoing SM procedure related to the received transaction identifier value and stop any related timer.

The actions to be taken in the network on receiving a SM STATUS message with any other SM cause value are an implementation dependent option.

6.1.3.7 Protocol configuration options

The MS and the GGSN may communicate parameters by means of the protocol configuration options information element or extended protocol configuration options information element when activating, modifying or deactivating a PDP context. Such parameters can e.g. be used to convey information from external protocols between the MS and the GGSN. An overview of how the protocol configuration options information element is used is specified in 3GPP TS 27.060 [36a].

The protocol configuration options information element and the extended protocol configuration options information element is transparent to the SGSN.

NOTE 1: The MS and the network negotiate support of the extended protocol configuration options IE end-to-end for each PDN connection, as the information element can only be used if it is supported also by the GGSN/PDN GW.

If supported by the network and the MS end-to-end for a PDN connection, protocol configuration options shall be exchanged via the extended protocol configuration options IE. Otherwise the protocol configuration options IE is used.

For the MS, the extended protocol configuration options is supported by the network and the MS end-to-end for a PDN connection if the network has indicated support of the extended protocol configuration options IE in the last ATTACH ACCEPT or ROUTING AREA UPDATING ACCEPT message, and

- the PDP Type requested for the default PDP context is non-IP; or
- the network has included the extended protocol configuration options IE in at least one session management message received by the MS for this PDN connection.

For the SGSN, the extended protocol configuration options is supported by the network and the MS end-to-end for a PDN connection if the MS has indicated support of the extended protocol configuration options IE in the last ATTACH REQUEST or ROUTING AREA UPDATING REQUEST message, and

- the PDP Type requested for the default PDP context is non-IP; or
- the SGSN has received the extended protocol configuration options IE in at least one message sent by the GGSN or PDN GW towards the MS for this PDN connection (for details see 3GPP TS 29.274 [16D]).

NOTE 2: For the GGSN or PDN GW, the extended protocol configuration options is supported by the network and the MS end-to-end for a PDN connection if:

- the GGSN initiates a network requested PDP context activation with offered PDP Type non-IP; or
- the last support indication received from the SGSN or S-GW indicates that extended protocol configuration options is supported for this PDN connection (for details see 3GPP TS 29.274 [16D]).

6.1.3.8 MBMS context activation

The purpose of this procedure is to establish an MBMS context in the MS and in the network for a specific IP Multicast Address using a specific NSAPI for MBMS user plane transmission. The MS shall only initiate the MBMS context activation when requested by the network. However, the trigger for the activation request by the network is initiated by the MS at the application layer (see 3GPP TS 23.246 [106]).

6.1.3.8.1 Successful MBMS context activation

In order to request an MBMS context activation, the network sends a REQUEST MBMS CONTEXT ACTIVATION message to the MS, enters the state MBMS-ACTIVE-PENDING and starts timer T3385. The message shall contain the IP multicast address, the APN and the Linked NSAPI.

Upon receipt of a REQUEST MBMS CONTEXT ACTIVATION message, the MS shall validate the message by verifying the NSAPI given in the Linked NSAPI IE to be one of the active PDP context(s), stop the timer T3396 if it is running for the APN indicated in the message and send an ACTIVATE MBMS CONTEXT REQUEST, enter state MBMS-ACTIVE-PENDING and start timer T3380. The message shall contain an IP multicast address and an APN, which shall be the same as the IP multicast address and the APN requested by the network in the REQUEST MBMS CONTEXT ACTIVATION message. Furthermore, the MS shall include the Supported MBMS bearer capabilities, i.e. the maximum downlink bit rate the MS can handle.

Upon receipt of the ACTIVATE MBMS CONTEXT REQUEST message, the network shall stop timer T3385. If the network accepts the request, it shall reply with an ACTIVATE MBMS CONTEXT ACCEPT message.

Upon receipt of the message ACTIVATE MBMS CONTEXT ACCEPT the MS shall stop timer T3380 and shall enter the state MBMS-ACTIVE.

6.1.3.8.2 Unsuccessful MBMS context activation requested by the MS

6.1.3.8.2.1 General

Upon receipt of an ACTIVATE MBMS CONTEXT REQUEST message the network may reject the MS initiated MBMS context activation by sending an ACTIVATE MBMS CONTEXT REJECT message to the MS. The sender of the message shall include the same TI as included in the ACTIVATE MBMS CONTEXT REQUEST and an additional cause code that typically indicates one of the following causes:

- # 8: Operator Determined Barring;
- # 24: MBMS bearer capabilities insufficient for the service;
- # 26: insufficient resources;
- # 27: missing or unknown APN;
- # 29: user authentication failed;
- # 30: activation rejected by GGSN, Serving GW or PDN GW;
- # 31: activation rejected, unspecified;
- # 32: service option not supported;
- # 33: requested service option not subscribed;
- # 34: service option temporarily out of order; or
- # 95 - # 111: protocol errors.

The network may include a Back-off timer value IE in the ACTIVATE MBMS CONTEXT REJECT message.

If the Back-off timer value IE is included and the SM cause value is different from #26 "insufficient resources", the network may include the Re-attempt indicator IE to indicate whether the MS is allowed to attempt an MBMS context activation procedure in an equivalent PLMN.

Upon receipt of an ACTIVATE MBMS CONTEXT REJECT message, the MS shall stop timer T3380 and enter/remain in state PDP-INACTIVE.

6.1.3.8.2.2 Handling of network rejection due to SM cause #26

If the SM cause value is #26 "insufficient resources" and the Back-off timer value IE is included, the MS shall ignore the Re-attempt indicator IE provided by the network, if any, and take different actions depending on the timer value

received for timer T3396 in the Back-off timer value IE (if the MS is configured for dual priority, exceptions are specified in subclause 6.1.3.12):

- i) if the timer value indicates neither zero nor deactivated, the MS shall stop timer T3396 associated with the corresponding APN, if it is running. The MS shall then start timer T3396 with the value provided in the Back-off timer value IE and shall not send another ACTIVATE MBMS CONTEXT REQUEST message for the same APN that was sent by the MS until timer T3396 expires or timer T3396 is stopped. The MS shall not stop timer T3396 upon a PLMN change or inter-system change;
- ii) if the timer value indicates that this timer is deactivated, the MS shall not send another ACTIVATE MBMS CONTEXT REQUEST message for the same APN that was sent by the MS, until the MS is switched off or the SIM/USIM is removed or the MS receives REQUEST MBMS CONTEXT ACTIVATION message for the same APN from the network. The timer T3396 remains deactivated upon a PLMN change or inter-system change; and
- iii) if the timer value indicates that this timer is zero, the MS may send another ACTIVATE MBMS CONTEXT REQUEST message for the same APN.

If the Back-off timer value IE is not included, then the MS may send another ACTIVATE MBMS CONTEXT REQUEST message for the same APN.

If the MS is switched off when the timer T3396 is running, the MS shall behave as follows when the MS is switched on and the SIM/USIM in the MS remains the same:

- let t_1 be the time remaining for T3396 timeout at switch off and let t be the time elapsed between switch off and switch on. If t_1 is greater than t , then the timer shall be restarted with the value $t_1 - t$. If t_1 is equal to or less than t , then the timer need not be restarted. If the MS is not capable of determining t , then the MS shall restart the timer with the value t_1 ; and
- if prior to switch off, timer T3396 was running because an ACTIVATE PDP CONTEXT REQUEST, ACTIVATE SECONDARY PDP CONTEXT REQUEST, MODIFY PDP CONTEXT REQUEST or ACTIVATE MBMS CONTEXT REQUEST message containing the low priority indicator set to "MS is configured for NAS signalling low priority" was rejected with timer T3396, and if timer T3396 is restarted at switch on, then the MS configured for dual priority shall handle session management requests as indicated in subclause 6.1.3.12.

6.1.3.8.2.3 Handling of network rejection due to SM cause other than SM cause #26

If the SM cause value is different from #26 "insufficient resources", and the Back-off timer value IE is included, the MS shall take different actions depending on the timer value received in the Back-off timer value IE:

- i) if the timer value indicates neither zero nor deactivated, the MS shall start the back-off timer with the value provided in the Back-off timer value IE for the MBMS context activation procedure and PLMN and APN combination. The MS shall not send another ACTIVATE MBMS CONTEXT REQUEST message in the PLMN for the same APN that was sent by the MS until the back-off timer expires, the MS is switched off or the SIM/USIM is removed;
- ii) if the timer value indicates that this timer is deactivated, the MS shall not send another ACTIVATE MBMS CONTEXT REQUEST message in the PLMN for the same APN that was sent by the MS until the MS is switched off or the SIM/USIM is removed; and
- iii) if the timer value indicates that this timer is zero, the MS may send an ACTIVATE MBMS CONTEXT REQUEST message in the PLMN for the same APN.

If the Back-off timer value IE is not included, then the MS shall ignore the Re-attempt indicator IE provided by the network, if any.

- i) Additionally, if the SM cause value is #8 "operator determined barring", #27 "missing or unknown APN", #32 "service option not supported", or #33 "requested service option not subscribed", the MS shall proceed as follows:
 - if the MS is registered in its HPLMN or in a PLMN that is within the EHPLMN list, the MS shall behave as described above in the present subclause, using the configured SM_RetryWaitTime value as specified in 3GPP TS 24.368 [135] or in USIM file NAS_{CONFIG} as specified in 3GPP TS 31.102 [112], if available, as back-off timer value; and

- otherwise, if the MS is not registered in its HPLMN or in a PLMN that is within the EHPLMN list, or if the SM_RetryWaitTime value is not configured, the MS shall behave as described above in the present subclause using the default value of 12 minutes for the back-off timer.
- ii) For SM cause values different from #8 "operator determined barring", #27 "missing or unknown APN", #32 "service option not supported", or #33 "requested service option not subscribed", the MS behaviour regarding the start of a back-off timer is unspecified.

The MS shall not stop any back-off timer upon a PLMN change or inter-system change. If the network indicates that a back-off timer for the MBMS context activation procedure and PLMN and APN combination is deactivated, then it remains deactivated upon a PLMN change or inter-system change.

NOTE 1: This means the back-off timer can still be running or be deactivated for the given SM procedure and PLMN and APN combination when the MS returns to the PLMN or when it performs inter-system change back from S1 mode to A/Gb or Iu mode. Thus the MS can still be prevented from sending another ACTIVATE MBMS CONTEXT REQUEST message in the PLMN for the same APN.

If the back-off timer is started upon receipt of an ACTIVATE MBMS CONTEXT REJECT message (i.e. the timer value was provided by the network, a configured value is available or the default value is used as explained above) or the back-off timer is deactivated, the MS behaves as follows:

- i) after a PLMN change the MS may send an ACTIVATE MBMS CONTEXT REQUEST message for the same APN in the new PLMN, if the back-off timer is not running and is not deactivated for the MBMS context activation procedure and the combination of new PLMN and APN;

Furthermore as an implementation option, for the SM cause values #8 "operator determined barring", #27 "missing or unknown APN", #32 "service option not supported" or #33 "requested service option not subscribed", if the network does not include a Re-attempt indicator IE, the MS may decide not to automatically send another ACTIVATE MBMS CONTEXT REQUEST message for the same APN, if the MS registered to a new PLMN which is in the list of equivalent PLMNs.

- ii) if the network includes the Re-attempt indicator IE, the MS shall ignore any indication provided in the IE regarding whether re-attempt in S1 mode is allowed. If the Re-attempt indicator IE indicates that re-attempt in an equivalent PLMN is not allowed, then depending on the timer value received in the Back-off timer value IE, for each combination of a PLMN from the equivalent PLMN list and the APN the MS shall start a back-off timer for the MBMS context activation procedure with the value provided by the network, or deactivate the respective back-off timer.

NOTE 2: The back-off timer is used to describe a logical model of the required MS behaviour. This model does not imply any specific implementation, e.g. as a timer or timestamp.

NOTE 3: Reference to back-off timer in this section can either refer to use of timer T3396 or to use of a different packet system specific timer within the MS. Whether the MS uses T3396 as a back-off timer or it uses different packet system specific timers as back-off timers is left up to MS implementation. This back-off timer is stopped when the MS is switched off or the SIM/USIM is removed.

6.1.3.8.3 Unsuccessful MBMS context activation requested by the network

Upon receipt of the REQUEST MBMS CONTEXT ACTIVATION message, the MS may reject the network requested MBMS context activation by sending the REQUEST MBMS CONTEXT ACTIVATION REJECT message to the network. The sender of the message shall include the same TI as included in the REQUEST MBMS CONTEXT ACTIVATION and an additional cause code that typically indicates one of the following causes:

- # 26: insufficient resources;
- # 31: activation rejected, unspecified;
- # 40: feature not supported; or
- # 95 - # 111: protocol errors.

The network shall stop timer T3385 and enter in state PDP-INACTIVE.

6.1.3.8.4 Abnormal cases

The following abnormal cases can be identified:

- a) Expiry of timers in the mobile station: On the first expiry of the timer T3380, the MS shall resend the **ACTIVATE MBMS CONTEXT REQUEST** and shall reset and restart timer T3380. This retransmission is repeated four times, i.e. on the fifth expiry of timer T3380, the MS shall release all resources possibly allocated for this invocation and shall abort the procedure; no automatic MBMS context activation re-attempt shall be performed.
- b) Expiry of timers on the network side: On the first expiry of the timer T3385, the network shall resend the message **REQUEST MBMS CONTEXT ACTIVATION** and shall reset and restart timer T3385. This retransmission is repeated four times, i.e. on the fifth expiry of timer T3385, the network shall release possibly allocated resources for this activation and shall abort the procedure.
- c) MBMS context activation request for an already activated MBMS context (on the mobile station side): If the MS receives a **REQUEST MBMS CONTEXT ACTIVATION** message with the same combination of APN and IP multicast address (i.e. PDP type and PDP address) as an already activated MBMS context, the MS shall deactivate the existing MBMS context locally without notification to the network and proceed with the requested MBMS context activation.
- d) MBMS context activation request for an already activated MBMS context (on the network side): If the network receives an **ACTIVATE MBMS CONTEXT REQUEST** message with the same combination of APN and IP multicast address (i.e. PDP type and PDP address) as an already activated MBMS context, the network shall deactivate the existing MBMS context locally without notification to the MS and proceed with the requested MBMS context activation.

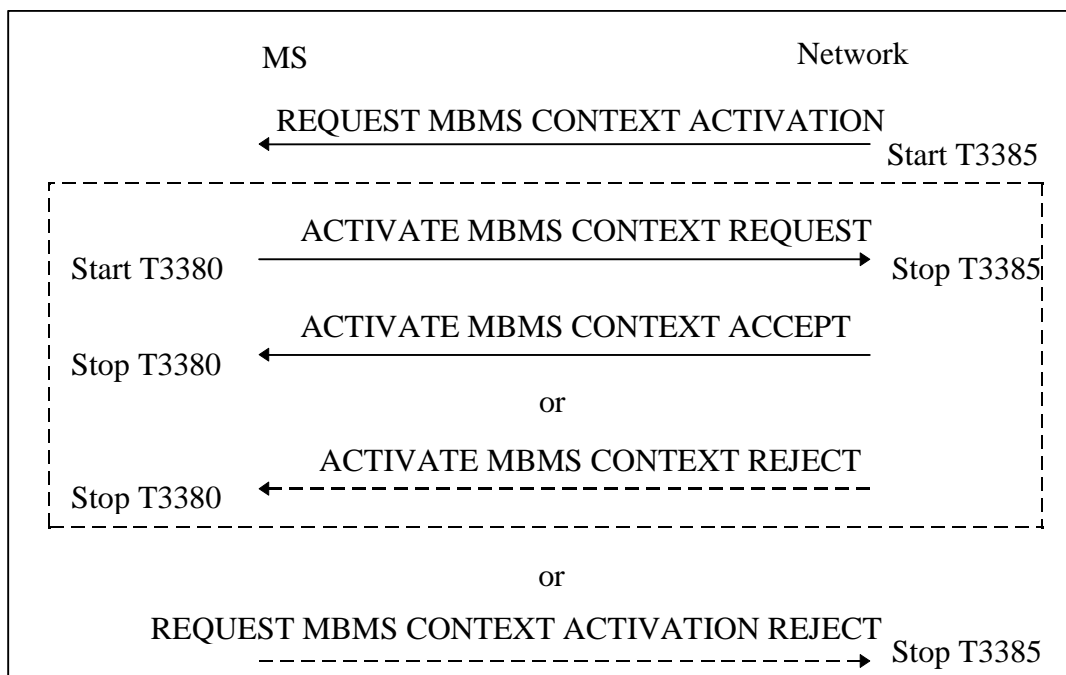

Figure 6.10/3GPP TS 24.008: MBMS context activation procedure

6.1.3.9 MBMS context deactivation

The purpose of this procedure is to deactivate an existing MBMS context in the MS and the network. The MS shall only initiate the MBMS context deactivation when requested by the network, however the trigger for the deactivation request by the network may be initiated by the MS at application layer or by the network, see 3GPP TS 23.246 [106].

After a successful MBMS context deactivation, the associated MBMS NSAPI and TI values shall be released in both the MS and the network and can be reassigned to another MBMS context.

The MBMS context deactivation procedure makes use of the messaging and signalling of the PDP context deactivation procedure as described in the subclauses 6.1.3.9.1 and 6.1.3.9.2.

6.1.3.9.1 MBMS context deactivation initiated by the network

In order to request an MBMS context deactivation, the network sends a DEACTIVATE PDP CONTEXT REQUEST message to the MS, enters the state MBMS-INACTIVE-PENDING and starts timer T3395. The message contains the transaction identifier (TI) in use for the MBMS context to be deactivated and a cause code that typically indicates one of the following causes:

- # 36: regular deactivation;
- # 38: network failure;
- # 47: multicast group membership time-out.

The MS shall reply with a DEACTIVATE PDP CONTEXT ACCEPT message and enter the state PDP-INACTIVE. Upon receipt of the DEACTIVATE PDP CONTEXT ACCEPT message, the network shall stop the timer T3395 and enter the state PDP-INACTIVE.

6.1.3.9.2 Abnormal cases

The following abnormal cases can be identified:

a) Expiry of timers:

On the first expiry of the timer T3395, the network shall resend the message DEACTIVATE PDP CONTEXT REQUEST and shall reset and restart the timer T3395. This retransmission is repeated, i.e. on the fifth expiry of the timer T3395, the network shall erase the MBMS context related data for that MS.

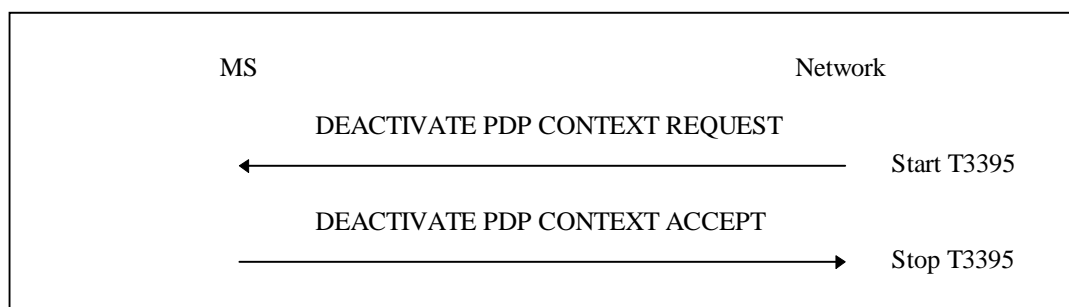

Figure 6.11/3GPP TS 24.008: MBMS context deactivation procedure

6.1.3.10 MBMS protocol configuration options

The MS and the GGSN may communicate parameters related to the MBMS bearer by means of the MBMS protocol configuration options information element when activating or deactivating an MBMS context. For example, such parameters can be used to convey information between the MS and the GGSN.

The MBMS protocol configuration options information element is transparent to the SGSN.

6.1.3.11 Handling of APN based congestion control

The network may detect and start performing the APN based congestion control when one or more APN congestion criteria as specified in 3GPP TS 23.060 [74] are met. The network may store an APN congestion back-off time on a per MS and congested APN basis. If the MS does not provide an APN for the PDP context activation, then the SGSN uses the APN which is used in GGSN/PDN GW selection procedure as congested APN. When APN based congestion control is active, the network may reject session management requests except the modify PDP context requests from UEs or deactivate existing PDP contexts with SM cause value #26 "insufficient resources".

In the MS, session management timers T3396 for APN based congestion control are started and stopped on a per APN basis. The APN associated with T3396 is the APN sent by the MS when the PDN connection is established. If no APN is included in the ACTIVATE PDP CONTEXT REQUEST message, then T3396 is associated with no APN. For this purpose the MS shall memorize the APN provided to the network during the PDP context activation. The timer T3396

associated with no APN will never be started due to any SM procedure related to an emergency PDN connection. If the timer T3396 associated with no APN is running, it does not affect the ability of the MS to request an emergency PDN connection.

If timer T3396 is running or is deactivated, and the MS is an MS configured to use AC11 – 15 in selected PLMN, then the MS is allowed to initiate any session management procedure for the respective APN.

6.1.3.11A Handling of group specific session management congestion control

The network may detect and start performing the group specific session management congestion control when one or more group congestion criteria as specified in 3GPP TS 23.060 [74] are met. When group specific session management congestion control is active, the mechanism for APN based congestion control as specified in subclause 6.1.3.11 shall be followed.

6.1.3.12 Handling session management request for MS configured for dual priority

If timer T3396 is running for a specific APN due to one of the following reasons:

- an ACTIVATE PDP CONTEXT REQUEST, ACTIVATE SECONDARY PDP CONTEXT REQUEST, MODIFY PDP CONTEXT REQUEST or ACTIVATE MBMS CONTEXT REQUEST message containing the low priority indicator set to "MS is configured for NAS signalling low priority" was rejected with a timer value for timer T3396 and SM cause value #26 "insufficient resources";
- a DEACTIVATE PDP CONTEXT REQUEST message was received with a timer value for timer T3396 and SM cause value #26 "insufficient resources" for a PDP context established with the low priority indicator set to "MS is configured for NAS signalling low priority", or
- because the MS received a DEACTIVATE PDP CONTEXT REQUEST message containing a timer value for timer T3396 and SM cause value #26 "insufficient resources" for a PDP context established with the low priority indicator set to "MS is configured for NAS signalling low priority";

upon request of the upper layers the MS can:

- send an ACTIVATE PDP CONTEXT REQUEST or ACTIVATE MBMS CONTEXT REQUEST message to the same APN, with low priority indicator set to "MS is not configured for NAS signalling low priority"; or,
- send an ACTIVATE SECONDARY PDP CONTEXT REQUEST or MODIFY PDP CONTEXT REQUEST message, with low priority indicator set to "MS is not configured for NAS signalling low priority", for an active PDP context established with low priority indicator set to "MS is not configured for NAS signalling low priority" exists.

If timer T3396 is running, because any of the following messages containing the low priority indicator set to "MS is configured for NAS signalling low priority" was rejected with a timer value for timer T3396 and SM cause value #26 "insufficient resources":

- an ACTIVATE PDP CONTEXT REQUEST without an APN and with request type different from "emergency"; or
- an ACTIVATE SECONDARY PDP CONTEXT REQUEST or MODIFY PDP CONTEXT REQUEST message for a non-emergency PDN connection established without APN sent by the MS,

or because the MS received a DEACTIVATE PDP CONTEXT REQUEST message containing a timer value for timer T3396 and SM cause value #26 "insufficient resources" for a non-emergency PDN connection established without an APN and established with the low priority indicator set to "MS is configured for NAS signalling low priority", then upon request of the upper layers the MS can:

- send an ACTIVATE PDP CONTEXT REQUEST message without an APN and with low priority indicator set to "MS is not configured for NAS signalling low priority" for establishment an non-emergency PDN connection; or
- send an ACTIVATE SECONDARY PDP CONTEXT REQUEST or MODIFY PDP CONTEXT REQUEST message, with low priority indicator set to "MS is not configured for NAS signalling low priority", for an active non-emergency PDP context established without an APN and with low priority indicator set to "MS is not configured for NAS signalling low priority".

For requests with low priority indicator set to "MS is configured for NAS signalling low priority", the MS shall follow the procedures specified in subclause 6.1.3.1.3.

6.1.3.13 Handling of network rejection not due to APN based congestion control

The network may include a back-off timer value in a session management reject message to regulate the time interval at which the MS may retry the same procedure. For SM cause values other than #26 "insufficient resources", the network may also include the re-attempt indicator to indicate whether the MS is allowed to re-attempt the corresponding EPS session management procedure for the same APN in S1 mode after inter-system change.

NOTE 1: If the network includes this back-off timer value, then the MS is blocked from sending another SM request for the same procedure for the same PLMN and APN combination for the specified duration. Therefore, the operator needs to exercise caution in determining the use of this timer value.

NOTE 2: If the re-attempt indicator is not provided by the network, an MS registered in its HPLMN or in an EHPLMN can use the configured SM_RetryAtRATChange value specified in the NAS configuration MO or in the USIM NAS_{CONFIG} file to derive the re-attempt indicator as specified in subclauses 6.1.3.1.3.3, 6.1.3.2.2.3, and 6.1.3.3.3.3.

If re-attempt in S1 mode is allowed, the MS shall consider the back-off timer to be applicable only to the GPRS session management in A/Gb and Iu mode for the rejected session management procedure and the given PLMN and APN combination. If re-attempt in S1 mode is not allowed, the MS shall consider the back-off timer to be applicable to both NAS protocols, i.e. applicable to the GPRS session management in A/Gb and Iu mode for the rejected session management procedure and to the EPS session management in S1 mode for the corresponding EPS session management procedure and the given PLMN and APN combination.

The APN of the PLMN and APN combination associated with the back-off timer is the APN sent by the MS when the PDP connection is established. If no APN is included in the ACTIVATE PDP CONTEXT REQUEST message, then the back-off timer is associated with the combination of the PLMN and no APN. For this purpose the MS shall memorize the APN provided to the network during the PDP context activation. The back-off timer associated with the combination of a PLMN with no APN will never be started due to any SM procedure related to an emergency PDP connection. If the back-off timer associated with the combination of a PLMN with no APN is running, it does not affect the ability of the MS to request an emergency PDP connection.

The network may additionally indicate in the re-attempt indicator that a command to back-off is applicable not only for the PLMN in which the MS received the session management reject message, but for each PLMN included in the equivalent PLMN list at the time when the session management reject message was received.

If the back-off timer is running or is deactivated for a given PLMN and APN combination, and the MS is an MS configured to use AC11 – 15 in selected PLMN, then the MS is allowed to initiate any GPRS session management procedure for this PLMN and APN combination.

6.1.3.14 Handling of WLAN offload control

In networks that support offloading of traffic to WLAN, as specified in 3GPP TS 25.331 [23c], a permission to offload is determined for the MS and the PDP context in accordance with 3GPP TS 23.060 [74] subclause 5.3.21.

6.2 void

6.3 Coordination between SM and GMM for supporting ISR

The MS with its TIN set as "RAT-related TMSI" for which ISR is activated shall change its TIN to "P-TMSI" to locally deactivate ISR and stop the periodic tracking area update timer T3412 or T3423, if running:

- upon modification of any PDP context which was activated before the ISR is activated in the MS;
- upon deactivation of the last remaining PDP context in the MS;
- at the time when the MS performs intersystem change from A/Gb mode to S1 mode or from Iu mode to S1 mode if any PDP context activated after the ISR was activated in the MS exists, and the MS is in EMM-IDLE mode on completion of intersystem change; or

- upon deactivation of last non-emergency PDP context in the MS, if the MS has only a PDN connection for emergency bearer services remaining.

ISR remains activated on the network side in the above cases.

6.4 MSISDN notification procedure

The MSISDN notification procedure allows the MS to query the network for its MSISDN for the purpose of user information. In order to request the MSISDN, the MS shall encode the protocol configuration options information element (subclause 10.5.6.3) in the MS to network direction to indicate MSISDN query. The network shall then provide the MSISDN, if available, in the protocol configuration options information element in the network to MS direction. Querying the network and handling of the provided MSISDN by the MS is implementation dependent, in a similar way to the USSD notification or application mode defined in 3GPP TS 23.090 [132].

NOTE: The MS might store the provided MSISDN in the corresponding USIM file (see 3GPP TS 31.102 [112] subclause 4.2.26) and such an MS could check this USIM file to determine whether to query the network.

The network shall provide only one MSISDN. As a result, a provided MSISDN shall supercede any MSISDN that was previously provided in the protocol configuration options information element. The MSISDN provided is for user information only, and the MS shall not use the MSISDN in any NAS signalling procedure. If the MSISDN is stored in the ME, the ME shall retain the MSISDN at power off. The MSISDN stored in the ME, if any, can only be used if the IMSI from the USIM matches the IMSI stored in non-volatile memory, else the MS shall delete the MSISDN.

7 Examples of structured procedures

See 3GPP TS 23.108 [9a].

8 Handling of unknown, unforeseen, and erroneous protocol data

8.1 General

The procedures specified in 3GPP TS 24.008 and call-related supplementary service handling in 3GPP TS 24.010 [21] apply to those messages which pass the checks described in this subclause.

This subclause also specifies procedures for the handling of unknown, unforeseen, and erroneous protocol data by the receiving entity. These procedures are called "error handling procedures", but in addition to providing recovery mechanisms for error situations they define a compatibility mechanism for future extensions of the protocols.

Error handling concerning the value part of the Facility IE and of the SS Version Indicator IE are not in the scope of the present document. It is defined in 3GPP TS 24.010 [21] and the 3GPP TS 24.08x series.

Sub subclauses 8.1 to 8.8 shall be applied in order of precedence.

Most error handling procedures are mandatory for the mobile station.

Detailed error handling procedures in the network are implementation dependent and may vary from PLMN to PLMN. However, when extensions of this protocol are developed, networks will be assumed to have the error handling that is indicated in this subclause as mandatory ("shall") and that is indicated as strongly recommended ("should"). Subclauses 8.2, 8.3, 8.4, 8.5 and 8.7.2 do not apply to the error handling in the network applied to the receipt of initial layer 3 message: If the network diagnoses an error described in one of these subclauses in the initial layer 3 message received from the mobile station, it shall either:

- try to recognize the classmark and then take further implementation dependent actions; or
- release the RR-connection.

Also, the error handling of the network is only considered as mandatory or strongly recommended when certain thresholds for errors are not reached during a dedicated connection.

For definition of semantical and syntactical errors see 3GPP TS 24.007 [20], subclause 11.4.2.

8.2 Message too short

When a message is received that is too short to contain a complete message type information element, that message shall be ignored, cf. 3GPP TS 24.007 [20].

8.3 Unknown or unforeseen transaction identifier

8.3.1 Call Control

The mobile station and the network shall ignore a Call Control message received with TI EXT bit = 0. Otherwise, if the TI EXT bit = 1 or no extension is used, the behaviour described below shall be followed.

The mobile station and network shall reject a SETUP, EMERGENCY SETUP or START CC message received with octet 1 part of the TI value coded as "111" by sending RELEASE COMPLETE with cause #81 "Invalid transaction identifier value" The TI value in RELEASE COMPLETE shall be the complete TI value including the extension octet from the message that caused the rejection.

Any message other than SETUP, EMERGENCY SETUP or START CC received with octet 1 part of the TI value coded as "111" shall be ignored.

For a call control message received with octet 1 part of the TI value not coded as "111", the following procedures shall apply:

- a) For a network that does not support the "Network initiated MO call" option and for all mobile stations:

Whenever any call control message except EMERGENCY SETUP, SETUP or RELEASE COMPLETE is received specifying a transaction identifier which is not recognized as relating to an active call or to a call in progress, the receiving entity shall send a RELEASE COMPLETE message with cause #81 "invalid transaction identifier value" using the received transaction identifier value and remain in the Null state.

For a network that does support the "Network initiated MO call" option \$(CCBS)\$:

Whenever any call control message except EMERGENCY SETUP, SETUP, START CC or RELEASE COMPLETE is received specifying a transaction identifier which is not recognized as relating to an active call or to a call in progress, the receiving entity shall send a RELEASE COMPLETE message with cause #81 "invalid transaction identifier value" using the received transaction identifier value and remain in the Null state.

- b) When a RELEASE COMPLETE message is received specifying a transaction identifier which is not recognized as relating to an active call or to a call in progress, the MM connection associated with that transaction identifier shall be released.

- c) For a network that does not support the "Network initiated MO call" option and for all mobile stations:

When an EMERGENCY SETUP or, a SETUP message is received specifying a transaction identifier which is not recognized as relating to an active call or to a call in progress, and with a transaction identifier flag incorrectly set to "1", this message shall be ignored.

For a network that does support the "Network initiated MO call" option \$(CCBS)\$:

When an EMERGENCY SETUP, a START CC or, a SETUP message is received specifying a transaction identifier which is not recognised as relating to an active call or to a call in progress, and with a transaction identifier flag incorrectly set to "1", this message shall be ignored.

- d) When a SETUP message is received by the mobile station specifying a transaction identifier which is recognized as relating to an active call or to a call in progress, this SETUP message shall be ignored.
- e) For a network that does not support the "Network initiated MO call" option:

When an EMERGENCY SETUP message or a SETUP message is received by the network specifying a transaction identifier which is recognized as relating to an active call or to a call in progress, this message need not be treated and the network may perform other actions.

For a network that does support the "Network initiated MO call" option \$(CCBS)\$:

When an EMERGENCY SETUP message or a START CC message is received by the network specifying a transaction identifier which is recognised as relating to an active call or to a call in progress, this message need not be treated and the network may perform other actions.

The same applies to a SETUP message unless the transaction has been established by a START_CC message and the network is in the "recall present" state (N0.6).

8.3.2 Session Management

The mobile station and network shall ignore a session management message with TI EXT bit = 0. Otherwise, the following procedures shall apply:

- a) Whenever any session management message except ACTIVATE PDP CONTEXT REQUEST, ACTIVATE SECONDARY PDP CONTEXT REQUEST, or SM-STATUS is received by the network specifying a transaction identifier which is not recognized as relating to an active PDP context or MBMS context, or to a PDP context or MBMS context that is in the process of activation or deactivation, the network shall send a SM-STATUS message with cause #81 "invalid transaction identifier value" using the received transaction identifier value including the extension octet and remain in the PDP-INACTIVE state.
- b) Whenever any session management message except REQUEST PDP CONTEXT ACTIVATION, REQUEST SECONDARY PDP CONTEXT ACTIVATION, REQUEST MBMS CONTEXT ACTIVATION, or SM-STATUS is received by the MS specifying a transaction identifier which is not recognized as relating to an active context or to a context that is in the process of activation or deactivation, the MS shall send a SM-STATUS message with cause #81 "invalid transaction identifier value" using the received transaction identifier value including the extension octet and remain in the PDP-INACTIVE state.
- c) When a REQUEST PDP CONTEXT ACTIVATION message, REQUEST SECONDARY PDP CONTEXT ACTIVATION message or REQUEST MBMS CONTEXT ACTIVATION message is received by the MS with a transaction identifier flag set to "1", this message shall be ignored.
- d) When an ACTIVATE PDP CONTEXT REQUEST message is received by the network specifying a transaction identifier which is not recognized as relating to a PDP context that is in the process of activation, and with a transaction identifier flag set to "1", this message shall be ignored.
- e) Whenever an ACTIVATE PDP CONTEXT REQUEST or ACTIVATE SECONDARY PDP CONTEXT REQUEST message is received by the network specifying a transaction identifier relating to a PDP context or MBMS context not in state PDP-INACTIVE, the network shall deactivate the old PDP context or MBMS context relating to the received transaction identifier without notifying the MS. Furthermore, the network shall continue with the activation procedure of a new PDP context as indicated in the received message. Whenever an ACTIVATE MBMS CONTEXT REQUEST message is received by the network specifying a transaction identifier relating to an MBMS context not in state PDP-INACTIVE, the network shall deactivate the old MBMS context relating to the received transaction identifier without notifying the MS. Furthermore, the network shall continue with the activation procedure of a new MBMS context as indicated in the received message.
- f) Whenever a REQUEST PDP CONTEXT ACTIVATION message or REQUEST SECONDARY PDP CONTEXT ACTIVATION message is received by the MS specifying a transaction identifier relating to a PDP context or MBMS context not in state PDP-INACTIVE, the MS shall locally deactivate the old PDP context or MBMS context relating to the received transaction identifier. Furthermore, the MS shall continue with the activation procedure of a new PDP context as indicated in the received message.

Whenever a REQUEST MBMS CONTEXT ACTIVATION message is received by the MS specifying a transaction identifier relating to a PDP context or MBMS context not in state PDP-INACTIVE, the MS shall locally deactivate the old PDP context or MBMS context relating to the received transaction identifier. Furthermore, the MS shall continue with the activation procedure of a new MBMS context as indicated in the received message.

- g) When an ACTIVATE SECONDARY PDP CONTEXT REQUEST message is received by the network specifying a transaction identifier which is not recognized as relating to a PDP context that is in the process of activation and with a transaction identifier flag set to "1", this message shall be ignored.

8.4 Unknown or unforeseen message type

If a mobile station receives an RR, MM or CC message with message type not defined for the PD or not implemented by the receiver in unacknowledged mode, it shall ignore the message.

If a mobile station receives an RR, MM or CC message with message type not defined for the PD or not implemented by the receiver in acknowledged mode, it shall return a status message (STATUS, MM STATUS depending on the protocol discriminator) with cause # 97 "message type non-existent or not implemented".

If a mobile station receives a GMM message or SM message with message type not defined for the PD or not implemented by the receiver, it shall return a status message (GMM STATUS or SM STATUS depending on the protocol discriminator) with cause # 97 "message type non-existent or not implemented".

If the network receives an MM message with message type not defined for the PD or not implemented by the receiver in a protocol state where reception of an unsolicited message with the given PD from the mobile station is not foreseen in the protocol, the network actions are implementation dependent. Otherwise, if the network receives a message with message type not defined for the PD or not implemented by the receiver, it shall ignore the message except that it should return a status message (STATUS, MM STATUS, GMM STATUS or SM STATUS depending on the protocol discriminator) with cause #97 "message type non-existent or not implemented".

NOTE: A message type not defined for the PD in the given direction is regarded by the receiver as a message type not defined for the PD, see 3GPP TS 24.007 [20].

If the mobile station receives a message not compatible with the protocol state, the mobile station shall ignore the message except for the fact that, if an RR connection exists, it returns a status message (STATUS, MM STATUS depending on the protocol discriminator) with cause #98 "Message type not compatible with protocol state". When the message was a GMM message the GMM-STATUS message with cause #98 "Message type not compatible with protocol state" shall be returned. When the message was a SM message the SM-STATUS message with cause #98 "Message type not compatible with protocol state" shall be returned.

If the network receives a message not compatible with the protocol state, the network actions are implementation dependent.

NOTE: The use by GMM and SM of unacknowledged LLC may lead to messages "not compatible with the protocol state".

8.5 Non-semantic mandatory information element errors

When on receipt of a message,

- an "imperative message part" error; or
- a "missing mandatory IE" error;

is diagnosed or when a message containing:

- a syntactically incorrect mandatory IE; or
- an IE unknown in the message, but encoded as "comprehension required" (see 3GPP TS 24.007 [20]); or
- an out of sequence IE encoded as "comprehension required" (see 3GPP TS 24.007 [20]) is received,

the mobile station shall proceed as follows:

If the message is not one of the messages listed in subclauses 8.5.1, 8.5.2, 8.5.3, 8.5.4 and 8.5.5 a), b), f) or h), the mobile station shall ignore the message except for the fact that, if an RR connection exists, it shall return a status message (STATUS, MM STATUS depending on the protocol discriminator) with cause # 96 "Invalid mandatory information". If the message was a GMM message the GMM-STATUS message with cause #96 "

Invalid mandatory information" shall be returned. If the message was an SM message the SM-STATUS message with cause # 96 "invalid mandatory information" shall be returned.

- the network shall proceed as follows:

When the message is not one of the messages listed in subclause 8.5.3 b), c), d) or e) and 8.5.5 a), c), d), e) or g), the network shall either:

- try to treat the message (the exact further actions are implementation dependent), or
- ignore the message except that it should return a status message (STATUS, or MM STATUS (depending on the protocol discriminator), GMM STATUS, or SM STATUS) with cause # 96 "Invalid mandatory information".

8.5.1 Radio resource management

See 3GPP TS 44.018 [84].

8.5.2 Mobility management

No exceptional cases are described for mobility management messages.

8.5.3 Call control

- a) If the message is a SETUP message, a RELEASE COMPLETE message with cause # 96 "invalid mandatory information" shall be returned.
- b) If the message is a DISCONNECT message, a RELEASE message shall be returned with cause value # 96 "invalid mandatory information" and subclause 5.4. "call clearing" applies as normal.
- c) If the message is a RELEASE message, a RELEASE COMPLETE message shall be returned with cause value # 96 "invalid mandatory information".
- d) If the message is a RELEASE COMPLETE message, it shall be treated as a normal RELEASE COMPLETE message.
- e) If the message is a HOLD REJECT or RETRIEVE REJECT message, it shall be treated as a normal HOLD REJECT or RETRIEVE REJECT message.
- f) If the message is a STATUS message and received by the network, a RELEASE COMPLETE message may be returned with cause value # 96 "invalid mandatory information".

8.5.4 GMM mobility management

No exceptional cases are described for mobility management messages.

8.5.5 Session management

- a) If the message is a DEACTIVATE PDP CONTEXT REQUEST, a DEACTIVATE PDP CONTEXT ACCEPT message shall be returned. All resources allocated for that context shall be released.
- b) If the message is a REQUEST PDP CONTEXT ACTIVATION, a REQUEST PDP CONTEXT ACTIVATION REJECT message with cause # 96 "Invalid mandatory information" shall be returned.
- c) If the message is an ACTIVATE PDP CONTEXT REQUEST, an ACTIVATE PDP CONTEXT REJECT message with cause # 96 "Invalid mandatory information" shall be returned.
- d) If the message is an ACTIVATE SECONDARY PDP CONTEXT REQUEST, an ACTIVATE SECONDARY PDP CONTEXT REJECT message with cause # 96 "Invalid mandatory information" shall be returned.
- e) If the message is a MODIFY PDP CONTEXT REQUEST, a MODIFY PDP CONTEXT REJECT message with cause # 96 "Invalid mandatory information" shall be returned.

- f) If the message is a REQUEST MBMS CONTEXT ACTIVATION, a REQUEST MBMS CONTEXT ACTIVATION REJECT message with cause # 96 "Invalid mandatory information" shall be returned.
- g) If the message is an ACTIVATE MBMS CONTEXT REQUEST, an ACTIVATE MBMS CONTEXT REJECT message with cause # 96 "Invalid mandatory information" shall be returned.
- h) If the message is a REQUEST SECONDARY PDP CONTEXT ACTIVATION, a REQUEST SECONDARY PDP CONTEXT ACTIVATION REJECT message with cause # 96 "Invalid mandatory information" shall be returned.

8.6 Unknown and unforeseen IEs in the non-imperative message part

8.6.1 IEs unknown in the message

The MS shall ignore all IEs unknown in a message which are not encoded as "comprehension required" (see 3GPP TS 24.007 [20]).

The network shall take the same approach.

8.6.2 Out of sequence IEs

The MS shall ignore all out of sequence IEs in a message which are not encoded as "comprehension required" (see 3GPP TS 24.007 [20]).

The network should take the same approach.

8.6.3 Repeated IEs

If an information element with format T, TV, or TLV is repeated in a message in which repetition of the information element is not specified in clause 9 of the present document, only the contents of the information element appearing first shall be handled and all subsequent repetitions of the information element shall be ignored. When repetition of information elements is specified, only the contents of specified repeated information elements shall be handled. If the limit on repetition of information elements is exceeded, the contents of information elements appearing first up to the limit of repetitions shall be handled and all subsequent repetitions of the information element shall be ignored.

The network should follow the same procedures.

8.7 Non-imperative message part errors

This category includes:

- syntactically incorrect optional IEs;
- conditional IE errors.

8.7.1 Syntactically incorrect optional IEs

The MS shall treat all optional IEs that are syntactically incorrect in a message as not present in the message.

The network shall take the same approach.

8.7.2 Conditional IE errors

When the MS upon receipt of an RR, MM or CC message diagnoses a "missing conditional IE" error or an "unexpected conditional IE" error or when it receives an RR, MM or CC message containing at least one syntactically incorrect conditional IE, it shall ignore the message except for the fact that, if an RR connection exists, it shall return a status message (STATUS, or MM STATUS depending on the PD) with cause value # 100 "conditional IE error".

When the MS upon receipt of a GMM or SM message diagnoses a "missing conditional IE" error or an "unexpected conditional IE" error or when it receives a GMM or SM message containing at least one syntactically incorrect conditional IE, it shall ignore the message and it shall return a status message (GMM STATUS or SM STATUS depending on the PD) with cause value # 100 "conditional IE error".

When the network receives a message and diagnose a "missing conditional IE" error or an "unexpected conditional IE" error or when it receives a message containing at least one syntactically incorrect conditional IE, the network shall either

- try to treat the message (the exact further actions are implementation dependent), or
- ignore the message except that it should return a status message (STATUS, MM STATUS, GMM STATUS or SM STATUS depending on the protocol discriminator) with cause # 100 "conditional IE error".

8.8 Messages with semantically incorrect contents

When a message with semantically incorrect contents is received, the foreseen reactions of the procedural part of 3GPP TS 24.008 (i.e. of clauses 3, 4, 5, 6) are performed. If however no such reactions are specified, the MS shall ignore the message except for the fact that, if an RR connection exists, it returns a status message (STATUS, or MM STATUS depending on the PD) with cause value # 95 "semantically incorrect message". If the message was a GMM message the GMM-STATUS message with cause #95 "semantically incorrect message" shall be returned. If the message was an SM message the SM-STATUS message with cause # 95 "semantically incorrect message" shall be returned.

The network should follow the same procedure except that a status message is not normally transmitted.

Semantic checking of the Facility information element value part (defined in 3GPP TS 24.080 [24]) is the subject of the technical specifications 3GPP TS 24.010 [21] and the 3GPP TS 24.08x series.

9 Message functional definitions and contents

This clause defines the structure of the messages of those layer 3 protocols defined in 3GPP TS 24.008. These are standard L3 messages as defined in 3GPP TS 24.007 [20].

Each definition given in the present clause includes:

- a) a brief description of the message direction and use, including whether the message has:
 1. Local significance, i.e. relevant only on the originating or terminating access;
 2. Access significance, i.e. relevant in the originating and terminating access, but not in the network;
 3. Dual significance, i.e. relevant in either the originating or terminating access and in the network; or
 4. Global significance, i.e. relevant in the originating and terminating access and in the network.
- b) a table listing the information elements known in the message and their order of their appearance in the message. In messages for circuit-switched call control also a *shift* information element shall be considered as known even if not included in the table. All information elements that may be repeated are explicitly indicated. (V and LV formatted IEs, which compose the imperative part of the message, occur before T, TV, and TLV formatted IEs which compose the non-imperative part of the message, cf. 3GPP TS 24.007 [20].) In a (maximal) sequence of consecutive information elements with half octet length, the first information element with half octet length occupies bits 1 to 4 of octet N, the second bits 5 to 8 of octet N, the third bits 1 to 4 of octet N+1 etc. Such a sequence always has an even number of elements.

For each information element the table indicates:

1. the information element identifier, in hexadecimal notation, if the IE has format T, TV, or TLV. Usually, there is a default IEI for an information element type; default IEIs of different IE types of the same protocol are different. If the IEI has half octet length, it is specified by a notation representing the IEI as a hexadecimal digit followed by a "-" (example: B-).

NOTE 1: The same IEI may be used for different information element types in different messages of the same protocol.

NOTE 2: In the CC protocol the IEI of the locking shift and non-locking shift information elements is the same in all messages and is not used for any other information elements.

2. the name of the information element (which may give an idea of the semantics of the element). The name of the information element (usually written in italics) followed by "IE" or "information element" is used in 3GPP TS 24.008 as reference to the information element within a message.
 3. the name of the type of the information element (which indicates the coding of the value part of the IE), and generally, the referenced subclause of clause 10 of 3GPP TS 24.008 describing the value part of the information element.
 4. the presence requirement indication (M, C, or O) for the IE as defined in 3GPP TS 24.007 [20].
 5. The format of the information element (T, V, TV, LV, TLV) as defined in 3GPP TS 24.007 [20].
 6. The length of the information element (or permissible range of lengths), in octets, in the message, where "?" means that the maximum length of the IE is only constrained by link layer protocol, and in the case of the Facility IE by possible further conditions specified in 3GPP TS 24.010 [21]. This indication is non-normative.
- c.) subclauses specifying, where appropriate, conditions for IEs with presence requirement C or O in the relevant message which together with other conditions specified in 3GPP TS 24.008 define when the information elements shall be included or not, what non-presence of such IEs means, and - for IEs with presence requirement C - the static conditions for presence and/or non-presence of the IEs (see 3GPP TS 24.007 [20]).

9.1 Messages for Radio Resources management

See 3GPP TS 44.018 [84].

9.2 Messages for mobility management

Table 9.2.1/3GPP TS 24.008 summarizes the messages for mobility management.

Table 9.2.1/3GPP TS 24.008: Messages for mobility management

Registration messages:	Reference
IMSI DETACH INDICATION	9.2.12
LOCATION UPDATING ACCEPT	9.2.13
LOCATION UPDATING REJECT	9.2.14
LOCATION UPDATING REQUEST	9.2.15
Security messages:	Reference
AUTHENTICATION REJECT	9.2.1
AUTHENTICATION REQUEST	9.2.2
AUTHENTICATION RESPONSE	9.2.3
AUTHENTICATION FAILURE	9.2.3a
IDENTITY REQUEST	9.2.10
IDENTITY RESPONSE	9.2.11
TMSI REALLOCATION COMMAND	9.2.17
TMSI REALLOCATION COMPLETE	9.2.18
Connection management messages:	Reference
CM SERVICE ACCEPT	9.2.5
CM SERVICE PROMPT	9.2.5a
CM SERVICE REJECT	9.2.6
CM SERVICE ABORT	9.2.7
CM SERVICE REQUEST	9.2.9
CM RE-ESTABLISHMENT REQUEST	9.2.4
ABORT	9.2.8
Miscellaneous message:	Reference
MM INFORMATION	9.2.15a
MM STATUS	9.2.16
MM NULL	9.2.19

9.2.1 Authentication reject

This message is sent by the network to the mobile station to indicate that authentication has failed (and that the receiving mobile station shall abort all activities). See table 9.2.2/3GPP TS 24.008.

Message type: AUTHENTICATION REJECT

Significance: dual

Direction: network to mobile station

Table 9.2.2/3GPP TS 24.008: AUTHENTICATION REJECT message content

IEI	Information element	Type/Reference	Presence	Format	Length
	Mobility management protocol discriminator	Protocol discriminator 10.2	M	V	1/2
	Skip Indicator	Skip Indicator 10.3.1	M	V	1/2
	Authentication Reject message type	Message type 10.4	M	V	1

9.2.2 Authentication request

This message is sent by the network to the mobile station to initiate authentication of the mobile station identity. See table 9.2.3/3GPP TS 24.008.

Message type: AUTHENTICATION REQUEST

Significance: dual

Direction: network to mobile station

Table 9.2.3/3GPP TS 24.008: AUTHENTICATION REQUEST message content

IEI	Information element	Type/Reference	Presence	Format	Length
	Mobility management protocol discriminator	Protocol discriminator 10.2	M	V	1/2
	Skip Indicator	Skip Indicator 10.3.1	M	V	1/2
	Authentication Request message type	Message type 10.4	M	V	1
	Ciphering key sequence number	Ciphering key sequence number 10.5.1.2	M	V	1/2
	Spare half octet	Spare half octet 10.5.1.8	M	V	1/2
	Authentication parameter RAND (UMTS challenge or GSM challenge)	Auth. parameter RAND 10.5.3.1	M	V	16
20	Authentication Parameter AUTN	Auth. parameter AUTN 10.5.3.1.1	O	TLV	18

9.2.2.1 Authentication Parameter AUTN

This IE shall be present if and only if the authentication challenge is a UMTS authentication challenge. The presence or absence of this IE defines- in the case of its absence- a GSM authentication challenge or- in the case of its presence- a UMTS authentication challenge.

The MS shall ignore the IE if a SIM is inserted in the MS.

In UMTS, the MS shall reject the AUTHENTICATION REQUEST message as specified in subclause 4.3.2.5.1 if this IE is not present and a USIM is inserted in the MS.

9.2.3 Authentication response

This message is sent by the mobile station to the network to deliver a calculated response to the network. See table 9.2.4/3GPP TS 24.008.

Message type: AUTHENTICATION RESPONSE

Significance: dual

Direction: mobile station to network

Table 9.2.4/3GPP TS 24.008: AUTHENTICATION RESPONSE message content

IEI	Information element	Type/Reference	Presence	Format	Length
	Mobility management protocol discriminator	Protocol discriminator 10.2	M	V	1/2
	Skip Indicator	Skip Indicator 10.3.1	M	V	1/2
	Authentication Response message type	Message type 10.4	M	V	1
	Authentication Response parameter	Auth. Response parameter 10.5.3.2	M	V	4
21	Authentication Response Parameter (extension)	Auth. Response parameter 10.5.3.2.1	O	TLV	3-14

9.2.3.1 Authentication Response Parameter

This IE contains the SRES, if it was a GSM authentication challenge, or the RES (all or just the 4 most significant octets of) if it was a UMTS authentication challenge (see also subclause 9.2.3.2).

9.2.3.2 Authentication Response Parameter (extension)

This IE shall be included if and only if the authentication challenge was a UMTS authentication challenge and the RES parameter is greater than 4 octets in length. It shall contain the least significant remaining bits of the RES (the four most significant octets shall be sent in the Authentication Response Parameter IE (see subclause 9.2.3.1))

This IE shall not be included if a SIM is inserted in the MS.

9.2.3a Authentication Failure

This message is sent by the mobile station to the network to indicate that authentication of the network has failed. See table 9.2.4a/3GPP TS 24.008.

Message type: AUTHENTICATION FAILURE

Significance: dual

Direction: mobile station to network

Table 9.2.4a/3GPP TS 24.008: AUTHENTICATION FAILURE message content

IEI	Information element	Type/Reference	Presence	Format	Length
	Mobility management Protocol discriminator	Protocol discriminator 10.2	M	V	1/2
	Skip Indicator	Skip Indicator 10.3.1	M	V	1/2
	Authentication Failure Message type	Message type 10.4	M	V	1
	Reject Cause	Reject Cause 10.5.3.6	M	V	1
22	Authentication Failure parameter	Authentication Failure parameter 10.5.3.2.2	O	TLV	16

9.2.3a.1 Authentication Failure parameter

This IE shall be sent if and only if the reject cause was "Synch failure". It shall include the response to the authentication challenge from the USIM, which is made up of the AUTS parameter (see 3GPP TS 33.102 [5a]).

9.2.4 CM Re-establishment request

This message is sent by the mobile station to the network to request re-establishment of a connection if the previous one has failed. See table 9.2.5/3GPP TS 24.008.

Message type: CM RE-ESTABLISHMENT REQUEST

Significance: dual

Direction: mobile station to network

Table 9.2.5/3GPP TS 24.008: CM RE-ESTABLISHMENT REQUEST message content

IEI	Information element	Type/Reference	Presence	Format	Length
	Mobility management protocol discriminator	Protocol discriminator 10.2	M	V	½
	Skip Indicator	Skip Indicator 10.3.1	M	V	½
	CM Re-Establishment Request message type	Message type 10.4	M	V	1
	Ciphering key sequence number	Ciphering key sequence number 10.5.1.2	M	V	½
	Spare half octet	Spare half octet 10.5.1.8	M	V	½
	Mobile station classmark	Mobile station classmark 2 10.5.1.6	M	LV	4
	Mobile identity	Mobile identity 10.5.1.4	M	LV	2-9
13	Location area identification	Location area identification 10.5.1.3	C	TV	6
D-	Device properties	Device properties 10.5.7.8	O	TV	1

NOTE: In A/Gb mode, the maximum number of octets that can be transferred is 20.

9.2.4.1 Location area identification

The *location area identification* information element shall appear when a TMSI is used as mobile identity, to render that mobile identity non-ambiguous. This is the LAI stored in the SIM/USIM.

9.2.4.2 Mobile Station Classmark

This IE shall include for multiband mobile station the Classmark 2 corresponding to the frequency band in use.

9.2.4.3 Device properties

This IE shall be included if the MS is configured for NAS signalling low priority.

9.2.5 CM service accept

This message is sent by the network to the mobile station to indicate that the requested service has been accepted. See table 9.2.6/3GPP TS 24.008.

Message type: CM SERVICE ACCEPT

Significance: dual

Direction: network to mobile station

Table 9.2.6/3GPP TS 24.008: CM SERVICE ACCEPT message content

IEI	Information element	Type/Reference	Presence	Format	Length
	Mobility management protocol discriminator	Protocol discriminator 10.2	M	V	1/2
	Skip Indicator	Skip Indicator 10.3.1	M	V	1/2
	CM Service Accept message type	Message type 10.4	M	V	1

9.2.5a CM service prompt \$(CCBS)\$

A mobile station that does not support the "Network initiated MO call" option shall treat this message as a message with message type not defined for the PD.

This message is sent by the network to the mobile station to request the mobile to establish a service for the specified CM protocol using the specified SAPI, e.g. circuit switched connection establishment on SAPI 0, supplementary services activation on SAPI 0, or short message transfer on SAPI 3. See Table 9.2.7/3GPP TS 24.008.

Message type: CM SERVICE PROMPT

Significance: dual

Direction: network to mobile station

Table 9.2.7/3GPP TS 24.008: CM SERVICE PROMPT message content

IEI	Information element	Type/Reference	Presence	Format	Length
	Mobility management protocol discriminator	Protocol discriminator 10.2	M	V	1/2
	Skip Indicator	Skip Indicator 10.3.1	M	V	1/2
	CM Service Prompt message type	Message type 10.4	M	V	1
	PD and SAPI of CM	PD and SAPI 10.5.1.10a	M	V	1

9.2.6 CM service reject

This message is sent by the network to the mobile station to indicate that the requested service cannot be provided. See table 9.2.8/3GPP TS 24.008.

Message type: CM SERVICE REJECT

Significance: dual

Direction: network to mobile station

Table 9.2.8/3GPP TS 24.008: CM SERVICE REJECT message content

IEI	Information element	Type/Reference	Presence	Format	Length
	Mobility management protocol discriminator	Protocol discriminator 10.2	M	V	1/2
	Skip Indicator	Skip Indicator 10.3.1	M	V	1/2
	CM Service Reject message type	Message type 10.4	M	V	1
	Reject cause	Reject cause 10.5.3.6	M	V	1
36	T3246 value	MM timer 10.5.3.16	O	TLV	3

9.2.6.1 T3246 value

This IE may be included when the CS domain NAS level mobility management congestion control is active.

9.2.7 CM service abort

This message is sent by the mobile station to the network to request the abortion of the first MM connection establishment in progress and the release of the RR connection. See table 9.2.9/3GPP TS 24.008.

Message type: CM SERVICE ABORT

Significance: dual

Direction: mobile station to network

Table 9.2.9/3GPP TS 24.008: CM SERVICE ABORT message content

IEI	Information element	Type/Reference	Presence	Format	Length
	Mobility management protocol discriminator	Protocol discriminator 10.2	M	V	1/2
	Skip Indicator	Skip Indicator 10.3.1	M	V	1/2
	CM Service Abort message type	Message type 10.4	M	V	1

9.2.8 Abort

This message is sent by the network to the mobile station to initiate the abortion of all MM connections and to indicate the reason for the abortion. See table 9.2.10/3GPP TS 24.008.

Message type: ABORT

Significance: dual

Direction: network to mobile station

Table 9.2.10/3GPP TS 24.008: ABORT message content

IEI	Information element	Type/Reference	Presence	Format	Length
	Mobility management protocol discriminator	Protocol discriminator 10.2	M	V	1/2
	Skip Indicator	Skip Indicator 10.3.1	M	V	1/2
	Abort message type	Message type 10.4	M	V	1
	Reject cause	Reject cause 10.5.3.6	M	V	1

9.2.9 CM service request

This message is sent by the mobile station to the network to request a service for the connection management sublayer entities, e.g. circuit switched connection establishment, supplementary services activation, short message transfer, location services. See table 9.2.11/3GPP TS 24.008.

Message type: CM SERVICE REQUEST

Significance: dual

Direction: mobile station to network

Table 9.2.11/3GPP TS 24.008: CM SERVICE REQUEST message content

IEI	Information element	Type/Reference	Presence	Format	Length
	Mobility management protocol discriminator	Protocol discriminator 10.2	M	V	½
	Skip Indicator	Skip Indicator 10.3.1	M	V	½
	CM Service Request message type	Message type 10.4	M	V	1
	CM service type	CM service type 10.5.3.3	M	V	½
	Ciphering key sequence number	Ciphering key sequence number 10.5.1.2	M	V	½
	Mobile station classmark	Mobile station classmark 2 10.5.1.6	M	LV	4
	Mobile identity	Mobile identity 10.5.1.4	M	LV	2-9
8-	Priority	Priority Level 10.5.1.11	O	TV	1
C-	Additional update parameters	Additional update parameters 10.5.3.14	O	TV	1
D-	Device properties	Device properties 10.5.7.8	O	TV	1

9.2.9.1 Mobile Station Classmark

This IE shall include for multiband mobile station the Classmark 2 corresponding to the frequency band in use.

9.2.9.2 Priority

May be included by mobile station supporting eMLPP to indicate the priority requested.

This information element is only meaningful when the CM service type is:

- Mobile originating call establishment;
- Emergency call establishment;
- Voice group call establishment;
- Voice broadcast call establishment.

9.2.9.3 Additional update parameters

The MS shall include this IE during CS fallback for a mobile originating call or if the MS is requested by the upper layers to set up a mobile originating "DRVCC call" (see subclause 4.5.1.1).

9.2.9.4 Device properties

This IE shall be included if the MS is configured for NAS signalling low priority.

9.2.10 Identity request

This message is sent by the network to the mobile station to request a mobile station to submit the specified identity to the network. See table 9.2.12/3GPP TS 24.008.

Message type: IDENTITY REQUEST

Significance: dual

Direction: network to mobile station

Table 9.2.12/3GPP TS 24.008: IDENTITY REQUEST message content

IEI	Information element	Type/Reference	Presence	Format	Length
	Mobility management protocol discriminator	Protocol discriminator 10.2	M	V	1/2
	Skip Indicator	Skip Indicator 10.3.1	M	V	1/2
	Identity Request message type	Message type 10.4	M	V	1
	Identity type	Identity type 10.5.3.4	M	V	1/2
	Spare half octet	Spare half octet 10.5.1.8	M	V	1/2

9.2.11 Identity response

This message is sent by the mobile station to the network in response to an IDENTITY REQUEST message providing the requested identity. See table 9.2.13/3GPP TS 24.008.

Message type: IDENTITY RESPONSE

Significance: dual

Direction: mobile station to network

Table 9.2.13/3GPP TS 24.008: IDENTITY RESPONSE message content

IEI	Information element	Type/Reference	Presence	Format	Length
	Mobility management protocol discriminator	Protocol discriminator 10.2	M	V	1/2
	Skip Indicator	Skip Indicator 10.3.1	M	V	1/2
	Identity Response message type	Message type 10.4	M	V	1
	Mobile identity	Mobile identity 10.5.1.4	M	LV	2-10
E-	P-TMSI type	P-TMSI type 10.5.5.29	O	TV	1
1B	Routing area identification	Routing area identification 2 10.5.5.15a	O	TLV	8
19	P-TMSI signature	P-TMSI signature 2 10.5.5.8a	O	TLV	5

9.2.12 IMSI detach indication

This message is sent by the mobile station to the network to set a deactivation indication in the network. See table 9.2.14/3GPP TS 24.008.

Message type: IMSI DETACH INDICATION

Significance: dual

Direction: mobile station to network

Table 9.2.14/3GPP TS 24.008: IMSI DETACH INDICATION message content

IEI	Information element	Type/Reference	Presence	Format	Length
	Mobility management protocol discriminator	Protocol discriminator 10.2	M	V	1/2
	Skip Indicator	Skip Indicator 10.3.1	M	V	1/2
	IMSI Detach Indication message type	Message type 10.4	M	V	1
	Mobile station classmark	Mobile station classmark 1 10.5.1.5	M	V	1
	Mobile identity	Mobile identity 10.5.1.4	M	LV	2-9

9.2.12.1 Mobile Station Classmark

This IE shall include for multiband mobile station the Classmark 1 corresponding to the frequency band in use.

9.2.13 Location updating accept

This message is sent by the network to the mobile station to indicate that updating or IMSI attach in the network has been completed. See table 9.2.15/3GPP TS 24.008.

Message type: LOCATION UPDATING ACCEPT

Significance: dual

Direction: network to mobile station

Table 9.2.15/3GPP TS 24.008: LOCATION UPDATING ACCEPT message content

IEI	Information element	Type/Reference	Presence	Format	Length
	Mobility management protocol discriminator	Protocol discriminator 10.2	M	V	½
	Skip Indicator	Skip Indicator 10.3.1	M	V	½
	Location Updating Accept message type	Message type 10.4	M	V	1
	Location area identification	Location area identification 10.5.1.3	M	V	5
17	Mobile identity	Mobile identity 10.5.1.4	O	TLV	3-10
A1	Follow on proceed	Follow on proceed 10.5.3.7	O	T	1
A2	CTS permission	CTS permission 10.5.3.10	O	T	1
4A	Equivalent PLMNs	PLMN list 10.5.1.13	O	TLV	5-47
34	Emergency Number List	Emergency Number List 10.5.3.13	O	TLV	5-50
35	Per MS T3212	GPRS Timer 3 10.5.7.4a	O	TLV	3
D-	Non-3GPP NW provided policies	Non-3GPP NW provided policies 10.5.5.37	O	TV	1

9.2.13.1 Follow on proceed

The *follow on proceed* information element appears if the network wishes to indicate that the mobile station may attempt an MM connection establishment using the same RR connection.

9.2.13.2 CTS permission

The *CTS permission* information element appears if the network wishes to allow the mobile station to use GSM-Cordless Telephony System in the Location Area.

9.2.13.3 Equivalent PLMNs

The *Equivalent PLMNs* information element is included if the network wants to inform the mobile station of equivalent PLMNs.

9.2.13.4 Emergency Number List

This IE may be sent by the network. If this IE is sent, the contents of this IE indicates a list of emergency numbers valid within the same country as the PLMN from which this IE is received.

9.2.13.5 Per MS T3212

This IE may be sent by the network to provide the MS with a periodic LAU timer that may be different to the broadcast value, e.g. to lengthen the timer.

9.2.13.6 Non-3GPP NW provided policies

This IE is included if the network needs to indicate whether emergency numbers provided via non-3GPP access can be used to initiate MS detected emergency calls (see 3GPP TS 24.302 [156]). If this IE is not included then the MS shall interpret this as a receipt of an information element with all bits of the value part coded as zero.

9.2.14 Location updating reject

This message is sent by the network to the mobile station to indicate that updating or IMSI attach has failed. See table 9.2.16/3GPP TS 24.008.

Message type: LOCATION UPDATING REJECT

Significance: dual

Direction: network to mobile station

Table 9.2.16/3GPP TS 24.008: LOCATION UPDATING REJECT message content

IEI	Information element	Type/Reference	Presence	Format	Length
	Mobility management protocol discriminator	Protocol discriminator 10.2	M	V	1/2
	Skip Indicator	Skip Indicator 10.3.1	M	V	1/2
	Location Updating Reject message type	Message type 10.4	M	V	1
	Reject cause	Reject cause 10.5.3.6	M	V	1
36	T3246 value	MM timer 10.5.3.16	O	TLV	3

9.2.14.1 T3246 value

This IE may be included when the CS domain NAS level mobility management congestion control is active.

9.2.15 Location updating request

This message is sent by the mobile station to the network either to request update of its location file (normal updating or periodic updating) or to request IMSI attach. See table 9.2.17/3GPP TS 24.008.

Message type: LOCATION UPDATING REQUEST

Significance: dual

Direction: mobile station to network

Table 9.2.17/3GPP TS 24.008: LOCATION UPDATING REQUEST message content

IEI	Information element	Type/Reference	Presence	Format	Length
	Mobility management protocol discriminator	Protocol discriminator 10.2	M	V	1/2
	Skip Indicator	Skip Indicator 10.3.1	M	V	1/2
	Location Updating Request message type	Message type 10.4	M	V	1
	Location updating type	Location updating type 10.5.3.5	M	V	1/2
	Ciphering key sequence number	Ciphering key sequence number 10.5.1.2	M	V	1/2
	Location area identification	Location area identification 10.5.1.3	M	V	5
	Mobile station classmark	Mobile station classmark 1 10.5.1.5	M	V	1
	Mobile identity	Mobile identity 10.5.1.4	M	LV	2-9
33	Mobile station classmark for UMTS	Mobile station classmark 2 10.5.1.6	O	TLV	5
C-	Additional update parameters	Additional update parameters 10.5.3.14	O	TV	1
D-	Device properties	Device properties 10.5.7.8	O	TV	1
E-	MS network feature support	MS network feature support 10.5.1.15	O	TV	1

NOTE: In A/Gb mode, the maximum number of octets that can be transferred is 20.

9.2.15.1 Location area identification

The location area identification stored in the SIM/USIM is used.

9.2.15.2 Mobile Station Classmark

This IE shall include for multiband MS the Classmark 1 corresponding to the frequency band in use.

9.2.15.3 Mobile Station Classmark for Iu mode

This IE shall be included when the mobile station is in Iu mode network. The IE shall not be included when the mobile station is in A/Gb mode network.

9.2.15.4 Additional update parameters

The MS shall include this IE if, during CS fallback for a CS call, or upon request from the upper layers to set up a mobile originating "DRVCC call", the MS determines that it has to perform location updating when it enters a GERAN or UTRAN cell (see subclauses 4.5.1.1 and 4.5.1.3.4).

9.2.15.5 Device properties

This IE shall be included if the MS is configured for NAS signalling low priority.

9.2.15.6 MS network feature support

This IE shall be included if the MS supports extended periodic timer T3212 and the Additional update parameters IE is not included.

9.2.15a MM information

This message is sent by the network to the mobile station to provide the mobile station with subscriber specific information. See table 9.2.18/3GPP TS 24.008.

Message type: MM INFORMATION

Significance: dual

Direction: network to mobile station

Table 9.2.18/3GPP TS 24.008 MM INFORMATION message content

IEI	Information element	Type/Reference	Presence	Format	Length
	Mobility management protocol discriminator	Protocol discriminator 10.2	M	V	1/2
	Skip Indicator	Skip Indicator 10.3.1	M	V	1/2
	MM Information message type	Message type 10.4	M	V	1
43	Full name for network	Network Name 10.5.3.5a	O	TLV	3-?
45	Short name for network	Network Name 10.5.3.5a	O	TLV	3-?
46	Local time zone	Time Zone 10.5.3.8	O	TV	2
47	Universal time and local time zone	Time Zone and Time 10.5.3.9	O	TV	8
48	LSA Identity	LSA Identifier 10.5.3.11	O	TLV	2-5
49	Network Daylight Saving Time	Daylight Saving Time 10.5.3.12	O	TLV	3

9.2.15a.1 Full name for network

This IE may be sent by the network. If this IE is sent, the contents of this IE indicate the "full length name of the network" that the network wishes the mobile station to associate with the MCC and MNC contained in the Location Area Identification of the cell to which the mobile station sent its Channel Request message.

9.2.15a.2 Short name for network

This IE may be sent by the network. If this IE is sent, the contents of this IE indicate the "abbreviated name of the network" that the network wishes the mobile station to associate with the MCC and MNC contained in the Location Area Identification of the cell to which the mobile station sent its Channel Request message.

9.2.15a.3 Local time zone

This IE may be sent by the network. The mobile station should assume that this time zone applies to the Location Area of the cell to which the Channel Request message was sent.

If the local time zone has been adjusted for Daylight Saving Time, the network shall indicate this by including the IE Network Daylight Saving Time.

9.2.15a.4 Universal time and local time zone

This IE may be sent by the network. The mobile station should assume that this time zone applies to the Location Area of the cell to which the Channel Request message was sent. The mobile station shall not assume that the time information is accurate.

If the local time zone has been adjusted for Daylight Saving Time, the network shall indicate this by including the IE Network Daylight Saving Time.

9.2.15a.5 LSA Identity

This IE may be sent by the network. The contents of this IE indicate the LSA identity of the serving cell.

9.2.15a.6 Network Daylight Saving Time

This IE may be sent by the network. If this IE is sent, the contents of this IE indicates the value that has been used to adjust the local time zone.

9.2.16 MM Status

This message is sent by the mobile station or the network at any time to report certain error conditions listed in clause 8. See table 9.2.19/3GPP TS 24.008.

Message type: MM STATUS

Significance: local

Direction: both

Table 9.2.19/3GPP TS 24.008: MM STATUS message content

IEI	Information element	Type/Reference	Presence	Format	Length
	Mobility management protocol discriminator	Protocol discriminator 10.2	M	V	1/2
	Skip Indicator	Skip Indicator 10.3.1	M	V	1/2
	MM Status message type	Message type 10.4	M	V	1
	Reject cause	Reject cause 10.5.3.6	M	V	1

9.2.17 TMSI reallocation command

This message is sent by the network to the mobile station to reallocate or delete a TMSI. See table 9.2.20/3GPP TS 24.008.

Message type: TMSI REALLOCATION COMMAND

Significance: dual

Direction: network to mobile station

Table 9.2.20/3GPP TS 24.008: TMSI REALLOCATION COMMAND message content

IEI	Information element	Type/Reference	Presence	Format	Length
	Mobility management protocol discriminator	Protocol discriminator 10.2	M	V	1/2
	Skip Indicator	Skip Indicator 10.3.1	M	V	1/2
	TMSI Reallocation Command message type	Message type 10.4	M	V	1
	Location area identification	Location area identification 10.5.1.3	M	V	5
	Mobile identity	Mobile identity 10.5.1.4	M	LV	2-9

9.2.18 TMSI reallocation complete

This message is sent by the mobile station to the network to indicate that reallocation or deletion of a TMSI has taken place. See table 9.2.21/3GPP TS 24.008.

Message type: TMSI REALLOCATION COMPLETE

Significance: dual

Direction: mobile station to network

Table 9.2.21/3GPP TS 24.008: TMSI REALLOCATION COMPLETE message content

IEI	Information element	Type/Reference	Presence	Format	Length
	Mobility management protocol discriminator	Protocol discriminator 10.2	M	V	1/2
	Skip Indicator	Skip Indicator 10.3.1	M	V	1/2
	TMSI Reallocation Complete message type	Message type 10.4	M	V	1

9.2.19 MM Null

This message is sent in mobile to network direction.

This message is not used on the radio interface. When received by the network it shall be ignored.

The introduction of this message solves interworking issues.

Message type: MM NULL

Table 9.2.22/3GPP TS 24.008 MM NULL message content

IEI	Information element	Type/Reference	Presence	Format	Length
	Mobility management protocol discriminator	Protocol discriminator 10.2	M	V	1/2
	Skip Indicator	Skip Indicator 10.3.1	M	V	1/2
	MM Null message type	Message type 10.4	M	V	1

9.3 Messages for circuit-switched call control

Table 9.54/3GPP TS 24.008 summarizes the messages for circuit-switched call control.

Table 9.54/3GPP TS 24.008: Messages for circuit-mode connections call control.

Call establishment messages:	Reference
ALERTING	9.3.1
CALL CONFIRMED (NOTE)	9.3.2
CALL PROCEEDING	9.3.3
CONNECT	9.3.5
CONNECT ACKNOWLEDGE	9.3.6
EMERGENCY SETUP (NOTE)	9.3.8
PROGRESS	9.3.17
CC-ESTABLISHMENT	9.3.17a
CC-ESTABLISHMENT CONFIRMED	9.3.17b
START CC	9.3.23a
SETUP	9.3.23
Call information phase messages:	Reference
MODIFY (NOTE)	9.3.13
MODIFY COMPLETE (NOTE)	9.3.14
MODIFY REJECT (NOTE)	9.3.15
USER INFORMATION	9.3.31
Call clearing messages:	Reference
DISCONNECT	9.3.7
RELEASE	9.3.18
RELEASE COMPLETE	9.3.19
Messages for supplementary service control	Reference
FACILITY	9.3.9
HOLD (NOTE)	9.3.10
HOLD ACKNOWLEDGE (NOTE)	9.3.11
HOLD REJECT (NOTE)	9.3.12
RETRIEVE (NOTE)	9.3.20
RETRIEVE ACKNOWLEDGE (NOTE)	9.3.21
RETRIEVE REJECT (NOTE)	9.3.22
Miscellaneous messages	Reference
CONGESTION CONTROL	9.3.4
NOTIFY	9.3.16
START DTMF (NOTE)	9.3.24
START DTMF ACKNOWLEDGE (NOTE)	9.3.25
START DTMF REJECT (NOTE)	9.3.26
STATUS	9.3.27
STATUS ENQUIRY	9.3.28
STOP DTMF (NOTE)	9.3.29
STOP DTMF ACKNOWLEDGE (NOTE)	9.3.30

NOTE: Not supported by Blue Book ITU-T Recommendation Q.931 [53].

9.3.1 Alerting

9.3.1.1 Alerting (network to mobile station direction)

This message is sent by the network to the calling mobile station to indicate that the called user alerting has been initiated.

See table 9.55/3GPP TS 24.008.

Message type: ALERTING

Significance: global

Direction: network to mobile station

Table 9.55/3GPP TS 24.008: ALERTING message content (network to mobile station direction)

IEI	Information element	Type/Reference	Presence	Format	Length
	Call control protocol discriminator	Protocol discriminator 10.2	M	V	1/2
	Transaction identifier	Transaction identifier 10.3.2	M	V	1/2
	Alerting message type	Message type 10.4	M	V	1
1C	Facility	Facility 10.5.4.15	O	TLV	2-?
1E	Progress indicator	Progress indicator 10.5.4.21	O	TLV	4
7E	User-user	User-user 10.5.4.25	O	TLV	3-131

9.3.1.1.1 Facility

This information element may be used for functional operation of supplementary services.

9.3.1.1.2 Progress indicator

This information element may be included by the network:

- in order to pass information about the call in progress, e.g., in the event of interworking;
- to make the mobile station attach the user connection for speech; and/or
- to make a mobile station supporting multimedia CAT during the alerting phase of a mobile originated multimedia call establishment attach the user connection and setup an H.324 call.

9.3.1.1.3 User-user

This information element may be included by the network if the called remote user included a *user-user* information element in the ALERTING message.

9.3.1.2 Alerting (mobile station to network direction)

This message is sent by the called mobile station to the network, to indicate that the called user alerting has been initiated.

See table 9.55a/3GPP TS 24.008.

Message type: ALERTING

Significance: global

Direction: mobile station to network

Table 9.55a/3GPP TS 24.008: ALERTING message content (mobile station to network direction)

IEI	Information element	Type/Reference	Presence	Format	Length
	Call control protocol discriminator	Protocol discriminator 10.2	M	V	1/2
	Transaction identifier	Transaction identifier 10.3.2	M	V	1/2
	Alerting message type	Message type 10.4	M	V	1
1C	Facility	Facility 10.5.4.15	O	TLV	2-?
7E	User-user	User-user 10.5.4.25	O	TLV	3-131
7F	SS version	SS version indicator 10.5.4.24	O	TLV	2-3

9.3.1.2.1 Facility

This information element may be used for functional operation of supplementary services.

9.3.1.2.2 User-user

This information element may be included when the called mobile station wants to return information to the calling remote user.

9.3.1.2.3 SS version

This information element shall not be included if the *facility* information element is not present in this message.

This information element shall be included or excluded as defined in 3GPP TS 24.010 [21]. This information element should not be transmitted unless explicitly required by 3GPP TS 24.010 [21].

9.3.2 Call confirmed

This message is sent by the called mobile station to confirm an incoming call request.

See table 9.56/3GPP TS 24.008.

Message type: CALL CONFIRMED

Significance: local

Direction: mobile station to network

Table 9.56/3GPP TS 24.008: CALL CONFIRMED message content

IEI	Information element	Type/Reference	Presence	Format	Length
	Call control protocol discriminator	Protocol discriminator 10.2	M	V	1/2
	Transaction identifier	Transaction identifier 10.3.2	M	V	1/2
	Call confirmed message type	Message type 10.4	M	V	1
D-	Repeat Indicator	Repeat Indicator 10.5.4.22	C	TV	1
04	Bearer capability 1	Bearer capability 10.5.4.5	O	TLV	3-16
04	Bearer capability 2	Bearer capability 10.5.4.5	O	TLV	3-16
08	Cause	Cause 10.5.4.11	O	TLV	4-32
15	CC Capabilities	Call Control Capabilities 10.5.4.5a	O	TLV	4
2D	Stream Identifier	Stream Identifier 10.5.4.28	O	TLV	3
40	Supported Codecs	Supported Codec List 10.5.4.32	O	TLV	5-n

9.3.2.1 Repeat indicator

The *repeat indicator* information element shall be included if *bearer capability 1* information element and *bearer capability 2* IE are both included in the message.

9.3.2.2 Bearer capability 1 and bearer capability 2

The *bearer capability 1* information element shall be included if and only if at least one of the following six cases holds:

- the mobile station wishes another bearer capability than that given by the *bearer capability 1* information element of the incoming SETUP message;
- the *bearer capability 1* information element is missing or not fully specified in the SETUP message;
- the *bearer capability 1* information element received in the SETUP message is accepted and the "radio channel requirement" of the mobile station is other than "full rate support only mobile station";
- the *bearer capability 1* information element received in the SETUP message indicates speech and is accepted and the mobile station supports CTM text telephony;
- the *bearer capability 1* information element received in the SETUP message indicates speech and is accepted and the mobile station supports other codecs for GERAN than GSM speech version 1;
- the *bearer capability 1* information element received in the SETUP message included the "fixed network user rate" parameter.

When the *bearer capability 1* information element is followed by the *bearer capability 2* IE in the SETUP, the above rules apply to both *bearer capability 1* IE and *bearer capability 2* IE. Except those cases identified in 3GPP TS 27.001 [36], if either *bearer capability* needs to be included, both shall be included.

Furthermore, both *bearer capability* information elements may be present if the mobile station wishes to reverse the order of occurrence of the *bearer capability* information elements (which is referred to in the *repeat indicator* information element, see subclause 10.5.4.22) in cases identified in 3GPP TS 27.001 [36].

If the mobile station wishes to indicate capability for an alternative call mode, which can be entered during the call through in-call modification, this is indicated by adding a *bearer capability information element* (*bearer capability 2* information element, see subclause 5.3.6).

9.3.2.3 Cause

This information element is included if the mobile station is compatible but the user is busy.

9.3.2.4 CC Capabilities

This information element may be included by the mobile station to indicate its call control capabilities.

9.3.2.5 Stream Identifier

This information element shall be included by the mobile station supporting multicall.

9.3.2.6 Supported Codecs

This information element shall be included for speech calls, if the mobile station supports UMTS radio access.

9.3.3 Call proceeding

This message is sent by the network to the calling mobile station to indicate that the requested call establishment information has been received, and no more call establishment information will be accepted.

See table 9.57/3GPP TS 24.008.

Message type: CALL PROCEEDING

Significance: local

Direction: network to mobile station

Table 9.57/3GPP TS 24.008: CALL PROCEEDING message content

IEI	Information element	Type/Reference	Presence	Format	Length
	Call control protocol discriminator	Protocol discriminator 10.2	M	V	1/2
	Transaction identifier	Transaction identifier 10.3.2	M	V	1/2
	Call proceeding message type	Message type 10.4	M	V	1
D-	Repeat Indicator	Repeat Indicator 10.5.4.22	C	TV	1
04	Bearer capability 1	Bearer capability 10.5.4.5	O	TLV	3-16
04	Bearer capability 2	Bearer capability 10.5.4.5	O	TLV	3-16
1C	Facility	Facility 10.5.4.15	O	TLV	2-?
1E	Progress indicator	Progress indicator 10.5.4.21	O	TLV	4
8-	Priority granted	Priority Level 10.5.1.11	O	TV	1
2F	Network Call Control Capabilities	Network Call Control cap. 10.5.4.29	O	TLV	3

9.3.3.1 Repeat indicator

This information element is included if and only if *bearer capability 1 IE* and *bearer capability 2 IE* are both contained in the message.

9.3.3.2 Bearer capability 1 and bearer capability 2

The *bearer capability 1* information element shall be included if the network has to specify at least one of the negotiable parameters described in 3GPP TS 27.001 [36], or if the *bearer capability 1* information element received in the SETUP message included the "fixed network user rate" parameter.

When the *bearer capability 1* information element is followed by the *bearer capability 2* IE in the SETUP, the above rule applies to both *bearer capability 1* IE and *bearer capability 2* IE. Except those cases identified in 3GPP TS 27.001 [36], if either *bearer capability* needs to be included, both shall be included.

9.3.3.3 Facility

This information element may be used for functional operation of supplementary services.

9.3.3.4 Progress Indicator

This information element may be included:

- in order to pass information about the call in progress e.g. in the event of interworking; and/or
- to make the MS attach the user connection for speech.

9.3.3.5 Priority granted

The priority field is provided by the network in the case that eMLPP is supported.

9.3.3.6 Network Call Control Capabilities

This information shall be included by the network to indicate its call control capabilities if the network supports multicall and there are no other ongoing calls to the MS.

9.3.4 Congestion control

This message is sent by the network to indicate the establishment or termination of flow control on the transmission of USER INFORMATION messages.

See table 9.58/3GPP TS 24.008.

Message type: CONGESTION CONTROL

Significance: local (note)

Direction: network to mobile station

Table 9.58/3GPP TS 24.008: CONGESTION CONTROL message content

IEI	Information element	Type/Reference	Presence	Format	Length
	Call control protocol discriminator	Protocol discriminator 10.2	M	V	1/2
	Transaction identifier	Transaction identifier 10.3.2	M	V	1/2
	Congestion control message type	Message type 10.4	M	V	1
	Congestion level	Congestion level 10.5.4.12	M	V	1/2
	Spare half octet	Spare half octet 10.5.1.8	M	V	1/2
08	Cause	Cause 10.5.4.11	O	TLV	4-32

NOTE: This message has local significance, but may carry information of global significance.

9.3.4.1 Cause

This information element is included if the user to user information has been discarded as a result of the congestion situation.

9.3.5 Connect

9.3.5.1 Connect (network to mobile station direction)

This message is sent by the network to the calling mobile station to indicate call acceptance by the called user.

See table 9.59/3GPP TS 24.008.

Message type: CONNECT

Significance: global

Direction: network to mobile station

Table 9.59/3GPP TS 24.008: CONNECT message content(network to mobile station direction)

IEI	Information element	Type/Reference	Presence	Format	Length
	Call control protocol discriminator	Protocol discriminator 10.2	M	V	1/2
	Transaction identifier	Transaction identifier 10.3.2	M	V	1/2
	Connect message type	Message type 10.4	M	V	1
1C	Facility	Facility 10.5.4.15	O	TLV	2-?
1E	Progress indicator	Progress indicator 10.5.4.21	O	TLV	4
4C	Connected number	Connected number 10.5.4.13	O	TLV	3-14
4D	Connected subaddress	Connected subaddress 10.5.4.14	O	TLV	2-23
7E	User-user	User-user 10.5.4.25	O	TLV	3-131

9.3.5.1.1 Facility

This information element may be used for functional operation of supplementary services.

9.3.5.1.2 Progress indicator

This information element may be included by the network:

- in order to pass information about the call in progress e.g. in the event of interworking; and/or
- to make the MS attach the user connection for speech.

9.3.5.1.3 User-user

This information element may be included by the network if the remote user awarded the call included a user- user information element in the CONNECT message.

9.3.5.2 Connect (mobile station to network direction)

This message is sent by the called mobile station to the network to indicate call acceptance by the called user.

See table 9.59a/3GPP TS 24.008.

Message type: CONNECT

Significance: global

Direction: mobile station to network

Table 9.59a/3GPP TS 24.008: CONNECT message content (mobile station to network direction)

IEI	Information element	Type/Reference	Presence	Format	Length
	Call control protocol discriminator	Protocol discriminator 10.2	M	V	1/2
	Transaction identifier	Transaction identifier 10.3.2	M	V	1/2
	Connect message type	Message type 10.4	M	V	1
1C	Facility	Facility 10.5.4.15	O	TLV	2-?
4D	Connected subaddress	Connected subaddress 10.5.4.14	O	TLV	2-23
7E	User-user	User-user 10.5.4.25	O	TLV	3-131
7F	SS version	SS version indicator 10.5.4.24	O	TLV	2-3
2D	Stream Identifier	Stream Identifier 10.5.4.28	O	TLV	3

9.3.5.2.1 Facility

This information element may be used for functional operation of supplementary services.

9.3.5.2.2 User-user

This information element is included when the answering mobile station wants to return user information to the calling remote user.

9.3.5.2.3 SS version

This information element shall not be included if the *facility* information element is not present in this message.

This information element shall be included or excluded as defined in 3GPP TS 24.010 [21]. This information element should not be transmitted unless explicitly required by 3GPP TS 24.010 [21].

9.3.5.2.4 Stream Identifier

This information element shall be included by a mobile station that supports multicall when a mobile station has indicated "No Bearer" as the SI value in the CALL CONFIRMED message.

9.3.6 Connect acknowledge

This message is sent by the network to the called mobile station to indicate that the mobile station has been awarded the call. It shall also be sent by the calling mobile station to the network to acknowledge the offered connection.

See table 9.60/3GPP TS 24.008.

Message type: CONNECT ACKNOWLEDGE

Significance: local

Direction: both

Table 9.60/3GPP TS 24.008: CONNECT ACKNOWLEDGE message content

IEI	Information element	Type/Reference	Presence	Format	Length
	Call control protocol discriminator	Protocol discriminator 10.2	M	V	1/2
	Transaction identifier	Transaction identifier 10.3.2	M	V	1/2
	Connect acknowledge message type	Message type 10.4	M	V	1

9.3.7 Disconnect

9.3.7.1 Disconnect (network to mobile station direction)

This message is sent by the network to indicate that the end-to-end connection is cleared.

See table 9.61/3GPP TS 24.008.

Message type: DISCONNECT

Significance: global

Direction: network to mobile station

Table 9.61/3GPP TS 24.008: DISCONNECT message content (network to mobile station direction)

IEI	Information element	Type/Reference	Presence	Format	Length
	Call control protocol discriminator	Protocol discriminator 10.2	M	V	1/2
	Transaction identifier	Transaction identifier 10.3.2	M	V	1/2
	Disconnect message type	Message type 10.4	M	V	1
	Cause	Cause 10.5.4.11	M	LV	3-31
1C	Facility	Facility 10.5.4.15	O	TLV	2-?
1E	Progress indicator	Progress indicator 10.5.4.21	O	TLV	4
7E	User-user	User-user 10.5.4.25	O	TLV	3-131
7B	Allowed actions \$(CCBS)\$	Allowed actions 10.5.4.27	O	TLV	3

9.3.7.1.1 Facility

This information element may be used for functional operation of supplementary services, such as the user-user service.

9.3.7.1.2 Progress indicator

This information element is included by the network to make the MS attach the user connection for speech and react in a specific way during call clearing (see subclause 5.4.4).

9.3.7.1.3 User-user

This information element may be included by the network when the remote user initiates call clearing and included a user-user information element in the DISCONNECT message.

9.3.7.1.4 Allowed actions \$(CCBS)\$

This information element may be included by the network to inform the MS about further possible reactions.

9.3.7.2 Disconnect (mobile station to network direction)

This message is sent by the mobile station to request the network to clear an end-to-end connection.

See table 9.61a/3GPP TS 24.008.

Message type: DISCONNECT

Significance: global

Direction: mobile station to network

Table 9.61a/3GPP TS 24.008: DISCONNECT message content (mobile station to network direction)

IEI	Information element	Type/Reference	Presence	Format	Length
	Call control protocol discriminator	Protocol discriminator 10.2	M	V	1/2
	Transaction identifier	Transaction identifier 10.3.2	M	V	1/2
	Disconnect message type	Message type 10.4	M	V	1
	Cause	Cause 10.5.4.11	M	LV	3-31
1C	Facility	Facility 10.5.4.15	O	TLV	2-?
7E	User-user	User-user 10.5.4.25	O	TLV	3-131
7F	SS version	SS version indicator 10.5.4.24	O	TLV	2-3

9.3.7.2.1 Facility

This information element may be used for functional operation of supplementary services, such as the user-user service.

9.3.7.2.2 User-user

This information element is included when the mobile station initiates call clearing and wants to pass user information to the remote user at call clearing time.

9.3.7.2.3 SS version

This information element shall not be included if the *facility* information element is not present in this message.

This information element shall be included or excluded as defined in 3GPP TS 24.010 [21]. This information element should not be transmitted unless explicitly required by 3GPP TS 24.010 [21].

9.3.8 Emergency setup

This message is sent from the mobile station to initiate emergency call establishment.

See table 9.62/3GPP TS 24.008.

Message type: EMERGENCY SETUP

Significance: global

Direction: mobile station to network

Table 9.62/3GPP TS 24.008: EMERGENCY SETUP message content

IEI	Information element	Type/Reference	Presence	Format	Length
	Call control protocol discriminator	Protocol discriminator 10.2	M	V	1/2
	Transaction identifier	Transaction identifier 10.3.2	M	V	1/2
	Emergency setup message type	Message type 10.4	M	V	1
04	Bearer capability	Bearer capability 10.5.4.5	O	TLV	3-11
2D	Stream Identifier	Stream Identifier 10.5.4.28	O	TLV	3
40	Supported Codecs	Supported Codec List 10.5.4.32	O	TLV	5-n
2E	Emergency category	Service category 10.5.4.33	O	TLV	3

9.3.8.1 Bearer capability

If the element is not included, the network shall by default assume speech and select the speech codec according to subclauses 5.2.1.2 and 5.2.1.11. If this information element is included, it shall indicate speech, the appropriate speech version(s) and have the appropriate value of radio channel requirement field.

This information element shall be included by an ME supporting CTM text telephony or supporting at least one speech version for GERAN other than GSM FR speech version 1.

9.3.8.2 Stream Identifier

This information element shall be included by the mobile station supporting multicall.

9.3.8.3 Supported Codecs

This information element shall be included if the mobile station supports UMTS radio access.

9.3.8.4 Emergency category

This information element shall be included if the emergency category is available from the SIM/USIM or the mobile station.

If this information element is included, it shall indicate the selected emergency call category.

If the element is not included, the network shall by default assume a non-specific emergency call.

9.3.9 Facility

9.3.9.1 Facility (network to mobile station direction)

This message is sent by the network to the mobile station to request or acknowledge a supplementary service. The supplementary service to be invoked and its associated parameters are specified in the facility information element.

See table 9.62a/3GPP TS 24.008.

Message type: FACILITY

Significance: local (NOTE 1)

Direction: network to mobile station

Table 9.62a/3GPP TS 24.008: FACILITY message content (network to mobile station direction)

IEI	Information element	Type/Reference	Presence	Format	Length
	Call control protocol discriminator	Protocol discriminator 10.2	M	V	1/2
	Transaction identifier	Transaction identifier 10.3.2	M	V	1/2
	Facility message type	Message type 10.4	M	V	1
	Facility (note 2)	Facility 10.5.4.15	M	LV	1-?

NOTE 1: This message has local significance; however, it may carry information of global significance.

NOTE 2: The *facility* information element has no upper length limit except that given by the maximum number of octets in a L3 message, see 3GPP TS 44.006 [19].

9.3.9.2 Facility (mobile station to network direction)

This message is sent by the mobile station to the network to request or acknowledge a supplementary service. The supplementary service to be invoked and its associated parameters are specified in the facility information element.

See table 9.62b/3GPP TS 24.008.

Message type: FACILITY

Significance: local (note 1)

Direction: mobile station to network

Table 9.62b/3GPP TS 24.008: FACILITY message content (mobile station to network direction)

IEI	Information element	Type/Reference	Presence	Format	Length
	Call control protocol discriminator	Protocol discriminator 10.2	M	V	1/2
	Transaction identifier	Transaction identifier 10.3.2	M	V	1/2
	Facility message type	Message type 10.4	M	V	1
	Facility (note 2)	Facility 10.5.4.15	M	LV	1-?
7F	SS version	SS version indicator 10.5.4.24	O	TLV	2-3

NOTE 1: This message has local significance; however, it may carry information of global significance.

NOTE 2: The *facility* information element has no upper length limit except that given by the maximum number of octets in a L3 message, see 3GPP TS 44.006 [19].

9.3.9.2.1 SS version

This information element shall be included or excluded as defined in 3GPP TS 24.010 [21]. This information element should not be transmitted unless explicitly required by 3GPP TS 24.010 [21].

9.3.10 Hold

This message is sent by the mobile user to request the hold function for an existing call.

See table 9.62c/3GPP TS 24.008 for the content of the HOLD message.

For the use of this message, see 3GPP TS 24.010 [21].

Message type: HOLD

Significance: local

Direction: mobile station to network

Table 9.62c/3GPP TS 24.008: HOLD message content

IEI	Information element	Type/Reference	Presence	Format	Length
	Call control protocol discriminator	Protocol discriminator 10.2	M	V	1/2
	Transaction identifier	Transaction identifier 10.3.2	M	V	1/2
	Hold message type	Message type 10.4	M	V	1

9.3.11 Hold Acknowledge

This message is sent by the network to indicate that the hold function has been successfully performed.

See table 9.62d/3GPP TS 24.008 for the content of the HOLD ACKNOWLEDGE message.

For the use of this message, see 3GPP TS 24.010 [21].

Message type: HOLD ACKNOWLEDGE

Significance: local

Direction: network to mobile station

Table 9.62d/3GPP TS 24.008: HOLD ACKNOWLEDGE message content

IEI	Information element	Type/Reference	Presence	Format	Length
	Call control protocol discriminator	Protocol discriminator 10.2	M	V	1/2
	Transaction identifier	Transaction identifier 10.3.2	M	V	1/2
	Hold Acknowledge message type	Message type 10.4	M	V	1

9.3.12 Hold Reject

This message is sent by the network to indicate the denial of a request to hold a call.

See table 9.62e/3GPP TS 24.008 for the content of the HOLD REJECT message.

For the use of this message, see 3GPP TS 24.010 [21].

Message type: HOLD REJECT

Significance: local

Direction: network to mobile station

Table 9.62e/3GPP TS 24.008: HOLD REJECT message content

IEI	Information element	Type/Reference	Presence	Format	Length
	Call control protocol discriminator	Protocol discriminator 10.2	M	V	1/2
	Transaction identifier	Transaction identifier 10.3.2	M	V	1/2
	Hold Reject message type	Message type 10.4	M	V	1
	Cause	10.5.4.11	M	LV	3-31

9.3.13 Modify

This message is sent by the mobile station to the network or by the network to the mobile station to request a change in bearer capability for a call.

See table 9.63/3GPP TS 24.008.

Message type: MODIFY

Significance: global

Direction: both

Table 9.63/3GPP TS 24.008: MODIFY message content

IEI	Information element	Type/Reference	Presence	Format	Length
	Call control protocol discriminator	Protocol discriminator 10.2	M	V	1/2
	Transaction identifier	Transaction identifier 10.3.2	M	V	1/2
	Modify message type	Message type 10.4	M	V	1
	Bearer capability	Bearer capability 10.5.4.5	M	LV	2-15
7C	Low layer comp.	Low layer comp. 10.5.4.18	O	TLV	2-18
7D	High layer comp.	High layer comp. 10.5.4.16	O	TLV	2-5
A3	Reverse call setup direction	Reverse call setup direction 10.5.4.22a	O	T	1
A4	Network-initiated Service Upgrade indicator	Network-initiated Service Upgrade indicator 10.5.4.3x	O	T	1

9.3.13.1 Low layer compatibility

This information element shall be included if it was included in the initial SETUP message.

9.3.13.2 High layer compatibility

This information element shall be included if it was included in the initial SETUP message.

9.3.13.3 Reverse call setup direction

This information element is included or omitted in the mobile to network direction according to the rules defined in subclause 5.3.4.3.1.

9.3.13.4 Void

9.3.13.5 Network-initiated Service Upgrade indicator

This information element shall be included only if the MODIFY message was sent by the network to switch from speech to UDI/RDI multimedia due to a network-initiated service upgrade.

9.3.14 Modify complete

This message is sent by the mobile station to the network or by the network to the mobile station to indicate completion of a request to change bearer capability for a call.

See table 9.64/3GPP TS 24.008.

Message type: MODIFY COMPLETE

Significance: global

Direction: both

Table 9.64/3GPP TS 24.008: MODIFY COMPLETE message content

IEI	Information element	Type/Reference	Presence	Format	Length
	Call control protocol discriminator	Protocol discriminator 10.2	M	V	1/2
	Transaction identifier	Transaction identifier 10.3.2	M	V	1/2
	Modify complete message type	Message type 10.4	M	V	1
	Bearer capability	Bearer capability 10.5.4.5	M	LV	2-15
7C	Low layer comp.	Low layer comp. 10.5.4.18	O	TLV	2-18
7D	High layer comp.	High layer comp. 10.5.4.16	O	TLV	2-5
A3	Reverse call setup direction	Reverse call setup direction 10.5.4.22a	O	T	1

9.3.14.1 Low layer compatibility

This information element shall be included if it was included in the initial SETUP message.

9.3.14.2 High layer compatibility

This information element shall be included if it was included in the initial SETUP message.

9.3.14.3 Reverse call setup direction

This information element is included or omitted according to the rules defined in subclause 5.3.4.3.2.

9.3.15 Modify reject

This message is sent by the mobile station to the network or by the network to the mobile station to indicate failure of a request to change the bearer capability for a call.

See table 9.65/3GPP TS 24.008.

Message type: MODIFY REJECT

Significance: global

Direction: both

Table 9.65/3GPP TS 24.008: MODIFY REJECT message content

IEI	Information element	Type/Reference	Presence	Format	Length
	Call control protocol discriminator	Protocol discriminator 10.2	M	V	1/2
	Transaction identifier	Transaction identifier 10.3.2	M	V	1/2
	Modify reject message type	Message type 10.4	M	V	1
	Bearer capability	Bearer capability 10.5.4.5	M	LV	2-15
	Cause	Cause 10.5.4.11	M	LV	3-31
7C	Low layer comp.	Low layer comp. 10.5.4.18	O	TLV	2-18
7D	High layer comp.	High layer comp. 10.5.4.16	O	TLV	2-5

9.3.15.1 Low layer compatibility

This information element shall be included if it was included in the initial SETUP message.

9.3.15.2 High layer compatibility

This information element shall be included if it was included in the initial SETUP message.

9.3.16 Notify

This message is sent either from the mobile station or from the network to indicate information pertaining to a call, such as user suspended.

See table 9.66/3GPP TS 24.008.

Message type: NOTIFY

Significance: access

Direction: both

Table 9.66/3GPP TS 24.008: NOTIFY message content

IEI	Information element	Type/Reference	Presence	Format	Length
	Call control protocol discriminator	Protocol discriminator 10.2	M	V	1/2
	Transaction identifier	Transaction identifier 10.3.2	M	V	1/2
	Notify message type	Message type 10.4	M	V	1
	Notification indicator	Notification indicator 10.5.4.20	M	V	1

9.3.17 Progress

This message is sent from the network to the mobile station to indicate the progress of a call in the event of interworking or in connection with the provision of in-band information/patterns.

See table 9.67/3GPP TS 24.008.

Message type: PROGRESS

Significance: global

Direction: network to mobile station

Table 9.67/3GPP TS 24.008: PROGRESS message content

IEI	Information element	Type/Reference	Presence	Format	Length
	Call control protocol discriminator	Protocol discriminator 10.2	M	V	1/2
	Transaction identifier	Transaction identifier 10.3.2	M	V	1/2
	Progress message type	Message type 10.4	M	V	1
	Progress indicator	Progress indicator 10.5.4.21	M	LV	3
7E	User-user	User-user 10.5.4.25	O	TLV	3-131

9.3.17.1 User-user

This information element is included when the PROGRESS message is sent by the network when the call has been cleared by the remote user before it reached the active state to indicate that the remote user wants to pass user information at call clearing time.

9.3.17.2 Progress indicator

This information element may be included by the network:

- in order to pass information about the call in progress, e.g., in the event of interworking;
- to make the mobile station attach the user connection for speech; and/or
- to make a mobile station supporting multimedia CAT during the alerting phase of a mobile originated multimedia call establishment attach the user connection and setup an H.324 call.

9.3.17a CC-Establishment \$(CCBS)\$

A mobile station that does not support the "Network initiated MO call" option shall treat this message as a message with message type not defined for the PD.

This message is sent from the network to the mobile station to provide information on the call that the mobile station should attempt to establish.

See Table 9.67a/3GPP TS 24.008.

Message type: CC-ESTABLISHMENT

Significance: local

Direction: network to mobile station

Table 9.67a/3GPP TS 24.008: CC-Establishment message content

IEI	Information element	Type/Reference	Presence	Format	Length
	Call control protocol discriminator	Protocol discriminator 10.2	M	V	1/2
	Transaction identifier	Transaction identifier 10.3.2	M	V	1/2
	CC-Establishment message type	Message type 10.4	M	V	1
	Setup container	Container 10.5.4.22b	M	LV	3-n

9.3.17a.1 Void**9.3.17a.2 Setup container**

This information element contains the contents of a SETUP message (Mobile Station to Network).

9.3.17b CC-Establishment confirmed \$(CCBS)\$

A Network that does not support the "Network initiated MO call" option shall treat this message as a message with message type not defined for the PD.

This message is sent by the mobile station to the network to indicate the requested channel characteristics for the call which may be initiated by the mobile station.

See Table 9.67b/3GPP TS 24.008.

Message type: CC-ESTABLISHMENT CONFIRMED

Significance: local

Direction: mobile station to network

Table 9.67b/3GPP TS 24.008: CC-ESTABLISHMENT CONFIRMED message content

IEI	Information element	Type/Reference	Presence	Format	Length
	Call control protocol discriminator	Protocol discriminator 10.2	M	V	1/2
	Transaction identifier	Transaction identifier 10.3.2	M	V	1/2
	CC-Establishment confirmed message type	Message type 10.4	M	V	1
D-	Repeat Indicator	Repeat Indicator 10.5.4.22	C	TV	1
04	Bearer capability 1	Bearer capability 10.5.4.5	M	TLV	3-16
04	Bearer capability 2	Bearer capability 10.5.4.5	O	TLV	3-16
08	Cause	Cause 10.5.4.11	O	TLV	4-32
40	Supported Codecs	Supported Codec List 10.5.4.32	O	TLV	5-n

9.3.17b.1 Repeat indicator

The *repeat indicator* information element shall be included if *bearer capability 1* information element and *bearer capability 2* IE are both included in the message.

9.3.17b.2 Bearer capability 1 and bearer capability 2

If, in any subsequent SETUP message to be sent on this transaction the *bearer capability 1* information element is to be followed by the *bearer capability 2* IE, then the *bearer capability 2* IE shall be included in this message.

9.3.17b.3 Cause

This information element is included if the mobile station is compatible but the user is busy.

9.3.17b.4 Supported Codecs

This information element shall be included for speech calls, if the mobile station supports UMTS radio access.

9.3.18 Release

9.3.18.1 Release (network to mobile station direction)

This message is sent, from the network to the mobile station to indicate that the network intends to release the transaction identifier, and that the receiving equipment shall release the transaction identifier after sending RELEASE COMPLETE.

See table 9.68/3GPP TS 24.008.

Message type: RELEASE

Significance: local (note)

Direction: network to mobile station

Table 9.68/3GPP TS 24.008: RELEASE message content (network to mobile station direction)

IEI	Information element	Type/Reference	Presence	Format	Length
	Call control protocol discriminator	Protocol discriminator 10.2	M	V	1/2
	Transaction identifier	Transaction identifier 10.3.2	M	V	1/2
	Release message type	Message type 10.4	M	V	1
08	Cause	Cause 10.5.4.11	O	TLV	4-32
08	Second cause	Cause 10.5.4.11	O	TLV	4-32
1C	Facility	Facility 10.5.4.15	O	TLV	2-?
7E	User-user	User-user 10.5.4.25	O	TLV	3-131

NOTE: This message has local significance; however, it may carry information of global significance when used as the first call clearing message.

9.3.18.1.1 Cause

This information element shall be included if this message is used to initiate call clearing.

9.3.18.1.2 Second cause

This information element may be included under the conditions described in subclause 5.4.4.1.2.3 "Abnormal cases" (Clearing initiated by the network).

9.3.18.1.3 Facility

This information element may be included for functional operation of supplementary services.

9.3.18.1.4 User-user

This information element may be included in the network to mobile station direction, when the RELEASE message is used to initiate call clearing, in order to transport user-user information from the remote user.

9.3.18.2 Release (mobile station to network direction)

This message is sent from the mobile station to the network to indicate that the mobile station intends to release the transaction identifier, and that the receiving equipment shall release the transaction identifier after sending RELEASE COMPLETE.

See table 9.68a/3GPP TS 24.008.

Message type: RELEASE

Significance: local (note)

Direction: mobile station to network direction

Table 9.68a/3GPP TS 24.008: RELEASE message content (mobile station to network direction)

IEI	Information element	Type/Reference	Presence	Format	Length
	Call control protocol discriminator	Protocol discriminator 10.2	M	V	1/2
	Transaction identifier	Transaction identifier 10.3.2	M	V	1/2
	Release message type	Message type 10.4	M	V	1
08	Cause	Cause 10.5.4.11	O	TLV	4-32
08	Second cause	Cause 10.5.4.11	O	TLV	4-32
1C	Facility	Facility 10.5.4.15	O	TLV	2-?
7E	User-user	User-user 10.5.4.25	O	TLV	3-131
7F	SS version	SS version indicator 10.5.4.24	O	TLV	2-3

NOTE: This message has local significance; however, it may carry information of global significance when used as the first call clearing message.

9.3.18.2.1 Cause

This information element shall be included if this message is used to initiate call clearing.

9.3.18.2.2 Second cause

This information element may be included under the conditions described in subclause 5.4.3.5 "Abnormal cases" (Clearing initiated by the mobile station).

9.3.18.2.3 Facility

This information element may be included for functional operation of supplementary services.

9.3.18.2.4 User-user

This information element is included when the RELEASE message is used to initiate call clearing and the mobile station wants to pass user information to the remote user at call clearing time.

9.3.18.2.5 SS version

This information element shall not be included if the *facility* information element is not present in this message.

This information element shall be included or excluded as defined in 3GPP TS 24.010 [21]. This information element should not be transmitted unless explicitly required by 3GPP TS 24.010 [21].

9.3.18a Recall \$(CCBS)\$

A mobile station that does not support the "Network initiated MO call" option shall treat this message as a message with message type not defined for the PD.

This message is sent from the network to the mobile station to initiate the sending of the SETUP message. In addition it provides information for user notification.

See Table 9.68b/3GPP TS 24.008.

Message type: RECALL

Significance: local

Direction: network to mobile station

Table 9.68b/3GPP TS 24.008: Recall message content

IEI	Information element	Type/Reference	Presence	Format	Length
	Call control protocol discriminator	Protocol discriminator 10.2	M	V	1/2
	Transaction identifier	Transaction identifier 10.3.2	M	V	1/2
	Recall message type	Message type 10.4	M	V	1
	Recall Type	Recall Type 10.5.4.21a	M	V	1
	Facility	Facility 10.5.4.15	M	LV	2-n

9.3.18a.1 Recall Type

The purpose of the recall type information element is to describe the reason for the recall.

9.3.18a.2 Facility

The information element shall be included for functional operation of supplementary services.

9.3.19 Release complete

9.3.19.1 Release complete (network to mobile station direction)

This message is sent from the network to the mobile station to indicate that the network has released the transaction identifier and that the mobile station shall release the transaction identifier.

See table 9.69/3GPP TS 24.008.

Message type: RELEASE COMPLETE

Significance: local (note)

Direction: network to mobile station direction

Table 9.69/3GPP TS 24.008: RELEASE COMPLETE message content (network to mobile station direction)

IEI	Information element	Type/Reference	Presence	Format	Length
	Call control protocol discriminator	Protocol discriminator 10.2	M	V	1/2
	Transaction identifier	Transaction identifier 10.3.2	M	V	1/2
	Release complete message type	Message type 10.4	M	V	1
08	Cause	Cause 10.5.4.11	O	TLV	4-32
1C	Facility	Facility 10.5.4.15	O	TLV	2-?
7E	User-user	User-user 10.5.4.25	O	TLV	3-131

NOTE: This message has local significance; however, it may carry information of global significance when used as the first call clearing message.

9.3.19.1.1 Cause

This information element shall be included if the message is used to initiate call clearing.

9.3.19.1.2 Facility

This information element may be included for functional operation of supplementary services.

9.3.19.1.3 User-user

This information element is included in the network to mobile station direction, when the RELEASE COMPLETE message is used to initiate call clearing, in order to transport user-user information from the remote user.

9.3.19.2 Release complete (mobile station to network direction)

This message is sent from the mobile station to the network to indicate that the mobile station has released the transaction identifier and that the network shall release the transaction identifier.

See table 9.69a/3GPP TS 24.008.

Message type: RELEASE COMPLETE

Significance: local (note)

Direction: mobile station to network direction

Table 9.69a/3GPP TS 24.008: RELEASE COMPLETE message content (mobile station to network direction)

IEI	Information element	Type/Reference	Presence	Format	Length
	Call control protocol discriminator	Protocol discriminator 10.2	M	V	1/2
	Transaction identifier	Transaction identifier 10.3.2	M	V	1/2
	Release complete message type	Message type 10.4	M	V	1
08	Cause	Cause 10.5.4.11	O	TLV	4-32
1C	Facility	Facility 10.5.4.15	O	TLV	2-?
7E	User-user	User-user 10.5.4.25	O	TLV	3-131
7F	SS version	SS version indicator 10.5.4.24	O	TLV	2-3

NOTE: This message has local significance; however, it may carry information of global significance when used as the first call clearing message.

9.3.19.2.1 Cause

This information element shall be included if the message is used to initiate call clearing.

9.3.19.2.2 Facility

This information element may be included for functional operation of supplementary services.

9.3.19.2.3 User-user

This information element is included in the mobile station to network direction when the RELEASE COMPLETE message is used to initiate call clearing and the mobile station wants to pass user information to the remote user at call clearing time.

9.3.19.2.4 SS version.

This information element shall not be included if the *facility* information element is not present in this message.

This information element shall be included or excluded as defined in 3GPP TS 24.010 [21]. This information element should not be transmitted unless explicitly required by 3GPP TS 24.010 [21].

9.3.20 Retrieve

This message is sent by the mobile user to request the retrieval of a held call.

See table 9.69b/3GPP TS 24.008 for the content of the RETRIEVE message.

For the use of this message, see 3GPP TS 24.010 [21].

Message type: RETRIEVE

Significance: local

Direction: mobile station to network

Table 9.69b/3GPP TS 24.008: RETRIEVE message content

IEI	Information element	Type/Reference	Presence	Format	Length
	Call control protocol discriminator	Protocol discriminator 10.2	M	V	1/2
	Transaction identifier	Transaction identifier 10.3.2	M	V	1/2
	Retrieve message type	Message type 10.4	M	V	1

9.3.21 Retrieve Acknowledge

This message is sent by the network to indicate that the retrieve function has been successfully performed.

See table 9.69c/3GPP TS 24.008 for the content of the RETRIEVE ACKNOWLEDGE message.

For the use of this message, see 3GPP TS 24.010 [21].

Message type: RETRIEVE ACKNOWLEDGE

Significance: local

Direction: network to mobile station

Table 9.69c/3GPP TS 24.008: RETRIEVE ACKNOWLEDGE message content

IEI	Information element	Type/Reference	Presence	Format	Length
	Call control protocol discriminator	Protocol discriminator 10.2	M	V	1/2
	Transaction identifier	Transaction identifier 10.3.2	M	V	1/2
	Retrieve Acknowledge message type	Message type 10.4	M	V	1

9.3.22 Retrieve Reject

This message is sent by the network to indicate the inability to perform the requested retrieve function.

See table 9.69d/3GPP TS 24.008 for the content of the RETRIEVE REJECT message.

For the use of this message, see 3GPP TS 24.010 [21].

Message type: RETRIEVE REJECT

Significance: local

Direction: network to mobile station

Table 9.69d/3GPP TS 24.008: RETRIEVE REJECT message content

IEI	Information element	Type/Reference	Presence	Format	Length
	Call control Protocol discriminator	Protocol discriminator 10.2	M	V	1/2
	Transaction identifier	Transaction identifier 10.3.2	M	V	1/2
	Retrieve Reject Message type	Message type 10.4	M	V	1
	Cause	10.5.4.11	M	LV	3-31

9.3.23 Setup

9.3.23.1 Setup (mobile terminated call establishment)

This message is sent by the network to the mobile station to initiate a mobile terminated call establishment.

See table 9.70/3GPP TS 24.008.

Message type: SETUP

Significance: global

Direction: network to mobile station

Table 9.70/3GPP TS 24.008: SETUP message content (network to mobile station direction)

IEI	Information element	Type/Reference	Presence	Format	Length
	Call control Protocol discriminator	Protocol discriminator 10.2	M	V	1/2
	Transaction identifier	Transaction identifier 10.3.2	M	V	1/2
	Setup Message type	Message type 10.4	M	V	1
D-	BC repeat indicator	Repeat indicator 10.5.4.22	C	TV	1
04	Bearer capability 1	Bearer capability 10.5.4.5	O	TLV	3-16
04	Bearer capability 2	Bearer capability 10.5.4.5	O	TLV	3-16
1C	Facility	Facility 10.5.4.15	O	TLV	2-?
1E	Progress indicator	Progress indicator 10.5.4.21	O	TLV	4
34	Signal	Signal 10.5.4.23	O	TV	2
5C	Calling party BCD Number	Calling party BCD num. 10.5.4.9	O	TLV	3-14
5D	Calling party sub-Address	Calling party subaddr. 10.5.4.10	O	TLV	2-23
5E	Called party BCD Number	Called party BCD num. 10.5.4.7	O	TLV	3-19
6D	Called party sub-Address	Called party subaddr. 10.5.4.8	O	TLV	2-23
74	Redirecting party BCD number	Redirecting party BCD num. 10.5.4.21b	O	TLV	3-19
75	Redirecting party sub-address	Redirecting party subaddress. 10.5.4.21c	O	TLV	2-23
D-	LLC repeat indicator	Repeat indicator 10.5.4.22	O	TV	1
7C	Low layer Compatibility I	Low layer comp. 10.5.4.18	O	TLV	2-18
7C	Low layer Compatibility II	Low layer comp. 10.5.4.18	C	TLV	2-18
D-	HLC repeat indicator	Repeat indicator 10.5.4.22	O	TV	1
7D	High layer Compatibility i	High layer comp. 10.5.4.16	O	TLV	2-5
7D	High layer Compatibility ii	High layer comp. 10.5.4.16	C	TLV	2-5
7E	User-user	User-user 10.5.4.25	O	TLV	3-35
8-	Priority	Priority Level 10.5.1.11	O	TV	1
19	Alert	Alerting Pattern 10.5.4.26	O	TLV	3
2F	Network Call Control Capabilities	Network Call Control cap. 10.5.4.29	O	TLV	3
3A	Cause of No CLI	Cause of No CLI 10.5.4.30	O	TLV	3
41	Backup bearer capability	Backup bearer capability 10.5.4.4a	O	TLV	3-15

9.3.23.1.1 BC repeat indicator

The *BC repeat indicator* information element is included if and only if *bearer capability 1* information element and *bearer capability 2* IE are both present in the message.

9.3.23.1.2 Bearer capability 1 and bearer capability 2

The *bearer capability 1* information element may be omitted in the case where the mobile subscriber is allocated only one directory number for all services (ref.: 3GPP TS 29.007 [38]). The *bearer capability 2* IE is missing at least if the *bearer capability 1* IE is missing.

If the MSC wishes to indicate capability for an alternative call mode, which can be entered through fallback, this is indicated by adding a *bearer capability information element* (bearer capability) 2 element (see subclause 5.3.6).

9.3.23.1.3 Facility

This information element may be included for functional operation of supplementary services.

9.3.23.1.4 Progress indicator

This information element is included by the network

- in order to pass information about the call in progress e.g. in the event of interworking and/or
- to make the MS attach the user connection for speech.

9.3.23.1.4a Called party BCD number

For all bands except for PCS1900, the maximum length of this IE sent by the network shall be 13 octets

9.3.23.1.5 Called party subaddress

Included in the Network-to-mobile station direction if the calling user includes a *called party subaddress* information element in the SETUP message.

9.3.23.1.6 LLC repeat indicator

The *LLC repeat indicator* information element is included if and only if both following conditions hold:

- The *BC repeat indicator* IE is contained in the message.
- The *low layer compatibility I* IE is contained in the message.

If included, the *LLC repeat indicator* shall specify the same repeat indication as the *BC repeat indicator* IE.

9.3.23.1.7 Low layer compatibility I

Included in the network-to-mobile station direction if the calling user specified a low layer compatibility.

9.3.23.1.8 Low layer compatibility II

Included if and only if the *LLC repeat indicator* information element is contained in the message.

9.3.23.1.9 HLC repeat indicator

The *HLC repeat indicator* information element is included if and only both following conditions hold:

- The *BC repeat indicator* IE is contained in the message.
- The *high layer compatibility i* IE is contained in the message.

If included, the *HLC repeat indicator* shall specify the same repeat indication as the *BC repeat indicator* IE.

9.3.23.1.10 High layer compatibility i

Included in the network-to-mobile station direction if the calling user specified a high layer compatibility.

9.3.23.1.11 High layer compatibility ii

Included if and only if the *HLC repeat indicator* information element is contained in the message.

9.3.23.1.12 User-user

May be included in the network to called mobile station direction when the calling remote user included a user-user information element in the SETUP message.

9.3.23.1.13 Redirecting party BCD number

May be included in the network to called mobile station direction when the call has been redirected.

9.3.23.1.14 Redirecting party subaddress

May be included in the network to called mobile station direction when the calling remote user included a called party subaddress in the SETUP message and the call has been redirected

9.3.23.1.15 Priority

May be included by the network to indicate the priority of the incoming call if eMLPP is used.

9.3.23.1.16 Alert \$(Network Indication of Alerting in the MS)\$

May be included by the network to give some indication about alerting (category or level). If supported in the MS, this optional indication is to be used by the MS as specified in 3GPP TS 22.101 [8].

9.3.23.1.17 Network Call Control Capabilities

This information shall be included by the network to indicate its call control capabilities if the network supports multicall.and there are no other ongoing calls to the MS.

9.3.23.1.18 Cause of No CLI

This IE may be included by the network as defined by 3GPP TS 24.081 [25].

When both Calling Party BCD number IE and Cause of No CLI IE are included in SETUP message then the Cause of No CLI IE provides additional information on why the number digits are not present.

9.3.23.1.19 Backup bearer capability

The *backup bearer capability* IE may be included by the network only if there are no *bearer capability* IEs contained in the message.

NOTE: The MSC may use the *backup bearer capability* IE if it is not able to provide a complete *bearer capability* IE.

9.3.23.2 Setup (mobile originating call establishment)

This message is sent from the mobile station to the network to initiate a mobile originating call establishment.

See table 9.70a/3GPP TS 24.008.

Message type: SETUP

Significance: global

Direction: mobile station to network

Table 9.70a/3GPP TS 24.008: SETUP message content (mobile station to network direction)

IEI	Information element	Type/Reference	Presence	Format	Length
	Call control protocol discriminator	Protocol discriminator 10.2	M	V	1/2
	Transaction identifier	Transaction identifier 10.3.2	M	V	1/2
	Setup message type	Message type 10.4	M	V	1
D-	BC repeat indicator	Repeat indicator 10.5.4.22	C	TV	1
04	Bearer capability 1	Bearer capability 10.5.4.5	M	TLV	3-16
04	Bearer capability 2	Bearer capability 10.5.4.5	O	TLV	3-16
1C	Facility(simple recall alignment)	Facility 10.5.4.15	O	TLV	2-
5D	Calling party sub-address	Calling party subaddr. 10.5.4.10	O	TLV	2-23
5E	Called party BCD number	Called party BCD num. 10.5.4.7	M	TLV	3-43
6D	Called party sub-address	Called party subaddr. 10.5.4.8	O	TLV	2-23
D-	LLC repeat indicator	Repeat indicator 10.5.4.22	O	TV	1
7C	Low layer compatibility I	Low layer comp. 10.5.4.18	O	TLV	2-18
7C	Low layer compatibility II	Low layer comp. 10.5.4.18	O	TLV	2-18
D-	HLC repeat indicator	Repeat indicator 10.5.4.22	O	TV	1
7D	High layer compatibility i	High layer comp. 10.5.4.16	O	TLV	2-5
7D	High layer compatibility ii	High layer comp. 10.5.4.16	O	TLV	2-5
7E	User-user	User-user 10.5.4.25	O	TLV	3-35
7F	SS version	SS version indicator 10.5.4.24	O	TLV	2-3
A1	CLIR suppression	CLIR suppression 10.5.4.11a	C	T	1
A2	CLIR invocation	CLIR invocation 10.5.4.11b	C	T	1
15	CC capabilities	Call Control Capabilities 10.5.4.5a	O	TLV	4
1D	Facility \$(CCBS)\$ (advanced recall alignment)	Facility 10.5.4.15	O	TLV	2-?
1B	Facility (recall alignment Not essential) \$(CCBS)\$	Facility 10.5.4.15	O	TLV	2-?
2D	Stream Identifier	Stream Identifier 10.5.4.28	O	TLV	3
40	Supported Codecs	Supported Codec List 10.5.4.32	O	TLV	5-n
A3	Redial	Redial 10.5.4.34	O	T	1

9.3.23.2.1 BC repeat indicator

The *BC repeat indicator* information element is included if and only if *bearer capability 1* IE and *bearer capability 2* IE are both present in the message.

9.3.23.2.2 Facility

The information element may be included for functional operation of supplementary services.

Three different codings of this IE exist, for further details see 3GPP TS 24.010 [21].

9.3.23.2.3 LLC repeat indicator

The *LLC repeat indicator* information element is included if and only if both following conditions hold:

- The *BC repeat indicator* IE is contained in the message.
- The *low layer compatibility I* IE is contained in the message.

If included, the *LLC repeat indicator* shall specify the same repeat indication as the *BC repeat indicator* IE.

9.3.23.2.4 Low layer compatibility I

The information element is included in the MS-to-network direction when the calling MS wants to pass low layer compatibility information to the called user.

9.3.23.2.5 Low layer compatibility II

Included if and only if the *LLC repeat indicator* information element is contained in the message.

9.3.23.2.6 HLC repeat indicator

The *HLC repeat indicator* information element is included if and only if both following conditions hold:

- The *BC repeat indicator* IE is contained in the message.
- The *high layer compatibility i* IE is contained in the message.

If included, the *HLC repeat indicator* shall specify the same repeat indication as the *BC repeat indicator* IE.

9.3.23.2.7 High layer compatibility i

The information element is included when the calling MS wants to pass high layer compatibility information to the called user.

9.3.23.2.8 High layer compatibility ii

Included if and only if the *HLC repeat indicator* information element is contained in the message.

9.3.23.2.9 User-user

The information element is included in the calling mobile station to network direction when the calling mobile station wants to pass user information to the called remote user.

9.3.23.2.10 SS version

This information element shall not be included if the *facility* information element is not present in this message.

This information element shall be included or excluded as defined in 3GPP TS 24.010 [21]. This information element should not be transmitted unless explicitly required by 3GPP TS 24.010 [21].

9.3.23.2.11 CLIR suppression

The information element may be included by the MS (see 3GPP TS 24.081 [25]). If this information element is included the *CLIR invocation* IE shall not be included.

9.3.23.2.12 CLIR invocation

The information element may be included by the MS (see 3GPP TS 24.081 [25]). If this information element is included the *CLIR suppression* IE shall not be included.

9.3.23.2.13 CC Capabilities

This information element may be included by the mobile station to indicate its call control capabilities.

9.3.23.2.14 Stream Identifier

This information element shall be included by the mobile station supporting multicall.

9.3.23.2.15 Bearer capability 1 and bearer capability 2

If the mobile station wishes to indicate capability for an alternative call mode, which can be entered through fallback, this is indicated by adding a *bearer capability information element* (bearer capability) 2 element (see subclause 5.3.6).

9.3.23.2.16 Supported Codecs

This information element shall be included for speech calls, if the mobile station supports UMTS radio access.

9.3.23.2.17 Redial

This information element shall be included if the mobile station is attempting to set up a call to switch from speech to multimedia or vice-versa.

9.3.23a Start CC \$(CCBS)\$

A Network that does not support the "Network initiated MO call" option shall treat this message as a message with message type not defined for the PD.

This message is sent by the mobile station to the network to open a Call Control transaction which the network has requested the mobile station to open.

See Table 9.70b/3GPP TS 24.008.

Message type: START CC

Significance: local

Direction: mobile station to network

Table 9.70b/3GPP TS 24.008: START CC message content

IEI	Information element	Type/Reference	Presence	Format	Length
	Call control Protocol discriminator	Protocol discriminator 10.2	M	V	1/2
	Transaction identifier	Transaction identifier 10.3.2	M	V	1/2
	Start CC message type	Message type 10.4	M	V	1
15	CC Capabilities	Call Control Capabilities 10.5.4.5a	O	TLV	4

9.3.23a.1 CC Capabilities

This information element may be included by the mobile station to indicate its call control capabilities

9.3.24 Start DTMF

This message is sent by the mobile station to the network and contains the digit the network should reconvert back into a DTMF tone which is then applied towards the remote user.

See table 9.71/3GPP TS 24.008.

Message type: START DTMF

Significance: local

Direction: mobile station to network

Table 9.71/3GPP TS 24.008: START DTMF message content

IEI	Information element	Type/Reference	Presence	Format	Length
	Call control protocol discriminator	Protocol discriminator 10.2	M	V	1/2
	Transaction identifier	Transaction identifier 10.3.2	M	V	1/2
	Start DTMF message type	Message type 10.4	M	V	1
2C	Keypad facility	Keypad facility 10.5.4.17	M	TV	2

9.3.25 Start DTMF Acknowledge

This message is sent by the network to the mobile station to indicate the successful initiation of the action requested by the START DTMF message (conversion of the digit contained in this message into a DTMF tone).

See table 9.72/3GPP TS 24.008.

Message type: START DTMF ACKNOWLEDGE

Significance: local

Direction: network to mobile station

Table 9.72/3GPP TS 24.008: START DTMF ACKNOWLEDGE message content

IEI	Information element	Type/Reference	Presence	Format	Length
	Call control protocol discriminator	Protocol discriminator 10.2	M	V	1/2
	Transaction identifier	Transaction identifier 10.3.2	M	V	1/2
	Start DTMF acknowledge message type	Message type 10.4	M	V	1
2C	Keypad facility	Keypad facility 10.5.4.17	M	TV	2

9.3.25.1 Keypad facility

This information element contains the digit corresponding to the DTMF tone that the network applies towards the remote user.

9.3.26 Start DTMF reject

This message is sent by the network to the mobile station, if the network can not accept the START DTMF message.

See table 9.73/3GPP TS 24.008.

Message type: START DTMF REJECT

Significance: local

Direction: network to mobile station

Table 9.73/3GPP TS 24.008: START DTMF REJECT message content

IEI	Information element	Type/Reference	Presence	Format	Length
	Call control protocol discriminator	Protocol discriminator 10.2	M	V	1/2
	Transaction identifier	Transaction identifier 10.3.2	M	V	1/2
	Start DTMF reject message type	Message type 10.4	M	V	1
	Cause	Cause 10.5.4.11	M	LV	3-31

9.3.27 Status

This message is sent by the mobile station or the network at any time during a call to report certain error conditions listed in clause 8. It shall also be sent in response to a STATUS ENQUIRY message.

See table 9.74/3GPP TS 24.008.

Message type: STATUS

Significance: local

Direction: both

Table 9.74/3GPP TS 24.008: STATUS message content

IEI	Information element	Type/Reference	Presence	Format	Length
	Call control protocol discriminator	Protocol discriminator 10.2	M	V	1/2
	Transaction identifier	Transaction identifier 10.3.2	M	V	1/2
	Status message type	Message type 10.4	M	V	1
	Cause	Cause 10.5.4.11	M	LV	3-31
	Call state	Call state 10.5.4.6	M	V	1
24	Auxiliary states	Auxiliary states 10.5.4.4	O	TLV	3

9.3.27.1 Auxiliary states

The information element is included if and only if the call state is "active" or "mobile originating modify" and any auxiliary state is different from "idle". For the definition of the auxiliary states see 3GPP TS 24.083 [27] and 3GPP TS 24.084 [28]

9.3.28 Status enquiry

This message is sent by the mobile station or the network at any time to solicit a STATUS message from the peer layer 3 entity. Sending of STATUS message in response to a STATUS ENQUIRY message is mandatory.

See table 9.75/3GPP TS 24.008.

Message type: STATUS ENQUIRY

Significance: local

Direction: both

Table 9.75/3GPP TS 24.008: STATUS ENQUIRY message content

IEI	Information element	Type/Reference	Presence	Format	Length
	Call control protocol discriminator	Protocol discriminator 10.2	M	V	1/2
	Transaction identifier	Transaction identifier 10.3.2	M	V	1/2
	Status enquiry message type	Message type 10.4	M	V	1

9.3.29 Stop DTMF

This message is sent by a mobile station to the network and is used to stop the DTMF tone sent towards the remote user.

See table 9.76/3GPP TS 24.008.

Message type: STOP DTMF

Significance: local

Direction: mobile station to network

Table 9.76/3GPP TS 24.008: STOP DTMF message content

IEI	Information element	Type/Reference	Presence	Format	Length
	Call control protocol discriminator	Protocol discriminator 10.2	M	V	1/2
	Transaction identifier	Transaction identifier 10.3.2	M	V	1/2
	Stop DTMF message type	Message type 10.4	M	V	1

9.3.30 Stop DTMF acknowledge

This message is sent by the network to the mobile station to indicate that the sending of the DTMF tone has been stopped.

See table 9.77/3GPP TS 24.008.

Message type: STOP DTMF ACKNOWLEDGE

Significance: local

Direction: network to mobile station

Table 9.77/3GPP TS 24.008: STOP DTMF ACKNOWLEDGE message content

IEI	Information element	Type/Reference	Presence	Format	Length
	Call control protocol discriminator	Protocol discriminator 10.2	M	V	1/2
	Transaction identifier	Transaction identifier 10.3.2	M	V	1/2
	Stop DTMF acknowledge message type	Message type 10.4	M	V	1

9.3.31 User information

This message is sent by the mobile station to the network to transfer information to the remote user. This message is also sent by the network to the mobile station to deliver information transferred from the remote user. This message is used if the user-to-user transfer is part of an allowed information transfer as defined in 3GPP TS 24.010 [21].

See table 9.78/3GPP TS 24.008.

Message type: USER INFORMATION

Significance: access

Direction: both

Table 9.78/3GPP TS 24.008: USER INFORMATION message content

IEI	Information element	Type/Reference	Presence	Format	Length
	Call control protocol discriminator	Protocol discriminator 10.2	M	V	1/2
	Transaction identifier	Transaction identifier 10.3.2	M	V	1/2
	User Information message type	Message type 10.4	M	V	1
	User-user	User-user 10.5.4.25	M	LV	2-130
A0	More data	More data 10.5.4.19	O	T	1

9.3.31.1 User-user

Some networks may only support a maximum length of 35 octets. Procedures for interworking are not currently defined and are for further study.

R98 and earlier versions of this protocol specified a minimum length of 3 octets for this information element (not counting the IEI). To avoid interworking problems with mobile stations supporting only R98 or earlier versions of the protocol, the network shall deliver the User information message to these mobile stations only if the length of the User-user IE is greater or equal to 3 octets (not counting the IEI).

9.3.31.2 More data

The information element is included by the sending user to indicate that another USER INFORMATION message pertaining to the same message block will follow.

9.4 GPRS Mobility Management Messages

9.4.1 Attach request

This message is sent by the MS to the network in order to perform a GPRS or combined GPRS attach. See table 9.4.1/3GPP TS 24.008.

Message type: ATTACH REQUEST

Significance: dual

Direction: MS to network

Table 9.4.1/3GPP TS 24.008: ATTACH REQUEST message content

IEI	Information Element	Type/Reference	Presence	Format	Length
	Protocol discriminator	Protocol discriminator 10.2	M	V	1/2
	Skip indicator	Skip indicator 10.3.1	M	V	½
	Attach request message identity	Message type 10.4	M	V	1
	MS network capability	MS network capability 10.5.5.12	M	LV	3 - 9
	Attach type	Attach type 10.5.5.2	M	V	½
	GPRS ciphering key sequence number	Ciphering key sequence number 10.5.1.2	M	V	½
	DRX parameter	DRX parameter 10.5.5.6	M	V	2
	Mobile identity	Mobile identity 10.5.1.4	M	LV	6 - 9
	Old routing area identification	Routing area identification 10.5.5.15	M	V	6
	MS Radio Access capability	MS Radio Access capability 10.5.5.12a	M	LV	6 - 51
19	Old P-TMSI signature	P-TMSI signature 10.5.5.8	O	TV	4
17	Requested READY timer value	GPRS Timer 10.5.7.3	O	TV	2
9-	TMSI status	TMSI status 10.5.5.4	O	TV	1
33	PS LCS Capability	PS LCS Capability 10.5.5.22	O	TLV	3 - 4
11	Mobile station classmark 2	Mobile station classmark 2 10.5.1.6	O	TLV	5
20	Mobile station classmark 3	Mobile station classmark 3 10.5.1.7	O	TLV	2 - 34
40	Supported Codecs	Supported Codec List 10.5.4.32	O	TLV	5 - n
58	UE network capability	UE network capability 10.5.5.26	O	TLV	4 - 15
1A	Additional mobile identity	Mobile identity 10.5.1.4	O	TLV	7
1B	Additional old routing area identification	Routing area identification 2 10.5.5.15a	O	TLV	8
5D	Voice domain preference and UE's usage setting	Voice domain preference and UE's usage setting 10.5.5.28	O	TLV	3
D-	Device properties	Device properties 10.5.7.8	O	TV	1
E-	P-TMSI type	P-TMSI type 10.5.5.29	O	TV	1
C-	MS network feature support	MS network feature support 10.5.1.15	O	TV	1
14	Old location area identification	Location Area Identification 2 10.5.5.30	O	TLV	7
F-	Additional update type	Additional update type 10.5.5.0	O	TV	1
10	TMSI based NRI container	Network resource identifier container 10.5.5.31	O	TLV	4
6A	T3324 value	GPRS Timer 2 10.5.7.4	O	TLV	3
39	T3312 extended value	GPRS Timer 3 10.5.7.4a	O	TLV	3
6E	Extended DRX parameters	Extended DRX parameters 10.5.5.32	O	TLV	3

9.4.1.1 Old P-TMSI signature

The MS shall include this IE, if the MS holds a valid P-TMSI, P-TMSI signature and RAI, or if the TIN indicates "GUTI" and the MS holds a valid GUTI, or if the TIN is deleted and the MS holds a valid GUTI, but no valid P-TMSI and RAI. If the MS is configured for "AttachWithIMSI" as specified in 3GPP TS 24.368 [135] or 3GPP TS 31.102 [112] and is attaching in a new PLMN which is neither the registered PLMN nor in the list of equivalent PLMNs, the MS shall not include this IE.

9.4.1.2 Requested READY timer value

This IE may be included if the MS wants to indicate a preferred value for the READY timer.

9.4.1.3 TMSI status

This IE shall be included if the MS performs a combined GPRS attach and no valid TMSI is available.

9.4.1.4 PS LCS Capability

This IE shall be included if the MS supports at least one positioning method for the provision of location services (LCS) via the PS domain in Gb-mode.

9.4.1.5 UE network capability

An MS supporting S1 mode shall include this IE to indicate its capabilities to the network.

9.4.1.6 Mobile station classmark 2

This IE shall be included if the MS supports SRVCC to GERAN or UTRAN.

9.4.1.7 Mobile station classmark 3

This IE shall be included if the MS supports SRVCC to GERAN.

9.4.1.8 Supported Codecs

This IE shall be included if the MS supports SRVCC to GERAN or UTRAN to indicate its supported speech codecs for CS speech calls.

9.4.1.9 Additional mobile identity

The MS shall include this IE, if the TIN indicates "GUTI" and the MS holds a valid GUTI, P-TMSI and RAI. If the MS is configured for "AttachWithIMSI" as specified in 3GPP TS 24.368 [135] or 3GPP TS 31.102 [112] and is attaching in a new PLMN which is neither the registered PLMN nor in the list of equivalent PLMNs, the MS shall not include this IE.

9.4.1.10 Additional old routing area identification

The MS shall include this IE, if the TIN indicates "GUTI" and the MS holds a valid GUTI, P-TMSI and RAI.

9.4.1.11 Voice domain preference and UE's usage setting

This IE shall be included if:

- the MS supports CS fallback and SMS over SGs, or the MS is configured to support IMS voice, or both; and
- the MS supports WB-S1 mode.

9.4.1.12 Device properties

This IE shall be included if the MS is configured for NAS signalling low priority.

9.4.1.13 P-TMSI type

The MS shall include this IE if the type of identity in the Mobile identity IE is set to "TMSI/P-TMSI/M-TMSI".

9.4.1.14 MS network feature support

This IE shall be included if the MS supports extended periodic timer T3312.

9.4.1.15 Old location area identification

The MS shall include this IE during a combined attach procedure, if the MS holds a valid LAI and the MS supports EMM combined procedures.

9.4.1.16 Additional update type

The MS shall include this IE if the MS initiates a combined GPRS attach procedure for GPRS services and "SMS-only service".

9.4.1.17 TMSI based NRI container

The MS shall include this IE during a combined attach procedure if it has a valid TMSI.

9.4.1.18 T3324 value

The MS may include this IE to request the use of PSM.

9.4.1.19 T3312 extended value

The MS may include this IE to request a particular T3312 value if the T3324 value IE is included.

9.4.1.20 Extended DRX parameters

The MS may include this IE to request the use of eDRX.

9.4.2 Attach accept

This message is sent by the network to the MS to indicate that the corresponding attach request has been accepted. See table 9.4.2/3GPP TS 24.008.

Message type: ATTACH ACCEPT

Significance: dual

Direction: network to MS

Table 9.4.2/3GPP TS 24.008: ATTACH ACCEPT message content

IEI	Information Element	Type/Reference	Presence	Format	Length
	Protocol discriminator	Protocol discriminator 10.2	M	V	1/2
	Skip indicator	Skip indicator 10.3.1	M	V	1/2
	Attach accept message identity	Message type 10.4	M	V	1
	Attach result	Attach result 10.5.5.1	M	V	1/2
	Force to standby	Force to standby 10.5.5.7	M	V	1/2
	Periodic RA update timer	GPRS Timer 10.5.7.3	M	V	1
	Radio priority for SMS	Radio priority 10.5.7.2	M	V	1/2
	Radio priority for TOM8	Radio priority 2 10.5.7.5	M	V	1/2
	Routing area identification	Routing area identification 10.5.5.15	M	V	6
19	P-TMSI signature	P-TMSI signature 10.5.5.8	O	TV	4
17	Negotiated READY timer value	GPRS Timer 10.5.7.3	O	TV	2
18	Allocated P-TMSI	Mobile identity 10.5.1.4	O	TLV	7
23	MS identity	Mobile identity 10.5.1.4	O	TLV	7-10
25	GMM cause	GMM cause 10.5.5.14	O	TV	2
2A	T3302 value	GPRS Timer 2 10.5.7.4	O	TLV	3
8C	Cell Notification	Cell Notification 10.5.5.21	O	T	1
4A	Equivalent PLMNs	PLMN List 10.5.1.13	O	TLV	5-47
B-	Network feature support	Network feature support 10.5.5.23	O	TV	1
34	Emergency Number List	Emergency Number List 10.5.3.13	O	TLV	5-50
A-	Requested MS Information	Requested MS Information 10.5.5.25	O	TV	1
37	T3319 value	GPRS Timer 2 10.5.7.4	O	TLV	3
38	T3323 value	GPRS Timer 2 10.5.7.4	O	TLV	3
39	T3312 extended value	GPRS Timer 3 10.5.7.4a	O	TLV	3
66	Additional network feature support	Additional network feature support 10.5.5.23A	O	TLV	3
6A	T3324 value	GPRS Timer 2 10.5.7.4	O	TLV	3
6E	Extended DRX parameters	Extended DRX parameters 10.5.5.32	O	TLV	3
C-	User Plane integrity indicator	User Plane integrity indicator 10.5.5.34	O	TV	1
31	Replayed MS network capability	MS network capability 10.5.5.12	O	TLV	4-10
33	Replayed MS Radio Access capability	MS Radio Access capability 10.5.5.12a	O	TLV	6 - 51
65	DCN-ID	DCN-ID 10.5.5.35	O	TLV	4
63	PLMN identity of the CN operator	PLMN identity of the CN operator 10.5.5.36	O	TLV	5
D-	Non-3GPP NW provided policies	Non-3GPP NW provided policies 10.5.5.37	O	TV	1

9.4.2.1 P-TMSI signature

This IE may be included to assign an identity to the MS's GMM context.

9.4.2.2 Negotiated READY timer value

This IE may be included to indicate a value for the READY timer.

9.4.2.3 Allocated P-TMSI

This IE may be included to assign a P-TMSI to an MS in case of a GPRS or combined GPRS attach.

9.4.2.4 MS identity

This IE may be included to assign or unassign a TMSI to an MS in case of a combined GPRS attach.

9.4.2.5 GMM cause

This IE shall be included when IMSI attach for non-GPRS services was not successful during a combined GPRS attach procedure.

9.4.2.6 T3302 value

This IE may be included to indicate a value for the T3302 timer.

9.4.2.7 Cell Notification (A/Gb mode only)

In A/Gb mode, this IE shall be included by the SGSN in order to indicate the ability to support the Cell Notification.

9.4.2.8 Equivalent PLMNs

The *Equivalent PLMNs* information element is included if the network wants to inform the mobile station of equivalent PLMNs.

9.4.2.9 Network feature support

This IE may be included to inform the MS of the support of certain features. If this IE is not included then the respective features are not supported.

9.4.2.10 Emergency Number List

This IE may be sent by the network. If this IE is sent, the contents of this IE indicates a list of emergency numbers valid within the same country as the PLMN from which this IE is received.

9.4.2.11 Requested MS Information

This IE may be sent by the network to request the MS to provide feature-related information.

9.4.2.12 T3319 value

This IE may be included to indicate a value for timer T3319.

9.4.2.13 T3323 value

The network may include this IE to indicate a value for timer T3323.

If the IE is not included, the MS shall use the default value.

9.4.2.14 T3312 extended value

The network may include this IE to provide the MS with a longer periodic routing area update timer.

9.4.2.15 Additional network feature support

The network may include this IE to inform the MS of the support of certain features. If this IE is not included then the MS shall interpret this as a receipt of an information element with all bits of the value part coded as zero.

9.4.2.16 T3324 value

The network shall include the T3324 value IE if:

- the MS included the T3324 value IE in the ATTACH REQUEST message; and
- the network supports PSM and accepts the use of PSM.

9.4.2.17 Extended DRX parameters

The network shall include the Extended DRX parameters IE if:

- the MS included the Extended DRX parameters IE in the ATTACH REQUEST message; and
- the network supports eDRX and accepts the use of eDRX.

9.4.2.18 User Plane integrity indicator

The network shall include the User Plane integrity indicator IE if the MS shall enable integrity protection of user plane data in LLC layer.

9.4.2.19 Replayed MS network capability

The network may include this IE if integrity protection and replay protection of GMM messages is to be used.

9.4.2.20 Replayed MS radio access capability

The network may include this IE if integrity protection and replay protection of GMM messages is to be used.

9.4.2.21 DCN-ID

This IE is included in the message when the network wishes to provide a DCN-ID to the MS.

9.4.2.22 PLMN identity of the CN operator

This IE is included in the message when the common PLMN identity included in the RAI does not identify the CN operator that has accepted the GPRS attach request in a shared network or in a multi-operator core network (MOCN) with common GERAN.

9.4.2.23 Non-3GPP NW provided policies

This IE is included if the network needs to indicate whether emergency numbers provided via non-3GPP access can be used to initiate MS detected emergency calls (see 3GPP TS 24.302 [156]). If this IE is not included then the MS shall interpret this as a receipt of an information element with all bits of the value part coded as zero.

9.4.3 Attach complete

This message is sent by the MS to the network if at least one of the following conditions is fulfilled:

- a P-TMSI and/or a TMSI was included within the *attach accept* message; or

- the network has requested the MS to provide feature-related information.

See table 9.4.3/3GPP TS 24.008.

Message type: ATTACH COMPLETE

Significance: dual

Direction: MS to network

Table 9.4.3/3GPP TS 24.008: ATTACH COMPLETE message content

IEI	Information Element	Type/Reference	Presence	Format	Length
	Protocol discriminator	Protocol discriminator 10.2	M	V	1/2
	Skip indicator	Skip indicator 10.3.1	M	V	1/2
	Attach complete message identity	Message type 10.4	M	V	1
27	Inter RAT handover information	Inter RAT information container 10.5.5.24	O	TLV	3-250
2B	E-UTRAN inter RAT handover information	E-UTRAN inter RAT information container 10.5.5.27	O	TLV	3-257

9.4.3.1 Inter RAT handover information

This IE shall be included if the network has requested this information in the *attach accept* message.

9.4.3.2 E-UTRAN inter RAT handover information

This IE shall be included if the network has requested this information in the *attach accept* message.

9.4.4 Attach reject

This message is sent by the network to the MS to indicate that the corresponding attach request has been rejected. See table 9.4.4/3GPP TS 24.008.

Message type: ATTACH REJECT

Significance: dual

Direction: network to MS

Table 9.4.4/3GPP TS 24.008: ATTACH REJECT message content

IEI	Information Element	Type/Reference	Presence	Format	Length
	Protocol discriminator	Protocol discriminator 10.2	M	V	1/2
	Skip indicator	Skip indicator 10.3.1	M	V	1/2
	Attach reject message identity	Message type 10.4	M	V	1
	GMM cause	GMM cause 10.5.5.14	M	V	1
2A	T3302 value	GPRS Timer 2 10.5.7.4	O	TLV	3
3A	T3346 value	GPRS timer 2 10.5.7.4	O	TLV	3

9.4.4.1 T3302 value

This IE may be included to indicate a value for the T3302 timer.

In Iu mode, if the MS is not attaching for emergency services, the network shall not include this IE if this message is to be sent non-integrity protected. If the MS is attaching for emergency bearer services, the network may include this IE if this message is to be sent non-integrity protected.

In Iu mode, if the MS is not attaching for emergency services, the MS shall ignore the contents of this IE if this message is received without integrity protection. If the MS is attaching for emergency bearer services, the MS shall use the received contents of this IE if this message is received without integrity protection.

If this IE is not included or if in Iu mode the message is not integrity protected, the MS shall use the default value.

9.4.4.2 T3346 value

This IE may be included when the NAS level mobility management congestion control is active.

9.4.5 Detach request

9.4.5.1 Detach request (mobile terminated detach)

This message is sent by the network to request the release of a GMM context. See table 9.4.5.1/3GPP TS 24.008.

Message type: DETACH REQUEST

Significance: dual

Direction: network to MS

Table 9.4.5.1/3GPP TS 24.008:DETACH REQUEST message content

IEI	Information Element	Type/Reference	Presence	Format	Length
	Protocol discriminator	Protocol discriminator 10.2	M	V	1/2
	Skip indicator	Skip indicator 10.3.1	M	V	1/2
	Detach request message identity	Message type 10.4	M	V	1
	Detach type	Detach type 10.5.5.5	M	V	1/2
	Force to standby	Force to standby 10.5.5.7	M	V	1/2
25	GMM cause	GMM cause 10.5.5.14	O	TV	2

9.4.5.1.1 GMM cause

This IE shall be included in case the detach reason has to be indicated to the MS, e.g. due to a failed IMEI check.

9.4.5.2 Detach request (mobile originating detach)

This message is sent by the MS to request the release of a GMM context. See table 9.4.5.2/3GPP TS 24.008.

Message type: DETACH REQUEST

Significance: dual

Direction: MS to network

Table 9.4.5.2/3GPP TS 24.008:DETACH REQUEST message content

IEI	Information Element	Type/Reference	Presence	Format	Length
	Protocol discriminator	Protocol discriminator 10.2	M	V	1/2
	Skip indicator	Skip indicator 10.3.1	M	V	1/2
	Detach request message identity	Message type 10.4	M	V	1
	Detach type	Detach type 10.5.5.5	M	V	1/2
	Spare half octet	Spare half octet 10.5.1.8	M	V	1/2
18	P-TMSI	Mobile identity 10.5.1.4	O	TLV	7
19	P-TMSI signature	P-TMSI signature 2 10.5.5.8a	O	TLV	5

9.4.5.2.1 P-TMSI

This IE shall be included by the MS, if the P-TMSI is available.

9.4.5.2.2 P-TMSI signature

This IE shall be included if the MS has a valid P-TMSI signature.

9.4.6 Detach accept

9.4.6.1 Detach accept (mobile terminated detach)

This message is sent by the MS to indicate that the detach procedure has been completed. See table 9.4.6.1/3GPP TS 24.008.

Message type: DETACH ACCEPT

Significance: dual

Direction: MS to network

Table 9.4.6.1/3GPP TS 24.008:DETACH ACCEPT message content

IEI	Information Element	Type/Reference	Presence	Format	Length
	Protocol discriminator	Protocol discriminator 10.2	M	V	1/2
	Skip indicator	Skip indicator 10.3.1	M	V	1/2
	Detach accept message identity	Message type 10.4	M	V	1

9.4.6.2 Detach accept (mobile originating detach)

This message is sent by the network to indicate that the detach procedure has been completed. See table 9.4.6.2/3GPP TS 24.008.

Message type: DETACH ACCEPT

Significance: dual

Direction: network to MS

Table 9.4.6.2/3GPP TS 24.008:DETACH ACCEPT message content

IEI	Information Element	Type/Reference	Presence	Format	Length
	Protocol discriminator	Protocol discriminator 10.2	M	V	1/2
	Skip indicator	Skip indicator 10.3.1	M	V	1/2
	Detach accept message identity	Message type 10.4	M	V	1
	Force to standby	Force to standby 10.5.5.7	M	V	1/2
	Spare half octet	Spare half octet 10.5.1.8	M	V	1/2

9.4.7 P-TMSI reallocation command

This message is sent by the network to the MS to reallocate a P-TMSI and optionally assign a DCN-ID. See table 9.4.7/3GPP TS 24.008.

Message type: P-TMSI REALLOCATION COMMAND

Significance: dual

Direction: network to MS

Table 9.4.7/3GPP TS 24.008: P-TMSI REALLOCATION COMMAND message content

IEI	Information Element	Type/Reference	Presence	Format	Length
	Protocol discriminator	Protocol discriminator 10.2	M	V	1/2
	Skip indicator	Skip indicator 10.3.1	M	V	1/2
	P-TMSI reallocation command message identity	Message type 10.4	M	V	1
	Allocated P-TMSI	Mobile identity 10.5.1.4	M	LV	6
	Routing area identification	Routing area identification 10.5.5.15	M	V	6
	Force to standby	Force to standby 10.5.5.7	M	V	1/2
	Spare half octet	Spare half octet 10.5.1.8	M	V	1/2
19	P-TMSI signature	P-TMSI signature 10.5.5.8	O	TV	4
65	DCN-ID	DCN-ID 10.5.5.35	O	TLV	4

9.4.7.1 P-TMSI signature

This IE may be included to assign an identity to the MS's GMM context.

9.4.7.2 DCN-ID

This IE may be included to assign a new DCN-ID to the MS.

9.4.8 P-TMSI reallocation complete

This message is sent by the MS to the network to indicate that reallocation of a P-TMSI has taken place. See table 9.4.8/3GPP TS 24.008.

Message type: P-TMSI REALLOCATION COMPLETE

Significance: dual

Direction: MS to network

Table 9.4.8/3GPP TS 24.008: P-TMSI REALLOCATION COMPLETE message content

IEI	Information Element	Type/Reference	Presence	Format	Length
	Protocol discriminator	Protocol discriminator 10.2	M	V	1/2
	Skip indicator	Skip indicator 10.3.1	M	V	1/2
	P-TMSI reallocation complete message identity	Message type 10.4	M	V	1

9.4.9 Authentication and ciphering request

This message is sent by the network to the MS to initiate authentication of the MS identity. Additionally, the ciphering mode is set, indicating whether ciphering will be performed or not. See table 9.4.9/3GPP TS 24.008.

Message type: AUTHENTICATION AND CIPHERING REQUEST

Significance: dual

Direction: network to MS

Table 9.4.9/TS 24.008: AUTHENTICATION AND CIPHERING REQUEST message content

IEI	Information Element	Type/Reference	Presence	Format	Length
	Protocol discriminator	Protocol discriminator 10.2	M	V	1/2
	Skip indicator	Skip indicator 10.3.1	M	V	1/2
	Authentication and ciphering request message identity	Message type 10.4	M	V	1
	Ciphering algorithm	Ciphering algorithm 10.5.5.3	M	V	1/2
	IMEISV request	IMEISV request 10.5.5.10	M	V	1/2
	Force to standby	Force to standby 10.5.5.7	M	V	1/2
	A&C reference number	A&C reference number 10.5.5.19	M	V	1/2
21	Authentication parameter RAND	Authentication parameter RAND 10.5.3.1	O	TV	17
8-	GPRS ciphering key sequence number	Ciphering key sequence number 10.5.1.2	C	TV	1
28	Authentication parameter AUTN	Authentication parameter AUTN 10.5.3.1.1	O	TLV	18
31	Replayed MS network capability	MS network capability 10.5.5.12	O	TLV	4-10
9-	Integrity algorithm	Integrity algorithm 10.5.5.3a	O	TV	1
43	Message authentication code	Message authentication code 10.5.5.33	O	TLV	6
33	Replayed MS Radio Access capability	MS Radio Access capability 10.5.5.12a	O	TLV	6 - 51

9.4.9.1 Authentication Parameter RAND

This IE shall only be included if authentication shall be performed.

9.4.9.2 GPRS ciphering key sequence number

This IE is included if and only if the *Authentication parameter RAND* is contained in the message.

9.4.9.3 Authentication Parameter AUTN

This IE shall be present if and only if the authentication challenge is a UMTS authentication challenge. The presence or absence of this IE defines- in the case of its absence- a GSM authentication challenge or- in the case of its presence- a UMTS authentication challenge.

The MS shall ignore the IE if a SIM is inserted in the MS.

In UMTS, the MS shall reject the AUTHENTICATION & CIPHERING REQUEST message as specified in subclause 4.7.7.5.1 if this IE is not present and a USIM is inserted in the MS.

9.4.9.4 Replayed MS network capability

This IE is included if integrity protection and replay protection of GMM messages is to be used.

9.4.9.5 Integrity algorithm

This IE is included if integrity protection and replay protection of GMM messages is to be used.

9.4.9.6 Message authentication code

This IE is included if integrity protection of AUTHENTICATION AND CIPHERING REQUEST message and AUTHENTICATION AND CIPHERING RESPONSE messages is to be used.

9.4.9.7 Replayed MS Radio Access Capability

This IE is included if integrity protection and replay protection of GMM messages is to be used.

9.4.10 Authentication and ciphering response

This message is sent by the MS to the network in response to an *Authentication and ciphering request* message. See table 9.4.10/3GPP TS 24.008.

Message type: AUTHENTICATION AND CIPHERING RESPONSE

Significance: dual

Direction: MS to network

Table 9.4.10/3GPP TS 24.008: AUTHENTICATION AND CIPHERING RESPONSE message content

IEI	Information Element	Type/Reference	Presence	Format	Length
	Protocol discriminator	Protocol discriminator 10.2	M	V	1/2
	Skip indicator	Skip indicator 10.3.1	M	V	1/2
	Authentication and ciphering response message identity	GPRS message type 10.4	M	V	1
	A&C reference number	A&C reference number 10.5.5.19	M	V	1/2
	Spare half octet	Spare half octet 10.5.1.8	M	V	1/2
22	Authentication parameter Response	Authentication Response parameter 10.5.3.2	O	TV	5
23	IMEISV	Mobile identity 10.5.1.4	O	TLV	11
29	Authentication Response parameter (extension)	Authentication Response parameter 10.5.3.2.1	O	TLV	3-14
43	Message authentication code	Message authentication code 10.5.5.33	O	TLV	6

9.4.10.1 Authentication Response Parameter

This IE is included if authentication was requested within the corresponding *authentication and ciphering request* message. This IE contains the SRES, if the authentication challenge was for GSM or the RES (all or just the 4 most significant octets of) if it is a UMTS authentication challenge (see also subclause 9.4.10.2)

9.4.10.2 IMEISV

This IE is included if requested within the corresponding *authentication and ciphering request* message.

9.4.10.3 Authentication Response Parameter (extension)

This IE shall be included if and only if the authentication challenge was a UMTS authentication challenge and the RES parameter is greater than 4 octets in length. It shall contain the least significant remaining bits of the RES (the four most significant octets shall be sent in the Authentication Response Parameter IE (see subclause 9.2.3.1))

This IE shall not be included if a SIM is inserted in the MS.

9.4.10.4 Message authentication code

This IE is included if integrity protection and replay protection of GMM messages is to be used.

9.4.10a Authentication and Ciphering Failure

This message is sent by the mobile station to the network to indicate that authentication of the network has failed. See table 9.4.10a/3GPP TS 24.008.

Message type: AUTHENTICATION AND CIPHERING FAILURE

Significance: dual

Direction: mobile station to network

Table 9.4.10a/3GPP TS 24.008: AUTHENTICATION AND CIPHERING FAILURE message content

IEI	Information element	Type/Reference	Presence	Format	Length
	Mobility management Protocol discriminator	Protocol discriminator 10.2	M	V	1/2
	Skip Indicator	Skip Indicator 10.3.1	M	V	1/2
	Authentication and Ciphering Failure Message type	Message type 10.4	M	V	1
	GMM Cause	GMM Cause 10.5.5.14	M	V	1
30	Authentication Failure parameter	Authentication Failure parameter 10.5.3.2.2	O	TLV	16

9.4.10a.1 Authentication Failure parameter

This IE shall be sent if and only if the GMM cause was "Synch failure". It shall include the response to the authentication challenge from the USIM, which is made up of the AUTS parameter (see 3GPP TS 33.102 [5a]).

9.4.11 Authentication and ciphering reject

This message is sent by the network to the MS to indicate that authentication has failed (and that the receiving MS shall abort all activities). See table 9.4.11/3GPP TS 24.008.

Message type: AUTHENTICATION AND CIPHERING REJECT

Significance: dual

Direction: network to MS

Table 9.4.11/3GPP TS 24.008: AUTHENTICATION AND CIPHERING REJECT message content

IEI	Information Element	Type/Reference	Presence	Format	Length
	Protocol discriminator	Protocol discriminator 10.2	M	V	1/2
	Skip indicator	Skip indicator 10.3.1	M	V	1/2
	Authentication and ciphering reject message identity	Message type 10.4	M	V	1

9.4.12 Identity request

This message is sent by the network to the MS to request submission of the MS identity according to the specified identity type. See table 9.4.12/3GPP TS 24.008.

Message type: IDENTITY REQUEST

Significance: dual

Direction: network to MS

Table 9.4.12/3GPP TS 24.008: IDENTITY REQUEST message content

IEI	Information Element	Type/Reference	Presence	Format	Length
	Protocol discriminator	Protocol discriminator 10.2	M	V	1/2
	Skip indicator	Skip indicator 10.3.1	M	V	1/2
	Identity request message identity	Message type 10.4	M	V	1
	Identity type	Identity type 2 10.5.5.9	M	V	1/2
	Force to standby	Force to standby 10.5.5.7	M	V	1/2

9.4.13 Identity response

This message is sent by the MS to the network in response to an *identity request* message providing the requested identity. See table 9.4.13/3GPP TS 24.008.

Message type: IDENTITY RESPONSE

Significance: dual

Direction: MS to network

Table 9.4.13/3GPP TS 24.008: IDENTITY RESPONSE message content

IEI	Information Element	Type/Reference	Presence	Format	Length
	Protocol discriminator	Protocol discriminator 10.2	M	V	1/2
	Skip indicator	Skip indicator 10.3.1	M	V	1/2
	Identity response message identity	Message type 10.4	M	V	1
	Mobile identity	Mobile identity 10.5.1.4	M	LV	4 - 10

9.4.14 Routing area update request

This message is sent by the MS to the network either to request an update of its location file or to request an IMSI attach for non-GPRS services. See table 9.4.14/3GPP TS 24.008.

Message type: ROUTING AREA UPDATE REQUEST

Significance: dual

Direction: MS to network

Table 9.4.14/3GPP TS 24.008: ROUTING AREA UPDATE REQUEST message content

IEI	Information Element	Type/Reference	Presence	Format	Length
	Protocol discriminator	Protocol discriminator 10.2	M	V	1/2
	Skip indicator	Skip indicator 10.3.1	M	V	1/2
	Routing area update request message identity	Message type 10.4	M	V	1
	Update type	Update type 10.5.5.18	M	V	1/2
	GPRS ciphering key sequence number	Ciphering key sequence number 10.5.1.2	M	V	1/2
	Old routing area identification	Routing area identification 10.5.5.15	M	V	6
	MS Radio Access capability	MS Radio Access capability 10.5.5.12a	M	LV	6 - 51
19	Old P-TMSI signature	P-TMSI signature 10.5.5.8	O	TV	4
17	Requested READY timer value	GPRS Timer 10.5.7.3	O	TV	2
27	DRX parameter	DRX parameter 10.5.5.6	O	TV	3
9-	TMSI status	TMSI status 10.5.5.4	O	TV	1
18	P-TMSI	Mobile identity 10.5.1.4	O	TLV	7
31	MS network capability	MS network capability 10.5.5.12	O	TLV	4 - 10
32	PDP context status	PDP context status 10.5.7.1	O	TLV	4
33	PS LCS Capability	PS LCS Capability 10.5.5.22	O	TLV	3 - 4
35	MBMS context status	MBMS context status 10.5.7.6	O	TLV	2 - 18
58	UE network capability	UE network capability 10.5.5.26	O	TLV	4 - 15
1A	Additional mobile identity	Mobile identity 10.5.1.4	O	TLV	7
1B	Additional old routing area identification	Routing area identification 2 10.5.5.15a	O	TLV	8
11	Mobile station classmark 2	Mobile station classmark 2 10.5.1.6	O	TLV	5
20	Mobile station classmark 3	Mobile station classmark 3 10.5.1.7	O	TLV	2 - 34
40	Supported Codecs	Supported Codec List 10.5.4.32	O	TLV	5 - n
5D	Voice domain preference and UE's usage setting	Voice domain preference and UE's usage setting 10.5.5.28	O	TLV	3
E-	P-TMSI type	P-TMSI type 10.5.5.29	O	TV	1
D-	Device properties	Device properties 10.5.7.8	O	TV	1
C-	MS network feature support	MS network feature support 10.5.1.15	O	TV	1
14	Old location area identification	Location Area Identification 2 10.5.5.30	O	TLV	7
F-	Additional update type	Additional update type 10.5.5.0	O	TV	1
10	TMSI based NRI container	Network resource identifier container 10.5.5.31	O	TLV	4
6A	T3324 value	GPRS Timer 2 10.5.7.4	O	TLV	3
39	T3312 extended value	GPRS Timer 3 10.5.7.4a	O	TLV	3
6E	Extended DRX parameters	Extended DRX parameters 10.5.5.32	O	TLV	3

9.4.14.1 Old P-TMSI signature

The MS shall include this IE, if the MS received the IE from the network in an ATTACH ACCEPT or ROUTING AREA UPDATE ACCEPT message, or if the TIN indicates "GUTI" and the MS holds a valid GUTI.

9.4.14.2 Requested READY timer value

This IE may be included if the MS wants to indicate a preferred value for the READY timer.

9.4.14.3 DRX parameter

This IE shall be included if the MS changes the access network from GSM to UMTS, or the MS wants to indicate new DRX parameters to the network.

9.4.14.4 TMSI status

This IE shall be included if the MS performs a combined routing area update and no valid TMSI is available.

9.4.14.5 P-TMSI (lu mode only)

This IE shall be included by the MS.

9.4.14.6 MS network capability

This IE shall be included by the MS to indicate its capabilities to the network.

9.4.14.7 PDP context status

This IE shall be included by the MS.

9.4.14.8 PS LCS Capability

This IE shall be included if the MS supports at least one positioning method for the provision of location services (LCS) via the PS domain in Gb-mode.

9.4.14.9 MBMS context status

This IE shall be included by the MS, if it has MBMS contexts with an SM state different from PDP-INACTIVE.

9.4.14.10 Additional mobile identity

This IE shall be included by the MS, if the TIN indicates "GUTI" and the MS holds a valid GUTI and P-TMSI and RAI.

9.4.14.11 Additional old routing area identification

This IE shall be included by the MS, if the TIN indicates "GUTI" and the MS holds a valid GUTI and P-TMSI and RAI.

9.4.14.12 UE network capability

An MS supporting S1 mode shall include this IE, unless the update type indicates "periodic update".

9.4.14.13 Mobile station classmark 2

This IE shall be included if the MS supports SRVCC to GERAN or UTRAN.

9.4.14.14 Mobile station classmark 3

This IE shall be included if the MS supports SRVCC to GERAN.

9.4.14.15 Supported Codecs

This IE shall be included if the MS supports SRVCC to GERAN or UTRAN to indicate its supported speech codecs for CS speech calls.

9.4.14.16 Voice domain preference and UE's usage setting

This IE shall be included if:

- the MS supports CS fallback and SMS over SGs, or the MS is configured to support IMS voice, or both, and
- the MS supports WB-S1 mode.

9.4.14.17 P-TMSI type

The MS shall include this IE.

9.4.14.18 Device properties

This IE shall be included if the MS is configured for NAS signalling low priority.

9.4.14.19 MS network feature support

This IE shall be included if the MS supports extended periodic timer T3312.

9.4.14.20 Old location area identification

The MS shall include this IE during a combined routing area updating procedure, if the MS holds a valid LAI and the MS supports EMM combined procedures.

9.4.14.21 Additional update type

The MS shall include this IE if the MS initiates a combined routing area updating procedure for GPRS services and "SMS-only service".

9.4.14.22 TMSI based NRI container

The MS shall include this IE if it has a valid TMSI.

9.4.14.23 T3324 value

The MS may include this IE to request the use of PSM.

9.4.14.24 T3312 extended value

The MS may include this IE to request a particular T3312 value if T3324 value IE is included.

9.4.14.25 Extended DRX parameters

The MS may include this IE to request the use of eDRX.

9.4.15 Routing area update accept

This message is sent by the network to the MS to provide the MS with GPRS mobility management related data in response to a *routing area update request* message. See table 9.4.15/3GPP TS 24.008.

Message type: ROUTING AREA UPDATE ACCEPT

Significance: dual

Direction: network to MS

Table 9.4.15/3GPP TS 24.008: ROUTING AREA UPDATE ACCEPT message content

IEI	Information Element	Type/Reference	Presence	Format	Length
	Protocol discriminator	Protocol discriminator 10.2	M	V	1/2
	Skip indicator	Skip indicator 10.3.1	M	V	1/2
	Routing area update accept message identity	Message type 10.4	M	V	1
	Force to standby	Force to standby 10.5.5.7	M	V	1/2
	Update result	Update result 10.5.5.17	M	V	1/2
	Periodic RA update timer	GPRS Timer 10.5.7.3	M	V	1
	Routing area identification	Routing area identification 10.5.5.15	M	V	6
19	P-TMSI signature	P-TMSI signature 10.5.5.8	O	TV	4
18	Allocated P-TMSI	Mobile identity 10.5.1.4	O	TLV	7
23	MS identity	Mobile identity 10.5.1.4	O	TLV	7-10
26	List of Receive N-PDU Numbers	Receive N-PDU Number list 10.5.5.11	O	TLV	4 - 19
17	Negotiated READY timer value	GPRS Timer 10.5.7.3	O	TV	2
25	GMM cause	GMM cause 10.5.5.14	O	TV	2
2A	T3302 value	GPRS Timer 2 10.5.7.4	O	TLV	3
8C	Cell Notification	Cell Notification 10.5.5.21	O	T	1
4A	Equivalent PLMNs	PLMN List 10.5.1.13	O	TLV	5-47
32	PDP context status	PDP context status 10.5.7.1	O	TLV	4
B-	Network feature support	Network feature support 10.5.5.23	O	TV	1
34	Emergency Number List	Emergency Number List 10.5.3.13	O	TLV	5-50
35	MBMS context status	MBMS context status 10.5.7.6	O	TLV	2 - 18
A-	Requested MS Information	Requested MS Information 10.5.5.25	O	TV	1
37	T3319 value	GPRS Timer 2 10.5.7.4	O	TLV	3
38	T3323 value	GPRS Timer 2 10.5.7.4	O	TLV	3
39	T3312 extended value	GPRS timer 3 10.5.7.4a	O	TLV	3
66	Additional network feature support	Additional network feature support 10.5.5.23A	O	TLV	3
6A	T3324 value	GPRS Timer2 10.5.7.4	O	TLV	3
6E	Extended DRX parameters	Extended DRX parameters 10.5.5.32	O	TLV	3
C-	User Plane integrity indicator	User Plane integrity indicator 10.5.5.34	O	TV	1
31	Replayed MS network capability	MS network capability 10.5.5.12	O	TLV	4-10
33	Replayed MS Radio Access Capability	MS Radio Access capability 10.5.5.12a	O	TLV	6 - 51
65	DCN-ID	DCN-ID 10.5.5.35	O	TLV	4
63	PLMN identity of the CN operator	PLMN identity of the CN operator 10.5.5.36	O	TLV	5

D-	Non-3GPP NW provided policies	Non-3GPP NW provided policies 10.5.5.37	O	TV	1
----	-------------------------------	--	---	----	---

9.4.15.1 P-TMSI signature

This IE may be included to assign an identity to the MS's GMM context.

9.4.15.2 Allocated P-TMSI

This IE may be included to assign a P-TMSI to an MS in case of a GPRS or combined routing area updating procedure.

9.4.15.3 MS identity

This IE may be included to assign or unassign a TMSI to a MS in case of a combined routing area updating procedure.

9.4.15.4 List of Receive N-PDU Numbers

This IE shall be included in case of an inter SGSN routing area updating from A/Gb mode to A/Gb mode, or inter SGSN routing area updating from Iu mode to A/Gb mode, or intra SGSN routing area updating from Iu mode to A/Gb mode, if there are PDP contexts that have been activated in LLC acknowledged transfer mode.

9.4.15.5 Negotiated READY timer value

This IE may be included to indicate a value for the READY timer.

9.4.15.6 GMM cause

This IE shall be included if the combined GPRS routing area updating procedure was successful for GPRS services only.

9.4.15.7 T3302 value

This IE may be included to indicate a value for the T3302 timer.

In Iu mode, if the MS is not attached for emergency bearer services, the network shall not include this IE if this message is to be sent non-integrity protected. If the MS is attached for emergency bearer services, the network may include this IE if this message is to be sent non-integrity protected.

In Iu mode, if this message is received without integrity protection the MS not attached for emergency bearer services shall ignore the contents of this IE and use the default value. If the MS is attached for emergency bearer services, the MS shall use the received contents of this IE if this message is received without integrity protection.

If this IE is not included in the message in A/Gb mode or if in Iu mode this IE is not included in an integrity protected message, the MS shall use the default value.

9.4.15.8 Cell Notification (A/Gb mode only)

In A/Gb mode, this IE shall be included if by the SGSN in order to indicate the ability to support the Cell Notification.

9.4.15.9 Equivalent PLMNs

The *Equivalent PLMNs* information element is included if the network wants to inform the mobile station of equivalent PLMNs.

9.4.15.10 PDP context status

This IE shall be included by the NW.

9.4.15.11 Network feature support

This IE may be included to inform the MS of the support of certain features. If this IE is not included then the respective features are not supported.

9.4.15.12 Emergency Number List

This IE may be sent by the network. If this IE is sent, the contents of this IE indicates a list of emergency numbers valid within the same MCC as in the cell on which this IE is received.

9.4.15.13 MBMS context status

This IE shall be included by the network, if it has MBMS contexts for the MS with an SM state different from PDP-INACTIVE.

9.4.15.14 Requested MS Information

This IE may be sent by the network to request the MS to provide feature-related information.

9.4.15.15 T3319 value

This IE may be included to indicate a value for timer T3319.

9.4.15.16 T3323 value

The network may include this IE to indicate a value for timer T3323.

If the IE is not included, the MS shall use the default value.

9.4.15.17 T3312 extended value

The network may include this IE to provide the MS with a longer periodic routing area update timer.

9.4.15.18 Additional network feature support

The network may include this IE to inform the MS of the support of certain features. If this IE is not included then the MS shall interpret this as a receipt of an information element with all bits of the value part coded as zero.

9.4.15.19 T3324 value

The network shall include the T3324 value IE if:

- the MS included the T3324 value IE in the ROUTING AREA UPDATE REQUEST message; and
- the network supports PSM and accepts the use of PSM.

9.4.15.20 Extended DRX parameters

The network shall include the Extended DRX parameters IE if:

- the MS included the Extended DRX parameters IE in the ROUTING AREA UPDATE REQUEST message; and
- the network supports eDRX and accepts the use of eDRX.

9.4.15.21 User Plane integrity indicator

The network shall include the User Plane integrity indicator IE if the MS shall enable integrity protection of user plane data in LLC layer.

9.4.15.22 Replayed MS network capability

The network may include this IE if integrity protection and replay protection of GMM messages is to be used.

9.4.15.23 Replayed MS Radio Access Capability

The network may include this IE if integrity protection and replay protection of GMM messages is to be used.

9.4.15.24 DCN-ID

This IE is included in the message when the network wishes to provide a DCN-ID to the MS.

9.4.15.25 PLMN identity of the CN operator

This IE is included in the message when the common PLMN identity included in the RAI does not identify the CN operator that has accepted the routing area update request in a shared network or in a multi-operator core network (MOCN) with common GERAN.

9.4.15.26 Non-3GPP NW provided policies

This IE is included if the network needs to indicate whether emergency numbers provided via non-3GPP access can be used to initiate UE detected emergency calls (see 3GPP TS 24.302 [156]). If this IE is not included then the UE shall interpret this as a receipt of an information element with all bits of the value part coded as zero.

9.4.16 Routing area update complete

This message shall be sent by the MS to the network in response to a *routing area update accept message* if at least one of the following conditions is fulfilled:

- a P-TMSI and/or a TMSI has been assigned;
- there are established LLC connections; or
- the network has requested the MS to provide feature-related information.

See table 9.4.16/3GPP TS 24.008.

Message type: ROUTING AREA UPDATE COMPLETE

Significance: dual

Direction: MS to network

Table 9.4.16/3GPP TS 24.008: ROUTING AREA UPDATE COMPLETE message content

IEI	Information Element	Type/Reference	Presence	Format	Length
	Protocol discriminator	Protocol discriminator 10.2	M	V	1/2
	Skip indicator	Skip indicator 10.3.1	M	V	1/2
	Routing area update complete message identity	Message type 10.4	M	V	1
26	List of Receive N-PDU Numbers	Receive N-PDU Number list 10.5.5.11	O	TLV	4 – 19
27	Inter RAT handover information	Inter RAT information container 10.5.5.24	O	TLV	3-250
2B	E-UTRAN inter RAT handover information	E-UTRAN inter RAT information container 10.5.5.27	O	TLV	3-257

9.4.16.1 List of Receive N-PDU Numbers

This IE shall be included if the *routing area update accept message* contained this IE.

9.4.16.2 Inter RAT handover information

This IE shall be included if the network has requested this information in the *routing area update accept message*.

9.4.16.3 E-UTRAN inter RAT handover information

This IE shall be included if the network has requested this information in the *routing area update accept message*.

9.4.17 Routing area update reject

This message is sent by the network to the MS in order to reject the routing area update procedure. See table 9.4.17/3GPP TS 24.008.

Message type: ROUTING AREA UPDATE REJECT

Significance: dual

Direction: network to MS

Table 9.4.17/3GPP TS 24.008: ROUTING AREA UPDATE REJECT message content

IEI	Information Element	Type/Reference	Presence	Format	Length
	Protocol discriminator	Protocol discriminator 10.2	M	V	1/2
	Skip indicator	Skip indicator 10.3.1	M	V	1/2
	Routing area update reject message identity	Message type 10.4	M	V	1
	GMM cause	GMM cause 10.5.5.14	M	V	1
	Force to standby	Force to standby 10.5.5.7	M	V	1/2
	Spare half octet	Spare half octet 10.5.1.8	M	V	1/2
2A	T3302 value	GPRS Timer 2 10.5.7.4	O	TLV	3
3A	T3346 value	GPRS timer 2 10.5.7.4	O	TLV	3

9.4.17.1 T3302 value

This IE may be included to indicate a value for the T3302 timer.

In Iu mode, if the MS is not attached for emergency bearer services, the network shall not include this IE if this message is to be sent non-integrity protected. If the MS is attached for emergency bearer services, the network may include this IE if this message is to be sent non-integrity protected.

In Iu mode, the MS not attached for emergency bearer services shall ignore the contents of this IE if this message is received without integrity protection. If the MS is attached for emergency bearer services, the MS shall use the received contents of this IE if this message is received without integrity protection.

If this IE is not included or if in Iu mode the message is not integrity protected, the MS shall use the default value.

9.4.17.2 T3346 value

This IE may be included when the general NAS level mobility management congestion control is active.

9.4.18 GMM Status

This message is sent by the MS or by the network at any time to report certain error conditions listed in clause 8. See table 9.4.18/3GPP TS 24.008.

Message type: GMM STATUS

Significance: local

Direction: both

Table 9.4.18/3GPP TS 24.008: GMM STATUS message content

IEI	Information Element	Type/Reference	Presence	Format	Length
	Protocol discriminator	Protocol discriminator 10.2	M	V	1/2
	Skip indicator	Skip indicator 10.3.1	M	V	1/2
	GMM Status message identity	Message type 10.4	M	V	1
	GMM cause	GMM cause 10.5.5.14	M	V	1

9.4.19 GMM Information

This message is sent by the network at any time to sent certain information to the MS. See table 9.4.19/3GPP TS 24.008.

Message type: GMM INFORMATION

Significance: local

Direction: network to MS

Table 9.4.19/3GPP TS 24.008: GMM INFORMATION message content

IEI	Information Element	Type/Reference	Presence	Format	Length
	Protocol discriminator	Protocol discriminator 10.2	M	V	1/2
	Skip indicator	Skip indicator 10.3.1	M	V	1/2
	GMM Information message identity	Message type 10.4	M	V	1
43	Full name for network	Network name 10.5.3.5a	O	TLV	3 - ?
45	Short name for network	Network name 10.5.3.5a	O	TLV	3 - ?
46	Local time zone	Time zone 10.5.3.8	O	TV	2
47	Universal time and local time zone	Time zone and time 10.5.3.9	O	TV	8
48	LSA Identity	LSA Identifier 10.5.3.11	O	TLV	2-5
49	Network Daylight Saving Time	Daylight Saving Time 10.5.3.12	O	TLV	3

9.4.19.1 Full name for network

This IE may be sent by the network. If this IE is sent, the contents of this IE indicate the "full length name of the network" that the network wishes the mobile station to associate with the MCC and MNC contained in the routing area identification of the current cell.

9.4.19.2 Short name for network

This IE may be sent by the network. If this IE is sent, the contents of this IE indicate the "abbreviated name of the network" that the network wishes the mobile station to associate with the MCC and MNC contained in the routing area identification of the cell the MS is currently in.

9.4.19.3 Local time zone

This IE may be sent by the network. The mobile station should assume that this time zone applies to the routing area of the cell the MS is currently in.

If the local time zone has been adjusted for Daylight Saving Time, the network shall indicate this by including the IE Network Daylight Saving Time.

9.4.19.4 Universal time and local time zone

This IE may be sent by the network. The mobile station should assume that this time zone applies to the routing area the MS is currently in. The mobile station shall not assume that the time information is accurate.

If the local time zone has been adjusted for Daylight Saving Time, the network shall indicate this by including the IE Network Daylight Saving Time.

9.4.19.5 LSA Identity

This IE may be sent by the network. The contents of this IE indicate the LSA identity of the serving cell.

9.4.19.6 Network Daylight Saving Time

This IE may be sent by the network. If this IE is sent, the contents of this IE indicates the value that has been used to adjust the local time zone.

9.4.20 Service Request (lu mode only)

This message is sent by the MS to transfer to establish logical association between the MS and the network. See table 9.4.20/3GPP TS 24.008.

Message type: Service Request

Significance: dual

Direction: MS to network

Table 9.4.20/3GPP TS 24.008: Contents of Service Request message content

IEI	Information Element	Type/Reference	Presence	Format	Length
	Protocol discriminator	Protocol discriminator 10.2	M	V	1/2
	Skip indicator	Skip indicator 10.3.1	M	V	1/2
	Service Request message identity	Message type 10.4	M	V	1
	Ciphering key sequence number	Ciphering key sequence number 10.5.1.2	M	V	1/2
	Service type	Service type 10.5.5.20	M	V	1/2
	P-TMSI	Mobile station identity 10.5.1.4	M	LV	6
32	PDP context status	PDP context status 10.5.7.1	O	TLV	4
35	MBMS context status	MBMS context status 10.5.7.6	O	TLV	2 - 18
36	Uplink data status	Uplink data status 10.5.7.7	O	TLV	4
D-	Device properties	Device properties 10.5.7.8	O	TV	1

9.4.20.1 PDP context status

This IE shall be included by the MS.

9.4.20.2 MBMS context status

This IE shall be included by the MS, if it has MBMS contexts with an SM state different from PDP-INACTIVE.

9.4.20.3 Uplink data status

This IE may be included by the MS when the Service Type is set to "data".

9.4.20.4 Device properties

This IE shall be included if the MS is configured for NAS signalling low priority.

9.4.21 Service Accept (lu mode only)

This message is sent by the network in response to a *Service Request* message. See table 9.4.21/3GPP TS 24.008.

Message type: Service Accept

Significance: dual

Direction: network to MS

Table 9.4.21/3GPP TS 24.008: Contents of Service Accept message content

IEI	Information Element	Type/Reference	Presence	Format	Length
	Protocol discriminator	Protocol discriminator 10.2	M	V	1/2
	Skip indicator	Skip indicator 10.3.1	M	V	1/2
	Service Accept message identity	Message type 10.4	M	V	1
32	PDP context status	PDP context status 10.5.7.1	O	TLV	4
35	MBMS context status	MBMS context status 10.5.7.6	O	TLV	2 - 18

9.4.21.1 PDP context status

This IE shall be included by the NW.

9.4.21.2 MBMS context status

This IE shall be included by the network, if it has MBMS contexts for the MS with an SM state different from PDP-INACTIVE.

9.4.22 Service Reject (lu mode only)

This message is sent by the network to the MS in order to reject the Service request procedure. See table 9.4.22/3GPP TS 24.008.

Message type: Service Reject

Significance: dual

Direction: network to MS

Table 9.4.22/3GPP TS 24.008: Contents of Service Reject message content

IEI	Information Element	Type/Reference	Presence	Format	Length
	Protocol discriminator	Protocol discriminator 10.2	M	V	1/2
	Skip indicator	Skip indicator 10.3.1	M	V	1/2
	Service Reject message identity	Message type 10.4	M	V	1
	GMM cause	GMM cause 10.5.5.14	M	V	1
3A	T3346 value	GPRS timer 2 10.5.7.4	O	TLV	3

9.4.22.1 T3346 value

This IE may be included when the general NAS level mobility management congestion control is active.

9.5 GPRS Session Management Messages

9.5.1 Activate PDP context request

This message is sent by the MS to the network to request activation of a PDP context. See table 9.5.1/3GPP TS 24.008.

Message type: ACTIVATE PDP CONTEXT REQUEST

Significance: global

Direction: MS to network

Table 9.5.1/3GPP TS 24.008: ACTIVATE PDP CONTEXT REQUEST message content

IEI	Information Element	Type/Reference	Presence	Format	Length
	Protocol discriminator	Protocol discriminator 10.2	M	V	1/2
	Transaction identifier	Transaction identifier 10.3.2	M	V	1/2– 3/2
	Activate PDP context request message identity	Message type 10.4	M	V	1
	Requested NSAPI	Network service access point identifier 10.5.6.2	M	V	1
	Requested LLC SAPI	LLC service access point identifier 10.5.6.9	M	V	1
	Requested QoS	Quality of service 10.5.6.5	M	LV	13-21
	Requested PDP address	Packet data protocol address 10.5.6.4	M	LV	3 - 23
28	Access point name	Access point name 10.5.6.1	O	TLV	3 - 102
27	Protocol configuration options	Protocol configuration options 10.5.6.3	O	TLV	3 - 253
A-	Request type	Request type 10.5.6.17	O	TV	1
C-	Device properties	Device properties 10.5.7.8	O	TV	1
33	NBIFOM container	NBIFOM container 10.5.6.21	O	TLV	3 – 257
7B	Extended protocol configuration options	Extended protocol configuration options 10.5.6.3a	O	TLV-E	4 - 65538
5C	Extended QoS	Extended quality of service 10.5.6.5B	O	TLV	12

9.5.1.1 Access point name

This IE is included in the message when the MS selects a specific external network to be connected to.

9.5.1.2 Protocol configuration options

This IE is included in the message when the MS wishes to transmit (protocol) data (e.g. configuration parameters, error codes or messages/events) to the network and the extended protocol configuration options IE is not supported by the MS or the network or both end-to-end for the PDN connection (see subclause 6.1.3.7).

This IE shall be included if the MS supports Network Requested Bearer Control procedures or Local IP address in TFTs and the PDP Type requested is different from non-IP.

9.5.1.3 Request type

This IE is included in the message to indicate whether the PDP context request is for a handover from a non-3GPP access network or to activate a PDP context for emergency bearer services.

9.5.1.4 Device properties

This IE shall be included if the MS is configured for NAS signalling low priority.

9.5.1.5 NBIFOM container

This information element is used to transfer information associated with network-based IP flow mobility, see 3GPP TS 24.161 [158].

9.5.1.6 Extended protocol configuration options

This IE is included in the message when the MS wishes to transmit (protocol) data (e.g. configuration parameters, error codes or messages/events) to the network and the extended protocol configuration options IE is supported by the network and the MS end-to-end for the PDN connection (see subclause 6.1.3.7).

9.5.1.7 Extended QoS

This IE is included in the message when the MS wishes to transmit the maximum and guaranteed bit rate values to the network and at least one of the values to be transmitted exceeds the maximum bit rate value as specified in the quality of service information element in subclause 10.5.6.5.

9.5.2 Activate PDP context accept

This message is sent by the network to the MS to acknowledge activation of a PDP context. See table 9.5.2/3GPP TS 24.008.

Message type: ACTIVATE PDP CONTEXT ACCEPT
Significance: global
Direction: network to MS

Table 9.5.2/3GPP TS 24.008: ACTIVATE PDP CONTEXT ACCEPT message content

IEI	Information Element	Type/Reference	Presence	Format	Length
	Protocol discriminator	Protocol discriminator 10.2	M	V	1/2
	Transaction identifier	Transaction identifier 10.3.2	M	V	1/2– 3/2
	Activate PDP context accept message identity	Message type 10.4	M	V	1
	Negotiated LLC SAPI	LLC service access point identifier 10.5.6.9	M	V	1
	Negotiated QoS	Quality of service 10.5.6.5	M	LV	13-21
	Radio priority	Radio priority 10.5.7.2	M	V	1/2
	Spare half octet	Spare half octet 10.5.1.8	M	V	1/2
2B	PDP address	Packet data protocol address 10.5.6.4	O	TLV	4-24
27	Protocol configuration options	Protocol configuration options 10.5.6.3	O	TLV	3-253
34	Packet Flow Identifier	Packet Flow Identifier 10.5.6.11	O	TLV	3
39	SM cause	SM cause 2 10.5.6.6a	O	TLV	3
B-	Connectivity type	Connectivity type 10.5.6.19	O	TV	1
C-	WLAN offload indication	WLAN offload acceptability 10.5.6.20	O	TV	1
33	NBIFOM container	NBIFOM container 10.5.6.21	O	TLV	3 – 257
7B	Extended protocol configuration options	Extended protocol configuration options 10.5.6.3a	O	TLV-E	4 - 65538
5C	Extended QoS	Extended quality of service 10.5.6.5B	O	TLV	12

9.5.2.1 PDP address

This IE shall be included by the network if the MS has requested the activation of a PDP context with the PDP type IPv4 or IPv6 or IPv4v6 and dynamic addressing.

9.5.2.2 Protocol configuration options

This IE is included in the message when the network wishes to transmit (protocol) data (e.g. configuration parameters, error codes or messages/events) to the MS and the extended protocol configuration options IE is not supported by the MS or the network or both end-to-end for the PDN connection (see subclause 6.1.3.7).

This IE is also included to indicate the selected Bearer Control Mode to be applied as well as the network support for Local IP address in TFTs for all active PDP contexts sharing the same PDP Address and APN, if the PDN type is different from Non-IP, and the extended protocol configuration options IE is not supported by the MS or the network or both end-to-end for the PDN connection (see subclause 6.1.3.7).

9.5.2.3 Packet Flow Identifier

This IE may be included if the network wants to indicate the Packet Flow Identifier associated to the PDP context. The network shall not include this IE if the MS has not indicated PFC procedure support in PFC feature mode field of MS Network Capability IE.

If the MS has not indicated PFC procedure support, then it shall ignore this IE, if received.

9.5.2.4 SM cause

This IE shall be included if the network accepts the requested PDN connectivity with restrictions.

9.5.2.5 Connectivity type

The network shall include the connectivity type IE if:

- the network is configured to indicate when a PDN connection is a LIPA PDN connection; and
- the present PDN connection is a LIPA PDN connection.

9.5.2.6 WLAN offload indication

This IE shall be included in the message when the network wishes to indicate if the UE is allowed to offload the traffic of the associated PDN connection to WLAN(s), as specified in subclause 10.5.6.20.

9.5.2.7 NBIFOM container

This information element is used to transfer information associated with network-based IP flow mobility, see 3GPP TS 24.161 [158].

9.5.2.8 Extended protocol configuration options

This IE is included in the message when the network wishes to transmit (protocol) data (e.g. configuration parameters, error codes or messages/events) to the MS and the extended protocol configuration options IE is supported by both the MS and the network end-to-end for the PDN connection (see subclause 6.1.3.7).

This IE is also included to indicate the selected Bearer Control Mode to be applied as well as the network support for Local IP address in TFTs for all active PDP contexts sharing the same PDP Address and APN, if the PDN type is different from Non-IP, and the extended protocol configuration options IE is supported by both the MS and the network end-to-end for the PDN connection (see subclause 6.1.3.7).

9.5.2.9 Extended QoS

This IE is included in the message when the network wishes to transmit the maximum and guaranteed bit rate values to the MS and at least one of the values to be transmitted exceeds the maximum bit rate value as specified in the quality of service information element in subclause 10.5.6.5.

9.5.3 Activate PDP context reject

This message is sent by the network to the MS to reject activation of a PDP context.
See table 9.5.3/3GPP TS 24.008.

Message type: ACTIVATE PDP CONTEXT REJECT

Significance: global

Direction: network to MS

Table 9.5.3/3GPP TS 24.008: ACTIVATE PDP CONTEXT REJECT message content

IEI	Information Element	Type/Reference	Presence	Format	Length
	Protocol discriminator	Protocol discriminator 10.2	M	V	1/2
	Transaction identifier	Transaction identifier 10.3.2	M	V	1/2– 3/2
	Activate PDP context reject message identity	Message type 10.4	M	V	1
	SM cause	SM Cause 10.5.6.6	M	V	1
27	Protocol configuration options	Protocol configuration options 10.5.6.3	O	TLV	3 - 253
37	Back-off timer value	GPRS timer 3 10.5.7.4a	O	TLV	3
6B	Re-attempt indicator	Re-attempt indicator 10.5.6.5A	O	TLV	3
33	NBIFOM container	NBIFOM container 10.5.6.21	O	TLV	3 – 257
7B	Extended protocol configuration options	Extended protocol configuration options 10.5.6.3a	O	TLV-E	4 - 65538

9.5.3.1 Protocol configuration options

This IE is included in the message when the network wishes to transmit (protocol) data (e.g. configuration parameters, error codes or messages/events) to the MS and the extended protocol configuration options IE is not supported by the MS or the network or both end-to-end for the PDN connection (see subclause 6.1.3.7).

9.5.3.2 Back-off timer value

The network may include this IE if the SM cause is not #50 "PDP type IPv4 only allowed", #51 "PDP type IPv6 only allowed", #57 "PDP type IPv4v6 only allowed", #58 "PDP type non IP only allowed", nor #65 "maximum number of PDP contexts reached", to request a minimum time interval before procedure retry is allowed.

9.5.3.3 Re-attempt indicator

The network may include this IE only if the SM cause value is #50 "PDP type IPv4 only allowed", #51 "PDP type IPv6 only allowed", #57 "PDP type IPv4v6 only allowed", #58 "PDP type non IP only allowed", or #66 "requested APN not supported in current RAT and PLMN combination", or if the network includes the Back-off timer value IE and the SM cause value is not #26 "insufficient resources".

9.5.3.4 NBIFOM container

This information element is used to transfer information associated with network-based IP flow mobility, see 3GPP TS 24.161 [158].

9.5.3.5 Extended protocol configuration options

This IE is included in the message when the network wishes to transmit (protocol) data (e.g. configuration parameters, error codes or messages/events) to the MS and the extended protocol configuration options IE is supported by both the MS and the network end-to-end for the PDN connection (see subclause 6.1.3.7).

9.5.4 Activate Secondary PDP Context Request

This message is sent by the MS to the network to request activation of an additional PDP context associated with the same PDP address and APN as an already active PDP context. See Table 9.5.4/3GPP TS 24.008.

Message type: ACTIVATE SECONDARY PDP CONTEXT REQUEST

Significance: global

Direction: MS to network

Table 9.5.4/3GPP TS 24.008: ACTIVATE SECONDARY PDP CONTEXT REQUEST message content

IEI	Information Element	Type/Reference	Presence	Format	Length
	Protocol discriminator	Protocol discriminator 10.2	M	V	½
	Transaction identifier	Transaction identifier 10.3.2	M	V	½– 3/2
	Activate secondary PDP context request message identity	Message type 10.4	M	V	1
	Requested NSAPI	Network service access point identifier 10.5.6.2	M	V	1
	Requested LLC SAPI	LLC service access point identifier 10.5.6.9	M	V	1
	Requested QoS	Quality of service 10.5.6.5	M	LV	13-21
	Linked TI	Linked TI 10.5.6.7	M	LV	2-3
36	TFT	Traffic Flow Template 10.5.6.12	O	TLV	3-257
27	Protocol configuration options	Protocol configuration options 10.5.6.3	O	TLV	3-253
C-	Device properties	Device properties 10.5.7.8	O	TV	1
33	NBIFOM container	NBIFOM container 10.5.6.21	O	TLV	3 – 257
7B	Extended protocol configuration options	Extended protocol configuration options 10.5.6.3a	O	TLV-E	4 - 65538
5C	Extended QoS	Extended quality of service 10.5.6.5B	O	TLV	12

9.5.4.1 TFT

This IE shall be included if a linked PDP context without TFT has already been activated.

9.5.4.2 Protocol configuration options

This IE is included in the message when the MS wishes to transmit (protocol) data (e.g. configuration parameters, error codes or messages/events) to the network and the extended protocol configuration options IE is not supported by the MS or the network or both end-to-end for the PDN connection (see subclause 6.1.3.7).

9.5.4.3 Device properties

This IE shall be included if the MS is configured for NAS signalling low priority.

9.5.4.4 NBIFOM container

This information element is used to transfer information associated with network-based IP flow mobility, see 3GPP TS 24.161 [158].

9.5.4.5 Extended protocol configuration options

This IE is included in the message when the MS wishes to transmit (protocol) data (e.g. configuration parameters, error codes or messages/events) to the network and the extended protocol configuration options IE is supported by both the MS and the network end-to-end for the PDN connection (see subclause 6.1.3.7).

9.5.4.6 Extended QoS

This IE is included in the message when the MS wishes to transmit the maximum and guaranteed bit rate values to the network and at least one of the values to be transmitted exceeds the maximum bit rate value as specified in the quality of service information element in subclause 10.5.6.5.

9.5.5 Activate Secondary PDP Context Accept

This message is sent by the network to the MS to acknowledge activation of an additional PDP context associated with the same PDP address and APN as an already active PDP context. See Table 9.5.5/3GPP TS 24.008.

Message type: ACTIVATE SECONDARY PDP CONTEXT ACCEPT

Significance: global

Direction: network to MS

Table 9.5.5/3GPP TS 24.008: ACTIVATE SECONDARY PDP CONTEXT ACCEPT message content

IEI	Information Element	Type/Reference	Presence	Format	Length
	Protocol discriminator	Protocol discriminator 10.2	M	V	1/2
	Transaction identifier	Transaction identifier 10.3.2	M	V	1/2– 3/2
	Activate secondary PDP context accept message identity	Message type 10.4	M	V	1
	Negotiated LLC SAPI	LLC service access point identifier 10.5.6.9	M	V	1
	Negotiated QoS	Quality of service 10.5.6.5	M	LV	13-21
	Radio priority	Radio priority 10.5.7.2	M	V	1/2
	Spare half octet	Spare half octet 10.5.1.8	M	V	1/2
34	Packet Flow Identifier	Packet Flow Identifier 10.5.6.11	O	TLV	3
27	Protocol configuration options	Protocol configuration options 10.5.6.3	O	TLV	3-253
C-	WLAN offload indication	WLAN offload acceptability 10.5.6.20	O	TV	1
33	NBIFOM container	NBIFOM container 10.5.6.21	O	TLV	3 – 257
7B	Extended protocol configuration options	Extended protocol configuration options 10.5.6.3a	O	TLV-E	4 - 65538
5C	Extended QoS	Extended quality of service 10.5.6.5B	O	TLV	12

9.5.5.1 Packet Flow Identifier

This IE may be included if the network wants to indicate the Packet Flow Identifier associated to the PDP context. The network shall not include this IE if the MS has not indicated PFC procedure support in PFC feature mode field of MS Network Capability IE.

If the MS has not indicated PFC procedure support, then it shall ignore this IE, if received.

9.5.5.2 Protocol configuration options

This IE is included in the message when the network wishes to transmit (protocol) data (e.g. configuration parameters, error codes or messages/events) to the MS and the extended protocol configuration options IE is not supported by the MS or the network or both end-to-end for the PDN connection (see subclause 6.1.3.7).

9.5.5.3 WLAN offload indication

This IE shall be included in the message when the network wishes to indicate if the UE is allowed to offload the traffic of the associated PDN connection to WLAN(s), as specified in subclause 10.5.6.20.

9.5.5.4 NBIFOM container

This information element is used to transfer information associated with network-based IP flow mobility, see 3GPP TS 24.161 [158].

9.5.5.5 Extended protocol configuration options

This IE is included in the message when the network wishes to transmit (protocol) data (e.g. configuration parameters, error codes or messages/events) to the MS and the extended protocol configuration options IE is supported by both the MS and the network end-to-end for the PDN connection (see subclause 6.1.3.7).

9.5.5.6 Extended QoS

This IE is included in the message when the network wishes to transmit the maximum and guaranteed bit rate values to the MS and at least one of the values to be transmitted exceeds the maximum bit rate value as specified in the quality of service information element in subclause 10.5.6.5.

9.5.6 Activate Secondary PDP Context Reject

This message is sent by the network to the MS to reject activation of an additional PDP context associated with the same PDP address and APN as an already active PDP context. See Table 9.5.6/3GPP TS 24.008.

Message type: ACTIVATE SECONDARY PDP CONTEXT REJECT

Significance: global

Direction: network to MS

Table 9.5.6/3GPP TS 24.008: ACTIVATE SECONDARY PDP CONTEXT REJECT message content

IEI	Information Element	Type/Reference	Presence	Format	Length
	Protocol discriminator	Protocol discriminator 10.2	M	V	1/2
	Transaction identifier	Transaction identifier 10.3.2	M	V	1/2– 3/2
	Activate secondary PDP context reject message identity	Message type 10.4	M	V	1
	SM cause	SM Cause 10.5.6.6	M	V	1
27	Protocol configuration options	Protocol configuration options 10.5.6.3	O	TLV	3 – 253
37	Back-off timer value	GPRS timer 3 10.5.7.4a	O	TLV	3
6B	Re-attempt indicator	Re-attempt indicator 10.5.6.5A	O	TLV	3
33	NBIFOM container	NBIFOM container 10.5.6.21	O	TLV	3 – 257
7B	Extended protocol configuration options	Extended protocol configuration options 10.5.6.3a	O	TLV-E	4 - 65538

9.5.6.1 Protocol configuration options

This IE is included in the message when the network wishes to transmit (protocol) data (e.g. configuration parameters, error codes or messages/events) to the MS and the extended protocol configuration options IE is not supported by the MS or the network or both end-to-end for the PDN connection (see subclause 6.1.3.7).

9.5.6.2 Back-off timer value

The network may include this IE if the SM cause is not #65 "maximum number of PDP contexts reached", to request a minimum time interval before procedure retry is allowed.

9.5.6.3 Re-attempt indicator

The network may include this IE only if it includes the Back-off timer value IE and the SM cause value is not #26 "insufficient resources".

9.5.6.4 NBIFOM container

This information element is used to transfer information associated with network-based IP flow mobility, see 3GPP TS 24.161 [158].

9.5.6.5 Extended protocol configuration options

This IE is included in the message when the network wishes to transmit (protocol) data (e.g. configuration parameters, error codes or messages/events) to the MS and the extended protocol configuration options IE is supported by both the MS and the network end-to-end for the PDN connection (see subclause 6.1.3.7).

9.5.7 Request PDP context activation

This message is sent by the network to the MS to initiate activation of a PDP context.
See table 9.5.7/3GPP TS 24.008.

Message type: REQUEST PDP CONTEXT ACTIVATION

Significance: global

Direction: network to MS

Table 9.5.7/3GPP TS 24.008: REQUEST PDP CONTEXT ACTIVATION message content

IEI	Information Element	Type/Reference	Presence	Format	Length
	Protocol discriminator	Protocol discriminator 10.2	M	V	1/2
	Transaction identifier	Transaction identifier 10.3.2	M	V	1/2– 3/2
	Request PDP context activation message identity	Message type 10.4	M	V	1
	Offered PDP address	Packet data protocol address 10.5.6.4	M	LV	3 - 23
28	Access point name	Access point name 10.5.6.1	O	TLV	3 – 102
27	Protocol configuration options	Protocol configuration options 10.5.6.3	O	TLV	3 – 253
33	NBIFOM container	NBIFOM container 10.5.6.21	O	TLV	3 – 257
7B	Extended protocol configuration options	Extended protocol configuration options 10.5.6.3a	O	TLV-E	4 - 65538

9.5.7.1 Protocol configuration options

This IE is included in the message when the network wishes to transmit (protocol) data (e.g. configuration parameters, error codes or messages/events) to the MS and the extended protocol configuration options IE is not supported by the MS or the network or both end-to-end for the PDN connection (see subclause 6.1.3.7).

9.5.7.2 NBIFOM container

This information element is used to transfer information associated with network-based IP flow mobility, see 3GPP TS 24.161 [158].

9.5.7.3 Extended protocol configuration options

This IE is included in the message when the network wishes to transmit (protocol) data (e.g. configuration parameters, error codes or messages/events) to the MS and the extended protocol configuration options IE is supported by both the MS and the network end-to-end for the PDN connection (see subclause 6.1.3.7).

9.5.8 Request PDP context activation reject

This message is sent by the MS to the network to reject initiation of a PDP context activation. See table 9.5.8/3GPP TS 24.008.

Message type: REQUEST PDP CONTEXT ACTIVATION REJECT

Significance: global

Direction: MS to network

Table 9.5.8/3GPP TS 24.008: REQUEST PDP CONTEXT ACTIVATION REJECT message content

IEI	Information Element	Type/Reference	Presence	Format	Length
	Protocol discriminator	Protocol discriminator 10.2	M	V	1/2
	Transaction identifier	Transaction identifier 10.3.2	M	V	1/2– 3/2
	Request PDP context act. reject message identity	Message type 10.4	M	V	1
	SM cause	SM cause 10.5.6.6	M	V	1
27	Protocol configuration options	Protocol configuration options 10.5.6.3	O	TLV	3 – 253
33	NBIFOM container	NBIFOM container 10.5.6.21	O	TLV	3 – 257
7B	Extended protocol configuration options	Extended protocol configuration options 10.5.6.3a	O	TLV-E	4 - 65538

9.5.8.1 Protocol configuration options

This IE is included in the message when the MS wishes to transmit (protocol) data (e.g. configuration parameters, error codes or messages/events) to the network and the extended protocol configuration options IE is not supported by the MS or the network or both end-to-end for the PDN connection (see subclause 6.1.3.7).

9.5.8.2 NBIFOM container

This information element is used to transfer information associated with network-based IP flow mobility, see 3GPP TS 24.161 [158].

9.5.8.3 Extended protocol configuration options

This IE is included in the message when the MS wishes to transmit (protocol) data (e.g. configuration parameters, error codes or messages/events) to the network and the extended protocol configuration options IE is supported by both the MS and the network end-to-end for the PDN connection (see subclause 6.1.3.7).

9.5.9 Modify PDP context request (Network to MS direction)

This message is sent by the network to the MS to request modification of an active PDP context. See table 9.5.9/3GPP TS 24.008.

Message type: MODIFY PDP CONTEXT REQUEST (NETWORK TO MS DIRECTION)

Significance: global

Direction: network to MS

Table 9.5.9/3GPP TS 24.008: MODIFY PDP CONTEXT REQUEST (Network to MS direction) message content

IEI	Information Element	Type/Reference	Presence	Format	Length
	Protocol discriminator	Protocol discriminator 10.2	M	V	1/2
	Transaction identifier	Transaction identifier 10.3.2	M	V	1/2– 3/2
	Modify PDP context request message identity	Message type 10.4	M	V	1
	Radio priority	Radio priority 10.5.7.2	M	V	1/2
	Spare half octet	Spare half octet 10.5.1.8	M	V	1/2
	Requested LLC SAPI	LLC service access point identifier 10.5.6.9	M	V	1
	New QoS	Quality of service 10.5.6.5	M	LV	13-21
2B	PDP address	Packet data protocol address 10.5.6.4	O	TLV	4-24
34	Packet Flow Identifier	Packet Flow Identifier 10.5.6.11	O	TLV	3
27	Protocol configuration options	Protocol configuration options 10.5.6.3	O	TLV	3 – 253
36	TFT	Traffic Flow Template 10.5.6.12	O	TLV	3 - 257
C-	WLAN offload indication	WLAN offload acceptability 10.5.6.20	O	TV	1
33	NBIFOM container	NBIFOM container 10.5.6.21	O	TLV	3 – 257
7B	Extended protocol configuration options	Extended protocol configuration options 10.5.6.3a	O	TLV-E	4 - 65538
5C	Extended QoS	Extended quality of service 10.5.6.5B	O	TLV	12

9.5.9.1 PDP address

If the MS requested external PDP address allocation at PDP context activation via an APN and this was confirmed by the network in the ACTIVATE PDP CONTEXT ACCEPT message, then the network shall include the PDP address IE in the MODIFY PDP CONTEXT REQUEST message once the address has been actually allocated, in order to update the PDP context in the MS.

9.5.9.2 Packet Flow Identifier

This IE may be included if the network wants to indicate the Packet Flow Identifier associated to the PDP context. The network shall not include this IE if the MS has not indicated PFC procedure support in PFC feature mode field of MS Network Capability IE.

If this IE is not included, the MS shall keep the old Packet Flow Identifier value. If the MS has not indicated PFC procedure support, then it shall ignore this IE, if received.

9.5.9.3 Protocol configuration options

This IE is included in the message when the network wishes to transmit (protocol) data (e.g. configuration parameters, error codes or messages/events) to the MS and the extended protocol configuration options IE is not supported by both the MS and the network end-to-end for the PDN connection (see subclause 6.1.3.7). This IE is also included to indicate the selected Bearer Control Mode to be applied when the extended protocol configuration options IE is not supported by the MS or the network or both end-to-end for the PDN connection (see subclause 6.1.3.7).

9.5.9.4 TFT

This IE is included in the message to provide the MS with uplink and downlink packet filters when the protocol configuration options information element indicates the selected Bearer Control Mode 'MS/NW'.

9.5.9.5 WLAN offload indication

This IE shall be included in the message when the network wishes to indicate if the UE is allowed to offload the traffic of the associated PDN connection to WLAN(s), as specified in subclause 10.5.6.20.

9.5.9.6 NBIFOM container

This information element is used to transfer information associated with network-based IP flow mobility, see 3GPP TS 24.161 [158].

9.5.9.7 Extended protocol configuration options

This IE is included in the message when the network wishes to transmit (protocol) data (e.g. configuration parameters, error codes or messages/events) to the MS and the extended protocol configuration options IE is supported by both the MS and the network end-to-end for the PDN connection (see subclause 6.1.3.7). This IE is also included to indicate the selected Bearer Control Mode to be applied when the extended protocol configuration options IE is supported by both the MS and the network end-to-end for the PDN connection (see subclause 6.1.3.7).

9.5.9.8 Extended QoS

This IE is included in the message when the network wishes to transmit the maximum and guaranteed bit rate values to the MS and at least one of the values to be transmitted exceeds the maximum bit rate value as specified in the quality of service information element in subclause 10.5.6.5.

9.5.10 Modify PDP context request (MS to network direction)

This message is sent by the MS to the network to request modification of an active PDP context. See table 9.5.10/3GPP TS 24.008.

Message type: MODIFY PDP CONTEXT REQUEST (MS TO NETWORK DIRECTION)

Significance: global

Direction: MS to network

Table 9.5.10/3GPP TS 24.008: MODIFY PDP CONTEXT REQUEST (MS to network direction) message content

IEI	Information Element	Type/Reference	Presence	Format	Length
	Protocol discriminator	Protocol discriminator 10.2	M	V	1/2
	Transaction identifier	Transaction identifier 10.3.2	M	V	1/2– 3/2
	Modify PDP context request message identity	Message type 10.4	M	V	1
32	Requested LLC SAPI	LLC service access point identifier 10.5.6.9	O	TV	2
30	Requested new QoS	Quality of service 10.5.6.5	O	TLV	14-22
31	New TFT	Traffic Flow Template 10.5.6.12	O	TLV	3-257
27	Protocol configuration options	Protocol configuration options 10.5.6.3	O	TLV	3-253
C-	Device properties	Device properties 10.5.7.8	O	TV	1
33	NBIFOM container	NBIFOM container 10.5.6.21	O	TLV	3 – 257
7B	Extended protocol configuration options	Extended protocol configuration options 10.5.6.3a	O	TLV-E	4 - 65538
5C	Extended QoS	Extended quality of service 10.5.6.5B	O	TLV	12

9.5.10.1 Requested LLC SAPI

This IE may be included in the message to request a new LLC SAPI if a new QoS is requested.

9.5.10.2 Requested new QoS

This IE may be included in the message to request a modification of the QoS.

9.5.10.3 New TFT

This IE may be included in the message to request a new TFT or modification of an existing TFT or transfer extra parameters to the network (e.g. the Authorization Token; see 3GPP TS 24.229 [95]).

9.5.10.4 Protocol configuration options

This IE is included in the message when the MS wishes to transmit (protocol) data (e.g. configuration parameters, error codes or messages/events) to the network and the extended protocol configuration options IE is not supported by the MS or the network or both end-to-end for the PDN connection (see subclause 6.1.3.7).

9.5.10.5 Device properties

This IE shall be included if the MS is configured for NAS signalling low priority.

9.5.10.6 NBIFOM container

This information element is used to transfer information associated with network-based IP flow mobility, see 3GPP TS 24.161 [158].

9.5.10.7 Extended protocol configuration options

This IE is included in the message when the MS wishes to transmit (protocol) data (e.g. configuration parameters, error codes or messages/events) to the network and the extended protocol configuration options IE is supported by both the MS and the network end-to-end for the PDN connection (see subclause 6.1.3.7).

9.5.10.8 Extended QoS

This IE is included in the message when the MS wishes to transmit the maximum and guaranteed bit rate values to the network and at least one of the values to be transmitted exceeds the maximum bit rate value as specified in the quality of service information element in subclause 10.5.6.5.

9.5.11 Modify PDP context accept (MS to network direction)

This message is sent by the MS to the network to acknowledge the modification of an active PDP context. See table 9.5.11/3GPP TS 24.008.

Message type: MODIFY PDP CONTEXT ACCEPT (MS TO NETWORK DIRECTION)

Significance: global

Direction: MS to network

Table 9.5.11/3GPP TS 24.008: MODIFY PDP CONTEXT ACCEPT (MS TO NETWORK DIRECTION) message content

IEI	Information Element	Type/Reference	Presence	Format	Length
	Protocol discriminator	Protocol discriminator 10.2	M	V	1/2
	Transaction identifier	Transaction identifier 10.3.2	M	V	1/2– 3/2
	Modify PDP context accept message identity	Message type 10.4	M	V	1
27	Protocol configuration options	Protocol configuration options 10.5.6.3	O	TLV	3 – 253
33	NBIFOM container	NBIFOM container 10.5.6.21	O	TLV	3 – 257
7B	Extended protocol configuration options	Extended protocol configuration options 10.5.6.3a	O	TLV-E	4 - 65538

9.5.11.1 Protocol configuration options

This IE is included in the message when the MS wishes to transmit (protocol) data (e.g. configuration parameters, error codes or messages/events) to the network and the extended protocol configuration options IE is not supported by the MS or the network or both end-to-end for the PDN connection (see subclause 6.1.3.7).

9.5.11.2 NBIFOM container

This information element is used to transfer information associated with network-based IP flow mobility, see 3GPP TS 24.161 [158].

9.5.11.3 Extended protocol configuration options

This IE is included in the message when the MS wishes to transmit (protocol) data (e.g. configuration parameters, error codes or messages/events) to the network and the extended protocol configuration options IE is supported by both the MS and the network end-to-end for the PDN connection (see subclause 6.1.3.7).

9.5.12 Modify PDP context accept (Network to MS direction)

This message is sent by the network to the MS to acknowledge the modification of an active PDP context. See table 9.5.12/3GPP TS 24.008.

Message type: MODIFY PDP CONTEXT ACCEPT (NETWORK TO MS DIRECTION)

Significance: global

Direction: Network to MS

Table 9.5.12/3GPP TS 24.008: MODIFY PDP CONTEXT ACCEPT (NETWORK to MS direction) message content

IEI	Information Element	Type/Reference	Presence	Format	Length
	Protocol discriminator	Protocol discriminator 10.2	M	V	½
	Transaction identifier	Transaction identifier 10.3.2	M	V	½– 3/2
	Modify PDP context accept message identity	Message type 10.4	M	V	1
30	Negotiated QoS	Quality of service 10.5.6.5	O	TLV	14-22
32	Negotiated LLC SAPI	LLC service access point identifier 10.5.6.9	O	TV	2
8	New radio priority	Radio priority 10.5.7.2	O	TV	1
34	Packet Flow Identifier	Packet Flow Identifier 10.5.6.11	O	TLV	3
27	Protocol configuration options	Protocol configuration options 10.5.6.3	O	TLV	3 – 253
C-	WLAN offload indication	WLAN offload acceptability 10.5.6.20	O	TV	1
33	NBIFOM container	NBIFOM container 10.5.6.21	O	TLV	3 – 257
7B	Extended protocol configuration options	Extended protocol configuration options 10.5.6.3a	O	TLV-E	4 - 65538
5C	Extended QoS	Extended quality of service 10.5.6.5B	O	TLV	12

9.5.12.1 Negotiated QoS

This IE is included in the message if the network assigns a new QoS.

9.5.12.2 Negotiated LLC SAPI

This IE is included in the message if the network assigns a new LLC SAPI.

9.5.12.3 New radio priority

This IE is included in the message only if the network modifies the radio priority.

9.5.12.4 Packet Flow Identifier

This IE may be included if the network wants to indicate the Packet Flow Identifier associated to the PDP context. The network shall not include this IE if the MS has not indicated PFC procedure support in PFC feature mode field of MS Network Capability IE.

If this IE is not included, the MS shall keep the old Packet Flow Identifier value. If the MS has not indicated PFC procedure support, then it shall ignore this IE, if received.

9.5.12.5 Protocol configuration options

This IE is included in the message when the network wishes to transmit (protocol) data (e.g. configuration parameters, error codes or messages/events) to the MS and the extended protocol configuration options IE is not supported by the MS or the network or both end-to-end for the PDN connection (see subclause 6.1.3.7).

9.5.12.6 WLAN offload indication

This IE shall be included in the message when the network wishes to indicate if the UE is allowed to offload the traffic of the associated PDN connection to WLAN(s), as specified in subclause 10.5.6.20.

9.5.12.7 NBIFOM container

This information element is used to transfer information associated with network-based IP flow mobility, see 3GPP TS 24.161 [158].

9.5.12.8 Extended protocol configuration options

This IE is included in the message when the network wishes to transmit (protocol) data (e.g. configuration parameters, error codes or messages/events) to the MS and the extended protocol configuration options IE is supported by both the MS and the network end-to-end for the PDN connection (see subclause 6.1.3.7).

9.5.12.9 Extended QoS

This IE is included in the message when the network wishes to transmit the maximum and guaranteed bit rate values to the MS and at least one of the values to be transmitted exceeds the maximum bit rate value as specified in the quality of service information element in subclause 10.5.6.5.

9.5.13 Modify PDP Context Reject

This message is sent by the network or the MS to reject a modification of an active PDP context. See Table 9.5.13/3GPP TS 24.008.

Message type: MODIFY PDP CONTEXT REJECT

Significance: global

Direction: both

Table 9.5.13/3GPP TS 24.008: MODIFY PDP CONTEXT REJECT message content

IEI	Information Element	Type/Reference	Presence	Format	Length
	Protocol discriminator	Protocol discriminator 10.2	M	V	1/2
	Transaction identifier	Transaction identifier 10.3.2	M	V	1/2– 3/2
	Modify PDP Context Reject	Message type 10.4	M	V	1
	SM cause	SM Cause 10.5.6.6	M	V	1
27	Protocol configuration options	Protocol configuration options 10.5.6.3	O	TLV	3 – 253
37	Back-off timer value	GPRS timer 3 10.5.7.4a	O	TLV	3
6B	Re-attempt indicator	Re-attempt indicator 10.5.6.5A	O	TLV	3
33	NBIFOM container	NBIFOM container 10.5.6.21	O	TLV	3 – 257
7B	Extended protocol configuration options	Extended protocol configuration options 10.5.6.3a	O	TLV-E	4 - 65538

9.5.13.1 Protocol configuration options

This IE is included in the message when the network wishes to transmit (protocol) data (e.g. configuration parameters, error codes or messages/events) to the MS and the extended protocol configuration options IE is not supported by the MS or the network or both end-to-end for the PDN connection (see subclause 6.1.3.7).

9.5.13.2 Back-off timer value

The network may include this IE to request a minimum time interval before procedure retry is allowed.

9.5.13.3 Re-attempt indicator

The network may include this IE only if it includes the Back-off timer value IE and the SM cause value is not #26 "insufficient resources".

9.5.13.4 NBIFOM container

This information element is used to transfer information associated with network-based IP flow mobility, see 3GPP TS 24.161 [158].

9.5.13.5 Extended protocol configuration options

This IE is included in the message when the network wishes to transmit (protocol) data (e.g. configuration parameters, error codes or messages/events) to the MS and the extended protocol configuration options IE is supported by both the MS and the network end-to-end for the PDN connection (see subclause 6.1.3.7).

9.5.14 Deactivate PDP context request

This message is sent to request deactivation of an active PDP context or an active MBMS context. See table 9.5.14/3GPP TS 24.008.

Message type: DEACTIVATE PDP CONTEXT REQUEST

Significance: global

Direction: both

Table 9.5.14/3GPP TS 24.008: DEACTIVATE PDP CONTEXT REQUEST message content

IEI	Information Element	Type/Reference	Presence	Format	Length
	Protocol discriminator	Protocol discriminator 10.2	M	V	1/2
	Transaction identifier	Transaction identifier 10.3.2	M	V	1/2– 3/2
	Deactivate PDP context request message identity	Message type 10.4	M	V	1
	SM cause	SM cause 10.5.6.6	M	V	1
9-	Tear down indicator	Tear down indicator 10.5.6.10	O	TV	1
27	Protocol configuration options	Protocol configuration options 10.5.6.3	O	TLV	3 – 253
35	MBMS protocol configuration options	MBMS protocol configuration options 10.5.6.15	O	TLV	3 – 253
37	T3396 value	GPRS timer 3 10.5.7.4a	O	TLV	3
C-	WLAN offload indication	WLAN offload acceptability 10.5.6.20	O	TV	1
7B	Extended protocol configuration options	Extended protocol configuration options 10.5.6.3a	O	TLV-E	4 - 65538

9.5.14.1 Tear down indicator

This IE is included in the message in order to indicate whether only the PDP context associated with this specific TI or all active PDP contexts sharing the same PDP address and APN as the PDP context associated with this specific TI shall be deactivated.

If this IE is received for an MBMS context, it shall be ignored by the receiver.

9.5.14.2 Protocol configuration options

This IE is included in the message when the MS or the network wishes to transmit (protocol) data (e.g. configuration parameters, error codes or messages/events) to the peer entity and the extended protocol configuration options IE is not supported by the MS or the network or both end-to-end for the PDN connection (see subclause 6.1.3.7).

If this IE is received for an MBMS context, it shall be ignored by the receiver.

9.5.14.3 MBMS protocol configuration options

This IE is included in the message when the MS or the network wishes to transmit MBMS bearer related (protocol) data (e.g. configuration parameters, error codes or messages/events) to the peer entity for an MBMS context.

If the IE is received for a PDP context, it shall be ignored by the receiver.

9.5.14.4 T3396 value

The network may include this IE if the ESM cause is #26 "insufficient resources".

9.5.14.5 WLAN offload indication

This IE shall be included in the message when the network wishes to indicate if the UE is allowed to offload the traffic of the associated PDN connection to WLAN(s), as specified in subclause 10.5.6.20. If the SGSN wishes to deactivate all PDP contexts of a PDN connection, SGSN shall not include this IE.

9.5.14.6 Void

9.5.14.7 Extended protocol configuration options

This IE is included in the message when the MS or the network wishes to transmit (protocol) data (e.g. configuration parameters, error codes or messages/events) to the peer entity and the extended protocol configuration options IE is supported by the MS or the network or both end-to-end for the PDN connection (see subclause 6.1.3.7).

If this IE is received for an MBMS context, it shall be ignored by the receiver.

9.5.15 Deactivate PDP context accept

This message is sent to acknowledge deactivation of the PDP context requested in the corresponding *Deactivate PDP context request* message. See table 9.5.15/3GPP TS 24.008.

Message type: DEACTIVATE PDP CONTEXT ACCEPT

Significance: global

Direction: both

Table 9.5.15/3GPP TS 24.008: DEACTIVATE PDP CONTEXT ACCEPT message content

IEI	Information Element	Type/Reference	Presence	Format	Length
	Protocol discriminator	Protocol discriminator 10.2	M	V	1/2
	Transaction identifier	Transaction identifier 10.3.2	M	V	1/2– 3/2
	Deactivate PDP context accept message identity	Message type 10.4	M	V	1
27	Protocol configuration options	Protocol configuration options 10.5.6.3	O	TLV	3 – 253
35	MBMS protocol configuration options	MBMS protocol configuration options 10.5.6.15	O	TLV	3 – 253
7B	Extended protocol configuration options	Extended protocol configuration options 10.5.6.3a	O	TLV-E	4 - 65538

9.5.15.1 Protocol configuration options

This IE is included in the message when the MS or the network wishes to transmit (protocol) data (e.g. configuration parameters, error codes or messages/events) to the peer entity and the extended protocol configuration options IE is not supported by the MS or the network or both end-to-end for the PDN connection (see subclause 6.1.3.7).

If this IE is received for an MBMS context, it shall be ignored by the receiver.

9.5.15.2 MBMS protocol configuration options

This IE is included in the message when the MS or the network wishes to transmit MBMS bearer related (protocol) data (e.g. configuration parameters, error codes or messages/events) to the peer entity for an MBMS context.

If the IE is received for a PDP context, it shall be ignored by the receiver.

9.5.15.3 Void

9.5.15.4 Extended protocol configuration options

This IE is included in the message when the MS or the network wishes to transmit (protocol) data (e.g. configuration parameters, error codes or messages/events) to the peer entity and the extended protocol configuration options IE is supported by both the MS and the network end-to-end for the PDN connection (see subclause 6.1.3.7).

If this IE is received for an MBMS context, it shall be ignored by the receiver.

9.5.15a Request Secondary PDP Context Activation

This message is sent by the network to the MS to request activation of a secondary PDP context. See table 9.5.15a/3GPP TS 24.008.

Message type: REQUEST SECONDARY PDP CONTEXT ACTIVATION

Significance: global

Direction: network to MS

Table 9.5.15a/3GPP TS 24.008: REQUEST SECONDARY PDP CONTEXT ACTIVATION message content

IEI	Information Element	Type/Reference	Presence	Format	Length
	Protocol discriminator	Protocol discriminator 10.2	M	V	1/2
	Transaction identifier	Transaction identifier 10.3.2	M	V	1/2– 3/2
	Request secondary PDP context activation message identity	Message type 10.4	M	V	1
	Required QoS	Quality of service 10.5.6.5	M	LV	13-21
	Linked TI	Linked TI 10.5.6.7	M	LV	2-3
36	TFT	Traffic Flow Template 10.5.6.12	O	TLV	3-257
27	Protocol configuration options	Protocol configuration options 10.5.6.3	O	TLV	3 – 253
C-	WLAN offload indication	WLAN offload acceptability 10.5.6.20	O	TV	1
33	NBIFOM container	NBIFOM container 10.5.6.21	O	TLV	3 – 257
7B	Extended protocol configuration options	Extended protocol configuration options 10.5.6.3a	O	TLV-E	4 - 65538
5C	Extended QoS	Extended quality of service 10.5.6.5B	O	TLV	12

9.5.15a.1 TFT

The network shall include this IE. This IE provides the MS with uplink and downlink packet filters.

9.5.15a.2 Protocol configuration options

This IE is included in the message when the network wishes to transmit (protocol) data (e.g. configuration parameters, error codes or messages/events) to the MS end-to-end for the PDN connection (see subclause 6.1.3.7).

9.5.15a.3 WLAN offload indication

This IE shall be included in the message when the network wishes to indicate if the UE is allowed to offload the traffic of the associated PDN connection to WLAN(s), as specified in subclause 10.5.6.20.

9.5.15a.4 NBIFOM container

This information element is used to transfer information associated with network-based IP flow mobility, see 3GPP TS 24.161 [158].

9.5.15a.5 Extended protocol configuration options

This IE is included in the message when the network wishes to transmit (protocol) data (e.g. configuration parameters, error codes or messages/events) to the MS and the extended protocol configuration options IE is supported by both the MS and the network end-to-end for the PDN connection (see subclause 6.1.3.7).

9.5.15a.6 Extended QoS

This IE is included in the message when the network wishes to transmit the maximum and guaranteed bit rate values to the MS and at least one of the values to be transmitted exceeds the maximum bit rate value as specified in the quality of service information element in subclause 10.5.6.5.

9.5.15b Request Secondary PDP Context Activation Reject

This message is sent by the MS to the network to reject the request of a secondary PDP context activation. See table 9.5.15b/3GPP TS 24.008.

Message type: REQUEST SECONDARY PDP CONTEXT ACTIVATION REJECT

Significance: global

Direction: MS to network

Table 9.5.15b/3GPP TS 24.008: REQUEST SECONDARY PDP CONTEXT ACTIVATION REJECT message content

IEI	Information Element	Type/Reference	Presence	Format	Length
	Protocol discriminator	Protocol discriminator 10.2	M	V	1/2
	Transaction identifier	Transaction identifier 10.3.2	M	V	1/2– 3/2
	Request secondary PDP context activation reject message identity	Message type 10.4	M	V	1
	SM cause	SM cause 10.5.6.6	M	V	1
27	Protocol configuration options	Protocol configuration options 10.5.6.3	O	TLV	3 – 253
33	NBIFOM container	NBIFOM container 10.5.6.21	O	TLV	3 – 257
7B	Extended protocol configuration options	Extended protocol configuration options 10.5.6.3a	O	TLV-E	4 - 65538

9.5.15b.1 Protocol configuration options

This IE is included in the message when the MS wishes to transmit (protocol) data (e.g. configuration parameters, error codes or messages/events) to the network end-to-end for the PDN connection (see subclause 6.1.3.7).

9.5.15b.2 NBIFOM container

This information element is used to transfer information associated with network-based IP flow mobility, see 3GPP TS 24.161 [158].

9.5.15b.3 Extended protocol configuration options

This IE is included in the message when the MS wishes to transmit (protocol) data (e.g. configuration parameters, error codes or messages/events) to the network and the extended protocol configuration options IE is supported by both the MS and the network end-to-end for the PDN connection (see subclause 6.1.3.7).

9.5.16 Void

9.5.16a Notification

This message is sent by the network to inform the MS about events which are relevant for the upper layer using the PDP context or having requested a session management procedure. See table 9.5.16a/3GPP TS 24.008.

Message type: NOTIFICATION

Significance: local

Direction: network to MS

Table 9.5.16a/3GPP TS 24.008: NOTIFICATION message content

IEI	Information Element	Type/Reference	Presence	Format	Length
	Protocol discriminator	Protocol discriminator 10.2	M	V	1/2
	Transaction identifier	Transaction identifier 10.3.2	M	V	1/2– 3/2
	Notification message identity	Message type 10.4	M	V	1
	Notification indicator	Notification indicator 10.5.6.18	M	LV	2

9.5.17 Void

9.5.18 Void

9.5.19 Void

9.5.20 Void

9.5.21 SM Status

This message is sent by the network or the MS to pass information on the status of the indicated context and report certain error conditions (eg. as listed in clause 8). See table 9.5.21/3GPP TS 24.008.

Message type: SM Status

Significance: local

Direction: both

Table 9.5.21/3GPP TS 24.008: SM STATUS message content

IEI	Information Element	Type/Reference	Presence	Format	Length
	Protocol discriminator	Protocol discriminator 10.2	M	V	1/2
	Transaction identifier	Transaction identifier 10.3.2	M	V	1/2– 3/2
	SM Status message identity	Message type 10.4	M	V	1
	SM Cause	SM Cause 10.5.6.6	M	V	1

9.5.22 Activate MBMS Context Request

This message is sent by the MS to the network as an explicit response to a *Request MBMS Context Activation* message. See table 9.5.22/3GPP TS 24.008.

Message type: ACTIVATE MBMS CONTEXT REQUEST

Significance: global

Direction: MS to network

TABLE 9.5.22 : ACTIVATE MBMS CONTEXT REQUEST message content

IEI	Information Element	Type/	Presence	Format	Length
	Protocol discriminator	Protocol discriminator 10.2	M	V	1/2
	Transaction identifier	Transaction identifier 10.3.2	M	V	1/2– 3/2
	Activate MBMS context request message identity	Message type 10.4	M	V	1
	Requested MBMS NSAPI	Enhanced Network service access point identifier 10.5.6.16	M	V	1
	Requested LLC SAPI	LLC service access point identifier 10.5.6.9	M	V	1
	Supported MBMS bearer capabilities	MBMS bearer capabilities 10.5.6.14	M	LV	2 – 3
	Requested multicast address	Packet data protocol address 10.5.6.4	M	LV	3 - 23
	Access point name	Access point name 10.5.6.1	M	LV	2 – 101
35	MBMS protocol configuration options	MBMS protocol configuration options 10.5.6.15	O	TLV	3 - 253
C-	Device properties	Device properties 10.5.7.8	O	TV	1

NOTE: The MBMS NSAPI will be used in Iu mode when the network chooses a point-to-point MBMS bearer for the transfer of MBMS data in the user plane.

9.5.22.1 MBMS protocol configuration options

This IE is included in the message when the MS wishes to transmit MBMS bearer related (protocol) data (e.g. configuration parameters, error codes or messages/events) to the peer entity for an MBMS context.

9.5.22.2 Device properties

This IE shall be included if the MS is configured for NAS signalling low priority.

9.5.23 Activate MBMS Context Accept

This message is sent by the network to the MS to acknowledge activation of an MBMS context. See table 9.5.23/3GPP TS 24.008.

Message type: ACTIVATE MBMS CONTEXT ACCEPT

Significance: global

Direction: network to MS

TABLE 9.5.23 : ACTIVATE MBMS CONTEXT ACCEPT message content

IEI	Information Element	Type/Reference	Presence	Format	Length
	Protocol discriminator	Protocol discriminator 10.2	M	V	1/2
	Transaction identifier	Transaction identifier 10.3.2	M	V	1/2– 3/2
	Activate MBMS context accept message identity	Message type 10.4	M	V	1
	Temporary Mobile Group Identity	Temporary Mobile Group Identity 10.5.6.13	M	LV	4-7
	Negotiated LLC SAPI	LLC service access point identifier 10.5.6.9	M	V	1
35	MBMS protocol configuration options	MBMS protocol configuration options 10.5.6.15	O	TLV	3 - 253

9.5.23.1 MBMS protocol configuration options

This IE is included in the message when the network wishes to transmit MBMS bearer related (protocol) data (e.g. configuration parameters, error codes or messages/events) to the peer entity for an MBMS context.

9.5.24 Activate MBMS Context Reject

This message is sent by the network to the MS to reject activation of a MBMS context.
See table 9.5.24/3GPP TS 24.008.

Message type: ACTIVATE MBMS CONTEXT REJECT

Significance: global

Direction: network to MS

TABLE 9.5.24 : ACTIVATE MBMS CONTEXT REJECT message content

IEI	Information Element	Type/Reference	Presence	Format	Length
	Protocol discriminator	Protocol discriminator 10.2	M	V	1/2
	Transaction identifier	Transaction identifier 10.3.2	M	V	1/2– 3/2
	Activate MBMS context reject message identity	Message type 10.4	M	V	1
	SM cause	SM Cause 10.5.6.6	M	V	1
35	MBMS protocol configuration options	MBMS protocol configuration options 10.5.6.15	O	TLV	3 - 253
37	Back-off timer value	GPRS timer 3 10.5.7.4a	O	TLV	3
6B	Re-attempt indicator	Re-attempt indicator 10.5.6.5A	O	TLV	3

9.5.24.1 MBMS protocol configuration options

This IE is included in the message when the network wishes to transmit MBMS bearer related (protocol) data (e.g. configuration parameters, error codes or messages/events) to the peer entity for an MBMS context.

9.5.24.2 Back-off timer value

The network may include this IE to request a minimum time interval before procedure retry is allowed.

9.5.24.3 Re-attempt indicator

The network may include this IE only if the network includes the Back-off timer value IE and the SM cause value is not #26 "insufficient resources".

9.5.25 Request MBMS Context Activation

This message is sent by the network to the MS to initiate activation of an MBMS context.
See table 9.5.25/3GPP TS 24.008.

Message type: REQUEST MBMS CONTEXT ACTIVATION

Significance: global

Direction: network to MS

TABLE 9.5.25 : REQUEST MBMS CONTEXT ACTIVATION message content

IEI	Information Element	Type/Reference	Presence	Format	Length
	Protocol discriminator	Protocol discriminator 10.2	M	V	1/2
	Transaction identifier	Transaction identifier 10.3.2	M	V	1/2– 3/2
	Request MBMS context activation message identity	Message type 10.4	M	V	1
	Linked NSAPI	Network service access point identifier 10.5.6.2	M	V	1
	Offered Multicast address	Packet data protocol address 10.5.6.4	M	LV	3 - 23
	Access point name	Access point name 10.5.6.1	M	LV	2 – 101
35	MBMS protocol configuration options	MBMS protocol configuration options 10.5.6.15	O	TLV	3 - 253

9.5.25.1 Linked NSAPI

This IE is included in the message to allow the MS to associate the MBMS context with the PDP context over which the IGMP/MLD join message was sent.

9.5.25.2 MBMS protocol configuration options

This IE is included in the message when the network wishes to transmit MBMS bearer related (protocol) data (e.g. configuration parameters, error codes or messages/events) to the peer entity for an MBMS context.

9.5.26 Request MBMS Context Activation Reject

This message is sent by the MS to the network to reject initiation of an MBMS context activation.
See table 9.5.26/3GPP TS 24.008.

Message type: REQUEST MBMS CONTEXT ACTIVATION REJECT

Significance: global

Direction: MS to network

TABLE 9.5.26 : REQUEST MBMS CONTEXT ACTIVATION REJECT message content

IEI	Information Element	Type/Reference	Presence	Format	Length
	Protocol discriminator	Protocol discriminator 10.2	M	V	1/2
	Transaction identifier	Transaction identifier 10.3.2	M	V	1/2– 3/2
	Request MBMS context act. reject message identity	Message type 10.4	M	V	1
	SM cause	SM Cause 10.5.6.6	M	V	1
35	MBMS protocol configuration options	MBMS protocol configuration options 10.5.6.15	O	TLV	3 – 253

9.5.26.1 MBMS protocol configuration options

This IE is included in the message when the MS wishes to transmit MBMS bearer related (protocol) data (e.g. configuration parameters, error codes or messages/events) to the peer entity for an MBMS context.

10 General message format and information elements coding

The figures and text in this clause describe the Information Elements contents.

10.1 Overview

Within the Layer 3 protocols defined in 3GPP TS 24.008, every message is a standard L3 message as defined in 3GPP TS 24.007 [20]. This means that the message consists of the following parts:

- a) protocol discriminator;
- b) transaction identifier;
- c) message type;
- d) other information elements, as required.

This organization is illustrated in the example shown in figure 10.1/3GPP TS 24.008.

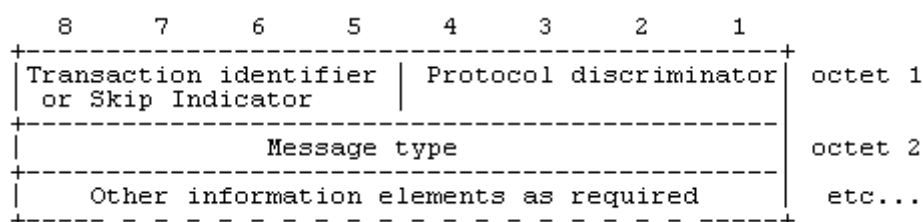

Figure 10.1/3GPP TS 24.008 General message organization example

Unless specified otherwise in the message descriptions of clause 9, a particular information element shall not be present more than once in a given message.

The term "default" implies that the value defined shall be used in the absence of any assignment, or that this value allows negotiation of alternative values in between the two peer entities.

When a field extends over more than one octet, the order of bit values progressively decreases as the octet number increases. The least significant bit of the field is represented by the lowest numbered bit of the highest numbered octet of the field.

10.2 Protocol Discriminator

The Protocol Discriminator (PD) and its use are defined in 3GPP TS 24.007 [20].

10.3 Skip indicator and transaction identifier

10.3.1 Skip indicator

Bits 5 to 8 of the first octet of every Mobility Management message and GPRS Mobility Management message contains the skip indicator.

With the exception of the following cases for a shared GERAN network in A/Gb mode,

- when the MS is sending a LOCATION UPDATING REQUEST, CM SERVICE REQUEST, IMSI DETACH INDICATION or CM RE-ESTABLISHMENT REQUEST message; or

- when the network is receiving a LOCATION UPDATING REQUEST, PAGING RESPONSE, CM SERVICE REQUEST, IMSI DETACH INDICATION or CM RE-ESTABLISHMENT REQUEST message,

the skip indicator field shall be handled as follows:

- a) A message received with skip indicator different from 0000 shall be ignored. A message received with skip indicator encoded as 0000 shall not be considered an error that causes the message to be ignored.
- b) A protocol entity sending a Mobility Management message or a GPRS Mobility Management message shall encode the skip indicator as 0000.

In a shared GERAN network in A/Gb mode:

- a) When the MS is sending a LOCATION UPDATING REQUEST, CM SERVICE REQUEST, IMSI DETACH INDICATION or CM RE-ESTABLISHMENT REQUEST message,
 - if the MS is a GERAN network sharing supporting MS, the MS shall encode the skip indicator IE to indicate the chosen PLMN identity from the PLMN identities in the broadcast system information (see 3GPP TS 44.018 [84]) according to table 10.3.1;
 - otherwise, the MS shall encode the skip indicator as 0000.
- b) When the network is receiving a LOCATION UPDATING REQUEST, PAGING RESPONSE, CM SERVICE REQUEST, IMSI DETACH INDICATION or CM RE-ESTABLISHMENT REQUEST message,
 - if the skip indicator is encoded as 0000, the message shall not be considered an error that causes the message to be ignored;
 - if the skip indicator is different from 0000, the message shall not be considered an error and shall be processed by the receiving MM entity. The MS shall be considered as GERAN network sharing supporting MS.

NOTE: The skip indicator handling of PAGING RESPONSE message on the MS and the BSS is specified in 3GPP TS 44.018 [84].

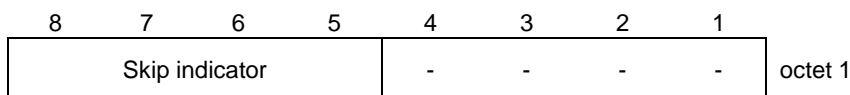

Figure 10.3.1: Skip indicator

Table 10.3.1/3GPP TS 24.008: Skip indicator

Bits	8	7	6	5	
	0	0	0	0	Skip Indicator without indication of selected PLMN
	0	0	0	1	PLMN identity of the Common PLMN in the broadcast system information
	0	0	1	0	PLMN identity of the first Additional PLMN in the broadcast system information
	0	0	1	1	PLMN identity of the second Additional PLMN in the broadcast system information
	0	1	0	0	PLMN identity of the third Additional PLMN in the broadcast system information
	0	1	0	1	PLMN identity of the fourth Additional PLMN in the broadcast system information
	0	1	1	0	Reserved
	0	1	1	1	Reserved

All other values shall be interpreted as "Skip Indicator without indication of selected PLMN".

Value 0000 indicates no indication of selected PLMN from the MS, which happens in UTRAN, or non-shared GERAN or Multi-Operator Core Network (MOCN) with common GERAN configurations or in a shared GERAN if the MS does not support GERAN network sharing.

10.3.2 Transaction identifier

Bits 5 to 8 of the first octet of every message belonging to the protocols "Call Control; call related SS messages" and "Session Management" contain the transaction identifier (TI). The transaction identifier and its use are defined in 3GPP TS 24.007 [20].

For the session management protocol, the extended TI mechanism may be used (see 3GPP TS 24.007 [20]).

For the call control protocol, the extended TI mechanism shall be supported for the purpose of protocol error handling as specified in subclause 8.3.1

10.4 Message Type

The message type IE and its use are defined in 3GPP TS 24.007 [20]. Tables 10.3/3GPP TS 24.008, 10.4/3GPP TS 24.008, and 10.4a/3GPP TS 24.008 define the value part of the message type IE used in the Mobility Management protocol, the Call Control protocol, and Session management protocol.

Table 10.2/3GPP TS 24.008: Message types for Mobility Management

8	7	6	5	4	3	2	1	
x	x	0	0	-	-	-	-	Registration messages:
				0	0	0	1	- IMSI DETACH INDICATION
				0	0	1	0	- LOCATION UPDATING ACCEPT
				0	1	0	0	- LOCATION UPDATING REJECT
				1	0	0	0	- LOCATION UPDATING REQUEST
x	x	0	1	-	-	-	-	Security messages:
				0	0	0	1	- AUTHENTICATION REJECT
				0	0	1	0	- AUTHENTICATION REQUEST
				0	1	0	0	- AUTHENTICATION RESPONSE
				1	1	0	0	- AUTHENTICATION FAILURE.....
				1	0	0	0	- IDENTITY REQUEST
				1	0	0	1	- IDENTITY RESPONSE
				1	0	1	0	- TMSI REALLOCATION COMMAND
				1	0	1	1	- TMSI REALLOCATION COMPLETE
x	x	1	0	-	-	-	-	Connection management messages:
				0	0	0	1	- CM SERVICE ACCEPT
				0	0	1	0	- CM SERVICE REJECT
				0	0	1	1	- CM SERVICE ABORT
				0	1	0	0	- CM SERVICE REQUEST
				0	1	0	1	- CM SERVICE PROMPT
				0	1	1	0	- Reserved (see NOTE)
				1	0	0	0	- CM RE-ESTABLISHMENT REQUEST
				1	0	0	1	- ABORT
x	x	1	1	-	-	-	-	Miscellaneous messages:
				0	0	0	0	- MM NULL
				0	0	0	1	- MM STATUS
				0	0	1	0	- MM INFORMATION

NOTE: This value was allocated but never used in earlier phases of the protocol.

When the radio connection started with a core network node of earlier than R99, bit 8 shall be set to 0 and bit 7 is reserved for the send sequence number in messages sent from the mobile station. In messages sent from the network, bits 7 and 8 are coded with a "0". See 3GPP TS 24.007 [20].

When the radio connection started with a core network node of R'99 or later, bits 7 and 8 are reserved for the send sequence number in messages sent from the mobile station. In messages sent from the network, bits 7 and 8 are coded with a "0". See 3GPP TS 24.007 [20].

Table 10.3/3GPP TS 24.008: Message types for Call Control and call related SS messages

8	7	6	5	4	3	2	1	
x	x	0	0	0	0	0	0	escape to nationally specific message types; see 1) below
x	x	0	0	-	-	-	-	Call establishment messages:
				0	0	0	1	- ALERTING
				1	0	0	0	- CALL CONFIRMED
				0	0	1	0	- CALL PROCEEDING
				0	1	1	1	- CONNECT
				1	1	1	1	- CONNECT ACKNOWLEDGE
				1	1	1	0	- EMERGENCY SETUP
				0	0	1	1	- PROGRESS
				0	1	0	0	- CC-ESTABLISHMENT
				0	1	1	0	- CC-ESTABLISHMENT CONFIRMED
				1	0	1	1	- RECALL
				1	0	0	1	- START CC
				0	1	0	1	- SETUP
x	x	0	1	-	-	-	-	Call information phase messages:
				0	1	1	1	- MODIFY
				1	1	1	1	- MODIFY COMPLETE
				0	0	1	1	- MODIFY REJECT
				0	0	0	0	- USER INFORMATION
				1	0	0	0	- HOLD
				1	0	0	1	- HOLD ACKNOWLEDGE
				1	0	1	0	- HOLD REJECT
				1	1	0	0	- RETRIEVE
				1	1	0	1	- RETRIEVE ACKNOWLEDGE
				1	1	1	0	- RETRIEVE REJECT
x	x	1	0	-	-	-	-	Call clearing messages:
				0	1	0	1	- DISCONNECT
				1	1	0	1	- RELEASE
				1	0	1	0	- RELEASE COMPLETE
x	x	1	1	-	-	-	-	Miscellaneous messages:
				1	0	0	1	- CONGESTION CONTROL
				1	1	1	0	- NOTIFY
				1	1	0	1	- STATUS
				0	1	0	0	- STATUS ENQUIRY
				0	1	0	1	- START DTMF
				0	0	0	1	- STOP DTMF
				0	0	1	0	- STOP DTMF ACKNOWLEDGE
				0	1	1	0	- START DTMF ACKNOWLEDGE
				0	1	1	1	- START DTMF REJECT
				1	0	1	0	- FACILITY

1): When used, the message type is defined in the following octet(s), according to the national specification.

When the radio connection started with a core network node of earlier than R99, bit 8 shall be set to 0 and bit 7 is reserved for the send sequence number in messages sent from the mobile station. In messages sent from the network, bits 7 and 8 are coded with a "0". See 3GPP TS 24.007 [20].

When the radio connection started with a core network node of R'99 or later, bits 7 and 8 are reserved for the send sequence number in messages sent from the mobile station. In messages sent from the network, bits 7 and 8 are coded with a "0". See 3GPP TS 24.007 [20].

Table 10.4/3GPP TS 24.008: Message types for GPRS mobility management

Bits								
8	7	6	5	4	3	2	1	
0	0	-	-	-	-	-	-	Mobility management messages
0	0	0	0	0	0	0	1	Attach request
0	0	0	0	0	0	1	0	Attach accept
0	0	0	0	0	0	1	1	Attach complete
0	0	0	0	0	1	0	0	Attach reject
0	0	0	0	0	1	0	1	Detach request
0	0	0	0	0	1	1	0	Detach accept
0	0	0	0	1	0	0	0	Routing area update request
0	0	0	0	1	0	0	1	Routing area update accept
0	0	0	0	1	0	1	0	Routing area update complete
0	0	0	0	1	0	1	1	Routing area update reject
0	0	0	0	1	1	0	0	Service Request
0	0	0	0	1	1	0	1	Service Accept
0	0	0	0	1	1	1	0	Service Reject
0	0	0	1	0	0	0	0	P-TMSI reallocation command
0	0	0	1	0	0	0	1	P-TMSI reallocation complete
0	0	0	1	0	0	1	0	Authentication and ciphering req
0	0	0	1	0	0	1	1	Authentication and ciphering resp
0	0	0	1	0	1	0	0	Authentication and ciphering rej
0	0	0	1	1	1	0	0	Authentication and ciphering failure
0	0	0	1	0	1	0	1	Identity request
0	0	0	1	0	1	1	0	Identity response
0	0	1	0	0	0	0	0	GMM status
0	0	1	0	0	0	0	1	GMM information

Table 10.4a/3GPP TS 24.008: Message types for GPRS session management

Bits								
8	7	6	5	4	3	2	1	
0	1	-	-	-	-	-	-	Session management messages
0	1	0	0	0	0	0	1	Activate PDP context request
0	1	0	0	0	0	1	0	Activate PDP context accept
0	1	0	0	0	0	1	1	Activate PDP context reject
0	1	0	0	0	1	0	0	Request PDP context activation
0	1	0	0	0	1	0	1	Request PDP context activation rej.
0	1	0	0	0	1	1	0	Deactivate PDP context request
0	1	0	0	0	1	1	1	Deactivate PDP context accept
0	1	0	0	1	0	0	0	Modify PDP context request(Network to MS direction)
0	1	0	0	1	0	0	1	Modify PDP context accept (MS to network direction)
0	1	0	0	1	0	1	0	Modify PDP context request(MS to network direction)
0	1	0	0	1	0	1	1	Modify PDP context accept (Network to MS direction)
0	1	0	0	1	1	0	0	Modify PDP context reject
0	1	0	0	1	1	0	1	Activate secondary PDP context request
0	1	0	0	1	1	1	0	Activate secondary PDP context accept
0	1	0	0	1	1	1	1	Activate secondary PDP context reject
0	1	0	1	0	0	0	0	Reserved: was allocated in earlier phases of the protocol
0	1	0	1	0	0	0	1	Reserved: was allocated in earlier phases of the protocol
0	1	0	1	0	0	1	0	Reserved: was allocated in earlier phases of the protocol
0	1	0	1	0	0	1	1	Reserved: was allocated in earlier phases of the protocol
0	1	0	1	0	1	0	0	Reserved: was allocated in earlier phases of the protocol
0	1	0	1	0	1	0	1	SM Status
0	1	0	1	0	1	1	0	Activate MBMS Context Request
0	1	0	1	0	1	1	1	Activate MBMS Context Accept
0	1	0	1	1	0	0	0	Activate MBMS Context Reject
0	1	0	1	1	0	0	1	Request MBMS Context Activation
0	1	0	1	1	0	1	0	Request MBMS Context Activation Reject
0	1	0	1	1	0	1	1	Request Secondary PDP Context Activation
0	1	0	1	1	1	0	0	Request Secondary PDP Context Activation Reject
0	1	0	1	1	1	0	1	Notification

10.5 Other information elements

The different formats (V, LV, T, TV, TLV) and the four categories of information elements (type 1, 2, 3, and 4) are defined in 3GPP TS 24.007 [20].

The first octet of an information element in the non-imperative part contains the IEI of the information element. If this octet does not correspond to an IEI known in the message, the receiver shall determine whether this IE is of type 1 or 2 (i.e. it is an information element of one octet length) or an IE of type 4 (i.e. that the next octet is the length indicator indicating the length of the remaining of the information element) (see 3GPP TS 24.007 [20]).

This allows the receiver to jump over unknown information elements and to analyse any following information elements.

The information elements which are common for at least two of the three protocols Radio Resources management, Mobility Management and Call Control, are listed in subclause 10.5.1.

The information elements for the protocols Mobility Management and Call Control are listed in subclauses 10.5.3 and 10.5.4 respectively. Default information element identifiers are listed in annex K.

NOTE: Different information elements may have the same default information element identifier if they belong to different protocols.

The descriptions of the information element types in subclauses 10.5.1, 10.5.3, and 10.5.4 are organized in alphabetical order of the IE types. Each IE type is described in one subclause.

The subclause may have an introduction:

- possibly explaining the purpose of the IE;
- possibly describing whether the IE belongs to type 1, 2, 3, 4 or 5;
- possibly indicating the length that the information element has if it is either type 5 or if it is used in format TV (type 1 and 3) or TLV (type 4).

A figure of the subclause defines the structure of the IE indicating:

- possibly the position and length of the IEI. (However it depends on the message in which the IE occurs whether the IE contains an IEI.);
- the fields the IE value part is composed of;
- possibly the position and length of the length indicator. (However it depends on the IE type whether the IE contains a length indicator or not.);
- possibly octet numbers of the octets that compose the IE (see clause a) below).

Finally, the subclause contains tables defining the structure and value range of the fields that compose the IE value part. The order of appearance for information elements in a message is defined in clause 9.

The order of the information elements within the imperative part of messages has been chosen so that information elements with 1/2 octet of content (type 1) go together in succession. The first type 1 information element occupies bits 1 to 4 of octet N, the second bits 5 to 8 of octet N, the third bits 1 to 4 of octet N + 1 etc. If the number of type 1 information elements is odd then bits 5 to 8 of the last octet occupied by these information elements contains a spare half octet IE in format V.

Where the description of information elements in the present document contains bits defined to be "spare bits", these bits shall set to the indicated value (0 or 1) by the sending side, and their value shall be ignored by the receiving side. With few exceptions, spare bits are indicated as being set to "0" in 3GPP TS 24.008.

10.5.1 Common information elements.

10.5.1.1 Cell identity

The purpose of the *Cell Identity* information element is to identify a cell within a location area.

The *Cell Identity* information element is coded as shown in figure 10.5.1/3GPP TS 24.008 and table 10.5.1/3GPP TS 24.008.

The *Cell Identity* is a type 3 information element with 3 octets length.

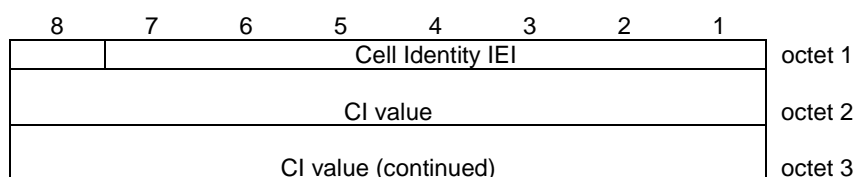

Figure 10.5.1/3GPP TS 24.008 *Cell Identity* information element

Table 10.5.1/3GPP TS 24.008: Cell Identity information element

<p>CI value, Cell identity value (octet 2 and 3)</p> <p>In the CI value field bit 8 of octet 2 is the most significant bit and bit 1 of octet 3 the least significant bit.</p> <p>The coding of the cell identity is the responsibility of each administration. Coding using full hexadecimal representation may be used.</p> <p>The cell identity consists of 2 octets.</p>
--

10.5.1.2 Cipherng Key Sequence Number

In a GSM authentication challenge, the purpose of the *Cipherng Key Sequence Number* information element is to make it possible for the network to identify the cipherng key K_c which is stored in the mobile station without invoking the authentication procedure.

The cipherng key sequence number is allocated by the network and sent with the AUTHENTICATION REQUEST or AUTHENTICATION AND CIPHERING REQUEST message to the mobile station where it is stored together with the calculated keys, e.g. K_c , CK, IK, K_{c128} , Kint.

The *Cipherng Key Sequence Number* information element is coded as shown in figure 10.5.2/3GPP TS 24.008 and table 10.5.2/3GPP TS 24.008.

In a UMTS authentication challenge, the purpose of the *Cipherng Key Sequence Number* information element is to make it possible for the network to identify the cipherng key CK and integrity key IK which are stored in the MS without invoking the authentication procedure. CK and IK form a Key Set Identifier (KSI) (see 3GPP TS 33.102 [5a]) which is encoded the same as the CKSN and is therefore included in the CKSN field.

The cipherng key sequence number is a type 1 information element.

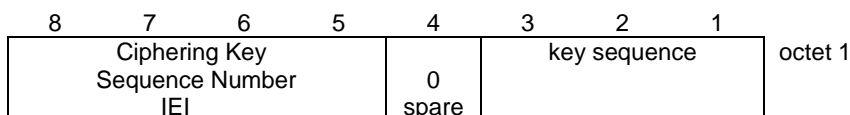
**Figure 10.5.2/3GPP TS 24.008 Cipherng Key Sequence Number information element****Table 10.5.2/3GPP TS 24.008: Cipherng Key Sequence Number information element**

Key sequence (octet 1)		
Bits		
3	2	1
0	0	0
through Possible values for the cipherng key		
1	1	0
sequence number		
1	1	1
No key is available (MS to network); Reserved (network to MS)		

10.5.1.3 Location Area Identification

The purpose of the *Location Area Identification* information element is to provide an unambiguous identification of location areas within the area covered by the 3GPP system.

The *Location Area Identification* information element is coded as shown in figure 10.5.3/3GPP TS 24.008 and table 10.5.3/3GPP TS 24.008.

The *Location Area Identification* is a type 3 information element with 6 octets length.

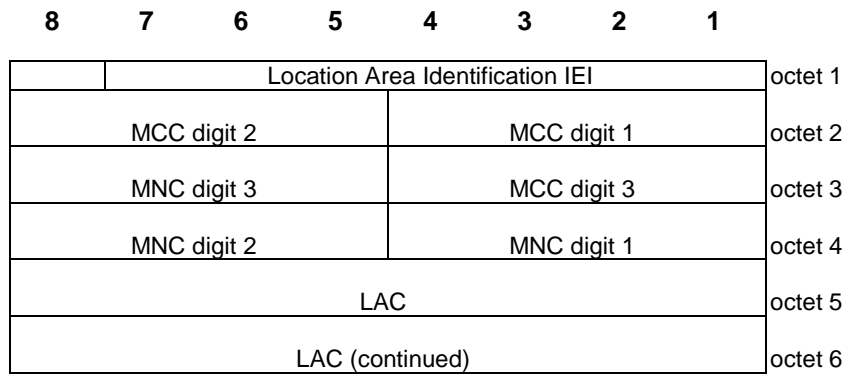

Figure 10.5.3/3GPP TS 24.008 *Location Area Identification* information element

Table 10.5.3/3GPP TS 24.008: Location Area Identification information element

<p>MCC, Mobile country code (octet 2 and 3) The MCC field is coded as in ITU-T Rec. E212, Annex A.</p> <p>If the LAI is deleted the MCC and MNC shall take the value from the deleted LAI.</p> <p>In abnormal cases, the MCC stored in the mobile station can contain elements not in the set {0, 1 ... 9}. In such cases the mobile station should transmit the stored values using full hexadecimal encoding. When receiving such an MCC, the network shall treat the LAI as deleted.</p> <p>MNC, Mobile network code (octet 3 bits 5 to 8, octet 4) The coding of this field is the responsibility of each administration but BCD coding shall be used. The MNC shall consist of 2 or 3 digits. For PCS 1900 for NA, Federal regulation mandates that a 3-digit MNC shall be used. However a network operator may decide to use only two digits in the MNC in the LAI over the radio interface. In this case, bits 5 to 8 of octet 3 shall be coded as "1111". Mobile equipment shall accept LAI coded in such a way.</p> <p>NOTE 1: In earlier versions of this protocol, the possibility to use a one digit MNC in LAI was provided on the radio interface. However as this was not used this possibility has been deleted.</p> <p>NOTE 2: In earlier versions of this protocol, bits 5 to 8 of octet 3 were coded as "1111". Mobile equipment compliant with these earlier versions of the protocol may be unable to understand the 3-digit MNC format of the LAI, and therefore unable to register on a network broadcasting the LAI in this format.</p> <p>In abnormal cases, the MNC stored in the mobile station can have:</p> <ul style="list-style-type: none"> - digit 1 or 2 not in the set {0, 1 ... 9}, or - digit 3 not in the set {0, 1 ... 9, F} hex. <p>In such cases the mobile station shall transmit the stored values using full hexadecimal encoding. When receiving such an MNC, the network shall treat the LAI as deleted.</p> <p>The same handling shall apply for the network, if a 3-digit MNC is sent by the mobile station to a network using only a 2-digit MNC.</p> <p>LAC, Location area code (octet 5 and 6) In the LAC field bit 8 of octet 5 is the most significant bit and bit 1 of octet 6 the least significant bit. The coding of the location area code is the responsibility of each administration except that two values are used to mark the LAC, and hence the LAI, as deleted. Coding using full hexadecimal representation may be used. The location area code consists of 2 octets. If a LAI has to be deleted then all bits of the location area code shall be set to one with the exception of the least significant bit which shall be set to zero. If a SIM/USIM is inserted in a Mobile Equipment with the location area code containing all zeros, then the Mobile Equipment shall recognise this LAC as part of a deleted LAI</p>

10.5.1.4 Mobile Identity

The purpose of the *Mobile Identity* information element is to provide either the international mobile subscriber identity, IMSI, the temporary mobile subscriber identity, TMSI/P-TMSI/M-TMSI, the international mobile equipment identity, IMEI, the international mobile equipment identity together with the software version number, IMEISV, or the temporary mobile group identity (TMGI), associated with the optional MBMS Session Identity.

The IMSI shall not exceed 15 digits, the TMSI/P-TMSI/M-TMSI is 4 octets long, and the IMEI is composed of 15 digits, the IMEISV is 16 digits (see 3GPP TS 23.003 [10]). The TMGI is at maximum 6 octets long and is defined in subclause 10.5.6.13. The MBMS Session Identity, if included, is 1 octet long (see 3GPP TS 48.018 [86]).

For packet paging the network shall select the mobile identity type with the following priority:

- 1- P-TMSI: The P-TMSI shall be used if it is available.
- 2- IMSI: The IMSI shall be used in cases where no P-TMSI is available.

For MBMS (pre-)notification (see 3GPP TS 44.018 [84] and 3GPP TS 44.060 [76]) the network shall select the mobile identity type "TMGI and optional MBMS Session Identity".

NOTE 1: The type of identity "TMGI and optional MBMS Session Identity" is only used by the MBMS (pre-)notification procedure in of A/Gb mode.

For all other transactions with the following exceptions:

- emergency call establishment, emergency call re-establishment, mobile terminated call establishment, the identification procedure, the GMM identification procedure, the GMM authentication, GPRS attach, routing area updating, and ciphering procedure and the ciphering mode setting procedure; and
- location updating when the MS is configured for "AttachWithIMSI" as specified in 3GPP TS 24.368 [135] or 3GPP TS 31.102 [112] and the selected PLMN is neither the registered PLMN nor in the list of equivalent PLMNs;

the mobile station and the network shall select the mobile identity type with the following priority:

- 1- TMSI: The TMSI shall be used if it is available.
- 2- IMSI: The IMSI shall be used in cases where no TMSI is available.

For mobile terminated call establishment the mobile station shall select the same mobile identity type as received from the network in the PAGING REQUEST message. In case of enhanced DTM CS establishment (see 3GPP TS 44.018 [84]) the mobile station shall select the mobile identity type with the following priority in the PAGING RESPONSE message:

- 1- TMSI: The TMSI shall be used if it is available.
- 2- IMSI: The IMSI shall be used in cases where no TMSI is available.

For the PAGING RESPONSE message sent as a response to a paging for CS fallback, the MS shall:

- select the TMSI as mobile identity type if the network has, in E-UTRAN,
 - paged the MS for CS fallback using the S-TMSI; or
 - indicated TMSI in the CS SERVICE NOTIFICATION message (see 3GPP TS 24.301 [120]);
- select the IMSI as mobile identity type if the network has, in E-UTRAN,
 - paged the MS for CS fallback using the IMSI; or
 - indicated IMSI in the CS SERVICE NOTIFICATION message (see 3GPP TS 24.301 [120]).

For emergency call establishment and re-establishment the mobile station shall select the mobile identity type with the following priority:

- 1- TMSI: The TMSI shall be used if it is available and if the location update status is UPDATED, and the stored LAI is equal to the one received on the BCCH from the current serving cell.
- 2- IMSI: The IMSI shall be used in cases where no TMSI is available or TMSI is available but either the update status is different from UPDATED, or the stored LAI is different from the one received on the BCCH from the current serving cell.
- 3- IMEI: The IMEI shall be used in cases where no SIM/USIM is available or the SIM/USIM is considered as not valid by the mobile station or no IMSI or TMSI is available.

In the identification procedure and in the GMM identification procedure the mobile station shall select the mobile identity type which was requested by the network, if available. If the requested identity is not available, then the mobile station shall indicate the identity type "No Identity".

In the ciphering mode setting procedure and in the GMM authentication and ciphering procedure the mobile shall select the IMEISV.

The *Mobile Identity* information element is coded as shown in figure 10.5.4/3GPP TS 24.008 and table 10.5.4/3GPP TS 24.008.

The *Mobile Identity* is a type 4 information element with a minimum length of 3 octet and 11 octets length maximal. Further restriction on the length may be applied, e.g. number plans.

8	7	6	5	4	3	2	1	
Mobile Identity IEI								octet 1
Length of mobile identity contents								octet 2
Identity digit 1				odd/ even indic	Type of identity			octet 3
Identity digit p+1				Identity digit p				octet 4*

Figure 10.5.4/3GPP TS 24.008 *Mobile Identity* information element

8	7	6	5	4	3	2	1	
Mobile Identity IEI								octet 1
Length of Mobile Identity contents								octet 2
0	0	MBMS Sess Id indic	MCC/ MNC indic	odd/ even indic	Type of identity			octet 3
MBMS Service ID								octet 4 octet 5 octet 6
MCC digit 2				MCC digit 1				octet 6a*
MNC digit 3				MCC digit 3				octet 6b*
MNC digit 2				MNC digit 1				octet 6c*
MBMS Session Identity								octet 7*

Figure 10.5.4a/3GPP TS 24.008: *Mobile Identity* information element for type of identity "TMGI and optional MBMS Session Identity"

Table 10.5.4/3GPP TS 24.008: *Mobile Identity* information element

Type of identity (octet 3)

Bits

3 2 1

0 0 1 IMSI
 0 1 0 IMEI
 0 1 1 IMEISV
 1 0 0 TMSI/P-TMSI/M-TMSI
 1 0 1 TMGI and optional MBMS Session Identity
 0 0 0 No Identity (note 1)

All other values are reserved.

Odd/even indication (octet 3)

Bit

4

0 even number of identity digits and also when the TMSI/P-TMSI or TMGI and optional MBMS Session Identity is used
 1 odd number of identity digits

Identity digits (octet 3 etc)

For the IMSI, IMEI and IMEISV this field is coded using BCD coding. If the number of identity digits is even then bits 5 to 8 of the last octet shall be filled with an end mark coded as "1111".

For Type of identity "No Identity", the Identity digit bits shall be encoded with all 0s and the Length of mobile identity contents parameter shall be set to one of the following values:

- "1" if the identification procedure is used (see subclause 9.2.11);
- "3" if the GMM identification procedure is used (see subclause 9.4.13)
- "3" if the EMM identification procedure is used (see 3GPP TS 24.301 [120])

If the mobile identity is the TMSI/P-TMSI/M-TMSI then bits 5 to 8 of octet 3 are coded as "1111" and bit 8 of octet 4 is the most significant bit and bit 1 of the last octet the least significant bit. The coding of the TMSI/P-TMSI is left open for each administration.

For type of identity "TMGI and optional MBMS Session Identity" the coding of octet 3 etc is as follows:

MCC/MNC indication (octet 3)

Bit

5

0 MCC/MNC is not present
 1 MCC/MNC is present

MBMS Session Identity indication (octet 3)

Bit

6

0 MBMS Session Identity is not present
 1 MBMS Session Identity is present

MBMS Service ID (octet 4, 5 and 6)

The contents of the MBMS Service ID field are coded as octets 3 to 5 of the *Temporary Mobile Group Identity* IE in Figure 10.5.154/3GPP TS 24.008. Therefore, bit 8 of octet 4 is the most significant bit and bit 1 of octet 6 the least significant bit. The coding of the MBMS Service ID is the responsibility of each administration. Coding using full hexadecimal representation may be used. The MBMS Service ID consists of 3 octets.

MCC, Mobile country code (octet 6a, octet 6b bits 1 to 4)

The MCC field is coded as in ITU-T Rec. E.212 [46], Annex A.

<p>MNC, Mobile network code (octet 6b bits 5 to 8, octet 6c)</p> <p>The coding of this field is the responsibility of each administration but BCD coding shall be used. The MNC shall consist of 2 or 3 digits. If a network operator decides to use only two digits in the MNC, bits 5 to 8 of octet 6b shall be coded as "1111".</p> <p>The contents of the MCC and MNC digits are coded as octets 6 to 8 of the <i>Temporary Mobile Group Identity</i> IE in Figure 10.5.154/3GPP TS 24.008.</p> <p>MBMS Session Identity (octet 7)</p> <p>The MBMS Session Identity field is encoded as the value part of the MBMS Session Identity IE as specified in 3GPP TS 48.018 [86].</p>
<p>NOTE 1: This can be used in the case when a fill paging message without any valid identity has to be sent on the paging subchannel and when the requested identity is not available at the mobile station during the identity request procedure.</p>

10.5.1.5 Mobile Station Classmark 1

The purpose of the *Mobile Station Classmark 1* information element is to provide the network with information concerning aspects of high priority of the mobile station equipment. This affects the manner in which the network handles the operation of the mobile station. The Mobile Station Classmark information indicates general mobile station characteristics and it shall therefore, except for fields explicitly indicated, be independent of the frequency band of the channel it is sent on.

The *Mobile Station Classmark 1* information element is coded as shown in figure 10.5.5/3GPP TS 24.008 and table 10.5.5/3GPP TS 24.008.

The *Mobile Station Classmark 1* is a type 3 information element with 2 octets length.

8	7	6	5	4	3	2	1	
Mobile Station Classmark 1 IE1								octet 1
0 spare	Revision level	ES IND	A5/1	RF power capability				octet 2

Figure 10.5.5/3GPP TS 24.008 Mobile Station Classmark 1 information element

Table 10.5.5/3GPP TS 24.008: *Mobile Station Classmark 1* information element

Revision level (octet 2)

Bits

7 6

- | | | |
|---|---|--|
| 0 | 0 | Reserved for GSM phase 1 |
| 0 | 1 | Used by GSM phase 2 mobile stations |
| 1 | 0 | Used by mobile stations supporting R99 or later versions of the protocol |
| 1 | 1 | Reserved for future use. If the network receives a revision level specified as 'reserved for future use', then it shall use the highest revision level supported by the network. |

ES IND (octet 2, bit 5) "Controlled Early Classmark Sending" option implementation

An MS not supporting A/Gb mode shall set this bit to '0'.

An MS supporting A/Gb mode shall indicate the associated capability (see table):

- | | |
|---|--|
| 0 | "Controlled Early Classmark Sending" option is not implemented in the MS |
| 1 | "Controlled Early Classmark Sending" option is implemented in the MS |

NOTE 1: The value of the ES IND gives the implementation in the MS. It's value is **not** dependent on the broadcast SI 3 Rest Octet <Early Classmark Sending Control> value.

A5/1 algorithm supported (octet 2, bit4) (Note 2)

An MS not supporting A/Gb mode shall set this bit to '1'.

An MS supporting A/Gb mode shall indicate the associated capability (see table):

- | | |
|---|---|
| 0 | encryption algorithm A5/1 available |
| 1 | encryption algorithm A5/1 not available |

RF power capability (octet 2)

When GSM 450, GSM 480, GSM 710, GSM 750, T-GSM 810, GSM 850, GSM 900 P, E [or R] band is used (for exceptions see 3GPP TS 44.018 [84]), the MS shall indicate the RF power capability of the band used (see table):

When UMTS is used, a single band GSM 450, GSM 480, GSM 710, GSM 750, T-GSM 810, GSM 850, GSM 900 P, E [or R] MS shall indicate the RF power capability corresponding to the (GSM) band it supports (see table). In this case information on which single band is supported is found in classmark 3.

Bits

3 2 1

- | | | | |
|---|---|---|---------|
| 0 | 0 | 0 | class 1 |
| 0 | 0 | 1 | class 2 |
| 0 | 1 | 0 | class 3 |
| 0 | 1 | 1 | class 4 |
| 1 | 0 | 0 | class 5 |

All other values are reserved.

When the GSM 1800 or GSM 1900 band is used (for exceptions see 3GPP TS 44.018 [84], sub-clause 3.4.18), the MS shall indicate the RF power capability of the band used (see table):

When UMTS is used, a single band GSM 1800 or GSM 1900 MS shall indicate the RF power capability corresponding to the (GSM) band it supports (see table). In this case, information on which single band is supported is found in classmark 3.

Bits

3 2 1

- | | | | |
|---|---|---|---------|
| 0 | 0 | 0 | class 1 |
| 0 | 0 | 1 | class 2 |
| 0 | 1 | 0 | class 3 |

All other values are reserved.

When UMTS is used, an MS not supporting any GSM band or a multiband GSM MS shall code this field as follows (see table):

Bits

3 2 1

- | | | | |
|---|---|---|--|
| 1 | 1 | 1 | RF power capability is irrelevant in this information element. |
|---|---|---|--|

All other values are reserved.

NOTE 2: The requirements for the support of the A5 algorithms in the MS are specified in 3GPP TS 43.020 [13].

10.5.1.6 Mobile Station Classmark 2

The purpose of the *Mobile Station Classmark 2* information element is to provide the network with information concerning aspects of both high and low priority of the mobile station equipment. This affects the manner in which the network handles the operation of the mobile station. The Mobile Station Classmark information indicates general mobile station characteristics and it shall therefore, except for fields explicitly indicated, be independent of the frequency band of the channel it is sent on.

The *Mobile Station Classmark 2* information element is coded as shown in figure 10.5.6/3GPP TS 24.008, table 10.5.6a/3GPP TS 24.008 and table 10.5.6b/3GPP TS 24.008.

The *Mobile Station Classmark 2* is a type 4 information element with 5 octets length.

8	7	6	5	4	3	2	1	
Mobile station classmark 2 IEI								octet 1
Length of mobile station classmark 2 contents								octet 2
0 spare	Revision level		ES IND	A5/1	RF power capability			octet 3
0 spare	PS capa.	SS Screen. Indicator		SM ca pabi.	VBS	VGCS	FC	octet 4
CM3	0 spare	LCSVA CAP	UCS2	SoLSA	CMSP	A5/3	A5/2	octet 5

NOTE 1: Owing to backward compatibility problems, bit 8 of octet 4 should not be used unless it is also checked that the bits 8, 7 and 6 of octet 3 are not "0 0 0".

Figure 10.5.6/3GPP TS 24.008 Mobile Station Classmark 2 information element

Table 10.5.6a/3GPP TS 24.008: Mobile Station Classmark 2 information element

Revision level (octet 3)	
Bits	
7	6
0	0
Reserved for GSM phase 1	
0	1
Used by GSM phase 2 mobile stations	
1	0
Used by mobile stations supporting R99 or later versions of the protocol	
1	1
Reserved for future use. If the network receives a revision level specified as 'reserved for future use', then it shall use the highest revision level supported by the network.	
ES IND (octet 3, bit 5) "Controlled Early Classmark Sending" option implementation	
AN MS not supporting A/Gb mode shall set this bit to '0'.	
An MS supporting A/Gb mode shall indicate the associated capability (see table):	
0	"Controlled Early Classmark Sending" option is not implemented in the MS
1	"Controlled Early Classmark Sending" option is implemented in the MS
NOTE 1: The value of the ES IND gives the implementation in the MS. It's value is not dependent on the broadcast SI 3 Rest Octet <Early Classmark Sending Control> value	

Table 10.5.6a/3GPP TS 24.008: Mobile Station Classmark 2 information element

A5/1 algorithm supported (octet 3, bit 4) (Note 4)	
An MS not supporting A/Gb mode shall set this bit to '1'.	
An MS supporting A/Gb mode shall indicate the associated capability (see table)	
0	encryption algorithm A5/1 available
1	encryption algorithm A5/1 not available
RF Power Capability (Octet 3)	
When T-GSM 380, T-GSM 410, GSM 450, GSM 480, GSM 710, GSM 750, T-GSM 810, GSM 850, GSM 900 P, E [or R] band is used (for exceptions see 3GPP TS 44.018 [84]), the MS shall indicate the RF power capability of the band used (see table).	
When UMTS or E-UTRAN is used, a single band T-GSM 380, T-GSM 410, GSM 450, GSM 480, GSM 710, GSM 750, T-GSM 810, GSM 850, GSM 900 P, E [or R] MS shall indicate the RF power capability corresponding to the (GSM) band it supports (see table). In this case, information on which single band is supported is found in classmark 3.	
Bits	
3 2 1	
0 0 0	class 1
0 0 1	class 2
0 1 0	class 3
0 1 1	class 4
1 0 0	class 5
All other values are reserved.	
When the GSM 1800 or GSM 1900 band is used (for exceptions see 3GPP TS 44.018 [84]) The MS shall indicate the RF power capability of the band used (see table).	
When UMTS or E-UTRAN is used, a single band GSM 1800 or GSM 1900 MS shall indicate the RF power capability corresponding to the (GSM) band it supports (see table). In this case, information on which single band is supported is found in classmark 3	
Bits	
3 2 1	
0 0 0	class 1
0 0 1	class 2
0 1 0	class 3
All other values are reserved.	
When UMTS or E-UTRAN is used, an MS not supporting any GSM band or a multiband GSM MS shall code this field as follows (see table):	
Bits	
3 2 1	
1 1 1	RF Power capability is irrelevant in this information element
All other values are reserved.	
PS capability (pseudo-synchronization capability) (octet 4)	
An MS not supporting A/Gb mode shall set this bit to '0'.	
An MS supporting A/Gb mode shall indicate the associated capability (see table):	
Bit 7	
0	PS capability not present
1	PS capability present
SS Screening Indicator (octet 4)	
Bits	
6 5	
0 0	defined in 3GPP TS 24.080 [24]
0 1	defined in 3GPP TS 24.080 [24]
1 0	defined in 3GPP TS 24.080 [24]
1 1	defined in 3GPP TS 24.080 [24]
SM capability (MT SMS pt to pt capability) (octet 4)	
Bit 4	
0	Mobile station does not support mobile terminated point to point SMS
1	Mobile station supports mobile terminated point to point SMS

Table 10.5.6a/3GPP TS 24.008: Mobile Station Classmark 2 information element

VBS notification reception (octet 4)	
An MS not supporting A/Gb mode shall set this bit to '0'.	
An MS supporting A/Gb mode shall indicate the associated capability (see table):	
Bit 3	
0	no VBS capability or no notifications wanted
1	VBS capability and notifications wanted
VGCS notification reception (octet 4)	
An MS not supporting A/Gb mode shall set this bit to '0'.	
An MS supporting A/Gb mode shall indicate the associated capability (see table):	
Bit 2	
0	no VGCS capability or no notifications wanted
1	VGCS capability and notifications wanted
FC Frequency Capability (octet 4)	
When the T-GSM 400, GSM 400, or GSM 700, or T-GSM 810, or GSM 850, or GSM 1800, or GSM 1900 band or UMTS or E-UTRAN is used (for exceptions see 3GPP TS 44.018 [84]), for definitions of frequency band see 3GPP TS 45.005 [33]), this bit shall be sent with the value '0'.	
NOTE 2: This bit conveys no information about support or non support of the E-GSM or R-GSM bands when T-GSM 400, GSM 400, GSM 700, T-GSM 810, GSM 850, GSM 1800, GSM 1900 band or UMTS or E-UTRAN is used.	
When a GSM 900 band is used (for exceptions see 3GPP TS 44.018 [84]):	
Bit 1	
0	The MS does not support the E-GSM or R-GSM band (For definition of frequency bands see 3GPP TS 45.005 [33])
1	The MS does support the E-GSM or R-GSM (For definition of frequency bands see 3GPP TS 45.005 [33])
NOTE 3: For mobile station supporting the R-GSM band further information can be found in MS Classmark 3.	
CM3 (octet 5, bit 8)	
0	The MS does not support any options that are indicated in CM3
1	The MS supports options that are indicated in classmark 3 IE
LCS VA capability (LCS value added location request notification capability) (octet 5, bit 6)	
This information field indicates the support of the LCS value added location request notification via CS domain as defined in 3GPP TS 23.271 [105].	
0	location request notification via CS domain not supported
1	location request notification via CS domain supported
UCS2 treatment (octet 5, bit 5)	
This information field indicates the likely treatment by the mobile station of UCS2 encoded character strings. For backward compatibility reasons, if this field is not included, the value 0 shall be assumed by the receiver.	
0	the ME has a preference for the default alphabet (defined in 3GPP TS 23.038 [8b]) over UCS2.
1	the ME has no preference between the use of the default alphabet and the use of UCS2.

Table 10.5.6a/3GPP TS 24.008: Mobile Station Classmark 2 information element

SoLSA (octet 5, bit 4)	
An MS not supporting A/Gb mode shall set this bit to '0'.	
An MS supporting A/Gb mode shall indicate the associated capability (see table):	
0	The ME does not support SoLSA.
1	The ME supports SoLSA.
CMSP: CM Service Prompt (octet 5, bit 3) \$(CCBS)\$	
0	"Network initiated MO CM connection request" not supported.
1	"Network initiated MO CM connection request" supported for at least one CM protocol.
A5/3 algorithm supported (octet 5, bit 2) (Note 4)	
An MS not supporting A/Gb mode shall set this bit to '0'.	
An MS supporting A/Gb mode shall indicate the associated capability (see table):	
0	encryption algorithm A5/3 not available
1	encryption algorithm A5/3 available
A5/2 algorithm supported (octet 5, bit 1) (Note 4)	
The MS shall set this bit to '0'.	
The network shall accept any received value.	
0	encryption algorithm A5/2 not available
1	Not used. This value was allocated in earlier versions of the protocol.
NOTE 4: The requirements for the support of the A5 algorithms in the MS are specified in 3GPP TS 43.020 [13].	

NOTE 2: Additional mobile station capability information might be obtained by invoking the classmark interrogation procedure when GSM is used.

10.5.1.7 Mobile Station Classmark 3

The purpose of the *Mobile Station Classmark 3* information element is to provide the network with information concerning aspects of the mobile station. The contents might affect the manner in which the network handles the operation of the mobile station. The Mobile Station Classmark information indicates general mobile station characteristics and it shall therefore, except for fields explicitly indicated, be independent of the frequency band of the channel it is sent on.

The *Mobile Station Classmark 3* is a type 4 information element with a maximum of 34 octets length.

The value part of a *Mobile Station Classmark 3* information element is coded as shown in figure 10.5.1.7/3GPP TS 24.008 and table 10.5.1.7/3GPP TS 24.008.

NOTE: The 34 octet limit is so that the CLASSMARK CHANGE message will fit in up to two layer 2 frames.

SEMANTIC RULE: a multiband mobile station shall provide information about all frequency bands it can support. A single band mobile station shall not indicate the band it supports in the *Multiband Supported*, *GSM 400 Bands Supported*, *GSM 710 Associated Radio Capability*, *GSM 750 Associated Radio Capability*, *T-GSM 810 Associated Radio Capability*, *GSM 850 Associated Radio Capability* or *GSM 1900 Associated Radio Capability* fields in the *Mobile Station Classmark 3*. Due to shared radio frequency channel numbers between GSM 1800 and GSM 1900, the mobile should indicate support for either GSM 1800 band OR GSM 1900 band.

SEMANTIC RULE: a mobile station shall include the MS Measurement Capability field if the *Multi Slot Class* field contains a value of 19 or greater (see 3GPP TS 45.002 [32]).

Typically, the number of spare bits at the end is the minimum to reach an octet boundary. The receiver may add any number of bits set to "0" at the end of the received string if needed for correct decoding.

```

<Classmark 3 Value part> ::=
  < spare bit >
  { < Multiband supported : { 000 } >
    < A5 bits >
  | < Multiband supported : { 101 | 110 } >
    < A5 bits >
    < Associated Radio Capability 2 : bit(4) >
    < Associated Radio Capability 1 : bit(4) >
  | < Multiband supported : { 001 | 010 | 100 } >
    < A5 bits >
    < spare bit >(4)
    < Associated Radio Capability 1 : bit(4) > }
  { 0 | 1 < R Support > }
  { 0 | 1 < HSCSD Multi Slot Capability > }
  < UCS2 treatment: bit >
  < Extended Measurement Capability : bit >
  { 0 | 1 < MS measurement capability > }
  { 0 | 1 < MS Positioning Method Capability > }
  { 0 | 1 < ECSD Multi Slot Capability > }
  { 0 | 1 < 8-PSK Struct > }
  { 0 | 1 < GSM 400 Bands Supported : { 01 | 10 | 11 } >
    < GSM 400 Associated Radio Capability: bit(4) > }

  { 0 | 1 <GSM 850 Associated Radio Capability : bit(4) > }
  { 0 | 1 <GSM 1900 Associated Radio Capability : bit(4) > }
  < UMTS FDD Radio Access Technology Capability : bit >
  < UMTS 3.84 Mcps TDD Radio Access Technology Capability : bit >
  < CDMA 2000 Radio Access Technology Capability : bit >

  { 0 | 1 < DTM GPRS Multi Slot Class : bit(2) >
    < Single Slot DTM : bit >
    { 0 | 1 < DTM EGPRS Multi Slot Class : bit(2) > } }
  { 0 | 1 < Single Band Support > }
  { 0 | 1 <GSM 750 Associated Radio Capability : bit(4)>}
  -- Release 4 starts here.

  < UMTS 1.28 Mcps TDD Radio Access Technology Capability : bit >
  < GERAN Feature Package 1 : bit >

  { 0 | 1 < Extended DTM GPRS Multi Slot Class : bit(2) >
    < Extended DTM EGPRS Multi Slot Class : bit(2) > }

  { 0 | 1 < High Multislot Capability : bit(2) > }
  --Release 5 starts here.

  0 -- The value '1' was allocated in an earlier version of the protocol and shall not be used.
  < GERAN Feature Package 2 : bit >

  < GMSK Multislot Power Profile : bit (2) >
  < 8-PSK Multislot Power Profile : bit (2) >

  { 0 | 1 < T-GSM 400 Bands Supported : { 01 | 10 | 11 } >
    < T-GSM 400 Associated Radio Capability: bit(4) > }
  -- Release 6 starts here.

  0 -- The value '1' was allocated in an earlier version of the protocol and shall not be used.

  < Downlink Advanced Receiver Performance : bit (2)>

  < DTM Enhancements Capability : bit >

  { 0 | 1 < DTM GPRS High Multi Slot Class : bit(3) >
    < Offset required : bit>
    { 0 | 1 < DTM EGPRS High Multi Slot Class : bit(3) > } }

  < Repeated ACCH Capability : bit >

  { 0 | 1 <GSM 710 Associated Radio Capability : bit(4)>}
  { 0 | 1 <T-GSM 810 Associated Radio Capability : bit(4)>}
  -- Release 7 starts here.
  < Ciphering Mode Setting Capability : bit >

```

```

< Additional Positioning Capabilities : bit >

< E-UTRA FDD support : bit > -- Release 8 starts here
< E-UTRA TDD support : bit >
< E-UTRA Measurement and Reporting support : bit >
< Priority-based reselection support : bit >

< UTRA CSG Cells Reporting : bit > -- Release 9 starts here
< VAMOS Level : bit(2) >

< TIGHTER Capability : bit(2) > -- Release 10 starts here
< Selective Ciphering of Downlink SACCH : bit >

< CS to PS SRVCC from GERAN to UTRA : bit(2) > -- Release 11 starts here
< CS to PS SRVCC from GERAN to E-UTRA : bit(2)>

< GERAN Network Sharing support : bit >
< E-UTRA Wideband RSRQ measurements support : bit >

< ER Band Support : bit > -- Release 12 starts here
< UTRA Multiple Frequency Band Indicators support : bit >
< E-UTRA Multiple Frequency Band Indicators support: bit >
< Extended TSC Set Capability support: bit >
< Extended EARFCN value range : bit > -- Late addition of a release 11 feature
< spare bits > ;

< A5 bits > ::=
  < A5/7 : bit > < A5/6 : bit > < A5/5 : bit > < A5/4 : bit > ;

<R Support>::=
  < R-GSM band Associated Radio Capability : bit(3) > ;

< HSCSD Multi Slot Capability > ::=
  < HSCSD Multi Slot Class : bit(5) > ;

< MS Measurement capability > ::=
  < SMS_VALUE : bit (4) >
  < SM_VALUE : bit (4) > ;

< MS Positioning Method Capability > ::=
  < MS Positioning Method : bit(5) > ;

< ECSD Multi Slot Capability > ::=
  < ECSD Multi Slot Class : bit(5) > ;

< 8-PSK Struct> ::=
  < Modulation Capability : bit >
  { 0 | 1 < 8-PSK RF Power Capability 1: bit(2) > }
  { 0 | 1 < 8-PSK RF Power Capability 2: bit(2) > }

< Single Band Support > ::=
  < GSM Band : bit (4) > ;

```

Figure 10.5.1.7/3GPP TS 24.008 Mobile Station Classmark 3 information element

Table 10.5.1.7/3GPP TS 24.008: Mobile Station Classmark 3 information element

Multiband Supported (3 bit field)	
Band 1 supported	
Bit 1	
0	P-GSM not supported
1	P-GSM supported
Band 2 supported	
Bit 2	
0	E-GSM or R-GSM not supported
1	E-GSM or R-GSM supported
Band 3 supported	
Bit 3	
0	GSM 1800 not supported
1	GSM 1800 supported
The indication of support of P-GSM band or E-GSM or R-GSM band is mutually exclusive.	
When the 'Band 2 supported' bit indicates support of E-GSM or R-GSM, the presence of the <R Support> field, see below, indicates if the E-GSM or R-GSM band is supported.	
In this version of the protocol, the sender indicates in this field either none, one or two of these 3 bands supported.	
For single band mobile station or a mobile station supporting none of the GSM 900 bands(P-GSM, E-GSM and R-GSM) and GSM 1800 bands, all bits are set to 0.	
A5/4	
0	Encryption algorithm A5/4 not available
1	Encryption algorithm A5/4 available
A5/5	
0	Encryption algorithm A5/5 not available
1	Encryption algorithm A5/5 available
A5/6	
0	Encryption algorithm A5/6 not available
1	Encryption algorithm A5/6 available
A5/7	
0	Encryption algorithm A5/7 not available
1	Encryption algorithm A5/7 available
Associated Radio capability 1 and 2 (4 bit fields)	
If either of P-GSM or E-GSM or R-GSM is supported, the radio capability 1 field indicates the radio capability for P-GSM, E-GSM or R-GSM, and the radio capability 2 field indicates the radio capability for GSM 1800 if supported, and is spare otherwise.	
If none of P-GSM or E-GSM or R-GSM are supported, the radio capability 1 field indicates the radio capability for GSM 1800, and the radio capability 2 field is spare.	
The radio capability contains the binary coding of the power class associated with the band indicated in multiband support bits (see 3GPP TS 45.005 [33]).	

(continued...)

Table 10.5.1.7/3GPP TS 24.008 (continued): Mobile Station Classmark 3 information element**R-GSM band Associated Radio Capability (3 bit field)**

In case where the R-GSM band is supported the R-GSM band associated radio capability field contains the binary coding of the power class associated (see 3GPP TS 45.005 [33]) (regardless of the number of GSM bands supported). A mobile station supporting the R-GSM band shall also when appropriate, (see 10.5.1.6) indicate its support in the 'FC' bit in the Mobile Station Classmark 2 information element.

NOTE: The coding of the power class for P-GSM, E-GSM, R-GSM and GSM 1800 in radio capability 1 and/or 2 is different to that used in the Mobile Station Classmark 1 and Mobile Station Classmark 2 information elements.

HSCSD Multi Slot Class (5 bit field)

In case the MS supports the use of multiple timeslots for HSCSD then the HSCSD Multi Slot Class field is coded as the binary representation of the multislot class defined in 3GPP TS 45.002 [32].

UCS2 treatment (1 bit field)

This information field indicates the likely treatment by the mobile station of UCS2 encoded character strings. If not included, the value 0 shall be assumed by the receiver.

- 0 the ME has a preference for the default alphabet (defined in 3GPP TS 23.038 [8b]) over UCS2.
- 1 the ME has no preference between the use of the default alphabet and the use of UCS2.

Extended Measurement Capability (1 bit field)

This bit indicates whether the mobile station supports 'Extended Measurements' or not

- 0 the MS does not support Extended Measurements
- 1 the MS supports Extended Measurements

SMS_VALUE (Switch-Measure-Switch) (4 bit field)

The SMS field indicates the time needed for the mobile station to switch from one radio channel to another, perform a neighbour cell power measurement, and the switch from that radio channel to another radio channel.

Bits

- | | |
|---------|------------------------------------|
| 4 3 2 1 | |
| 0 0 0 0 | 1/4 timeslot (~144 microseconds) |
| 0 0 0 1 | 2/4 timeslot (~288 microseconds) |
| 0 0 1 0 | 3/4 timeslot (~433 microseconds) |
| ... | |
| 1 1 1 1 | 16/4 timeslot (~2307 microseconds) |

SM_VALUE (Switch-Measure) (4 bit field)

The SM field indicates the time needed for the mobile station to switch from one radio channel to another and perform a neighbour cell power measurement.

Bits

- | | |
|---------|------------------------------------|
| 4 3 2 1 | |
| 0 0 0 0 | 1/4 timeslot (~144 microseconds) |
| 0 0 0 1 | 2/4 timeslot (~288 microseconds) |
| 0 0 1 0 | 3/4 timeslot (~433 microseconds) |
| ... | |
| 1 1 1 1 | 16/4 timeslot (~2307 microseconds) |

MS Positioning Method (5 bit field)

This field indicates the Positioning Method(s) supported by the mobile station for the provision of location services (LCS) via the CS domain in A-mode.

MS assisted E-OTD

Bit 5

- 0 MS assisted E-OTD not supported
- 1 MS assisted E-OTD supported

Table 10.5.1.7/3GPP TS 24.008 (continued): Mobile Station Classmark 3 information element

<u>MS based E-OTD</u>	
<u>Bit 4</u>	
0	MS based E-OTD not supported
1	MS based E-OTD supported
<u>MS assisted GPS</u>	
<u>Bit 3</u>	
0	MS assisted GPS not supported
1	MS assisted GPS supported
<u>MS based GPS</u>	
<u>Bit 2</u>	
0	MS based GPS not supported
1	MS based GPS supported
<u>MS Conventional GPS</u>	
<u>Bit 1</u>	
0	conventional GPS not supported
1	conventional GPS supported
ECSD Multi Slot class (5 bit field)	
An MS that supports ECSD shall include this field to indicate its ECSD capability. Whether the MS is capable of 8-PSK modulation in uplink is indicated by the value of the Modulation Capability field in the 8-PSK struct. The ECSD Multi Slot Class field is coded as the binary representation of the multislot class defined in 3GPP TS 45.002 [32].	
8-PSK struct	
The MS shall include the 8-PSK struct if it supports ECSD or DTM EGPRS or both.	
Modulation Capability	
The Modulation Capability field indicates the modulation scheme the MS supports in addition to GMSK.	
0	8-PSK supported for downlink reception only
1	8-PSK supported for uplink transmission and downlink reception
8-PSK RF Power Capability 1 (2 bit field)	
If 8-PSK modulation is supported for both uplink and downlink, the 8-PSK RF Power Capability 1 field indicates the radio capability for 8-PSK modulation in GSM 400, GSM 700, GSM 850 or GSM 900.	
8-PSK RF Power Capability 2 (2 bit field)	
If 8-PSK modulation is supported for both uplink and downlink, the 8-PSK RF Power Capability 2 field indicates the radio capability for 8-PSK modulation in GSM 1800 or GSM 1900 if supported, and is not included otherwise.	
The respective 8-PSK RF Power Capability 1 and 8-PSK RF Power Capability 2 fields contain the following coding of the 8-PSK modulation power class (see 3GPP TS 45.005 [33]):	
Bits	2 1
	0 0 Reserved
	0 1 Power class E1
	1 0 Power class E2
	1 1 Power class E3

Table 10.5.1.7/3GPP TS 24.008 (continued): Mobile Station Classmark 3 information element**GSM 400 Bands Supported (2 bit field)**

See the semantic rule for the sending of this field.

Bits

2 1	
0 1	GSM 480 supported, GSM 450 not supported
1 0	GSM 450 supported, GSM 480 not supported
1 1	GSM 450 supported, GSM 480 supported

GSM 400 Associated Radio Capability (4 bit field)

If either GSM 450 or GSM 480 or both is supported, the GSM 400 Associated Radio Capability field indicates the radio capability for GSM 450 and/or GSM 480.

The radio capability contains the binary coding of the power class associated with the band indicated in GSM 400 Bands Supported bits (see 3GPP TS 45.005 [33]).

NOTE: The coding of the power class for GSM 450 and GSM 480 in GSM 400 Associated Radio Capability is different to that used in the Mobile Station Classmark 1 and Mobile Station Classmark 2 information elements.

GSM 850 Associated Radio Capability (4 bit field)

See the semantic rule for the sending of this field.

This field indicates whether GSM 850 band is supported and its associated radio capability.

The radio capability contains the binary coding of the power class associated with the GSM 850 band (see 3GPP TS 45.005 [33]).

Note: the coding of the power class for GSM 850 in GSM 850 Associated Radio Capability is different to that used in the Mobile Station Classmark 1 and Mobile Station Classmark 2 information elements.

GSM 1900 Associated Radio Capability (4 bit field)

See the semantic rule for the sending of this field.

This field indicates whether GSM 1900 band is supported and its associated radio capability.

The radio capability contains the binary coding of the power class associated with the GSM 1900 band (see 3GPP TS 45.005 [33]).

Note: the coding of the power class for GSM 1900 in GSM 1900 Associated Radio Capability is different to that used in the Mobile Station Classmark 1 and Mobile Station Classmark 2 information elements.

Table 10.5.1.7/3GPP TS 24.008 (continued): *Mobile Station Classmark 3* information element

UMTS FDD Radio Access Technology Capability (1 bit field)

- 0 UMTS FDD not supported
- 1 UMTS FDD supported

UMTS 3.84 Mcps TDD Radio Access Technology Capability (1 bit field)

- 0 UMTS 3.84 Mcps TDD not supported
- 1 UMTS 3.84 Mcps TDD supported

CDMA 2000 Radio Access Technology Capability (1 bit field)

- 0 CDMA2000 not supported
- 1 CDMA2000 supported

DTM GPRS Multi Slot Class (2 bit field)

This field indicates the DTM GPRS multislot capabilities of the MS. It is coded as follows:

Bit

- | | |
|-----|---|
| 2 1 | |
| 0 0 | Unused. If received, the network shall interpret this as '01' |
| 0 1 | Multislot class 5 supported |
| 1 0 | Multislot class 9 supported |
| 1 1 | Multislot class 11 supported |

If a multislot class type 1 MS indicates the support of a DTM GPRS multislot class for which three uplink timeslots can be assigned, the mobile station shall support Extended Dynamic Allocation.

This field shall contain one of the following values if the *DTM GPRS High Multi Slot Class* field is present:

- Multislot class 9 if DTM GPRS High Multi Slot Class is set to indicate Class 31/36 or Class 41;
- Multislot class 11 if DTM GPRS High Multi Slot Class is set to indicate Classes 32/37, 33/38 or Classes 42, 43, 44.

The same multislot capability is applicable also for EGPRS2 if supported.

Single Slot DTM (1 bit field)

This field indicates whether the MS supports single slot DTM operation (see 3GPP TS 43.055 [87]). It is coded as follows:

- 0 Single Slot DTM not supported
- 1 Single Slot DTM supported

An MS indicating support for Extended DTM GPRS multislot class or Extended DTM EGPRS multislot class shall set this bit to '1'. The network may ignore the bit in this case.

DTM EGPRS Multi Slot Class (2 bit field)

This field indicates the DTM EGPRS multislot capabilities of the MS. Whether the MS is capable of 8-PSK modulation in uplink is indicated by the value of the Modulation Capability field in the 8-PSK struct. This field shall be included only if the mobile station supports EGPRS DTM. This field is coded as the DTM GPRS Multi Slot Class field.

If a multislot class type 1 MS indicates the support of a DTM EGPRS multislot class for which three uplink timeslots can be assigned, the mobile station shall support Extended Dynamic Allocation.

This field shall contain one of the following values if the *DTM EGPRS High Multi Slot Class* field is present:

- Multislot class 9 if DTM EGPRS High Multi Slot Class is set to indicate Class 31/36 or Class 41;
- Multislot class 11 if DTM EGPRS High Multi Slot Class is set to indicate Classes 32/37, 33/38 or Classes 42, 43, 44.

Single Band Support

This field shall be sent if the mobile station supports UMTS and one and only one GSM band with the exception of R-GSM; this field shall not be sent otherwise

GSM Band (4 bit field)

Bits

- | | |
|---------|-----------------------|
| 4 3 2 1 | |
| 0 0 0 0 | E-GSM is supported |
| 0 0 0 1 | P-GSM is supported |
| 0 0 1 0 | GSM 1800 is supported |
| 0 0 1 1 | GSM 450 is supported |

0 1 0 0 GSM 480 is supported
 0 1 0 1 GSM 850 is supported
 0 1 1 0 GSM 1900 is supported
 0 1 1 1 GSM 750 is supported
 1 0 0 0 GSM 710 is supported
 1 0 0 1 T-GSM 810 is supported

All other values are reserved for future use.

NOTE: When this field is received, the associated RF power capability is found in Classmark 1 or 2.

GSM 750 Associated Radio Capability (4 bit field)

See the semantic rule for the sending of this field.

This field indicates whether GSM 750 band is supported and its associated radio capability.

The radio capability contains the binary coding of the power class associated with the GSM 750 band (see 3GPP TS 45.005 [33]).

NOTE: The coding of the power class for GSM 750 in GSM 750 Associated Radio Capability is different to that used in the Mobile Station Classmark 1 and Mobile Station Classmark 2 information elements.

UMTS 1.28 Mcps TDD Radio Access Technology Capability (1 bit field)

0 UMTS 1.28 Mcps TDD not supported
 1 UMTS 1.28 Mcps TDD supported

GERAN Feature Package 1 (1 bit field)

This field indicates whether the MS supports the GERAN Feature Package 1 (see 3GPP TS 44.060 [76]). It is coded as follows:

0 GERAN feature package 1 not supported.
 1 GERAN feature package 1 supported.

Extended DTM GPRS Multi Slot Class (2 bit field)

This field indicates the extended DTM GPRS multislot capabilities of the MS and shall be interpreted in conjunction with the DTM GPRS Multi Slot Class field. It is coded as follows, where 'DGMSC' denotes the DTM GPRS Multi Slot Class field:

DGMSC Bit	2 1	Bit 2 1	
0 0	0 0	0 0	Unused. If received, it shall be interpreted as '01 00'
0 0	0 0	0 1	Unused. If received, it shall be interpreted as '01 00'
0 0	0 0	1 0	Unused. If received, it shall be interpreted as '01 00'
0 0	0 0	1 1	Unused. If received, it shall be interpreted as '01 00'
0 1	0 0	0 0	Multislot class 5 supported
0 1	0 0	0 1	Multislot class 6 supported
0 1	0 0	1 0	Unused. If received, it shall be interpreted as '01 00'
0 1	0 0	1 1	Unused. If received, it shall be interpreted as '01 00'
1 0	0 0	0 0	Multislot class 9 supported
1 0	0 0	0 1	Multislot class 10 supported
1 0	0 0	1 0	Unused. If received, it shall be interpreted as '10 00'
1 0	0 0	1 1	Unused. If received, it shall be interpreted as '10 00'
1 1	0 0	0 0	Multislot class 11 supported
1 1	0 0	0 1	Unused. If received, it shall be interpreted as '11 00'
1 1	0 0	1 0	Unused. If received, it shall be interpreted as '11 00'
1 1	0 0	1 1	Unused. If received, it shall be interpreted as '11 00'

The presence of this field indicates that the MS supports combined fullrate and halfrate GPRS channels in the downlink. When this field is not present, the MS supports the multislot class indicated by the *DTM GPRS Multi Slot Class field*.

If this field is included, it shall contain one of the following values if the *DTM GPRS High Multi Slot Class field* is present:

- Multislot class 10 if DTM GPRS High Multi Slot Class is set to indicate Class 31/36 or Class 41;
- Multislot class 11 if DTM GPRS High Multi Slot Class is set to indicate Classes 32/37, 33/38 or Classes 42, 43, 44.

Extended DTM EGPRS Multi Slot Class (2 bit field)

This field is not considered when the DTM EGPRS Multi Slot Class field is not included. This field indicates the extended DTM EGPRS multislot capabilities of the MS and shall be interpreted in conjunction with the DTM

EGPRS Multi Slot Class field. This field is coded as the Extended DTM GPRS Multi Slot Class field. The presence of this field indicates that the MS supports combined fullrate and halfrate GPRS channels in the downlink. When this field is not present, the MS supports the multislot class indicated by the *DTM EGPRS Multi Slot Class* field.

If this field is included, it shall contain one of the following values if the *DTM EGPRS High Multi Slot Class* field is present:

- Multislot class 10 if DTM EGPRS High Multi Slot Class is set to indicate Class 31/36 or Class 41;
- Multislot class 11 if DTM EGPRS High Multi Slot Class is set to indicate Classes 32/37, 33/38 or Classes 42, 43, 44.

High Multislot Capability (2 bit field)

This field indicates the support of multislot classes 30 to 45, see 3GPP TS 45.002 [32].

The High Multislot Capability is individually combined with each multislot class field sent by the MS (the possible multislot class fields are: GPRS multislot class, EGPRS multislot class) to extend the related multislot class with the rule described in the MS Radio Access Capability IE. The same capability is applicable also to EGPRS2 if supported.

GERAN Feature Package 2 (1 bit field)

This field indicates the MS support of the GERAN Feature Package 2. The GERAN Feature Package 2 includes **Enhanced Power Control (EPC)** (see 3GPP TS 45.008 [34]).

- 0 GERAN feature package 2 not supported.
- 1 GERAN feature package 2 supported.

GMSK Multislot Power Profile (2 bit field)

This field indicates the GMSK multislot power capability parameter GMSK_MULTISLOT_POWER_PROFILE as described in 3GPP TS 45.005 [33].

Bits

- 2 1
- 0 0 GMSK_MULTISLOT_POWER_PROFILE 0
- 0 1 GMSK_MULTISLOT_POWER_PROFILE 1
- 1 0 GMSK_MULTISLOT_POWER_PROFILE 2
- 1 1 GMSK_MULTISLOT_POWER_PROFILE 3

8-PSK Multislot Power Profile (2 bit field)

This field indicates the 8-PSK multislot power capability parameter 8-PSK_MULTISLOT_POWER_PROFILE as described in 3GPP TS 45.005 [33]. If the MS does not support 8-PSK in the uplink, then it shall set this field to '0'.

Bits

- 2 1
- 0 0 8-PSK_MULTISLOT_POWER_PROFILE 0
- 0 1 8-PSK_MULTISLOT_POWER_PROFILE 1
- 1 0 8-PSK_MULTISLOT_POWER_PROFILE 2
- 1 1 8-PSK_MULTISLOT_POWER_PROFILE 3

T-GSM 400 Bands Supported (2 bit field)

See the semantic rule for the sending of this field.

Bits

- 2 1
- 0 1 T-GSM 380 supported, T-GSM 410 not supported
- 1 0 T-GSM 410 supported, T-GSM 380 not supported
- 1 1 T-GSM 410 supported, T-GSM 380 supported

T-GSM 400 Associated Radio Capability (4 bit field)

If either T-GSM 410 or T-GSM 380 or both is supported, the T-GSM 400 Associated Radio Capability field indicates the radio capability for T-GSM 410 and/or T-GSM 380.

The radio capability contains the binary coding of the power class associated with the band indicated in T-GSM 400 Bands Supported bits (see 3GPP TS 45.005 [33]).

NOTE: The coding of the power class for T-GSM 410 and T-GSM 380 in T-GSM 400 Associated Radio Capability is different to that used in the Mobile Station Classmark 1 and Mobile Station Classmark 2 information elements.

Downlink Advanced Receiver Performance (2 bit field)

This field indicates Downlink Advanced Receiver Performance capabilities of the MS (see 3GPP TS 45.005 [33]).

Bits

2 1

0 0 Downlink Advanced Receiver Performance not supported

0 1 Downlink Advanced Receiver Performance – phase I supported

1 0 Downlink Advanced Receiver Performance – phase II supported

The value '11' shall not be used by the MS.

If the value '11' is received by the network, it shall be interpreted as '10'.

DTM Enhancements Capability (1 bit field)

This field indicates whether the mobile station supports enhanced DTM CS establishment and enhanced DTM CS release or not. It is coded as follows:

0 The mobile station does not support enhanced DTM CS establishment and enhanced DTM CS release procedures.

1 The mobile station supports enhanced DTM CS establishment and enhanced DTM CS release procedures.

DTM GPRS High Multi Slot Class (3 bit field)

This field indicates the DTM GPRS multislot capabilities of the MS. It is coded as follows:

Bit

3 2 1

0 0 0 Unused. If received, the network shall interpret this as '0 0 1'

0 0 1 Multislot class 31 or 36 supported

0 1 0 Multislot class 32 or 37 supported

0 1 1 Multislot class 33 or 38 supported

1 0 0 Multislot class 41 supported

1 0 1 Multislot class 42 supported

1 1 0 Multislot class 43 supported

1 1 1 Multislot class 44 supported

The presence of this field indicates that the MS supports the DTM extension to high multislot classes. When this field is not present, the MS supports the DTM multislot class indicated by the *DTM GPRS Multi Slot Class field*.

The values '0 0 1', '0 1 0' and '0 1 1' shall be interpreted as indicating DTM GPRS multislot class 36, 37 or 38 respectively if the *Offset required* field indicates that the offset t_0 is required; in all other cases those codepoints shall be interpreted as indicating DTM GPRS multislot class 31, 32 or 33 respectively.

Offset required (1 bit field)

This field indicates whether the GPRS multislot class of the mobile station is such that the Timing Advance offset t_0 is required (see 3GPP TS 45.002 [32]). It is coded as follows:

0 The mobile station does not require the offset

1 The mobile station requires the offset

DTM EGPRS High Multi Slot Class (3 bit field)

This field indicates the DTM EGPRS multislot capabilities of the MS. This field may be included only if the mobile station supports EGPRS DTM. This field is coded as the DTM GPRS High Multi Slot Class field. When this field is not present, the MS supports the DTM multislot class indicated by the *DTM EGPRS Multi Slot Class field*.

The values '0 0 1', '0 1 0' and '0 1 1' shall be interpreted as indicating DTM EGPRS multislot class 36, 37 or 38 respectively if the *Offset required* field indicates that the Timing Advance offset t_0 is required; in all other cases those codepoints shall be interpreted as indicating DTM EGPRS multislot class 31, 32 or 33 respectively.

The same multislot capability is applicable also for EGPRS2 if supported

Repeated ACCH Capability (1 bit field)

This field indicates whether the MS supports Repeated SACCH and Repeated Downlink FACCH (see 3GPP TS 44.006 [19]). It is coded as follows:

0 The mobile station does not support Repeated SACCH

1 The mobile station supports Repeated SACCH and Repeated Downlink FACCH

An MS that only supports Repeated Downlink FACCH shall set this bit field to '0'.

GSM 710 Associated Radio Capability (4 bit field)

See the semantic rule for the sending of this field.

This field indicates whether GSM 710 band is supported and its associated radio capability.

The radio capability contains the binary coding of the power class associated with the GSM 710 band (see 3GPP TS 45.005 [33]).

NOTE: The coding of the power class for GSM 710 in GSM 710 Associated Radio Capability is different to that used in the Mobile Station Classmark 1 and Mobile Station Classmark 2 information elements.

T-GSM 810 Associated Radio Capability (4 bit field)

See the semantic rule for the sending of this field.

This field indicates whether T- GSM 810 band is supported and its associated radio capability.

The radio capability contains the binary coding of the power class associated with the T-GSM 810 band (see 3GPP TS 45.005 [33]).

NOTE: The coding of the power class for T-GSM 810 in T-GSM 810 Associated Radio Capability is different to that used in the Mobile Station Classmark 1 and Mobile Station Classmark 2 information elements.

Ciphering Mode Setting Capability (1 bit field)

This field indicates whether the MS supports the Ciphering Mode Setting IE in the

DTM ASSIGNMENT COMMAND message (see 3GPP TS 44.018 [84]). It is coded as follows:

- 0 The mobile station does not support the Ciphering Mode Setting IE in the DTM ASSIGNMENT COMMAND message
- 1 The mobile station supports the Ciphering Mode Setting IE in the DTM ASSIGNMENT COMMAND message

Additional Positioning Capabilities (1 bit field)

This field indicates whether the mobile station supports additional positioning capabilities which can be retrieved using RRLP. It is coded as follows:

- 0 The mobile station does not support additional positioning capabilities which can be retrieved using RRLP
- 1 The mobile station supports additional positioning capabilities which can be retrieved using RRLP.

E-UTRA FDD support (1 bit field)

Bit

- 0 E-UTRA FDD not supported
- 1 E-UTRA FDD supported

E-UTRA TDD support (1 bit field)

Bit

- 0 E-UTRA TDD not supported
- 1 E-UTRA TDD supported

E-UTRA Measurement and Reporting support (1 bit field)

This field indicates whether the mobile station supports E-UTRAN neighbouring cell measurements and measurement reporting in dedicated mode and, if the mobile station is DTM capable, also in dual transfer mode. If both "E-UTRA FDD support" and "E-UTRA TDD support" bits are set to '0', this field shall be set to '0'. If one of or both "E-UTRA FDD support" and "E-UTRA TDD support" bits are set to '1', this field may be set to '0' or '1'. It is coded as follows:

Bit

- 0 E-UTRAN Neighbour Cell measurements and measurement reporting while having an RR connection not supported
- 1 E-UTRAN Neighbour Cell measurements and measurement reporting while having an RR connection supported

Priority-based reselection support (1 bit field)

This field indicates whether the mobile station supports priority-based cell reselection. It is coded as follows:

Bit

- 0 Priority-based cell reselection not supported
- 1 Priority-based cell reselection supported

UTRA CSG Cells Reporting (1 bit field)

This field indicates whether the mobile station supports reporting of measurements and routing parameters (see 3GPP TS 44.018 [84]) for UTRAN CSG cells in dedicated mode and, if the mobile station is DTM capable, also in dual transfer mode. This capability shall apply to each UTRA radio access mode supported by the mobile. It is coded as follows:

Bit

- 0 Reporting of UTRAN CSG cells not supported
- 1 Reporting of UTRAN CSG cells supported

VAMOS Level (2 bit field)

This field indicates the VAMOS support of the MS and the VAMOS level supported. It is coded as follows:

Bits

2 1

- 0 0 VAMOS not supported
- 0 1 VAMOS I supported
- 1 0 VAMOS II supported
- 1 1 VAMOS III supported.

TIGHTER Capability (2 bit field)

This field indicates Tightened Link Level Performance support in the MS (see 3GPP TS 45.005 [33]). The tightened performance applies to the traffic channels and signalling channels specified in 3GPP TS 45.005 [33]. The field is coded as follows:

Bits

2 1

- 0 0 TIGHTER not supported
- 0 1 TIGHTER supported for speech and signalling channels only
- 1 0 TIGHTER supported for speech and signalling channels and for GPRS and EGPRS, but not for EGPRS2
- 1 1 TIGHTER supported for speech and signalling channels and for GPRS, EGPRS and EGPRS2

Selective Ciphering of Downlink SACCH (1 bit field)

This field indicates whether the mobile station supports Selective Ciphering of Downlink SACCH (see 3GPP TS 44.018 [84]). It is coded as follows:

Bit

- 0 Selective Ciphering of Downlink SACCH not supported
- 1 Selective Ciphering of Downlink SACCH supported

CS to PS SRVCC from GERAN to UTRA (2 bit field)

This field indicates whether the mobile station supports CS to PS SRVCC to UTRAN. If "UMTS FDD Radio Access Technology Capability" and "UMTS 1.28 Mcps TDD Radio Access Technology Capability" bits are set to '0' this field shall be set to '00'. If one or both bits are set to '1' this field may be set to '01' or '10' or '11'. It is coded as follows:

Bits

2 1

- 0 0 CS to PS SRVCC from GERAN to U MTS FDD and 1.28 Mcps TDD not supported
- 0 1 CS to PS SRVCC from GERAN to UMTS FDD supported
- 1 0 CS to PS SRVCC from GERAN to UMTS 1.28 Mcps TDD supported
- 1 1 CS to PS SRVCC from GERAN to UMTS FDD and 1.28 Mcps TDD supported

CS to PS SRVCC from GERAN to E-UTRA (2 bit field)

This field indicates whether the mobile station supports CS to PS SRVCC to E-UTRAN. If both "E-UTRA FDD support" and "E-UTRA TDD support" bits are set to '0', this field shall be set to '00'. If one or both "E-UTRA FDD support" and "E-UTRA TDD support" bits are set to '1', this field may be set to '01' or '10' or '11'. A mobile station not compliant to the UE E-UTRA capability requirements as defined in 3GPP TS 36.306 [153] shall set this field to '00'. It is coded as follows:

Bits

2 1

- 0 0 CS to PS SRVCC from GERAN to E-UTRA FDD and TDD not supported
- 0 1 CS to PS SRVCC from GERAN to E-UTRA FDD supported
- 1 0 CS to PS SRVCC from GERAN to E-UTRA TDD supported
- 1 1 CS to PS SRVCC from GERAN to E-UTRA FDD and TDD supported

GERAN Network Sharing support (1 bit field)

This field indicates whether the mobile station supports GERAN network sharing. A mobile station supporting GERAN network sharing shall also support the extended EARFCN value range in GERAN and indicate this in the respective bit. The field is coded as follows:

Bit

- 0 GERAN network sharing not supported
- 1 GERAN network sharing supported

E-UTRA Wideband RSRQ measurements support (1 bit field)

This field indicates whether the mobile station supports E-UTRA wideband RSRQ measurements (see 3GPP TS 45.008 [151]). It is coded as follows:

Bit

- 0 E-UTRA wideband RSRQ measurements not supported
- 1 E-UTRA wideband RSRQ measurements supported

ER Band Support (1 bit field)

This field indicates whether the mobile station supports ER-GSM band (see 3GPP TS 45.005 [33]). It is coded as follows:

Bit

- 0 ER-GSM not supported
- 1 ER-GSM supported

NOTE: When ER-GSM is supported, the associated RF power capability is found in Mobile Station Classmark 1, Mobile Station Classmark 2 and/or Mobile Station Classmark 3. The ER-GSM band associated radio capability is the same as for the R-GSM band (see R-GSM band Associated Radio Capability).

UTRA Multiple Frequency Band Indicators support (1 bit field)

This field indicates whether the mobile station supports multiple radio frequency bands in UTRAN (see 3GPP TS 25.331 [23c]) and whether it understands signalling of overlapping UTRA frequency bands (see 3GPP TS 44.018 [84]). It is coded as follows:

Bit

- 0 Multiple Frequency Band Indicators in UTRAN not supported
- 1 Multiple Frequency Band Indicators in UTRAN supported

E-UTRA Multiple Frequency Band Indicators support (1 bit field)

This field indicates whether the mobile station supports multiple radio frequency bands in E-UTRAN (see 3GPP TS 36.331 [129]) and whether it understands signalling of overlapping E-UTRA frequency bands (see 3GPP TS 44.018 [84]). It is coded as follows:

Bit

- 0 Multiple Frequency Band Indicators in E-UTRAN not supported
- 1 Multiple Frequency Band Indicators in E-UTRAN supported

Extended TSC Set Capability support (1 bit field)

This field indicates whether the mobile station supports the extended TSC sets when operating in the PS or CS domain (see 3GPP TS 45.002 [32]). It is coded as follows:

Bit

- 0 Extended TSC sets not supported
- 1 Extended TSC sets supported

Extended EARFCN value range (1 bit field)

This field indicates whether the mobile station supports the extended EARFCN value range in GERAN (see 3GPP TS 44.018 [84]). It is coded as follows:

Bit

- 0 Extended EARFCN value range not supported
- 1 Extended EARFCN value range supported

10.5.1.8 Spare Half Octet

This element is used in the description of messages in clause 9 when an odd number of half octet type 1 information elements are used. This element is filled with spare bits set to zero and is placed in bits 5 to 8 of the octet unless otherwise specified.

10.5.1.9 Descriptive group or broadcast call reference

The purpose of the *Descriptive Group or Broadcast Call Reference* is to provide information describing a voice group or broadcast call. The IE of the *Descriptive Group or Broadcast Call Reference* is composed of the group or broadcast call reference together with a service flag, an acknowledgement flag, the call priority and the group cipher key number.

The *Descriptive Group or Broadcast Call Reference* information element is coded as shown in figure 10.5.8/3GPP TS 24.008 and Table 10.5.8/3GPP TS 24.008

The *Descriptive Group or Broadcast Call Reference* is a type 3 information element with 6 octets length.

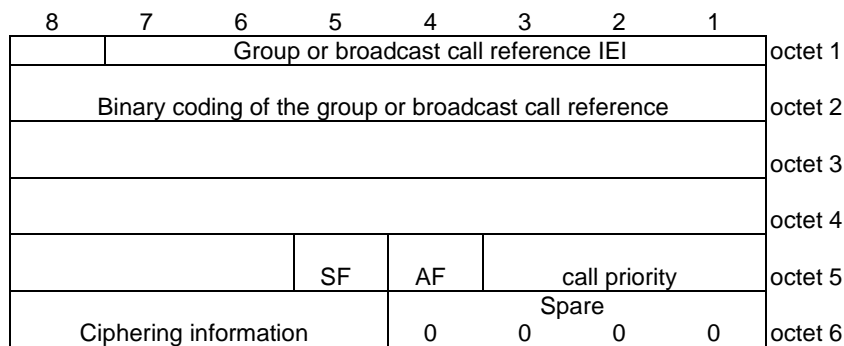

Figure 10.5.8/3GPP TS 24.008 Descriptive Group or Broadcast Call Reference

Table 10.5.8/3GPP TS 24.008 Descriptive Group or Broadcast Call Reference

Binary code of the group or broadcast call reference				
The length of the binary code has 27 bits which is encoded in the octet 2, 3, 4 and Bits 8,7,6 (octet 5).				
The highest bit of the BC is the bit 8 in the octet 2 and the lowest bit is allocated in the bit 6 in the octet 5. (see also 3GPP TS 23.003 [10])				
SF Service flag (octet 5)				
Bit				
5				
0	VBS (broadcast call reference)			
1	VGCS (group call reference)			
AF Acknowledgement flag (octet 5), network to MS direction:				
Bit				
4				
0	acknowledgement is not required			
1	acknowledgement is required			
Call priority (octet 5)				
Bit				
3	2	1		
0	0	0	no priority applied	
0	0	1	call priority level 4	
0	1	0	call priority level 3	
0	1	1	call priority level 2	
1	0	0	call priority level 1	
1	0	1	call priority level 0	
1	1	0	call priority level B	
1	1	1	call priority level A	
Ciphering information (octet 6)				
Bit				
8	7	6	5	
0	0	0	0	no ciphering
0	0	0	1	ciphering with cipher key number 1
0	0	1	0	ciphering with cipher key number 2
0	0	1	1	ciphering with cipher key number 3
0	1	0	0	ciphering with cipher key number 4
0	1	0	1	ciphering with cipher key number 5
0	1	1	0	ciphering with cipher key number 6
0	1	1	1	ciphering with cipher key number 7
1	0	0	0	ciphering with cipher key number 8
1	0	0	1	ciphering with cipher key number 9
1	0	1	0	ciphering with cipher key number A
1	0	1	1	ciphering with cipher key number B
1	1	0	0	ciphering with cipher key number C
1	1	0	1	ciphering with cipher key number D
1	1	1	0	ciphering with cipher key number E
1	1	1	1	ciphering with cipher key number F
AF Acknowledgement flag (octet 5), MS to network direction:				
Bit 4 is spare and shall be set to "0".				
Call priority (octet 5)				
Bits 1 to 3 are spare and shall be set to "0".				
Ciphering information (octet 6)				
Bits 5 to 8 are spare and shall be set to "0".				

10.5.1.10 Group Cipher Key Number

The purpose of the *Group Cipher Key Number* is to provide information on the group cipher key to be used for ciphering and deciphering by the mobile station.

The *Group Cipher Key Number* information element is coded as shown in figure 10.5.9/3GPP TS 24.008 and Table 10.5.9/3GPP TS 24.008

The *Group Cipher Key Number* is a type 1 information element with 1 octet length.

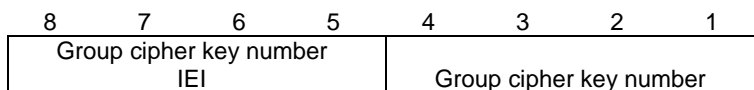

Figure 10.5.9/3GPP TS 24.008 *Group Cipher Key Number*

Table 10.5.9/3GPP TS 24.008 *Group Cipher Key Number*

Group cipher key number					
Bit	4	3	2	1	
0	0	0	0	0	spare
0	0	0	0	1	cipher key number 1
0	0	0	1	0	cipher key number 2
0	0	1	0	0	cipher key number 3
0	0	1	1	0	cipher key number 4
0	1	0	0	0	cipher key number 5
0	1	0	1	0	cipher key number 6
0	1	1	0	0	cipher key number 7
0	1	1	1	0	cipher key number 8
1	0	0	0	0	cipher key number 9
1	0	0	1	0	cipher key number A
1	0	1	0	0	cipher key number B
1	0	1	1	0	cipher key number C
1	1	0	0	0	cipher key number D
1	1	0	1	0	cipher key number E
1	1	1	0	0	cipher key number F
1	1	1	1	0	cipher key number F

10.5.1.10a PD and SAPI \$(CCBS)\$

The purpose of the *PD and SAPI* information element is to provide information concerning Protocol Discriminators and Service Access Point Identifiers.

The *PD and SAPI* information element is coded as shown in figure 10.5.10/3GPP TS 24.008 and table 10.5.10/3GPP TS 24.008.

The *PD and SAPI* is a type 3 information element with 2 octets length.

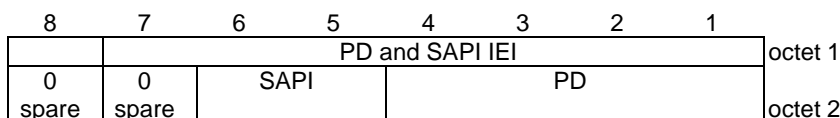

**Figure 10.5.10/3GPP TS 24.008
PD and SAPI information element**

Table 10.5.1.10/3GPP TS 24.008: PD and SAPI information element

SAPI: Service Access Point Identifier (octet 2)	
Bits	
6	5
0 0	SAPI 0
0 1	reserved
1 0	reserved
1 1	SAPI 3
PD: Protocol Discriminator (octet 2)	
bits 4-1	
Encoded as specified in subclause 11.2.1 of 3GPP TS 24.007 [20].	

10.5.1.11 Priority Level

The purpose of the *Priority Level* is to provide information defining the priority level requested or applied. The *Priority Level* IE may be included in CM_SERVICE_REQUEST, CALL_PROCEEDING and SETUP messages.

The *Priority Level* information element is coded as shown in figure 10.5.11/3GPP TS 24.008 and table 10.5.11/3GPP TS 24.008.

The *Priority Level* is a type 1 information element with 1 octet length.

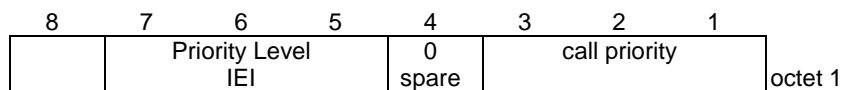
**Figure 10.5.11/3GPP TS 24.008 Priority Level****Table 10.5.11/3GPP TS 24.008 Priority Level**

Call priority (octet 1)			
Bit			
3	2	1	
0 0 0	no priority applied		
0 0 1	call priority level 4		
0 1 0	call priority level 3		
0 1 1	call priority level 2		
1 0 0	call priority level 1		
1 0 1	call priority level 0		
1 1 0	call priority level B		
1 1 1	call priority level A		

10.5.1.12 Core Network System Information (lu mode only)

The purpose of the *Core Network System Information* is to provide the MS with actual parameter settings of system information parameters controlling MM and GMM functionality. The Core Network system information is included in specific information elements within some RRC messages sent to MS, see 3GPP TS 25.331 [23c].

NOTE: These IEs do not have an IEI or a length indicator, because these IEs are never present in any layer 3 messages, Hence these IEs do not conform to the general IE rules defined in 3GPP TS 24.007 [20].

10.5.1.12.1 CN Common GSM-MAP NAS system information

The purpose of the *CN Common GSM-MAP NAS system information* element is to provide the MS with actual parameter settings of parameters relevant for both MM and GMM functionality. The coding of the information element

identifier and length information is defined in the 3GPP TS 25.331 [23c]. Only the coding of the content is in the scope of the present document.

The content of the *CN common GSM-MAP NAS system information* element is coded as shown in figure 10.5.1.12.1/3GPP TS 24.008 and table 10.5.1.12.1/3GPP TS 24.008.

The length of this element content is two octets. The MS shall ignore any additional octets received.

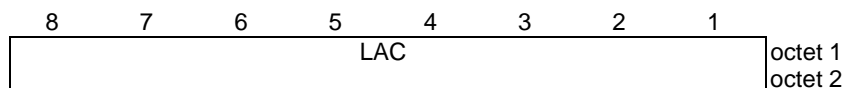

Figure 10.5.1.12.1/3GPP TS 24.008 Common system information element

Table 10.5.1.12.1/3GPP TS 24.008: Common system information element

LAC, Location Area Code (2 octet field) This field is the binary representation of the Location Area Code, see 3GPP TS 23.003 [10]. The LAC field consists of 16 bits. Bit 8 in octet 1 is the most significant bit and bit 1 in octet 2 is the least significant bit.
--

10.5.1.12.2 CS domain specific system information

The purpose of the *CN domain specific GSM-MAP NAS system information* element, when used for the CS domain, is to provide the MS with actual parameter settings of parameters relevant only for MM functionality. The coding of the information element identifier and length information is defined in the 3GPP TS 25.331 [23c]. Only the coding of the content is in the scope of the present document.

For CS domain, the content of the *CN domain specific GSM-MAP NAS system information* element is coded as shown in figure 10.5.1.12.2/3GPP TS 24.008 and table 10.5.1.12.2/3GPP TS 24.008. The length of this element content is two octets. The MS shall ignore any additional octets received.

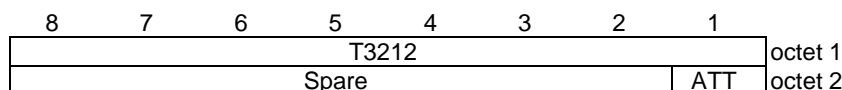

Figure 10.5.1.12.2/3GPP TS 24.008 CS domain specific system information element

Table 10.5.1.12.2/3GPP TS 24.008: CS domain specific system information element

T3212 timeout value (1 octet field) The T3212 timeout field is coded as the binary representation of the timeout value for periodic updating in decihours. Bit 8 in octet 1 is the most significant bit and bit 1 in octet 1 is the least significant bit. Range: 1 to 255 The value 0 is used for infinite timeout value i.e. periodic updating shall not be used
ATT, Attach-detach allowed (1 bit field): Bit 1 0 MSs shall not apply IMSI attach and detach procedure. 1 MSs shall apply IMSI attach and detach procedure
The bits 2 – 8 of octet 2 are spare and shall be coded all zeros.

10.5.1.12.3 PS domain specific system information

The purpose of the *CN domain specific GSM-MAP NAS system information* element, when used for the PS domain, is to provide the MS with actual parameter settings of parameters relevant only for GMM functionality. The coding of the information element identifier and length information is defined in the 3GPP TS 25.331 [23c]. Only the coding of the content is in the scope of the present document.

For PS domain, the content of the *CN domain specific GSM-MAP NAS system information* element is coded as shown in figure 10.5.1.12.3/3GPP TS 24.008 and table 10.5.1.12.3/3GPP TS 24.008. The length of this element content is two octets. The MS shall ignore any additional octets received.

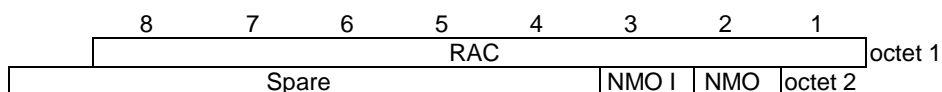

Figure 10.5.1.12.3/3GPP TS 24.008 PS domain specific system information element

Table 10.5.1.12.3/3GPP TS 24.008: PS domain specific system information element

<p>RAC, Routing Area Code (8 bit field) This field is the binary representation of the Routing Area Code, see 3GPP TS 23.003 [10]. Bit 8 in octet 1 is the most significant bit and bit 1 in octet 1 is the least significant bit.</p> <p>NMO, Network Mode of Operation (1 bit field) This field is the binary representation of the Network Mode of Operation, see 3GPP TS 23.060 [74] Bit 1 0 Network Mode of Operation I 1 Network Mode of Operation II</p> <p>NMO I, Network Mode of Operation I (1 bit field) This field is the binary representation of whether the Network Mode of Operation I is applicable for the MS configured for NMO_I_Behaviour, see 3GPP TS 24.368 [135] or 3GPP TS 31.102 [112] Bit 2 0 Network Mode of Operation indicated in Bit 1 (NMO, Network Mode of Operation) is used for MS configured for NMO_I_Behaviour 1 Network Mode of Operation I is used for MS configured for NMO_I_Behaviour</p> <p>The bits 3 – 8 of octet 2 are spare and shall be coded all zeros.</p>
--

10.5.1.13 PLMN list

The purpose of the *PLMN List* information element is to provide a list of PLMN codes to the mobile station.

The *PLMN List* information element is coded as shown in figure 10.5.13/3GPP TS 24.008 and table 10.5.13/3GPP TS 24.008.

The *PLMN List* is a type 4 information element with a minimum length of 5 octets and a maximum length of 47 octets.

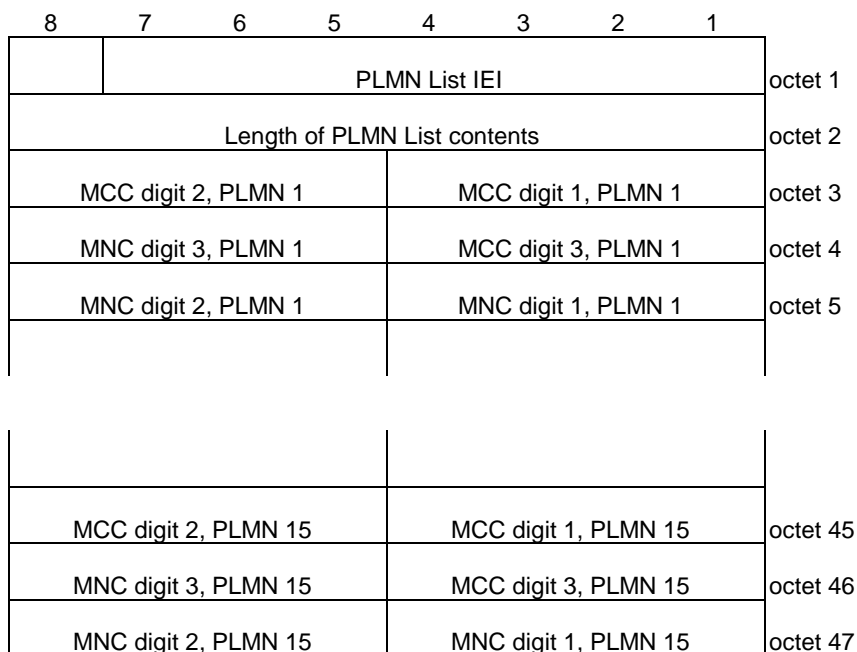

Figure 10.5.13/3GPP TS 24.008 PLMN List information element

Table 10.5.13/3GPP TS 24.008: PLMN List information element

<p>MCC, Mobile country code (octet 3, octet 4 bits 1 to 4) The MCC field is coded as in ITU-T Rec. E212, Annex A.</p> <p>MNC, Mobile network code (octet 5, octet 4 bits 5 to 8). The coding of this field is the responsibility of each administration but BCD coding shall be used. The MNC shall consist of 2 or 3 digits. For PCS 1900 for NA, Federal regulation mandates that a 3-digit MNC shall be used. However a network operator may decide to use only two digits in the MNC over the radio interface. In this case, bits 5 to 8 of octet 4 shall be coded as "1111". Mobile equipment shall accept MNC coded in such a way.</p>
--

10.5.1.14 NAS container for PS HO

The purpose of the *NAS container for PS HO* information element is to indicate the NAS specific information for the PS handover to A/Gb mode. The *NAS container for PS HO* information element is included in the PS HO command message, see 3GPP TS 44.060 [76]. The coding of the information element identifier and length information is defined in 3GPP TS 44.060 [76].

The content of the *NAS container for PS HO* information element is coded as shown in figure 10.5.1.14/3GPP TS 24.008 and table 10.5.1.14/3GPP TS 24.008. The length of this information element is 5 octets. The MS shall ignore any additional octets received.

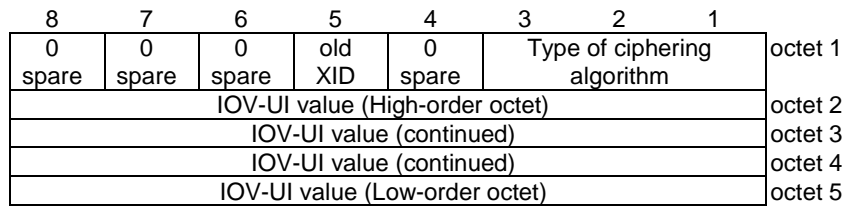

Figure 10.5.1.14/3GPP TS 24.008 NAS container for PS HO information element

Table 10.5.1.14/3GPP TS 24.008: NAS container for PS HO information element

Type of ciphering algorithm (octet 1, bits 1 to 3)			
Bits			
3	2	1	
0	0	0	ciphering not used
0	0	1	GPRS Encryption Algorithm GEA/1
0	1	0	GPRS Encryption Algorithm GEA/2
0	1	1	GPRS Encryption Algorithm GEA/3
1	0	0	GPRS Encryption Algorithm GEA/4
1	0	1	GPRS Encryption Algorithm GEA/5
1	1	0	GPRS Encryption Algorithm GEA/6
1	1	1	GPRS Encryption Algorithm GEA/7
Bit 4 of octet 1 is spare and shall be coded as zero.			
old XID (octet 1, bit 5):			
With this bit the network indicates, which LLC layer parameters and layer-3 parameters the MS shall use in the target cell after it has performed the Reset of LLC and SMDCP.			
Bit 5			
0	The MS shall perform a Reset of LLC and SMDCP without old XID indicator as specified in 3GPP TS 44.064 [78a] and 3GPP TS 44.065 [78].		
1	The MS shall perform a Reset of LLC and SMDCP with old XID indicator as specified in 3GPP TS 44.064 [78a] and 3GPP TS 44.065 [78].		
The bits 6 – 8 of octet 1 are spare and shall be coded all zeroes.			
IOV-UI value (octet 2 to 5)			
The IOV-UI value consists of 32 bits, the format is defined in 3GPP TS 44.064 [78a].			

10.5.1.15 MS network feature support

The purpose of the MS network feature support information element is to indicate support of mobility management parameters during the tracking area updating, location updating, routing area updating, IMSI attach, GPRS attach, and EPS attach procedures.

The MS network feature support information element is coded as shown in figure 10.5.1.15/3GPP TS 24.008 and table 10.5.1.15/3GPP TS 24.008.

The MS network feature support information element is a type 1 information element.

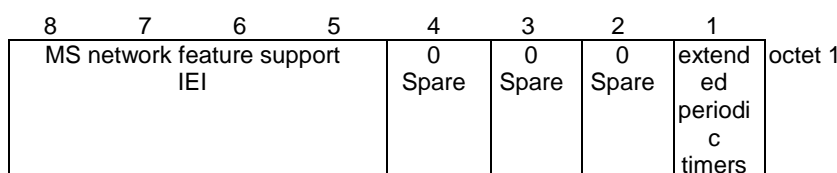

Figure 10.5.1.15/3GPP TS 24.008: MS network feature support information element

Table 10.5.1.15/3GPP TS 24.008: MS network feature support information element

Extended periodic timers (octet 1)
Bit
1
0 MS does not support the extended periodic timer in this domain
1 MS supports the extended periodic timer in this domain
The relevant extended periodic timer is T3212 for MM messages, T3312 for GMM messages, and T3412 for EMM messages.
Bits 4, 3 and 2 of octet 1 are spare and shall be coded as zero.

10.5.2 Radio Resource management information elements.

See 3GPP TS 44.018 [84].

10.5.3 Mobility management information elements.

10.5.3.1 Authentication parameter RAND

The purpose of the *Authentication Parameter RAND* information element is to provide the mobile station with a non-predictable number to be used to calculate the authentication response signature SRES and the ciphering key Kc (for a GSM authentication challenge), or the response RES and both the ciphering key CK and integrity key IK (for a UMTS authentication challenge).

The *Authentication Parameter RAND* information element is coded as shown in figure 10.5.75/3GPP TS 24.008 and table 10.5.89/3GPP TS 24.008.

The *Authentication Parameter RAND* is a type 3 information element with 17 octets length.

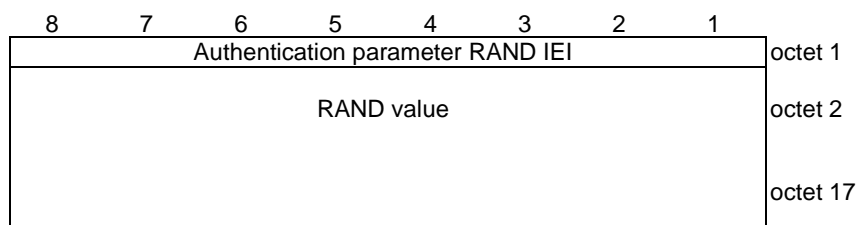
**Figure 10.5.75/3GPP TS 24.008 Authentication Parameter RAND information element****Table 10.5.89/3GPP TS 24.008: Authentication Parameter RAND information element**

RAND value (octet 2, 3,... and 17)
The RAND value consists of 128 bits. Bit 8 of octet 2 is the most significant bit while bit 1 of octet 17 is the least significant bit.

10.5.3.1.1 Authentication Parameter AUTN (UMTS and EPS authentication challenge)

The purpose of the *Authentication Parameter AUTN* information element is to provide the MS with a means of authenticating the network.

The *Authentication Parameter AUTN* information element is coded as shown in figure 10.5.75.1/3GPP TS 24.008 and table 10.5.89.1/3GPP TS 24.008.

The *Authentication Parameter AUTN* is a type 4 information element with a length of 18 octets.

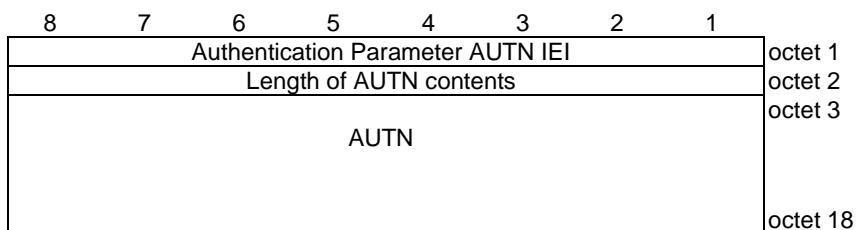

Figure 10.5.75.1/3GPP TS 24.008 Authentication Parameter AUTN information element (UMTS and EPS authentication challenge)

Table 10.5.89.1/3GPP TS 24.008 Authentication Parameter AUTN information element (UMTS and EPS authentication challenge)

AUTN value (octets 3 to 18) The AUTN consists of (SQN xor AK) AMF MAC =48+16+64 bits (see 3GPP TS 33.102 [5a]) Bit 8 of octet 9 is the "separation bit" of the AMF field (see 3GPP TS 33.401 [123]).
--

10.5.3.2 Authentication Response parameter

The purpose of the *authentication response parameter* information element is to provide the network with the authentication response calculated in the SIM/USIM.

The *Authentication Parameter SRES* information element is coded as shown in figure 10.5.76/3GPP TS 24.008 and tables 10.5.90 a & b /3GPP TS 24.008.

The *Authentication Response Parameter* is a type 3 information element with 5 octets length. In a GSM authentication challenge, the response calculated in the SIM/USIM (SRES) is 4 bytes in length, and is placed in the *Authentication Response Parameter* information element.

In a UMTS authentication challenge, the response calculated in the USIM (RES) may be up to 16 octets in length. The 4 most significant octets shall be included in the *Authentication Response Parameter* information element. The remaining part of the RES shall be included in the Authentication Response Parameter (extension) IE (see subclause 10.5.3.2.1)

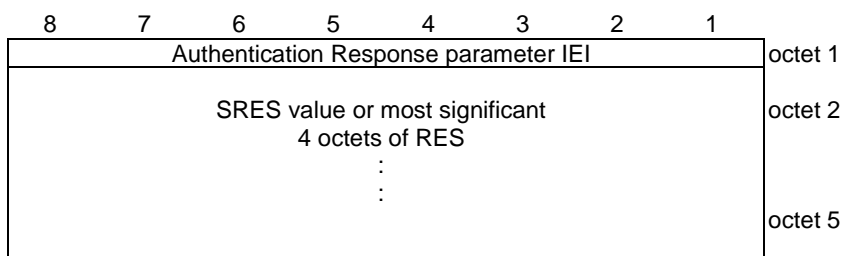

Figure 10.5.76/3GPP TS 24.008 Authentication Response Parameter information element

Table 10.5.90a/3GPP TS 24.008: Authentication Response Parameter information element (SRES) (GSM authentication challenge only)

SRES value (octet 2, 3, 4 and 5) The SRES value consists of 32 bits. Bit 8 of octet 2 is the most significant bit while bit 1 of octet 5 is the least significant bit.

Table 10.5.90b/3GPP TS 24.008: *Authentication Response Parameter* information element (RES) (UMTS authentication challenge only)

RES value (octet 2, 3, 4 and 5) This contains the most significant 4 octets of RES If RES>4 octets, the remaining octets of RES shall appear in the Authentication Response Parameter (extension) IE (see subclause 10.5.3.2.1)

10.5.3.2.1 Authentication Response Parameter (extension) (UMTS authentication challenge only)

This IE is included if the authentication response parameter RES is longer than 4 octets (UMTS only) and therefore does not fit in the Authentication Response Parameter field (see 10.5.3.2).

The Authentication Response parameter (extension) IE is coded as shown in figure 10.5.76.1/3GPP TS 24.008 and table 10.5.90.1/3GPP TS 24.008.

The Authentication Response parameter (extension) IE is a type 4 information element with a minimum length of 3 octets and a maximum length of 14 octets.

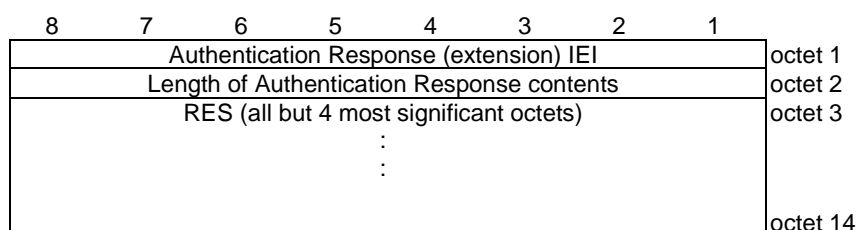

Figure 10.5.76.1/3GPP TS 24.008 Authentication Response Parameter (extension) information element (UMTS authentication challenge only)

Table 10.5.90.1/3GPP TS 24.008: *Authentication Response Parameter (extension)* information element (RES)

RES (extension) value (octet 3 to 14) This contains all but the 4 most significant octets of RES

10.5.3.2.2 Authentication Failure parameter (UMTS and EPS authentication challenge)

The purpose of the *Authentication Failure parameter* information element is to provide the network with the necessary information to begin a re-authentication procedure (see 3GPP TS 33.102 [5a]) in the case of a 'Synch failure', following a UMTS or EPS authentication challenge.

The Authentication Failure parameter IE is coded as shown in figure 10.5.76.2/3GPP TS 24.008 and table 10.5.90.2/3GPP TS 24.008.

The Authentication Failure parameter IE is a type 4 information element with a length of 16 octets.

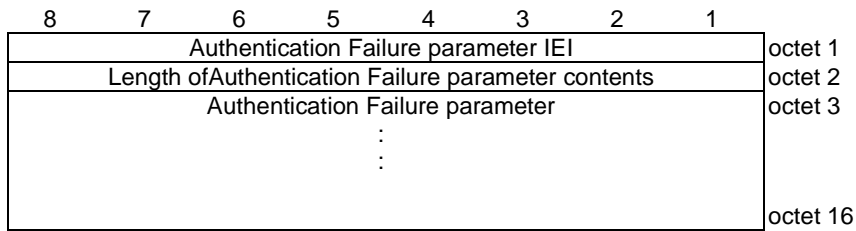

Figure 10.5.76.2/3GPP TS 24.008 Authentication Failure parameter information element (UMTS and EPS authentication challenge)

Table 10.5.90.2/3GPP TS 24.008: Authentication Failure parameter information element

Authentication Failure parameter value (octet 3 to 16)
This contains AUTS (see 3GPP TS 33.102 [5a])

10.5.3.3 CM service type

The purpose of the *CM Service Type* information element is to specify which service is requested from the network.

The *CM Service Type* information element is coded as shown in figure 10.5.77/3GPP TS 24.008 and table 10.5.91/3GPP TS 24.008.

The *CM Service Type* is a type 1 information element.

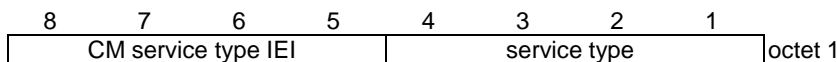

Figure 10.5.77/3GPP TS 24.008 CM Service Type information element

Table 10.5.91/3GPP TS 24.008: CM Service Type information element

Service type (octet 1)	
Bits	
4 3 2 1	
0 0 0 1	Mobile originating call establishment or packet mode connection establishment
0 0 1 0	Emergency call establishment
0 1 0 0	Short message service
1 0 0 0	Supplementary service activation
1 0 0 1	Voice group call establishment
1 0 1 0	Voice broadcast call establishment
1 0 1 1	Location Services (NOTE)
All other values are reserved.	
NOTE: this service type shall only be used by a type A LMU if the MM connection was requested for the transmission of LCS signalling messages specified in 3GPP TS 44.071 [23a].	

10.5.3.4 Identity type

The purpose of the *Identity Type* information element is to specify which identity is requested.

The *Identity Type* information element is coded as shown in figure 10.5.78/3GPP TS 24.008 and table 10.5.92/3GPP TS 24.008.

The *Identity Type* is a type 1 information element.

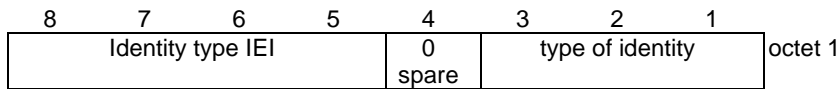

Figure 10.5.78/3GPP TS 24.008 *Identity Type* information element

Table 10.5.92/3GPP TS 24.008: *Identity Type* information element

Type of identity (octet 1)			
Bits			
3	2	1	
0	0	1	IMSI
0	1	0	IMEI
0	1	1	IMEISV
1	0	0	TMSI
1	0	1	P-TMSI, RAI, P-TMSI signature
All other values are reserved.			

10.5.3.5 Location updating type

The purpose of the *Location Updating Type* information element is to indicate whether a normal updating, a periodic updating or an IMSI attach is wanted. It may also indicate that a follow-on request has been received from the mobile station CM layer.

The *Location Updating Type* information element is coded as shown in figure 10.5.79/3GPP TS 24.008 and table 10.5.93/3GPP TS 24.008.

The *Location Updating Type* is a type 1 information element.

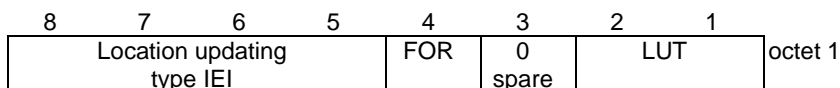

Figure 10.5.79/3GPP TS 24.008 *Location Updating Type* information element

Table 10.5.93/3GPP TS 24.008: *Location Updating Type* information element

LUT (octet 1)		
Bits		
2	1	
0	0	Normal location updating
0	1	Periodic updating
1	0	IMSI attach
1	1	Reserved
FOR (octet 1)		
The Follow-On Request bit (FOR) is coded as follows:		
Bits		
4		
0	No follow-on request pending	
1	Follow-on request pending	

10.5.3.5a Network Name

The purpose of this information element is to pass a text string to the mobile station.

The *Network Name* information element is coded as shown in figure 10.5.80/3GPP TS 24.008 and table 10.5.94/3GPP TS 24.008.

If the coding scheme UCS2 is used and Chinese-Japanese-Korean-Vietnamese (CJKV) ideographs as defined in ISO/IEC 10646 [72] are received in the text string, the MS shall use the MCC of the PLMN from which it received the network name information element to determine the language for those CJKV ideographs as specified in table 10.5.93a/3GPP TS 24.008:

Table 10.5.93a/3GPP TS 24.008: MCC to CJKV ideograph language mapping table

MCC(s)	Country/Region	Language (C, J, K, or V)
460, 461	Mainland China	Chinese-G
466	Taiwan	Chinese-T
454	HongKong	Chinese-T
455	Macao	Chinese-T
440, 441	Japan	J (Kanji)
450, 467	Korea	K (Hanja)
452	Vietnam	V (Chunom)

NOTE: This is due to CJKV ideograph language ambiguity in UCS2, in the sense that the same hexadecimal code can be mapped to different character displays dependent on the used language. The coding of CJKV ideographs itself does not allow to discriminate the CJKV ideograph language.

The *Network Name* is a type 4 information element with a minimum length of 3 octets. No upper length limit is specified except for that given by the maximum number of octets in a L3 message (see 3GPP TS 44.006 [19]).

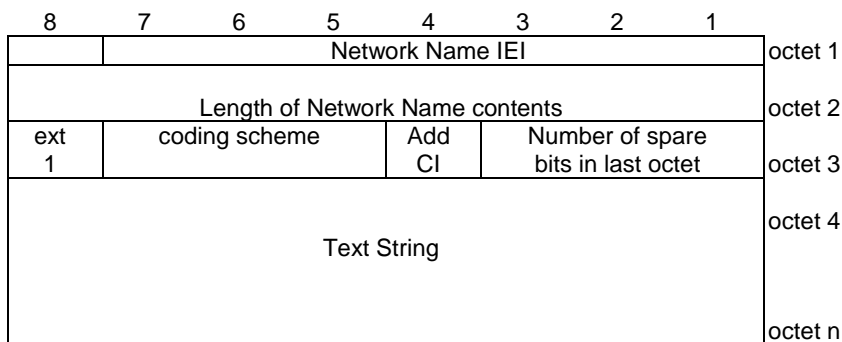

Figure 10.5.80/3GPP TS 24.008 Network Name information element

Table 10.5.94/3GPP TS 24.008 Network Name information element

Number of spare bits in last octet (octet 3, bits 1 to 3)	
2 1	
0 0 1	bit 8 is spare and set to "0" in octet n
0 1 0	bits 7 and 8 are spare and set to "0" in octet n
0 1 1	bits 6 to 8(inclusive) are spare and set to "0" in octet n
1 0 0	bits 5 to 8(inclusive) are spare and set to "0" in octet n
1 0 1	bits 4 to 8(inclusive) are spare and set to "0" in octet n
1 1 0	bits 3 to 8(inclusive) are spare and set to "0" in octet n
1 1 1	bits 2 to 8(inclusive) are spare and set to "0" in octet n
0 0 0	this field carries no information about the number of spare bits in octet n
Add CI (octet 3, bit 4)	
0	The MS should not add the letters for the Country's Initials to the text string
1	The MS should add the letters for the Country's Initials and a separator (e.g. a space) to the text string
Coding Scheme (octet 3, bits 5-7)	
0 0 0	Cell Broadcast data coding scheme, GSM default alphabet, language unspecified, defined in 3GPP TS 23.038 [8b]
0 0 1	UCS2 (16 bit) [72]
0 1 0	reserved
to	
1 1 1	
Text String (octet 4 to octet n, inclusive)	
Encoded according to the Coding Scheme defined by octet 3, bits 5-7	

10.5.3.6 Reject cause

The purpose of the *Reject Cause* information element is to indicate the reason why a request from the mobile station is rejected by the network.

The *Reject Cause* information element is coded as shown in figure 10.5.81/3GPP TS 24.008 and table 10.5.95/3GPP TS 24.008.

The *Reject Cause* is a type 3 information element with 2 octets length.

**Figure 10.5.81/3GPP TS 24.008 Reject Cause information element**

Table 10.5.95/3GPP TS 24.008: *Reject Cause* information element

Reject cause value (octet 2)								
Bits								
8	7	6	5	4	3	2	1	
0	0	0	0	0	0	1	0	IMSI unknown in HLR
0	0	0	0	0	0	1	1	Illegal MS
0	0	0	0	0	1	0	0	IMSI unknown in VLR
0	0	0	0	0	1	0	1	IMEI not accepted
0	0	0	0	0	1	1	0	Illegal ME
0	0	0	0	1	0	1	1	PLMN not allowed
0	0	0	0	1	1	0	0	Location Area not allowed
0	0	0	0	1	1	0	1	Roaming not allowed in this location area
0	0	0	0	1	1	1	1	No Suitable Cells In Location Area
0	0	0	1	0	0	0	1	Network failure
0	0	0	1	0	1	0	0	MAC failure
0	0	0	1	0	1	0	1	Synch failure
0	0	0	1	0	1	1	0	Congestion
0	0	0	1	0	1	1	1	GSM authentication unacceptable
0	0	0	1	1	0	0	1	Not authorized for this CSG
0	0	1	0	0	0	0	0	Service option not supported
0	0	1	0	0	0	0	1	Requested service option not subscribed
0	0	1	0	0	0	1	0	Service option temporarily out of order
0	0	1	0	0	1	1	0	Call cannot be identified
0	0	1	1	0	0	0	0	}
								to
								}
0	0	1	1	1	1	1	1	}
0	1	0	1	1	1	1	1	Semantically incorrect message
0	1	1	0	0	0	0	0	Invalid mandatory information
0	1	1	0	0	0	0	1	Message type non-existent or not implemented
0	1	1	0	0	0	1	0	Message type not compatible with the protocol state
0	1	1	0	0	0	1	1	Information element non-existent or not implemented
0	1	1	0	0	1	0	0	Conditional IE error
0	1	1	0	0	1	0	1	Message not compatible with the protocol state
0	1	1	0	1	1	1	1	Protocol error, unspecified

Any other value received by the mobile station shall be treated as 0010 0010, 'Service option temporarily out of order'. Any other value received by the network shall be treated as 0110 1111, 'Protocol error, unspecified'.

NOTE: The listed reject cause values are defined in Annex G.

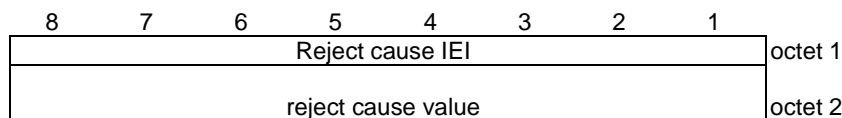
10.5.3.7 Follow-on Proceed

The purpose of the *Follow-on Proceed* information element is to indicate that an MM connection may be established on an existing RR connection.

The *Follow-on Proceed* information element is coded as shown in figure 10.5.82/3GPP TS 24.008.

The *Follow-on Proceed* is a type 2 information element.

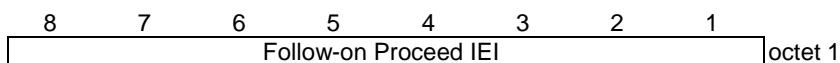

Figure 10.5.82/3GPP TS 24.008 *Follow-on Proceed* information element

10.5.3.8 Time Zone

The purpose of this information element is to encode the offset between universal time and local time in steps of 15 minutes.

The *Time Zone* information element is coded as shown in figure 10.5.83/3GPP TS 24.008 and table 10.5.96/3GPP TS 24.008.

The *Time Zone* is a type 3 information element with a length of 2 octets.

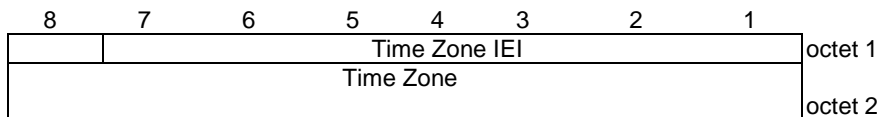

Figure 10.5.83/3GPP TS 24.008 *Time Zone* information element

Table 10.5.96/3GPP TS 24.008 *Time Zone* information element

<p>Time Zone (octet 2, bits 1-8) This field uses the same format as the Timezone field used in the TP-Service-Centre-Time-Stamp, which is defined in 3GPP TS 23.040 [90], and its value shall be set as defined in 3GPP TS 22.042 [89]</p>

10.5.3.9 Time Zone and Time

The purpose of the timezone part of this information element is to encode the offset between universal time and local time in steps of 15 minutes.

The purpose of the time part of this information element is to encode the universal time at which this information element may have been sent by the network.

The *Time Zone and Time* information element is coded as shown in figure 10.5.84/3GPP TS 24.008 and table 10.5.97/3GPP TS 24.008.

The *Time Zone and Time* is a type 3 information element with a length of 8 octets.

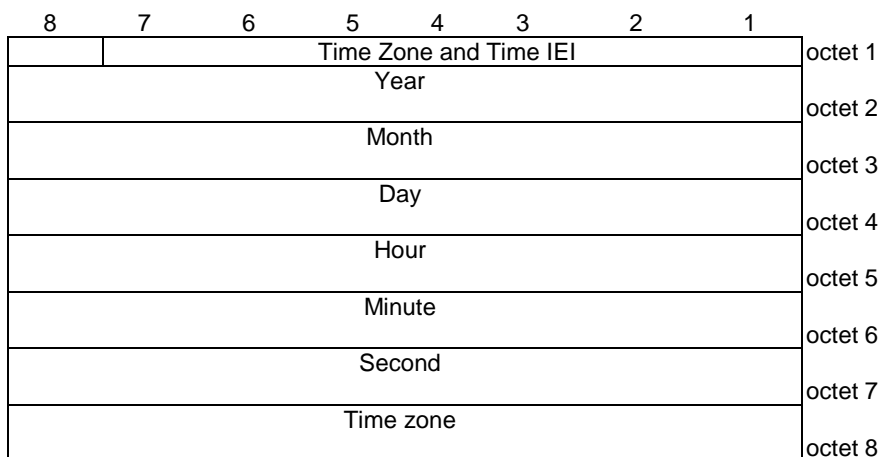

Figure 10.5.84/3GPP TS 24.008 *Time Zone and Time* information element

Table 10.5.97/3GPP TS 24.008 *Timezone and Time* information element

<p>Year (octet 2, bits 1-8)</p> <p>This field uses the same format as the Year field used in the TP-Service-Centre-Time-Stamp, which is defined in 3GPP TS 23.040 [90], and its value shall be set as defined in 3GPP TS 22.042 [89]</p> <p>Month (octet 3, bits 1-8)</p> <p>This field uses the same format as the Month field used in the TP-Service-Centre-Time-Stamp, which is defined in 3GPP TS 23.040 [90], and its value shall be set as defined in 3GPP TS 22.042 [89].</p> <p>Day (octet 4, bits 1-8)</p> <p>This field uses the same format as the Day field used in the TP-Service-Centre-Time-Stamp, which is defined in 3GPP TS 23.040 [90], and its value shall be set as defined in 3GPP TS 22.042 [89].</p> <p>Hour (octet 5, bits 1-8)</p> <p>This field uses the same format as the Hour field used in the TP-Service-Centre-Time-Stamp, which is defined in 3GPP TS 23.040 [90], and its value shall be set as defined in 3GPP TS 22.042 [89].</p> <p>Minute (octet 6, bits 1-8)</p> <p>This field uses the same format as the Minute field used in the TP-Service-Centre-Time-Stamp, which is defined in 3GPP TS 23.040 [90], and its value shall be set as defined in 3GPP TS 22.042 [89].</p> <p>Second (octet 7, bits 1-8)</p> <p>This field uses the same format as the Second field used in the TP-Service-Centre-Time-Stamp, which is defined in 3GPP TS 23.040 [90], and its value shall be set as defined in 3GPP TS 22.042 [89].</p> <p>Time Zone (octet 8, bits 1-8)</p> <p>This field uses the same format as the Time Zone field used in the TP-Service-Centre-Time-Stamp, which is defined in 3GPP TS 23.040 [90], and its value shall be set as defined in 3GPP TS 22.042 [89].</p>
--

NOTE: Due to ambiguities in earlier versions of the protocol specifications, some mobile stations may interpret the received NITZ time as local time. This may result in incorrect time settings in the mobile.

10.5.3.10 CTS permission

The purpose of the *CTS permission* information element is to indicate that the mobile station is allowed to use GSM-Cordless Telephony System in the Location Area. The *CTS permission* information element is coded as shown in figure 10.5.84a/3GPP TS 24.008.

The *CTS permission* is a type 2 information element.

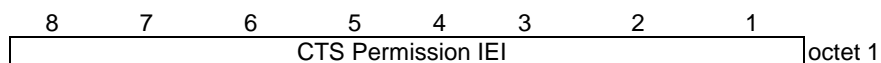

Figure 10.5.84a/3GPP TS 24.008 *CTS permission* information element

10.5.3.11 LSA Identifier

This element uniquely identifies a LSA.

The *LSA Identifier* information element is coded as shown in figure 10.68c/3GPP TS 24.008.

The *LSA Identifier* is a type 4 information element with a length of 2 or 5 octets.

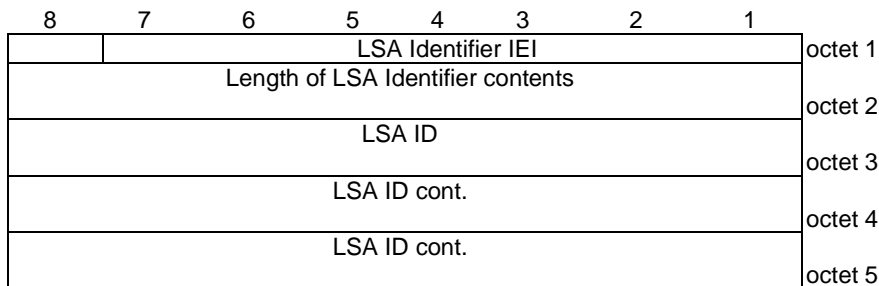

Figure 10.68c/3GPP TS 24.008 *LSA Identifier* information element

If the Length = 0, then no LSA ID is included. This is used to indicate that the MS has moved to an area where there is no LSA available for that MS.

Octets 3-5 are coded as specified in 3GPP TS 23.003 [10], 'Identification of Localised Service Area'. Bit 8 of octet 3 is the most significant bit.

10.5.3.12 Daylight Saving Time

The purpose of this information element is to encode the Daylight Saving Time in steps of 1 hour.

The *Daylight Saving Time* information element is coded as shown in figure 10.5.84b/3GPP TS 24.008 and table 10.5.97a/3GPP TS 24.008.

The *Daylight Saving Time* is a type 4 information element with a length of 3 octets.

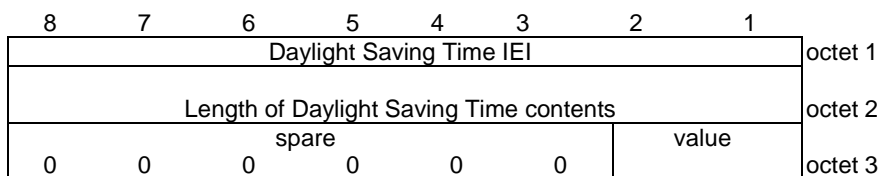

Figure 10.5.84b/3GPP TS 24.008 *Daylight Saving Time* information element

Table 10.5.97a/3GPP TS 24.008: *Daylight Saving Time* information element

Daylight Saving Time value (octet 3)		
Bits		
2	1	
0	0	No adjustment for Daylight Saving Time
0	1	+1 hour adjustment for Daylight Saving Time
1	0	+2 hours adjustment for Daylight Saving Time
1	1	Reserved

10.5.3.13 Emergency Number List

The purpose of this information element is to encode emergency number(s) for use within the country where the IE is received.

The *Emergency Number List* information element is coded as shown in figure 10.5.84c/3GPP TS 24.008.

The *Emergency Number List IE* is a type 4 information element with a minimum length of 5 octets and a maximum length of 50 octets.

8	7	6	5	4	3	2	1	
Emergency Number List IEI								octet 1
Length of Emergency Number List IE contents								octet 2
Length of 1 st Emergency Number information (Note 1)								octet 3
Spare		Emergency Service Category Value						octet 4
0	0	0						
Number digit 2				Number digit 1				octet 5 (Note 2)
Number digit 4				Number digit 3				octet 6*
:				:				:
(Note 3)								octet j-1*
Length of 2 nd Emergency Number information (Note 1)								octet j*
Spare		Emergency Service Category Value						octet j+1*
0	0	0						
Number digit 2				Number digit 1				octet j+2*
Number digit 4				Number digit 3				(Note 2) octet j+3*
:				:				:
(Note 3)								octet j+k*
:								:
:								:
Length of xth Emergency Number information (Note 1)								octet n*
Spare		Emergency Service Category Value						octet n+1*
0	0	0						
Number digit 2				Number digit 1				octet n+2*
Number digit 4				Number digit 3				(Note 2) octet n+3*
:				:				:
(Note 3)								octet n+m*
:								:

NOTE 1: The length contains the number of octets used to encode the Emergency Service Category Value and the Number digits.

NOTE 2: The number digit(s) in octet 5 precedes the digit(s) in octet 6 etc. The number digit, which would be entered first, is located in octet 5, bits 1 to 4. The contents of the number digits are coded as shown in table 10.5.118/3GPP TS 24.008.

NOTE 3: If the emergency number contains an odd number of digits, bits 5 to 8 of the last octet of the respective emergency number shall be filled with an end mark coded as "1111".

Figure 10.5.84c/3GPP TS 24.008 Emergency Number List information element

Table 10.5.97aa/3GPP TS 24.008: *Emergency Number List* information element

Emergency Service Category Value (octet 4, j+1, n+1, etc.; bit 1 to 5)
Bits 1 to 5 are coded as bits 1 to 5 of octet 3 of the Service Category information element as specified in subclause 10.5.4.33.

10.5.3.14 Additional update parameters

The purpose of the Additional update parameters information element is to provide additional information during the location updating procedure and during MM connection establishment.

The Additional update parameters information element is coded as shown in figure 10.5.84d/3GPP TS 24.008 and table 10.5.97b/3GPP TS 24.008.

The Additional update parameters information element is a type 1 information element.

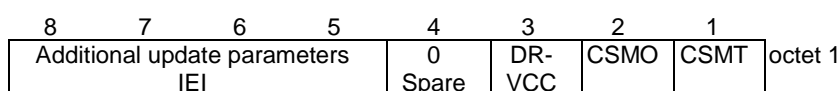
**Figure 10.5.84d/3GPP TS 24.008: *Additional update parameters* information element****Table 10.5.97b/3GPP TS 24.008: *Additional update parameters* information element**

Additional update parameters value (octet 1, bit 1 to 4)
CSMT (1 bit field)
Bit
1
0 No additional information.
1 CS fallback mobile terminating call
CSMO (1 bit field)
Bit
2
0 No additional information.
1 CS fallback mobile originating call
DRVCC call (1 bit field)
Bit
3
0 No additional information.
1 DRVCC call
Bit 4 of octet 1 is spare and shall be coded as zero.

10.5.3.15 Void

10.5.3.16 MM Timer

The purpose of the *MM timer* information element is to specify MM specific timer values, e.g. for the timer T3246.

The *MM timer* is a type 4 information element with 3 octets length.

The *MM timer* information element is coded as shown in figure 10.5.3.16-1/3GPP TS 24.008 and table 10.5.3.16-1/3GPP TS 24.008.

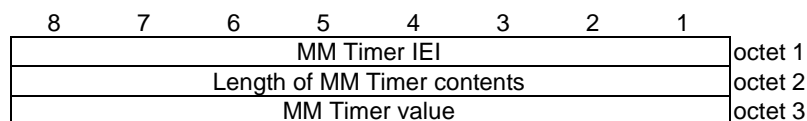

Figure 10.5.3.16-1/3GPP TS 24.008: *MM Timer* information element

Table 10.5.3.16-1/3GPP TS 24.008: *MM Timer* information element

<p>Timer value (octet 3)</p> <p>Bits 5 to 1 represent the binary coded timer value.</p> <p>Bits 6 to 8 defines the timer value unit for the MM timer as follows:</p> <p>Bits</p> <p>8 7 6</p> <p>0 0 0 value is incremented in multiples of 2 seconds</p> <p>0 0 1 value is incremented in multiples of 1 minute</p> <p>0 1 0 value is incremented in multiples of decihours</p> <p>1 1 1 value indicates that the timer is deactivated.</p> <p>Other values shall be interpreted as multiples of 1 minute in this version of the protocol.</p> <p>The value indicated is constructed by multiplying the value in bits 5 to 1 with the timer value unit in bits 8 to 6, unless the timer value unit indicates the timer being deactivated.</p>

10.5.4 Call control information elements

10.5.4.1 Extensions of codesets

There is a certain number of possible information element identifier values using the formatting rules described in subclause 10.5: 128 from the type 3 & 4 information element format and at least 8 from the type 1 & 2 information element format.

One value in the type 1 format is specified for shift operations described below. One other value in both the type 3 & 4 and type 1 format is reserved. This leaves 133 information element identifier values available for assignment.

It is possible to expand this structure to eight codesets of 133 information element identifier values each. One common value in the type 1 format is employed in each codeset to facilitate shifting from one codeset to another. The contents of this shift information element identifies the codeset to be used for the next information element or elements. The codeset in use at any given time is referred to as the "active codeset". By convention, codeset 0 is the initially active codeset.

Two codeset shifting procedures are supported: locking shift and non-locking shift.

Codeset 5 is reserved for information elements reserved for national use.

Codeset 6 is reserved for information elements specific to the local network (either public or private).

Codeset 7 is reserved for user-specific information elements.

The coding rules specified in subclause 10.5 shall apply for information elements belonging to any active codeset.

The mobile station and the network shall not apply the "comprehension required" scheme (see 3GPP TS 24.007 [20]) to information elements belonging to codesets different from codeset 0.

IEIs with bits 5, 6, 7 and 8 all set to zero should not be allocated for new optional information elements in codesets different from codeset 0, because there are legacy mobile stations that apply the "comprehension required" scheme also to these information elements, e.g. if such a mobile station receives a SETUP message containing an unknown information element from codeset 5 with an IEI with bits 5, 6, 7 and 8 all set to zero, then the mobile station will release the call.

Transitions from one active codeset to another (i.e. by means of the locking shift procedure) may only be made to a codeset with a higher numerical value than the codeset being left.

An information element belonging to codeset 5, 6 or 7 may appear together with information elements belonging to codeset 0, by using the non-locking shift procedure (see subclause 10.5.4.3).

A user or network equipment shall have the capability to recognize a shift information element and to determine the length of the following information element, although the equipment need not be able to interpret and act on the content of the information element. This enables the equipment to determine the start of the subsequent information element.

10.5.4.2 Locking shift procedure

The locking shift procedure employs an information element to indicate the new active codeset. The specified codeset remains active until another locking shift information element is encountered which specifies the use of another codeset. For example, codeset 0 is active at the start of message content analysis. If a locking shift to codeset 5 is encountered, the next information elements will be interpreted according to the information element identifiers assigned in codeset 5, until another shift information element is encountered. This procedure is used only to shift to a higher order codeset than the one being left.

The locking shift is valid only within that message which contains the locking shift information element. At the start of every message content analysis, the active codeset is codeset 0.

The locking shift information element uses the type 1 information element format and coding shown in figure 10.5.85/3GPP TS 24.008 and table 10.5.98/3GPP TS 24.008.

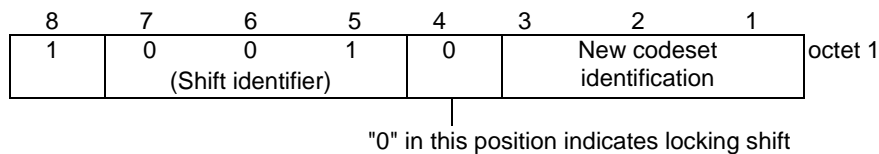

Figure 10.5.85/3GPP TS 24.008 Locking shift element

Table 10.5.98/3GPP TS 24.008: Locking shift element

Codeset identification (octet 1):			
Bits			
3	2	1	
0	0	0	not applicable
0	0	1	}
to			} reserved
1	0	0	}
1	0	1	codeset 5: information elements for national use
1	1	0	codeset 6: information elements specific to the local network (either public or private)
1	1	1	codeset 7: user-specific information elements

10.5.4.3 Non-locking shift procedure

The non-locking shift procedure provides a temporary shift to the specified lower or higher codeset. The non-locking shift procedure uses a type 1 information element to indicate the codeset to be used to interpret the next information

element. After the interpretation of the next information element, the active codeset is again used for interpreting any following information elements. For example, codeset 0 is active at the beginning of message content analysis. If a non-locking shift to codeset 6 is encountered, only the next information element is interpreted according to the information element identifiers assigned in codeset 6. After this information element is interpreted, codeset 0 will again be used to interpret the following information elements. A non-locking shift information element indicating the current codeset shall not be regarded as an error.

A locking shift information element shall not follow directly a non-locking shift information element. If this combination is received, it shall be interpreted as though a locking shift information element had been received.

The non-locking shift information element uses the type 1 information format and coding shown in figure 10.5.86/3GPP TS 24.008 and table 10.5.99/3GPP TS 24.008.

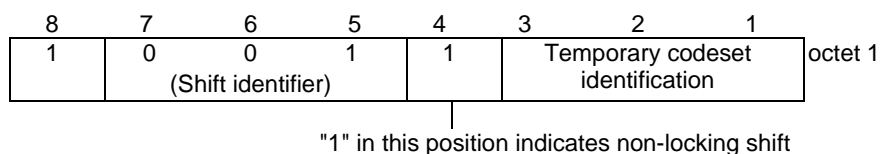

Figure 10.5.86/3GPP TS 24.008 Non-locking shift element

Table 10.5.99/3GPP TS 24.008: Non-locking shift element

Codeset identification (octet 1):			
Bits			
3	2	1	
0	0	0	codeset 0 (initially active): 3GPP TS 24.008 information elements
0	0	1	}
			} reserved
1	0	0	}
1	0	1	codeset 5: information elements for national use
1	1	0	codeset 6: information elements specific to the local network (either public or private)
1	1	1	codeset 7: user-specific information elements

10.5.4.4 Auxiliary states

The purpose of the auxiliary states information element is to describe the current status of the auxiliary states of a call in the call control states "active" and "mobile originating modify" (see 3GPP TS 24.083 [27] and 3GPP TS 24.084 [28]).

The auxiliary states information element is coded as shown in figure 10.5.87/3GPP TS 24.008, table 10.5.100/3GPP TS 24.008 and table 10.5.101/3GPP TS 24.008.

The auxiliary states is a type 4 information element with 3 octets length.

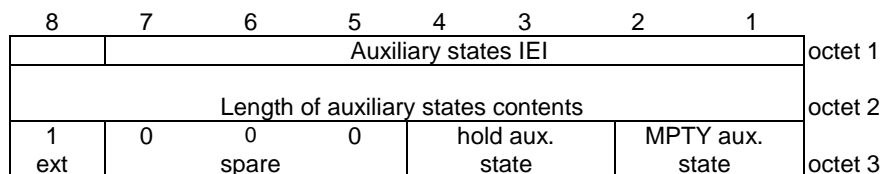

Figure 10.5.87/3GPP TS 24.008 Auxiliary states information element

Table 10.5.100/3GPP TS 24.008: Auxiliary states information element

Hold auxiliary state (octet 3)			
Bits			
4	3		
0	0	idle	Note 1
0	1	hold request	Note 1
1	0	call held	Note 1
1	1	retrieve request	Note 1
Note 1: These states are defined in 3GPP TS 24.083 [27].			

Table 10.5.101/3GPP TS 24.008: Auxiliary states information element

Multi party auxiliary state (octet 3)			
Bits			
2	1		
0	0	idle	Note 2
0	1	MPTY request	Note 2
1	0	call in MPTY	Note 2
1	1	split request	Note 2
Note 2: These states are defined in 3GPP TS 24.084 [28].			

10.5.4.4a Backup bearer capability

The purpose of the *backup bearer capability* IE is to indicate a requested service to a MS in case a complete description of the bearer service by a *bearer capability* IE is not available. The *backup bearer capability* information element is not subject to compatibility checking as described in annex B.

The *backup bearer capability* IE is coded as shown in figure 10.5.87a/3GPP TS 24.008 and tables 10.5.101a/3GPP TS 24.008 to 10.5.101m/3GPP TS 24.008.

The *backup bearer capability* is a type 4 information element with a minimum length of 3 octets and a maximum length of 15 octets.

	8	7	6	5	4	3	2	1		
	Backup bearer capability IEI								octet 1	
	Length of the backup bearer capability contents								octet 2	
1 ext	radio channel requirement		co- ding std	trans fer mode	information transfer capability				octet 3	
1 ext	comp -ress.	Structure		dupl. mode	confi gur.	NIRR	esta- bli.		octet 4*	
0/1 ext	0 0 access id.		rate adaption		signalling access protocol				octet 5*	
1 ext	Other IT C		Other rate adaption		0	0	0	Spare	octet 5a*	
0/1 ext	0 1 layer 1 id.		User information layer 1 protocol				sync/ async		octet 6*	
0/1 ext	numb. stop bits	nego- tia- tion	numb. data bits	user rate						octet 6a*
0/1 ext	intermed. rate		NIC on TX	NIC on RX	Parity				octet 6b*	
0/1 ext	connection element		modem type						octet 6c*	
0/1 ext	Other modem type		Fixed network user rate						octet 6d*	
0/1 ext	Acceptable channel codings				Maximum number of traffic channels				octet 6e*	
0/1 ext	UIMI			Wanted air interface user rate					octet 6f*	
1 ext	Acceptable channel codings Extended			Asymmetry Indication		0	0	Spare	octet 6g*	
1 ext	1 0 layer 2 id.		User information layer 2 protocol						octet 7*	

Figure 10.5.87a/3GPP TS 24.008 Backup bearer capability information element

NOTE: The coding of the octets of the *backup bearer capability* IE is not conforming to the coding of the *bearer capability* IE in ITU-T Recommendation Q.931 [53].

Table 10.5.101a/3GPP TS 24.008: Backup bearer capability information element

Radio channel requirement (octet 3)
In A/Gb mode and GERAN lu mode, i.e. not applicable for UTRAN lu mode data services.
Bits 6 and 7 are spare bits. The sending side (i.e. the network) shall set bit 7 to value 0 and bit 6 to value 1.
Coding standard (octet 3)
Bit
5
0 GSM standardized coding as described below
1 reserved
Transfer mode (octet 3)
Bit
4
0 circuit mode
1 packet mode
Information transfer capability (octet 3)
Bits
3 2 1
0 0 0 speech
0 0 1 unrestricted digital information
0 1 0 3.1 kHz audio, ex PLMN
0 1 1 facsimile group 3
1 0 1 Other ITC (See Octet 5a)
1 1 1 reserved, to be used in the network.
The meaning is: alternate speech/facsimile group 3 - starting with speech.
All other values are reserved

Table 10.5.101b/3GPP TS 24.008: Backup bearer capability information element

<p>Compression (octet 4) Bit 7 is spare and shall be set to "0".</p> <p>Structure (octet 4)</p> <p>Bits 6 5 0 0 service data unit integrity 1 1 unstructured</p> <p>All other values are reserved.</p> <p>Duplex mode (octet 4) Bit 4 0 half duplex 1 full duplex</p> <p>Configuration (octet 4) Bit 3 0 point-to-point</p> <p>All other values are reserved.</p> <p>NIRR (octet 4) (Negotiation of Intermediate Rate Requested) In A/Gb mode and GERAN lu mode, i.e. not applicable for UTRAN lu modedata services. Bit 2 is spare and shall be set to "0".</p> <p>Establishment (octet 4) Bit 1 0 demand</p> <p>All other values are reserved</p>

Table 10.5.101c/3GPP TS 24.008: Backup bearer capability information element

<p>Access identity (octet 5) Bits 7 6 0 0 octet identifier</p> <p>All other values are reserved</p> <p>Rate adaption (octet 5) Bits 5 4 0 0 no rate adaption 0 1 rate adaptation according to ITU-T Rec. V.110 [60] and ITU-T Rec. X.30 [65] 1 0 flag stuffing according to ITU-T Rec. X.31 [66] 1 1 Other rate adaption (see octet 5a)</p> <p>Signalling access protocol (octet 5) Bits 3 2 1 0 0 1 according to ITU-T Rec. Q.920 [49] and ITU-T Rec. Q.930 [50]</p> <p>All other values are reserved.</p>
--

Table 10.5.101d/3GPP TS 24.008: Backup bearer capability information element

Other ITC (octet 5a)	
If the value "Other ITC" is not signalled in the field "ITC" then the contents of this field shall be ignored.	
Bit	
7 6	
0 0	restricted digital information
All other values are reserved	
Other rate adaption (octet 5a)	
If the value "Other rate adaption" is not signalled in the field "Rate adaption" then the contents of this field shall be ignored.	
In UTRAN Iu mode, PIAFS (see 3GPP TS 27.001 [36]) shall be considered. In A/Gb mode and GERAN Iu mode, the call shall be rejected if PIAFS is requested.	
Bit	
5 4	
0 0	according to ITU-T Rec. V.120 [61]
0 1	according to ITU-T Rec. H.223 [146] and ITU-T Rec. H.245 [119]
1 0	PIAFS
All other values are reserved.	

Table 10.5.101e/3GPP TS 24.008: Backup bearer capability information element

Layer 1 identity (octet 6)	
Bits	
7 6	
0 1	octet identifier
All other values are reserved	
User information layer 1 protocol (octet 6)	
Bits	
5 4 3 2	
0 0 0 0	default layer 1 protocol
All other values reserved.	
Synchronous/asynchronous (octet 6)	
Bit	
1	
0	synchronous
1	asynchronous

Table 10.5.101f/3GPP TS 24.008: Backup bearer capability information element

Number of Stop Bits (octet 6a)	
Bit	
7	
0	1 bit (This value is also used in the case of synchronous mode)
1	2 bits
Negotiation (octet 6a)	
Bit	
6	
0	in-band negotiation not possible
NOTE: See ITU-T Rec. V.110 [60] and ITU-T Rec. X.30 [65]	
All other values are reserved	
Number of data bits excluding parity bit if present (octet 6a)	
Bit	
5	
0	7 bits
1	8 bits (this value is also used in the case of bit oriented protocols)
User rate (octet 6a)	
In A/Gb mode and GERAN lu mode only.	
Bits	
4 3 2 1	
0 0 0 0	User rate unknown
0 0 0 1	0.3 kbit/s (according to ITU-T Rec. X.1 [142] and ITU-T Rec. V.110 [60])
0 0 1 0	1.2 kbit/s (according to ITU-T Rec. X.1 [142] and ITU-T Rec. V.110 [60])
0 0 1 1	2.4 kbit/s (according to ITU-T Rec. X.1 [142] and ITU-T Rec. V.110 [60])
0 1 0 0	4.8 kbit/s (according to ITU-T Rec. X.1 [142] and ITU-T Rec. V.110 [60])
0 1 0 1	9.6 kbit/s (according to ITU-T Rec. X.1 [142] and ITU-T Rec. V.110 [60])
0 1 1 0	12.0 kbit/s transparent (non compliance with ITU-T Rec. X.1 [142] and ITU-T Rec. V.110 [60])
0 1 1 1	reserved: was allocated in earlier phases of the protocol.
All other values are reserved.	
For facsimile group 3 calls the user rate indicates the first and maximum speed the mobile station is using.	

Table 10.5.101g/3GPP TS 24.008: Backup bearer capability information element

<p>Octet 6b for rate adaptation Intermediate rate (octet 6b) according to ITU-T Rec. V.110 [60] and ITU-T Rec. X.30 [65] In A/Gb mode and GERAN lu mode only. If the value "User rate unknown" is signalled in the field "User rate" then the contents of this field shall be ignored.</p>	
<p>Bits 7 6</p>	
0 0	reserved
0 1	reserved
1 0	8 kbit/s
1 1	16 kbit/s
<p>Network independent clock (NIC) on transmission (Tx) (octet 6b) (See ITU-T Rec. V.110 [60] and ITU-T Rec. X.30 [65]). In A/Gb mode and GERAN lu mode only.</p>	
<p>Bit 5</p>	
0	does not require to send data with network independent clock
1	requires to send data with network independent clock
<p>Network independent clock (NIC) on reception (Rx) (octet 6b) (See ITU-T Rec. V.110 [60] and ITU-T Rec. X.30 [65]) In A/Gb mode and GERAN lu mode only.</p>	
<p>Bit 4</p>	
0	cannot accept data with network independent clock (i.e. sender does not support this optional procedure)
1	can accept data with network independent clock (i.e. sender does support this optional procedure)
<p>Parity information (octet 6b)</p>	
<p>Bits 3 2 1</p>	
0 0 0	odd
0 1 0	even
0 1 1	none
1 0 0	forced to 0
1 0 1	forced to 1
<p>All other values are reserved.</p>	

Table 10.5.101h/3GPP TS 24.008: Backup bearer capability information element

Connection element (octet 6c)	
Bit	
7 6	
0 0	transparent
0 1	non transparent (RLP)
1 0	both, transparent preferred
1 1	both, non transparent preferred
The network should use the 4 values depending on its capabilities to support the different modes.	
Modem type (octet 6c)	
Bits	
5 4 3 2 1	
0 0 0 0 0	none
0 0 0 0 1	according to ITU-T Rec. V.21 [54] (note 1)
0 0 0 1 0	according to ITU-T Rec. V.22 [55] (note 1)
0 0 0 1 1	according to ITU-T Rec. V.22 bis [56] (note 1)
0 0 1 0 0	reserved: was allocated in earlier phases of the protocol
0 0 1 0 1	according to ITU-T Rec. V.26 ter [58] (note 1)
0 0 1 1 0	according to ITU-T Rec. V.32 [59]
0 0 1 1 1	modem for undefined interface
0 1 0 0 0	autobauding type 1
All other values are reserved.	
Note 1: In A/Gb mode and GERAN lu mode only.	

Table 10.5.101i/3GPP TS 24.008: Backup bearer capability information element

Other modem type (octet 6d)	
Bits	
7 6	
0 0	no other modem type specified in this field
1 0	according to ITU-T Rec. V.34 [148]
All other values are reserved.	
Fixed network user rate (octet 6d)	
Bit	
5 4 3 2 1	
0 0 0 0 0	Fixed network user rate not applicable/No meaning is associated with this value.
0 0 0 0 1	9.6 kbit/s (according to ITU-T Rec. X.1 [142] and ITU-T Rec. V.110 [60])
0 0 0 1 0	14.4 kbit/s (according to ITU-T Rec. X.1 [142] and V.110 [60])
0 0 0 1 1	19.2 kbit/s (according to ITU-T Rec. X.1 [142] and V.110 [60])
0 0 1 0 0	28.8 kbit/s (according to ITU-T Rec. X.1 [142] and V.110 [60])
0 0 1 0 1	38.4 kbit/s (according to ITU-T Rec. X.1 [142] and V.110 [60])
0 0 1 1 0	48.0 kbit/s (according to ITU-T Rec. X.1 [142] and V.110 [60] (synch) (note 1))
0 0 1 1 1	56.0 kbit/s (according to ITU-T Rec. X.1 [142] and V.110 [60] (synch) /bit transparent)
0 1 0 0 0	64.0 kbit/s bit transparent
0 1 0 0 1	33.6 kbit/s bit transparent (note 2)
0 1 0 1 0	32.0 kbit/s (according to ITU-T Rec. I.460 [79])
0 1 0 1 1	31.2 kbit/s (according to ITU-T Rec. V.34 [148] (note 2))
The value "0 1 0 1 1" shall be used only by the network to inform the MS about FNUR modification due to negotiation between the modems in a 3.1 kHz multimedia call.	
All other values are reserved.	
Note 1: In A/Gb mode and GERAN lu mode only.	
Note 2: In UTRAN lu mode only	

Table 10.5.101j/3GPP TS 24.008: Backup bearer capability information element

Acceptable channel codings (octet 6e):
Bits 4 to 7 are spare and shall be set to "0".

Maximum number of traffic channels (octet 6e):
Bits 1 to 3 are spare and shall be set to "0".

Table 10.5.101k/3GPP TS 24.008: Backup bearer capability information element

UIMI, User initiated modification indication (octet 6f),

7 6 5

0 0 0 User initiated modification not allowed/applicable
0 0 1 User initiated modification up to 1 TCH/F allowed/may be requested
0 1 0 User initiated modification up to 2 TCH/F allowed/may be requested
0 1 1 User initiated modification up to 3 TCH/F allowed/may be requested
1 0 0 User initiated modification up to 4 TCH/F allowed/may be requested

All other values shall be interpreted as "User initiated modification up to 4 TCH/F may be requested".

User initiated modification indication is not applicable for transparent connection.

Wanted air interface user rate (octet 6f):
Bits 1 to 4 are spare and shall be set to "0".

Table 10.5.101l/3GPP TS 24.008: Backup bearer capability information element

Layer 2 identity (octet 7)

Bits

7 6

1 0 octet identifier

All other values are reserved

User information layer 2 protocol (octet 7)

Bits

5 4 3 2 1

0 0 1 1 0 reserved: was allocated in earlier phases of the protocol
0 1 0 0 0 according to ISO/IEC 6429 [42], codeset 0 (DC1/DC3)
0 1 0 0 1 reserved: was allocated but never used in earlier phases of the protocol
0 1 0 1 0 videotex profile 1
0 1 1 0 0 COPnoFICt (Character oriented Protocol with no Flow Control mechanism)
0 1 1 0 1 reserved: was allocated in earlier phases of the protocol

All other values are reserved.

Table 10.5.101m/3GPP TS 24.008: Backup bearer capability information element

Acceptable Channel Codings extended (octet 6g): Bits 3 to 7 are spare and shall be set to "0". Bits 2 and 1 are spare.
--

10.5.4.4a.1 Static conditions for the backup bearer capability IE contents

If the information transfer capability field (octet 3) indicates "speech", octets 4, 5, 5a, 5b, 6, 6a, 6b, 6c, 6d, 6e, 6f, 6g and 7 shall not be included.

If the information transfer capability field (octet 3) indicates a value different from "speech", octets 4 and 5 shall be included, octets 6, 6a, 6b, 6c, 6d, 6e, 6f and 6g are optional. In case octet 6 is included, octets 6a, 6b, and 6c shall also be included. In case octet 6d is included, octets 6e, 6f and 6g may be included. If the information transfer capability field (octet 3) indicates "facsimile group 3" and octet 6c is included, the modem type field (octet 6c) shall indicate "none".

If the information transfer capability field (octet 3) indicates "other ITC" or the rate adaption field (octet 5) indicates "other rate adaption", octet 5a shall be included.

The modem type field (octet 6c) shall not indicate "autobauding type 1" unless the connection element field (octet 6c) indicates "non transparent".

10.5.4.5 Bearer capability

The purpose of the bearer capability information element is to describe a bearer service. The use of the bearer capability information element in relation to compatibility checking is described in annex B.

The bearer capability information element is coded as shown in figure 10.5.88/3GPP TS 24.008 and tables 10.5.102/3GPP TS 24.008 to 10.5.115/3GPP TS 24.008.

The bearer capability is a type 4 information element with a minimum length of 3 octets and a maximum length of 16 octets.

	8	7	6	5	4	3	2	1	
	Bearer capability IEI								octet 1
	Length of the bearer capability contents								octet 2
0/1 ext	radio channel requirement		co-ding std	trans fer mode	information transfer capability				octet 3
0/1 ext	0 co-ding	CTM	0 spare	speech version indication				octet 3a *	
0/1 ext	0 co-ding	0 spare	0 spare	Speech version Indication				octet 3b etc*	
1 ext	comp -ress.	structure		dupl. mode	confi gur.	NIRR	esta-bli.		octet 4*
0/1 ext	0 access id.	0	rate adaption		signalling access protocol			octet 5*	
0/1 ext	Other ITC		Other rate adaption		0	0	0	octet 5a*	
1 ext	Hdr/ noHdr	Multi frame	Mode	LLI	Assig nor/e	Inb. neg	0 Spare		octet 5b*
0/1 ext	0 layer 1 id.		User information layer 1 protocol				sync/ async	octet 6*	
0/1 ext	numb. stop bits	nego-tia-tion	numb. data bits	user rate				octet 6a*	
0/1 ext	intermed. rate		NIC on TX	NIC on RX	Parity			octet 6b*	
0/1 ext	connection element		modem type					octet 6c*	
0/1 ext	Other modem type		Fixed network user rate					octet 6d*	
0/1 ext	Acceptable channel codings				Maximum number of traffic channels				octet 6e*
0/1 ext	UIMI			Wanted air interface user rate					octet 6f*
1 ext	Acceptable channel codings extended			Asymmetry Indication		0 0		Spare	octet 6g*
1 ext	1 layer 2 id.	0	User information layer 2 protocol					octet 7*	

Figure 10.5.88/3GPP TS 24.008 Bearer capability information element

NOTE 1: The coding of the octets of the bearer capability information element is not conforming to ITU Recommendation Q.931 [53].

An MS shall encode the Bearer Capability information element according to A/Gb mode call control requirements also if it is requesting for a service in Iu mode, with the following exceptions:

1. A mobile station not supporting A/Gb mode and GERAN Iu mode for the requested bearer service shall set the following parameters to the value "0":
 - Maximum number of traffic channels (octet 6e, bits 1-3)
 - Acceptable Channel coding(s) (octet 6e, bits 4, 5 and 7)
2. Furthermore, a mobile station not supporting A/Gb mode and GERAN Iu mode for the requested bearer service shall also set the following parameters to the value "0", if the respective octets have to be included in the bearer capability information element according to subclause 10.5.4.5.1 and 3GPP TS 27.001 [36]:
 - UIMI, User initiated modification indication (octet 6f, bits 5-7)
 - Acceptable Channel Codings extended (octet 6g, bits 5-7)

For UTRAN Iu mode the following parameters are irrelevant for specifying the radio access bearer, because multiple traffic channels (multislot) are not deployed, see 3GPP TS 23.034 [104]. However, the parameters if received, shall be stored in the MSC, and used for handover to A/Gb or GERAN Iu mode:

- Maximum number of traffic channels (octet 6e, bits 1-3)
- Acceptable Channel coding(s) (octet 6e, bits 4, 5 and 7)
- UIMI, User initiated modification indication (octet 6f, bits 5-7)
- Acceptable Channel Codings extended (octet 6g, bits 5-7)

NOTE 2: The following parameters are relevant in UTRAN Iu mode for non transparent data calls for deciding which RLP version to negotiate in order to avoid renegotiation of RLP version in case of inter-system handover from UTRAN Iu mode to A/Gb or GERAN Iu mode, see 3GPP TS 24.022 [141]:

- Maximum number of traffic channels (octet 6e, bits 1-3)
- Wanted air interface user rate (octet 6f, bits 1- 4)
- UIMI, User initiated modification indication (octet 6f, bits 5-7).

Table 10.5.102/3GPP TS 24.008: Bearer capability information element

Radio channel requirement (octet 3), network to MS direction In A/Gb mode and GERAN Iu mode, i.e. not applicable for UTRAN Iu mode data services.	
Bits 6 and 7 are spare bits. The sending side (i.e. the network) shall set bit 7 to value 0 and bit 6 to value 1.	
Radio channel requirement (octet 3) MS to network direction	
When information transfer capability (octet 3) indicates other values than speech:	
Bits	
7 6	
0 0	reserved
0 1	full rate support only MS
1 0	dual rate support MS/half rate preferred
1 1	dual rate support MS/full rate preferred
When information transfer capability (octet 3) indicates the value speech and no speech version indication is present in octet 3a etc.:	
Bits	
7 6	
0 0	reserved
0 1	full rate support only MS/fullrate speech version 1 supported
1 0	dual rate support MS/half rate speech version 1 preferred, full rate speech version 1 also supported
1 1	dual rate support MS/full rate speech version 1 preferred, half rate speech version 1 also supported
When information transfer capability (octet 3) indicates the value speech and speech version indication(s) is(are) present in octet 3a etc.:	
Bits	
7 6	
0 0	reserved
0 1	the mobile station supports at least full rate speech version 1 but does not support half rate speech version 1. The complete voice codec preference is specified in octet(s) 3a etc.
1 0	The mobile station supports at least full rate speech version 1 and half rate speech version 1. The mobile station has a greater preference for half rate speech version 1 than for full rate speech version 1. The complete voice codec preference is specified in octet(s) 3a etc.
1 1	The mobile station supports at least full rate speech version 1 and half rate speech version 1. The mobile station has a greater preference for full rate speech version 1 than for half rate speech version 1. The complete voice codec preference is specified in octet(s) 3a etc.

(continued...)

Table 10.5.102/3GPP TS 24.008: Bearer capability information element (continued)

Coding standard (octet 3)	
Bit	
5	
0	GSM standardized coding as described below
1	reserved
Transfer mode (octet 3)	
Bit	
4	
0	circuit mode
1	packet mode
Information transfer capability (octet 3)	
Bits	
3 2 1	
0 0 0	speech
0 0 1	unrestricted digital information
0 1 0	3.1 kHz audio, ex PLMN
0 1 1	facsimile group 3
1 0 1	Other ITC (See Octet 5a)
1 1 1	reserved, to be used in the network.
	The meaning is: alternate speech/facsimile group 3 - starting with speech.
All other values are reserved	

Table 10.5.103/3GPP TS 24.008 Bearer capability information element

<p>Octet(s) 3a etc. MS to network direction</p> <p>Octet(s) 3a etc., bits 1 to 4 shall only be used to convey speech coding information belonging to a A/Gb mode or GERAN lu mode. When included for a UTRAN lu mode call establishment they shall be used for handover to A/Gb mode or GERAN lu mode.</p> <p>A mobile station supporting CTM text telephony, but not supporting A/Gb mode or GERAN lu mode shall encode octet 3a, bits 1 to 4 as "no speech version supported for GERAN".</p> <p>Coding</p> <p>Bit</p> <p>7</p> <p>0 octet used for extension of information transfer capability</p> <p>1 octet used for other extension of octet 3</p> <p>When information transfer capability (octet 3) indicates speech and coding (bit 7 in octet 3a etc.) is coded as 0, bits 1 through 6 are coded:</p> <p>CTM text telephony indication (octet 3a)</p> <p>Bit</p> <p>6</p> <p>0 CTM text telephony is not supported</p> <p>1 CTM text telephony is supported</p> <p>Bit 6 in octet(s) 3b etc. is spare.</p> <p>Bit 5 in octet(s) 3a etc. is spare.</p> <p>Speech version indication (octet(s) 3a etc.)</p> <p>Bits</p> <p>4 3 2 1</p> <p>0 0 0 0 GSM full rate speech version 1 (note 2)</p> <p>0 0 1 0 GSM full rate speech version 2 (note 2)</p> <p>0 1 0 0 GSM full rate speech version 3 (note 2)</p> <p>0 1 1 0 GSM full rate speech version 4 (note 2)</p> <p>1 0 0 0 GSM full rate speech version 5 (note 2)</p> <p>0 0 0 1 GSM half rate speech version 1 (note 2)</p> <p>0 1 0 1 GSM half rate speech version 3 (note 2)</p> <p>0 1 1 1 GSM half rate speech version 4 (note 2)</p> <p>1 0 1 1 GSM half rate speech version 6 (note 2)</p> <p>1 1 1 1 no speech version supported for GERAN (note 1)</p> <p>All other values have the meaning "speech version tbd" and shall be ignored when received.</p> <p>NOTE 1: This value shall only be used by an MS supporting CTM text telephony, but not supporting A/Gb or GERAN lu mode.</p> <p>NOTE 2: As defined in 3GPP TS 26.103 [83] and 3GPP TS 48.008 [85].</p> <p>If octet 3 is extended with speech version indication(s) (octets 3a etc.), all speech versions supported shall be indicated and be included in order of preference (the first octet (3a) has the highest preference and so on).</p> <p>If information transfer capability (octet 3) indicates speech and coding (bit 7 in octet 3a etc.) is coded as 1, or the information transfer capability does not indicate speech, then the extension octet shall be ignored.</p> <p>Octet(s) 3a etc. network to MS direction</p> <p>The octet(s) 3a etc. shall be ignored by the MS.</p>

Table 10.5.104/3GPP TS 24.008: Bearer capability information element

Compression (octet 4), network to MS direction:	
Bit	
7	
0	data compression not possible
1	data compression possible
Compression (octet 4), MS to network direction:	
Bit	
7	
0	data compression not allowed
1	data compression allowed
Structure (octet 4)	
Bits	
6 5	
0 0	service data unit integrity
1 1	unstructured
All other values are reserved.	
Duplex mode (octet 4)	
Bit	
4	
0	half duplex
1	full duplex
Configuration (octet 4)	
Bit	
3	
0	point-to-point
All other values are reserved.	
NIRR (octet 4)	
(Negotiation of Intermediate Rate Requested)	
In A/Gb mode and GERAN lu mode, i.e. not applicable for UTRAN lu mode data services.	
Bit	
2	
0	No meaning is associated with this value.
1	Data up to and including 4.8 kb/s, full rate, non-transparent, 6 kb/s radio interface rate is requested.
Establishment (octet 4)	
Bit	
1	
0	demand
All other values are reserved	

Table 10.5.105/3GPP TS 24.008: Bearer capability information element

<p>Access identity (octet 5)</p> <p>Bits</p> <p>7 6</p> <p>0 0 octet identifier</p> <p>All other values are reserved</p> <p>Rate adaption (octet 5)</p> <p>Bits</p> <p>5 4</p> <p>0 0 no rate adaption</p> <p>0 1 rate adaptation according to ITU-T Rec. V.110 [66] and ITU-T Rec. X.30 [65]</p> <p>1 0 flag stuffing according to ITU-T Rec. X.31 [66]</p> <p>1 1 Other rate adaption (see octet 5a)</p> <p>Signalling access protocol (octet 5)</p> <p>Bits</p> <p>3 2 1</p> <p>0 0 1 according to ITU-T Rec. Q.920 [49] and ITU-T Rec. Q.930 [50]</p> <p>0 1 0 reserved: was allocated in earlier phases of the protocol</p> <p>0 1 1 reserved: was allocated in earlier phases of the protocol</p> <p>1 0 0 reserved: was allocated in earlier phases of the protocol</p> <p>1 0 1 reserved: was allocated in earlier phases of the protocol</p> <p>1 1 0 reserved: was allocated in earlier phases of the protocol</p> <p>All other values are reserved.</p>

Table 10.5.106/3GPP TS 24.008: Bearer capability information element

<p>Other ITC (octet 5a)</p> <p>If the value "Other ITC" is not signalled in the field "ITC" then the contents of this field shall be ignored.</p> <p>Bit</p> <p>7 6</p> <p>0 0 restricted digital information</p> <p>All other values are reserved</p> <p>Other rate adaption (octet 5a)</p> <p>If the value " Other rate adaption" is not signalled in the field "Rate adaption" then the contents of this field shall be ignored.</p> <p>In UTRAN lu mode, PIAFS (see 3GPP TS 27.001 [36]) shall be considered. In A/Gb mode and GERAN lu mode, the call shall be rejected if PIAFS is requested.</p> <p>Bit</p> <p>5 4</p> <p>0 0 according to ITU-T Rec. V.120 [61]</p> <p>0 1 according to ITU-T Rec. H.223 [146] and ITU-T Rec. H.245 [119]</p> <p>1 0 PIAFS</p> <p>All other values are reserved.</p>
--

Table 10.5.107/3GPP TS 24.008: Bearer capability information element

Rate adaption header/no header (octet 5b)
Bit
7
0 Rate adaption header not included
1 Rate adaption header included
Multiple frame establishment support in data link (octet 5b)
Bit
6
0 Multiple frame establishment not supported, only UI frames allowed
1 Multiple frame establishment supported
Mode of operation (octet 5b)
Bit
5
0 Bit transparent mode of operation
1 Protocol sensitive mode of operation
Logical link identifier negotiation (octet 5b)
Bit
4
0 Default, LLI=256 only
1 Full protocol negotiation, (note: A connection over which protocol negotiation will be executed is indicated in bit 2 of octet 5b)
Assignor/Assignee (octet 5b)
Bit
3
0 Message originator is "default assignee"
1 Message originator is "assignor only"
In band/Out of band negotiation (octet 5b)
Bit
2
0 Negotiation is done in-band using logical link zero
1 Negotiation is done with USER INFORMATION messages on a temporary signalling connection
Bit 1 is spare and set to the value "0"

Table 10.5.108/3GPP TS 24.008: Bearer capability information element

Layer 1 identity (octet 6)
Bits
7 6
0 1 octet identifier
All other values are reserved
User information layer 1 protocol (octet 6)
Bits
5 4 3 2
0 0 0 0 default layer 1 protocol
All other values reserved.
Synchronous/asynchronous (octet 6)
Bit
1
0 synchronous
1 asynchronous

Table 10.5.109/3GPP TS 24.008: Bearer capability information element

Number of Stop Bits (octet 6a)
Bit
7
0 1 bit (This value is also used in the case of synchronous mode)
1 2 bits
Negotiation (octet 6a)
Bit
6
0 in-band negotiation not possible
NOTE: See ITU-T Rec. V.110 [60] and ITU-T Rec. X.30 [65]
All other values are reserved
Number of data bits excluding parity bit if present (octet 6a)
Bit
5
0 7 bits
1 8 bits (this value is also used in the case of bit oriented protocols)
User rate (octet 6a)
In A/Gb mode and GERAN lu mode only.
Bits
4 3 2 1
0 0 0 1 0.3 kbit/s according to ITU-T Rec. X.1 [142] and ITU-T Rec. V.110 [60]
0 0 1 0 1.2 kbit/s according to ITU-T Rec. X.1 [142] and ITU-T Rec. V.110 [60]
0 0 1 1 2.4 kbit/s according to ITU-T Rec. X.1 [142] and ITU-T Rec. V.110 [60]
0 1 0 0 4.8 kbit/s according to ITU-T Rec. X.1 [142] and ITU-T Rec. V.110 [60]
0 1 0 1 9.6 kbit/s according to ITU-T Rec. X.1 [142] and ITU-T Rec. V.110 [60]
0 1 1 0 12.0 kbit/s transparent (non compliance with ITU-T Rec. X.1 [142] and ITU-T Rec. V.110 [60])
0 1 1 1 reserved: was allocated in earlier phases of the protocol.
All other values are reserved.
For facsimile group 3 calls the user rate indicates the first and maximum speed the mobile station is using.

Table 10.5.110/3GPP TS 24.008: Bearer capability information element

<p>Octet 6b for V.110/X.30 rate adaptation Intermediate rate (octet 6b) In A/Gb mode and GERAN lu mode only.</p> <p>Bits 7 6 0 0 reserved 0 1 reserved 1 0 8 kbit/s 1 1 16 kbit/s</p> <p>Network independent clock (NIC) on transmission (Tx) (octet 6b) (See ITU-T Rec. V.110 [60] and ITU-T Rec. X.30 [65]) In A/Gb mode and GERAN lu mode only.</p> <p>Bit 5 0 does not require to send data with network independent clock 1 requires to send data with network independent clock</p> <p>Network independent clock (NIC) on reception (Rx) (octet 6b) (See ITU-T Rec. V.110 [60] and ITU-T Rec. X.30 [65]) In A/Gb mode and GERAN lu mode only.</p> <p>Bit 4 0 cannot accept data with network independent clock (i.e. sender does not support this optional procedure) 1 can accept data with network independent clock (i.e. sender does support this optional procedure)</p> <p>Parity information (octet 6b) Bits 3 2 1 0 0 0 odd 0 1 0 even 0 1 1 none 1 0 0 forced to 0 1 0 1 forced to 1</p> <p>All other values are reserved.</p>

Table 10.5.111/3GPP TS 24.008: Bearer capability information element

<p>Connection element (octet 6c)</p> <p>Bit</p> <p>7 6</p> <p>0 0 transparent</p> <p>0 1 non transparent (RLP)</p> <p>1 0 both, transparent preferred</p> <p>1 1 both, non transparent preferred</p> <p>The requesting end (e.g. the one sending the SETUP message) should use the 4 values depending on its capabilities to support the different modes. The answering party shall only use the codings 00 or 01, based on its own capabilities and the proposed choice if any. If both MS and network support both transparent and non transparent, priority should be given to the MS preference.</p> <p>Modem type (octet 6c)</p> <p>Bits</p> <p>5 4 3 2 1</p> <p>0 0 0 0 0 none</p> <p>0 0 0 0 1 according to ITU-T Rec. V.21 [54] (note 1)</p> <p>0 0 0 1 0 according to ITU-T Rec. V.22 [55] (note 1)</p> <p>0 0 0 1 1 according to ITU-T Rec. V.22 bis [56] (note 1)</p> <p>0 0 1 0 0 reserved: was allocated in earlier phases of the protocol</p> <p>0 0 1 0 1 according to ITU-T Rec.V.26 ter [58] (note 1)</p> <p>0 0 1 1 0 according to ITU-T Rec. V.32 [59]</p> <p>0 0 1 1 1 modem for undefined interface</p> <p>0 1 0 0 0 autobauding type 1</p> <p>All other values are reserved.</p> <p>Note 1: In A/Gb mode and GERAN lu mode only.</p>
--

Table 10.5.112/3GPP TS 24.008: Bearer capability information element

Other modem type (octet 6d)	
Bits	
7 6	
0 0	no other modem type specified in this field
1 0	V.34
All other values are reserved.	
Fixed network user rate (octet 6d)	
Bit	
5 4 3 2 1	
0 0 0 0 0	Fixed network user rate not applicable/No meaning is associated with this value.
0 0 0 0 1	9.6 kbit/s (according to ITU-T Rec. X.1 [142] and ITU-T Rec. V.110 [60])
0 0 0 1 0	14.4 kbit/s (according to ITU-T Rec. X.1 [142] and ITU-T Rec. V.110 [60])
0 0 0 1 1	19.2 kbit/s (according to ITU-T Rec. X.1 [142] and ITU-T Rec. V.110 [60])
0 0 1 0 0	28.8 kbit/s (according to ITU-T Rec. X.1 [142] and ITU-T Rec. V.110 [60])
0 0 1 0 1	38.4 kbit/s (according to ITU-T Rec. X.1 [142] and ITU-T Rec. V.110 [60])
0 0 1 1 0	48.0 kbit/s (according to ITU-T Rec. X.1 [142] and ITU-T Rec. V.110 [60]) (synch) (note 1)
0 0 1 1 1	56.0 kbit/s (according to ITU-T Rec. X.1 [142] and ITU-T Rec. V.110 [60]) (synch) /bit transparent)
0 1 0 0 0	64.0 kbit/s bit transparent
0 1 0 0 1	33.6 kbit/s bit transparent (note 2)
0 1 0 1 0	32.0 kbit/s Recommendation I.460 [79]
0 1 0 1 1	31.2 kbit/s Recommendation V.34 [148] (note 2)
The value "0 1 0 1 1" shall be used only by the network to inform the MS about FNUR modification due to negotiation between the modems in a 3.1 kHz multimedia call.	
All other values are reserved.	
Note 1: In A/Gb mode and GERAN lu mode only.	
Note 2: In UTRAN lu mode only	

Table 10.5.113/3GPP TS 24.008: Bearer capability information element

Acceptable channel codings (octet 6e), mobile station to network direction:	
Bit	
7	
0	TCH/F14.4 not acceptable
1	TCH/F14.4 acceptable
Bit	
6	
0	Spare
Bit	
5	
0	TCH/F9.6 not acceptable
1	TCH/F9.6 acceptable
Bit	
4	
0	TCH/F4.8 not acceptable
1	TCH/F4.8 acceptable
Acceptable channel codings (octet 6e), network to MS direction: Bits 4 to 7 are spare and shall be set to "0".	
Maximum number of traffic channels (octet 6e), MS to network direction:	
Bits	
3 2 1	
0 0 0	1 TCH
0 0 1	2 TCH
0 1 0	3 TCH
0 1 1	4 TCH
1 0 0	5 TCH
1 0 1	6 TCH
1 1 0	7 TCH
1 1 1	8 TCH
Maximum number of traffic channels (octet 6e), network to MS direction: Bits 1 to 3 are spare and shall be set to "0".	

Table 10.5.114/3GPP TS 24.008: Bearer capability information element

UIMI, User initiated modification indication (octet 6f),	
7 6 5	
0 0 0	User initiated modification not allowed/required/applicable
0 0 1	User initiated modification up to 1 TCH/F allowed/may be requested
0 1 0	User initiated modification up to 2 TCH/F allowed/may be requested
0 1 1	User initiated modification up to 3 TCH/F allowed/may be requested
1 0 0	User initiated modification up to 4 TCH/F allowed/may be requested
All other values shall be interpreted as "User initiated modification up to 4 TCH/F may be requested".	
User initiated modification indication is not applicable for transparent connection.	
Wanted air interface user rate (octet 6f), MS to network direction:	
Bits	
4 3 2 1	
0 0 0 0	Air interface user rate not applicable/No meaning associated with this value
0 0 0 1	9.6 kbit/s
0 0 1 0	14.4 kbit/s
0 0 1 1	19.2 kbit/s
0 1 0 1	28.8 kbit/s
0 1 1 0	38.4 kbit/s
0 1 1 1	43.2 kbit/s
1 0 0 0	57.6 kbit/s
1 0 0 1	interpreted by the network as 38.4 kbit/s in this version of the protocol
1 0 1 0	interpreted by the network as 38.4 kbit/s in this version of the protocol
1 0 1 1	interpreted by the network as 38.4 kbit/s in this version of the protocol
1 1 0 0	interpreted by the network as 38.4 kbit/s in this version of the protocol
All other values are reserved.	
Wanted air interface user rate (octet 6f), network to MS direction:	
Bits 1 to 4 are spare and shall be set to "0".	

Table 10.5.115/3GPP TS 24.008: Bearer capability information element

<p>Layer 2 identity (octet 7)</p> <p>Bits</p> <p>7 6</p> <p>1 0 octet identifier</p> <p>All other values are reserved</p> <p>User information layer 2 protocol (octet 7)</p> <p>Bits</p> <p>5 4 3 2 1</p> <p>0 0 1 1 0 reserved: was allocated in earlier phases of the protocol</p> <p>0 1 0 0 0 according to ISO/IEC 6429 [42], codeset 0 (DC1/DC3)</p> <p>0 1 0 0 1 reserved: was allocated but never used in earlier phases of the protocol</p> <p>0 1 0 1 0 videotex profile 1</p> <p>0 1 1 0 0 COPnoFICt (Character oriented Protocol with no Flow Control mechanism)</p> <p>0 1 1 0 1 reserved: was allocated in earlier phases of the protocol</p> <p>All other values are reserved.</p>
--

Table 10.5.115a/3GPP TS 24.008: Bearer capability information element

<p>Acceptable Channel Codings extended (octet 6g) mobile station to network direction:</p> <p>Bit</p> <p>7</p> <p>0 TCH/F28.8 not acceptable</p> <p>1 TCH/F28.8 acceptable</p> <p>Bit</p> <p>6</p> <p>0 TCH/F32.0 not acceptable</p> <p>1 TCH/F32.0 acceptable</p> <p>Bit</p> <p>5</p> <p>0 TCH/F43.2 not acceptable</p> <p>1 TCH/F43.2 acceptable</p> <p>Channel Coding Asymmetry Indication</p> <p>Bits</p> <p>4 3</p> <p>0 0 Channel coding symmetry preferred</p> <p>1 0 Downlink biased channel coding asymmetry is preferred</p> <p>0 1 Uplink biased channel coding asymmetry is preferred</p> <p>1 1 Unused, if received it shall be interpreted as "Channel coding symmetry preferred"</p> <p>EDGE Channel Codings (octet 6g), network to MS direction:</p> <p>Bits 3 to 7 are spare and shall be set to "0".</p> <p>Bits 2 and 1 are spare.</p>

10.5.4.5.1 Static conditions for the bearer capability IE contents

If the information transfer capability field (octet 3) indicates "speech", octets 4, 5, 5a, 5b, 6, 6a, 6b, 6c, 6d, 6e, 6f, 6g and 7 shall not be included.

If the information transfer capability field (octet 3) indicates "speech", octet 3a etc. shall be included only if the mobile station supports CTM text telephony or if it supports at least one speech version for GERAN other than:

- GSM full rate speech version 1; or
- GSM half rate speech version 1.

If the information transfer capability field (octet 3) indicates a value different from "speech", octets 4, 5, 6, 6a, 6b, and 6c shall be included, octets 6d, 6e, 6f and 6g are optional. In the network to MS direction in case octet 6d is included, octets 6e, 6f and 6g may be included. In the MS to network direction in case octet 6d is included octet 6e shall also be included and 6f and 6g may be included.

If the information transfer capability field (octet 3) indicates "facsimile group 3", the modem type field (octet 6c) shall indicate "none".

If the information transfer capability field (octet 3) indicates "other ITC" or the rate adaption field (octet 5) indicates "other rate adaption", octet 5a shall be included.

If the rate adaption field (octet 5) indicates "other rate adaption" and the other rate adaption field (octet 5a) indicates "V.120", octet 5b shall be included.

The modem type field (octet 6c) shall not indicate "autobauding type 1" unless the connection element field (octet 6c) indicates "non transparent".

10.5.4.5a Call Control Capabilities

The purpose of the Call Control Capabilities information element is to identify the call control capabilities of the mobile station.

The Call Control Capabilities information element is coded as shown in figure 10.5.89/3GPP TS 24.008 and table 10.5.116/3GPP TS 24.008.

The Call Control Capabilities is a type 4 information element with a length of 4 octets.

8	7	6	5	4	3	2	1	
Call Control Capabilities IEI								octet 1
Length of Call Control Capabilities contents								octet 2
Maximum number of supported bearers				MCAT	ENICM	PCP	DTMF	octet3
0	0	0	0	Maximum number of speech bearers				octet 4
spare								

Figure 10.5.89/3GPP TS 24.008 Call Control Capabilities information element

Table 10.5.116/3GPP TS 24.008: Call Control Capabilities

DTMF (octet 3, bit 1)	
0	This value is reserved for earlier versions of the protocol.
1	This value indicates that the mobile station supports DTMF as specified in subclause 5.5.7 of the present document.
PCP (octet 3, bit 2)	
0	This value indicates that the mobile station does not support the Prolonged Clearing Procedure
1	This value indicates that the mobile station supports the Prolonged Clearing Procedure.
ENICM (octet 3, bit 3)	
0	This value indicates that the mobile station does not support the Enhanced Network-initiated In-Call Modification procedure.
1	This value indicates that the mobile station supports the Enhanced Network-initiated In-Call Modification procedure as specified in subclause 5.3.4.3 of the present document.
MCAT (octet 3, bit 4)	
0	This value indicates that the mobile station does not support Multimedia CAT.
1	This value indicates that the mobile station supports Multimedia CAT during the alerting phase of a mobile originated multimedia call establishment as specified in subclause 5.3.6.4 of the present document.
Maximum number of supported bearers (octet 3, bit 5 to bit 8)	
0 0 0 0	1 bearer supported
All values are interpreted as the binary representation of the number of bearers supported.	
Bit 5 of octet 3 is the least significant bit and bit 8 of octet 3 is the most significant bit.	
Maximum number of speech bearers (octet 4, bit 1 to bit 4)	
All values are interpreted as the binary representation of the number of bearers supported.	
Bit 1 of octet 4 is the least significant bit and bit 4 of octet 4 is the most significant bit.	
Note:	In this version of the protocol, the MS should not indicate more than one speech bearer.

10.5.4.6 Call state

The purpose of the call state information element is to describe the current status of a call, (see subclause 5.1).

The call state information element is coded as shown in figure 10.5.90/3GPP TS 24.008 and table 10.5.117/3GPP TS 24.008.

The call state is a type 3 information element with 2 octets length.

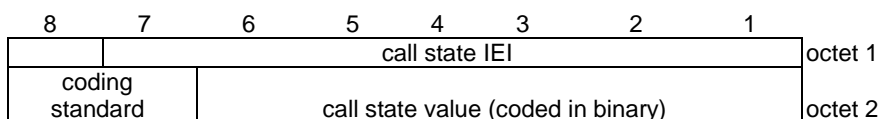

Figure 10.5.90/3GPP TS 24.008 Call state information element

Table 10.5.117/3GPP TS 24.008: Call state information element

Coding standard (octet 2)							
Bits							
8	7						
0 0	standardized coding as described in ITU-T Rec. Q.931						
0 1	reserved for other international standards						
1 0	national standard						
1 1	standard defined for the GSM PLMNS as described below						
Coding standards other than "1 1 - Standard defined for the GSM PLMNS" shall not be used if the call state can be represented with the GSM standardized coding.							
The mobile station or network need not support any other coding standard than "1 1 - Standard defined for the GSM PLMNS".							
If a call state IE indicating a coding standard not supported by the receiver is received, call state "active" shall be assumed.							
Call state value (octet 2)							
Bits							
6	5	4	3	2	1		
0	0	0	0	0	0	U0 - null	NO - null
0	0	0	0	1	0	U0.1- MM connection pending	N0.1- MM connection pending
1	0	0	0	1	0	U0.2- CC prompt present	N0.2- CC connection pending
1	0	0	0	1	1	U0.3- Wait for network information	N0.3- Network answer pending
1	0	0	1	0	0	U0.4- CC-Establishment present	N0.4- CC-Establishment present
1	0	0	1	0	1	U0.5- CC-Establishment confirmed	N0.5- CC-Establishment confirmed
1	0	0	1	1	0	U0.6- Recall present	N0.6- Recall present
0	0	0	0	0	1	U1 - call initiated	N1 - call initiated
0	0	0	0	1	1	U3 - mobile originating call proceeding	N3 - mobile originating call proceeding
0	0	0	1	0	0	U4 - call delivered	N4 - call delivered
0	0	0	1	1	0	U6 - call present	N6 - call present
0	0	0	1	1	1	U7 - call received	N7 - call received
0	0	1	0	0	0	U8 - connect request	N8 - connect request
0	0	1	0	0	1	U9 - mobile terminating call confirmed	N9 - mobile terminating call confirmed
0	0	1	0	1	0	U10- active	N10- active
0	0	1	0	1	1	U11- disconnect request	
0	0	1	1	0	0	U12- disconnect indication	N12-disconnect indication
0	1	0	0	1	1	U19- release request	N19- release request
0	1	1	0	1	0	U26- mobile originating modify	N26- mobile originating modify
0	1	1	0	1	1	U27- mobile terminating modify	N27- mobile terminating modify
0	1	1	1	0	0		N28- connect indication

10.5.4.7 Called party BCD number

The purpose of the called party BCD number information element is to identify the called party.

The called party BCD number information element is coded as shown in figure 10.5.91/3GPP TS 24.008 and table 10.5.118/3GPP TS 24.008.

The called party BCD number is a type 4 information element with a minimum length of 3 octets and a maximum length of 43 octets. For PCS 1900 the maximum length is 19 octets.

8	7	6	5	4	3	2	1	
Called party BCD number IEI								octet 1
Length of called party BCD number contents								octet 2
1	type of number			Numbering plan identification				octet 3
ext								
Number digit 2				Number digit 1				octet 4*
Number digit 4				Number digit 3				octet 5*
								:
2)								:

Figure 10.5.91/3GPP TS 24.008 Called party BCD number information element

NOTE 1: The number digit(s) in octet 4 precedes the digit(s) in octet 5 etc. The number digit which would be entered first is located in octet 4, bits 1 to 4.

NOTE 2: If the called party BCD number contains an odd number of digits, bits 5 to 8 of the last octet shall be filled with an end mark coded as "1111".

Since the information element must contain the complete called party BCD number there is no need for an additional complete indication.

Table 10.5.118/3GPP TS 24.008: Called party BCD number

Type of number (octet 3) (Note 1)			
Bits			
7	6	5	
0	0	0	unknown (Note 2)
0	0	1	international number (Note 3, Note 5)
0	1	0	national number (Note 3)
0	1	1	network specific number (Note 4)
1	0	0	dedicated access, short code
1	0	1	reserved
1	1	0	reserved
1	1	1	reserved for extension

NOTE 1: For the definition of "number" see ITU-T Recommendation I.330 [48] and 3GPP TS 23.003 [10].

NOTE 2: The type of number "unknown" is used when the user or the network has no knowledge of the type of number, e.g. international number, national number, etc. In this case the number digits field is organized according to the network dialling plan, e.g. prefix or escape digits might be present.

NOTE 3: Prefix or escape digits shall not be included.

NOTE 4: The type of number "network specific number" is used to indicate administration/service number specific to the serving network, e.g. used to access an operator.

NOTE 5: The international format shall be accepted by the MSC when the call is destined to a destination in the same country as the MSC.

Table 10.5.118/3GPP TS 24.008: Called party BCD number (continued)

Numbering plan identification (octet 3)			
Number plan (applies for type of number = 000, 001, 010 and 100)			
Bits			
4	3	2	1
0	0	0	0
0	0	0	1
0	0	1	1
0	1	0	0
1	0	0	0
1	0	0	1
1	0	1	1
1	1	1	1

unknown
ISDN/telephony numbering plan (ITU-T Rec. E.164 [45] / ITU-T Rec. E.163 [44])
data numbering plan (ITU-T Rec. X.121 [69])
telex numbering plan (ITU-T Rec. F.69 [47])
national numbering plan
private numbering plan
reserved for CTS (see 3GPP TS 44.056 [91])
reserved for extension

All other values are reserved.

- When an MS is the recipient of number information from the network, any incompatibility between the number digits and the number plan identification shall be ignored and a STATUS message shall not be sent to the network.
- In the case of numbering plan "unknown", the number digits field is organized according to the network dialling plan; e.g. prefix or escape digits might be present.

Table 10.5.118/3GPP TS 24.008: Called party BCD number (continued)

Number digits (octets 4, etc.)			
Bits			
4	3	2	1
8	7	6	5
0	0	0	0
0	0	0	1
0	0	1	0
0	0	1	1
0	1	0	0
0	1	0	1
0	1	1	0
0	1	1	1
1	0	0	0
1	0	0	1
1	0	1	0
1	0	1	1
1	1	0	0
1	1	0	1
1	1	1	0
1	1	1	1

or

Number digit value

0
1
2
3
4
5
6
7
8
9
*

a
b
c
used as an endmark in the case of an odd number of number digits

10.5.4.8 Called party subaddress

The purpose of the Called party subaddress is to identify the subaddress of the called party of a call. For the definition of a subaddress see ITU-T Rec. I.330 [48].

The Called party subaddress information element is coded as shown in figure 10.5.92/3GPP TS 24.008 and Table 10.5.119/3GPP TS 24.008.

The called party subaddress is a type 4 information element with a minimum length of 2 octets and a maximum length of 23 octets.

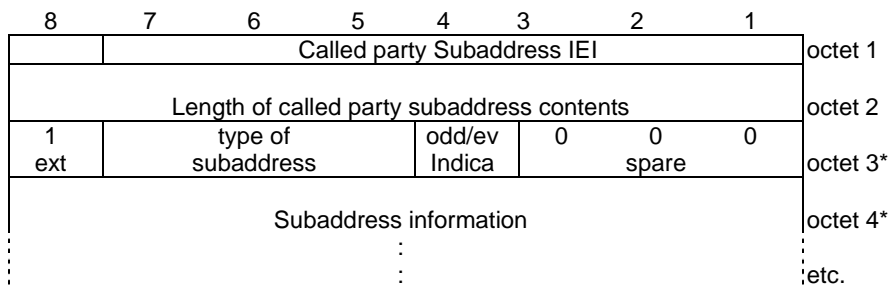

Figure 10.5.92/3GPP TS 24.008 Called party subaddress

Table 10.5.119/3GPP TS 24.008: Called party subaddress

Type of subaddress (octet 3)	
Bits	
7	6
5	
0	0
0	1
0	0
NSAP (see ITU-T Rec. X.213 [144]/ISO 8348 AD2)	
User specified	
All other values are reserved	
Odd/even indicator (octet 3)	
Bit	
4	
0	even number of address signals
1	odd number of address signals
NOTE 1: The odd/even indicator is used when the type of subaddress is "user specified" and the coding is BCD.	
Subaddress information (octet 4, etc...)	
The NSAP X.213/ISO8348AD2 address shall be formatted as specified by octet 4 which contains the Authority and Format Identifier (AFI). The encoding is made according to the "preferred binary encoding" as defined in X.213 [144]/ISO8348AD2. For the definition of this type of subaddress, see ITU-T Rec. I.334 [145].	
A coding example is given in ANNEX A.	
For User-specific subaddress, this field is encoded according to the user specification, subject to a maximum length of 20 octets.	
NOTE 2: It is recommended that users apply NSAP subaddress type since this subaddress type allows the use of decimal, binary and IA5 characters in a standardised manner.	

10.5.4.9 Calling party BCD number

The purpose of the calling party BCD number information element is to identify the origin of a call.

The calling party BCD number information element is coded as shown in figure 10.5.93/3GPP TS 24.008 and table 10.5.120/3GPP TS 24.008.

The calling party BCD number is a type 4 information element. In the network to mobile station direction it has a minimum length of 3 octets and a maximum length of 14 octets. (This information element is not used in the mobile station to network direction.)

8	7	6	5	4	3	2	1		
Calling party BCD number IEI								octet 1	
Length of calling party BCD number contents								octet 2	
0/1 ext	type of number			Numbering plan identification				octet 3	
1 ext	presentat. indicator	0	0	0	spare			screening indicator	octet 3a*
Number digit 2				Number digit 1				octet 4*	
Number digit 4				Number digit 3				octet 5*	
								⋮	
								⋮	

Figure 10.5.93/3GPP TS 24.008 Calling party BCD number information element

The contents of octets 3, 4, etc. are coded as shown in table 10.5.118. The coding of octet 3a is defined in table 10.5.120 below.

If the calling party BCD number contains an odd number of digits, bits 5 to 8 of the last octet shall be filled with an end mark coded as "1111".

Table 10.5.120/3GPP TS 24.008: Calling party BCD number

Presentation indicator (octet 3a)		
Bits		
7	6	
0	0	Presentation allowed
0	1	Presentation restricted
1	0	Number not available due to interworking
1	1	Reserved
If octet 3a is omitted the value "00 - Presentation allowed" is assumed.		
Screening indicator (octet 3a)		
Bits		
2	1	
0	0	User-provided, not screened
0	1	User-provided, verified and passed
1	0	User-provided, verified and failed
1	1	Network provided
If octet 3a is omitted the value "0 0 - User provided, not screened" is assumed.		

10.5.4.10 Calling party subaddress

The purpose of the Calling party subaddress is to identify a subaddress associated with the origin of a call. For the definition of a subaddress see ITU-T Rec. I.330 [48].

The Calling party subaddress information element is coded as shown in figure 10.5.94/3GPP TS 24.008 and table 10.5.121/3GPP TS 24.008.

The calling party subaddress is a type 4 information element with a minimum length of 2 octets and a maximum length of 23 octets.

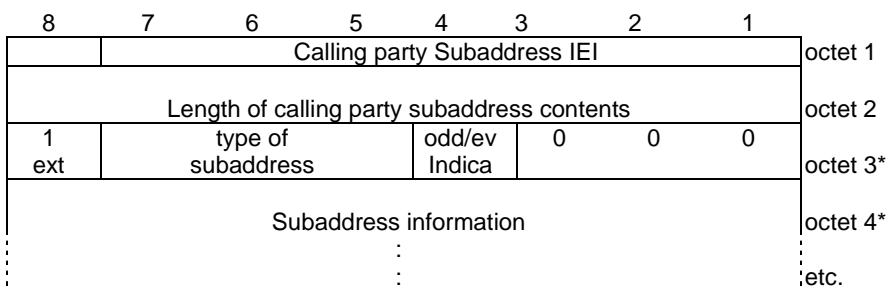

Figure 10.5.94/3GPP TS 24.008 Calling party subaddress

Table 10.5.121/3GPP TS 24.008: Calling party subaddress

Type of subaddress (octet 3)	
Bits	
7 6 5	
0 0 0	NSAP (see ITU-T Rec. X.213 [144]/ISO 8348 AD2)
0 1 0	User specified
All other values are reserved	
Odd/even indicator (octet 3)	
Bit	
4	
0	even number of address signals
1	odd number of address signals
The odd/even indicator is used when the type of subaddress is "user specified" and the coding is BCD	
Subaddress information (octet 4, etc...)	
The NSAP X.213/ISO8348AD2 address shall be formatted as specified by octet 4 which contains the Authority and Format Identifier (AFI). The encoding is made according to the "preferred binary encoding" as defined in ITU-T Rec. X.213 [144]/ISO8348AD2. For the definition of this type of this type of subaddress, see ITU-T Rec. I.334 [145].	
A coding example is given in annex A.	
For User-specific subaddress, this field is encoded according to the user specification, subject to a maximum length of 20 octets.	
NOTE:	It is recommended that users apply NSAP subad dress type since this subaddress type allows the use of decimal, binary and IA5 characters in a standardised manner.

10.5.4.11 Cause

The purpose of the cause information element is to describe the reason for generating certain messages, to provide diagnostic information in the event of procedural errors and to indicate the location of the cause originator.

The cause information element is coded as shown in figure 10.5.95/3GPP TS 24.008 and tables 10.5.122 and 10.5.123/3GPP TS 24.008.

The cause is a type 4 information element with a minimum length of 4 octets and a maximum length of 32 octets.

The cause information element may be repeated in a message.

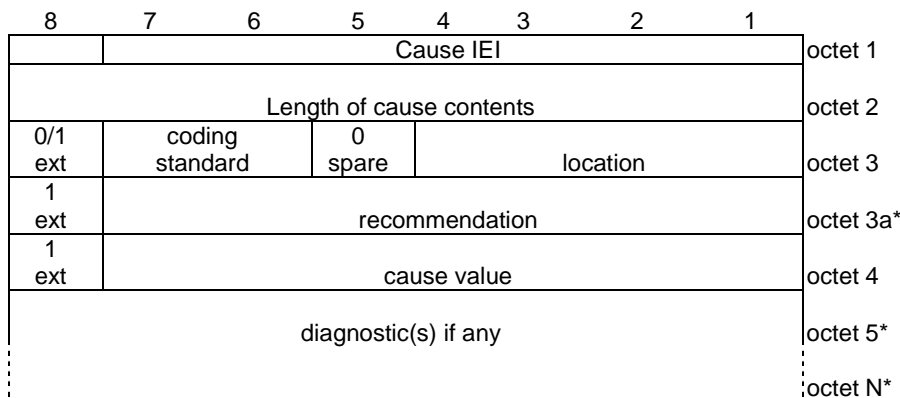

Figure 10.5.95/3GPP TS 24.008 Cause information element

If the default value applies for the recommendation field, octet 3a shall be omitted.

Table 10.5.122/3GPP TS 24.008: Cause information element

Coding standard (octet 3)	
Bits	
7	6
0 0	Coding as specified in ITU-T Rec. Q.931
0 1	Reserved for other international standards
1 0	National standard
1 1	Standard defined for the GSM PLMNs as described below and in table 10.5.123/3GPP TS 24.008
Coding standards other than "1 1 - Standard defined for the GSM PLMNS" shall not be used if the cause can be represented with the GSM standardized coding.	
The mobile station or network need not support any other coding standard than "1 1 - Standard defined for the GSM PLMNS".	
If a cause IE indicating a coding standard not supported by the receiver is received, cause "interworking, unspecified" shall be assumed.	
Location (octet 3)	
Bits	
4	3
2	1
0 0 0 0	user
0 0 0 1	private network serving the local user
0 0 1 0	public network serving the local user
0 0 1 1	transit network
0 1 0 0	public network serving the remote user
0 1 0 1	private network serving the remote user
0 1 1 1	international network
1 0 1 0	network beyond interworking point
All other values are reserved.	
Recommendation (octet 3a)	
Octet 3a shall not be included if the coding standard is coded as "1 1 - Standard defined for GSM PLMNS".	
If the coding standard is different from "1 1 - Standard defined for GSM PLMNS", the coding of octet 3a, if included, and octets 4 to N is according to that coding standard.	

Table 10.5.122/3GPP TS 24.008: Cause information element (continued)

Cause value (octet 4)	
The cause value is divided in two fields: a class (bits 5 through 7) and a value within the class (bits 1 through 4).	
The class indicates the general nature of the event.	
Class (000):	normal event
Class (001):	normal event
Class (010):	resource unavailable
Class (011):	service or option not available
Class (100):	service or option not implemented
Class (101):	invalid message (e.g. parameter out of range)
Class (110):	protocol error (e.g. unknown message)
Class (111):	interworking
The cause values are listed in Table 10.5.123/3GPP TS 24.008 below and defined in Annex H.	
Diagnostic(s) (octet 5)	
Diagnostic information is not available for every cause, see Table 10.5.123/3GPP TS 24.008 below.	
When available, the diagnostic(s) is coded in the same way as the corresponding information element in clause 10.	
The inclusion of diagnostic(s) is optional.	

Table 10.5.123/3GPP TS 24.008: Cause information element values

Cause value							Cause num.	Cause	Diag-nostic	Remarks
Class			Value							
7	6	5	4	3	2	1				
0	0	0	0	0	0	1	1.	Unassigned (unallocated) number	Note 9	
0	0	0	0	0	1	1	3.	No route to destination	Note 9	
0	0	0	0	1	1	0	6.	Channel unacceptable	-	
0	0	0	1	0	0	0	8.	Operator determined barring	-	
0	0	0	1	1	0	1	13.	Call completed elsewhere	-	
0	0	1	0	0	0	0	16.	Normal call clearing	Note 9	
0	0	1	0	0	0	1	17.	User busy	Note 1	
0	0	1	0	0	1	0	18.	No user responding	-	
0	0	1	0	0	1	1	19.	User alerting, no answer	-	
0	0	1	0	1	0	1	21.	Call rejected	Note 9 - user supplied diagnostic (note 4)	
0	0	1	0	1	1	0	22.	Number changed	New destination(note 5)	
0	0	1	1	0	0	0	24.	Call rejected due to feature at the destination	-	
0	0	1	1	0	0	1	25.	Pre-emption	-	
0	0	1	1	0	1	0	26.	Non selected user clearing	-	
0	0	1	1	0	1	1	27.	Destination out of order	-	
0	0	1	1	1	0	0	28.	Invalid number format (incomplete number)	-	
0	0	1	1	1	0	1	29.	Facility rejected	Note 1	
0	0	1	1	1	1	0	30.	Response to STATUS ENQUIRY	-	
0	0	1	1	1	1	1	31.	Normal, unspecified	-	
0	1	0	0	0	1	0	34.	No circuit/channel available	Note 1	
0	1	0	0	1	1	0	38.	Network out of order	-	
0	1	0	1	0	0	1	41.	Temporary failure	-	
0	1	0	1	0	1	0	42.	Switching equipment congestion	-	
0	1	0	1	0	1	1	43.	Access information discarded	Discarded information element identifiers (note 6)	
0	1	0	1	1	0	0	44.	requested circuit/channel not available	-	
0	1	0	1	1	1	1	47.	Resources unavailable, unspecified	-	
0	1	1	0	0	0	1	49.	Quality of service unavailable	Note 9	
0	1	1	0	0	1	0	50.	Requested facility not subscribed	Note 1	
0	1	1	0	1	1	1	55.	Incoming calls barred within the CUG	Note 1	
0	1	1	1	0	0	1	57.	Bearer capability not authorized	Note 3	
0	1	1	1	0	1	0	58.	Bearer capability not presently available	Note 3	
0	1	1	1	1	1	1	63.	Service or option not available, unspecified	-	
1	0	0	0	0	0	1	65.	Bearer service not implemented	Note 3	

(continued)

Table 10.5.123/3GPP TS 24.008 (concluded): Cause information element values

Cause value							Cause num.	Cause	Diag-nostic	Remarks
Class	Value									
7	6	5	4	3	2	1				
1	0	0	0	1	0	0	68.	ACM equal to or greater than ACMmax		
1	0	0	0	1	0	1	69.	Requested facility not implemented	Note 1	
1	0	0	0	1	1	0	70.	Only restricted digital information bearer capability is available		
1	0	0	1	1	1	1	79.	Service or option not implemented, unspecified	-	
1	0	1	0	0	0	1	81.	Invalid transaction identifier value	-	
1	0	1	0	1	1	1	87.	User not member of CUG	Note 1	
1	0	1	1	0	0	0	88.	Incompatible destination	Incompatible parameter (Note 2)	
1	0	1	1	0	1	1	91.	Invalid transit network selection	-	
1	0	1	1	1	1	1	95.	Semantically incorrect message	-	
1	1	0	0	0	0	0	96.	Invalid mandatory information	Information element identifier(s)	
1	1	0	0	0	0	1	97.	Message type non-existent or not implemented	Message type	
1	1	0	0	0	1	0	98.	Message type not compatible with protocol state	Message type	
1	1	0	0	0	1	1	99.	Information element non-existent or not implemented	Information element identifier(s) (notes 6,7)	
1	1	0	0	1	0	0	100.	Conditional IE error	Information element identifier(s) (note 6)	
1	1	0	0	1	0	1	101.	Message not compatible with protocol state	Message type	
1	1	0	0	1	1	0	102.	Recovery on timer expiry	Timer number (note 8)	
1	1	0	1	1	1	1	111.	Protocol error, unspecified	-	
1	1	1	1	1	1	1	127.	Interworking, unspecified	-	

All other values in the range 0 to 31 shall be treated as cause 31.

All other values in the range 32 to 47 shall be treated as cause 47.

All other values in the range 48 to 63 shall be treated as cause 63.

All other values in the range 64 to 79 shall be treated as cause 79.

All other values in the range 80 to 95 shall be treated as cause 95.

All other values in the range 96 to 111 shall be treated as cause 111.

All other values in the range 112 to 127 shall be treated as cause 127.

NOTE 1: Diagnostics for supplementary services are handled as follows:

octet 5, bit 8:

This is an extension bit as defined in the preliminary part of subclause 10.5. In this version of this protocol, this bit shall be set to 1. If it is set to zero, the contents of the following octets shall be ignored.

octet 5, bit 7-1:

0000001 - Outgoing calls barred within CUG

0000010 - No CUG selected

0000011 - Unknown CUG index

0000100 - CUG index incompatible with requested basic service

0000101 - CUG call failure, unspecified

0000110 - CLIR not subscribed

0000111 - CCBS possible

0001000 - CCBS not possible

All other values shall be ignored.

NOTE 2: The incompatible parameter is composed of the incompatible information element identifier.

NOTE 3: The format of the diagnostic field for cause numbers 57, 58 and 65 is as shown in figure 10.5.88/3GPP TS 24.008 and tables 10.5.102/3GPP TS 24.008 to 10.5.115/3GPP TS 24.008.

NOTE 4: The user supplied diagnostics field is encoded according to the user specification, subject to the maximum length of the cause information element. The coding of user supplied diagnostics should be made in such a way that it does not conflict with the coding described in note 9 below.

NOTE 5: The new destination is formatted as the called party BCD number information element, including information element identifier.

NOTE 6: Locking and non-locking shift procedures described in subclause 10.5.4.2 and clause 3 are applied. In principle, information element identifiers are ordered in the same order as the information elements in the received message.

NOTE 7: When only the locking shift information element is included and no information element identifier follows, it means that the codeset in the locking shift itself is not implemented.

NOTE 8: The timer number is coded in IA5 characters, e.g., T308 is coded as "3" "0" "8". The following coding is used in each octet:

bit 8: spare "0"

bits 7-1: IA5 character

Octet 5 carries "3", octet 5a carries "0", etc.

NOTE 9: The following coding is used for octet 5:

bit 8 : 1

bits 7-3: 00000

bits 2-1: condition as follows:

00 - unknown

01 - permanent

10 - transient

10.5.4.11a CLIR suppression

The CLIR suppression information element may be sent by the mobile station to the network in the SETUP message. The use is defined in 3GPP TS 24.081 [25].

The CLIR suppression information element is coded as shown in figure 10.5.96/3GPP TS 24.008.

The CLIR suppression is a type 2 information element.

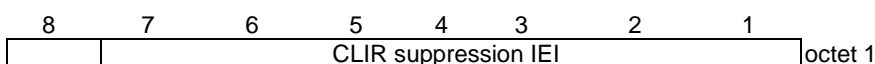

Figure 10.5.96/3GPP TS 24.008 CLIR suppression information element

10.5.4.11b CLIR invocation

The CLIR invocation information element may be sent by the mobile station to the network in the SETUP message. The use is defined in 3GPP TS 24.081 [25].

The CLIR invocation information element is coded as shown in figure 10.5.97/3GPP TS 24.008.

The CLIR invocation is a type 2 information element.

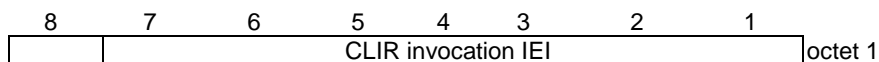

Figure 10.5.97/3GPP TS 24.008 CLIR invocation information element

10.5.4.12 Congestion level

The purpose of the congestion level information element is to describe the congestion status of the call.

The congestion level information element is coded as shown in figure 10.5.98/3GPP TS 24.008 and table 10.5.124/3GPP TS 24.008.

The congestion level is a type 1 information element.

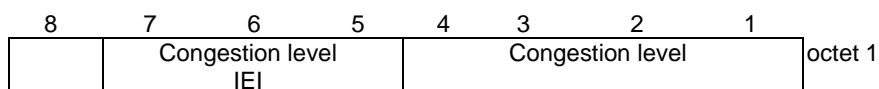

Figure 10.5.98/3GPP TS 24.008 Congestion level information element

Table 10.5.124/3GPP TS 24.008: Congestion level information element

Congestion level (octet 1)			
Bits			
4	3	2	1
0	0	0	0
1	1	1	1
receiver ready			
receiver not ready			
All other values are reserved.			

10.5.4.13 Connected number

The purpose of the connected number information element is to identify the connected party of a call.

The connected number information element is coded as shown in figure 10.5.99/3GPP TS 24.008.

The connected number is a type 4 information element with a minimum length of 3 octets and a maximum length of 14 octets.

8	7	6	5	4	3	2	1	
Connected number IEI								octet 1
Length of connected number contents								octet 2
0/1 ext	Type of number			Number plan identification				octet 3 note 1)
1 ext	Presentation indicator	0	0	0	Spare			octet 3a* note 1)
Number digit 2				Number digit 1				octet 4* note 1)
Number digit 4				Number digit 3				octet 5* note 1)
note 2)								:
								:

Figure 10.5.99/3GPP TS 24.008

NOTE 1: The contents of octets 3,4,5, etc. ... are coded as shown in table 10.5.118/3GPP TS 24.008. The coding of octet 3a is defined in table 10.5.120/3GPP TS 24.008.

NOTE 2: If the connected number contains an odd number of digits, bits 5 to 8 of the last octet shall be filled with the end mark coded as "1111".

10.5.4.14 Connected subaddress

The purpose of the connected subaddress information element is to identify a subaddress associated with the connected party of a call.

The connected subaddress information element is coded as shown in figure 10.5.100/3GPP TS 24.008.

The connected subaddress is a type 4 information element with a minimum length of 2 octets and a maximum length of 23 octets.

8	7	6	5	4	3	2	1	
Connected subaddress IEI								octet 1
Length of connected subaddress contents								octet 2
	Type of subaddress	odd/even indicator	0	0	Spare			octet 3*
Subaddress information								octet 4*
								:
								:
								etc.

Figure 10.5.100/3GPP TS 24.008

The coding for Type of subaddress, odd/even indicator, and subaddress information is in table 10.5.119/3GPP TS 24.008.

10.5.4.15 Facility

The purpose of the facility information element is to transport supplementary service related information. Within the scope of 3GPP TS 24.008 the content of the Facility information field is an array of octets. The usage of this transportation mechanism is defined in 3GPP TS 24.080 [24].

The facility information element is coded as shown in figure 10.5.101/3GPP TS 24.008.

The facility is a type 4 information element with a minimum length of 2 octets. No upper length limit is specified except for that given by the maximum number of octets in a L3 message (see 3GPP TS 44.006 [19]).

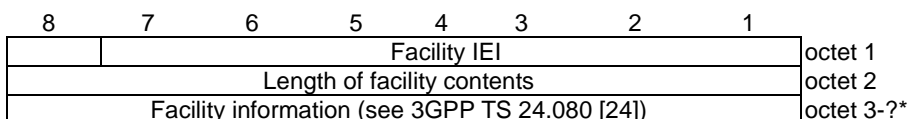

Figure 10.5.101/3GPP TS 24.008

10.5.4.16 High layer compatibility

The purpose of the high layer compatibility information element is to provide a means which should be used by the remote user for compatibility checking. See annex B.

The high layer compatibility information element is coded as shown in figure 10.5.102/3GPP TS 24.008 and table 10.5.125/3GPP TS 24.008.

The high layer compatibility is a type 4 information element with a minimum length of 2 octets and a maximum length of 5 octets.

NOTE: The high layer compatibility information element is transported transparently by a PLMN between a call originating entity (e.g. a calling user) and the addressed entity (e.g. a remote user or a high layer function network node addressed by the call originating entity). However, if explicitly requested by the user (at subscription time), a network which provides some capabilities to realize teleservices may interpret this information to provide a particular service.

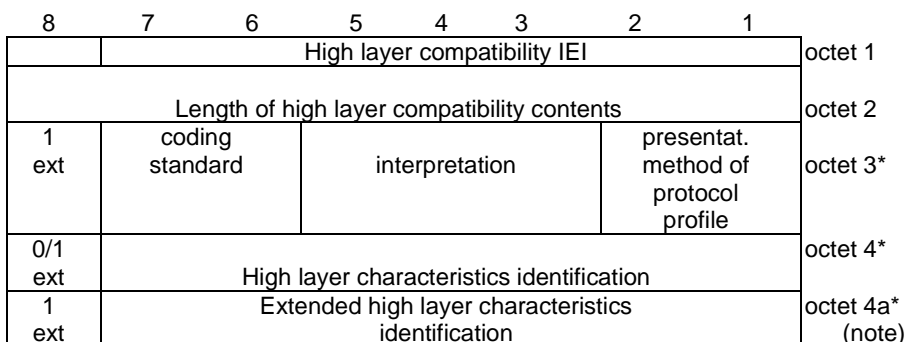

Figure 10.5.102/3GPP TS 24.008 High layer compatibility information element

If the value part of the IE is empty, the IE indicates "not applicable".

NOTE: Octet 4a may be present e.g. when octet 4 indicates Maintenance or Management, or audio visual.

Table 10.5.125/3GPP TS 24.008: High layer compatibility information element

Coding standard (octet 3) see ITU Recommendation Q.931.
Interpretation (octet 3) see ITU Recommendation Q.931.
Presentation method of protocol profile (octet 3) see ITU Recommendation Q.931.
High layer characteristics identification (octet 4) see ITU Recommendation Q.931.
Extended high layer characteristics identification (octet 4a) see ITU Recommendation Q.931.

10.5.4.16.1 Static conditions for the high layer compatibility IE contents

Either the value part of the IE is empty, or it contains at least octet 3 and 4.

10.5.4.17 Keypad facility

The purpose of the keypad facility information element is to convey IA5 characters, e.g. entered by means of a terminal keypad (see note).

The keypad facility information element is coded as shown in figure 10.5.103/3GPP TS 24.008.

The keypad facility is a type 3 information element with 2 octets length.

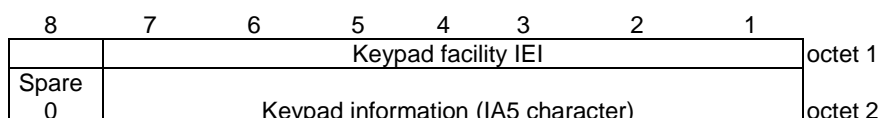

Figure 10.5.103/3GPP TS 24.008 Keypad facility information element

NOTE: In the 3GPP system this information element is only used to transfer one DTMF digit (0, 1, ..., 9, A, B, C, D, *, #) as one IA5 character.

10.5.4.18 Low layer compatibility

The purpose of the low layer compatibility information element is to provide a means which should be used for compatibility checking by an addressed entity (e.g., a remote user or an interworking unit or a high layer function network node addressed by the calling user). The low layer compatibility information element is transferred transparently by a PLMN between the call originating entity (e.g. the calling user) and the addressed entity.

Except for the information element identifier, the low layer compatibility information element is coded as in ITU recommendation Q.931.

For backward compatibility reasons coding of the modem type field according to ETS 300 102-1 (12-90) shall also be supported.

The low layer compatibility is a type 4 information element with a minimum length of 2 octets and a maximum length of 18 octets.

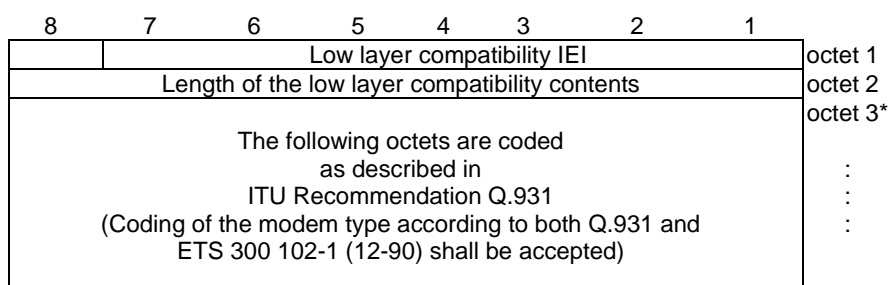

Figure 10.5.104/3GPP TS 24.008 Low layer compatibility information element

If the value part of the IE is empty, the IE indicates "not applicable".

10.5.4.19 More data

The more data information element is sent by the mobile station to the network or to the network to the mobile station in a USER INFORMATION message. The presence of the more data information element indicates to the destination remote user/mobile station that another USER INFORMATION message will follow containing information belonging to the same block.

The use of the more data information element is not supervised by the network.

The more data information element is coded as shown in figure 10.5.105/3GPP TS 24.008.

The more data is a type 2 information element.

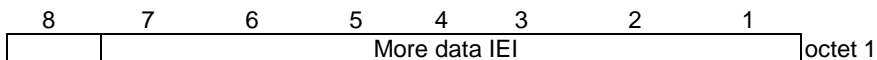

Figure 10.5.105/3GPP TS 24.008 More data information element

10.5.4.20 Notification indicator

The purpose of the notification indicator information element is to indicate information pertaining to a call.

The notification indicator element is coded as shown in figure 10.5.106/3GPP TS 24.008 and table 10.5.126/ 3GPP TS 24.008.

The notification indicator is a type 3 information element with 2 octets length.

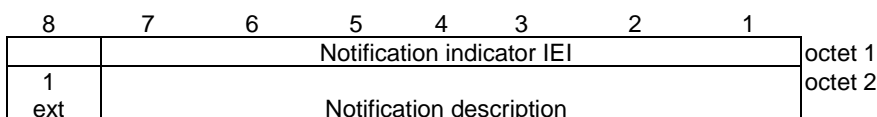

Figure 10.5.106/3GPP TS 24.008 Notification indicator information element

Table 10.5.126/3GPP TS 24.008: Notification indicator information element

Notification description (octet 2)								
Bits								
	7	6	5	4	3	2	1	
	0	0	0	0	0	0	0	User suspended
	0	0	0	0	0	0	1	User resumed
	0	0	0	0	0	1	0	Bearer change
All other values are reserved.								

10.5.4.21 Progress indicator

The purpose of the progress indicator information element is to describe an event which has occurred during the life of a call.

The progress indicator information element is coded as shown in figure 10.5.107/3GPP TS 24.008 and table 10.5.127/3GPP TS 24.008.

The progress indicator is a type 4 information element with a length of 4 octets.

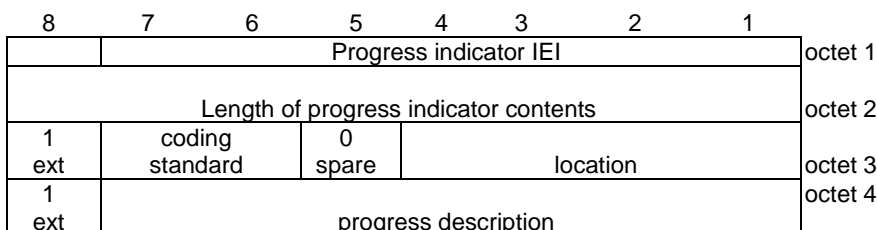

Figure 10.5.107/3GPP TS 24.008 Progress indicator information element

Table 10.5.127/3GPP TS 24.008: Progress indicator information element

Coding standard (octet 3)								
Bits								
7	6							
0 0	Standardized coding, as described in ITU-T Rec. Q.931							
0 1	Reserved for other international standards							
1 0	National standard							
1 1	Standard defined for the GSM&PLMNS as described below							
Coding standards other than "1 1 - Standard defined for the GSM PLMNS" shall not be used if the progress description can be represented with the GSM&standardized coding.								
The mobile station or network need not support any other coding standard than "1 1 - Standard defined for the GSM PLMNS".								
If a progress indicator IE indicating a coding standard not supported by the receiver is received, progress description "Unspecific" shall be assumed.								
Location (octet 3)								
Bits								
4	3	2	1					
0 0 0 0	User							
0 0 0 1	Private network serving the local user							
0 0 1 0	Public network serving the local user							
0 1 0 0	Public network serving the remote user							
0 1 0 1	Private network serving the remote user							
1 0 1 0	Network beyond interworking point							
All other values are reserved.								
Note: Depending on the location of the users, the local public network and remote public network may be the same network.								
Progress description (octet 4)								
Bits								
7	6	5	4	3	2	1	No.	
0	0	0	0	0	0	1	1.	Call is not end-to-end PLMN/ISDN, further call progress information may be available in-band
0	0	0	0	0	1	0	2.	Destination address in non-PLMN/ISDN
0	0	0	0	0	1	1	3.	Origination address in non-PLMN/ISDN
0	0	0	0	1	0	0	4.	Call has returned to the PLMN/ISDN
0	0	0	1	0	0	0	8.	In-band information or appropriate pattern now available
0	0	0	1	0	0	1	9.	In-band multimedia CAT available
0	1	0	0	0	0	0	32.	Call is end-to-end PLMN/ISDN
1	0	0	0	0	0	0	64.	Queueing
All other values								Unspecific

10.5.4.21a Recall type \$(CCBS)\$

The purpose of the recall type information element is to describe the reason for the recall.

The recall type information element is coded as shown in Figure 10.5.108/3GPP TS 24.008 and Table 10.5.128/3GPP TS 24.008.

The recall type is a type 3 information element with 2 octets length.

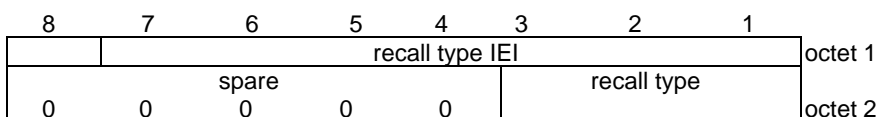

Figure 10.5.108/3GPP TS 24.008 Recall type information element

Table 10.5.128/3GPP TS 24.008: Recall type information element

recall type (octet 2, bits 1 to 4)			
Bits			
3	2	1	
0	0	0	- CCBS
0	0	1	}
		to	} - shall be treated as CCBS (intended for other similar types of Recall)
1	1	0	}
1	1	1	- reserved

10.5.4.21b Redirecting party BCD number

The purpose of the redirecting party BCD number information element is to identify the redirecting party.

The redirecting party BCD number information element is coded as shown in figure 10.5.108a/3GPP TS 24.008.

The redirecting party BCD number is a type 4 information element. In the network to mobile station direction it has a minimum length of 3 octets and a maximum length of 19 octets.

8	7	6	5	4	3	2	1	
Redirecting party BCD number IEI								octet 1
Length of redirecting party BCD number contents								octet 2
0/1 ext	type of number			Numbering plan identification				octet 3 (note 1)
1 ext	presentat. indicator	0	0	0	Screening indicator			octet 3a* (note 1)
Number digit 2				Number digit 1				octet 4* (note 1)
Number digit 4				Number digit 3				octet 5* (note 1)
								:
Note 2)								:

**Figure 10.5.108a/3GPP TS 24.008
Redirecting party BCD number information element**

NOTE 1: The contents of octets 3, 4, etc. are coded as shown in table 10.5.118/3GPP TS 24.008. The coding of octet 3a is defined in table 10.5.120/3GPP TS 24.008.

NOTE 2: If the redirecting party BCD number contains an odd number of digits, bits 5 to 8 of the last octet shall be filled with an end mark coded as "1111".

10.5.4.21c Redirecting party subaddress

The purpose of the Redirecting party subaddress is to identify a subaddress associated with the redirecting party. For the definition of a subaddress see Rec. ITU-T I.330.

The Redirecting party subaddress information element is coded as shown in figure 10.5.108b/3GPP TS 24.008 and table 10.5.121/3GPP TS 24.008.

The Redirecting party subaddress is a type 4 information element with a minimum length of 2 octets and a maximum length of 23 octets.

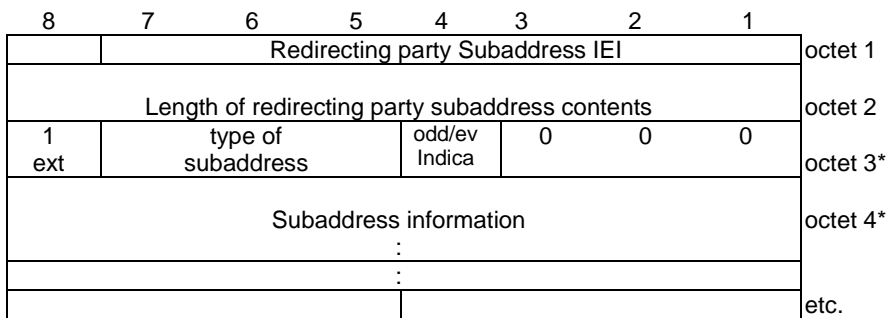

Figure 10.5.108b/3GPP TS 24.008
Redirecting party subaddress information element

10.5.4.22 Repeat indicator

The purpose of the repeat indicator information element is to indicate how the associated repeated information elements shall be interpreted, when included in a message. The repeat indicator information element is included immediately before the first occurrence of the associated information element which will be repeated in a message. "Mode 1" refers to the first occurrence of that information element, "mode 2" refers to the second occurrence of that information element in the same message.

The repeat indicator information element is coded as shown in figure 10.5.109/3GPP TS 24.008 and table 10.5.129/3GPP TS 24.008.

The repeat indicator is a type 1 information element.

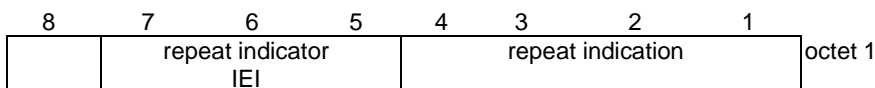

Figure 10.5.109/3GPP TS 24.008 Repeat indicator information element

Table 10.5.129/3GPP TS 24.008: Repeat indicator information element

Repeat indication (octet 1)				
Bits				
4	3	2	1	
0	0	0	1	Circular for successive selection "mode 1 alternate mode 2"
0	0	1	0	Support of fallback – mode 1 preferred, mode 2 selected if setup of mode 1 fails
0	0	1	1	reserved: was allocated in earlier phases of the protocol
0	1	0	0	Service change and fallback – mode 1 alternate mode 2, mode 1 preferred
All other values are reserved.				

10.5.4.22a Reverse call setup direction

This information element may be included in a MODIFY and MODIFY COMPLETE message to indicate that the direction of the data call to which the MODIFY message relates is opposite to the call setup direction.

The *reverse call setup direction* information element is coded as shown in figure 10.5.110/3GPP TS 24.008.

The *reverse call setup direction* is a type 2 information element

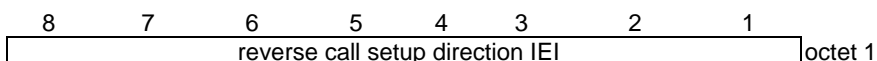

Figure 10.5.110/3GPP TS 24.008 Reverse call setup direction information element

10.5.4.22b SETUP Container \$(CCBS)\$

This information element contains the contents of a SETUP message (Mobile Station to Network). This means that the Call Control protocol discriminator IE, the Transaction Identifier IE and the Setup message type IE are not included.

The SETUP Container information element is coded as shown in figure 10.5.111/3GPP TS 24.008.

The SETUP Container is a type 4 information. No upper length limit is specified except for that given by the maximum number of octets in a L3 message (see 3GPP TS 44.006 [19]).

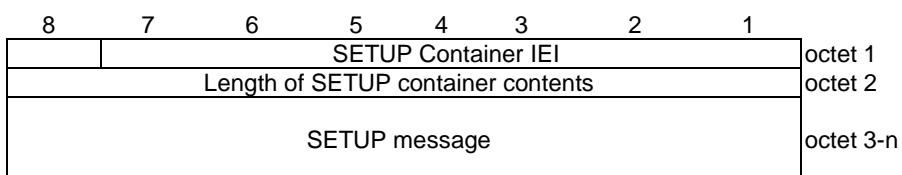

Figure 10.5.111/3GPP TS 24.008 Octet j (j = 3, 4 ... n) is the unchanged octet j of the SETUP message.

10.5.4.23 Signal

The purpose of the signal information element is to allow the network to convey information to a user regarding tones and alerting signals (see subclauses 5.2.2.3.2 and 7.3.3.).

The signal information element is coded as shown in figure 10.5.112/3GPP TS 24.008 and table 10.5.130/3GPP TS 24.008.

The signal is a type 3 information element with 2 octets length.

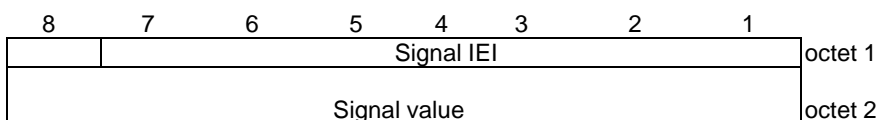

Figure 10.5.112/3GPP TS 24.008 Signal information element

Table 10.5.130/3GPP TS 24.008: Signal information element

Signal value (octet 2)								
Bits								
8	7	6	5	4	3	2	1	
0	0	0	0	0	0	0	0	dial tone on
0	0	0	0	0	0	0	1	ring back tone on
0	0	0	0	0	0	1	0	intercept tone on
0	0	0	0	0	0	1	1	network congestion tone on
0	0	0	0	0	1	0	0	busy tone on
0	0	0	0	0	1	0	1	confirm tone on
0	0	0	0	0	1	1	0	answer tone on
0	0	0	0	0	1	1	1	call waiting tone on
0	0	0	0	1	0	0	0	off-hook warning tone on
0	0	1	1	1	1	1	1	tones off
0	1	0	0	1	1	1	1	alerting off

All other values are reserved.

10.5.4.24 SS Version Indicator

The purpose of the SS version indicator information element is to aid the decoding of the Facility information element as described in 3GPP TS 24.010 [21]. Within the scope of 3GPP TS 24.008 the contents of the SS Version information field is an array of one or more octets. The usage of the SS version information field is defined in 3GPP TS 24.080 [24].

The SS version indicator information element is coded as shown in figure 10.5.113/3GPP TS 24.008.

The SS version indicator is a type 4 information element with a minimum length of 2 octets. No upper length limit is specified except for that given by the maximum number of octets in a L3 message (see 3GPP TS 44.006 [19]).

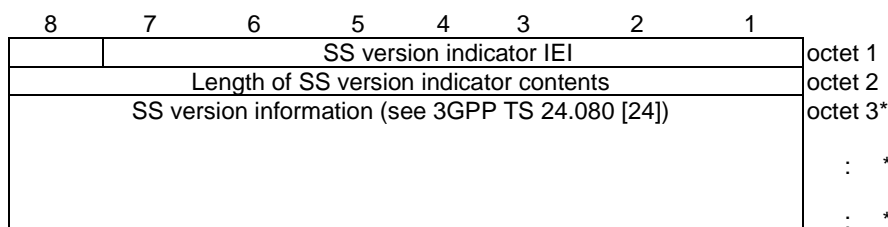
**Figure 10.5.113/3GPP TS 24.008**

NOTE: Usually, this information element has only one octet of content.

10.5.4.25 User-user

The purpose of the user-user information element is to convey information between the mobile station and the remote ISDN user.

The user-user information element is coded as shown in figure 10.5.114/3GPP TS 24.008 and table 10.5.131/3GPP TS 24.008. There are no restrictions on the content of the user-user information field.

The user-user is a type 4 information element with a minimum length of 3 octets and a maximum length of either 35 or 131 octets. In the SETUP message the user-user information element has a maximum size of 35 octets in a GSM PLMN. In the USER INFORMATION, ALERTING, CONNECT, DISCONNECT, PROGRESS, RELEASE and RELEASE COMPLETE messages the user-user information element has a maximum size of 131 octets in a GSM PLMN.

In other networks than GSM PLMNs the maximum size of the user-user information element is 35 or 131 octets in the messages mentioned above. The evolution to a single maximum value is the long term objective; the exact maximum value is the subject of further study.

NOTE: The user-user information element is transported transparently through a GSM PLMN.

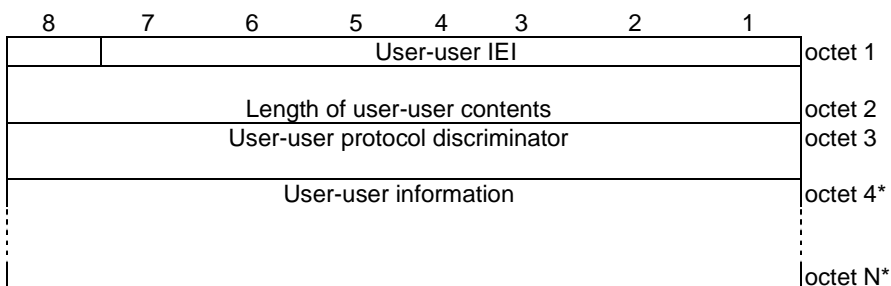

Figure 10.5.114/3GPP TS 24.008 User-user information element

Table 10.5.131/3GPP TS 24.008: User-user information element

User-user protocol discriminator (octet 3)								
Bits								
8	7	6	5	4	3	2	1	
0	0	0	0	0	0	0	0	User specific protocol (Note 1)
0	0	0	0	0	0	0	1	OSI high layer protocols
0	0	0	0	0	0	1	0	X.244 (Note 2)
0	0	0	0	0	0	1	1	Reserved for system management convergence function
0	0	0	0	0	1	0	0	IA5 characters (Note 3)
0	0	0	0	0	1	1	1	rate adaption according to ITU-T Rec. V.120 [61]
0	0	0	0	1	0	0	0	user-network call control messages according to ITU-T Rec. Q.931 [53]
0	0	0	1	0	0	0	0	Reserved for other network layer or layer 3 protocols
0	0	1	1	1	1	1	1	
0	1	0	0	0	0	0	0	National use
0	1	0	0	1	1	1	0	
0	1	0	0	1	1	1	1	
0	1	0	1	0	0	0	0	Reserved for other network layer or layer 3 protocols
1	1	1	1	1	1	1	0	

All other values are reserved.

NOTE 1: The user information is structured according to user needs.
 NOTE 2: The user information is structured according to ITU-T Rec. X.244 which specifies the structure of ITU-T Rec. X.25 [143] call user data.
 NOTE 3: The user information consists of IA5 characters.
 NOTE 4: When the user-user protocol discriminator is set to "3GPP capability exchange protocol", the user-user information is coded according to 3GPP TS 24.279 [116].

10.5.4.26 Alerting Pattern \$(NIA)\$

The purpose of the Alerting Pattern information element is to allow the network to convey information related to the alert to be used by the MS (see 3GPP TS 22.101 [8]).

The Alerting Pattern information element is coded as shown in figure 10.5.115/3GPP TS 24.008 and table 10.5.132/3GPP TS 24.008.

The Alerting Pattern IE is a type 4 information element with 3 octet length.

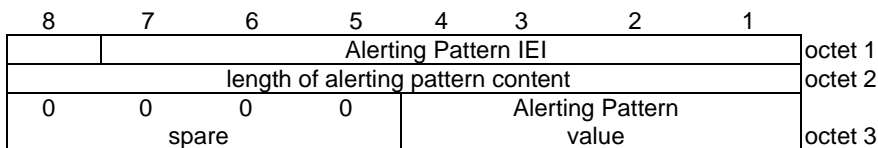

Figure 10.5.115/3GPP TS 24.008 Alerting Pattern information element

Table 10.5.132/3GPP TS 24.008: Alerting Pattern information element

Alerting Pattern value (octet 3)				
Bits				
4	3	2	1	
0	0	0	0	alerting pattern 1
0	0	0	1	alerting pattern 2
0	0	1	0	alerting pattern 3
0	1	0	0	alerting pattern 5
0	1	0	1	alerting pattern 6
0	1	1	0	alerting pattern 7
0	1	1	1	alerting pattern 8
1	0	0	0	alerting pattern 9
all other values are reserved				

Alerting pattern 1, 2 and 3 indicate alerting levels 0, 1 and 2.

Alerting pattern 5 to 9 indicate alerting categories 1 to 5

10.5.4.27 Allowed actions \$(CCBS)\$

The purpose of the *Allowed actions* information element is to provide the mobile station with information about further allowed procedures.

The *Allowed actions* information element is coded as shown in figure 10.5.116/3GPP TS 24.008 and table 10.5.133/3GPP TS 24.008.

The *Allowed actions* is a type 4 information element with 3 octets length.

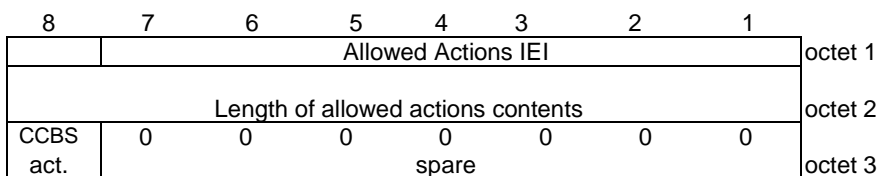

Figure 10.5.116/3GPP TS 24.008 Allowed actions information element

Table 10.5.133/3GPP TS 24.008: Allowed actions information element

CCBS activation (octet 3)	
Bits	
8	
0	Activation of CCBS not possible
1	Activation of CCBS possible

10.5.4.28 Stream Identifier

The purpose of the stream identifier (SI) information element is to associate a particular call with a Radio Access Bearer (RAB), and to identify whether a new traffic channel shall be assigned within the interface controlled by these signalling procedures. The SI value indicated in the CC protocol shall be sent in the RAB setup message. And mobile station is informed the relationship between the call and the RAB.

The Stream identifier information element is coded as shown in figure 10.5.117/3GPP TS 24.008 and table 10.5.134/3GPP TS 24.008.

The Stream Identifier is a type 4 information element with 3 octets length.

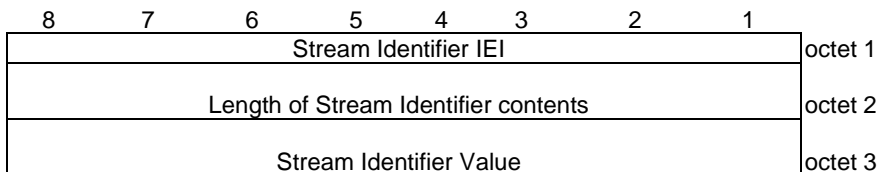

Figure 10.5.117/3GPP TS 24.008: Stream Identifier information element

Table 10.5.134/3GPP TS 24.008: Stream Identifier information element

Stream Identifier value(octet 3)									
Bit									
	8	7	6	5	4	3	2	1	
	0	0	0	0	0	0	0	0	No bearer
	0	0	0	0	0	0	0	1	1
			⋮						
	1	1	1	1	1	1	1	1	255

10.5.4.29 Network Call Control Capabilities

The purpose of the *Network Call Control Capabilities* information element is to identify the call control capabilities of the network. The contents might affect the manner in which the mobile station handles the call.

The Network Call Control Capabilities information element is coded as shown in figure 10.5.118/3GPP TS 24.008 and table 10.5.135/3GPP TS 24.008.

The Network Call Control Capabilities is a type 4 information element with a length of 3 octets.

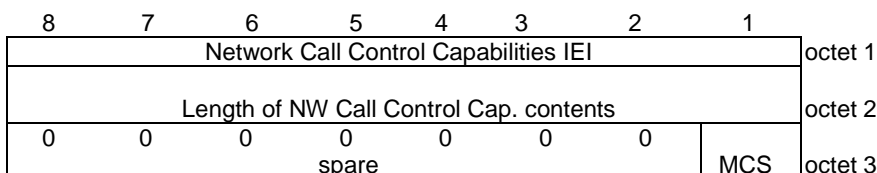

Figure 10.5.118/3GPP TS 24.008 Network Call Control Capabilities information element

Table 10.5.135/3GPP TS 24.008: Network Call Control Capabilities

MCS (octet 3, bit 1)	
0	This value indicates that the network does not support the multicall.
1	This value indicates that the network supports the multicall.

10.5.4.30 Cause of No CLI

Cause of No CLI information element provides the mobile station the detailed reason why Calling party BCD number is not notified (see 3GPP TS 24.081 [25]).

The *Cause of No CLI* information element is coded as shown in figure 10.5.118a/3GPP TS 24.008 and table 10.5.135a/3GPP TS 24.008.

The *Cause of No CLI* is a type 4 information element with the length of 3 octets.

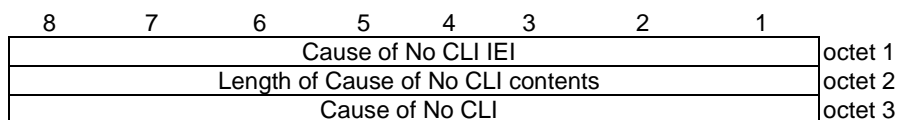

Figure 10.5.118a/3GPP TS 24.008 Cause of No CLI information element

Table 10.5.135a/3GPP TS 24.008: Cause of No CLI information element

Cause of No CLI (octet 3)								
Bits								
8	7	6	5	4	3	2	1	
0	0	0	0	0	0	0	0	Unavailable
0	0	0	0	0	0	0	1	Reject by user
0	0	0	0	0	0	1	0	Interaction with other service
0	0	0	0	0	0	1	1	Coin line/payphone
Other values shall be interpreted as "Unavailable".								

10.5.4.31 Void

10.5.4.32 Supported codec list

The purpose of the *Supported Codec List* information element is to provide the network with information about the speech codecs supported by the mobile.

The *Supported Codec List* information element is coded as shown in figure 10.5.118c/3GPP TS 24.008.

The *Supported Codec List* information element is a type 4 information element with a minimum length of 5 octets and a maximum length of m+3 octets.

Speech codec information belonging to GERAN and UTRAN shall be conveyed by this information element.

8	7	6	5	4	3	2	1	
Supported Codec List IEI								octet 1
Length Of Supported Codec list								octet 2
System Identification 1 (SysID 1)								octet 3
Length Of Bitmap for SysID 1								octet 4
Codec Bitmap for SysID 1, bits 1 to 8								octet 5
Codec Bitmap for SysID 1, bits 9 to 16								octet 6
System Identification 2 (SysID 2)								octet j
Length Of Bitmap for (SysID 2)								octet j+1
Codec Bitmap for (SysID 2), bits 1 to 8								octet j+2
Codec Bitmap for (SysID 2), bits 9 to 16								octet j+3
System Identification x (SysID x)								octet m
Length Of Bitmap for (SysID x)								octet m+1
Codec Bitmap for (SysID x), bits 1 to 8								octet m+2
Codec Bitmap for (SysID x), bits 9 to 16								octet m+3

Figure 10.5.118c/3GPP TS 24.008 Supported codec list information element

Table 10.5.4.135c/3GPP TS 24.008: Supported Codec List information element

<p>Octet 3, (j), m etc SysID indicates the radio access technology for which the subsequent Codec Bitmap indicates the supported codec types. Coding of this Octet is defined in 3GPP TS 26.103 [83].</p> <p>Octet 4, (j+1), m+1 etc Length Of Codec Bitmap for SysID indicates the number of octets included in the list for the given SysID.</p> <p>Octets (5 & 6), (j+2 & j+3), (m+2 & m+3) etc The coding of the Codec Bitmap is defined in 3GPP TS 26.103 [83].</p> <p>NOTE: If the Codec Bitmap for a SysID is 1 octet, it is an indication that all codecs of the 2nd octet are not supported. If the Codec Bitmap for a SysID is more than 2 octets, the network shall ignore the additional octet(s) of the bitmap and process the rest of the information element.</p>

10.5.4.33 Service category

The purpose of the *Service category* information element is to provide the network with information about services invoked by the user equipment.

The *Service category* information element is coded as shown in figure 10.5.118d/3GPP TS 24.008 and table 10.5.135d/3GPP TS 24.008

The *Service category* is a type 4 information element with a minimum length of 3 octets.

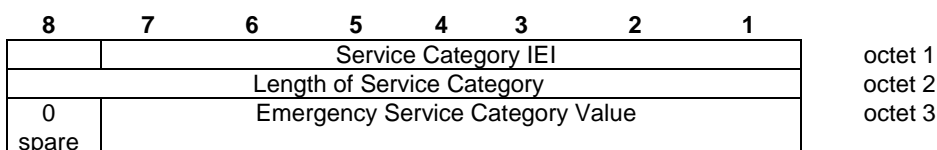

Figure 10.5.118d/3GPP TS 24.008 Service Category information element

Table 10.5.135d/3GPP TS 24.008: Service Category information element

<p>Emergency Service Category Value (octet 3) The meaning of the Emergency Category Value is derived from the following settings (see 3GPP TS 22.101 [8] clause 10):</p> <ul style="list-style-type: none"> Bit 1 Police Bit 2 Ambulance Bit 3 Fire Brigade Bit 4 Marine Guard Bit 5 Mountain Rescue Bit 6 manually initiated eCall Bit 7 automatically initiated eCall Bit 8 is spare and set to "0" <p>A mobile station not initiating an eCall shall set bit 6 and bit 7 to "0" and may set one or more of bit 1, bit 2, bit 3, bit 4 or bit 5 to "1". If more than one of these bits is set to "1", routing to a combined emergency centre (e.g. ambulance and fire brigade in Japan) is required.</p> <p>A mobile station initiating an eCall shall set either bit 6 or bit 7 to "1" and shall set all other bits to "0". A MSC supporting eCall shall use the information indicated in bit 6 and bit 7 to route the manually or automatically initiated eCall to an operator defined emergency call centre.</p> <p>If the MSC can not match the received service category to any of the emergency centres, or if no bit is set to "1", the MSC shall route the emergency call to an operator defined default emergency centre.</p>

10.5.4.34 Redial

The purpose of the *Redial* information element is to indicate to the network that a call is the result of a redial attempt to switch from speech to multimedia or vice-versa.

The *Redial* information element is coded as shown in figure 10.5.118e/3GPP TS 24.008

The *Redial* is a type 2 information element with a length of 1 octet.

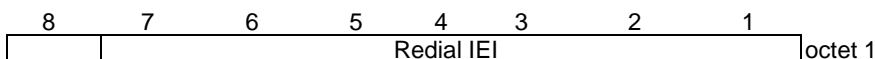

Figure 10.5.118e/3GPP TS 24.008 Redial information element

10.5.4.35 Network-initiated Service Upgrade indicator

The purpose of the *Network-initiated Service Upgrade indicator* information element is to indicate to the mobile station that the in-call modification procedure is due to a network-initiated upgrade from speech to UDI/RDI multimedia (see 3GPP TS 23.172 [97]).

The *Network-initiated Service Upgrade indicator* information element is coded as shown in figure 10.5.118f/3GPP TS 24.008.

The *Network-initiated Service Upgrade indicator* is a type 2 information element with a length of 1 octet.

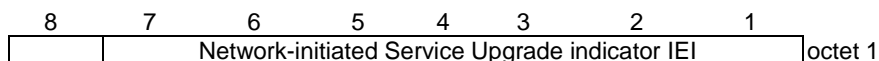

Figure 10.5.118f/3GPP TS 24.008 Network-initiated Service Upgrade indicator information element

10.5.5 GPRS mobility management information elements

10.5.5.0 Additional update type

See subclause 9.9.3.0B in 3GPP TS 24.301 [120].

10.5.5.1 Attach result

The purpose of the *attach result* information element is to specify the result of a GPRS attach procedure.

The *attach result* is a type 1 information element.

The *attach result* information element is coded as shown in figure 10.5.117a/3GPP TS 24.008 and table 10.5.134a/3GPP TS 24.008.

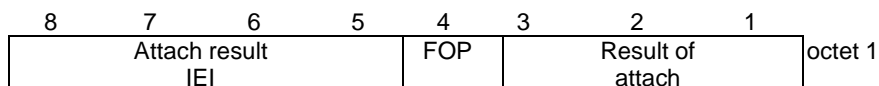

Figure 10.5.117a/3GPP TS 24.008: *Attach result* information element

Table 10.5.134a/3GPP TS 24.008: *Attach result* information element

Result of attach (octet 1)			
Bits			
3	2	1	
0	0	1	GPRS only attached
0	1	1	Combined GPRS/IMSI attached
All other values are reserved.			
Follow-on proceed (octet 1)			
Bit			
4			
0			Follow-on proceed
1			No follow-on proceed
Follow-on proceed is applicable only in lu mode. This indication shall be ignored if received in A/Gb mode.			

10.5.5.2 Attach type

The purpose of the *attach type* information element is to indicate the type of the requested attach, i.e. whether the MS wants to perform a GPRS or combined GPRS attach.

The *attach type* is a type 1 information element.

The *attach type* information element is coded as shown in figure 10.5.117b/3GPP TS 24.008 and table 10.5.135b/3GPP TS 24.008.

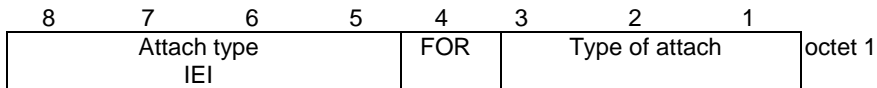

Figure 10.5.117b/3GPP TS 24.008: *Attach type* information element

Table 10.5.135b/3GPP TS 24.008: *Attach type* information element

Type of attach (octet 1, bit 1 to 3)	
Bits	
3 2 1	
0 0 1	GPRS attach
0 1 0	Not used. This value was allocated in earlier versions of the protocol (Note1)
0 1 1	Combined GPRS/IMSI attach
1 0 0	Emergency attach
All other values are interpreted as <i>GPRS attach</i> in this version of the protocol.	
Follow-on request (octet 1, bit 4)	
Bits	
4	
0	No follow-on request pending
1	Follow-on request pending
Follow-on request pending is applicable only in lu mode.	
NOTE 1: The code point "010" if received by the network, it shall be interpreted as "Combined GPRS/IMSI attach".	

10.5.5.3 Cipherring algorithm

The purpose of the *cipherring algorithm* information element is to specify which cipherring algorithm shall be used.

The *cipherring algorithm* is a type 1 information element.

The *cipherring algorithm* information element is coded as shown in figure 10.5.119/3GPP TS 24.008 and table 10.5.136/3GPP TS 24.008.

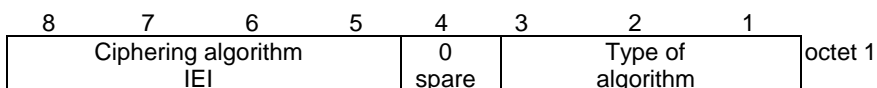

Figure 10.5.119/3GPP TS 24.008: *Cipherring algorithm* information element

Table 10.5.136/3GPP TS 24.008: *Ciphering algorithm* information element

Type of ciphering algorithm (octet 1)			
Bits			
3	2	1	
0	0	0	ciphering not used
0	0	1	GPRS Encryption Algorithm GEA/1
0	1	0	GPRS Encryption Algorithm GEA/2
0	1	1	GPRS Encryption Algorithm GEA/3
1	0	0	GPRS Encryption Algorithm GEA/4
1	0	1	GPRS Encryption Algorithm GEA/5
1	1	0	GPRS Encryption Algorithm GEA/6
1	1	1	GPRS Encryption Algorithm GEA/7

10.5.5.3a Integrity algorithm

The purpose of the integrity *algorithm* information element is to specify which integrity algorithm shall be used.

The integrity *algorithm* is a type 1 information element.

The integrity *algorithm* information element is coded as shown in figure 10.5.5.3a-1/3GPP TS 24.008 and table 10.5.5.3a-1/3GPP TS 24.008.

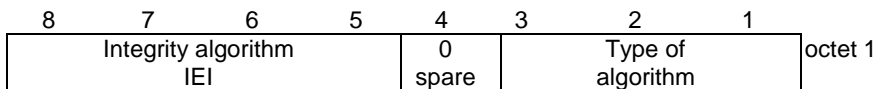

Figure 10.5.5.3a-1/3GPP TS 24.008: *Integrity algorithm* information element

Table 10.5.5.3a-1/3GPP TS 24.008: *Integrity algorithm* information element

Type of integrity algorithm (octet 1)			
Bits			
3	2	1	
0	0	0	GPRS Integrity Algorithm GIA/4
0	0	1	GPRS Integrity Algorithm GIA/5
0	1	0	GPRS Integrity Algorithm GIA/6
0	1	1	GPRS Integrity Algorithm GIA/7
All other values are reserved.			

10.5.5.4 TMSI status

The purpose of the *TMSI status* information element is to indicate whether a valid TMSI is available in the MS or not.

The *TMSI status* is a type 1 information element.

The *TMSI status* information element is coded as shown in figure 10.5.120/3GPP TS 24.008 and table 10.5.137/3GPP TS 24.008.

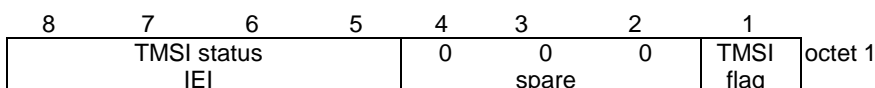

Figure 10.5.120/3GPP TS 24.008: *TMSI status* information element

Table 10.5.137/3GPP TS 24.008: TMSI status information element

TMSI flag (octet 1)	
Bit	
1	
0	no valid TMSI available
1	valid TMSI available

10.5.5.5 Detach type

The purpose of the *detach type* information element is to indicate which type of detach is requested by the MS. In the network to MS direction the *detach type* information element is used to indicate the reason why a detach request is sent.

The *detach type* is a type 1 information element.

The *detach type* information element is coded as shown in figure 10.5.121/3GPP TS 24.008 and table 10.5.138/3GPP TS 24.008.

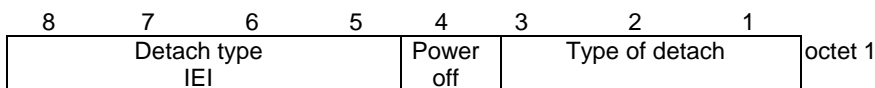

Figure 10.5.121/3GPP TS 24.008: Detach type information element

Table 10.5.138/3GPP TS 24.008: Detach type information element

Type of detach (octet 1)	
In the MS to network direction:	
Bits	
3	2 1
0 0 1	GPRS detach
0 1 0	IMSI detach
0 1 1	Combined GPRS/IMSI detach
All other values are interpreted as <i>Combined GPRS/IMSI detach</i> by this version of the protocol.	
In the network to MS direction:	
Bits	
3	2 1
0 0 1	re-attach required
0 1 0	re-attach not required
0 1 1	IMSI detach (after VLR failure)
All other values are interpreted as <i>re-attach not required</i> by this version of the protocol.	
Power off (octet 1)	
In the MS to network direction:	
Bit	
4	
0	normal detach
1	power switched off
In the network to MS direction the <i>Power off</i> bit shall be spare and set to zero.	

10.5.5.6 DRX parameter

The purpose of the *DRX parameter* information element is to indicate whether the MS uses DRX mode or not.

The *DRX parameter* is a type 3 information element with a length of 3 octets.

The value part of a *DRX parameter* information element is coded as shown in table 10.5.139/3GPP TS 24.008.

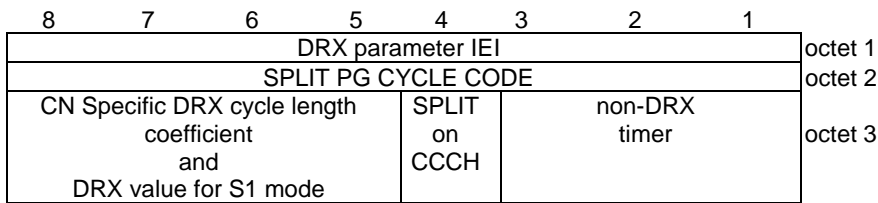

Figure 10.5.122/3GPP TS 24.008: DRX parameter information element

Table 10.5.139/3GPP TS 24.008: DRX parameter information element

SPLIT PG CYCLE CODE, octet 2	
The octet contains the binary coded value of the SPLIT PG CYCLE CODE. The SPLIT PG CYCLE value is derived from the SPLIT PG CYCLE CODE as follows:	
0	704 (equivalent to no DRX)
1 to 64	1 to 64, respectively
65	71
66	72
67	74
68	75
69	77
70	79
71	80
72	83
73	86
74	88
75	90
76	92
77	96
78	101
79	103
80	107
81	112
82	116
83	118
84	128
85	141
86	144
87	150
88	160
89	171
90	176
91	192
92	214
93	224
94	235
95	256
96	288
97	320
98	352
All other values are reserved and shall be interpreted as 1 by this version of the protocol.	
SPLIT on CCCH, octet 3 (bit 4)	
0	Split pg cycle on CCCH is not supported by the mobile station
1	Split pg cycle on CCCH is supported by the mobile station

non-DRX timer, octet 3			
bit			
3	2	1	
0	0	0	no non-DRX mode after transfer state
0	0	1	max. 1 sec non-DRX mode after transfer state
0	1	0	max. 2 sec non-DRX mode after transfer state
0	1	1	max. 4 sec non-DRX mode after transfer state
1	0	0	max. 8 sec non-DRX mode after transfer state
1	0	1	max. 16 sec non-DRX mode after transfer state
1	1	0	max. 32 sec non-DRX mode after transfer state
1	1	1	max. 64 sec non-DRX mode after transfer state
CN Specific DRX cycle length coefficient and DRX value for S1 mode, octet 3			
This field represents two separate values. For Iu mode, it represents the 'CN domain specific DRX cycle length' as defined in 3GPP TS 25.331 [23c]. For S1 mode, it represents the DRX cycle parameter 'T' as defined in 3GPP TS 36.304 [121].			
bit			
8	7	6	5 Iu and S1 mode specific
0	0	0	0 For Iu mode, CN Specific DRX cycle length coefficient not specified by the MS, ie. the system information value 'CN domain specific DRX cycle length' is used . For S1 mode, DRX value not specified by the MS.
0	1	1	0 CN Specific DRX cycle length coefficient 6 and T = 32
0	1	1	1 CN Specific DRX cycle length coefficient 7 and T = 64
1	0	0	0 CN Specific DRX cycle length coefficient 8 and T = 128
1	0	0	1 CN Specific DRX cycle length coefficient 9 and T = 256
All other values shall be interpreted as "CN Specific DRX cycle length coefficient not specified by the MS " and "DRX value not specified by the MS" by this version of the protocol.			
NOTE: For Iu mode and S1 mode, this field (octet 3 bits 8 to 5) is used, but was spare in earlier versions of this protocol.			

10.5.5.7 Force to standby

The purpose of the *force to standby* information element is to force the MS to stop the READY timer in order to prevent the MS to perform cell updates.

In Iu mode, the network shall always indicate *force to standby not indicated* in the *force to standby* information element.

The *force to standby* is a type 1 information element.

The *force to standby* information element is coded as shown in figure 10.5.123/3GPP TS 24.008 and table 10.5.140/3GPP TS 24.008.

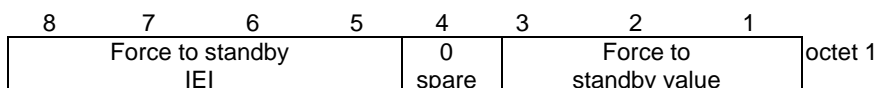

Figure 10.5.123/3GPP TS 24.008: Force to standby information element

Table 10.5.140/3GPP TS 24.008: Force to standby information element

Force to standby value (octet 1)			
Bits			
3	2	1	
0	0	0	Force to standby not indicated
0	0	1	Force to standby indicated
All other values are interpreted as <i>force to standby not indicated</i> by this version of the protocol.			

10.5.5.8 P-TMSI signature

The purpose of the *P-TMSI signature* information element is to identify a GMM context of an MS.

The *P-TMSI signature* is a type 3 information element with 4 octets length.

The *P-TMSI signature* information element is coded as shown in figure 10.5.124/3GPP TS 24.008 and table 10.5.141/3GPP TS 24.008.

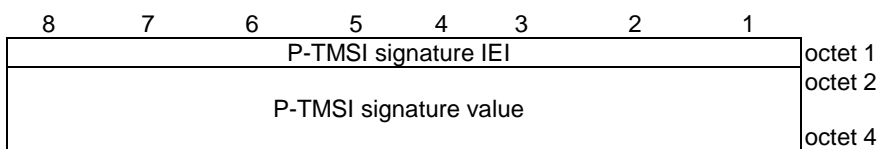

Figure 10.5.124/3GPP TS 24.008: P-TMSI signature information element

Table 10.5.141/3GPP TS 24.008: P-TMSI signature information element

P-TMSI signature value
Octets 2, 3 and 4 contain the binary representation of the P-TMSI signature.
Bit 1 of octet 4 is the least significant bit and bit 8 of octet 2 is the most significant bit.

10.5.5.8a P-TMSI signature 2

The purpose of the *P-TMSI signature 2* information element is to identify a GMM context of an MS.

The *P-TMSI signature 2* is a type 4 information element with 5 octets length.

The *P-TMSI signature 2* information element is coded as shown in figure 10.5.124a/3GPP TS 24.008 and table 10.5.141a/3GPP TS 24.008.

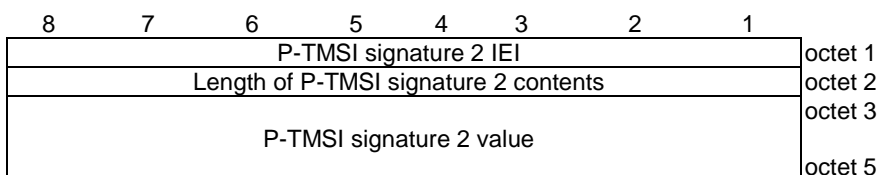

Figure 10.5.124a/3GPP TS 24.008: P-TMSI signature 2 information element

Table 10.5.141a/3GPP TS 24.008: P-TMSI signature 2 information element

P-TMSI signature 2 value is coded as octets 2 to 4 of the *P-TMSI signature* IE.

10.5.5.9 Identity type 2

The purpose of the *identity type 2* information element is to specify which identity is requested.

The *identity type 2* is a type 1 information element.

The *identity type 2* information element is coded as shown in figure 10.5.125/3GPP TS 24.008 and table 10.5.142/3GPP TS 24.008.

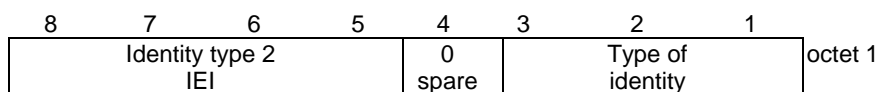

Figure 10.5.125/3GPP TS 24.008: Identity type 2 information element

Table 10.5.142/3GPP TS 24.008: Identity type 2 information element

Type of identity (octet 1)

Bits

3	2	1	
0	0	1	IMSI
0	1	0	IMEI
0	1	1	IMEISV
1	0	0	TMSI

All other values are interpreted as *IMSI* by this version of the protocol.

10.5.5.10 IMEISV request

The purpose of the *IMEISV request* information element is to indicate that the IMEISV shall be included by the MS in the authentication and ciphering response message.

The *IMEISV request* is a type 1 information element.

The *IMEISV request* information element is coded as shown in figure 10.5.126/3GPP TS 24.008 and table 10.5.143/3GPP TS 24.008.

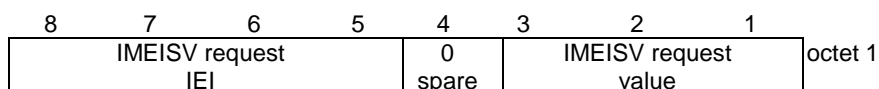

Figure 10.5.126/3GPP TS 24.008: IMEISV request information element

Table 10.5.143/3GPP TS 24.008: *IMEISV request* information element

IMEISV request value (octet 1)			
Bits			
3	2	1	
0	0	0	IMEISV not requested
0	0	1	IMEISV requested
All other values are interpreted as <i>IMEISV not requested</i> by this version of the protocol.			

10.5.5.11 Receive N-PDU Numbers list

The purpose of the *Receive N-PDU Numbers list* information element is to specify the current SNDCP Receive N-PDU Number values.

The *Receive N-PDU Number list* is a type 4 information element with a length of 4 to 19 octets.

The value part of a *Receive N-PDU Number list* information element is coded as shown in figure 10.5.127/3GPP TS 24.008 and table 10.5.144/3GPP TS 24.008.

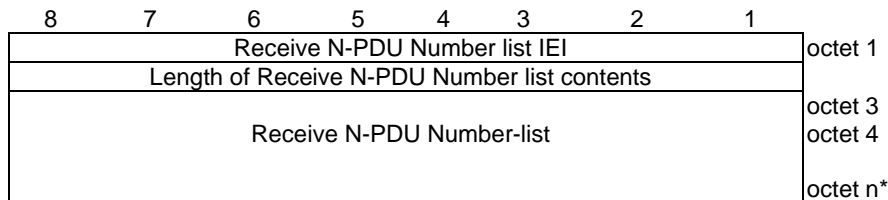

Figure 10.5.127/3GPP TS 24.008: *Receive N-PDU Number list* information element

Table 10.5.144/3GPP TS 24.008: Receive N-PDU Number list information element

```

Receive N-PDU Number -list value ::=
{
  < Receive N-PDU Number -list >
  < Padding bits>
};

< Receive N-PDU Number-list > ::= < sapi : bit-string(4) > < Receive N-PDU
Number-value : bit-string(8) > { < Receive N-PDU Number-list> | < null > };

< nsapi > ::=
{ 0101 };|-- NSAPI 5
{ 0110 };|-- NSAPI 6
{ 0111 };|-- NSAPI 7
{ 1000 };|-- NSAPI 8
{ 1001 };|-- NSAPI 9
{ 1010 };|-- NSAPI 10
{ 1011 };|-- NSAPI 11
{ 1100 };|-- NSAPI 12
{ 1101 };|-- NSAPI 13
{ 1110 };|-- NSAPI 14
{ 1111 }; -- NSAPI 15

< Receive N-PDU Number-value > ::= { 0 | 1 } (8);
-- Contains the binary coded representation of the receive N-PDU Number value.
-- The first bit in transmission order is the most significant bit.

<Padding bits> ::= null | 0000;
    
```

10.5.5.12 MS network capability

The purpose of the *MS network capability* information element is to provide the network with information concerning aspects of the mobile station related to GPRS. The contents might affect the manner in which the network handles the operation of the mobile station. The *MS network capability* information indicates general mobile station characteristics and it shall therefore, except for fields explicitly indicated, be independent of the frequency band of the channel it is sent on.

The *MS network capability* is a type 4 information element with a maximum of 10 octets length.

The value part of a *MS network capability* information element is coded as shown in figure 10.5.128/3GPP TS 24.008 and table 10.5.145/3GPP TS 24.008.

NOTE: The requirements for the support of the GEA algorithms in the MS are specified in 3GPP TS 43.020 [13].

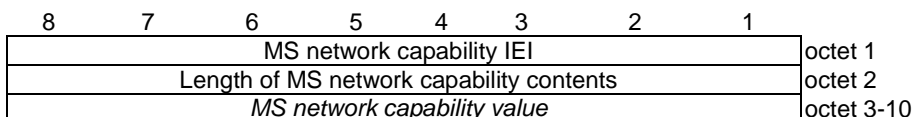

Figure 10.5.128/3GPP TS 24.008 MS network capability information element

Table 10.5.145/3GPP TS 24.008 *MS network capability* information element

<MS network capability value part> ::=

<GEA1 bits>

<SM capabilities via dedicated channels: bit>

<SM capabilities via GPRS channels: bit>

<UCS2 support: bit>

<SS Screening Indicator: bit string(2)>

<SoLSA Capability : bit>

<Revision level indicator: bit>

<PFC feature mode: bit>

<Extended GEA bits>

<LCS VA capability: bit>

<PS inter-RAT HO from GERAN to UTRAN Iu mode capability: bit>

<PS inter-RAT HO from GERAN to E-UTRAN S1 mode capability: bit>

<EMM Combined procedures Capability: bit>

<ISR support: bit>

<SRVCC to GERAN/UTRAN capability: bit>

<EPC capability: bit>

<NF capability: bit>

<GERAN network sharing capability: bit>

<User plane integrity protection support: bit>

<GIA/4: bit>

<GIA/5: bit>

<GIA/6: bit>

<GIA/7: bit>

<ePCO IE indicator: bit>

<Restriction on use of enhanced coverage capability: bit>

<Dual connectivity of E-UTRA with NR capability: bit>

<Spare bits>;

<GEA1 bits> ::= < GEA/1 :bit>;

<Extended GEA bits> ::= <GEA/2:bit><GEA/3:bit>< GEA/4:bit >< GEA/5:bit >< GEA/6:bit ><GEA/7:bit>;

<Spare bits> ::= null | {<spare bit> < Spare bits >};

SS Screening Indicator

0 0 defined in 3GPP TS 24.080 [24]

0 1 defined in 3GPP TS 24.080 [24]

1 0 defined in 3GPP TS 24.080 [24]

1 1 defined in 3GPP TS 24.080 [24]

SM capabilities via dedicated channels

0 Mobile station does not support mobile terminated point to point SMS via CS domain

1 Mobile station supports mobile terminated point to point SMS via CS domain

SM capabilities via GPRS channels

0 Mobile station does not support mobile terminated point to point SMS via PS domain

1 Mobile station supports mobile terminated point to point SMS via PS domain

UCS2 support

This information field indicates the likely treatment by the mobile station of UCS2 encoded character strings.

0 the ME has a preference for the default alphabet (defined in 3GPP TS 23.038 [8b]) over UCS2.

1 the ME has no preference between the use of the default alphabet and the use of UCS2.

GPRS Encryption Algorithm GEA/1 (NOTE)

The MS shall set this bit to '0'.

The network shall accept any received value in order to support MSs that are compliant to earlier versions of this

specification.

- 0 encryption algorithm **GEA/1** not available
- 1 Not used. This value was allocated in earlier versions of the protocol.

SoLSA Capability

- 0 The ME does not support SoLSA.
- 1 The ME supports SoLSA.

Revision level indicator

- 0 used by a mobile station not supporting R99 or later versions of the protocol
- 1 used by a mobile station supporting R99 or later versions of the protocol

PFC feature mode

- 0 Mobile station does not support BSS packet flow procedures
- 1 Mobile station does support BSS packet flow procedures

GEA/2 (NOTE)

- 0 encryption algorithm GEA/2 not available
- 1 encryption algorithm GEA/2 available

GEA/3 (NOTE)

- 0 encryption algorithm GEA/3 not available
- 1 encryption algorithm GEA/3 available

GEA/4 (NOTE)

- 0 encryption algorithm GEA/4 not available
- 1 encryption algorithm GEA/4 available

GEA/5 (NOTE)

- 0 encryption algorithm GEA/5 not available
- 1 encryption algorithm GEA/5 available

GEA/6 (NOTE)

- 0 encryption algorithm GEA/6 not available
- 1 encryption algorithm GEA/6 available

GEA/7 (NOTE)

- 0 encryption algorithm GEA/7 not available
- 1 encryption algorithm GEA/7 available

LCS VA capability (LCS value added location request notification capability)

This information field indicates the support of the LCS value added location request notification via PS domain as defined in 3GPP TS 23.271 [105].

- 0 location request notification via PS domain not supported
- 1 location request notification via PS domain supported

PS inter-RAT HO from GERAN to UTRAN Iu mode capability

This information field indicates the support of the PS inter-RAT HO from GERAN to UTRAN Iu mode.

- 0 PS inter-RAT HO from GERAN to UTRAN Iu mode not supported
- 1 PS inter-RAT HO from GERAN to UTRAN Iu mode supported

PS inter-RAT HO from GERAN to E-UTRAN S1 mode capability

This information field indicates the support of the PS inter-RAT HO from GERAN to E-UTRAN S1 mode. A mobile station not compliant to the UE E-UTRA capability requirements as defined in 3GPP TS 36.306 [153] shall set this field to '0'.

- 0 PS inter-RAT HO from GERAN to E-UTRAN S1 mode not supported
- 1 PS inter-RAT HO from GERAN to E-UTRAN S1 mode supported

EMM Combined procedures capability

This information field indicates the support of EMM combined procedures. The MS shall not change this information field from the one that was included in the GMM or EMM ATTACH REQUEST message.

- 0 Mobile station does not support EMM combined procedures
- 1 Mobile station supports EMM combined procedures

ISR support

- 0 The mobile station does not support ISR.
- 1 The mobile station supports ISR.

SRVCC to GERAN/UTRAN capability

- 0 SRVCC from UTRAN HSPA or E-UTRAN to GERAN/UTRAN not supported
- 1 SRVCC from UTRAN HSPA or E-UTRAN to GERAN/UTRAN supported

EPC capability

This information field indicates if the MS supports access to the EPC via access networks other than GERAN or UTRAN. The network can use this information to decide whether to select a PDN Gateway or a GGSN. The MS shall set the indication to "0" if a SIM is inserted in the MS.

- 0 EPC not supported
- 1 EPC supported

NF capability

This information field indicates if the MS supports the notification procedure.

- 0 Mobile station does not support the notification procedure.
- 1 Mobile station supports the notification procedure.

GERAN network sharing capability

This information field indicates if the MS supports GERAN network sharing.

- 0 Mobile station does not support GERAN network sharing.
- 1 Mobile station supports GERAN network sharing.

User plane integrity protection support

- 0 The mobile station does not support user plane integrity protection.
- 1 The mobile station supports user plane integrity protection.

GIA/4 (NOTE)

- 0 integrity algorithm GIA/4 not available
- 1 integrity algorithm GIA/4 available

GIA/5 (NOTE)

- 0 integrity algorithm GIA/5 not available
- 1 integrity algorithm GIA/5 available

GIA/6 (NOTE)

- 0 integrity algorithm GIA/5 not available
- 1 integrity algorithm GIA/5 available

GIA/7 (NOTE)

- 0 integrity algorithm GIA/5 not available
- 1 integrity algorithm GIA/5 available

ePCO IE indicator

- 0 used by a mobile station not supporting extended protocol configuration options IE
- 1 used by a mobile station supporting extended protocol configuration options IE

Restriction on use of enhanced coverage capability

This information field indicates if the MS supports restriction on use of enhanced coverage

- 0 Mobile station does not support restriction on use of enhanced coverage
- 1 Mobile station supports restriction on use of enhanced coverage

Dual connectivity of E-UTRA with NR capability

This information field indicates if the MS supports dual connectivity of E-UTRA with NR

- 0 Mobile station does not support dual connectivity of E-UTRA with NR
- 1 Mobile station supports dual connectivity of E-UTRA with NR

NOTE: The requirements for the support of the GEA and the GIA algorithms in the MS are specified in 3GPP TS 43.020 [13].

10.5.5.12a MS Radio Access capability

The purpose of the *MS Radio Access capability* information element is to provide the radio part of the network with information concerning radio aspects of the mobile station. The contents might affect the manner in which the network handles the operation of the mobile station.

The *MS Radio Access capability* is a type 4 information element, with a maximum length of 52 octets.

The *MS Radio Access capability* information element is coded as shown in figure 10.5.128a/3GPP TS 24.008 and table 10.5.146/3GPP TS 24.008.

For the indication of the radio access capabilities the following conditions shall apply:

- Among the three Access Type Technologies GSM 900-P, GSM 900-E and GSM 900-R only one shall be present.
- Due to shared radio frequency channel numbers between GSM 1800 and GSM 1900, the mobile station should provide the relevant radio access capability for either GSM 1800 band OR GSM 1900 band, not both.
- The MS shall indicate its supported Access Technology Types during a single MM procedure.
- If the alternative coding by using the Additional access technologies struct is chosen by the mobile station, the mobile station shall indicate its radio access capability for the serving BCCH frequency band in the first included Access capabilities struct, if this information element is not sent in response to an Access Technologies Request from the network or if none of the requested Access Technology Types is supported by the MS. Otherwise, the mobile station shall include the radio access capabilities for the frequency bands it supports in the order of priority requested by the network (see 3GPP TS 44.060 [76]).
- The first Access Technology Type shall not be set to "1111".

For error handling the following shall apply:

- If a received Access Technology Type is unknown to the receiver, it shall ignore all the corresponding fields.
- If within a known Access Technology Type a receiver recognizes an unknown field it shall ignore it.
- For more details about error handling of MS radio access capability see 3GPP TS 48.018 [86].

NOTE: The requirements for the support of the A5 algorithms in the MS are specified in 3GPP TS 43.020 [13].

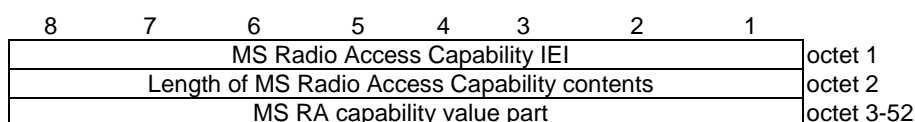

Figure 10.5.128a/3GPP TS 24.008 MS Radio Access Capability information element

Table 10.5.146/3GPP TS 24.008: *MS Radio Access Capability* Information Element

```

<MS RA capability value part > ::=
  <MS RA capability value part struct >
  <spare bits>**; -- may be used for future enhancements

<MS RA capability value part struct > ::= --recursive structure allows any number of Access technologies
  { { <Access Technology Type: bit (4) > exclude 1111
    <Access capabilities : <Access capabilities struct > > }

    | { <Access Technology Type: bit (4) == 1111 > -- structure adding Access technologies with same
capabilities
    <Length : bit (7) > -- length in bits of list of Additional access technologies and spare bits
    <bit (val (Length))
    & {
      { 1 <Additional access technologies: <Additional access technologies struct > > } ** 0
      <spare bits>**
    } >
  } >

  { 0 | 1 <MS RA capability value part struct > } ;

<Additional access technologies struct > ::=
  <Access Technology Type : bit (4) >
  <GMSK Power Class : bit (3) >
  <8PSK Power Class : bit (2) > ;

<Access capabilities struct > ::=
  <Length : bit (7) > -- length in bits of Content and spare bits
  <bit (val (Length))
  & {
    <Access capabilities : <Content>>
    <spare bits>**
  } > ; -- expands to the indicated length

<Content > ::=
  <RF Power Capability : bit (3) >
  { 0 | 1 <A5 bits : <A5 bits > > } -- zero means that the same values apply for parameters as in the immediately

```

preceding Access capabilities field within this IE

< ES IND : bit >

< PS : bit >

< VGCS : bit >

< VBS : bit >

{ 0 | 1 < Multislot capability : Multislot capability struct > } -- zero means that the same values for multislot

parameters as given in an earlier Access capabilities field within this IE apply also here

-- Additions in release 99

{ 0 | 1 < 8PSK Power Capability : bit(2) > }

< COMPACT Interference Measurement Capability : bit >

< Revision Level Indicator : bit >

< UMTS FDD Radio Access Technology Capability : bit > -- 3G RAT

< UMTS 3.84 Mcps TDD Radio Access Technology Capability : bit > -- 3G RAT

< CDMA 2000 Radio Access Technology Capability : bit > -- 3G RAT

-- Additions in release 4

< UMTS 1.28 Mcps TDD Radio Access Technology Capability: bit > -- 3G RAT

< GERAN Feature Package 1 : bit >

{ 0 | 1 < Extended DTM GPRS Multi Slot Class : bit(2) >

< Extended DTM EGPRS Multi Slot Class : bit(2) > }

< Modulation based multislot class support : bit >

-- Additions in release 5

{ 0 | 1 < High Multislot Capability : bit(2) > }

0 -- The value '1' was allocated in an earlier version of the protocol and shall not be used.

< GMSK Multislot Power Profile : bit (2) >

< 8-PSK Multislot Power Profile : bit (2) >

-- Additions in release 6

< Multiple TBF Capability : bit >

< Downlink Advanced Receiver Performance : bit(2) >

< Extended RLC/MAC Control Message Segmentation Capability : bit >

< DTM Enhancements Capability : bit >

{ 0 | 1 < DTM GPRS High Multi Slot Class : bit(3) >

{ 0 | 1 < DTM EGPRS High Multi Slot Class : bit(3) > } }

< PS Handover Capability : bit >

-- Additions in release 7

< DTM Handover Capability : bit >

{ 0 | 1 < Multislot Capability Reduction for Downlink Dual Carrier: bit (3) >

< Downlink Dual Carrier for DTM Capability : bit > }

< Flexible Timeslot Assignment : bit >

< GAN PS Handover Capability : bit >

< RLC Non-persistent Mode : bit >

< Reduced Latency Capability : bit >

< Uplink EGPRS2 : bit(2) >

< Downlink EGPRS2 : bit(2) >

-- Additions in release 8

< E-UTRA FDD support : bit >

< E-UTRA TDD support : bit >

< GERAN to E-UTRA support in GERAN packet transfer mode: bit(2) >

< Priority-based reselection support : bit >

-- Additions in release 9

< Enhanced Flexible Timeslot Assignment : Enhanced Flexible Timeslot Assignment struct >

< Indication of Upper Layer PDU Start Capability for RLC UM : bit >

< EMST Capability : bit >

< MTTI Capability : bit >

< UTRA CSG Cells Reporting : bit >

< E-UTRA CSG Cells Reporting : bit >

-- Additions in release 10

< DTR Capability : bit >

< EMSR Capability : bit >

< Fast Downlink Frequency Switching Capability : bit >

< TIGHTER Capability : bit(2) >

-- Additions in release 11

< FANR Capability : bit >

```
< IPA Capability : bit>
< GERAN Network Sharing support : bit>
< E-UTRA Wideband RSRQ measurements support : bit>
-- Additions in release 12
< UTRA Multiple Frequency Band Indicators support : bit >
< E-UTRA Multiple Frequency Band Indicators support : bit >
{ 0      -- DLMC not supported
  | 1 < DLMC Capability : DLMC Capability struct > }
< Extended TSC Set Capability support : bit >
-- Late addition of a release 11 feature
< Extended EARFCN value range: bit>
-- Additions in release 13
< (EC-)PCH monitoring support: bit(2)>
-- Additions in release 14
{ 0      -- Default requirement as specified in TS 45.010 applies
  | 1 < MS Sync Accuracy: bit (4) > }
< EC uplink coverage enhancement support : bit (1)>
-- Additions in release 15
< MTA Access Security support: bit(1) >
< EC paging indication channel monitoring support: bit(1) >;
-- error: struct too short, assume features do not exist
-- error: struct too long, ignore data and jump to next Access technology
```

Table 10.5.146/3GPP TS 24.008 (continued): *MS Radio Access Capability IE*

```

< Multislot capability struct > ::=
  { 0 | 1 < HSCSD multislot class : bit (5) > }
  { 0 | 1 < GPRS multislot class : bit (5) > < GPRS Extended Dynamic Allocation Capability : bit > }
  { 0 | 1 < SMS_VALUE : bit (4) > < SM_VALUE : bit (4) > }
-- Additions in release 99
  { 0 | 1 < ECSD multislot class : bit (5) > }
  { 0 | 1 < EGPRS multislot class : bit (5) > < EGPRS Extended Dynamic Allocation Capability : bit > }
  { 0 | 1 < DTM GPRS Multi Slot Class: bit(2)>
    <Single Slot DTM : bit>
    {0 | 1 <DTM EGPRS Multi Slot Class : bit(2)> } } ;
-- error: struct too short, assume features do not exist

<A5 bits> ::= < A5/1 : bit> <A5/2 : bit> <A5/3 : bit> <A5/4 : bit> <A5/5 : bit> <A5/6 : bit> <A5/7 : bit>; -- bits for circuit
mode ciphering algorithms. These fields are not used by the network and may be excluded by the MS.

```

```

< Enhanced Flexible Timeslot Assignment struct > ::=
  { 0 | 1 < Alternative EFTA Multislot Class : bit(4) >
    < EFTA Multislot Capability Reduction for Downlink Dual Carrier: bit (3) > };

```

```

< DLMC Capability struct > ::=
  { 0 | 1 < DLMC - Non-contiguous intra-band reception : bit(2) >
    < DLMC - Inter-band reception : bit(1) > }
  < DLMC - Maximum Bandwidth : bit(2) >
  < DLMC - Maximum Number of Downlink Timeslots : bit(6) >
  < DLMC - Maximum Number of Downlink Carriers : bit(3) > ;

```

Access Technology Type

This field indicates the access technology type to be associated with the following access capabilities.

Bits

4 3 2 1

0 0 0 0 GSM P

0 0 0 1 GSM E --note that GSM E covers GSM P

0 0 1 0 GSM R --note that GSM R covers GSM E and GSM P

0 0 1 1 GSM 1800

0 1 0 0 GSM 1900

0 1 0 1 GSM 450

0 1 1 0 GSM 480

0 1 1 1 GSM 850

1 0 0 0 GSM 750

1 0 0 1 GSM T 380

1 0 1 0 GSM T 410

1 0 1 1-- This value was allocated in an earlier version of the protocol and shall not be used.

1 1 0 0 GSM 710

1 1 0 1 GSM T 810

1 1 1 1 Indicates the presence of a list of Additional access technologies

All other values are treated as unknown by the receiver.

A MS which does not support any GSM access technology type shall set this field to '0000'.

RF Power Capability, GMSK Power Class (3 bit field)

This field contains the binary coding of the power class used for GMSK associated with the indicated Access Technology Type (see 3GPP TS 45.005 [33]).

A MS which does not support any GSM access technology type shall set this field to '000'.

8PSK Power Capability (2 bit field)

If 8-PSK modulation is supported for uplink, this field indicates the radio capability for 8-PSK modulation. The following coding is used (see 3GPP TS 45.005 [33]):

Bits 2 1

0 0 Reserved

0 1 Power class E1

1 0 Power class E2

1 1 Power class E3

The presence of this field also indicates 8PSK modulation capability in the uplink.

8PSK Power Class (2 bit field)

This field indicates the radio capability for 8-PSK modulation. The following coding is used (see 3GPP TS 45.005 [33]):

Bits	2 1	
	0 0	8PSK modulation not supported for uplink
	0 1	Power class E1
	1 0	Power class E2
	1 1	Power class E3

Additional access technologies struct

This structure contains the GMSK Power Class and 8PSK Power Class for an additional Access Technology. All other capabilities for this indicated Access Technology are the same as the capabilities indicated by the preceding Access capabilities struct.

A5/1

- 0 encryption algorithm A5/1 not available
- 1 encryption algorithm A5/1 available

A5/2

The MS shall set this bit to '0'.

The network shall accept any received value.

- 0 encryption algorithm A5/2 not available
- 1 Not used. This value was allocated in earlier versions of the protocol.

A5/3

- 0 encryption algorithm A5/3 not available
- 1 encryption algorithm A5/3 available

A5/4

- 0 encryption algorithm A5/4 not available
- 1 encryption algorithm A5/4 available

A5/5

- 0 encryption algorithm A5/5 not available
- 1 encryption algorithm A5/5 available

A5/6

- 0 encryption algorithm A5/6 not available
- 1 encryption algorithm A5/6 available

A5/7

- 0 encryption algorithm A5/7 not available
- 1 encryption algorithm A5/7 available

ES IND – (Controlled early Classmark Sending)

- 0 "controlled early Classmark Sending" option is not implemented
- 1 "controlled early Classmark Sending" option is implemented

Table 10.5.146/3GPP TS 24.008 (concluded): *MS Radio Access Capability IE*

PS – (Pseudo Synchronisation)

- 0 PS capability not present
- 1 PS capability present

VGCS – (Voice Group Call Service)

- 0 no VGCS capability or no notifications wanted
- 1 VGCS capability and notifications wanted.

VBS – (Voice Broadcast Service)

- 0 no VBS capability or no notifications wanted
- 1 VBS capability and notifications wanted

HSCSD Multi Slot Class

The Multi Slot Class field is coded as the binary representation of the multislot class defined in 3GPP TS 45.002 [32]. This field is not used by the network and may be excluded by the MS. Range 1 to 18, all other values are reserved.

GPRS Multi Slot Class

The GPRS Multi Slot Class field is coded as the binary representation of the multislot class defined in 3GPP TS 45.002 [32].

ECSD Multi Slot Class

The presence of this field indicates ECSD capability. Whether the MS is capable of 8-PSK modulation in uplink is indicated by the presence of 8-PSK Power Capability field. The Multi Slot Class field is coded as the binary representation of the multislot class defined in 3GPP TS 45.002 [32]. This field is not used by the network and may be excluded by the MS.

Range 1 to 18, all other values are reserved.

EGPRS Multi Slot Class

The presence of this field indicates EGPRS capability. Whether the MS is capable of 8-PSK modulation in uplink is indicated by the presence of 8-PSK Power Capability field. The EGPRS Multi Slot Class field is coded as the binary representation of the multislot class defined in 3GPP TS 45.002 [32].

The same multislot capability is applicable also for EGPRS2 if supported.

The same multislot capability is applicable also for Downlink Multi Carrier configuration if supported.

The same multislot capability is applicable also for EC-GSM-IoT if supported, see 3GPP TS 43.064 [159].

GPRS Extended Dynamic Allocation Capability

- 0 Extended Dynamic Allocation Capability for GPRS is not implemented
- 1 Extended Dynamic Allocation Capability for GPRS is implemented

If a multislot class type 1 MS indicates in the GPRS Multi Slot Class field the support of a multislot class for which three or more uplink timeslots can be assigned, Extended Dynamic Allocation for GPRS shall be implemented in the mobile station.

EGPRS Extended Dynamic Allocation Capability

- 0 Extended Dynamic Allocation Capability for EGPRS and EGPRS2 (if supported) is not implemented
- 1 Extended Dynamic Allocation Capability for EGPRS and EGPRS2 (if supported) is implemented

If a multislot class type 1 MS indicates in the EGPRS Multi Slot Class field the support of a multislot class for which three or more uplink timeslots can be assigned, Extended Dynamic Allocation for EGPRS and EGPRS2 (if supported) shall be implemented in the mobile station.

SMS_VALUE (Switch-Measure-Switch) (4 bit field)

The SMS field indicates the time needed for the mobile station to switch from one radio channel to another, perform a neighbor cell power measurement, and the switch from that radio channel to another radio channel. This field is not used by the network and may be excluded by the MS.

Bits

4 3 2 1

0 0 0 0 1/4 timeslot (~144 microseconds)

0 0 0 1 2/4 timeslot (~288 microseconds)

0 0 1 0 3/4 timeslot (~433 microseconds)

...

1 1 1 1 16/4 timeslot (~2307 microseconds)

(SM_VALUE) Switch-Measure (4 bit field)

The SM field indicates the time needed for the mobile station to switch from one radio channel to another and perform a neighbour cell power measurement. This field is not used by the network and may be excluded by the MS.

Bits

4 3 2 1

0 0 0 0 1/4 timeslot (~144 microseconds)

0 0 0 1	2/4 timeslot (~288 microseconds)
0 0 1 0	3/4 timeslot (~433 microseconds)
...	
1 1 1 1	16/4 timeslot (~2307 microseconds)

DTM GPRS Multi Slot Class (2 bit field)

This field indicates the DTM GPRS multislot capabilities of the MS. It is coded as follows:

Bits

2 1

- 0 0 Unused. If received, the network shall interpret this as '01'
- 0 1 Multislot class 5 supported
- 1 0 Multislot class 9 supported
- 1 1 Multislot class 11 supported

This field shall contain one of the following values if the *DTM GPRS High Multi Slot Class* field is present:

Multislot class 9 if DTM GPRS High Multi Slot Class is set to indicate Class 31/36 or Class 41;

Multislot class 11 if DTM GPRS High Multi Slot Class is set to indicate Classes 32/37, 33/38 or Classes 42, 43, 44.

Single Slot DTM (1 bit field)

This field indicates whether the MS supports single slot DTM operation (see 3GPP TS 43.055 [87]).

Bit

- 0 Single Slot DTM not supported
- 1 Single Slot DTM supported

An MS indicating support for Extended DTM GPRS multislot class or Extended DTM EGPRS multislot class shall set this bit to '1'. The network may ignore the bit in this case.

DTM EGPRS Multi Slot Class (2 bit field)

This field indicates the DTM EGPRS multislot capabilities of the MS. This field shall be included only if the mobile station supports EGPRS DTM. This field is coded as the DTM GPRS multislot Class field.

This field shall contain one of the following values if the *DTM EGPRS High Multi Slot Class* field is present:

Multislot class 9 if DTM EGPRS High Multi Slot Class is set to indicate Class 31/36 or Class 41;

Multislot class 11 if DTM EGPRS High Multi Slot Class is set to indicate Classes 32/37, 33/38 or Classes 42, 43, 44.

The same multislot capability is applicable also for EGPRS2 if supported.

COMPACT Interference Measurement Capability (1 bit field)

- 0 COMPACT Interference Measurement Capability is not implemented
- 1 COMPACT Interference Measurement Capability is implemented

Revision Level Indicator (1 bit field)

Bit

- 0 The ME is Release '98 or older
- 1 The ME is Release '99 onwards

UMTS FDD Radio Access Technology Capability (1 bit field)

Bit

- 0 UMTS FDD not supported
- 1 UMTS FDD supported

UMTS 3.84 Mcps TDD Radio Access Technology Capability (1 bit field)

Bit

- 0 UMTS 3.84 Mcps TDD not supported
- 1 UMTS 3.84 Mcps TDD supported

CDMA 2000 Radio Access Technology Capability (1 bit field)

Bit

- 0 CDMA 2000 not supported
- 1 CDMA 2000 supported

UMTS 1.28 Mcps TDD Radio Access Technology Capability (1 bit field)

Bit

- 0 UMTS 1.28 Mcps TDD not supported
- 1 UMTS 1.28 Mcps TDD supported

GERAN Feature Package 1 (1 bit field)

The support of interworking towards E-UTRA is indicated separately in the "**GERAN to E-UTRA support in GERAN packet transfer mode**" field. This field indicates whether the MS supports the GERAN Feature Package 1 (see 3GPP TS 44.060 [76]). It is coded as follows:

- 0 GERAN feature package 1 not supported.
 1 GERAN feature package 1 supported.

Extended DTM GPRS Multi Slot Class (2 bit field)

This field indicates the extended DTM GPRS capabilities of the MS and shall be interpreted in conjunction with the DTM GPRS Multi Slot Class field. It is coded as follows, where 'DGMSC' denotes the DTM GPRS multislot class field:

DGMSC Bit	2 1	Bit 2 1	
	0 0	0 0	Unused. If received, it shall be interpreted as '01 00'
	0 0	0 1	Unused. If received, it shall be interpreted as '01 00'
	0 0	1 0	Unused. If received, it shall be interpreted as '01 00'
	0 0	1 1	Unused. If received, it shall be interpreted as '01 00'
	0 1	0 0	Multislot class 5 supported
	0 1	0 1	Multislot class 6 supported
	0 1	1 0	Unused. If received, it shall be interpreted as '01 00'
	0 1	1 1	Unused. If received, it shall be interpreted as '01 00'
	1 0	0 0	Multislot class 9 supported
	1 0	0 1	Multislot class 10 supported
	1 0	1 0	Unused. If received, it shall be interpreted as '10 00'
	1 0	1 1	Unused. If received, it shall be interpreted as '10 00'
	1 1	0 0	Multislot class 11 supported
	1 1	0 1	Unused. If received, it shall be interpreted as '11 00'
	1 1	1 0	Unused. If received, it shall be interpreted as '11 00'
	1 1	1 1	Unused. If received, it shall be interpreted as '11 00'

The presence of this field indicates that the MS supports combined fullrate and halfrate GPRS channels in the downlink. When this field is not present, the MS supports the multislot class indicated by the *DTM GPRS Multi Slot Class* field.

If this field is included, it shall contain one of the following values if the *DTM GPRS High Multi Slot Class* field is present:

Multislot class 10 if DTM GPRS High Multi Slot Class is set to indicate Class 31/36 or Class 41;
 Multislot class 11 if DTM GPRS High Multi Slot Class is set to indicate Classes 32/37, 33/38 or Classes 42, 43, 44.

Extended DTM EGPRS Multislot Class (2 bit field)

This field is not considered when the DTM EGPRS Multislot Class field is not included. This field indicates the extended DTM EGPRS multislot capabilities of the MS and shall be interpreted in conjunction with the DTM EGPRS Multislot Class field. This field is coded as the Extended DTM GPRS Multislot Class field. The presence of this field indicates that the MS supports combined fullrate and halfrate GPRS channels in the downlink. When this field is not present, the MS supports the multislot class indicated by the DTM EGPRS Multi Slot Class field.

If this field is included, it shall contain one of the following values if the *DTM EGPRS High Multi Slot Class* field is present:

Multislot class 10 if DTM EGPRS High Multi Slot Class is set to indicate Class 31/36 or Class 41;
 Multislot class 11 if DTM EGPRS High Multi Slot Class is set to indicate Classes 32/37, 33/38 or Classes 42, 43, 44.

Modulation based multislot class support (1 bit field)

- Bit
 0 "Modulation based multislot class" not supported
 1 "Modulation based multislot class" supported

High Multislot Capability (2 bit field)

The High Multislot Capability is individually combined with each multislot class field sent by the MS (the possible multislot class fields are: GPRS multislot class, EGPRS multislot class) to extend the related multislot class to multislot classes 30 to 45, see 3GPP TS 45.002 [32]. The same capability is applicable also to EGPRS2 if supported. The same capability is applicable also to Downlink Multi Carrier configuration if supported.

For each multislot class, the following mapping is done:

Bits	2 1	coded multislot class field	actual multislot class
	0 0	8	30
	0 0	10, 23, 28, 29	39
	0 0	11, 20, 25	32
	0 0	12, 21, 22, 26, 27	33
	0 0	Any other	Multislot Class field value

0 1	8	35
0 1	10, 19, 24	36
0 1	11, 23, 28, 29	45
0 1	12, 21, 22, 26, 27	38
0 1	Any other	Multislot Class field value
1 0	8	40
1 0	10, 19, 24	41
1 0	11, 20, 25	42
1 0	12, 23, 28, 29	44
1 0	Any other	Multislot Class field value
1 1	12, 21, 22, 26, 27	43
1 1	11, 20, 25	37
1 1	10, 19, 24	31
1 1	9, 23, 28, 29	34
1 1	Any other	Multislot Class field value

GMSK Multislot Power Profile (2 bit field)

For detailed definitions, see the Mobile Station Classmark 3 information element.

8-PSK Multislot Power Profile (2 bit field)

For detailed definitions, see the Mobile Station Classmark 3 information element.

Multiple TBF Capability (1 bit field)

Bit

- 0 Multiple TBF procedures in A/Gb mode not supported
- 1 Multiple TBF procedures in A/Gb mode supported

Downlink Advanced Receiver Performance (2 bit field)

This field indicates Downlink Advanced Receiver Performance capabilities of the MS (see 3GPP TS 45.005 [33]).

Bits

- 2 1
- 0 0 Downlink Advanced Receiver Performance not supported
- 0 1 Downlink Advanced Receiver Performance – phase I supported
- 1 0 Downlink Advanced Receiver Performance – phase II supported

The value '11' shall not be used by the MS.

If the value '11' is received by the network, it shall be interpreted as '10'.

Extended RLC/MAC Control Message Segmentation capability (1 bit field)

Bit

- 0 Extended RLC/MAC control message segmentation not supported
- 1 Extended RLC/MAC control message segmentation supported

DTM Enhancements Capability (1 bit field)

This field indicates whether the mobile station supports enhanced DTM CS establishment and enhanced DTM CS release or not. It is coded as follows:

Bit

- 0 The mobile station does not support enhanced DTM CS establishment and enhanced DTM CS release procedures.
- 1 The mobile station supports enhanced DTM CS establishment and enhanced DTM CS release procedures.

DTM GPRS High Multi Slot Class (3 bit field)

This field indicates the DTM GPRS multislot capabilities of the MS. It is coded as follows:

Bit

- 3 2 1
- 0 0 0 Unused. If received, the network shall interpret this as '0 0 1'
- 0 0 1 Multislot class 31 or 36 supported
- 0 1 0 Multislot class 32 or 37 supported
- 0 1 1 Multislot class 33 or 38 supported
- 1 0 0 Multislot class 41 supported
- 1 0 1 Multislot class 42 supported
- 1 1 0 Multislot class 43 supported
- 1 1 1 Multislot class 44 supported

The presence of this field indicates that the MS supports the DTM extension to high multislot classes. When this field is not present, the MS supports the DTM multislot class indicated by the *DTM GPRS Multi Slot Class field*.

The values '0 0 1', '0 1 0' and '0 1 1' shall be interpreted as indicating DTM GPRS multislot class 36, 37 or 38 respectively in case the MS indicates support for one of the GPRS multislot classes 35 to 39; in all other cases those codepoints shall be interpreted as indicating DTM GPRS multislot class 31, 32 or 33 respectively.

This field shall be ignored if the High Multislot Capability field is not present.

DTM EGPRS High Multi Slot Class (3 bit field)

This field indicates the DTM EGPRS multislot capabilities of the MS. This field may be included only if the mobile station supports EGPRS DTM. This field is coded as the DTM GPRS High Multi Slot Class field. When this field is not present, the MS supports the DTM multislot class indicated by the *DTM EGPRS Multi Slot Class field*.

The values '0 0 1', '0 1 0' and '0 1 1' shall be interpreted as indicating DTM EGPRS multislot class 36, 37 or 38 respectively in case the MS indicates support for one of the EGPRS multislot classes 35 to 39; in all other cases those codepoints shall be interpreted as indicating DTM EGPRS multislot class 31, 32 or 33 respectively.

This field shall be ignored if the High Multislot Capability field is not present.

The same multislot capability is applicable also for EGPRS2 if supported.

PS Handover Capability (1 bit field)

This field indicates whether the mobile station supports PS Handover. The PS Handover Capability applies to all RATs and modes indicated as supported in this information element, except for E-UTRA, where the support is indicated separately in the "GERAN to E-UTRA support in GERAN packet transfer mode" field.

Bit

- 0 The mobile station does not support PS Handover.
- 1 The mobile station supports PS Handover

DTM Handover Capability (1 bit field)

This field indicates whether the mobile station supports DTM Handover. The DTM Handover Capability applies to all RATs and modes indicated as supported in this information element. It is coded as follows:

Bit

- 0 The mobile station does not support DTM Handover.
- 1 The mobile station supports DTM Handover

Multislot Capability Reduction for Downlink Dual Carrier (3 bit field)

This field indicates the receive multislot capability reduction of a dual carrier capable mobile station applicable to EGPRS and EGPRS2 support when EFTA is not used (see 3GPP TS 45.002 [32]). This reduction applies to the maximum number of downlink timeslots for dual carrier operation derived from the (DTM) EGPRS (high) multislot class. The field is coded as follows:

Bit

3 2 1

- 0 0 0 No reduction
- 0 0 1 The MS supports 1 timeslot fewer than the maximum number of receive timeslots
- 0 1 0 The MS supports 2 timeslots fewer than the maximum number of receive timeslots
- 0 1 1 The MS supports 3 timeslots fewer than the maximum number of receive timeslots
- 1 0 0 The MS supports 4 timeslots fewer than the maximum number of receive timeslots
- 1 0 1 The MS supports 5 timeslots fewer than the maximum number of receive timeslots
- 1 1 0 The MS supports 6 timeslots fewer than the maximum number of receive timeslots
- 1 1 1 Reserved for future use

The presence of this field also indicates that the mobile station supports dual carrier in the downlink for EGPRS.

Downlink Dual Carrier for DTM Capability (1 bit field)

This field indicates whether the mobile station supports DTM during downlink dual carrier operation.

Bit

- 0 The mobile station does not support DTM during downlink dual carrier operation
- 1 The mobile station supports DTM during downlink dual carrier operation

If the mobile station supports DTM during downlink dual carrier operation as indicated by this field, the *Multislot Capability Reduction for Downlink Dual Carrier* field provided in the *MS Radio Access Capability* IE is applicable to EGPRS DTM support as well.

Flexible Timeslot Assignment (1 bit field)

This field indicates whether the mobile station supports Flexible Timeslot Assignment (see 3GPP TS 45.002 [32]).

- 0 The mobile station does not support Flexible Timeslot Assignment
- 1 The mobile station supports Flexible Timeslot Assignment

GAN PS Handover Capability (1 bit field)

This field indicates whether or not the mobile station supports PS Handover from GERAN/UTRAN cell to a GAN cell. The field is coded as follows:

Bit

- 0 The mobile station does not support PS Handover from GERAN/UTRAN cell to a GAN cell
- 1 The mobile station supports PS Handover from GERAN/UTRAN cell to a GAN cell

RLC Non-persistent Mode Capability (1 bit field)

This field indicates whether the mobile station supports RLC Non-persistent Mode (see 3GPP TS 44.060 [76]).

- 0 The mobile station does not support RLC Non-persistent Mode
- 1 The mobile station supports RLC Non-persistent Mode

Reduced Latency Capability (1 bit field)

This field indicates whether the mobile station supports Reduced TTI configurations and Fast Ack/Nack Reporting (see 3GPP TS 44.060 [76]) in packet transfer mode for both EGPRS and, if supported, EGPRS2.

- 0 The mobile station does not support Reduced TTI configurations and Fast Ack/Nack Reporting
- 1 The mobile station supports Reduced TTI configurations and Fast Ack/Nack Reporting

A mobile station whose multislot class does not allow the support of Reduced TTI configurations in packet transfer mode due to a limited number of uplink or downlink timeslots (see 3GPP TS 45.002 [32]) shall set the *Reduced Latency Capability* field to '0'.

Uplink EGPRS2 (2 bit field)

This field indicates whether the mobile station supports EGPRS2-A or EGPRS2-A and EGPRS2-B in the uplink.

Bit

2 1

- 0 0 The mobile station does not support either EGPRS2-A or EGPRS2-B in the uplink
- 0 1 The mobile station supports EGPRS2-A in the uplink
- 1 0 The mobile station supports both EGPRS2-A and EGPRS2-B in the uplink
- 1 1 This value is not used in this release/version of the specifications. If received it shall be interpreted as '10'

Downlink EGPRS2 (2 bit field)

This field indicates whether the mobile station supports EGPRS2-A or EGPRS2-A and EGPRS2-B in the downlink.

Bit

2 1

- 0 0 The mobile station does not support either EGPRS2-A or EGPRS2-B in the downlink
- 0 1 The mobile station supports EGPRS2-A in the downlink
- 1 0 The mobile station supports both EGPRS2-A and EGPRS2-B in the downlink
- 1 1 This value is not used in this release/version of the specifications. If received it shall be interpreted as '10'

E-UTRA FDD support (1 bit field)

Bit

- 0 E-UTRA FDD not supported
- 1 E-UTRA FDD supported

E-UTRA TDD support (1 bit field)

Bit

- 0 E-UTRA TDD not supported
- 1 E-UTRA TDD supported

GERAN to E-UTRA support in GERAN packet transfer mode (2 bit field)

This field indicates the capabilities supported by the mobile station in packet transfer mode for GERAN to E-UTRA interworking. If both "**E-UTRA FDD support**" and "**E-UTRA TDD support**" bits are set to '0', the bit field shall be set to '0 0'. If one or both of "**E-UTRA FDD support**" and "**E-UTRA TDD support**" bits are set to '1', the bit field may be any of the listed values. The bit field is coded as follows:

Bit

2 1

- 0 0 None
- 0 1 E-UTRAN Neighbour Cell measurements and MS autonomous cell reselection to E-UTRAN supported

- 1 0 CCN towards E-UTRAN, E-UTRAN Neighbour Cell measurement reporting and Network controlled cell reselection to E-UTRAN supported in addition to capabilities indicated by '01'
- 1 1 PS Handover to E-UTRAN supported in addition to capabilities indicated by '01' and '10'

Priority-based reselection support (1 bit field)

This field indicates whether the mobile station supports priority-based cell reselection.

- 0 Priority-based cell reselection not supported
- 1 Priority-based cell reselection supported

Alternative EFTA multislot class (4 bit field)

The presence of the Alternative EFTA multislot class field indicates that the mobile station supports Enhanced Flexible Timeslot Assignment, EFTA, (see 3GPP TS 45.002 [32]). This field shall be ignored if the High Multislot Capability field is not present. The Alternative EFTA multislot class field is used together with the (DTM) EGPRS (high) multislot class to determine the mobile stations capabilities when using Enhanced Flexible Timeslot Assignment, EFTA, and is coded as follows:

- Bit
- | | |
|---------|--|
| 4 3 2 1 | |
| 0 0 0 0 | No Alternative EFTA multislot class is indicated. Use (DTM) EGPRS (high) multislot class only. |
| 0 0 0 1 | Alternative EFTA multislot class 1 |
| 0 0 1 0 | Alternative EFTA multislot class 2 |
| 0 0 1 1 | Alternative EFTA multislot class 3 |
| 0 1 0 0 | |
| to | |
| 1 1 1 1 | Unused. If received, these values shall be interpreted as '0000' |

EFTA Multislot Capability Reduction for Downlink Dual Carrier (3 bit field)

This field indicates the receive multislot capability reduction of a dual carrier capable mobile station applicable to EGPRS and EGPRS2 support when Enhanced Flexible Timeslot Assignment is used (see 3GPP TS 45.002 [32]). This reduction applies to the maximum number of downlink timeslots for dual carrier operation derived from the *Alternative EFTA Multislot Class* field. The coding of this field is the same as the coding of the *Multislot Capability Reduction for Downlink Dual Carrier* field.

This field shall be ignored if a mobile station does not support Downlink Dual Carrier.

Indication of Upper Layer PDU Start Capability for RLC UM (1 bit field)

This field indicates whether the mobile station supports "Indication of Upper Layer PDU Start for RLC UM" (see 3GPP TS 44.060 [76]) for RLC unacknowledged mode of operation. The field is coded as follows:

- 0 The mobile station does not support "Indication of Upper Layer PDU Start for RLC UM"
- 1 The mobile station supports "Indication of Upper Layer PDU Start for RLC UM"

EMST Capability (1 bit field)

This field indicates whether the mobile station supports Enhanced Multiplexing for Single TBF (EMST) (see 3GPP TS 44.060 [76]).

- 0 The mobile station does not support EMST
- 1 The mobile station supports EMST

MTTI Capability (1 bit field)

This field indicates whether the mobile station supports multiple TTI (MTTI) configurations (see 3GPP TS 44.060 [76])

- Bit
- 0 MTTI configurations not supported
- 1 MTTI configurations supported

UTRA CSG Cells Reporting (1 bit field)

This field indicates whether the mobile station supports reporting of measurements and routing parameters (see 3GPP TS 44.060 [76]) for UTRAN CSG cells in packet transfer mode. This capability shall apply to each UTRA radio access mode supported by the mobile.

- Bit
- 0 Reporting of UTRAN CSG cells in packet transfer mode not supported
- 1 Reporting of UTRAN CSG cells in packet transfer mode supported

E-UTRA CSG Cells Reporting (1 bit field)

This field indicates whether the mobile station supports reporting of measurements and routing parameters (see 3GPP TS 44.060 [76]) for E-UTRAN CSG cells in packet transfer mode. This capability shall apply to each E-UTRA radio access mode supported by the mobile.

Bit

- 0 Reporting of E-UTRAN CSG cells in packet transfer mode not supported
- 1 Reporting of E-UTRAN CSG cells in packet transfer mode supported

DTR Capability (1 bit field)

This field indicates whether the mobile station supports Dynamic Timeslot Reduction (DTR), see 3GPP TS 44.060 [76].

- 0 The mobile station does not support DTR
- 1 The mobile station supports DTR

EMSR Capability (1 bit field)

This field indicates whether the mobile station supports Enhanced Multiplexing for Single RLC Entity (EMSR), see 3GPP TS 44.060 [76].

- 0 The mobile station does not support EMSR
- 1 The mobile station supports EMSR

Fast Downlink Frequency Switching Capability (1 bit field)

This field indicates whether the mobile station supports fast downlink frequency switching between two consecutive TDMA frames (see 3GPP TS 45.002 [32]).

- 0 Fast downlink frequency switching not supported
- 1 Fast downlink frequency switching supported

TIGHTER Capability (2 bit field)

This field indicates Tightened Link Level Performance support in the MS (see 3GPP TS 45.005 [33]). The tightened performance applies to the traffic channels and signalling channels specified in 3GPP TS 45.005 [33].

Bits

2 1

- 0 0 TIGHTER not supported
- 0 1 TIGHTER supported for speech and signalling channels only
- 1 0 TIGHTER supported for speech and signalling channels and for GPRS and EGPRS, but not for EGPRS2
- 1 1 TIGHTER supported for speech and signalling channels and for GPRS, EGPRS and EGPRS2

FANR Capability (1 bit field)

This field indicates whether the mobile station supports Fast Ack/Nack Reporting (see 3GPP TS 44.060 [76]) in packet transfer mode for EGPRS and, if supported, EGPRS2. If the mobile station indicates support for Reduced TTI configurations and Fast Ack/Nack Reporting using the Reduced Latency Capability Indicator then the network shall ignore FANR Capability information.

- 0 The mobile station does not support Fast Ack/Nack Reporting
- 1 The mobile station supports Fast Ack/Nack Reporting

IPA Capability (1 bit field)

This field indicates whether the mobile station supports Immediate Packet Assignment (IPA), see 3GPP TS 44.018 [84].

Bit

- 0 The mobile station does not support IPA
- 1 The mobile station supports IPA

GERAN Network Sharing support (1 bit field)

This field indicates whether the mobile station supports GERAN network sharing. A mobile station supporting GERAN network sharing shall also support the extended EARFCN value range in GERAN and indicate this in the respective bit.

Bit

- 0 The mobile station does not support GERAN network sharing
- 1 The mobile station supports GERAN network sharing

E-UTRA Wideband RSRQ measurements support (1 bit field)

This field indicates whether the mobile station supports E-UTRA wideband RSRQ measurements (see 3GPP TS 45.008 [151]).

Bit	
0	The mobile station does not support E-UTRA wideband RSRQ measurements
1	The mobile station supports E-UTRA wideband RSRQ measurements
UTRA Multiple Frequency Band Indicators support (1 bit field)	
This field indicates whether the mobile station supports multiple radio frequency bands in UTRAN (see 3GPP TS 25.331 [23c]) and whether it understands signalling of overlapping UTRA frequency bands (see 3GPP TS 44.060 [76]).	
Bit	
0	The mobile station does not support Multiple Frequency Band Indicators in UTRAN
1	The mobile station supports Multiple Frequency Band Indicators in UTRAN
E-UTRA Multiple Frequency Band Indicators support (1 bit field)	
This field indicates whether the mobile station supports multiple radio frequency bands in E-UTRAN (see 3GPP TS 36.331 [129]) and whether it understands signalling of overlapping E-UTRA frequency bands (see 3GPP TS 44.060 [76]).	
Bit	
0	The mobile station does not support Multiple Frequency Band Indicators in E-UTRAN
1	The mobile station supports Multiple Frequency Band Indicators in E-UTRAN
DLMC - Non-contiguous intra-band reception (2 bit field)	
This field indicates the intra-band non-contiguous reception mode (see 3GPP TS 45.005 [33]) supported by the mobile station in Downlink Multicarrier configurations. The absence of this field indicates that a mobile station does not support intra-band non-contiguous reception.	
Bit	
2 1	
0 0	Not supported
0 1	Supported in band E-GSM or GSM850
1 0	Supported in band DCS1800 or PCS1900
1 1	Supported in band E-GSM, or GSM850, or DCS1800 or PCS1900
DLMC - Inter-band reception (1 bit field)	
This field indicates the inter-band reception mode (see 3GPP TS 45.005 [33]) supported by the mobile station in Downlink Multicarrier configuration. The absence of this field indicates that a mobile station does not support inter-band reception.	
Bit	
0	Not supported
1	Supported in band combination (E-GSM, DCS1800), or band combination (GSM850, PCS1900).
DLMC - Maximum Bandwidth (2 bit field)	
This field indicates the maximum bandwidth supported by a mobile station.	
Bit	
2 1	
0 0	Bandwidth = 5 MHz
0 1	Bandwidth = 10 MHz
1 0	Bandwidth = 15 MHz
1 1	Bandwidth = 20 MHz
DLMC - Maximum Number of Downlink Timeslots (6 bit field)	
This field indicates the maximum number of downlink timeslots supported by a mobile station in Downlink Multi Carrier configuration.	
Bit	
6 5 4 3 2 1	
0 0 0 0 0 0	6 TS supported
0 0 0 0 0 1	8 TS supported
0 0 0 1 0 1	10 TS supported
0 0 0 1 1 1	12 TS supported
...	
...	
1 1 1 1 0 1	128 TS supported
1 1 1 1 1 0	reserved
1 1 1 1 1 1	reserved

DLMC - Maximum Number of Downlink Carriers (3 bit field)

This field indicates the maximum number of downlink carriers supported by a mobile station in Downlink Multi Carrier configuration.

Bit

3 2 1

0 0 0 2 carriers supported
 0 0 1 4 carriers supported
 0 1 0 6 carriers supported
 0 1 1 8 carriers supported
 1 0 0 10 carriers supported
 1 0 1 12 carriers supported
 1 1 0 14 carriers supported
 1 1 1 16 carriers supported

Extended TSC Set Capability support (1 bit field)

This field indicates whether the mobile station supports the extended TSC sets when operating in the PS or CS domain (see 3GPP TS 45.002 [32]).

Bit

0 The mobile station does not support Extended TSC sets
 1 The mobile station supports Extended TSC sets

Extended EARFCN value range (1 bit field)

This field indicates whether the mobile station supports the extended EARFCN value range in GERAN (see 3GPP TS 44.060 [76]).

Bit

0 The mobile station does not support extended EARFCN value range
 1 The mobile station supports extended EARFCN value range

(EC-)PCH monitoring support (2 bit field)

This field indicates if the mobile station is capable of monitoring the PCH channel, the EC-PCH channel or both for paging based reachability.

Bit

2 1

0 0 PCH supported
 0 1 EC-PCH supported
 1 0 PCH and EC-PCH supported
 1 1 reserved

EC-PCH support also indicates EC-GSM-IoT capability, see 3GPP TS 43.064 [159].

MS Sync Accuracy (4 bit field)

This field indicates the guaranteed synchronization accuracy (i.e the assessment of the BTS timing) achievable by the MS when synchronizing to the downlink during the MTA and procedure and is coded as the MS Sync Accuracy field in 3GPP TS 49.031 [165].

EC uplink coverage enhancement support (1 bit field)

This field indicates if the mobile station supports uplink coverage class CC5.

Bit

0 The mobile station does not support uplink coverage class CC5
 1 The mobile station supports uplink coverage class CC5

MTA Access Security support (1 bit field)

This field indicates if the mobile station supports MTA Access Security comprising the support of the MTA Access Security and BSS Duplication Detection methods.

Bit

0 The mobile station does not support MTA Access Security
 1 The mobile station supports MTA Access Security

EC paging indication channel monitoring support (1 bit field)

This field indicates if the mobile station supports monitoring of the EC paging indication channel, see 3GPP TS 43.064 [159].

Bit	
0	The mobile station does not support monitoring of the EC paging indication channel
1	The mobile station supports monitoring of the EC paging indication channel

10.5.5.13 Spare

This is intentionally left spare.

10.5.5.14 GMM cause

The purpose of the GMM cause information element is to indicate the reason why a GMM request from the mobile station is rejected by the network.

The GMM cause information element is coded as shown in figure 10.5.129/3GPP TS 24.008 and table 10.5.147/3GPP TS 24.008.

The GMM cause is a type 3 information element with 2 octets length.

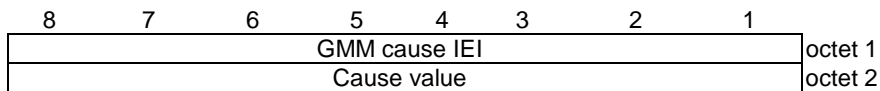

Figure 10.5.129/3GPP TS 24.008: GMM cause information element

Table 10.5.147/3GPP TS 24.008: GMM cause information element

Cause value (octet 2)								
Bits								
8	7	6	5	4	3	2	1	
0	0	0	0	0	0	1	0	IMSI unknown in HLR
0	0	0	0	0	0	1	1	Illegal MS
0	0	0	0	0	1	0	1	IMEI not accepted
0	0	0	0	0	1	1	0	Illegal ME
0	0	0	0	0	1	1	1	GPRS services not allowed
0	0	0	0	1	0	0	0	GPRS services and non-GPRS services not allowed
0	0	0	0	1	0	0	1	MS identity cannot be derived by the network
0	0	0	0	1	0	1	0	Implicitly detached
0	0	0	0	1	0	1	1	PLMN not allowed
0	0	0	0	1	1	0	0	Location Area not allowed
0	0	0	0	1	1	0	1	Roaming not allowed in this location area
0	0	0	0	1	1	1	0	GPRS services not allowed in this PLMN
0	0	0	0	1	1	1	1	No Suitable Cells In Location Area
0	0	0	1	0	0	0	0	MSC temporarily not reachable
0	0	0	1	0	0	0	1	Network failure
0	0	0	1	0	1	0	0	MAC failure
0	0	0	1	0	1	0	1	Synch failure
0	0	0	1	0	1	1	0	Congestion
0	0	0	1	0	1	1	1	GSM authentication unacceptable
0	0	0	1	1	0	0	1	Not authorized for this CSG
0	0	0	1	1	1	0	0	SMS provided via GPRS in this routing area
0	0	1	0	1	0	0	0	No PDP context activated
0	0	1	1	0	0	0	0	}
			to					}
0	0	1	1	1	1	1	1	} retry upon entry into a new cell
0	1	0	1	1	1	1	1	}
0	1	1	0	0	0	0	0	Semantically incorrect message
0	1	1	0	0	0	0	1	Invalid mandatory information
0	1	1	0	0	0	1	0	Message type non-existent or not implemented
0	1	1	0	0	0	1	0	Message type not compatible with the protocol state
0	1	1	0	0	0	1	1	Information element non-existent or not implemented
0	1	1	0	0	1	0	0	Conditional IE error
0	1	1	0	0	1	0	1	Message not compatible with the protocol state
0	1	1	0	1	1	1	1	Protocol error, unspecified

Any other value received by the mobile station shall be treated as 0110 1111, "Protocol error, unspecified". Any other value received by the network shall be treated as 0110 1111, "Protocol error, unspecified".

NOTE: The listed reject cause values are defined in annex G.

10.5.5.15 Routing area identification

The purpose of the *routing area identification* information element is to provide an unambiguous identification of routing areas within the GPRS coverage area.

The *routing area identification* is a type 3 information element with 7 octets length.

The *routing area identification* information element is coded as shown in figure 10.5.130/3GPP TS 24.008 and table 10.5.148/3GPP TS 24.008.

8	7	6	5	4	3	2	1	
Routing Area Identification IEI								octet 1
MCC digit 2				MCC digit 1				octet 2
MNC digit 3				MCC digit 3				octet 3
MNC digit 2				MNC digit 1				octet 4
LAC								octet 5
LAC cont'd								octet 6
RAC								octet 7

Figure 10.5.130/3GPP TS 24.008: Routing area identification information element

Table 10.5.148/3GPP TS 24.008: Routing area identification information element

MCC, Mobile country code (octet 2 and 3)

The MCC field is coded as in ITU-T Rec. E212, Annex A.

If the RAI is deleted, the MCC and MNC shall take the value from the deleted RAI.

In abnormal cases, the MCC stored in the mobile station can contain elements not in the set {0, 1 ... 9}. In such cases the mobile station should transmit the stored values using full hexadecimal encoding. When receiving such an MCC, the network shall treat the RAI as deleted.

MNC, Mobile network code (octet 3 bits 5 to 8, octet 4)

The coding of this field is the responsibility of each administration but BCD coding shall be used. The MNC shall consist of 2 or 3 digits. For PCS 1900 for NA, Federal regulation mandates that a 3-digit MNC shall be used. However a network operator may decide to use only two digits in the MNC in the RAI over the radio interface. In this case, bits 5 to 8 of octet 3 shall be coded as "1111". Mobile equipment shall accept RAI coded in such a way.

NOTE 1: In earlier versions of this protocol, the possibility to use a one digit MNC in RAI was provided on the radio interface. However as this was not used this possibility has been deleted.

NOTE 2: In earlier versions of this protocol, bits 5 to 8 of octet 3 were coded as "1111". Mobile equipment compliant with these earlier versions of the protocol may be unable to understand the 3-digit MNC format of the RAI, and therefore unable to register on a network broadcasting the RAI in this format.

In abnormal cases, the MNC stored in the mobile station can have:

- digit 1 or 2 not in the set {0, 1 ... 9}, or
- digit 3 not in the set {0, 1 ... 9, F} hex.

In such cases the mobile station shall transmit the stored values using full hexadecimal encoding. When receiving such an MNC, the network shall treat the RAI as deleted.

The same handling shall apply for the network, if a 3-digit MNC is sent by the mobile station to a network using only a 2-digit MNC.

LAC, Location area code (octet 5 and 6)

In the LAC field bit 8 of octet 5 is the most significant bit and bit 1 of octet 6 the least significant bit.

The coding of the location area code is the responsibility of each administration except that two values are used to mark the LAC, and hence the RAI, as deleted. Coding using full hexadecimal representation may be used. The location area code consists of 2 octets.

If a RAI has to be deleted then all bits of the location area code shall be set to one with the exception of the least significant bit which shall be set to zero. If a SIM/USIM is inserted in a Mobile Equipment with the location area code containing all zeros, then the Mobile Equipment shall recognise this LAC as part of a deleted RAI.

RAC, Routing area code (octet 7)

In the RAC field bit 8 of octet 7 is the most significant. The coding of the routing area code is the responsibility of each administration. Coding using full hexadecimal representation may be used. The routing area code consists of 1 octet.

10.5.5.15a Routing area identification 2

The purpose of the *Routing area identification 2* information element is to provide an unambiguous identification of routing areas within the GPRS coverage area.

The *Routing area identification 2* is a type 4 information element with a length of 8 octets.

The *Routing area identification 2* information element is coded as shown in figure 10.5.130a/3GPP TS 24.008 and table 10.5.148a/3GPP TS 24.008.

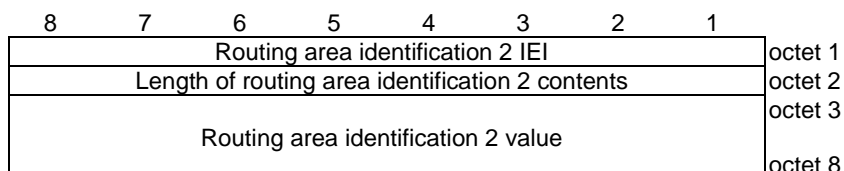

Figure 10.5.130a/3GPP TS 24.008: *Routing area identification 2* information element

Table 10.5.148a/3GPP TS 24.008: *Routing area identification 2* information element

<p>Routing area identification 2 value (octet 3 to 8)</p> <p>The routing area identification 2 value is coded as octet 2 to 7 of the Routing area identification information element.</p>

10.5.5.16 Spare

This is intentionally left spare.

10.5.5.17 Update result

The purpose of the *update result* information element is to specify the result of the associated updating procedure.

The *update result* is a type 1 information element.

The *update result* information element is coded as shown in figure 10.5.131/3GPP TS 24.008 and table 10.5.149/3GPP TS 24.008.

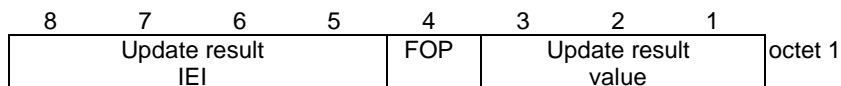

Figure 10.5.131/3GPP TS 24.008: *Update result* information element

Table 10.5.149/3GPP TS 24.008: Update result information element

Update result value (octet 1)	
Bits	
3	2 1
0 0 0	RA updated
0 0 1	combined RA/LA updated
1 0 0	RA updated and ISR activated
1 0 1	combined RA/LA updated and ISR activated
All other values are reserved.	
Follow-on proceed (octet 1, bit 4)	
Bit	
4	
0	Follow-on proceed
1	No follow-on proceed
Follow-on proceed is applicable only in lu mode. This indication shall be ignored if received in A/Gb mode.	

10.5.5.18 Update type

The purpose of the *update type* information element is to specify the area the updating procedure is associated with.

The *update type* is a type 1 information element.

The *update type* information element is coded as shown in figure 10.5.132/3GPP TS 24.008 and table 10.5.150/3GPP TS 24.008.

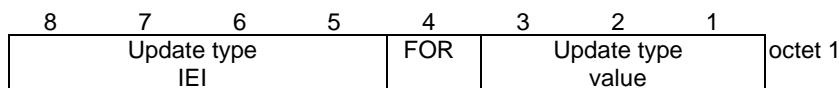

Figure 10.5.132/3GPP TS 24.008: Update type information element

Table 10.5.150/3GPP TS 24.008: Update type information element

Update type value (octet 1, bit 1 to 3)	
Bits	
3	2 1
0 0 0	RA updating
0 0 1	combined RA/LA updating
0 1 0	combined RA/LA updating with IMSI attach
0 1 1	Periodic updating
All other values are reserved.	
Follow-on request (octet 1, bit 4)	
Bit	
4	
0	No follow-on request pending
1	Follow-on request pending
Follow-on request pending is applicable only in lu mode.	

10.5.5.19 A&C reference number

The purpose of the *A&C reference* number information element is to indicate to the network in the AUTHENTICATION AND CIPHERING RESPONSE message which AUTHENTICATION AND CIPHERING REQUEST message the MS is replying to.

The A&C reference number is a type 1 information element.

The A&C reference number information element is coded as shown in figure 10.5.134/3GPP TS 24.008 and table 10.5.152/3GPP TS 24.008.

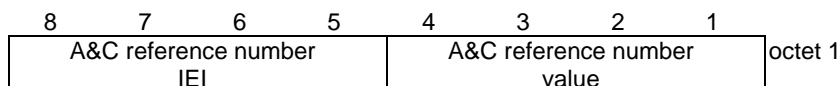

Figure 10.5.134/3GPP TS 24.008: A&C reference number information element

Table 10.5.152/3GPP TS 24.008: A&C reference number information element

A&C reference number value (octet 1)
Unformatted 4 bit field

10.5.5.20 Service type

The purpose of the *service type* information element is to specify the purpose of the Service request procedure.

The *service type* is a type 1 information element.

The *service type* information element is coded as shown in figure 10.5.135/3GPP TS 24.008 and table 10.5.153a/3GPP TS 24.008.

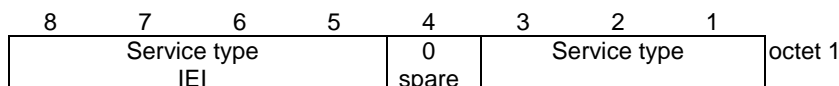

Figure 10.5.135/3GPP TS 24.008: Service type information element

Table 10.5.153a/3GPP TS 24.008: Service type information element

Service type value (octet 1)
Bits
3 2 1
0 0 0 Signalling
0 0 1 Data
0 1 0 Paging Response
0 1 1 MBMS Multicast Service Reception
1 0 0 MBMS Broadcast Service Reception
All other values are reserved.

10.5.5.21 Cell Notification

The purpose of the Cell Notification information element is to indicate that the Cell Notification is supported by the network and shall be then used by MS.

The Cell Notification information element is coded as shown in figure 10.5.135a/3GPP TS 24.008.

The Cell Notification is a type 2 information element.

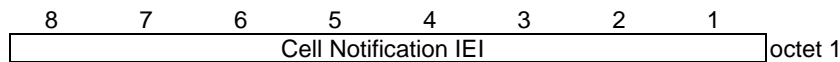

Figure 10.5.135a/3GPP TS 24.008: Cell Notification information element

10.5.5.22 PS LCS Capability

The purpose of the *PS LCS Capability* element is to indicate the positioning methods and additional positioning capabilities supported by the MS for the provision of location services (LCS) via the PS domain in Gb-mode.

The *PS LCS Capability* is a type 4 information element with a length of 4 octets.

The *PS LCS Capability* element is coded as shown in figure 10.5.135b/3GPP TS 24.008 and table 10.5.153b/3GPP TS 24.008.

8	7	6	5	4	3	2	1	
PS LCS Capability IEI								
Length of PS LCS Capability contents								
MTA-E	MTA-R	APC	OTD-A	OTD-B	GPS-A	GPS-B	GPS-C	
		Spare				MOTD	MTA-A	
0	0	0	0	0	0			

octet 1

octet 2

octet 3

octet 4*

Figure 10.5.135b/3GPP TS 24.008: *PS LCS Capability* information elementTable 10.5.153b/3GPP TS 24.008 *PS LCS Capability* information element

<i>PS LCS Capability</i> value (octet 3, bit 1 to 8)	
MTA-E (Multilateration Timing Advance using Extended Access Burst method)	
Bit 8	0 MTA-E not supported 1 MTA-E supported
MTA-R (Multilateration Timing Advance using RLC data block method)	
Bit 7	0 MTA-R not supported 1 MTA-R supported
APC (Additional Positioning Capabilities)	
Bit 6	0 Additional Positioning Capabilities which can be retrieved by RRLP are not supported 1 Additional Positioning Capabilities which can be retrieved by RRLP are supported
OTD-A (MS assisted E-OTD)	
Bit 5	0 MS assisted E-OTD not supported 1 MS assisted E-OTD supported
OTD-B (MS based E-OTD)	
Bit 4	0 MS based E-OTD not supported 1 MS based E-OTD supported
GPS-A (MS assisted GPS)	
Bit 3	0 MS assisted GPS not supported 1 MS assisted GPS supported
GPS-B (MS based GPS)	
Bit 2	0 MS based GPS not supported 1 MS based GPS supported
GPS-C (Conventional GPS)	
Bit 1	0 Conventional GPS not supported 1 Conventional GPS supported
<i>PS LCS Capability</i> value (octet 4, bit 1 to 2)	
MOTD (Multilateration Observed Time Difference)	
Bit 2	0 MOTD not supported 1 MOTD supported
MTA-A (Multilateration Timing Advance using Access Burst method)	
Bit 1	0 MTA-A not supported 1 MTA-A supported
Octet 4, bits 3-8 are spare and shall be coded as 0.	

10.5.5.23 Network feature support

The purpose of the *network feature support* information element is to indicate whether certain features are supported by the network. If this IE is not included then the respective features are not supported.

The *network feature support* is a type 1 information element.

The *network feature support* information element is coded as shown in figure 10.5.135c/3GPP TS 24.008 and table 10.5.153c/3GPP TS 24.008.

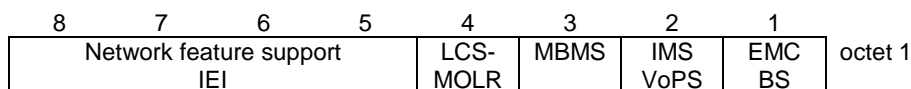

Figure 10.5.135c/3GPP TS 24.008: *Network feature support* information element

Table 10.5.153c/3GPP TS 24.008: *Network feature support* information element

Network feature support value (octet 1, bit 1 to 4)	
LCS-MOLR (1 bit field)	
Bit	
4	
0	LCS-MOLR via PS domain not supported
1	LCS-MOLR via PS domain supported
MBMS (1 bit field)	
Bit	
3	
0	MBMS not supported
1	MBMS supported
IMS voice over PS session indicator (IMS VoPS) (1 bit field)	
Bit	
2	
0	IMS voice over PS session in lu mode and A/Gb mode not supported
1	IMS voice over PS session supported in lu mode, but not supported in A/Gb mode
Emergency bearer services indicator (EMC BS) (1 bit field)	
Bit	
1	
0	Emergency bearer services in lu mode and A/Gb mode not supported
1	Emergency bearer services supported in lu mode, but not supported in A/Gb mode

10.5.5.23A Additional network feature support

The purpose of the *Additional network feature support* information element is to indicate whether certain features are supported by the network.

The *Additional network feature support* is a type 4 information element with a length of 3 octets.

The *Additional network feature support* information element is coded as shown in figure 10.5.5.23A/3GPP TS 24.008 and table 10.5.5.23A/3GPP TS 24.008.

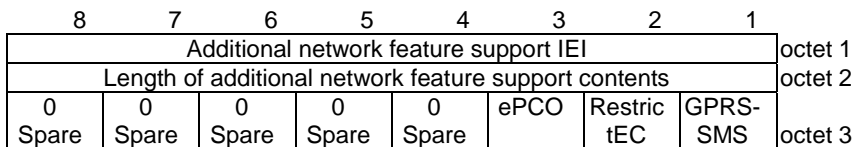

Figure 10.5.5.23A: Additional network feature support information element

Table 10.5.5.23A: Additional network feature support information element

GPRS-SMS supported (GPRS-SMS) (octet 3, bit 1)	
Bit	
1	
0	SMS via GPRS supported
1	SMS via GPRS not supported
Restriction on enhanced coverage (RestrictEC) (octet 3, bit 2)	
Bit	
2	
0	Enhanced coverage not restricted
1	Enhanced coverage restricted
ePCO IE supported (ePCO) (octet 3, bit 3)	
Bit	
3	
0	extended protocol configuration options IE not supported
1	extended protocol configuration options IE supported
Bits 4 to 8 of octet 3 are spare and shall be coded all zero.	

10.5.5.24 Inter RAT information container

The purpose of the *Inter RAT information container* information element is to supply the network with Iu mode related information that needs to be transferred at PS inter-system handover to Iu mode (see 3GPP TS 43.129 [113]).

The *Inter RAT information container* information element is coded as shown in figure 10.5.150/3GPP TS 24.008.

The *Inter RAT information container* information element is a type 4 information element with a minimum length of 3 octets and a maximum length of 250 octets.

The Inter RAT information container contains:

- predefined configuration status information;
- mobile station security information to be used after handover to Iu mode, which includes the START-PS value that is stored by the MS at handover from Iu mode to A/Gb mode (see 3GPP TS 33.102 [5a]); and/or
- the specific Iu mode radio capabilities of the mobile station, i.e. UE RAC (see 3GPP TS 25.331 [23c]).

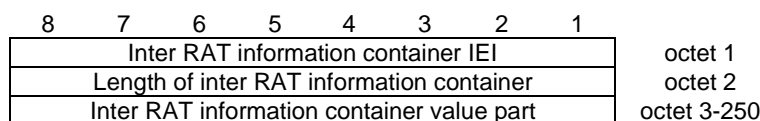

Figure 10.5.150/3GPP TS 24.008: Inter RAT information container information element

The value part of the *Inter RAT information container* information element is the INTER RAT HANDOVER INFO as defined in 3GPP TS 25.331 [23c]. If this field includes padding bits, they are defined in 3GPP TS 25.331 [23c].

10.5.5.25 Requested MS information

The purpose of the *Requested MS information* information element is to indicate whether certain feature-related information is requested from the MS by the network. If this IE is not included then no information is requested.

The *Requested MS information* information element is coded as shown in figure 10.5.151/3GPP TS 24.008 and table 10.5.166/3GPP TS 24.008.

The *Requested MS information* is a type 1 information element.

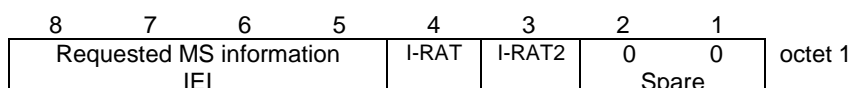

Figure 10.5.151/3GPP TS 24.008: Requested MS information information element

Table 10.5.166/3GPP TS 24.008: Requested MS information information element

Requested MS information value (octet 1, bit 1 to 4)	
I-RAT (1 bit field)	
Bit	
4	
0	Inter RAT information container IE not requested
1	Inter RAT information container IE requested
I-RAT2 (1 bit field)	
Bit	
3	
0	See NOTE.
NOTE:	The value '1' was allocated in a previous version of the protocol and shall not be used. The behaviour of a mobile station receiving the <i>Requested MS information</i> IE with the I-RAT2 field set to the value '1' is not specified. Network implementations following previous versions of the specification can set the I-RAT2 bit to request E-UTRAN Inter RAT information container IE, but an MS implementation following this version of the specification does not provide this information in the response and the procedure where the request is included can fail.

10.5.5.26 UE network capability

See subclause 9.9.3.34 in 3GPP TS 24.301 [120].

10.5.5.27 E-UTRAN inter RAT information container

The purpose of the *E-UTRAN inter RAT information container* information element is to supply the network with E-UTRAN related information that needs to be transferred at Inter-RAT PS handover to E-UTRAN (see 3GPP TS 23.401 [122]).

The *E-UTRAN inter RAT information container* information element is coded as shown in figure 10.5.151/3GPP TS 24.008.

The *E-UTRAN inter RAT information container* information element is a type 4 information element with a minimum length of 3 octets and an upper length limit of 257 octets.

8	7	6	5	4	3	2	1	
E-UTRAN Inter RAT information container IEI								octet 1
Length of E-UTRAN Inter RAT information container								octet 2
E-UTRAN Inter RAT information container value part								octet 3-257

Figure 10.5.151/3GPP TS 24.008: E-UTRAN inter RAT information container information element

The value part of the *E-UTRAN inter RAT information container* information element is formatted and coded according to the *UE-EUTRA-Capability* IE defined in 3GPP TS 36.331 [129].

10.5.5.28 Voice domain preference and UE's usage setting

The purpose of the *Voice domain preference and UE's usage setting* information element is to provide the network with the UE's usage setting and the voice domain preference for WB-S1 mode. The network uses the UE's usage setting and the voice domain preference for E-UTRAN (see 3GPP TS 24.167 [13B]) only to select the RFSP index.

The UE's usage setting bit indicates the value configured on the ME as defined in 3GPP TS 23.221 [131].

The voice domain preference for E-UTRAN bit indicates the value configured on the ME of the Voice domain preference for E-UTRAN as defined in 3GPP TS 24.167 [134].

The *Voice domain preference and UE's usage setting* information element is coded as shown in figure 10.5.151A/3GPP TS 24.008 and table 10.5.166A/3GPP TS 24.008.

8	7	6	5	4	3	2	1	
<i>Voice domain preference and UE's usage setting</i> IEI								octet 1
<i>Length of Voice domain preference and UE's usage setting contents</i>								octet 2
0	0	0	0	0	UE's usage setting	Voice domain preference for E-UTRAN		octet 3
Spare	Spare	Spare	Spare	Spare				

Figure 10.5.151A/3GPP TS 24.008: Voice domain preference and UE's usage setting information element

Table 10.5.166A/3GPP TS 24.008: Voice domain preference and UE's usage setting information element

Voice domain preference and UE's usage setting value (octet 3, bit 1 to 3)	
UE's usage setting (1 bit field)	
Bit	
3	
0	Voice centric
1	Data centric
Voice domain preference for E-UTRAN (2 bit field)	
Bit	
2 1	
0 0	CS Voice only
0 1	IMS PS Voice only
1 0	CS voice preferred, IMS PS Voice as secondary
1 1	IMS PS voice preferred, CS Voice as secondary
MS not supporting IMS voice shall indicate "CS Voice only".	
MS only supporting IMS voice shall indicate "IMS PS Voice only".	

10.5.5.29 P-TMSI type

The purpose of the P-TMSI type information element is to indicate whether the P-TMSI included in the same message in an information element of type mobile identity, or the P-TMSI used by the MS to derive a foreign TLLI (see subclause 4.7.1.4.1) represents a native P-TMSI or a mapped P-TMSI.

The P-TMSI type information element information element is coded as shown in figure 10.5.5.29.1 and table 10.5.5.29.1.

The P-TMSI type is a type 1 information element.

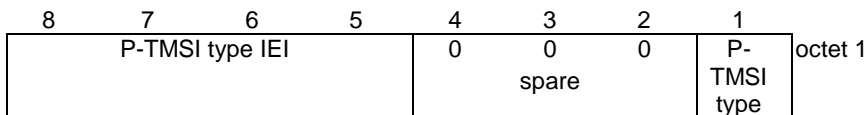

Figure 10.5.5.29.1: P-TMSI type information element

Table 10.5.5.29.1: P-TMSI type information element

P-TMSI type (octet 1)	
Bit	
1	
0	Native P-TMSI
1	Mapped P-TMSI
Bits 2 to 4 of octet 1 are spare and shall be coded as zero.	

10.5.5.30 Location Area Identification 2

The purpose of the *Location Area Identification 2* information element is to provide an unambiguous identification of location areas within the area covered by the 3GPP system.

The *Location Area Identification 2* information element is coded as shown in figure 10.5.5.30/3GPP TS 24.008 and table 10.5.5.30/3GPP TS 24.008.

The *Location Area Identification 2* is a type 4 information element with 7 octets length.

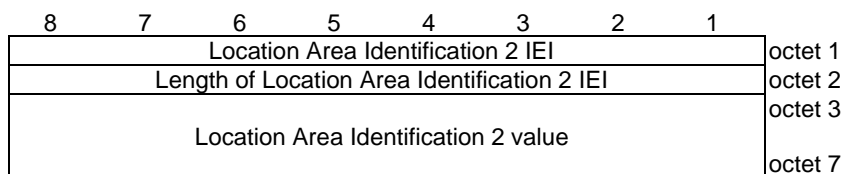

Figure 10.5.5.30/3GPP TS 24.008: Location Area Identification 2 information element

Table 10.5.5.30/3GPP TS 24.008: Location Area Identification 2 information element

Location Area Identification 2 value (octet 3 to 7)	
The Location Area Identification 2 value is coded as octet 2 to 6 of the <i>Location Area Identification</i> information element.	

10.5.5.31 Network resource identifier container

The purpose of the *Network resource identifier container* information element is to provide a part of the allocated TMSI that the network will use to determine the actual NRI.

The *Network resource identifier container* is a type 4 information element with a length of 4 octets.

The *Network resource identifier container* information element is coded as shown in figure 10.5.5.31/3GPP TS 24.008 and table 10.5.5.31/3GPP TS 24.008.

8	7	6	5	4	3	2	1	
Network resource identifier container IEI								octet 1
Length of Network resource identifier container contents								octet 2
NRI container value								octet 3
NRI container value	spare							octet 4
	0	0	0	0	0	0	0	

Figure 10.5.5.31/3GPP TS 24.008 Network resource identifier container information element

Table 10.5.5.31/3GPP TS 24.008: Network resource identifier container information element

<p>NRI container value (octet 3 and bit 7-8 of octet 4) The NRI container value consists of 10 bits which correspond to bits 23 to 14 of the valid TMSI.</p> <p>NRI container value shall start with bit 8 of octet 3, which corresponds to bit 23 of TMSI. Bit 7 of octet 4 corresponds to TMSI bit 14.</p> <p>Bits 6, 5, 4, 3, 2, and 1 in octet 4 are spare and shall be set to zero.</p>
--

10.5.5.32 Extended DRX parameters

The purpose of the *Extended DRX parameters* information element is to indicate that the MS wants to use eDRX and for the network to indicate the Paging Time Window length value and the extended DRX cycle value to be used for eDRX.

The *Extended DRX parameters* is a type 4 information element with a length of 3 octets.

The *Extended DRX parameters* information element is coded as shown in figure 10.5.5.32/3GPP TS 24.008 and table 10.5.5.32/3GPP TS 24.008.

8	7	6	5	4	3	2	1	
Extended DRX parameters IEI								octet 1
Length of Extended DRX parameters								octet 2
Paging Time Window				eDRX value				octet 3

Figure 10.5.5.32/3GPP TS 24.008: Extended DRX parameters information element

Table 10.5.5.32/3GPP TS 24.008: Extended DRX parameters information element

Paging Time Window (PTW), octet 3 (bit 8 to 5)

The field contains a PTW value. The PTW value can be applied for lu mode, WB-S1 mode, NB-S1 mode, WB-N1 mode, and NB-N1 mode as specified below.

lu mode

The field contains the PTW value in seconds for lu mode. The PTW value is used as specified in 3GPP TS 23.682 [133a]. The PTW value is derived as follows:

bit

8	7	6	5	Paging Time Window length
0	0	0	0	0 seconds (PTW not used)
0	0	0	1	1 second
0	0	1	0	2 seconds
0	0	1	1	3 seconds
0	1	0	0	4 seconds
0	1	0	1	5 seconds
0	1	1	0	6 seconds
0	1	1	1	7 seconds
1	0	0	0	8 seconds
1	0	0	1	9 seconds
1	0	1	0	10 seconds
1	0	1	1	12 seconds
1	1	0	0	14 seconds
1	1	0	1	16 seconds
1	1	1	0	18 seconds
1	1	1	1	20 seconds

WB-S1 mode and WB-N1 mode

The field contains the PTW value in seconds for WB-S1 mode and WB-N1 mode. The PTW value is used as specified in 3GPP TS 23.682 [133a] and 3GPP TS 23.501 [166]. The PTW value is derived as follows:

bit

8	7	6	5	Paging Time Window length
0	0	0	0	1,28 seconds
0	0	0	1	2,56 seconds
0	0	1	0	3,84 seconds
0	0	1	1	5,12 seconds
0	1	0	0	6,4 seconds
0	1	0	1	7,68 seconds
0	1	1	0	8,96 seconds
0	1	1	1	10,24 seconds
1	0	0	0	11,52 seconds
1	0	0	1	12,8 seconds
1	0	1	0	14,08 seconds
1	0	1	1	15,36 seconds
1	1	0	0	16,64 seconds
1	1	0	1	17,92 seconds
1	1	1	0	19,20 seconds
1	1	1	1	20,48 seconds

NB-S1 mode and NB-N1 mode

The field contains the PTW value in seconds for NB-S1 mode and NB-N1 mode. The PTW value is used as specified in 3GPP TS 23.682 [133a] and 3GPP TS 23.501 [166]. The PTW value is derived as follows:

bit

8	7	6	5	Paging Time Window length
0	0	0	0	2,56 seconds
0	0	0	1	5,12 seconds
0	0	1	0	7,68 seconds
0	0	1	1	10,24 seconds
0	1	0	0	12,8 seconds
0	1	0	1	15,36 seconds
0	1	1	0	17,92 seconds
0	1	1	1	20,48 seconds
1	0	0	0	23,04 seconds
1	0	0	1	25,6 seconds

1 0 1 0	28,16 seconds
1 0 1 1	30,72 seconds
1 1 0 0	33,28 seconds
1 1 0 1	35,84 seconds
1 1 1 0	38,4 seconds
1 1 1 1	40,96 seconds

eDRX value, octet 3 (bit 4 to 1)

The octet contains the eDRX value field. The parameter values are applied for A/Gb mode, lu mode or S1 mode according to the tables below.

A/Gb mode

The field contains the eDRX value for A/Gb mode. The GERAN eDRX cycle length duration and Number of 51-MF per GERAN eDRX cycle values are derived from the eDRX value as follows:

bit				GERAN eDRX cycle length duration	Number of 51-MF per GERAN eDRX cycle
4	3	2	1		
0	0	0	0	~1,88 seconds (NOTE 1, NOTE 2)	8
0	0	0	1	~3,76 seconds (NOTE 1, NOTE 2)	16
0	0	1	0	~7,53 seconds (NOTE 1, NOTE 2)	32
0	0	1	1	12,24 seconds (NOTE 2)	52
0	1	0	0	24,48 seconds (NOTE 2)	104
0	1	0	1	48,96 seconds (NOTE 2)	208
0	1	1	0	97,92 seconds (NOTE 2)	416
0	1	1	1	195,84 seconds (NOTE 2)	832
1	0	0	0	391,68 seconds (NOTE 2)	1664
1	0	0	1	783,36 seconds (NOTE 2)	3328
1	0	1	0	1566,72 seconds (NOTE 2)	6656
1	0	1	1	3133,44 seconds (NOTE 2)	13312

All other values shall be interpreted as 0000 by this version of the protocol.

NOTE 1: The listed values are rounded.

NOTE 2: The value in seconds can be calculated with the formula $((3,06 / 13) * (\text{Number of 51-MF}))$. See 3GPP TS 45.001 [157], subclause 5.1.

lu mode

The field contains the eDRX value for lu mode. The UTRAN eDRX cycle length duration value is derived from the eDRX value as follows:

bit				UTRAN eDRX cycle length duration
4	3	2	1	
0	0	0	0	10,24 seconds
0	0	0	1	20,48 seconds
0	0	1	0	40,96 seconds
0	0	1	1	81,92 seconds
0	1	0	0	163,84 seconds
0	1	0	1	327,68 seconds
0	1	1	0	655,36 seconds
0	1	1	1	1310,72 seconds
1	0	0	0	1966,08 seconds
1	0	0	1	2621,44 seconds

All other values shall be interpreted as 0000 by this version of the protocol.

S1 mode
 The field contains the eDRX value for S1 mode. The E-UTRAN eDRX cycle length duration value and the eDRX cycle parameter 'T_{eDRX}' as defined in 3GPP TS 36.304 [121] are derived from the eDRX value as follows:

bit	E-UTRAN eDRX cycle length duration	eDRX cycle parameter 'T _{eDRX} '
4 3 2 1		
0 0 0 0	5,12 seconds (NOTE 4)	NOTE 3
0 0 0 1	10,24 seconds (NOTE 4)	2 ⁰
0 0 1 0	20,48 seconds	2 ¹
0 0 1 1	40,96 seconds	2 ²
0 1 0 0	61,44 seconds (NOTE 5)	6
0 1 0 1	81,92 seconds	2 ³
0 1 1 0	102,4 seconds (NOTE 5)	10
0 1 1 1	122,88 seconds (NOTE 5)	12
1 0 0 0	143,36 seconds (NOTE 5)	14
1 0 0 1	163,84 seconds	2 ⁴
1 0 1 0	327,68 seconds	2 ⁵
1 0 1 1	655,36 seconds	2 ⁶
1 1 0 0	1310,72 seconds	2 ⁷
1 1 0 1	2621,44 seconds	2 ⁸
1 1 1 0	5242,88 seconds (NOTE 6)	2 ⁹
1 1 1 1	10485,76 seconds (NOTE 6)	2 ¹⁰

All other values shall be interpreted as 0000 by this version of the protocol.

NOTE 3: For E-UTRAN, and for E-UTRA connected to 5GCN, eDRX cycle length duration of 5,12 seconds the eDRX cycle parameter 'T_{eDRX}' is not used as a different algorithm compared to the other values is applied. See 3GPP TS 36.304 [121] for details.

NOTE 4: The value is applicable only in WB-S1 mode and in WB-N1 mode. If received in NB-S1 mode or in NB-N1 mode it is interpreted as if the Extended DRX parameters IE were not included in the message by this version of the protocol.

NOTE 5: The value is applicable only in WB-S1 mode and in WB-N1 mode. If received in NB-S1 mode or in NB-N1 mode it is interpreted as 0010 by this version of the protocol.

NOTE 6: The value is applicable only in NB-S1 mode and in NB-N1 mode. If received in WB-S1 mode or in WB-N1 mode it is interpreted as 1101 by this version of the protocol.

10.5.5.33 Message authentication code

The purpose of the *Message authentication code* information element is to protect the integrity of a NAS message.

The *Message authentication code* is a type 3 information element with 6 octets length.

The *Message authentication code* information element is coded as shown in figure 10.5.5.33-1/3GPP TS 24.008 and table 10.5.5.33-1/3GPP TS 24.008.

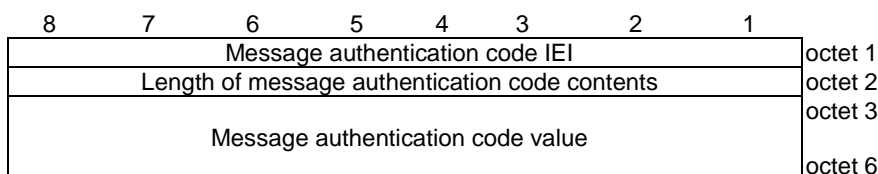

Figure 10.5.5.33-1/3GPP TS 24.008: Message authentication code information element

Table 10.5.5.33-1/3GPP TS 24.008: Message authentication code information element

<p>Message authentication code value (octet 3 to 6)</p> <p>This field contains the 32 bit message authentication code calculated for GMM integrity protection. Bit 1 of octet 3 contains the most significant bit, and bit 8 of octet 6 the least significant bit of these 4 octets.</p>
--

10.5.5.34 User Plane integrity indicator

The purpose of the *User Plane integrity indicator* information element is to indicate to the MS that it shall integrity protect user plane data in LLC layer.

The *User Plane integrity indicator* is allocated by the network and sent with the ATTACH ACCEPT message or ROUTING AREA UPDATE ACCEPT message to the mobile station.

The *User Plane integrity indicator* information element is coded as shown in figure 10.5.5.34-1/3GPP TS 24.008 and table 10.5.5.34-1/3GPP TS 24.008.

In A/Gb mode, in the case when a UMTS security context is established and if the MS supports integrity protection, the purpose of the *User Plane integrity indicator* information element is to request the MS to start integrity protection of user plane data in LLC layer.

The *User Plane integrity indicator* is a type 1 information element.

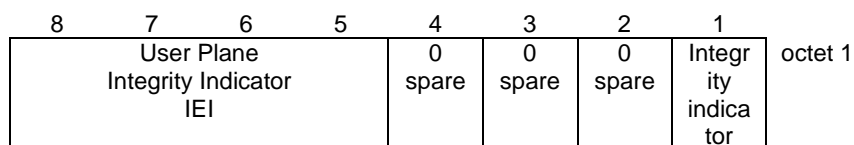
**Figure 10.5.5.34-1/3GPP TS 24.008 User Plane integrity indicator information element****Table 10.5.5.34-1/3GPP TS 24.008: User Plane integrity indicator information element**

User Plane integrity indicator (octet 1)	
Bits	
1	
0	MS shall disable integrity protection of user plane data in LLC layer
1	MS shall enable integrity protection of user plane data in LLC layer
Bits 2 to 4 are spare and shall be set to "0".	

10.5.5.35 DCN-ID

The purpose of the *DCN-ID* information element is to provide a DCN-ID for the registered PLMN to the MS.

The *DCN-ID* is a type 4 information element with 4 octets length.

The *DCN-ID* information element is coded as shown in figure 10.5.5.35-1/3GPP TS 24.008 and table 10.5.5.35-1/3GPP TS 24.008.

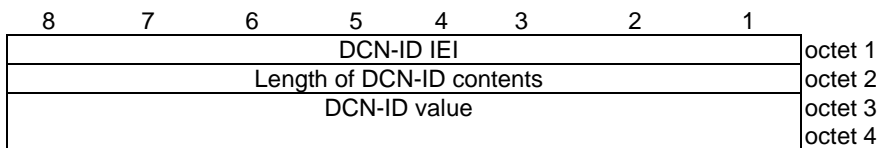

Figure 10.5.5.35-1/3GPP TS 24.008: DCN-ID information element

Table 10.5.5.35-1/3GPP TS 24.008: DCN-ID information element

DCN-ID value (octet 3 to 4)
This field contains the 16 bit DCN-ID. The coding of the DCN-ID value part is defined in 3GPP TS 23.003 [2].

10.5.5.36 PLMN identity of the CN operator

The purpose of the *PLMN identity of the CN operator* information element is to indicate the PLMN identity of the CN operator that has accepted the GPRS attach request or routing area update request in a shared network or in a multi-operator core network (MOCN) with common GERAN.

The *PLMN identity of the CN operator* is a type 4 information element with 5 octets length.

The *PLMN identity of the CN operator* information element is coded as shown in figure 10.5.5.36-1/3GPP TS 24.008 and table 10.5.5.36-1/3GPP TS 24.008.

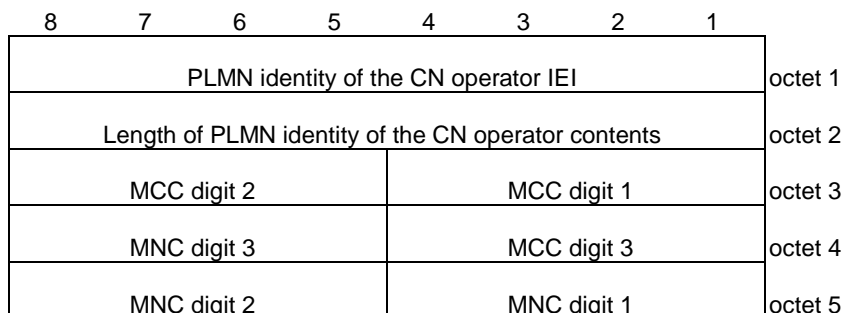

Figure 10.5.5.36-1/3GPP TS 24.008 PLMN identity of the CN operator information element

Table 10.5.5.36-1/3GPP TS 24.008: PLMN identity of the CN operator information element

MCC, Mobile country code (octet 3, octet 4 bits 1 to 4) The MCC field is coded as in ITU-T Rec. E212, Annex A.
MNC, Mobile network code (octet 5, octet 4 bits 5 to 8). The coding of this field is the responsibility of each administration but BCD coding shall be used. The MNC shall consist of 2 or 3 digits. For PCS 1900 for NA, Federal regulation mandates that a 3-digit MNC shall be used. However a network operator may decide to use only two digits in the MNC over the radio interface. In this case, bits 5 to 8 of octet 4 shall be coded as "1111". Mobile equipment shall accept MNC coded in such a way.

10.5.5.37 Non-3GPP NW provided policies

The purpose of the *Non-3GPP NW provided policies* information element is to indicate to the MS whether emergency numbers provided via non-3GPP access (see 3GPP TS 24.302 [156]) can be used to initiate UE detected emergency calls.

The *Non-3GPP NW provided policies* is indicated by the network and sent with the ATTACH ACCEPT message or ROUTING AREA UPDATE ACCEPT message to the mobile station.

The *Non-3GPP NW provided policies* information element is coded as shown in figure 10.5.5.37-1/3GPP TS 24.008 and table 10.5.5.37-1/3GPP TS 24.008.

The *Non-3GPP NW provided policies* is a type 1 information element.

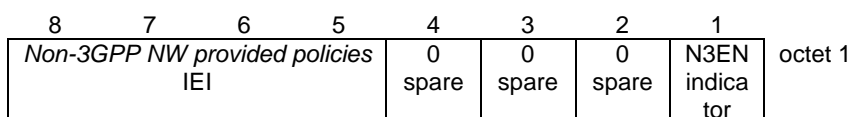

Figure 10.5.5.37-1/3GPP TS 24.008 *Non-3GPP NW provided policies* IE

Table 10.5.5.37-1/3GPP TS 24.008: *Non-3GPP NW provided policies* IE

Non-3GPP emergency number (N3EN) indicator (octet 1)	
Bits	
1	
0	use of non-3GPP emergency numbers not permitted
1	use of non-3GPP emergency numbers permitted
Bits 2 to 4 are spare and shall be set to "0".	

10.5.6 Session management information elements

10.5.6.1 Access point name

The purpose of the *Access point name* information element is to identify the packet data network to which the GPRS user wishes to connect and to notify the access point of the packet data network that wishes to connect to the MS.

The *Access point name* is a label or a fully qualified domain name according to DNS naming conventions (see 3GPP TS 23.003 [10]).

The *Access point name* is a type 4 information element with a minimum length of 3 octets and a maximum length of 102 octets.

The *Access point name* information element is coded as shown in figure 10.5.152/3GPP TS 24.008.

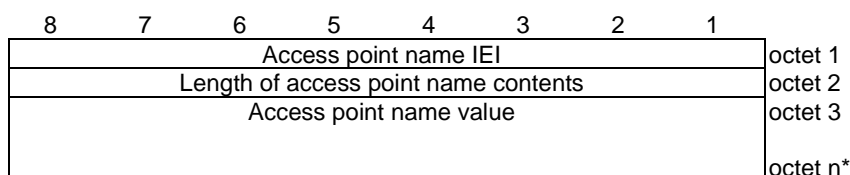

Figure 10.5.152/3GPP TS 24.008: *Access point name* information element

The value part is defined in 3GPP TS 23.003 [10].

10.5.6.2 Network service access point identifier

The purpose of the *Network service access point identifier* information element is to identify the service access point that is used for the GPRS data transfer at layer 3.

The *Network service access point identifier* is a type 3 information element with a length of 2 octets.

The value part of a *Network service access point identifier* information element is coded as shown in figure 10.5.153/3GPP TS 24.008 and table 10.5.167/3GPP TS 24.008.

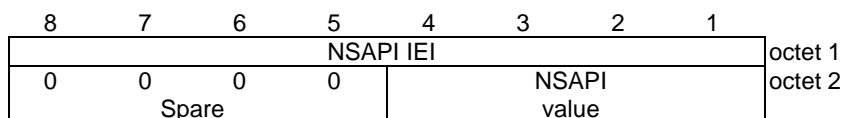

Figure 10.5.153/3GPP TS 24.008: *Network service access point identifier* information element

Table 10.5.167/3GPP TS 24.008: *Network service access point identifier* information element

NSAPI value (octet 2)				
Bits				
4	3	2	1	
0	0	0	0	reserved
0	0	0	1	reserved
0	0	1	0	reserved
0	0	1	1	reserved
0	1	0	0	reserved
0	1	0	1	NSAPI 5
0	1	1	0	NSAPI 6
0	1	1	1	NSAPI 7
1	0	0	0	NSAPI 8
1	0	0	1	NSAPI 9
1	0	1	0	NSAPI 10
1	0	1	1	NSAPI 11
1	1	0	0	NSAPI 12
1	1	0	1	NSAPI 13
1	1	1	0	NSAPI 14
1	1	1	1	NSAPI 15

10.5.6.3 Protocol configuration options

10.5.6.3.1 General

The purpose of the *protocol configuration options* information element is to:

- transfer external network protocol options associated with a PDP context activation, and
- transfer additional (protocol) data (e.g. configuration parameters, error codes or messages/events) associated with an external protocol or an application.

The *protocol configuration options* is a type 4 information element with a minimum length of 3 octets and a maximum length of 253 octets.

The *protocol configuration options* information element is coded as shown in figure 10.5.136/3GPP TS 24.008 and table 10.5.154/3GPP TS 24.008.

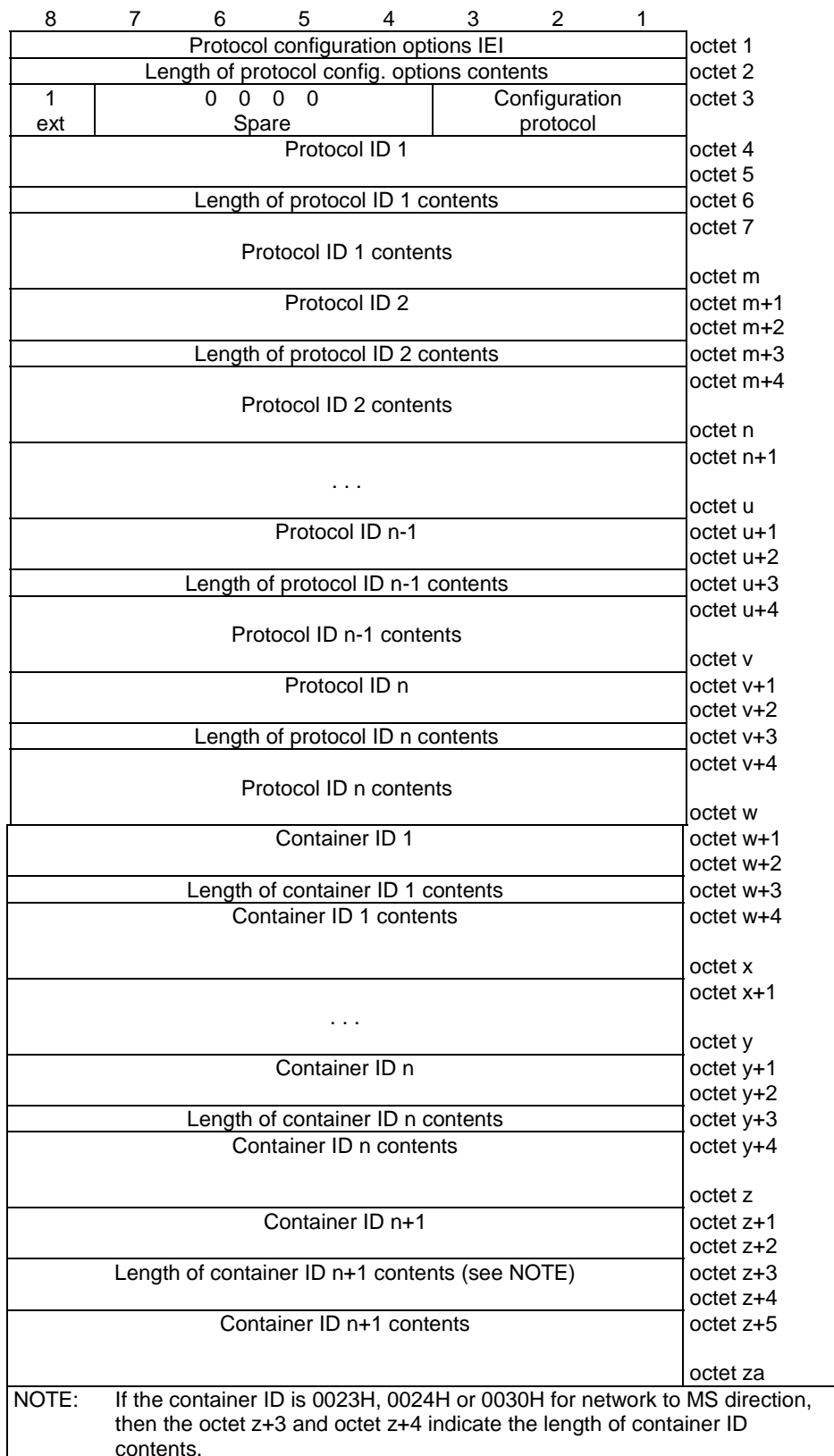

Figure 10.5.136/3GPP TS 24.008: Protocol configuration options information element

Table 10.5.154/3GPP TS 24.008: *Protocol configuration options* information element

Configuration protocol (octet 3)

Bits

3 2 1

0 0 0 PPP for use with IP PDP type or IP PDN type (see 3GPP TS 24.301 [120])

All other values are interpreted as PPP in this version of the protocol.

After octet 3, i.e. from octet 4 to octet z, two logical lists are defined:

- the Configuration protocol options list (octets 4 to w), and
- the Additional parameters list (octets w+1 to z).

Configuration protocol options list (octets 4 to w)

The *configuration protocol options list* contains a variable number of logical units, they may occur in an arbitrary order within the *configuration protocol options list*.

Each unit is of variable length and consists of a:

- protocol identifier (2 octets);
- the length of the protocol identifier contents of the unit (1 octet); and
- the protocol identifier contents itself (n octets).

The *protocol identifier* field contains the hexadecimal coding of the configuration protocol identifier. Bit 8 of the first octet of the *protocol identifier* field contains the most significant bit and bit 1 of the second octet of the *protocol identifier* field contains the least significant bit.

If the *configuration protocol options list* contains a protocol identifier that is not supported by the receiving entity the corresponding unit shall be ignored.

The *length of the protocol identifier contents* field contains the binary coded representation of the length of the *protocol identifier contents* field of a unit. The first bit in transmission order is the most significant bit.

The *protocol identifier contents* field of each unit contains information specific to the configuration protocol specified by the *protocol identifier*.

At least the following protocol identifiers (as defined in RFC 3232 [103]) shall be supported in this version of the protocol:

- C021H (LCP);
- C023H (PAP) (see NOTE 3);
- C223H (CHAP) (see NOTE 3); and
- 8021H (IPCP).

The support of other protocol identifiers is implementation dependent and outside the scope of the present document.

The *protocol identifier contents* field of each unit corresponds to a "Packet" as defined in RFC 1661 [102] that is stripped off the "Protocol" and the "Padding" octets.

The detailed coding of the *protocol identifier contents* field is specified in the RFC that is associated with the protocol identifier of that unit.

Additional parameters list (octets w+1 to z)

The *additional parameters list* is included when special parameters and/or requests (associated with a PDP context) need to be transferred between the MS and the network. These parameters and/or requests are not related to a specific configuration protocol (e.g. PPP), and therefore are not encoded as the "Packets" contained in the *configuration protocol options list*.

The *additional parameters list* contains a list of special parameters, each one in a separate container. The type of the parameter carried in a container is identified by a specific *container identifier*. In this version of the protocol, the following container identifiers are specified:

MS to network direction:

- 0001H (P-CSCF IPv6 Address Request);
- 0002H (IM CN Subsystem Signaling Flag);
- 0003H (DNS Server IPv6 Address Request);
- 0004H (Not Supported);
- 0005H (MS Support of Network Requested Bearer Control indicator);
- 0006H (Reserved);
- 0007H (DSMIPv6 Home Agent Address Request);
- 0008H (DSMIPv6 Home Network Prefix Request);
- 0009H (DSMIPv6 IPv4 Home Agent Address Request);
- 000AH (IP address allocation via NAS signalling);
- 000BH (IPv4 address allocation via DHCPv4);
- 000CH (P-CSCF IPv4 Address Request);
- 000DH (DNS Server IPv4 Address Request);
- 000EH (MSISDN Request);
- 000FH (IFOM-Support-Request);
- 0010H (IPv4 Link MTU Request);
- 0011H (MS support of Local address in TFT indicator) (see NOTE 4);
- 0012H (P-CSCF Re-selection support);
- 0013H (NBIFOM request indicator);
- 0014H (NBIFOM mode);
- 0015H (Non-IP Link MTU Request);
- 0016H (APN rate control support indicator);
- 0017H (3GPP PS data off UE status);
- 0018H (Reliable Data Service request indicator);
- 0019H (Additional APN rate control for exception data support indicator);
- 001AH (PDU session ID);
- 001BH (reserved);
- 001CH (Reserved);
- 001DH (Reserved);
- 001EH (Reserved);
- 001FH (Reserved);
- 0020H (Ethernet Frame Payload MTU Request);
- 0021H (Unstructured Link MTU Request);
- 0022H (5GSM cause value);
- 0023H (QoS rules with the length of two octets support indicator);

- 0024H (QoS flow descriptions with the length of two octets support indicator);
- 0025H (Reserved)
- 0026H (Reserved);
- 0027H (ACS information request);
- 0028H (Reserved);
- 0029H (Reserved);
- 002AH (Reserved);
- 002BH (Reserved);
- 0030H (ATSSS request);
- 0031H (DNS server security information indicator); and
- FF00H to FFFFH reserved for operator specific use.

Network to MS direction:

- 0001H (P-CSCF IPv6 Address);
- 0002H (IM CN Subsystem Signaling Flag);
- 0003H (DNS Server IPv6 Address);
- 0004H (Policy Control rejection code);
- 0005H (Selected Bearer Control Mode);
- 0006H (Reserved);
- 0007H (DSMIPv6 Home Agent Address) ;
- 0008H (DSMIPv6 Home Network Prefix);
- 0009H (DSMIPv6 IPv4 Home Agent Address);
- 000AH (Reserved);
- 000BH (Reserved);
- 000CH (P-CSCF IPv4 Address);
- 000DH (DNS Server IPv4 Address);
- 000EH (MSISDN);
- 000FH (IFOM-Support);
- 0010H (IPv4 Link MTU);
- 0011H (Network support of Local address in TFT indicator);
- 0012H (Reserved);
- 0013H (NBIFOM accepted indicator);
- 0014H (NBIFOM mode);
- 0015H (Non-IP Link MTU);
- 0016H (APN rate control parameters);
- 0017H (3GPP PS data off support indication);

- 0018H (Reliable Data Service accepted indicator);
- 0019H (Additional APN rate control for exception data parameters);
- 001AH (reserved);
- 001BH (S-NSSAI);
- 001CH (QoS rules);
- 001DH (Session-AMBR);
- 001EH (PDU session address lifetime);
- 001FH (QoS flow descriptions);
- 0020H (Ethernet Frame Payload MTU);
- 0021H (Unstructured Link MTU);
- 0022H (Reserved);
- 0023H (QoS rules with the length of two octets);
- 0024H (QoS flow descriptions with the length of two octets);
- 0025H (Small data rate control parameters);
- 0026H (Additional small data rate control for exception data parameters);
- 0027H (ACS information);
- 0028H (Initial small data rate control parameters);
- 0029H (Initial additional small data rate control for exception data parameters);
- 002AH (Initial APN rate control parameters);
- 002BH (Initial additional APN rate control for exception data parameters);
- 0030H (ATSSS response with the length of two octets);
- 0031H (DNS server security information with length of two octets); and
- FF00H to FFFFH reserved for operator specific use.

If the *additional parameters list* contains a container identifier that is not supported by the receiving entity the corresponding unit shall be ignored.

The *container identifier* field is encoded as the *protocol identifier* field and the *length of container identifier contents* field is encoded as the *length of the protocol identifier contents* field.

When the *container identifier* indicates P-CSCF IPv6 Address Request, DNS Server IPv6 Address Request, MSISDN Request or DNS server security information indicator, the *container identifier contents* field is empty and the *length of container identifier contents* indicates a length equal to zero. If the *container identifier contents* field is not empty, it shall be ignored. The DNS server security information indicator indicates that the MS supports receiving DNS server security information with length of two octets.

When the *container identifier* indicates IM CN Subsystem Signaling Flag (see 3GPP TS 24.229 [95]), the *container identifier contents* field is empty and the *length of container identifier contents* indicates a length equal to zero. If the *container identifier contents* field is not empty, it shall be ignored. In Network to MS direction this information may be used by the MS to indicate to the user whether the requested dedicated signalling PDP context was successfully established.

When the *container identifier* indicates P-CSCF IPv6 Address, the *container identifier contents* field contains one IPv6 address corresponding to a P-CSCF

address (see 3GPP TS 24.229 [95]). This IPv6 address is encoded as a 128-bit address according to IETF RFC 4291 [99]. When there is a need to include more than one P-CSCF IPv6 address, then more logical units with the *container identifier* indicating P-CSCF IPv6 Address are used. If more than 3 instances of the P-CSCF IPv6 Address logical unit are received by the MS, then the MS may ignore all but the first 3 instances of the P-CSCF IPv6 Address logical unit received.

When the *container identifier* indicates DNS Server IPv6 Address, the *container identifier contents* field contains one IPv6 DNS server address (see 3GPP TS 27.060 [36a]). This IPv6 address is encoded as a 128-bit address according to IETF RFC 4291 [99]. When there is a need to include more than one DNS Server IPv6 address, then more logical units with the *container identifier* indicating DNS Server IPv6 Address are used.

When the *container identifier* indicates Policy Control rejection code, the *container identifier contents* field contains a Go interface related cause code from the GGSN to the MS (see 3GPP TS 29.207 [100]). The *length of container identifier contents* indicates a length equal to one. If the *container identifier contents* field is empty or its actual length is greater than one octet, then it shall be ignored by the receiver.

When the *container identifier* indicates MS Support of Network Requested Bearer Control indicator, the *container identifier contents* field is empty and the *length of container identifier contents* indicates a length equal to zero. If the *container identifier contents* field is not empty, it shall be ignored.

When the *container identifier* indicates Selected Bearer Control Mode, the *container identifier contents* field contains the selected bearer control mode, where '01H' indicates that 'MS only' mode has been selected and '02H' indicates that 'MS/NW' mode has been selected. The *length of container identifier contents* indicates a length equal to one. If the *container identifier contents* field is empty or its actual length is greater than one octet, then it shall be ignored by the receiver.

When the *container identifier* indicates DSMIPv6 Home Agent Address Request, the *container identifier contents* field is empty and the *length of container identifier contents* indicates a length equal to zero. If the *container identifier contents* field is not empty, it shall be ignored.

When the *container identifier* indicates DSMIPv6 Home Network Prefix Request, the *container identifier contents* field is empty and the *length of container identifier contents* indicates a length equal to zero. If the *container identifier contents* field is not empty, it shall be ignored.

When the *container identifier* indicates DSMIPv6 IPv4 Home Agent Address Request, the *container identifier contents* field is empty and the *length of container identifier contents* indicates a length equal to zero. If the *container identifier contents* field is not empty, it shall be ignored.

When the *container identifier* indicates DSMIPv6 Home Agent Address, the *container identifier contents* field contains one IPv6 address corresponding to a DSMIPv6 HA address (see 3GPP TS 24.303 [124] and 3GPP TS 24.327 [125]). This IPv6 address is encoded as a 128-bit address according to IETF RFC 4291 [99].

When the *container identifier* indicates DSMIPv6 Home Network Prefix, the *container identifier contents* field contains one IPv6 Home Network Prefix (see 3GPP TS 24.303 [124] and 3GPP TS 24.327 [125]). This IPv6 prefix is encoded as an IPv6 address according to IETF RFC 4291 [99] followed by 8 bits which specifies the prefix length.

When the *container identifier* indicates DSMIPv6 IPv4 Home Agent Address, the *container identifier contents* field contains one IPv4 address corresponding to a DSMIPv6 IPv4 Home Agent address (see 3GPP TS 24.303 [124] and 3GPP TS 24.327 [125]).

When the *container identifier* indicates P-CSCF IPv4 Address Request, the *container identifier contents* field is empty and the *length of container identifier contents* indicates a length equal to zero. If the *container identifier contents* field is not empty, it shall be ignored.

When the *container identifier* indicates DNS Server IPv4 Address Request, the *container identifier contents* field is empty and the *length of container identifier contents* indicates a length equal to zero. If the *container identifier contents* field is not empty, it shall be ignored.

When the *container identifier* indicates P-CSCF IPv4 Address, the *container identifier contents* field contains one IPv4 address corresponding to the P-CSCF address to be used. When there is a need to include more than one P-CSCF IPv4 address, then more logical units with the *container identifier* indicating P-CSCF IPv4 Address are used. If more than 3 instances of the P-CSCF IPv4 Address logical unit are received by the MS, then the MS may ignore all but the first 3 instances of the P-CSCF IPv4 Address logical unit received.

When the *container identifier* indicates DNS Server IPv4 Address, the *container identifier contents* field contains one IPv4 address corresponding to the DNS server address to be used. When there is a need to include more than one DNS Server IPv4 address, then more logical units with the *container identifier* indicating DNS Server IPv4 Address are used.

P-CSCF IPv4 Address Request, P-CSCF IPv4 Address, DNS Server IPv4 Address Request and DNS Server IPv4 Address are applicable in S1-mode and N1-mode.

When the *container identifier* indicates IP address allocation via NAS signalling, the *container identifier contents* field is empty and the *length of container identifier contents* indicates a length equal to zero. If the *container identifier contents* field is not empty, it shall be ignored.

When the *container identifier* indicates IP address allocation via DHCPv4, the *container identifier contents* field is empty and the *length of container identifier contents* indicates a length equal to zero. If the *container identifier contents* field is not empty, it shall be ignored.

When the *container identifier* indicates MSISDN, the *container identifier contents* field contains the MSISDN (see 3GPP TS 23.003 [10]) assigned to the MS. Use of the MSISDN provided is defined in subclause 6.4.

When the *container identifier* indicates IFOM Support Request (see 3GPP TS 24.303 [124] and 3GPP TS 24.327 [125]), the *container identifier contents* field is empty and the *length of container identifier contents* indicates a length equal to zero. If the *container identifier contents* field is not empty, it shall be ignored.

When the *container identifier* indicates IFOM Support, the *container identifier contents* field is empty and the *length of container identifier contents* indicates a length equal to zero. If the *container identifier contents* field is not empty, it shall be ignored. This information indicates that the Home Agent supports IFOM.

When the *container identifier* indicates IPv4 Link MTU Request, the *container identifier contents* field is empty and the *length of container identifier contents* indicates a length equal to zero. If the *container identifier contents* field is not empty, it shall be ignored.

When the *container identifier* indicates IPv4 Link MTU, the *length of container identifier contents* indicates a length equal to two. The *container identifier contents* field contains the binary coded representation of the IPv4 link MTU size in octets. Bit 8 of the first octet of the *container identifier contents* field contains the most significant bit and bit 1 of the second octet of the *container identifier contents* field contains the least significant bit. If the *length of container identifier contents* is different from two octets, then it shall be ignored by the receiver.

When the *container identifier* indicates MS support of Local address in TFT, the *container identifier contents* field is empty and the *length of container identifier contents* indicates a length equal to zero. If the *container identifier contents* field is not empty, it shall be ignored. This information indicates that the MS supports Local address in TFTs.

When the *container identifier* indicates Network support of Local address in TFT, the *container identifier contents* field is empty and the *length of container identifier contents* indicates a length equal to zero. If the *container identifier contents* field is

not empty, it shall be ignored. This information indicates that the network supports Local address in TFTs.

When the *container identifier* indicates P-CSCF Re-selection support, the *container identifier contents* field is empty and the *length of container identifier contents* indicates a length equal to zero. If the *container identifier contents* field is not empty, it shall be ignored. This PCO parameter may be present only if a container with P-CSCF IPv4 Address Request or P-CSCF IPv6 Address Request is present. This information indicates that the UE supports P-CSCF re-selection based on procedures specified in 3GPP TS 24.229 [95] subclauses B.2.2.1C, L.2.2.1C, R.2.2.1C, U.2.2.1C and W.2.2.1C.

When the *container identifier* indicates NBIFOM request indicator, the *container identifier contents* field is empty and the *length of container identifier contents* indicates a length equal to zero. If the *container identifier contents* field is not empty, it shall be ignored. This information indicates that the MS requests the NBIFOM usage.

When the *container identifier* indicates NBIFOM accepted indicator, the *container identifier contents* field is empty and the *length of container identifier contents* indicates a length equal to zero. If the *container identifier contents* field is not empty, it shall be ignored. This information indicates that the network accepts UE's request of the NBIFOM usage.

When the *container identifier* indicates NBIFOM mode, the *length of container identifier contents* indicates a length equal to one. If the *length of container identifier contents* indicates length different to one, it shall be ignored. The *container identifier contents* field containing value 00H indicates the UE-initiated NBIFOM mode. The *container identifier contents* field containing value 01H indicates the network-initiated NBIFOM mode. The *container identifier contents* field containing a value other than 00H and other than 01H shall be ignored.

When the *container identifier* indicates Non-IP Link MTU Request, the *container identifier contents* field is empty and the *length of container identifier contents* indicates a length equal to zero. If the *container identifier contents* field is not empty, it shall be ignored. This information indicates that the MS requests link MTU for "non-IP" PDN connection.

When the *container identifier* indicates Non-IP Link MTU, the *length of container identifier contents* indicates a length equal to two. The *container identifier contents* field contains the binary coded representation of the link MTU size for non-IP PDN connection in octets which is at least 128 octets. Bit 8 of the first octet of the *container identifier contents* field contains the most significant bit and bit 1 of the second octet of the *container identifier contents* field contains the least significant bit. If the *length of container identifier contents* is different from two octets, then it shall be ignored by the receiver.

When the *container identifier* indicates APN rate control support indicator, the *container identifier contents* field is empty and the *length of container identifier contents* indicates a length equal to zero. If the *container identifier contents* field is not empty, it shall be ignored. This information indicates that the MS supports APN rate control functionality.

When the *container identifier* indicates APN rate control parameters, the *container identifier contents* field contains parameters for APN rate control functionality. The container contents are coded as described in subclause 10.5.6.3.2.

When the *container identifier* indicates Initial APN data rate control parameters, the *container identifier contents* field contains status parameters for APN rate control functionality. The container contents are coded as described in subclause 10.5.6.3.8.

When the *container identifier* indicates 3GPP PS data off UE status, the *container identifier contents* field contains information of the status of 3GPP PS data off in the UE for a PDN connection where "01H" indicates 'deactivated' and "02H" indicates 'activated'. The *length of container identifier contents* indicates a length equal to one. If the *container identifier contents* field is empty or its actual length is greater than one octet, then it shall be ignored by the receiver.

When the *container identifier* indicates 3GPP PS data off support indication, the *container identifier contents* field is empty. The *length of container identifier contents* indicates a length equal to zero. If the *container identifier contents* field is not empty, then it shall be ignored by the receiver.

When the *container identifier* indicates Reliable Data Service request indicator, the *container identifier contents* field is empty and the *length of container identifier contents* indicates a length equal to zero. If the *container identifier contents* field is not empty, it shall be ignored. This information indicates that the MS requests the Reliable Data Service usage as specified in 3GPP TS 24.250 [162].

When the *container identifier* indicates Reliable Data Service accepted indicator, the *container identifier contents* field is empty and the *length of container identifier contents* indicates a length equal to zero. If the *container identifier contents* field is not empty, it shall be ignored. This information indicates that the network accepts UE's request of the Reliable Data Service usage as specified in 3GPP TS 24.250 [162].

When the *container identifier* indicates Additional APN rate control for exception data support indicator, the *container identifier contents* field is empty and the *length of container identifier contents* indicates a length equal to zero. If the *container identifier contents* field is not empty, it shall be ignored. This information indicates that the MS supports additional APN rate control for exception data functionality.

When the *container identifier* indicates Additional APN rate control for exception data parameters, the *container identifier contents* field contains parameters for additional APN rate control for exception data functionality. The container contents are coded as described in subclause 10.5.6.3.3.

When the *container identifier* indicates Initial additional APN rate control for exception data parameters, the *container identifier contents* field contains status parameters for additional APN rate control for exception data functionality. The container contents are coded as described in subclause 10.5.6.3.9.

When the *container identifier* indicates PDU session identity, the *container identifier contents* field contains the PDU session identity assigned by the MS. The encoding of the PDU session identity and its usage are defined in 3GPP TS 24.007 [20].

When the *container identifier* indicates S-NSSAI, the *container identifier contents* field contains one S-NSSAI value followed by one PLMN ID that the S-NSSAI relates to. The S-NSSAI value is coded as the value part of S-NSSAI information element as specified in subclause 9.11.2.8 of 3GPP TS 24.501 [167]. The PLMN ID is encoded as the value of the PLMN identity of the CN operator IE in subclause 10.5.5.36. The usage of the S-NSSAI and the associated PLMN ID is defined in 3GPP TS 24.501 [167].

When the *container identifier* indicates QoS rules, the *container identifier contents* field contains the QoS rules for the QoS flow corresponding to the EPS bearer of the PDN connection. The QoS rules is coded as the value part of QoS rules information element as specified in subclause 9.11.4.13 of 3GPP TS 24.501 [167]. The usage of the QoS rules is specified in 3GPP TS 24.501 [167].

When the *container identifier* indicates Session-AMBR, the *container identifier contents* field contains the Session-AMBR for the PDU session corresponding to the PDN connection. The Session-AMBR is coded as the value part of Session-AMBR information element as specified in subclause 9.11.4.14 of 3GPP TS 24.501 [167]. The usage of the Session-AMBR is specified in 3GPP TS 24.501 [167].

When the *container identifier* indicates PDU session address lifetime, the *length of container identifier contents* indicates a length equal to two. The *container identifier contents* field contains the binary coded representation of how long the network is willing to maintain the PDU session in units of seconds. Bit 8 of the first octet of the *container identifier contents* field contains the most significant bit and bit 1 of the second octet of the *container identifier contents* field contains the least significant bit. If the *length of container identifier contents* is different from two octets, then it shall be ignored by the receiver.

When the *container identifier* indicates QoS flow descriptions, the *container identifier contents* field contains the QoS flow descriptions for the QoS flow corresponding to the EPS bearer of the PDN connection. The QoS flow descriptions is coded as the

value part of QoS flow descriptions information element as specified in subclause 9.11.4.12 of 3GPP TS 24.501 [167]. The usage of the QoS flow descriptions is specified in 3GPP TS 24.501 [167].

When the *container identifier* indicates Ethernet Frame Payload MTU Request, the *container identifier contents* field is empty and the *length of container identifier contents* indicates a length equal to zero. If the *container identifier contents* field is not empty, it shall be ignored. This information indicates that the MS requests link MTU for an Ethernet PDU session.

When the *container identifier* indicates Ethernet Frame Payload MTU, the *length of container identifier contents* indicates a length equal to two. The *container identifier contents* field contains the binary coded representation of Ethernet frame payload MTU size, i.e. the maximum size of a payload of an Ethernet frame which can be sent via an Ethernet PDU session in octets. Bit 8 of the first octet of the *container identifier contents* field contains the most significant bit and bit 1 of the second octet of the *container identifier contents* field contains the least significant bit. If the *length of container identifier contents* is different from two octets, then it shall be ignored by the receiver.

When the *container identifier* indicates Unstructured Link MTU Request, the *container identifier contents* field is empty and the *length of container identifier contents* indicates a length equal to zero. If the *container identifier contents* field is not empty, it shall be ignored. This information indicates that the MS requests link MTU for an Unstructured PDU session.

When the *container identifier* indicates Unstructured Link MTU, the *length of container identifier contents* indicates a length equal to two. The *container identifier contents* field contains the binary coded representation of unstructured link MTU size, i.e. the maximum size of a message which can be sent via an Unstructured PDU session in octets. Bit 8 of the first octet of the *container identifier contents* field contains the most significant bit and bit 1 of the second octet of the *container identifier contents* field contains the least significant bit. If the *length of container identifier contents* is different from two octets, then it shall be ignored by the receiver.

When the *container identifier* indicates 5GSM cause value, the *container identifier contents* field contains a 5GSM cause value. The encoding of the 5GSM cause value and its usage are specified in 3GPP TS 24.501 [167].

When the *container identifier* indicates QoS rules with the length of two octets support indicator, the *container identifier contents* field is empty and the *length of container identifier contents* indicates a length equal to zero. If the *container identifier contents* field is not empty, it shall be ignored. The *length of container identifier contents* field consists of one octet. This information indicates that the MS supports receiving QoS rules with the length of two octets.

When the *container identifier* indicates QoS flow descriptions with the length of two octets support indicator, the *container identifier contents* field is empty and the *length of container identifier contents* indicates a length equal to zero. If the *container identifier contents* field is not empty, it shall be ignored. The *length of container identifier contents* field consists of one octet. This information indicates that the MS supports receiving QoS flow descriptions with the length of two octets.

When the *container identifier* indicates QoS rules with the length of two octets, the *container identifier contents* field contains the QoS rules for the QoS flow corresponding to the EPS bearer of the PDN connection if the MS has indicated the support of receiving QoS rules with the length of two octets. The QoS rules with the length of two octets is coded as the value part of QoS rules information element as specified in subclause 9.11.4.13 of 3GPP TS 24.501 [167]. The usage of the QoS rules is specified in 3GPP TS 24.501 [167]. See NOTE 2.

When the *container identifier* indicates QoS flow descriptions with the length of two octets, the *container identifier contents* field contains the QoS flow descriptions for the QoS flow corresponding to the EPS bearer of the PDN connection if the MS has indicated the support of receiving QoS flow descriptions with the length of two octets. The QoS flow descriptions with the length of two octets is coded as the value part of QoS flow descriptions information element as specified in

subclause 9.11.4.12 of 3GPP TS 24.501 [167]. The usage of the QoS flow descriptions is specified in 3GPP TS 24.501 [167]. See NOTE 2.

When the *container identifier* indicates Small data rate control parameters, the *container identifier contents* field contains parameters for small data rate control functionality. The container contents are coded as described in subclause 10.5.6.3.4.

When the *container identifier* indicates Initial small data rate control parameters, the *container identifier contents* field contains status parameters for small data rate control functionality. The container contents are coded as described in subclause 10.5.6.3.6.

When the *container identifier* indicates Additional small data rate control for exception data parameters, the *container identifier contents* field contains parameters for additional small data rate control for exception data functionality. The container contents are coded as described in subclause 10.5.6.3.5.

When the *container identifier* indicates Initial additional small data rate control for exception data parameters, the *container identifier contents* field contains status parameters for additional small data rate control for exception data functionality. The container contents are coded as described in subclause 10.5.6.3.7.

When the *container identifier* indicates ACS information request, the *container identifier contents* field is empty and the *length of container identifier contents* indicates a length equal to zero. If the *container identifier contents* field is not empty, it shall be ignored. This information indicates that the MS requests ACS information.

When the *container identifier* indicates ACS information, the *length of container identifier contents* indicates non-zero length. The *container identifier contents* field contains the UTF-8 (see IETF RFC 3629 [168]) coded representation of an ACS URL. Bit 8 of the first octet of the *container identifier contents* field contains the most significant bit and bit 1 of the last octet of the *container identifier contents* field contains the least significant bit.

When the *container identifier* indicates ATSSS request, the *container identifier contents* field is coded according to 3GPP TS 24.193 [171] subclause 6.1.6.2. The length of container identifier contents field consists of one octet. This information indicates that the MS supports receiving ATSSS response with the length of two octets.

When the *container identifier* indicates ATSSS response with the length of two octets, the *container identifier contents* field is coded according to 3GPP TS 24.193 [171] subclause 6.1.6.3. See NOTE 2.

When the *container identifier* indicates DNS server security information with length of two octets, the *container identifier contents* field contains one of the parameters: security protocol type, port number, authentication domain name, SPKI pin sets, root certificate, raw public key. When there is a need to send more than one parameter, then multiple containers with the *container identifier* indicating DNS server security information with length of two octets are used, each containing one parameter. The first octet of *container identifier contents* of the DNS server security information with length of two octets contains the type and all octets excluding the first octet of the *container identifier contents* field of the DNS server security information with length of two octets contain the value part. If the DNS server security information with length of two octets contains security protocol type then the type is set to 0x00 and the value part is set to 0x00 if the security protocol type is TLS (see IETF RFC 7858 [172]) and 0x01 if the security protocol type is DTLS (see IETF RFC 8094 [173]). If the DNS server security information with length of two octets contains port number then the type is set to 0x01 and the value part to content is set ephemeral port (see IETF RFC 6056 [174]). If the DNS server security information with length of two octets contains authentication domain name then the type is set to 0x02 and the value part is set authentication domain name (The FQDN shall be encoded as defined in IETF RFC 1035 [175]). If the DNS server security information with length of two octets contains SPKI pin set then the type is set to 0x03 and the value part is set SPKI pin set (The SPKI pin set shall be encoded as in DER as specified in X 690.3 [177]). If the DNS server security information with length of two octets contains a root certificate then the type is set to 0x04 and the value part is set the root certificate (the root certificate is encoded as in DER as specified in X 690 [177]). If the DNS server security information with length of two

octets contains raw public key then the type is set to 0x05 and the value part is set to raw public key (The raw public key shall be encoded as in DER as specified in X 690.3 [177]).

When the container identifier indicates operator specific use, the Container contents starts with MCC and MNC of the operator providing the relevant application and can be followed by further application specific information. The coding of MCC and MNC is as in octet 2 to 4 of the *Location Area Identification* information element in subclause 10.5.1.3.

NOTE 1: The *additional parameters list* and the *configuration protocol options list* are logically separated since they carry different type of information. The beginning of the *additional parameters list* is marked by a logical unit, which has an identifier (i.e. the first two octets) equal to a *container identifier* (i.e. it is not a *protocol identifier*).

NOTE 2: If the QoS rules with the length of two octets, the QoS flow descriptions with the length of two octets, ATSSS response with the length of two octets is included, or DNS server security information with length of two octets, then extended protocol configuration options as specified in the subclause 10.5.6.3A shall be used.

NOTE 3: If PAP/CHAP protocol is supported by the UE in N1 mode, the UE can use the PAP/CHAP protocol identifiers in the extended protocol configuration options information element in N1 mode.

NOTE 4: The MS operating in single-registration mode shall indicate the support of Local address in TFT in N1 mode as specified in subclause 6.4.1.2 of 3GPP TS 24.501 [167].

10.5.6.3.2 APN rate control parameters

The purpose of the *APN rate control parameters* container contents is to indicate the APN rate control parameters.

The *APN rate control parameters* container contents are coded as shown in figure 10.5.136A/3GPP TS 24.008 and table 10.5.154A/3GPP TS 24.008.

The *APN rate control parameters* container contents can be 1 octet long or 4 octets long. If the *APN rate control parameters* container contents is longer than 4 octets, the 5th octet and later octets are ignored.

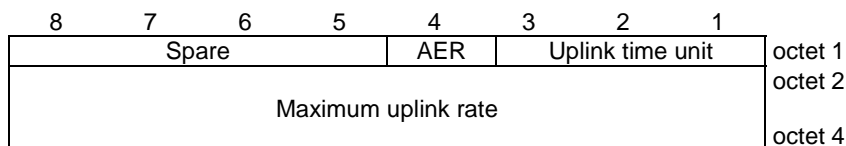

Figure 10.5.136A/3GPP TS 24.008: *APN rate control parameters*

Table 10.5.154A/3GPP TS 24.008: APN rate control parameters

Additional exception reports (AER) (octet 1)			
Bit			
4			
0	Additional exception reports at maximum rate reached are not allowed		
1	Additional exception reports at maximum rate reached are allowed		
Uplink time unit (octet 1)			
Bit			
3	2	1	
0	0	0	unrestricted
0	0	1	minute
0	1	0	hour
0	1	1	day
1	0	0	week
All other values shall be interpreted as 000 by this version of the protocol.			
Maximum uplink rate (octet 2 to octet 4) is a binary coded representation of the maximum number of messages the UE is restricted to send per time unit. The time unit is indicated in the uplink time unit. If the uplink time unit is set to "unrestricted", the maximum uplink data volume the UE can send is not restricted.			

10.5.6.3.3 Additional APN rate control parameters for exception data

The purpose of the *Additional APN rate control parameters for exception data* container contents is to indicate the additional APN rate control parameters for exception data.

The *Additional APN rate control parameters for exception data* container contents are coded as shown in figure 10.5.6.3.3-1/3GPP TS 24.008 and table 10.5.6.3.3-1/3GPP TS 24.008.

The *Additional APN rate control parameters for exception data* container contents can be 1 octet long or 3 octets long. If the *Additional APN rate control parameters for exception data* container contents is longer than 3 octets, the 4th octet and later octets are ignored.

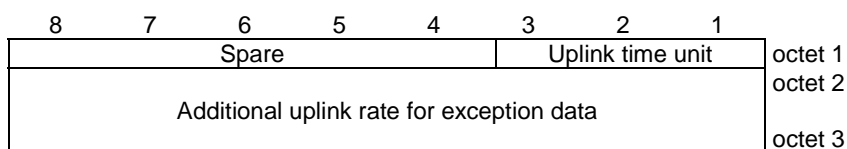

Figure 10.5.6.3.3-1/3GPP TS 24.008: Additional APN rate control parameters for exception data

Table 10.5.6.3.3-1/3GPP TS 24.008: Additional APN rate control parameters for exception data

Uplink time unit (octet 1)			
Bit			
3		2	1
0	0	0	unrestricted
0	0	1	minute
0	1	0	hour
0	1	1	day
1	0	0	week
All other values shall be interpreted as 000 by this version of the protocol.			
Additional uplink rate for exception data (octet 2 to octet 3) is a binary coded representation of the maximum number of messages for exception data the UE is restricted to send per time unit. The time unit is indicated in the uplink time unit. If the uplink time unit is set to "unrestricted", the maximum additional uplink rate volume for exception data the UE can send is not restricted.			

10.5.6.3.4 Small data rate control parameters

See subclause 10.5.6.3.2 in current specification.

10.5.6.3.5 Additional small data rate control parameters for exception data

See subclause 10.5.6.3.3 in current specification.

10.5.6.3.6 Initial small data rate control parameters

The purpose of the *Initial small data rate control parameters* container contents is to indicate the Initial small data rate control parameters.

The *Initial small data rate control parameters* container contents are coded as shown in figure 10.5.6.3.6-1/3GPP TS 24.008 and table 10.5.6.3.6-1/3GPP TS 24.008.

The *Initial small data rate control parameters* container contents is 7 octets long. If the *Initial small data rate control parameters* container contents is longer than 7 octets, the 8th octet and later octets are ignored.

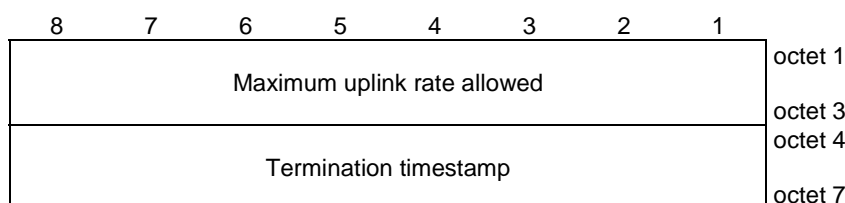

Figure 10.5.6.3.6-1/3GPP TS 24.008: *Initial small data rate control parameters*

Table 10.5.6.3.6-1/3GPP TS 24.008: *Initial small data rate control parameters*

<p>Maximum uplink rate allowed (octet 1 to octet 3) is a binary coded representation of the maximum allowed number of messages the UE is allowed to send before the validity period of the initial small data rate control parameters expires.</p> <p>Termination timestamp (octet 4 to octet 7) is a binary coded representation of the UTC time when the validity period of the initial small data rate control parameters expires. Octets 4 to 7 are encoded in the same format as the first four octets of the 64-bit timestamp format as defined in clause 6 of IETF RFC 5905 [169].</p> <p>NOTE: The encoding is defined as the time in seconds relative to 00:00:00 on 1 January 1900.</p>

10.5.6.3.7 Initial additional small data rate control for exception data parameters

See subclause 10.5.6.3.6 in current specification.

10.5.6.3.8 Initial APN rate control parameters

See subclause 10.5.6.3.6 in current specification.

10.5.6.3.9 Initial additional APN rate control for exception data parameters

See subclause 10.5.6.3.6 in current specification.

10.5.6.3A Extended protocol configuration options

The purpose of the *extended protocol configuration options* information element is to:

- transfer external network protocol options associated with a PDP context activation, and

- transfer additional (protocol) data (e.g. configuration parameters, error codes or messages/events) associated with an external protocol or an application.

The *extended protocol configuration options* is a type 6 information element with a minimum length of 4 octets and a maximum length of 65538 octets.

The *extended protocol configuration options* information element is coded as shown in figure 10.5.6.3A.1 and table 10.5.6.3A.1.

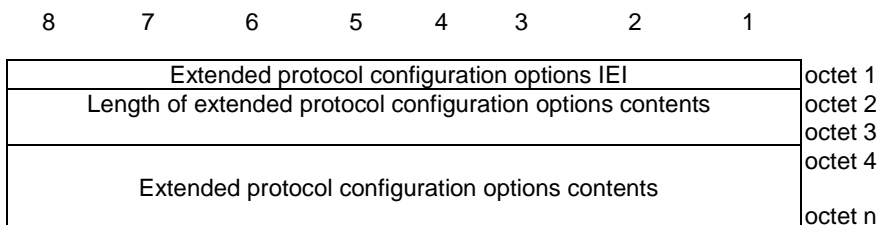

Figure 10.5.6.3A.1: Extended protocol configuration options information element

Table 10.5.6.3A.1: Extended protocol configuration options information element

Extended protocol configuration options contents (octet 4 to octet n); Max value of 65535 octets The contents of extended protocol configuration options is coded as octet 3 and above of protocol configuration options IE shown in subclause 10.5.6.3.

10.5.6.4 Packet data protocol address

The purpose of the *packet data protocol address* information element is to identify an address associated with a PDP.

The *packet data protocol address* is a type 4 information element with minimum length of 4 octets and a maximum length of 24 octets.

The *packet data protocol address* information element is coded as shown in figure 10.5.137/3GPP TS 24.008 and table 10.5.155/3GPP TS 24.008.

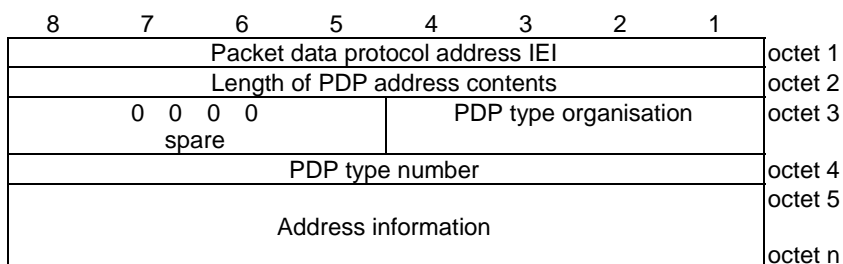

Figure 10.5.137/3GPP TS 24.008: Packet data protocol address information element

Table 10.5.155/3GPP TS 24.008: Packet data protocol address information element

Length of PDP address contents (octet 2) If the value of octet 2 equals 0000 0010, then: - No PDP address is included in this information element; and
--

<p>- If the PDP type is IP, dynamic addressing is applicable.</p> <p>NOTE: For PPP no address is required in this information element.</p> <p>PDP type organisation (octet 3)</p> <p>Bits</p> <p>4 3 2 1</p> <p>In MS to network direction :</p> <p>0 0 0 0 ETSI allocated address</p> <p>0 0 0 1 IETF allocated address</p> <p>1 1 1 1 Empty PDP type</p> <p>All other values are reserved.</p> <p>In network to MS direction :</p> <p>0 0 0 0 ETSI allocated address</p> <p>0 0 0 1 IETF allocated address</p> <p>All other values are reserved.</p> <p>If bits 4,3,2,1 of octet 3 are coded 0 0 0 0</p> <p>PDP type number value (octet 4)</p> <p>Bits</p> <p>8 7 6 5 4 3 2 1</p> <p>0 0 0 0 0 0 0 0 Reserved, used in earlier version of this protocol</p> <p>0 0 0 0 0 0 0 1 PDP-type PPP</p> <p>0 0 0 0 0 0 1 0 non IP</p> <p>All other values are reserved in this version of the protocol.</p> <p>If bits 4,3,2,1 of octet 3 are coded 0 0 0 1</p> <p>PDP type number value (octet 4)</p> <p>Bits</p> <p>8 7 6 5 4 3 2 1</p> <p>0 0 1 0 0 0 0 1 IPv4 address</p> <p>0 1 0 1 0 1 1 1 IPv6 address</p> <p>1 0 0 0 1 1 0 1 IPv4v6 address</p> <p>All other values shall be interpreted as IPv4 address in this version of the protocol.</p> <p>In MS to network direction:</p> <p>If bits 4,3,2,1 of octet 3 are coded 1 1 1 1</p> <p>PDP type number value (octet 4)</p> <p>bits 8 to 1 are spare and shall be coded all 0.</p> <p>Octet 3, bits 8, 7, 6, and 5 are spare and shall be coded all 0.</p>

If PDP type number indicates IPv4, the Address information in octet 5 to octet 8 contains the IPv4 address. Bit 8 of octet 5 represents the most significant bit of the IP address and bit 1 of octet 8 the least significant bit.

If PDP type number indicates IPv6, the Address information in octet 5 to octet 20 contains the IPv6 address. Bit 8 of octet 5 represents the most significant bit of the IP address and bit 1 of octet 20 the least significant bit.

If PDP type number indicates IPv4v6:

The Address information in octet 5 to octet 8 contains the IPv4 address. Bit 8 of octet 5 represents the most significant bit of the IP address and bit 1 of octet 8 the least significant bit.

The Address information in octet 9 to octet 24 contains the IPv6 address. Bit 8 of octet 9 represents the most significant bit of the IP address and bit 1 of octet 24 the least significant bit.

If PDP type number indicates IPv4 or IPv4v6 and DHCPv4 is to be used to allocate the IPv4 address, the IPv4 address shall be coded as 0.0.0.0.

10.5.6.5 Quality of service

The purpose of the *quality of service* information element is to specify the QoS parameters for a PDP context.

The QoS IE is defined to allow backward compatibility to earlier version of Session Management Protocol.

The *quality of service* is a type 4 information element with a minimum length of 14 octets and a maximum length of 22 octets. The QoS requested by the MS shall be encoded both in the QoS attributes specified in octets 3-5 and in the QoS attributes specified in octets 6-14.

In the MS to network direction and in the network to MS direction the following applies:

- Octets 15-22 are optional. If octet 15 is included, then octet 16 shall also be included, and octets 17-22 may be included.
- If octet 17 is included, then octet 18 shall also be included and octets 19-22 may be included.
- If octet 19 is included, then octet 20 shall also be included, and octets 21 and 22 may be included.
- If octet 21 is included, then octet 22 shall also be included.
- A QoS IE received without octets 6-22, without octets 14-22, without octets 15-22, without octets 17-22, without octets 19-22 or without octets 21-22 shall be accepted by the receiving entity.

NOTE: This behavior is required for interworking with entities supporting an earlier version of the protocol, or when the Maximum bit rate for downlink or for downlink and uplink is negotiated to a value lower than 8700 kbps.

The *quality of service* information element is coded as shown in figure 10.5.138/3GPP TS 24.008 and table 10.5.156/3GPP TS 24.008.

8	7	6	5	4	3	2	1	
Quality of service IEI								octet 1
Length of quality of service IE								octet 2
0 0 spare		Delay class			Reliability class			octet 3
Peak throughput				0 spare		Precedence class		octet 4
0 0 0 spare			Mean throughput					octet 5
Traffic Class			Delivery order		Delivery of erroneous SDU			octet 6
Maximum SDU size								octet 7
Maximum bit rate for uplink								octet 8
Maximum bit rate for downlink								octet 9
Residual BER				SDU error ratio				octet 10
Transfer delay						Traffic Handling priority		octet 11
Guaranteed bit rate for uplink								octet 12
Guaranteed bit rate for downlink								octet 13
0 0 0 spare			Signal- ling Indicat- ion	Source Statistics Descriptor				octet 14
Maximum bit rate for downlink (extended)								octet 15
Guaranteed bit rate for downlink (extended)								octet 16
Maximum bit rate for uplink (extended)								octet 17
Guaranteed bit rate for uplink (extended)								octet 18
Maximum bit rate for downlink (extended-2)								octet 19
Guaranteed bit rate for downlink (extended-2)								octet 20
Maximum bit rate for uplink (extended-2)								octet 21
Guaranteed bit rate for uplink (extended-2)								octet 22

Figure 10.5.138/3GPP TS 24.008: *Quality of service* information element

Table 10.5.156/3GPP TS 24.008: Quality of service information element

Reliability class, octet 3 (see 3GPP TS 23.107 [81])
Bits
3 2 1
In MS to network direction:
0 0 0 Subscribed reliability class
In network to MS direction:
0 0 0 Reserved
In MS to network direction and in network to MS direction:
0 0 1 Unused. If received, it shall be interpreted as '010' (Note)
0 1 0 Unacknowledged GTP; Acknowledged LLC and RLC, Protected data
0 1 1 Unacknowledged GTP and LLC; Acknowledged RLC, Protected data
1 0 0 Unacknowledged GTP, LLC, and RLC, Protected data
1 0 1 Unacknowledged GTP, LLC, and RLC, Unprotected data
1 1 1 Reserved
All other values are interpreted as <i>Unacknowledged GTP and LLC; Acknowledged RLC, Protected data</i> in this version of the protocol.
If network supports EPS, then it should not assign Reliability class value '010'.
NOTE: this value was allocated in earlier versions of the protocol.
Delay class, octet 3 (see 3GPP TS 22.060 [73] and 3GPP TS 23.107 [81])
Bits
6 5 4
In MS to network direction:
0 0 0 Subscribed delay class
In network to MS direction:
0 0 0 Reserved
In MS to network direction and in network to MS direction:
0 0 1 Delay class 1
0 1 0 Delay class 2
0 1 1 Delay class 3
1 0 0 Delay class 4 (best effort)
1 1 1 Reserved

All other values are interpreted as *Delay class 4 (best effort)* in this version of the protocol.

Bit 7 and 8 of octet 3 are spare and shall be coded all 0.

Precedence class, octet 4 (see 3GPP TS 23.107 [81])

Bits

3 2 1

In MS to network direction:

0 0 0 Subscribed precedence

In network to MS direction:

0 0 0 Reserved

In MS to network direction and in network to MS direction:

0 0 1 High priority

0 1 0 Normal priority

0 1 1 Low priority

1 1 1 Reserved

All other values are interpreted as *Normal priority* in this version of the protocol.

Bit 4 of octet 4 is spare and shall be coded as 0.

Peak throughput, octet 4 (see 3GPP TS 23.107 [81])

This field is the binary representation of the Peak Throughput Class (1 to 9). The corresponding peak throughput to each peak throughput class is indicated.

Bits

8 7 6 5

In MS to network direction:

0 0 0 0 Subscribed peak throughput

In network to MS direction:

0 0 0 0 Reserved

In MS to network direction and in network to MS direction:

0 0 0 1 Up to 1 000 octet/s

0 0 1 0 Up to 2 000 octet/s

0 0 1 1 Up to 4 000 octet/s

0 1 0 0 Up to 8 000 octet/s

0 1 0 1 Up to 16 000 octet/s

0 1 1 0 Up to 32 000 octet/s

0 1 1 1 Up to 64 000 octet/s

1 0 0 0 Up to 128 000 octet/s

1 0 0 1 Up to 256 000 octet/s

1 1 1 1 Reserved

All other values are interpreted as *Up to 1 000 octet/s* in this version of the protocol.

Mean throughput, octet 5 (see 3GPP TS 23.107 [81])

This field is the binary representation of the Mean Throughput Class (1 to 18; mean throughput class 30 is reserved and 31 is best effort). The corresponding mean throughput to each mean throughput class is indicated.

Bits

5 4 3 2 1

In MS to network direction:

0 0 0 0 Subscribed mean throughput

In network to MS direction:

0 0 0 0 Reserved

In MS to network direction and in network to MS direction:

0 0 0 1 100 octet/h

0 0 0 1 0 200 octet/h

0 0 0 1 1 500 octet/h

0 0 1 0 0 1 000 octet/h

0 0 1 0 1 2 000 octet/h

0 0 1 1 0 5 000 octet/h

0 0 1 1 1 10 000 octet/h

0 1 0 0 0 20 000 octet/h

0 1 0 0 1 50 000 octet/h

0 1 0 1 0 100 000 octet/h

0 1 0 1 1 200 000 octet/h

0 1 1 0 0 500 000 octet/h

0 1 1 0 1 1 000 000 octet/h

0 1 1 1 0 2 000 000 octet/h

0 1 1 1 1 5 000 000 octet/h

1 0 0 0 0 10 000 000 octet/h

1 0 0 0 1 20 000 000 octet/h

1 0 0 1 0 50 000 000 octet/h

1 1 1 1 0 Reserved

1 1 1 1 1 Best effort

The value Best effort indicates that throughput shall be made available to the MS on a per need and availability basis.

All other values are interpreted as *Best effort* in this version of the protocol.

Bits 8 to 6 of octet 5 are spare and shall be coded all 0.

Delivery of erroneous SDUs, octet 6 (see 3GPP TS 23.107 [81])

Bits

3 2 1

In MS to network direction:

0 0 0 Subscribed delivery of erroneous SDUs

In network to MS direction:

0 0 0 Reserved

In MS to network direction and in network to MS direction:

0 0 1 No detect ('-')

0 1 0 Erroneous SDUs are delivered ('yes')

0 1 1 Erroneous SDUs are not delivered ('no')

1 1 1 Reserved

The network shall map all other values not explicitly defined onto one of the values defined in this version of the protocol.

The network shall return a negotiated value which is explicitly defined in this version of this protocol.

The MS shall consider all other values as reserved.

Delivery order, octet 6 (see 3GPP TS 23.107 [81])

Bits

5 4 3

In MS to network direction:

0 0 Subscribed delivery order

In network to MS direction:

0 0 Reserved

In MS to network direction and in network to MS direction:

0 1 With delivery order ('yes')

1 0 Without delivery order ('no')

1 1 Reserved

Traffic class, octet 6 (see 3GPP TS 23.107 [81])

Bits

8 7 6

In MS to network direction:

0 0 0 Subscribed traffic class

In network to MS direction:

0 0 0 Reserved

In MS to network direction and in network to MS direction:

0 0 1 Conversational class

0 1 0 Streaming class

0 1 1 Interactive class

1 0 0 Background class

1 1 1 Reserved

The network shall map all other values not explicitly defined onto one of the values defined in this version of the protocol. The network shall return a negotiated value which is explicitly defined in this version of this protocol.

The MS shall consider all other values as reserved.

Maximum SDU size, octet 7 (see 3GPP TS 23.107 [81])

In MS to network direction:

0 0 0 0 0 0 0 0 Subscribed maximum SDU size

1 1 1 1 1 1 1 1 Reserved

In network to MS direction:

0 0 0 0 0 0 0 0 Reserved

1 1 1 1 1 1 1 1 Reserved

In MS to network direction and in network to MS direction:

For values in the range 00000001 to 10010110 the Maximum SDU size value is binary coded in 8 bits, using a granularity of 10 octets, giving a range of values from 10 octets to 1500 octets.

Values above 10010110 are as below:

1 0 0 1 0 1 1 1 1502 octets

1 0 0 1 1 0 0 0 1510 octets

1 0 0 1 1 0 0 1 1520 octets

The network shall map all other values not explicitly defined onto one of the values defined in this version of the protocol. The network shall return a negotiated value which is explicitly defined in this version of this protocol.

The MS shall consider all other values as reserved.

Maximum bit rate for uplink, octet 8

Bits

8 7 6 5 4 3 2 1

In MS to network direction:

0 0 0 0 0 0 0 0 Subscribed maximum bit rate for uplink

In network to MS direction:

0 0 0 0 0 0 0 0 Reserved

In MS to network direction and in network to MS direction:

0 0 0 0 0 0 0 1 The maximum bit rate is binary coded in 8 bits, using a granularity of 1 kbps

0 0 1 1 1 1 1 1 giving a range of values from 1 kbps to 63 kbps in 1 kbps increments.

0 1 0 0 0 0 0 0 The maximum bit rate is 64 kbps + ((the binary coded value in 8 bits – 01000000) * 8 kbps)

0 1 1 1 1 1 1 1 giving a range of values from 64 kbps to 568 kbps in 8 kbps increments.

1 0 0 0 0 0 0 0 The maximum bit rate is 576 kbps + ((the binary coded value in 8 bits – 10000000) * 64 kbps)

1 1 1 1 1 1 1 0 giving a range of values from 576 kbps to 8640 kbps in 64 kbps increments.

1 1 1 1 1 1 1 1 0kbps

If the sending entity wants to indicate a Maximum bit rate for uplink higher than 8640 kbps, it shall set octet 8 to "11111110", i.e. 8640 kbps, and shall encode the value for the Maximum bit rate in octet 17.

The network shall map all other values not explicitly defined onto one of the values defined in this version of the protocol. The network shall return a negotiated value which is explicitly defined in this version of the protocol.

Maximum bit rate for downlink, octet 9 (see 3GPP TS 23.107 [81])

Coding is identical to that of Maximum bit rate for uplink.

If the sending entity wants to indicate a Maximum bit rate for downlink higher than 8640 kbps, it shall set octet 9 to "11111110", i.e. 8640 kbps, and shall encode the value for the Maximum bit rate in octet 15.

The network shall map all other values not explicitly defined onto one of the values defined in this version of the protocol. The network shall return a negotiated value which is explicitly defined in this version of the protocol.

In this version of the protocol, for messages specified in the present document, the sending entity shall not request 0 kbps for both the Maximum bitrate for downlink and the Maximum bitrate for uplink at the same time. Any entity receiving a request for 0 kbps in both the Maximum bitrate for downlink and the Maximum bitrate for uplink shall consider that as a syntactical error (see clause 8).

Residual Bit Error Rate (BER), octet 10 (see 3GPP TS 23.107 [81])

Bits

8 7 6 5

In MS to network direction:

0 0 0 0 Subscribed residual BER

In network to MS direction:

0 0 0 0 Reserved

In MS to network direction and in network to MS direction:

The Residual BER value consists of 4 bits. The range is from $5 \cdot 10^{-2}$ to $6 \cdot 10^{-8}$.

0 0 0 1 $5 \cdot 10^{-2}$

0 0 1 0 $1 \cdot 10^{-2}$

0 0 1 1 $5 \cdot 10^{-3}$

0 1 0 0 $4 \cdot 10^{-3}$

0 1 0 1 $1 \cdot 10^{-3}$

0 1 1 0 $1 \cdot 10^{-4}$

0 1 1 1 $1 \cdot 10^{-5}$

1 0 0 0 $1 \cdot 10^{-6}$

1 0 0 1 $6 \cdot 10^{-8}$

1 1 1 1 Reserved

The network shall map all other values not explicitly defined onto one of the values defined in this version of the protocol. The network shall return a negotiated value which is explicitly defined in this version of the protocol.

The MS shall consider all other values as reserved.

SDU error ratio, octet 10 (see 3GPP TS 23.107 [81])

Bits

4 3 2 1

In MS to network direction:

0 0 0 0 Subscribed SDU error ratio

In network to MS direction:

0 0 0 0 Reserved

In MS to network direction and in network to MS direction:

The SDU error ratio value consists of 4 bits. The range is is from $1 \cdot 10^{-1}$ to $1 \cdot 10^{-6}$.

0 0 0 1 $1 \cdot 10^{-2}$

0 0 1 0 $7 \cdot 10^{-3}$

0 0 1 1 $1 \cdot 10^{-3}$

0 1 0 0 $1 \cdot 10^{-4}$

0 1 0 1 $1 \cdot 10^{-5}$

0 1 1 0 $1 \cdot 10^{-6}$

0 1 1 1 $1 \cdot 10^{-1}$

1 1 1 1 Reserved

The network shall map all other values not explicitly defined onto one of the values defined in this version of the protocol. The network shall return a negotiated value which is explicitly defined in this version of the protocol.

The MS shall consider all other values as reserved.

Traffic handling priority, octet 11 (see 3GPP TS 23.107 [81])

Bits

2 1

In MS to network direction:

0 0 Subscribed traffic handling priority

In network to MS direction:

0 0 Reserved

In MS to network direction and in network to MS direction:

0 1 Priority level 1

1 0 Priority level 2

1 1 Priority level 3

The Traffic handling priority value is ignored if the Traffic Class is Conversational class, Streaming class or Background class.

Transfer delay, octet 11 (See 3GPP TS 23.107 [81])

Bits

8 7 6 5 4 3

In MS to network direction:

0 0 0 0 0 0 Subscribed transfer delay

In network to MS direction:

0 0 0 0 0 0 Reserved

In MS to network direction and in network to MS direction:

0 0 0 0 0 1 The Transfer delay is binary coded in 6 bits, using a granularity of 10 ms

0 0 1 1 1 1 giving a range of values from 10 ms to 150 ms in 10 ms increments

0 1 0 0 0 0 The transfer delay is 200 ms + ((the binary coded value in 6 bits – 010000) * 50 ms)

0 1 1 1 1 1 giving a range of values from 200 ms to 950 ms in 50ms increments

1 0 0 0 0 0 The transfer delay is 1000 ms + ((the binary coded value in 6 bits – 100000) * 100 ms)

1 1 1 1 1 0 giving a range of values from 1000 ms to 4000 ms in 100ms increments

1 1 1 1 1 1 Reserved

The Transfer delay value is ignored if the Traffic Class is Interactive class or Background class.

Guaranteed bit rate for uplink, octet 12 (See 3GPP TS 23.107 [81])

Coding is identical to that of Maximum bit rate for uplink.

If the sending entity wants to indicate a Guaranteed bit rate for uplink higher than 8640 kbps, it shall set octet 12 to "11111110", i.e. 8640 kbps, and shall encode the value for the Guaranteed bit rate in octet 18.

The network shall map all other values not explicitly defined onto one of the values defined in this version of the protocol. The network shall return a negotiated value which is explicitly defined in this version of the protocol.

The Guaranteed bit rate for uplink value is ignored if the Traffic Class is Interactive class or Background class, or Maximum bit rate for uplink is set to 0 kbps.

Guaranteed bit rate for downlink, octet 13(See 3GPP TS 23.107 [81])

Coding is identical to that of Maximum bit rate for uplink.

If the sending entity wants to indicate a Guaranteed bit rate for downlink higher than 8640 kbps, it shall set octet 13 to "11111110", i.e. 8640 kbps, and shall encode the value for the Guaranteed bit rate in octet 16.

The network shall map all other values not explicitly defined onto one of the values defined in this version of the protocol. The network shall return a negotiated value which is explicitly defined in this version of the protocol.

The Guaranteed bit rate for downlink value is ignored if the Traffic Class is Interactive class or Background class, or Maximum bit rate for downlink is set to 0 kbps.

Source Statistics Descriptor, octet 14 (see 3GPP TS 23.107 [81])

Bits

4 3 2 1

In MS to network direction

0 0 0 0 unknown

0 0 0 1 speech

The network shall consider all other values as unknown.

In network to MS direction

Bits 4 to 1 of octet 14 are spare and shall be coded all 0.

The Source Statistics Descriptor value is ignored if the Traffic Class is Interactive class or Background class.

Signalling Indication, octet 14 (see 3GPP TS 23.107 [81])

Bit

5

In MS to network direction and in network to MS direction:

0 Not optimised for signalling traffic

1 Optimised for signalling traffic

If set to '1' the QoS of the PDP context is optimised for signalling

The Signalling Indication value is ignored if the Traffic Class is Conversational class, Streaming class or Background class.

Bits 8 to 6 of octet 14 are spare and shall be coded all 0.

Maximum bit rate for downlink (extended), octet 15

Bits

8 7 6 5 4 3 2 1

In MS to network direction and in network to MS direction:

0 0 0 0 0 0 0 0 Use the value indicated by the Maximum bit rate for downlink in octet 9.

For all other values: Ignore the value indicated by the Maximum bit rate for downlink in octet 9 and use the following value:

0 0 0 0 0 0 0 1 The maximum bit rate is 8600 kbps + ((the binary coded value in 8 bits) * 100 kbps),
0 1 0 0 1 0 1 0 giving a range of values from 8700 kbps
to 16000 kbps in 100 kbps increments.

0 1 0 0 1 0 1 1 The maximum bit rate is 16 Mbps + ((the binary coded value in 8 bits - 01001010) * 1 Mbps),
1 0 1 1 1 0 1 0 giving a range of values from 17 Mbps to 128 Mbps in 1 Mbps increments.

1 0 1 1 1 0 1 1 The maximum bit rate is 128 Mbps + ((the binary coded value in 8 bits - 10111010) * 2 Mbps),
1 1 1 1 1 0 1 0 giving a range of values from 130 Mbps to 256 Mbps in 2 Mbps increments.

If the sending entity wants to indicate a Maximum bit rate for downlink higher than 256 Mbps, it shall set octet 15 to "11111010", i.e. 256 Mbps, and shall encode the value for the maximum bit rate in octet 19.

The network shall map all other values not explicitly defined onto one of the values defined in this version of the protocol. The network shall return a negotiated value which is explicitly defined in this version of the protocol.

Guaranteed bit rate for downlink (extended), octet 16

Bits

8 7 6 5 4 3 2 1

In MS to network direction and in network to MS direction:

0 0 0 0 0 0 0 0 Use the value indicated by the Guaranteed bit rate for downlink in octet 13.

For all other values: Ignore the value indicated by the Guaranteed bit rate for downlink in octet 9 and use the following value:

0 0 0 0 0 0 0 1 The guaranteed bit rate is 8600 kbps + ((the binary coded value in 8 bits) * 100 kbps),
0 1 0 0 1 0 1 0 giving a range of values from 8700 kbps to 16000 kbps in 100 kbps increments.

0 1 0 0 1 0 1 1 The guaranteed bit rate is 16 Mbps + ((the binary coded value in 8 bits - 01001010) * 1 Mbps),
1 0 1 1 1 0 1 0 giving a range of values from 17 Mbps to 128 Mbps in 1 Mbps increments.

1 0 1 1 1 0 1 1 The guaranteed bit rate is 128 Mbps + ((the binary coded value in 8 bits - 10111010) * 2 Mbps),
 1 1 1 1 1 0 1 0 giving a range of values from 130 Mbps to 256 Mbps in 2 Mbps increments.

If the sending entity wants to indicate a Guaranteed bit rate for downlink higher than 256 Mbps, it shall set octet 16 to "11111010", i.e. 256 Mbps, and shall encode the value for the guaranteed bit rate in octet 20.

The network shall map all other values not explicitly defined onto one of the values defined in this version of the protocol. The network shall return a negotiated value which is explicitly defined in this version of the protocol.

Maximum bit rate for uplink (extended), octet 17

This field is an extension of the Maximum bit rate for uplink in octet 8. The coding is identical to that of the Maximum bit rate for downlink (extended).

If the sending entity wants to indicate a Maximum bit rate for uplink higher than 256 Mbps, it shall set octet 17 to "11111010", i.e. 256 Mbps, and shall encode the value for the maximum bit rate in octet 21.

The network shall map all other values not explicitly defined onto one of the values defined in this version of the protocol. The network shall return a negotiated value which is explicitly defined in this version of the protocol.

Guaranteed bit rate for uplink (extended), octet 18

This field is an extension of the Guaranteed bit rate for uplink in octet 12. The coding is identical to that of the Guaranteed bit rate for downlink (extended).

If the sending entity wants to indicate a Guaranteed bit rate for uplink higher than 256 Mbps, it shall set octet 18 to "11111010", i.e. 256 Mbps, and shall encode the value for the guaranteed bit rate in octet 22.

The network shall map all other values not explicitly defined onto one of the values defined in this version of the protocol. The network shall return a negotiated value which is explicitly defined in this version of the protocol.

Maximum bit rate for downlink (extended-2), octet 19

Bits

8 7 6 5 4 3 2 1

In MS to network direction and in network to MS direction:

0 0 0 0 0 0 0 0 Use the value indicated by the Maximum bit rate for downlink in octet 9 and octet 15.

For all other values: Ignore the value indicated by the Maximum bit rate for downlink in octet 9 and octet 15 and use the following value:

0 0 0 0 0 0 0 1 The maximum bit rate is 256 Mbps + ((the binary coded value in 8 bits) * 4 Mbps),
 0 0 1 1 1 1 0 1 giving a range of values from 260 Mbps to 500 Mbps in 4 Mbps increments.

0 0 1 1 1 1 1 0 The maximum bit rate is 500 Mbps + ((the binary coded value in 8 bits - 00111101) * 10 Mbps),
 1 0 1 0 0 0 0 1 giving a range of values from 510 Mbps to 1500 Mbps in 10 Mbps increments.

1 0 1 0 0 0 1 0 The maximum bit rate is 1500 Mbps + ((the binary coded value in 8 bits - 10100001) * 100 Mbps),
 1 1 1 1 0 1 1 0 giving a range of values from 1600 Mbps to 10 Gbps in 100 Mbps increments.

If the sending entity wants to indicate a Maximum bit rate for downlink higher than 10 Gbps, it shall set octet 19 to "11110110", i.e. 10 Gbps, and shall encode the value for the maximum bit rate in the extended quality of service information element specified in subclause 10.5.6.5B.

The network shall map all other values not explicitly defined onto one of the values defined in this version of the protocol. The network shall return a negotiated value which is explicitly defined in this version of the protocol.

The MS shall map all other values not explicitly defined onto the maximum value defined in this version of the protocol.

Guaranteed bit rate for downlink (extended-2), octet 20

Bits

8 7 6 5 4 3 2 1

In MS to network direction and in network to MS direction:

0 0 0 0 0 0 0 0 Use the value indicated by the Maximum bit rate for downlink in octet 13 and octet 16.

For all other values: Ignore the value indicated by the Maximum bit rate for downlink in octet 13 and octet 16 and use the following value:

0 0 0 0 0 0 0 1 The guaranteed bit rate is 256 Mbps + ((the binary coded value in 8 bits) * 4 Mbps),

0 0 1 1 1 0 1 giving a range of values from 260 Mbps to 500 Mbps in 4 Mbps increments.

0 0 1 1 1 1 0 The guaranteed bit rate is 500 Mbps + ((the binary coded value in 8 bits - 00111101) * 10 Mbps),
 1 0 1 0 0 0 1 giving a range of values from 510 Mbps to 1500 Mbps in 10 Mbps increments.

1 0 1 0 0 0 1 The guaranteed bit rate is 1500 Mbps + ((the binary coded value in 8 bits - 10100001) * 100 Mbps),
 1 1 1 1 0 1 1 0 giving a range of values from 1600 Mbps to 10 Gbps in 100 Mbps increments.

If the sending entity wants to indicate a Guaranteed bit rate for downlink higher than 10 Gbps, it shall set octet 20 to "11110110", i.e. 10 Gbps, and shall encode the value for the guaranteed bit rate in the extended quality of service information element specified in subclause 10.5.6.5B.

The network shall map all other values not explicitly defined onto one of the values defined in this version of the protocol. The network shall return a negotiated value which is explicitly defined in this version of the protocol.

The MS shall map all other values not explicitly defined onto the maximum value defined in this version of the protocol.

Maximum bit rate for uplink (extended-2), octet 21

This field is an extension of the Maximum bit rate for uplink in octet 17. The coding is identical to that of the Maximum bit rate for downlink (extended 2).

If the sending entity wants to indicate a Maximum bit rate for uplink higher than 10 Gbps, it shall set octet 21 to "11110110", i.e. 10 Gbps, and shall encode the value for the maximum bit rate in the extended quality of service information element specified in subclause 10.5.6.5B.

The network shall map all other values not explicitly defined onto one of the values defined in this version of the protocol. The network shall return a negotiated value which is explicitly defined in this version of the protocol.

The MS shall map all other values not explicitly defined onto the maximum value defined in this version of the protocol.

Guaranteed bit rate for uplink (extended-2), octet 22

This field is an extension of the Guaranteed bit rate for uplink in octet 18. The coding is identical to that of the Guaranteed bit rate for downlink (extended-2).

If the sending entity wants to indicate a Guaranteed bit rate for uplink higher than 10 Gbps, it shall set octet 22 to "11110110", i.e. 10 Gbps, and shall encode the value for the guaranteed bit rate in the extended quality of service information element specified in subclause 10.5.6.5B.

The network shall map all other values not explicitly defined onto one of the values defined in this version of the protocol. The network shall return a negotiated value which is explicitly defined in this version of the protocol.

The MS shall map all other values not explicitly defined onto the maximum value defined in this version of the protocol.

10.5.6.5A Re-attempt indicator

The purpose of the *Re-attempt indicator* information element is to indicate a condition under which the MS is allowed, in the current PLMN for the same APN, to re-attempt an EPS session management procedure (see 3GPP TS 24.301 [120]) corresponding to the session management procedure which was rejected by the network.

The *Re-attempt indicator* information element is coded as shown in figure 10.5.6.5A and table 10.5.6.5A.

8	7	6	5	4	3	2	1	
<i>Reattempt indicator IEI</i>								octet 1
<i>Length of Reattempt indicator contents</i>								octet 2
0 Spare	0 Spare	0 Spare	0 Spare	0 Spare	0 Spare	EPLM NC value	RATC value	octet 3

Figure 10.5.6.5A: Re-attempt indicator information element

Table 10.5.6.5A: Re-attempt indicator information element

Re-attempt indicator	
RATC (octet 3, bit 1)	
0	MS is allowed to re-attempt the procedure in S1 mode
1	MS is not allowed to re-attempt the procedure in S1 mode
EPLMNC (octet 3, bit 2)	
0	MS is allowed to re-attempt the procedure in an equivalent PLMN
1	MS is not allowed to re-attempt the procedure in an equivalent PLMN
Bits 3 to 8 of octet 3 are spare and shall be encoded as zero.	

10.5.6.5B Extended quality of service

See subclause 9.9.4.30 in 3GPP TS 24.301 [120].

NOTE: This IE has been added for protocol alignment with EPS in this version of the specification. This IE is used only to indicate bit rates higher than 10 Gbps and such bit rates are currently not supported.

10.5.6.6 SM cause

The purpose of the *SM cause* information element is to indicate the reason why a session management request is rejected.

The *SM cause* is a type 3 information element with 2 octets length.

The *SM cause* information element is coded as shown in figure 10.5.139/3GPP TS 24.008 and table 10.5.157/3GPP TS 24.008.

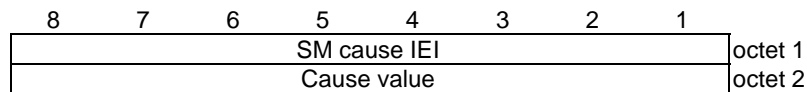

Figure 10.5.139/3GPP TS 24.008: *SM cause* information element

Table 10.5.157/3GPP TS 24.008: *SM cause* information element

Cause value (octet 2)	
Bits	
8	7 6 5 4 3 2 1
0 0 0 0 1 0 0 0	Operator Determined Barring
0 0 0 1 1 0 0 0	MBMS bearer capabilities insufficient for the service
0 0 0 1 1 0 0 1	LLC or SNDCP failure(A/Gb mode only)
0 0 0 1 1 0 1 0	Insufficient resources
0 0 0 1 1 0 1 1	Missing or unknown APN
0 0 0 1 1 1 0 0	Unknown PDP address or PDP type
0 0 0 1 1 1 0 1	User authentication failed
0 0 0 1 1 1 1 0	Activation rejected by GGSN, Serving GW or PDN GW
0 0 0 1 1 1 1 1	Activation rejected, unspecified
0 0 1 0 0 0 0 0	Service option not supported
0 0 1 0 0 0 0 1	Requested service option not subscribed
0 0 1 0 0 0 1 0	Service option temporarily out of order
0 0 1 0 0 0 1 1	NSAPI already used (not sent)
0 0 1 0 0 1 0 0	Regular deactivation
0 0 1 0 0 1 0 1	QoS not accepted
0 0 1 0 0 1 1 0	Network failure
0 0 1 0 0 1 1 1	Reactivation requested
0 0 1 0 1 0 0 0	Feature not supported
0 0 1 0 1 0 0 1	Semantic error in the TFT operation
0 0 1 0 1 0 1 0	Syntactical error in the TFT operation
0 0 1 0 1 0 1 1	Unknown PDP context
0 0 1 0 1 1 0 0	Semantic errors in packet filter(s)
0 0 1 0 1 1 0 1	Syntactical errors in packet filter(s)
0 0 1 0 1 1 1 0	PDP context without TFT already activated
0 0 1 0 1 1 1 1	Multicast group membership time-out
0 0 1 1 0 0 0 0	Request rejected, BCM violation
0 0 1 1 0 0 1 0	PDP type IPv4 only allowed
0 0 1 1 0 0 1 1	PDP type IPv6 only allowed
0 0 1 1 1 0 0 1	PDP type IPv4v6 only allowed
0 0 1 1 1 0 1 0	PDP type non IP only allowed
0 0 1 1 1 0 1 0	Single address bearers only allowed
0 0 1 1 1 0 0 0	Collision with network initiated request
0 0 1 1 1 1 0 0	Bearer handling not supported
0 1 0 0 0 0 0 1	Maximum number of PDP contexts reached
0 1 0 0 0 1 0 0	Requested APN not supported in current RAT and PLMN combination
0 1 0 1 0 0 0 1	Invalid transaction identifier value
0 1 0 1 1 1 1 1	Semantically incorrect message
0 1 1 0 0 0 0 0	Invalid mandatory information
0 1 1 0 0 0 0 1	Message type non-existent or not implemented
0 1 1 0 0 0 1 0	Message type not compatible with the protocol state
0 1 1 0 0 0 1 1	Information element non-existent or not implemented
0 1 1 0 0 1 0 0	Conditional IE error
0 1 1 0 0 1 0 1	Message not compatible with the protocol state
0 1 1 0 1 1 1 1	Protocol error, unspecified
0 1 1 1 0 0 0 0	APN restriction value incompatible with active PDP context
0 1 1 1 0 0 0 1	Multiple accesses to a PDN connection not allowed

Any other value received by the mobile station shall be treated as 0010 0010, "Service option temporarily out of order". Any other value received by the network shall be treated as 0110 1111, "Protocol error, unspecified".

NOTE: The listed cause values are defined in Annex I

10.5.6.6A SM cause 2

The purpose of the *SM cause 2* information element is to provide further information when PDP context activation initiated by the mobile station is successful.

The *SM cause 2* is a type 4 information element with 3 octets length.

The *SM cause 2* information element is coded as shown in figure 10.5.139a/3GPP TS 24.008 and table 10.5.157a/3GPP TS 24.008.

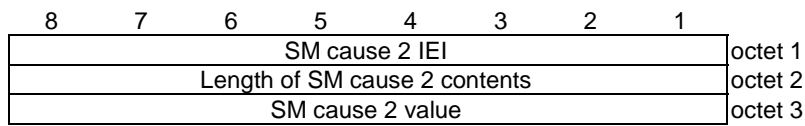

Figure 10.5.139a/3GPP TS 24.008: *SM cause 2* information element

Table 10.5.157a/3GPP TS 24.008: *SM cause 2* information element

SM cause 2 value is coded as octet 2 of the *SM cause* information element.

10.5.6.7 Linked TI

The purpose of the *Linked TI* information element is to specify the active PDP context from which the PDP address for the new PDP context could be derived by the network.

The *Linked TI* is a type 4 information element with a minimum length of 3 octets and a maximum length of 4 octets.

The *Linked TI* information element is coded as shown in figure 10.5.140/3GPP TS 24.008.

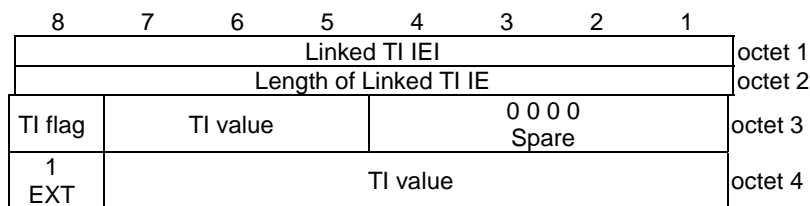

Figure 10.5.140/3GPP TS 24.008: *Linked TI* information element

The coding of the TI flag, the TI value and the EXT bit is defined in 3GPP TS 24.007[20].

10.5.6.8 Spare

10.5.6.9 LLC service access point identifier

The purpose of the *LLC service access point identifier* information element is to identify the service access point that is used for the GPRS data transfer at LLC layer.

The *LLC service access point identifier* is a type 3 information element with a length of 2 octets.

The value part of a *LLC service access point identifier* information element is coded as shown in figure 10.5.141/3GPP TS 24.008 and table 10.5.159/3GPP TS 24.008.

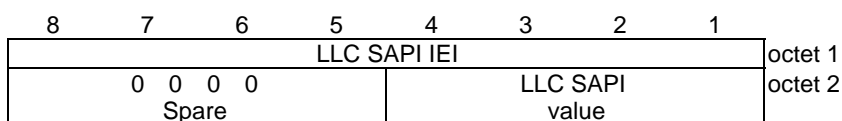

Figure 10.5.141/3GPP TS 24.008: *LLC service access point identifier* information element

Table 10.5.159/3GPP TS 24.008: LLC service access point identifier information element

LLC SAPI value (octet 2)	
Bit	
4 3 2 1	
0 0 0 0	LLC SAPI not assigned
0 0 1 1	SAPI 3
0 1 0 1	SAPI 5
1 0 0 1	SAPI 9
1 0 1 1	SAPI 11
All other values are reserved.	

10.5.6.10 Tear down indicator

The purpose of the *tear down indicator* information element is to indicate whether only the PDP context associated with this specific TI or all active PDP contexts sharing the same PDP address and APN as the PDP context associated with this specific TI shall be deactivated.

The *tear down indicator* is a type 1 information element.

The *tear down indicator* information element is coded as shown in figure 10.5.142/3GPP TS 24.008 and table 10.5.160/3GPP TS 24.008.

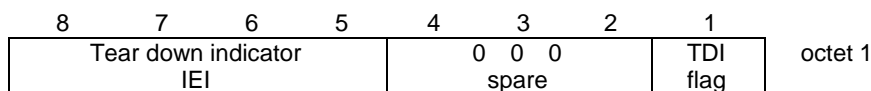
**Figure 10.5.142/3GPP TS 24.008: Tear down indicator information element****Table 10.5.160/3GPP TS 24.008: Tear down indicator information element**

Tear down indicator(TDI) flag (octet 1)	
Bit	
1	
0	tear down not requested
1	tear down requested

10.5.6.11 Packet Flow Identifier

The *Packet Flow Identifier (PFI)* information element indicates the Packet Flow Identifier for a Packet Flow Context.

The *Packet Flow Identifier* is a type 4 information element with 3 octets length.

The *Packet Flow Identifier* information element is coded as shown in figure 10.5.143/3GPP TS 24.008 and table 10.5.161/3GPP TS 24.008.

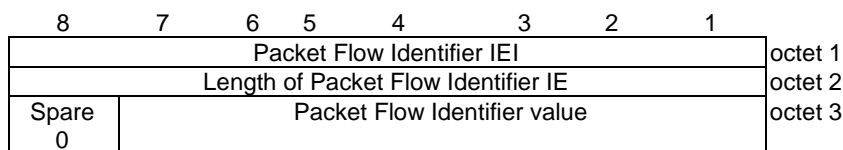

Figure 10.5.143/3GPP TS 24.008: *Packet Flow Identifier* information element

Table 10.5.161/3GPP TS 24.008: *Packet Flow Identifier* information element

Packet Flow Identifier value (octet 3)	
Bits	
7 6 5 4 3 2 1	
0 0 0 0 0 0 0	Best Effort
0 0 0 0 0 0 1	Signaling
0 0 0 0 0 1 0	SMS
0 0 0 0 0 1 1	TOM8
0 0 0 0 1 0 0 } to } reserved	
0 0 0 0 1 1 1 }	
0 0 0 1 0 0 0 } to } dynamically assigned	
1 1 1 1 1 1 1 }	

10.5.6.12 Traffic Flow Template

The purpose of the *traffic flow template* information element is to specify the TFT parameters and operations for a PDP context. In addition, this information element may be used to transfer extra parameters to the network (e.g. the Authorization Token; see 3GPP TS 24.229 [95]). The TFT may contain packet filters for the downlink direction, the uplink direction or packet filters that are applicable to both directions. The packet filters determine the traffic mapping to PDP contexts. The downlink packet filters shall be used by the network and the uplink packet filters shall be used by the MS. A packet filter that is applicable to both directions shall be used by the network as a downlink packet filter and by the MS as an uplink packet filter.

The *traffic flow template* is a type 4 information element with a minimum length of 3 octets. The maximum length for the IE is 257 octets.

NOTE 1: The IE length restriction is due to the maximum length that can be encoded in a single length octet.

NOTE 2: A maximum size IPv4 packet filter can be 32 bytes. Therefore, 7 maximum size IPv4 type packet filters, plus the last packet filter which can contain max 30 octets can fit into one TFT IE, i.e. if needed not all packet filter components can be defined into one message. A maximum size IPv6 packet filter can be 60 bytes. Therefore, only 4 maximum size IPv6 packet filters can fit into one TFT IE. However, using "Add packet filters to existing TFT", it's possible to create a TFT data structure including 16 maximum size IPv4 or IPv6 filters.

The *traffic flow template* information element is coded as shown in figure 10.5.144/3GPP TS 24.008 and table 10.5.162/3GPP TS 24.008.

NOTE 3: The 3GPP TS 24.301 [120] reuses the *traffic flow template* information element for the purpose of the traffic flow aggregate description, where the use of individual TFT parameters, e.g. the packet filter identifier in the parameter list, can differ from this specification.

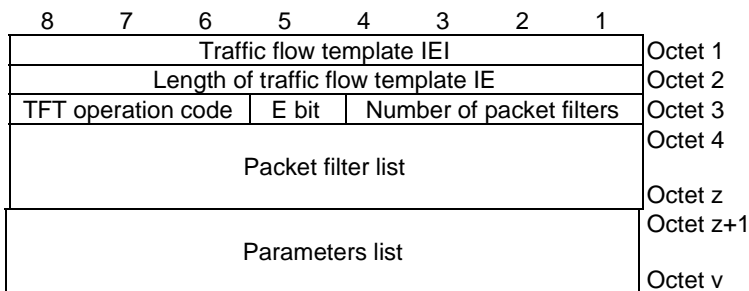

Figure 10.5.144/3GPP TS 24.008: *Traffic flow template* information element

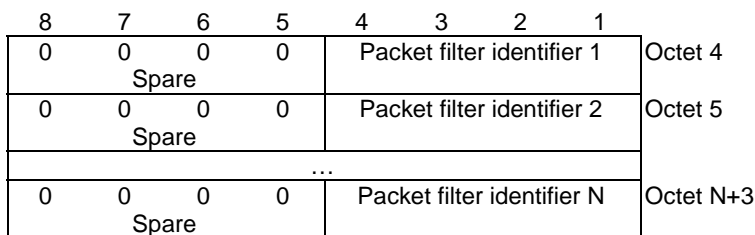

Figure 10.5.144a/3GPP TS 24.008: *Packet filter list* when the TFT operation is "delete packet filters from existing TFT" (z=N+3)

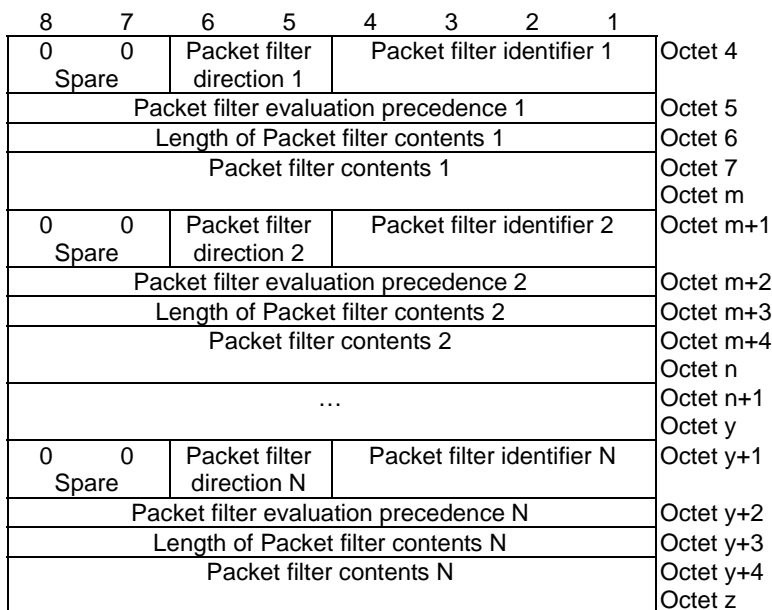

Figure 10.5.144b/3GPP TS 24.008: *Packet filter list* when the TFT operation is "create new TFT", or "add packet filters to existing TFT" or "replace packet filters in existing TFT"

8	7	6	5	4	3	2	1	
Parameter identifier 1								Octet z+1
Length of Parameter contents 1								Octet z+2
Parameter contents 1								Octet z+3
Parameter identifier 2								Octet k
Length of Parameter contents 2								Octet k+1
Parameter contents 2								Octet k+2
...								Octet k+3
Parameter identifier N								Octet p
Length of Parameter contents N								Octet p+1
Parameter contents N								Octet q
Parameter identifier N								Octet q+1
Length of Parameter contents N								Octet q+2
Parameter contents N								Octet q+3
Parameter identifier N								Octet v

Figure 10.5.144c/3GPP TS 24.008: *Parameters list*

Table 10.5.162/3GPP TS 24.008: *Traffic flow template* information element

TFT operation code (octet 3)

Bits

8 7 6

0 0 0 Ignore this IE

0 0 1 Create new TFT

0 1 0 Delete existing TFT

0 1 1 Add packet filters to existing TFT

1 0 0 Replace packet filters in existing TFT

1 0 1 Delete packet filters from existing TFT

1 1 0 No TFT operation

1 1 1 Reserved

The TFT operation code "No TFT operation" shall be used if a *parameters list* is included but no *packet filter list* is included in the *traffic flow template* information element.

The TFT operation code "Ignore this IE" shall be used by the MS if the Traffic flow aggregate information element has presence requirement "M" in a message, but the information element does not serve any useful purpose in the specific procedure for which the message is sent (see 3GPP TS 24.301 [120], subclauses 6.5.3.2 and 6.5.4.2). If the TFT operation code indicates "Ignore this IE", the MS shall also set the E bit and the number of packet filters to zero.

If the TFT operation code is set to "Ignore this IE" and the the E bit and the number of packet filters to zero, then the network shall ignore the contents of the traffic flow template information element.

E bit (bit 5 of octet 3)

The *E bit* indicates if a *parameters list* is included in the TFT IE and it is encoded as follows:

0 *parameters list* is not included

1 *parameters list* is included

Number of packet filters (octet 3)

The *number of packet filters* contains the binary coding for the number of packet filters in the *packet filter list*. The *number of packet filters* field is encoded in bits 4 through 1 of octet 3 where bit 4 is the most significant and bit 1 is the least significant bit. For the "delete existing TFT" operation and for the "no TFT operation", the *number of packet filters* shall be coded as 0. For all other operations, the number of packet filters shall be greater than 0 and less than or equal to 15.

Packet filter list (octets 4 to z)

The *packet filter list* contains a variable number of packet filters. For the "delete existing TFT" operation and the "no TFT operation", the *packet filter list* shall be empty.

For the "delete packet filters from existing TFT" operation, the *packet filter list* shall contain a variable number of packet filter identifiers. This number shall be derived from the coding of the *number of packet filters* field in octet 3.

For the "create new TFT", "add packet filters to existing TFT" and "replace packet filters in existing TFT" operations, the *packet filter list* shall contain a variable number of packet filters. This number shall be derived from the coding of the *number of packet filters* field in octet 3.

Each packet filter is of variable length and consists of

- a packet filter identifier and direction (1 octet);
- a packet filter evaluation precedence (1 octet);
- the length of the packet filter contents (1 octet); and
- the packet filter contents itself (v octets).

The *packet filter identifier* field is used to identify each packet filter in a TFT. The least significant 4 bits are used.

The *packet filter direction* is used to indicate, in bits 5 and 6, for what traffic direction the filter applies:

00 - pre Rel-7 TFT filter

01 - downlink only
 10 - uplink only
 11 - bidirectional
 Bits 8 through 7 are spare bits.

The *packet filter evaluation precedence* field is used to specify the precedence for the packet filter among all packet filters in all TFTs associated with this PDP address. Higher the value of the *packet filter evaluation precedence* field, lower the precedence of that packet filter is. The first bit in transmission order is the most significant bit.

The *length of the packet filter contents* field contains the binary coded representation of the length of the *packet filter contents* field of a packet filter. The first bit in transmission order is the most significant bit.

The *packet filter contents* field is of variable size and contains a variable number (at least one) of *packet filter components*. Each *packet filter component* shall be encoded as a sequence of a one octet *packet filter component type identifier* and a fixed length *packet filter component value* field. The *packet filter component type identifier* shall be transmitted first.

In each packet filter, there shall not be more than one occurrence of each packet filter component type. Among the "IPv4 remote address type" and "IPv6 remote address type" packet filter components, only one shall be present in one packet filter. Among the "single local port type" and "local port range type" packet filter components, only one shall be present in one packet filter. Among the "single remote port type" and "remote port range type" packet filter components, only one shall be present in one packet filter.

The term *local* refers to the MS and the term *remote* refers to an external network entity.

Packet filter component type identifier

Bits

8 7 6 5 4 3 2 1	
0 0 0 1 0 0 0 0	IPv4 remote address type
0 0 0 1 0 0 0 1	IPv4 local address type
0 0 1 0 0 0 0 0	IPv6 remote address type
0 0 1 0 0 0 0 1	IPv6 remote address/prefix length type
0 0 1 0 0 0 1 1	IPv6 local address/prefix length type
0 0 1 1 0 0 0 0	Protocol identifier/Next header type
0 1 0 0 0 0 0 0	Single local port type
0 1 0 0 0 0 0 1	Local port range type
0 1 0 1 0 0 0 0	Single remote port type
0 1 0 1 0 0 0 1	Remote port range type
0 1 1 0 0 0 0 0	Security parameter index type
0 1 1 1 0 0 0 0	Type of service/Traffic class type
1 0 0 0 0 0 0 0	Flow label type
1 0 0 0 0 0 0 1	Destination MAC address type
1 0 0 0 0 0 1 0	Source MAC address type
1 0 0 0 0 0 1 1	802.1Q C-TAG VID type
1 0 0 0 0 1 0 0	802.1Q S-TAG VID type
1 0 0 0 0 1 0 1	802.1Q C-TAG PCP/DEI type
1 0 0 0 0 1 1 0	802.1Q S-TAG PCP/DEI type
1 0 0 0 0 1 1 1	Ethertype type

All other values are reserved.

The description and valid combinations of packet filter component type identifiers in a packet filter are defined in 3GPP TS 23.060 [74] subclause 15.3.2.

For "IPv4 remote address type", the *packet filter component value* field shall be encoded as a sequence of a four octet *IPv4 address* field and a four octet *IPv4 address mask* field. The *IPv4 address* field shall be transmitted first.

For "IPv4 local address type", the *packet filter component value* field shall be encoded as defined for "IPv4 remote address type".

Both the MS and network indication for support of the Local address in TFTs are required to use this packet filter component.

For "IPv6 remote address type", the *packet filter component value* field shall be encoded as a sequence of a sixteen octet *IPv6 address* field and a sixteen octet *IPv6 address mask* field. The *IPv6 address* field shall be transmitted first.

For "IPv6 remote address/prefix length type", the *packet filter component value* field shall be encoded as a sequence of a sixteen octet *IPv6 address* field and one octet *prefix length* field. The *IPv6 address* field shall be transmitted first.

This parameter shall be used, instead of IPv6 remote address type, when both the MS and network indication for support of the Local address in TFT are present.

For "IPv6 local address/prefix length type", the *packet filter component value* field shall be encoded as defined for "IPv6 remote address /prefix length".

Both the MS and network indication for support of the Local address in TFTs are required to use this packet filter component.

NOTE 1: Local IP address and mask can be used when IPv6 prefix delegation is used (see 3GPP TS 23.060 [74] subclause 9.2.1.2).

NOTE 2: After inter-system change from N1 mode to S1 mode, the MS operating in single-registration mode in a network supporting N26 interface shall deem that Local address in TFT is supported by the network on the PDN connection corresponding to the PDU session (see subclause 6.1.4.1 of 3GPP TS 24.501 [167]).

For "Protocol identifier/Next header type", the *packet filter component value* field shall be encoded as one octet which specifies the IPv4 protocol identifier or IPv6 next header.

For "Single local port type" and "Single remote port type", the *packet filter component value* field shall be encoded as two octet which specifies a port number.

For "Local port range type" and "Remote port range type", the *packet filter component value* field shall be encoded as a sequence of a two octet *port range low limit* field and a two octet *port range high limit* field. The *port range low limit* field shall be transmitted first.

For "Security parameter index", the *packet filter component value* field shall be encoded as four octet which specifies the IPSec security parameter index.

For "Type of service/Traffic class type", the *packet filter component value* field shall be encoded as a sequence of a one octet *Type-of-Service/Traffic Class* field and a one octet *Type-of-Service/Traffic Class mask* field. The *Type-of-Service/Traffic Class* field shall be transmitted first.

For "Flow label type", the *packet filter component value* field shall be encoded as three octet which specifies the IPv6 flow label. The bits 8 through 5 of the first octet shall be spare whereas the remaining 20 bits shall contain the IPv6 flow label.
Parameters list (octets z+1 to v)

For "destination MAC address type" and "source MAC address type", the *packet filter component value* field shall be encoded as 6 octets which specify a MAC address.

For "802.1Q C-TAG VID type", the *packet filter component value* field shall be encoded as two octets which specify the VID of the customer-VLAN tag (C-TAG). The bits 8 through 5 of the first octet shall be spare whereas the remaining 12 bits shall contain the VID.

For "802.1Q S-TAG VID type", the *packet filter component value* field shall be encoded as two octets which specify the VID of the service-VLAN tag (S-TAG). The bits 8 through 5 of the first octet shall be spare whereas the remaining 12 bits shall contain the VID.

For "802.1Q C-TAG PCP/DEI type", the *packet filter component value* field shall be encoded as one octet which specifies the 802.1Q C-TAG PCP and DEI. The bits 8

through 5 of the octet shall be spare, the bits 4 through 2 contain the PCP and bit 1 contains the DEI.

For "802.1Q S-TAG PCP/DEI type", the *packet filter component value* field shall be encoded as one octet which specifies the 802.1Q S-TAG PCP. The bits 8 through 5 of the octet shall be spare, the bits 4 through 2 contain the PCP and bit 1 contains the DEI.

For "ethertype type", the *packet filter component value* field shall be encoded as two octets which specify an ethertype.

The *parameters list* contains a variable number of parameters that may be transferred. If the *parameters list* is included, the *E bit* is set to 1; otherwise, the *E bit* is set to 0.

Each parameter included in the *parameters list* is of variable length and consists of:

- a parameter identifier (1 octet);
- the length of the parameter contents (1 octet); and
- the parameter contents itself (v octets).

The *parameter identifier* field is used to identify each parameter included in the *parameters list* and it contains the hexadecimal coding of the parameter identifier.

Bit 8 of the *parameter identifier* field contains the most significant bit and bit 1 contains the least significant bit. In this version of the protocol, the following parameter identifiers are specified:

- 01H (Authorization Token);
- 02H (Flow Identifier); and
- 03H (Packet Filter Identifier).

If the *parameters list* contains a parameter identifier that is not supported by the receiving entity the corresponding parameter shall be discarded.

The *length of parameter contents* field contains the binary coded representation of the length of the *parameter contents* field. The first bit in transmission order is the most significant bit.

When the *parameter identifier* indicates Authorization Token, the *parameter contents* field contains an authorization token, as specified in 3GPP TS 29.207 [100]. The first octet is the most significant octet of the authorization token and the last octet is the least significant octet of the authorization token.

The *parameters list* shall be coded in a way that an Authorization Token (i.e. a parameter with identifier 01H) is always followed by one or more Flow Identifiers (i.e. one or more parameters with identifier 02H).

If the *parameters list* contains two or more consecutive Authorization Tokens without any Flow Identifiers in between, the receiver shall treat this as a semantical TFT error.

When the *parameter identifier* indicates Flow Identifier, the *parameter contents* field contains the binary representation of a flow identifier. The Flow Identifier consists of four octets. Octets 1 and 2 contains the Media Component number as specified in 3GPP TS 29.207 [100]. Bit 1 of octet 2 is the least significant bit, and bit 8 of octet 1 is the most significant bit. Octets 3 and 4 contains the IP flow number as specified in 3GPP TS 29.207 [100]. Bit 1 of octet 4 is the least significant bit, and bit 8 of octet 3 is the most significant bit.

When the *parameter identifier* indicates Packet Filter Identifier, the *parameter contents* field contains the binary representation of one or more packet filter identifiers. Each packet filter identifier is encoded in one octet, in the 4 least significant bits. This parameter is used by the MS and the network to identify one or more packet filters in a TFT when modifying the QoS of a PDP context without modifying the packet filter itself.

10.5.6.13 Temporary Mobile Group Identity (TMGI)

The purpose of the TMGI element is for group paging in MBMS.

The TMGI information element is a type 4 information element with a minimum length of 5 octets and a maximum length of 8 octets. If octet 6 is included, then octets 7 and 8 shall also be included.

The content of the TMGI element is shown in Figure 10.5.154/3GPP TS 24.008 and table 10.5.168/3GPP TS 24.008.

8	7	6	5	4	3	2	1	
Temporary Mobile Group Identity IEI								Octet 1
Length of Temporary Mobile Group Identity contents								Octet 2
MBMS Service ID								Octet 3
MBMS Service ID								Octet 4
MBMS Service ID								Octet 5
MCC digit 2				MCC digit 1				Octet 6*
MNC digit 3				MCC digit 3				Octet 7*
MNC digit 2				MNC digit 1				Octet 8*

Figure 10.5.154/3GPP TS 24.008: TMGI information element

Table 10.5.168/3GPP TS 24.008: TMGI information element

<p>MBMS Service ID (octet 3, 4 and 5)</p> <p>In the MBMS Service ID field bit 8 of octet 3 is the most significant bit and bit 1 of octet 5 the least significant bit. The coding of the MBMS Service ID is the responsibility of each administration. Coding using full hexadecimal representation may be used. The MBMS Service ID consists of 3 octets.</p> <p>MCC, Mobile country code (octet 6, octet 7 bits 1 to 4)</p> <p>The MCC field is coded as in ITU-T Rec. E.212 [46], Annex A.</p> <p>MNC, Mobile network code (octet 7 bits 5 to 8, octet 8)</p> <p>The coding of this field is the responsibility of each administration but BCD coding shall be used. The MNC shall consist of 2 or 3 digits. If a network operator decides to use only two digits in the MNC, bits 5 to 8 of octet 7 shall be coded as "1111".</p>

10.5.6.14 MBMS bearer capabilities

The purpose of the *MBMS bearer capabilities* information element is to indicate the maximum bit rate for downlink supported by the MS for an MBMS context.

NOTE: The information element indicates the static physical capabilities of the MS, independent of the radio access (UTRAN or GERAN), the radio conditions, or other CS or PS services possibly activated by the MS.

The *MBMS bearer capabilities* is a type 4 information element with a maximum length of 4 octets.

The *MBMS bearer capabilities* information element is coded as shown in figure 10.5.155/3GPP TS 24.008 and table 10.5.169/3GPP TS 24.008.

8	7	6	5	4	3	2	1	
MBMS bearer capabilities IEI								Octet 1
Length of MBMS bearer capabilities IE								Octet 2
Maximum bit rate for downlink								Octet 3
Maximum bit rate for downlink (extended)								Octet 4

Figure 10.5.155/3GPP TS 24.008: MBMS bearer capabilities information element

Table 10.5.169/3GPP TR 24.008: MBMS bearer capabilities information element

<p>Maximum bit rate for downlink, octet 3 (see 3GPP TS 23.107 [81])</p> <p>The coding is identical to that of the maximum bit rate for downlink, octet 9, in the <i>Quality of service</i> information element (see subclause 10.5.6.5).</p> <p>If the sending entity wants to indicate a maximum bit rate for downlink higher than 8640 kbps, it shall set octet 3 to "11111110", i.e. 8640 kbps, and shall encode the value for the maximum bit rate in octet 4.</p> <p>Maximum bit rate for downlink (extended), octet 4</p> <p>The coding is identical to that of the maximum bit rate for downlink (extended), octet 15, in the <i>Quality of service</i> information element (see subclause 10.5.6.5).</p>
--

10.5.6.15 MBMS protocol configuration options

The purpose of the *MBMS protocol configuration options* information element is to:

- transfer protocol options associated with the bearer level of an MBMS context activation, and
- transfer additional MBMS bearer related (protocol) data (e.g. configuration parameters, error codes or messages/events).

The *MBMS protocol configuration options* is a type 4 information element with a minimum length of 3 octets and a maximum length of 253 octets.

The *MBMS protocol configuration options* information element is coded as shown in figure 10.5.156/3GPP TS 24.008 and table 10.5.170/3GPP TS 24.008.

8	7	6	5	4	3	2	1	
MBMS protocol configuration options IEI								octet 1
Length of MBMS protocol configuration options contents								octet 2
0	0	0	0	0	0	0	0	octet 3
Spare								

Figure 10.5.156/3GPP TS 24.008: MBMS protocol configuration options information element

Table 10.5.170/3GPP TR 24.008: MBMS protocol configuration options information element

<p>Bits 1 to 8 of octet 3 are spare and shall be coded as "0".</p> <p>NOTE: The reason for defining the information element is to have a transparent mechanism in the SGSN available from the introduction of MBMS. This will ensure that MS – GGSN communication is possible if new MBMS bearer service related parameters are defined.</p>
--

10.5.6.16 Enhanced network service access point identifier

The purpose of the *Enhanced network service access point identifier* information element is to identify the service access point that is used at layer 3.

The *Enhanced network service access point identifier* is a type 3 information element with a length of 2 octets.

The value part of an *Enhanced network service access point identifier* information element is coded as shown in figure 10.5.157/3GPP TS 24.008 and table 10.5.171/3GPP TS 24.008.

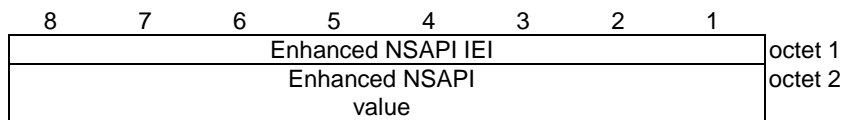

Figure 10.5.157/3GPP TS 24.008: Enhanced network service access point identifier information element

Table 10.5.171/3GPP TS 24.008: Enhanced network service access point identifier information element

Enhanced NSAPI value (octet 2, bits 1 to 7)								
Bits								
8	7	6	5	4	3	2	1	
0	0	0	0	0	0	0	0	Reserved
through								
0	1	1	1	1	1	1	1	Reserved
1	0	0	0	0	0	0	0	NSAPI 128 for Multimedia Broadcast/Multicast Service (MBMS) Multicast mode
through								
1	1	1	1	1	1	1	0	NSAPI 254 for Multimedia Broadcast/Multicast Service (MBMS) Multicast mode
1	1	1	1	1	1	1	1	Reserved (NOTE)
NOTE: NSAPI 255 is reserved for use by lower layers in the point-to-point radio bearer allocation message for Multimedia Broadcast/Multicast Service (MBMS) Broadcast mode (see 3GPP TS 25.331 [23c]).								

10.5.6.17 Request type

The purpose of the Request type information element is to indicate whether the MS requests to establish a new connectivity to a PDN or keep the connection(s) to which it has connected via non-3GPP access, or to keep the PDU session to which it has connected via 3GPP access.

The Request type information element is also used to indicate that the MS is requesting connectivity to a PDN that provides emergency bearer services, or DN that provides emergency services or keep the connection that provides emergency services to which it has connected via non-3GPP access, or to keep the PDU session to which it has connected via 3GPP access.

The Request type information element is coded as shown in figure 10.5.158/3GPP TS 24.008 and table 10.5.173/3GPP TS 24.008.

The Request type is a type 1 information element.

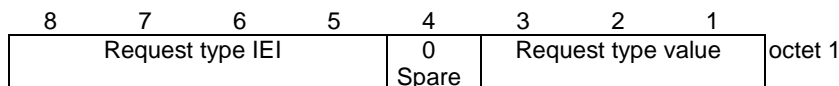

Figure 10.5.158/3GPP TS 24.008: Request type information element

Table 10.5.173/3GPP TS 24.008: Request type information element

Request type value (octet 1)	
Bits	
3	2 1
0 0 1	initial request
0 1 0	Handover (NOTE 1)
0 1 1	RLOS (NOTE 3)
1 0 0	emergency
1 1 0	handover of emergency bearer services (NOTE 1) (NOTE 2)
All other values are reserved.	
Bit 4 of octet 1 is spare and shall be coded as zero.	
NOTE 1: This code point denotes a transfer of a PDN connection from non-3GPP access to 3GPP access (and vice versa), or a transfer of a PDU session from N1 mode to S1 mode (see 3GPP TS 24.501 [167]). Such transfers are not handovers controlled by 3GPP connected mode mobility procedures as specified in e.g. 3GPP TS 25.331 [23c] or 3GPP TS 36.331 [129].	
NOTE 2: "handover of emergency bearer services" is not applicable in A/Gb-mode and lu-mode and shall be treated as "reserved".	
NOTE 3: "RLOS" is not applicable in A/Gb-mode and lu-mode and shall be treated as "initial request". "RLOS" shall be treated as "initial request" in S1 mode by network not supporting access to RLOS.	

10.5.6.18 Notification indicator

The purpose of the Notification indicator information element is to inform the MS about an event which is relevant for the upper layer using a PDP context or having requested a session management procedure.

The Notification indicator information element is coded as shown in figure 10.5.159/3GPP TS 24.008 and table 10.5.174/3GPP TS 24.008.

The Notification indicator is a type 4 information element with 3 octets length.

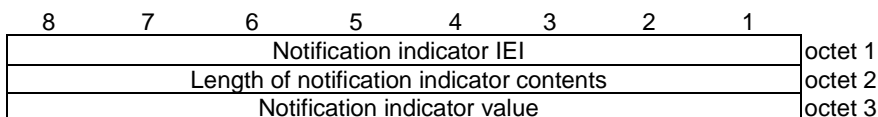

Figure 10.5.159/3GPP TS 24.008: Notification indicator information element

Table 10.5.174/3GPP TS 24.008: Notification indicator information element

Notification indicator value (octet 3)	
Bits	
8	7 6 5 4 3 2 1
0 0 0 0 0 0 1	SRVCC handover cancelled, IMS session re-establishment required (see 3GPP TS 23.216 [126])
0 0 0 0 0 0 1 0	Unused, shall be ignored if received by the MS
0 1 1 1 1 1 1	
All other values are reserved.	

10.5.6.19 Connectivity type

The purpose of the *Connectivity type* information element is to specify the type of connectivity selected by the network for the PDN connection.

The *Connectivity type* information element is coded as shown in figure 10.5.6.19-1/3GPP TS 24.008 and table 10.5.6.19-1/3GPP TS 24.008.

The *Connectivity type* is a type 1 information element.

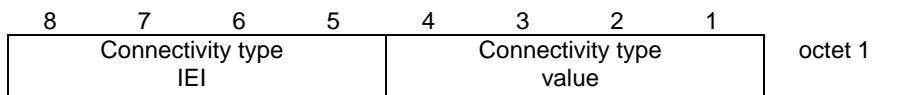

Figure 10.5.6.19-1/3GPP TS 24.008: *Connectivity type* information element

Table 10.5.6.19-1/3GPP TS 24.008: *Connectivity type* information element

Connectivity type value (octet 1)	
Bits	
4 3 2 1	
0 0 0 0	The PDN connection type is not indicated
0 0 0 1	The PDN connection is considered a LIPA PDN connection
All other values shall be interpreted as "the PDN connection type is not indicated".	

10.5.6.20 WLAN offload acceptability

The purpose of the *WLAN offload acceptability* information element is to indicate whether traffic can be offloaded using a PDN connection via a WLAN, or not.

The values "offloading the traffic of the PDN connection via a WLAN when in S1 mode is acceptable" and "offloading the traffic of the PDN connection via a WLAN when in Iu mode is acceptable" map to "indication that the PDP context is offloadable" as defined in 3GPP TS 23.060 [74] and 3GPP TS 23.401 [122]. The value "offloading the traffic of the PDN connection via a WLAN when in S1 mode is not acceptable" and "offloading the traffic of the PDN connection via a WLAN when in Iu mode is not acceptable" map to "indication that the PDP context is not offloadable" as defined in 3GPP TS 23.060 [74] and 3GPP TS 23.401 [122]. The procedures in 3GPP TS 23.060 [74] when the MS receives the UTRAN offload acceptability value in A/Gb mode or Iu mode apply. The procedures in 3GPP TS 23.401 [122] when the MS receives the E-UTRAN offload acceptability value in S1 mode apply.

The *WLAN offload acceptability* information element is coded as shown in figure 10.5.6.20-1/3GPP TS 24.008 and table 10.5.6.20-1/3GPP TS 24.008.

The *WLAN offload acceptability* is a type 1 information element.

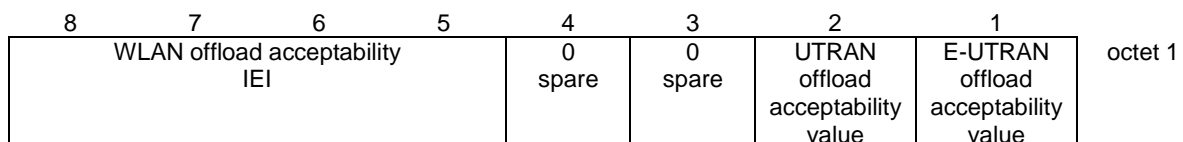

Figure 10.5.6.20-1/3GPP TS 24.008: *WLAN offload acceptability* information element

Table 10.5.6.20-1/3GPP TS 24.008: WLAN offload acceptability information element

E-UTRAN offload acceptability value (octet 1)	
Bit	
1	
0	Offloading the traffic of the PDN connection via a WLAN when in S1 mode is not acceptable
1	Offloading the traffic of the PDN connection via a WLAN when in S1 mode is acceptable
UTRAN offload acceptability value (octet 1)	
Bit	
2	
0	Offloading the traffic of the PDN connection via a WLAN when in lu mode is not acceptable
1	Offloading the traffic of the PDN connection via a WLAN when in lu mode is acceptable
Bits 3 and 4 of octet 1 are spare and shall be coded as zero	

10.5.6.21 NBIFOM container

The purpose of the *NBIFOM container* information element is to transfer parameters associated with the network-based IP flow mobility (NBIFOM).

The *NBIFOM container* is a type 4 information element with a minimum length of 3 octets and a maximum length of 257 octets.

The *NBIFOM container* information element is coded as shown in figure 10.5.6.21-1/3GPP TS 24.008 and table 10.5.6.21-1/3GPP TS 24.008.

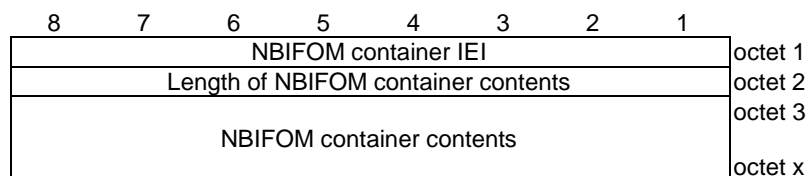

Figure 10.5.6.21-1/3GPP TS 24.008: NBIFOM container information element

Table 10.5.6.21-1/3GPP TS 24.008: NBIFOM container information element

NBIFOM container contents field contains the NBIFOM parameter list as defined in 3GPP TS 24.161 [158], subclause 6.1.

10.5.7 GPRS Common information elements

10.5.7.1 PDP context status

The purpose of the *PDP context status* information element is to indicate the state of each PDP context which can be identified by NSAPI.

The *PDP context status* information element is a type 4 information element with 4 octets length.

The *PDP context status* information element is coded as shown in figure 10.5.148/3GPP TS 24.008 and table 10.5.164/3GPP TS 24.008.

8	7	6	5	4	3	2	1	
PDP context status IEI								octet 1
Length of PDP context status contents								Octet 2
NSAPI (7)	NSAPI (6)	NSAPI (5)	NSAPI (4)	NSAPI (3)	NSAPI (2)	NSAPI (1)	NSAPI (0)	octet 3
NSAPI (15)	NSAPI (14)	NSAPI (13)	NSAPI (12)	NSAPI (11)	NSAPI (10)	NSAPI (9)	NSAPI (8)	octet 4

Figure 10.5.148/3GPP TS 24.008 PDP context status information element

Table 10.5.164/3GPP TS 24.008: PDP context status information element

NSAPI(x) shall be coded as follows:

NSAPI(0) - NSAPI(4):
are coded as '0' and shall be treated as spare in this version of the protocol.

NSAPI(5) – NSAPI(15):
0 indicates that the SM state of the corresponding PDP context is PDP-INACTIVE.
1 indicates that the SM state of the corresponding PDP context is not PDP-INACTIVE.

10.5.7.2 Radio priority

The purpose of the *radio priority* information element is to specify the priority level that the MS shall use at the lower layers for transmission of data related to a PDP context or for mobile originated SMS transmission.

The *radio priority* information element is coded as shown in figure 10.5.145/3GPP TS 24.008 and table 10.5.161/3GPP TS 24.008.

The *radio priority* is a type 1 information element.

8	7	6	5	4	3	2	1	
Radio priority IEI				0 spare	Radio priority level value			octet 1

Figure 10.5.145/3GPP TS 24.008: Radio priority information element

Table 10.5.161/3GPP TS 24.008: Radio priority information element

Radio priority level value (octet 1)
Bits
3 2 1

0 0 1 priority level 1 (highest)
0 1 0 priority level 2
0 1 1 priority level 3
1 0 0 priority level 4 (lowest)

All other values are interpreted as priority level 4 by this version of the protocol.

10.5.7.3 GPRS Timer

The purpose of the *GPRS timer* information element is to specify GPRS specific timer values, e.g. for the READY timer.

The *GPRS timer* is a type 3 information element with 2 octets length.

The *GPRS timer* information element is coded as shown in figure 10.5.146/3GPP TS 24.008 and table 10.5.172/3GPP TS 24.008.

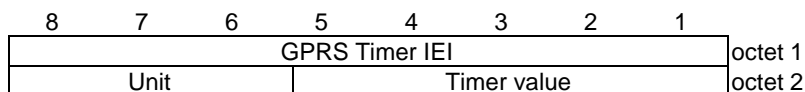

Figure 10.5.146/3GPP TS 24.008: GPRS *Timer* information element

Table 10.5.172/3GPP TS 24.008: GPRS *Timer* information element

<p>Timer value (octet 2)</p> <p>Bits 5 to 1 represent the binary coded timer value.</p> <p>Bits 6 to 8 defines the timer value unit for the GPRS timer as follows:</p> <p>Bits</p> <p>8 7 6</p> <p>0 0 0 value is incremented in multiples of 2 seconds</p> <p>0 0 1 value is incremented in multiples of 1 minute</p> <p>0 1 0 value is incremented in multiples of decihours</p> <p>1 1 1 value indicates that the timer is deactivated.</p> <p>Other values shall be interpreted as multiples of 1 minute in this version of the protocol.</p>
--

10.5.7.4 GPRS Timer 2

The purpose of the *GPRS timer 2* information element is to specify GPRS specific timer values, e.g. for the timer T3302 or timer T3319.

The *GPRS timer 2* is a type 4 information element with 3 octets length.

The *GPRS timer 2* information element is coded as shown in figure 10.5.147/3GPP TS 24.008 and table 10.5.163/3GPP TS 24.008.

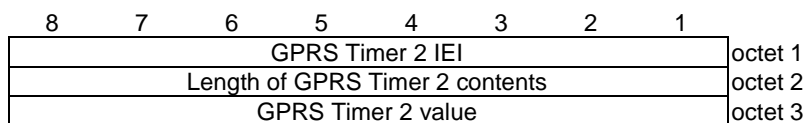

Figure 10.5.147/3GPP TS 24.008: GPRS *Timer 2* information element

Table 10.5.163/3GPP TS 24.008: GPRS *Timer 2* information element

<p>GPRS Timer 2 value is coded as octet 2 of the <i>GPRS timer</i> information element.</p>

10.5.7.4a GPRS Timer 3

The purpose of the *GPRS timer 3* information element is to specify GPRS specific timer values, e.g. for the timer T3396.

The *GPRS timer 3* is a type 4 information element with 3 octets length.

The *GPRS timer 3* information element is coded as shown in figure 10.5.147a/3GPP TS 24.008 and table 10.5.163a/3GPP TS 24.008.

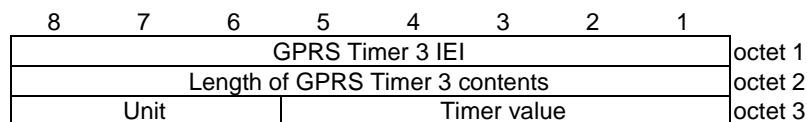

Figure 10.5.147a/3GPP TS 24.008: GPRS *Timer 3* information element

Table 10.5.163a/3GPP TS 24.008: GPRS *Timer 3* information element

<p>GPRS Timer 3 value (octet 3)</p> <p>Bits 5 to 1 represent the binary coded timer value.</p> <p>Bits 6 to 8 defines the timer value unit for the GPRS timer as follows:</p> <p>Bits</p> <p>8 7 6</p> <p>0 0 0 value is incremented in multiples of 10 minutes</p> <p>0 0 1 value is incremented in multiples of 1 hour</p> <p>0 1 0 value is incremented in multiples of 10 hours</p> <p>0 1 1 value is incremented in multiples of 2 seconds</p> <p>1 0 0 value is incremented in multiples of 30 seconds</p> <p>1 0 1 value is incremented in multiples of 1 minute</p> <p>1 1 0 value is incremented in multiples of 320 hours (NOTE 1)</p> <p>1 1 1 value indicates that the timer is deactivated (NOTE 2).</p> <p>NOTE 1: This timer value unit is only applicable to the T3312 extended value IE and the T3412 extended value IE (see 3GPP TS 24.301 [120]). If the UE receives the IE in an integrity protected message, then it shall interpret the value as multiples of 320 hours. Otherwise it shall interpret the value as multiples of 1 hour.</p> <p>If the network receives the IE in S1 mode, the network shall interpret the value as multiples of 320 hours, regardless whether the IE is received in an integrity protected message (e.g., an ATTACH REQUEST message or TRACKING AREA UPDATE REQUEST message (see 3GPP TS 24.301 [120])) or not. Otherwise it shall interpret the value as multiples of 1 hour.</p> <p>NOTE 2: This timer value unit is not applicable to the T3412 extended value IE. If this timer value is received, the T3412 extended value IE shall be considered as not included in the message (see 3GPP TS 24.301 [120]).</p>
--

10.5.7.5 Radio priority 2

The purpose of the *radio priority 2* information element is to specify the priority level that the MS shall use at the lower layers for transmission of mobile originated TOM8 transmission.

The *radio priority 2* information element is coded as shown in figure 10.5.148/3GPP TS 24.008 and table 10.5.164/3GPP TS 24.008.

The *radio priority* is a type 1 information element.

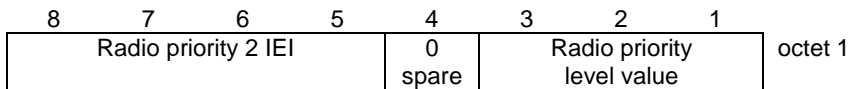

Figure 10.5.148/3GPP TS 24.008: Radio priority 2 information element

Table 10.5.164/3GPP TS 24.008: Radio priority 2 information element

Radio priority level value (octet 1, bits 1-3)	
Bits	
3 2 1	
0 0 1	priority level 1 (highest)
0 1 0	priority level 2
0 1 1	priority level 3
1 0 0	priority level 4 (lowest)
All other values are interpreted as priority level 4 by this version of the protocol.	

10.5.7.6 MBMS context status

The purpose of the *MBMS context status* information element is to indicate the state of each MBMS context which can be identified by an NSAPI.

The *MBMS context status* information element is a type 4 information element with a minimum length of 2 octets and a maximum length of 18 octets.

The *MBMS context status* information element is coded as shown in figure 10.5.149/3GPP TS 24.008 and table 10.5.165/3GPP TS 24.008.

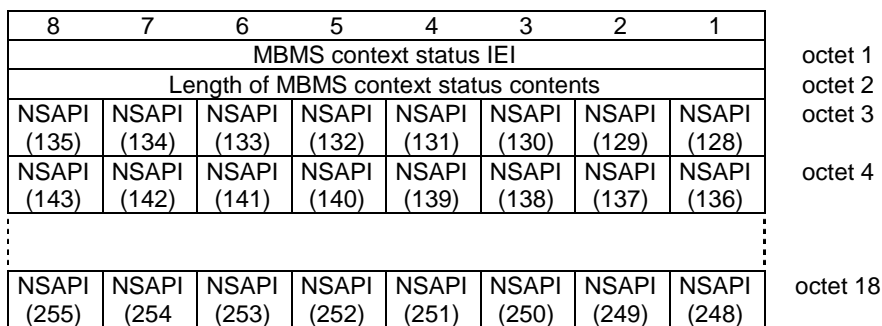

Figure 10.5.149/3GPP TS 24.008 MBMS context status information element

Table 10.5.165/3GPP TS 24.008: MBMS context status information element

For x = 128 to 255, NSAPI(x) shall be coded as follows:
0 indicates that the SM state of the corresponding MBMS context is PDP-INACTIVE.
1 indicates that the SM state of the corresponding MBMS context is not PDP-INACTIVE.
If octets are not included in the information element, the receiver shall interpret the NSAPI(x) values of these octets as set to 0.

10.5.7.7 Uplink data status

The purpose of the *Uplink data status* information element is to indicate to the network which preserved PDP contexts have uplink data pending.

The *Uplink data status* information element is a type 4 information element with 4 octets length.

The *Uplink data status* information element is coded as shown in figure 10.5.149/3GPP TS 24.008 and table 10.5.166/3GPP TS 24.008.

8	7	6	5	4	3	2	1	
Uplink data status IEI								octet 1
Length of Uplink data status contents								octet 2
NSAPI (7)	NSAPI (6)	NSAPI (5)	Spare (0)	Spare (0)	Spare (0)	Spare (0)	Spare (0)	octet 3
NSAPI (15)	NSAPI (14)	NSAPI (13)	NSAPI (12)	NSAPI (11)	NSAPI (10)	NSAPI (9)	NSAPI (8)	octet 4

Figure 10.5.149A/3GPP TS 24.008 Uplink data status information element

Table 10.5.166/3GPP TS 24.008: Uplink data status information element

NSAPI uplink status (octet 3 and 4)

Octet 3, bits 1 to 5 are all spare and shall be encoded as 0

NSAPI(5) – NSAPI(15) (octets 3 – 4):

0 no uplink data are pending for the preserved PDP context or the PDP context is PDP-INACTIVE or is PDP-ACTIVE with a RAB already established.

1 uplink data are pending for the preserved PDP context.

10.5.7.8 Device properties

The purpose of the *Device properties* information element is to indicate if the MS is configured for NAS signalling low priority. The network uses the *Device properties* information element for core-network congestion handling and for charging purposes.

The *Device properties* information element is coded as shown in figure 10.5.7.8.1/3GPP TS 24.008 and table 10.5.7.8.1/3GPP TS 24.008.

The *Device properties* is a type 1 information element.

8	7	6	5	4	3	2	1	
Device properties IEI				0 Spare	0 Spare	0 Spare	Low priority	octet 1

Figure 10.5.7.8.1/3GPP TS 24.008: Device properties information element

Table 10.5.7.8.1/3GPP TS 24.008: Device properties information element

Low priority (octet 1)	
Bit	
1	
0	MS is not configured for NAS signalling low priority
1	MS is configured for NAS signalling low priority
The value "0" can also be used by an MS configured for NAS signalling low priority for the exception cases specified in subclause 1.8.	
Bits 2, 3 and 4 of octet 1 are spare and shall be coded as zero.	

11 List of system parameters

The description of timers in the following table should be considered a brief summary. The precise details are found in clauses 3 to 6, which should be considered the definitive descriptions.

11.1 Timers and counters for radio resource management

See 3GPP TS 44.018 [84].

11.2 Timers of mobility management

Table 11.1/3GPP TS 24.008: Mobility management timers - MS-side

TIMER NUM.	MM STATE	TIME OUT VAL.	CAUSE FOR START	NORMAL STOP	AT THE EXPIRY
T3210	LOCATION UPDATING INITIATED	20s	- LOCATION UPDATING REQUEST sent	- LOCATION UPDATING ACCEPT - LOCATIONG UPDATING_REJECT - AUTHHTICATION _REJECT - Lower layer failure	Start T3211
T3211	MM IDLE,	15s	- LOCATION UPDATING REJECT with other cause values as described in section 4.4.4.9 - lower layer failure or RR connection released after RR connection abort during location updating procedure	- cell change - request for MM connection establishment - change of LA	Restart the location updating procedure.
T3212	MM IDLE	Note 1	- termination of MM service or MM signalling	- initiation of MM service or MM signalling	initiate periodic updating
T3213	LOCATION UPDATING INITIATED	4s	- location updating failure	- change of BCCH parameter	new random attempt
T3214	LOCATION UPDATING INITIATED WAIT FOR OUTGOING MM CONNECTION IMSI DETACH INITIATED	20s	AUTHENTICATION FAILURE Cause = 'MAC failure' or 'GSM authentication unacceptable' sent	- AUTHENTICATION REQUEST received - AUTHENTICATION REJECT received - Lower layer failure	Consider the network as 'false' (see 4.3.2.6.1)
T3216	LOCATION UPDATING INITIATED WAIT FOR OUTGOING MM CONNECTION IMSI DETACH INITIATED	15s	AUTHENTICATION FAILURE Cause = Synch failure sent	- AUTHENT REQUEST received - AUTHENTICATION REJECT received - Lower layer failure	Consider the network as 'false' (see 4.3.2.6.1)
T3218	LOCATION UPDATING INITIATED WAIT FOR OUTGOING MM CONNECTION IMSI DETACH INITIATED	20s	- RAND and RES stored as a result of of a UMTS authentication challenge - RAND and SRES stored as a result of of a GSM authentication challenge	- CIPHERING MODE COMMAND received (A/Gb mode only) - SECURITY MODE COMMAND received (lu mode only) - CM SERVICE ACCEPT received - CM SERVICE REJECT received - LOCATION UPDATING ACCEPT received - AUTHENTICATION REJECT received - AUTHENTICATION FAILURE sent - enter MM IDLE or NULL	Delete the stored RAND and either RES (if it was a UMTS authentication challenge) or SRES (if it was a GSM authentication challenge)
T3220	IMSI DETACH INITIATED	5s	- IMSI DETACH	- release from RM-sublayer	enter Null or Idle, ATTEMPTING TO UPDATE

T3230	<p>WAIT FOR OUTGOING MM CONNECTION</p> <p>WAIT FOR ADDITIONAL OUTGOING MM CONNECTION</p> <p>WAIT FOR REESTABLISH</p>	15s	<ul style="list-style-type: none"> - CM SERVICE REQUEST CM RE-ESTABLISHMENT REQUEST 	<ul style="list-style-type: none"> - Cipher mode setting - CM SERVICE REJECT received - CM SERVICE ACCEPT received - CM SERVICE ABORT sent 	provide release ind.
T3240	<p>WAIT FOR NETWORK COMMAND</p> <p>LOCATION UPDATE REJECTED</p>	10s	see subclause 11.2.1	see subclause 11.2.1	abort the RR connection
T3241	RR CONNECTION RELEASE NOT ALLOWED	300s	see subclause 11.2.1	see subclause 11.2.1	abort the RR connection
T3242	All except NULL	Note 5	eCall only MS enters MM IDLE state after an emergency call <ul style="list-style-type: none"> - eCall only MS capable of eCall over IMS performs intersystem change from S1 mode to lu or A/Gb mode while timer T3444 (see 3GPP TS 24.301 [120]) is running 	<ul style="list-style-type: none"> - Removal of eCall only restriction - Intersystem change from lu or A/Gb mode to S1 mode for MS capable of eCall over IMS 	Perform eCall Inactivity procedure in subclause 4.4.7 or GMM eCall inactivity procedure in subclause 4.7.15
T3243	All except NULL	Note 6	eCall only MS enters MM IDLE state after a test/reconfiguration call <ul style="list-style-type: none"> - eCall only MS capable of eCall over IMS enters PMM-IDLE (lu mode) state after a test/reconfiguration call - return to packet idle mode at eCall only MS capable of eCall over IMS after a test/reconfiguration call (A/Gb mode) - eCall only MS capable of eCall over IMS performs intersystem change from S1 mode to lu or A/Gb mode while timer T3445 (see 3GPP TS 24.301 [120]) is running 	<ul style="list-style-type: none"> - Removal of eCall only restriction - Intersystem change from lu or A/Gb mode to S1 mode for MS capable of eCall over IMS 	Perform eCall Inactivity procedure in subclause 4.4.7 or GMM eCall inactivity procedure in subclause 4.7.15

T3245	All except NULL	Note 2	see subclause 4.1.1.6 (A/Gb or lu mode only) see subclause 5.3.7a in 3GPP TS 24.301[120] (S1 mode only) see subclause 5.3.19a in 3GPP TS 24.501 [167] (N1 mode only) see subclause 4.6 in 3GPP TS 24.502 [178] (N1 mode only)	- SIM/USIM is removed	see subclause 4.1.1.6 (A/Gb or lu mode only) see subclause 5.3.7a in 3GPP TS 24.301[120] (S1 mode only) see subclause 5.3.19a in 3GPP TS 24.501 [167] (N1 mode only) see subclause 4.6 in 3GPP TS 24.502 [178] (N1 mode only)
T3246	LOCATION UPDATING INITIATED WAIT FOR OUTGOING MM CONNECTION WAIT FOR ADDITIONAL OUTGOING MM CONNECTION WAIT FOR REESTABLISH	Note 3	LOCATION UPDATING REJECT or CM SERVICE REJECT received with a timer value for T3246; "Extended wait time" for CS domain from the lower layers	- paging - see subclause 4.1.1.7	Restart the Location update procedure or CM service request procedure, dependent on MM state and update status
T3247	All except NULL	Note 4	see subclauses 4.1.1.6A, 4.3.2.5 and 4.7.7.5 (A/Gb or lu mode only) see subclauses 5.3.7B and 5.4.2.5 in 3GPP TS 24.301 [120] (S1 mode only) see subclauses 5.3.20, 5.4.1.2.2.11 and 5.4.1.3.5 in 3GPP TS 24.501 [167] (N1 mode only)	- SIM/USIM is removed or the entry of the "list of subscriber data" with the SNPN identity of the current SNPN is updated (see 3GPP TS 23.122 [14] and 3GPP TS 24.501 [167]); or - the MS is switched off	see subclause 4.1.1.6A (A/Gb or lu mode only) see subclause 5.3.7B in 3GPP TS 24.301 [120] (S1 mode only) see subclauses 5.3.20, 5.4.1.2.2.11 and 5.4.1.3.5 in 3GPP TS 24.501 [167] (N1 mode only)
<p>NOTE 1: The timeout value is broadcasted in a SYSTEM INFORMATION message or received in a LOCATION UPDATING ACCEPT message.</p> <p>NOTE 2: The MS starts the timer with a random value, uniformly drawn from the range between 12h and 24h.</p> <p>NOTE 3: The timer value is provided by the network in a LOCATION UPDATING REJECT or a CM SERVICE REJECT message or as an "Extended wait time" value by the lower layers, or chosen randomly from a default value range of 15 – 30 minutes.</p> <p>NOTE 4: The MS starts the timer with a random value, uniformly drawn from the range between 30 minutes and 60 minutes.</p> <p>NOTE 5: If the timer is started by an eCall only MS capable of eCall over IMS due to performing intersystem change from S1 mode to lu or A/Gb mode while timer T3444 (see 3GPP TS 24.301 [120]) is running, the MS starts the timer with a value set to the time left on timer T3444. Otherwise the MS starts the timer with a value set to 12 hours.</p> <p>NOTE 6: If the timer is started by an eCall only MS capable of eCall over IMS due to performing intersystem change from S1 mode to lu or A/Gb mode while timer T3445 (see 3GPP TS 24.301 [120]) is running, the MS starts the timer with a value set to the time left on timer T3445. Otherwise the MS starts the timer with a value set to 12 hours.</p>					

Table 11.2/3GPP TS 24.008: Mobility management timers - network-side

TIMER NUM.	MM STATE	TIME OUT VAL.	CAUSE FOR START	NORMAL STOP	AT THE EXPIRY	AT THE SECOND EXPIRY
T3250	TMSI REALLOCATION INITIATED	12s	TMSI REALLOCATION COMMAND or LOCATION UPDATING ACCEPT with new TMSI sent	TMSI REALLOCATION COMPLETE received	Optionally Release RR connection	
T3255		Note 2	LOCATION UPDATING ACCEPT sent with "Follow on Proceed"	CM SERVICE REQUEST	Release RR Connection or use for mobile station terminating call	
T3260	AUTHENTICATION INITIATED	12s	AUTHENTICATION REQUEST sent	AUTHENTICATION RESPONSE received AUTHENTICATION FAILURE received	Optionally Release RR connection	
T3270	IDENTIFICATION INITIATED	12s	IDENTITY REQUEST sent	IDENTITY RESPONSE received	Optionally Release RR connection	

NOTE 2: The value of this timer is not specified by this recommendation.

11.2.1 Timer T3240 and Timer T3241

Timer T3240 is started in the mobile station when:

- the mobile station receives a LOCATION UPDATING ACCEPT message completing a location updating procedure in the cases specified in subclauses 4.4.4.6 and 4.4.4.8;
- the mobile station receives a LOCATION UPDATING REJECT message in the cases specified in subclause 4.4.4.7;
- the mobile station has sent a CM SERVICE ABORT message as specified in subclause 4.5.1.7;
- the mobile station has released or aborted all MM connections in the cases specified in 4.3.2.5, 4.3.5.2, 4.5.1.1, and 4.5.3.1;
- the mobile station receives the paging message from network and enter the MM state 9 (WAIT FOR NETWORK COMMAND).

Timer T3240 is stopped, reset, and started again at receipt of an MM message.

Timer T3240 is stopped and reset (but not started) at receipt of a CM message that initiates establishment of an CM connection (an appropriate SETUP, REGISTER, or CP-DATA message as defined in 3GPP TS 24.008, 3GPP TS 24.010 [21] or 3GPP TS 24.011 [22]).

If timer T3240 expires, the MS shall abort the RR connection and enter the MM state MM IDLE.

Timer T3241 is started in the mobile station when entering MM state RR CONNECTION RELEASE NOT ALLOWED.

Timer T3241 is stopped and reset (but not started) when the MM state RR CONNECTION RELEASE NOT ALLOWED is left.

If timer T3241 expires, the MS shall abort the RR connection and enter the MM state MM IDLE.

11.2.2 Timers of GPRS mobility management

Table 11.3/3GPP TS 24.008: GPRS Mobility management timers - MS side

TIMER NUM.	TIMER VALUE	STATE	CAUSE OF START	NORMAL STOP	ON THE 1 st , 2 nd , 3 rd , 4 th EXPIRY Note 3
T3310	15s NOTE 2	GMM-REG-INIT	ATTACH REQUEST sent	ATTACH ACCEPT received ATTACH REJECT received	Retransmission of ATTACH REQUEST
T3311	15s	GMM-DEREG ATTEMPTING TO ATTACH or GMM-REG ATTEMPTING TO UPDATE GMM-REG NORMAL SERVICE	ATTACH REJECT with other cause values as described in chapter 'GPRS Attach' ROUTING AREA UPDATE REJECT with other cause values as described in chapter 'Routing Area Update' Low layer failure	Change of the routing area GPRS attach procedure initiated RAU procedure initiated lu mode - PMM CONNECTED mode entered (NOTE 1) A/Gb mode - READY timer is started (Note 1)	Restart of the GPRS attach or the RAU procedure with updating of the relevant attempt counter
T3316	30s NOTE 2	GMM-REG-INIT GMM-REG GMM-DEREG-INIT GMM-RA-UPDATING-INT GMM-SERV-REQ-INIT (lu mode only)	RAND and RES stored as a result of a UMTS authentication challenge RAND and SRES stored as a result of a GSM authentication challenge	Security mode setting (lu mode only) SERVICE ACCEPT received. (lu mode only) SERVICE REJECT received (lu mode only) ROUTING AREA UPDATE ACCEPT received AUTHENTICATION AND CIPHERING REJECT received AUTHENTICATION AND CIPHERING FAILURE sent Enter GMM-DEREGISTERED, GMM-NULL or PMM-IDLE mode (lu mode only)	Delete the stored RAND, and either RES (if it was a UMTS authentication challenge) or SRES (if it was a GSM authentication challenge)

T3318	20s NOTE 2	GMM-REG-INIT GMM-REG GMM-DEREG-INIT GMM-RA-UPDATING-INT GMM-SERV-REQ-INIT (lu mode only)	AUTHENTICATION AND CIPHERING FAILURE (cause='MAC failure' or 'GSM authentication unacceptable') sent	AUTHENTICATION AND CIPHERING REQUEST received AUTHENTICATION AND CIPHERING REJECT received Lower layer failure PS signalling connection released (lu mode only) Inter-system change to S1 mode performed GPRS services suspended (Gb mode only)	On first expiry, the MS should consider the network as false and will follow subclause 4.7.7.6.1, if the MS is not attached for emergency bearer services. On the first expiry, the MS will follow subclause 4.7.7.6, under "for items f and g", if the MS is attached for emergency bearer services.
T3320	15s NOTE 2	GMM-REG-INIT GMM-REG GMM-DEREG-INIT GMM-RA-UPDATING-INT GMM-SERV-REQ-INIT (lu mode only)	AUTHENTICATION AND CIPHERING FAILURE (cause=synch failure) sent	AUTHENTICATION AND CIPHERING REQUEST received AUTHENTICATION AND CIPHERING REJECT received Lower layer failure PS signalling connection released (lu mode only) Inter-system change to S1 mode performed GPRS services suspended (Gb mode only)	On first expiry, the MS should consider the network as false and will follow the subclause 4.7.7.6.1, if the MS is not attached for emergency bearer services. On the first expiry, the MS will follow subclause 4.7.7.6, under "for items f and g", if the MS is attached for emergency bearer services.
T3321	15s NOTE 2	GMM-DEREG-INIT GMM-REG. IMSI-DETACH-INITIATED	DETACH REQUEST sent	DETACH ACCEPT received	Retransmission of the DETACH REQUEST
T3330	15s NOTE 2	GMM-ROUTING-UPDATING-INITIATED	ROUTING AREA UPDATE REQUEST sent	ROUTING AREA UPDATE ACCEPT received ROUTING AREA UPDATE REJECT received	Retransmission of the ROUTING AREA UPDATE REQUEST message

T3340 (lu mode only)	10s	GMM-DEREG GMM-REG	ATTACH REJECT, DETACH REQUEST, ROUTING AREA UPDATE REJECT or SERVICE REJECT with any of the causes #3, #6, #7, #8, #11, #12, #13, #15, or #25. ATTACH ACCEPT or ROUTING AREA UPDATE ACCEPT is received with "no follow-on proceed" indication and user plane radio access bearers have not been setup. DETACH ACCEPT received after the MS sent DETACH REQUEST with detach type to "IMSI detach" AUTHENTICATION AND CIPHERING REJECT received	PS signalling connection released	Release the PS signalling connection and proceed as described in subclause 4.7.1.9
NOTE 1: The conditions for which this applies are described in subclause 4.7.5.1.5. NOTE 2: If the MS is using EC-GSM-IoT, the timer value shall be calculated as described in subclause 4.7.2.12.					

Table 11.3a/3GPP TS 24.008: GPRS Mobility management timers – MS side

TIMER NUM.	TIMER VALUE	STATE	CAUSE OF START	NORMAL STOP	ON EXPIRY
T3302	Default 12 min NOTE 5	GMM-DEREG or GMM-REG	At attach failure and the attempt counter is greater than or equal to 5. At routing area updating failure and the attempt counter is greater than or equal to 5. ATTACH ACCEPT with MM cause #16 or #17 and the attempt counter is equal to 5, or ATTACH ACCEPT with MM cause #22, as described in subclause 4.7.3.2.3.2. ROUTING AREA UPDATE ACCEPT with MM cause #16 or #17 and the attempt counter is equal to 5, or ROUTING AREA UPDATE ACCEPT with MM cause #22, as described in subclause 4.7.5.2.3.2. DETACH REQUEST received with no cause code and detach type IE indicates "re-attach not required", as described in subclause 4.7.4.2.2.	GPRS attach procedure initiated RAU procedure initiated	On every expiry, initiation of the GPRS attach procedure or RAU procedure
T3312	Default 54 min NOTE 8	GMM-REG	In A/Gb mode, when READY state is left. In lu mode, when PMM-CONNECTED mode is left.	When entering state GMM-DEREG,READY state in A/Gb mode, or PMM-CONNECTED mode in lu mode.	Initiation of the Periodic RAU procedure if the MS is not attached for emergency bearer services or T3323 started under the conditions as specified in subclause 4.7.2.2. Implicit detach from network if the MS is attached for emergency bearer services.
T3314 READY (A/Gb mode only)	Default 44 sec NOTE 2	All except GMM-DEREG	Transmission of a PTP PDU	Forced to Standby	No cell-updates are performed
T3317 (lu mode only)	15s	GMM-SERVICE-REQUEST-INITIATED	SERVICE REQUEST sent	Security mode control procedure is completed, SERVICE ACCEPT received, or SERVICE REJECT received	Abort the procedure
T3319 (lu mode only)	Default 30s NOTE 1 NOTE 4	GMM-REG	Completion of the Security Mode Control procedure after sending a SERVICE REQUEST with service type "data". Reception of a SERVICE ACCEPT message.	When entering PMM-IDLE mode. When the radio access bearer is released for any active PDP context. When entering state GMM-DEREG	SERVICE REQUEST with service type "data" may be invoked again, if required.

T3323	NOTE 6	GMM-REGISTERED	T3312 expires while ISR is activated and either T3346 is running or the MS is in one of the following states: -GMM-REGISTERED.NO-CELL-AVAILABLE; -GMM-REGISTERED.PLMN-SEARCH; -GMM-REGISTERED.UPDATE-NEEDED;or -GMM-REGISTERED.LIMITED-SERVICE.	When entering state GMM-DEREGISTERED or when entering PMM-CONNECTED mode.	Deactivation of ISR by setting TIN to "GUTI"
T3324	NOTE 9	GMM-REGISTERED.NORMAL-SERVICE EMM-REGISTERED.NORMAL-SERVICE (defined in 3GPP TS 24.301 [120]) 5GMM-REGISTERED.NORMAL-SERVICE over 3GPP access (defined in 3GPP TS 24.501 [167])	In A/Gb mode, when READY state is left. In lu mode, when PMM-CONNECTED mode is left. In S1 mode, when the EMM-CONNECTED mode is left (defined in 3GPP TS 24.301 [120]). In N1 mode, when the 5GMM-CONNECTED mode over 3GPP access is left (defined in 3GPP TS 24.501 [167])	When entering state GMM-DEREGISTERED, READY state in A/Gb mode, or PMM-CONNECTED mode in lu mode, When entering state EMM-DEREGISTERED, or EMM-CONNECTED mode in S1 mode (defined in 3GPP TS 24.301 [120]). When entering state 5GMM-DEREGISTERED over 3GPP access, or 5GMM-CONNECTED mode in N1 mode over 3GPP access (defined in 3GPP TS 24.501 [167])	The MS may activate PSM if in GMM-REGISTERED.NORMAL-SERVICE. The MS may activate PSM if in EMM-REGISTERED.NORMAL-SERVICE (defined in 3GPP TS 24.301 [120]). The MS may activate MICO mode if in 5GMM-REGISTERED.NORMAL-SERVICE over 3GPP access (defined in 3GPP TS 24.501 [167])
T3325	Default 60s NOTE 10	GMM-REGISTERED.NORMAL-SERVICE EMM-REGISTERED.NORMAL-SERVICE (defined in 3GPP TS 24.301 [120])	In A/Gb mode and lu mode when T3317 expires and service request attempt counter is greater than or equal to 5 In S1 mode when T3417 expires and service request attempt counter is greater than or equal to 5	When entering state other than GMM-REGISTERED.NORMAL-SERVICE state, or. When entering state other than EMM-REGISTERED.NORMAL-SERVICE state, or. MS camped to a new PLMN other than the PLMN on which timer started, or DRB established from network.	The MS may initiate SERVICE REQUEST procedure

T3346	NOTE 7	<p>GMM- DEREGISTERE D. ATTEMPTING- TO-ATTACH GMM- REGISTERED. ATTEMPTING- TO-UPDATE GMM- REGISTERED EMM- DEREGISTERE D. ATTEMPTING- TO-ATTACH EMM- REGISTERED. ATTEMPTING- TO-UPDATE EMM- REGISTERED (defined in 3GPP TS 24.30 1 [120]). 5GMM- DEREGISTERE D. ATTEMPTING- REGISTRATIO N 5GMM- REGISTERED. ATTEMPTING- REGISTRATIO N-UPDATE 5GMM- REGISTERED (defined in 3GPP TS 24.50 1 [167]).</p>	<p>ATTACH REJECT, ROUTING AREA UPDATE REJECT or SERVICE REJECT received with a timer value for T3346; "Extended wait time" for PS domain from the lower layers (defined in 3GPP TS 25.331 [23c]). ATTACH REJECT, TRACKING AREA UPDATE REJECT or SERVICE REJECT (defined in 3GPP TS 24.301 [120]) received with a timer value for T3346; "Extended wait time" from the lower layers. (defined in 3GPP TS 36.331 [129]). REGISTRATION REJECT, DE- REGISTRATION REQUEST or SERVICE REJECT (defined in 3GPP TS 24.501 [167]) received with a timer value for T3346.</p>	<p>- Paging received or DETACH REQUEST with the detach type "re- attach required" received - see subclause 4.1.1.7 (A/Gb mode or lu mode only) - see subclause 5.3.9 in 3GPP TS 24.301 [122] (S1 mode only) - see subclause 5.3.9 in 3GPP TS 24.501 [167] (N1 mode only)</p>	<p>Initiation of GPRS attach procedure, routing area updating procedure or service request procedure, dependent on GMM state and GPRS update status. Initiation of EPS attach procedure, tracking area updating procedure or service request procedure, dependent on EMM state and EPS update status. (defined in 3GPP TS 24.301 [1 20]) Initiation of registration procedure or service request procedure, dependent on 5GMM state and 5GS update status. (defined in 3GPP TS 24.501 [1 67])</p>
<p>NOTE 1: The default value of this timer is used if the network does not indicate another value in a GMM signalling procedure.</p> <p>NOTE 2: The default value of this timer is used if neither the MS nor the Network send another value, or if the Network sends this value, in a signalling procedure.</p> <p>NOTE 3: Typically, the procedures are aborted on the fifth expiry of the relevant timer. Exceptions are described in the corresponding procedure description.</p> <p>NOTE 4: The purpose of this timer is to prevent the MS from repeating the SERVICE REQUEST message with service type "data" too early in case the request to setup the radio access bearer is queued by the radio access network.</p> <p>NOTE 5: The cases in which the default value of this timer is used are described in subclause 4.7.2.7.</p> <p>NOTE 6: The value of this timer may be provided by the network to the MS in the ATTACH ACCEPT message and ROUTING AREA UPDATE ACCEPT message. The default value of this timer is identical to the value of timer T3312.</p> <p>NOTE 7: The timer value is provided by the network in an ATTACH REJECT, ROUTING AREA UPDATE REJECT, TRACKING AREA UPDATE REJECT, REGISTRATION REJECT, DE-REGISTRATION REQUEST or SERVICE REJECT message or as a "Extended wait time" value by the lower layers, or chosen randomly from a default value range of 15 – 30 minutes. In this release, receipt of the "Extended wait time" as part of 5GMM from the lower layers is not defined.</p> <p>NOTE 8: The cases in which the default value of this timer is used are described in subclause 4.7.2.2.</p> <p>NOTE 9: The timer value is provided by the network in an ATTACH ACCEPT, ROUTING AREA UPDATE ACCEPT, TRACKING AREA UPDATE ACCEPT or REGISTRATION ACCEPT message.</p> <p>NOTE 10: The value of this timer is UE implementation specific, with a minimum value of 60 seconds.</p>					

Table 11.4/3GPP TS 24.008: GPRS Mobility management timers - network side

TIMER NUM.	TIMER VALUE	STATE	CAUSE OF START	NORMAL STOP	ON THE 1 st , 2 nd , 3 rd , 4 th EXPIRY Note 3
T3322	6s NOTE 1	GMM- DEREG-INIT	DETACH REQUEST sent	DETACH ACCEPT received	Retransmission of DETACH REQUEST
T3350	6s NOTE 1	GMM- COMMON- PROC-INIT	ATTACH ACCEPT sent with P-TMSI and/or TMSI RAU ACCEPT sent with P-TMSI and/or TMSI P-TMSI REALLOCATION COMMAND sent	ATTACH COMPLETE received RAU COMPLETE received P-TMSI REALLOCATION COMPLETE received	Retransmission of the same message type, i.e. ATTACH ACCEPT, RAU ACCEPT or REALLOCATION COMMAND
T3360	6s NOTE 1	GMM- COMMON- PROC-INIT	AUTHENTICATION AND CIPHERING REQUEST sent	AUTHENTICATION AND CIPHERING RESPONSE received AUTHENTICATION-AND CIPHERING-FAILURE received	Retransmission of AUTHENTICATION AND CIPHERING REQUEST
T3370	6s NOTE 1	GMM- COMMON- PROC-INIT	IDENTITY REQUEST sent	IDENTITY RESPONSE received	Retransmission of IDENTITY REQUEST
NOTE 1 If the SGSN supports EC-GSM-IoT and if the MS is using EC-GSM-IoT, the timer value is calculated as described in subclause 4.7.2.12.					

Table 11.4a/3GPP TS 24.008: GPRS Mobility management timers - network side

TIMER NUM.	TIMER VALUE	STATE	CAUSE OF START	NORMAL STOP	ON EXPIRY
T3313	NOTE 1 NOTE 9	GMM-REGISTERED	Paging procedure initiated	Paging procedure completed	Network dependent
T3314 READY (A/Gb mode only)	Default 44 sec NOTE 2	All except GMM-DEREGISTERED	Receipt of a PTP PDU	Forced to Standby Completion of a successful GPRS attach or routing area updating procedure in lu mode. Indication received from HLR/HSS that the MS performed an EPS attach or indication received from the MME that the MS is performing a tracking area updating procedure.	The network shall page the MS if a PTP PDU has to be sent to the MS
T3315	NOTE 7	GMM-REGISTERED	Paging procedure initiated for an MS which the network accepted the request to use eDRX	Paging procedure completed Paging procedure is aborted	Paging procedure is aborted and the network proceeds as specified in 3GPP TS 23.060 [74]
mobile reachable	NOTE 4	All except GMM-DEREGISTERED	In A/Gb mode, when entering STANDBY state In lu mode, when entering PMM-IDLE mode.	PTP PDU received	Network dependent but typically paging is halted on 1st expiry if the MS is not attached for emergency bearer services. Implicitly detach the MS which is attached for the emergency bearer services. Start implicit detach timer if ISR is activated.
implicit detach timer	NOTE 5	All except GMM-DEREGISTERED	The mobile reachable timer expires while the network is in PMM-IDLE mode or STANDBY state.	PTP PDU received	Implicitly detach the MS on 1st expiry
active timer	NOTE 6	All except GMM-DEREGISTERED	In A/Gb mode, when entering STANDBY state. In lu mode, when entering PMM-IDLE mode.	PTP PDU received	Network dependent but typically paging is halted on 1st expiry

- NOTE 1: The value of this timer is network dependent.
- NOTE 2: The default value of this timer is used if neither the MS nor the Network send another value, or if the Network sends this value, in a signalling procedure. The value of this timer should be slightly shorter in the network than in the MS, this is a network implementation issue.
- NOTE 3: Typically, the procedures are aborted on the fifth expiry of the relevant timer. Exceptions are described in the corresponding procedure description.
- NOTE 4: The default value of this timer is 4 minutes greater than T3312. If T3346 is larger than T3312 and the SGSN includes timer T3346 in the ROUTING AREA UPDATE REJECT message or the SERVICE REJECT message, the value of the mobile reachable timer and implicit detach timer is set such that the sum of the timer values is greater than T3346. If the MS is attached for emergency bearer services, the value of this timer is set equal to T3312.
- NOTE 5: The value of this timer is network dependent. If ISR is activated, the default value of this timer is 4 minutes greater than T3323.
- NOTE 6: If the network includes timer T3324 in the ATTACH ACCEPT message or ROUTING AREA UPDATE ACCEPT message and if the MS is not attached for emergency bearer services and has no PDN connection for emergency bearer services, the value of this timer is equal to the value of timer T3324.
- NOTE 7: The value of this timer is smaller than the value of timer T3-RESPONSE (see 3GPP TS 29.274 [16D]).
- NOTE 8: If the SGSN supports EC-GSM-IoT and if the MS is using EC-GSM-IoT, the timer value is calculated as described in subclause 4.7.2.12.
- NOTE 9: If the SGSN supports EC-GSM-IoT and if the MS is using EC-GSM-IoT, then the timer value shall be calculated by using a multiplier which value is network dependent.

11.2.3 Timers of GPRS session management

Table 11.2c/3GPP TS 24.008: GPRS session management timers - MS side

TIMER NUM.	TIMER VALUE	STATE	CAUSE OF START	NORMAL STOP	ON THE 1 st , 2 nd , 3 rd , 4 th EXPIRY
T3380	30s NOTE 3	PDP- ACTIVE-PEND or MBMS ACTIVE- PENDING	ACTIVATE PDP CONTEXT REQUEST, ACTIVATE SECONDARY PDP CONTEXT REQUEST or ACTIVATE MBMS CONTEXT REQUEST sent	ACTIVATE PDP CONTEXT ACCEPT, ACTIVATE SECONDARY PDP CONTEXT ACCEPT or ACTIVATE MBMS CONTEXT ACCEPT received ACTIVATE PDP CONTEXT REJECT, ACTIVATE SECONDARY PDP CONTEXT REJECT or ACTIVATE MBMS CONTEXT REJECT received	Retransmission of ACTIVATE PDP CONTEXT REQ, ACTIVATE SECONDARY PDP CONTEXT REQUEST or ACTIVATE MBMS CONTEXT REQUEST
T3381	8s NOTE 3	PDP-MODIFY- PENDING	MODIFY PDP CONTEXT REQUEST sent	MODIFY PDP CONTEXT ACCEPT received	Retransmission of MODIFY PDP CONTEXT REQUEST
T3390	8s NOTE 3	PDP- INACT-PEND	DEACTIVATE PDP CONTEXT REQUEST sent	DEACTIVATE PDP CONTEXT ACC received	Retransmission of DEACTIVATE PDP CONTEXT REQUEST

T3396	NOTE 1	<p>PDP-ACT-PEND or MBMS ACTIVE-PENDING</p> <p>PROCEDURE TRANSACTION PENDING (defined in 3GPP TS 24.301 [120])</p> <p>PROCEDURE TRANSACTION PENDING (defined in 3GPP TS 24.501 [167])</p>	<p>ACTIVATE PDP CONTEXT REJECT, ACTIVATE MBMS CONTEXT REJECT, ACTIVATE SECONDARY PDP CONTEXT REJECT, DEACTIVATE PDP CONTEXT REQUEST or MODIFY PDP CONTEXT REJECT received with SM cause #26 and with a timer value for T3396</p> <p>PDN CONNECTIVITY REJECT, BEARER RESOURCE MODIFICATION REJECT, BEARER RESOURCE ALLOCATION REJECT or DEACTIVATE EPS BEARER CONTEXT REQUEST (defined in 3GPP TS 24.301 [120]) received with ESM cause #26 and with a timer value for T3396</p> <p>PDU SESSION ESTABLISHMENT REJECT, PDU SESSION MODIFICATION REJECT, or PDU SESSION RELEASE COMMAND (defined in 3GPP TS 24.501 [167]) received with 5GSM cause #26 and with a timer value for T3396</p>	<p>REQUEST PDP CONTEXT ACTIVATION or REQUEST SECONDARY PDP CONTEXT ACTIVATION or MODIFY PDP CONTEXT REQUEST or REQUEST MBMS CONTEXT ACTIVATION or ACTIVE DEFAULT EPS BEARER CONTEXT REQUEST or ACTIVATE DEDICATED EPS BEARER CONTEXT REQUEST or MODIFY EPS BEARER CONTEXT REQUEST or DETACH REQUEST with the detach type "re-attach required" or paging for EPS services using IMSI or paging for GPRS services using IMSI received or PDU SESSION RELEASE COMMAND or PDU SESSION MODIFICATION COMMAND or DEREGISTRATION REQUEST with the re-registration type "re-registration required".</p>	None
-------	--------	--	--	--	------

Back-off timer	12 min NOTE 2	PDP- ACT-PEND PROCEDURE TRANSACTION PENDING (defined in 3GPP TS 24.301 [120])	<p>ACTIVATE PDP CONTEXT REJECT, ACTIVATE MBMS CONTEXT REJECT, ACTIVATE SECONDARY PDP CONTEXT REJECT, or MODIFY PDP CONTEXT REJECT received with SM cause value #8 "operator determined barring", #27 "missing or unknown APN", #32 "service option not supported", or #33 "requested service option not subscribed", or received with an SM cause different from #26 "insufficient resources" and with a back-off timer value as specified in subclauses 6.1.3.1.3.3, 6.1.3.2.2.3, 6.1.3.3.3.3, and 6.1.3.8.2.3</p> <p>PDN CONNECTIVITY REJECT, BEARER RESOURCE MODIFICATION REJECT or BEARER RESOURCE ALLOCATION REJECT (defined in 3GPP TS 24.301 [120]) received with ESM cause value #8 "operator determined barring", #27 "missing or unknown APN", #32 "service option not supported", or #33 "requested service option not subscribed", or received with an ESM cause different from #26 "insufficient resources" and with a back-off timer value as specified in 3GPP TS 24.301 [120]</p> <p>PDU SESSION ESTABLISHMENT REJECT or PDU SESSION MODIFICATION REJECT (defined in 3GPP TS 24.501 [167]) received with 5GSM cause value #8 "operator determined barring", #27 "missing or unknown DNN", #32 "service option not supported", #33 "requested service option not subscribed" or #70 "missing or unknown DNN in a slice", or received with an 5GSM cause different from #26 "insufficient resources", #67 "insufficient resources for specific slice and DNN", or #69 "insufficient resources for specific slice" and with a back-off timer value as specified in 3GPP TS 24.501 [167]</p>	None	None
----------------	------------------	--	--	------	------

NOTE 1: The value of this timer or the value of this timer unit can be provided by the network operator when:

- a request to activate a PDP context, a request to activate a MBMS context or a request to modify a PDP context is rejected by the network with a certain SM cause;
- a request to deactivate a PDP context is received with a certain SM cause value;
- a request to establish a PDN connection, a request to allocate bearer resources or a request to modify bearer resources (defined in 3GPP TS 24.301 [120]) is rejected by the network with a certain ESM cause;
- a request to deactivate a EPS bearer context is received with a certain ESM cause value;
- a request to establish a PDU session or a request to modify a PDU session (defined in 3GPP TS 24.501 [167]) is rejected by the network:
 - 1) with a certain 5GSM cause; or
 - 2) indication that the 5GSM message was not forwarded due to DNN based congestion control; or
- a command to release a PDU session is received with a certain 5GSM cause value.

If the timer unit is not set to indicate that the timer is deactivated, the value of the timer when included with SM cause, ESM cause, 5GSM cause #26, or due to DNN based congestion control is zero or the timer value is taken randomly from an operator dependent range not greater than 70 hours. If the PDN CONNECTIVITY REJECT was sent together with an ATTACH REJECT message and the ATTACH REJECT message was not integrity protected, MS uses a random value from a default range of 10mins to 30mins.

NOTE 2: The default value of 12 minutes applies only for certain SM, ESM and 5GSM cause values as specified in subclauses 6.1.3.1.3.3, 6.1.3.2.2.3, and 6.1.3.3.3.3 in 3GPP TS 24.301 [120] and 3GPP TS 24.501 [167].

NOTE 3: If the MS is using EC-GSM-IoT, the timer value shall be calculated as described in subclause 4.7.2.12.

NOTE 1: Typically, the procedures are aborted on the fifth expiry of the relevant timer. Exceptions are described in the corresponding procedure description.

NOTE 2: The back-off timer is used to describe a logical model of the required MS behaviour. This model does not imply any specific implementation, e.g. as a timer or timestamp.

NOTE 3: Reference to back-off timer in this section can either refer to use of timer T3396 or to use of a different packet system specific timer within the MS. Whether the MS uses T3396 as a back-off timer or it uses different packet system specific timers as back-off timers is left up to MS implementation.

Table 11.2d/3GPP TS 24.008: GPRS session management timers - network side

TIMER NUM.	TIMER VALUE	STATE	CAUSE OF START	NORMAL STOP	ON THE 1 st , 2 nd , 3 rd , 4 th EXPIRY
T3385	8s NOTE 1	PDP- ACT-PEND or MBMS ACTIVE- PENDING	REQUEST PDP CONTEXT ACTIVATION or REQUEST SECONDARY PDP CONTEXT ACTIVATION or REQUEST MBMS CONTEXT ACTIVATION sent	ACTIVATE PDP CONTEXT REQUEST or ACTIVATE SECONDARY PDP CONTEXT REQUEST or ACTIVATE MBMS CONTEXT REQUEST received	Retransmission of REQUEST PDP CONTEXT ACTIVATION or REQUEST SECONDARY PDP CONTEXT ACTIVATION or REQUEST MBMS CONTEXT ACTIVATION
T3386	8s NOTE 1	PDP- MOD-PEND	MODIFY PDP CONTEXT REQUEST sent	MODIFY PDP CONTEXT ACC received	Retransmission of MODIFY PDP CONTEXT REQ
T3395	8s NOTE 1	PDP- INACT-PEND or MBMS INACTIVE- PENDING	DEACTIVATE PDP CONTEXT REQUEST sent	DEACTIVATE PDP CONTEXT ACC received	Retransmission of DEACTIVATE PDP CONTEXT REQ
NOTE 1: If the SGSN supports EC-GSM-IoT and if the MS is using EC-GSM-IoT, the timer value shall be calculated as described in subclause 4.7.2.12.					

NOTE 4: Typically, the procedures are aborted on the fifth expiry of the relevant timer. Exceptions are described in the corresponding procedure description.

11.3 Timers of circuit-switched call control

Table 11.3/3GPP TS 24.008: Call control timers - MS side

TIM NUM.	TIM VAL	STATE OF CALL	CAUSE OF START	NORMAL STOP	AT FIRST EXPIRY	AT SECOND EXPIRY
T303	30s	Call initiated	CM SER RQ sent	ALERT,CONN, CALL PROC, or REL COMP received	Clear the call	Timer is not restarted
T305	30s	Disconnect Request	DISC sent	REL or DISC received	REL sent.	Timer is not restarted
T308	30s	Release request	REL sent	REL COMP or REL received	Retrans. RELEASE restart T308	Call ref. release
T310 Note 1	30s	Outgoing call Proceeding	CALL PROC received	ALERT,CONN, DISC or PROG rec.	Send DISC	Timer is not restarted
T313	30s	Connect Request	CONN sent	CONNECT ACKnowledge received	Send DISC	Timer is not restarted
T322	Note 2	All states	STATUS ENQUIRY sent	STATUS, REL, REL COMP or DISC received	Retrans. STATUS ENQUIRY or Clear the call	Clear the call
T323	30s	Modify Request	MOD sent	MOD COMP or MOD REJ received	Clear the call	Timer is not restarted
T324	15s	Modify request	MOD received	MOD COMP or MOD REJ sent	MOD REJ with old bearer capability	Timer is not restarted
T332	30s	Wait for network info	START_CC sent	CC-EST. received	Clear the call	Timer is not restarted
T335	30s	CC-Est. Confirmed	CC-EST CONF.sent	RECALL received	Clear the call	Timer is not restarted
T336	10s		START DTMF sent	START DTMF ACK or START DTMF REJECT received	The MS considers the DTMF Procedure (for the digit) to be terminated	Timer is not restarted
T337	10s		STOP DTMF sent	STOP DTMF ACK received	The MS considers the DTMF procedure (for the current digit) to be terminated	Timer is not restarted

NOTE 1: T310 is not started if progress indicator #1, #2, or #64 has been delivered in the CALL PROCEEDING message or in a previous PROGRESS message.

NOTE 2: The value of this timer is implementation dependent.

Table 11.4/3GPP TS 24.008: Call control timers - network side

TIM NUM.	DFT TIM VAL	STATE OF CALL	CAUSE FOR START	NORMAL STOP	AT FIRST EXPIRY	AT SECOND EXPIRY
T301 Note 1	Min18 0s	Call received	ALERT received	CONN received	Clear the call	Timer is not restarted
T303	Note 2	Call present	SETUP sent	CALL CONF or REL COMP received	Clear the call	Timer is not restarted
T305	30s	Disconnect Indication	DISC without progress indic. #8 sent or CCBS Possible	REL or DISC received	Network sends RELEASE	Timer is not restarted
T306	30s	Disconnect Indication	DISC with progress indic. #8 sent but no CCBS possible	REL or DISC received	Stop the tone/announc. Send REL	Timer is not restarted
T308	Note 2	Release request	REL sent	REL COMP or REL received	Retrans. RELEASE restart T308	Release call reference
T310	Note 2	Incoming call proceeding	CALL CONF received	ALERT, CONN or DISC received	Clear the call	Timer is not restarted
T313	Note 2	Connect Indication	CON sent	CON ACK received	Clear the call	Timer is not restarted
T322	Note 2	All states	STATUS ENQUIRY sent	STATUS, REL, REL COMP or DISC received	Retran. STATUS ENQUIRY or Clear the call	Clear the call
T323	30s	Modify request	MOD sent	MOD COMP or MOD REJ received	Clear the call	Timer is not restarted
T331	Note 2	CC Connec. Pending	CM-SERV PROMPT sent	START CC received	Clear the call	Timer is not restarted
T333	Note 2	CC-Est. Present	START CC received	CC-EST.CONF or REL COMP received	Clear the call	Timer is not restarted
T334 Note 3	Min 15s	CC-Est. Confirmed	RECALL sent	SETUP received	Clear the call	Timer is not restarted
T338	Note 2	Disconnect indication	DISC with CCBS possible	REL or DISC received	stop any tone/announc. Send REL	Timer is not restarted

NOTE 1: The network may already have applied an internal alerting supervision function; e.g. incorporated within call control. If such a function is known to be operating on the call, then timer T301 is not used.

NOTE 2: These time values are set by the network operator.

NOTE 3: When applied to the supplementary service CCBS, the timer T334 can either represent the recall timer T4 or the notification timer T10 (see 3GPP TS 23.093 [88a]). Thus the timer T334 can take two different values. 3GPP TS 23.093 [88a] defines the range of these values.

Annex A (informative): Example of subaddress information element coding

This annex gives an example of how the Called Party Subaddress IE is encoded to carry subaddress digits that use IA5 characters. This example is also applicable to the Calling Party Subaddress IE.

8	7	6	5	4	3	2	1	octet
0	1	1	0	1	1	0	1	1
called party subaddress IEI								
0	0	0	0	0	1	1	1	2
Length								
1 not ext	0	0	0	X	0	0	0	3
NSAP (X.213/ISO 8348 AD2)				odd/ev note 1	note 2			
0	1	0	1	0	0	0	0	4
AFI (note 3)								
IA5 Character (note 4)								5
IA5 Character (note 4)								6
IA5 Character (note 4)								9

NOTE 1: The value of this bit has no significance when the type of subaddress is "NSAP".

NOTE 2: These bits are spare.

NOTE 3: The Authority and Format Identifier code 50 (in BCD) indicates that the subaddress consists of IA5 characters (see ISO standard 8348 AD2).

NOTE 4: IA5 character as defined in ITU-T Recommendation T.50 [52]/ISO 646 and then encoded into two semi-octets according to the "preferred binary encoding" defined in X.213 [144]/ISO 8348 AD2. (Each character is converted into a number in the range 32 to 127 using the ISO 646 encoding with zero parity and the parity bit in the most significant position. This number is then reduced by 32 to give a new number in the range 0 to 95. The new number is then treated as a pair of decimal digits with the value of each digit being encoded in a semi-octet.)

NOTE 5: the number of IA5 characters in the subaddress may vary, subject to an upper limit of 19 IA5 characters.

Annex B (normative): Compatibility checking

B.1 Introduction

This annex describes the various compatibility checks which shall be carried out to ensure that the best matched MS and network capabilities are achieved on a call between a PLMN and the ISDN.

Three different processes of compatibility checking shall be performed:

- i) at the user-to-network interface on the calling side (see B.2);
- ii) at the network-user interface on the called side (see B.3.2);
- iii) user-to-user (see B.3.3).

NOTE: In this context and throughout this annex the term "called user" is the end point entity which is explicitly addressed.

For details on the coding of the information required for compatibility checking, see annex C.

B.2 Calling side compatibility checking

B.2.1 Compatibility checking of the CM SERVICE REQUEST message

The network shall check if the service requested in the CM SERVICE REQUEST message is permitted for that subscriber.

B.2.2 Compatibility/Subscription checking of the SETUP message

At the calling side the network shall check that the basic service(s) requested by the calling MS in the Bearer Capability information element(s) match(es) with the basic services provided to that subscriber by the PLMN. If for at least one bearer capability information element contained in the SETUP message a mismatch is detected, then the network shall proceed as follows:

- if the SETUP message contained two bearer capability information elements for only one of which a mismatch is detected, the network shall either:
 - under the conditions specified in 3GPP TS 27.001 [36] (e.g. TS 61 and TS 62), accept the SETUP message with a CALL PROCEEDING message containing the, possibly negotiated, bearer capability information element for which no mismatch is detected, or
 - reject the call using one of the causes listed in annex H.
- otherwise the network shall reject the call using one of the causes listed in annex H.

Network services are described in 3GPP TS 22.002 [3] and 3GPP TS 22.003 [4] as bearer services and teleservices, respectively.

B.3 Called side compatibility checking

In this clause, the word "check" means that the MS examines the contents of the specified information element.

B.3.1 Compatibility checking with addressing information

If an incoming SETUP message is offered to the MS with addressing information (i.e. sub-address or called party number) the following shall occur:

- a) if the MS has a DDI number or a sub-address, then the information in any Called Party BCD Number or any Called Party subaddress information elements of the incoming SETUP message shall be checked by the MS against the corresponding part of the number assigned to the user (e.g. for DDI) or the user's own sub-address.

In the cases of a mismatch, the MS shall release the call. In the case of a match, the compatibility checking described in B.3.2 and B.3.3 shall be performed.

- b) if the MS has no DDI number and no sub-address, then the Called Party BCD Number and Called Party Sub-address information element shall be ignored for the purposes of compatibility checking. The compatibility checking described in B.3.2 and B.3.3 shall be performed.

NOTE: According to the user's requirements, compatibility checking can be performed in various ways from the viewpoint of execution order and information to be checked, e.g. first DDI number/sub-address and then bearer capability or vice versa.

B.3.2 Network-to-MS compatibility checking

When the network is providing a basic service at the called side, the MS shall check that the basic service(s) offered by the network in the Bearer Capability information element(s) match(es) the basic services that the MS is able to support. If a mismatch is detected, then the MS shall proceed as follows:

- if the SETUP message contained two bearer capability information elements for only one of which a mismatch is detected, the MS shall either:
 - under the conditions specified in 3GPP TS 27.001 [36] (e.g. TS 61 and TS 62), accept the SETUP message with a CALL CONFIRMED message containing the, possibly negotiated, bearer capability information element for which no mismatch is detected, or
 - reject the call using cause No. 88 "incompatible destination".
- otherwise the MS shall reject the offered call using a RELEASE COMPLETE message with cause No. 88 "incompatible destination".

NOTE: The *backup bearer capability* IE is not subject to compatibility checking.

When interworking with existing networks, limitations in network or distant user signalling (e.g. in the case of an incoming call from a PSTN or a call from an analogue terminal) may restrict the information available to the called MS in the incoming SETUP message (e.g. missing Bearer Capability Information Element or missing High Layer Compatibility Information Element). For compatibility checking, and handling of such calls see 3GPP TS 27.001 [36].

B.3.3 User-to-User compatibility checking

See 3GPP TS 27.001 [36].

B.4 High layer compatibility checking

See 3GPP TS 27.001 [36].

Annex C (normative): Low layer information coding principles

C.1 Purpose

This annex describes principles that shall be used when the calling MS specifies information during call setup regarding low layer capabilities required in the network and by the destination terminal. Refer also to 3GPP TS 27.001 [36].

NOTE: In this context and throughout this annex the term "called user" is the end point entity which is explicitly addressed. This may also be an explicitly addressed interworking unit (IWU) (see ITU-T I.500-Series Recommendations and ITU-T Recommendation X.31 case a).

C.2 Principles

C.2.1 Definition of types of information

There are three different types of information that the calling PLMN user may specify during call setup to identify low layer capabilities needed in the network and in the destination terminal:

- a) type I information is information about the calling terminal which is only used at the destination end to allow a decision regarding terminal compatibility. An example would be the user information layer 3 protocol. Type I information is encoded in octets 5 to 7 of the low layer compatibility information element;
- b) type II information is only used by the network (PLMN) to which the calling user is connected for selection of PLMN specific network resources, e.g. channel type or specific functionality within the interworking function (IWF, see 3GPP TS 23.093 [88a]). This type of information is always present. An example is the connection element. Type II information is coded in:
 - i) octet 3 of the bearer capability information element when the information transfer capability required by the calling user is speech ;
 - ii) octets 3, 4, 5, and optionally octet 7 of the bearer capability information element when the information transfer capability required by the calling user is not speech;
- c) type III information is required for selection of a basic service from the choice of basic services offered by the network and together with type II information for selection of an appropriate interworking function (IWF, see 3GPP TS 29.007 [38]), as well as for terminal compatibility checking at the destination terminal. An example is the information transfer capability. Type III information is always present and is encoded in:
 - i) octet 3 of the bearer capability information element when the information transfer capability required by the calling user is speech ;
 - ii) octets 3, 5, 6, 6a, 6b and 6c of the bearer capability information element when the information transfer capability required by the calling user is not speech;

C.2.2 Examination by network

Type I information is user-to-user (i.e. at the calling side not examined by network) while type II and III information should be available for examination by the destination user and the network.

NOTE: In the case of a mobile terminated call, if the type II and type III information is not sufficient for the selection of an appropriate interworking function, the type I information will also be examined by the network.

C.2.3 Location of type I information

Type I information (i.e. terminal information only significant to the called user) shall, when used, be included in the low layer compatibility information element.

C.2.4 Location of types II and III information

Type II information is included in the bearer capability information element. Type III information is also included in the bearer capability information element. The network may use and modify type III information (e.g. to provide interworking).

In any case a modification of the bearer capability information element has to be performed when interworking to the fixed network (e.g. ISDN) is required, where the signalling of the radio interface has to be mapped to fixed network signalling (e.g. mapping of GSM BCIE to ISDN BCIE, see 3GPP TS 29.007 [38]).

C.2.5 Relationship between bearer capability and low layer compatibility information elements

There shall be no contradiction of information between the low layer compatibility and the bearer capability at the originating side. However, as some bearer capability code points may be modified during the transport of the call (e.g. by the interworking function), this principle implies that there should be minimal duplication of information between the bearer capability information element and the low layer compatibility information element.

NOTE: If as a result of duplication, a contradiction occurs at the terminating side between the bearer capability information element and the low layer compatibility information element at the terminating side, the receiving entity shall ignore the conflicting information in the low layer compatibility information element.

Annex D (informative): Examples of bearer capability information element coding

This annex gives examples of the coding of bearer capability information elements for various telecommunication services. This annex is included for information purposes only. In the case of any inconsistency between this annex and 3GPP TS 27.001 [36], then 3GPP TS 27.001 [36] shall take precedence over this annex.

D.1 Coding for speech for a full rate support only mobile station

D.1.1 Mobile station to network direction

8	7	6	5	4	3	2	1	
0	0	0	0	0	1	0	0	octet 1
Bearer capability IEI								
0	0	0	0	0	0	0	1	octet 2
Length of the bearer capability contents								
1	0	1	0	0	0	0	0	octet 3
not ext	full rate only		GSM	circ. mode	speech			

D.1.2 Network to mobile station direction

8	7	6	5	4	3	2	1	
0	0	0	0	0	1	0	0	octet 1
Bearer capability IEI								
0	0	0	0	0	0	0	1	octet 2
Length of the bearer capability contents								
1	0	1	0	0	0	0	0	octet 3
not ext	spare	spare	GSM	circ. mode	speech			

D.2 An example of a coding for modem access with V22-bis, 2,4 kbit/s, 8 bit no parity

D.2.1 Mobile station to network direction, data compression allowed

8	7	6	5	4	3	2	1	
0	0	0	0	0	1	0	0	octet 1
Bearer capability IEI								
0	0	0	0	0	1	1	1	octet 2
Length of the bearer capability contents								
1 not ext	1	0	0	0	0	1	0	octet 3
dual, half preferred		GSM		circ. mode	3.1 kHz audio ex PLMN			
1 not ext	1	0	0	1	0	0	0	octet 4
comp- ress.	SDU integrity		full dupl.	pt to pt	no NIRR	de- mand		
1 not ext	0	0	0	0	0	0	1	octet 5
access id.		no rate adaption			1.440/450			
0 ext	0	1	0	0	0	0	1	octet 6
layer 1		default layer 1					async	
0 ext	0	0	1	0	0	1	1	octet 6a
1 bit	no neg		8 bits	2.4 kbit/s				
0 ext	1	1	0	0	0	1	1	octet 6b
16 kbit/s inter. rate		no NICtx	no NICrx	(parity) none				
1 not ext	0	1	0	0	0	1	1	octet 6c
non trans RLP)		V.22 bis						

D.2.2 Network to mobile station direction, data compression possible

8	7	6	5	4	3	2	1	
0	0	0	0	0	1	0	0	octet 1
Bearer capability IEI								
0	0	0	0	0	1	1	1	octet 2
Length of the bearer capability contents								
1 not ext	0 spare	1 spare	0 GSM	0 circ. mode	0	1	0	octet 3
3.1 kHz audio ex PLMN								
1 not ext	1 comp- ress.	0 SDU integrity		1 full dupl.	0 pt to pt	0 no NIRR	0 de- mand	octet 4
1 not ext	0 access id.		0 no rate adaption		0	0 1.440/450		octet 5
0 ext	0 layer 1		0 default layer 1				1 async	octet 6
0 ext	0 1 bit	0 no neg	1 8 bits	0	0	1	1	octet 6a
2.4 kbit/s								
0 ext	1 16 kbit/s inter. rate		0 no NICtx	0 no NICrx	0 (parity) none			octet 6b
1 not ext	0 non trans (RLP)		0 V.22 bis					octet 6c

D.3 An example of a coding for group 3 facsimile (9,6 kbit/s, transparent)

D.3.1 Mobile station to network direction

8	7	6	5	4	3	2	1		
0	0	0	0	0	1	0	0	octet 1	
Bearer capability IEI									
0	0	0	0	0	1	1	1	octet 2	
Length of the bearer capability contents									
1 not ext	0	1	0	0	0	1	1	octet 3	
full rate only MS		GSM	circ. mode	facsimile group 3					
1 not ext	0	1	1	1	0	0	0	octet 4	
comp- ress.	unstructured		full dupl.	pt to pt	no NIRR	de- mand			
1 not ext	0	0	0	0	0	0	1	octet 5	
access id.		no rate adaption		1.440/450					
0 ext	0	1	0	0	0	0	0	octet 6	
layer 1		default layer 1						sync	
0 ext	0	0	1	0	1	0	1	octet 6a	
(syn)	no neg	(syn)	9.6 kbit/s						
0 ext	1	1	0	0	0	1	1	octet 6b	
16 kbit/s inter. rate		no NICtx	no NICrx	(parity) none					
1 not ext	0	0	0	0	0	1	1	octet 6c	
transparent		none (modem type)							

D.3.2 Network to mobile station direction

8	7	6	5	4	3	2	1	
0	0	0	0	0	1	0	0	octet 1
Bearer capability IEI								
0	0	0	0	0	1	1	1	octet 2
Length of the bearer capability contents								
1 not ext	0 spare	1 spare	0 GSM	0 circ. mode	0	1	1	octet 3
facsimile group 3								
1 not ext	0 comp- ress.	1 unstructured	1	1 full dupl.	0 pt to pt	0 no NIRR	0 de- mand	octet 4
1 not ext	0 access id.	0	0 no rate adaption	0	0	0	1 1.440/450	octet 5
0 ext	0 layer 1	1	0	0	0	0	0 sync	octet 6
default layer 1								
0 ext	0 (syn)	0 no neg	1 (syn)	0	1	0	1 9.6 kbit/s	octet 6a
0 ext	1 16 kbit/s inter. rate	1	0 no NICtx	0 no NICrx	0	1	1 (parity) none	octet 6b
1 not ext	0 transparent	0	0	0	0	0	0 none (modem type)	octet 6c

Annex E (informative): Comparison between call control procedures specified in 3GPP TS 24.008 and ITU-T Recommendation Q.931

This annex summarizes a comparison of the procedures for call control as specified in ITU-T Recommendation Q.931 (blue book) and 3GPP TS 24.008.

If no comment is given, it means that the procedures specified in ITU-T Recommendation Q.931 and 3GPP TS 24.008 are similar. However, it should be noted that even in such cases the procedures may be described in slightly different ways in the two documents.

Table E.1/3GPP TS 24.008: Circuit-switched call control procedures

Procedure	Q.931	3GPP TS 24.008
Call establishment at the originating interface	5.1	5.2.1
- call request	5.1.1	5.2.1.1.1 en-bloc sending only
- B-channel selection originating	5.1.2	not applicable
- overlap sending	5.1.3	not supported
- invalid call information	5.1.4	5.2.1.1.2
- call proceeding, en-bloc sending	5.1.5.1	5.2.1.1.3
- call proceeding, overlap sending	5.1.5.2	not supported
- notification of interworking at the originating interf.	5.1.6	5.2.1.1.4
- call confirmation indication	5.1.7	5.2.1.1.5
- call connected	5.1.8	5.2.1.1.6
- call rejection	5.1.9	5.2.1.1.7
- transit network selection	5.1.10	5.2.1.1.8

Table E.1/3GPP TS 24.008: Circuit-switched call control procedures (continued)

Procedure	Q.931	3GPP TS 24.008
Call establishment at the destination interface	5.2	5.2.2
- call indication	5.2.1	5.2.2.1 procedure for multiple terminal configuration not required, i.e. delivery of SETUP messages on broadcast data links is not supported
- compatibility checking	5.2.2	5.2.2.2 equivalent, except that delivery of SETUP messages on broadcast data links is not supported
- B-channel selection destination	5.2.3	not applicable
- overlap receiving	5.2.4	not supported
- call confirmation information	5.2.5	5.2.2.3 equivalent, except that delivery of SETUP messages on broadcast data links is not supported
- notification of interworking at the terminating interf.	5.2.6	5.2.2.4
- call accept indication	5.2.7	5.2.2.5
- active indication	5.2.8	5.2.2.6 equivalent, except that SETUP messages are not sent on broadcast data links
- non-selected user clearing	5.2.9	not applicable

Table E.1/3GPP TS 24.008: Circuit-switched call control procedures (continued)

Procedure	Q.931	3GPP TS 24.008
Call clearing	5.3	5.4
- terminology	5.3.1	5.4.1 terminology adapted to A/Gb mode and GERAN lu mode applications
- exception conditions	5.3.2	5.4.2 only case a) of clause 5.3.2 of Rec. Q.931 applies. All other exceptions apply to functions which are not relevant to A/Gb mode and GERAN lu mode
- clearing initiated by the user/MS	5.3.3	5.4.3
- clearing initiated by the network	5.3.4	5.4.4
- clearing when tones/announcements are provided	5.3.4.1	5.4.4.1.1 and 5.4.4.2.1 exception: if not already connected, the traffic channel is connected in order to provide the tone/announcement
- clearing when tones/announcements are not provided	5.3.4.2	5.4.4.1.2 and 5.4.4.2.3
- completion of clearing	5.3.4.3	5.4.4.1.3 and 5.4.4.2.5
Clear collision	5.3.5	5.4.5

Table E.1/3GPP TS 24.008: Circuit-switched call control procedures (continued)

Procedure	Q.931	3GPP TS 24.008
In-band tones and announcements	5.4	5.5.1
Restart procedure	5.5	not supported
Call rearrangements	5.6	5.3.4 call suspension/call re-establishment not supported on the radio path. The functions, if required, are to be supported locally in the MS. On the radio interface, the notification procedure of Rec. Q.931 (clause 5.6.7) applies
Call collisions	5.7	5.5.2 call collisions cannot occur
Emergency call establishment at the originating interface	not specified not supported	5.2.1.2
In-call modification	Annex O Rec. Q.931 is incomplete with regard to in-call modification procedures	5.3.4
DTMF protocol control procedures	not specified not supported	5.3.3
Call re-establishment	not specified not supported	5.5.4
Status enquiry procedure	5.8.10, 5.8.11	5.5.3
User-to-user signalling	7	3GPP TS 24.010 [21]
User notification procedure	5.9	5.3.1

Annex F (informative): A/Gb mode specific cause values for radio resource management

See 3GPP TS 44.018 [84].

Annex G (informative): 3GPP specific cause values for mobility management

This annex describes the cause values for the mobility management procedures for non-GPRS services (MM) and GPRS services (GMM). Clauses G1 to G5 are valid for both MM and GMM. However, the following codes are applicable for non-GPRS services only:

#38 Call cannot be identified

Clause G.6 applies only for GMM procedures.

G.1 Causes related to MS identification

Cause value = 2 IMSI unknown in HLR

This cause is sent to the MS if the MS is not known (registered) in the HLR, or if the MS has packet only subscription (see 3GPP TS 29.272 [150]). This cause code does not affect operation of the GPRS service, although it may be used by a GMM procedure.

Cause value = 3 Illegal MS

This cause is sent to the MS when the network refuses service to the MS either because an identity of the MS is not acceptable to the network or because the MS does not pass the authentication check, i.e. the SRES received from the MS is different from that generated by the network. When used by an MM procedure, except the authentication procedure, this cause does not affect operation of the GPRS service.

Cause value = 4 IMSI unknown in VLR

This cause is sent to the MS when the given IMSI is not known at the VLR.

Cause value = 5 IMEI not accepted

This cause is sent to the MS if the network does not accept emergency call establishment using an IMEI or not accept attach procedure for emergency services using an IMEI.

Cause value = 6 Illegal ME

This cause is sent to the MS if the ME used is not acceptable to the network, e.g. blacklisted. When used by an MM procedure, this cause does not affect operation of the GPRS service.

G.2 Cause related to subscription options

Cause value = 11 PLMN not allowed

This cause is sent to the MS if it requests service, or if the network initiates a detach request, in a PLMN where the MS, by subscription or due to operator determined barring is not allowed to operate.

Cause value = 12 Location Area not allowed

This cause is sent to the MS if it requests service, or if the network initiates a detach request, in a location area where the HPLMN determines that the MS, by subscription, is not allowed to operate.

NOTE 1: If cause #12 is sent to a roaming subscriber the subscriber is denied service even if other PLMNs are available on which registration was possible.

Cause value = 13 Roaming not allowed in this location area

This cause is sent to an MS which requests service, or if the network initiates a detach request, in a location area of a PLMN which by subscription offers roaming to that MS but not in that location area.

Cause value = 15 No Suitable Cells In Location Area

This cause is sent to the MS if it requests service, or if the network initiates a detach request, in a location area where the MS, by subscription, is not allowed to operate, but when it should find another allowed location area or tracking area in the same PLMN or an equivalent PLMN.

NOTE 2: Cause #15 and cause #12 differ in the fact that cause #12 does not trigger the MS to search for another allowed location area on the same PLMN.

Cause value = 25 Not authorized for this CSG

This cause is sent to the MS if it requests access, or if the network initiates a detach request, in a CSG cell where the MS either has no subscription to operate or the MS's subscription has expired and it should find another cell in the same PLMN or an equivalent PLMN.

NOTE 3: The MS not supporting CSG will not receive cause# 25, as such a MS is not supposed to try to access a CSG cell.

G.3 Causes related to PLMN specific network failures and congestion/Authentication Failures

Cause value = 20 MAC failure

This cause is sent to the network if the USIM detects that the MAC in the AUTHENTICATION REQUEST or AUTHENTICATION_AND_CIPHERING REQUEST message is not fresh (see 3GPP TS 33.102 [5a]).

Cause value = 21 Synch failure

This cause is sent to the network if the USIM detects that the SQN in the AUTHENTICATION REQUEST or AUTHENTICATION_AND_CIPHERING REQUEST message is out of range (see 3GPP TS 33.102 [5a]).

Cause value = 17 Network failure

This cause is sent to the MS if the MSC cannot service an MS generated request because of PLMN failures, e.g. problems in MAP.

Cause value = 22 Congestion

This cause is sent to the MS if the network cannot serve a request from the MS because of congestion (e.g. congestion of the MSC or SGSN or GGSN or PDN Gateway; no channel; facility busy/congested etc.).

Cause value = 23 GSM authentication unacceptable

This cause is sent to the network in Iu mode if a USIM is inserted in the MS and there is no Authentication Parameter AUTN IE present in the AUTHENTICATION REQUEST or AUTHENTICATION_AND_CIPHERING REQUEST message.

G.4 Causes related to nature of request

Cause value = 32 Service option not supported

This cause is sent when the MS requests a service/facility in the CM SERVICE REQUEST message which is not supported by the PLMN.

Cause value = 33 Requested service option not subscribed

This cause is sent when the MS requests a service option for which it has no subscription.

Cause value = 34 Service option temporarily out of order

This cause is sent when the MSC cannot service the request because of temporary outage of one or more functions required for supporting the service.

Cause value = 38 Call cannot be identified

This cause is sent when the network cannot identify the call associated with a call re-establishment request.

G.5 Causes related to invalid messages

Cause value = 95 Semantically incorrect message.

See annex H, subclause H.5.10.

Cause value = 96 Invalid mandatory information.

See annex H, subclause H.6.1.

Cause value = 97 Message type non-existent or not implemented.

See annex H, subclause H.6.2.

Cause value = 98 Message type not compatible with protocol state.

See annex H, subclause H.6.3.

Cause value = 99 Information element non-existent or not implemented.

See annex H, subclause H.6.4.

Cause value = 100 Conditional IE error.

See annex H, subclause H.6.5.

Cause value = 101 Message not compatible with protocol state.

See annex H, subclause H.6.6.

Cause value = 111 Protocol error, unspecified.

See annex H, subclause H.6.8.

G.6 Additional cause codes for GMM

Cause value = 7 GPRS services not allowed

This cause is sent to the MS when it is not allowed to operate GPRS services.

Cause value = 8 GPRS services and non-GPRS services not allowed

This cause is sent to the MS when it is not allowed to operate either GPRS or non-GPRS services.

Cause value = 9 MS identity cannot be derived by the network

This cause is sent to the MS when the network cannot derive the MS's identity from the P-TMSI/GUTI, e.g. because no matching identity/context can be found in the network.

Cause value = 10 Implicitly detached

This cause is sent to the MS either if the network has implicitly detached the MS, e.g. some while after the mobile reachable timer has expired, or if the GMM context data related to the subscription does not exist in the SGSN e.g. because of a SGSN restart, or because of a periodic routing area update request routed to a new SGSN.

Cause value = 14 GPRS services not allowed in this PLMN

This cause is sent to the MS which requests GPRS service, or if the network initiates a detach request in a PLMN which does not offer roaming for GPRS services to that MS.

Cause value = 16 MSC temporarily not reachable

This cause is sent to the MS if it requests a combined GPRS attach or routing are updating in a PLMN where the MSC is temporarily not reachable via the GPRS part of the network.

Cause value = 28 SMS provided via GPRS in this routing area

This cause is sent to the MS if the SGSN decides not to establish a Gs association since the MS is supposed to send and receive short messages via GPRS.

Cause value = 40 No PDP context activated

This cause is sent to the MS if the MS requests an establishment of the radio access bearers for all active PDP contexts by sending a SERVICE REQUEST message indicating "data" to the network, but the SGSN does not have any active PDP context(s).

Annex H (informative): 3GPP specific cause values for call control

H.1 Normal class

H.1.1 Cause No. 1 "unassigned (unallocated) number"

This cause indicates that the destination requested by the mobile station cannot be reached because, although the number is in a valid format, it is not currently assigned (allocated).

H.1.2 Cause No. 3 "no route to destination"

This cause indicates that the called user cannot be reached because the network through which the call has been routed does not serve the destination desired.

H.1.3 Cause No. 6 "channel unacceptable"

This cause indicates the channel most recently identified is not acceptable to the sending entity for use in this call.

H.1.4 Cause No. 8 "operator determined barring"

This cause indicates that the MS has tried to access a service that the MS's network operator or service provider is not prepared to allow.

H.1.4a Cause No. 13 "call completed elsewhere"

This cause indicates that the call is being cleared by the network towards the present device because the called user has responded to the call on another device. This cause only applies when the MSC/VLR is an MSC server enhanced for ICS as specified in 3GPP TS 24.292 [163] and performs interworking with SIP as specified in 3GPP TS 29.292 [164].

H.1.5 Cause No.16 "normal call clearing"

This cause indicates that the call is being cleared because one of the users involved in the call has requested that the call be cleared.

Under normal situations, the source of this cause is not the network.

H.1.6 Cause No.17 "user busy"

This cause is used when the called user has indicated the inability to accept another call.

It is noted that the user equipment is compatible with the call.

H.1.7 Cause No. 18 "no user responding"

This cause is used when a user does not respond to a call establishment message with either an alerting or connect indication within the prescribed period of time allocated (defined by the expiry of either timer T303 or T310).

H.1.1.8 Cause No. 19 "user alerting, no answer"

This cause is used when a user has provided an alerting indication but has not provided a connect indication within a prescribed period of time.

H.1.1.9 Cause No. 21 "call rejected"

This cause indicates that the equipment sending this cause does not wish to accept this call, although it could have accepted the call because the equipment sending this cause is neither busy nor incompatible.

H.1.1.10 Cause No. 22 "number changed"

This cause is returned to a calling mobile station when the called party number indicated by the calling mobile station is no longer assigned. The new called party number may optionally be included in the diagnostic field. If a network does not support this capability, cause No. 1 "unassigned (unallocated) number" shall be used.

H.1.1.10a Cause No. 24 "call rejected due to feature at the destination"

This cause is returned when the call is rejected due to a feature at the destination, e.g. Anonymous Call Rejection. This cause is only generated by the network. This cause is not generated by the MS.

H.1.1.11 Cause No. 25 "pre-emption"

This cause is returned to the network when a mobile station clears an active call which is being pre-empted by another call with higher precedence.

H.1.1.12 Cause No. 26 "non-selected user clearing"

Not supported. Treated as cause no. 31.

H.1.1.13 Cause No. 27 "destination out of order"

This cause indicates that the destination indicated by the mobile station cannot be reached because the interface to the destination is not functioning correctly. The term "not functioning correctly" indicates that a signalling message was unable to be delivered to the remote user; e.g., a physical layer or data link layer failure at the remote user, user equipment off-line, etc.

H.1.1.14 Cause No. 28 "invalid number format (incomplete number)"

This cause indicates that the called user cannot be reached because the called party number is not a valid format or is not complete.

H.1.1.15 Cause No. 29 "facility rejected"

This cause is returned when a facility requested by user can not be provided by the network.

H.1.1.16 Cause No. 30 "response to STATUS ENQUIRY"

This cause is included in STATUS messages if the message is sent in response to a STATUS ENQUIRY message. See also subclause 5.5.3.

H.1.17 Cause No. 31 "normal, unspecified"

This cause is used to report a normal event only when no other cause in the normal class applies.

H.2 Resource unavailable class

H.2.1 Cause No. 34 "no circuit/channel available"

This cause indicates that there is no appropriate circuit/channel presently available to handle the call.

H.2.2 Cause No. 38 "network out of order"

This cause indicates that the network is not functioning correctly and that the condition is likely to last a relatively long period of time; e.g., immediately re-attempting the call is not likely to be successful.

H.2.3 Cause No. 41 "temporary failure"

This cause indicates that the network is not functioning correctly and that the condition is not likely to last a long period of time; e.g., the mobile station may wish to try another call attempt almost immediately.

H.2.4 Cause No. 42 "switching equipment congestion"

This cause indicates that the switching equipment generating this cause is experiencing a period of high traffic.

H.2.5 Cause No. 43 "access information discarded"

This cause indicates that the network could not deliver access information to the remote user as requested; i.e., a user-to-user information, low layer compatibility, high layer compatibility, or sub-address as indicated in the diagnostic.

It is noted that the particular type of access information discarded is optionally included in the diagnostic.

H.2.6 Cause No. 44 "requested circuit/channel not available"

This cause is returned when the circuit or channel indicated by the requesting entity cannot be provided by the other side of the interface.

H.2.7 Cause No. 47 "resource unavailable, unspecified"

This cause is used to report a resource unavailable event only when no other cause in the resource unavailable class applies.

H.3 Service or option not available class

H.3.1 Cause No. 49 "quality of service unavailable"

This cause indicates to the mobile station that the requested quality of service, as defined in ITU-T Recommendation X.213 [144], cannot be provided.

H.3.2 Cause No. 50 "Requested facility not subscribed"

This cause indicates that the requested supplementary service could not be provided by the network because the user has not completed the necessary administrative arrangements with its supporting networks.

H.3.3 Cause No. 55 "Incoming calls barred within the CUG"

This cause indicates that although the called party is a member of the CUG for the incoming CUG call, incoming calls are not allowed within this CUG.

H.3.4 Cause No. 57 "bearer capability not authorized"

This cause indicates that the mobile station has requested a bearer capability which is implemented by the equipment which generated this cause but the mobile station is not authorized to use.

H.3.5 Cause No. 58 "bearer capability not presently available"

This cause indicates that the mobile station has requested a bearer capability which is implemented by the equipment which generated this cause but which is not available at this time.

H.3.6 Cause No. 63 "service or option not available, unspecified"

This cause is used to report a service or option not available event only when no other cause in the service or option not available class applies.

H.3.7 Cause No. 68 "ACM equal to or greater than ACMmax"

This cause is used by the mobile to indicate that call clearing is due to ACM being greater than or equal to ACMmax.

H.4 Service or option not implemented class

H.4.1 Cause No. 65 "bearer service not implemented"

This cause indicates that the equipment sending this cause does not support the bearer capability requested.

H.4.2 Cause No. 69 "Requested facility not implemented"

This cause indicates that the equipment sending this cause does not support the requested supplementary service.

H.4.3 Cause No. 70 "only restricted digital information bearer capability is available"

This cause indicates that one equipment has requested an unrestricted bearer service, but that the equipment sending this cause only supports the restricted version of the requested bearer capability.

H.4.4 Cause No. 79 "service or option not implemented, unspecified"

This cause is used to report a service or option not implemented event only when no other cause in the service or option not implemented class applies.

H.5 Invalid message (e.g., parameter out of range) class

H.5.1 Cause No. 81 "invalid transaction identifier value"

This cause indicates that the equipment sending this cause has received a message with a transaction identifier which is not currently in use on the MS-network interface.

H.5.2 Cause No. 87 "user not member of CUG"

This cause indicates that the called user for the incoming CUG call is not a member of the specified CUG.

H.5.3 Cause No. 88 "incompatible destination"

This cause indicates that the equipment sending this cause has received a request to establish a call which has low layer compatibility, high layer compatibility, or other compatibility attributes (e.g., data rate) which cannot be accommodated.

H.5.4 Cause No. 91 "invalid transit network selection"

For further study. Treated as cause no. 95.

H.5.5 Cause No. 95 "semantically incorrect message"

This cause is used to report receipt of a message with semantically incorrect contents (see subclause 8.8).

H.6 Protocol error (e.g., unknown message) class

H.6.1 Cause No. 96 "invalid mandatory information"

This cause indicates that the equipment sending this cause has received a message with a non-semantical mandatory IE error (see subclause 8.5).

H.6.2 Cause No. 97 "message type non-existent or not implemented"

This cause indicates that the equipment sending this cause has received a message with a message type it does not recognize either because this is a message not defined, or defined but not implemented by the equipment sending this cause.

H.6.3 Cause No. 98 "message type not compatible with protocol state"

This cause indicates that the equipment sending this cause has received a message not compatible with the protocol state (subclause 8.4).

H.6.4 Cause No. 99 "information element non-existent or not implemented"

This cause indicates that the equipment sending this cause has received a message which includes information elements not recognized because the information element identifier is not defined or it is defined but not implemented by the equipment sending the cause. However, the information element is not required to be present in the message in order for the equipment sending the cause to process the message.

H.6.5 Cause No. 100 "conditional IE error"

This cause indicates that the equipment sending this cause has received a message with conditional IE errors (see subclause 8.7.2).

H.6.6 Cause No. 101 "message not compatible with protocol state"

This cause indicates that a message has been received which is incompatible with the protocol state or that a STATUS message has been received indicating an incompatible call state.

H.6.7 Cause No. 102 "recovery on timer expiry"

This cause indicates that a procedure has been initiated by the expiry of a timer in association with 3GPP TS 24.008 error handling procedures.

H.6.8 Cause No. 111 "protocol error, unspecified"

This cause is used to report a protocol error event only when no other cause in the protocol error class applies.

H.7 Interworking class

H.7.1 Cause No. 127 "interworking, unspecified"

This cause indicates that there has been interworking with a network which does not provide causes for actions it takes; thus, the precise cause for a message which is being sent cannot be ascertained.

Annex I (informative): GPRS specific cause values for GPRS Session Management

I.1 Causes related to nature of request

Cause value = 8 Operator Determined Barring

This cause code is used by the network to indicate that the requested service was rejected by the SGSN due to Operator Determined Barring.

Cause value = 24 MBMS bearer capabilities insufficient for the service

This cause code is used by the network to indicate that an MBMS context activation request was rejected by the network, because the MBMS bearer capabilities are insufficient for the MBMS service.

Cause value = 25 LLC or SNDCP failure (A/Gb mode only)

This cause code is used by the MS indicate that a PDP context is deactivated because of a LLC or SNDCP failure (e.g. if the SM receives a *SNSM-STATUS.request* message with cause "DM received" or "invalid XID response", see 3GPP TS 44.065 [78])

Cause value = 26 Insufficient resources

This cause code is used by the MS or by the network to indicate that a PDP context activation request, secondary PDP context activation request, PDP context modification request, or MBMS context activation request cannot be accepted due to insufficient resources.

Cause value = 27 Missing or unknown APN

This cause code is used by the network to indicate that the requested service was rejected by the external packet data network because the access point name was not included although required, or if the access point name could not be resolved.

Cause value = 28 Unknown PDP address or PDP type

This cause code is used by the network to indicate that the requested service was rejected by the external packet data network because the PDP address or type could not be recognised.

Cause value = 29 User authentication failed

This cause code is used by the network to indicate that the requested service was rejected by the external packet data network due to a failed user authentication.

Cause value = 30 Activation rejected by GGSN, Serving GW or PDN GW

This cause code is used by the network to indicate that the requested service was rejected by the GGSN, Serving GW or PDN GW.

Cause value = 31 Activation rejected, unspecified

This cause code is used by the network or by the MS to indicate that the requested service was rejected due to unspecified reasons.

Cause value = 32 Service option not supported

This cause code is used by the network when the MS requests a service which is not supported by the PLMN.

Cause value = 33 Requested service option not subscribed

See Annex G, clause 4.

Cause value = 34 Service option temporarily out of order

See Annex G, clause 4.

Cause value = 35 NSAPI already used

This cause code may be used by a network to indicate that the NSAPI requested by the MS in the PDP context activation request is already used by another active PDP context of this MS.

Never to be sent, but can be received from a R97/R98 network at PDP context activation

Cause value = 36 Regular deactivation

This cause code is used to indicate a regular MS or network initiated PDP context deactivation or a regular network initiated MBMS context deactivation.

Cause value = 37 QoS not accepted

This cause code is used by the MS if the new QoS cannot be accepted that were indicated by the network in the PDP Context Modification procedure.

Cause value = 38 Network failure

This cause code is used by the network to indicate that the requested service is rejected due to an error situation in the network.

Cause value = 39 Reactivation requested

This cause code is used by the network to request a PDP context reactivation (e.g. after a GGSN restart or after selection of a different GGSN by the network for Selected IP Traffic Offload).

Cause value = 40 Feature not supported

This cause code is used by the MS to indicate that the PDP context activation or the MBMS context activation initiated by the network is not supported by the MS.

Cause value = 41 semantic error in the TFT operation.

This cause code is used by the network or the MS to indicate that there is a semantic error in the TFT operation included in a secondary PDP context activation request or an MS-initiated PDP context modification or a network requested secondary PDP context activation.

Cause value = 42 syntactical error in the TFT operation.

This cause code is used by the network or the MS to indicate that there is a syntactical error in the TFT operation included in a secondary PDP context activation request or an MS-initiated PDP context modification or a network requested secondary PDP context activation.

Cause value = 43 unknown PDP context

This cause code is used by the network or the MS to indicate that the PDP context identified by the Linked TI IE in the secondary PDP context activation request or a network requested secondary PDP context activation is not active.

Cause value = 44 semantic errors in packet filter(s)

This cause code is used by the network or the MS to indicate that there is one or more semantic errors in packet filter(s) of the TFT included in a secondary PDP context activation request or an MS-initiated PDP context modification or a network requested secondary PDP context activation.

Cause value = 45 syntactical error in packet filter(s)

This cause code is used by the network or the MS to indicate that there is one or more syntactical errors in packet filter(s) of the TFT included in a secondary PDP context activation request or an MS-initiated PDP context modification or a network requested secondary PDP context activation.

Cause value = 46 PDP context without TFT already activated

This cause code is used by the network or the MS to indicate that it has already activated a PDP context without TFT.

Cause value = 47 Multicast group membership time-out

This cause code is used by the network to indicate that the MBMS context is deactivated because the timer supervising the IGMP group membership interval (see RFC 3376 [107], subclause 8.4) or the MLD multicast listener interval (see RFC 2710 [108], subclause 7.4, and RFC 3810 [148], subclause 9.4) expired.

Cause value = 48 Request rejected, Bearer Control Mode violation

This cause code is used by the network or the MS to indicate that the requested service was rejected because of Bearer Control Mode violation.

Cause value = 50 PDP type IPv4 only allowed

This cause code is used by the network to indicate that only PDP type IPv4 is allowed for the requested PDN connectivity.

Cause value = 51 PDP type IPv6 only allowed

This cause code is used by the network to indicate that only PDP type IPv6 is allowed for the requested PDN connectivity.

Cause value = 52 single address bearers only allowed

This cause code is used by the network to indicate that the requested PDN connectivity is accepted with the restriction that only single IP version bearers are allowed.

Cause value = 56 Collision with network initiated request.

This cause code is used by the network to indicate that the MS-initiated request was rejected since the network has requested a secondary PDP context activation for the same service using a network-initiated procedure.

Cause value = 57 PDP type IPv4v6 only allowed

This cause code is used by the network to indicate that only PDP types IPv4, IPv6 or IPv4v6 are allowed for the requested PDN connectivity.

Cause value = 58 PDP type non IP only allowed

This cause code is used by the network to indicate that only PDP type non IP is allowed for the requested PDN connectivity.

Cause value = 60 Bearer handling not supported

This cause code is used by the network to indicate that the procedure requested by the MS was rejected because the bearer handling is not supported.

Cause value = 65 Maximum number of PDP contexts reached

This cause code is used by the network to indicate that the procedure requested by the MS was rejected as the network has reached the maximum number of simultaneously active PDP contexts for the MS.

Cause value = 66 Requested APN not supported in current RAT and PLMN combination

This cause code is used by the network to indicate that the procedure requested by the MS was rejected because the requested APN is not supported in the current RAT and PLMN.

Cause value = 112 APN restriction value incompatible with active PDP context.

This cause code is used by the network to indicate that the PDP context(s) or MBMS context(s) have an APN restriction value that is not allowed in combination with a currently active PDP context. Restriction values are defined in 3GPP TS 23.060 [74], subclause 15.4.

Cause value = 113 Multiple accesses to a PDN connection not allowed

This ESM cause is used by the network to indicate that multiple accesses to a PDN connection for NBIFOM is not allowed.

I.2 Causes related to invalid messages

Cause value = 81 Invalid transaction identifier value.

See annex H, subclause H.5.1.

Cause value = 95 Semantically incorrect message.

See annex H, subclause H.5.5.

Cause value = 96 Invalid mandatory information.

See annex H, subclause H.6.1.

Cause value = 97 Message type non-existent or not implemented.

See annex H, subclause H.6.2.

Cause value = 98 Message type not compatible with protocol state.

See annex H, subclause H.6.3.

Cause value = 99 Information element non-existent or not implemented.

See annex H, subclause H.6.4.

Cause value = 100 Conditional IE error.

See annex H, subclause H.6.5.

Cause value = 101 Message not compatible with protocol state.

See annex H, subclause H.6.6.

Cause value = 111 Protocol error, unspecified.

See annex H, subclause H.6.8.

I.3 Void

Annex J (informative): Algorithm to encode frequency list information elements

See 3GPP TS 44.018 [84].

Annex K (informative): Default Codings of Information Elements

The information in this annex does NOT define the value of any IEI for any particular message. This annex exists to aid the design of new messages, in particular with regard to backward compatibility with phase 1 mobile stations.

K.1 Common information elements.

For the common information elements types listed below, the default coding of information element identifier bits is summarized in table K.1/3GPP TS 24.008.

Table K.1/3GPP TS 24.008: Default information element identifier coding for common information elements

8	7	6	5	4	3	2	1		Reference clause
1	:	:	:	-	-	-	-	Type 1 info elements	
1	1	1	1	-	-	-	-	Note 1	
0	:	:	:	:	:	:	:	Type 3 & 4 info elements	
0	0	0	1	0	0	0	1	Note 1	
0	0	0	1	0	0	1	1	Location Area Identification	10.5.1.3
0	0	0	1	0	1	1	1	Mobile Identity	10.5.1.4
0	0	0	1	1	0	0	0	Note 1	
0	0	0	1	1	1	1	1	Note 1	
0	0	1	0	0	0	0	0	Mobile Station classmark 3	10.5.1.7
								Spare Half Octet	10.5.1.8
All other values are reserved									

NOTE 1: These values were allocated but never used in earlier phases of the protocol.

NOTE 2: For GPRS common information elements no default values are defined:

K.2 Radio Resource management information elements.

See 3GPP TS 44.018 [84], annex K.

K.3 Mobility management information elements.

For the mobility management information elements listed below, the default coding of the information element identifier bits is summarized in table K.3/3GPP TS 24.008.

Table K.3/3GPP TS 24.008: Default information element identifier coding for mobility management information elements

								Reference clause
8	7	6	5	4	3	2	1	
								Type 1 info elements
1	0	0	1	-	-	-	-	Note
1	1	0	0	-	-	-	-	Note
1	1	1	0	-	-	-	-	Note
								Type 2 info elements
1	0	1	0	-	-	-	-	Follow-on Proceed
				0	0	0	1	10.5.3.7
				0	0	1	0	10.5.3.10
								Type 3 & 4 info elements
0	1	0	0	0	0	0	1	Note
0	1	0	0	0	0	1	0	Note
0	1	0	0	0	1	0	0	Note
All other values are reserved								

NOTE: These values were allocated but never used in earlier versions of the protocol

K.4 Call control information elements.

For the call control information elements listed below, the default coding of the information element identifiers is defined in table K.4/3GPP TS 24.008.

Table K.4/3GPP TS 24.008: Default information element identifier coding for call control information elements

								Reference clause
8	7	6	5	4	3	2	1	
1	:	:	:	-	-	-	-	Type 1 info elements
	0	0	1	-	-	-	-	shift
								10.5.4.2 and .3
	0	1	1	-	-	-	-	Note
	1	0	1	-	-	-	-	Repeat indicator
								10.5.4.22
1	0	1	0	:	:	:	:	Type 2 information elements
				0	0	0	0	More data
				0	0	0	1	CLIR Suppression
				0	0	1	0	CLIR Invocation
				0	0	1	1	Reverse call setup direction
								10.5.4.19
								10.5.4.11a
								10.5.4.11b
								10.5.4.22a
0	:	:	:	:	:	:	:	Type 3 & 4 info elements
	0	0	0	0	1	0	0	Bearer capability
	0	0	0	1	0	0	0	Cause
	0	0	1	0	1	0	0	Note
	0	0	1	0	1	0	1	Call Control Capabilities
	0	0	1	1	1	0	0	Facility
	0	0	1	1	1	1	0	Progress indicator
	0	1	0	0	1	0	0	Auxiliary states
	0	1	0	0	1	1	1	Note
	0	1	0	1	1	0	0	Keypad facility
	0	1	1	0	1	0	0	Signal
	1	0	0	1	1	0	0	Connected number
	1	0	0	1	1	0	1	Connected subaddress
	1	0	1	1	1	0	0	Calling party BCD number
	1	0	1	1	1	0	1	Calling party subaddress
	1	0	1	1	1	1	0	Called party BCD number
	1	1	0	1	1	0	1	Called party subaddress
	1	1	1	0	1	0	0	Redirecting Party BCD
	1	1	1	1	1	0	1	Redirecting Party subaddress
	1	1	1	1	1	0	0	Low layer compatib.
	1	1	1	1	1	0	1	High layer compatib.
	1	1	1	1	1	1	0	User-user
	1	1	1	1	1	1	1	SS version indicator
								10.5.4.5
								10.5.4.11
								10.5.4.5a
								10.5.4.15
								10.5.4.21
								10.5.4.4
								10.5.4.17
								10.5.4.23
								10.5.4.13
								10.5.4.14
								10.5.4.9
								10.5.4.10
								10.5.4.7
								10.5.4.8
								10.5.4.21b
								10.5.4.21c
								10.5.4.18
								10.5.4.16
								10.5.4.25
								10.5.4.24

NOTE: These values were allocated but never used in earlier phases of the protocol.

Annex L (normative): Establishment cause (lu mode only)

L.1 Mapping of NAS procedure to RRC establishment cause(lu mode only)

When MM requests the establishment of an RR connection, the RRC establishment cause used by the MS shall be selected according to the CS NAS procedure as specified in table L.1.1.

Table L.1.1/3GPP TS 24.008: Mapping of CS NAS procedure to establishment cause

CS NAS procedure	RRC Establishment cause (according 3GPP TS 25.331 [23c])
Originating CS speech call	Originating Conversational Call
Originating CS data call	Originating Conversational Call
CS Emergency call	Emergency call
Call re-establishment	Call re-establishment
Location update	Registration
IMSI Detach	Detach
MO SMS via CS domain	Originating Low Priority Signalling
Supplementary Services	Originating High Priority Signalling
Answer to circuit switched paging	Set equal to the value of the paging cause used in the reception of paging in the RRC layer
Answer to paging for CS fallback	Terminating Conversational Call
	Terminating High Priority Signalling, if in the E-UTRAN, the RRC connection is released with cause CS Fallback High Priority.
SS part of Location services	Originating High Priority Signalling
Any CS NAS procedure where the initiating uplink signalling message has the Device properties IE with low priority indicator set to "MS is configured for NAS signalling low priority"	Delay tolerant

When MM requests the establishment of an RR connection, if the MS is configured for EAB (see the "ExtendedAccessBarring" leaf of the NAS configuration MO in 3GPP TS 24.368 [135] or 3GPP TS 31.102 [112]), the MS is not an MS configured to use AC11 – 15 in selected PLMN, the MS is not answering to paging and the RRC Establishment cause is not set to "Emergency call", then the MM shall indicate to the lower layer for the purpose of access control that EAB applies for this request.

NOTE 1: void.

NOTE 2: EAB override is not supported in the CS domain.

When GMM requests the establishment of a PS signalling connection, the RRC establishment cause used by the MS shall be selected according to the PS NAS procedure as specified in Table L.1.2.

Table L.1.2/3GPP TS 24.008: Mapping of PS NAS procedure to establishment cause

PS NAS procedure	RRC Establishment cause (according 3GPP TS 25.331 [23c])
GPRS Attach	If the ATTACH REQUEST has Attach type not set to "Emergency attach", the RRC establishment cause shall be set to Registration except when the MS initiates attach procedure to establish emergency bearer services.
	If the ATTACH REQUEST has Attach type set to "Emergency attach" or if the ATTACH REQUEST has Attach type not set to "Emergency attach" but the MS initiates the attach procedure on receiving request from upper layer to establish emergency bearer services, the RRC establishment cause shall be set to Emergency call. (See Note 2)
Routing Area Update – for the case of 'Directed Signalling Connection Re-Establishment (see chapter 4.7.2.5.)	If the MS does not have a PDN connection established for emergency bearer services, the RRC establishment cause shall be set to Call Re-Establishment.
	If the MS has a PDN connection established for emergency bearer services, the RRC establishment cause shall be set to Emergency call. (See Note 2)
Routing area Update – all cases other than 'Directed Signalling Connection Re-Establishment or answer to packet paging	If the MS does not have a PDN connection established for emergency bearer services, the RRC establishment cause shall be set to Registration.
	If the MS has a PDN connection established for emergency bearer services, or is initiating a PDP CONTEXT ACTIVATION that has request type set to "emergency", the RRC establishment cause shall be set to Emergency call. (See Note 2)
GPRS Detach	Detach
Request to re-establish RABs	If the request is not to re-establish RABs for emergency bearer services, the RRC establishment cause shall be set to either 'Originating Conversational Call' or 'Originating Streaming Call' or 'Originating Interactive Call' or 'Originating Background Call' – depending on the Traffic Class in QoS of the "most demanding" Traffic Class, considering all active PDP contexts. (see Note 1)
	If the request is to re-establish RABs for emergency bearer services, the RRC establishment cause shall be set to Emergency call. (See Note 2)
Request to establish a PS signalling connection for MBMS	MBMS reception or MBMS p-t-p RB request
Activate PDP Context	If the ACTIVATE PDP CONTEXT REQUEST has the Request Type not set to "emergency", the RRC establishment cause shall be set to either 'Originating Conversational Call' or 'Originating Streaming Call' or 'Originating Interactive Call' or 'Originating Background Call' – depending on the Traffic Class in QoS of the "most demanding" Traffic Class, considering all active PDP contexts together with the PDP context to be activated. (see Note 1) – If Traffic Class in QoS is not 'Conversational Class' or 'Streaming Class' or 'Interactive Class' or 'Background Class' but is 'Subscribed Traffic Class', then 'Originating Subscribed traffic Call' shall be used.
	If the ACTIVATE PDP CONTEXT REQUEST has the Request Type set to "emergency", the RRC establishment cause shall be set to Emergency call. (See Note 2)
Modify PDP Context	Originating High Priority Signalling
Deactivate PDP Context	Originating High Priority Signalling
MO SMS via PS domain	Originating Low Priority Signalling
SS part of Location services	Originating High Priority Signalling
Answer to packet paging	If the MS does not have a PDN connection established for emergency bearer services, the RRC establishment cause shall be set equal to the value of the paging cause used in the reception of paging in the RRC layer.
	If the MS has a PDN connection established for emergency bearer services, the RRC establishment cause shall be set to Emergency call. (See Note 2)
Any PS NAS procedure where the initiating uplink signalling message has the Device propertiesE with low priority indicator set to "MS is configured for NAS signalling low priority"	Delay tolerant

NOTE 1: For classification of "most demanding" Traffic Class the following ranking order applies: "Conversational" followed by "Streaming" followed by "Interactive" followed by "Background", where "Conversational" is the most demanding Traffic class in terms of being delay sensitive.
NOTE 2: The emergency bearer services are only supported in UTRAN Iu mode.

NOTE 3: The RRC establishment cause can be used by the network to prioritise the connection establishment request from the MS at high load situations in the network.

When GMM requests the establishment of a PS signalling connection, if the MS is configured for EAB (see the "ExtendedAccessBarring" leaf of the NAS configuration MO as specified in 3GPP TS 24.368 [135] or 3GPP TS 31.102 [112]), the GMM shall indicate to the lower layer for the purpose of access control that EAB applies for this request except for the following cases:

- the MS is an MS configured to use AC11 – 15 in selected PLMN;
- the MS is answering to paging;
- the RRC Establishment cause is set to "Emergency call";
- the MS is configured to allow overriding EAB (see the "Override_ExtendedAccessBarring" leaf of the NAS configuration MO as specified in 3GPP TS 24.368 [135] or 3GPP TS 31.102 [112]) and receives an indication from the upper layers to override EAB; or
- the MS is configured to allow overriding EAB (see the "Override_ExtendedAccessBarring" leaf of the NAS configuration MO as specified in 3GPP TS 24.368 [135] or 3GPP TS 31.102 [112]) and already has a PDN connection that was established with EAB override.

NOTE 4: void.

Annex M (normative): Additional Requirements for backward compatibility with PCS 1900 for NA revision 0 ME

This annex provides additional requirements to support network mechanisms for backward compatibility with PCS 1900 for NA revision 0 mobile equipments (applicable until July 1, 1998).

PCS 1900 for NA revision 0 mobile equipments are defined to understand Mobile Network Codes made of up to 2 digits. However federal regulation mandates that a 3-digit MNC shall be allocated by each administration to network operators. Therefore each network operator is identified by a 3-digit Mobile Country Code and a 3-digit Mobile Network Code. An operator whose network code complies to the allocation principle specified for PCS 1900 for NA and wants to achieve for a transition period of time the backward compatibility with PCS 1900 for NA revision 0 mobile equipments shall apply the following:

- The network shall send over the air interface the 3-digit Mobile Country Code and only the two most significant digits of the Mobile Network Code (the value of the "digit" sent instead of the 3rd digit is specified in 3GPP TS 24.008, subclause 10.5.1.3) (see note).

When a PCS 1900 for NA (revision greater than 0) mobile equipment recognizes over the air the Mobile Country Code and the two most significant digits of the Mobile Network Code as being the HPLMN codes of the current IMSI, the mobile equipment shall take into account the value of the sixth IMSI digit read from the SIM/USIM. If this value matches to a value contained in the limited set of values for the least significant MNC digit assigned by the number administration bodies for PCS 1900 for NA then the following applies for the mobile equipment:

- The value sent over the air instead of the 3rd MNC digit in the Location Area Identification (for coding see 3GPP TS 24.008, subclause 10.5.1.3) shall be interpreted as the value of the sixth IMSI digit read from the SIM/USIM.

NOTE: It is still a network operator option to apply this requirement after July 1, 1998. However, in this case the following shall be considered:

1. Network selection considerations for overlapping networks:

- Networks overlapping to the HPLMN, identified over the radio interface by an identical combination MCC1 MCC2 MCC3 MNC1 MNC2 (possible after July 1, 1998) may be selectable by PCS 1900 for NA mobile equipments revision 0 with the same priority as the HPLMN or presented to the user as the HPLMN.

2. Roaming considerations:

- Roamers (SIM/USIM) from networks identified by an identical combination MCC1 MCC2 MCC3 MNC1 MNC2 (possible after July 1, 1998) when roaming into the operator network with PCS 1900 for NA mobile equipments revision 0, may cause these equipments to exhibit an unpredictable behaviour (e.g. looping in the HPLMN selection and registration procedures).
- Home subscribers (SIM/USIM) roaming with PCS 1900 for NA mobile equipments revision 0 into networks identified by an identical combination MCC1 MCC2 MCC3 MNC1 MNC2 (possible after July 1, 1998), may consider being attached to the HPLMN.

Annex N (normative): Ranking of reject causes for Location Registration (MM and GMM) in a shared network

This annex describes how the reject cause is determined:

- for a network sharing non-supporting MS in a shared network with multi-operator core network (MOCN) configuration; or
- for any MS in a multi-operator core network (MOCN) with common GERAN,

when a location registration request from the MS is redirected among CN operators via the shared RAN (see 3GPP TS 23.251 [109]) and is rejected by all core networks. In the following, the term 'location registration' is used for location area updating, GPRS attach, combined GPRS attach, routing area updating, and combined routing area updating.

i) If the location registration request was either:

- 1) accepted;
- 2) rejected with a reject cause different from #11, #12, #13, #14, #15, #17, and #25; or
- 3) rejected with a reject cause #17 when the MSC or the SGSN received an error not indicating "system failure", "data missing" or "unexpected data value" from the HLR (see 3GPP TS 29.002 [37] and 3GPP TS 29.010 [152]),

then one of the following actions is taken:

- in UTRAN Iu mode, the MSC or SGSN shall include the redirection completed information element in the RANAP DIRECT TRANSFER message transmitting the location registration accept message or location registration reject message to the RNC. According to 3GPP TS 25.413 [19c], the RNC will then forward the location registration accept message or the location registration reject message to the MS.
- in A/Gb mode, the MSC shall use DTAP message and SGSN shall use BSSGP DL-UNIDATA message to carry the location registration accept message or location registration reject message to the BSC. According to 3GPP TS 48.008 [85] and 3GPP TS 48.018 [86], the BSC will then forward the location registration accept message or location registration reject message to the MS.

ii) If the location registration request was either:

- 1) rejected with one of the reject causes #11, #12, #13, #14, #15, and #25; or
- 2) rejected with a reject cause #17 when the MSC or the SGSN received an error indicating "system failure", "data missing" or "unexpected data value" from the HLR (see 3GPP TS 29.002 [37] and 3GPP TS 29.010 [152]),

then one of the following actions is taken:

- in UTRAN Iu mode, the MSC or SGSN shall include a redirection indication in the RANAP DIRECT TRANSFER message transmitting the location registration reject message to the RNC. According to 3GPP TS 25.413 [19c], the RNC will then initiate the redirection procedure towards the next CN operator and treat the response from the core network according to (i) and (ii).
- in A/Gb mode, the MSC shall use BSSMAP Reroute Command message and SGSN shall use BSSGP DL-UNIDATA message to transmit the location registration reject message to the BSC with a redirection indication. According to 3GPP TS 48.008 [85] and 3GPP TS 48.018 [86], the BSC will then initiate the redirection procedure towards the next CN operator and treat the response from the core network according to (i), (ii) and (iii).

iii) If the location registration request was rejected including a redirection indication and with one of the reject causes #11, #12, #13, #14, #15, #17, and #25 by all CN operators taking part in a shared network, the RNC for UTRAN Iu mode or the BSC for A/Gb mode shall determine the reject cause with the highest rank from the received reject causes and send a location registration reject message containing this reject cause to the MS.

The ranking of the reject causes, from the lowest rank to the highest rank, is given by:

#11 < #12 < #13 < #14 < #15 < #25 < #17.

- iv) If the location registration request was rejected with one of the reject causes #11, #12, #13, #14, and #15 by all CN operators taking part in a shared network in a specific location area, but there is at least one additional CN operator taking part in a shared network in another location area of the shared network defined by the same common PLMN identity, the RNC for UTRAN Iu mode or the BSC for A/Gb mode shall send a location registration reject message with the reject cause #15 to the MS.

Annex O (normative): 3GPP capability exchange protocol

O.1 Scope

This annex specifies the protocol data units used by the 3GPP capability exchange protocol and procedures for the handling of unknown, unforeseen, and erroneous protocol data by the receiving MS.

The 3GPP capability exchange protocol provides services for the end-to-end exchange of capabilities between MSs. It is a separate protocol which uses the user-to-user signalling service 1 of the layer 3 call control protocol as a means of transport.

Functional procedures which use the 3GPP capability exchange protocol in the context of CSI are specified in 3GPP TS 24.279 [116].

O.2 User-user protocol contents

The user-user protocol contents is included in the user-user information element described in subclause 10.5.4.25.

The user-user protocol contents is structured like the non-imperative part of a standard L3 message (see 3GPP TS 24.007 [20], subclause 11.2) and is composed of a variable number of information elements of type 1, 2, 3 and 4. The different formats (TV, TLV) and the categories of information elements (type 1, 2, 3 and 4) are defined in 3GPP TS 24.007 [20].

Within the user-user protocol contents the information elements may occur in an arbitrary order.

All information elements shall be included only once.

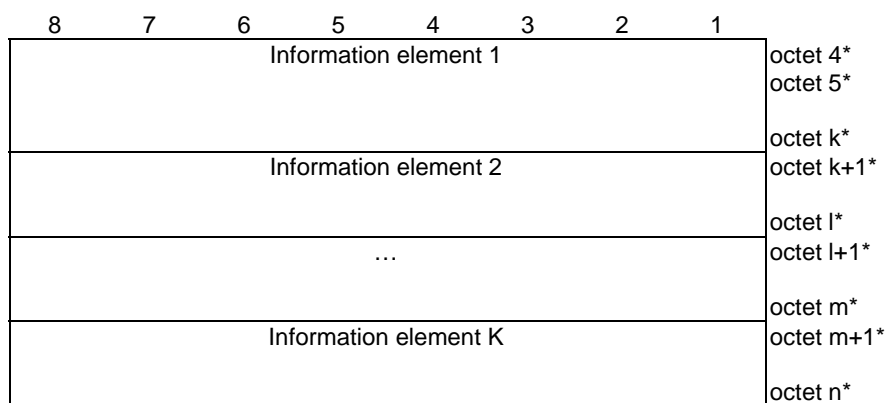

Figure O.1/3GPP TS 24.008 User-user information when the user-user protocol indicator is set to "3GPP capability exchange protocol"

O.3 Information element identifier

The information element identifier and its use are defined in 3GPP TS 24.007 [20].

For the information elements defined in subclause O.4, the coding of the information element identifier bits is defined in table O.2/3GPP TS 24.008.

For a method to determine from the information element identifier whether an unknown information element is of type 1 or 2 (i.e. it is an information element of one octet length) or type 4 (i.e. the next octet is the length indicator indicating the length of the remaining of the information element) see 3GPP TS 24.007 [20], subclause 11.2.4.

Table O.1/3GPP TS 24.008: Information element identifier coding for user-user protocol information elements

8	7	6	5	4	3	2	1	Reference clause	
Type 1 information elements:									
1	0	0	0	-	-	-	-	Radio environment capability	O.4.2
1	1	0	0	-	-	-	-	IM Status	O.4.4
Type 2 information elements:									
1	0	1	0	-	-	-	-	Unused	
Type 3 and 4 information elements:									
0	0	0	1	0	0	0	1	Personal ME identifier	O.4.1
0	0	1	0	0	0	0	0	UE capability version	O.4.3
All other values are unused									

O.4 Information elements

O.4.1 Personal ME identifier

The purpose of the *personal ME identifier* is to discriminate between MEs used by the same user (see TS 24.279 [116], subclause 4.2).

NOTE: As the personal ME identifier is generated randomly, it is not guaranteed that it uniquely identifies a specific ME used by the same user.

The *personal ME identifier* has the form PMI-XXXX, where XXXX is a 4-digit hexadecimal number. Only the hexadecimal number XXXX is coded in the *personal ME identifier* information element.

The *personal ME identifier* information element is coded as shown in figure O.2/3GPP TS 24.008 and table O.2/3GPP TS 24.008.

The *personal ME identifier* is a type 3 information element with 3 octets length.

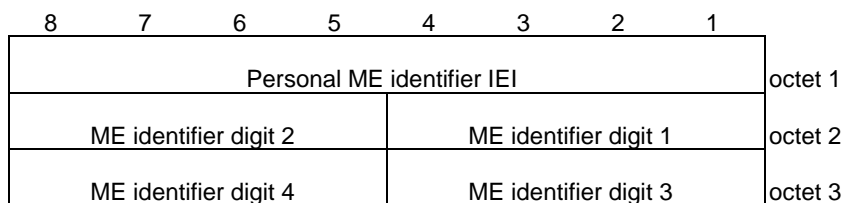

Figure O.2/3GPP TS 24.008 Personal ME identifier

Table O.2/3GPP TS 24.008: Personal ME identifier

ME identifier digits (octets 2, 3)					
Bits 1 to 4 or bits 5 to 8, respectively, contain the binary encoding of a hexadecimal ME identifier digit. Digit 1 is the leftmost digit in the 4-digit hexadecimal number XXXX.					
4	3	2	1	Or	ME identifier digit value
8	7	6	5		
0	0	0	0		0
0	0	0	1		1
0	0	1	0		2
0	0	1	1		3
0	1	0	0		4
0	1	0	1		5
0	1	1	0		6
0	1	1	1		7
1	0	0	0		8
1	0	0	1		9
1	0	1	0		A
1	0	1	1		B
1	1	0	0		C
1	1	0	1		D
1	1	1	0		E
1	1	1	1		F

O.4.2 Radio environment capability

The purpose of the *radio environment capability* is to provide information about the current radio environment of the MS.

The *radio environment capability* information element is coded as shown in figure O.3/3GPP TS 24.008 and table O.3/3GPP TS 24.008.

The *radio environment capability* is a type 1 information element with 1 octet length.

8	7	6	5	4	3	2	1	
Radio environment capability IEI				0	0	0	CS/ PS	octet 1
				spare	spare	Spare		

Figure O.3/3GPP TS 24.008 Radio environment capability contents**Table O.3/3GPP TS 24.008: Radio environment capability contents**

CS and PS capability (octet 1, bit 1)	
The CS and PS capability indicates whether the MS is in a radio environment that supports simultaneous use of CS and PS services (see 3GPP TS 24.279 [116]).	
0	simultaneous use of CS and PS services not supported
1	simultaneous use of CS and PS services supported
Bits 2 to 4 of octet 1 are spare and shall be coded as zero.	

O.4.3 UE capability version

The purpose of the *UE capability version* is to inform the receiving MS that the capability of the sending MS has changed since the last UE capability exchange (see 3GPP TS 24.279 [116]).

The *UE capability version* information element is coded as shown in figure O.4/3GPP TS 24.008 and table O.4/3GPP TS 24.008.

The *UE capability version* has the form UCV-XX, where XX is a 2-digit hexadecimal number. Only the hexadecimal number XX is coded in the UE capability version information element.

The *UE capability version* information element is coded as shown in figure O.4/3GPP TS 24.008 and table O.4/3GPP TS 24.008.

The *UE capability version* is a type 3 information element with 2 octets length.

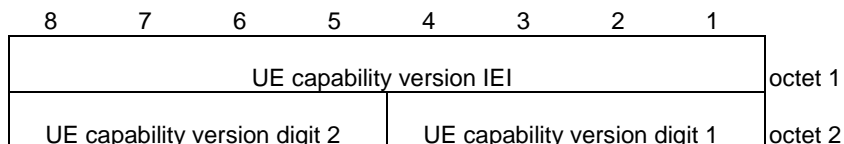

Figure O.4/3GPP TS 24.008: UE capability version

Table O.4/3GPP TS 24.008: UE capability version

UE capability version digits(octet 2)					
Bits 1 to 4 and bits 5 to 8, respectively, contain the binary encoding of a 2-digit hexadecimal UE capability version. Digit 1 is the leftmost digit.					
Bits					UE capability version digit value
4 3 2 1 Or					
8 7 6 5					
0 0 0 0					0
0 0 0 1					1
0 0 1 0					2
0 0 1 1					3
0 1 0 0					4
0 1 0 1					5
0 1 1 0					6
0 1 1 1					7
1 0 0 0					8
1 0 0 1					9
1 0 1 0					A
1 0 1 1					B
1 1 0 0					C
1 1 0 1					D
1 1 1 0					E
1 1 1 1					F

O.4.4 IM Status

The purpose of the *IM Status* is to provide information about the IMS capability and registration state of a specific public user identity and its MS.

NOTE: The definition of what is a public user identity can be found in 3GPP TS 23.003 [10].

The *IM Status* information element is coded as shown in figure O.5/3GPP TS 24.008 and table O.5/3GPP TS 24.008.

The *IM Status* is a type 1 information element with 1 octet length.

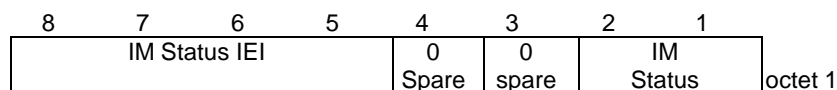

Figure O.5/3GPP TS 24.008 IM Status contents

Table O.5/3GPP TS 24.008: IM Status contents

IM Status (octet 1)		
Bits		
2	1	
0	0	MS is not IM subsystem capable
0	1	MS is IM subsystem registered
1	0	MS is IM subsystem capable and willing to register to IM subsystem (NOTE 1)
1	1	MS is IM subsystem capable but will not register to IM subsystem (NOTE 2)
Bits 3 to 4 of octet 1 are spare and shall be coded as zero.		
NOTE 1: This value indicates that a terminal can be configured to allow IMS registration without user intervention when required, for example when prompted by receiving an IM Status of "MS is IM subsystem registered" or "MS is IM subsystem capable and willing to register to IM subsystem" during establishment of a CS call.		
NOTE 2: This value indicates that the terminal will not IMS register without user permission.		

O.5 Handling of unknown, unforeseen, and erroneous protocol data

O.5.1 General

The following subclauses specifies procedures for the handling of unknown, unforeseen, and erroneous protocol data by the receiving MS. These procedures are called "error handling procedures", but in addition to providing recovery mechanisms for error situations they define a compatibility mechanism for future extensions of the protocols.

Subclauses O.5.2 to O.5.5 shall be applied in order of precedence.

For the definition of semantical and syntactical errors see 3GPP TS 24.007 [20], subclause 11.4.2.

Where the description of information elements in the present document contains bits defined to be "spare bits", these bits shall set to the indicated value (usually 0) by the sending side, and their value shall be ignored by the receiving side.

O.5.2 Not supported IEs, unknown IEIs

The MS shall ignore all information elements which are not supported and all information elements with unknown IEI.

O.5.3 Repeated IEs

If an information element, for which repetition is not specified in subclause O.2, is repeated in the user-user protocol contents, only the contents of the information element appearing first shall be handled and all subsequent repetitions of the information element shall be ignored. When repetition of information elements is specified, only the contents of specified repeated information elements shall be handled. If the limit on repetition of information elements is exceeded, the contents of information elements appearing first up to the limit of repetitions shall be handled and all subsequent repetitions of the information element shall be ignored.

O.5.4 Syntactically incorrect IEs

The MS shall treat all IEs that are syntactically incorrect as not present in the user-user protocol contents.

O.5.5 Semantically incorrect IEs

When an IE with semantically incorrect contents is received, the foreseen reactions specified for the respective procedure are performed (e.g. in the context of CSI see 3GPP TS 24.279 [116], clauses 5, 6). If however no such reactions are specified, the MS shall ignore the IE.

Annex P (normative): Mobility management for IMS voice termination

P.1 Introduction

The present annex specifies additional requirements for GMM and EMM in the MS for the support of terminating access domain selection for voice calls or voice sessions by the network.

Support of these mobility management procedures can be configured in the MS by a setting. Whether the mobility management for IMS voice termination setting is stored in the IMS management object as defined in 3GPP TS 24.167 [134] (see the "Mobility Management for IMS Voice Termination" leaf) or in an alternative way in the ME is an implementation option. If this setting is missing, then mobility management for IMS voice termination is disabled.

P.2 Activation of mobility management for IMS voice termination

An MS activates mobility management for IMS voice termination when:

- 1) the MS's availability for voice calls in the IMS (see 3GPP TS 24.301 [120], subclause 3.1) changes from "not available" to "available";
- 2) the MS is enabled for mobility management for IMS voice termination;
- 3) the IMS voice over PS session indicator received for Iu mode has the value
 - "IMS voice over PS session supported in Iu mode, but not supported in A/Gb mode", orthe IMS voice over PS session indicator received for S1 mode has the value
 - "IMS voice over PS session in S1 mode supported"; and
- 4) at least one of the two parameters voice domain preference for UTRAN and voice domain preference for E-UTRAN as defined in 3GPP TS 24.167 [134] is not "CS voice only".

The MS deactivates mobility management for IMS voice termination when the MS's availability for voice calls in the IMS (see 3GPP TS 24.301 [120], subclause 3.1) changes from "available" to "not available".

P.3 Inter-system change between A/Gb mode and Iu mode

An MS is required to perform routing area updating for IMS voice termination if:

- 1) the upper layers have indicated that the MS is available for voice calls in the IMS (see 3GPP TS 24.301 [120], subclause 3.1);
- 2) the MS is enabled for mobility management for IMS voice termination;
- 3) the "IMS voice over PS session indicator" received for Iu mode has the value "IMS voice over PS session supported in Iu mode, but not supported in A/Gb mode"; and
- 4) the voice domain preference for UTRAN as defined in 3GPP TS 24.167 [134] is not "CS voice only".

P.4 Inter-system change between A/Gb mode and S1 mode

An MS is required to perform routing area updating for IMS voice termination at inter-system change from S1 mode to A/Gb mode and tracking area updating for IMS voice termination at inter-system change from A/Gb mode to S1 mode if:

- 1) conditions 1 and 2 of annex P.3 are fulfilled;
- 2) the "IMS voice over PS session indicator" received for S1 mode has the value "IMS voice over PS session in S1 mode supported"; and
- 3) the voice domain preference for E-UTRAN as defined in 3GPP TS 24.167 [134] is not "CS voice only".

P.5 Inter-system change between Iu mode and S1 mode

An MS is required to perform routing area updating for IMS voice termination at inter-system change from S1 mode to Iu mode and tracking area updating for IMS voice termination at inter-system change from Iu mode to S1 mode if:

- 1) conditions 1 and 2 of annex P.3 are fulfilled; and
- 2) any of the following conditions a, b and c is fulfilled:
 - a) the IMS voice over PS session indicators received for Iu mode and S1 mode have the values
 - "IMS voice over PS session supported in Iu mode, but not supported in A/Gb mode" and
 - "IMS voice over PS session in S1 mode not supported", andthe voice domain preference for UTRAN as defined in 3GPP TS 24.167 [134] is not "CS voice only";
 - b) the IMS voice over PS session indicators received for Iu mode and S1 mode have the values
 - "IMS voice over PS session in Iu mode and A/G mode not supported" and
 - "IMS voice over PS session in S1 mode supported", andthe voice domain preference for E-UTRAN as defined in 3GPP TS 24.167 [134] is not "CS voice only"; or
 - c) the IMS voice over PS session indicators received for Iu mode and S1 mode have the values
 - "IMS voice over PS session supported in Iu mode, but not supported in A/Gb mode" and
 - "IMS voice over PS session in S1 mode supported", andexactly one of the voice domain preferences for UTRAN and E-UTRAN as defined in 3GPP TS 24.167 [134] is "CS voice only".

Annex Q (normative): Application specific Congestion control for Data Communication (ACDC) (Iu mode only)

The MS may support the procedures in this annex.

When GMM requests the establishment of a PS signalling connection, if the MS supports ACDC, the GMM layer shall determine the ACDC category applicable to the request based on the application identifier received from the upper layers and the configuration information in the "ACDCConf" leaf of ACDC MO as specified in 3GPP TS 24.105 [154] or in the USIM EF_{ACDC} as specified in 3GPP TS 31.102 [112].

NOTE 1: As an implementation option, the upper layers can determine the ACDC category and send it to the GMM layer. Then the GMM layer need not read the ACDC MO or USIM to determine the ACDC category.

The GMM sublayer shall indicate to the lower layers, for the purpose of access control:

- the ACDC category that applies to this request if only one ACDC category is applicable;
- the highest ranked ACDC category among the ACDC categories that applies to this request if multiple ACDC categories are applicable; or
- this request is for an uncategorized application if an application identifier received from the upper layers is not mapped to any ACDC category,

except for the following cases:

- the MS is a MS configured to use AC11 – 15 in selected PLMN;
- the MS is answering to paging;
- the RRC Establishment cause is set to "Emergency call"; or
- if conditions MO MMTEL voice call is started or MO MMTEL video call is started or MO SMSoIP is started, is satisfied.

NOTE 2: The request from the GMM sublayer refers to either a request to establish an initial NAS signalling connection or a request to re-establish a NAS signalling connection.

If the MS supports ACDC and access is barred because of ACDC, the GMM layer shall keep track of the ACDC category for which access is barred and it shall not send a request for the same ACDC category or a lower ACDC category until access is granted.

If the MS supports ACDC and access is barred because of ACDC, the GMM layer shall not send a request for any uncategorized application until access is granted.

Annex R (informative): Change History

Release 4 for 3GPP TS 24.008 v4.0.0 is based on 3GPP TS 24.008 version 3.5.0.

Date	TSG #	TSG Doc.	CR	Rev	Subject/Comment	Old	New
09-2000	TSG-CN-9				New release 4 for 24.008, based on V3.5.0 which was approved at the same Plenary.		
12-2000	NP-09	NP-000448	073	5	CC Enhancements for Codec Selection	3.5.0	4.0.0
12-2000	NP-09	NP-000447	245	3	Emergency Call Additions	3.5.0	4.0.0
12-2000	NP-10	NP-000667	262	1	The Group or Broadcast Call Reference from the mobile station to the network	4.0.0	4.1.0
12-2000	NP-10	NP-000669	264	1	GSM 700 addition into MS classmark & radio access capability IE	4.0.0	4.1.0
12-2000	NP-10	NP-000670	268		Clarification to the network initiated GPRS detach procedure (IMSI detach)	4.0.0	4.1.0
12-2000	NP-10	NP-000670	278		Correction of update status on Authentication Reject	4.0.0	4.1.0
12-2000	NP-10	NP-000671	283		Description Of Timer T3317 on expiry	4.0.0	4.1.0
12-2000	NP-10	NP-000671	286	2	Removal of "recently deactivated" condition for PDP contexts and some references corrections	4.0.0	4.1.0
12-2000	NP-10	NP-000672	290	2	The application of security procedures to emergency calls	4.0.0	4.1.0
12-2000	NP-10	NP-000671	295	1	Updating of Bearer Capability IE	4.0.0	4.1.0
12-2000	NP-10	NP-000673	301		3.1 kHz multimedia calls at 33.6 kbit/s data rate	4.0.0	4.1.0
12-2000	NP-10	NP-000673	303		32 kbit/s UDI/RDI multimedia	4.0.0	4.1.0
12-2000	NP-10	NP-000676	310	1	Change of reference to 26.103 for use of codec bitmap in the Supported Codec List	4.0.0	4.1.0
12-2000	NP-10	NP-000668	311		Introduction of EGPRS for DTM	4.0.0	4.1.0
12-2000	NP-10	NP-000670	312		Clarification of response handling of Service Request	4.0.0	4.1.0
12-2000	NP-10	NP-000670	313		Clarification of RAB re-establishment	4.0.0	4.1.0
12-2000	NP-10	NP-000670	314		APN used for detection of duplicated PDP context activation	4.0.0	4.1.0
12-2000	NP-10	NP-000670	315	1	Unsynchronized PDP contexts handling - MS less	4.0.0	4.1.0
12-2000	NP-10	NP-000671	317		Correction on TFT setting condition	4.0.0	4.1.0
12-2000	NP-10	NP-000672	318		Correction of the timer list	4.0.0	4.1.0
12-2000	NP-10	NP-000670	319		Correction of PDP context duplication handling	4.0.0	4.1.0
12-2000	NP-10	NP-000670	321		DRX parameter range correction	4.0.0	4.1.0
12-2000	NP-10	NP-000671	323		RR connection replaced with PS signalling connection	4.0.0	4.1.0
	Jan-01				Correction of the version and date in the Header title /Page1	4.1.0	4.1.1

Date	TSG #	TSG Doc.	CR	Rev	Subject/Comment	Old	New
03-2001	NP_11	NP-010123	266	2	Addition of type 4 IEs for P-TMSI Signature and GPRS Timer	4.1.1	4.2.0
03-2001	NP_11	NP-010127	281	4	Optional support of UMTS AKA by a GSM only R99 ME	4.1.1	4.2.0
03-2001	NP_11	NP-010116	324	1	Add new cause value on 'ODB for the Packet Oriented Services'	4.1.1	4.2.0
03-2001	NP_11	NP-010123	328	1	Correction to MM timer handling	4.1.1	4.2.0
03-2001	NP_11	NP-010151	334	1	Add UMTS 1.28 Mcps TDD capability support to MS CM3	4.1.1	4.2.0
03-2001	NP_11	NP-010123	336		Clarification of the establishment confirm for the signalling connection	4.1.1	4.2.0
03-2001	NP_11	NP-010123	338		Clarification of the location update abnormal cases b) and c) on the MS side	4.1.1	4.2.0
03-2001	NP_11	NP-010205	344	4	unsynchronised PDP contexts - MS less (2)	4.1.1	4.2.0
03-2001	NP_11	NP-010128	345	1	Update of MS classmark 2 and MS Network Capability to support LCS	4.1.1	4.2.0
03-2001	NP_11	NP-010123	348		Correction of GPRS ciphering key sequence number IE1	4.1.1	4.2.0
03-2001	NP_11	NP-010123	350	1	Collisions cases of core network initiated paging and MS initiated GMM specific procedures	4.1.1	4.2.0
03-2001	NP_11	NP-010125	358		Using RAU procedure for MS RAC IE update	4.1.1	4.2.0
03-2001	NP_11	NP-010129	360	1	Connection re-establishment on forward handover without lur	4.1.1	4.2.0
03-2001	NP_11	NP-010147	363	2	Roaming restrictions for GPRS service	4.1.1	4.2.0
03-2001	NP_11	NP-010205	365	3	Correction related to Cause of no CLI	4.1.1	4.2.0
03-2001	NP_11	NP-010129	367	1	Clarification of TFT request during secondary PDP context activation.	4.1.1	4.2.0
03-2001	NP_11	NP-010146	377		Correction of DTM Multislot Capabilities in MS Classmark 3 and MS Radio Classmark	4.1.1	4.2.0
03-2001	NP_11	NP-010147	378		Alignment of MS identity IE length in ATTACH ACCEPT and RAU ACCEPT Messages	4.1.1	4.2.0
03-2001	NP_11	NP-010207	379	1	Mapping of upper layer event to establishment cause	4.1.1	4.2.0
03-2001	NP_11	NP-010207	380	1	Resume at Intersystem change from GSM to UMTS	4.1.1	4.2.0

Date	TSG #	TSG Doc.	CR	Rev	Subject/Comment	Old	New
03-2001	NP_11	NP-010207	381	1	Collision case of CN initiated paging and MS initiated MM specific procedures	4.1.1	4.2.0
03-2001	NP_11	NP-010151	382		Addition of 1.28 Mcps UTRA TDD capability support to MS Radio Access Capability	4.1.1	4.2.0
03-2001	NP_11	NP-010154	383		Add cause value #8(ODB) to the PDP context deactivation initiated by the network	4.1.0	4.2.0
03-2001	NP_11	NP-010155	384	1	Re-transmission of AUTHENTICATION REQUEST and AUTHENTICATION & CIPHERING REQUEST messages	4.1.1	4.2.0
03-2001	NP_11	NP-010205	385	1	MS behaviour for "RB Release followed by RB setup"	4.1.1	4.2.0
03-2001	NP_11	NP-010160	386		Presence of PDP address IE in Activate PDP Context Accept	4.1.1	4.2.0
03-2001	NP_11	NP-010160	387		Correction of Revision Level in MS Classmark and MS Network Capability	4.1.1	4.2.0
03-2001	NP_11	NP-010160	388		Unsync_MSmore_Rel4	4.1.1	4.2.0
03-2001	NP_11	NP-010160	389	1	Correction of incorrect references	4.1.1	4.2.0
03-2001	NP_11	NP-010210	391	1	Equiv handling of PLMN with different PLMN codes	4.1.1	4.2.0
03-2001	NP_11	NP-010208	392		Removal of CODEC type octet in supported CODECS list	4.1.1	4.2.0
06-2001					Editorials. Page 371 was missing,- which is a part of the table 10.5.146 (MS Radio Access Capability IE). Editors note in 4.5.1.3.1 is deleted, and in chapter 4.7.3.2.4 and 4.7.5.2.4 the cause value #8 was swapped back to its original place as it was in v4.1.1.	4.2.0	4.2.1
06-2001	NP_12	NP-010275	333	2	Length of User-user IE	4.2.1	4.3.0
06-2001	NP_12	NP-010355	394		Missing SM cause 40 in table 10.5.6.6	4.2.1	4.3.0
06-2001	NP_12	NP-010272	396	3	Modification to MS's MM states to enable LCS signalling on RR layer	4.2.1	4.3.0
06-2001	NP_12	NP-010352	400		Stored list of equivalent PLMNs and error/abnormal cases	4.2.1	4.3.0
06-2001	NP_12	NP-010351	403	4	CLASSMARK1, 2 and 3 corrections.	4.2.1	4.3.0
06-2001	NP_12	NP-010355	411	2	Clarification of Network Initiated GPRS Detach Procedure	4.2.1	4.3.0
06-2001	NP_12	NP-010275	416	2	Partial Roaming – restriction by location area	4.2.1	4.3.0
06-2001	NP_12	NP-010275	418	2	The priority in the CALL PROCEEDING message for eMLPP supporting network	4.2.1	4.3.0
06-2001	NP_12	NP-010271	419	1	Clean up related to V.23, X.75, X.25 and X.32	4.2.1	4.3.0
06-2001	NP_12	NP-010275	421	1	Handling of MM reject causes 2, 3 and 6 by mobile stations	4.2.1	4.3.0
06-2001	NP_12	NP-010273	422		Extended uplink TBF	4.2.1	4.3.0
06-2001	NP_12	NP-010267	423	1	Correct coding errors in the MS Radio Access Capability IE	4.2.1	4.3.0
06-2001	NP_12	NP-010343	428	1	Alignment of 24.008 authentication procedures with 33.102	4.2.1	4.3.0
06-2001	NP_12	NP-010268	426	1	Introduction of GTT (CTM) support	4.3.0	5.0.0
09-2001	NP-13	NP-010493	444	1	Old RAI handling	5.0.0	5.1.0
09-2001	NP-13	NP-010499	452	1	Modification of session management between MS and network	5.0.0	5.1.0
09-2001	NP-13	NP-010533	475	2	Introduction of default codec UMTS_AMR_2	5.0.0	5.1.0
09-2001	NP-13	NP-010493	457		Correction of Protocol configuration options	5.0.0	5.1.0
09-2001	NP-13	NP-010490	465		Clarification of 8-PSK power class coding	5.0.0	5.1.0
09-2001	NP-13	NP-010498	468	2	Definition of new DTM multislot classes	5.0.0	5.1.0
09-2001	NP-13	NP-010496	474		Remove references to specific sections of 25.331	5.0.0	5.1.0
12-2001	NP-14	NP-010660	458	3	Introduction of Source Statistics Descriptor	5.1.0	5.2.0
12-2001	NP-14	NP-010648	479	1	Correction of the criteria for the usage of combined RAU	5.1.0	5.2.0
12-2001	NP-14	NP-010654	481		Correction of default codec selection criterion	5.1.0	5.2.0
12-2001	NP-14	NP-010678	487	1	Mapping of NAS procedures to RRC Establishment Causes	5.1.0	5.2.0
12-2001	NP-14	NP-010660	488		Correction of missing actions on RAND and T3218, T3316	5.1.0	5.2.0
12-2001	NP-14	NP-010658	489	2	LCS capability for GPRS	5.1.0	5.2.0
12-2001	NP-14	NP-010659	493	2	Usage of TMSI in Intra Domain Connection of RAN Nodes to Multiple CN Nodes	5.1.0	5.2.0
12-2001	NP-14	NP-010655	495	2	RRC Establishment Causes for LCS Procedures	5.1.0	5.2.0
12-2001	NP-14	NP-010647	498		P-TMSI Signature handling	5.1.0	5.2.0
12-2001	NP-14	NP-010652	501		Correction of maximum transfer delay value in Qos IE	5.1.0	5.2.0
12-2001	NP-14	NP-010647	507		Handling of new/old TLLI in the network	5.1.0	5.2.0
12-2001	NP-14	NP-010660	510	2	Clarification on the EDGE parameters in the Mobile Station Classmark 3 IE	5.1.0	5.2.0
12-2001	NP-14	NP-010657	516	2	Use of Supported Codec List (SCL) IE for all codec types	5.1.0	5.2.0
12-2001	NP-14	NP-010700	527	4	Impact of regional roaming restrictions on the GMM context	5.1.0	5.2.0
12-2001	NP-14	NP-010678	528	2	Conditions for the deletion of the equivalent PLMN list	5.1.0	5.2.0
12-2001	NP-14	NP-010665	532		Correction of references in 24.008	5.1.0	5.2.0
12-2001	NP-14	NP-010690	534	1	Introduction of GERAN feature indicator	5.1.0	5.2.0
03-2002					Editorial clean-up by ETSI/MCC.	5.2.0	
03-2002	NP-15	NP-020042	520	2	P-TMSI allocation in Attach procedure	5.2.0	5.3.0
03-2002	NP-15	NP-020042	537	1	Mobile terminated call with single numbering scheme	5.2.0	5.3.0
03-2002	NP-15	NP-020039	546		Missing 3rd MNC definition	5.2.0	5.3.0
03-2002	NP-15	NP-020042	550	1	Applicability of CM3 IE Modulation Capability information	5.2.0	5.3.0

Date	TSG #	TSG Doc.	CR	Rev	Subject/Comment	Old	New
03-2002	NP-15	NP-020043	556	3	Upgrading PCO for supporting IMS services	5.2.0	5.3.0
03-2002	NP-15	NP-020044	557	2	Upgrading TFT for supporting IMS services	5.2.0	5.3.0
03-2002	NP-15	NP-020038	564	1	Handling for QoS profile parameter "transfer delay"	5.2.0	5.3.0
03-2002	NP-15	NP-020038	571	1	Conditions for including R97 QoS attributes in the QoS IE	5.2.0	5.3.0
03-2002	NP-15	NP-020133	575		Deletion of reference to 23.071 in 24.008	5.2.0	5.3.0
06-2002	NP-16	NP-020220	536	2	Correction of codec negotiation procedure	5.3.0	5.4.0
06-2002	NP-16	NP-020241	551	3	Service change and fallback for UDI/RDI multimedia calls	5.3.0	5.4.0
06-2002	NP-16	NP-020242	554	2	Restriction of the 0kbits maximum bitrate	5.3.0	5.4.0
06-2002	NP-16	NP-020223	578	2	Authentication not accepted by MS	5.3.0	5.4.0
06-2002	NP-16	NP-020219	581	1	Correction to CS domain specific system information	5.3.0	5.4.0
06-2002	NP-16	NP-020219	592	2	Impact of regional roaming restrictions on the MM state	5.3.0	5.4.0
06-2002	NP-16	NP-020223	595		Correction of repeat indicator IE	5.3.0	5.4.0
06-2002	NP-16	NP-020223	598		Removal of the coding rules of type 4 IEs	5.3.0	5.4.0
06-2002	NP-16	NP-020221	601	1	Correction to text on DTMF handling	5.3.0	5.4.0
06-2002	NP-16	NP-020242	607	1	Handling of SM STATUS(#81, #97) and invalid T1 of Secondary PDP context	5.3.0	5.4.0
06-2002	NP-16	NP-020219	612		R97 and R99 compatibility	5.3.0	5.4.0
06-2002	NP-16	NP-020242	615		Deletion of ePLMN list when the fifth RAU attempt is reached	5.3.0	5.4.0
06-2002	NP-16	NP-020242	618	1	Conditions when to update the "RPLMN Last used Access Technology" information	5.3.0	5.4.0
06-2002	NP-16	NP-020242	619	1	SIM removal and change of RA during detach procedure	5.3.0	5.4.0
06-2002	NP-16	NP-020216	625	1	Conflicting behaviour when UE receives AUTHENTICATION_REJECT	5.3.0	5.4.0
06-2002	NP-16	NP-020242	626		Correction of definition of SSD in QoS IE	5.3.0	5.4.0
06-2002	NP-16	NP-020225	630		Support for IMS media Multiplexing in Session Management – TFT	5.3.0	5.4.0
06-2002	NP-16	NP-020242	631		Addition of missing references to TS 25.304	5.3.0	5.4.0
06-2002	NP-16	NP-020242	632	1	DRX parameter update with RAU procedure	5.3.0	5.4.0
06-2002	NP-16	NP-020225	634	1	PCO in Session Management procedures	5.3.0	5.4.0
06-2002	NP-16	NP-020217	639	1	Alternative coding of radio access capabilities	5.3.0	5.4.0
06-2002	NP-16	NP-020300	641	1	Indication of support of LCS via the PS domain in lu-mode	5.3.0	5.4.0
06-2002	NP-16	NP-020311	642	2	Addition of missing code point for 8-PSK Half Rate AMR	5.3.0	5.4.0
09-2002	NP-17	NP-020382	561	3	MM behaviour in case of a combined attach reject for the PS service	5.4.0	5.5.0
09-2002	NP-17	NP-020384	643	2	GERAN lu Mode Capability	5.4.0	5.5.0
09-2002	NP-17	NP-020380	644		Go related error code to UE	5.4.0	5.5.0
09-2002	NP-17	NP-020369	650		Removal of CBQ2	5.4.0	5.5.0
09-2002	NP-17	NP-020381	651	1	Usage of the Service Request procedure	5.4.0	5.5.0
09-2002	NP-17	NP-020394	652	1	MS behavior in case of change of network mode of operation	5.4.0	5.5.0
09-2002	NP-17	NP-020382	653	1	MS behavior in case of T3312 expiry	5.4.0	5.5.0
09-2002	NP-17	NP-020382	654	1	Ambiguous MM behavior in case of a failed combined Attach or RAU	5.4.0	5.5.0
09-2002	NP-17	NP-020368	667		Usage of Service Request type 'data'	5.4.0	5.5.0
09-2002	NP-17	NP-020371	668		Introduction of PCO in more session management messages	5.4.0	5.5.0
09-2002	NP-17	NP-020372	669		Request for DNS IPv6 server address	5.4.0	5.5.0
09-2002	NP-17	NP-020371	670		Clean-up of text for the PCO-IE	5.4.0	5.5.0
09-2002	NP-17	NP-020368	673	3	Correction to service request procedure	5.4.0	5.5.0
09-2002	NP-17	NP-020371	675		Indication of successful establishment of Dedicated Signalling PDP context to the UE	5.4.0	5.5.0
09-2002	NP-17	NP-020368	678	1	Routing Area Update at network change	5.4.0	5.5.0
09-2002	NP-17	NP-020371	679	1	Coding of Authorisation Token in Traffic Flow Template	5.4.0	5.5.0
09-2002	NP-17	NP-020382	687		Precedence of different RAU	5.4.0	5.5.0
12-2002	NP-18	NP-020546	697	1	No MT calls after resumption of GPRS in Network Operation Mode I	5.5.0	5.6.0
12-2002	NP-18	NP-020570	698		Inclusion of EDGE RF Power Capability in the CM3 IE	5.5.0	5.6.0
12-2002	NP-18	NP-020670	701	3	Flow Identifier Encoding	5.5.0	5.6.0
12-2002	NP-18	NP-020548	703	1	Clarification of the codec change procedure	5.5.0	5.6.0
12-2002	NP-18	NP-020629	704		Use of "LLC SAPI not assigned" by the network	5.5.0	5.6.0
12-2002	NP-18	NP-020545	707	1	Cell barring after Network authentication rejection from the UE	5.5.0	5.6.0
12-2002	NP-18	NP-020674	716	4	Downloading of local emergency numbers to the mobile station	5.5.0	5.6.0
12-2002	NP-18	NP-020549	721	1	Correcting errors and making improvements to references	5.5.0	5.6.0
12-2002	NP-18	NP-020547	724		Clarification on revision level	5.5.0	5.6.0
03-2003	NP-19	NP-030042	730		Correction on CC Capabilities IE length	5.6.0	5.7.0
03-2003	NP-19	NP-030055	731	1	Support of UMTS authentication by GERAN only terminals	5.6.0	5.7.0
03-2003	NP-19	NP-030141	736	2	MS RAC for UMTS only terminal	5.6.0	5.7.0
03-2003	NP-19	NP-030055	737	1	High multislot classes for type 1 mobiles	5.6.0	5.7.0
03-2003	NP-19	NP-030054	738	2	Signalling PDP Context Indication to Core Network	5.6.0	5.7.0
03-2003	NP-19	NP-030055	740	1	Missing IEI definition in locking shift (CC) IE and non-locking shift (CC) IE	5.6.0	5.7.0
03-2003	NP-19	NP-030055	741	1	Combined RAU successful for GPRS only, missing GMM cause IE	5.6.0	5.7.0

Date	TSG #	TSG Doc.	CR	Rev	Subject/Comment	Old	New
03-2003	NP-19	NP-030055	746		Enhanced Power Control (EPC) information in classmark 3	5.6.0	5.7.0
03-2003	NP-19	NP-030062	747		Introduction of USIM in the figure "Overview mobility management protocol"	5.6.0	5.7.0
03-2003	NP-19	NP-030057	733	1	Interruption of DL user data transmission during P-TMSI reallocation	5.7.0	6.0.0
03-2003	NP-19	NP-030058	739	2	Implementation of new frequency ranges into 24.008	5.7.0	6.0.0
06-2003	NP-20	NP-030284	750		MS RAC encoding	6.0.0	6.1.0
06-2003	NP-20	NP-030269	756	3	Bearer Capability IE	6.0.0	6.1.0
06-2003	NP-20	NP-030273	760		Alignment of parameter 'signalling information' with other QoS parameters	6.0.0	6.1.0
06-2003	NP-20	NP-030273	764	1	Cleanup and correction of the PCO-IE	6.0.0	6.1.0
06-2003	NP-20	NP-030271	767	1	Indication of the MS support of "Modulation based multislot class"	6.0.0	6.1.0
06-2003	NP-20	NP-030284	768		Wrong references in SETUP and redirected number/subaddress IEs	6.0.0	6.1.0
06-2003	NP-20	NP-030270	772		Alignment on BC IE coding for FAX between TS24.008 and TS27.001	6.0.0	6.1.0
06-2003	NP-20	NP-030267	776		Unciphered transmission of Authentication and Ciphering Failure in A/Gb mode	6.0.0	6.1.0
06-2003	NP-20	NP-030282	780		Correction of the static conditions for the bearer capability IE contents	6.0.0	6.1.0
06-2003	NP-20	NP-030270	784	1	Clarification of the procedure for the change of DRX parameter	6.0.0	6.1.0
09-2003					ETSI/MCC changed chapter numbering from 10.5.4.5.1 to 10.5.4.4a.1 for Backup BC IE. Wrong since v6.0.0	6.1.0	6.2.0
09-2003	NP-21	NP-030416	787		Correction of the static conditions for the 'backup' bearer capability IE contents	6.1.0	6.2.0
09-2003	NP-21	NP-030416	793		Deletion of EFRPLMNAct	6.1.0	6.2.0
09-2003	NP-21	NP-030416	795	1	Clarification of handover – BC-IE	6.1.0	6.2.0
09-2003	NP-21	NP-030347	797	2	Support of the maximum bit rate for HSDPA	6.1.0	6.2.0
09-2003	NP-21	NP-030420	798		Source of the CS domain specific system information	6.1.0	6.2.0
09-2003	NP-21	NP-030420	799	1	Signaling connection release after GMM procedure	6.1.0	6.2.0
09-2003	NP-21	NP-030406	807	2	Clarification of BC negotiation for multimedia calls	6.1.0	6.2.0
09-2003	NP-21	NP-030405	813	1	Change of DTM core capability	6.1.0	6.2.0
09-2003	NP-21	NP-030416	815	1	CR on introduction of mobile station multislot power classes.	6.1.0	6.2.0
12-2003	NP-22	NP-030485	803	2	TFT error handling	6.2.0	6.3.0
12-2003	NP-22	NP-030485	816		ePLMN list extension	6.2.0	6.3.0
12-2003	NP-22	NP-030485	818	1	SM signalling in case tear down is requested	6.2.0	6.3.0
12-2003	NP-22	NP-030487	819		Addition of multiple TBF capability flag to MS RAC IE	6.2.0	6.3.0
12-2003	NP-22	NP-030485	820		Order of frequency bands in MS Radio Access Capability IE	6.2.0	6.3.0
12-2003	NP-22	NP-030481	822		Correction to the Multislot Power Profile Classes	6.2.0	6.3.0
12-2003	NP-22	NP-030485	823		Correction of timer handling in diagram 4.7.7a	6.2.0	6.3.0
12-2003	NP-22	NP-030485	826		Removal of codepoint for GTP ack mode	6.2.0	6.3.0
12-2003	NP-22	NP-030485	827		SSD and Signalling indication in QoS IE	6.2.0	6.3.0
03-2004	NP-23	NP-040038	831	2	Use of TMSI/IMSI in CM SERVICE REQUEST message in case of emergency call redirection and change of LAI	6.3.0	6.4.0
03-2004	NP-23	NP-040038	832		Clarification on the meaning of MS network capability indicator bits	6.3.0	6.4.0
03-2004	NP-23	NP-040025	836	1	Conditions for PFI usage	6.3.0	6.4.0
03-2004	NP-23	NP-040038	841	2	Added Session Management (SM) Cause Value for APN Type Conflict	6.3.0	6.4.0
03-2004	NP-23	NP-040038	842		Correction of the condition for the tear down of PDP contexts	6.3.0	6.4.0
03-2004	NP-23	NP-040038	844		Status of PFI value after PDP context modification	6.3.0	6.4.0
03-2004	NP-23	NP-040038	845	1	MS reaction upon RRC connection release with cause "Directed signalling connection re-establishment"	6.3.0	6.4.0
03-2004	NP-23	NP-040099	846	3	Handling of key sets	6.3.0	6.4.0
03-2004	NP-23	NP-040038	849	2	Clarification of UE behaviour at network initiated GPRS Detach	6.3.0	6.4.0
03-2004	NP-23	NP-040038	851		MS class behaviour in case of a network initiated detach with detach type "IMSI detach"	6.3.0	6.4.0
06-2004	NP-24	NP-040185	856	1	Clarification of the use of service type 'Location services'	6.4.0	6.5.0
06-2004	NP-24	NP-040186	860	1	Correction of the network initiated in-call modification	6.4.0	6.5.0
06-2004	NP-24	NP-040187	863	1	Suspension of CM layer services during GMM procedures	6.4.0	6.5.0
06-2004	NP-24	NP-040187	866	1	LCS VA capability in MS network capability IE for PS	6.4.0	6.5.0
06-2004	NP-24	NP-040203	869	1	Introduction of Flexible Layer One lu capability	6.4.0	6.5.0
06-2004	NP-24	NP-040203	871	2	Identity request for identity that is not available	6.4.0	6.5.0
06-2004	NP-24	NP-040186	879	2	Reference to 4.7.x.4	6.4.0	6.5.0
06-2004	NP-24	NP-040190	881	1	Handling of key sets at inter-system change	6.4.0	6.5.0
09-2004	NP-25	NP-040432	882	4	Follow-on proceed for the PS domain	6.5.0	6.6.0
09-2004	NP-25	NP-040375	901	3	Clarification on the registered PLMN for UEs that support network sharing in a shared network	6.5.0	6.6.0
09-2004	NP-25	NP-040376	905		Introduction of Downlink Advanced Receiver Performance (DARP) capability	6.5.0	6.6.0
09-2004	NP-25	NP-040377	889	1	Introduction of the MBMS general procedure and states	6.5.0	6.6.0

Date	TSG #	TSG Doc.	CR	Rev	Subject/Comment	Old	New
09-2004	NP-25	NP-040377	890	1	Introduction of the MBMS Context Activation procedure	6.5.0	6.6.0
09-2004	NP-25	NP-040377	891	1	Introduction of the MBMS Context Activation messages	6.5.0	6.6.0
09-2004	NP-25	NP-040377	896		Update of the Service Request procedure - MBMS	6.5.0	6.6.0
09-2004	NP-25	NP-040377	894		Introduction of the MBMS Multicast Service Deactivation procedure - Reuse of PDP context deactivation messages	6.5.0	6.6.0
09-2004	NP-25	NP-040377	895	1	Introduction of the MBMS Multicast Service Deactivation messages - Reuse of PDP context deactivation messages	6.5.0	6.6.0
09-2004	NP-25	NP-040377	898	1	Introduction of MBMS context handling	6.5.0	6.6.0
09-2004	NP-25	NP-040377	897	1	Update of Annex I for MBMS	6.5.0	6.6.0
09-2004	NP-25	NP-040378	904		Introduction of Extended RLC/MAC Control Message segmentation capability	6.5.0	6.6.0
09-2004	NP-25	NP-040378	883	1	Mapping of QoS Traffic Class to RRC Establishment Cause	6.5.0	6.6.0
09-2004	NP-25	NP-040378	852	3	Network Search for recovering from Faulty Networks	6.5.0	6.6.0
09-2004	NP-25	NP-040379	886	2	Correction to list of received N-PDU number in Rau Accept message	6.5.0	6.6.0
12-2004	NP-26	NP-040504	907		MBMS update	6.6.0	6.7.0
12-2004	NP-26	NP-040504	908	2	NSAPI at MBMS context activation	6.6.0	6.7.0
12-2004	NP-26	NP-040510	922		Addition of DTM enhancements capability	6.6.0	6.7.0
12-2004	NP-26	NP-040513	926	2	Location registration in a shared network when multiple PLMNs are broadcast	6.6.0	6.7.0
12-2004	NP-26	NP-040513	927	1	Reject cause ranking during rerouting in MOCN	6.6.0	6.7.0
12-2004	NP-26	NP-040514	910	2	Correction of terminology -GSM and UMTS	6.6.0	6.7.0
12-2004	NP-26	NP-040514	911	1	Paging for GPRS Services in GSM	6.6.0	6.7.0
12-2004	NP-26	NP-040514	912	1	Service request conditions	6.6.0	6.7.0
12-2004	NP-26	NP-040514	913	1	Service request - Abnormal cases in the MS	6.6.0	6.7.0
12-2004	NP-26	NP-040514	914	2	No follow on proceed indication	6.6.0	6.7.0
12-2004	NP-26	NP-040514	915	3	Mobile identity - No identity	6.6.0	6.7.0
12-2004	NP-26	NP-040514	920	1	Correction of the description of causes #7 and #8 in Annex G.6	6.6.0	6.7.0
12-2004	NP-26	NP-040514	921	1	CC cause reference correction	6.6.0	6.7.0
12-2004	NP-26	NP-040514	923		Handling of zero T3312 timer value	6.6.0	6.7.0
12-2004	NP-26	NP-040514	924		Introduction of new references for DTMF	6.6.0	6.7.0
03-2005	NP-27	NP-050070	933	2	Defining TMGI and MBMS Session Id in the mobile identity field	6.7.0	6.8.0
03-2005	NP-27	NP-050070	934	1	Correct GPRS SM List and MBMS IE Descriptions	6.7.0	6.8.0
03-2005	NP-27	NP-050070	958		Mapping of 'MBMS notification response' to RRC establishment cause	6.7.0	6.8.0
03-2005	NP-27	NP-050071	931	1	Synchronization of MBMS context status between UE and SGSN	6.7.0	6.8.0
03-2005	NP-27	NP-050071	954	1	MBMS Session Management clarifications	6.7.0	6.8.0
03-2005	NP-27	NP-050071	956	1	Introduction of MBMS in clause 8	6.7.0	6.8.0
03-2005	NP-27	NP-050076	952	1	Detach for PS and CS during a ongoing CS connection	6.7.0	6.8.0
03-2005	NP-27	NP-050076	951	1	GPRS attach type while in DTM	6.7.0	6.8.0
03-2005	NP-27	NP-050076	953	1	Condition for Combined RAU after a DTM connection	6.7.0	6.8.0
03-2005	NP-27	NP-050076	935	1	Missing Messages in MM and CC Summary Tables	6.7.0	6.8.0
03-2005	NP-27	NP-050076	932		Correction of the heading of subclause 4.7.3.1.6, bullet d.1	6.7.0	6.8.0
03-2005	NP-27	NP-050077	957	2	Modification of MS Behaviour under GPRS Attach with Reject Cause #14	6.7.0	6.8.0

Date	TSG #	TSG Doc.	CR	Rev	Subject/Comment	Old	New
03-2005	NP-27	NP-050083	939	3	Addition of domain specific access control	6.7.0	6.8.0
03-2005	NP-27	NP-050085	950	2	Provision of MS specific UTRAN capabilities for the PS handover from GERAN to UTRAN	6.7.0	6.8.0
06-2005	CP-28	CP-050058	987		GSM 750 corrections	6.8.0	6.9.0
06-2005	CP-28	CP-050062	977	1	Introduction of MBMS support indication to the UE	6.8.0	6.9.0
06-2005	CP-28	CP-050067	982		Correction on handling of forbidden lists	6.8.0	6.9.0
06-2005	CP-28	CP-050069	974	1	Cell Update triggered by low layers	6.8.0	6.9.0
06-2005	CP-28	CP-050069	989		Extension of DTM to high multislot classes	6.8.0	6.9.0
06-2005	CP-28	CP-050069	975		MS initiated RAU for re-negotiation of MS configuration	6.8.0	6.9.0
06-2005	CP-28	CP-050069	973	1	Handling of duplicated RAU on the network side	6.8.0	6.9.0
06-2005	CP-28	CP-050069	978	2	Clarification on locking shift procedure	6.8.0	6.9.0
06-2005	CP-28	CP-050069	984	1	Mobile identity IE length when 'No identity'	6.8.0	6.9.0
06-2005	CP-28	CP-050069	916	4	Attach type and Update type IEs	6.8.0	6.9.0
06-2005	CP-28	CP-050069	972	1	Corrections of designations and references of figures and tables	6.8.0	6.9.0
06-2005	CP-28	CP-050071	990	1	SCUDIF: Introduction of a Network-initiated Service Upgrade capability	6.8.0	6.9.0
06-2005	CP-28	CP-050071	991	1	SCUDIF: Introduction of a Network-initiated Service Upgrade indicator	6.8.0	6.9.0
06-2005	CP-28	CP-050071	983	1	SCUDIF: Introduction of a new timer for service change	6.8.0	6.9.0
06-2005	CP-28	CP-050072	937	3	SETUP Message Enhancement for Voice Video Switching	6.8.0	6.9.0
06-2005	CP-28	CP-050231	962	5	Transparent data call request in dual mode case	6.8.0	6.9.0
06-2005	CP-28	CP-050058	988		Introduction of GSM 710	6.9.0	7.0.0
09-2005	CP-29	CP-050355	1012	2	Clarification in TFT for the 'parameters list'	7.0.0	7.1.0
09-2005	CP-29	CP-050356	1003	1	Mapping RRC's "MBMS p-t-p RB Request" to a NAS service type	7.0.0	7.1.0
09-2005	CP-29	CP-050356	995	1	MBMS context procedures cleanup	7.0.0	7.1.0
09-2005	CP-29	CP-050356	997		T3390 is not used for MBMS	7.0.0	7.1.0
09-2005	CP-29	CP-050361	1014	1	Support of encryption algorithms in mobile stations	7.0.0	7.1.0
09-2005	CP-29	CP-050361	1016		Correction of terminology	7.0.0	7.1.0
09-2005	CP-29	CP-050366	1001	1	Correction of the definition of cause #13 "Roaming not allowed in this location area"	7.0.0	7.1.0
09-2005	CP-29	CP-050366	1004		Editorial alignment of SM Cause values	7.0.0	7.1.0
09-2005	CP-29	CP-050366	1009	2	Clarification to Quality of Service Information Element	7.0.0	7.1.0
09-2005	CP-29	CP-050366	1022	1	Clarification of requirement on the emergency category	7.0.0	7.1.0
09-2005	CP-29	CP-050366	963	3	Guard timer for PS signaling connection release	7.0.0	7.1.0
09-2005	CP-29	CP-050366	999	1	Alignment of GMM T3317 timer value	7.0.0	7.1.0
09-2005	CP-29	CP-050370	1023	1	Introduction of T-GSM 810	7.0.0	7.1.0
09-2005	CP-29	CP-050449	1006	2	Modifications for PS HO in A/Gb mode	7.0.0	7.1.0
12-2005	CP-30	CP-050535	1032	1	Description of 8-PSK capability on the uplink in MS Classmark 3	7.1.0	7.2.0

Date	TSG #	TSG Doc.	CR	Rev	Subject/Comment	Old	New
12-2005	CP-30	CP-050536	1039		Emergency number length in Emergency Number List IE	7.1.0	7.2.0
12-2005	CP-30	CP-050536	1035		Correction of wrong codepoint in the user-user information IE	7.1.0	7.2.0
12-2005	CP-30	CP-050540	1025		MBMS INACTIVE state does not exist	7.1.0	7.2.0
12-2005	CP-30	CP-050545	1041	1	Correction of Mobile Identity used in PAGING RESPONSE message	7.1.0	7.2.0
12-2005	CP-30	CP-050553	1027	3	Rationalised guard timer for Service Request (Service Type = Data)	7.1.0	7.2.0
03-2006	CP-31	CP-060126	1044	1	Use on cause #12 in VPLMNs	7.2.0	7.3.0
03-2006	CP-31	CP-060114	1050	4	Correction of domain specific access control	7.2.0	7.3.0
03-2006	CP-31	CP-060115	1052	-	Missing subclause in TS 24.008	7.2.0	7.3.0
03-2006	CP-31	CP-060179	1054	2	Inclusion of support for DTM Handover for GERAN A/Gb mode	7.2.0	7.3.0
03-2006	CP-31	CP-060126	1056	1	Clarification for collision of PDP context activation	7.2.0	7.3.0
03-2006	CP-31	CP-060121	1062	1	Transfer of Text from the Combinational Services TR 24.879 to TS 24.008	7.2.0	7.3.0
03-2006	CP-31	CP-060113	1064	-	Inclusion of support for Repeated SACCH	7.2.0	7.3.0
06-2006	CP-32	CP-060262	1067		Incorrect reference to RFC 3513	7.3.0	7.4.0
06-2006	CP-32	CP-060267	1081	1	Indication of support for Repeated ACCH	7.3.0	7.4.0
06-2006	CP-32	CP-060353	1071	2	Removal of references to "MBMS notification response" service type	7.3.0	7.4.0
09-2006	CP-33	CP-060454	1103	2	Mitigating the risk of DoS attacks that utilises non-integrity protected NAS messages	7.4.0	7.5.0
09-2006	CP-33	CP-060455	1098	1	Enhanced NSAPI for MBMS Broadcast Mode	7.4.0	7.5.0
09-2006	CP-33	CP-060459	1089	2	Clarification on the handling of T3311 and T3302 timers during DSAC	7.4.0	7.5.0
09-2006	CP-33	CP-060459	1085	1	Procedure at UE after unbarred for both domains on DSAC in NMO I	7.4.0	7.5.0
09-2006	CP-33	CP-060459	1083	1	Postponed RAU if T3312 expires while PS domain is barred	7.4.0	7.5.0
09-2006	CP-33	CP-060473	1104	4	Coding of the User-User Information Element for IMS status	7.4.0	7.5.0
09-2006	CP-33	CP-060506	1099	1	Implementation option to improve the performance of MM/GMM signaling procedures	7.4.0	7.5.0
11-2006	CP-34	CP-060658	1115	1	Correction of the GPRS MS action in NMO I when PS is barred	7.5.0	7.6.0
11-2006	CP-34	CP-060658	1111	2	Clarification on the detach procedure during domain specific access class barring	7.5.0	7.6.0
11-2006	CP-34	CP-060670	1053	4	PDP Context Activity Indication for Service Request (Service Type = Data)	7.5.0	7.6.0
11-2006	CP-34	CP-060670	1116	-	Deletion of LAI and PLMN from forbidden lists after LOCATION UPDATING ACCEPT	7.5.0	7.6.0
11-2006	CP-34	CP-060670	1117	-	Adding a Ciphering Mode Setting indicator to MS Classmark3	7.5.0	7.6.0
11-2006	CP-34	CP-060744	1108	5	Initiation of Service Request to support MBMS broadcast services	7.5.0	7.6.0
03-2007	CP-35	CP-070143	1118	1	Addition of support for Network Bearer	7.6.0	7.7.0
03-2007	CP-35	CP-070155	1119	2	Criteria used by network to select a CKSN/KSI value	7.6.0	7.7.0

Date	TSG #	TSG Doc.	CR	Rev	Subject/Comment	Old	New
03-2007	CP-35	CP-070155	1120	1	Authentication parameter values stored in the UE separately for the CS and the PS domain	7.6.0	7.7.0
03-2007	CP-35	CP-070156	1122		Downlink Dual carrier multislot class indication	7.6.0	7.7.0
03-2007	CP-35	CP-070155	1124	1	Corrections to Network initiated PDP context modification procedure	7.6.0	7.7.0
03-2007	CP-35	CP-070155	1128	2	Introduction of Downlink Advanced Receiver Performance – phase II capability	7.6.0	7.7.0
06-2007	CP-36	CP-070369	1136	1	Signalling connection for MBMS reception in PTP mode	7.7.0	7.8.0
06-2007	CP-36	CP-070386	1142	1	Support of higher maximum bitrate and guaranteed bit rate in the QoS IE	7.7.0	7.8.0
06-2007	CP-36	CP-070387	1144	2	MS indication of support of GAN PS Handover	7.7.0	7.8.0
06-2007	CP-36	CP-070387	1138	1	Clarification for the Codec Bitmap	7.7.0	7.8.0
06-2007	CP-36	CP-070387	1137	-	Bearer capability IE for Emergency calls and EFR capable terminals	7.7.0	7.8.0
06-2007	CP-36	CP-070387	1133	-	Indication of Flexible Timeslot Assignment support	7.7.0	7.8.0
06-2007	CP-36	CP-070392	1134	1	Introduction of Latency Reduction capabilities	7.7.0	7.8.0
09-2007	CP-37	CP-070582	1149	1	Prohibition of implementing A5/2 in terminals A5/2 in termi	7.8.0	7.9.0
09-2007	CP-37	CP-070591	1148	2	Stage 3 alignment of Network Bearer control when BCM is MS/NW	7.8.0	7.9.0
09-2007	CP-37	CP-070598	1147	1	Extension of MS Classmark 3 IE length	7.8.0	7.9.0
09-2007	CP-37	CP-070598	1146	1	Clarification of UE behavior after receipt of ATTACH ACCEPT with Cause IE in response to combined ATTACH REQUEST	7.8.0	7.9.0
09-2007	CP-37	CP-070598	1145	2	Addition of Positioning Capability Transfer over RRLP	7.8.0	7.9.0
12-2007	CP-38	CP-070789	1158	1	Correction to MBMS context deactivation	7.9.0	7.10.0
12-2007	CP-38	CP-070789	1156	2	Correction to the TMGI	7.9.0	7.10.0
12-2007	CP-38	CP-070804	1153	1	Introduction of EGPRS2 capabilities	7.9.0	7.10.0
12-2007	CP-38	CP-070815	1152	1	Correction of misleading comments in the MS Classmark 3 and MS Radio Access Capability	7.10.0	8.0.0
03-2008	CP-39	CP-080034	1168		TMGI misalignment between figure and table text	8.0.0	8.1.0
03-2008	CP-39	CP-080136	1165		Handling of NAS-layer cause value when in GAN	8.0.0	8.1.0
06-2008	CP-40	CP-080339	1177		Correction of description of security handling during inter-system handover	8.1.0	8.2.0
06-2008	CP-40	CP-080347	1174	1	Correction of handling unknown or unforeseen transaction identifier in session management	8.1.0	8.2.0
06-2008	CP-40	CP-080347	1191		Downlink Dual Carrier capability signalling for DTM	8.1.0	8.2.0
06-2008	CP-40	CP-080361	1186	2	RAU attempt counter and PLMN-SEARCH substate	8.1.0	8.2.0
06-2008	CP-40	CP-080361	1172	1	Add cause value #112 (APN restriction value incompatible with active PDP context) to the PDP context deactivation initiated by the network	8.1.0	8.2.0
06-2008	CP-40	CP-080361	1184		Correction of MM states in the tables in the timer section	8.1.0	8.2.0
06-2008	CP-40	CP-080361	1178		Correction to CS messages and tables	8.1.0	8.2.0
06-2008	CP-40	CP-080362	1193	2	Changes to TS24.008_AccessControl	8.1.0	8.2.0
06-2008	CP-40	CP-080363	1169	3	eCall identifier for differential routing	8.1.0	8.2.0

Date	TSG #	TSG Doc.	CR	Rev	Subject/Comment	Old	New
09-2008	CP-41	CP-080534	1189	4	Avoidance of MM signalling for an eCall only terminal	8.2.0	8.3.0
09-2008	CP-41	CP-080536	1201	1	Correction for IMSI detach procedure during dedicated mode	8.2.0	8.3.0
09-2008	CP-41	CP-080519	1203	1	Latency Reduction support for non RTTI capable MSs	8.2.0	8.3.0
09-2008	CP-41	CP-080519	1205	1	Stage 2 alignment related to Network bearer control	8.2.0	8.3.0
09-2008	CP-41	CP-080529	1207	1	Clarification of access control for PPAC	8.2.0	8.3.0
09-2008	CP-41	CP-080536	1209	1	TMSI reallocation in a location area where the UE isn't updated	8.2.0	8.3.0
12-2008	CP-42	CP-080860	1211	2	Changes to TS24.008_AccessControl	8.3.0	8.4.0
12-2008	CP-42	CP-080834	1213	1	Multimedia CAT in the CS domain	8.3.0	8.4.0
12-2008	CP-42	CP-080867	1214	3	Paging response for CS Fallback	8.3.0	8.4.0
12-2008	CP-42	CP-080837	1216		Indication of mobile station's E-UTRAN capability	8.3.0	8.4.0
12-2008	CP-42	CP-080838	1218	3	CSG access control for HNB - defining new cause value and UE behavior	8.3.0	8.4.0
12-2008	CP-42	CP-080867	1219	1	CR on 24.008 -CSFB timer	8.3.0	8.4.0
12-2008	CP-42	CP-080867	1226	1	ISR for CSFB	8.3.0	8.4.0
12-2008	CP-42	CP-080866	1227	2	NAS recovery specification in TS 24.008	8.3.0	8.4.0
12-2008	CP-42	CP-080866	1228	1	DRX Parameter support for S1 mode	8.3.0	8.4.0
12-2008	CP-42	CP-080873	1229	1	Corrections for GPRS attach attempt counter and routing area update attempt counter	8.3.0	8.4.0
12-2008	CP-42	CP-080866	1233	1	P-TMSI signature handling due to S1 mode to lu or A/Gb mode intersystem change	8.3.0	8.4.0
12-2008	CP-42	CP-080866	1238	1	Support of EPS NAS protocols	8.3.0	8.4.0
12-2008	CP-42	CP-080868	1239	1	Introduction of UE network capability IE	8.3.0	8.4.0
12-2008	CP-42	CP-080866	1240	1	PCO for IP address allocation options	8.3.0	8.4.0
12-2008	CP-42	CP-080868	1242	2	Indication of HSPA SRVCC capability	8.3.0	8.4.0
12-2008	CP-42				Editorial cleanup by MCC	8.3.0	8.4.0
03-2009	CP-43	CP-090125	1243	2	Additon of E-UTRAN support in MS Network Capability	8.4.0	8.5.0
03-2009	CP-43	CP-090130	1246	1	Security context handling on inter RAT mobility to GERAN/UTRAN	8.4.0	8.5.0
03-2009	CP-43	CP-090125	1247	2	AMF coding for EPS	8.4.0	8.5.0
03-2009	CP-43	CP-090130	1248	2	SM and GMM sublayers coordination for supporting ISR	8.4.0	8.5.0
03-2009	CP-43	CP-090131	1249	2	UE specific DRX Parameters handling in ATTACH/RAU procedure	8.4.0	8.5.0
03-2009	CP-43	CP-090159	1253	1	Corrections for attach and RAU attempt counters	8.4.0	8.5.0
03-2009	CP-43	CP-090153	1254	1	ISR local deactivation in the UE	8.4.0	8.5.0
03-2009	CP-43	CP-090159	1255	2	Miscellaneous corrections for 24.008	8.4.0	8.5.0
03-2009	CP-43	CP-090156	1257	2	CC and MM procedures for SRVCC	8.4.0	8.5.0
03-2009	CP-43	CP-090157	1266	1	Invoking detach procedure through a CSG cell	8.4.0	8.5.0
03-2009	CP-43	CP-090157	1267	1	Miscellaneous corrections	8.4.0	8.5.0
03-2009	CP-43	CP-090157	1268	1	LU/RAU after manual selection of CSG cell	8.4.0	8.5.0

Date	TSG #	TSG Doc.	CR	Rev	Subject/Comment	Old	New
03-2009	CP-43	CP-090159	1270	2	Correction of initial conditions when UE registered for CS services in an area supporting NMO III moves to another area with a different NMO	8.4.0	8.5.0
03-2009	CP-43	CP-090159	1271		Reference corrections	8.4.0	8.5.0
03-2009	CP-43	CP-090153	1274	1	Addition of CS Fallback capability support in MS Network Capability	8.4.0	8.5.0
03-2009	CP-43	CP-090129	1275		NAS recovery on/off mechanism(3G)	8.4.0	8.5.0
03-2009	CP-43	CP-090125	1277	1	Add new subclause which describes coordination between GMM and EMM	8.4.0	8.5.0
03-2009	CP-43	CP-090129	1278	1	Proposal of UE EMM behavior on reception of error cause #9 when UE executed RAU, combined RAU and Service Request	8.4.0	8.5.0
03-2009	CP-43	CP-090126	1279	2	Clarifications for request type	8.4.0	8.5.0
03-2009	CP-43	CP-090131	1280	3	Use of S-TMSI for the GPRS attach procedure	8.4.0	8.5.0
03-2009	CP-43	CP-090157	1281	2	Update of CSG list in manual mode	8.4.0	8.5.0
03-2009	CP-43	CP-090123	1283	1	Enhancement of inter RAT information container	8.4.0	8.5.0
03-2009	CP-43	CP-090128	1284	2	Introducing E-UTRAN UE RAC Information	8.4.0	8.5.0
03-2009	CP-43	CP-090130	1285		Removal of EN for RAU reject (cause #12)	8.4.0	8.5.0
03-2009	CP-43	CP-090131	1286	2	Update the PDN type with IPv4v6	8.4.0	8.5.0
03-2009	CP-43	CP-090125	1290	1	Attach and routing area update abnormal cases: interaction with EMM	8.4.0	8.5.0
03-2009	CP-43	CP-090153	1292	1	T3280 removal and corrections to procedures for CS fallback	8.4.0	8.5.0
03-2009	CP-43	CP-090157	1295	1	Clarification on CSG related NAS behavior	8.4.0	8.5.0
03-2009	CP-43	CP-090130	1297	1	Proposal of UE EMM behavior on reception of error cause #10 when UE executed RAU, combined RAU and Service Request	8.4.0	8.5.0
06-2009	CP-44	CP-090410	1298		Combined RAU Reject(cause #12)	8.5.0	8.6.0
06-2009	CP-44	CP-090410	1299		Authentication failure parameter applicability	8.5.0	8.6.0
06-2009	CP-44	CP-090424	1303	1	Subclause on PDP address allocation	8.5.0	8.6.0
06-2009	CP-44	CP-090421	1304	2	Mobile Id for Paging Response	8.5.0	8.6.0
06-2009	CP-44	CP-090424	1306	1	Clarification of TMSI reallocation procedure	8.5.0	8.6.0
06-2009	CP-44	CP-090410	1308	1	Introduction of "reserved" code points for Request type IE	8.5.0	8.6.0
06-2009	CP-44	CP-090410	1314	1	Correction for the main state change in the MS	8.5.0	8.6.0
06-2009	CP-44	CP-090421	1317		New trigger for location area updating procedure	8.5.0	8.6.0
06-2009	CP-44	CP-090421	1318		MM state when MS is under E-UTRAN coverage	8.5.0	8.6.0
06-2009	CP-44	CP-090421	1319		Emergency calls handling	8.5.0	8.6.0
06-2009	CP-44	CP-090424	1321	1	Behaviour of GPRS MS operating in MS operation mode A or B on Service Reject with cause #7	8.5.0	8.6.0
06-2009	CP-44	CP-090410	1323	1	Correction to mobile identity IE	8.5.0	8.6.0
06-2009	CP-44	CP-090426	1326	1	Introduction of MS E-UTRA Capabilities	8.5.0	8.6.0
06-2009	CP-44	CP-090410	1327		Replacing TRACKING AREA UPDATE REQUEST by ROUTING AREA UPDATE REQUEST	8.5.0	8.6.0
09-2009	CP-45	CP-090652	1307	3	Protocol Configuration Options support of PAP CHAP in EPS	8.6.0	8.7.0

Date	TSG #	TSG Doc.	CR	Rev	Subject/Comment	Old	New
09-2009	CP-45	CP-090652	1311	7	Providing the MSISDN to the MS	8.6.0	8.7.0
09-2009	CP-45	CP-090733	1320	3	Update of triggers for normal and combined routing area updating procedure	8.6.0	8.7.0
09-2009	CP-45	CP-090653	1328	1	Security corrections to the RAU procedure	8.6.0	8.7.0
09-2009	CP-45	CP-090653	1331		Replacing "UE" by "MS"	8.6.0	8.7.0
09-2009	CP-45	CP-090677	1332	1	Clarifications related to manual CSG selection	8.6.0	8.7.0
09-2009	CP-45	CP-090773	1333	3	Correction of security key handling for SR VCC	8.6.0	8.7.0
09-2009	CP-45	CP-090677	1337		Correction to abnormal cases on the network side	8.6.0	8.7.0
09-2009	CP-45	CP-090652	1339	2	Interaction between A/Gb or Lu mode and S1 mode	8.6.0	8.7.0
09-2009	CP-45	CP-090652	1340	1	Local ISR deactivation upon last PDP context deactivation	8.6.0	8.7.0
09-2009	CP-45	CP-090674	1341	1	Emergency calls when the MS is not registered to CS domain and camped on an E-UTRAN cell	8.6.0	8.7.0
09-2009	CP-45	CP-090679	1343	1	Cause code to resolve race condition between UE-initiated and NW-initiated secondary PDP context activation	8.6.0	8.7.0
09-2009	CP-45	CP-090652	1344	2	Inclusion of DNS server and P-CSCF IPv4 addresses in PCO	8.6.0	8.7.0
09-2009	CP-45	CP-090650	1345		Align the description of default bearer	8.6.0	8.7.0
09-2009	CP-45	CP-090668	1348	1	eCall miscellaneous corrections	8.6.0	8.7.0
09-2009	CP-45	CP-090668	1350	1	Amendments to mobility management procedures	8.6.0	8.7.0
09-2009	CP-45	CP-090651	1357	2	Corrections to the figure of the GMM main states in the MS	8.6.0	8.7.0
09-2009	CP-45	CP-090653	1358	1	Security for inter-system RAU from S1 mode	8.6.0	8.7.0
09-2009	CP-45	CP-090651	1360		Corrections for description of cause #25	8.6.0	8.7.0
09-2009	CP-45	CP-090651	1361	1	Correction on SM error cause #30	8.6.0	8.7.0
09-2009	CP-45	CP-090668	1368	1	Determination of "eCall only" mode of operation	8.6.0	8.7.0
09-2009	CP-45	CP-090675	1372	1	Parameters for SMS over SGs charging	8.6.0	8.7.0
09-2009	CP-45	CP-090689	1330	1	Introducing reject cause value for emergency service over GPPS	8.7.0	9.0.0
09-2009	CP-45	CP-090690	1334	3	PDN Connection request type for emergency	8.7.0	9.0.0
09-2009	CP-45	CP-090682	1336	1	Periodic routing area updating: editorial correction	8.7.0	9.0.0
09-2009	CP-45	CP-090689	1346	2	GPRS Attach for emergency services	8.7.0	9.0.0
09-2009	CP-45	CP-090689	1347	1	GPRS detach for emergency services	8.7.0	9.0.0
09-2009	CP-45	CP-090682	1353	2	Enhanced Flexible Timeslot Assignment	8.7.0	9.0.0
09-2009	CP-45	CP-090682	1354	1	Modification of Length Indicator Usage	8.7.0	9.0.0
09-2009	CP-45	CP-090690	1359	1	Support indications for IMS Voice over PS session and emergency call	8.7.0	9.0.0
09-2009	CP-45	CP-090689	1367	2	HLR detach request and PDP context deactivation by the SGSN	8.7.0	9.0.0
09-2009	CP-45	CP-090694	1370	1	Update of allowed CSG list after successful manual selection of a CSG cell in a different PLMN	8.7.0	9.0.0
09-2009	CP-45	CP-090692	1371	1	Introduction of 128-bit ciphering key for A5/4 and GEA/4	8.7.0	9.0.0
12-2009	CP-46	CP-090918	1374	1	Correction for detach procedure	9.0.0	9.1.0
12-2009	CP-46	CP-090930	1375	2	Add paging optimization procedure for CSG cell	9.0.0	9.1.0

Date	TSG #	TSG Doc.	CR	Rev	Subject/Comment	Old	New
12-2009	CP-46	CP-090935	1376	3	Clarification on the Closed mode CSG cell	9.0.0	9.1.0
12-2009	CP-46	CP-090922	1377	3	UE voice capabilities/settings in MS network capability	9.0.0	9.1.0
12-2009	CP-46	CP-090922	1378	5	Triggering conditions update for RAU	9.0.0	9.1.0
12-2009	CP-46	CP-090935	1379	3	Operator CSG List	9.0.0	9.1.0
12-2009	CP-46	CP-090899	1382	1	Handling of cause #15 in UE with S1 mode support	9.0.0	9.1.0
12-2009	CP-46	CP-090930	1386	1	Detach on Timeout of Periodical Update Timer	9.0.0	9.1.0
12-2009	CP-46	CP-090917	1388	1	Clarification on setting SI value after SRVCC handover	9.0.0	9.1.0
12-2009	CP-46	CP-090915	1396	2	LAU clarification for ISR and CSFB interworking	9.0.0	9.1.0
12-2009	CP-46	CP-090935	1397	5	Processing the reject cause code #25 for the Operator CSG List	9.0.0	9.1.0
12-2009	CP-46	CP-090920	1399		PDP type IPv4v6 address length corrections	9.0.0	9.1.0
12-2009	CP-46	CP-090930	1400	2	PDP Context activation and modification for emergency bearer services	9.0.0	9.1.0
12-2009	CP-46	CP-090922	1401	1	Correction to conditions for GMM initiating service request	9.0.0	9.1.0
12-2009	CP-46	CP-090915	1403	1	Missing establishment cause code mapping for CS fallback	9.0.0	9.1.0
12-2009	CP-46	CP-090922	1410		Introduction of Enhanced Multiplexing for Single TBF capability	9.0.0	9.1.0
12-2009	CP-46	CP-090899	1413		Key derivation in idle mode inter-RAT mobility	9.0.0	9.1.0
12-2009	CP-46	CP-090898	1414		Correction for Separation bit of AMF	9.0.0	9.1.0
12-2009	CP-46	CP-090930	1420		GMM state machine on the UE side for emergency attach	9.0.0	9.1.0
12-2009	CP-46	CP-090930	1421	2	GMM context handling for emergency attach	9.0.0	9.1.0
12-2009	CP-46	CP-090930	1423	2	MS behaviour in case of EMC	9.0.0	9.1.0
12-2009	CP-46	CP-090930	1424	2	Deactivate non-EMC bearers with CSG ID not in allowed CSG list	9.0.0	9.1.0
12-2009	CP-46	CP-090930	1425	1	Handling of the forbidden list	9.0.0	9.1.0
12-2009	CP-46	CP-090930	1426	2	Authentication procedure for EMC attach	9.0.0	9.1.0
12-2009	CP-46	CP-090922	1427	1	Introduction of generic notification procedure	9.0.0	9.1.0
12-2009	CP-46	CP-090930	1428		Checks restrictions on attach for emergency bearer services	9.0.0	9.1.0
12-2009	CP-46	CP-090930	1437	1	GPRS update status while UE is attached for emergency bearer services	9.0.0	9.1.0
12-2009	CP-46	CP-090939	1438		128-bit ciphering key for SRVCC	9.0.0	9.1.0
12-2009	CP-46	CP-090939	1439		Correction to the definition of the UMTS security context and faulty message	9.0.0	9.1.0
12-2009	CP-46	CP-091052	1441	2	Alignment with TS23.401 caused by changing the term CSFB to "CSFB and SMS over SGs".	9.0.0	9.1.0
12-2009	CP-46	CP-090919	1409	4	Protecting the allowed CSG list	9.0.0	9.1.0
03-2010	CP-47	CP-100144	1392	5	Normal and Periodic Routing Area Update Procedure	9.1.0	9.2.0
03-2010	CP-47	CP-100144	1418	3	Deactive ISR for UE attached for emergency bearer services	9.1.0	9.2.0
03-2010	CP-47	CP-100103	1445		Removal of T-GSM 900 capability	9.1.0	9.2.0
03-2010	CP-47	CP-100144	1446	1	Disabling Integrity Checking for GMM, SM messages	9.1.0	9.2.0
03-2010	CP-47	CP-100144	1447		MS Initiated Detach Procedure	9.1.0	9.2.0

Date	TSG #	TSG Doc.	CR	Rev	Subject/Comment	Old	New
03-2010	CP-47	CP-100140	1448	1	Clarification to key derivation at SRVCC	9.1.0	9.2.0
03-2010	CP-47	CP-100134	1450	1	Correction on CSG Id removal from Allowed CSG list	9.1.0	9.2.0
03-2010	CP-47	CP-100106	1452	2	GPRS Kc handling at inter-system change from E-UTRAN to UTRAN/GERAN	9.1.0	9.2.0
03-2010	CP-47	CP-100129	1454	2	Kc handling in SRVCC	9.1.0	9.2.0
03-2010	CP-47	CP-100144	1455	1	Definition of attached for emergency bearer service	9.1.0	9.2.0
03-2010	CP-47	CP-100134	1456	1	Selective camping capability correction	9.1.0	9.2.0
03-2010	CP-47	CP-100134	1457	2	Defining Selective camping capability IE	9.1.0	9.2.0
03-2010	CP-47	CP-100144	1458	2	RRC establishment cause for EMC of lu mode	9.1.0	9.2.0
03-2010	CP-47	CP-100126	1460	2	Handling of Paging Response for CSFB	9.1.0	9.2.0
03-2010	CP-47	CP-100134	1461		Handling of CSFB mobile originating call	9.1.0	9.2.0
03-2010	CP-47	CP-100144	1462	1	Handling authentication failure for EMC during RAU	9.1.0	9.2.0
03-2010	CP-47	CP-100126	1467	1	Alignment term "CSFB and SMS over SGs" with TS23.401 (Part II)	9.1.0	9.2.0
03-2010	CP-47	CP-100106	1469	2	Clarification on routing parameter for access stratum	9.1.0	9.2.0
03-2010	CP-47	CP-100135	1470	2	Operator specific values for PCO	9.1.0	9.2.0
03-2010	CP-47	CP-100148	1471	1	Use of Cause #25 when MS's subscription to CSG has expired – 24.008	9.1.0	9.2.0
03-2010	CP-47	CP-100134	1473		Handling of inter RAT information container and E-UTRAN inter RAT information container	9.1.0	9.2.0
03-2010	CP-47	CP-100126	1476	1	Removing triggers for rau after S1 mode to UTRAN lu mode intersystem change due to CS fallback without PS handover	9.1.0	9.2.0
03-2010	CP-47	CP-100126	1478	1	Corrections on periodic routing area update timer and GERAN/UTRAN Deactivate ISR timers in the UE	9.1.0	9.2.0
03-2010	CP-47	CP-100134	1483	1	Using NAS-token in Attach Request	9.1.0	9.2.0
03-2010	CP-47	CP-100144	1486	2	Emergency secondary PDP context activation	9.1.0	9.2.0
03-2010	CP-47	CP-100130	1488	1	MM cause #25 for MM connection establishment	9.1.0	9.2.0
03-2010	CP-47	CP-100144	1489		Definition of non-emergency PDP context	9.1.0	9.2.0
03-2010	CP-47	CP-100144	1490		MS Substate PLMN Search	9.1.0	9.2.0
03-2010	CP-47	CP-100144	1491	2	Attach for emergency bearer services to a network not supporting EM BS	9.1.0	9.2.0
03-2010	CP-47	CP-100134	1493	1	Corrections to Network Feature Support IE.	9.1.0	9.2.0
03-2010	CP-47	CP-100126	1498	2	Correction of CSFB capability indicator	9.1.0	9.2.0
03-2010	CP-47	CP-100144	1499	2	Mobility aspects of Emergency attached UEs	9.1.0	9.2.0
03-2010	CP-47	CP-100132	1501		Introduction of indication of support of GERAN to UTRAN priority-based cell reselection – Option 1	9.1.0	9.2.0
03-2010	CP-47	CP-100211	1504	2	Correct terminating domain selection for IMS voice UEs	9.1.0	9.2.0
06-2010	CP-48	CP-100371	1509	2	Correction of LAU initiation during CSFB	9.2.0	9.3.0
06-2010	CP-48	CP-100354	1510	2	Correction of LAU for CSFB in NMO I	9.2.0	9.3.0
06-2010	CP-48	CP-100351	1514		Requested QoS in PDP context activation procedure	9.2.0	9.3.0

Date	TSG #	TSG Doc.	CR	Rev	Subject/Comment	Old	New
06-2010	CP-48	CP-100355	1515	1	GPRS Kc128 handling at inter-system change from E-UTRAN to UTRAN/GERAN	9.2.0	9.3.0
06-2010	CP-48	CP-100360	1517	3	GMM Authentication procedure for emergency services	9.2.0	9.3.0
06-2010	CP-48	CP-100354	1518	1	Security context deletion	9.2.0	9.3.0
06-2010	CP-48	CP-100355	1521		Multiple TTI TBF capability	9.2.0	9.3.0
06-2010	CP-48	CP-100355	1522		Interpretation of Multislot Class Parameters for EFTA	9.2.0	9.3.0
06-2010	CP-48	CP-100354	1525	1	Correction of conditions for RAU and ISR deactivation for T-ADS	9.2.0	9.3.0
06-2010	CP-48	CP-100360	1536	2	Some corrections to the EMC procedure.	9.2.0	9.3.0
06-2010	CP-48	CP-100350	1538	2	Clarification to network initiated detach procedure with cause #25	9.2.0	9.3.0
06-2010	CP-48	CP-100355	1544	1	Correction to MS Radio Access Capability Information Element encoding	9.2.0	9.3.0
06-2010	CP-48	CP-100349	1547	1	Derivation of the security context for CS domain because of SRVCC	9.2.0	9.3.0
06-2010	CP-48	CP-100354	1548	1	Correction to the applicability of security key for inter-sytem change from S1 to lu	9.2.0	9.3.0
06-2010	CP-48	CP-100365	1549	1	Correction to the derivation of GPRS GSM Kc128 for inter-sytem change from S1 to Gb	9.2.0	9.3.0
06-2010	CP-48	CP-100365	1550	1	Correction to 128-bit ciphering key handling	9.2.0	9.3.0
06-2010	CP-48	CP-100360	1551	2	Emergency attach reject from GMM in shared networks	9.2.0	9.3.0
09-2010	CP-49	CP-100501	1532	2	Corrections for Selective Camping	9.3.0	9.4.0
09-2010	CP-49	CP-100491	1553	4	Correction to timer T3242 and T3243 values (eCall only MS)	9.3.0	9.4.0
09-2010	CP-49	CP-100506	1554	2	Clarification to the T3302 timer value when a UE is emergency attached without security procedure.	9.3.0	9.4.0
09-2010	CP-49	CP-100506	1555	2	Handling of Detach Procedure for IMSI services on a CSG cell which is no longer valid for the UE.and IMS EMG call is active.	9.3.0	9.4.0
09-2010	CP-49	CP-100506	1560	1	Clarification to timer T3318 and T3320 timer description in the EMC case.	9.3.0	9.4.0
09-2010	CP-49	CP-100485	1581	1	Correction to the protocol configuration options IEI	9.3.0	9.4.0
09-2010	CP-49	CP-100501	1585	4	Handling of location updating after CS fallback for mobile terminating calls	9.3.0	9.4.0
09-2010	CP-49	CP-100507	1593	2	Introduction of MS CSG interworking capabilities	9.3.0	9.4.0
09-2010	CP-49	CP-100501	1595		Correction of implementation error of CR1372R1	9.3.0	9.4.0
09-2010	CP-49	CP-100501	1598	2	Handling of collision of a Network Initiated Detach procedure with a Service Request procedure and a RAU procedure.	9.3.0	9.4.0
09-2010	CP-49	CP-100495	1603	1	Location updating during CS fallback	9.3.0	9.4.0
09-2010	CP-49	CP-100506	1604	1	Correction on storage of equivalent PLMNs list	9.3.0	9.4.0
09-2010	CP-49	CP-100520	1613		Corrections to UE mode of operation selection taking into account the UE's availability for voice calls in the IMS	9.3.0	9.4.0
09-2010	CP-49	CP-100501	1621	2	Alignment with 23.060 for SM cause value #52 "single address bearers only allowed"	9.3.0	9.4.0
09-2010	CP-49	CP-100517	1528	2	Local ISR deactivation in the UE when T3412 has expired	9.4.0	10.0.0
09-2010	CP-49	CP-100517	1540	3	Correcting ISR handling in UE	9.4.0	10.0.0

Date	TSG #	TSG Doc.	CR	Rev	Subject/Comment	Old	New
09-2010	CP-49	CP-100514	1562	5	PDN connection redirection in SIPTO scenario	9.4.0	10.0.0
09-2010	CP-49	CP-100514	1563	1	Clarification on PDP Context re-activation	9.4.0	10.0.0
09-2010	CP-49	CP-100517	1564	1	Correction for value setting of the mobile reachable timer	9.4.0	10.0.0
09-2010	CP-49	CP-100517	1566	2	Correction for implicit detach timer	9.4.0	10.0.0
09-2010	CP-49	CP-100520	1573	1	eCALL INACTIVE state and ATT flag	9.4.0	10.0.0
09-2010	CP-49	CP-100642	1579	2	Maximum number of packet filters	9.4.0	10.0.0
09-2010	CP-49	CP-100517	1586		LLC SAPI on PDP context activation for an MS capable of S1 mode	9.4.0	10.0.0
09-2010	CP-49	CP-100520	1587	1	MS behaviour when the network unexpectedly sets Selected Bearer Control Mode	9.4.0	10.0.0
09-2010	CP-49	CP-100520	1594		Introduction of Dynamic Timeslot Reduction capability	9.4.0	10.0.0
09-2010	CP-49	CP-100517	1599	1	TIN setting after location updating	9.4.0	10.0.0
09-2010	CP-49	CP-100520	1600	2	Handling of cause #27 (missing or unknown APN)	9.4.0	10.0.0
09-2010	CP-49	CP-100517	1605	1	Correction on network initiated GPRS detach with cause #2	9.4.0	10.0.0
09-2010	CP-49	CP-100520	1608		Clarifying the updation of forbidden LA list	9.4.0	10.0.0
09-2010	CP-49	CP-100520	1610	1	Clarification on READY timer behaviour	9.4.0	10.0.0
09-2010	CP-49	CP-100520	1617		Correction to UTRAN Network sharing	9.4.0	10.0.0
12-2010	CP-50	CP-100761	1589	4	Correcting CJKV ideograph language ambiguity with the NITZ feature and UCS2	10.0.0	10.1.0
12-2010	CP-50	CP-100748	1625	1	Add HNB name	10.0.0	10.1.0
12-2010	CP-50	CP-100760	1628	1	Attach with IMSI	10.0.0	10.1.0
12-2010	CP-50	CP-100760	1629	7	Extended Routing Area Update Timer	10.0.0	10.1.0
12-2010	CP-50	CP-100760	1630	4	Rejection due to per APN congestion	10.0.0	10.1.0
12-2010	CP-50	CP-100760	1631	3	Modified GMM Cause values for NIMTC	10.0.0	10.1.0
12-2010	CP-50	CP-100761	1632		Authentication not accepted by the network	10.0.0	10.1.0
12-2010	CP-50	CP-100751	1634	1	MS capability indication of VAMOS	10.0.0	10.1.0
12-2010	CP-50	CP-100742	1635	1	Correction of conditions for setting the CMST flag	10.0.0	10.1.0
12-2010	CP-50	CP-100761	1638	1	Deleting unnecessary trigger for initiating LAU procedure	10.0.0	10.1.0
12-2010	CP-50	CP-100742	1648	1	DCDL for EFTA	10.0.0	10.1.0
12-2010	CP-50	CP-100761	1649	1	Enhanced Multiplexing for a Single RLC Entity (EMSR)	10.0.0	10.1.0
12-2010	CP-50	CP-100747	1653	1	Handling of equivalent PLMN list when attached for emergency bearer services only	10.0.0	10.1.0
12-2010	CP-50	CP-100760	1655	1	NMOI indicator for MTC	10.0.0	10.1.0
12-2010	CP-50	CP-100761	1657	1	Correctin to the use of label "UMTS only" in various procedure.	10.0.0	10.1.0
12-2010	CP-50	CP-100736	1660	1	Correction of normal stop conditions for eCall and other timers	10.0.0	10.1.0
12-2010	CP-50	CP-100761	1662	1	Correction to the network initiated detach procedure with detach type "Re-attach required"	10.0.0	10.1.0
12-2010	CP-50	CP-100758	1669	3	Cause value for terminating eMPS CS Fallback calls	10.0.0	10.1.0
12-2010	CP-50	CP-100760	1670	4	RAU procedure when Low Priority indicator in MS changes	10.0.0	10.1.0

Date	TSG #	TSG Doc.	CR	Rev	Subject/Comment	Old	New
12-2010	CP-50	CP-100761	1672	2	Explicit signalling of native vs mapped P-TMSI during RAU	10.0.0	10.1.0
12-2010	CP-50	CP-100760	1673	2	Adding NAS signalling priority indication in Attach Request	10.0.0	10.1.0
12-2010	CP-50	CP-100754	1674		IFOM support PCO definition	10.0.0	10.1.0
12-2010	CP-50	CP-100742	1678	2	Correcting conditions for inclusion of "voice domain preference and UE's usage setting" IE in Attach and RAU.	10.0.0	10.1.0
12-2010	CP-50	CP-100760	1681	3	Clarifying the APN congestion control for EMC attached MS	10.0.0	10.1.0
12-2010	CP-50	CP-100747	1685	1	Correction on GMM authentication failure for EMC services	10.0.0	10.1.0
12-2010	CP-50	CP-100760	1686	1	SM procedures for low priority	10.0.0	10.1.0
12-2010	CP-50	CP-100761	1690		Correction of bearer capability length	10.0.0	10.1.0
12-2010	CP-50	CP-100753	1641	4	PDN disconnection for LIPA	10.0.0	10.1.0
12-2010	CP-50	CP-100767	1644	4	Introduction of MOCN GERAN	10.0.0	10.1.0
03-2011	CP-51	CP-110193	1683	3	Handling of periodic RAU timer, mobile reachable timer and MM back-off timer	10.1.0	10.2.0
03-2011	CP-51	CP-110195	1691	3	Clarification to the handling of SM cause value 27	10.1.0	10.2.0
03-2011	CP-51	CP-110193	1692	3	Clarification to the handling of timer T3245	10.1.0	10.2.0
03-2011	CP-51	CP-110193	1693	5	Handling of secondary PDP context activation procedure in case of APN congestion	10.1.0	10.2.0
03-2011	CP-51	CP-110195	1696	2	Explicit Signalling Indication During Attach	10.1.0	10.2.0
03-2011	CP-51	CP-110195	1701	3	Introduce cause value to reflect call rejection due to destination feature	10.1.0	10.2.0
03-2011	CP-51	CP-110183	1704	3	Corrections to the PDP Context Deactivation	10.1.0	10.2.0
03-2011	CP-51	CP-110193	1705	2	Low priority indication by the MS for the service request procedure	10.1.0	10.2.0
03-2011	CP-51	CP-110193	1706	2	Integrity protection of periodic updates	10.1.0	10.2.0
03-2011	CP-51	CP-110193	1710	1	Attach with IMSI Alignment of Terminology	10.1.0	10.2.0
03-2011	CP-51	CP-110193	1711	1	Specific requirements Alignment of Terminology	10.1.0	10.2.0
03-2011	CP-51	CP-110193	1712	1	NMO I behavior	10.1.0	10.2.0
03-2011	CP-51	CP-110183	1713	5	Notify UE when a HNB provides access to a residential/enterprise IP network	10.1.0	10.2.0
03-2011	CP-51	CP-110195	1715		Clarification to SM cause value#31	10.1.0	10.2.0
03-2011	CP-51	CP-110193	1717	3	Storage and handling of the NAS signalling low priority indicator	10.1.0	10.2.0
03-2011	CP-51	CP-110195	1720	2	Correction on GPRS detach and service request collision	10.1.0	10.2.0
03-2011	CP-51	CP-110195	1721	1	Correction on MS substate selection	10.1.0	10.2.0
03-2011	CP-51	CP-110195	1722	2	Correction to reject cause value 48 name	10.1.0	10.2.0
03-2011	CP-51	CP-110195	1723	2	Correction to Unsuccessful secondary PDP context activation procedure initiated by the MS	10.1.0	10.2.0
03-2011	CP-51	CP-110193	1724	2	Completion of introduction of "Low priority" indication in 24.008 CS messages	10.1.0	10.2.0
03-2011	CP-51	CP-110193	1725	4	Adding NAS signalling priority indication in SM messages	10.1.0	10.2.0
03-2011	CP-51	CP-110195	1726	1	Handling of Location Updating and CS Service Request after CS fallback for mobile originating calls	10.1.0	10.2.0

Date	TSG #	TSG Doc.	CR	Rev	Subject/Comment	Old	New
03-2011	CP-51	CP-110195	1727	3	Correction of the handling of the P-TMSI type IE	10.1.0	10.2.0
03-2011	CP-51	CP-110195	1728	1	Maximum Transmission Unit in Protocol configuration options	10.1.0	10.2.0
03-2011	CP-51	CP-110199	1731	1	Allocation of TI and assignment of CC state to alerting call for SRVCC	10.1.0	10.2.0
03-2011	CP-51	CP-110195	1734		GMM state after lower layers failure during TAU when TIN=GUTI	10.1.0	10.2.0
03-2011	CP-51	CP-110195	1735	3	Stopping T3311 when UE moves to PMM-CONNECTED mode	10.1.0	10.2.0
03-2011	CP-51	CP-110253	1744	1	Changing "P-TMSI or IMSI" Information Element to "Mobile Identity"	10.1.0	10.2.0
03-2011	CP-51	CP-110171	1747		Correction to detection of CSG cell based on CSG ID	10.1.0	10.2.0
03-2011	CP-51	CP-110193	1750	4	EAB support	10.1.0	10.2.0
03-2011	CP-51	CP-110195	1753	1	Correction on PPAC description to include GPRS Attach procedure	10.1.0	10.2.0
03-2011	CP-51	CP-110195	1756	1	Radio resource sublayer address TLLI handling	10.1.0	10.2.0
03-2011	CP-51	CP-110193	1758	2	SM Backoff timer, Editor's note removal	10.1.0	10.2.0
03-2011	CP-51	CP-110195	1761	1	MS initiated PDP Context Activation without PDP address	10.1.0	10.2.0
03-2011	CP-51	CP-110183	1762	3	Restriction on the use of PDN connection for LIPA	10.1.0	10.2.0
03-2011	CP-51	CP-110195	1763		Editorial correction on Congestion level IE definition	10.1.0	10.2.0
03-2011	CP-51	CP-110253	1765	1	RRC establishment cause for emergency PDP after normal GPRS attach	10.1.0	10.2.0
03-2011	CP-51	CP-110195	1766		Missing handling of undefined values for MBR and GBR by the MS	10.1.0	10.2.0
03-2011	CP-51	CP-110206	1700	4	Mobility management congestion control and back-off timer	10.1.0	10.2.0
03-2011	CP-51	CP-110305	1699	3	Device properties and RRC establishment cause = Delay tolerant – 24.008	10.1.0	10.2.0
06-2011	CP-52	CP-110462	1776	1	Corrections for overload behavior	10.2.0	10.3.0
06-2011	CP-52	CP-110462	1779	1	Clearly specify conditions for UE actions at switch off for T3245, T3346 and T3396.	10.2.0	10.3.0
06-2011	CP-52	CP-110462	1780	1	Further clarification of PLMN reselection and handling of MM back-off timer	10.2.0	10.3.0
06-2011	CP-52	CP-110466	1782	1	Modifications to Emergency Number List IE.	10.2.0	10.3.0
06-2011	CP-52	CP-110466	1785		Support of IPv6 Prefix Delegation	10.2.0	10.3.0
06-2011	CP-52	CP-110446	1788		Manipulation of CSG ID entries (in ACL and OCL) and the associated PLMNID - 3G	10.2.0	10.3.0
06-2011	CP-52	CP-110462	1792		Specification of missing timer identities	10.2.0	10.3.0
06-2011	CP-52	CP-110476	1793		Correct conditions for including the connectivity type IE	10.2.0	10.3.0
06-2011	CP-52	CP-110476	1794	1	Correct the trigger of the LIPA PDN disconnection	10.2.0	10.3.0
06-2011	CP-52	CP-110462	1795	1	Reference to NAS configuration in USIM	10.2.0	10.3.0
06-2011	CP-52	CP-110462	1796	2	Inter RAT Change	10.2.0	10.3.0
06-2011	CP-52	CP-110462	1798	2	Handling Network initiated procedure when backoff timer is running	10.2.0	10.3.0
06-2011	CP-52	CP-110462	1799	2	Emergency attach during backoff	10.2.0	10.3.0
06-2011	CP-52	CP-110462	1801	1	alignment about MM congestion control	10.2.0	10.3.0

Date	TSG #	TSG Doc.	CR	Rev	Subject/Comment	Old	New
06-2011	CP-52	CP-110462	1808	2	Correction on MS behavior for SM cause #26 and #27	10.2.0	10.3.0
06-2011	CP-52	CP-110462	1812	1	Clarification about APN based congestion control procedure	10.2.0	10.3.0
06-2011	CP-52	CP-110462	1815	2	Correction of T3396 handling for PDN connection reactivation	10.2.0	10.3.0
06-2011	CP-52	CP-110464	1818	2	Clarification to condition of sending the Network feature during periodic RAU procedure.	10.2.0	10.3.0
06-2011	CP-52	CP-110462	1820	1	Per MS T3212 rather than T3212 multiplier	10.2.0	10.3.0
06-2011	CP-52	CP-110462	1822	2	Attach with IMSI in CS domain at PLMN change for MTC devices	10.2.0	10.3.0
06-2011	CP-52	CP-110466	1790		Introduction of fast downlink frequency switching capability	10.2.0	10.3.0
06-2011	CP-52	CP-110462	1791	2	Addition of MM backoff timer for CS	10.2.0	10.3.0
06-2011	CP-52	CP-110466	1806	1	Preservation and network controlled QoS	10.2.0	10.3.0
06-2011	CP-52	CP-110463	1807	1	NAS signalling low priority indication for exception cases	10.2.0	10.3.0
06-2011	CP-52	CP-110515	1827	1	Signalling of TIGHTER capabilities	10.2.0	10.3.0
09-2011	CP-53	CP-110680	1770	4	Handling mobile reachable timer for back-off UE with emergency PDN connection	10.3.0	10.4.0
09-2011	CP-53	CP-110680	1821	6	Call forwarding, paging and long periodic timers	10.3.0	10.4.0
09-2011	CP-53	CP-110680	1831	1	PDP Context Deactivation	10.3.0	10.4.0
09-2011	CP-53	CP-110680	1832	1	Handling Timers T3246, T3346	10.3.0	10.4.0
09-2011	CP-53	CP-110680	1833	1	Timer Table Update with EPS details	10.3.0	10.4.0
09-2011	CP-53	CP-110680	1834	2	Handling NAS Low Priority Indication	10.3.0	10.4.0
09-2011	CP-53	CP-110680	1835	4	Correction and clarification on the terminologies of NAS level congestion control	10.3.0	10.4.0
09-2011	CP-53	CP-110682	1847	1	Clarification of UE behavior when combined RAU is not accepted	10.3.0	10.4.0
09-2011	CP-53	CP-110680	1850	1	Clarify the bit in the device properties	10.3.0	10.4.0
09-2011	CP-53	CP-110683	1854	2	Clarification on periodic routing area update	10.3.0	10.4.0
09-2011	CP-53	CP-110680	1856	1	Scope of SM APN congestion control	10.3.0	10.4.0
09-2011	CP-53	CP-110680	1859	2	Handling of paging for MT in CS when a MM back-off timer is running	10.3.0	10.4.0
09-2011	CP-53	CP-110680	1861	4	Clarification of RAU triggered after paging	10.3.0	10.4.0
09-2011	CP-53	CP-110680	1862	1	Establishing emergency services when T3246 or T3346 is running	10.3.0	10.4.0
09-2011	CP-53	CP-110680	1882	1	Correction to cause #22 handling	10.3.0	10.4.0
09-2011	CP-53	CP-110680	1908	1	Clarification on paging response for CSFB when a MM back-off timer is running	10.3.0	10.4.0
09-2011	CP-53	CP-110680	1910	1	T3323 may not be started	10.3.0	10.4.0
09-2011	CP-53	CP-110680	1911		Removal of EMM cause	10.3.0	10.4.0
09-2011	CP-53	CP-110665	1914	2	Reject Cause handling while MS attaching for emergency bearer services	10.3.0	10.4.0
09-2011	CP-53	CP-110680	1917	1	Value of timer T3312 in the network	10.3.0	10.4.0
09-2011	CP-53	CP-110708	1855	5	Correction to network-initiated detach procedure	10.3.0	10.4.0
09-2011	CP-53	CP-110694	1783	4	Clarifications for removal of numbers from the Local Emergency Numbers List	10.4.0	11.0.0

Date	TSG #	TSG Doc.	CR	Rev	Subject/Comment	Old	New
09-2011	CP-53	CP-110695	1842	1	Editorial correction to the SM cause #27	10.4.0	11.0.0
09-2011	CP-53	CP-110690	1853	3	Starting deactivate ISR timer in substate PLMN-SEARCH when T3312 expires	10.4.0	11.0.0
09-2011	CP-53	CP-110694	1858	1	GPRS detach procedure collision handling	10.4.0	11.0.0
09-2011	CP-53	CP-110695	1863	1	Correction on packet filter list description	10.4.0	11.0.0
09-2011	CP-53	CP-110697	1866	4	vSRVCC Enhancements in TS 24.008 excluding vSRVCC indicator (terminology variant 1)	10.4.0	11.0.0
09-2011	CP-53	CP-110695	1871	1	Emergency Attach from PLMN-SEARCH, ATTACH NEEDED	10.4.0	11.0.0
09-2011	CP-53	CP-110695	1878	2	Clarification to the codec selection during SRVCC HO procedure	10.4.0	11.0.0
09-2011	CP-53	CP-110692	1885	2	EAB reference for UTRAN	10.4.0	11.0.0
09-2011	CP-53	CP-110694	1886	1	Clarification to the GMM procedures when a UE receives GMM cause #10	10.4.0	11.0.0
09-2011	CP-53	CP-110695	1897	1	RPLMN to PLMN in handling of Emergency Numbers List	10.4.0	11.0.0
09-2011	CP-53	CP-110695	1901	1	Support for multiple MCC countries	10.4.0	11.0.0
09-2011	CP-53	CP-110691	1902	1	Correction on TIN setting for LAU procedure	10.4.0	11.0.0
09-2011	CP-53	CP-110695	1903	1	Correction on integrity checking	10.4.0	11.0.0
09-2011	CP-53	CP-110694	1904	1	Handling of timer T3302	10.4.0	11.0.0
09-2011	CP-53	CP-110694	1906	2	Stopping of timer T3311 and T3302	10.4.0	11.0.0
09-2011	CP-53	CP-110694	1907		Correction to references	10.4.0	11.0.0
09-2011	CP-53	CP-110694	1916	2	Handling of timer T3312	10.4.0	11.0.0
09-2011	CP-53	CP-110695	1918	1	Editorial corrections in TS 24.008	10.4.0	11.0.0
12-2011	CP-54	CP-110882	1802	11	Re-attach for emergency bearer service	11.0.0	11.1.0
12-2011	CP-54	CP-110851	1923	1	PSAP Callback for eCalls	11.0.0	11.1.0
12-2011	CP-54	CP-110871	1925	4	Setting Mobile Reachable timer, Implicit Detach Timer	11.0.0	11.1.0
12-2011	CP-54	CP-110884	1928		Codec negotiation after vSRVCC HO.	11.0.0	11.1.0
12-2011	CP-54	CP-110871	1930		Timer granularity of GPRS timer 3	11.0.0	11.1.0
12-2011	CP-54	CP-110888	1932	1	Resetting GPRS attach attempt counter after successful EPS attach	11.0.0	11.1.0
12-2011	CP-54	CP-110882	1933	2	Update of handling of collision between MS initiated detach procedure and network initiated detach procedure with "re-attached required"	11.0.0	11.1.0
12-2011	CP-54	CP-110888	1934	1	Correction on starting deactivate ISR timer in substate PLMN-SEARCH when T3312 expires	11.0.0	11.1.0
12-2011	CP-54	CP-110882	1938	2	Emergency bearer services from GMM-REGISTERED substates	11.0.0	11.1.0
12-2011	CP-54	CP-110882	1941		IMSI detach and GMM common procedure collision	11.0.0	11.1.0
12-2011	CP-54	CP-110882	1942	3	Correction to authentication not accepted by the MS	11.0.0	11.1.0
12-2011	CP-54	CP-110882	1943	1	Handling of equivalent PLMN list for GPRS services during the attach and RAU procedure.	11.0.0	11.1.0
12-2011	CP-54	CP-110882	1947	2	Correction to MS initiated PDP context modification without changing packet filter(s) procedure	11.0.0	11.1.0
12-2011	CP-54	CP-110879	1950	1	Clarifications for user connection attachment for SRVCC	11.0.0	11.1.0

Date	TSG #	TSG Doc.	CR	Rev	Subject/Comment	Old	New
12-2011	CP-54	CP-110871	1952	1	Removal of undefined "forbidden PLMN for attach in S1 mode" list.	11.0.0	11.1.0
12-2011	CP-54	CP-110882	1953	1	Update of the forbidden PLMN list for GPRS services on receipt of Detach request	11.0.0	11.1.0
12-2011	CP-54	CP-110882	1954	1	Clarification of network's knowledge of MS's valid CSG subscription	11.0.0	11.1.0
12-2011	CP-54	CP-110882	1957	1	Clarification to the description of the cause value #22 (congestion)	11.0.0	11.1.0
12-2011	CP-54	CP-110871	1963		Correction of MM back-off timer reference	11.0.0	11.1.0
12-2011	CP-54	CP-110871	1965	1	Clarification on SM backoff while paged using IMSI	11.0.0	11.1.0
12-2011	CP-54	CP-110871	1967	2	Correction of LAU trigger when EMM/GMM backoff	11.0.0	11.1.0
12-2011	CP-54	CP-110860	1973		START value storage on USIM at SRVCC handover	11.0.0	11.1.0
12-2011	CP-54	CP-110875	1975	1	Introduction of Selective Ciphering on SACCH	11.0.0	11.1.0
12-2011	CP-54	CP-110888	1976	1	Correction to length field label of routing area identification 2 IE	11.0.0	11.1.0
12-2011	CP-54	CP-110882	1977	1	Removal of cause values #52 from activate PDP context reject	11.0.0	11.1.0
12-2011	CP-54	CP-110871	1979	1	Default Value for SM back-off timer	11.0.0	11.1.0
12-2011	CP-54	CP-110859	1987	4	Old LAI in Attach/RAU procedure	11.0.0	11.1.0
12-2011	CP-54	CP-110884	1993		Remove Editor's Note on assumed BS30 properties	11.0.0	11.1.0
12-2011	CP-54	CP-110871	1996	2	Release of the NAS signalling connection after completion of MS-initiated detach procedure	11.0.0	11.1.0
12-2011	CP-54	CP-110882	1997	2	MM state in combine GMM procedure initiated	11.0.0	11.1.0
12-2011	CP-54	CP-110882	1998	1	MLD RFC references	11.0.0	11.1.0
12-2011	CP-54	CP-110874	1999	2	Coordination between SM and GMM for supporting ISR	11.0.0	11.1.0
12-2011	CP-54	CP-110871	2001	1	LAU trigger when GMM backoff timer running	11.0.0	11.1.0
12-2011	CP-54	CP-110871	2018	2	Remove "CN congestion" indication and Introduce CN domain indicator	11.0.0	11.1.0
12-2011	CP-54	CP-110871	2020	2	Correction on the MO CSFB procedure during T3246 running	11.0.0	11.1.0
12-2011	CP-54	CP-110883	1893	4	Full support of Multi-Operator Core Network by GERAN	11.0.0	11.1.0
01-2012					Editorial corrections (reset of corrupted style B1, addition of missing line break in 5.1.2.2.2d)	11.1.0	11.1.1
01-2012					Correction of implementation error of CR2018	11.1.1	11.1.2
03-2012	CP-55	CP-120114	1920	7	Selected PLMN Id indication for the CS domain	11.1.2	11.2.0
03-2012	CP-55	CP-120126	1948	2	Clarifications for user connection attachment for vSRVCC	11.1.2	11.2.0
03-2012	CP-55	CP-120125	1994	3	Handling of security related parameters at switch on and switch off	11.1.2	11.2.0
03-2012	CP-55	CP-120125	2026		RRC Establishment cause correction for emergency and detach	11.1.2	11.2.0
03-2012	CP-55	CP-120100	2030	1	Removal of LLC Acknowledged mode	11.1.2	11.2.0
03-2012	CP-55	CP-120125	2031		Normal stop of T303.	11.1.2	11.2.0
03-2012	CP-55	CP-120105	2036	1	Modification of the location registration method in CS fallback procedure	11.1.2	11.2.0
03-2012	CP-55	CP-120098	2044	1	Correction of Combined RA/LA update triggers by CSFB UE	11.1.2	11.2.0

Date	TSG #	TSG Doc.	CR	Rev	Subject/Comment	Old	New
03-2012	CP-55	CP-120125	2046		Correction of the Emergency number list IE	11.1.2	11.2.0
03-2012	CP-55	CP-120123	2047	2	Extended Access Barring for UTRAN	11.1.2	11.2.0
03-2012	CP-55	CP-120125	2049		Clarification and alignment of CC#38 applicability	11.1.2	11.2.0
03-2012	CP-55	CP-120122	2050	1	Local ISR deactivation in the MS upon change of the UE's usage setting or the voice domain preference for E-UTRAN	11.1.2	11.2.0
03-2012	CP-55	CP-120125	2052	1	Correction of "Extended Wait Time" in the timer tables.	11.1.2	11.2.0
03-2012	CP-55	CP-120111	2054	2	Release of NAS signalling connection with EWT	11.1.2	11.2.0
03-2012	CP-55	CP-120125	2058	1	Rejecting SM messages with low priority indicator	11.1.2	11.2.0
03-2012	CP-55	CP-120125	2060	2	Indication of supporting T3312 extended value in RAU	11.1.2	11.2.0
03-2012	CP-55	CP-120125	2061	1	Correction of LAU trigger when EMM/GMM backoff	11.1.2	11.2.0
03-2012	CP-55	CP-120125	2065		Removing reference to non- existent timer T3247	11.1.2	11.2.0
03-2012	CP-55	CP-120111	2067		Location Update when T3346 is running in NMO1	11.1.2	11.2.0
03-2012	CP-55	CP-120125	2068	1	Clarification of location update type for manual CSG selection	11.1.2	11.2.0
03-2012	CP-55	CP-120122	2069	1	QoS for default bearer	11.1.2	11.2.0
03-2012	CP-55	CP-120111	2073	3	Handling NAS signalling low priority indication	11.1.2	11.2.0
03-2012	CP-55	CP-120111	2076	3	Correction to the handling of wait time from AS	11.1.2	11.2.0
03-2012	CP-55	CP-120120	2077	2	Call clearing in CS for rSRVCC	11.1.2	11.2.0
03-2012	CP-55	CP-120111	2080	1	Correction for RAU triggering while T3346 and receiving of paging	11.1.2	11.2.0
03-2012	CP-55	CP-120111	2082	1	Back-off timer handling in connected mode mobility	11.1.2	11.2.0
03-2012	CP-55	CP-120122	2084		Handling of stored RAND and RES values in case of connection aborted	11.1.2	11.2.0
03-2012	CP-55	CP-120102	2085	1	Re-attach for emergency bearer service	11.1.2	11.2.0
03-2012	CP-55	CP-120106	2086	1	Call Control state modelling for aSRVCC	11.1.2	11.2.0
03-2012	CP-55	CP-120120	2087	1	Call Control state modelling for rSRVCC	11.1.2	11.2.0
03-2012	CP-55				Editorial corrections	11.2.0	11.2.1
06-2012	CP-56	CP-120305	1983	6	State verification to avoid state mismatch	11.2.1	11.3.0
06-2012	CP-56	CP-120308	2048	3	Extension of maximum bitrates in QoS IE	11.2.1	11.3.0
06-2012	CP-56	CP-120308	2062	2	Correction of detach procedure collision	11.2.1	11.3.0
06-2012	CP-56	CP-120308	2088	2	Traffic flow aggregate description and TFT IE extension	11.2.1	11.3.0
06-2012	CP-56	CP-120315	2089	7	SMS-only Support for PS-only Subscription	11.2.1	11.3.0
06-2012	CP-56	CP-120308	2090	1	Correction to RAU trigger for the support of terminating access domain selection for voice calls	11.2.1	11.3.0
06-2012	CP-56	CP-120308	2092	1	FANR capability indication	11.2.1	11.3.0
06-2012	CP-56	CP-120308	2093		Checking T3246 for CS Fallback emergency call	11.2.1	11.3.0
06-2012	CP-56	CP-120312	2094	1	Introduction of GERAN network sharing capability	11.2.1	11.3.0
06-2012	CP-56	CP-120293	2099	3	Additional trigger to GPRS detach and abnormal case handling	11.2.1	11.3.0
06-2012	CP-56	CP-120308	2102	5	Application of ESM backoff Timer when UE received ESM cause #50 or #51(Alt.3)	11.2.1	11.3.0

Date	TSG #	TSG Doc.	CR	Rev	Subject/Comment	Old	New
06-2012	CP-56	CP-120308	2104	3	Addition of SM-backoff timer handling for NW initiated PDN connectivity deactivation	11.2.1	11.3.0
06-2012	CP-56	CP-120308	2106		Correction to incomplete title of reference	11.2.1	11.3.0
06-2012	CP-56	CP-120308	2107	1	Handling of the Local Emergency Numbers List	11.2.1	11.3.0
06-2012	CP-56	CP-120302	2109	4	Trigger to Location Update procedure due to Manual PLMN selection when T3346 timer is running.	11.2.1	11.3.0
06-2012	CP-56	CP-120308	2112	1	Clarification to the GMM cause #9	11.2.1	11.3.0
06-2012	CP-56	CP-120308	2113	1	Clarification to the description of GPRS UPDATE Status	11.2.1	11.3.0
06-2012	CP-56	CP-120315	2115	1	Extended access barring not applicable for MT, AC11-15	11.2.1	11.3.0
06-2012	CP-56	CP-120318	2116	3	ISR deactivation and RAU/combined RAU in connected mode mobility from E-UTRAN to GERAN	11.2.1	11.3.0
06-2012	CP-56	CP-120296	2125	1	Corrections to Alternative EFTA multislot class field	11.2.1	11.3.0
06-2012	CP-56	CP-120317	2126		Request for call clearing from upper layer after CS to PS handover	11.2.1	11.3.0
06-2012	CP-56	CP-120313	2128	2	Mobility management procedures for IMS voice terminations	11.2.1	11.3.0
06-2012	CP-56	CP-120315	2129	2	"SMS only" definition	11.2.1	11.3.0
06-2012	CP-56	CP-120315	2130	5	Combined procedures for "SMS only"	11.2.1	11.3.0
06-2012	CP-56	CP-120315	2131	3	Cause value for PS-only	11.2.1	11.3.0
06-2012	CP-56	CP-120315	2132	4	"SMS supported" indication	11.2.1	11.3.0
06-2012	CP-56	CP-120315	2133	4	GPRS MS behavior for "SMS only"	11.2.1	11.3.0
06-2012	CP-56	CP-120302	2135	1	Abnormal cases when Extended Wait Time is received	11.2.1	11.3.0
06-2012	CP-56	CP-120308	2139		Alignment of disconnecting PDN connection	11.2.1	11.3.0
06-2012	CP-56	CP-120308	2140	4	Correction of APN based congestion control	11.2.1	11.3.0
06-2012	CP-56	CP-120302	2141	2	Correction of high priority user	11.2.1	11.3.0
06-2012	CP-56	CP-120318	2143	1	Clarification on the EPS re-use of the Traffic Flow Template IE format	11.2.1	11.3.0
06-2012	CP-56	CP-120308	2144	2	PDP context for emergency call	11.2.1	11.3.0
06-2012	CP-56	CP-120309	2145	3	Gs Support for MSC in Pool to avoid dual VLR registration	11.2.1	11.3.0
06-2012	CP-56	CP-120308	2150	1	Timer of mobility management in MM state 9	11.2.1	11.3.0
06-2012	CP-56	CP-120308	2157	1	Allowing MS with AC 11-15 to access the network when T3396 is running	11.2.1	11.3.0
06-2012	CP-56	CP-120308	2160	1	Improvement in the definition of cause codes	11.2.1	11.3.0
06-2012	CP-56	CP-120315	2161	2	SM Timer handling for dual priority requirement	11.2.1	11.3.0
06-2012	CP-56	CP-120309	2163	1	Restatement of detach and re-attach upon end of attached for emergency bearer service – 24.008	11.2.1	11.3.0
06-2012	CP-56	CP-120315	2169	2	MM timer handling for dual priority requirement	11.2.1	11.3.0
06-2012	CP-56	CP-120302	2172	1	Back-off timer handling in connected mode mobility/GERAN	11.2.1	11.3.0
06-2012	CP-56	CP-120308	2174	1	Correction on behavior of MS configured for AC 11-15	11.2.1	11.3.0
06-2012	CP-56	CP-120315	2175	2	Handling of NAS signalling low priority overriding indication	11.2.1	11.3.0
06-2012	CP-56	CP-120308	2176	1	New SM cause codes	11.2.1	11.3.0

Date	TSG #	TSG Doc.	CR	Rev	Subject/Comment	Old	New
06-2012	CP-56	CP-120308	2178	1	Capability indication for Immediate Packet Assignment	11.2.1	11.3.0
06-2012	CP-56	CP-120317	2147	2	Providing UE's PS Domain Registration Info to MSC for rSRVCC	11.2.1	11.3.0
06-2012	CP-56	CP-120313	2119	2	Outstanding NAS Modifications as a result of vSRVCC handover	11.2.1	11.3.0
09-2012	CP-57	CP-120593	2105	5	Security context mapping for SRVCC from CS to PS	11.3.0	11.4.0
09-2012	CP-57	CP-120589	2164	4	Posibility to ignore paging for non-GPRS services	11.3.0	11.4.0
09-2012	CP-57	CP-120594	2165	2	CKSN allocation for idle mode inter-system change	11.3.0	11.4.0
09-2012	CP-57	CP-120594	2179	2	Correction and completion of handling of the maximum number of active PDP contexts	11.3.0	11.4.0
09-2012	CP-57	CP-120594	2180	1	Clearing of the maximum number of active PDP contexts	11.3.0	11.4.0
09-2012	CP-57	CP-120584	2183	1	Corrections to Gs Support for MSC in Pool	11.3.0	11.4.0
09-2012	CP-57	CP-120589	2188	4	Additional condition for attach exceptions	11.3.0	11.4.0
09-2012	CP-57	CP-120594	2192	1	RAU/combined RAU after E-UTRAN/UTRAN to GERAN Inter RAT handover	11.3.0	11.4.0
09-2012	CP-57	CP-120584	2193	1	Considering ePLMN for SM backoff Timer with cause #50 or #51	11.3.0	11.4.0
09-2012	CP-57	CP-120585	2196	2	Skip Indicator for GERAN sharing	11.3.0	11.4.0
09-2012	CP-57	CP-120581	2198	2	Clarify MS behaviour after deletion of forbidden lists	11.3.0	11.4.0
09-2012	CP-57	CP-120594	2199	2	Setting method of EMM combined procedure capability bit	11.3.0	11.4.0
09-2012	CP-57	CP-120589	2203	2	CS congestion control handling for combined procedure	11.3.0	11.4.0
09-2012	CP-57	CP-120581	2206	2	Handling of MM procedure during combined RAU procedure	11.3.0	11.4.0
09-2012	CP-57	CP-120584	2207		Correcting error introduced by C1-122339	11.3.0	11.4.0
09-2012	CP-57	CP-120572	2211	1	IMSI detach triggered by last PDP context deactivation	11.3.0	11.4.0
09-2012	CP-57	CP-120589	2213	5	Handling of PDN connection for dual-priority functionality	11.3.0	11.4.0
09-2012	CP-57	CP-120589	2214	3	Correction on handling of SM NAS request for dual-priority	11.3.0	11.4.0
09-2012	CP-57	CP-120589	2215	1	Correction on handling of SM back-off timer for dual-priority	11.3.0	11.4.0
09-2012	CP-57	CP-120589	2216		Dual priority definition	11.3.0	11.4.0
09-2012	CP-57	CP-120587	2218	3	Clarifications for user connection attachment for vSRVCC – removal of editor's note	11.3.0	11.4.0
09-2012	CP-57	CP-120584	2219		Low Priority Indicator vs NAS Signalling Low Priority Indication Terminology	11.3.0	11.4.0
09-2012	CP-57	CP-120584	2221	2	Removing NMO-III	11.3.0	11.4.0
09-2012	CP-57	CP-120584	2222	1	Changes to the security context handling at power on	11.3.0	11.4.0
09-2012	CP-57	CP-120589	2227	2	UE configured for "Override_ExtendedAccessBarring"	11.3.0	11.4.0
09-2012	CP-57	CP-120584	2228	1	Clarifying in GMM substates ATTEMPTING-TO-ATTACH and ATTEMPTING-TO-UPDATE, CM layer triggered GMM message will be sent if T3346 is not running	11.3.0	11.4.0
09-2012	CP-57	CP-120594	2229	1	Correct the requirement on QoS modification of default PDP context	11.3.0	11.4.0
09-2012	CP-57	CP-120594	2230	1	Remove the "combined routing area update procedure" in CSFB mobile terminating call	11.3.0	11.4.0
09-2012	CP-57	CP-120584	2234		Correction of device properties in cause mapping	11.3.0	11.4.0
09-2012	CP-57	CP-120584	2239	2	Clarification on description of SMS over GPRS	11.3.0	11.4.0

Date	TSG #	TSG Doc.	CR	Rev	Subject/Comment	Old	New
09-2012	CP-57	CP-120589	2240		Correction on NAS signalling low priority overriding handling	11.3.0	11.4.0
12-2012	CP-58	CP-120803	2187	8	Cause code setting for combined procedures in case of PS-only subscription	11.4.0	11.5.0
12-2012	CP-58	CP-120794	2225	4	Detecting a request for emergency service	11.4.0	11.5.0
12-2012	CP-58	CP-120794	2235	2	Addition of a trigger condition of a MS to enter EMM-DEREGISTERED state	11.4.0	11.5.0
12-2012	CP-58	CP-120794	2236	2	Coordination between EMM and GMM parameters for MS receiving GMM cause #22	11.4.0	11.5.0
12-2012	CP-58	CP-120794	2241	2	Fixes to P-CSCF addresses and DNS Server IP addresses included in the PCO	11.4.0	11.5.0
12-2012	CP-58	CP-120807	2243	2	T3212 trigger in network initiated GPRS detach	11.4.0	11.5.0
12-2012	CP-58	CP-120794	2244	2	Emergency handling for abnormal cases	11.4.0	11.5.0
12-2012	CP-58	CP-120794	2245		GMM state correction for network initiated GPRS detach	11.4.0	11.5.0
12-2012	CP-58	CP-120794	2246		Correction on NRI container IE	11.4.0	11.5.0
12-2012	CP-58	CP-120807	2250	1	Fix timer specification	11.4.0	11.5.0
12-2012	CP-58	CP-120803	2251	1	Corrections for Dual priority PDP contex handling	11.4.0	11.5.0
12-2012	CP-58	CP-120792	2253	1	TI flassignment in an originating call case	11.4.0	11.5.0
12-2012	CP-58	CP-120794	2254	2	Correction to Combined Attach/RAU Accept abnormal case handling	11.4.0	11.5.0
12-2012	CP-58	CP-120794	2263		Correcting description of MM update status U2	11.4.0	11.5.0
12-2012	CP-58	CP-120797	2264	2	Encoding the Skip Indicator for GERAN Network Sharing	11.4.0	11.5.0
12-2012	CP-58	CP-120794	2265	6	Network behavior in case of PDP Context Activation Procedure	11.4.0	11.5.0
12-2012	CP-58	CP-120803	2266	4	MS knowledge that the back-off timer is running for low or normal priority	11.4.0	11.5.0
12-2012	CP-58	CP-120794	2268	7	Handling maximum number of active PDP contexts	11.4.0	11.5.0
12-2012	CP-58	CP-120798	2270	2	Access class control in shared networks	11.4.0	11.5.0
12-2012	CP-58	CP-120797	2271	1	GERAN network sharing in PS domain	11.4.0	11.5.0
12-2012	CP-58	CP-120797	2272	1	Terminology consistency for GERAN network sharing	11.4.0	11.5.0
12-2012	CP-58	CP-120803	2273	4	Clarification on handling of SM for dual priority	11.4.0	11.5.0
12-2012	CP-58	CP-120792	2275	4	Corrections to UE behaviour on originating aSRVCC call	11.4.0	11.5.0
12-2012	CP-58	CP-120803	2276	2	Clarification on UE with T3396 running receiving a new T3396 value	11.4.0	11.5.0
12-2012	CP-58	CP-120794	2277	1	MM state when GPRS service only is accepted in combined procedures	11.4.0	11.5.0
12-2012	CP-58	CP-120794	2286	1	Correction to the timer table 11.2.3	11.4.0	11.5.0
12-2012	CP-58	CP-120789	2291		Correction to session management handling for MBMS context activation	11.4.0	11.5.0
12-2012	CP-58	CP-120803	2293	2	Handling of timer T3396 for dual priority MS	11.4.0	11.5.0
12-2012	CP-58	CP-120806	2295	1	Removing UTRA to UTRA rSRVCC	11.4.0	11.5.0
12-2012	CP-58	CP-120794	2296	1	MS behaviour when receiving mobile identity during periodic RAU	11.4.0	11.5.0
12-2012	CP-58	CP-120794	2297	2	Reject cause #8 used for normal RAU and SR	11.4.0	11.5.0

Date	TSG #	TSG Doc.	CR	Rev	Subject/Comment	Old	New
12-2012	CP-58	CP-120794	2298		Clean-up the confusion on term "network sharing"	11.4.0	11.5.0
12-2012	CP-58	CP-120794	2299	2	NW-initiated detach with re-attach not required and no cause code	11.4.0	11.5.0
12-2012	CP-58	CP-120794	2300	1	Correction on handling for attach and NW initiated detach procedure collision	11.4.0	11.5.0
12-2012	CP-58	CP-120794	2301		Bullet correction	11.4.0	11.5.0
12-2012	CP-58	CP-120817	2255	3	Removing LAU trigger and combined RAU trigger for TIN="RAT-related TMSI"	11.5.0	12.0.0
03-2013	CP-59	CP-130129	2304	1	Correction of the use of RRC establishment cause	12.0.0	12.1.0
03-2013	CP-59	CP-130115	2306	2	Correction and cleanup of maximum number of context procedures	12.0.0	12.1.0
03-2013	CP-59	CP-130187	2307	6	LU after intersystem change from S1	12.0.0	12.1.0
03-2013	CP-59	CP-130129	2308	1	Spelling of mobile reachable timer	12.0.0	12.1.0
03-2013	CP-59	CP-130108	2310		Correction of reference to 29.272	12.0.0	12.1.0
03-2013	CP-59	CP-130103	2313	2	Corrections for attachment of user connection in "call delivered" state for SRVCC.	12.0.0	12.1.0
03-2013	CP-59	CP-130124	2314	2	Addition of SRVCC in the pre-alerting (before ringing) phase.	12.0.0	12.1.0
03-2013	CP-59	CP-130125	2315	2	LAU trigger for the case the MS is in 2G/3G when T3423 expires	12.0.0	12.1.0
03-2013	CP-59	CP-130125	2316	3	Correction to ISR handling during PS handover	12.0.0	12.1.0
03-2013	CP-59	CP-130189	2330	4	Specification of value of timer T322	12.0.0	12.1.0
03-2013	CP-59	CP-130184	2331	1	Clarification to timer T3312 in the time timer table	12.0.0	12.1.0
03-2013	CP-59	CP-130129	2335	1	Abnormal case handling when in NMOII LAU/RAU fails but RAU/LAU succeeds	12.0.0	12.1.0
03-2013	CP-59	CP-130129	2336	2	GPRS MS in NMO I and the ATT flag	12.0.0	12.1.0
03-2013	CP-59	CP-130129	2338	1	Stopping T3340 when radio bearers are established	12.0.0	12.1.0
03-2013	CP-59	CP-130129	2339	1	Correction to the ATT flag description	12.0.0	12.1.0
03-2013	CP-59	CP-130112	2341	2	Mobile CS to PS SRVCC capability	12.0.0	12.1.0
06-2013	CP-60	CP-130264	2329	3	Performing Emergency Attach from Attempting to Attach/Update substates	12.1.0	12.2.0
06-2013	CP-60	CP-130264	2334	4	Correct the requests from CM layers for combined attach/RAU trigger	12.1.0	12.2.0
06-2013	CP-60	CP-130255	2343	1	MS Network Sharing capability	12.1.0	12.2.0
06-2013	CP-60	CP-130264	2345		Corrections to spelling of implicit detach timer	12.1.0	12.2.0
06-2013	CP-60	CP-130250	2347	2	Introduction of additional Cause Codes as triggers for redirection for MOCN.	12.1.0	12.2.0
06-2013	CP-60	CP-130264	2350	2	Setting of Device properties IE by NAS for MSs allowed to use AC 11 to 15	12.1.0	12.2.0
06-2013	CP-60	CP-130250	2352	2	Prohibited usage of GEA1 by SA3	12.1.0	12.2.0
06-2013	CP-60	CP-130264	2353	1	Correction to T3321 in timer tables	12.1.0	12.2.0
06-2013	CP-60	CP-130264	2354	1	Clarifications on terminology of last PDP context	12.1.0	12.2.0
06-2013	CP-60	CP-130264	2355	2	Modification of Cause #65 to not include consideration for emergency PDP contexts.	12.1.0	12.2.0

Date	TSG #	TSG Doc.	CR	Rev	Subject/Comment	Old	New
06-2013	CP-60	CP-130244	2358		Correction to the exception of not stopping T3396 for dual-priority MS	12.1.0	12.2.0
06-2013	CP-60	CP-130264	2361		Limit the emergency services to UTRAN lu mode for service request procedure	12.1.0	12.2.0
06-2013	CP-60	CP-130264	2362	3	GERAN lu mode	12.1.0	12.2.0
06-2013	CP-60	CP-130267	2363	1	Terminology for SIPTO at the local network	12.1.0	12.2.0
06-2013	CP-60	CP-130267	2364	2	Updates to GMM and SM procedures because of SIPTO at the local network	12.1.0	12.2.0
06-2013	CP-60	CP-130264	2380	2	Clarifications of RAU following SRVCC handover	12.1.0	12.2.0
06-2013	CP-60	CP-130264	2381	4	Coordination between SM and GMM for supporting ISR	12.1.0	12.2.0
06-2013	CP-60	CP-130264	2383	2	Correction on encoding for Quality of Service information element	12.1.0	12.2.0
06-2013	CP-60	CP-130264	2384	1	Non-GPRS update triggered during periodic routing area update	12.1.0	12.2.0
06-2013	CP-60	CP-130264	2386	2	Clarification to the attach attempt counter	12.1.0	12.2.0
06-2013	CP-60	CP-130264	2387	2	MS behaviour on cause #25 in messages that are NOT integrity protected	12.1.0	12.2.0
06-2013	CP-60	CP-130264	2388		Updating forbidden lists during RAU for a MS with emergency bearers	12.1.0	12.2.0
06-2013	CP-60	CP-130264	2390		Addition of T3302 timer handling	12.1.0	12.2.0
09-2013	CP-61	CP-130510	2392		Correction of conditions brought about by approval of C1-132663	12.2.0	12.3.0
09-2013	CP-61	CP-130510	2393	1	Addition of cause #25 to "abnormal cases in the MS"	12.2.0	12.3.0
09-2013	CP-61	CP-130510	2403	2	Correction on encoding for Quality of Service information element	12.2.0	12.3.0
09-2013	CP-61	CP-130498	2407	3	Including the last used LTE PLMN ID in the EPLMN list for CSFB return	12.2.0	12.3.0
09-2013	CP-61	CP-130510	2409	1	Non-GPRS update triggered during periodic routing area update	12.2.0	12.3.0
09-2013	CP-61	CP-130510	2413	1	Conditions when T3346 is not running	12.2.0	12.3.0
09-2013	CP-61	CP-130510	2416	1	MS Class Mark3 Table numbering	12.2.0	12.3.0
09-2013	CP-61	CP-130514	2420	1	Service request procedure for SIPTO at the local network with stand-alone GW	12.2.0	12.3.0
09-2013	CP-61	CP-130514	2422	1	Local home network identifier	12.2.0	12.3.0
09-2013	CP-61	CP-130499	2429	3	Allow access to CS Services for AC 11-15 when timer T3246 is running	12.2.0	12.3.0
09-2013	CP-61	CP-130494	2434	2	Reset LAU Counter	12.2.0	12.3.0
09-2013	CP-61	CP-130510	2437	1	Remove mention of starting T3246 when noT3246 timeout value was provided by the network	12.2.0	12.3.0
09-2013	CP-61	CP-130510	2439	1	Suitable cell search when the MS receives a reject cause code #15 or #25	12.2.0	12.3.0
09-2013	CP-61	CP-130510	2442	1	MS behavior for MS abnormal case in RAU procedure	12.2.0	12.3.0
12-2013	CP-62	CP-130737	2324	3	Correction of Back-off timer handling for GERAN	12.3.0	12.4.0
12-2013	CP-62	CP-130762	2411	3	MS-originated detach procedure during attach and routing area updating procedures	12.3.0	12.4.0
12-2013	CP-62	CP-130762	2415	3	Deletion of the ePLMNs list upon receipt of #9, #10 or #40	12.3.0	12.4.0

Date	TSG #	TSG Doc.	CR	Rev	Subject/Comment	Old	New
12-2013	CP-62	CP-130762	2421	2	Correcting trigger for completion of CM Service Request procedure	12.3.0	12.4.0
12-2013	CP-62	CP-130737	2425	2	MS's inconsistent behaviour when PS back-off timer is running	12.3.0	12.4.0
12-2013	CP-62	CP-130762	2448	2	SM cause #50,51,52 handling at the MS	12.3.0	12.4.0
12-2013	CP-62	CP-130769	2449	2	Detect that SIPTO@LN PDN connection involves a stand-alone GW after during inter-SGSN HO	12.3.0	12.4.0
12-2013	CP-62	CP-130762	2456		P-TMSI handling in Network abnormal case in attach procedure	12.3.0	12.4.0
12-2013	CP-62	CP-130762	2457		Stop ongoing user data transmission for MS abnormal case in RAU procedure	12.3.0	12.4.0
12-2013	CP-62	CP-130762	2463		Correction of condition for including an IMEI in the Attach Request	12.3.0	12.4.0
12-2013	CP-62	CP-130762	2465	1	Clarification of PDP context modification	12.3.0	12.4.0
12-2013	CP-62	CP-130762	2466	4	PS signalling connection release with "follow-on proceed" and no service request pending	12.3.0	12.4.0
12-2013	CP-62	CP-130760	2468	1	Introduction of VAMOS III Capability Indicator	12.3.0	12.4.0
12-2013	CP-62	CP-130762	2469	1	TCRT: Introduction of ER-GSM band	12.3.0	12.4.0
12-2013	CP-62	CP-130762	2470		Reference Corrections for TS 24.008	12.3.0	12.4.0
12-2013	CP-62	CP-130745	2472	1	MS Wideband RSRQ Measurement capability	12.3.0	12.4.0
12-2013	CP-62	CP-130738	2476	1	Handling of Mobile Identity, old RAI and P-TMSI signature for combined Attach	12.3.0	12.4.0
12-2013	CP-62	CP-130762	2477	2	Clarification to the periodic RAU procedure when rejected with GMM cause #10	12.3.0	12.4.0
12-2013	CP-62	CP-130762	2479	1	Syntactic rules in comments in the MS RAC IE	12.3.0	12.4.0
12-2013	CP-62	CP-130762	2480		GERAN lu mode correction	12.3.0	12.4.0
12-2013	CP-62	CP-130745	2482	2	Cases of #17 to trigger redirection	12.3.0	12.4.0
12-2013	CP-62	CP-130762	2485	1	Paging response when running T3346	12.3.0	12.4.0
12-2013	CP-62	CP-130762	2486	2	Requirement for resetting the RAU attempt counter	12.3.0	12.4.0
12-2013	CP-62	CP-130762	2487		MS behavior in state GMM-REGISTERED.ATTEMPTING-TO-UPDATE	12.3.0	12.4.0
12-2013	CP-62	CP-130769	2491		Update of PDP context activation for SIPTO at the local network	12.3.0	12.4.0
12-2013	CP-62	CP-130762	2492		Correction on a normal RAU trigger	12.3.0	12.4.0
12-2013	CP-62	CP-130762	2494	2	Cleanup of duplicate requirements, message and procedure names	12.3.0	12.4.0
12-2013	CP-62	CP-130762	2495	1	Clarification of requirements for MSs configured for dual priority	12.3.0	12.4.0
12-2013	CP-62	CP-130754	2499	2	Clarification for T3323 start condition	12.3.0	12.4.0
12-2013	CP-62	CP-130762	2500		Clarification on handling of timer T3396	12.3.0	12.4.0
12-2013	CP-62	CP-130762	2502	1	Reset of location update attempt counter	12.3.0	12.4.0
12-2013	CP-62	CP-130769	2382	4	ISR handling for SIPTO at the local network	12.3.0	12.4.0
12-2013	CP-62	CP-130813	2412	4	Update of ePLMN list for an MS with a PDN connection for emergency bearer services	12.3.0	12.4.0
03-2014	CP-63	CP-140127	2462	7	Selective RAU when ISR is activated	12.4.0	12.5.0
03-2014	CP-63	CP-140134	2484	5	TMSI handling during routing area update procedures	12.4.0	12.5.0

Date	TSG #	TSG Doc.	CR	Rev	Subject/Comment	Old	New
03-2014	CP-63	CP-140142	2488	3	Handling Service Request failure due to timeout	12.4.0	12.5.0
03-2014	CP-63	CP-140144	2496	3	Conditions to ignore paging for non-GPRS services	12.4.0	12.5.0
03-2014	CP-63	CP-140144	2510	3	Emergency Attach in the network not supporting IMS emergency call for limited service state	12.4.0	12.5.0
03-2014	CP-63	CP-140134	2515	2	Disabling the request for E-UTRAN inter RAT handover information	12.4.0	12.5.0
03-2014	CP-63	CP-140134	2517		Minimum UE capability requirements for an MS to support CS to PS SRVCC from GERAN to E-UTRAN	12.4.0	12.5.0
03-2014	CP-63	CP-140144	2520	2	Missing condition for cause of start of T3302	12.4.0	12.5.0
03-2014	CP-63	CP-140144	2523	1	Clarification on T3396 stopping conditions	12.4.0	12.5.0
03-2014	CP-63	CP-140135	2524	1	Removing redundant SIPTO@LN procedures	12.4.0	12.5.0
03-2014	CP-63	CP-140135	2525	1	Aligning SIPTO@LN IE name with IE name used in TS 25.413	12.4.0	12.5.0
03-2014	CP-63	CP-140136	2527	3	Introduction of UE power saving mode	12.4.0	12.5.0
03-2014	CP-63	CP-140141	2531	1	Correction of term 'GMM-CONNECTED mode' to 'PMM-CONNECTED' mode'	12.4.0	12.5.0
03-2014	CP-63	CP-140144	2535		Handling of T3246 and T3346 when the MS is switched off	12.4.0	12.5.0
03-2014	CP-63	CP-140200	2538	2	RRC Establishment Cause for RAU procedure	12.4.0	12.5.0
06-2014	CP-64	CP-140310	2490	5	Continuation of EAB override for requests on a PDN connection established with EAB override.	12.5.0	12.6.0
06-2014	CP-64	CP-140331	2497	4	Conditions for performing RAU for MS configured with Dual Priority	12.5.0	12.6.0
06-2014	CP-64	CP-140459	2505	9	TFT filter settings	12.5.0	12.6.0
06-2014	CP-64	CP-140331	2508	3	Cases of #17 to trigger redirection	12.5.0	12.6.0
06-2014	CP-64	CP-140331	2546	3	T3346 and T3312 correction	12.5.0	12.6.0
06-2014	CP-64	CP-140331	2547	1	Capability indicator for MFBI-support	12.5.0	12.6.0
06-2014	CP-64	CP-140331	2548	1	Setting "Call in MPTY" MPTY auxiliary state after access transfer of a conference call	12.5.0	12.6.0
06-2014	CP-64	CP-140311	2550		Correction of wrong action and reference to procedure when handling reject cause #8	12.5.0	12.6.0
06-2014	CP-64	CP-140331	2552	2	Disable E-UTRA capability for GPRS only detach	12.5.0	12.6.0
06-2014	CP-64	CP-140331	2553	2	New RAU trigger for PMM mode re-synchronization	12.5.0	12.6.0
06-2014	CP-64	CP-140331	2555	5	Handling of Abnormal Cases related to Emergency PDP Activation Request Procedure	12.5.0	12.6.0
06-2014	CP-64	CP-140331	2556	1	PS signaling connection release	12.5.0	12.6.0
06-2014	CP-64	CP-140331	2557		Implicit detach cause value used for P-RAU	12.5.0	12.6.0
06-2014	CP-64	CP-140331	2558		A missed handling for a non-semantic mandatory IE error	12.5.0	12.6.0
06-2014	CP-64	CP-140447	2559	3	Correction to TFT checks	12.5.0	12.6.0
06-2014	CP-64	CP-140331	2560	6	Correction to packet filters	12.5.0	12.6.0
06-2014	CP-64	CP-140323	2563	3	Timer T3324 expiry	12.5.0	12.6.0
06-2014	CP-64	CP-140323	2564	2	Power saving mode activation	12.5.0	12.6.0
06-2014	CP-64	CP-140323	2565	3	Editorials on power saving mode	12.5.0	12.6.0

Date	TSG #	TSG Doc.	CR	Rev	Subject/Comment	Old	New
06-2014	CP-64	CP-140329	2566	1	Correction to Service Request procedure	12.5.0	12.6.0
06-2014	CP-64	CP-140331	2543	7	BCM handling in NW init procedures	12.5.0	12.6.0
06-2014	CP-64	CP-140331	2567	1	TMSI reallocation – abnormal cases in the MS	12.5.0	12.6.0
06-2014	CP-64	CP-140323	2568	2	Corrections for newly introduced PSM	12.5.0	12.6.0
06-2014	CP-64	CP-140329	2569	3	Handling of Service request procedure for emergency bearer services.	12.5.0	12.6.0
06-2014	CP-64	CP-140323	2572	2	No data transmission when PSM is activated	12.5.0	12.6.0
06-2014	CP-64	CP-140323	2573	2	PSM not applying for MS with emergency bearer service	12.5.0	12.6.0
06-2014	CP-64	CP-140331	2576	3	Start T3340 for cause values #7 and #8	12.5.0	12.6.0
06-2014	CP-64	CP-140331	2577	2	TMSI reallocation – abnormal cases in the network side	12.5.0	12.6.0
06-2014	CP-64	CP-140308	2579		Removing editor's note on handling ongoing signalling when a CS to PS handover occurs	12.5.0	12.6.0
06-2014	CP-64	CP-140331	2581	1	Paging at GERAN stops T3246	12.5.0	12.6.0
06-2014	CP-64	CP-140331	2582	1	Correcting inconsistent text - CR2415r3 based on unofficial version of 24.008 v12.3.0	12.5.0	12.6.0
06-2014	CP-64	CP-140331	2584	1	Correction of selective RAU if PS back-off timer is running	12.5.0	12.6.0
06-2014	CP-64	CP-140323	2608	5	The set of mobile reachable timer considering PSM	12.5.0	12.6.0
06-2014	CP-64	CP-140331	2609	2	Correction for attempt counter	12.5.0	12.6.0
06-2014	CP-64	CP-140331	2589	1	Clarification of for how long the MS remembers selected ciphering algorithm	12.5.0	12.6.0
06-2014	CP-64	CP-140331	2590	2	Emergency call clarifications	12.5.0	12.6.0
06-2014	CP-64	CP-140331	2591	1	ISR should be activated in the UE when T3412 is deactivated.	12.5.0	12.6.0
06-2014	CP-64	CP-140323	2592	2	Clarifications on emergency attach and PSM	12.5.0	12.6.0
06-2014	CP-64	CP-140328	2596	1	RAU trigger with RRC connection failure	12.5.0	12.6.0
06-2014	CP-64	CP-140331	2597	1	Name alignment on LOCATION UPDATING ACCEPT message	12.5.0	12.6.0
06-2014	CP-64	CP-140323	2601	1	T3324 value set to zero	12.5.0	12.6.0
06-2014	CP-64	CP-140331	2604	1	Mapping between the RAU procedure and the RRC establishment cause	12.5.0	12.6.0
06-2014	CP-64	CP-140323	2605	2	ISR deactivation for Power Saving Mode	12.5.0	12.6.0
06-2014	CP-64	CP-140323	2606		Corrections to UE power saving mode	12.5.0	12.6.0
09-2014	CP-65	CP-140664	2583	4	Stopping T3412 for RAU ACCEPT (ISR not activated)	12.6.0	12.7.0
09-2014	CP-65	CP-140640	2595	4	Correction on handling of cause #27 (missing or unknown APN)	12.6.0	12.7.0
09-2014	CP-65	CP-140664	2612	1	Setting TIN to P-TMSI if RAU is done to update DRX parameters	12.6.0	12.7.0
09-2014	CP-65	CP-140660	2613	3	PCO parameters for P-CSCF restoration support	12.6.0	12.7.0
09-2014	CP-65	CP-140664	2615		Clarification of actions for MS in LIMITED SERVICE state	12.6.0	12.7.0
09-2014	CP-65	CP-140664	2616	1	Avoiding failure of LCS/RRLP Procedure due to CM SERVICE ABORT procedure.	12.6.0	12.7.0
09-2014	CP-65	CP-140664	2617	2	PS signalling connection release in order to perform PLMN search.	12.6.0	12.7.0
09-2014	CP-65	CP-140572	2618	2	Service request counter for AC 11-15 UEs	12.6.0	12.7.0

Date	TSG #	TSG Doc.	CR	Rev	Subject/Comment	Old	New
09-2014	CP-65	CP-140664	2619	1	TMSI handling in the combined attach procedure	12.6.0	12.7.0
09-2014	CP-65	CP-140664	2624	1	Editorial Corrections	12.6.0	12.7.0
09-2014	CP-65	CP-140657	2625	3	Optimization for PSM	12.6.0	12.7.0
09-2014	CP-65	CP-140664	2628		Stop NAS retry timer upon receipt of EWT from AS	12.6.0	12.7.0
09-2014	CP-65	CP-140664	2629		Correction for location update attempt counter	12.6.0	12.7.0
09-2014	CP-65	CP-140647	2630	1	Introduction of Downlink Multi-Carrier	12.6.0	12.7.0
09-2014	CP-65	CP-140657	2631		Correction on the implicit detach timer set	12.6.0	12.7.0
09-2014	CP-65	CP-140657	2632		Correction on the Periodic RA update timer IE	12.6.0	12.7.0
09-2014	CP-65	CP-140657	2634	1	MS network feature support usage with PSM	12.6.0	12.7.0
09-2014	CP-65	CP-140643	2637	1	Correction to EAB override	12.6.0	12.7.0
09-2014	CP-65	CP-140644	2639		Disabling the request for E-UTRAN inter RAT handover information	12.6.0	12.7.0
09-2014	CP-65	CP-140664	2640	1	Editorial on secondary PDP context activation procedure	12.6.0	12.7.0
09-2014	CP-65	CP-140661	2641	2	Local IP address and mask	12.6.0	12.7.0
09-2014	CP-65	CP-140670	2643	2	Adding an indication of WLAN offloading permission to the MS per activated context	12.6.0	12.7.0
09-2014	CP-65	CP-140724	2635	1	Correction to P-TMSI reallocation – abnormal cases	12.6.0	12.7.0
12-2014	CP-66	CP-140836	2627	4	Request for emergency services allowed even if back-off timer running	12.7.0	12.8.0
12-2014	CP-66	CP-140854	2645	6	Enable per RAN indication of WLAN offloading permission	12.7.0	12.8.0
12-2014	CP-66	CP-140836	2650		Correction of typo in the term "MS configured to use AC11 – 15 in selected PLMN"	12.7.0	12.8.0
12-2014	CP-66	CP-140854	2651	3	Handling of WLAN offload indication from the SGSN	12.7.0	12.8.0
12-2014	CP-66	CP-140836	2652	1	Correction of wrong reference to "MM cause"	12.7.0	12.8.0
12-2014	CP-66	CP-140843	2657		Implicit detach timer setting for PSM MS	12.7.0	12.8.0
12-2014	CP-66	CP-140836	2666	1	Reference correction	12.7.0	12.8.0
12-2014	CP-66	CP-140824	2668		Stopping wrong timer in Combined routing area updating procedure	12.7.0	12.8.0
12-2014	CP-66	CP-140846	2669	4	Trigger to re-initiate service request procedure.	12.7.0	12.8.0
12-2014	CP-66	CP-140854	2672		SGSN initiating SM procedure	12.7.0	12.8.0
12-2014	CP-66	CP-140836	2674	1	Abnormal case in the MS during P-TMSI reallocation procedure	12.7.0	12.8.0
12-2014	CP-66	CP-140836	2677		Setting the values of MRT and IDT in the SGSN	12.7.0	12.8.0
12-2014	CP-66	CP-140836	2678	1	PDP context handling upon inter-system change	12.7.0	12.8.0
12-2014	CP-66	CP-140824	2682	3	Conditions to stop the APN based timer	12.7.0	12.8.0
12-2014	CP-66	CP-140836	2686	1	Clarification on GMM/MM Procedure Timer handling during network authentication failure while an emergency call is active	12.7.0	12.8.0
12-2014	CP-66	CP-140854	2687	6	Add WLAN offload indication to NAS	12.7.0	12.8.0
12-2014	CP-66	CP-140836	2688	2	"old" P-TMSI for the case of multiple P-TMSI REALLOCATION COMMAND messages	12.7.0	12.8.0
12-2014	CP-66	CP-140843	2689	2	Condition for including the T3324 IE	12.7.0	12.8.0

Date	TSG #	TSG Doc.	CR	Rev	Subject/Comment	Old	New
12-2014	CP-66	CP-140843	2691	5	Trigger to RAU procedure	12.7.0	12.8.0
12-2014	CP-66	CP-140836	2697	1	Correction for handling of NAS signaling low priority indication	12.7.0	12.8.0
12-2014	CP-66	CP-140836	2698		Amendment to T3340 starting cause	12.7.0	12.8.0
12-2014	CP-66	CP-140854	2671	1	Add WLAN offload indication to NAS	12.7.0	12.8.0
12-2014	CP-66	CP-140992	2655	9	Handling secondary PDP context without a TFT	12.7.0	12.8.0
12-2014	CP-66	CP-140858	2646	1	T3230 timer handling in case of CM SERVICE ABORT procedure.	12.8.0	13.0.0
12-2014	CP-66	CP-140858	2653	1	Removal of text on static PDP address usage and detection	12.8.0	13.0.0
12-2014	CP-66	CP-140858	2673	1	Removal of GPRS update status in sub-states NORMAL-SERVICE and LIMITED-SERVICE of GMM-DEREGISTERED	12.8.0	13.0.0
12-2014	CP-66	CP-140858	2675	2	Update to P-TMSI reallocation procedure	12.8.0	13.0.0
12-2014	CP-66	CP-140858	2685		Correction of CS/PS mode of operation	12.8.0	13.0.0
12-2014	CP-66	CP-140858	2690	1	Editorials on PSM	12.8.0	13.0.0
03-2015	CP-67	CP-150077	2703	2	Initiating a location update in unsuccessful and abnormal cases	13.0.0	13.1.0
03-2015	CP-67	CP-150083	2704	1	Initiating a location update in additional unsuccessful cases	13.0.0	13.1.0
03-2015	CP-67	CP-150083	2705	1	Correction of periodic RAU for an MS attached for GPRS and non-GPRS services	13.0.0	13.1.0
03-2015	CP-67	CP-150083	2706	1	Correction of MS reaction upon receipt of MM/GMM cause #25	13.0.0	13.1.0
03-2015	CP-67	CP-150070	2710	1	Introduction of extended TSC sets	13.0.0	13.1.0
03-2015	CP-67	CP-150077	2712	1	Initiation of normal RAU due to CSFB	13.0.0	13.1.0
03-2015	CP-67	CP-150064	2714	2	Handling of Activate PDP context reject from the SGSN due to APN based congestion control	13.0.0	13.1.0
03-2015	CP-67	CP-150064	2716	1	Correction on SM congestion control handling	13.0.0	13.1.0
03-2015	CP-67	CP-150069	2718	4	MS data retry handling for SM procedures	13.0.0	13.1.0
03-2015	CP-67	CP-150083	2719	2	Failure of LCS/RRLP procedures due to CM SERVICE ABORT	13.0.0	13.1.0
03-2015	CP-67	CP-150054	2722		Stopping T3396 for Unsuccessful MBMS context activation	13.0.0	13.1.0
03-2015	CP-67	CP-150075	2724	2	Clarification on WLAN offload indication	13.0.0	13.1.0
03-2015	CP-67	CP-150083	2728	1	Clarification to the Mobile Reachable Timer in timer table.	13.0.0	13.1.0
03-2015	CP-67	CP-150064	2737	1	Correction of TFT checks for secondary PDP contexts	13.0.0	13.1.0
03-2015	CP-67	CP-150083	2732	1	Conditions to reset the location update attempt counter	13.0.0	13.1.0
03-2015	CP-67	CP-150192	2727	3	Unsuccessful PDP context activation with #50 or #51	13.0.0	13.1.0
03-2015	CP-67	CP-150203	2711	5	Correcting SM re-activation attempts at PLMN change when only one IP version is supported by the network.	13.0.0	13.1.0
06-2015	CP-68	CP-150315	2740	4	Correction of UE retry behaviour after rejection by the network	13.1.0	13.2.0
06-2015	CP-68	CP-150303	2743	2	Correction of TFT checks for secondary PDP contexts	13.1.0	13.2.0
06-2015	CP-68	CP-150323	2744	1	Initiating a location update upon receipt of RAU Reject with GMM cause #10	13.1.0	13.2.0
06-2015	CP-68	CP-150329	2745		Handling of authentication timers after loss or release of signalling connection	13.1.0	13.2.0
06-2015	CP-68	CP-150329	2746	1	Handling of access class barring when accessing the network for emergency bearer services	13.1.0	13.2.0

Date	TSG #	TSG Doc.	CR	Rev	Subject/Comment	Old	New
06-2015	CP-68	CP-150329	2747		Setting of the Device properties IE for CS emergency call	13.1.0	13.2.0
06-2015	CP-68	CP-150329	2752	3	Correcting range from which a timer value for T3396 is drawn	13.1.0	13.2.0
06-2015	CP-68	CP-150329	2753	1	Clarifications on using PLMN Selector List after #14 "GPRS services not allowed in this PLMN" for MS using SIM/USIM.	13.1.0	13.2.0
06-2015	CP-68	CP-150315	2755		Remove the note for SM cause value #27	13.1.0	13.2.0
06-2015	CP-68	CP-150329	2757	1	Clarification on T3346	13.1.0	13.2.0
06-2015	CP-68	CP-150329	2761		Correction on MS's behaviour for EWT from the lower layers	13.1.0	13.2.0
06-2015	CP-68	CP-150329	2765	1	Handling of GMM cause code #10(implicitly detached)	13.1.0	13.2.0
06-2015	CP-68	CP-150329	2766	1	Handling of timers T3245,T3246 and T3346	13.1.0	13.2.0
06-2015	CP-68	CP-150329	2767	1	Handling of ESM cause value #50, #51	13.1.0	13.2.0
06-2015	CP-68	CP-150329	2768		Removal of dependency on GPRS update status from GMM-DEREGISTERED.ATTEMPTING-TO-ATTACH	13.1.0	13.2.0
06-2015	CP-68	CP-150329	2770	2	Clarification to respond to paging during congestion.	13.1.0	13.2.0
06-2015	CP-68	CP-150329	2771	1	Clarification to allow IMSI Detach during congestion.	13.1.0	13.2.0
06-2015	CP-68	CP-150303	2776	7	Capability indicator for extended EARFCN value range in GERAN	13.1.0	13.2.0
06-2015	CP-68	CP-150329	2778	1	Clarifications on EAB Override and Override Low Priority Access Indicator	13.1.0	13.2.0
06-2015	CP-68	CP-150329	2783	1	Clarification on TFT for abnormal cases of PDP Context modification	13.1.0	13.2.0
06-2015	CP-68	CP-150329	2785		Respond to paging with IMSI in Limited Service state	13.1.0	13.2.0
06-2015	CP-68	CP-150329	2786		Alignment of MS behaviour for EWT in Service Request procedure	13.1.0	13.2.0
06-2015	CP-68	CP-150315	2789	2	MS back-off timer for GPRS session management rejections	13.1.0	13.2.0
06-2015	CP-68	CP-150329	2790		Removal of duplicate lines for RRC connection release controlled by Timer T3240.	13.1.0	13.2.0
06-2015	CP-68	CP-150329	2791		Aligning with SA2 requirement of NMO1 networks.	13.1.0	13.2.0
06-2015	CP-68	CP-150329	2793		Timer table update for timer T3211	13.1.0	13.2.0
06-2015	CP-68	CP-150329	2796	1	Stopping timer T3340 upon receiving downlink signalling	13.1.0	13.2.0
06-2015	CP-68	CP-150329	2804	1	Clarifications on normal stop of timers T3246 and T3346	13.1.0	13.2.0
06-2015	CP-68	CP-150329	2805	1	Correction of merged subclauses	13.1.0	13.2.0
06-2015	CP-68	CP-150329	2806	2	UE behaviour after SRVCC transfer of conference calls when MSC does not support mid-call procedures	13.1.0	13.2.0
06-2015	CP-68	CP-150313	2782	2	Trigger to initiate routing area procedure (PSM)	13.1.0	13.2.0
06-2015	CP-68	CP-150329	2784	1	Enable ISR for Ps-only MS	13.1.0	13.2.0
06-2015	CP-68	CP-150326	2800	3	Updates to mobile reachable timer and network behaviour because of MONTE	13.1.0	13.2.0
09-2015	CP-69	CP-150534	2773	4	Handling of Application specific Congestion control for Data Communication (ACDC)	13.2.0	13.3.0
09-2015	CP-69	CP-150529	2777	2	Correction of the handling of the equivalent PLMN list after location updating	13.2.0	13.3.0
09-2015	CP-69	CP-150526	2807		NBIFOM - Coding of NBIFOM PCO parameters	13.2.0	13.3.0

Date	TSG #	TSG Doc.	CR	Rev	Subject/Comment	Old	New
09-2015	CP-69	CP-150526	2808	2	NBIFOM - coding of Access usability	13.2.0	13.3.0
09-2015	CP-69	CP-150511	2813		Rollback of changes on reset attempt counters – 24.008	13.2.0	13.3.0
09-2015	CP-69	CP-150526	2816	2	NBIFOM - coding of RAN rules related indications	13.2.0	13.3.0
09-2015	CP-69	CP-150505	2819		Correction of SM cause for rejection of TFT operation	13.2.0	13.3.0
09-2015	CP-69	CP-150529	2820	2	Correction of criterion for clearing a maximum number of PDP contexts	13.2.0	13.3.0
09-2015	CP-69	CP-150529	2821		Deactivation of PSM for MM and mobile originating CS transactions	13.2.0	13.3.0
09-2015	CP-69	CP-150529	2822	2	Correction of criterion for stopping timers T3246 and T3346	13.2.0	13.3.0
09-2015	CP-69	CP-150516	2824		Removal of incorrect reference to PLMN selection	13.2.0	13.3.0
09-2015	CP-69	CP-150523	2825	2	Back-off timer mechanism for equivalent PLMNs	13.2.0	13.3.0
09-2015	CP-69	CP-150526	2832	1	Network-initiated IP flow mobility	13.2.0	13.3.0
09-2015	CP-69	CP-150523	2834	1	Correction of MS retry behaviour after rejection with #8, #27, #32, #33	13.2.0	13.3.0
09-2015	CP-69	CP-150529	2835		MS-initiated detach for "switch off" and change of cell into a new RAI	13.2.0	13.3.0
09-2015	CP-69	CP-150529	2836	1	Expiry of T3312 when the MS is attached for emergency bearer services	13.2.0	13.3.0
09-2015	CP-69	CP-150529	2837	2	Clarification on the handling of the back-off timer when the MS is switched off	13.2.0	13.3.0
09-2015	CP-69	CP-150529	2839		Enhancement on NW initiated PDP context deactivation	13.2.0	13.3.0
09-2015	CP-69	CP-150529	2840		Handling of back-off timer at switch-on	13.2.0	13.3.0
09-2015	CP-69	CP-150585	2842	3	Delete the incorrect cause values in UE requested bearer resource modification procedure	13.2.0	13.3.0
09-2015	CP-69	CP-150529	2844		Clarification to allow imsi detach only in registered area.	13.2.0	13.3.0
09-2015	CP-69	CP-150529	2845		Correction to reference	13.2.0	13.3.0
09-2015	CP-69	CP-150526	2831	1	UE-initiated IP flow mobility	13.2.0	13.3.0
09-2015	CP-69	CP-150536	2843	3	Introduction of extended idle mode DRX cycle	13.2.0	13.3.0
12-2015	CP-70	CP-150710	2811	3	Incorrect test condition on linkage of override EAB and override NSLPI	13.3.0	13.4.0
12-2015	CP-70	CP-150706	2848	1	Define SM cause for the rejection of additional access to a PDN connection	13.3.0	13.4.0
12-2015	CP-70	CP-150710	2849	3	Alignment on NW initiated PDP context deactivation	13.3.0	13.4.0
12-2015	CP-70	CP-150702	2851	1	Addition of MS retry behaviour for MBMS session management procedures	13.3.0	13.4.0
12-2015	CP-70	CP-150710	2853	3	Signaling related to emergency bearer services	13.3.0	13.4.0
12-2015	CP-70	CP-150706	2854	1	Coding of NBIFOM container	13.3.0	13.4.0
12-2015	CP-70	CP-150713	2855	5	Extended DRX IE addition	13.3.0	13.4.0
12-2015	CP-70	CP-150713	2858	2	Extended DRX accepted by the network	13.3.0	13.4.0
12-2015	CP-70	CP-150706	2860	3	Inclusion of RAN rules and access usability IEs in NBIFOM container	13.3.0	13.4.0
12-2015	CP-70	CP-150710	2864	2	Clarification while PLMN is in Forbidden PLMN for GPRS Service List	13.3.0	13.4.0

Date	TSG #	TSG Doc.	CR	Rev	Subject/Comment	Old	New
12-2015	CP-70	CP-150710	2865	1	Clarification for paging with P-TMSI	13.3.0	13.4.0
12-2015	CP-70	CP-150713	2866	3	Interaction between PSM and eDRX	13.3.0	13.4.0
12-2015	CP-70	CP-150713	2867	3	eDRX abbreviation, reference to TS 24.008 and some corrections	13.3.0	13.4.0
12-2015	CP-70	CP-150713	2868		eDRX and emergency bearer services	13.3.0	13.4.0
12-2015	CP-70	CP-150713	2869	3	Lack of requirement on mandating repeating the request of eDRX at RAU	13.3.0	13.4.0
12-2015	CP-70	CP-150713	2870	2	Support of eDRX in the MS	13.3.0	13.4.0
12-2015	CP-70	CP-150702	2871	1	Correction to the MS retry behaviour for PDP context activation procedure	13.3.0	13.4.0
12-2015	CP-70	CP-150710	2872		Void of unused reference	13.3.0	13.4.0
12-2015	CP-70	CP-150704	2873	2	Group specific congestion control	13.3.0	13.4.0
12-2015	CP-70	CP-150710	2877	4	Clarification about timer T3245 usage	13.3.0	13.4.0
12-2015	CP-70	CP-150702	2878		Correction to MS-initiated secondary PDP context activation and modification procedures after rejection with #32, #33	13.3.0	13.4.0
12-2015	CP-70	CP-150713	2879		use of the eDRX parameters provided by the network	13.3.0	13.4.0
12-2015	CP-70	CP-150713	2882	1	IMSI paging without eDRX parameters	13.3.0	13.4.0
12-2015	CP-70	CP-150688	2885	2	Correction of MS-initiated detach request during routing area updating procedure	13.3.0	13.4.0
12-2015	CP-70	CP-150710	2886		T3245 timer range clarification	13.3.0	13.4.0
12-2015	CP-70	CP-150710	2887	2	Correction to NOTE in Mobility Management timers – MS side	13.3.0	13.4.0
12-2015	CP-70	CP-150710	2888		Clarification regarding update status in Legacy RAT	13.3.0	13.4.0
12-2015	CP-70	CP-150716	2891		Dedicated core networks	13.3.0	13.4.0
12-2015	CP-70	CP-150713	2892	1	Paging for an MS which the network accepted to use eDRX	13.3.0	13.4.0
12-2015	CP-70	CP-150710	2893		Fixing underlined text	13.3.0	13.4.0
12-2015	CP-70	CP-150701	2894		P-CSCF Re-selection support over WLAN	13.3.0	13.4.0
12-2015	CP-70	CP-150710	2895	3	Handling of back off timer T3346 and T3396	13.3.0	13.4.0
12-2015	CP-70	CP-150719	2897	1	ACDC handling for emergency call and IMS	13.3.0	13.4.0
12-2015	CP-70	CP-150719	2898	1	Handling of ACDC mechanism	13.3.0	13.4.0
12-2015	CP-70	CP-150710	2903	3	New time unit in GPRS Timer 3 IE in support of operations of machine type devices	13.3.0	13.4.0
12-2015	CP-70	CP-150710	2904	1	Incorrect reference about treating the active cell as barred	13.3.0	13.4.0
12-2015	CP-70	CP-150702	2905		Retry restriction for default APN	13.3.0	13.4.0
12-2015	CP-70	CP-150710	2906		Stop running T3423	13.3.0	13.4.0
03-2016	CP-71	CP-160069	2912	5	Handling of uncategorized app for ACDC	13.4.0	13.5.0
03-2016	CP-71	CP-160069	2913		ACDC applied to lu mode only	13.4.0	13.5.0
03-2016	CP-71	CP-160072	2918	6	Paging handling for MSs using eDRX	13.4.0	13.5.0
03-2016	CP-71	CP-160085	2921		Correction on active timer in timer table	13.4.0	13.5.0
03-2016	CP-71	CP-160072	2923	1	Correction to Extended DRX parameters IE	13.4.0	13.5.0
03-2016	CP-71	CP-160072	2925	2	Handling when MS wants to disable eDRX	13.4.0	13.5.0

Date	TSG #	TSG Doc.	CR	Rev	Subject/Comment	Old	New
03-2016	CP-71	CP-160085	2927	6	Correction of handling NAS reject messages without integrity protection	13.4.0	13.5.0
03-2016	CP-71	CP-160078	2929		NBIFOM mode for Network to MS direction	13.4.0	13.5.0
03-2016	CP-71	CP-160072	2930		Enabling eDRX when T3346 running	13.4.0	13.5.0
03-2016	CP-71	CP-160131	2931	2	PDP context deactivation without tear down indicator	13.4.0	13.5.0
03-2016	CP-71	CP-160085	2933		Correction of handling of timer T3346 and T3396 at detach without switch-off	13.4.0	13.5.0
03-2016	CP-71	CP-160072	2936		Handling PRAU Accept without integrity protection.	13.4.0	13.5.0
03-2016	CP-71	CP-160085	2937	2	Naming service request guard timer	13.4.0	13.5.0
03-2016	CP-71	CP-160133	2938	2	eDRX cleanup	13.4.0	13.5.0
03-2016	CP-71	CP-160085	2940	1	Correction of SM Retry Timer to SM_RetryWaitTime	13.4.0	13.5.0
03-2016	CP-71	CP-160132	2945		Correction to T3250 in the Timer Table	13.4.0	13.5.0
06-2016	CP-72	CP-160312	2926	8	Use of eDRX in case of emergency bearer services	13.5.0	13.6.0
06-2016	CP-72	CP-160315	2932	5	Handling of T3396 for PDN connections established without APN	13.5.0	13.6.0
06-2016	CP-72	CP-160318	2944	5	Update of NAS timers to support extended coverage in GSM	13.5.0	13.6.0
06-2016	CP-72	CP-160315	2946		Correction of the handing of the Re-attempt indicator IE for cause #66	13.5.0	13.6.0
06-2016	CP-72	CP-160318	2947		Further corrections of handling of NAS reject messages without integrity protection	13.5.0	13.6.0
06-2016	CP-72	CP-160312	2949	4	Addition of NB-IoT eDRX cycles	13.5.0	13.6.0
06-2016	CP-72	CP-160318	2952	1	Cleanup for NAS reject messages without Integrity protection	13.5.0	13.6.0
06-2016	CP-72	CP-160307	2954	1	Correction of ACDC handling for IMS service in UTRAN	13.5.0	13.6.0
06-2016	CP-72	CP-160312	2955	4	Addition of NB-IoT PTW periods	13.5.0	13.6.0
06-2016	CP-72	CP-160312	2956	1	Interaction between legacy DRX and eDRX	13.5.0	13.6.0
06-2016	CP-72	CP-160309	2958	1	Update to voice domain preference and UE's usage setting conditions	13.5.0	13.6.0
06-2016	CP-72	CP-160318	2965	1	Handling of PLMN background scan timer during PSM	13.5.0	13.6.0
06-2016	CP-72	CP-160310	2968	1	Addition of integrity protection to GMM	13.5.0	13.6.0
06-2016	CP-72	CP-160325	2969	1	Local deactivation related to NBIFOM multi-access PDN connection	13.5.0	13.6.0
06-2016	CP-72	CP-160325	2970		Delete the NBIFOM container IE	13.5.0	13.6.0
06-2016	CP-72	CP-160334	2973	1	CS domain congestion handling in Legacy.	13.5.0	13.6.0
06-2016	CP-72	CP-160309	2961	4	Link MTU for non-IP connection	13.5.0	13.6.0
06-2016	CP-72	CP-160309	2964	2	Addition of APN rate control parameters	13.5.0	13.6.0
06-2016	CP-72	CP-160325	2967	1	"Multiple accesses to a PDN connection not allowed" in NW-initiated PDN disconnection procedure	13.5.0	13.6.0
06-2016	CP-72	CP-160331	2948	2	Correction of MS behaviour in substate ATTEMPTING-TO-UPDATE	13.6.0	14.0.0
06-2016	CP-72	CP-160331	2953		Correction to back-off timer in SM timer table	13.6.0	14.0.0
06-2016	CP-72	CP-160331	2966	1	T3396 running due to the release message from network	13.6.0	14.0.0
06-2016	CP-72	CP-160330	2950	3	Addition of support for Non-IP data for EC-EGPRS	13.6.0	14.0.0

Date	TSG #	TSG Doc.	CR	Rev	Subject/Comment	Old	New
06-2016	CP-72	CP-160331	2971	1	Correction to the identification procedure	13.6.0	14.0.0
06-2016	CP-72	CP-160331	2972	1	Correction to the TMSI allocation procedure	13.6.0	14.0.0

Change history							
Date	Meeting	TDoc	CR	Rev	Cat	Subject/Comment	New version
2016-09	CT#73	CP-160492	2975		A	Correction for non-supported eDRX values	14.1.0
2016-09	CT#73	CP-160491	2977	3	A	Corrections to GPRS integrity protection in GSM	14.1.0
2016-09	CT#73	CP-160492	2980		A	Wrong ordering of and repeated requirements on eDRX parameters handling	14.1.0
2016-09	CT#73	CP-160491	2982	1	A	Correction to IEI of Integrity protection algorithm	14.1.0
2016-09	CT#73	CP-160512	2985	1	B	Support of SRVCC for eCall over IMS	14.1.0
2016-09	CT#73	CP-160510	2987	3	A	Correction to GMM NAS timers for applying extension to support Clot_EC_GSM	14.1.0
2016-09	CT#73	CP-160486	2989	1	A	Correction on eDRX values for NB-IoT	14.1.0
2016-09	CT#73	CP-160519	2990	1	F	Correction on MS response to GMM common procedure	14.1.0
2016-09	CT#73	CP-160486	2992	1	A	Correction to APN rate control	14.1.0
2016-09	CT#73	CP-160488	2994	1	A	Introduction of (EC-)PCH monitoring support capability signalling in MSRAC IE	14.1.0
2016-09	CT#73	CP-160563	2995		F	Minor corrections for EC GPRS	14.1.0
2016-12	CT#74	CP-160798	2996	4	B	Handover of emergency PDN connection from non-3GPP access to 3GPP access	14.2.0
2016-12	CT#74	CP-160753	2999	1	F	Corrections to handling of non-integrity protected reject messages	14.2.0
2016-12	CT#74	CP-160753	3000		D	Correcting other rate adaptation to other rate adaption	14.2.0
2016-12	CT#74	CP-160719	3002		A	Correction of handling of PLMN-specific PS attempt counter	14.2.0
2016-12	CT#74	CP-160738	3003	2	B	Addition of DCN ID handling for eDecor	14.2.0
2016-12	CT#74	CP-160725	3005		A	Correction for GPRS integrity protection	14.2.0
2016-12	CT#74	CP-160725	3007	1	A	Reset of IOV_Updates counter	14.2.0
2016-12	CT#74	CP-160745	3008	1	B	Addition of Non-IP related cause values	14.2.0
2016-12	CT#74	CP-160738	3009	2	F	DCN-ID in P-TMSI Reallocation Command Message	14.2.0
2016-12	CT#74	CP-160723	3011		A	Correction of the remapping of unsupported eDRX timer values	14.2.0
2016-12	CT#74	CP-160753	3012		F	'Deactivated' value in the T3412 extended value IE	14.2.0
2016-12	CT#74	CP-160753	3013		F	Detach procedure triggered due to SIM/USIM removal	14.2.0
2016-12	CT#74	CP-160720	3015		A	Alignment of MTU for CP user data	14.2.0
2016-12	CT#74	CP-160738	3016	1	B	Trigger RAU at Default DCN-ID change	14.2.0
2016-12	CT#74	CP-160738	3017	2	B	Addition of lu mode DCN-ID provisioning	14.2.0
2016-12	CT#74	CP-160745	3018		F	Normative handling on non-IP not supported for secondary PDP context activation	14.2.0
2016-12	CT#74	CP-160738	3019		B	Addition of PLMN ID of the selected CN operator handling for eDecor	14.2.0
2016-12	CT#74	CP-160719	3022	3	A	Correction of handling of reject due to lack of subscription	14.2.0
2016-12	CT#74	CP-160719	3024	1	A	Applicability of 2G GPRS integrity protection	14.2.0
2016-12	CT#74	CP-160810	3026	3	A	Definition of value "0" of the TFT operation code in the traffic flow template IE	14.2.0
2016-12	CT#74	CP-160718	3029	1	A	Correction to cases which all PDP contexts to a given APN are deactivated	14.2.0
2017-03	CT#75	CP-170136	2943	8	B	DRVCC from WiFi to CS	14.3.0
2017-03	CT#75	CP-170129	3033		F	Correction of cause value numbers for NonIP	14.3.0
2017-03	CT#75	CP-170121	3039	2	B	Restriction of use of Coverage Enhancement	14.3.0
2017-03	CT#75	CP-170130	3040	7	B	Introduction of 3GPP PS data off UE status and 3GPP PS data off support indicator	14.3.0
2017-03	CT#75	CP-170119	3042	3	A	Correction to the handling of non-integrity protected reject messages	14.3.0
2017-03	CT#75	CP-170129	3043	3	B	Addition of ePCO for GPRS	14.3.0
2017-03	CT#75	CP-170122	3044	3	F	Resolve DCN-ID length	14.3.0
2017-03	CT#75	CP-170119	3046		A	Further corrections of handling of NAS reject messages without integrity protection	14.3.0
2017-03	CT#75	CP-170136	3053	3	F	(Sol A) Extended DRX parameters handling	14.3.0
2017-06	CT#76	CP-171089	3038	4	B	Indicating policy related to emergency numbers/types received via non-3GPP access	14.4.0
2017-06	CT#76	CP-171089	3056	3	B	Emergency call detection when the UE is connected to both 3GPP and WLAN access	14.4.0
2017-06	CT#76	CP-171084	3057	2	F	Correction of ePCO for GPRS	
2017-06	CT#76	CP-171073	3060	1	B	Support for capability negotiation of reliable data service via PCO	14.4.0
2017-06	CT#76	CP-171092	3061	2	F	Extend Call Disconnect cause with a new cause "Call completed elsewhere"	14.4.0
2017-06	CT#76	CP-171073	3062	2	F	MS support of restriction on enhanced coverage	14.4.0
2017-06	CT#76	CP-171092	3063		D	Fixing figure and table labels	14.4.0
2017-06	CT#76	CP-171074	3064	1	B	Addition of A/Gb mode DCN-ID provisioning	14.4.0
2017-06	CT#76	CP-171084	3065		F	Correction to add SM #57 and SM#58 to SM cause IE	14.4.0
2017-06	CT#76	CP-171092	3067	1	F	Correction on the length of Maximum uplink rate parameter	14.4.0
2017-06	CT#76	CP-171158	3069	4	A	Further corrections to the handling of NAS reject messages without integrity protection	14.4.0
2017-09	CT#77	CP-172111	3072		B	Indicating, via LAU, policy related to emergency numbers/types received via non-3GPP access	14.5.0

2017-09	CT#77	CP-172106	3073		F	Correction of erroneous definition of extended protocol configuration options	14.5.0
2017-09	CT#77	CP-172097	3074		F	Correction of ill-defined condition "in GSM"	14.5.0
2017-09	CT#77	CP-172114	3075	2	F	Extending time for sending DETACH REQUEST in EC GSM IoT	14.5.0
2017-09	CT#77	CP-172114	3076	1	B	Introduction of Multilateration and indication of CC5 support	14.5.0
2017-09	CT#77	CP-172098	3080	1	F	Handling of inter-RAT mobility for MS in eCall only mode capable of eCall over IMS	14.5.0
2017-09	CT#77	CP-172114	3081		F	Keep forbidden PLMN after receiving integrity protected MM/GMM #11,14	14.5.0
2017-09	CT#77	CP-172087	3085	2	A	Setting release of 3GPP TS 44.118 to Release 11	14.5.0
2017-09	CT#77	CP-172116	3070	2	F	Extending maximum bitrate in QoS IE	15.0.0
2017-09	CT#77	CP-172116	3071	1	B	Addition of MS NAS capability for support of dual connectivity with NR	15.0.0
2017-09	CT#77					addition of missing IEI value	15.0.1
2017-12	CT#78	CP-173072	3086		F	Handling of extended QoS IE	15.1.0
2017-12	CT#78	CP-173047	3087	1	A	Correcting trigger for completion of CM Service Request procedure	15.1.0
2017-12	CT#78	CP-173078	3088		F	Correction of the handling of counters for "SIM/USIM considered invalid" events	15.1.0
2017-12	CT#78	CP-173045	3098	1	A	Corrections to the eCall category bit usage	15.1.0
2017-12	CT#78	CP-173067	3100		A	Correction to handling of non-integrity protected GMM #14	15.1.0
2017-12	CT#78	CP-173072	3101	2	B	Extended Quality of Service IE applicability	15.1.0
2017-12	CT#78	CP-173078	3102		F	Starting T3302 for NW initiated Deatch with no cause value and "re-attach not required"	15.1.0
2017-12	CT#78	CP-173060	3104	1	A	Enhancement of APN rate control for MO exception data	15.1.0
2017-12	CT#78	CP-173078	3105		F	Correction to the handling of non-integrity protected reject messages	15.1.0
2017-12	CT#78	CP-173078	3106		F	Correction to CC_U1_CALL_INIT State	15.1.0
2018-03	CT#79	CP-180081	3109	1	F	Correction of references for Extended QoS IE	15.2.0
2018-03	CT#79	CP-180079	3111		B	bSRVCC-MT NAS	15.2.0
2018-03	CT#79	CP-180089	3115	2	F	Updating periodic RAU timer and PSM during service request	15.2.0
2018-03	CT#79	CP-180077	3116	4	B	S-NSSAI of a PDN connection context vie (e)PCO	15.2.0
2018-03	CT#79	CP-180065	3118	2	A	Correction of applicability of time value unit 110 in GPRS Timer 3 for T3412 extended value IE	15.2.0
2018-03	CT#79	CP-180077	3119	1	B	Session AMBR and QoS rules in (e)PCO	15.2.0
2018-03	CT#79	CP-180077	3121		B	5G SM - PDU session address lifetime PCO parameter	15.2.0
2018-03	CT#79	CP-180089	3122	5	D	Identify the Local Emergency Number List	15.2.0
2018-03	CT#79	CP-180089	3123		F	Corrections in handling of Attach/RAU reject with cause #3, #6 or #8	15.2.0
2018-03	CT#79	CP-180089	3124	1	F	Corrections in handling GPRS Attach Reject with GMM cause #14 in VPLMN	15.2.0
2018-06	CT#80	CP-181076	3126		F	Applying EAB for access barring and skiping EAB for paging	15.3.0
2018-06	CT#80	CP-181076	3127		F	Correction on ACDC for access control	15.3.0
2018-06	CT#80	CP-181059	3128	2	B	Clarify that the newly introduced Extended Local Emergency Number List does not apply to the CS domain	15.3.0
2018-06	CT#80	CP-181059	3129	1	B	Intersystem change from N1 mode to A/Gb or lu mode	15.3.0
2018-06	CT#80	CP-181076	3130		F	Deleting equivalent PLMNs for network initiated detach	15.3.0
2018-06	CT#80	CP-181074	3131	1	B	Enabling 3GPP PS data off in roaming	15.3.0
2018-06	CT#80	CP-181059	3132	2	B	Adding 5GS NAS messages to clause 11	15.3.0
2018-06	CT#80	CP-181076	3134		F	Wrong "slogan" for cause value 98, message not compatible with protocol state	15.3.0
2018-06	CT#80	CP-181076	3135	2	F	Corrections to handling of timer T3302	15.3.0
2018-06	CT#80	CP-181076	3136		C	Incrementing of counter for "SIM/USIM considered invalid for non-GPRS services" in lu mode	15.3.0
2018-06	CT#80	CP-181076	3137		F	Correction on service request as paging response	15.3.0
2018-09	CT#81	CP-182128	3133	1	B	5G QoS - PCO parameter due to restructuring QoS rules	15.4.0
2018-09	CT#81	CP-182158	3140	1	F	Pass Emergency Number List to upper layers	15.4.0
2018-09	CT#81	CP-182128	3141	1	F	Correction for MTUs for Ethernet and Unstructured PDU sessions	15.4.0
2018-09	CT#81	CP-182158	3143	1	B	Introduction of capability support for Security for MTA in network configuration without LLC security	15.4.0
2018-09	CT#81	CP-182128	3144		F	Change NR coverage to NG-RAN coverage	15.4.0
2018-09	CT#81	CP-182128	3149	2	F	Setting T3396 due to "DNN based congestion control"	15.4.0
2018-12	CT#82	CP-183066	3152	1	A	Correction for 3GPP PS data off and non-IP user data packets	15.5.0
2018-12	CT#82	CP-183031	3153		F	Correction in semantic of MTUs for Ethernet and Unstructured PDU sessions	15.5.0
2018-12	CT#82	CP-183076	3155	1	F	Correct validity of emergency number list	15.5.0
2018-12	CT#82	CP-183031	3156	1	F	Addition of 5GSM cause value in PCO/ePCO (Solution 1)	15.5.0
2018-12	CT#82	CP-183076	3158		F	CSN1 error - Multilateration and indication of CC5 support and Security for MTA	15.5.0
2018-12	CT#82	CP-183076	3159	1	F	Clarification during TMSI reallocation procedure.	15.5.0
2018-12	CT#82	CP-183066	3162	1	A	Correction for indicating 3GPP PS data off status	15.5.0
2018-12	CT#82	CP-183031	3163	2	F	Location area updating procedure upon moving from NG-RAN to GERAN or UTRAN coverage	15.5.0
2018-12	CT#82	CP-183031	3164	1	F	Clarification on the encoding of 5GC parameters in the PCO	15.5.0

2018-12	CT#82	CP-183076	3166	1	B	Introduction of capability support for EC paging indication channel monitoring	15.5.0
2019-03	CT#83	CP-190100	3165	2	F	Collision between paging for non-GPRS services and MS initiated PS NAS procedures	15.6.0
2019-03	CT#83	CP-190083	3168	2	F	Removal of wrong reference for back-off timer	15.6.0
2019-03	CT#83	CP-190083	3169	2	F	Including QoS rules or QoS flow descriptions with the length of two octets in ePCO	15.6.0
2019-03	CT#83	CP-190106	3167	4	B	SINE_5G: Back-off timer update for 5GS	16.0.0
2019-03	CT#83	CP-190215	3170	4	B	Request Type for supporting UE access to RLOS	16.0.0
2019-06	CT#84	CP-191147	3171		B	Ethernet based packet filters	16.1.0
2019-06	CT#84	CP-191137	3172		B	PCO parameters for ACS information	16.1.0
2019-06	CT#84	CP-191144	3175		F	"RLOS" request type in EPC network not supporting access to RLOS	16.1.0
2019-06	CT#84	CP-191144	3176		F	Correction to referred specification for definition of RLOS	16.1.0
2019-06	CT#84	CP-191128	3177	1	B	Small data rate control, PCO parameters	16.1.0
2019-06	CT#84	CP-191128	3178		B	Update to the eDRX timers to reference UEs in NB-N1 and WB-N1 mode	16.1.0
2019-06	CT#84	CP-191131	3180	1	F	Coordination between GMM and 5GMM	16.1.0
2019-06	CT#84	CP-191147	3182	1	F	Detach procedure clarification	16.1.0
2019-06	CT#84	CP-191131	3184		B	T3247 update	16.1.0
2019-06	CT#84	CP-191128	3185	1	B	Update to timer table to allow the use of timer T3324 for MICO mode	16.1.0
2019-06	CT#84	CP-191128	3186		F	Update reference to TS 24.250	16.1.0
2019-06	CT#84	CP-191147	3187		F	Clarification for GMM cause #3, #6, #8, and #11	16.1.0
2019-06	CT#84	CP-191131	3189	1	F	Indication of support for P-CSCF re-selection from UE to SMF	16.1.0
2019-09	CT#85	CP-192040	3193	1	A	Multislot capability declaration for EC-GSM-IoT supporting MS	16.2.0
2019-09	CT#85	CP-192071	3194		F	Keep equivalent PLMNs list for GMM cause #7	16.2.0
2019-09	CT#85	CP-192070	3195		F	5GSM cause #27 and #70 for back-off timer	16.2.0
2019-09	CT#85	CP-192072	3197	1	F	T3247 for a UE operating in SNPN access mode	16.2.0
2019-12	CT#86	CP-193087	3199	1	F	Coding for small data rate control status	16.3.0
2019-12	CT#86	CP-193091	3200		B	CK and IK derivation for 5G-SRVCC	16.3.0
2019-12	CT#86	CP-193091	3201		B	Call establishment for 5G-SRVCC	16.3.0
2019-12	CT#86	CP-193116	3202	1	F	Correction of handling of GPRS detach procedure in ATTEMPTING-TO-UPDATE	16.3.0
2019-12	CT#86	CP-193116	3203	1	F	Corrections and enhancements for T3340	16.3.0
2019-12	CT#86	CP-193116	3204		F	Correcting timer calculation for GPRS MS using EC-GSM-IoT	16.3.0
2019-12	CT#86	CP-193116	3207		F	Correction of the erroneous maximum length of the Quality of service IE	16.3.0
2019-12	CT#86	CP-193084	3209		A	Correction to the length of two octets support indicator	16.3.0
2020-03	CT#87e	CP-200113	3211	1	B	ATSSS PCO parameters for 5G-RG	16.4.0
2020-06	CT#88e	CP-201131	3214		F	Remove invalid cases in error handling for TFT operation	16.5.0
2020-06	CT#88e	CP-201095	3216	1	B	Encoding of initial APN data rate control parameters	16.5.0
2020-06	CT#88e	CP-201131	3217		F	Correction to Handling of T3321 timer	16.5.0
2020-06	CT#88e	CP-201131	3218	1	F	Clarification of the cause of start of T3245	16.5.0
2020-06	CT#88e	CP-201131	3219	1	F	Correction to handling of #3/#6/#8	16.5.0
2020-06	CT#88e	CP-201131	3220		F	Correction to handling of #9	16.5.0
2020-06	CT#88e	CP-201131	3221	1	F	Correction to handling of paging in GMM-REG.ATTEMPTING-TO-UPDATE	16.5.0
2020-06	CT#88e	CP-201131	3222		F	Correction to handling of paging in MM IDLE ATTEMPTING TO UPDATE state	16.5.0
2020-06	CT#88e	CP-201131	3223		F	Correction to GMM-DEREGISTERED.ATTEMPTING-TO-ATTACH	16.5.0
2020-06	CT#88e	CP-201131	3224	1	F	Correction to GMM-DEREGISTERED.NORMAL-SERVICE	16.5.0
2020-06	CT#88e	CP-201101	3225		F	T3346 triggers for 5GS	16.5.0
2020-06	CT#88e	CP-201321	3226	2	B	Provisioning of DNS server security information to the UE	16.5.0
2020-06	CT#88e	CP-201131	3227		F	No retry in 4G for PDP type related SM causes	16.5.0
2020-09	CT#89e	CP-202145	3229	3	A	PAP/CHAP Information over 5GC	16.6.0
2020-09	CT#89e	CP-202149	3232	1	F	Align description of Request type values with its use in 5GS	16.6.0
2020-09	CT#89e	CP-202166	3234	1	F	Support P-CSCF and DNS IPv4 Address in ePCO for N1 mode in Rel-16	16.6.0
2020-09	CT#89e	CP-202166	3237	1	F	Clarification for SR attempt count reset	16.6.0
2020-09	CT#89e	CP-202166	3238		F	Correction to typo in CR#3224	16.6.0
2020-09	CT#89e	CP-202166	3239		F	Handling of T3321 in AUTH REJ	16.6.0
2020-09	CT#89e	CP-202170	3242	1	F	T3245 for a UE operating in SNPN access mode: 24.008	16.6.0

2021-03	CT#91e	CP-210114	3255	1	F	Removing descriptions about a UE operating in SNPN access operation mode	16.7.0
2021-03	CT#91e	CP-210107	3262	1	F	Local IP address in TFT negotiation in 5GS for 5G-4G interworking	16.7.0

History

Document history		
V16.5.0	July 2020	Publication
V16.6.0	October 2020	Publication
V16.7.0	April 2021	Publication