

ETSI TS 123 540 V17.2.0 (2023-07)



5G;
5G System: Technical realization
of Service Based Short Message Service;
Stage 2
(3GPP TS 23.540 version 17.2.0 Release 17)



Reference

RTS/TSGC-0423540vh20

Keywords

5G

ETSI

650 Route des Lucioles
F-06921 Sophia Antipolis Cedex - FRANCE

Tel.: +33 4 92 94 42 00 Fax: +33 4 93 65 47 16

Siret N° 348 623 562 00017 - APE 7112B
Association à but non lucratif enregistrée à la
Sous-Préfecture de Grasse (06) N° w061004871

Important notice

The present document can be downloaded from:
<https://www.etsi.org/standards-search>

The present document may be made available in electronic versions and/or in print. The content of any electronic and/or print versions of the present document shall not be modified without the prior written authorization of ETSI. In case of any existing or perceived difference in contents between such versions and/or in print, the prevailing version of an ETSI deliverable is the one made publicly available in PDF format at www.etsi.org/deliver.

Users of the present document should be aware that the document may be subject to revision or change of status. Information on the current status of this and other ETSI documents is available at <https://portal.etsi.org/TB/ETSIDeliverableStatus.aspx>

If you find errors in the present document, please send your comment to one of the following services:
<https://portal.etsi.org/People/CommitteeSupportStaff.aspx>

If you find a security vulnerability in the present document, please report it through our Coordinated Vulnerability Disclosure Program:
<https://www.etsi.org/standards/coordinated-vulnerability-disclosure>

Notice of disclaimer & limitation of liability

The information provided in the present deliverable is directed solely to professionals who have the appropriate degree of experience to understand and interpret its content in accordance with generally accepted engineering or other professional standard and applicable regulations.

No recommendation as to products and services or vendors is made or should be implied.

No representation or warranty is made that this deliverable is technically accurate or sufficient or conforms to any law and/or governmental rule and/or regulation and further, no representation or warranty is made of merchantability or fitness for any particular purpose or against infringement of intellectual property rights.

In no event shall ETSI be held liable for loss of profits or any other incidental or consequential damages.

Any software contained in this deliverable is provided "AS IS" with no warranties, express or implied, including but not limited to, the warranties of merchantability, fitness for a particular purpose and non-infringement of intellectual property rights and ETSI shall not be held liable in any event for any damages whatsoever (including, without limitation, damages for loss of profits, business interruption, loss of information, or any other pecuniary loss) arising out of or related to the use of or inability to use the software.

Copyright Notification

No part may be reproduced or utilized in any form or by any means, electronic or mechanical, including photocopying and microfilm except as authorized by written permission of ETSI.

The content of the PDF version shall not be modified without the written authorization of ETSI.
The copyright and the foregoing restriction extend to reproduction in all media.

© ETSI 2023.
All rights reserved.

Intellectual Property Rights

Essential patents

IPRs essential or potentially essential to normative deliverables may have been declared to ETSI. The declarations pertaining to these essential IPRs, if any, are publicly available for **ETSI members and non-members**, and can be found in ETSI SR 000 314: "*Intellectual Property Rights (IPRs); Essential, or potentially Essential, IPRs notified to ETSI in respect of ETSI standards*", which is available from the ETSI Secretariat. Latest updates are available on the ETSI Web server (<https://ipr.etsi.org/>).

Pursuant to the ETSI Directives including the ETSI IPR Policy, no investigation regarding the essentiality of IPRs, including IPR searches, has been carried out by ETSI. No guarantee can be given as to the existence of other IPRs not referenced in ETSI SR 000 314 (or the updates on the ETSI Web server) which are, or may be, or may become, essential to the present document.

Trademarks

The present document may include trademarks and/or tradenames which are asserted and/or registered by their owners. ETSI claims no ownership of these except for any which are indicated as being the property of ETSI, and conveys no right to use or reproduce any trademark and/or tradename. Mention of those trademarks in the present document does not constitute an endorsement by ETSI of products, services or organizations associated with those trademarks.

DECT™, **PLUGTESTS™**, **UMTS™** and the ETSI logo are trademarks of ETSI registered for the benefit of its Members. **3GPP™** and **LTE™** are trademarks of ETSI registered for the benefit of its Members and of the 3GPP Organizational Partners. **oneM2M™** logo is a trademark of ETSI registered for the benefit of its Members and of the oneM2M Partners. **GSM®** and the GSM logo are trademarks registered and owned by the GSM Association.

Legal Notice

This Technical Specification (TS) has been produced by ETSI 3rd Generation Partnership Project (3GPP).

The present document may refer to technical specifications or reports using their 3GPP identities. These shall be interpreted as being references to the corresponding ETSI deliverables.

The cross reference between 3GPP and ETSI identities can be found under <https://webapp.etsi.org/key/queryform.asp>.

Modal verbs terminology

In the present document "**shall**", "**shall not**", "**should**", "**should not**", "**may**", "**need not**", "**will**", "**will not**", "**can**" and "**cannot**" are to be interpreted as described in clause 3.2 of the [ETSI Drafting Rules](#) (Verbal forms for the expression of provisions).

"**must**" and "**must not**" are **NOT** allowed in ETSI deliverables except when used in direct citation.

Contents

Intellectual Property Rights	2
Legal Notice	2
Modal verbs terminology.....	2
Foreword.....	5
1 Scope	7
2 References	7
3 Definitions of terms and abbreviations.....	7
3.1 Terms.....	7
3.2 Abbreviations	8
4 Architecture to support SBI-based SMS	8
4.1 Architecture to support SBI-based SMS	8
4.2 Reference point to support SBI-based SMS	10
4.3 Service based interface to support SBI-based SMS	10
5 Procedures for SBI-based SMS.....	11
5.1 Procedure for SBI-based MT SMS.....	11
5.1.1 General.....	11
5.1.2 Successful Mobile Terminated short message transfer without SMS Router/ IP-SM-GW.....	12
5.1.3 Successful Mobile Terminated short message transfer via SMS Router	14
5.1.4 Successful Mobile Terminated short message transfer via IP-SM-GW.....	16
5.1.5 Unsuccessful Mobile Terminated short message transfer without SMS Router/IP-SM-GW	18
5.1.6 Unsuccessful Mobile Terminated short message transfer via IP-SM-GW	20
5.1.7 GPSI-to-Subscription-Network resolution procedure.....	21
5.1.7.1 General	21
5.1.7.2 GPSI-to-Subscription-Network resolution triggered by the SMS-GMSC	22
5.1.7.2.1 General	22
5.1.7.2.2 GPSI-to-Subscription-Network resolution triggered by the SMS-GMSC for Direct routing.....	23
5.1.7.2.3 GPSI-to-Subscription-Network resolution triggered by the SMS-GMSC for Indirect routing	24
5.1.7.3 SCP supports GPSI-to-Subscription-Network resolution procedure.....	25
5.1.7.3.1 General	25
5.1.7.3.2 SCP supports GPSI-to-Subscription-Network resolution with MNPF	26
5.1.7.3.3 SCP supports GPSI-to-Subscription-Network resolution with NRF	27
5.1.7.3.4 SCP supports GPSI-to-Subscription-Network resolution with MNPF for Direct routing	28
5.1.7.3.5 SCP supports GPSI-to-Subscription-Network resolution with MNPF for Indirect routing.....	30
5.1.7.4 GPSI-to-Subscription-Network resolution using NRF.....	31
5.1.8 Alert.....	34
5.1.9 Unsuccessful Mobile Terminated short message transfer via SMS Router	35
5.2 Procedure for SBI-based MO SMS	36
5.2.1 General.....	36
5.2.2 Procedure for Successful Mobile Originated short message transfer.....	37
5.2.3 Unsuccessful Mobile Originated short message transfer	37
5.2.4 MSISDN-less MO SMS message transfer	39
6 Services for SBI-based SMS	40
6.1 General	40
6.2 UDM services for SBI-based SMS.....	40
6.2.1 General.....	40
6.2.2 Nudm_ReportSMDeliveryStatus service.....	40
6.2.2.1 General.....	40
6.2.2.2 Nudm_ReportSMDeliveryStatus_Request service operation	40
6.2.3 Nudm_EventExposure service.....	40
6.2.4 Nudm_UECM service.....	41
6.3 SMS-IWMSC services for SBI-based SMS	41
6.3.1 General.....	41

6.3.2	Niwmsc_SMSservice service	41
6.3.2.1	General	41
6.3.2.2	Niwmsc_SMSservice_MoForwardSm service operation	41
6.4	SMSF services for SBI-based SMS	41
6.4.1	General	41
6.4.2	Nsmsf_SMSservice service	42
6.4.2.1	General	42
6.4.2.2	Nsmsf_SMSservice_MtForwardSm service operation	42
6.5	IP-SM-GW services for SBI-based SMS	42
6.5.1	General	42
6.5.2	Nipsmgw_SMSservice service	42
6.5.2.1	General	42
6.5.2.2	Nipsmgw_SMSservice_RoutingInfo service operation	42
6.5.2.3	Nipsmgw_SMSservice_MtForwardSm service operation	43
6.6	SMS Router services for SBI-based SMS	43
6.6.1	General	43
6.6.2	Nrouter_SMSservice service	43
6.6.2.1	General	43
6.6.2.2	Nrouter_SMSservice_RoutingInfo service operation	43
6.6.2.3	Nrouter_SMSservice_MtForwardSm service operation	43
6.7	MNPF services for SBI-based SMS	44
6.7.1	General	44
6.7.2	Nmnpf_NPStatus service	44
6.7.2.1	General	44
6.7.2.2	Nmnpf_NPStatus_Get service operation	44
6.8	NEF services for SBI-based SMS	44
6.8.1	General	44
6.8.2	Nnef_SMSservice service	45
6.8.2.1	General	45
6.8.2.2	Nnef_SMSservice_MoForwardSm service operation	45
Annex A (informative): Change history		46
History		47

Foreword

This Technical Specification has been produced by the 3rd Generation Partnership Project (3GPP).

The contents of the present document are subject to continuing work within the TSG and may change following formal TSG approval. Should the TSG modify the contents of the present document, it will be re-released by the TSG with an identifying change of release date and an increase in version number as follows:

Version x.y.z

where:

- x the first digit:
 - 1 presented to TSG for information;
 - 2 presented to TSG for approval;
 - 3 or greater indicates TSG approved document under change control.
- y the second digit is incremented for all changes of substance, i.e. technical enhancements, corrections, updates, etc.
- z the third digit is incremented when editorial only changes have been incorporated in the document.

In the present document, modal verbs have the following meanings:

- shall** indicates a mandatory requirement to do something
- shall not** indicates an interdiction (prohibition) to do something

The constructions "shall" and "shall not" are confined to the context of normative provisions, and do not appear in Technical Reports.

The constructions "must" and "must not" are not used as substitutes for "shall" and "shall not". Their use is avoided insofar as possible, and they are not used in a normative context except in a direct citation from an external, referenced, non-3GPP document, or so as to maintain continuity of style when extending or modifying the provisions of such a referenced document.

- should** indicates a recommendation to do something
- should not** indicates a recommendation not to do something
- may** indicates permission to do something
- need not** indicates permission not to do something

The construction "may not" is ambiguous and is not used in normative elements. The unambiguous constructions "might not" or "shall not" are used instead, depending upon the meaning intended.

- can** indicates that something is possible
- cannot** indicates that something is impossible

The constructions "can" and "cannot" are not substitutes for "may" and "need not".

- will** indicates that something is certain or expected to happen as a result of action taken by an agency the behaviour of which is outside the scope of the present document
- will not** indicates that something is certain or expected not to happen as a result of action taken by an agency the behaviour of which is outside the scope of the present document
- might** indicates a likelihood that something will happen as a result of action taken by some agency the behaviour of which is outside the scope of the present document

might not indicates a likelihood that something will not happen as a result of action taken by some agency the behaviour of which is outside the scope of the present document

In addition:

is (or any other verb in the indicative mood) indicates a statement of fact

is not (or any other negative verb in the indicative mood) indicates a statement of fact

The constructions "is" and "is not" do not indicate requirements.

1 Scope

The present document defines the Stage 2 architecture, procedures and services to support service based short message service (SMS) in 5G system (5GS).

2 References

The following documents contain provisions which, through reference in this text, constitute provisions of the present document.

- References are either specific (identified by date of publication, edition number, version number, etc.) or non-specific.
- For a specific reference, subsequent revisions do not apply.
- For a non-specific reference, the latest version applies. In the case of a reference to a 3GPP document (including a GSM document), a non-specific reference implicitly refers to the latest version of that document *in the same Release as the present document*.

- [1] 3GPP TR 21.905: "Vocabulary for 3GPP Specifications".
- [2] 3GPP TS 23.040: "Technical realization of the Short Message Service (SMS)".
- [3] 3GPP TS 23.501: "System architecture for the 5G System (5GS); Stage 2".
- [4] 3GPP TS 23.502: "Procedures for the 5G System (5GS); Stage 2".
- [5] 3GPP TS 23.632: "User data interworking, coexistence and migration; Stage 2".
- [6] 3GPP TS 29.540: "5G System; SMS Services; Stage 3".
- [7] 3GPP TS 29.503: "5G System; Unified Data Management Services; Stage 3".
- [8] 3GPP TS 24.011: "Point-to-Point (PP) Short Message Service (SMS) support on mobile radio interface".
- [9] 3GPP TS 29.573: "5G System; Public Land Mobile Network (PLMN) Interconnection; Stage 3".
- [10] 3GPP TS 29.510: "5G System; Network Function Repository Services; Stage 3".
- [11] 3GPP TS 29.500: "5G System; Technical Realization of Service Based Architecture; Stage 3".
- [12] IETF RFC 6116: "The E.164 to Uniform Resource Identifiers (URI) Dynamic Delegation Discovery System (DDDS) Application (ENUM)".
- [13] IETF RFC 4002: "IANA Registration for Enumservice 'web' and 'ft'".
- [14] IETF RFC 6118: "Update of Legacy IANA Registrations of Enumservices".
- [15] 3GPP TS 23.204: "Support of Short Message Service (SMS) over generic 3GPP Internet Protocol (IP) access; Stage 2".

3 Definitions of terms and abbreviations

3.1 Terms

For the purposes of the present document, the terms given in 3GPP TR 21.905 [1] and the following apply. A term defined in the present document takes precedence over the definition of the same term, if any, in 3GPP TR 21.905 [1].

alert-SC: service element provided by a GSM/UMTS/EPS/5GS PLMN to inform an SC which has previously initiated unsuccessful short message delivery attempt(s) to a specific MS/UE, that the MS/UE is now recognized by the PLMN to have recovered operation.

Gateway MSC For Short Message Service (SMS-GMSC): function of an MSC capable of receiving a short message from an SC, interrogating an HLR/HSS/UDM for routing information and SMS info, and delivering the short message to the VMSC/SGSN/MME/SMSF of the recipient MS/UE.

Interworking MSC For Short Message Service (SMS-IWMSC): function of an MSC capable of receiving a short message from within the PLMN and submitting it to the recipient SC.

IP-Short-Message-Gateway (IP-SM-GW): function responsible for protocol interworking between the IP-based UE and the SC.

Service Centre (SC): function responsible for the relaying and store and forwarding of a short message between an SME and an MS/UE.

3.2 Abbreviations

For the purposes of the present document, the abbreviations given in 3GPP TR 21.905 [1] and the following apply. An abbreviation defined in the present document takes precedence over the definition of the same abbreviation, if any, in 3GPP TR 21.905 [1].

GPSI	Generic Public Subscription Identifier
MNPF	Mobile Number Portability Function
MO SMS	Mobile Originated Short Message Service
MT SMS	Mobile Terminated Short Message Service
NAS	Non-Access-Stratum
NP	Number Portability
NRF	Network Repository Function
SBA	Service Based Architecture
SBI	Service Based Interface
SCP	Service Communication Proxy
SMS	Short Message Service
SM MO	Short Message Mobile Originated
SM MT	Short Message Mobile Terminated
SMSF	Short Message Service Function
SMSoNAS	SMS over NAS
UDM	Unified Data Management

4 Architecture to support SBI-based SMS

4.1 Architecture to support SBI-based SMS

Figure 4.1-1 shows the non-roaming architecture to support SBI-based SMS.

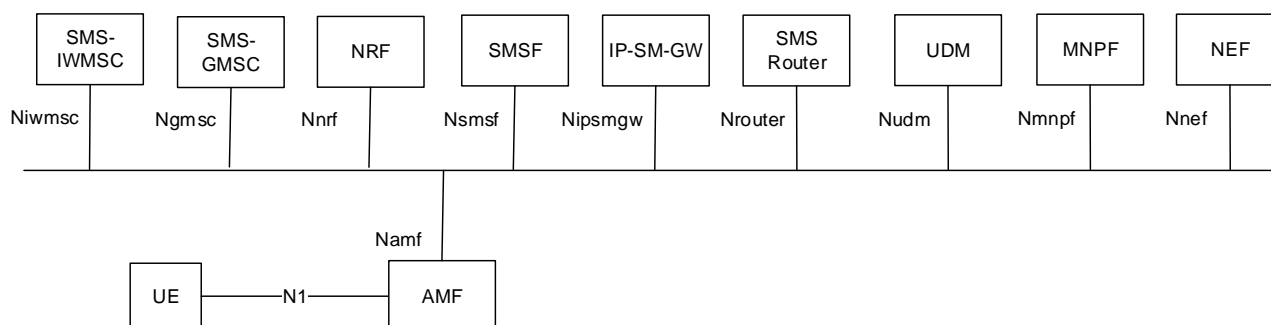

Figure 4.1-1: Non-roaming System Architecture for SBI-based SMS

Figure 4.1-2a, Figure 4.1-2b Figure 4.1-2c and Figure 4.1-2d depict the non-roaming architecture to support SBI-based SMS, using the reference point representation showing how various network functions interact with each other

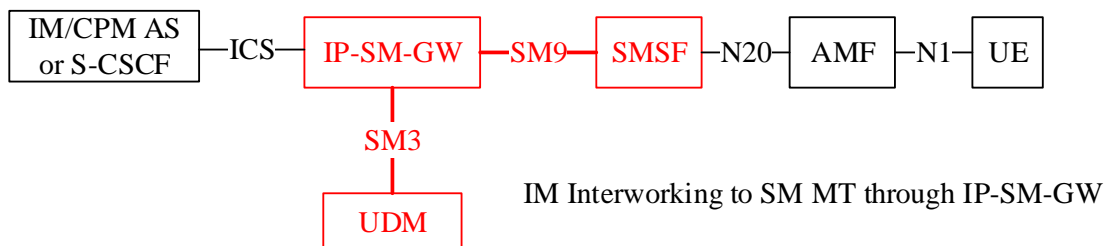
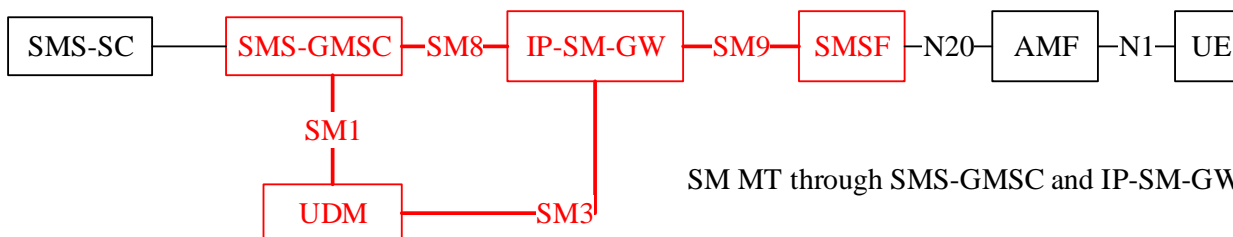
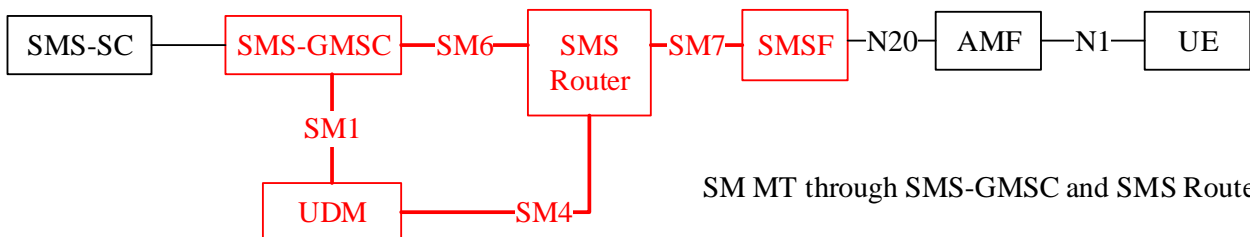
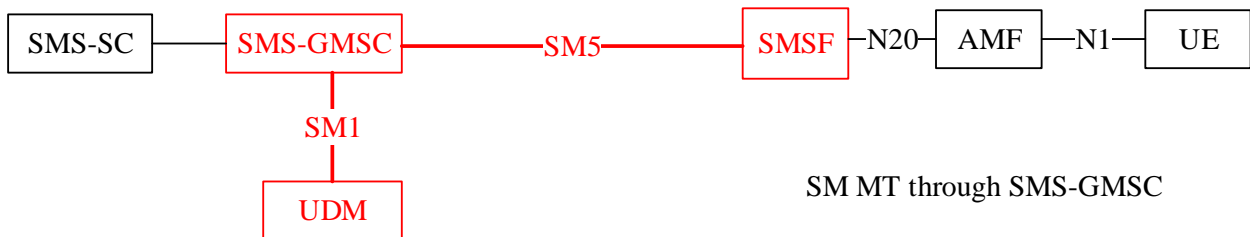

Figure 4.1-2a: Non-roaming System Architecture for SBI-based MT SMS in reference point representation

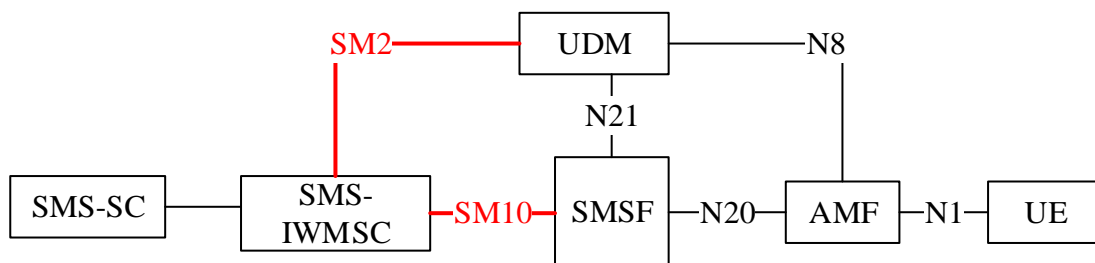

Figure 4.1-2b: Non-roaming System Architecture for SBI-based MO SMS in reference point representation

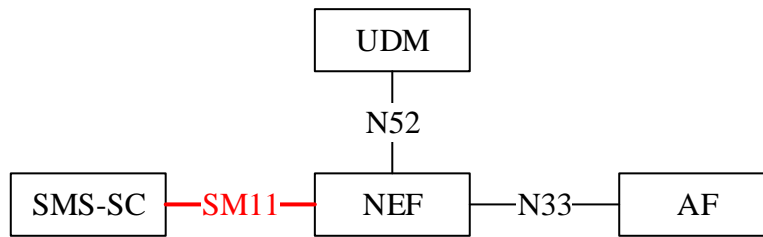

Figure 4.1-2c: Architecture for SBI-based MSISDN-less MO SMS in reference point representation

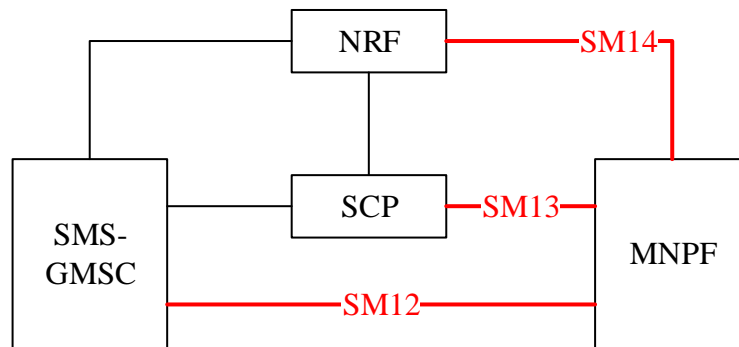

Figure 4.1-2d: Architecture for NP staute Retrieval from MNPF in reference point representation

NOTE 1: The newly introduced reference points for SMS_SBI are marked in red, and numbered from SM1 to SM14.

4.2 Reference point to support SBI-based SMS

Besides the reference point to support SMS over NAS described in clause 4.4.2.2 of TS 23.501 [3], the following reference points are needed to support SBI-based SMS:

- Reference point SM1: Reference point for routing information between SMS-GMSC and UDM.
- Reference point SM2: Reference point between SMS-IWMSC and UDM.
- Reference point SM3: Reference point for routing information between IP-SM-GW and UDM.
- Reference point SM4: Reference point for routing information between SMS Router and UDM.
- Reference point SM5: Reference point for SMS message transfer between SMS-GMSC and SMSF.
- Reference point SM6: Reference point for SMS message transfer between SMS-GMSC and SMS Router.
- Reference point SM7: Reference point for SMS message transfer between SMSF and SMS Router.
- Reference point SM8: Reference point for SMS message transfer between SMS-GMSC and IP-SM-GW.
- Reference point SM9: Reference point for SMS message transfer between SMSF and IP-SM-GW
- Reference point SM10: Reference point for SMS message transfer between SMS-IWMSC and SMSF.
- Reference point SM11: Reference point for SMS message transfer between SMS-SC and NEF.
- Reference point SM12: Reference point for SMS message transfer between SMS-GMSC and MNPF.
- Reference point SM13: Reference point for SMS message transfer between SCP and MNPF.
- Reference point SM14: Reference point for SMS message transfer between NRF and MNPF.

4.3 Service based interface to support SBI-based SMS

Besides the service based interfaces to support SMS over NAS described in clause 4.4.2.3 of TS 23.501 [3], the following service based interfaces are needed to support SBI-based SMS.

Nudm: Service-based interface exhibited by UDM

Nnrf: Service-based interface exhibited by NRF

Ngmsc: Service-based interface exhibited by SMS-GMSC

Niwmsc: Service-based interface exhibited by SMS-IWMSC

Nipsmgw: Service-based interface exhibited by IP-SM-GW

Nrouter: Service-based interface exhibited by SMS Router

Nnef: Service-based interface exhibited by NEF

Nmnpf: Service-based interface exhibited by MNPF

5 Procedures for SBI-based SMS

5.1 Procedure for SBI-based MT SMS

5.1.1 General

The procedure is used to support the Mobile Terminated short message transfer for SBI-based interfaces as defined in clause 4.1, which is based on Short message mobile terminated procedure defined in clause 10.1 of 3GPP TS 23.040 [2] and clauses 4.13.3.6, 4.13.3.7 and 4.13.3.8 of 3GPP TS 23.502 [4].

This new services introduced in this procedure can be registered in NRF, and discovered by NF service consumers.

SMSF/SMS Router/IP-SM-GW should indicate whether it supports SMS_SBI or not. For the case of SMSF/IP-SM-GW, "SBI support indication" should be brought when SMSF/IP-SM-GW registers in UDM. For the case of SMS Router, "SBI support indication" should be configured locally in UDM, together with the SMS Router address. UDM stores the "SBI support indication" indication and provides it to the SMS-GMSC during Routing Info retrieval. SMS-GMSC selects legacy or SBI based protocol based on the indication received during Routing Info retrieval.

5.1.2 Successful Mobile Terminated short message transfer without SMS Router/ IP-SM-GW

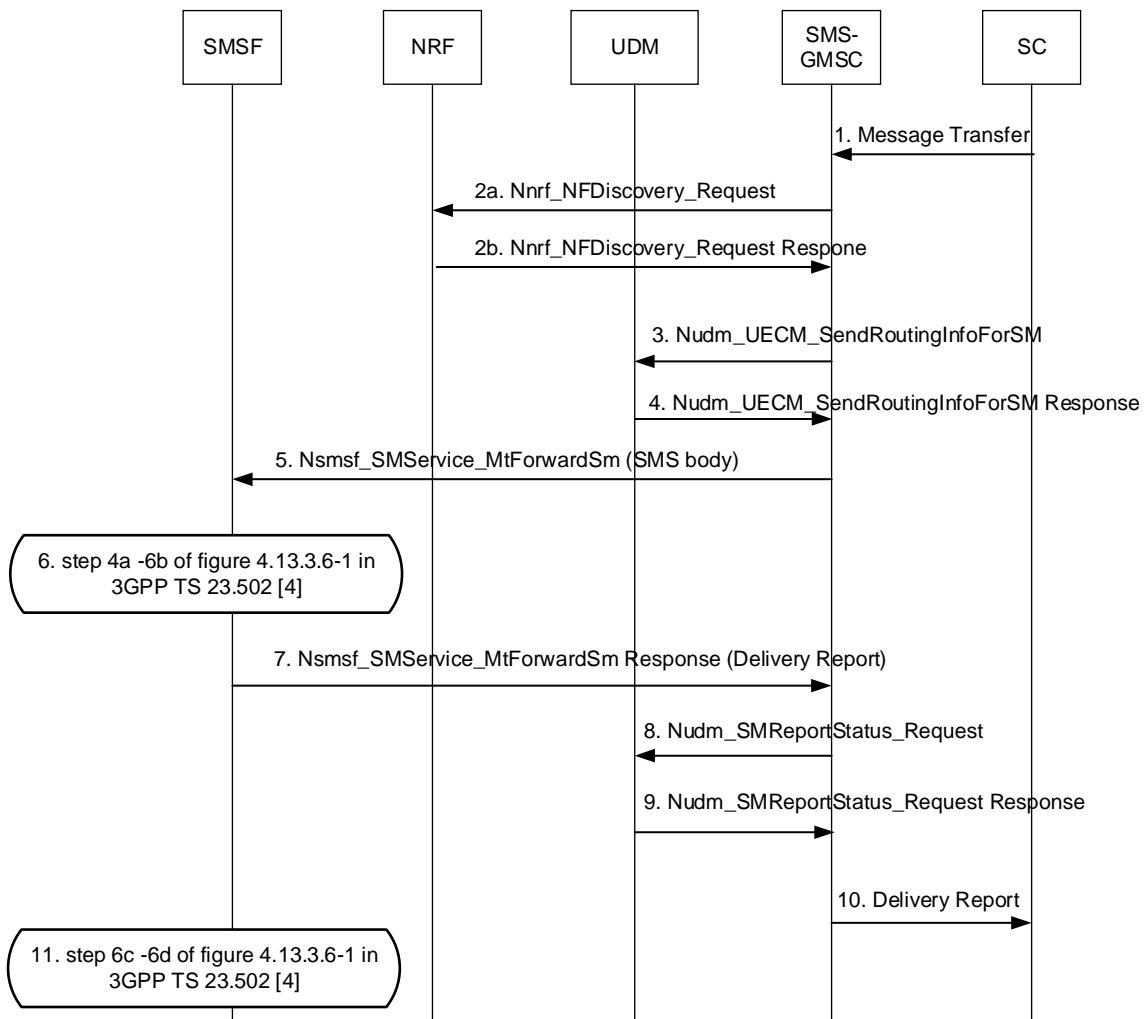

Figure 5.1.2-1: MT SMS over NAS without SMS Router/ IP-SM-GW

1. MT SMS interaction between SC and SMS-GMSC follow the current procedure as defined in 3GPP TS 23.040 [2].
- 2a-2b. The SMS-GMSC should query the NRF to find the UDM instance(s), supporting SMS SBI interfaces, and managing that manages the user subscriptions of the GPSI. The SMS-GMSC may need to retrieve the PLMN ID of the recipients GPSI before the discovery of the UDM instance based on the GPSI-to-Subscription-Network resolution procedure defined in clause 5.1.7.
3. SMS-GMSC invokes Nudm_UECM_SendRoutingInfoForSM (GPSI) to the UDM to get the routing information of the nodes available for MT SMS delivery, in this case the registered serving SMSF instances for all access types for the UE.
4. The UDM shall check the registration/reachability flags to determine the potential target nodes and responds to the SMS-GMSC by sending Nudm_UECM_SendRoutingInfoForSM response, in this procedure the SMSF instance Id and the indication for SMSF SMS_SBI support are included in the response message. The UDM shall include the SMSF for 3GPP access and the SMSF for non-3GPP access separately, if both the SMSFs are currently known to be valid for the UE.

5. The SMS-GMSC forwards the SMS message to the SMSF. If the SMS-GMSC has more than one SMSF address to use for SMS transport towards the UE, then the SMS-GMSC chooses which SMSF address to use first, based on operator local policy.

The SMS-GMSC selects protocol based on the indication for SMSF SMS_SBI support.

If SMSF indicates it supports SMS_SBI, SMS-GMSC forwards the SMS message to the SMSF by invoking Nsmsf_SMSservice_MtForwardSm service operation.

If SMSF indicates that it does not support SMS_SBI, SMS-GMSC should forward SMS message to SMSF by legacy MAP/Diameter protocol. And the following steps follow the procedures for legacy MT SMS message transfer, as illustrated in Figure 15a of TS23.040 [2].

6. MT SMS over NAS procedure between SMSF, AMF and UE is same as the definition in step 4a to 6b of Figure 4.13.3.6-1 of 3GPP TS 23.502 [4].
7. The SMSF delivers the delivery report to SMS-GMSC by sending the Nsmsf_SMSservice_MtForwardSm response to the SMS-GMSC.
8. The SMS-GMSC updates the SM-Delivery Report Status to UDM by invoking Nudm_SMReportStatus_Request.
9. UDM responses Nudm_SMReportStatus_Request response to SMS-GMSC.
10. The SMS-GMSC delivers the delivery report to SC as defined in TS 23.040 [2].
11. MT SMS over NAS procedure between SMSF, AMF and UE is same as the definition in step 6c to 6d of Figure 4.13.3.6-1 of 3GPP TS 23.502 [4].

5.1.3 Successful Mobile Terminated short message transfer via SMS Router

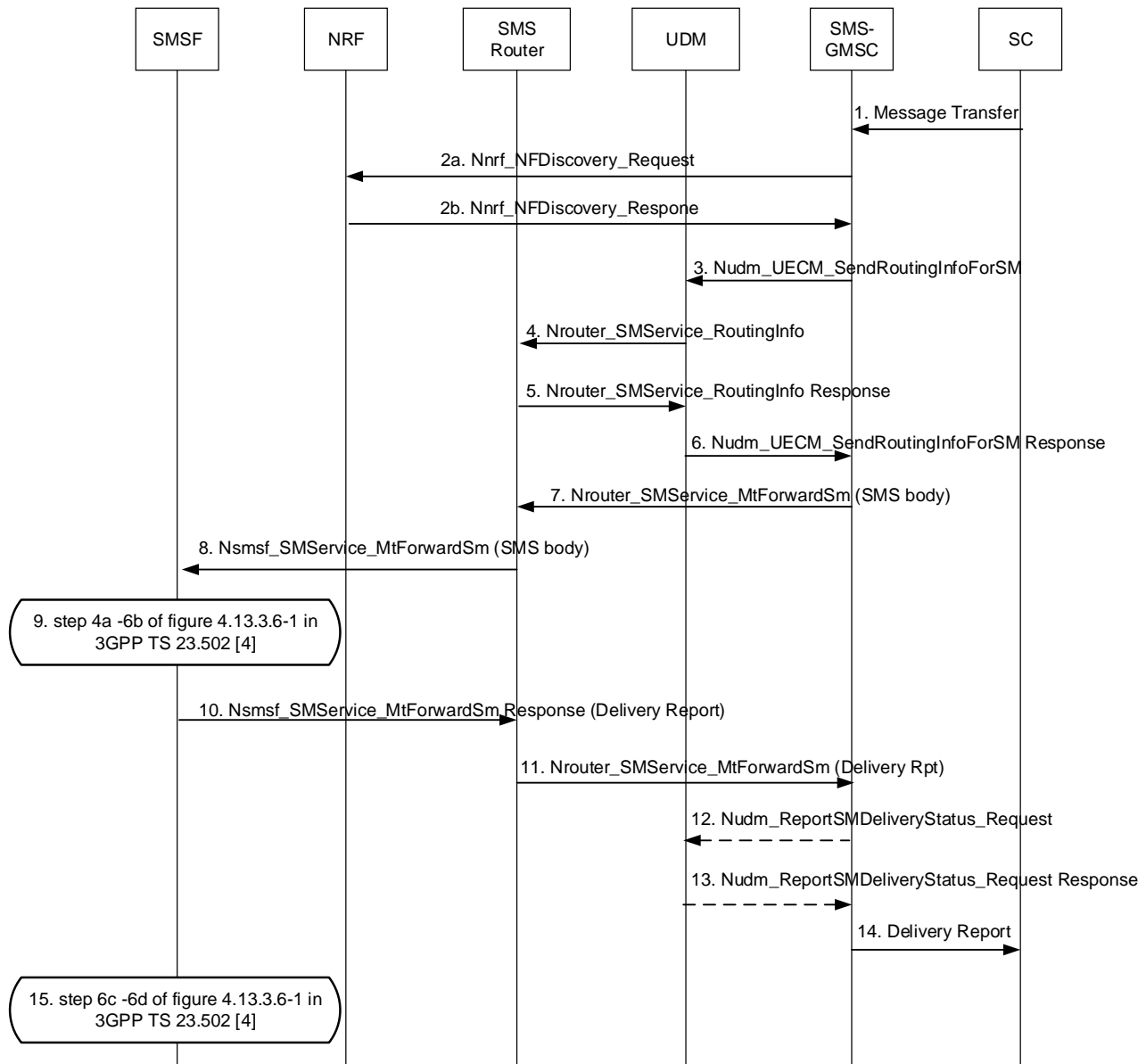

Figure 5.1.3-1: MT SMS over NAS via SMS Router

1. MT SMS interaction between SC and SMS-GMSC follow the current procedure as defined in 3GPP TS 23.040 [2].
- 2a-2b. The SMS-GMSC should query the NRF to find the UDM instance(s), supporting SMS SBI interfaces, and managing that manages the user subscriptions of the GPSI. The SMS-GMSC may need to retrieve the PLMN ID of the recipients GPSI before the discovery of the UDM instance based on the GPSI-to-Subscription-Network resolution procedure defined in clause 5.1.7.
3. SMS-GMSC invokes Nudm_UECM_SendRoutingInfoForSM (GPSI) to the UDM to get the serving node information for all access types for the UE.
4. The UDM shall check the registration/reachability flags to determine the potential target nodes, e.g. SMSF. For MT SM transfer via SMS Router, the UDM shall invoke the Nrouter_SMSService_RoutingInfo to provide the SMSF Instance Id to the SMS Router. The address of the SMS Router to be contacted by the UDM may be configured locally.
5. The SMS Router shall send Nrouter_SMSService_RoutingInfo response to the UDM.

6. UDM responds to the SMS-GMSC by sending Nudm_UECM_SendRoutingInfoForSM response, including SMS Router address, the indication for SMSF SMS_SBI support and the indication for SMS Router SMS_SBI support.
- 7-8. The SMS-GMSC forwards the SMS message to the SMS Router, and then SMS Router forwards the SMS message to the SMSF. If the SMS Router has more than one SMSF address to use for SMS transport towards the UE, then the SMS Router chooses which SMSF address to use first, based on operator local policy.

The SMS-GMSC selects protocol based on the indications for SMSF SMS_SBI support and SMS Router SMS_SBI support.

If both SMSF and SMS Router indicate support for SMS_SBI, SMS-GMSC forwards the SMS message to the SMS Router by invoking Nrouter_SMSService_MtForwardSm service operation. And then the SMS Router forwards the SMS message to the SMSF by invoking Nsmsf_SMSService_MtForwardSm service operation.

If SMSF or SMS Router indicates that it does not support SMS_SBI, SMS-GMSC should forward SMS message to SMS Router by legacy MAP/Diameter protocol. Then SMS Router forwards the SMS message to the SMSF by legacy MAP/Diameter protocol. The following steps follow the procedures for legacy MT SMS message transfer, as illustrated in Figure 15aa of TS23.040.
9. MT SMS over NAS procedure between SMSF, AMF and UE is same as the definition in step 4a to 6b of Figure 4.13.3.6-1 in 3GPP TS 23.502 [4].
10. The SMSF delivers the delivery report to SMS Router by sending the Nsmsf_SMSService_MtForwardSm response to the SMS Router.
11. The SMS Router delivers the delivery report to SMS-GMSC by sending the Nrouter_SMSService_MtForwardSm response to the SMS-GMSC.
- 12-13. The SMS-GMSC may report the SM-Delivery Status to the UDM by invoking Nudm_ReportSMDeliveryStatus_Request and UDM responses Nudm_ReportSMDeliveryStatus_Request response to SMS-GMSC.
14. The SMS-GMSC delivers the delivery report to SC as defined in 3GPP TS 23.040 [2].
15. MT SMS over NAS procedure between SMSF, AMF and UE is same as the definition in step 6c to 6d of Figure 4.13.3.6-1 in 3GPP TS 23.502 [4].

5.1.4 Successful Mobile Terminated short message transfer via IP-SM-GW

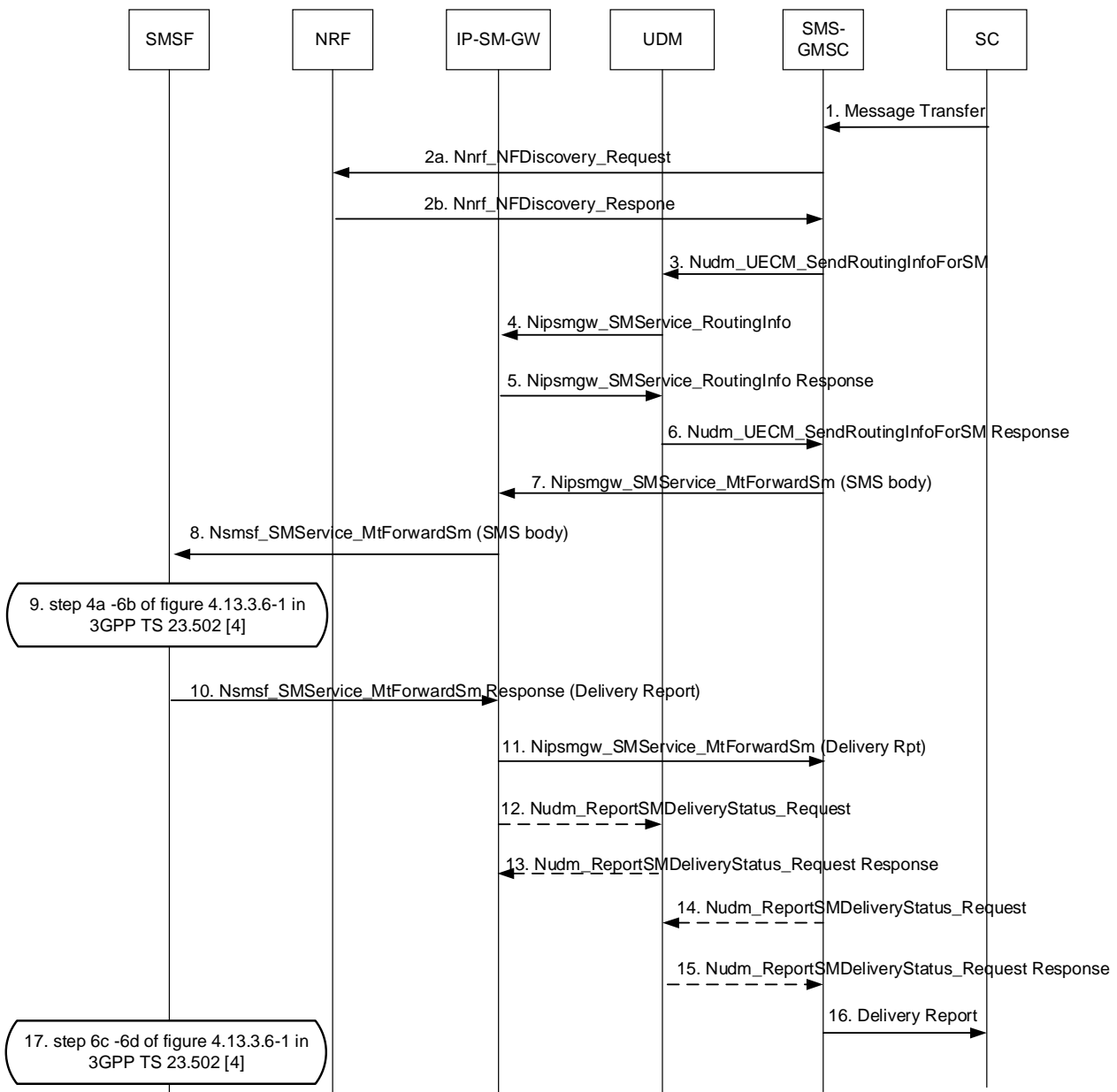

Figure 5.1.4-1: MT SMS over NAS via IP-SM-GW

1. MT SMS interaction between SC and SMS-GMSC follow the current procedure as defined in 3GPP TS 23.040 [2].
- 2a-2b. The SMS-GMSC should query the NRF to find the UDM instance(s), supporting SMS SBI interfaces, and managing that manages the user subscriptions of the GPSI. The SMS-GMSC may need to retrieve the PLMN ID of the recipients GPSI before the discovery of the UDM instance based on the GPSI-to-Subscription-Network resolution procedure defined in clause 5.1.7.
3. The SMS-GMSC invokes Nudm_UECM_SendRoutingInfoForSM (GPSI) to the UDM to get the serving node information for all access types for the UE.
4. The UDM shall check the registration/reachability flags to determine the potential target nodes, e.g. SMSF. For MT SM transfer via IP-SM-GW, the UDM shall invoke the Nipsmgw_SMSservice_RoutingInfo to provide the

SMSF Instance Id to the IP-SM-GW. The address of the IP-SM-GW to be contacted by the UDM may be configured locally.

5. The IP-SM-GW shall send Nipmsgw_SMSservice_RoutingInfo response to the UDM.
6. The UDM responds to the SMS-GMSC by sending Nudm_UECM_SendRoutingInfoForSM response, including IP-SM-GW address, the indication for SMSF SMS_SBI support and the indication for IP-SM-GW SMS_SBI support.
- 7-8. The SMS-GMSC forwards the SMS message to the IP-SM-GW, and then IP-SM-GW performs service authorization and domain selection to determine the domain for delivery of the Short Message as defined in 3GPP TS 23.204 [15]. If the SMSF is selected, the IP-SM-GW forwards the SMS message to the SMSF. If the IP-SM-GW has more than one SMSF address to use for SMS transport towards the UE, then the IP-SM-GW chooses which SMSF address to use first based on operator local policy.

The SMS-GMSC selects protocol based on the indication for SMSF SMS_SBI support and IP-SM-GW SBI support:

If both SMSF and IP-SM-GW indicate support for SMS_SBI, SMS-GMSC forwards the SMS message to the IP-SM-GW by invoking Nipmsgw_SMSservice_MtForwardSm service operation. And then the IP-SM-GW forwards the SMS message to the SMSF by invoking Nsmsf_SMSservice_MtForwardSm service operation.

If SMSF or IP-SM-GW indicates that it does not support SMS_SBI, SMS-GMSC should forward SMS message to IP-SM-GW by legacy MAP/Diameter protocol. Then IP-SM-GW forwards the SMS message to the SMSF by legacy MAP/Diameter protocol. The following steps follow the procedures for legacy MT SMS message transfer, as illustrated in Figure 15aa of TS23.040 [2].

9. The MT SMS over NAS procedure between SMSF, AMF and UE is the same as in step 4a to 6b of Figure 4.13.3.6-1 of 3GPP TS 23.502 [4].
10. The SMSF delivers the delivery report to the IP-SM-GW by sending the Nsmsf_SMSservice_MtForwardSm response to the IP-SM-GW.
11. The IP-SM-GW delivers the delivery report to the SMS-GMSC by sending the Nipmsgw_SMSservice_MtForwardSm response to the SMS-GMSC.
12. The IP-SM-GW may report the SM-Delivery Status to the UDM by invoking Nudm_ReportSMDeliveryStatus_Request.
13. The UDM responds with Nudm_ReportSMDeliveryStatus_Request response to the IP-SM-GW.
- 14-15. The SMS-GMSC may report the SM-Delivery Status to the UDM by invoking Nudm_ReportSMDeliveryStatus_Request and the UDM shall ignore the information provided in this report.
16. The SMS-GMSC delivers the delivery report to the SC as defined in 3GPP TS 23.040 [2].
17. The MT SMS over NAS procedure between SMSF, AMF and UE is the same as in step 6c to 6d of Figure 4.13.3.6-1 of 3GPP TS 23.502 [4].

5.1.5 Unsuccessful Mobile Terminated short message transfer without SMS Router/IP-SM-GW

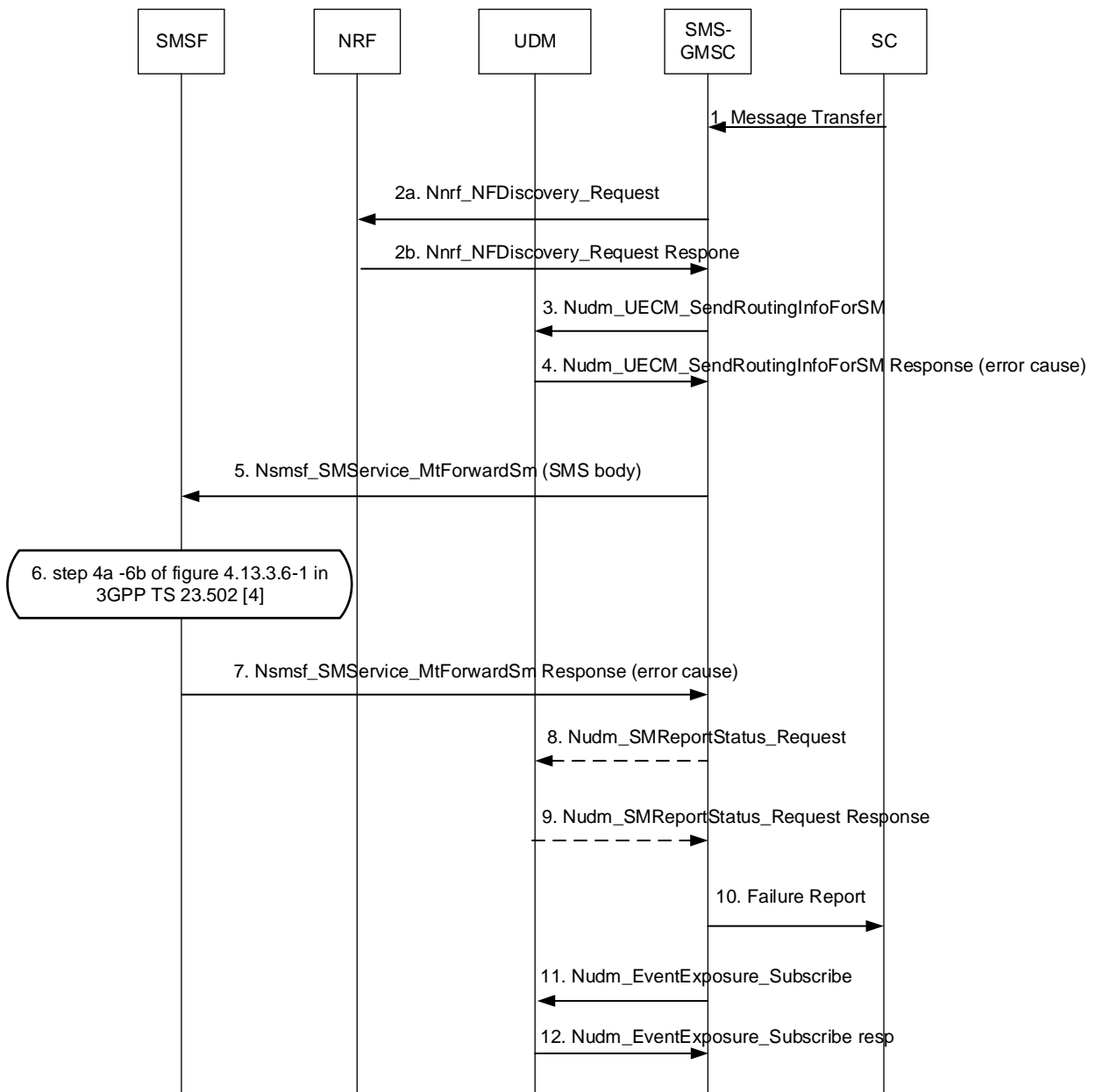

Figure 5.1.5-1: Unsuccessful MT SMS over NAS without SMS Router/ IP-SM-GW

1. MT SMS interaction between SC and SMS-GMSC follow the current procedure as defined in 3GPP TS 23.040 [2].
- 2a-2b. The SMS-GMSC should query the NRF to find the UDM instance(s), supporting SMS SBI interfaces, and managing that manages the user subscriptions of the GPSI. If there is no available UDM returned from NRF, the SMS-GMSC may send error response to the SC.
3. SMS-GMSC invokes Nudm_UECM_SendRoutingInfoForSM (GPSI) to the UDM to get the routing information of the nodes available for MT SMS delivery, in this case the registered serving SMSF instance for all access types for UE.

4. The UDM shall check the registration/reachability flags to determine the potential target nodes. If the UDM is failed at this step, e.g. user not found in the UDM, the UDM shall respond to the SMS-GMSC by sending Nudm_UECM_SendRoutingInfoForSM response with error cause. If there is no target node address registered in the UDM, a response with error case indicating absent subscriber for SM is sent to the SMS-GMSC and the procedure continues in step 11.
5. If successful response is returned in step 4, the SMS-GMSC forwards the SMS message to the SMSF by invoking Nsmsf_SMSservice_MtForwardSm service operation. If the SMS-GMSC has more than one SMSF address to use for SMS transport towards the UE, then the SMS-GMSC chooses which SMSF address to use first based on operator local policy.
6. MT SMS over NAS procedure between SMSF, AMF and UE is same as the definition in step 4a to 6b of Figure 4.13.3.6-1 of 3GPP TS 23.502 [4].
7. If the AMF informs the SMSF that it cannot deliver the MT-SMS to the UE in step 6, e.g. UE is not reachable, or the SMSF is failed at this step, e.g. memory capacity exceeded, the SMSF shall send the Nsmsf_SMSservice_MtForwardSm response with error cause to the SMS-GMSC.

If the SMS-GMSC has more than one SMSF address to use for SMS transport towards the UE, then upon receiving MT-SMS failure report, the SMS-GMSC, based on operator local policy, may re-attempt the MT-SMS delivery via the other SMSF. If MT-SMS delivery also fails over the other SMSF, then the SMS-GMSC continues with step 8.

8. The SMS-GMSC may report the SM-Delivery Status (e.g. UE is not reachable or memory capacity exceeded) to UDM by invoking Nudm_ReportSMDeliveryStatus_Request.
9. UDM responses Nudm_ReportSMDeliveryStatus_Request response to SMS-GMSC.
10. The SMS-GMSC sends the failure report to SC as defined in TS 23.040 [2].
11. The SMS-GMSC subscribes in UDM to be notified when the UE becomes reachable for SMS (i.e. when the UE gets in radio contact with the AMF while an SMSF is actually registered, or when an SMSF gets registered) by using the Nudm_EventExposure_Subscribe service operation for Reachability for SMS event as defined in 3GPP TS 23.502 [4].
12. If applicable, the UDM subscribes to UE reachability notification in the AMF(s) using the Namf_EventExposure service and sets the relevant reachability flags. The UDM acknowledges the event subscription created by the SMS-GMSC.

5.1.6 Unsuccessful Mobile Terminated short message transfer via IP-SM-GW

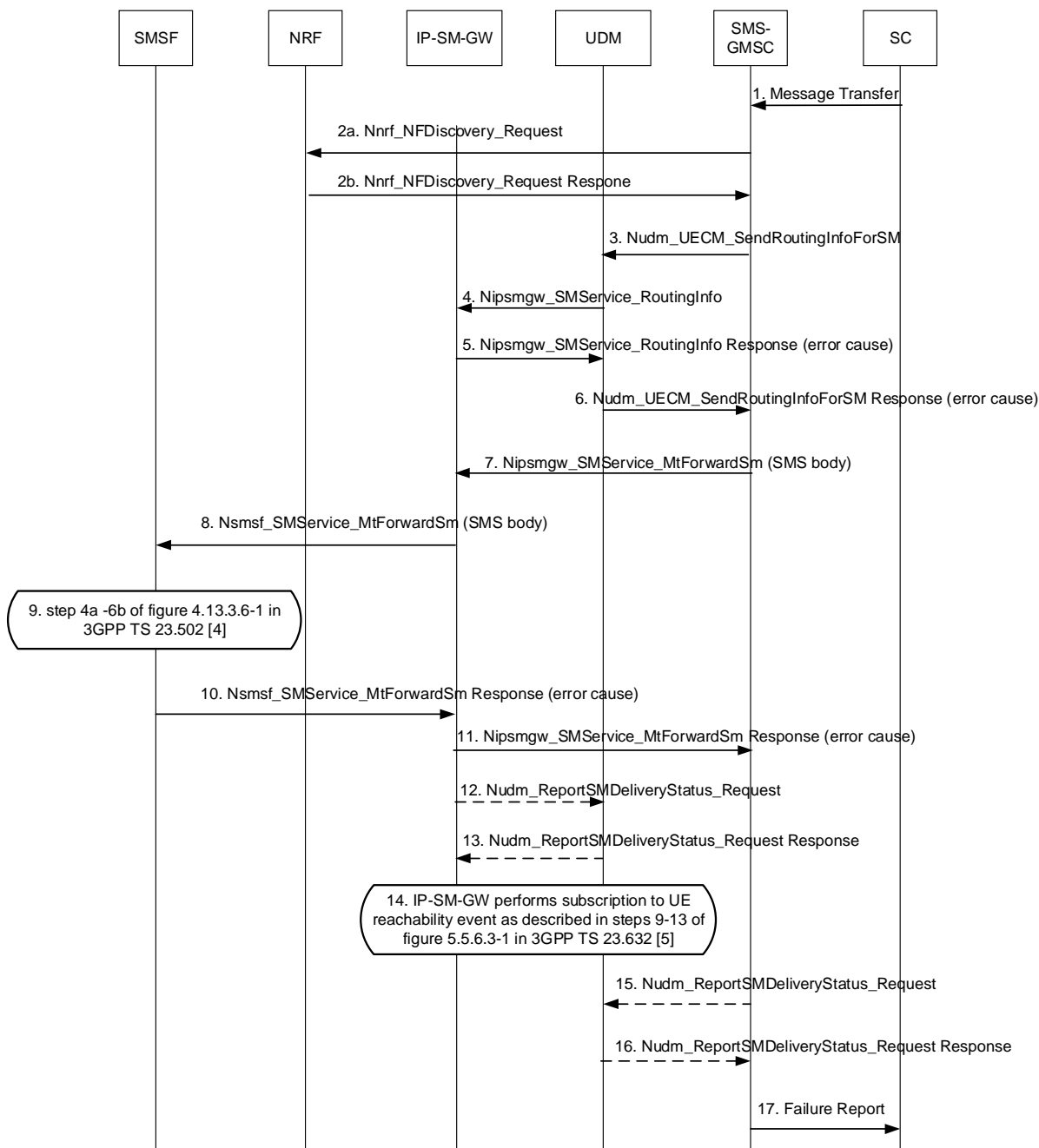

Figure 5.1.6-1: Unsuccessful MT SMS over NAS via IP-SM-GW

1. MT SMS interaction between SC and SMS-GMSC follow the current procedure as defined in 3GPP TS 23.040 [2].
- 2a-2b. The SMS-GMSC should query the NRF to find the UDM instance(s), supporting SMS SBI interfaces, and managing that manages the user subscriptions of the GPSI. If there is no available UDM returned from NRF, the SMS-GMSC may send error response to the SC.
3. SMS-GMSC invokes Nudm_UECM_SendRoutingInfoForSM (GPSI) to the UDM to get the serving node information for UE.

4. The UDM shall check the registration/reachability flags to determine the potential target nodes, e.g. SMSF. For MT SM transfer via IP-SM-GW, the UDM shall invoke the Nipmsgw_SMSservice_RoutingInfo to provide the SMSF Instance Id to the IP-SM-GW. The address of the IP-SM-GW to be contacted by the UDM may be configured locally.
5. If any failure at this step, the IP-SM-GW shall send Nipmsgw_SMSservice_RoutingInfo response with error cause to the UDM.
6. If the UDM receives error response from IP-SM-GW in step 5 or UDM is failed after step 3, e.g. user not found in the UDM, the UDM shall respond to the SMS-GMSC by sending Nudm_UECM_SendRoutingInfoForSM response with error cause. If there is no target node address registered in the UDM, a response with error case indicating absent subscriber for SM is sent to the SMS-GMSC and the procedure continues in step 14.
7. If successful response is returned in step 6, the SMS-GMSC forwards the SMS message to the IP-SM-GW by invoking Nipmsgw_SMSservice_MtForwardSm service operation.
8. The IP-SM-GW performs service authorization and domain selection to determine the domain for delivery of the Short Message as defined in 3GPP TS 23.204 [15]. If the SMSF is selected, the IP-SM-GW forwards the SMS message to the SMSF by invoking Nsmsf_SMSservice_MtForwardSm service operation. If the IP-SM-GW has more than one SMSF address to use for SMS transport towards the UE, then the IP-SM-GW chooses which SMSF address to use first based on operator local policy.
9. MT SMS over NAS procedure between SMSF, AMF and UE is same as the definition in step 4a to 6b of Figure 4.13.3.6-1 of 3GPP TS 23.502 [4].
10. If the AMF informs the SMSF that it cannot deliver the MT-SMS to the UE in step 9, e.g. UE is not reachable, or the SMSF is failed at this step, e.g. memory capacity exceeded, the SMSF shall send the Nsmsf_SMSservice_MtForwardSm response with error cause to the IP-SM-GW.
11. If the IP-SM-GW receives error response from SMSF in step 10 and the IP-SM-GW has tried all selectable domains and accesses or the IP-SM-GW is failed after step 7, the IP-SM-GW shall send the Nipmsgw_SMSservice_MtForwardSm response with error cause to the SMS-GMSC.
- 12-13. The IP-SM-GW may report the SM-Delivery Status (e.g. UE is not reachable or memory capacity exceeded) to UDM by invoking Nudm_ReportSMDeliveryStatus_Request.
14. The IP-SM-GW subscribes in HSS to be notified when the UE becomes reachable again, and subsequently the HSS subscribes in the UDM to UE reachability for SMS over IP event, as defined in clause 5.5.6 of 3GPP TS 23.632 [5]. If applicable, the UDM subscribes to UE reachability notification in the AMF(s) using the Namf_EventExposure service and sets the relevant reachability flags.
- 15-16. The SMS-GMSC may report the SM-Delivery Status to UDM by invoking Nudm_ReportSMDeliveryStatus_Request and the UDM shall ignore the information provided in this report.
17. If the SMS-GMSC receives error response from IP-SM-GW in step 6 or step 11, the SMS-GMSC sends the failure report to SC as defined in TS 23.040 [2].

5.1.7 GPSI-to-Subscription-Network resolution procedure

5.1.7.1 General

MT SMS delivery procedure requires routing based on the GPSI of the SMS recipient for interactions between the SMS-GMSC and the UDM, e.g., to retrieve the SMS routing information (e.g., the SMSF address) or report delivery status. In case that the SMS recipient belongs to a PLMN different from the PLMN of the SMS sender, the signaling takes place across PLMN borders.

When using service-based interface between the SMS-GMSC and the UDM, if the GPSI is the only known SMS recipient's identifier, the SMS-GMSC needs to determine the target PLMN to be able to interact with the UDM in the home PLMN of the SMS recipient. The SMS-GMSC can determine the target PLMN using one of the following mechanisms:

- GPSI-to-Subscription-Network resolution triggered by the NF consumer, described in clause 5.1.7.2.
- GPSI-to-Subscription-Network resolution using NRF, described in clause 5.1.7.4.

- GPSI-to-Subscription-Network resolution delegated by SCP, described in clause 5.1.7.3

It is assumed that the domain part in an External Identifier identifies the home PLMN and hence it is not required to determine the target PLMN when the GPSI is an External Identifier. The procedures described in the present clause 5.1.7 apply only when the GPSI is an MSISDN.

NOTE: While these mechanisms are defined to determine the target PLMN for interactions between the SMS entities such as SMS-GMSC and the UDM requiring routing based on the GPSI of the SMS recipient, it can be applicable to any use case and procedure requiring selection of the target PLMN based on GPSI in 5GS.

When the recipient GPSI belongs to the same country as the originating network and MNPF is not implemented in the country, the SMS-GMSC may skip the procedure and may directly discover UDM profile for invoking UDM service operation for routing information retrieval. In this case the SMS-GMSC determines the target PLMN ID from the recipient's GPSI Prefix (e.g. CC+NDC) while sending the discovery request to the NRF.

5.1.7.2 GPSI-to-Subscription-Network resolution triggered by the SMS-GMSC

5.1.7.2.1 General

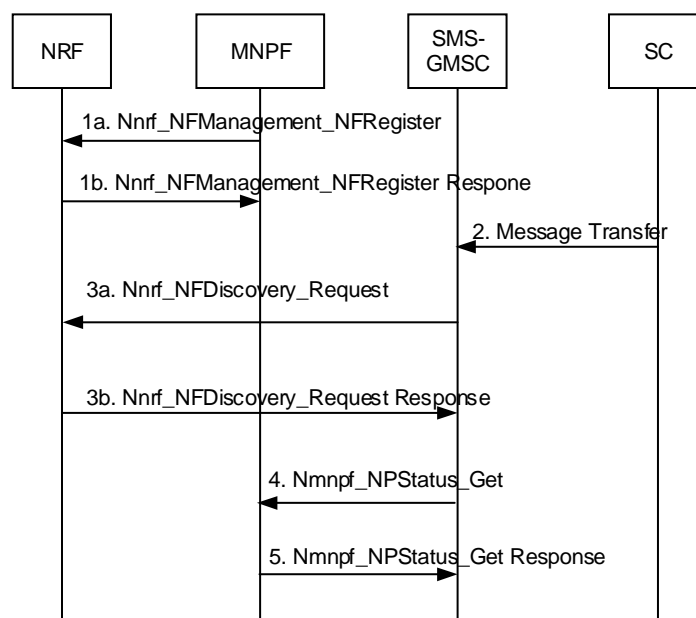

Figure 5.1.7.2-1: GPSI-to-Subscription-Network resolution triggered by the SMS-GMSC

- 1a-1b. The MNPF registers in the NRF with a new NF Type (e.g. MNPF).
2. MT SMS interaction between SC and SMS-GMSC follow the current procedure as defined in 3GPP TS 23.040 [2].
- 3a-3b. The SMS-GMSC should query the NRF to find the MNPF instance that manages the PLMN ID of the recipients GPSI's subscription network. The MNPF may belong to the same PLMN with SMS-GMSC or belong to the number range holder network which is different with the PLMN of SMS-GMSC. In latter case, the local NRF forwards the discovery request to the NRF of the number range holder PLMN.
4. SMS-GMSC invokes Nmpnf_NPStatus_Get (GPSI) to the MNPF to get the target PLMN ID of the GPSI.
5. MNPF checks the portability status of the recipient GPSI and responds back with the target PLMN ID.

After step 5, the Mobile Terminated short message transfer procedures defined in clause 5.1 is performed from step 2a. The SMS-GMSC uses the target PLMN ID to discover the UDM NF profile via NRF for sending the routing information query to the UDM. If the target PLMN ID is not own network, the local NRF forwards the discovery request to the NRF of the target PLMN.

5.1.7.2.2 GPSI-to-Subscription-Network resolution triggered by the SMS-GMSC for Direct routing

When MNPF is implemented in a country or number portability domain with direct routing mechanism, the originating network first does the number portability query to identify the recipient GPSI's subscription PLMN before routing any messages based on GPSI.

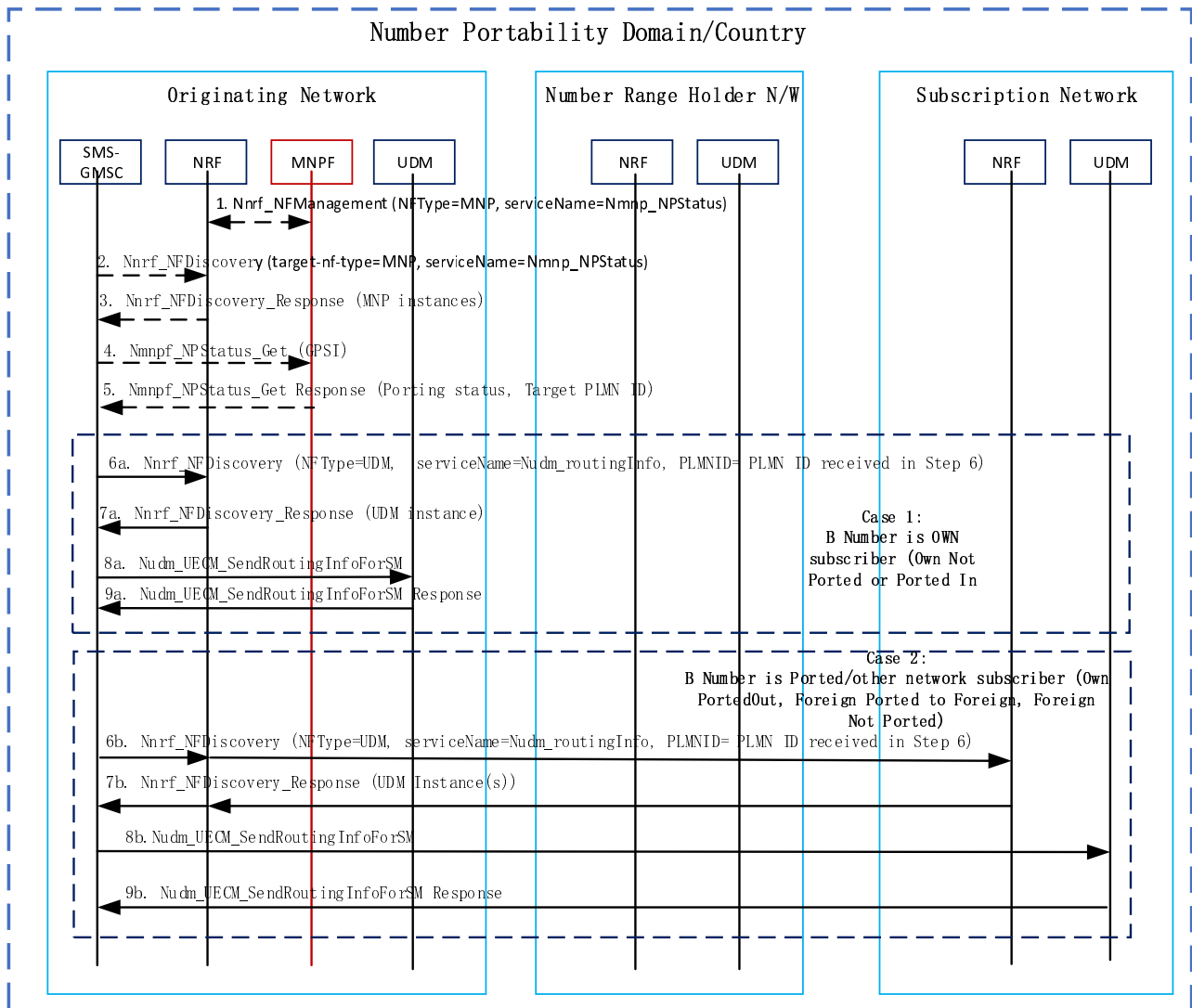

Figure 5.1.7.2.2-1 GPSI-to-Subscription-Network resolution triggered by the SMS-GMSC (Direct Routing)

1. If the MNPF is deployed, the MNPF registers in the NRF with a new NF Type (e.g. MNPF).
- 2-3. The SMS-GMSC should query the NRF to find the MNPF instance that manages the PLMN ID of the recipients GPSI's subscription network.
4. SMS-GMSC invokes Nnmpf_NPStatus_Get (GPSI) to the MNPF to get the target PLMN ID of the GPSI.
5. MNPF checks the portability status of the recipient GPSI and responds back with the target PLMN ID.

NOTE: When the recipient GPSI belongs to the same country as the originating network and MNPF is not implemented in the country, the steps 1-5 is skipped. In this case the SMS-GMSC determines the target PLMN ID from the recipient's GPSI Prefix (e.g. CC+NDC) based on local configuration.6-7. SMS-GMSC shall query the NRF to find the UDM instance serving the target PLMN based on target PLMN ID received in step 6. For step 7b-8b, if the target PLMN ID is not the originating network, the local NRF forwards the discovery request to the NRF of the target PLMN.

8-9. SMS-GMSC invokes Nudm_UECM_SendRoutingInfoForSM (GPSI) to the UDM of the target PLMN to get the serving node instance for UE. The UDM shall check the registration/reachability flags to determine the potential target nodes and responds to the SMS-GMSC by sending Nudm_UECM_SendRoutingInfoForSM response, in this procedure the SMSF instance Id is included in the response message.

5.1.7.2.3 GPSI-to-Subscription-Network resolution triggered by the SMS-GMSC for Indirect routing

When MNP is implemented in a country or number portability domain with indirect routing mechanism, the signalling messages are always routed to the number range holder network, the number range holder then performs a number portability check and forwards the request to the subscription network if the number is ported out. For the case of international SMS termination also indirect routing is applied. In the case of international SMS termination, the originating network is outside the number portability domain and may not have any knowledge of whether number portability is implemented in the country of the recipient GPSI.

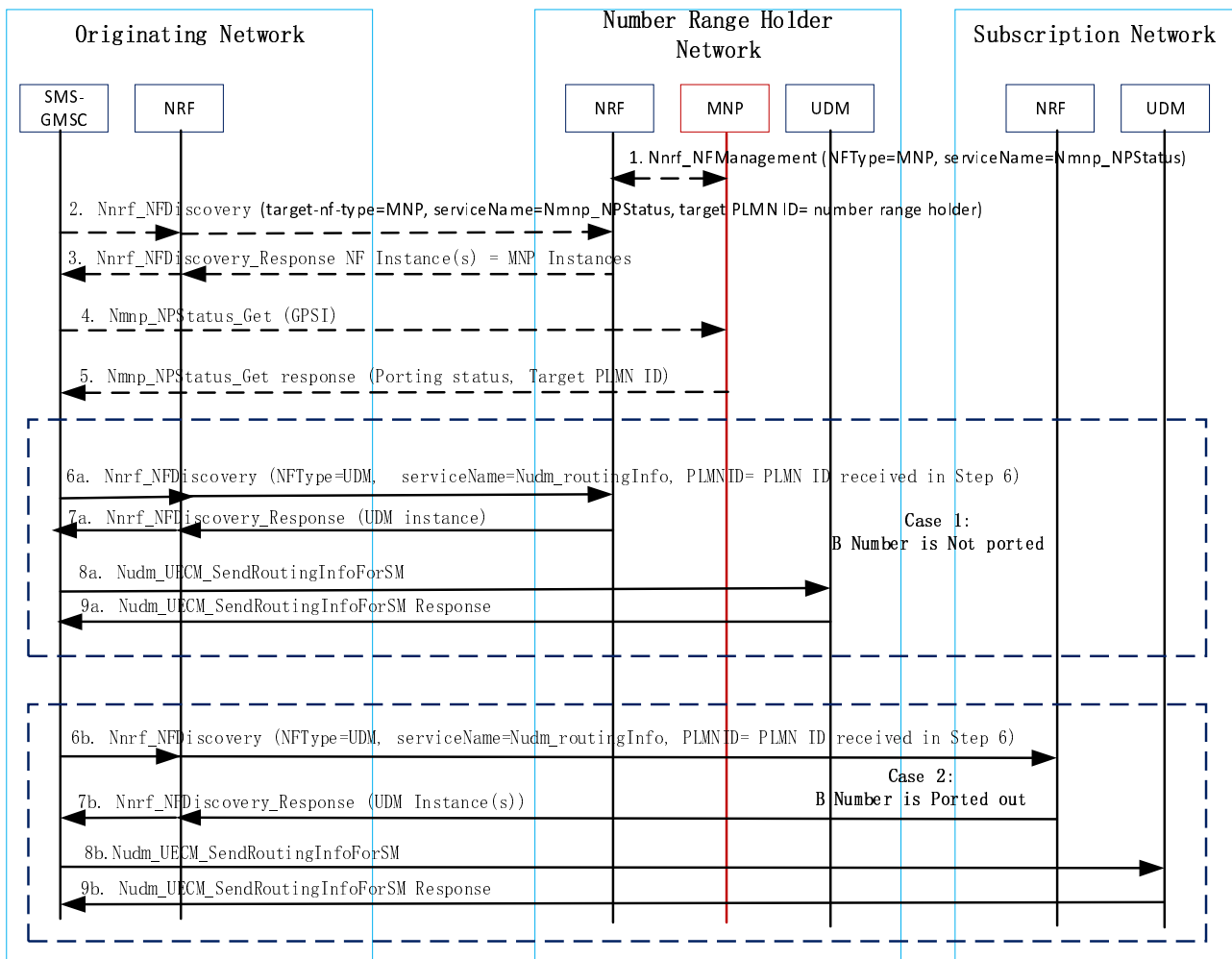

Figure 5.1.7.2.3-1 GPSI-to-Subscription-Network resolution triggered by the SMS-GMSC (Indirect Routing)

1. If the MNP NF is deployed in the Number Range Holder PLMN, the MNP NF registers in the NRF of the number range holder PLMN with a new NF Type (e.g. MNP).
- 2-3. The SMS-GMSC should query the local NRF to find the MNP instance that manages the PLMN ID of the recipients GPSI's subscription network, the local NRF forwards the discovery request to the NRF of the number range holder PLMN. 4. SMS-GMSC invokes Nmnp_NPStatus_Get (GPSI) to the MNP NF to get the target PLMN ID of the GPSI.
5. MNP NF checks the portability status of the recipient GPSI and responds back with the target PLMN ID.

NOTE: When the recipient GPSI belongs to the same country as the number range holder network and MNP is not implemented in the country, the steps 1-5 is skipped. In this case the SMS-GMSC determines the target PLMN ID from the recipient's GPSI Prefix (e.g. CC+NDC) based on local configuration.

6-7. SMS-GMSC shall query the NRF to find the UDM instance serving the target PLMN based on target PLMN ID received in step 6.

- For step 7a-8a, if the target PLMN ID belongs to the number range holder PLMN, the local NRF forwards the discovery request to the NRF of the number range holder PLMN.
- For step 7b-8b, if the target PLMN ID belongs to the Subscription PLMN, the local NRF forwards the discovery request to the NRF of the Subscription PLMN.

8-9. SMS-GMSC invokes Nudm_UECM_SendRoutingInfoForSM (GPSI) to the UDM of the target PLMN to get the serving node instance for UE. The UDM shall check the registration/reachability flags to determine the potential target nodes and responds to the SMS-GMSC by sending Nudm_UECM_SendRoutingInfoForSM response, in this procedure the SMSF instance Id is included in the response message.

5.1.7.3 SCP supports GPSI-to-Subscription-Network resolution procedure

5.1.7.3.1 General

This procedure is used to retrieve the PLMN ID of the recipients GPSI for further discovery of UDM NF profiles for invoking UDM service operation for routing information retrieval. In indirect Communication with Delegated Discovery, the SCP is the service consumer of the GPSI-to-Subscription-Network resolution service in MNPF and routes an SBI message based on GPSI when MNPF is implemented. The SCP shall use the discovery factors (see 3GPP TS 29.500 [11], clause 6.10) provided by the SMS-GMSC to determine when to invoke the MNPF resolution, and to obtain the identity (GPSI) of the recipient.

The SMS-GMSC sends routing information retrieval request to the SCP and the SCP uses the PLMN ID as the target PLMN ID in the discovery request towards NRF to discover the UDM NF profiles in the subscription network of the SMS recipient.

5.1.7.3.2 SCP supports GPSI-to-Subscription-Network resolution with MNPF

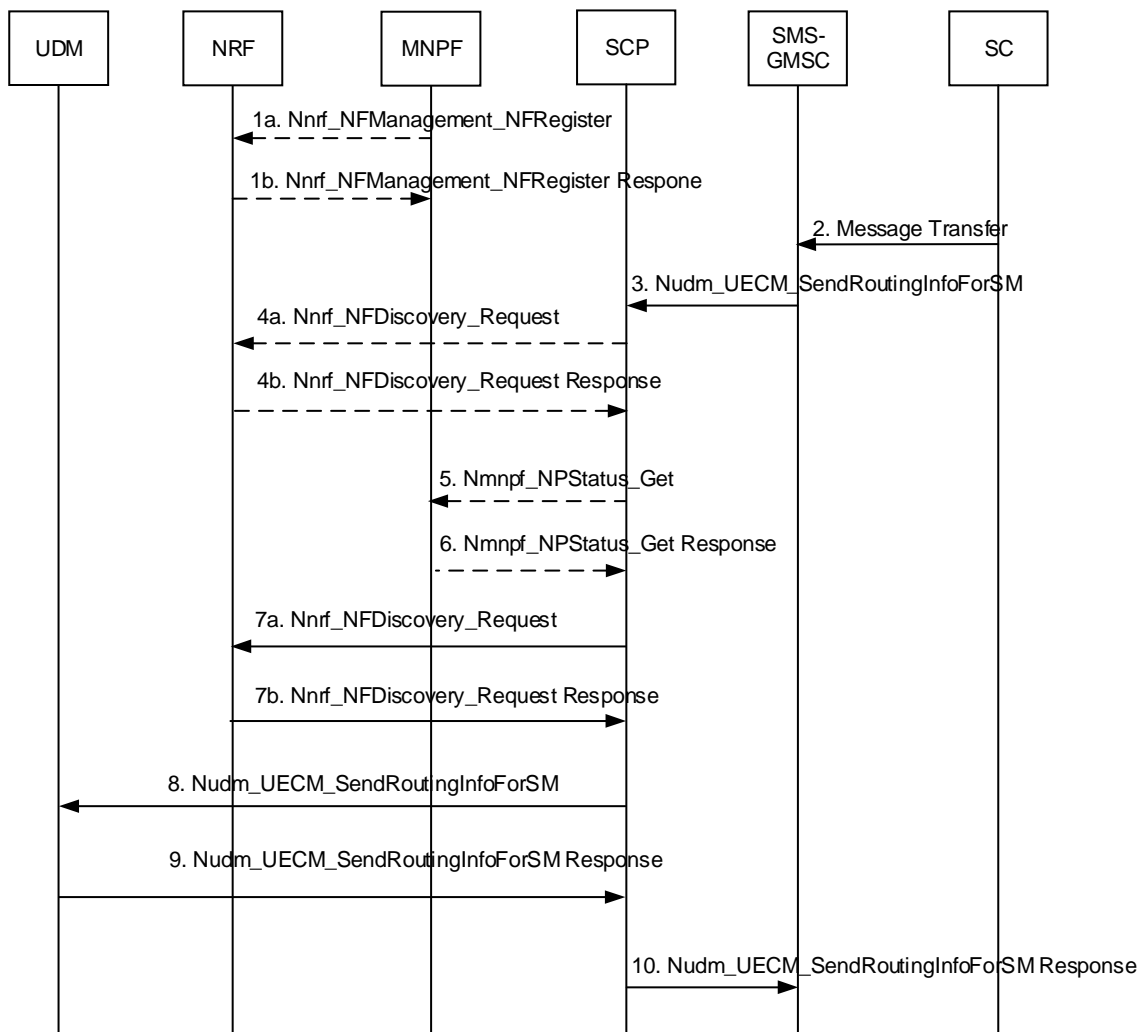

Figure 5.1.7.3.2-1: SCP supports GPSI-to-Subscription-Network resolution with MNPF

- 1a-1b. If the MNPF is deployed, the MNPF registers in the NRF with a new NF Type (e.g. MNPF).
- 2. MT SMS interaction between SC and SMS-GMSC follow the current procedure as defined in 3GPP TS 23.040 [2].
- 3. The SMS-GMSC sends Nudm_UECM_SendRoutingInfoForSM to the SCP to get the serving node instance for UE from the UDM. As specified in the Indirect Communication with Delegated Discovery model, the Nudm_UECM_SendRoutingInfoForSM shall contain the discovery factors containing the GPSI (pointing to the Number Range Holder Network) and an indicator (i.e. "target-nw-resolution") that Subscription Network resolution is delegated to the SCP. The "target-nw-resolution" may also be sent by an SCP to the next hop SCP. The SCP receives the "target-nw-resolution" shall query the NF service consumer (MNPF) to obtain the PLMN ID of the recipient GPSI's subscription network.
- 4a-4b. The SCP shall query the NRF to find the MNPF instance that manages the PLMN ID of the recipients GPSI's subscription network. The MNPF may belong to the same PLMN with SMS-GMSC or belong to the number range holder network which is different with the PLMN of SMS-GMSC. In latter case, the local NRF forwards the discovery request to the NRF of the number range holder PLMN.
- 5. The SCP determines the target PLMN of the recipients GPSI's subscription network using the SBI service of the MNPF i.e. the SCP invokes Nmnpf_NPStatus_Get (GPSI) to the MNPF.
- 6. MNPF checks the portability status of the recipient GPSI and responds back with the target PLMN ID.

NOTE: If SCP is co-located with MNPF, steps between SCP and NRF to discover the MNPF, and steps between SCP and MNPF can be skipped.

7a-7b. SCP shall query the NRF to find the UDM instance serving the target PLMN based on target PLMN ID received in step 6.

8. SCP invokes Nudm_UECM_SendRoutingInfoForSM (GPSI) to the UDM to get the serving node instance for UE.

9. The UDM shall check the registration/reachability flags to determine the potential target nodes and responds to the SCP by sending Nudm_UECM_SendRoutingInfoForSM response, in this procedure the SMSF instance Id is included in the response message.

10. SCP forward the responds to the SMS-GMSC by sending Nudm_UECM_SendRoutingInfoForSM response (SMS Router address).

5.1.7.3.3 SCP supports GPSI-to-Subscription-Network resolution with NRF

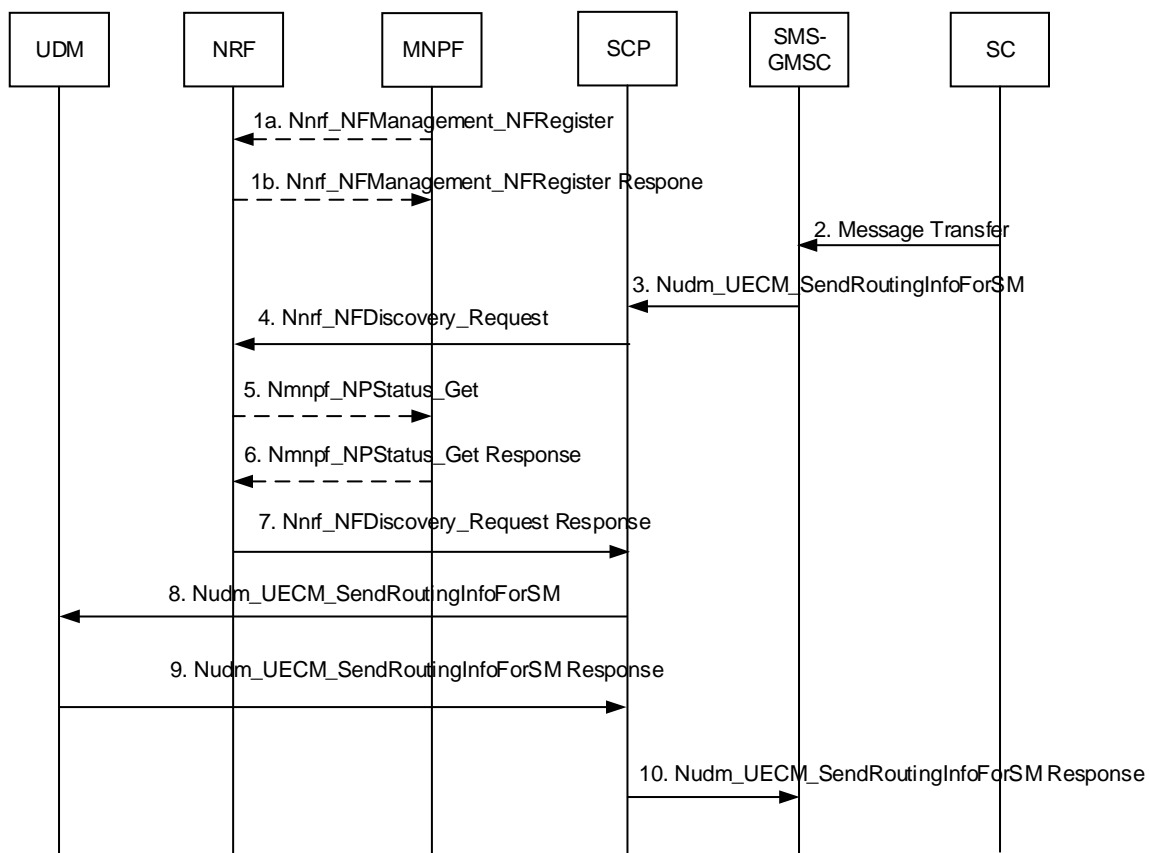

Figure 5.1.7.3.3-1: SCP supports GPSI-to-Subscription-Network resolution with NRF

1a-1b. If the MNPF is deployed, the MNPF registers in the NRF with a new NF Type (e.g. MNPF).

2. MT SMS interaction between SC and SMS-GMSC follow the current procedure as defined in 3GPP TS 23.040 [2].

3. The SMS-GMSC sends Nudm_UECM_SendRoutingInfoForSM to the SCP to get the serving node instance for UE from the UDM. The Nudm_UECM_SendRoutingInfoForSM contains the NF service discovery factors with the GPSI (pointing to the Number Range Holder Network) and an indicator (i.e. "target-nw-resolution") indicating that Subscription Network resolution is delegated to the SCP. The "target-nw-resolution" may also be sent by an SCP to the next hop SCP.

4. The SCP should query the NRF to find the UDM instance that manages the user subscriptions using the GPSI. The NRF receives the "target-nw-resolution" shall query the NF service consumer (MNPF) to obtain the PLMN ID of the recipient GPSI's subscription network.

5. The NRF determines the target PLMN of the recipients GPSI's subscription network using the SBI service of the MNPF i.e. the NRF invokes Nmnpf_NPStatus_Get (GPSI) to the MNPF. As an implementation choice the NRF may determine the target PLMN by other means, e.g. local configuration of ENUM query.
6. MNPF checks the portability status of the recipient GPSI and responds back with the target PLMN ID.
7. NRF returns the UDM instance related to the GPSI and target PLMN Id to the SCP. For inter-PLMN discovery, the local NRF shall query the NRF in the target PLMN to find the UDM instance. If there are not NF instances available that can serve the request, the local NRF provides the discovery response indicating the consumer NF to use a legacy interface for the next operation request in the procedure.
8. SCP invokes Nudm_UECM_SendRoutingInfoForSM (GPSI) to the UDM to get the serving node instance for UE.
9. The UDM shall check the registration/reachability flags to determine the potential target nodes and responds to the SCP by sending Nudm_UECM_SendRoutingInfoForSM response, in this procedure the SMSF instance Id is included in the response message.
10. SCP forward the responds to the SMS-GMSC by sending Nudm_UECM_SendRoutingInfoForSM response (SMS Router address).

5.1.7.3.4 SCP supports GPSI-to-Subscription-Network resolution with MNPF for Direct routing

Figure 5.1.7.3.4-1 shows the procedure for Direct Communication with Delegated Discovery, the SCP is the service consumer of the GPSI-to-Subscription-Network resolution service in MNPF and routes an SBI message based on GPSI when direct routing of MNPF is implemented.

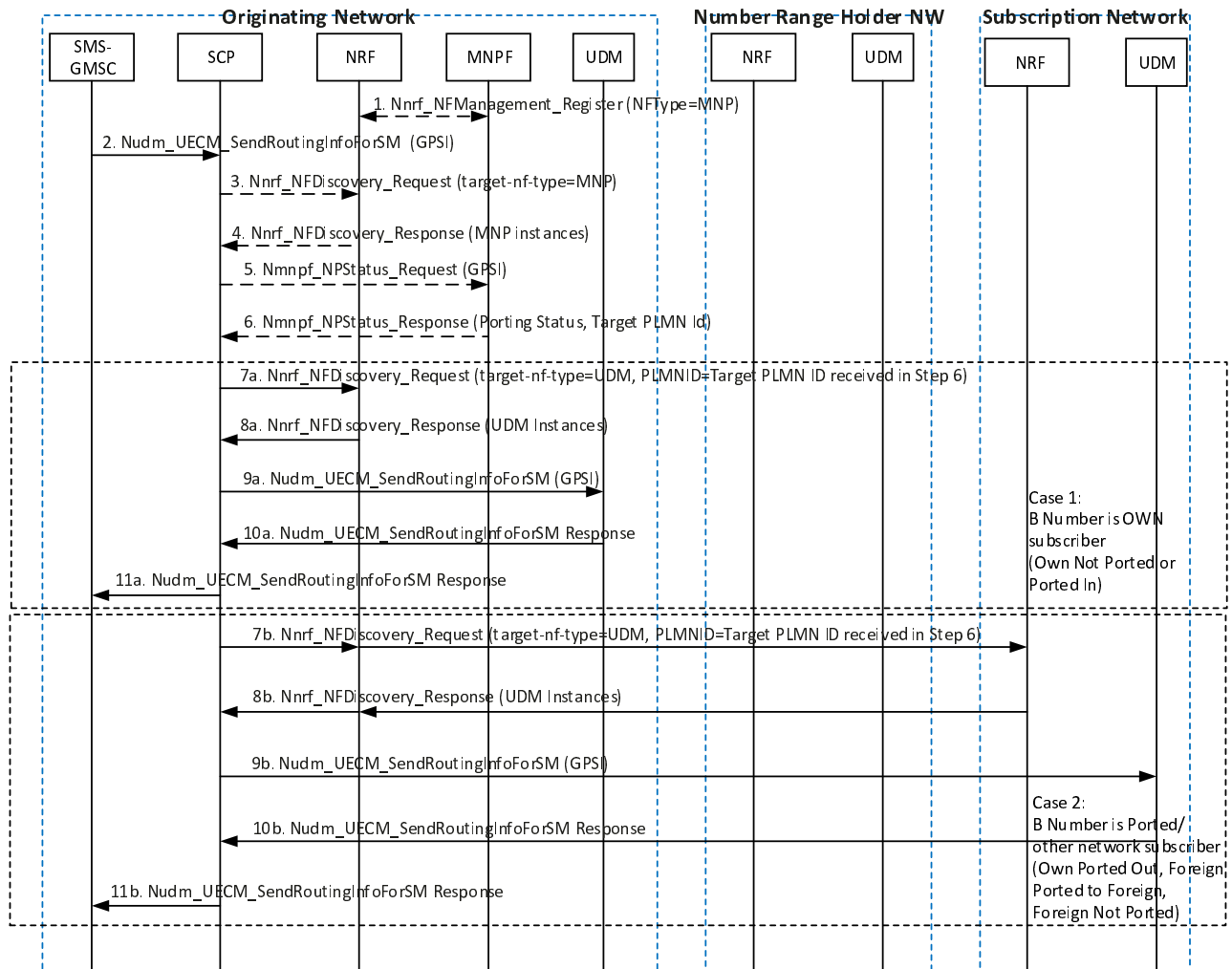

Figure 5.1.7.3.4-1 SCP supports the GPSI-to-Subscription-Network resolution with MNPf for Direct Routing

1. If the MNPf is deployed, the MNPf registers in the NRF with a new NF Type (e.g. MNPf).
2. The SMS-GMSC sends Nudm_UECM_SendRoutingInfoForSM to the SCP to get the serving node instance for UE from the UDM. As specified in the Indirect Communication with Delegated Discovery model, the Nudm_UECM_SendRoutingInfoForSM shall contain the discovery factors containing the GPSI (pointing to the Number Range Holder Network) and an indicator that Subscription Network resolution is delegated to the SCP.
- 3-4. The SCP shall query the NRF to find the MNPf instance that manages the PLMN ID of the recipients GPSI's subscription network.
5. The SCP determines the target PLMN of the recipients GPSI's subscription network using the SBI service of the MNPf i.e. the SCP invokes Nmpf_NPStatus_Get (GPSI) to the MNPf.
6. MNPf checks the portability status of the recipient GPSI and responds back with the target PLMN ID.

NOTE 1: If SCP is co-located with MNPf, steps between SCP and NRF to discover the MNPf, and steps between SCP and MNPf can be skipped.

NOTE 2: When the recipient GPSI belongs to the same country as the originating network and MNPf is not implemented in the country, steps between SCP and MNPf can be skipped. In this case the SMS-GMSC or SCP determines the target PLMN ID from the recipient's GPSI Prefix (e.g. CC+NDC) based on local configuration.

7-8. SCP shall query the NRF to find the UDM instance serving the target PLMN based on target PLMN ID received in step 6. For step 7b-8b, if the target PLMN ID is not the originating network, the local NRF forwards the discovery request to the NRF of the target PLMN.

9-10. SCP invokes Nudm_UECM_SendRoutingInfoForSM (GPSI) to the UDM of the target PLMN to get the serving node instance for UE. The UDM shall check the registration/reachability flags to determine the potential target nodes and responds to the SCP by sending Nudm_UECM_SendRoutingInfoForSM response, in this procedure the SMSF instance Id is included in the response message.

11. SCP forward the responds to the SMS-GMSC by sending Nudm_UECM_SendRoutingInfoForSM response (SMS Router address).

5.1.7.3.5 SCP supports GPSI-to-Subscription-Network resolution with MNPf for Indirect routing

Figure 5.1.7.3.5-1 shows the procedure for Indirect Communication with Delegated Discovery, the SCP is the service consumer of the GPSI-to-Subscription-Network resolution service in MNPf NF and routes an SBI message based on GPSI when indirect routing of MNPf is implemented.

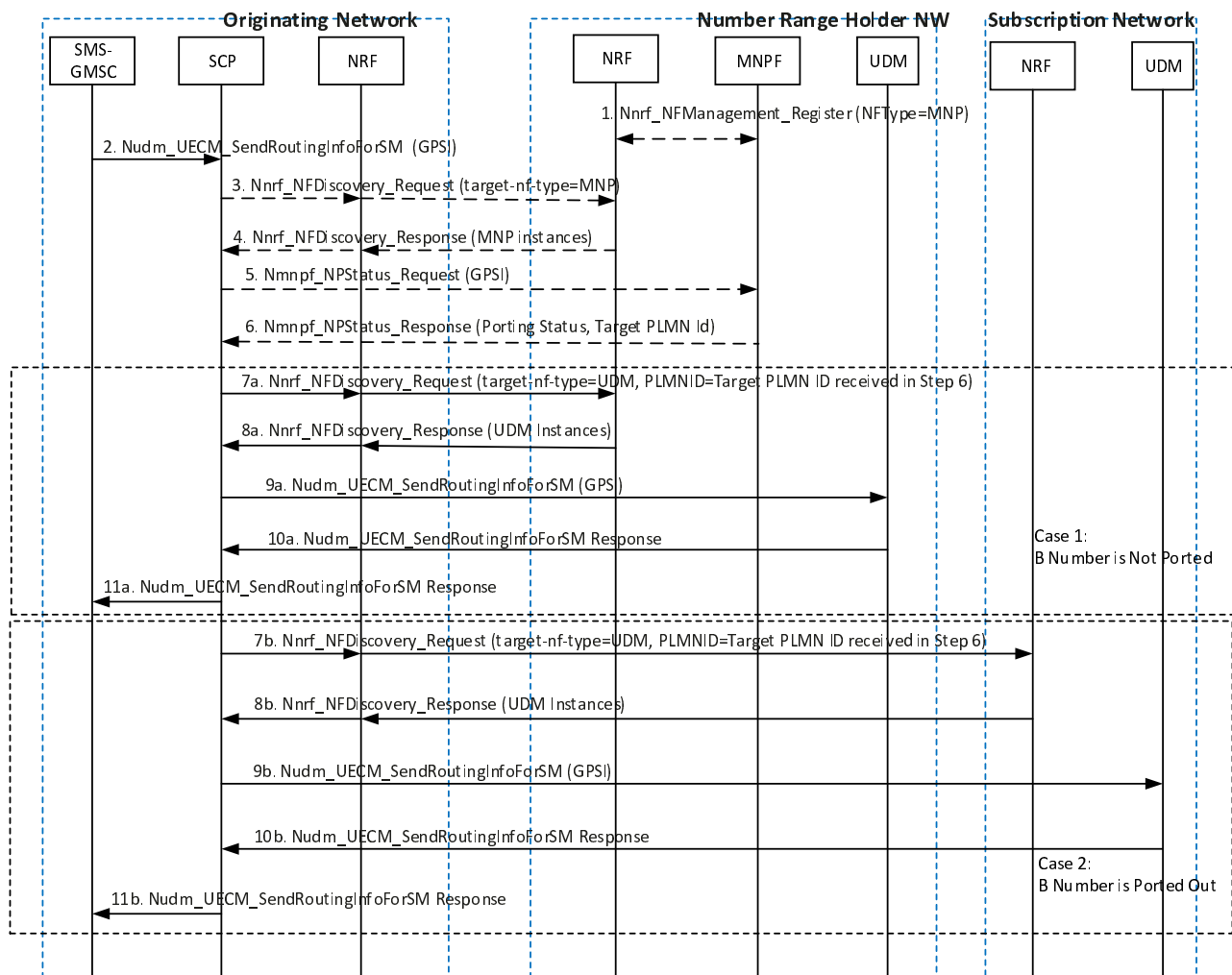

Figure 5.1.7.3.5-1 SCP supports GPSI-to-Subscription-Network resolution with MNPf for Indirect routing

1. If the MNPf is deployed in the Number Range Holder PLMN, the MNPf registers in the NRF of the number range holder PLMN with a new NF Type (e.g. MNPf).

2. The SMS-GMSC sends Nudm_UECM_SendRoutingInfoForSM to the SCP to get the serving node instance for UE from the UDM. As specified in the Indirect Communication with Delegated Discovery model, the Nudm_UECM_SendRoutingInfoForSM shall contain the discovery factors containing the GPSI (pointing to the Number Range Holder Network) and an indicator that Subscription Network resolution is delegated to the SCP.
- 3-4. The SCP shall query the local NRF to find the MNPF instance that manages the PLMN ID of the recipients GPSI's subscription network, the local NRF forwards the discovery request to the NRF of the number range holder PLMN.
5. The SCP determines the target PLMN of the recipients GPSI's subscription network using the SBI service of the MNPF i.e. the SCP invokes Nmpf_NPStatus_Get (GPSI) to the MNPF.
6. MNPF checks the portability status of the recipient GPSI and responds back with the target PLMN ID.

NOTE 1: If SCP is co-located with MNPF, steps between SCP and NRF to discover the MNPF, and steps between SCP and MNPF can be skipped.

NOTE 2: When the recipient GPSI belongs to the same country as the number range holder network and MNPF is not implemented in the country, the steps between SCP and MNPF can be skipped. In this case the SMS-GMSC or SCP determines the target PLMN ID from the recipient's GPSI Prefix (e.g. CC+NDC) based on local configuration.

- 7-8. SCP shall query the local NRF to find the UDM instance serving the target PLMN based on target PLMN ID received in step 6.
 - For step 7a-8a, if the target PLMN ID belongs to the number range holder PLMN, the local NRF forwards the discovery request to the NRF of the number range holder PLMN.
 - For step 7b-8b, if the target PLMN ID belongs to the Subscription PLMN, the local NRF forwards the discovery request to the NRF of the Subscription PLMN.
- 9-10. SCP invokes Nudm_UECM_SendRoutingInfoForSM (GPSI) to the UDM of the target PLMN to get the serving node instance for UE. The UDM shall check the registration/reachability flags to determine the potential target nodes and responds to the SCP by sending Nudm_UECM_SendRoutingInfoForSM response, in this procedure the SMSF instance Id is included in the response message.
11. SCP forwards the responds to the SMS-GMSC by sending Nudm_UECM_SendRoutingInfoForSM response (SMS Router address).

5.1.7.4 GPSI-to-Subscription-Network resolution using NRF

Figure 5.1.7.4-1 shows the procedure to determine the target PLMN based on the GPSI using the discovery and selection framework via the NRF as defined in 3GPP TS 23.501 [3] and 3GPP TS 23.502 [4].

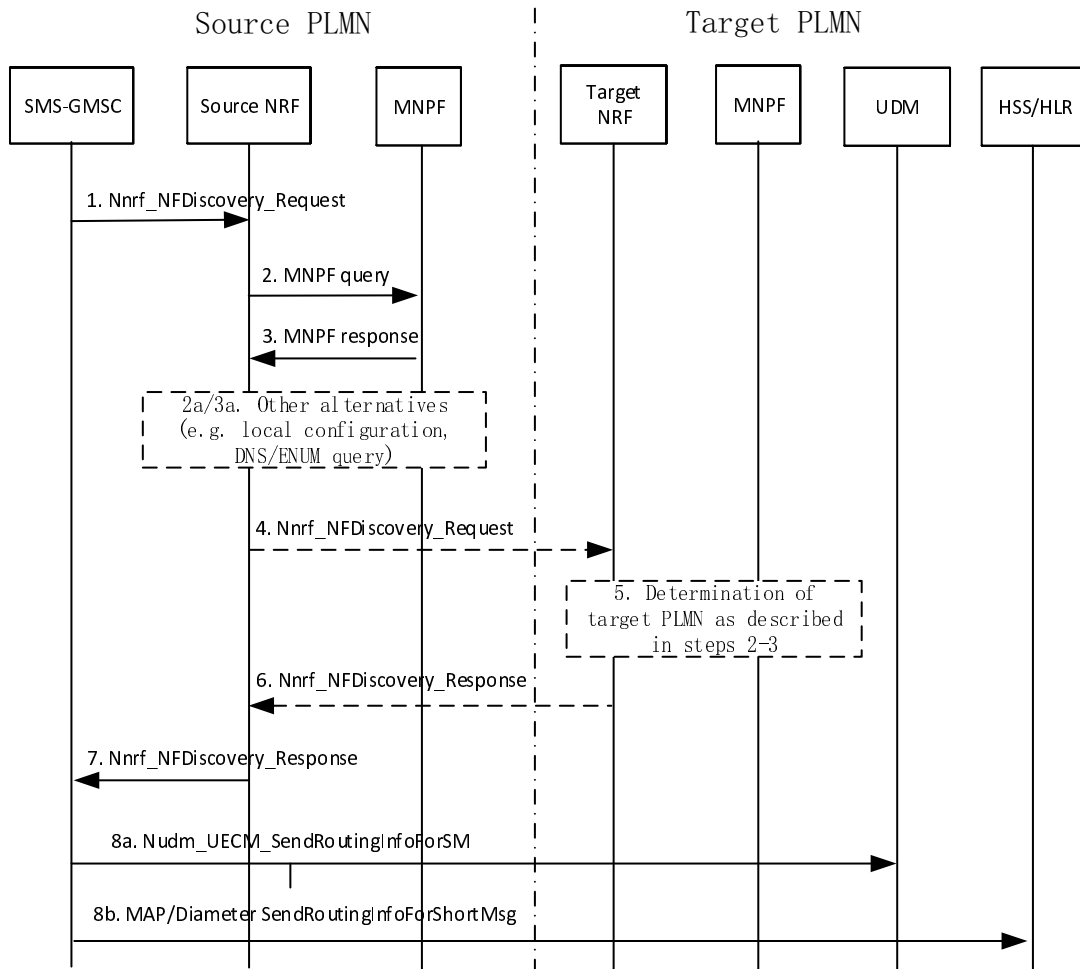

Figure 5.1.7.4-1: Determination of target PLMN based on GPSI using NRF

1. The SMS-GMSC located in the PLMN of the SMS sender contacts the NRF in the source PLMN to perform NF/NF service discovery of the UDM instance(s). The discovery request is based on the GPSI of the SMS recipient and includes an indication for the NRF to determine the target PLMN and interface to be used (SBI or legacy interface).
2. Based on the indication to determine the target PLMN and interface to be used included in the discovery request, the NRF in the source PLMN retrieves the target PLMN ID by consuming the SBI services of the MNPF described in clause 6.7. The NRF performs an NP query to the MNPF using SBI for the GPSI of the SMS recipient.
3. The MNPF provides in the response the target PLMN information corresponding to the GPSI of the SMS recipient and the procedure continues in step 4.
- 2a-3a. The NRF may, as an alternative implementation option to steps 2-3, obtain the target PLMN information by other means, e.g., using DNS/ENUM resolution, local configuration in the NRF or direct access to Number Portability (NP) databases via non-SBI, if applicable.

NOTE 1: NP applies to GPSIs representing E.164 addresses (i.e., MSISDN). NP is subject to regional and regulatory requirements and is accomplished through the retrieval of ported data from NP databases. Support of ENUM or direct access to NP via non-SBI interfaces and the exact means to make the number portability data available to the NRF is subject to and configured per operator policy.

The NRF may use the DNS/ENUM translation mechanism to resolve the GPSI of the SMS recipient in E.164 format to a URI as specified in IETF RFC 6116 [12]. The NRF performs an ENUM query for the GPSI of the SMS recipient in step 2a. The output of the lookup process in the DNS/ENUM server is a URI that is provided in the ENUM response and points to the source PLMN or the NRF in the target PLMN with which the source

PLMN has an interconnection agreement using SBI, so that the NRF in the source PLMN can send an inter-PLMN service discovery request to the NRF in the target PLMN.

NOTE 2: The DNS/ENUM server searches for an ENUM record matching the GPSI of the SMS recipient. An ENUM record for the individual GPSI or number series provisioned in the DNS/ENUM server can be used to indicate whether the user belongs to the same PLMN or another PLMN in the same or different country. A URI as a result of the lookup process in the DNS/ENUM server can be provided by provisioning an ENUM service using the http or https scheme URI as defined in IETF RFC 4002 [13] and IETF RFC 6118 [14].

4. Based on the response from the MNPF, the NRF in the source PLMN determines the target PLMN where to search for UDM instances.

If the NRF has obtained the target PLMN information by other means in steps 2a-3a, the NRF determines the target PLMN based on the information from ENUM response, NP databases via non-SBI and/or local configuration.

If the GPSI belongs to the source PLMN, the source NRF searches for UDM instances matching the discovery criteria that can serve the request in the source PLMN using SBI services and provides the discovery response in step 7.

If the GPSI belongs to a different PLMN, the NRF in the source PLMN checks whether the source PLMN has an interconnection agreement using SBI with the target PLMN and, in that case, sends an inter-PLMN discovery request to the NRF in the target PLMN to retrieve the UDM instances that can serve the SMS recipient, as defined in clause 4.17.5 of 3GPP TS 23.502 [4] and 3GPP TS 29.510 [10]. The discovery request across PLMNs shall include the GPSI of the SMS recipient, the indication to determine the target PLMN and interface to be used and may include an indication that NP information has been already obtained, if applicable.

5. Based on the indication to determine the target PLMN and interface to be used included in the discovery request from the source NRF, the NRF in the target PLMN applies the behaviour described for the source NRF in steps 2-3 (or alternatively, steps 2a-3a).

The target NRF may perform a query to the MNPF using SBI if NP is required and NP information has not been retrieved previously (e.g., if source and target PLMNs belong to different countries or portability domains and NP is required in the target PLMN). The target NRF obtains the PLMN ID of the new target PLMN in the response from the MNPF.

6. The target NRF provides the inter-PLMN discovery response including one of the following:

- UDM instance(s) matching the discovery criteria in the target PLMN.
- Information about a new target PLMN as a result of an NP query performed in the target PLMN selected first by the source PLMN, if applicable. The source NRF may then send an inter-PLMN discovery request to the NRF in the new target PLMN if there is an interconnection agreement based on SBI.
- No UDM instance(s) found in the target PLMN, implying that SBI interactions should not be used.

7. If the source NRF finds UDM instances matching the filter criteria in the source PLMN or receives UDM instances from the target NRF in the response to a discovery request across PLMNs in step 6, the source NRF provides the UDM instances in the discovery response to the SMS-GMSC.

If the source NRF receives information about a new target PLMN in the discovery response from the target NRF as a result of an NP query performed in the target PLMN, the source NRF checks whether the source PLMN has an interconnection agreement using SBI with the new target PLMN and, in that case, sends a discovery request across PLMNs to the new target NRF as described in step 4.

If no UDM instances can serve the request using SBI, the source NRF provides the discovery response indicating the SMS-GMSC to use a non-SBI interface for the next operation request in the procedure.

- 8a. If the discovery response includes UDM instances that can serve the SMS recipient, the SMS-GMSC sends the operation request using SBI to e.g., retrieve the SMS routing information from the UDM, and the SBI-based MT SMS procedure can be executed as described in clause 5.1.
- 8b. If no UDM instances are provided in the discovery response, the SMS-GMSC sends the operation request via legacy interface using MAP/Diameter to e.g., retrieve the SMS routing information from the HLR/HSS/UDM.

5.1.8 Alert

Figure 5.1.8-1 depicts procedure for alert.

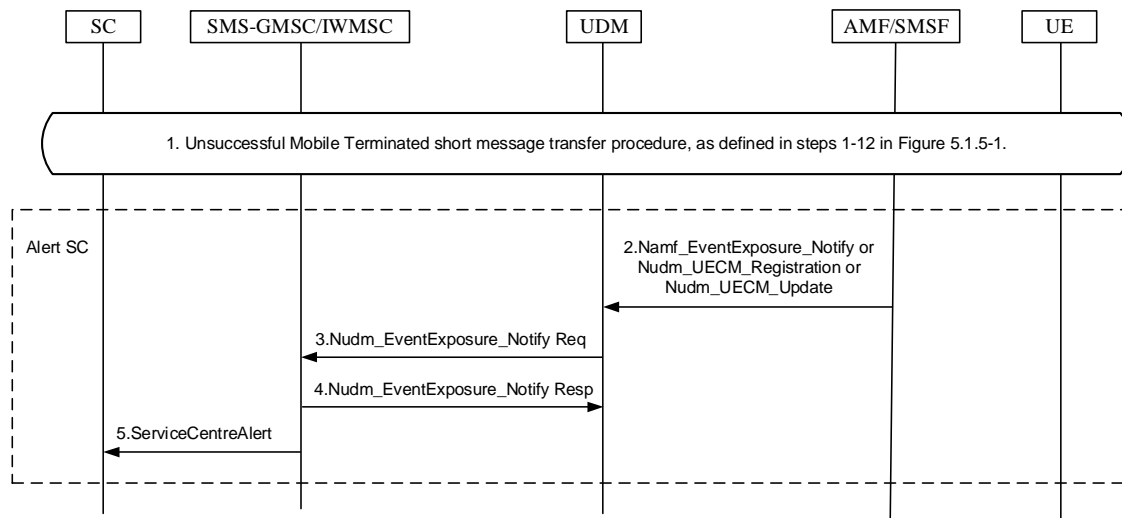

Figure 5.1.8-1: Procedure for alert

- 1 Unsuccessful Mobile Terminated short message transfer (without IP-SM-GW/SMS Router) procedure, as defined in steps 1-10 in Figure 5.1.5-1.
- 2 UDM receives Namf_EventExposure_Notify or Nudm_UECM_Registration operation from AMF or SMSF indicating that the UE is reachable for SMS delivery; or UDM receives Nudm_UECM_Update operation from SMSF indicating that the UE has memory capacity available.
- 3-4 The UDM notifies the "UE_MEMORY_AVAILABLE_FOR_SMS" or "UE_REACHABILITY_FOR_SMS" event to the SMS-GMSC/IWMSC accordingly. The UDM updates the corresponding reachability flags and deletes the subscription to UE reachability for SMS event created by the SMS-GMSC.
- 5 ServiceCentreAlert as defined in Operation 13 of Figure 20 in TS 23.040 [2].

5.1.9 Unsuccessful Mobile Terminated short message transfer via SMS Router

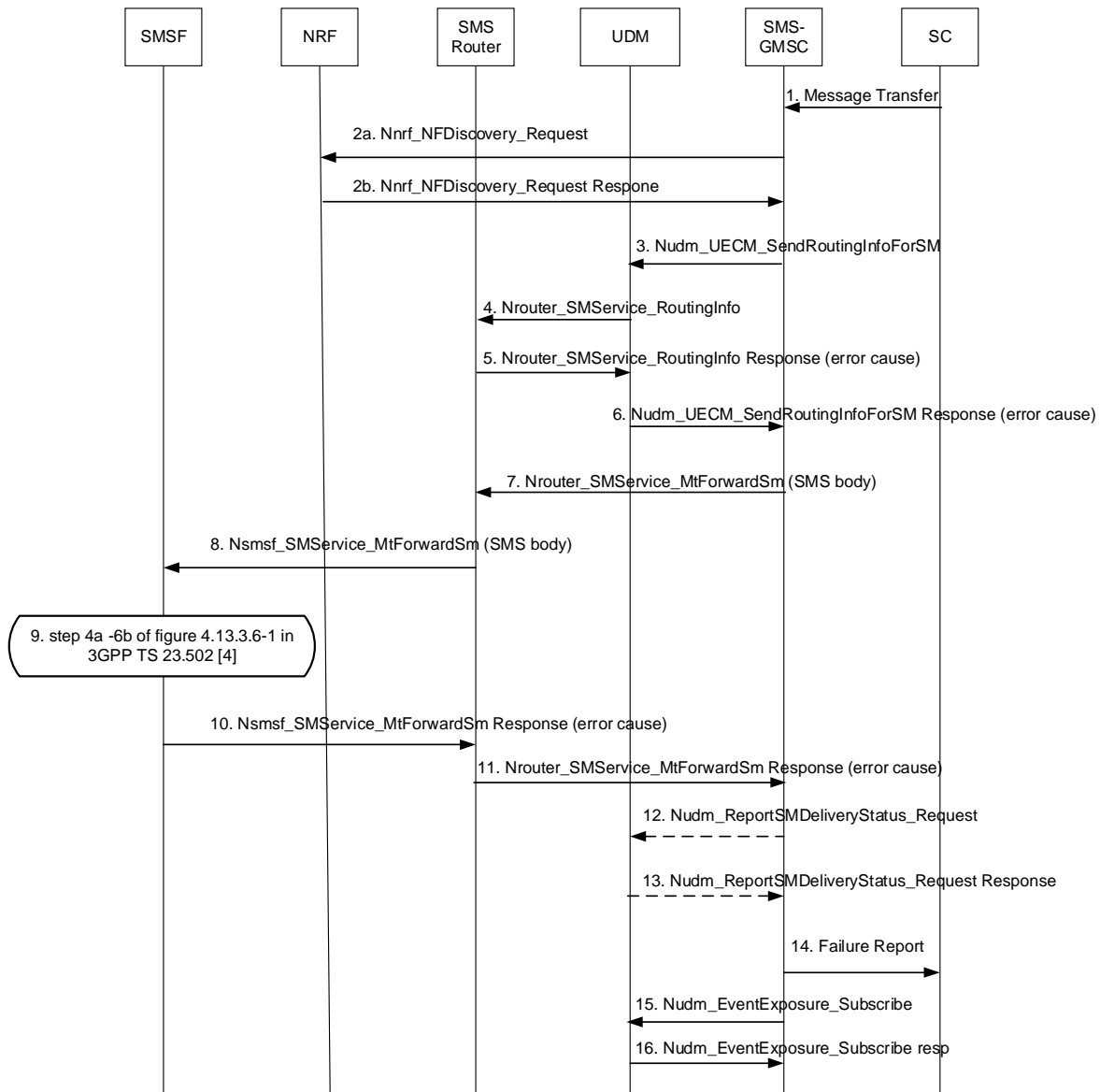

Figure 5.1.9-1: Unsuccessful MT SMS over NAS via SMS Router

1. MT SMS interaction between SC and SMS-GMSC follow the current procedure as defined in 3GPP TS 23.040 [2].
- 2a-2b. The SMS-GMSC should query the NRF to find the UDM instance that manages the user subscriptions using the GPSI. If there is no available UDM returned from NRF, the SMS-GMSC may send error response to the SC.
3. SMS-GMSC invokes Nudm_UECM_SendRoutingInfoForSM (GPSI) to the UDM to get the serving node information for all access types for the UE.
4. The UDM shall check the registration/reachability flags to determine the potential target nodes, e.g. SMSF. For MT SM transfer via SMS Router, the UDM shall invoke the Nrouter_SMSservice_RoutingInfo to provide the SMSF Instance Id to the SMS Router. The address of the SMS Router to be contacted by the UDM may be configured locally.

5. If any failure at this step, the SMS Router shall send `Nrouter_SMSservice_RoutingInfo` response with error cause to the UDM.
6. If the UDM receives error response from SMS Router in step 5 or UDM is failed after step 3, e.g. user not found in the UDM, the UDM shall respond to the SMS-GMSC by sending `Nudm_UECM_SendRoutingInfoForSM` response with error cause. If there is no target node address registered in the UDM, a response with error case indicating absent subscriber for SM is sent to the SMS-GMSC and the procedure continues in step 15.
7. If successful response is returned in step 6, the SMS-GMSC forwards the SMS message to the SMS Router by invoking `Nrouter_SMSservice_MtForwardSm` service operation.
8. The SMS Router forwards the SMS message to the SMSF by invoking `Nsmsf_SMSservice_MtForwardSm` service operation.
9. MT SMS over NAS procedure between SMSF, AMF and UE is same as the definition in step 4a to 6b of Figure 4.13.3.6-1 of 3GPP TS 23.502 [4].
10. If the AMF informs the SMSF that it cannot deliver the MT-SMS to the UE in step 9, e.g. UE is not reachable, or the SMSF is failed at this step, e.g. memory capacity exceeded, the SMSF shall send the `Nsmsf_SMSservice_MtForwardSm` response with error cause to the SMS Router.
11. If the SMS Router receives error response from SMSF in step 10 or the SMS Router is failed after step 7, the SMS Router shall send the `Nrouter_SMSservice_MtForwardSm` response with error cause to the SMS-GMSC.
- 12-13. The SMS-GMSC may report the SM-Delivery Status (e.g. UE is not reachable or memory capacity exceeded) to UDM by invoking `Nudm_ReportSMDeliveryStatus_Request`.
14. If the SMS-GMSC receives error response from SMS Router in step 6 or step 11, the SMS-GMSC sends the failure report to SC as defined in TS 23.040 [2].
15. The SMS-GMSC subscribes in UDM to be notified when the UE becomes reachable for SMS (i.e. when the UE gets in radio contact with the AMF while an SMSF is actually registered, or when an SMSF gets registered) by using the `Nudm_EventExposure_Subscribe` service operation for Reachability for SMS event as defined in 3GPP TS 23.502 [4].
16. If applicable, the UDM subscribes to UE reachability notification in the AMF(s) using the `Namf_EventExposure` service and sets the relevant reachability flags. The UDM acknowledges the event subscription created by the SMS-GMSC.

5.2 Procedure for SBI-based MO SMS

5.2.1 General

The procedure for SBI-based MO SMS is showed in Figure 5.2.2-1, which is based on MO SMS procedures in 3GPP TS 23.040 [2] clause 10.2. Compared to procedures in 3GPP TS 23.040 [2], new services are introduced in, including:

- `Niwmsc_SMSservice` service provided by SMS-IWMSC.

This new service is registered in NRF, and can be invoked by service consumers.

5.2.2 Procedure for Successful Mobile Originated short message transfer

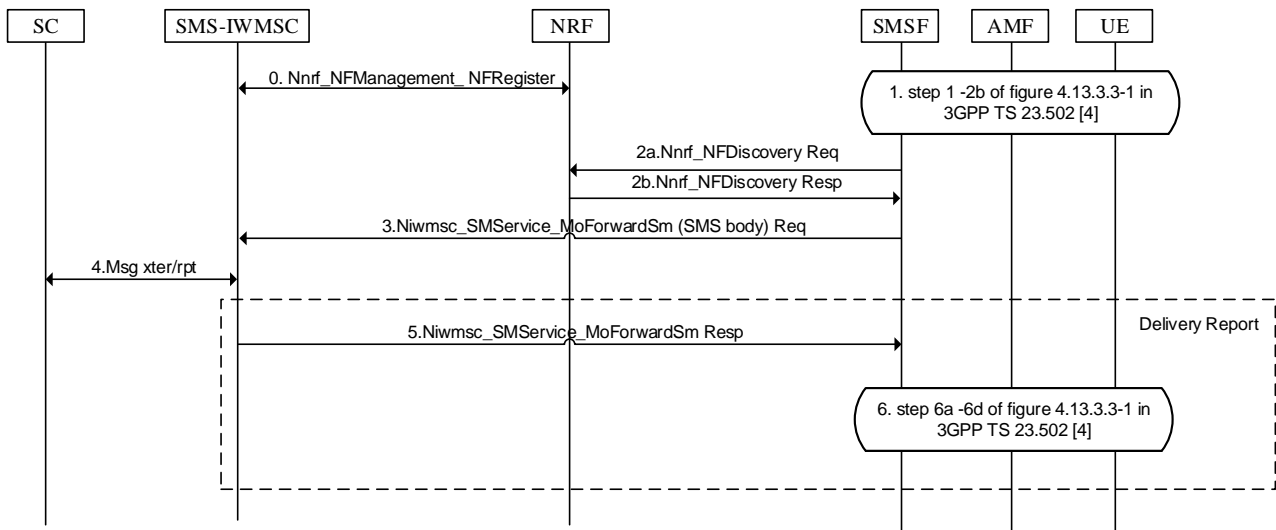

Figure 5.2.2-1: Procedures for successful SBI-based SM MO message transfer

- 0 SMS-IWMSC registers Niwmsc_SMSservice service in the NRF, during the NF registration procedure.
- 1 MO SM message transfer from UE to SMSF through AMF follows the current procedure as defined in 3GPP TS 23.040 [2]
- 2a If SMSF knows from local configuration that the target SMS-IWMSC does not support SBI, it shall quit the SBI-based procedure and fallback to legacy (MAP/Diameter) protocol based procedures, as defined in TS 23.040 [2],
or SMSF invokes the Nnrf_NFDiscovery to discover and select serving SMS-IWMSC with the parameters of SUPI and/or GPSI and/or location (e.g. TAIs, CGIs, etc.) and/or E.164 address of the SC.
- 2b If no SMS-IWMSC could be discovered, the NRF shall feedback to SMSF, and SMSF shall quit the SBI-based procedure and fallback to legacy (MAP/Diameter) protocol based procedures, as defined in TS 23.040 [2].
If a SMS-IWMSC is discovered and selected, NRF returns the IP addresses or FQDNs of the serving SMS-IWMSC to provide Niwmsc_SMSservice service to SMSF.
- 3 SMSF sends a Niwmsc_SMSservice_MoForwardSm service request to the URI of serving SMS-IWMSC, which is obtained in step 2b. The payload body of the request shall contain the SM record to be sent, the Service Centre address, the callbackURI for MO SMS Delivery Report, the timer for waiting the MO SMS Delivery Report, and optionally contains the Access Type.
- 4 MO SMS delivery procedure between SMS-IWMSC and SC is the same as the definition in step 4 of Figure 4.13.3.3-1 of 3GPP TS 23.502 [4].
- 5 SMS-IWMSC sends Niwmsc_SMSservice_MoForwardSm response to deliver the MO SMS delivery report to the URI of serving SMSF, which is obtained in step 3
- 6 MO SMS delivery report procedure between SMSF, AMF and UE is the same as the 3GPP TS 23.502 [4].
When no more SMS is to be sent, the procedure for CP-ack and SMS ack is the same as the 3GPP TS 23.502 [4].
These procedures are defined in step 6a to 6d of Figure 4.13.3.3-1 of 3GPP TS 23.502 [4].

5.2.3 Unsuccessful Mobile Originated short message transfer

Figure 5.2.3-1 depicts procedure for unsuccessful SBI-based SM MO message transfer

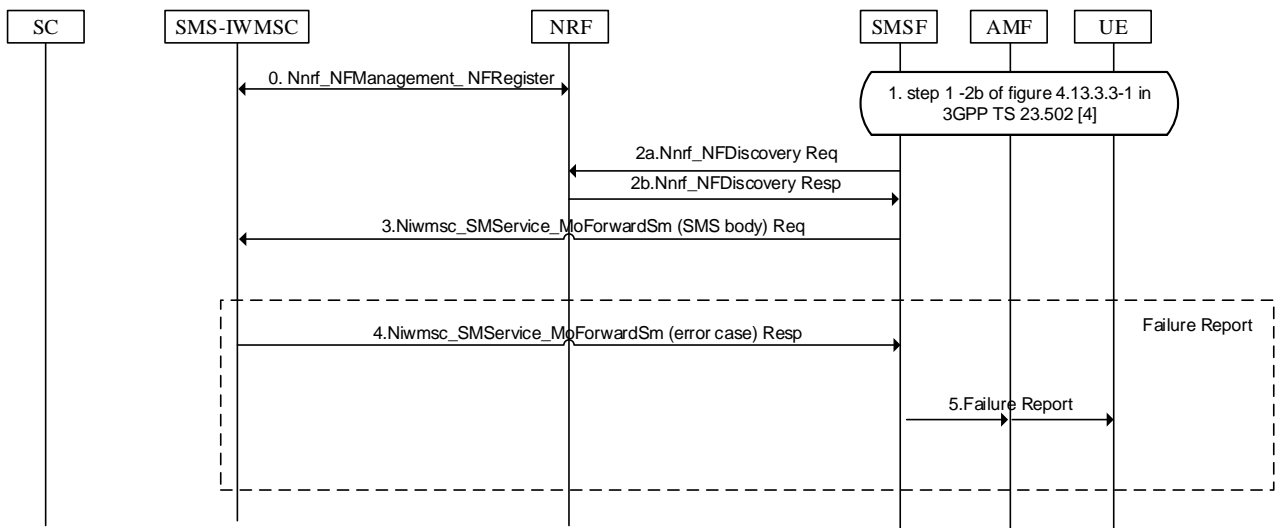

Figure 5.2.3-1: Procedures for unsuccessful SBI-based SM MO message transfer

0-3 The same as the procedures in step 0-3 of Figure 5.2.2-1 in clause 5.2.2

4 SMS-IWMSC sends Niwmsc_SMSERVICE_MoForwardSm response with HTTP status code for application errors as defined in Table 5.3.2-1.

5 Failure report from SMSF to UE, with the error cause code as defined in Table 5.3.2-2.

SMS-IWMSC indicates the different errors for MO SM transfer in MoForwardSm response according to the different failure scenarios which happened during MO SM transfer. The Application Errors used in Niwmsc_SMSERVICE_MoForwardSm response are defined in Table 5.3.2-1 below

Table 5.3.2-1: Application errors

Application Error	HTTP status code	Description
UNKNOWN_SERVICE_CENTRE_ADDRESS	403 Forbidden	The delivery of the MO short message failed because SMS-SC was unknown.
SERVICE_CENTRE_CONGESTION	403 Forbidden	The delivery of the MO short message failed because SMS-SC was in congestion.
USER_NOT_SERVICE_CENTER	403 Forbidden	The delivery of the short message failed because the user didn't belongs to the SMS-SC.
FACILITY_NOT_SUPPORTED	403 Forbidden	The delivery of the MO short message failed because of facility not supported.
INVALID_SME_ADDRESS	403 Forbidden	The delivery of the MO short message failed because the SME address is invalid.
UNREACHABLE_SMS_SC	504 Gateway Timeout	The delivery of the MO short message failed because the response is timeout.

If errors are indicated by the SMS-IWMSC, the SMSF shall send a failure report (i.e. a RP-ERROR message) to the UE, with the error cause coded as following map between errors indicated by SMS-IWMSC and error cause code in RP-ERROR message:

Table 5.3.2-2: MAP of Application errors

Return error from SMS-IWMSC	Cause value in the RP-ERROR message
The Response from SMS-IWMSC is timeout Unspecified 4xx/5xx error code	38 Network out of order
403 Forbidden with FACILITY_NOT_SUPPORTED	69 Requested facility not implemented
403 Forbidden with UNKNOWN_SERVICE_CENTRE_ADDRESS	1 Unassigned number
403 Forbidden with SERVICE_CENTRE_CONGESTION	42 Congestion
403 Forbidden with USER_NOT_SERVICE_CENTER	28 Unidentified subscriber
403 Forbidden with INVALID_SME_ADDRESS	21 Short message transfer rejected

NOTE: The coding and the use of the RP-ERROR message is specified in 3GPP TS 24.011 [8].

5.2.4 MSISDN-less MO SMS message transfer

The procedure for SBI-based MSISDN-less MO SMS message transfer is depicted in Figure 5.2.4-1,

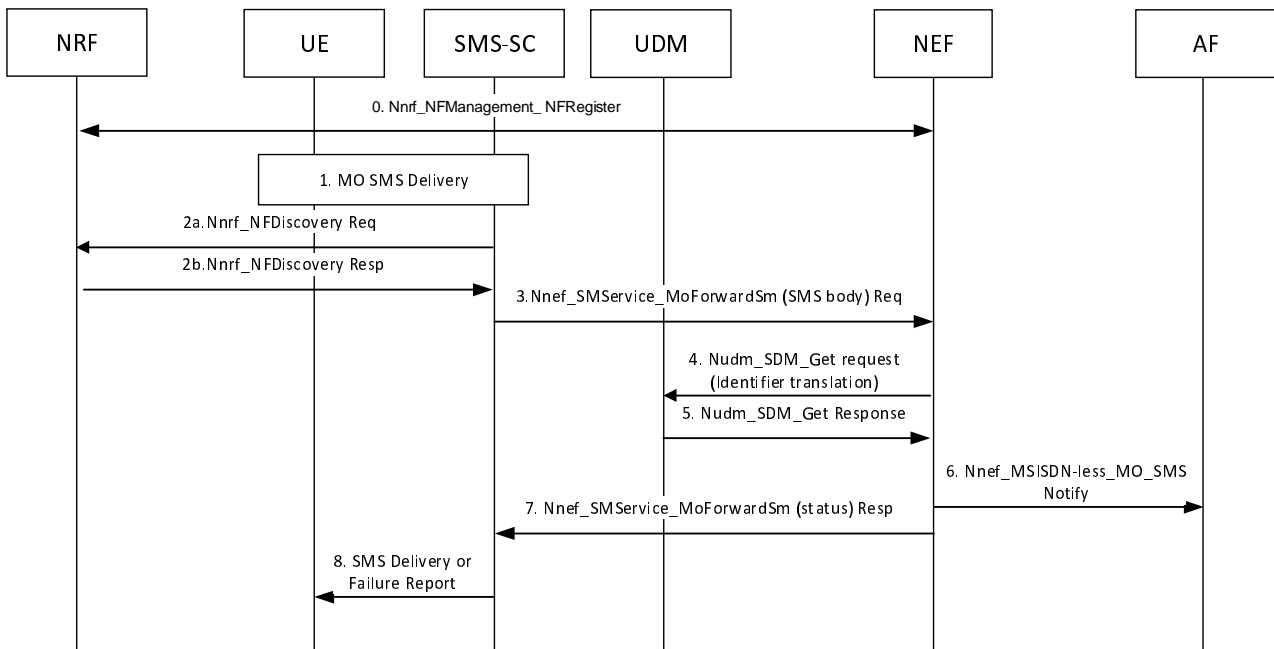

Figure 5.2.4-1: Procedures for MSISDN-less MO SMS message transfer

- 0 NEF registers Nnef_SMSService_MoForwardSm service and supporting long/short code ranges in NRF, during the NF registration procedure.
- 1 MO SMS transmit from UE to SMS-SC, as already defined in clause 5.2.2.
- 2a-2b SMS-SC provides destination SME address (long/short code of the AF) to NRF for NEF selection, and chooses Nnef_SMSService_MoForwardSm service for MSISDN-less MO SMS submit.
- 3 SMS-SC forwards MO SM to NEF, by invoking Nnef_SMSService_MoForwardSm service.
- 4-5 Nudm_SDM_Get and response between NEF and UDM, which refers to Step 3-Step 4 of Figure 4.13.7.2-1 in TS 23.502 [4].
- 6 The NEF provides a Nnef_MSISDN-less_MO_SMS Notify, which refers to Step 5 of Figure 4.13.7.2-1 in TS 23.502 [4].
- 7 NEF sends Nnef_SMSService_MoForwardSm response to SMS-SC, carrying a success or failure delivery indication to SMS-SC.

- 8 SMS-SC indicates success/failure back to UE using existing SBI-based SMS delivery report defined in clause 6.2.2.

6 Services for SBI-based SMS

6.1 General

This clause introduces the services for SBI-based SMS.

6.2 UDM services for SBI-based SMS

6.2.1 General

The following table illustrates the UDM services for SBI-based SMS.

Table 6.2.1-1: UDM Services for SBI-based SMS

Service Name	Service Operations	Operation Semantics	Service Provider(s)	Service Consumer(s)
UE Context Management (UECM)	SendRoutingInfoForSM	request / response	UDM	SMS-GMSC
ReportSMDeliveryStatus	Request	request / response	UDM	SMS-GMSC, IP-SM-GW,
EventExposure	Subscribe	subscribe / notify	UDM	SMS-GMSC

6.2.2 Nudm_ReportSMDeliveryStatus service

6.2.2.1 General

For the Nudm_ReportSMDeliveryStatus service the following service operations are defined:

- Request

6.2.2.2 Nudm_ReportSMDeliveryStatus_Request service operation

Service operation name: Nudm_ReportSMDeliveryStatus_Request

Description: reports the SM-Delivery Status to UDM.

Inputs, Required: GPSI, SM-Delivery status

Inputs, Optional: None.

Outputs, Required: report SM-Delivery status result.

Outputs, Optional: None.

6.2.3 Nudm_EventExposure service

Service Description: This service is defined in clause 5.2.3.5 of 3GPP TS 23.502 [4], in addition, this clause defines the enhancement of Nudm_EventExposure for alert sc.

Except the existing events that are exposed by UDM, events "UE_MEMORY_AVAILABLE_FOR_SMS" and "UE_REACHABILITY_FOR_SMS" should be supported.

6.2.4 Nudm_UECM service

Service Description: This service is defined in clause 5.2.3.2 of 3GPP TS 23.502 [4], in addition, this clause defines the enhancement of Nudm_UECM service.

The new service operation SendRoutingInfoForSM shall be supported to get the target valid node(s) serving the UE from the UDM, which will be used by the SMS-GMSC to deliver the MT SMS.

6.3 SMS-IWMSC services for SBI-based SMS

6.3.1 General

The following table illustrates the SMS-IWMSC services for SBI-based SMS.

Table 6.3.1-1: SMS-IWMSC Services for SBI-based SMS

Service Name	Service Operations	Operation Semantics	Service Provider(s)	Service Consumer(s)
SMSservice	MoForwardSm	request / response	SMS-IWMSC	SMSF

6.3.2 Niwmsc_SMSservice service

6.3.2.1 General

Service Description: This service can be used for SBI-based MO SM transfer and Delivery Report through SMS-IWMSC.

6.3.2.2 Niwmsc_SMSservice_MoForwardSm service operation

Service operation name: Niwmsc_SMSservice_MoForwardSm.

Description: Service request from consumer to SMS-IWMSC for MO SM transmit.

Inputs, Required: the SM record to be sent, the Service Centre address, the callbackURI for MO SMS Delivery Report, the timer for waiting MO SMS Delivery Report.

Inputs, Optional: Access Type.

Outputs, Required: On success, Delivery Report should be returned.

On failure or redirection, the appropriate HTTP status code (e.g. "403 Forbidden", "504 Gateway Timeout") indicating the error shall be returned.

Outputs, Optional: None.

6.4 SMSF services for SBI-based SMS

6.4.1 General

The following table illustrates the SMSF services for SBI-based SMS.

Table 6.4.1-1: SMSF Services for SBI-based SMS

Service Name	Service Operations	Operation Semantics	Service Provider(s)	Service Consumer(s)
SMSservice	MtForwardSm	request / response	SMSF	SMS-GMSC, IP-SM-GW, SMS Router

6.4.2 Nsmsf_SMSservice service

6.4.2.1 General

Service Description: This service can be used for SBI-based MT SM transfer through SMSF.

6.4.2.2 Nsmsf_SMSservice_MtForwardSm service operation

Service operation name: Nsmsf_SMSservice_MtForwardSm

Description: transfer downlink SMS message from consumer NF to SMSF.

Inputs, Required: GPSI, SMS payload

Inputs, Optional: None.

Outputs, Required: SMS message transmission result.

Outputs, Optional: None.

6.5 IP-SM-GW services for SBI-based SMS

6.5.1 General

The following table illustrates the IP-SM-GW services for SBI-based SMS.

Table 6.5.1-1: IP-SM-GW Services for SBI-based SMS

Service Name	Service Operations	Operation Semantics	Service Provider(s)	Service Consumer(s)
SMSservice	RoutingInfo	request / response	IP-SM-GW	UDM
	MtForwardSm	request / response	IP-SM-GW	SMS-GMSC

6.5.2 Nipsmgw_SMSservice service

6.5.2.1 General

Service Description: This service can be used for SBI-based MT SM transfer through IP-SM-GW.

6.5.2.2 Nipsmgw_SMSservice_RoutingInfo service operation

Service operation name: Nipsmgw_SMSservice_RoutingInfo

Description: provides the SMSF Instance Id to the IP-SM-GW.

Inputs, Required: GPSI, SMSF Instance Id.

Inputs, Optional: None.

Outputs, Required: Result.

Outputs, Optional: None.

6.5.2.3 Nipsmgw_SMSservice_MtForwardSm service operation

Service operation name: Nipsmgw_SMSservice_MtForwardSm

Description: transfer downlink SMS message from consumer NF to IP-SM-GW and return the MT SMS Delivery Report to the consumer NF.

Inputs, Required: GPSI, SMS payload

Inputs, Optional: None.

Outputs, Required: MT SMS Delivery Report.

Outputs, Optional: None.

6.6 SMS Router services for SBI-based SMS

6.6.1 General

The following table illustrates the SMS Router services for SBI-based SMS.

Table 6.6.1-1: SMS Router Services for SBI-based SMS

Service Name	Service Operations	Operation Semantics	Service Provider(s)	Service Consumer(s)
SMSservice	RoutingInfo	request / response	SMS Router	UDM
	MtForwardSm	request / response	SMS Router	SMS-GMSC

6.6.2 Nrouter_SMSservice service

6.6.2.1 General

Service Description: This service can be used for SBI-based MT SM transfer through SMS Router.

6.6.2.2 Nrouter_SMSservice_RoutingInfo service operation

Service operation name: Nrouter_SMSservice_RoutingInfo

Description: provides the SMSF Instance Id to the SMS Router.

Inputs, Required: GPSI, SMSF Instance Id.

Inputs, Optional: None.

Outputs, Required: Result.

Outputs, Optional: None.

6.6.2.3 Nrouter_SMSservice_MtForwardSm service operation

Service operation name: Nrouter_SMSservice_MtForwardSm

Description: transfer downlink SMS message from consumer NF to SMS Router and return the MT SMS Delivery Report to the consumer NF.

Inputs, Required: GPSI, SMS payload

Inputs, Optional: None.

Outputs, Required: MT SMS Delivery Report.

Outputs, Optional: None.

6.7 MNPF services for SBI-based SMS

6.7.1 General

The following table illustrates the MNPF services for SBI-based SMS.

Table 6.7.1-1: MNPF Services for SBI-based SMS

Service Name	Service Operations	Operation Semantics	Service Provider(s)	Service Consumer(s)
NPStatus	Get	request / response	MNPF	SMS-GMSC, SCP

6.7.2 Nmpf_NPStatus service

6.7.2.1 General

Service Description: This service can be used to retrieve the PLMN ID of the Subscription Network of a GPSI.

6.7.2.2 Nmpf_NPStatus_Get service operation

Service operation name: Nmpf_NPStatus_Get

Description: retrieve the PLMN ID of the Subscription Network of a GPSI.

Inputs, Required: GPSI.

Inputs, Optional: None.

Outputs, Required: PLMN Id.

Outputs, Optional: None.

6.8 NEF services for SBI-based SMS

6.8.1 General

The following table illustrates the NEF services for SBI-based SMS.

Table 6.8.1-1: NEF Services for SBI-based SMS

Service Name	Service Operations	Operation Semantics	Service Provider(s)	Service Consumer(s)
SMSservice	MoForwardSm	request / response	NEF	SMS-SC

6.8.2 Nnef_SMSservice service

6.8.2.1 General

This service can be used for SBI-based MO SM transfer through NEF for MSISDN-less MO SMS.

6.8.2.2 Nnef_SMSservice_MoForwardSm service operation

Service operation name: Nnef_SMSservice_MoForwardSm

Description: transmit MO SMS message from consumer NF to NEF.

Inputs, Required: SMS payload, Application port ID, SUPI, destination SME address (long/short code of the AF).

Inputs, Optional: None.

Outputs, Required: SMS message transmission result.

Outputs, Optional: None.

Annex A (informative): Change history

Change history							
Date	Meeting	TDoc	CR	Rev	Cat	Subject/Comment	New version
2021-10	CT4#106e	C4-215046				C4-215046 as basis	0.1.0
2021-10	CT4#106e	C4-215513				Implementation of C4-215417, C4-215418, C4-215453 and C4-215454 in CT4#106e	0.2.0
2021-12	CT4#107e	C4-216466				Implementation of C4-216442, C4-216443, C4-216444 and C4-216546 in CT4#107e	0.3.0
2022-01	CT4#107bis-e	C4-220540				Implementation of C4-220029, C4-220341, C4-220374, C4-220408 and C4-220409 in CT4#107bis-e	0.4.0
2022-02	CT4#108e	C4-221588				Implementation of C4-221438, C4-221573, C4-221595 and C4-221692 in CT4#108e	0.5.0
2022-04	CT4#109e	C4-222340				Implementation of C4-222229, C4-222271, C4-222301, C4-222329, C4-222330, C4-222394, C4-222395, C4-222396, C4-222397 and C4-222418 in CT4#109e	0.6.0
2022-05	CT4#110e	C4-223449				Implementation of C4-223277, C4-223342 and C4-223358 in CT4#110e	0.7.0
2022-06	CT#96	CP-221077				TS for information and approval	1.0.0
2022-06	CT#96	CP-221077				TS approved in CT#96	17.0.0
2022-09	CT#97e	CP-222027	0001	-	B	TS 23.540 Alignment of MNPF	17.1.0
2022-09	CT#97e	CP-222027	0002	-	B	Add NEF and MNPF in SBI-based SMS system architecture	17.1.0
2022-09	CT#97e	CP-222027	0003	-	F	Description of the Alert procedure	17.1.0
2022-09	CT#97e	CP-222027	0004	-	F	Correction on Operation Semantic of UDM service	17.1.0
2023-06	CT#100	CP-221072	0010	-	F	Indication of Memory Available from SMSF as trigger for the Alert procedure	17.2.0

History

Document history		
V17.0.0	July 2022	Publication
V17.1.0	October 2022	Publication
V17.2.0	July 2023	Publication