

# ETSI TS 123 502 V16.16.0 (2023-07)



**5G;  
Procedures for the 5G System (5GS)  
(3GPP TS 23.502 version 16.16.0 Release 16)**



---

**Reference**

RTS/TSGS-0223502v00

---

**Keywords**

5G

**ETSI**

---

650 Route des Lucioles  
F-06921 Sophia Antipolis Cedex - FRANCE

Tel.: +33 4 92 94 42 00 Fax: +33 4 93 65 47 16

Siret N° 348 623 562 00017 - APE 7112B  
Association à but non lucratif enregistrée à la  
Sous-Préfecture de Grasse (06) N° w061004871

---

**Important notice**

The present document can be downloaded from:

<https://www.etsi.org/standards-search>

The present document may be made available in electronic versions and/or in print. The content of any electronic and/or print versions of the present document shall not be modified without the prior written authorization of ETSI. In case of any existing or perceived difference in contents between such versions and/or in print, the prevailing version of an ETSI deliverable is the one made publicly available in PDF format at [www.etsi.org/deliver](http://www.etsi.org/deliver).

Users of the present document should be aware that the document may be subject to revision or change of status.

Information on the current status of this and other ETSI documents is available at

<https://portal.etsi.org/TB/ETSIDeliverableStatus.aspx>

If you find errors in the present document, please send your comment to one of the following services:

<https://portal.etsi.org/People/CommitteeSupportStaff.aspx>

If you find a security vulnerability in the present document, please report it through our

Coordinated Vulnerability Disclosure Program:

<https://www.etsi.org/standards/coordinated-vulnerability-disclosure>

---

**Notice of disclaimer & limitation of liability**

The information provided in the present deliverable is directed solely to professionals who have the appropriate degree of experience to understand and interpret its content in accordance with generally accepted engineering or other professional standard and applicable regulations.

No recommendation as to products and services or vendors is made or should be implied.

No representation or warranty is made that this deliverable is technically accurate or sufficient or conforms to any law and/or governmental rule and/or regulation and further, no representation or warranty is made of merchantability or fitness for any particular purpose or against infringement of intellectual property rights.

In no event shall ETSI be held liable for loss of profits or any other incidental or consequential damages.

Any software contained in this deliverable is provided "AS IS" with no warranties, express or implied, including but not limited to, the warranties of merchantability, fitness for a particular purpose and non-infringement of intellectual property rights and ETSI shall not be held liable in any event for any damages whatsoever (including, without limitation, damages for loss of profits, business interruption, loss of information, or any other pecuniary loss) arising out of or related to the use of or inability to use the software.

---

**Copyright Notification**

No part may be reproduced or utilized in any form or by any means, electronic or mechanical, including photocopying and microfilm except as authorized by written permission of ETSI.

The content of the PDF version shall not be modified without the written authorization of ETSI.

The copyright and the foregoing restriction extend to reproduction in all media.

© ETSI 2023.  
All rights reserved.

---

# Intellectual Property Rights

## Essential patents

IPRs essential or potentially essential to normative deliverables may have been declared to ETSI. The declarations pertaining to these essential IPRs, if any, are publicly available for **ETSI members and non-members**, and can be found in ETSI SR 000 314: "*Intellectual Property Rights (IPRs); Essential, or potentially Essential, IPRs notified to ETSI in respect of ETSI standards*", which is available from the ETSI Secretariat. Latest updates are available on the ETSI Web server (<https://ipr.etsi.org/>).

Pursuant to the ETSI Directives including the ETSI IPR Policy, no investigation regarding the essentiality of IPRs, including IPR searches, has been carried out by ETSI. No guarantee can be given as to the existence of other IPRs not referenced in ETSI SR 000 314 (or the updates on the ETSI Web server) which are, or may be, or may become, essential to the present document.

## Trademarks

The present document may include trademarks and/or tradenames which are asserted and/or registered by their owners. ETSI claims no ownership of these except for any which are indicated as being the property of ETSI, and conveys no right to use or reproduce any trademark and/or tradename. Mention of those trademarks in the present document does not constitute an endorsement by ETSI of products, services or organizations associated with those trademarks.

**DECT™**, **PLUGTESTS™**, **UMTS™** and the ETSI logo are trademarks of ETSI registered for the benefit of its Members. **3GPP™** and **LTE™** are trademarks of ETSI registered for the benefit of its Members and of the 3GPP Organizational Partners. **oneM2M™** logo is a trademark of ETSI registered for the benefit of its Members and of the oneM2M Partners. **GSM®** and the GSM logo are trademarks registered and owned by the GSM Association.

---

# Legal Notice

This Technical Specification (TS) has been produced by ETSI 3rd Generation Partnership Project (3GPP).

The present document may refer to technical specifications or reports using their 3GPP identities. These shall be interpreted as being references to the corresponding ETSI deliverables.

The cross reference between 3GPP and ETSI identities can be found under <https://webapp.etsi.org/key/queryform.asp>.

---

# Modal verbs terminology

In the present document "**shall**", "**shall not**", "**should**", "**should not**", "**may**", "**need not**", "**will**", "**will not**", "**can**" and "**cannot**" are to be interpreted as described in clause 3.2 of the [ETSI Drafting Rules](#) (Verbal forms for the expression of provisions).

"**must**" and "**must not**" are **NOT** allowed in ETSI deliverables except when used in direct citation.

# Contents

Intellectual Property Rights .....	2
Legal Notice .....	2
Modal verbs terminology.....	2
Foreword.....	20
1 Scope .....	21
2 References .....	21
3 Definitions, symbols and abbreviations .....	23
3.1 Definitions .....	23
3.2 Abbreviations .....	24
4 System procedures.....	24
4.1 General .....	24
4.2 Connection, Registration and Mobility Management procedures .....	24
4.2.1 General.....	24
4.2.2 Registration Management procedures.....	24
4.2.2.1 General .....	24
4.2.2.2 Registration procedures.....	24
4.2.2.2.1 General .....	24
4.2.2.2.2 General Registration .....	26
4.2.2.2.3 Registration with AMF re-allocation.....	41
4.2.2.3 Deregistration procedures .....	44
4.2.2.3.1 General .....	44
4.2.2.3.2 UE-initiated Deregistration.....	44
4.2.2.3.3 Network-initiated Deregistration.....	46
4.2.3 Service Request procedures .....	47
4.2.3.1 General .....	47
4.2.3.2 UE Triggered Service Request.....	47
4.2.3.3 Network Triggered Service Request .....	59
4.2.4 UE Configuration Update .....	66
4.2.4.1 General .....	66
4.2.4.2 UE Configuration Update procedure for access and mobility management related parameters .....	67
4.2.4.3 UE Configuration Update procedure for transparent UE Policy delivery .....	71
4.2.5 Reachability procedures.....	72
4.2.5.1 General .....	72
4.2.5.2 UE Reachability Notification Request procedure .....	72
4.2.5.3 UE Activity Notification procedure .....	74
4.2.6 AN Release .....	75
4.2.7 N2 procedures .....	78
4.2.7.1 N2 Configuration .....	78
4.2.7.2 NGAP UE-TNLA-binding related procedures .....	78
4.2.7.2.1 Creating NGAP UE-TNLA-bindings during Registration and Service Request .....	78
4.2.7.2.2 Creating NGAP UE-TNLA-bindings during handovers.....	79
4.2.7.2.3 Re-Creating NGAP UE-TNLA-bindings subsequent to NGAP UE-TNLA-binding release .....	79
4.2.7.2.4 NGAP UE-TNLA-binding update procedure .....	80
4.2.7.2.5 NGAP UE-TNLA-binding per UE Release procedure .....	80
4.2.7.3 AMF Failure or Planned Maintenance handling procedure .....	80
4.2.8 Void .....	81
4.2.8a UE Capability Match Request procedure.....	81
4.2.9 Network Slice-Specific Authentication and Authorization procedure.....	82
4.2.9.1 General .....	82
4.2.9.2 Network Slice-Specific Authentication and Authorization .....	83
4.2.9.3 AAA Server triggered Network Slice-Specific Re-authentication and Re-authorization procedure.....	85
4.2.9.4 AAA Server triggered Slice-Specific Authorization Revocation.....	86
4.2.10 N3 data transfer establishment procedure when Control Plane CIoT 5GS Optimisation is enabled .....	87
4.2.10.1 UE triggered N3 data transfer establishment procedure.....	87

4.2.10.2	SMF triggered N3 data transfer establishment procedure .....	87
4.3	Session Management procedures .....	88
4.3.1	General .....	88
4.3.2	PDU Session Establishment .....	89
4.3.2.1	General .....	89
4.3.2.2	UE Requested PDU Session Establishment .....	89
4.3.2.2.1	Non-roaming and Roaming with Local Breakout .....	89
4.3.2.2.2	Home-routed Roaming .....	102
4.3.2.2.3	SMF selection .....	107
4.3.2.2.4	Multiple PDU Sessions towards the same DNN and S-NSSAI .....	110
4.3.2.3	Secondary authorization/authentication by an DN-AAA server during the PDU Session establishment .....	110
4.3.3	PDU Session Modification .....	113
4.3.3.1	General .....	113
4.3.3.2	UE or network requested PDU Session Modification (non-roaming and roaming with local breakout) .....	113
4.3.3.3	UE or network requested PDU Session Modification (home-routed roaming) .....	119
4.3.4	PDU Session Release .....	122
4.3.4.1	General .....	122
4.3.4.2	UE or network requested PDU Session Release for Non-Roaming and Roaming with Local Breakout .....	122
4.3.4.3	UE or network requested PDU Session Release for Home-routed Roaming .....	127
4.3.5	Session continuity, service continuity and UP path management .....	130
4.3.5.1	Change of SSC mode 2 PDU Session Anchor with different PDU Sessions .....	130
4.3.5.2	Change of SSC mode 3 PDU Session Anchor with multiple PDU Sessions .....	131
4.3.5.3	Change of SSC mode 3 PDU Session Anchor with IPv6 Multi-homed PDU Session .....	132
4.3.5.4	Addition of additional PDU Session Anchor and Branching Point or UL CL .....	135
4.3.5.5	Removal of additional PDU Session Anchor and Branching Point or UL CL .....	136
4.3.5.6	Change of additional PDU Session Anchor for IPv6 multi-homing or UL CL .....	138
4.3.5.7	Simultaneous change of Branching Point or UL CL and additional PSA for a PDU Session .....	139
4.3.5.8	Ethernet PDU Session Anchor Relocation .....	142
4.3.6	Application Function influence on traffic routing .....	144
4.3.6.1	General .....	144
4.3.6.2	Processing AF requests to influence traffic routing for Sessions not identified by an UE address .....	146
4.3.6.3	Notification of User Plane Management Events .....	147
4.3.6.4	Transferring an AF request targeting an individual UE address to the relevant PCF .....	150
4.3.7	CN-initiated selective deactivation of UP connection of an existing PDU Session .....	151
4.4	SMF and UPF interactions .....	153
4.4.1	N4 session management procedures .....	153
4.4.1.1	General .....	153
4.4.1.2	N4 Session Establishment procedure .....	153
4.4.1.3	N4 Session Modification procedure .....	154
4.4.1.4	N4 Session Release procedure .....	154
4.4.2	N4 Reporting Procedures .....	155
4.4.2.1	General .....	155
4.4.2.2	N4 Session Level Reporting Procedure .....	155
4.4.3	N4 Node Level Procedures .....	157
4.4.3.1	N4 Association Setup Procedure .....	157
4.4.3.2	N4 Association Update Procedure .....	157
4.4.3.3	N4 Association Release Procedure .....	158
4.4.3.4	N4 Report Procedure .....	158
4.4.3.5	N4 PFD management Procedure .....	159
4.4.4	SMF Pause of Charging procedure .....	160
4.5	User Profile management procedures .....	161
4.5.1	Subscriber Data Update Notification to AMF .....	161
4.5.2	Session Management Subscriber Data Update Notification to SMF .....	162
4.5.3	Purge of subscriber data in AMF .....	162
4.6	Security procedures .....	163
4.7	ME Identity check procedure .....	163
4.8	RAN-CN interactions .....	163
4.8.1	Connection Inactive and Suspend procedure .....	163
4.8.1.1	Connection Inactive procedure .....	163

4.8.1.2	Connection Suspend procedure.....	163
4.8.2	Connection Resume procedure .....	164
4.8.2.1	General .....	164
4.8.2.2	Connection Resume in RRC Inactive procedure.....	165
4.8.2.3	Connection Resume in CM-IDLE with Suspend procedure .....	165
4.8.2.4	Connection Resume in CM-IDLE with Suspend and MO EDT procedure.....	167
4.8.3	N2 Notification procedure .....	169
4.9	Handover procedures.....	170
4.9.1	Handover procedures in 3GPP access.....	170
4.9.1.1	General .....	170
4.9.1.2	Xn based inter NG-RAN handover .....	170
4.9.1.2.1	General .....	170
4.9.1.2.2	Xn based inter NG-RAN handover without User Plane function re-allocation.....	171
4.9.1.2.3	Xn based inter NG-RAN handover with insertion of intermediate UPF .....	174
4.9.1.2.4	Xn based inter NG-RAN handover with re-allocation of intermediate UPF .....	176
4.9.1.3	Inter NG-RAN node N2 based handover .....	177
4.9.1.3.1	General .....	177
4.9.1.3.2	Preparation phase.....	179
4.9.1.3.3	Execution phase.....	185
4.9.1.3.3a	Execution phase for DAPS handover .....	188
4.9.1.4	Inter NG-RAN node N2 based handover, Cancel .....	190
4.9.2	Handover of a PDU Session procedure between 3GPP and untrusted non-3GPP access .....	190
4.9.2.0	General .....	190
4.9.2.1	Handover of a PDU Session procedure from untrusted non-3GPP to 3GPP access (non-roaming and roaming with local breakout).....	190
4.9.2.2	Handover of a PDU Session procedure from 3GPP to untrusted non-3GPP access (non-roaming and roaming with local breakout).....	191
4.9.2.3	Handover of a PDU Session procedure from untrusted non-3GPP to 3GPP access (home routed roaming).....	192
4.9.2.3.1	The target AMF is in the PLMN of the N3IWF .....	192
4.9.2.3.2	The target AMF is not in the PLMN of the N3IWF (i.e. N3IWF in HPLMN).....	193
4.9.2.4	Handover of a PDU Session procedure from 3GPP to untrusted non-3GPP access (home routed roaming).....	193
4.9.2.4.1	The selected N3IWF is in the registered PLMN.....	193
4.9.2.4.2	The UE is roaming and the selected N3IWF is in the home PLMN.....	194
4.9.3	Handover of a PDU Session procedure between 3GPP and trusted non-3GPP access.....	195
4.9.3.0	General .....	195
4.10	NG-RAN Location reporting procedures .....	195
4.11	System interworking procedures with EPC.....	196
4.11.0	General.....	196
4.11.0a	Impacts to EPS Procedures .....	197
4.11.0a.1	General .....	197
4.11.0a.2	Interaction with PCC.....	197
4.11.0a.3	Mobility Restrictions.....	198
4.11.0a.4	PGW Selection.....	198
4.11.0a.5	PDN Connection Establishment.....	198
4.11.0a.6	Network Configuration .....	199
4.11.0a.7	Interactions with DN-AAA Server.....	199
4.11.1	N26 based Interworking Procedures .....	199
4.11.1.1	General .....	199
4.11.1.2	Handover procedures .....	201
4.11.1.2.1	5GS to EPS handover using N26 interface .....	201
4.11.1.2.2	EPS to 5GS handover using N26 interface .....	206
4.11.1.2.3	Handover Cancel .....	214
4.11.1.3	Idle Mode Mobility procedures.....	216
4.11.1.3.1	General .....	216
4.11.1.3.2	5GS to EPS Idle mode mobility using N26 interface .....	216
4.11.1.3.2A	5GS to EPS Idle mode mobility using N26 interface with data forwarding.....	219
4.11.1.3.3	EPS to 5GS Mobility Registration Procedure (Idle and Connected State) using N26 interface....	220
4.11.1.3.3A	EPS to 5GS Idle mode mobility using N26 interface with data forwarding.....	225
4.11.1.3.4	EPS to 5GS Mobility Registration Procedure (Idle) using N26 interface with AMF reallocation .....	226

4.11.1.4	Procedures for EPS bearer ID allocation.....	227
4.11.1.4.1	EPS bearer ID allocation .....	227
4.11.1.4.2	EPS bearer ID transfer .....	230
4.11.1.4.3	EPS bearer ID revocation .....	231
4.11.1.5	Impacts to EPS Procedures .....	232
4.11.1.5.1	General .....	232
4.11.1.5.2	E-UTRAN Initial Attach .....	232
4.11.1.5.3	Tracking Area Update .....	233
4.11.1.5.4	Session Management .....	234
4.11.1.5.5	5GS to EPS handover using N26 interface .....	236
4.11.1.5.6	UE triggered Service Request.....	236
4.11.1.5.7	Establishment of S1-U bearer during Data Transport in Control Plane CIoT EPS Optimisation .....	236
4.11.1.6	EPS interworking information storing Procedure .....	236
4.11.2	Interworking procedures without N26 interface .....	236
4.11.2.1	General .....	236
4.11.2.2	5GS to EPS Mobility.....	237
4.11.2.3	EPS to 5GS Mobility.....	239
4.11.2.4	Impacts to EPS Procedures .....	242
4.11.2.4.1	E-UTRAN Attach.....	242
4.11.2.4.2	Session Management .....	244
4.11.2.4.3	Void.....	244
4.11.3	Handover procedures between EPS and 5GC-N3IWF .....	244
4.11.3.1	Handover from EPS to 5GC-N3IWF .....	244
4.11.3.2	Handover from 5GC-N3IWF to EPS .....	245
4.11.3a	Handover procedures between EPS and 5GC-TNGF .....	245
4.11.3a.1	Handover from EPS to 5GC-TNGF .....	245
4.11.3a.2	Handover from 5GC-TNGF to EPS .....	246
4.11.4	Handover procedures between EPC/ePDG and 5GS .....	246
4.11.4.1	Handover from EPC/ePDG to 5GS .....	246
4.11.4.2	Handover from 5GS to EPC/ePDG .....	247
4.11.4.3	Impacts to EPC/ePDG Procedures .....	248
4.11.4.3.1	General .....	248
4.11.4.3.2	ePDG FQDN construction.....	248
4.11.4.3.3	Initial Attach with GTP on S2b .....	248
4.11.4.3.3a	Initial Attach for emergency session (GTP on S2b) .....	248
4.11.4.3.4	Interaction with PCC .....	249
4.11.4.3.5	UE initiated Connectivity to Additional PDN with GTP on S2b .....	249
4.11.4.3.6	Use of N10 interface instead of S6b.....	249
4.11.5	Impacts to 5GC Procedures .....	250
4.11.5.1	General .....	250
4.11.5.2	Registration procedure .....	250
4.11.5.3	UE Requested PDU Session Establishment procedure .....	251
4.11.5.4	UE or Network Requested PDU Session Modification procedure .....	253
4.11.5.5	Xn based inter NG-RAN handover .....	253
4.11.5.6	Inter NG-RAN node N2 based handover .....	253
4.11.5.7	UE or Network Requested PDU Session Release procedure .....	253
4.11.5.8	Network Configuration .....	254
4.11.6	Interworking for common network exposure.....	254
4.11.6.1	Subscription and Notification of availability or expected level of support of a service API .....	254
4.11.6.2	Unsubscribing to N11otification of availability or expected level of support of a service API.....	255
4.11.6.3	Configuration of monitoring events for common network exposure .....	256
4.12	Procedures for Untrusted non-3GPP access .....	257
4.12.1	General.....	257
4.12.2	Registration via Untrusted non-3GPP Access .....	257
4.12.2.1	General .....	257
4.12.2.2	Registration procedure for untrusted non-3GPP access .....	257
4.12.2.3	Emergency Registration for untrusted non-3GPP Access.....	260
4.12.3	Deregistration procedure for untrusted non-3gpp access.....	261
4.12.4	N2 procedures via Untrusted non-3GPP Access.....	262
4.12.4.1	Service Request procedures via Untrusted non-3GPP Access .....	262
4.12.4.2	Procedure for the UE context release in the N3IWF.....	262

4.12.4.3	CN-initiated selective deactivation of UP connection of an existing PDU Session associated with Untrusted non-3GPP Access .....	264
4.12.5	UE Requested PDU Session Establishment via Untrusted non-3GPP Access.....	264
4.12.6	UE or Network Requested PDU Session Modification via Untrusted non-3GPP access .....	266
4.12.7	UE or network Requested PDU Session Release via Untrusted non-3GPP access.....	267
4.12.8	Mobility from a non-geographically selected AMF to a geographically selected AMF.....	269
4.12a	Procedures for Trusted non-3GPP access.....	270
4.12a.1	General.....	270
4.12a.2	Registration via Trusted non-3GPP Access .....	270
4.12a.2.1	General .....	270
4.12a.2.2	Registration procedure for trusted non-3GPP access .....	270
4.12a.2.3	Emergency Registration for trusted non-3GPP Access .....	273
4.12a.3	Deregistration procedure for Trusted non-3GPP access .....	273
4.12a.4	N2 procedures via Trusted non-3GPP Access .....	273
4.12a.4.1	Service Request procedures via Trusted non-3GPP Access.....	273
4.12a.4.2	Procedure for the UE context release in the TNGF.....	273
4.12a.4.3	CN-initiated selective deactivation of UP connection of an existing PDU Session associated with Trusted non-3GPP Access.....	274
4.12a.5	UE Requested PDU Session Establishment via Trusted non-3GPP Access .....	274
4.12a.6	UE or network Requested PDU Session Modification via Trusted non-3GPP access.....	275
4.12a.7	UE or network Requested PDU Session Release via Trusted non-3GPP access .....	275
4.12a.8	Mobility from a non-geographically selected AMF to a geographically selected AMF.....	275
4.12a.9	Support of mobility from source to target TNAP .....	276
4.12b	Procedures for devices that do not support 5GC NAS over WLAN access .....	276
4.12b.1	General.....	276
4.12b.2	Initial Registration & PDU Session Establishment.....	276
4.12b.3	Deregistration procedure.....	279
4.12b.4	N2 procedures.....	280
4.12b.4.1	Service Request procedures .....	280
4.12b.4.2	Procedure for the UE context release in the TWIF .....	280
4.12b.4.3	CN-initiated selective deactivation of UP connection of an existing PDU Session.....	280
4.13	Specific services .....	280
4.13.1	General.....	280
4.13.2	Application Triggering .....	281
4.13.2.1	General .....	281
4.13.2.2	The procedure of "Application Triggering" Service .....	281
4.13.3	SMS over NAS procedures.....	283
4.13.3.1	Registration procedures for SMS over NAS .....	283
4.13.3.2	Deregistration procedures for SMS over NAS .....	284
4.13.3.3	MO SMS over NAS in CM-IDLE (baseline) .....	285
4.13.3.4	Void.....	286
4.13.3.5	MO SMS over NAS in CM-CONNECTED.....	286
4.13.3.6	MT SMS over NAS in CM-IDLE state via 3GPP access.....	287
4.13.3.7	MT SMS over NAS in CM-CONNECTED state via 3GPP access.....	288
4.13.3.8	MT SMS over NAS via non-3GPP access .....	288
4.13.3.9	Unsuccessful Mobile terminating SMS delivery re-attempt .....	288
4.13.4	Emergency Services.....	289
4.13.4.1	General .....	289
4.13.4.2	Emergency Services Fallback .....	289
4.13.5	Location Services procedures .....	291
4.13.5.0	General .....	291
4.13.5.1	5GC-NI-LR Procedure .....	291
4.13.5.2	5GC-MT-LR Procedure without UDM Query .....	291
4.13.5.3	5GC-MT-LR Procedure .....	291
4.13.5.4	UE Assisted and UE Based Positioning Procedure .....	291
4.13.5.5	Network Assisted Positioning Procedure .....	291
4.13.5.6	Obtaining Non-UE Associated Network Assistance Data .....	291
4.13.5.7	Location continuity for Handover of an Emergency session from NG-RAN .....	291
4.13.6	Support of IMS Voice.....	291
4.13.6.1	EPS fallback for IMS voice.....	291
4.13.6.2	Inter RAT Fallback in 5GC for IMS voice.....	293
4.13.6.3	Transfer of PDU session used for IMS voice from non-3GPP access to 5GS .....	294



4.13.7	MSISDN-less MO SMS.....	295
4.13.7.1	General.....	295
4.13.7.2	The procedure of MSISDN-less MO SMS Service.....	296
4.13.8	Support of 5G LAN-type service.....	297
4.13.8.1	Support of 5G VN group management.....	297
4.13.8.2	Support of 5G VN group communication.....	297
4.13.8.2.1	General.....	297
4.13.8.2.2	group-level N4 session management procedures.....	297
4.14	Support for Dual Connectivity.....	297
4.14.1	RAN Initiated QoS Flow Mobility.....	297
4.15	Network Exposure.....	299
4.15.1	General.....	299
4.15.2	External Exposure of Network Capabilities.....	301
4.15.2a	Data Collection from an AF.....	301
4.15.3	Event Exposure using NEF.....	301
4.15.3.1	Monitoring Events.....	301
4.15.3.2	Information flows.....	306
4.15.3.2.1	AMF service operations information flow.....	306
4.15.3.2.2	UDM service operations information flow.....	306
4.15.3.2.3	NEF service operations information flow.....	308
4.15.3.2.3a	Void.....	311
4.15.3.2.3b	Specific NEF service operations information flow for loss of connectivity and UE reachability.....	311
4.15.3.2.4	Exposure with bulk subscription.....	313
4.15.3.2.5	Information flow for downlink data delivery status with SMF buffering.....	314
4.15.3.2.6	GMLC service operations information flow.....	315
4.15.3.2.7	Information flow for Availability after DDN Failure with SMF buffering.....	315
4.15.3.2.8	Information flow for downlink data delivery status with UPF buffering.....	317
4.15.3.2.9	Information flow for Availability after DDN Failure with UPF buffering.....	318
4.15.3.3	Void.....	320
4.15.4	Core Network Internal Event Exposure.....	320
4.15.4.1	General.....	320
4.15.4.2	Exposure of Mobility Events from AMF.....	320
4.15.5	Void.....	321
4.15.6	External Parameter Provisioning.....	322
4.15.6.1	General.....	322
4.15.6.2	NEF service operations information flow.....	322
4.15.6.3	Expected UE Behaviour parameters.....	324
4.15.6.3a	Network Configuration parameters.....	325
4.15.6.3b	5G VN group data.....	326
4.15.6.3c	5G VN Group membership management parameters.....	327
4.15.6.4	Set a chargeable party at AF session setup.....	327
4.15.6.5	Change the chargeable party during the session.....	328
4.15.6.6	Setting up an AF session with required QoS procedure.....	329
4.15.6.6a	AF session with required QoS update procedure.....	330
4.15.6.7	Service specific parameter provisioning.....	331
4.15.6.8	Set a policy for a future AF session.....	333
4.15.7	Network status reporting.....	333
4.16	Procedures and flows for Policy Framework.....	334
4.16.1	AM Policy Association Establishment.....	334
4.16.1.1	General.....	334
4.16.1.2	AM Policy Association Establishment with new Selected PCF.....	334
4.16.1.3	Void.....	335
4.16.2	AM Policy Association Modification.....	335
4.16.2.0	General.....	335
4.16.2.1	AM Policy Association Modification initiated by the AMF.....	335
4.16.2.1.1	AM Policy Association Modification initiated by the AMF without AMF relocation.....	335
4.16.2.1.2	AM Policy Association Modification with old PCF during AMF relocation.....	336
4.16.2.2	AM Policy Association Modification initiated by the PCF.....	338
4.16.3	AM Policy Association Termination.....	338
4.16.3.1	General.....	338
4.16.3.2	AMF-initiated AM Policy Association Termination.....	339

4.16.3.3	Void.....	339
4.16.4	SM Policy Association Establishment .....	340
4.16.5	SM Policy Association Modification.....	341
4.16.5.0	General .....	341
4.16.5.1	SMF initiated SM Policy Association Modification .....	341
4.16.5.2	PCF initiated SM Policy Association Modification .....	342
4.16.6	SM Policy Association Termination .....	344
4.16.7	Negotiations for future background data transfer .....	345
4.16.7.1	General .....	345
4.16.7.2	Procedures for future background data transfer .....	346
4.16.7.3	Procedure for BDT warning notification.....	348
4.16.8	Procedures on interaction between PCF and CHF .....	349
4.16.8.1	General .....	349
4.16.8.2	Initial Spending Limit Retrieval.....	349
4.16.8.3	Intermediate Spending Limit Report Retrieval .....	350
4.16.8.4	Final Spending Limit Report Retrieval .....	351
4.16.8.5	Spending Limit Report.....	352
4.16.8.6	CHF report the removal of the subscriber .....	352
4.16.9	Update of the subscription information in the PCF .....	353
4.16.10	Void .....	354
4.16.11	UE Policy Association Establishment .....	354
4.16.12	UE Policy Association Modification .....	355
4.16.12.1	UE Policy Association Modification initiated by the AMF .....	355
4.16.12.1.1	UE Policy Association Modification initiated by the AMF without AMF relocation .....	355
4.16.12.1.2	UE Policy Association Modification with old PCF during AMF relocation .....	357
4.16.12.2	UE Policy Association Modification initiated by the PCF.....	358
4.16.13	UE Policy Association Termination .....	359
4.16.13.1	AMF-initiated UE Policy Association Termination.....	359
4.16.13.2	PCF-initiated UE Policy Association Termination .....	361
4.17	Network Function Service Framework Procedure .....	361
4.17.1	NF service Registration .....	361
4.17.2	NF service update .....	362
4.17.3	NF service deregistration.....	363
4.17.4	NF/NF service discovery by NF service consumer in the same PLMN.....	363
4.17.5	NF/NF service discovery across PLMNs in the case of discovery made by NF service consumer .....	364
4.17.6	SMF Provisioning of available UPFs using the NRF .....	365
4.17.6.1	General .....	365
4.17.6.2	SMF provisioning of UPF instances using NRF .....	365
4.17.7	NF/NF service status subscribe/notify in the same PLMN .....	367
4.17.8	NF/NF service status subscribe/notify across PLMNs.....	367
4.17.9	Delegated service discovery when NF service consumer and NF service producer are in same PLMN..	369
4.17.10	Delegated service discovery when NF service consumer and NF service producer are in different PLMNs.....	370
4.17.11	Indirect Communication without delegated discovery Procedure .....	371
4.17.12	Binding between NF service consumer and NF service producer .....	371
4.17.12.1	General .....	371
4.17.12.2	Binding created as part of service response .....	371
4.17.12.3	Binding created as part of service request.....	372
4.17.12.4	Binding for subscription requests.....	373
4.18	Procedures for Management of PFDs.....	375
4.18.1	General.....	375
4.18.2	PFD management via NEF (PFDf) .....	376
4.18.3	PFD management in the SMF.....	376
4.18.3.1	PFD Retrieval by the SMF.....	376
4.18.3.2	Management of PFDs in the SMF.....	377
4.19	Network Data Analytics .....	378
4.19.1	Void .....	378
4.19.2	Void .....	378
4.20	UE Parameters Update via UDM Control Plane Procedure .....	378
4.20.1	General.....	378
4.20.2	UE Parameters Update via UDM Control Plane Procedure.....	378
4.20.3	Void .....	379

4.21	Secondary RAT Usage Data Reporting Procedure.....	379
4.22	ATSSS Procedures .....	381
4.22.1	General.....	381
4.22.2	UE Requested MA PDU Session Establishment .....	381
4.22.2.1	Non-roaming and Roaming with Local Breakout .....	381
4.22.2.2	Home-routed Roaming.....	382
4.22.2.2.1	Home-routed Roaming - UE registered to the same PLMN.....	382
4.22.2.2.2	Home-routed Roaming - UE registered to different PLMNs.....	383
4.22.3	UE Requested PDU Session Establishment with Network Modification to MA PDU Session.....	384
4.22.3.1	Overview.....	384
4.22.3.2	Non-roaming or roaming with local breakout.....	384
4.22.3.3	Home-routed, the UE registered to the same VPLMN over both access .....	385
4.22.3.4	Home-routed, the UE registered to different PLMNs over both access .....	386
4.22.4	Access Network Performance Measurements.....	387
4.22.5	Reporting of Access Availability.....	387
4.22.6	EPS Interworking.....	387
4.22.6.1	General .....	387
4.22.6.2	Impacts to EPS interworking procedures .....	387
4.22.6.2.1	5GS to EPS handover using N26 interface .....	387
4.22.6.2.2	5GS to EPS idle mode mobility using N26 interface .....	388
4.22.6.2.3	EPS bearer ID allocation .....	388
4.22.6.2.4	EPS bearer ID revocation .....	388
4.22.6.2.5	5GS to EPS mobility without N26 interface.....	388
4.22.6.3	Network Modification to MA PDU Session after a UE moving from EPC.....	389
4.22.7	Adding / Re-activating / De-activating User-Plane Resources .....	390
4.22.8	UE or network requested MA PDU Session Modification .....	390
4.22.8.1	General.....	390
4.22.8.2	UE or network requested MA PDU Session Modification (non-roaming and roaming with local breakout) .....	391
4.22.8.3	UE or network requested MA PDU Session Modification (home-routed roaming) .....	391
4.22.9	Connection, Registration and Mobility Management procedures.....	392
4.22.9.1	Registration procedures.....	392
4.22.9.2	UE Triggered Service Request.....	393
4.22.9.3	N2 based handover.....	393
4.22.9.4	Network Triggered Service Request .....	393
4.22.10	MA PDU Session Release .....	394
4.22.10.1	General.....	394
4.22.10.2	UE or network requested MA PDU Session Release (non-roaming and roaming with local breakout) .....	394
4.22.10.3	UE or network requested MA PDU Session Release (home-routed roaming).....	395
4.23	Support of deployments topologies with specific SMF Service Areas.....	396
4.23.1	General.....	396
4.23.2	I-SMF selection .....	396
4.23.3	Registration procedure.....	396
4.23.3a	Deregistration procedure.....	398
4.23.4	Service Request procedures .....	398
4.23.4.1	General .....	398
4.23.4.2	UE Triggered Service Request without I-SMF change/removal.....	398
4.23.4.3	UE Triggered Service Request with I-SMF insertion/change/removal .....	399
4.23.4.4	Network Triggered Service Request .....	405
4.23.5	PDU Session Management procedure.....	405
4.23.5.1	PDU Session establishment procedure.....	405
4.23.5.2	PDU Session Release procedure .....	406
4.23.5.3	PDU Session modification procedure .....	406
4.23.6	I-SMF Related Procedures with PCF.....	407
4.23.6.1	General .....	407
4.23.6.2	Policy Update Procedures with I-SMF.....	407
4.23.6.3	Reporting UP path change to the AF.....	407
4.23.7	Inter NG-RAN node N2 based handover .....	408
4.23.7.1	General .....	408
4.23.7.2	Inter NG-RAN node N2 based handover without I-SMF change/removal .....	408
4.23.7.2.1	General .....	408

4.23.7.2.2	Preparation phase.....	408
4.23.7.2.3	Execution phase.....	408
4.23.7.2.4	Handover Cancel .....	409
4.23.7.3	Inter NG-RAN node N2 based handover with I-SMF insertion/change/removal .....	409
4.23.7.3.1	General .....	409
4.23.7.3.2	Preparation phase.....	410
4.23.7.3.3	Execution phase.....	416
4.23.7.3.4	Handover Cancel .....	420
4.23.8	AN Release procedure involving I-SMF .....	422
4.23.9	Branching Point or UL CL controlled by I-SMF .....	422
4.23.9.0	Overview.....	422
4.23.9.1	Addition of PDU Session Anchor and Branching Point or UL CL controlled by I-SMF .....	423
4.23.9.2	Removal of PDU Session Anchor and Branching Point or UL CL controlled by I-SMF .....	425
4.23.9.3	Change of PDU Session Anchor for IPv6 multi-homing or UL CL controlled by I-SMF .....	426
4.23.9.4	Simultaneous change of Branching Point or UL CL and additional PSA controlled by I-SMF .....	428
4.23.9a	Void.....	429
4.23.10	CN-initiated selective deactivation of UP connection of an existing PDU Session involving I-SMF .....	429
4.23.11	Xn based handover.....	429
4.23.11.1	General.....	429
4.23.11.2	Xn based handover with insertion of intermediate SMF.....	429
4.23.11.3	Xn based handover with re-allocation of intermediate SMF.....	431
4.23.11.4	Xn based handover with removal of intermediate SMF.....	433
4.23.11.5	Xn based handover without change of intermediate SMF .....	435
4.23.12	N26 based Interworking Procedures with I-SMF .....	435
4.23.12.1	General.....	435
4.23.12.2	5GS to EPS Idle mode mobility using N26 interface with I-SMF removal .....	435
4.23.12.2A	5GS to EPS Idle mode mobility using N26 interface with Data forwarding and I-SMF removal .....	435
4.23.12.3	EPS to 5GS mobility registration procedure (Idle and Connected State) using N26 interface with I-SMF insertion .....	435
4.23.12.3A	EPS to 5GS Idle mode mobility using N26 interface with Data forwarding and I-SMF insertion .....	436
4.23.12.4	Procedures for EPS bearer ID allocation.....	436
4.23.12.5	EPS to 5GS mobility registration procedure (Idle) using N26 interface with AMF reallocation and I-SMF insertion .....	436
4.23.12.6	5GS to EPS handover using N26 interface with I-SMF removal.....	436
4.23.12.7	EPS to 5GS handover using N26 interface with I-SMF insertion.....	436
4.23.12.7.1	Preparation phase.....	436
4.23.12.7.2	Execution phase.....	437
4.23.12.8	Impact to 5GC procedures .....	437
4.23.12.8.1	General .....	437
4.23.12.8.2	UE Triggered Service Request with I-SMF insertion/change/removal .....	437
4.23.12.8.3	PDU Session establishment procedure .....	437
4.23.12.8.4	PDU Session modification procedure.....	437
4.23.12.8.5	Inter NG-RAN node N2 based handover with I-SMF insertion/change/removal.....	437
4.23.12.8.6	Xn based handover with insertion of I-SMF .....	438
4.23.13	Non N26 based Interworking Procedures with I-SMF.....	438
4.23.13.1	General.....	438
4.23.13.2	Mobility procedure without N26 interface from EPS to 5GS .....	438
4.23.13.3	Mobility procedure without N26 interface from EPC/ePDG to 5GS .....	438
4.23.13.4	Mobility procedure without N26 interface from 5GS to EPS .....	438
4.23.13.5	Mobility procedure without N26 interface from 5GS to EPC/ePDG .....	438
4.23.14	Pause of charging.....	439
4.23.15	PDU Session mobility between 3GPP and non-3GPP access.....	439
4.23.16	Handover of a PDU Session procedure between 3GPP and untrusted non-3GPP access .....	439
4.23.16.1	Handover of a PDU Session procedure from untrusted non-3GPP to 3GPP access (non-roaming and roaming with local breakout).....	439
4.23.16.2	Handover of a PDU Session procedure from 3GPP to untrusted non-3GPP access (non-roaming and roaming with local breakout).....	439
4.23.16.3	Handover of a PDU Session procedure from untrusted non-3GPP to 3GPP access (home routed roaming).....	440
4.23.16.3.1	The target AMF is in the PLMN of the N3IWF .....	440
4.23.16a	Handover of a PDU Session procedure between 3GPP and trusted non-3GPP access.....	440
4.23.16a.1	General.....	440

4.24	Procedures for UPF Anchored Data Transport in Control Plane CIoT 5GS Optimisation.....	440
4.24.1	UPF anchored Mobile Originated Data Transport in Control Plane CIoT 5GS Optimisation.....	440
4.24.2	UPF anchored Mobile Terminated Data Transport in Control Plane CIoT 5GS Optimisation.....	443
4.25	Procedures for NEF based Non-IP Data Delivery.....	447
4.25.1	General.....	447
4.25.2	SMF-NEF Connection Establishment.....	447
4.25.3	NIDD Configuration.....	448
4.25.4	NEF Anchored Mobile Originated Data Transport.....	450
4.25.5	NEF Anchored Mobile Terminated Data Transport.....	451
4.25.6	NIDD Authorization Update.....	454
4.25.7	SMF Initiated SMF-NEF Connection Release procedure.....	455
4.25.8	NEF Initiated SMF-NEF Connection Release procedure.....	455
4.25.9	NEF Anchored Group NIDD via NEF anchored unicast MT data.....	457
4.26	Network Function/NF Service Context Transfer Procedures.....	457
4.26.1	General.....	457
4.26.2	NF/NF Service Context Transfer Push Procedure.....	458
4.26.3	NF/NF Service Context Transfer Pull procedure.....	458
4.26.4	Context Transfer due to decommissioning.....	459
4.26.5	SMF Service Context Transfer procedures.....	459
4.26.5.1	General.....	459
4.26.5.2	I-SMF Context Transfer procedure.....	459
4.26.5.3	SMF Context Transfer procedure, LBO or no Roaming, no I-SMF.....	459
4.27	Procedures for Enhanced Coverage Restriction Control via NEF.....	462
4.27.1	General.....	462
5	Network Function Service procedures.....	463
5.1	Network Function Service framework procedures.....	463
5.1.1	Network Function Service Discovery.....	463
5.2	Network Function services.....	463
5.2.1	General.....	463
5.2.2	AMF Services.....	463
5.2.2.1	General.....	463
5.2.2.2	Namf_Communication service.....	464
5.2.2.2.1	General.....	464
5.2.2.2.2	Namf_Communication_UEContextTransfer service operation.....	465
5.2.2.2.3	Namf_Communication_RegistrationStatusUpdate service operation.....	469
5.2.2.2.4	Namf_Communication_N1MessageNotify service operation.....	469
5.2.2.2.5	Namf_Communication_N1N2MessageSubscribe service operation.....	470
5.2.2.2.6	Namf_Communication_N1N2MessageUnSubscribe service operation.....	470
5.2.2.2.7	Namf_Communication_N1N2MessageTransfer service operation.....	471
5.2.2.2.7A	Namf_Communication_N1N2TransferFailureNotification service operation.....	472
5.2.2.2.8	Namf_Communication_N2InfoSubscribe service operation.....	472
5.2.2.2.9	Namf_Communication_N2InfoUnsubscribe service operation.....	472
5.2.2.2.10	Namf_Communication_N2InfoNotify service operation.....	472
5.2.2.2.11	Namf_Communication_CreateUEContext service operation.....	473
5.2.2.2.12	Namf_Communication_ReleaseUEContext service operation.....	473
5.2.2.2.13	Namf_Communication_EBIAssignment service operation.....	473
5.2.2.2.14	Namf_Communication_AMFStatusChangeSubscribe service operation.....	474
5.2.2.2.15	Namf_Communication_AMFStatusChangeUnSubscribe service operation.....	474
5.2.2.2.16	Namf_Communication_AMFStatusChangeNotify service operation.....	474
5.2.2.2.17	Namf_Communication_NonUeN2MessageTransfer service operation.....	474
5.2.2.2.18	Namf_Communication_NonUeN2InfoSubscribe service operation.....	475
5.2.2.2.19	Namf_Communication_NonUeN2InfoUnSubscribe service operation.....	475
5.2.2.2.20	Namf_Communication_NonUeN2InfoNotify service operation.....	475
5.2.2.2.21	Namf_Communication_RelocateUEContext service operation.....	475
5.2.2.2.22	Namf_Communication_CancelRelocateUEContext service operation.....	476
5.2.2.3	Namf_EventExposure service.....	476
5.2.2.3.1	General.....	476
5.2.2.3.2	Namf_EventExposure_Subscribe service operation.....	477
5.2.2.3.3	Namf_EventExposure_UnSubscribe service operation.....	478
5.2.2.3.4	Namf_EventExposure_Notify service operation.....	478
5.2.2.4	Namf_MT service.....	479

5.2.2.4.1	General .....	479
5.2.2.4.2	Namf_MT_EnableUERachability service operation .....	479
5.2.2.4.3	Namf_MT_ProvideDomainSelectionInfo .....	479
5.2.2.5	Namf_Location service .....	479
5.2.2.5.1	General .....	479
5.2.2.5.2	Namf_Location_ProvidePositioningInfo service operation.....	480
5.2.2.5.3	Namf_Location_EventNotify service operation.....	480
5.2.2.5.4	Namf_Location_ProvideLocationInfo service operation .....	480
5.2.2.5.5	Namf_Location_CancelLocation service operation .....	481
5.2.3	UDM Services .....	481
5.2.3.1	General .....	481
5.2.3.2	Nudm_UECM (UECM) service.....	482
5.2.3.2.1	Nudm_UECM_Registration service operation.....	482
5.2.3.2.2	Nudm_UECM_DeregistrationNotification service operation .....	482
5.2.3.2.3	Nudm_UECM_Deregistration service operation.....	483
5.2.3.2.4	Nudm_UECM_Get service operation.....	483
5.2.3.2.5	Nudm_UECM_Update service operation.....	483
5.2.3.2.6	Nudm_UECM_PCscfRestoration service operation.....	483
5.2.3.3	Nudm_SubscriberDataManagement (SDM) Service .....	484
5.2.3.3.1	General .....	484
5.2.3.3.2	Nudm_SDM_Get service operation .....	491
5.2.3.3.3	Nudm_SDM_Notification service operation.....	492
5.2.3.3.4	Nudm_SDM_Subscribe service operation .....	492
5.2.3.3.5	Nudm_SDM_Unsubscribe service operation .....	492
5.2.3.3.6	Nudm_SDM_Info service operation.....	493
5.2.3.3.7	Void.....	493
5.2.3.4	Nudm_UEAuthentication Service.....	493
5.2.3.4.1	General .....	493
5.2.3.4.2	Nudm_UEAuthentication_Get service operation .....	493
5.2.3.4.3	Nudm_UEAuthentication_ResultConfirmation service operation .....	493
5.2.3.5	Nudm_EventExposure service .....	493
5.2.3.5.1	General .....	493
5.2.3.5.2	Nudm_EventExposure_Subscribe service operation.....	494
5.2.3.5.3	Nudm_EventExposure_Unsubscribe service operation.....	494
5.2.3.5.4	Nudm_EventExposure_Notify service operation .....	494
5.2.3.6	Nudm_ParameterProvision service .....	494
5.2.3.6.1	General .....	494
5.2.3.6.2	Nudm_ParameterProvision_Update service operation.....	495
5.2.3.6.3	Nudm_ParameterProvision_Create service operation.....	495
5.2.3.6.4	Nudm_ParameterProvision_Delete service operation .....	496
5.2.3.6.5	Nudm_ParameterProvision_Get service operation.....	496
5.2.3.7	Nudm_NIDDAuthorisation service.....	496
5.2.3.7.1	General .....	496
5.2.3.7.2	Nudm_NIDDAuthorisation_Get service operation .....	496
5.2.3.7.3	Nudm_NIDDAuthorisation_UpdateNotify service operation .....	496
5.2.4	5G-EIR Services .....	497
5.2.4.1	General .....	497
5.2.4.2	N5g-eir_EquipmentIdentityCheck service .....	497
5.2.4.2.1	General .....	497
5.2.4.2.2	N5g-eir_EquipmentIdentityCheck_Get service operation.....	497
5.2.5	PCF Services.....	497
5.2.5.1	General .....	497
5.2.5.2	Npcf_AMPolicyControl service.....	498
5.2.5.2.1	General .....	498
5.2.5.2.2	Npcf_AMPolicyControl_Create service operation.....	499
5.2.5.2.3	Npcf_AMPolicyControl_UpdateNotify service operation .....	499
5.2.5.2.4	Npcf_AMPolicyControl_Delete service operation.....	499
5.2.5.2.5	Npcf_AMPolicyControl_Update service operation.....	499
5.2.5.3	Npcf_PolicyAuthorization Service .....	500
5.2.5.3.1	General .....	500
5.2.5.3.2	Npcf_PolicyAuthorization_Create service operation .....	500
5.2.5.3.3	Npcf_PolicyAuthorization_Update service operation.....	500

5.2.5.3.4	Npcf_PolicyAuthorization_Delete service operation .....	501
5.2.5.3.5	Npcf_PolicyAuthorization_Notify service operation .....	501
5.2.5.3.6	Npcf_PolicyAuthorization_Subscribe service operation .....	501
5.2.5.3.7	Npcf_PolicyAuthorization_Unsubscribe service operation .....	502
5.2.5.4	Npcf_SMPolicyControl service .....	502
5.2.5.4.1	General .....	502
5.2.5.4.2	Npcf_SMPolicyControl_Create service operation .....	502
5.2.5.4.3	Npcf_SMPolicyControl_UpdateNotify service operation .....	503
5.2.5.4.4	Npcf_SMPolicyControl_Delete service operation .....	503
5.2.5.4.5	Npcf_SMPolicyControl_Update service operation .....	503
5.2.5.5	Npcf_BDTPolicyControl Service .....	504
5.2.5.5.1	General .....	504
5.2.5.5.2	Npcf_BDTPolicyControl_Create service operation .....	504
5.2.5.5.3	Npcf_BDTPolicyControl_Update service operation .....	504
5.2.5.5.4	Npcf_BDTPolicyControl_Notify service operation .....	505
5.2.5.6	Npcf_UEPolicyControl Service .....	505
5.2.5.6.1	General .....	505
5.2.5.6.2	Npcf_UEPolicyControl_Create service operation .....	505
5.2.5.6.3	Npcf_UEPolicyControl_UpdateNotify service operation .....	506
5.2.5.6.4	Npcf_UEPolicyControl_Delete service operation .....	506
5.2.5.6.5	Npcf_UEPolicyControl_Update service operation .....	506
5.2.5.7	Npcf_EventExposure service .....	507
5.2.5.7.1	General .....	507
5.2.5.7.2	Npcf_EventExposure_Subscribe service operation .....	507
5.2.5.7.3	Npcf_EventExposure_Unsubscribe service operation .....	507
5.2.5.7.4	Npcf_EventExposure_Notify service operation .....	507
5.2.6	NEF Services .....	508
5.2.6.1	General .....	508
5.2.6.2	Nnef_EventExposure service .....	511
5.2.6.2.1	General .....	511
5.2.6.2.2	Nnef_EventExposure_Subscribe operation .....	511
5.2.6.2.3	Nnef_EventExposure_Unsubscribe service operation .....	511
5.2.6.2.4	Nnef_EventExposure_Notify service operation .....	512
5.2.6.3	Nnef_PFDManagement service .....	512
5.2.6.3.1	General .....	512
5.2.6.3.2	Nnef_PFDManagement_Fetch service operation .....	512
5.2.6.3.3	Nnef_PFDManagement_Subscribe service operation .....	512
5.2.6.3.4	Nnef_PFDManagement_Notify service operation .....	512
5.2.6.3.5	Nnef_PFDManagement_Unsubscribe service operation .....	512
5.2.6.3.6	Nnef_PFDManagement_Create service operation .....	513
5.2.6.3.7	Nnef_PFDManagement_Update service operation .....	513
5.2.6.3.8	Nnef_PFDManagement_Delete service operation .....	513
5.2.6.4	Nnef_ParameterProvision service .....	513
5.2.6.4.1	General .....	513
5.2.6.4.2	Nnef_ParameterProvision_Update service operation .....	513
5.2.6.4.3	Nnef_ParameterProvision_Create service operation .....	514
5.2.6.4.4	Nnef_ParameterProvision_Delete service operation .....	514
5.2.6.4.5	Nnef_ParameterProvision_Get service operation .....	514
5.2.6.5	Nnef_Trigger service .....	514
5.2.6.5.1	General .....	514
5.2.6.5.2	Nnef_Trigger_Delivery service operation .....	514
5.2.6.5.3	Nnef_Trigger_DeliveryNotify service operation .....	515
5.2.6.6	Nnef_BDTPNegotiation service .....	515
5.2.6.6.1	General .....	515
5.2.6.6.2	Nnef_BDTPNegotiation_Create service operation .....	515
5.2.6.6.3	Nnef_BDTPNegotiation_Update service operation .....	515
5.2.6.6.4	Nnef_BDTPNegotiation_Notify service operation .....	515
5.2.6.7	Nnef_TrafficInfluence service .....	516
5.2.6.7.1	General .....	516
5.2.6.7.2	Nnef_TrafficInfluence_Create operation .....	516
5.2.6.7.3	Nnef_TrafficInfluence_Update operation .....	516
5.2.6.7.4	Nnef_TrafficInfluence_Delete operation .....	516

5.2.6.7.4A	Nnef_TrafficInfluence_Get operation .....	517
5.2.6.7.5	Nnef_TrafficInfluence_Notify operation.....	517
5.2.6.7.6	Nnef_TrafficInfluence_AppRelocationInfo operation .....	517
5.2.6.8	Nnef_ChargeableParty service .....	517
5.2.6.8.1	General .....	517
5.2.6.8.2	Nnef_ChargeableParty_Create service operation.....	517
5.2.6.8.3	Nnef_ChargeableParty_Update service operation.....	518
5.2.6.8.4	Nnef_ChargeableParty_Notify service operation.....	518
5.2.6.9	Nnef_AFsessionWithQoS service.....	518
5.2.6.9.1	General .....	518
5.2.6.9.2	Nnef_AFsessionWithQoS_Create service operation.....	518
5.2.6.9.3	Nnef_AFsessionWithQoS_Notify service operation.....	519
5.2.6.9.4	Nnef_AFsessionWithQoS_Revoke service operation.....	519
5.2.6.9.5	Nnef_AFsessionWithQoS_Update service operation.....	519
5.2.6.10	Nnef_MSISDN-less_MO_SMS service.....	519
5.2.6.10.1	General .....	519
5.2.6.10.2	Nnef_MSISDN-less_MO_SMSNotify service operation.....	519
5.2.6.11	Nnef_ServiceParameter service .....	520
5.2.6.11.1	General .....	520
5.2.6.11.2	Nnef_ServiceParameter_Create operation.....	520
5.2.6.11.3	Nnef_ServiceParameter_Update operation.....	520
5.2.6.11.4	Nnef_ServiceParameter_Delete operation.....	520
5.2.6.11.5	Nnef_ServiceParameter_Get operation .....	520
5.2.6.12	Nnef_APISupportCapability service.....	521
5.2.6.12.1	General .....	521
5.2.6.12.2	Nnef_APISupportCapability_Subscribe service operation.....	521
5.2.6.12.3	Nnef_APISupportCapability_Notify service operation.....	521
5.2.6.12.4	Nnef_APISupportCapability_Unsubscribe service operation .....	521
5.2.6.13	Nnef_NIDDConfiguration service .....	522
5.2.6.13.1	General .....	522
5.2.6.13.2	Nnef_NIDDConfiguration_Create service operation .....	522
5.2.6.13.3	Nnef_NIDDConfiguration_TriggerNotify service operation .....	522
5.2.6.13.4	Nnef_NIDDConfiguration_UpdateNotify service operation.....	522
5.2.6.13.5	Nnef_NIDDConfiguration_Delete service operation .....	522
5.2.6.14	Nnef_NIDD service .....	522
5.2.6.14.1	General .....	522
5.2.6.14.2	Nnef_NIDD_Delivery service operation.....	523
5.2.6.14.3	Nnef_NIDD_DeliveryNotify service operation.....	523
5.2.6.14.4	Nnef_NIDD_GroupDeliveryNotify service operation .....	523
5.2.6.15	Nnef_SMContext service .....	523
5.2.6.15.1	General .....	523
5.2.6.15.2	Nnef_SMContext_Create service operation .....	523
5.2.6.15.3	Nnef_SMContext_Delete service operation .....	523
5.2.6.15.4	Nnef_SMContext_DeleteNotify service operation.....	524
5.2.6.15.5	Nnef_SMContext_Delivery service operation.....	524
5.2.6.16	Nnef_AnalyticsExposure service .....	524
5.2.6.16.1	General .....	524
5.2.6.16.2	Nnef_AnalyticsExposure_Subscribe operation .....	524
5.2.6.16.3	Nnef_AnalyticsExposure_Unsubscribe service operation.....	525
5.2.6.16.4	Nnef_AnalyticsExposure_Notify service operation .....	525
5.2.6.16.5	Nnef_AnalyticsExposure_Fetch service operation.....	525
5.2.6.17	Nnef_UCMFProvisioning service.....	525
5.2.6.17.1	General .....	525
5.2.6.17.2	Nnef_UCMFProvisioning_Create operation .....	525
5.2.6.17.3	Nnef_UCMFProvisioning_Delete operation .....	526
5.2.6.17.4	Nnef_UCMFProvisioning_Update operation.....	526
5.2.6.18	Nnef_ECRestriction service.....	526
5.2.6.18.1	General .....	526
5.2.6.18.2	Nnef_ECRestriction_Get service operation.....	526
5.2.6.18.3	Nnef_ECRestriction_Update service operation.....	527
5.2.6.19	Nnef_ApplyPolicy service .....	527
5.2.6.19.1	General .....	527



5.2.6.19.2	Nnef_ApplyPolicy_Create service operation .....	527
5.2.6.19.3	Nnef_ApplyPolicy_Update service operation .....	527
5.2.6.19.4	Nnef_ApplyPolicy_Delete service operation .....	527
5.2.6.20	Void.....	528
5.2.6.21	Nnef_Location service .....	528
5.2.6.21.1	General .....	528
5.2.6.21.2	Nnef_Location_LocationUpdateNotify service operation.....	528
5.2.6A	Void.....	528
5.2.7	NRF Services.....	529
5.2.7.1	General.....	529
5.2.7.2	Nnrf_NFManagement service.....	529
5.2.7.2.1	General .....	529
5.2.7.2.2	Nnrf_NFManagement_NFRegister service operation .....	529
5.2.7.2.3	Nnrf_NFManagement_NFUpdate service operation.....	531
5.2.7.2.4	Nnrf_NFManagement_NFDeregister service operation.....	531
5.2.7.2.5	Nnrf_NFManagement_NFStatusSubscribe service operation.....	531
5.2.7.2.6	Nnrf_NFManagement_NFStatusNotify service operation .....	532
5.2.7.2.7	Nnrf_NFManagement_NFStatusUnsubscribe service operation.....	532
5.2.7.3	Nnrf_NFDiscovery service .....	533
5.2.7.3.1	General .....	533
5.2.7.3.2	Nnrf_NFDiscovery_Request service operation .....	533
5.2.7.4	Nnrf_AccessToken_service .....	536
5.2.7.4.1	General .....	536
5.2.7.4.2	Nnrf_AccessToken_Get Service Operation.....	536
5.2.8	SMF Services.....	536
5.2.8.1	General.....	536
5.2.8.2	Nsmf_PDUSession Service.....	537
5.2.8.2.1	General .....	537
5.2.8.2.2	Nsmf_PDUSession_Create service operation .....	537
5.2.8.2.3	Nsmf_PDUSession_Update service operation .....	538
5.2.8.2.4	Nsmf_PDUSession_Release service operation .....	539
5.2.8.2.5	Nsmf_PDUSession_CreateSMContext service operation .....	540
5.2.8.2.6	Nsmf_PDUSession_UpdateSMContext service operation .....	540
5.2.8.2.7	Nsmf_PDUSession_ReleaseSMContext service operation .....	541
5.2.8.2.8	Nsmf_PDUSession_SMContextStatusNotify service operation .....	541
5.2.8.2.9	Nsmf_PDUSession_StatusNotify service operation.....	542
5.2.8.2.10	Nsmf_PDUSession_ContextRequest service operation .....	542
5.2.8.2.11	Nsmf_PDUSession_ContextPush service operation.....	543
5.2.8.2.12	Nsmf_PDUSession_SendMOData service operation.....	544
5.2.8.2.13	Nsmf_PDUSession_TransferMOData service operation .....	544
5.2.8.2.14	Nsmf_PDUSession_TransferMTData service operation.....	544
5.2.8.3	Nsmf_EventExposure Service.....	545
5.2.8.3.1	General .....	545
5.2.8.3.2	Nsmf_EventExposure_Notify service operation .....	546
5.2.8.3.2A	Nsmf_EventExposure_AppRelocationInfo service operation.....	547
5.2.8.3.3	Nsmf_EventExposure_Subscribe service operation.....	547
5.2.8.3.4	Nsmf_EventExposure_UnSubscribe service operation .....	547
5.2.8.4	Nsmf_NIDD Service.....	548
5.2.8.4.1	General .....	548
5.2.8.4.2	Nsmf_NIDD_Delivery service operation.....	548
5.2.9	SMSF Services.....	548
5.2.9.1	General.....	548
5.2.9.2	Nsmsf_SMSservice service .....	548
5.2.9.2.1	General .....	548
5.2.9.2.2	Nsmsf_SMSservice_Activate service operation .....	548
5.2.9.2.3	Nsmsf_SMSservice_Deactivate service operation.....	549
5.2.9.2.4	Nsmsf_SMSservice_UplinkSMS service operation.....	549
5.2.10	AUSF Services.....	549
5.2.10.1	General.....	549
5.2.10.2	Nausf_UEAuthentication service.....	549
5.2.10.2.1	General .....	549
5.2.10.2.2	Nausf_UEAuthentication_Authenticate service operation.....	550

5.2.10.2.3	Void .....	550
5.2.10.3	Nausf_SoRProtection service .....	550
5.2.10.3.1	General .....	550
5.2.10.3.2	Nausf_SoRProtection Protect service operation .....	550
5.2.10.4	Nausf_UPUProtection service .....	550
5.2.10.4.1	General .....	550
5.2.10.4.2	Nausf_UPUProtection Protect service operation .....	550
5.2.10.5	Void .....	550
5.2.11	NWDAF Services .....	550
5.2.11.1	Void .....	550
5.2.11.2	Void .....	550
5.2.11.3	Void .....	550
5.2.12	UDR Services .....	550
5.2.12.1	General .....	550
5.2.12.2	Nudr_DataManagement (DM) service .....	552
5.2.12.2.1	General .....	552
5.2.12.2.2	Nudr_DM_Query service operation .....	556
5.2.12.2.3	Nudr_DM_Create service operation .....	556
5.2.12.2.4	Nudr_DM_Delete service operation .....	556
5.2.12.2.5	Nudr_DM_Update service operation .....	557
5.2.12.2.6	Nudr_DM_Subscribe service operation .....	557
5.2.12.2.7	Nudr_DM_Unsubscribe service operation .....	557
5.2.12.2.8	Nudr_DM_Notify service operation .....	557
5.2.12.3	Nudr_GroupIDmap service .....	558
5.2.12.3.1	General .....	558
5.2.12.3.2	Nudr_GroupIDmap_query service operation .....	558
5.2.13	BSF Services .....	558
5.2.13.1	General .....	558
5.2.13.2	Nbsf_Management service .....	558
5.2.13.2.1	General .....	558
5.2.13.2.2	Nbsf_Management_Register service operation .....	558
5.2.13.2.3	Nbsf_Management_Deregister service operation .....	559
5.2.13.2.4	Nbsf_Management_Discovery service operation .....	559
5.2.13.2.5	Nbsf_Management_Update service operation .....	559
5.2.14	UDSF Services .....	559
5.2.14.1	General .....	559
5.2.14.2	Nudsf_UnstructuredDataManagement service .....	560
5.2.14.2.1	General .....	560
5.2.14.2.2	Nudsf_UnstructuredDataManagement_Query service operation .....	560
5.2.14.2.3	Nudsf_UnstructuredDataManagement_Create service operation .....	560
5.2.14.2.4	Nudsf_UnstructuredDataManagement_Delete service operation .....	560
5.2.14.2.5	Nudsf_UnstructuredDataManagement_Update service operation .....	561
5.2.15	LMF Services .....	561
5.2.16	NSSF Services .....	561
5.2.16.1	General .....	561
5.2.16.2	Nnssf_NSSelection service .....	561
5.2.16.2.1	Nnssf_NSSelection_Get service operation .....	561
5.2.16.3	Nnssf_NSSAIAvailability service .....	563
5.2.16.3.1	General .....	563
5.2.16.3.2	Nnssf_NSSAIAvailability_Update service operation .....	563
5.2.16.3.3	Nnssf_NSSAIAvailability_Notify service operation .....	563
5.2.16.3.4	Nnssf_NSSAIAvailability_Subscribe service operation .....	564
5.2.16.3.5	Nnssf_NSSAIAvailability_Unsubscribe service operation .....	564
5.2.16.3.6	Nnssf_NSSAIAvailability_Delete service operation .....	564
5.2.17	CHF Spending Limit Control Service .....	565
5.2.17.1	General .....	565
5.2.17.2	Nchf_SpendingLimitControl service .....	565
5.2.17.2.1	General .....	565
5.2.17.2.2	Nchf_SpendingLimitControl Subscribe service operation .....	565
5.2.17.2.3	Nchf_SpendingLimitControl Unsubscribe service operation .....	565
5.2.17.2.4	Nchf_SpendingLimitControl Notify service operation .....	565
5.2.18	UCMF Services .....	566

5.2.18.1	General .....	566
5.2.18.2	Nucmf_Provisioning service .....	566
5.2.18.2.1	Nucmf_Provisioning_Create service operation .....	566
5.2.18.2.2	Nucmf_Provisioning_Delete service operation .....	566
5.2.18.2.3	Nucmf_Provisioning_Update service operation .....	567
5.2.18.3	Nucmf_UECapabilityManagement Service .....	567
5.2.18.3.1	Nucmf_UECapabilityManagement Resolve service operation .....	567
5.2.18.3.2	Nucmf_UECapabilityManagement_Assign service operation .....	567
5.2.18.3.3	Nucmf_UECapabilityManagement_Subscribe service operation .....	568
5.2.18.3.4	Nucmf_UECapabilityManagement_Unsubscribe service operation .....	568
5.2.18.3.5	Nucmf_UECapabilityManagement_Notify service operation .....	568
5.2.19	AF Services .....	569
5.2.19.1	General .....	569
5.2.19.2	Naf_EventExposure service .....	569
5.2.19.2.1	General .....	569
5.2.19.2.2	Naf_EventExposure_Subscribe service operation .....	570
5.2.19.2.3	Naf_EventExposure_Unsubscribe service operation .....	570
5.2.19.2.4	Naf_EventExposure_Notify service operation .....	570
5.2.20	NSSAAF services .....	571
5.2.20.1	General .....	571
5.2.20.2	Nnssaaf_NSSAA service .....	571
5.2.20.2.1	General .....	571
5.2.20.2.2	Nnssaaf_NSSAA_Authenticate service operation .....	571
5.2.20.2.3	Nnssaaf_NSSAA_Re-AuthenticationNotification service operation .....	571
5.2.20.2.4	Nnssaaf_NSSAA_RevocationNotification service operation .....	571
<b>Annex A (informative):    Drafting rules and conventions for NF services .....</b>		<b>572</b>
A.1	General .....	572
A.2	Naming .....	572
A.2.1	Service naming .....	572
A.2.2	Service operation naming .....	572
A.3	Representation in an information flow .....	573
A.4	Reference to services and service operations in procedures .....	574
A.5	Service and service operation description template .....	574
A.6	Design Guidelines for NF services .....	574
A.6.1	Self-Containment .....	574
A.6.2	Reusability .....	575
A.6.3	Use Independent Management Schemes .....	575
<b>Annex B (informative):    Drafting Rules for Information flows .....</b>		<b>576</b>
<b>Annex C (informative):    Generating EPS PDN Connection parameters from 5G PDU Session parameters .....</b>		<b>577</b>
<b>Annex D (normative):    UE Presence in Area of Interest .....</b>		<b>578</b>
D.1	Determination of UE presence in Area of Interest by AMF .....	578
D.2	Determination of UE presence in Area of Interest by NG-RAN .....	578
<b>Annex E (normative):    Delegated SMF and PCF discovery in the Home Routed and specific SMF Service Areas scenarios .....</b>		<b>580</b>
E.0	Overview .....	580
E.1	Delegated SMF discovery in the Home Routed scenario .....	580
E.2	Delegated I-SMF discovery .....	582
E.3	Delegated PCF discovery in the Roaming scenario .....	584

<b>Annex F (informative):</b>	<b>Information flows for 5GS integration with TSN .....</b>	<b>586</b>
F.1	5GS Bridge information reporting .....	586
F.2	5GS Bridge configuration .....	587
<b>Annex G (informative):</b>	<b>Change history .....</b>	<b>590</b>
History .....		617

---

# Foreword

This Technical Specification has been produced by the 3rd Generation Partnership Project (3GPP).

The contents of the present document are subject to continuing work within the TSG and may change following formal TSG approval. Should the TSG modify the contents of the present document, it will be re-released by the TSG with an identifying change of release date and an increase in version number as follows:

Version x.y.z

where:

- x the first digit:
  - 1 presented to TSG for information;
  - 2 presented to TSG for approval;
  - 3 or greater indicates TSG approved document under change control.
- y the second digit is incremented for all changes of substance, i.e. technical enhancements, corrections, updates, etc.
- z the third digit is incremented when editorial only changes have been incorporated in the document.

---

# 1 Scope

The present document defines the Stage 2 procedures and Network Function Services for the 5G system architecture which is described in the TS 23.501 [2] and for the policy and charging control framework which is described in TS 23.503 [20].

---

# 2 References

The following documents contain provisions which, through reference in this text, constitute provisions of the present document.

- References are either specific (identified by date of publication, edition number, version number, etc.) or non-specific.
- For a specific reference, subsequent revisions do not apply.
- For a non-specific reference, the latest version applies. In the case of a reference to a 3GPP document (including a GSM document), a non-specific reference implicitly refers to the latest version of that document *in the same Release as the present document*.

- [1] 3GPP TR 21.905: "Vocabulary for 3GPP Specifications".
- [2] 3GPP TS 23.501: "System Architecture for the 5G System; Stage 2".
- [3] IETF RFC 7296: "Internet Key Exchange Protocol Version 2 (IKEv2)".
- [4] Void.
- [5] Void.
- [6] IETF RFC 4861: "Neighbor Discovery for IP version 6 (IPv6)".
- [7] 3GPP TS 23.040: "Technical realization of the Short Message Service (SMS)".
- [8] IETF RFC 4862: "IPv6 Stateless Address Autoconfiguration".
- [9] 3GPP TS 38.300: "NR and NG-RAN Overall Description; Stage 2".
- [10] 3GPP TS 38.413: "NG-RAN; NG Application Protocol (NGAP)".
- [11] Void.
- [12] 3GPP TS 38.331: "NR; Radio Resource Control (RRC); Protocol Specification".
- [13] 3GPP TS 23.401: "General Packet Radio Service (GPRS) enhancements for Evolved Universal Terrestrial Radio Access Network (E-UTRAN) access".
- [14] Void.
- [15] 3GPP TS 33.501: "Security Architecture and Procedures for 5G System".
- [16] 3GPP TS 36.331: "Evolved Universal Terrestrial Radio Access (E-UTRA); Radio Resource Control (RRC); Protocol specification".
- [17] 3GPP TS 29.500: "5G System; Technical Realization of Service Based Architecture; Stage 3".
- [18] 3GPP TS 29.518: "5G System; Access and Mobility Management Services; Stage 3".
- [19] Void.
- [20] 3GPP TS 23.503: "Policy and Charging Control Framework for the 5G System".
- [21] IETF RFC 4191: "Default Router Preferences and More-Specific Routes".

- [22] 3GPP TS 23.122: "Non-Access-Stratum (NAS) functions related to Mobile Station in idle mode".
- [23] 3GPP TS 23.682: "Architecture enhancements to facilitate communications with packet data networks and applications".
- [24] 3GPP TS 23.203: "Policy and charging control architecture".
- [25] 3GPP TS 24.501: "Non-Access-Stratum (NAS) protocol for 5G System (5GS); Stage 3".
- [26] 3GPP TS 23.402: "Architecture enhancements for non-3GPP accesses".
- [27] Void.
- [28] 3GPP TS 23.167: "IP Multimedia Subsystem (IMS) emergency sessions".
- [29] Void.
- [30] Void.
- [31] Void.
- [32] 3GPP TS 29.507: "Access and Mobility Policy Control Service; Stage 3".
- [33] 3GPP TS 23.003: "Numbering, Addressing and Identification".
- [34] Void.
- [35] 3GPP TS 23.251: "Network sharing; Architecture and functional description".
- [36] 3GPP TS 29.502: "5G System; Session Management Services; Stage 3".
- [37] 3GPP TS 29.510: "5G System; Network function repository services; Stage 3".
- [38] 3GPP TS 23.380: "IMS Restoration Procedures".
- [39] 3GPP TS 32.421: "Telecommunication management; Subscriber and equipment trace; Trace concepts and requirements".
- [40] IETF RFC 4555: "IKEv2 Mobility and Multihoming Protocol (MOBIKE)".
- [41] 3GPP TS 24.502: "Access to the 3GPP 5G Core Network (5GCN) via Non-3GPP Access Networks (N3AN); Stage 3".
- [42] 3GPP TS 32.290: "Services, operations and procedures of charging using Service Based Interface (SBI)".
- [43] 3GPP TS 36.304: "Evolved Universal Terrestrial Radio Access (E-UTRA); User Equipment (UE) procedures in idle mode".
- [44] 3GPP TS 38.304: "NR; User Equipment (UE) procedures in idle mode".
- [45] 3GPP TS 32.255: "5G system; 5G data connectivity domain charging; Stage 2".
- [46] 3GPP TS 36.300: "Evolved Universal Terrestrial Radio Access (E-UTRA) and Evolved Universal Terrestrial Radio Access Network (E-UTRAN); Overall description; Stage 2".
- [47] 3GPP TS 29.513: "5G System; Policy and Charging Control signalling flows and QoS parameter mapping; Stage 3".
- [48] IEEE Std 802.11-2016 (Revision of IEEE Std 802.11-2012): "IEEE Standard for Information technology - Telecommunications and information exchange between systems Local and metropolitan area networks - Specific requirements - Part 11: Wireless LAN Medium Access Control (MAC) and Physical Layer (PHY) Specifications".
- [49] IETF RFC 2410: "The NULL Encryption Algorithm and its use with IPsec".
- [50] 3GPP TS 23.288: "Architecture enhancements for 5G System (5GS) to support network data analytics services; Stage 2".

- [51] 3GPP TS 23.273: "5G System (5GS) Location Services (LCS); Stage 2".
- [52] 3GPP TS 29.503: "5G System; Unified Data Management Services; Stage 3".
- [53] 3GPP TS 23.316: "Wireless and wireline convergence access support for the 5G System (5GS)".
- [54] 3GPP TS 23.222: "Functional architecture and information flows to support Common API Framework for 3GPP Northbound APIs; Stage 2".
- [55] 3GPP TS 23.228: "IP Multimedia Subsystem (IMS); Stage 2".
- [56] 3GPP TS 36.321: "Evolved Universal Terrestrial Radio Access (E-UTRA); Medium Access Control (MAC) protocol specification".
- [57] 3GPP TS 29.512: "5G System; Session Management Policy Control Service; Stage 3".
- [58] 3GPP TS 29.525: "5G System; UE Policy Control Service; Stage 3".
- [59] IETF RFC 6696: "EAP Extensions for the EAP Re-authentication Protocol (ERP)", July 2012.
- [60] IETF RFC 5295: "Specification for the Derivation of Root Keys from an Extended Master Session Key (EMSK)", Aug. 2008.
- [61] 3GPP TS 23.272: "Circuit Switched (CS) fallback in Evolved Packet System (EPS); Stage 2".
- [62] 3GPP TS 29.501: "5G System; Principles and Guidelines for Services Definition; Stage 3".
- [63] 3GPP TS 29.561: "5G System; Interworking between 5G Network and external Data Networks; Stage 3".
- [64] 3GPP TS 29.413: "Application of the NG Application Protocol (NGAP) to non-3GPP access".
- [65] IEEE Std 802.1Qcc-2018: "Standard for Local and metropolitan area networks - Bridges and Bridged Networks - Amendment: Stream Reservation Protocol (SRP) Enhancements and Performance Improvements".
- [66] IEEE Std 802.1Q-2018: "IEEE Standard for Local and Metropolitan Area Networks-Bridges and Bridged Networks".
- [67] Void.
- [68] 3GPP TS 23.632: "User Data Interworking, Coexistence and Migration".
- [69] 3GPP TS 29.244: "Interface between the Control Plane and the User Plane nodes".
- [70] 3GPP TS 29.571: "5G System; Common Data Types for Service Based Interfaces; Stage 3".
- [71] 3GPP TS 32.256: "Charging Management; 5G connection and mobility domain charging; Stage 2".
- [72] 3GPP TS 38.423: "NG-RAN; Xn Application Protocol (XnAP)".
- [73] 3GPP TS 23.287: "Architecture enhancements for 5G System (5GS) to support Vehicle-to-Everything (V2X) services".
- [74] 3GPP TS 23.216: "Single Radio Voice Call Continuity (SRVCC); Stage 2".

---

## 3 Definitions, symbols and abbreviations

### 3.1 Definitions

For the purposes of the present document, the terms and definitions given in TR 21.905 [1], TS 23.501 [2] and TS 23.503 [20] apply. A term defined in TS 23.501 [2] or TS 23.503 [20] takes precedence over the definition of the same term, if any, in any other specifications.



## 3.2 Abbreviations

For the purposes of the present document, the abbreviations given in TR 21.905 [1], TS 23.501 [2] and TS 23.503 [20] apply. An abbreviation defined in TS 23.501 [2] or TS 23.503 [20] takes precedence over the definition of the same abbreviation, if any, in any other specifications.

---

# 4 System procedures

## 4.1 General

The clause 4 describes the procedures and Network Function services for the 5GS by end-to-end information flows and these information flows make use of NF service operations, defined in clause 5, for the communication within the 5GC Control Plane.

## 4.2 Connection, Registration and Mobility Management procedures

### 4.2.1 General

The Connection Management is used to establish and release the Control Plane signalling connection between the UE and the AMF. The Registration Management is used to register or deregister a UE/user with the 5GS and establish the user context in the 5GS. The Mobility Management functions are used to keep track of the current location of a UE. The procedures in clause 4.2 provides Connection, Registration and Mobility Management functionality.

### 4.2.2 Registration Management procedures

#### 4.2.2.1 General

The Registration and Deregistration procedures in clause 4.2.2 provides the required functionality to register or deregister a UE/user with the 5GS. Additional functionality to support Registration Management for non-3GPP access is defined in clause 4.12. Additional functionality to support Registration Management for specific services such as SMS over NAS is defined in clause 4.13.

#### 4.2.2.2 Registration procedures

##### 4.2.2.2.1 General

A UE needs to register with the network to get authorized to receive services, to enable mobility tracking and to enable reachability. The UE initiates the Registration procedure using one of the following Registration types:

- Initial Registration to the 5GS;
- Mobility Registration Update upon changing to a new Tracking Area (TA) outside the UE's Registration Area in both CM-CONNECTED and CM-IDLE state, or when the UE needs to update its capabilities or protocol parameters that are negotiated in Registration procedure with or without changing to a new TA, a change in the UE's Preferred Network Behaviour that would create an incompatibility with the Supported Network Behaviour provided by the serving AMF, or when the UE intends to retrieve LADN Information; or
- Periodic Registration Update (due to a predefined time period of inactivity); or
- Emergency Registration.

The General Registration call flow in clause 4.2.2.2.2 applies on all these Registration procedures, but the periodic registration need not include all parameters that are used in other registration cases.

The following are the cleartext IEs, as defined in TS 24.501 [25] that can be sent by the UE in the Registration Request message if the UE has no NAS security context:

- Registration type
- SUCI or 5G-GUTI or PEI
- Security parameters
- additional GUTI
- 4G Tracking Area Update
- the indication that the UE is moving from EPS.

Aspects related to dual registration in 3GPP and non-3GPP access are described in clause 4.12. The general Registration call flow in clause 4.2.2.2.2 is also used for the case of registration in 3GPP access when the UE is already registered in a non-3GPP access and vice versa. Registration in 3GPP access when the UE is already registered in a non-3GPP access scenario may require an AMF change, as further detailed in clause 4.12.8.

The general Registration call flow in clause 4.2.2.2.2 is also used by UEs in limited service state (see TS 23.122 [22]) registering for emergency services only (referred to as Emergency Registration), see clause 5.16.4 of TS 23.501 [2].

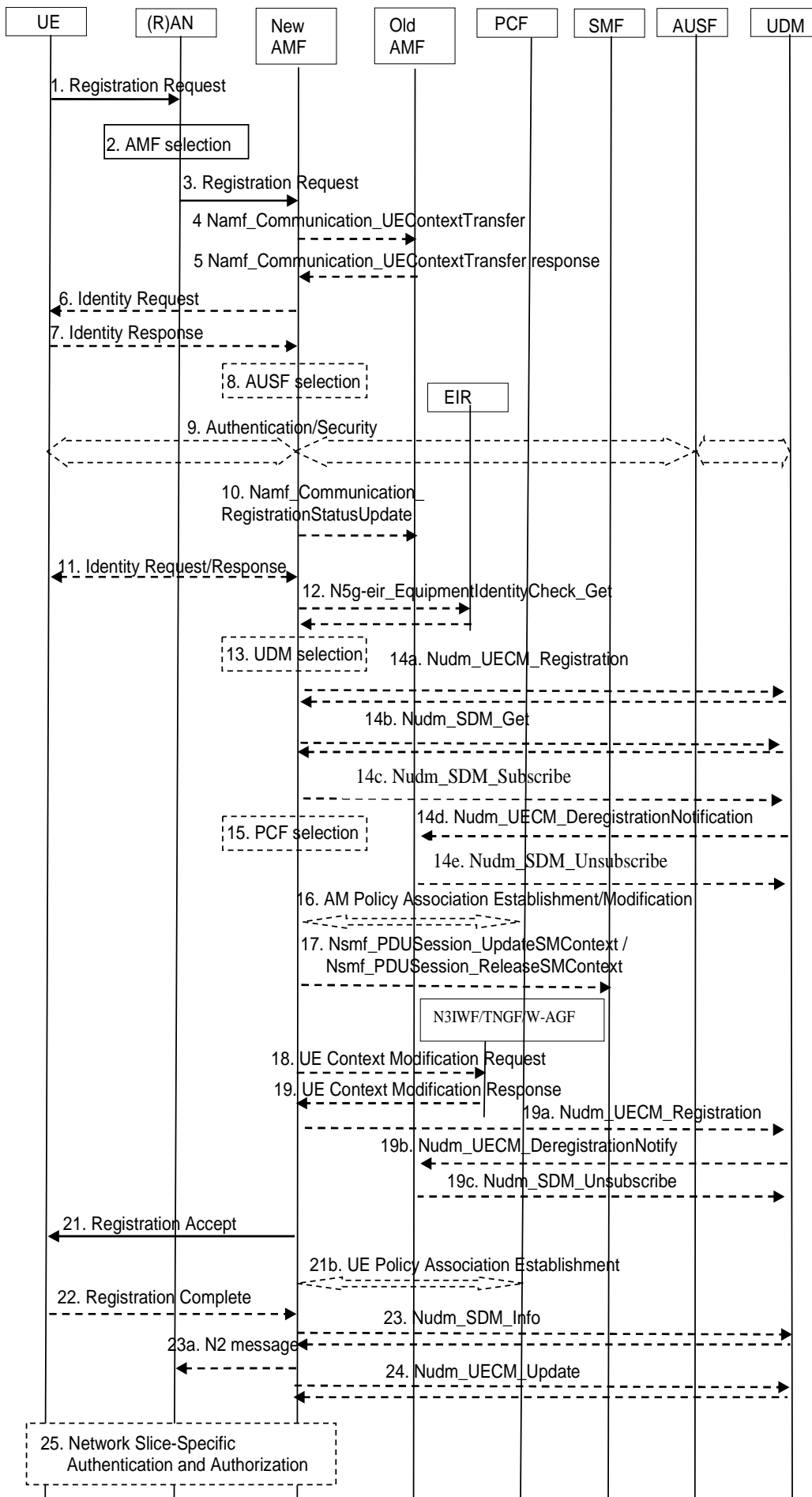
During the initial registration the PEI is obtained from the UE. If the PEI is needed (e.g. for EIR check), the AMF shall retrieve the PEI when it establishes the NAS security context with a Security Mode Command during initial registration. The AMF operator may check the PEI with an EIR. If the PEI was retrieved by the AMF (either from the UE or another AMF), AMF shall provide it to the UDM using Nudm\_UECM\_Registration in order to ensure that the UDM always has the latest PEI available e.g. for reporting event Change of SUPI-PEI association. The AMF passes the PEI to the UDM, to the SMF and the PCF. The UDM may store this data in UDR by Nudr\_SDM\_Update.

NOTE 1: The use of NSI ID in the 5GC is optional and depends on the deployment choices of the operator.

During the registration the Home Network can provide Steering of Roaming information to the UE via the AMF (i.e. a list of preferred PLMN/access technology combinations or HPLMN indication that 'no change of the "Operator Controlled PLMN Selector with Access Technology" list stored in the UE is needed). The Home Network can include an indication for the UE to send an acknowledgement of the reception of this information. Details regarding the handling of Steering of Roaming information including how this information is managed between the AMF and the UE are defined in TS 23.122 [22].

The AMF determines Access Type and RAT Type as defined in clause 5.3.2.3 of TS 23.501 [2].

4.2.2.2.2 General Registration



### Figure 4.2.2.2-1: Registration procedure

1. UE to (R)AN: AN message (AN parameters, Registration Request (Registration type, SUCI or 5G-GUTI or PEI, [last visited TAI (if available)], Security parameters, [Requested NSSAI], [Mapping Of Requested NSSAI], [Default Configured NSSAI Indication], [UE Radio Capability Update], [UE MM Core Network Capability], [PDU Session status], [List Of PDU Sessions To Be Activated], [Follow-on request], [MICO mode preference], [Requested Active Time], [Requested DRX parameters for E-UTRA and NR], [Requested DRX parameters for NB-IoT], [extended idle mode DRX parameters], [LADN DNN(s) or Indicator Of Requesting LADN Information], [NAS message container], [Support for restriction of use of Enhanced Coverage], [Preferred Network Behaviour], [UE paging probability information], [UE Policy Container (the list of PSIs, indication of UE support for ANDSP and the operating system identifier)] and [UE Radio Capability ID], PEI)).

NOTE 1: The UE Policy Container and its usage is defined in TS 23.503 [20].

In the case of NG-RAN, the AN parameters include e.g. 5G-S-TMSI or GUAMI, the Selected PLMN ID (or PLMN ID and NID, see clause 5.30 of TS 23.501 [2]) and NSSAI information, the AN parameters also include Establishment cause. The Establishment cause provides the reason for requesting the establishment of an RRC connection. Whether and how the UE includes the NSSAI information as part of the AN parameters is dependent on the value of the Access Stratum Connection Establishment NSSAI Inclusion Mode parameter, as specified in clause 5.15.9 of TS 23.501 [2].

The AN parameters shall also include an IAB-Indication if the UE is an IAB-node accessing 5GS.

The Registration type indicates if the UE wants to perform an Initial Registration (i.e. the UE is in RM-DEREGISTERED state), a Mobility Registration Update (i.e. the UE is in RM-REGISTERED state and initiates a Registration procedure due to mobility or due to the UE needs to update its capabilities or protocol parameters, or to request a change of the set of network slices it is allowed to use), a Periodic Registration Update (i.e. the UE is in RM-REGISTERED state and initiates a Registration procedure due to the Periodic Registration Update timer expiry, see clause 4.2.2.2.1) or an Emergency Registration (i.e. the UE is in limited service state).

When the UE is using E-UTRA, the UE indicates its support of CIoT 5GS Optimisations, which is relevant for the AMF selection, in the RRC connection establishment signalling associated with the Registration Request.

When the UE is performing an Initial Registration the UE shall indicate its UE identity in the Registration Request message as follows, listed in decreasing order of preference in the case of registration with a PLMN:

- i) a 5G-GUTI mapped from an EPS GUTI, if the UE has a valid EPS GUTI.
- ii) a native 5G-GUTI assigned by the PLMN to which the UE is attempting to register, if available;
- iii) a native 5G-GUTI assigned by an equivalent PLMN to the PLMN to which the UE is attempting to register, if available;
- iv) a native 5G-GUTI assigned by any other PLMN, if available.

NOTE 2: This can also be a 5G-GUTIs assigned via another access type.

- v) Otherwise, the UE shall include its SUCI in the Registration Request as defined in TS 33.501 [15].

When the UE performing an Initial Registration has both a valid EPS GUTI and a native 5G-GUTI, the UE shall also indicate the native 5G-GUTI as Additional GUTI. If more than one native 5G-GUTIs are available, the UE shall select the 5G-GUTI in decreasing order of preference among items (ii)-(iv) in the list above.

When registering with an SNPN with 5G-GUTI as UE identity, the UE shall only use the 5G-GUTI previously assigned by the same SNPN.

The NAS message container shall be included if the UE is sending a Registration Request message as an Initial NAS message and the UE has a valid 5G NAS security context and the UE needs to send non-clear-text IEs, see clause 4.4.6 of TS 24.501 [25]. If the UE does not need to send non-clear-text IEs, the UE shall send a Registration Request message without including the NAS message container.

If the UE does not have a valid 5G NAS security context, the UE shall send the Registration Request message without including the NAS message container. The UE shall include the entire Registration Request message (i.e. containing clear-text IEs and non-clear-text IEs) in the NAS message container that is sent as part of the Security Mode Complete message in step 9b.

When the UE is performing an Initial Registration (i.e. the UE is in RM-DEREGISTERED state) with a native 5G-GUTI then the UE shall indicate the related GUAMI information in the AN parameters. When the UE is performing an Initial Registration with its SUCI, the UE shall not indicate any GUAMI information in the AN parameters.

When the UE is performing an Initial Registration or a Mobility Registration and if CIoT 5GS Optimisations are supported the UE shall indicate its Preferred Network Behaviour (see clause 5.31.2 of TS 23.501 [2]). If S1 mode is supported the UE's EPC Preferred Network Behaviour is included in the S1 UE network capabilities in the Registration Request message, see clause 8.2.6.1 of TS 24.501 [25].

For an Emergency Registration, the SUCI shall be included if the UE does not have a valid 5G-GUTI available; the PEI shall be included when the UE has no SUPI and no valid 5G-GUTI. In other cases, the 5G-GUTI is included and it indicates the last serving AMF.

The UE may provide the UE's usage setting based on its configuration as defined in clause 5.16.3.7 of TS 23.501 [2]. The UE provides Requested NSSAI as described in clause 5.15.5.2.1 of TS 23.501 [2] and in the case of Initial Registration or Mobility Registration Update, the UE includes the Mapping Of Requested NSSAI (if available), which is the mapping of each S-NSSAI of the Requested NSSAI to the HPLMN S-NSSAIs, to ensure that the network is able to verify whether the S-NSSAI(s) in the Requested NSSAI are permitted based on the Subscribed S-NSSAIs. In the case of inter PLMN mobility, if the serving PLMN S-NSSAI(s) corresponding to the established PDU Session(s) are not present in the UE, the associated HPLMN S-NSSAI(s) associated with the established PDU Session(s) shall be provided in the Mapping Of Requested NSSAI as described in the clause 5.15.5.2.1 TS 23.501 [2].

The UE includes the Default Configured NSSAI Indication if the UE is using a Default Configured NSSAI, as defined in TS 23.501 [2].

The UE may include UE paging probability information if it supports the assignment of WUS Assistance Information from the AMF (see TS 23.501 [2]).

In the case of Mobility Registration Update, the UE includes in the List Of PDU Sessions To Be Activated the PDU Sessions for which there are pending uplink data. When the UE includes the List Of PDU Sessions To Be Activated, the UE shall indicate PDU Sessions only associated with the access the Registration Request is related to. As defined in TS 24.501 [25] the UE shall include always-on PDU Sessions which are accepted by the network in the List Of PDU Sessions To Be Activated even if there are no pending uplink data for those PDU Sessions.

NOTE 3: A PDU Session corresponding to a LADN is not included in the List Of PDU Sessions To Be Activated when the UE is outside the area of availability of the LADN.

The UE MM Core Network Capability is provided by the UE and handled by AMF as defined in clause 5.4.4a of TS 23.501 [2]. The UE includes in the UE MM Core Network Capability an indication if it supports Request Type flag "handover" for PDN connectivity request during the attach procedure as defined in clause 5.17.2.3.1 of TS 23.501 [2]. If the UE supports 'Strictly Periodic Registration Timer Indication', the UE indicates its capability of 'Strictly Periodic Registration Timer Indication' in the UE MM Core Network Capability. If the UE supports CAG, the UE indicates its capability of "CAG supported" in the UE MM Core Network Capability.

The UE may provide either the LADN DNN(s) or an Indication Of Requesting LADN Information as described in clause 5.6.5 of TS 23.501 [2].

If available, the last visited TAI shall be included in order to help the AMF produce Registration Area for the UE.

The Security parameters are used for Authentication and integrity protection, see TS 33.501 [15]. Requested NSSAI indicates the Network Slice Selection Assistance Information (as defined in clause 5.15 of TS 23.501 [2]). The PDU Session status indicates the previously established PDU Sessions in the UE. When the UE is connected to the two AMFs belonging to different PLMN via 3GPP access and non-3GPP access then the PDU Session status indicates the established PDU Session of the current PLMN in the UE.

The Follow-on request is included when the UE has pending uplink signalling and the UE doesn't include List Of PDU Sessions To Be Activated, or the Registration type indicates the UE wants to perform an Emergency Registration. In Initial Registration and Mobility Registration Update, UE provides the UE Requested DRX parameters, as defined in clause 5.4.5 of TS 23.501 [2]. The UE may provide the extended idle mode DRX parameters as defined in clause 5.31.7.2 of TS 23.501 [2] to request extended idle mode DRX.

The UE provides UE Radio Capability Update indication as described in TS 23.501 [2].

The UE includes the MICO mode preference and optionally a Requested Active Time value if the UE wants to use MICO Mode with Active Time.

The UE may indicate its Service Gap Control Capability in the UE MM Core Network Capability, see clause 5.31.16 of TS 23.501 [2].

For a UE with a running Service Gap timer in the UE, the UE shall not set Follow-on Request indication or Uplink data status in the Registration Request message (see clause 5.31.16 of TS 23.501 [2]), except for network access for regulatory prioritized services like Emergency services or exception reporting.

If UE supports RACS and has been assigned UE Radio Capability ID(s), the UE shall indicate a UE Radio Capability ID as defined in clause 5.4.4.1a of TS 23.501 [2] as non-cleartext IE.

The PEI may be retrieved in initial registration from the UE as described in clause 4.2.2.2.1.

2. If a 5G-S-TMSI or GUAMI is not included or the 5G-S-TMSI or GUAMI does not indicate a valid AMF the (R)AN, based on (R)AT and Requested NSSAI, if available, selects an AMF

The (R)AN selects an AMF as described in clause 6.3.5 of TS 23.501 [2]. If UE is in CM-CONNECTED state, the (R)AN can forward the Registration Request message to the AMF based on the N2 connection of the UE.

If the (R)AN cannot select an appropriate AMF, it forwards the Registration Request to an AMF which has been configured, in (R)AN, to perform AMF selection.

3. (R)AN to new AMF: N2 message (N2 parameters, Registration Request (as described in step 1) and [LTE-M Indication]).

When NG-RAN is used, the N2 parameters include the Selected PLMN ID (or PLMN ID and NID, see clause 5.30 of TS 23.501 [2]), Location Information and Cell Identity related to the cell in which the UE is camping, UE Context Request which indicates that a UE context including security information needs to be setup at the NG-RAN.

When NG-RAN is used, the N2 parameters shall also include the Establishment cause and IAB-Indication if the indication is received in AN parameters in step 1.

Mapping Of Requested NSSAI is provided only if available.

If the Registration type indicated by the UE is Periodic Registration Update, then steps 4 to 19 may be omitted.

When the Establishment cause is associated with priority services (e.g. MPS, MCS), the AMF includes a Message Priority header to indicate priority information. Other NFs relay the priority information by including the Message Priority header in service-based interfaces, as specified in TS 29.500 [17].

The RAT Type the UE is using is determined (see clause 4.2.2.2.1) and based on it the AMF determines whether the UE is performing Inter-RAT mobility to or from NB-IoT. If the AMF receives the LTE M indication, then it considers that the RAT Type is LTE-M and stores the LTE-M Indication in UE Context.

If a UE includes a Preferred Network Behaviour, this defines the Network Behaviour the UE supports and is expecting to be available in the network as defined in clause 5.31.2 of TS 23.501 [2].

If the UE has included the Preferred Network Behaviour and what the UE indicated it supports in Preferred Network Behaviour is incompatible with the network support, the AMF shall reject the Registration Request with an appropriate cause value (e.g. one that avoids retries on this PLMN).

If there is a Service Gap timer running in the UE Context in AMF for the UE and Follow-on Request indication or Uplink data status is included in the Registration Request message, the AMF shall ignore the Follow-on Request indication and Uplink data status and not perform any of the actions related to the status.

If the UE has included a UE Radio Capability ID in step 1 and the AMF supports RACS, the AMF stores the Radio Capability ID in UE context.

4. [Conditional] new AMF to old AMF: Namf\_Communication\_UEContextTransfer (complete Registration Request) or new AMF to UDSF: Nudsf\_Unstructured Data Management\_Query().

(With UDSF Deployment): If the UE's 5G-GUTI was included in the Registration Request and the serving AMF has changed since last Registration procedure, new AMF and old AMF are in the same AMF Set and UDSF is deployed, the new AMF retrieves the stored UE's SUPI and UE context directly from the UDSF using Nudsf\_UnstructuredDataManagement\_Query service operation or they can share stored UE context via implementation specific means if UDSF is not deployed. This includes also event subscription information by each NF consumer for the given UE. In this case, the new AMF uses integrity protected complete Registration request NAS message to perform and verify integrity protection.

(Without UDSF Deployment): If the UE's 5G-GUTI was included in the Registration Request and the serving AMF has changed since last Registration procedure, the new AMF may invoke the Namf\_Communication\_UEContextTransfer service operation on the old AMF including the complete Registration Request NAS message, which may be integrity protected, as well as the Access Type, to request the UE's SUPI and UE Context. See clause 5.2.2.2.2 for details of this service operation. In this case, the old AMF uses either 5G-GUTI and the integrity protected complete Registration request NAS message, or the SUPI and an indication that the UE is validated from the new AMF, to verify integrity protection if the context transfer service operation invocation corresponds to the UE requested. The old AMF also transfers the event subscriptions information by each NF consumer, for the UE, to the new AMF. If the old AMF has not yet reported a non-zero MO Exception Data Counter to the (H-)SMF, the Context Response also includes the MO Exception Data Counter.

If the old AMF has PDU Sessions for another access type (different from the Access Type indicated in this step) and if the old AMF determines that there is no possibility for relocating the N2 interface to the new AMF, the old AMF returns UE's SUPI and indicates that the Registration Request has been validated for integrity protection, but does not include the rest of the UE context.

For inter PLMN mobility, UE Context information includes HPLMN S-NSSAIs corresponding to the Allowed NSSAI for each Access Type, without Allowed NSSAI of old PLMN.

NOTE 4: The new AMF Sets the indication that the UE is validated according to step 9a, if the new AMF has performed successful UE authentication after previous integrity check failure in the old AMF.

NOTE 5: The NF consumers do not need to subscribe for the events once again with the new AMF after the UE is successfully registered with the new AMF.

If the new AMF has already received UE contexts from the old AMF during handover procedure, then step 4,5 and 10 shall be skipped.

For an Emergency Registration, if the UE identifies itself with a 5G-GUTI that is not known to the AMF, steps 4 and 5 are skipped and the AMF immediately requests the SUPI from the UE. If the UE identifies itself with PEI, the SUPI request shall be skipped. Allowing Emergency Registration without a user identity is dependent on local regulations.

5. [Conditional] old AMF to new AMF: Response to Namf\_Communication\_UEContextTransfer (SUPI, UE Context in AMF (as per Table 5.2.2.2.2-1)) or UDSF to new AMF: Nudsf\_Unstructured Data Management\_Query(). The old AMF may start an implementation specific (guard) timer for the UE context.

If the UDSF was queried in step 4, the UDSF responds to the new AMF for the Nudsf\_Unstructured Data Management\_Query invocation with the related contexts including established PDU Sessions, the old AMF includes SMF information DNN, S-NSSAI(s) and PDU Session ID, active NGAP UE-TNLA bindings to N3IWF/TNGF/W-AGF, the old AMF includes information about the NGAP UE-TNLA bindings. If the Old AMF was queried in step 4, Old AMF responds to the new AMF for the Namf\_Communication\_UEContextTransfer invocation by including the UE's SUPI and UE Context.

If old AMF holds information about established PDU Session(s) and it is not an Initial Registration, the old AMF includes SMF information, DNN(s), S-NSSAI(s) and PDU Session ID(s).

If old AMF holds UE context established via N3IWF, W-AGF or TNGF, the old AMF includes the CM state via N3IWF, W-AGF or TNGF. If the UE is in CM-CONNECTED state via N3IWF, W-AGF or TNGF, the old AMF includes information about the NGAP UE-TNLA bindings.

If old AMF fails the integrity check of the Registration Request NAS message, the old AMF shall indicate the integrity check failure. If the new AMF is configured to allow emergency services for unauthenticated UE, the new AMF behaves as follows:



- If the UE has only an emergency PDU Session, the AMF either skips the authentication and security procedure or accepts that the authentication may fail and continues the Mobility Registration Update procedure; or
- If the UE has both emergency and non emergency PDU Sessions and authentication fails, the AMF continues the Mobility Registration Update procedure and deactivates all the non-emergency PDU Sessions as specified in clause 4.3.4.2.

NOTE 6: The new AMF can determine if a PDU Session is used for emergency service by checking whether the DNN matches the emergency DNN.

If old AMF holds information about AM Policy Association and the information about UE Policy Association (i.e. the Policy Control Request Trigger for updating UE Policy as defined in TS 23.503 [20]), the old AMF includes the information about the AM Policy Association, the UE Policy Association and PCF ID. In the roaming case, V-PCF ID and H-PCF ID are included.

During inter PLMN mobility, the handling of the UE Radio Capability ID in the new AMF is as defined in TS 23.501 [2].

NOTE 7: When new AMF uses UDSF for context retrieval, interactions between old AMF, new AMF and UDSF due to UE signalling on old AMF at the same time is implementation issue.

6. [Conditional] new AMF to UE: Identity Request ().

If the SUCI is not provided by the UE nor retrieved from the old AMF the Identity Request procedure is initiated by AMF sending an Identity Request message to the UE requesting the SUCI.

7. [Conditional] UE to new AMF: Identity Response ().

The UE responds with an Identity Response message including the SUCI. The UE derives the SUCI by using the provisioned public key of the HPLMN, as specified in TS 33.501 [15].

8. The AMF may decide to initiate UE authentication by invoking an AUSF. In that case, the AMF selects an AUSF based on SUPI or SUCI, as described in clause 6.3.4 of TS 23.501 [2].

If the AMF is configured to support Emergency Registration for unauthenticated SUPIs and the UE indicated Registration type Emergency Registration, the AMF skips the authentication or the AMF accepts that the authentication may fail and continues the Registration procedure.

9a. If authentication is required, the AMF requests it from the AUSF; if Tracing Requirements about the UE are available at the AMF, the AMF provides Tracing Requirements in its request to AUSF. Upon request from the AMF, the AUSF shall execute authentication of the UE. The authentication is performed as described in TS 33.501 [15]. The AUSF selects a UDM as described in clause 6.3.8 of TS 23.501 [2] and gets the authentication data from UDM.

Once the UE has been authenticated the AUSF provides relevant security related information to the AMF. If the AMF provided a SUCI to AUSF, the AUSF shall return the SUPI to AMF only after the authentication is successful.

After successful authentication in new AMF, which is triggered by the integrity check failure in old AMF at step 5, the new AMF invokes step 4 above again and indicates that the UE is validated (i.e. through the reason parameter as specified in clause 5.2.2.2.2).

9b If NAS security context does not exist, the NAS security initiation is performed as described in TS 33.501 [15]. If the UE had no NAS security context in step 1, the UE includes the full Registration Request message as defined in TS 24.501 [25].

The AMF decides if the Registration Request needs to be rerouted as described in clause 4.2.2.2.3, where the initial AMF refers to the AMF.

9c. The AMF initiates NGAP procedure to provide the 5G-AN with security context as specified in TS 38.413 [10] if the 5G-AN had requested for UE Context. Also, if the AMF decides that EPS fallback is supported (e.g. based on UE capability to support Request Type flag "handover" for PDN connectivity request during the attach procedure as defined in clause 5.17.2.3.1 of TS 23.501 [2], subscription data and local policy), the AMF shall send an indication "Redirection for EPS fallback for voice is possible" towards 5G-AN as specified in

TS 38.413 [10]. Otherwise, the AMF indicates "Redirection for EPS fallback for voice is not possible". In addition, if Tracing Requirements about the UE are available at the AMF, the AMF provides the 5G-AN with Tracing Requirements in the NGAP procedure.

9d. The 5G-AN stores the security context and acknowledges to the AMF. The 5G-AN uses the security context to protect the messages exchanged with the UE as described in TS 33.501 [15].

10. [Conditional] new AMF to old AMF: Namf\_Communication\_RegistrationStatusUpdate (PDU Session ID(s) to be released due to slice not supported).

If the AMF has changed the new AMF informs the old AMF that the registration of the UE in the new AMF is completed by invoking the Namf\_Communication\_RegistrationStatusUpdate service operation.

If the authentication/security procedure fails, then the Registration shall be rejected and the new AMF invokes the Namf\_Communication\_RegistrationStatusUpdate service operation with a reject indication towards the old AMF. The old AMF continues as if the UE context transfer service operation was never received.

If one or more of the S-NSSAIs used in the old Registration Area cannot be served in the target Registration Area, the new AMF determines which PDU Session cannot be supported in the new Registration Area. The new AMF invokes the Namf\_Communication\_RegistrationStatusUpdate service operation including the rejected PDU Session ID towards the old AMF. Then the new AMF modifies the PDU Session Status correspondingly. The old AMF informs the corresponding SMF(s) to locally release the UE's SM context by invoking the Nsmf\_PDUSession\_ReleaseSMContext service operation.

If new AMF received in the UE context transfer in step 2 the information about the AM Policy Association and the UE Policy Association and decides, based on local policies, not to use the PCF(s) identified by the PCF ID(s) for the AM Policy Association and the UE Policy Association, then it will inform the old AMF that the AM Policy Association and the UE Policy Association in the UE context is not used any longer and then the PCF selection is performed in step 15.

11. [Conditional] new AMF to UE: Identity Request/Response (PEI).

If the PEI was not provided by the UE nor retrieved from the old AMF the Identity Request procedure is initiated by AMF sending an Identity Request message to the UE to retrieve the PEI. The PEI shall be transferred encrypted unless the UE performs Emergency Registration and cannot be authenticated.

For an Emergency Registration, the UE may have included the PEI in the Registration Request. If so, the PEI retrieval is skipped.

If the UE supports RACS as indicated in UE MM Core Network Capability, the AMF shall use the PEI of the UE to obtain the IMEI/TAC for the purpose of RACS operation.

12. Optionally the new AMF initiates ME identity check by invoking the N5g-eir\_EquipmentIdentityCheck\_Get service operation (see clause 5.2.4.2.2).

The PEI check is performed as described in clause 4.7.

For an Emergency Registration, if the PEI is blocked, operator policies determine whether the Emergency Registration procedure continues or is stopped.

13. If step 14 is to be performed, the new AMF, based on the SUPI, selects a UDM, then UDM may select a UDR instance. See clause 6.3.9 of TS 23.501 [2].

The AMF selects a UDM as described in clause 6.3.8 of TS 23.501 [2].

14a-c. If the AMF has changed since the last Registration procedure, or if the UE provides a SUPI which doesn't refer to a valid context in the AMF, or if the UE registers to the same AMF it has already registered to a non-3GPP access (i.e. the UE is registered over a non-3GPP access and initiates this Registration procedure to add a 3GPP access), the new AMF registers with the UDM using Nudm\_UECM\_Registration for the access to be registered (and subscribes to be notified when the UDM deregisters this AMF).

The AMF provides the "Homogenous Support of IMS Voice over PS Sessions" indication (see clause 5.16.3.3 of TS 23.501 [2]) to the UDM. The "Homogenous Support of IMS Voice over PS Sessions" indication shall not be included unless the AMF has completed its evaluation of the support of "IMS Voice over PS Session" as specified in clause 5.16.3.2 of TS 23.501 [2].

During initial Registration, if the AMF and UE supports SRVCC from NG-RAN to UTRAN the AMF provides UDM with the UE SRVCC capability.

If the AMF determines that only the UE SRVCC capability has changed, the AMF sends UE SRVCC capability to the UDM.

NOTE 8: At this step, it is possible that the AMF does not have all the information needed to determine the setting of the IMS Voice over PS Session Supported indication for this UE (see clause 5.16.3.2 of TS 23.501 [2]). Hence the AMF can send the "Homogenous Support of IMS Voice over PS Sessions" later on in this procedure.

If the AMF does not have subscription data for the UE, the AMF retrieves the Access and Mobility Subscription data, SMF Selection Subscription data, UE context in SMF data and LCS mobile origination using Nudm\_SDM\_Get. If the AMF already has subscription data for the UE but the SoR Update Indicator in the UE context requires the AMF to retrieve SoR information depending on the NAS Registration Type ("Initial Registration" or "Emergency Registration") (see Annex C of TS 23.122 [22]), the AMF retrieves the Steering of Roaming information using Nudm\_SDM\_Get. This requires that UDM may retrieve this information from UDR by Nudr\_DM\_Query. After a successful response is received, the AMF subscribes to be notified using Nudm\_SDM\_Subscribe when the data requested is modified, UDM may subscribe to UDR by Nudr\_DM\_Subscribe. The GPSI is provided to the AMF in the Access and Mobility Subscription data from the UDM if the GPSI is available in the UE subscription data. The UDM may provide indication that the subscription data for network slicing is updated for the UE. If the UE is subscribed to MPS in the serving PLMN, "MPS priority" is included in the Access and Mobility Subscription data provided to the AMF. If the UE is subscribed to MCX in the serving PLMN, "MCX priority" is included in the Access and Mobility Subscription data provided to the AMF. The UDM also provides the IAB-Operation allowed indication to AMF as part of the Access and Mobility Subscription data. The AMF shall trigger the setup of the UE context in NG-RAN, or modification of the UE context in NG-RAN if the initial setup is at step 9c, including an indication that the IAB-node is authorized.

The new AMF provides the Access Type it serves for the UE to the UDM and the Access Type is set to "3GPP access". The UDM stores the associated Access Type together with the serving AMF and does not remove the AMF identity associated to the other Access Type if any. The UDM may store in UDR information provided at the AMF registration by Nudr\_DM\_Update.

If the UE was registered in the old AMF for an access and the old and the new AMFs are in the same PLMN, the new AMF sends a separate/independent Nudm\_UECM\_Registration to update UDM with Access Type set to access used in the old AMF, after the old AMF relocation is successfully completed.

The new AMF creates an UE context for the UE after getting the Access and Mobility Subscription data from the UDM. The Access and Mobility Subscription data includes whether the UE is allowed to include NSSAI in the 3GPP access RRC Connection Establishment in clear text. The Access and Mobility Subscription data may include Enhanced Coverage Restricted information. If received from the UDM and the UE included support for restriction of use of Enhanced Coverage in step 1, the AMF determines whether Enhanced Coverage is restricted or not for the UE as specified in clause 5.31.12 of TS 23.501 [2] and stores the updated Enhanced Coverage Restricted information in the UE context.

The Access and Mobility Subscription data may include the NB-IoT UE Priority.

The subscription data may contain Service Gap Time parameter. If received from the UDM, the AMF stores this Service Gap Time in the UE Context in AMF for the UE.

For an Emergency Registration in which the UE was not successfully authenticated, the AMF shall not register with the UDM.

The AMF enforces the Mobility Restrictions as specified in clause 5.3.4.1.1 of TS 23.501 [2]. For an Emergency Registration, the AMF shall not check for Mobility Restrictions, access restrictions, regional restrictions or subscription restrictions. For an Emergency Registration, the AMF shall ignore any unsuccessful registration response from UDM and continue with the Registration procedure.

NOTE 9: The AMF can, instead of the Nudm\_SDM\_Get service operation, use the Nudm\_SDM\_Subscribe service operation with an Immediate Report Indication that triggers the UDM to immediately return the subscribed data if the corresponding feature is supported by both the AMF and the UDM.

14d. When the UDM stores the associated Access Type (e.g. 3GPP) together with the serving AMF as indicated in step 14a, it will cause the UDM to initiate a Nudm\_UECM\_DeregistrationNotification (see clause 5.2.3.2.2) to the old AMF corresponding to the same (e.g. 3GPP) access, if one exists. If the timer started in step 5 is not running, the old AMF may remove the UE context for the same Access Type. Otherwise, the AMF may remove UE context for the same Access Type when the timer expires. If the serving NF removal reason indicated by the UDM is Initial Registration, then, as described in clause 4.2.2.3.2, the old AMF invokes the Nsmf\_PDUSession\_ReleaseSMContext (SM Context ID) service operation towards all the associated SMF(s) of the UE to notify that the UE is deregistered from old AMF for the same Access Type. The SMF(s) shall release the PDU Session on getting this notification.

If the old AMF has established an AM Policy Association and a UE Policy Association with the PCF(s) and the old AMF did not transfer the PCF ID(s) to the new AMF (e.g. new AMF is in different PLMN), the old AMF performs an AMF-initiated Policy Association Termination procedure, as defined in clause 4.16.3.2 and performs an AMF-initiated UE Policy Association Termination procedure, as defined in clause 4.16.13.1. In addition, if the old AMF transferred the PCF ID(s) in the UE context but the new AMF informed in step 10 that the AM Policy Association information and UE Policy Association information in the UE context will not be used then the old AMF performs an AMF-initiated Policy Association Termination procedure, as defined in clause 4.16.3.2 and performs an AMF-initiated UE Policy Association Termination procedure, as defined in clause 4.16.13.1.

If the old AMF has an N2 connection for that UE (e.g. because the UE was in RRC Inactive state but has now moved to E-UTRAN or moved to an area not served by the old AMF), the old AMF shall perform AN Release (see clause 4.2.6) with a cause value that indicates that the UE has already locally released the NG-RAN's RRC Connection.

14e. [Conditional] If old AMF does not have UE context for another access type (i.e. non-3GPP access), the Old AMF unsubscribes with the UDM for subscription data using Nudm\_SDM\_unsubscribe.

15. If the AMF decides to initiate PCF communication, the AMF acts as follows.

If the new AMF decides to use the (V-)PCF identified by the (V-)PCF ID included in UE context from the old AMF in step 5, the AMF contacts the (V-)PCF identified by the (V-)PCF ID to obtain policy. If the AMF decides to perform PCF discovery and selection and the AMF selects a (V-)PCF and may select an H-PCF (for roaming scenario) as described in clause 6.3.7.1 of TS 23.501 [2] and according to the V-NRF to H-NRF interaction described in clause 4.3.2.2.3.3.

16. [Optional] new AMF performs an AM Policy Association Establishment/Modification. For an Emergency Registration, this step is skipped.

If the new AMF selects a new (V-)PCF in step 15, the new AMF performs AM Policy Association Establishment with the selected (V-)PCF as defined in clause 4.16.1.2.

If the (V-)PCF identified by the (V-)PCF ID included in UE context from the old AMF is used, the new AMF performs AM Policy Association Modification with the (V-)PCF as defined in clause 4.16.2.1.2.

If the AMF notifies the Mobility Restrictions (e.g. UE location) to the PCF for adjustment, or if the PCF updates the Mobility Restrictions itself due to some conditions (e.g. application in use, time and date), the PCF shall provide the updated Mobility Restrictions to the AMF. If the subscription information includes Tracing Requirements, the AMF provides the PCF with Tracing Requirements.

If the AMF supports DNN replacement, the AMF provides the PCF with the Allowed NSSAI and, if available, the Mapping Of Allowed NSSAI.

If the PCF supports DNN replacement, the PCF provides the AMF with triggers for DNN replacement.

17. [Conditional] AMF to SMF: Nsmf\_PDUSession\_UpdateSMContext ().

For an Emergency Registered UE (see TS 23.501 [2]), this step is applied when the Registration Type is Mobility Registration Update.

The AMF invokes the Nsmf\_PDUSession\_UpdateSMContext (see clause 5.2.8.2.6) in the following scenario(s):

- If the List Of PDU Sessions To Be Activated is included in the Registration Request in step 1, the AMF sends Nsmf\_PDUSession\_UpdateSMContext Request to SMF(s) associated with the PDU Session(s) in order to activate User Plane connections of these PDU Session(s). Steps from step 5 onwards described in

clause 4.2.3.2 are executed to complete the User Plane connection activation without sending the RRC Inactive Assistance Information and without sending MM NAS Service Accept from the AMF to (R)AN described in step 12 of clause 4.2.3.2. When a User Plane connection for a PDU Session is activated, the AS layer in the UE indicates it to the NAS layer.

- If the AMF has determined in step 3 that the UE is performing Inter-RAT mobility to or from NB-IoT, the AMF sends Nsmf\_PDUSession\_UpdateSMContext Request to SMF(s) associated with the UEs PDU Session(s), so the SMF(s) can update them according to the "PDU Session continuity at inter RAT mobility" subscription data. Steps from step 5 onwards described in clause 4.2.3.2 are executed without sending MM NAS Service Accept from the AMF to (R)AN described in step 12 of clause 4.2.3.2.

When the serving AMF has changed, the new serving AMF notifies the SMF for each PDU Session that it has taken over the responsibility of the signalling path towards the UE: the new serving AMF invokes the Nsmf\_PDUSession\_UpdateSMContext service operation using SMF information received from the old AMF at step 5. It also indicates whether the PDU Session is to be re-activated.

NOTE 10: If the UE moves into a different PLMN, the AMF in the serving PLMN can insert or change the V-SMF(s) in the serving PLMN for Home Routed PDU session(s). In addition, a V-SMF is removed if the UE moves from a VPLMN into the HPLMN. In these cases, the same procedures described in clause 4.23.3 are applied for the V-SMF change as for the I-SMF change (i.e. by replacing the I-SMF with V-SMF). During inter-PLMN change, if the same SMF is used, session continuity can be supported depending on operator policies.

Steps from step 5 onwards described in clause 4.2.3.2 are executed. In the case that the intermediate UPF insertion, removal, or change is performed for the PDU Session(s) not included in "PDU Session(s) to be re-activated", the procedure is performed without N11 and N2 interactions to update the N3 user plane between (R)AN and 5GC.

The AMF invokes the Nsmf\_PDUSession\_ReleaseSMContext service operation towards the SMF in the following scenario:

- If any PDU Session status indicates that it is released at the UE, the AMF invokes the Nsmf\_PDUSession\_ReleaseSMContext service operation towards the SMF in order to release any network resources related to the PDU Session.

If the serving AMF is changed, the new AMF shall wait until step 18 is finished with all the SMFs associated with the UE. Otherwise, steps 19 to 22 can continue in parallel to this step.

18. [Conditional] If the new AMF and the old AMF are in the same PLMN, the new AMF sends a UE Context Modification Request to N3IWF/TNGF/W-AGF as specified in TS 29.413 [64].

If the AMF has changed and the old AMF has indicated that the UE is in CM-CONNECTED state via N3IWF, W-AGF or TNGF and if the new AMF and the old AMF are in the same PLMN, the new AMF creates an NGAP UE association towards the N3IWF/TNGF/W-AGF to which the UE is connected. This automatically releases the existing NGAP UE association between the old AMF and the N3IWF/TNGF/W-AGF.

19. N3IWF/TNGF/W-AGF sends a UE Context Modification Response to the new AMF.

19a. [Conditional] After the new AMF receives the response message from the N3IWF, W-AGF or TNGF in step 19, the new AMF registers with the UDM using Nudm\_UECM\_Registration as step 14a, but with the Access Type set to "non-3GPP access". The UDM stores the associated Access Type together with the serving AMF and does not remove the AMF identity associated to the other Access Type if any. The UDM may store in UDR information provided at the AMF registration by Nudr\_DM\_Update.

19b. [Conditional] When the UDM stores the associated Access Type (i.e. non-3GPP) together with the serving AMF as indicated in step 19a, it will cause the UDM to initiate a Nudm\_UECM\_DeregistrationNotification (see clause 5.2.3.2.2) to the old AMF corresponding to the same (i.e. non-3GPP) access. The old AMF removes the UE context for non-3GPP access.

19c. The Old AMF unsubscribes with the UDM for subscription data using Nudm\_SDM\_unsubscribe.

20a. Void.

21. New AMF to UE: Registration Accept (5G-GUTI, Registration Area, [Mobility restrictions], [PDU Session status], [Allowed NSSAI], [Mapping Of Allowed NSSAI], [Configured NSSAI for the Serving PLMN],

[Mapping Of Configured NSSAI], [rejected S-NSSAIs], [Pending NSSAI], [Mapping Of Pending NSSAI], [Periodic Registration Update timer], [Active Time], [Strictly Periodic Registration Timer Indication], [LADN Information], [accepted MICO mode], [IMS Voice over PS session supported Indication], [Emergency Service Support indicator], [Accepted DRX parameters for E-UTRA and NR], [Accepted DRX parameters for NB-IoT], [extended idle mode DRX parameters], [Paging Time Window], [Network support of Interworking without N26], [Access Stratum Connection Establishment NSSAI Inclusion Mode], [Network Slicing Subscription Change Indication], [Operator-defined access category definitions], [List of equivalent PLMNs], [Enhanced Coverage Restricted information], [Supported Network Behaviour], [Service Gap Time], [PLMN-assigned UE Radio Capability ID], [PLMN-assigned UE Radio Capability ID deletion], [WUS Assistance Information], [Truncated 5G-S-TMSI Configuration]).

If the Requested NSSAI does not include S-NSSAIs which map to S-NSSAIs of the HPLMN subject to Network Slice-Specific Authentication and Authorization and the AMF determines that no S-NSSAI can be provided in the Allowed NSSAI for the UE in the current UE's Tracking Area and if no default S-NSSAI(s) not yet involved in the current UE Registration procedure could be further considered, the AMF shall reject the UE Registration and shall include in the rejection message the list of Rejected S-NSSAIs, each of them with the appropriate rejection cause value.

The Allowed NSSAI for the Access Type for the UE is included in the N2 message carrying the Registration Accept message. The Allowed NSSAI contains only S-NSSAIs that do not require, based on subscription information, Network Slice-Specific Authentication and Authorization and, based on the UE Context in the AMF, those S-NSSAIs for which Network Slice-Specific Authentication and Authorization previously succeeded, regardless of the Access Type. The Mapping Of Pending NSSAI is the mapping of each S-NSSAI of the Pending NSSAI for the Serving PLMN to the HPLMN S-NSSAIs.

If the UE has indicated its support for Network Slice-Specific Authentication and Authorization procedure in the UE MM Core Network Capability in the Registration Request, AMF includes in the Pending NSSAI the S-NSSAIs that map to an S-NSSAI of the HPLMN which in the subscription information has indication that it is subject to Network Slice-Specific Authentication and Authorization, as described in clause 4.6.2.4 of TS 24.501 [25]. In such case, the AMF then shall trigger at step 25 the Network Slice-Specific Authentication and Authorization procedure, specified in clause 4.2.9.2, except, based on Network policies, for those S-NSSAIs for which Network Slice-Specific Authentication and Authorization have already been initiated on another Access Type for the same S-NSSAI(s). The UE shall not attempt re-registration with the S-NSSAIs included in the list of Pending NSSAIs until the Network Slice-Specific Authentication and Authorization procedure has been completed, regardless of the Access Type.

If the UE has not indicated its support for Network Slice-Specific Authentication and Authorization procedure in the UE 5GMM Core Network Capability in the Registration Request and the Requested NSSAI includes S-NSSAIs which map to HPLMN S-NSSAIs subject to Network Slice-Specific Authentication and Authorization, the AMF includes those S-NSSAIs in the Requested NSSAI in the Rejected S-NSSAIs.

If no S-NSSAI can be provided in the Allowed NSSAI because:

- all the S-NSSAI(s) in the Requested NSSAI are to be subject to Network Slice-Specific Authentication and Authorization; or
- no Requested NSSAI was provided or none of the S-NSSAIs in the Requested NSSAI matches any of the Subscribed S-NSSAIs and all the S-NSSAI(s) marked as default in the Subscribed S-NSSAIs are to be subject to Network Slice-Specific Authentication and Authorization.

The AMF shall provide an empty Allowed NSSAI. Upon receiving an empty Allowed NSSAI and a Pending NSSAI, the UE is registered in the PLMN but shall wait for the completion of the Network Slice-Specific Authentication and Authorization procedure without attempting to use any service provided by the PLMN on any access, except e.g. emergency services (see TS 24.501 [25]), until the UE receives an Allowed NSSAI.

The AMF stores the NB-IoT Priority retrieved in Step 14 and associates it to the 5G-S-TMSI allocated to the UE.

The AMF sends a Registration Accept message to the UE indicating that the Registration Request has been accepted. 5G-GUTI is included if the AMF allocates a new 5G-GUTI. Upon receiving a Registration Request message of type "Initial Registration" or "mobility registration update" from the UE, the AMF shall include a new 5G-GUTI in the Registration Accept message. Upon receiving a Registration Request message of type "periodic registration update" from the UE, the AMF should include a new 5G-GUTI in the Registration Accept message. If the UE is already in RM-REGISTERED state via another access in the same PLMN, the UE shall

use the 5G-GUTI received in the Registration Accept for both registrations. If no 5G-GUTI is included in the Registration Accept, then the UE uses the 5G-GUTI assigned for the existing registration also for the new registration. If the AMF allocates a new Registration area, it shall send the Registration area to the UE via Registration Accept message. If there is no Registration area included in the Registration Accept message, the UE shall consider the old Registration Area as valid. Mobility Restrictions is included if mobility restrictions applies for the UE and Registration Type is not Emergency Registration. The AMF indicates the established PDU Sessions to the UE in the PDU Session status. The UE removes locally any internal resources related to PDU Sessions that are not marked as established in the received PDU Session status. If the AMF invokes the Nsmf\_PDUSession\_UpdateSMContext procedure for UP activation of PDU Session(s) in step 18 and receives rejection from the SMF, then the AMF indicates to the UE the PDU Session ID and the cause why the User Plane resources were not activated. When the UE is connected to the two AMFs belonging to different PLMN via 3GPP access and non-3GPP access then the UE removes locally any internal resources related to the PDU Session of the current PLMN that are not marked as established in received PDU Session status. If the PDU Session status information was in the Registration Request, the AMF shall indicate the PDU Session status to the UE.

If the RAT Type is NB-IoT and the network is configured to use the Control Plane Relocation Indication procedure then the AMF shall include in the Registration Accept message the Truncated 5G-S-TMSI Configuration that the UE using Control Plane CIoT 5GS Optimisation uses to create the Truncated 5G-S-TMSI, see clause 5.31.4.3 of TS 23.501 [2].

The Allowed NSSAI provided in the Registration Accept is valid in the Registration Area and it applies for all the PLMNs which have their Tracking Areas included in the Registration Area. The Mapping Of Allowed NSSAI is the mapping of each S-NSSAI of the Allowed NSSAI to the HPLMN S-NSSAIs. The Mapping Of Configured NSSAI is the mapping of each S-NSSAI of the Configured NSSAI for the Serving PLMN to the HPLMN S-NSSAIs.

The AMF shall include in the Registration Accept message the LADN Information for the list of LADNs, described in clause 5.6.5 of TS 23.501 [2], that are available within the Registration area determined by the AMF for the UE. The AMF may include Operator-defined access category definitions to let the UE determine the applicable Operator-specific access category definitions as described in TS 24.501 [25].

If the UE included MICO mode in the Registration Request, then AMF responds in the Registration Accept message whether MICO mode should be used. When MICO mode is allowed for the UE, the AMF may include an Active Time value and/or Strictly Periodic Registration Timer Indication in the Registration Accept message. The AMF determines the Periodic Registration Update timer value, Active Time value and the Strictly Periodic Registration Timer Indication based on local configuration, Expected UE Behaviour if available, UE indicated preferences, UE capability, UE subscription information and network policies, or any combination of them so as to enable UE power saving, as described in clause 5.31.7 of TS 23.501 [2]. The AMF determines to apply the Strictly Periodic Registration Timer Indication to the UE if the UE indicates its capability of the Strictly Periodic Registration Timer Indication in the registration request message, as described in step 1. If the AMF provides the Periodic Registration Update timer value with the Strictly Periodic Registration Timer Indication to the UE, the UE and the AMF start the Periodic Registration Update timer after this step, as described in clause 5.31.7.5 of TS 23.501 [2].

In the case of registration over 3GPP access, the AMF Sets the IMS Voice over PS session supported Indication as described in clause 5.16.3.2 of TS 23.501 [2]. In order to set the IMS Voice over PS session supported Indication the AMF may need to perform the UE Capability Match Request procedure in clause 4.2.8a to check the compatibility of the UE and NG-RAN radio capabilities related to IMS Voice over PS. If the AMF hasn't received Voice Support Match Indicator from the NG-RAN on time then, based on implementation, AMF may set IMS Voice over PS session supported Indication and update it at a later stage.

In the case of registration over non-3GPP access, the AMF Sets the IMS Voice over PS session supported Indication as described in clause 5.16.3.2a of TS 23.501 [2].

The Emergency Service Support indicator informs the UE that emergency services are supported, i.e. the UE is allowed to request PDU Session for emergency services. If the AMF received "MPS priority" from the UDM as part of Access and Mobility Subscription data, based on operator policy, "MPS priority" is included in the Registration Accept message to the UE to inform the UE whether configuration of Access Identity 1 is valid within the selected PLMN, as specified in TS 24.501 [25]. If the AMF received "MCX priority" from the UDM as part of Access and Mobility Subscription data, based on operator policy and UE subscription to MCX Services, "MCX priority" is included in the Registration Accept message to the UE to inform the UE whether configuration of Access Identity 2 is valid within the selected PLMN, as specified in TS 24.501 [25]. The

Accepted DRX parameters are defined in clause 5.4.5 of TS 23.501 [2]. The AMF includes Accepted DRX parameters for NB-IoT, if the UE included Requested DRX parameters for NB-IoT in the Registration Request message. The AMF Sets the Network support of Interworking without N26 parameter as described in clause 5.17.2.3.1 of TS 23.501 [2]. If the AMF accepts the use of extended idle mode DRX, the AMF includes the extended idle mode DRX parameters and Paging Time Window as described in 5.31.7.2 of TS 23.501 [2].

If the UDM intends to indicate the UE that subscription has changed, the Network Slicing Subscription Change Indication is included. If the AMF includes Network Slicing Subscription Change Indication, then the UE shall locally erase all the network slicing configuration for all PLMNs and, if applicable, update the configuration for the current PLMN based on any received information.

The Access Stratum Connection Establishment NSSAI Inclusion Mode, as specified in clause 5.15.9 of TS 23.501 [2], is included to instruct the UE on what NSSAI, if any, to include in the Access Stratum connection establishment. The AMF can set the value to modes of operation a,b,c defined in clause 5.15.9 of TS 23.501 [2] in the 3GPP Access only if the Inclusion of NSSAI in RRC Connection Establishment Allowed indicates that it is allowed to do so.

For a UE registered in a PLMN, the AMF may provide a List of equivalent PLMNs which is handled as specified in TS 24.501 [25]. For a UE registered in an SNPN, the AMF shall not provide a list of equivalent PLMNs to the UE.

If the UE included support for restriction of use of Enhanced Coverage in step 1, the AMF sends the Enhanced Coverage Restricted information to the NG-RAN in N2 message. The AMF also sends Enhanced Coverage Restricted information to the UE in the Registration Accept message.

If the UE receives Enhanced Coverage Restricted information in the Registration Accept message, the UE shall store this information and shall use the value of Enhanced Coverage Restricted information to determine if Enhanced Coverage feature should be used or not.

If the UE and the AMF have negotiated to enable MICO mode and the AMF uses the Extended connected timer, then the AMF provides the Extended Connected time value to NG-RAN (see clause 5.31.7.3 of TS 23.501 [2]) in this step. The Extended Connected Time value indicates the minimum time the RAN should keep the UE in RRC-CONNECTED state regardless of inactivity.

The AMF indicates the CIoT 5GS Optimisations it supports and accepts in the Supported Network Behaviour information (see clause 5.31.2 of TS 23.501 [2]) if the UE included Preferred Network Behaviour in its Registration Request.

The AMF may steer the UE from 5GC by rejecting the Registration Request. The AMF should take into account the Preferred and Supported Network Behaviour (see clause 5.31.2 of TS 23.501 [2]) and availability of EPC to the UE before steering the UE from 5GC.

If the AMF accepts MICO mode and knows there may be mobile terminated data or signalling pending, the AMF maintains the N2 connection for at least the Extended Connected Time as described in clause 5.31.7.3 of TS 23.501 [2] and provides the Extended Connected Time value to the RAN.

The AMF includes Service Gap Time if Service Gap Time is present in the subscription information (steps 14a-c) or the Service Gap Time has been updated by the Subscriber Data Update Notification to AMF procedure (see clause 4.5.1) and the UE has indicated UE Service Gap Control Capability.

If the UE receives a Service Gap Time in the Registration Accept message, the UE shall store this parameter and apply Service Gap Control (see clause 5.31.16 of TS 23.501 [2]).

If the network supports WUS grouping (see TS 23.501 [2]), the AMF shall send the WUS Assistance Information to the UE. If the UE provided the UE paging probability information in Step 1, the AMF takes it into account to determine the WUS Assistance Information.

When the UE and the AMF supports RACS as defined in clause 5.4.4.1a of TS 23.501 [2] and the AMF needs to configure the UE with a UE Radio Capability ID and the AMF already has the UE radio capabilities other than NB-IoT radio capabilities for the UE, the AMF may provide the UE with the UE Radio Capability ID for the UE radio capabilities the UCMF returns to the AMF in a Nucmf\_assign service operation for this UE. Alternatively, when the UE and the AMF support RACS, the AMF may provide the UE with an indication to delete any PLMN-assigned UE Radio Capability ID in this PLMN (see clause 5.4.4.1a of TS 23.501 [2]).



If the UE is "CAG supported" and the AMF needs to update the CAG information of the UE, the AMF may include the CAG information as part of the Mobility Restrictions in the Registration Accept message.

- 21b. [Optional] The new AMF performs a UE Policy Association Establishment as defined in clause 4.16.11. For an Emergency Registration, this step is skipped.

The new AMF sends a Npcf\_UEPolicyControl Create Request to PCF. PCF sends a Npcf\_UEPolicyControl Create Response to the new AMF.

PCF triggers UE Configuration Update Procedure as defined in clause 4.2.4.3.

22. [Conditional] UE to new AMF: Registration Complete ().

The UE sends a Registration Complete message to the AMF when it has successfully updated itself after receiving any of the [Configured NSSAI for the Serving PLMN], [Mapping Of Configured NSSAI] and a Network Slicing Subscription Change Indication, or CAG information in step 21.

The UE sends a Registration Complete message to the AMF to acknowledge if a new 5G-GUTI was assigned.

If new 5G-GUTI was assigned, then the UE passes the new 5G-GUTI to its 3GPP access' lower layer when a lower layer (either 3GPP access or non-3GPP access) indicates to the UE's RM layer that the Registration Complete message has been successfully transferred across the radio interface.

NOTE 11: The above is needed because the NG-RAN may use the RRC Inactive state and a part of the 5G-GUTI is used to calculate the Paging Frame (see TS 38.304 [44] and TS 36.304 [43]). It is assumed that the Registration Complete is reliably delivered to the AMF after the 5G-AN has acknowledged its receipt to the UE.

When the List Of PDU Sessions To Be Activated is not included in the Registration Request and the Registration procedure was not initiated in CM-CONNECTED state, the AMF releases the signalling connection with UE, according to clause 4.2.6.

When the Follow-on request is included in the Registration Request, the AMF should not release the signalling connection after the completion of the Registration procedure.

If the AMF is aware that some signalling is pending in the AMF or between the UE and the 5GC, the AMF should not release the signalling connection immediately after the completion of the Registration procedure.

If PLMN-assigned UE Radio Capability ID is included in step 21, the AMF stores the PLMN-assigned UE Radio Capability ID in UE context if receiving Registration Complete message.

If the UE receives PLMN-assigned UE Radio Capability ID deletion indication in step 21, the UE shall delete the PLMN-assigned UE Radio Capability ID(s) for this PLMN.

23. [Conditional] AMF to UDM: If the Access and Mobility Subscription data provided by UDM to AMF in 14b includes Steering of Roaming information with an indication that the UDM requests an acknowledgement of the reception of this information from the UE, the AMF provides the UE acknowledgement to UDM using Nudm\_SDM\_Info. For more details regarding the handling of Steering of Roaming information refer to TS 23.122 [22].

- 23a. For Registration over 3GPP Access, if the AMF does not release the signalling connection, the AMF sends the RRC Inactive Assistance Information to the NG-RAN.

For Registration over non-3GPP Access, if the UE is also in CM-CONNECTED state on 3GPP access, the AMF sends the RRC Inactive Assistance Information to the NG-RAN.

The AMF also uses the Nudm\_SDM\_Info service operation to provide an acknowledgment to UDM that the UE received CAG information, or the Network Slicing Subscription Change Indication (see step 21 and step 22) and acted upon it.

24. [Conditional] AMF to UDM: After step 14a and in parallel to any of the preceding steps, the AMF shall send a "Homogeneous Support of IMS Voice over PS Sessions" indication to the UDM using Nudm\_UECM\_Update:

- If the AMF has evaluated the support of IMS Voice over PS Sessions, see clause 5.16.3.2 of TS 23.501 [2] and

- If the AMF determines that it needs to update the Homogeneous Support of IMS Voice over PS Sessions, see clause 5.16.3.3 of TS 23.501 [2].

25. [Conditional] If the UE indicates its support for Network Slice-Specific Authentication and Authorization procedure in the UE MM Core Network Capability in Registration Request and any S-NSSAI of the HPLMN is subject to Network Slice-Specific Authentication and Authorization, the related procedure is executed at this step (see clause 4.2.9.1). Once the Network Slice-Specific Authentication and Authorization procedure is completed for all S-NSSAIs, the AMF shall trigger a UE Configuration Update procedure to deliver an Allowed NSSAI containing also the S-NSSAIs for which the Network Slice-Specific Authentication and Authorization was successful and include any rejected NSSAIs with an appropriate rejection cause value.

The AMF shall remove the mobility restriction if the Tracking Areas of the Registration Area were previously assigned as a Non-Allowed Area due to pending Network Slice-Specific Authentication and Authorization.

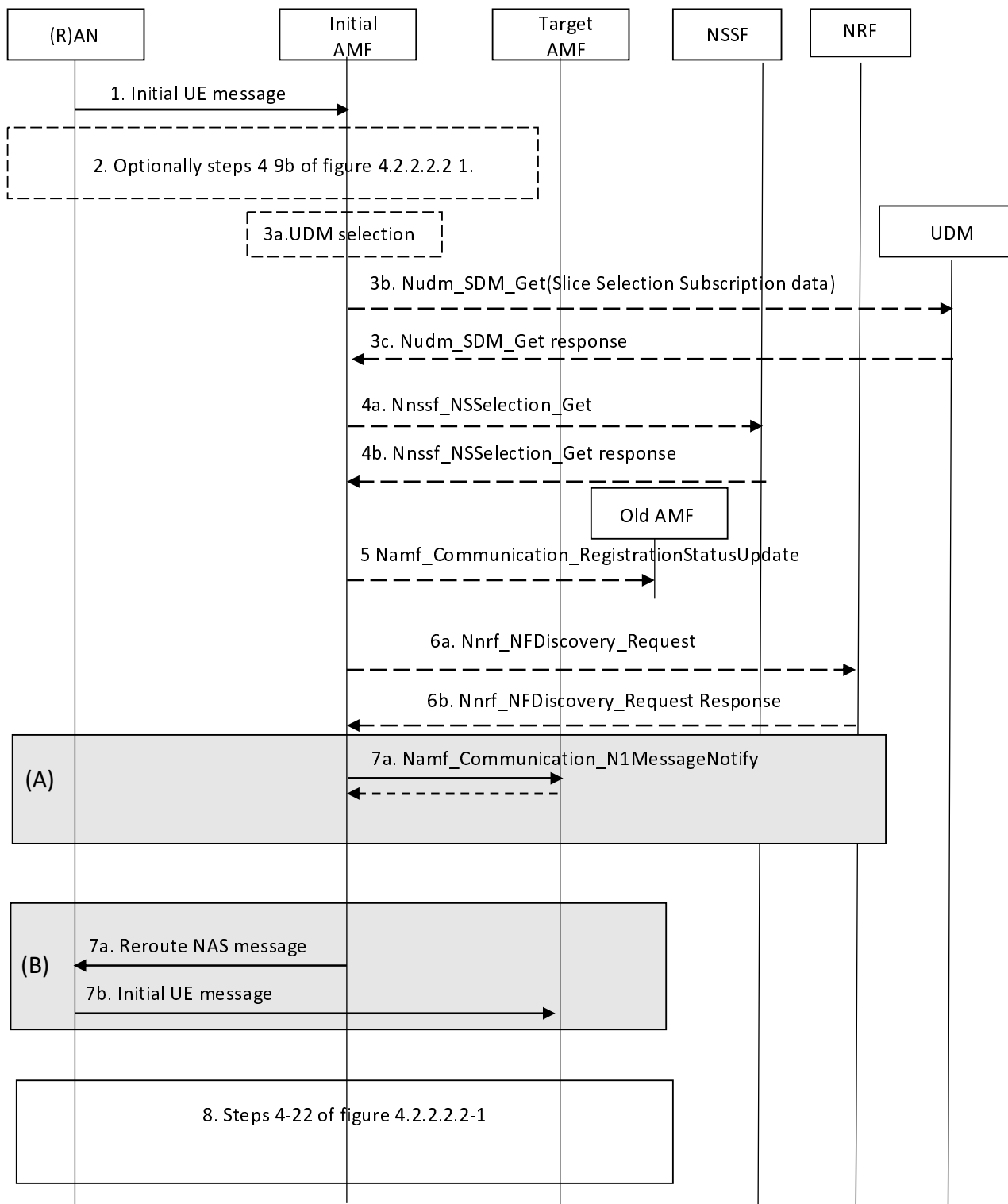
The AMF stores an indication in the UE context for any S-NSSAI of the HPLMN subject to Network Slice-Specific Authentication and Authorization for which the Network Slice-Specific Authentication and Authorization succeeds.

Once completed the Network Slice-Specific Authentication and Authorization procedure, if the AMF determines that no S-NSSAI can be provided in the Allowed NSSAI for the UE, which is already authenticated and authorized successfully by a PLMN and if no default S-NSSAI(s) could be further considered, the AMF shall execute the Network-initiated Deregistration procedure described in clause 4.2.2.3.3 and shall include in the explicit De-Registration Request message the list of Rejected S-NSSAIs, each of them with the appropriate rejection cause value.

The mobility related event notifications towards the NF consumers are triggered at the end of this procedure for cases as described in clause 4.15.4.

#### 4.2.2.2.3 Registration with AMF re-allocation

When an AMF receives a Registration request, the AMF may need to reroute the Registration request to another AMF, e.g. when the initial AMF is not the appropriate AMF to serve the UE. The Registration with AMF re-allocation procedure, described in figure 4.2.2.2.3-1, is used to reroute the NAS message of the UE to the target AMF during a Registration procedure.



**Figure 4.2.2.3-1: Registration with AMF re-allocation procedure**

The initial AMF and the target AMF register their capability at the NRF.

1. Steps 1 and 2 of figure 4.2.2.2-1 have occurred and the (R)AN sends the Registration request message within an Initial UE message to the initial AMF.
2. If the AMF needs the SUPI and/or UE's subscription information to decide whether to reroute the Registration Request or if the Registration Request was not sent integrity protected or integrity protection is indicated as failed, then AMF performs steps 4 to 9a or to 9b of figure 4.2.2.2-1.

3a. [Conditional] If the initial AMF needs UE's subscription information to decide whether to reroute the Registration Request and UE's slice selection subscription information was not provided by old AMF, the AMF selects a UDM as described in clause 6.3.8 of TS 23.501 [2].

3b. Initial AMF to UDM: Nudm\_SDM\_Get (SUPI, Slice Selection Subscription data).

The initial AMF request UE's Slice Selection Subscription data from UDM by invoking the Nudm\_SDM\_Get (see clause 5.2.3.3.1) service operation. UDM may get this information from UDR by Nudr\_DM\_Query(SUPI, Slice Selection Subscription data).

3c. UDM to initial AMF: Response to Nudm\_SDM\_Get. The AMF gets the Slice Selection Subscription data including Subscribed S-NSSAIs.

UDM responds with slice selection data to initial AMF.

4a. [Conditional] Initial AMF to NSSF: Nnssf\_NSSelection\_Get (Requested NSSAI, [Mapping Of Requested NSSAI], Subscribed S-NSSAI(s) with the default S-NSSAI indication, TAI, Allowed NSSAI for the other access type (if any), [Mapping of Allowed NSSAI], PLMN ID of the SUPI).

If there is a need for slice selection, (see clause 5.15.5.2.1 of TS 23.501 [2]), e.g. the initial AMF cannot serve all the S-NSSAI(s) from the Requested NSSAI permitted by the subscription information, the initial AMF invokes the Nnssf\_NSSelection\_Get service operation from the NSSF by including Requested NSSAI, optionally Mapping Of Requested NSSAI, Subscribed S-NSSAIs with the default S-NSSAI indication, Allowed NSSAI for the other access type (if any), Mapping of Allowed NSSAI, PLMN ID of the SUPI and the TAI of the UE.

4b. [Conditional] NSSF to Initial AMF: Response to Nnssf\_NSSelection\_Get (AMF Set or list of AMF addresses, Allowed NSSAI for the first access type, [Mapping Of Allowed NSSAI], [Allowed NSSAI for the second access type], [Mapping of Allowed NSSAI], [NSI ID(s)], [NRF(s)], [List of rejected (S-NSSAI(s), cause value(s))], [Configured NSSAI for the Serving PLMN], [Mapping Of Configured NSSAI]).

The NSSF performs the steps specified in point (B) in clause 5.15.5.2.1 of TS 23.501 [2]. The NSSF returns to initial AMF the Allowed NSSAI for the first access type, optionally the Mapping Of Allowed NSSAI, the Allowed NSSAI for the second access type (if any), optionally the Mapping of Allowed NSSAI and the target AMF Set or, based on configuration, the list of candidate AMF(s). The NSSF may return NSI ID(s) associated to the Network Slice instance(s) corresponding to certain S-NSSAI(s). The NSSF may return the NRF(s) to be used to select NFs/services within the selected Network Slice instance(s). It may return also information regarding rejection causes for S-NSSAI(s) not included in the Allowed NSSAI. The NSSF may return Configured NSSAI for the Serving PLMN and possibly the associated mapping of the Configured NSSAI.

NOTE 1: The NRF(s) returned by the NSSF, if any, belong to any level of NRF (see clause 6.2.6 of TS 23.501 [2]) according to the deployment decision of the operator.

5. [Conditional] Initial AMF to old AMF: Namf\_Communication\_RegistrationStatusUpdate (failure cause ).

If another AMF is selected, the initial AMF sends a reject indication to the old AMF telling that the UE Registration procedure did not fully complete at the initial AMF. The old AMF continues as if the Namf\_Communication\_UEContextTransfer had never been received.

6a. [Conditional] Initial AMF to NRF: Nnrf\_NFDiscovery\_Request (NF type, AMF Set).

If the initial AMF does not locally store the target AMF address and if the initial AMF intends to use direct reroute to target AMF or the reroute via (NG-R)AN message needs to include AMF address, then the initial AMF invokes the Nnrf\_NFDiscovery\_Request service operation from the NRF to find a proper target AMF which has required NF capabilities to serve the UE. The NF type is set to AMF. The AMF Set is included in the Nnrf\_NFDiscovery\_Request.

6b. [Conditional] NRF to AMF: Response to Nnrf\_NFDiscovery\_Request (list of (AMF pointer, AMF address, plus additional selection rules and NF capabilities)).

The NRF replies with the list of potential target AMF(s). The NRF may also provide the details of the services offered by the candidate AMF(s) along with the notification end-point for each type of notification service that the selected AMF had registered with the NRF, if available. As an alternative, it provides a list of potential target AMFs and their capabilities and optionally, additional selection rules. Based on the information about registered NFs and required capabilities, a target AMF is selected by the initial AMF.

If the security association has been established between the UE and initial AMF, to avoid a registration failure, the initial AMF shall forward the NAS message to the target AMF by executing step 7(A).

NOTE 2: The security context in the initial AMF is not transferred to the target AMF if initial AMF forward the NAS message to the target AMF via (R)AN. In this case the UE rejects the NAS message sent from target AMF as the security context in the UE and target AMF are not synchronized.

NOTE 3: Network slice isolation cannot be completely maintained in case the AMF reallocation is executed by step 7(A).

If the initial AMF is not part of the target AMF Set and is not able to get a list of candidate AMF(s) by querying the NRF with the target AMF Set (e.g. the NRF locally pre-configured on AMF does not provide the requested information, the query to the appropriate NRF provided by the NSSF is not successful, or the initial AMF has knowledge that the initial AMF is not authorized as serving AMF etc.) then the initial AMF shall forward the NAS message to the target AMF via (R)AN executing step 7(B) unless the security association has been established between the UE and initial AMF; the Allowed NSSAI and the AMF Set are included to enable the (R)AN to select the target AMF as described in clause 6.3.5 of TS 23.501 [2].

7(A). If the initial AMF, based on local policy and subscription information, decides to forward the NAS message to the target AMF directly, the initial AMF invokes the `Namf_Communication_N1MessageNotify` to the target AMF, carrying the rerouted NAS message. The `Namf_Communication_N1MessageNotify` service operation includes AN access information (e.g. the information enabling (R)AN to identify the N2 terminating point, CAG Identifier(s) of the CAG cell) and the full Registration Request message and the UE's SUPI and MM Context if available. If the initial AMF has obtained the information from the NSSF as described at step 4b, that information except the AMF Set or list of AMF addresses is included. The target AMF then updates the (R)AN with a new updated N2 termination point for the UE in the first message from target AMF to RAN in step 8.

7(B). If the initial AMF, based on local policy and subscription information, decides to forward the NAS message to the target AMF via (R)AN unless the target AMF(s) are returned from the NSSF and identified by a list of candidate AMF(s), the initial AMF sends a Reroute NAS message to the (R)AN (step 7a). The Reroute NAS message includes the information about the target AMF and the full Registration Request message. If the initial AMF has obtained the information as described at step 4b, that information is included. The (R)AN sends the Initial UE message to the target AMF (step 7b) indicating reroute due to slicing including the information from step 4b that the NSSF provided.

8. After receiving the Registration Request message transmitted at step 7(A)a or step 7(B)b, the target AMF continues with the Registration procedure from step 4 until 22 of figure 4.2.2.2-1 (with the target AMF corresponding to the new AMF), which includes the UE context retrieved from old AMF. If the 5G security context is received from the initial AMF, the target AMF continue using that one instead of the 5G security context retrieved from old AMF. If the initial AMF decides to forward the NAS message to the target AMF (step 7(A), the first message from the target AMF to (R)AN (either Initial Context Setup Request, or Downlink NAS Transport) contain the AMF name of the initial AMF and target AMF UE NGAP ID.

### 4.2.2.3 Deregistration procedures

#### 4.2.2.3.1 General

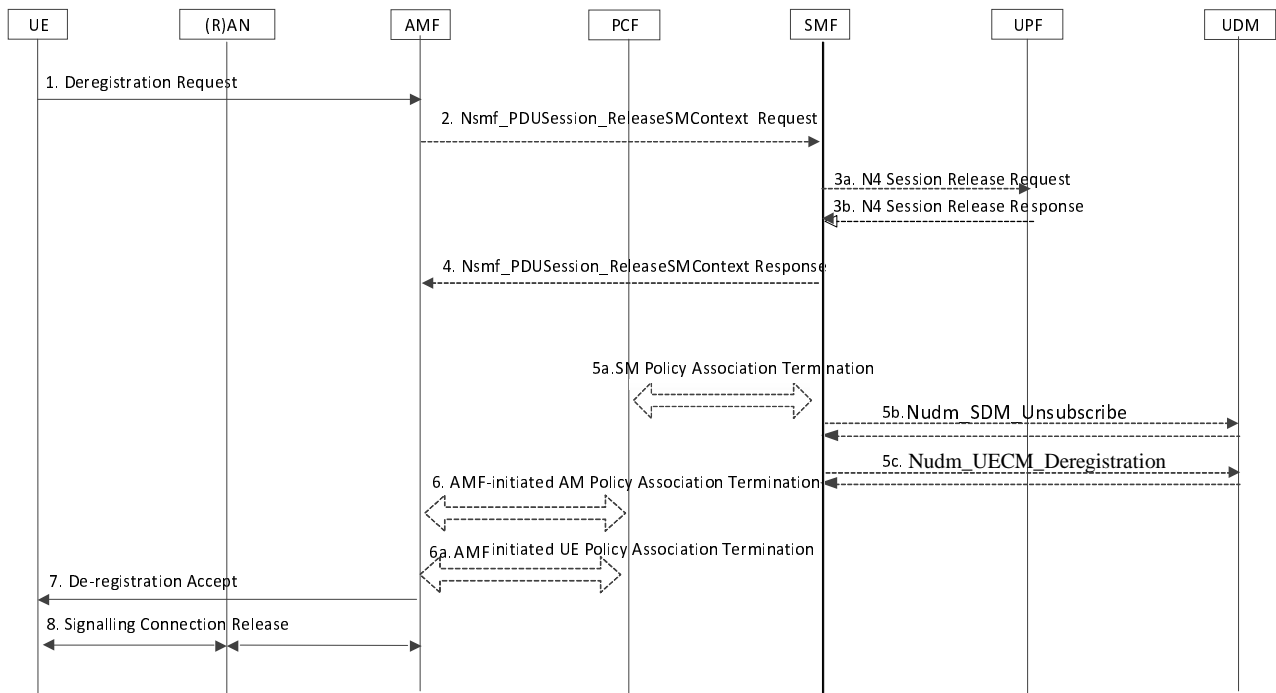
The Deregistration procedure allows:

- the UE to inform the network that it does not want to access the 5GS any longer and
- the network to inform the UE that it does not have access to the 5GS any longer.

The Deregistration request by the UE and Deregistration request by the network include whether the Deregistration applies to the 3GPP access, to the non-3GPP access, or to both. When the UE is registered to both accesses in the same PLMN, the Deregistration message can be sent over any access regardless of the access the Deregistration is applied to.

#### 4.2.2.3.2 UE-initiated Deregistration

The UE uses this procedure to deregister from the registered PLMN as shown in Figure 4.2.2.3.2-1.



**Figure 4.2.2.3.2-1: UE-initiated Deregistration**

1. The UE sends NAS message Deregistration Request (5G-GUTI, Deregistration type (e.g. Switch off), Access Type) to the AMF.

Access type indicates whether the Deregistration procedure applies to the 3GPP access, to the non-3GPP access, or to both if the 3GPP access and non-3GPP access of the UE are served by the same AMF (refer to TS 23.501 [2]). The AMF shall invoke the Deregistration procedure for the target access indicated by the UE.

2. [Conditional] AMF to SMF (or V-SMF): Nsmf\_PDUSession\_ReleaseSMContext (SM Context ID).

If the UE has no established PDU Session over the target access indicated in step 1, then steps 2 to 5 are not executed. All PDU Sessions over the target access(es), which belong to the UE are released by the AMF sending Nsmf\_PDUSession\_ReleaseSMContext Request (SM Context ID) message to the SMF (or V-SMF) for each PDU Session. If the AMF determines that the secondary RAT usage reporting is required for the PDU Session, the AMF shall execute step 7 and 8 and then wait for the completion of step 8 to receive the secondary RAT usage data from the NG-RAN. After that, steps 2 to 6 in this procedure are performed to e.g. release the PDU Session(s).

For home routed roaming case, the V-SMF initiates the release of the PDU Session at the H-SMF by invoking the Nsmf\_PDUSession\_Release request.

3. [Conditional] The SMF (or H-SMF) releases all resources e.g. the IP address / Prefix(es) that were allocated to the PDU Session and releases the corresponding User Plane resources:
  - 3a. [Conditional] The SMF (or H-SMF) sends N4 Session Release Request (N4 Session ID) message to the UPF(s) of the PDU Session. The UPF(s) shall drop any remaining packets of the PDU Session and release all tunnel resource and contexts associated with the N4 Session.
  - 3b. [Conditional] The UPF(s) acknowledges the N4 Session Release Request by the transmission of an N4 Session Release Response (N4 Session ID) message to the SMF.
4. [Conditional] The SMF (or V-SMF) responds with Nsmf\_PDUSession\_ReleaseSMContext Response message.

For home routed roaming case, the H-SMF responds to the V-SMF with a Nsmf\_PDUSession\_Release response. The V-SMF releases the corresponding User Plane resources. The V-SMF responds to AMF with Nsmf\_PDUSession\_ReleaseSMContext Response message.

- 5a. [Conditional] If dynamic PCC applied to this session the SMF performs an SM Policy Association Termination procedure as defined in clause 4.16.6.

5b-c. [Conditional] If it is the last PDU Session the SMF is handling for the UE for the associated (DNN, S-NSSAI), the SMF unsubscribes from Session Management Subscription data changes notification with the UDM by means of the Nudm\_SDM\_Unsubscribe service operation. The SMF invokes the Nudm\_UECM\_Deregistration service operation so that the UDM removes the association it had stored between the SMF identity and the associated DNN and PDU Session Id.

6. [Conditional] If there is any association with the PCF for this UE and the UE is no more registered over any access, the AMF performs a AMF-initiated AM Policy Association Termination procedure as defined in clause 4.16.3.2 delete the association with the PCF.

6a. [Conditional] If there is any association with the PCF for this UE and the UE is no more registered over any access, the AMF performs a AMF-initiated UE Policy Association Termination procedure as defined in clause 4.16.13.1 delete the association with the PCF.

7. [Conditional] The AMF sends NAS message Deregistration Accept to UE depending on the Deregistration type i.e. if Deregistration type is switch-off, AMF does not send Deregistration Accept message.

8. [Conditional] AMF to AN: N2 UE Context Release Request (Cause)

If the target access for Deregistration procedure is 3GPP access or both 3GPP access and non-3GPP access and there is N2 signalling connection to NG-RAN, the AMF sends N2 UE Release command to NG-RAN with Cause set to Deregistration to release N2 signalling connection. The details of this step are covered by steps 2 to 4 in the AN Release procedure, as described in clause 4.2.6.

If the target access for Deregistration procedure is non-3GPP access or both 3GPP access and non-3GPP access and there is N2 signalling connection to the N3IWF/TNGF/W-AGF, the AMF sends N2 UE Release command to N3IWF/TNGF/W-AGF with Cause set to Deregistration to release N2 signalling connection. The details of this step are covered by steps 2 to 5 in the "Deregistration procedure for (un)trusted non-3gpp access", as described in clauses 4.12.3 / 4.12a.3 and in clause 7.2.1 of TS 23.316 [53] for W-5GAN access.

#### 4.2.2.3.3 Network-initiated Deregistration

The procedure depicted in Figure 4.2.2.3.3-1 shows Network-initiated Deregistration procedure. The AMF can initiate this procedure for either explicit (e.g. by O&M intervention or if the AMF determines that no S-NSSAI can be provided in the Allowed NSSAI for the UE) or implicit (e.g. expiring of Implicit Deregistration timer). The UDM can trigger this procedure for operator-determined purposes to request the removal of a subscriber's RM context and PDU Session(s) of the UE.

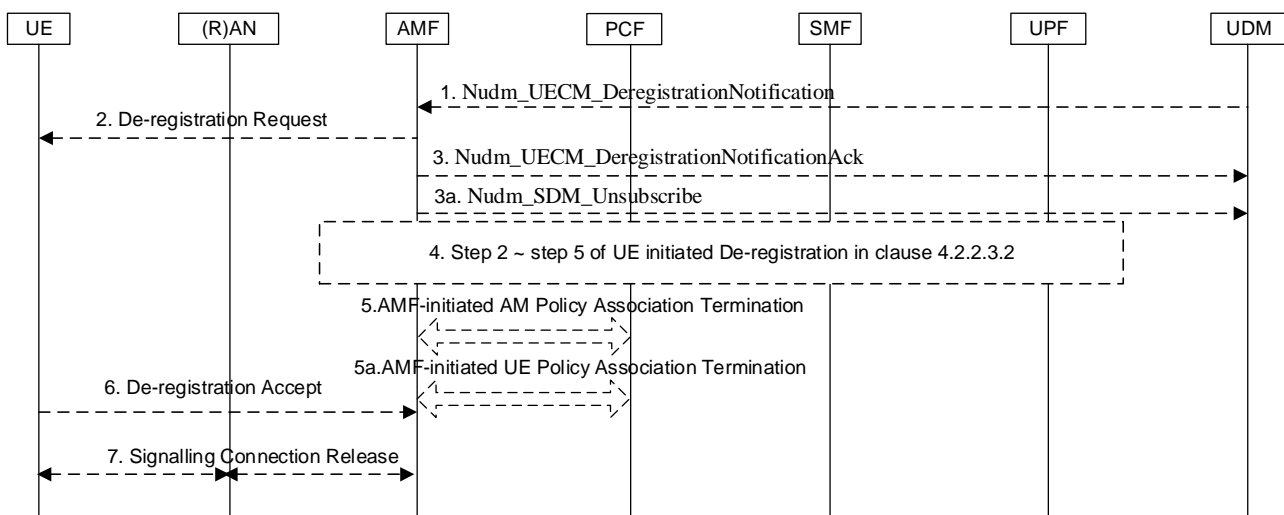


Figure 4.2.2.3.3-1: Network-initiated Deregistration

1. [Conditional] If the UDM wants to request the immediate deletion of a subscriber's RM contexts and PDU Sessions, the UDM shall send a Nudm\_UECM\_DeregistrationNotification (SUPI, Access Type, Removal Reason) message with Removal Reason set to Subscription Withdrawn to the registered AMF. The Access Type may indicate 3GPP Access, non-3GPP Access or both.

2. If the AMF receives Nudm\_UECM\_DeregistrationNotification in Step 1 with Removal Reason as Subscription Withdrawn, the AMF executes Deregistration procedure over the access(es) the Access Type indicates.

The AMF-initiated Deregistration procedure is either explicit (e.g. by O&M intervention or if the AMF determines that no S-NSSAI can be provided in the Allowed NSSAI for the UE) or implicit. The AMF does not send the Deregistration Request message to the UE for Implicit Deregistration. If the UE is in CM-CONNECTED state, the AMF may explicitly deregister the UE by sending a Deregistration Request message (Deregistration type, Access Type, [list of Rejected S-NSSAIs, each of them with the appropriate rejection cause value]) to the UE. The Deregistration type may be set to Re-registration in which case the UE should re-register at the end of the Deregistration procedure. Access Type indicates whether Deregistration procedure applies to the 3GPP access or non-3GPP access, or both. If the Deregistration Request message is sent over 3GPP access and the UE is in CM-IDLE state in 3GPP access, the AMF pages the UE. The list of Rejected S-NSSAIs, each of them with the appropriate rejection cause value, is provided if the AMF determines that no S-NSSAI can be provided to the UE in the Allowed NSSAI.

If the UE has established PDU Session associated with emergency service, the AMF shall not initiate Deregistration procedure. In this case, the AMF performs network requested PDU Session Release for any PDU session associated with non-emergency service as described in clause 4.3.4.

3. [Conditional] If the Deregistration procedure is triggered by UDM (Step 1), the AMF acknowledges the Nudm\_UECM\_DeRegistrationNotification to the UDM.

If Access Type indicates 3GPP Access or non-3GPP Access and AMF does not have UE context for another access type, or if Access Type indicates both, the AMF unsubscribes with the UDM using Nudm\_SDM\_Unsubscribe service operation.

4. [Conditional] If the UE has any established PDU Session over the target access for deregistration indicated in step 2, then step 2 ~ step 5 of UE-initiated Deregistration procedure in clause 4.2.2.3.2 is performed.
5. [Conditional] As in step 6 of Figure 4.2.2.3.2-1.
- 5a. [Conditional] As in step 6a of Figure 4.2.2.3.2-1.
6. [Conditional] If the UE receives the Deregistration Request message from the AMF in step 2, the UE sends a Deregistration Accept message to the AMF any time after step 2. The NG-RAN forwards this NAS message to the AMF along with the TAI+ Cell identity of the cell which the UE is using.
7. [Conditional] AMF to AN: N2 UE Context Release Request (Cause): as in step 8 of Figure 4.2.2.3.2.

If the UE is deregistered over only 3GPP access or non-3GPP access and the AMF does not have UE context for the other, or if the procedure applies to both access types, then at any time, AMF can unsubscribe from the UDM, otherwise the AMF can deregister from UDM using Nudm\_UECM\_Deregistration request by indicating its associating access type.

## 4.2.3 Service Request procedures

### 4.2.3.1 General

The Service Request procedure is used by a UE in CM-IDLE state or the 5GC to request the establishment of a secure connection to an AMF. The Service Request procedure is also used both when the UE is in CM-IDLE and in CM-CONNECTED to activate a User Plane connection for an established PDU Session.

The UE shall not initiate a Service Request procedure if there is an ongoing Service Request procedure.

### 4.2.3.2 UE Triggered Service Request

The UE in CM-IDLE state initiates the Service Request procedure in order to send uplink signalling messages, user data, to request emergency services fallback, or as a response to a network paging request. The UE shall not initiate UE Triggered Service Request from CM-IDLE if there is a Service Gap timer running. After receiving the Service Request message, the AMF may perform authentication. After the establishment of the signalling connection to an AMF, the UE or network may send signalling messages, e.g. PDU Session establishment from UE to the SMF, via the AMF.



The Service Request procedure is used by a UE in CM-CONNECTED to request activation of a User Plane connection for PDU Sessions and to respond to a NAS Notification message from the AMF. When a User Plane connection for a PDU Session is activated, the AS layer in the UE indicates it to the NAS layer.

For any Service Request, the AMF responds with a Service Accept message to synchronize PDU Session status between UE and network, if necessary. The AMF responds with a Service Reject message to UE, if the Service Request cannot be accepted by network. The AMF may steer the UE from 5GC by rejecting the Service Request. The AMF should take into account the Preferred and Supported Network Behaviour (see clause 5.31.2 of TS 23.501 [2]) and availability of EPC to the UE before steering the UE from 5GC. The Service Reject message may include an indication or cause code requesting the UE to perform Registration procedure.

For this procedure, the impacted SMF and UPF, if any, are all under control of the PLMN serving the UE, e.g. in Home Routed roaming case the SMF and UPF in HPLMN are not involved if V-SMF relocation is not triggered.

For Service Request due to user data, network may take further actions if User Plane connection activation is not successful.

The procedure in this clause 4.2.3.2 is applicable to the scenarios with or without intermediate UPF and with or without intermediate UPF reselection.

If the UE initiates Service Request procedures via non-3GPP Access, functions defined in the clause 4.12.4.1 are applied.

The User Plane of all PDU Sessions with redundant I-UPFs or with redundant N3/N9 tunnels for URLLC shall be activated during the Service Request procedure if the UE in CM-IDLE state initiates the Service Request procedure from 3GPP access. If the redundant I-UPFs are to be added/replaced/removed, the N4 Session procedure to manage the I-UPF is done for each I-UPF in steps 6c, 6d,7a, 7b, 8a, 8b, 9, 10, 17a,17b, 20a, 20b, 21a,21b, 22a and 22b of the figure 4.2.3.2-1. If the redundant N3/N9 tunnels are used for URLLC and the I-UPF is to be added/replaced/removed, the N4 Session procedure to update the tunnel is done for each N3/N9 tunnel in steps 6c, 6d,7a, 7b, 8a, 8b, 9, 10, 17a, 17b. 20a, 20b, 21a and 21b of the figure 4.2.3.2-1.

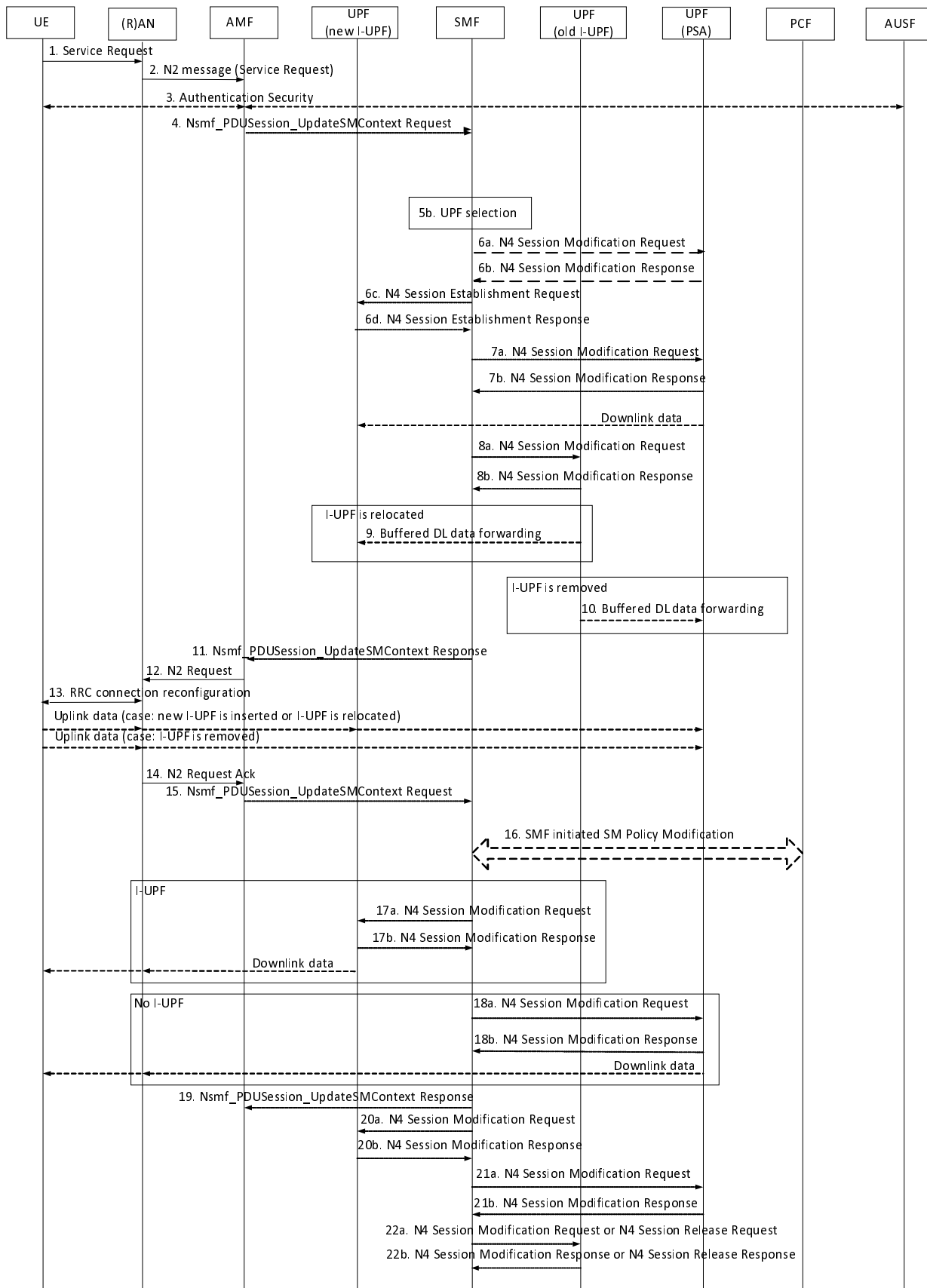


Figure 4.2.3.2-1: UE Triggered Service Request procedure

1. UE to (R)AN: AN message (AN parameters, Service Request (List Of PDU Sessions To Be Activated, List Of Allowed PDU Sessions, security parameters, PDU Session status, 5G-S-TMSI, [NAS message container], Exempt Indication)).

The NAS message container shall be included if the UE is sending a Service Request message as an Initial NAS message and the UE needs to send non-clear-text IEs, see clause 4.4.6 of TS 24.501 [25].

The List Of PDU Sessions To Be Activated is provided by UE when the UE wants to re-activate the PDU Session(s). The List Of Allowed PDU Sessions is provided by the UE when the Service Request is a response of a Paging or a NAS Notification for a PDU Session associated with non-3GPP access and identifies the PDU Sessions that can be transferred to 3GPP access.

In the case of NG-RAN:

- The AN parameters include 5G-S-TMSI, Selected PLMN ID (or PLMN ID and NID, see clause 5.30 of TS 23.501 [2]), Establishment cause and may also include NSSAI information. The Establishment cause provides the reason for requesting the establishment of an RRC connection. Whether and how the UE includes the NSSAI information as part of the AN parameters is dependent on the value of the Access Stratum Connection Establishment NSSAI Inclusion Mode parameter, as specified in clause 5.15.9 of TS 23.501 [2].
- The UE sends Service Request message towards the AMF encapsulated in an RRC message to the NG-RAN. The RRC message(s) that can be used to carry the 5G-S-TMSI and this NAS message are described in TS 38.331 [12] and TS 36.331 [16].

If the Service Request is triggered by the UE for user data, the UE identifies, using the List Of PDU Sessions To Be Activated, the PDU Session(s) for which the UP connections are to be activated in Service Request message. When the UE includes the List Of PDU Sessions To Be Activated, the UE shall indicate PDU Sessions only associated with the access the Service Request is related to. If the Service Request is triggered by the UE for signalling only, the UE doesn't identify any List Of PDU Sessions To Be Activated. If this procedure is triggered for paging response and the UE has at the same time some user data to be transferred, the UE identifies the PDU Session(s) whose UP connections are to be activated in Service Request message, by the List Of PDU Sessions To Be Activated. Otherwise the UE does not identify any PDU Session(s) in the Service Request message for paging response. As defined in TS 24.501 [25] the UE shall include always-on PDU Sessions which are accepted by the network in the List Of PDU Sessions To Be Activated even if there are no pending uplink data for those PDU Sessions or when the Service Request is triggered for signalling only or when the Service Request is triggered for paging response.

If the Service Request over 3GPP access is triggered in response to the paging or NAS Notification indicating non-3GPP access, the Service Request message shall identify the list of PDU Sessions associated with the non-3GPP access that can be re-activated over 3GPP access in the List Of Allowed PDU Sessions, as described in clause 4.2.3.3 (step 6) of this specification and in clause 5.6.8 of TS 23.501 [2]. When the UE over 3GPP access is in NB-N1 mode and the resulting number of PDU Sessions with user plane resources activated for the UE does not exceed the maximum number of supported user plane resources (0, 1 or 2), based on whether the UE supports UP data transfer and the UE's 5GMM Core Network Capability as described in clause 5.31.19 of TS 23.501 [2], the AMF shall notify the SMF that reactivation of the user-plane resources for the corresponding PDU session(s) associated with non-3GPP access can be performed as defined in TS 24.501 [25].

If the Service Request is triggered to report PS Data Off status change and the UE is in Non-Allowed Area, the UE shall send Service Request message with an indication that the message is exempted from restriction (e.g. Non-Allowed Area). In this case, if the UE is in Non-Allowed Area, the UE shall not include the List Of PDU Sessions To Be Activated and as a result the always-on PDU Session is not re-activated during the Service Request procedure.

The PDU Session status indicates the PDU Sessions available in the UE.

The UE shall not trigger a Service Request procedure for a PDU Session corresponding to a LADN when the UE is outside the area of availability of the LADN.

NOTE 1: A PDU Session corresponding to a LADN is not included in the List Of PDU Sessions To Be Activated when the UE is outside the area of availability of the LADN.

For UE in CM-CONNECTED state, only the List Of PDU Sessions To Be Activated and List Of Allowed PDU Sessions need to be included in the Service Request.

2. (R)AN to AMF: N2 Message (N2 parameters, Service Request).

Details of this step are described in TS 38.413 [10]. If the AMF can't handle the Service Request it will reject it.

When NG-RAN is used, the N2 parameters include the 5G-S-TMSI, Selected PLMN ID (or PLMN ID and NID, see clause 5.30 of TS 23.501 [2]), Location information and Establishment cause, UE Context Request.

If the UE is in CM-IDLE state, the NG-RAN obtains the 5G-S-TMSI in RRC procedure. NG-RAN selects the AMF according to 5G-S-TMSI. The Location Information relates to the cell in which the UE is camping.

Based on the PDU Session status, the AMF may initiate PDU Session Release procedure in the network for the PDU Sessions whose PDU Session ID(s) were indicated by the UE as not available.

When the Establishment cause is associated with priority services (e.g. MPS, MCS), the AMF includes a Message Priority header to indicate priority information. Other NFs relay the priority information by including the Message Priority header in service-based interfaces, as specified in TS 29.500 [17].

The AMF enforces the Mobility Restrictions as specified in clause 5.3.4.1.1 of TS 23.501 [2].

If there is a Service Gap timer running in AMF for the UE and the AMF is not waiting for a MT paging response from the UE and the Service Request is not for regulatory prioritized services like Emergency services or not for exception reporting, the AMF rejects the Service Request with an appropriate cause. In addition, AMF may also provide a UE with a Mobility Management Back-off timer set to the remaining value of the Service Gap timer.

If the AMF supports RACS and the AMF detects that the selected PLMN is different from the currently registered PLMN for the UE, the AMF determines the UE Radio Capability ID of the newly selected PLMN to the gNB as described in clause 5.4.4.1a of TS 23.501 [2].

- 3a) AMF to (R)AN: N2 Request (security context, Mobility Restriction List, list of recommended cells / TAs / NG-RAN node identifiers).

If the 5G-AN had requested for UE Context or there is a requirement for AMF to provide this e.g. the AMF needs to initiate fallback procedure as in clause 4.13.4.2 for Emergency services, AMF initiates NGAP procedure as specified in TS 38.413 [10]. For UE in CM-IDLE state, 5G-AN stores the Security Context in the UE AN context. Mobility Restriction List is described in clause 5.3.4.1 of TS 23.501 [2].

The 5G-AN uses the Security Context to protect the messages exchanged with the UE as described in TS 33.501 [15].

If the NG-RAN node had provided the list of recommended cells / TAs / NG-RAN node identifiers during the AN Release procedure (see clause 4.2.6), the AMF shall include it in the N2 Request. The RAN may use this information to allocate the RAN Notification Area when the RAN decides to enable RRC Inactive state for the UE.

3. If the Service Request was not sent integrity protected or integrity protection verification failed, the AMF shall reject the Service Request as stated in TS 24.501 [25].

If the UE in CM-IDLE state triggered the Service Request to establish a signalling connection only, after successful establishment of the signalling connection the UE and the network can exchange NAS signalling and steps 4 to 11 and 15 to 22 are skipped.

If the UE in Non-Allowed Area triggered the Service Request with an indication that the message is exempted from restriction (e.g. Non-Allowed Area), the AMF should accept the Service Request. In this case, if the UE is in Non-Allowed Area, the AMF rejects user plane setup request from the SMF except for emergency services.

If the procedure was triggered in response to paging or NAS notification indicating non-3GPP access and the AMF received N1 SM Container only from the SMF in step 3a of clause 4.2.3.3, the AMF sends the NAS signalling including the N1 SM Container to the UE in step 7 of clause 4.2.3.3 without updating the access associated to the PDU Session.

4. [Conditional] AMF to SMF: Nsmf\_PDUSession\_UpdateSMContext Request (PDU Session ID(s), Operation Type, UE location information, Access Type, RAT Type, UE presence in LADN service area, Indication of Access Type can be changed, [MO Exception Data Counter]).

The Nsmf\_PDUSession\_UpdateSMContext Request is invoked:

- If the UE identifies List Of PDU Sessions To Be Activated in the Service Request message;
- This procedure is triggered by the SMF but the PDU Session(s) identified by the UE correlates to other PDU Session ID(s) than the one triggering the procedure; or

- If this procedure is triggered by the SMF in response to paging or NAS notification indicating 3GPP access or if this step onwards is invoked following step 4a of clause 4.2.3.3 and the current UE location is outside the "Area of validity for the N2 SM information" provided by the SMF in step 3a of clause 4.2.3.3 or the "Area of validity for the N2 SM information" was not provided by the SMF in step 3a of clause 4.2.3.3, the AMF shall not send the N2 information provided by the SMF in step 3a of clause 4.2.3.3. Otherwise, if the current UE location is in the "Area of validity for the N2 SM information", steps 4 to 11 are skipped; or
- If this procedure is triggered by the SMF in response to paging or NAS notification indicating non-3GPP access and the AMF received N2 SM Information only, or both N1 SM Container and N2 SM Information in step 3a of clause 4.2.3.3.

If the DNN corresponds to an LADN then the "UE presence in LADN service area" indicates if the UE is IN or OUT of the LADN service area. If the AMF does not provide the "UE presence in LADN service area" indication and the SMF determines that the DNN corresponds to a LADN, then the SMF considers that the UE is OUT of the LADN service area.

The AMF determines the PDU Session(s) for which the UP connection(s) shall be activated and sends an Nsmf\_PDUSession\_UpdateSMContext Request to SMF(s) associated with the PDU Session(s) with Operation Type set to "UP activate" to indicate establishment of User Plane resources for the PDU Session(s). The AMF determines Access Type and RAT Type, see clause 4.2.2.2.1. If the RAT type is NB-IoT, the AMF shall ensure that the number of PDU session(s) for which UP connection(s) are active does not exceed this UE's maximum number of supported user plane resources (0, 1 or 2) based on whether the UE supports UP data transfer and the UE 5GMM Core Network Capability as described in clause 5.31.19 of TS 23.501 [2].

If the procedure was triggered in response to paging or NAS Notification indicating non-3GPP access, the AMF received N2 SM Information in step 3a of clause 4.2.3.3 and the PDU Session for which the UE was paged or notified is not in the List Of Allowed PDU Sessions provided by the UE, the AMF notifies the SMF that the UE is not reachable. For other PDU Sessions in the List Of Allowed PDU Sessions the Service Request Procedure succeeds without re-activating the User Plane of any PDU Sessions, unless they have also been included by the UE in the List Of PDU Sessions To Be Activated.

If the procedure was triggered in response to paging or NAS notification indicating non-3GPP access and the PDU Session for which the UE was paged or notified is in the List Of Allowed PDU Sessions provided by the UE and the AMF received N2 SM Information only or N1 SM Container and N2 SM Information from the SMF in step 3a of clause 4.2.3.3, the AMF notifies the SMF that the access type of the PDU session can be changed. The AMF discards any already received N1 SM Container and N2 SM Information. In Home Routed roaming case, the V-SMF triggers Nsmf\_PDUSession\_Update service operation towards the H-SMF to notify the access type of the PDU Session can be changed and the procedure continues as specified in clause 4.3.3.3 from step 1a to step 10.

If the UE is accessing via the NB-IoT RAT, the AMF may inform all (H-)SMFs whether the RRC establishment cause is set to "MO exception data", as described in clause 5.31.14.3 of TS 23.501 [2]. The AMF may immediately send the MO Exception Data Counter to the (H-)SMF.

The AMF may receive a Service Request to establish another NAS signalling connection via a new NG-RAN while it has maintained an old NAS signalling connection for UE still via an old NG-RAN. The new NG-RAN and the old NG-RAN can be the same NG-RAN node. In this case, AMF shall trigger the AN release procedure toward the old NG-RAN to release the old NAS signalling connection as defined in clause 4.2.6 and:

- For the PDU Sessions indicated by the UE in the List Of PDU Sessions To Be Activated, the AMF requests the SMF to activate the PDU Session(s) immediately by performing this step 4; and

NOTE 2: This activates the UP of PDU Session(s) using resources of the new NG-RAN.

- For the PDU Sessions indicated by the old NG-RAN in the "List of PDU Session ID(s) with active N3 user plane" but not in the List Of PDU Sessions To Be Activated sent by the UE, the AMF requests the SMF to deactivate the PDU Session(s).

NOTE 3: This deactivates the UP of PDU Session(s) that are no more needed by the UE.

5a. Void.

5b. If the PDU Session ID corresponds to a LADN and the SMF determines that the UE is outside the area of availability of the LADN based on the "UE presence in LADN service area" from the AMF, the SMF decides to (based on local policies) either:

- keep the PDU Session, but reject the activation of User Plane connection for the PDU Session and inform the AMF about it. If the procedure has been triggered by a Network Triggered Service Request as described in clause 4.3.2.3, the SMF may notify the UPF that originated the Data Notification to discard downlink data for the PDU Sessions and/or to not provide further Data Notification messages; or
- to release the PDU Session: the SMF releases the PDU Session and informs the AMF that the PDU Session is released.

In any case of the two cases above the SMF answers to the AMF (step10) with an appropriate reject cause and the User Plane Activation of PDU Session is stopped.

Otherwise, based on the location info received from the AMF, the SMF checks the UPF Selection Criteria according to clause 6.3.3 of TS 23.501 [2] and determines to perform one of the following:

- accepts the activation of UP connection and continue using the current UPF(s);
- accepts the activation of UP connection and selects a new intermediate UPF (or add/remove an intermediate UPF), if the UE has moved out of the service area of the UPF that was previously connecting to the AN, while maintaining the UPF(s) acting as PDU Session Anchor. The steps to perform I-UPF addition/change/removal are described as conditional steps in the following of the current procedure; or

NOTE 4: If the old and/or new I-UPF implements an UL CL or BP functionality and a PDU Session Anchor for connectivity to the local access to the Data Network as described in clause 5.6.4.2 of TS 23.501 [2], the signalling described in the current clause is intended as the signalling to add, remove or change the PDU Session Anchor and must be complemented by the signalling to add, release or change the UL CL or BP as described respectively in clauses 4.3.5.4, 4.3.5.5 and 4.3.5.7.

- rejects the activation of UP connection of a PDU Session of SSC mode 2 and trigger re-establishment of the PDU Session after Service Request procedure to perform the allocation of a new UPF to act as PDU Session Anchor, e.g. the UE has moved out of the service area of the anchor UPF which is connecting to NG-RAN.

In the case that the SMF fails to find suitable I-UPF, the SMF decides to (based on local policies) either:

- trigger re-establishment of PDU Session. After Service Request procedure, SMF sends N1 SM message to the UE via the AMF by invoking Namf\_Communication\_N1N2MessageTransfer containing the cause indicating PDU Session re-establishment is required for the UE; or
- keep the PDU Session, but reject the activation request of User Plane connection for the PDU Session and inform the AMF about it; or
- release the PDU Session after Service Request procedure.

If the SMF has determined that the UE is performing Inter-RAT mobility to or from the NB-IoT RAT then the SMF uses the "PDU Session continuity at inter RAT mobility" to determine how to handle the PDU Session.

6a. [Conditional] SMF to UPF (PSA): N4 Session Modification Request.

Depending on the network deployment, the CN Tunnel Info of UPF (PSA) allocated for N3 or N9 interface may be changed during the Service Request procedure, e.g. UPF connected to different IP domains. If different CN Tunnel Info need be used, the SMF sends N4 Session Modification Request message to UPF (PSA) and requests CN Tunnel Info providing the target Network Instance.

6b. [Conditional] UPF (PSA) to SMF: N4 Session Modification Response.

The UPF (PSA) sends an N4 Session Establishment Response message to the SMF. The UPF provides CN Tunnel Info to the SMF. The UPF (PSA) associate the CN Tunnel Info with UL Packet detection rules provided by the SMF.

If the redundant I-UPFs are used for URLLC, each I-UPF provides UL CN Tunnel Info for N3 interface to the SMF in the N4 Session Establishment Response message.

If the redundant N3 tunnels are used for URLLC, the UPF (PSA) provides redundant UL CN Tunnel Info for N3 interface to the SMF in N4 Session Establishment Response message.

6c. [Conditional] SMF to new UPF (intermediate): N4 Session Establishment Request.

If the SMF selects a new UPF to act as intermediate UPF for the PDU Session, or if the SMF selects to insert an intermediate UPF for a PDU Session which did not have an intermediate UPF, an N4 Session Establishment Request message is sent to the new UPF, providing Packet detection, Data forwarding, enforcement and reporting rules to be installed on the intermediate UPF. The CN Tunnel Info (on N9) of PSA, i.e. which is used to establish the N9 tunnel, for this PDU Session is also provided to the intermediate UPF.

If a new UPF is selected by the SMF to replace the old (intermediate) UPF, the SMF may also include a request for the new UPF to allocate a second tunnel endpoint for buffered DL data from the old I-UPF and to indicate via usage reporting end marker reception on this second tunnel. In this case, the UPF is instructed by the SMF to buffer the DL data it may receive at the same time from the UPF (PSA).

6d. New UPF (intermediate) to SMF: N4 Session Establishment Response.

The new intermediate UPF sends an N4 Session Establishment Response message to the SMF. The UPF provides DL CN Tunnel Info as requested by SMF in step 6c. The SMF starts a timer, to be used in step 22a to release the resource in old intermediate UPF if there is one.

7a. [Conditional] SMF to UPF (PSA): N4 Session Modification Request.

If the SMF selects a new UPF to act as intermediate UPF for the PDU Session, the SMF sends N4 Session Modification Request message to PDU Session Anchor UPF, providing DL Tunnel Info from new intermediate UPF. If the new intermediate UPF was added for the PDU Session, the UPF (PSA) begins to send the DL data to the new I-UPF as indicated in the DL CN Tunnel Info. The UPF (PSA) sends one or more "end marker" packets for each N9 tunnel to the old I-UPF immediately after switching the path to new I-UPF.

If the Service Request is triggered by the network and the SMF removes the old I-UPF but does not replace it with a new I-UPF, the SMF may also include a request for the UPF to allocate a second tunnel endpoint for buffered DL data from the old I-UPF and to indicate end marker reception on this second tunnel via usage reporting. In this case, the UPF (PSA) begins to buffer the DL data it may receive at the same time from the N6 interface. The UPF (PSA) sends one or more "end marker" packets for each N9 tunnel to the old I-UPF immediately after switching the path to (R)AN.

7b. The UPF (PSA) sends N4 Session Modification Response message to SMF.

If requested by SMF, the UPF (PSA) sends DL CN tunnel info for the old (intermediate) UPF to the SMF. The SMF starts a timer, to be used in step 22a to release the resource in old intermediate UPF if there is one.

If the UPF that connects to RAN is the UPF (PSA) and if the SMF finds that the PDU Session is activated when receiving the Nsmf\_PDUSession\_UpdateSMContext Request in step 4 with Operation Type set to "UP activate" to indicate establishment of User Plane resources for the PDU Session(s), it deletes the AN Tunnel Info and initiates an N4 Session Modification procedure to remove Tunnel Info of AN in the UPF.

8a. [Conditional] SMF to old UPF (intermediate): N4 Session Modification Request (New UPF address, New UPF DL Tunnel ID)

If the service request is triggered by the network and the SMF removes the old (intermediate) UPF, the SMF sends the N4 Session Modification Request message to the old (intermediate) UPF, providing the DL Tunnel Info for the buffered DL data. If the SMF allocated new I-UPF, the DL Tunnel Info is from the new (intermediate) UPF acting as N3 terminating point. If the SMF did not allocate a new I-UPF, the DL Tunnel Info is from the new UPF (PSA) acting as N3 terminating point. The SMF starts a timer to monitor the forwarding tunnel as step 6d or 7b.

If the old I-UPF receives end marker packets and there is no associated tunnel to forward these packets, the old I-UPF discards the received end marker packets and does not send any Data Notification to SMF.

If the SMF find the PDU Session is activated when receiving the Nsmf\_PDUSession\_UpdateSMContext Request in step 4 with Operation Type set to "UP activate" to indicate establishment of User Plane resources for the PDU Session(s), it deletes the AN Tunnel Info and initiates an N4 Session Modification procedure to remove Tunnel Info of AN in the UPF.

## 8b. old UPF (intermediate) to SMF: N4 Session Modification Response

The old (intermediate) UPF sends N4 Session Modification Response message to SMF.

## 9. [Conditional] old UPF (intermediate) to new UPF (intermediate): buffered downlink data forwarding

If the I-UPF is changed and forwarding tunnel was established to the new I-UPF, the old (intermediate) UPF forwards its buffered data to the new (intermediate) UPF acting as N3 terminating point. If indicated by SMF in step 6c, the new I-UPF reports to SMF when end marker packet is received. Then the SMF initiates N4 Session Modification procedure to indicate the new I-UPF to send the buffered downlink packet(s) received from the UPF (PSA).

## 10. [Conditional] old UPF (intermediate) to UPF (PSA): buffered downlink data forwarding

If the old I-UPF is removed and no new I-UPF is assigned for the PDU Session and forwarding tunnel was established to the UPF (PSA), the old (intermediate) UPF forwards its buffered data to the UPF (PSA) acting as N3 Terminating Point. If indicated by SMF in step 7a, the UPF (PSA) reports to SMF when the end marker packet has been received. Then the SMF initiates N4 Session Modification procedure to request the UPF (PSA) to send the buffered DL data received from the N6 interface.

## 11. [Conditional] SMF to AMF: Nsmf\_PDUSession\_UpdateSMContext Response (N2 SM information (PDU Session ID, QFI(s), QoS profile(s), CN N3 Tunnel Info, S-NSSAI, User Plane Security Enforcement, UE Integrity Protection Maximum Data Rate, RSN), N1 SM Container, Cause) to the AMF. If the UPF that connects to RAN is the UPF (PSA), the N3 CN Tunnel Info is the UL CN Tunnel Info of the UPF (PSA). If the UPF that connects to RAN is the new intermediate UPF, the CN N3 Tunnel Info is the UL Tunnel Info of the intermediate UPF.

For the PDU Session with redundant I-UPFs or with redundant N3 tunnels for URLLC, the two UL N3 CN Tunnel Info are included, the SMF also indicates the NG-RAN that one of the CN Tunnel Info is used as the redundancy tunnel of the PDU session as described in clause 5.33.2.2 of TS 23.501 [2].

The SMF shall send N1 SM Container and/or N2 SM Information to the AMF when applicable. (e.g. when the SMF was notified from the AMF that the access type of the PDU Session can be changed in step 4).

For a PDU Session that the SMF has determined to accept the activation of UP connection in step 5a or 5b, the SMF generates only N2 SM information and sends Nsmf\_PDUSession\_UpdateSMContext Response to the AMF to establish the User Plane(s). The N2 SM information contains information that the AMF shall provide to the NG-RAN. The SMF may indicate for each QoS Flow whether redundant transmission shall be performed by a corresponding redundant transmission indicator. If the SMF decided to change the PSA UPF for the SSC mode 3 PDU Session, the SMF triggers the change of SSC mode 3 PDU Session anchor as an independent procedure described in clause 4.3.5.2 or clause 4.3.5.3 after accepting the activation of UP of the PDU Session.

The SMF can reject the activation of UP of the PDU Session by including a cause in the Nsmf\_PDUSession\_UpdateSMContext Response. Following are some of the cases:

- If the PDU Session corresponds to a LADN and the UE is outside the area of availability of the LADN as described in step 5b;
- If the AMF notified the SMF that the UE is reachable only for regulatory prioritized service and the PDU Session to be activated is not for a regulatory prioritized service; or
- If the SMF decided to change the PSA UPF for the requested PDU Session as described in step 5b. In this case, after sending Nsmf\_PDUSession\_UpdateSMContext Response, the SMF triggers another procedure to instruct UE to re-establish the PDU Session as described in clause 4.3.5.1 for SSC mode 2.
- If the SMF received negative response in Step 6b due to UPF resource unavailability.

If the PDU Session has been assigned any EPS bearer ID, the SMF also includes the mapping between EPS bearer ID(s) and QFI(s) into the N2 SM information to be sent to the NG-RAN.

The User Plane Security Enforcement information is determined by the SMF upon PDU session establishment as described in clause 5.10.3 of TS 23.501 [2]. If the User Plane Security Enforcement information indicates that Integrity Protection is "Preferred" or "Required", the SMF also includes the UE Integrity Protection Maximum Data Rate.



The RSN is included when applicable, as determined by the SMF during PDU Session establishment as described in clause 5.33.2.1 of TS 23.501 [2].

12. AMF to (R)AN: N2 Request (N2 SM information received from SMF, security context, Mobility Restriction List, UE-AMBR, MM NAS Service Accept, list of recommended cells / TAs / NG-RAN node identifiers, UE Radio Capability, Core Network Assistance Information, Tracing Requirements, UE Radio Capability ID). The Allowed NSSAI for the Access Type for the UE is included in the N2 message. If the subscription information includes Tracing Requirements, the AMF includes Tracing Requirements in the N2 Request.

If the UE triggered the Service Request while in CM-CONNECTED state, only N2 SM information received from SMF and MM NAS Service Accept are included in the N2 Request.

If the Service Request procedure is triggered by the Network (as described in clause 4.2.3.3) while the UE is in CM-CONNECTED state, only N2 SM information received from SMF is included in the N2 Request.

If the Service Request procedure is triggered by the Network (as described in clause 4.2.3.3) while the UE is in CM-IDLE state, only N2 SM information received from SMF and MM NAS Service Accept is included in the N2 Request.

For a UE that was in CM-IDLE state when the Service Request was triggered, the NG-RAN stores the Security Context. If the Service Request is not triggered by UE for a signalling connection only, RAN also stores QoS Information for the QoS Flows of the PDU Sessions that are activated and N3 Tunnel IDs in the UE RAN context and Mobility Restriction List (as described in clause 5.3.4.1 of TS 23.501 [2]).

MM NAS Service Accept includes PDU Session status in AMF. Any local PDU Session Release during the Session Request procedure is indicated to the UE via the Session Status. PDU Session Reactivation Result is provided in Service Accept for the PDU sessions in the List Of PDU Sessions To Be Activated and the PDU Session in the List of Allowed PDU Sessions which has caused paging or NAS notification. If the PDU Session Reactivation Result of a PDU Session is failure, the cause of the failure is also provided.

If there are multiple PDU Sessions that involves multiple SMFs, AMF does not need to wait for responses from all SMFs in step 11 before it sends N2 SM information to the RAN. However, the AMF shall wait for all responses from the SMFs before it sends MM NAS Service Accept message to the UE.

AMF shall include at least one N2 SM information from SMF if this step is triggered for PDU Session User Plane activation. AMF may send additional N2 SM information from SMFs in separate N2 message(s) (e.g. N2 tunnel setup request), if there is any. Alternatively, if multiple SMFs are involved, the AMF may send one N2 Request message to (R)AN after all the Nsmf\_PDUSession\_UpdateSMContext Response service operations from all the SMFs associated with the UE are received.

If the NG-RAN node had provided the list of recommended cells / TAs / NG-RAN node identifiers during the AN Release procedure (see clause 4.2.6), the AMF shall include it in the N2 Request. The NG-RAN may use this information to allocate the RAN Notification Area when the NG-RAN decides to enable RRC Inactive state for the UE.

The AMF includes the UE's "RRC Inactive Assistance Information" as defined in clause 5.3.3.2.5 of TS 23.501 [2].

If the NG-RAN node does not support RACS and the AMF have UE Radio Capability ID but not the UE Radio Capability information, then AMF will use Nsmf\_UECapabilityManagement\_Resolve to try to retrieve the corresponding UE Radio Capability information.

If the NG-RAN node does not support RACS, or the AMF does not have UE Radio Capability ID in UE context, the AMF shall include the UE Radio Capability information, if available, to the NG-RAN node as described in TS 23.501 [2]. If the RAT Type is NB-IoT then NB-IoT specific UE Radio Access Capability Information is included instead, if available.

If AMF has UE Radio Capability ID in UE context valid for the PLMN the UE is currently in and the NG-RAN supports RACS, the AMF signals the UE Radio Capability ID. If the NG-RAN node does not have mapping between the UE Radio Capability ID and the corresponding UE radio capabilities, it shall use the non-UE associated procedure described in TS 38.413 [10] to retrieve the mapping from the AMF.

The AMF may include the Core Network Assistance Information which includes Core Network assisted RAN parameters tuning and Core Network assisted RAN paging information as defined in TS 23.501 [2].

If the UE included support for restriction of use of Enhanced Coverage, the AMF sends Enhanced Coverage Restricted information to the (R)AN in the N2 message.

If the UE and the AMF have negotiated to enable MICO mode and the AMF uses the Extended connected timer, then the AMF provides the Extended Connected time value to NG-RAN (see clause 5.31.7.3 of TS 23.501 [2]) in this step. The Extended Connected Time value indicates the minimum time the RAN should keep the UE in RRC-CONNECTED state regardless of inactivity.

If the AMF accepted MICO mode in the last registration procedure and knows there may be mobile terminated data or signalling pending, the AMF maintains the N2 connection for at least the Extended Connected Time as described in clause 5.31.7.3 of TS 23.501 [2] and provides the Extended Connected Time value to the RAN in N2 message with Service Accept message. The RAN should keep the UE in RRC-CONNECTED state for an Extended Connected Time period in order to ensure the downlink data and/or signalling is delivered to the UE.

If the RAN receives two CN Tunnel Info for a PDU session in step 11 for redundant transmission, RAN also allocates two AN Tunnel Info correspondingly and indicate to SMF one of the AN Tunnel Info is used as the redundancy tunnel of the PDU session as described in clause 5.33.2.2 of TS 23.501 [2].

13. (R)AN to UE: The NG-RAN performs RRC Connection Reconfiguration with the UE depending on the QoS Information for all the QoS Flows of the PDU Sessions whose UP connections are activated and Data Radio Bearers. For a UE that was in CM-IDLE state, if the Service Request is not triggered by UE for a signalling connection only, the User Plane security is established at this step, which is described in detail in TS 38.331 [12] and TS 36.331 [16]. For a UE that was in CM-IDLE state, if the Service Request is triggered by UE for a signalling connection only, AS security context may be established in this step, which is described in detail in TS 38.331 [12] and TS 36.331 [16].

If the N2 Request includes a NAS message, the NG-RAN forwards the NAS message to the UE. The UE locally deletes context of PDU Sessions that are not available in 5GC.

NOTE 5: The reception of the Service Accept message does not imply the successful activation of the User Plane radio resources.

NOTE 6: If not all the requested User Plane AN resources are successfully activated, see TS 38.413 [10].

After the User Plane radio resources are setup, the uplink data from the UE can now be forwarded to NG-RAN. The NG-RAN sends the uplink data to the UPF address and Tunnel ID provided in the step 11.

If the NG-RAN can not establish redundant user plane for the PDU Session as indicated by the RSN parameter, the NG-RAN takes the decision on how to proceed with the PDU Session as described in TS 23.501 [2].

14. [Conditional] (R)AN to AMF: N2 Request Ack (List of PDU Sessions To Be Established with N2 SM information (AN Tunnel Info, List of accepted QoS Flows for the PDU Sessions whose UP connections are activated, List of rejected QoS Flows for the PDU Sessions whose UP connections are activated), List of PDU Sessions that failed to be established with the failure cause given in the N2 SM information element).

The message may include N2 SM information(s), e.g. AN Tunnel Info. NG-RAN may respond N2 SM information with separate N2 message (e.g. N2 tunnel setup response) if AMF sends separate N2 message in step 11.

If multiple N2 SM information are included in the N2 Request message in step 12, the N2 Request Ack includes multiple N2 SM information and information to enable the AMF to associate the responses to relevant SMF.

15. [Conditional] AMF to SMF: Nsmf\_PDUSession\_UpdateSMContext Request (N2 SM information, RAT Type, Access Type) per PDU Session to the SMF. The AMF determines Access Type and RAT Type, see clause 4.2.2.2.1.

If the AMF received N2 SM information (one or multiple) in step 14, then the AMF shall forward the N2 SM information to the relevant SMF per PDU Session ID. If the UE Time Zone has changed compared to the last reported UE Time Zone then the AMF shall include the UE Time Zone IE in this message.

If the PDU Session is moved from the non-3GPP access to 3GPP access (i.e. N3 tunnel for the PDU Session is established successfully), the SMF and AMF update associated access of the PDU Session. The UE updates associated access of the PDU Session when the user plane resource for the PDU Session is successfully established.

Procedure for unpausing a charging pause initiated earlier is specified in clause 4.4.4.

If a PDU Session is rejected by the serving NG-RAN with an indication that the PDU Session was rejected because User Plane Security Enforcement is not supported in the serving NG-RAN and the User Plane Enforcement Policy indicates "Required" as described in clause 5.10.3 of TS 23.501 [2], the SMF shall trigger the release of this PDU Session. In all other cases of PDU Session rejection, the SMF can decide whether to release the PDU Session or to deactivate the UP connection of this PDU Session.

If some of the QoS Flows of a PDU Session are not accepted by the serving NG-RAN, the SMF shall initiate the PDU Session Modification procedure to remove the non-accepted QoS Flows from the PDU Session after this procedure is completed.

16. [Optional] SMF to PCF: If dynamic PCC is deployed and if Policy Control Request Trigger condition(s) have been met (e.g. change of Access Type, change of UE location), SMF performs SMF initiated SM Policy Modification procedure as defined in clause 4.16.5.1. The PCF may provide updated policies.
- 17a. [Conditional] SMF to new intermediate UPF: N4 Session Modification Request (AN Tunnel Info and List of accepted QFI(s)).

If the SMF selected a new UPF to act as intermediate UPF for the PDU Session in step 5b, the SMF initiates a N4 Session Modification procedure to the new I-UPF and provides AN Tunnel Info. The Downlink Data from the new I-UPF can now be forwarded to NG-RAN and UE.

- 17b. [Conditional] UPF to SMF: N4 Session Modification Response.
- 18a. [Conditional] SMF to UPF (PSA): N4 Session Modification Request (AN Tunnel Info, List of rejected QoS Flows).

If a User Plane is to be setup or modified and after the modification there is no I-UPF, the SMF initiates a N4 Session Modification procedure to UPF (PSA) and provides AN Tunnel Info. The Downlink Data from the UPF (PSA) can now be forwarded to NG-RAN and UE.

For QoS Flows in the List of rejected QoS Flows, the SMF shall instruct the UPF to remove the rules (e.g. Packet Detection Rules etc.) which are associated with the QoS Flows.

If SMF decides to perform redundant transmission for one or more QoS Flows of the PDU, the SMF also indicates the UPF (PSA) to perform packet duplication for the QoS Flow(s) in downlink direction by forwarding rules.

If the PCC rule(s) are updated in step 16, the SMF may initiate a N4 Session Modification procedure to UPF (PSA) based on the updated PCC rule(s).

- 18b. [Conditional] UPF to SMF: N4 Session Modification Response.
19. [Conditional] SMF to AMF: Nsmf\_PDUSession\_UpdateSMContext Response.
- 20a. [Conditional] SMF to new UPF (intermediate): N4 Session Modification Request.

If forwarding tunnel has been established to the new I-UPF and if the timer SMF set for forwarding tunnel at step 8a has expired, SMF sends N4 Session modification request to new (intermediate) UPF acting as N3 terminating point to release the forwarding tunnel.

- 20b. [Conditional] new UPF (intermediate) to SMF: N4 Session modification response.

New (intermediate) UPF acting as N3 terminating point sends N4 Session Modification response to SMF.

- 21a. [Conditional] SMF to UPF (PSA): N4 Session Modification Request.

If forwarding tunnel has been established to the UPF (PSA) and if the timer SMF set for forwarding tunnel at step 7b has expired, SMF sends N4 Session modification request to UPF (PSA) acting as N3 Terminating Point to release the forwarding tunnel.

- 21b. [Conditional] UPF (PSA) to SMF: N4 Session Modification Response.

UPF (PSA) acting as N3 Terminating Point sends N4 Session Modification Response to SMF.

22a. [Conditional] SMF to old UPF: N4 Session Modification Request or N4 Session Release Request.

If the SMF decided to continue using the old UPF in step 5b, the SMF sends an N4 Session Modification Request, providing AN Tunnel Info.

If the SMF decided to select a new UPF to act as intermediate UPF in step 5b and the old UPF is not PSA UPF, the SMF initiates resource release, after timer in step 6b or 7b expires, by sending an N4 Session Release Request (Release Cause) to the old intermediate UPF.

22b. [Conditional] Old intermediate UPF to SMF: N4 Session Modification Response or N4 Session Release Response.

The old UPF acknowledges with an N4 Session Modification Response or N4 Session Release Response message to confirm the modification or release of resources.

For the mobility related events described in clause 4.15.4, the AMF invokes the Namf\_EventExposure\_Notify service operation after step 4.

Upon reception of the Namf\_EventExposure\_Notify with an indication that the UE is reachable, if the SMF has pending DL data the SMF invokes the Namf\_Communication\_N1N2MessageTransfer service operation to the AMF to establish the User Plane(s) for the PDU Sessions, otherwise the SMF resumes sending DL data notifications to the AMF in the case of DL data.

Upon reception of the Namf\_EventExposure\_Notify with an indication that UE is reachable only for regulatory prioritized service, the SMF deactivates the PDU Session if the service of the PDU Session is not regulatory prioritized. For home routed roaming case, the V-SMF triggers the deactivation of the PDU Session, in addition, the H-SMF refrains from sending downlink signalling if the signalling is not related to regulatory prioritized service upon receiving the notification.

#### 4.2.3.3 Network Triggered Service Request

This procedure is used when the network needs to signal (e.g. N1 signalling to UE, Mobile-terminated SMS, User Plane connection activation for PDU Session(s) to deliver mobile terminating user data) with a UE. When the procedure is triggered by SMSF, PCF, LMF, GMLC, NEF or UDM, the SMF in the following figure should be replaced by the respective NF. If the UE is in CM-IDLE state or CM-CONNECTED state in 3GPP access, the network initiates a Network Triggered Service Request procedure. If the UE is in CM-IDLE state and asynchronous type communication is not activated, the network sends a Paging Request to (R)AN/UE. The Paging Request triggers the UE Triggered Service Request procedure in the UE. If asynchronous type communication is activated, the network stores the received message and forward the message to the (R)AN and/or the UE (i.e. synchronizes the context with the (R)AN and/or the UE) when the UE enters CM-CONNECTED state.

If the UE is in CM-IDLE state in non-3GPP access and if the UE is simultaneously registered over 3GPP and non-3GPP accesses in a PLMN, the network shall initiate a Network Triggered Service Request procedure over 3GPP access.

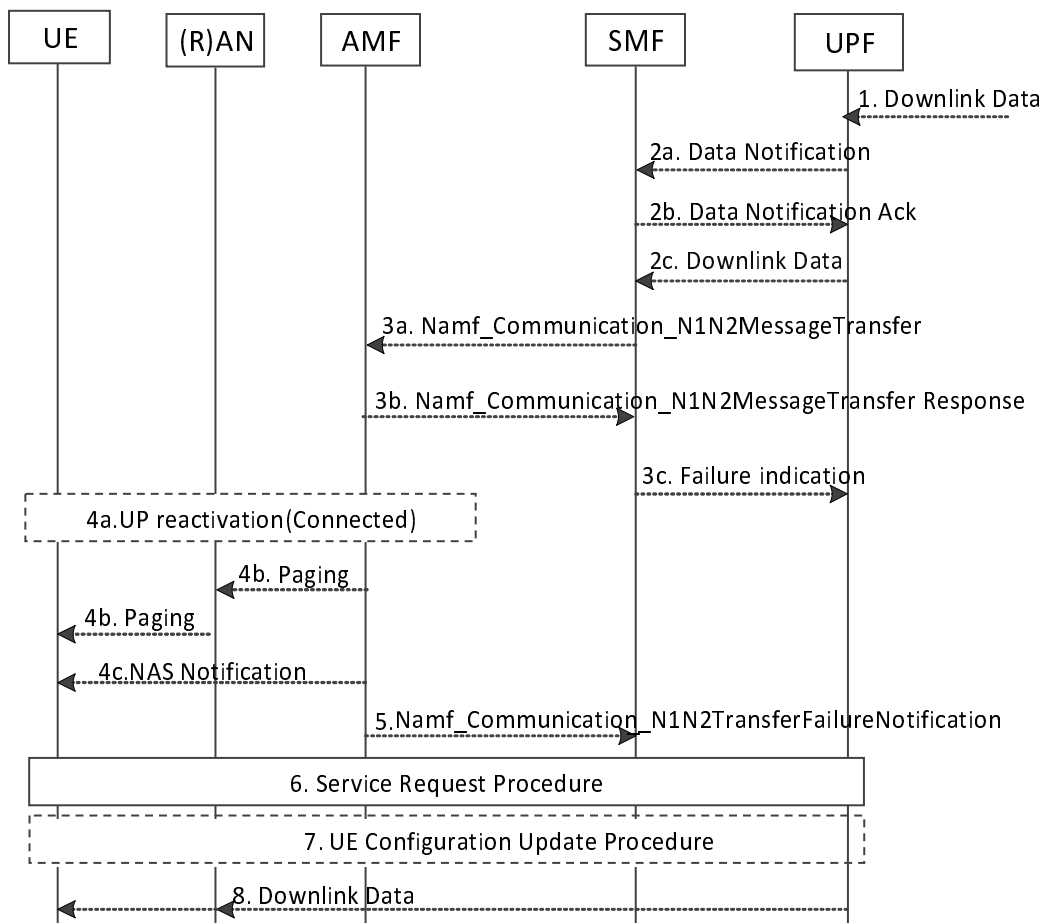
If the UE is in CM-IDLE state in 3GPP access and in CM-CONNECTED state in non-3GPP access and if the UE is simultaneously registered over 3GPP and non-3GPP accesses in the same PLMN, the network may initiate a Network Triggered Service Request procedure for 3GPP access via non-3GPP access.

For this procedure, the impacted SMF and UPF are all under control of the PLMN serving the UE, e.g. in Home Routed roaming case the SMF and UPF in HPLMN are not involved.

The procedure below covers the following non exhaustive list of use-cases for 3GPP access (detailed conditions of when the steps apply are stated in the procedure below):

- The SMF needs to setup N3 tunnel to deliver downlink packet to the UE for a PDU Session and the UE is in CM-IDLE state: Step 3a contains an N2 message and Step 4b (paging) is performed.
- The SMF needs to setup N3 tunnel to deliver downlink packet to the UE for a PDU Session and the UE is in CM-CONNECTED state: Step 3a contains an N2 message and Step 4a (UP reactivation) is performed.
- NF (e.g. SMF, SMSF, PCF or LMF) needs to send an N1 message to the UE, using the Namf\_Communication\_N1N2MessageTransfer service operation and the UE is in CM-IDLE state: Step 3a contains an N1 message, Step 3b contains cause "Attempting to reach UE" and Step 4b (paging) occurs.

- The LMF triggers AMF, using the Namf\_Communication\_N1N2MessageTransfer service operation, to setup a NAS connection with the UE and the UE is in CM-IDLE state: Step 3b contains cause "Attempting to reach UE" and step 4b (paging) occurs.
- The GMLC triggers AMF, using the Namf\_Location\_ProvideLocation service operation, to setup a NAS connection with the UE and the UE is in CM-IDLE state: Step 4b (paging) occurs.
- The PCF needs to send a message to the UE, using the Npcf\_AMPolicyControl\_Create Response service operation, or the Npcf\_AMPolicyControl\_UpdateNotify service operation and the UE is in CM-IDLE state: Step 3a contains a message and step 4b (paging) occurs.
- NF (e.g. SMSF or SMF) triggers AMF, using the Namf\_MT\_EnableUEReachability service operation, to setup a NAS connection with the UE and the UE is in CM-IDLE state: The trigger is specific to the procedure and Step 4b (paging) occurs.



**Figure 4.2.3.3-1: Network Triggered Service Request**

1. When a UPF receives downlink data for a PDU Session and there is no AN Tunnel Info stored in UPF for the PDU Session, based on the instruction from the SMF (as described in clause 5.8.3 of TS 23.501 [2]), the UPF may buffer the downlink data (steps 2a and 2b), or forward the downlink data to the SMF (step 2c).
- 2a. UPF to SMF: Data Notification (N4 Session ID, Information to identify the QoS Flow for the DL data packet, DSCP).
  - On arrival of the first downlink data packet for any QoS Flow, the UPF shall send Data Notification message to the SMF, if the SMF has not previously notified the UPF to not send the Data Notification to the SMF (in which case the next steps are skipped).
  - If the UPF receives downlink data packets for another QoS Flow in the same PDU Session, the UPF shall send another Data Notification message to the SMF.

- If the Paging Policy Differentiation feature (as specified in clause 5.4.3 of TS 23.501 [2]) is supported by the UPF and if the PDU Session type is IP, the UPF shall also include the DSCP in TOS (IPv4) / TC (IPv6) value from the IP header of the downlink data packet and the information to identify the QoS Flow for the DL data packet.

2b. SMF to UPF: Data Notification Ack.

2c. The UPF forwards the downlink data packets towards the SMF if the SMF instructed the UPF to do so (i.e. the SMF will buffer the data packets).

- If the Paging Policy Differentiation feature is supported by the SMF and if the PDU Session type is IP, the SMF determines the Paging Policy Indicator based on the DSCP in TOS (IPv4) / TC (IPv6) value from the IP header of the received downlink data packet and identifies the corresponding QoS Flow from the QFI of the received DL data packet.

3a. [Conditional] SMF to AMF: Namf\_Communication\_N1N2MessageTransfer (SUPI, PDU Session ID, N1 SM container (SM message), N2 SM information (QFI(s), QoS profile(s), CN N3 Tunnel Info, S-NSSAI), Area of validity for N2 SM information, ARP, Paging Policy Indicator, 5QI, N1N2TransferFailure Notification Target Address, Extended Buffering support), or NF to AMF: Namf\_Communication\_N1N2MessageTransfer (SUPI, N1 message).

The SMF shall not include both N1 SM Container and N2 SM Information in Namf\_Communication\_N1N2MessageTransfer unless the N1 SM Container is related to the N2 SM Information.

If this step is triggered by a notification from UPF, upon reception of a Data Notification message, for a PDU Session corresponding to a LADN, the SMF takes actions as specified in clause 5.6.5 of TS 23.501 [2]. The SMF may notify the UPF that originated the Data Notification to discard downlink data for the PDU Sessions and/or to not provide further Data Notification messages.

Otherwise, the SMF determines whether to contact the AMF. The SMF does not contact the AMF:

- if the SMF had previously been notified that the UE is unreachable; or
- if the UE is reachable only for regulatory prioritized service and the PDU Session is not for regulatory prioritized service.

The SMF determines the AMF and invokes the Namf\_Communication\_N1N2MessageTransfer to the AMF including the PDU Session ID of the PDU Session. If this step is triggered by a notification from the UPF in step 2a, the SMF determines the PDU Session ID based on the N4 Session ID received in step 2a.

The SMF determines whether Extended Buffering applies based on local policy and the capability of the SMF (for SMF-based buffering) or the capability of the UPF (for UPF-based buffering). If Extended Buffering applies, the SMF includes "Extended Buffering support" indication in Namf\_Communication\_N1N2MessageTransfer.

If the SMF, while waiting for the User Plane Connection to be activated, receives any additional Data Notification message or, in the case that the SMF buffers the data packets, additional data packets for a QoS Flow associated with a higher priority (i.e. ARP priority level) than the priority indicated to the AMF in the previous Namf\_Communication\_N1N2MessageTransfer, or the SMF derive a different Paging Policy Indicator according to the additional Data Notification or the DSCP of the data packet, the SMF invokes a new Namf\_Communication\_N1N2MessageTransfer indicating the higher priority or different Paging Policy Indicator to the AMF.

If the SMF, while waiting for the User Plane to be activated, receives a message from a new AMF other than the one to which the SMF invoked the Namf\_Communication\_N1N2MessageTransfer, the SMF re-invokes the Namf\_Communication\_N1N2MessageTransfer towards the new AMF.

When supporting Paging Policy Differentiation, the SMF determines the Paging Policy Indicator related to the downlink data that has been received from the UPF or triggered the Data Notification message, based on the DSCP as described in clause 5.4.3 of TS 23.501 [2] and indicates the Paging Policy Indicator in the Namf\_Communication\_N1N2MessageTransfer.

NOTE 1: AMF may receive request message(s) from other network functions which leads to signalling towards UE/RAN, e.g. Network-initiated Deregistration, SMF initiated PDU Session Modification. If the UE is in CM-CONNECTED state and the AMF only delivers N1 message towards UE, the flow continues in step 6 below.

The N2 SM information is optional and is not provided e.g. in the case that the SMF only wants to send an N1 message such as PDU Session Modification Command with only updating the UE with a PCO.

3b. [conditional] The AMF responds to the SMF.

If the UE is in CM-IDLE state at the AMF and the AMF is able to page the UE the AMF sends a Namf\_Communication\_N1N2MessageTransfer response to the SMF immediately to indicate to the SMF that AMF is attempting to reach UE and the N2 SM information provided in step 3a, may be ignored by the AMF once the UE is reachable and the SMF may be asked to provide the N2 SM information again.

While waiting for the UE to respond to a previous paging request, if the AMF receives an Namf\_Communication\_N1N2MessageTransfer Request message with the same or a lower priority than the previous message triggering the paging, or if the AMF has determined not to trigger additional paging requests for this UE based on local policy, the AMF rejects the Namf\_Communication\_N1N2MessageTransfer Request message.

If the UE is in CM-CONNECTED state at the AMF then the AMF sends a Namf\_Communication\_N1N2MessageTransfer response to the SMF immediately to indicate that the N1/N2 message has been sent out.

If the UE is in CM-IDLE state and the AMF determines that the UE is not reachable for paging, the AMF shall send an Namf\_Communication\_N1N2MessageTransfer response to the NF from which AMF received the request message in step 3a to indicate that the UE is not reachable, or the AMF performs asynchronous type communication and stores the UE context based on the received message, it shall send an Namf\_Communication\_N1N2MessageTransfer response to indicate that asynchronous type communication is invoked. If asynchronous type communication is invoked, the AMF initiates communication with the UE and (R)AN when the UE is reachable e.g. when the UE enters CM-CONNECTED state.

If the AMF has determined the UE is unreachable for the SMF (e.g. due to the UE in MICO mode, the UE using extended idle mode DRX or the UE is only registered over non-3GPP access and its state is CM-IDLE), then the AMF rejects the request from the SMF. The AMF may include in the reject message an indication that the SMF need not trigger the Namf\_Communication\_N1N2MessageTransfer Request to the AMF, if the SMF has not subscribed to the event of the UE reachability. If the SMF included the Extended Buffering Support indication, the AMF indicates the Estimated Maximum Wait time, in the reject message, for the SMF to determine the Extended Buffering time. If the UE is in MICO mode, the AMF determines the Estimated Maximum Wait time based on the next expected periodic registration by the UE or by implementation. If the UE is using extended idle mode DRX, the AMF determines the Estimated Maximum Wait time based on the start of the next Paging Time Window. The AMF stores an indication that the SMF has been informed that the UE is unreachable.

If the AMF has determined the UE is reachable and the AMF detects the UE is in a Non-Allowed Area unless the request from the SMF is for regulatory prioritized service, the AMF rejects the request from the SMF and notifies the SMF that the UE is reachable only for regulatory prioritized service. The AMF stores an indication that the SMF has been informed that the UE is reachable only for regulatory prioritized service.

If the Registration procedure with AMF change is in progress when the old AMF receives the Namf\_Communication\_N1N2MessageTransfer, the old AMF may reject the request with an indication that the Namf\_Communication\_N1N2MessageTransfer has been temporarily rejected.

Upon reception of an Namf\_Communication\_N1N2MessageTransfer response with an indication that its request has been temporarily rejected, the SMF shall start a locally configured guard timer and wait for any message to come from an AMF. Upon reception of a message from an AMF, the SMF shall re-invoke the Namf\_Communication\_N1N2MessageTransfer (with N2 SM info and/or N1 SM info) to the AMF from which it received the message. Otherwise the SMF takes the step 3c at expiry of the guard timer. If the SMF decides that the control plane buffering applies, the SMF shall request UPF to start forwarding the downlink data PDU towards the SMF.

3c. [Conditional] SMF responds to the UPF

SMF may notify the UPF about the User Plane setup failure.

If the SMF receives an indication from the AMF that the UE is unreachable or reachable only for regulatory prioritized service and the SMF determines that Extended Buffering does not apply, the SMF may, based on network policies, either:

- indicate to the UPF to stop sending Data Notifications;
- indicate to the UPF to stop buffering DL data and discard the buffered data;
- indicate to the UPF to stop sending Data Notifications and stop buffering DL data and discard the buffered data; or
- refrains from sending further Namf\_Communication\_N1N2MessageTransfer message for DL data to the AMF while the UE is unreachable.

Then the SMF subscribes to the AMF for UE reachability event notifications.

Based on operator policies, the SMF applies the pause of charging procedure as specified in clause 4.4.4.

If the SMF receives an indication from the AMF that the Namf\_Communication\_N1N2MessageTransfer message requested from an SMF has been temporarily rejected, the SMF may, based on network policies, indicate to the UPF to apply temporary buffering.

If the SMF receives an "Estimated Maximum Wait time" from the AMF and Extended Buffering applies, the SMF may either:

- If the DL data buffering in the SMF applies, store the DL Data for an Extended Buffering time. The SMF does not send any additional Namf\_Communication\_N1N2MessageTransfer message if subsequent downlink data packets are received. If the Extended Buffering timer expires, the SMF discards the buffered downlink data.
- If the DL data buffering in the UPF applies, send a Failure indication with an indication to the UPF to buffer the DL data with an Extended Buffering time and optionally a DL Buffering Suggested Packet Count. The Suggested Number of Downlink Packets network configuration parameter (if available) may be used to derive the value for DL Buffering Suggested Packet Count. The SMF may also indicate to the UPF to stop sending Data Notifications.

The Extended Buffering time is determined by the SMF and should be larger or equal to the Estimated Maximum Wait time received from the AMF.

If the UPF receives an Extended Buffering indication from the SMF, the UPF initiates Extended Buffering of the downlink data and starts an Extended Buffering timer. If the Extended Buffering timer expires, the UPF discards the buffered downlink data.

4a. [Conditional] If the UE is in CM-CONNECTED state in the access associated with the PDU Session ID received from the SMF in step 3a, the steps 4 to 22 in UE Triggered Service Request procedure (see clause 4.2.3.2) are performed for this PDU Session (i.e. establish the radio resources and, in the case that the User Plane is to be activated, to establish the N3 tunnel) without sending a Paging message to the (R)AN node and the UE. In step 12 of clause 4.2.3.2, the AMF does not send the NAS Service Accept message to the UE. The rest of this procedure is omitted.

4b. [Conditional] If the UE is in CM-IDLE state in 3GPP access and the PDU Session ID received from the SMF in step 3a has been associated with 3GPP access and based on local policy the AMF decides to notify the UE through 3GPP access even when UE is in CM-CONNECTED state for non-3GPP access, the AMF may send a Paging message to NG-RAN node(s) via 3GPP access.

If the UE is simultaneously registered over 3GPP and non-3GPP accesses in the same PLMN, the UE is in CM-IDLE state in both 3GPP access and non-3GPP access and the PDU Session ID in step 3a is associated with non-3GPP access, the AMF sends a Paging message with associated access "non-3GPP" to NG-RAN node(s) via 3GPP access.

If the UE is in RM-REGISTERED state and CM-IDLE and reachable in 3GPP access, the AMF sends a Paging message (NAS ID for paging, Registration Area list, Paging DRX length, Paging Priority, access associated to the PDU Session, Enhanced Coverage Restricted information, WUS Assistance Information) to (R)AN node(s) belonging to the Registration Area(s) in which the UE is registered, then the NG-RAN node pages the UE, including the access associated to the PDU Session in the paging message if received from the AMF, see



TS 38.331 [12]. If extended idle mode DRX was accepted by the AMF in the last registration procedure, the AMF includes extended idle mode DRX cycle length and Paging Time Window in the Paging message. The AMF shall ensure that the correct Paging DRX length is provided based on the accepted UE Specific DRX of the current RAT.

NOTE 2: The usage of the Access associated with a PDU Session when paging an UE is defined in clause 5.6.8 of TS 23.501 [2].

NOTE 3: This step is performed also when the UE and the network support User Plane CIoT 5GS Optimisation and the previous RRC connection has been suspended.

Different paging strategies may be configured in the AMF for different combinations of DNN, Paging Policy Indicator (if supported), ARP and 5QI.

For RRC-inactive state, the paging strategies may be configured in the (R)AN for different combinations of Paging Policy Indicator, ARP and 5QI.

Paging Priority is included only:

- if the AMF receives an `Namf_Communication_N1N2MessageTransfer` message with an ARP value associated with priority services (e.g. MPS, MCS), as configured by the operator.
- One Paging Priority level can be used for multiple ARP values. The mapping of ARP values to Paging Priority level (or levels) is configured by operator policy in the AMF and in NG-RAN.

The (R)AN may prioritise the paging of UEs according to the Paging Priority.

If the AMF, while waiting for a UE response to the Paging Request message sent without Paging Priority, receives an `Namf_Communication_N1N2MessageTransfer` message, which indicates an ARP value associated with priority services (e.g. MPS, MCS), as configured by the operator, the AMF shall send another paging message with the suitable Paging Priority. For subsequent received `Namf_Communication_N1N2MessageTransfer` messages with the same or higher priority, the AMF may determine whether to send the Paging message with suitable Paging Priority based on local policy.

Paging strategies may include:

- paging retransmission scheme (e.g. how frequently the paging is repeated or with what time interval);
- determining whether to send the Paging message to the (R)AN nodes during certain AMF high load conditions;
- whether to apply sub-area based paging (e.g. first page in the last known cell-id or TA and retransmission in all registered TAs).

NOTE 4: Setting of Paging Priority in the Paging message is independent from any paging strategy.

The AMF and the (R)AN may support further paging optimisations in order to reduce the signalling load and the network resources used to successfully page a UE by one or several of the following means:

- by the AMF implementing specific paging strategies (e.g. the N2 Paging message is sent to the (R)AN nodes that served the UE last);
- by the AMF considering Information On Recommended Cells And NG-RAN nodes provided by the (R)AN at transition to CM-IDLE state. The AMF takes the (R)AN nodes related part of this information into account to determine the (R)AN nodes to be paged and provides the information on recommended cells within the N2 Paging message to each of these (R)AN nodes;
- by the (R)AN considering the Paging Attempt Count Information provided by the AMF at paging.

If the UE Radio Capability for Paging Information is available in the AMF, the AMF adds the UE Radio Capability for Paging Information in the N2 Paging message to the (R)AN nodes.

If the Information On Recommended Cells And (R)AN nodes For Paging is available in the AMF, the AMF shall take that information into account to determine the (R)AN nodes for paging and, when paging a (R)AN node, the AMF may transparently convey the information on recommended cells to the (R)AN node.

The AMF may include in the N2 Paging message(s) the paging attempt count information. The paging attempt count information shall be the same for all (R)AN nodes selected by the AMF for paging.

If the AMF has Paging Assistance Data for CE capable UE stored in the UE Context in AMF and Enhanced Coverage is not restricted for the UE then the AMF shall include Paging Assistance Data for CE capable UE in the N2 paging message for all NG-RAN nodes selected by the AMF for paging.

The AMF may include in the N2 Paging message(s) the WUS Assistance Information, if available. If the WUS Assistance Information is included by the N2 Paging message, the NG-eNB takes it into account when paging the UE (see TS 36.300 [46]).

The AMF may include in the N2 paging message the PLMN ID(s) of Serving PLMN and equivalent PLMN(s) supported by NG-RAN and corresponding CAG information per PLMN ID which including an Allowed CAG list and optionally an indication whether the UE is only allowed to access 5GS via CAG cells, if available. If the above information is included in N2 paging message, the NG-RAN node may take it into account when determining the cells where paging will be performed (see TS 38.413 [10]).

If the UE and NG-eNB support WUS, then:

- if the NGAP Paging message contains the *Assistance Data for Recommended Cells* IE (see TS 38.413 [10]), the NG-eNB shall only broadcast the UE's Wake Up Signal in the last used cell;
- else (i.e. the *Assistance Data for Recommended Cells* IE is not included in the NGAP Paging message) the eNodeB should not broadcast the UE's Wake Up Signal.

- 4c. [Conditional] If the UE is simultaneously registered over 3GPP and non-3GPP accesses in the same PLMN and the UE is in CM-CONNECTED state in 3GPP access and the PDU Session ID in step 3a is associated with non-3GPP access, the AMF sends a NAS Notification message containing the non-3GPP Access Type to the UE over 3GPP access and sets a Notification timer. Step 5 is omitted.

If the UE is simultaneously registered over 3GPP and non-3GPP accesses in the same PLMN and the UE is in CM-CONNECTED state for non-3GPP access and in CM-IDLE for 3GPP access and if the PDU Session ID in step 3a is associated with 3GPP access and based on local policy the AMF decides to notify the UE through non-3GPP access, the AMF may send a NAS Notification message containing the 3GPP Access Type to the UE over non-3GPP access and sets a Notification timer.

NOTE 5: This step is performed also when the UE and the network support User Plane CIoT 5GS Optimisation in 3GPP access and the previous RRC connection has been suspended.

5. [Conditional] AMF to SMF: Namf\_Communication\_N1N2Transfer Failure Notification.

The AMF supervises the paging procedure with a timer. If the AMF receives no response from the UE to the Paging Request message, the AMF may apply further paging according to any applicable paging strategy described in step 4b.

The AMF notifies the SMF by sending Namf\_Communications\_N1N2MessageTransfer Failure Notification to the Notification Target Address provided by the SMF in step 3a if the UE does not respond to paging, unless the AMF is aware of an ongoing MM procedure that prevents the UE from responding, i.e. the AMF receives an N14 Context Request message indicating that the UE performs Registration procedure with another AMF.

When a Namf\_Communication\_N1N2Transfer Failure Notification is received, SMF informs the UPF (if applicable).

Procedure for pause of charging at SMF is specified in clause 4.4.4.

6. If the UE is in CM-IDLE state in 3GPP access, upon reception of paging request for a PDU Session associated to 3GPP access, the UE shall initiate the UE Triggered Service Request procedure (clause 4.2.3.2) or, if the UE is enabled to use User Plane CIoT 5GS Optimisation and there is suspended access stratum context stored in the UE, the UE initiates the Connection Resume in CM-IDLE with Suspend procedure (clause 4.8.2.3). To support the buffered data forwarding, the SMF instruct the UPF to establish a Data forwarding tunnel between the old UPF and the new UPF or to the PSA as described at steps 6a, 7a, 8a of clause 4.2.3.2.

If the UE is in CM-IDLE state in both non-3GPP and 3GPP accesses, upon reception of paging request for a PDU Session associated to non-3GPP access, the UE shall initiate the UE Triggered Service Request procedure (clause 4.2.3.2) which shall contain the List Of Allowed PDU Sessions that, according to UE policies and

whether the S-NSSAIs of these PDU Sessions are within the Allowed NSSAI for 3GPP access, can be re-activated over the 3GPP access. If there is no PDU Session that can be re-activated over the 3GPP access, the UE includes an empty List Of Allowed PDU Sessions. If the AMF receives a Service Request message from the UE via non-3GPP access as described in clause 4.12.4.1 (e.g. because the UE successfully connects to a non-3GPP access), the AMF stops the paging procedure and processes the received Service Request procedure. If the AMF receives the Service Request message and the List Of Allowed PDU Sessions provided by the UE does not include the PDU Session for which the UE was paged, the AMF notifies the SMF that the UE was reachable but did not accept to re-activate the PDU Session by invoking Namf\_EventExposure\_Notify service as described in step 4 of clause 4.2.3.2.

If the UE is in CM-IDLE state in non-3GPP access and in CM-CONNECTED state in 3GPP access, upon reception of NAS Notification message over 3GPP access containing the non-3GPP Access Type, the UE shall initiate the UE Triggered Service Request procedure (clause 4.2.3.2) with the List Of Allowed PDU Sessions that, according to UE policies and whether the S-NSSAIs of these PDU Sessions are within the Allowed NSSAI for 3GPP access, can be re-activated over the 3GPP access. If there is no PDU Session that can be re-activated over the 3GPP access, the UE include an empty List Of Allowed PDU Sessions. When the AMF receives the Service Request message and the List of Allowed PDU Sessions provided by the UE does not include the PDU Session for which the UE was notified, the AMF notifies the SMF that the UE was reachable but did not accept to re-activate the PDU Session by invoking Namf\_EventExposure\_Notify service. If the AMF receives a Service Request message from the UE via non-3GPP access as described in clause 4.12.4.1 (e.g. because the UE successfully connects to a non-3GPP access), the AMF stops the Notification timer and processes the received Service Request procedure.

- Alternatively, if the UE is in CM-IDLE state in non-3GPP access with the Mobility Management back-off timer running, upon reception of Paging Message over 3GPP access containing the non-3GPP Access Type, the UE on stopping the back-off timer (for both accesses), shall initiate the UE Triggered Service Request procedure (clause 4.12.4.1) over non-3GPP access if non-3GPP access is available. When the AMF receives a Service Request message from the UE via non-3GPP access, the AMF stops the Paging timer and processes the received Service Request.

NOTE 6: A scenario where the UE is CM-IDLE over non-3GPP access and yet non-3GPP access is available, is when the UE over the non-3GPP access is running the Mobility Management back-off timer and network has released the NAS signalling connection upon service reject.

If the UE is in CM-IDLE state in 3GPP access and in CM-CONNECTED state in non-3GPP access, upon reception of NAS Notification message over non-3GPP access identifying the 3GPP access type, the UE shall initiate the UE triggered Service Request procedure (clause 4.2.3.2) over the 3GPP access when 3GPP access is available. If the AMF does not receive the Service Request message before Notification timer expires, the AMF may either page the UE through 3GPP access or notify the SMF that the UE was not able to re-activate the PDU Session.

The User Plane of all PDU Sessions for URLLC shall be activated during the Service Request procedure if the UE initiates the Service Request from 3GPP access in CM-IDLE state as described in clause 4.2.3.2.

7. If the AMF has paged the UE to trigger the Service Request Procedure, the AMF shall initiate the UE configuration update procedure as defined in clause 4.2.4.2 to assign a new 5G-GUTI.
8. The UPF transmits the buffered downlink data toward UE via (R)AN node which performed the Service Request procedure. If data is buffered in the SMF, the SMF delivers buffered downlink data to the UPF.

The network also sends downlink signalling to the UE if the procedure is triggered due to request from other NFs, as described in step 3a.

## 4.2.4 UE Configuration Update

### 4.2.4.1 General

UE configuration may be updated by the network at any time using UE Configuration Update procedure. UE configuration includes:

- Access and Mobility Management related parameters decided and provided by the AMF. This includes the Configured NSSAI and its mapping to the Subscribed S-NSSAIs, the Allowed NSSAI and its mapping to Subscribed S-NSSAIs, the Service Gap time, the list of Rejected NSSAIs if the UE Configuration Update

procedure is triggered by the AMF after Network Slice-Specific Authentication and Authorization of S-NSSAIs, the Truncated 5G-S-TMSI Configuration. If the UE and the AMF support RACS, this may also include a PLMN-assigned UE Radio Capability ID or alternatively a PLMN-assigned UE Radio Capability ID deletion indication.

- UE Policy provided by the PCF.

When AMF wants to change the UE configuration for access and mobility management related parameters the AMF initiates the procedure defined in clause 4.2.4.2. When the PCF wants to change or provide new UE Policies in the UE, the PCF initiates the procedure defined in clause 4.2.4.3.

If the UE Configuration Update procedure requires the UE to initiate a Registration procedure, the AMF indicates this to the UE explicitly.

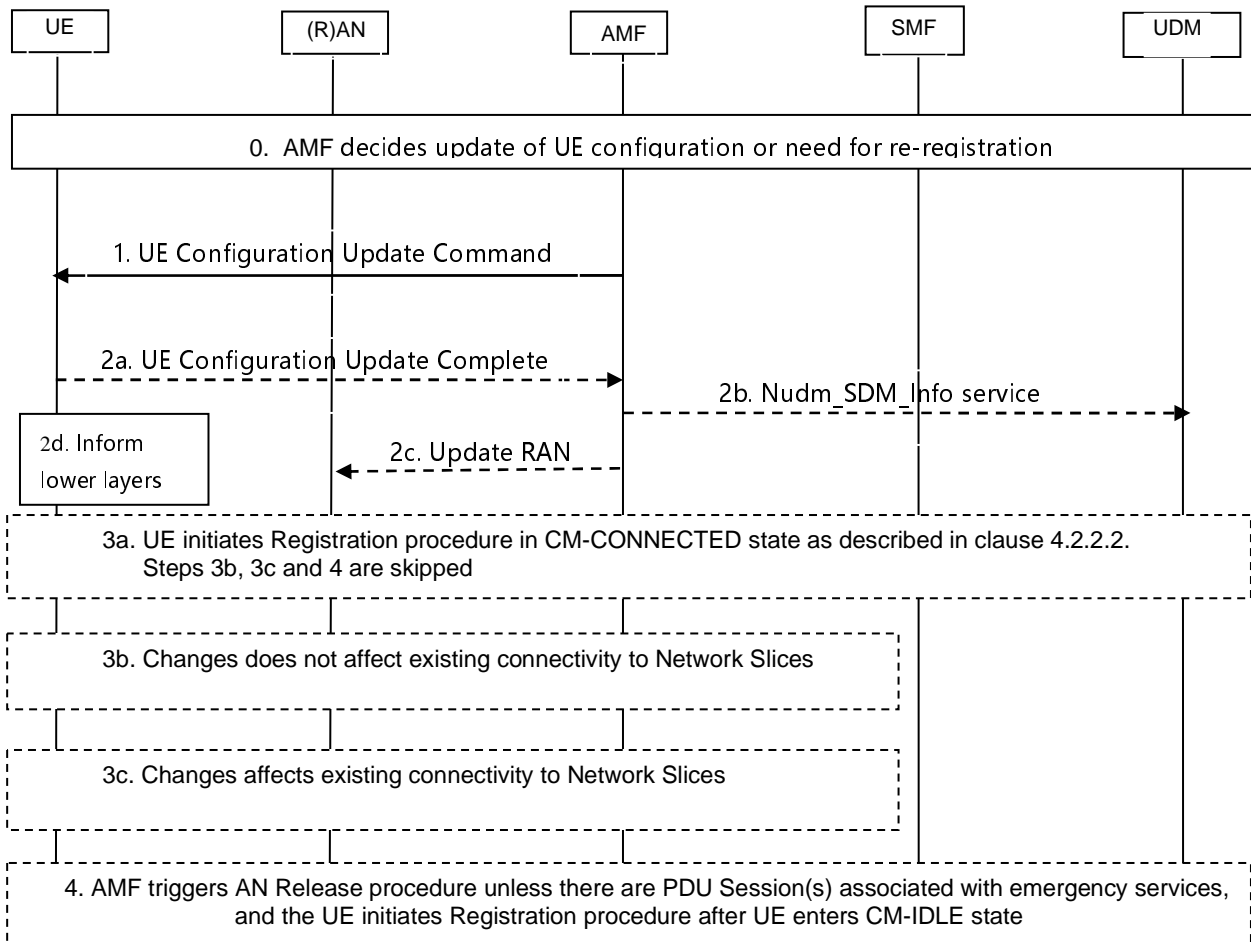
The procedure in clause 4.2.4.2 may be triggered also when the AAA Server that performed Network Slice-Specific Authentication and Authorization for an S-NSSAI revokes the authorization.

#### 4.2.4.2 UE Configuration Update procedure for access and mobility management related parameters

This procedure is initiated by the AMF when the AMF wants to update access and mobility management related parameters in the UE configuration.

This procedure is also used to trigger UE to perform, based on network indication, either Mobility Registration Update procedure while the UE is in CM-CONNECTED state to modify NAS parameters that require negotiation (e.g. MICO mode) or to steer the UE towards EPC as specified in clause 5.31.3 of TS 23.501 [2], or Mobility Registration Update procedure after the UE enters CM-IDLE state (e.g. for changes to Allowed NSSAI that require re-registration). If a Registration procedure is needed, the AMF provides an indication to the UE to initiate a Registration procedure.

UE Configuration Update shall be sent over the Access Type (i.e. 3GPP access or non-3GPP access) the UE Configuration Update is applied to, when applicable. If the AMF wants to update NAS parameters in the UE which require UE acknowledgement, then the AMF provides an indication to the UE of whether the UE shall acknowledge the command or not. The AMF should not request acknowledgement of the NITZ command. The AMF shall request acknowledgement for NSSAI information (e.g. Allowed NSSAI), 5G-GUTI, TAI List and Mobility Restrictions, LADN Information, MICO, Operator-defined access category definitions, PLMN-assigned UE Radio Capability ID and SMS subscription.



**Figure 4.2.4.2-1: UE Configuration Update procedure for access and mobility management related parameters**

0. AMF determines the necessity of UE configuration change due to various reasons (e.g. UE mobility change, NW policy, reception of Subscriber Data Update Notification from UDM, change of Network Slice configuration, need to assign PLMN-assigned UE Radio Capability ID, change of Enhanced Coverage Restriction information in the UE context) or that the UE needs to perform a Registration Procedure. If a UE is in CM-IDLE, the AMF can wait until the UE is in CM-CONNECTED state or triggers Network Triggered Service Request (in clause 4.2.3.3).

NOTE 1: It is up to the network implementation whether the AMF can wait until the UE is in CM-CONNECTED state or trigger the Network Triggered Service Request.

NOTE 2: The AMF can check whether Network Slice configuration needs to be updated by using the Nnssf\_NSSelection\_Get service operation and in such case the AMF compares the stored information with the output from the NSSF to decide whether an update of the UE is required.

The AMF may include Mobility Restriction List in N2 message that delivers UE Configuration Update Command to the UE if the service area restriction for the UE is updated.

1. The AMF sends UE Configuration Update Command containing one or more UE parameters (Configuration Update Indication, 5G-GUTI, TAI List, Allowed NSSAI, Mapping Of Allowed NSSAI, Configured NSSAI for the Serving PLMN, Mapping Of Configured NSSAI, rejected S-NSSAIs, NITZ, Mobility Restrictions, LADN Information, MICO, Operator-defined access category definitions, SMS Subscribed Indication, [PLMN-assigned UE Radio Capability ID], [PLMN-assigned UE Radio Capability ID deletion indication]) to UE. Optionally, the AMF may update the rejected S-NSSAIs in the UE Configuration Update command.

The AMF includes one or more of 5G-GUTI, TAI List, Allowed NSSAI, Mapping Of Allowed NSSAI, Configured NSSAI for the Serving PLMN, Mapping Of Configured NSSAI, rejected S-NSSAIs, NITZ (Network Identity and Time Zone), Mobility Restrictions parameters, LADN Information, Operator-defined access

category definitions, PLMN-assigned UE Radio Capability ID, or SMS Subscribed Indication if the AMF wants to update these NAS parameters without triggering a UE Registration procedure.

The AMF may include in the UE Configuration Update Command also Configuration Update Indication parameters indicating whether:

- Network Slicing Subscription Change has occurred;
- the UE shall acknowledge the command; and
- whether a Registration procedure is requested.

If the AMF indicates Network Slicing Subscription Change, then the UE shall locally erase all the network slicing configuration for all PLMNs and, if applicable, update the configuration for the current PLMN based on any received information. If the AMF indicates Network Slicing Subscription Change, the UE shall also be requested to acknowledge in step 2.

If the AMF also includes in the UE Configuration Update Command message a new Configured NSSAI for the Serving PLMN, then the AMF should also include a new Allowed NSSAI with, if available, the associated Mapping Of Allowed NSSAI, unless the AMF cannot determine the new Allowed NSSAI after the Subscribed S-NSSAI(s) are updated, in which case the AMF does not include in the UE Configuration Update Command message any Allowed NSSAI.

When the UE and the AMF supports RACS as defined in clause 5.4.4.1a of TS 23.501 [2] and the AMF needs to configure the UE with a UE Radio Capability ID and the AMF already has the UE radio capabilities other than NB-IoT radio capabilities for the UE and, the AMF may provide the UE with the UE Radio Capability ID for the UE radio capabilities the UCMF returns to the AMF in a Nucmf\_assign service operation for this UE.

- 2a. If the UE Configuration Update Indication requires acknowledgement of the UE Configuration Update Command, then the UE shall send a UE Configuration Update complete message to the AMF. The AMF should request acknowledgement for all UE Configuration Updates, except when only NITZ is provided. If Registration procedure is not required, steps 3a, 3b, 3c and step 4 are skipped. If the Configuration Update Indication is included in the UE Configuration Update Command message and it requires a Registration procedure, depending on the other NAS parameters included in the UE Configuration Update command, the UE shall execute steps 3a or 3b or 3c+4 as applicable.

If the PLMN-assigned UE Radio Capability ID is included in step 1, the AMF stores the UE Radio Capability ID in UE context if receiving UE Configuration Update complete message.

If the UE receives PLMN-assigned UE Radio Capability ID deletion indication in step 1, the UE shall delete the PLMN-assigned UE Radio Capability ID(s) for this PLMN. If UE Configuration Update is only for this purpose, the following steps are skipped.

- 2b. [Conditional] The AMF also uses the Nudm\_SDM\_Info service operation to provide an acknowledgment to UDM that the UE received CAG information as part of the Mobility Restrictions (if the CAG information was updated), or the Network Slicing Subscription Change Indication (if this was indicated in step 1) and acted upon it.
- 2c. [Conditional] If the AMF has reconfigured the 5G-GUTI over 3GPP access, the AMF informs the NG-RAN of the new UE Identity Index Value (derived from the new 5G-GUTI) when the AMF receives the acknowledgement from the UE in step 2a.

[Conditional] If the UE is registered to the same PLMN via both 3GPP and non-3GPP access and if the AMF has reconfigured the 5G-GUTI over non-3GPP access and the UE is in CM-CONNECTED state over 3GPP access, then the AMF informs the NG-RAN of the new UE Identity Index Value (derived from the new 5G-GUTI) when the AMF receives the acknowledgement from the UE in step 2a.

[Conditional] If the AMF has configured the UE with a PLMN-assigned UE Radio Capability ID, the AMF informs NG-RAN of the UE Radio Capability ID, when it receives the acknowledgement from the UE in step 2a.

[Conditional] If the Mobility Restrictions for the UE were updated and the Mobility Restrictions were not provided in the N2 message that delivers the UE Configuration Update Command, the AMF provides the NG-RAN with updated Mobility Restrictions unless the AMF releases the UE in this step (see below).

If the AMF initiated the UE Configuration Update procedure due to receiving Nudm\_SDM\_Notification and the CAG information has changed such that a CAG Identifier has been removed from the Allowed CAG list or the UE is only allowed to access CAG cells, the AMF shall release the NAS signalling connection by triggering the AN release procedure for UEs that are not receiving Emergency Services as defined in TS 23.501 [2].

NOTE 3: When the UE is accessing the network for emergency service the conditions in clause 5.16.4.3 of TS 23.501 [2] apply.

2d [Conditional] If the UE is configured with a new 5G-GUTI in step 2a via non-3GPP access and the UE is registered to the same PLMN via both 3GPP and non-3GPP access, then the UE passes the new 5G-GUTI to its 3GPP access' lower layers.

If the UE is configured with a new 5G-GUTI in step 2a over the 3GPP access, the UE passes the new 5G-GUTI to its 3GPP access' lower layers.

NOTE 4: Steps 2c and 2d are needed because the NG-RAN may use the RRC Inactive state and a part of the 5G-GUTI is used to calculate the Paging Frame (see TS 38.304 [44] and TS 36.304 [43]). It is assumed that the UE Configuration Update Complete is reliably delivered to the AMF after the 5G-AN has acknowledged its receipt to the UE.

3a. [Conditional] If only NAS parameters that can be updated without transition from CM-IDLE are included (e.g. MICO mode, Enhanced Coverage Restricted information) the UE shall initiate a Registration procedure immediately after the acknowledgement to re-negotiate the updated NAS parameter(s) with the network. Steps 3b, 3c and step 4 are skipped.

3b. [Conditional] If a new Allowed NSSAI and/or a new Mapping Of Allowed NSSAI and/or a new Configured NSSAI provided by the AMF to the UE in step 1 does not affect the existing connectivity to Network Slices (i.e. any S-NSSAI(s) the UE is connected to), the AMF needs not release the NAS signalling connection for the UE after receiving the acknowledgement in step 2 and immediate registration is not required. The UE can start immediately using the new Allowed NSSAI and/or the new Mapping Of Allowed NSSAI. The UE cannot connect to an S-NSSAI included in the new Configured NSSAI for the Serving PLMN but not included in the new Allowed NSSAI until the UE performs a Registration procedure and includes a Requested NSSAI based on the new Configured NSSAI, following the requirements described in clause 5.15.5.2 of TS 23.501 [2]. Steps 3c and 4 are skipped.

The AMF may, based on its policy, provide anyway an indication that a Registration procedure is required even though the UE Configuration Update Command in step 1 does not affect the existing connectivity to Network Slices: in such a case only step 3c is skipped.

3c. [Conditional] If a new Allowed NSSAI and/or a new Mapping Of Allowed NSSAI and/or a new Configured NSSAI provided by the AMF to the UE in step 1 affects ongoing existing connectivity to Network Slices, then the AMF shall provide an indication that the UE shall initiate a Registration procedure.

4. [Conditional] After receiving the acknowledgement in step 2, the AMF shall release the NAS signalling connection for the UE, unless there is one established PDU Sessions associated with regulatory prioritized services. If there is one established PDU Session associated with regulatory prioritized services, the AMF informs SMFs to release the PDU Session(s) associated with non regulatory prioritized services for this UE (see clause 4.3.4).

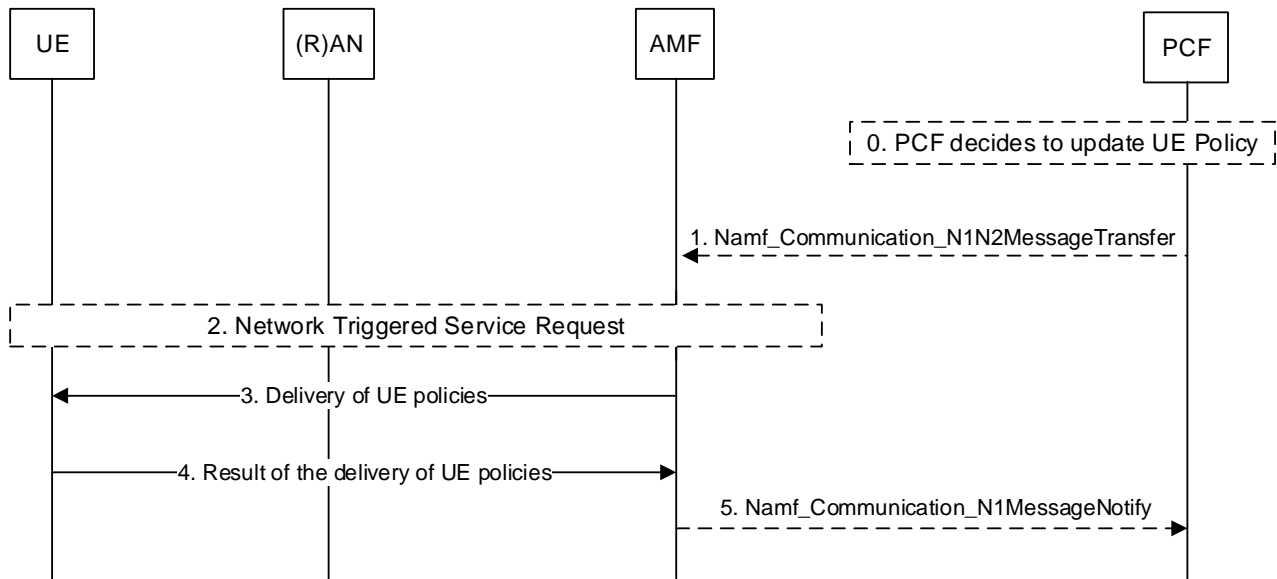
The AMF shall reject any NAS Message from the UE carrying PDU Session Establishment Request for a non-emergency PDU Session before the required Registration procedure has been successfully completed by the UE.

The UE initiates a Registration procedure (see clauses 4.2.2.2.2 and 4.13.3.1) with registration type Mobility Registration Update after the UE enters CM-IDLE state and shall not include the 5G-S-TMSI or GUAMI in Access Stratum signalling and shall include, subject to the conditions set out in clause 5.15.9 of TS 23.501 [2], a Requested NSSAI in access stratum signalling. If there is an established PDU Session associated with emergency service and the UE has received an indication to perform the Registration procedure, the UE shall initiate the Registration procedure only after the PDU Session associated with emergency service is released.

NOTE 5: Receiving UE Configuration Update command without an indication requesting to perform re-registration, can still trigger Registration procedure by the UE for other reasons.

#### 4.2.4.3 UE Configuration Update procedure for transparent UE Policy delivery

This procedure is initiated when the PCF wants to update UE policy information (i.e. UE policy) in the UE configuration. In the non-roaming case the V-PCF is not involved and the role of the H-PCF is performed by the PCF. For the roaming scenarios, the V-PCF interacts with the AMF and the H-PCF interacts with the V-PCF.



**Figure 4.2.4.3-1: UE Configuration Update procedure for transparent UE Policy delivery**

0. PCF decides to update UE policy based on triggering conditions such as an initial registration, registration with 5GS when the UE moves from EPS to 5GS, or need for updating UE policy as follows:
- For the case of initial registration and registration with 5GS when the UE moves from EPS to 5GS, the PCF compares the list of PSIs included in the UE policy information in Npcf\_UEPolicyControl\_Create request and determines, as described in clause 6.1.2.2.2 of TS 23.503 [20], whether UE policy information have to be updated and be provided to the UE via the AMF using DL NAS TRANSPORT message; and
  - For the network triggered UE policy update case (e.g. the change of UE location, the change of Subscribed S-NSSAIs as described in clause 6.1.2.2.2 of TS 23.503 [20]), the PCF checks the latest list of PSIs to decide which UE policies have to be sent to the UE.

The PCF checks if the size of the resulting UE policy information exceeds a predefined limit:

- If the size is under the limit, then UE policy information are included in a single Namf\_Communication\_N1N2MessageTransfer service operation as described below.
- If the size exceeds the predefined limit, the PCF splits the UE policy information in smaller, logically independent UE policy information ensuring the size of each is under the predefined limit. Each UE policy information will be then sent in separated Namf\_Communication\_N1N2MessageTransfer service operations as described below.

NOTE 1: NAS messages from AMF to UE do not exceed the maximum size limit allowed in NG-RAN (PDCP layer), so the predefined size limit in PCF is related to that limitation.

NOTE 2: The mechanism used to split the UE policy information is described in TS 29.507 [32].

1. PCF invokes Namf\_Communication\_N1N2MessageTransfer service operation provided by the AMF. The message includes SUPI, UE Policy Container.
2. If the UE is registered and reachable by AMF in either 3GPP access or non-3GPP access, AMF shall transfers transparently the UE Policy container to the UE via the registered and reachable access.

If the UE is registered in both 3GPP and non-3GPP accesses and reachable on both access and served by the same AMF, the AMF transfers transparently the UE Policy container to the UE via one of the accesses based on the AMF local policy.



If the UE is not reachable by AMF over both 3GPP access and non-3GPP access, the AMF reports to the PCF that the UE Policy container could not be delivered to the UE using `Namf_Communication_N1N2TransferFailureNotification` as in the step 5 in clause 4.2.3.3.

If AMF decides to transfer transparently the UE Policy container to the UE via 3GPP access, e.g. the UE is registered and reachable by AMF in 3GPP access only, or if the UE is registered and reachable by AMF in both 3GPP and non-3GPP accesses served by the same AMF and the AMF decides to transfer transparently the UE Policy container to the UE via 3GPP access based on local policy and the UE is in CM-IDLE and reachable by AMF in 3GPP access, the AMF starts the paging procedure by sending a Paging message described in the step 4b of Network Triggered Service Request (in clause 4.2.3.3). Upon reception of paging request, the UE shall initiate the UE Triggered Service Request procedure (clause 4.2.3.2).

3. If the UE is in CM-CONNECTED over 3GPP access or non-3GPP access, the AMF transfers transparently the UE Policy container (UE policy information) received from the PCF to the UE. The UE Policy container includes the list of Policy Sections as described in TS 23.503 [20].
4. The UE updates the UE policy provided by the PCF and sends the result to the AMF.
5. If the AMF received the UE Policy container and the PCF subscribed to be notified of the reception of the UE Policy container then the AMF forwards the response of the UE to the PCF using `Namf_Communication_N1MessageNotify`.

The PCF maintains the latest list of PSIs delivered to the UE and updates the latest list of PSIs in the UDR by invoking `Nudr_DM_Update` (SUPI, Policy Data, Policy Set Entry, updated PSI data) service operation.

If the PCF is notified about UE Policy delivery failure the PCF may initiate UE Policy Association Modification procedure to provide a new trigger "Connectivity state changes" in Policy Control Request Trigger of UE Policy Association to AMF as defined in clause 4.16.12.2.

NOTE 3: For backward compatibility the PCF may subscribe the "Connectivity state changes (IDLE or CONNECTED)" event in Rel-15 AMF as defined in clause 5.2.2.3.

## 4.2.5 Reachability procedures

### 4.2.5.1 General

Elements of this procedure are used for UDM/NF initiated UE Reachability Notification requests, e.g. for "SMS over NAS".

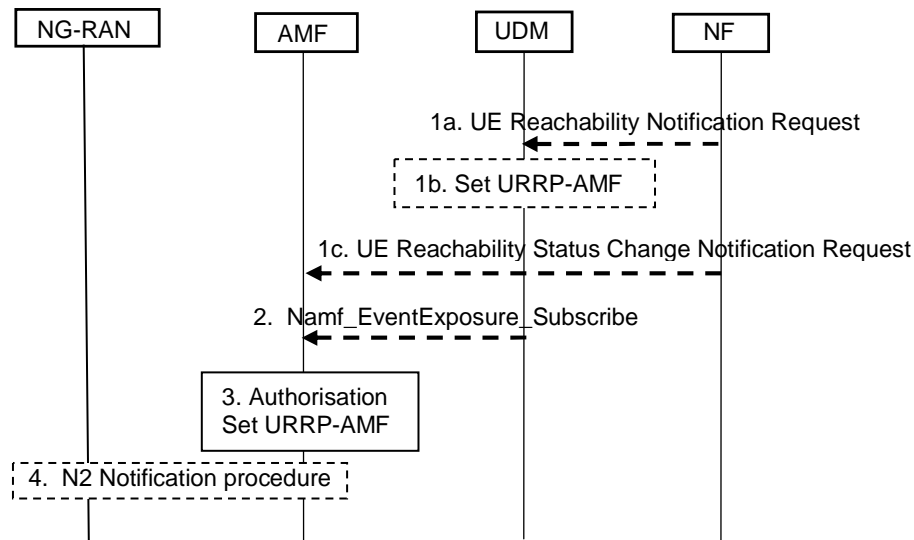
The procedure applies to UEs that are in RRC-Idle, RRC-Inactive and RRC-Connected states.

There are two procedures necessary for any service related entity that would need to be notified by the reachability of the UE:

- UE Reachability Notification Request procedure; and
- UE Activity Notification procedure.

### 4.2.5.2 UE Reachability Notification Request procedure

The UE Reachability Notification Request procedure is illustrated in figure 4.2.5.2-1.



**Figure 4.2.5.2-1: UE Reachability Notification Request Procedure**

1a. [Conditional] When a service-related entity requests the UDM to provide an indication regarding UE reachability, the UDM checks whether that service-related entity is authorized to perform this request on this subscriber. The service-related entity may subscribe in UDM to receive notifications about UE Reachability or UE Reachability for SMS delivery events as defined in clause 4.15.3.

NOTE 1: This request for UE Reachability Notification is received in UDM using different interfaces/services depending on the service-related entity. For example, an SBI capable service-related entity can use the Nudm\_EventExposure\_Subscribe service while an SMS-GMSC triggers this procedure as described in TS 23.040 [7].

The UDM may retrieve from the UDR the list of NF IDs for Network Functions authorized by the HPLMN to request notifications on this UE's reachability.

If the entity is not authorized, the UDM may reject the request (e.g. if the requesting entity is recognized as being a valid entity, but not authorized for that subscriber) or discard it silently (e.g. if the requesting entity is not recognized). Appropriate O&M reports are generated.

1b. [Conditional] The UDM stores the identity of the service-related entity.

In the case that the service-related entity is an SMS-GMSC, the UDM stores the SC address within the MWD list. Otherwise, if the service-related entity is an SBI capable service-related entity, the UDM stores the address of the SBI capable service-related entity in the form of a subscription to the Nudm\_EventExposure service.

If the UE Reachability Notification Request is for SMS over NAS and no SMSF is registered for the target UE, steps 2 to 4 are skipped.

Otherwise the UDM sets the URRP-AMF flag parameter and continues with step 2.

1c. [Conditional] An NF (e.g. SMF) may subscribe event of UE reachability status change by using the Namf\_EventExposure\_Subscribe service operation. Steps 2 to 4 are skipped.

The AMF invokes the Namf\_EventExposure\_Notify service operation to report the current reachability state of a UE to the NF if requested by the consumer NF.

2. [Conditional] If the value of URRP-AMF flag parameter changes from "not set" to "set" and an AMF is registered in the UDM for the target UE, the UDM initiates Namf\_EventExposure\_Subscribe service operation for UE reachability for UE reachable for DL traffic (SUPI, UE Reachability) towards the AMF. The UDM may indicate if direct notification to NF shall be used by the AMF. When direct notification to NF is indicated to the AMF, the URRP-AMF is not set in the UDM in step 1a for NF initiated requests. If the service-related entity requested UDM to receive notifications about UE Reachability for SMS delivery, the UDM shall not indicate direct notification to NF.

NOTE 2: The UDM can trigger UE Reachability Notification Request procedure with two different AMFs for a UE which is connected to 5G Core Network over 3GPP access and non-3GPP access simultaneously. Also, for interworking with EPC, the UDM/HSS can trigger UE Reachability Notification Request procedure with MME as described in TS 23.401 [13].

3. The AMF checks that the requesting entity is authorized to perform this request on this subscriber.

If the AMF has an MM Context for that user, the AMF stores the NF ID in the URRP-AMF information, associated with URRP-AMF information flag to indicate the need to report to the UDM or directly to the NF with a UE Activity Notification (see clause 4.2.5.3).

4. [Conditional] For UE reachability for UE reachable for DL traffic, if the UE state in AMF is in CM-CONNECTED state and the Access Type is 3GPP access, the AMF initiates N2 Notification procedure (see clause 4.8.3) with reporting type set to Single RRC-Connected state notification.

### 4.2.5.3 UE Activity Notification procedure

The UE Activity Notification procedure is illustrated in figure 4.2.5.3-1.

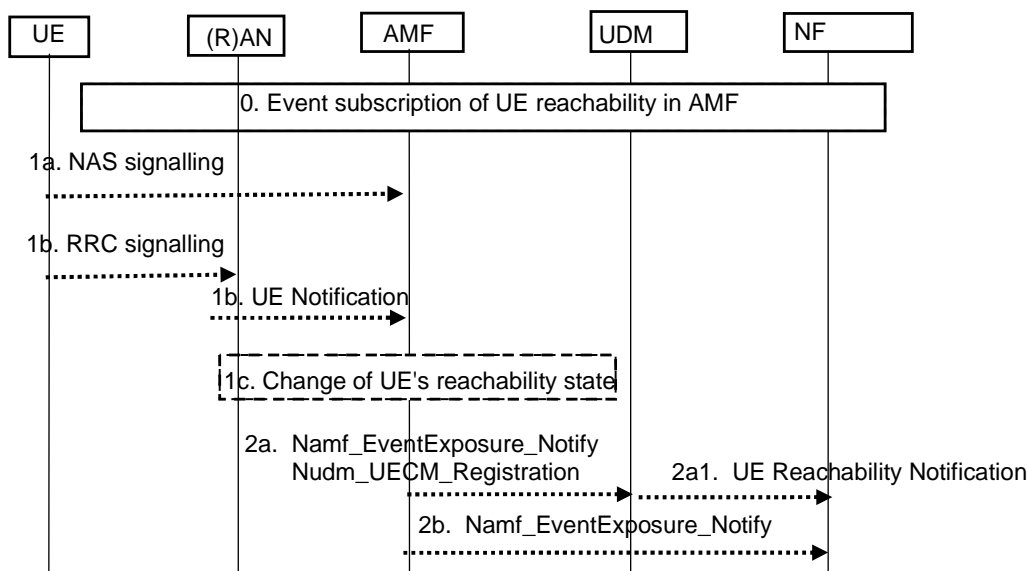


Figure 4.2.5.3-1: UE Activity Procedure

0. Event has been subscribed in the AMF for UE reachability for DL traffic or for UE reachability status change.

1a. For a UE in CM-IDLE, the AMF receives (N1) NAS signalling implying UE is reachable for DL traffic, e.g. a Registration Request or Service Request message from the UE, the AMF performs step 2;

1b. For a UE in CM-CONNECTED, if the AMF has initiated the N2 Notification procedure in Step 4 of clause 4.2.5.2 and when the AMF receives a (N2) UE Notification (see clause 4.8.3) or a (N2) Path Switch Request (see clause 4.9.1.2) implying UE is reachable for DL traffic from the NG-RAN, the AMF performs step 2. Otherwise, i.e. UE is in CM-CONNECTED and AMF has not initiated N2 Notification procedure, the AMF performs step 2; or

1c. The UE's reachability state changes from reachable to unreachable, then AMF performs step 2.

2a. For event subscription of "UE reachable for DL traffic", if the AMF has an MM context for the UE and the URRP-AMF information flag associated with the subscribing NF is set to report once that the UE is reachable for DL traffic, the AMF initiates the Namf\_EventExposure\_Notify service operation (SUPI, UE Reachable) message (or Nudm\_UECM\_Registration service operation when applicable) to the UDM following step 1a or step 1b. The AMF clears the corresponding URRP-AMF information if applicable for the UE.

2a1. When the UDM receives the Namf\_EventExposure\_Notify service operation (SUPI, UE-Reachable) message or Nudm\_UECM\_Registration service from AMF for a UE that has URRP-AMF information flag set in the UDM, it triggers appropriate notifications to the service-related entities associated with the URRP-AMF information flag that have subscribed to the UDM for UE Reachability notifications.

If SMSF is registered, it also triggers appropriate notifications to the service-related entities associated with the URRP-AMF information flag that have subscribed to the UDM for UE reachability for SMS delivery notification (e.g. SMS-GMSC, HSS). UDM clears the URRP-AMF information for the UE.

If no SMSF is registered and there are service-related entities subscribed to the UDM for the UE reachability for SMS delivery notification, the UDM clears the URRP-AMF information for the UE but does not notify any service-related entity.

When the UDM receives the Nudm\_UECM\_Registration service from SMSF for a UE that has service-related entities subscribed to the UDM for the UE reachability for SMS delivery notification and no URRP-AMF flag set in the UDM, the UDM triggers appropriate notifications to the service-related entities that have subscribed to the UDM for UE reachability for SMS delivery notification).

**NOTE:** The UE Reachability Notification is sent by the UDM using different interfaces/services depending on the service-related entity. For example, an SBI capable service-related entity can receive the notification using the Nudm\_EventExposure\_Notify service operation (if previously subscribed) while an SMS-SC gets the notification as described in TS 23.040 [7] based on the SC address stored in the MWD list.

2b. If in step 0 the AMF received Namf\_EventExposure\_Subscribe\_service operation directly from an NF authorised to receive direct notifications in the case of UE reachability status change, or the UDM indicated that the notification needs to be sent directly to the NF in the case of UE reachability for DL traffic, the AMF initiates the Namf\_EventExposure\_Notify service operation (SUPI, UE reachability state) message directly to the NF.

## 4.2.6 AN Release

This procedure is used to release the logical NG-AP signalling connection for the UE between the (R)AN and the AMF and the associated N3 User Plane connections and (R)AN signalling connection between the UE and the (R)AN and the associated (R)AN resources.

When the NG-AP signalling connection is lost due to (R)AN or AMF failure, the AN release is performed locally by the AMF or the (R)AN as described in the procedure flow below without using or relying on any of the signalling shown between (R)AN and AMF. The AN release causes all UP connections of the UE to be deactivated.

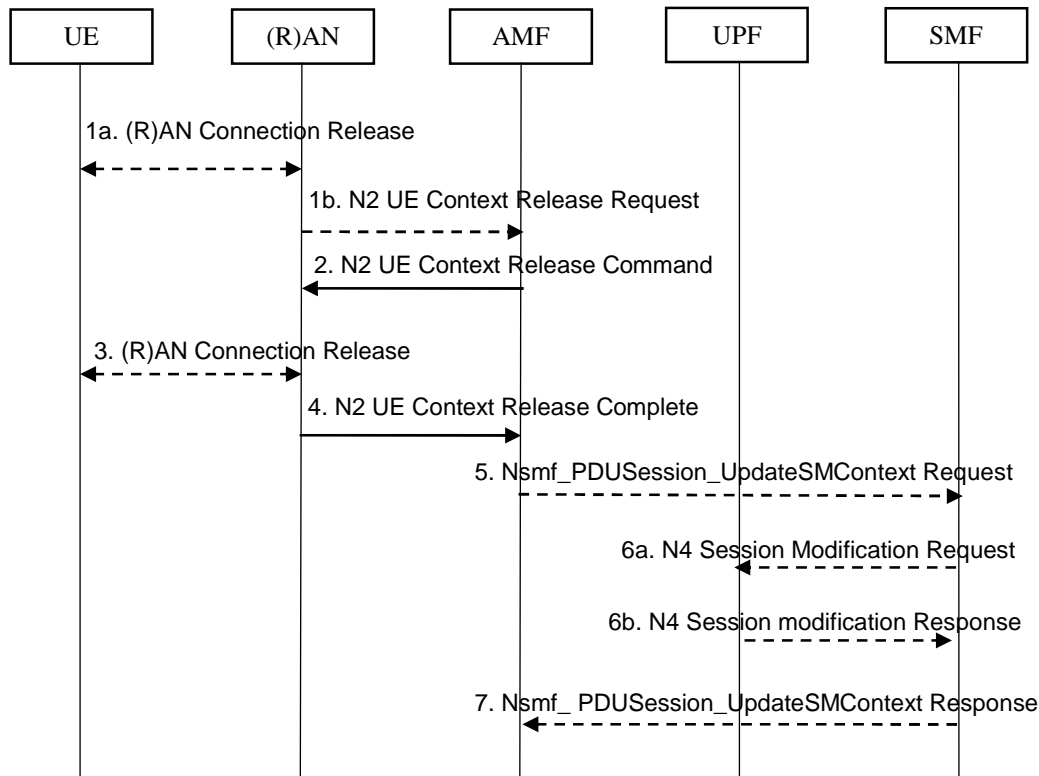
The initiation of AN release may be due to:

- (R)AN-initiated with cause e.g. O&M Intervention, Unspecified Failure, (R)AN (e.g. Radio) Link Failure, User Inactivity, Inter-System Redirection, request for establishment of QoS Flow for IMS voice, Release due to UE generated signalling connection release, mobility restriction, Release Assistance Information (RAI) from the UE, etc.; or
- AMF-initiated with cause e.g. Unspecified Failure, etc.

Both (R)AN-initiated and AMF-initiated AN Release procedures are shown in Figure 4.2.6-1.

If Service Gap Control shall be applied for the UE (see clause 5.31.16 of TS 23.501 [2]) and the Service Gap timer is not already running, the Service Gap timer shall be started in AMF and UE when entering CM-IDLE, unless the connection was initiated after a paging of an MT event, or after a Registration procedure without Uplink data status or after a Registration procedure for regulatory prioritized services like Emergency services or exception reporting.

For this procedure, the impacted SMF and UPF are all under control of the PLMN serving the UE, e.g. in Home Routed roaming case the SMF and UPF in HPLMN are not involved.



**Figure 4.2.6-1: AN Release procedure**

1. If there is some confirmed (R)AN conditions (e.g. Radio Link Failure) or for other (R)AN internal reason, the (R)AN may decide to initiate the UE context release in the (R)AN. In this case, the (R)AN sends an N2 UE Context Release Request (Cause, List of PDU Session ID(s) with active N3 user plane) message to the AMF. Cause indicates the reason for the release (e.g. AN Link Failure, O&M intervention, unspecified failure, etc.). The List of PDU Session ID(s) indicates the PDU Sessions served by (R)AN of the UE. If the (R)AN is NG-RAN, this step is described in clause 8.3.2 of TS 38.413 [10]. If the (R)AN is an N3IWF this step is described in clause 4.12.4.2.

If the reason for the release is the NG-RAN received an AS Release Assistance Indicator as defined in TS 36.331 [16], NG-RAN should not immediately release the RRC connection but instead send an N2 UE Context Release Request message to the AMF. If the AS RAI indicates only a single downlink transmission is expected then NG-RAN should only send the N2 UE Context Release Request after a single downlink NAS PDU or N3 data PDU has been transferred.

If N2 Context Release Request cause indicates the release is requested due to user inactivity or AS RAI then the AMF continues with the AN Release procedure unless the AMF is aware of pending MT traffic or signalling.

2. AMF to (R)AN: If the AMF receives the N2 UE Context Release Request message or due to an internal AMF event, including the reception of Service Request or Registration Request to establish another NAS signalling connection still via (R)AN, the AMF sends an N2 UE Context Release Command (Cause) to the (R)AN. The Cause indicates either the Cause from (R)AN in step 1 or the Cause due to an AMF event. If the (R)AN is a NG-RAN this step is described in detail in clause 8.3.3 of TS 38.413 [10]. If the (R)AN is an N3IWF/TNGF/W-AGF this step is described in clauses 4.12.4.2 / 4.12a and in clause 7.2.5 of TS 23.316 [53] for W-5GAN access.

If the AMF receives Service Request or Registration Request to establish another NAS signalling connection still via (R)AN, after successfully authenticating the UE, the AMF releases the old NAS signalling connection and then continues the Service Request or Registration Request procedure.

3. [Conditional] If the (R)AN connection (e.g. RRC connection or NWu connection) with the UE is not already released (step 1), either:
  - a) the (R)AN requests the UE to release the (R)AN connection. Upon receiving (R)AN connection release confirmation from the UE, the (R)AN deletes the UE's context, or

- b) if the Cause in the N2 UE Context Release Command indicates that the UE has already locally released the RRC connection, the (R)AN locally releases the RRC connection.
4. The (R)AN confirms the N2 Release by returning an N2 UE Context Release Complete (List of PDU Session ID(s) with active N3 user plane, User Location Information, Age of Location Information) message to the AMF. The List of PDU Session ID(s) indicates the PDU Sessions served by (R)AN of the UE. The AMF stores always the latest UE Radio Capability information or NB-IoT specific UE Radio Access Capability Information received from the NG-RAN node received as described in TS 38.413 [10]. The N2 signalling connection between the AMF and the (R)AN for that UE is released. If the UE is served by an NG-eNB that supports WUS, then the NG-eNB should include the Information On Recommended Cells And RAN nodes For Paging; otherwise the (R)AN may provide the list of recommended cells / TAs / NG-RAN node identifiers for paging to the AMF.

If the PLMN has configured secondary RAT usage reporting, the NG-RAN node may provide RAN usage data Report.

This step shall be performed promptly after step 2, i.e. it shall not be delayed, for example, in situations where the UE does not acknowledge the RRC Connection Release.

The NG-RAN includes Paging Assistance Data for CE capable UE, if available, in the N2 UE Context Release Complete message. The AMF stores the received Paging Assistance Data for CE capable UE in the UE context for subsequent Paging procedure.

5. [Conditional] AMF to SMF: For each of the PDU Sessions in the N2 UE Context Release Complete, the AMF invokes Nsmf\_PDUSession\_UpdateSMContext Request (PDU Session ID, PDU Session Deactivation, Cause, Operation Type, User Location Information, Age of Location Information, N2 SM Information (Secondary RAT usage data)). The Cause in step 5 is the same Cause in step 2. If List of PDU Session ID(s) with active N3 user plane is included in step 1b, the step 5 to 7 are performed before step 2. The Operation Type is set to "UP deactivate" to indicate deactivation of user plane resources for the PDU Session.

For PDU Sessions using Control Plane CIoT 5GS Optimisation and if the UE has negotiated the use of extended Idle mode DRX, the AMF informs the SMF immediately that the UE is not reachable for downlink data. For PDU Sessions using Control Plane CIoT 5GS Optimisation and if the UE has negotiated the use of MICO mode with Active Time, the AMF informs the SMF that the UE is not reachable for downlink data once the Active Time has expired.

- 6a [Conditional] SMF to UPF: N4 Session Modification Request (AN or N3 UPF Tunnel Info to be removed, Buffering on/off).

For PDU Sessions not using Control Plane CIoT 5GS Optimisation, the SMF initiates an N4 Session Modification procedure indicating the need to remove Tunnel Info of AN or UPF terminating N3. Buffering on/off indicates whether the UPF shall buffer incoming DL PDU or not.

If the SMF has received an indication from the AMF that the UE is not reachable for downlink data for PDU Sessions using Control Plane CIoT 5GS Optimisation, the SMF may initiate an N4 Session Modification procedure to activate buffering in the UPF.

If multiple UPFs are used in the PDU Session and the SMF determines to release the UPF terminating N3, step 6a is performed towards the UPF (e.g. PSA) terminating N9 towards the current N3 UPF. The SMF then releases the N4 session towards the N3 UPF (the N4 release is not shown on the call flow).

See clause 4.4 for more details.

If the cause of AN Release is because of User Inactivity, or UE Redirection, the SMF shall preserve the GBR QoS Flows. Otherwise, the SMF shall trigger the PDU Session Modification procedure (see clause 4.3.3) for the GBR QoS Flows of the UE after the AN Release procedure is completed.

If the redundant I-UPFs are used for URLLC, the N4 Session Modification Request procedure is done for each I-UPF. In this case, SMF selects both the redundant I-UPFs to buffer the DL packets for this PDU Session or drop the DL packets for this PDU session or forward the DL packets for this PDU session to the SMF, based on buffering instruction provided by the SMF as described in clause 5.8.3.2 or 5.8.3.3 of TS 23.501 [2].

If the redundant N3 tunnels are used for URLLC, the N4 Session Modification Request procedure to the UPF of N3 terminating point is to remove the dual AN Tunnel Info for N3 tunnel of the corresponding PDU Session.

6b. [Conditional] UPF to SMF: N4 Session Modification Response acknowledging the SMF request.

See clause 4.4 for more details.

7. [Conditional] SMF to AMF: Nsmf\_PDUSession\_UpdateSMContext Response for step 5.

Upon completion of the procedure, the AMF considers the N2 and N3 as released and enters CM-IDLE state.

After completion of the procedure, the AMF reports towards the NF consumers are triggered for cases in clause 4.15.4.

After completion of the procedure, if steps 5 to 7 were performed before step 2 and the AMF received N2 SM information from NG-RAN in step 4 (e.g. Secondary RAT usage data report), the AMF initiates a Nsmf\_PDUSession\_UpdateSMContext towards SMF to deliver the N2 SM information.

## 4.2.7 N2 procedures

### 4.2.7.1 N2 Configuration

At power up, restart and when modifications are applied, the 5G-AN node and AMF use non-UE related N2 signalling to exchange configuration data. Full details of this configuration data are specified in TS 38.300 [9], but the following highlights some aspects.

The AMF supplies the 5G-AN node with information about:

- a) the AMF Name and the GUAMI(s) configured on that AMF Name;
- b) the set of TNL associations to be established between the NG-RAN node and the AMF;
- c) weight factor associated with each of the TNL association within the AMF; and
- d) weight factor for each AMF Name within the AMF Set; and
- e) (optional) for each GUAMI(s) configured on that AMF the corresponding backup AMF Name.

The weight factors are used for load distribution of the initial N2 messages. The AMF chooses whether or not to use the same TNL association for the initial N2 message and subsequent messages for that UE. TNL associations configured with a weight factor set to zero are not permitted for the initial N2 message, but can be used for subsequent N2 messages.

Deployments that rely solely on 5GC-based load balancing can set the weight factors associated with TNL associations that are permitted for the initial N2 message to the same value.

### 4.2.7.2 NGAP UE-TNLA-binding related procedures

#### 4.2.7.2.1 Creating NGAP UE-TNLA-bindings during Registration and Service Request

When a UE connects to the 5GC via a 5G-AN node without providing any UE identities (i.e. a GUAMI or a 5G-S-TMSI), or the UE provides a GUAMI or a 5G-S-TMSI but the 5G-AN node cannot associate to any of its connected AMFs, the following steps are performed:

1. The 5G-AN node selects an AMF as defined in clause 6.3.5 of TS 23.501 [2].
2. The 5G-AN node creates an NGAP UE-TNLA-binding for the UE by selecting a TNL association from the available TNL associations permitted for the initial message e.g. N2 INITIAL UE MESSAGE for the selected AMF, as defined in clause 5.21.1.3 of TS 23.501 [2] and forwards the UE message to the AMF via the selected TNL association.
3. The AMF may decide to use the TNL association selected by the 5G-AN or the AMF may modify the NGAP UE-TNLA-binding by triangular redirection.

NOTE 1: This process could take place during the Registration procedure (for Initial Registration, Mobility Registration Update).

4. The AMF may decide to modify the NGAP UE-TNLA-binding toward other 5G-AN nodes such as N3IWF. This is done if the AMF is changed and old AMF have existing NGAP UE-TNLA-bindings toward other 5G-AN nodes.

When a UE connects to the 5GC via a 5G-AN node with a 5G-S-TMSI or GUAMI associated with the AMF usable by the 5G-AN node, the following steps are performed:

1. The 5G-AN node creates an NGAP UE-TNLA-binding for the UE by selecting a TNL association from the available TNL associations permitted for the initial N2 message for the AMF identified by the UE's 5G-S-TMSI or GUAMI.
2. The AMF may decide to use the TNL association selected by the 5G-AN or the AMF may modify the NGAP UE-TNLA-binding by triangular redirection.

NOTE 2: This process could take place during the Registration procedure or Service Request procedure.

#### 4.2.7.2.2 Creating NGAP UE-TNLA-bindings during handovers

During an Xn-based inter NG-RAN node handover, the following applies

- If an NGAP UE-TNLA-binding exists for a UE, the source 5G-AN node supplies the target 5G-AN node with the corresponding TNL address of the AMF for the currently used TNL association.
- If the target 5G-AN does not have a TNL association towards the TNL address of the AMF received from the source 5G-AN node, the target 5G-AN node establishes a TNL association towards the TNL address received from the source 5G-AN node, creates an NGAP UE-TNLA-binding to this TNL association and sends the N2 Path Switch Request via this TNL association.
- Otherwise, the target 5G-AN node creates an NGAP UE-TNLA-binding for the UE by selecting a TNL association from the available TNL associations towards the TNL address, permitted for the initial N2 message for the AMF identified by the UE's GUAMI.
- The AMF may decide to use the TNL association selected by the 5G-AN or the AMF may modify the NGAP UE-TNLA-binding by triangular redirection.

During an inter NG-RAN node handover without Xn interface (i.e. during an N2 handover) the following applies:

- If an NGAP UE-TNLA-binding exists for a UE, the source 5G-AN node sends the N2 Handover Required message using the corresponding TNL address of the AMF.
- Otherwise the 5G-AN node creates an NGAP UE-TNLA-binding for the UE by selecting a TNL association from the available TNL associations permitted for the initial N2 message for the AMF identified by the UE's GUAMI.
- The target AMF selects a TNL association from the available TNL associations for the target 5G-AN node and sends the N2 Handover Request message via this TNL association. The target 5G-AN node creates an NGAP UE-TNLA-binding for the UE based on the TNL association selected by the target AMF.

#### 4.2.7.2.3 Re-Creating NGAP UE-TNLA-bindings subsequent to NGAP UE-TNLA-binding release

If the AMF has released the NGAP UE-TNLA-binding in the 5G-AN node for a UE and the 5G-AN node needs to send an N2 message for this UE, the following applies:

- The 5G-AN node checks the GUAMI stored in the UE context and the associated AMF:
  - If the GUAMI is available, 5G-AN selects the AMF which owns that GUAMI.
  - If GUAMI has been marked as unavailable (i.e. based on AMF unavailable status indication received from AMF) but one corresponding target AMF has been indicated, 5G-AN selects that target AMF even if the GUAMI has not been updated as available by the target AMF.
  - If GUAMI has been marked as unavailable (i.e. based on AMF unavailable status indication received from AMF) and no corresponding target AMF has been indicated, the 5G-AN selects an AMF from the AMF Set based on AMF Set ID of the GUAMI, as defined in clause 6.3.5 of TS 23.501 [2].



- The 5G-AN node creates an NGAP UE-TNLA-binding for the UE by selecting a TNL association from the available TNL associations permitted for the initial N2 message with the selected AMF, as defined in clause 5.21.1.3 of TS 23.501 [2] and sends the N2 message to the AMF via the selected TNL association.
- The AMF may decide to use the TNL association selected by the 5G-AN or the AMF may modify the NGAP UE-TNLA-binding by triangular redirection.

If the NGAP UE-TNLA-binding has been released for a UE and the AMF needs to send an N2 message for this UE, the following applies:

- The AMF selects a TNL association from the available TNL associations for the target 5G-AN node and sends the N2 message via this TNL association. The target 5G-AN node creates an NGAP UE-TNLA-binding for the UE based on the TNL association selected by the AMF.

The TNL association chosen by the AMF always takes precedence.

NOTE: This addresses situations where 5G-AN node and AMF select a TNL association for a UE concurrently.

#### 4.2.7.2.4 NGAP UE-TNLA-binding update procedure

At any time the AMF may decide to re-bind the NGAP UE association to a new TNL association:

- by sending a UE-specific NGAP message on a new TNL association (triangular redirection), if:
  - AMF responds to the 5G-AN node initiated NGAP message (i.e. triangular redirection) as described in clauses 4.2.7.2.1, 4.2.7.2.2 and 4.2.7.2.3; or
  - AMF initiated UE-specific NGAP message needs to be sent to 5G-AN node;
- by sending a UE-specific NGAP UE-TNLA binding release message to 5G-AN and the 5G-AN node updates the NGAP UE-TNLA binding with the new TNL association.

#### 4.2.7.2.5 NGAP UE-TNLA-binding per UE Release procedure

At any time the AMF may decide to release the NGAP UE-TNLA binding while keeping the UE in CM-CONNECTED state while keeping the corresponding N3 interface. The AMF releases the NGAP UE-TNLA binding by sending a UE-specific NGAP UE-TNLA binding release message on the current TNL association.

If the AMF releases the NGAP UE-TNLA-binding without sending AMF unavailable status indication, then the AN may immediately trigger creation of a new NGAP-UE-TNLA-binding with the same AMF for subsequent N2 messages or may leave the NGAP UE association without NGAP UE-TNLA-binding. In the latter case the new NGAP UE-TNLA-binding is re-created upon the subsequent AN-initiated or AMF-initiated UE-specific N2 signalling as specified in clause 4.2.7.2.3.

If the AMF releases the NGAP UE-TNLA-binding after AMF unavailable status indication, then the AN has to re-create the NGAP-UE-TNLA-binding with a different AMF. The 5G-AN re-creates N2AP UE-TNLA-binding for subsequent N2 messages for the given UE as specified in clause 4.2.7.2.3.

#### 4.2.7.3 AMF Failure or Planned Maintenance handling procedure

For UE(s) in CM-CONNECTED state:

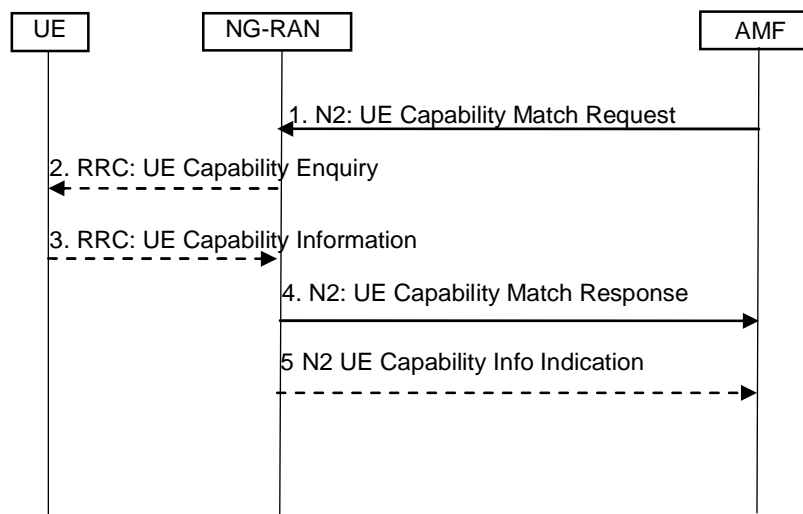
- If AMF failure is detected by 5G-AN, all NGAP UE TNLA binding for UEs served by that AMF are released.
- If AMF becomes unavailable due to planned maintenance, the AMF notifies the 5G-AN about the unavailable GUAMI(s) and provides optionally a target AMF Name corresponding to each unavailable GUAMI. The 5G-AN releases all NGAP UE TNLA binding of the UEs related to the indicated unavailable GUAMI(s) unless the notification from the AMF includes an indicator that the AMF will rebind or release the NGAP UE TNLA binding on a per UE-basis. In that case, if 5G-AN supports, the 5G-AN waits the release until the timer expires so that the AMF may release or rebind the N2AP UE-TNLA binding on per UE-basis.
- For the release NGAP TNLA binding, the affected UE is kept in CM-CONNECTED state and the corresponding N3 interface is also kept.

For UE(s) in CM-IDLE state, when it subsequently returns from CM-IDLE state and the 5G-AN receives an initial NAS message with a 5G S-TMSI or GUAMI, the 5G-AN uses 5G S-TMSI or GUAMI to select the target AMF, the 5G-AN forwards N2 message.

## 4.2.8 Void

### 4.2.8a UE Capability Match Request procedure

If the AMF requires more information on the UE radio capabilities support to be able to set the IMS voice over PS Session Supported Indication (see clause 5.16.3 of TS 23.501 [2]), then the AMF may send a UE Radio Capability Match Request message to the NG-RAN. This procedure is typically used during the registration procedure or when AMF has not received the Voice Support Match Indicator (as part of the 5GMM Context).



**Figure 4.2.8a-1: UE Capability Match Request**

1. The AMF indicates whether the AMF wants to receive Voice support match indicator. The AMF may include the UE radio capability information it has previously received from NG-RAN.
2. Upon receiving the UE Capability Match Request message, if the NG-RAN has not already received the UE radio capabilities from the UE or from AMF in step 1, the NG-RAN requests the UE to upload the UE radio capability information.
3. The UE provides the NG-RAN with its UE radio capabilities sending the RRC UE Capability Information.
4. The NG-RAN checks whether the UE radio capabilities are compatible with the network configuration for ensuring voice service continuity of voice calls initiated in IMS.

For determining the appropriate UE Radio Capability Match Response, the NG-RAN is configured by the operator to check whether the UE supports certain capabilities required for Voice continuity of voice calls using IMS PS. In a shared network, the NG-RAN keeps a configuration separately per PLMN.

NOTE 1: What checks to perform depends on network configuration, i.e. following are some examples of UE capabilities to be taken into account:

- E-UTRAN/NG-RAN Voice over PS capabilities;
- the Radio capabilities for E-UTRAN/NG-RAN FDD and/or TDD; and/or
- the support of E-UTRAN/NG-RAN frequency bands;
- the SRVCC from NG-RAN to UTRAN capabilities and the support of UTRAN frequency bands.

NOTE 2: The network configuration considered in the decision for the Voice Support Match Indicator is homogenous within a certain area (e.g. AMF Set) in order to guarantee that the Voice Support Match Indicator from the NG-RAN is valid within such area.

The NG-RAN provides a Voice Support Match Indicator to the AMF to indicate whether the UE capabilities and networks configuration are compatible for ensuring voice service continuity of voice calls initiated in IMS.

The AMF stores the received Voice support match indicator in the 5GMM Context and uses it as an input for setting the IMS voice over PS Session Supported Indication.

5. If NG-RAN requested radio capabilities from UE in step 2 and 3, the NG-RAN also sends the UE radio capabilities to the AMF. The AMF stores the UE radio capabilities without interpreting them for further provision to the NG-RAN according to clause 5.4.4.1 of TS 23.501 [2].

NOTE 3: Steps 4 and 5 could be received by the AMF in any order.

## 4.2.9 Network Slice-Specific Authentication and Authorization procedure

### 4.2.9.1 General

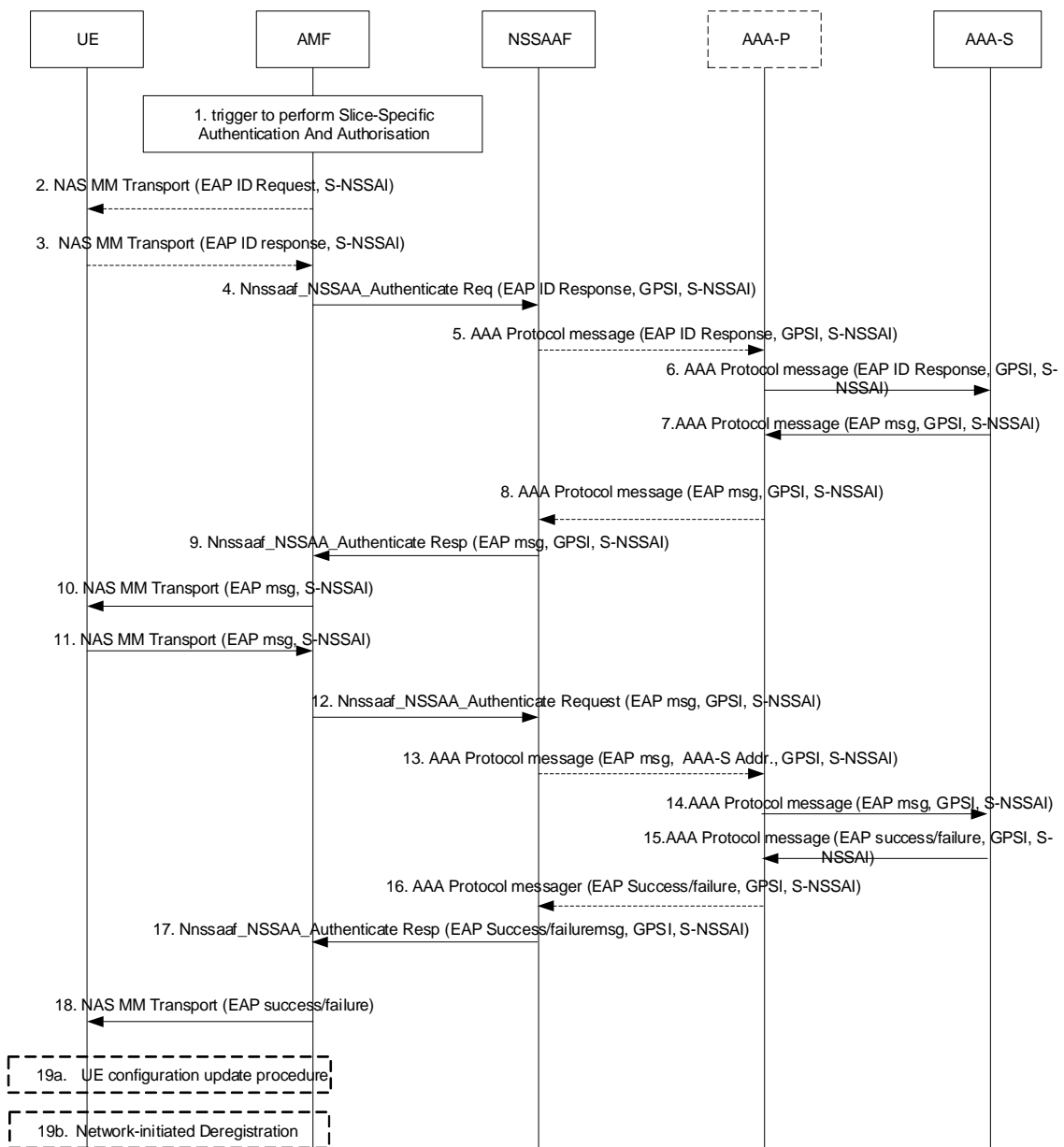
The Network Slice-Specific Authentication and Authorization procedure is triggered for an S-NSSAI requiring Network Slice-Specific Authentication and Authorization with an AAA Server (AAA-S) which may be hosted by the H-PLMN operator or by a third party which has a business relationship with the H-PLMN, using the EAP framework as described in TS 33.501 [15]. An AAA Proxy (AAA-P) in the HPLMN may be involved e.g. if the AAA Server belongs to a third party.

This procedure is triggered by the AMF during a Registration procedure when some Network Slices require Slice-Specific Authentication and Authorization, when AMF determines that Network Slice-Specific Authentication and Authorization is required for an S-NSSAI in the current Allowed NSSAI (e.g. subscription change), or when the AAA Server that authenticated the Network Slice triggers a re-authentication.

The AMF performs the role of the EAP Authenticator and communicates with the AAA-S via the Network Slice Specific Authentication and Authorization Function (NSSAAF). The NSSAAF undertakes any AAA protocol interworking with the AAA protocol supported by the AAA-S.

The Network Slice-Specific Authentication and Authorization procedure requires the use of a GPSI. In other words, a subscription that contains S-NSSAIs subject to Network Slice-Specific Authentication and Authorization shall include at least one GPSI.

### 4.2.9.2 Network Slice-Specific Authentication and Authorization



**Figure 4.2.9.2-1: Network Slice-Specific Authentication and Authorization procedure**

1. For S-NSSAIs that are requiring Network Slice-Specific Authentication and Authorization, based on change of subscription information, or triggered by the AAA-S, the AMF may trigger the start of the Network Slice Specific Authentication and Authorization procedure.

If Network Slice Specific Authentication and Authorization is triggered as a result of Registration procedure, the AMF may determine, based on UE Context in the AMF, that for some or all S-NSSAI(s) subject to Network Slice Specific Authentication and Authorization, the UE has already been authenticated following a Registration procedure on a first access. Depending on Network Slice Specific Authentication and Authorization result (e.g. success/failure) from the previous Registration, the AMF may decide, based on Network policies, to skip Network Slice Specific Authentication and Authorization for these S-NSSAIs during the Registration on a second access.

If the Network Slice Specific Authentication and Authorization procedure corresponds to a re-authentication and re-authorization procedure triggered as a result of AAA Server-triggered UE re-authentication and re-

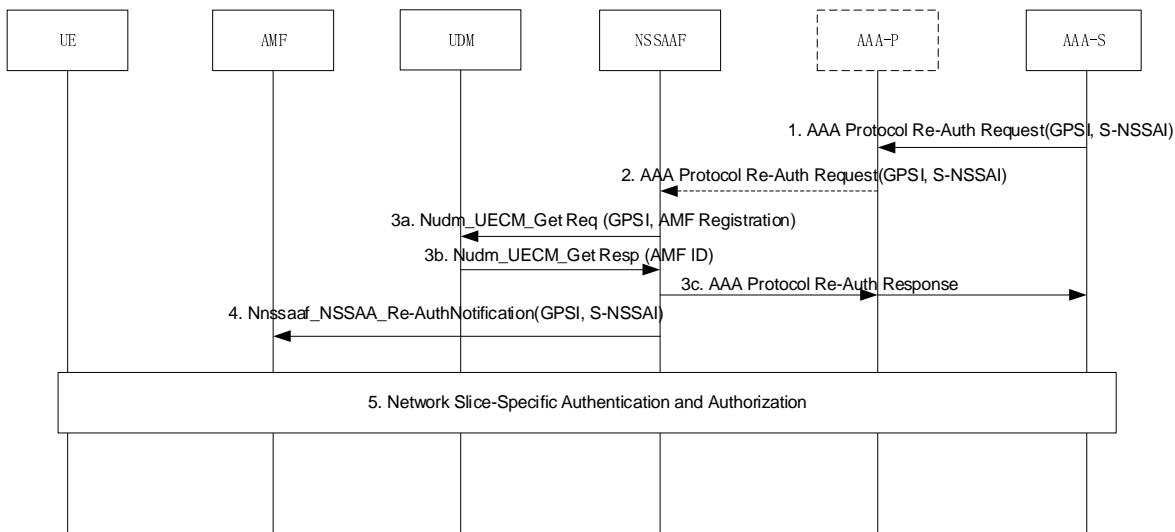
authorization for one or more S-NSSAIs, as described in 4.2.9.2, or triggered by the AMF based on operator policy or a subscription change and if S-NSSAIs that are requiring Network Slice-Specific Authentication and Authorization are included in the Allowed NSSAI for each Access Type, the AMF selects an Access Type to be used to perform the Network Slice Specific Authentication and Authorization procedure based on network policies.

2. The AMF may send an EAP Identity Request for the S-NSSAI in a NAS MM Transport message including the S-NSSAI. This is the S-NSSAI of the H-PLMN, not the locally mapped S-NSSAI value.
3. The UE provides the EAP Identity Response for the S-NSSAI alongside the S-NSSAI in an NAS MM Transport message towards the AMF.
4. The AMF sends the EAP Identity Response to the NSSAAF in a Nnssaaf\_NSSAA\_Authenticate Request (EAP Identity Response, GPSI, S-NSSAI).

NOTE: If the UE subscription includes multiple GPSIs, the AMF uses any GPSI in the list provided by the UDM for NSSAA procedures.

5. If the AAA-P is present (e.g. because the AAA-S belongs to a third party and the operator deploys a proxy towards third parties), the NSSAAF forwards the EAP ID Response message to the AAA-P, otherwise the NSSAAF forwards the message directly to the AAA-S. The NSSAAF is responsible to send the NSSAA requests to the appropriate AAA-S based on local configuration of AAA-S address per S-NSSAI. The NSSAAF uses towards the AAA-P or the AAA-S an AAA protocol message of the same protocol supported by the AAA-S.
6. The AAA-P forwards the EAP Identity message to the AAA-S addressable by the AAA-S address together with S-NSSAI and GPSI. The AAA-S stores the GPSI to create an association with the EAP Identity in the EAP ID response message, so the AAA-S can later use it to revoke authorization or to trigger reauthentication.
- 7-14. EAP-messages are exchanged with the UE. One or more than one iteration of these steps may occur.
15. EAP authentication completes. The AAA-S stores the S-NSSAI for which the authorisation has been granted, so it may decide to trigger reauthentication and reauthorization based on its local policies. An EAP-Success/Failure message is delivered to the AAA-P (or if the AAA-P is not present, directly to the NSSAAF) with GPSI and S-NSSAI.
16. If the AAA-P is used, the AAA-P sends an AAA Protocol message including (EAP-Success/Failure, S-NSSAI, GPSI) to the NSSAAF.
17. The NSSAAF sends the Nnssaaf\_NSSAA\_Authenticate Response (EAP-Success/Failure, S-NSSAI, GPSI) to the AMF.
18. The AMF transmits a NAS MM Transport message (EAP-Success/Failure) to the UE. The AMF shall store the EAP result for each S-NSSAI for which the NSSAA procedure in steps 1-17 was executed.
- 19a. [Conditional] If a new Allowed NSSAI (i.e. including any new S-NSSAIs in a Requested NSSAI for which the NSSAA procedure succeeded and/or excluding any S-NSSAI(s) in the existing Allowed NSSAI for the UE for which the procedure has failed) and/or new Rejected S-NSSAIs (i.e. including any S-NSSAI(s) in the existing Allowed NSSAI for the UE for which the procedure has failed, or any new requested S-NSSAI(s) for which the NSSAA procedure failed) need to be delivered to the UE, or if the AMF re-allocation is required, the AMF initiates the UE Configuration Update procedure, for each Access Type, as described in clause 4.2.4.2. If the Network Slice-Specific Re-Authentication and Re-Authorization fails and there are PDU session(s) established that are associated with the S-NSSAI for which the NSSAA procedure failed, the AMF shall initiate the PDU Session Release procedure as specified in clause 4.3.4 to release the PDU sessions with the appropriate cause value.
- 19b. [Conditional] If the Network Slice-Specific Authentication and Authorization fails for all S-NSSAIs (if any) in the existing Allowed NSSAI for the UE and (if any) for all S-NSSAIs in the Requested NSSAI, the AMF shall execute the Network-initiated Deregistration procedure described in clause 4.2.2.3.3 and it shall include in the explicit De-Registration Request the list of Rejected S-NSSAIs, each of them with the appropriate rejection cause value.

### 4.2.9.3 AAA Server triggered Network Slice-Specific Re-authentication and Re-authorization procedure

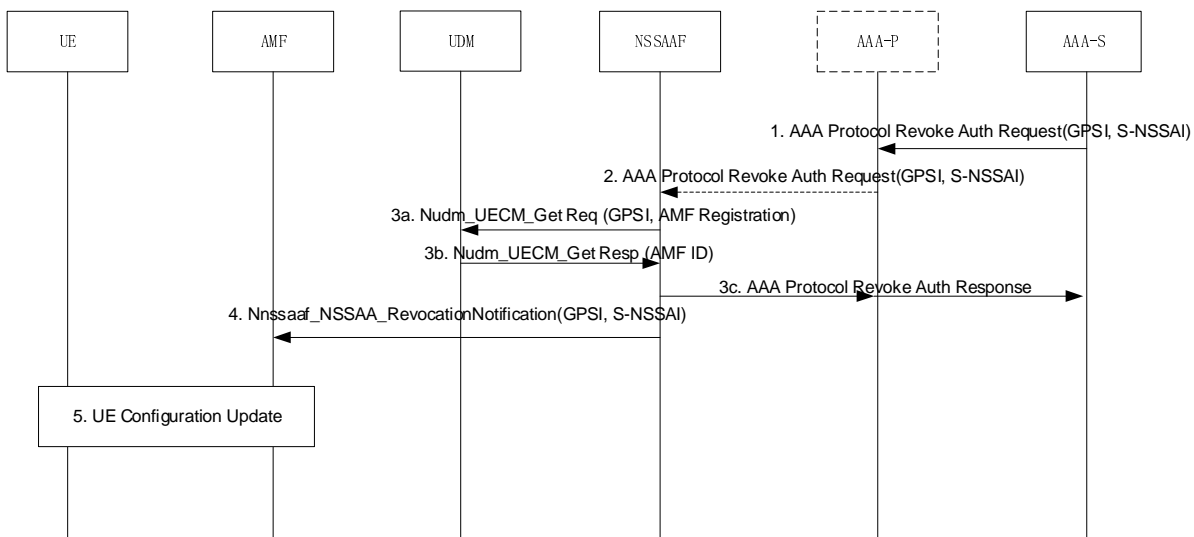


**Figure 4.2.9.3-1: AAA Server initiated Network Slice-Specific Re-authentication and Re-authorization procedure**

1. The AAA-S requests the re-authentication and re-authorization for the Network Slice specified by the S-NSSAI in the AAA protocol Re-Auth Request message, for the UE identified by the GPSI in this message. This message is sent to a AAA-P, if the AAA-P is used (e.g. the AAA Server belongs to a third party), otherwise it is sent directly to the NSSAAF.
2. The AAA-P, if present, relays the request to the NSSAAF.
- 3a-3b. NSSAAF gets AMF ID from UDM using Nudm\_UECM\_Get with the GPSI in the received AAA message.
- 3c. The NSSAAF provides an acknowledgement to the AAA protocol Re-Auth Request message. If the AMF is not registered in UDM the procedure is stopped here.
4. If the AMF is registered in UDM, the NSSAAF notifies the AMF to re-authenticate/re-authorize the S-NSSAI for the UE using Nnssaaf\_NSSAA\_Re-AuthNotification with the GPSI and S-NSSAI in the received AAA message. The callback URI of the notification for the AMF is derived via NRF as specified in TS 29.501 [62].
5. If the UE is registered with the S-NSSAI in the Mapping Of Allowed NSSAI, the AMF triggers the Network Slice-Specific Authentication and Authorization procedure defined in clause 4.2.9.1. If the S-NSSAI is included in the Allowed NSSAI for 3GPP access and non-3GPP access, AMF selects an access type to perform NSSAA based on network policies. If the S-NSSAI is only included in the Allowed NSSAI of non-3GPP access and UE is CM-IDLE in non-3GPP access, the AMF marks the S-NSSAI as pending. In this case, when UE becomes CM-CONNECTED in non-3GPP access, the AMF initiates NSSAA if needed.

If the UE is registered but the S-NSSAI is not in the Mapping Of Allowed NSSAI, the AMF removes any status of the corresponding S-NSSAI subject to Network Slice-Specific Authentication and Authorization in the UE context it may have kept, so that an NSSAA is executed next time the UE requests to register with the S-NSSAI.

#### 4.2.9.4 AAA Server triggered Slice-Specific Authorization Revocation



**Figure 4.2.9.4-1: AAA Server-initiated Network Slice-Specific Authorization Revocation procedure**

1. The AAA-S requests the revocation of authorization for the Network Slice specified by the S-NSSAI in the AAA protocol Revoke Auth Request message, for the UE identified by the GPSI in this message. This message is sent to AAA-P if it is used.
2. The AAA-P, if present, relays the request to the NSSAAF.
- 3a-3b. The NSSAAF gets AMF ID from UDM using Nudm\_UECM\_Get with the GPSI in the received AAA message.
- 3c. The NSSAAF provides an acknowledgement to the AAA protocol Re-Auth Request message. If the AMF is not registered in UDM the procedure is stopped here.
4. If the AMF is registered in UDM, the NSSAAF notifies the AMF to revoke the S-NSSAI authorization for the UE using Nnssaaf\_NSSAA\_RevocationNotification with the GPSI and S-NSSAI in the received AAA message. The callback URI of the notification for the AMF is derived via NRF as specified in TS 29.501 [62].
5. If the UE is registered with the S-NSSAI in the Mapping Of Allowed NSSAI, the AMF updates the UE configuration to revoke the S-NSSAI from the current Allowed NSSAI, for any Access Type for which Network Slice Specific Authentication and Authorization had been successfully run on this S-NSSAI. The UE Configuration Update may include a request to Register if the AMF needs to be re-allocated. The AMF provides a new Allowed NSSAI to the UE by removing the S-NSSAI for which authorization has been revoked. The AMF provides new rejected NSSAIs to the UE including the S-NSSAI for which authorization has been revoked. If no S-NSSAI is left in Allowed NSSAI for an access after the revocation and a Default NSSAI exists that requires no Network Slice Specific Authentication or for which a Network Slice Specific Authentication did not previously fail over this access, then the AMF may provide a new Allowed NSSAI to the UE containing the Default NSSAI. If no S-NSSAI is left in Allowed NSSAI for an access after the revocation and no Default NSSAI can be provided to the UE in the Allowed NSSAI or a previous Network Slice Specific Authentication failed for the Default NSSAI over this access, then the AMF shall execute the Network-initiated Deregistration procedure for the access as described in clause 4.2.2.3.3 and it shall include in the explicit De-Registration Request message the list of Rejected S-NSSAIs, each of them with the appropriate rejection cause value. If there are PDU session(s) established that are associated with the revoked S-NSSAI, the AMF shall initiate the PDU Session Release procedure as specified in clause 4.3.4 to release the PDU sessions with the appropriate cause value.

If the UE is registered but the S-NSSAI is not in the Mapping Of Allowed NSSAI, the AMF removes any status it may have kept of the corresponding S-NSSAI subject to Network Slice-Specific Authentication and Authorization in the UE context.

## 4.2.10 N3 data transfer establishment procedure when Control Plane CIoT 5GS Optimisation is enabled

### 4.2.10.1 UE triggered N3 data transfer establishment procedure

If UE and AMF successfully negotiate N3 data transfer in addition to Control Plane CIoT 5GS Optimisation based on the Preferred and Supported Network Behaviour as defined in clause 5.31.2 of TS 23.501 [2], then the UE may, e.g. based on the amount of data to be transferred in uplink, initiate N3 data transfer establishment procedure for any PDU session for which Control Plane Only Indicator was not included.

The UE triggered N3 data transfer establishment procedure may be initiated by the UE in CM-IDLE or CM-CONNECTED state and follows the UE triggered Service Request procedure as defined in clause 4.2.3.2 with the following differences.

#### Step 1.

The UE includes in the AN message a Service Request for Control Plane CIoT 5GS Optimisation (List Of PDU Sessions To Be Activated, List Of Allowed PDU Sessions, security parameters, PDU Session status, [NAS message container])).

The List Of PDU Sessions To Be Activated is provided by UE when the UE wants to activate user plane resources for the PDU Session(s). The UE shall not include PDU sessions for which Control Plane Only Indicator was received in the List Of PDU Sessions To Be Activated. If the UE is camping on NB-IoT, the UE shall construct the List of PDU Sessions To Be Activated to not exceed 2 PDU session(s) with active user plane resources.

If this procedure is triggered for paging response and the UE has at the same time some user data to be transferred, the UE may decide to request N3 data transfer establishment for one of more PDU sessions. The UE indicates this in the List Of PDU Sessions To Be Activated. Otherwise the UE does not identify any PDU Session in the List Of PDU Sessions To Be Activated.

#### Step 4 or 5a.

Upon reception of Nsmf\_PDUSession\_UpdateSMContext Request or after SMF initiated SM Policy Association Modification, based on UE request and local policies, the SMF decides whether to establish N3 data transfer for the PDU session. The SMF shall not decide to establish N3 data transfer for a PDU session for which Control Plane Only Indicator was received.

#### Step 11.

The SMF indicates in Nsmf\_PDUSession\_UpdateSMContext Response whether to establish N3 data transfer, i.e. activate Data Radio Bearer and N3 tunnel, for the PDU session.

#### Step 12.

If the RAT type is NB-IoT, the AMF shall ensure that number of PDU Sessions with active user plane resources does not exceed 2. If the AMF decides to not include a PDU Session to be activated in the N2 message, the AMF indicates this to the SMF in step 15 Nsmf\_PDUSession\_UpdateSMContext Request in the List of PDU Sessions that failed to be established with the failure cause given in the N2 SM information element.

The AMF includes a NAS service accept for Control Plane CIoT 5GS Optimisation containing information on the PDU sessions with established N3 data transfer, based on the request(s) from the SMF(s) in step 11.

The network starts using N3 bearers for all DL data on this PDU session. Control Plane CIoT 5GS Optimisation is considered enabled for data transfer for all PDU sessions without established N3 data transfer.

#### Step 13.

The UE starts using N3 bearers for all UL data on this PDU session.

### 4.2.10.2 SMF triggered N3 data transfer establishment procedure

If UE and AMF successfully negotiate N3 data transfer in addition to Control Plane CIoT 5GS Optimisation based on the Preferred and Supported Network Behaviour as defined in clause 5.31.2, then the SMF may, e.g. based on the



amount of data to be transferred or due to congestion, initiate N3 data transfer establishment procedure for any PDU session for which Control Plane Only Indicator was not included.

The SMF triggered N3 data transfer establishment procedure may be initiated by the SMF while the UE is in CM-IDLE or CM-CONNECTED state and follows the Network Triggered Service Request procedure defined in clause 4.2.3.3 with the following differences:

Step 3a.

The SMF request the activation of Data Radio Bearer and N3 tunnel for the PDU session in `Namf_Communication_N1N2MessageTransfer`.

Step 3b.

If the RAT type is NB-IoT and the UE already has 2 PDU Sessions with active user plane resources, the AMF shall not proceed with the rest of the procedure and instead the AMF shall respond with `Namf_Communication_N1N2MessageTransfer` Response with appropriate failure message.

Step 6.

The UE triggered N3 data transfer establishment procedure defined in clause 4.2.10.1 is applied instead of Service Request procedure from clause 4.2.3.2.

Step 7.

When the N3 data transfer is set up for a PDU session, the UE and the network shall only use user plane radio bearers to transfer data PDUs on that PDU Session.

## 4.3 Session Management procedures

### 4.3.1 General

Clause 4.3 defines the Session Management related procedures. It refers to clause 4.4 for the N4 interactions.

As defined in clause 5.6.3 of TS 23.501 [2], considering the case of Home Routed PDU Session, the NAS SM information processing by SMF considers following kind of NAS SM information:

- Information that both the V-SMF and H-SMF process: indication of the nature of the NAS SM signalling (e.g. PDU Session Establishment Request), PDU Session Type, Session-AMBR, UE addressing information (allocated IPv4 address, interface identifier).
- Information that is not visible to the V-SMF, only processed by the H-SMF: SSC mode, Protocol Configuration Options, SM PDU DN Request Container, QoS Rule(s) and QoS Flow level QoS parameters if any for the QoS Flow(s) associated with the QoS rule(s).

NOTE 1: "Information that is not visible to the V-SMF" refers to information that the V-SMF is to relay between the UE and the H-SMF (and that it can store in CDR) but that the V-SMF is not assumed to process otherwise.

The NAS SM information processing split between V-SMF and H-SMF is transparent to the UE.

Both V-SMF and H-SMF process information interpreted by the AMF as the PDU Session ID, the DNN, the S-NSSAI (with values for the Serving PLMN and HPLMN processed by the V-SMF and with a value for the HPLMN processed by the H-SMF).

In the case of Home Routed PDU Session the H-SMF provides also the V-SMF with the IPv6 Prefix allocated to the PDU Session.

NOTE 2: IPv6 Prefix allocated to the PDU Session is provided to allow the V-SMF fulfilling regulatory requirements for data storage in the visited country.

In non roaming and LBO cases the SMF processes all NAS SM information.

In HR roaming scenarios, in order to support SM features only requiring support from the H-SMF without impacting the V-SMF, as specified in detail in TS 29.502 [36]:

- The V-SMF transfers NAS SM information, which is not visible to the V-SMF, in a container towards the H-SMF;
- The V-SMF transfers NAS SM information which it does not comprehend (unknown IEs or IEs with an unknown value not set to "reserved" according to the release to which the V-SMF complies), in a different container towards the H-SMF;
- The H-SMF transfers NAS SM information which the V-SMF does not need to interpret, in one container towards the V-SMF;
- The V-SMF appends unknown NAS SM information received in the N16 container at the end of the NAS SM message it sends to the UE.

## 4.3.2 PDU Session Establishment

### 4.3.2.1 General

A PDU Session establishment may correspond to:

- a UE initiated PDU Session Establishment procedure.
- a UE initiated PDU Session handover between 3GPP and non-3GPP.
- a UE initiated PDU Session handover from EPS to 5GS.
- a Network triggered PDU Session Establishment procedure. In this case the network sends the device trigger message to application(s) on the UE side. The payload included in Device Trigger Request message contains information on which application on the UE side is expected to trigger the PDU Session establishment request. Based on that information, the application(s) on the UE side trigger the PDU Session Establishment procedure. For more detail refer to clause 4.13.2.

If the UE is simultaneously registered to a non-3GPP access via a N3IWF/TNGF/W-AGF located in a PLMN different from the PLMN of the 3GPP access, the functional entities in the following procedures are located in the PLMN of the access used to exchange NAS with the UE for the PDU Session.

As specified in clause 5.6.1 of TS 23.501 [2], a PDU Session may be associated either (a) with a single access type at a given time, i.e. either 3GPP access or non-3GPP access, or (b) simultaneously with multiple access types, i.e. one 3GPP access and one non-3GPP access. A PDU Session associated with multiple access types is referred to as Multi Access-PDU (MA PDU) Session and it may be requested by ATSSS-capable UEs.

The following clause 4.3.2.2 specifies the procedures for establishing PDU Sessions associated with a single access type at a given time. The particular procedures associated with MA PDU Sessions are specified as part of the ATSSS procedures in clause 4.22.

### 4.3.2.2 UE Requested PDU Session Establishment

#### 4.3.2.2.1 Non-roaming and Roaming with Local Breakout

Clause 4.3.2.2.1 specifies PDU Session establishment in the non-roaming and roaming with local breakout cases. The procedure is used to:

- Establish a new PDU Session;
- Handover a PDN Connection in EPS to PDU Session in 5GS without N26 interface;
- Switching an existing PDU Session between non-3GPP access and 3GPP access. The specific system behaviour in this case is further defined in clauses 4.9.2 and 4.9.3; or
- Request a PDU Session for Emergency services.

In the case of roaming, the AMF determines if a PDU Session is to be established in LBO or Home Routing. In the case of LBO, the procedure is as in the case of non-roaming with the difference that the AMF, the SMF, the UPF and the PCF are located in the visited network. PDU Sessions for Emergency services are never established in Home Routed mode. If Control Plane CIoT 5GS Optimisation is enabled for the PDU session with LBO, the NEF is not used as the anchor of this PDU Session.

NOTE 1: UE provides both the S-NSSAIs of the Home PLMN and Visited PLMN to the network as described in clause 5.15.5.3 of TS 23.501 [2].

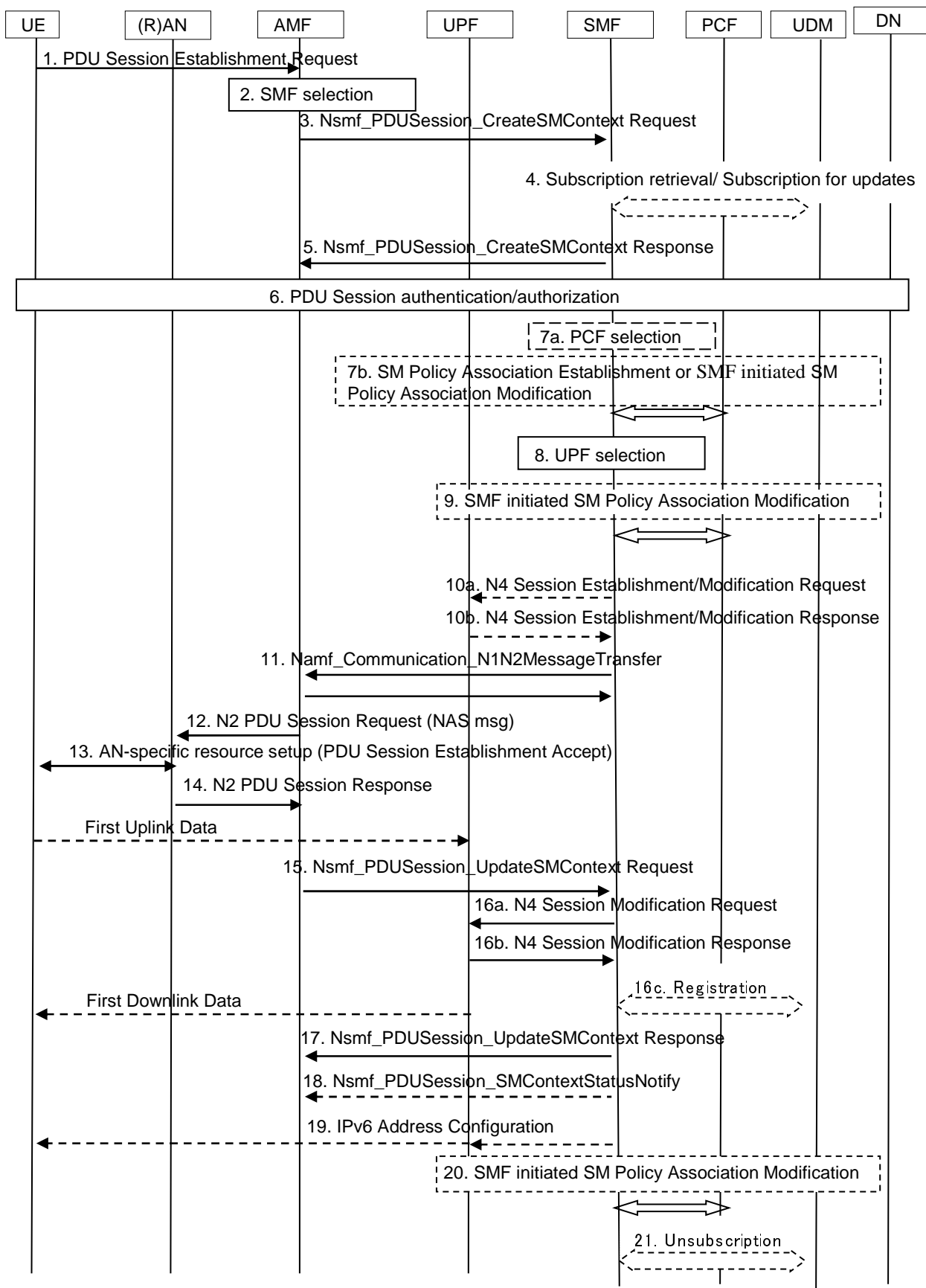


Figure 4.3.2.2.1-1: UE-requested PDU Session Establishment for non-roaming and roaming with local breakout

The procedure assumes that the UE has already registered on the AMF thus unless the UE is Emergency Registered the AMF has already retrieved the user subscription data from the UDM.

1. From UE to AMF: NAS Message (S-NSSAI(s), UE Requested DNN, PDU Session ID, Request type, Old PDU Session ID, N1 SM container (PDU Session Establishment Request, [Port Management Information Container])).

In order to establish a new PDU Session, the UE generates a new PDU Session ID.

The UE initiates the UE Requested PDU Session Establishment procedure by the transmission of a NAS message containing a PDU Session Establishment Request within the N1 SM container. The PDU Session Establishment Request includes a PDU session ID, Requested PDU Session Type, a Requested SSC mode, 5GSM Capability, PCO, SM PDU DN Request Container, [Number Of Packet Filters], [Header Compression Configuration], UE Integrity Protection Maximum Data Rate and [Always-on PDU Session Requested].

The Request Type indicates "Initial request" if the PDU Session Establishment is a request to establish a new PDU Session and indicates "Existing PDU Session" if the request refers to an existing PDU Session switching between 3GPP access and non-3GPP access or to a PDU Session handover from an existing PDN connection in EPC. If the request refers to an existing PDN connection in EPC, the S-NSSAI is set as described in clause 5.15.7.2 of TS 23.501 [2].

When Emergency service is required and an Emergency PDU Session is not already established, a UE shall initiate the UE Requested PDU Session Establishment procedure with a Request Type indicating "Emergency Request".

The Request Type indicates "Emergency Request" if the PDU Session Establishment is a request to establish a PDU Session for Emergency services. The Request Type indicates "Existing Emergency PDU Session" if the request refers to an existing PDU Session for Emergency services switching between 3GPP access and non-3GPP access or to a PDU Session handover from an existing PDN connection for Emergency services in EPC.

The 5GSM Core Network Capability is provided by the UE and handled by SMF as defined in clause 5.4.4b of TS 23.501 [2].

The Number Of Packet Filters indicates the number of supported packet filters for signalled QoS rules for the PDU Session that is being established. The number of packet filters indicated by the UE is valid for the lifetime of the PDU Session. For presence condition, see TS 24.501 [25].

The UE Integrity Protection Maximum Data Rate indicates the maximum data rate up to which the UE can support UP integrity protection. The UE shall provide the UE Integrity Protection Data Rate capability independently of the Access Type over which the UE sends the PDU Session Establishment Request.

If the use of header compression for Control Plane CIoT 5GS optimisation was negotiated successfully between the UE and the network in the previous registration procedure, the UE shall include the Header Compression Configuration, unless "Unstructured" PDU Session Type is indicated. The Header Compression Configuration includes the information necessary for the header compression channel setup. Optionally, the Header Compression Configuration may include additional header compression context parameters.

The NAS message sent by the UE is encapsulated by the AN in a N2 message towards the AMF that should include User location information and Access Type Information.

The PDU Session Establishment Request message may contain SM PDU DN Request Container containing information for the PDU Session authorization by the external DN.

The UE includes the S-NSSAI from the Allowed NSSAI of the current access type. If the Mapping of Allowed NSSAI was provided to the UE, the UE shall provide both the S-NSSAI of the VPLMN from the Allowed NSSAI and the corresponding S-NSSAI of the HPLMN from the Mapping Of Allowed NSSAI.

If the procedure is triggered for SSC mode 3 operation, the UE shall also include the Old PDU Session ID which indicates the PDU Session ID of the on-going PDU Session to be released, in NAS message. The Old PDU Session ID is included only in this case.

The AMF receives from the AN the NAS SM message (built in step 1) together with User Location Information (e.g. Cell Id in the case of the NG-RAN).

The UE shall not trigger a PDU Session establishment for a PDU Session corresponding to a LADN when the UE is outside the area of availability of the LADN.

If the UE is establishing a PDU session for IMS and the UE is configured to discover the P-CSCF address during connectivity establishment, the UE shall include an indicator that it requests a P-CSCF IP address(es) within the SM container.

The PS Data Off status is included in the PCO in the PDU Session Establishment Request message.

The UE capability to support Reliable Data Service is included in the PCO in the PDU Session Establishment Request message.

If the UE has indicated that it supports transfer of Port Management Information Containers as per UE 5GSM Core Network Capability, then the UE shall include the MAC address of the DS-TT Ethernet port used for this PDU session. If the UE is aware of the UE-DS-TT Residence Time, then the UE shall additionally include the UE-DS-TT Residence Time.

If the UE requests to establish always-on PDU session, the UE includes an Always-on PDU Session Requested indication in the PDU Session Establishment Request message.

Port Management Information Container is received from DS-TT and includes port management capabilities, i.e. information indicating which standardized and deployment-specific port management information is supported by DS-TT as defined in clause 5.28.3 of TS 23.501 [2].

2. The AMF determines that the message corresponds to a request for a new PDU Session based on that Request Type indicates "initial request" and that the PDU Session ID is not used for any existing PDU Session of the UE. If the NAS message does not contain an S-NSSAI, the AMF determines an S-NSSAI of the Serving PLMN for the requested PDU Session from the current Allowed NSSAI for the UE. If there is only one S-NSSAI in the Allowed NSSAI, this S-NSSAI shall be used. If there is more than one S-NSSAI in the Allowed NSSAI, the S-NSSAI selected is either according to the UE subscription, if the subscription contains only one default S-NSSAI and the corresponding mapped HPLMN S-NSSAI of the Serving PLMN is included in the Allowed NSSAI, or based on operator policy (e.g. also ensures any UE Requested DNN is allowed for the selected S-NSSAI)). When the NAS Message contains an S-NSSAI of the Serving PLMN but it does not contain a DNN, the AMF determines the DNN for the requested PDU Session by selecting the default DNN for this S-NSSAI if the default DNN is present in the UE's Subscription Information (or for the corresponding S-NSSAI of the HPLMN, in the case of LBO); otherwise the serving AMF selects a locally configured DNN for this S-NSSAI of the Serving PLMN. If the AMF cannot select an SMF (e.g. the UE requested DNN is not supported by the network, or the UE requested DNN is not in the Subscribed DNN List for the S-NSSAI (or its mapped value for the HPLMN in the case of LBO) and wildcard DNN is not included in the Subscribed DNN list), the AMF shall, based on operator policies received from PCF, either reject the NAS Message containing PDU Session Establishment Request from the UE with an appropriate cause or request PCF to replace the UE requested DNN by a selected DNN. If the DNN requested by the UE is present in the UE subscription information but indicated for replacement in the operator policies received from PCF, the AMF shall request the PCF to perform a DNN replacement to a selected DNN. AMF requests DNN replacement as specified in clause 4.16.2.1.1. If the DNN requested by the UE is present in the UE subscription information but not supported by the network and not indicated for replacement in the operator policies received from PCF, the AMF shall reject the NAS Message containing PDU Session Establishment Request from the UE with an appropriate cause value.

The AMF selects an SMF as described in clause 6.3.2 of TS 23.501 [2] and clause 4.3.2.2.3. If the Request Type indicates "Initial request" or the request is due to handover from EPS or from non-3GPP access serving by a different AMF, the AMF stores an association of the S-NSSAI(s), the DNN, the PDU Session ID, the SMF ID as well as the Access Type of the PDU Session.

During registration procedures, the AMF determines the use of the Control Plane CIoT 5GS Optimisation or User Plane CIoT 5GS Optimisation based on UEs indications in the 5G Preferred Network Behaviour, the serving operator policies and the network support of CIoT 5GS optimisations. The AMF selects an SMF that supports Control Plane CIoT 5GS optimisation or User Plane CIoT 5GS Optimisation as described in clause 6.3.2 of TS 23.501 [2].

If the Request Type is "initial request" and if the Old PDU Session ID indicating the existing PDU Session is also contained in the message, the AMF selects an SMF as described in clause 4.3.5.2 and stores an association of the new PDU Session ID, the S-NSSAI(s), the selected SMF ID as well as Access Type of the PDU Session.

If the Request Type indicates "Existing PDU Session", the AMF selects the SMF based on SMF-ID received from UDM. The case where the Request Type indicates "Existing PDU Session" and either the AMF does not recognize the PDU Session ID or the subscription context that the AMF received from UDM during the Registration or Subscription Profile Update Notification procedure does not contain an SMF ID corresponding to the PDU Session ID constitutes an error case. The AMF updates the Access Type stored for the PDU Session.

If the Request Type indicates "Existing PDU Session" referring to an existing PDU Session moved between 3GPP access and non-3GPP access, then if the Serving PLMN S-NSSAI of the PDU Session is present in the Allowed NSSAI of the target access type, the PDU Session Establishment procedure can be performed in the following cases:

- the SMF ID corresponding to the PDU Session ID and the AMF belong to the same PLMN;
- the SMF ID corresponding to the PDU Session ID belongs to the HPLMN;

Otherwise the AMF shall reject the PDU Session Establishment Request with an appropriate reject cause.

NOTE 2: The SMF ID includes the PLMN ID that the SMF belongs to.

The AMF shall reject a request coming from an Emergency Registered UE and the Request Type indicates neither "Emergency Request" nor "Existing Emergency PDU Session". When the Request Type indicates "Emergency Request", the AMF is not expecting any S-NSSAI and DNN value provided by the UE and uses locally configured values instead. The AMF stores the Access Type of the PDU Session.

If the Request Type indicates "Emergency Request" or "Existing Emergency PDU Session", the AMF selects the SMF as described in clause 5.16.4 of TS 23.501 [2].

3. From AMF to SMF: Either Nsmf\_PDUSession\_CreateSMContext Request (SUPI, selected DNN, UE requested DNN, S-NSSAI(s), PDU Session ID, AMF ID, Request Type, PCF ID, Priority Access, [Small Data Rate Control Status], N1 SM container (PDU Session Establishment Request), User location information, Access Type, RAT Type, PEI, GPSI, UE presence in LADN service area, Subscription For PDU Session Status Notification, DNN Selection Mode, Trace Requirements, Control Plane CIoT 5GS Optimisation indication, or Control Plane Only indicator) or Nsmf\_PDUSession\_UpdateSMContext Request (SUPI, DNN, S-NSSAI(s), SM Context ID, AMF ID, Request Type, N1 SM container (PDU Session Establishment Request), User location information, Access Type, RAT type, PEI, Serving Network (PLMN ID, or PLMN ID and NID, see clause 5.18 of TS 23.501 [2])).

If the AMF does not have an association with an SMF for the PDU Session ID provided by the UE (e.g. when Request Type indicates "initial request"), the AMF invokes the Nsmf\_PDUSession\_CreateSMContext Request, but if the AMF already has an association with an SMF for the PDU Session ID provided by the UE (e.g. when Request Type indicates "existing PDU Session"), the AMF invokes the Nsmf\_PDUSession\_UpdateSMContext Request.

The AMF sends the S-NSSAI of the Serving PLMN from the Allowed NSSAI to the SMF. For roaming scenario in local breakout (LBO), the AMF also sends the corresponding S-NSSAI of the HPLMN from the Mapping Of Allowed NSSAI to the SMF.

The AMF ID is the UE's GUAMI which uniquely identifies the AMF serving the UE. The AMF forwards the PDU Session ID together with the N1 SM container containing the PDU Session Establishment Request received from the UE. The GPSI shall be included if available at AMF.

The AMF determines Access Type and RAT Type, see clause 4.2.2.2.1.

The AMF provides the PEI instead of the SUPI when the UE in limited service state has registered for Emergency services (i.e. Emergency Registered) without providing a SUPI. The PEI is defined in clause 5.9.3 of TS 23.501 [2]. If the UE in limited service state has registered for Emergency services (i.e. Emergency Registered) with a SUPI but has not been authenticated the AMF indicates that the SUPI has not been authenticated. The SMF determines that the UE has not been authenticated when it does not receive a SUPI for the UE or when the AMF indicates that the SUPI has not been authenticated.

If the AMF determines that the selected DNN corresponds to an LADN then the AMF provides the "UE presence in LADN service area" that indicates if the UE is IN or OUT of the LADN service area.

If the Old PDU Session ID is included in step 1 and if the SMF is not to be reallocated, the AMF also includes Old PDU Session ID in the Nsmf\_PDUSession\_CreateSMContext Request.

DNN Selection Mode is determined by the AMF. It indicates whether an explicitly subscribed DNN has been provided by the UE in its PDU Session Establishment Request.

The SMF may use DNN Selection Mode when deciding whether to accept or reject the UE request.

When the Establishment cause received as part of AN parameters during the Registration procedure or Service Request procedure is associated with priority services (e.g. MPS, MCS), the AMF includes a Message Priority header to indicate priority information. The SMF uses the Message Priority header to determine if the UE request is subject to exemption from NAS level congestion control. Other NFs relay the priority information by including the Message Priority header in service-based interfaces, as specified in TS 29.500 [17].

In the local breakout case, if the SMF (in the VPLMN) is not able to process some part of the N1 SM information that Home Routed Roaming is required and the SMF responds to the AMF that it is not the right SMF to handle the N1 SM message by invoking Nsmf\_PDUSession\_CreateSMContext Response service operation. The SMF includes a proper N11 cause code triggering the AMF to proceed with home routed case. The procedure starts again at step 2 of clause 4.3.2.2.2.

The AMF may include a PCF ID in the Nsmf\_PDUSession\_CreateSMContext Request. This PCF ID identifies the H-PCF in the non-roaming case and the V-PCF in the local breakout roaming case.

The AMF includes Trace Requirements if Trace Requirements have been received in subscription data.

If the AMF decides to use the Control Plane CIoT 5GS Optimisation or User Plane CIoT 5GS Optimisation as specified in step 2 or to only use Control Plane CIoT 5GS Optimisation for the PDU session as described in clause 5.31.4 of TS 23.501 [2], the AMF sends the Control Plane CIoT 5GS Optimisation indication or Control Plane Only indicator to the SMF.

If the AMF determines that the RAT type is NB-IoT and the number of PDU Sessions with user plane resources activated for the UE has reached the maximum number of supported user plane resources (0, 1 or 2) based on whether the UE supports UP data transfer and the UE's 5GMM Core Network Capability as described in Clause 5.31.19 of TS 23.501 [2], the AMF may either reject the PDU Session Establishment Request or continue with the PDU Session establishment and include the Control Plane CIoT 5GS Optimisation indication or Control Plane Only indicator to the SMF.

The AMF includes the latest Small Data Rate Control Status if it has stored it for the PDU Session.

If the RAT type was included in the message, then the SMF stores the RAT type in SM Context.

If the UE supports CE mode B and use of CE mode B is not restricted according to the Enhanced Coverage Restriction information in the UE context in the AMF, then the AMF shall include the extended NAS-SM timer indication. Based on the extended NAS-SM timer indication, the SMF shall use the extended NAS-SM timer setting for the UE as specified in TS 24.501 [25].

4. If Session Management Subscription data for corresponding SUPI, DNN and S-NSSAI of the HPLMN is not available, then SMF retrieves the Session Management Subscription data using Nudm\_SDM\_Get (SUPI, Session Management Subscription data, selected DNN, S-NSSAI of the HPLMN, Serving PLMN ID, [NID]) and subscribes to be notified when this subscription data is modified using Nudm\_SDM\_Subscribe (SUPI, Session Management Subscription data, selected DNN, S-NSSAI of the HPLMN, Serving PLMN ID, [NID]). UDM may get this information from UDR by Nudr\_DM\_Query (SUPI, Subscription Data, Session Management Subscription data, selected DNN, S-NSSAI of the HPLMN, Serving PLMN ID, [NID]) and may subscribe to notifications from UDR for the same data by Nudr\_DM\_subscribe.

The SMF may use DNN Selection Mode when deciding whether to retrieve the Session Management Subscription data e.g. if the (selected DNN, S-NSSAI of the HPLMN) is not explicitly subscribed, the SMF may use local configuration instead of Session Management Subscription data.

If the Request Type in step 3 indicates "Existing PDU Session" or "Existing Emergency PDU Session" the SMF determines that the request is due to switching between 3GPP access and non-3GPP access or due to handover from EPS. The SMF identifies the existing PDU Session based on the PDU Session ID. In such a case, the SMF does not create a new SM context but instead updates the existing SM context and provides the representation of the updated SM context to the AMF in the response.

If the Request Type is "Initial request" and if the Old PDU Session ID is included in Nsmf\_PDUSession\_CreateSMContext Request, the SMF identifies the existing PDU Session to be released based on the Old PDU Session ID.



Subscription data includes the Allowed PDU Session Type(s), Allowed SSC mode(s), default 5QI and ARP, subscribed Session-AMBR, SMF-Associated external parameters.

Static IP address/prefix may be included in the subscription data if the UE has subscribed to it.

The SMF checks the validity of the UE request: it checks

- Whether the UE request is compliant with the user subscription and with local policies;
- (If the selected DNN corresponds to an LADN), whether the UE is located within the LADN service area based on the "UE presence in LADN service area" indication from the AMF. If the AMF does not provide the "UE presence in LADN service area" indication and the SMF determines that the selected DNN corresponds to a LADN, then the SMF considers that the UE is OUT of the LADN service area.

The SMF determines whether the PDU Session requires redundancy and the SMF determines the RSN as described in clause 5.33.2.1 of TS 23.501 [2]. If the SMF determines that redundant handling is not allowed or not possible for the given PDU Session, the SMF shall either reject the establishment of the PDU Session or accept the establishment of a PDU session without redundancy handling based on local policy.

If the UE request is considered as not valid, the SMF decides to not accept to establish the PDU Session.

NOTE 3: The SMF can, instead of the Nudm\_SDM\_Get service operation, use the Nudm\_SDM\_Subscribe service operation with an Immediate Report Indication that triggers the UDM to immediately return the subscribed data if the corresponding feature is supported by both the SMF and the UDM.

5. From SMF to AMF: Either Nsmf\_PDUSession\_CreateSMContext Response (Cause, SM Context ID or N1 SM container (PDU Session Reject (Cause))) or an Nsmf\_PDUSession\_UpdateSMContext Response depending on the request received in step 3.

If the SMF received Nsmf\_PDUSession\_CreateSMContext Request in step 3 and the SMF is able to process the PDU Session establishment request, the SMF creates an SM context and responds to the AMF by providing an SM Context ID.

If the UP Security Policy for the PDU Session is determined to have Integrity Protection set to "Required", the SMF may, based on local configuration, decide whether to accept or reject the PDU Session request based on the UE Integrity Protection Maximum Data Rate.

NOTE 4: The SMF can e.g. be configured to reject a PDU Session if the UE Integrity Protection Maximum Data Rate has a very low value, if the services provided by the DN would require higher bitrates.

When the SMF decides to not accept to establish a PDU Session, the SMF rejects the UE request via NAS SM signalling including a relevant SM rejection cause by responding to the AMF with Nsmf\_PDUSession\_CreateSMContext Response. The SMF also indicates to the AMF that the PDU Session ID is to be considered as released, the SMF proceeds to step 20 and the PDU Session Establishment procedure is stopped.

6. Optional Secondary authentication/authorization.

If the Request Type in step 3 indicates "Existing PDU Session", the SMF does not perform secondary authentication/authorization.

If the Request Type received in step 3 indicates "Emergency Request" or "Existing Emergency PDU Session", the SMF shall not perform secondary authentication\authorization.

If the SMF needs to perform secondary authentication/authorization during the establishment of the PDU Session by a DN-AAA server as described in clause 5.6.6 of TS 23.501 [2], the SMF triggers the PDU Session establishment authentication/authorization as described in clause 4.3.2.3.

- 7a. If dynamic PCC is to be used for the PDU Session, the SMF performs PCF selection as described in clause 6.3.7.1 of TS 23.501 [2]. If the Request Type indicates "Existing PDU Session" or "Existing Emergency PDU Session", the SMF shall use the PCF already selected for the PDU Session.

Otherwise, the SMF may apply local policy.

- 7b. The SMF may perform an SM Policy Association Establishment procedure as defined in clause 4.16.4 to establish an SM Policy Association with the PCF and get the default PCC Rules for the PDU Session. The SMF

shall include the 3GPP Data Off status if received in step 1. The GPSI shall be included if available at SMF. If the Request Type in step 3 indicates "Existing PDU Session", the SMF provides information on the Policy Control Request Trigger condition(s) that have been met by an SMF initiated SM Policy Association Modification procedure as defined in clause 4.16.5.1. The PCF may provide policy information defined in clause 5.2.5.4 (and in TS 23.503 [20]) to SMF.

The PCF, based on the Emergency DNN, sets the ARP of the PCC rules to a value that is reserved for Emergency services as described in TS 23.503 [20].

NOTE 5: The purpose of step 7 is to receive PCC rules before selecting UPF. If PCC rules are not needed as input for UPF selection, step 7 can be performed after step 8.

8. If the Request Type in step 3 indicates "Initial request", the SMF selects an SSC mode for the PDU Session as described in clause 5.6.9.3 of TS 23.501 [2]. The SMF also selects one or more UPFs as needed as described in clause 6.3.3 of TS 23.501 [2]. In the case of PDU Session Type IPv4 or IPv6 or IPv4v6, the SMF allocates an IP address/prefix for the PDU Session (unless configured otherwise) as described in clause 5.8.2 of TS 23.501 [2]. In the case of PDU Session Type IPv6 or IPv4v6, the SMF also allocates an interface identifier to the UE for the UE to build its link-local address. For Unstructured PDU Session Type the SMF may allocate an IPv6 prefix for the PDU Session and N6 point-to-point tunnelling (based on UDP/IPv6) as described in clause 5.6.10.3 of TS 23.501 [2]. For Ethernet PDU Session Type, neither a MAC nor an IP address is allocated by the SMF to the UE for this PDU Session.

If the AMF indicated Control Plane CIoT 5GS Optimisation in step 3 for this PDU session, then,

- 1) For Unstructured PDU Session Type, the SMF checks whether UE's subscription include a "NEF Identity for NIDD" for the DNN/S-NSSAI combination. When the "NEF Identity for NIDD" is present in the UE's subscription data, the SMF will select the NEF identified for the S-NSSAI and selected DNN in the "NEF Identity for NIDD" as the anchor of this PDU Session. Otherwise, the SMF will select a UPF as the anchor of this PDU Session.
- 2) For other PDU Session Types, the SMF will perform UPF selection to select a UPF as the anchor of this PDU Session.

If the Request Type in Step 3 is "Existing PDU Session", the SMF maintains the same IP address/prefix that has already been allocated to the UE in the source network.

If the Request Type in step 3 indicates "Existing PDU Session" referring to an existing PDU Session moved between 3GPP access and non-3GPP access the SMF maintains the SSC mode of the PDU Session, the current PDU Session Anchor and IP address.

NOTE 6: The SMF may decide to trigger e.g. new intermediate UPF insertion or allocation of a new UPF as described in step 5 in clause 4.2.3.2.

If the Request Type indicates "Emergency Request", the SMF selects the UPF as described in clause 5.16.4 of TS 23.501 [2] and selects SSC mode 1.

SMF may select a UPF (e.g. based on requested DNN/S-NSSAI) that supports NW-TT functionality.

9. SMF may perform an SMF initiated SM Policy Association Modification procedure as defined in clause 4.16.5.1 to provide information on the Policy Control Request Trigger condition(s) that have been met. If Request Type is "initial request" and dynamic PCC is deployed and PDU Session Type is IPv4 or IPv6 or IPv4v6, SMF notifies the PCF (if the Policy Control Request Trigger condition is met) with the allocated UE IP address/prefix(es).

NOTE 7: If an IP address/prefix has been allocated before step 7 (e.g. subscribed static IP address/prefix in UDM/UDR) or the step 7 is performed after step 8, the IP address/prefix can be provided to PCF in step 7 and the IP address/prefix notification in this step can be skipped.

PCF may provide updated policies to the SMF. The PCF may provide policy information defined in clause 5.2.5.4 (and in TS 23.503 [20]) to SMF.

10. If Request Type indicates "initial request", the SMF initiates an N4 Session Establishment procedure with the selected UPF(s), otherwise it initiates an N4 Session Modification procedure with the selected UPF(s):

10a. The SMF sends an N4 Session Establishment/Modification Request to the UPF and provides Packet detection, enforcement and reporting rules to be installed on the UPF for this PDU Session. If the SMF is

configured to request IP address allocation from UPF as described in clause 5.8.2 of TS 23.501 [2] then the SMF indicates to the UPF to perform the IP address/prefix allocation and includes the information required for the UPF to perform the allocation. If the selective User Plane deactivation is required for this PDU Session, the SMF determines the Inactivity Timer and provides it to the UPF. The SMF provides Trace Requirements to the UPF if it has received Trace Requirements. If the Reliable Data Service is enabled for the PDU Session by the SMF as specified in TS 23.501 [2], the RDS Configuration information is provided to the UPF in this step. The SMF provides Small Data Rate Control parameters to the UPF for the PDU Session, if required. The SMF provides the Small Data Rate Control Status to the UPF, if received from the AMF. If the Serving PLMN intends to enforce Serving PLMN Rate Control (see clause 5.31.14.2 of TS 23.501 [2]) for this PDU session then the SMF shall provide Serving PLMN Rate Control parameters to UPF for limiting the rate of downlink control plane data packets.

For a PDU Session of type Ethernet, SMF (e.g. for a certain requested DNN/S-NSSAI) may include an indication to request UPF to provide port numbers.

If SMF decides to perform redundant transmission for one or more QoS Flows of the PDU session as described in clause 5.33.1.2 of TS 23.501 [2], two CN Tunnel Info are requested by the SMF from the UPF. The SMF also indicates the UPF to eliminate the duplicated packet for the QoS Flow in uplink direction. The SMF indicates the UPF that one CN Tunnel Info is used as the redundancy tunnel of the PDU session described in clause 5.33.2.2 of TS 23.501 [2].

If SMF decides to insert two I-UPFs between the PSA UPF and the NG-RAN for redundant transmission as described in clause 5.33.1.2 of TS 23.501 [2], the SMF requests the corresponding CN Tunnel Info and provides them to the I-UPFs and PSA UPF respectively. The SMF also indicates the PSA UPF to eliminate the duplicated packet for the QoS Flow in uplink direction. The SMF indicates the PSA UPF that one CN Tunnel Info is used as the redundancy tunnel of the PDU session described in clause 5.33.2.2 of TS 23.501 [2].

NOTE 8: The method to perform elimination and reordering on RAN/UPF based on the packets received from the two GTP-U tunnels is up to RAN/UPF implementation. The two GTP-U tunnels are terminated at the same RAN node and UPF.

If Control Plane CIoT 5GS Optimisation is enabled for this PDU session and the SMF selects the NEF as the anchor of this PDU Session in step 8, the SMF performs SMF-NEF Connection Establishment Procedure as described in clause 4.25.2.

10b. The UPF acknowledges by sending an N4 Session Establishment/Modification Response.

If the SMF indicates in step 10a that IP address/prefix allocation is to be performed by the UPF then this response contains the requested IP address/prefix. The requested CN Tunnel Info is provided to SMF in this step. If SMF indicated the UPF to perform packet duplication and elimination for the QoS Flow in step 10a, two CN Tunnel Info are allocated by the UPF and provided to the SMF. If SMF decides to insert two I-UPFs between the PSA UPF and the NG-RAN for redundant transmission as described in clause 5.33.1.2 of TS 23.501 [2], CN Tunnel Info of two I-UPFs and the UPF (PSA) are allocated by the UPFs and provided to the SMF. The UPF indicates the SMF that one CN Tunnel Info is used as the redundancy tunnel of the PDU session as described in clause 5.33.2.2 of TS 23.501 [2].

If SMF requested UPF to provide port numbers then UPF includes the DS-TT port and Bridge ID in the response according to TS 23.501 [2].

If multiple UPFs are selected for the PDU Session, the SMF initiate N4 Session Establishment/Modification procedure with each UPF of the PDU Session in this step.

NOTE 9: If the PCF has subscribed to the UE IP address change Policy Control Trigger (as specified in clause 6.1.3.5 of TS 23.503 [20]) then the SMF notifies the PCF about the IP address/prefix allocated by the UPF. This is not shown in figure 4.3.2.2.1-1.

11. SMF to AMF: Namf\_Communication\_N1N2MessageTransfer (PDU Session ID, N2 SM information (PDU Session ID, QFI(s), QoS Profile(s), CN Tunnel Info, S-NSSAI from the Allowed NSSAI, Session-AMBR, PDU Session Type, User Plane Security Enforcement information, UE Integrity Protection Maximum Data Rate, RSN), N1 SM container (PDU Session Establishment Accept ([QoS Rule(s) and QoS Flow level QoS parameters if needed for the QoS Flow(s) associated with the QoS rule(s)], selected SSC mode, S-NSSAI(s), UE Requested DNN, allocated IPv4 address, interface identifier, Session-AMBR, selected PDU Session Type, [Reflective QoS Timer] (if available), [P-CSCF address(es)], [Control Plane Only indicator], [Header Compression

Configuration], [Always-on PDU Session Granted], [Small Data Rate Control parameters], [Small Data Rate Control Status], [Serving PLMN Rate Control])). If multiple UPFs are used for the PDU Session, the CN Tunnel Info contains tunnel information related with the UPFs that terminate N3.

The SMF may provide the SMF derived CN assisted RAN parameters tuning to the AMF by invoking Nsmf\_PDUSession\_SMContextStatusNotify (SMF derived CN assisted RAN parameters tuning) service. The AMF stores the SMF derived CN assisted RAN parameters tuning in the associated PDU Session context for this UE.

The N2 SM information carries information that the AMF shall forward to the (R)AN which includes:

- The CN Tunnel Info corresponds to the Core Network address(es) of the N3 tunnel corresponding to the PDU Session. If two CN Tunnel Info are included for the PDU session for redundant transmission, the SMF also indicates the NG-RAN that one of the CN Tunnel Info used as the redundancy tunnel of the PDU session as described in clause 5.33.2.2 of TS 23.501 [2].
- One or multiple QoS profiles and the corresponding QFIs can be provided to the (R)AN. This is further described in clause 5.7 of TS 23.501 [2]. The SMF may indicate for each QoS Flow whether redundant transmission shall be performed by a corresponding redundant transmission indicator.
- The PDU Session ID may be used by AN signalling with the UE to indicate to the UE the association between (R)AN resources and a PDU Session for the UE.
- A PDU Session is associated to an S-NSSAI of the HPLMN and, if applicable, to a S-NSSAI of the VPLMN and a DNN. The S-NSSAI provided to the (R)AN, is the S-NSSAI with the value for the Serving PLMN (i.e. the HPLMN S-NSSAI or, in LBO roaming case, the VPLMN S-NSSAI).
- User Plane Security Enforcement information is determined by the SMF as described in clause 5.10.3 of TS 23.501 [2].
- If the User Plane Security Enforcement information indicates that Integrity Protection is "Preferred" or "Required", the SMF also includes the UE Integrity Protection Maximum Data Rate as received in the PDU Session Establishment Request.
- The use of the RSN parameter by NG-RAN is described in clause 5.33.2.1 of TS 23.501 [2].

The N1 SM container contains the PDU Session Establishment Accept that the AMF shall provide to the UE. If the UE requested P-CSCF discovery then the message shall also include the P-CSCF IP address(es) as determined by the SMF and as described in clause 5.16.3.4 of TS 23.501 [2]. The PDU Session Establishment Accept includes S-NSSAI from the Allowed NSSAI. For LBO roaming scenario, the PDU Session Establishment Accept includes the S-NSSAI from the Allowed NSSAI for the VPLMN and also it includes the corresponding S-NSSAI of the HPLMN from the Mapping Of Allowed NSSAI that SMF received in step 3.

If the PDU Session being established was requested to be an always-on PDU Session, the SMF shall indicate whether the request is accepted by including an Always-on PDU Session Granted indication in the PDU Session Establishment Accept message. If the PDU Session being established was not requested to be an always-on PDU Session but the SMF determines that the PDU Session needs to be established as an always-on PDU Session, the SMF shall include an Always-on PDU Session Granted indication in the PDU Session Establishment Accept message indicating that the PDU session is an always-on PDU Session.

If Control Plane CIoT 5GS Optimisation is enabled for this PDU session, the N2 SM information is not included in this step. If Control Plane CIoT 5GS optimisation is enabled for this PDU session and the UE has sent the Header Compression Configuration in the PDU Session Establishment Request and the SMF supports the header compression parameters, the SMF shall include the Header Compression Configuration in the PDU Session Establishment Accept message. If the UE has included Header Compression context parameters in Header Compression Configuration in the PDU Session Establishment Request, the SMF shall establish the header compression context and may acknowledge the Header Compression context parameters. If the header compression context is not established during the PDU Session Establishment procedure, before using the compressed format for sending the data, the UE and the SMF need to establish the header compression context based on the Header Compression Configuration. If the SMF has received the Control Plane Only Indicator in step 3, the SMF shall include the Control Plane Only Indicator in the PDU Session Establishment Accept message. The SMF shall indicate the use of Control Plane only on its CDR. If the Small Data Rate Control is configured in the SMF, the SMF shall also include Small Data Rate Control parameters and the Small Data Rate Control Status (if received from the AMF) in the PDU Session Establishment Accept message as described in

clause 5.31.14.3 of TS 23.501 [2]. If the Serving PLMN intends to enforce Serving PLMN Rate Control (see clause 5.31.14.2 of TS 23.501 [2]) for this PDU session then the SMF shall include the Serving PLMN Rate Control parameters in the PDU Session Establishment Accept message. The UE shall store and use Serving PLMN Rate Control parameters as the maximum allowed limit of uplink control plane user data.

If the UE indicates the support of RDS in the PCO in the PDU Session Establishment Request and RDS is enabled for the PDU Session, the SMF shall inform the UE that RDS is enabled in the PCO in the PDU Session Establishment Accept (see clause 5.31.6 of TS 23.501 [2]).

If the NIDD parameters (e.g. maximum packet size) were received from NEF during the SMF-NEF Connection Establishment procedure in step 10, the SMF shall inform the UE of the NIDD parameters in the PCO in the PDU Session Establishment Accept (see clause 5.31.5 of TS 23.501 [2]).

Multiple QoS Rules, QoS Flow level QoS parameters if needed for the QoS Flow(s) associated with those QoS rule(s) and QoS Profiles may be included in the PDU Session Establishment Accept within the N1 SM and in the N2 SM information.

The `Namf_Communication_N1N2MessageTransfer` contains the PDU Session ID allowing the AMF to know which access towards the UE to use.

If the PDU session establishment failed anywhere between step 5 and step 11, then the `Namf_Communication_N1N2MessageTransfer` request shall include the N1 SM container with a PDU Session Establishment Reject message (see clause 8.3.3 of TS 24.501 [25]) and shall not include any N2 SM container. The (R)AN sends the NAS message containing the PDU Session Establishment Reject to the UE. In this case, steps 12-17 are skipped.

12. AMF to (R)AN: N2 PDU Session Request (N2 SM information, NAS message (PDU Session ID, N1 SM container (PDU Session Establishment Accept)), [CN assisted RAN parameters tuning]). If the N2 SM information is not included in the step 11, an N2 Downlink NAS Transport message is used instead.

The AMF sends the NAS message containing PDU Session ID and PDU Session Establishment Accept targeted to the UE and the N2 SM information received from the SMF within the N2 PDU Session Request to the (R)AN.

If the SMF derived CN assisted RAN parameters tuning are stored for the activated PDU Session(s), the AMF may derive updated CN assisted RAN parameters tuning and provide them to the (R)AN.

13. (R)AN to UE: The (R)AN may issue AN specific signalling exchange with the UE that is related with the information received from SMF. For example, in the case of a NG-RAN, an RRC Connection Reconfiguration may take place with the UE establishing the necessary NG-RAN resources related to the QoS Rules for the PDU Session request received in step 12.

(R)AN also allocates (R)AN Tunnel Info for the PDU Session. In the case of Dual Connectivity, the Master RAN node may assign some (zero or more) QFIs to be setup to a Master RAN node and others to the Secondary RAN node. The AN Tunnel Info includes a tunnel endpoint for each involved (R)AN node and the QFIs assigned to each tunnel endpoint. A QFI can be assigned to either the Master RAN node or the Secondary RAN node and not to both.

If the (R)AN receives two CN Tunnel Info for a PDU session in step 12 for redundant transmission, (R)AN also allocates two AN Tunnel Info correspondingly and indicate to SMF one of the AN Tunnel Info is used as the redundancy tunnel of the PDU session as described in clause 5.33.2.2 of TS 23.501 [2].

(R)AN forwards the NAS message (PDU Session ID, N1 SM container (PDU Session Establishment Accept)) provided in step 12 to the UE. (R)AN shall only provide the NAS message to the UE if the AN specific signalling exchange with the UE includes the (R)AN resource additions associated to the received N2 command.

If MICO mode is active and the NAS message Request Type in step 1 indicated "Emergency Request", then the UE and the AMF shall locally deactivate MICO mode.

If the N2 SM information is not included in the step 11, then the following steps 14 to 16b and step 17 are omitted.

14. (R)AN to AMF: N2 PDU Session Response (PDU Session ID, Cause, N2 SM information (PDU Session ID, AN Tunnel Info, List of accepted/rejected QFI(s), User Plane Enforcement Policy Notification)).

The AN Tunnel Info corresponds to the Access Network address of the N3 tunnel corresponding to the PDU Session.

If the (R)AN rejects QFI(s) the SMF is responsible of updating the QoS rules and QoS Flow level QoS parameters if needed for the QoS Flow associated with the QoS rule(s) in the UE accordingly.

The NG-RAN rejects the establishment of UP resources for the PDU Session when it cannot fulfil User Plane Security Enforcement information with a value of Required. The NG-RAN notifies the SMF when it cannot fulfil a User Plane Security Enforcement with a value of Preferred.

If the NG-RAN cannot establish redundant user plane for the PDU Session as indicated by the RSN parameter, the NG-RAN takes the decision on whether to reject the establishment of RAN resources for the PDU Session based on local policies as described in TS 23.501 [2].

15. AMF to SMF: Nsmf\_PDUSession\_UpdateSMContext Request (SM Context ID, N2 SM information, Request Type).

The AMF forwards the N2 SM information received from (R)AN to the SMF.

If the list of rejected QFI(s) is included in N2 SM information, the SMF shall release the rejected QFI(s) associated QoS profiles.

If the N2 SM information indicates failure of user plane resource setup, the SMF shall reject the PDU session establishment by including a N1 SM container with a PDU Session Establishment Reject message (see clause 8.3.3 of TS 24.501 [25]) in the Nsmf\_PDUSession\_UpdateSMContext Response in step 17. Step 16 is skipped in this case and instead the SMF releases the N4 Session with UPF.

If the User Plane Enforcement Policy Notification in the N2 SM information indicates that no user plane resources could be established and the User Plane Enforcement Policy indicated "required" as described in clause 5.10.3 of TS 23.501 [2], the SMF shall reject the PDU session establishment by including a N1 SM container with a PDU Session Establishment Reject message (see clause 8.3.3 of TS 24.501 [25]) in the Nsmf\_PDUSession\_UpdateSMContext Response in step 17. Step 16 is skipped in this case.

- 16a. The SMF initiates an N4 Session Modification procedure with the UPF. The SMF provides AN Tunnel Info to the UPF as well as the corresponding forwarding rules.

If SMF decides to perform redundant transmission for one or more QoS Flows of the PDU, the SMF also indicates the UPF to perform packet duplication for the QoS Flow(s) in downlink direction by forwarding rules.

In the case of redundant transmission with two I-UPFs for one or more QoS Flows of the PDU, the SMF provides AN Tunnel Info to two I-UPFs and also indicates the UPF (PSA) to perform packet duplication for the QoS Flow(s) in downlink direction by forwarding rules. The SMF also provides the UL Tunnel Info of the UPF (PSA) to the two I-UPFs and the DL Tunnel Info of the two I-UPFs to the UPF (PSA).

NOTE 10: If the PDU Session Establishment Request was due to mobility between 3GPP and non-3GPP access or mobility from EPC, the downlink data path is switched towards the target access in this step.

- 16b. The UPF provides an N4 Session Modification Response to the SMF.

If multiple UPFs are used in the PDU Session, the UPF in step 16 refers to the UPF terminating N3.

After this step, the UPF delivers any down-link packets to the UE that may have been buffered for this PDU Session.

- 16c. If Request Type in step 3 indicates neither "Emergency Request" nor "Existing Emergency PDU Session" and, if the SMF has not yet registered for this PDU Session, then the SMF registers with the UDM using Nudm\_UECM\_Registration (SUPI, DNN, S-NSSAI, PDU Session ID, SMF Identity, Serving PLMN ID, [NID]) for a given PDU Session. As a result, the UDM stores following information: SUPI, SMF identity and the associated DNN, S-NSSAI, PDU Session ID and Serving Network (PLMN ID, [NID], see clause 5.18 of TS 23.501 [2]). The UDM may further store this information in UDR by Nudr\_DM\_Update (SUPI, Subscription Data, UE context in SMF data).

If the Request Type received in step 3 indicates "Emergency Request":

- For an authenticated non-roaming UE, based on operator configuration (e.g. related with whether the operator uses a fixed SMF for Emergency calls, etc.), the SMF may register in the UDM using

Nudm\_UECM\_Registration (SUPI, PDU Session ID, SMF identity, Indication of Emergency Services) for a given PDU Session that is applicable for emergency services. As a result, the UDM shall store the applicable PDU Session for Emergency services.

- For an unauthenticated UE or a roaming UE, the SMF shall not register in the UDM for a given PDU Session.

#### 17. SMF to AMF: Nsmf\_PDUSession\_UpdateSMContext Response (Cause).

The SMF may subscribe to the UE mobility event notification from the AMF (e.g. location reporting, UE moving into or out of Area Of Interest), after this step by invoking Namf\_EventExposure\_Subscribe service operation as specified in clause 5.2.2.3.2. For LADN, the SMF subscribes to the UE moving into or out of LADN service area event notification by providing the LADN DNN as an indicator for the Area Of Interest (see clause 5.6.5 and 5.6.11 of TS 23.501 [2]).

After this step, the AMF forwards relevant events subscribed by the SMF.

#### 18. [Conditional] SMF to AMF: Nsmf\_PDUSession\_SMContextStatusNotify (Release)

If during the procedure, any time after step 5, the PDU Session establishment is not successful, the SMF informs the AMF by invoking Nsmf\_PDUSession\_SMContextStatusNotify (Release). The SMF also releases any N4 session(s) created, any PDU Session address if allocated (e.g. IP address) and releases the association with PCF, if any. In this case, step 19 is skipped.

#### 19. SMF to UE: In the case of PDU Session Type IPv6 or IPv4v6, the SMF generates an IPv6 Router Advertisement and sends it to the UE. If Control Plane ClIoT 5GS Optimisation is enabled for this PDU Session the SMF sends the IPv6 Router Advertisement via the AMF for transmission to the UE using the Mobile Terminated Data Transport in Control Plane ClIoT 5GS Optimisation procedures (see clause 4.24.2), otherwise the SMF sends the IPv6 Router Advertisement via N4 and the UPF.

#### 20. When the trigger for 5GS Bridge information available is armed, then the SMF may initiate the SM Policy Association Modification as described in 4.16.5.1.

If the UE has indicated support of transferring Port Management Information Containers, then SMF informs PCF that a 5GS Bridge information is available. SMF provides the 5GS Bridge information (e.g. 5GS Bridge ID, port number of the DS-TT Ethernet port, MAC address of the DS-TT Ethernet port and UE-DS-TT Residence Time as provided by the UE) to PCF. TSN AF calculates the bridge delay for each port pair, i.e. composed of DS-TT Ethernet port and NW-TT Ethernet port, using the UE-DS-TT Residence Time for all NW-TT Ethernet port(s) serving the 5GS Bridge indicated by the 5GS Bridge ID. If SMF received a Port Management Information Container from either the UE or the UPF, then SMF provides the Port Management Information Container and port number of the related port to the PCF as described in clause 5.28.3.2 of TS 23.501 [2]. If SMF received a Bridge Management Information Container from the UPF, then SMF provides the Bridge Management Information Container to the PCF as described in clause 5.28.3.2 of TS 23.501 [2].

#### 21. If the PDU Session establishment failed after step 4, the SMF shall perform the following:

The SMF unsubscribes to the modifications of Session Management Subscription data for the corresponding (SUPI, DNN, S-NSSAI of the HPLMN), using Nudm\_SDM\_Unsubscribe (SUPI, Session Management Subscription data, DNN, S-NSSAI of the HPLMN), if the SMF is no more handling a PDU Session of the UE for this (DNN, S-NSSAI of the HPLMN). The UDM may unsubscribe to the modification notification from UDR by Nudr\_DM\_Unsubscribe (SUPI, Subscription Data, Session Management Subscription data, S-NSSAI of the HPLMN, DNN).

### 4.3.2.2.2 Home-routed Roaming

This procedure is used in the case of home-routed roaming scenarios.

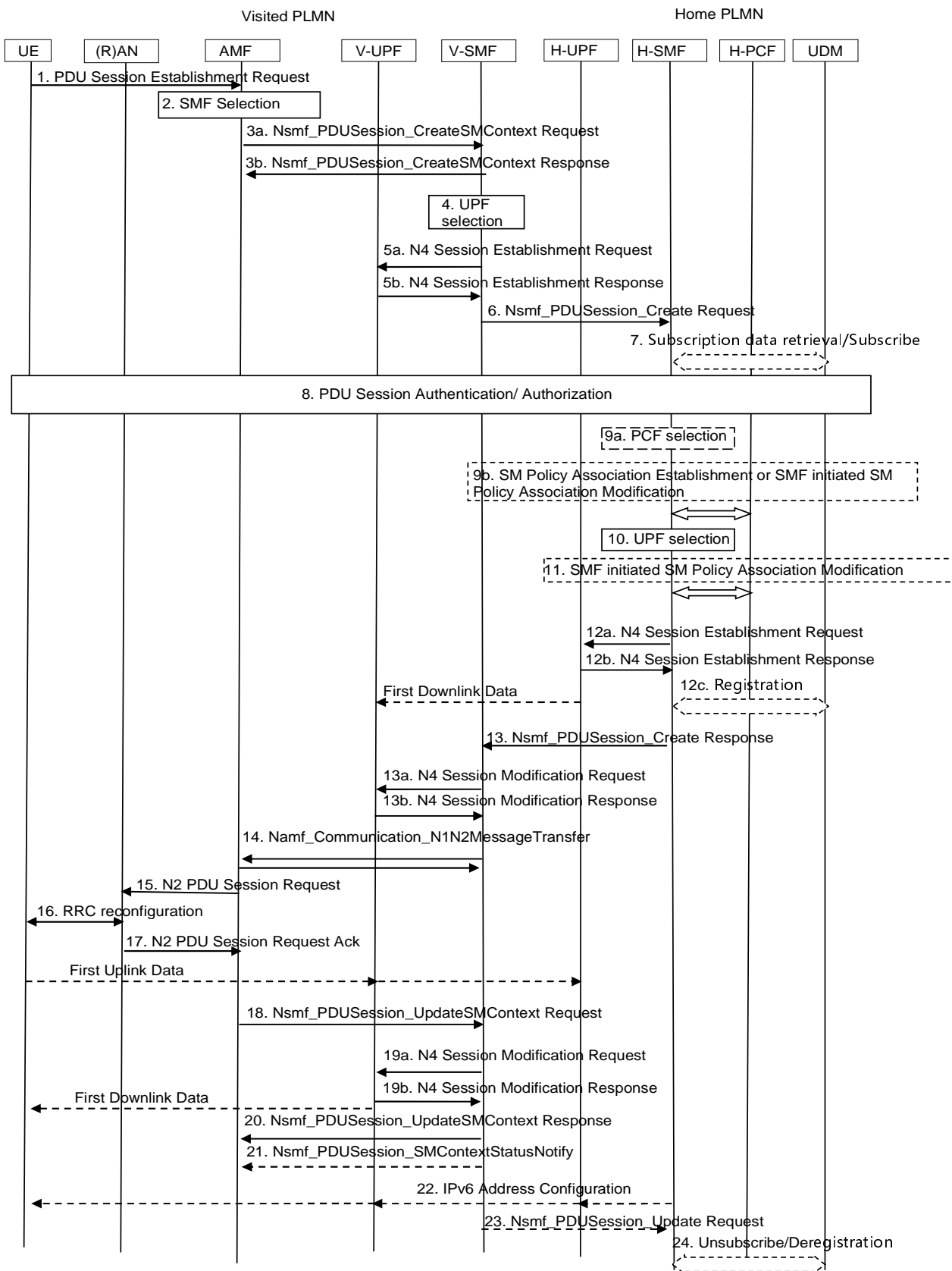


Figure 4.3.2.2.2-1: UE-requested PDU Session Establishment for home-routed roaming scenarios

1. This step is the same as step 1 in clause 4.3.2.2.1.
2. As in step 2 of clause 4.3.2.2.1 except that, if the UE does not include an S-NSSAI in the PDU Session request, both a Serving PLMN S-NSSAI (in the Allowed NSSAI) and its corresponding HPLMN S-NSSAI values are



selected by the AMF. Also, the AMF in the serving PLMN selects both an SMF in the Serving PLMN using the S-NSSAI of the Serving PLMN mapping to the S-NSSAIs of the HPLMN used for the PDU Session and, additionally an SMF in the HPLMN using the S-NSSAI of the HPLMN used for the PDU Session, as described in clause 4.3.2.2.3. The AMF may also receive alternative H-SMFs from the NRF. If Control Plane CIoT 5GS Optimisation is enabled for the PDU Session, the AMF selects V-SMF and H-SMF that supports the Control Plane CIoT 5GS Optimisation (see clause 6.3.2 of TS 23.501 [2]). The AMF stores the association of the S-NSSAI(s), the DNN, the PDU Session ID, the SMF ID in VPLMN as well as Access Type of the PDU Session. Whether to perform DNN replacement is based on operator agreement.

In step 3 of clause 4.3.2.2.1, in local breakout roaming case, if V-SMF responds to AMF indicating that V-SMF is not able to process some part of the N1 SM information, the AMF proceeds with home routed case from this step and may select an SMF in the VPLMN different from the V-SMF selected earlier.

3a. As in step 3 of clause 4.3.2.2.1 with the addition that:

- the AMF also provides the identity of the H-SMF it has selected in step 2 and both the VPLMN S-NSSAI from the Allowed NSSAI and the corresponding S-NSSAI of the HPLMN, which is in the mapping the VPLMN S-NSSAI from the Allowed NSSAI. The H-SMF is provided when the PDU Session is home-routed. The AMF may also provide the identity of alternative H-SMFs, if it has received in step 2.
- The V-SMF does not use DNN Selection Mode received from the AMF but relays this information to the H-SMF.

If the AMF is reusing an already established association with a V-SMF for the PDU Session ID provided by the UE (e.g. when Request Type indicates "existing PDU Session"), the AMF invokes the Nsmf\_PDUSession\_UpdateSMContext Request.

The AMF may include the H-PCF ID in this step and V-SMF will pass it to the H-SMF in step 6. This will enable the H-SMF to select the same H-PCF in step 9a.

If Control Plane CIoT 5GS Optimisation is used for the PDU Session and the "Invoke NEF indication" in the subscription data is set for the S-NSSAI / DNN combination, the AMF includes an "Invoke NEF" flag in Nsmf\_PDUSession\_CreateSMContext Request.

3b: This step is the same as step 5 of clause 4.3.2.2.1. If the PDU Session Type is Unstructured and the V-SMF received an "Invoke NEF" flag in step 3a, then it skips steps 4 and 5.

4. The V-SMF selects a UPF in VPLMN as described in clause 6.3.3 of TS 23.501 [2].

5. The V-SMF initiates an N4 Session Establishment procedure with the selected V-UPF:

5a. The V-SMF sends an N4 Session Establishment Request to the V-UPF. The V-SMF provides Trace Requirements to the V-UPF if the V-SMF has received Trace Requirements from AMF.

5b. The V-UPF acknowledges by sending an N4 Session Establishment Response. The CN Tunnel Info is provided to V-SMF in this step.

6. V-SMF to H-SMF: Nsmf\_PDUSession\_Create Request (SUPI, GPSI (if available), V-SMF SM Context ID, DNN, S-NSSAI with the value defined by the HPLMN, PDU Session ID, V-SMF ID, V-CN-Tunnel-Info, PDU Session Type, PCO, Number Of Packet Filters, User location information, Access Type, RAT Type, PCF ID, [Small Data Rate Control Status], SM PDU DN Request Container, DNN Selection Mode, Control Plane CIoT 5GS Optimisation Indication, [Always-on PDU Session Requested], AMF ID, Serving Network, the QoS constraints from the VPLMN) or Nsmf\_PDUSession\_Update Request (V-CN-Tunnel-Info, PCO, User location information, Access Type, RAT Type, SM PDU DN Request Container, Control Plane CIoT 5GS Optimisation Indication, [Always-on PDU Session Requested], Serving Network). Protocol Configuration Options may contain information that H-SMF may needs to properly establish the PDU Session (e.g. SSC mode or SM PDU DN Request Container to be used to authenticate the UE by the DN-AAA as defined in clause 4.3.2.3). The H-SMF may use DNN Selection Mode when deciding whether to accept or reject the UE request. If the V-SMF does not receive any response from the H-SMF due to communication failure on the N16 interface, depending on operator policy the V-SMF may create the PDU Session to one of the alternative H-SMF(s) if additional H-SMF information is provided in step 3a, as specified in detail in TS 29.502 [36]. The Small Data Rate Control Status is included if received from the AMF. The Control Plane CIoT 5GS Optimisation Indication is set by the V-SMF, if the PDU Session is intended for Control Plane CIoT 5GS Optimisation. The QoS constraints from the

VPLMN contains a 5QI and corresponding ARP value that the VPLMN can accept for the QoS Flow associated with the default QoS rule and the highest Session-AMBR that the VPLMN can accept.

NOTE 1: The QoS constraints from the VPLMN are provided by the VPLMN to avoid the risk that V-SMF rejects the PDU Session in step 13 when controlling SLA with the HPLMN.

V-SMF SM Context ID contains the addressing information it has allocated for service operations related with this PDU Session. The H-SMF stores an association of the PDU Session and V-SMF Context ID for this PDU Session for this UE.

If the H-SMF needs to use V-SMF services for this PDU Session (invoking Nsmf\_PDUSession\_Update Request) before step 13, at the first invocation of Nsmf\_PDUSession\_Update Request the H-SMF provides the V-SMF with the H-SMF SM Context ID it has allocated for service operations related with this PDU Session.

If the RAT type was included in the message, then the H-SMF stores the RAT type in SM Context.

If the V-SMF has an association with the H-SMF for the indicated PDU Session ID, the V-SMF invokes Nsmf\_PDUSession\_Update Request. Otherwise the V-SMF invokes Nsmf\_PDUSession\_Create Request.

7-12b. These steps are the same as steps 4-10 in clause 4.3.2.2.1 with the following differences:

- These steps are executed in Home PLMN;
- The H-SMF does not provide the Inactivity Timer to the H-UPF as described in step 9a in clause 4.3.2.2.1.
- If the QoS constraints from the VPLMN is provided in step 6 and PCF is deployed, the H-SMF provides the QoS constraints from the VPLMN to PCF. The PCF takes this into account when making policy decisions. In case dynamic PCC is not deployed, the SMF takes this into account when generating the default QoS rule.
- Step 5 of clause 4.3.2.2.1 is not executed.

When PCF is deployed, the SMF shall further report the PS Data Off status to PCF if the PS Data Off event trigger is provisioned, the additional behaviour of SMF and PCF for 3GPP PS Data Off is defined in TS 23.503 [20].

12c. This step is the same as step 16c in clause 4.3.2.2.1 with the following difference:

- The H-SMF registers for the PDU Session with the UDM using Nudm\_UECM\_Registration (SUPI, DNN, S-NSSAI with the value defined by the HPLMN, PDU Session ID).

13. H-SMF to V-SMF: Nsmf\_PDUSession\_Create Response (QoS Rule(s), QoS Flow level QoS parameters if needed for the QoS Flow(s) associated with the QoS rule(s), PCO including session level information that the V-SMF is not expected to understand, selected PDU Session Type and SSC mode, Reliable Data Service Support, H-CN Tunnel Info, QFI(s), QoS profile(s), Session-AMBR, Reflective QoS Timer (if available), information needed by V-SMF in the case of EPS interworking such as the PDN Connection Type, User Plane Policy Enforcement)

If the PDU Session being established was requested to be an always-on PDU Session, the H-SMF shall indicate to the V-SMF whether the request is accepted or not via the Always-on PDU Session Granted indication in the response message to V-SMF. If the PDU Session being established was not requested to be an always-on PDU Session but the H-SMF determines that the PDU Session needs to be established as an always-on PDU Session, the H-SMF shall indicate it to the V-SMF by including Always-on PDU Session Granted indication that the PDU Session is an always-on PDU Session.

The information that the H-SMF may provide is the same than defined for step 11 of Figure 4.3.2.2.1-1.

The H-CN Tunnel Info contains the tunnel information for uplink traffic towards H-UPF.

Multiple QoS Rules and QoS Flow level QoS parameters for the QoS Flow(s) associated with the QoS rule(s) may be included in the Nsmf\_PDUSession\_Create Response.

The V-SMF may apply VPLMN policies related with the SLA negotiated with the HPLMN or with QoS values supported by the VPLMN; such policies may result in that V-SMF does not accept the PDU Session or does not accept some of the QoS Flows requested by the H-SMF. If the V-SMF does not accept the PDU Session, the V-SMF triggers the V-SMF initiated PDU Session Release procedure from step 1b-3b as defined in clause 4.3.4.3. When the V-SMF accepts at least one QoS flow, it transfers (via the AMF) the corresponding N2 (and NAS)

request towards the 5G AN (and the UE) but does not issue requests for the QoS Flow(s) it has rejected due these policies. The V-SMF notifies the H-SMF about the rejected QoS Flows in step 23 below.

If Control Plane CIoT 5GS Optimisation is enabled for the PDU Session, certain information, e.g. H-CN tunnel info, is not provided in the response to V-SMF.

V-SMF stores the indication of Small Data Rate Control applicability on this PDU Session, if it is received in Nsmf\_PDUSession\_Create Response.

13a-13b. The V-SMF initiates an N4 Session Modification procedure with the V-UPF. The V-SMF may provide N4 rules to the V-UPF for this PDU Session, including rules to forward UL traffic to the H-UPF.

14-18. These steps are the same as steps 11-15 in clause 4.3.2.2.1 with the following differences:

- These steps are executed in Visited PLMN;
- The V-SMF stores an association of the PDU Session and H-SMF ID for this PDU Session for this UE;
- If the H-SMF indicates the PDU Session can be established as an always-on PDU Session, the V-SMF shall further check whether the PDU Session can be established as an always-on PDU Session based on local policies. The V-SMF notifies the UE whether the PDU Session is an always-on PDU Session or not via the Always-on PDU Session Granted indication in the PDU Session Establishment Accept message.
- If the N2 SM information indicates failure of user plane resource setup and the V-SMF rejected the PDU session establishment as described in step 15 in clause 4.3.2.2.1, step 19 is skipped and instead the V-SMF releases the N4 Session with V-UPF.
- If an alternative H-SMF is selected for the PDU Session and the corresponding selected alternative H-SMF ID has not been previously provided to the AMF, the V-SMF provides the selected alternative H-SMF ID to the AMF.

NOTE 2: The selected alternative H-SMF ID can be provided to AMF earlier, e.g. in step 8 if PDU Session Authentication/Authorization is performed.

- If Control Plane CIoT 5GS Optimisation is enabled for the PDU Session, steps 19, 20 and 23 below are omitted.

19a. The V-SMF initiates an N4 Session Modification procedure with the V-UPF. The V-SMF may provide N4 rules to the V-UPF for this PDU Session, including rules to forward DL traffic to the AN.

19b. The V-UPF provides a N4 Session Modification Response to the V-SMF.

After this step, the V-UPF delivers any down-link packets to the UE that may have been buffered for this PDU Session.

20. This step is the same as step 17 in clause 4.3.2.2.1 with the following differences:

- The SMF is a V-SMF. The H-SMF and V-SMF subscribe to UE reachability event from AMF.

21. This step is same as step 18 in clause 4.3.2.2.1. In addition, if during the procedure, after step 14, the PDU Session establishment is not successful as specified in step 15 of clause 4.3.2.2.1, the V-SMF triggers the V-SMF initiated PDU Session Release procedure from step 1b-3b as defined in clause 4.3.4.3.

22. H-SMF to UE, via H-UPF and V-UPF in VPLMN: In the case of PDU Session Type IPv6 or IPv4v6, the H-SMF generates an IPv6 Router Advertisement and sends it to the UE via N4 and the H-UPF and V-UPF. If the Control Plane CIoT 5GS Optimisation is enabled for this PDU session the V-UPF forwards the IPv6 Router Advertisement to the V-SMF for transmission to the UE using the Mobile Terminated Data Transport in Control Plane CIoT 5GS Optimisation procedures (see clause 4.24.2).

23. If the V-SMF received in step 18 an indication that the (R)AN has rejected some QFI(s) or if the V-SMF has rejected some QFI(s) in step 13, the V-SMF notifies the H-SMF via a Nsmf\_PDUSession\_Update Request. The H-SMF is responsible of updating accordingly the QoS rules and QoS Flow level QoS parameters if needed for the QoS Flow(s) associated with the QoS rule(s) in the UE.

24. This step is the same as step 20 in clause 4.3.2.2.1 with the following differences:

- this step is executed in the Home PLMN;
- the SMF also deregisters for the given PDU Session using Nudm\_UECM\_Deregistration (SUPI, DNN, PDU Session ID). The UDM may update corresponding UE context by Nudr\_DM\_Update (SUPI, Subscription Data, UE context in SMF data).

NOTE 3: The SMF in HPLMN can initiate H-SMF initiated PDU Session Release procedure as defined in clause 4.3.4.3, already after step 13.

#### 4.3.2.2.3 SMF selection

##### 4.3.2.2.3.1 General

The SMF selection function, as described in clause 6.3.2 of TS 23.501 [2], is supported by the AMF and is used to allocate an SMF that manages the PDU Session.

The SMF selection function described in this clause does not apply to the selection of an SMF for Emergency services. For SMF selection for Emergency services is described in clause 5.16.4.5 of TS 23.501 [2].

Two main branches of deployment scenarios to consider:

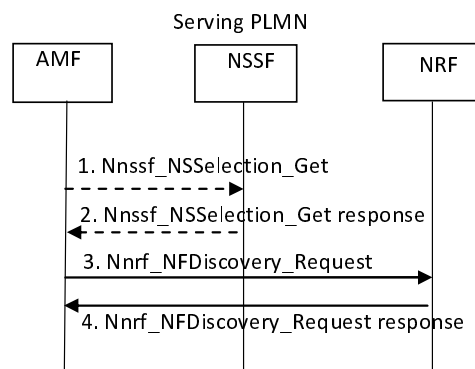
- Non-roaming and roaming with local breakout, see clause 4.3.2.2.3.2
- Home routed roaming, see clause 4.3.2.2.3.3

In the case of non-roaming and local breakout, there are two operational scenarios dependent on the configuration of AMF and the deployment option of NSSF in the serving PLMN.

In the case of home-routed, there are two main options dependent on the operators' choices in terms of involvement of NRF, NSSF and configuration of AMF. The decision of which option to use is part of the roaming agreements.

NOTE: The use of NSI ID and the use of multiple NRFs in the network are optional and depend on the deployment choices of the operator.

##### 4.3.2.2.3.2 Non-roaming and roaming with local breakout



**Figure 4.3.2.2.3.2-1: SMF selection for non-roaming and roaming with local breakout scenarios**

This procedure may be skipped altogether if SMF information is available in the AMF by other means (e.g. locally configured); otherwise:

- when the serving AMF is aware of the appropriate NRF to be used to select NFs/services within the corresponding Network Slice instance based on configuration or based on the Network Slice selection information received during Registration, only steps 3 and 4 in the following procedure are executed as described in Figure 4.3.2.2.3.2-1;
- when the serving AMF is not aware of the appropriate NRF to be used to select NFs/services within the corresponding Network Slice instance, all steps in the following procedure are executed as described in Figure 4.3.2.2.3.2-1.

1. The AMF invokes the Nnssf\_NSSelection\_Get service operation from the NSSF in serving PLMN with the S-NSSAI of the Serving PLMN from the Allowed NSSAI requested by the UE, PLMN ID of the SUPI, TAI of the UE and the indication that the request is within a procedure of PDU Session establishment in either the non-roaming or roaming with local breakout scenario.
2. The NSSF in serving PLMN selects the Network Slice instance, determines and returns the appropriate NRF to be used to select NFs/services within the selected Network Slice instance and optionally may return a NSI ID corresponding to the Network Slice instance.
3. AMF queries the appropriate NRF in serving PLMN by issuing the Nnrf\_NFDiscovery\_Request including at least the S-NSSAI of the Serving PLMN for this PDU Session from the Allowed NSSAI, PLMN ID of the SUPI, DNN and possibly NSI ID if the AMF has stored an NSI ID for the S-NSSAI of the Serving PLMN for this PDU Session from the Allowed NSSAI.

NOTE: The list of parameters for SMF selection is defined in clause 6.3.2 of TS 23.501 [2]. See also clause 5.34.3 of TS 23.501 [2] for I-SMF selection.

4. The NRF in serving PLMN provides to the AMF, e.g. FQDN or IP address, of a set of the discovered SMF instance(s) or Endpoint Address(es) of SMF service instance(s) in Nnrf\_NFDiscovery\_Request response message and possibly an NSI ID for the selected Network Slice instance corresponding to the S-NSSAI for subsequent NRF queries.

4.3.2.2.3.3 Home routed roaming

The selection of the SMF in VPLMN is performed in the same way as for non-roaming and roaming with local breakout (see clause 4.3.2.2.3.2). The selection of the SMF in HPLMN is performed by means of one of two main options. Which of these two options to use is decided based on Service Level Agreements between the operators.

NOTE 1: The procedures described in this clause are not limited to SMF selection but can be used to discover and select any NF/NF service in the HPLMN part of a Network Slice instance.

In the first option, requiring the use of NSSF in both the VPLMN and the HPLMN, the selection of the SMF in HPLMN is performed by means of the procedure depicted in Figure 4.3.2.2.3.3-1.

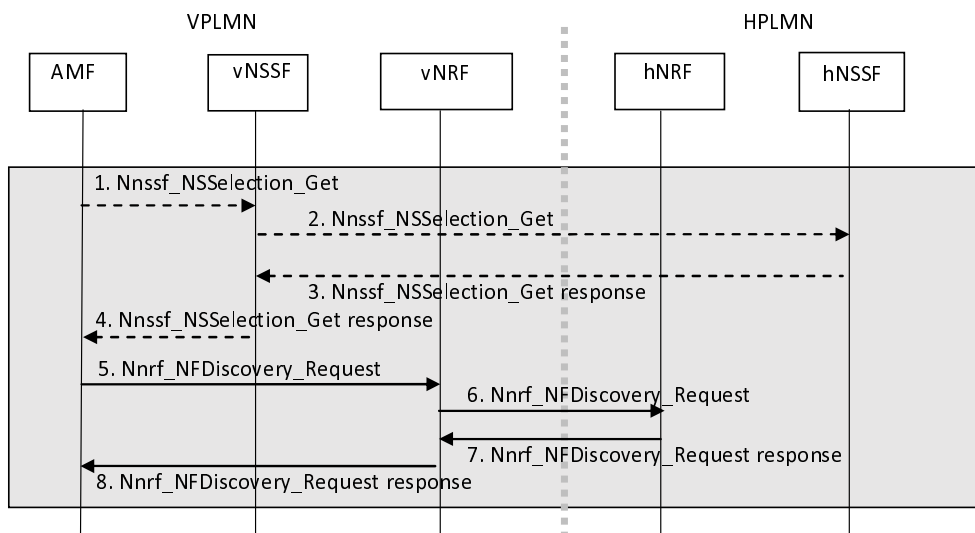


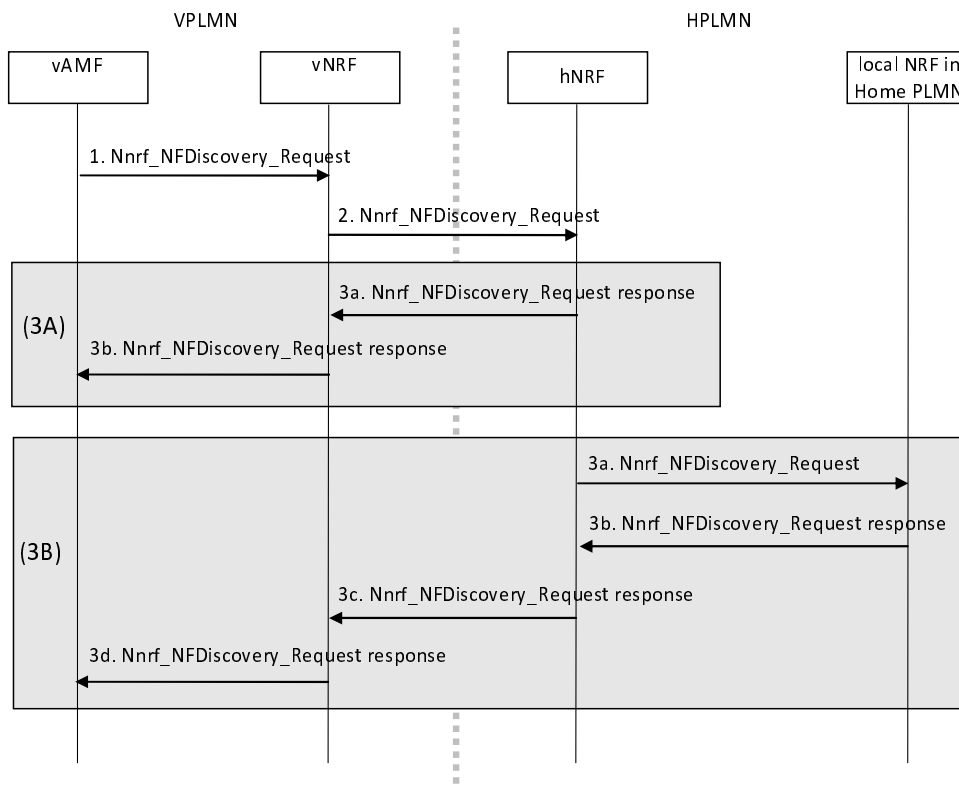
Figure 4.3.2.2.3.3-1: Option 1 for SMF selection for home-routed roaming scenarios

1. Based on the operator's configuration, if the AMF is not aware of the appropriate NRF to be used to select NFs/services in the HPLMN, the AMF invokes the Nnssf\_NSSelection\_Get service operation from the NSSF in VPLMN with the VPLMN S-NSSAI from the Allowed NSSAI requested by the UE for this PDU Session, the HPLMN S-NSSAI that maps to the VPLMN S-NSSAI, PLMN ID of the SUPI, the TAI of the UE and the indication that the request is within a procedure of PDU Session establishment in the home-routed roaming scenario.

2. If slicing configuration information for the S-NSSAI in the HPLMN is not available (e.g. the NSSF has no cached information), the NSSF of the VPLMN invokes the Nnssf\_NSSelection\_Get service operation from NSSF of the HPLMN according to the PLMN ID of SUPI by including the HPLMN S-NSSAI.
3. The NSSF in HPLMN may include the NSI ID, if needed, for the Network Slice instance in HPLMN selected for the corresponding S-NSSAI of the HPLMN in the Nnssf\_NSSelection\_Get response. The NSSF in HPLMN also includes the appropriate hNRF to be used to select NFs/services within HPLMN in the Nnssf\_NSSelection\_Get response.
4. The serving NSSF includes in the Nnssf\_NSSelection\_Get response all the information that has been received from the NSSF in HPLMN when responding to the AMF.
5. The AMF queries the target vNRF using the Nnrf\_NFDDiscovery\_Request by including PLMN ID of the SUPI, DNN, HPLMN S-NSSAI and possibly an HPLMN NSI ID if the AMF has stored an NSI ID for the selected Network Slice instance corresponding to the HPLMN S-NSSAI.
6. The NRF in serving PLMN identifies NRF in HPLMN (hNRF) based on the information provided by the NSSF in the serving PLMN and it invokes the Nnrf\_NFDDiscovery\_Request service from hNRF according to the procedure in Figure 4.17.4-1 to get the expected SMF instance(s) deployed in the HPLMN. As the vNRF in VPLMN triggers the "NF Discovery" on behalf of the AMF, the NRF in the VPLMN shall not replace the information of the NF, i.e. AMF ID, in the Nnrf\_NFDDiscovery\_Request message it sends to the hNRF.
- 7-8. The hNRF provides to the AMF, via vNRF, the information e.g. FQDN or IP address, of a set of the SMF instance(s) in Nnrf\_NFDDiscovery\_Request response message and possibly an NSI ID for the selected Network Slice instance corresponding to the S-NSSAI of the HPLMN for subsequent NRF queries.

When the NSSF is not deployed in HPLMN then the AMF in VPLMN relies on either the configuration to obtain the NRF in HPLMN or on the option below.

The second option for the selection of the SMF in HPLMN is performed by means of the procedure depicted in Figure 4.3.2.2.3.3-2.



**Figure 4.3.2.2.3.3-2: Option 2 for SMF selection for home-routed roaming scenarios**

1. Based on the operator's configuration, the AMF queries the vNRF with PLMN ID of the SUPI, PLMN ID of the serving PLMN, DNN, the HPLMN S-NSSAI that maps to the S-NSSAI from the Allowed NSSAI of the Serving

PLMN the UE has requested, NSI ID (if the AMF has stored an HPLMN NSI ID for the selected Network Slice instance corresponding to the S-NSSAI of the HPLMN) and DNN.

2. The vNRF queries, on behalf of the AMF in VPLMN, the hNRF identified by means of the PLMN ID of the SUPI. The NRF in VPLMN requests "NF Discovery" service from hNRF according to the procedure in Figure 4.17.4-1 to get the expected SMF instance(s) deployed in the HPLMN. As the NRF in the serving PLMN triggers the "NF Discovery" on behalf of the AMF, the NRF in the VPLMN shall not replace the information of the NF, i.e. AMF ID, in the Nnrf\_NFDiscovery\_Request message it sends to the hNRF.

Depending on the available information and based on configuration, the hNRF may either execute steps in 3(A) or in 3(B).

- 3(A) The hNRF provides to the AMF, via vNRF, the information e.g. FQDN or IP address, of a set of the discovered SMF instance(s) and possibly an NSI ID for the selected HPLMN part of the Network Slice instance corresponding to the S-NSSAI of the HPLMN for subsequent NRF queries in Nnrf\_NFDiscovery\_Request response message(steps 3a and 3b).
- 3(B) The hNRF queries, on behalf of the AMF, an appropriate local NRF in HPLMN (e.g. a slice level NRF); this local NRF provides the IP address or the FQDN of expected SMF instance(s) and possibly an NSI ID for the selected HPLMN part of the Network Slice instance corresponding to the S-NSSAI of the HPLMN for subsequent NRF queries (steps 3a and 3b) that the hNRF returns, via vNRF, to the AMF (steps 3c and 3d).

#### 4.3.2.2.4 Multiple PDU Sessions towards the same DNN and S-NSSAI

A UE may establish multiple PDU Sessions associated with the same DNN and S-NSSAI and the AMF may select the same SMF or different SMFs as specified in clause 6.3.2 of TS 23.501 [2].

During PDU Session establishment, the AMF checks if the SMF selection subscription data indicates that the same SMF is required for multiple PDU Sessions and if required, the AMF checks if any SMF is already selected for the same DNN and S-NSSAI, if so, the same SMF will be used for the additional PDU Session.

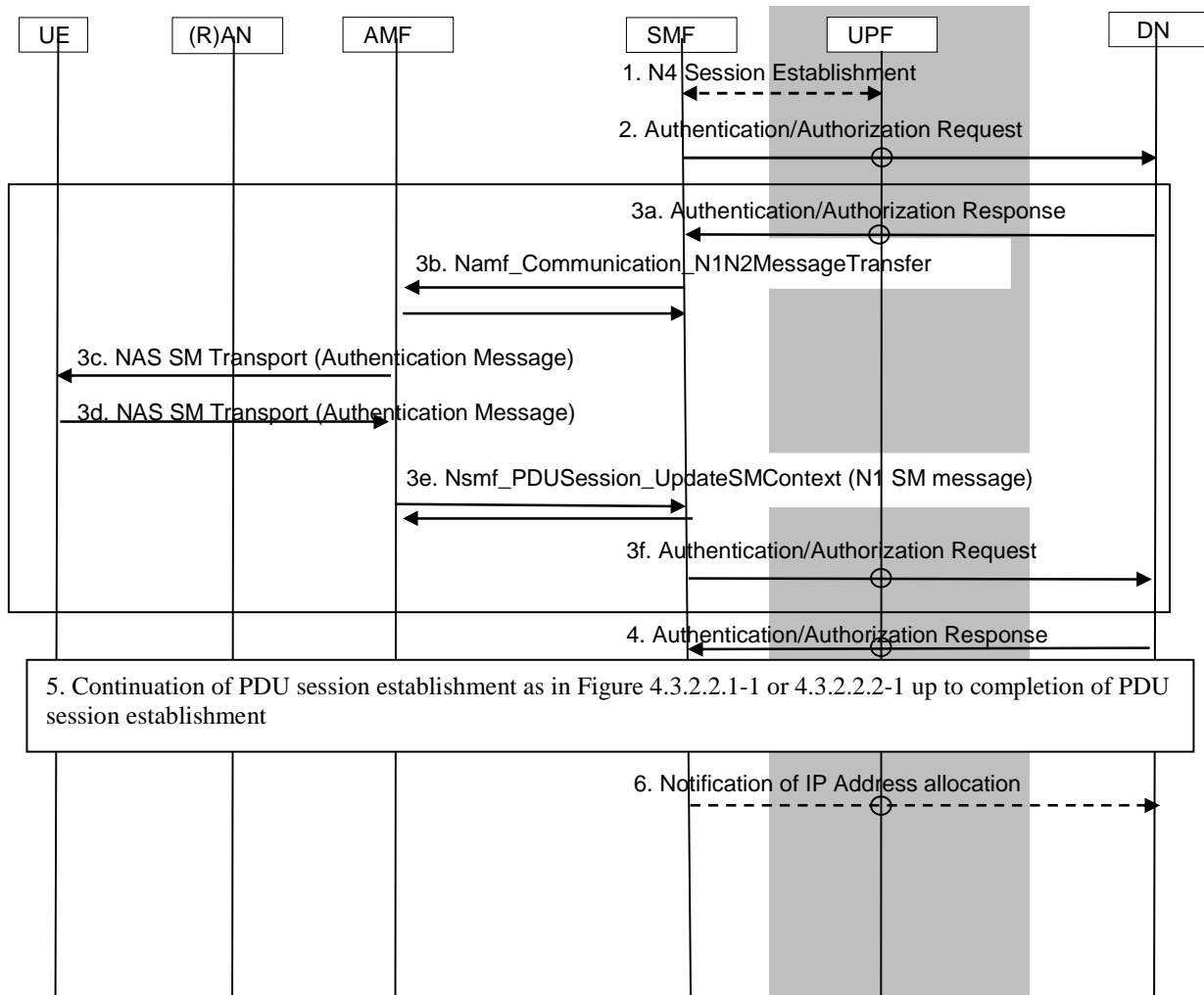
NOTE 1: The SMF ID can be notified from UDM to the AMF when one AMF is selected for 3GPP access in VPLMN and a different AMF is selected in HPLMN for non-3GPP access.

NOTE 2: The same SMF is selected for multiple PDU Sessions towards the same DNN and S-NSSAI to facilitate the selection of the same PCF e.g. for the purpose of usage monitoring.

#### 4.3.2.3 Secondary authorization/authentication by an DN-AAA server during the PDU Session establishment

The PDU Session establishment authentication/authorization is optionally triggered by the SMF during a PDU Session establishment and performed transparently via a UPF or directly with the DN-AAA server without involving the UPF if the DN-AAA server is located in the 5GC and reachable directly, as described in clause 5.6.6 of TS 23.501 [2].

In the case of Home Routed Roaming, unless specified otherwise, the SMF in the information flow defined in this clause is the H-SMF.



**Figure 4.3.2.3-1: PDU Session Establishment authentication/authorization by a DN-AAA server**

NOTE 1: Steps 2, 3a, 3f and 4 are not defined in this specification. Steps 3 can be repeated depending on the mechanism used.

NOTE 2: When the SMF directly communicates with the DN-AAA server without involving the UPF, Step 1 is skipped and Step 2, 3a, 3f, 4 and 6 are executed without involving the UPF.

0. The SMF determines that it needs to contact the DN-AAA server. The SMF identifies the DN-AAA server based on local configuration or using the DN-specific identity (TS 33.501 [15]) provided by the UE inside the SM PDU DN Request Container provided by the UE in the PDU Session Establishment request or inside the EAP message in the PDU Session Authentication Complete message (TS 24.501 [25]).

NOTE 3: The content of the SM PDU DN Request Container is defined in TS 24.501 [25].

1. If there is no existing N4 session that can be used to carry DN-related messages between the SMF and the DN, the SMF selects a UPF and triggers N4 session establishment.
2. The SMF initiates the authentication procedure with the DN-AAA via the UPF to authenticate the DN-specific identity provided by the UE as specified in TS 29.561 [63].

When available, the SMF provides the GPSI in the signalling exchanged with the DN-AAA.

The UPF transparently relays the message received from the SMF to the DN-AAA server.

- 3a. The DN-AAA server sends an Authentication/Authorization message towards the SMF. The message is carried via the UPF.
- 3b. Transfer of DN Request Container information received from DN-AAA towards the UE.



In non-roaming and LBO cases, the SMF invokes the `Namf_Communication_N1N2MessageTransfer` service operation on the AMF to transfer the DN Request Container information within N1 SM information sent towards the UE.

In the case of Home Routed roaming, the H-SMF initiates a `Nsmf_PDUSession_Update` service operation to request the V-SMF to transfer DN Request Container to the UE and the V-SMF invokes the `Namf_Communication_N1N2MessageTransfer` service operation on the AMF to transfer the DN Request Container information within N1 SM information sent towards the UE. In `Nsmf_PDUSession_Update` Request, the H-SMF additionally includes the H-SMF SM Context ID.

3c: The AMF sends the N1 NAS message to the UE

3d-3e. Transfer of DN Request Container information received from UE towards the DN-AAA.

When the UE responds with a N1 NAS message containing DN Request Container information, the AMF informs the SMF by invoking the `Nsmf_PDUSession_UpdateSMContext` service operation. The SMF issues an `Nsmf_PDUSession_UpdateSMContext` response.

In the case of Home Routed roaming, the V-SMF relays the N1 SM information to the H-SMF using the information of PDU Session received in step 3b via a `Nsmf_PDUSession_Update` service operation.

3f: The SMF (In HR case it is the H-SMF) sends the content of the DN Request Container information (authentication message) to the DN-AAA server via the UPF.

Step 3 may be repeated until the DN-AAA server confirms the successful authentication/authorization of the PDU Session.

4. The DN-AAA server confirms the successful authentication/authorization of the PDU Session. The DN-AAA server may provide:

- an SM PDU DN Response Container to the SMF to indicate successful authentication/authorization;
- DN Authorization Data as defined in clause 5.6.6 of TS 23.501 [2];
- a request to get notified with the IP address(es) allocated to the PDU Session and/or with N6 traffic routing information or MAC address(es) used by the UE for the PDU Session; and
- an IP address (or IPV6 Prefix) for the PDU Session.

The N6 traffic routing information is defined in clause 5.6.7 of TS 23.501 [2].

After the successful DN authentication/authorization, a session is kept between the SMF and the DN-AAA. If the SMF receives a DN Authorization Data, the SMF uses the DN Authorization Profile Index to apply the policy and charging control (see clause 5.6.6 of TS 23.501 [2]).

5. The PDU Session establishment continues and completes. In the step 7b of the Figure 4.3.2.2.1-1, if the SMF receives the DN Authorization Profile Index in DN Authorization Data from the DN-AAA, it sends the DN Authorization Profile Index to retrieve the PDU Session related policy information (described in clause 6.4 of TS 23.503 [20]) and the PCC rule(s) (described in clause 6.3 of TS 23.503 [20]) from the PCF. If the SMF receives the DN authorized Session AMBR in DN Authorization Data from the DN-AAA, it sends the DN authorized Session AMBR within the Session AMBR to the PCF to retrieve the authorized Session AMBR (described in clause 6.4 of TS 23.503 [20]). For PDU Session of Ethernet type, the SMF may instruct the UPF to handle VLAN information of the Ethernet frames related with the PDU Session received and sent on N6 or N19 or internal interface, as described in clause 5.6.10.2 of TS 23.501 [2].

6. If requested so in step 4 or if configured so by local policies, the SMF notifies the DN-AAA with the IP/MAC address(es) and/or with N6 traffic routing information allocated to the PDU Session together with the GPSI.

Later on the SMF notifies the DN-AAA if the DN-AAA had requested to get notifications about:

- Allocation or release of an IPV6 Prefix for the PDU Session of IP type or addition or removal of source MAC addresses for the PDU Session of Ethernet type (e.g. using IPV6 multi-homing as defined in clause 5.6.4.3 of TS 23.501 [2]).
- Change of N6 traffic routing information.

When later on the PDU Session gets released as described in clause 4.3.4, the SMF notifies the DN-AAA.

The DN-AAA server may revoke the authorization for a PDU Session or update DN authorization data for a PDU Session. According to the request from DN-AAA server, the SMF may release or update the PDU Session.

At any time after the PDU Session establishment, the DN-AAA server or SMF may initiate Secondary Re-authentication procedure for the PDU Session as specified in clause 11.1.3 of TS 33.501 [15]. Step 3a to step 3f are performed to transfer the Secondary Re-authentication message between the UE and the DN-AAA server. The Secondary Re-authentication procedure may start from step 3a (DN-AAA initiated Secondary Re-authentication procedure) or step 3b (SMF initiated Secondary Re-authentication procedure). For the DN-AAA server initiated Secondary Re-authentication, the message in step 3a shall include GPSI, if available and the IP/MAC address(es) of the PDU session, for SMF to identify the corresponding UE and PDU session.

DN-AAA may initiate DN-AAA Re-authorization without performing re-authentication based on local policy. DN-AAA Re-authorization procedure may start from step 4.

During Secondary Re-authentication/Re-authorization, if the SMF receives DN Authorization Profile Index and/or DN authorized Session AMBR, the SMF reports the received value(s) to the PCF (as described in TS 23.501 [2]) by triggering the Policy Control Request Trigger as described in TS 23.503 [20].

### 4.3.3 PDU Session Modification

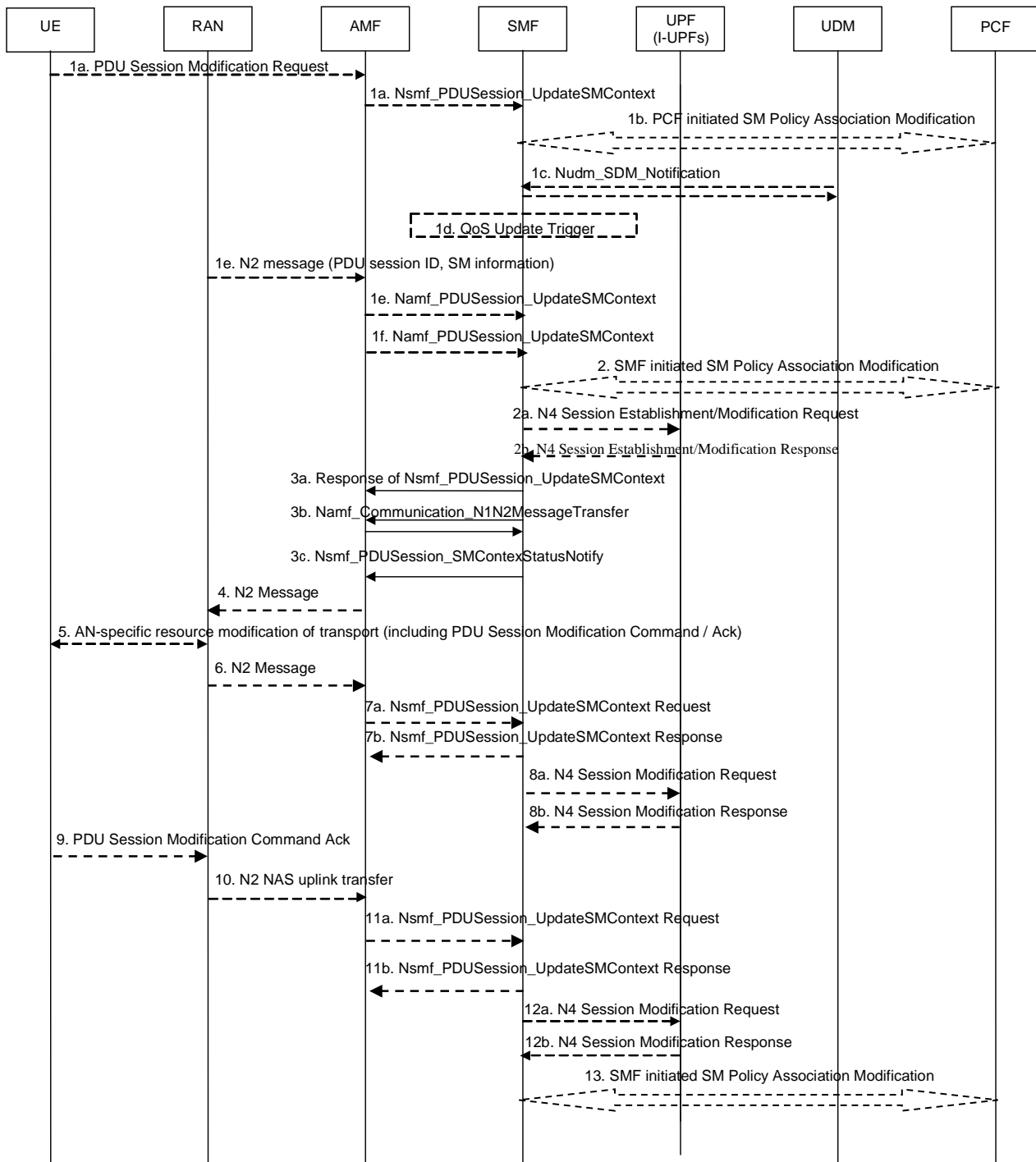
#### 4.3.3.1 General

The procedure is used when one or several of the QoS parameters exchanged between the UE and the network are modified.

**NOTE:** The conditions when to use this procedure for QoS change as well as the QoS parameters exchanged between the UE and the network are defined in clause 5.7 of TS 23.501 [2].

#### 4.3.3.2 UE or network requested PDU Session Modification (non-roaming and roaming with local breakout)

The UE or network requested PDU Session Modification procedure (non-roaming and roaming with local breakout scenario) is depicted in figure 4.3.3.2-1.



**Figure 4.3.3.2-1: UE or network requested PDU Session Modification (for non-roaming and roaming with local breakout)**

1. The procedure may be triggered by following events:

1a. (UE initiated modification) The UE initiates the PDU Session Modification procedure by the transmission of an NAS message (N1 SM container (PDU Session Modification Request (PDU session ID, Packet Filters, Operation, Requested QoS, Segregation, 5GSM Core Network Capability, Number Of Packet Filters, [Always-on PDU Session Requested])), PDU Session ID, UE Integrity Protection Maximum Data Rate, [Port Management Information Container]) message. Depending on the Access Type, if the UE was in CM-IDLE state, this SM-NAS message is preceded by the Service Request procedure. The NAS message is forwarded by the (R)AN to the AMF with an indication of User location Information. The AMF invokes Nsmf\_PDUSession\_UpdateSMContext (SM Context ID, N1 SM container (PDU Session Modification Request)).

When the UE requests specific QoS handling for selected SDF(s), the PDU Session Modification Request includes Packet Filters describing the SDF(s), the requested Packet Filter Operation (add, modify, delete) on the indicated Packet Filters, the Requested QoS and optionally a Segregation indication. The Segregation indication is included when the UE recommends to the network to bind the applicable SDF(s) on a distinct and dedicated QoS Flow e.g. even if an existing QoS Flow can support the requested QoS. The network should abide by the UE request, but is allowed to proceed instead with binding the selected SDF(s) on an existing QoS Flow.

NOTE 1: Only one QoS Flow is used for traffic segregation. If UE makes subsequent requests for segregation of additional SDF(s), the additional SDF(s) are multiplexed on the existing QoS Flow that is used for segregation.

The UE shall not trigger a PDU Session Modification procedure for a PDU Session corresponding to a LADN when the UE is outside the area of availability of the LADN.

The PS Data Off status, if changed, shall be included in the PCO in the PDU Session Modification Request message.

For a PDU Session which was established in the EPS, when the UE moves from EPS to 5GS for the first time, the UE includes an Always-on PDU Session Requested indication in the PDU Session Modification Request message if it wants to change the PDU Session to an always-on PDU Session.

When PCF is deployed, the SMF shall further report the PS Data Off status to PCF if the PS Data Off event trigger is provisioned, the additional behaviour of SMF and PCF for 3GPP PS Data Off is defined in TS 23.503 [20].

The 5GSM Core Network Capability is provided by the UE and handled by SMF as defined in clause 5.4.4b of TS 23.501 [2].

The UE Integrity Protection Maximum Data Rate indicates the maximum data rate up to which the UE can support UP integrity protection. It is set as defined in TS 23.501 [2].

The Number Of Packet Filters indicates the number of supported packet filters for signalled QoS rules as described in clause 5.17.2.2.2 of TS 23.501 [2].

Port Management Information Container is received from DS-TT and includes Ethernet-port related management information as defined in clause 5.28.3 of TS 23.501 [2].

- 1b. (PCF initiated SM Policy Association Modification) The PCF performs a PCF initiated SM Policy Association Modification procedure as defined in clause 4.16.5.2 to notify SMF about the modification of policies. This may e.g. have been triggered by a policy decision or upon AF requests, e.g. Application Function influence on traffic routing as described in step 5 in clause 4.3.6.2 or AF to provide Port management information Container.

If the QoS Monitoring for URLLC is requested by the AF, the PCF generates the QoS Monitoring policy for the corresponding service data flow and provides the policy in the PCC rules to the SMF in this step.

- 1c. (SMF requested modification) The UDM updates the subscription data of SMF by Nudm\_SDM\_Notification (SUPI, Session Management Subscription Data). The SMF updates the Session Management Subscription Data and acknowledges the UDM by returning an Ack with (SUPI).
- 1d. (SMF requested modification) The SMF may decide to modify PDU Session. This procedure also may be triggered based on locally configured policy or triggered from the (R)AN (see clause 4.2.6 and clause 4.9.1). It may also be triggered if the UP connection is activated (as described in Service Request procedure) and the SMF has marked that the status of one or more QoS Flows are deleted in the 5GC but not synchronized with the UE yet.

If the SMF receives one of the triggers in step 1b ~ 1d, the SMF starts SMF requested PDU Session Modification procedure.

- 1e. (AN initiated modification) (R)AN shall indicate to the SMF when the AN resources onto which a QoS Flow is mapped are released irrespective of whether notification control is configured. (R)AN sends the N2 message (PDU Session ID, N2 SM information) to the AMF. The N2 SM information includes the QFI, User location Information and an indication that the QoS Flow is released. The AMF invokes Nsmf\_PDUSession\_UpdateSMContext (SM Context ID, N2 SM information).

(AN initiated notification control) If notification control is configured for a GBR QoS Flow, (R)AN sends a N2 message (PDU Session ID, N2 SM information) to SMF when the (R)AN decides the QoS targets of the QoS Flow cannot be fulfilled or can be fulfilled again, respectively. The N2 SM information includes the QFI and an indication that the QoS targets for that QoS Flow cannot be fulfilled or can be fulfilled again, respectively. When QoS targets cannot be fulfilled, the N2 SM information indicates a reference to the Alternative QoS Profile matching the values of the QoS parameters that the NG-RAN is currently fulfilling as specified in clause 5.7.2.4 of TS 23.501 [2]. The AMF invokes Nsmf\_PDUSession\_UpdateSMContext (SM Context ID, N2 SM information). If the PCF has subscribed to the event, SMF reports this event to the PCF for each PCC Rule for which notification control is set in step 2.

- 1f. (AMF initiated modification) If the UE supports CE mode B and use of CE mode changes from restricted to unrestricted or vice versa in the Enhanced Coverage Restriction information in the UE context in the AMF and the UE has already established PDU sessions, then the AMF shall trigger a PDU session modification to the SMFs serving the UE's PDU sessions when the AMF determines that NAS-SM timer shall be updated due to the change of Enhanced Coverage Restriction and include the extended NAS-SM indication only if use of CE mode B is now unrestricted in the Enhanced Coverage Restriction information in the UE context in the AMF.

Based on the extended NAS-SM timer indication, the SMF shall use the extended NAS-SM timer setting for the UE as specified in TS 24.501 [25].

2. The SMF may need to report some subscribed event to the PCF by performing an SMF initiated SM Policy Association Modification procedure as defined in clause 4.16.5.1. This step may be skipped if PDU Session Modification procedure is triggered by step 1b or 1d. If dynamic PCC is not deployed, the SMF may apply local policy to decide whether to change the QoS profile.

Steps 2a to 7 are not invoked when the PDU Session Modification requires only action at a UPF (e.g. gating).

- 2a. The SMF may update the UPF with N4 Rules related to new or modified QoS Flow(s).

NOTE 2: This allows the UL packets with the QFI of a new or modified QoS Flow to be transferred.

If redundant transmission has not been activated to the PDU session and the SMF decides to perform redundant transmission for the QoS Flow, the SMF indicates to the UPF to perform packet duplication and elimination for the QoS Flow.

If redundant transmission has been activated on the PDU Session and the SMF decides to stop redundant transmission, the SMF indicates the UPF to release the CN Tunnel Info which is used as the redundancy tunnel of the PDU Session and also indicates the UPF to stop packet duplication and elimination for the corresponding QoS Flow(s).

NOTE 3: The method to perform elimination and reordering on RAN/UPF based on the packets received from the two GTP-U tunnels is up to RAN/UPF implementation. The two GTP-U tunnels are terminated at the same RAN node and UPF.

If redundant transmission has not been activated to the PDU Session and the SMF decides to perform redundant transmission for the QoS Flow with two I-UPFs between the PSA UPF and the NG-RAN, the SMF sends a N4 Session Establishment Request message to the I-UPFs including UL CN Tunnel Info of the PSA UPF and a request to allocate CN Tunnel Info.

- 2b. The UPF(s) respond to the SMF. If redundant transmission has not been activated to the PDU session and the SMF indicated the UPF to perform packet duplication and elimination for the QoS Flow in step 2a, the UPF allocates an additional CN Tunnel Info. The additional CN Tunnel Info is provided to the SMF.

If redundant transmission has not been activated to the PDU Session and the SMF decides to perform redundant transmission for the QoS Flow with two I-UPFs in step 2a, the UPFs allocate CN Tunnel Info. The CN Tunnel Info of each I-UPF is provided to the SMF.

- 3a. For UE or AN initiated modification, the SMF responds to the AMF through Nsmf\_PDUSession\_UpdateSMContext Response ([N2 SM information (PDU Session ID, QFI(s), QoS Profile(s), [Alternative QoS Profile(s)], Session-AMBR), [CN Tunnel Info(s)], N1 SM container (PDU Session Modification Command (PDU Session ID, QoS rule(s), QoS rule operation, QoS Flow level QoS parameters if needed for the QoS Flow(s) associated with the QoS rule(s), Session-AMBR, [Always-on PDU Session Granted], [Port Management Information Container]))]). See clause 5.7 of TS 23.501 [2] for the QoS Profile,

Alternative QoS Profile and QoS rule and QoS Flow level QoS parameters. Alternative QoS Profile is only valid for AN initiated modification.

If the PDU Session Modification was requested by the UE to modify a PDU Session to an always-on PDU Session, the SMF shall include an Always-on PDU Session Granted indication in the PDU Session Modification Command to indicate whether the PDU Session is to be changed to an always-on PDU Session or not via the Always-on PDU Session Granted indication in the PDU Session Modification Command.

The N2 SM information carries information that the AMF shall provide to the (R)AN. It may include the QoS profiles and the corresponding QFIs to notify the (R)AN that one or more QoS flows were added, or modified. It may include only QFI(s) to notify the (R)AN that one or more QoS flows were removed. The SMF may indicate for each QoS Flow whether redundant transmission shall be performed by a corresponding redundant transmission indicator. If the SMF decides to activate redundant transmission in step 2a, the SMF includes the allocated additional CN Tunnel Info in the N2 SM information. If the SMF decides to perform redundant transmission for new QoS Flow with two I-UPFs in step 2a, the SMF includes the allocated CN Tunnel Info of the two I-UPFs in the N2 SM information. If the PDU Session Modification was triggered by the (R)AN Release in step 1e the N2 SM information carries an acknowledgement of the (R)AN Release. If the PDU Session Modification was requested by the UE for a PDU Session that has no established User Plane resources, the N2 SM information provided to the (R)AN includes information for establishment of User Plane resources.

If redundant transmission has been activated on the PDU Session and the SMF decides to stop redundant transmission in step 2a, the SMF indicates the (R)AN to release the AN Tunnel and stop packet duplication and elimination associated with the redundancy tunnel of the PDU Session.

The N1 SM container carries the PDU Session Modification Command that the AMF shall provide to the UE. It may include the QoS rules, QoS Flow level QoS parameters if needed for the QoS Flow(s) associated with the QoS rule(s) and corresponding QoS rule operation and QoS Flow level QoS parameters operation to notify the UE that one or more QoS rules were added, removed or modified.

If port number and a Port Management Information Container have been received from PCF in Step 2 and the port number matches the port number assigned for the DS-TT Ethernet port for this PDU session, then SMF includes the Port Management Information Container in the N1 SM container.

The SMF may need to send transparently through NG-RAN the PDU Session Modification Command to inform the UE about changes in the QoS parameters (i.e. 5QI, GFBR, MFBR) that the NG-RAN is currently fulfilling after the SMF receives QoS Notification Control as defined in clause 5.7.2.4 of TS 23.501 [2]. When the SMF sends on the PDU Session Modification Command transparently through NG-RAN, the N2 SM information is not included as part of the Namf\_Communication\_N1N2MessageTransfer.

- 3b. For SMF requested modification, the SMF invokes Namf\_Communication\_N1N2MessageTransfer ([N2 SM information] (PDU Session ID, QFI(s), QoS Profile(s), [Alternative QoS Profile(s)], Session-AMBR, [CN Tunnel Info(s)], QoS Monitoring indication, QoS Monitoring reporting frequency, [TSCAI(s)]), N1 SM container (PDU Session Modification Command (PDU Session ID, QoS rule(s), QoS Flow level QoS parameters if needed for the QoS Flow(s) associated with the QoS rule(s), QoS rule operation and QoS Flow level QoS parameters operation, Session-AMBR))).

The SMF may indicate for each QoS Flow whether redundant transmission shall be performed by a corresponding redundant transmission indicator. If the SMF decides to activate redundant transmission in step 2a, the SMF includes the allocated additional CN Tunnel Info in the N2 SM information. If the SMF decides to perform redundant transmission for new QoS Flow with two I-UPFs in step 2a, the SMF includes the allocated CN Tunnel Info of the two I-UPFs in the N2 SM information.

If redundant transmission has been activated on the PDU Session and the SMF decides to stop redundant transmission in step 2a, the SMF indicates the (R)AN to release the AN Tunnel and stop packet duplication and elimination associated with the redundancy tunnel of the PDU Session.

The SMF indicates the request for QoS Monitoring for the QoS Flow according to the information received from the PCF in step 1b, or based on SMF local policy, e.g. when the RAN rejected the creation of a specific QoS Flow for URLLC. In the case of receiving the QoS Monitoring indication, the RAN enables the RAN part of UL/DL packet delay measurement for the QoS Flow and the QoS Monitoring reporting frequency is used by RAN to determine the packet delay measurement frequency of the RAN part. The TSCAI is defined in clause 5.27.2 of TS 23.501 [2].

If the UE is in CM-IDLE state and an ATC is activated, the AMF updates and stores the UE context based on the Namf\_Communication\_N1N2MessageTransfer and steps 4, 5, 6 and 7 are skipped. When the UE is reachable e.g. when the UE enters CM-CONNECTED state, the AMF forwards the N1 message to synchronize the UE context with the UE.

- 3c. For SMF requested modification due to updated SMF-Associated parameters from the UDM, the SMF may provide the SMF derived CN assisted RAN parameters tuning to the AMF. The SMF invokes Nsmf\_PDUSession\_SMContextStatusNotify (SMF derived CN assisted RAN parameters tuning) towards the AMF. The AMF stores the SMF derived CN assisted RAN parameters tuning in the associated PDU Session context for this UE.
4. The AMF may send N2 ([N2 SM information received from SMF], NAS message (PDU Session ID, N1 SM container (PDU Session Modification Command))) Message to the (R)AN.
5. The (R)AN may issue AN specific signalling exchange with the UE that is related with the information received from SMF. For example, in the case of a NG-RAN, an RRC Connection Reconfiguration may take place with the UE modifying the necessary (R)AN resources related to the PDU Session or if only N1 SM container is received in step 4 from AMF, RAN transports only the N1 SM container to the UE.

The (R)AN may consider the updated CN assisted RAN parameters tuning to reconfigure the AS parameters.

As part of this, the N1 SM container is provided to the UE. If the N1 SM container includes a Port Management Information Container then the UE provides the container to DS-TT.

6. The (R)AN may acknowledge N2 PDU Session Request by sending a N2 PDU Session Ack (N2 SM information (List of accepted/rejected QFI(s), AN Tunnel Info, PDU Session ID, Secondary RAT usage data), User location Information) Message to the AMF. In the case of Dual Connectivity, if one or more QFIs were added to the PDU Session, the Master RAN node may assign one or more of these QFIs to a NG-RAN node which was not involved in the PDU Session earlier. In this case the AN Tunnel Info includes a new N3 tunnel endpoint for QFIs assigned to the new NG-RAN node. Correspondingly, if one or more QFIs were removed from the PDU Session, a (R)AN node may no longer be involved in the PDU Session anymore and the corresponding tunnel endpoint is removed from the AN Tunnel Info. The NG-RAN may reject QFI(s) if it cannot fulfil the User Plane Security Enforcement information for a corresponding QoS Profile, e.g. due to the UE Integrity Protection Maximum Data Rate being exceeded. When receiving the request for QoS Monitoring, the (R)AN may indicate its rejection to perform QoS Monitoring, e.g. due to the (R)AN load condition.

If the PLMN has configured secondary RAT usage reporting, the NG-RAN node may provide RAN Usage Data Report. The User Location Information shall include the serving cell's ID and, if Dual Connectivity is activated for the UE, the PSCell ID.

If the redundant transmission has not been activated to the PDU session and the SMF indicates to the RAN that one of the QoS Flow shall perform redundant transmission, the RAN includes an additional AN tunnel info in N2 SM information.

7. The AMF forwards the N2 SM information and the User location Information received from the AN to the SMF via Nsmf\_PDUSession\_UpdateSMContext service operation. The SMF replies with a Nsmf\_PDUSession\_UpdateSMContext Response.

If the N2 SM information indicates failure of whole N2 SM request (i.e. no part of the N2 SM request is successful in (R)AN), the SMF assumes that the NAS PDU, if provided in step 3, was not forwarded by NG-RAN to UE, as described in TS 38.413 [10]. In this case, if the PDU Session modification is UE triggered the SMF shall reject the PDU session modification by including a N1 SM container with a PDU Session Modification Reject message (see clause 8.3.3 of TS 24.501 [25]) in the Nsmf\_PDUSession\_UpdateSMContext Response in step 7b. Step 8 is skipped in this case.

Otherwise, the SMF assumes that the NAS PDU was sent to UE successfully. If the (R)AN rejects QFI(s), the SMF is responsible of updating the QoS rules and QoS Flow level QoS parameters if needed for the QoS Flow(s) associated with the QoS rule(s) in the UE accordingly, i.e. the SMF shall trigger a separate NAS PDU Session Modification procedure after step 11 to align the SM context of this PDU Session in UE.

8. The SMF may update N4 session of the UPF(s) that are involved by the PDU Session Modification by sending N4 Session Modification Request message to the UPF (see NOTE 3).

The SMF may update the UPF with N4 Rules related to new, modified or removed QoS Flow(s), unless it was done already in step 2a.

NOTE 4: This allows the DL packets of the new or modified QoS Flow to be transferred.

If an additional AN Tunnel Info is returned by RAN in step 6, the SMF informs the UPF about this AN Tunnel Info for redundant transmission. In the case of redundant transmission with two I-UPFs, the SMF provides AN Tunnel Info to two I-UPFs. If CN Tunnel Info of two I-UPFs is allocated by the UPFs in step 2b, the SMF also provides the DL CN Tunnel Info of two I-UPFs to the UPF (PSA).

If the QoS Monitoring for URLLC is enabled for the QoS Flow, the SMF provides the N4 rules containing the QoS Monitoring policy generated according to the information received in step 1b to the UPF via the N4 Session Modification Request message.

If port number and a Port Management Information Container have been received from PCF in Step 2 and the port number matches the port number of the NW-TT Ethernet port for this PDU session, then SMF includes the Port Management Information Container in the N4 Session Modification Request. If the N4 Session Modification Request includes a Port Management Information Container, then UPF also includes a Port Management Information Container in the N4 Session Modification Response.

9. The UE acknowledges the PDU Session Modification Command by sending a NAS message (PDU Session ID, N1 SM container (PDU Session Modification Command Ack, [Port Management Information Container])) message.
10. The (R)AN forwards the NAS message to the AMF.
11. The AMF forwards the N1 SM container (PDU Session Modification Command Ack) and User Location Information received from the AN to the SMF via Nsmf\_PDUSession\_UpdateSMContext service operation. The SMF replies with a Nsmf\_PDUSession\_UpdateSMContext Response.  
  
If the SMF initiated modification is to delete QoS Flows (e.g. triggered by PCF) which do not include QoS Flow associated with the default QoS rule and the SMF does not receive response from the UE, the SMF marks that the status of those QoS Flows is to be synchronized with the UE.
12. The SMF may update N4 session of the UPF(s) that are involved by the PDU Session Modification by sending N4 Session Modification Request (N4 Session ID) message to the UPF. For a PDU Session of Ethernet PDU Session Type, the SMF may notify the UPF to add or remove Ethernet Packet Filter Set(s) and forwarding rule(s).

NOTE 5: The UPFs that are impacted in the PDU Session Modification procedure depends on the modified QoS parameters and on the deployment. For example in the case of the session AMBR of a PDU Session with an UL CL changes, only the UL CL is involved. This note also applies to the step 8.

13. If the SMF interacted with the PCF in step 1b or 2, the SMF notifies the PCF whether the PCC decision could be enforced or not by performing an SMF initiated SM Policy Association Modification procedure as defined in clause 4.16.5.1. If the trigger for 5GS Bridge information available is armed and the SMF received a Port Management Information Container from either UE or UPF, then SMF provides the Port Management Information Container and the port number of the related port to the PCF in this step, as described in clause 5.28.3.2 of TS 23.501 [2]. If the trigger for 5GS Bridge information available is armed and the SMF received the Bridge Management Information Container from UPF, then the SMF provides the Bridge Management Information Container to the PCF as described in clause 5.28.3.2 of TS 23.501 [2].

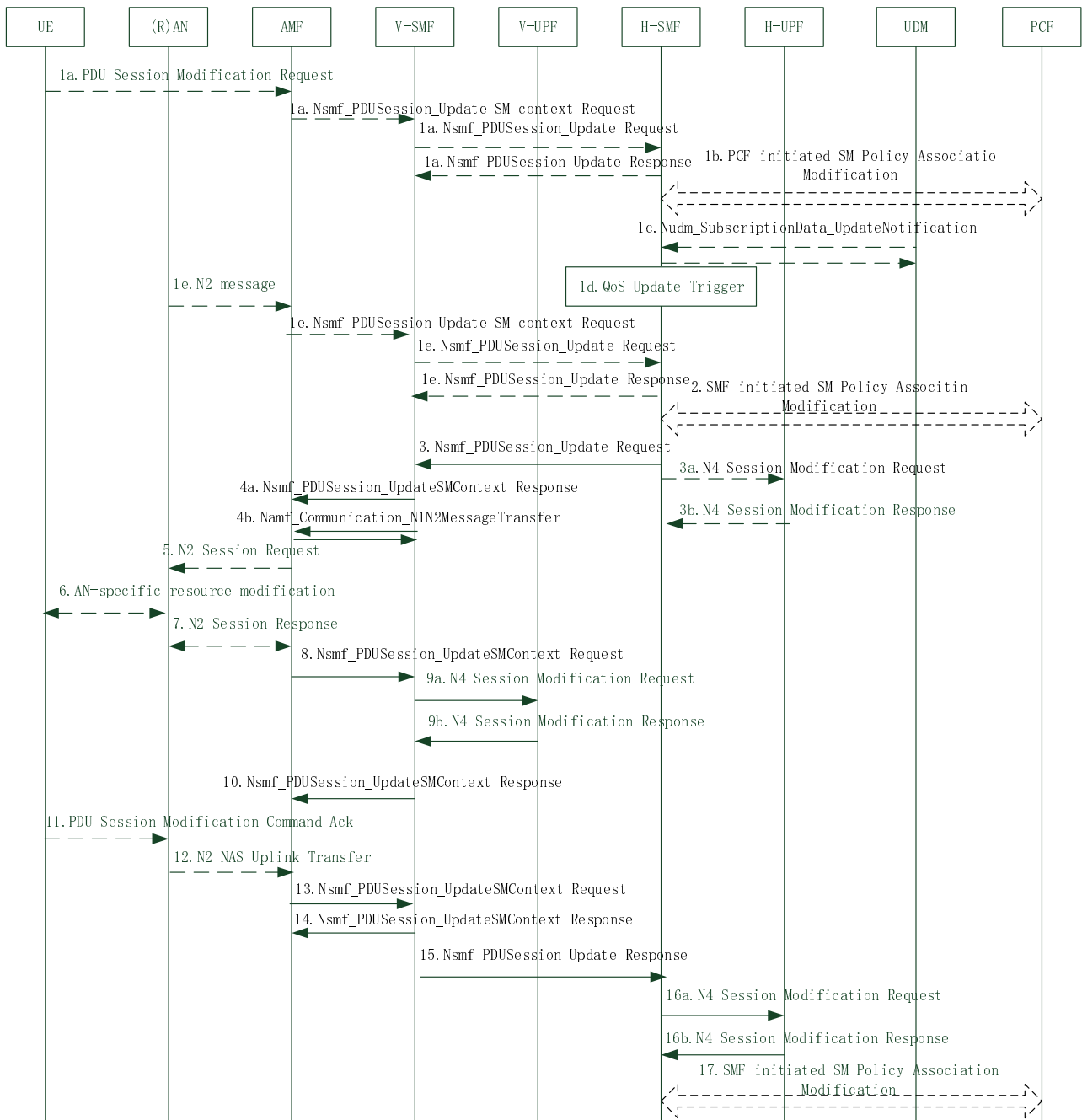
SMF notifies any entity that has subscribed to User Location Information related with PDU Session change.

If step 1b is triggered to perform Application Function influence on traffic routing by step 5 in clause 4.3.6.2, the SMF may reconfigure the User Plane of the PDU Session as described in step 6 in clause 4.3.6.2.

#### 4.3.3.3 UE or network requested PDU Session Modification (home-routed roaming)

The UE or network requested PDU Session Modification procedure (home-routed roaming scenario) is depicted in figure 4.3.3.3-1.





**Figure 4.3.3.3-1: UE or network requested PDU Session Modification (for home-routed roaming scenario)**

1. The procedure is triggered by one of the following events:

1a. (UE or serving network requested) As in step 1a of clause 4.3.3.2 with the addition that:

- The V-SMF checks whether it can accept the request from the UE;
- The V-SMF invokes an Nsmf\_PDUSession\_Update Request (SM Context ID, UE request for PDU Session Modification or the QoS modification request from the VPLMN, UE location information, Time Zone, the current Access Type, PCO, [Always-on PDU Session Requested]) service operation to inform the H-SMF to update the PDU Session. The H-SMF responds to the request immediately. If the AMF notified the V-SMF that the access type of the PDU session can be changed, as described in the UE Triggered Service Request procedure in clause 4.2.3.2, the V-SMF shall also indicate that the access type can be changed.

The PS Data Off status, if changed, shall be included in PCO (Protocol Configuration Option) in the PDU Session Modification Request message.

When PCF is deployed, the SMF shall further report the PS Data Off status to PCF if the PS Data Off event trigger is provisioned, the additional behaviour of SMF and PCF for 3GPP PS Data Off is defined in TS 23.503 [20].

1b. (HPLMN requested) This step is the same as step 1b in clause 4.3.3.2. If the H-SMF received the indication that the access type of the PDU session can be changed, the H-SMF shall indicate the target access type to the PCF in the Access Type information of the Npcf\_SMPolicyControl\_Update Request.

1c. (HPLMN requested) This step is the same as step 1c in clause 4.3.3.2.

1d. (HPLMN requested) This step is the same as step 1d in clause 4.3.3.2.

1e. As in step 1e of clause 4.3.3.2 with addition that:

- The AMF invokes Nsmf\_PDUSession\_UpdateSMContext (SM context ID, N2 SM information) and sends it to the V-SMF;
- The V-SMF invokes an Nsmf\_PDUSession\_Update Request (SM context ID, ULI, AN type, QoS Flow to be released) service operation to inform the H-SMF to update the PDU Session. The H-SMF responds to the request immediately. For AN initiated notification control in step 1e of clause 4.3.3.2, the V-SMF includes also QoS Flow notification information as specified in clause 5.7 of TS 23.501 [2].

NOTE 1: SM Context ID between AMF and V-SMF and between V-SMF and H-SMF are different. SM Context ID has local significance per SMF instance.

2. This step is the same as steps 2 in clause 4.3.3.2 with the SMF is H-SMF.

3. (UE or serving network requested or HPLMN requested) The H-SMF invokes the Nsmf\_PDUSession\_Update Request (SM Context ID, QoS profiles, [Alternative QoS profile(s)], Session-AMBR, information needed to build the SM PDU Session Modification Command message towards the UE including the QoS rule(s) and QoS Flow level QoS parameters if needed for the QoS Flow(s) associated with the QoS rule(s) and QoS rule operation and the QoS Flow level QoS parameters operation) service operation to the V-SMF.

Based on operator policies and roaming agreements, the V-SMF may decide to fully accept or reject the QoS information provided by the H-SMF. The V-SMF shall also be able to accept a subset of the QoS flows requested to be created or modified within a single H-SMF request i.e. V-SMF can accept some QoS flows and reject other QoS flows in same response to H-SMF.

3a-3b (HPLMN requested) These steps are executed if new QoS Flow(s) are to be created. The SMF updates the UPF with UL Packet Detection Rules of the new QoS Flow.

NOTE 2: This allows the UL packets with the QFI of the new QoS Flow to be transferred.

If an Always-on PDU Session Granted indication was provided by the H-SMF to indicate that the PDU Session is to be changed to an always-on PDU Session, the V-SMF decides whether to accept or reject the request from the H-SMF based on local policies.

4a-4b. These steps are the same as step 3a-3b in clause 4.3.3.2 but controlled from the V-SMF. The V-SMF uses the information received in step 3 to generate any N1 and/or N2 signalling to be sent towards the UE and/or the (R)AN.

5-7. These steps are the same as step 4-6 in clause 4.3.3.2.

8. This step is the same as step 7a in clause 4.3.3.2 with the difference that the SMF is V-SMF.

If the N2 SM information indicates modification failure and the V-SMF rejected the PDU session modification as described in step 7 in clause 4.3.3.2, step 9 is skipped.

9a-9b are the same as step 8a-8b in clause 4.3.3.2 but executed in Visited PLMN

10. This step is the same as step 7b in clause 4.3.3.2 with the difference that the SMF is V-SMF.

11-12. These steps are the same as steps 8-9 in 4.3.3.2.

13-14. These steps are the same as step 11a-11b in clause 4.3.3.2 but executed in Visited PLMN.

15. V-SMF responds to the H-SMF with an Nsmf\_PDUSession\_Update response carrying the information like PCO provided by the UE in the SM PDU Session Modification Command Ack message from the UE to the V-SMF, Secondary RAT usage data. The H-SMF shall modify the PDU Session context.

If the V-SMF has rejected QFI(s) (step3) or the (R)AN has rejected QFI(s) in step 6 of Figure 4.3.3.2-1, the H-SMF is responsible of later updating the QoS rules and QoS Flow level QoS parameters if needed for the QoS Flow(s) associated with the QoS rule(s) in the UE.

16-17. These steps are the same as steps 12-13 in clause 4.3.3.2 with the difference that the SMF is H-SMF.

## 4.3.4 PDU Session Release

### 4.3.4.1 General

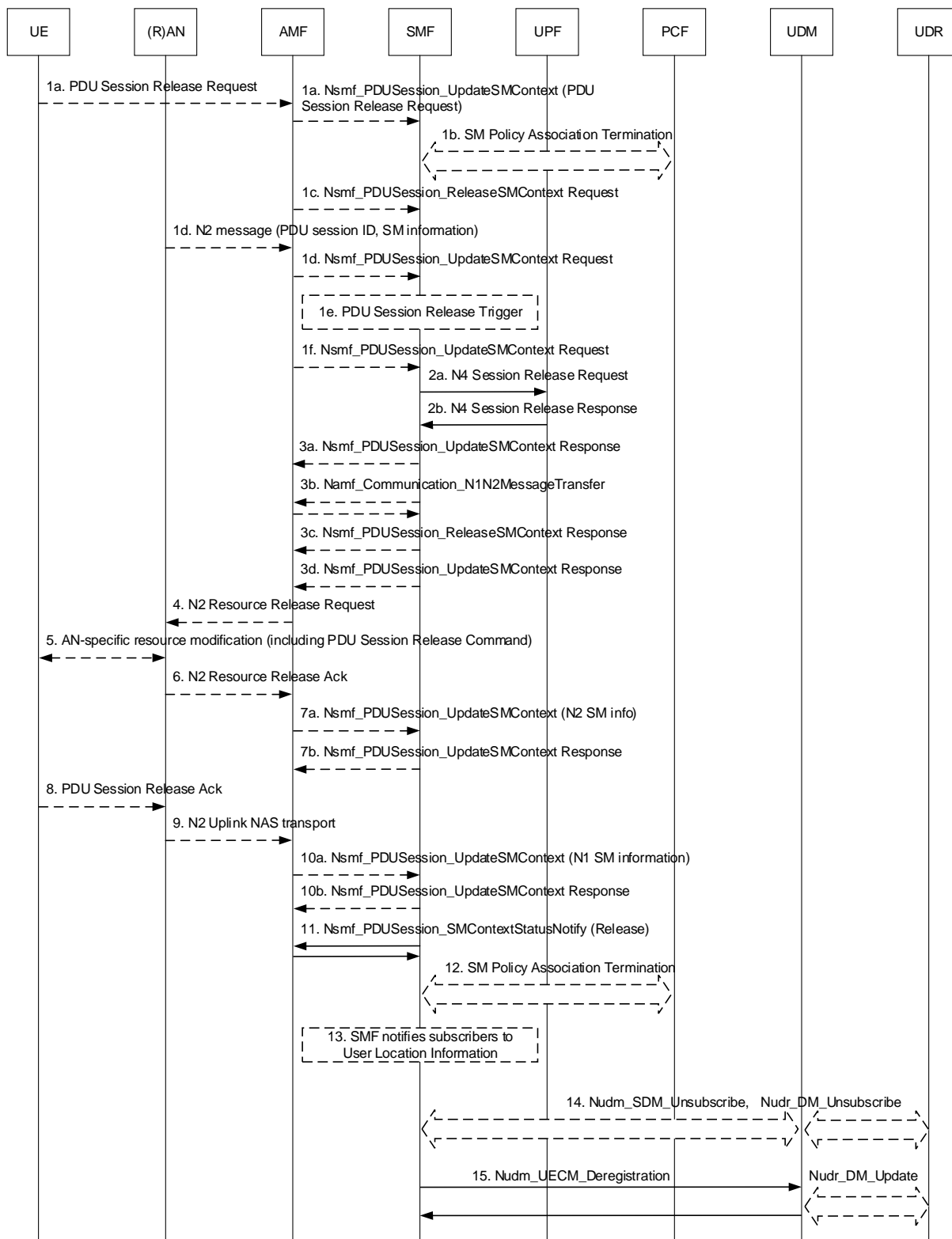
The PDU Session Release procedure is used to release all the resources associated with a PDU Session, including:

- The IP address/Prefixes allocated for an IP-based PDU Session; this may include the release of multiple Prefixes in the case of Multi-homing (as defined in TS 23.501 [2]).
- Any UPF resource (including N3/N9/N19 termination) that was used by the PDU Session. For N19 termination, the UPF resource may be released if all the PDU Sessions associated with the 5G VN group are released.
- Any access resource that was used by the PDU Session.

The SMF takes care to notify any entity associated with PDU Session: PCF, DN (e.g. when DN authorization has taken place at PDU Session establishment), etc. of a PDU Session Release.

### 4.3.4.2 UE or network requested PDU Session Release for Non-Roaming and Roaming with Local Breakout

Figure 4.3.4.2-1 captures both the UE Requested PDU Session Release procedure and the network requested PDU Session Release procedure. The procedure allows the UE to request the release of one PDU Session. The procedure also allows the AMF, the SMF or the PCF to initiate the release of a PDU Session. In the case of LBO, the procedure is as in the case of non-roaming with the difference that the AMF, the SMF, the UPF and the PCF are located in the visited network.



**Figure 4.3.4.2-1: UE or network requested PDU Session Release for non-roaming and roaming with local breakout**

1. The procedure is triggered by one of the following events:

1a. (UE requested) The UE initiates the UE Requested PDU Session Release procedure by the transmission of an NAS message (N1 SM container (PDU Session Release Request (PDU session ID))), PDU Session ID) message. The NAS message is forwarded by the (R)AN to the AMF with an indication of User Location Information. This message is relayed to the SMF corresponding to the PDU Session ID via N2 and the AMF.

The AMF invokes the Nsmf\_PDUSession\_UpdateSMContext service operation and provides the N1 SM container to the SMF together with User Location Information (ULI) received from the (R)AN.

NOTE 1: Depending on the Access Type, when the UE is in CM-IDLE state, the UE can trigger a Service Request procedure before being able to release the PDU Session.

- 1b. (PDU Session Release initiated by the PCF) The PCF may invoke an SM Policy Association Termination procedure as defined in clause 4.16.6 to request the release of the PDU Session.
- 1c. The AMF may invoke the Nsmf\_PDUSession\_ReleaseSMContext service operation to request the release of the PDU Session in the case of mismatch of PDU Session status between UE and AMF or other cases where neither N1 nor N2 SM signalling is needed before the releasing of SM context.
- 1d. (R)AN may decide to indicate to the SMF that the PDU Session related resource is released, e.g. when all the QoS Flow(s) of the PDU Session are released.

NOTE 2: In this case, it's up to SMF to decide whether to keep the PDU Session with user plane connection deactivated or release the PDU Session.

- 1e. (PDU Session Release initiated by the SMF) The SMF may decide to release a PDU Session under the following scenarios:
  - Based on a request from the DN (cancelling the UE authorization to access to the DN);
  - Based on a request from the UDM (subscription change) or from the CHF;
  - If the SMF received an event notification from the AMF that the UE is out of LADN service area
  - Based on locally configured policy (e.g. the release procedure may be related with the UPF re-allocation for SSC mode 2 / mode 3); or
  - If the SMF is notified by the (R)AN that the PDU Session resource establishment has failed during mobility procedure.

If the SMF receives one of the triggers in step 1a, 1b, 1c, or 1e the SMF starts PDU Session Release procedure.

- 1f. The AMF may invoke the Nsmf\_PDUSession\_UpdateSMContext service operation with a release indication to request the release of the PDU Session where N1 or N2 SM signalling may be needed before releasing the SM context (e.g. due to a change of the set of network slices for a UE where a network slice instance is no longer available as described in clause 5.15.5.2.2 of TS 23.501 [2] or the AAA Server triggered Network Slice-Specific Re-authentication and Re-authorization procedure fails as specified in clause 4.2.9.2 or the AAA Server triggered Slice-Specific Authorization Revocation takes place as specified in clause 4.2.9.4 or AMF determines that Control Plane Only indication associated with PDU Session is not applicable any longer as described in clause 5.31.4.1 of TS 23.501 [2]).
2. The SMF releases the IP address / Prefix(es) that were allocated to the PDU Session and releases the corresponding User Plane resources:
  - 2a. The SMF sends an N4 Session Release Request (N4 Session ID) message to the UPF(s) of the PDU Session. The UPF(s) shall drop any remaining packets of the PDU Session and release all tunnel resource and contexts associated with the N4 Session.
  - 2b. The UPF(s) acknowledges the N4 Session Release Request by the transmission of an N4 Session Release Response (N4 Session ID, [Small Data Rate Control Status], [APN Rate Control Status]) message to the SMF.

The UPF includes Small Data Rate Control Status if the PDU Session used Small Data Rate Control.

If a NEF has been selected as anchor of the Control Plane CIoT 5GS Optimisation enabled PDU session which is Unstructured PDU Session Type as described in clause 4.3.2.2 and the SMF-NEF Connection is released for this PDU Session.

NOTE 3: If there are multiple UPFs associated with the PDU Session (e.g. due to the insertion of UL CL or Branching Point, or redundant I-UPFs if the redundant I-UPFs are used for URLLC), the Session Release Request procedure (steps 2a and 2b) is done for each UPF. In order to avoid charging of PDUs that later get dropped, the SMF performs the N4 Session Release first with the UPF(s) performing usage reporting, before releasing the other UPF(s) that forward traffic for the same user plane resources.

- 3 If the PDU Session Release is initiated by the PCF and SMF and the SMF has been notified by the AMF that UE is unreachable, e.g. due to the UE is in MICO mode or periodical registration failure, the procedure continues in step 11 by SMF notifying the AMF that the PDU Session is released by invoking the Nsmf\_PDUSession\_SMContextStatusNotify. The rest of step 3 and the steps 4-10 are skipped.

If the PDU Session Release procedure was triggered by steps 1a, 1b, 1d or 1e above, the SMF creates an N1 SM including PDU Session Release Command message (PDU Session ID, Cause). The Cause may indicate a trigger to establish a new PDU Session with the same characteristics (e.g. when procedures related with SSC mode 2 are invoked).

If the User Plane connection of the PDU Session is activated, the message sent by the SMF to the AMF shall include N2 SM Resource Release request. If the User Plane connection of the PDU Session is not activated, the message sent by the SMF to the AMF shall not include N2 SM Resource Release request.

NOTE 4: SSC modes are defined in clause 5.6.9 of TS 23.501 [2].

- 3a. (If the PDU Session Release is initiated by the UE in step 1a or has been triggered by (R)AN in step 1d) The SMF responds to the AMF with the Nsmf\_PDUSession\_UpdateSMContext response (N2 SM Resource Release request, N1 SM container (PDU Session Release Command)). N2 SM Resource Release request is included if the PDU Session Release is initiated by the UE and if the UP connection of the PDU Session is active. Neither N2 SM Resource Release request nor N1 SM container is included if the PDU Session Release is triggered by (R)AN and the SMF decides to keep the PDU session with user plane connection deactivated and the subsequent steps are skipped.

- 3b. If the PDU Session Release is initiated by the SMF or the PCF, the SMF invokes the Namf\_Communication\_N1N2MessageTransfer service operation (N1 SM container (PDU Session Release Command), skip indicator).

If the UP connection of the PDU Session is active, the SMF shall also include the N2 Resource Release request (PDU Session ID) in the Namf\_Communication\_N1N2MessageTransfer, to release the (R)AN resources associated with the PDU Session.

The "skip indicator" tells the AMF whether it may skip sending the N1 SM container to the UE (e.g. when the UE is in CM-IDLE state). SMF includes the "skip indicator" in the Namf\_Communication\_N1N2MessageTransfer except when the procedure is triggered to change PDU Session Anchor of a PDU Session with SSC mode 2.

If the UE is in CM-IDLE state and "skip indicator" is included in the Namf\_Communication\_N1N2MessageTransfer service operation, the AMF acknowledges the step 3b by sending an Namf\_Communication\_N1N2MessageTransfer Response message ("N1 SM Message Not Transferred") to SMF and steps 4 to 10 are skipped.

- 3c. If the PDU Session Release is initiated by the AMF in step 1c, i.e. the SMF received the Nsmf\_PDUSession\_ReleaseSMContext Request from the AMF, the SMF responds to the AMF with the Nsmf\_PDUSession\_ReleaseSMContext response, optionally including the Small Data Rate Control Status and APN Rate Control Status.

If the UPF included APN Rate Control Status and/or Small Data Rate Control Status in step 2 then the SMF includes APN Rate Control and/or Small Data Rate Control Status and the AMF stores the Small Data Rate Control Status and/or the APN Rate Control Status in the UE context in AMF.

The AMF and SMF shall remove all contexts (including the PDU Session ID) associated with the PDU Session which are indicated as released at the UE. The SMF shall remove any event subscriptions on the AMF by the SMF that becomes no more needed due to the PDU Session Release. The steps 4 to 11 are skipped.

- 3d. If the PDU Session Release is initiated by the AMF in step 1f, i.e. the SMF received the Nsmf\_PDUSession\_UpdateSMContext Request from the AMF with a release indication to request the release of the PDU Session, the SMF responds to the AMF with the Nsmf\_PDUSession\_UpdateSMContext Response

which may contain the N1 SM container (PDU Session Release Command) to release the PDU session at the UE.

If the UP connection of the PDU Session is active, the Nsmf\_PDUSession\_UpdateSMContext Response shall also include the N2 Resource Release request (PDU Session ID) to release the (R)AN resources associated with the PDU Session.

4. If the UE is in CM-IDLE state and "N1 SM delivery can be skipped" is not indicated, the AMF initiates the network triggered Service Request procedure to transmit the NAS message (PDU Session ID, N1 SM container) to the UE and the steps 6, 7 are skipped.

If the message received from the SMF in step 3 does not include N2 SM Resource Release request, the AMF transmits the NAS message (PDU Session ID, N1 SM container) to the UE and the steps 6, 7 are skipped.

If the PDU Session is Control Plane CIoT 5GS Optimisation enabled, the SMF shall not include N2 SM Resource Release request in the message sent to the AMF, the AMF transmits the NAS message (PDU Session ID, N1 SM container) to the UE and the steps 6, 7 are skipped.

If the UE is in CM-CONNECTED state and the received message from the SMF in step 3 includes N2 SM Resource Release request, the AMF transfers the SM information received from the SMF in step 4 (N2 SM Resource Release request, N1 SM container) to the (R)AN.

If the message from the SMF includes Small Data Rate Control Status then the AMF stores it in the UE Context in AMF.

5. When the (R)AN has received an N2 SM request to release the AN resources associated with the PDU Session it issues AN specific signalling exchange(s) with the UE to release the corresponding AN resources.

In the case of a NG-RAN, the NAS message is sent to the UE in an RRC message which may take place with the UE releasing the NG-RAN resources related to the PDU Session. If NG-RAN resources do not need to be released (i.e. the User Plane of the PDU Session is deactivated), the NAS message is sent to the UE in an RRC message which does not release the NG-RAN resources related to the PDU Session.

During this procedure, the (R)AN sends any NAS message (N1 SM container (PDU Session Release Command)) received from the AMF in step 5.

6. [Conditional] If the (R)AN had received a N2 SM request to release the AN resources, the (R)AN acknowledges the N2 SM Resource Release Request by sending an N2 SM Resource Release Ack (User Location Information, Secondary RAT usage data) Message to the AMF.

If the PLMN has configured secondary RAT usage reporting, the NG-RAN node may provide RAN Usage Data Report.

- 7a. The AMF invokes the Nsmf\_PDUSession\_UpdateSMContext (N2 SM Resource Release Ack (Secondary RAT usage data), User Location Information) to the SMF.
- 7b. The SMF responds to the AMF with an Nsmf\_PDUSession\_UpdateSMContext response.
8. The UE acknowledges the PDU Session Release Command by sending a NAS message (PDU Session ID, N1 SM container (PDU Session Release Ack)) message over the (R)AN.
9. [Conditional] The (R)AN forwards the NAS message from the UE by sending a N2 NAS uplink transport (NAS message (PDU Session ID, N1 SM container (PDU Session Release Ack)), User Location Information) to the AMF.
- 10a. The AMF invokes the Nsmf\_PDUSession\_UpdateSMContext (N1 SM container (PDU Session Release Ack, User Location Information) to the SMF.
- 10b. The SMF responds to the AMF with an Nsmf\_PDUSession\_UpdateSMContext response.

Steps 8-10 may happen before steps 6-7.

11. If steps 3a, 3b or 3d were performed, the SMF waits until it has received replies to the N1 and N2 information provided in step 3, as needed.

The SMF invokes Nsmf\_PDUSession\_SMContextStatusNotify to notify AMF that the SM context for this PDU Session is released. If the UPF included Small Data Rate Control Status and/or APN Rate Control Status in step 2 then the SMF includes Small Data Rate Control Status and/or APN Rate Control Status in its request to the AMF in this step. The AMF releases the association between the SMF ID and the PDU Session ID, DNN, as well as S-NSSAI and stores the Small Data Rate Control Status and/or the APN Rate Control Status in the UE context in AMF. The SMF shall remove any event subscriptions on the AMF that becomes no more needed due to the PDU Session Release.

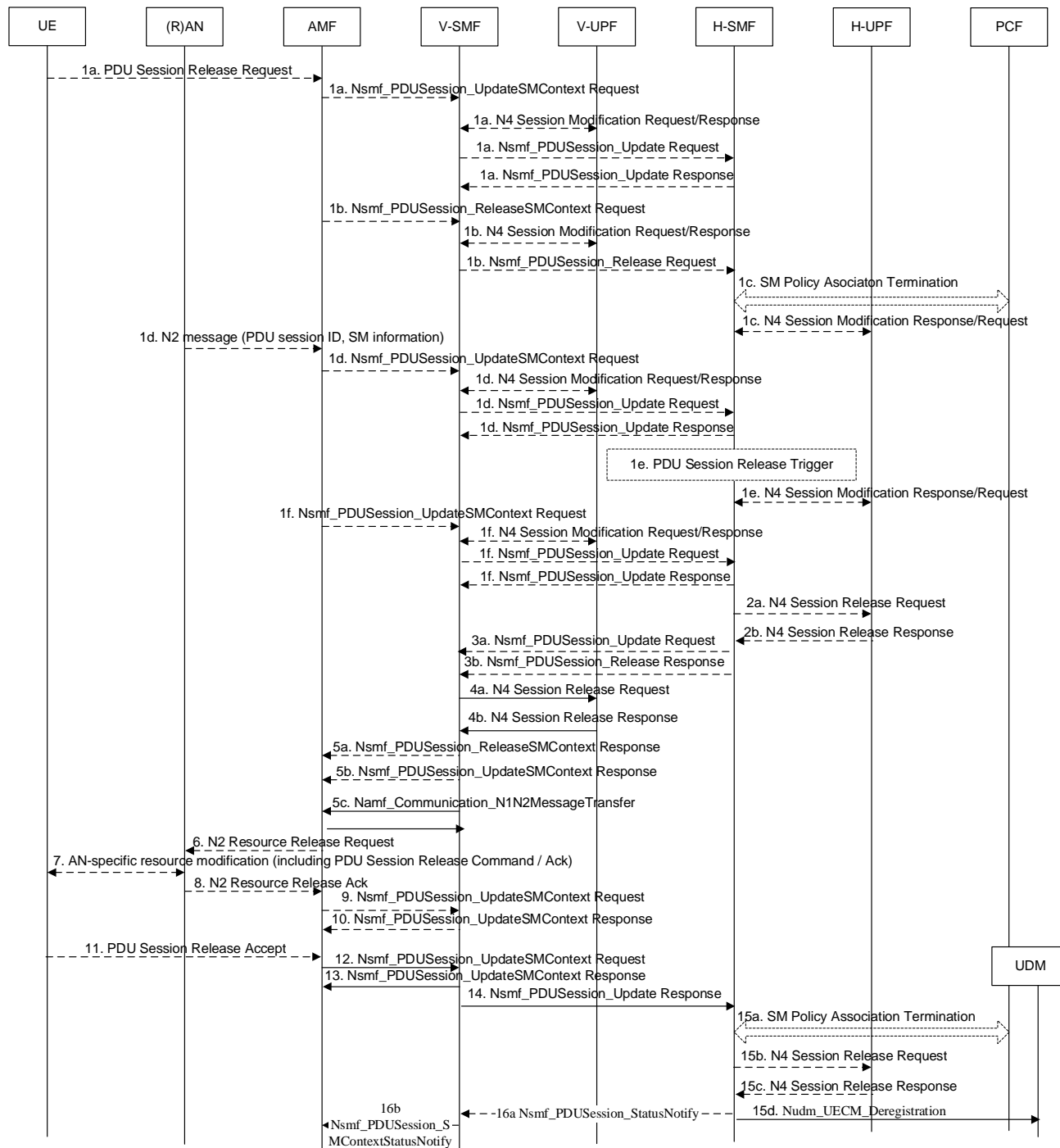
NOTE 5: The UE and the 5GC will get synchronized about the status of the (released) PDU Session at the next Service Request or Registration procedure.

12. If Dynamic PCC applied to this session the SMF invokes an SM Policy Association Termination procedure as defined in clause 4.16.6 to delete the PDU Session.
13. SMF notifies any entity that has subscribed to User Location Information related with PDU Session change.
14. If it is the last PDU Session the SMF is handling for the UE for the associated (DNN, S-NSSAI), the SMF unsubscribes from Session Management Subscription data changes notification with the UDM by means of the Nudm\_SDM\_Unsubscribe (SUPI, DNN, S-NSSAI) service operation. The UDM may unsubscribe the subscription notification from UDR by Nudr\_DM\_Unsubscribe (SUPI, Subscription Data, Session Management Subscription data, DNN, S-NSSAI).
15. The SMF invokes the Nudm\_UECM\_Deregistration service operation including the DNN and the PDU Session Id. The UDM removes the association it had stored between the SMF identity and the associated DNN and PDU Session Id. The UDM may update this information by Nudr\_DM\_Update (SUPI, Subscription Data, UE context in SMF data).

#### 4.3.4.3 UE or network requested PDU Session Release for Home-routed Roaming

This procedure is used in the case of home-routed roaming scenarios.





**Figure 4.3.4.3-1: UE or network requested PDU Session Release for home-routed roaming**

1. The procedure is triggered by one of the following events:
  - 1a. (UE initiated release) As in step 1a of clause 4.3.4.2 with the addition that:
    - the V-SMF initiates N4 Session Modification to instruct the V-UPF to stop forwarding uplink traffic; and
    - the V-SMF invokes the Nsmf\_PDUSession\_Update Request (SM Context ID, information from the SM message from the UE e.g. PCO, "Trigger PDU Session Release" indication, Timezone, User Location Information) service operation to request the H-SMF to release the PDU Session. The H-SMF responds to the request immediately.

1b. (Serving network initiated release) The serving network initiates the PDU Session Release during UE or serving network initiated Deregistration procedure as specified in clause 4.2.2.3. There is no NAS SM message between the UE and the V-SMF in this case. This step is the same as step 1c in clause 4.3.4.2, with the addition that:

- the V-SMF initiates N4 Session Modification to instruct the V-UPF to stop forwarding uplink traffic; and
- the V-SMF initiates the release of the PDU Session at the H-SMF by invoking the Nsmf\_PDUSession\_Release request.

The serving network also initiates the PDU Session Release where neither N1 nor N2 SM signalling is needed before releasing the SM context as in step 1c in clause 4.3.4.2 if e.g. due to the set of network slices for a UE changes where a network slice instance is no longer available (e.g. as described in clause 5.15.5.2.2 of TS 23.501 [2]), or the AAA Server triggered Network Slice-Specific Re-authentication and Re-authorization procedure fails as specified in clause 4.2.9.2 or the AAA Server triggered Slice-Specific Authorization Revocation takes place as specified in clause 4.2.9.4).

1c. (HPLMN initiated release) This step is the same as step 1b in clause 4.3.4.2, with the addition that:

- the H-SMF initiates N4 Session Modification to instruct the H-UPF to stop forwarding downlink traffic.

1d. This step is the same as step 1d in clause 4.3.4.2, with the addition that:

- the V-SMF initiates N4 Session Modification to instruct the V-UPF to stop forwarding uplink traffic; and
- the V-SMF invokes the Nsmf\_PDUSession\_Update Request towards H-SMF.

1e. (HPLMN initiated release) This step is the same as step 1e in clause 4.3.4.2, with the addition that:

- the H-SMF initiates N4 Session Modification to instruct the H-UPF to stop forwarding downlink traffic.

1f. This step is the same as step 1f in clause 4.3.4.2, with the addition that:

- the V-SMF initiates N4 Session Modification to instruct the V-UPF to stop forwarding uplink traffic; and
- the V-SMF invokes the Nsmf\_PDUSession\_Update Request towards H-SMF.

If the SMF receives one of the triggers in step 1a, 1c or 1e, the H-SMF starts PDU Session Release procedure.

When a SMF above initiates N4 Session Modification to instruct the UPF to stop forwarding traffic this means also to stop taking into account the traffic for usage monitoring.

2a-2b. (UE-, (R)AN- or Serving network initiated) This step is performed in case the PDU Session Release is triggered by a message from V-SMF. These steps are the same as steps 2a-2b in clause 4.3.4.2. The SMF is the SMF in HPLMN.

NOTE 1: This step 2a-2b can correspond to steps 1a, 1b, 1d, 1f.

3a. (UE or HPLMN initiated release) The H-SMF prepares the SM Release PDU Session Command message and initiates the PDU Session Release towards the UE by invoking the Nsmf\_PDUSession\_Update Request service operation towards the V-SMF. The Nsmf\_PDUSession\_Update Request contains necessary information to build the SM Release PDU Session Command by the V-SMF towards the UE (for example a Release Cause or PCO).

3b. (Serving network initiated release) The H-SMF responds to the PDU release request from the V-SMF with a Nsmf\_PDUSession\_Release response.

If the UPF included Small Data Rate Control Status in step 2 then the SMF includes Small Data Rate Control Status in the request to the AMF.

If the Control Plane CIoT 5GS Optimisation is enabled for this PDU Session, the steps 4a and 4b are skipped.

4a-4b. The V-SMF releases the corresponding User Plane resources. This includes the same procedure in step 2 but controlled from the SMF in VPLMN.

5-13. These steps are the same as steps 3-10 in clause 4.3.4.2.

14. (UE or HPLMN initiated release) The V-SMF responds to the Nsmf\_PDUSession\_Update Request invoked at step 3a and confirms the PDU Session Release. The Nsmf\_PDUSession\_Update response may carry information such as PCO received from the UE in SM PDU Session Release Accept. as well as User Location Information, Time Zone and Secondary RAT Usage Data.

15a. (UE or HPLMN or Serving network initiated release) The H-SMF releases the SM policy control association with the PCF by invoking the SM Policy Association Termination procedure defined in clause 4.16.6. For serving network initiated PDU Session Release case, this step happens between step 1b and step 3b.

15b-15c. (HPLMN initiated release) In case the PDU Session Release is HPLMN-initiated (i.e. triggers in 1c, 1e), the H-SMF releases the corresponding User Plane resources. This includes the same procedure as in step 2.

15d. As in step 15 of clause 4.3.4.2, the SMF invokes the Nudm\_UECM\_Deregistration service operation.

NOTE 2: Step 15d does not necessarily take place after step 15c.

16. (UE or HPLMN initiated release) The H-SMF shall remove all contexts associated with the PDU Session:

16a. The H-SMF requests the V-SMF to release all contexts associated with the PDU Session by invoking the Nsmf\_PDUSession\_StatusNotify (Release) operation.

16b. The V-SMF requests the AMF to release all contexts associated with the PDU Session by invoking the Nsmf\_PDUSession\_SMContextStatusNotify (Release). The AMF releases the association between the SMF ID and the PDU Session ID.

## 4.3.5 Session continuity, service continuity and UP path management

### 4.3.5.1 Change of SSC mode 2 PDU Session Anchor with different PDU Sessions

The following procedure is triggered by SMF in order to change the PDU Session Anchor serving a PDU Session of SSC mode 2 for a UE when neither multi-homing nor UL CL applies to the PDU Session. This procedure releases the existing PDU Session associated with an old PDU Session Anchor (i.e. UPF1 in figure 4.3.5.1-1) and immediately establishes a new PDU Session with a new PDU Session Anchor (i.e. UPF2 in figure 4.3.5.1-1) to the same DN.

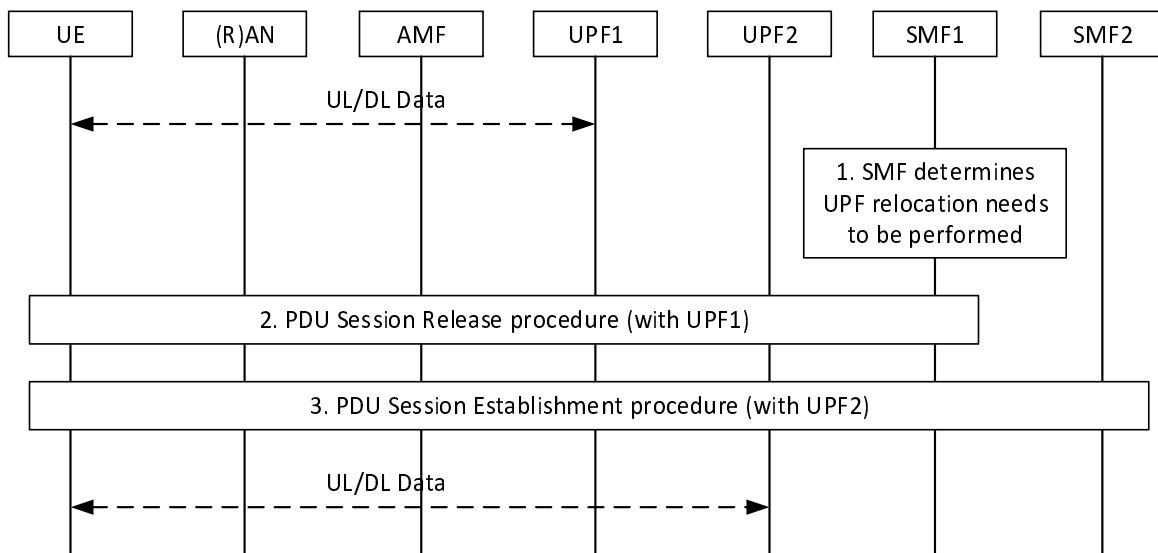


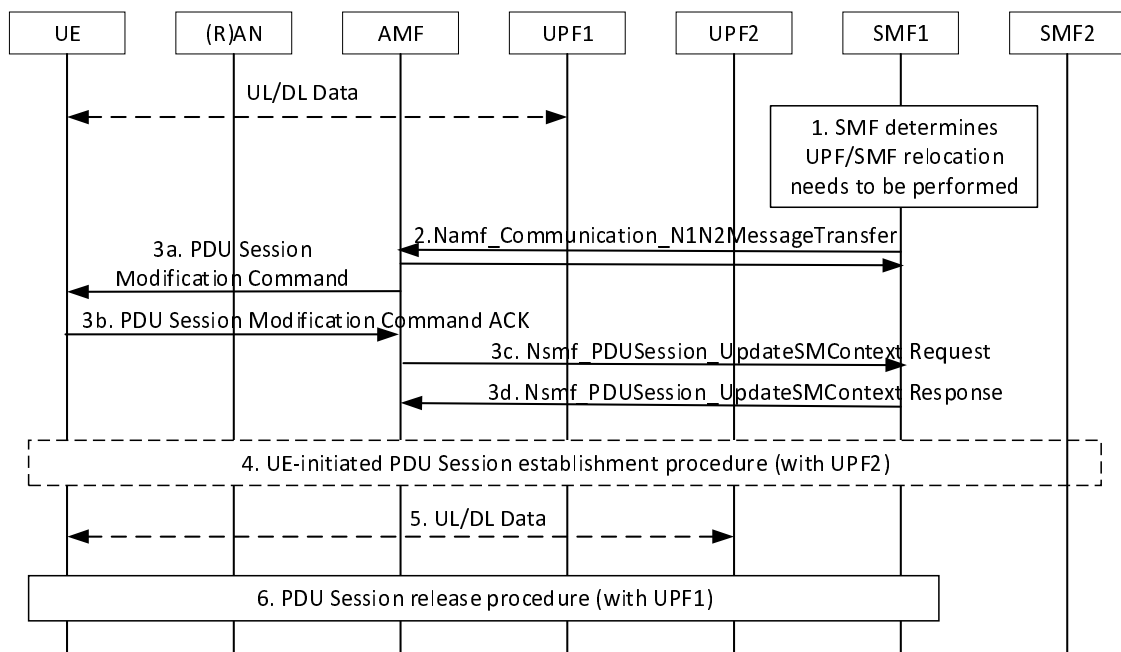
Figure 4.3.5.1-1: Change of SSC mode 2 PSA for a PDU Session

1. The SMF determines that the serving UPF needs to be changed due to events that may benefit from such change.
2. The PDU Session Release procedure is initiated as described in clause 4.3.4. The SMF sends an N1 SM Information to the UE via the AMF by invoking Namf\_Communication\_N1N2MessageTransfer as described in Step 3b of clause 4.3.4.2. The PDU Session Release Command message in N1 SM Information contains the PDU Session ID and Cause indicating that a PDU Session re-establishment to the same DN is required.

- Upon reception of PDU Session Release Command with Cause indicating that a PDU Session re-establishment to the same DN is required as sent in step 2, the UE generates a new PDU Session ID and initiates PDU Session Establishment procedure as described in clause 4.3.2.2. Then, the AMF selects an SMF as described in clause 6.4.2 of TS 23.501 [2] and the SMF can select a new UPF (i.e. UPF2) for the re-established PDU Session of SSC mode 2.

#### 4.3.5.2 Change of SSC mode 3 PDU Session Anchor with multiple PDU Sessions

The following procedure is triggered by SMF in order to change the PDU Session Anchor serving a PDU Session of SSC mode 3 for a UE. This procedure releases the existing PDU Session associated with an old PDU Session Anchor (i.e. UPF1 in figure 4.3.5.2-1) after having established a new PDU Session to the same DN with a new PDU Session Anchor (i.e. UPF2 in figure 4.3.5.2-1), which is controlled by the same SMF. The SMF may determine that a new SMF needs to be reallocated.



**Figure 4.3.5.2-1: Change of SSC mode 3 PDU Session Anchor with multiple PDU Sessions**

- The SMF determines that the serving UPF or the SMF needs to be changed. If the "Indication of application relocation possibility" attributes in the PCC rule indicates no DNAI change takes place once selected for this application, the SMF determines that the SMF can not be changed.
- If the SMF had sent an early notification to the AF and the runtime coordination between 5GC and AF is enabled based on local configuration as specified in clause 4.3.6.3, according to the indication of "AF acknowledgment to be expected" included in AF subscription to SMF events, the SMF waits for a notification response from the AF. If the SMF receives a negative notification response from the AF, the SMF may stop the procedure.

The SMF invokes the `Namf_Communication_N1N2MessageTransfer` (PDU Session ID, SMF Reallocation requested indication, N1 SM container (PDU Session Modification Command (Cause, PCO (PDU Session Address Lifetime value)))) where PDU Session ID indicates the existing PDU Session to be relocated and Cause indicates that a PDU Session re-establishment to the same DN is required.

The SMF Reallocation requested indication indicates whether the SMF is requested to be reallocated.

The PDU Session Address Lifetime value is delivered to the UE upper layers in PCO and indicates how long the network is willing to maintain the PDU Session. The SMF starts a PDU Session Release timer corresponding to the PDU Session Address Lifetime value.

- The AMF forwards the NAS message to the UE. The UE can provide the release timer value to the upper layers if received in the PDU Session Modification Command.
- The UE acknowledges the PDU Session Modification Command.

3c. The AMF forwards the N1 SM container (PDU Session Modification Command ACK) received from the (R)AN to the SMF1 via Nsmf\_PDUSession\_UpdateSMContext service operation.

3d. The SMF1 replies with a Nsmf\_PDUSession\_UpdateSMContext Response.

4. If the UE receives PDU Session Modification Command, the UE may decide to initiate the PDU Session Establishment procedure described in clause 4.3.2.2, to the same DN with the following differences:

In Step 1 of clause 4.3.2.2.1, according to the SSC mode, UE generates a new PDU Session ID and initiates the PDU Session Establishment Request using the new PDU Session ID. The new PDU Session ID is included as PDU Session ID in the NAS request message and the Old PDU Session ID which indicates the existing PDU Session to be released is also provided to AMF in the NAS request message.

In Step 2 of clause 4.3.2.2.1, if SMF reallocation was requested in Step 2 of this clause, the AMF selects a different SMF. Otherwise, the AMF sends the Nsmf\_PDUSession\_CreateSMContext Request to the same SMF serving the Old PDU Session ID.

In Step 3 of clause 4.3.2.2.1, the AMF include both PDU Session ID and Old PDU Session ID in Nsmf\_PDUSession\_CreateSMContext Request. The SMF detects that the PDU Session establishment request is related to the trigger in step 2 based on the presence of an Old PDU Session ID in the Nsmf\_PDUSession\_CreateSMContext Request. The SMF stores the new PDU Session ID and selects a new PDU Session Anchor (i.e. UPF2) for the new PDU Session.

If the runtime coordination between 5GC and AF is enabled based on local configuration, according to the indication of "AF acknowledgment to be expected" included in AF subscription to SMF events, the SMF sends a late notification to the AF before Step 11 of clause 4.3.2.2.1 and waits for a notification response from the AF. If the SMF received a negative notification response from the AF, the SMF may stop the procedure. Otherwise the SMF continue the following procedures to activate the UP path of the new PDU Session.

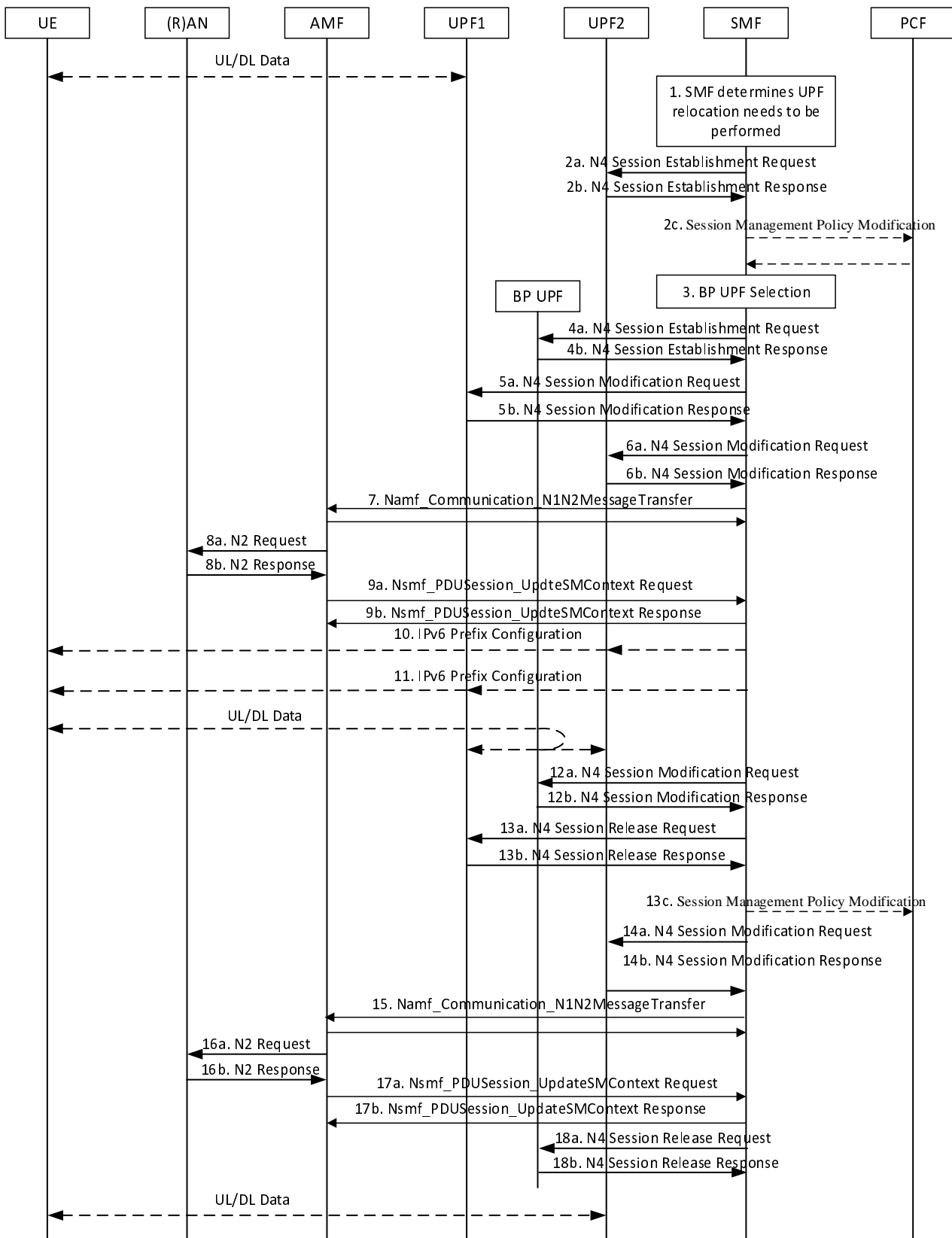
5. After the new PDU Session is established the UE starts using the IP address/prefix associated with the new PDU Session for all new traffic and may also proactively move existing traffic flow (where possible) from the old PDU Session to the new PDU Session.

NOTE: The mechanisms used by the UE to proactively move existing traffic flows from one IP address/prefix to another are outside the scope of 3GPP specifications.

6. The old PDU Session is released as described in clause 4.3.4 either by the UE before the timer provided in step 3 expires (e.g. once the UE has consolidated all traffic on new PDU Session or if the session is no more needed) or by the SMF upon expiry of this timer.

#### 4.3.5.3 Change of SSC mode 3 PDU Session Anchor with IPv6 Multi-homed PDU Session

Clause 4.3.5.3 describes a procedure for service continuity with SSC mode 3 that uses the multi-homed PDU Session described in clause 5.6.4.3 of TS 23.501 [2]. In this case the SMF prepares a new PDU Session Anchor first and then notifies the UE of the existence of a new IP prefix, as depicted in figure 4.3.5.3-1. This procedure is applicable only to PDU Sessions of IPv6 type.



**Figure 4.3.5.3-1: Change of PDU Session Anchor with IPv6 Multi homed PDU Session**

The UE has an established PDU Session with the PDU Session Anchor (i.e. UPF1 in Figure 4.3.5.3-1). The PDU Session's User Plane involves at least the (R)AN and the PDU Session Anchor.

1. At some point the SMF decides to allocate to the PDU Session the PDU Session with a new PDU Session Anchor.

2. The SMF selects a new UPF and using N4 configures the UPF as a new PDU Session Anchor (i.e. UPF2 in Figure 4.3.5.3-1) of the multi-homed PDU Session. In the process a new IPv6 prefix (IP@2) is allocated for the PDU Session. If the PCF has subscribed to the IP allocation/release event, the SMF performs a Session Management Policy Modification procedure as defined in clause 4.16.5 to provide the new allocated IPv6 prefix to the PCF. The PCF invokes Nbsf\_Management\_Update service operation to register the tuple (IPv6 prefix, PCF id) for the PDU session identified by (SUPI, DNN, S-NSSAI) in the BSF.

If the runtime coordination between 5GC and AF is enabled based on local configuration, according to the indication of "AF acknowledgment to be expected" included in AF subscription to SMF events, the SMF sends an early notification to the AF after the new UPF (new PSA) is selected and waits for a notification response from the AF. If the SMF receives a negative notification response from the AF, the SMF may stop the procedure.

3. The SMF selects a Branching Point (BP) UPF as described in Clause of 6.3.3 of TS 23.501 [2]. The selection of BP UPF may consider the location of UPF1 and UPF2 to ensure a suitable location of the BP UPF relative to the UPF1 and the UPF2.

NOTE 1: If BP UPF is co-located with one of PDU Session Anchors, steps between SMF and BP UPF can be skipped.

4. The SMF configures via N4 the UPF selected in step 3 (BP UPF in Figure 4.3.5.3-1) as a Branching Point for the multi-homed PDU Session. It provides the Branching Point with the necessary UL traffic forwarding rules (related with the prefix of the IPv6 source address of UL traffic). Also, the SMF provides AN Tunnel Info for N3 tunnel setup and CN Tunnel Info for N9 tunnel setup to the BP UPF and obtains CN Tunnel Info from the BP UPF.

5-6. The SMF performs N4 Session Modification procedure with PSAs. During this procedure, the SMF provides CN Tunnel Info received from the BP UPF to set up an N9 tunnel between BP and PSAs.

7. The SMF invokes the Namf\_Communication\_N1N2MessageTransfer service operation containing N2 SM Information with CN Tunnel Info for the N3 tunnel setup.

8. The AMF sends an N2 Request including N2 SM Information received from the SMF to the (R)AN. The (R)AN acknowledges to the AMF with an N2 Response.

9a. The AMF carries the N2 Response sent by the (R)AN to the SMF by invoking the Nsmf\_PDUSession\_UpdateSMContext service operation.

9b. The SMF responds to Nsmf\_PDUSession\_UpdateSMContext service operation from the AMF.

- 10-11. If the runtime coordination between 5GC and AF is enabled based on local configuration as specified in clause 4.3.6.3, according to the indication of "AF acknowledgment to be expected" is included in AF subscription to SMF events, the SMF sends a late notification to the AF and waits for a notification response from the AF. If the SMF receives a negative notification response from the AF, the SMF may stop the procedure.

The SMF notifies the UE of the availability of the new IP prefix. This is performed using an IPv6 Router Advertisement message (RFC 4861 [6]). The SMF sends a Router Advertisement to the UE via the new PSA with a new prefix (IP@2) and sends another Router Advertisement to the UE via the old PSA with the old prefix (IP@1) and zero value in the preferred lifetime field and a value in the valid lifetime field according to RFC 4862 [8]. The UE shall update the valid lifetime of the old prefix (IP@1) to the signalled value regardless of the remaining lifetime. The valid lifetime value indicates the time how long the SMF is willing to keep the old prefix. The valid lifetime value may be decided by SMF based on local configuration.

The UE starts using IP@2 for all new traffic and may also proactively move existing traffic flow (where possible) from IP@1 to IP@2.

NOTE 2: The mechanisms used by the UE to proactively move existing traffic flows from one IP prefix to another are outside the scope of 3GPP specifications.

12. After the timer expires, the SMF releases the UE's old IPv6 prefix (IP@1). At this point the UE implicitly releases the old IP prefix. The SMF sends an N4 Session Modification Request to the BP to release UP resource for N9 tunnel between the BP and old PSA.

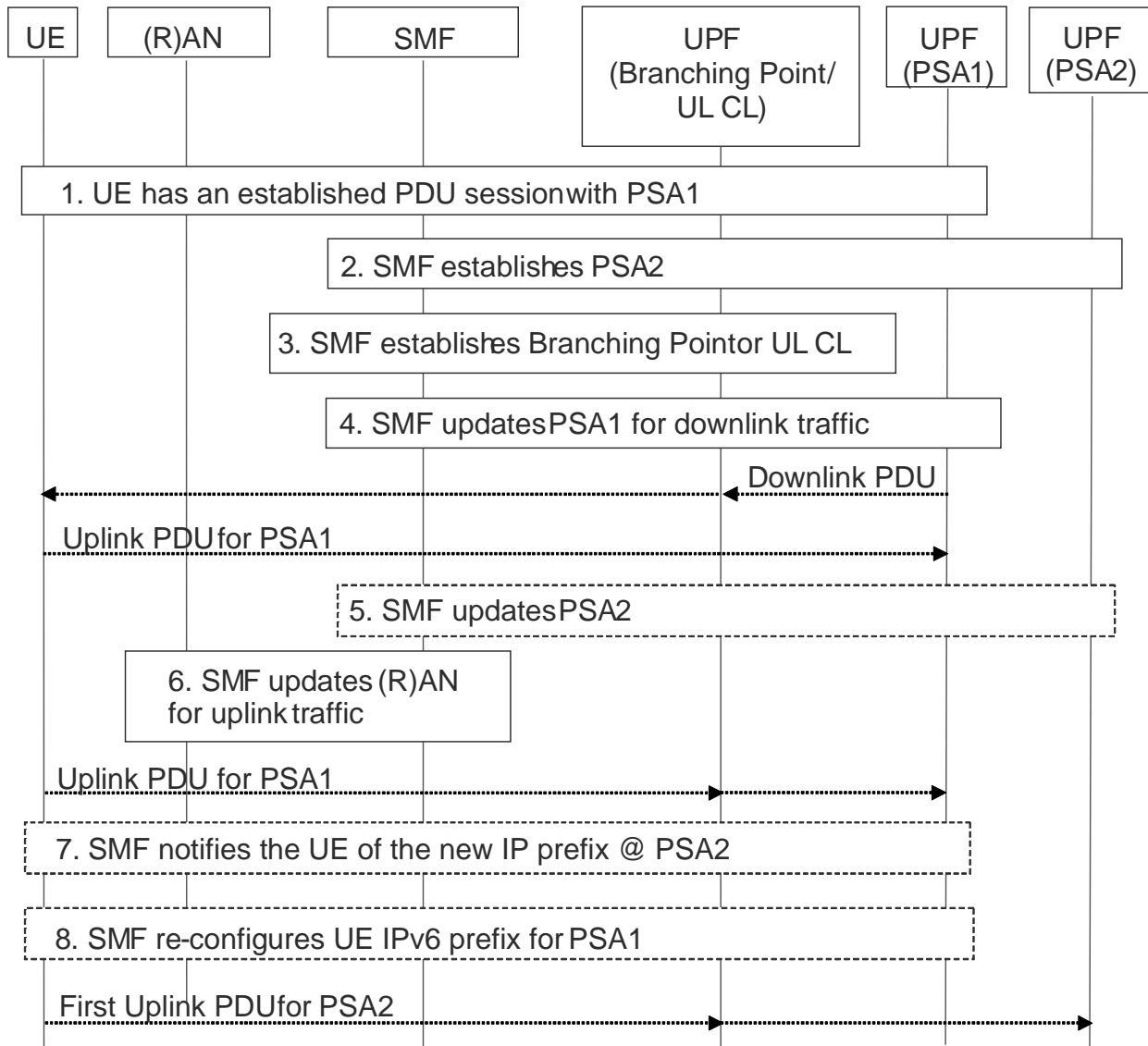
13. The SMF releases the old PDU Session context with the old PDU Session Anchor (UPF1 in Figure 4.3.5.3-1). If the PCF has subscribed to the IP allocation/release event, the SMF performs a Session Management Policy Modification procedure as defined in clause 4.16.5 to notify the PCF of the IPv6 prefix release. The PCF shall

invoke Nbsf\_Management\_Update service operation to remove the tuple (IPv6prefix, PCF id) for the PDU session identified by (SUPI, DNN,S-NSSAI) in BSF.

14-18. The SMF may optionally release the Branching Point from the User Plane path.

#### 4.3.5.4 Addition of additional PDU Session Anchor and Branching Point or UL CL

Clause 4.3.5.4 describes a procedure to add a PDU Session Anchor and a Branching Point or UL CL for an established PDU Session.



**Figure 4.3.5.4-1: Addition of additional PDU Session Anchor and Branching Point or UL CL**

1. UE has an established PDU Session with a UPF including the PDU Session Anchor 1 (PSA1 in Figure 4.3.5.4-1). The PDU Session User Plane involves at least the (R)AN and the PDU Session Anchor 1.
2. At some point the SMF decides to establish a new PDU Session Anchor e.g. due to UE mobility, new flow detection. The SMF selects a UPF and using N4 establish the new PDU Session Anchor 2 (PSA2 in Figure 4.3.5.4-1) of the PDU Session. In the case of IPv6 multi-homing PDU Session, the SMF also ensures that a new IPv6 prefix corresponding to PSA2 is allocated and if the PCF has subscribed to the IP allocation/release event, the SMF performs the Session Management Policy Modification procedure as defined in clause 4.16.5 to provide the new allocated IPv6 prefix to the PCF.



If the runtime coordination between 5GC and AF is enabled based on local configuration, according to the indication of "AF acknowledgment to be expected" is included in AF subscription to SMF events, the SMF sends an early notification to the AF after new PSA (PSA2 in Figure 4.3.5.4-1) is selected and waits for a notification response from the AF before configuring the new PSA. If the SMF receives a negative notification response from the AF, the SMF may stop the procedure.

3. The SMF selects a UPF and using N4 establish the Branching Point (in the case of IPv6 multi-homing) or a UL CL for the PDU Session. It provides the necessary uplink forwarding rules towards PSA1 and PSA2 including the PSA1 CN Tunnel Info and the PSA2 CN Tunnel Info. In addition, the AN Tunnel Info is provided for downlink forwarding. In the case of IPv6 multi-homing, the SMF also provides traffic filters for the IPv6 prefixes corresponding to PSA1 and PSA2 indicating what traffic shall be forwarded towards PSA1 and PSA2 respectively.

In the case of UL CL, the SMF provides traffic filters indicating what traffic shall be forwarded towards PSA1 and PSA2 respectively. If the runtime coordination between 5GC and AF is enabled based on local configuration, according to the indication of "AF acknowledgment to be expected" is included in AF subscription to SMF events, the SMF sends a late notification to the AF and waits for a notification response from the AF before configuring the UL CL. If the SMF receives a negative notification response from the AF, the SMF may stop the procedure.

NOTE 1: If the Branching Point or UL CL and the PSA2 are co-located in a single UPF then steps 2 and 3 can be merged. If a Branching Point is already allocated, step 3 is skipped.

4. The SMF updates the PSA1 via N4. It provides the Branching Point or UL CL CN Tunnel Info for the downlink traffic.

NOTE 2: If the Branching Point or UL CL and the PSA1 are co-located in a single UPF then steps 3 and 4 can be merged.

5. The SMF updates PSA2 via N4. It provides the Branching Point or UL CL CN Tunnel Info for down-link traffic.

NOTE 3: If the Branching Point or UL CL and the PSA2 are co-located in a single UPF then step 5 is not needed.

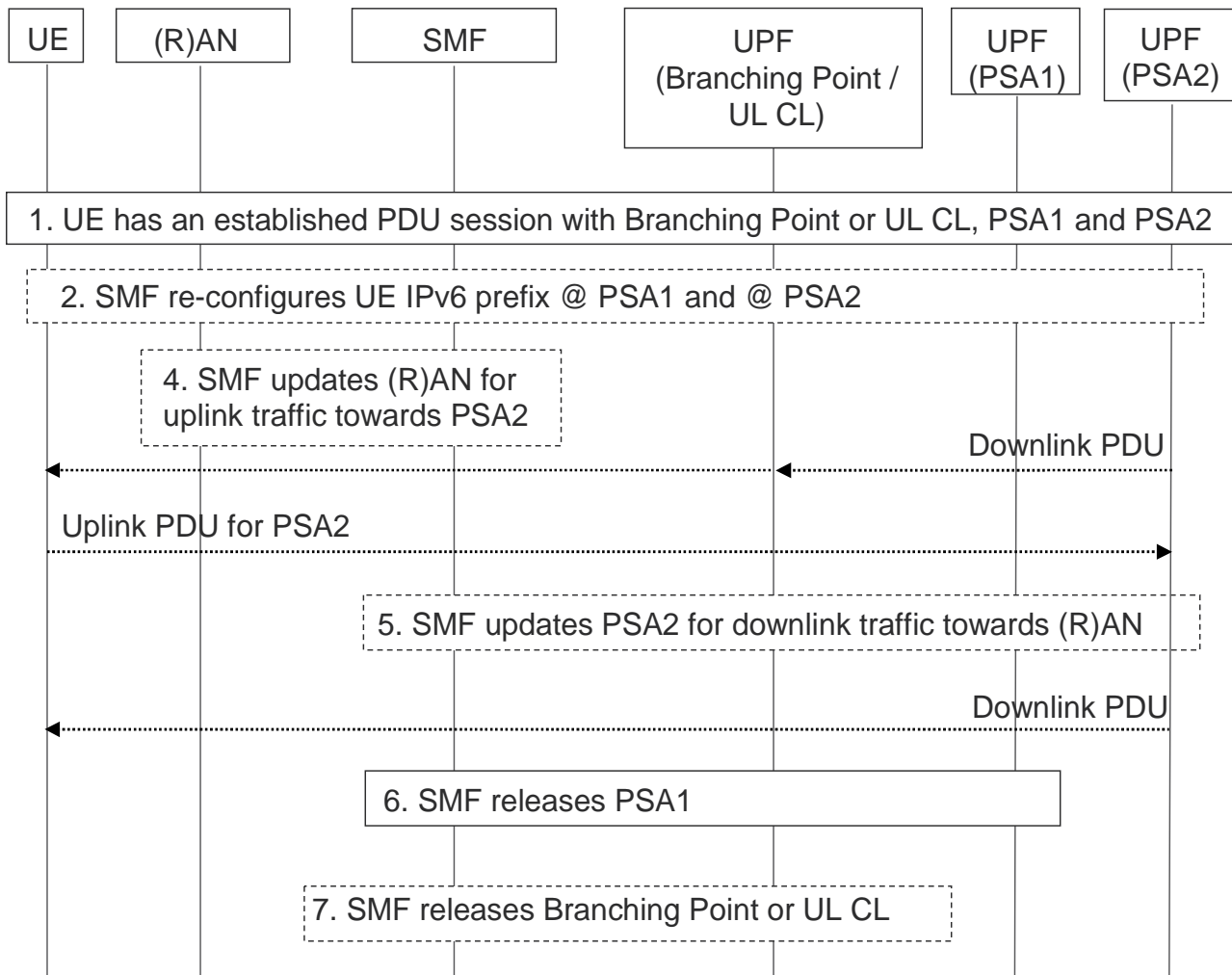
6. The SMF updates (R)AN via N2 SM information over N1.1. It provides the new CN Tunnel Info corresponding to the UPF (Branching Point or UL CL). In the case of UL CL, if there is an existing UPF between the (R)AN and new inserted UL CL, the SMF updates the existing UPF via N4 instead of updating the (R)AN.
7. In the case of IPv6 multi-homing, the SMF notifies the UE of the availability of the new IP prefix @ PSA2. This is performed using an IPv6 Router Advertisement message (RFC 4861 [6]). Also, the SMF sends IPv6 multi-homed routing rule along with the IPv6 prefix to the UE using an IPv6 Router Advertisement message (RFC 4191 [21]) as described in clause 5.8.2.2.2 of TS 23.501 [2].

If the runtime coordination between 5GC and AF is enabled based on local configuration, according to the indication of "AF acknowledgment to be expected" included in AF subscription to SMF events, the SMF sends a late notification to the AF and waits for a notification response from the AF before sending the new IP prefix to the UE. If the SMF receives a negative notification response from the AF, the SMF may stop the procedure.

8. In the case of IPv6 multi-homing, the SMF may re-configure the UE for the original IP prefix @ PSA1, i.e. SMF sends IPv6 multi-homed routing rule along with the IPv6 prefix to the UE using an IPv6 Router Advertisement message (RFC 4191 [21]) as described in clause 5.8.2.2.2 of TS 23.501 [2].

#### 4.3.5.5 Removal of additional PDU Session Anchor and Branching Point or UL CL

Clause 4.3.5.5 describes a procedure to remove a PDU Session Anchor and (optionally) remove Branching Point or UL CL for an established PDU Session.



**Figure 4.3.5.5-1: Removal of additional PDU Session Anchor and Branching Point or UL CL**

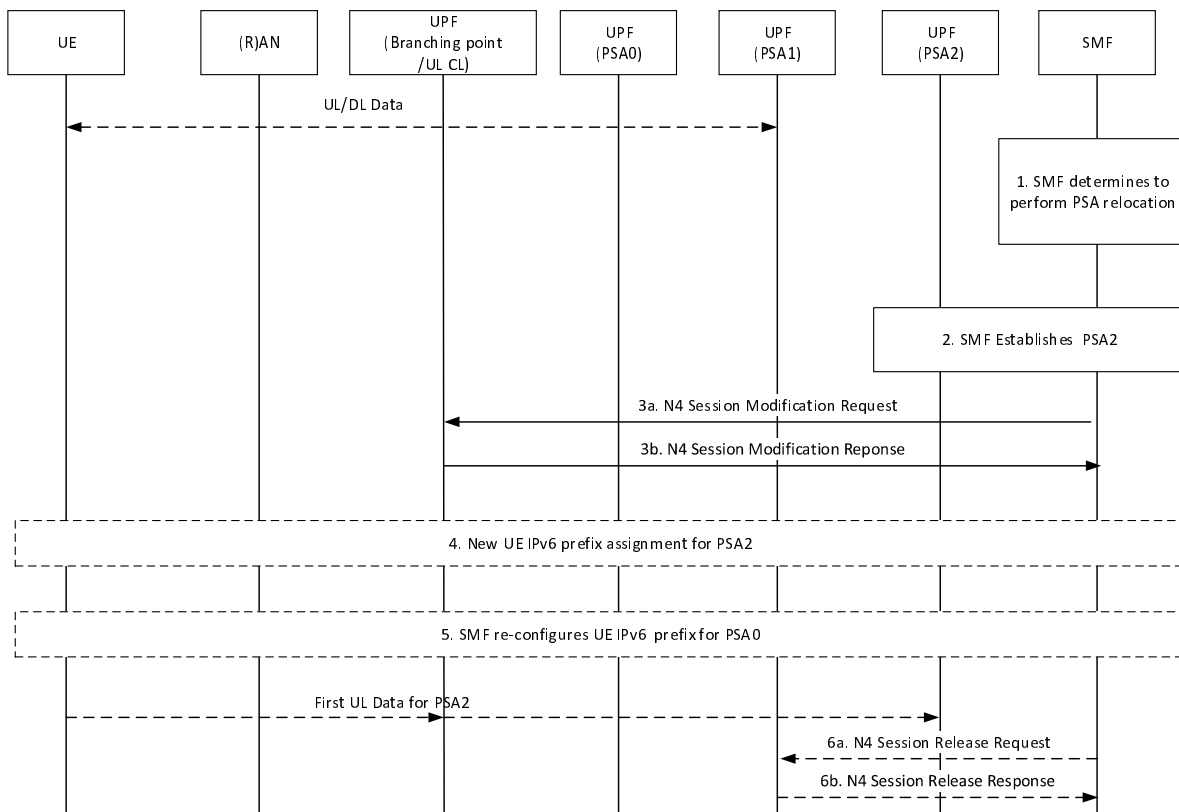
1. UE has an established PDU Session with a UPF including the Branching Point or UL CL, the PDU Session Anchor 1 (PSA1 in Figure 4.3.5.5-1) and the PDU Session Anchor 2 (PSA2 in Figure 4.3.5.5-1).

At some point the SMF decides to remove the PDU Session Anchor 1 e.g. due to UE mobility, flow terminated.

2. In the case of IPv6 multi-homing, the SMF notifies the UE to stop using the IPv6 prefix corresponding to PSA1. This is performed by IPv6 Router Advertisement message (RFC 4861 [6] and RFC 4862 [8]). Also, the SMF sends IPv6 multi-homed routing rule along with the IPv6 prefix corresponding to PSA2 to the UE as described in clause 5.8.2.2.2 of TS 23.501 [2]. Based on the information provided in the Router Advertisement, the UE starts using the IPv6 prefix (corresponding to PSA2) for all the traffic.
4. If the Branching Point or UL CL is to be released, the SMF updates the (R)AN with the PSA2 CN Tunnel Info. In the case of UL CL, if there is an existing UPF between the (R)AN and the UL CL to be removed, the SMF updates the existing UPF via N4 instead of updating the (R)AN.
5. If the Branching Point or UL CL is to be released, the SMF updates via N4 the PSA2 providing the AN Tunnel Info. In the case of UL CL, if there is an existing UPF between the (R)AN and the UL CL to be removed, the SMF updates the PSA2 providing the UPF CN tunnel Info.
6. The SMF releases via N4 the PSA1. In the case of IPv6 multi-homing, the SMF also releases the corresponding IPv6 prefix and if the PCF has subscribed to the IP allocation/release event, the SMF performs the Session Management Policy Modification procedure as defined in clause 4.16.5 to notify the PCF of the IPv6 prefix release.
7. If steps 4 and 5 were executed, the SMF releases the Branching Point / UL CL.

### 4.3.5.6 Change of additional PDU Session Anchor for IPv6 multi-homing or UL CL

The following procedure is triggered by an SMF when the SMF needs to modify IPv6 multi-homing or UL CL rule (i.e. traffic filter in the Branching Point or the UL CL) in order to move the some or whole traffic flows of the existing additional PDU Session Anchor which was established by the IPv6 multi-homing or the UL CL operations (i.e. PSA1 in figure 4.3.5.6-1) to a new additional PDU Session Anchor (i.e. PSA2 in figure 4.3.5.6-1) which is established under the same Branching Point or UL CL for a UE where the UE already has a PDU Session Anchor which was established before the event of Branching Point or UL CL insertion (i.e. PSA0 in figure 4.3.5.6-1). This procedure establishes a new additional PDU Session Anchor (i.e. PSA2) and conditionally releases the existing additional PDU Session Anchor (i.e. PSA1), while modifying IPv6 multi-homing or UL CL rule in the same Branching Point or UL CL under controlled by the same SMF.



**Figure 4.3.5.6-1: Change of additional PSA for a PDU Session in IPv6 multi-homing or UL CL case**

1. The SMF decides to change one additional PSA of a PDU Session with IPv6 multi-homing or UL CL, due to events that may benefit from such change or upon request from an Application Function.
2. If the runtime coordination between 5GC and AF is enabled based on local configuration, according to the indication of "AF acknowledgment to be expected" included in AF subscription to SMF events, the SMF sends an early notification to the AF after PSA2 is selected and waits for a notification response from the AF before configuring the PSA2. If the SMF receives a negative notification response from the AF, the SMF may stop the procedure.

The SMF sends an N4 Session Establishment Request to PSA2 and provides the tunnel ID of Branching Point or UL CL, Packet detection, enforcement and reporting rules to be installed on the PSA2 for this PDU Session. If a tunnel ID is allocated by the SMF, the tunnel ID is provided to PSA2 in this step.

The PSA2 acknowledges by sending an N4 Session Establishment Response. The tunnel ID of PSA2 is provided to the SMF in this step.

In the case of IPv6 multi-homing PDU Session, a new IPv6 prefix corresponding to PSA2 is allocated (by the SMF or by the UPF depending on the deployment) and if the PCF has subscribed to the IP allocation/release event, the SMF performs the Session Management Policy Modification Procedure as defined in clause 4.16.5 to provide the new allocated IPv6 prefix to the PCF.

- 3a. In the case of PDU session with UL CL, if the runtime coordination between 5GC and AF is enabled based on local configuration, according to the indication of "AF acknowledgment to be expected" included in AF subscription to SMF events, the SMF sends a late notification to the AF and waits for a notification response from the AF. If the SMF receives a negative notification response from the AF, the SMF may stop the procedure.

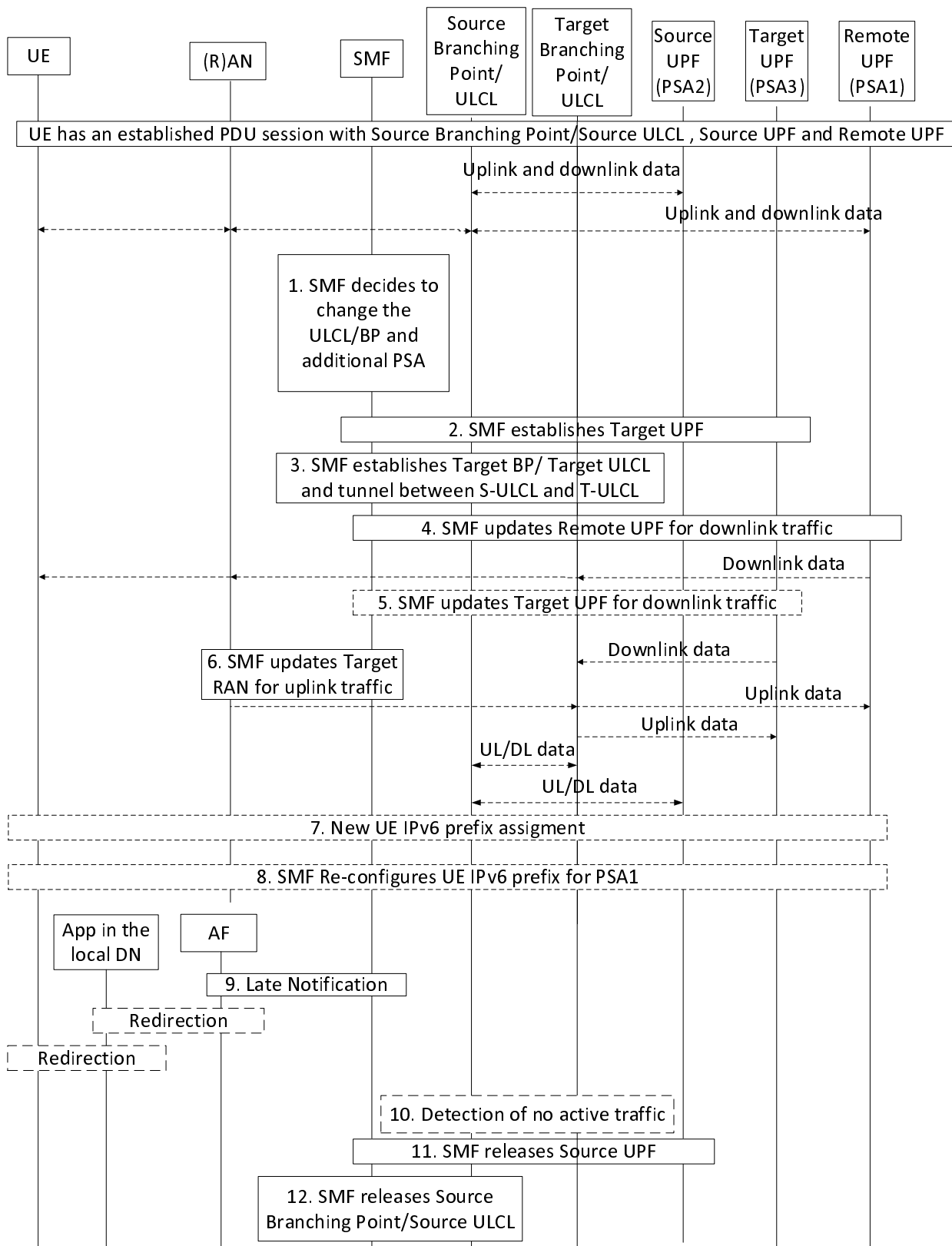
The SMF sends an N4 Session Modification Request to the Branching Point or UL CL to update the UL traffic filter according to new allocated IPv6 prefix allocated to PSA 2 or the UL CL rules regarding to the traffic flows that the SMF tries to move from PSA1 to PSA2. The N4 Session Modification Request message contains the identifications of traffic filter that needs to be updated and the tunnel ID of PSA2.

- NOTE: The identification of a traffic filter can be either the index of the traffic filter, or a single value of the information field in traffic filter (e.g. the tunnel ID of next hop), or a combination value of some information field in the traffic filter (e.g. the tunnel ID of next hop with source port number).
- 3b. The Branching Point or the UL CL acknowledges by N4 Session Modification Response the Branching Point or when the UL CL successfully updates all the traffic filters that the SMF requests to modify.
4. In the case of IPv6 multi-homing PDU Session, if the runtime coordination between 5GC and AF is enabled based on local configuration, according to the indication of "AF acknowledgment to be expected" included in AF subscription to SMF events, the SMF sends a late notification to the AF and waits for a notification response from the AF. If the SMF receives a negative notification response from the AF, the SMF may stop the procedure.
- In the case of IPv6 multi-homing PDU Session, The SMF notifies the UE of the availability of the new IP prefix @ PSA2. This is performed using an IPv6 Router Advertisement message (RFC 4861 [6]). Also, the SMF sends IPv6 multi-homed routing rule along with the IPv6 prefix to the UE using an IPv6 Router Advertisement message (RFC 4191 [21]) as described in clause 5.8.2.2.2 of TS 23.501 [2].
5. In the case of IPv6 multi-homing PDU Session, The SMF may re-configure the UE for the original IP prefix @ PSA0,i.e. SMF sends IPv6 multi-homed routing rule along with the IPv6 prefix to the UE using an IPv6 Router Advertisement message (RFC 4191 [21]) as described in clause 5.8.2.2.2 of TS 23.501 [2].
6. Step 6 occurs only if the Branching Point or UL CL does not have any traffic filter on the PDU Session which forwards a traffic flow to PSA1.
- 6a. The SMF sends an N4 Session Release Request with N4 session ID to PSA1. The PSA1 shall release all tunnel resources and contexts associated with the N4 session.
- 6b. PSA1 sends an N4 Session Release Response with N4 session ID to the SMF at the same moment that PSA1 successfully releases all tunnel resources and contexts associated with the N4 session.

#### 4.3.5.7 Simultaneous change of Branching Point or UL CL and additional PSA for a PDU Session

Simultaneous change of UL CL or Branching Point and additional PSA can be performed after Xn based handover, N2 based handover and Service Request procedures.

The following procedure is triggered by SMF in order to change the Branching Point or the UL CL and additional PSA serving a PDU Session for a UE.



**Figure 4.3.5.7-1: Simultaneous change of Branching Point or UL CL and additional PSA for a PDU Session**

UE has an established PDU Session with a UPF including the PDU Session Anchor (Remote UPF). The PDU Session user plane involves at least the Source (R)AN, Source Branching Point or Source UL CL, local Source UPF (PSA2) and

the Remote UPF (PDU Session Anchor, PSA1), where Source Branching Point or Source UL CL and PSA2 can be co-located.

1. At some point SMF decides to change the Branching Point or the UL CL due to UE mobility.
2. The SMF selects a local Target UPF (PSA3) and using N4 establishes the local Target UPF for the PDU Session. In the case of IPv6 multi-homing PDU Session, the SMF also allocates a new IPv6 prefix corresponding to PSA3 and if the PCF has subscribed to the IP allocation/release event, the SMF performs the Session Management Policy Modification procedure as defined in clause 4.16.5 to provide the new allocated IPv6 prefix to the PCF.

The SMF may send an earlier notification to the AF after PSA3 is selected. If the runtime coordination between 5GC and AF is enabled based on local configuration as specified in clause 4.3.6.3, according to the indication of "AF acknowledgment to be expected" included in AF subscription to SMF events, the SMF waits for a notification response from the AF before configuring the PSA3. If the SMF receives a negative notification response from the AF, the SMF may stop the procedure.

3. The SMF selects a UPF and using N4 establishes the Target Branching Point or Target UL CL for the PDU Session. SMF provides the necessary uplink forwarding rules towards the PSA3 and PSA1 including the Tunnel Info for each UPF. If session continuity upon UL CL relocation is used, the SMF also uses N4 to establish an N9 forwarding tunnel between the Source UL CL and Target UL CL, including the Tunnel Info for each UPF. In addition, the AN Tunnel Info to target (R)AN is provided for downlink forwarding. In the case of UL CL, the SMF provides traffic filters indicating what traffic shall be forwarded towards PSA3, PSA1 and Source UL CL, respectively. In the case of IPv6 multi-homing, the SMF also provides traffic filters for the IPv6 prefixes corresponding to PSA3 and PSA1 indicating what traffic shall be forwarded towards PSA3 and PSA1 respectively. Target Branching Point or Target UL CL provides the CN Tunnel Info for downlink traffic.

NOTE 1: If the Target Branching Point or Target UL CL and the PSA3 are co-located in a single UPF then steps 2 and 3 can be merged.

NOTE 2: When session continuity upon UL CL relocation is used, the downlink traffic at this point goes through Source UL CL, Target UL CL and Target (R)AN.

4. The SMF updates the PSA1 via N4. It provides the PDU Session CN Tunnel Info for the downlink traffic.
5. The SMF updates the PSA3. It provides the CN Tunnel Info for downlink traffic.

NOTE 3: If the Target Branching Point or the Target UL CL and the PSA3 are co-located in a single UPF then step 5 is not needed.

6. In the case of PDU session with UL CL, if the runtime coordination between 5GC and AF is enabled based on local configuration, according to the indication of "AF acknowledgment to be expected" included in AF subscription to SMF events, the SMF sends a late notification to the AF and waits for a notification response from the AF. If the SMF receives a negative notification response from the AF, the SMF may stop the procedure and remove the Target Branching Point or Target UL CL and PSA3.

The SMF updates (R)AN via N2 SM information over N11. It provides the new CN Tunnel Info corresponding to the Target Branching Point or the Target UL CL. If there is an existing UPF between the Target (R)AN and Target Branching Point or Target UL CL, the SMF updates the existing UPF via N4 instead of updating the (R)AN.

NOTE 4: When session continuity upon UL CL relocation is used, the uplink traffic destined to PSA2 at this point goes through Target (R)AN, Target UL CL and Source UL CL.

7. In the case of IPv6 multi-homing PDU Session, if the runtime coordination between 5GC and AF is enabled based on local configuration, according to the indication of "AF acknowledgment to be expected" included in AF subscription to SMF events, the SMF sends a late notification to the AF and waits for a notification response from the AF. If the SMF receives a negative notification response from the AF, the SMF may stop the procedure.

In the case of IPv6 multi-homing, the SMF notifies the UE of the availability of the new IP prefix @ PSA3. This is performed using an IPv6 Router Advertisement message (RFC 4861 [6]). Also, the SMF sends IPv6 multi-homed routing rule along with the IPv6 prefix to the UE using an IPv6 Router Advertisement message (RFC 4191 [21]) as described in clause 5.8.2.2.2 of TS 23.501 [2].

8. In the case of IPv6 multi-homing, the SMF may re-configure the UE for the original IP prefix @ PSA1, i.e. SMF sends IPv6 multi-homed routing rule along with the IPv6 prefix to the UE using an IPv6 Router Advertisement message (RFC 4191 [21]) as described in clause 5.8.2.2.2 of TS 23.501 [2].
9. The SMF sends a Late Notification to the AF indicating a change of DNAI as described in clause 4.3.6.3. In cases where target local DN is associated with another AF instance, SMF also sends notification to target AF as described in 4.3.6.3 and cancels any future notification message to source AF as it is no longer involved.

NOTE 5: The message can include routing information to the application located in the target local DN. Alternatively the routing information to the application located in the target local DN can be determined by the AF based on the new DNAI, in which case the AF can invoke the AF triggered influence on traffic routing procedure targeting single UE as described in clause 4.3.6.4, which assists the SMF in generation of the routing rule on the Target UL CL towards PSA3 (i.e. towards the application located in the target local DN). It is up to network configuration whether the routing information to the application located in the target local DN is configured in the SMF or in the AF.

NOTE 6: When session continuity upon UL CL relocation is used the AF can also trigger mechanisms that are out of the scope of this specification (e.g. IP-level or HTTP-level redirection) by which the traffic is redirected towards the application in the target local DN. Based on this redirection the UE starts using a new destination IP address which leads the Target UL CL to force the traffic towards PSA3.

10. When session continuity upon UL CL relocation is used, detection of no active traffic over the N9 forwarding tunnel is performed during a time interval provisioned by the SMF for User Plane inactivity report in order to release the N9 forwarding tunnel. The detection can be done by Source UL CL, which notifies the SMF of no active traffic over the N9 forwarding tunnel.

NOTE 7: It is up to network configuration whether the detection of no active traffic is performed by the Source UL CL or the Target UL CL. As an alternative to the detection of no active traffic, the AF can send an explicit notification to the SMF when traffic to/from this UE ceases to exist, leading the SMF to release the Source UL CL and the Source UPF (PSA2).

11. The SMF releases via N4 the PSA2.

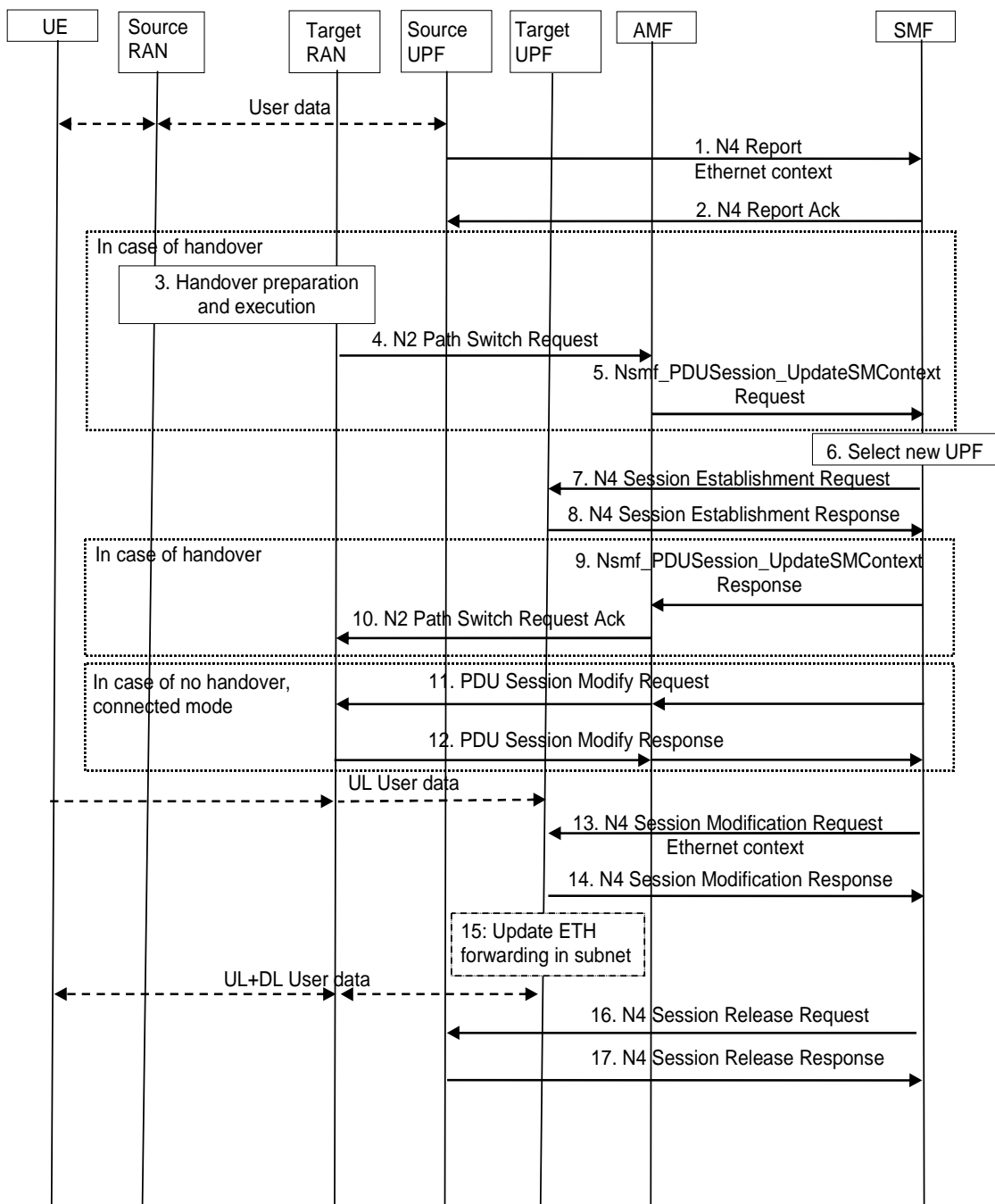
12. The SMF releases the Source Branching Point or the Source UL CL.

NOTE 8: If the Target Branching Point or Target UL CL and the PSA2 are co-located in a single UPF then steps 11 and 12 can be merged.

#### 4.3.5.8 Ethernet PDU Session Anchor Relocation

This procedure allows for Ethernet PDU Sessions to change the PDU Session Anchor (PSA) while the session remains set up. Originally the Ethernet PDU Session goes via the Source UPF acting as the PSA. The Ethernet context which contains all Ethernet specific information including the MAC address of the UE and possibly its VLAN tag(s) is reported from the Source PSA UPF to the SMF. It is possible to report multiple MAC addresses (with their VLAN tag(s)) if these are reachable via the UE.

The SMF determines whether and when a serving PDU Session anchor for an Ethernet PDU Session needs to be changed and selects the Target PSA UPF, establishes the N4 session at the Target PSA UPF. The information within the Ethernet context is sent to the Target UPF. Based on the information in the Ethernet context, the Target PSA UPF may take action to update the Ethernet forwarding in the data network.



**Figure 4.3.5.8-1: Ethernet PDU Session Anchor Relocation**

Initially, the Ethernet PDU Session is established with the user data going via the Source UPF. The Source UPF acts as the PSA.

1. The Source UPF reports the Ethernet context which contains all Ethernet specific information including the MAC address of the UE and possibly its VLAN tag(s) that the UPF has learned from the UE side to the SMF. In the case of any changes in the Ethernet context, the change is updated to the SMF so that the SMF maintains an up-to-date state of the Ethernet context. This signalling is realized based on N4 reporting.
2. The UPF's report is acknowledged.
- 3-5. In the case of handover, the RAN handover preparation and execution is followed by path switch signalling to the AMF and corresponding signalling to SMF, as defined in clause 4.9.1.2.



6. The SMF decides that the PSA is to be changed for the Ethernet PDU Session and selects the Target UPF that will act as the new PSA. The decision may be triggered by a mobility event, such as receiving the message in step 5.
7. The Target UPF N4 session is established. The SMF provides the N3 tunnel endpoint used by RAN.
8. The establishment of the new N4 session is acknowledged from the Target UPF to the SMF. The UPF provides its N3 tunnel endpoint.
- 9-10. In the case of handover, the SMF signals to the RAN via the AMF to provide the Path Switch Request Ack, which includes the update of the uplink N3 tunnel endpoint to the target UPF. This signalling is defined in clause 4.9.1.2. In steps 9-10, an indication is sent from the SMF via the AMF to the RAN node indicating that the RAN node should not expect to receive an end marker packet. The RAN node may skip trying to reorder the downlink packets.
- 11-12. If there is no handover and the UE is in connected mode, the SMF sends PDU Session Modify Request message to the RAN via the AMF, which includes the update of the uplink N3 tunnel endpoint to the target UPF. The RAN acknowledges the message. The RAN node does not need to reorder the downlink packets.

NOTE 1: Due to the change in the end to end path, packet re-ordering can occur both for the handover and no handover cases. If necessary, upper layer protocols can ensure in sequence delivery.

After steps 9-10 or 11-12, uplink Ethernet frames pass via the target UPF. Downlink Ethernet frames may continue to be delivered from the source UPF to the RAN node. In the case of handover, the Ethernet frames are forwarded from the source RAN node to the target RAN node.

- 13-14. The SMF sends an N4 Session Modification Request to the Target UPF which includes the information in Ethernet context (i.e. MAC address and VLAN tag(s)) and a trigger for updating the Ethernet forwarding (next step). The Target UPF acknowledges by an N4 Session Modification Response.
15. The Target UPF may assist in the update of Ethernet forwarding tables of Ethernet switches in the DN via a variety of mechanisms, the use of which are specific to the DN and the specification of which are out-of-scope for 3GPP.

NOTE 2: The UPF acting as a switch in the DN, can for example issue a Gratuitous ARP (GARP) containing the MAC address(es) of the UE that has switched to the new anchor, or the UPF can send an unsolicited Neighbor Discovery Protocol (NDP) Neighbor Advertisement message indicating the UE MAC addresses, or the UPF can generate a uplink Ethernet frame with the UE's MAC addresses as source MAC addresses (and possibly its VLAN tag(s)) and configurable payload which will be dropped by endhosts, or the UPF can send another message or Ethernet frame compatible with DN protocols.

In the case of a central controller in the Ethernet network which sets the forwarding tables, the central controller can be instructed that the given MAC address is reachable at the new location.

When multiple MAC addresses are present in the Ethernet context, the update of the Ethernet forwarding is performed for each MAC address.

16. The N4 session is released at the Source UPF. The source UPF may wait for a configurable period before it stops delivering downlink Ethernet frames for the given PDU Session.
17. The N4 session release is acknowledged from the Source UPF to the SMF.

## 4.3.6 Application Function influence on traffic routing

### 4.3.6.1 General

Clause 4.3.6 describes the procedures between an Application Function and the SMF to maintain an efficient user plane path for Application Functions that require it.

As described in clause 5.6.7 of TS 23.501 [2], an Application Function may send requests to influence SMF routing decisions for User Plane traffic of PDU Sessions. The AF requests may influence UPF (re)selection and allow routing of user traffic to a local access (identified by a DNAI) to a Data Network. The AF may also provide in its request subscriptions to SMF events.

The following cases can be distinguished:

- AF requests targeting an individual UE by a UE address; these requests are routed (by the AF or by the NEF) to an individual PCF using the BSF. This is described in clause 4.3.6.4.

NOTE 1: Such requests target an on-going PDU Session. Whether the AF needs to use the NEF or not is according to local deployment.

- AF requests described in clause 5.6.7 of TS 23.501 [2] targeting a group of UE(s), or any UE accessing a combination of DNN and S-NSSAI, or targeting individual UE by a GPSI as described in table 5.6.7-1. These AF requests may also affect UE(s) with an established PDU session. For such requests the AF shall contact the NEF and the NEF stores the AF request information in the UDR. PCF(s) receive a corresponding notification if they had subscribed to the creation / modification/ deletion of the AF request information corresponding to UDR Data Keys / Data Sub-Keys. This is defined in clause 6.3.7.2 of TS 23.501 [2] and further described in clause 4.3.6.2.

NOTE 2: Such requests can target on-going or future PDU Sessions.

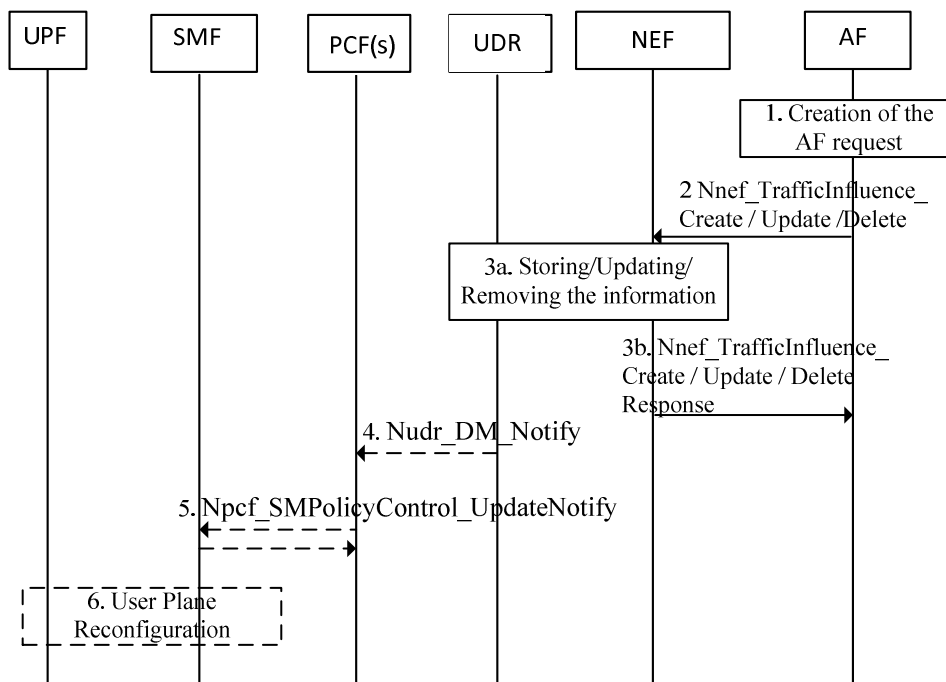
If the AF interacts with PCF via the NEF, the NEF performs the following mappings where needed:

- Map the AF-Service-Identifier into DNN and S-NSSAI combination, determined by local configuration.
- Map the AF-Service-Identifier into a list of DNAI(s) and Routing Profile ID(s) determined by local configuration.

The NEF can only provide this mapping when the DNAI(s) being used by the applications are statically defined. When the DNAI(s) where applications are instantiated may vary dynamically, the AF should provide the target DNAI(s) in its request together with either Routing Profile ID(s) or with N6 traffic routing information.

- Map the GPSI in Target UE Identifier into SUPI, according to information received from UDM.
- Map the External Group Identifier in Target UE Identifier into Internal Group Identifier, according to information received from UDM.
- Map the geographic zone identifier(s) in Spatial Validity Condition into areas of validity, determined by local configuration.

#### 4.3.6.2 Processing AF requests to influence traffic routing for Sessions not identified by an UE address



**Figure 4.3.6.2-1: Processing AF requests to influence traffic routing for Sessions not identified by an UE address**

NOTE 1: The 5GC functions used in this scenario are assumed to all belong to the same PLMN (HPLMN in non-roaming case or VPLMN in the case of a PDU Session in LBO mode).

NOTE 2: Nnef\_TrafficInfluence\_Create or Nnef\_TrafficInfluence\_Update or Nnef\_TrafficInfluence\_Delete service operations invoked from an AF located in the HPLMN for local breakout and home routed roaming scenarios are not supported.

1. To create a new request, the AF invokes an Nnef\_TrafficInfluence\_Create service operation. The content of this service operation (AF request) is defined in clause 5.2.6.7. The request contains also an AF Transaction Id. If it subscribes to events related with PDU Sessions the AF indicates also where it desires to receive the corresponding notifications (AF notification reporting information).

To update or remove an existing request, the AF invokes an Nnef\_TrafficInfluence\_Update or Nnef\_TrafficInfluence\_Delete service operation providing the corresponding AF Transaction Id.

2. The AF sends its request to the NEF. If the request is sent directly from the AF to the PCF, the AF reaches the PCF selected for the existing PDU Session by configuration or by invoking Nbsf\_management\_Discovery service.

The NEF ensures the necessary authorization control, including throttling of AF requests and, as described in clause 4.3.6.1, mapping from the information provided by the AF into information needed by the 5GC.

3. (in the case of Nnef\_TrafficInfluence\_Create or Update): The NEF stores the AF request information in the UDR (Data Set = Application Data; Data Subset = AF traffic influence request information, Data Key = AF Transaction Internal ID, S-NSSAI and DNN and/or Internal Group Identifier or SUPI).

NOTE 3: Both the AF Transaction Internal ID and, S-NSSAI and DNN and/or Internal Group Identifier or SUPI are regarded as Data Key when the AF request information are stored into the UDR, see Table 5.2.12.2.1-1.

(in the case of Nnef\_TrafficInfluence\_delete): The NEF deletes the AF requirements in the UDR (Data Set = Application Data; Data Subset = AF traffic influence request information, Data Key = AF Transaction Internal ID).

The NEF responds to the AF.

4. The PCF(s) that have subscribed to modifications of AF requests (Data Set = Application Data; Data Subset = AF traffic influence request information, Data Key = S-NSSAI and DNN and/or Internal Group Identifier or SUPI) receive(s) a Nudr\_DM\_Notify notification of data change from the UDR.
5. The PCF determines if existing PDU Sessions are potentially impacted by the AF request. For each of these PDU Sessions, the PCF updates the SMF with corresponding new PCC rule(s) by invoking Npcf\_SMPolicyControl\_UpdateNotify service operation as described in steps 5 and 6 in clause 4.16.5.

If the AF request includes a notification reporting request for UP path change, the PCF includes in the PCC rule(s) the information required for reporting the event, including the Notification Target Address pointing to the NEF or AF and the Notification Correlation ID containing the AF Transaction Internal ID.

6. When a PCC rule is received from the PCF, the SMF may take appropriate actions to reconfigure the User plane of the PDU Session such as:
  - Adding, replacing or removing a UPF in the data path to e.g. act as an UL CL or a Branching Point e.g. as described in clause 4.3.5.
  - Allocate a new Prefix to the UE (when IPv6 multi-Homing applies)
  - Updating the UPF in the target DNAI with new traffic steering rules

Subscribe to notifications from the AMF for an Area Of Interest via Namf\_EventExposure\_Subscribe service operation

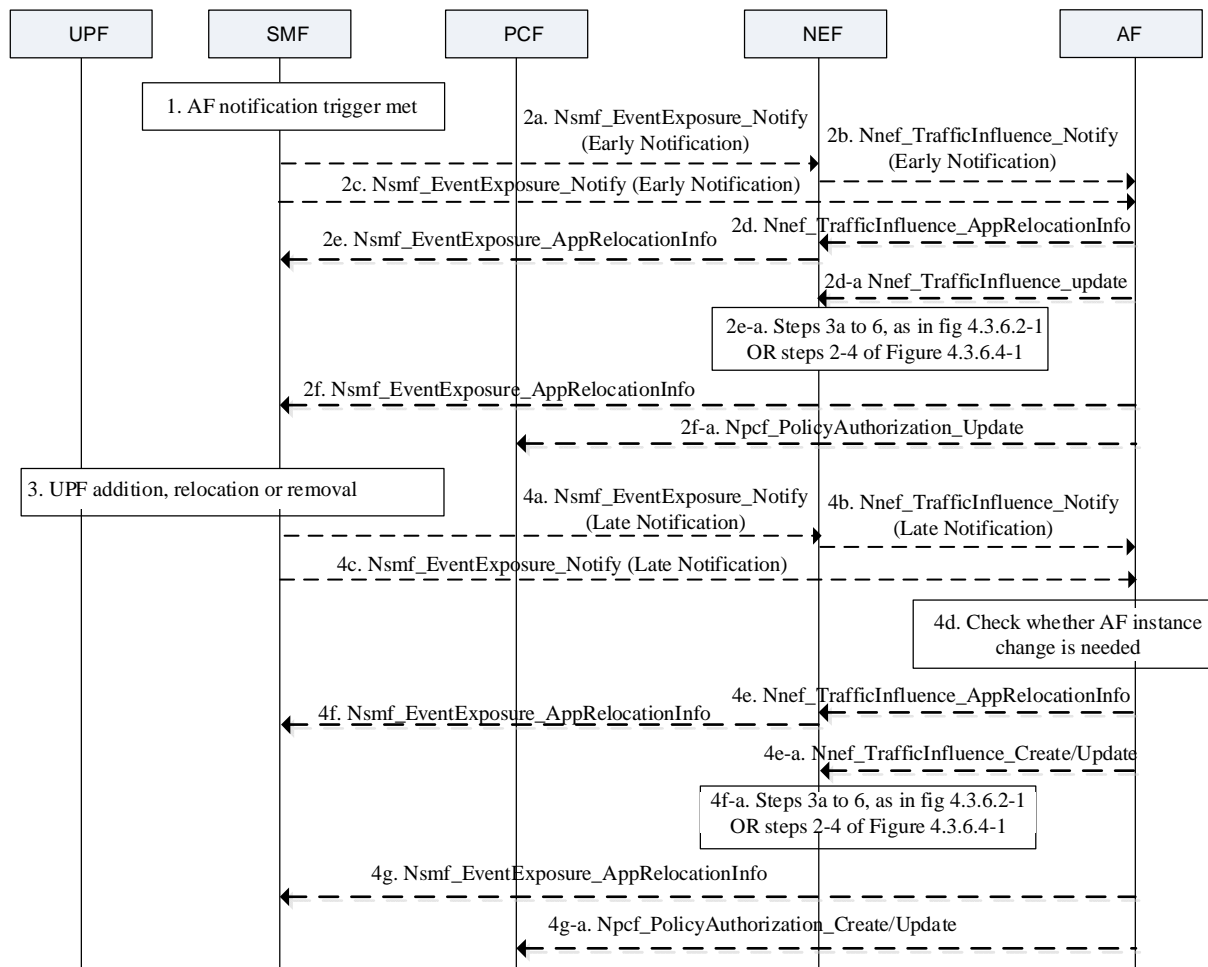
#### 4.3.6.3 Notification of User Plane Management Events

The SMF may send a notification to the AF if the AF had subscribed to user plane management event notifications as described in clause 4.3.6.2 and in clause 5.6.7 of TS 23.501 [2]. The following are the examples of such events:

- A PDU Session Anchor identified in the AF subscription request has been established or released.
- A DNAI has changed.
- The SMF has received a request for AF notification and the on-going PDU Session meets the conditions to notify the AF.
- Ethernet PDU Session Anchor Relocation as defined in clause 4.3.5.8.

The SMF uses notification reporting information received from PCF to issue the notification either via an NEF (2a, 2b and 4a, 4b) or directly to the AF (2c and 4c).

The following flow depicts the sequence of events:



**Figure 4.3.6.3-1: Notification of user plane management event**

1. A condition for an AF notification has been met as described above. The SMF sends notification to the NF that is subscribed for SMF notifications. Further processing of the SMF notification depends on the receiving NF, as shown in steps 2a and 2c.
  - 2a. If early notification via NEF is requested by the AF, the SMF notifies the NEF of the target DNAI of the PDU Session by invoking Nsmf\_EventExposure\_Notify service operation.
  - 2b. When the NEF receives Nsmf\_EventExposure\_Notify, the NEF performs information mapping (e.g. AF Transaction Internal ID provided in Notification Correlation ID to AF Transaction ID, SUPI to GPSI, etc.) as applicable according to clause 5.6.7 of TS 23.501 [2] and triggers the appropriate Nnef\_TrafficInfluence\_Notify message. In this case, step 2c is not applicable.
  - 2c. If early direct notification is requested by the AF, the SMF notifies the AF of the target DNAI of the PDU Session by invoking Nsmf\_EventExposure\_Notify service operation.
  - 2d. The AF replies to Nnef\_TrafficInfluence\_Notify by invoking Nnef\_TrafficInfluence\_AppRelocationInfo service operation either immediately or after any required application relocation in the target DNAI is completed. AF includes N6 traffic routing details corresponding to the target DNAI. AF may reply in negative e.g. if the AF determines that the application relocation cannot be completed successfully and/or on time.
  - 2d-a. If information sent via Nnef\_TrafficInfluence\_Create is to be changed e.g. N6 traffic routing details corresponding to the target DNAI, the AF invokes Nnef\_TrafficInfluence\_update service operation in order for PCF to be able to include this information in PCC rules sent to SMF.
- If the AF includes information such as N6 traffic routing details corresponding to the target DNAI in Nnef\_TrafficInfluence\_AppRelocationInfo it shall include the same information in Nnef\_TrafficInfluence\_update.

- 2e. When the NEF receives Nnef\_TrafficInfluence\_AppRelocationInfo, the NEF triggers the appropriate Nsmf\_EventExposure\_AppRelocationInfo message.
- 2e-a. When the NEF receives Nnef\_TrafficInfluence\_update, the NEF triggers step 3a as in figure 4.3.6.2-1 or step 2 of figure 4.3.6.4-1 if targeting an individual UE by a UE address.
- 2f. The AF replies to Nsmf\_EventExposure\_Notify by invoking Nsmf\_EventExposure\_AppRelocationInfo service operation either immediately or after any required application relocation in the target DNAI is completed. AF includes N6 traffic routing details corresponding to the target DNAI. AF may reply in negative e.g. if the AF determines that the application relocation cannot be completed successfully on time.
- 2f-a. If information sent via Npcf\_PolicyAuthorization\_Create is to be changed e.g. N6 traffic routing details corresponding to the target DNAI, the AF invokes Npcf\_PolicyAuthorization\_Update service operation in order for PCF to be able to include this information in PCC rules sent to SMF.
- If the AF includes information such as N6 traffic routing details corresponding to the target DNAI in Nsmf\_EventExposure\_AppRelocationInfo it shall include the same information in Npcf\_PolicyAuthorization\_Update.
3. The SMF enforces the change of DNAI or addition, change, or removal of a UPF.
- If the runtime coordination between 5GC and AF is enabled based on local configuration, according to the indication of "AF acknowledgment to be expected" included in AF subscription to SMF events, the SMF may wait for a response from the AF to the early notification before this step. The SMF does not perform this step until it receives a positive response from the AF, as described in clause 5.6.7 of TS 23.501 [2].
- 4a. If late notification via NEF is requested by the AF, the SMF notifies the NEF of the target DNAI of the PDU Session by invoking Nsmf\_EventExposure\_Notify service operation.
- If the runtime coordination between 5GC and AF is enabled based on local configuration, according to the indication of "AF acknowledgment to be expected" included in AF subscription to SMF events, the SMF may send late notification and wait for a positive response from the AF before activating the new UP path, as described in clause 5.6.7 of TS 23.501 [2].
- 4b. When the NEF receives Nsmf\_EventExposure\_Notify, the NEF performs information mapping (e.g. AF Transaction Internal ID provided in Notification Correlation ID to AF Transaction ID, SUPI to GPSI, etc.) as applicable according to clause 5.6.7 of TS 23.501 [2] and triggers the appropriate message. In this case, step 4c is not applicable.
- 4c. If late direct notification is requested by the AF, the SMF notifies the AF of the target DNAI of the PDU Session by invoking Nsmf\_EventExposure\_Notify service operation.
- 4d. When the AF receives either the Nnef\_TrafficInfluence\_Notify message or the Nsmf\_EventExposure\_Notify message, the AF checks whether it can serve the target DNAI. If the AF instance change is needed, the AF determines the proper target AF for the target DNAI and performs the AF migration.

NOTE 1: The determination of the target AF for the target DNAI and the AF migration to the target AF are out of the scope of this release.

- 4e. The AF replies to Nnef\_TrafficInfluence\_Notify by invoking Nnef\_TrafficInfluence\_AppRelocationInfo service operation either immediately or after any required application relocation in the target DNAI is completed. AF includes N6 traffic routing details corresponding to the target DNAI. AF may reply in negative e.g. if the AF determines that the application relocation cannot be completed successfully on time.
- 4e-a. If information sent via Nnef\_TrafficInfluence\_Create/Update is to be changed e.g. N6 traffic routing details corresponding to the target DNAI, the AF invokes Nnef\_TrafficInfluence\_Create or Nnef\_TrafficInfluence\_Update service operation in order for PCF to be able to include this information in PCC rules sent to SMF. The Nnef\_TrafficInfluence\_Create shall be used if the AF is notified (e.g. in step 4b) that the UE IP address is changed and the initial Nnef\_TrafficInfluence\_Create was targeted to an individual UE address, otherwise the Nnef\_TrafficInfluence\_Update may be used.
- If the AF includes information such as N6 traffic routing details corresponding to the target DNAI in Nnef\_TrafficInfluence\_AppRelocationInfo it shall include the same information in Nnef\_TrafficInfluence\_Create or Nnef\_TrafficInfluence\_Update, whichever is appropriate.

4f. When the NEF receives Nnef\_TrafficInfluence\_AppRelocationInfo, the NEF triggers the appropriate Nsmf\_EventExposure\_AppRelocationInfo message.

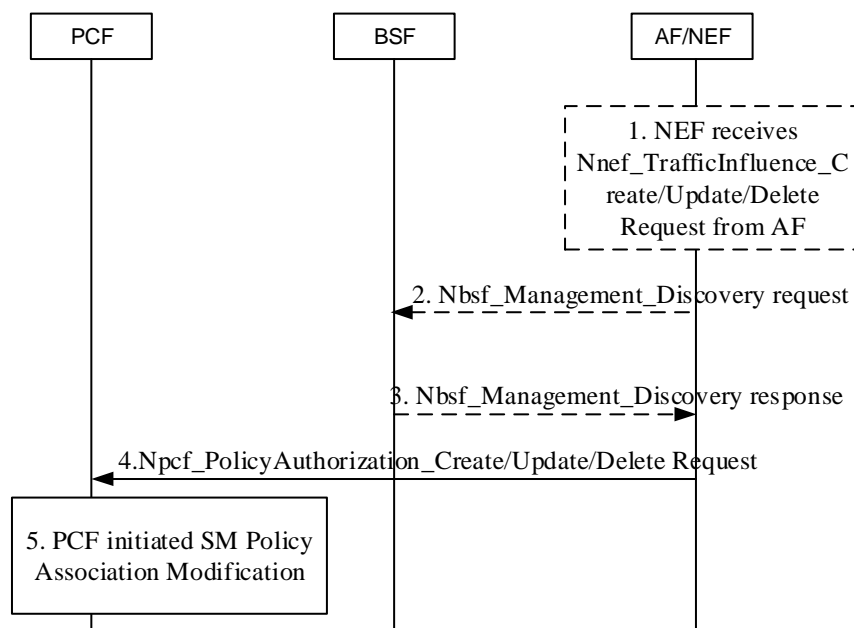
4f-a. When the NEF receives Nnef\_TrafficInfluence\_Create/update, the NEF triggers step 3a as in figure 4.3.6.2-1 or step 2 of figure 4.3.6.4-1 if targeting an individual UE by a UE address.

4g. The AF replies to Nsmf\_EventExposure\_Notify by invoking Nsmf\_EventExposure\_AppRelocationInfo service operation either immediately or after any required application relocation in the target DNAI is completed. AF includes N6 traffic routing details corresponding to the target DNAI. AF may reply in negative e.g. if the AF determines that the application relocation cannot be completed successfully on time.

4g-a. If information sent via Npcf\_PolicyAuthorization\_Create/Update is to be changed e.g. N6 traffic routing details corresponding to the target DNAI, the AF invokes Npcf\_PolicyAuthorization\_Create or Npcf\_PolicyAuthorization\_Update service operation in order for PCF to be able to include this information in PCC rules sent to SMF. The Npcf\_PolicyAuthorization\_Create shall be used if the AF is notified (e.g. in step 4c) that the UE IP address is changed, otherwise the Npcf\_PolicyAuthorization\_Update may be used.

If the AF includes information such as N6 traffic routing details corresponding to the target DNAI in Nsmf\_EventExposure\_AppRelocationInfo it shall include the same information in Npcf\_PolicyAuthorization\_Create or Npcf\_PolicyAuthorization\_Update, whichever is appropriate.

#### 4.3.6.4 Transferring an AF request targeting an individual UE address to the relevant PCF



**Figure 4.3.6.4-1: Handling an AF request targeting an individual UE address to the relevant PCF**

Depending on the AF deployment (see clause 6.2.10 of TS 23.501 [2]), the AF may send the AF request to PCF directly, in which case step 1 is skipped, or via the NEF.

1. [Conditional] If the AF sends the AF request via NEF, the AF sends Nnef\_TrafficInfluenceCreate/Update/Delete Request targeting an individual UE address to the NEF. This request corresponds to an AF request to influence traffic routing that targets an individual UE address.

When NEF receives an AF request from AF, the NEF ensures the necessary authorization control and, as described in clause 4.3.6.1, mapping from the information provided by the AF into information needed by the 5GC. The NEF responds to the AF.

2. [Conditional] AF/NEF consumes Nbsf\_Management\_Discovery service operation (providing at least the UE address) to find out the address of the relevant PCF if the PCF address is not available on the NEF based on local configuration, otherwise step 1 is skipped.

NOTE: The AF/NEF finds the BSF based on local configuration or using the NRF.

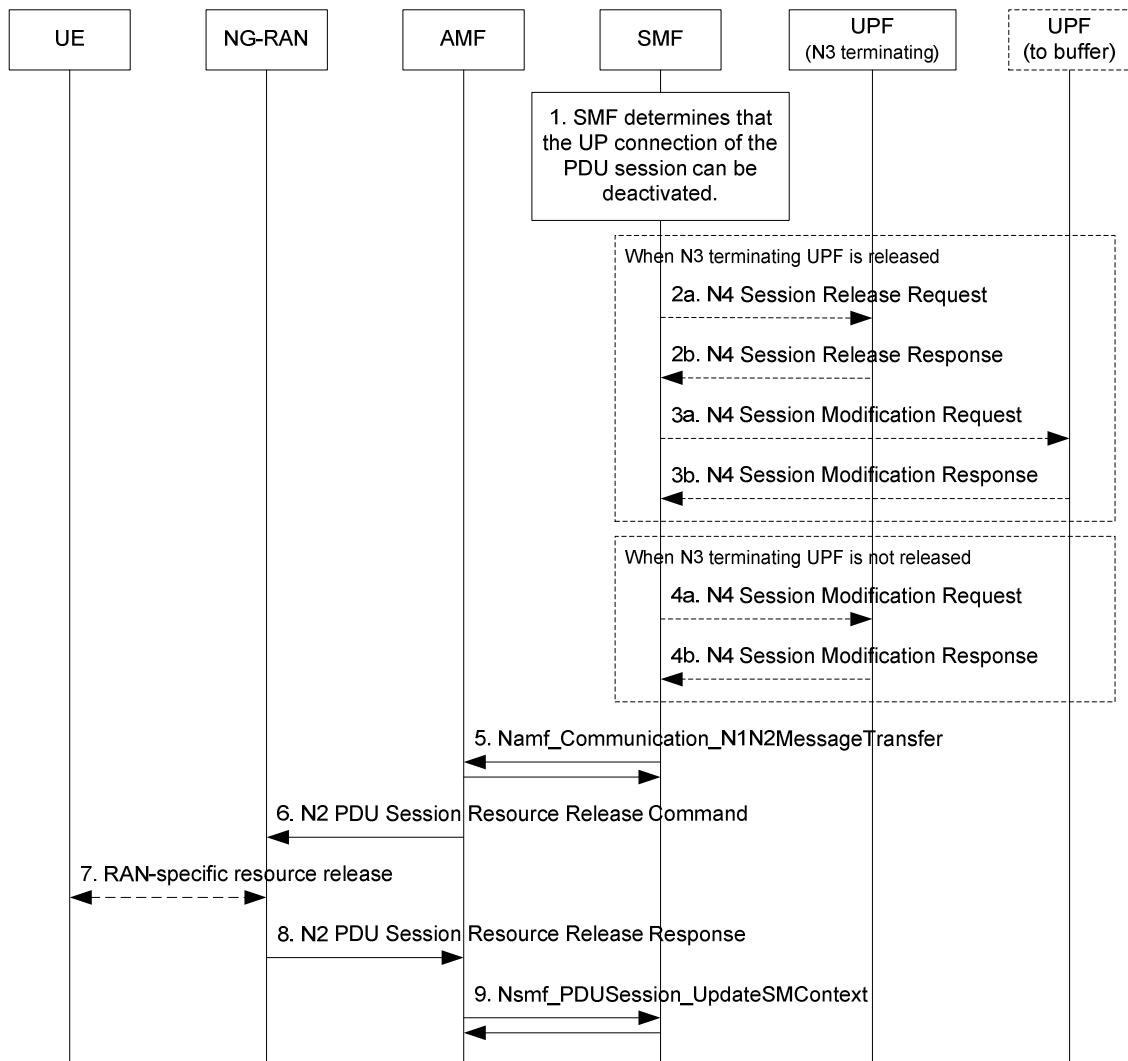
3. BSF provides the PCF address in the Nbsf\_Management\_Discovery response to AF/NEF.
4. If step 1 was performed, NEF invokes the Npcf\_PolicyAuthorization service to the PCF to transfer the AF request. If an AF sends the AF request directly to the PCF, AF invokes Npcf\_PolicyAuthorization service and the PCF responds to the AF.
5. The PCF updates the SMF with corresponding new PCC rule(s) with PCF initiated SM Policy Association Modification procedure as described in clause 4.16.5.2. When a PCC rule is received from the PCF, the SMF may take appropriate actions, when applicable, to reconfigure the User plane of the PDU Session, such as:
  - Adding, replacing or removing UPF(s) in the data path, e.g. to act as UL CL, Branching Point and/or PDU Session Anchor e.g. as described in clause 4.3.5.
  - Allocate a new Prefix to the UE (when IPv6 multi-Homing applies).
  - Updating the UPF regarding the target DNAI with new traffic steering rules.
  - Subscribe to notifications from the AMF for an Area Of Interest via Namf\_EventExposure\_Subscribe service operation.

#### 4.3.7 CN-initiated selective deactivation of UP connection of an existing PDU Session

The following procedure is used to deactivate UP connection (i.e. data radio bearer and N3 tunnel) for an established PDU Session of a UE in CM-CONNECTED state.

For an always-on PDU Session, the SMF should not configure the UPF to report inactivity.





**Figure 4.3.7-1: CN-initiated deactivation of UP connection for an established PDU Session**

- The SMF determines that the UP connection of the PDU Session can be deactivated in following cases:
  - During handover procedure, if all the QoS Flows of a PDU Session are rejected by the target NG-RAN (as described in clause 4.9.1), or if a PDU Session is failed to setup indicated by the AMF (see step 7 of clause 4.9.1.3.3). SMF proceeds with step 2 and step 3, the steps 5 to 9 are skipped;
  - The UPF detects that the PDU Session has no data transfer for a specified Inactivity period as described in clause 4.4.2.2;
  - For a LADN PDU Session, the AMF notifies to the SMF that the UE moved out of the LADN service area; or
  - The AMF notifies to the SMF that the UE moved out of the Allowed Area.

The SMF may decide to release the UPF of N3 terminating point. In that case the SMF proceeds with step 2 and step 3. Otherwise, if the SMF decides to keep the UPF of N3 terminating points, the SMF proceeds with step 4.

- The SMF may initiate an N4 Session Release procedure to release the intermediate UPF of N3 terminating point. If there are multiple intermediate UPFs, this step can be performed for each UPFs to be released. The SMF needs to initiate N4 Session Modification procedure to the UPF (i.e. N9 terminating point or PDU Session Anchor) connecting to the released UPF in step 3.
- If the intermediate UPF(s) of N3 terminating point is released in step 2, the SMF initiates an N4 Session Modification procedure towards the UPF (PDU Session Anchor or another intermediate UPF) connecting to the released UPF, indicating the need to remove CN Tunnel Info for N9 tunnel of the corresponding PDU Session. In this case, the UPF connecting to the released UPF buffers the DL packets for this PDU Session or drops the

DL packets for this PDU session or forwards the DL packets for this PDU session to the SMF, based on buffering instruction provided by the SMF as described in clause 5.8.3.2 or clause 5.8.3.3 of TS 23.501 [2]. If the PDU Session corresponds to a LADN and the UE moved out of the LADN service area, the SMF may notify the UPF connecting to the released UPF to discard downlink data for the PDU Sessions and/or to not provide further Data Notification messages.

Otherwise, N4 Session Modification procedure occurs toward N3 terminating point.

4. If the UPF of N3 terminating point is not released in step 2, the SMF initiates an N4 Session Modification procedure indicating the need to remove AN Tunnel Info for N3 tunnel of the corresponding PDU Session. In this case, the UPF buffers the DL packets for this PDU Session or drops the DL packets for this PDU session or forwards the DL packets for this PDU session to the SMF, based on buffering instruction provided by the SMF as described in clause 5.8.3.2 or clause 5.8.3.3 of TS 23.501 [2]. If the PDU Session corresponds to a LADN and the UE moved out of the LADN service area, the SMF may notify the UPF to discard downlink data for the PDU Sessions and/or to not provide further Data Notification messages.
5. The SMF invokes the Namf\_Communication\_N1N2MessageTransfer service operation (PDU Session ID, N2 SM Information (N2 Resource Release Request (PDU Session ID))) to release the NG-RAN resources associated with the PDU Session.
6. The AMF sends the N2 PDU Session Resource Release Command including N2 SM information (N2 Resource Release Request (PDU Session ID)) received from the SMF via N2 to the NG-RAN.
7. The NG-RAN may issue NG-RAN specific signalling exchange (e.g. RRC Connection Reconfiguration) with the UE to release the NG-RAN resources related to the PDU Session received from the AMF in step 5. When a User Plane connection for a PDU Session is released, the AS layer in the UE indicates it to the NAS layer.  
  
If the UE is in RRC Inactive state, this step is skipped. When the UE becomes RRC Connected state from RRC Inactive state, the NG-RAN and UE synchronize the released radio resources for the deactivated PDU Session as described in TS 36.331 [16] and TS 38.331 [12].
8. The NG-RAN acknowledges the N2 PDU Session Resource Release Command to the AMF including N2 SM Resource Release Ack (User Location Information, Secondary RAT Usage Data).
9. The AMF invokes the Nsmf\_PDUSession\_UpdateSMContext service operation (N2 SM Information(Secondary RAT Usage Data)) to acknowledge the Namf service received in step 5.

## 4.4 SMF and UPF interactions

### 4.4.1 N4 session management procedures

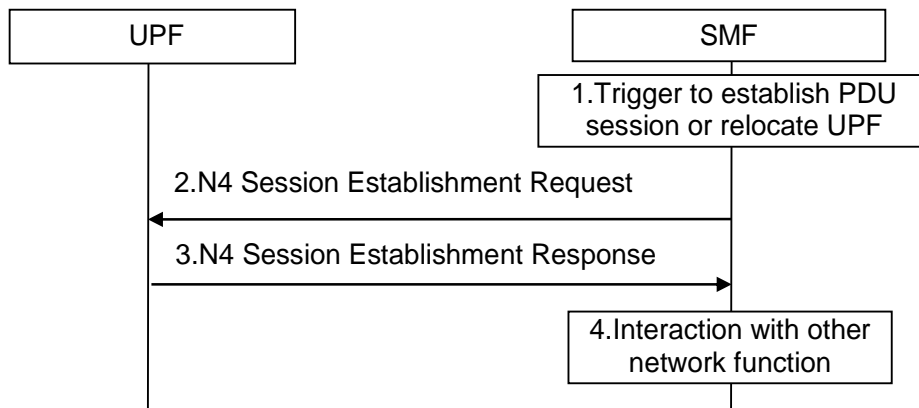
#### 4.4.1.1 General

N4 session management procedures are used to control the functionality of the UPF. The SMF can create, update and remove the N4 session context in the UPF, which is described in clause 5.8.2 of TS 23.501 [2].

The following N4 session management procedures exist: N4 Session Establishment procedure, N4 session Modification procedure and N4 session release procedure. All of them are initiated by the SMF.

#### 4.4.1.2 N4 Session Establishment procedure

The N4 Session Establishment procedure is used to create the initial N4 session context for a PDU Session at the UPF. The SMF assigns a new N4 Session ID and provides it to the UPF. The N4 Session ID is stored by both entities and used to identify the N4 session context during their interaction. The SMF also stores the relation between the N4 Session ID and PDU Session for a UE.

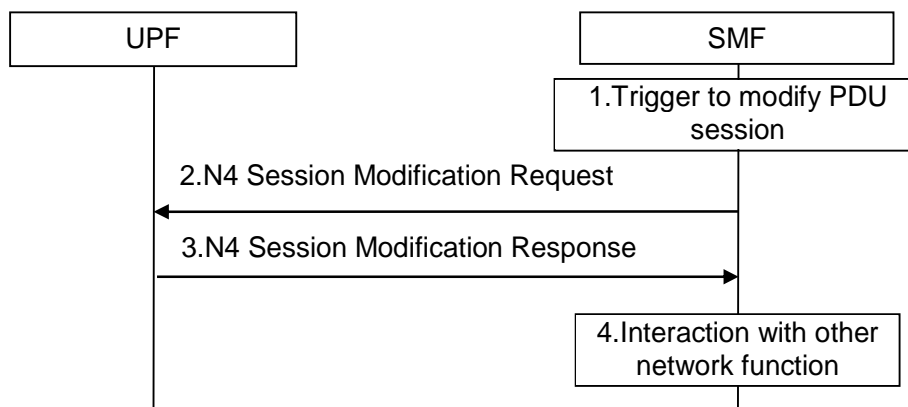


**Figure 4.4.1.2-1 N4 Session Establishment procedure**

1. SMF receives the trigger to establish a new PDU Session or change the UPF for an established PDU Session.
2. The SMF sends an N4 session establishment request message to the UPF that contains the structured control information which defines how the UPF needs to behave.
3. The UPF responds with an N4 session establishment response message containing any information that the UPF has to provide to the SMF in response to the control information received.
4. The SMF interacts with the network function which triggered this procedure (e.g. AMF or PCF).

#### 4.4.1.3 N4 Session Modification procedure

The N4 Session Modification procedure is used to update the N4 session context of an existing PDU Session at the UPF, which is executed between SMF and UPF whenever PDU Session related parameters have to be modified.

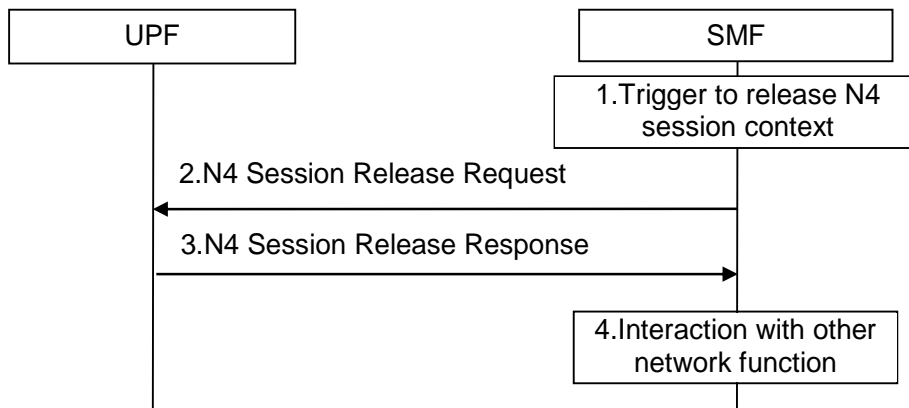


**Figure 4.4.1.3-1 N4 Session Modification procedure**

1. SMF receives the trigger to modify the existing PDU Session.
2. The SMF sends an N4 session modification request message to the UPF that contains the update for the structured control information which defines how the UPF needs to behave.
3. The UPF identifies the N4 session context to be modified by the N4 Session ID. Then, the UPF updates the parameters of this N4 session context according to the list of parameters sent by the SMF. The UPF responds with an N4 session modification response message containing any information that the UPF has to provide to the SMF in response to the control information received.
4. The SMF interacts with the network entity which triggered this procedure (e.g. AMF or PCF).

#### 4.4.1.4 N4 Session Release procedure

The N4 session release procedure is used to remove the N4 session context of an existing PDU Session at the UPF.



**Figure 4.4.1.4-1 N4 Session Release procedure**

1. SMF receives the trigger to remove the N4 session context for the PDU Session.
2. The SMF sends an N4 session release request message to the UPF.
3. The UPF identifies the N4 session context to be removed by the N4 Session ID and removes the whole session context. The UPF responds with an N4 session release response message containing any information that the UPF has to provide to the SMF.
4. The SMF interacts with the network entity which triggered this procedure (e.g. AMF or PCF).

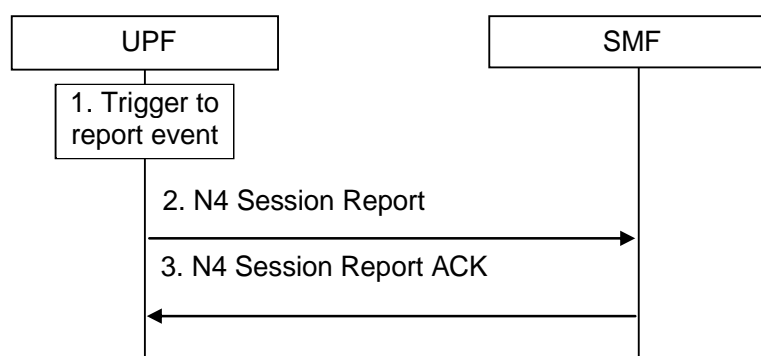
## 4.4.2 N4 Reporting Procedures

### 4.4.2.1 General

The N4 reporting procedure is used by the UPF to report events to the SMF.

### 4.4.2.2 N4 Session Level Reporting Procedure

This procedure is used by the UPF to report events related to an N4 session for an individual PDU Session. The triggers for event reporting were configured on the UPF during N4 Session Establishment/Modification procedures by the SMF.



**Figure 4.4.2.2-1: N4 Session Level Reporting procedure**

1. The UPF detects that an event has to be reported. The reporting triggers include the following cases:
  - (1) Measurement information reporting (Usage Report).

Measurement information shall be collected in the UPF and reported to the SMF as defined in clause 5.8 and clause 5.12 of TS 23.501 [2].

NOTE 1: The Usage Report is also used for the reporting of other events or information. For details refer to clause 7.5.8.3 of TS 29.244 [69].

(2) Start of traffic detection (Usage Report).

When traffic detection is requested by SMF and the start of traffic is detected for a Packet Detection Rule (PDR) as described in clause 5.8 of TS 23.501 [2], the UPF shall report the start of traffic detection to the SMF and indicate the corresponding PDR rule ID.

(3) Stop of traffic detection (Usage Report).

When traffic detection is requested by SMF and the end of traffic is detected for a PDR as described in clause 5.8 of TS 23.501 [2], the UPF shall report the stop of traffic detection to the SMF and indicate the corresponding PDR rule ID.

(4) Detection of 1st downlink packet for a QoS Flow of a PDU Session with UP Connection deactivated (Downlink Data Report).

When UPF receives the first downlink packet for a QoS Flow but no N3/N9 tunnel for downlink data transmission exists and the buffering is performed by the UPF, it shall report the detection of 1st downlink packet to SMF also indicating the QoS Flow for which the downlink packet was received (for the purpose of downlink data notification). The UPF shall also report the DSCP of the packet if the PDU Session type is IP (to support the Paging Policy Differentiation feature described in clause 5.4.3 of TS 23.501 [2]).

(5) Detection of PDU Session Inactivity for a specified period (User Plane Inactivity Report).

When an Inactivity Timer for a PDU Session is provided by SMF during N4 Session Establishment/Modification procedure and the UPF detects the PDU Session has no data transfer for a period specified by the Inactivity Timer, it shall report PDU Session Inactivity to the SMF.

NOTE 2: As described in clause 4.3.7, an Inactivity Timer to the UPF is not provided by the SMF for always-on PDU Sessions.

(6) The UL, DL or round trip packet delay measurement reporting (Session Report).

When the QoS Monitoring for URLLC is enabled for the QoS Flow, the UPF calculates the UL, DL or round trip packet delay of the QoS Flow. If the redundant transmission on N3/N9 interfaces is activated, the UPF performs packet delay monitoring for both UP paths and reports the packet delay of the two UP paths respectively. When the reporting trigger(s) is satisfied, e.g. the measured packet delay value exceeds the reporting threshold, or the reporting period expires, or the PDU Session is released, the UPF reports the calculated packet delay value(s) to the SMF. When receiving the measurement reports from the UPF, the SMF sends the reports to the target, i.e. either to the PCF or to the AF (may be via NEF), according to the information for QoS Monitoring for URLLC received in the PCC rules. If the PCF received the report, the PCF sends the reports to the AF, based on the procedure as defined in the clause 4.16.5.1.

(7) TSC Management Information available (TSC Management Information).

When TSC management information is available, the UPF shall provide the TSC management information in the TSC Management Information to the SMF as defined in clause 5.8.2.11.14 of TS 23.501 [2].

(8) Discard Downlink Traffic detection (Downlink Data Report).

When discarded downlink traffic detection is requested by SMF for a PDR and the first downlink packet is discarded after being buffered for this PDR as described in clause 5.8.3.2 of TS 23.501 [2], the UPF shall report the discarded downlink traffic detection to the SMF and indicate the corresponding PDR rule ID (for the purpose of downlink data delivery status notification).

(9) Buffered Downlink Traffic detection (Downlink Data Report).

When buffered downlink traffic detection is requested by SMF for a PDR and the first downlink packet is buffered for this PDR as described in clause 5.8.3.2 of TS 23.501 [2], the UPF shall report the buffered downlink traffic detection to the SMF and indicate the corresponding PDR rule ID (for the purpose of downlink data delivery status notification).

2. The UPF sends an N4 session report message (N4 Session ID, list of [Usage Report, Downlink Data Report, Session Report, User Plane Inactivity Report, TSC Management Information]) to the SMF.
3. The SMF identifies the N4 session context based on the received N4 Session ID and applies the reported information for the corresponding PDU Session. The SMF responds with an N4 session report ACK message.

## 4.4.3 N4 Node Level Procedures

### 4.4.3.1 N4 Association Setup Procedure

The N4 Association Setup procedure is used to setup an N4 association between the SMF and the UPF, to enable the SMF to use the resources of the UPF subsequently to establish N4 Sessions. The SMF and UPF may exchange the supported functionalities on each side during these procedures.

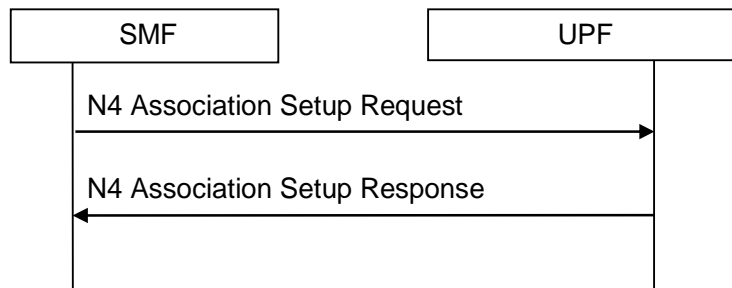
The setup of an N4 association is initiated by the SMF. SMF and UPF may additionally support an N4 association initiated by UPF.

The SMF should only establish an N4 association with a UPF that supports F-TEID allocation at the UPF.

The SMF initiates the N4 Association Setup procedure to request to setup an N4 association towards a UPF prior to establishing a first N4 session on this UPF.

When receiving an N4 Association Setup Request, the UPF shall send an N4 Association Setup Response.

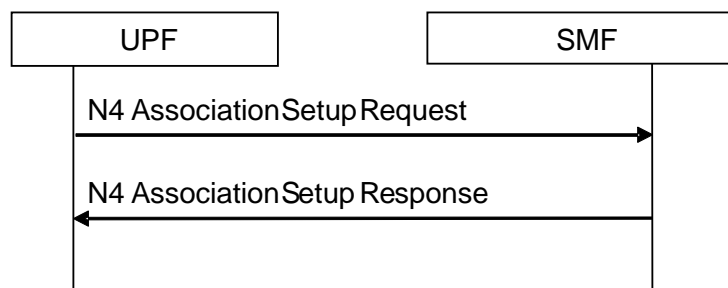
N4 Association Setup procedure can be used to request the UPF to measure and report the clock drift between the TSN time and 5GS time for one or more TSN time domains by provisioning TSN Clock Drift Report and providing the corresponding Time domain number(s) as specified in TS 29.244 [69]. The SMF may omit the Time domain number in the request; in this case the UPF shall report the clock drift for all Time domains the UPF is connected to.



**Figure 4.4.3.1-1: N4 association setup procedure initiated by SMF**

The UPF may initiate the N4 Association Setup procedure to request to setup an N4 association towards a SMF prior to establishing a first N4 session on this UPF.

When receiving an N4 Association Setup Request, the SMF shall send an N4 Association Setup Response.

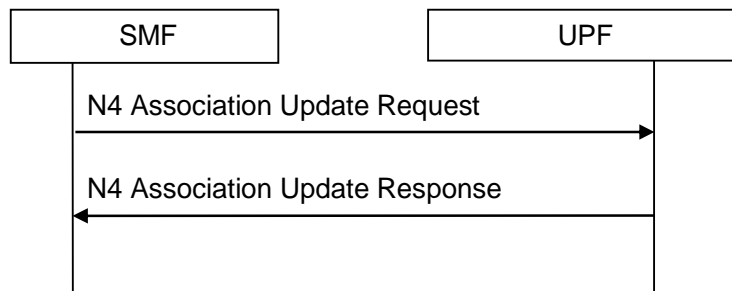


**Figure 4.4.3.1-2: N4 association setup procedure initiated by UPF**

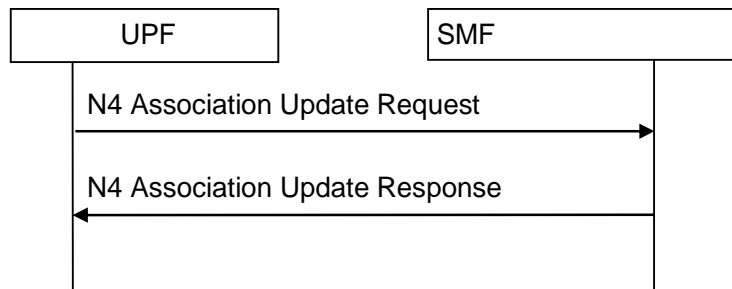
### 4.4.3.2 N4 Association Update Procedure

The N4 Association Update procedure shall be used to modify an existing N4 association between the SMF and the UPF. It may be initiated by the UPF or by the SMF to update the supported features or available resources of the UP function.

N4 Association Update procedure can be used by the SMF to update the provisioning of TSN Clock Drift Report as specified in clause 4.4.3.1.



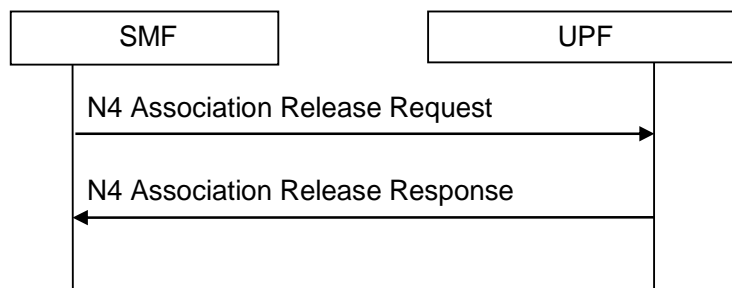
**Figure 4.4.3.2-1: SMF initiated N4 association update procedure**



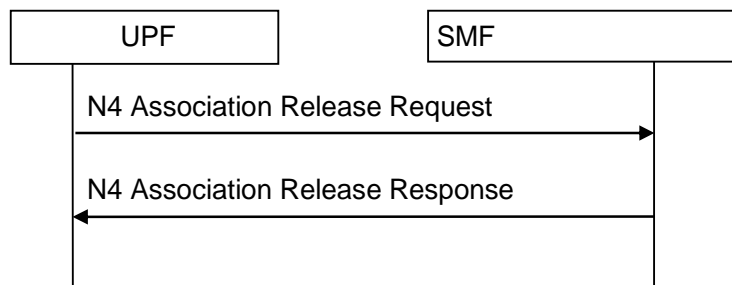
**Figure 4.4.3.2-2: UPF initiated N4 association update procedure**

#### 4.4.3.3 N4 Association Release Procedure

The N4 Association Release procedure shall be used to terminate the N4 association between the SMF and the UPF due to e.g. OAM reasons. The N4 Association Release Request may be initiated by the SMF or UPF.



**Figure 4.4.3.3-1: SMF initiated N4 association release procedure**

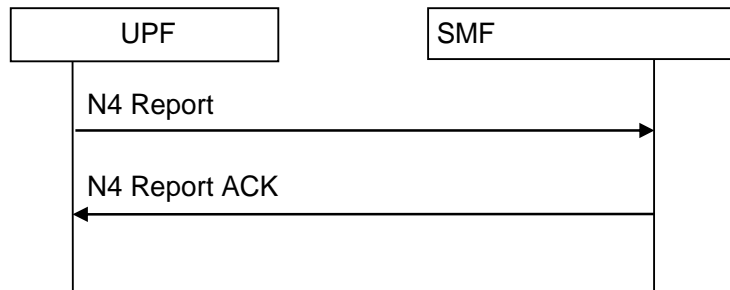


**Figure 4.4.3.3-2: UPF initiated N4 association release procedure**

#### 4.4.3.4 N4 Report Procedure

The N4 Report procedure shall be used by the UPF to report information to the SMF which is not related to a specific N4 session, e.g. to report a user plane path failure affecting all the N4 sessions towards a remote GTP-U peer.

N4 Report procedure can be used by the UPF to report the clock drift between the TSN time and 5GS time for one or more TSN working domains as specified in TS 29.244 [69].



**Figure 4.4.3.4-1: N4 report procedure**

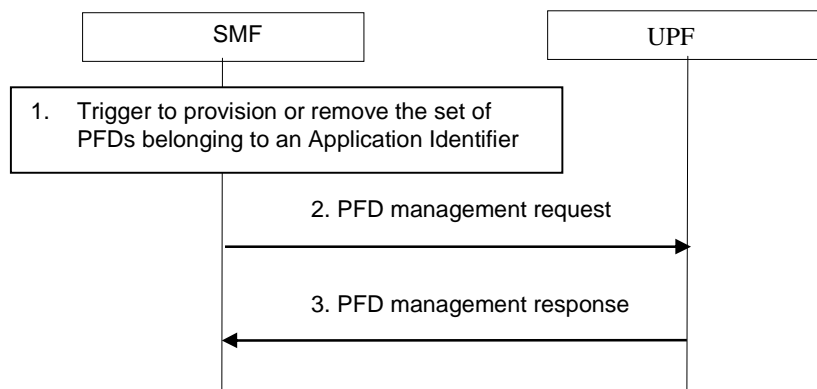
The UPF detects that an event has to be reported and starts the procedure by sending an N4 Report message (UPF ID, list of [event, status]) to the SMF. The SMF responds with an N4 report ACK message (SMF ID). The event parameter contains the name of the event and UPF ID. The status parameter contains the actual information the control plane function is interested in. If the UPF detects clock drifting between 5G time and one or more TSN working domains, the UPF reports the corresponding TSN domain number and the time offset and cumulative rate Ratio according to the provisioning from the SMF as defined in clause 5.27.2 of TS 23.501 [2]. The UPF includes the Network Instance (if available) and the combination of DNN and S-NSSAI (if available) in the report.

**NOTE:** When the UPF supports more than one NW-TT, the SMF can use the Network Instance or DNN/S-NSSAI to associate the report with the corresponding N4 sessions and NW-TT.

#### 4.4.3.5 N4 PFD management Procedure

This N4 procedure is used by the SMF to provision or remove all PFD(s) belonging to an Application Identifier in the UPF. PFD sets belonging to different Application Identifiers can be managed with the same PFD management request message.

The N4 PFD management procedure is a node level procedure, i.e. independent of any PDU Session.



**Figure 4.4.3.5-1: PFD management in the UPF**

1. The SMF is triggered to provision or remove the PFD set belonging to an Application Identifier in the following cases:

When the caching timer expires and there's no active PCC rule that refers to the corresponding application identifier, the SMF informs the UPF to remove the PFD(s) identified by the Application Identifier.

When a PCC rule is provided for an Application Identifier corresponding to the PFD(s) that are not already provided to the UPF, the SMF shall provide the PFD(s) to the UPF (if there are no PFD(s) cached, the SMF retrieves them from the NEF (PFDF), as described in TS 23.503 [20]).

When any update of the PFD(s) is received from NEF (PFDF) and there are still active PCC rules in UPF for the Application Identifier.



2. The SMF sends a PFD management request to the UPF to provision/remove the PFD(s) corresponding to the Application Identifier(s).
3. The UPF updates the PFD(s) according to the request and acknowledges by responding with a PFD management response message.

#### 4.4.4 SMF Pause of Charging procedure

The SMF Pause of Charging procedure aims for the SMF charging and usage monitoring data to more accurately reflect the downlink traffic actually sent to the AN.

The following are example triggers for the SMF to enable the pause of charging

- Operator specified criteria/threshold (e.g. number/fraction of packets/bytes dropped at UPF in downlink since last time the N3 tunnel towards the AN was released). The SMF requests the UPF to notify the SMF whenever the criteria/threshold is met.
- Indication of "Radio Link Failure" (see clause 4.2.6).

Based on operator policies, if the trigger for the SMF to enable the pause of charging is met, the SMF shall pause the charging. When the SMF pauses charging the following applies:

- Towards the UPF(s) where the Usage Reporting is configured, the SMF shall modify the Usage Reporting Rules for the PDU Session so that the usage collection for charging is stopped.
- The SMF may request the UPF to limit the rate of downlink traffic sent to the downstream UPF or the AN.

NOTE 1: A consequence of using this procedure is that SMF charging data does not correspond to the volume that traversed the UPF and it is therefore not possible to count the downlink packets dropped between the PDU Session Anchor (PSA) UPF and the downstream UPF.

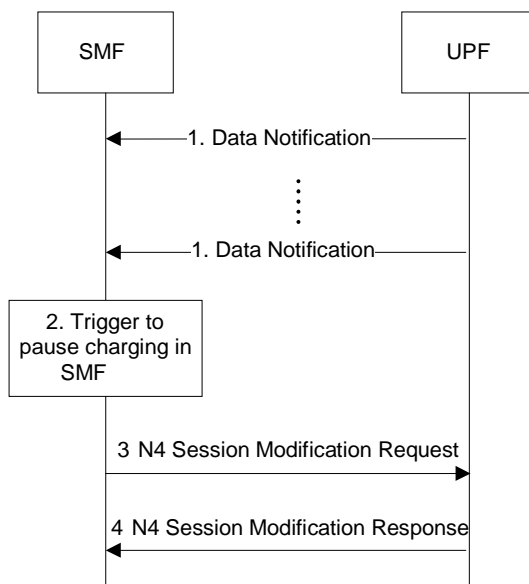
NOTE 2: In this release of the specification, pause of charging procedure does not address the issue of packets dropped by the NG-RAN.

In home routed roaming scenarios, based on operator's policy, the H-SMF may indicate to the V-SMF if the feature is to be enabled on a per PDU Session basis. This is indicated to the V-SMF by a "PDU Session Charging Pause Enabled" Indication in the Nsmf\_PDUSession\_Create Response during the PDU Session Establishment procedure. This is an indication to the V-SMF that when the criteria for pause of SMF charging are met at the VPLMN (as described further down in this clause) charging at the H-SMF can be paused.

The H-SMF shall stop any charging and usage monitoring actions for the PDU Session upon receiving a "Start Pause of Charging" Indication in a Nsmf\_PDUSession\_Update request from the V-SMF. When the H-SMF receives a Nsmf\_PDUSession\_Update request for a PDU Session with a "Stop Pause of Charging" Indication, then the H-SMF shall resume charging for the PDU Session.

Regardless of operator policy/configuration, the downlink user plane packets received at the (V-)UPF shall trigger Data Notifications as described in clause 4.2.3.3.

When the (V-)SMF receives a Nsmf\_PDUSession\_UpdateSMContext request or a Namf\_EventExposure\_Notify about UE reachability, the (V-)SMF shall consider the PDU Session charging as being unpaused if it had been paused previously.



**Figure 4.4.4-1: SMF Pause of charging procedure**

1. The UPF receives downlink data packets for a PDU Session that does not have an N3 tunnel and the UPF sends data notification to the SMF. The packets are buffered or discarded in the UPF based on operator policy.
2. Based on operator policy/configuration the SMF triggers the procedure to pause PDU Session charging. Triggering criteria are based on SMF operator policy/configuration.
3. SMF sends a N4 Session Modification Request message to the UPF where the Usage Reporting is configured, modifying the Usage Reporting Rules for the PDU Session so that the usage collection for charging is stopped. In home routed roaming scenarios, the V-SMF sends a Nsmf\_PDUSession\_Update request to the H-SMF with a "Start Pause of Charging" Indication. The H-SMF then requests the H-UPF to stop usage collection as mentioned before.
4. UPF confirms with a N4 Session Modification Response message.

## 4.5 User Profile management procedures

### 4.5.1 Subscriber Data Update Notification to AMF

Whenever the user profile is changed for a user in the UDM/UDR and the changes affect the user profile in the AMF, the UDM shall notify these changes to the affected AMF by the means of invoking Nudm\_SDM\_Notification service operation. Then the AMF adds or modifies the user profile.

The Nudm\_SDM\_Notification service operation specified in clause 5.2.3.3 is used by the UDM to update subscriber data stored in the AMF.

The AMF takes appropriate action according to the changed subscriber data as follows, e.g.:

- initiating an AMF initiated Deregistration procedure if the updated subscription data indicates the UE is not allowed to roam in this network; and
- updating UE context stored at AN to modify the subscribed UE-AMBR.
- initiating UE Configuration Update procedure as defined in clause 4.2.4.2.
- initiating UE Parameters Update via UDM Control Plane Procedure as defined in clause 4.20.

UDM can also use the Nudm\_SDM\_Notification service operation to update the Steering of Roaming information stored in the UE via the AMF (i.e. a list of preferred PLMN/access technology combinations or HPLMN indication that 'no change of the "Operator Controlled PLMN Selector with Access Technology" list stored in the UE is needed). UDM can include an indication for the UE to send an acknowledgement of the reception of this information. The AMF

provides the acknowledgement sent from the UE to UDM using the Nudm\_SDM\_Info service operation. For more details regarding the handling of Steering of Roaming information refer to TS 23.122 [22].

When the subscribed S-NSSAIs change, UDM provides a Network Slicing Subscription Change Indication to the UE via the AMF. Once the AMF updates the UE and obtains an acknowledgment from the UE, the AMF informs the UDM that the UE received the Network Slicing Subscription Change Indication using the Nudm\_SDM\_Info service operation.

When the CAG information in the subscription data changes, or when the SUPI and PEI association changes, UDM provides a CAG information Subscription Change Indication to the AMF. Once the AMF updates the UE and obtains an acknowledgment from the UE, the AMF informs the UDM that the UE received the CAG information using the Nudm\_SDM\_Info service operation.

If the AMF received a changed Service Gap Time parameter in the updated subscription data and if the UE has indicated Service Gap Control capability the AMF shall provide the new Service Gap Time value to the UE in the next Registration Accept message, or, if the UE does not send any Registration Request within a certain time period that shall be longer than any MICO mode or eDRX interval used by the UE, the AMF may initiate a UE Configuration Update procedure.

## 4.5.2 Session Management Subscriber Data Update Notification to SMF

Whenever the session management subscriber data is changed for a user in the UDM/UDR and if the SMF subscribed for the update of the session management subscriber data to be notified, the UDM shall notify these changes to the affected SMF by the means of invoking Nudm\_SDM\_Notification service operation. Then the SMF modifies the session management subscriber data in the UE SM context.

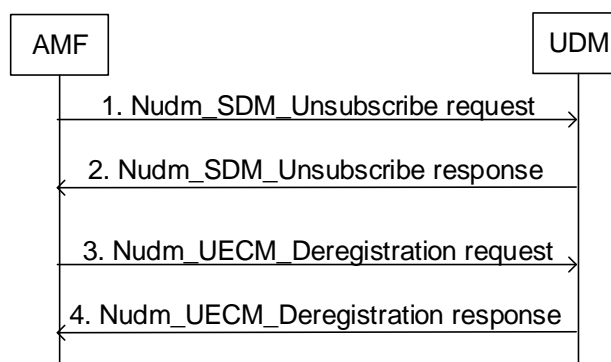
The Nudm\_SDM\_Notification service operation specified in clause 5.2.3.3 is used by the UDM to update session management subscriber data stored in the SMF.

The SMF initiates appropriate action according to the changed subscriber data, e.g. including:

- initiating an SMF initiated PDU Session Modification procedure; or
- initiating an SMF initiated PDU Session Release procedure.

## 4.5.3 Purge of subscriber data in AMF

An AMF may, as an implementation option, purge the subscriber data and MM context of a UE after the implicit or explicit Deregistration of the UE. In this case, the AMF shall unsubscribe and deregister from the UDM, where UDM may further do corresponding operation from UDR, by the means of following "Purge of subscriber data in AMF" procedure.



**Figure 4.5.3-1: Purge of Subscriber Data in AMF**

1. After purging the subscriber data and MM context of a deregistered UE, the AMF unsubscribes to changes to subscription data using Nudm\_SDM\_Unsubscribe request operation (see clause 5.2.3.3.4), for the data the AMF has previously subscribed (see clause 4.2.2.2.2, step 14b). The UDM unsubscribes the AMF from the data indicated.

The UDM may unsubscribe to changes to subscription data from UDR by using Nudr\_DM\_Unsubscribe for the data the UDM has previously subscribed (see clause 4.2.2.2.2, step 14b).

2. The UDM sends a response back using Nudm\_SDM\_Unsubscribe response operation.
3. The AMF deregisters from UDM using Nudm\_UECM\_Deregistration request (SUPI, NF ID, Access Type) operation (see clause 5.2.3.2.3). The UDM may update UE context in UDR by Nudr\_DM\_Update (SUPI, Subscription Data).
4. The UDM sets the UE Purged flag associated with the Access Type and acknowledges with a Nudm\_UECM\_Deregistration response operation.

## 4.6 Security procedures

Security procedures for the 5GS are specified in 33.501 [15].

## 4.7 ME Identity check procedure

The AMF initiates Mobile Equipment Identity Check procedure by invoking the N5g-eir\_MEIdentityCheck\_Get service operation as defined in clause 5.2.4.2.2.

## 4.8 RAN-CN interactions

### 4.8.1 Connection Inactive and Suspend procedure

#### 4.8.1.1 Connection Inactive procedure

This procedure may be initiated by the serving NG-RAN node when the UE is in CM-CONNECTED with RRC Connected state and has received the "RRC Inactive Assistance Information" from the AMF as defined in clause 5.3.3.2.5 of TS 23.501 [2]. NG-RAN initiates the transition to RRC Inactive state as defined in TS 38.300 [9].

#### 4.8.1.2 Connection Suspend procedure

This procedure may be initiated by the serving NG-RAN node when the UE is in CM-CONNECTED and has at least one PDU session with active user plane connection and NG-eNB has received indication from the AMF that User Plane CIoT 5GS Optimisation, as defined in clause 5.31.18 of TS 23.501 [2], is supported for the UE.

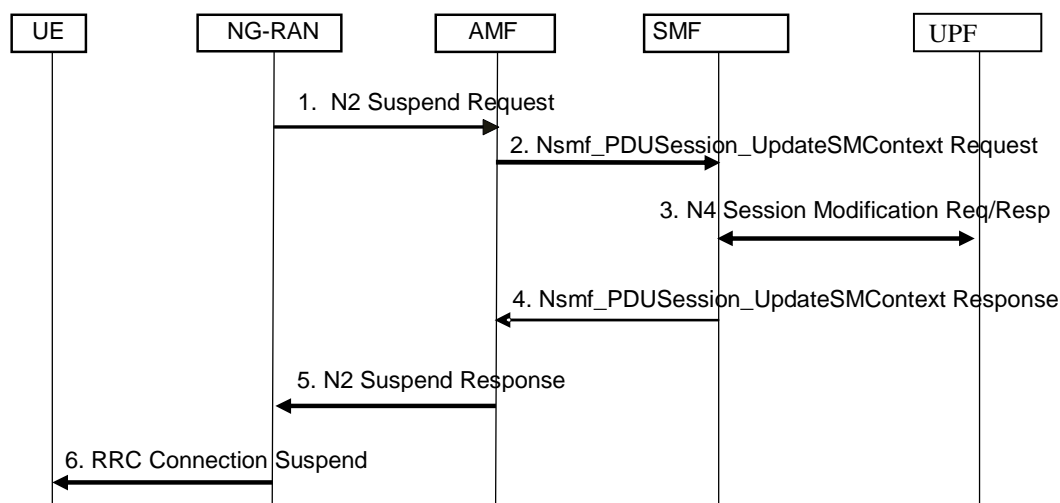


Figure 4.8.1.2-1: NG-RAN initiated Connection Suspend procedure

1. NG-RAN to AMF: The NG-RAN sends the N2 Suspend Request message to the AMF, see TS 38.413 [10]. The AMF enters CM-IDLE with Suspend indicator. Context information related to the NGAP UE association, UE Context and PDU session context, necessary to resume the connection is stored in the UE, NG-RAN node and in the AMF. The NG-RAN may include the Suspend cause and the N2 SM information.

If the UE is served by an NG-eNB that supports WUS, then the NG-eNB should include the Information On Recommended Cells And RAN nodes For Paging in the N2 Suspend Request message; otherwise NG-RAN may include the Information On Recommended Cells And NG-RAN For Paging in the N2 Suspend Request message. If available, the AMF shall store this information to be used when paging the UE.

The NG-RAN includes Information for Enhanced Coverage, if available, in the N2 Suspend Request message.

If Service Gap Control is being applied to the UE (see clause 4.3.17.9) and the Service Gap timer is not already running, the Service Gap timer shall be started in the AMF when entering CM-IDLE, unless the connection was initiated after a paging of an MT event, or after a mobility registration procedure without Follow-on Request indication or after a mobility registration procedure for regulatory prioritized services like Emergency services or exception reporting.

2. AMF to SMF: For each of the PDU Sessions in the N2 Suspend Request, the AMF invokes Nsmf\_PDUSession\_UpdateSMContext Request (PDU Session ID, Cause, Operation type, User Location Information, Age of Location Information, N2 SM Information (Secondary RAT usage data)). The Operation Type is set to "UP Suspend" to indicate suspend of user plane resources for the PDU Session.
3. SMF to UPF: N4 Session Modification Request (AN Tunnel Info to be suspended, Buffering on/off).

The SMF initiates an N4 Session Modification procedure indicating the need to release the tunnel info of AN terminating N3 between AN and UPF. Buffering on/off indicates whether the UPF shall buffer incoming DL PDU or not.

The UPF sends N4 Session Modification Response to acknowledge the SMF request.

The SMF shall maintain the N3 tunnel info (including both AN Tunnel Info and the CN Tunnel Info).

NOTE: The UPF maintains the CN tunnel info as it may receive uplink packets from the AN.

4. SMF to AMF: The SMF sends Nsmf\_PDUSession\_UpdateSMContext response to the AMF.
5. AMF to NG-RAN: After response for each PDU session in step 4, the AMF sends N2 Suspend Response to NG-RAN to successfully terminate the Connection Suspend procedure initiated by the NG-RAN, see TS 38.413 [10].
6. The NG-RAN sends RRC message to suspend the RRC Connection towards the UE including UE Resume ID, see TS 36.300 [46]).

If Service Gap Control is applied for the UE (see clause 5.31.16 of TS 23.501 [2]) and the Service Gap timer is not already running, the Service Gap timer shall be started in the UE when entering CM-IDLE, unless the connection was initiated as a response to paging of an MT event, or after a mobility registration procedure without Follow-on Request Indication set or after a mobility registration procedure for regulatory prioritized services like Emergency services or exception reporting.

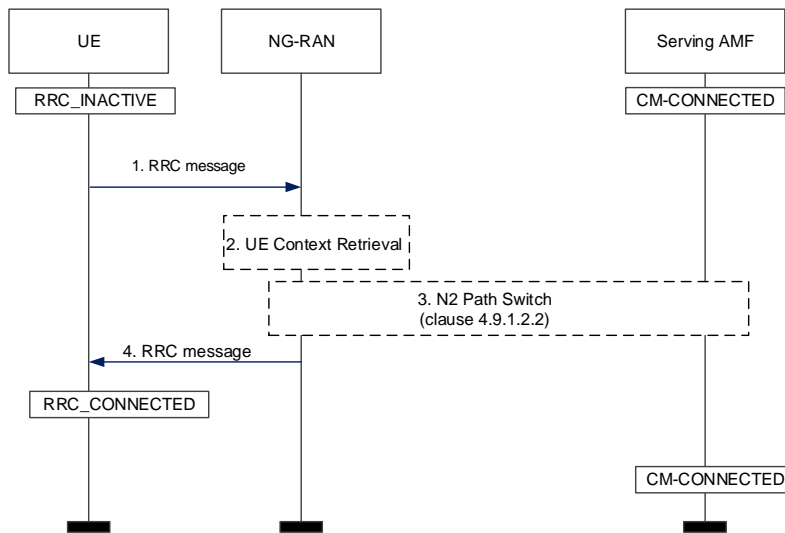
## 4.8.2 Connection Resume procedure

### 4.8.2.1 General

The Connection Resume procedure is used by a UE to request the establishment of a secure connection between a UE and the network when the UE is in CM-CONNECTED with RRC Inactive state, or in CM-IDLE with Suspend indicator for the UE supporting User Plane ClIoT 5GS Optimisation. The UE initiates the procedure when upper layers or the AS (when responding to RAN paging or upon triggering RNA updates) requests the resumption of a suspended RRC connection. NG-RAN details are specified in TS 38.300 [9] and TS 38.331 [12] for NR and in TS 36.300 [46] and TS 36.331 [16] for E-UTRA.

### 4.8.2.2 Connection Resume in RRC Inactive procedure

The Connection Resume procedure is used by the UE to perform RRC Inactive to RRC Connected state transition. Triggers for the UE to initiate this procedure are defined in clause 5.3.3.2.5 of TS 23.501 [2].



**Figure 4.8.2.2-1: Connection Resume in RRC Inactive**

1. UE to NG-RAN: RRC message (Resume ID).

The UE initiates the transition from RRC Inactive state to RRC Connected state, see TS 38.300 [9]. The UE provides its Resume ID needed by the NG-RAN to access the UE's stored Context.

2. [Conditional] NG-RAN performs UE Context Retrieval.

UE Context Retrieval is performed when the UE Context associated with the UE attempting to resume its connection is not locally available at the accessed NG-RAN. The UE Context Retrieval procedure via NG-RAN is specified in TS 38.300 [9].

3. [Conditional] N2 Path switch procedure.

If the accessed NG-RAN is able to retrieve the UE Context, the accessed NG-RAN node initiates N2 Path Switch procedure, i.e. steps 1 to 8 of clause 4.9.1.2.2 and including Xn data forwarding.

If the Connection Resume procedure is a response to RAN paging which is triggered by 5GC due to an N2 interface procedure, NG-RAN and 5GC handle the N2 interface procedure as a collision described in clause 4.9.1.2.

The NG-RAN sends UE Notification message to report that UE is in RRC Connected if an AMF requested N2 Notification (see clause 4.8.3) to NG-RAN.

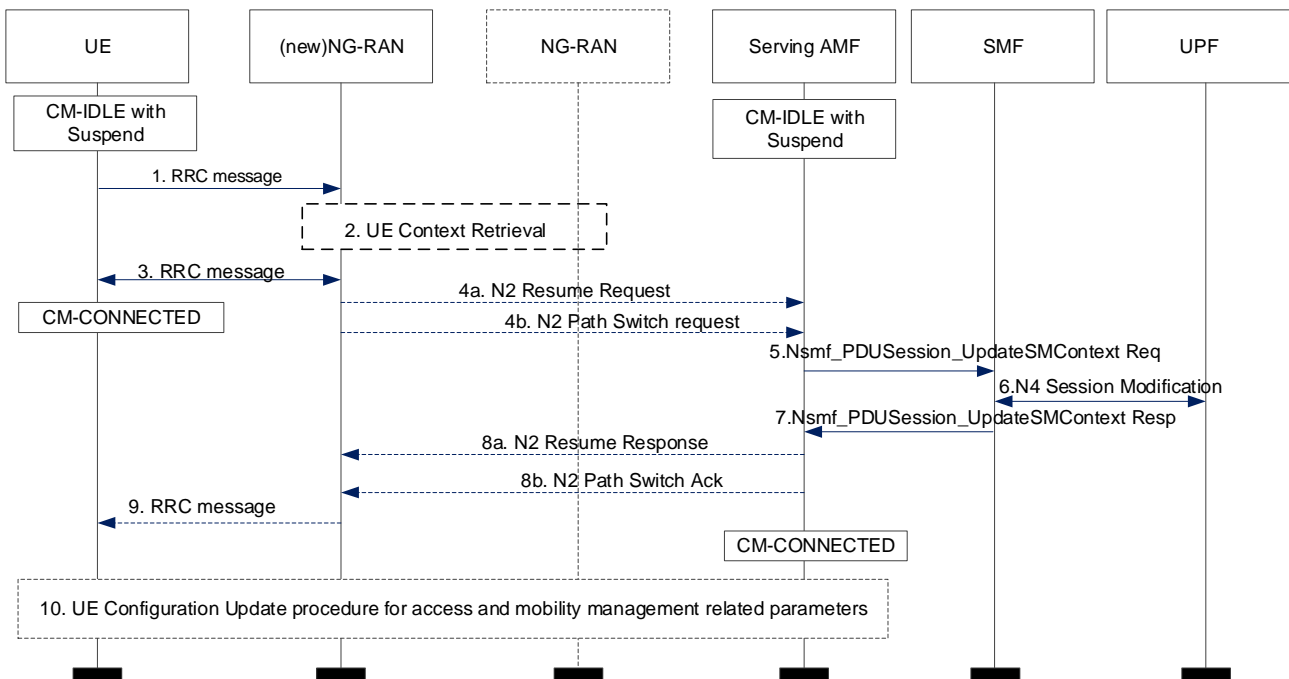
4. NG-RAN to UE: RRC message.

The NG-RAN confirms to the UE that the UE has entered RRC Connected state.

NOTE: Steps 3 and 4 can be executed in parallel.

### 4.8.2.3 Connection Resume in CM-IDLE with Suspend procedure

For the UE supporting User Plane CIoT 5GS Optimisation, the Connection Resume procedure is used by the UE to perform RRC\_IDLE with Suspend to RRC\_CONNECTED state transition. Triggers for the UE to initiate this procedure are defined in clause 5.31.18 of TS 23.501 [2].



**Figure 4.8.2.3-1: Connection Resume in CM-IDLE with Suspend**

1. UE to NG-RAN: RRC message (Resume ID).

The UE initiates the transition from CM-IDLE and RRC IDLE state with Suspend to CM-CONNECTED and RRC Connected state, see TS 36.300 [46]. The UE provides its Resume ID needed by the NG-RAN to access the UE's stored Context.

2. [Conditional] NG-RAN performs UE Context Retrieval.

UE Context Retrieval may be performed when the UE Context associated with the UE attempting to resume its connection is not locally available at the accessed NG-RAN. The UE Context Retrieval procedure via NG-RAN is specified in TS 38.300 [9].

3. NG-RAN and UE continues the resume procedure and access stratum configuration synchronization is performed between the UE and the network. UE enters CM-CONNECTED and RRC\_CONNECTED.

4. NG-RAN to AMF:

- a) If the NG-RAN is the same as the NG-RAN when UE is suspended, the NG-RAN sends N2 Resume Request to AMF including Resume cause and N2 SM information which indicates the PDU sessions successfully resumed and PDU sessions failed or partially failed to resume the user plane resource.
- b) If the NG-RAN is different from the NG-RAN when UE is suspended and the new NG-RAN is able to retrieve the UE Context from the old NG-RAN, the new NG-RAN node initiates N2 Path Switch Request towards AMF, i.e. Steps 1b of clause 4.9.1.2.2.

5. AMF to SMF: For each of the PDU Sessions indicated in step 4, the AMF invokes Nsmf\_PDUSession\_UpdateSMContext Request (PDU Session ID, Cause, Operation type, User Location Information, Age of Location Information, N2 SM Information). The Operation Type is set to "UP Resume" to indicate resume of user plane resources for the PDU Session.

For PDU Session(s) to be switched to the new NG-RAN, upon receipt of the Nsmf\_PDUSession\_UpdateSMContext request, the SMF determines whether the existing UPF can continue to serve the UE. If the existing UPF cannot continue to serve the UE, steps 3 to 7 of clause 4.9.1.2.3 or clause 4.9.1.2.4 are performed depending on whether the existing UPF is a PDU Session Anchor and flow continues in step 7. Otherwise, step 6 is performed if the existing UPF can continue to serve the PDU Session.

If the RRC connection is resumed and the UE is accessing via the NB-IoT RAT with the RRC resume cause set to "MO exception data" the AMF updates all (H-)SMFs. If AMF indicates "MO exception data" then it includes the MO Exception Data Counter. The AMF maintains the MO Exception Data Counter for Small Data Rate

Control purposes as described in clause 5.31.14.3 of TS 23.501 [2]. Each (H-)SMF should be updated for every RRC Connection which is triggered for "MO exception data".

In the home-routed roaming case, if Small Data Rate Control applies, the V-SMF waits for H-SMF response before proceeding with the N3 establishment.

6. SMF to UPF: N4 Session Modification Request (AN Tunnel Info to be resumed, Buffering on/off).

The SMF initiates an N4 Session Modification procedure indicating the resume of AN tunnel. Buffering on/off indicates whether the UPF shall buffer incoming DL PDU or not.

If step 4a) is performed, the AN tunnel info is the one maintained by the SMF during Connection Suspend procedure, step 3 of clause 4.8.1.2. If step 4b) is performed, the AN tunnel info is part of the N2 SM information received by SMF in step 5.

The UPF sends N4 Session Modification Response to acknowledge the SMF request.

7. SMF to AMF: The SMF sends Nsmf\_PDUSession\_UpdateSMContext response to the AMF.

If new CN tunnel information is allocated for the PDU session, i.e. in the case of new AN tunnel is received in step 6, the SMF includes the new CN tunnel information as part of the N2 SM information.

If the resume for PDU session is unsuccessful, the SMF shall include the resume failure as part of the N2 SM information.

8. AMF to NG-RAN: After response for each PDU session in step 7, the AMF sends N2 Resume Response to NG-RAN and indicates success, including N2 SM information for PDU session received in step 7, if at least one PDU session is resumed successfully. If none of the PDU sessions is resumed successfully, AMF indicates failure to NG-RAN.

The AMF sends N2 Path Switch Acknowledge with PDU session resume information, if Path Switch Request is received in step 4.

The AMF may provide Extended Connected Time value to the NG-RAN. If the NG-RAN receives the Extended Connected Time value, the NG-RAN may take this information into account when determining user inactivity.

9. [Conditional] NG-RAN to UE: RRC message.

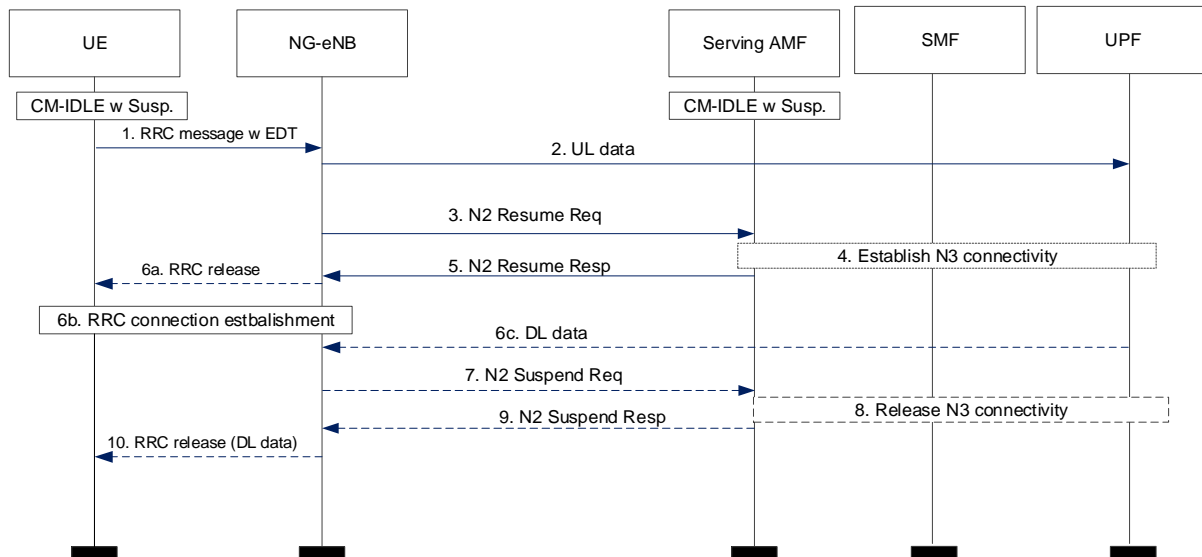
The NG-RAN may reconfigure the RRC connection based on resume result received from AMF.

10. If the AMF has paged the UE to trigger the Connection Resume procedure, the AMF shall initiate the UE configuration update procedure as defined in clause 4.2.4.2 to assign a new 5G-GUTI.

#### 4.8.2.4 Connection Resume in CM-IDLE with Suspend and MO EDT procedure

The Connection Resume with Early Data Transmission procedure is used by the UE to optimise sending user data in a single uplink packet and single uplink followed by single downlink packet cases for a UE in CM-IDLE with Suspend.





**Figure 4.8.2.4-1: Connection Resume in RRC Idle with Suspend with EDT**

1. UE to NG-eNB: RRC message (Resume ID, AS RAI) with UL EDT.

The UE initiates the transition from RRC IDLE with Suspend state to RRC Connected state, see TS 36.300 [46].

The UE may include AS Release Assistance information indicating:

- No further Uplink and Downlink Data transmission, or
- Only a single Downlink Data transmission subsequent to the Uplink transmission.

2. The NG-eNB deciphers the EDT UL data received from the UE and forwards it to the UPF using the N3 UL TEID in the AS context.

3. The NG-eNB sends N2 Resume Request to AMF including Resume cause and N2 SM.

If the UE included AS Release Assistance information indicating No further Uplink and Downlink Data transmission in step 1, NG-eNB may request for immediate transition to RRC IDLE with Suspend.

If the NG-eNB requests for immediate transition to RRC IDLE with Suspend, the NG-eNB should include Paging Assistance Data for CE capable UE in the N2 Resume Request message. If the NG-eNB supports WUS and requests for immediate transition to RRC IDLE with Suspend, the NG-eNB should include Information on Recommended Cells and RAN Nodes for Paging in the N2 Resume Request message. The AMF stores this information in the UE context for subsequent Paging procedure.

4. [Conditional] The AMF interacts with SMF to establish the N3 tunnel, except for the case:

- The AMF receives a request for immediate transition to RRC IDLE with Suspend in step 3; and
- the AMF is not aware of any downlink data or signalling pending.

5. The AMF sends an N2 Resume Response to NG-eNB.

If the AMF received a request for immediate transition to RRC IDLE with Suspend in step 3 and there is no downlink data or signalling pending, the AMF includes a Suspend indication, keeps the UE in CM-IDLE with Suspend and restarts the Periodic Registration Timer unless the Strictly Periodic Registration Timer Indication has been provided to the UE during the previous registration procedure.

Otherwise the AMF sends an N2 Resume Response to NG-eNB after the N3 Connectivity has been established and moves the UE to CM-CONNECTED. If the AMF knows of mobile terminating data or signalling pending, the AMF may include the Extended Connected Time value to the RAN

6. [Conditional] RRC procedure:

6a. If the AMF included the Suspend indication, the NG-eNB releases the RRC Connection with Suspend. The procedure is complete and following steps are skipped.

6b. If the AMF did not include the Suspend indication and:

- The UE did not include AS Release Assistance Indication; or
- The AMF included the Extended Connected Time value.

the NG-eNB sends an RRC Resume message to the UE and the UE moves to CM-CONNECTED and RRC Connected. The procedure is complete and the following steps are skipped.

6c. Otherwise, if the AMF did not include Extended Connected Time value and the UE included AS Release Assistance information with only a single Downlink Data transmission subsequent to the Uplink transmission, the NG-eNB waits for the DL data to arrive and proceeds to steps 7-10.

7-9. The NG-eNB releases the N3 connectivity by sending an N2 Suspend Request to AMF including Suspend cause and N2 SM. Steps 2-4 of Connection Suspend procedure in clause 4.8.1.2 is executed.

10. [Conditional] NG-eNB to UE: RRC message (with DL data).

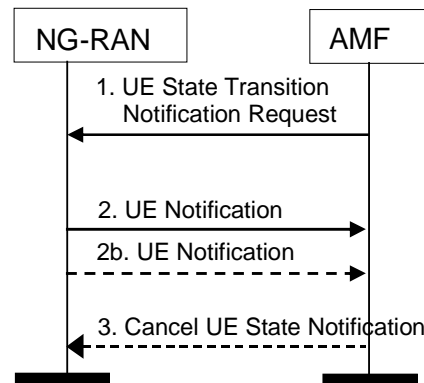
The NG-eNB ciphers received DL data.

The NG-eNB releases the RRC Connection with Suspend including the DL EDT data.

### 4.8.3 N2 Notification procedure

This procedure is used by an AMF to request the NG-RAN to report RRC state information, when the target UE is in CM-CONNECTED state. When AMF has requested reporting of subsequent state changes, the need for the NG-RAN to continue reporting ceases when the UE transitions to CM-IDLE or the AMF sends a cancel indication. This procedure may be used for services that require RRC state information (e.g. 5GC MT control and paging assistance, O&M and collection of statistics), or for subscription to the service by other NFs. See TS 38.413 [10] for details of the procedure.

Reporting of RRC state transitions can be requested per UE by AMF. Continuous reporting of all RRC state transitions can be enabled by operator local configuration.



**Figure 4.8.3-1: RRC state transition notification**

1. The AMF sends a UE State Transition Notification Request to the NG-RAN as described in TS 38.413 [10]. The UE State Transition Notification Request message shall identify the UE for which notification(s) are requested and may contain a reporting type. The reporting type either indicates subsequent state transitions shall be notified at every RRC state transition (i.e. from RRC Connected state to RRC Inactive state, or from RRC Inactive to RRC Connected state), or it indicates Single RRC-Connected state notification.
2. The NG-RAN sends the UE Notification message to report the current RRC state for the UE (i.e. RRC Inactive state or RRC Connected state). The current UE location information (i.e. TAI + Cell Identity) is always included when RRC state information is reported.

- 2b. When the AMF has requested reporting about subsequent state transitions, the NG-RAN sends subsequent UE Notification messages to the AMF at every RRC state transition until the UE transitions to CM-IDLE or NG-RAN receives a Cancel UE State Notification message from the AMF.

When the AMF has requested reporting for Single RRC-Connected state notification and UE is in RRC-Connected state, the NG-RAN sends one UE Notification message but no subsequent messages. If UE is in RRC-Inactive state, the NG-RAN sends one UE Notification message plus one subsequent UE Notification message when RRC state transits to RRC-Connected.

3. The AMF can send a Cancel UE State Notification message to inform the NG-RAN that it should terminate notifications for a given UE. This message should only be used when notification(s) about subsequent state transitions was requested at every RRC state transition.

## 4.9 Handover procedures

### 4.9.1 Handover procedures in 3GPP access

#### 4.9.1.1 General

These procedures are used to hand over a UE from a source NG-RAN node to a target NG-RAN node using the Xn or N2 reference points. This can be triggered, for example, due to new radio conditions, load balancing or due to specific service e.g. in the presence of QoS Flow for voice, the source NG-RAN node being NR may trigger handover to E-UTRA connected to 5GC.

The RRC Inactive Assistance Information is included in N2 Path Switch Request Ack message for Xn based handover or Handover Request message for N2 based handover (see clause 5.3.3.2.5 of TS 23.501 [2]).

#### 4.9.1.2 Xn based inter NG-RAN handover

##### 4.9.1.2.1 General

Clause 4.9.1.2 includes details regarding the Xn based inter NG-RAN handover with and without UPF re-allocation.

Xn handovers are only supported for intra-AMF mobility.

The handover preparation and execution phases are performed as specified in TS 38.300 [9], in the case of handover to a shared network, source NG-RAN determines a PLMN or an SNPN to be used in the target network as specified by TS 23.501 [2]. If the serving PLMN changes during Xn-based handover, the source NG-RAN node shall indicate to the target NG-RAN node (in the Mobility Restriction List) the selected PLMN ID to be used in the target network. During Xn based handover into a shared NG-RAN node the source NG RAN node shall include the serving NID (if available) in the Mobility Restriction List to be used by the target NG-RAN node.

NOTE: When an SNPN is used in the source NG-RAN, the same SNPN is used in the target network.

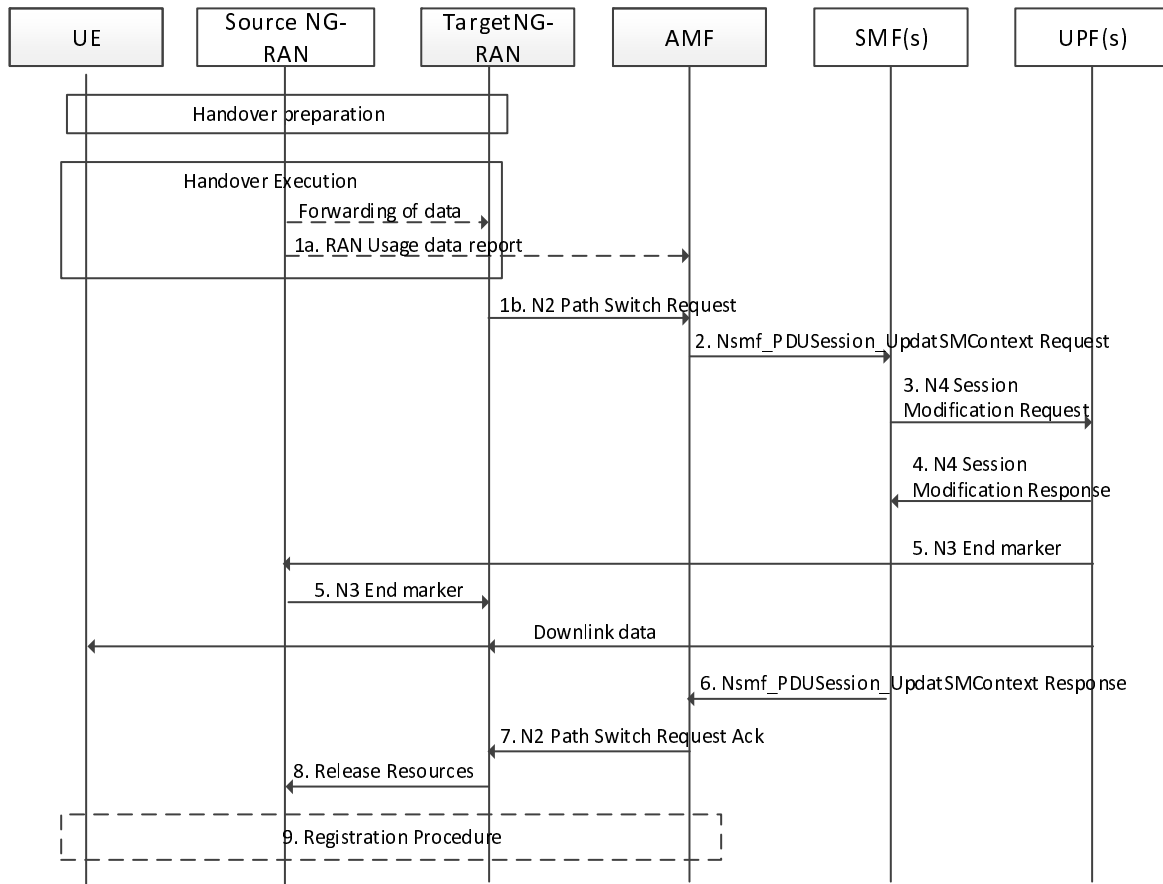
If the AMF generates the N2 downlink signalling during the ongoing handover and receives a rejection to a N2 interface procedure (e.g. Location Reporting Control; DL NAS message transfer; etc.) from the NG-RAN with an indication that a Xn based handover procedure is in progress, the AMF may reattempt the same N2 interface procedure either when the handover is complete or the handover is deemed to have failed, when possible. The failure is known by expiry of the timer guarding the N2 interface procedure.

Upon reception for an SMF initiated N1 and/or N2 request(s) with an indication that the request has been temporarily rejected due to handover procedure in progress, the SMF starts a locally configured guard timer. Any NF (e.g. the SMF) should hold any signalling messages targeted towards AMF for a given UE during the handover preparation phase unless it detects that the handover execution is completed or handover has failed/cancelled. The NF (e.g. the SMF) may re-attempt, up to a pre-configured number of times, when either it detects that the handover is completed or has failed using message reception or at expiry of the guard timer.

#### 4.9.1.2.2 Xn based inter NG-RAN handover without User Plane function re-allocation

This procedure is used to hand over a UE from a source NG-RAN to target NG-RAN using Xn when the AMF is unchanged and the SMF decides to keep the existing UPF. The UPF referred in this clause 4.9.1.2.2 is the UPF which terminates N3 interface in the 5GC for non-roaming or local breakout roaming scenario, V-UPF which terminates N3 interface in 5GC for home routed roaming scenario. The SMF referred in this clause 4.9.1.2.2 is the V-SMF for home routed roaming scenario. The presence of IP connectivity between the Source UPF and Target NG-RAN is assumed.

The call flow is shown in figure 4.9.1.2.2-1.



**Figure 4.9.1.2.2-1: Xn based inter NG-RAN handover without UPF re-allocation**

- 1a. If the PLMN has configured secondary RAT usage reporting, the source NG-RAN node during the handover execution phase may provide RAN usage data Report (N2 SM Information (Secondary RAT usage data), Handover Flag, Source to Target transparent container) to the AMF. The source NG-RAN node shall provide this only when the Target NG-RAN has confirmed handover over Xn interface. The Handover Flag indicates to the AMF that it should buffer the N2 SM Information containing the usage data report before forwarding it.

If the source NG-RAN and target NG-RAN support RACS as defined in TS 23.501 [2], the source NG-RAN provides the UE's UE Radio Capability ID to the target NG-RAN. If the source NG-RAN has knowledge that the target NG-RAN might not have a local copy of the Radio Capability corresponding to the UE Radio Capability ID (i.e. because the source NG-RAN had itself to retrieve the UE's Radio Capability from the AMF) then the source NG-RAN may also send some or all of the UE's Radio Capability to the target NG-RAN (the size limit based on local configuration) in Xn signalling as defined in TS 38.423 [72]. In the case of inter-PLMN handover, when the source and target NG-RAN support RACS as defined in TS 23.501 [2] and the source NG-RAN determines based on local configuration that the target PLMN does not support the UE Radio Capability ID assigned by the source PLMN, then the source NG-RAN shall provide the UE radio access capabilities to the target NG-RAN and shall not send the UE Radio Capability ID. If, as permitted in TS 38.423 [72], the target NG-RAN during the handover preparation received the UE radio access capabilities but did not receive the UE Radio Capability ID, NG-RAN shall proceed with handover using the received UE radio access capabilities. If the target NG-RAN received both the UE radio access capabilities and the UE Radio Capability ID, then the target NG-RAN shall use any locally stored UE radio access capability information corresponding to the UE

Radio Capability ID. If none are stored locally, the target NG-RAN may request the full UE radio access capability information from the core network. If the full UE radio access capability information is not promptly received from the core network, or the target NG-RAN chooses not to request them, then the target NG-RAN shall proceed with the UE radio access capabilities sent by the source NG-RAN. The target NG-RAN shall not use the UE radio access capability information received from the source NG-RAN for any other UE with the same the UE Radio Capability ID.

- 1b. Target NG-RAN to AMF: N2 Path Switch Request (List of PDU Sessions To Be Switched with N2 SM Information, List of PDU Sessions that failed to be established with the failure cause given in the N2 SM information element, UE Location Information)

The Target NG-RAN sends an N2 Path Switch Request message to an AMF to inform that the UE has moved to a new target cell and provides a List Of PDU Sessions To Be Switched. AN Tunnel Info for each PDU Session to be switched is included in the N2 SM Information.

If redundant transmission is performed for one or more QoS Flows in the PDU Session, two AN Tunnel Info are provided by the Target NG-RAN and the Target NG-RAN indicates to the SMF one of the AN Tunnel Info is used as the redundancy tunnel of the PDU Session as described in clause 5.33.2.2 of TS 23.501 [2]. If only one AN Tunnel Info is provided by the Target NG-RAN for the PDU session, the SMF may release these QoS Flows by triggering PDU Session Modification procedure as specified in clause 4.3.3 after the handover procedure.

The serving PLMN ID is included in the message. The target NG-RAN shall include the PDU Session in the PDU Sessions Rejected list:

- If none of the QoS Flows of a PDU Session are accepted by the Target NG-RAN; or
- If the corresponding network slice is not supported in the Target NG-RAN; or
- When the NG-RAN cannot set up user plane resources fulfilling the User Plane Security Enforcement with a value Required, the NG-RAN rejects the establishment of user plane resources for the PDU Session.

If the NG-RAN cannot set up user plane resources fulfilling the User Plane Security Enforcement with a value Preferred, the NG-RAN establishes the user plane resources for the PDU session and shall include the PDU Session in the PDU Sessions Modified list.

PDU Sessions Rejected contains an indication of whether the PDU session was rejected because User Plane Security Enforcement is not supported in the Target NG-RAN. Depending on the type of target cell, the Target NG-RAN includes appropriate information in this message.

For the PDU Sessions to be switched to the Target NG-RAN, the N2 Path Switch Request message shall include the list of accepted QoS Flows. For each QoS Flow accepted with an Alternative QoS Profile as specified in TS 23.501 [2], the N2 SM Information shall include a reference to the fulfilled Alternative QoS Profile.

2. AMF to SMF: Nsmf\_PDUSession\_UpdateSMContext Request (N2 SM information received from T-RAN in step 1b and N2 SM Information from source NG-RAN (Secondary RAT usage data), UE Location Information, UE presence in LADN service area). The N2 SM Information here from source NG-RAN is the one buffered at step 1a when applicable.

The AMF sends N2 SM information by invoking the Nsmf\_PDUSession\_UpdateSMContext request service operation for each PDU Session in the lists of PDU Sessions received in the N2 Path Switch Request.

The Nsmf\_PDUSession\_UpdateSMContext Request contains either an indication that the PDU Session Is To Be Switched (together with information on the N3 addressing to use and on the transferred QoS flows) or an indication that the PDU Session is to be Rejected (together with a rejection cause).

For a PDU Sessions to be switched to the Target NG-RAN, upon receipt of the Nsmf\_PDUSession\_UpdateSMContext request, the SMF determines whether the existing UPF can continue to serve the UE. If the existing UPF cannot continue to serve the UE, steps 3-11 of clause 4.9.1.2.3 or 4.9.1.2.4 are performed depending on whether the existing UPF is a PDU Session Anchor. Otherwise, the following steps 3 to 6 are performed if the existing UPFs can continue to serve the PDU Session.

In the case that the AMF determines that the PDU Session is related to a LADN, then the AMF provides the "UE presence in LADN service area" to the SMF. If the AMF does not provide the "UE presence in LADN service area" indication and the SMF determines that the DNN corresponds to a LADN, then the SMF considers that the

UE is OUT of the LADN service area. The SMF takes actions for the LADN PDU Session as defined in clause 5.6.5 of TS 23.501 [2] based on the "UE presence in LADN service area" indication.

If a PDU Session is rejected by the Target NG-RAN with an indication that the PDU session was rejected because User Plane Security Enforcement is not supported in the Target NG-RAN and the User Plane Enforcement Policy indicates "Required" as described in clause 5.10.3 of TS 23.501 [2], the SMF triggers the release of this PDU Session. In all other cases of PDU Session rejection, the SMF can decide whether to release the PDU Session or to deactivate the UP connection of this PDU Session.

If some of the QoS Flows of a PDU Session are not accepted by the Target NG-RAN, the SMF shall initiate the PDU Session Modification procedure to remove the non-accepted QoS Flows from the PDU Session(s) after the handover procedure is completed.

For the PDU Session(s) that do not have active N3 UP connections before handover procedure, the SMF(s) keep the inactive status after handover procedure.

If the UE moves into a non-Allowed Area, the AMF also notifies via Namf\_EventExposure\_Notify to each NF Consumer (e.g. SMFs of the established PDU Sessions) which has subscribed for UE reachability event, that the UE is only reachable for regulatory prioritized services. The SMF then deactivates the PDU session if this PDU Session is not for emergency service.

### 3. SMF to UPF: N4 Session Modification Request (AN Tunnel Info)

For PDU Sessions that are modified by the Target NG-RAN, the SMF sends an N4 Session Modification Request message to the UPF. The SMF may notify the UPF that originated the Data Notification to discard downlink data for the PDU Sessions and/or to not provide further Data Notification messages.

Depending on the network deployment, the CN Tunnel Info of UPF used for connection to Target NG-RAN and connection to Source NG-RAN may be different, e.g. due to Source and Target NG-RAN are in different IP domains. In this case the SMF may ask the UPF to allocate new CN Tunnel Info, providing the target Network Instance.

### 4. UPF to SMF: N4 Session Modification Response (CN Tunnel Info)

For the PDU Sessions that are switched, the UPF returns an N4 Session Modification Response message to the SMF after requested PDU Sessions are switched. Tunnel identifiers for UL traffic are included only for PDU Sessions whose user plane resources are not being released and was requested by the SMF. If redundant transmission is performed for one or more QoS Flows of a PDU Session and different CN Tunnel Info were requested by the SMF, the UPF allocates two different CN Tunnel Info and indicates the SMF that one CN Tunnel Info is used as the redundancy tunnel of the PDU session as described in clause 5.33.2.2 of TS 23.501 [2]. For the PDU Sessions that are deactivated, the UPF returns an N4 Session Modification Response message to the SMF after the N3 (R)AN tunnel information is released.

### 5. In order to assist the reordering function in the Target NG-RAN, the UPF (as specified in clause 5.8.2.9 of TS 23.501 [2]) sends one or more "end marker" packets for each N3 tunnel on the old path immediately after switching the path. The UPF starts sending downlink packets to the Target NG-RAN.

### 6. SMF to AMF: Nsmf\_PDUSession\_UpdateSMContext Response (N2 SM information)

The SMF sends an Nsmf\_PDUSession\_UpdateSMContext response (N2 SM Information (CN Tunnel Info, updated CN PDB for the accepted QoS Flows, Updated TSCAIs for the accepted QoS Flows)) to the AMF for PDU Sessions which have been switched successfully. The CN Tunnel Info of UPF send to AMF is used to setup N3 tunnel. If redundant transmission is performed for one or more QoS Flows of a PDU Session, two CN Tunnel Info are sent and the SMF indicates to the Target NG-RAN one of the CN Tunnel Info is used as the redundancy tunnel of the PDU Session as described in clause 5.33.2.2 of TS 23.501 [2]. The SMF sends an Nsmf\_PDUSession\_UpdateSMContext response without including the CN Tunnel Info to the AMF for the PDU Sessions for which user plane resources are deactivated or released and then the SMF releases the PDU Session(s) which is to be released using a separate procedure as defined in clause 4.3.4. For each accepted GBR QoS Flow of Delay-critical resource type, the dynamic CN PDB and TSCAI may be updated and sent to the Target NG-RAN by the SMF. The SMF may update the CN PDB and TSCAI in the response or using a separate PDU Session Modification procedure, based on local configuration.

If the Source NG-RAN does not support Alternative QoS Profiles (see TS 23.501 [2]) and the Target NG-RAN supports them, the SMF sends the Alternative QoS Profiles (see TS 23.501 [2]) to the Target NG-RAN on a per QoS Flow basis, if available.

NOTE: Step 6 can occur any time after receipt of N4 Session Modification Response at the SMF.

7. AMF to NG-RAN: N2 Path Switch Request Ack (N2 SM Information, Failed PDU Sessions, UE Radio Capability ID).

Once the Nsmf\_PDUSession\_UpdateSMContext response is received from all the SMFs, the AMF aggregates received CN Tunnel Info and sends this aggregated information as a part of N2 SM Information along with the Failed PDU Sessions in N2 Path Switch Request Ack to the Target NG-RAN. If none of the requested PDU Sessions have been switched successfully, the AMF shall send an N2 Path Switch Request Failure message to the Target NG-RAN.

If the UE Radio Capability ID is included in the N2 Path Switch Request Ack message, when there is no corresponding UE radio capabilities set for UE Radio Capability ID at the target NR-RAN, the target NG-RAN shall request the AMF to provide the UE radio capabilities set corresponding to UE Radio Capability ID to the target NG-RAN.

8. By sending a Release Resources message to the Source NG-RAN, the Target NG-RAN confirms success of the handover. It then triggers the release of resources with the Source NG-RAN.
9. [Conditional] The UE may initiate Mobility Registration Update procedure if one of the triggers of registration procedure applies as described in clause 4.2.2.2.2. In this case, only steps 1, 2, 3, 17 and 21 in clause 4.2.2.2.2 are performed.

For the mobility related events as described in clause 4.15.4, the AMF invokes the Namf\_EventExposure\_Notify service operation.

Upon reception of the Namf\_EventExposure\_Notify with an indication that UE is reachable only for regulatory prioritized service, the SMF deactivates the PDU Session if the service of the PDU Session is not regulatory prioritized. For home routed roaming case, the V-SMF triggers the deactivation of the PDU Session, in addition, the H-SMF refrains from sending downlink signalling if the signalling is not related to regulatory prioritized service upon receiving the notification.

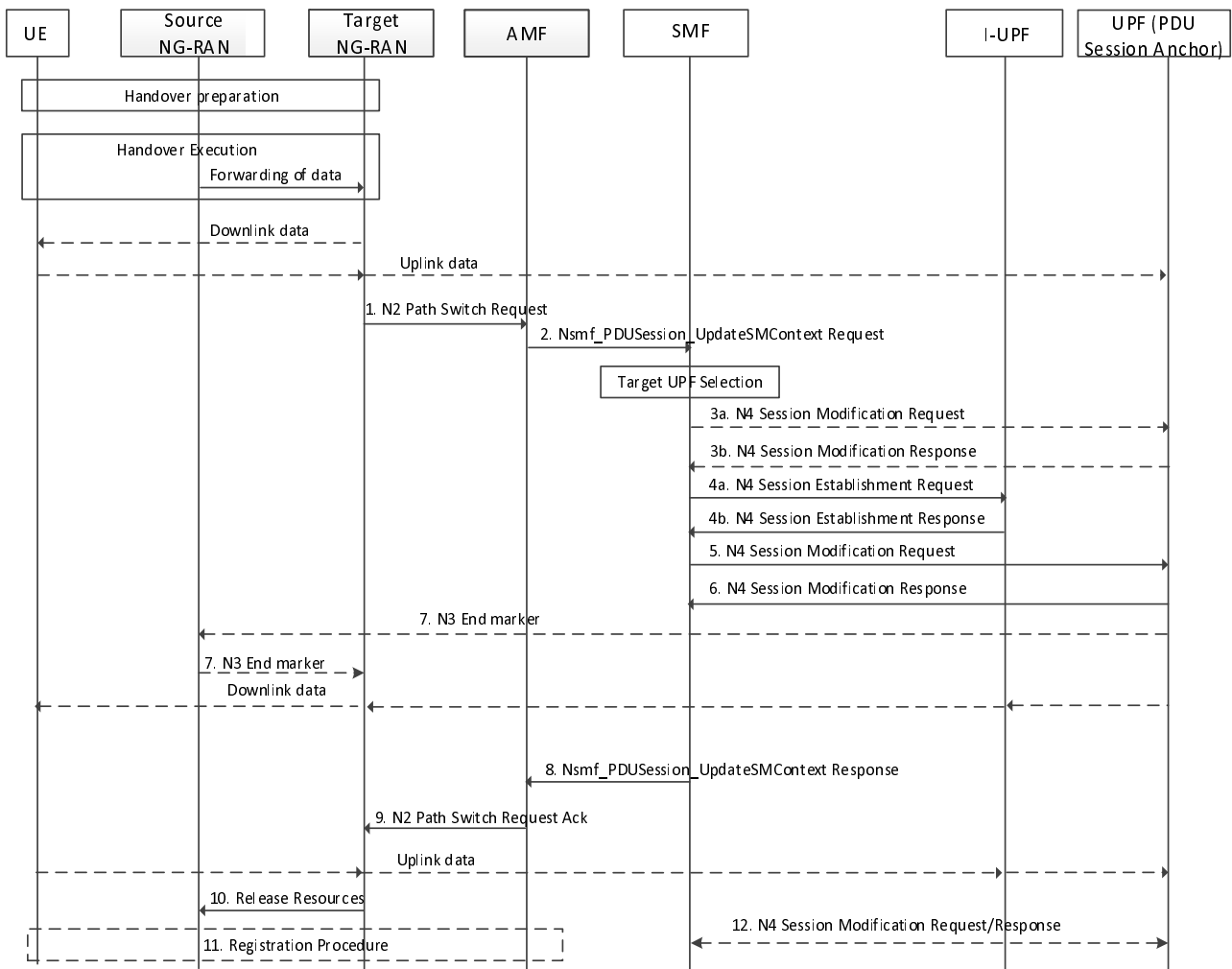
#### 4.9.1.2.3 Xn based inter NG-RAN handover with insertion of intermediate UPF

This procedure is used to hand over a UE from a Source NG-RAN to a Target NG-RAN using Xn when the AMF is unchanged and the SMF decides that insertion of a new additional intermediate UPF is needed. If redundant transmission is performed for one or more QoS Flows of a PDU Session to be switched to the target NG-RAN, the SMF may select two Intermediate UPFs (I-UPFs) and set up two N3 and N9 tunnels between the Target NG-RAN and the UPF (PSA) via the two I-UPFs as described in clause 5.33.2.2 of TS 23.501 [2].

In the case of using UL CL, the I-UPF can be regarded as UL CL and additional PSA providing local access to a DN. In the case of using Branching Point, the I-UPF can be regarded as BP.

It is assumed that the PDU Session for the UE comprises of only one UPF that acts as a PDU Session Anchor at the time of this Handover procedure for non-roaming and local breakout roaming scenario. In the case of home routed roaming scenario, the PDU Session of the UE comprises of at least one UPF in the VPLMN and one UPF in the HPLMN at the time of this handover procedure. In this case, additional insertion of an N3 terminating intermediate UPF will not have impact on the connectivity between the UPF in VPLMN and UPF in HPLMN. The presence of IP connectivity between the UPF (PDU Session Anchor) and Source NG-RAN, between the UPF (PDU Session Anchor) and Target NG-RAN and between the intermediate UPF (I-UPF) and Target NG-RAN, is assumed. (If there is no IP connectivity between UPF (PDU Session Anchor) and Target NG-RAN, it is assumed that the N2-based handover procedure in clause 4.9.1.3 shall be used instead).

The call flow is shown in figure 4.9.1.2.3-1.



**Figure 4.9.1.2.3-1: Xn based inter NG-RAN handover with insertion of intermediate UPF**

Steps 1-2 are the same as described in clause 4.9.1.2.2.

3a. [Conditional] SMF to UPF (PSA): N4 Session Modification Request.

If the SMF selects a new UPF to act as intermediate UPF for the PDU Session and the different CN Tunnel Info need be used, the SMF sends N4 Session Modification Request message to UPF (PSA).

3b. [Conditional] UPF (PSA) to SMF: N4 Session Modification Response.

The UPF (PSA) sends an N4 Session Establishment Response message to the SMF. The UPF provides CN Tunnel Info (on N9) to the SMF. If redundant transmission is performed for one or more QoS Flows of the PDU Session, the UPF (PSA) provides two CN Tunnel Info (on N9) to the SMF and indicates the SMF that one CN Tunnel Info is used as redundancy tunnel of the PDU Session as described in in clause 5.33.2.2 of TS 23.501 [2]. The UPF (PSA) associate the CN Tunnel Info (on N9) with UL Packet detection rules provided by the SMF.

4a. SMF to I-UPF: N4 Session Establishment Request (Target NG-RAN Tunnel Info, CN Tunnel Info of the PDU Session Anchor)

For PDU Sessions to be updated, if the UE has moved out of the service area of UPF connecting to the serving NG-RAN node, the SMF then selects an I-UPF based on UPF Selection Criteria according to clause 6.3.3 of TS 23.501 [2]. An N4 Session Establishment Request message is sent to the I-UPF. The CN Tunnel Info of the PDU Session Anchor, which is used to setup N9 tunnel, is included in the N4 Session Establishment Request message.

4b. I-UPF to SMF: N4 Session Establishment Response.

The I-UPF sends an N4 Session Establishment Response message to the SMF. The UL and DL CN Tunnel Info of I-UPF is sent to the SMF.



If SMF select two Intermediate UPFs (I-UPFs) to perform redundant transmission for a PDU session, step 4a and 4b are performed between the SMF and each I-UPF.

5. SMF to PDU Session Anchor: N4 Session Modification Request (DL CN Tunnel Info of the I-UPF).

The SMF sends N4 Session Modification Request message to the PDU Session Anchor.

If a different CN Tunnel Info is used on N9 in UPF (PSA), the SMF starts a timer to release the CN Tunnel for N3. Otherwise the SMF does not need to start a timer to release the CN Tunnel Info used on N3 in UPF(PSA) (i.e. CN Tunnel Info is common for both N3 and N9).

If redundant transmission is performed for one or more QoS Flows of the PDU Session, the SMF provides two DL CN Tunnel Info (for N9) to the UPF (PSA) and indicates to the UPF (PSA) one of the DL CN Tunnel Info is used as redundancy tunnel of the PDU Session.

6. PDU Session Anchor to SMF: N4 Session Modification Response.

The PDU Session Anchor responds with the N4 Session Modification Response message after requested PDU Sessions are switched. At this point, PDU Session Anchor starts sending downlink packets to the Target NG-RAN via I-UPF.

7. In order to assist the reordering function in the Target NG-RAN, the PDU Session Anchor sends one or more "end marker" packets for each N3 tunnel on the old path immediately after switching the path, the source NG-RAN shall forward the "end marker" packets to the target NG-RAN.
8. SMF to AMF: Nsmf\_PDUSession\_UpdateSMContext Response (N2 SM Information (UL CN Tunnel Info of the I-UPF, updated QoS parameters for accepted QoS Flows)).

The SMF sends an Nsmf\_PDUSession\_UpdateSMContext response to the AMF.

Steps 8-11 are same as steps 6-9 defined in clause 4.9.1.2.2.

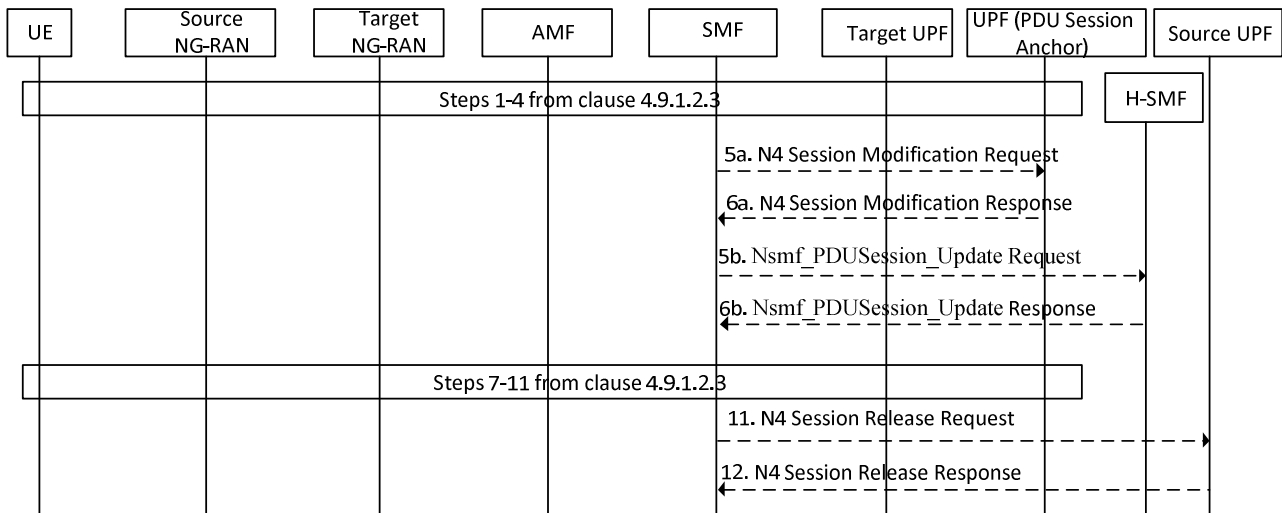
12. After the timer set in step 5 expires, the SMF informs the PDU Session Anchor to remove the CN Tunnel for N3 via N4 Session Modification procedure.

#### 4.9.1.2.4 Xn based inter NG-RAN handover with re-allocation of intermediate UPF

This procedure is used to hand over a UE from a Source NG-RAN to a Target NG-RAN using Xn when the AMF is unchanged and the SMF decides that the intermediate UPF (I-UPF) is to be changed. In the case of using UL CL, the I-UPF can be regarded as UL CL and additional PSA provides local access to a DN, the simultaneous change of UL-CL and the additional PSA is described in clause 4.3.5.7. In the case of using Branching Point, the I-UPF can be regarded as BP.

It is assumed that the PDU Session for the UE comprises of a UPF that acts as a PDU Session Anchor and an intermediate UPF at the time of this Handover procedure for non-roaming and local breakout roaming scenario. In the case of home routed roaming scenario, the PDU Session of the UE comprises of at least one UPF in the VPLMN and UPF in the HPLMN which acts as a PDU Session Anchor at the time of this handover procedure. The Source UPF referred in this clause 4.9.1.2.4 is the UPF which terminates N3 interface in the 5GC. The presence of IP connectivity between the Source UPF and Source NG-RAN, between the source UPF and Target NG-RAN and between the Target UPF and Target NG-RAN, is assumed. (If there is no IP connectivity between source UPF and Target NG-RAN, it is assumed that the N2-based handover procedure in clause 4.9.1.3 shall be used instead).

The call flow is shown in figure 4.9.1.2.4-1.



**Figure 4.9.1.2.4-1: Xn based inter NG-RAN handover with intermediate UPF re-allocation**

Steps 1-4 are same as steps 1-4 described in clause 4.9.1.2.3 except that the I-UPF in clause 4.9.1.2.3 is replaced by Target UPF.

5. [Conditional] The SMF sends N4 Session Modification Request message to the PDU Session Anchor. The DL CN Tunnel Info of the Target UPF is included in this message. If redundant transmission is performed for one or more QoS Flows of the PDU Session, the SMF provides two DL CN Tunnel Info (for N9) to the UPF (PSA) and indicates to the UPF (PSA) one of the DL CN Tunnel Info is used as redundancy tunnel of the PDU Session.

In the case of home routed roaming, if the N9 terminating V-UPF, which is connected to with home UPF, is changed, the V-SMF invokes an Nsmf\_PDUSession\_Update Request (DL CN Tunnel Info) service operation toward the H-SMF.

6. [Conditional] The SMF associated with the PDU Session Anchor responds with the N4 Session Modification Response message. In the case of home routed roaming, the H-SMF responds with the Nsmf\_PDUSession\_Update Response service operation toward the V-SMF once H-UPF is updated with the DL Tunnel Info of the T-UPF. At this point, PDU Session Anchor starts sending downlink packets to the Target NG-RAN via Target UPF.

Steps 7-11 are same as steps 7-11 described in clause 4.9.1.2.3 except that the I-UPF in clause 4.9.1.2.3 is replaced by Target UPF.

If the Source UPF acts as a UL CL or BP, the SMF indicates to only one of the PDU Session Anchors to send the "end marker" packets. To ensure the "end marker" is the last user plane packet on the old path, the SMF should modify the path on other PDU Session Anchors before it indicates the PDU Session Anchor to send the "end marker" packets.

11. The timer is started in step 4 if the source UPF is not the PSA UPF. When this timer is expired, the SMF initiates Source UPF(s) Release procedure by sending an N4 Session Release Request (Release Cause).
12. The Source UPF(s) acknowledges with an N4 Session Release Response message to confirm the release of resources.

### 4.9.1.3 Inter NG-RAN node N2 based handover

#### 4.9.1.3.1 General

Clause 4.9.1.3 includes details regarding the inter NG-RAN node N2 based handover without Xn interface.

The source NG-RAN decides to initiate an N2-based handover to the target NG-RAN. This can be triggered, for example, due to new radio conditions or load balancing, if there is no Xn connectivity to the target NG-RAN, an error indication from the target NG-RAN after an unsuccessful Xn-based handover (i.e. no IP connectivity between T-RAN and S-UPF), or based on dynamic information learnt by the S-RAN.

The availability of a direct forwarding path is determined in the source NG-RAN and indicated to the SMFs. If IP connectivity is available between the source and target NG-RAN and security association(s) is in place between them, a direct forwarding path is available.

If a direct forwarding path is not available, indirect forwarding may be used. The SMFs use the indication from the source NG-RAN to determine whether to apply indirect forwarding.

If both source NG-RAN and source AMF support DAPS the source NG-RAN may decide that some of the DRBs are subject for DAPS handover as defined in TS 38.300 [9]; in this case, the source NG-RAN provides the DAPS information indicating the request concerns a DAPS handover for the DRB as part of the Source to Target (NG-RAN) Transparent Container. If the target NG-RAN accepts that the request concerns DAPS handover and both Target NG-RAN and Target AMF support DAPS, the DAPS handover will be performed and target NG-RAN provides DAPS response information as part of the Target to Source (NG-RAN) Transparent Container.

In the case of handover to a shared network, the source NG-RAN determines a PLMN to be used in the target network as specified by TS 23.501 [2]. The source NG-RAN shall indicate the selected PLMN ID to be used in the target network to the AMF as part of the Tracking Area sent in the HO Required message.

NOTE: When an SNPN is used in the source NG-RAN, the same SNPN is used in the target network.

If the AMF generates the N2 downlink signalling during the ongoing handover and receives a rejection to a N2 interface procedure (e.g. DL NAS message transfer; Location reporting control; etc.) from the NG-RAN with an indication that an Inter NG-RAN node handover procedure is in progress, the AMF may reattempt the same N2 interface procedure either when the handover is complete or the handover is deemed to have failed if the AMF is still the serving AMF, when possible. If the Inter NG-RAN node handover changes the serving AMF, the source AMF shall terminate any other ongoing N2 interface procedures except the handover procedure.

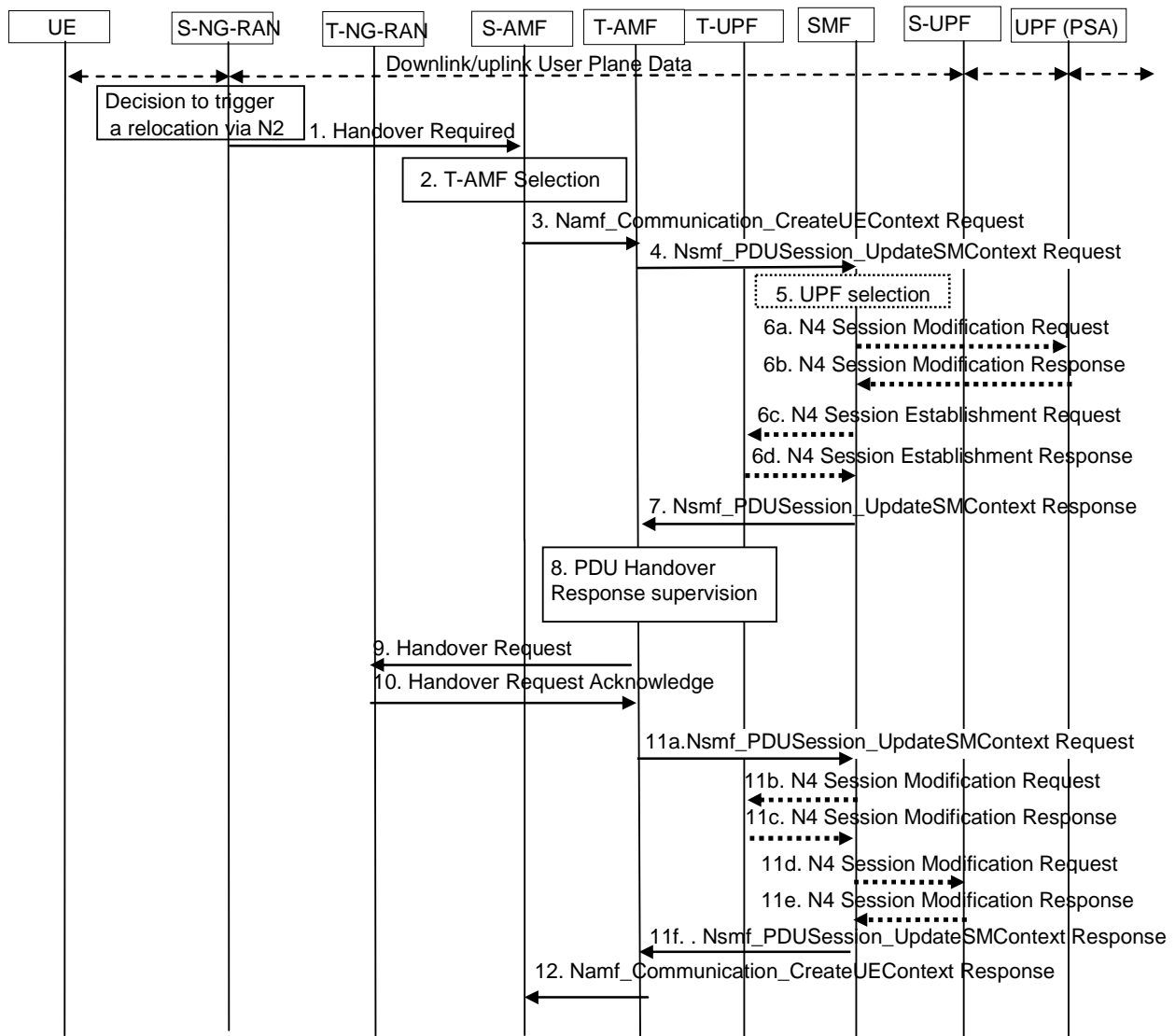
In order to minimize the number of procedures rejected by NG-RAN, the AMF should pause non-handover related N2 interface procedures (e.g. DL NAS message transfer, Location Report Control, etc.) while a handover is ongoing (i.e. from the time that a Handover Required has been received until either the Handover procedure has succeeded (Handover Notify) or failed (Handover Failure)) and continue them once the Handover procedure has completed if the AMF is still the serving AMF.

If during the handover procedure the AMF detects that the AMF needs be changed, the AMF shall reject any SMF initiated N2 request received since handover procedure started and shall include an indication that the request has been temporarily rejected due to handover procedure in progress.

Upon reception for an SMF initiated N1 and/or N2 request(s) with an indication either from the NG-RAN (via N2 SM Info) or AMF that the request has been temporarily rejected due to handover procedure in progress, the SMF starts a locally configured guard timer. The SMF should hold any signalling messages targeted towards AMF for a given UE during the handover preparation phase unless it detects that the handover execution is completed or handover has failed/cancelled. The SMF may re-attempt, up to a pre-configured number of times, when either it detects that the handover is completed or has failed using message reception or at expiry of the guard timer.

In the case of home routed roaming scenario, the SMF in the Inter NG-RAN node N2 based handover procedure (Figure 4.9.1.3.2-1 and Figure 4.9.1.3.3-1) interacting with the S-UPF, T-UPF, S-AMF and T-AMF is the V-SMF and the SMF (Figure 4.9.1.3.3-1) interacting with the UPF (PSA) is the H-SMF.

4.9.1.3.2 Preparation phase



**Figure 4.9.1.3.2-1: Inter NG-RAN node N2 based handover, Preparation phase**

1. S-RAN to S-AMF: Handover Required (Target ID, Source to Target transparent container, SM N2 info list, PDU Session IDs, intra system handover indication).

Source to Target transparent container includes NG-RAN information created by S-RAN to be used by T-RAN and is transparent to 5GC. It also contains for each PDU session the corresponding QoS flows /DRBs information subject to data forwarding. It may also contain DAPS Information if DAPS handover is supported by S-RAN and S-AMF and DAPS handover is requested for one or more DRBs as described in TS 38.300 [9].

All PDU Sessions handled by S-RAN (i.e. all existing PDU Sessions with active UP connections) shall be included in the Handover Required message, indicating which of those PDU Session(s) are requested by S-RAN to handover. The SM N2 info includes Direct Forwarding Path Availability if direct data forwarding is available.

Direct Forwarding Path Availability indicates whether direct forwarding is available from the S-RAN to the T-RAN. This indication from S-RAN can be based on e.g. the presence of IP connectivity and security association(s) between the S-RAN and the T-RAN.

If the source NG RAN and target NG RAN support RACS as defined in TS 23.501 [2], the Source to Target transparent container need not carry the UE radio access capabilities (instead the UE Radio Capability ID is supplied from the CN to the T-RAN). However, if the source NG-RAN has knowledge that the target NG-RAN might not have a local copy of the Radio Capability corresponding to the UE Radio Capability ID (i.e. because the source NG-RAN had itself to retrieve the UE's Radio Capability from the AMF) then the source NG-RAN

may also send some (or all) of the UE's Radio Capability to the target NG-RAN (the size limit based on local configuration). In the case of inter-PLMN handover, when the source and target NG-RAN support RACS as defined in TS 23.501 [2] and the source NG-RAN determines based on local configuration that the target PLMN does not support the UE Radio Capability ID assigned by the source PLMN, then the source NG-RAN includes the UE radio access capabilities in the Source to Target transparent container.

2. T-AMF Selection: When the S-AMF can't serve the UE anymore, the S-AMF selects the T-AMF as described in clause 6.3.5 on "AMF Selection Function" in TS 23.501 [2].
3. [Conditional] S-AMF to T-AMF: Namf\_Communication\_CreateUEContext Request (N2 Information (Target ID, Source to Target transparent container, SM N2 information list, PDU Session IDs), UE context information (SUPI, Service area restriction, Allowed NSSAI for each Access Type if available, Tracing Requirements, LTE M Indication, the list of PDU Session IDs along with the corresponding SMF information and the corresponding S-NSSAI(s), PCF ID(s), DNN, UE Radio Capability ID and UE Radio Capability Information). If the subscription information includes Tracing Requirements, the old AMF provides the target AMF with Tracing Requirements.

In inter PLMN mobility case, UE context information includes HPLMN S-NSSAIs corresponding to the Allowed NSSAI for each Access Type, without Allowed NSSAI of source PLMN. The target AMF may determine the Allowed NSSAI based on the HPLMN S-NSSAIs received in step 3, or else the target AMF queries the NSSF by invoking Nnssf\_NSSSelection\_Get service operation with the HPLMN S-NSSAIs and PLMN ID of SUPI.

The S-AMF initiates Handover resource allocation procedure by invoking the Namf\_Communication\_CreateUEContext service operation towards the T-AMF.

When the S-AMF can still serve the UE, this step and step 12 are not needed.

If Service area restrictions are available in the S-AMF, they may be forwarded to the T-AMF as described in clause 5.3.4.1.2 of TS 23.501 [2].

If both Home and Visited PCF ID(s) are provided by the S-AMF, the T-AMF contacts the (V-) PCF identified by the (V-)PCF ID. If the (V-)PCF identified by the (V-)PCF ID is not used or there are no PCF ID(s) received from the S-AMF, the T-AMF may select the PCF(s) as described in clause 6.3.7.1 of TS 23.501 [2] and according to the V-NRF to H-NRF interaction described in clause 4.3.2.2.3.3. The T-AMF informs the S-AMF that the PCF ID is not used, as defined in step 12 and then the S-AMF terminates the AM Policy Association with the PCF identified by the PCF ID.

4. [Conditional] T-AMF to SMF: Nsmf\_PDUSession\_UpdateSMContext (PDU Session ID, Target ID, T-AMF ID, N2 SM Information).

For each PDU Session indicated by S-RAN, the AMF invokes the Nsmf\_PDUSession\_UpdateSMContext Request to the associated SMF. However, if the S-NSSAI associated with PDU Session is not available in the T-AMF, the T-AMF does not invoke Nsmf\_PDUSession\_UpdateSMContext for this PDU Session.

PDU Session ID indicates a PDU Session candidate for N2 Handover. Target ID corresponds to Target ID provided by S-RAN in step 1. SM N2 Info includes the Direct Forwarding Path Availability if the direct data forwarding is available between the S-RAN and the T-RAN and has been inserted by the S-RAN.

If the (T-)AMF detects that the UE moves into a non-allowed area based on Service area restrictions, the (T-)AMF notifies each NF consumer which has subscribed for UE reachability event (e.g. SMFs corresponding to the list of PDU Sessions received in UE Context from (S-)AMF via Namf\_EventExposure\_Notify that the UE is only reachable for regulatory prioritized services.

5. [Conditional] Based on the Target ID, SMF checks if N2 Handover for the indicated PDU Session can be accepted. The SMF checks also the UPF Selection Criteria according to clause 6.3.3 of TS 23.501 [2]. If UE has moved out of the service area of the UPF connecting to NG-RAN, SMF selects a new intermediate UPF. If redundant transmission is performed for one or more QoS Flows of the PDU Session, the SMF selects two new Intermediate UPFs to support the redundant transmission based on two N3 and N9 tunnels between the T-RAN and the UPF (PSA) as described in clause 5.33.2.2 of TS 23.501 [2]. In this case, step 6c and 6d are performed between SMF and each T-UPF.

In the case that the SMF fails to find a suitable I-UPF, the SMF decides to (based on local policies) either:

- trigger re-establishment of PDU Session. After handover procedure, SMF sends N1 message to the UE via the AMF by invoking `Namf_Communication_N1N2MessageTransfer` containing the cause indicating PDU Session re-establishment is required for the UE; or
- keep the PDU Session, but reject the activation request of User Plane connection for the PDU Session and inform the AMF about it; or
- release the PDU Session after handover procedure.

6a. [Conditional] SMF to UPF (PSA): N4 Session Modification Request.

If the SMF selects a new UPF to act as intermediate UPF for the PDU Session and the different CN Tunnel Info need be used, the SMF sends N4 Session Modification Request message to UPF (PSA). The SMF provides the CN Tunnel Info (on N9) if the CN Tunnel Info is allocated by the SMF and UL Packet detection rules associate the CN Tunnel Info (on N9) to be installed on the UPF (PSA).

If redundant transmission is performed for one or more QoS Flows of the PDU Session and the different CN Tunnel Info need be used, the SMF provides two CN Tunnel Info (on N9) to the UPF (PSA) if the CN Tunnel Info is allocated by the SMF and indicates to the UPF (PSA) one of the CN Tunnel Info is used as redundancy tunnel of the PDU Session.

6b. [Conditional] UPF (PSA) to SMF: N4 Session Modification Response.

The UPF (PSA) sends an N4 Session Modification Response message to the SMF. If the UPF (PSA) allocates CN Tunnel Info (on N9) of UPF (PSA), it provides CN Tunnel Info (on N9) to the SMF. If redundant transmission is performed for one or more QoS Flows of the PDU Session, the UPF (PSA) provides two CN Tunnel Info (on N9) of UPF (PSA) to the SMF and indicates the SMF that one CN Tunnel Info is used as redundancy tunnel of the PDU Session as described in in clause 5.33.2.2 of TS 23.501 [2]. The UPF (PSA) associate the CN Tunnel Info (on N9) with UL Packet detection rules provided by the SMF.

6c. [Conditional] SMF to T-UPF (intermediate): N4 Session Establishment Request.

If the SMF selects a new intermediate UPF, i.e. the target UPF (T-UPF), for the PDU Session and if CN Tunnel Info is allocated by the T-UPF, an N4 Session Establishment Request message is sent to the T-UPF, providing Packet detection, enforcement and reporting rules to be installed on the T-UPF. The CN Tunnel Info (on N9) of UPF (PSA) for this PDU Session, which is used to setup N9 tunnel, is also provided to the T-UPF.

6d. T-UPF (intermediate) to SMF: N4 Session Establishment Response.

The T-UPF sends an N4 Session Establishment Response message to the SMF with DL CN Tunnel Info and UL CN Tunnel Info (i.e. N3 tunnel info). The SMF starts a timer to release the resource of S-UPF, which is to be used in step 13a of the Execution Phase.

7. SMF to T-AMF: `Nsmf_PDUSession_UpdateSMContext` Response (PDU Session ID, N2 SM Information, Reason for non-acceptance).

If N2 handover for the PDU Session is accepted, the SMF includes in the `Nsmf_PDUSession_UpdateSMContext` response the N2 SM Information containing the N3 UP address and the UL CN Tunnel ID of the UPF, the QoS parameters, TSCAI and the User Plane Security Enforcement information for the Target NG-RAN. If redundant transmission is performed for one or more QoS Flows of the PDU Session, two UL CN Tunnel Info are included in the N2 SM Information. If the N2 SM information received at step 4 does not include the Direct Forwarding Path Availability and the SMF knows that there is no indirect data forwarding connectivity between source and target, the N2 SM Information includes a Data forwarding not possible indication. If the SMF indicated that Direct Forwarding is applicable in step 4, the SMF should further include a "Direct Forwarding Path Availability" indication in the N2 SM information container. The SMF sends the Alternative QoS Profiles (see TS 23.501 [2]) to the Target NG-RAN on a per QoS Flow basis, if available.

If N2 handover for the PDU Session is not accepted as described in step 5, the SMF does not include an N2 SM Information regarding the PDU Session to avoid establishment of radio resources at the target NG-RAN. Instead of that, the SMF provides a reason for non-acceptance. If the SMF has received notification from (T-)AMF that the UE is only reachable for regulatory prioritized services, the SMF does not include any N2 SM info regarding the PDU Session for non-regulatory prioritized services to avoid establishment of radio resources at the target NG-RAN. If the SMF receives notification from (T-)AMF that UE is only reachable for regulatory prioritized service after this step via `Namf_EventExposure_Notify`, the SMF deactivates the PDU Session after handover procedure finish if the PDU Session is not for regulatory prioritized services.

8. AMF supervises the Nsmf\_PDUSession\_UpdateSMContext Response messages from the involved SMFs. The lowest value of the Max delay indications for the PDU Sessions that are candidates for handover gives the maximum time AMF may wait for Nsmf\_PDUSession\_UpdateSMContext Response messages before continuing with the N2 Handover procedure. At expiry of the maximum wait time or when all Nsmf\_PDUSession\_UpdateSMContext Response messages are received, AMF continues with the N2 Handover procedure (Handover Request message in step 9).

NOTE: The delay value for each PDU Session is locally configured in the AMF and implementation specific.

9. T-AMF to T-RAN: Handover Request (Source to Target transparent container, N2 MM Information, N2 SM Information list, Tracing Requirements, UE Radio Capability ID). If the subscription information includes Tracing Requirements, the target AMF provides the target RAN with Tracing Requirements in the Handover Request.

T-AMF determines T-RAN based on Target ID. T-AMF may allocate a 5G-GUTI valid for the UE in the AMF and target TAI.

Source to Target transparent container is forwarded as received from S-RAN. N2 MM Information includes e.g. security information and Mobility Restriction List if available in the T-AMF.

N2 SM Information list includes N2 SM Information received from SMFs for the T-RAN in the Nsmf\_PDUSession\_UpdateSMContext Response messages received within allowed max delay supervised by the T-AMF mentioned in step 8.

Mobility Restriction List is sent in N2 MM Information if available in the Target AMF.

T-AMF provides the UE Radio Capability ID to T-RAN if RACS is supported. If the UE Radio Capability ID is included in the Handover Request message and no UE radio access capabilities are provided in the Source to Target transparent container, when there is no corresponding UE radio capabilities set for UE Radio Capability ID at T-RAN, T-RAN shall request the T-AMF to provide the UE radio capabilities set corresponding to UE Radio Capability ID to the T-RAN. If the Source to Target transparent container contains the UE radio access capabilities and the T-RAN did not receive the UE Radio Capability ID from the T-AMF, NG-RAN shall proceed with handover using the received UE radio access capabilities. If the T-RAN received both the UE radio access capabilities and the UE Radio Capability ID, then the T-RAN shall use any locally stored UE radio access capability information corresponding to the UE Radio Capability ID. If none are stored locally, the T-RAN may request the full UE radio access capability information from the core network. If the full UE radio access capability information is not promptly received from the core network, or the T-RAN chooses not to request them, then the T-RAN shall proceed with the UE radio access capabilities sent by the source RAN node. The T-RAN shall not use the UE radio access capability information received from the source RAN node for any other UE with the same the UE Radio Capability ID.

10. T-RAN to T-AMF: Handover Request Acknowledge (Target to Source transparent container, List of PDU Sessions to Hand-over with N2 SM information, List of PDU Sessions that failed to be established with the failure cause given in the N2 SM information element).

Target to Source transparent container includes a UE container with an access stratum part and a NAS part. The UE container is sent transparently via T-AMF, S-AMF and S-RAN to the UE. If DAPS handover is supported by the T-RAN and T-AMF and the DAPS Information for one or more DRBs had been received in the Source to Target Transparent Container, the T-RAN includes the DAPS Response information in the Target to Source Transparent Container as described in TS 38.300 [9].

T-RAN creates List Of PDU Sessions failed to be setup and reason for failure (e.g. T-RAN decision, S-NSSAI is not available, unable to fulfil User Plane Security Enforcement) based on T-RAN determination. The information is provided to the S-RAN.

The N2 SM information in the List Of PDU Sessions to Hand-over, contains per each PDU Session ID T-RAN N3 addressing information i.e. N3 UP address and Tunnel ID of T-RAN for the PDU Session.

If redundant transmission is performed for one or more QoS Flows of the PDU Session, the T-RAN provides two AN Tunnel Info for the PDU Session in the N2 SM information. The T-RAN indicates to the SMF one of the AN Tunnel Info is used as the redundancy tunnel of the PDU session as described in clause 5.33.2.2 of TS 23.501 [2]. If only one AN Tunnel Info is provided by the Target NG-RAN for the PDU session, the SMF may release these QoS Flows by triggering PDU Session Modification procedure as specified in clause 4.3.3 after the handover procedure.

The N2 SM information may also include:

- an Indication whether UP integrity protection is performed or not on the PDU Session based on User Plane Security Enforcement information received in N2 SM information in step 9.
- if the PDU Session has at least one QoS Flow subject for data forwarding, N3 UP address and Tunnel ID of T-RAN for receiving forwarded data. The T-RAN provides data forwarding addresses for each data forwarding tunnel which it decided to setup.
- For each QoS Flow accepted with an Alternative QoS Profile (see TS 23.501 [2]), the Target NG-RAN shall include a reference to the fulfilled Alternative QoS Profile.

- 11a. AMF to SMF: Nsmf\_PDUSession\_UpdateSMContext Request (PDU Session ID, N2 SM response received from T-RAN in step 10).

For each N2 SM response received from the T-RAN (N2 SM information included in Handover Request Acknowledge), AMF sends the received N2 SM response to the SMF indicated by the respective PDU Session ID.

If no new T-UPF is selected, SMF stores the N3 tunnel info of T-RAN from the N2 SM response if N2 handover is accepted by T-RAN.

The SMF/UPF allocates the N3 UP address and Tunnel IDs for indirect data forwarding corresponding to the data forwarding tunnel endpoints established by T-RAN.

If a PDU Session is indicated as a rejected PDU Session by the Target NG-RAN with an indication that the PDU session was rejected because User Plane Security Enforcement is not supported in the Target NG-RAN and the User Plane Enforcement Policy indicates "Required" as described in clause 5.10.3 of TS 23.501 [2], the SMF triggers the release of this PDU Session. In all other cases of PDU Session rejection, the SMF can decide whether to release the PDU Session (possibly triggering the re-establishment of the PDU Session as described in step 5) or to deactivate the UP connection of this PDU Session.

If some of the QoS Flows of a PDU Session are not accepted by the Target NG-RAN, the SMF shall initiate the PDU Session Modification procedure to remove the non-accepted QoS Flows from the PDU Session(s) after the handover procedure is completed.

- 11b. [Conditional] SMF to T-UPF: N4 Session Modification Request (T-RAN SM N3 forwarding Information list, indication to allocate DL forwarding tunnel(s) for indirect forwarding)

If the SMF selected a T-UPF in step 6a, the SMF updates the T-UPF by providing the T-RAN SM N3 forwarding information list by sending a N4 Session Modification Request to the T-UPF.

If indirect forwarding applies based on indication from the S-RAN and the UPF is re-allocated and if the SMF decides to setup the indirect forwarding tunnel on the same T-UPF, the SMF also requests in the N4 Session Modification Request message to the T-UPF, to allocate DL forwarding tunnel(s) for indirect forwarding.

Indirect forwarding may be performed via a UPF which is different from the T-UPF, in which case the SMF selects a T-UPF for indirect forwarding.

- 11c. [Conditional] T-UPF to SMF: N4 Session Modification Response (T-UPF SM N3 forwarding Information list).

The T-UPF allocates Tunnel Info and returns an N4 Session Modification Response message to the SMF.

The T-UPF SM N3 forwarding info list includes T-UPF N3 address, T-UPF N3 Tunnel identifiers for forwarding data

- 11d. [Conditional] SMF to S-UPF: N4 Session Modification Request (T-RAN SM N3 forwarding Information list or T-UPF SM N3 forwarding Information list, indication to allocate DL forwarding tunnel(s) for indirect forwarding).

If the UPF is re-allocated, this message includes the T-UPF SM N3 forwarding info list. If the UPF is not re-allocated, this message includes the T-RAN SM N3 forwarding info list.



If indirect forwarding applies based on indication from NG-RAN and UPF allocates tunnel identities, the SMF indicates in the N4 Session Modification Request message to the S-UPF to allocate DL forwarding tunnel(s) for indirect forwarding.

Indirect forwarding may be performed via a UPF which is different from the S-UPF.

- 11e. [Conditional] S-UPF to SMF: N4 Session Modification Response (S-UPF SM N3 forwarding Information list).

The S-UPF allocates Tunnel Info and returns an N4 Session establishment Response message to the SMF.

The S-UPF SM N3 forwarding Information list includes S-UPF N3 address, S-UPF N3 Tunnel identifiers for DL data forwarding.

- 11f. SMF to T-AMF: Nsmf\_PDUSession\_UpdateSMContext Response (N2 SM Information).

The SMF sends an Nsmf\_PDUSession\_UpdateSMContext Response message per PDU Session to T-AMF.

The SMF creates an N2 SM information containing the DL forwarding Tunnel Info to be sent to the S-RAN by the AMF. The SMF includes this information in the Nsmf\_PDUSession\_UpdateSMContext response. The DL forwarding Tunnel Info can be one of the following information:

- If direct forwarding applies, then the SMF includes the T-RAN N3 forwarding information the SMF received in step 11a.
- If the indirect forwarding tunnel is setup in step 11b or 11d, then the SMF includes the T-UPF or S-UPF DL forwarding information containing the N3 UP address and the DL Tunnel ID of the UPF.

12. [Conditional] T-AMF to S-AMF: Namf\_Communication\_CreateUEContext Response (N2 information necessary for S-AMF to send Handover Command to S-RAN including Target to Source transparent container, PDU Sessions failed to be setup list, N2 SM information (N3 DL forwarding Information, PCF ID)).

AMF supervises the Nsmf\_PDUSession\_UpdateSMContext Response message from the involved SMFs. At expiry of the maximum wait time or when all Nsmf\_PDUSession\_UpdateSMContext Response messages are received, T-AMF sends the Namf\_Communication\_CreateUEContext Response to the S-AMF.

The PDU Sessions failed to be setup list includes the List Of PDU Sessions failed to be setup received from target RAN in step 10 and the Non-accepted PDU session List generated by the T-AMF.

Non-accepted PDU Session List includes following PDU Session(s) with proper cause value:

- Non-accepted PDU Session(s) by the SMF(s);
- Non-accepted PDU Session(s) by the AMF due to no response from the SMF within maximum wait time; and
- Non-accepted PDU Session(s) by the AMF due to non-available S-NSSAI in the T-AMF, which is decided at step 4.

The Target to Source transport container is received from the T-RAN. The N2 SM Information is received from the SMF in step 11f.

4.9.1.3.3 Execution phase

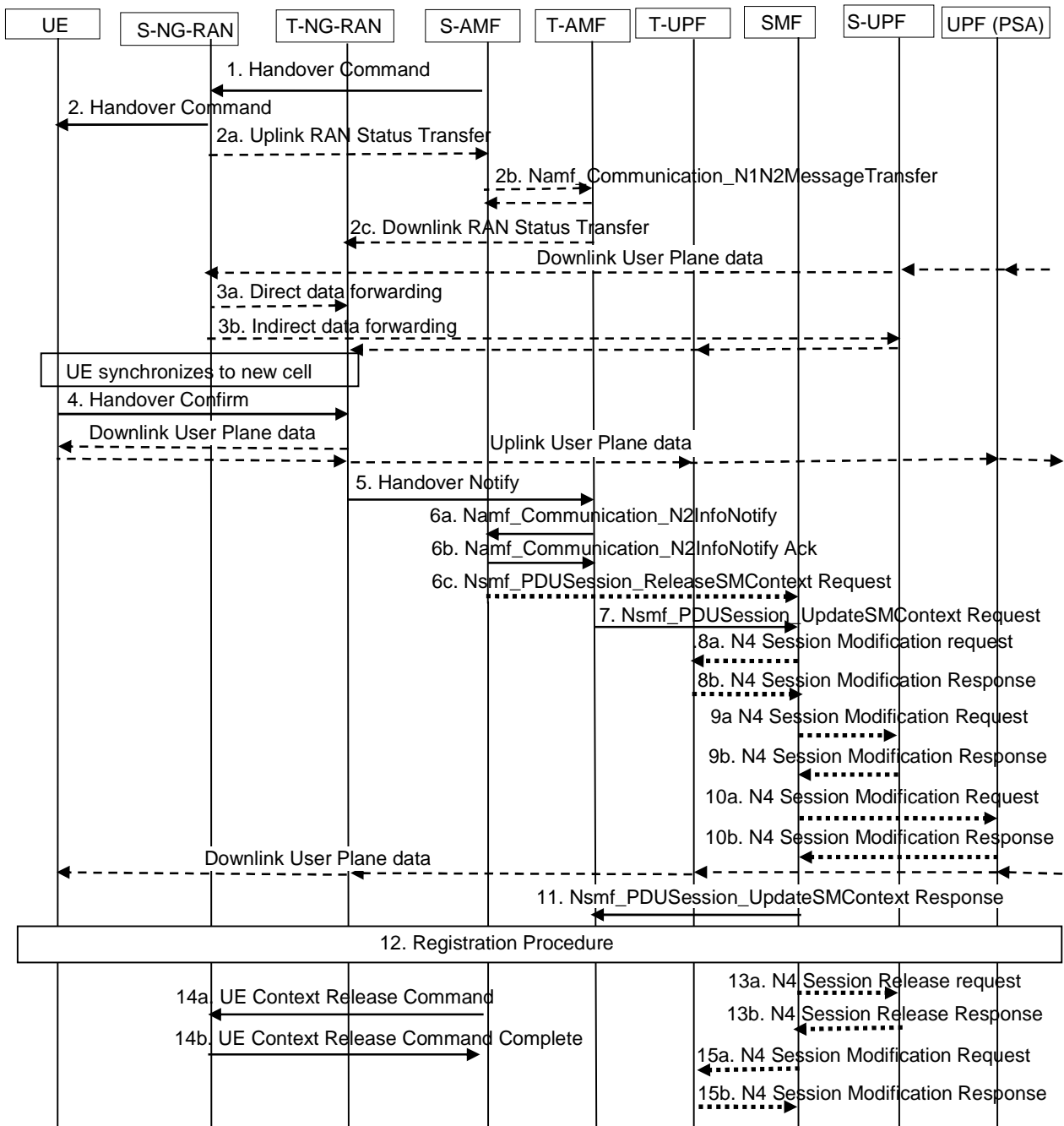


Figure 4.9.1.3.3-1: inter NG-RAN node N2 based handover, execution phase

NOTE 1: Registration of serving AMF with the UDM is not shown in the figure for brevity.

1. S-AMF to S-RAN: Handover Command (Target to Source transparent container, List Of PDU Sessions to be handed-over with N2 SM information containing information received from T-RAN during the handover preparation phase, List Of PDU Sessions failed to be setup).

Target to Source transparent container is forwarded as received from S-AMF. If DAPS Response information for one or more DRBs is received by S-RAN and indicates that DAPS handover is accepted, the execution phase for DAPS handover procedure as described in clause 4.9.1.3.3a is performed.

The SM forwarding info list includes T-RAN SM N3 forwarding info list for direct forwarding or S-UPF SM N3 forwarding info list for indirect data forwarding

S-RAN uses the PDU Sessions failed to be setup list and the indicated reason for failure to decide whether to proceed with the N2 Handover procedure.

If the S-RAN supports and receives a reference to an Alternative QoS Profile for an accepted QoS Flow, it shall take it into account for deciding whether or not to proceed with the N2 Handover procedure (see TS 23.501 [2]).

2. S-RAN to UE: Handover Command (UE container).

UE container is a UE part of the Target to Source transparent container which is sent transparently from T-RAN via AMF to S-RAN and is provided to the UE by the S-RAN.

2a0. If the PLMN has configured secondary RAT usage reporting and the source NG-RAN has Secondary RAT usage data to report, the source NG-RAN node may provide RAN usage data report message (N2 SM Information (Secondary RAT usage data), Handover Flag) as in clause 4.21 to the AMF. The Handover Flag indicates to the AMF that it should buffer the N2 SM Information containing the usage data report before forwarding it.

NOTE 2: This step is not shown in this figure but the secondary RAT usage data reporting procedure is shown in figure 4.21-1 in clause 4.21.

2a. - 2c. The S-RAN sends the Uplink RAN Status Transfer message to the S-AMF, as specified in TS 36.300 [46] and TS 38.300 [9]. The S-RAN may omit sending this message if none of the radio bearers of the UE shall be treated with PDCP status preservation.

If there is an AMF relocation, the S-AMF sends this information to the T-AMF via the Namf\_Communication\_N1N2MessageTransfer service operation and the T-AMF acknowledges. The S-AMF or, if the AMF is relocated, the T-AMF, sends the information to the T-RAN via the Downlink RAN Status Transfer message, as specified in TS 36.300 [46] and TS 38.300 [9].

3. Uplink packets are sent from T-RAN to T-UPF and UPF (PSA). Downlink packets are sent from UPF (PSA) to S-RAN via S-UPF. The S-RAN should start forwarding of downlink data from the S-RAN towards the T-RAN for QoS Flows or DRBs subject to data forwarding. This may be either direct (step 3a) or indirect forwarding (step 3b).

4. UE to T-RAN: Handover Confirm.

After the UE has successfully synchronized to the target cell, it sends a Handover Confirm message to the T-RAN. Handover is by this message considered as successful by the UE.

5. T-RAN to T-AMF: Handover Notify.

Handover is by this message considered as successful in T-RAN.

6a. [Conditional] T-AMF to S-AMF: Namf\_Communication\_N2InfoNotify.

The T-AMF notifies to the S-AMF about the N2 handover notify received from the T-RAN by invoking the Namf\_Communication\_N2InfoNotify.

A timer in S-AMF is started to supervise when resources in S-RAN shall be release.

6b. [Conditional] S-AMF to T-AMF: Namf\_Communication\_N2InfoNotify ACK (N2 SM Information (Secondary RAT usage data)).

The S-AMF acknowledges by sending the Namf\_Communication\_N2InfoNotify ACK to the T-AMF. The N2 SM Information here is the one buffered at step 2a0 when applicable.

6c. [Conditional] S-AMF to SMF: Nsmf\_PDUSession\_ReleaseSMContext Request (SM Context ID, N2 SM Information (Secondary RAT Usage Data)).

If the PDU Session(s) is not accepted by the T-AMF (e.g. S-NSSAI associated with the PDU Session is not available in the T-AMF), S-AMF triggers PDU Session Release procedure as specified in clause 4.3.4.2 after the S-AMF is notified for the reception of N2 Handover Notify in step 6a.

7. T-AMF to SMF: Nsmf\_PDUSession\_UpdateSMContext Request (Handover Complete indication for PDU Session ID, UE presence in LADN service area, N2 SM Information (Secondary RAT usage data)). The N2 SM Information here is the one received at step 6b when applicable.

Handover Complete indication is sent per each PDU Session to the corresponding SMF to indicate the success of the N2 Handover.

When an Nsmf\_PDUSession\_UpdateSMContext Response message arrived too late during the handover preparation phase (see step 8 of clause 4.9.1.3.2), or the PDU Session with SMF involvement is not accepted by T-RAN, Nsmf\_PDUSession\_UpdateSMContext Request (SM Context ID, Operation Type) is sent to the corresponding SMF allowing the SMF to deallocate a possibly allocated N3 UP address and Tunnel ID of the selected UPF. A PDU Session handled by that SMF is considered deactivated and handover attempt is terminated for that PDU Session.

In the case that the AMF determines that the PDU Session is related to a LADN then the AMF provides the "UE presence in LADN service area". If the AMF does not provide the "UE presence in LADN service area" indication and the SMF determines that the DNN corresponds to a LADN, then the SMF considers that the UE is OUT of the LADN service area.

The SMF takes actions for the LADN PDU Session as defined in clause 5.6.5 of TS 23.501 [2] based on the "UE presence in LADN service area" indication.

For each QoS Flow for which the SMF has received a reference to the fulfilled Alternative QoS Profile in step 10 of clause 4.9.1.3.2, the SMF notifies the PCF and the UE as described in TS 23.501 [2].

8a. [Conditional] SMF to T-UPF (intermediate): N4 Session Modification Request.

If new T-UPF is inserted or an existing intermediate S-UPF is re-allocated, the SMF shall send N4 Session Modification Request indicating DL AN Tunnel Info of T-RAN to the T-UPF.

8b. [Conditional] T-UPF to SMF: N4 Session Modification Response.

The T-UPF acknowledges by sending N4 Session Modification Response message to SMF.

9a. [Conditional] SMF to S-UPF (intermediate): N4 Session Modification Request.

If UPF is not re-allocated, the SMF shall send N4 Session Modification Request indicating DL AN Tunnel Info of T-RAN to the S-UPF.

9b. [Conditional] S-UPF to SMF: N4 Session Modification Response.

The S-UPF acknowledges by sending N4 Session Modification Response message to SMF.

10a. [Conditional] SMF to UPF (PSA): N4 Session Modification Request.

For non-roaming or local breakout roaming scenario, the SMF sends N4 Session Modification Request message to PDU Session Anchor UPF, UPF (PSA), providing N3 AN Tunnel Info of T-RAN or the DL CN Tunnel Info of T-UPF if a new T-UPF is inserted or an existing intermediate S-UPF is re-allocated. If redundant transmission is performed for one or more QoS Flows of the PDU Session, two N3 AN Tunnel Info of T-RAN or two DL CN Tunnel Info of two T-UPFs are provided and the SMF indicates to the UPF (PSA) one of the AN/CN Tunnel Info is used as redundancy tunnel of the PDU Session. If the existing intermediate S-UPF terminating N9 toward the H-UPF (PDU Session Anchor) is re-allocated for the home routed roaming scenario, the V-SMF invokes an Nsmf\_PDUSession\_Update Request (DL CN Tunnel Info) service operation toward the H-SMF.

In the case of the S-UPF acts as a UL CL or BP, the SMF indicates only one of the PDU Session Anchors to send the "end marker" packets. To ensure the "end marker" is the last user plane packet on the old path, the SMF should modify the path on other PDU Session Anchors before it indicates the PDU Session Anchor to send the "end marker" packets.

If T-UPF is not inserted or an existing intermediate S-UPF is not re-allocated, step 10a and step 10b are skipped.

10b. [Conditional] UPF (PSA) to SMF: N4 Session Modification Response.

The UPF (PSA) sends N4 Session Modification Response message to SMF. In order to assist the reordering function in the T-RAN, the UPF (PSA) sends one or more "end marker" packets for each N3 tunnel on the old path immediately after switching the path, the source NG-RAN shall forward the "end marker" packets to the target NG-RAN. At this point, UPF (PSA) starts sending downlink packets to the T-RAN, via T-UPF if a new T-UPF is inserted or an existing intermediate S-UPF is re-allocated. In the case of home routed roaming scenario, the H-SMF responds with the Nsmf\_PDUSession\_Update Response service operation to V-SMF once the H-UPF (PDU Session Anchor) is updated with the UL Tunnel Info of the T-UPF.

When there are multiple UPFs(PSA), step 10a and step 10b are performed for each UPFs(PSA).

11. SMF to T-AMF: Nsmf\_PDUSession\_UpdateSMContext Response (PDU Session ID).

SMF confirms reception of Handover Complete.

If indirect data forwarding applies, the SMF starts an indirect data forwarding timer, to be used to release the resource of indirect data forwarding tunnel.

12. The UE initiates Mobility Registration Update procedure as described in clause 4.2.2.2.2.

The target AMF knows that it is a Handover procedure and therefore the target AMF performs only a subset of the Registration procedure, specifically the steps 4, 5 and 10 in the Registration procedure for the context transfer between source AMF and target AMF are skipped.

The target AMF, based on the S-NSSAIs subject to Network Slice-Specific Authentication and Authorization status information from source AMF in step 3 of clause 4.9.1.3.2, may decide to skip step 25 in the Registration procedure (i.e. NSSAA procedure) or whether to perform it if the status is pending.

13a. [Conditional] SMF to S-UPF (intermediate): N4 Session Release Request.

If there is a source intermediate UPF, the SMF initiates resource release, after timer in step 6 or indirect data forwarding timer expires, by sending an N4 Session Release Request (Release Cause) to source UPF. This message is also used to release the indirect data forwarding resource in S-UPF.

13b. S-UPF to SMF: N4 Session Release Response.

The S-UPF acknowledges with an N4 Session Release Response message to confirm the release of resources.

In the case of indirect data forwarding, the resource of indirect data forwarding is also released.

14a. AMF to S-RAN: UE Context Release Command ().

After the timer in step 6a expires, the AMF sends UE Context Release Command.

14b. S-RAN to AMF: UE Context Release Complete ().

The source NG-RAN releases its resources related to the UE and responds with a UE Context Release Complete () message.

15a. [Conditional] SMF to T-UPF: N4 Session Modification Request.

If indirect forwarding applies and UPF is re-allocated, after timer of indirect data forwarding expires, the SMF sends N4 Session Modification Request to T-UPF to release the indirect data forwarding resource.

15b. [Conditional] T-UPF to SMF: N4 Session Modification Response.

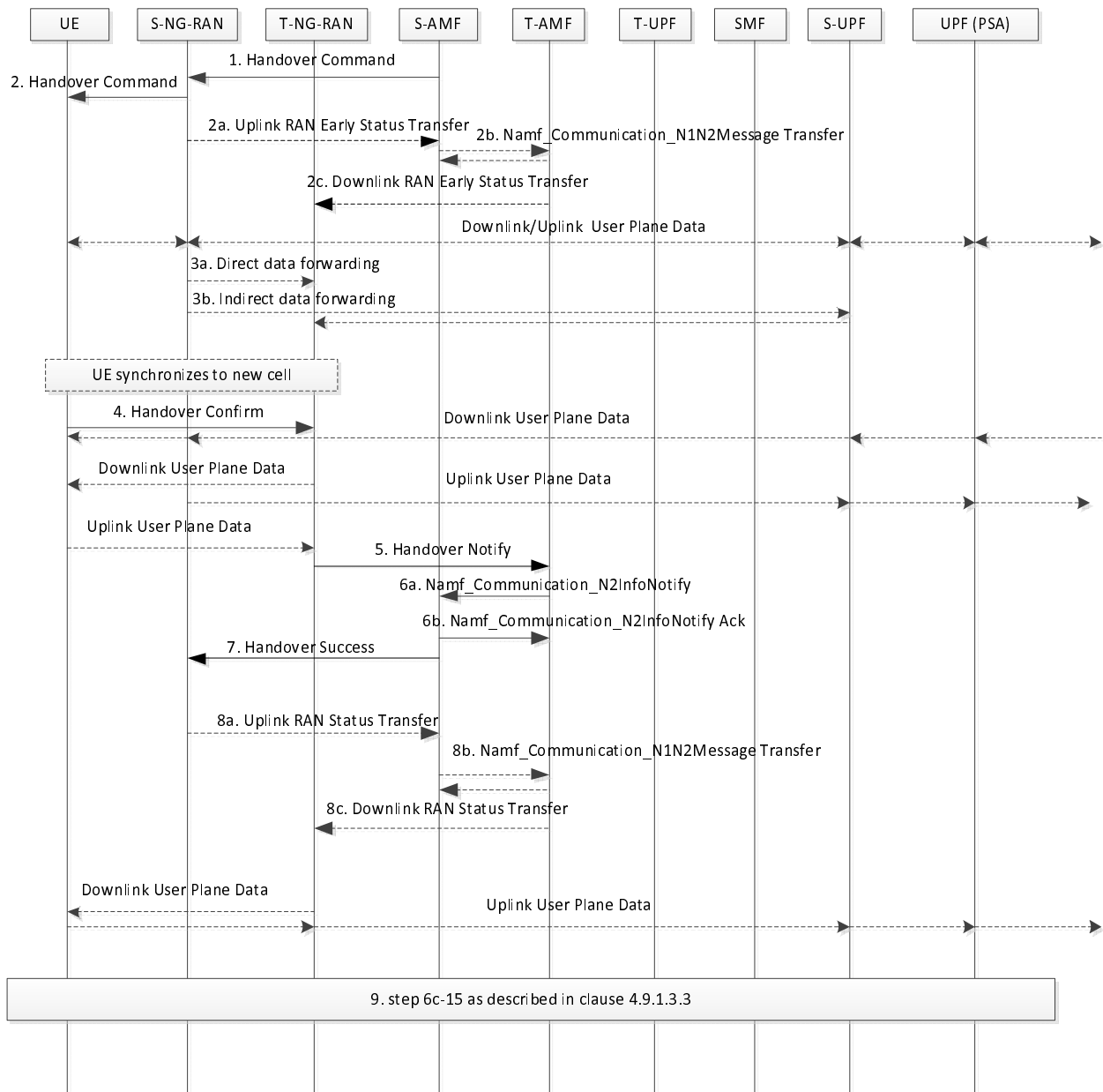
The T-UPF acknowledges with an N4 Session Modification Response message to confirm the release of indirect data forwarding resources.

If the AMF is subscribed to Mobility Event by other NFs, the AMF notifies the event to the corresponding NFs by invoking the Namf\_EventExposure\_Notify service operation as described in clause 4.15.4.2.

Upon reception of the Namf\_EventExposure\_Notify with an indication that UE is reachable only for regulatory prioritized service, the SMF deactivates the PDU Session if the service of the PDU Session is not regulatory prioritized. For home routed roaming case, the V-SMF triggers the deactivation of the PDU Session, in addition, the H-SMF refrains from sending downlink signalling if the signalling is not related to regulatory prioritized service upon receiving the notification.

#### 4.9.1.3.3a Execution phase for DAPS handover

This procedure applies only if at the end of the Preparation phase it has been determined that at least one DRB of the UE is subject to a DAPS related Handover.



**Figure 4.9.1.3.3a-1: inter NG-RAN node N2 based DAPS handover, execution phase**

1 to 2. Same as step 1 to step 2 in clause 4.9.1.3.3 with the following difference.

DAPS Response information received in the Target to Source Transparent Container indicates the DAPS handover is accepted for one or more DRBs.

2a to 2c. The S-RAN sends the Uplink RAN Early Status Transfer message to the S-AMF as specified in TS 38.413 [10]. For the DRBs not subjecting to DAPS, steps 2a to 2c in clause 4.9.1.3.3 may be performed.

If there is an AMF change, the S-AMF sends this information to the T-AMF via the Namf\_Communication\_N1N2MessageTransfer service operation and the T-AMF acknowledges. The S-AMF or, if the AMF is relocated, the T-AMF, sends the information to the T-RAN via the Downlink RAN Early Status Transfer message, as specified in TS 38.413 [10].

3. Same as step 3 in clause 4.9.1.3.3.

4. Same as step 4 in clause 4.9.1.3.3.

5. T-RAN to T-AMF: same as step 5 in clause 4.9.1.3.3 with the difference that the Handover Notify includes a Notify Source NG-RAN node information which is used to notify the S-RAN that the UE has successfully accessed the T-RAN.

6a. [Conditional] T-AMF to S-AMF: Namf\_Communication\_N2InfoNotify.

The T-AMF notifies the S-AMF as in step 6a in clause 4.9.1.3.3 with the difference that Notify Source NG-RAN node information is included.

6b. [Conditional] S-AMF to T-AMF: Namf\_Communication\_N2InfoNotify ACK.

The S-AMF acknowledges by sending the Namf\_Communication\_N2InfoNotify ACK to the T-AMF as in step 6b in clause 4.9.1.3.3.

7. S-AMF to S-RAN: Handover Success.

The S-AMF informs the S-RAN node that the UE has successfully accessed the T-RAN as described in TS 38.413 [10], S-RAN stops the UL data transfer for the UE.

8a to 8c. The S-RAN initiates step 8a. Step 8a to 8c are the same as step 2a to 2c in clause 4.9.1.3.3 for the DRB(s) subject to DAPS.

9. Step 6c to step 15 in clause 4.9.1.3.3 are performed.

#### 4.9.1.4 Inter NG-RAN node N2 based handover, Cancel

Prior to sending a Handover Command to the UE, the source NG-RAN node may attempt cancellation of handover during the handover procedure. The reason for cancellation may include timer expiration, internal failure within the source NG-RAN node or UE returned to source cell etc. The handover cancellation is initiated by sending a Handover Cancel request to the source AMF. This is done in order to release the resources reserved for the handover in the target system.

The AMF shall cancel the handover resources as defined in clause 4.11.1.2.3 for case the source RAN is NG-RAN.

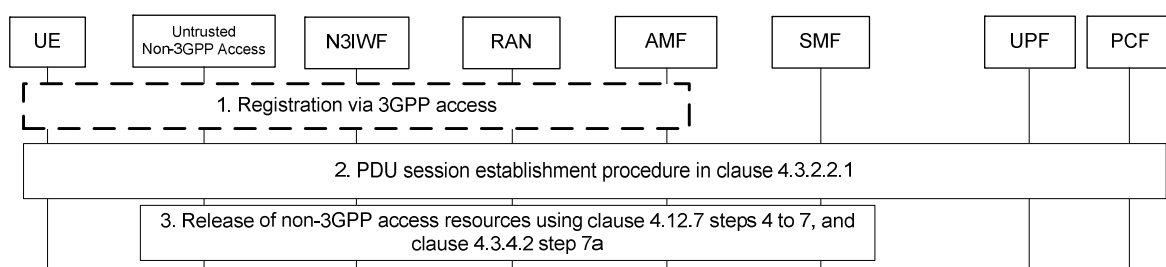
### 4.9.2 Handover of a PDU Session procedure between 3GPP and untrusted non-3GPP access

#### 4.9.2.0 General

The procedures in this clause are used to hand over a PDU Session between 3GPP access and non-3GPP access. This can be triggered, for example, due to radio conditions, user interaction, etc. When the UE triggers handover of a PDU Session between 3GPP access and non-3GPP access and the procedure fails due to e.g. not allowed by policy or AN rejected resource setup, etc. the network should not release the PDU Session.

#### 4.9.2.1 Handover of a PDU Session procedure from untrusted non-3GPP to 3GPP access (non-roaming and roaming with local breakout)

Clause 4.9.2.1 specifies how to hand over a UE from a source Untrusted non-3GPP access to a target 3GPP access and how a UE can handover a PDU Session from untrusted non-3GPP access to 3GPP access. It is based on the PDU Session Establishment procedure for 3GPP access as specified in clause 4.3.2.



**Figure 4.9.2.1-1: Handover of a PDU Session procedure from untrusted non-3GPP access to 3GPP access (non-roaming and roaming with local breakout)**

1. If the UE is not registered via 3GPP access, the UE shall initiate Registration procedure as defined in clause 4.2.2.2.2.

- The UE performs a PDU Session Establishment procedure with the PDU Session ID of the PDU Session to be moved as specified clause 4.3.2.2.1 (PDU Session Establishment for Non-roaming and Roaming with Local Breakout).

When sending the PDU Session Establishment Accept, within the N1 SM container and in the N2 SM information, the SMF shall include all QoS information (e.g. QoS Rule(s) in N1 SM container, QFI(s) and QoS Profile(s) in N2 SM information) for the QoS Flow(s) that are applicable to the PDU Session for the target access.

- If the User Plane of the PDU Session is activated in non-3GPP access, the V-SMF executes the release of resources in non-3GPP access by initiating a Namf\_Communication\_N1N2MessageTransfer (to send N2 resource release request) which triggers performing steps 4 to 7 specified in clause 4.12.7, followed by step 7aa/7b specified in clause 4.3.4.2 in order to release the resources over the source non-3GPP access. Because the PDU Session shall not be released, the SMF shall not send the PDU Session Release Command to the UE. Hence, in steps 4 and 7 of clause 4.12.7 as well as in step 7a of clause 4.3.4.2, the messages do not include the N1 SM container but only the N2 Resource Release Request (resp. Ack). Since the PDU Session is not to be released, the SMF shall not execute step 11 of clause 4.3.4.2 and the SM context between the AMF and the SMF is maintained.

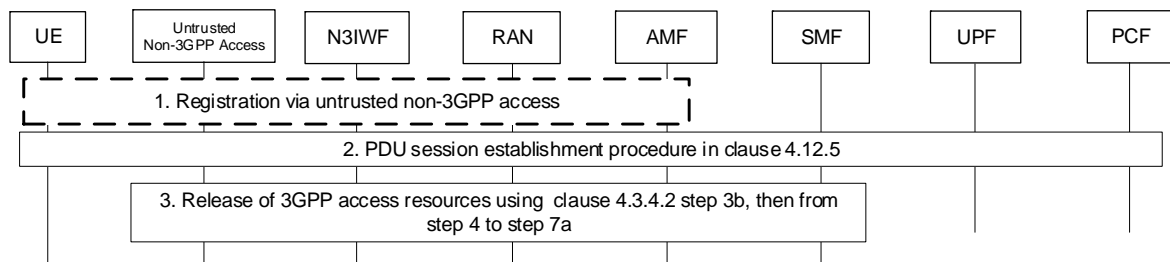
If the User Plane of the PDU Session is deactivated in non-3GPP access, this step is skipped.

The steps 2 and 3 shall be repeated for all PDU Sessions to be moved from to untrusted non-3GPP access to 3GPP access.

If the UE is moving to the NB-IoT RAT type of 3GPP access, the PDU Session Establishment request would be rejected by AMF when the UP resources exceeds the UE's maximum number of supported UP resources as described in clause 5.4.5.2.4 of TS 24.501 [25].

#### 4.9.2.2 Handover of a PDU Session procedure from 3GPP to untrusted non-3GPP access (non-roaming and roaming with local breakout)

Clause 4.9.2.2 specifies how to hand over a UE from a source 3GPP access to a target Untrusted non-3GPP access and how a UE can handover a PDU Session from 3GPP access to untrusted non-3GPP access. It is based on the PDU Session Establishment procedure for non-3GPP access as specified in clause 4.12.5.



**Figure 4.9.2.2-1: Handover of a PDU Session from 3GPP access to untrusted non-3GPP access (non-roaming and roaming with local breakout)**

- If the UE is not registered via untrusted non-3GPP access, the UE shall initiate Registration procedure as defined in clause 4.12.2.
- The UE performs PDU Session Establishment procedure with the PDU Session ID of the PDU Session to be moved as specified in clause 4.12.5.

When sending the PDU Session Establishment Accept, within the N1 SM container and in the N2 SM information, the SMF shall include all QoS information (e.g. QoS Rule(s) in N1 SM container, QFI(s) and QoS Profile(s) in N2 SM information) for the QoS Flow(s) that are applicable to the PDU Session for the target access.

- If the User Plane of the PDU Session is activated in 3GPP access, the SMF executes the release of resource in 3GPP access by performing step 3b, then steps 4 to 7a/7b specified in clause 4.3.4.2 (UE or network requested PDU Session Release for Non-Roaming and Roaming with Local Breakout) in order to release the resources over the source 3GPP access. Because the PDU Session shall not be released, the SMF shall not send the PDU



Session Release Command to the UE. Hence, in steps 3b, 4, 6 and 7a of clause 4.3.4.2, messages do not include the N1 SM container but only the N2 Resource Release Request (resp. Ack). Since the PDU Session is not to be released, the SMF shall not execute step 11 of clause 4.3.4.2 and the SM context between the AMF and the SMF is maintained.

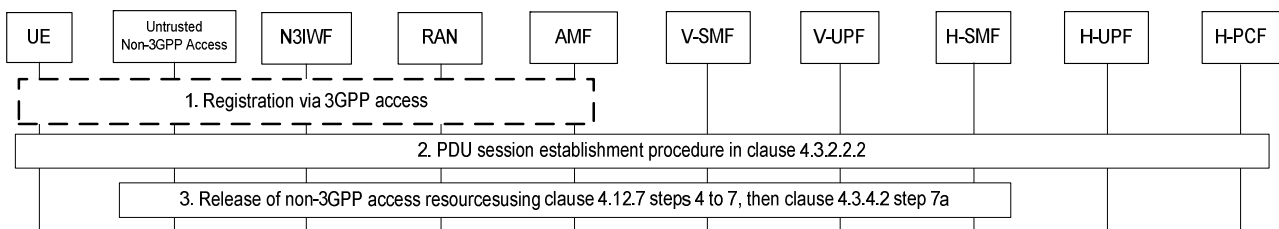
If the User Plane of the PDU Session is deactivated in 3GPP access, this step is skipped.

The steps 2 and 3 shall be repeated for all PDU Sessions to be moved from 3GPP access to untrusted non-3GPP access.

If the PDU Session is associated with Control Plane Only Indication, the AMF shall reject the PDU Session establishment request as the Control Plane ClIoT Optimisation feature is not supported over non-3GPP accesses as described in clause 5.4.5.2.5 of TS 24.501 [25].

### 4.9.2.3 Handover of a PDU Session procedure from untrusted non-3GPP to 3GPP access (home routed roaming)

#### 4.9.2.3.1 The target AMF is in the PLMN of the N3IWF



**Figure 4.9.2.3.1 -1: Handover of a PDU Session procedure from untrusted non-3GPP access to 3GPP access (home routed roaming)**

1. If the UE is not registered via 3GPP access, the UE shall initiate Registration procedure as defined in clause 4.2.2.2.2. The NG-RAN selects the same AMF as the one used via non-3GPP access.
2. The UE performs a PDU Session Establishment procedure with the PDU Session ID of the PDU Session to be moved as specified clause 4.3.2.2.2 (PDU Session Establishment for Home Routed Roaming). The AMF selects the same V-SMF as the one used via non-3GPP access.

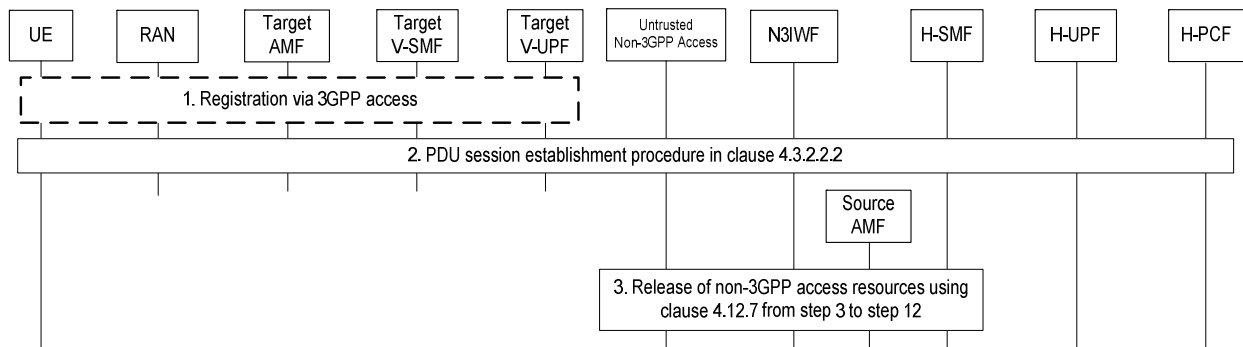
In the Nsmf\_PDUSession\_Update Response the H-SMF shall include all QoS information for the QoS Flow(s) applicable to the PDU Session for the target access so that when sending the PDU Session Establishment Accept, within the N1 SM container and in the N2 SM information, the V-SMF can include all QoS information (e.g. QoS Rule(s) in N1 SM container, QFI(s) and QoS Profile(s) in N2 SM information) for the QoS Flow(s) acceptable according to VPLMN policies. In case of Handover for a PDU Session eligible to EPS Interworking, the Nsmf\_PDUSession\_Update Response should also contain: EPS bearer context(s), linked EBI.

3. If the User Plane of the PDU Session is activated in non-3GPP access, the V-SMF executes the release of resource in non-3GPP access by initiating a Namf\_Communication\_N1N2MessageTransfer (to send N2 resource release request) which triggers performing steps 4 to 7 specified in clause 4.12.7, followed by step 7a/7b specified in clause 4.3.4.2 in order to release the resources over the source non-3GPP access. Because the PDU Session shall not be released, the SMF shall not send the PDU Session Release Command to the UE. Hence, in steps 4 and 7 of clause 4.12.7 as well as in step 7a of clause 4.3.4.2, the messages do not include the N1 SM container but only the N2 Resource Release Request (resp. Ack). Since the PDU Session is not to be released, the SMF shall not execute step 11 of clause 4.3.4.2 and the SM context between the AMF and the SMF is maintained.

If the User Plane of the PDU Session is deactivated in non-3GPP access, this step is skipped.

The steps 2 and 3 shall be repeated for all PDU Sessions to be moved from to untrusted non-3GPP access to 3GPP access.

4.9.2.3.2 The target AMF is not in the PLMN of the N3IWF (i.e. N3IWF in HPLMN)



**Figure 4.9.2.3.2-1: Handover of a PDU Session procedure from untrusted non-3GPP access with N3IWF in the HPLMN to 3GPP access (home routed roaming)**

1. If the UE is not registered via 3GPP access, the UE shall initiate Registration procedure as defined in clause 4.2.2.2.2. This includes the retrieval of the SMF-IDs corresponding to each of the PDU Sessions.
2. The UE performs a PDU Session Establishment procedure with the PDU Session ID of the PDU Session to be moved as specified clause 4.3.2.2.2 (PDU Session Establishment for Home Routed Roaming).

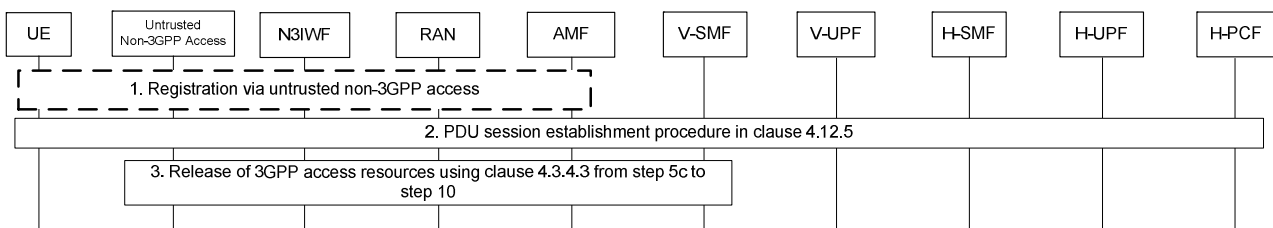
In the Nsmf\_PDUSession\_Create Response the H-SMF shall include all QoS information for the QoS Flow(s) applicable to the PDU Session for the target access so that when sending the PDU Session Establishment Accept, within the N1 SM container and in the N2 SM information, the V-SMF can include all QoS information (e.g. QoS Rule(s) in N1 SM container, QFI(s) and QoS Profile(s) in N2 SM information) for the QoS Flow(s) acceptable according to VPLMN policies.

3. The H-SMF executes the release of resources in non-3GPP AN by performing steps 3-12 specified in clause 4.12.7 with the following exceptions:
  - the H-SMF interfaces the source AMF (in the home PLMN). The H-SMF shall not send the N1 SM Container (PDU Session Release Command) to the UE;
  - The Npcf\_SMPolicyControl\_Delete service operation to PCF shall not be performed.
  - Nsmf\_PDUSession\_SMContextStatusNotify service operation invoked by the H-SMF to the source AMF indicates the PDU Session is moved to different access.

The steps 2 and 3 shall be repeated for all PDU Sessions to be moved from to untrusted non-3GPP access to 3GPP access.

4.9.2.4 Handover of a PDU Session procedure from 3GPP to untrusted non-3GPP access (home routed roaming)

4.9.2.4.1 The selected N3IWF is in the registered PLMN



**Figure 4.9.2.4.1-1: Handover of a PDU Session procedure from 3GPP access to untrusted non-3GPP access (home routed roaming)**

1. If the UE is not registered via untrusted non-3GPP access, the UE shall initiate Registration procedure as defined in clause 4.12.2. The N3IWF selects the same AMF as the one used via 3GPP access.

- The UE performs PDU Session Establishment procedure with the PDU Session ID of the PDU Session to be moved as specified in clause 4.12.5. The AMF selects the same V-SMF as the one used via 3GPP access.

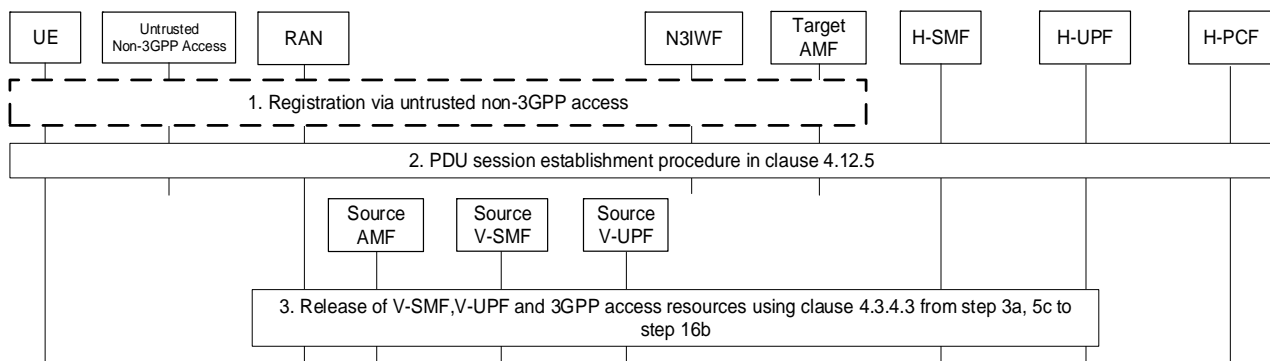
In the Nsmf\_PDUSESSION\_Update Response the H-SMF shall include all QoS information for the QoS Flow(s) applicable to the PDU Session for the target access so that when sending the PDU Session Establishment Accept, within the N1 SM container and in the N2 SM information, the V-SMF can include all QoS information (e.g. QoS Rule(s) in N1 SM container, QFI(s) and QoS Profile(s) in N2 SM information) for the QoS Flow(s) acceptable according to VPLMN policies.

- If the User Plane of the PDU Session is activated in 3GPP access, the V-SMF executes the release of resources in 3GPP access by performing step 5c to 10 specified in clause 4.3.4.3 (UE or network requested PDU Session Release for Home Routed Roaming) in order to release the resources over the source 3GPP access. Because the PDU Session shall not be released, the SMF shall not send the PDU Session Release Command to the UE. Hence, in steps 5c, 6, 8 and 9 of clause 4.3.4.3, the messages do not include the N1 SM container but only the N2 Resource Release Request (resp. Ack). Since the PDU Session is not to be released, the SMF shall not execute step 11 of clause 4.3.4.2 and the SM context between the AMF and the SMF is maintained.

If the User Plane of the PDU Session is deactivated in 3GPP access, this step is skipped.

The steps 2 and 3 shall be repeated for all PDU Sessions to be moved from 3GPP access to untrusted non-3GPP access.

#### 4.9.2.4.2 The UE is roaming and the selected N3IWF is in the home PLMN



**Figure 4.9.2.4.2-1: Handover of a PDU Session procedure from 3GPP access to untrusted non-3GPP access with N3IWF in the HPLMN (home routed roaming)**

- If the UE is not registered via untrusted non-3GPP access, the UE shall initiate Registration procedure as defined in clause 4.12.2. This includes the retrieval of the SMF-IDs corresponding to each of the PDU Sessions.
- The UE performs PDU Session Establishment procedure with the PDU Session ID of the PDU Session to be moved as specified in clause 4.12.5.

In the Nsmf\_PDUSESSION\_Create Response the H-SMF shall include all QoS information for the QoS Flow(s) applicable to the PDU Session for the target access so that when sending the PDU Session Establishment Accept, within the N1 SM container and in the N2 SM information, the V-SMF can include all QoS information (e.g. QoS Rule(s) in N1 SM container, QFI(s) and QoS Profile(s) in N2 SM information) for the QoS Flow(s) acceptable according to VPLMN policies.

- The H-SMF executes the release of resources in source V-SMF, V-UPF, V-AMF and 3GPP AN by performing steps 3a, 5c to 16b specified in clause 4.3.4.3 with the following exceptions:
  - the H-SMF indicates in the Nsmf\_PDUSESSION\_Update Request that the UE shall not be notified. This shall result in the V-SMF not sending the N1 Container (PDU Session Release Command) to the UE;
  - Nsmf\_PDUSESSION\_StatusNotify service operation invoked by H-SMF to V-SMF indicates PDU Session is moved to different access;
  - Nsmf\_PDUSESSION\_SMContextStatusNotify service operation invoked by the V-SMF to the AMF indicates the PDU Session is moved to different access;
  - The Npcf\_SMPolicyControl\_Delete service operation to PCF shall not be performed.

The steps 2 and 3 shall be repeated for all PDU Sessions to be moved from 3GPP access to untrusted non-3GPP access.

## 4.9.3 Handover of a PDU Session procedure between 3GPP and trusted non-3GPP access

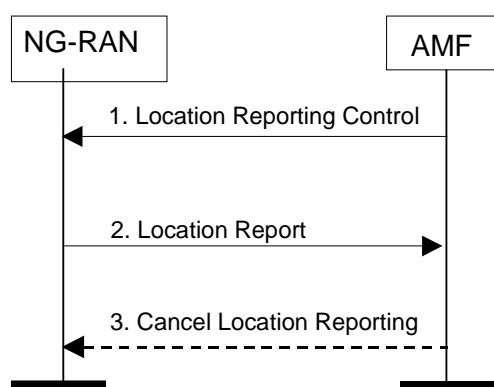
### 4.9.3.0 General

The handover of a PDU Session between 3GPP access and trusted non-3GPP access shall be supported as specified in clause 4.9.2 for all types of handover of a PDU Session between 3GPP access and untrusted non-3GPP access, with the following modifications and clarifications:

- The untrusted non-3GPP access is substituted by a trusted non-3GPP access point (TNAP).
- The N3IWF is substituted by the TNGF.
- The registration via untrusted non-3GPP access is substituted by the registration via trusted non-3GPP access as specified in clause 4.12a.2.2.
- A PDU Session is activated over trusted non-3GPP access as specified in clause 4.12a.5.

## 4.10 NG-RAN Location reporting procedures

This procedure is used by an AMF to request the NG-RAN to report where the UE is currently located when the target UE is in CM-CONNECTED state. The need for the NG-RAN to continue reporting ceases when the UE transitions to CM-IDLE or the AMF sends cancel indication to NG-RAN. This procedure may be used for services that require accurate cell identification (e.g. emergency services, lawful intercept, charging), or for subscription to the service by other NFs. When Dual Connectivity is activated, PSCell information is only reported if requested by the AMF.



**Figure 4.10-1: NG-RAN Location Reporting Procedure**

1. AMF to NG-RAN: Location Reporting Control (Reporting Type, Location Reporting Level, (Area Of Interest, Request Reference ID)).

The AMF sends a Location Reporting Control message to the NG-RAN. The Location Reporting Control message shall identify the UE for which reports are requested and shall include Reporting Type and Location Reporting Level. The Location Reporting Control message may also include Area Of Interest and Request Reference ID. Location Reporting Level could be TAI+ Cell Identity. Reporting Type indicates whether the message is intended to trigger a single standalone report about the current Cell Identity serving the UE or start the NG-RAN to report whenever the UE changes cell, or ask the NG-RAN to report whenever the UE moves out or into the Area Of Interest. If the Reporting Type indicates to report whenever the UE changes cell and if PSCell reporting is requested and Dual Connectivity is in use, the Master RAN node shall also report to the AMF whenever the PSCell changes. If the Reporting Type indicates to start the NG-RAN to report when UE moves out of or into the Area Of Interest, the AMF also provides the requested Area Of Interest information in the Location Reporting Control message. The AMF may include a Request Reference ID in the Location Report Control message to identify the request of reporting for an Area Of Interest. If multiple Areas Of Interest are included in the message, the Request Reference ID identifies each Area of Interest.

NOTE 1: Requesting reports whenever the UE changes cell can increase signalling load on multiple interfaces. Requesting reports for all changes in PSCell ID can further increase signalling load. Hence it is recommended that any such reporting is only applied for a limited number of subscribers,

2. NG-RAN to AMF: Location Report (UE Location, UE Presence in Area Of Interest, Request Reference ID, Timestamp).

The NG-RAN sends a Location Report message informing the AMF about the location of the UE which shall be represented as the requested Location Reporting Level. If PSCell reporting is requested and Dual Connectivity is activated, then the Master NG-RAN node shall also include the PSCell ID.

When UE is in CM-CONNECTED with RRC Inactive state, if NG-RAN has received Location Reporting Control message from AMF with the Reporting Type indicating single stand-alone report, the NG-RAN shall perform NG-RAN paging before reporting the location to the AMF. The NG-RAN should send the Location Report promptly and shall not wait to attempt to create a Dual Connectivity configuration. However, if PSCell reporting is requested and the PSCell ID is known to the Master RAN node, then it shall be included in the Location Report.

When UE is in CM-CONNECTED with RRC Inactive state, if NG-RAN has received Location Reporting Control message from AMF with the Reporting Type indicating continuous reporting whenever the UE changes cell, the NG-RAN shall send a Location Report message to the AMF including the UE's last known location with time stamp. If the UE was using Dual Connectivity immediately before entering CM-CONNECTED with RRC Inactive state and PSCell reporting is requested, then the Location Report shall also include the PSCell ID.

When UE is in CM-CONNECTED, if NG-RAN has received Location Reporting Control message from AMF with the Reporting Type of Area Of Interest based reporting, the NG-RAN shall track the UE presence in Area Of Interest and send a Location Report message to AMF including the UE Presence in the Area Of Interest (i.e. IN, OUT, or UNKNOWN) as described in clause D.2 and the UE's current location (including the PSCell ID if PSCell reporting is requested and Dual Connectivity is activated) when the UE is in RRC Connected state, or, when the UE is in RRC Inactive state, the UE's last known location (including the PSCell ID if PSCell reporting is requested and the UE was using Dual Connectivity immediately before entering CM-CONNECTED with RRC Inactive state) with time stamp if the NG-RAN perceives that the UE presence in the Area Of Interest is different from the last one reported. When the NG-RAN detects that the UE has moved out of or into multiple areas of interest, it sends multiple pairs of UE Presence in the Area Of Interest and the Request Reference ID in one Location Report message to AMF. If UE transitions from RRC Inactive state to RRC Connected state, NG-RAN shall check the latest location (including the PSCell ID if PSCell reporting is requested and Dual Connectivity is activated) of UE and follow the rules when UE is in RRC Connected.

The AMF may receive Location Report even if the UE presence in Area Of Interest is not changed. The AMF stores the latest received PSCell ID with its associated timestamp. The AMF stores the latest received PSCell ID with its associated timestamp, when available.

3. AMF to NG-RAN: Cancel Location Report (Reporting Type, Request Reference ID).

The AMF can send a Cancel Location Reporting message to inform the NG-RAN that it should terminate the location reporting for a given UE corresponding to the Reporting Type or the location reporting for Area Of Interest indicated by Request Reference ID. This message is needed when the reporting type was requested for continuously reporting or for the Area Of Interest. The AMF may include the Request Reference ID which indicates the requested Location Reporting Control for the Area Of Interest, so that the NG-RAN should terminate the location reporting for the Area Of Interest.

NOTE 2: Location reporting related information of the source NG-RAN node is transferred to the target NG-RAN node during Xn handover.

In this release the location reporting procedure is applicable only to 3GPP access.

## 4.11 System interworking procedures with EPC

### 4.11.0 General

Clause 4.11 includes the following:

- Procedures for interworking with EPS based on N26 interface (clause 4.11.1) and interworking without N26 interface (clause 4.11.2);
- Handover procedures between EPS and 5GC-N3IWF (clause 4.11.3), handover procedures between EPS and 5GC-TNGF (clause 4.11.3a) and handover procedures between EPC/ePDG and 5GS (clause 4.11.4);
- Impact to 5GC procedure due to interworking with EPC (clause 4.11.5);
- Interworking for common network exposure (clause 4.11.6).

In clause 4.11, UEs are assumed to support both 5GC NAS and EPC NAS unless explicitly stated otherwise.

## 4.11.0a Impacts to EPS Procedures

### 4.11.0a.1 General

This clause captures changes to procedures in TS 23.401 [13] that are common to interworking based on N26 and interworking without N26.

### 4.11.0a.2 Interaction with PCC

When interworking with 5GS is supported and a "SMF+PGW-C" is selected for a PDN connection, policy interactions between PDN GW and PCRF specified in TS 23.401 [13] are replaced by equivalent interactions between SMF+PGW-C and PCF as follows:

- IP-CAN Session Establishment procedure defined in TS 23.203 [24] is replaced by SM Policy Association Establishment Procedure as described in clause 4.16.4. The SMF+PGW-C includes the information elements received in Create Session Request message into the Npcf\_SMPolicyControl\_Create Service as follows: the SUPI contains the IMSI, the DNN contains the APN, the PEI contains either the IMEISV or IMEI, the Session AMBR contains the APN-AMBR and the default QoS information that contains the default EPS bearer QoS, note that QCI values are mapped into 5QI values. The SMF+PGW-C may receive PCC Rules and PDU Session Policy Information, 5G QoS information in the PCC Rule and in PDU Session Policy Information are mapped into EPS QoS information as defined in clause 4.11.1.1 and Annex C.
- (PCEF-initiated) IP-CAN Session Modification procedure defined in TS 23.203 [24] is replaced by SM Policy Association Modification procedure as described in clause 4.16.5.1.
- The SMF+PGW-C includes the information elements received in Modify Bearer Request or Modify Bearer Command message into the Npcf\_SMPolicyControl\_Update Service with the following modifications, the subscribed Session AMBR includes the subscribed APN-AMBR and subscribed default QoS information includes the default EPS bearer QoS, note that QCI values are mapped into 5QI values. The SMF+PGW-C includes the stored SUPI. The SMF+PGW-C may receive PCC Rules and PDU Session Policy Information, 5G QoS information in the PCC Rule and in PDU Session Policy Information are mapped into EPS QoS information as defined in clause 4.11.1.1 and Annex C.
- The SMF+PGW-C includes the information elements received in Delete Bearer Command message into the Npcf\_SMPolicyControl\_Update Service with the following modifications, The SMF+PGW-C includes the stored SUPI.
- (PCRF-initiated) IP-CAN Session Modification procedure defined in TS 23.203 [24] is replaced by SM Policy Association Modification procedure as described in clause 4.16.5.2. The SMF+PGW-C may receive PCC Rules and PDU Session Policy Information, 5G QoS information in the PCC Rule and in PDU Session Policy Information are mapped into EPS QoS information as defined in clause 4.11.1.1 and Annex C.
- IP-CAN Session Termination procedure defined in TS 23.203 [24] is replaced by SM Policy Association Termination procedure as described in clause 4.16.6. The SMF+PGW-C includes the information elements received in Delete Session Request message by the SMF+PGW-C into the Npcf\_SMPolicyControl\_Delete Service. The SMF+PGW-C includes the stored SUPI.

### 4.11.0a.3 Mobility Restrictions

The UE's subscription may include access restriction for NR in 5GS and restriction for Core Network Type (5GC). If so, the HSS provides these restrictions to the MME. The MME includes these restrictions in the Handover Restriction List to the E-UTRAN. The MME and E-UTRAN use these restrictions to determine if mobility of the UE to 5GS or NR connected to 5GS should be permitted.

### 4.11.0a.4 PGW Selection

When the UE requests to establish a non-emergency PDN connection to an APN, the MME may use the UE's support for 5GC NAS indication included in the UE Network Capability and/or UE's subscription from HSS that includes UE's mobility restriction parameters related to 5GS and/or indication of support for interworking with 5GS for this APN to determine if SMF+PGW-C or a standalone PGW-C should be selected. If both PGW-C and SMF+PGW-C is available, then MME may select SMF+PGW-C when UE's subscription from HSS indicate support for interworking with 5GS for the APN.

**NOTE:** If restriction for Core Network Type indicates that the UE can access to 5GC, it implies that the UE has 5G subscription data.

When the UE performs emergency attach or requests to establish an emergency PDN connection, the MME may use the UE's support for 5GC NAS indication included in the UE Network Capability and/or local configuration to determine if an emergency SMF+PGW-C or a standalone emergency PGW-C should be selected. An emergency SMF+PGW-C needs to be configured in Emergency Configuration Data in the MME if it is to be selected.

To enable a differentiation of the emergency gateway based on UE's support of 5GC NAS, the Emergency Configuration Data in the MME defined in TS 23.401 [26] is extended with the IE listed in Table 4.11.0a.4-1.

**Table 4.11.0a.4-1: MME Emergency Configuration Data Extensions**

Field	Description
Emergency SMF+PGW-C identity	The statically configured identity of a combined SMF+PGW-C used for emergency APN. The SMF+PGW-C identity may be either an FQDN or an IP address. (NOTE)
<b>NOTE:</b> The FQDN always resolves to one SMF+PGW-C.	

### 4.11.0a.5 PDN Connection Establishment

During establishment of non-emergency PDN connection in the EPC, the UE and the SMF+PGW-C exchange information via PCO as described in clause 5.15.7 of TS 23.501 [2]. If the SMF+PGW-C supports more than one S-NSSAI and the APN is valid for more than one S-NSSAI, before the SMF+PGW-C provides an S-NSSAI to the UE, the SMF+PGW-C should check such that the selected S-NSSAI is among the UE's subscribed S-NSSAIs and that the S-NSSAI is not subject to Network Slice-Specific Authentication and Authorization, by retrieving the Subscribed S-NSSAI from UDM using the Nudm\_SDM\_Get service operation (the SMF+PGW-C discovers and selects a UDM as described in clause 6.3.8 of TS 23.501 [2]). If the SMF+PGW-C is in a VPLMN, the SMF+PGW-C uses the Nnssf\_NSSelection\_Get service operation to retrieve a mapping of the Subscribed S-NSSAIs to Serving PLMN S-NSSAI values. If the S-NSSAIs supported by the SMF+PGW-C are all subject to NSSAA, then the SMF+PGW-C should reject the PDN connection establishment. The SMF+PGW-C uses the Nudm\_SDM\_Subscribe service operation to subscribe the change of the Session Management Subscription data. If the SMF+PGW-C is notified from UDM with subscription data change, the SMF+PGW-C takes actions for the PDN connection as described in clause 5.17.2.1 of TS 23.501 [2].

During establishment of non-emergency PDN connection in the EPC, if SMF+PGW-C is selected for a UE that has 5GS subscription but does not support 5GC NAS and is accessing via EPC/E-UTRAN and if the SMF+PGW-C supports more than one S-NSSAI and the APN is valid for more than one S-NSSAI, the SMF+PGW-C+PGW-C may proceed as specified in first paragraph of this clause or select any S-NSSAI associated with the APN of the PDN connection. The SMF+PGW-C shall not provide any 5GS related parameters to the UE.

**NOTE:** The SMF+PGW-C knows that the UE does not support 5GS NAS if the UE does not provide PDU Session ID in PCO (see clause 5.15.7 of TS 23.501 [2]).

During establishment of emergency PDN connection:

- The SMF+PGW-C is to be derived from the emergency APN or to be statically configured in the Emergency Configuration Data in MME.
- 5GC interworking support with N26 or without N26 is determined based on UE's 5G NAS capability and local configuration (in the Emergency Configuration Data in MME).
- The S-NSSAI configured for the emergency APN in SMF+PGW-C is not sent to the UE by the SMF+PGW-C. One S-NSSAI is configured for the emergency APN.

During establishment of non-emergency PDN connection and emergency PDN connection, if SMF+PGW-C is selected for a UE that does not support 5GC NAS, the SMF+PGW-C creates unique PDU Session ID for each PDN connection of the UE.

The unique PDU Session ID can be created based on the EPS Bearer IDs assigned by the MME for the PDN Connections associated with the UE and not be in the range of PDU Session ID values that can be created by a 5GC NAS capable UE.

#### 4.11.0a.6 Network Configuration

To avoid the need for identifier coordination between MMEs, AMFs and SGSNs, the MME provides to the eNB its served GUMMEIs by separating the values between native MME GUMMEI values, values mapped from AMF and values mapped from SGSN.

#### 4.11.0a.7 Interactions with DN-AAA Server

In this version of the specification, secondary authentication with a DN-AAA server, as specified in clause 4.3.2.3, is not supported when the UE is in EPS. Secondary authorization (without authentication of the UE) with a DN-AAA server, as specified in clause 4.3.2.3, is supported when the UE is in EPS.

NOTE 1: This implies that when data connectivity to the DN is initiated as a PDU session over 5GC it can be subject to EAP based secondary authentication mechanism (see TS 33.501 [15]) whereas, when data connectivity to the same DN is initiated as a PDN connection over EPC it cannot be subject to EAP based secondary authentication mechanism. This discrepancy occurs regardless of whether the data connection is later on moved between EPC and 5GC.

NOTE 2: Secondary authorization without authentication means no signalling exchange with the UE.

If secondary authentication and authorization has been performed for the PDU Session while the UE was in 5GS and the UE has moved to EPS, the following applies:

- DN-AAA re-authorization (without re-authentication signalling) can be performed even when the UE is in EPS, e.g. to provide new parameters from the DN-AAA Server to SMF+PGW-C.
- Re-authentication cannot be performed while the UE is in EPS because there is no support of the related signalling in EPS. In case the SMF+PGW-C receives a re-authentication request from the DN-AAA, the SMF+PGW-C informs the DN-AAA Server that the UE is not available for re-authentication at the moment. The SMF+PGW-C should not initiate PDN connection release at this point: the DN-AAA decides the actions to take, based on the reply from SMF+PGW-C and local policy which may also trigger a DN-AAA server request to release the PDU Session/PDN connection of the UE.

### 4.11.1 N26 based Interworking Procedures

#### 4.11.1.1 General

N26 interface is used to provide seamless session continuity for single registration mode UE.

Interworking between EPS and 5GS is supported with IP address preservation by assuming SSC mode 1.

When the UE is served by the 5GC, during PDU Session establishment and GBR QoS Flow establishment, SMF+PGW-C performs EPS QoS mappings, from the 5G QoS parameters obtained from the PCF and allocates TFT with the PCC rules obtained from the PCF if PCC is deployed. Otherwise, EPS QoS mappings and TFT allocation are mapped by the SMF+PGW-C locally. The PGW+SMF ignores 5G QoS parameters that are not applicable to EPC (e.g.



QoS Notification control). If a TFT is to be allocated for a downlink unidirectional EPS bearer mapped from a downlink only QoS Flow, the SMF+PGW-C shall allocate a TFT packet filter that effectively disallows any useful uplink packet as specified in TS 23.401 [13]. EPS Bearer IDs are allocated by the serving AMF requested by the SMF if the SMF determines that EPS Bearer IDs need to be assigned to the QoS Flows. For each PDU Session, EPS bearer IDs are allocated to the default EPS bearer and dedicated bearers. The SMF shall be able to determine the QoS flows that require EPS Bearer IDs, based on the QoS profile and operator policies.

NOTE 1: Based on operator policies, an SMF can map all non-GBR QoS flows to default EPS bearer in which case it requests only one EBI for all the non-GBR QoS flows. Alternatively, an SMF can also map one non-GBR QoS flow to one dedicated EPS bearer in which case it requests a dedicated EBI for non-GBR QoS flow that should be mapped to dedicated EPS bearer. In between these two extreme cases, the SMF can also map more than one (but not all) non-GBR QoS Flow to the same EPS bearer (either default EPS bearer or dedicated EPS bearer).

NOTE 2: To reduce the probability of AMF revoking the EBI corresponding to the QoS Flow associated with the default QoS rule, ARP priority level of dedicated QoS Flows can be set to higher value than that of the QoS Flow associated with the default QoS rule within the same PDU Session.

When a new QoS Flow needs to be mapped to an EPS Bearer ID that has already been assigned for an existing QoS Flow, the SMF includes the already assigned EPS Bearer ID in the QoS Flow description sent to the UE.

For Ethernet and Unstructured PDU Session Types, only EPS Bearer ID for the default EPS Bearer is allocated. The EPS Bearer IDs for these EPS bearers are provided to the SMF+PGW-C by the AMF and are provided to the UE and NG-RAN by the SMF+PGW-C using N1 SM NAS message and N2 SM message. The UE is also provided with the mapped QoS parameters. The UE and the SMF+PGW-C store the association between the QoS Flow and the corresponding EBI and the EPS QoS parameters. When the QoS Flow is deleted e.g. due to PDU Session status synchronization or PDU Session Modification, the UE and the SMF+PGW-C delete any possibly existing EPS QoS parameters associated with the deleted QoS Flow.

In this release, for a PDU Session for a LADN or for Multi-homed IPv6 PDU Session, the SMF doesn't allocate any EBI or mapped QoS parameters.

For PDU Sessions with UP integrity protection of UP Security Enforcement Information set to Required, the SMF does not allocate any EBI or mapped QoS parameters.

When the UE is served by the EPC, during PDN connection establishment, the UE allocates the PDU Session ID and sends it to the SMF+PGW-C via PCO. During PDN Connection establishment and dedicated bearer establishment, SMF+PGW-C performs EPS QoS mappings, from the 5G QoS parameters obtained from the PCF and allocates TFT with the PCC rules obtained from the PCF if PCC is deployed. Otherwise, EPS QoS mappings and TFT allocation are mapped by the SMF+PGW-C locally. Other 5G QoS parameters corresponding to the PDN connection, e.g. Session AMBR and QoS rules and QoS Flow level QoS parameters if needed for the QoS Flow(s) associated with the QoS rule(s), are sent to UE in PCO. The UE and the SMF+PGW-C store the association between the EPS Context and the PDU Session Context to use it in the case of handover from EPS to 5GS. During the EPS bearer establishment/modification procedure, QoS rules corresponding to the related EPS bearers are allocated and sent to UE in PCO. The 5G QoS parameters are stored in the UE and are to be used when the UE is handed over from EPS to the 5GS. The 5G QoS parameters may be provided to SMF+PGW-C by the PCF, if PCC is deployed. On mobility from EPS to 5GS, the UE sets the SSC mode of the mapped PDU Session to SSC mode 1. The UE and the SMF+PGW-C store the association between the EPS bearer and the corresponding 5G QoS Rules and QoS Flow level QoS parameters if needed for the QoS Flow(s) associated with the QoS rule(s). When the EPS bearer is deleted e.g. due to EPS bearer status synchronization or bearer deactivation, the UE and the SMF+PGW-C delete any possibly existing 5G QoS Rule(s) and QoS Flow level QoS parameters if any for the QoS Flow(s) associated with the QoS rule(s) associated with the deleted EPS bearer.

In the roaming case, if the VPLMN supports interworking with N26, the UE shall operate in Single Registration mode.

During the 5GS-EPS handover, indirect forwarding may apply for the downlink data forwarding performed as part of the handover. From its configuration data the AMF knows whether indirect forwarding applies and it requests to allocate downlink data forwarding paths on UPFs for indirect forwarding. From its configuration data the MME knows whether indirect forwarding applies and it requests to allocate downlink data forwarding paths on Serving GWs for indirect forwarding. It is configured on AMF and MME whether indirect downlink data forwarding does not apply, applies always or applies only for inter PLMN inter RAT handovers.

During the 5GS-EPS handover, direct forwarding may apply for the downlink data forwarding performed as part of the handover. From its configuration data the source RAN node knows whether direct forwarding applies and indicates to source CN the direct data forwarding is available.

During 5GS-EPS handover, on the target side, the CN informs the target RAN node whether data forwarding is possible or not.

During interworking from EPS to 5GS, as the SMF+PGW-C may have different IP addresses when being accessed over S5/S8 and N11/N16 respectively, the AMF shall discover the SMF instance by an NF/NF service discovery procedure using the FQDN for the S5/S8 interface received from the MME as a query parameter.

This is required for both non-roaming and roaming with local breakout, as well as for home routed roaming.

NOTE 3: As the AMF is not aware of the S-NSSAI assigned for the PDN Connection, the NF/NF service discovery used to find the SMF instance can use PLMN level NRF.

During interworking from 5GS to EPS, as a PDU Session may be released while the UE is served by EPS, if Small Data Rate Control is used the SMF+PGW-C obtains the Small Data Rate Control Status from the PGW-U+UPF in the N4 Session Modification procedure or from the SCEF+NEF and passes the Small Data Rate Control Status in the PDU Session Context Response to the AMF, for the AMF to store. The time to store the Small Data Rate Control Statuses is implementation specific. If the UE and PGW-U+UPF / SCEF+NEF have stored APN Rate Control parameters and optionally APN Rate Control Status they are only applied when the UE is served by EPS.

During interworking from EPS to 5GS the UE and PGW-U+UPF / SCEF+NEF store the APN Rate Control parameters and APN Rate Control Status while the UE is served by 5GS, so they can be used if the UE moves back to EPS.

At EPS to 5GS mobility

- the UE considers as released the PDN connections that were established over EPS and for which the UE has not received mapped 5GS QoS parameters from the network.
- The MME does not transfer to 5GS a PDN connection that does not support 5GS interworking, e.g. PDN connection was established on a standalone PGW, or 5GS interworking is restricted by subscription data.

## 4.11.1.2 Handover procedures

### 4.11.1.2.1 5GS to EPS handover using N26 interface

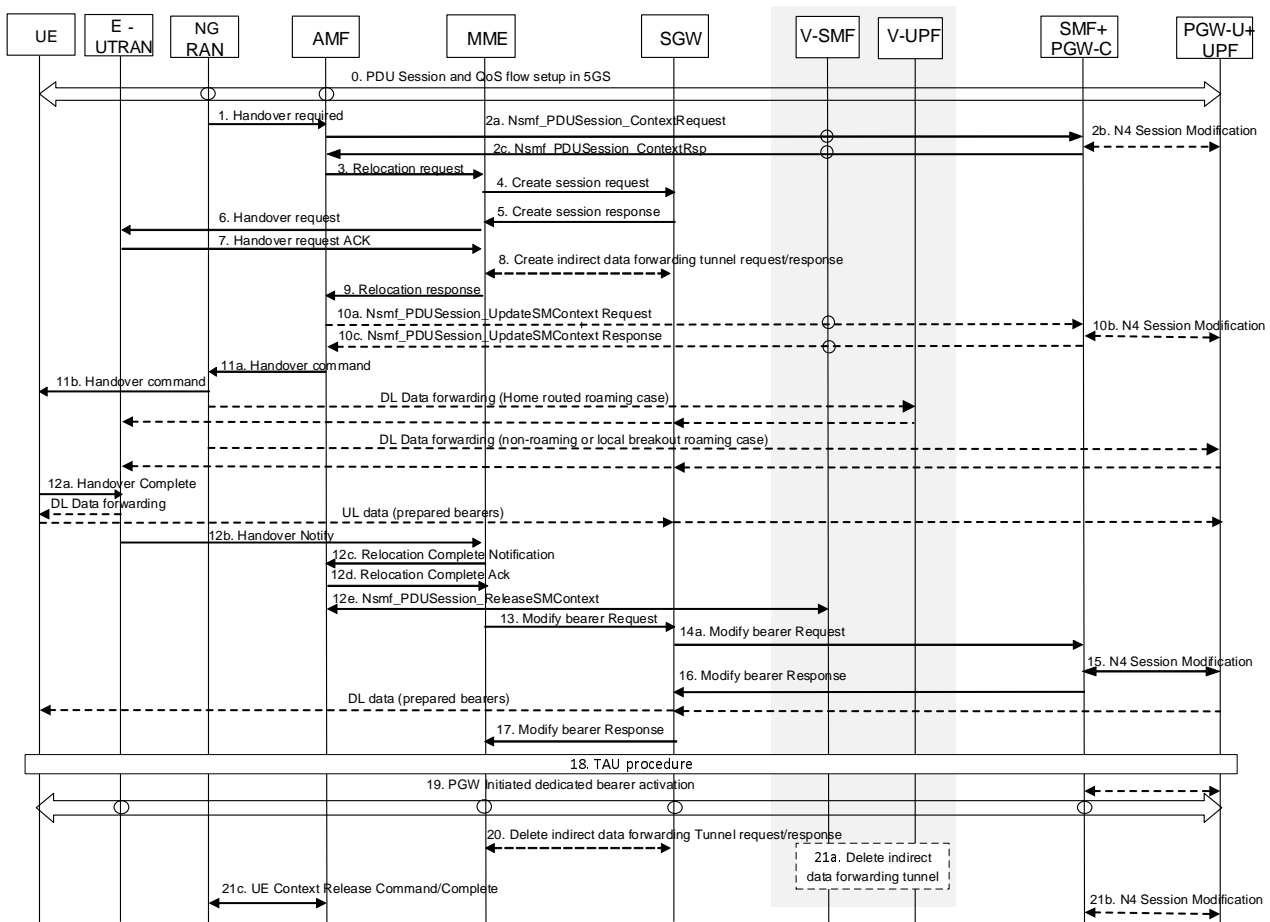
Figure 4.11.1.2.1-1 describes the handover procedure from 5GS to EPS when N26 is supported.

In the case of handover to a shared EPS network, the source NG-RAN determines a PLMN to be used in the target network as specified by TS 23.501 [2]. The source NG-RAN shall indicate the selected PLMN ID to be used in the target network to the AMF as part of the TAI sent in the HO Required message.

In the case of handover from a shared NG-RAN, the AMF may provide the MME with an indication that the 5GS PLMN is a preferred PLMN at later change of the UE to a 5GS shared networks.

During the handover procedure, as specified in clause 4.9.1.3.1, the source AMF shall reject any SMF+PGW-C initiated N2 request received since handover procedure started and shall include an indication that the request has been temporarily rejected due to handover procedure in progress.

Upon reception of a rejection for an SMF+PGW-C initiated N2 request(s) with an indication that the request has been temporarily rejected due to handover procedure in progress, the SMF+PGW-C behaves as specified in TS 23.401 [13].



**Figure 4.11.1.2.1-1: 5GS to EPS handover for single-registration mode with N26 interface**

The procedure involves a handover to EPC and setup of default EPS bearer and dedicated bearers for QoS Flows that have EBI assigned, in EPC in steps 1-16 and re-activation, if required, of dedicated EPS bearers for non-GBR QoS Flows that have no EBI assigned, in step 19. This procedure can be triggered, for example, due to new radio conditions, load balancing or in the presence of QoS Flow for normal voice or IMS emergency voice, the source NG-RAN node may trigger handover to EPC.

For Ethernet and Unstructured PDU Session Types, the PDN Type Ethernet and non-IP respectively are used, when supported, in EPS.

When EPS supports PDN Type non-IP but not PDN type Ethernet, PDN type non-IP is used also for Ethernet PDU sessions. The SMF shall also set the PDN Type of the EPS Bearer Context to non-IP in this case. After the handover to EPS, the PDN Connection will have PDN Type non-IP, but it shall be locally associated in UE and SMF to PDU Session Type Ethernet or Unstructured respectively.

In the roaming home routed case, the SMF+PGW-C always provides the EPS Bearer ID and the mapped QoS parameters to UE. The V-SMF caches the EPS Bearer ID and the mapped QoS parameters obtained from H-SMF for this PDU session. This also applies in the case that the HPLMN operates the interworking procedure without N26.

NOTE 1: The IP address preservation cannot be supported, if SMF+PGW-C in the HPLMN doesn't provide the mapped QoS parameters.

1. NG-RAN decides that the UE should be handed over to the E-UTRAN. If NG-RAN is configured to perform Inter RAT mobility due to IMS voice fallback triggered by QoS flow setup and request to setup QoS flow for IMS voice was received, NG-RAN responds indicating rejection of the QoS flow establishment because of mobility due to fallback for IMS voice via N2 SM information and triggers handover to E-UTRAN. The NG-RAN sends a Handover Required (Target eNB ID, Direct Forwarding Path Availability, Source to Target Transparent Container, inter system handover indication) message to the AMF. NG-RAN indicates bearers corresponding to the 5G QoS Flows for data forwarding in Source to Target Transparent Container.

If the source NG-RAN and target E-UTRAN support RACS as defined in TS 23.501 [2], the Source to Target transparent container need not carry the UE radio access capabilities (instead the UE Radio Capability ID is supplied from the CN to the target E-UTRAN). However, if the source NG-RAN has knowledge that the target E-UTRAN might not have a local copy of the Radio Capability corresponding to the UE Radio Capability ID (i.e. because the source NG-RAN had itself to retrieve the UE's Radio Capability from the AMF) then the source NG-RAN may also send some (or all) of the UE's Radio Capability to the target E-UTRAN (the size limit based on configuration). In the case of inter-PLMN handover, when the source NG-RAN and target E-UTRAN support RACS as defined in TS 23.501 [2] and TS 23.401 [13] and the source NG-RAN determines that the target PLMN does not support the UE Radio Capability ID assigned by the source PLMN based on local configuration, then the source NG-RAN includes the UE radio access capabilities in the Source to Target transparent container.

Direct Forwarding Path Availability indicates whether direct forwarding is available from the NG-RAN to the E-UTRAN. This indication from NG-RAN can be based on e.g. the presence of IP connectivity and security association(s) between the NG-RAN and the E-UTRAN.

If the handover is triggered due to Emergency fallback, the NG-RAN may forward the Emergency indication to the target eNB in the Source to Target Transparent Container and the target eNB allocates radio bearer resources taking received indication into account.

2a-2c. The AMF determines from the 'Target eNB Identifier' IE that the type of handover is Handover to E-UTRAN. The AMF selects an MME as described in clause 4.3.8.3 of TS 23.401 [13].

The AMF determines for a PDU Session whether to retrieve context including mapped UE EPS PDN Connection from the V-SMF (in the case of HR roaming) or the SMF+PGW-C (in the case of non roaming or LBO roaming) as follows:

- If the AMF determines that one or more of the EBI(s) can be transferred, the AMF sends Nsmf\_PDUSession\_ContextRequest to the V-SMF or SMF+PGW-C and includes in the message EBI value(s) if any that cannot be transferred.
- The EBI values(s) that cannot be transferred is determined by the AMF if the target MME does not support 15 EPS bearers, i.e. the AMF determines the EBI values in range 1-4 as not to be transferred to EPS and if there are still more than 8 EBI values associated with PDU Sessions, the AMF then determines EBI value(s) not to be transferred to EPS based on S-NSSAI and ARP as specified in clause 5.17.2.2.1 of TS 23.501 [2].
- The AMF does not retrieve the context for a PDU Session that cannot be transferred to EPS due to no EBI allocated, or allocated EBIs not transferrable, or combination of the two.

When the AMF sends Nsmf\_PDUSession\_ContextRequest the AMF provides also the target MME capability to the V-SMF or the SMF+PGW-C to allow it to determine whether to include EPS Bearer context for Ethernet PDN Type or non-IP PDN Type or not.

When Nsmf\_PDUSession\_Context Request is received in the V-SMF or the SMF+PGW-C, the V-SMF or the SMF+PGW-C provides context that includes the mapped EPS PDN Connection as follows:

- If there is EBI list not to be transferred and the EBI value of the QoS Flow associated with the default QoS Rule is included in that list, the V-SMF or the SMF+PGW-C shall not return the PDN Connection context (which implies the whole PDU Session is not transferred to EPS), otherwise if the EBI value of the QoS Flow associated with the default QoS Rule is not included in EBI list not to be transferred, the V-SMF or PGW C+SMF shall not provide the EPS bearer context(s) mapped from QoS Flow(s) associated with the EBI list not to be transferred.
- For PDU Sessions with PDU Session Type Ethernet, if the UE and target MME supports Ethernet PDN type, the V-SMF or the PGW C+SMF provides Context for Ethernet PDN Type, otherwise if the target MME does not support Ethernet Type but support non-IP Type, the V-SMF or the PGW C+SMF provides Context for non-IP PDN Type. For PDU Sessions with PDU Session Type Unstructured, the V-SMF or the SMF+PGW-C provides Context for non-IP PDN Type.

In the case of non roaming or LBO roaming, when Nsmf\_PDUSession\_ContextRequest is received in PGW C+SMF, if the SMF+PGW-C determines that EPS Bearer Context can be transferred to EPS and the CN Tunnel Info for EPS bearer(s) have not been allocated before, the SMF+PGW-C sends N4 Session modification to the PGW-U+UPF to establish the CN tunnel for each EPS bearer and provides EPS Bearer Contexts to AMF, as described in step 8 of clause 4.11.1.4.1. The PGW-U+UPF is ready to receive the uplink packet from E-UTRAN.

This step is performed with all the SMF+PGW-Cs corresponding to PDU Sessions of the UE which are associated with 3GPP access and have at least one EBI(s) determined to be transferred to EPS.

NOTE 2: The AMF knows the MME capability to support 15 EPS bearers, Ethernet PDN type and/or non-IP PDN type or not through local configuration.

In home routed roaming scenario, the UE's EPS PDN Contexts are obtained from the V-SMF. If Small Data Rate Control applies on PDU Session, the V-SMF retrieves the SM Context, including Small Rate Control Status information from the H-SMF using Nsmf\_PDUSession\_Context Request.

3. The AMF sends a Forward Relocation Request as in step 3 in clause 5.5.1.2.2 (S1-based handover, normal) in TS 23.401 [13], with the following modifications and clarifications:
  - Parameter "Return preferred" may be included. Return preferred is an optional indication by the MME of a preferred return of the UE to the 5GS PLMN at a later access change to a 5GS shared network. An MME may use this information as specified by TS 23.501 [2].
  - The SGW address and TEID for both the control-plane or EPS bearers in the message are such that target MME selects a new SGW.
  - The AMF determines, based on configuration and the Direct Forwarding Path Availability, the Direct Forwarding Flag to inform the target MME whether direct data forwarding is applicable.
  - The AMF includes the mapped SM EPS UE Contexts for PDU Sessions with and without active UP connections.
  - Subject to operator policy if the secondary RAT access restriction condition is the same for EPS and 5GS, the AMF may set EPS secondary RAT access restriction condition based on the UE's subscription data.
- 4-5. Step 4 and 4a respectively in clause 5.5.1.2.2 (S1-based handover, normal) in TS 23.401 [13].
6. Step 5 (Handover Request) in clause 5.5.1.2.2 (S1-based handover, normal) in TS 23.401 [13] with the following modification:
  - Handover Request may contain information Handover Restriction List with information about PLMN IDs as specified by clause 5.2a of TS 23.251 [35] for eNodeB functions.
  - The target eNB should establish E-RABs indicated by the list of EPS bearer to be setup provided by the MME, even if they are not included in the source to target container.
- 7-9. Step 5a through 7 in clause 5.5.1.2.2 (S1-based handover, normal) in TS 23.401 [13].
- 10a. If data forwarding applies, the AMF sends the Nsmf\_PDUSession\_UpdateSMContext Request (data forwarding information) to the SMF+PGW-C. If multiple SMF+PGW-Cs serves the UE, the AMF maps the EPS bearers for Data forwarding to the SMF+PGW-C address(es) based on the association between the EPS bearer ID(s) and PDU Session ID(s). In home-routed roaming case, the AMF requests the V-SMF to create indirect forwarding tunnel if indirect forwarding applies.
- 10b. If indirect data forwarding applies, the SMF+PGW-C may select an intermediate PGW-U+UPF for data forwarding. The SMF+PGW-C maps the EPS bearers for Data forwarding to the 5G QoS flows based on the association between the EPS bearer ID(s) and QFI(s) for the QoS flow(s) in the SMF+PGW-C and then sends the QFIs, Serving GW Address(es) and TEID(s) for data forwarding to the PGW-U+UPF. The CN Tunnel Info is provided by the PGW-U+UPF to SMF+PGW-C in this response. In home-routed roaming case, the V-SMF selects the V-UPF for data forwarding.
- 10c. The SMF+PGW-C returns an Nsmf\_PDUSession\_UpdateSMContext Response (Cause, Data Forwarding tunnel Info, QoS flows for Data Forwarding). Based on the correlation between QFI(s) and Serving GW Address(es) and TEID(s) for data forwarding, the PGW-U+UPF maps the QoS flow(s) into the data forwarding tunnel(s) in EPC.
11. The AMF sends the Handover Command to the source NG-RAN (Transparent container (radio aspect parameters that the target eNB has set-up in the preparation phase), Data forwarding tunnel info, QoS flows for Data Forwarding). The source NG-RAN commands the UE to handover to the target Access Network by sending the HO Command. The UE correlates the ongoing QoS Flows with the indicated EPS Bearer IDs to be setup in the HO command. The UE locally deletes the PDU Session if the QoS Flow associated with the default QoS rule

in the PDU Session does not have an EPS Bearer ID assigned. If the QoS Flow associated with the default QoS rule has an EPS Bearer ID assigned, the UE keeps the PDU Session (PDN connection) and for the remaining QoS Flow(s) that do not have EPS bearer ID(s) assigned, the UE locally deletes the QoS rule(s) and the QoS Flow level QoS parameters if any associated with those QoS Flow(s) and notifies the impacted applications that the dedicated QoS resource has been released. The UE deletes any UE derived QoS rules. The EPS Bearer ID that was assigned for the QoS flow of the default QoS rule in the PDU Session becomes the EPS Bearer ID of the default bearer in the corresponding PDN connection.

If indirect data forwarding is applied, Data forwarding tunnel info includes CN tunnel info for data forwarding per PDU session. For the QoS Flows indicated in the "QoS Flows for Data Forwarding", NG-RAN initiate data forwarding via to the PGW-U+UPF based on the CN Tunnel Info for Data Forwarding per PDU Session. Then the PGW-U+UPF maps data received from the data forwarding tunnel(s) in the 5GS to the data forwarding tunnel(s) in EPS and sends the data to the target eNodeB via the Serving GW.

If direct data forwarding is applied, Data forwarding tunnel info includes E-UTRAN tunnel info for data forwarding per EPS bearer. NG-RAN initiate data forwarding to the target E-UTRAN based on the Data Forwarding Tunnel Info for Data Forwarding per EPS bearer.

12-12c. Step 13 to step 14 from clause 5.5.1.2.2 (S1-based handover, normal) in TS 23.401 [13] with the following clarification:

- The AMF requests the release of the PDU Session which is associated with 3GPP access and not expected to be transferred to EPC, i.e. the AMF requests the release of:
- PDU Session(s) whose corresponding SMF+PGW-C(s) are not contacted by AMF for SM context because the AMF determines that none of EBI(s) for the PDU Session can be transferred to EPS at step 2a; and
- PDU Session(s) for which the SM context retrieval failed at step 2c.

12d. The AMF acknowledges MME with Relocation Complete Ack message. A timer in AMF is started to supervise when resource in NG-RAN shall be released.

12e. In the case of home routed roaming, the AMF invokes Nsmf\_PDUSession\_ReleaseSMContext Request (V-SMF only indication) to the V-SMF. This service operation request the V-SMF to remove only the SM context in V-SMF, i.e. not release PDU Session context in the SMF+PGW-C.

If indirect forwarding tunnel(s) were previously established, the V-SMF starts a timer and releases the SM context on expiry of the timer. If no indirect forwarding tunnel has been established, the V-SMF immediately releases the SM context and its UP resources for this PDU Session in V-UPF locally.

13. Step 15 from clause 5.5.1.2.2 (S1-based handover, normal) in TS 23.401 [13].

14a. Step 16 (Modify Bearer Request) from clause 5.5.1.2.2 (S1-based handover, normal) in TS 23.401 [13] with the following clarification:

- If the PDU Session (PDN connection) has QoS Flows that do not have EPS bearer ID(s) assigned, or QoS Flow(s) for which the mapped EPS bearers are not included in Modify Bearer Request, the SMF+PGW-C deletes the PCC rule(s) associated with those QoS Flows and informs the PCF about the removed PCC rule(s).

NOTE 4: If the QoS flow is deleted, the IP flows of the deleted QoS rules will continue flowing on the default EPS bearer if it does not have an assigned TFT. If the default EPS bearer has an assigned TFT, the IP flows of the deleted QoS Flow may be interrupted until step 19 when dedicated bearer activation is triggered by a request from the PCF.

The SMF+PGW-C may need to report some subscribed event to the PCF by performing an SMF initiated SM Policy Association Modification procedure as defined in clause 4.16.5.

15. The SMF+PGW-C initiates a N4 Session Modification procedure towards the UPF+PGW-U to update the User Plane path, i.e. the downlink User Plane for the indicated PDU Session is switched to E-UTRAN. The SMF+PGW-C releases the resource of the CN tunnel for PDU Session in UPF+PGW-U.

16. Step 16a (Modify Bearer Response) from clause 5.5.1.2.2 (S1-based handover, normal) in TS 23.401 [13]. At this stage the User Plane path is established for the default bearer and the dedicated EPS bearers between the UE, target eNodeB, Serving GW and the PGW-U+UPF. The SMF+PGW-C uses the EPS QoS parameters as

assigned for the dedicated EPS bearers during the QoS Flow establishment. SMF+PGW-C maps all the other IP flows to the default EPS bearer (see NOTE 4).

If indirect forwarding tunnel(s) were previously established, the SMF+PGW-C starts a timer, to be used to release the resource used for indirect data forwarding.

17. Step 17 from clause 5.5.1.2.2 (S1-based handover, normal) in TS 23.401 [13].

18. The UE initiates a Tracking Area Update procedure as specified in step 18 of clause 5.5.1.2.2 (S1-based handover, normal) in TS 23.401 [13].

This includes the deregistration of the old AMF for 3GPP access from the HSS+UDM as specified in clause 4.11.1.5.3. Any registration associated with the non-3GPP access in the old AMF is not removed (i.e. an AMF that was serving the UE over both 3GPP and non-3GPP accesses does not consider the UE as deregistered over non 3GPP access and will remain registered and subscribed to subscription data updates in UDM).

NOTE 5: The behaviour whereby the HSS+UDM cancels location of CN node of the another type, i.e. AMF, is similar to HSS behaviour for MME and Gn/Gp SGSN registration (see TS 23.401 [13]). The target AMF that receives the cancel location from the HSS+UDM is the one associated with 3GPP access.

When the UE decides to deregister over non-3GPP access or the old AMF decides not to maintain a UE registration for non-3GPP access anymore, the old AMF then deregisters from UDM by sending a Nudm\_UECM\_Deregistration service operation, unsubscribes from Subscription Data updates by sending an Nudm\_SDM\_Unsubscribe service operation to UDM and releases all the AMF and AN resources related to the UE.

19. If PCC is deployed, the PCF may decide to provide the previously removed PCC rules to the SMF+PGW-C again thus triggering the SMF+PGW-C to initiate dedicated bearer activation procedure. This procedure is specified in clause 5.4.1 of TS 23.401 [13] with modification captured in clause 4.11.1.5.4. This step is applicable for PDN Type IP or Ethernet, but not for non-IP PDN Type.

20. Step 21 from clause 5.5.1.2.2 (S1-based handover, normal) in TS 23.401 [13].

21. In the case of home routed roaming, at the expiry of the timer at V-SMF started at step 12e, the V-SMF locally releases the SM context and the UP resource for the PDU Session including the resources used for indirect forwarding tunnel(s) that were allocated at step 10.

In non-roaming or local breakout roaming, if SMF+PGW-C has started a timer in step 16, at the expiry of the timer, the SMF+PGW-C sends N4 Session Modification Request to PGW-U+UPF to release the resources used for the indirect forwarding tunnel(s) that were allocated at step 10.

When the timer set in step 12d expires, AMF also sends a UE Context Release Command message to the source NG RAN. The source NG RAN releases its resources related to the UE and responds with a UE Context Release Complete message.

#### 4.11.1.2.2 EPS to 5GS handover using N26 interface

##### 4.11.1.2.2.1 General

N26 interface is used to provide seamless session continuity for single registration mode.

The procedure involves a handover to 5GS and setup of QoS Flows in 5GS.

In the home routed roaming case, the PGW-C+ SMF in the HPLMN always receives the PDU Session ID from UE and provides PDN Connection associated 5G QoS parameter(s) and S-NSSAI to the UE. This also applies in the case that the HPLMN operates the interworking procedure without N26.

In the case of handover to a shared 5GS network, the source E-UTRAN determines a PLMN to be used in the target network as specified by clause 5.2a of TS 23.251 [35] for eNodeB functions. A supporting MME may provide the AMF via N26 with an indication that source EPS PLMN is a preferred PLMN when that PLMN is available at later change of the UE to an EPS shared network.

NOTE 1: If the UE has active EPS bearer for normal voice or IMS emergency voice, the source E-UTRAN can be configured to not trigger any handover to 5GS.

If the PDN Type of a PDN Connection in EPS is non-IP and is locally associated in UE and SMF to PDU Session Type Ethernet or Unstructured, the PDU Session Type in 5GS shall be set to Ethernet or Unstructured respectively.

NOTE 2: If the non-IP PDN Type is locally associated in UE and SMF to PDU Session Type Ethernet, it means that Ethernet PDN Type is not supported in EPS.

NOTE 3: The IP address continuity can't be supported, if SMF+PGW-C in the HPLMN doesn't provide the mapped QoS parameters.

4.11.1.2.2.2 Preparation phase

Figure 4.11.1.2.2.2-1 shows the preparation phase of the Single Registration-based Interworking from EPS to 5GS procedure.

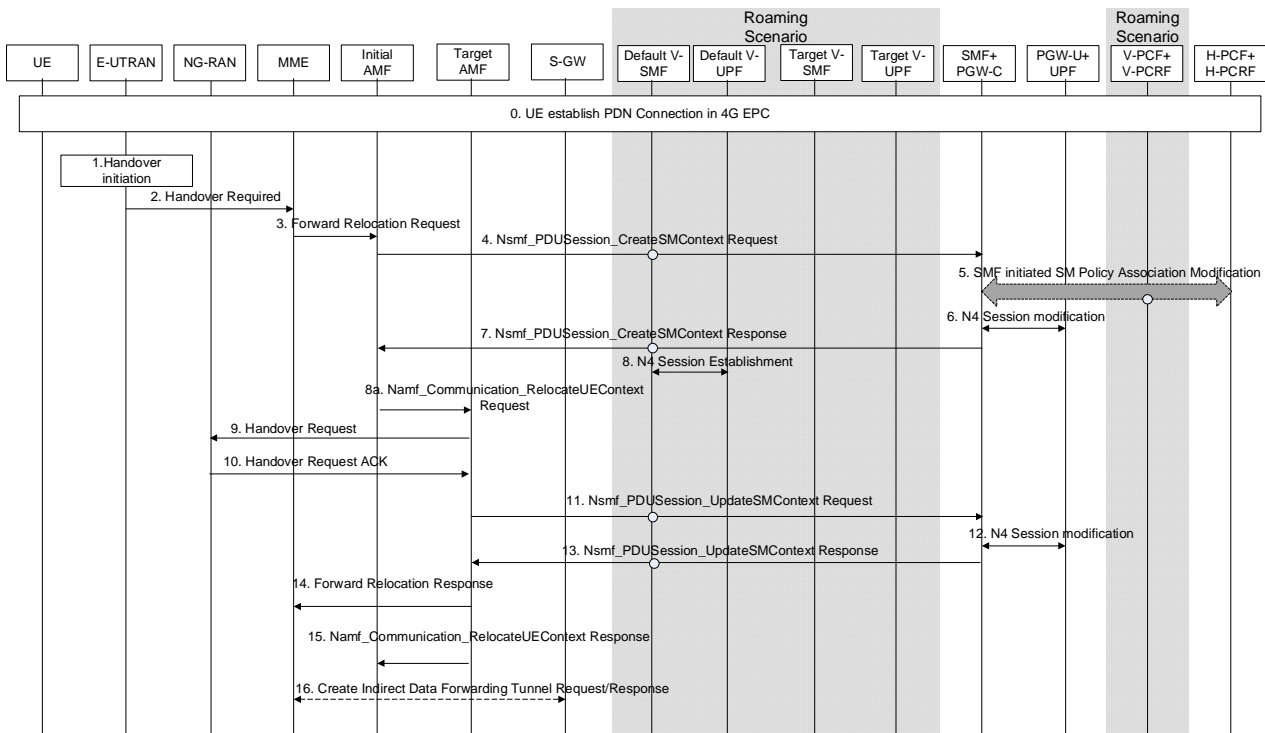


Figure 4.11.1.2.2.2-1: EPS to 5GS handover using N26 interface, preparation phase

This procedure applies to the Non-Roaming (TS 23.501 [2] Figure 4.3.1-1), Home-routed roaming (TS 23.501 [2] Figure 4.3.2-1) and Local Breakout roaming Local Breakout (TS 23.501 [2] Figure 4.3.2-2) cases.

- For non-roaming scenario, V-SMF, v-UPF and v-PCF are not present
- For home-routed roaming scenario, the SMF+PGW-C and UPF+PGW-U are in the HPLMN. v-PCF are not present
- For local breakout roaming scenario, V-SMF and v-UPF are not present. SMF+PGW-C and UPF+PGW-U are in the VPLMN.

In local-breakout roaming case, the v-PCF interacts wit the SMF+PGW-C.

1 - 2. Step 1 - 2 from clause 5.5.1.2.2 (S1-based handover, normal) in TS 23.401 [13].

3. Step 3 from clause 5.5.1.2.2 (S1-based handover, normal) in TS 23.401 [13] with the following modifications:

An additional optional parameter Return preferred. Return preferred is an optional indication provided by the MME to indicate a preferred return of the UE to the last used EPS PLMN at a later access change to an EPS shared network. Based on the Return Preferred indication, the initial AMF may store the last used EPS PLMN ID in the UE Context.



The initial AMF converts the received EPS MM Context into the 5GS MM Context. This includes converting the EPS security context into a mapped 5G security context as described in TS 33.501 [15]. The MME UE context includes IMSI, ME Identity, UE security context, UE Network Capability and EPS Bearer context(s) and may also include LTE-M Indication. The MME EPS Bearer context(s) include for each EPS PDN connection the IP address and FQDN for the S5/S8 interface of the SMF+PGW-C and APN and for each EPS bearer the IP address and CN Tunnel Info at the UPF+PGW-U for uplink traffic. If the AMF received the LTE-M indication in the EPS MM Context, then it considers that the RAT Type is LTE-M.

The initial AMF queries the (PLMN level) NRF in serving PLMN by issuing the Nnrf\_NFDiscovery\_Request including the FQDN for the S5/S8 interface of the SMF+PGW-C and the NRF provides the IP address or FQDN of the N11/N16 interface of the SMF+PGW-C.

If the initial AMF cannot retrieve the address of the corresponding SMF for a PDN connection, it will not move the PDN connection to 5GS.

NOTE 1: If the initial AMF holds a native 5G security context for the UE, the initial AMF may activate this native 5G security context by initiating a NAS SMC upon completing the handover procedure.

4. The initial AMF invokes the Nsmf\_PDUSession\_CreateSMContext service operation (UE EPS PDN Connection, initial AMF ID, data Forwarding information, Target ID) on the SMF identified by the SMF+PGW-C address and indicates HO Preparation Indication (to avoid switching the UP path). The initial AMF ID uniquely identifies the initial AMF serving the UE. This step is performed for each PDN Connection and the corresponding SMF+PGW-C address/ID in the UE context the initial AMF received in step 3. The SMF finds the corresponding PDU Session based on EPS Bearer Context(s).

Based on configuration and the Direct Forwarding Flag received from the MME, the initial AMF determines the applicability of data forwarding and indicates to the SMF whether the direct data forwarding or indirect data forwarding is applicable.

Target ID corresponds to Target ID provided by the MME in step 3.

For home-routed roaming scenario, the initial AMF selects a default V-SMF per PDU Session and invokes the Nsmf\_PDUSession\_CreateSMContext service operation (UE PDN Connection Contexts, initial AMF ID, SMF + PGW-C address, S-NSSAI). The S-NSSAI is the S-NSSAI configured in initial AMF for interworking, which is associated with default V-SMF.

The default V-SMF selects the SMF+PGW-C using the received H-SMF address as received from the initial AMF and initiates a Nsmf\_PDUSession\_Create service operation with the SMF+PGW-C and indicates HO Preparation Indication.

Step 5 and step 6 are skipped if the SMF+PGW-C (H-SMF+PGW-C in the case of home-routed scenario) determines that session continuity from EPS to 5GS is not supported for the PDU Session (e.g. PDU Session ID was not received for the PDN connection in EPS or PDU Session ID was received but mapped 5GS parameters were not provided to the UE due to 5GS interworking not supported).

NOTE 2: When there are lots of PDN connections attempted to be transferred to 5GS while there was no PDU Session ID received from the UE over EPS, the performance counters related with failed PDN connections transfer from EPS to 5GS can get high values. Likewise, in this case, the performance counters related with target NG RAN not receiving N2 SM information corresponding to EPS bearers received from E-UTRAN can get high values.

5. If dynamic PCC is deployed, the SMF+ PGW-C (H-SMF for home-routed scenario) may initiate SMF initiated SM Policy Modification towards the PCF.
6. The SMF+PGW-C requests the PGW-U+UPF to allocate the CN Tunnel Info for PDU Session. The SMF+PGW-C send N4 Session modification to PGW-U+UPF to establish the CN tunnel for PDU Session at PGW-U+UPF. The PGW-U+UPF is ready to receive the uplink packets from NG-RAN. The PGW-U+UPF allocates the PGW-U CN Tunnel Info for PDU Session and sends it to the SMF+PGW-C. This step is performed at all SMF+PGW-Cs allocated to the UE for each PDU Session of the UE.
7. The SMF+PGW-C (default V-SMF in the case of home-routed roaming scenario only) sends a Nsmf\_PDUSession\_CreateSMContext Response (PDU Session ID, S-NSSAI, allocated EBIs, N2 SM Information (QoS Profile(s), EPS Bearer Setup List, Mapping between EBI(s) and QFI(s), CN Tunnel-Info, cause code)) to the initial AMF.

For home-routed roaming scenario the step 8 need be executed first. The CN Tunnel-Info provided to the initial AMF in N2 SM Information is the V-CN Tunnel-Info.

The SMF includes mapping between EBI(s) and QFI(s) as part of N2 SM Information container. If the SMF+PGW-C (H-SMF+PGW-C in the case of home-routed scenario) determines that session continuity from EPS to 5GS is not supported for the PDU Session (e.g. PDU Session ID was not received for the PDN connection in EPS), then it does not provide SM information for the corresponding PDU Session but includes the appropriate cause code for rejecting the PDU Session transfer within the N2 SM Information and release the PDN connection locally in the SMF+PGW-C. If neither indirect forwarding nor direct forwarding is applicable, the SMF shall further include a "Data forwarding not possible" indication in the N2 SM information container. If SMF is indicated that Direct Forwarding is applicable, the SMF shall further include a "Direct Forwarding Path Availability" indication in the N2 SM information container. In home routed roaming case, the S-NSSAI included in N2 SM Information container is the S-NSSAI received in step 4.

The initial AMF stores an association of the PDU Session ID, S-NSSAI and the SMF ID. The AMF stores also the allocated EBI(s) associated to the PDU Session ID.

If the PDN Type of a PDN Connection in EPS is non-IP and is locally associated in SMF to PDU Session Type Ethernet, the PDU Session Type in 5GS shall be set to Ethernet. If the PDN type of a PDN Connection in EPS is non-IP and is locally associated in UE and SMF to PDU Session Type Unstructured, the PDU Session Type in 5GS shall be set to Unstructured.

NOTE 3: If the non-IP PDN Type is locally associated in SMF to PDU Session Type Ethernet, it means that Ethernet PDN Type is not supported in EPS.

In the case of PDU Session Type Ethernet, that was using PDN type non-IP in EPS, the SMF creates QoS rules and QoS Flow level QoS parameters for the QoS Flow(s) associated with the QoS rule(s) based on the PCC Rules received from PCF.

8. For home-routed roaming scenario only: The default V-SMF selects a default v-UPF and initiates an N4 Session Establishment procedure with the selected default v-UPF. The default V-SMF provides the default v-UPF with packet detection, enforcement and reporting rules to be installed on the UPF for this PDU Session, including H-CN Tunnel Info.

The default v-UPF acknowledges by sending an N4 Session Establishment Response message. The V-CN Tunnel Info is allocated by the v-UPF and provided to the default V-SMF in this step.

8a. Based on the received S-NSSAI from the SMF+PGW-C, the Initial AMF may reselect a target AMF as described in clause 5.15.5.2.1 of TS 23.501 [2] and invokes Namf\_Communication\_RelocateUEContext request (SUPI, Target 5GAN Node ID, PDU session ID and the S-NSSAI associated with N2 SM Information received in step 7, Source to Target Transparent Container, 5GS MM Context, MME Tunnel Endpoint Identifier for Control Plane, MME Address for Control plane, PDU Session ID and its associated S-NSSAI of the VPLMN value for each PDU Session, the corresponding S-NSSAI of HPLMN value for home routed PDU Session(s), SMF+PGW-C ID of each PDU Session, default V-SMF ID and SM Context ID of each PDU Session, allocated EBIs of each PDU Session, Allowed NSSAI received from NSSF) to the selected target AMF.

NOTE 4: When there is no need of AMF reallocation, then the target AMF in following steps is the same as the initial AMF.

NOTE 5: In the case of Home routed PDU Session the S-NSSAI associated with N2 SM information used in steps 8, 8a and 9 is the S-NSSAI configured for interworking in the initial AMF. Otherwise the S-NSSAI received from the SMF in step 7 can be used in steps 8, 8a and 9 for the S-NSSAI associated with N2 SM information.

9. The target AMF sends a Handover Request (Source to Target Transparent Container, Allowed NSSAI, PDU session ID and the S-NSSAI received from Source AMF associated with the corresponding N2 SM Information (QFI(s), QoS Profile(s), EPS Bearer Setup List, V-CN Tunnel Info, Mapping between EBI(s) and QFI(s)), Mobility Restriction List, UE Radio Capability ID) message to the NG-RAN. The target AMF provides NG-RAN with a PLMN list in the Mobility Restriction List containing at least the serving PLMN, taking into account the last used EPS PLMN ID and the Return preferred indication. The Mobility Restriction List contain information about PLMN IDs as specified by TS 23.501 [2].

NG-RAN can use the source to target transparent container and N2 SM Information container to determine which QoS flows have been proposed for forwarding and decide for which of those QoS flows it accepts the data forwarding or not.

The target AMF provides the UE Radio Capability ID to NG-RAN if RACS is supported. If the UE Radio Capability ID is included in the Handover Request message, when there is no corresponding UE radio capabilities set for UE Radio Capability ID at NG-RAN and no UE radio access capabilities are provided in the Source to Target transparent container, NG-RAN shall request the T-AMF to provide the UE radio capabilities set corresponding to UE Radio Capability ID to the NG-RAN. If the Source to Target transparent container contains the UE radio access capabilities and the T-RAN did not receive the UE Radio Capability ID from the T-AMF, NG-RAN shall proceed with handover using the received UE access radio capabilities. If the T-RAN received both the UE radio access capabilities and the UE Radio Capability ID, then the T-RAN shall use any locally stored UE radio access capability information corresponding to the UE Radio Capability ID. If none are stored locally, the T-RAN may request the full UE radio access capability information from the core network. If the full UE radio access capability information is not promptly received from the core network, or the T-RAN chooses not to request them, then the T-RAN shall proceed with the UE radio access capabilities sent by the source RAN node. The T-RAN shall not use the UE radio access capability information received from the source RAN node for any other UE with the same the UE Radio Capability ID.

10. The NG-RAN sends a Handover Request Acknowledge (Target to Source Transparent Container, List of PDU Sessions to Hand-over with N2 SM response (PDU Session ID, list of accepted QFI(s), AN Tunnel Info, Data Forwarding Tunnel Info), List of PDU Sessions that failed to be established with the failure cause given in the N2 SM information element) message to the target AMF.

If indirect data forwarding is applied, the NG-RAN includes one assigned TEID/TNL address per PDU Session (for which there is at least one QoS flow for which it has accepted the forwarding) within the SM Info container. It also includes the list of QoS flows for which it has accepted the forwarding. According to the mapping between EBI(s) and QFI(s), if one EPS bearer in EPS is mapped to multiple QoS flows in 5GS, all such QoS flows need to be accepted to support indirect data forwarding during EPS to 5GS mobility. Otherwise, the NG RAN rejects the indirect data forwarding for the QoS flows which are mapped to the EPS bearer.

If direct data forwarding is applied, the NG-RAN includes one assigned TEID/TNL per E-RAB accepted for direct data forwarding.

When the target NG-RAN rejects the handover with a Handover Failure, steps 11-13 and step 16 are not executed.

11. The target AMF sends an Nsmf\_PDUSession\_UpdateSMContext Request (PDU Session ID, N2 SM response received from NG-RAN in step 10) message to the SMF for updating N3 tunnel information. In home routed roaming case, the Data Forwarding Tunnel Info is handled by the default V-SMF and will not be sent to the SMF+PGW-C.
12. SMF+PGW-C (default V-SMF in home-routed roaming scenario) performs preparations for N2 Handover by indicating N3 UP address and Tunnel ID of NG-RAN to the UPF if N2 Handover is accepted by NG-RAN. If indirect data forwarding is applied, SMF+PGW-C indicates the mapping between the TEID where the UPF receives data forwarded by the source SGW and the QFI(s) and N3 Tunnel Info for data forwarding where the UPF is selected to forward such data (e.g. an intermediate UPF). If the EPS bearer is mapped to multiple QoS flows and an intermediate UPF is selected for data forwarding, only one QFI is selected by the SMF+PGW-C from QFIs corresponding to the QoS flows.

If indirect data forwarding is applied in home routed roaming case, the default V-SMF sends a default V-UPF for data forwarding the mapping between the TEID where the UPF receives data forwarded by the source SGW and the QFI and N3 Tunnel Info for data forwarding. If the EPS bearer is mapped to multiple QoS flows and an intermediate UPF is selected for data forwarding, only one QFI is selected by the SMF+PGW-C from QFIs corresponding to the QoS flows.

If N2 Handover is not accepted by NG-RAN, SMF+PGW-C deallocates N3 UP address and Tunnel ID of the selected UPF.

The EPS Bearer Setup list is a list of EPS bearer Identifiers successfully handover to 5GC, which is generated based on the list of accepted QFI(s).

If a PDU Session is rejected by the Target NG-RAN with an indication that the PDU session was rejected because User Plane Security Enforcement is not supported in the Target NG-RAN and the User Plane

Enforcement Policy indicates "Required" as described in clause 5.10.3 of TS 23.501 [2], the SMF triggers the release of this PDU Session. In all other cases of PDU Session rejection, the SMF can decide whether to release the PDU Session or to deactivate the UP connection of this PDU Session.

If some of the QoS Flows of a PDU Session are not accepted by the Target NG-RAN, the SMF shall initiate the PDU Session Modification procedure to remove the non-accepted QoS Flows from the PDU Session(s) after the handover procedure is completed.

13. SMF+PGW-C (default V-SMF in home-routed roaming scenario) to target AMF: Nsmf\_PDUSession\_UpdateSMContext Response (PDU Session ID, EPS Bearer Setup List). The data forwarding information is included in the EPS Bearer Setup List. In home routed roaming case, the default V-SMF provides the tunnel information for data forwarding.

This message is sent for each received Nsmf\_PDUSession\_UpdateSMContext\_Request message.

14. The target AMF sends the message Forward Relocation Response (Cause, Target to Source Transparent Container, Serving GW change indication, EPS Bearer Setup List, target AMF Tunnel Endpoint Identifier for Control Plane, Addresses and TEIDs) to MME. The EPS Bearer Setup list is the combination of EPS Bearer Setup list from different SMF+PGW-C(s).

In the case of Handover Failure in step 10, the target AMF provides to the MME the failure related information such as the Target RAN to Source RAN Failure Information.

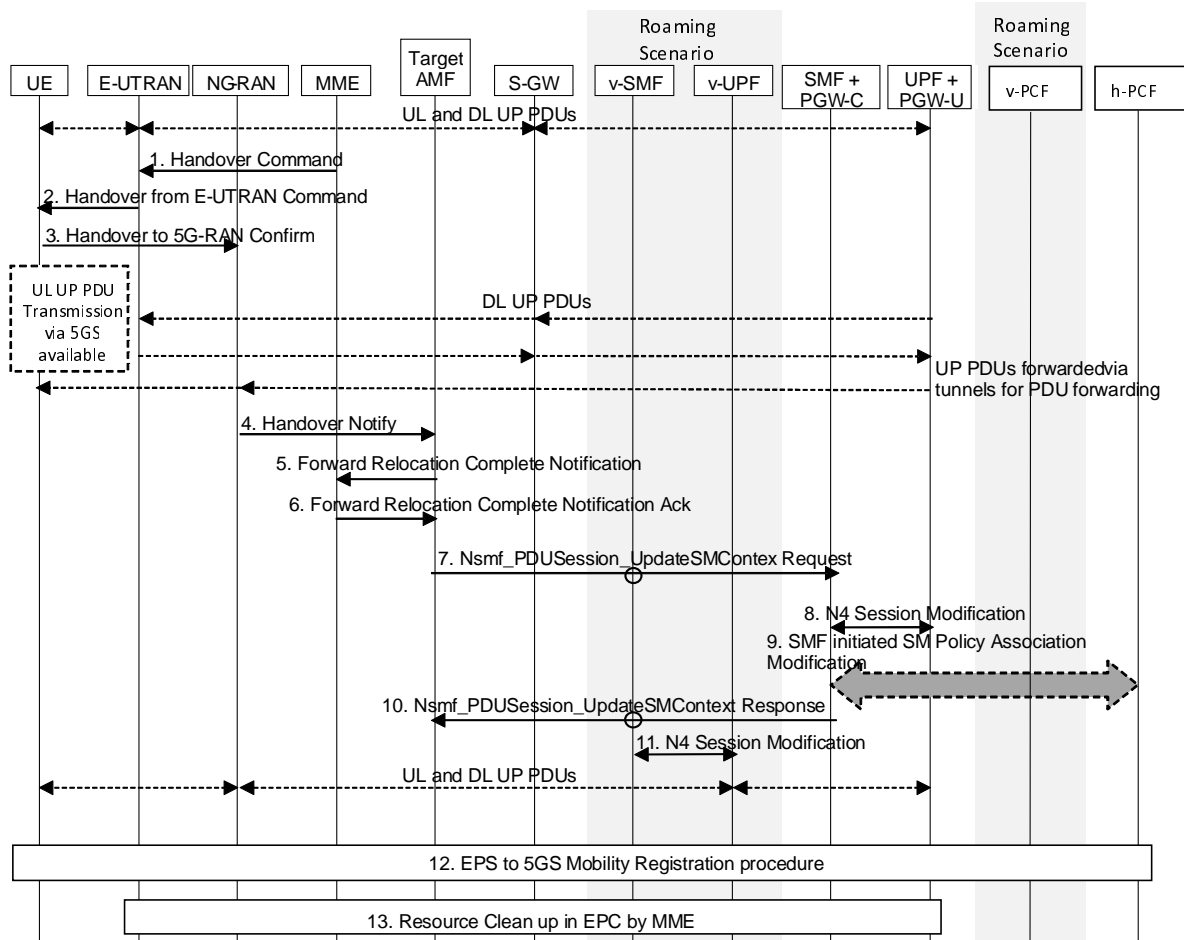
15. The target AMF invokes Namf\_Communication\_RelocateUEContext response (Cause) to the initial AMF if step 8a had been performed. The target AMF indicates whether the Relocate UE Context (hand-Over) succeeded or failed.

If the target NG RAN has rejected the Handover Request in step 10, the Namf\_Communication\_RelocateUEContext response indicates a failure due to RAN rejection. Then the initial AMF invokes the Nsmf\_PDUSession\_UpdateSMContext request towards the SMF+PGW-C(s) contacted at step 4 indicating . The Nsmf\_PDUSession\_UpdateSMContext request contains an indication that this is due to a handover rejected by the target RAN.

16. Step 8 from clause 5.5.1.2.2 (S1-based handover, normal) in TS 23.401 [13] is executed if the source MME determines that indirect data forwarding applies.

#### 4.11.1.2.2.3 Execution phase

Figure 4.11.1.2.2.3-1 shows the Single Registration-based Interworking from EPS to 5GS procedure.



**Figure 4.11.1.2.2.3-1: EPS to 5GS handover using N26 interface, execution phase**

NOTE: Step 6 P-GW-C+SMF Registration in the UDM is not shown in the figure for simplicity.

1 - 2. Step 9 - 11 from clause 5.5.1.2.2 (S1-based handover, normal) in TS 23.401 [13]. Different from step 9a of clause 5.5.1.2.2 (S1-based handover, normal) in TS 23.401 [13], upon reception of Handover Command, the UE will keep the QoS Flow context for which it did not receive the corresponding radio resources in the NG-RAN until the QoS Flow is released by the network using PDU Session Modification procedure in clause 4.3.3. If the QoS Flow with a default QoS Rule of a PDU Session does not have the corresponding radio resources in the NG-RAN, UE considers that the user plane of this PDU Session is deactivated.

3. Handover Confirm: the UE confirms handover to the NG-RAN.

The UE moves from the E-UTRAN and synchronizes with the target NG-RAN. The UE may resume the uplink transmission of user plane data only for those QFIs and Session IDs for which there are radio resources allocated in the NG-RAN.

The E-UTRAN sends DL data to the Data Forwarding address received in step 1. If the indirect data forwarding is applied, the E-UTRAN forward the DL data to NG-RAN via the SGW and the v-UPF. The v-UPF forwards the data packets to the NG-RAN using the N3 Tunnel Info for data forwarding, adding the QFI information. The target NG-RAN prioritizes the forwarded packets over the fresh packets for those QoS flows for which it had accepted data forwarding.

If Direct data forwarding is applied, the E-UTRAN forwards the DL data packets to the NG-RAN via the direct data forwarding tunnel.

4. Handover Notify: the NG-RAN notifies to the target AMF that the UE is handed over to the NG-RAN.

5. Then the target AMF knows that the UE has arrived to the target side and informs the MME by sending a Forward Relocation Complete Notification message.

6. Step 14 from clause 5.5.1.2.2 (S1-based handover, normal) in TS 23.401 [13].

7. Target AMF to SMF +PGW-C (V-SMF in the case of roaming and Home-routed case): Nsmf\_PDUSession\_UpdateSMContext Request (Handover Complete Indication for PDU Session ID). In the Home-routed roaming case, the V-SMF invokes Nsmf\_PDUSession\_Update Request (V-CN Tunnel Info, Handover Complete Indication) to SMF+PGW-C.

Handover Complete Indication is sent per each PDU Session to the corresponding SMF +PGW-C (sent by V-SMF in the roaming and Home-routed case) to indicate the success of the N2 Handover.

If indirect forwarding is used, a timer in SMF+PGW-C (V-SMF in the case of roaming and Home-routed case) is started to supervise when resources in UPF (for indirect data forwarding) shall be released.

8. The SMF + PGW-C updates the UPF + PGW-U with the V-CN Tunnel Info, indicating that downlink User Plane for the indicated PDU Session is switched to NG-RAN or V-UPF in the case of roaming in Home-routed case and the CN tunnels for EPS bearers corresponding to the PDU session can be released.

For each EPS Bearer one or more "end marker" is sent to Serving GW by the UPF+PGW-U immediately after switching the path. The UPF + PGW-U starts sending downlink packets to the V-UPF.

9. If PCC infrastructure is used, the SMF + PGW-C informs the PCF about the change of, for example, the RAT type and UE location.

10. SMF +PGW-C to target AMF: Nsmf\_PDUSession\_UpdateSMContext Response (PDU Session ID).

SMF +PGW-C confirms reception of Handover Complete.

- If the SMF has not yet registered for this PDU Session ID, then the SMF registers with the UDM using Nudm\_UECM\_Registration (SUPI, DNN, PDU Session ID) for a given PDU Session as in step 4 of PDU Session Establishment Procedure in clause 4.3.2.

11. For home-routed roaming scenario: The V-SMF provides to the v-UPF with the N3 DL AN Tunnel Info. This step is executed after step 7.

12. The UE performs the EPS to 5GS Mobility Registration Procedure from step 2 in clause 4.11.1.3.3. The UE includes the UE Policy Container containing the list of PSIs, indication of UE support for ANDSP and OSId if available. If the UE holds a native 5G-GUTI it also includes the native 5G-GUTI as an additional GUTI in the Registration Request. The UE shall select the 5G-GUTI for the additional GUTI as follows, listed in decreasing order of preference:

- a native 5G-GUTI assigned by the PLMN to which the UE is attempting to register, if available;
- a native 5G-GUTI assigned by an equivalent PLMN to the PLMN to which the UE is attempting to register, if available;
- a native 5G-GUTI assigned by any other PLMN, if available.

The additional GUTI enables the target AMF to find the UE's 5G security context (if available). The target AMF provides NG-RAN with a PLMN list in the Handover Restriction List containing at least the serving PLMN, taking into account of the last used EPS PLMN ID and Return preferred indication as part of the Registration procedure execution and target AMF signalling to NG-RAN. The Handover Restriction List contains a list of PLMN IDs as specified by TS 23.501 [2].

13. Step 19 from clause 5.5.1.2.2 (S1-based handover, normal) in TS 23.401 [13]. Step 20a - 20b from clause 5.5.1.2.2 (S1-based handover, normal) in TS 23.401 [13], with the following modification:

For the PDN connections which that are not possible to be transferred to 5GS, (e.g. PDN connections anchored in a standalone PGW), the MME initiates PDN connection release procedure as specified in TS 23.401 [13].

14. If indirect forwarding was used, then the expiry of the timer started at step 7 triggers the SMF+PGW-C (V-SMF in the case of roaming and Home-routed case) to release temporary resources used for indirect forwarding that were allocated at steps 11 to 13 in clause 4.11.1.2.2.2.

### 4.11.1.2.3 Handover Cancel

Instead of completing the handover procedure, the source RAN node (NG-RAN, E-UTRAN) may at any time, during the handover procedure, up to the time when a handover command message is sent to the UE, cancel the handover. The reason for cancelling may be e.g. due to a timer expiration or due to other events within the source RAN node and is initiated by sending a handover cancel message to the source CN node (AMF or MME).

A handover cancel message shall also be sent by the source RAN node after a handover command message is sent to the UE for the case where the handover fails and the UE returns to the old cell or radio contact with the UE is lost. This is done in order to release the resources reserved for the handover in the target system.

During EPS to 5GS handover when the initial AMF has invoked a target AMF (as described in step 8a in clause 4.11.1.2.2),

- when the source MME has received a N26 Forward Relocation Response from the target AMF, the MME sends N26 Cancel Relocation Request directly to the target AMF and the initial AMF is not involved at all in the Cancel Relocation procedure.
- When the source MME has not received a response from the target AMF, the MME sends N26 Cancel Relocation Request to the initial AMF:
  - if the initial AMF has already invoked the target AMF, the initial AMF indicates the Cancel Relocation to the target AMF and the target AMF becomes responsible of the Handover Cancellation (e.g. the target AMF initiates Nsmf\_PDUSession\_UpdateSMContext request indicating Handover Cancel towards the SMF+PGW-C(s) unless the target AMF has already indicated a Handover failure due to prior target NG RAN rejection of the Handover);
  - otherwise the initial AMF handles the relocation cancellation.

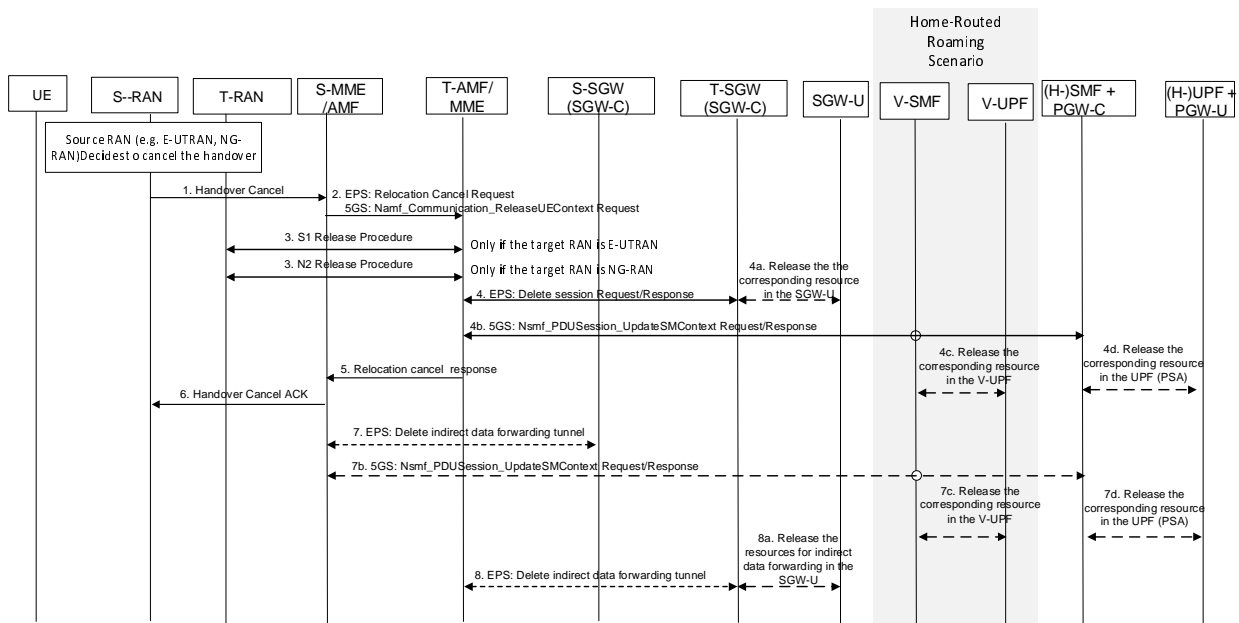


Figure 4.11.1.2.3-1: Handover Cancel procedure

1. When the source RAN (NG-RAN, E-UTRAN) decides to cancel the handover to the target system, the source RAN initiates handover cancel message to the source CN node (AMF or MME).
2. After receiving the handover cancel message from the source RAN, if the source CN node or the target CN node is MME, it sends a Relocation Cancel Request message to the target CN node (MME or AMF). If both the source CN node and target CN node are AMF, the source AMF invokes the Namf\_Communication\_ReleaseUEContext Request (UE Context ID, Relocation Cancel Indication) toward the target AMF. During EPS to 5GS handover with AMF reallocation if the initial AMF has invoked a target AMF, the initial AMF invokes the Namf\_Communication\_CancelRelocateUEContext Request (UE Context ID) toward the target AMF.

3. The target CN node (MME or AMF) triggers release of resources towards target RAN node. The target RAN node releases the AN resources allocated for the handover.
4. If the target CN node is MME, the MME sends the Delete Session Request to the SGW/SGW-C (see clause 5.5.2.5.2 of TS 23.401 [13]).
- 4a. [Conditional] The SGW-C releases the corresponding resource in the SGW-U if allocated during the handover preparation.
- 4b. If the target CN node is AMF, the AMF invokes the Nsmf\_PDUSession\_UpdateSMContext request (Relocation Cancel Indication) toward the SMF in non-roaming and local breakout roaming scenarios.

For home-routed roaming scenario, AMF invokes the Nsmf\_PDUSession\_UpdateSMContext request (Relocation Cancel Indication) toward the (target) V-SMF and the V-SMF invokes the Nsmf\_PDUSession\_Update Request (Relocation Cancel Indication) towards the H-SMF.

Based on the Relocation Cancel Indication, the SMF(s) deletes the session resources established during handover preparation phase in SMF(s) and UPF(s).

- 4c. [Conditional] The (target) V-SMF releases the corresponding resource in the (target) V-UPF if allocated during the handover preparation.
- 4d. [Conditional] The (H-)SMF+PGW-C releases the corresponding resource in the (H-)UPF+PGW-U if allocated during the handover preparation.
5. The target CN node (MME or AMF) sends Relocation Cancel Response towards the source CN node (AMF or MME).
6. The source CN node (AMF or MME) responds with handover cancel ACK towards the source RAN.
7. [Conditional] If target CN node is AMF and the source CN is MME and indirect forwarding tunnel had been set up during handover preparation phase then cancellation of handover triggers the MME to release the temporary resources used for indirect forwarding.
- 7b. [Conditional] If the source CN is AMF and the target CN node is MME and if indirect forwarding tunnel had been setup during handover preparation phase, then cancellation of handover triggers the AMF to release the session resources established during handover preparation phase in SMF(s) and UPF(s).
  - The AMF invokes the Nsmf\_PDUSession\_UpdateSMContext request (Relocation Cancel Indication) toward the SMF in non-roaming and local breakout roaming scenarios.
  - For home-routed roaming scenario, the AMF invokes the Nsmf\_PDUSession\_UpdateSMContext request (Relocation Cancel Indication) toward the V-SMF and the V-SMF invokes the Nsmf\_PDUSession\_Update Request (Relocation Cancel Indication) towards the H-SMF.

Based on the Relocation Cancel Indication, the SMF(s) deletes the session resources established during handover preparation phase in SMF(s) and UPF(s).

- 7c. [Conditional] In home routed roaming case, the V-SMF releases the corresponding resource in the target V-UPF if allocated during the handover preparation.
- 7d. [Conditional] In non-roaming or LBO case, the SMF+PGW-C releases the corresponding resource in the UPF+PGW-U if allocated during the handover preparation.
8. [Conditional] If target CN node is MME and indirect forwarding tunnel is setup during handover preparation phase then cancellation of handover triggers the target MME to release the temporary resources used for indirect forwarding.
- 8a. [Conditional] The SGW-C releases the resources for indirect forwarding in the SGW-U if allocated during the handover preparation.



### 4.11.1.3 Idle Mode Mobility procedures

#### 4.11.1.3.1 General

When a UE moves from EPC to 5GC, the UE always performs Registration procedure.

When a UE moves from 5GC to EPC, the UE performs either Tracking Area Update or Initial Attach.

The UE performs Tracking Area Update procedure if

- Both the UE and the EPC support "attach without PDN connectivity", or
- The UE has at least one PDU Session for which Session Continuity is supported during interworking, i.e. the UE has EPS Bearer ID and mapped EPS QoS parameters received as described in clause 4.11.1.1.

The UE performs an initial attach procedure if

- The UE is registered without PDU Session in 5GC or the UE is registered only with PDU Session for which Session Continuity is not supported during interworking to EPC and
- Either the UE or the EPC does not support attach without PDN connectivity.

#### 4.11.1.3.2 5GS to EPS Idle mode mobility using N26 interface

In the case of network sharing the UE selects the target PLMN ID according to clause 5.18.3 of TS 23.501 [2].

Clause 4.11.1.3.2 covers the case of idle mode mobility from 5GC to EPC. UE performs Tracking Area Update procedure in E-UTRA/EPS when it moves from NG-RAN/5GS to E-UTRA/EPS coverage area.

The procedure involves a Tracking Area Update to EPC and setup of default EPS bearer and dedicated bearers in EPC in steps 1-11 and re-activation, if required.

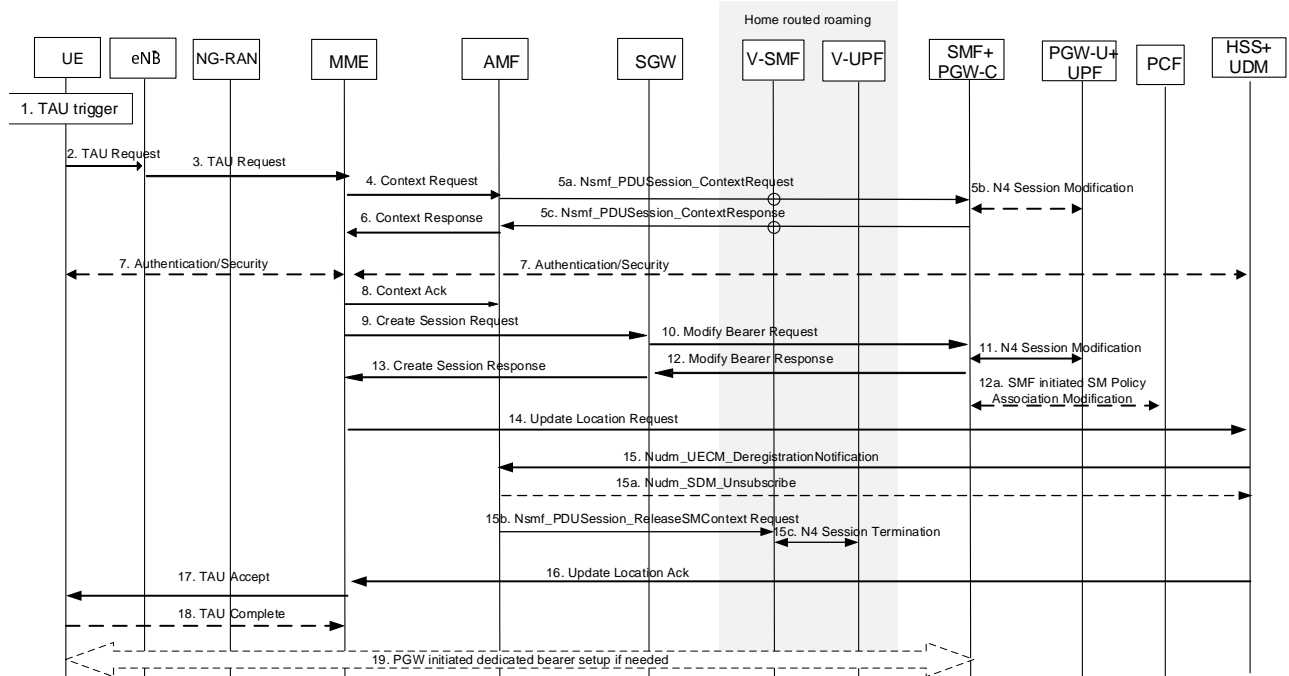


Figure 4.11.1.3.2-1: 5GS to EPS Idle mode mobility using N26 interface

The TAU procedure in TS 23.401 [13] is used with the following 5GS interaction:

1. Step 1 from clause 5.3.3.1 (Tracking Area Update procedure with Serving GW change) in TS 23.401 [13].

2. Step 2 from clause 5.3.3.1 (Tracking Area Update procedure with Serving GW change) in TS 23.401 [13] with the modification captured in clause 4.11.1.5.3.
- 3-4. Steps 3-4 from clause 5.3.3.1 (Tracking Area Update procedure with Serving GW change) in TS 23.401 [13].
- 5a. The AMF verifies the integrity of the TAU request message:

The AMF determines for a PDU Session whether to retrieve context including mapped UE EPS connection from V-SMF (in the case of HR roaming) or from the SMF+PGW-C (in the case of non roaming or LBO roaming) as follows:

- If the AMF determines that one or more of the EBI(s) can be transferred, the AMF sends Nsmf\_PDUSession\_ContextRequest to the V-SMF or SMF+PGW-C and includes in the message EBI value(s) if any that cannot be transferred.
- The EBI values(s) that cannot be transferred is determined by the AMF if the target MME does not support 15 EPS bearers, i.e. the AMF determines the EBI values in range 1-4 as not to be transferred to EPS and if there are still more than 8 EBI values associated with PDU Sessions, the AMF then determines EBI value(s) not to be transferred to EPS based on S-NSSAI and ARP as specified in clause 5.17.2.2.1 of TS 23.501 [2].
- The AMF does not retrieve the context for a PDU Session that cannot be transferred to EPS due to no EBI allocated, or allocated EBIs not transferrable, or combination of the two.

In non-roaming or LBO roaming, the AMF retrieves context that includes the mapped EPS Bearer Contexts.

- The AMF provides in Nsmf\_PDUSession\_ContextRequest the target MME capability to the PGW C+SMF in the request to allow the SMF+PGW-C to determine whether to include EPS Bearer context for Ethernet PDN type or non-IP PDN Type or not.
- If the AMF includes in Nsmf\_PDUSession\_ContextRequest EBI list not to be transferred and if the EBI value of the QoS Flow associated with the default QoS Rule is included in that list, the SMF+PGW-C shall not return the PDN Connection context (which implies the whole PDU Session is not transferred to EPS), otherwise if the EBI value of the QoS Flow associated with the default QoS Rule is not included in the EBI list not to be transferred, the V-SMF or SMF+PGW-C shall not provide the EPS bearer context(s) mapped from QoS Flow(s) associated with that list.

The above step is performed with all the SMF+PGW-Cs corresponding to PDU Sessions of the UE which are associated with 3GPP access and have EBI(s) allocated to them.

In Home Routed roaming, the AMF requests the V-SMF to provide SMF Context by using Nsmf\_PDUSession\_ContextRequest.

NOTE 1: The AMF knows the MME capability to support 15 EPS bearers, Ethernet PDN Type and/or non-IP PDN type or not through local configuration.

- 5b. For Non-roaming or roaming with local breakout scenario, if the CN Tunnel Info for EPS bearer(s) have not been allocated before, the SMF sends N4 Session Modification Request to PGW-U+UPF to establish the tunnel for each EPS bearers and PGW-U+UPF provides the PGW-U Tunnel Info for each EPS bearers to SMF+PGW-C.

NOTE 2: In home routed roaming case, the CN Tunnel Info for each EPS bearer has been prepared by the SMF+PGW-C and provided to the V-SMF as specified in clause 4.11.1.4.1.

- 5c. For PDU Sessions that are anchored a UPF, in non-roaming or roaming with local breakout, the SMF+PGW-C returns mapped EPS bearer contexts, which includes PGW-C control plane tunnel information of the PDN connection corresponding to the PDU session, EBI for each EPS bearer, PGW-U tunnel information for each EPS bearer and EPS QoS parameters for each EPS bearer. For PDU Sessions with PDU Session Type Ethernet, if the UE and target MME supports Ethernet PDN type, the SMF+PGW-C provides SM Context for Ethernet PDN Type, otherwise if the UE or target MME does not support Ethernet Type but support non-IP Type, the SMF+PGW-C provides SM Context for non-IP PDN Type. For PDU Sessions with PDU Session Type Unstructured, the SMF provides SM Context for non-IP PDN Type. In home routed roaming, V-SMF provides the SM Context.

For PDU Sessions that are anchored at an NEF, the SMF returns an SCEF+NEF ID and an EBI for each PDN connection corresponding to a PDU Session.

If the SMF+PGW-C has marked that the status of one or more QoS Flows are deleted in the 5GC but not synchronized with the UE yet according to clause 4.3.3.2, the SMF+PGW-C does not return to the AMF the EPS context(s) if all its associated QoS Flows are marked as deleted, that is, the SMF+PGW-C returns to the AMF the EPS bearer contexts mapped from QoS Flows where at least one of the QoS Flow for the EPS bearer is not marked as deleted.

6. The AMF responds with a Context Response message carrying mapped MM context (including mapped security context), Return preferred and SM EPS UE Context (default and dedicated GBR bearers) to the MME. If the verification of the integrity protection fails, the AMF returns an appropriate error cause. Return preferred is an optional indication by the AMF of a preferred return of the UE to the 5GS PLMN at a later access change to a 5GS shared network. The AMF may start an implementation specific (guard) timer for the UE context.

From the received context and the Tracking Area indicated by the RAN, the MME can determine whether the UE is performing Inter-RAT mobility to or from NB-IoT.

- 7 - 14. Steps 6-12 from clause 5.3.3.1 (Tracking Area Update procedure with Serving GW change) in TS 23.401 [13] are performed with following addition and modification:

In the step 10, if the PDU Session (PDN connection) has QoS Flows that do not have EPS bearer ID(s) assigned, the SMF+PGW-C deletes the PCC rule(s) associated with those QoS Flows and informs the PCF about the removed PCC rule(s).

In the step 11, the SMF+PGW-C requests the PGW-U+UPF to establish the tunnel for each EPS bearer by providing SGW-U Tunnel Info.

In step 10, the SMF+PGW-C may need to report some subscribed event to the PCF by performing an SMF initiated SM Policy Association Modification procedure as defined in clause 4.16.5. If the mapped EPS bearers are not included in Modify Bearer Request, the SMF+PGW-C deletes the PCC rule(s) associated with the QoS Flows corresponding to those mapped EPS bearers.

Step 9a from clause 5.3.3.1 (Tracking Area Update procedure with Serving GW change) in TS 23.401 [13] with the modification captured in clause 4.11.1.5.3

If the SCEF connection is to be established, the steps 9-13 are replaced with the steps 2-3 from clause 5.13.1.2 of TS 23.682 [23]. The SCEF+NEF ID and the EBI received from the AMF are included in the Create SCEF Connection Request.

- 15-15c. The HSS+UDM invokes Nudm\_UECM\_DeregistrationNotification to notify the AMF associated with 3GPP access with reason as 5GS to EPS Mobility. If the timer started in step 6 is not running, the old AMF removes the UE context. Otherwise, the AMF may remove UE context when the timer expires.

The AMF requests the release of the PDU Session(s) which is associated with 3GPP access and not expected to be transferred to EPC, i.e. AMF requests the release of:

- PDU Session(s) whose corresponding SMF+PGW-C(s) are not contacted by AMF for SM context because the AMF determines that none of EBI(s) for the PDU Session can be transferred to EPS at step 5a; and
- PDU Session(s) for which the SM context retrieval failed at step 5c.

The AMF requests the release of the SM context in the V-SMF only and the V-SMF releases resource in the V-UPF, for Home Routed PDU Session with EBIs allocated. The 5GC may also keep UE context to allow the use of native security parameters when UE moves back from EPS to 5GS later.

If PCC is enabled, the AMF initiates AM Policy Association Termination procedure as defined in clause 4.16.3.2 and UE Policy Association Termination procedure as defined in clause 4.16.13.1.

Registration associated with the non-3GPP access in the AMF is not removed (i.e. an AMF that was serving the UE over both 3GPP and non-3GPP accesses does not consider the UE as deregistered over non 3GPP access and will remain registered and subscribed to subscription data updates in UDM).

When the UE decides to deregister over non-3GPP access or the old AMF decides not to maintain a UE registration for non-3GPP access anymore, the old AMF then deregisters from UDM by sending a Nudm\_UECM\_Deregistration service operation, unsubscribes from Subscription Data updates by sending a Nudm\_SDM\_Unsubscribe service operation to UDM and releases all the AMF and AN resources related to the UE.

16 - 18. Steps 17-21 from clause 5.3.3.1 (Tracking Area Update procedure with Serving GW change) in TS 23.401 [13] with the following modification:

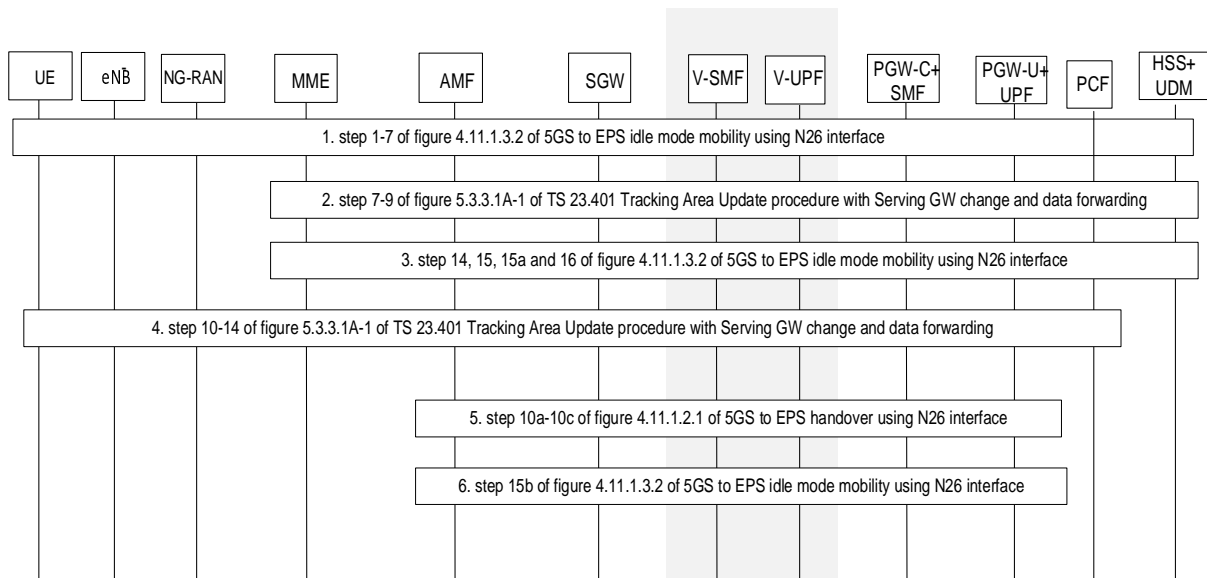
- The MME may provide the eNodeB with a PLMN list in the Handover Restriction List taking into account the last used 5GS PLMN ID and the Return preferred indication. The Handover Restriction List contains a list of PLMN IDs as specified by clause 5.2a of TS 23.251 [35] for eNodeB functions.
- The MME may not release the signalling connection with the UE based on the indication received in the step 1 that the UE is moving from 5GC.

19. [conditional] Step 19 from clause 4.11.1.2.1 applies.

If some of the QoS Flow(s) for an EPS bearer were marked as deleted, the SMF+PGW-C may initiate bearer modification as specified in clause 5.4.3 of TS 23.401 [13] to remove the TFT filter(s) corresponding to the Packet Filter Set(s) in the QoS rules.

#### 4.11.1.3.2A 5GS to EPS Idle mode mobility using N26 interface with data forwarding

Figure 4.11.1.3.2A-1 describes the idle mode mobility registration procedure from 5GS to EPS when N26 is supported with data forwarding.



**Figure 4.11.1.3.2A-1: 5GS to EPS Idle mode mobility using N26 interface with data forwarding**

1. Steps 1-7 from clause 4.11.1.3.2 with the following enhancements:

- The (V-)SMF includes the Buffered DL Data Waiting indication in the Nsmf\_PDUSession\_Response in step 5c of figure 4.11.1.3.2-1, if the Extended buffering timer is running in (V-)SMF.
- The AMF forwards the Buffered DL Data Waiting indication to MME in step 6 of figure 4.11.1.3.2-1, if it's received from SMF above.

2. Steps 7-9 from clause 5.3.3.1A of TS 23.401 [13].

3. Steps 14, 15, 15a and 16 from clause 4.11.1.3.2.

4. Steps 10-14 from clause 5.3.3.1A of TS 23.401 [13].

5. Steps 10a, b, c from clause 4.11.1.2.1 with the following enhancements:

- If data forwarding tunnel information (i.e. Forwarding F-TEID) is received from MME in step 14 of figure 5.3.3.1A-1 of TS 23.401 [13] in step 4 above, the AMF provides the data forwarding tunnel info to (V-)SMF in Nsmf\_PDUSession\_UpdateSMContext Request. The (V-)SMF provides the data forwarding tunnel info to (V-)UPF if data is buffered in (V-)UPF.

- The (V-)SMF and (V-)UPF forwards data using the provided SGW forwarding tunnel above. The (V-)SMF also initiates a timer to release the SM context or data forwarding tunnel of the PDU session.

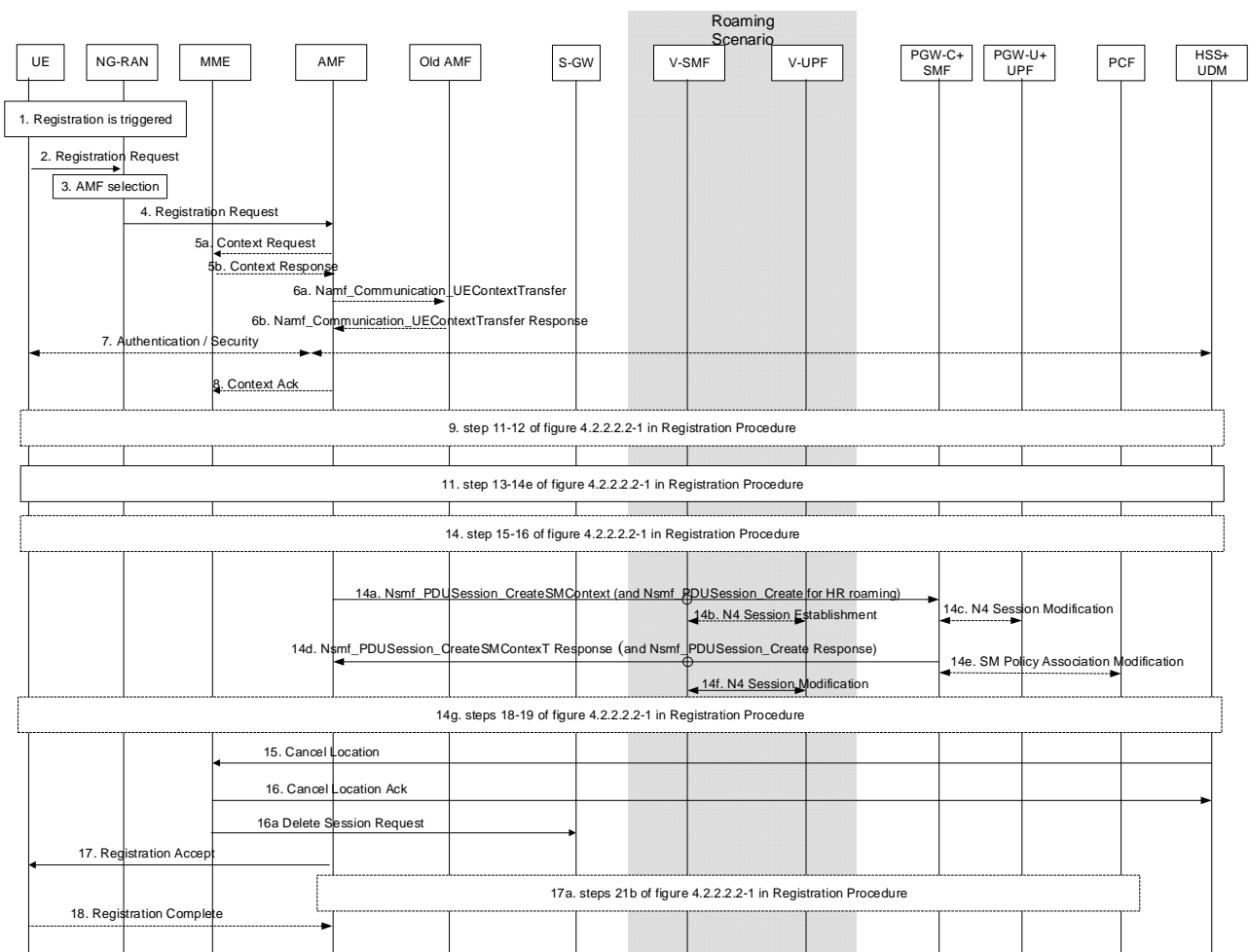
The data received by the Serving GW on the forwarding tunnel is forwarded on the (newly) established tunnel to eNB.

6. Step 15b from clause 4.11.1.3.2 with following enhancements:

The (V-)SMF initiates the release of data forwarding tunnel after the timer in step 5 above is expired.

### 4.11.1.3.3 EPS to 5GS Mobility Registration Procedure (Idle and Connected State) using N26 interface

Figure 4.11.1.3.3-1 describes the mobility registration procedure from EPS to 5GS when N26 is supported for idle and connected states.



**Figure 4.11.1.3.3-1: EPS to 5GS mobility for single-registration mode with N26 interface**

1. The Registration procedure is triggered, e.g. the UE moves into NG-RAN coverage. Step 2 to 9 except step 5, 6 and 8 follow the Registration procedure in clause 4.2.2 with following enhancement.
2. The UE sends Registration Request with registration type set to "Mobility Registration Update".

The UE includes 5G-GUTI mapped from EPS GUTI as the old GUTI, the native 5G-GUTI (if available) as additional GUTI and indicating that the UE is moving from EPC. The UE includes the UE Policy Container containing the list of PSIs, indication of UE support for ANDSP and OSId if available.

When the Registration Request is triggered due to UE mobility from EPS to 5GS, if the UE has locally deleted the EPS bearer which has allocated 5GS parameters and the EPS bearer status has not been synchronized with the network, the UE shall include the EPS bearer status in the Registration Request. If the UE has not received

mapped 5GS QoS parameters from the network for PDN connection(s), the UE locally releases those PDN connection(s).

The Additional GUTI is provided both in Idle state and Connected state, if available. The Additional 5G-GUTI enables the AMF to retrieve the UE's MM context from the old AMF (if available). The UE includes the S-NSSAIs associated with the established PDN connections in the Requested NSSAI in RRC and NAS (as described in clause 5.15.7 of TS 23.501 [2]). In the case of Configured NSSAI applicable to this PLMN or an Allowed NSSAI are not present in the UE, the associated HPLMN S-NSSAI(s) shall be provided in the mapping of Requested NSSAI in the NAS as described in the clause 5.15.5.2.1 TS 23.501 [2].

In the case of idle mode mobility the UE additionally includes a TAU request message integrity protected using the EPS security context (for further security verification by the MME) in the Registration Request. If the UE holds a native 5G-GUTI for this PLMN then the UE also includes the GUAMI part of the native 5G-GUTI in RRC to enable the NG-RAN to route the Registration Request to the same AMF (if available) and otherwise the UE provides in RRC signalling a GUAMI mapped from the EPS GUTI and indicates it as "Mapped from EPS".

The UE integrity protects the Registration Request message using a 5G security context (if available).

3-4. Steps 2-3 of clause 4.2.2.2.2 are performed.

In the case of idle mode mobility, the AMF derives S-NSSAIs values for the Serving PLMN based on the S-NSSAIs values for the HPLMN, received in NAS Registration Request, associated with the established PDN connections, the AMF may send the S-NSSAIs values for the HPLMN to NSSF by invoking Nnssf\_NSSelection\_Get service operation and NSSF provides corresponding S-NSSAIs values for VPLMN to AMF.

NOTE 1: In connected mode mobility, the AMF derives S-NSSAIs values during the handover procedure.

Steps 5 and 8 are not performed when this procedure is part of EPS to 5GS handover.

- 5a. [Conditional] This step is only performed for IDLE mode mobility. The AMF derives the MME address and 4G GUTI from the old 5G-GUTI and sends Context Request to MME including EPS GUTI mapped from 5G-GUTI and the TAU request message according to TS 23.401 [13]. The MME validates the TAU message.
- 5b. [Conditional] If step 5a is performed, step 5 from clause 5.3.3.1 (Tracking Area Update procedure with Serving GW change) in TS 23.401 [13] is performed with the modification captured in clause 4.11.1.5.3.

The AMF converts the received EPS MM Context into the 5GS MM Context. The received EPS UE context includes IMSI, ME Identity, UE EPS security context, UE Network Capability and EPS Bearer context(s) and may also include LTE-M Indication. The MME EPS Bearer context includes for each EPS PDN connection the IP address and FQDN for the S5/S8 interface of the SMF+PGW-C and APN. If the SCEF connection is invoked, the MME EPS Bearer context includes the SCEF+NEF ID of the PDN connection, EBI, APN, User Identity. The AMF disregards any LTE-M Indication received in the EPS UE context and instead takes into account the LTE M Indication received from NG-RAN, at step 1.

The AMF can determine whether the UE is performing Inter-RAT mobility to or from NB-IoT based on the received "TAI of last TAU" in the EPC MM Context and the RAT Type used for the Registration Request.

If the Context Response includes the FQDN for the S5/S8 interface of the SMF+PGW-C, the AMF queries the NRF in serving PLMN by issuing the Nnrf\_NFDiscovery\_Request including the FQDN for the S5/S8 interface of the SMF+PGW-C and the NRF provides the IP address or FQDN of the N11/N16 interface of the SMF+PGW-C.

If the Context Response includes an SCEF+NEF ID, the AMF performs the SMF selection.

The Context Response may include new information Return Preferred. Return Preferred is an indication by the MME of a preferred return of the UE to the last used EPS PLMN at a later access change to an EPS shared network. Based on the Return Preferred indication, the AMF may store the last used EPS PLMN ID in UE Context.

If the AMF cannot retrieve the address of the corresponding SMF for a PDN connection, it will not move the PDN connection to 5GS.

Step 6 is performed only if the AMF is different from the old AMF and the old AMF is in the same PLMN as the AMF.

- 6a. [Conditional] If the UE includes the 5G-GUTI as Additional GUTI in the Registration Request message, the AMF sends message to the old AMF. The old AMF validates the Registration request message.

The AMF retrieves UE's SUPI and MM Context, event subscription information by each consumer NF and the list of SM PDU Session ID/associated SMF ID for the UE using one of the following three options:

- AMF may invoke the Namf\_Communication\_UEContextTransfer to the old AMF identified by the additional 5G-GUTI; or
  - if the old AMF and the AMF are in the same AMF Set and UDSF is deployed, AMF may invoke Nudsf\_UnstructuredDataManagement\_Query service operation for the UE identified by the additional 5G-GUTI from the UDSF; or
  - if the old AMF and the AMF are in the same AMF Set, AMF may use implementation specific means to share UE context.
- 6b. [Conditional] If step 6a is performed, the response is performed as described in step 5 in clause 4.2.2.2.2. If a native 5G security context for 3GPP access is available in the AMF (or has been retrieved in step 6a), the AMF may continue to use this security context. Otherwise, the AMF shall either derive a mapped security context from the EPS security context obtained from the MME or initiate an authentication procedure to the UE.

If the new AMF determines that the UE has emergency PDU Session and the AMF is configured to allow emergency services for unauthenticated UE, the new AMF behaves as follows:

- If the UE has only an emergency PDU Session, the AMF either skips the authentication and security procedure in step 7 or accepts that the authentication may fail and continues the Mobility Registration Update procedure; or
- If the UE has both emergency and non emergency PDU Sessions and authentication fails, the AMF continues the Mobility Registration Update procedure and deactivates all the non-emergency PDU Sessions as specified in clause 4.3.4.2.

NOTE 2: The new AMF can determine if a PDU Session is used for emergency service by checking whether the DNN matches the emergency DNN.

7. [Conditional] If the AMF determines to initiate the authentication procedure to the UE in step 6b (e.g. the AMF can not obtain the UE MM context from AMF or other reasons), steps 8-9 of clause 4.2.2.2.2 are optionally performed.
- 7a. In the case of idle mode mobility, the AMF decide whether a new AMF needs to be selected. If a new AMF is to be selected, the AMF reroute the Registration request to the new AMF as described in clause 4.11.1.3.4, where the initial AMF refers to the AMF.
8. [Conditional] If step 5b is performed and the AMF accepts to serve the UE, the AMF sends Context Acknowledge (Serving GW change indication) to MME according to TS 23.401 [13].
9. Steps 11-12 of clause 4.2.2.2.2 are optionally performed.
10. Void.
11. Steps 13-14e of clause 4.2.2.2.2 are performed: This includes that if an MM context is retrieved from the old AMF in step 6 (i.e. corresponding to an existing UE registration for non-3GPP access in 5GC), then the AMF indicates to the UDM that the AMF identity to be registered in the UDM applies to both 3GPP and non-3GPP accesses by sending separate/independent Nudm\_UECM\_Registration service operations for "3GPP Access" and "non-3GPP Access".
12. Void.
13. Void.
- 14-14f. Step 16 of clause 4.2.2.2.2 (AM Policy Association Establishment) is optionally performed.

In the home-routed roaming case and connected state mobility, based on the S-NSSAI value for the Serving PLMN of the PDU Session(s), the AMF decides whether V-SMF change is needed or not. If the V-SMF reallocation is not needed and if the two values (i.e. the S-NSSAI value configured in AMF for interworking and S-NSSAI value for the Serving PLMN) are different, the AMF invokes Nsmf\_PDUSession\_UpdateSMContext

(PDU Session ID, S-NSSAI value for the Serving PLMN). The V-SMF updates 5G AN with the new S-NSSAI of VPLMN by sending a N2 SM message to 5G AN via AMF. If the V-SMF change is needed, the AMF performs as the case of I-SMF change defined in clause 4.23.4.3 with the difference that I-SMF in clause 4.23.4.3 is replaced by V-SMF and with following modifications:

- In step 3 of clause 4.23.4.3, the AMF sends indication of no NG-RAN change to the new V-SMF.
- In step 4a of clause 4.23.4.3, when the new V-SMF retrieves SM context from the old V-SMF, the new V-SMF sends indication of no NG-RAN change as it is received in step 3.
- In step 4b of clause 4.23.4.3, as the old V-SMF receives the indication of no NG-RAN change, the old V-SMF returns additional N3 tunnel information of NG-RAN.
- In step 6 of clause 4.23.4.3, the new I-SMF should reuse the N3 tunnel information of NG-RAN received from old I-SMF/SMF.
- In step 9 of clause 4.23.4.3, when the new V-SMF sends a Nsmf\_PDUSession\_CreateSMContext Response, the new V-SMF includes PDU Session Resource Modify in N2 SM information.

In the home-routed roaming case and idle state mobility, the AMF selects a default V-SMF per PDU Session and invokes Nsmf\_PDUSession\_CreateSMContext service operation of the V-SMF to create an association with the AMF. It includes UE EPS PDN Connection, H-SMF ID, S-NSSAI and indicates all the PDU Session(s) to be re-activated as received in the Registration request message along with List Of PDU Sessions To Be Activated. The S-NSSAI is the S-NSSAI configured in AMF for interworking, which is associated with default V-SMF. The V-SMF creates the association and based on the received SMF ID, the V-SMF invokes Nsmf\_PDUSession\_Create request service operation of the H-SMF and provides the information received from the AMF. Before invoking PDUSession\_Create service operation, the V-SMF request the V-UPF to provide the CN tunnel info. The subsequent handling is performed as follows:

- The H-SMF finds the corresponding PDU Session based on the PDN Connection Context in the request. The H-SMF initiates N4 Session modification procedure to establish the CN tunnel for the PDU Session. The tunnel info for PDU Session is allocated by PGW-U+UPF and provided to the SMF+PGW-C. The H-SMF responds V-SMF with the PDU Session ID corresponding to the PDN Connection Context in the request, the allocated EBI(s) information, the S-NSSAI of the PDU Session, S-NSSAI of HPLMN, UE EPS PDN connection(s) and other PDU session parameters, such as PDU Session Type, Session AMBR in the Nsmf\_PDUSession\_Create response.
- The V-SMF updates its SM contexts and returns a Nsmf\_PDU\_Session\_CreateSMContextResponse message including the information received from the H-SMF. The V-SMF updates the V-UPF of the CN tunnel info of SMF+PGW-C. The V-SMF also includes the N2 SM Context in the response message sent to the AMF if the corresponding PDU Session is in the received List Of PDU Sessions To Be Activated. The V-SMF stores an association of the PDU Session ID and the H-SMF ID. The AMF stores the V-SMF ID and it also stores S-NSSAI and the allocated EBI(s) associated to the PDU Session ID. Based on the S-NSSAI value for the Serving PLMN of the PDU Session(s) the AMF decides whether V-SMF relocation is needed or not. If V-SMF relocation is not needed and if the two values (i.e. the S-NSSAI value configured in AMF for interworking and S-NSSAI value for the Serving PLMN) are different, the AMF sends the S-NSSAI value for the Serving PLMN to V-SMF by invoking Nsmf\_PDUSession\_UpdateSMContext service operation. The V-SMF updates NG RAN with the S-NSSAI value for the Serving PLMN via N2 SM message. If V-SMF relocation is needed, the AMF performs V-SMF relocation as defined in clause 4.23.4.3.

In non-roaming and LBO cases and idle state mobility, AMF invokes Nsmf\_PDUSession\_CreateSMContext Request (UE EPS PDN Connection) service operation of the SMF+PGW-C and indicates all the PDU Session(s) to be re-activated as received in the Registration request message along with List Of PDU Sessions To Be Activated. This step is performed for each PDN Connection and the corresponding SMF+PGW-C address/ID in the UE context the AMF received in Step 6.

The SMF+PGW-C finds the corresponding PDU Session based on the PDN Connection Context in the request.

If the P-GW-C+SMF (H-SMF+PGW-C in the case of home-routed roaming case) determines that session continuity from EPS to 5GS is not supported for the PDU Session (e.g. if PDU Session ID was not received by the SMF+PGW-C for the PDN connection or PDU Session ID was received but mapped 5GS parameters were not provided to the UE due to 5GS interworking not supported), then it does not provide SM information for the corresponding PDU Session but includes the appropriate cause code for rejecting the PDU Session transfer



within the N2 SM Information. The PDN connection(s) not further transferred to 5GC are locally released at the P-GW-C+SMF.

Otherwise if session continuity from EPS to 5GS is supported for the PDU Session, the SMF+PGW-C finds the corresponding PDU Session based on the PDN Connection Context in the request. The SMF+PGW-C initiates N4 Session modification procedure to establish the CN tunnel for the PDU Session and for Idle state mobility registration, releases the resource of the CN tunnels for EPS bearers corresponding to the PDU session as well. If the SMF+PGW-C has not yet registered for this PDU Session ID, the SMF+PGW-C registers with the UDM using Nudm\_UECM\_Registration (SUPI, DNN, PDU Session ID) for a given PDU Session as in step 4 of PDU Session Establishment Procedure in clause 4.3.2. The tunnel info for PDU Session is allocated by PGW-U+UPF and provided to the SMF+PGW-C. The SMF+PGW-C updates its SM contexts and returns the AMF a Nsmf\_PDUSESSION\_CreateSMContext Response message including the PDU Session ID corresponding to the PDN Connection Context in the request, the allocated EBI(s) information, the S-NSSAI of the PDU Session and the N2 SM Context if the corresponding PDU Session is in the received List Of PDU Sessions To Be Activated. The AMF stores an association of the PDU Session ID and the SMF ID, S-NSSAI and the allocated EBI(s) associated to the PDU Session ID. Based on the allocated EBI(s) information received from all the related SMF+PGW-C for this UE, an EPS bearer status, which reflects all existing EPS bearer, is generated by the AMF.

NOTE 3: For Connected State mobility registration, the release of CN tunnels for EPS bearers and UDM registration for the session corresponding to the PDU session is performed in the handover execution phase.

If the PDN Type of a PDN Connection in EPS is non-IP and it was originally established as Ethernet PDU Session when UE was camping in 5GS (known based on local context information that was set to PDU Session Type Ethernet in UE and SMF), the PDU Session Type in 5GS shall be set to Ethernet by the SMF and UE. If the PDN type of a PDN Connection in EPS is non-IP and is locally associated in UE and SMF to PDU Session Type Unstructured, the PDU Session Type in 5GS shall be set to Unstructured by the SMF and UE.

NOTE 4: If the non-IP PDN Type is originally established as Ethernet PDU Session, it means that Ethernet PDN Type is not supported in EPS.

If the AMF has received the EPS Bearer Status in the Registration Request from UE, the AMF shall send the EPS Bearer Status to all corresponding SMF+PGW-Cs. If the SMF+PGW-C receives the EPS Bearer Status from AMF, the SMF+PGW-C shall check whether the EPS bearer(s) has been deleted by UE but not notified to network. If yes, the SMF+PGW-C shall release those EPS bearer(s), the corresponding 5G QoS Rule(s) and the QoS Flow level QoS parameters locally.

If the SCEF+NEF ID is provided to the SMF, the SMF establishes the SMF-NEF connection as described in steps 2-3 from clause 4.25.2, the SMF provides the SCEF+NEF ID, EBI, APN, User Identity to the SCEF+NEF and the SCEF+NEF updates the SM contexts and returns the NEF ID, PDU Session ID, DNN and User Identity to the SMF.

If the UE is performing Inter-RAT mobility to or from NB-IoT, the (H-)SMF will maintain, reconnect, release or leave PDU Session handling to the local VPLMN policy in the case of roaming for each PDU session according to the "PDU Session continuity at inter RAT mobility" subscription information. If the (H-)SMF does not have "PDU Session continuity at inter RAT mobility" for a PDU session, the (H-)SMF retrieves it from the UDM before determining any action. The SMF may use local policy to determine the handling a PDU Session if "PDU Session continuity at inter RAT mobility" cannot be retrieved from the UDM.

15 - 16a. HSS+UDM cancels the location of the UE in the MME as defined in steps 13 - 14 from clause 5.3.3.1 (Tracking Area Update procedure with Serving GW change) in TS 23.401 [13]. Subsequently, the steps 18 - 19 from clause 5.3.3.1 (Tracking Area Update procedure with Serving GW change) in TS 23.401 [13] are also executed with the following modification:

According to configuration, for the PDN connections which are anchored in a standalone PGW, the MME initiates PDN connection release procedure as specified in TS 23.401 [13].

17-18. These steps follow the steps 21, 21b and 22 of Registration procedure in clause 4.2.2.2.2.

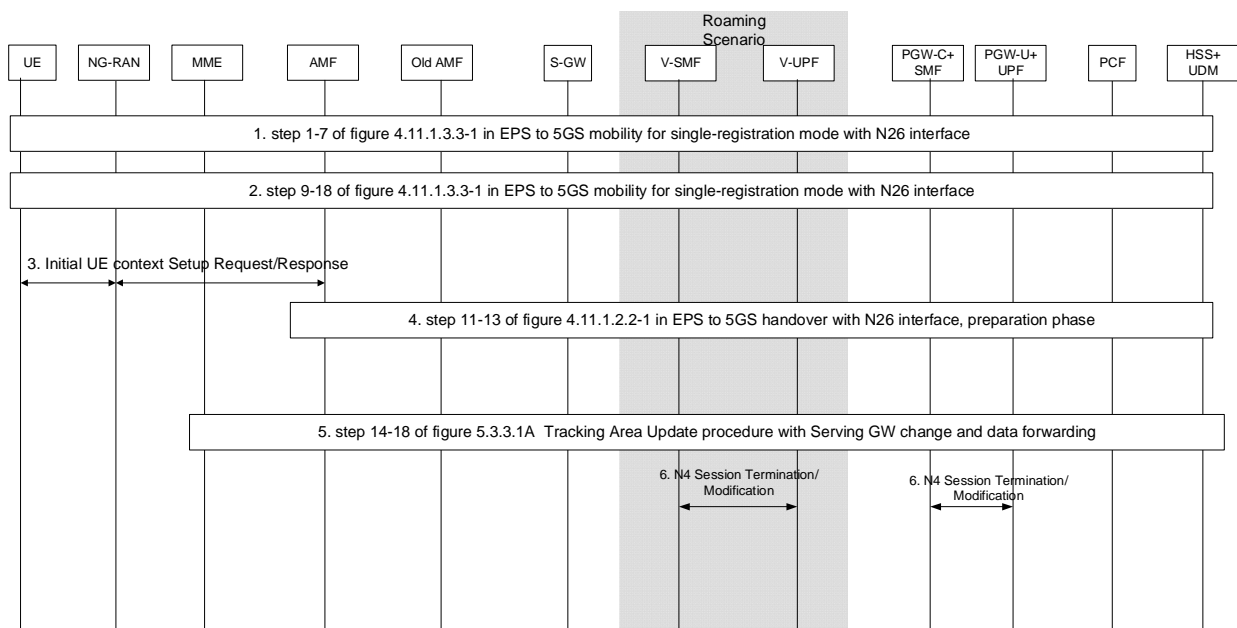
The Registration Accept message shall include the updated 5G-GUTI to be used by the UE in that PLMN over any access. If the active flag was included in the Registration request, The AMF may provide NG-RAN with a Mobility Restriction List taking into account the last used EPS PLMN ID and the Return preferred indication. The Mobility Restriction List contains a list of PLMN IDs as specified by TS 23.501 [2]. The Allowed NSSAI in

the Registration Accept message shall contain at least the S-NSSAIs corresponding to the active PDN Connection(s) and the corresponding mapping to the HPLMN S-NSSAIs.

The AMF shall include the EPS bearer status, which is generated at step 14, in the Registration Accept message. Based on the received EPS bearer status information, the UE shall check whether there are QoS Flow(s) existing locally but no associated EPS bearer(s) in the received EPS bearer status. The UE shall locally delete the 5G QoS Rule(s) and QoS Flow level QoS parameters of the QoS Flow(s) if the associated EPS bearer(s) do not exist in the received EPS bearer status.

#### 4.11.1.3.3A EPS to 5GS Idle mode mobility using N26 interface with data forwarding

Figure 4.11.1.3.3A-1 describes the idle mode mobility registration procedure from EPS to 5GS when N26 is supported with data forwarding.



**Figure 4.11.1.3.3A-1: EPS to 5GS Idle mode mobility using N26 interface with data forwarding**

1. Step 1-7 from clause 4.11.1.3.3 with the following enhancements:

- In step 5b of the figure 4.11.1.3.3-1, if the old MME indicates Buffered DL Data Waiting in the Context Response (as specified in step 5 of clause 5.3.3.1A in TS 23.401 [13]).
- For Control Plane CIoT EPS Optimisation, when the DL data is buffered in old MME and the DL Data Expiration Time has not expired, the old MME shall discard the buffered DL data (as specified in step of clause 5.3.3.1A in TS 23.401 [13]).

2. Steps 9-18 from clause 4.11.1.3.3 with following enhancements:

In step 14a of the figure 4.11.1.3.3-1, the AMF forwards the Buffered DL Data Waiting indication from above to (V-)SMF in Nsmf\_PDUSession\_CreateSMContext service operation.

If the Buffered DL Data Waiting indication is provided by AMF, the (V-)SMF and (V-)UPF shall allocate the user plane resource and include the N2 SM information (i.e. the V-CN Tunnel-Info) in the Nsmf\_PDUSession\_CreateSMContext Response towards the AMF in step 14d of the figure 4.11.1.3.3-1 to trigger the user plane setup in NG-RAN.

NOTE: AMF may send NAS message Registration Accept in step 17 of figure 4.11-1.3.3-1 as part of the N2 message in step 3 below.

3. AMF to NG-RAN: N2 message (N2 MM information, N2 SM information list).

If N2 SM information is received from SMF in step 2 above, the AMF sends a N2 request message to setup the user plane resource.

NG-RAN performs RRC connection Reconfiguration with the UE to setup the user plane resource and response to AMF with N2 response message with N2 SM information.

4. Steps 11-13 from clause 4.11.1.2.2.2 with the following enhancement:

Based on Buffered DL Data Waiting indication received in step 2 above, the (V-)SMF and (V-)UPF allocate data forwarding tunnel resource and provide the CN tunnel information for data forwarding from EPS (i.e. Forwarding F TEID) in Nsmf\_PDUSession\_UpdateSMContext Response to AMF in step 13 of figure 4.11.1.2.2.2-1. The (V-) SMF also starts a timer for release of resources for data forwarding.

The (V-) SMF may select a different UPF from the serving (V-)UPF for data forwarding.

The (V-)SMF shall not provide Charging Enforcement Rules and QoS Enforcement Rules to the (V-)UPF for DL packets that were received via the forwarding tunnel.

5. Steps 14-18 from clause 5.3.3.1A in TS 23.401 [13] with following changes.

The AMF sends the Context Acknowledge message to MME as in step 14 of figure 5.3.3.1A-1 of TS 23.401 [13], including the CN tunnel information (i.e. Forwarding F TEID) for data forwarding from EPS received from (V-)SMF in step 4 above.

The Serving GW forwards the buffered DL data to the (V-)UPF based on the Forwarding F-TEID received from MME. The data received by the (V-)UPF on the forwarding F-TEID is forwarded by the (V-)UPF on the (newly) established N3 tunnel to the NG-RAN.

6. SMF to UPF: N4 Session Termination/Modification.

At the expiration of the timer started in step 4 above, the (V-) SMF starts the release of resource established in step 4 for data forwarding and informs the (V-)UPF.

4.11.1.3.4 EPS to 5GS Mobility Registration Procedure (Idle) using N26 interface with AMF reallocation

During Idle state mobility registration procedure from EPS to 5GS, the initial AMF may select a new AMF based on S-NSSAIs associated with the established PDU Session, received in NAS Registration Request.

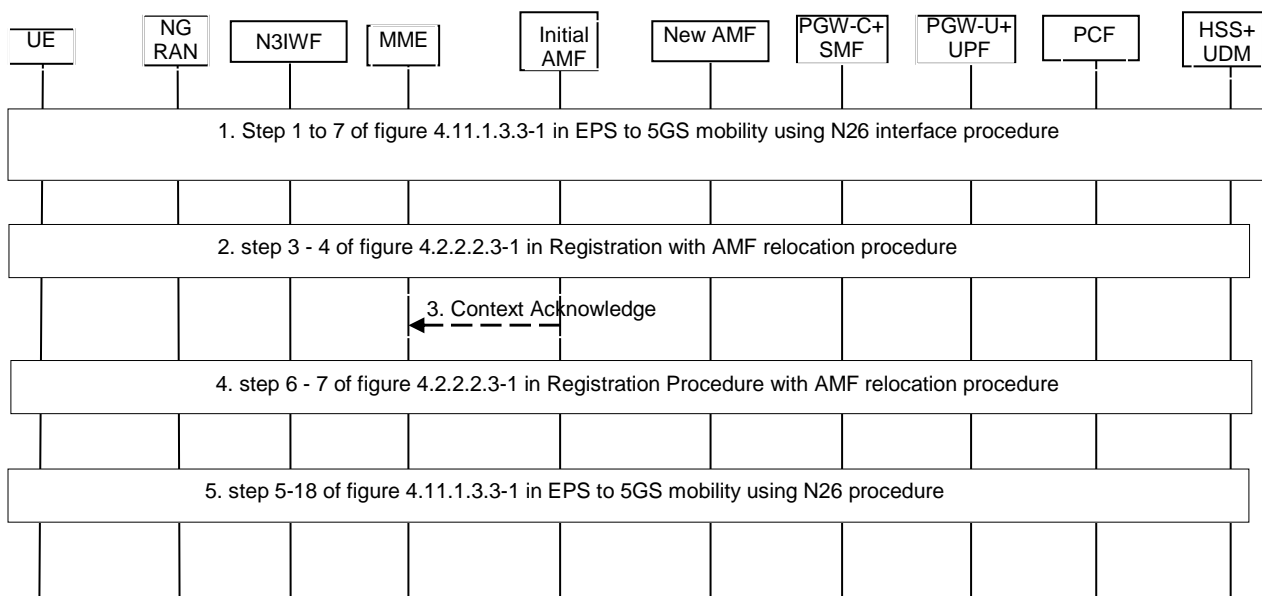


Figure 4.11.1.3.4-1: EPS to 5GS mobility with AMF re-allocation for single-registration mode and N26 interface configuration

1. Step 1 to 7 of clause 4.11.1.3.3 in EPS to 5GS mobility using N26 interface is performed.

2. Step 3 to 4 of clause 4.2.2.2.3 in Registration with AMF reallocation procedure is performed with the difference that before the Network Slice selection the AMF needs to derive the S-NSSAI for the serving PLMN as described in clause 5.15.5.2.1 of TS 23.501 [2].
3. [Conditional] Initial AMF to MME: Context Acknowledge (failure cause) to MME according to TS 23.401 [13].  

The initial AMF decides a new AMF needs to be reselected. The initial AMF sends a Context Acknowledge message with cause code indicating that the procedure is not successful. The MME shall continue as if Context Request was never received.
4. Step 6 to 7 of clause 4.2.2.2.3 in Registration with AMF reallocation procedure are performed.
5. After receiving the Registration Request message, the new AMF continues the registration from step 5 until step 18 of figure 4.11.1.3.3 (EPS to 5GS mobility using N26 procedure), which includes the UE context retrieved from old AMF. If the 5G security context is received from the initial AMF, the new AMF continues using that one instead of the mapped 5G security context retrieved from MME.

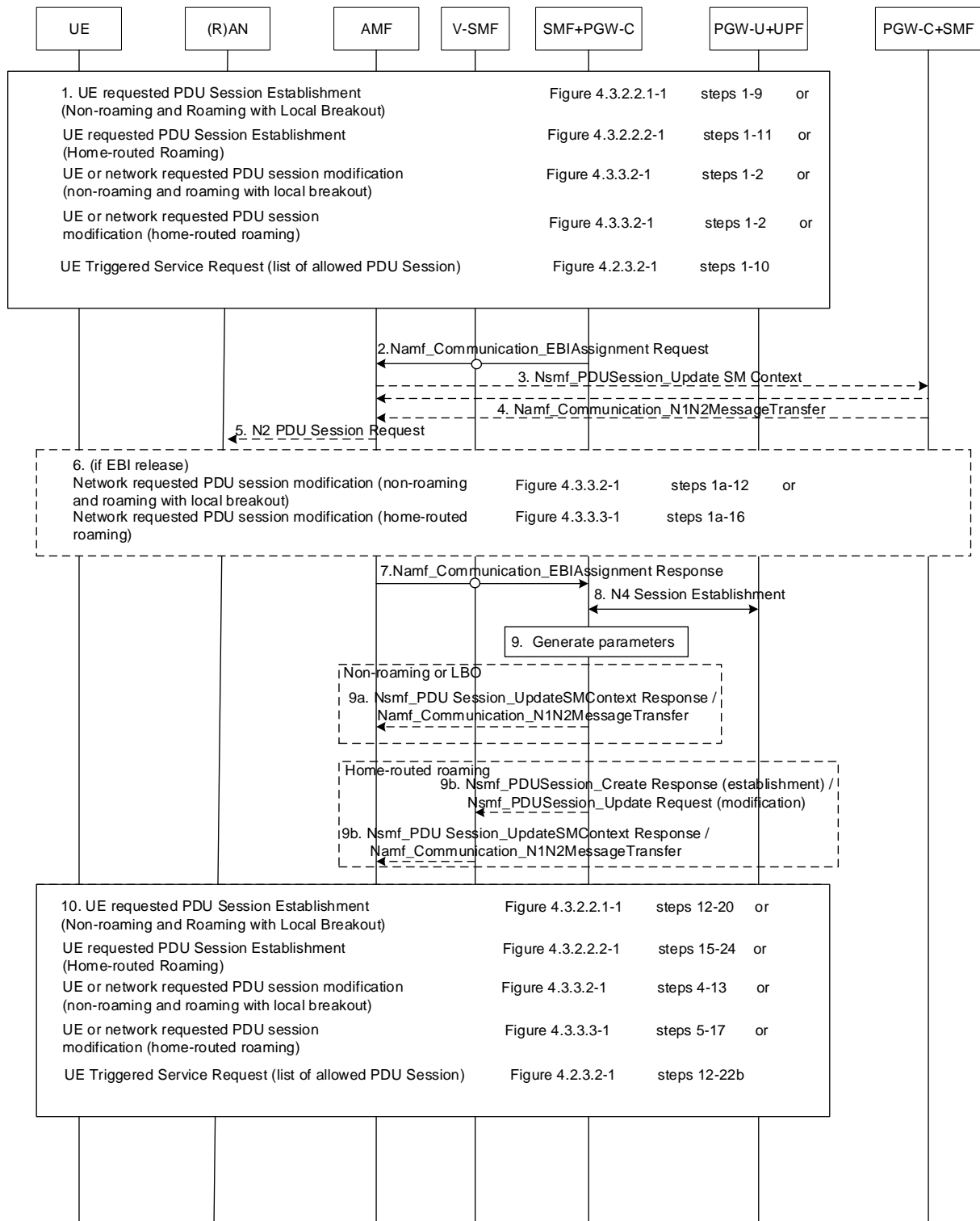
#### 4.11.1.4 Procedures for EPS bearer ID allocation

##### 4.11.1.4.1 EPS bearer ID allocation

Following procedures are updated to allocate EPS bearer ID(s) towards EPS bearer(s) mapped from QoS flow(s) and provide the EPS bearer ID(s) to the NG-RAN:

- UE requested PDU Session Establishment (Non-roaming and Roaming with Local Breakout (clause 4.3.2.2.1) including Request Types "Initial Request", "Existing PDU Session", "Initial emergency request" and "Existing emergency PDU session").
- UE requested PDU Session Establishment (Home-routed Roaming (clause 4.3.2.2.2) including Request Types "Initial Request" and "Existing PDU Session").
- UE or network requested PDU Session Modification (non-roaming and roaming with local breakout) (clause 4.3.3.2).
- UE or network requested PDU Session Modification (home-routed roaming) (clause 4.3.3.3).
- UE Triggered Service Request (clause 4.2.3.2) to move PDU Session(s) from non-3GPP access to 3GPP access

EBI allocation shall apply to PDU Session via 3GPP access supporting EPS interworking with N26. EBI allocation shall not apply to PDU Session via 3GPP access supporting EPS interworking without N26 and shall not apply to PDU Session via non-3GPP access supporting EPS interworking.



**Figure 4.11.1.4.1-1: Procedures for EPS bearer ID allocation**

1. Procedure as listed in this step is initiated as specified in the relevant clauses of this specification. The relevant steps of the procedure as specified in the figure above are executed.
2. If the SMF+PGW-C (or H-SMF in the case of home routed case), determines, based on the indication of EPS interworking support with N26 as defined in clauses 4.11.5.2, 4.11.5.3 and 4.11.5.4 and operator policies e.g. User Plane Security Enforcement information, Access Type, that EPS bearer ID(s) needs to be assigned to the QoS flow(s) in the PDU Session, SMF+PGW-C invokes Namf\_Communication\_EBIAssignment Request (PDU Session ID, ARP list) (via V-SMF Nsmf\_PDUSession\_Update in the case of home routed case). When V-SMF receives Nsmf\_PDUSession\_Update request from H-SMF for EPS bearer ID allocation request, V-SMF needs to

invoke `Namf_Communication_EBIAssignment Request` (PDU Session ID, ARP list). If the SMF+PGW-C (or H-SMF in the case of home-routed roaming) serves multiple PDU sessions for the same DNN but different S-NSSAIs for a UE, then the SMF shall only request EBIs for PDU sessions served by a common UPF (PSA). If different UPF (PSA) are serving those PDU sessions, then the SMF chooses one of the UPF (PSA) for this determination based on operator policy. When the PDU session is established via non-3GPP access, the SMF+PGW-C shall not trigger EBI allocation procedure.

Steps 3 to 6 apply only when AMF needs to revoke EBI previously allocated for an UE in order to serve a new SMF request of EBI for the same UE.

3. [Conditional] If the AMF has no available EBIs, the AMF may revoke an EBI that was assigned to QoS flow(s) based on the ARP(s) and S-NSSAI stored during PDU Session establishment, EBIs information in the UE context and local policies. If an assigned EBI is to be revoked, the AMF takes the ARP pre-emption vulnerability and the ARP priority level into consideration and revokes EBIs with a higher value of the ARP priority level first. The AMF invokes `Nsmf_PDUSession_UpdateSMContext` (EBI(s) to be revoked) to request the related SMF (called "SMF serving the released resources") to release the mapped EPS QoS parameters corresponding to the EBI to be revoked. The AMF stores the association of the assigned EBI, ARP pair to the corresponding PDU Session ID and SMF address.
4. The "SMF serving the released resources" that receives the request in step 3 shall evaluate if any of the revoked EBI(s) corresponds to the QoS Flow associated with the default QoS rule. If the revoked EBI corresponds to the QoS Flow associated with the default QoS rule, the SMF shall release the EBI(s) corresponding to all other QoS Flows of the PDU Session and update the AMF of this release by sending `Namf_Communication_EBIAssignment Request` (PDU Session ID, Released EBI List). Next, the SMF shall invoke `Namf_Communication_N1N2Message Transfer` (N2 SM information (PDU Session ID, EBI(s) to be revoked), N1 SM container (PDU Session Modification Command (PDU Session ID, EBI(s) to be revoked))) to inform the (R)AN and the UE to remove the mapped EPS QoS parameters corresponding to the EBI(s) to be revoked. In home routed roaming scenario, the H-SMF includes EBI(s) to be revoked to V-SMF to inform V-SMF to remove the mapped EPS bearer context corresponding to the EBI(s) to be revoked.

NOTE 1: The SMF can also decide to remove the QoS flow if it is not acceptable to continue the service when no corresponding EPS QoS parameters can be assigned.

For home routed roaming scenario, the "SMF serving the released resources" sends an N4 Session Modification Request to request the PGW-U+UPF to release N4 Session corresponding to the revoked EBI(s).

In home routed roaming case, the V-SMF starts a VPLMN initiated QoS modification for the PDU Session and the `Namf_Communication_N1N2Message Transfer` is invoked by the V-SMF based on the corresponding QoS modification message received from H-SMF.

5. If the UE is in CM-CONNECTED state, the AMF sends N2 PDU Session Resource Modify Request (N2 SM information received from SMF, NAS message (PDU Session ID, N1 SM container (PDU Session Modification Command))) Message to the (R)AN.

If the UE is in CM-IDLE state and an ATC is activated, the AMF updates and stores the UE context based on the `Namf_Communication_N1N2MessageTransfer` and step 5-6 are skipped. When the UE is reachable, e.g. when the UE enters CM-CONNECTED state, the AMF forwards the N1 message to synchronize the UE context with the UE.

6. The rest steps of the procedure are executed as specified in the figure above.

7. If the AMF successfully assigns EBI(s), it responds with the assigned EBI(s). Otherwise, it responds with a cause indicating EBI assignment failure. If the PDU Session is associated to an S-NSSAI subject for Network Slice-Specific Authentication and Authorization the AMF should indicate EBI assignment failure.

If a PDU Session from another SMF already exists towards the same DNN, the AMF either rejects the EBI assignment request, or revokes the EBI(s) from the existing PDU Session(s) to the same DNN but different SMFs if the AMF makes the decision based on the operator policy, that the existing PDU Session cannot support EPS interworking N26.

The AMF stores the DNN and SMF+PGW-C in which the PDU Session(s) support EPS interworking to UDM in clause 4.11.1.6.

NOTE 2: The above applies only when the S-NSSAI(s) for the PDU Sessions are different, otherwise the same SMF is selected for PDU Sessions to the same DNN.

8. The SMF+PGW-C sends an N4 Session Establishment/Modification Request to the PGW-U+UPF.

For home routed roaming scenario, if the EBI is assigned successfully, the SMF+PGW-C prepares the CN Tunnel Info for each EPS bearer. For non roaming and LBO scenario, if the EBI is assigned successfully, the SMF+PGW-C may prepare the CN Tunnel Info for each EPS bearer.

The PGW-U+UPF allocates the PGW-U tunnel info for the EPS bearer and sends it to the SMF+PGW-C. The PGW-U+UPF is ready to receive uplink packets from E-UTRAN.

NOTE 3: In the home routed roaming scenario the SMF+PGW-C prepares the CN Tunnel Info for each EPS bearer and provide it to V-SMF. Thus when the UE move to EPC network, the V-SMF does not need interact with the SMF+PGW-C to get the EPS bearer context(s).

9. If the SMF+PGW-C receives any EBI(s) from the AMF, it adds the received EBI(s) into the mapped EPS bearer context(s).

In home routed roaming scenario, the SMF+PGW-C generates EPS bearer context which includes per EPS bearer PGW-U tunnel information. In addition, if the default EPS bearer is generated for the corresponding PDN Connection of PDU Session (i.e. during the PDU Session establishment procedure), the SMF+PGW-C generates the PGW-C tunnel information of the PDN connection and include it in UE EPS PDN connection.

- 9a. [Conditional] In non-roaming or LBO scenario, the SMF+PGW-C includes the mapped EPS bearer context(s) and the corresponding QoS Flow(s) to be sent to the UE in the N1 SM container. SMF+PGW-C also indicates the mapping between the QoS Flow(s) and mapped EPS bearer context(s) in the N1 SM container. SMF+PGW-C also includes the mapping between the received EBI(s) and QFI(s) into the N2 SM information to be sent to the NG-RAN. The SMF+PGW-C sends the N1 SM container and N2 SM information to AMF via the Nsmf\_PDUSession\_UpdateSMContext Response in the case of the PDU Session Modification procedure triggered by UE or AN, or UE Triggered Service Request procedure that results in session transfer from N3GPP to 3GPP, otherwise, via the Namf\_Communication\_N1N2MessageTransfer.
- 9b [Conditional] In home routed roaming scenario, the SMF+PGW-C sends mapped EPS bearer context(s), the mapping between the received EBI(s) and QFI(s), linked EBI and EPS bearer context(s) to V-SMF via Nsmf\_PDUSession\_Create Response in the case of PDU Session Establishment, or via Nsmf\_PDUSession\_Update Request in the case of PDU Session Modification. The V-SMF stores the EPS bearer context(s) and generates N1 SM container and N2 SM information and forwards them to AMF via the Nsmf\_PDUSession\_UpdateSMContext Response in the case of the PDU Session Modification procedure triggered by UE or AN, or UE Triggered Service Request procedure that results in session transfer from N3GPP to 3GPP, otherwise, via the Namf\_Communication\_N1N2MessageTransfer.
10. The N1 SM container and N2 SM information are sent to the UE and NG-RAN respectively. The relevant steps of the procedure as specified in the figure above are executed.

#### 4.11.1.4.2 EPS bearer ID transfer

Following procedures are updated to transfer EPS bearer ID(s) allocation information to target AMF.

- step 14d in figure 4.11.1.3.3-1 in EPS to 5GS Idle mode mobility with N26 (clause 4.11.1.3.3).
- step 7 in figure 4.11.1.2.2.2-1 in EPS to 5GS handover using N26 interface prepare phase (clause 4.11.1.2.2.2).



**Figure 4.11.1.4.2-1: Procedures for EPS bearer IDs transfer**

1. The AMF sends an Nsmf\_PDUSession\_CreateSMContext Request message to the SMF in above case;
2. The SMF+PGW-C to AMF: Nsmf\_PDUSession\_CreateSMContext Response with the allocated EBI information.

#### 4.11.1.4.3 EPS bearer ID revocation

Following procedures are updated to revoke the EPS bearer ID(s) assigned to the QoS flow(s):

- UE or network requested PDU Session Release for Non-roaming and Roaming with Local Breakout (clause 4.3.4.2).
- UE or network requested PDU Session Release for Home-routed Roaming (clause 4.3.4.3).
- UE or network requested PDU Session Modification (non-roaming and roaming with local breakout) (clause 4.3.3.2).
- UE or network requested PDU Session Modification (home-routed roaming) (clause 4.3.3.3).
- Handover of a PDU Session procedure from 3GPP to untrusted non-3GPP access (non-roaming and roaming with local breakout) (clause 4.9.2.2)
- Handover of a PDU Session procedure from 3GPP to untrusted non-3GPP access (home routed roaming) (clause 4.9.2.4)

When the PDU Session is released as described in clauses 4.3.4.2 or 4.3.4.3, 4.9.2.2, or 4.9.2.4 and the SMF invokes Nsmf\_PDUSession\_StatusNotify to notify AMF that the SM context for this PDU Session is released, the AMF releases the association between the SMF ID and the PDU Session ID and releases the EBIs assigned for this PDU Session. When all the PDU sessions which are allocated with EBIs are released in the same SMF, the AMF may revoke DNN and SMF+PGW-C FQDN for S5/S8 interface in the UDM using Nudm\_UECM\_Update service operation.

**NOTE 1:** If the SMF+PGW-C in which the PDU sessions support EPS interworking is changed for the same DNN, the AMF can update the DNN and new SMF+PGW-C FQDN for S5/S8 interface in the UDM using Nudm\_UECM\_Update service operation.

When the UE initiates a PDU Session Modification as described in clauses 4.3.3.2 or 4.3.3.3 and the SMF needs to release the assigned EBI from a QoS flow (e.g. when the QoS flow is released), the SMF can indicate the Released EBI list in the Nsmf\_PDUSession\_UpdateSMContext Response to the AMF. The AMF releases the corresponding EBI allocation for this PDU Session.

When the AMF decides to revoke some EBI(s), e.g. when the AMF receives a new EBI allocation request but there is no EBI available, the AMF may decide to revoke EBI(s) for another PDU Session, the AMF initiates a PDU Session Modification as described in clauses 4.3.3.2 or 4.3.3.3 and includes EBI list to be revoked in the Nsmf\_PDUSession\_UpdateSMContext Request. The SMF releases the indicated EBI(s) for the PDU Session.

When the AMF initiates a PDU Session Modification as described in clauses 4.3.3.2 or 4.3.3.3 to change the status of EPS interworking with N26 to "not supported", the AMF releases the EBIs assigned for this PDU Session and SMF release the assigned EBIs from the QoS Flows belonging to this PDU Session.

When the SMF initiates a PDU Session Modification as described in clauses 4.3.3.2 or 4.3.3.3 and the SMF needs to release the assigned EBI from a QoS flow (e.g. when the QoS flow is released), the SMF invokes



Namf\_Communication\_EBIAssignment and indicates the Released EBI list to the AMF. The AMF releases the corresponding EBI allocation for this PDU Session.

When the handover of a PDU Session procedure from 3GPP to untrusted non-3GPP access is performed in clause 4.9.2.2 or clause 4.9.2.4.1, the AMF, the SMF and the UE releases locally the EBI(s) allocated for this PDU Session.

When the handover of a PDU Session procedure from 3GPP to untrusted non-3GPP access is performed in clause 4.9.2.4.2, the H-SMF invokes Nsmf\_PDUSESSION\_StatusNotify to notify V-AMF to release the association between the SMF ID and the PDU Session ID and, as a result, the EBI(s) assigned for this PDU Session are released. The UE releases locally the EBI(s) allocated for this PDU Session.

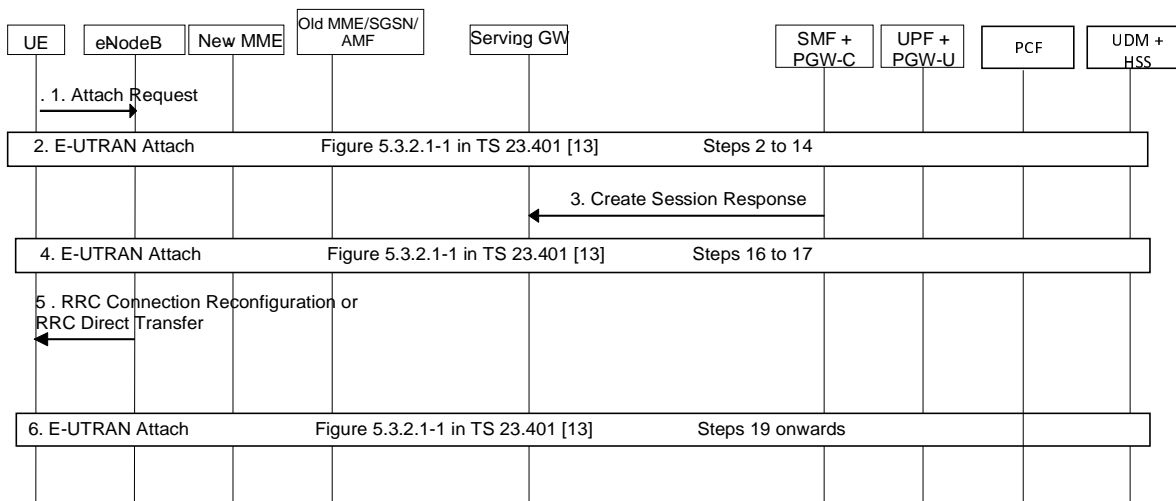
## 4.11.1.5 Impacts to EPS Procedures

### 4.11.1.5.1 General

This clause captures changes to procedures in TS 23.401 [13] due to interworking with 5GS based on N26. The handover procedures between EPS and 5GS captured in clause 4.11.1.2 capture impacts to clause 5.5.1.2.2 of TS 23.401 [13] (S1-based handover, normal).

### 4.11.1.5.2 E-UTRAN Initial Attach

The E-UTRAN Initial Attach Procedure specified in clause 5.3.2.1 of TS 23.401 [13] is impacted as shown in Figure 4.11.1.5.2-1 when interworking with 5GS using N26 interface is supported.



**Figure 4.11.1.5.2-1: Impacts to E-UTRAN Initial Attach procedure**

1. The UE sends an Attach Request message as specified in TS 23.401 [13] with the following modifications:
  - If the UE was previously registered in 5GS, the UE provides in Access Stratum signalling a GUMMEI mapped from the 5G-GUTI and indicates it as a native GUMMEI and should in addition indicate it as "Mapped from 5G-GUTI".
  - If the UE was previously registered in 5GS, the UE provides, in the Attach Request message, an EPS GUTI mapped from 5G-GUTI sent as old Native GUTI and indicates that it is moving from 5GC. The UE integrity protects the Attach Request message using the 5G security context.
  - A UE that supports 5GC NAS procedures shall indicate its support of 5G NAS as part of its UE Core Network Capability IE.
  - If the UE includes ESM message container for PDN Connection Establishment and the Request type is "initial request", the UE shall allocate a PDU Session ID and include it in the PCO. The PDU Session ID shall be unique across all other PDN connections of the UE.

- MME may steer the UE from EPC by rejecting the Attach request with an appropriate cause value. If the UE supports any of the CIoT 5GS Optimisations included in 5GC Preferred Network Behaviour, then the UE shall include its 5GC Preferred Network Behaviour if it included its EPC Preferred Network Behaviour in the Attach request. The MME should take into account availability of 5GC to the UE and the Preferred and Supported Network Behaviour (see clause 5.31.2 of TS 23.501 [2]) before steering the UE from EPC.
2. The relevant steps of the procedure as specified in the figure above are executed with the following modification:
    - The HSS/UDM on receiving Update Location Request from MME, de-register any old AMF by sending an Nudm\_UECM\_DeregistrationNotification service operation to the registered AMF for 3GPP access.
    - Step 7 and step 10 as specified in clause 5.3.2.1 of TS 23.401 [13] (i.e. IP-CAN Session Termination) is replaced by SM Policy Association Termination procedure as specified in clause 4.16.6.
    - Step 14 as specified in clause 5.3.2.1 of TS 23.401 [13] (i.e. IP-CAN Session Establishment/Modification) are replaced by SM Policy Association Establishment/Modification procedure as specified in clause 4.16.4 and clause 4.16.5.
  3. Step 15 as specified in clause 5.3.2.1 of TS 23.401 [13] with the following modification:
    - The SMF+PGW-C allocates 5G QoS parameters corresponding to PDN connection, e.g. Session AMBR, QoS rules and QoS Flow level QoS parameters if needed for the QoS Flow associated with the QoS rule(s) and then includes them in PCO.
  4. The relevant steps of the procedure as specified in the figure above are executed.
  5. Step 18 as specified in clause 5.3.2.1 of TS 23.401 [13] with the following modification:
    - The 5G QoS parameters for the PDU session and for the QoS Flow associated with the default QoS rule are stored in the UE.
  6. The relevant steps of the procedure as specified in the figure above are executed.

#### 4.11.1.5.3 Tracking Area Update

The following changes are applied to clause 5.3.3.1 (Tracking area update procedure with Serving GW change) in TS 23.401 [13]:

- Step 2: The UE shall in Access Stratum signalling include GUMMEI that is mapped from 5G-GUTI following the mapping rules specified in TS 23.501 [2] and the UE indicates it as a native GUMMEI and should in addition indicate it as "Mapped from 5G-GUTI". The UE shall, in the TAU request message, include EPS GUTI that is mapped from 5G-GUTI following the mapping rules specified in TS 23.501 [2]. The UE indicates that it is moving from 5GC. The UE integrity protects the TAU request message using the 5G security context. If the UE supports any of the CIoT 5GS Optimisations included in 5GC Preferred Network Behaviour, then the UE shall include its 5GC Preferred Network Behaviour if it included its EPC Preferred Network Behaviour in the TAU request.

MME may steer the UE from EPC by rejecting the TAU request with an appropriate cause value. The MME should take into account availability of 5GC to the UE and the Preferred and Supported Network Behaviour (see clause 5.31.2 of TS 23.501 [2]) before steering the UE from EPC.

- Step 5 and message Context Response may include new information Return preferred.

Return preferred is an indication by the AMF of a preferred return of the UE to the last used 5GS PLMN at a later access change to a 5GS shared network.

The MME may store the last used 5GS PLMN ID in UE's MM Context.

The MME may provide E-UTRAN with a Handover Restriction List taking into account the last used 5GS PLMN ID and the Return Preferred indication. The Handover Restriction List contains a list of PLMN IDs as specified by TS 23.251 [35].

- Step 9a IP-CAN Session Modification procedure:

It is replaced by SM Policy Association Modification as specified in clause 4.16.5.

- Step 13 and HSS use of Cancel Location

The HSS/UDM de-registers any old AMF node by sending an Nudm\_UECM\_DeregistrationNotification service operation to the registered AMF for 3GPP access. The registered AMF for 3GPP access initiates AM Policy Association Termination procedure as defined in clause 4.16.3.2 and UE Policy Association Termination procedure as defined in clause 4.16.13.1.

- Step 17: If the DNN and SMF+PGW-C FQDN for S5/S8 interface association exist, the HSS/UDM sends APN mapped form DNN and SMF+PGW-C FQDN for S5/S8 to UE.
- Step 20 and MME processing of the partial Tracking Area Update (TAU) procedure.

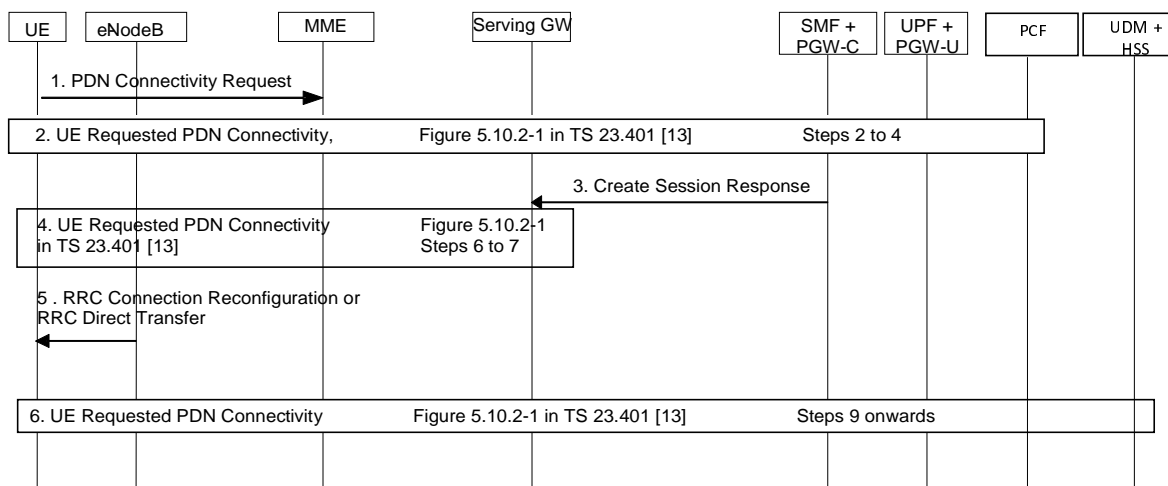
The MME may use an indication Return preferred from Context Response at step 6 when deciding the PLMN list content.

The MME may provide the eNodeB with a PLMN list. The Handover Restriction List contains a list of PLMN IDs as specified by TS 23.501 [2].

### 4.11.1.5.4 Session Management

#### 4.11.1.5.4.1 PDN Connection Request

The UE Requested PDN Connectivity Procedure specified in clause 5.10.2 of TS 23.401 [13] is impacted as shown in in Figure 4.11.1.5.4.1-1 when interworking with 5GS is supported.



**Figure 4.11.1.5.4.1-1: Impacts to UE Requested PDN Connectivity Procedure**

1. UE sends a PDN connectivity Request to the MME as specified in step 1 in clause 5.10.2 of TS 23.401 [13] with the following modification:
  - If the UE is 5G NAS capable and the Request type is "initial request", the UE shall allocate a PDU Session ID and include it in the PCO. The PDU Session ID shall be unique across all other PDN connections of the UE.
2. The relevant steps of the procedure as specified in the figure above are executed. In step 4 of TS 23.401 [13], IP Session Establishment/Modification procedure is replaced by SM Policy Association Establishment/Modification procedure as specified in clauses 4.16.4 and 4.16.5.
3. Step 6 as specified in clause 5.10.2 of TS 23.401 [13] is executed with the following modification:
  - If the SMF+PGW-C accepts to provide interworking of the PDN connection with 5GC, the SMF+PGW-C shall allocate 5G QoS parameters corresponding to PDN connection, e.g. Session AMBR, QoS rules and QoS Flow level QoS parameters if needed for the QoS Flow(s) associated with the QoS rule(s) and then include them in PCO.

- If the SMF+PGW-C accepts to provide interworking of the PDN connection with 5GC, the SMF+PGW-C shall determine the S-NSSAI associated with the PDN connection based on the operator policy and send the S-NSSAI together with the PLMN ID to the UE in the PCO.
  - If the SMF+PGW-C accepts to provide interworking of the PDN connection with 5GC the SMF+PGW-C, if Small Data Rate Control is used, provides the Small Data Rate Control parameters to the UE in the PCO.
4. The relevant steps of the procedure as specified in the figure above are executed.
  5. Step 8 as specified in clause 5.10.2 of TS 23.401 [13] with the following modification:
    - If 5G QoS parameters are included in the PCO, the UE shall store them. If 5G QoS parameters are not included in the PCO, the UE shall note that session continuity for this PDN connection on mobility to 5G is not provided by the network.
    - If the S-NSSAI and the PLMN ID associated with the PDN connection are included in the PCO, the UE shall store them.
    - If the Small Data Rate Control parameters are included in the PCO, the UE shall store them.
  6. The relevant steps of the procedure as specified in the figure above are executed.

#### 4.11.1.5.4.2 UE or MME Requested PDN Disconnection

The procedure as specified in clause 5.10.3 of TS 23.401 [13] applies with the following modification:

- Step 8.(RRC Connection Reconfiguration): On receiving the NAS Deactivate EPS Bearer Context Request(LBI) message, if the UE has mapped 5G parameters for the PDU session, the UE deletes the corresponding mapped 5GS PDU session.

In addition if the SMF+PGW-C has registered to HSS+UDM for this PDN connection before, the SMF+PGW-C invokes the Nudm\_UECM\_Deregistration service operation to notify the UDM to remove the association between the SMF+PGW-C identity and the associated DNN and PDU Session Id as described in the step 12 of clause 4.3.4.2. If there is no PDN connection for the associated (DNN, S-NSSAI) handled by the SMF+PGW-C, the SMF+PGW-C unsubscribes from Session Management Subscription data changes notification with the HSS+UDM by means of the Nudm\_SDM\_Unsubscribe (SUPI, DNN, S-NSSAI) service operation as described in step 12 of clause 4.3.4.2.

#### 4.11.1.5.4.3 Dedicated Bearer Activation, Bearer Modification and Bearer Deactivation

The procedures specified in clauses 5.4.1 through 5.4.5 of TS 23.401 [13] apply with the following modifications:

- PCRF initiated IP-CAN Modification in TS 23.401 [13] is replaced with PCF initiated SM Policy Association Modification as specified in clause 4.16.5.2. PCEF initiated IP-CAN Session Modification/Termination TS 23.401 [13] is replaced with SM Policy Association Modification/Termination as specified in clauses 4.16.5 and 4.16.6.
- In the step where the PDN-GW sends a Create Bearer Request, i.e.
  - Step 2 in clause 5.4.1 of TS 23.401 [13] (Dedicated Bearer Activation)
 the PCO includes mapped 5GS QoS parameters for the EPS bearer being created.
- In the step where the PDN-GW sends an Update Bearer Request, i.e.:
  - Step 2 in clause 5.4.2.1 of TS 23.401 [13] (PDN GW initiated bearer modification with bearer QoS update)
  - Step 5 in clause 5.4.2.2 of TS 23.401 [13] (HSS Initiated Subscribed QoS Modification)
  - Step 2 in clause 5.4.3 of TS 23.401 [13] (PDN GW initiated bearer modification without bearer QoS update) if TFT or APN-AMBR is being modified

the PCO includes the modification to the mapped 5GS QoS parameters, if impacted by the modification, corresponding to the EPS bearer being modified.

- In the step where the UE receives the NAS Session Management message from the MME which contains the PCO relayed via the MME, i.e.:

- Step 5 in clause 5.4.1 of TS 23.401 [13] (Dedicated Bearer Activation)
- Step 5 in clause 5.4.2.1 of TS 23.401 [13] (PDN GW initiated bearer modification with bearer QoS update)
- Step 5 in clause 5.4.3 of TS 23.401 [13] (PDN GW initiated bearer modification without bearer QoS update) if TFT or APN-AMBR is being modified

the UE updates the mapped 5G QoS parameters as included in the PCO from the PDN-GW.

- In the step where the UE receives EPS bearer request message, i.e.
  - Step 5 in clause 5.4.4.1 of TS 23.401 [13] (PDN GW initiated bearer deactivation)

the UE also deletes the mapped 5GS QoS flow and its associated parameter.

#### 4.11.1.5.5 5GS to EPS handover using N26 interface

In step 3 of clause 4.11.1.2.1, the Forward Relocation Request may include new information Return Preferred.

Return Preferred is an indication by the AMF of a preferred return of the UE to the last used 5GS PLMN at a later access change to a 5GS shared network.

The MME may store the last used 5GS PLMN ID in UE's MM Context.

The MME may provide E-UTRAN with a Handover Restriction List taking into account the last used 5GS PLMN ID and the Return Preferred indication. The Handover Restriction List contains a list of PLMN IDs as specified by TS 23.251 [35].

#### 4.11.1.5.6 UE triggered Service Request

The following changes are applied to clause 5.3.4.1 (UE triggered Service Request) in TS 23.401 [13]:

- Step 4: MME may steer the UE from EPC by rejecting the service request with an appropriate cause value. The MME should take into account availability of 5GC to the UE and the Preferred and Supported Network Behaviour (see clause 5.31.2 of TS 23.501 [2]) before steering the UE from EPC.

#### 4.11.1.5.7 Establishment of S1-U bearer during Data Transport in Control Plane ClOT EPS Optimisation

The following changes are applied to clause 5.3.4B.4 (Establishment of S1-U bearer during Data Transport in Control Plane ClOT EPS Optimisation) in TS 23.401 [13]:

- Step 3: MME may steer the UE from EPC by rejecting the Control Plane Service Request with an appropriate cause value. The MME should take into account availability of 5GC to the UE and the Preferred and Supported Network Behaviour (see clause 5.31.2 of TS 23.501 [2]) before steering the UE from EPC.

#### 4.11.1.6 EPS interworking information storing Procedure

Depending on the operator's configuration, the AMF serving the 3GPP access store DNN and SMF+PGW-C FQDN for S5/S8 interface in the UDM using Nudm\_UECM\_Update service operation when N26 is deployed.

### 4.11.2 Interworking procedures without N26 interface

#### 4.11.2.1 General

Clause 4.11.2 defines the procedures to support interworking between 5GS and EPS without any N26 interface between AMF and MME.

During interworking from EPS to 5GS, as the SMF+PGW-C may have different IP addresses when being accessed over S5/S8 and N11/N16 respectively, the AMF shall discover the SMF instance by an NF/NF service discovery procedure using the FQDN for the S5/S8 interface received from the UDM as a query parameter.

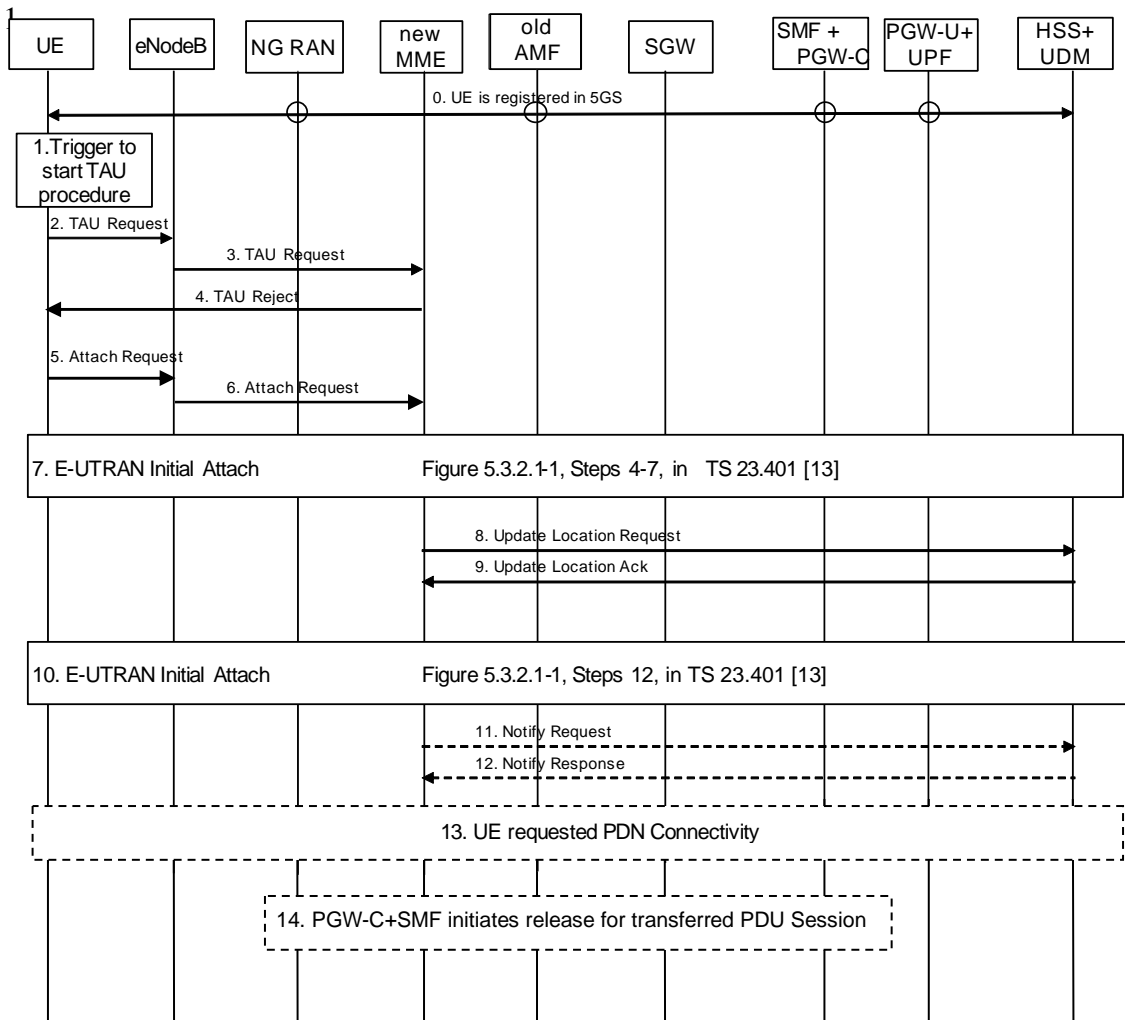
This is required for both non-roaming and roaming with local breakout, as well as for home routed roaming.

NOTE: As the AMF is not aware of the S-NSSAI assigned for the PDN Connection, the NF/NF service discovery used to find the SMF instance can use PLMN level NRF.

### 4.11.2.2 5GS to EPS Mobility

The following procedure is used by UEs in single-registration or dual registration mode on mobility from 5GS to EPS.

In the case of network sharing the UE selects the target PLMN ID according to clause 5.18.3 of TS 23.501 [2].



**Figure 4.11.2.2-1: Mobility procedure from 5GS to EPS without N26 interface**

The UE operating in single-registration mode can start the procedure from Step 1 or Step 5. The UE operating in dual-registration mode starts the procedure from Step 5.

NOTE 1: The network has indicated the "Interworking without N26" to the UE. To support IP address preservation, the UE in single-registration mode starts the procedure from Step 5. If the UE in single-registration mode starts the procedure from Step 1, the IP address preservation is not provided.

0. UE is registered in 5GS and established PDU sessions. The FQDN for the S5/S8 interface of the SMF+PGW-C is also stored in the UDM by the SMF+PGW-C during PDU Session setup in addition to what is specified in clause 4.3.2.2.1 and clause 4.3.2.2.2.

NOTE 2: At 5GS to EPS mobility, the MME use the FQDN for the S5/S8 interface of the SMF+PGW-C to find the SMF+PGW-C and when UE moves back from EPS to 5GS, the AMF uses FQDN for the S5/S8 interface of the SMF+PGW-C to find the SMF+PGW-C.

1. Step 1 as in clause 5.3.3.1 (Tracking Area Update) in TS 23.401 [13].

2. Step 2 as in clause 5.3.3.1 (Tracking Area Update) in TS 23.401 [13] with the following modifications:

The UE shall provide a EPS-GUTI that is mapped from the 5G-GUTI following the mapping rules specified in TS 23.501 [2]. The UE indicates that it is moving from 5GC.

3. Step 3 as in clause 5.3.3.1 (Tracking Area Update) in TS 23.401 [13].
4. If the MME determined that the old node is an AMF based on UE's GUTI mapped from 5G-GUTI and the MME is configured to support 5GS-EPS interworking without N26 procedure, the MME sends a TAU Reject to the UE.
5. Step 1 as in clause 5.3.2.1 (E-UTRAN Initial Attach) in TS 23.401 [13] with the modifications captured in clause 4.11.2.4.1.
6. Step 2 as in clause 5.3.2.1 (E-UTRAN Initial Attach) in TS 23.401 [13].
7. Steps 4-7 as in clause 5.3.2.1 (E-UTRAN Initial Attach) in TS 23.401 [13], with the modifications captured in clause 4.11.2.4.1.
8. Step 8 as in clause 5.3.2.1 (E-UTRAN Initial Attach) in TS 23.401 [13], with the modifications captured in clause 4.11.2.4.1.
9. Step 11 as in clause 5.3.2.1 (E-UTRAN Initial Attach) in TS 23.401 [13], with the following modifications:

The subscription profile the MME receives from HSS+UDM includes per DNN/APN at most one SMF+PGW-C FQDN as described in in clause 5.17.2.1 of TS 23.501 [2].
10. Steps 12-24 as in clause 5.3.2.1 (E-UTRAN Initial Attach) in TS 23.401 [13], with the modifications as described in clause 4.11.2.4.1.
11. Step 25 as in clause 5.3.2.1 (E-UTRAN Initial Attach) in TS 23.401 [13].
12. Step 26 as in clause 5.3.2.1 (E-UTRAN Initial Attach) in TS 23.401 [13].
13. If the UE has remaining PDU Sessions in 5GS which it wants to transfer to EPS and maintain the same IP address/prefix, the UE performs the UE requested PDN Connectivity Procedure as specified in clause 5.10.2 of TS 23.401 [13] and sets the Request Type to "handover" in Step 1 of the procedure with modification captured in clause 4.11.2.4.2. UE provides an APN and the PDU Session ID corresponding to the PDU Session it wants to transfer to EPS. The UE provides the PDU Session ID in PCO as described in clause 4.11.1.1.

UEs in single-registration mode performs this step for each PDU Session immediately after completing the E-UTRAN Initial Attach procedure. UEs in dual-registration mode may perform this step any time after the completing of E-UTRAN Initial Attach procedure. Also, UEs in dual-registration mode may perform this step only for a subset of PDU Sessions.

The MME determines the SMF+PGW-C address for the Create Session Request based on the APN received from the UE and the subscription profile received from the HSS+UDM in Step 9 or when the HSS+UDM notifies the MME for the new SMF+PGW-C ID in the updated subscription profile.

The SMF+PGW-C uses the PDU Session ID to correlate the transferred PDN connection with the PDU Session in 5GC.

As a result of the procedure the PGW-U+UPF starts routing DL data packets to the Serving GW for the default and any dedicated EPS bearers established for this PDN connection.

14. For Non-Roaming case and Roaming with Local Breakout, the SMF+PGW-C initiates release of the PDU Session(s) in 5GS transferred to EPS as specified in clause 4.3.4.2 with the following clarification:

- In step 2, the SMF+PGW-C shall not release IP address/prefix(es) allocated for the PDU Session;
- If UP connection of the PDU Session is not active, step 3b is not executed, thus the steps triggered by step 3b are not executed;

If UP connection of the PDU Session is active, the SMF invokes the Namf\_Communication\_N1N2MessageTransfer service operation in step 3b without including N1 SM container (PDU Session Release Command);

- In step 11, Nsmf\_PDUSession\_SMContextStatusNotify service operation invoked by the SMF to notify AMF that the SM context for this PDU Session is released due to handover to EPS.

For Home Routed roaming, the SMF+PGW-C initiates release of the PDU Session(s) in 5GS transferred to EPS as specified in clause 4.3.4.3 with the following clarification:

- In step 3a, the H-SMF invokes the Nsmf\_PDUSession\_Update service operation without including N1 SM container (PDU Session Release Command);
- In step 16a, Nsmf\_PDUSession\_StatusNotify operation invoked by H-SMF to notify the V-SMF that the PDU session context is released due to handover to EPS;
- In step 16b, Nsmf\_PDUSession\_SMContextStatusNotify service operation invoked by the V-SMF to notify AMF that the SM context for this PDU Session is released due to handover to EPS.

#### 4.11.2.3 EPS to 5GS Mobility

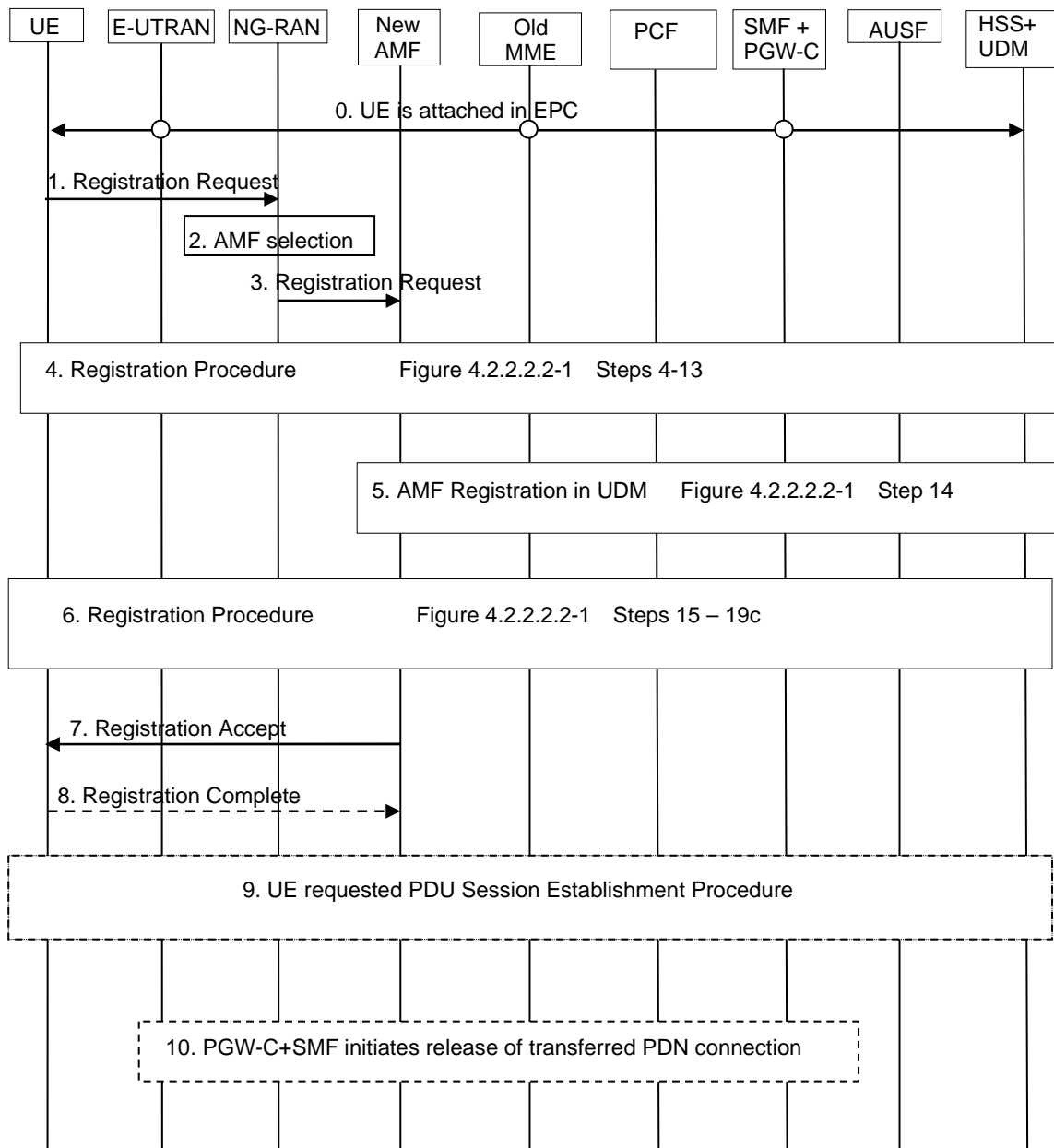
The following procedure is used by UEs in single-registration mode on mobility from EPS to 5GS.

In the case of network sharing the UE selects the target PLMN ID according to clause 5.18.3 of TS 23.501 [2].

This procedure is also used by UEs in dual-registration mode to perform registration in 5GS when the UE is also registered in EPC. The procedure is the General Registration procedure as captured in clause 4.2.2. Difference from that procedure are captured below.

The UE has one or more ongoing PDN connections including one or more EPS bearers. During the PDN connection establishment, the UE allocates the PDU Session ID and sends it to the SMF+PGW-C via PCO, as described in clause 4.11.1.1.





**Figure 4.11.2.3-1: Mobility procedure from EPS to 5GS without N26 interface**

0. The UE is attached in EPC as specified in clause 4.11.2.4.1.

1. Step 1 in clause 4.2.2.2.2 (General Registration) with the following clarifications:

The UE indicates that it is moving from EPC. The UE in single registration mode provides the Registration type set to "mobility registration update", a 5G-GUTI mapped from the 4G-GUTI and a native 5G-GUTI (if available) as an Additional GUTI. The UE includes the UE Policy Container containing the list of PSIs, indication of UE support for ANDSP and OSId if available. The UE shall select the 5G-GUTI for the additional GUTI as follows, listed in decreasing order of preference:

- a native 5G-GUTI assigned by the PLMN to which the UE is attempting to register, if available;
- a native 5G-GUTI assigned by an equivalent PLMN to the PLMN to which the UE is attempting to register, if available;
- a native 5G-GUTI assigned by any other PLMN, if available.

The UE in dual registration mode provides the Registration type set to "initial registration" and a native 5G-GUTI or SUCI. In single registration mode, the UE also includes at least the S-NSSAIs (with values for the

Serving PLMN) associated with the established PDN connections in the Requested NSSAI in RRC Connection Establishment.

2. Step 2 as in clause 4.2.2.2.
3. Step 3 as in clause 4.2.2.2.2 (General Registration), with the following modifications:

If the Registration type is "mobility registration update" and the UE indicates that it is moving from EPC in step 1 and the AMF is configured to support 5GS-EPS interworking procedure without N26 interface, the AMF treats this registration request as "initial Registration" and the AMF skips the PDU Session status synchronization.

NOTE 1: The UE operating in single registration mode includes the PDU Session IDs corresponding to the PDN connections to the PDU Session status.

If the UE has provided a 5G-GUTI mapped from 4G-GUTI in step 1 and the AMF is configured to support 5GS-EPS interworking procedure without N26 interface, the AMF does not perform steps 4 and 5 in clause 4.2.2.2 (UE context transfer from the MME).

4. Steps 4-13 as in clause 4.2.2.2.2 (General Registration), with the following modifications:

If the UE has included an additional GUTI in the Registration Request, then the new AMF attempts to retrieve the UE's security context from the old AMF in steps 4 and 5.

If the UE's security context is not available in the old AMF or if the UE has not provided an additional GUTI then the AMF retrieves the SUCI from the UE in steps 6 and 7.

5. Step 14 as in clause 4.2.2.2.2 (General Registration), with the following modifications:

If the UE indicates that it is moving from EPC and the Registration type is set to "initial registration" or "mobility registration update" in step 1 and AMF is configured to support 5GS-EPS interworking without N26 procedure, the AMF sends an Nudm\_UECM\_Registration Request message to the HSS+UDM indicating that registration of an MME at the HSS+UDM, if any, shall not be cancelled. The HSS+UDM does not send cancel location to the old MME.

NOTE 2: If the UE does not maintain registration in EPC, upon reachability time-out, the MME can implicitly detach the UE and release the possible remaining PDN connections in EPC.

The subscription profile the AMF receives from HSS+UDM includes the DNN/APN and SMF+PGW-C FQDN for S5/S8 interface for each PDN connection established in EPC. For emergency PDU Session, the AMF receives Emergency Information containing SMF+PGW-C FQDN from HSS+UDM.

6. Steps 15-19c as in clause 4.2.2.2.2 (General Registration).
7. Step 21 as in clause 4.2.2.2.2 (General Registration) with the following modifications:

The AMF includes an "Interworking without N26" indicator to the UE.

If the UE had provided PDU Session Status information in step 1, the AMF Sets the PDU Session Status to not synchronized.

8. Step 22 as in clause 4.2.2.2.2 (General Registration)
9. UE requested PDU Session Establishment procedure as in clause 4.3.2.2.1.

If the UE had setup PDN Connections in EPC which it wants to transfer to 5GS and maintain the same IP address/prefix and the UE received "Interworking without N26" indicator in step 7, the UE performs the UE requested PDU Session Establishment Procedure as in clause 4.3.2.2 and sets the Request Type to "Existing PDU Session" or "Existing Emergency PDU Session" in step 1 of the procedure. The UE provides a DNN for non-emergency PDU Session, the PDU Session ID and S-NSSAI corresponding to the existing PDN connection it wants to transfer from EPS to 5GS. The S-NSSAI is set as described in clause 5.15.7.2 of TS 23.501 [2].

If the Request Type indicates "Existing Emergency PDU Session", the AMF shall use the Emergency Information received from the HSS+UDM which contains SMF+PGW-C FQDN for S5/S8 interface for the emergency PDN connection established in EPS and the AMF shall use the S-NSSAI locally configured in Emergency Configuration Data.

UEs in single-registration mode performs this step for each PDN connection immediately after the step 8. UEs in dual-registration mode may perform this step any time after step 8. Also, UEs in dual-registration mode may perform this step only for a subset of PDU Sessions. The AMF determines the S5/S8 interface of the SMF+PGW-C for the PDU Session based on the DNN received from the UE and the SMF+PGW-C ID in the subscription profile received from the HSS+UDM in step 5 or when the HSS+UDM notifies the AMF for the new SMF+PGW-C ID in the updated subscription profile. The AMF queries the NRF in serving PLMN by issuing the `Nnrf_NFDDiscovery_Request` including the FQDN for the S5/S8 interface of the SMF+PGW-C and the NRF provides the IP address or FQDN of the N11/N16 interface of the SMF+PGW-C. The AMF invokes the `Nsmf_PDUSession_CreateSMContext` service with the SMF address provided by the NRF. The AMF includes the PDU Session ID to the request sent to the SMF+PGW-C.

The SMF+PGW-C uses the PDU Session ID to determine the correct PDU Session.

After step 16a of Figure 4.3.2.2.1-1 in clause 4.3.2.2.1, user plane is switched from EPS to 5GS.

As specified clause 4.3.2.2, if the SMF has not yet registered for the PDU Session ID, then the SMF registers with the UDM using `Nudm_UECM_Registration` (SUPI, DNN, PDU Session ID) and if Session Management Subscription data for corresponding SUPI, DNN and S-NSSAI is not available, then SMF retrieves the Session Management Subscription data using `Nudm_SDM_Get` (SUPI, Session Management Subscription data, DNN, S-NSSAI) and subscribes to be notified when this subscription data is modified using `Nudm_SDM_Subscribe` (SUPI, Session Management Subscription data, DNN, S-NSSAI).

NOTE 3: The SMF can, instead of the `Nudm_SDM_Get` service operation, use the `Nudm_SDM_Subscribe` service operation with an Immediate Report Indication that triggers the UDM to immediately return the subscribed data if the corresponding feature is supported by both the SMF and the UDM.

10. The SMF+PGW-C performs release of the resources in EPC for the PDN connections(s) transferred to 5GS by performing the PDN GW initiated bearer deactivation procedure as defined in clause 5.4.4.1 of TS 23.401 [13], except the steps 4-7.

#### 4.11.2.4 Impacts to EPS Procedures

##### 4.11.2.4.1 E-UTRAN Attach

Impact on clause 5.3.2.1 of TS 23.401 [13] from adding support for the optional network functionality dual registration mode:

- Step 1:

The UE constructs the Attach Request message according to the following principles:

- If UE operates in single-registration mode, the UE indicates that it is moving from 5GC and provides a native 4G-GUTI or a 4G-GUTI mapped from 5G GUTI (indicated as native GUTI), if available, otherwise the IMSI, or
- If the UE operates in dual-registration mode, the UE indicates that it is moving from 5GC and provides native 4G-GUTI, or
- If the UE sent a TAU in step 2 and it was rejected because the MME could not derive the UE identity, the UE provides IMSI.

If the UE wants to transfer a PDU Session to EPC as part of the Attach procedure, it includes a PDN CONNECTIVITY Request message in the Attach Request and provides a Request type "Handover", DNN/APN and PDU Session ID of the PDU Session (clause 5.3.2.1 of TS 23.401 [13]). The UE provides the PDU Session ID in PCO as described in clause 4.11.1.1. For PDU Session of Ethernet Type, if the UE and the network support Ethernet PDN Type in EPS which is negotiated during PDU Session Establishment as described in clause 4.11.5, the UE includes PDN Type Ethernet in PDN CONNECTIVITY Request message.

If the TAU was rejected in step 2 the IP address preservation is not provided. In this case the UE provides IMSI in the Attach Request and does not provide a Request Type "Handover" in the PDN CONNECTIVITY Request if included in the Attach Request.

The UE provides an EPS bearer ID for all mapped EPS bearers in the EPS bearer status. For the initial Attach Request the EPS bearer status is empty.

NOTE 1: The UE is aware the network is configured to support 5GS-EPS interworking without N26 procedure. The UE does not include the EPS bearer IDs corresponding to the 5G QoS flows to the EPS bearer status.

If the UE supports 5GC NAS procedures (see clause 5.17.2 of TS 23.501 [2]), then the UE shall indicate its support of 5G NAS in a NAS indicator.

- Step 3:

If the UE provided a 4G-GUTI mapped from 5G-GUTI and the MME is configured to support 5GS-EPS interworking without N26 procedure, the MME does not perform step 3, Identification Request to old MME/SGSN/AMF in clause 5.3.2.1 of TS 23.401 [13].

NOTE 2: As the 4G-GUTI mapped from 5G-GUTI is unknown identity to the MME, the MME sends an Identity Request to the UE to request the IMSI. The UE responds with Identity Response (IMSI).

- Step 8:

If the UE indicates that it is moving from 5GC (Attach Request) and the MME is configured to support 5GS-EPS interworking without N26 procedure, the MME sends an Update Location Request message to the HSS+UDM indicating that registration of an AMF at the HSS+UDM, if any, shall not be cancelled. The HSS+UDM does not send Nudm\_UECM\_DeregistrationNotification to the old AMF.

NOTE 3: If the UE does not maintain registration in 5GC, upon reachability time-out, the AMF can implicitly detach the UE and release the possible remaining PDU Sessions in 5GC.

- Step 11:

The HSS+UDM selects one of the SMF+PGW-C FQDN for one APN based on operator's policy. The HSS+UDM sends selected SMF+PGW-C FQDN along with APN to the MME for the UE.

- Step 12:

The MME determines the SMF+PGW-C address for the Create Session Request based on the APN received from the UE and the subscription profile received from the HSS+UDM.

- Step 13:

The SMF+PGW-C uses the PDU Session ID received from the UE in PCO to correlate the transferred PDN connection with the PDU Session in 5GC.

In this release, if the Handover Indication is present in the Create Session Request and the SMF+PGW-C detects it corresponds to a PDU Session for a LADN in 5GC, the SMF+PGW-C rejects the request.

- Step 14:

IP-CAN Session Modification procedure is replaced by SM Policy Association Modification Procedure as described in clause 4.16.5.

- Step 17:

If the UE indicated support for 5GC NAS procedures (see clause 5.11.3) and the MME supports procedures for interworking with 5GC without N26, the MME may indicate in the Attach Accept, that interworking without N26 is supported. UE handling of this indicator is defined in TS 23.501 [2].

- Step 23a:

As a result of the procedure the PGW-U+UPF starts routing DL data packets to the Serving GW for the default and any dedicated EPS bearers established for this PDN connection.

- Step 25:

Notify Request is sent to HSS/UDM if the network supports the procedures for 5GC interworking without N26 and that the UE is allowed to access 5GC (condition that is identified based on the subscription data). For emergency attach, Notify Request is sent to HSS/UDM if the network supports the procedures for 5GC interworking without N26 and operator policy allows handover of emergency session to 5GS.

#### 4.11.2.4.2 Session Management

##### 4.11.2.4.2.1 PDN Connection Request

Same procedure as specified in clause 4.11.1.5.4.1 is used with the following clarification:

Step 6. The relevant steps of the procedure as specified in the figure above are executed with the following modification:

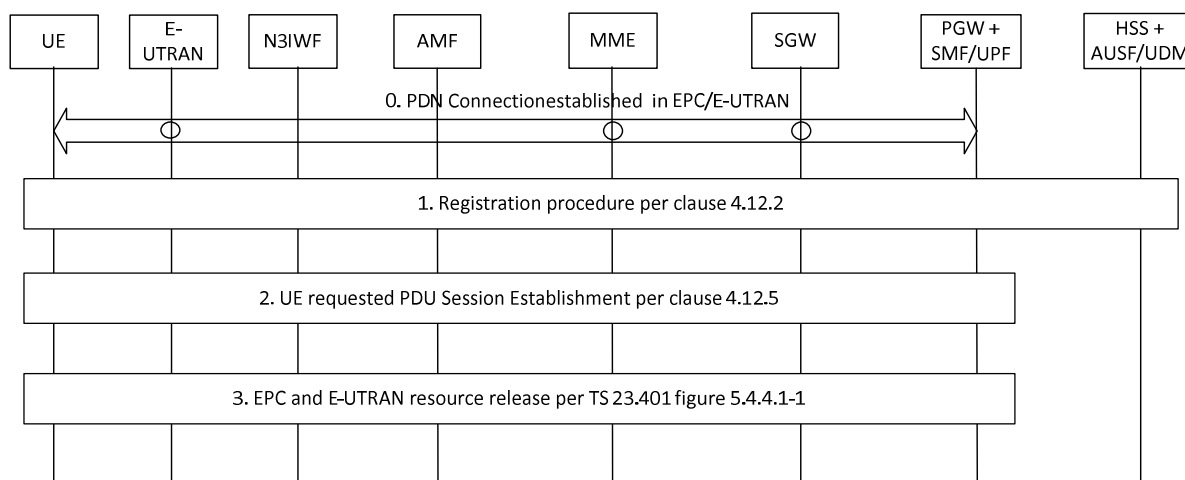
- Additional condition to trigger Notify Request to HSS in step 15 of Figure 5.10.2-1 of TS 23.401 [13] is that the network supports the procedures for 5GC interworking without N26 and that the UE is allowed to use 5GS in the subscription data. If the Request Type of the UE requested connectivity procedure indicates "Emergency", MME triggers Notify Request to HSS if the network supports the procedures for 5GC interworking without N26 and operator policy allows handover of emergency session to 5GS.

For an unauthenticated or roaming UE, if the Request Type of the UE requested connectivity procedure indicates "Emergency", the MME shall not send any Notify Request to an HSS.

##### 4.11.2.4.3 Void

### 4.11.3 Handover procedures between EPS and 5GC-N3IWF

#### 4.11.3.1 Handover from EPS to 5GC-N3IWF



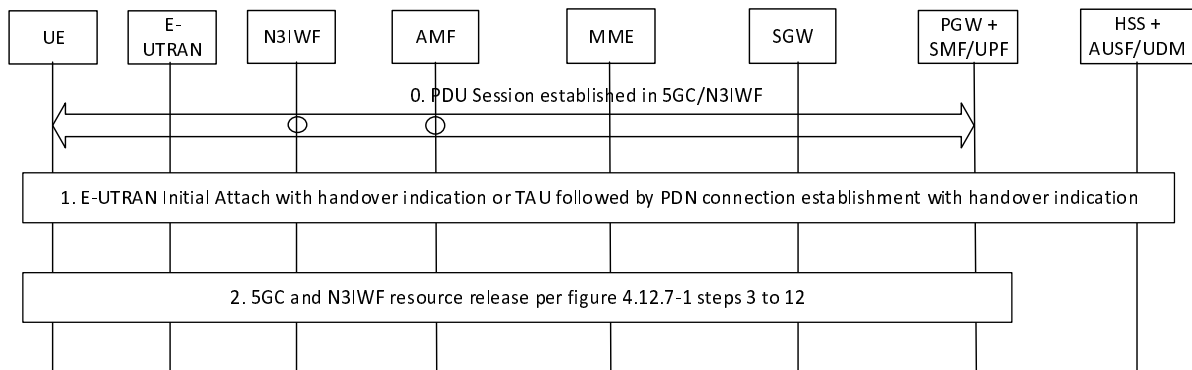
**Figure 4.11.3.1-1: Handover from EPS to 5GC-N3IWF**

0. Initial status: one or more PDN connections have been established in EPC between the 5G capable UE and the PGW via E-UTRAN.
1. The UE initiates Registration procedure on untrusted non-3GPP access via N3IWF (with 5G-GUTI is available or SUCI if not) per clause 4.12.2.
2. The UE initiates a UE requested PDU Session Establishment with Existing PDU Session indication in 5GC via Untrusted non-3GPP Access via N3IWF per clause 4.12.5.

If the Request Type indicates "Existing Emergency PDU Session", the AMF shall use the Emergency Information received from the HSS+UDM which contains SMF+PGW-C FQDN for S5/S8 interface for the emergency PDN connection established in EPS and the AMF shall use the S-NSSAI locally configured in Emergency Configuration Data.

The combined PGW+SMF/UPF initiates a PDN GW initiated bearer deactivation as described in clause 5.4.4.1 of TS 23.401 [13] to release the EPC and E-UTRAN resources.

### 4.11.3.2 Handover from 5GC-N3IWF to EPS



**Figure 4.11.3.2-1: Handover from 5GC-N3IWF to EPS**

0. Initial status: one or more PDU Sessions have been established in 5GC between the UE and the SMF/UPF via untrusted non-3GPP access and N3IWF. During PDU Session setup and in addition to what is specified in clause 4.3.2.2.1 and clause 4.3.2.2.2, the AMF includes an indication that EPS interworking is supported to the SMF+PGW-C as specified in clause 4.11.5.3 and the SMF+PGW-C sends the FQDN related to the S5/S8 interface to the HSS+UDM which stores it as described in clause 4.11.5.
1. For the UE to move PDU session(s) from 5GC/N3IWF to EPC/E-UTRAN, the UE's behaviour is as follows:
  - If the UE is operating in single-registration mode (as described in clause 5.17.2.1 of TS 23.501 [2]) and the UE is registered via 3GPP access to 5GC,
    - the UE behaves as specified in clause 4.11.1 or 4.11.2 and moves its PDU session from 5GC/N3IWF to EPC/E-UTRAN using the PDN connection establishment with "Handover" indication procedure as described in TS 23.401 [13].
    - otherwise, i.e. either the UE is operating in single registration mode and is not registered via 3GPP access to 5GC, or the UE is operating in dual registration mode and
  - if the UE is not attached to EPC/E-UTRAN, the UE initiates Handover Attach procedure in E-UTRAN as described in TS 23.401 [13] for a non-3GPP to EPS handover with "Handover" indication, except note 17.
  - otherwise (i.e. the UE is attached to EPC/E-UTRAN), the UE initiates the PDN Connection establishment with "Handover" indication procedure as described in TS 23.401 [13].
2. The combined PGW+SMF/UPF initiates a network requested PDU Session Release via untrusted non-3GPP access and N3IWF according to Figure 4.12.7-1 steps 3 to 12 to release the 5GC and N3IWF resources with the following exception:
  - the H-SMF indicates in the Nsmf\_PDUSession\_Update Request that the UE shall not be notified. This shall result in the V-SMF not sending the N1 SM Container (PDU Session Release Command) to the UE.
  - Nsmf\_PDUSession\_StatusNotify service operation invoked by H-SMF to V-SMF indicates the PDU Session is moved to a different system;
  - Nsmf\_PDUSession\_SMContextStatusNotify service operation invoked by the (V-)SMF indicates the PDU Session is moved to another system.
  - The Npcf\_SMPolicyControl\_Delete service operation to PCF shall not be performed.

### 4.11.3a Handover procedures between EPS and 5GC-TNGF

#### 4.11.3a.1 Handover from EPS to 5GC-TNGF

The handover procedure from EPS to 5GC-TNGF is supported as specified in clause 4.11.3.1 for handover procedure from EPS to 5GC-N3IWF with the following differences:

- The untrusted non-3GPP access is substituted by trusted non-3GPP access point (TNAP).
- The N3IWF is substituted by TNGF.
- The registration procedure via trusted non-3GPP access as specified in clause 4.12a.2 shall be performed in step 1.
- The UE requested PDU Session Establishment with Existing PDU Session indication in 5GC via trusted non-3GPP access is performed in step 2 as specified clause 4.12a.5.

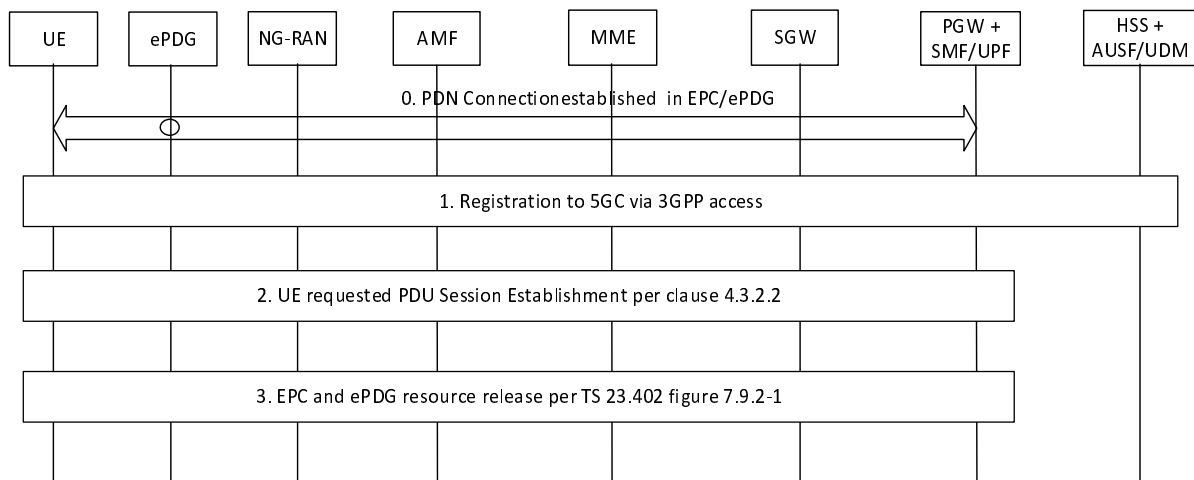
#### 4.11.3a.2 Handover from 5GC-TNGF to EPS

The handover procedure from 5GC-TNGF to EPS is supported as specified in clause 4.11.3.2 for handover procedure from 5GC-N3IWF to EPS with the following differences:

- The untrusted non-3GPP access is substituted by trusted non-3GPP access point (TNAP).
- The N3IWF is substituted by TNGF.
- The network requested PDU Session Release via TNAP and TNGF shall be initiated as specified in clause 4.12a.7 from steps 3 to 12.

### 4.11.4 Handover procedures between EPC/ePDG and 5GS

#### 4.11.4.1 Handover from EPC/ePDG to 5GS



**Figure 4.11.4.1-1: Handover from EPC/ePDG to 5GS**

0. Initial status: one or more PDN Connections have been established between the UE and the EPC/ePDG via untrusted non-3GPP access as specified in clauses 7.2.4 and 7.6.3 of TS 23.402 [26] with modification described in clauses 4.11.4.3.3 and 4.11.4.3.5.
1. For the UE to move its PDU session(s) from EPC/ePDG to 5GC/3GPP access, the UE's behaviour is as follows:
  - If the UE is operating in single-registration mode (as described in clause 5.17.2.1 of TS 23.501 [2]) and the UE is attached to EPC/E-UTRAN:
    - the UE behaves as specified in clause 4.11.1 or clause 4.11.2 and gets registered to 5GC via 3GPP access.
  - otherwise i.e. either the UE is operating in single registration mode and is not attached to EPC/E-UTRAN, or the UE is operating in dual registration mode and
  - if the UE is already registered in 5GS via 3GPP access, the UE skips to step 2.

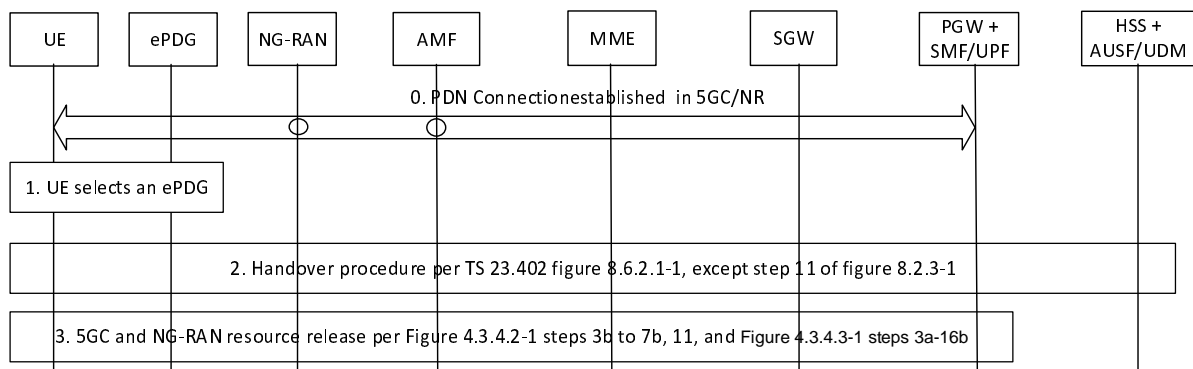
- otherwise (i.e UE is not registered in 5GS via 3GPP access), the UE performs Registration procedure of type initial registration in 5GS via 3GPP access as described in clause 4.2.2.2.
2. The UE initiates a UE requested PDU Session Establishment via 3GPP Access according to clause 4.3.2.2 and includes the "Existing PDU Session" indication or "Existing Emergency PDU Session" and the PDU Session ID.

For Request Type "Existing PDU Session", the UE provides a DNN, the PDU Session ID and S-NSSAI corresponding to the existing PDN connection it wants to transfer from EPC/ePDG to 5GS. The S-NSSAI and PLMN ID sent to the UE are set in the same way as for EPS to 5GS mobility as specified in clause 5.15.7.1 of TS 23.501 [2].

If the Request Type indicates "Existing Emergency PDU Session", the AMF shall use the Emergency Information containing SMF+PGW-C FQDN for the S2b interface it has received from the HSS+UDM. The SMF+PGW-C FQDN was sent by PGW-C when the Emergency PDN connection was established in EPC via ePDG and the AMF shall use the S-NSSAI locally configured in Emergency Configuration Data.

3. The combined PGW+SMF/UPF initiates a PDN GW initiated Resource Allocation Deactivation with GTP on S2b as described in clause 7.9.2 of TS 23.402 [26] to release the EPC and ePDG resources when S6b is used. When S6b is not used between SMF+PGW-C and AAA, impacts to step 5 of TS 23.402 [26] Figure 7.9.2-1 are captured in clause 4.11.4.3.6.

#### 4.11.4.2 Handover from 5GS to EPC/ePDG



**Figure 4.11.4.2-1: Handover from 5GS to EPC/ePDG**

0. Initial status: one or more PDU Sessions have been established between the UE and the SMF/UPF via NG-RAN.
1. The UE connects to an untrusted non-3GPP access and the N3IWF-ePDG selection process results in selecting an ePDG.
2. The UE initiates a Handover Attach procedure as described in clause 8.6.2.1 of TS 23.402 [26], except step 11 of referenced figure 8.2.3-1 that corresponds to the release of resources in source system.
3. The combined PGW+SMF/UPF initiates a network requested PDU Session Release via 3GPP access according to Figure 4.3.4.2-1 steps 3b to 7b, step 11 or Figure 4.3.4.3-1 steps 3a-16b to release the 5GC and NG-RAN resources with the following exception:
  - For non-roaming or local breakout in clause 4.3.4.2, the SMF does not include N1 SM Container in Namf\_Communication\_N1N2MessageTransfer service operation.
  - For home routing roaming in clause 4.3.4.3, the H-SMF indicates in the Nsmf\_PDUSession\_Update Request that the UE shall not be notified. This shall result in the V-SMF not sending the N1 SM Container (PDU Session Release Command) to the UE.
  - Nsmf\_PDUSession\_StatusNotify service operation invoked by H-SMF to V-SMF and Nsmf\_PDUSession\_SMContextStatusNotify service operation invoked by the (V-)SMF to the AMF indicate that the PDU Session is moved to a different system.
  - The Npcf\_SMPolicyControl\_Delete service operation to PCF shall not be performed.



### 4.11.4.3 Impacts to EPC/ePDG Procedures

#### 4.11.4.3.1 General

This clause captures enhancements to procedures in TS 23.402 [26] to support interworking with 5GS. The architecture for interworking is shown in clause 4.3.4 of TS 23.501 [2], with the ePDG connected to SMF+PGW-C and UPF+PGW-U using GTP based S2b.

#### 4.11.4.3.2 ePDG FQDN construction

Clause 4.5.4.2 of TS 23.402 [26] applies with the following modification:

- Tracking/Location Area Identity FQDN: When the 5GC NAS capable UE uses the Tracking Area of the NG-RAN when the UE is registered with the 5GC when constructing the Tracking Area Identity FQDN.

#### 4.11.4.3.3 Initial Attach with GTP on S2b

The procedure in clause 7.2.4 of TS 23.402 [26] applies with the following modifications:

- In Step A.1 IKEv2 tunnel establishment procedure, the 5GC NAS capable UE shall indicate its support of 5GC NAS in IKEv2. The UE allocates a PDU Session ID and also includes this in IKEv2 to the ePDG.
- In Step A.1, UE's mobility restriction parameters related to 5GS or indication of support for interworking with 5GS for this APN or both as defined for MME in clause 4.11.0a.3 apply to the ePDG and are obtained by the ePDG as part of the reply from the HSS via the 3GPP AAA Server. These parameters and the 5G NAS support indicator from the UE, may be used by the ePDG to determine if a combined SMF+PGW-C or a standalone PGW should be selected.
- In Step B.1, if the UE supports 5G NAS and the PDN connection is not restricted to interworking with 5GS by user subscription, the ePDG shall send the 5GS Interworking Indication and the PDU Session ID to the SMF+PGW-C.
- In Step B.1, if the SMF+PGW-C supports more than one S-NSSAI and the APN is valid for more than one S-NSSAI, the SMF+PGW-C selects S-NSSAI as specified in clause 4.11.0a.5.
- In Step D.1 (Create Session Response), the SMF+PGW-C assigns a S-NSSAI to be associated with the PDN connection as specified in clause 5.15.7.1 of TS 23.501 [2]. The SMF+PGW-C sends the S-NSSAI to the ePDG together with a PLMN ID that the S-NSSAI relates to.
- In Steps B.1 and D.1, if the UE does not support 5GC NAS but has 5GS subscription and a SMF+PGW-C is selected and interaction with UDM, PCF and UPF is required, the SMF+PGW-C assigns PDU Session ID as specified in clause 4.11.0a.5. The SMF+PGW-C shall not provide any 5GS related parameters to the UE.
- In the IKEv2 Authentication Response message, the ePDG sends S-NSSAI and the PLMN ID that the S-NSSAI relates to, to the UE. The UE associates the received S-NSSAI and the PLMN ID that the S-NSSAI relates to, with the PDN Connection.

#### 4.11.4.3.3a Initial Attach for emergency session (GTP on S2b)

The procedure in clause 7.2.5 of TS 23.402 [26] applies with the following modification:

- Step 3 (Create Session Request): ePDG determines if interworking with 5GC is supported based on UE's 5G NAS capability and local configuration. In SMF+PGW-C, only one S-NSSAI is configured for the emergency APN. An emergency SMF+PGW-C identity should be configured as part of the Emergency Configuration Data specified in clause 13.5 of TS 23.402 [26].
- Step 6 (Create Session Response), compared to step D.1 of clause 4.11.4.3.3, SMF+PGW-C does not include S-NSSAI in PCO for emergency PDN connection.

#### 4.11.4.3.4 Interaction with PCC

When interworking with 5GS is supported and a SMF+PGW-C is selected by the ePDG, policy interactions between PDN GW and PCRF specified in TS 23.402 [26] are replaced by equivalent interactions between SMF+PGW-C and PCF as captured in clause 4.11.0a.2.

If SMF+PGW-C is selected and interaction with PCF is required for a UE that does not support 5GC NAS, the SMF+PGW-C determines the PDU Session ID and S-NSSAI in the same way as for PDN connection via MME as specified in clause 4.11.0a.5.

#### 4.11.4.3.5 UE initiated Connectivity to Additional PDN with GTP on S2b

The procedure in clause 7.6.3 of TS 23.402 [26] references the Initial Attach procedure with GTP on S2b. Impacts to the initial attach procedure with GTP on S2b are captured in clause 4.11.4.3.3 above. If the additional PDN connection is for emergency service, impact as captured in clause 4.11.4.3.3a applies.

#### 4.11.4.3.6 Use of N10 interface instead of S6b

This clause applies to scenarios when ePDG is connected to SMF+PGW-C and S6b is not used. It is applicable for procedures specified in TS 23.402 [26] including mobility between EPC/ePDG and EPC/EUTRAN and also for mobility between EPC/ePDG and 5GS.

When S6b, as specified in TS 23.402 [26], is not deployed between SMF+PGW-C and AAA and the UE creates and deletes a PDN connection via ePDG connected to SMF+PGW-C, the registration and de-registration of PDN GW is performed on the N10 interface instead of the S6b interface.

If SMF+PGW-C is selected for a UE that does not support 5GC NAS, the SMF+PGW-C determines the PDU Session ID and S-NSSAI in the same way as for PDN connection via EPC/EUTRAN as specified in clause 4.11.0a.5.

For roaming scenario with local-breakout (TS 23.501 [2], Figure 4.3.4.2.1), the use of N10 interface instead of S6b interface may be based on support of this feature from HSS+UDM to SMF+PGW-C on N10 interface.

The specific impacts to procedures in clauses 7 and 8 of TS 23.402 [26] are as follows:

##### 7.2.4 Initial Attach with GTP on S2b

- Instead of Step C.1 in Figure 7.2.4-1 of TS 23.402 [26], step 16c (Nudm\_UECM\_Registration with an optional indication that access is from ePDG) from Figure 4.3.2.2.1-1 are performed between the SMF+PGW-C and HSS+UDM. Based on this indication, the HSS+UDM does not send notification of PGW-C assignment on SWx to AAA.

##### 7.2.5 Initial Attach for emergency session (GTP on S2b)

- Instead of step 5 in Figure 7.2.5-1 of TS 23.402 [26], step 16c (Nudm\_UECM\_Registration with an optional indication that access is from ePDG) from Figure 4.3.2.2.1-1 are performed between the SMF+PGW-C and HSS+UDM. Based on this indication, the HSS+UDM does not send notification of PGW-C assignment on SWx to AAA.

The indication of access from ePDG is forwarded on the interface between UDM and HSS.

#### 7.4.3 UE/ePDG-initiated Detach Procedure and UE-Requested PDN Disconnection with GTP on S2b

##### 7.4.3.1 Non-Roaming, Home Routed Roaming and Local Breakout Case

- Instead of Step A.2 in Figure 7.4.3-1 of TS 23.402 [26], step 12 (Nudm\_UECM\_Deregistration) from Figure 4.3.4.2-1 is performed between the SMF+PGW-C and HSS+UDM.

##### 7.4.4 HSS/AAA-initiated Detach Procedure with GTP on S2b

##### 7.4.4.1 Non-Roaming, Home Routed Roaming and Local Breakout Case

- Instead of step 3 in Figure 7.4.1-1 of TS 23.402 [26] (referenced by Figure 7.4.4-1 of TS 23.402 [26]), Step 12 (Nudm\_UECM\_Deregistration) from Figure 4.3.4.2-1 is performed between the SMF+PGW-C and HSS+UDM

## 7.9.2 PDN GW initiated Resource Allocation Deactivation with GTP on S2b

- Instead of step 5 in Figure 7.9.2-1 of TS 23.402 [26], Step 12 (Nudm\_UECM\_Deregistration) from Figure 4.3.4.2-1 is performed between the SMF+PGW-C and HSS+UDM.

### 8.6.1.1 General Procedure for GTP based S5/S8 for E-UTRAN Access

- Step 18 of clause 8.6.1.1 of TS 23.402 [26] refers to clause 7.9.2 of TS 23.402 [26]. The Nudm\_UECM\_Deregistration in the impacted referenced clause 7.9.2 above is not performed as resources in the SMF+PGW-C are not released.

### 8.6.2.13 GPP Access to Untrusted Non-3GPP IP Access Handover with GTP on S2b

- In Step B.2 of clause 8.6.2.1 of TS 23.402 [26], if the registration of the SMF+PGW-C in the HSS+UDM is not already done, step 16c (Nudm\_UECM\_Registration with an optional indication that access is from ePDG) from Figure 4.3.2.2.1-1 is performed between the SMF+PGW-C and HSS+UDM.

The impacts to procedure in clause 4.11.4.1 (Handover from EPC/ePDG to 5GS) are as follows:

- For step 0, the impacts to clause 7.2.4 of TS 23.402 [26] are captured above.
- In step 2, if the Request Type indicates "Existing Emergency PDU Session", the AMF shall use the Emergency Information containing SMF+PGW-C FQDN for the S2b interface and the S\_NSSAI locally configured in Emergency Configuration Data.
- In step 3, the impacts to clause 7.9.2 of TS 23.402 [26] are captured above. Nudm\_UECM\_Deregistration is not performed by SMF+PGW-C, as resources in the SMF+PGW-C are not released.

The impacts to procedures in clause 4.11.4.2 (Handover from 5GS to EPC/ePDG) are as follows:

- For step 2, impacts to clause 8.6.2.1 (3GPP Access to Untrusted Non-3GPP IP Access Handover with GTP on S2b) of TS 23.402 [26] are captured above and Step 16c of Figure 4.3.2.2.1-1 is not performed as SMF+PGW-C already registered in the HSS+UDM when the UE is in 5GS.

## 4.11.5 Impacts to 5GC Procedures

### 4.11.5.1 General

This clause captures impacts to 5GC procedures in other clauses of this specification to support interworking with EPS. These impacts are applicable to interworking based on N26 and interworking without N26 for PDU Session via 3GPP access and for PDU Session via non-3GPP access.

This clause also captures the impact to 5GC if the UE was previously in GERAN/UTRAN as specified in clause 5.17.2.4 of TS 23.501 [2].

### 4.11.5.2 Registration procedure

The following impacts are applicable to clause 4.2.2.2 (Registration procedure):

- Step 1: If the Registration type is set to "Initial Registration", the UE is not registered in EPS and the UE provides the 5G-GUTI mapped from EPS GUTI as the old GUTI, then the UE includes complete EPS Attach Request in the Registration request message.
- Step 4: If the Registration type is "Initial Registration" as in step 1 of the Registration Procedure captured in clause 4.2.2.2.2, the target AMF may perform Identification Request towards MME along with complete EPS Attach Request message for MME to verify it as in step 3 as specified in clause 5.3.2.1 of TS 23.401 [13].

NOTE 1: The steps above apply to interworking with N26.

- Step 14a:
  - If the AMF does not have event subscription information from the UDM, the AMF indicates it in Nudm\_UECM\_Registration. The UDM then provides event subscriptions (possibly retrieved from UDR) if any.

- If mobility between GERAN/UTRAN and 5GS is required (as specified in clause 5.17.2.4 of TS 23.501 [2]), at Initial Registration, the AMF serving 3GPP access shall also register with the Nudm\_UECM\_Registration even if the AMF has a valid context.
- Step 14d: If mobility between GERAN/UTRAN and 5GS is required (as specified in clause 5.17.2.4 of TS 23.501 [2]), when the UDM stores the associated 3GPP Access Type together with the serving AMF as indicated in step 14a, it will also cause cancellation of any other previously registered serving node (e.g. MME if AMF does not indicate not to cancel or SGSN) via HSS/HLR.

NOTE 2: Upon mobility from GERAN/UTRAN to 5GS as specified in clause 5.17.2.4 of TS 23.501 [2], the previously registered SGSN needs to be cancelled from HSS/HLR, otherwise the incoming session can fail.

- At the end of registration procedure, the AMF may initiate synchronization of event subscriptions with the UDM if the AMF does not indicate unavailability of event subscription in step 14a.

NOTE 3: The details how synchronization can be done is left to stage 3.

For PDU Session via 3GPP access the following impacts are applicable to clause 4.2.2.2 (Registration procedure) when the UE has established PDU Session(s):

In clause 4.3.2.2.1 Non-roaming and Roaming with Local Breakout:

- Step 17: Additional trigger for step 17 Nsmf\_PDUSession\_UpdateSMContext are:
  - If status of interworking with EPS for a PDU session changes, e.g. due to change of 5GMM capability (e.g. "S1 mode supported"), the UE subscription data change (e.g. Core Network Type Restriction to EPC), the AMF invokes Nsmf\_PDUSession\_UpdateSMContext (EPS Interworking Indication with N26 or without N26) to SMF. The SMF determines whether the PDU session supports interworking with EPS need be changed. If it needs to be changed, the SMF invokes Nudm\_UECM\_Update service operation to add or remove the PGW-C FQDN for S5/S8 interface from the UE context in SMF data stored at the UDM.

For interworking with the N26 interface, if status of interworking with EPS for a PDU session is changed at SMF+PGW-C, the SMF+PGW-C invokes EBI allocation or revocation as described in clause 4.11.1.4.1 and clause 4.11.1.4.2 respectively.

For PDU Session via non-3GPP access, the AMF determines if EPS interworking is supported and sends the indication to the SMF in the same way as for PDU Session via 3GPP access. The SMF makes the final decision on the EPS interworking in the same way as for PDU Session via 3GPP access with the following modification:

If the SMF does not receive the interworking indication, the SMF makes its decision based on subscription.

#### 4.11.5.3 UE Requested PDU Session Establishment procedure

For PDU Session via 3GPP, the following impacts are applicable to clause 4.3.2.2 (UE Requested PDU Session Establishment procedure) to support interworking with EPS:

In clause 4.3.2.2.1 Non-roaming and Roaming with local breakout:

- Step 1: In PDU Session Establishment Request message, the UE includes also the UE capability of Ethernet PDN type support in EPS to the SMF (or H-SMF in home routing roaming);
- Step 3: The AMF determines that a PDU Session supports EPS interworking with N26 or without N26, based on e.g. 5GMM capability (e.g. "S1 mode supported"), UE subscription data (e.g. Core Network Type Restriction to EPS, EPC interworking support per (S-NSSAI, subscribed DNN)) and network configuration if EPS interworking with N26 or without N26 is supported. The AMF then includes in the Nsmf\_PDUSession\_CreateSMContext an indication whether the PDU Session supports EPS Interworking with N26 or without N26.

For PDU Session with Request Type "initial emergency request", the AMF decides the EPS interworking with N26 or without N26 based on 5GMM capability and local configuration.

For PDU Session with Request Type "Existing Emergency PDU Session", the AMF shall use Emergency Information received from HSS+UDM and the S-NSSAI locally configured in Emergency Configuration Data.

If the Request Type indicates "Existing PDU Session" the AMF selects the SMF based on SMF-ID or SMF+PGW-C FQDN received from UDM during the Registration or Subscription Profile Update Notification procedure. The case where the AMF does not recognize the PDU Session ID or the subscription context that the AMF received from UDM neither contains an SMF ID nor a SMF+PGW-C FQDN corresponding to the PDU Session ID constitutes as an error case.

NOTE 1: If the AMF receives from the UDM, for a PDU Session, both a SMF ID and a SMF+PGW-C FQDN, the SMF ID takes precedence.

If the AMF has stored APN Rate Control Status and the PDU Session is considered a new first PDU Session to a DNN that is the same as the APN in stored APN Rate Control Status and interworking with EPC is enabled for this PDU Session, then the AMF sends the APN Rate Control Status to the SMF.

- Step 4: If the EPS Interworking indication received from AMF indicates that the UE supports EPS interworking and the SMF determines, based on the EPS interworking support indication from the AMF and additional UE subscription data (e.g. whether UP integrity protection of UP Security Enforcement Information is not set to required, EPS interworking is allowed for this DNN and S-NSSAI), that the PDU Session supports EPS interworking, the SMF+PGW-C FQDN for S5/S8 interface is included in the Nudm\_UECM\_Registration Request.
- Step 10a: If APN Rate Control Status is received from the AMF then the SMF provides the configured APN Rate Control Status to the PGW-U+UPF.
- Step 13 In PDU Session Establishment Accept message, the SMF also includes indication of Ethernet PDN type supported if the Ethernet PDN type is supported by both the UE and the SMF+PGW-C. The SMF and the UE stores the information if Ethernet PDN type is supported for later use when UE moves from 5GS to EPS.

NOTE 2: The subscription data "EPS interworking support indication" is used by AMF when determining the EPS interworking support for the PDU Session. Therefore, when the UE establishes the PDU Session via the 3GPP access, the SMF does not need to consider the same subscription data "EPS interworking support indication" again.

In clause 4.3.2.2.2 Home-routed Roaming:

- Step 3a: Same impact as for step 3 for the non-roaming and roaming with local breakout case above.
- Step 5: Same impact as for step 10a for the Non-roaming and Roaming with Local Breakout case above.
- Step 6 The V-SMF pass the EPS interworking support indication received from the AMF to the H-SMF in Nsmf\_PDUSession\_Create.
- Step 7: If the EPS interworking indication received from V-SMF indicates that the PDU Session supports EPS interworking and the H-SMF determines, based on the EPS interworking support indication from the AMF and additional information such as UP integrity protection of UP Security Enforcement Information as described in clause 4.11.1.1, that the PDU Session supports EPS interworking, the SMF+PGW-C FQDN for S5/S8 interface is included in the Nudm\_UECM\_Registration Request.
- Step 15: Same impact as in step 13 for the non-roaming and roaming with local breakout case above with the difference that it's the home SMF+PGW-C that includes the indication of Ethernet PDN type supported.

For interworking with the N26 interface, if the PDU Session supports interworking with EPS, the SMF+PGW-C invokes EBI allocation as described in clause 4.11.1.4.1.

For non-emergency PDU Session via non-3GPP, the AMF determines if EPS interworking is supported and sends the indication to the SMF in the same way as for PDU Session via 3GPP. The SMF makes the final decision on the EPS interworking in the same way as for PDU Session via 3GPP with the following modification:

- If the SMF does not receive the interworking indication, the SMF makes its decision based on subscription.

For emergency PDU Session via non-3GPP, the AMF determines if EPS interworking is supported and sends the indication to the SMF in the same way as for emergency PDU Session via 3GPP supporting EPS interworking.

#### 4.11.5.4 UE or Network Requested PDU Session Modification procedure

For PDU Session via 3GPP, the following impacts are applicable to clause 4.3.3.2 (UE or network requested PDU Session Modification (non-roaming and roaming with local breakout)) to support interworking with EPS:

- Step 1: In addition to the triggers listed in step 1 of clause 4.3.3.2, the procedure may be also triggered by the following event:
  - AMF initiated modification: If the support of EPS Interworking for this PDU Session has changed, e.g. the change of the UE's subscription data (e.g. Core Network Type Restriction to EPS), or change of 5GMM capability (e.g. "S1 mode supported"), the AMF invokes Nsmf\_PDUSession\_UpdateSMContext update the status of EPS interworking support in the to SMF.
- Step 3a: This step also applies to AMF initiated modification. For AMF initiated modification, the SMF may determines whether the PDU session supports EPS interworking need be changed. If it need be changed, the SMF invokes Nudm\_UECM\_Update service operation to add or remove the PGW-C FQDN for S5/S8 interface from the UE context in SMF data stored at the UDM,

For PDU Session via 3GPP, the following impacts are applicable to clause 4.3.3.3 (UE or network requested PDU Session Modification (home-routed roaming)) to support interworking with EPS:

- Step 1a (AMF to V-SMF): Same impact as for step 1 of clause 4.3.3.2 above.
- Step 1a (V-SMF to H-SMF): The V-SMF pass the status of EPS interworking support to the H-SMF.
- Step 1a (H-SMF to V-SMF): Same impact as for clause 3a of 4.3.3.2 above.

For interworking with the N26 interface, if status of interworking with EPS for a PDU session is changed at SMF+PGW-C, the SMF+PGW-C invokes EBI allocation or revocation as described in clause 4.11.1.4.1 and clause 4.11.1.4.2 respectively.

For PDU Session via non-3GPP access, the AMF determines if EPS interworking is supported and sends the indication to the SMF in the same way as for PDU Session via 3GPP access. The SMF makes the final decision on the EPS interworking in the same way as for PDU Session via 3GPP access with the following modification:

If the SMF does not receive the interworking indication, the SMF makes its decision based on subscription.

#### 4.11.5.5 Xn based inter NG-RAN handover

The following impacts are applicable to clause 4.9.1.2.1 (General) to support interworking with EPS:

- If there is Mapping between EBI(s) and QFI(s) for the UE in the source NG-RAN, the source NG-RAN sends the Mapping to target NG-RAN during handover.

#### 4.11.5.6 Inter NG-RAN node N2 based handover

The following impacts are applicable to clause 4.9.1.3.2 (Preparation phase) to support interworking with EPS:

- Step 7: If the PDU session supports EPS interworking, the N2 SM information contains the Mapping between EBI(s) and QFI(s).

#### 4.11.5.7 UE or Network Requested PDU Session Release procedure

The following impacts are applicable to clause 4.3.4.2 (UE or network requested PDU Session Release for Non-Roaming and Roaming with Local Breakout) to support interworking with EPS:

- Step 2b: If the released PDU Session used APN Rate Control in EPC then the PGW-U+UPF provides the APN Rate Control Status to the SMF if the released PDU Session supported interworking with EPC and it is the last PDU Session to the DNN that is the same as the APN identified in the APN Rate Control Status.

- Step 3: If the PGW-U+UPF provided APN Rate Control Status to the SMF then the SMF provides the APN Rate Control Status to the AMF.

The following impacts are applicable to clause 4.3.4.3 (UE or network requested PDU Session Release for Home-routed Roaming) to support interworking with EPS:

- Step 2b: Same impact as for step 2b for the Non-roaming and Roaming with Local Breakout case above.
- Step 3: Same impact as for step 3 for the Non-roaming and Roaming with Local Breakout case above.

#### 4.11.5.8 Network Configuration

To avoid the need for identifier coordination between AMFs and MMEs, the AMF provides to the NG-RAN its served GUAMIs by separating the values between native AMF values and the values mapped from MME.

### 4.11.6 Interworking for common network exposure

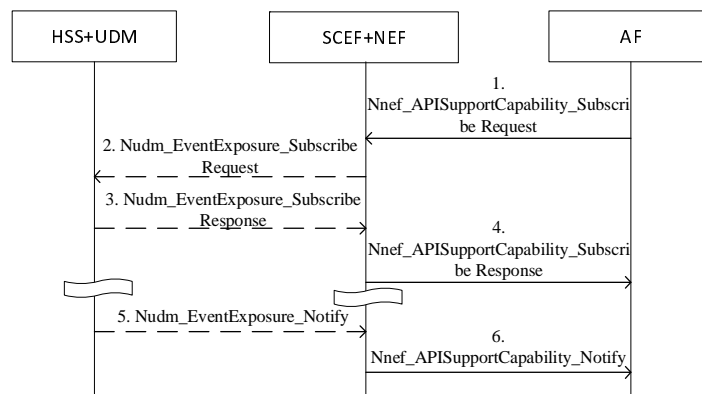
#### 4.11.6.1 Subscription and Notification of availability or expected level of support of a service API

Figure 4.11.6.1 1 represent the information flow subscribing and notifying the availability or expected level of support of a service API.

For the subscription to Nnef\_APISupportCapability service, the subscription request may include the Duration of Reporting. If the Duration of Reporting is expired, the SCEF+NEF deletes the subscription without any explicit signalling interaction.

For the CN type Change Event subscription to the HSS+UDM, the subscription request may include the Duration of Reporting. If the Duration of Reporting is expired, the HSS+UDM locally unsubscribe the CN Type Change Event without any explicit signalling interaction.

The SCEF+NEF informs the AF of the API Indication which indicates list of available north-bound API(s).



**Figure 4.11.6.1-1: Subscription and Notification of availability or expected level of support of a service API**

1. The AF subscribes to Nnef\_APISupportCapability service for a UE or a group of UEs by sending Nnef\_APISupportCapability\_Subscribe Request (UE ID or External Group ID, Report Type, callback URI, Duration of Reporting) message.

The callback URI parameter is optional and is used in step 6 if provided.

The Report Type can be either One-time report or Continuous report. If this is a subscription for Continuous report type, then the Duration of Reporting may be included. The Duration of Reporting is optional and is used to indicate when the subscription is invalid. If the SCEF+NEF has established direct connection with MME or AMF or SMF, steps 2 - 3 and step 5 are omitted. If this is a subscription for One-time report type and if the Freshness Timer of last One-time report type subscribe request is not expired or a direct connection has been set up with MME or AMF or SMF, the SCEF+NEF determines the CN type locally, steps 2 - 3 are omitted.

2. SCEF+NEF subscribes the CN Type Change Event to HSS+UDM by sending Nudm\_EventExposure\_Subscribe Request (CN Type Change, Report Type, UE ID or External Group ID, Duration of Reporting) message.

If Duration of Reporting is received at step 1, it shall include Duration of Reporting in this message.

3. The HSS+UDM determines the CN type that is serving the indicated UE or the indicated group of UEs based on the registered MME or AMF. The HSS+UDM informs SCEF+NEF of the CN type by sending Nudm\_EventExposure\_Subscribe Response (CN Type) message. If the Report Type indicates One-time report, the HSS+UDM delete the CN Type Change Event subscription after sending the response with CN Type. The Freshness Timer is set in SCEF+NEF per operator's policy, e.g. based on the statistics of UE activities. If the Report Type indicates Continuous report, HSS+UDM stores the CN Type Change Event subscription.
4. According to the CN type received or local stored, the SCEF+NEF determines the availability or expected level of support of common north-bound APIs for the indicated UE or the indicated group of UEs. SCEF+NEF responds to AF by sending Nnef\_APISupportCapability\_Subscribe Response (API Indication).

If the subscription is for One-time report type, then steps 5 - 6 are omitted.

5. When HSS+UDM detects that the indicated UE is switching between EPC and 5GC the HSS+UDM determines the CN type that is serving the indicated UE or the indicated group of UEs. The HSS+UDM informs SCEF+NEF of the CN type by sending Nudm\_EventExposure\_Notify (CN type).

The CN type denotes the 5GC or EPC or 5GC+EPC serving the UE or the group of UEs.

6. According to the CN type received and local detected, the SCEF+NEF node determines the availability or expected level of support of common north-bound APIs for the indicated UE or the indicated group of UEs. SCEF+NEF inform AF of such API information by sending Nnef\_APISupportCapability\_Notify (API Indication) message.

If callback URI is provided at step 1, then SCEF+NEF will send the Nnef\_APISupportCapability\_Notify (API Indication) message to the node addressed by callback URI.

Upon reception of API Indication in step 4 or step 6, the AF obtains the availability or expected level of support of a given service for the indicated UE or the indicated group of UEs. If required, the AF can select the valid north-bound API based on such API information.

#### 4.11.6.2 Unsubscribing to N11otification of availability or expected level of support of a service API

Figure 4.11.6.2 1 represent the information flow unsubscribing to Continuous report type subscription of the availability or expected level of support of a service API.

If the AF invokes Nnef\_APISupportCapability\_Subscribe service to SCEF+NEF node with the Duration of Reporting parameter for Continuous report type, the subscription on the SCEF+NEF and HSS+UDM are implicitly unsubscribed if the Duration of Reporting timer expires, i.e. the explicit unsubscribe service operation is not needed.

If the explicit unsubscribe operation is needed, the information flow is as follows.

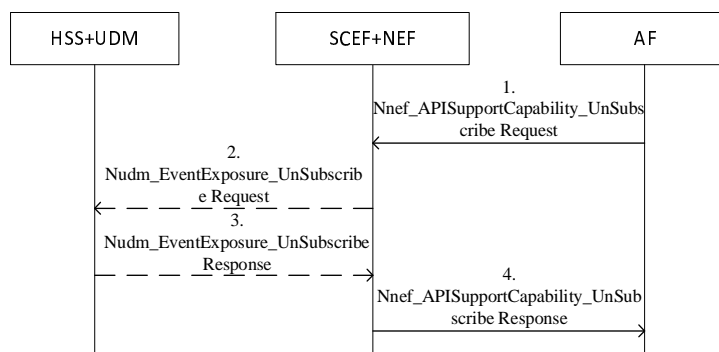


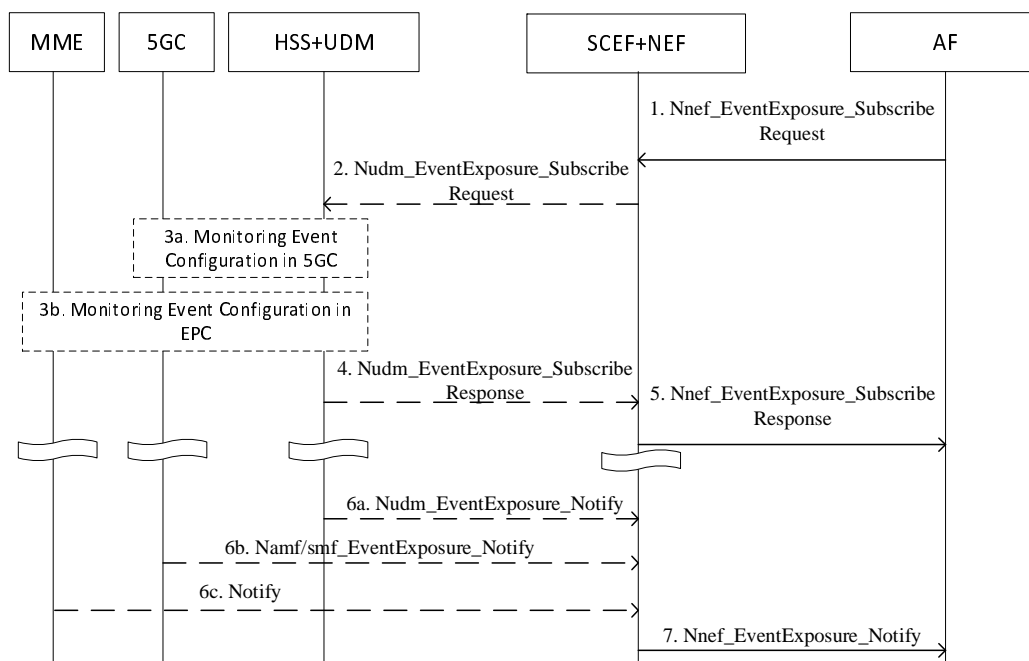
Figure 4.11.6.2 1: Unsubscribing to notification of the availability or expected level of support of a service API



1. The AF unsubscribes to Nnef\_APISupportCapability service for a UE or a group of UEs by sending APISupportCapability\_Unsubscribe Request (UE ID or External Group ID) message.
2. If SCEF+NEF has subscribed to CN Type Change Event for the indicated UE or the indicated group of UEs, SCEF+NEF unsubscribes the CN Type Change Event by sending Ndm\_EventExposure\_Unsubscribe Request (CN Type Change, UE ID or External Group ID) message to HSS+UDM.
3. HSS+UDM deletes the CN Type Change Event subscription for the indicated UE or the indicated group of UEs, HSS+UDM responds to the SCEF+NEF by sending Ndm\_EventExposure\_Unsubscribe Response (Operation execution result indication) message.
4. If result indication indicates the operation is successful, the SCEF+NEF deletes the subscription to Nnef\_APISupportCapability service. SCEF+NEF acknowledges the operation result by sending Nnef\_APISupportCapability\_Unsubscribe Response (Operation execution result indication) to AF.

#### 4.11.6.3 Configuration of monitoring events for common network exposure

Figure 4.11.6.3-1 represent the information flow to configure monitoring events applicable to both EPC and 5GC using 5GC procedures towards UDM in scenarios where interworking between 5GS and EPC is possible.



**Figure 4.11.6.3-1: Configuration of monitoring events for common network exposure**

1. The AF configures a monitoring event via the SCEF+NEF using the Nnef\_EventExposure\_Subscribe service operation.
2. SCEF+NEF configures the monitoring event in the UDM+HSS using the Nudm\_EventExposure\_Subscribe service operation.

The combined SCEF+NEF indicates that the monitoring event is also applicable to EPC (i.e. the event must be reported both by 5GC and EPC). Depending on the type of event, the SCEF+NEF may include a SCEF address (i.e. if the event needs to be configured in the MME and the corresponding notification needs to be sent directly to the SCEF).

3. The HSS+UDM configures the monitoring event. For events that need to be reported from a serving node (e.g. location change) the HSS+UDM requests the configuration of the monitoring event to the corresponding serving node in the 5GC and EPC. The HSS+UDM uses the corresponding Event Exposure Subscribe service operation to configure monitoring events in 5GC serving NFs (e.g. Namf\_EventExposure\_Subscribe or Nsmf\_EventExposure\_Subscribe). The HSS+UDM uses the procedures defined in TS 23.682 [23] to configure

monitoring events in MME. The HSS+UDM provides the MME with the SCEF address during the configuration of the monitoring event in EPC. If the HSS and UDM are deployed as separate network entities, UDM shall use HSS services to configure the monitoring event in EPC as defined in TS 23.632 [68].

4. The HSS+UDM replies the SCEF+NEF with the indication that the monitoring event was successfully configured in 5GC and EPC by sending the Nudm\_EventExposure\_Subscribe Response.
5. The SCEF+NEF responds to AF by sending Nnef\_EventExposure\_Subscribe Response.
6. The SCEF+NEF is notified when HSS+UDM or the serving node at the 5GC or EPC detects the corresponding event. The HSS+UDM notifies the SCEF+NEF using the Nudm\_EventExposure\_Notify service operation. A serving NF in the 5GC notifies the SCEF+NEF using the corresponding Event Exposure Notify service operation (e.g. Namf\_EventExposure\_Notify or Nsmf\_EventExposure\_Notify). The MME notifies the SCEF+NEF using the procedures defined in TS 23.682 [23] using the SCEF address provided by the HSS+UDM in step 3.
7. The SCEF+NEF notifies the AF using the Nnef\_EventExposure\_Notify service operation.

## 4.12 Procedures for Untrusted non-3GPP access

### 4.12.1 General

Clause 4.12 defines the procedures to support Untrusted non-3GPP access by describing the differences compared to the defined procedures in other clauses. The procedures for Untrusted non-3GPP access are also used by a UE that accesses SNPN services via a PLMN over 3GPP access.

### 4.12.2 Registration via Untrusted non-3GPP Access

#### 4.12.2.1 General

Clause 4.12.2 specifies how a UE can register to 5GC via an untrusted non-3GPP Access Network. It is based on the Registration procedure specified in clause 4.2.2.2 and it uses a vendor-specific EAP method called "EAP-5G". The EAP-5G packets utilize the "Expanded" EAP type and the existing 3GPP Vendor-Id registered with IANA under the SMI Private Enterprise Code registry. The "EAP-5G" method is used between the UE and the N3IWF and is utilized only for encapsulating NAS messages (not for authentication). If the UE needs to be authenticated, mutual authentication is executed between the UE and AUSF. The details of the authentication procedure are specified in TS 33.501 [15].

In Registration and subsequent Registration procedures via untrusted non-3GPP access, the NAS messages are always exchanged between the UE and the AMF. When possible, the UE can be authenticated by reusing the existing UE security context in AMF.

#### 4.12.2.2 Registration procedure for untrusted non-3GPP access

The signalling flow in Figure 4.12.2.2-1 does not show all the details of a registration procedure via untrusted non-3GPP access. It shows primarily the steps executed between the UE and N3IWF. All the details of a registration procedure, including interactions with PCF, UDM, etc. are specified in clause 4.2.2.2.

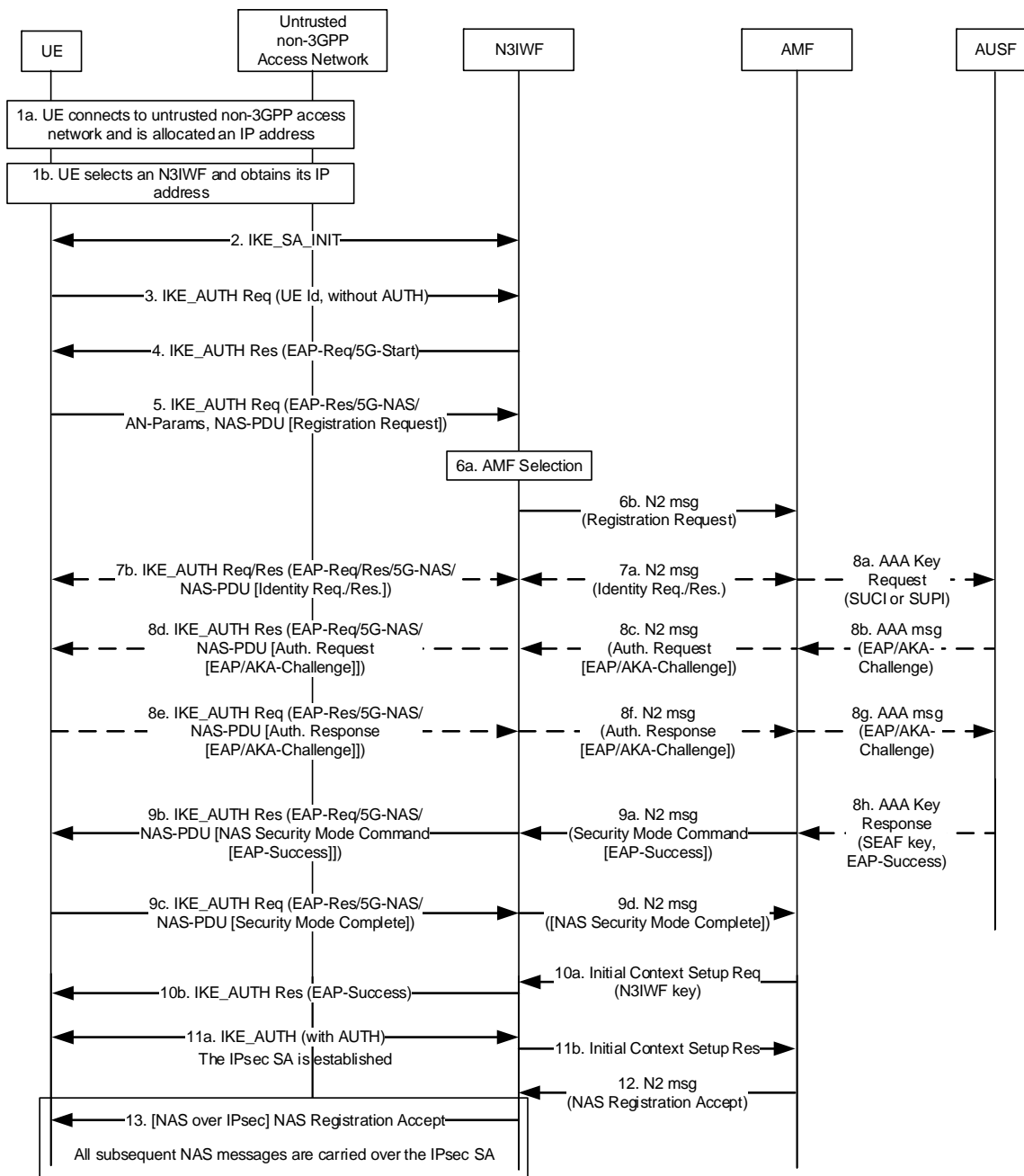


Figure 4.12.2.2-1: Registration via untrusted non-3GPP access

1. The UE connects to an untrusted non-3GPP Access Network with any appropriate authentication procedure and it is assigned an IP address. For example, a non-3GPP authentication method can be used, e.g. no authentication (in the case of a free WLAN), EAP with pre-shared key, username/password, etc. When the UE decides to attach to 5GC network, the UE selects an N3IWF in a 5G PLMN, as described in clause 6.3.6 of TS 23.501 [2].
2. The UE proceeds with the establishment of an IPsec Security Association (SA) with the selected N3IWF by initiating an IKE initial exchange according to RFC 7296 [3]. After step 2, all subsequent IKE messages are encrypted and integrity protected by using the IKE SA established in this step.
3. The UE shall initiate an IKE\_AUTH exchange by sending an IKE\_AUTH request message. The AUTH payload is not included in the IKE\_AUTH request message, which indicates that the IKE\_AUTH exchange shall use EAP signalling (in this case EAP-5G signalling). If the UE supports MOBIKE, it shall include a Notify payload in the IKE\_AUTH request, as specified in RFC 4555 [40], indicating that MOBIKE is supported. In addition, as specified in TS 33.501 [15], if the UE is provisioned with the N3IWF root certificate, it shall include the CERTREQ payload within the IKE\_AUTH request message to request the N3IWF's certificate.

4. The N3IWF responds with an IKE\_AUTH response message, which includes an EAP-Request/5G-Start packet. The EAP-Request/5G-Start packet informs the UE to initiate an EAP-5G session, i.e. to start sending NAS messages encapsulated within EAP-5G packets. If the N3IWF has received a CERTREQ payload from the UE, the N3IWF shall include the CERT payload in the IKE\_AUTH response message containing the N3IWF's certificate. How the UE uses the N3IWF's certificate is specified in TS 33.501 [15].
5. The UE shall send an IKE\_AUTH request, which includes an EAP-Response/5G-NAS packet that contains the Access Network parameters (AN parameters) and a Registration Request message. The AN parameters contain information that is used by the N3IWF for selecting an AMF in the 5G core network. This information includes e.g. the GUAMI, the Selected PLMN ID (or PLMN ID and NID, see clause 5.30 of TS 23.501 [2]), the Requested NSSAI and the Establishment cause. The Establishment cause provides the reason for requesting a signalling connection with 5GC. Whether and how the UE includes the Requested NSSAI as part of the AN parameters is dependent on the value of the Access Stratum Connection Establishment NSSAI Inclusion Mode parameter, as specified in clause 5.15.9 of TS 23.501 [2].

NOTE 1: The N3IWF does not send an EAP-Identity request because the UE includes its identity in the first IKE\_AUTH. This is in line with RFC7296, clause 3.16.

6. The N3IWF shall select an AMF based on the received AN parameters and local policy, as specified in clause 6.3.5 of TS 23.501 [2]. The N3IWF shall then forward the Registration Request received from the UE to the selected AMF within an N2 message. This message contains N2 parameters that include the Selected PLMN ID and the Establishment cause.
7. The selected AMF may decide to request the SUCI by sending a NAS Identity Request message to UE. This NAS message and all subsequent NAS messages are sent to UE encapsulated within EAP/5G-NAS packets.
8. The AMF may decide to authenticate the UE by invoking an AUSF. In this case, the AMF shall select an AUSF as specified in clause 6.3.4 of TS 23.501 [2] based on SUPI or SUCI.

The AUSF executes the authentication of the UE as specified in TS 33.501 [15]. The AUSF selects a UDM as described in clause 6.3.8 of TS 23.501 [2] and gets the authentication data from UDM. The authentication packets are encapsulated within NAS authentication messages and the NAS authentication messages are encapsulated within EAP/5G-NAS packets. After the successful authentication:

- In step 8h, the AUSF shall send the anchor key (SEAF key) to AMF which is used by AMF to derive NAS security keys and a security key for N3IWF (N3IWF key). The UE also derives the anchor key (SEAF key) and from that key it derives the NAS security keys and the security key for N3IWF (N3IWF key). The N3IWF key is used by the UE and N3IWF for establishing the IPsec Security Association (in step 11).
- In step 8h, the AUSF shall also include the SUPI, if in step 8a the AMF provided to AUSF a SUCI.

NOTE 2: EAP-AKA' or 5G-AKA are allowed for the authentication of UE via non-3GPP access, as specified in TS 33.501 [15]. Figure 4.12.2.2-1 only shows authentication flow using EAP-AKA'. Authentication methods other than EAP-AKA' or 5G-AKA are also allowed for UE accessing SNPN services via a PLMN, as specified in TS 33.501 [15], Annex I.

- 9a. The AMF shall send a NAS Security Mode Command to UE in order to activate NAS security. If an EAP-AKA' authentication was successfully executed in step 8, the AMF shall encapsulate the EAP-Success received from AUSF within the NAS Security Mode Command message.
- 9b. The N3IWF shall forward the NAS Security Mode Command message to UE within an EAP/5G-NAS packet.
- 9c. The UE completes the EAP-AKA' authentication (if initiated in step 8), creates a NAS security context and an N3IWF key and sends the NAS Security Mode Complete message within an EAP/5G-NAS packet.
- 9d. The N3IWF relays the NAS Security Mode Complete message to the AMF.
- 10a. Upon receiving NAS Security Mode Complete, the AMF shall send an NGAP Initial Context Setup Request message that includes the N3IWF key.
- 10b. This triggers the N3IWF to send an EAP-Success to UE, which completes the EAP-5G session. No further EAP-5G packets are exchanged.
11. The IPsec SA is established between the UE and N3IWF by using the common N3IWF key that was created in the UE in step 9c and received by the N3IWF in step 10a. This IPsec SA is referred to as the "signalling IPsec

SA". After the establishment of the signalling IPsec SA, the N3IWF notifies the AMF that the UE context (including AN security) was created by sending a NGAP Initial Context Setup Response. The signalling IPsec SA shall be configured to operate in tunnel mode and the N3IWF shall assign to UE an "inner" IP address. If the N3IWF has received an indication that the UE supports MOBIKE (see step 3), then the N3IWF shall include a Notify payload in the IKE\_AUTH response message sent in step 11a, indicating that MOBIKE shall be supported, as specified in RFC 4555 [40].

All subsequent NAS messages exchanged between the UE and N3IWF shall be sent via the signalling IPsec SA and shall be carried over TCP/IP. The UE shall send NAS messages within TCP/IP packets with source address the "inner" IP address of the UE and destination address the NAS\_IP\_ADDRESS that is received in step 11a. The N3IWF shall send NAS messages within TCP/IP packets with source address the NAS\_IP\_ADDRESS and destination address the "inner" IP address of the UE. The TCP connection used for reliable NAS transport between the UE and N3IWF shall be initiated by the UE right after the signalling IPsec SA is established in step 11a. The UE shall send the TCP connection request to the NAS\_IP\_ADDRESS and to the TCP port number specified in TS 24.502 [41].

12. The AMF sends the NAS Registration Accept message to the N3IWF. The N2 Message includes the Allowed NSSAI for the access type for the UE.
13. The N3IWF forwards the NAS Registration Accept message to UE via the established signalling IPsec SA. If the NAS Registration Accept message is received by the N3IWF before the IPsec SA is established, the N3IWF shall store it and forward it to the UE only after the establishment of the signalling IPsec SA.

The AMF provides the Access Type set to "Non-3GPP access" to the UDM when it registers with the UDM.

NOTE 3: The Access Type is set to "Non-3GPP access" even when the UE accesses SNPN services via PLMN over 3GPP access.

#### 4.12.2.3 Emergency Registration for untrusted non-3GPP Access

Emergency Registration procedure is used by UEs requiring to perform emergency services but cannot gain normal services from the network. These UEs are in limited service state as defined in TS 23.122 [22].

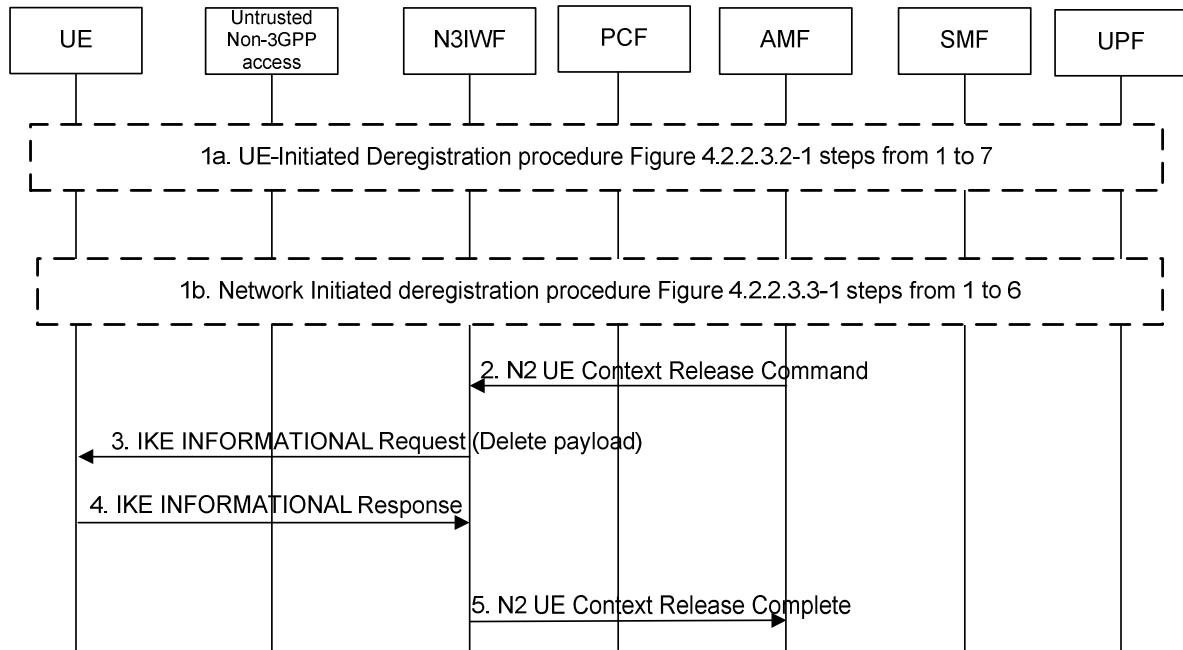
The regular registration procedure described in clause 4.12.2 applies with the following differences:

- If the UE has no SUPI and no valid 5G-GUTI, PEI shall be included instead of its encrypted Permanent User ID (SUCI) in the NAS message.
- NSSAI shall not be included by the UE. The AMF shall not send the Allowed NSSAI in the Registration Accept message.
- If the AMF is not configured to support Emergency Registration, the AMF shall reject any Registration Request that indicates Registration type "Emergency Registration".
- If the AMF is configured to support Emergency Registration for unauthenticated UEs and the UE indicated Registration Type "Emergency Registration", the AMF skips the authentication and security setup or the AMF accepts that the authentication may fail and continues the Emergency Registration procedure.
- If the authentication is performed successfully, the NAS messages will be protected by the NAS security functions (integrity and ciphering). The AMF shall derive the N3IWF key, per TS 33.501 [15] and shall provide it to the N3IWF after the authentication completion using an NGAP Initial Context Setup Request message as in the regular registration procedure.
- If the authentication is skipped or authentication fails, the NAS messages will not be protected by the NAS security functions (integrity and ciphering). However, the AMF shall create an N3IWF key and shall provide it to the N3IWF after the authentication completion (whenever authentication has failed or has been skipped) using an NGAP Initial Context Setup Request message. The N3IWF shall use it to complete IKE SA establishment and shall acknowledge the AMF by sending an NGAP Initial Context Setup Response message.

NOTE: According to TS 33.501 [15], the UE and the AMF independently generate the KAMF (and derived keys) in an implementation defined way and populate the 5G NAS security context with this KAMF to be used when activating a 5G NAS security context."

- As in step 14 of figure 4.2.2.2.2-1 for Emergency Registration, if the UE was not successfully authenticated, the AMF shall not update the UDM. Also for an Emergency Registration, the AMF shall not check for access restrictions, regional restrictions or subscription restrictions.
- Steps 16 and 21b of figure 4.2.2.2.2-1 are not performed since AM and UE policy for the UE are not required for Emergency Registration.

### 4.12.3 Deregistration procedure for untrusted non-3gpp access



**Figure 4.12.3-1: Deregistration procedure for untrusted non-3gpp access**

- The Deregistration procedure is triggered by one of the events:
    - For UE-initiated Deregistration as in steps from 1 to 7 of Figures 4.2.2.3.2-1.
    - For network initiated deregistration as in steps from 1 to 6 of Figure 4.2.2.3.3-1.
- If the UE is in CM-CONNECTED state either in 3GPP access, non-3GPP access or both,
- the AMF may explicitly deregister the UE by sending a Deregistration request message ( Deregistration type, access type set to non-3GPP) to the UE as in step 2 of Figure 4.2.2.3.3-1.
  - the UDM may want to request the deletion of the subscribers RM contexts and PDU Sessions with the reason for removal set to subscription withdrawn to the registered AMF as in step 1 of Figure 4.2.2.3.3-1.
- AMF to N3IWF: The AMF sends a N2 Context UE Release Command message to the N3IWF with the cause set to Deregistration to release N2 signalling as defined in step 4 of clause 4.12.4.2.
  - N3IWF to UE: The N3IWF sends INFORMATIONAL Request (Delete payload) message to the UE. The Delete payload is included to indicate the release of the IKE SA.
  - UE to N3IWF: The UE sends an empty INFORMATIONAL Response message to acknowledge the release of the IKE SA as described in RFC 7296 [3]. Non-3GPP access specific resources are released including the IKEv2 tunnel (and the associated IPSec resources) and the local UE contexts in N3IWF (N3 tunnel Id).
  - N3IWF to AMF: The N3IWF acknowledges the N2 UE Context Release Command message by sending N2 UE Context Release Complete message to the AMF as defined in step 7 of clause 4.12.4.2.

## 4.12.4 N2 procedures via Untrusted non-3GPP Access

### 4.12.4.1 Service Request procedures via Untrusted non-3GPP Access

The Service Request procedure via Untrusted non-3GPP Access shall be used by a UE in CM-IDLE state over non-3GPP access to request the re-establishment of the NAS signalling connection and the re-establishment of the user plane for all or some of the PDU Sessions which are associated to non-3GPP access.

The Service Request procedure via Untrusted non-3GPP Access shall be used by a UE in CM-CONNECTED state over non-3GPP access to request the re-establishment of the user plane for one or more PDU Sessions which are associated to non-3GPP access.

When the UE is in CM-IDLE state over non-3GPP access, the Service Request procedure via Untrusted non-3GPP Access is as described in clause 4.2.3.2 (UE Triggered Service Request) with the following exceptions:

- The Service Request procedure is never a response to a Paging, i.e. there is no Network Triggered Service Request procedure via Untrusted non-3GPP Access.
- The (R)AN corresponds to an N3IWF.
- The UE establishes a "signalling IPsec SA" with the N3IWF by using the procedure specified in clause 4.12.2 for the registration via untrusted non-3GPP access. In particular, the UE includes the Service Request and the AN parameters in an EAP-5G packet, which is further encapsulated in an IKE\_AUTH request.
- The AN parameters include the Selected PLMN ID (or PLMN ID and NID, see clause 5.30 of TS 23.501 [2]) and Establishment cause. The Establishment cause provides the reason for requesting a signalling connection with the 5GC. The UE includes GUAMI information in the AN parameters. The N3IWF selects the AMF according to GUAMI information.
- The N2 parameters sent from N3IWF to AMF include the Establishment cause.
- The user plane between the UE and N3IWF is established not with RRC signalling but with IKEv2 signalling, as specified in clause 4.12.5 (i.e. by using an IKEv2 Create\_Child\_SA exchange). The user plane of each PDU Session consists of one or more Child SAs.

When the UE is in CM-CONNECTED state over non-3GPP access, the Service Request procedure via Untrusted non-3GPP Access is as described in clause 4.2.3.2 (UE Triggered Service Request) with the following exceptions:

- All NAS signalling exchanged between the UE and network is transferred within the established "signalling IPsec SA".
- The (R)AN corresponds to an N3IWF.
- The user plane between the UE and N3IWF is established not with RRC signalling but with IKEv2 signalling, as specified in clause 4.12.5 (i.e. by using an IKEv2 Create\_Child\_SA exchange). The user plane of each PDU Session consists of one or more Child SAs.

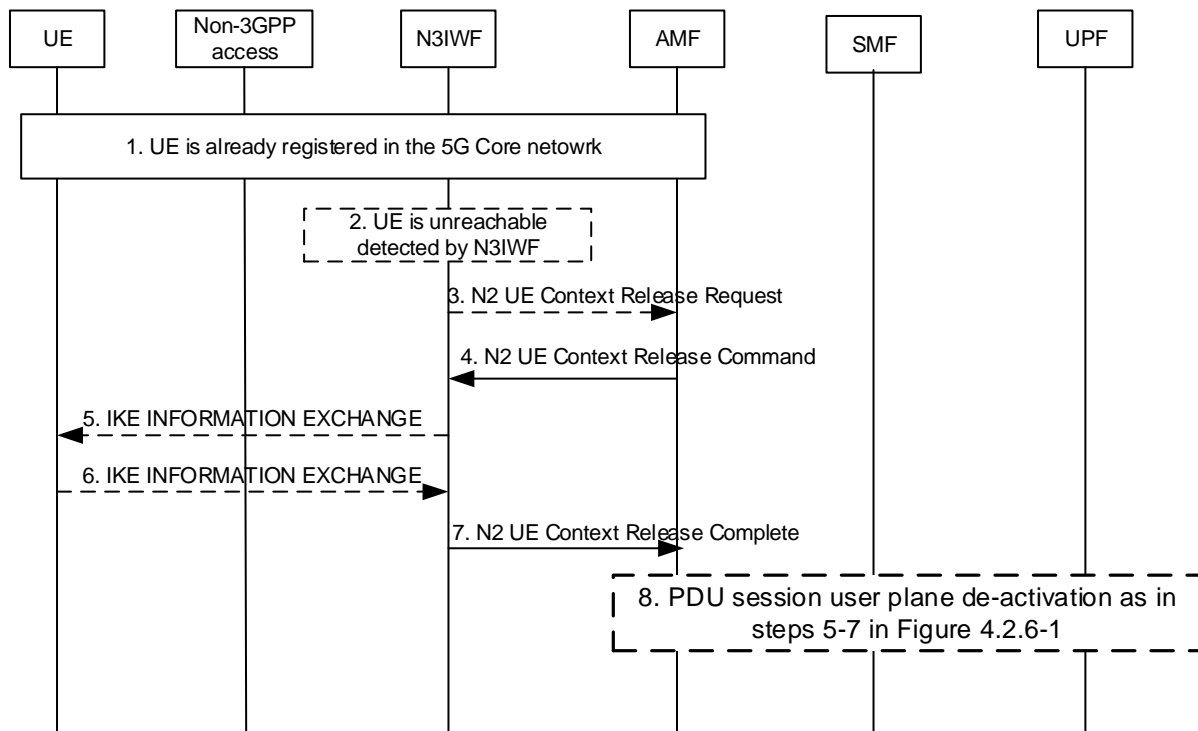
When the UE is in CM-CONNECTED state over non-3GPP access and the network receives downlink data for a PDU Session over non-3GPP access that has no user plane, the steps 1-4a in clause 4.2.3.3 (Network Triggered Service Request) shall be performed with the following exceptions:

- The (R)AN corresponds to an N3IWF.
- The user plane between the UE and N3IWF is established (in step 4a) with IKEv2 signalling, as specified in clause 4.12.5 (i.e. by using an IKEv2 Create\_Child\_SA exchange). The user plane of each PDU Session consists of one or more Child SAs.

### 4.12.4.2 Procedure for the UE context release in the N3IWF

This procedure is used to release the N2 signalling connection and the N3 User Plane connection. If the procedure is initiated by the AMF the IKEv2 SA for a UE is being released. The procedure will move the UE from CM-CONNECTED to CM-IDLE in AMF and all UE related context information is deleted in the N3IWF.

Both N3IWF-initiated and AMF-initiated UE context release in the N3IWF procedures are shown in Figure 4.12.4.2-1.



**Figure 4.12.4.2-1: Procedure for the UE context release in the N3IWF**

1. The UE has already registered in the 5GC and may have established one or multiple PDU Sessions.
2. The N3IWF detects that the UE is not reachable.
3. The N3IWF sends a N2 UE Context Release Request message to the AMF This step is equivalent to step 1b of Figure 4.2.6-1.

NOTE: AN Release procedure can also be triggered by an AMF internal event and in that case step 2 and step 3 do not take place.

4. AMF to N3IWF: If the AMF receives the N2 UE Context Release Request from N3IWF or if due to an internal AMF event the AMF wants to release N2 signalling, the AMF sends an N2 UE Context Release Command (Cause) to the N3IWF. The cause indicated is cause from step 3 or a cause due to internal AMF event. This step is equivalent to step 2 of Figure 4.2.6-1.
5. If the IKEv2 tunnel has not been released yet, the N3IWF performs the release of the IPsec tunnel as defined in RFC 7296 [3] indicating to release the IKE SA and any Child IPsec SA if existing. The N3IWF sends to the UE the indication of the release reason if received in step 4.
6. The UE sends an empty INFORMATIONAL Response message to acknowledge the release of the IKE SA as described in RFC 7296 [3]. The N3IWF deletes the UE's context after receiving the empty INFORMATIONAL Response message.
7. N3IWF to AMF: The N3IWF confirms the release of the UE-associated N2-logical connection by returning N2 UE Release Complete (list of PDU Session ID(s) with active N3 user plane) to the AMF as in step 4 defined in clause 4.2.6. The AMF marks the UE as CM-IDLE state in untrusted non-3GPP access.
8. For each of the PDU Sessions in the N2 UE Context Release Complete, the steps 5 to 7 in clause 4.2.6 are performed (PDU Session Update SM Context). After the AMF receives the Nsmf\_PDUSession\_UpdateSMContext Response as in step 7 of clause 4.2.6, the AMF considers the N3 connection as released. If list of PDU Session ID(s) with active N3 user plane is included in step 3, then this step is performed before step 4.



### 4.12.4.3 CN-initiated selective deactivation of UP connection of an existing PDU Session associated with Untrusted non-3GPP Access

The procedure described in clause 4.3.7 (CN-initiated selective deactivation of UP connection of an existing PDU Session) is used for CN-initiated selective deactivation of UP connection for an established PDU Session associated with non-3GPP Access of a UE in CM-CONNECTED state, with the following exceptions:

- The NG-RAN corresponds to an N3IWF.
- The user plane between the UE and N3IWF, i.e. Child SA(s) for the PDU Session, is released not with RRC signalling but with IKEv2 signalling, as specified in clause 4.12.7.

### 4.12.5 UE Requested PDU Session Establishment via Untrusted non-3GPP Access

Clause 4.12.5 specifies how a UE can establish a PDU Session via an untrusted non-3GPP Access Network as well as to hand over an existing PDU Session between 3GPP access and non-3GPP access. The procedure applies in non-roaming, roaming with LBO as well as in home-routed roaming scenarios.

For non-roaming and LBO scenarios, if the UE is simultaneously registered to a 3GPP access in a PLMN different from the PLMN of the N3IWF, the functional entities in the following procedures are located in the PLMN of the N3IWF. For home-routed roaming scenarios, the AMF, V-SMF and associated UPF in VPLMN in the following procedure is located in the PLMN of the N3IWF.

The procedure below is based on the PDU Session Establishment procedure specified in clause 4.3.2.2.1 (for non-roaming and roaming with LBO) and the PDU Session Establishment procedure specified in clause 4.3.2.2.2 (for home-routed roaming).

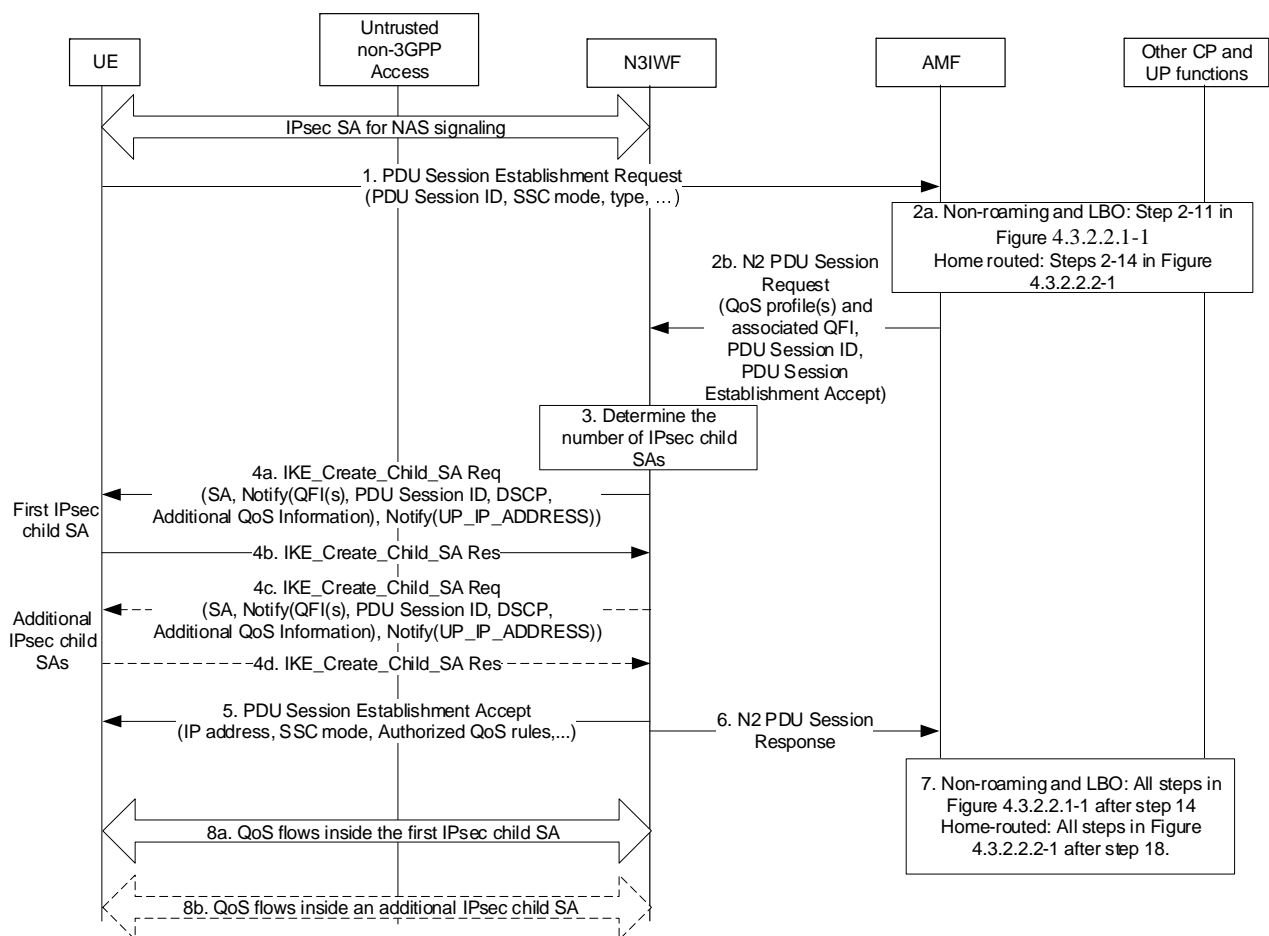


Figure 4.12.5-1: PDU Session establishment via untrusted non-3GPP access

1. The UE shall send a PDU Session Establishment Request message to AMF as specified in step 1 of clause 4.3.2.2.1. This message shall be sent to N3IWF via the IPsec SA for NAS signalling (established as specified in clause 4.12.2) and the N3IWF shall transparently forward it to AMF in the 5GC.
- 2a. In the case of non-roaming or roaming with Local Breakout, steps 2-11 specified in clause 4.3.2.2.1 are executed according to the PDU Session Establishment procedure over 3GPP access. In the case of home-routed roaming, steps 2-14 specified in clause 4.3.2.2.2 are executed according to the PDU Session Establishment procedure over 3GPP access.
- 2b. As described in step 12 of clause 4.3.2.2.1, the AMF shall send a N2 PDU Session Request message to N3IWF to establish the access resources for this PDU Session.
3. Based on its own policies and configuration and based on the QoS profiles received in the previous step, the N3IWF shall determine the number of IPsec Child SAs to establish and the QoS profiles associated with each IPsec Child SA. For example, the N3IWF may decide to establish one IPsec Child SA and associate all QoS profiles with this IPsec Child SA. In this case, all QoS Flows of the PDU Session would be transferred over one IPsec Child SA.
- 4a. The N3IWF shall send to UE an IKE Create\_Child\_SA request according to the IKEv2 specification in RFC 7296 [3] to establish the first IPsec Child SA for the PDU Session. The IKE Create\_Child\_SA request indicates that the requested IPsec Child SA shall operate in tunnel mode. This request shall include a 3GPP-specific Notify payload which contains (a) the QFI(s) associated with the Child SA, (b) the identity of the PDU Session associated with this Child SA, (c) optionally, a DSCP value associated with the Child SA, (d) optionally a Default Child SA indication and (e) optionally, the Additional QoS Information specified in clause 4.12a.5

The IKE Create\_Child\_SA request shall also include another 3GPP-specific Notify payload, which contains the UP\_IP\_ADDRESS that is specified in step 8 below.

If a DSCP value is included, then the UE and the N3IWF shall mark all IP packets sent over this Child SA with this DSCP value. There shall be one and only one Default Child SA per PDU session. The UE shall send all QoS Flows to this Child SA for which there is no mapping information to a specific Child SA. The IKE Create\_Child\_SA request also contains other information (according to RFC 7296 [3]) such as the SA payload, the Traffic Selectors (TS) for the N3IWF and the UE, etc.

After receiving the IKE Create\_Child\_SA request, if the Additional QoS Information is received, the UE may reserve non-3GPP Access Network resources according to the Additional QoS Information.

- 4b. If the UE accepts the new IPsec Child SA, the UE shall send an IKE Create\_Child\_SA response according to the IKEv2 specification in RFC 7296 [3]. During the IPsec Child SA establishment the UE shall not be assigned an IP address.
- 4c-4d. If in step 3 the N3IWF determined to establish multiple IPsec Child SAs for the PDU Session, then additional IPsec Child SAs shall be established, each one associated with one or more QFI(s), optionally with a DSCP value, with a UP\_IP\_ADDRESS and optionally with the Additional QoS Information specified in clause 4.12a.5. For each IPsec Child SA, if the Additional QoS Information is received, the UE may reserve non-3GPP Access Network resources according to the Additional QoS Information for the IPsec Child SA.
5. After all IPsec Child SAs are established, the N3IWF shall forward to UE via the signalling IPsec SA (see clause 4.12.2.2) the PDU Session Establishment Accept message received in step 2b.
6. The N3IWF shall send to AMF an N2 PDU Session Response.
7. In the case of non-roaming or roaming with Local Breakout, all steps specified in clause 4.3.2.2.1 after step 14 are executed according to the PDU Session Establishment procedure over 3GPP access. In the case of home-routed roaming, all steps specified in clause 4.3.2.2.2 after step 18 are executed according to the PDU Session Establishment procedure over 3GPP access.
8. On the user-plane:
  - When the UE has to transmit an UL PDU, the UE shall determine the QFI associated with the UL PDU (by using the QoS rules of the PDU Session), it shall encapsulate the UL PDU inside a GRE packet and shall forward the GRE packet to N3IWF via the IPsec Child SA associated with this QFI. The header of the GRE packet carries the QFI associated with the UL PDU. The UE shall encapsulate the GRE packet into an IP packet with source address the "inner" IP address of the UE and destination address the UP\_IP\_ADDRESS associated with the Child SA.

- When the N3IWF receives a DL PDU via N3, the N3IWF uses the QFI and the identity of the PDU Session in order to determine the IPsec Child SA to use for sending the DL PDU over NWu. The N3IWF encapsulates the DL PDU inside a GRE packet and copies the QFI in the header of the GRE packet. The N3IWF may include also in the GRE header a Reflective QoS Indicator (RQI), which shall be used by the UE to enable reflective QoS. The N3IWF shall encapsulate the GRE packet into an IP packet with source address the UP\_IP\_ADDRESS associated with the Child SA and destination address the "inner" IP address of the UE.

### 4.12.6 UE or Network Requested PDU Session Modification via Untrusted non-3GPP access

The UE or network requested PDU Session Modification procedure via untrusted non-3GPP access is depicted in figure 4.12.6-1. The procedure applies in non-roaming, roaming with LBO as well as in home-routed roaming scenarios.

For non-roaming and LBO scenarios, the functional entities in the following procedures are located in the PLMN of the N3IWF.

The procedure below is based on the PDU Session Modification procedure specified in clause 4.3.3.2 (for non-roaming and roaming with LBO) and on the PDU Session Modification procedure specified in clause 4.3.3.3 (for home-routed roaming).

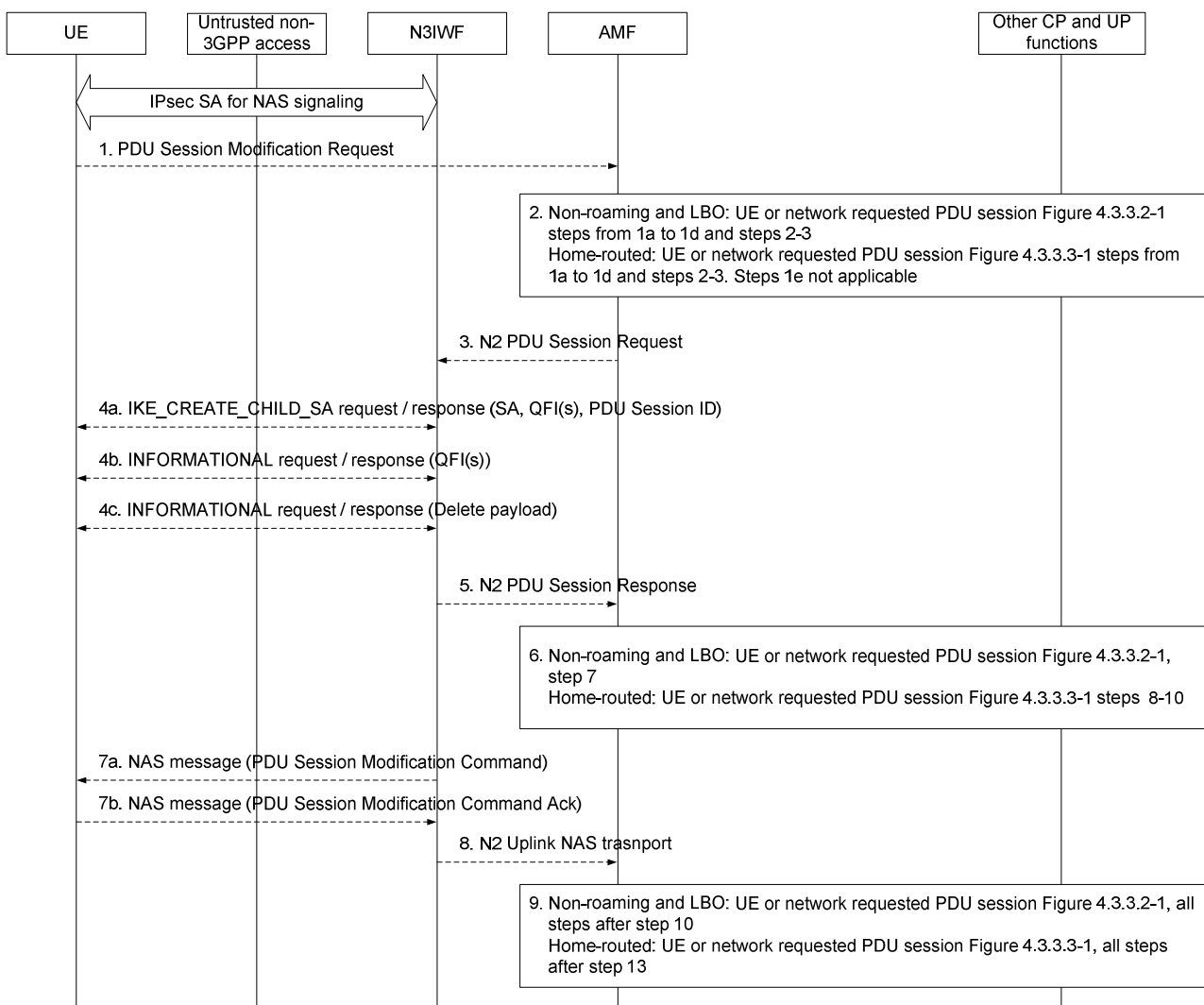


Figure 4.12.6-1: UE or Network Requested PDU Session Modification via untrusted non-3GPP access

1. If the PDU Session Modification procedure is initiated by the UE, the UE shall send a PDU Session Modification Request message to AMF as specified in step 1 of clause 4.3.2.2. The message shall be sent to

N3IWF via the established IPsec SA for NAS signalling. The N3IWF shall transparently forward the PDU Session Modification Request to AMF/SMF.

2. In the case of non-roaming or LBO, the steps 1a (from AMF) to 1e and steps 2-3 as per the PDU Session Modification procedure in clause 4.3.3.2 are executed.

In the case of home-routed, the steps 1a (from AMF) to 1d and steps 2-3 as per the PDU Session Modification procedure in clause 4.3.3.3 are executed.

3. The AMF sends N2 PDU Session Resource Modify Request (N2 SM information received from SMF, NAS message) message to the N3IWF. This step is the same as step 4 in clause 4.3.3.2 (for non-roaming and roaming with Local Breakout) and step 5 in clause 4.3.3.3 (for home-routed roaming).
4. The N3IWF may issue IKEv2 signalling exchange with the UE that is related with the information received from SMF according to the IKEv2 specification in RFC 7296 [3]. Based on the N2 SM information received from the SMF, the N3IWF may perform one of the following:
  - 4a. The N3IWF may decide to create a new Child SA for the new QoS Flow(s). In this case, the N3IWF establishes a new Child SA by sending an IKE\_CREATE\_CHILD\_SA request message, which includes the SA, the PDU Session ID, the QFI(s), optionally a DSCP value and optionally the Additional QoS Information specified in clause 4.12a.5. If the Additional QoS Information is received, the UE may reserve non-3GPP Access Network resources according to the Additional QoS Information.
  - 4b. The N3IWF may decide to add or remove QoS Flow(s) to/from an existing Child SA. In this case, the N3IWF updates the QoS Flow and Child SA mapping information by sending an INFORMATIONAL request message, which includes the QFI(s) associated with the Child SA and optionally the Additional QoS Information specified in clause 4.12a.5, which contains the new QoS information that should be associated with the existing Child SA. If the Additional QoS Information is received, the UE may update the reserved non-3GPP Access Network resources for the existing Child SA according to the Additional QoS Information.
  - 4c. The N3IWF may decide to delete an existing Child SA, e.g. when there is no QoS Flow mapped to this Child SA. In this case, the N3IWF deletes the existing Child SA by sending INFORMATIONAL request message, which includes a Delete payload.

NOTE: If the N3IWF has included the Default Child SA indication during the establishment of one of the Child SAs of the PDU Session, the N3IWF may not update the mapping between QoS Flows Child SAs.

5. The N3IWF acknowledges N2 PDU Session Request by sending a N2 PDU Session Response Message to the AMF to acknowledge the success or failure of the request.
6. In the case of non-roaming or LBO, step 7 as per the PDU Session Modification procedure in clause 4.3.3.2 is executed. In the case of home-routed, the steps 8-10 as per the PDU Session Modification procedure in clause 4.3.3.3 are executed.
7. The N3IWF sends the PDU Session Modification Command to UE (if received in step 3) and receives the response message from UE.

Steps 4a/4c and step 7 may happen consecutively. Steps 7b map happen before step 4b/4d.

8. The N3IWF forwards the NAS message to the AMF.
9. For non-roaming and roaming with LBO, all the steps after step 10 in clause 4.3.3.2 are executed according to the general PDU Session Modification procedure. For home-routed roaming, all steps after step 13 in clause 4.3.3.3 are executed according to the general PDU Session Modification procedure.

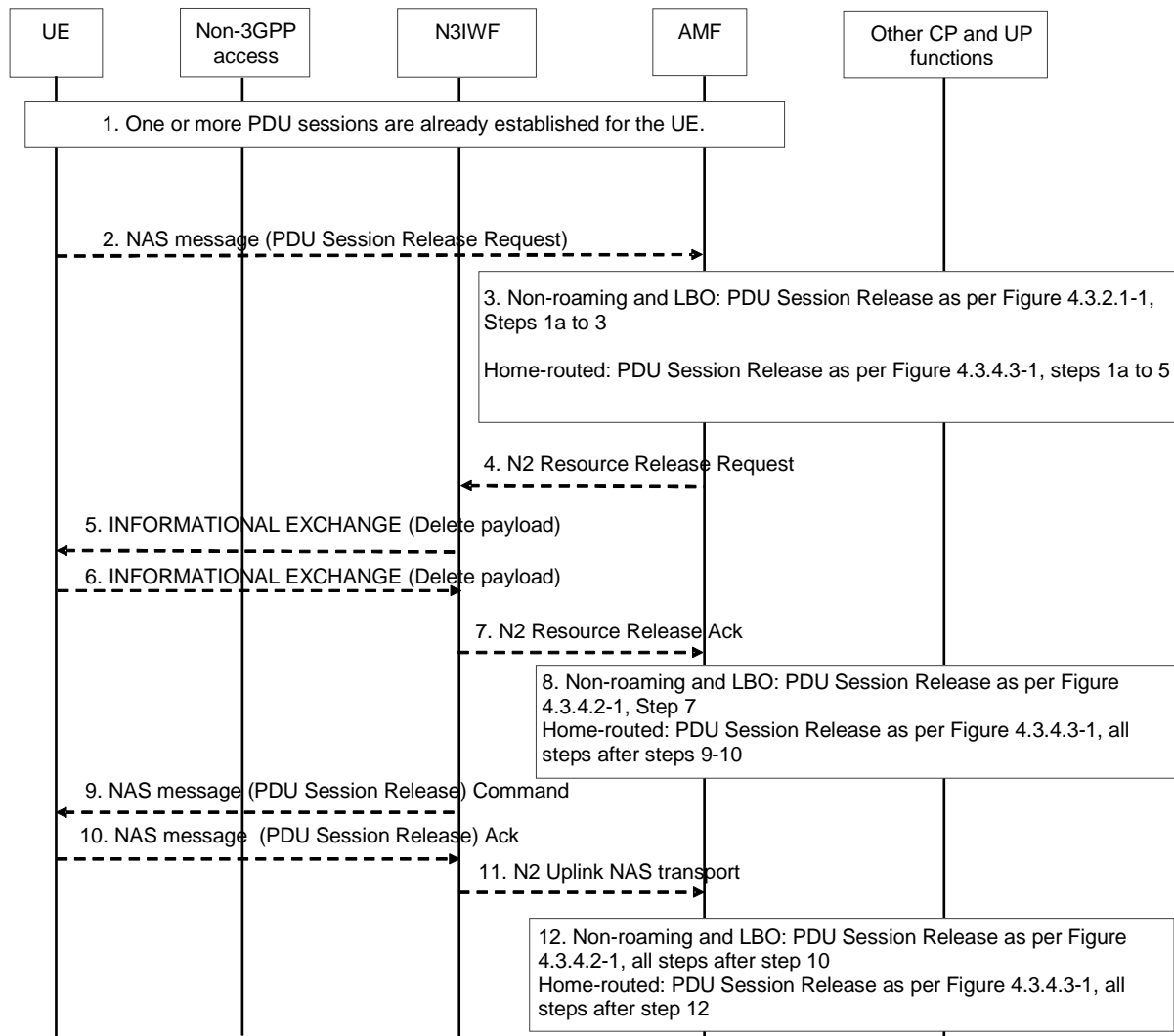
## 4.12.7 UE or network Requested PDU Session Release via Untrusted non-3GPP access

Clause 4.12.7 specifies how a UE or network can release a PDU Session via an untrusted non-3GPP Access Network. The UE requested PDU Session Release procedure via Untrusted non-3GPP access applies in non-roaming, roaming with LBO as well as in home-routed roaming scenarios.

For non-roaming and LBO scenarios, if the UE is simultaneously registered to a 3GPP access in a PLMN different from the PLMN of the N3IWF, the functional entities in the following procedures are located in the PLMN of the N3IWF.

For home-routed roaming scenarios, the AMF, V-SMF and associated UPF in VPLMN in the following procedure is located in the PLMN of the N3IWF.

NOTE: If the UE is simultaneously registered to 3GPP access in the same PLMN as non-3GPP access, when non-3GPP access is not available to the UE (e.g. due to out of non-3GPP access coverage) or UE is in CM-IDLE for non-3GPP access, the UE may perform the PDU Session Release procedure via 3GPP access as described in clause 4.3.4.



**Figure 4.12.7-1: UE Requested PDU Session Release via Untrusted non-3GPP access**

1. One or more PDU Sessions are already established for the UE using the procedure described in clause 4.12.2.
2. The UE sends a NAS message (N1 SM container (PDU Session Release Request), PDU Session ID) to the AMF via the N3IWF as defined in clause 4.3.4.
3. For non-roaming and roaming with LBO, the steps 1a (from AMF) to 4 according to the PDU Session Release procedure defined in clause 4.3.4.2 are executed. For home-routed roaming, the steps 1a (from AMF) to step 7 according to the PDU Session Release procedure defined in clause 4.3.4.3 are executed.
4. This step is the same as step 4 in clause 4.3.4.2 (non-roaming and LBO) and step 6 in clause 4.3.4.3 (home-routed roaming).

If the message received from the SMF does not include N2 SM Resource Release request, the AMF sends N2 Downlink NAS transport (N1 SM container (PDU Session Release Command), PDU Session ID,Cause) message to the N3IWF and steps 5 to 8 are skipped.

5. Upon receiving AN session release request message from the AMF, the N3IWF triggers the release of the corresponding Child SA by sending INFORMATIONAL EXCHANGE (Delete Payload) to the UE. Delete payload is included in the message listing the SPIs of the Child SAs to be deleted to this PDU Session as described in RFC 7296 [3].
6. The UE responds with INFORMATIONAL EXCHANGE (Delete Payload) message. Delete payload is included for the paired SAs going in the other direction as described in RFC 7296 [3].
7. This step is the same as step 6 in 4.3.4.2 (non-roaming and LBO) and step 8 in clause 4.3.4.3 (home-routed roaming).
8. For non-roaming and roaming with LBO, steps 7 according to the PDU Session Release procedure defined in clause 4.3.4.2 are executed. For home-routed roaming, step 9-10 according to the PDU Session Release procedure defined in clause 4.3.4.3 are executed.
9. The N3IWF delivers the NAS message (N1 SM container (PDU Session Release Command), PDU Session ID, Cause) to the UE.
10. The UE sends a NAS message (N1 SM container (PDU Session Release Ack), PDU Session ID) to the N3IWF.
11. This step is the same as step 9 in 4.3.4.2 (non-roaming and LBO) and step 11 in clause 4.3.4.3 (home-routed roaming).

Steps 5 and 9 may happen consecutively. Step 10 may happen before step 6.

12. For non-roaming and roaming with LBO, all steps after step 10 in the PDU Session Release procedure defined in clause 4.3.4.2 are executed. In the case of home-routed roaming, all steps after step 12 in the PDU Session Release procedure defined in clause 4.3.4.3 are executed.

The network requested PDU Session Release procedure via Untrusted non-3GPP access is the same as the network requested PDU Session Release Procedure specified in clause 4.3.4.2 (for Non-Roaming and Roaming with Local Breakout) with the following differences:

- The (R)AN corresponds to an N3IWF.
- In step 5 the N3IWF upon receiving N2 SM request to release the AN resources associated with the PDU Session from the AMF, the N3IWF triggers the release of the corresponding Child SA to the UE as specified in step 5 and 6, in Figure 4.12.7-1.
- User Location Information is not included in the step 6, 7a, 9, 10a and 12 of the procedure.

### 4.12.8 Mobility from a non-geographically selected AMF to a geographically selected AMF

This procedure describes the AMF change that takes place when an UE initially served via non-3GPP access by an AMF selected based on non-geographical criteria (e.g. because the UE had no 3GPP access coverage or because only non-geographically selectable N3IWF are deployed) gets 3GPP access and is now to be served by an AMF selected in the same PLMN by the NG-RAN based on geographical criteria.

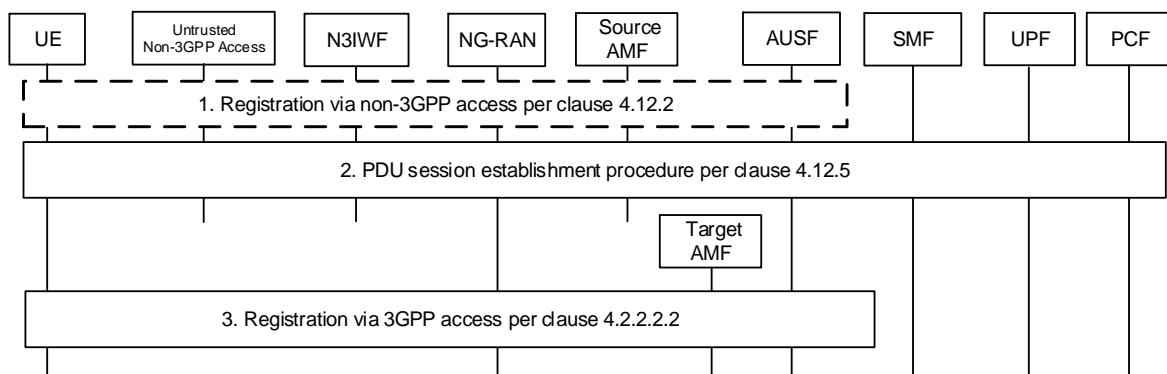


Figure 4.12.8-1: Mobility from a non-geographically selected AMF to a geographically selected AMF

1. The UE registers over non-3GPP access, as described in clause 4.12.2. During this procedure:
  - a An AMF (source AMF) is selected by the N3IWF in step 6a, based on non-geographical criteria (e.g. because the UE has no 3GPP access coverage or because only non-geographically selectable N3IWF are deployed).
  - b The UE receives, within the Registration Accept message, a 5G-GUTI containing a GUAMI of the non-geographically selected AMF. The UE also receives an Allowed NSSAI and optionally Mapping Of Allowed NSSAI.
2. The UE may activate PDU Sessions over non-3GPP access, as described in clause 4.12.5.
3. The UE gets 3GPP access and issues a Registration Request over 3GPP access as defined in step 1 of Figure 4.2.2.2.2-1, providing its 5G-GUTI.

If the 5G-GUTI does not indicate an AMF of the same Region ID as that of the NG-RAN, the NG-RAN selects an AMF Set and an AMF in the AMF Set as described in clause 6.3.5 of TS 23.501 [2].

Steps 3 to 22 of Figure 4.2.2.2.2-1 take place including following aspects:

- step 4 of Figure 4.2.2.2.2-1 takes place i.e. the new AMF invokes the Namf\_Communication\_UEContextTransfer service operation on the old AMF to request the UE's SUPI and MM Context.
- in step 5 of Figure 4.2.2.2.2-1, the old AMF includes information about active NGAP association to N3IWF.
- in step 18 of Figure 4.2.2.2.2-1, the new AMF modifies the NGAP association toward N3IWF.
- in step 21 of Figure 4.2.2.2.2-1, the Registration Accept message shall include the updated 5G-GUTI that the UE will use to update its 3GPP and non-3GPP registration contexts.

## 4.12a Procedures for Trusted non-3GPP access

### 4.12a.1 General

Clause 4.12a defines the procedures to support trusted non-3GPP access by describing the differences compared to the defined procedures in other clauses.

### 4.12a.2 Registration via Trusted non-3GPP Access

#### 4.12a.2.1 General

Clause 4.12a.2 specifies how a UE can register to 5GC via a trusted non-3GPP Access Network. The utilized procedure is very similar with the 5GC registration procedure over untrusted non-3GPP access in clause 4.12.2.2 and it is based on the Registration procedure specified in clause 4.2.2.2.2. It uses the same vendor-specific EAP method (called "EAP-5G") as the one specified in clause 4.12.2.1. In this case, the "EAP-5G" method is used between the UE and the TNGF and is utilized for encapsulating NAS messages.

In Registration and subsequent Registration procedures via trusted non-3GPP access, the NAS messages are always exchanged between the UE and the AMF. When possible, the UE can be authenticated by reusing the existing UE security context in AMF.

#### 4.12a.2.2 Registration procedure for trusted non-3GPP access

The UE connects to a trusted non-3GPP Access Network (TNAN) and it also registers to 5GC over via this TNAN, by using the EAP-based procedure shown in the figure 4.12a.2.2. This procedure is very similar with the 5GC registration procedure over untrusted non-3GPP access in clause 4.12.2.2. The link between the UE and the TNAN can be any data link (L2) that supports EAP encapsulation, e.g. PPP, PANA, Ethernet, IEEE 802.3, IEEE 802.11, etc. The interface between the TNAN and TNGF is an AAA interface.

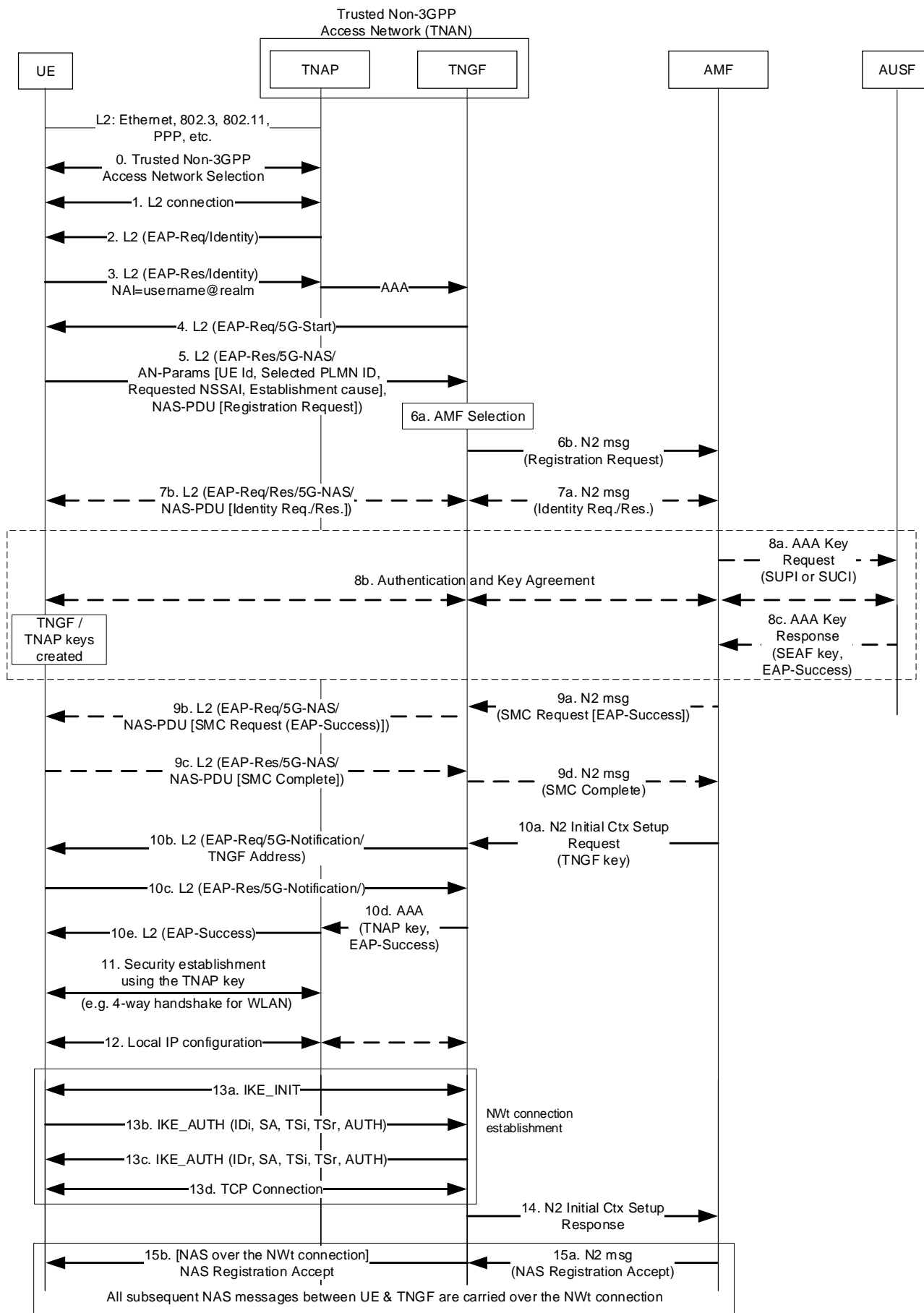


Figure 4.12a.2.2-1: Registration via trusted non-3GPP access



0. The UE selects a PLMN and a TNAN for connecting to this PLMN by using the Trusted Non-3GPP Access Network selection procedure specified in clause 6.3.12 of TS 23.501 [2]. During this procedure, the UE discovers the PLMNs with which the TNAN supports trusted connectivity (e.g. "5G connectivity").
1. A layer-2 connection is established between the UE and the TNAP. In the case of IEEE 802.11 [48], this step corresponds to an 802.11 Association. In the case of PPP, this step corresponds to a PPP LCP negotiation. In other types of non-3GPP access (e.g. Ethernet), this step may not be required.
- 2-3. An EAP procedure is initiated. EAP messages are encapsulated into layer-2 packets, e.g. into IEEE 802.3/802.1x packets, into IEEE 802.11/802.1x packets, into PPP packets, etc. The NAI provided by the UE indicates that the UE requests "5G connectivity" to a specific PLMN, e.g. NAI = "<any\_username>@nai.5gc.mnc<MNC>.mcc<MCC>.3gppnetwork.org". This NAI triggers the TNAP to send an AAA request to a TNGF, which operates as an AAA proxy. Between the TNAP and TNGF the EAP packets are encapsulated into AAA messages. The AAA request also include the TNAP identifier, which can be treated as the User Location Information.
- 4-10. An EAP-5G procedure is executed as the one specified in clause 4.12.2.2 for the untrusted non-3GPP access with the following modifications:
  - A TNGF key (instead of an N3IWF key) is created in the UE and in the AMF after the successful authentication. The TNGF key is transferred from the AMF to TNGF in step 10a (within the N2 Initial Context Setup Request). The TNGF derives a TNAP key, which is provided to the TNAP. The TNAP key depends on the non-3GPP access technology (e.g. it is a Pairwise Master Key in the case of IEEE 802.11 [48]). How these security keys are created, it is specified in TS 33.501 [15].
  - In step 5 the UE shall include the Requested NSSAI in the AN parameters only if allowed, according to the conditions defined in clause 5.15.9 of TS 23.501 [2], for the trusted non-3GPP access. The UE shall also include a UE Id in the AN parameters, e.g. a 5G-GUTI if available from a prior registration to the same PLMN.
  - In the N2 message sent in step 6b, the TNGF includes a UE Location Information (ULI) that contains a "null" IP address (e.g. 0.0.0.0) because the UE is not yet assigned an IP address. After the UE is assigned an IP address, the TNGF includes this address in subsequent N2 messages.
  - After receiving the TNGF key from AMF in step 10a, the TNGF shall send to UE an EAP-Request/5G-Notification packet containing the "TNGF Contact Info", which includes the IP address of TNGF. After receiving an EAP-Response/5G-Notification packet from the UE in step 10c, the TNGF shall send message 10d containing the EAP-Success packet.
11. The TNAP key is used to establish layer-2 security between the UE and TNAP. In the case of IEEE 802.11 [48], a 4-way handshake is executed, which establishes a security context between the WLAN AP and the UE that is used to protect unicast and multicast traffic over the air.
12. The UE receives IP configuration from the TNAN, e.g. with DHCP.
13. At this point, the UE has successfully connected to the TNAN and has obtained IP configuration. The UE sets up a secure NWt connection with the TNGF as follows:

The UE initiates an IKE\_INIT exchange using the IP address of TNGF received during the EAP-5G signalling, in step 10b. Subsequently, the UE initiates an IKE\_AUTH exchange and provides its identity. The identity provided by the UE in the IKEv2 signalling should be the same as the UE Id included in the AN parameters in step 5. This enables the TNGF to locate the TNGF key that was created before for this UE, during the authentication in step 8. The TNGF key is used for mutual authentication. NULL encryption is negotiated between the UE and the TNGF, as specified in RFC 2410 [49].

In step 13c, the TNGF provides to UE (a) an "inner" IP address, (b) a NAS\_IP\_ADDRESS and a TCP port number and (c) a DSCP value. After this step, an IPsec SA is established between the UE and TNGF. This is referred to as the "signalling IPsec SA" and operates in Tunnel mode. Operation in Tunnel mode enables the use of MOBIKE [40] for re-establishing the IPsec SAs when the IP address of the UE changes during mobility events. All IP packets exchanged between the UE and TNGF via the "signalling IPsec SA" shall be marked with the above DSCP value. The UE and the TNAP may map the DSCP value to a QoS level (e.g. to an EDCA Access Class [48]) supported by the underlying non-3GPP Access Network. The mapping of a DSCP value to a QoS level of the non-3GPP Access Network is outside the scope of 3GPP.

Right after the establishment of the "signalling IPsec SA", the UE shall setup a TCP connection with the TNGF by using the NAS\_IP\_ADDRESS and the TCP port number received in step 13c. The UE shall send NAS messages within TCP/IP packets with source address the "inner" IP address of the UE and destination address the NAS\_IP\_ADDRESS. The TNGF shall send NAS messages within TCP/IP packets with source address the NAS\_IP\_ADDRESS and destination address the "inner" IP address of the UE.

This concludes the setup of the NWt connection between the UE and the TNGF. All subsequent NAS messages between UE and TNGF are carried over this NWt connection (i.e. encapsulated in TCP/IP/ESP).

14. After the NWt connection is successfully established, the TNGF responds to AMF with an N2 Initial Context Setup Response message.
15. Finally, the NAS Registration Accept message is sent by the AMF and is forwarded to UE via the established NWt connection. Now the UE can use the TNAN (a) to transfer non-seamless offload traffic and (b) to establish one or more PDU Sessions.

#### 4.12a.2.3 Emergency Registration for trusted non-3GPP Access

Emergency Registration procedure for trusted non-3GPP access shall be supported as specified in clause 4.12.2.3 for untrusted non-3GPP access with the following differences:

- The regular registration shall refer to clause 4.12a.2.
- The N3IWF is substituted by the TNGF.
- The N3IWF key is substituted by the TNGF key.

#### 4.12a.3 Deregistration procedure for Trusted non-3GPP access

The Deregistration procedure via trusted non-3GPP access shall be supported as specified in clause 4.12.3 for the untrusted non-3GPP access with the following modifications:

- The untrusted non-3GPP access is substituted by a trusted non-3GPP access point (TNAP).
- The N3IWF is substituted by the TNGF.
- If the UE has reserved QoS resources over non-3GPP access by using the Additional QoS Information (specified in clause 4.12a.5), then the UE shall release these resources.

#### 4.12a.4 N2 procedures via Trusted non-3GPP Access

##### 4.12a.4.1 Service Request procedures via Trusted non-3GPP Access

The Service Request procedure via trusted non-3GPP access shall be supported as specified in clause 4.12.4.1 for the untrusted non-3GPP access with the following modifications:

- The untrusted non-3GPP access is substituted by a trusted non-3GPP access.
- The N3IWF is substituted by the TNGF.
- The user plane between the UE and TNGF is established with IKEv2 signalling, as specified in clause 4.12a.5 (i.e. by using an IKEv2 Create\_Child\_SA exchange). The IKEv2 Create Child SA Request shall include the Additional QoS Information to reserve non-3GPP specific QoS resources as defined in clause 4.12a.5.

##### 4.12a.4.2 Procedure for the UE context release in the TNGF

This procedure for releasing the N2 signalling connection and the N3 user plane connection for a UE connected to 5GC via trusted non-3GPP access, shall be the same as the procedure specified in clause 4.12.4.2 for the untrusted non-3GPP access with the following modifications:

- The untrusted non-3GPP access is substituted by a trusted non-3GPP access point (TNAP).
- The N3IWF is substituted by the TNGF.

- If the UE has reserved any non-3GPP specific QoS resources, the UE releases these resources when the IKEv2 Child SA is released.

#### 4.12a.4.3 CN-initiated selective deactivation of UP connection of an existing PDU Session associated with Trusted non-3GPP Access

The procedure described in clause 4.3.7 (CN-initiated selective deactivation of UP connection of an existing PDU Session) is used for CN-initiated selective deactivation of UP connection for an established PDU Session associated with trusted non-3GPP Access for a UE in CM-CONNECTED state, with the following exceptions:

- The NG-RAN corresponds to a TNAN including a TNGF.
- The user plane between the UE and TNGF, i.e. Child SA(s) for the PDU Session, is released not with RRC signalling but with IKEv2 signalling, as specified in clause 4.12a.7.
- If the UE has reserved any non-3GPP specific QoS resources, the UE releases these resources when the IKEv2 Child SA is released.

#### 4.12a.5 UE Requested PDU Session Establishment via Trusted non-3GPP Access

After the UE registers to 5GC via trusted non-3GPP access, the UE may request a PDU Session establishment by using the same procedure as the one specified in clause 4.12.5 for untrusted non-3GPP access, with the following modifications:

- The N3IWF in Figure 4.12.5-1 should be substituted with a TNGF and the Untrusted non-3GPP access should be substituted with a Trusted non-3GPP Access Point (TNAP).
- The TNGF may send a TNGF Identities parameter to AMF inside an N2 Uplink NAS Transport message. The TNGF Identities parameter contains a list of identifiers (i.e. FQDNs or IP addresses) of N3 terminations supported by the TNGF. If received by the AMF, it shall forward it to the SMF, which may use it as input to UPF selection.
- The IKEv2 Create Child SA Request message that is sent by the TNGF to UE (in steps 4a and 4c), in order to establish a child SA for one or more QoS flows, shall also include Additional QoS Information. The Additional QoS Information shall contain:
  - a) If the IPsec child SA carries a GBR flow: QoS Characteristics and GBR QoS Flow Information:
    - The QoS Characteristics are associated with the 5QI of the GBR flow and are defined in clause 5.7.3 of TS 23.501 [2]. The TNGF either receives the QoS Characteristics via the N2 interface (in the case of a dynamically assigned 5QI), or is pre-configured with the QoS Characteristics (in the case of a standardized 5QI).
    - The GBR QoS Flow Information (defined in TS 38.413 [10]) is part of the QoS Profile received via the N2 interface and contains: MFBR, GFBR and optionally Maximum Packet Loss Rate. The Notification Control is not included in the QoS profile.
  - b) If the IPsec child SA carries a non-GBR flow: QoS Characteristics:
    - The QoS Characteristics are defined in bullet a) above.

The TNGF may aggregate multiple GBR flows or multiple non-GBR flows into the same IPsec child SA. In this case, the TNGF derives, in an implementation specific way, the QoS Characteristics of the aggregated flow by considering the QoS Characteristics of the individual flows. Similarly, the TNGF derives, in an implementation specific way, the GBR QoS Flow Information of an aggregated GBR flow by considering the GBR QoS Flow Information of the individual GBR flows.

**NOTE:** The above behaviour of the TNGF does not create any impact on the N2 interface.

- After receiving an IKEv2 Create Child SA Request message, the UE shall use the Additional QoS Information contained in this message to determine what QoS resources to reserve over the non-3GPP access, including e.g. guaranteed bit rates and delay bounds for UL/DL communication. How the UE determines what QoS resources

to reserve over the non-3GPP access and how these QoS resources are reserved, is outside the scope of 3GPP specifications.

- If the UE fails to reserve QoS resources over non-3GPP access for the QoS flows associated with the child SA (e.g. because the non-3GPP Access Network rejects the allocation of the requested bit rates), the UE shall reject the IKEv2 Child SA Request.

#### 4.12a.6 UE or network Requested PDU Session Modification via Trusted non-3GPP access

The UE or network requested PDU Session Modification procedure via trusted non-3GPP access is the same procedure as the one specified in clause 4.12.6 for untrusted non-3GPP access, with the following modifications:

- The N3IWF in Figure 4.12.6-1 should be substituted with a TNGF and the Untrusted non-3GPP access should be substituted with a Trusted non-3GPP Access Point (TNAP).
- The IKEv2 Create Child SA Request sent by the TNGF in step 4a, in order to create new QoS flow(s) for the PDU Session, shall include the Additional QoS Information defined in clause 4.12a.5. If the UE decides to reserve QoS resources over non-3GPP access for the QoS flows associated with the Child SA but fails to reserve these resources, the UE shall reject the IKEv2 Child SA Request.
- The IKEv2 Informational Request sent by the TNGF in step 4b shall include the Additional QoS Information defined in clause 4.12a.5, when the IKEv2 Informational Request is sent to modify one or more existing QoS flows. If the UE decides to reserve QoS resources over non-3GPP access for the QoS flows associated with the Child SA but fails to reserve these resources, the UE shall indicate the failure in the IKEv2 Informational Response. The TNGF includes the list of QoS flows which are failed to setup in step 5.
- The IKEv2 Informational Request sent by the TNGF in step 4c to release an existing IKEv2 Child SA shall trigger the UE to release the resources reserved over non-3GPP access for this IKEv2 Child SA.
- If, after the PDU Session establishment, the UE determines that the QoS resources reserved over non-3GPP access for the QoS flows associated with a Child SA are released, then the UE shall initiate an INFORMATIONAL exchange, as specified in RFC 7296 [3], to delete the Child SA. After the Child SA is deleted, the TNGF initiates PDU Session Modification procedure as described in step 1e, in clause 4.3.3.2, including the list of QoS flows, which are released.

#### 4.12a.7 UE or network Requested PDU Session Release via Trusted non-3GPP access

The UE or the network can release a PDU Session via a trusted non-3GPP Access Network as specified in clause 4.12.7 for the untrusted non-3GPP access with the following modifications:

- The untrusted non-3GPP access is substituted by a trusted non-3GPP access point (TNAP).
- The N3IWF is substituted by the TNGF.
- If the UE reserved any non-3GPP specific QoS resources, the UE releases these resources when the IKEv2 Child SA is released.

#### 4.12a.8 Mobility from a non-geographically selected AMF to a geographically selected AMF

The procedure specified in clause 4.12.8 for untrusted non-3GPP access applies also to the trusted non-3GPP access with the following modifications:

- The untrusted non-3GPP access is substituted by a trusted non-3GPP access point (TNAP).
- The N3IWF is substituted by the TNGF.
- The PDU Session is activated in step 2 as specified in clause 4.12a.5.

## 4.12a.9 Support of mobility from source to target TNAP

In this Release, if the UE moves from a source TNAP to a target TNAP, the UE shall perform a full authentication via the target TNAP to re-connect to the 5G system.

## 4.12b Procedures for devices that do not support 5GC NAS over WLAN access

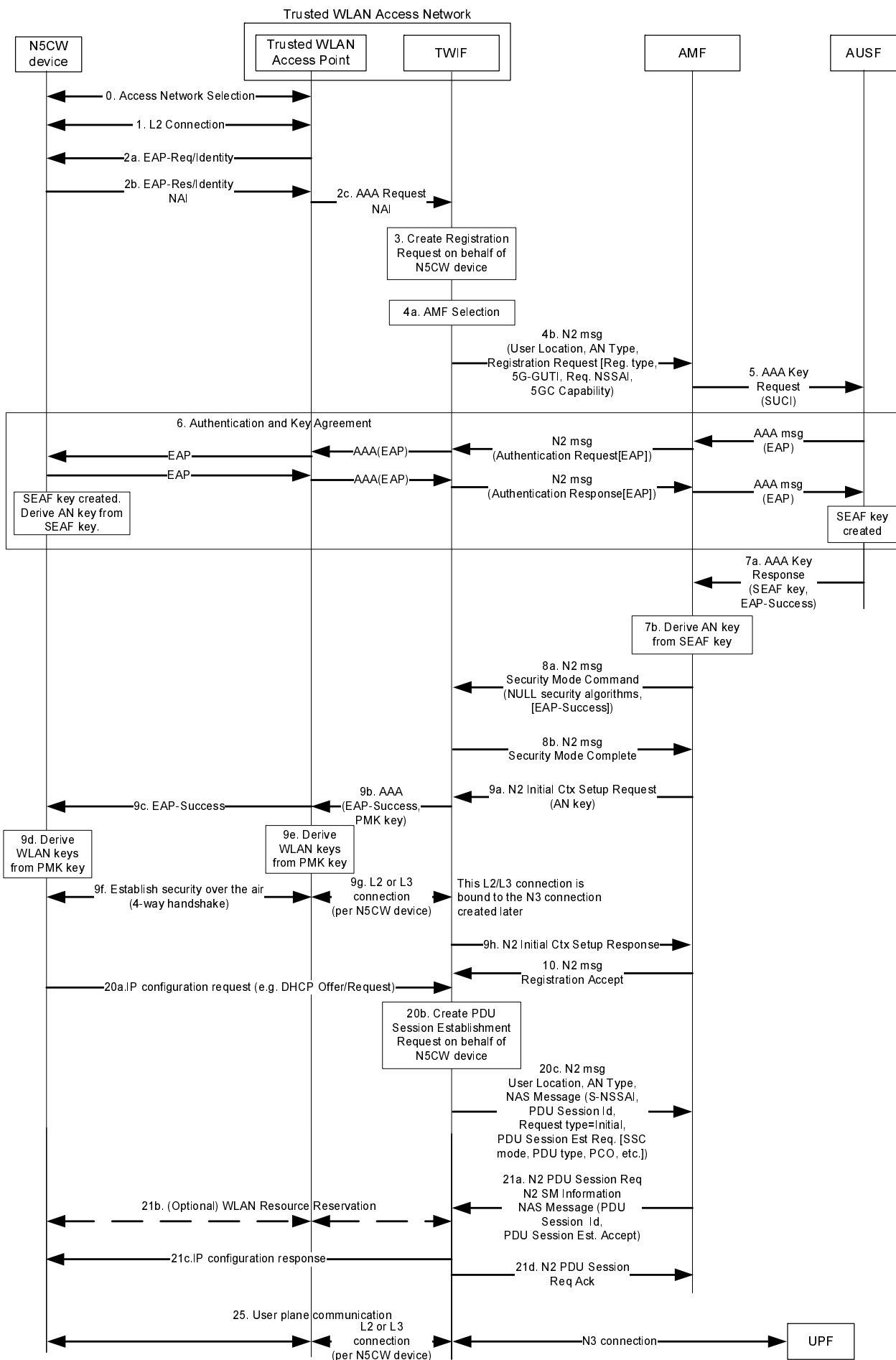
### 4.12b.1 General

As specified in clause 4.2.8.5 of TS 23.501 [2], devices that do not support 5GC NAS signalling over WLAN access (referred to as "Non-5G-Capable over WLAN" devices, or N5CW devices for short), may access 5GC in a PLMN via a trusted WLAN Access Network that supports a Trusted WLAN Interworking Function (TWIF). The following clause specifies how a N5CW device can be registered to 5GC and how it can send data via a PDU Session.

A N5CW device may be 5G-capable over 3GPP access, in which case it is also a 5G UE over 3GPP access.

### 4.12b.2 Initial Registration & PDU Session Establishment

Figure 4.12b.2-1 illustrates how the N5CW device can connect to a trusted WLAN Access Network and simultaneously register to a 5G core network. A single EAP-based authentication procedure is executed for connecting the N5CW device to the trusted WLAN Access Network and for registering the N5CW device to the 5G core network.



### Figure 4.12b.2-1: Initial registration and PDU session establishment

0. The N5CW device selects a PLMN and a trusted WLAN that supports "5G connectivity-without-NAS" to this PLMN by using the procedure specified in clause 6.3.12a of TS 23.501 [2], "Access Network selection for devices that do not support 5GC NAS over WLAN".

Steps 1-10: Initial registration to 5GC.

1. The N5CW device associates with the selected trusted WLAN and the EAP authentication procedure is initiated.
2. The N5CW device provides its Network Access Identity (NAI). The Trusted WLAN Access Point (TWAP) selects a Trusted WLAN Interworking Function (TWIF), e.g. based on the received realm and sends an AAA request to the selected TWIF.

If the N5CW device has not registered over 3GPP access to 5GC of the selected PLMN when the above procedure is initiated, then the NAI includes the SUCI as specified in clause 28.7.7 of TS 23.003 [33]. For example, NAI=type1.rid678.schid0.useriduser17@nai.5gc-nn.mnc<MNC>.mcc<MCC>.3gppnetwork.org. If the selected PLMN is VPLMN, the N5CW device may use the Decorated NAI format as specified in clause 28.7.9 of TS 23.003 [33] to indicate to TWAN which is the VPLMN to be selected, for example, NAI=nai.5gc-nn.mnc<MNC\_Home>.mcc<MCC\_Home>.3gppnetwork.org!type1.rid678.schid0.useriduser17@nai.5gc-nn.mnc<MNC\_visited>.mcc<MCC\_visited>.3gppnetwork.org.

If the N5CW device has registered to 5GC over 3GPP access to 5GC of the selected PLMN (i.e. it is also a 5G UE) when the above procedure is initiated, then the NAI includes the 5G-GUTI assigned to N5CW device over 3GPP access. This enables the TWIF in step 4a below to select the same AMF as the one serving the N5CW device over 3GPP access.

The NAI provided by the N5CW device in step 2b indicates that the N5CW device wants "5G connectivity-without-NAS" towards a specific PLMN (i.e. the HPLMN). For example, with NAI=<5G-GUTI>@nai.5gc-nn.mnc123.mcc45.3gppnetwork.org, the N5CW device indicates that it wants "5G connectivity-without-NAS" (5gc-nn) to the PLMN with MCC=45 and MNC=123.

3. The TWIF creates a 5GC Registration Request message on behalf of the N5CW device. The TWIF uses default values to populate the parameters in the Registration Request message, which are the same for all N5CW devices. The Registration type indicates "Initial Registration".

If the TWIF receives a Decorated NAI and it supports the Decorated NAI, in Registration Request message the TWIF send the NAI which corresponds to the HPLMN by removing the decoration, for example NAI=type1.rid678.schid0.useriduser17@nai.5gc-nn.mnc<MNC\_Home>.mcc<MCC\_Home>.3gppnetwork.org.

4. The TWIF selects an AMF (e.g. by using the 5G-GUTI in the NAI, or selects the AMF of the VPLMN indicated by the realm of the decoration in the Decorated NAI, for example "mnc<MNC\_visited>.mcc<MCC\_visited>.3gppnetwork.org" or selects the AMF by using the local configuration. TWIF sends an N2 message to the AMF including the Registration Request, the User Location and an AN Type.
5. The AMF triggers an authentication procedure by sending a request to AUSF indicating the AN type.
6. An EAP authentication procedure takes place between the N5CW device and AUSF. Over the N2 interface, the EAP messages are encapsulated within NAS Authentication messages. The type of EAP authentication procedure is specified in TS 33.501 [15].
7. After a successful authentication, the AUSF sends to AMF the EAP-Success message and the created SEAF key. The AMF derives an AN key from the received SEAF key.
8. The NAS Security Mode Command (SMC) is sent from the AMF to the TWIF. The selected NAS security algorithms of integrity protection and ciphering are set to NULL.
9. The AMF sends an N2 Initial Context Setup Request and provides the AN key to TWIF. In turn, the TWIF derives a Pairwise Master Key (PMK) from the AN key and sends the PMK key and the EAP-Success message to the Trusted WLAN Access Point, which forwards the EAP-Success to the N5CW device. The PMK is the key used to secure the WLAN air-interface communication according to IEEE 802.11 specification [48]. A layer-2 or layer-3 connection is established between the Trusted WLAN Access Point and the TWIF for transporting all user-plane traffic of the N5CW device to TWIF. This connection is later bound to an N3 connection that is created for this N5CW device.

10. Finally, the AMF sends a Registration Accept message to TWIF. At this point, the N5CW device is connected to the WLAN Access Network and is registered to 5GC.

Steps 20-21: PDU Session Establishment.

20. The TWIF creates a PDU Session Establishment Request message on behalf of the N5CW device and sends this message to AMF. This may be triggered by receiving an IP configuration request (e.g. DHCP Offer/Request) from the N5CW device. The TWIF may use default values to populate the parameters in the PDU Session Establishment Request message, but may also skip some PDU session parameters and let the AMF or the SMF determine these parameters based on the N5CW device subscription information received during the registration procedure. This way, default PDU session parameters can be used per N5CW device.

The value of the PDU Session id provided by TWIF in step 20c shall always be the same. It will be a value reserved for the PDU sessions requested by the TWIF and it will be different from the values that can be used by the N5CW device when requesting a PDU session over 3GPP access. This way, the PDU session id provided by the TWIF cannot be the same with the PDU Session Id of any PDU session established by the N5CW device over 3GPP access.

21. The AMF sends upon request of the SMF an N2 PDU Session Request message to TWIF in order to reserve the appropriate Access Network resources. This N2 message includes the PDU Session Establishment Accept message. In step 21b, the TWIF may reserve WLAN access resources for the user-plane communication between the N5CW device and TWIF. If and how this resource reservation is performed is outside the scope of 3GPP.

After the establishment of the PDU session, the TWIF assigns IP configuration data to N5CW device (e.g. with DHCP). The IP address assigned to N5CW device is the IP address allocated to the PDU session.

Step 25: User plane communication.

The TWIF binds the N5CW device-specific L2/L3 connection created in step 9g with the N3 connection created in step 21. All user-plane traffic sent by the N5CW device is forwarded to TWIF via the L2/L3 connection and then to UPF via the N3 connection. The TWIF operates as a Layer-2 relay.

The TWIF may receive URSP rules (see TS 23.503 [20]), which indicate the traffic that should be offloaded locally by TWIF (sent outside the PDU session) and the traffic that should be sent inside the PDU session.

The above procedure supports only one PDU session per N5CW device whose parameters are either configured for all N5CW devices in the TWIF or are derived from default values in the N5CW device subscription.

If the TWIF is co-located with one or more local UPFs then:

- In step 20c (N2 Uplink NAS Transport), the TWIF may send a TWIF Identities parameter to AMF. The TWIF Identities parameter contains a list of identifiers (i.e. FQDNs or IP addresses) of N3 terminations supported by the TWIF.
- If received by the AMF, it shall forward it to the SMF when invoking Nsmf\_PDUSessionCreateSMContext i.e. at the establishment of the PDU Session. The SMF may use this information to select a local UPF for the PDU Session.

### 4.12b.3 Deregistration procedure

The Deregistration procedure for devices (N5CW devices) that do not support 5G NAS signalling over WLAN access shall be supported as specified in clause 4.12a.3 for the trusted non-3GPP access with the following modifications:

- The TNAP is substituted by a trusted WLAN access point (TWAP).
- The TNGF is substituted by the Trusted WLAN Interworking Function (TWIF).
- The TWIF sends and receives NAS deregistration request/accept messages on behalf of N5CW device.
- For both UE/Network-initiated deregistration procedures, the TWIF may initiate the release of Yt' connection between the N5CW device and TWIF.
- UE-initiated deregistration procedure can be initiated by the TWIF, when it has lost connectivity to the N5CW device.



## 4.12b.4 N2 procedures

### 4.12b.4.1 Service Request procedures

The Service Request procedure for devices that do not support 5G NAS signalling over WLAN access shall be used by a TWIF when the CM state in TWIF for a N5CW device is CM-IDLE over Trusted WLAN to request the re-establishment of the NAS signalling connection and the re-establishment of the user plane for all or some of the PDU Sessions which are associated to non-3GPP access.

The Service Request procedure for N5CW devices shall be used by a TWIF when the CM state in TWIF for a N5CW device is CM-CONNECTED over trusted WLAN to request the re-establishment of the user plane for one or more PDU Sessions which are associated to non-3GPP access.

This Service Request procedure shall be supported as specified in clause 4.12a.4.1 for the trusted non-3GPP access with the following modifications:

- The trusted non-3GPP access is substituted by a trusted WLAN access point (TWAP).
- The TNGF is substituted by the TWIF.
- The TWIF sends and receives NAS messages on behalf of N5CW device.
- The user plane between the N5CW device and TWIF is established with Yt' connection instead of IKEv2 signalling.

### 4.12b.4.2 Procedure for the UE context release in the TWIF

This procedure for releasing the N2 signalling connection and the N3 user plane connection for a N5CW device connected to 5GC via trusted WLAN access, shall be the same as the procedure specified in clause 4.12a.4.2 for the trusted non-3GPP access with the following modifications:

- The trusted non-3GPP access is substituted by a TWAP.
- The TNGF is substituted by the TWIF.
- The TWIF may initiate the release of Yt' connection between the N5CW device and TWIF.

### 4.12b.4.3 CN-initiated selective deactivation of UP connection of an existing PDU Session

The procedure described in clause 4.3.7 (CN-initiated selective deactivation of UP connection of an existing PDU Session) is used for CN-initiated selective deactivation of UP connection for an established PDU Session associated with Trusted WLAN access for a N5CW device in CM-CONNECTED state, with the following exceptions:

- The NG-RAN corresponds to a TNAN including a TWIF.
- The user plane between the N5CW device and TWIF is released without neither RRC signalling nor IKEv2 signalling.

## 4.13 Specific services

### 4.13.1 General

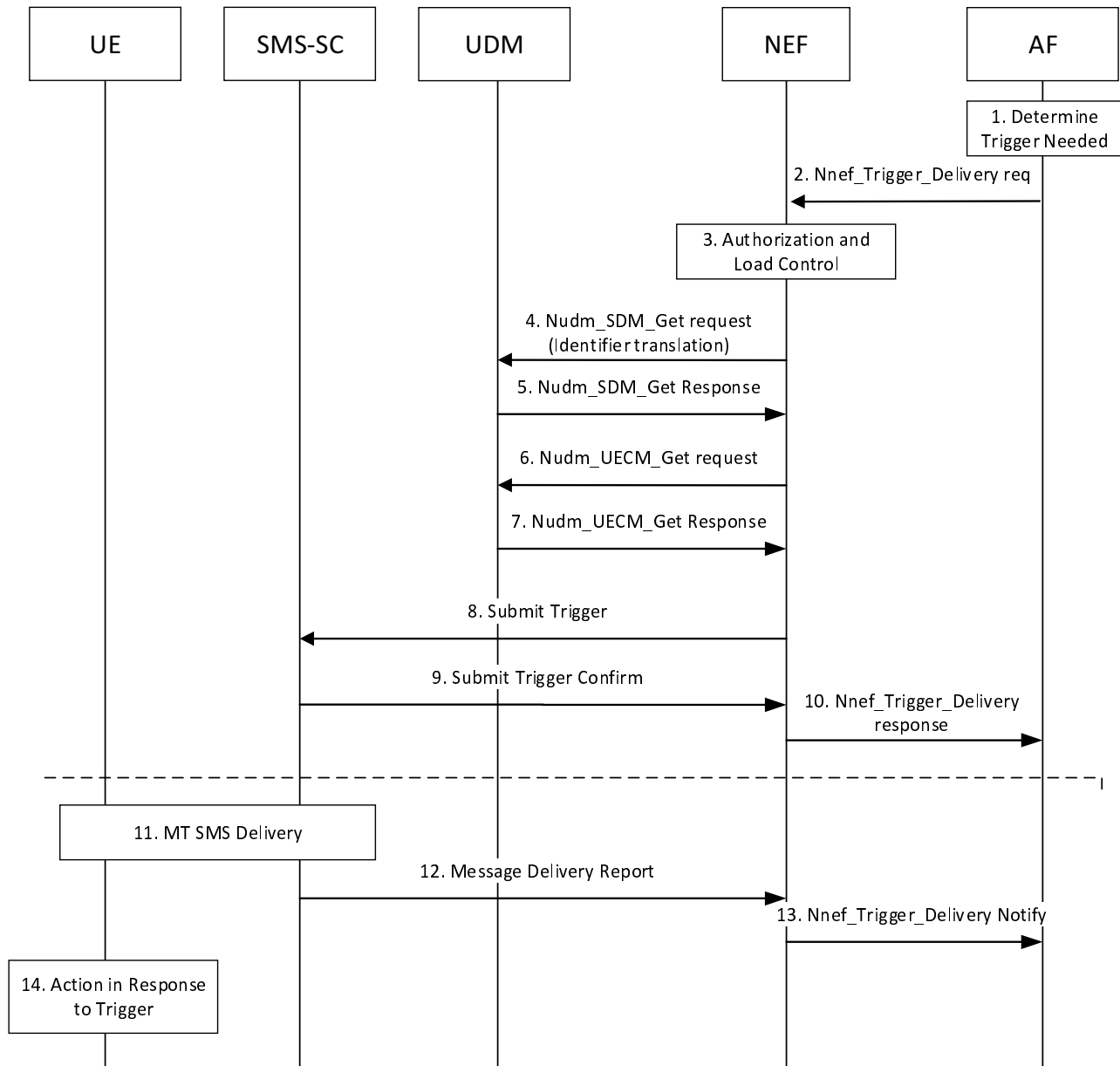
Clause 4.13 defines the additional procedures or additions to the existing procedures to support specific services such as SMS over NAS.

## 4.13.2 Application Triggering

### 4.13.2.1 General

The AF invokes the Nnef\_Trigger service to request that the network send an Application trigger to the UE.

### 4.13.2.2 The procedure of "Application Triggering" Service



**Figure 4.13.2.2-1: Device triggering procedure via Nnef**

1. The AF determines the need to trigger the device. If the AF has no contact details for the NEF, it shall discover and select NEF services.
2. The AF invokes the Nnef\_Trigger\_Delivery request service.
3. The NEF checks that the AF is authorised to send trigger requests and that the AF has not exceeded its quota or rate of trigger submission over Nnef. If this check fails, the NEF sends an Nnef\_Trigger\_Delivery response with a cause value indicating the reason for the failure condition and the flow stops at this step. Otherwise, the flow continues with step 4.

4. The NEF invokes Nudm\_SDM\_Get (Identifier Translation, GPSI and AF Identifier) to resolve the GPSI to SUPI when the AF is authorized to trigger the UE.

NOTE 1: Optionally, mapping from GPSI (External Id) to GPSI (MSISDN) is also provided for legacy SMS infrastructure not supporting MSISDN-less SMS.

5. The UDM may invoke the Nudr\_DM\_Query service to retrieve a list of AF's that are allowed to trigger the UE and determines, based on UDM policy, which identifier (SUPI or MSISDN) should be used to trigger the UE. The UDM provides a Nudm\_SDM\_Get response (SUPI, optionally MSISDN). If the AF is not allowed to send a trigger message to this UE, or there is no valid subscription information for this user, the NEF sends an Nnef\_Trigger\_Delivery response with a cause value indicating the reason for the failure condition and the flow stops at this step. Otherwise this flow continues with step 6.

NOTE 2: The presence of an MSISDN in the reply is interpreted as an indication to the NEF that MSISDN is used (instead of IMSI) to identify the UE when sending the SMS to the SMS-SC via T4.

6. The NEF invokes Nudm\_UECM\_Get (GPSI, SMS) to retrieve the UE SMSF identities.
7. The UDM may invoke the Nudr\_DM\_Query service to retrieve the UE SMSF identities. The UDM provides a Nudm\_UECM\_Get response with the corresponding UE SMSF identities. UDM policy (possibly dependent on the VPLMN ID) may influence which serving node identities are returned.

NOTE 3: The NEF can cache serving node information for the UE. However, this can increase the probability of trigger delivery attempt failures when the cached serving node information is stale.

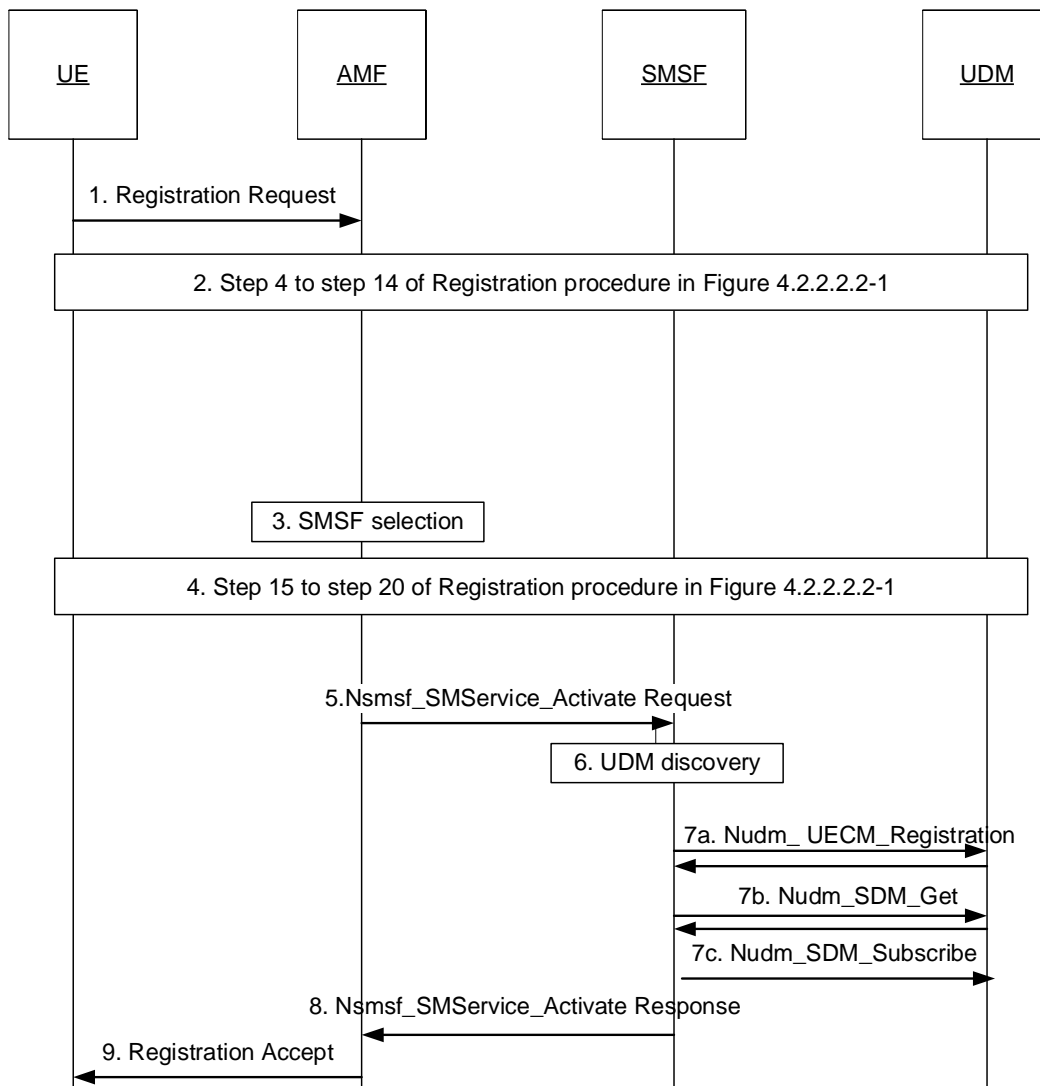
8. The NEF selects a suitable SMS-SC based on configured information. The NEF acts as an MTC-IWF and sends a Submit Trigger (GPSI, SUPI, AF Identifier, trigger reference number, validity period, priority, SMSF serving node ID(s) (if available, are obtained from UDM in step 7), SMS Application port ID, trigger payload, Trigger Indication) message to the SMS-SC.

If the NEF indicates that "Absent subscriber" was received from the UDM, the SMS-SC should not submit the message, but store it directly and send Routing Information for SM to request the UDM to add the SMS-SC address to the Message Waiting List.

9. The SMS-SC sends a Submit Trigger Confirm message to the NEF to confirm that the submission of the SMS has been accepted by the SMS-SC.
10. The NEF sends a Nnef\_Trigger\_Delivery response to the AF to indicate if the Device Trigger Request has been accepted for delivery to the UE.
11. The SMS\_SC performs MT SMS delivery as defined in clause 4.13.3. The SMS-SC may provide the routing information that it received in step 6 to SMS-GMSC to avoid UDM interrogation. The SMS-SC generates the necessary CDR information and includes the AF Identifier. The SMS Application port ID, which is included in the SM User Data Header and the Trigger Indication are included in the CDRs in order to enable differentiated charging. The SMS-SC stores the trigger payload, without routing information. If the message delivery fails and is attempted to be delivered again, UDM interrogation will be performed. If the message delivery fails and the validity period of this trigger message is not set to zero, the SMS-SC shall send a SM Message Delivery Status Report to request the UDM to add the SMS-SC address to the Message Waiting list. When the message delivery is later re-attempted, a new UDM interrogation will be performed by the SMS-GMSC using SUPI or MSISDN. UDM interrogations using SUPI shall not be forwarded or relayed to SMS-Router or IP-SM-GWs. The UDM may include up to four serving node identities (MSC or MME, SGSN, IP-SM-GW, AMF) in the response to SMS-GMSC.
12. If the message delivery fails (either directly or when validity period of the trigger message expires) or when the message delivery succeeds, the SMS-SC shall send a Message Delivery Report (cause code, trigger reference number, AF Identifier) to the NEF.
13. The NEF provides a Nnef\_Trigger\_DeliveryNotify message to the AF with a Delivery Report indicating the trigger delivery outcome (e.g. succeeded, unknown or failed and the reason for the failure). The NEF generates the necessary CDR information including the GPSI and AF Identifier.
14. In response to the received device trigger, the UE takes specific actions and may take into consideration the content of the trigger payload. This action typically involves initiation of immediate or later communication with the AF.

### 4.13.3 SMS over NAS procedures

#### 4.13.3.1 Registration procedures for SMS over NAS



**Figure 4.13.3.1-1: Registration procedure supporting SMS over NAS**

1. During Registration procedure in 5GS defined in Figure 4.2.2.2-1, to enable SMS over NAS transporting, the UE includes an "SMS supported" indication in Registration Request in step 1-3 indicating the UE's capability for SMS over NAS transport. The "SMS supported" indication indicates whether the UE supports SMS delivery over NAS.
2. Step 4 to step 14 of the Registration procedure in Figure 4.2.2.2-1 are performed. The AMF may retrieve the SMS Subscription data and UE Context in SMSF data using Nudm\_SDM\_Get. This requires that UDM may retrieve this information from UDR by Nudr\_DM\_Query. The UDM includes the SMSF information in the Nudm\_SDM\_Get response message if the stored SMSF belongs to the same PLMN of the AMF. After a successful response is received and if SMS service is allowed, the AMF subscribes to be notified using Nudm\_SDM\_Subscribe when the SMS Subscription data is modified and UDM may subscribe to UDR by Nudr\_DM\_Subscribe.

The AMF can also receive UE context information containing SMSF Information from old AMF. When AMF re-allocation happens during the Registration procedure, the old AMF transfers SMSF Information to the new AMF as part of UE context in step 5 of Figure 4.2.2.2-1.

NOTE 1: The AMF can, instead of the Nudm\_SDM\_Get service operation, use the Nudm\_SDM\_Subscribe service operation with an Immediate Report Indication that triggers the UDM to immediately return the subscribed data if the corresponding feature is supported by both the AMF and the UDM.

3. If the "SMS supported" indication is included in the Registration Request, the AMF checks in the SMS Subscription data that was received in step 2 whether the SMS service is allowed to the UE. If SMS service is allowed and the UE context received in step 2 includes an available SMSF of the serving PLMN, the AMF activates this SMSF Address and continues the registration procedure. If SMS service is allowed but an SMSF of the serving PLMN was not received in step 2, the AMF discovers and selects an SMSF to serve the UE as described in clause 6.3.10 of TS 23.501 [2].
4. Step 15 to step 20 of the Registration procedure in Figure 4.2.2.2-1 are performed.
5. The AMF invokes Nsmsf\_SMSservice\_Activate service operation from the SMSF. The invocation includes AMF address, Access Type, RAT Type, Trace Requirements, GPSI (if available) and SUPI. AMF uses the SMSF Information derived from step 3. Trace Requirements is provided if it has been received by AMF as part of subscription data.
6. The SMSF discovers a UDM as described in clause 6.3.8 of TS 23.501 [2].
- 7a. If the UE context for the current Access Type already exists in the SMSF, the SMSF shall replace the old AMF address with the new AMF address.

Otherwise, the SMSF considers this a Registration request from a new Access Type and the SMSF registers with the UDM using Nudm\_UECM\_Registration with Access Type. As a result, the UDM stores the following information: SUPI, SMSF identity, SMSF address, Access Type in UE Context in SMSF data. The UDM may further store SMSF Information in UDR by Nudr\_DM\_Update (SUPI, Subscription Data, UE Context in SMSF data).

If the Nsmsf\_SMSservice\_Activate request contains two Access Types and one of them is already registered in the SMSF, the SMSF shall replace the old AMF address with the new AMF address for that Access Type. The SMSF shall then register the other Access Type with the UDM using Nudm\_UECM\_Registration request.

- 7b-7c SMSF retrieves SMS Management Subscription data (e.g. SMS teleservice, SMS barring list) using Nudm\_SDM\_Get and this requires that UDM may get this information from UDR by Nudr\_DM\_Query (SUPI, Subscription Data, SMS Management Subscription data). After a successful response is received, the SMSF subscribes to be notified using Nudm\_SDM\_Subscribe when the SMS Management Subscription data is modified and UDM may subscribe to notifications from UDR by Nudr\_DM\_Subscribe.

SMSF also creates a UE context to store the SMS subscription information and the AMF address that is serving this UE.

NOTE 2: The SMSF can, instead of the Nudm\_SDM\_Get service operation, use the Nudm\_SDM\_Subscribe service operation with an Immediate Report Indication that triggers the UDM to immediately return the subscribed data if the corresponding feature is supported by both the SMSF and the UDM.

8. The SMSF responds back to the AMF with Nsmsf\_SMSservice\_Activate service operation response message. The AMF stores the SMSF Information received as part of the UE context.
9. The AMF includes the "SMS allowed" indication to the UE in the Registration Accept message of step 21 of Figure 4.2.2.2-1 only after step 8 in which the AMF has received a positive indication from the selected SMSF.

The "SMS allowed" indication in the Registration Accept message indicates to the UE whether the network allows the SMS message delivery over NAS.

#### 4.13.3.2 Deregistration procedures for SMS over NAS

If UE indicates to AMF that it no longer wants to send and receive SMS over NAS (e.g. not including "SMS supported" indication in subsequent Registration Request message) or AMF considers that UE is deregistered on specific Access Type(s) or AMF receives Deregistration Notification from UDM for specific Access Type(s) indicating UE Initial Registration, Subscription Withdrawn or 5GS to EPS Mobility as specified in clause 5.2.3.2.2, then:

- AMF may, if the UE is not registered at other Access Type at the AMF any more, unsubscribe from SMS Subscription data changes notification with the UDM by means of the Nudm\_SDM\_Unsubscribe service operation.
- AMF invokes Nsmsf\_SMSservice\_Deactivate service operation to trigger the release of UE Context for SMS on SMSF for the impacted Access Type(s) based on local configurations.
- AMF may, if the UE is not registered at other Access Type at the AMF anymore, delete or deactivate the stored SMSF address in its UE Context.
- The SMSF unsubscribes from SMS Management Subscription data changes notification with the UDM by means of the Nudm\_SDM\_Unsubscribe service operation if the UE is not registered at other Access Type for SMS over NAS service at the SMSF anymore.
- The SMSF shall invoke Nudm\_UECM\_Deregistration (SUPI, NF ID, Access Type) service operation from UDM to trigger UDM to delete SMSF address of the UE for the impacted Access Type(s). The SMSF also removes the UE Context for SMS for the impacted Access Type(s), including AMF address.
- The UDM may update UE context in SMSF in UDR by Nudr\_DM\_Update (SUPI, Subscription Data, SMS Subscription data, SMSF address). The UDM may remove the corresponding subscription of data change notification in UDR by Nudr\_DM\_Unsubscribe service operation.

4.13.3.3 MO SMS over NAS in CM-IDLE (baseline)

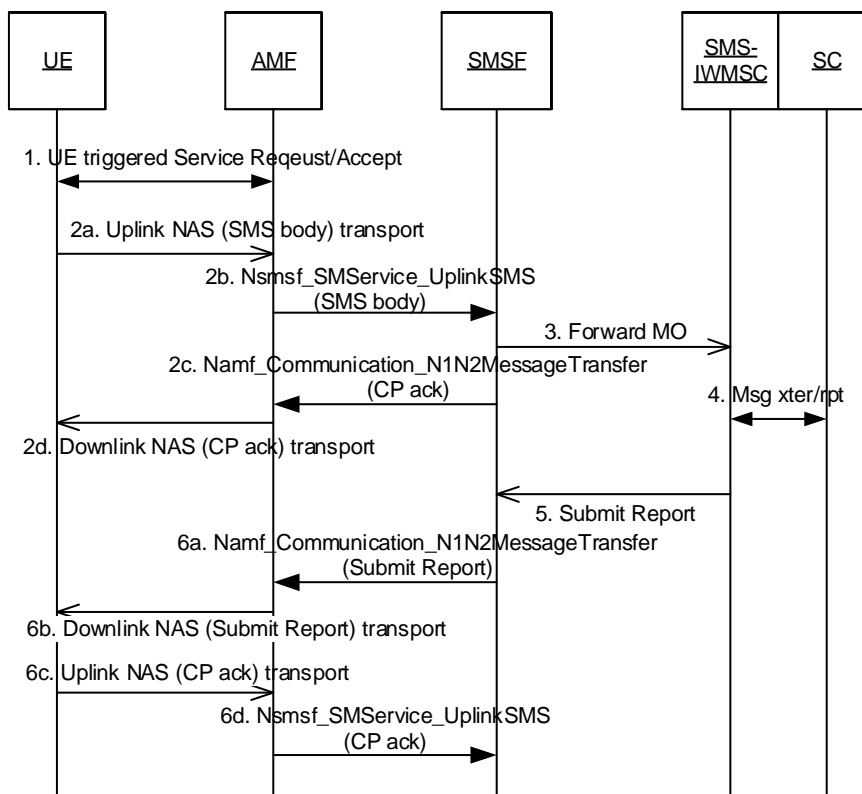


Figure 4.13.3.3-1: MO SMS over NAS

1. The UE performs domain selection for UE originating SMS as defined in clause 5.16.3.8 of TS 23.501 [2] if SMS delivery via non 3GPP access is allowed and possible. If an UE under CM-IDLE state is going to send uplink SMS message, then UE and network perform the UE Triggered Service Request procedure firstly as defined in clause 4.2.3.2 to establish a NAS signalling connection to AMF.

- 2a. The UE builds the SMS message to be sent as defined in TS 23.040 [7] (i.e. the SMS message consists of CP-DATA/RP-DATA/TPDU/SMS-SUBMIT parts). The SMS message is encapsulated in an NAS message with an indication indicating that the NAS message is for SMS transporting. The UE send the NAS message to the AMF.
- 2b. The AMF forwards the SMS message and SUPI to the SMSF serving the UE over N20 message by invoking Nsmsf\_SMSservice\_UplinkSMS service operation. In order to permit the SMSF to create an accurate charging record, the AMF adds the IMEISV, the current UE Location Information (ULI) of the UE as defined in clause 5.6.2 of TS 23.501 [2] and, if the UE has sent the SMS via 3GPP access, the local time zone.
- 2c. The SMSF invokes Namf\_Communication\_N1N2MessageTransfer service operation to forward SMS ack message to AMF.
- 2d. The AMF forwards the SMS ack message from the SMSF to the UE using downlink unit data message.
- 3-5. The SMSF checks the SMS management subscription data. If SMS delivery is allowed, the procedure defined in TS 23.040 [7] applies.
- 6a-6b. The SMSF forwards the submit report to AMF by invoking Namf\_Communication\_N1N2MessageTransfer service operation which is forwarded to UE via Downlink NAS transport. If the SMSF knows the submit report is the last message to be transferred for UE, the SMSF shall include a last message indication in the Namf\_Communication\_N1N2MessageTransfer service operation so that the AMF knows no more SMS data is to be forwarded to UE.

NOTE: The behaviour of AMF based on the "last message indication" is implementation specific.

If the UE has more than one SMS message to send, the AMF and SMSF forwards SMS /SMS ack/submit report the same way as described in step 2a-6b.

- 6c-6d. When no more SMS is to be sent, UE returns a CP-ack as defined in TS 23.040 [7] to SMSF. The AMF forwards the SMS ack message by invoking Nsmsf\_SMSservice\_UplinkSMS service operation to SMSF.

#### 4.13.3.4 Void

#### 4.13.3.5 MO SMS over NAS in CM-CONNECTED

MO SMS in CM-CONNECTED State procedure is specified by reusing the MO SMS in CM-IDLE State without the UE Triggered Service Request procedure.

4.13.3.6 MT SMS over NAS in CM-IDLE state via 3GPP access

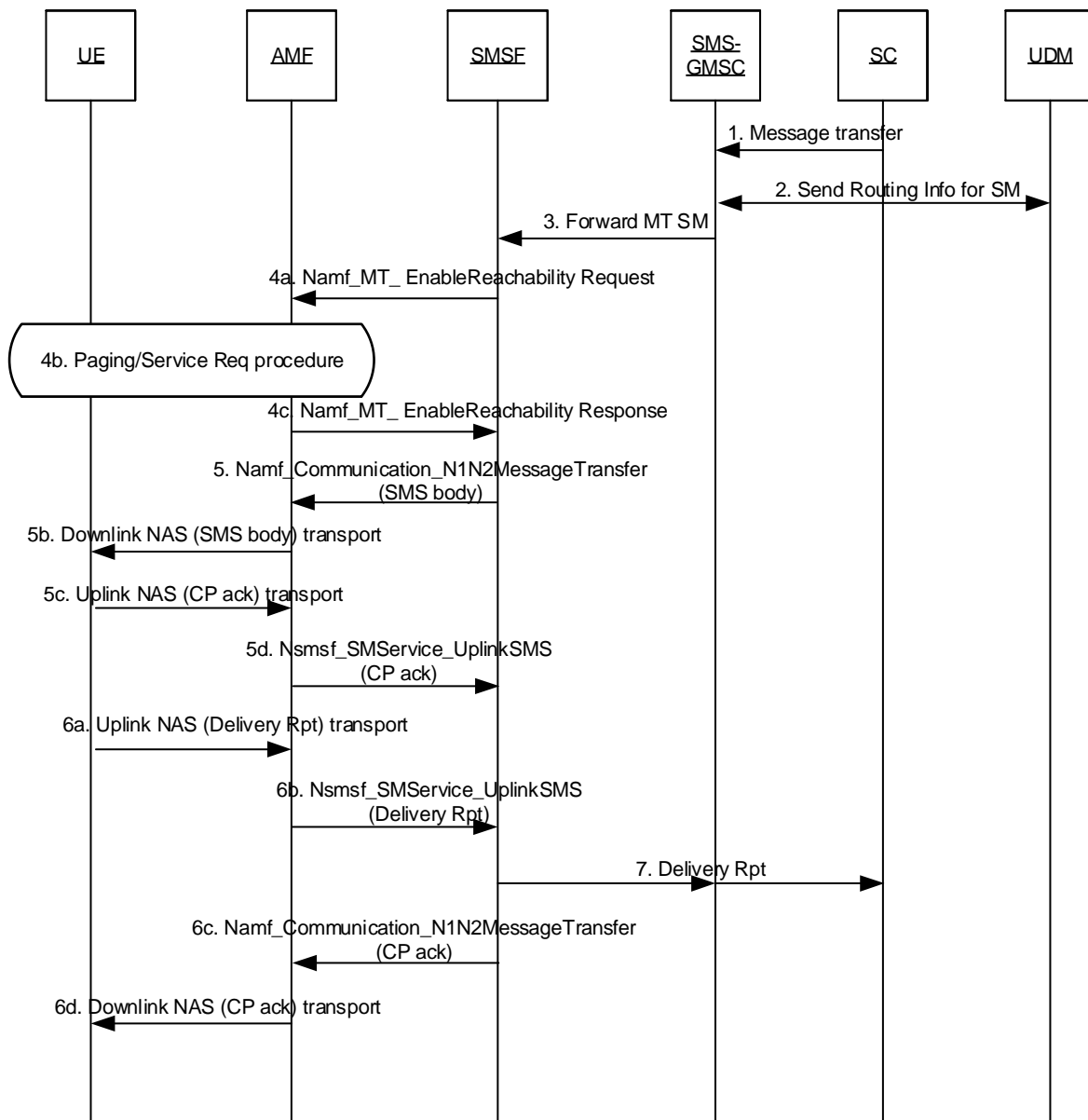


Figure 4.13.3.6-1: MT SMS over NAS in CM\_IDLE state via 3GPP access

1-3 MT SMS interaction between SC/SMS-GMSC/UDM follow the current procedure as defined in TS 23.040 [7]. If there are two AMFs serving the UE, one is for 3GPP access and another is for non-3GPP access, there are two SMSF addresses stored in UDM/UDR. The UDM shall return both SMSF addresses.

4. The SMSF checks the SMS management subscription data. If SMS delivery is allowed, SMSF invokes Namf\_MT\_EnableUERachability service operation to AMF. AMF pages the UE using the procedure defined in clause 4.2.3.4. The UE responds to the page with Service Request procedure.

If the AMF indicates SMSF that UE is not reachable, the procedure of the unsuccessful Mobile terminating SMS delivery described in clause 4.13.3.9 is performed and the following steps are skipped.

If the UE access to the AMF via both 3GPP access and non-3GPP access, the AMF determines the Access Type to transfer the MT-SMS based on operator local policy.



5a-5b. SMSF forward the SMS message to be sent as defined in TS 23.040 [7] (i.e. the SMS message consists of CP-DATA/RP-DATA/TPDU/SMS-DELIVER parts) to AMF by invoking Namf\_Communication\_N1N2MessageTransfer service operation. The AMF transfers the SMS message to the UE.

5c-5d. The UE acknowledges receipt of the SMS message to the SMSF. For uplink unitdata message toward the SMSF, the AMF invokes Nsmsf\_SMSservice\_UplinkSMS service operation to forward the message to SMSF. In order to permit the SMSF to create an accurate charging record, the AMF also includes IMEISV, the current UE Location Information (ULI) of the UE as defined in clause 5.6.2 of TS 23.501 [2] and, if the SMS is delivered to the UE via 3GPP access, the local time zone.

6a-6b. The UE returns a delivery report as defined in TS 23.040 [7]. The delivery report is encapsulated in an NAS message and sent to the AMF which is forwarded to SMSF by invoking Nsmsf\_SMSservice\_UplinkSMS service operation.

6c-6d. The SMSF acknowledges receipt of the delivery report to the UE. The SMSF uses Namf\_Communication\_N1N2MessageTransfer service operation to send SMS CP ack message to the AMF. The AMF encapsulates the SMS message via a NAS message to the UE. If SMSF has more than one SMS to send, the SMSF and the AMF forwards subsequent SMS /SMS ack/ delivery report the same way as described in step 4-6c.

If the SMSF knows the SMS CP ack is the last message to be transferred for UE, the SMSF shall include a last message indication in the Namf\_Communication\_N1N2MessageTransfer service operation so that the AMF knows no more SMS data is to be forwarded to UE.

NOTE: The behaviour of AMF based on the "last message indication" is implementation specific.

7. In parallel to steps 6c and 6d, the SMSF delivers the delivery report to SC as defined in TS 23.040 [7].

#### 4.13.3.7 MT SMS over NAS in CM-CONNECTED state via 3GPP access

MT SMS in CM-CONNECTED procedure is specified by reusing the MT SMS in CM-IDLE state with the following modification:

- There is no need for the AMF to perform Paging of the UE and can immediately continue with a message to SMSF via N20 to allow the SMSF to start forward the MT SMS.
- If the delivery of the NAS PDU containing the SMS fails e.g. if the UE is in RRC Inactive and NG-RAN paging was not successful, the NG-RAN initiates the UE context release in the AN procedure and provides notification of non-delivery to the AMF. The AMF provides an indication of non-delivery to the SMSF.

#### 4.13.3.8 MT SMS over NAS via non-3GPP access

MT SMS procedure via non-3GPP access is specified by reusing the MT SMS via 3GPP access in CM-CONNECTED state with the following modification:

- If the UE accesses the network via both 3GPP and non-3GPP accesses and the AMF determines to deliver MT-SMS via non-3GPP access based on operator policy in step 4, the NAS message is transferred via non-3GPP Access Network.

#### 4.13.3.9 Unsuccessful Mobile terminating SMS delivery re-attempt

The procedure of Unsuccessful Mobile terminating SMS delivery re-attempt is defined as follows:

- If the UE is registered over both 3GPP access and non-3GPP access in the same AMF (i.e. the UE is registered in the same PLMN for both access types):
  - if the MT-SMS delivery over one Access Type has failed, the AMF, based on operator local policy, may re-attempt the MT-SMS delivery over the other Access Type before indicating failure to SMSF;
  - if the MT-SMS delivery on both Access Types has failed, the AMF shall inform the SMSF immediately.
- If the AMF informs the SMSF that it cannot deliver the MT-SMS to the UE, the SMSF sends a failure report to the first SMS-GMSC (which can be co-located with IP-SM-GW or SMS Router) as defined in TS 23.040 [7]. If

the SMS-GMSC has more than one entity for SMS transport towards the UE, then upon receiving MT-SMS failure report, the SMS-GMSC, based on operator local policy, may re-attempt the MT-SMS delivery via the other entity.

- After the first SMS-GMSC informs the UDM/HSS that the UE is not able to receive MT-SMS, the UDM shall set the URRP-AMF flag and store the SC address in the MWD list as defined in TS 23.040 [7].
- If the UE is registered in an AMF and the UDM has not subscribed to UE Reachability Notification in the AMF yet, the UDM immediately initiates a subscription procedure as specified in clause 4.2.5.2.
- When the AMF detects UE activities, it notifies UDM with UE Activity Notification as described in clause 4.2.5.3. If the UE is registered in an SMSF, the UDM clears its URRP-AMF flag and the UDM/HSS clears the MWD list and alerts related SCs to retry MT-SMS delivery. Otherwise, if the UE is not registered in an SMSF, the UDM clears its URRP-AMF flag but the UDM/HSS keeps the MWD list to notify the SC upon subsequent SMSF registration for the UE.
- When the SMS-GMSC requests routing information from UDM/HSS for a UE not registered in 5GC, or for a registered UE which has not been yet registered for SMS service, the UDM/HSS responds to the SMS-GMSC that the UE is absent, stores the SC address in the MWD list (if not yet stored) and indicates that to the SC as defined in TS 23.040 [7].

When the UDM receives an Nudm\_UECM\_Registration Request from an SMSF for a UE for which the MWD list is stored and no URRP-AMF flag is set, the UDM/HSS alerts the related SCs to retry the MT-SMS delivery and clears the MWD list.

NOTE: This scenario assumes that the UE is not in 2G/3G/4G coverage.

## 4.13.4 Emergency Services

### 4.13.4.1 General

If the 5GS supports Emergency Services, the support is indicated to UE via the Registration Accept message on per-TA-list and per-RAT basis, as described in TS 23.501 [2].

If the 5GS supports Emergency Services Fallback, the support is indicated to UE via the Registration Accept message on per-TA-list and per-RAT basis, as described in TS 23.501 [2].

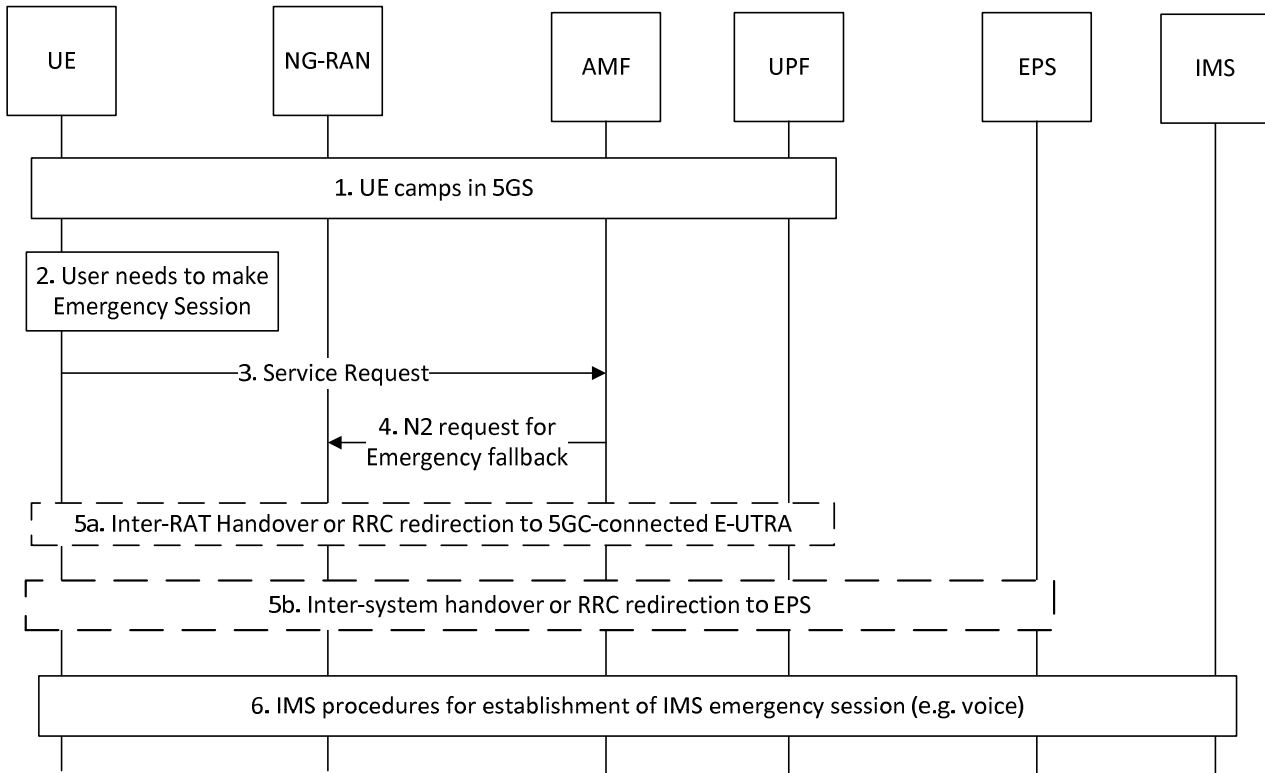
The UE shall follow the domain selection rules for emergency session attempts as described in TS 23.167 [28].

If the 5GC has indicated Emergency Services Fallback support for the TA and RAT where the UE is currently camping and if the UE supports emergency services fallback, the UE shall initiate the Emergency Services Fallback procedure described in clause 4.13.4.2.

At QoS Flow establishment request for Emergency Services, the procedure described in clause 4.13.6.2 Inter RAT Fallback in 5GC for IMS voice or the procedure described in clause 4.13.6.1 EPS fallback for IMS voice may be triggered by the network, when configured.

### 4.13.4.2 Emergency Services Fallback

The call flow in Figure 4.13.4.2-1 describes the procedure for emergency services fallback.



**Figure 4.13.4.2-1: Emergency Services Fallback**

1. UE camps on E-UTRA or NR cell in the 5GS (in either CM\_IDLE or CM\_CONNECTED state).
2. UE has a pending IMS emergency session request (e.g. voice) from the upper layers.
3. If the AMF has indicated support for emergency services using fallback via the Registration Accept message for the current RAT, the UE sends a Service Request message indicating that it requires emergency services fallback. The UE is not required to include the PDU Sessions that are not relevant for the emergency service in the List Of PDU Sessions to be Activated in the Service Request for the emergency service.

NOTE 1: If the UE includes PDU Sessions to be Activated in the Service Request for the emergency service, it will delay the Emergency Services Fallback procedure.

4. 5GC triggers a request for Emergency Services Fallback by executing an NG-AP procedure in which it indicates to NG-RAN that this is a fallback for emergency services. The AMF based on the support of Emergency Services in EPC or 5GC may indicate the target CN for the RAN node to know whether inter-RAT fallback or inter-system fallback is to be performed. When AMF initiates Redirection for UE(s) that have been successfully authenticated, AMF includes the security context in the request to trigger fallback towards NG-RAN.
5. Based on the target CN if indicated in message 4 or otherwise based on the RAN configuration, one of the following procedures is executed by NG-RAN:
  - 5a. NG-RAN initiates handover (see clause 4.9.1.3) or redirection to a 5GC-connected E-UTRAN cell, if UE is currently camped on NR.
  - 5b. NG-RAN initiates handover (see clause 4.11.1.2.1) or redirection to E-UTRAN connected to EPS. NG-RAN uses the security context provided by the AMF to secure the redirection procedure.

If the redirection procedure is used either in 5a or 5b the target CN type (EPC or 5GC) is also conveyed to the UE in order to be able to perform the appropriate NAS procedures (S1 or N1 Mode). The UE uses the emergency indication in the RRC message as specified in clause 6.2.2 of TS 36.331 [16] and E-UTRAN provides the emergency indication to AMF (during Registration triggered by step 5a) and MME (during Tracking Area Update triggered by step 5b). Both the Registration and the Tracking Area Update requests should contain

Follow-on request and active flag respectively to indicate that the UE has "user data pending". For the handover procedure used in step 5b see clause 4.11.1.2.1, step 1.

In step 5b, if the MME does not support emergency services for that UE, the MME should act such that the call for emergency service is likely to succeed promptly, e.g. if the UE successfully completed a combined TA/LA Update with the network, by using the CSFB procedures specified in TS 23.272 [61].

NOTE 2: If such a combined TA/LA Update is not successful, or the UE did not request a combined update, then, as specified in TS 23.167 [28], the UE autonomously selects a RAT that may (but which might not) support the CS domain.

6. After handover or redirection to the target cell the UE establishes a PDU Session / PDN connection for IMS emergency services and performs the IMS procedures for establishment of an IMS emergency session (e.g. voice) as defined in TS 23.167 [28].

At least for the duration of the emergency voice call, the E-UTRAN connected to EPC is configured to not trigger any handover to 5GS and the target NG-RAN is configured to not trigger inter NG-RAN handover back to source NG-RAN.

## 4.13.5 Location Services procedures

### 4.13.5.0 General

Location Service procedures are defined in TS 23.273 [51].

### 4.13.5.1 5GC-NI-LR Procedure

Location Service procedures are defined in TS 23.273 [51].

### 4.13.5.2 5GC-MT-LR Procedure without UDM Query

Location Service procedures are defined in TS 23.273 [51].

### 4.13.5.3 5GC-MT-LR Procedure

Location Service procedures are defined in TS 23.273 [51].

### 4.13.5.4 UE Assisted and UE Based Positioning Procedure

Location Service procedures are defined in TS 23.273 [51].

### 4.13.5.5 Network Assisted Positioning Procedure

Location Service procedures are defined in TS 23.273 [51].

### 4.13.5.6 Obtaining Non-UE Associated Network Assistance Data

Location Service procedures are defined in TS 23.273 [51].

### 4.13.5.7 Location continuity for Handover of an Emergency session from NG-RAN

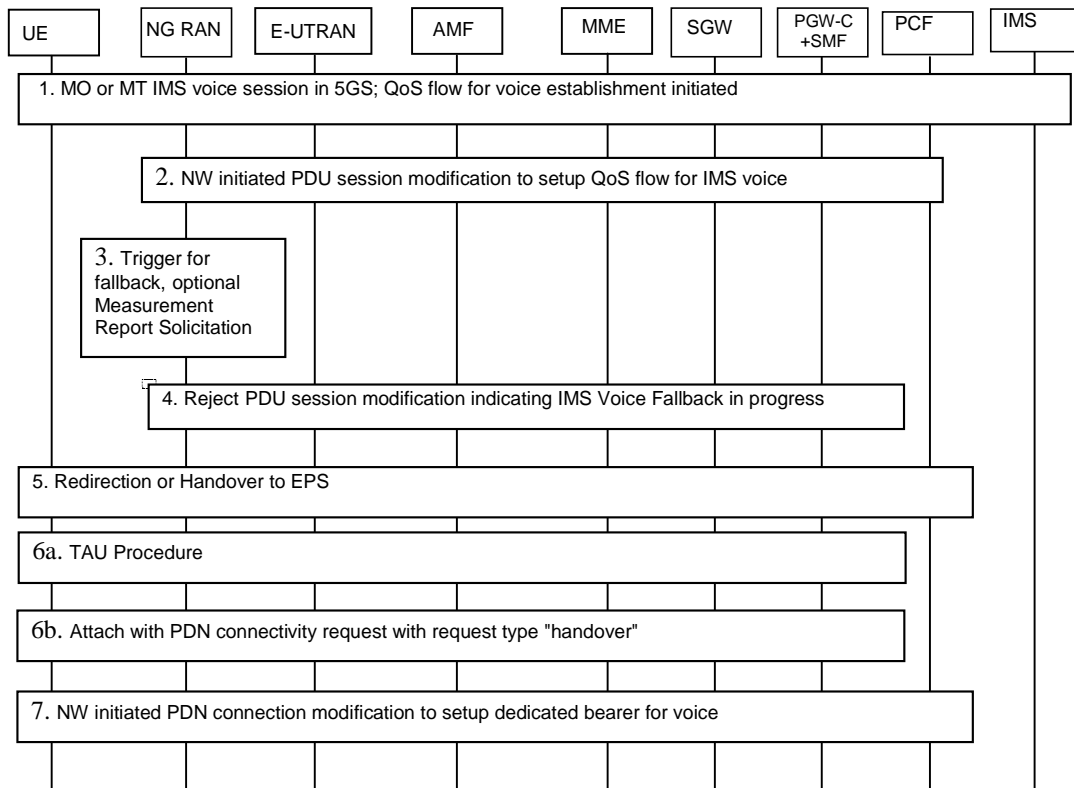
Location Service procedures are defined in TS 23.273 [51].

## 4.13.6 Support of IMS Voice

### 4.13.6.1 EPS fallback for IMS voice

Figure 4.13.6.1-1 describes the EPS fallback procedure for IMS voice.

When the UE is served by the 5G System, the UE has one or more ongoing PDU Sessions each including one or more QoS Flows. The serving PLMN AMF has sent an indication towards the UE during the Registration procedure that IMS voice over PS session is supported, see clause 5.16.3.10 of TS 23.501 [2] and the UE has registered in the IMS. If N26 is not supported, the serving PLMN AMF sends an indication towards the UE during the Registration procedure that interworking without N26 is supported, see clause 5.17.2.3.1 of TS 23.501 [2].



**Figure 4.13.6.1-1: EPS Fallback for IMS voice**

1. UE camps on NG-RAN in the 5GS and an MO or MT IMS voice session establishment has been initiated.
2. Network initiated PDU Session modification to setup QoS flow for voice reaches the NG-RAN (see N2 PDU Session Request in clause 4.3.3).
3. NG-RAN is configured to support EPS fallback for IMS voice and decides to trigger fallback to EPS, taking into account UE capabilities, indication from AMF that "Redirection for EPS fallback for voice is possible" (received as part of initial context setup, handover resource allocation or path switch request acknowledge as defined in TS 38.413 [10]), network configuration (e.g. N26 availability configuration) and radio conditions. If NG-RAN decides not to trigger fallback to EPS, then the procedure stops here and following steps are not executed.

NG-RAN may initiate measurement report solicitation from the UE including E-UTRAN as target.

NOTE 1: If AMF has indicated that "Redirection for EPS fallback for voice is not possible", then EPS fallback for IMS voice is not performed in step 5. If NG-RAN has not received indication "Redirection for EPS fallback for voice", the decision to execute EPS fallback for IMS voice or not is based on network configuration (e.g. based on N26 availability and other criteria).

4. NG-RAN responds indicating rejection of the PDU Session modification to setup QoS flow for IMS voice received in step 2 by PDU Session Modification Response message towards the SMF+PGW-C (or H-SMF+PGW-C via V-SMF, in the case of home routed roaming scenario) via AMF with an indication that mobility due to fallback for IMS voice is ongoing. The SMF+PGW-C maintains the PCC rule(s) associated with the QoS Flow(s) and reports the EPS Fallback event to the PCF if PCF has subscribed to this event.
5. NG-RAN initiates either handover (see clause 4.11.1.2.1), or AN Release via inter-system redirection to EPS (see clause 4.2.6 and clause 4.11.1.3.2), taking into account UE capabilities. The SMF+PGW-C reports change of the RAT type if subscribed by PCF as specified in clause 4.11.1.2.1, or clause 4.11.1.3.2.6. When the UE is connected to EPS, either 6a or 6b is executed

6a. In the case of 5GS to EPS handover, see clause 4.11.1.2.1 and in the case of inter-system redirection to EPS with N26 interface, see clause 4.11.1.3.2. In either case the UE initiates TAU procedure and the UE includes active flag in the request in the case of inter-system redirection to EPS; or

6b. In the case of inter-system redirection to EPS without N26 interface, see clause 4.11.2.2. If the UE supports Request Type flag "handover" for PDN connectivity request during the attach procedure as described in clause 5.3.2.1 of TS 23.401 [13] and has received the indication that interworking without N26 is supported, then the UE initiates Attach with PDN connectivity request with request type "handover".

In the case of inter-system redirection for the emergency service, the UE uses the emergency indication in the RRC message as specified in clause 6.2.2 of TS 36.331 [16] and E-UTRAN provides the emergency indication to MME during Tracking Area Update or Attach procedure. For the handover procedure see clause 4.11.1.2.1, step 1.

7. After completion of the mobility procedure to EPS or as part of the 5GS to EPS handover procedure, the SMF+PGW-C re-initiates the setup of the dedicated bearer(s) for the maintained PCC rule(s) in step 4 including of the dedicated bearer for IMS voice, mapping the 5G QoS to EPC QoS parameters as specified in clause 4.11.1.2.1. The SMF+PGW-C reports about Successful Resource Allocation and Access Network Information if subscribed by PCF.

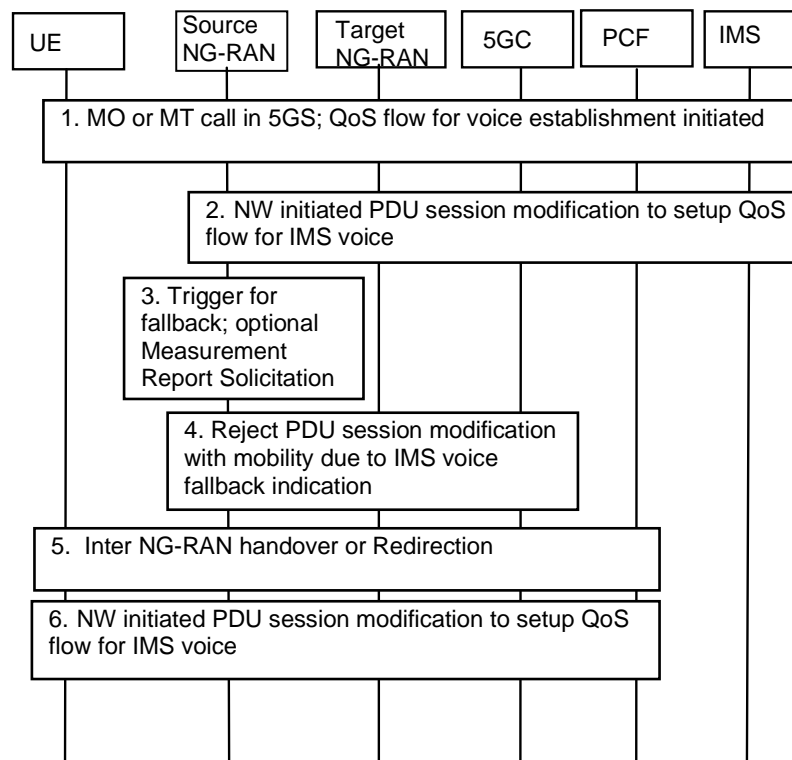
The IMS signalling related to IMS voice call establishment continues after step 1 as specified in the TS 23.228 [55].

At least for the duration of the voice call in EPS the E-UTRAN is configured to not trigger any handover to 5GS.

#### 4.13.6.2 Inter RAT Fallback in 5GC for IMS voice

Figure 4.13.6.2-1 describes the RAT fallback procedure in 5GC for IMS voice.

When the UE is served by the 5GC, the UE has one or more ongoing PDU Sessions each including one or more QoS Flows. The serving PLMN AMF has sent an indication towards the UE during the Registration procedure that IMS voice over PS session is supported, see clause 5.16.3.10 of TS 23.501 [2] and the UE has registered in the IMS.



**Figure 4.13.6.2-1: RAT Fallback for IMS voice**

1. UE camps on source NG-RAN in the 5GS and an MO or MT IMS voice session establishment has been initiated.

2. Network initiated PDU Session modification to setup QoS flow for IMS voice reaches the source NG-RAN (see N2 PDU Session Request in clause 4.3.3).
3. If source NG-RAN is configured to support RAT fallback for IMS voice, source NG-RAN decides to trigger RAT fallback, taking into account on UE capabilities, network configuration and radio conditions.

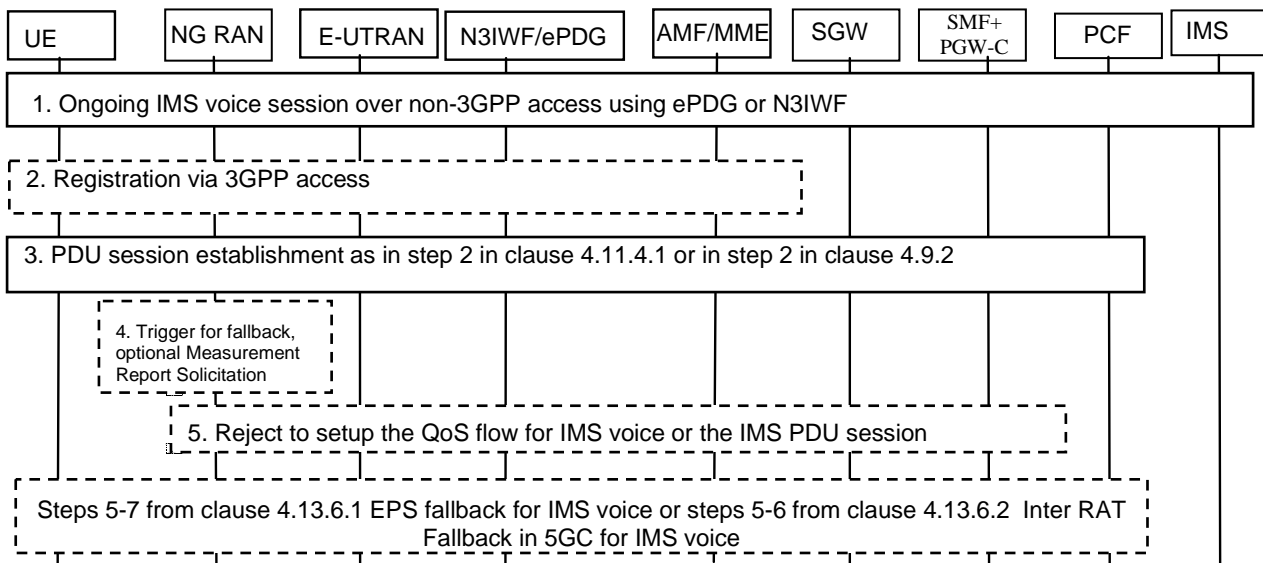
Source NG-RAN may initiate measurement report solicitation from the UE including target NG-RAN.

4. Source NG-RAN responds indicating rejection of the PDU Session modification to setup QoS flow for IMS voice received in step 2 by PDU Session Response message towards the SMF (or V-SMF, in the case of roaming scenario) via AMF with an indication that mobility due to fallback for IMS voice is ongoing. The SMF maintains the PCC rule(s) associated with the QoS Flow(s).
5. Source NG-RAN initiates Xn based Inter NG-RAN handover (see clause 4.9.1.2) or N2 based inter NG-RAN handover (see clause 4.9.1.3), or redirection to E-UTRA connected to 5GC (see clause 4.2.6). The SMF reports change of the RAT type if subscribed by PCF.
6. After completion of the Inter NG-RAN (inter-RAT) handover or redirection to E-UTRA connected to 5GC, the SMF re-initiates the PDU Session modification to setup QoS flow for IMS voice. The SMF reports about Successful Resource Allocation and Access Network Information if subscribed by PCF.

The IMS signalling related to IMS voice call establishment continues after step 1 as specified in TS 23.228 [55].

At least for the duration of the IMS voice call the target NG-RAN is configured to not trigger inter NG-RAN handover back to source NG-RAN.

#### 4.13.6.3 Transfer of PDU session used for IMS voice from non-3GPP access to 5GS



**Figure 4.13.6.3-1: Transfer of PDU session used for IMS voice from non-3GPP access to 5GS**

When the UE has an ongoing IMS voice session via non-3GPP access using ePDG or N3IWF and the session is transferred to NG-RAN, depending on the selected RAT in 5GS (NR or E-UTRA) and the support of EPS/inter-RAT fallback in NG-RAN, either the IMS voice session continues over NG-RAN (E-UTRA) or EPS/inter-RAT fallback is triggered.

Steps 1, 2 and 3 apply to either of the above two cases.

1. UE has ongoing IMS voice session via non-3GPP access using ePDG or N3IWF. UE is triggered to move to 3GPP access and camps in NG-RAN.
2. If the UE is not registered via 3GPP access, the UE shall initiate Registration procedure as defined in clause 4.2.2.2.2.

3. UE initiates PDU session establishment for the PDU session used for IMS voice service in order to initiate handover from EPC/ePDG to 5GS as defined in clause 4.11.4.1 step 2 or to initiate handover from N3IWF to 3GPP access in 5GC in step 2 of clauses 4.9.2.1 and 4.9.2.3. The SMF accepts the PDU session transfer from the UE.

NOTE 1: If the UE is aware (e.g. implementation-dependent mechanisms) that voice over NR may not be natively supported in the current Registration area, the UE can attempt to move to E-UTRA to initiate a handover of the IMS PDU Session to EPC or 5GC to continue the IMS voice session. The remaining steps are not executed.

4. NG-RAN may decide to trigger EPS or inter-RAT fallback, taking into account UE capabilities, indication from AMF that "Redirection for EPS fallback for voice is possible" (received as part of initial context setup as defined in TS 38.413 [10]), network configuration (e.g. N26 availability configuration) and radio conditions. NG-RAN may initiate measurement report solicitation from the UE including E-UTRA as target.

If NG-RAN does not trigger EPS or inter-RAT fallback, then the procedure stops here and following steps are not executed.

NOTE 2: If the AMF has indicated that "Redirection for EPS fallback for voice is not possible", then EPS fallback for IMS voice is not performed. If NG-RAN has not received indication "Redirection for EPS fallback for voice", the decision to execute EPS fallback for IMS voice or not is based on network configuration (e.g. based on N26 availability and other criteria).

5. NG-RAN responds indicating rejection either to set up the QoS flow for IMS voice or the entire PDU session used for IMS voice service as received in step 3 towards the SMF+PGW-C (or H-SMF+P-GW-C via V-SMF, in the case of roaming scenario) via AMF with an indication that mobility due to fallback for IMS voice is ongoing. The SMF+PGW-C reports the EPS Fallback event to the PCF if the PCF has subscribed to this event.

If NG-RAN responds indicating rejection to set up the QoS flow for IMS voice, steps 5-7 from clause 4.13.6.1 are executed if EPS fallback is triggered, or steps 5-6 from clause 4.13.6.2 are executed if inter-RAT Fallback for IMS voice is triggered. The SMF+PGW-C executes the release of resources in non-3GPP AN as specified in step 3 of clauses 4.11.4.1, 4.9.2.1 and 4.9.2.3.

NOTE 3: The timing of executing the release of resources in non-3GPP AN will depend on whether NG-RAN decides to trigger EPS or inter-RAT fallback but will take place at least after step 5.

If NG-RAN rejects entire PDU session used for IMS voice service, the SMF should stop the ongoing procedure and keep the PDN connection / PDU Session at non-3GPP side. The NG-RAN performs AN release with redirection or handover procedure.

NOTE 4: Depending on UE implementation, the UE can re-initiate handover of an IMS voice session over non-3GPP access to EPS if the inter-system change from 5GS to EPS is triggered by the NG-RAN and the UE does not receive a response to the PDU session establishment request i.e. when the establishment of the entire PDU session used for voice is rejected by NG-RAN.

## 4.13.7 MSISDN-less MO SMS

### 4.13.7.1 General

The Nnef\_MSISDN-less\_MO\_SMS service is used by the NEF to send the MSISDN-less MO SMS to the AF.



## 4.13.7.2 The procedure of MSISDN-less MO SMS Service

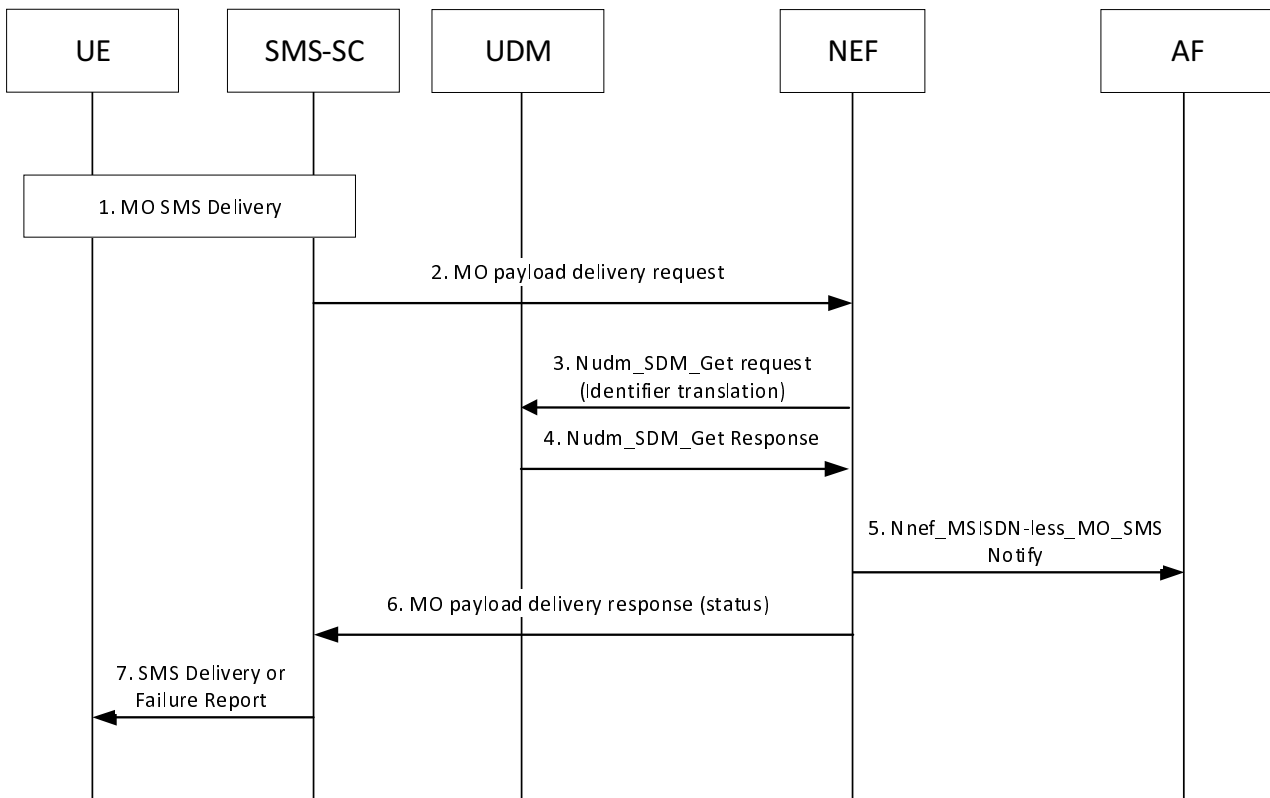


Figure 4.13.7.2-1: MSISDN-less MO SMS procedure via Nnef

1. The UE uses SMS over NAS procedures in clause 4.13.3 to send an SMS to the AF.

The service centre address points to the SMS-SC which contains the function described in this procedure, the destination SME address is set to short/long code of the AF and the Application Port ID element of the TP-User-Data field is set to the appropriate value.

For MSISDN-less subscription, the dummy MSISDN is used. This MSISDN and the IMSI of the UE are sent to SMS-SC.

2. SMS-SC uses the destination SME address (long/short code of the AF) to identify the corresponding NEF based on a pre-configured mapping table. SMS-SC extracts the SMS payload, Application port ID and IMSI of the UE and delivers them to NEF along with the destination SME address (long/short code of the AF). The NEF acts as an MTC-IWF in this procedure.
3. The NEF invokes Nudm\_SDM\_Get (Identifier Translation, IMSI, Application Port ID, AF Identifier) to resolve the IMSI and Application Port ID to a GPSI (External Id).
4. The UDM provides a Nudm\_SDM\_Get response (GPSI). If the UE is not allowed to send an SMS payload to this AF, or there is no valid subscription information for this user, the flow proceeds to step 6.
5. The NEF provides a Nnef\_MSISDN-less\_MO\_SMSNotify (SMS payload, GPSI and Application Port ID) message to the AF. The AF is identified with the destination SME address (long/short code of the AF) received from step 2. The payload is delivered directly to the AF, it is not processed by NEF.
6. The NEF, acting as an MTC-IWF, returns a success or failure delivery indication to SMS-SC.
7. SMS-SC indicates success/failure back to UE using existing SMS delivery report defined in TS 23.040 [7].

## 4.13.8 Support of 5G LAN-type service

### 4.13.8.1 Support of 5G VN group management

The information of 5G VN group is provided by the AF to the NEF and is stored in the UDR, by using the NEF service operations information flow procedure described in clause 4.15.6.2.

### 4.13.8.2 Support of 5G VN group communication

#### 4.13.8.2.1 General

This clause specifies the procedures for 5G VN group communication.

#### 4.13.8.2.2 group-level N4 session management procedures

The SMF shall create an group-level N4 session on the UPF for a 5G VN group when N19-based forwarding is applied. The group-level N4 Session management procedures enable the SMF to create, update or delete the group-level N4 Session, e.g. add or delete N4 rules, allocate or release the N19 tunnel resources.

In the case of N19-based forwarding is applied, the followings apply for the PDU Sessions targeting the (DNN, S-NSSAI) associated with a 5G VN group:

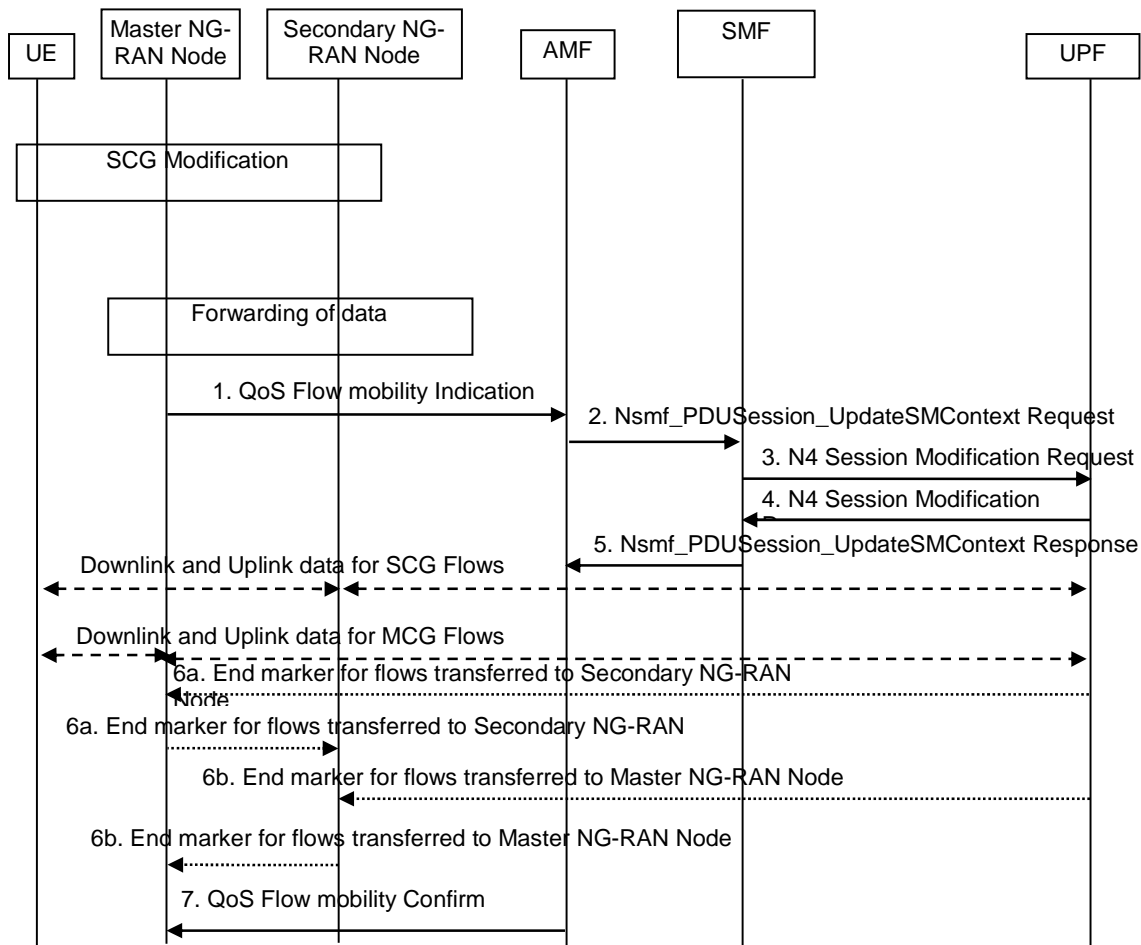
- If the PDU Sessions targeting the same 5G VN group are anchored at different UPFs, the SMF shall create the group-level N4 Session in each involved UPF via N4 Session Establishment procedure (clause 4.4.1.2) in order to establish N19 tunnel(s) between the UPFs and install the N4 rules.
- If the last PDU Session for this 5G VN group is released on a UPF, the SMF may delete the group-level N4 Session in the UPF via N4 Session Release procedure (clause 4.4.1.4) and release the N19 tunnel(s) between this UPF and other UPF(s) serving the 5G VN group via update of the corresponding N4 rules.
- If an address of the UE within the 5G VN group is allocated or released, the SMF may update the N4 rules (e.g. PDRs and FARs) related to the UE address into the group-level N4 Session context via N4 Session Modification procedure (clause 4.4.1.3).

## 4.14 Support for Dual Connectivity

### 4.14.1 RAN Initiated QoS Flow Mobility

This procedure is used to transfer QoS Flows to and from Secondary RAN Node. During this procedure, the SMF and UPF are never re-allocated. The UPF referred in this clause 4.14.1 is the UPF which terminates N3 interface in the 5GC. The presence of IP connectivity between the UPF and the Master RAN node, as well as between the UPF and the Secondary RAN node is assumed.

If QoS Flows for multiple PDU Sessions need to be transferred to or from Secondary RAN Node, the procedure shown in the Figure 4.14.1-1 below is repeated for each PDU Session.



**Figure 4.14.1-1: NG-RAN initiated QoS Flow mobility procedure**

1. The Master RAN node sends a N2 QoS Flow mobility Indication (PDU Session ID, QFI(s), AN Tunnel Info, User Location Information) message to the AMF. AN Tunnel Info includes the new RAN tunnel endpoint for the QFI(s) for which the AN Tunnel Info shall be modified. The User Location Information shall include the serving cell's ID and, if Dual Connectivity is activated for the UE, the PSCell ID.
2. AMF to SMF: Nsmf\_PDUSession\_UpdateSMContext reqs (N2 QoS Flow mobility Indication message PDU Session ID).
3. The SMF sends an N4 Session Modification Request (PDU Session ID(s), QFI(s), AN Tunnel Info for downlink user plane) message to the UPF.
4. The UPF returns an N4 Session Modification Response (CN Tunnel Info for uplink traffic) message to the SMF after requested QFIs are switched.

NOTE: Step 7 can occur any time after receipt of N4 Session Modification Response at the SMF.

5. SMF to AMF: Nsmf\_PDUSession\_UpdateSMContext response (N2 SM information (CN Tunnel Info for uplink traffic)) for QFIs of the PDU Session which have been switched successfully. If none of the requested QFIs have been switched successfully, the SMF shall send an N2 QoS Flow mobility Failure message.
6. In order to assist the reordering function in the Master RAN node and/or Secondary RAN node, for each affected N3 tunnel the UPF sends one or more "end marker" packets on the old tunnel immediately after switching the tunnel for the QFI. The UPF starts sending downlink packets to the Target NG-RAN.
7. The AMF relays message 5 to the Master RAN node.

## 4.15 Network Exposure

### 4.15.1 General

The network capability exposure comprises

- Exposure of network events externally as well as internally towards core network NFs;
- Exposure of provisioning capability towards external functions;
- Exposure of policy and charging capabilities towards external functions;
- Exposure of core network internal capabilities for analytics.
- Exposure of analytics to external party.
- Retrieval of data from external party by NWDAAF.

When subscribing to event reporting the NF consumer(s) provide:

- One or multiple Event ID(s). An Event ID identifies the type of event being subscribed to (e.g. PDU Session Release, UE mobility out of an Area of Interest, etc.).
- Event Filter Information: Provides Event Parameter Types and Event Parameter Value(s) to be matched against, in order to meet the condition for notifying the subscribed Event ID e.g. the Event Parameter Type could be "Area of interest" and Event Parameter Value list could be list of TAs; The Event Filter depends on the Event ID. The Event Filter Information is provided per Event ID(s) being subscribed to: within a subscription different Event ID(s) may be associated with different Event Filter Information.
- Event Reporting Information described in the Table 4.15.1-1 below. Within a subscription all Event ID(s) are associated with a unique Event Reporting Information.
- Target of Event Reporting: this may indicate a specific UE or PDU Session, a group of UE(s) or any UE (i.e. all UEs), Within a subscription all Event ID (s) are associated with the same Target of Event Reporting (possibly corresponding to multiple UE or multiple PDU Sessions).
- A Notification Target Address (+ Notification Correlation ID) allowing the Event Receiving NF to correlate notifications received from the Event provider with this subscription. A subscription is associated with a unique Notification Target Address (+ Notification Correlation ID). In the case that the NF consumer subscribes to the NF producer on behalf of other NF, the NF consumer includes the Notification Target Address(+Notification Correlation ID) of other NF for the Event ID which is to be notified to other NF directly and the Notification Target Address(+Notification Correlation ID) of itself for the Subscription change related event notification. Each Notification Target Address(+ Notification Correlation ID) is associated with related (set of) Event ID(s).
- An Expiry time represents the time upto which the subscription is desired to be kept as active. The NF service consumer may suggest an Expiry time and provide to the NF service producer. Based on the operator's policy, the NF service producer decides whether the subscription can be expired. If the subscription can be expired, the NF service producer determines the Expiry time and provide it in the response to the NF service consumer. If the event subscription is about to expire based on the received Expiry time and the NF service consumer wants to keep receiving notifications, the NF service consumer update the subscription with the NF service producer in order to extend the Expiry time. Once the Expiry time associated with the subscription is reached, the subscription becomes invalid at the NF service producer. If the NF service consumer wants to keep receiving notifications, it shall create a new subscription with the NF service producer.

When the subscription is accepted by the Event provider NF, the consumer NF receives from the event provider NF an identifier (Subscription Correlation ID) allowing to further manage (modify, delete) this subscription.

NOTE 1: The Notification Correlation ID is allocated by the consumer NF that subscribes to event reporting and the Subscription Correlation ID is allocated by the NF that notifies when the event is met. Both correlation identifiers can be assigned the same value, although in principle they are supposed to be different, as they are optimized for finding the subscription related context within each NF.

The consumer NF may use an operation dedicated to subscription modification to add or remove Event ID(s) to this subscription or to modify Event Filter Information.

Events are subscribed by the consumer NF(s) by providing Event Filters. The contents of the Event Reporting Information along with the presence requirement of each information element is described in Table 4.15.1-1.

**Table 4.15.1-1: Event Reporting Information**

Event Reporting Information Parameter	Description	Presence requirement
Event reporting mode	Mode of reporting - e.g. reporting up to a maximum number of reports, periodic reporting along with periodicity, reporting up to a maximum duration	mandatory
Maximum number of reports	Maximum number of reports after which the event subscription ceases to exist	(see NOTE 2)
Maximum duration of reporting	Maximum duration after which the event subscription ceases to exist	(see NOTE 2)
Immediate reporting flag	The Event provider NF notifies the current status of the subscribed event, if available, immediately to the consumer NF.	
Sampling ratio	Percentage of sampling (1%..100%) among impacted UEs.	optional (see NOTE 3)
Group Reporting Guard Time	Parameter for group-based monitoring configuration to indicate the time for which the Monitoring Event Reporting(s) related with the UEs in a group can be aggregated before sending them to the consumer NF.	optional
NOTE 2: The requester shall include 2) Maximum number of reports or 3) Maximum duration of reporting, or both, depending on 1) Event reporting mode.		
NOTE 3: Parameter only applicable to certain event IDs reporting metrics (e.g. Number of UEs present in a geographical area) used and used e.g. by the NWDAF for data collection.		

NOTE 4: Explicit unsubscribe by the NF consumer is still possible.

Maximum number of reports is applicable to the subscription to one UE or a group of UE(s). When the subscription is applied to a group of UE(s), the initial value of the parameter is applied to each individual member UE. The count of number of reports is per UE and per Event Type granularity also for group member UE.

Maximum duration of reporting is applicable to the subscription to one UE, a group of UE(s) or any UE. When the subscription is applied to a group of UE(s), this parameter applies to each group member UE. When the subscription is applied to any UE, this parameter applies to all the impacted UEs.

If for a given subscription Maximum duration of reporting is included then the subscription is cancelled locally in the NF as soon as Maximum duration of reporting is reached. If the Maximum number of reports is reached for a given subscription, the NEF cancels the subscription in the affected NFs. If both Maximum Number of reports and Maximum duration of reporting are included then the subscription expires or is cancelled as soon as one of the conditions is met.

Sampling ratio is applicable to subscription targeting a group of UEs or any UE. When a sampling ratio is provided, a random subset is selected among the target UEs according to the sampling ratio and only the events related to this subset are reported. A UE remains selected until it is no longer managed by the event provider NF. A UE newly managed by the NF may become selected.

Group Reporting Guard Time is an optional parameter for group-based monitoring configuration to indicate the time for which the Monitoring Event Reporting(s) related with the UEs in a group can be aggregated before sending them to the consumer NF. The value of the Group Reporting Guard time should be set less than the Maximum duration of reporting. For the continuous monitoring reporting, unless the Maximum duration of reporting has been reached, the Group Reporting Guard timer is restarted when it expires. If the time left until the Maximum duration of reporting is less than the Group Reporting Guard Time, then the Group Reporting Guard timer shall be set to expire when the Maximum duration of reporting expires. If the Maximum duration of reporting is expired, the Group Reporting Guard Time, if running, shall be considered to expire and aggregated Monitoring Event Reporting(s) is sent to destination immediately.

Table 4.15.1-1 indicates the presence requirements for the Event Reporting Information.

Corresponding notifications contain at least the Notification Correlation ID together with the Event ID and the individual target (e.g. UE or PDU Session ID) associated with the notification.

If the NF service consumer decides to terminate the event subscription, it unsubscribes the event subscription by sending unsubscription request to the event provider NF. After receiving unsubscription request from the NF service consumer, the event provider NF terminates the event subscription.

The following clauses describe the external exposure of network capabilities and core network internal event and capability exposure.

When the immediate reporting flag is set, the first corresponding event report is included in the subscription response message, if corresponding information is available at the reception of the subscription request of the event.

During Monitoring Event Subscription as in clause 4.15.3, Parameter Provisioning as in clause 4.15.6, NIDD configuration as in clause 4.25.3 and Enhanced Coverage Restriction Control as in clause 4.27.1, the optional parameter MTC Provider Information is a reference parameter that may be provided by AF or determined by NEF based on which AF it communicates with. The MTC Provider Information identifies the MTC Service Provider and/or MTC Application.

NOTE 5: The MTC Provider Information can be used by Service Providers for, e.g. to distinguish their different customers.

NOTE 6: The MTC Provider Information is an optional parameter. The NEF can validate the provided MTC Provider Information and override it to a NEF selected MTC Provider Information based on configuration. How the NEF determines the MTC Provider Information, if not present, is left to implementation (e.g. based on the requesting AF).

## 4.15.2 External Exposure of Network Capabilities

The Network Exposure Function (NEF) supports external exposure of capabilities of network functions. External exposure can be categorized as Monitoring capability, Provisioning capability, Policy/Charging capability, network status reporting capability and Analytics reporting capability. The Monitoring capability is for monitoring of specific event for UE in 5GS and making such monitoring events information available for external exposure via the NEF. The Provisioning capability is for allowing external party to provision of information which can be used for the UE in 5GS. The Policy/Charging capability is for handling QoS and charging policy for the UE based on the request from external party. The Analytics capability is for allowing external party to acquire analytics information generated by 5G System.

The details for the External Exposure of Analytics capabilities as well as interactions between NEF, external party and NWDAF are described in TS 23.288 [50].

### 4.15.2a Data Collection from an AF

The Network Exposure Function (NEF) supports the capability to collect data from an AF as specified in TS 23.501 [2].

## 4.15.3 Event Exposure using NEF

### 4.15.3.1 Monitoring Events

The Monitoring Events feature is intended for monitoring of specific events in 3GPP system and making such monitoring events information reported via the NEF. It is comprised of means that allow NFs in 5GS for configuring the specific events, the event detection and the event reporting to the requested party.

To support monitoring features in roaming scenarios, a roaming agreement needs to be made between the HPLMN and the VPLMN. If the AMF/SMF in the VPLMN determine that normalisation of an event report is required, the AMF/SMF normalises the event report before sending it to the NEF.

The set of capabilities required for monitoring shall be accessible via NEF to NFs in 5GS. Monitoring Events via the UDM, the AMF, the SMF and the GMLC enables NEF to configure a given Monitor Event at UDM, AMF, SMF or GMLC and reporting of the event via UDM and/or AMF, SMF or GMLC. Depending on the specific monitoring event or information, it is the AMF, GMLC or the UDM that is aware of the monitoring event or information and makes it reported via the NEF.

The following table enumerates the monitoring events and their detection criteria:

**Table 4.15.3.1-1: List of events for monitoring capability**

Event	Detection criteria	Which NF detects the event
Loss of Connectivity	<p>Network detects that the UE is no longer reachable for either signalling or user plane communication (see NOTE 4).</p> <p>The AF may provide a Maximum Detection Time, which indicates the maximum period of time without any communication with the UE after which the AF is to be informed that the UE is considered to be unreachable (see NOTE 7).</p>	AMF
UE reachability	<p>Detected when the UE transitions to CM-CONNECTED state or when the UE will become reachable for paging, e.g. Periodic Registration Update timer. It indicates when the UE becomes reachable for sending downlink data to the UE.</p> <p>The AF may provide the following parameters:</p> <ol style="list-style-type: none"> <li>1) Maximum Latency;</li> <li>2) Maximum Response Time;</li> <li>3) Suggested number of downlink packets. (see NOTE 5 and NOTE 7).</li> </ol> <p>This event requires the Reachability Filter set to UE reachable for DL traffic" (see clause 5.2.2.3.1-1). For the usage of this event, see clauses 4.2.5.2 and 4.2.5.3.</p> <p>When requesting UE reachability monitoring, the AF may in addition request Idle Status Indication to be included in the UE reachability event reporting.</p>	AMF, UDM



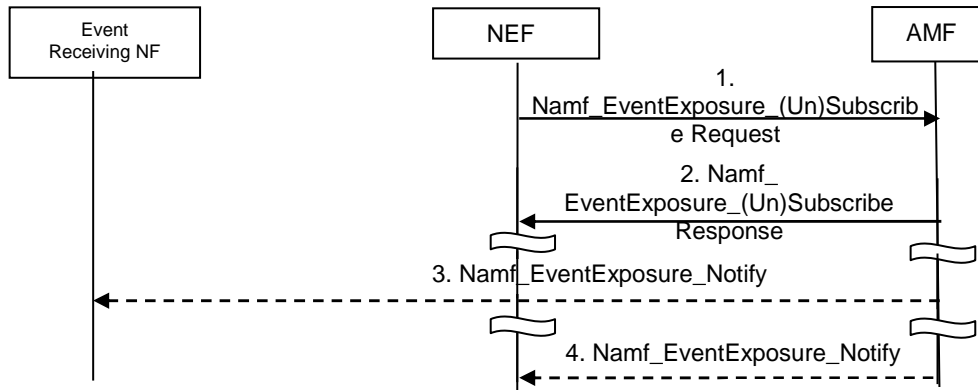
Location Reporting	<p>This event is detected based on the Event Reporting Information Parameters that were received in the Monitoring Request (one-time reporting, maximum number of reports, maximum duration of reporting, periodicity, etc. as specified in clause 4.15.1).</p> <p>It reports either the Current Location or the Last Known Location of a UE.</p> <p>When AMF is the detecting NF: One-time and Continuous Location Reporting are supported. For Continuous Location Reporting the serving node(s) sends a notification every time it becomes aware of a location change, with the granularity depending on the accepted accuracy of location (see NOTE 1).</p> <p>For One-time Reporting with immediate reporting flag set, AMF reports the Last Known Location immediately.</p> <p>When AMF is the detecting NF: If the immediate reporting flag is not set, the AMF reports the UE Current Location (In case the AMF does not have the UE current location in the granularity as requested by the location report, the AMF retrieves the information via NG-RAN Location reporting procedure as defined in clause 4.10).</p> <p>When GMLC is the detecting NF: Immediate and Deferred Location Reporting is supported. For Deferred Location Reporting the event types UE availability, Area, Periodic Location and Motion are supported.</p>	AMF, GMLC
Change of SUPI-PEI association	This event is detected when the association between PEI and subscription (SUPI) changes (USIM change).	UDM
Roaming status	<p>This event is detected based on the UE's current roaming status (the serving PLMN and/or whether the UE is in its HPLMN) and notification is sent when that status changes. (see NOTE 2).</p> <p>If the UE is registered via both 3GPP and N3GPP Access Type, then both instances of Roaming status are included.</p>	UDM
Communication failure	This event is detected when RAN or NAS level failure is detected based on connection release and it identifies RAN/NAS release code.	AMF
Availability after Downlink Data Notification failure	<p>This event is detected when the UE becomes reachable again after downlink data delivery failure.</p> <p>When requesting Availability after Downlink Data Notification failure monitoring, the AF may in addition request Idle Status Indication to be included in the UE reachability event reporting.</p>	AMF

PDU Session Status	This event is detected when PDU session is established or released. (see NOTE 6)	SMF
Number of UEs present in a geographical area	This event is detected based on the Event Reporting Information Parameters that were received in the Monitoring Request (Level of aggregation, Sampling ratio, see clause 4.15.1). It indicates the number of UEs that are in the geographic area described by the AF. The AF may ask for the UEs that the system knows by its normal operation to be within the area (Last Known Location) or the AF may request the system to also actively look for the UEs within the area (Current Location).	AMF
CN Type change	The event is detected when the UE moves between EPC and 5GC. It indicates the current CN type for a UE or a group of UEs when detecting that the UE switches between being served by a MME and an AMF or when accepting the event subscription. (see NOTE 3)	UDM
Downlink data delivery status	It indicates the downlink data delivery status in the core network. Events are reported at the first occurrence of packets being buffered, transmitted or discarded, including: - Downlink data in extended buffering, including: - First data packet buffered event - Estimated buffering time, as per clause 4.2.3.3 - First downlink data transmitted event - First downlink data discarded event	SMF
UE reachability for SMS delivery	This event is detected when an SMSF is registered for a UE and the UE is reachable as determined by the AMF and the UDM. This enables the UE to receive an SMS. See clauses 4.2.5.2 and 4.2.5.3.	UDM
<p>NOTE 1: Location granularity for event request, or event report, or both could be at cell level (Cell ID) or TA level. The granularity can also be expressed by other formats such as geodetic uncertainty shapes (e.g. polygons, circles, etc.) or civic addresses (e.g. streets, districts, etc.) which can be mapped by NEF to AMF specific granularity levels.</p> <p>NOTE 2: Roaming status means whether the UE is in HPLMN or VPLMN based on the most recently received registration state in the UDM.</p> <p>NOTE 3: CN type of CN Type change event is defined in clause 5.17.5.1 of TS 23.501 [2].</p> <p>NOTE 4: In the case of UDM service operation information flow, the UDM should set the subscribed periodic registration timer to a smaller value than the value of Maximum Detection Time, since the value of the mobile reachable timer is larger than the value of the periodic registration timer.</p> <p>NOTE 5: Maximum Latency, Maximum Response Time and Suggested number of downlink packets are defined in clause 4.15.6.3a.</p> <p>NOTE 6: The NEF makes a mapping between the 5GS internal event "PDU Session Status" and the T8 API event "PDN Connectivity Status".</p> <p>NOTE 7: The preferred method for provisioning Network Configuration Parameters is External Parameter Provisioning specified in clause 4.15.6.3a. Provisioning event specific parameters as part of Monitoring Request is expected to be used only by the AF that does not support Parameter Provisioning procedure specified in clause 4.15.6.3a.</p>		

### 4.15.3.2 Information flows

#### 4.15.3.2.1 AMF service operations information flow

The procedure is used by the NF to subscribe to notifications and to explicitly cancel a previous subscription. Cancelling is done by sending `Namf_EventExposure_UnSubscribe` request identifying Subscription Correlation ID. The notification steps 3 and 4 are not applicable in cancellation case.



**Figure 4.15.3.2.1-1: Namf\_EventExposure\_Subscribe, Unsubscribe and Notify operations**

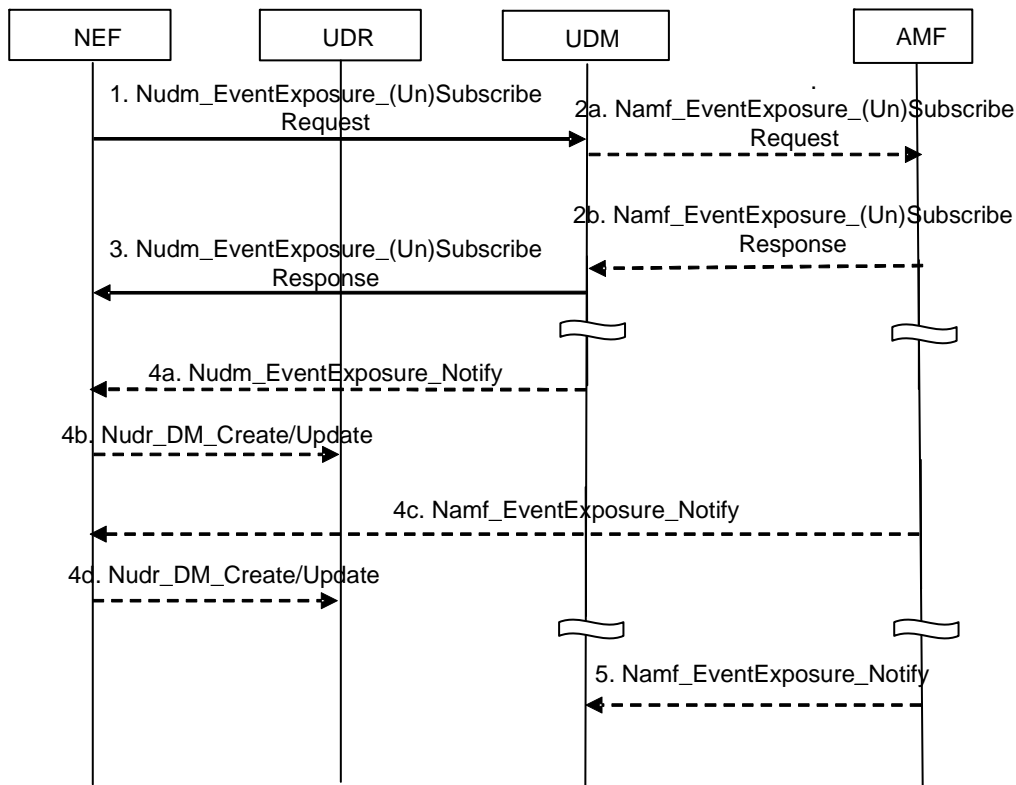
1. A NEF sends a request to subscribe to a (set of) Event ID(s) in AMF in `Namf_EventExposure_Subscribe` request. The NEF could be the same NF subscribing to receive the event notification reports (i.e. Event Receiving NF) or it could be a different NF. The NEF subscribes to one or several Event(s) (identified by Event ID) and provides the associated notification endpoint of the Event Receiving NF. If the NEF itself is not the Event Receiving NF, the NEF shall additionally provide the notification endpoint of itself besides the notification endpoint of Event Receiving NF. Each notification endpoint is associated with the related (set of) Event ID(s). This is to assure the NEF can receive the notification of subscription change related event (e.g. Subscription Correlation ID Change).

Event Reporting information defines the type of reporting requested. If the reporting event subscription is authorized by the AMF, the AMF records the association of the event trigger and the requester identity.

2. AMF acknowledges the execution of `Namf_EventExposure_Subscribe`.
3. [Conditional - depending on the Event] The AMF detects the monitored event occurs and sends the event report by means of `Namf_EventExposure_Notify` message, to the notification endpoint of the Event Receiving NF.
4. [Conditional- depending on the Event] The AMF detects the subscription change related event occurs, e.g. Subscription Correlation ID change due to AMF reallocation, it sends the event report by means of `Namf_EventExposure_Notify` message to the NEF.

#### 4.15.3.2.2 UDM service operations information flow

The procedure is used by the NEF to subscribe to notifications and to explicitly cancel a previous subscription. Cancelling is done by sending `Nudm_EventExposure_Unsubscribe` request identifying the subscription to cancel. The notification steps 4 and 5 are not applicable in cancellation case.



**Figure 4.15.3.2.2-1: Nudm\_EventExposure\_Subscribe, Unsubscribe and Notify operations**

1. The NEF subscribes to one or several monitoring events by sending Nudm\_EventExposure\_Subscribe request. The NEF subscribes to one or several Event(s) (identified by Event ID) and provides the associated notification endpoint of the NEF.

Event Reporting Information defines the type of reporting requested. If the reporting event subscription is authorized by the UDM, the UDM records the association of the event trigger and the requester identity.

The subscription may include Maximum number of reports and/or Maximum duration of reporting IE and optionally MTC Provider Information.

- 2a. [Conditional] Some events (e.g. loss of connectivity), require that UDM sends Namf\_EventExposure\_Subscribe request to the AMF serving that UE. As the UDM itself is not the Event Receiving NF, the UDM shall additionally provide the notification endpoint of itself besides the notification endpoint of NEF. Each notification endpoint is associated with the related (set of) Event ID(s). This is to assure the UDM can receive the notification of subscription change related event.

The UDM sends the Namf\_EventExposure\_Subscribe request to all serving AMF(s) (if subscription applies to a UE or a group of UE(s)), or to all the AMF(s) in the same PLMN as UDM (if subscription applies to any UE). The UDM stores the subscription even if the target UE or group member UE is not registered at the time of subscription.

- NOTE 1: If the single target UE or group member UE, registers later on with an AMF which does not have event subscription or group event subscription(s) for that UE or UE group, then the UDM creates subscriptions to those event(s) with the AMF during the Registration procedure as specified in clause 4.2.2.2.2.

If the subscription applies to a group of UE(s), the UDM shall include the same notification endpoint of itself, i.e. Notification Target Address (+ Notification Correlation Id), in the subscriptions to all UE's serving AMF(s).

- NOTE 2: The same notification endpoint of UDM is to help the AMF identify whether the subscription for the requested group event is same or not when a new group member UE is registered.

- 2b. [Conditional] AMF acknowledges the execution of Namf\_EventExposure\_Subscribe.
3. UDM acknowledges the execution of Nudm\_EventExposure\_Subscribe.

If the subscription is applicable to a group of UE(s) and the Maximum number of reports is included in the Event Report information in step 1, the Number of UEs (including all group member UEs irrespective of their registration state) within this group is included in the acknowledgement. If AMF provides the first event report in step 2b, the UDM includes the event report in the acknowledgement.

4a - 4b. [Conditional - depending on the Event] The UDM detects the monitored event occurs and sends the event report, by means of Nudm\_EventExposure\_Notify message, to the associated notification endpoint of the NEF, along with the time stamp. NEF may store the information in the UDR along with the time stamp using either Nudr\_DM\_Create or Nudr\_DM\_Update service operation as appropriate.

4c - 4d. [Conditional - depending on the Event] The AMF detects the monitored event occurs and sends the event report, by means of Namf\_EventExposure\_Notify message, to the associated notification endpoint of the NEF, along with the time stamp. NEF may store the information in the UDR along with the time stamp using either Nudr\_DM\_Create or Nudr\_DM\_Update service operation as appropriate.

If the AMF has a maximum number of reports stored for the UE, the AMF shall decrease its value by one for the reported event.

For both step 4a and step 4c, when the maximum number of reports is reached and if the subscription is applied to a UE, The NEF unsubscribes the monitoring event(s) to the UDM and the UDM unsubscribes the monitoring event(s) to AMF serving that UE.

For both step 4a and step 4c, when the maximum number of reports is reached for an individual group member UE, the NEF uses the Number of UEs received in step 3 and the Maximum number of reports to determine if reporting for the group is complete. If the NEF determines that reporting for the group is complete, the NEF unsubscribes the monitoring event(s) to the UDM and the UDM unsubscribes the monitoring event(s) to all AMF(s) serving the UEs belonging to that group.

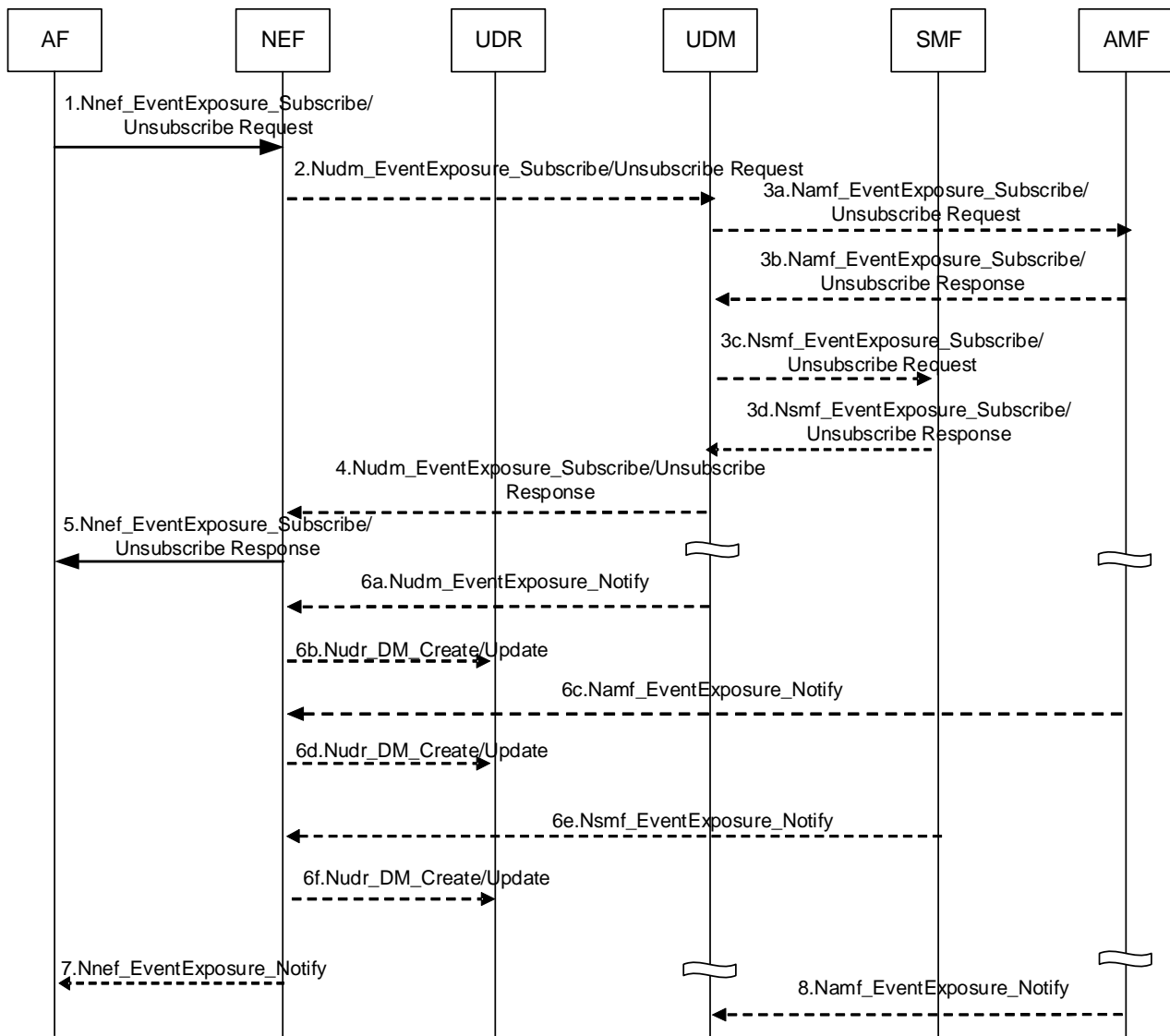
NOTE 3: If an expiry time as specified in clause 6.2.6.2.6 of TS 29.518 [18] is not included in the event subscription, then the life time of the event subscription needs to be controlled by other means as there is no time based cancellation at all even if any group member UEs fail to register.

When the Maximum duration of reporting expires in the NEF, the UDM and the AMF, then each of these nodes shall locally unsubscribe the monitoring event.

5. [Conditional - depending on the Event] The AMF detects the subscription change related event occurs, e.g. Subscription Correlation ID change due to AMF reallocation or addition of new Subscription Correlation ID due to a new group UE registered, it sends the event report by means of Namf\_EventExposure\_Notify message to the associated notification endpoint of the UDM.

#### 4.15.3.2.3 NEF service operations information flow

The procedure is used by the AF to subscribe to notifications and to explicitly cancel a previous subscription. Cancelling is done by sending Nnef\_EventExposure\_Unsubscribe request identifying the subscription to cancel with Subscription Correlation ID. The notification steps 6 to 8 are not applicable in cancellation case.



**Figure 4.15.3.2.3-1: Nnef\_EventExposure\_Subscribe, Unsubscribe and Notify operations**

1. The AF subscribes to one or several Event(s) (identified by Event ID) and provides the associated notification endpoint of the AF by sending Nnef\_EventExposure\_Subscribe request.

Event Reporting Information defines the type of reporting requested (e.g. one-time reporting, periodic reporting or event based reporting, for Monitoring Events). If the reporting event subscription is authorized by the NEF, the NEF records the association of the event trigger and the requester identity. The subscription may also include Maximum number of reports and/or Maximum duration of reporting IE and optionally MTC Provider Information.

2. [Conditional - depending on authorization in step 1] The NEF subscribes to received Event(s) (identified by Event ID) and provides the associated notification endpoint of the NEF to UDM by sending Nudm\_EventExposure\_Subscribe request. The NEF maps the AF-Identifier into DNN and S-NSSAI combination based on local configuration and include DNN, S-NSSAI in the request.

If the reporting event subscription is authorized by the UDM, the UDM records the association of the event trigger and the requester identity. Otherwise, the UDM continues in step 4 indicating failure.

- 3a. [Conditional] If the requested event (e.g. monitoring of Loss of Connectivity) requires AMF assistance, then the UDM sends the Namf\_EventExposure\_Subscribe to the AMF serving the requested user. The UDM sends the Namf\_EventExposure\_Subscribe request to the all serving AMF(s) (if subscription applies to a UE or a group of UE(s)), or all the AMF in the same PLMN as the UDM (if subscription applies to any UE).

NOTE 1: If the UE, which is a member of a group, registers with an AMF which does not have group event subscription(s) for that group, then the UDM creates subscriptions to those event(s) with the AMF during the Registration procedure in clause 4.2.2.2.2.

As the UDM itself is not the Event Receiving NF, the UDM shall additionally provide the notification endpoint of itself besides the notification endpoint of NEF. Each notification endpoint is associated with the related (set of) Event ID(s). This is to assure the UDM can receive the notification of subscription change related event.

If the subscription applies to a group of UE(s), the UDM shall include the same notification endpoint of itself, i.e. Notification Target Address (+ Notification Correlation Id), in the subscriptions to all UE's serving AMF(s).

NOTE 2: The same notification endpoint of UDM is to help the AMF identify whether the subscription for the requested group event is same or not when a new group member UE is registered.

3b. [Conditional] AMF acknowledges the execution of Namf\_EventExposure\_Subscribe.

3c. [Conditional] If the requested event (e.g. PDU Session Status) requires SMF assistance, then the UDM sends the Nsmf\_EventExposure\_Subscribe Request message to each SMF where at least one UE identified in step 2 has a PDU session established. The NEF notification endpoint received in step 2 is included in the message.

NOTE 3: In the home routed case, the UDM sends the subscription to the V-SMF via the H-SMF.

3d. [Conditional] The SMF acknowledges the execution of Nsmf\_EventExposure\_Subscribe.

4. [Conditional] UDM acknowledges the execution of Nudm\_EventExposure\_Subscribe.

If the subscription is applicable to a group of UE(s) and the Maximum number of reports is included in the Event Report information in step 1, the Number of UEs (including all group member UEs irrespective of their registration state) is included in the acknowledgement. If AMF or SMF provides the first event report in step 3b or 3d, the UDM includes the event reporting in the acknowledgement.

5. NEF acknowledges the execution of Nnef\_EventExposure\_Subscribe to the requester that initiated the request. If the NEF has received the first event report already in step 4, the NEF includes the event report in the acknowledgement.

6a - 6b. [Conditional - depending on the Event] The UDM (depending on the Event) detects the event occurs and sends the event report, by means of Nudm\_EventExposure\_Notify message to the associated notification endpoint of the NEF along with the time stamp. NEF may store the information in the UDR along with the time stamp using either Nudr\_DM\_Create or Nudr\_DM\_Update service operation as appropriate.

6c - 6d. [Conditional - depending on the Event] The AMF detects the event occurs and sends the event report, by means of Namf\_EventExposure\_Notify message to associated notification endpoint of the NEF along with the time stamp. NEF may store the information in the UDR along with the time stamp using either Nudr\_DM\_Create or Nudr\_DM\_Update service operation as appropriate.

If the AMF has a maximum number of reports stored for the UE or the individual member UE, the AMF shall decrease its value by one for the reported event.

For both step 6a and step 6b, when the maximum number of reports is reached and if the subscription is applied to a UE, The NEF unsubscribes the monitoring event(s) to the UDM and the UDM unsubscribes the monitoring event(s) to AMF serving for that UE.

For both step 6a and step 6b, when the maximum number of reports is reached for an individual group member UE, the NEF uses the Number of UEs received in step 4 and the Maximum number of reports to determine if reporting for the group is complete. If the NEF determines that reporting for the group is complete, the NEF unsubscribes the monitoring event(s) to the UDM and the UDM unsubscribes the monitoring event(s) to all AMF(s) serving the UEs belonging to that group.

NOTE 4: If an expiry time as specified in clause 6.2.6.2.6 of TS 29.518 [18] is not included in the event subscription, then the life time of the event subscription needs to be controlled by other means as there is no time based cancellation at all even if any group member UEs fail to register.

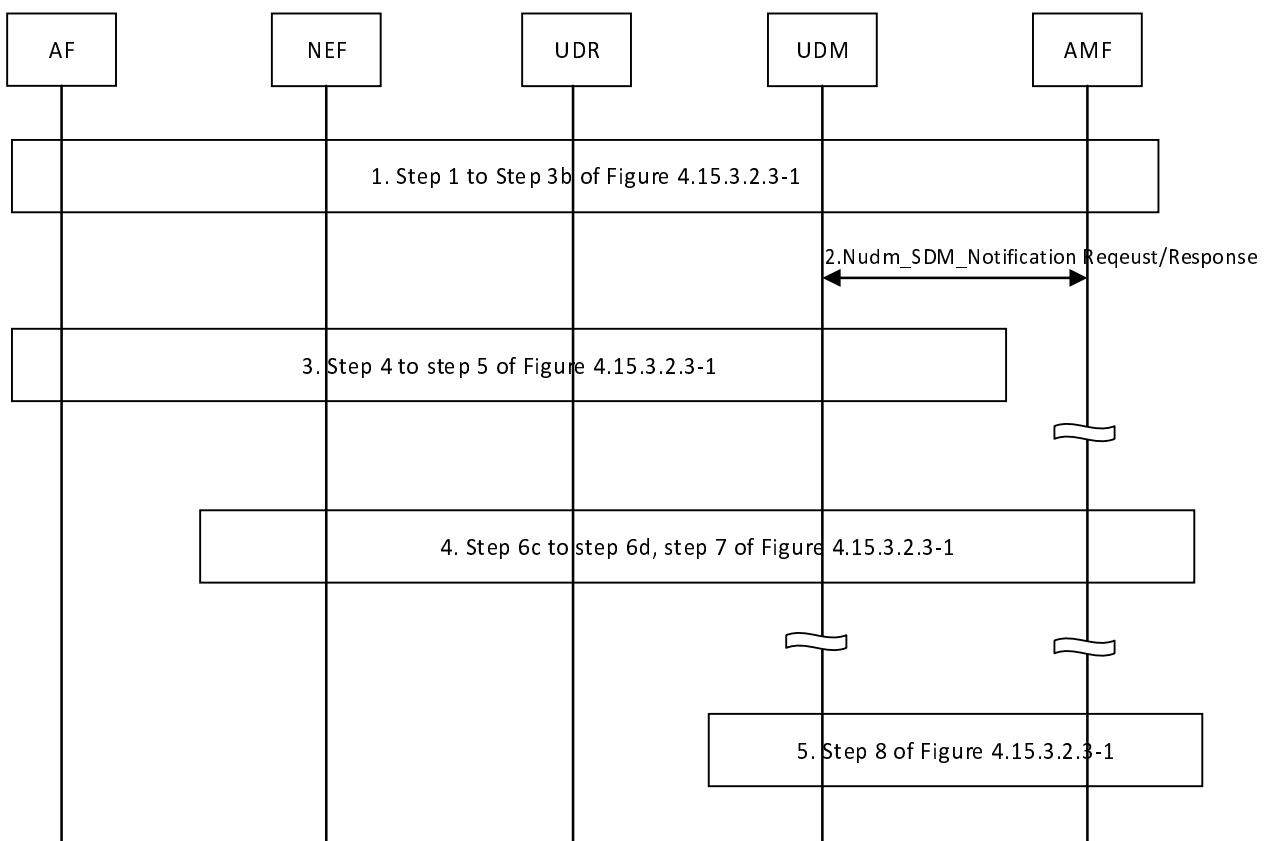
When the Maximum duration of reporting expires in the NEF, the UDM and the AMF, then each of these nodes shall locally unsubscribe the monitoring event.

- 6e - 6f. [Conditional - depending on the Event] When the SMF detects a subscribed event, the SMF sends the event report, by means of Nsmf\_EventExposure\_Notify message, to the associated notification endpoint of the NEF provided in step 3c. NEF may store the information in the UDR along with the time stamp using either Nudr\_DM\_Create or Nudr\_DM\_Update service operation as appropriate.
- 7. [Conditional - depending on the Event in steps 6a-6f] The NEF forwards to the AF the reporting event received by either Nudm\_EventExposure\_Notify and/or Namf\_EventExposure\_Notify. In the case of the PDU Session Status event, the NEF maps it to an PDN Connectivity Status notification when reporting to the AF.
- 8. [Conditional - depending on the Event] The AMF detects the subscription change related event occurs, e.g. Subscription Correlation ID change due to AMF reallocation or addition of new Subscription Correlation ID due to a new group UE registered, it sends the event report, by means of Namf\_EventExposure\_Notify message to the associated notification endpoint of the UDM.

4.15.3.2.3a Void

4.15.3.2.3b Specific NEF service operations information flow for loss of connectivity and UE reachability

The procedure is used by the AF to subscribe to notifications and to explicitly cancel a previous subscription for loss of connectivity and UE reachability.



**Figure 4.15.3.2.3b-1: Nef\_EventExposure\_Subscribe, Unsubscribe and Notify operations or loss of connectivity and UE reachability**

- 1. Step 1 to step 3b of Figure 4.15.3.2.3-1 are performed with the following differences:
  - For Loss of Connectivity, the subscription request may include Maximum Detection Time (see Table 4.15.3.1-1).



- For UE reachability, the subscription request may include Maximum Latency, Maximum Response Time and/or Suggested number of downlink packets (see Table 4.15.3.1-1). In step 3a of Figure 4.15.3.2.3-1, the UDM may include Maximum Response Time in the subscription request to the AMF.

NOTE 1: It is expected that Maximum Latency, Maximum Response Time and/or Suggested number of downlink packets included in the subscription request is only used by the AF that does not support Parameter Provisioning procedure specified in clause 4.15.6.3a.

- For UE reachability, the AF may include Idle Status Indication request. If Idle Status Indication request is included, the NEF includes it in Nudm\_EventExposure\_Subscribe message. If the UDM receives Idle Status Indication request, it includes it in Namf\_EventExposure\_Subscribe message. If the NEF does not support the requested Idle Status Indication, then depending on operator policies, the NEF rejects the request.
2. [Conditional] If the subscribed periodic registration timer has not been set according to any subscription request, or a Network Configuration as defined in clause 4.15.6.3a the UDM shall set the subscribed periodic registration timer using the Maximum Detection Time or Maximum Latency; otherwise if the subscribed periodic registration timer was previously set by a different subscription identified by a different Notification Target Address (+ Notification Correlation ID), or set by a different Network Configuration identified by a different NEF reference ID for the same UE and if the newly received Maximum Detection Time or Maximum Latency is lower than the provided subscribed periodic registration timer, the UDM shall set the subscribed periodic registration timer using the newly received Maximum Detection Time or Maximum Latency.

If Nudm\_EventExposure\_Unsubscribe request is performed in step 1, the UDM shall recalculate the subscribed periodic registration timer based on the remaining event subscriptions and/or Network Configurations.

In addition for UE reachability subscription, if the newly received Maximum Response Time is longer than the provided subscribed Active Time (i.e. previously provided Maximum Response Time), the UDM shall set the subscribed Active Time using the newly received Maximum Response Time. If the suggested number of downlink packets is newly received, the UDM shall add the newly received suggested number of downlink packets to the currently used value of suggested number of downlink packets if the aggregated value is within the operator defined range.

If Nudm\_EventExposure\_Unsubscribe request is performed in step 1, the UDM shall recalculate the subscribed Active Time and/or Suggested Number of Downlink Packets based on the remaining event subscriptions and/or Network Configurations.

If the subscribed periodic registration timer or the subscribed Active Time are set or modified, the UDM sends the Nudm\_SDM\_Notification request to related serving AMF(s). If the AMF receives a subscribed periodic registration timer value from the UDM, it allocates the received value to the UE as the periodic registration timer at subsequent Registration procedure. The AMF starts monitoring of the expiration of the mobile reachable timer for Loss of Connectivity (if required) and starts monitoring of the UE entering connected mode for UE reachability (if required).

If the suggested number of downlink packets are set or modified, the UDM sends the Nudm\_SDM\_Notification request to related serving SMF(s). The SMF configures the data buffer at the SMF/UPF according the suggested number of downlink packets.

If the provided value is updated by the UDM, the UDM may notify the NEF (which then notifies the AF) of the actual value that is being applied in the 3GPP network.

3. Step 4 to step 5 of Figure 4.15.3.2.3-1 are performed.
4. Step 6c to step 6d of Figure 4.15.3.2.3-1 are performed with the following differences:
- For Loss of Connectivity, the event is detected when the mobile reachability timer expires.
  - For UE reachability, the event is detected when the UE changes to connected mode or when the UE will become reachable for paging.
  - For UE reachability, if Idle Status Indication request was included in step 1 and the AMF supports Idle Status Indication, the AMF includes also the Idle Status Indication.
5. Step 8 of Figure 4.15.3.2.3-1 is performed.

4.15.3.2.4 Exposure with bulk subscription

Based on operator configuration NEF may perform bulk subscription with the NFs that provides necessary services. This feature is controlled by local policies of the NEF that control which events (set of Event ID(s)) and UE(s) are target of a bulk subscription.

When the NEF performs bulk subscription (subscribes for any UE (i.e. all UEs), group of UE(s) (e.g. identifying a certain type of UEs such as IoT UEs)), it subscribes to all the NFs that provide the necessary services (e.g. In a given PLMN, NEF may subscribe to all AMFs that support reachability notification for IoT UEs). Upon receiving bulk subscription from the NEF, the NFs store this information. Whenever the corresponding event(s) occur for the requested UE(s) as in bulk subscription request, NFs notify the NEF with the requested information.

The following call flow shows how network exposure can happen for one UE, groups of UE(s) (e.g. identifying a certain type of UEs such as IoT UEs) or any UE.

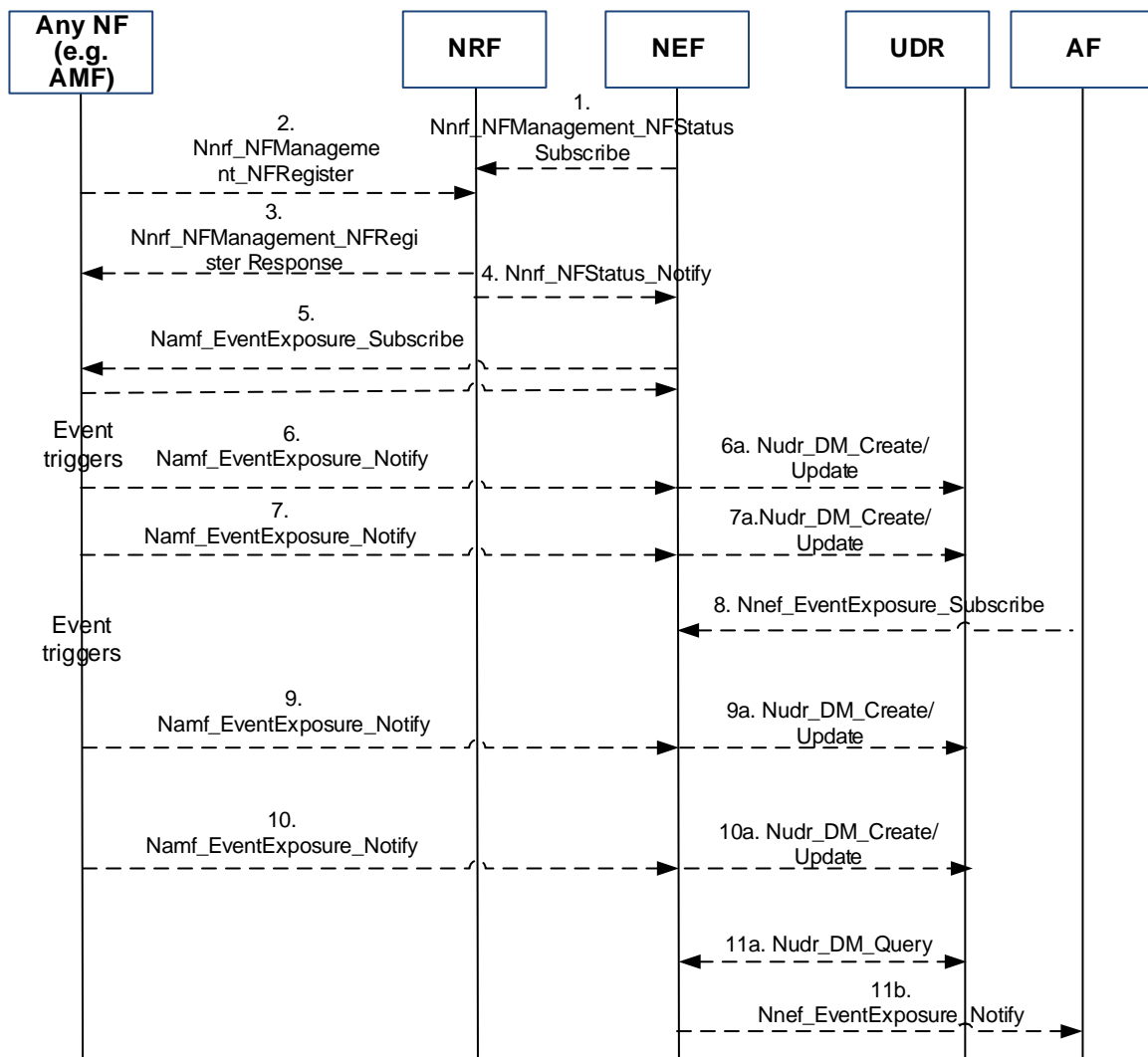


Figure 4.15.3.2.4-1: NF registration/status notification and Exposure with bulk subscription

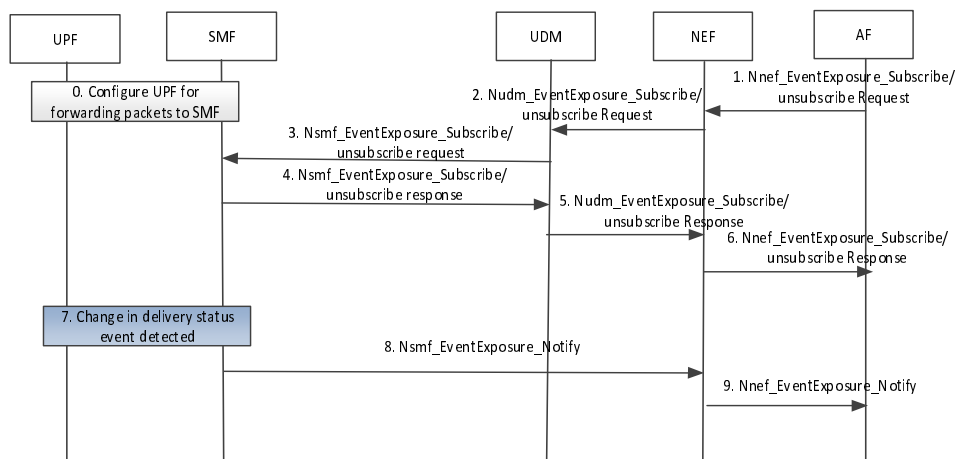
1. NEF registers with the NRF for any newly registered NF along with its NF services.
2. When an NF instantiates, it registers itself along with the supported NF services with the NRF.
3. NRF acknowledges the registration
4. NRF notifies the NEF with the newly registered NF along with the supported NF services.
5. NEF evaluates the NF and NF services supported against the pre-configured events within NEF. Based on that, NEF subscribes with the corresponding NF either for a single UE, group of UE(s) (e.g. identifying a certain type of UEs such as IoT UEs), any UE. NF acknowledges the subscription with the NEF.

- 6 - 7. When the event trigger happens, NF notifies the requested information towards the subscribing NEF along with the time stamp. NEF may store the information in the UDR along with the time stamp using either Nudr\_DM\_Create or Nudr\_DM\_Update service operation as appropriate.
8. Application registers with the NEF for a certain event identified by event filters. If the registration for the event is authorized by the NEF, the NEF records the association of the event and the requester identity.
- 9 - 10. When the event trigger happens, NF notifies the requested information towards the subscribing NEF. NEF may store the information in the UDR using either Nudr\_DM\_Create or Nudr\_DM\_Update service operation as appropriate.
- 11a-b. NEF reads from UDR with Nudr\_DM\_Query and notifies the application along with the time stamp for the corresponding subscribed events.

#### 4.15.3.2.5 Information flow for downlink data delivery status with SMF buffering

The procedure is used if the SMF requests the UPF to forward downlink data packets that are subject of extended buffering in the SMF. The procedure describes a mechanism for the Application Function to subscribe downlink data delivery status notifications. The downlink data delivery status notifications relates to high latency communication, see also clauses 4.24.2 and 4.2.3.3.

Cancelling the subscription is done by sending Nnef\_EventExposure\_Unsubscribe request identifying the subscription to cancel with Subscription Correlation ID in the same order as indicated in figure 4.15.3.2.5-1 for the corresponding subscribe requests. Step 0 and the notification steps 7 to 9 are not applicable in cancellation case.



**Figure 4.15.3.2.5-1: Information flow for downlink data delivery status with SMF buffering**

0. The SMF (in the non-roaming case the SMF, in the roaming case the V-SMF, in the case of PDU session with I-SMF the I-SMF) configures the relevant UPF to forward downlink data packets towards the SMF as described in clause 5.8.3 in 23.501 [2]. The SMF decides to apply this behaviour based on the "expected UE behaviour". Alternatively, step 0 is triggered by step 3,
1. The AF sends Nnef\_EventExposure\_Subscribe Request to NEF requesting notification for event "Downlink data delivery status" with traffic descriptor (e.g. the source of the downlink IP or Ethernet traffic) for a UE or group of UEs. If the reporting event subscription is authorized by the NEF, the NEF records the association of the event trigger and the requester identity. The Downlink data delivery status events include:
  - First downlink Packet in extended buffering event:
    - This event is triggered when the first new downlink data packet is buffered with extended buffering matching the traffic descriptor.
    - in notifications about this Downlink data delivery status, the SMF provides the Extended Buffering time as determined in clause 4.2.3.3.
  - First downlink Packet discarded:

- This event occurs when the first packet matching the traffic descriptor is discarded because the Extended Buffering time, as determined by the SMF, expires or the amount of downlink data to be buffered is exceeded.
  - First Downlink Packet transmitted:
    - This event occurs when the first packet matching the traffic descriptor is transmitted after previous buffering or discarding of corresponding packet(s) because the UE of the PDU Session becomes ACTIVE and buffered data can be delivered to UE according to clause 4.2.3.3.
2. The NEF sends the Nudm\_EventExposure\_Subscribe Request to UDM. Identifier of the UE or group of UEs, the traffic descriptor, monitoring event received from AF in step 1 and notification endpoint of the NEF are included in the message. If the reporting event subscription is authorized by the UDM, the UDM records the association of the event trigger and the requester identity. Otherwise, the UDM continues in step 5 indicating failure.
  3. The UDM sends the Nsmf\_EventExposure\_Subscribe Request message to each SMF where at least one UE identified in step 2 has a PDU session established. If the UDM is able to derive the applicable DNN and S-NSSAI from the traffic descriptor via configured information, the UDM may send Nsmf\_EventExposure\_Subscribe Request messages only to SMFs with PDU sessions with that DNN and S-NSSAI for such UEs and includes the Identifier of the UE or Internal-Group-Id, traffic descriptor, monitoring event and the notification endpoint of NEF received in step 2 are included in the message. If the UDM becomes aware that such a UE has a PDU session established with the DNN and S-NSSAI corresponding to the traffic descriptor at a later time than when receiving step 2, the UDM then executes step 3.
 

In the case of home-routed PDU session or PDU session with I-SMF, the UDM sends the Nsmf\_EventExposure\_Subscribe Request message to each H-SMF or SMF and the H-SMF or SMF further sends Nsmf\_EventExposure\_Subscribe Request message to each related V-SMF or I-SMF. Steps 7-8 are performed by V-SMF or I-SMF.
  4. The SMF sends the Nsmf\_EventExposure\_Subscribe Response message to the UDM.
  5. The UDM send sends the Nsmf\_EventExposure\_Subscribe response message to the NEF.
  6. The NEF sends the Nsmf\_EventExposure\_Subscribe response to the AF.
  7. The SMF detects a change in Downlink Data Delivery Status event as described in clause 4.2.3. The SMF becomes aware that Downlink Packet(s) require extended buffering via a Namf\_Communication\_N1N2MessageTransfer service operation with the AMF. If the SMF decides to discard packets, the "Downlink Packet(s) discarded event" is detected. The SMF detects that previously buffered packets can be transmitted by the fact that the related PDU session becomes ACTIVE.
  8. The SMF sends the Nsmf\_EventExposure\_Notify with Downlink Delivery Status event message to NEF.
  9. The NEF sends Nnef\_EventExposure\_Notify with Downlink Delivery Status event message to AF.

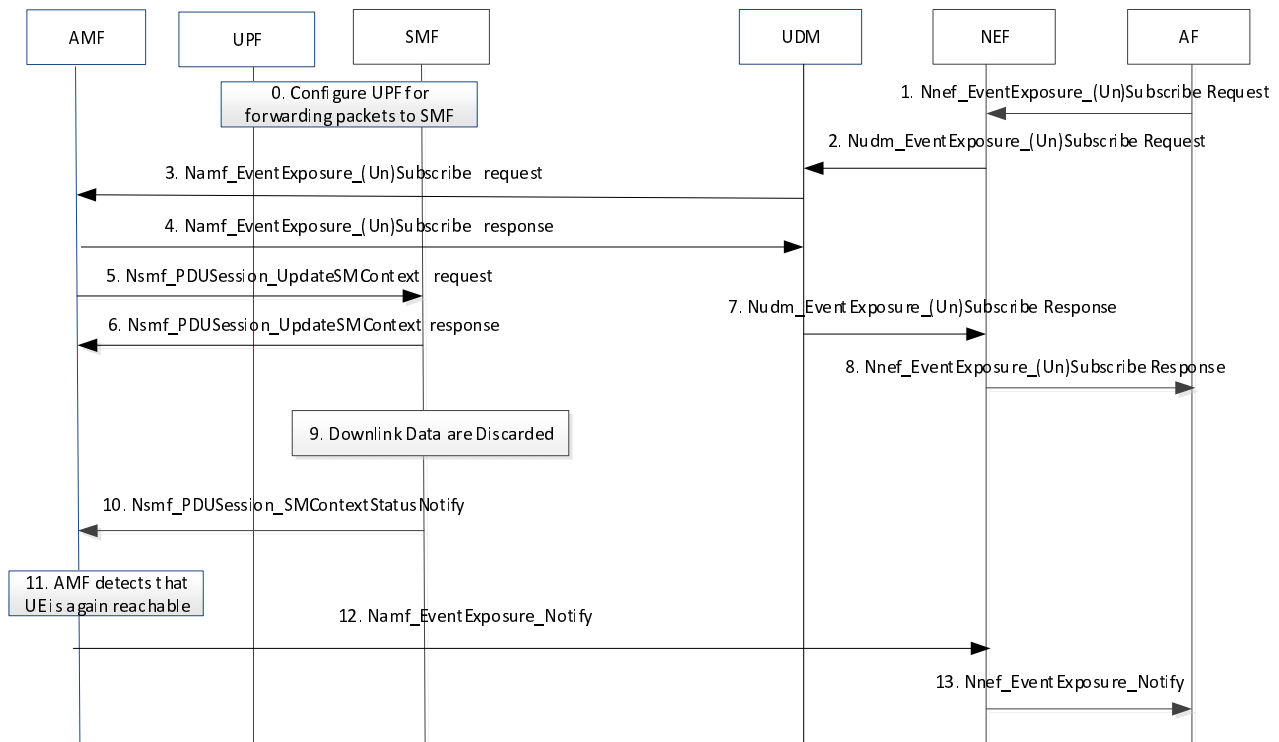
#### 4.15.3.2.6 GMLC service operations information flow

The procedure is used by the NF to subscribe to notifications and to explicitly cancel a previous subscription. The GMLC service operations information flow is defined in clause 6.1.2 and clause 6.3 of TS 23.273 [51].

#### 4.15.3.2.7 Information flow for Availability after DDN Failure with SMF buffering

The procedure is used if the SMF requests the UPF to forward packets that are subject of buffering in the SMF. The procedure describes a mechanism for the Application Function to subscribe to notifications about availability after downlink data notification failure. The Availability after Downlink Data Notification failure event is related to high latency communication, see also clauses 4.24.2 and 4.2.3.3.

Cancelling the subscription is done by sending EventExposure\_Unsubscribe requests identifying the subscription to cancel with the Subscription Correlation ID in the same order as indicated in figure 4.15.3.2.7-1 for the corresponding subscribe requests (the AMF unsubscribes the DDN Failure status notification by sending the Nsmf\_PDUSession\_UpdateSMContext Request message to each SMF in step 5). Step 0 and the notification steps 9 to 13 are not applicable in the cancellation case.



**Figure 4.15.3.2.7-1: Information flow for availability after DDN Failure with SMF buffering**

0. The SMF (in the no-roaming case the H-SMF, in the roaming case the V-SMF, in the case of PDU session with I-SMF the I-SMF) configures the relevant UPF to forward packets to the SMF as described in clause 5.8.3 in 23.501 [2]. The SMF decides to apply this behaviour based on the "expected UE behaviour". Alternatively, step 0 is triggered by step 5.

1. The AF sends Nnef\_EventExposure\_Subscribe Request to the NEF requesting notifications for "Availability after DDN Failure" for a UE or group of UEs and providing a traffic descriptor identifying the source of the downlink IP or Ethernet traffic. If the reporting event subscription is authorized by the NEF, the NEF records the association of the event trigger and the requester identity.

The AF may include Idle Status Indication request in the Nnef\_EventExposure\_Subscribe Request. If Idle Status Indication request is included, the NEF includes it in Nudm\_EventExposure\_Subscribe message. If the NEF does not support the requested Idle Status Indication, then depending on operator policies, the NEF rejects the request.

2. The NEF sends the Nudm\_EventExposure\_Subscribe Request to UDM. Identifier of the UE or group of UEs, the traffic descriptor, monitoring event received from AF at step 1 and notification endpoint of the NEF are included in the message. If the reporting event subscription is authorized by the UDM, the UDM records the association of the event trigger and the requester identity. Otherwise, the UDM continues in step 7 indicating failure.

If the UDM receives Idle Status Indication request, it includes it in Namf\_EventExposure\_Subscribe message.

3. The UDM sends Namf\_EventExposure\_Subscribe messages to the AMF(s) which serve the UE(s) identified in step 2 to subscribe to "Availability after DDN Failure". The UDM includes the DNN and S-NSSAI as well as the Traffic Descriptor if available. A separate subscription is used for each UE. The NEF notification endpoint received in step 2 is included in the message. If the UDM becomes aware that such a UE is registered at a later time than when receiving step 2, the UDM then executes step 3.

4. The AMF acknowledges the execution of Namf\_EventExposure\_Subscribe.

5. If PDU Session exists for the DNN and S-NSSAI, the AMF subscribes to DDN Failure status notification by sending the Nsmf\_PDUSession\_UpdateSMContext Request message to each SMF, requesting the SMF to notify DDN Failure. The AMF also includes in Nsmf\_PDUSession\_UpdateSMContext the Traffic Descriptor and NEF correlation ID if received from the UDM. For new PDU Session establishment towards a DNN and S-NSSAI, the AMF subscribes to DDN Failure status notification in Nsmf\_PDUSession\_CreateSMContext Request message if the UDM has subscribed to Availability after DDN Failure event.

In the case of home-routed PDU session or PDU session with I-SMF, the AMF sends Nsmf\_PDUSession\_UpdateSMContext Request message(s) to the related V-SMF(s) or I-SMF(s). Steps 9-10 are performed by those V-SMF(s) or I-SMF(s).

6. The (I/V-)SMF sends the Nsmf\_PDUSession\_UpdateSMContext response message to the AMF.

NOTE: Step 7 can happen any time after step 4.

7. The UDM sends the Nudm\_EventExposure\_Subscribe response to the NEF.

8. The NEF sends the Nsmf\_EventExposure\_Subscribe response to the AF.

9-10. The SMF is informed that the UE is unreachable via a Namf\_Communication\_N1N2MessageTransfer service operation. The SMF then decides to discard downlink packets received from the UPF. By comparing those discarded downlink packets received from the UPF with the Traffic Descriptor(s) received in the event subscription(s), the SMF determines whether DDN Failure due to any traffic from an AF is to be notified to the AMF and if so, the SMF sends the DDN Failure status, by means of Nsmf\_PDUSession\_SMContextStatusNotify message including NEF Correlation ID, to the AMF. If the UE is not reachable after the AMF received the DDN Failure notification from the SMF, the AMF shall set a Notify-on-available-after-DDN-failure flag corresponding to the NEF Correlation ID.

11-12. [Conditional] The AMF detects the UE is reachable and sends the event report(s) based on the Notify-on-available-after-DDN-failure flag, by means of Namf\_EventExposure\_Notify message(s), only to the NEF(s) indicated as notification endpoint(s) identified via the corresponding subscription in step 3. In this way, only the AF(s) for which DL traffic transmission failed are notified.

If the AMF received Idle Status Indication request in step 3 and the AMF supports Idle Status Indication, the AMF includes also the Idle Status Indication.

13. The NEF sends Nnef\_EventExposure\_Notify message with the "Availability after DDN Failure" event to AF.

#### 4.15.3.2.8 Information flow for downlink data delivery status with UPF buffering

The procedure is used if the SMF requests the UPF to buffer packets. The procedure describes a mechanism for the Application Function to subscribe to notifications about downlink data delivery status. The downlink data delivery status notifications relates to high latency communication, see also clauses 4.24.2 and 4.2.3.3.

Cancelling is done by sending Nnef\_EventExposure\_Unsubscribe request identifying the subscription to cancel with Subscription Correlation ID. Steps 2 to 5 are not applicable in the cancellation case.

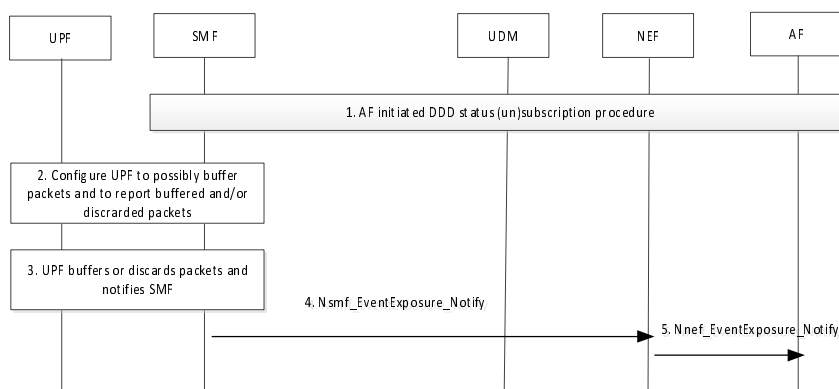


Figure 4.15.3.2.8-1: Information flow for downlink data delivery status with UPF buffering

1. AF interacts with NEF to subscribe DDD status event in SMF as described in steps 0-6 of clause 4.15.3.2.5.

In the case of subscription cancelling and SMF having interacted with the PCF during event subscription, the SMF reports to the PCF the unsubscribe of the DDD status event. The PCF updates or removes the PCC rule and this triggers the SMF to update or remove the corresponding PDR in the UPF. In case of home-routed PDU Session, the SMF unsubscribes the DDD status event from the V-SMF which in turn updates the N4 information (deactivating the notifications) in the V-UPF. In case of PDU Session with I-SMF, the SMF provides updated N4 information (deactivating the notifications) to the I-SMF which in turn updates the I-UPF.

2. If the UPF is configured to apply extended buffering, step 2 is executed immediately after step 1. Otherwise, step 2 is executed when the SMF is informed that the UE is unreachable via a `Namf_Communication_N1N2MessageTransfer` service operation as described in clause 4.2.3 and the SMF then also updates the PDR(s) for flows requiring extended buffering to requests the UPF to buffer downlink packets. If the DDD status event with traffic descriptor has been received in the SMF in step 1, if extended DL Data buffering in the UPF applies, the SMF checks whether an installed PDR for the Traffic Descriptor exists and if so, requests the UPF to provide the requested type(s) of notifications. If PCC is not used and there is no installed PDR with the exact same traffic descriptor, the SMF copies the installed PDR that would have previously matched the incoming traffic described by the traffic descriptor, but provides that traffic descriptor, a higher priority and the requested type(s) of notifications. If PCC is used and if the "DDD Status event subscription with Traffic Descriptor" PCRT is set as defined in clause 6.1.3.5 of TS 23.503 [20], the SMF interacts with the PCF and forwards the traffic descriptor before contacting the UPF; the PCF then updates an existing PCC rule or provides a new PCC rule taking into consideration the traffic descriptor for the subscribed DDD status event.

NOTE: If a new PCC rule is provided by the PCF for the DDD status event detection, the PCF populates the PCC rules as defined in clause 6.1.3.5 of TS 23.503 [20].

In the case of home-routed PDU Session, the V-SMF generates the N4 information (activating the notifications) for the V-UPF based on local configuration.

In the case of PDU Session with I-SMF, the SMF provides N4 information (activating the notifications) to the I-SMF based on local policy or the "DDD Status event subscription with Traffic Descriptor" PCRT from PCF. The I-SMF updates the I-UPF with this N4 information.

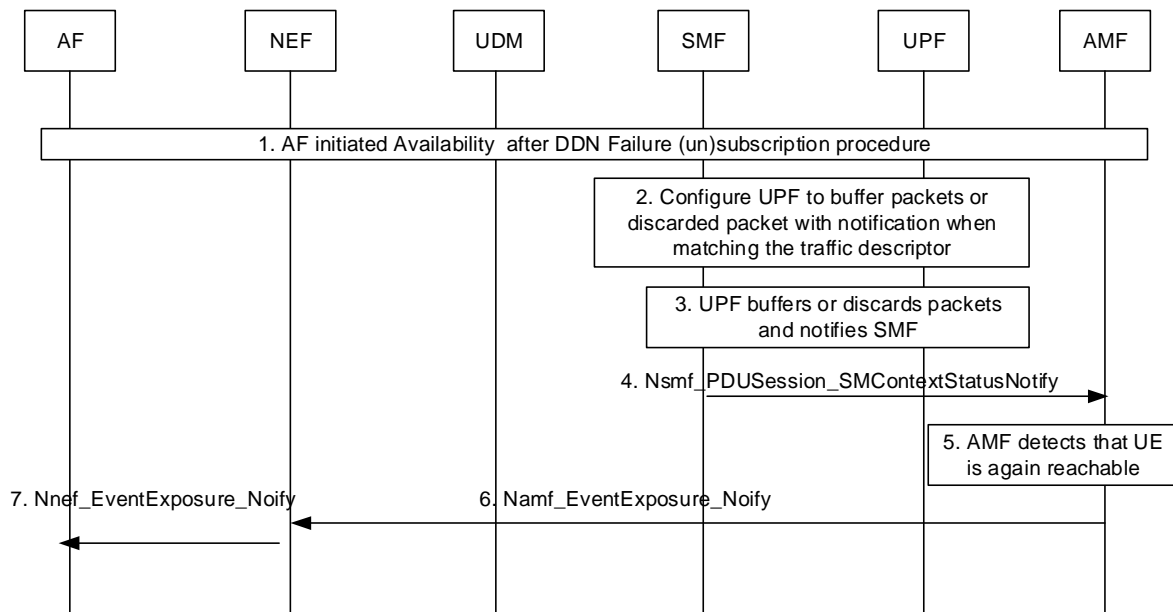
For home-routed PDU Session or PDU Session with I-SMF, steps 3-4 below are performed by V-SMF/V-UPF or I-SMF/I-UPF.

3. The UPF reports when there is buffered or discarded traffic matching the received PDR to the SMF. The SMF detects that previously buffered packets can be transmitted by the fact that the related PDU session becomes ACTIVE.
4. The SMF sends the `Nsmf_EventExposure_Notify` with Downlink Delivery Status event message to NEF.
5. The NEF sends `Nnef_EventExposure_Notify` with Downlink Delivery Status event message to AF.

#### 4.15.3.2.9 Information flow for Availability after DDN Failure with UPF buffering

The procedure is used if the SMF requests the UPF to buffer packets. The procedure describes a mechanism for the Application Function to subscribe to notifications about availability after DDN failure.

Cancelling is done by sending `Nnef_EventExposure_Unsubscribe` request identifying the subscription to cancel with Subscription Correlation ID. Steps 2 to 7 are not applicable in the cancellation case.



**Figure 4.15.3.2.9-1: Information flow for availability after DDN Failure event with UPF buffering**

1. AF interacts with NEF to subscribe availability after DDN failure event in AMF/SMF as described in steps 0-8 of clause 4.15.3.2.7.

In case of subscription cancelling from AMF and SMF having interacted with the PCF during event subscription, the SMF reports to the PCF for the unsubscribe of DDN failure event. The PCF updates or removes the PCC rule and this triggers the SMF to update or remove the corresponding PDR and FAR in the UPF.

In the case of PDU Session with I-SMF or home-routed PDU Session, the AMF unsubscribes the DDN failure event towards I/V-SMF. In case of home-routed PDU Session, the V-SMF updates the N4 information (deactivating the notifications) in the V-UPF. In case of PDU Session with I-SMF, the I-SMF may request N4 information (deactivating the notifications) from the SMF and provides the Traffic Descriptor to the SMF. The SMF provides updated N4 information (deactivating the notifications) to the I-SMF which in turn updates the I-UPF.

2. The SMF checks whether an installed PDR for the Traffic Descriptor exists and if so, requests the UPF to report when the first downlink packet is received and when it is discarded in the UPF. If PCC is not used and there is no installed PDR with the exact same traffic descriptor, the SMF copies the installed PDR that would have previously matched the incoming traffic described by the traffic descriptor, but provides that traffic descriptor, a higher priority and requests the UPF to report when the first downlink packet is received and when it is discarded in the UPF.

If PCC is used and if the "DDN Failure event subscription with Traffic Descriptor" PCRT is set as defined in clause 6.1.3.5 of TS 23.503 [20], the SMF interacts with the PCF and forwards the traffic descriptor before contacting the UPF; the PCF then updates an existing PCC rule or provides a new PCC rule taking into consideration the traffic descriptor for the subscribed DDN failure event.

**NOTE 1:** If a new PCC rule is provided by the PCF for the DDN failure event detection, the PCF populates the PCC rules as defined in clause 6.1.3.5 of TS 23.503 [20].

In the case of PDU Session with I-SMF or home-routed PDU Session, the AMF subscribes the DDN failure event towards the I/V-SMF. In the case of home-routed PDU Session, the V-SMF generates the N4 information (activating the notifications) for the V-UPF based on local configuration.

In the case of PDU Session with I-SMF, the I-SMF may request N4 information (activating the notifications) from the SMF based on local configuration and provides the Traffic Descriptor to the SMF. The SMF provides updated N4 information (activating the notifications) to the I-SMF which in turn updates the I-UPF.

For home-routed PDU Session or PDU Session with I-SMF, steps 3-4 below are performed by V-SMF/V-UPF or I-SMF/I-UPF.



- 3-4. When the first downlink packet matching the traffic descriptor is received in the UPF, if in step 2 the SMF indicated drop notification to the UPF, the UPF notifies the SMF and the SMF reports the DDN Failure status with NEF Correlation ID, by means of Nsmf\_PDUSession\_SMContextStatusNotify message, to the AMF indicated as notification endpoint.

When the first downlink packet matching the traffic descriptor is received in the UPF, if in step 2 the SMF indicated buffer notification to the UPF, the UPF notifies the SMF and the SMF may initiate Network Triggered Service Request as specified in clause 4.2.3.3. If the AMF responds Namf\_Communication\_N1N2MessageTransfer response with failure (e.g. due to UE not reachable, or paging no response), in addition to what is specified in clause 4.2.3.3, the SMF reports DDN Failure status with NEF Correlation ID, by means of Nsmf\_PDUSession\_SMContextStatusNotify message, to the AMF indicated as notification endpoint.

When the AMF receives DDN Failure status from the SMF, the AMF shall set a Notify-on-available-after-DDN-failure flag corresponding to the Notification Correlation Id and the identifier of the UE if available.

- 5-6. [Conditional] The AMF detects the UE is reachable and sends the event report(s) based on the Notify-on-available-after-DDN-failure flag, by means of Namf\_EventExposure\_Notify message(s), only to the NEF(s) indicated as notification endpoint(s) identified via the corresponding subscription in step 1. In this way, only the AF(s) for which DL traffic transmission failed are notified.

If the AMF received Idle Status Indication request in step 1 and the AMF supports Idle Status Indication, the AMF includes also the Idle Status Indication in Namf\_EventExposure\_Notify message.

7. The NEF sends Nnef\_EventExposure\_Notify message with the "Availability after DDN Failure" event to AF.

If the AMF included Idle Status Indication, the NEF includes it in Nnef\_EventExposure message.

#### 4.15.3.3 Void

### 4.15.4 Core Network Internal Event Exposure

#### 4.15.4.1 General

The exposure of events internally within the 5GC NFs is explained in the following clauses. Only the event notifications that are independent of the ongoing system procedure are specified in this clause. For the event notifications that are part of the system procedure, see the system procedure descriptions under clause 4.2 to clause 4.14.

#### 4.15.4.2 Exposure of Mobility Events from AMF

The AMF invokes the Namf\_EventExposure\_Notify to provide mobility related events to NF consumers that have subscribed for the events by invoking Namf\_EventExposure\_Subscribe, in the following scenarios listed below and after Namf\_EventExposure\_Subscribe service operation.

- During Registration procedure, Inter NG-RAN node N2 based handover procedure, when there is a change of AMF (within the same AMF Set or across the AMF Set), the new AMF receives all event subscriptions from old AMF or UDSF. For each event subscription:

if the event subscription only applies to the UE, the new AMF allocates a new Subscription Correlation ID and notify the NF consumer of the new Subscription Correlation ID associated with the change of Subscription Correlation ID event.

if the event subscription applies to a group of UE(s) and there is no corresponding subscription for this group (identified by the internal group Id and notification endpoint) at the new AMF, the new AMF shall create corresponding event subscription, allocate a new Subscription Correlation Id and send it to the received notification endpoint, i.e. Notification Target Address (+Notification Correlation Id), associated with the addition of Subscription Correlation ID event. The new AMF does not need to allocate another Subscription Correlation ID for any subsequent registrations of the members of the same group. The initial Maximum number of reports and the remaining number of reports within the Maximum number of reports quota for the UE is transferred from the old AMF.

NOTE: For group monitoring, even if the remaining number of reports is zero, indicating that reporting for the group event has been completed by the old AMF for this UE, the new AMF uses the received information related to initial event subscription to create the corresponding group event subscription.

- During Registration procedure, when there is a change of AMF, the new AMF notifies each NF that has subscribed for UE reachability event about the UE reachability status.
- During Registration, Handover, UE Triggered Service Request procedure in CM-IDLE state, Location Reporting, N2 Notification and AN Release procedures, the AMF determines the UE presence in Area Of Interest (i.e. IN, OUT or UNKNOWN status ) as described in Annex D.1 and notifies the NF Consumers of the UE presence in an Area Of Interest if the NF consumers (e.g. SMF) had subscribed for this Area Of Interest and if the UE presence in Area Of Interest is different from the one reported earlier.
- During Registration and Handover procedure or during Service Area Restriction update by UDM or PCF, if the UE is moving from an Allowed Area to a Non-Allowed Area, then the AMF informs all the NF consumers (e.g. SMF), that have subscribed for UE reachability event, that the UE is reachable only for regulatory prioritized service. The SMF shall explicitly subscribe UE reachability unless the established PDU Session is related to regulatory prioritized service.
- If the AMF had notified an SMF of the UE being reachable only for regulatory prioritized service earlier, the AMF informs the NF consumers (e.g. SMF), that have subscribed for UE reachability event, that the UE is reachable if the UE enters into Allowed Area.
- During Registration procedure and Service Request procedure, if the AMF had notified an SMF earlier of the UE being unreachable and that SMF need not invoke Namf\_Communication\_N1N2MessageTransfer to the AMF due to DL data notifications, the AMF informs the SMF when the UE becomes reachable.
- During Registration procedure and Service Request procedure, if the AMF had notified an SMF earlier that the UE is unreachable together with an Estimated Maximum Wait time, then the AMF informs the SMF when the UE becomes reachable. When the SMF learns that the UE is reachable and:
  - if the SMF performs Extended Buffering for a PDU session, the SMF sends the buffered data to the UPF and invokes the Namf\_Communication\_N1N2MessageTransfer service operation to the AMF to establish the User Plane(s) for the PDU Sessions, or the buffered data is delivered to the UE as per the procedure in clause 4.24.2 starting from step 2g for a PDU session using Control Plane CIoT 5GS Optimisation;
  - if the UPF performs Extended Buffering for a PDU session, the SMF invokes the Namf\_Communication\_N1N2MessageTransfer service operation to the AMF to establish the User Plane(s) for the PDU Sessions, or the buffered data is delivered to the UE as per the procedure in clause 4.24.2 starting from step 8a for a PDU session using Control Plane CIoT 5GS Optimisation.
- If NEF had subscribed for UE reachability event notification for Extend Buffering, then the AMF informs the NEF when the UE becomes reachable. When the NEF learns that the UE is reachable, it invokes the Nsmf\_NIDD\_Delivery service operation of the corresponding SMF to deliver the buffered data to the UE as per the procedure in the clause 4.25.5 starting from step 2 for a PDU session using Control Plane CIoT 5GS Optimisation.
- During Registration procedure, Handover without Registration procedure and Service Request procedure, if the NF consumers had subscribed for UE reachability status, the AMF notifies the UE reachability status changes.
- If the Mobile Reachable Timer expires the AMF notifies the NF consumers that have subscribed for the corresponding events that the UE is not reachable.
- If the UDM had subscribed for UE reachability event notification either to be reported to the UDM or to an NF consumer directly, then the AMF notifies the UE reachability event to the UDM or to the NF consumer as specified in clause 4.2.5.2.
- If UE's TAC is already known by the AMF, then, the AMF notifies UE TAC to the NF consumers (e.g. to NWDAF). If UE TAC is unknown, then the AMF notifies the UE TAC when it obtained the UE TAC from the UE.

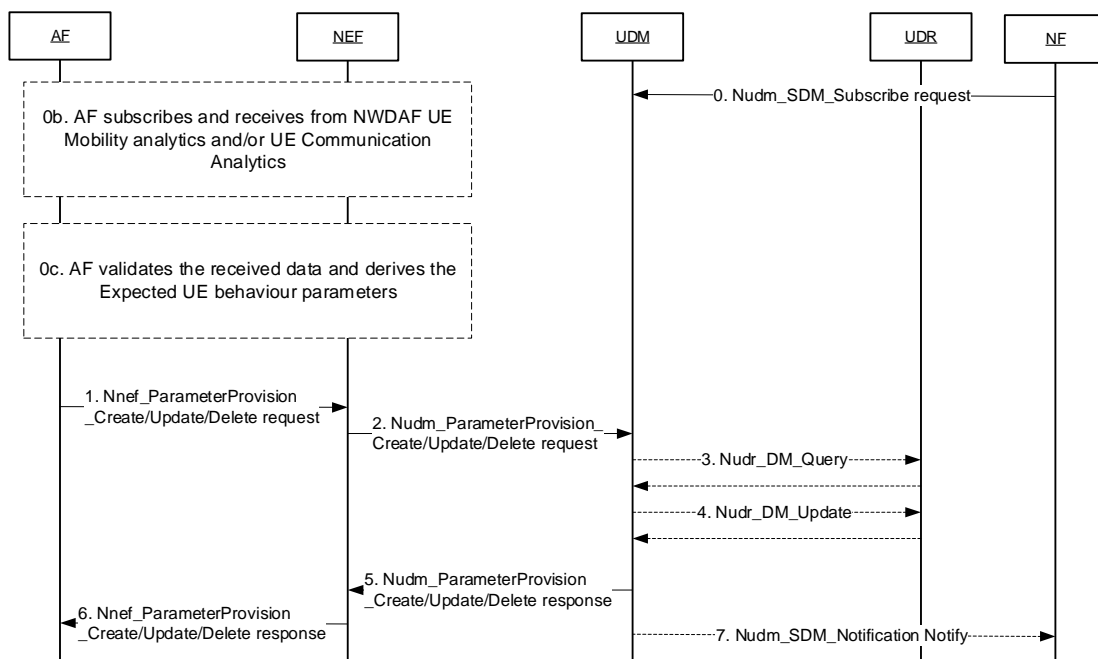
## 4.15.5 Void

## 4.15.6 External Parameter Provisioning

### 4.15.6.1 General

Provisioning capability allows an external party to provision the information, such as expected UE behaviour and service specific parameters, or the 5G VN group information to 5G network functions. In the case of provisioning the expected UE behavioural information, the expected UE behavioural information consists of information on expected UE movement and communication characteristics. In the case of provisioning the 5G VN group information the provisioning information consists of information on 5G VN group. The service specific information consists of information to support the specific service in 5G system. Provisioned data can be used by the other NFs.

### 4.15.6.2 NEF service operations information flow



**Figure 4.15.6.2-1: Nnef\_ParameterProvision\_Create / Nnef\_ParameterProvision\_Update / Nnef\_ParameterProvision\_Delete request/response operations**

0. NF subscribes to UDM notifications of UE and/or Group Subscription data updates.

NOTE 1: The NF can subscribe to Group Subscription data from UDM in this step and be notified of Group Subscription data updates in step 7 using the Shared Data feature defined in TS 29.503 [52].

0b. [Conditional, on using NWDAF-assisted values] The AF may subscribe to NWDAF via NEF in order to learn the UE mobility analytics and/or UE Communication analytics for a UE or group of UEs by applying the procedure specified in clause 6.1.1.2 of TS 23.288 [50]. The Analytics Id is set to any of the values specified in clause 6.7.1 of TS 23.288 [50].

0c. [Conditional, on using NWDAF-assisted values] AF validates the received data and derives any of the Expected UE behaviour parameters defined in clause 4.15.6.3 for a UE or group of UEs.

1. The AF provides one or more parameter(s) to be created or updated in a Nnef\_ParameterProvision\_Create or Nnef\_ParameterProvision\_Update or Nnef\_ParameterProvision\_Delete Request to the NEF.

The GPSI identifies the UE and the Transaction Reference ID identifies the transaction request between NEF and AF. For the case of Nnef\_ParameterProvision\_Create, The NEF assigns a Transaction Reference ID to the Nnef\_ParameterProvision\_Create request.

NEF checks whether the requestor is allowed to perform the requested service operation by checking requestor's identifier (i.e. AF ID).

For a Create request associated with a 5G VN group, the External Group ID identifies the 5G VN Group.

The payload of the Nnef\_ParameterProvision\_Update Request includes one or more of the following parameters:

- Expected UE Behaviour parameters (see clause 4.15.6.3); or
- Network Configuration parameters (see clause 4.15.6.3a); or
- External Group Id and 5G VN group data (i.e. 5G-VN configuration parameters) (see clause 4.15.6.3b), or
- 5G VN group membership management parameters (see clause 4.15.6.3c); or
- Location Privacy Indication parameters of the "LCS privacy" Data Subset of the Subscription Data (see clause 5.2.3.3.1 and clause 7.1 of TS 23.273 [51]); or
- MTC Provider Information.

The AF may request to delete 5G VN configuration by sending Nnef\_ParameterProvision\_Delete to the NEF.

2. If the AF is authorised by the NEF to provision the parameters, the NEF requests to create, update and store, or delete the provisioned parameters as part of the subscriber data via Nudm\_ParameterProvision\_Create, Nudm\_ParameterProvision\_Update or Nudm\_ParameterProvision\_Delete Request message, the message includes the provisioned data and NEF reference ID and optionally MTC Provider Information.

If the AF is not authorised to provision the parameters, then the NEF continues in step 6 indicating the reason to failure in Nnef\_ParameterProvision\_Create/Update/Delete Response message. Step 7 does not apply in this case.

NOTE 2: For non-roaming case and no authorisation or validation by the UDM required and if the request is not associated with a 5G VN group, the NEF can directly forward the external parameter to the UDR via Nudr\_DM\_Update Request message. And in this case, the UDR responds to NEF via Nudr\_DM\_Update Response message.

3. UDM may read from UDR, by means of Nudr\_DM\_Query, corresponding subscription information in order to validate required data updates and authorize these changes for this subscriber or Group for the corresponding AF.
4. If the AF is authorised by the UDM to provision the parameters for this subscriber, the UDM resolves the GPSI to SUPI and requests to create, update or delete the provisioned parameters as part of the subscriber data via Nudr\_DM\_Create/Update/Delete Request message, the message includes the provisioned data.

If a new 5G VN group is created, the UDM shall assign a unique Internal Group ID for the 5G VN group and include the newly assigned Internal Group ID in the Nudr\_DM\_Create Request message. If the list of 5G VN group members is changed or if 5G VN group data has changed, the UDM updates the UE and/or Group subscription data according to the AF/NEF request.

UDR stores the provisioned data as part of the UE and/or Group subscription data and responds with Nudr\_DM\_Create/Update/Delete Response message.

When the 5G VN group data (as described in clause 4.15.6.3b) or 5G VN group membership is updated, the UDR notifies to the subscribed PCF by sending Nudr\_DM\_Notify as defined in clause 4.16.12.2.

If the AF is not authorised to provision the parameters, then the UDM continues in step 5 indicating the reason to failure in Nudm\_ParameterProvision\_Update Response message and step 7 is not executed.

The UDM classifies the received parameters (i.e. Expected UE Behaviour parameters or Suggested Number of Downlink Packets or the 5G VN configuration parameters or Location Privacy Indication parameters), into AMF associated and SMF associated parameters. The UDM may use the AF ID received from the NEF in step 2 to relate the received parameter with a particular subscribed DNN and/or S-NSSAI. The UDM stores the SMF-Associated parameters under corresponding Session Management Subscription data type.

Each parameter or parameter set may be associated with a validity time. The validity time is stored at the UDM/UDR and in each of the NFs, to which parameters are provisioned (e.g. in AMF or SMF). Upon expiration of the validity time, each node deletes the parameters autonomously without explicit signalling.

5. UDM responds the request with Nudm\_ParameterProvision\_Create/Update/Delete Response. If the procedure failed, the cause value indicates the reason.
6. NEF responds the request with Nnef\_ParameterProvision\_Create/Update/Delete Response. If the procedure failed, the cause value indicates the reason.
7. [Conditional this step occurs only after successful step 4] UDM notifies the subscribed Network Function (e.g. AMF) of the updated UE and/or Group subscription data via Nudm\_SDM\_Notification Notify message.
  - a) If the NF is AMF, the UDM performs Nudm\_SDM\_Notification (SUPI or Internal Group Identifier, AMF-Associated Expected UE Behaviour parameters, Subscribed Periodic Registration Timer, subscribed Active Time, etc.) service operation. The AMF identifies whether there are overlapping parameter set(s) and merges the parameter set(s) in the Expected UE Behaviour, if necessary. The AMF uses the received parameters to derive the appropriate UE configuration of the NAS parameters and to derive Core Network assisted RAN parameters. The AMF may determine a Registration area based on parameters Stationary indication or Expected UE Moving Trajectory.
  - b) If the NF is SMF, the UDM performs Nudm\_SDM\_Notification (SUPI or Internal Group Identifier, SMF-Associated Expected UE Behaviour parameter set, DNN/S-NSSAI, Suggested Number of Downlink Packets, etc.) service operation.

The SMF stores the received parameters and associates them with a PDU Session based on the DNN and S-NSSAI included in the message from UDM. The SMF identifies whether there are overlapping parameter set(s) in the Expected UE behaviour and merges the parameter set(s), if necessary. The SMF may use the parameters as follows:

- SMF configures the UPF accordingly. The SMF can use the Scheduled Communication Type parameter or Suggested Number of Downlink Packets parameter to configure the UPF with how many downlink packets to buffer. The SMF may use the parameter Communication duration time to determine to deactivate UP connection and to perform CN-initiated selective deactivation of UP connection of an existing PDU Session.
- The SMF may derive SMF derived CN assisted RAN information for the PDU Session. The SMF provides the SMF derived CN assisted RAN information to the AMF as described in PDU Session establishment procedure or PDU Session modification procedure.

NOTE 3: The NEF (in NOTE 1) or the UDM (in step 3) can also update the corresponding UDR data via Nudr\_DM\_Create/Delete as appropriate.

#### 4.15.6.3 Expected UE Behaviour parameters

These Expected UE Behaviour parameters characterise the foreseen behaviour of a UE or a group of UEs. Sets of these parameters may be provided via the NEF to be stored as part of the subscriber data. Each parameter within the Expected UE Behaviour shall have an associating validity time. The validity time indicates when the Expected UE Behaviour parameter expires and shall be deleted by the related NFs. The validity time may be set to indicate that the particular Expected UE Behaviour parameter has no expiration time. When the validity time expires, the related NFs delete their local copy of the associated Expected UE Behaviour parameter(s). The provision procedure of the Expected UE Behaviour is realized by external parameter provision procedure defined in clause 4.15.6.2.

The Expected UE Behaviour parameters stored as AMF-Associated Expected UE Behaviour parameters which is per UE level and SMF-Associated Expected UE Behaviour parameters which is per PDU session level in UDM. AMF retrieves the AMF-Associated Expected UE Behaviour parameters from UDM which may related to both PDU session(s) and SMS transmission. SMF retrieves the SMF-Associated Expected UE Behaviour parameters from UDM for the specific PDU session. AMF and SMF uses the Expected UE Behaviour parameters as described in clause 5.4.6.2 of TS 23.501 [2].

**Table 4.15.6.3-1: Description of Expected UE Behaviour parameters**

<b>Expected UE Behaviour parameter</b>	<b>Description</b>
Expected UE Moving Trajectory	Identifies the UE's expected geographical movement Example: A planned path of movement
Stationary Indication	Identifies whether the UE is stationary or mobile [optional]
Communication Duration Time	Indicates for how long the UE will normally stay in CM-Connected for data transmission. Example: 5 minutes. [optional]
Periodic Time	Interval Time of periodic communication Example: every hour. [optional]
Scheduled Communication Time	Time and day of the week when the UE is available for communication. Example: Time: 13:00-20:00, Day: Monday. [optional]
Battery Indication	Identifies power consumption criticality for the UE: if the UE is battery powered with not rechargeable/not replaceable battery, battery powered with rechargeable/replaceable battery, or not battery powered. [optional]
Traffic Profile	Identifies the type of data transmission: single packet transmission (UL or DL), dual packet transmission (UL with subsequent DL or DL with subsequent UL), multiple packets transmission [optional]
Scheduled Communication Type	Indicates that the Scheduled Communication Type is Downlink only or Uplink only or Bi-directional [To be used together with Scheduled Communication Time] Example: <Scheduled Communication Time>, DL only. [optional]
Expected Time and Day of Week in Trajectory	Identifies the time and day of week when the UE is expected to be at each location included in the Expected UE Moving Trajectory. [optional]

The Expected UE Moving Trajectory and the Expected Time and Day of Week in Trajectory may be used by the AMF. All other parameters may be used by the AMF and by the SMF.

The Scheduled Communication Type and the Traffic Profile should not be used by the AMF to release the UE when NAS Release Assistance Information from the UE is available.

In the case of NB-IoT UEs, the parameters may be forwarded to the RAN to allow optimisation of Uu resource allocation for NB-IoT UE differentiation.

#### 4.15.6.3a Network Configuration parameters

The Network Configuration parameters are the parameters sent from an AF by invoking the Nnef\_ParameterProvision Service as described in clause 4.15.6.2.

The Network Configuration parameters are described in Table 4.15.6.3a-1.

**Table 4.15.6.3a-1: Description of Network Configuration parameters**

<b>Network Configuration parameter</b>	<b>Description</b>
Maximum Response Time	Identifies the time for which the UE stays reachable to allow the AF to reliably deliver the required downlink data. [optional]
Maximum Latency	Identifies maximum delay acceptable for downlink data transfers. Example: in order of 1 minute to multiple hours. [optional]
Suggested Number of Downlink Packets	Identifies the number of packets that the core network is suggested to buffer if the UE is not reachable. Example: 5 packets. [optional]

The parameters Maximum Response Time and Maximum Latency are stored in the UDM and the Maximum Response Time is sent to the AMF for event monitoring as specified in 4.15.3.2.3b.

The AMF may use the Maximum Response Time parameter as guide to configure:

- Extended Connected time for MICO mode;
- when to send reachability notifications to AF relative to expected reachability events (e.g. paging occasions).

If the UDM received multiple Network Configuration requests, the UDM shall accept the request as long as the Maximum Latency (if received) and/or the Maximum Response Time (if received) are within the range defined by operator policies. The UDM shall use the minimum value of Maximum Latency(s) to derive the subscribed periodic registration timer and use the maximum value of Maximum Response Time(s) to derive the subscribed Active Time as specified in step 2 of clause 4.15.3.2.3b. If the newly derived value is changed comparing to the one last time sent to the AMF, the UDM notify the AMF of the updated value via Nudm\_SDM\_Notification message. If there is a deletion of Network Configuration request, the UDM re-calculates the values (see step 2 in clause 4.15.3.2.3b) and notify the AMF if needed.

The Suggested Number of Downlink Packets is classified as SMF associated subscription data. If the NEF is providing DNN and S-NSSAI as specified in clause 4.15.3.2.3, then the UDM is able to associate the parameters with subscribed DNN and S-NSSAI and provides the Suggested Number of Downlink Packets consolidated as specified in 4.15.3.2.3b to the SMF for the PDU Session associated with the specific DNN and S-NSSAI as specified in clause 4.15.6.2. The SMF may use the Suggested Number of Downlink Packets parameter to configure the number of packets to buffer in the SMF/UPF (in the case of UPF anchored PDU sessions) or in the NEF (in the case of NEF anchored PDU session) when the UE is not reachable and extended buffering of downlink data is activated.

A Validity Time may be associated with any of the Network Configuration parameters. When the validity time expires, the related NFs delete their local copy of the associated Network Configuration parameter(s). If the deletion results in subscribed value change, the UDM shall notify the AMF or SMF of the changed value.

#### 4.15.6.3b 5G VN group data

The 5G VN group data is described in Table 4.15.6.3b-1.

**Table 4.15.6.3b-1: Description of 5G VN group data**

Parameters	Description
DNN	DNN for the 5G VN group
S-NSSAI	S-NSSAI for the 5G VN group
PDU Session Type	PDU Session Types allowed for 5G VN group
Application descriptor	There may be multiple instances of this information; this information may be used to build URSP sent to 5G VN group members (NOTE 1)
Information related with secondary authentication / authorization	This may indicate: <ul style="list-style-type: none"> <li>- the need for secondary authentication/authorization (as defined in clause 5.6 of TS 23.501 [2]);</li> <li>- the need for SMF to request the UE IP address from the DN-AAA server.</li> </ul> If at least one of secondary authentication/authorization or DN-AAA UE IP address allocation is needed, the AF may provide DN-AAA server addressing information.
NOTE 1: As described in TS 23.503 [20], the PCF may be configured with a mapping from Application Descriptor to other information required to construct the URSP rules, e.g. IP filters and SSC mode.	

The information described in Table 4.15.6.3b-1 corresponds to 5G VN group data that an AF may provide together with External Group ID.

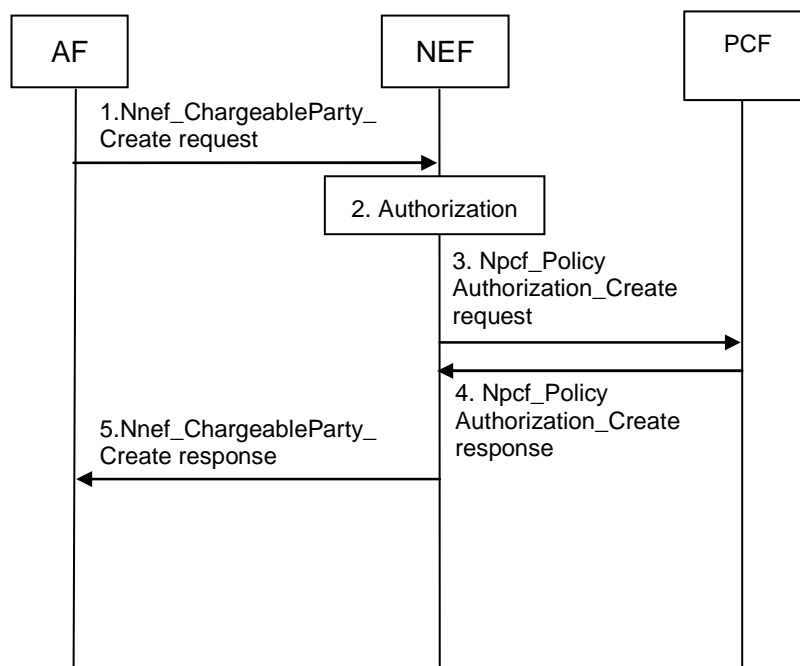
**4.15.6.3c 5G VN Group membership management parameters**

5G VN group membership management parameters that an AF may provide are described in Table 4.15.6.3c-1.

**Table 4.15.6.3b-1: Description of 5G VN Group membership management parameters**

Parameters	Description
List of GPSI	List of 5G VN Group members, each member is identified by GPSI
External Group ID	A identifier for 5G VN group

**4.15.6.4 Set a chargeable party at AF session setup**



**Figure 4.15.6.4-1: Set the chargeable party at AF session set-up**



1. When setting up the connection between an ASP sponsoring a session and the UE, the ASP may communicate with the AF to request to become the chargeable party for the session to be set up by sending a Nnef\_ChargeableParty\_Create request message (AF Identifier, UE address, Flow description(s), Sponsor Information, Sponsoring Status, Background Data Transfer Reference ID) to the NEF. The Sponsoring Status indicates whether sponsoring is started or stopped, i.e. whether the 3rd party service provider is the chargeable party or not. The Background Data Transfer Reference ID parameter identifies a previously negotiated transfer policy for background data transfer as defined in clause 4.16.7. The NEF assigns a Transaction Reference ID to the Nnef\_ChargeableParty\_Create request.
2. The NEF authorizes the AF request to sponsor the application traffic and stores the sponsor information together with the AF Identifier and the Transaction Reference ID. If the authorisation is not granted, step 2 is skipped and the NEF replies to the AF with a Result value indicating that the authorisation failed.

NOTE: Based on operator configuration, the NEF may skip this step. In this case the authorization is performed by the PCF in step 3.

3. The NEF interacts with the PCF by triggering a Npcf\_PolicyAuthorization\_Create request message and provides IP filter information or Ethernet filter information, sponsored data connectivity information (as defined in TS 23.203 [24]), Background Data Transfer Reference ID (if received from the AF) and Sponsoring Status (if received from the AF) to the PCF.
4. The PCF determines whether the request is allowed and notifies the NEF if the request is not authorized. If the request is not authorized, NEF responds to the AF in step 5 with a Result value indicating that the authorization failed.
5. The NEF sends a Nnef\_ChargeableParty\_Create response message (Transaction Reference ID, Result) to the AF. Result indicates whether the request is granted or not.

#### 4.15.6.5 Change the chargeable party during the session

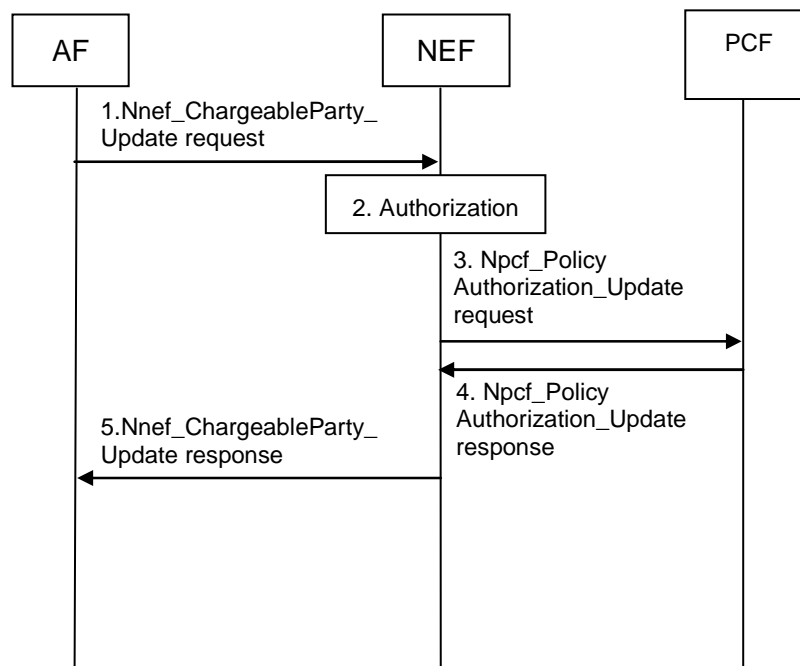


Figure 4.15.6.5-1: Change the chargeable party during the session

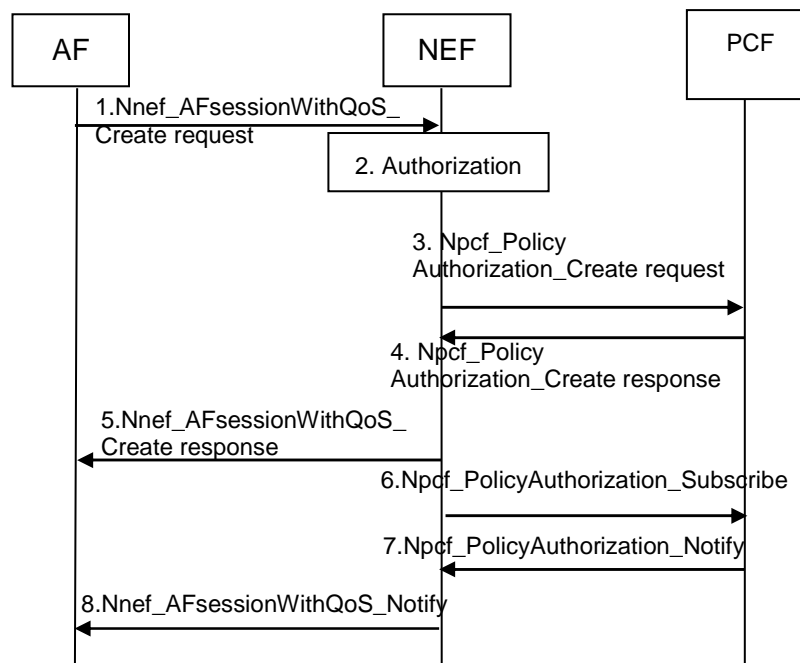
1. For the ongoing AF session, the AF may send a Nnef\_ChargeableParty\_Update request message (AF Identifier, Transaction Reference ID, Sponsoring Status, Background Data Transfer Reference ID) to the NEF. The Sponsoring Status indicates whether sponsoring is enabled or disabled, i.e. whether the 3rd party service provider is the chargeable party or not. The Background Data Transfer Reference ID parameter identifies a previously negotiated transfer policy for background data transfer as defined in clause 4.16.7. The Transaction Reference ID provided in the Change chargeable party request message is set to the Transaction Reference ID that was assigned, by the NEF, to the a Nnef\_ChargeableParty\_Create request.

- The NEF authorizes the AF request of changing the chargeable party. If the authorisation is not granted, step 3 is skipped and the NEF replies to the AF with a Result value indicating that the authorisation failed.

NOTE: Based on operator configuration, the NEF may skip this step. In this case the authorization is performed by the PCF in step 3.

- The NEF interacts with the PCF by triggering a Npcf\_PolicyAuthorization\_Update request and provides IP filter information or Ethernet filter information, sponsored data connectivity information (as defined in TS 23.203 [24]), Background Data Transfer Reference ID (if received from the AF) and Sponsoring Status (if received from the AF) to the PCF.
- The PCF determines whether the request is allowed and notifies the NEF if the request is not authorized. If the request is not authorized, NEF responds to the AF in step 5 with a Result value indicating that the authorization failed.
- The NEF sends a Nnef\_ChargeableParty\_Update response message (Transaction Reference ID, Result) to the AF. Result indicates whether the request is granted or not.

#### 4.15.6.6 Setting up an AF session with required QoS procedure



**Figure 4.15.6.6-1: Setting up an AF session with required QoS procedure**

- The AF sends a request to reserve resources for an AF session using Nnef\_AFsessionWithQoS\_Create request message (UE address, AF Identifier, Flow description(s), QoS reference, (optional) Alternative Service Requirements (containing one or more QoS reference parameters in a prioritized order)) to the NEF. Optionally, a period of time or a traffic volume for the requested QoS can be included in the AF request. The NEF assigns a Transaction Reference ID to the Nnef\_AFsessionWithQoS\_Create request.
- The NEF authorizes the AF request and may apply policies to control the overall amount of pre-defined QoS authorized for the AF. If the authorisation is not granted, steps 3 and 4 are skipped and the NEF replies to the AF with a Result value indicating that the authorisation failed.
- The NEF interacts with the PCF by triggering a Npcf\_PolicyAuthorization\_Create request and provides UE address, AF Identifier, Flow description(s), the QoS reference and the optional Alternative Service Requirements (containing one or more QoS reference parameters in a prioritized order). Any optionally received period of time or traffic volume is also included and mapped to sponsored data connectivity information (as defined in TS 23.203 [24]).
- The PCF determines whether the request is authorized and notifies the NEF if the request is not authorized.

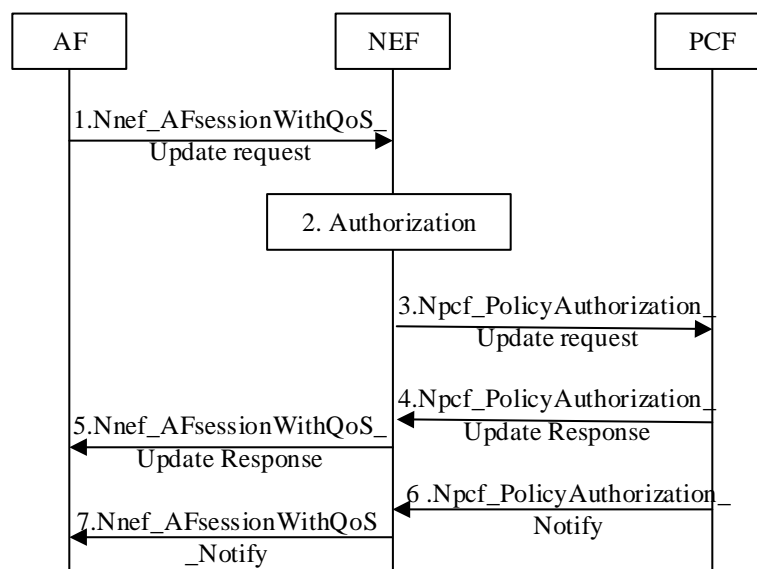
If the request is authorized, the PCF derives the required QoS parameters based on the information provided by the NEF and determines whether this QoS is allowed (according to the PCF configuration for this AF) and notifies the result to the NEF. In addition, if the Alternative Service Requirements are provided, the PCF derives the Alternative QoS parameter set(s) from the one or more QoS reference parameters contained in the Alternative Service Requirements in the same prioritized order (as defined in TS 23.503 [20]).

If the request is not authorized, or the required QoS is not allowed, NEF responds to the AF in step 5 with a Result value indicating the failure cause.

5. The NEF sends a Nnef\_AFsessionWithQoS\_Create response message (Transaction Reference ID, Result) to the AF. Result indicates whether the request is granted or not.
6. The NEF shall send a Npcf\_PolicyAuthorization\_Subscribe message to the PCF to subscribe to notifications of Resource allocation status and may subscribe to other events described in clause 6.1.3.18 of TS 23.503 [20].
7. When the event condition is met, e.g. that the establishment of the transmission resources corresponding to the QoS update succeeded or failed, the PCF sends Npcf\_PolicyAuthorization\_Notify message to the NEF notifying about the event.
8. The NEF sends Nnef\_AFsessionWithQoS\_Notify message with the event reported by the PCF to the AF.

The AF may send Nnef\_AFsessionWithQoS\_Revoke request to NEF in order to revoke the AF request. The NEF authorizes the revoke request and triggers the Npcf\_PolicyAuthorization\_Delete and the Npcf\_PolicyAuthorization\_Unsubscribe operations for the AF request.

#### 4.15.6.6a AF session with required QoS update procedure



**Figure 4.15.6.6a-1: AF session with required QoS update procedure**

1. For an established AF session with required QoS, the AF may send a Nnef\_AFsessionWithQoS\_Update request message (AF Identifier, Transaction Reference ID, [Flow description(s)], [QoS reference], [Alternative Service Requirements (containing one or more QoS reference parameters in a prioritized order)]) to NEF for updating the reserved resources. Optionally, a period of time or a traffic volume for the requested QoS can be included in the AF request. The Transaction Reference ID provided in the AF session with required QoS update request message is set to the Transaction Reference ID that was assigned, by the NEF, to the Nnef\_AFsessionWithQoS\_Create request message.
2. The NEF authorizes the AF request of updating AF session with required QoS and may apply policies to control the overall amount of pre-defined QoS authorized for the AF. If the authorisation is not granted, steps 3 and 4 are skipped and the NEF replies to the AF with a Result value indicating that the authorisation failed.
3. The NEF interacts with the PCF by triggering a Npcf\_PolicyAuthorization\_Update request and provides UE address, AF Identifier, Flow description(s), the QoS reference and the optional Alternative Service Requirements (containing one or more QoS reference parameters in a prioritized order). Any optionally received period of time

or traffic volume is also included and mapped to sponsored data connectivity information (as defined in TS 23.203 [24]).

4. The PCF determines whether the request is authorized.

If the request is authorized, the PCF derives the required QoS parameters based on the information provided by the NEF and determines whether this QoS is allowed (according to the PCF configuration for this AF) and notifies the result to the NEF. In addition, if the Alternative Service Requirements are provided, the PCF derives the Alternative QoS parameter set(s) from the one or more QoS reference parameters contained in the Alternative Service Requirements in the same prioritized order (as defined in TS 23.503 [20]).

If the request is not authorized or the required QoS is not allowed, NEF responds to the AF in step 5 with a Result value indicating the failure cause.

5. The NEF sends a Nnef\_AFsessionWithQoS\_Update response message (Transaction Reference ID, Result) to the AF. Result indicates whether the request is granted or not.
6. The PCF sends Npcf\_PolicyAuthorization\_Notify message to the NEF when the modification of the transmission resources corresponding to the QoS update succeeded or failed.
7. The NEF sends Nnef\_AFsessionWithQoS\_Notify message with the event reported by the PCF to the AF.

#### 4.15.6.7 Service specific parameter provisioning

This clause describes the procedures for enabling the AF to provide service specific parameters to 5G system via NEF.

The AF may issue requests on behalf of applications not owned by the PLMN serving the UE.

NOTE 1: In the case of architecture without CAPIF support, the AF is locally configured with the API termination points for the service. In the case of architecture with CAPIF support, the AF obtains the service API information from the CAPIF core function via the Availability of service APIs event notification or Service Discover Response as specified in TS 23.222 [54].

The AF request sent to the NEF contains the information as below:

- 1)- Service Description.

Service Description is the information to identify a service the Service Parameters are applied to. The Service Description in the AF request can be represented by the combination of DNN and S-NSSAI, an AF-Service-Identifier or an application identifier.

- 2) Service Parameters.

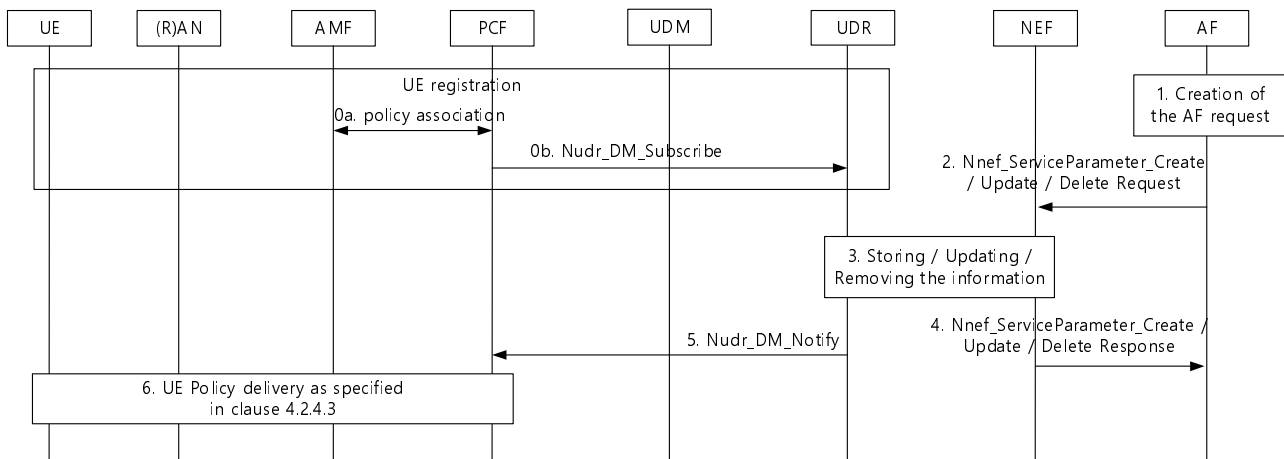
Service Parameters are the service specific information which needs to be provisioned in the Network and delivered to the UE in order to support the service identified by the Service Description.

- 3) Target UE(s) or a group of UEs.

Target UE(s) or a group of UEs indicate the UE(s) who the Service Parameters shall be delivered to. Individual UEs can be identified by GPSI, or an IP address/Prefix or a MAC address. Groups of UEs can be identified by an External Group Identifiers as defined in TS 23.682 [23]. If identifiers of target UE(s) or a group of UEs are not provided, then the Service Parameters shall be delivered to any UEs using the service identified by the Service Description.

The NEF authorizes the AF request received from the AF and stores the information in the UDR as "Application Data". The Service Parameters are delivered to the targeted UE by the PCF when the UE is reachable.

Figure 4.15.6.7-1 shows procedure for service specific parameter provisioning. The AF uses Nnef\_ServiceParameter service to provide the service specific parameters to the PLMN and the UE.



**Figure 4.15.6.7-1: Service specific information provisioning**

1. To create a new request, the AF invokes an Nnef\_ServiceParameter\_Create service operation.

To update or remove an existing request, the AF invokes an Nnef\_ServiceParameter\_Update or Nnef\_ServiceParameter\_Delete service operation together with the corresponding Transaction Reference ID which was provided to the AF in Nnef\_ServiceParameter\_Create response message.

The content of this service operation (AF request) includes the information described in clause 5.2.6.11.

2. The AF sends its request to the NEF. The NEF authorizes the AF request. The NEF performs the following mappings:
  - Map the AF-Service-Identifier into DNN and S-NSSAI combination, determined by local configuration.
  - Map the GPSI in Target UE Identifier into SUPI, according to information received from UDM.
  - Map the External Group Identifier in Target UE Identifier into Internal Group Identifier, according to information received from UDM.

(in the case of Nnef\_ServiceParameter\_Create): The NEF assigns a Transaction Reference ID to the Nnef\_ServiceParameter\_Create request.

3. (in the case of Nnef\_ServiceParameter\_Create or Update): The NEF stores the AF request information in the UDR as the "Application Data" (Data Subset setting to "Service specific information") together with the assigned Transaction Reference ID.

(in the case of Nnef\_ServiceParameter\_delete): The NEF deletes the AF request information from the UDR.

4. The NEF responds to the AF. In the case of Nnef\_ServiceParameter\_Create response message, the response message includes the assigned Transaction Reference ID.

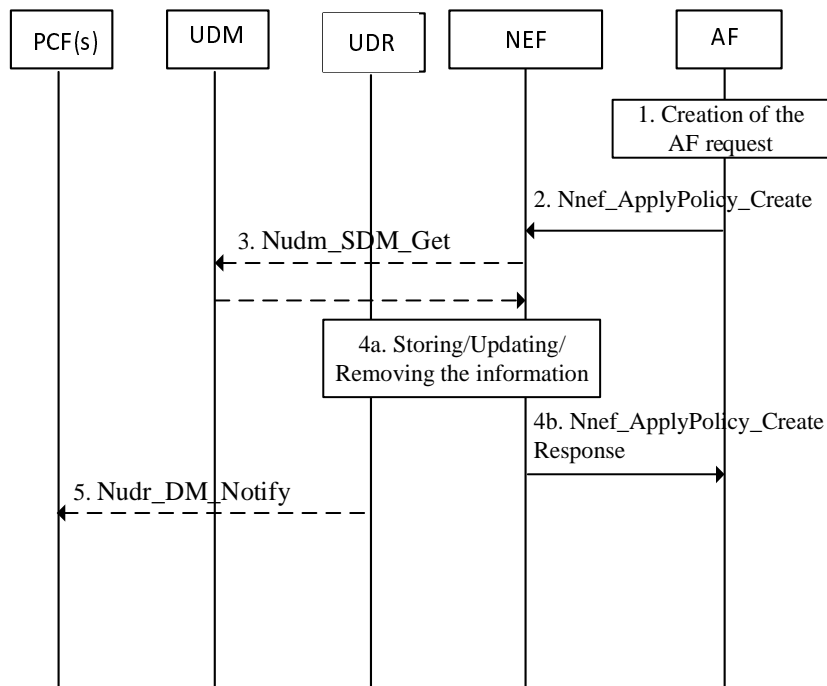
If the UE is registered to the network and the PCF performs the subscription to notification to the data modified in the UDR by invoking Nudr\_DM\_Subscribe (AF service parameter provisioning information, SUPI, Data Set setting to "Application Data", Data Subset setting to "Service specific information") at step 0, the following steps are performed:

5. The PCF(s) receive(s) a Nudr\_DM\_Notify notification of data change from the UDR.

NOTE 2: PCF does not have to subscribe for each UE the application specific information, e.g. if PCF has already received the application specific information for a group of UE or for a DNN by a subscription of other UE. The same application specific information is delivered to every UE in a group or a DNN.

6. The PCF initiates UE Policy delivery as specified in clause 4.2.4.3.

#### 4.15.6.8 Set a policy for a future AF session



**Figure 4.15.6.8-1: Set a policy for a future AF session**

1. The AF previously negotiated policy for background data transfer using the Procedure for future background data transfer as described in clause 4.16.7.2.
2. The AF requests that the previously negotiated policy for background data transfer be applied to a group of UE(s) or any UE, by invoking the Nnef\_ApplyPolicy\_Create service operation (AF Identifier, External Identifier or External Group Identifier, Background Data Transfer Reference ID). The Background Data Transfer Reference ID parameter identifies a previously negotiated transfer policy for background data transfer as defined in clause 4.16.7. The NEF assigns a Transaction Reference ID to the Nnef\_ApplyPolicy\_Create request. The NEF authorizes the AF request and stores the AF Identifier and the Transaction Reference ID.
3. The NEF invokes Nudm\_SDM\_Get (Identifier Translation, GPSI) to resolve the GPSI (External Identifier) to a SUPI or the NEF requests to resolve the External Group Identifier into the Internal Group Identifier using Nudm\_SDM\_Get (Group Identifier Translation, External Group Identifier).
- 4a. The NEF stores the AF request information in the UDR (Data Set = Application Data; Data Subset = Background Data Transfer, Data Key = Internal Group Identifier or SUPI).
- 4b. The NEF responds to the Nnef\_ApplyPolicy\_Create Request (Transaction Reference ID).
5. The PCF(s) that have subscribed to modifications of AF requests (Data Set = Application Data; Data Subset = Background Data Transfer, Data Key = Internal Group Identifier or SUPI) receive(s) a Nudr\_DM\_Notify notification of data change from the UDR.

#### 4.15.7 Network status reporting

This clause contains the detailed description and the procedures for the network status reporting capability.

An AF may request for being notified about the network status, in a specific geographical area or for a specific UE.

The following methods are supported:

- The AF requests to be informed, one-time, about the network status. This procedure is referred to as one-time network status request;
- The AF requests to be informed, continuously, about the network status. This procedure is referred to as continuous network status request;

The procedure as described in clause 6.1.1.2 or clause 6.1.2.2 of TS 23.288 [50] is used by an AF to retrieve Network Status Result (NSR) from the network for a specific geographic area or for a specific UE.

After receiving the request for network status notification from the AF, the NEF retrieves user data congestion analytics information from NWDAF, as defined in TS 23.288 [50].

Based on the user data congestion analytics information the NEF receives from the NWDAF, the NEF derives and reports the network status for the geographical area or for the UE as Network Status Result (NSR) to the AF. When reporting to the AF, the NSR shall not include any 3GPP location information.

NOTE 1: Either exact values for congestion status, as reported by NWDAF to NEF or abstracted values e.g. (High, Medium, Low) can be reported by the NEF to the AF. The calculation and the reporting of the NSR to the AF depends on operator configuration (e.g. SLAs, usage etc.).

When an AF requests one-time Network Status from the NEF, the NEF can optionally provide a time interval at which the AF is allowed to re-issue the same request for network status.

NOTE 2: The time interval provided by NEF can be ignored by the AF if the subsequent request on network status is considerably different with regards to the geographical area or the UE.

## 4.16 Procedures and flows for Policy Framework

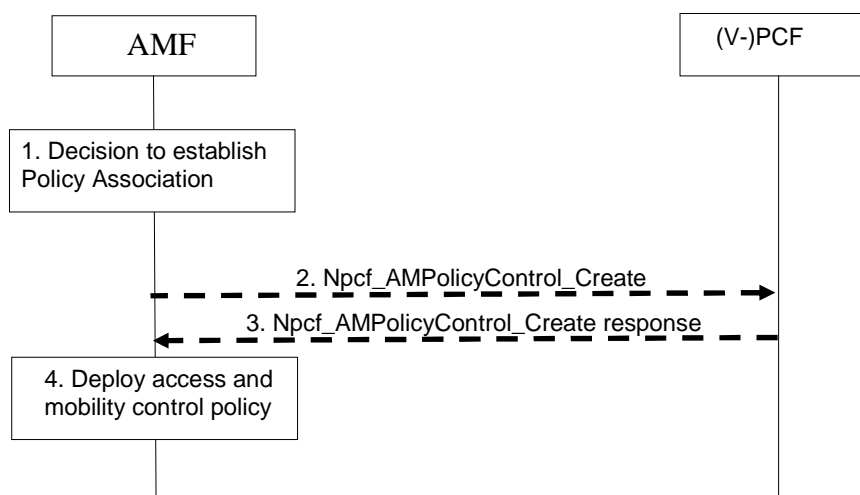
### 4.16.1 AM Policy Association Establishment

#### 4.16.1.1 General

There are three cases considered for AM Policy Association Establishment:

1. UE initial registration with the network.
2. The AMF re-allocation with PCF change in handover procedure and registration procedure.
3. EPS to 5GS mobility when there is no existing AM Policy Association between AMF and PCF for this UE.

#### 4.16.1.2 AM Policy Association Establishment with new Selected PCF



**Figure 4.16.1.2-1: AM Policy Association Establishment with new Selected PCF**

This procedure concerns both roaming and non-roaming scenarios.

In the non-roaming case the role of the V-PCF is performed by the PCF. For the roaming scenarios, the V-PCF interacts with the AMF.

1. Based on local policies, the AMF decides to establish AM Policy Association with the (V-)PCF then steps 2 to 3 are performed under the conditions described below.
2. [Conditional] If the AMF has not yet obtained Access and Mobility policy for the UE or if the Access and Mobility policy in the AMF are no longer valid, the AMF requests the PCF to apply operator policies for the UE from the PCF. The AMF sends Npcf\_AMPolicyControl\_Create to the (V-)PCF to establish an AM policy control association with the (V-)PCF. The request includes the following information: SUPI, Internal Group (see clause 5.9.7 of TS 23.501 [2]), subscription notification indication and, if available, Service Area Restrictions, RFSP index, Subscribed UE-AMBR, the Allowed NSSAI, GPSI which are retrieved from the UDM during the update location procedure and may include Access Type and RAT Type, PEI, ULI, UE time zone and Serving Network (PLMN ID, or PLMN ID and NID, see clause 5.34 of TS 23.501 [2]).
3. The (V-)PCF responds to the Npcf\_AMPolicyControl\_Create service operation. The (V-)PCF provides Access and mobility related policy information (e.g. Service Area Restrictions) as defined in clause 6.5 of TS 23.503 [20]. In addition, (V-)PCF can provide Policy Control Request Trigger of AM Policy Association to AMF.

The AMF is implicitly subscribed in the (V-)PCF to be notified of changes in the policies.

4. [Conditional] The AMF deploys the Access and mobility related policy information which includes storing the Service Area Restrictions and Policy Control Request Trigger of AM Policy Association, provisioning Service Area Restrictions to the UE and provisioning the RFSP index, the UE-AMBR and Service Area Restrictions to the NG-RAN as defined in TS 23.501 [2].

#### 4.16.1.3 Void

### 4.16.2 AM Policy Association Modification

#### 4.16.2.0 General

There are three cases considered for AM Policy Association Modification:

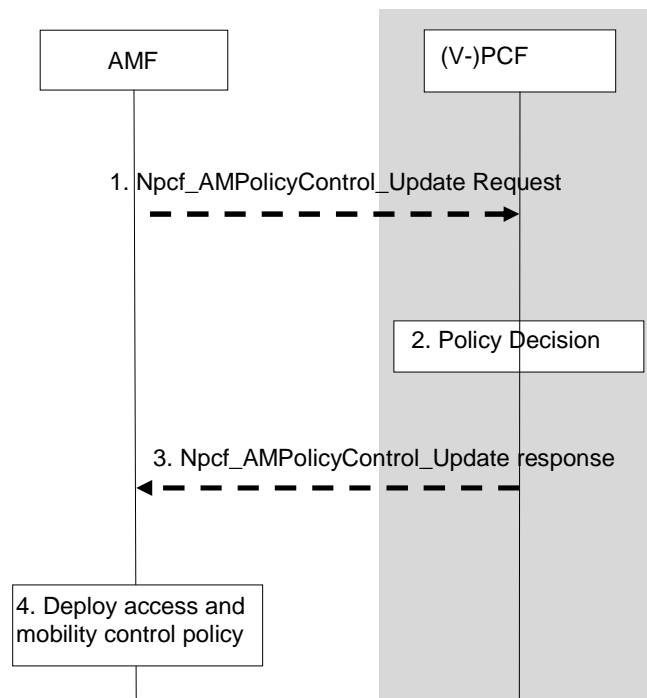
- Case A: A Policy Control Request Trigger condition is met: the procedure is initiated by the AMF.
- Case B: PCF local decision or trigger from other peers of the PCF (i.e. UDR): the procedure is initiated by the PCF.
- Case C: AM Policy Association Modification with the old PCF during AMF relocation: the procedure is initiated by the AMF.

#### 4.16.2.1 AM Policy Association Modification initiated by the AMF

##### 4.16.2.1.1 AM Policy Association Modification initiated by the AMF without AMF relocation

This procedure is applicable to Case A.





**Figure 4.16.2.1.1-1: AM Policy Association Modification initiated by the AMF**

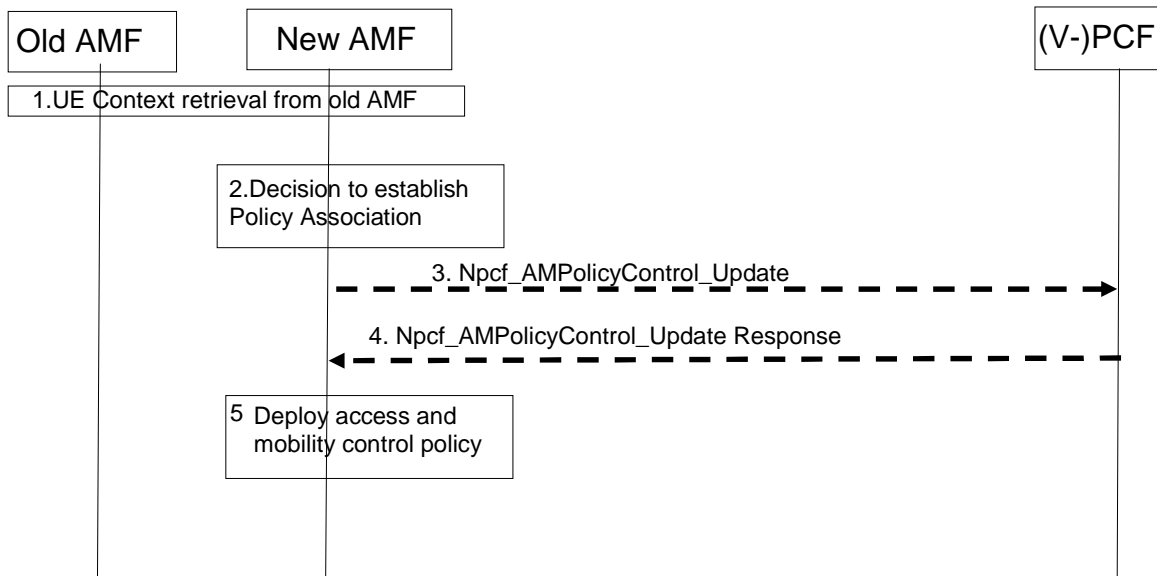
This procedure concerns both roaming and non-roaming scenarios.

In the non-roaming case the role of the V-PCF is performed by the PCF. For the roaming scenarios, the V-PCF interacts with the AMF.

1. When a Policy Control Request Trigger condition is met the AMF updates AM Policy Association and provides information on the conditions that have changed to the PCF by invoking `Npcf_AMPolicyControl_Update`.
2. The (V-)PCF stores the information received in step 1 and makes the policy decision.
3. The (V-)PCF responds to the AMF of the updated Access and Mobility related policy control information as defined in clause 6.5 of TS 23.503 [20] and the updated Policy Control Request Trigger parameters.
4. The AMF deploys the access and mobility control policy, which includes storing the Service Area Restrictions and Policy Control Request Trigger of AM Policy Association, provisioning the Service Area Restrictions to the UE and provisioning the RFSP index, UE-AMBR and Service Area Restrictions to the NG-RAN as defined in TS 23.501 [2].

#### 4.16.2.1.2 AM Policy Association Modification with old PCF during AMF relocation

This procedure is applicable to Case C. In this case, AMF relocation is performed without PCF change in handover procedure and registration procedure.



**Figure 4.16.2.1.2-1: AM Policy Association Modification with the old PCF during AMF relocation**

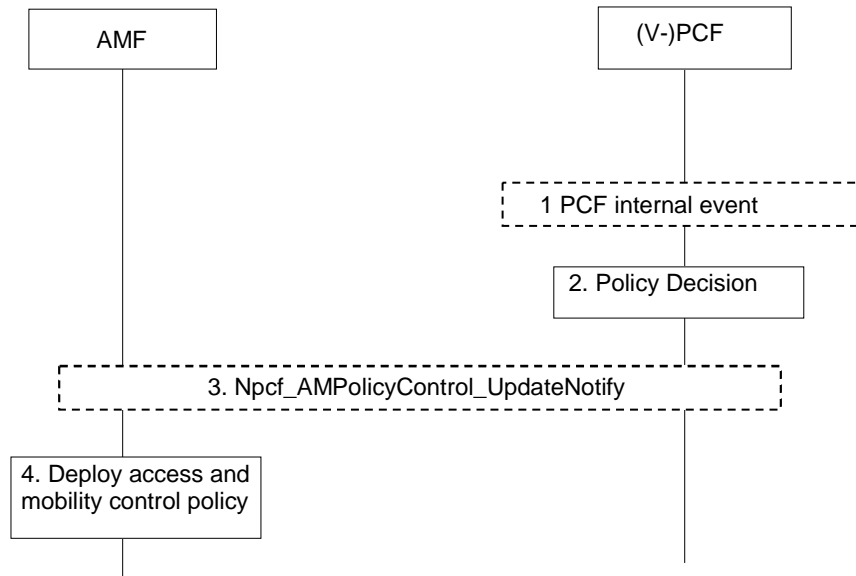
This procedure concerns both roaming and non-roaming scenarios.

In the non-roaming case the role of the V-PCF is performed by the PCF. For the roaming scenarios, the V-PCF interacts with the AMF.:

1. [Conditional] When the old AMF and the new AMF belong to the same PLMN, the old AMF transfers to the new AMF about the AM Policy Association information including policy control request trigger(s) and the PCF ID. For the roaming case, the new AMF receives V-PCF ID.
2. Based on local policies, the new AMF decides to establish UE Context with the (V-)PCF and contacts the (V-)PCF identified by the PCF ID received in step 1.
3. The new AMF sends `Npcf_AMPolicyControl_Update` to the (V-)PCF to update the AM policy association with the (V-)PCF. The request may include the following information: policy control request trigger which has been met, Subscribed Service Area Restrictions (if updated), subscribed RFSP index (if updated) which are retrieved from the UDM during the update location procedure and may include access type and RAT, PEI, ULI, UE time zone, service network. The (V-)PCF updates the stored information provided by the old AMF with the information provided by the new AMF.
4. The (V-)PCF may update the policy decision based on the information provided by the new AMF.
5. The AMF deploys the access and mobility control policy, which includes storing the Service Area Restrictions, provisioning Service Area Restrictions to the UE and provisioning the RFSP index, UE-AMBR and Service Area Restrictions to the NG-RAN.

### 4.16.2.2 AM Policy Association Modification initiated by the PCF

This procedure is applicable to AM Policy Association modification due to Case B.



**Figure 4.16.2.2-1: AM Policy Association Modification initiated by the PCF**

This procedure concerns both roaming and non-roaming scenarios.

In the non-roaming case the role of the V-PCF is performed by the PCF. For the roaming scenarios, the V-PCF interacts with the AMF.

NOTE: The V-PCF stores the access and mobility control policy information provided to the AMF.

1. [Conditional] PCF determines locally that the new status of the UE context requires new policies.
2. The (V-)PCF makes a policy decision.
3. The (V-)PCF sends `Npcf_AMPolicyControl_UpdateNotify` including AM Policy Association ID associated with the SUPI defined in TS 29.507 [32], Service Area Restrictions, UE-AMBR or RFSP index.
4. The AMF deploys the Access and mobility related policy information, which includes storing the Service Area Restrictions and Policy Control Request Trigger of AM Policy Association, provisioning of the Service Area Restrictions to the UE and provisioning the RFSP index, UE-AMBR and Service Area Restrictions to the NG-RAN.

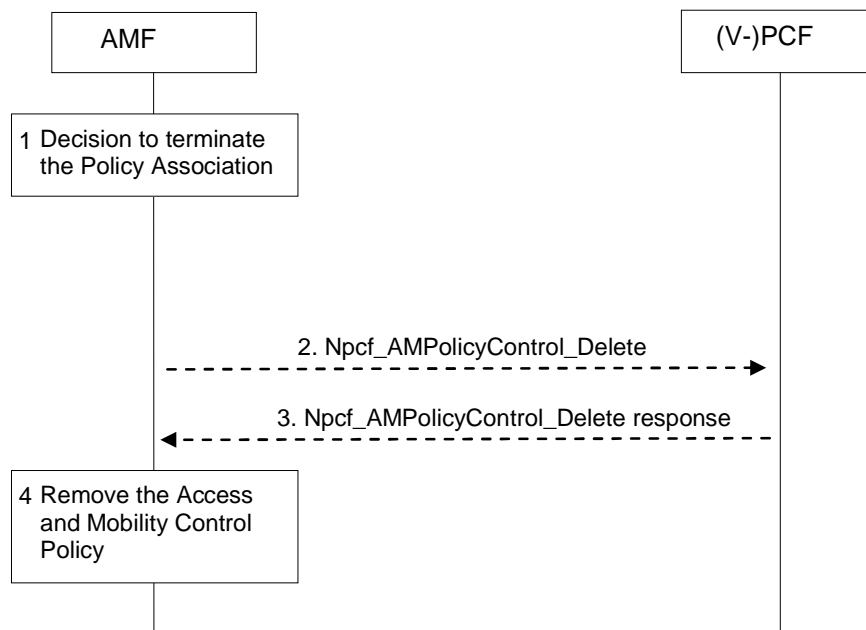
## 4.16.3 AM Policy Association Termination

### 4.16.3.1 General

The following case is considered for AM Policy Association Termination:

1. UE Deregistration from the network.
2. The mobility with change of AMF (e.g. new AMF is in different PLMN or new AMF in the same PLMN).
3. [Optional] 5GS to EPS mobility with N26 if the UE is not connected to the 5GC over a non-3GPP access in the same PLMN.

### 4.16.3.2 AMF-initiated AM Policy Association Termination



**Figure 4.16.3.2-1: AMF-initiated AM Policy Association Termination**

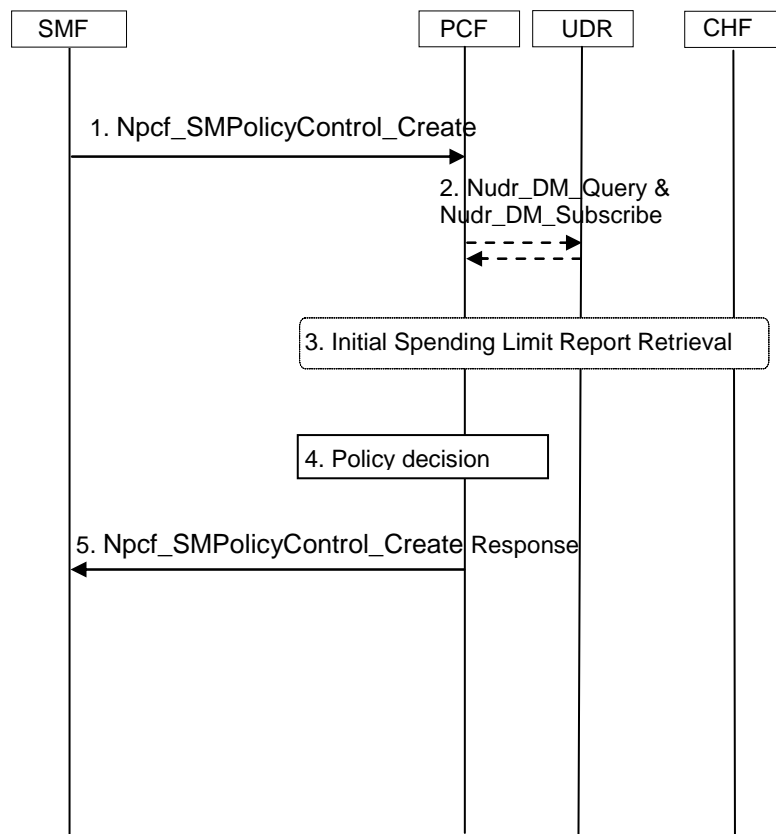
This procedure concerns both roaming and non-roaming scenarios.

In the non-roaming case the role of the V-PCF is performed by the PCF. For the roaming scenarios, the V-PCF interacts with the AMF.

1. The AMF decides to terminate the AM Policy Association during Deregistration procedure or due to mobility with change of AMF and (V-)PCF in the registration procedure or handover procedure, then if a AM Policy Association was established with the (V-)PCF steps 2 to 3 are performed.
2. The AMF sends the Npcf\_AMPolicyControl\_Delete service operation including AM Policy Association ID to the (V-)PCF.
3. The (V-)PCF removes the policy context for the UE and replies to the AMF with an Acknowledgement including success or failure.
4. The AMF removes the AM Policy Association for this UE, including the Access and Mobility Control Policy related to the UE. The AMF deletes the subscription to AMF detected events requested for that Policy Association.

### 4.16.3.3 Void

## 4.16.4 SM Policy Association Establishment



**Figure 4.16.4-1: SM Policy Association Establishment**

This procedure concerns both roaming and non-roaming scenarios.

In the non-roaming case the V-PCF is not involved. In the local breakout roaming case, the H-PCF is not involved. In the home routed roaming case, the V-PCF is not involved and the H-PCF interacts with the H-SMF.

This procedure is used in UE requests a PDU Session Establishment as explained in clause 4.3.2.2.1, for non-roaming and local breakout roaming. For home-routed roaming, as explained in clause 4.3.2.2.2.

For local breakout roaming, the interaction with HPLMN (e.g. step 3) is not used. In local breakout roaming, the V-PCF interacts with the UDR of the VPLMN.

1. The SMF determines that the PCC authorization is required and requests to establish an SM Policy Association with the PCF by invoking Npcf\_SMPolicyControl\_Create operation, including information about the PDU Session as specified in clause 5.2.5.4.2.

The SMF provides Trace Requirements to the PCF when it has received Trace Requirements and it has selected a different PCF than the one received from the AMF.

If the DNN Selection Mode indicates that the DNN is not explicitly subscribed, the PCF may use the local configuration instead of PDU Session policy control data in UDR.

The QoS constraints from the VPLMN are provided by the H-SMF to the H-PCF in the home routed roaming scenario as defined in clause 4.3.2.2.2.

2. If the PCF does not have the subscriber's subscription related information, it sends a request to the UDR by invoking Nudr\_DM\_Query (SUPI, DNN, S-NSSAI, Policy Data, PDU Session policy control data, Remaining allowed Usage data) service in order to receive the information related to the PDU Session. The PCF may request notifications from the UDR on changes in the subscription information by invoking Nudr\_DM\_Subscribe (Policy Data, SUPI, DNN, S-NSSAI, Notification Target Address (+ Notification Correlation Id), Event Reporting Information (continuous reporting), PDU Session policy control data, Remaining allowed Usage data) service.

3. If the PCF determines that the policy decision depends on the status of the policy counters available at the CHF and such reporting is not established for the subscriber, the PCF initiates an Initial Spending Limit Report Retrieval as defined in clause 4.16.8.2. If policy counter status reporting is already established for the subscriber and the PCF determines that the status of additional policy counters are required, the PCF initiates an Intermediate Spending Limit Report Retrieval as defined in clause 4.16.8.3.
4. The PCF makes the authorization and the policy decision. The PCF may reject `Npcf_SMPolicyControl_Create` request when Validation condition is not satisfied. (see clause 6.1.2.4 of TS 23.503 [20]).

PCF may invoke `Nbsf_Management_Register` service operation to create the binding information in BSF.

In the home-routed roaming scenario, the H-PCF ensures that the QoS constraints provided by the VPLMN are taken into account as described in TS 23.503 [20].

5. The PCF answers with a `Npcf_SMPolicyControl_Create` response; in its response the PCF may provide policy information defined in clause 5.2.5.4 (and in TS 23.503 [20]). The SMF enforces the decision. The SMF implicitly subscribes to changes in the policy decisions.

NOTE: After this step the PCF can subscribe to SMF events associated with the PDU Session.

## 4.16.5 SM Policy Association Modification

### 4.16.5.0 General

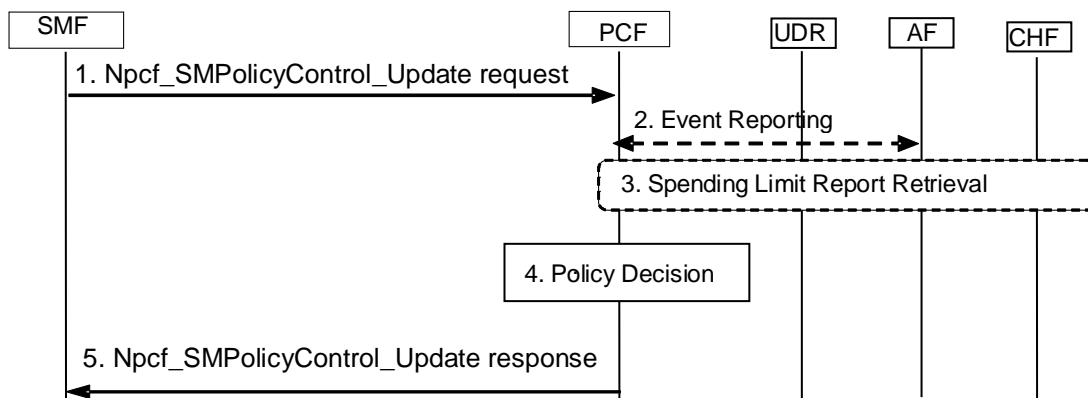
The following SM Policy Association Modification procedures concern both roaming and non-roaming scenarios.

In the non-roaming case the V-PCF is not involved. In the local breakout roaming case, the H-PCF is not involved. In the home routed roaming case, the V-PCF is not involved and the H-PCF interacts with the H-SMF.

The SM Policy Association Modification procedure may be initiated either by the SMF or by the PCF.

### 4.16.5.1 SMF initiated SM Policy Association Modification

The SMF may initiate the SM Policy Association Modification procedure if a Policy Control Request Trigger is met.



**Figure 4.16.5.1-1: SMF initiated SM Policy Association Modification**

For local breakout roaming, the interaction with HPLMN (e.g. step 2) is not used. In local breakout roaming, the V-PCF interacts with the UDR of the VPLMN.

1. When a Policy Control Request Trigger condition is met the SMF requests to update (`Npcf_SMPolicyControl_Update`) the SM Policy Association and provides information on the conditions that have been met as specified in clause 5.2.5.4.5.

If the SMF is notified by NRF that the stored PCF instance is not reachable, it should query the NRF for PCF instances within the PCF set and select another instance (see clause 6.3.1.0 of TS 23.501 [2]).

The QoS constraints from the VPLMN are provided by the H-SMF to the H-PCF in the home routed roaming scenario as defined in clause 4.3.2.2.2.

2. When an AF has subscribed to an event that is met due to the report from the SMF, the PCF reports the event to the AF by invoking the Npcf\_PolicyAuthorization\_Notify service operation.

When integration with TSN applies (see clause 5.28 of TS 23.501 [2]) and if the SMF has reported that new 5GS Bridge information has been detected and no AF session exists for this PDU session yet, then the PCF informs a pre-configured TSN AF using the Npcf\_PolicyAuthorization\_Notify service operation of 5GS Bridge information (e.g. 5GS Bridge ID, the port number of the DS-TT Ethernet port and MAC address of the DS-TT Ethernet port for the PDU Session).

When the TSN AF receives the Npcf\_PolicyAuthorization\_Notify message over the pre-configured AF session, the TSN AF shall use the Npcf\_PolicyAuthorization service described in clause 5.2.5.3 to request creation of a new AF session specific to the received MAC address of the DS-TT Ethernet port. The TSN AF shall then use the Npcf\_PolicyAuthorization service to subscribe for notifications for 5GS Bridge information Notification event over the newly established AF session.

If the SMF has reported UE-DS-TT Residence Time or PMIC with port number or BMIC, then the PCF also provides these information elements to the TSN AF, the TSN AF calculates the bridge delay for each port pair, i.e. composed of (DS-TT Ethernet port, NW-TT Ethernet port), using the UE-DS-TT Residence Time for all NW-TT Ethernet ports serving 5GS bridge indicated by the 5GS Bridge ID.

3. If the PCF determines a change to policy counter status reporting is required, it may alter the subscribed list of policy counters using the Initial, Intermediate or Final Spending Limit Report Retrieval procedures as defined in clause 4.16.8.
4. The PCF makes a policy decision as described in TS 23.503 [20]. The PCF may determine that updated or new policy information needs to be sent to the SMF.

If the SMF reported accumulated usage for the PDU session in step 1 the PCF deducts the value from the remaining allowed usage for the subscriber, DNN and S-NSSAI in the UDR by invoking Nudr\_DM\_Update (SUPI, DNN, S-NSSAI, Policy Data, Remaining allowed Usage data, updated data) service operation.

If the SMF reported accumulated usage for a MK(s) in step 1 the PCF deducts the value from the remaining allowed usage for the MK in the UDR by invoking Nudr\_DM\_Update (SUPI, DNN, S-NSSAI, Policy Data, Remaining allowed Usage data, updated data (including MK(s))) service operation.

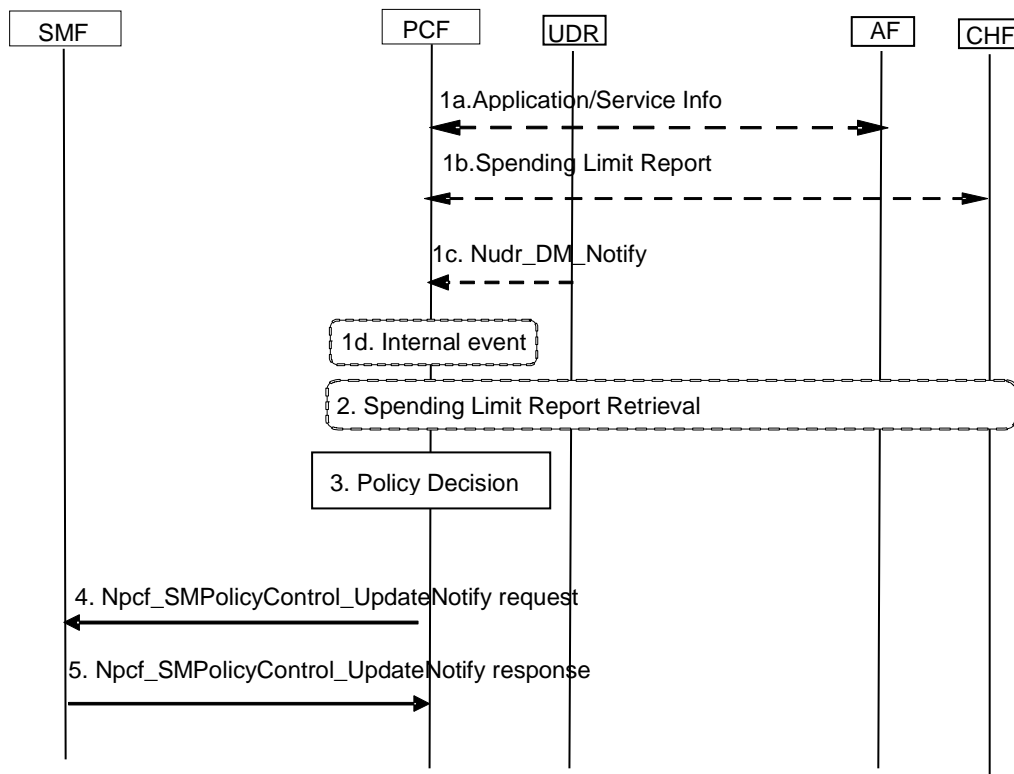
When new PCF instance is selected in step 1, the new PCF should invoke Nbsf\_Management\_Update service operation to update the binding information in BSF.

In the home-routed roaming scenario, the H-PCF ensures that the QoS constraints provided by the VPLMN are taken into account as described in TS 23.503 [20].

5. The PCF answers with a Npcf\_SMPolicyControl\_Update response with updated policy information about the PDU Session determined in step 4.

#### 4.16.5.2 PCF initiated SM Policy Association Modification

The PCF may initiate SM Policy Association Modification procedure based on local decision or triggered by other peers of the PCF (AF, CHF, UDR).



**Figure 4.16.5.2-1: PCF initiated SM Policy Association Modification**

This procedure may be triggered by a local decision of the PCF or based on triggers from other peers of the PCF (AF, CHF, UDR):

For local breakout roaming, the interaction with HPLMN (e.g. step 1b and step 2) is not used. In local breakout roaming, the V-PCF interacts with the UDR of the VPLMN.

- 1a. Alternatively, optionally, the AF provides/revokes service information to the PCF e.g. due to AF session signalling, by invoking `Npcf_PolicyAuthorization_Create Request` or `Npcf_PolicyAuthorization_Update Request` service operation. The PCF responds to the AF.
- 1b. Alternatively, optionally, the CHF provides a Spending Limit Report to the PCF as described in clause 4.16.8. and responds to the CHF.
- 1c. Alternatively, optionally, the UDR notifies the PCF about a policy subscription change by invoking `Nudr_DM_Notify` (Notification correlation Id, Policy Data, SUPI, updated data, "PDU Session Policy Control Data" | "Remaining allowed Usage data"); The PCF responds to the UDR.
- 1d. Alternatively, optionally, some internal event (e.g. timer, or local decision based on information received from NWDAF) occurs at the PCF.
2. If the PCF determines a change to policy counter status reporting is required, it may alter the subscribed list of policy counters using the Initial, Intermediate or Final Spending Limit Report Retrieval procedures as defined in clause 4.16.8.

NOTE: The PCF ensures that information received in step 1 and 2 can be used by later policy decisions.

3. The PCF makes a policy decision. The PCF may determine that updated or new policy information need to be sent to the SMF.

If the AF provided a Background Data Transfer Reference ID in step 1a, the PCF may retrieve it from the UDR by invoking the `Nudr_DM_Query` (BDT Reference Id, Policy Data, Background Data Transfer) service.

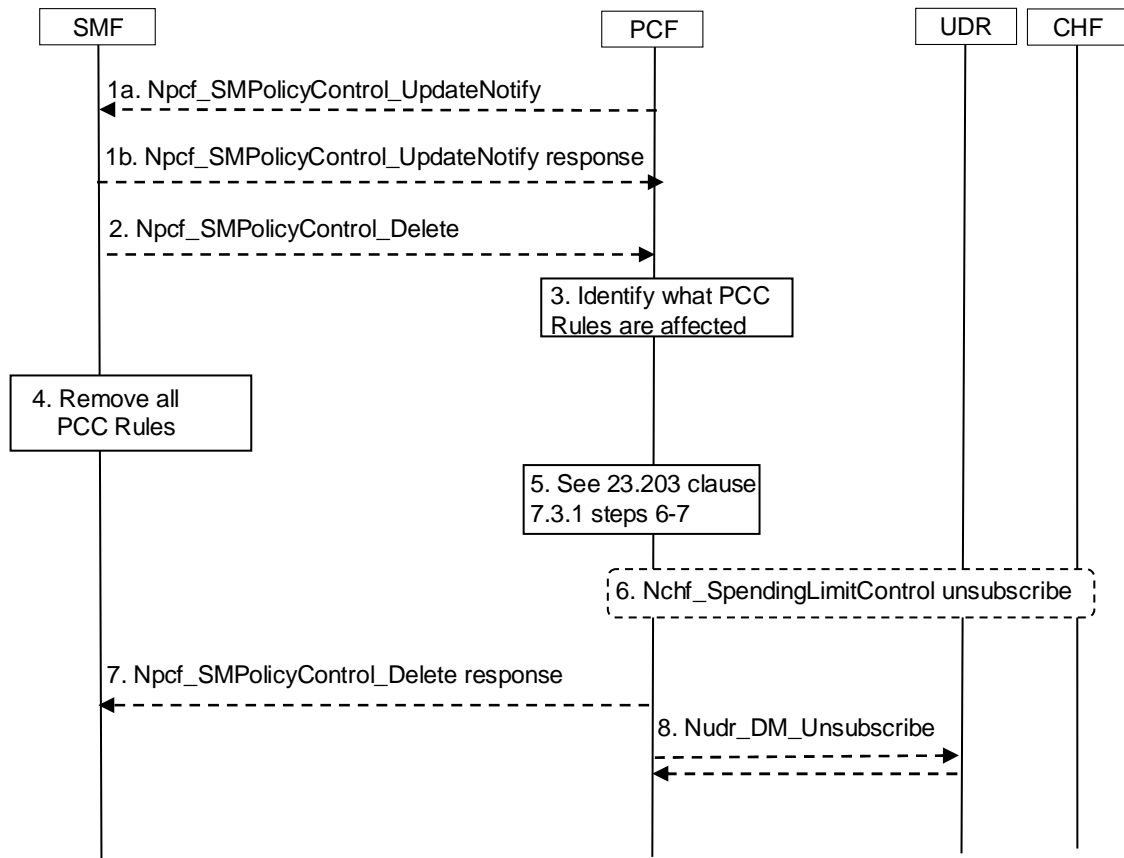
4. If the PCF has determined that SMF needs updated policy information in step 3 or if the PCF has received a Port Management Information Container, MAC address reported for the PDU Session and related port number from the AF in Step 1a, the PCF issues a `Npcf_SMPolicyControl_UpdateNotify` request with possibly updated policy information about the PDU Session.



5. The SMF acknowledges the PCF request with a Npcf\_SMPolicyControl\_UpdateNotify response.

If the Npcf\_SMPolicyControl\_UpdateNotify request is received from new PCF instance in the PCF Set, the SMF store the SM policy association towards the new PCF instance.

#### 4.16.6 SM Policy Association Termination



**Figure 4.16.6-1: SM Policy Association Termination**

This procedure concerns both roaming and non-roaming scenarios.

In the non-roaming case the V-PCF is not involved. In the local breakout roaming case, the H-PCF is not involved. In the home routed roaming case, the V-PCF is not involved and the H-PCF interacts only with the H-SMF.

The procedure for Session Management Policy Termination may be initiated by:

- (Case A) the PCF.
- (Case B) the SMF.

For local breakout roaming, the interaction with HPLMN (e.g. step 6) is not used. In local breakout roaming, the V-PCF interacts with the UDR of the VPLMN.

1. (Case A) The PCF may invoke the Npcf\_SMPolicyControl\_UpdateNotify service operation to request the release of a PDU Session. The SMF acknowledges the request.

The rest of the procedure corresponds to both Case A & B.

2. The SMF may invoke the Npcf\_SMPolicyControl\_Delete service operation to request the deletion of the SM Policy Association with the PCF. The SMF provides relevant information to the PCF.
3. When receiving the request from step 2, the PCF finds the PCC Rules that require an AF to be notified and removes PCC Rules for the PDU Session.

If the SMF reported accumulated usage for the PDU session in step 1 the PCF deducts the value from the remaining allowed usage for the subscriber, DNN and S-NSSAI in the UDR by invoking Nudr\_DM\_Update (SUPI, DNN, S-NSSAI, Policy Data, Remaining allowed Usage data, updated data) service operation.

If the SMF reported accumulated usage for a MK(s) in step 1 the PCF deducts the value from the remaining allowed usage for the MK in the UDR by invoking Nudr\_DM\_Update (SUPI, DNN, S-NSSAI, Policy Data, Remaining allowed Usage data, updated data (including MK(s))) service operation.

4. The SMF removes all policy information about the PDU Session associated with the PDU Session.
5. The PCF notifies the AF as explained in clause 7.3.1 steps 6-7 of TS 23.203 [24].

PCF may invoke Nbsf\_Management\_Deregister service operation to delete the binding created in BSF.

6. The PCF may invoke the procedure defined in clause 4.16.8 to unsubscribe to policy counter status reporting (If this is the last PDU Session for this subscriber requiring policy counter status reporting) or to modify the subscription to policy counter status reporting, (if any remaining existing PDU Sessions for this subscriber requires policy counter status reporting).
7. The PCF removes the information related to the terminated PDU Session and acknowledges to the SMF that the PCF handling of the PDU Session has terminated. This interaction is the response to the SMF request in step 2.
8. The PCF may (e.g. if it is the last PDU Session on the (DNN, S-NSSAI) couple) unsubscribe to the notification of the PDU Session related data modification from the UDR by invoking Nudr\_DM\_Unsubscribe (Subscription Correlation Id) if it had subscribed such notification.

## 4.16.7 Negotiations for future background data transfer

### 4.16.7.1 General

The procedure for future background data transfer as specified in clause 4.16.7.2 enables the negotiation between the NEF and the H-PCF about the transfer policies for the future background data transfer (as described in clause 6.1.2.4 of TS 23.503 [20]). The transfer policies consist of a desired time window for the background data transfer, a reference to a charging rate for the time window, network area information and optionally a maximum aggregated bitrate, as described in clause 6.1.2.4 of TS 23.503 [20].

This negotiation is preliminarily conducted (when AF initiates a procedure to NEF) before the UE's PDU Session establishment. When the AF wants to apply the Background Data Transfer Policy to an existing PDU Session, then at the time the background data transfer is about to start the AF invokes the Npcf\_PolicyAuthorization\_Create service directly with PCF, or via the NEF, to apply the background data transfer policy for an individual UE. When the AF wants to apply the Background Data Transfer Policy to a future PDU Session, then the AF invokes Nnef\_ApplyPolicy\_Create service to provide, to the NEF, the Background Data Transfer Reference ID together with the External Identifier or External Group Identifier of the UE(s) that are subject to the policy.

The procedure for BDT warning notification as specified in clause 4.16.7.3 enables the PCF to notify the AF that the network performance in the area of interest goes below the criteria set by the operator as described in clause 6.1.2.4 of TS 23.503 [20].

## 4.16.7.2 Procedures for future background data transfer

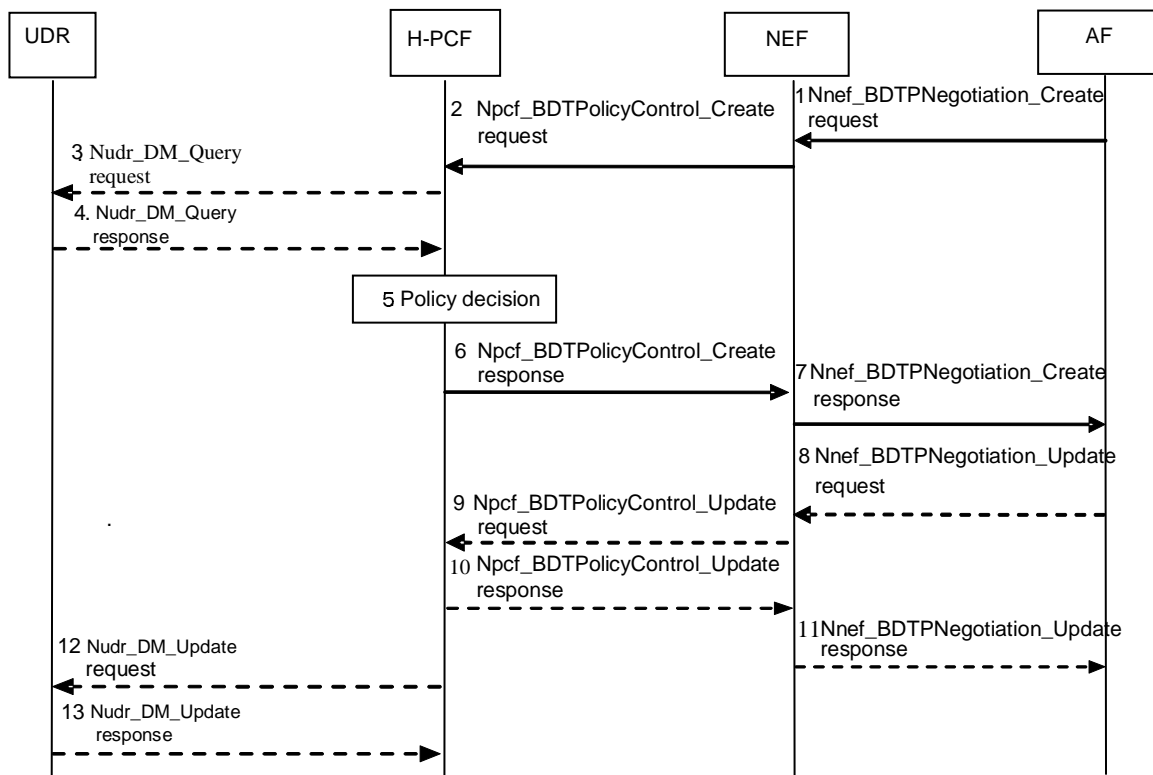


Figure 4.16.7.2-1: Negotiation for future background data transfer

1. The AF invokes the Nnef\_BDTPNegotiation\_Create (ASP id, Number of UEs, Volume per UE, Desired time window and optionally External Group Identifier, Network Area Information, Request for notification, MAC address or IP 3-tuple of Application server). The Request for notification is an indication that BDT warning notification should be sent to the AF.
- 2a. Based on an AF request, the NEF requests to translate the External Group Identifier into the Internal Group Identifier using Nudm\_SDM\_Get (Group Identifier Translation, External Group Identifier).
- 2b. The NEF invokes the Npcf\_BDTPolicyControl\_Create (ASP id, Number of UEs, Volume per UE, Desired time window and optionally Internal Group Identifier, the Network Area Information, Request for notification, MAC address or IP 3-tuple of Application server) with the H-PCF to authorize the creation of the policy regarding the background data transfer. If the PCF was provided with Request for notification, then PCF may send BDT warning notification to the AF as described in clause 4.16.7.3.

- 3 The H-PCF may request from the UDR the stored Background Data Transfer policies for all the ASPs using Nudr\_DM\_Query (Policy Data, Background Data Transfer) service operation.

NOTE 1: If only one PCF is deployed in the PLMN, the Background Data Transfer policy can be locally stored and no interaction with UDR is required.

4. The UDR provides all the stored Background Data Transfer policies and corresponding related information (i.e. volume of data to be transferred per UE, the expected amount of UEs) to the H-PCF.
5. The H-PCF determines, based on information provided by the AF and other available information one or more Background Data Transfer policies. The PCF may interact with the NWDAF and request the Network Performance analytics information for the Desired time window and the Network Area Information as defined in TS 23.288 [50].

NOTE 2: When the External Group Identifier was provided and the Network Area Information was not provided by the AF at step 1, the NWDAF derives the Network Area Information from the Internal Group ID as defined in clause 6.6 of TS 23.288 [50].

NOTE 3: The maximum aggregated bitrate is not enforced in the network.

6. The H-PCF send the acknowledge message to the NEF with the acceptable Background Data T Transfer policies and a Background Data Transfer Reference ID.
7. The NEF sends a Nnef\_BDTPNegotiation\_Create response to the AF to provide one or more background data transfer policies and the Background Data Transfer Reference ID to the AF. The AF stores the Background Data Transfer Reference ID for the future interaction with the PCF. If the NEF received only one background data transfer policy from the PCF, steps 8-11 are not executed and the flow proceeds to step 12. Otherwise, the flow proceeds to step 8.

NOTE 4: If the NEF receives only one Background Data T Transfer policy, the AF is not required to confirm.

8. The AF invokes the Nnef\_BDTPNegotiation\_Update service to provide the NEF with Background Data Transfer Reference ID and the selected background data transfer policy.
9. The NEF invokes the Npcf\_BDTPolicyControl\_Update service to provide the H-PCF with the selected background data transfer policy and the associated Background Data Transfer Reference ID.
10. The H-PCF sends the acknowledge message to the NEF.
11. The NEF sends the acknowledge message to the AF.
12. The H-PCF stores the Background Data Transfer Reference ID together with the new Background Data T Transfer policy, the corresponding related information (i.e. volume of data to be transferred per UE, the expected amount of UEs), optionally MAC address or IP 3-tuple of Application server the information of request for notification, together with the relevant information received from the AF (as defined in clause 6.1.2.4 of TS 23.503 [20]) in the UDR by invoking Nudr\_DM\_Update (BDT Reference id, Policy Data, Background Data Transfer). This step is not executed, when the PCF decides to locally store the Background Data Transfer policy.
13. The UDR sends a response to the H-PCF as its acknowledgement.

4.16.7.3 Procedure for BDT warning notification

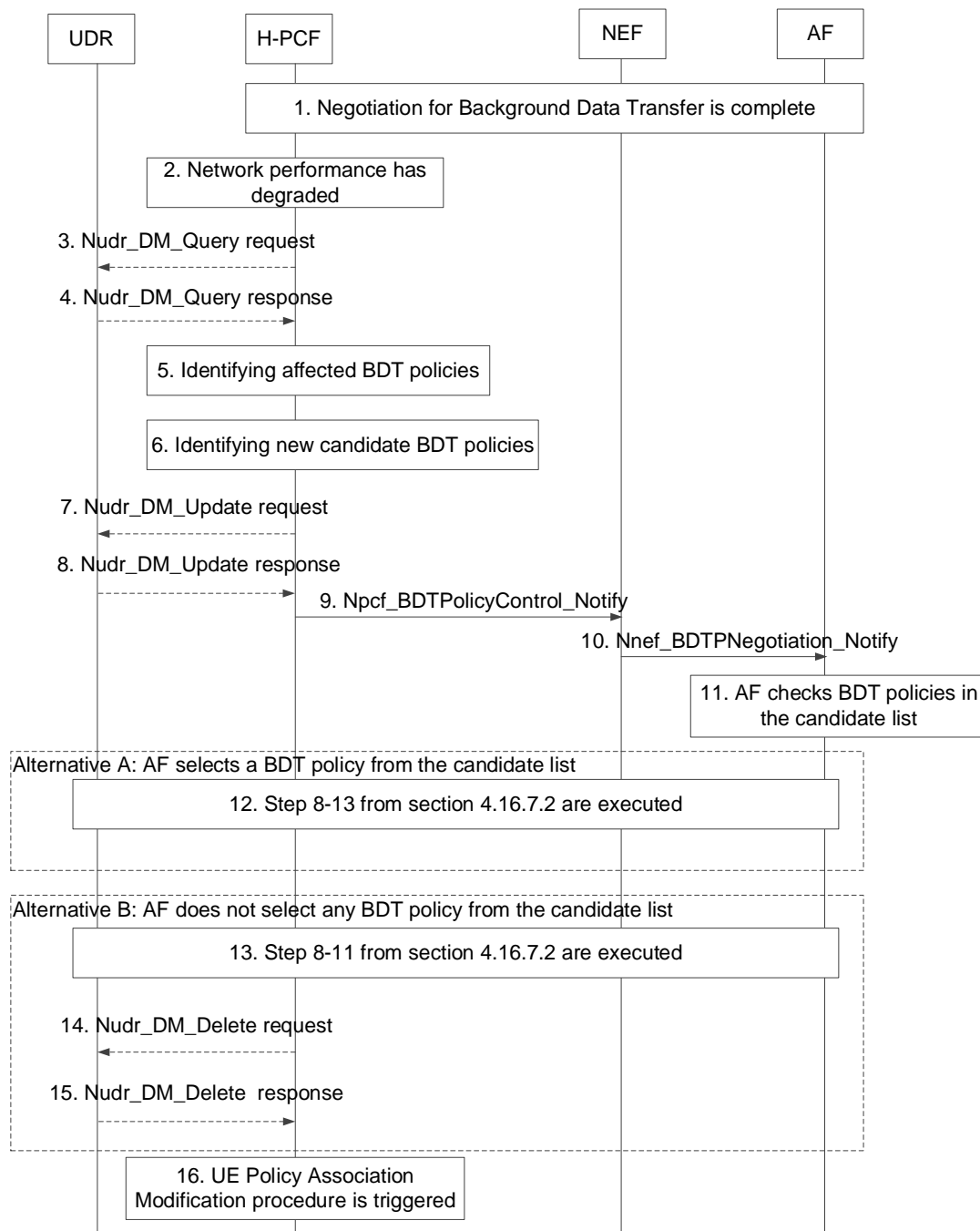


Figure 4.16.7.3-1: The procedure for BDT warning notification

1. The negotiation for Background Data Transfer (BDT) described in clause 4.16.7.2 is completed. In addition, the PCF has subscribed to analytics on "Network Performance" from NWDAF for the area of interest and time window of a background data transfer policy following the procedure and services described in TS 23.288 [50], including a Reporting Threshold in the Analytics Reporting information. The value for Reporting Threshold is set by the PCF based on operator configuration.
2. The PCF is notified with the network performance analytics in the area of interest from the NWDAF when the NWDAF determines that the network performance goes below the threshold as described for the Network Performance analytics in TS 23.288 [50].
3. The H-PCF may request from the UDR the stored BDT policies using Nudr\_DM\_Query (Policy Data, Background Data Transfer) service operation.

4. The UDR provides all the Background Transfer Policies together with the relevant information received from the AF (as defined in clause 6.1.2.4 of TS 23.503 [20]) to the H-PCF.
5. The H-PCF identifies the BDT policies affected by the notification received from NWDAF. For each of them, the H-PCF determines the ASP of which the background traffic will be influenced by the degradation of network performance and which requested the H-PCF to send the notification. The PCF then performs the following steps for each of the determined ASPs, i.e. Steps 6 - 16 can occur multiple times (i.e. once per ASP).
6. The PCF decides based on operator policies, whether a new list of candidate Background Data Transfer policies can be calculated for the ASP. If the PCF does not find any new candidate BDT policy, the previously negotiated BDT policy shall be kept, no interaction with that ASP shall occur and the procedure stops for that BDT policy.

NOTE 1: The BDT policies of an ASP which did not request to be notified are kept and no interaction with this ASP occurs.

7. The PCF sets the no longer valid BDT policy in the UDR as invalidated by invoking Nudr\_DM\_Update (Background Data Transfer Reference ID, invalidation flag) service.

NOTE 2: The BDT policies that are applicable for future sessions are checked by the PCF in step 6.

8. The UDR sends a response to the H-PCF as acknowledgement.
9. The PCF sends the notification to the NEF by invoking Npcf\_PolicyControl\_Notify (Background Data Transfer Reference ID, list of candidate Background Data Transfer policies) service operation.
10. The NEF sends the BDT warning notification to the AF by invoking Nnef\_BDTPNegotiation\_Notify (Background Data Transfer Reference ID, list of candidate Background Data Transfer policies) service operation.
11. The AF checks the new Background Data Transfer policies included in the candidate list in the BDT warning notification.
12. If the AF selects any of the new Background Data Transfer policies, the steps 8-13 from clause 4.16.7.2 are executed.
13. If the AF doesn't select any of the new Background Data Transfer policies, the steps 8-11 from clause 4.16.7.2 are executed, with the AF indicating that none of the candidate Background Data Transfer policies is acceptable.
- 14.-15. If the step 13 is executed, the PCF removes the no longer valid BDT policy from UDR for the corresponding Background Data Transfer Reference ID.

NOTE 3: The PCF can also remove the no longer valid BDT policy after an operator configurable time for the case that the AF does not respond.

16. If there is a new Background Data Transfer policy stored in the UDR or a BDT policy removed from the UDR, the PCFs are notified by the UDR accordingly. The PCFs check if the corresponding URSP rules need to be updated or removed and if so, use the procedure defined in clause 4.16.12.2 to update URSP rules for the relevant UEs.

The AF can send a Stop notification by invoking Nnef\_BDTPNegotiation\_Update service, when the AF requests not to receive the BDT warning notification anymore. Then, the NEF invokes Npcf\_BDTPolicyControl\_Update service in order to provide this information for the H-PCF.

## 4.16.8 Procedures on interaction between PCF and CHF

### 4.16.8.1 General

The PCF may interact with the CHF to make PCC decisions based on spending limits. In Home Routed roaming and Non-roaming case, the H-PCF will interact with the CHF in HPLMN.

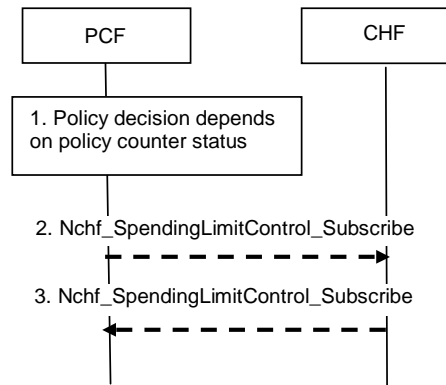
### 4.16.8.2 Initial Spending Limit Retrieval

This clause describes the signalling flow for the PCF to retrieve the status of the policy counters available at the CHF and to subscribe to spending limit reporting (i.e. to notifications of policy counter status changes) by the CHF. If the

PCF provides the list of policy counter identifier(s), the CHF returns the policy counter status per policy counter identifier provided by the PCF. If the PCF does not provide the list of policy counter identifier(s), the CHF returns the policy counter status of all policy counter(s), which are available for this subscriber.

The Initial Spending Limit Report Retrieval includes all subscriber Identifiers associated with the UE available at the PCF.

**NOTE:** If the CHF returns the status of all available policy counters some of these might not be relevant for a policy decision (e.g. those used in a policy decision only when roaming).



**Figure 4.16.8.2.1: Initial Spending Limit Report Retrieval**

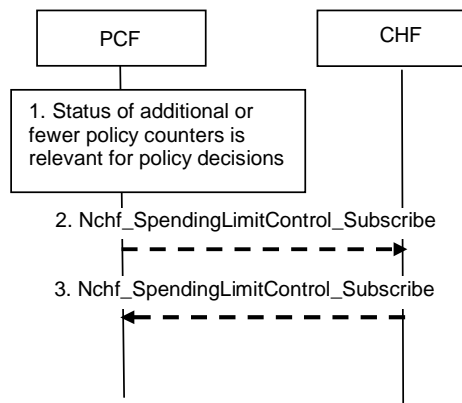
1. The PCF retrieves subscription information that indicates that policy decisions depend on the status of policy counter(s) held at the CHF and optionally the list of policy counter identifier(s).
2. The PCF sends Nchf\_SpendingLimitControl\_Subscribe if this is the first time policy counter status information is requested for the user identified by a SUPI. It includes: the subscriber ID (e.g. SUPI), the EventId "policy counter status change" and, optionally, the list of policy counter identifier(s) as Event Filter, the Notification Target Address, Event Reporting Information (continuous reporting).

The CHF responds to the Nchf\_SpendingLimitControl\_Subscribe service operation including the Subscription Correlation Id) and as Event Information provides a policy counter status and optionally pending policy counter statuses and their activation times, per required policy counter identifier and stores the PCF's subscription to spending limit reports for these policy counters. If no policy counter identifier(s) was provided the CHF returns the list of the policy counter status, optionally including pending policy counter statuses and their activation times, for all policy counter(s), which are available for this subscriber and stores the PCF's subscription to spending limit reports of all policy counters provided to the PCF.

#### 4.16.8.3 Intermediate Spending Limit Report Retrieval

This clause describes the signalling flow for the PCF to retrieve the status of additional policy counters available at the CHF or to unsubscribe from spending limit reporting. If the PCF provides the list of policy counter identifier(s), the CHF returns the policy counter status per policy counter identifier provided by the PCF.

**NOTE:** If the CHF returns the status of all available policy counters some of these might not be relevant for a policy decision, (e.g. those used in a policy decision only when roaming).



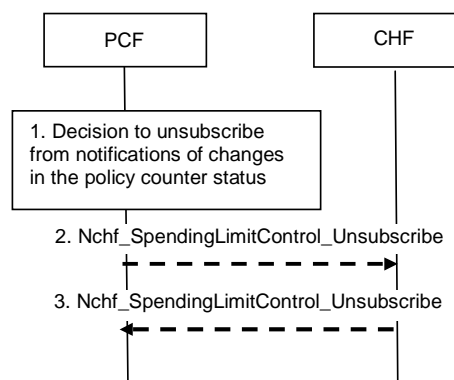
**Figure 4.16.8.3.1: Intermediate Spending Limit Report Retrieval**

1. The PCF determines that policy decisions depend on the status of additional policy counter(s) held at the CHF or that notifications of policy counter status changes for some policy counters are no longer required.
2. The PCF sends Nchf\_SpendingLimitControl\_Subscribe to the CHF, including the Subscription Correlation Id, the EventId "policy counter status change" and an updated list of policy counter identifier(s) as EventFilters, that overrides the previously stored list of policy counter identifier(s).

The CHF responds to the Nchf\_SpendingLimitControl\_Subscribe service operation and provides as Event Information the policy counter status and optionally pending policy counter statuses and their activation times, per required policy counter identifier and stores or removes the PCF's subscription to spending limit reporting by comparing the updated list with the existing PCF subscriptions. If no policy counter identifier(s) was provided, the CHF returns the policy counter status, optionally including pending policy counter statuses and their activation times, for all policy counter(s), which are available for this subscriber and stores the PCF's subscription to spending limit reports of all policy counters provided to the PCF.

#### 4.16.8.4 Final Spending Limit Report Retrieval

This clause describes the signalling flow for the PCF to cancel the subscriptions to status changes for the policy counters available at the CHF.



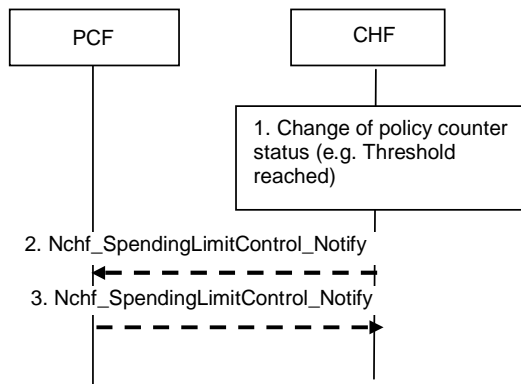
**Figure 4.16.8.4.1: Final Spending Limit Report Retrieval**

1. The PCF decides that notifications of policy counter status changes are no longer needed.
2. The PCF sends Nchf\_SpendingLimitControl\_Unsubscribe including the SubscriptionCorrelationId to the CHF to cancel the subscription to notifications of policy counter status changes from the CHF.
3. The CHF removes the PCF's subscription to spending limit reporting and responds to the Nchf\_SpendingLimitControl\_Unsubscribe service operation to the PCF.



#### 4.16.8.5 Spending Limit Report

This clause describes the signalling flow for the CHF to notify the change of the status of the subscribed policy counters available at the CHF for that subscriber. Alternatively, the signalling flow can be used by the CHF to provide one or more pending statuses for a subscribed policy counter together with the time they have to be applied.

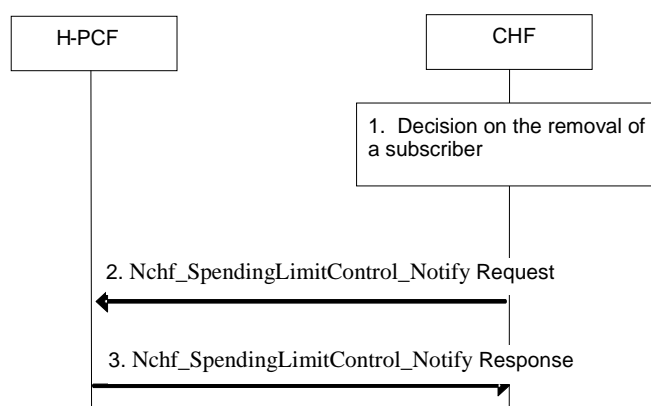


**Figure 4.16.8.5.1: Spending Limit Report**

1. The CHF detects that the status of a policy counter(s) has changed and the PCF subscribed to notifications of changes in the status of this policy counter. Alternatively, the CHF may detect that a policy counter status will change at a future point in time and decides to instruct the PCF to apply one or more pending statuses for a requested policy counter.
2. The CHF sends Nchf\_SpendingLimitControl\_Notify with the SUPI, Notification Target Address and in the Event Information the policy counter status and optionally pending policy counter statuses and their activation times, for each policy counter that has changed and for which the PCF subscribed to spending limit reporting. Alternatively, the CHF sends one or more pending statuses for any of the subscribed policy counters together with the time they have to be applied.
3. The PCF acknowledges sending Nchf\_SpendingLimitControl\_Notify response and takes that information into account as input for a policy decision.

#### 4.16.8.6 CHF report the removal of the subscriber

This clause describes the signalling flow for the CHF to report the removal of the subscriber.



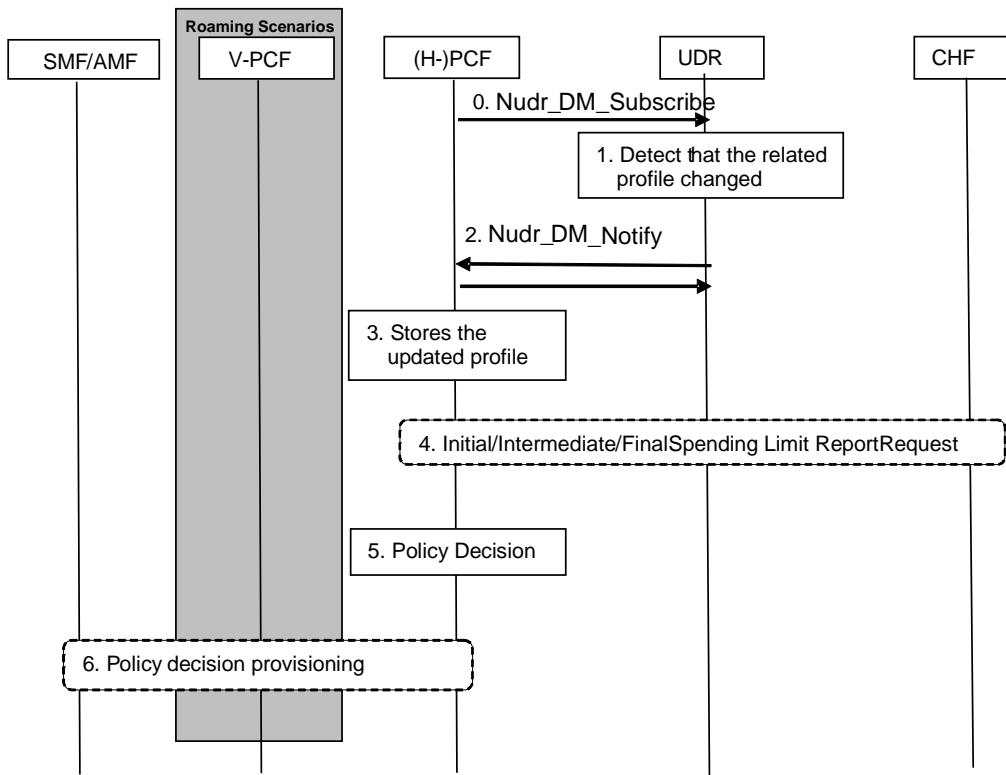
**Figure 4.16.8.6-1: CHF report the removal of the subscriber**

1. The CHF decides that a subscriber is removed.
2. The CHF sends the Nchf\_SpendingLimitControl\_Notify Request to H-PCF to notify the removal of the subscriber. The H-PCF removes the subscription to notification of policy counter status from CHF.

**NOTE:** Notification on the removing of a subscriber causes the H-PCF to make the applicable policy decision and act accordingly.

- The H-PCF responds to CHF using Nchf\_SpendingLimitControl\_Notify to acknowledge the receiving of the notification.

#### 4.16.9 Update of the subscription information in the PCF



**Figure-4.16.9-1: Procedure for update of the subscription information in the PCF**

NOTE: The V-PCF is not used for session management related policy decisions in this procedure.

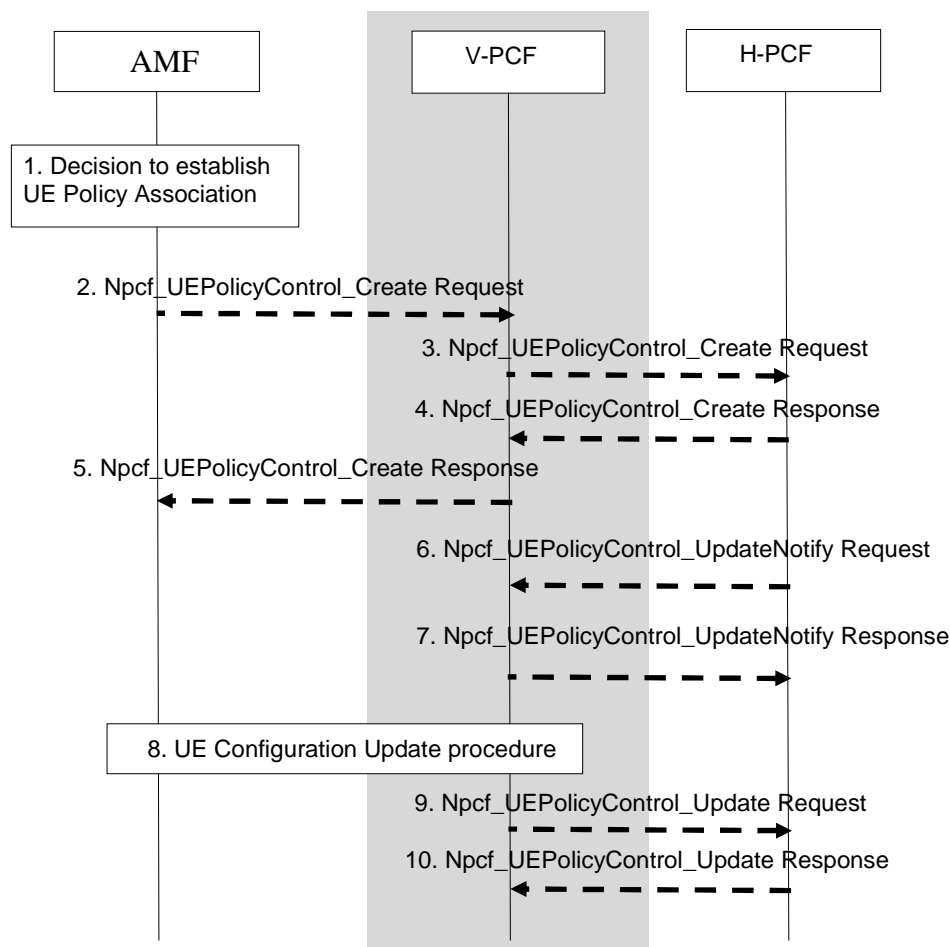
- The PCF performs the subscription to notification to the profile modified in the UDR by invoking Nudr\_DM\_Subscribe (Policy Data, SUPI, Notification Target Address (+ Notification Correlation Id), Event Reporting Information (continuous reporting), one or several of the following: "PDU Session Policy Control data", "Remaining allowed Usage data" or "UE context Policy Control data") service.
- The UDR detects that the related subscription profile has been changed.
- If subscribed by the PCF, the UDR notifies the PCF on the changed profile by invoking Nudr\_DM\_Notify (Notification Correlation Id, Policy Data, SUPI, updated data and one or several of the following data subtypes "PDU Session Policy Control Data" or "Remaining allowed Usage data" or "UE Context Policy Control data") service.
- The PCF stores the updated profile.
- If the updated subscriber profile requires the status of new policy counters available at the CHF then an Initial/Intermediate Spending Limit Report Retrieval is initiated by the PCF as defined in clauses 4.16.8.2 and 4.16.8.3. If the updated subscriber profile implies that no policy counter status is needed an Intermediate Spending Limit Report Request Retrieval is initiated by the PCF to unsubscribe or, if this is the last policy counter status, a Final Spending Limit Report Retrieval is initiated by the PCF as specified in clause 4.16.8.4.
- PCF makes an authorization and policy decision.
- The PCF provides new session management related policy decisions to the SMF, using the Policy related interaction in PDU Session Modification procedure in clause 4.16.6, new access and mobility related policy information to the AMF using the AM Policy Association Modification procedure in clause 4.16.2 or new UE policy information to the AMF using the UE Policy Association Modification procedure in clause 4.16.12.

## 4.16.10 Void

### 4.16.11 UE Policy Association Establishment

This procedure concerns the following scenarios:

1. UE initial registration with the network.
2. The AMF relocation with PCF change in handover procedure and registration procedure.
3. UE registration with 5GS when the UE moves from EPS to 5GS and there is no existing UE Policy Association between AMF and PCF for this UE.



**Figure 4.16.11-1: UE Policy Association Establishment**

This procedure concerns both roaming and non-roaming scenarios.

In the non-roaming case the V-PCF is not involved and the role of the H-PCF is performed by the PCF. For the roaming scenarios, the V-PCF interacts with the AMF and the H-PCF interacts with the V-PCF:

1. The AMF establishes UE Policy Association with the (V-)PCF when a UE Policy Container is received from the UE. If a UE Policy Container is not received from the UE, the AMF may establish UE Policy Association with the (V-)PCF based on AMF local configuration.

NOTE 1: In roaming scenario, the AMF local configuration can indicate whether UE Policy delivery is needed based on the roaming agreement with home PLMN of the UE.

2. The AMF sends a `Npcf_UEPolicyControl Create Request` with the following information: SUPI, may include Access Type and RAT, PEI, ULI, UE time zone, Serving Network (PLMN ID, or PLMN ID and NID, see

clause 5.34 of TS 23.501 [2]), the Internal-Group-ID-list and UE Policy Container (the list of stored PSIs, operating system identifier, Indication of UE support for ANDSP). In roaming scenario, based on operator policies, the AMF may provide to the V-PCF the PCF ID of the selected H-PCF. The V-PCF contacts the H-PCF. In roaming case, steps 3 and 4 are executed, otherwise step 5 follows.

3. The V-PCF forwards the information received from AMF in step 2 to the H-PCF. When a UE Policy Container is received at initial registration, the H-PCF may store the PEI, the OSId or the indication of UE support for ANDSP in the UDR using Nudr\_DM\_Create including DataSet "Policy Data" and Data Subset "UE context policy control data".
4. The H-PCF sends a Npcf\_UEPolicyControl Create Response to the V-PCF. The H-PCF may provide the Policy Control Request Trigger parameters in the Npcf\_UEPolicyControl Create Response.
5. The (V-) PCF sends a Npcf\_UEPolicyControl Create Response to the AMF. The (V-)PCF relays the Policy Control Request Trigger parameters in the Npcf\_UEPolicyControl Create Response.

The (V-)PCF also subscribes to notification of N1 message delivery of policy information to the UE using Namf\_Communication\_N1N2MessageSubscribe service which is not shown in this figure.

6. The (H-)PCF gets policy subscription related information and the latest list of PSIs from the UDR using Nudr\_DM\_Query service operation (SUPI, Policy Data, UE context policy control data, Policy Set Entry) if either or both are not available and makes a policy decision. The (H-)PCF may get the PEI, the OSId or the indication of UE support for ANDSP in the UDR using Nudr\_DM\_Query including DataSet "Policy Data" and Data Subset "UE context policy control data" if the AMF relocates and the PCF changes. The (H-)PCF may get the 5G VN group data and 5G VN group membership for each Internal-Group-ID received from the AMF using Nudr\_DM\_Query (Internal-Group-Id, Subscription Data, 5G VN Group Configuration). The (H-)PCF may store the 5G VN group data and 5G VN group membership for later use for other SUPIs that belong to the same Internal-Group-ID. The (H-)PCF may request notifications from the UDR on changes in the subscription information by invoking Nudr\_DM\_Subscribe (Policy Data, SUPI, DNN, S-NSSAI, Notification Target Address (+ Notification Correlation Id), Event Reporting Information (continuous reporting), UE context policy control data) service. The (H-)PCF may request notifications from the UDR on changes in the 5G VN group data or 5G VN group membership associated to each of the Internal-Group-Id provided to the PCF by invoking Nudr\_DM\_Subscribe (Subscription Data, 5G VN Group Configuration, Internal Group ID, Notification Target Address (+ Notification Correlation Id), Event Reporting Information (continuous reporting)) service. The (H-)PCF creates the UE policy container including UE policy information as defined in clause 6.6 of TS 23.503 [20] and in the case of roaming H-PCF provides the UE policy container in the Npcf\_UEPolicyControl UpdateNotify Request.
7. The V-PCF sends a response to H-PCF using Npcf\_UEPolicyControl UpdateNotify Response.

NOTE 2: Step 6 (and step 7) can be omitted. Then the (H-)PCF creates the UE policy container including UE policies in step 2 (in the case of non-roaming) or step 3 (in the case of roaming). This means that the potential interactions with UDR as in step 6 will have to be executed in step 2 (non-roaming) or step 3 (roaming).

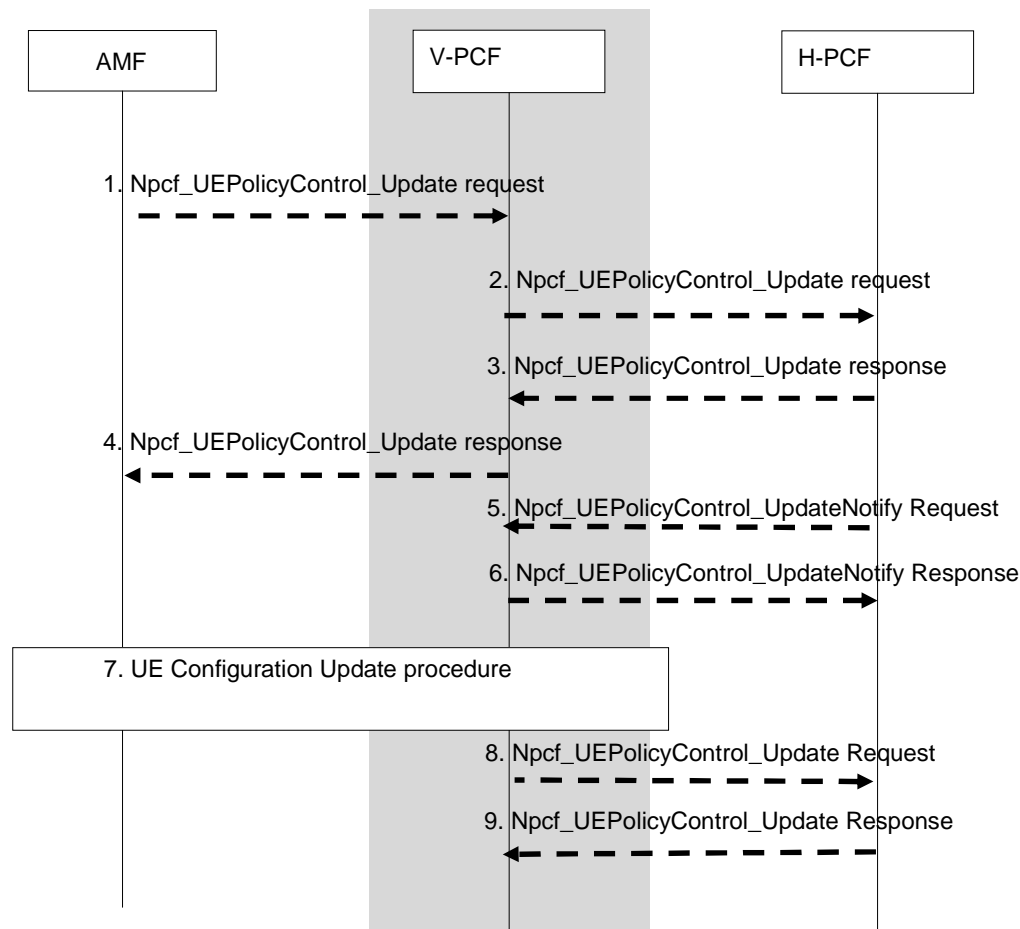
8. The (V-)PCF triggers UE Configuration Update Procedure in clause 4.2.4.3 to send the UE policy container including UE policy information to the UE. The (V-)PCF checks the size limit as described in clause 6.1.2.2.2 of TS 23.503 [20].
9. If the V-PCF received notification of the reception of the UE Policy container then the V-PCF forwards the notification response of the UE to the H-PCF using Npcf\_UEPolicyControl\_Update Request.
10. The H-PCF sends a response to the V-PCF.

## 4.16.12 UE Policy Association Modification

### 4.16.12.1 UE Policy Association Modification initiated by the AMF

#### 4.16.12.1.1 UE Policy Association Modification initiated by the AMF without AMF relocation

This procedure addresses the scenario where a Policy Control Request Trigger condition is met.



**Figure 4.16.12.1.1-1: UE Policy Association Modification initiated by the AMF**

This procedure concerns both roaming and non-roaming scenarios.

In the non-roaming case the V-PCF is not involved. In the roaming case, the AMF interacts with the V-PCF and the H-PCF interacts with the V-PCF.

1. When a Policy Control Request Trigger condition is met the AMF updates UE Policy Control Association and provides information on the conditions that have changed to the PCF. The AMF sends a Npcf\_UEPolicyControl Update Request with the following information: UE Policy Association ID associated with the SUPI defined in TS 29.525 [58] and the Policy Control Request Trigger met. In roaming scenario, based on operator policies, the AMF may provide to the V-PCF the PCF ID of the selected H-PCF. The V-PCF contacts the H-PCF.

See clause 4.2.3.2 of TS 29.525 [58] for more details on Policy Control Request Trigger.

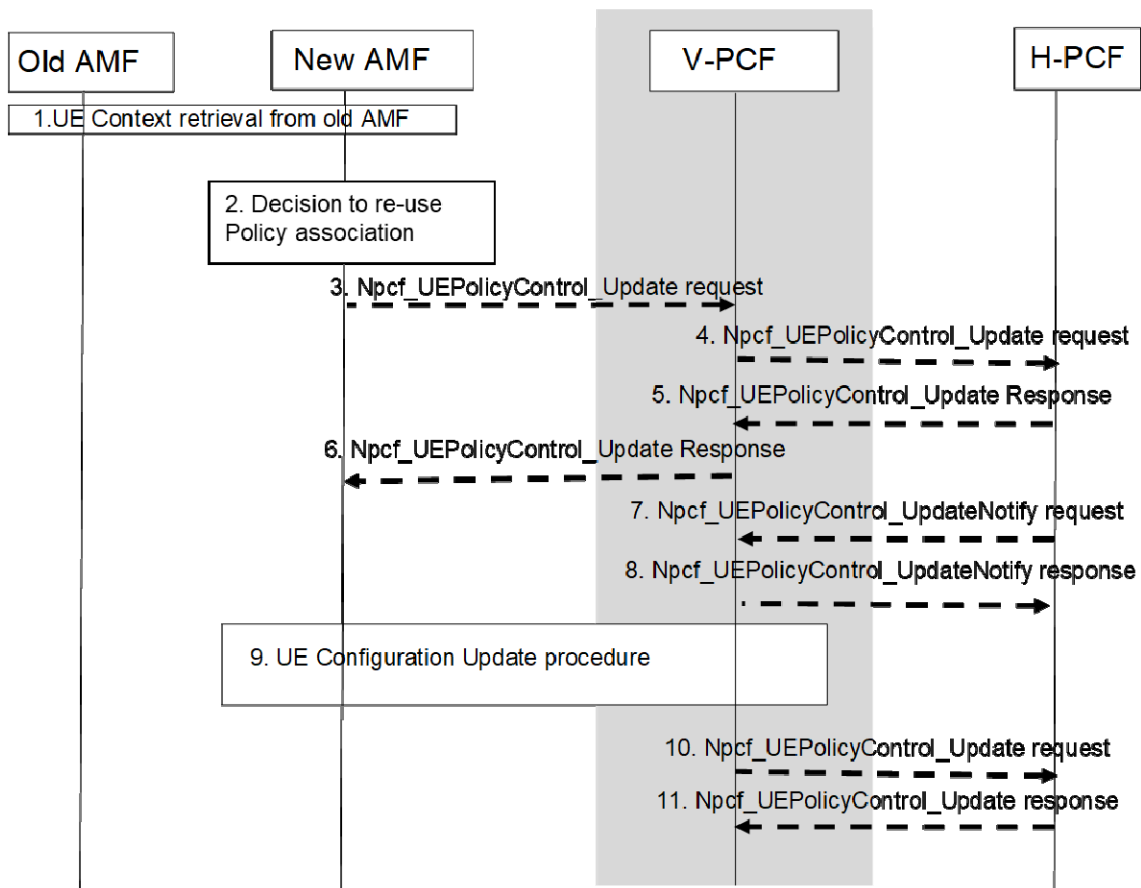
In the roaming case, steps 2 and 3 are executed, otherwise step 4 follows.

2. The V-PCF forwards the information received from AMF in step 1 to the (H-)PCF.
3. The H-PCF replies to the V-PCF.
4. The (V-) PCF sends a Npcf\_UEPolicyControl Update Response to the AMF.
5. The (H-)PCF may create the UE policy container including UE policy information as defined in clause 6.6 of TS 23.503 [20]. In the case of roaming the H-PCF may include the UE policy container in the Npcf\_UEPolicyControl UpdateNotify Request.
6. The (V-)PCF sends a response to H-PCF using Npcf\_UEPolicyControl UpdateNotify Response.

Steps 7, 8 and 9 are the same as steps 8, 9 and 10 of procedure UE Policy Association Establishment in clause 4.16.11.

## 4.16.12.1.2 UE Policy Association Modification with old PCF during AMF relocation

This procedure addresses the scenario where a UE Policy Association Modification with the old PCF during AMF relocation.



**Figure 4.16.12.1.2-1: Policy Association Modification with the old PCF during AMF relocation**

This procedure addresses both roaming and non-roaming scenarios.

In the non-roaming case the V-PCF is not involved. In the roaming case, the AMF interacts with the V-PCF and the V-PCF interacts with the H-PCF.

1. [Conditional] When the old AMF and the new AMF belong to the same PLMN, the old AMF transfers to the new AMF the UE Policy Association information including policy control request trigger(s) and the PCF ID(s). For the roaming case, the new AMF receives both V-PCF ID and H-PCF ID.
2. Based on local policies, the new AMF decides to re-use the UE policy association for the UE Context with the (V-)PCF and contacts the (V-)PCF identified by the PCF ID received in step 1.

**NOTE:** The scenario that only the H-PCF is reused by the new AMF but the V-PCF is not reused is not considered in this Release.

3. The new AMF sends Npcf\_UEPolicyControl\_Update to the (V-)PCF to update the UE policy association with the (V-)PCF. If a Policy Control Request Trigger condition is met, the information matching the trigger condition may also be provided by the new AMF.

In the roaming case, step 4 and 5 are executed, otherwise step 6 follows.

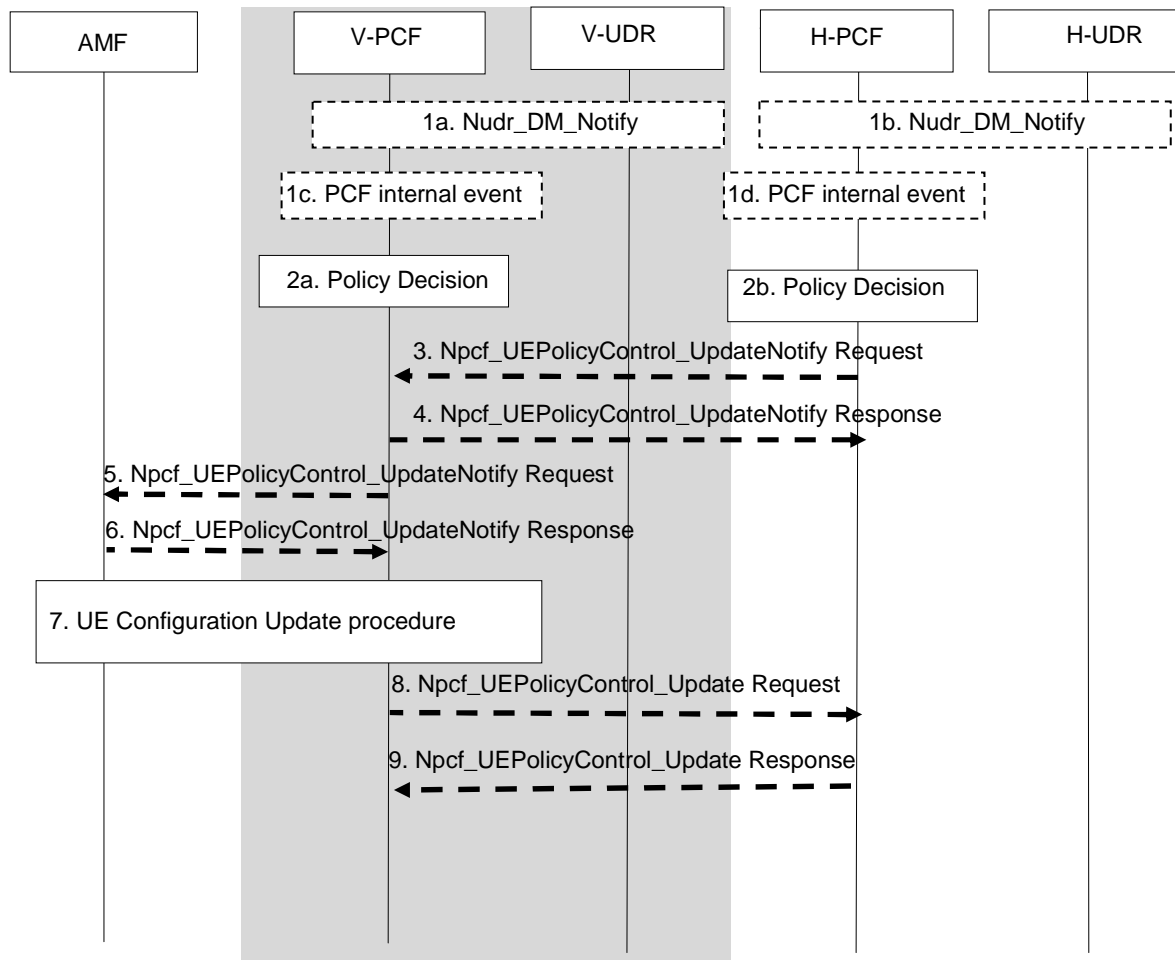
4. The V-PCF forwards the information received from new AMF in step 3 to the (H-)PCF.
5. The H-PCF replies to the V-PCF.
6. The (V-)PCF updates the stored information provided by the old AMF with the information provided by the new AMF. The (V-)PCF sends a Npcf\_UEPolicyControl Update Response to the AMF.

7. The (H-)PCF may create the UE policy container including UE policy information as defined in clause 6.6 of TS 23.503 [20]. In the case of roaming the H-PCF may include the UE policy container in the Npcf\_UEPolicyControl UpdateNotify Request.
8. The V-PCF sends a response to H-PCF using Npcf\_UEPolicyControl UpdateNotify Response.

Steps 9, 10 and 11 are the same as steps 8, 9 and 10 of procedure UE Policy Association Establishment in clause 4.16.11.

#### 4.16.12.2 UE Policy Association Modification initiated by the PCF

This procedure is used to update UE policy and/or UE policy triggers.



**Figure 4.16.12.2-1: UE Policy Association Modification initiated by the PCF**

This procedure concerns both roaming and non-roaming scenarios.

In the non-roaming case the V-PCF is not involved and the role of the H-PCF is performed by the PCF. In the roaming case, the H-PCF provides UE policy decision and provides the policy to the AMF via V-PCF.

- 1a and 1b. If (H-)PCF subscribed to notification of subscriber’s policy data change or 5G VN Group Configuration (5G VN group data, 5G VN group membership) change and a change is detected, the UDR notifies that the subscriber’s policy data of a UE or 5G VN Group Configuration (5G VN group data, 5G VN group membership) has been changed.

The UDR notifies the (H-)PCF of the updated policy control subscription information profile via Nudr\_DM\_Notify (Notification correlation Id, Policy Data, either UE context policy control data or Policy Set Entry data or both, SUPI), or

The UDR notifies the (H-)PCF of the updated 5G VN Group Configuration (5G VN group data, 5G VN group membership) via Nudr\_DM\_Notify (Notification correlation Id, 5G VN Group Configuration, Internal-Group-Identifier), or

The (V-)UDR notifies the (V-)PCF of the updated policy control subscription information profile via Nudr\_DM\_Notify (Notification correlation Id, Policy Data, PolicySetEntry Data, PLMN ID).

1c and 1d. PCF determines locally that UE policy information needs to be sent to the UE.

2a and 2b. The PCF makes the policy decision. If the group data is updated, the (H-) PCF checks the UE Policy Associations for those SUPIs within the Internal-Group-Id and may need to perform step 3 to step 9 for each UE Policy Association that needs to be updated with new UE Policies sent to each UE.

3. The (H-)PCF may create the UE policy container including UE policy information as defined in clause 6.1.2.2.2 of TS 23.503 [20]. In the case of roaming, the H-PCF may send the UE policy container in the Npcf\_UEPolicyControl UpdateNotify Request. The H-PCF may provide updated policy control triggers for the UE policy association.

4. The V-PCF sends a response to H-PCF using Npcf\_UEPolicyControl UpdateNotify Response.

5. The (V-)PCF provides the Policy Control Request Trigger parameters in the Npcf\_UEPolicyControl UpdateNotify Request to the AMF. In the case of roaming, the V-PCF may also provide UE policy information to the UE. The V-PCF may also provide updated policy control triggers for the UE policy association to the AMF.

6. The AMF sends a response to (V-)PCF.

Steps 7, 8 and 9 are the same as steps 8, 9 and 10 of procedure UE Policy Association Establishment in clause 4.16.11.

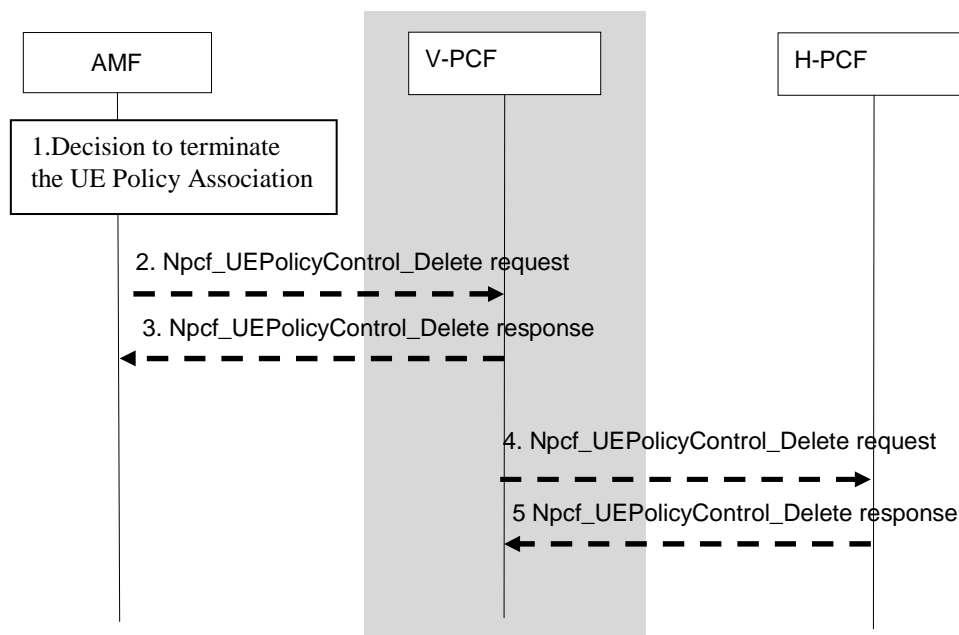
## 4.16.13 UE Policy Association Termination

### 4.16.13.1 AMF-initiated UE Policy Association Termination

The following case is considered for UE Policy Association Termination:

1. UE Deregistration from the network.
2. The mobility with change of AMF (e.g. new AMF is in different PLMN or new AMF in the same PLMN).
3. [Optional] 5GS to EPS mobility with N26 if the UE is not connected to the 5GC over a non-3GPP access in the same PLMN.





**Figure 4.16.13.1-1: AMF-initiated UE Policy Association Termination**

This procedure concerns both roaming and non-roaming scenarios.

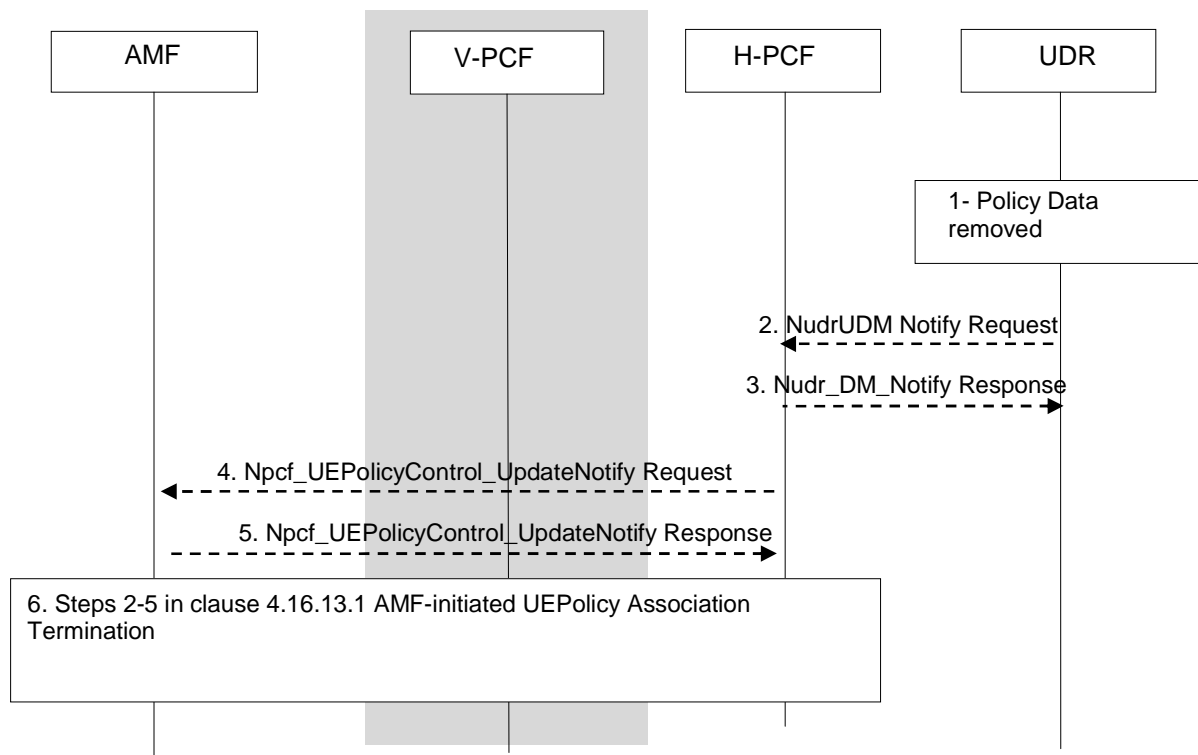
In the non-roaming case, the V-PCF is not involved and the role of the H-PCF is performed by the PCF. For the roaming scenarios, the V-PCF interacts with the AMF. The V-PCF contacts the H-PCF to request removing UE Policy Association.

1. The AMF decides to terminate the UE Policy Association.
2. The AMF sends the Npcf\_UEPolicyControl\_Delete service operation including UE Policy Association ID to the (V-)PCF.
3. The (V-)PCF removes the policy context for the UE and replies to the AMF with an Acknowledgement including success or failure. The V-PCF may interact with the H-PCF. The (V-)PCF may unsubscribe to subscriber policy data changes with UDR by Nudr\_DM\_Unsubscribe (Subscription Correlation Id). The AMF removes the UE Policy Context.

Step 4 and Step 5 apply only to the roaming case.

4. The V-PCF sends the Npcf\_UEPolicyControl\_Delete service operation including UE Policy Association ID to the H-PCF.
5. The H-PCF removes the policy context for the UE and replies to the V-PCF with an Acknowledgement including success or failure. The H-PCF may unsubscribe to subscriber policy data changes with UDR by Nudr\_DM\_Unsubscribe (Subscription Correlation Id) for subscriber policy changes.

### 4.16.13.2 PCF-initiated UE Policy Association Termination



**Figure 4.16.13.2-1: PCF-initiated UE Policy Association Termination**

This procedure concerns both roaming and non-roaming scenarios.

In the non-roaming case, the V-PCF is not involved and the role of the H-PCF is performed by the PCF. For the roaming scenarios, the H-PCF interacts with the V-PCF to request removing Policy Association.

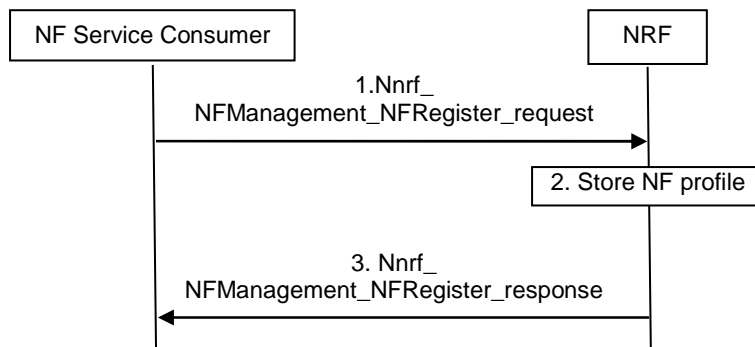
The PCF is subscribed to notification of changes in Data Set "Policy Data" for a UE Policy Association ID.

1. The Policy data is removed, either the Data Set "Policy Data" or the Data Subset "UE context policy control".
2. The UDR sends the Nudr\_DM\_Notify\_Request (Notification correlation Id, Policy Data, SUPI, UE Context Policy Control data, updated data) including the SUPI, the Data Set Identifier, the Data Subset Identifier and the Updated Data including empty "Policy Data" or empty "UE context policy control".
3. The PCF sends the Nudr\_DM\_Notify\_Response to confirm reception and the result to UDR.
4. The PCF may notify the AMF of the removal of the UE Policy Association via Npcf\_UEPolicyControl\_UpdateNotify service operation. Alternatively, the PCF may decide to maintain the Policy Association if a default profile is applied, in this case steps 4, 5 and 6 are not executed.
5. The AMF acknowledges the operation.
6. Steps 2-5 in clause 4.16.13.1 AMF-initiated UE Policy Association Termination are performed to remove the UE Policy Association for this UE and the subscription to Policy Control Request Triggers for that UE Policy Association.

## 4.17 Network Function Service Framework Procedure

### 4.17.1 NF service Registration

NOTE 1: The term "NF service consumer" in this clause refers to the consumer of the NRF services and should not be confused with the role of the NF (consumer or producer).



**Figure 4.17.1-1: NF Service Registration procedure**

1. NF service consumer, i. e. an NF instance sends Nnrf\_NFManagement\_NFRegister Request message to NRF to inform the NRF of its NF profile when the NF service consumer becomes operative for the first time. See clause 5.2.7.2.2 for relevant NF profile parameters

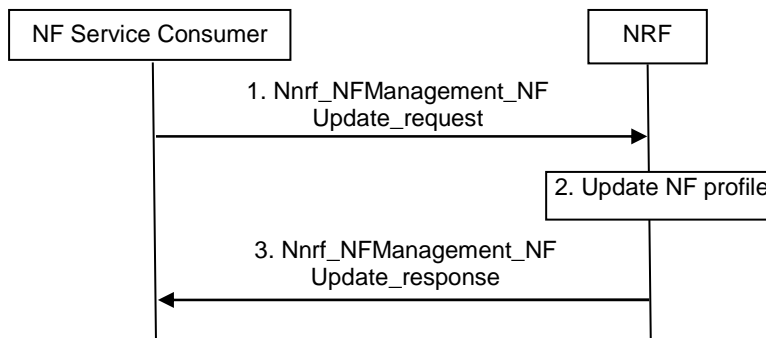
NOTE 2: NF service consumer's NF profile is configured by OAM system.

2. The NRF stores the NF profile of NF service consumer and marks the NF service consumer available.

NOTE 3: Whether the NF profile sent by NF service consumer to NRF needs to be integrity protected by the NF service consumer and verified by the NRF is to be decided by SA3.

3. The NRF acknowledge NF Registration is accepted via Nnrf\_NFManagement\_NFRegister response.

## 4.17.2 NF service update



**Figure 4.17.2-1: NF Service Update procedure**

1. NF service consumer i.e. an NF instance sends Nnrf\_NFManagement\_NFUpdate Request message (the updated NF profile of NF service consumer) to NRF to inform the NRF of its updated NF profile (e.g. with updated capacity) when e.g. triggered after a scaling operation. See clause 5.2.7.2.3 for relevant input and output parameters.

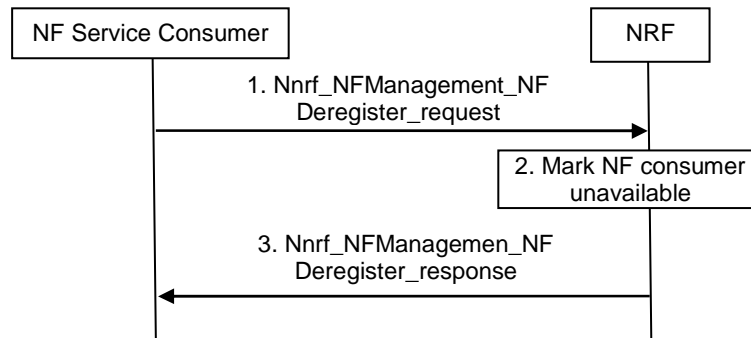
NOTE: The updated NF profile of NF instance are configured by OAM system.

2. The NRF updates the NF profile of NF service consumer.

3. The NRF acknowledge NF Update is accepted via Nnrf\_NFManagement\_NFUpdate response.

NOTE 4: When the NF service consumer registers to NRF via the SCP, the NF Service registration procedure can also be used by the SCP to derive the relation among NF instances, e.g. whether they belong to a specific NF Set.

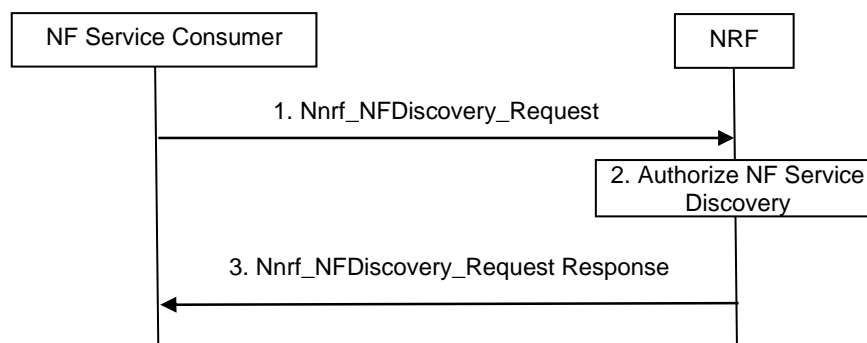
### 4.17.3 NF service deregistration



**Figure 4.17.3-1: NF Service Deregistration procedure**

1. NF service consumer i.e. an NF instance sends Nnrf\_NFManagement\_NFDeregister Request message to NRF to inform the NRF of its unavailability when e.g. it's about to gracefully shut down or disconnect from the network.
2. The NRF marks the NF service consumer unavailable. NRF may remove the NF profile of NF service consumer according to NF management policy.
3. The NRF acknowledge NF Deregistration is accepted via Nnrf\_NFManagement\_NFDeregister response.

### 4.17.4 NF/NF service discovery by NF service consumer in the same PLMN



**Figure 4.17.4-1: NF/NF service discovery in the same PLMN**

1. The NF service consumer intends to discover services available in the network based on service name and target NF type. The NF service consumer invokes Nnrf\_NFDiscovery\_Request (Expected NF service Name, NF Type of the expected NF instance, NF type of the NF consumer) from an appropriate configured NRF in the same PLMN. The parameter may include optionally producer NF Set ID, NF Service Set ID, SUPI, Data Set Identifier(s), External Group ID (for UDM, UDR discovery), UE's Routing Indicator (for UDM and AUSF discovery), S-NSSAI, NSI ID if available and other service related parameters. In addition, for AMF discovery, the parameters may include AMF Region ID, AMF Set ID, TAI. The NF service consumer may indicate a preference for target NF location in the Nnrf\_NFDiscovery\_Request. A complete list of parameters is provided in service definition in clause 5.2.7.3.2.

NOTE 1: The NF service consumer indicates its NF location for preference for target NF location.

NOTE 2: The use of NSI ID within a PLMN depends on the network deployment.

NOTE 3: The need for other service related parameters depends on the NF type of the expected NF instance(s) and refer to the clause 6.3 " Principles for Network function and Network Function Service discovery and selection" in TS 23.501 [2]. It is up to NF implementation whether one or multiple NF service instances are registered in the NRF.

2. The NRF authorizes the Nnrf\_NFDiscovery\_Request. Based on the profile of the expected NF/NF service and the type of the NF service consumer, the NRF determines whether the NF service consumer is allowed to discover the expected NF instance(s). If the expected NF instance(s) or NF service instance(s) are deployed in a certain network slice, NRF authorizes the discovery request according to the discovery configuration of the Network Slice, e.g. the expected NF instance(s) are only discoverable by the NF in the same network slice.
3. If allowed, the NRF determines a set of NF instance(s) matching the Nnrf\_NFDiscovery\_Request and internal policies of the NRF and sends the NF profile(s) of the determined NF instances. Each NF profile containing at least the output required parameters (see clause 5.2.7.3.2) to the NF service consumer via Nnrf\_NFDiscovery\_Request Response message.

If the target NF is UDR, UDM or AUSF, if SUPI was used as optional input parameter in the request, the NRF shall provide the corresponding UDR, UDM or AUSF instance(s) that matches the optional input SUPI. Otherwise, if SUPI is not provided in the request, the NRF shall return all applicable UDR instance(s) (e.g. based on the Data Set Id, NF type), UDM instance(s) or AUSF instance(s) (e.g. based on NF type) and if applicable, the information of the range of SUPI(s) and/or Data Set Id each UDR instance is supporting.

If the target NF is CHF, if SUPI, GPSI or PLMN ID was used as optional input parameter in the request, the NRF shall provide the corresponding CHF instance(s) that matches the optional input SUPI, GPSI or PLMN ID. The NRF shall provide the primary CHF instance and the secondary CHF instance pair(s) together, if configured in CHF instance profile. Otherwise, if neither SUPI/PLMN ID nor GPSI is provided in the request, the NRF shall return all applicable CHF instance(s) and if applicable, the information of the range of SUPI(s), GPSI(s) or PLMN ID(s).

If the NF service consumer provided a preferred target NF location, the NRF shall not limit the set of discovered NF instances or NF service instance(s) to the target NF location, e.g. the NRF may provide NF instance(s) or NF service instance(s) for which location is not the preferred target NF location if no NF instance or NF service instance could be found for the preferred target NF location.

#### 4.17.5 NF/NF service discovery across PLMNs in the case of discovery made by NF service consumer

In the case that the NF service consumer intends to discover the NF/NF service in home PLMN, the NRF in serving PLMN needs to request "NF Discovery" service from NRF in the home PLMN. The procedure is depicted in the figure below:

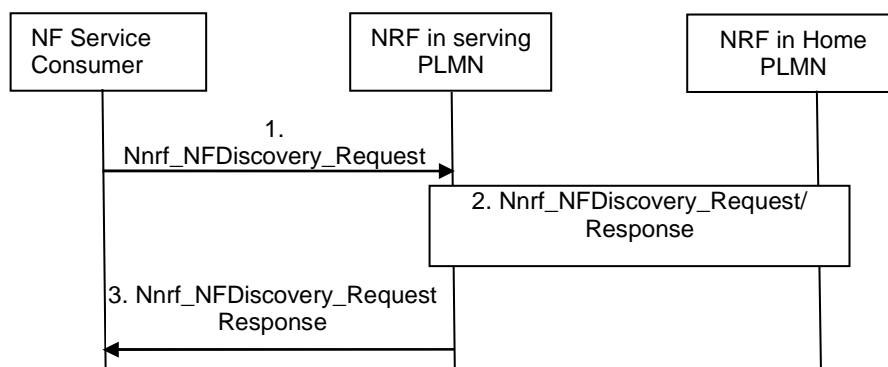


Figure 4.17.5-1: NF/NF service discovery across PLMNs

1. The NF service consumer in the serving PLMN invokes Nnrf\_NFDiscovery\_Request (Expected Service Name, NF type of the expected NF, home PLMN ID, serving PLMN ID, NF type of the NF service consumer) to an appropriate configured NRF in the serving PLMN. The request may also include optionally producer NF Set ID, NF Service Set ID, S-NSSAI, NSI ID if available and other service related parameters. A complete list of parameters is provided in service definition in clause 5.2.7.3.2.

NOTE 1: The use of NSI ID within a PLMN depends on the network deployment.

2. The NRF in serving PLMN identifies NRF in home PLMN (hNRF) based on the home PLMN ID and it requests "NF Discovery" service from NRF in home PLMN according the procedure in Figure 4.17.4-1 to get the expected NF profile(s) of the NF instance(s) deployed in the home PLMN. As the NRF in the serving PLMN triggers the "NF Discovery" on behalf of the NF service consumer, the NRF in the serving PLMN shall not replace the information of the service requester NF, i.e. NF consumer ID, in the Discovery Request message it sends to the hNRF.

The hNRF may further query an appropriate local NRF in the home PLMN based on the input information received from NRF of the serving PLMN. The FQDN of the local NRF or Endpoint Address of local NRF's NF Discovery service in the home PLMN may be configured in the hNRF or may need to be discovered based on the input information.

3. The NRF in serving PLMN provides same as step 3 in clause 4.17.4 applies.

## 4.17.6 SMF Provisioning of available UPFs using the NRF

### 4.17.6.1 General

This clause describes the provisioning of available UPFs in SMF using the NRF as documented in clause 6.3.3 of TS 23.501 [2].

This optional node-level step takes place prior to selecting the UPF for PDU Sessions and may be followed by N4 Node Level procedures defined in clause 4.4.3 where the UPF and the SMF exchange information such as the support of optional functionalities and capabilities.

As an option, UPF(s) may register in the NRF. This registration phase uses the Nnrf\_NFManagement\_NFRegister operation and hence does not use N4.

For the purpose of SMF provisioning of available UPFs, the SMF uses the Nnrf\_NFManagement\_NFStatusSubscribe, Nnrf\_NFManagement\_NFStatusNotify and Nnrf\_NFDiscovery services to learn about available UPFs.

NOTE 1: The protocol used by UPF to interact with NRF is described in TS 29.510 [37]

UPFs may be associated with UPF Provisioning Information in the NRF. The UPF Provisioning Information consists of:

- a list of (S-NSSAI, DNN);
- UE IPv4 Address Ranges and/or IPv6 Prefix Range(s) per (S-NSSAI, DNN); and

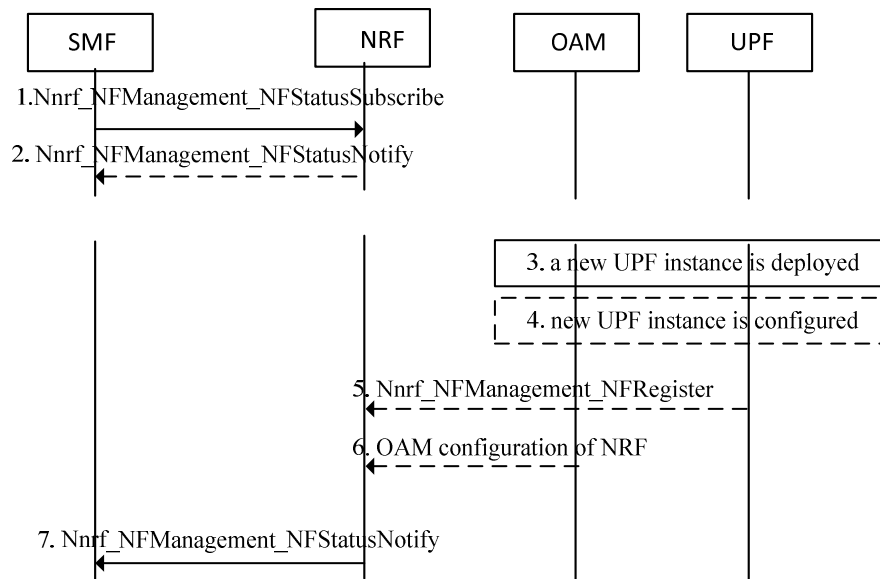
NOTE 2: The above information can be used by the SMF for UPF selection when static IP address/prefix allocation is required for a UE.

- a SMF Area Identity the UPF can serve. The SMF Area Identity allows limiting the SMF provisioning of UPF(s) using NRF to those UPF(s) associated with a certain SMF Area Identity. This can e.g. be used if an SMF is only allowed to control UPF(s) configured in NRF as belonging to a certain SMF Area Identity.
- the supported ATSSS steering functionality, i.e. whether MPTCP functionality or ATSSS-LL functionality or both are supported.

The SMF Area Identity and UE IPv4 Address Ranges and/or IPv6 Prefix Range(s) are optional in the UPF Provisioning Information.

### 4.17.6.2 SMF provisioning of UPF instances using NRF

This procedure applies when a SMF wants to get informed about UPFs available in the network and supporting a list of parameters.



**Figure 4.17.6.2-1: SMF provisioning of UPF instances using NRF procedure**

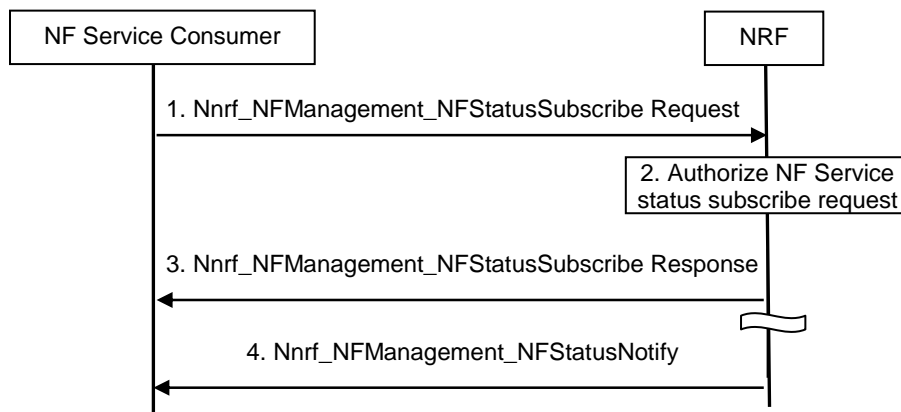
The following takes place when an SMF expects to be informed of UPFs available in the network:

- 1 The SMF issues a Nnrf\_NFManagement\_NFStatusSubscribe Service Operation providing the target UPF Provisioning Information it is interested in.
- 2 The NRF issues Nnrf\_NFManagement\_NFStatusNotify with the list of all UPFs that currently meet the SMF subscription. This notification indicates the subset of the target UPF Provisioning Information that is supported by each UPF.

The following takes place when a new UPF instance is deployed:

- 3 At any time a new UPF instance is deployed.
- 4 The UPF instance is configured with the NRF identity to contact for registration and with its UPF Provisioning Information. An UPF is not required to understand the UPF Provisioning Information beyond usage of this information to register in step 5.
- 5 The UPF instance issues an Nnrf\_NFManagement\_NFRegister Request operation providing its NF type, the FQDN or IP address of its N4 interface and the UPF Provisioning Information configured in step 4.
6. Alternatively (to steps 4 and 5) OAM registers the UPF on the NRF indicating the same UPF Provisioning Information as provided in step 5. This configuration mechanism is out of scope of this specification.
7. Based on the subscription in step 1, the NRF issues Nnrf\_NFManagement\_NFStatusNotify to all SMFs with a subscription matching the UPF Provisioning Information of the new UPF

#### 4.17.7 NF/NF service status subscribe/notify in the same PLMN



**Figure 4.17.7-1: NF/NF service status subscribe/notify in the same PLMN**

1. The NF service consumer subscribes to be notified of newly registered/updated/deregistered NF instances along with its NF services. The NF service consumer invokes Nnrf\_NFManagement\_NFStatusSubscribe Request from an appropriate configured NRF in the same PLMN.
2. The NRF authorizes the Nnrf\_NFManagement\_NFStatusSubscribe Request. Based on the profile of the expected NF/NF service and the type of the NF service consumer, the NRF determines whether the NF service consumer is allowed to subscribe to the status of the target NF instance(s) or NF service instance(s).
3. If allowed, the NRF acknowledges the execution of Nnrf\_NFManagement\_NFStatusSubscribe Request.
4. NRF notifies about newly registered/updated/deregistered NF instances along with its NF services to the subscribed NF service consumer.

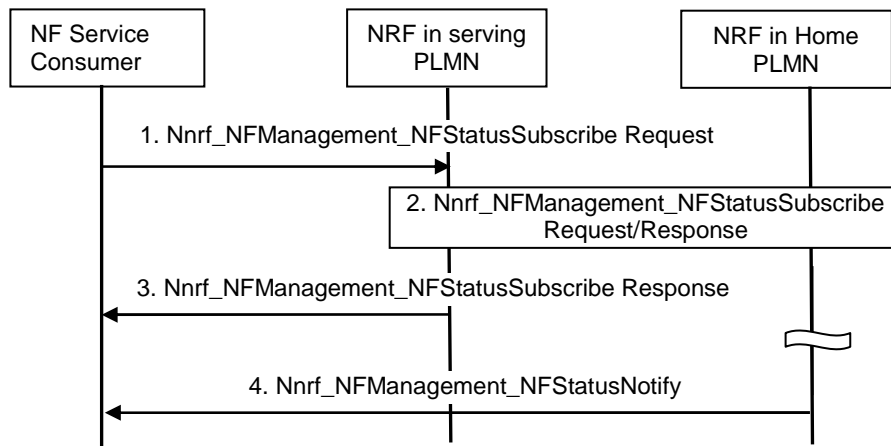
NOTE 1: The NF service consumer unsubscribes to receive NF status notifications by invoking Nnrf\_NFManagement\_NFStatusUnSubscribe service operation.

NOTE 2: When the NF or NF service instance becomes unavailable, the NRF invokes Nnrf\_NFManagement\_NFStatusNotify service to notify the NF service consumer based on the subscription.

#### 4.17.8 NF/NF service status subscribe/notify across PLMNs

In the case that the NF service consumer intends to subscribe to the status of NF/NF service instance(s) in home PLMN, the NRF in serving PLMN needs to request "NF status subscribe" service from NRF in the home PLMN. The notification is sent from the NRF in the home PLMN to the NF service consumer in the serving PLMN without the involvement of the NRF in the serving PLMN. The procedure is depicted in the figure below:





**Figure 4.17.8-1: NF/NF service status subscribe/notify across PLMNs**

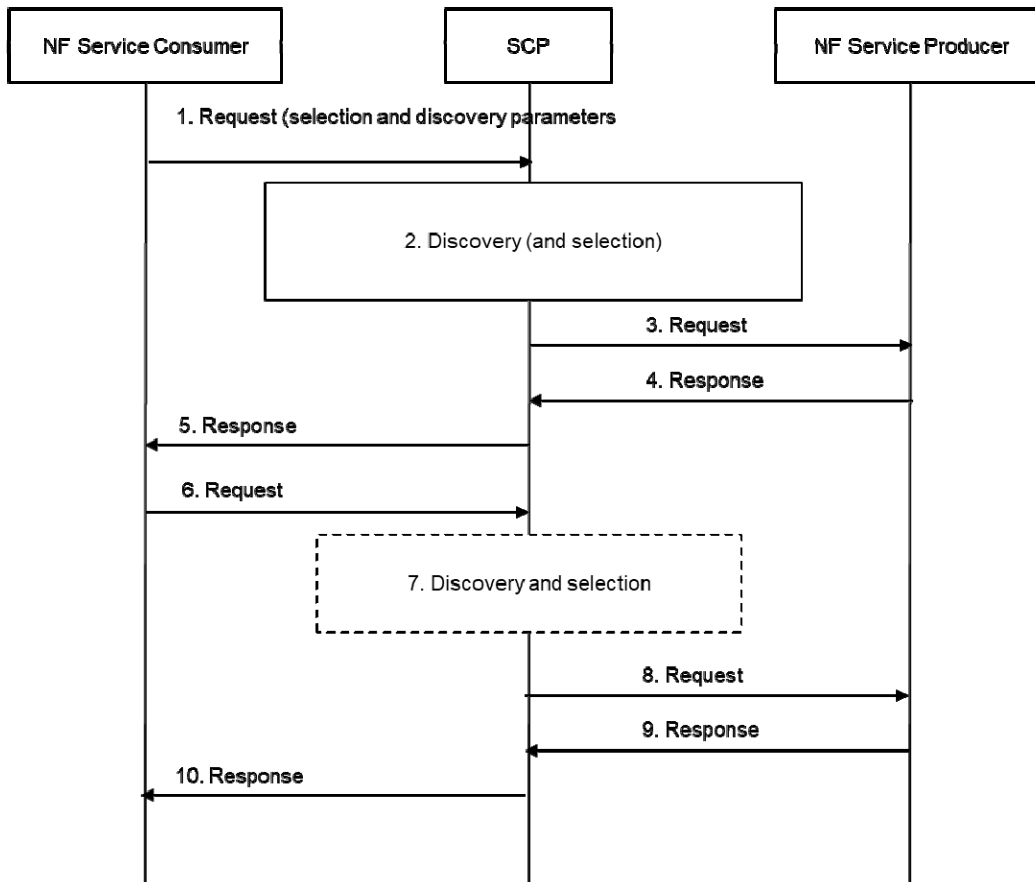
NOTE 1: The NRF in the home PLMN communicates with the NRF and the NF consumer in the serving PLMN via the SEPPs in the respective PLMNs. For the sake of clarity, SEPPs are not depicted in the flow.

1. The NF service consumer in the serving PLMN invokes Nnrf\_NFManagement\_NFStatusSubscribe Request from an appropriate configured NRF in the serving PLMN.
2. The NRF in serving PLMN identifies NRF in home PLMN (hNRF) based on the home PLMN ID and it requests Nnrf\_NFManagement\_NFStatusSubscribe service from NRF in home PLMN. As the NRF in the serving PLMN triggers the Nnrf\_NFManagement\_NFStatusSubscribe service on behalf of the NF service consumer, the NRF in the serving PLMN shall not replace the information of the service requester NF, i.e. NF consumer ID, in the status subscribe Request message it sends to the hNRF.
3. The NRF in serving PLMN acknowledges the execution of Nnrf\_NFManagement\_NFStatusSubscribe Request to the NF consumer in the serving PLMN.
4. NRF in the home PLMN notifies about newly registered/updated/deregistered NF instances along with its NF services to the subscribed NF service consumer in the serving PLMN.

NOTE 2: The NF service consumer unsubscribes to receive NF status notifications by invoking Nnrf\_NFManagement\_NFStatusUnSubscribe service operation.

NOTE 3: When the NF or NF service instance becomes unavailable, the NRF in the home PLMN invokes Nnrf\_NFManagement\_NFStatusNotify service to notify the NF service consumer in the serving PLMN based on the subscription.

#### 4.17.9 Delegated service discovery when NF service consumer and NF service producer are in same PLMN



**Figure 4.17.9-1: Delegated NF service discovery when NF service consumer and NF service producer are in same PLMN**

1. The NF service consumer intends to communicate with an NF service producer. The NF service consumer sends the service request to an SCP. The request may include discovery and selection parameters necessary to discover and select a NF service producer instance. The discovery and selection parameters are included in the request by the NF service consumer in a way that the SCP does not need to parse the request body.
2. The SCP may perform discovery upon the request either by interacting with an NRF using Nnrf\_NFDISCOVERY service NRF or may use information collected during the previous interactions with an NRF (by the Nnrf\_NFDISCOVERY service or Nnrf\_NFManagement\_NFStatusNotify service operation). The SCP together with the NRF authorizes the request. The SCP selects the target NF service producer.

NOTE 1: If the discovery and selection parameters in the request include a UE identity, e.g. SUPI or IMPI/IMPU, the SCP can resolve the requested NF's Group ID corresponding to the UE identity and then invoke the Nnrf\_NFDISCOVERY service, as defined in clause 6.3.1 of TS 23.501 [2].

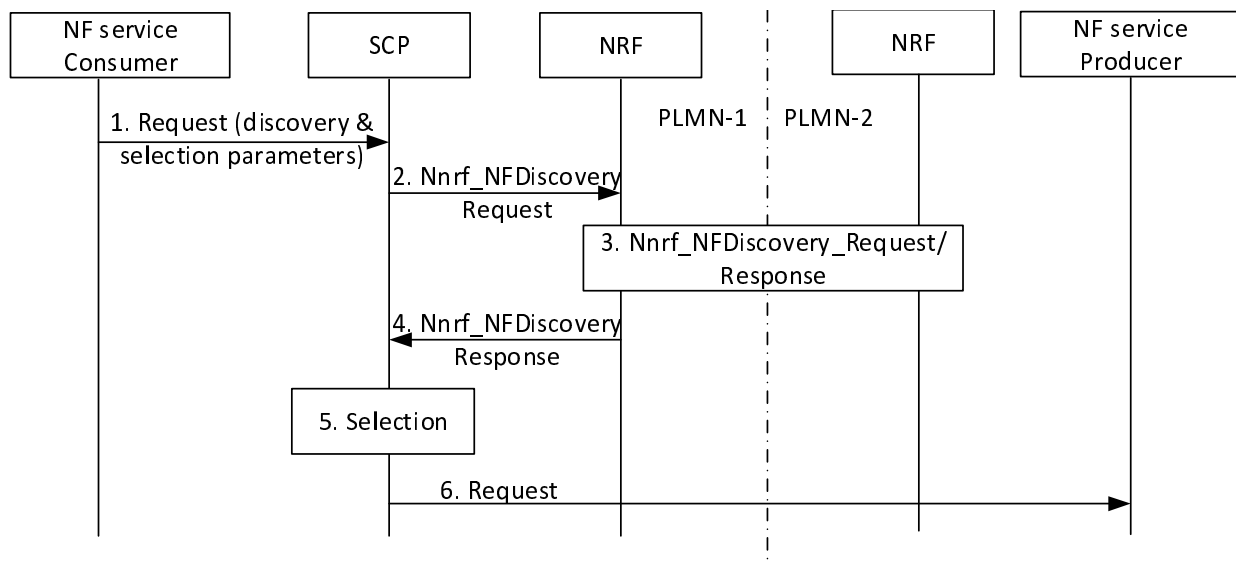
3. If the NF service consumer is authorized to communicate with the NF service producer, the SCP forwards the request to the selected NF service producer according to the configuration of the Network Slice, e.g. the expected NF instances are only reachable by NFs in the same network slice.
4. The NF service producer sends a response to the SCP. If the request in step 3 creates a resource in the NF service producer, such as depicted in Figure 4.17.9-1, the NF service producer responds with resource information identifying the created resource.
5. The SCP routes the response to the NF service consumer.

If the NF service consumer receives a resource address, it uses it for subsequent requests regarding the concerned resource. Otherwise, the procedure ends here.

6. On a subsequent operation on the created resource, the NF service consumer addresses the resource via the resource address returned by the NF service producer at step 4.
7. The SCP resolves the NF service producer address and selects a target NF service producer instance. The SCP then routes the request to the selected NF service producer instance. See the clause 6.3.1.0 of TS 23.501 [2] for the details of selection of a target NF service producer instance by SCP.
8. The SCP delivers the request to the NF service producer.
9. The NF service producer sends a response to the SCP. The NF service producer may respond with an updated resource information different to the one received in the previous response.
10. The SCP sends a response to the NF service consumer. If the resource information was updated, the NF service consumer uses the received resource information for subsequent operations (requests) on the resource.

NOTE 2: In the similar manner of handling the resource information, a binding indication may be also provided by the NF service producer and used for the subsequent requests of the NF service consumer. See more details in the clause 4.17.12.

#### 4.17.10 Delegated service discovery when NF service consumer and NF service producer are in different PLMNs



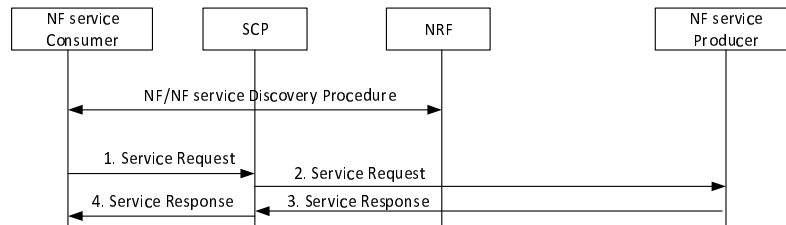
**Figure 4.17.10-1: Delegated NF service discovery when NF service consumer and NF service producer are in different PLMNs**

1. The NF service consumer intends to communicate with an NF service producer. The NF service consumer sends the request to an SCP. The request includes at least the source PLMN ID and the target PLMN ID in the discovery and selection parameters necessary for the SCP to discover and select a NF service producer instance. The discovery and selection parameters are included in the request by the NF service consumer in a way that the SCP does not need to parse the request body.
2. The SCP recognises that the request is for a NF service producer in another PLMN. SCP interacts with NRF using the Nnrf\_NFDiscovery service.
3. NRF in PLMN-1 and NRF in PLMN 2 interact using the Nnrf\_NFDiscovery service. See step 2 in clause 4.17.5.
4. SCP gets Nnrf\_NFDiscovery service response with NF profile(s).
5. SCP selects a NF service producer instance in PLMN-2.
6. SCP forwards the request to the selected NF service producer instance in PLMN-2.

Alternatively, SCP may send the discovery request directly to the NRF in PLMN-2, if it has the relevant NRF address and is authorized by the NRF in PLMN-2. Thus step 2 goes from SCP to NRF in PLMN-2 and step 4 goes from NRF in PLMN-2 to SCP and step 3 is omitted.

### 4.17.11 Indirect Communication without delegated discovery Procedure

This clause provides the call flow for indirect communication model without delegated discovery.



**Figure 4.17.11-1: Procedure for Indirect Communication without delegated discovery**

The NF/NF service discovery procedure is defined in clauses 4.17.4 and 4.17.5. In a successful discovery the NF service consumer gets the NF profile(s) matching the search criteria provided in the `Nnrf_NFDiscovery_Request` message.

1. When the NF Service Consumer needs to send a Service Request and has obtained an endpoint address for the appropriate resources of the NF service producer from the reply to a previous service operation, the NF Service Consumer should indicate that endpoint address as target for the Service Request. Otherwise, if the NF Service Consumer has stored results from the Discovery Procedure, the NF Service Consumer selects an appropriate NF Producer / NF Service Producer instance from the list of NF profiles provided by the NRF. The NF Service Consumer considers the NF and NF service parameters (e.g. TAI, S-NSSAI, locality, priority etc) in the NF profiles. The NF Service consumer requests service from the NF Service producer by sending a service request message to the NF service producer via the SCP and the NF Service Consumer may provide a Routing Binding Indication with the same contents as the previously received Binding Indication.
2. If the Routing Binding Indication is provided by the NF Service Consumer, SCP (re-)selects as specified in Table 6.3.1.0-1 of TS 23.501 [2] and routes the service request to target accordingly. If the Routing Binding Indication is not provided by the NF Service Consumer, then the SCP routes the service request based on routing information available.
3. The NF Service Producer responds via SCP.
4. SCP forwards the response.

### 4.17.12 Binding between NF service consumer and NF service producer

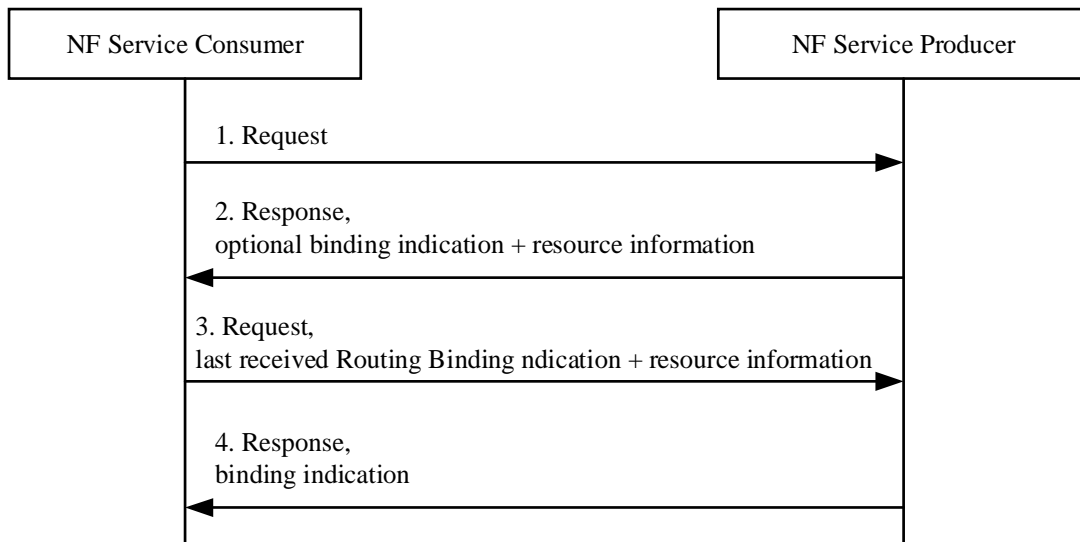
#### 4.17.12.1 General

This clause describes the procedures to establish binding between the NF service consumer and producer.

Direct Communication or Indirect Communication procedures may be used between the Consumer and Producer. In the case of Indirect Communication, an SCP is located between the Consumer and Producer.

#### 4.17.12.2 Binding created as part of service response

When the NF service consumer communicates with the NF service producer, the producer may return a binding indication to the consumer. The consumer stores the received binding indication and uses it for the subsequent requests concerning the data context.



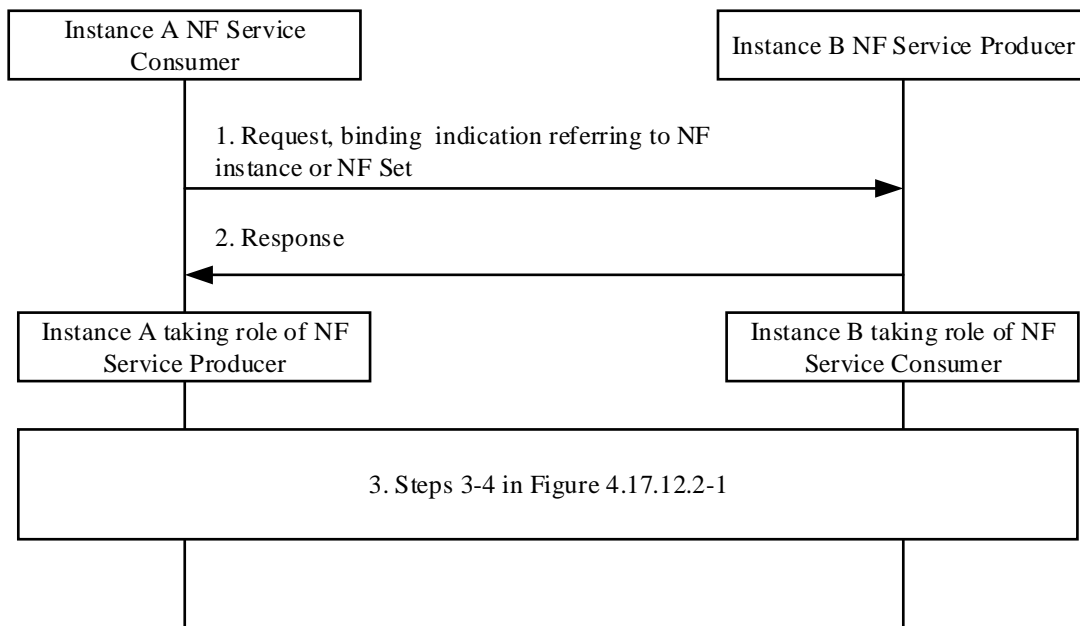
**Figure 4.17.12.2-1: Binding created as part of service response**

1. If Direct Communication is used, the NF service consumer selects the NF service producer and sends the request to the selected NF service producer. If Indirect Communication without delegated discovery is used, the NF service consumer selects the NF service producer set or instance and sends the request to the selected NF service producer via the SCP; if the NF server consumer only selects the NF service producer set, it provides the necessary selection parameters and the SCP selects the NF service producer instance. If Indirect Communication with delegated discovery is used, the NF service consumer sends the request to the SCP and provides within the service request to the SCP the discovery and selection parameters necessary to discover and select a NF service producer.
2. The NF service producer sends a response to the NF service consumer. In the response the NF service producer may include a binding indication. If the NF service consumer receives a resource information and binding indication as specified in Table 6.3.1.0-1 of TS 23.501 [2], it uses them for subsequent requests regarding the concerned resource. Otherwise, the procedure ends here.
3. The NF service consumer uses the binding indication and resource information received in the previous step for subsequent requests regarding the concerned resource. If indirect communication with delegated discovery is used, the NF service consumer includes a Routing Binding Indication with the same contents as the received Binding Indication. If indirect communication without delegated discovery is used, the NF service consumer also includes the Routing Binding Indication with the same contents as the received Binding Indication unless the NF service consumer performs a reselection. The SCP shall route the service request using the Routing Binding Indication and resource information sent from the NF service consumer.
4. The NF service producer sends a response to the consumer. The NF service producer may respond with an updated binding indication, different to the one received in the previous response.

#### 4.17.12.3 Binding created as part of service request

If the NF service consumer can also be as a NF service producer for later communication from the contacted producer, a service request sent to the producer may include binding indication.

**NOTE:** This clause only applies to an AMF, V-SMF or I-SMF as NF service consumer sending requests to an SMF and to an AMF as NF service consumer sending requests to an I-SMF or V-SMF, in step 1 unless further usage has been defined in stage 3. Implicit subscriptions are not described in this clause.



**Figure 4.17.12.3-1: Binding created as part of service request**

1. Instance A, as an NF service consumer sends a service request using either Direct Communication or Indirect communication via SCP and Instance B is selected as NF service producer. If Instance A can also be NF service producer for later communication for the concerned data context, it may include binding indication referring to NF service instance, NF service set, NF instance or NF Set as specified in Table 6.3.1.0-1 of TS 23.501 [2] in the request sent to the NF service producer; the binding indication shall be associated with an applicability indicating "other service" and include the service name. In this case, if indirect communication is used, the SCP sends to the Instance B the service request including the binding indication.
2. Instance B as the NF service producer sends a response to the NF service consumer.
3. When Instance B as NF service consumer needs to invoke the service provided by Instance A, Instance B sends a request using the binding indication received in step 1 as described in Steps 3-4 in Figure 4.17.12.2-1 with the following difference:
  - Based on the received binding indication, if delegated discovery is not used, the Instance B may need to discover the corresponding endpoint address of the Instance A.

#### 4.17.12.4 Binding for subscription requests

Binding for notifications can be created as part of an explicit or implicit subscription request. In this case, illustrated in Figure 4.17.12.4-1, the subscription request may include a Binding Indication 1 referring to NF service instance, NF service Set, NF instance or NF Set and additionally includes a service name of the NF service consumer as specified in Table 6.3.1.0-1 of TS 23.501 [2]. The NF Service Set ID, NF service instance ID and service name relate to the service of a NF service consumer that will handle the notification.

For direct communication, the NF service producer selects the target for the related notifications using the notification endpoint received in the subscription request. If the notification endpoint included in the subscription is not reachable, the Binding Indication received is used to discover an alternative notification endpoint, as specified in Table 6.3.1.0-1 of TS 23.501 [2].

For indirect communication, the NF service producer includes the notification endpoint received in the subscription and may include a Routing Binding Indication with the same contents as the received Binding Indication. If the notification endpoint included in the subscription is not reachable, the SCP selects the target for the related notifications using the received Routing Binding Indication as specified in Table 6.3.1.0-1 of TS 23.501 [2].

If the Binding Indication for Notifications needs to be updated, the NF service consumer may initiate a new Subscription request to the NF service producer with an updated Binding Indication or may include the Binding Indication in the acknowledgment of a Notification. A Subscription request may also contain updated Notification Correlation ID and Notification Target Address.

Binding for the subscription resource at the NF service producer can also be created: The Subscription Response message may contain a Binding Indication 2 referring to NF service instance, NF instance or NF Set of the NF service producer.

For direct communication, the NF service consumer selects the target for the related request to the producer, such as the request to update the subscription shown in Figure 4.17.12.4-1, using the received Binding Indication 2 as specified in Table 6.3.1.0-1 of TS 23.501 [2].

For indirect communication with delegated discovery, the NF service consumer includes a Routing Binding Indication with the same contents as the received Binding Indication 2. For indirect communication without delegated discovery, the NF service consumer also includes the Routing Binding Indication with the same contents as the received Binding Indication 2 unless it performs a reselection. The SCP selects the target for the related request using the received Routing Binding Indication 2 as specified in Table 6.3.1.0-1 of TS 23.501 [2].

If the Binding Indication for Subscription needs to be updated, the NF service producer may provide an updated binding indication in a notification request to the NF service consumer or in the response to a subsequent subscription update request from the NF service consumer.

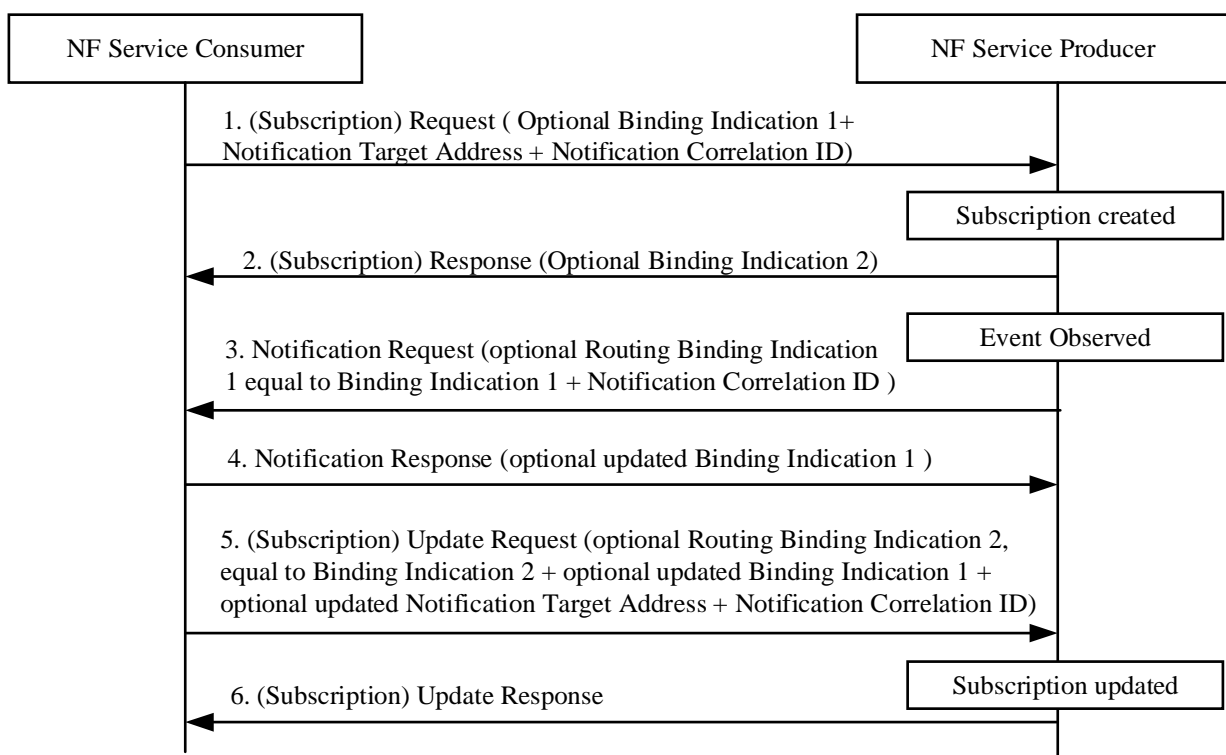
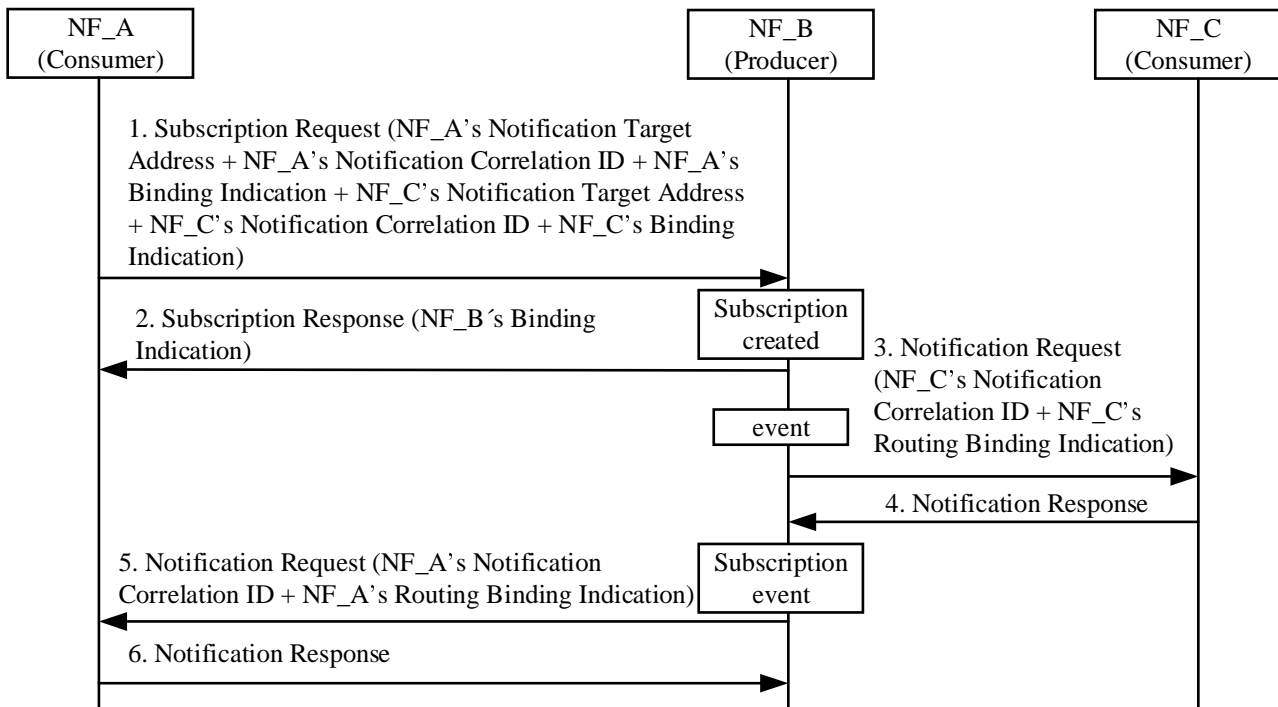


Figure 4.17.12.4-1: Binding in a subscription request



**Figure 4.17.12.4-2: Binding during subscription via another network function**

An NF service consumer may subscribe via another network function. For example, NF\_A may subscribe to NF\_B on behalf of NF\_C. NF\_A additionally subscribe to subscription related events. In this case, both the binding indication from NF\_C and NF\_A are provided to the NF service producer NF\_B. The Binding Indication for notifications to subscription related events shall be associated with an applicability indicating "subscription events".

The NF\_C's binding indication is used for reselection of a notification endpoint, which is used for event notification. The NF\_A's binding indication is used for reselection of a notification endpoint, which is used for subscription change event notification.

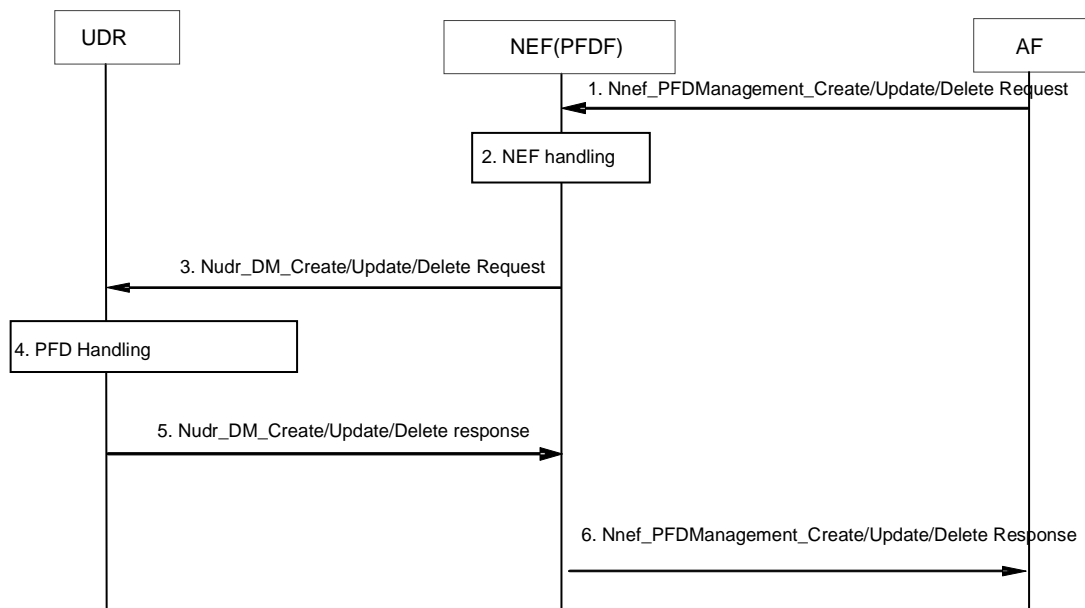
## 4.18 Procedures for Management of PFDs

### 4.18.1 General

NOTE: The PFD service is functionality within the NEF.



## 4.18.2 PFD management via NEF (PFDF)



**Figure 4.18.2-1 procedure for PFD management via NEF (PFDF)**

1. The AF invokes the Nnef\_PFDManagement\_Create/Update/Delete service. The Allowed Delay is an optional parameter. If the Allowed Delay is included, it indicates that the list of PFDs in this request should be provisioned within the time interval indicated by the Allowed Delay to the SMF(s) that have subscribed to the PFD management service using Nnef\_PFDManagement\_Subscribe service operation.
2. NEF checks whether the AF is authorized to perform this request and NEF (PFDF) checks if the AF is authorised to provision this PFD data based on the operator policies.
3. The NEF (PFDF) invokes the Nudr\_DM\_Create/Update/Delete (Application Identifier, one or more sets of PFDs, Allowed Delay) to the UDR.
4. The UDR updates the list of PFDs for the Application Identifier.
5. The UDR sends a Nudr\_DM\_Create/Update/Delete Response to the NEF (PFDF).
6. The NEF sends Nnef\_PFDManagement\_Create/Update/Delete Response to the Application Function.

## 4.18.3 PFD management in the SMF

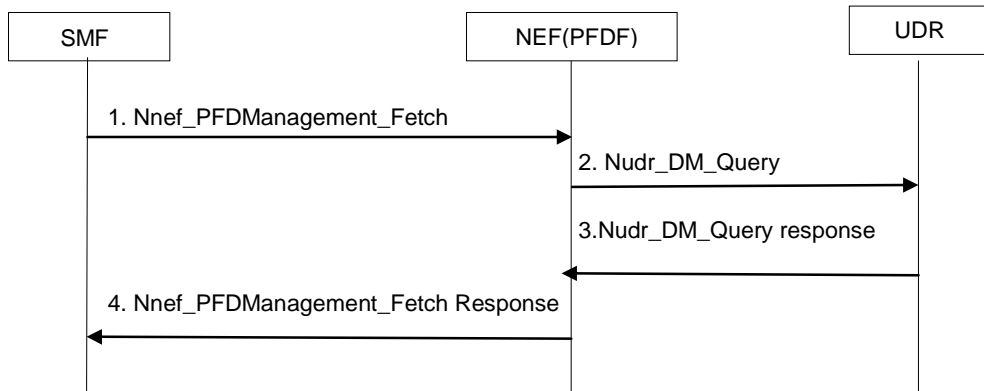
### 4.18.3.1 PFD Retrieval by the SMF

This procedure enables the SMF to retrieve PFDs for an Application Identifier from the NEF (PFDF) when a PCC rule with this Application Identifier is provided/activated and PFDs provided by the NEF (PFDF) are not available at the SMF.

In addition, this procedure enables the SMF to retrieve PFDs from the NEF (PFDF) when the caching timer for an Application Identifier elapses and a PCC Rule for this Application Identifier is still active.

The NEF (PFDF) retrieves the PFDs from UDR unless already available in NEF (PFDF).

The SMF may retrieve PFDs for one or more Application Identifiers in the same Request. All PFDs related to an Application Identifier are provided in the response from the UDR to NEF (PFDF).



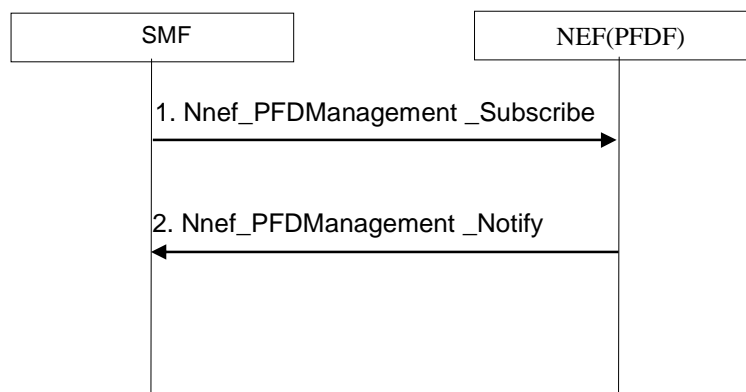
**Figure 4.18.3.1-1 PFD Retrieval by the SMF**

1. SMF invokes the Nnef\_PFDManagement\_Fetch (Application Identifier (s)) to the NEF (PFDF).
2. NEF (PFDF) checks if the PFDs for the Application Identifier (s) are available in the NEF (PFDF), if available, the NEF (PFDF) skips to step 4. If not, the NEF (PFDF) invokes Nudr\_DM\_Query (Application Identifier (s)) to retrieve the PFD(s) from UDR.
3. The UDR provides a Nudr\_DM\_Query response (Application Identifier(s), PFD(s)) to the NEF (PFDF).
4. The NEF (PFDF) replies to the SMF with Nnef\_PFDManagement\_Fetch (Application Identifier(s), PFD(s)).

#### 4.18.3.2 Management of PFDs in the SMF

This procedure enables the provisioning, modification or removal of PFDs associated with an application identifier in the SMF. Either the complete list of all PFDs of all application identifiers, the complete list of all PFDs of one or more application identifiers or a subset of PFDs for individual application identifiers may be managed.

Each PFD of an application identifier is associated with a PFD id if a subset of the PFD(s) associated with an application identifier can be provisioned, updated or removed. If always the full set of PFD(s) for an application identifier is managed in each transaction, PFD ids do not need to be provided.



**Figure 4.18.3.2-1 Management of PFDs in the SMF**

1. As pre-requisite condition to receiving push notifications, the SMF subscribes to PFD notifications from the NEF (PFDF) by sending Nnef\_PFDManagement\_Subscribe message.
2. The NEF (PFDF) invokes Nnef\_PFD\_Management\_Notify (Application Identifier, PFDs, PFDs operation) to the SMF(s) to which the PFD(s) shall be provided. The NEF (PFDF) may decide to delay the distribution of PFDs to the SMF(s) for some time to optimize the signalling load. If the NEF (PFDF) received an Allowed Delay for a PFD, the NEF (PFDF) shall distribute this PFD within the indicated time interval.

## 4.19 Network Data Analytics

The system procedures for Network Data Analytics are defined in clause 6 of TS 23.288 [50].

### 4.19.1 Void

### 4.19.2 Void

## 4.20 UE Parameters Update via UDM Control Plane Procedure

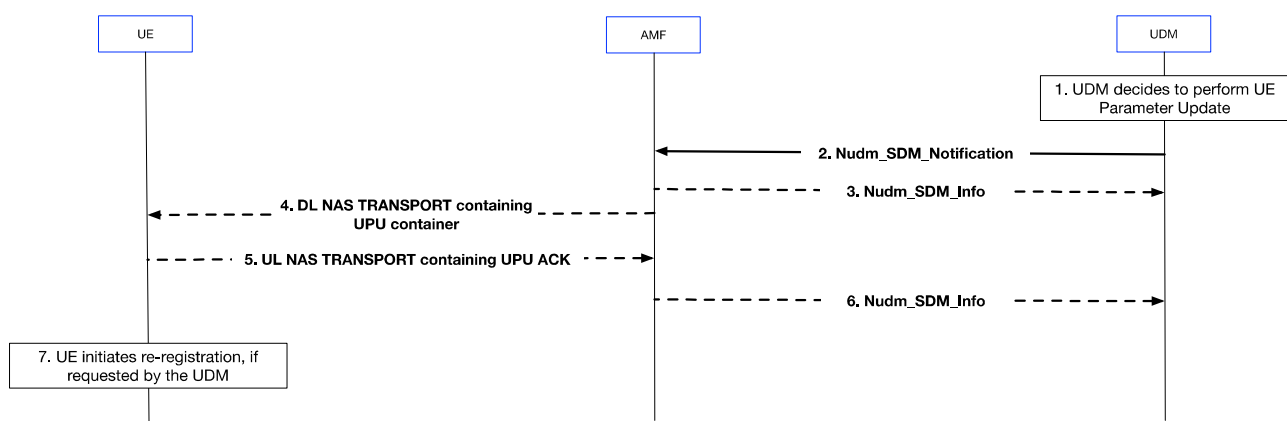
### 4.20.1 General

The purpose of the control plane solution for update of UE parameters is to allow the HPLMN or SNPN to update the UE with a specific set of parameters, generated and stored in the UDM, by delivering protected UDM Update Data via NAS signalling. The HPLMN or SNPN updates such parameters based on the operator policies.

The UDM Update Data that the UDM delivers to the UE may contain:

- one or more UE parameters including:
  - the updated Default Configured NSSAI (final consumer of the parameter is the ME).
  - the updated Routing Indicator Data (final consumer of the parameter is the USIM when the related credential is stored in the USIM, i.e. for PLMN or SNPN credentials; or final consumer of the parameter is the ME when the related credential is stored in the ME, i.e. for SNPN credentials).
- a "UE acknowledgement requested" indication.
- a "re-registration requested" indication.

### 4.20.2 UE Parameters Update via UDM Control Plane Procedure



**Figure 4.20.2-1: UE Parameters Update via UDM Control Plane Procedure**

1. UDM decides to perform UE parameter update due to "Routing Indicator update data" or "Default Configured NSSAI update data".
2. From UDM to the AMF: The UDM notifies the changes of the information related to the UE to the affected AMF by the means of invoking Nudm\_SDM\_Notification service operation. The Nudm\_SDM\_Notification service operation contains the UDM Update Data (e.g. "Routing Indicator update data", "Default Configured

NSSAI update data") that needs to be delivered transparently to the UE over NAS within the Access and Mobility Subscription data. The UDM update data includes:

- The updated parameters to be delivered to the UE (e.g. the updated Routing Indicator Data, the Default Configured NSSAI).
  - whether the UE needs to send an ack to the UDM.
  - whether the UE needs to re-register after updating the data.
3. From AMF to UDM: If AMF determines that the UE is not reachable, then AMF invokes the Nudm\_SDM\_Info service operation to UDM indicating that the transmission of UE Parameters Update data is not successful. The UDM considers the procedure as UE Parameters Update procedure as pending and subsequent steps from 4-7 are skipped.
  4. From AMF to the UE: the AMF sends a DL NAS TRANSPORT message to the served UE. The AMF includes in the DL NAS TRANSPORT message the transparent container received from the UDM.

The UE verifies based on mechanisms defined in TS 33.501 [15] that the UDM Update Data is provided by HPLMN or SNPN and:

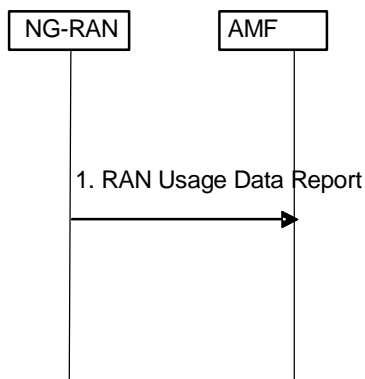
- If the security check on the UDM Update Data is successful, as defined in TS 33.501 [15] the UE either stores the information and uses those parameters from that point onwards, or forwards the information to the USIM; and
  - If the security check on the UDM Update Data fails, the UE discards the contents of the UDM Update Data.
5. The UE to the AMF: If the UE has verified that the UDM Update Data is provided by HPLMN or SNPN and the UDM has requested the UE to send an ack to the UDM, the UE sends an UL NAS TRANSPORT message to the serving AMF with a transparent container including the UE acknowledgement.
  6. The AMF to the UDM: If the AMF receives an UL NAS TRANSPORT message with a transparent container carrying a UE acknowledgement from the UE, the AMF sends a Nudm\_SDM\_Info request message including the transparent container to the UDM.
  7. If the UDM has requested the UE to re-register, the UE waits until it goes back to RRC idle and initiates a Registration procedure as defined in TS 24.501 [25].

### 4.20.3 Void

## 4.21 Secondary RAT Usage Data Reporting Procedure

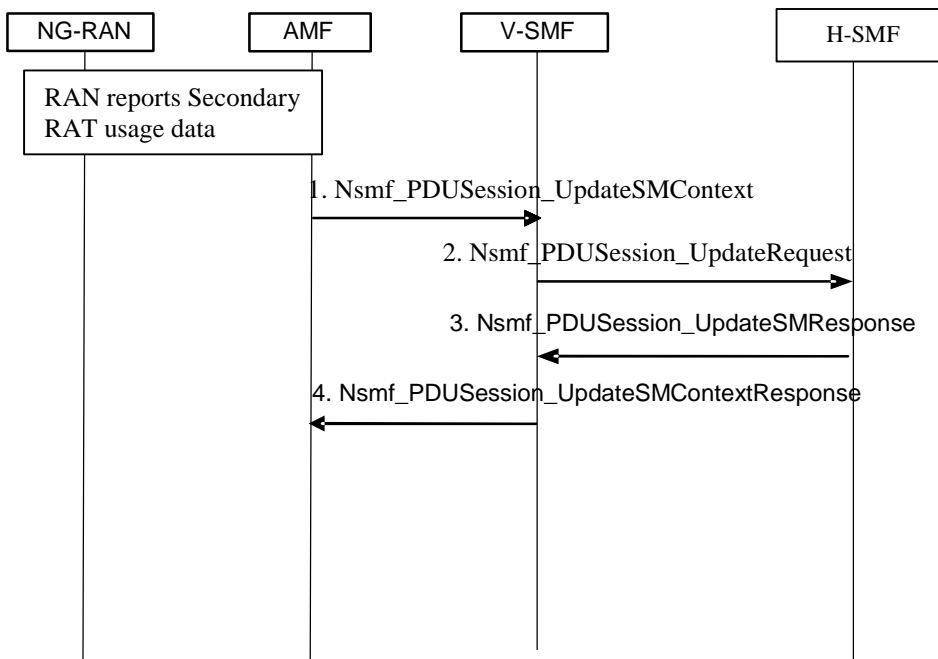
The procedure in Figure 4.21-1 may be used to report Secondary RAT Usage Data from NG-RAN node to the AMF. It is executed by the NG-RAN node to report the Secondary RAT Usage Data information towards AMF which is then reported towards SMF.

The procedure in Figure 4.21-2 may be used to report the Secondary RAT Usage Data from AMF towards the SMF. Optionally, it is used to report the Secondary RAT Usage Data from V-SMF to the H-SMF when the reporting to H-SMF is activated.



**Figure 4.21-1: RAN Secondary RAT Usage Data Reporting procedure**

1. The NG-RAN, if it supports Dual Connectivity with Secondary RAT (using NR radio, E-UTRA radio, or unlicensed spectrum using NR or E-UTRA radio) and it is configured to report Secondary RAT Usage Data for the UE, depending on certain conditions documented in this specification, it shall send a RAN Usage Data Report message to the AMF including the Secondary RAT Usage Data for the UE. The NG-RAN node will send only one RAN Usage Report for a UE when the UE is subject to handover by RAN. The RAN Usage Data Report includes a Handover Flag to indicate when the message is sent triggered by a handover.



**Figure 4.21-2: SMF Secondary RAT Usage Data Reporting procedure**

The NG-RAN, if it supports Dual Connectivity with Secondary RAT (using NR radio, E-UTRA radio, or unlicensed spectrum using NR or E-UTRA radio) and it is configured to report Secondary RAT usage data for the UE, it shall include the Secondary RAT usage data for the UE to the AMF in certain messages depending on certain conditions documented elsewhere in this TS.

1. The AMF forwards the N2 SM Information (Secondary RAT Usage Data) to the SMF in a Nsmf\_PDUSession\_UpdateSMContext Request.
2. The V-SMF sends the Nsmf\_PDUSession\_Update (Secondary RAT Usage Data) message to the H-SMF.
3. The H-SMF acknowledges receiving the Secondary RAT Usage data for the UE.
4. The V-SMF acknowledges receiving the Secondary RAT Usage data back to the AMF.

## 4.22 ATSSS Procedures

### 4.22.1 General

This clause specifies the procedures that enable the support of Access Traffic Steering, Switching and Splitting (ATSSS), as defined in clause 5.32 of TS 23.501 [2]. These procedures can be applied only by ATSSS-capable UEs and 5GC networks.

The key enabler of ATSSS is the Multi Access-PDU (MA PDU) Session. As specified in clause 5.32.1 of TS 23.501 [2], a MA PDU Session is a PDU Session associated with two independent N3/N9 tunnels between the PSA and RAN/AN and with multiple access types, i.e. with one 3GPP access and one non-3GPP access. The traffic of a MA PDU Session can be transferred over 3GPP access, or over non-3GPP access, or over both accesses. How the traffic is transferred over the available accesses of a MA PDU Session is governed by the applicable policy created by the 5GC network.

The UE determines whether ATSSS is supported by the network based on the MA PDU Session Support indicator provided by the AMF during the Registration procedures, as specified in clause 4.22.9.1. If the network does not support ATSSS, the UE shall not initiate the following procedures in this network:

- establishment of a MA PDU Session (clause 4.22.2);
- establishment of a PDU Session with "MA PDU Network-Upgrade Allowed" indication (clause 4.22.3);
- addition of user-plane resources over one access for an existing MA PDU Session, which has been established over the other access in a different network (clause 4.22.7); or
- PDU Session Modification with Request Type of "MA PDU request" or with "MA PDU Network-Upgrade Allowed" indication after moving from EPC to 5GC (clause 4.22.6.3).

### 4.22.2 UE Requested MA PDU Session Establishment

#### 4.22.2.1 Non-roaming and Roaming with Local Breakout

The signalling flow for a MA PDU Session establishment when the UE is not roaming, or when the UE is roaming and the PDU Session Anchor (PSA) is located in the VPLMN, is based on the signalling flow in Figure 4.3.2.2.1-1 with the following differences and clarifications:

- The PDU Session Establishment Request message may be sent over the 3GPP access or over the non-3GPP access. In the steps below, it is assumed that it is sent over the 3GPP access, unless otherwise specified.
- In step 1, the UE provides Request Type as "MA PDU Request" in UL NAS Transport message and its ATSSS Capabilities as defined in clause 5.32.2 of TS 23.501 [2] in PDU Session Establishment Request message.

The "MA PDU Request" Request Type in the UL NAS Transport message indicate to the network that this PDU Session Establishment Request is to establish a new MA PDU Session and to apply the ATSSS-LL functionality, or the MPTCP functionality, or both functionalities, for steering the traffic of this MA PDU session.

If the UE requests an S-NSSAI and the UE is registered over both accesses, it shall request an S-NSSAI that is allowed on both accesses.

- In step 2, if the AMF supports MA PDU sessions, then the AMF selects an SMF, which supports MA PDU sessions. In step 3, the AMF informs the SMF that the request is for a MA PDU Session by including "MA PDU Request" indication and, in addition, it indicates to SMF whether the UE is registered over both accesses. If the AMF determines that the UE is registered via both accesses but the requested S-NSSAI is not allowed on both accesses, then the AMF shall reject the MA PDU session establishment.

The AMF shall reject the PDU Session Establishment request if the request is for a LADN.

- In step 4, the SMF retrieves, via Session Management subscription data, the information whether the MA PDU session is allowed or not.
- In step 7, if dynamic PCC is to be used for the MA PDU Session, the SMF sends an "MA PDU Request" indication to the PCF in the SM Policy Control Create message and the ATSSS Capabilities of the MA PDU

session. The SMF provides the currently used Access Type(s) and RAT Type(s) to the PCF. The PCF decides whether the MA PDU session is allowed or not based on operator policy and subscription data.

The PCF provides PCC rules that include MA PDU session control information, as specified in TS 23.503 [20]. From the received PCC rules, the SMF derives (a) ATSSS rules, which will be sent to UE for controlling the traffic steering, switching and splitting in the uplink direction and (b) N4 rules, which will be sent to UPF for controlling the traffic steering, switching and splitting in the downlink direction. If the UE indicates the support of "ATSSS-LL Capability", the SMF may derive the Measurement Assistance Information.

If the SMF receives a UP Security Policy for the PDU Session with Integrity Protection set to "Required" and the MA PDU session is being established over non-3GPP access, the SMF does not verify whether the access can satisfy the UP Security Policy.

- In the remaining steps of Figure 4.3.2.2.1-1, the SMF establishes the user-plane resources over the 3GPP access, i.e. over the access where the PDU Session Establishment Request was sent on:
  - In step 10, the N4 rules derived by SMF for the MA PDU session are sent to UPF and two N3 UL CN tunnels info are allocated by the UPF. If the ATSSS LL functionality is supported for MA PDU Session, the SMF may instruct the UPF to initiate performance measurement for this MA PDU Session. If the MPTCP functionality is supported for the MA PDU Session, the SMF may instruct the UPF to activate MPTCP functionality for this MA PDU Session. In step 10a, the UPF allocates addressing information for the Performance Measurement Function (PMF) in the UPF. In step 10b, the UPF sends the addressing information for the PMF in the UPF to the SMF.
 

In step 10a, if the message from the SMF instructs the UPF to activate MPTCP functionality, the UPF allocates the UE "link-specific multipath" addresses/prefixes. In step 10b, the UPF sends the "link-specific multipath" addresses/prefixes and MPTCP proxy information to the SMF.
  - In step 11, for the MA PDU session, the SMF includes an "MA PDU session Accepted" indication in the Namf\_Communication\_N1N2MessageTransfer message to the AMF and indicates to AMF that the N2 SM Information included in this message should be sent over 3GPP access. The AMF marks this PDU session as MA PDU session based on the received "MA PDU session Accepted" indication.
  - In step 13, the UE receives a PDU Session Establishment Accept message, which indicates to UE that the requested MA PDU session was successfully established. This message includes the ATSSS rules for the MA PDU session, which were derived by SMF. If the ATSSS -LL functionality is supported for the PDU Session, the SMF may include the addressing information of PMF in the UPF into the Measurement Assistance Information. If the MPTCP functionality is supported for the MA PDU Session, the SMF shall include the "link-specific multipath" addresses/prefixes of the UE and the MPTCP proxy information.
- After step 18 in Figure 4.3.2.2.1-1, if the SMF was informed in step 2 that the UE is registered over both accesses, then the SMF initiates the establishment of user-plane resources over non-3GPP access too. The SMF sends a Namf\_Communication\_N1N2MessageTransfer to the AMF including N2 SM Information and indicates to AMF that the N2 SM Information should be sent over non-3GPP access. Namf\_Communication\_N1N2MessageTransfer does not include an N1 SM Container for the UE because this was sent to UE in step 13. After this step, the two N3 tunnels between the PSA and RAN/AN are established.

The last step above is not executed when the UE is registered over one access only, in which case the MA PDU Session is established with user-plane resources over one access only. How user-plane resources can be added over an access of the MA PDU Session is specified in clause 4.22.7.

## 4.22.2.2 Home-routed Roaming

### 4.22.2.2.1 Home-routed Roaming - UE registered to the same PLMN

When the UE is registered to the same VPLMN over 3GPP access and non-3GPP access, the MA PDU Session is established as specified in Figure 4.3.2.2.2-1 ("UE-requested PDU Session Establishment for home-routed roaming scenarios") with the differences and clarifications:

- The PDU Session Establishment Request message may be sent over the 3GPP access or over the non-3GPP access.

- In step 1, the UE provides Request Type as "MA PDU Request" in UL NAS Transport message and its ATSSS Capabilities, as defined in clause 5.32.2 of TS 23.501 [2] in PDU Session Establishment Request message.
- In step 2, if the AMF supports MA PDU sessions, then the AMF selects a V-SMF and an H-SMF, which supports MA PDU sessions. The V-SMF serves the UE over both accesses.
- In step 3, the AMF informs the SMF that the request is for a MA PDU Session by including an "MA PDU Request" indication and, in addition, the AMF indicates to V-SMF that the UE is registered over both accesses.
- In step 5, two DL N9 tunnel CN info and two UL N3 tunnel CN info are allocated by the V-SMF or by the V-UPF.
- In step 6, the V-SMF informs the H-SMF that the request is for a MA PDU Session by including an "MA PDU Request" indication and indicates to H-SMF that the UE is registered over both accesses.
- In step 7, the H-SMF retrieves, via Session Management subscription data, the information whether the MA PDU session is allowed or not.
- In step 9, if dynamic PCC is to be used for the MA PDU Session, the H-SMF sends an "MA PDU Request" indication to H-PCF in the SM Policy Control Create message and the ATSSS Capabilities of the MA PDU session. The H-SMF provides the currently used list of Access Type(s) and RAT Type(s) for the MA-PDU session to the H-PCF. The H-PCF decides whether the MA PDU session is allowed or not based on operator policy and subscription data.

The H-PCF provides the PCC rules containing MA PDU session control information and the H-SMF derives the ATSSS rules for the UE and the N4 rules for the H-UPF.

- In step 12, two UL N9 tunnel CN info are allocated by the H-SMF or by the H-UPF. After this step, the two N9 tunnels between the H-UPF and V-UPF are established.
- In step 13, the H-SMF sends "MA PDU session Accepted" indication to V-SMF in the Nsmf\_PDUSession\_Create Response message.
- In step 14, the V-SMF sends the "MA PDU session Accepted" indication in the Namf\_Communication\_N1N2MessageTransfer message to the AMF and indicates the AMF to send the N2 SM Information included in this message over the access that the UE sent the PDU Session Establishment Request. The AMF marks this PDU session as MA PDU session based on the received "MA PDU session Accepted" indication.

If the V-SMF received two UL N9 tunnel CN info from the H-SMF, the V-SMF also initiates the establishment of user-plane resources over the other access. The V-SMF sends an N1N2 Message Transfer to AMF including N2 SM Information and the other access type to indicate to AMF that the N2 SM Information should be sent over the other access. The N1N2 Message Transfer does not include an N1 SM Container for the UE which was sent to UE over the access that the UE sent the PDU Session Establishment Request.

- In step 16, the UE receives a PDU Session Establishment Accept message, which indicates to UE that the requested MA PDU session was successfully established. This message includes the ATSSS rules for the MA PDU session, which were derived by H-SMF and may include Measurement Assistance Information.
- After step 20, if the V-SMF was informed in step 3 that the UE is registered over both accesses, then the V-SMF initiates the establishment of user-plane resources over the other access too. The V-SMF sends an N1N2 Message Transfer to the AMF including N2 SM Information and indicates to the AMF over which access the N2 SM Information should be sent. The N1N2 Message Transfer does not include an N1 SM Container for the UE because this was sent to the UE in step 14. After this step, two N9 tunnels between the H-UPF and the V-UPF as well as two N3 tunnels between the V-UPF and RAN/AN are established, or, if the H-UPF is connected to two different V-UPFs, the H-UPF has one N9 tunnel with each V-UPF.

#### 4.22.2.2.2 Home-routed Roaming - UE registered to different PLMNs

When the UE is registered to different PLMNs over 3GPP access and non-3GPP access, the MA PDU Session is established first over one access as specified in Figure 4.3.2.2.2-1 ("UE-requested PDU Session Establishment for home-routed roaming scenarios") and then over the other access with the following differences and clarifications:



- In step 1, the UE provides Request Type as "MA PDU Request" in UL NAS Transport message and its ATSSS Capabilities, as defined in clause 5.32.2 of TS 23.501 [2].
- In step 2, if the AMF supports MA PDU sessions, then the AMF selects a V-SMF, which supports MA PDU sessions.
- In step 3, the AMF informs the V-SMF that the request is for a MA PDU Session (i.e. it includes an "MA PDU Request" indication).
- In step 6, the V-SMF informs the H-SMF that the request is for a MA PDU Session (i.e. it includes an "MA PDU Request" indication).
- In step 7, the H-SMF retrieves, via Session Management subscription data, the information whether the MA PDU session is allowed or not.
- In step 9, if dynamic PCC is to be used for the MA PDU Session, the H-SMF sends an "MA PDU Request" indication to PCF in the SM Policy Control Create message and the ATSSS Capabilities of the MA PDU session. The H-SMF provides the currently used Access Type(s) and RAT Type(s) for the MA-PDU session to the PCF. The PCF decides whether the MA PDU session is allowed or not based on operator policy and subscription data.
- In step 16, the UE receives a PDU Session Establishment Accept message, which indicates to UE that the requested MA PDU session was successfully established. This message includes the ATSSS rules for the MA PDU session, which were derived by H-SMF and may include Measurement Assistance Information.
- After the MA PDU Session is successfully established on the first access, the UE shall initiate again the MA PDU Session establishment procedure in Figure 4.3.2.2.2-1 over the other access with the following differences and clarifications:
  - In step 1, the UE shall send another PDU Session Establishment Request over the other access containing the same PDU Session ID that was provided over the first access. The UE also provides Request Type as "MA PDU Request" in UL NAS Transport message.
  - In step 12, new UL N9 tunnel CN info is allocated by the H-SMF or by the H-UPF.
  - In step 16, the UE receives another PDU Session Establishment Accept message, which may contain updated ATSSS rules for the MA PDU session.
  - After step 20, two N9 tunnels between the H-UPF and two different V-UPFs as well as two N3 tunnels between different V-UPF and RAN/AN are established, or two N3 tunnels, one is between V-UPF and RAN/AN over 3GPP access and the other is between H-UPF and RAN/AN over non 3GPP access, as well as one N9 tunnel between H-UPF and V-UPF are established.

## 4.22.3 UE Requested PDU Session Establishment with Network Modification to MA PDU Session

### 4.22.3.1 Overview

When an ATSSS-capable UE requests to establish a single-access PDU Session, but no policy in the UE and no local restrictions mandate a single access, the 5GC network may decide to modify it to a Multi-Access PDU (MA PDU) Session. This decision may be taken when e.g. the SMF wants to offload some traffic of the requested PDU Session to non-3GPP access or when the SMF wants to apply MPTCP to provide bandwidth aggregation for the requested PDU Session.

### 4.22.3.2 Non-roaming or roaming with local breakout

In the case of non-roaming or roaming with local breakout, the procedure for establishing a MA PDU Session when the UE requests a single-access PDU Session is the same with the procedure specified in clause 4.22.2.1.1, with the following clarifications and modifications:

- In step 1, the UE sets Request Type to initial request and it may include the "MA PDU Network-Upgrade Allowed" indication in UL NAS Transport message and its ATSSS Capabilities in PDU Session Establishment Request message, if the 5GC is ATSSS capable and no policy in the UE (e.g. no URSP rule) and no local

restrictions mandate a single access for the requested PDU Session. The "MA PDU Network-Upgrade Allowed" indication indicates that the requested single-access PDU Session may be converted to a MA PDU Session, if the 5GC network wants to.

- In step 2, if the AMF receives the "MA PDU Network-Upgrade Allowed" indication, the AMF may select a SMF that supports MA PDU sessions. The AMF does not send the "MA PDU Request" indication to SMF, but it sends the "MA PDU Network-Upgrade Allowed" indication, if received from the UE. If the AMF determines that the requested S-NSSAI is not allowed on both accesses, the AMF shall not forward "MA PDU Network-Upgrade Allowed" indication to the SMF. If the AMF sends the "MA PDU Network-Upgrade Allowed" indication to SMF, it shall also indicate to SMF whether the UE is registered over both accesses.

If the PDU Session Establishment request is for a LADN, the AMF shall not forward "MA PDU Network-Upgrade Allowed" indication to the SMF.

- After step 6, if SMF receives the "MA PDU Network-Upgrade Allowed" indication, the SMF may decide, if dynamic PCC is not to be used, to convert the single-access PDU Session requested by the UE into a MA PDU Session. The SMF may take this decision based on local operator policy, subscription data indicating whether the MA PDU session is allowed or not and/or other conditions, which are not specified in the present document.

If the SMF receives ATSSS Capabilities from the UE but does not receive "MA PDU Network-Upgrade Allowed" indication from the AMF, the SMF shall not convert the single-access PDU Session requested by the UE into a MA PDU Session.

If the SMF receives a UP Security Policy for the PDU Session with Integrity Protection set to "Required" and the MA PDU session is being established over non-3GPP access, the SMF does not verify whether the access can satisfy the UP Security Policy.

- In step 7, if dynamic PCC is to be used for the PDU Session, the SMF indicates to PCF that the SM policy control information is requested for a MA PDU Session via "MA PDU Network-Upgrade Allowed" indication if the MA PDU session is allowed based on the subscription data. The SMF provides the currently used Access Type(s) and RAT Type(s) for the MA-PDU session to the H-PCF. The SMF also provides the ATSSS Capabilities of the MA PDU session.
- In step 10, the N4 rules derived by SMF for the MA-PDU session are sent to UPF and two N3 UL CN tunnels info are allocated by the UPF.
- In step 11, for the MA PDU Session, the SMF sends an "MA PDU session Accepted" indication in the Namf\_Communication\_N1N2MessageTransfer message to the AMF. The AMF marks this PDU session as MA PDU session based on the received "MA PDU session Accepted" indication.
- The PDU Session Establishment Accept message includes ATSSS rules which indicate to UE that the requested PDU Session was converted by the network to a MA PDU Session.
- The SMF triggers the establishment of user-plane resources in both accesses, if it was informed in step 2 that the UE is registered over both accesses.

#### 4.22.3.3 Home-routed, the UE registered to the same VPLMN over both access

In the case of home-routed roaming, when the UE is registered to the same VPLMN over 3GPP access and non-3GPP access, the procedure for establishing a MA PDU Session when the VPLMN is ATSSS capable and the UE requests a single-access PDU Session but no policy in the UE and no local restrictions mandate a single access, is the same with the procedure specified in clause 4.22.2.2.1, with the following clarifications and modifications:

- In step 1, the UE sets Request Type to initial request and it may include an "MA PDU Network-Upgrade Allowed" indication in UL NAS Transport message and its ATSSS Capabilities as defined in clause 5.32.2 of TS 23.501 [2] in PDU Session Establishment Request message.
- In step 2, if the AMF receives the "MA PDU Network-Upgrade Allowed" indication, the AMF may select a V-SMF and a H-SMF that support MA PDU sessions. If the AMF determines that the requested S-NSSAI is not allowed on both accesses, the AMF shall not forward "MA PDU Network-Upgrade Allowed" indication to the V-SMF.

- In step 3, the AMF sends the "MA PDU Network-Upgrade Allowed" indication, if received from the UE. If the AMF sends the "MA PDU Network-Upgrade Allowed" indication to V-SMF, it shall also indicate to V-SMF whether the UE is registered over both accesses.
- In step 5, two DL N9 tunnel CN info and two UL N3 tunnel CN info are allocated by the V-SMF or by the V-UPF. Additionally, the V-SMF indicates to H-SMF the relationship between the DL N9 tunnel CN info and the access type. If the single CN Tunnel is established by the H-SMF, the DL N9 tunnel CN info binding to the access over which the NAS message is received is to be used.
- In step 6, the V-SMF provides the "MA PDU Network-Upgrade Allowed" indication, if received from AMF, together with an indication whether the UE is registered over both accesses.
- After step 6, if the H-SMF receives the "MA PDU Network-Upgrade Allowed" indication, the H-SMF may decide to convert the single-access PDU Session requested by the UE into a MA PDU Session, if dynamic PCC is not to be used. The H-SMF may take this decision based on local operator policy, subscription data indicating whether the MA PDU session is allowed or not and/or other conditions, which are not specified in the present document.

If the H-SMF receives ATSSS Capabilities from the UE but does not receive "MA PDU Network-Upgrade Allowed" indication from the AMF, the H-SMF shall not convert the single-access PDU Session requested by the UE into a MA PDU Session.

- In step 9, if dynamic PCC is to be used for the MA PDU Session, the H-SMF sends an "MA PDU Network-Upgrade Allowed" indication instead of "MA PDU Request" indication to H-PCF in the SM Policy Control Create message if the MA PDU session is allowed based on the subscription data. The H-SMF also provides the ATSSS Capabilities of the MA PDU session. The H-PCF decides whether the single-access PDU Session can be converted into an MA PDU session or not based on operator policy and subscription data.
- In step 13, the H-SMF sends "MA PDU session Accepted" indication to V-SMF in the Nsmf\_PDUSession\_Create Response message.
- In step 14, the V-SMF includes the "MA PDU session Accepted" indication in the Namf\_Communication\_N1N2MessageTransfer message to the AMF. The AMF mark this PDU session as MA PDU session based on the received "MA PDU session Accepted" indication.
- In step 16, the UE receives a PDU Session Establishment Accept message, which includes ATSSS rules and indicates to UE that the requested single-access PDU session was established as a MA PDU Session.
- After step 18, two N9 tunnels between the H-UPF and the V-UPF as well as two N3 tunnels between the V-UPF and 5G-AN are established, or, if the H-UPF is connected to two different V-UPFs, the H-UPF has one N9 tunnel with each V-UPF.

#### 4.22.3.4 Home-routed, the UE registered to different PLMNs over both access

In the case of home-routed roaming, when the UE is registered to different PLMNs over 3GPP access and non-3GPP access, the procedure for establishing a MA PDU Session when the UE requests a single-access PDU Session in an ATSSS capable PLMN but no policy in the UE and no local restrictions mandate a single access, is the same with the procedure specified in clause 4.22.2.2, with the following clarifications and modifications:

- In step 1, the UE sets Request Type to initial request and it may include an "MA PDU Network-Upgrade Allowed" indication in UL NAS Transport message and its ATSSS Capabilities as defined in clause 5.32.2 of TS 23.501 [2] in PDU Session Establishment Request message.
- In step 2, if the AMF receives the "MA PDU Network-Upgrade Allowed" indication, the AMF may select a V-SMF that supports MA PDU sessions.
- In step 3, the AMF sends the "MA PDU Network-Upgrade Allowed" indication, if received from the UE.
- In step 6, the V-SMF provides the "MA PDU Network-Upgrade Allowed" indication, if received from AMF.
- After step 6, if the H-SMF receives the "MA PDU Network-Upgrade Allowed" indication, the H-SMF may decide to convert the single-access PDU Session requested by the UE into a MA PDU Session, if dynamic PCC is not to be used. The H-SMF may take this decision based on local operator policy, subscription data indicating

whether the MA PDU session is allowed or not and/or other conditions, which are not specified in the present document.

- In step 9, if dynamic PCC is to be used for the MA PDU Session, the H-SMF sends an "MA PDU Network-Upgrade Allowed" indication to H-PCF in the SM Policy Control Create message if the MA PDU session is allowed based on the subscription data. The H-SMF also provides the ATSSS Capabilities of the MA PDU session.
- In step 13, the H-SMF sends "MA PDU session Accepted" indication to V-SMF in the Nsmf\_PDUSession\_Create Response message.
- In step 14, the V-SMF includes the "MA PDU session Accepted" indication in the Namf\_Communication\_N1N2MessageTransfer message to the AMF. The AMF mark this PDU session as MA PDU session based on the received "MA PDU session Accepted" indication.
- In step 16, the UE receives a PDU Session Establishment Accept message, which includes ATSSS rules and indicates to UE that the requested single-access PDU session was established as a MA PDU Session.
- After the MA PDU Session is established over one access, the UE shall send another PDU Session Establishment Request over the other access containing the same PDU Session ID that was provided over the first access. The UE also sets Request Type as "MA PDU Request" in UL NAS Transport message.

#### 4.22.4 Access Network Performance Measurements

The PMF of UE side or/and UPF side should be able to correlate the measurement packets with the corresponding access type in order to get the accurate measurement result for each access. The PMF of UE side correlates the sent measurement request and received measurement response messages via the same access type and the PMF of UPF side correlates the sent measurement request and received measurement response messages via the same N3 or N9 Tunnel. The PMF of UPF side shall record the relationship between the RTT measurement result and the N3 or N9 Tunnel.

NOTE: The frequency for RTT measurement for each access is decided by the PMF of the UE and the UPF respectively.

#### 4.22.5 Reporting of Access Availability

After the MA PDU session is established, if Reporting of Access Availability is required by network, the UE performs detection of the unavailability and availability of an access based on implementation. To report the availability/unavailability of the access, the UE sends the PMF-Access Report to the UPF via the user plane of any available access of the MA PDU session. The UPF shall use this report to decide which access can be used to deliver the downlink packets.

#### 4.22.6 EPS Interworking

##### 4.22.6.1 General

This clause includes procedures for interworking with EPS.

##### 4.22.6.2 Impacts to EPS interworking procedures

###### 4.22.6.2.1 5GS to EPS handover using N26 interface

Based on the signalling flow in Figure 4.11.1.2.1-1, the procedure is performed with the following differences and modifications:

- Step 2 is also performed with all the SMF+PGW-Cs corresponding to MA PDU Sessions with allocated EBI(s).
- In step 12e, the AMF requests the release of the 3GPP access of the MA PDU Session which has resources established for 3GPP access, but not expected to be transferred to EPC, i.e. no EBI(s) allocated to the MA PDU Session by triggering Nsmf\_PDUSession\_UpdateSMContext service operation.

NOTE: When the SMF received the release request from the AMF, the SMF decides whether the MA PDU Session is completely released or released over a single access based on its local policy.

- In step 16, if the MA PDU Session is established in both 3GPP and non-3GPP accesses and the MA PDU Session is moved to EPS, the SMF triggers the MA PDU Session Release procedure over non-3GPP access.

#### 4.22.6.2.2 5GS to EPS idle mode mobility using N26 interface

Based on the signalling flow in Figure 4.11.1.3.2-1, the procedure is performed with the following differences and modifications:

- Step 5a is also performed with all the SMF+PGW-Cs corresponding to the MA PDU Sessions with allocated EBI(s).
- In step 12, if the MA PDU Session is established in both 3GPP and non-3GPP accesses and the MA PDU Session is moved to EPS, the SMF triggers the MA PDU Session Release procedure over non-3GPP access.
- In step 15a, the AMF also requests the release of the MA PDU Session which has resources established for 3GPP access, but not expected to be transferred to EPS, i.e. no EBI(s) allocated to the MA PDU Session by triggering Nsmf\_PDUSession\_UpdateSMContext service operation.

NOTE: When the SMF received the release request from the AMF, the SMF decides whether the MA PDU Session is completely released or released over a single access based on its local policy.

#### 4.22.6.2.3 EPS bearer ID allocation

Based on the signalling flow in Figure 4.11.1.4.1-1, additionally for the MA PDU Session, with the following differences and clarifications:

- In step 1, the following procedures and relevant steps are also initiated during the UE Requested MA PDU Session Establishment, the UE Requested PDU Session Establishment with Network Modification to MA PDU Session and the UE or network requested MA PDU Session Modification procedures.
- In step 2, if the QoS Flow(s) of the MA PDU Session is established and the MA PDU Session is established over 3GPP access and other existing conditions satisfies EPS interworking, the SMF requests EBI allocation for the QoS Flow(s) of the MA PDU Session.

#### 4.22.6.2.4 EPS bearer ID revocation

Based on the clause 4.11.1.4.3, additionally the following procedures are updated to revoke the EPS bearer ID(s) assigned to the QoS Flow(s) in the MA PDU Session:

- UE or network requested MA PDU Session Release (non-roaming and roaming with local breakout) in clause 4.22.10.2.
- UE or network requested MA PDU Session Release (home-routed roaming) in clause 4.22.10.3.
- UE or network requested MA PDU Session Modification (non-roaming and roaming with local breakout) in clause 4.22.8.2.
- UE or network requested MA PDU Session Modification (home-routed roaming) in clause 4.22.8.3.
- When the MA PDU Session is released over 3GPP access, the UE and the SMF locally release the EBI(s) for the MA PDU Session. The SMF notifies the AMF of the released EBI(s) by sending Nsmf\_PDUSession\_SMContextStatusNotify service operation if the MA PDU Session is established in the same PLMN. If the MA PDU Session is established in different PLMNs, the SMF notifies the release of the MA PDU Session and as a result, the AMF removes associated EBI(s).

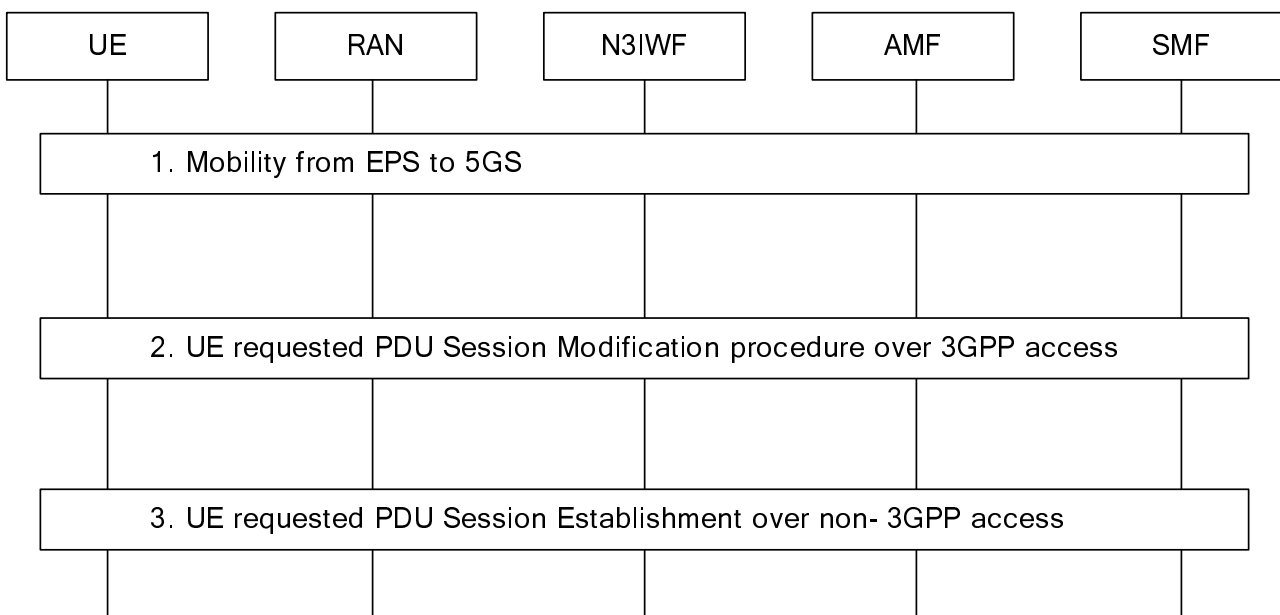
#### 4.22.6.2.5 5GS to EPS mobility without N26 interface

Based on the signalling flow in Figure 4.11.2.2-1, the procedure is performed with the following differences and modifications:

- In step 10 (and step 13 in clause 4.11.2.4.1), if the MA PDU Session is established in both 3GPP and non-3GPP accesses and the MA PDU Session is moved to EPS, the PGW-C + SMF triggers the MA PDU Session Release procedure over non-3GPP access. PGW-C + SMF and UE locally release the context related to ATSSS operation, e.g. ATSSS rules and Measurement Assistance Information for the relevant session.
- In step 13, during the additional PDN Connectivity Procedure, if the MA PDU Session is established in both 3GPP and non-3GPP accesses and the MA PDU Session is moved to EPS, the PGW-C + SMF triggers the MA PDU Session Release procedure over non-3GPP access. PGW-C + SMF and UE locally release the context related to ATSSS operation, e.g. ATSSS rules and Measurement Assistance Information for the relevant session(s).
- Step 14 is also performed for the MA PDU session(s) transferred to EPS.

#### 4.22.6.3 Network Modification to MA PDU Session after a UE moving from EPC

Figure 4.22.6.3-1 describes procedure for Network Modification to MA PDU Session after a UE is moving from EPS.



**Figure 4.22.6.3-1: Network Modification to MA PDU Session after a UE moving from EPS**

1. When the network supports interworking with N26 interface, a PDN Connection can be moved from EPS to 5GS as described in clause 4.11.1.2.2 and clause 4.11.1.3.3.
2. If the UE requests MA PDU session, or if no policy in the UE (e.g. no URSP rule) and no local restrictions mandate a single access for the PDU Session, the UE requests PDU Session Modification over 3GPP access as described in clause 4.22.8 with following modifications:
  - In step 1a, the UE provides Request Type as "MA PDU Request" in UL NAS Transport message, or, if no policy in the UE (e.g. no URSP rule) and no local restrictions mandate a single access for the PDU Session, the UE provides an "MA PDU Network-Upgrade Allowed" indication in UL NAS Transport message. The UE provides its ATSSS Capabilities, as defined in clause 5.32.2 of TS 23.501 [2] in PDU Session Modification Request message. If the AMF receives the "MA PDU Network-Upgrade Allowed" indication from the UE, the AMF may send it to the SMF. If the AMF determines that the UE is registered via both accesses in the same PLMN but the current S-NSSAI is not in the Allowed NSSAI for both accesses, the AMF shall reject the PDU session modification if the UE provides an "MA PDU Request" indication, or the AMF shall not forward "MA PDU Network-Upgrade Allowed" indication to the SMF if received from the UE.
  - In step 3a, if the SMF decides to change the PDU Session to MA PDU Session, the SMF includes ATSSS rule(s) in the PDU Session Modification Command message. The SMF may also include Measurement Assistance Information. When the SMF sends Nsmf\_PDUSession\_UpdateSMContext response, the SMF includes "MA PDU session Accepted" indication. The AMF marks the PDU Session as MA PDU Session

based on the indication. If the SMF was informed in step 1a that the UE is registered over both accesses, then the SMF initiates the establishment of user-plane resources over non-3GPP access too.

- In step 5, if the UE receives ATSSS rule(s) in the PDU Session Modification Command message, the UE stores that the PDU Session is MA PDU Session.
3. If the UE is registered to the different PLMN over 3GPP and non-3GPP access, the UE triggers the UE requested PDU Session Establishment procedure as described in clause 4.22.7 over non-3GPP access to add second access to the MA PDU Session.

## 4.22.7 Adding / Re-activating / De-activating User-Plane Resources

If the UE has established a MA PDU Session but the user-plane resources over one access of the MA PDU Session have not been established, then:

- If the UE wants to add user-plane resources over this access, the UE shall initiate the UE Requested PDU Session Establishment procedure over this access, as specified in clause 4.3.2.2. In the UL NAS Transport message, the UE sets Request Type as "MA PDU Request" and the same PDU Session ID of the established MA PDU Session. If only one N9 tunnel is established for the Home Routed roaming case as described in clause 4.22.2.2, additional N9 tunnel is established during this UE Requested PDU Session Establishment procedure. For the roaming with home-routed architecture as defined in TS 23.501 [2] figure 4.2.10-3, an N9 tunnel or an N3 tunnel is established during this PDU Session Establishment procedure, depending on the access for which the UE is requesting user-plane resources.
- The PDU Session Establishment Accept message received by the UE may contain updated ATSSS rules for the MA PDU session.
- If the SMF receives the PDU Session Establishment request message over an access and the SMF already has SM Contexts for the access, the SMF shall not release existing SM Contexts and shall re-activate user plane resources over the access while providing the PDU Session Establishment Accept message to the UE.

If the UE has established a MA PDU Session and the user-plane resources over one access of the MA PDU Session have been established but are currently inactive (e.g. because the UE is CM-IDLE over this access), then:

- If the UE wants to re-activate the user-plane resources over this access, then the UE shall initiate the Registration or UE Triggered Service Request procedure over this access, as specified in clause 4.22.9.2.
- If the network wants to re-activate the user-plane resources over 3GPP access of the MA PDU Session, or over non-3GPP access of the MA PDU Session, the network shall initiate the Network Triggered Service Request procedure, as specified in clause 4.22.9.4.

If the UE has established a MA PDU Session and the user plane resources are activated over either one access or both accesses, then:

- If the network wants to de-activate the user-plane resources over single access, then the network shall initiate the CN-initiated deactivation of UP connection procedure over this access, as specified in clause 4.3.7.

In all cases, if the UP security protection associated with this PDU session indicates that UP security is required, the SMF shall not establish resources over the 3GPP access unless the 3GPP Access Network can enforce the required UP security protection, even if resources were previously established over non-3GPP access.

## 4.22.8 UE or network requested MA PDU Session Modification

### 4.22.8.1 General

This procedure is triggered in the following cases:

- QoS Flow creation / modification (including GBR QoS Flow movement).
- Update of ATSSS rules and/or N4 rules.

#### 4.22.8.2 UE or network requested MA PDU Session Modification (non-roaming and roaming with local breakout)

The signalling flow for a MA PDU Session Modification when the UE is not roaming, or when the UE is roaming and the PDU Session Anchor (PSA) is located in the VPLMN, is based on the signalling flow in Figure 4.3.3.2-1 with the following differences and clarifications:

- In step 1b, the SMF may decide to update ATSSS rules and/or N4 rules based on updated PCC rules.
- In step 1d, if the UPF determines that it cannot send GBR traffic over the current ongoing access e.g. based on the N4 rules and access availability and unavailability report from the UE, the UPF shall send Access Availability report to the SMF. When the SMF receives the Access Availability report, the SMF may decide to move the GBR QoS Flow to the other access as described in clause 5.32.4 of TS 23.501 [2]. If the SMF decides to move the GBR QoS Flow, the SMF triggers this procedure and, afterwards moves the GBR QoS Flow to the target access.
- In step 3, if the SMF decides to move the GBR QoS Flow to the other access, the SMF sends N2 SM information to the target AN. The PDU Session Modification Command message is sent to the UE to update ATSSS rule of the UE so that the UE sends uplink GBR traffic over the target access. The SMF releases AN resources of the GBR QoS Flow in the source access.
- In step 3, when the SMF establishes user plane resources for a QoS flows, the SMF provides QoS profile to the AN as follows:
  - for Non-GBR QoS Flow, steps 3 to 8 are performed over each access for which the user plane resources are activated.
  - for GBR QoS Flow allowed in a single access, steps 3 to 8 are performed in the allowed access.
  - for GBR QoS Flow allowed in both accesses, steps 3 to 8 are performed in the access according to the decision by the SMF (as described in clause 5.32.4 of TS 23.501 [2]).
- In step 3, if the SMF wants to update ATSSS rules, the SMF includes updated ATSSS rules in the N1 SM container (PDU Session Modification Command). When the SMF provides N1 SM container and/or N2 SM information, the SMF includes access type in the Namf\_Communication\_N1N2MessageTransfer to provide routing information to the AMF.
- In step 8, if the SMF decides to moves GBR QoS Flow to the other access, the SMF may send updated N4 rules to the UPF.

#### 4.22.8.3 UE or network requested MA PDU Session Modification (home-routed roaming)

The signalling flow for a MA PDU Session Modification when the UE is registered to the same VPLMN over 3GPP access and non-3GPP access and the PDU Session Anchor (PSA) is located in the HPLMN, is based on the signalling flow in Figure 4.3.3.3-1 with the following differences and clarifications:

- In step 1b, the H-SMF may decide to update ATSSS rules and/or N4 rules based on updated PCC rules.
- In step 1d, if the H-UPF determines that it cannot send GBR traffic over the current ongoing access e.g. based on the N4 rules and access availability and unavailability report from the UE, the H-UPF shall send Access Availability report to the H-SMF. When the H-SMF receives the Access Availability report, the H-SMF may decide to move the GBR QoS Flow to the other access as described in clause 5.32.4 of TS 23.501 [2]. If the H-SMF decides to move GBR QoS Flow, the H-SMF triggers this procedure and, afterwards moves the GBR QoS flow to the target access.
- In step 3, if the H-SMF decides to move the GBR QoS Flow to the other access, the H-SMF sends updated GBR QoS Flow information contains associated access type and ATSSS rule to the V-SMF. Based on the information the V-SMF establishes AN resources for the GBR QoS Flow to the target access.
- In step 3, when the H-SMF provides GBR QoS Flow information, the H-SMF includes associated access type in Nsmf\_PDUSession\_Update. When the H-SMF provides non-GBR QoS Flow information, H-SMF provides the information for both accesses in Nsmf\_PDUSession\_Update.



- In step 3, if the H-SMF wants to update ATSSS rules, the H-SMF triggers Nsmf\_PDUSESSION\_Update and includes an updated ATSSS rules.
- In step 4, if the H-SMF decides to move the GBR QoS Flow to the other access, the PDU Session Modification Command message is sent to the UE to update ATSSS rule of the UE so that the UE sends uplink GBR traffic over the target access. The V-SMF releases AN resources of the GBR QoS Flow in the source access.
- In step 4, when the V-SMF establishes user plane resources for a QoS flows, the V-SMF provides QoS profile to the AN as follows:
  - for Non-GBR QoS Flow, steps 4 to 9 are performed over each access for which the MA PDU Session is established.
  - for GBR QoS Flow allowed in a single access, steps 4 to 9 are performed in the allowed access.
  - for GBR QoS Flow allowed in both accesses, steps 4 to 9 are performed in the access according to the decision by the SMF (as described in clause 5.32.4 of TS 23.501 [2]).
- In step 4, if the H-SMF provides updated ATSSS rules, the V-SMF includes the updated ATSSS rules in the N1 SM container (PDU Session Modification Command). When the V-SMF provides N1 SM container and/or N2 SM information, the V-SMF includes access type in the Namf\_Communication\_N1N2MessageTransfer to provide routing information to the AMF.

The description of signalling flow for a MA PDU Session Modification when the UE is registered to different PLMNs over 3GPP access and non-3GPP access and the PDU Session Anchor (PSA) is located in the HPLMN, is based on above procedure with the following differences and clarifications:

- The description of (V-)SMF providing QoS profile to the AN is not applicable and instead the regular procedures for QoS profile provisioning from (V-)SMF to (R)AN applies.

## 4.22.9 Connection, Registration and Mobility Management procedures

### 4.22.9.1 Registration procedures

The signalling flow for a Registration is based on the signalling flow in Figure 4.2.2.2.2-1 with the following differences and clarifications:

- In step 1, if the UE wants to re-activate the user plane of the MA PDU Session(s) over the access the Registration message is sent to, the UE indicates PDU Session ID(s) of the MA PDU Session(s) in the List Of PDU Sessions To Be Activated.
 

If the UE locally releases the MA PDU Session(s) in both accesses, the UE indicates it in the PDU Session Status. If the AMF receives the PDU Session Status and finds mismatch, regardless of roaming mode of the MA PDU Session(s) (i.e. non-roaming, local breakout roaming, home routed roaming in the same PLMN or home routed roaming in different PLMNs), the AMF invokes Nsmf\_PDUSESSION\_ReleaseSMContext service towards the SMF(s) in order to release any network resources related to the MA PDU Session(s).
- In step 4, the old AMF determines whether the new AMF support ATSSS or not based on the supported features provided by the new AMF.
- In step 5, if the old AMF determined in step 4 that the new AMF does not support ATSSS, the old AMF does not include the PDU Session context of the MA PDU Session(s) in the UE context transferred to the new AMF.
- If the old AMF has not included MA PDU Session(s) in the UE context in step 5, the old AMF informs the corresponding SMF(s) to release the MA PDU Session(s) by invoking the Nsmf\_PDUSESSION\_ReleaseSMContext service operation as described in clause 4.22.10.
- In step 21, the AMF provides an MA PDU Session Support indicator in Registration Accept message to inform the UE whether ATSSS is supported or not. The UE uses this indicator to determine whether an MA PDU session related procedure can be initiated or not, as described in clause 4.22.1.

In step 17, if the UE indicated to re-activate MA PDU Session(s) in the List Of PDU Sessions To Be Activated the AMF includes access type which the Registration Request message is received on when the AMF triggers

Nsmf\_PDUSession\_UpdateSMContext service operation. The SMF only re-activates user plane resources of the access type the Registration Request message is received on.

- In step 22, if the AMF indicates that the PDU Session(s) has been released in the PDU Session Status to the UE in Registration Accept message, the UE removes locally any internal resources related to the MA PDU Session(s) that are not marked as established.

#### 4.22.9.2 UE Triggered Service Request

The signalling flow for a UE Triggered Service Request is based on the signalling flow in Figure 4.2.3.2-1 with the following differences and clarifications:

- In step 1, if the UE wants to re-activate the user plane of the MA PDU Session(s) over the access the Service Request message is sent to, the UE indicates PDU Session ID(s) of the MA PDU Session(s) in the List Of PDU Sessions To Be Activated.

If the UE locally releases the MA PDU Session(s), the UE indicates it in the PDU Session Status. If the AMF receives the PDU Session Status and finds mismatch, regardless of roaming mode of the MA PDU Session (i.e. non-roaming, local breakout roaming, home routed roaming in the same PLMN or home routed roaming in different PLMNs), the AMF invokes Nsmf\_PDUSession\_ReleaseSMContext service towards the SMF(s) in order to release any network resources related to the MA PDU Session(s).

In step 4, if the UE indicated to re-activate MA PDU Session(s) in the List Of PDU Sessions To Be Activated the AMF includes access type which the Service Request message is received on when the AMF triggers Nsmf\_PDUSession\_UpdateSMContext service operation. The SMF only re-activates user plane resources of the access type the Service Request message is received on.

- In step 12, if the AMF indicates that the PDU Session(s) has been released in the PDU Session Status to the UE in Service Accept message, the UE removes locally any internal resources related to the MA PDU Session(s) that are not marked as established.

**NOTE:** For an MA PDU session established when UE was registered on only one access, during the registration on the second access, the AMF does not notify the SMF (for this MA PDU session) that the UE is now registered on the second access since this will occur later, i.e. when the UE sends the second PDU Session Establishment Request to add user plane resources.

#### 4.22.9.3 N2 based handover

Inter NG-RAN node N2 based handover, as described in clauses 4.9.1.3.2 and 4.9.1.3.3, is supported for the 3GPP access with the differences and clarifications described below.

- In step 2 of clause 4.9.1.3.2, the S-AMF determines whether or not the T-AMF supports ATSSS based on the supported features of the T-AMF provided by NRF or based on local configuration.
- In step 3 of clause 4.9.1.3.2, if the S-AMF determined in step 2 that the T-AMF does not support ATSSS, the S-AMF does not include the PDU Session context of the MA PDU Session(s) in the UE context transferred to the T-AMF.
- After step 6a of clause 4.9.1.3.3, if the S-AMF has not included MA PDU Session(s) in the UE context in step 3 of clause 4.9.1.3.2, the S-AMF informs the corresponding SMF(s) to release the MA PDU Session(s) by invoking the Nsmf\_PDUSession\_ReleaseSMContext service operation as described in clause 4.22.10.

#### 4.22.9.4 Network Triggered Service Request

The signalling flow for a Network Triggered Service Request is based on the signalling flow in Figure 4.2.3.3-1 with the following differences and clarifications:

- In step 3a, the SMF indicates to the AMF the access type (3GPP access or non-3GPP access) over which the user plane resources are to be activated for the MA PDU Session.
- In step 4, the AMF considers the MA PDU Session is associated with the access type the SMF has indicated in step 3a.

- In step 5, if the SMF requested to re-activate user-plane resources over 3GPP access and the AMF has determined the UE is unreachable over 3GPP access (e.g. the AMF receives no response from the UE to the Paging), the AMF shall notify that the UE is unreachable. The (H-) SMF shall indicate the Anchor UPF that the user-plane resources on 3GPP access is unavailable by triggering N4 Session Modification procedure. Further action by the UPF is implementation dependent.

If the SMF requested to re-activate the user-plane resources over non-3GPP access and the AMF has determined the UE is unreachable over non-3GPP access (e.g. the UE is in CM-IDLE on non-3GPP access), the AMF shall reject the request from the SMF. The (H-) SMF shall indicate the Anchor UPF that the user-plane resources on non-3GPP access is unavailable by triggering N4 Session Modification procedure. Further action by the UPF is implementation dependent.

NOTE: The provision of access availability/unavailability reports via user plane specified in clause 5.32.5.3 is UE implementation dependent. Such reporting by UE to UPF, can assist Anchor UPF to decide on handling DL traffic for the UE.

## 4.22.10 MA PDU Session Release

### 4.22.10.1 General

The MA PDU Session Release procedure is used to release the MA PDU Session, or release the MA PDU Session over a single access. The MA PDU Session Release over a single access may be triggered by the network due to e.g. when the UE is deregistered over an access or when the S-NSSAI of the MA PDU Session is no longer in the Allowed NSSAI over an access.

### 4.22.10.2 UE or network requested MA PDU Session Release (non-roaming and roaming with local breakout)

The signalling flow for a MA PDU Session Release when the UE is not roaming, or when the UE is roaming and the PDU Session Anchor (PSA) is located in the VPLMN, is based on the signalling flow in Figure 4.3.4.2-1 with the following differences and clarifications:

- In step 1, if the AMF needs to release the MA PDU Session over a single access, the AMF invokes the Nsmf\_PDUSession\_UpdateSMContext service operation to request the release of the MA PDU Session over a single access. In this case, the AMF includes in which access the MA PDU Session should be released.

NOTE: When the SMF received the release request from the AMF, the SMF decides whether the MA PDU Session is completely released or released over a single access based on its local policy.

- In step 1, if the AMF needs to release the MA PDU Session (e.g. locally released when the UE is CM-IDLE), the AMF invokes the Nsmf\_PDUSession\_ReleaseSMContext service operation to request the release of the MA PDU Session.
- In step 2a, if the SMF releases the MA PDU Session over a single access, the SMF sends an N4 Session Modification Request (N4 Session ID) message instead of N4 Session Release message to the UPF(s) of the MA PDU session.
- In step 2b, the UPF acknowledges the N4 Session Modification Request by the transmission of an N4 Session Modification Response (N4 Session ID) message to the SMF.
- In step 3, the SMF sends the PDU Session Release Command message to release the MA PDU session over a single access (either 3GPP access or non-3GPP access) or both accesses.
- In step 3, if the SMF releases the MA PDU Session over a single access, the SMF shall not include "skip indicator" in the Namf\_Communication\_N1N2MessageTransfer service.
- In step 3, if the SMF releases the MA PDU Session over both accesses and user plane resources are established in both accesses, the SMF includes both N1 SM container (PDU Session Release Command) and N2 SM Resource Release request together in the Nsmf\_PDUSession\_UpdateSMContext or Namf\_Communication\_N1N2MessageTransfer service so that the UE does not request to activate user plane resources. The SMF releases user plane resources of the other access by including N2 SM Resource Release only in Namf\_Communication\_N1N2MessageTransfer service.

- In step 3, when the SMF provides N1 SM container and/or N2 SM information, the SMF includes access type in the Namf\_Communication\_N1N2MessageTransfer to provide routing information to the AMF.
- In step 11, the SMF triggers Nsmf\_PDUSession\_SMContextStatusNotify service only when the MA PDU Session is released in both accesses.

#### 4.22.10.3 UE or network requested MA PDU Session Release (home-routed roaming)

The signalling flow for a MA PDU Session Release when the UE is registered to the same VPLMN over 3GPP access and non-3GPP access and the PDU Session Anchor (PSA) is located in the HPLMN, is based on the signalling flow in Figure 4.3.4.3-1 with the following differences and clarifications:

- In step 1, if the V-AMF needs to release the MA PDU Session over a single access, the V-AMF may invoke the Nsmf\_PDUSession\_UpdateSMContext service operation to request the release of the MA PDU Session over a single access. In this case, the AMF shall include in which access the MA PDU Session should be released. The V-SMF invokes Nsmf\_PDUSession\_Update service operation to request the release of the MA PDU Session over a single access. The V-SMF shall include in which access the MA PDU Session should be released.

NOTE: When the H-SMF received the release request from the V-SMF, the H-SMF decides whether the MA PDU Session is released or released over a single access based on its local policy.

- In step 1, if the V-AMF needs to release the MA PDU Session (e.g. locally released when the UE is CM-IDLE), the AMF invokes the Nsmf\_PDUSession\_ReleaseSMContext service operation to request the release of the MA PDU Session. The V-SMF invokes Nsmf\_PDUSession\_Release service operation to request the release of the MA PDU Session.
- In steps 2a-2b, if the SMF releases the MA PDU Session over a single access, these steps are the same as steps 2a-2b in clause 4.22.10.2.
- In step 3a, the H-SMF invokes Nsmf\_PDUSession\_Update service operation towards the V-SMF to release the MA PDU session over a single access (either 3GPP access or non-3GPP access) or both accesses.
- In step 5, the V-SMF sends the PDU Session Release Command message to release the MA PDU session over a single access (either 3GPP access or non-3GPP access) or both accesses.
- In step 5, if the V-SMF releases the MA PDU Session over a single Access Network, the V-SMF shall not include "skip indicator" in the Namf\_Communication\_N1N2MessageTransfer service.
- In step 5, if the V-SMF releases the MA PDU Session over both accesses and user plane resources are established in both accesses, the V-SMF includes both N1 SM container (PDU Session Release Command) and N2 SM Resource Release request together in the Nsmf\_PDUSession\_UpdateSMContext or Namf\_Communication\_N1N2MessageTransfer service so that the UE does not request to activate user plane resources. The V-SMF releases user plane resources of the other access by including N2 SM Resource Release only in Namf\_Communication\_N1N2MessageTransfer service.
- In step 5, when the V-SMF provides N1 SM container and/or N2 SM information, the V-SMF includes access type in the Namf\_Communication\_N1N2MessageTransfer to provide routing information to the V-AMF.
- In step 16, the H-SMF triggers Nsmf\_PDUSession\_StatusNotify service only when the MA PDU Session is released in both accesses. The V-SMF triggers Nsmf\_PDUSession\_SMContextStatusNotify service only when the MA PDU Session is released in both accesses.

The signalling flow for a MA PDU Session Release when the UE is registered to the different PLMNs over 3GPP access and non-3GPP access and the PDU Session Anchor (PSA) is located in the HPLMN, is based on the above procedure with the following differences and clarifications:

- In step 1a, the (V-)AMF can trigger the MA PDU session release over a single access or over both accesses as described in step 1 of clause 4.22.10.2.
- In step 3a, the H-SMF invokes Nsmf\_PDUSession\_Update service operation towards the V-SMF to release the MA PDU Session over a single access (either 3GPP access or non-3GPP access) or both accesses.

If the UE is registered to the HPLMN via an access and the H-SMF releases MA PDU Session over the access, the H-SMF invokes Namf\_Communication\_N1N2MessageTransfer.

- In step 5, the V-SMF releases the MA PDU Session over the access the H-SMF indicated in step 3a.

## 4.23 Support of deployments topologies with specific SMF Service Areas

### 4.23.1 General

This clause captures changes to 5GC procedures in other clauses of this specification and new procedures to support deployments topologies with specific SMF Service Areas that are defined in clause 5.34 of TS 23.501 [2].

For a Home Routed PDU Session, if a UE moves out of V-SMF serving area in the serving PLMN or a UE moves to another (serving) VPLMN, the V-SMF can change. In addition, V-SMF insertion/removal may take place at mobility between HPLMN and a VPLMN, in which case the PDU Session is Home Routed when served by the VPLMN. In these cases, the procedures below apply for the V-SMF insertion/change/removal (i.e. by replacing the I-SMF with V-SMF). When an AMF detects the need to change the V-SMF while the H-SMF does not support V-SMF change, the AMF shall not trigger the V-SMF change but shall trigger the release of the PDU Session.

For an established PDU session an I-SMF is inserted if the UE is not in the SMF Service Area. In this case, when an UE moves from HPLMN to a VPLMN, a V-SMF is inserted and the I-SMF is removed. For mobility from VPLMN to HPLMN, an I-SMF is inserted and the V-SMF is removed. The procedures of this clause apply in this case, i.e. by replacing the target or new I-SMF by a V-SMF for mobility from HPLMN to VPLMN and by replacing the source or old I-SMF by a V-SMF for mobility from VPLMN to HPLMN.

If at UE mobility the service area of the SMF does not include the location where the UE camps and the PDU Session is a MA PDU Session, then the AMF initiates the release of the MA PDU Session over all accesses served by this AMF. This applies to following procedures:

- Registration as defined in clause 4.23.3,
- Service Request as defined in clause 4.23.4,
- Xn Hand-over as defined in clause 4.23.11, or
- N2 Hand-Over as defined in clause 4.23.7.

For an established PDU Session supporting mechanisms for redundant transmission defined in clause 5.33.2 of TS 23.501 [2], or for a PDU Session supporting Time Sensitive Communications as defined in clauses 5.27 and 5.28 of TS 23.501 [2], if the UE moves out of SMF Service Area, the SMF may, based on local policy, release the PDU Session after the mobility procedure. This applies to following procedures: Registration procedure, Service Request procedure, Xn based handover procedure, N2 based handover procedure.

If dynamic CN PDB needs to be configured by the SMF and the I-SMF is involved in the PDU session, the I-SMF receives the Dynamic CN PDB value as part of QoS profile from SMF (over N16a) and forwards it to (R)AN via N2 SM message.

### 4.23.2 I-SMF selection

For non roaming or LBO roaming case, the AMF selects an SMF serving the PDU Session as described in clause 4.3.2.2.3. If the service area of the selected SMF does not control UPF that can serve the UE location, the AMF selects an I-SMF as described in clause 5.34.3 of TS 23.501 [2].

For home routed roaming case, the AMF selects V-SMF as described in clause 4.3.2.2.3.2 and reselects V-SMF as described in clause 5.34.3 of TS 23.501 [2].

When the delegated discovery is used, the SCP selects the SMF as described in clause 5.34.3 of TS 23.501 [2] and in Annex E.

### 4.23.3 Registration procedure

The following impacts are applicable to clause 4.2.2.2 (Registration procedure) when the UE has established PDU Session(s):

- Step 5: The UE context transferred from old AMF includes SMF information. If I-SMF is available for the PDU Session(s), the received SMF information includes I-SMF information and SMF information.
- Step 10: The (target) AMF determines whether I-SMF insertion/change/removal is needed. If the (target) AMF does not have the service area of the SMF(s), the (target) AMF queries the NRF to get service area information of the received SMF(s). The (target) AMF determines on a per PDU Session basis whether a (new) I-SMF needs to be selected based on UE location and service area of the received SMF information. It includes the following cases:
  - a. if the received SMF information includes only SMF information and service area of SMF includes the area where the UE camps, new I-SMF selection is not needed; or
  - b. if the received SMF information includes both I-SMF information and SMF information and service area of I-SMF includes the area where the UE camps, the I-SMF can be reused; or
  - c. if the received SMF information includes both I-SMF information and SMF information and the UE moves into the service area of SMF, the I-SMF removal process is triggered; or
  - d. if the received SMF information includes only SMF information and the service area of SMF does not include the area where the UE camps, the (target) AMF selects an I-SMF. The I-SMF insertion process is triggered; or
  - e. if the received SMF information includes both I-SMF and SMF information and the service area of SMF and I-SMF does not include the area where the UE camps, the (target) AMF selects a new I-SMF. The change of I-SMF process is triggered.
- For each PDU Session, if the UE context retrieved from the old AMF includes an I-SMF and the (target) AMF determines the I-SMF needs to be changed or removed, the (target) AMF includes a corresponding indication in `Namf_Communication_RegistrationStatusUpdate` sent to old AMF
- Step 17: the (target) AMF contacts the SMF/I-SMF ("cases" below are same as for step 10).

For case a), no additional change to step 17 of clause 4.2.2.2.2 is needed for the update of the PDU Session.

For case b), the SMF in step 17 of clause 4.2.2.2.2 is changed to I-SMF and in addition, the reference clause 4.2.3.2 is changed to clause 4.23.4.2. If the AMF has changed, the new AMF invokes `Nsmf_PDUSession_UpdateSMContext` (SM Context ID at SMF) towards the I-SMF.

For case c) i.e. for I-SMF removal, the (target) AMF invokes `Nsmf_PDUSession_CreateSMContext` (SM Context ID at SMF) towards the SMF. Steps from step 10 onwards as described in clause 4.23.4.3 are executed.

For cases d) and e), i.e. for I-SMF insertion or change, the (target) AMF invokes `Nsmf_PDUSession_CreateSMContext` (PDU Session ID, SM Context ID at SMF) towards the new I-SMF. Steps from step 3 onwards as described in clause 4.23.4.3 are executed with the following enhancements:

- Step 9 (for cases d and e): The N2 SM information is only provided by the I-SMF to the AMF when N3 tunnel needs to be established (i.e. due to buffered DL data in old I-SMF/old-I-UPF or AMF has indicated to I-SMF to active user plane for the PDU session based on List of PDU Sessions To Be Activated received from the UE).
- Step 16 (i.e. case c): The N2 SM information is only provided by the SMF to the AMF when N3 tunnel need to be established (i.e. due to buffered DL data in old I-SMF/old-I-UPF or the AMF has indicated to the SMF to active user plane for the PDU session based on List of PDU Sessions To Be Activated received from the UE).
- Step 17 is executed when N3 tunnel needs to be established. The NAS message Service Accept is replaced with Registration Accept (i.e. step 21 in clause 4.2.2.2).
- Step 17a and 17b is triggered by old AMF towards the old I-SMF based on the I-SMF change or removal indication received from target AMF, when the timer (i.e. started in step 5 of clause 4.2.2.2) in old AMF expires.

NOTE: Step 17a is executed by old AMF together with steps 14d and 14e in clause 4.2.2.2.

- Steps 18 to 21 (i.e. cases d and e) and steps 22 to 25 (i.e. case c): These steps are executed if N2 SM information is provided by the I-SMF/SMF in step 9 or step 16 above.

- Step 21: This step is omitted if step 17 of clause 4.23.4.3 is executed as described above.

### 4.23.3a Deregistration procedure

The following impacts are applicable to clause 4.2.2.3 (Deregistration procedures) when the UE has established PDU Session(s):

The V-SMF is replaced with I-SMF and the H-SMF is replaced with SMF.

In step 2, if ULCL/BP is included in the data path, the I-SMF releases the local UPF (PSA) and includes N4 information in the Nsmf\_PDUSession\_Release request.

## 4.23.4 Service Request procedures

### 4.23.4.1 General

The following two scenarios are considered:

- The I-SMF is available for the PDU Session and I-SMF is not changed or removed during the service request procedure. The procedure to support this scenario is described in clause 4.23.4.2.
- The I-SMF is inserted, changed or removed during service request procedure. The procedure to support this scenario is described in clause 4.23.4.3.

When the AMF receives the service request message, for each PDU Session to be activated based on the service area information of SMF and the location where the UE camped the AMF determines which procedure is used.

### 4.23.4.2 UE Triggered Service Request without I-SMF change/removal

When both I-SMF and SMF are available for a PDU session and no I-SMF change or removal is needed during the service request procedure, the procedure in this clause is used. Compared to the procedure in clause 4.2.3.2, the SMF is replaced with the I-SMF and the impacted intermediate UPF(s) are UPFs that are controlled by I-SMF. Differences are captured below:

- Steps 6a-6b, these steps are not needed as the CN Tunnel Info of UPF (PSA) allocated for N9 is available at the I-SMF when the I-SMF is inserted.
- Step 7a, if a new intermediate UPF is selected, the I-SMF invokes Nsmf\_PDUSession\_Update Request (DN Tunnel Info of the new intermediate UPF). The I-SMF may also include UE location Information, Time Zone RAT type, Access Type and Operation Type set to "UP Activate", if those information is changed and need to be notified to SMF. If DL Tunnel Info of new intermediate UPF is received, the SMF provides the DL Tunnel Info of new intermediate UPF received from I-SMF to UPF(PSA).
- Step 10, this step does not apply as in this scenario the I-UPF is always needed.
- Step 16, if the I-SMF needs to update SMF with e.g. change of UE location information, change of Time Zone, change of RAT type and/or change of Access type, the I-SMF invokes Nsmf\_PDUSession\_Update Request to send User Location Information, Time Zone, RAT type and/or Access Type to SMF. If the I-SMF invoked Nsmf\_PDUSession\_Update Request in step 7a with Operation Type "UP Activate", the I-SMF also includes an Operation Type set to "UP Activated".

If dynamic PCC is deployed and if Policy Control Request Trigger condition(s) have been met (e.g. change of Access Type, change of UE location), the SMF performs SMF initiated SM Policy Modification procedure as defined in clause 4.16.5.1 and may get the updated policy.

- Steps 18a-18b, these steps do not apply as in this scenario the I-UPF is always needed.
- Step 21a, this step does not apply as in this scenario the I-UPF is always needed.

#### 4.23.4.3 UE Triggered Service Request with I-SMF insertion/change/removal

When, as part of a UE Triggered Service Request, I-SMF is to be inserted, changed or removed, the procedure in this clause is used. It includes the following cases:

- the UE moves from SMF service area to new I-SMF service area, a new I-SMF is inserted (i.e. I-SMF insertion); or
- the UE moves from old I-SMF service area to new I-SMF service area, the I-SMF is changed (i.e. I-SMF change); or
- the UE moves from old I-SMF service area to SMF service area, the old I-SMF is removed (i.e. I-SMF removal).

If the service request is triggered by network due to downlink data and a new I-UPF is selected, forwarding tunnel is established between the old I-UPF (if the old I-UPF is different from PSA) and the new I-UPF to forward buffered data.

For Home Routed Roaming case, the I-SMF (old and new) and I-UPF (old and new) are located in Visited PLMN, while the SMF and UPF(PSA) are located in the Home PLMN. In this HR roaming case only the case of I-SMF change applies (there is always a V-SMF for the PDU Session).



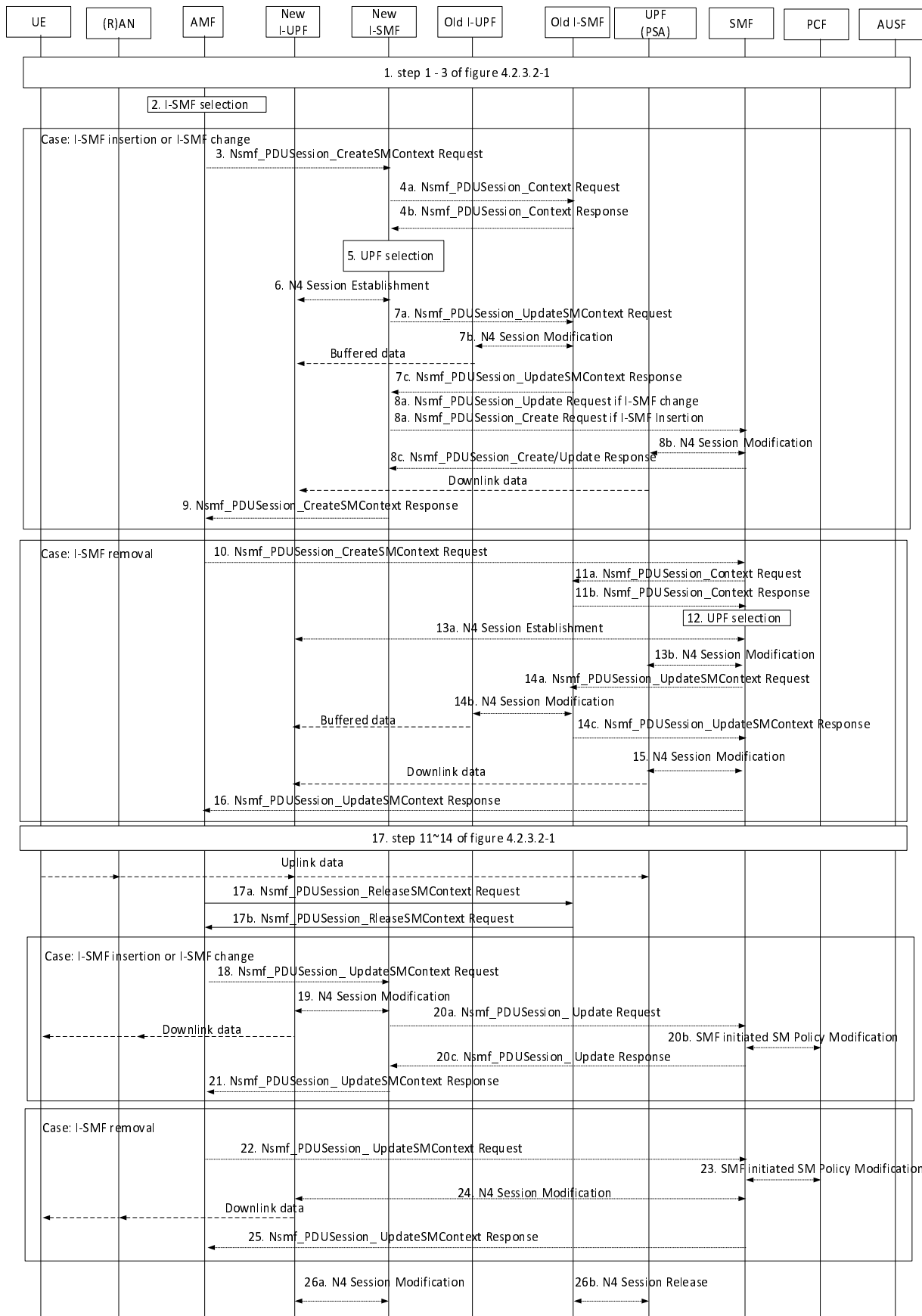


Figure 4.23.4.3-1: UE Triggered Service Request procedure with I-SMF insertion/change/removal

1. Same as the steps 1-3 defined clause 4.2.3.2.

2. The AMF determines whether new I-SMF needs to be selected based on UE location and service area of the SMF, if new I-SMF needs to be selected, the AMF selects a new I-SMF as described in clause 4.23.2.

Case: I-SMF insertion or I-SMF change, steps 3-9 are skipped for I-SMF removal case.

3. If the AMF has selected a new I-SMF, the AMF sends a Nsmf\_PDUSession\_CreateSMContext Request (PDU Session ID, SM Context ID, UE location info, Access Type, RAT Type, Operation Type) to the new I-SMF. The SM Context ID points to the old I-SMF in the case of I-SMF change or to SMF in the case of I-SMF insertion.

The AMF Set the Operation Type to "UP activate" to indicate establishment of N3 tunnel User Plane resources for the PDU Session(s). The AMF determines Access Type and RAT Type based on the Global RAN Node ID associated with the N2 interface.

If the UE Time Zone has changed compared to the last reported UE Time Zone then the AMF shall include the UE Time Zone IE in this message.

- 4a. The new I-SMF retrieves SM Context from the old I-SMF (in the case of I-SMF change) or SMF (in the case of I-SMF insertion) by invoking Nsmf\_PDUSession\_Context Request (SM context type, SM Context ID). The new I-SMF uses SM Context ID received from AMF for this service operation. SM Context ID is used by the recipient of Nsmf\_PDUSession\_Context Request in order to determine the targeted PDU Session. SM context type indicates that the requested information is all SM context, i.e. PDN Connection Context and 5G SM context.

- 4b. The old I-SMF in the case of I-SMF change or SMF in the case of I-SMF insertion responds with the SM context of the indicated PDU Session.

If there is Extended Buffering is applied and the Extended Buffering timer is still running in old-SMF or old I-UPF, or the service request is triggered by downlink data, the old I-SMF or SMF includes a forwarding indication in the response to indicate that a forwarding tunnel is needed for sending buffered downlink packets. For I-SMF insertion, if I-UPF controlled by SMF was available for the PDU Session, the SMF includes a forwarding indication.

5. The new I-SMF selects a new I-UPF: Based on the received SM context, e.g. S-NSSAI and UE location information, the new I-SMF selects a new I-UPF as described in clause 6.3.3 of TS 23.501 [2].
6. The new I-SMF initiates a N4 Session Establishment to the new I-UPF. The new I-UPF provide tunnel endpoints to the new I-SMF.

If forwarding indication was received, the new I-SMF also requests the new I-UPF to allocate tunnel endpoints to receive the buffered DL data from the old I-UPF and to indicate end marker reception on this tunnel via usage reporting. In this case, the new I-UPF begins to buffer the downlink packet(s) received from the UPF (PSA).

- 7a. If the tunnel endpoints for the buffered DL data were allocated, the new I-SMF invokes Nsmf\_PDUSession\_UpdateSMContext Request (tunnel endpoints for buffered DL data) to the old I-SMF in the case of I-SMF change in order to establish the forwarding tunnel. The new I-SMF uses the SM Context ID received from AMF for this service operation.

- 7b. The old I-SMF, in the case of I-SMF change initiates a N4 session modification to the old I-UPF to send the tunnel endpoints for buffered DL data to the old I-UPF. After this step, the old I-UPF starts to send buffered DL data to the new I-UPF.

If the old I-UPF receives end marker packets and there is no associated tunnel to forward these packets, the old I-UPF discards the received end marker packets and does not send any Data Notification to SMF.

- 7c. The old I-SMF, in the case of I-SMF change responds the new I-SMF with Nsmf\_PDUSession\_UpdateSMContext response.

- 8a. In the case of I-SMF change, the new I-SMF invokes Nsmf\_PDUSession\_Update Request (SM Context ID, new I-UPF DL tunnel information, SM Context ID at I-SMF, Access Type, RAT Type, DNAI list supported by the new I-SMF, Operation Type) towards the SMF. The new I-SMF uses the SM Context ID at SMF received from old I-SMF for this service operation.

In the case of I-SMF insertion, the new I-SMF invokes Nsmf\_PDUSession\_Create Request (new I-UPF DL tunnel information, new I-UPF tunnel endpoint for buffered DL data, SM Context ID at I-SMF, Access Type, RAT type, DNAI list supported by the new I-SMF, Operation Type) towards the SMF.

The SM Context ID at I-SMF is to be used by the SMF for further PDU Session operation, e.g. to notify the new I-SMF of PDU Session Release. If SM Context ID at the I-SMF exists (i.e. in the case of I-SMF change), the SMF shall replace the SM Context ID at I-SMF.

The new I-UPF tunnel endpoint for buffered DL data is used to establish the forwarding tunnel (from old I-UPF controlled by SMF to new I-UPF controlled by new I-SMF).

If the old I-UPF receives end marker packets and there is no associated tunnel to forward these packets, the old I-UPF discards the received end marker packets and does not send any Data Notification to SMF.

The Operation Type is set to "UP activate" to indicate that User Plane resource for the PDU Session is to be established.

8b. The SMF initiates N4 Session Modification toward the PDU Session Anchor UPF. During this step:

- The SMF provides the new I-UPF DL tunnel information.
- If different CN Tunnel Info need be used by PSA UPF, i.e. the CN Tunnel Info at the PSA for N3 and N9 are different, a CN Tunnel Info for the PDU Session Anchor UPF is allocated.
- For I-SMF insertion, if a new I-UPF tunnel endpoint for buffered DL data is received, the SMF triggers the transfer of buffered DL data to the new I-UPF tunnel endpoint for buffered DL data.

If the DL tunnel information has changed, the SMF indicates the UPF (PSA) to send one or more "end marker" packets for each N9 tunnel to the old I-UPF immediately after switching the path to new I-UPF. From now on the PDU Session Anchor UPF begins to send the DL data to the new I-UPF as indicated in the new I-UPF DL tunnel information. The UPF (PSA) sends one or more "end marker" packets for each N9 tunnel to the old I-UPF immediately after switching the path to new I-UPF. If indicated by the new I-SMF in step 6, the new I-UPF reports to SMF when "end marker" has been received. The new SMF initiates N4 Session Modification procedure to indicate the new I-UPF to send the DL packet(s) received from the UPF (PSA).

8c. The SMF responds to the new I-SMF with Nsmf\_PDUSession\_Update Response (the DNAI(s) of interest for this PDU Session in the case of I-SMF change) or Nsmf\_PDUSession\_Create Response (the DNAI(s) of interest for this PDU Session, Tunnel Info at UPF(PSA) for UL data in the case of I-SMF insertion if it is allocated in step 8b).

In the case of I-SMF insertion and the PDU session corresponds to a LADN, the SMF shall release the PDU session after the service request procedure is completed.

In the case of I-SMF insertion the SMF starts a timer to release resource, i.e. resource for the indirect data forwarding tunnel.

In the case of I-SMF insertion and the CN Tunnel Info at PSA for N9 is received in the response, I-SMF provides the CN Tunnel Info at the PSA for N9 to I-UPF via N4 Session Modification Request.

9. The new I-SMF sends a Nsmf\_PDUSession\_CreateSMContext Response (N2 SM information (PDU Session ID, QFI(s), QoS profile(s), CN N3 Tunnel Info, S-NSSAI, User Plane Security Enforcement, UE Integrity Protection Maximum Data Rate), N1 SM Container, Cause)) to the AMF. The CN N3 Tunnel Info is the UL Tunnel Info of the new I-UPF.

If the PDU Session has been assigned any EPS bearer ID, the new I-SMF also includes the mapping between EPS bearer ID(s) and QFI(s) into the N2 SM information to be sent to the NG-RAN.

The new I-SMF starts a timer to release resource, i.e. resource for the indirect data forwarding tunnel.

Case: I-SMF removal: steps 10 to 16 are skipped for I-SMF insertion or I-SMF change cases.

10. If the UE has moved from service area of old I-SMF into the service area of SMF, the AMF sends a Nsmf\_PDUSession\_CreateSMContext Request (SUPI, PDU Session ID, AMF ID, SM Context ID at I-SMF, UE location info, Access Type, RAT Type) to the SMF.

If the UE Time Zone has changed compared to the last reported UE Time Zone then the AMF shall include the UE Time Zone IE in this message.

The AMF Set the Operation Type to "UP activate" to indicate establishment of User Plane resources for the PDU Session(s). The AMF determines Access Type and RAT Type based, as defined in clause 4.2.3.2.

- 11a. The SMF retrieves SM Context from the I-SMF by invoking Nsmf\_PDUSession\_Context Request (SM context type). The SMF uses SM Context ID received from AMF for this service operation. SM context type indicates that the requested SM context is all, i.e. PDN Connection Context and 5G SM context.
- 11b. The old I-SMF responds with the SM context of the indicated PDU Session. If there is Extended Buffering is applied and the Extended Buffering timer is still running in old-SMF or old I-UPF, or the service request is triggered by downlink data (i.e. the old I-SMF received downlink data notification from old I-UPF), the old I-SMF includes a forwarding indication in the response to indicate that a forwarding tunnel is needed for sending buffered downlink packets from old I-UPF to new I-UPF or PSA (in the case that new I-UPF is not selected).
12. The SMF may select a new I-UPF: If the SMF determines that the service area of the PSA does not cover the UE location, the SMF selects a new I-UPF based on S-NSSAI and UE location information as described in clause 6.3.3 of TS 23.501 [2].

13. If a new I-UPF is selected by SMF, the SMF initiates a N4 Session Establishment to the new I-UPF. The new I-UPF provides tunnel endpoints to the SMF. If forwarding indication was received, the SMF requests the new I-UPF to allocate tunnel endpoints for forwarding data and to indicate end marker reception on this tunnel. In this case, the new I-UPF begins to buffer the downlink packet(s) received from the UPF (PSA).

If the new I-UPF is not selected, i.e. the PSA can serve the UE location, the SMF may initiate N4 Session Modification to the PSA to allocate UL N3 tunnel endpoints Info of PSA. The PSA provides the UL N3 tunnel endpoints to SMF. If the forwarding indication was received, the SMF requests the PSA to allocate the tunnel endpoints for the buffered DL data from the old I-UPF and indicate the PSA via usage reporting rule to report end marker to the SMF. In this case, the UPF (PSA) begins to buffer the DL data it may receive at the same time from the N6 interface. The UPF (PSA) sends one or more "end marker" packets according to the indication from SMF for each N9 tunnel to the old I-UPF immediately after switching the path to (R)AN. If indicated by the SMF, the UPF (PSA) reports to SMF when "end marker" packet is received. Then the SMF initiates N4 Session Modification procedure to indicate the UPF (PSA) to send the DL data received from the N6 interface.

- 14a. If the tunnel endpoints for the buffered DL data were allocated, the SMF invokes Nsmf\_PDUSession\_UpdateSMContext Request (tunnel endpoints for buffered DL data) to the old I-SMF in order to establish the forwarding tunnel. The SMF uses the SM Context ID received from AMF for this service operation.
- 14b. The old I-SMF initiates a N4 session modification to the old I-UPF and sends the tunnel endpoints for buffered DL data to the old I-UPF. After this step, the old I-UPF start to send buffered DL data to the new I-UPF or PSA if new I-UPF is not selected.

If the old I-UPF receives end marker packets and there is no associated tunnel to forward these packets, the old I-UPF discards the received end marker packets and does not send any Data Notification to SMF.

- 14c. The old I-SMF responds the SMF with Nsmf\_PDUSession\_UpdateSMContext response.
15. If a new I-UPF was selected by SMF, the SMF initiates N4 Session Modification toward the PDU Session Anchor UPF, providing the new I-UPF DL tunnel information. The PSA begins to send the DL data to the new I-UPF as indicated in the new I-UPF DL tunnel information. If the forwarding indication was received, the SMF indicates the PDU Session Anchor UPF to send one or more "end marker" packets. The UPF (PSA) sends one or more "end marker" packets according to the indication from SMF for each N9 tunnel to the old I-UPF immediately after switching the path to new I-UPF. If indicated by the SMF in step 13, the new I-UPF reports to SMF when "end marker" packet is received. The SMF initiates N4 Session Modification procedure to indicate the new I-UPF to send the DL packet(s) received from the UPF (PSA).
16. The SMF sends a Nsmf\_PDUSession\_CreateSMContext Response (N2 SM information (PDU Session ID, QFI(s), QoS profile(s), CN N3 Tunnel Info, S-NSSAI), N1 SM Container, Cause)) to the AMF. The CN N3 Tunnel Info is the UL Tunnel Info of the new I-UPF.

If the PDU Session has been assigned any EPS bearer ID, the SMF also includes the mapping between EPS bearer ID(s) and QFI(s) into the N2 SM information to be sent to the NG-RAN.

The SMF starts a timer to release the resource, i.e. resource for indirect data forwarding tunnel.

17. These steps are same as steps 12 to 14 in clause 4.2.3.2. After step 16, the Uplink data is transferred from (R)AN via new I-UPF (if exists) to PSA. If procedure in clause 4.2.3 is triggered together with this procedure, this step can be executed together with the corresponding steps in clause 4.2.3.

17a. If the step 9 or step 16 was successful response, in the case of I-SMF removal or change, the AMF sends Nsmf\_PDUSession\_ReleaseSMContext Request (I-SMF only indication) to old I-SMF for the release of resources in old I-SMF. The I-SMF only indication indicates to old I-SMF not to invoke resource release in SMF.

The old I-SMF starts a timer to release resources, i.e. resource for indirect data forwarding tunnel.

17b. The old I-SMF responds to AMF with Nsmf\_PDUSession\_ReleaseSMContext response.

Case: I-SMF insertion or I-SMF change: steps 18 to 21 are skipped for the I-SMF removal case.

18. The AMF sends an Nsmf\_PDUSession\_UpdateSMContext Request (N2 SM information, RAT type, Access type) to the new I-SMF.

If the AMF received N2 SM information (one or multiple) in step 17, then the AMF shall forward the N2 SM information to the relevant new I-SMF per PDU Session ID.

19. The new I-SMF updates the new I-UPF with the AN Tunnel Info and List of accepted QFI(s). Downlink data is now forwarded from new I-UPF to UE.

20a. The new I-SMF invokes Nsmf\_PDUSession\_Update request (RAT type, Access type, Operation Type) to SMF. The SMF updates associated access of the PDU Session.

The Operation Type is set to "UP activated" to indicate User Plane resource for the PDU Session has been established.

20b. If dynamic PCC is deployed, SMF may initiate notification about new location information to the PCF (if subscribed) by performing an SMF initiated SM Policy Modification procedure as defined in clause 4.16.5.1. The PCF may provide updated policies. If the PCC rule(s) are updated, the SMF may initiate a N4 Session Modification procedure to UPF (PSA) based on the updated PCC rule(s).

20c. The SMF responds with Nsmf\_PDUSession\_Update Response.

21. The new I-SMF sends a Nsmf\_PDUSession\_UpdateSMContext Response to AMF.

Case: I-SMF removal: steps 22 to 25 are skipped for the I-SMF insertion or I-SMF change cases.

22. The AMF sends a Nsmf\_PDUSession\_UpdateSMContext Request (N2 SM information, RAT Type, Access Type) to the SMF. The AMF determines Access Type and RAT Type based on the Global RAN Node ID associated with the N2 interface.

If the AMF received N2 SM information (one or multiple) in step 17, then the AMF shall forward the N2 SM information to the relevant new I-SMF per PDU Session ID.

23. If dynamic PCC is deployed, SMF may initiate notification about new location information to the PCF by performing an SMF initiated SM Policy Modification procedure as defined in clause 4.16.5.1. The PCF may provide updated policies.

24. If a new I-UPF was selected by the SMF, the SMF updates the new I-UPF with the AN Tunnel Info and List of accepted QFI(s), otherwise, the SMF updates the PSA with the AN Tunnel Info and List of accepted QFI(s).

25. The SMF sends a Nsmf\_PDUSession\_UpdateSMContext Response to AMF.

26a. In the case of I-SMF insertion or I-SMF change, upon timer set in step 9 expires and the indirect data forwarding tunnel was established before, the new I-SMF sends N4 Session Modification request to new I-UPF to release resources for the forwarding tunnel.

In the case of I-SMF removal, upon timer set in step 16 expires and the indirect data forwarding tunnel was established before, the SMF sends N4 Session Modification request to the new I-UPF or PSA to release the resource for the forwarding tunnel.

26b. In the case of I-SMF removal or change, upon timer set in step 17a expires and the indirect data forwarding tunnel was established before, the old I-SMF sends N4 Session Release request to the old I-UPF to release resources for the PDU Session. The old I-SMF releases the SM Context for the PDU Session. If the old I-UPF acts as UL CL and is not co-located with local PSA, the old I-SMF also sends N4 Session Release request to the local PSA to release resources for the PDU Session.

In the case of I-SMF insertion, upon timer set in step 8c expires and the indirect data forwarding tunnel was established before, the SMF sends N4 Session Release request to the old I-UPF to release the resource for the PDU Session.

#### 4.23.4.4 Network Triggered Service Request

For network triggered service request procedure, if the procedure is triggered by downlink packet, the procedure in clause 4.2.3.3 are impacted as following:

- if the I-SMF is available for the PDU Session, the procedure is triggered by I-SMF. Correspondingly, the SMF in that procedure is replaced by the I-SMF.
- The referenced clause 4.4.4 for pause of charging is changed to clause 4.23.14.
- Step 4a:
  - If I-SMF is not available for the PDU Session and no I-SMF insertion is needed, no additional change is needed.
  - If I-SMF is available for the PDU Session and no I-SMF change or removal is needed, steps 12 to 22 in clause 4.23.4.2 is performed where the SMF in that procedure is replaced by the I-SMF.
  - If I-SMF will be inserted, changed or removed, steps 2 to 25 in clause 4.23.4.3 is performed.
- Step 6: If the UE is in CM-IDLE state in 3GPP access, upon reception of paging request for a PDU Session associated to 3GPP access:
  - If I-SMF is not available for the PDU Session and no I-SMF insertion is needed, no additional change is needed.
  - If I-SMF is available for the PDU Session and no I-SMF change or removal is needed, UE Triggered Service Request procedure as defined in clause 4.23.4.2 is performed.
  - If I-SMF will be inserted, changed or removed, UE Triggered Service Request procedure as defined in clause 4.23.4.3 is performed.

#### 4.23.5 PDU Session Management procedure

##### 4.23.5.1 PDU Session establishment procedure

For non roaming or LBO roaming, it includes the following cases:

- If the service area of the selected SMF includes the current UE location, the UE requested PDU Session Establishment procedure is same as described in clause 4.3.2.2.1.
- If the service area of the selected SMF does not include the current UE location and the UE does not request for a MA PDU Session, the AMF selects an I-SMF that serves the area where UE camps. The UE requested PDU Session Establishment procedure for Home-routed Roaming defined in clause 4.3.2.2.2 is used to establish the PDU Session. Compared to the procedure defined in clause 4.3.2.2.2, the V-SMF and V-UPF are replaced by I-SMF and I-UPF and H-SMF and H-UPF are replaced by SMF and UPF(PSA) respectively. Also, only the S-NSSAI with the value defined by the serving PLMN is sent to the SMF. The I-SMF provides the DNAI list it supports to SMF and the SMF provides the DNAI(s) of interest for this PDU Session to I-SMF based on the DNAI list information received from I-SMF as defined in Figure 4.23.9.1-1 step 1.

This may happen e.g. at PDU Session mobility from non-3GPP access to 3GPP access as defined in clause 4.23.15.

- If the service area of the selected SMF does not include the current UE location and the UE requests a MA PDU Session, then the AMF rejects the MA PDU Session Establishment procedure.
- When the delegated discovery is used, the SCP selects the SMF as described in Annex E.
- If an I-SMF is selected and the PDU Session supports mechanisms for redundant transmission defined in clause 5.33.2.2 of TS 23.501 [2], the SMF rejects the PDU Session Establishment Request.

- If an I-SMF is selected and the PDU Session supports Time Sensitive Communications (as defined in clauses 5.27 and 5.28 of TS 23.501 [2]), or if the PDU session supports redundant transmission defined in clauses 5.33.2.1 or 5.33.2.3 of TS 23.501 [2], the SMF may, based on local policy, reject the PDU Session Establishment Request.

For the Home-Routed roaming case, the UE requested PDU Session Establishment procedure for Home-routed Roaming in clause 4.3.2.2.2 can be reused with the following change.

- If the service area of the selected V-SMF does not include the current UE location and the UE requests a MA PDU Session, then the AMF rejects the MA PDU Session Establishment procedure.

#### 4.23.5.2 PDU Session Release procedure

For the non roaming or LBO roaming case, the procedure defined in clause 4.3.4.3 (UE or network requested PDU Session Release for Home-routed Roaming) is used to release the PDU Session, with the V-SMF and V-UPF are replaced by I-SMF and I-UPF and H-SMF and H-UPF are replaced by SMF and UPF(PSA) respectively. Also if the ULCL/BP is included in the data path, in step 1 the I-SMF releases the local UPF (PSA) and includes N4 information in the Nsmf\_PDUSession\_Release or Nsmf\_PDUSession\_Update Request request respectively.

For AMF triggers PDU Session Release procedure in Registration procedure (see step 17 of clause 4.2.2.2.2) and Deregistration procedure (see step 2 of clause 4.2.2.3.2), if I-SMF is used for the session, the AMF invokes PDU Session Release operation towards the I-SMF, then I-SMF releases the PDU Session towards SMF.

#### 4.23.5.3 PDU Session modification procedure

For the non-roaming or LBO roaming case, the procedure defined in clause 4.3.3.3 (UE or network requested PDU Session Modification for Home-routed Roaming) is used to modify the PDU Session, with the V-SMF and V-UPF are replaced by I-SMF and I-UPF and H-SMF and H-UPF are replaced by SMF and UPF(PSA) respectively.

If the QoS Monitoring as defined in clause 5.33.3 of TS 23.501 [2] is triggered, the following enhancement to clause 4.3.3.3 applies:

- In step 3, if the SMF determines the need for QoS Monitoring for a QoS flow according to the information received from the PCF in step 1b, or based on SMF local policy, SMF includes QoS Monitoring indication and how frequently QoS Monitoring reporting to be performed, in Nsmf\_PDUSession\_Update Request message.
- In step 3, if, according to the information received from the PCF in step 1b, or based on SMF local policy, the SMF determines the need for GTP-U Path Monitoring as defined in clause 5.33.3.3 of TS 23.501 [2], the SMF includes QoS monitoring policy in Nsmf\_PDUSession\_Update Request message.
- In step 4b, if in step 3 the I-SMF received QoS Monitoring indication and may receive how frequently QoS Monitoring reporting to be performed in Nsmf\_PDUSession\_Update Request the I-SMF includes the QoS Monitoring indication and how frequently QoS Monitoring reporting to be performed in N2 SM message sent to the 5G AN.
- In step 4b, if in step 3 the I-SMF received QoS monitoring policy indication and may receive how frequently QoS Monitoring reporting to be performed in Nsmf\_PDUSession\_Update Request, the I-SMF includes such QoS monitoring policy also to I-UPF for GTP-U path monitoring.
- In step 15, the I-SMF sends Nsmf\_PDUSession\_Update Response to SMF. The SMF updates N4 session of the UPF PSA as defined for the case where is no I-SMF.
- If later on the RAN provides over N2 the QoS Monitoring Result with UL packet delay information comprising the packet delays of RAN and N3 interface, the I-SMF forwards this information to the SMF in Nsmf\_PDUSession\_Update Request message.
- I-SMF shall forward monitoring report (for QoS monitoring per GTP-U path) from I-UPF to SMF.

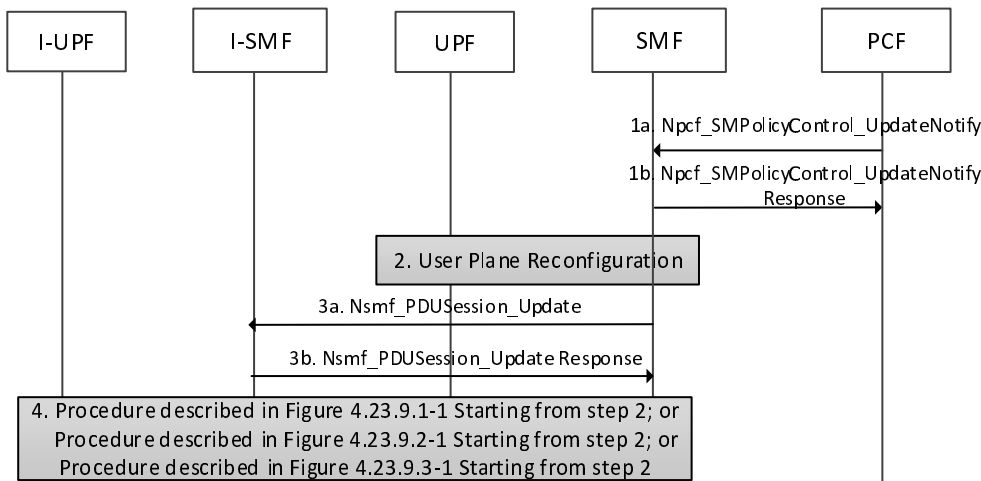
### 4.23.6 I-SMF Related Procedures with PCF

#### 4.23.6.1 General

This clause provides PCC related details for scenarios including an I-SMF.

#### 4.23.6.2 Policy Update Procedures with I-SMF

Figure 4.23.6-1 shows procedures related to provisioning of PCC rules containing traffic steering information related to an I-SMF.



**Figure 4.23.6-1: Policy Update procedure**

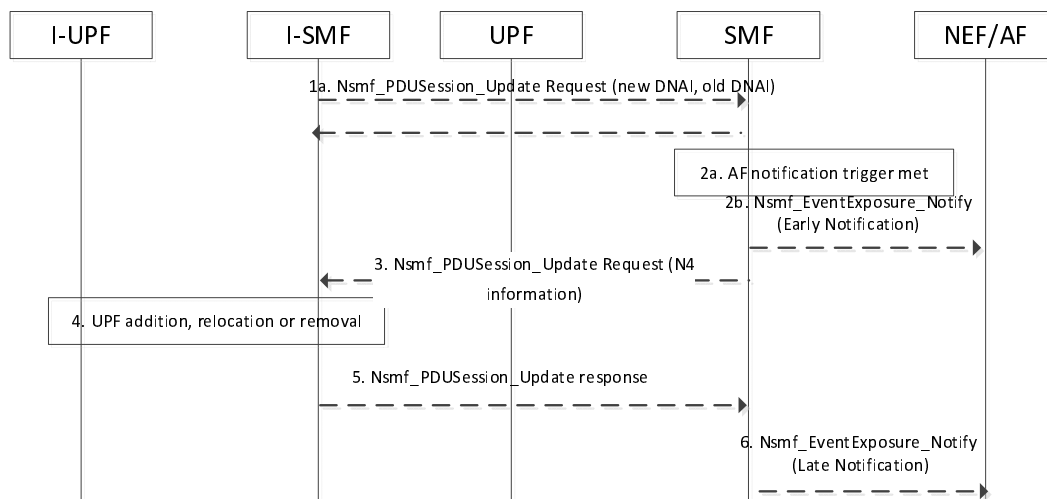
In cases where step 1a in figure 4.23.6-1 is triggered in response to PCF receiving AF request, below steps 3 and 4 are applicable, in addition to those steps as explained in clause 4.3.6.1.

Step 3: SMF provides to I-SMF with DNAI(s) of interest for this PDU Session for local traffic steering. If PCC rule changes for traffic offloaded via ULCL/BP due to the AF request, the SMF provides the updated N4 information to the I-SMF.

Step 4: The procedure described in clauses 4.23.9.1, 4.23.9.2 and 4.23.9.3, from step 2 is executed.

#### 4.23.6.3 Reporting UP path change to the AF

Figure 4.23.6.3-1 shows procedures related Reporting UP path change to the AF.



**Figure 4.23.6.3-1: Reporting UP path change to the AF**



- 1a. I-SMF indicates that UP path change may occur for the PDU Session via Nsmf\_PDUSession\_Update Request as described in clause 4.23.9; the SMF responds to the I-SMF.
2. If early notification has been requested by a PCC rule on behalf of AF as described in clause 4.3.6.2, then the SMF notifies the AF accordingly by invoking Nsmf\_EventExposure\_Notify service operation as described in clause 4.3.6.3. In this case the SMF may wait for further instructions of the AF.
3. SMF initiates Nsmf\_PDUSession\_Update Request with N4 information to control the local PSA and ULCL/BP as described in clause 4.23.9.
4. I-SMF enforces the change of DNAI or addition, change, or removal of UPF as described in clause 4.23.9.
5. I-SMF answers back to the Nsmf\_PDUSession\_Update from the SMF.
6. If late notification has been requested by a PCC rule on behalf of AF as described in clause 4.3.6.2, then the SMF notifies the AF accordingly by invoking Nsmf\_EventExposure\_Notify service operation as described in clause 4.3.6.3.

## 4.23.7 Inter NG-RAN node N2 based handover

### 4.23.7.1 General

The following two scenarios are considered:

- The I-SMF is available for the PDU Session and I-SMF is not changed or removed during the inter NG-RAN node N2 based handover procedure. The procedure to support this scenario is described in clause 4.23.7.2.
- The I-SMF is inserted, changed or removed during inter NG-RAN node N2 based handover procedure. The procedure to support this scenario is described in clause 4.23.7.3.

### 4.23.7.2 Inter NG-RAN node N2 based handover without I-SMF change/removal

#### 4.23.7.2.1 General

When both I-SMF and SMF are available for a PDU Session and no I-SMF change or removal is needed during inter NG-RAN node N2 handover procedure, the procedure defined in clause 4.9.1.3.2, 4.9.1.3.3 are used with the following differences.

#### 4.23.7.2.2 Preparation phase

Compared to the procedure in clause 4.9.1.3.2, the SMF interacting with the S-UPF, T-UPF, S-AMF and T-AMF is the I-SMF. The difference is following:

- Step 3: The N14 context exchanged between S-AMF and T-AMF contains the SM Context ID at I-SMF, or SM Context ID at SMF if I-SMF is not applicable before.
- Step 4: The T-AMF determines whether Target I-SMF needs to be selected based on UE location and service area of the SMF. In this case no I-SMF change or removal is needed.
- Step 5: The I-SMF checks whether I-UPF needs to be reallocated, i.e. select a T-UPF.

#### 4.23.7.2.3 Execution phase

Compared to the procedure for execution phase in 4.9.1.3.3, the SMF interacting with the S-UPF, T-UPF, S-AMF and T-AMF is the I-SMF. The difference is as following:

- Step 10a: If I-SMF is available for a PDU Session and the existing intermediate S-UPF is re-allocated, i.e. a new T-UPF is selected, the I-SMF invokes an Nsmf\_PDUSession\_Update Request (DL CN Tunnel Info of the T-UPF) service operation toward the SMF. The SMF sends N4 Session Modification Request message to PDU Session Anchor UPF, providing DL CN Tunnel Info to the PDU Session Anchor UPF. The PDU Session Anchor sends one or more "end marker" packets for each N3/N9 tunnel on the old path immediately after switching the path, the source NG-RAN shall forward the "end marker" packets to the target NG-RAN.

- Step 10b: The SMF responds with the Nsmf\_PDUSession\_Update Response service operation to I-SMF once the PDU Session Anchor UPF is updated with the DL Tunnel Info of the T-UPF.

#### 4.23.7.2.4 Handover Cancel

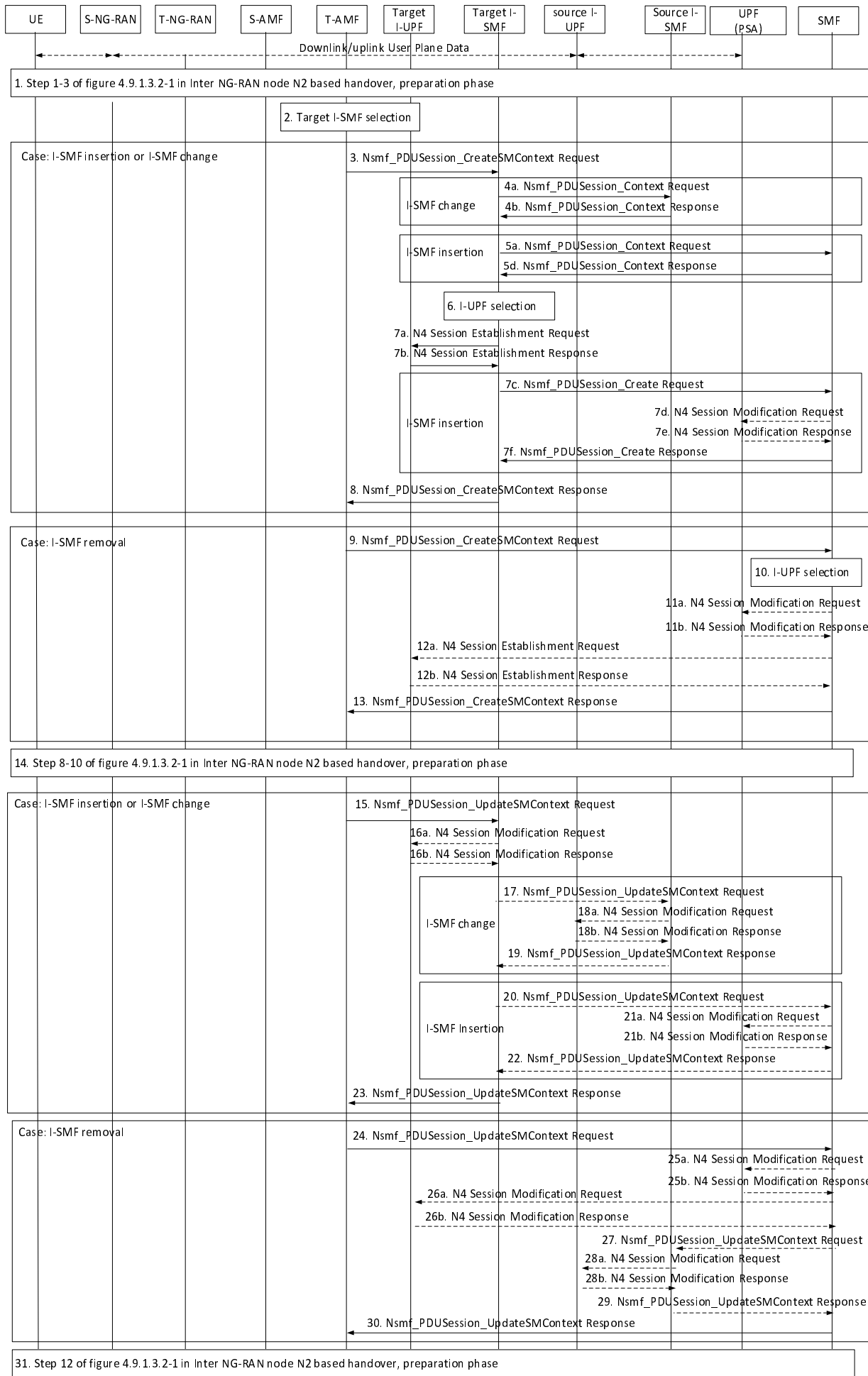
The home routed roaming procedure defined in clause 4.9.1.4 is applied, with V-SMF replaced by I-SMF.

#### 4.23.7.3 Inter NG-RAN node N2 based handover with I-SMF insertion/change/removal

##### 4.23.7.3.1 General

When I-SMF is inserted or changed or removed during inter NG-RAN node N2 handover, the procedures defined in this clause are used.

4.23.7.3.2 Preparation phase



**Figure 4.23.7.3.2-1: Inter NG-RAN node N2 based handover, preparation phase, with I-SMF insertion/change/removal**

1. Steps 1-3 in clause 4.9.1.3.2 are performed.
2. For PDU sessions in the UE context, the Target AMF determines whether a (new) Target I-SMF needs to be selected based on Target UE location and service area of the SMF or of the old I-SMF. If Target I-SMF needs to be selected, the AMF selects a Target I-SMF as described in clause 5.34.3 of TS 23.501 [2]. If the UE moves from the service area of the I-SMF to the service area of the SMF, the I-SMF will be removed.

The rest of steps are performed for PDU sessions requested to be handed over, i.e. the PDU Sessions with active UP connections.

Case: I-SMF insertion, or I-SMF change, step 3~8 are skipped for I-SMF removal case.

3. T-AMF to Target I-SMF: Nsmf\_PDUSession\_CreateSMContext (PDU Session ID, Target ID, T-AMF ID, SM Context ID).

The SM Context ID points to the source I-SMF in the case of I-SMF change or to SMF in the case of I-SMF insertion.

Case: I-SMF change, step 4 are skipped for I-SMF insertion case.

- 4a. (I-SMF change case) Target I-SMF to Source I-SMF: Target I-SMF retrieves SM Context from the source I-SMF by invoking Nsmf\_PDUSession\_Context Request (SM context type, SM Context ID).

The Target I-SMF uses SM Context ID received from T-AMF for this service operation. SM context type indicates that the requested information is all SM context, i.e. PDN Connection Context and 5G SM context. The SM Context ID is used by the recipient of Nsmf\_PDUSession\_Context Request in order to determine the targeted PDU Session.

- 4b. Source I-SMF to Target I-SMF: Nsmf\_PDUSession\_Context Response. The source I-SMF responds with the requested SM context.

Case: I-SMF insertion, step 5 are skipped for I-SMF change case.

- 5a. Target I-SMF to SMF: Target I-SMF retrieves SM Context from the SMF by invoking Nsmf\_PDUSession\_Context Request (SM context type, SM Context ID).

The Target I-SMF uses SM Context ID received from T-AMF for this service operation. SM context type indicates that the requested information is all SM context, i.e. PDN Connection Context and 5G SM context. The SM Context ID is used by the recipient of Nsmf\_PDUSession\_Context Request in order to determine the targeted PDU Session.

5b. Void.

5c. Void.

The UPF (PSA) sends an N4 Session Establishment Response message to the SMF. If the UPF (PSA) was requested CN Tunnel Info (on N9) of UPF (PSA), it provides CN Tunnel Info (on N9) to the SMF.

- 5d. SMF to Target I-SMF: Nsmf\_PDUSession\_Context Response. The SMF responds with the requested SM context.

6. The Target I-SMF selects a Target I-UPF: Based on the received SM context, e.g. S-NSSAI and UE location information, the Target I-SMF selects a Target I-UPF as described in clause 6.3.3 of TS 23.501 [2].

- 7a. The Target I-SMF to Target I-UPF: N4 Session Establishment Request.

An N4 Session Establishment Request message is sent to the Target I-UPF, providing Packet detection, enforcement and reporting rules to be installed on the Target I-UPF. The UL CN Tunnel Info (on N9) of UPF (PSA) for this PDU Session, which is used to setup N9 tunnel, is also provided to the Target I-UPF.

- 7b. Target I-UPF to Target I-SMF or SMF: N4 Session Establishment Response.

The Target I-UPF sends an N4 Session Establishment Response message to the Target I-SMF with DL CN Tunnel Info (i.e. N9 tunnel info) and UL CN Tunnel Info (i.e. N3 tunnel info).

Case: I-SMF insertion, step 7c~7f are skipped for I-SMF change case.

7c. Target I-SMF to SMF: Nsmf\_PDUSession\_Create Request (PDU Session ID, HO Preparation Indication).

7d. [Conditional] SMF to UPF (PSA): N4 Session Modification Request.

If different CN Tunnel Info need be used by PSA UPF, i.e. the CN Tunnel Info for N3 and N9 are different, the SMF request CN tunnel information from UPF.

7e. [Conditional] UPF(PSA) to SMF: N4 Session Modification Response.

The UPF (PSA) sends an N4 Session Modification Response message to the SMF with CN Tunnel Info (on N9).

7f. SMF to Target I-SMF: Nsmf\_PDUSession\_Create Response (PDU Session ID, CN Tunnel Info of UPF(PSA) for N9).

The Target I-SMF provides the CN Tunnel Info of UPF(PSA) for N9 to Target I-UPF via N4 Session Modification.

8. The Target I-SMF to T-AMF: Nsmf\_PDUSession\_CreateSMContext Response (PDU Session ID, N2 SM Information, Reason for non-acceptance).

If N2 handover for the PDU Session is accepted, the Target I-SMF includes in the Nsmf\_PDUSession\_CreateSMContext Response the N2 SM Information containing the N3 UP address and the UL CN Tunnel ID of the UPF and the QoS parameters.

Case: I-SMF removal, step 9~13 are skipped for I-SMF insertion, or I-SMF change case.

9. T-AMF to SMF: Nsmf\_PDUSession\_CreateSMContext (PDU Session ID, Target ID, T-AMF ID, SM Context ID). The SM Context ID points to the source I-SMF.

10. The SMF selects a Target I-UPF if the UE is not in the service area of the PDU Session Anchor UPF. The SMF selects a Target I-UPF as described in clause 6.3.3 of TS 23.501 [2].

11a. [Conditional] SMF to UPF(PSA): N4 Session Modification Request.

If the Target I-UPF was not selected (i.e. the service area of PSA covers UE location) and different CN Tunnel Info (on N3) need to be used by PSA, the SMF sends N4 Session Modification Request to UPF(PSA).

11b. [Conditional] UPF(PSA) to SMF: N4 Session Modification Response. The PSA UPF sends UL CN Tunnel Info (i.e. N3 tunnel info) to SMF.

12a. [Conditional] SMF to Target I-UPF: N4 Session Establishment Request.

If a Target I-UPF is selected by SMF in step 10, the SMF sends N4 Session Establishment Request to Target I-UPF.

An N4 Session Establishment Request message is sent to the Target I-UPF, providing Packet detection, enforcement and reporting rules to be installed on the Target I-UPF. The UL CN Tunnel Info (on N9) of UPF (PSA) for this PDU Session, which is used to setup N9 tunnel, is also provided to the Target I-UPF.

12b. [Conditional] Target I-UPF to SMF: N4 Session Establishment Response. The Target I-UPF sends an N4 Session Establishment Response message to the SMF with DL CN Tunnel Info (i.e. N9 tunnel info) and UL CN Tunnel Info (i.e. N3 tunnel info).

13. SMF to T-AMF: Nsmf\_PDUSession\_CreateSMContext Response (PDU Session ID, N2 SM Information, Reason for non-acceptance).

If N2 handover for the PDU Session is accepted, the Target I-SMF includes in the Nsmf\_PDUSession\_CreateSMContext Response the N2 SM Information containing the N3 UP address and the UL CN Tunnel ID of the UPF and the QoS parameters.

14. Same as step 8-10 clause 4.9.1.3.2 are performed.

Case: I-SMF insertion, or I-SMF change, step 15~23 are skipped for I-SMF removal case.

15. T-AMF to Target I-SMF: Nsmf\_PDUSession\_UpdateSMContext Request (PDU Session ID, N2 SM response received from T-RAN).

The Target I-SMF stores the N3 tunnel info of T-RAN from the N2 SM response if N2 handover is accepted by T-RAN.

- 16a. [Conditional]Target I-SMF to Target I-UPF: N4 Session modification request (T-RAN SM N3 forwarding Information list, indication to allocate DL forwarding tunnel(s) for indirect forwarding).

Indirect forwarding may be performed via a UPF which is different from the Target I-UPF, in which case the Target I-SMF selects another UPF for indirect forwarding.

- 16b. [Conditional]Target I-UPF to Target I-SMF: N4 Session Modification Response (Target I-UPF N9 forwarding Information list).

The Target I-UPF allocates Tunnel Info and returns an N4 Session Modification Response message to the Target I-SMF.

The Target I-UPF SM N9 forwarding info list includes Target I-UPF N9 address, Target I-UPF N9 Tunnel identifiers for forwarding data.

Case: I-SMF change, step 17~19 are skipped for I-SMF insertion case.

17. [Conditional]Target I-SMF to Source I-SMF: Nsmf\_PDUSession\_UpdateSMContext Request.

Target I-SMF invokes Nsmf\_PDUSession\_UpdateSMContext Request (Target I-UPF SM N9 forwarding Information list, Operation type) to the source I-SMF in order to establish the indirect forwarding tunnel. The Target I-SMF uses the SM Context ID received from Target AMF for this service operation. The Operation type indicates the establishment of forwarding tunnel(s) for indirect forwarding.

- 18a. [Conditional]The source I-SMF initiates a N4 session modification request (Target I-UPF SM N9 forwarding Information list, indication to allocate DL forwarding tunnel(s) for indirect forwarding) to the source I-UPF to establish indirect forwarding tunnel.

Indirect forwarding may be performed via a UPF which is different from the Source I-UPF.

- 18b. [Conditional]The source I-UPF to source I-SMF: N4 Session Modification Response (source I-UPF SM N3 forwarding Information list).

19. [Conditional]Source I-SMF to Target I-SMF: Nsmf\_PDUSession\_UpdateSMContext response (Source I-UPF SM N3 forwarding Information list).

Case: I-SMF insertion, step 20~22 are skipped for I-SMF change case.

20. [Conditional]Target I-SMF to SMF: Nsmf\_PDU Session\_UpdateSMContext.

The Target I-SMF invokes Nsmf\_PDUSession\_UpdateSMContext Request (Target I-UPF SM N9 forwarding Information list, Operation type) to the SMF in order to establish the indirect forwarding tunnel. The Target I-SMF uses the SM Context ID received from Target AMF for this service operation. The Operation type indicates the establishment of forwarding tunnel(s) for indirect forwarding.

- 21a. [Conditional]The SMF initiates a N4 session modification request (UPF SM N9 forwarding Information list, indication to allocate DL forwarding tunnel(s) for indirect forwarding) to the UPF(PSA) to establish indirect forwarding tunnel.

Indirect forwarding may be performed via a UPF which is different from the UPF(PSA).

- 21b [Conditional] The UPF(PSA) to SMF: N4 Session Modification Response (UPF SM N3 forwarding Information list).

22. [Conditional] The SMF to Target I-SMF: Nsmf\_PDUSession\_UpdateSMContext response (UPF SM N3 forwarding Information list).

23. Target I-SMF to T-AMF: Nsmf\_PDUSession\_UpdateSMContext Response (N2 SM Information).

Target I-SMF creates an N2 SM information containing the DL forwarding Tunnel Info to be sent to the S-RAN by Source AMF via the Target AMF. Target I-SMF includes this information in the Nsmf\_PDUSession\_UpdateSMContext response. The DL forwarding Tunnel Info can be one of the following information:

- If direct forwarding applies, then Target I-SMF includes the T-RAN N3 forwarding information received in step 15.
- If the indirect forwarding tunnel is setup, then the SMF includes Source I-UPF forwarding information containing the N3 UP address and the Tunnel ID of the Source I-UPF.

Case: I-SMF removal, step 24~30 are skipped for I-SMF insertion, or I-SMF change case.

24. T-AMF to SMF: Nsmf\_PDUSession\_UpdateSMContext Request (PDU Session ID, N2 SM response received from T-RAN).

The SMF stores the N3 tunnel info of T-RAN from the N2 SM response if N2 handover is accepted by T-RAN.

25a. [Conditional] SMF to UPF (PSA): N4 Session modification Request.

If the Target I-UPF is not selected (i.e. the service area of PSA covers UE location), the SMF sends N4 Session modification request to UPF(PSA) to allocate DL forwarding tunnel(s).

Indirect forwarding may be performed via a UPF which is different from the UPF(PSA), in which case the SMF selects another UPF for indirect forwarding.

25b. [Conditional] UPF (PSA) to SMF: N4 Session Modification Response (UPF N9 forwarding Information list).

26a. [Conditional] SMF to Target I-UPF:

If the Target I-UPF is selected, the SMF sends N4 Session modification request to Target I-UPF to allocate DL forwarding tunnel(s) for indirect forwarding;

Indirect forwarding may be performed via a UPF which is different from the Target I-UPF, in which case the SMF selects another UPF for indirect forwarding.

26b. [Conditional] Target I-UPF to SMF: N4 Session Modification Response (Target I-UPF N9 forwarding Information list).

27. [Conditional] SMF to Source I-SMF: Nsmf\_PDUSession\_UpdateSMContext.

The SMF invokes Nsmf\_PDUSession\_UpdateSMContext Request (SM N9 forwarding Information list, Operation type) to the source I-SMF in order to establish the indirect forwarding tunnel. The SMF uses the SM Context ID received from T-AMF for this service operation. The Operation type indicates the establishment of forwarding tunnel(s) for indirect forwarding.

28a. [Conditional] Source I-SMF to Source I-UPF: N4 Session Modification Request.

The source I-SMF initiates a N4 session modification request (Target I-UPF SM N9 forwarding Information list, indication to allocate DL forwarding tunnel(s) for indirect forwarding) to the source I-UPF to establish indirect forwarding tunnel.

Indirect forwarding may be performed via a UPF which is different from the Source I-UPF.

28b. [Conditional] The source I-UPF to source I-SMF: N4 Session Modification Response (source I-UPF SM N3 forwarding Information list).

29. [Conditional] The source I-SMF to SMF: Nsmf\_PDUSession\_UpdateSMContext response (Source I-UPF SM N3 forwarding Information list).

30. SMF to T-AMF: Nsmf\_PDUSession\_UpdateSMContext Response (N2 SM Information).

The SMF creates an N2 SM information containing the DL forwarding Tunnel Info to be sent to the S-RAN by the Source AMF via the Target AMF. The DL forwarding Tunnel Info can be one of the following information:

- If direct forwarding applies, then the SMF includes the T-RAN N3 forwarding information the SMF received in step 24.



- If the indirect forwarding tunnel is setup, then the SMF includes Source I-UPF forwarding information containing the N3 UP address and the Tunnel ID of the Source I-UPF.

31. Same as step 12 in clause 4.9.1.3.2 is performed.

4.23.7.3.3 Execution phase

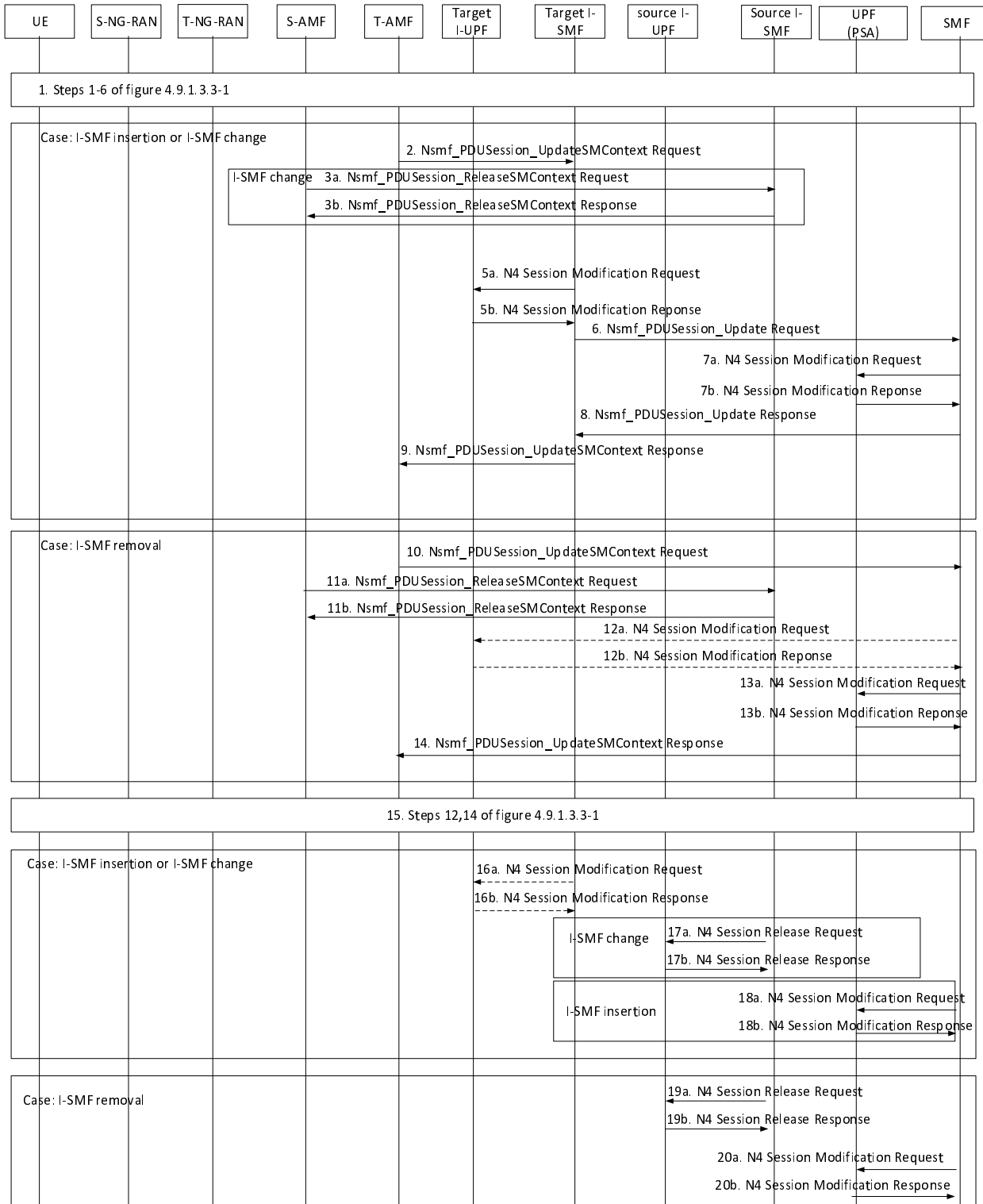


Figure 4.23.7.3.3-1: Inter NG-RAN node N2 based handover, execution phase, with I-SMF insertion/change/removal

1. Steps 1-6 in clause 4.9.1.3.3 are performed with the following change:

Step 6a: For PDU sessions in the UE context, if the I-SMF is either to be changed, or to be removed, the T-AMF includes an indication in `Namf_Communication_N2InfoNotify` to indicate the I-SMF change/removal.

Step 6c: The SMF in this step is source I-SMF in the case of I-SMF removal or change, or is SMF in the case of I-SMF insertion.

Case: I-SMF insertion, or I-SMF change, step 2~9 are skipped for I-SMF removal case.

2. T-AMF to Target I-SMF: `Nsmf_PDUSession_UpdateSMContext` Request (Handover Complete indication, (N2 SM Information (Secondary RAT usage data))).

Handover Complete indication is sent per each PDU Session to the corresponding Target I-SMF to indicate the success of the N2 Handover.

If in step 6b of clause 4.9.1.3.3 the source AMF has provided information for secondary RAT usage reporting the T-AMF propagates this information to the Target I-SMF.

Case: I-SMF change, step 3 is skipped for I-SMF insertion.

- 3a. S-AMF to Source I-SMF: `Nsmf_PDUSession_ReleaseSMContext` Request (I-SMF only indication).

After received N2 handover notify from T-AMF, if indication of I-SMF change/removal has been received, the S-AMF invokes `Nsmf_PDUSession_ReleaseSMContext` Request to inform the Source I-SMF to release the SM context of the PDU Session. The I-SMF only indication is used to inform the Source I-SMF not to invoke resource release in SMF. The Source I-SMF initiates a timer to release the SM Context of the PDU Session if indirect forwarding tunnel(s) were previously established, or the Source I-SMF has not received request from Target I-SMF to retrieve SM Context. Otherwise, the Source I-SMF immediately releases the SM Context.

- 3b. Source I-SMF to S-AMF: `Nsmf_PDUSession_ReleaseSMContext` Response.

4a. Void.

4b. Void.

- 5a. Target I-SMF to Target I-UPF: N4 Session Modification Request. The N4 Modification Request indicates DL AN Tunnel Info of T-RAN to UPF.

- 5b. The Target I-UPF to Target I-SMF: N4 Session Modification Response.

6. Target I-SMF to SMF:

In the case of I-SMF change, `Nsmf_PDUSession_Update` Request (PDU Session ID, DL CN Tunnel Info of Target I-UPF for N9, DNAI(s) supported by the I-SMF, Secondary RAT usage data).

In the case of I-SMF insertion, `Nsmf_PDUSession_Update` Request (PDU Session ID, DL CN Tunnel Info of Target I-UPF for N9, DNAI(s), Secondary RAT usage data, Handover Complete Indication). The SMF initiates a timer to release the resource, i.e. resource for indirect data forwarding tunnel.

If the T-AMF has provided information for secondary RAT usage reporting in step 2, the Target I-SMF propagates this information to the SMF.

- 7a. SMF to UPF (PSA): N4 Session Modification Request.

The SMF sends N4 Session Modification Request to UPF PSA, providing the DL CN Tunnel Info of Target I-UPF to the UPF PSA.

- 7b. UPF (PSA) to SMF: N4 Session Modification Response.

8. SMF to Target I-SMF: In the case of I-SMF change, `Nsmf_PDUSession_Update` Response. In the case of I-SMF insertion, `Nsmf_PDUSession_Create` Response. The SMF provides the DNAI(s) of interest for this PDU Session to Target I-SMF.

In the case of I-SMF insertion and the PDU session corresponds to a LADN, the SMF shall release the PDU session after the handover procedure is completed.

9. Target I-SMF to T-AMF: Nsmf\_PDUSession\_UpdateSMContext Response.

If indirect data forwarding applies, the Target I-SMF starts an indirect data forwarding timer, to be used to release the resource of indirect data forwarding tunnel.

Case: I-SMF removal, step 10~14 are skipped for I-SMF insertion, or I-SMF change case.

10. T-AMF to SMF: Nsmf\_PDUSession\_UpdateSMContext Request (Handover Complete indication, (N2 SM Information (Secondary RAT usage data))).

Handover Complete indication is sent per each PDU Session to the corresponding SMF to indicate the success of the N2 Handover.

If in step 6b of clause 4.9.1.3.3 the source AMF has provided information for secondary RAT usage reporting the T-AMF propagates this information to the SMF.

11a. S-AMF to Source I-SMF: Nsmf\_PDUSession\_ReleaseSMContext Request I-SMF only indication.

After received N2 handover notify from T-AMF, if indication of I-SMF change/removal has been received, the S-AMF invokes Nsmf\_PDUSession\_ReleaseSMContext Request to inform the Source I-SMF to release the SM context of the PDU Session. I-SMF only indication is used to inform the Source I-SMF not to invoke resource release in SMF. The Source I-SMF initiates a timer to release the SM Context of the PDU Session if indirect forwarding tunnel(s) were previously established, otherwise, the Source I-SMF immediately releases the SM Context.

11b. Source I-SMF to S-AMF: Nsmf\_PDUSession\_ReleaseSMContext Response.

12a. [Conditional]SMF to Target I-UPF: N4 Session Modification Request.

If the Target I-UPF is selected by SMF, the SMF to Target I-UPF: N4 Session Modification Request. The N4 Modification Request indicates DL AN Tunnel Info of T-RAN to Target I-UPF.

12b. [Conditional] Target I-UPF to SMF: N4 Session Modification Response

13a. SMF to UPF (PSA): N4 Session Modification Request.

The SMF sends N4 Session Modification Request to UPF(PSA). The N4 Modification Request indicates DL AN Tunnel Info of T-RAN to UPF(PSA) if Target I-UPF is not selected by SMF. The N4 Modification Request indicates DL CN Tunnel Info of Target I-UPF if Target I-UPF is selected by SMF.

13b. UPF (PSA) to SMF: N4 Session Modification Response. PDU Session Anchor sends one or more "end marker" packets for each N3/N9 tunnel on the old path immediately after switching the path, the source NG-RAN shall forward the "end marker" packets to the target NG-RAN.

14. SMF to T-AMF: Nsmf\_PDUSession\_UpdateSMContext Response (PDU Session ID).

If indirect data forwarding applies, the SMF starts an indirect data forwarding timer, to be used to release the resource of indirect data forwarding tunnel.

15. Steps 12, 14 in clause 4.9.1.3.3 are performed.

During the UE mobility registration procedure, if required, the T-AMF performs I-SMF insertion/change/removal for the PDU session which were not handed over, i.e. the PDU sessions without active UP connections. This takes place as described in clause 4.23.3 with the exception that there is no UE context retrieved from the old AMF and that steps 17a and 17b as described in clause 4.23.4.3 are not applicable.

Case: I-SMF insertion, or I-SMF change, step 16~18 are skipped for I-SMF removal case.

16a. [Conditional]Target I-SMF to Target I-UPF: N4 Session Modification Request.

After indirect data forwarding timer set in step 9 expires, the Target I-SMF sends an N4 Session Modification Request to Target I-UPF to release the indirect data forwarding resource in Target I-UPF.

16b. [Conditional]Target I-UPF to SMF: N4 Session Modification Response.

Case: I-SMF change, step 17 is skipped for I-SMF insertion.

17a. Source I-SMF to Source I-UPF: N4 Session Release Request.

Upon the timer set in step 3 expires, the Source I-SMF sends N4 Session Release Request (Release Cause) to Source I-UPF to release the resources for the PDU Session. This message is also used to release the indirect data forwarding resource in Source I-UPF.

If the Source I-UPF acts as UL CL and is not co-located with local PSA, the Source I-SMF also sends N4 Session Release Request to the local PSA to release the resources for the PDU Session.

17b. Source I-UPF to Source I-SMF: N4 Session Release Response.

The Source I-SMF releases SM Context of the PDU Session.

Case: I-SMF insertion, step 18 is skipped for I-SMF change.

18a. SMF to UPF: N4 Session Modification Request.

Upon the timer set in step 6 expires, if UPF(PSA) is used for indirect forwarding, the SMF sends an N4 Session Modification Request to UPF(PSA) to release the indirect data forwarding resource in UPF(PSA). If the UPF (PSA) uses different Tunnel Info for N3 and N9, this message is also used to release the N3 Tunnel. If I-UPF is used for indirect forwarding, the SMF sends an N4 Session Modification Request to the I-UPF to release the indirect data forwarding resource.

18b. UPF to SMF: N4 Session Modification Response.

If UPF(PSA) is used for indirect forwarding, the UPF (PSA) sends N4 Session Modification Response to SMF.

If I-UPF is used for indirect forwarding, the I-UPF sends N4 Session Modification Response to SMF.

Case: I-SMF removal, step 19~20 are skipped for I-SMF insertion, I-SMF change case.

19a. The Source I-SMF to Source I-UPF: N4 Session Release Request.

Upon the timer set in step 11 expires, the Source I-SMF sends N4 Session Release Request (Release Cause) to Source I-UPF to release the resources for the PDU Session. This message is also used to release the indirect data forwarding resource in Source I-UPF.

19b. Source I-UPF to Source I-SMF: N4 Session Release Response.

The Source I-SMF releases SM Context of the PDU Session.

20a. SMF to UPF: N4 Session Modification Request.

Upon the timer set in step 14 expires, if UPF(PSA) is used for indirect forwarding, the SMF sends an N4 Session Modification Request to UPF (PSA) to release the indirect forwarding resource in UPF (PSA). If the UPF (PSA) uses different Tunnel Info for N3 and N9, this message is also used to release the N3 Tunnel. If I-UPF is used for indirect forwarding, the SMF sends an N4 Session Modification Request to the I-UPF to release the indirect data forwarding resource.

20b. UPF to SMF: N4 Session Modification Response.

If UPF(PSA) is used for indirect forwarding, the UPF (PSA) sends N4 Session Modification Response to SMF.

If I-UPF is used for indirect forwarding, the I-UPF sends N4 Session Modification Response to SMF.

4.23.7.3.4 Handover Cancel

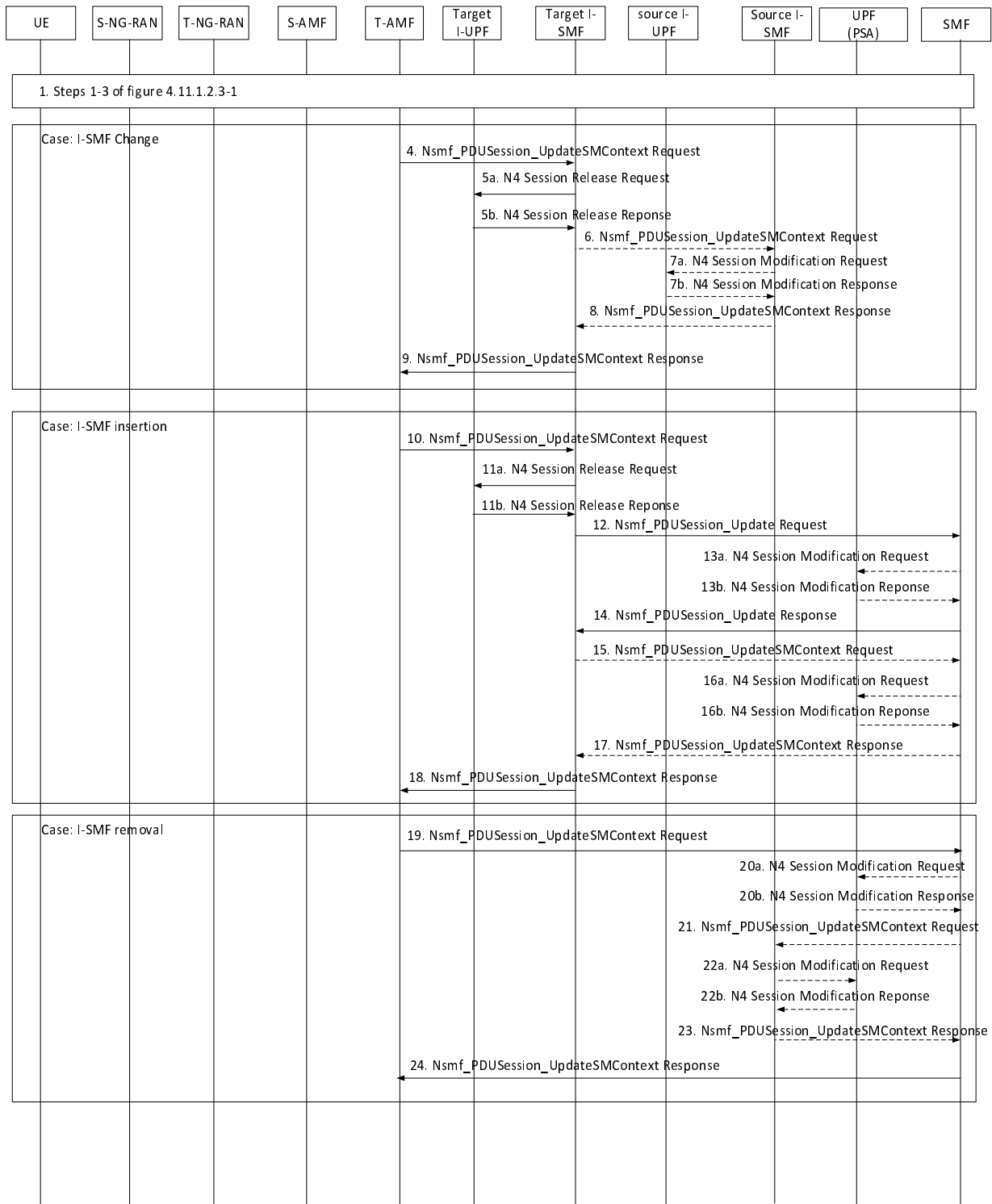


Figure 4.23.7.3.4-1: Handover Cancel procedure

1. Step 1~3 in clause 4.11.1.2.3 are performed.

Case: I-SMF Change, step 4~9 are skipped for I-SMF Insertion case and I-SMF Removal case.

4. T-AMF to Target I-SMF: Nsmf\_PDUSession\_UpdateSMContext Request (Relocation Cancel Indication).

The target AMF invokes Nsmf\_PDUSession\_UpdateSMContext Request (Relocation Cancel Indication) to the target I-SMF to release the SM Context and all resources allocated on the target I-SMF during preparation phase.

## 5a. Target I-SMF to Target I-UPF: N4 Session Release Request.

The target I-SMF invokes N4 Session Release Request to target I-UPF, to release all resources allocated for the N4 session.

## 5b. Target I-UPF to Target I-SMF: N4 Session Release Response.

## 6. [Conditional] Target I-SMF to Source I-SMF: Nsmf\_PDUSession\_UpdateSMContext Request (Relocation Cancel Indication).

If indirect forwarding tunnel is setup during preparation phase, the target I-SMF initiates Nsmf\_PDUSession\_UpdateSMContext Request to the source I-SMF, indicating the source I-SMF to delete the resources temporarily allocated for indirect forwarding tunnel.

## 7a. [Conditional] Source I-SMF to Source I-UPF: N4 Session Modification Request.

The source I-SMF invokes N4 Session Modification Request to source I-UPF, to delete all resources allocated for indirect forwarding tunnel.

## 7b. [Conditional] Source I-UPF to Source I-SMF: N4 Session Modification Response.

## 8. [Conditional] Source I-SMF to Target I-SMF: Nsmf\_PDUSession\_UpdateSMContext Response.

## 9. Target I-SMF to T-AMF: Nsmf\_PDUSession\_UpdateSMContext Response.

Case: I-SMF Insertion, step 10~18 are skipped for I-SMF Change case and I-SMF Removal case.

## 10. T-AMF to Target I-SMF: Nsmf\_PDUSession\_UpdateSMContext Request (Relocation Cancel Indication).

The target AMF invokes Nsmf\_PDUSession\_UpdateSMContext Request (Relocation Cancel Indication) to the target I-SMF to release the SM Context and all resources allocated on the target I-SMF during preparation phase.

## 11a. Target I-SMF to Target I-UPF: N4 Session Release Request.

The target I-SMF invokes N4 Session Release Request to target I-UPF, to release all resources allocated for the N4 session.

## 11b. Target I-UPF to Target I-SMF: N4 Session Release Response.

## 12. Target I-SMF to SMF: Nsmf\_PDUSession\_Update Request (PDU Session ID, Relocation Cancel Indication).

The target I-SMF invokes Nsmf\_PDUSession\_Update Request (PDU Session ID, Relocation Cancel Indication) to the SMF, to release the PDU Session resources allocated during preparation phase, e.g. CN Tunnel for N9.

## 13a. [Conditional] SMF to UPF (PSA): N4 Session Modification Request.

If CN Tunnel for N9 is allocated during preparation phase, i.e. the CN Tunnel for N3 and N9 are different, the SMF asks UPF (PSA) to release the CN Tunnel on N9.

## 13b. [Conditional] UPF(PSA) to SMF: N4 Session Modification Response.

## 14. SMF to Target I-SMF: Nsmf\_PDUSession\_Update Response.

## 15. [Conditional] Target I-SMF to SMF: Nsmf\_PDUSession\_UpdateSMContext Request (Operation Type).

If indirect forwarding tunnel is setup during preparation phase, the target I-SMF initiates Nsmf\_PDUSession\_UpdateSMContext Request (Operation Type) to the SMF, indicating the SMF to delete the resources temporarily allocated for indirect forwarding tunnel.

## 16a. [Conditional] SMF to UPF (PSA): N4 Session Modification Request.

The SMF invokes N4 Session Modification Request to UPF (PSA), to delete all resources allocated for indirect forwarding tunnel.

## 16b. [Conditional] UPF (PSA) to SMF: N4 Session Modification Response.

## 17. [Conditional] SMF to Target I-SMF: Nsmf\_PDUSession\_UpdateSMContext Response.

18. Target I-SMF to T-AMF: Nsmf\_PDUSession\_UpdateSMContext Response.

Case: I-SMF Removal, step 19~24 are skipped for I-SMF Insertion case and I-SMF Change case.

19. T-AMF to SMF: Nsmf\_PDUSession\_UpdateSMContext Request (Relocation Cancel Indication).

The target AMF invokes Nsmf\_PDUSession\_UpdateSMContext Request (Relocation Cancel Indication) to the SMF to release the SM Context and all resources allocated on the SMF during preparation phase.

20a. [Conditional] SMF to UPF (PSA): N4 Session Modification Request.

If CN Tunnel for N3 is allocated during preparation phase, i.e. the CN Tunnel for N3 and N9 are different, the SMF asks UPF (PSA) to release the CN Tunnel on N3.

20b. [Conditional] UPF (PSA) to SMF: N4 Session Modification Response.

21. [Conditional] SMF to Source I-SMF: Nsmf\_PDUSession\_UpdateSMContext Request (Operation Type).

If indirect forwarding tunnel is setup during preparation phase, the SMF initiates Nsmf\_PDUSession\_UpdateSMContext Request (Operation Type) to the source I-SMF, indicating the source I-SMF to delete the resources temporarily allocated for indirect forwarding tunnel.

22a. [Conditional] Source I-SMF to Source I-UPF: N4 Session Modification Request.

The source I-SMF invokes N4 Session Modification Request to source I-UPF, to delete all resources allocated for indirect forwarding tunnel.

22. [Conditional] Source I-UPF to SMF: N4 Session Modification Response.

23. [Conditional] Source I-SMF to SMF: Nsmf\_PDUSession\_UpdateSMContext Response.

24. SMF to T-AMF: Nsmf\_PDUSession\_UpdateSMContext Response.

## 4.23.8 AN Release procedure involving I-SMF

For the AN release procedure, if the PDU Session involves an I-SMF, the procedure defined in clause 4.2.6 applies with:

- The SMF and UPF in the procedure replaced by the I-SMF and I-UPF.

## 4.23.9 Branching Point or UL CL controlled by I-SMF

### 4.23.9.0 Overview

The procedures in this clause describe the Addition, Removal and Change of PDU Session Anchor (PSA2), Branching Point or UL CL controlled by I-SMF. They all rely on following principles:

1. When a (new) I-SMF is inserted (e.g. as described in clause 4.23.7 or clause 4.23.11), the I-SMF provides the DNAI list it supports to the SMF. This list is assumed to remain constant during the N16a association between the I-SMF and the SMF for a PDU Session.
2. Based on the DNAI list information received from I-SMF, the SMF may then at any time provide or update the list of DNAI(s) of interest for this PDU Session to I-SMF. This may take place e.g. when the I-SMF provides the DNAI list it supports or when new or updated or removed PCC rule(s) is/are received by the SMF as defined in clause 4.23.6. This list of DNAI(s) of interest for this PDU Session indicates to the I-SMF the list of DNAI(s) candidate for local traffic steering within the PDU Session.

An indication of whether Multi-homing is possible is also provided to the I-SMF and the I-SMF uses this information to decide whether multi-homing can be used for the PDU Session.

3. Whenever the I-SMF has inserted or removed or changed a local offload capability the I-SMF invokes a Nsmf\_PDUSession\_Update Request to indicate to the SMF the list of corresponding DNAI(s). Based on this indication the SMF invokes a Nsmf\_PDUSession\_Update Request to send the corresponding N4 information to the I-SMF.

4. Then SMF may then at any time invoke a Nsmf\_PDUSession\_Update Request to send N4 information to the I-SMF.
5. The I-SMF may at any time send a Nsmf\_PDUSession\_Update Request to forward to the SMF N4 events received from a local UPF; this may e.g. correspond to traffic reporting.
6. When source I-SMF is to be removed from a PDU Session (e.g. at I-SMF change or removal), the SMF issues the N4 information targeting the UL CL/BP (s) and L-PSA(s) controlled by this I-SMF, including requests to release the corresponding N4 Sessions.

When the Source I-SMF receives a Nsmf\_PDUSession\_ReleaseSMContext Request from AMF, it initiates a data forwarding timer (if indirect data forwarding applies) before releasing the resources of the PDU Session. When the Source I-SMF has received N4 release from SMF, it releases the UL CL/BP (s) and L-PSA(s) resources either directly if no data forwarding timer is started, or at the expiry of the data forwarding timer.

When IPv6 multi-homing is used and an I-SMF is removed, the SMF re-configure the UE to not use the original IP prefix @L-PSA(s).

### 4.23.9.1 Addition of PDU Session Anchor and Branching Point or UL CL controlled by I-SMF

This clause describes a procedure to add a PDU Session Anchor and Branching Point or UL CL controlled by I-SMF.

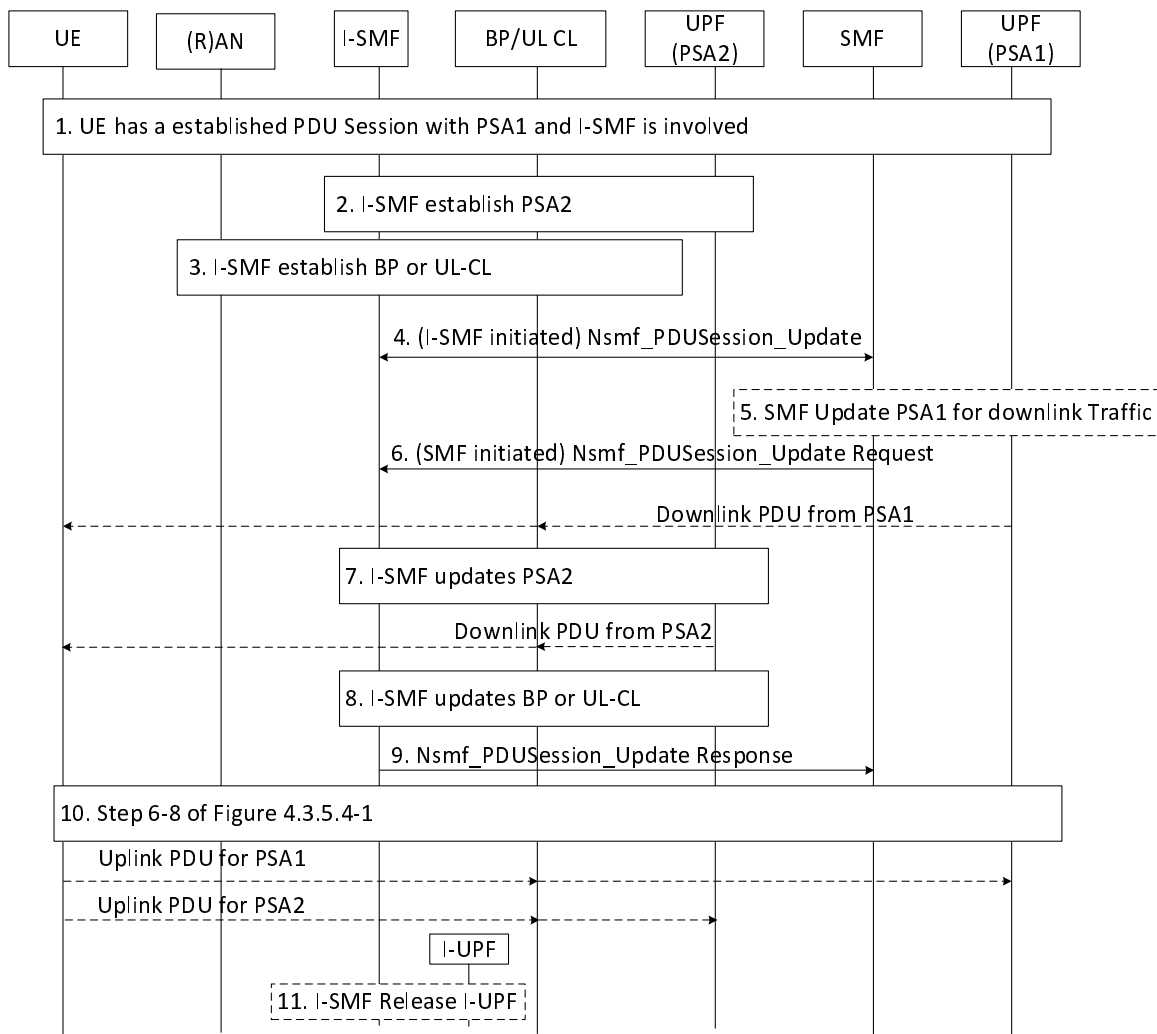


Figure 4.23.9.1-1: Addition of PDU Session Anchor and Branching Point or UL CL controlled by I-SMF



1. UE has an established PDU Session with a UPF including the PDU Session Anchor 1, which is controlled by SMF. The I-SMF and an I-UPF controlled by I-SMF have already been inserted for the PDU Session. Events described in item 1 and 2 of clause 4.23.9.0 have taken place.
2. At some point, using the list of DNAI(s) of interest for this PDU Session received from the SMF, the I-SMF decides to establish a new PDU Session Anchor e.g. due to UE mobility. The I-SMF selects a UPF and using N4 establishes the new PDU Session Anchor 2 (PSA2) of the PDU Session. During this step:
  - (if needed) the PSA2 CN Tunnel Info of the local N9 termination on the PSA2 may be determined,
  - In the case of IPv6 multi-homing applies to the PDU Session, a new IPv6 prefix corresponding to PSA2 is allocated by the I-SMF or by the UPF supporting the PSA2.
3. The I-SMF may select a UPF that will be acting as UL CL or Branching Point and replace the current I-UPF.

If a new UPF that will act as UL CL/Branching Point is selected (i.e. the existing I-UPF is replaced), the I-SMF uses N4 establishment to provide the 5G AN Tunnel Info, the PSA1 and (where applicable) PSA2 CN Tunnel Info to the new UPF.

NOTE 1: If the Branching Point or UL CL and the PSA2 are co-located in a single UPF then steps 2 and 3 can be merged.

4. The I-SMF invokes Nsmf\_PDUSession\_Update Request (Indication of UL CL or Branching Point insertion, IPv6 prefix @PSA2, DNAI(s) supported by PSA2, DL Tunnel Info of the new UL CL/Branching Point, if any) to SMF. Whether the UL CL/Branching Point and PSA2 are supported by the same UPF is transparent to the SMF. Multiple local PSAs (i.e. PSA2) may be inserted at one time, each corresponds to a DNAI and/or an IPv6 prefix in the case of multi-homing.

The I-SMF informs the SMF that a UL CL or Branching Point is inserted, the I-SMF provides DNAI(s) supported by PSA2 to the SMF. The DL Tunnel Info of UL CL/Branching Point is provided to SMF if a new UPF is selected to replace I-UPF in step 3.

In the case of IPv6 multi-homing PDU Session, the IPv6 prefix @PSA2 is also provided to SMF.

The SMF performs the Session Management Policy Modification procedure as defined in clause 4.16.5 to provide the new allocated IPv6 prefix to the PCF. The SMF may also send a notification to the AF, as described in clause 4.3.6.3.

The DNAI(s) supported by PSA2 may be used by the SMF to determine which PCC rules are to be applied at UPF(s) controlled by the I-SMF. The SMF acknowledges the Nsmf\_PDUSession\_Update from the I-SMF

5. If a new DL Tunnel Info of UL CL/ Branching Point has been provided in step 4, the SMF updates the PSA1 via N4 with the CN Tunnel Info for the downlink traffic. Now the downlink packets from PSA1 are sent to UE via the new UPF which will act as Branching Point/UL CL. The SMF may also update the forwarding rules in PSA1 if some traffic is to be moved to UPFs controlled by I-SMF.
6. The SMF provides I-SMF with N4 information for the PSA and for the UL CL with a SMF initiated Nsmf\_PDUSession\_Update Request (set of (N4 information, involved DNAI), Indication of no DNAI change, Indication of no local PSA change)). The SMF generates N4 information for local traffic handling based on PCC rules and CHF requests that will be enforced by UPFs controlled by I-SMF. The N4 information for local traffic handling corresponds to N4 rules (PDR, FAR, URR, QER, etc.) related with the support of a DNAI. This is described in clause 5.34.6 of TS 23.501 [2]. N4 information for local traffic handling may indicate information (as the 5G AN Tunnel Info) that the SMF does not know and that the I-SMF needs to determine itself to build actual rules sent to the UPF(s). If the rule is applied to the local PSA, the N4 information includes the associated DNAI.

If the "Indication of application relocation possibility" or "UE IP address preservation indication" attributes are included in the PCC rule, the SMF includes the corresponding Indication of no DNAI change and Indication no local PSA change respectively.

If the CN Tunnel Info at the PSA1 has changed, the SMF may also provide its new value.

The I-SMF uses N4 information for local traffic handling received from the SMF as well as 5G AN Tunnel Info received from the 5G AN via the AMF and local configuration to determine N4 rules to send to the UPF(s) it is controlling.

7. The I-SMF updates the PSA2 via N4 providing N4 rules determined in step 6. It also provides the Branching Point or UL CL CN Tunnel Info for down-link traffic if the PSA2 and the UL CL/Branching Point are supported by different UPF(s).

8. The I-SMF updates the Branching Point or UL CL via N4 providing N4 rules determined in step 6.

NOTE 2: If the Branching Point or UL CL and the PSA2 are co-located in a single UPF then step 7 and step 8 can be merged.

9. The I-SMF Issues a Nsmf\_PDUSession\_Update Response to SMF that may include N4 information received from the local UPF(s).

10. Steps 6-8 of clause 4.3.5.4 are performed. In the case of IPv6 multi-homing PDU Session, the SMF notifies the UE of the IPv6 prefix @PSA2 and updates the UE with IPv6 multi-homed routing rule via a PSA controlled by the SMF.

NOTE 3: Step 6 of clause 4.3.5.4 is skipped if the current I-UPF is selected to act as Branching Point or UL CL.

11. If a new UPF is selected to replace I-UPF in step 3, the I-SMF uses N4 Release to remove the I-UPF of the PDU Session. The I-UPF releases resources for the PDU Session.

### 4.23.9.2 Removal of PDU Session Anchor and Branching Point or UL CL controlled by I-SMF

This clause describes a procedure to remove a PDU Session Anchor and Branching Point or UL CL controlled by I-SMF.

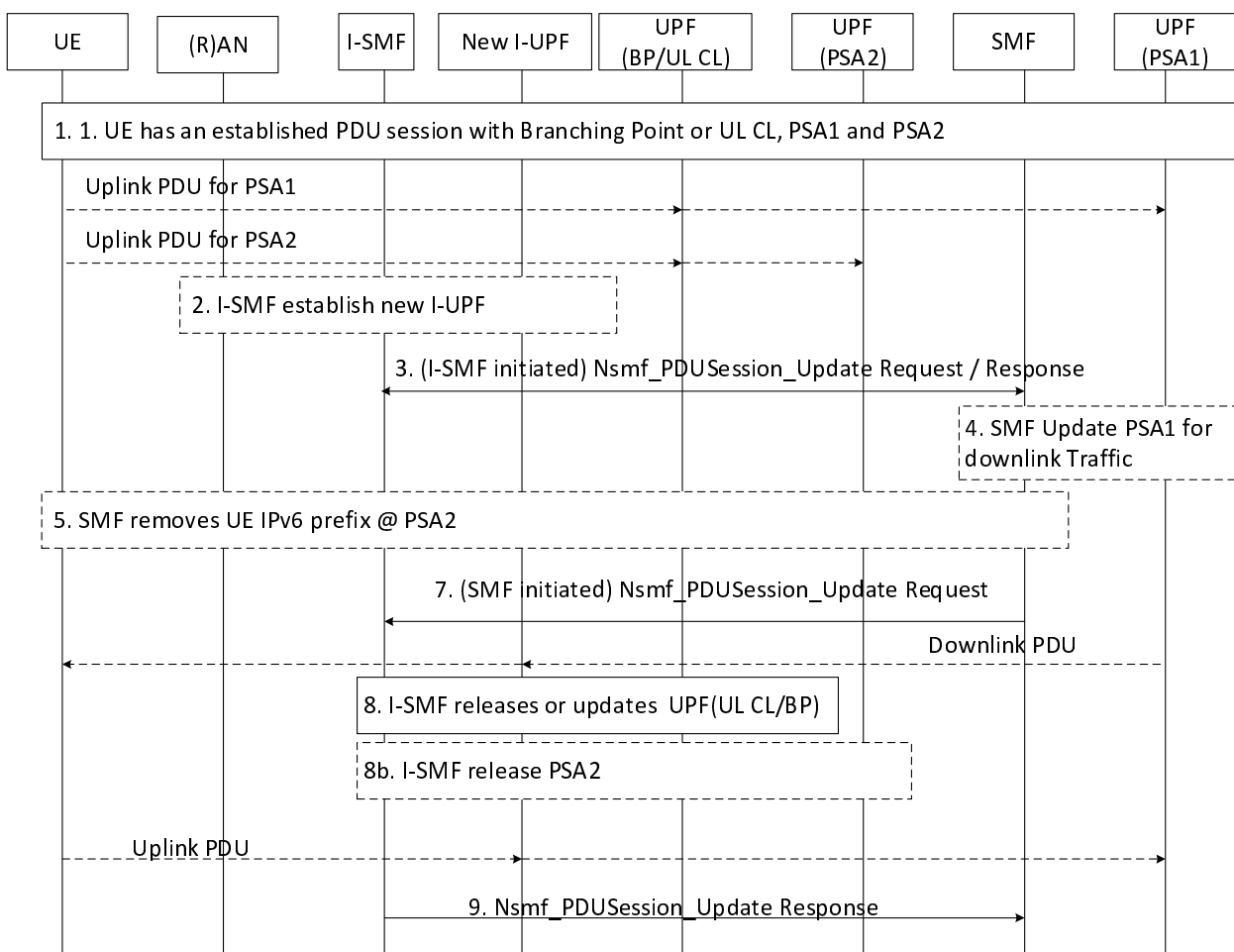


Figure 4. 23.9.2-1: Removal of PDU Session Anchor and Branching Point or UL CL controlled by I-SMF

1. UE has an established PDU Session with a UPF including the PDU Session Anchor 1 (controlled by SMF) and the UL-CL/BP and the PDU Session Anchor 2 (controlled by I-SMF). Events described in item 1 and 2 of clause 4.23.9.0 have taken place.

At some point the I-SMF decides to remove the PDU Session Anchor 2 and UL-CL/BP function, e.g. due to UE mobility.

2. The I-SMF may select a new UPF acting as new I-UPF and replace the existing I-UPF which was acting as UL-CL/BP before.

If a new UPF acting as new I-UPF is selected, the I-SMF uses N4 establishment to provide the PSA1 CN Tunnel Info and (R)AN Tunnel Info to the new I-UPF.

3. The I-SMF invokes Nsmf\_PDUSession\_Update Request (Indication of Removal of traffic offload, Removal of IPv6 prefix @PSA2, DNAI associated with the PSA2, DL Tunnel Info of new I-UPF, if any) to SMF. Multiple local PSAs may be removed, in this case, the I-SMF provides for each local PSA to be removed, the associated DNAI and an IPv6 prefix in the case of multi-homing.

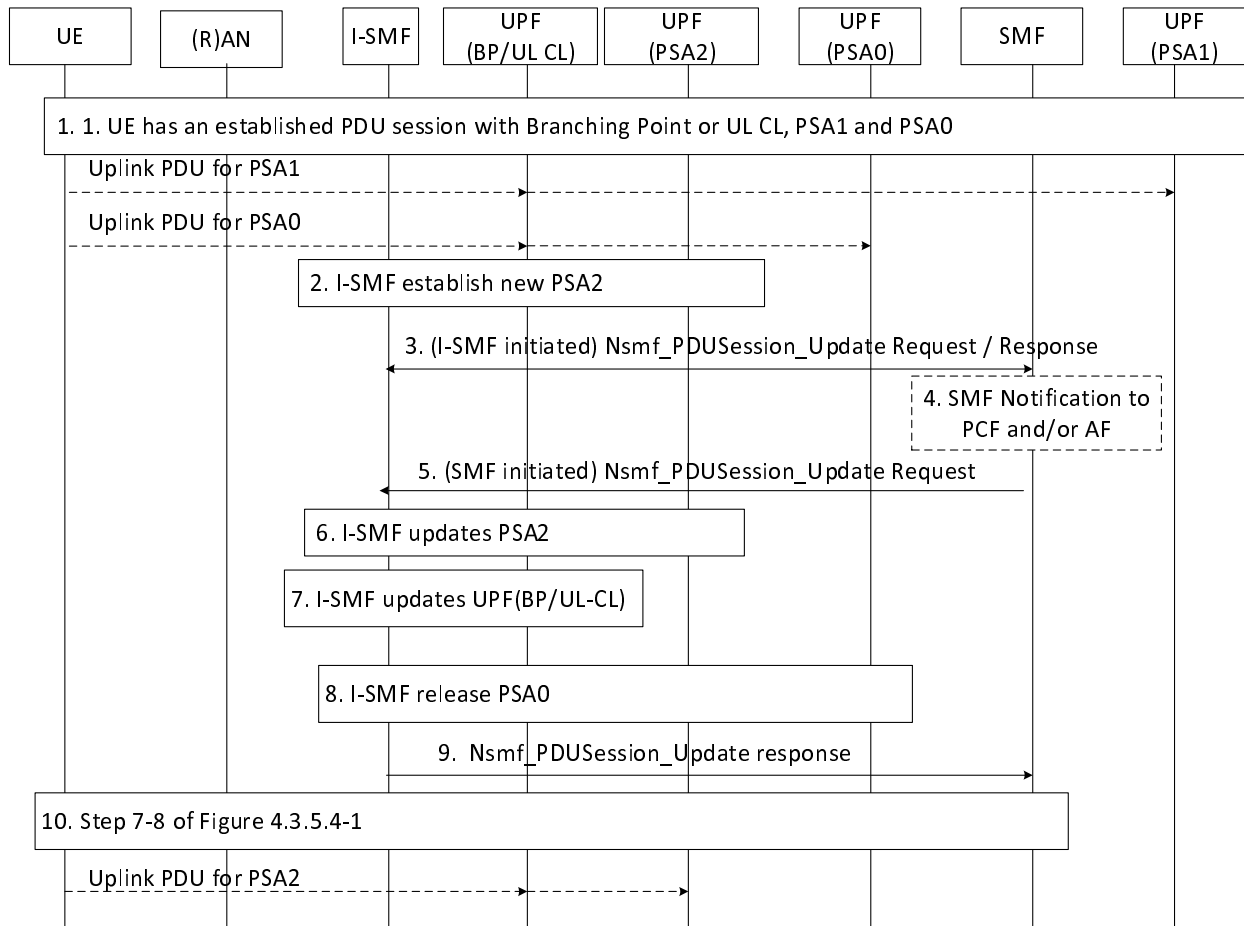
The I-SMF informs the SMF that local traffic offload is removed. In the case of IPv6 multi-homing, the I-SMF also notifies the SMF with the removal of the IPv6 prefix @PSA2.

The SMF issues a SM Policy Association Modification (clause 4.16.5) corresponding to the IP address allocation/release PCRT(Policy Control Request Trigger). The SMF may also send a notification to the AF, as described in clause 4.3.6.3.

4. If a new UPF that replaces existing I-UPF is selected in step 2, the SMF updates the PSA1 via N4. It provides the CN Tunnel Info of the new I-UPF for the downlink traffic. The SMF may update the packet handling rules in PSA1 as now all traffic is to be moved to PSA1.
5. In the case of IPv6 multi-homing, the SMF notifies the UE to stop using the IPv6 prefix corresponding to PSA2. Also the SMF sends IPv6 multi-homed routing rule along with the IPv6 prefix corresponding to PSA1 to the UE. Based on the information provided in the Router Advertisement, the UE starts using the IPv6 prefix (corresponding to PSA1) for corresponding traffic.
7. The SMF provides I-SMF with N4 information for the local UPF(s) with a SMF initiated Nsmf\_PDUSession\_Update Request; The N4 information indicates the removal of the traffic offload rules.
8. If a new UPF that replaces existing I-UPF is selected in step 2, the I-SMF releases the old I-UPF. Otherwise the I-SMF updates the existing I-UPF with new rules in order to remove the UL-CL/BP functionality from that I-UPF.  
  
If a new UPF that replaces existing I-UPF is selected in step 2, the SMF updates the (R)AN with the new I-UPF CN Tunnel Info.  
  
If the PSA2 is not collocated with UL-CL/BP function, the I-SMF releases it via N4.
9. The I-SMF answers to the SMF with a Nsmf\_PDUSession\_Update Response SMF that may include N4 information received from the local UPF(s).

#### 4.23.9.3 Change of PDU Session Anchor for IPv6 multi-homing or UL CL controlled by I-SMF

This clause describes a change of UL-CL/BP function, e.g. addition of a new PDU Session Anchor (i.e. PSA2) and release of the existing additional PDU Session Anchor (i.e. PSA0), via modifying IPv6 multi-homing or UL CL rule in the same Branching Point or UL CL under controlled by the same I-SMF.



**Figure 4.23.9.3-1: Change of PDU Session Anchor for Branching Point or UL CL controlled by I-SMF**

1. The UE has an established PDU Session with a UPF including the PDU Session Anchor 1 (controlled by SMF) and the PDU Session Anchor 0 (PSA0) and an I-UPF acting as UL CL or BP (controlled by I-SMF). Events described in item 1 and 2 of clause 4.23.9.0 have taken place.
2. At some point the I-SMF decides to establish a new PDU Session Anchor and release the existing PDU Session Anchor e.g. due to UE mobility. The I-SMF selects a UPF and using N4 establishes the new PDU Session Anchor 2 of the PDU Session.

In the case of IPv6 multi-homing PDU Session, the I-SMF ensures allocation of a new IPv6 prefix corresponding to PSA2.

3. The I-SMF invokes Nsmf\_PDUSession\_Update Request (Indication of Change of traffic offload, (new allocated IPv6 prefix @PSA2, DNAI(s) supported by PSA2), (Removal of IPv6 prefix @PSA0, DNAI(s) supported by PSA0)) to SMF.

The I-SMF informs the SMF that a change of traffic offload may occur. Multiple local PSAs may be changed. The I-SMF provides:

- for each local PSA to be added, the DNAI now reachable and in the case of multi-homing: the new allocated IPv6 prefix @PSA2;
  - for each local PSA no more reachable, the DNAI no more reachable and in the case of multi-homing, the old IPv6 prefix @PSA0.
4. The SMF may issue a SM Policy Association Modification (clause 4.16.5) corresponding to the IP address allocation/release PCRT. The SMF may also send an "early" notification to the AF, as described in clause 4.23.6.3.
  5. The SMF generates the N4 information based on DNAI(s) information received in step 3. The SMF provides I-SMF with N4 information for the PSA and for the UL CL with a SMF initiated Nsmf\_PDUSession\_Update

Request (set of (N4 information, involved DNAI), Indication of no DNAI change, Indication of no local PSA change)). The information includes N4 information to remove the traffic offload related to the DNAI(s) that are no more reachable and to enable the traffic offload related to the DNAI(s) that are now reachable.

6-7. Same as step 7-8 of clause 4.23.9.1

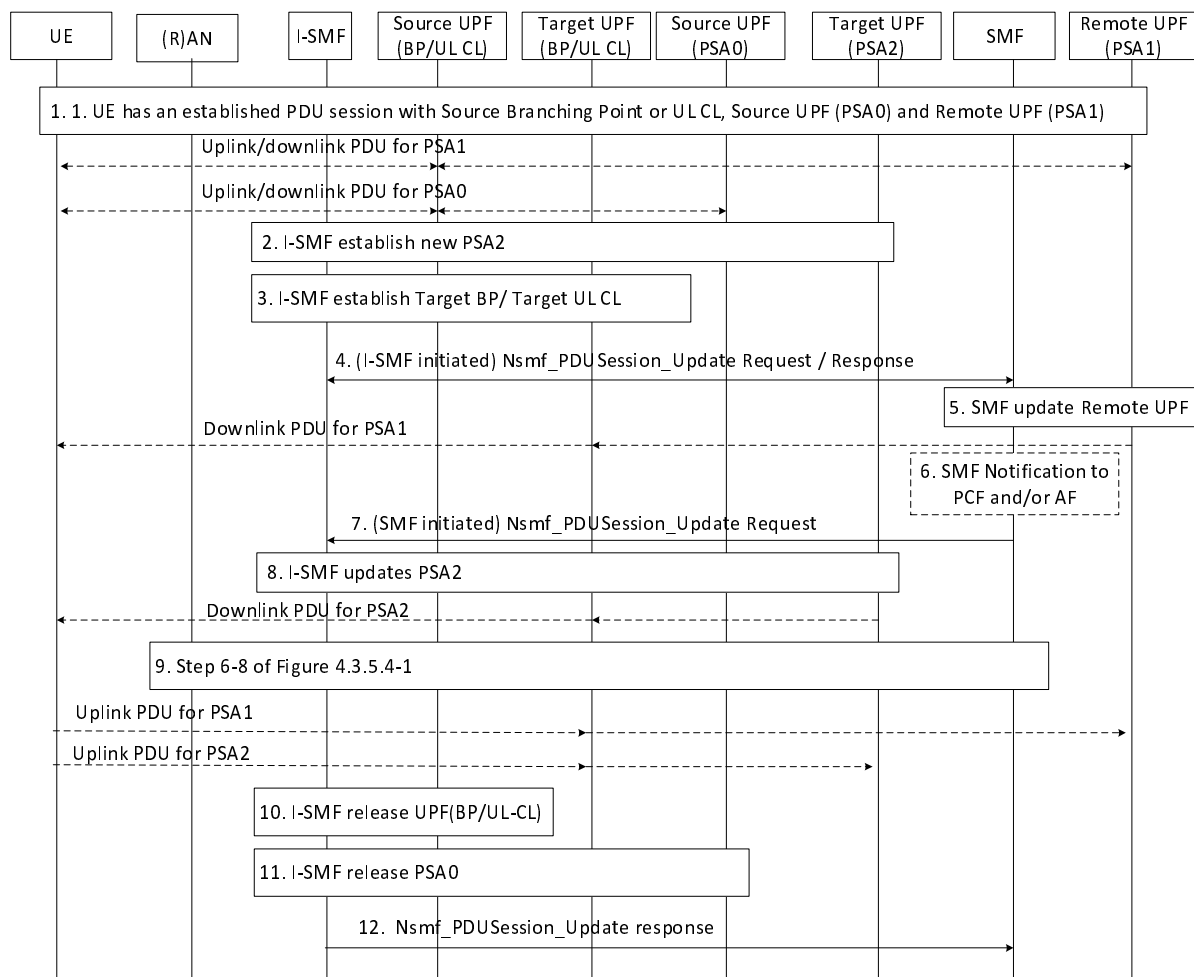
8. The I-SMF releases via N4 the PSA0 if PSA0 is not collocated with UL CL/BP, or updates the UL CL/BP to remove corresponding rules if PSA0 is collocated with UL CL/BP.

9. The I-SMF issues a Nsmf\_PDUSession\_Update Response to SMF that may include N4 information received from the local UPF(s) including the PSA0.

10. Same as step 7-8 of clause 4.3.5.4 are performed.

### 4.23.9.4 Simultaneous change of Branching Point or UL CL and additional PSA controlled by I-SMF

This clause describes simultaneous change of UL-CL/BP function and additional PSA, e.g. addition of a new UL CL/BP and PDU Session Anchor (i.e. PSA2) and release of the existing UL CL/BP and additional PDU Session Anchor (i.e. PSA0), with target UPF(s) and source UPF(s) are all controlled by I-SMF.



**Figure 4.23.9.4-1: Simultaneous change of Branching Point or UL CL and additional PSA controlled by I-SMF**

Comparing to the clause 4.23.9.3, this procedure in addition changes the source UL-CL/BP by a target UL-CL/BP.

1-2. These steps are the same steps 1-2 in clause 4.23.9.3.

3. The I-SMF selects a UPF and using N4 establishes the target UL CL or BP of the PDU Session.

4. The I-SMF invokes Nsmf\_PDUSession\_Update Request (Indication of Change of traffic offload, (new allocated IPv6 prefix @PSA2, DNAI(s) supported by PSA2), (Removal of IPv6 prefix @PSA0, DNAI(s) supported by PSA0), DL Tunnel Info of the new UL CL/Branching Point) to SMF.

The DL Tunnel Info of target UL CL/Branching Point is provided to SMF.

5. The SMF updates the remote PSA (PSA1) via N4 with the DL Tunnel Info of the Target UL CL/BP for the downlink traffic.
- 6-8. These steps are the same as steps 4-6 in clause 4.23.9.3.
9. Same as step 6-8 of clause 4.3.5.4. The I-SMF updates (R)AN for uplink traffic.
- 10-11. The I-SMF releases via N4 the source UL-CL/BP as the source UL-CL/BP is replaced by the target UL-CL/BP. The I-SMF also releases via N4 the PSA0 if PSA0 is not collocated with source UL CL/BP ;
12. This step is the same as step 9 in clause 4.23.9.3.

## 4.23.9a Void

### 4.23.10 CN-initiated selective deactivation of UP connection of an existing PDU Session involving I-SMF

For the CN-initiated selective deactivation of UP connection of an existing PDU Session procedure, if the PDU Session involved I-SMF, the procedure defined in clause 4.3.7 are impacted as following:

- The SMF and UPF in the procedure are replaced by the I-SMF and I-UPF.

### 4.23.11 Xn based handover

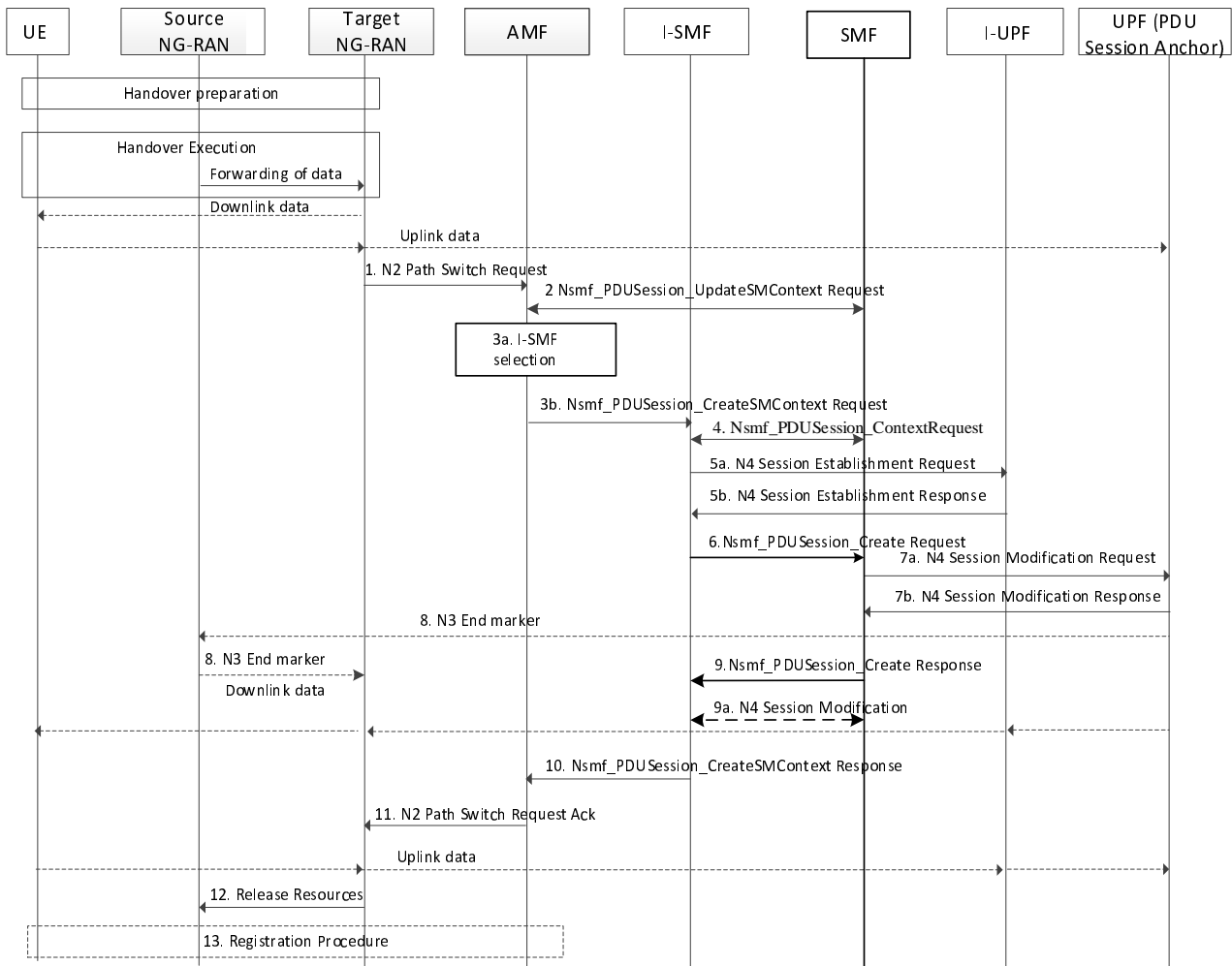
#### 4.23.11.1 General

This clause describes the Xn based handover with the insertion, reallocation and removal of I-SMF.

#### 4.23.11.2 Xn based handover with insertion of intermediate SMF

This procedure is used to hand over a UE from a Source NG-RAN to a Target NG-RAN using Xn interface (in this case the AMF is unchanged) and the AMF decides that insertion of a new intermediate I-SMF is needed. This procedure is used for non-roaming or local breakout roaming scenario.

The call flow is shown in figure 4.23.11.2-1.



**Figure 4.23.11.2-1: Xn based inter NG-RAN handover with insertion of intermediate SMF**

1. Step 1 is the same as described in clause 4.9.1.2.2.
2. For each PDU Session Rejected in the list of PDU Sessions received in the N2 Path Switch Request, the AMF perform same step as step 2 in clause 4.9.1.2.2.

The rest of this procedure applies for each PDU Session To Be Switched.

- 3a. The AMF checks if an I-SMF needs to be selected as described in clause 5.34.3 of TS 23.501 [2].
- 3b. If a new I-SMF is selected the AMF sends Nsmf\_PDUSession\_CreateSMContext Request (SUPI, AMF ID, SMF ID, SM Context ID, PDU Session To Be Switched with N2 SM Information (Secondary RAT usage data), UE Location Information, UE presence in LADN service area) to the new selected I-SMF.
4. The new I-SMF sends Nsmf\_PDUSession\_Context Request (SM context type, SM Context ID) to SMF to retrieve the SM Context.

The new I-SMF uses SM Context ID received from AMF for this service operation. SM context type indicates that the requested information is all SM context, i.e. PDN Connection Context and 5G SM context. The SM Context ID is used by the recipient of Nsmf\_PDUSession\_Context Request in order to determine the targeted PDU Session.

- 5a. I-SMF to I-UPF: N4 Session Establishment Request (Target NG-RAN Tunnel Info).

The I-SMF then selects a I-UPF based on UPF Selection Criteria according to clause 6.3.3 of TS 23.501 [2]. An N4 Session Establishment Request message is sent to the I-UPF. The target NG-RAN Tunnel Info is included in the N4 Session Establishment Request message.

- 5b. I-UPF to I-SMF: N4 Session Establishment Response.

The I-UPF sends an N4 Session Establishment Response message to the I-SMF. The UL CN Tunnel Info and DL CN Tunnel Info of I-UPF are sent to the I-SMF.

6. I-SMF to SMF: Nsmf\_PDUSession\_Create Request to the SMF (SUPI, PDU Session ID, Secondary RAT usage data, UE Location Information, UE presence in LADN service area, DL CN Tunnel Info of the I-UPF, DNAI list supported by the I-SMF).

The I-SMF provides the DNAI list it supports to the SMF as defined in Figure 4.23.9.1-1 step 1.

Secondary RAT usage data is extracted from N2 SM Information within PDU Session To Be Switched received from NG RAN.

- 7a. SMF to UPF (PSA): N4 Session Modification Request (DL CN Tunnel Info of the I-UPF).

The SMF provides the DL CN Tunnel Info of the I-UPF to the UPF(PSA).

If old I-UPF controlled by SMF does not exist and if different CN Tunnel Info need to be used by PSA UPF, i.e. the CN Tunnel Info at the PSA for N3 and N9 are different, the CN Tunnel Info at the PSA for N9 needs to be allocated. The CN Tunnel Info is provided from UPF to SMF in the response.

- 7b. UPF (PSA) to SMF: N4 Session Modification Response.

The PDU Session Anchor responds with the N4 Session Modification Response message after requested PDU Sessions are switched. At this point, PDU Session Anchor starts sending downlink packets to the Target NG-RAN via I-UPF.

PDU Session Anchor sends one or more "end marker" packets for each N3/N9 tunnel on the old path immediately after switching the path, the source NG-RAN shall forward the "end marker" packets to the target NG-RAN.

8. In order to assist the reordering function in the Target NG-RAN, the PDU Session Anchor sends one or more "end marker" packets for each N3/N9 tunnel on the old path immediately after switching the path, the source NG-RAN shall forward the "end marker" packets to the target NG-RAN.

9. SMF to I-SMF: Nsmf\_PDUSession\_Create Response (Information for local traffic steering location, CN Tunnel Info at the PSA for N9, updated CN PDB in the QoS parameters for accepted QoS Flows).

The SMF may update the CN PDB in the response or using a separate PDU Session Modification procedure, based on local configuration.

- 9a. If the CN Tunnel Info at PSA for N9 is allocated, it is included in the response and the I-SMF provides the CN Tunnel Info at the PSA for N9 to I-UPF via N4 Session Modification Request.

In the case of I-SMF insertion and the PDU session corresponds to a LADN, the SMF shall release the PDU session after the handover procedure is completed.

10. I-SMF to AMF: Nsmf\_PDUSession\_CreateSMContext Response (UL CN Tunnel Info of the I-UPF, updated CN PDB in the QoS parameters for accepted QoS Flows).

The SMF sends an Nsmf\_PDUSession\_CreateSMContext response to the AMF.

- 11-13. Steps 11-13 are same as steps 7-9 defined in clause 4.9.1.2.2 with the following addition:

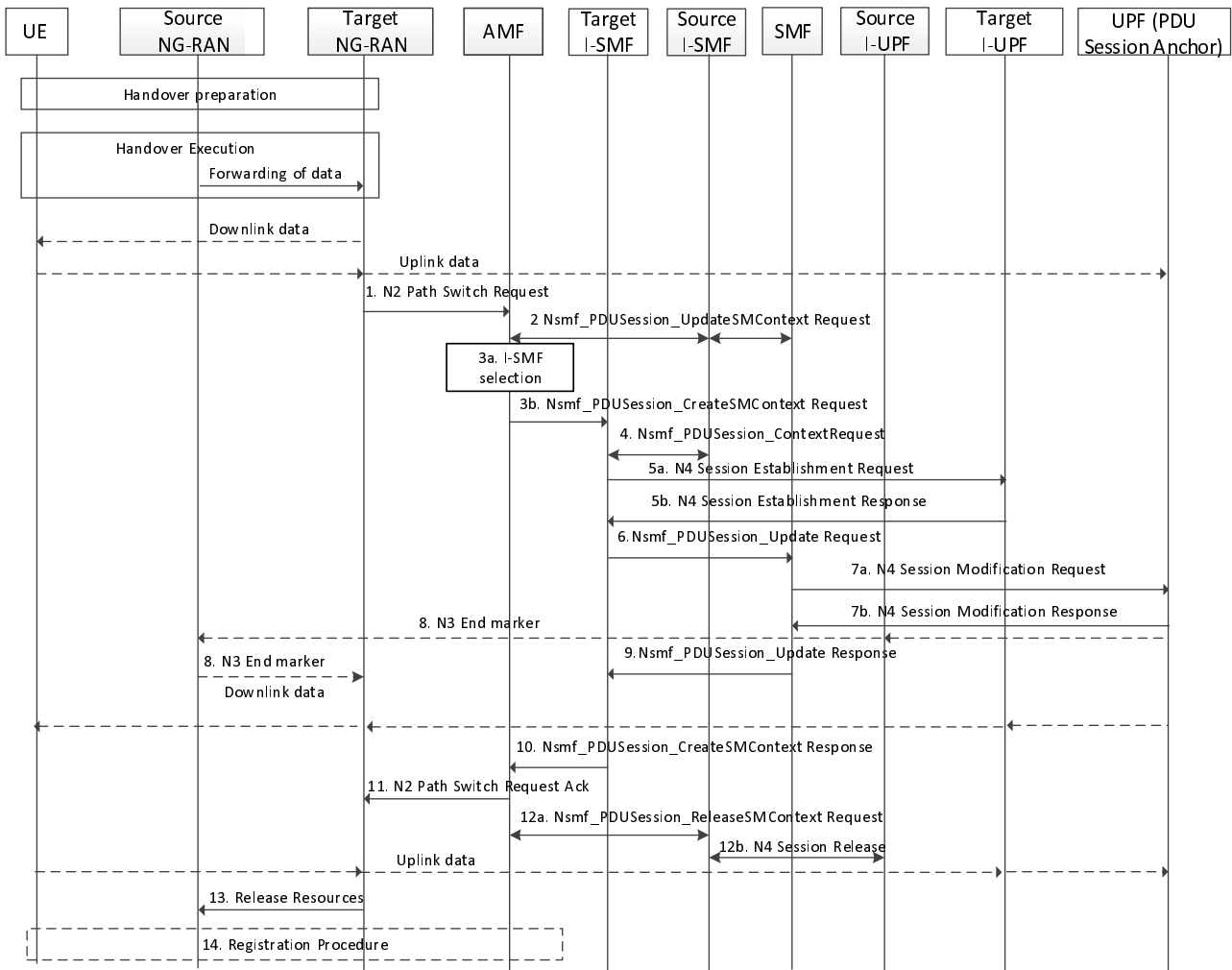
If a Source I-UPF controlled by SMF was serving the PDU Session, the SMF initiates Source I-UPF Release procedure by sending an N4 Session Release Request toward the Source I-UPF.

### 4.23.11.3 Xn based handover with re-allocation of intermediate SMF

This procedure is used to hand over a UE from a Source NG-RAN to a Target NG-RAN using Xn interface (in this case the AMF is unchanged) and the AMF decides that the intermediate SMF(I-SMF) is to be changed. This procedure is used for non-roaming or local breakout roaming scenario. In the case of home routed roaming scenario, this procedure is also used except the I-SMF is replaced by V-SMF.

The call flow is shown in figure 4.23.11.3 -1.





**Figure 4.23.11.3-1: Xn based inter NG-RAN handover with intermediate I-SMF re-allocation**

1-3. Steps 1-3 are same as steps 1-3 described in clause 4.23.11.2 except that in step 2 the AMF sends Nsmf\_PDUSession\_UpdateSMContext Request to source I-SMF and then the source I-SMF sends the Nsmf\_PDUSession\_Update Request to SMF.

4. The target I-SMF sends Nsmf\_PDUSession\_Context Request to Source I-SMF to retrieve 5G SM Context.

5a-11. Steps 5a-11 are same as steps 5a-11 described in clause 4.23.11.2 with the following difference:

In step 6, the target I-SMF invokes Nsmf\_PDUSession\_Update Request (Secondary RAT usage data, UE Location Information, UE presence in LADN service area, DL CN Tunnel Info of the I-UPF, DNAI list supported by target I-SMF) toward the SMF;

In step 9, the SMF respond with Nsmf\_PDUSession\_Update Response. The SMF may provide the DNAI(s) of interest for this PDU Session to I-SMF as described in step 1 of Figure 4.23.9.1-1. The SMF may update the CN PDB in the response or using a separate PDU Session Modification procedure, based on local configuration.

Secondary RAT usage data is extracted from PDU Session To Be Switched with N2 SM Information received from NG RAN.

12a. The AMF sends Nsmf\_PDUSession\_ReleaseSMContext Request (I-SMF only indication) to source I-SMF. The source I-SMF removes the SM context of this PDU session. An indication is included in this message to avoid invoking resource release in SMF.

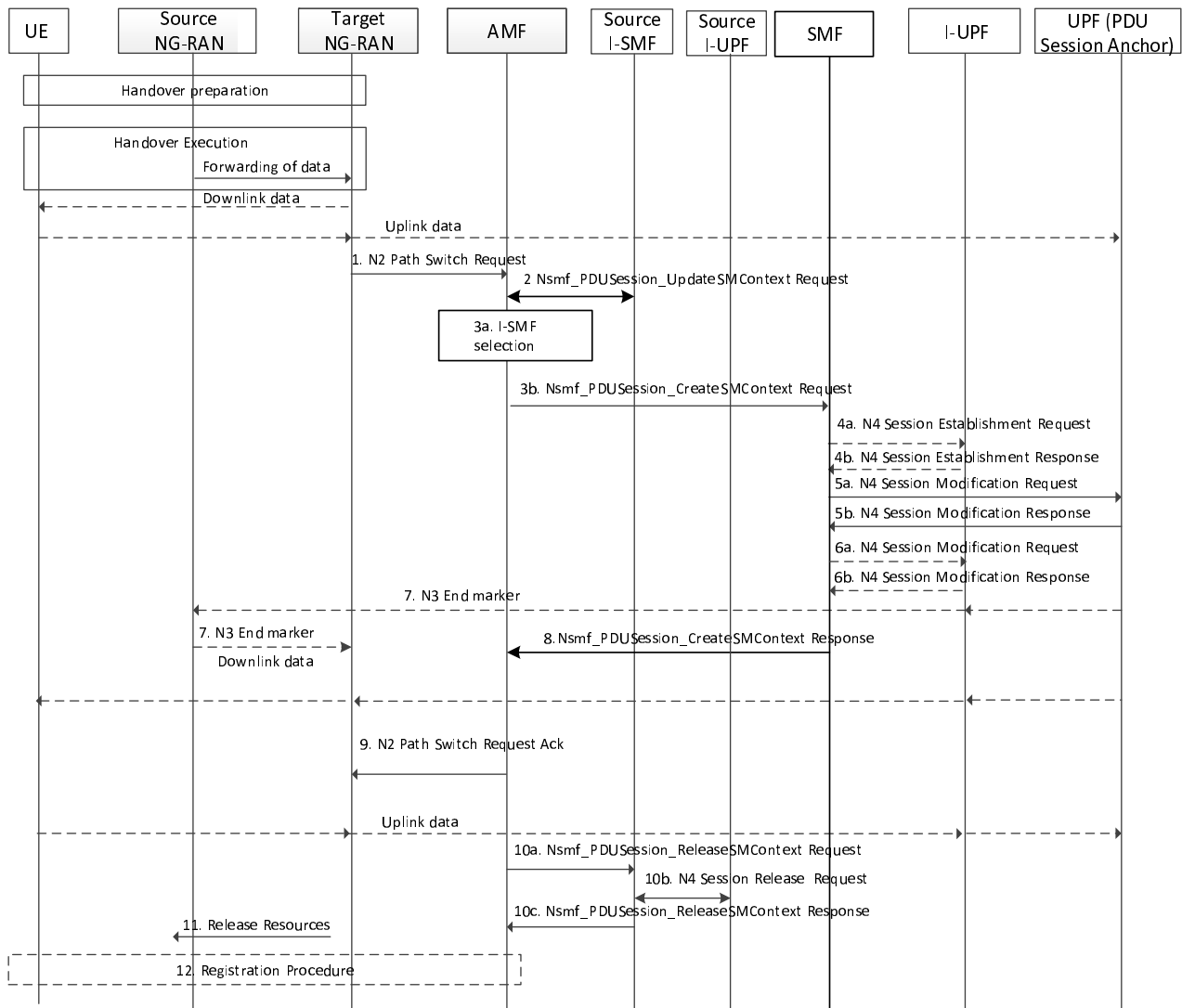
12b. The source I-SMF sends N4 Session Release to release the resource in source I-UPF. If the source I-UPF acts as UL CL and is not co-located with local PSA, the source I-SMF also sends N4 Session Release to the local PSA to release the resource for the PDU Session.

13-14. Steps 13-14 are same as steps 12-13 described in clause 4.23.11.2.

### 4.23.11.4 Xn based handover with removal of intermediate SMF

This procedure is used to hand over a UE from a Source NG-RAN to a Target NG-RAN using Xn interface(in this case the AMF is unchanged) and the AMF decides that removal of intermediate I-SMF is needed. This procedure is used for non-roaming or local breakout roaming scenario.

The call flow is shown in figure 4.23.11.4-1.



**Figure 4.23.11.4-1: Xn based inter NG-RAN handover with removal of intermediate SMF**

1. Step 1 is the same as described in clause 4.9.1.2.2.
2. For each PDU Session Rejected in the list of PDU Sessions received in the N2 Path Switch Request, the AMF sends Nsmf\_PDUSession\_UpdateSMContext Request to source I-SMF and then the source I-SMF sends the Nsmf\_PDUSession\_Update Request to SMF forwarding the failure cause. The SMF decides whether to release the PDU Session.

The rest of this procedure applies for each PDU Session To Be Switched.

- 3a. The AMF performs I-SMF selection as described in clause 5.34.3 of TS 23.501 [2] and the AMF decides to remove I-SMF in this case.
- 3b. The AMF sends Nsmf\_PDUSession\_CreateSMContext Request (SUPI, PDU Session ID, AMF ID, PDU Session To Be Switched with N2 SM Information (Secondary RAT usage data), UE Location Information, UE presence in LADN service area, Target NG-RAN Tunnel Info) to the SMF.

- 4a. [Conditional] SMF to I-UPF: N4 Session Establishment Request (Target NG-RAN Tunnel Info, UL CN Tunnel Info of the UPF (PSA)).

The SMF may select an I-UPF based on UPF Selection Criteria according to clause 6.3.3 of TS 23.501 [2]. If an I-UPF is selected, an N4 Session Establishment Request message is sent to the I-UPF. The target NG-RAN Tunnel Info is included in the N4 Session Establishment Request message.

- 4b. I-UPF to SMF: N4 Session Establishment Response.

The I-UPF sends an N4 Session Establishment Response message to the I-SMF. The UL and DL CN Tunnel Info of I-UPF is sent to the I-SMF.

- 5a. SMF to UPF (PSA): N4 Session Modification Request (DL CN Tunnel Info of the I-UPF if I-UPF is selected, or Target NG-RAN Tunnel Info if I-UPF is not selected).

The SMF provides the DL CN Tunnel Info of the I-UPF to the UPF (PSA) if I-UPF is selected.

If an I-UPF is not selected, the SMF provides the target NG-RAN Tunnel Info to the UPF (PSA). If different CN Tunnel Info need to be used by PSA UPF, i.e. the CN Tunnel Info for N3 and N9 are different, the SMF retrieves the new CN Tunnel Info from UPF.

- 5b. UPF (PSA) to SMF: N4 Session Modification Response.

If different CN Tunnel Info needs to be used by PSA UPF, i.e. the CN Tunnel Info for N3 and N9 are different, the CN Tunnel Info is allocated by the UPF and provided to the SMF.

The PDU Session Anchor responds with the N4 Session Modification Response message after requested PDU Sessions are switched. PDU Session Anchor sends one or more "end marker" packets for each N3/N9 tunnel on the old path immediately after switching the path, the source NG-RAN shall forward the "end marker" packets to the target NG-RAN. At this point, PDU Session Anchor starts sending downlink packets to the Target NG-RAN via I-UPF.

- 6a. [Conditional] SMF to I-UPF: N4 Session Modification Request (UL CN Tunnel Info of the UPF (PSA)).

If the UL CN Tunnel Info of the UPF (PSA) has been changed, the SMF provides the UL CN Tunnel Info of the UPF (PSA) to I-UPF.

- 6b. I-UPF to SMF: N4 Session Modification Response.

The I-UPF responds with the N4 Session Modification Response message.

7. In order to assist the reordering function in the Target NG-RAN, the PDU Session Anchor sends one or more "end marker" packets for each N3/N9 tunnel on the old path immediately after switching the path, the source NG-RAN shall forward the "end marker" packets to the target NG-RAN.

8. SMF to AMF: Nsmf\_PDUSession\_CreateSMContext Response (UL CN Tunnel Info of the I-UPF if I-UPF is selected, or CN Tunnel Info (on N3) of UPF (PSA) if I-UPF is not selected, updated CN PDB in the QoS parameters for accepted QoS Flows). The SMF may update the CN PDB in the response or using a separate PDU Session Modification procedure, based on local configuration.

The SMF sends an Nsmf\_PDUSession\_CreateSMContext response to the AMF.

9. Step 9 is same as step 7 defined in clause 4.9.1.2.2.

- 10a. AMF to source I-SMF: Nsmf\_PDUSession\_ReleaseSMContext request (I-SMF only Indication).

The AMF sends Nsmf\_PDUSession\_ReleaseSMContext request to source I-SMF. The I-SMF only indication is included in this message to avoid invoking resource release in SMF.

- 10b. Source I-SMF to source I-UPF: N4 Session Release Request/Response.

The source I-SMF sends N4 Session Release Request to source I-UPF in order to release resources for the PDU Session.

- 10c. Source I-SMF to AMF: Nsmf\_PDUSession\_ReleaseSMContext Response.

The source I-SMF responds to AMF with Nsmf\_PDUSession\_ReleaseSMContext response.

11-12. Steps 11-12 are same as steps 8-9 defined in clause 4.9.1.2.2.

#### 4.23.11.5 Xn based handover without change of intermediate SMF

When both I-SMF and SMF are available for a PDU Session and no I-SMF change or removal is needed during Xn based handover procedure, compared to the procedure defined in clause 4.9.1.2.2 and clause 4.9.1.2.4 the SMF is replaced with the I-SMF.

### 4.23.12 N26 based Interworking Procedures with I-SMF

#### 4.23.12.1 General

When UE moves from EPS to 5GS, for a each PDU Session, the AMF determines whether I-SMF needs to be inserted based on UE location and service area of the SMF+PGW-C.

This clause describes the N26 based Interworking Procedures with I-SMF insertion when UE move from EPS to 5GS and removal when UE moves from 5GS to EPS.

#### 4.23.12.2 5GS to EPS Idle mode mobility using N26 interface with I-SMF removal

For 5GS to EPS Idle mode mobility using N26 with I-SMF removal, the procedure "5GS to EPS Idle mode mobility using N26 interface" defined in clause 4.11.1.3.2 for the home routed-roaming case are re-used, with the following change:

- The V-SMF is replaced by I-SMF, H-SMF is replaced by SMF and V-UPF is replaced by I-UPF.
- The V-CN Tunnel Info is replaced by Tunnel Info at I-UPF, H-CN Tunnel Info is replaced by Tunnel Info at UPF (PSA).

#### 4.23.12.2A 5GS to EPS Idle mode mobility using N26 interface with Data forwarding and I-SMF removal

For 5GS to EPS Idle mode mobility using N26 with data forwarding and I-SMF removal, the procedure "5GS to EPS Idle mode mobility using N26 interface with data forwarding" defined in clause 4.11.1.3.2A for the home-routed roaming case is re-used, with the following change:

- The V-SMF is replaced by I-SMF, V-UPF is replaced by I-UPF and H-SMF is replaced by SMF.
- Data forwarding tunnel resource is established and the tunnel information is exchanged through N26 interface. Data buffered in I-SMF/I-UPF is forwarded to UE via Serving GW.

#### 4.23.12.3 EPS to 5GS mobility registration procedure (Idle and Connected State) using N26 interface with I-SMF insertion

For EPS to 5GS Mobility registration procedure using N26 with I-SMF insertion, the procedure "EPS to 5GS Mobility Registration Procedure (Idle and Connected State) using N26 interface" defined in clause 4.11.1.3.3 for the home routed-roaming case are re-used, with the following change:

- The V-SMF is replaced by I-SMF and H-SMF is replaced by SMF, V-UPF is replaced by I-UPF.
- The V-SMF selection is replaced by the I-SMF selection.
- The V-CN Tunnel Info is replaced by Tunnel Info at I-UPF, H-CN Tunnel Info is replaced by Tunnel Info at UPF(PSA).

#### 4.23.12.3A EPS to 5GS Idle mode mobility using N26 interface with Data forwarding and I-SMF insertion

For EPS to 5GS Mobility registration procedure using N26 with data forwarding and I-SMF insertion, the procedure "EPS to 5GS Idle Mobility using N26 interface with data forwarding" defined in clause 4.11.1.3.3A for the home routed-roaming case is re-used, with the following change:

- The V-SMF is replaced by I-SMF and H-SMF is replaced by SMF, V-UPF is replaced by I-UPF.
- The V-SMF selection is replaced by the I-SMF selection.
- The V-CN Tunnel Info is replaced by Tunnel Info at I-UPF, H-CN Tunnel Info is replaced by Tunnel Info at UPF(PSA).
- Data forwarding tunnel resource is established and the tunnel information is exchanged through N26 interface. Data buffered in Serving GW is forwarded to UE via I-SMF/I-UPF.

#### 4.23.12.4 Procedures for EPS bearer ID allocation

The EPS Bearer ID allocation procedure, EPS Bearer ID transfer procedure and EPS Bearer ID revocation procedure are performed as described for the home-routed roaming case in clause 4.11.1.4, with the following differences:

- H-SMF is replaced by SMF.
- V-SMF is replaced by I-SMF.
- In step 8 of clause 4.11.1.4.1, in addition to home routing roaming scenario, for scenario of deployments topologies with specific SMF Service Areas, if EBI is assigned successfully, the SMF+PGW-C also prepares CN Tunnel Info for each EPS bearer and provides this information to the I-SMF.

#### 4.23.12.5 EPS to 5GS mobility registration procedure (Idle) using N26 interface with AMF reallocation and I-SMF insertion

For EPS to 5GS Mobility registration procedure using N26 with AMF reallocation and I-SMF insertion, the procedure "EPS to 5GS Mobility Registration Procedure (Idle) using N26 interface with AMF reallocation" defined in clause 4.11.1.3.4 are re-used, with the following change:

- The V-SMF is replaced by I-SMF and H-SMF is replaced by SMF, V-UPF is replaced by I-UPF.
- The V-SMF selection is replaced by the I-SMF selection.
- The V-CN Tunnel Info is replaced by Tunnel Info at I-UPF, H-CN Tunnel Info is replaced by Tunnel Info at UPF(PSA).

#### 4.23.12.6 5GS to EPS handover using N26 interface with I-SMF removal

The procedure "5GS to EPS handover using N26 interface" in clause 4.11.1.2.1 for the home routed-roaming case is applied to handover from 5GS to EPS using N26 interface with I-SMF removal with the following changes:

- The V-SMF is replaced by I-SMF and H-SMF is replaced by SMF, V-UPF is replaced by I-UPF.

#### 4.23.12.7 EPS to 5GS handover using N26 interface with I-SMF insertion

##### 4.23.12.7.1 Preparation phase

For handover from EPS to 5GS using N26 interface, if I-SMF needs to be inserted, the preparation procedure defined in clause 4.11.1.2.2.1 for the home routed-roaming case are re-used, with the following changes:

- The V-SMF is replaced by I-SMF and H-SMF is replaced by SMF, V-UPF is replaced by I-UPF.
- The V-SMF selection is replaced by the I-SMF selection.

- The V-CN Tunnel Info is replaced by Tunnel Info at I-UPF, H-CN Tunnel Info is replaced by Tunnel Info at UPF(PSA).

#### 4.23.12.7.2 Execution phase

For handover from EPS to 5GS using N26 interface, if I-SMF needs to be inserted, the execution procedure defined in clause 4.11.1.2.2.2 for the home routed-roaming case are re-used, with the following change:

- The V-SMF is replaced by I-SMF and H-SMF is replaced by SMF, V-UPF is replaced by I-UPF.
- The V-SMF selection is replaced by the I-SMF selection.
- The V-CN Tunnel Info is replaced by Tunnel Info at I-UPF, H-CN Tunnel Info is replaced by Tunnel Info at UPF(PSA).

#### 4.23.12.8 Impact to 5GC procedures

##### 4.23.12.8.1 General

This clause captures impact to 5GC procedures in other clauses of clause 4.23 to support interworking with N26.

##### 4.23.12.8.2 UE Triggered Service Request with I-SMF insertion/change/removal

The following impact is applicable for UE triggered Service Request with I-SMF insertion in clause 4.23.4.3:

- In step 8a, when an I-SMF is inserted, if EBI(s) have been allocated before but the SMF+PGW-C has not prepared the CN Tunnel Info for each EPS bearer, the SMF+PGW-C requests the PGW-U+UPF to allocate the CN Tunnel for each EPS bearer for PDU Session(s). PGW-U+UPF allocates the PGW-U tunnel info for the EPS bearer and sends it to the SMF+PGW-C.
- In step 8c, the SMF+PGW-C provides also CN Tunnel Info for each EPS bearer to the I-SMF.

NOTE: The CN Tunnel Info for each EPS bearer provided to the I-SMF is to prepare for UE mobility to EPC network so that the I-SMF does not need interact with the SMF+PGW-C to get the EPS bearer context(s) at mobility to EPC.

##### 4.23.12.8.3 PDU Session establishment procedure

The following impact is applicable for PDU Session establishment in clause 4.23.5.1:

- If I-SMF is involved in the PDU Session establishment, after EBI has been successfully allocated, the SMF+PGW-C also prepares CN tunnel info for each EPS bearer and provides it to the I-SMF, see clause 4.23.12.4.

##### 4.23.12.8.4 PDU Session modification procedure

The following impact is applicable for PDU Session modification in clause 4.23.5.3:

- If I-SMF is involved in the PDU Session modification, if EBI needs to be allocated and the allocation is successful, the SMF+PGW-C also prepares CN tunnel info for each EPS bearer and provides it to the I-SMF, see clause 4.23.12.4.

##### 4.23.12.8.5 Inter NG-RAN node N2 based handover with I-SMF insertion/change/removal

The following impact is applicable for Inter NG-RAN node N2 based handover with I-SMF insertion in clause 4.23.7.3.2:

- In step 7c, at I-SMF insertion, if EBI(s) have been allocated before but the SMF+PGW-C has not prepared the CN Tunnel Info for each EPS bearer, the SMF+PGW-C requests the PGW-U+UPF to allocate the CN Tunnel for each EPS bearer for PDU Session(s). PGW-U+UPF allocates the PGW-U tunnel info for the EPS bearer and sends it to the SMF+PGW-C.

- In step 7f, the SMF+PGW-C provides also the CN Tunnel Info for each EPS bearer to the I-SMF.

#### 4.23.12.8.6 Xn based handover with insertion of I-SMF

The following impact is applicable Xn based handover with insertion of I-SMF in clause 4.23.11.2:

- In step 6, at I-SMF insertion, if EBI(s) have been allocated before but the SMF+PGW-C has not prepared the CN Tunnel Info for each EPS bearer, the SMF+PGW-C requests the PGW-U+UPF to allocate the CN Tunnel for each EPS bearer for PDU Session(s). PGW-U+UPF allocates the PGW-U tunnel info for the EPS bearer and sends it to the SMF+PGW-C.
- In step 9, the SMF+PGW-C provides also the CN Tunnel Info for each EPS bearer to the I-SMF.

### 4.23.13 Non N26 based Interworking Procedures with I-SMF

#### 4.23.13.1 General

When UE moves a PDU Session from EPS to 5GS, the AMF determines whether I-SMF needs to be inserted based on the UE location and the service area of the SMF+PGW-C.

This clause describes the non N26 based Interworking Procedures with I-SMF insertion when UE move a PDU Session from EPS to 5GS and I-SMF removal when UE moves a PDU Session from 5GS to EPS.

This may happen e.g. when the UE moves a PDU Session between an ePDG (over EPC) and 3GPP access over 5GC;

#### 4.23.13.2 Mobility procedure without N26 interface from EPS to 5GS

At Mobility procedure from EPS to 5GS without N26 interface the procedure described in Figure 4.11.2.3-1 takes place, with following difference:

- During step 9 of Figure 4.11.2.3-1 "UE requested PDU Session Establishment according to clause 4.3.2.2", the mechanisms described in clause 4.23.5.1 apply

#### 4.23.13.3 Mobility procedure without N26 interface from EPC/ePDG to 5GS

At Handover from EPC/ePDG to 5GS, the procedure described in Figure 4.11.4.1-1 takes place, with following difference:

- During step 2 of Figure 4.11.4.1-1 "UE requested PDU Session Establishment according to clause 4.3.2.2", the mechanisms described in clause 4.23.5.1 apply

#### 4.23.13.4 Mobility procedure without N26 interface from 5GS to EPS

At Mobility procedure from 5GS to EPS without N26 interface, the procedure described in Figure 4.11.2.2-1 takes place, with following difference:

- During step 14 of Figure 4.11.2.2-1 (SMF+PGW-C initiates release of the PDU Session(s) in 5GS transferred to EPS), if an I-SMF was involved in the PDU Session, the same mechanisms than in Home Routed roaming apply (release according to Figure 4.3.4.3-1) with the SMF playing the role of the H-SMF and the I-SMF playing the role of the V-SMF.

#### 4.23.13.5 Mobility procedure without N26 interface from 5GS to EPC/ePDG

At Handover from 5GS to EPC/ePDG, the procedure described in Figure 4.11.4.2-1 takes place, with following difference:

- During step 3 of Figure 4.11.4.2-1 (5GC and NG-RAN resource release), if an I-SMF was involved in the PDU Session, the same mechanisms than in Home Routed roaming apply (Figure 4.3.4.3-1 steps 3a-16b) with the SMF playing the role of the H-SMF and the I-SMF playing the role of the V-SMF.

#### 4.23.14 Pause of charging

When I-SMF is involved for a PDU Session, the procedure for pause of charging in home routed roaming case defined in clause 4.4.4 is applied by replacing the H-SMF with SMF and V-SMF with I-SMF.

When a Local UPF (PSA) is involved, the SMF stops or starts the usage reporting including usage reporting at the Local UPF (PSA) via the I-SMF.

For a PDU Session, if charging has been paused previously, in addition to the conditions for stopping pause of charging as described in clause 4.4.4, the charging is unpaused in the following case:

- When the SMF receives Nsmf\_PDUSession\_Create Request from a new I-SMF or Nsmf\_PDUSession\_CreateSMContext request from AMF.

#### 4.23.15 PDU Session mobility between 3GPP and non-3GPP access

In this Release of the specification, deployments topologies with specific SMF Service Areas apply only for 3GPP access.

At PDU Session mobility from 3GPP to non-3GPP access, an I-SMF may need to be removed because an I-SMF had been inserted when the PDU Session was served over 3GPP access.

At PDU Session mobility from non-3GPP to 3GPP access, an I-SMF may need to be inserted because the TA associated with the UE location over 3GPP requires the AMF to insert an I-SMF.

#### 4.23.16 Handover of a PDU Session procedure between 3GPP and untrusted non-3GPP access

##### 4.23.16.1 Handover of a PDU Session procedure from untrusted non-3GPP to 3GPP access (non-roaming and roaming with local breakout)

The following impacts are applicable to clause 4.9.2.1 when a PDU Session is handover from untrusted non-3GPP to 3GPP access (non-roaming and roaming with local breakout):

- Step2: The UE performs a PDU Session Establishment procedure with the PDU Session ID of the PDU Session to be moved as specified clause 4.23.5.1 and an I-SMF and an I-UPF may be selected and inserted for this PDU. If I-SMF is selected, in the Nsmf\_PDUSession\_Create Response the SMF shall include all QoS information for the QoS Flow(s) applicable to the PDU Session for the target access so that when sending the PDU Session Establishment Accept, within the N1 SM container and in the N2 SM information, the I-SMF can include all QoS information (e.g. QoS Rule(s) in N1 SM container, QFI(s) and QoS Profile(s) in N2 SM information) for the QoS Flow(s).

##### 4.23.16.2 Handover of a PDU Session procedure from 3GPP to untrusted non-3GPP access (non-roaming and roaming with local breakout)

When a PDU Session is handover from 3GPP access with an I-SMF to untrusted non-3GPP access (non-roaming and roaming with local breakout), following steps take place:

- 1) step 1 of clause 4.9.2.2;
- 2) step 2 of clause 4.9.2.2;
- 3) the step 3 in clause 4.9.2.4.2 is executed involving I-SMF instead of V-SMF, with following differences:
  - Figure 4.3.4.3-1 step 14 involving I-SMF instead of V-SMF;
  - Figure 4.3.4.3-1 step 16a: The SMF invokes Nsmf\_PDUSession\_StatusNotify (Release) indicating the release is due to a PDU Session Handover out of the I-SMF;



- Figure 4.3.4.3-1 step 16b: the I-SMF invoke the Nsmf\_PDUSession\_SMContextStatusNotify (Release) indicating the Release is due to a PDU Session Handover out of the I-SMF: the AMF determines that only the SMcontext with the I-SMF is to be released but that the PDU Session is not released.

The steps 2 to 3 above shall be repeated for all PDU Sessions to be moved from 3GPP access to untrusted non-3GPP access.

### 4.23.16.3 Handover of a PDU Session procedure from untrusted non-3GPP to 3GPP access (home routed roaming)

#### 4.23.16.3.1 The target AMF is in the PLMN of the N3IWF

The following impacts are applicable to clause 4.9.2.3.1 when a PDU Session is handover from untrusted non-3GPP to 3GPP access (home routed roaming) and target AMF is in the PLMN of the N3IWF:

- Step2: The UE performs a PDU Session Establishment procedure with the PDU Session ID of the PDU Session to be moved as specified clause 4.23.5.1. A different V-SMF and a different V-UPF may be selected for the PDU Session.

If a new V-SMF is selected, in the Nsmf\_PDUSession\_Create Response the H-SMF shall include all QoS information for the QoS Flow(s) applicable to the PDU Session for the target access so that when sending the PDU Session Establishment Accept, within the N1 SM container and in the N2 SM information, the V-SMF can include all QoS information (e.g. QoS Rule(s) in N1 SM container, QFI(s) and QoS Profile(s) in N2 SM information) for the QoS Flow(s) acceptable according to VPLMN policies.

- (additional) Step 4: If a new V-SMF and a new V-UPF are selected for the PDU Session, the step 3a and 14 in clause 4.3.4.3 are performed to release the resource in the old V-SMF and old V-UPF.

The steps 2 to 4 shall be repeated for all PDU Sessions to be moved from to untrusted non-3GPP access to 3GPP access.

### 4.23.16a Handover of a PDU Session procedure between 3GPP and trusted non-3GPP access

#### 4.23.16a.1 General

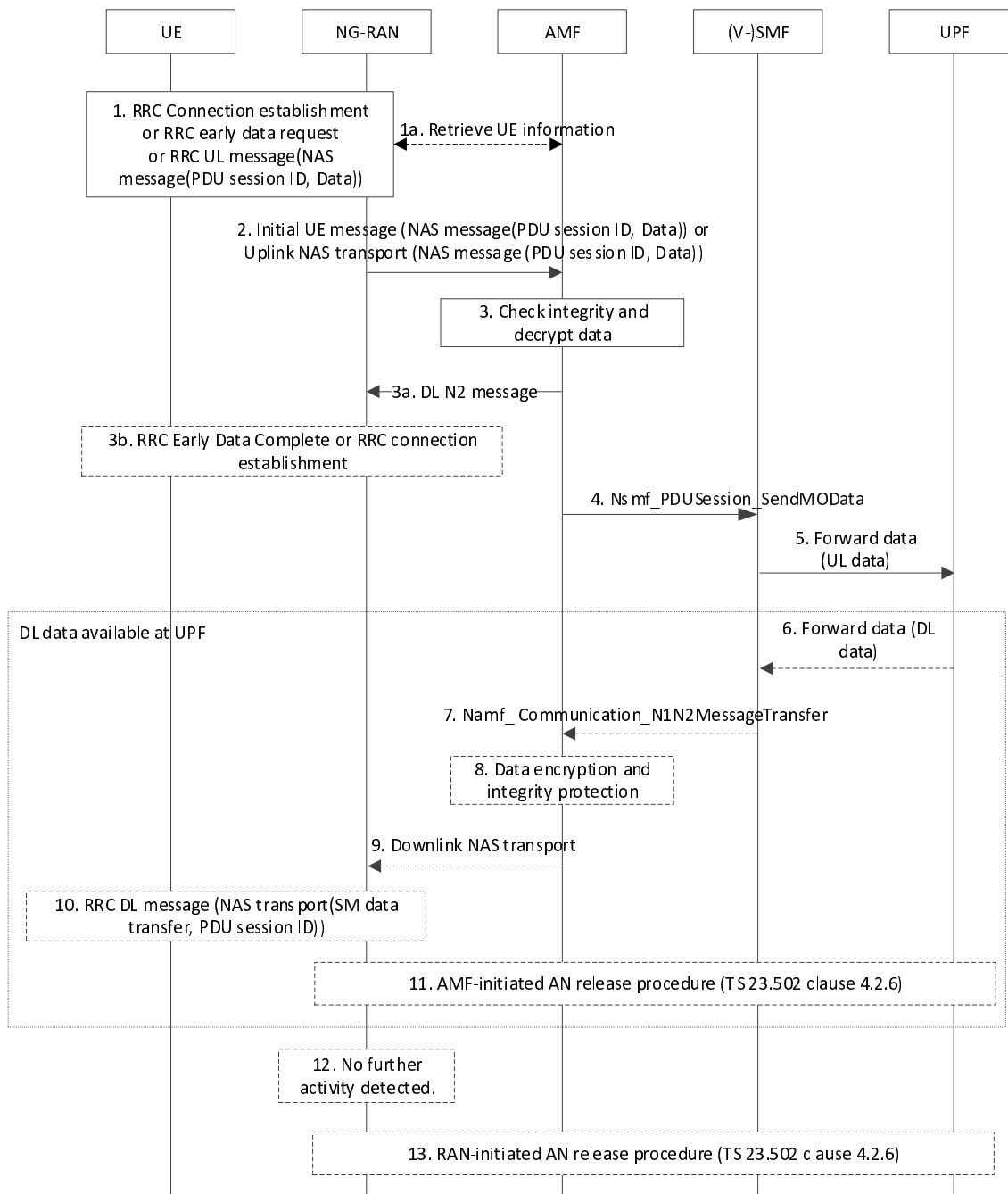
The handover of a PDU Session between 3GPP access and trusted non-3GPP access shall be supported as specified in clause 4.23.16 for all types of handover of a PDU Session between 3GPP access and untrusted non-3GPP access, with the following modifications and clarifications:

- The untrusted non-3GPP access is substituted by a trusted non-3GPP access point (TNAP).
- The N3IWF is substituted by the TNGF.
- The reference to clause 4.9.2 is substituted by clause 4.9.3 specifying handover of a PDU Session procedure between 3GPP and trusted non-3GPP access.

## 4.24 Procedures for UPF Anchored Data Transport in Control Plane Clot 5GS Optimisation

### 4.24.1 UPF anchored Mobile Originated Data Transport in Control Plane Clot 5GS Optimisation

This clause describes the procedures for Mobile Originated Transport in Control Plane Clot 5GS Optimisation where the PDU Session is terminated at a UPF.



**Figure 4.24.1-1: UPF anchored Mobile Originated Data Transport in Control Plane Clot 5GS Optimisation**

1. If the UE is CM-CONNECTED it sends a NAS message carrying the ciphered PDU session ID and ciphered uplink data as payload. If the UE is in CM-IDLE, the UE first establishes an RRC connection or sends the RRCEarlyDataRequest message and sends a NAS message as part of this.

The UE may also send NAS Release Assistance Information (NAS RAI) included in the NAS message. NAS RAI indicates that no further Uplink and Downlink Data transmissions are expected, or that only a single Downlink data transmission (e.g. Acknowledgement or response to Uplink data) subsequent to this Uplink Data transmission is expected.

- 1a. In the NB-IoT case, during step 1 the NG-RAN, based on configuration, may retrieve the NB-IoT UE Priority and the Expected UE Behaviour Parameters from the AMF, if not previously retrieved. Based on such parameters, the NG-RAN may apply prioritisation between requests from different UEs before triggering step 2 and throughout the RRC connection. The NG-RAN may retrieve additional parameters (e.g. UE Radio Capabilities).

2. NG-RAN forwards the NAS message to the AMF using the Initial NAS message procedure (if the UE was in CM-IDLE before step 1) or using the Uplink NAS transport procedure (if the UE was in CM-CONNECTED before step 1). If RRCEarlyDataRequest message was received in step 1, the NG-RAN includes "EDT Session" indication in the N2 Initial UE message.

The RAI signalled by MAC based on the Buffer Status Report (BSR), see TS 36.321 [56], shall not be used when using Control Plane CIoT 5GS Optimisations.

3. AMF checks the integrity of the incoming NAS message and deciphers the PDU session ID and uplink data.

If a NAS RAI is received from the UE and it conflicts with the Expected UE Behaviour, the NAS RAI takes precedence.

- 3a. If the AMF received "EDT Session" indication from the NG-RAN in step 2, the AMF sends an N2 message to the NG-RAN.

- a) In the case of NAS RAI with Uplink data and it indicated that Downlink data was not expected and the AMF does not expect any other signalling with the UE, the AMF shall

- either send a NAS service accept in the N2 Downlink NAS Transport message and include End Indication to indicate that no further data or signalling is expected with the UE; or
- alternatively, the AMF sends an N2 Connection Establishment Indication message including End Indication to indicate that no further data or signalling is expected with the UE.

- b) If the AMF determines more data or signalling may be pending, the AMF sends an N2 Downlink NAS Transport message or Initial Context Setup Request message without End Indication.

- 3b. If 3a was executed, the NG-RAN completes the RRC early data procedure as follows.

- a) For the case of 3a.a) the NG-RAN proceeds with RRCEarlyDataComplete message. The procedure is completed in step 5.

- b) For the case of 3a.b) the NG-RAN proceeds with RRC connection establishment procedure. In that case, all steps up to step 13 apply.

4. AMF determines the (V-)SMF handling the PDU session based on the PDU session ID contained in the NAS message and passes the PDU Session ID and the data to the (V-)SMF by invoking Nsmf\_PDUSession\_SendMOData service operation.

If NG-RAN forwarded the NAS message to the AMF using the Initial NAS message procedure in step 2 and the UE is accessing via NB-IoT RAT then the AMF may inform the (H-)SMFs whether the RRC establishment cause is set to "MO exception data", as described in clause 5.31.14.3 of TS 23.501 [2]. The AMF may immediately send the MO Exception Data Counter to the (H-)SMF.

If no Downlink Data is expected based on the NAS RAI from the UE in step 1 and if the AMF is not aware of pending MT traffic, then AMF does not wait for step 7 and continues with step 12.

5. The (V-)SMF decompresses the header if header compression applies to the PDU session and forwards the data to the UPF.

The UPF forwards the data to the DN based on data forwarding rule, e.g. in the case of unstructured data, tunnelling may be applied according to clause 5.6.10.3 of TS 23.501 [2].

6. [Conditional] In the non-roaming and LBO case, the UPF forwards available downlink data to the (V-)SMF, in the home-routed roaming case, the H-UPF forwards the data to the V-UPF then to the V-SMF.

7. [Conditional] The (V-)SMF compresses the header if header compression applies to the PDU session. The (V-)SMF forwards the downlink data and the PDU session ID to the AMF using the Namf\_Communication\_N1N2MessageTransfer service operation.

8. [Conditional] The AMF creates a DL NAS transport message with the PDU session ID and the downlink data. The AMF ciphers and integrity protects the NAS transport message

9. [Conditional] The AMF sends the DL NAS transport message to NG-RAN. If NAS RAI indicated for single uplink and single downlink packets (e.g. acknowledgment expected) and AMF has determined the data

transmission is for single uplink and single downlink packets, the AMF includes an End Indication in the DL NAS transport message to indicate that no further data or signalling is expected with the UE.

10. [Conditional] NG-RAN delivers the NAS payload over RRC to the UE.
11. If no further data or signalling is pending and AMF received NAS RAI indicating single downlink data transmission, then AMF triggers the AN release procedure (clause 4.2.6) and the procedure stops after this step.
12. [Conditional] If no further activity is detected by NG-RAN, then NG-RAN triggers the AN release procedure.
13. [Conditional] The UE's logical NG-AP signalling connection and RRC signalling connection are released according to clause 4.2.6.

NOTE: The details of the NGAP messages to be used for this procedure are specified in TS 38.413 [10].

#### 4.24.2 UPF anchored Mobile Terminated Data Transport in Control Plane CIoT 5GS Optimisation

This clause describes the procedures for Mobile Terminated Data Transport in Control Plane CIoT 5GS Optimisation where the PDU Session is terminated at a UPF.

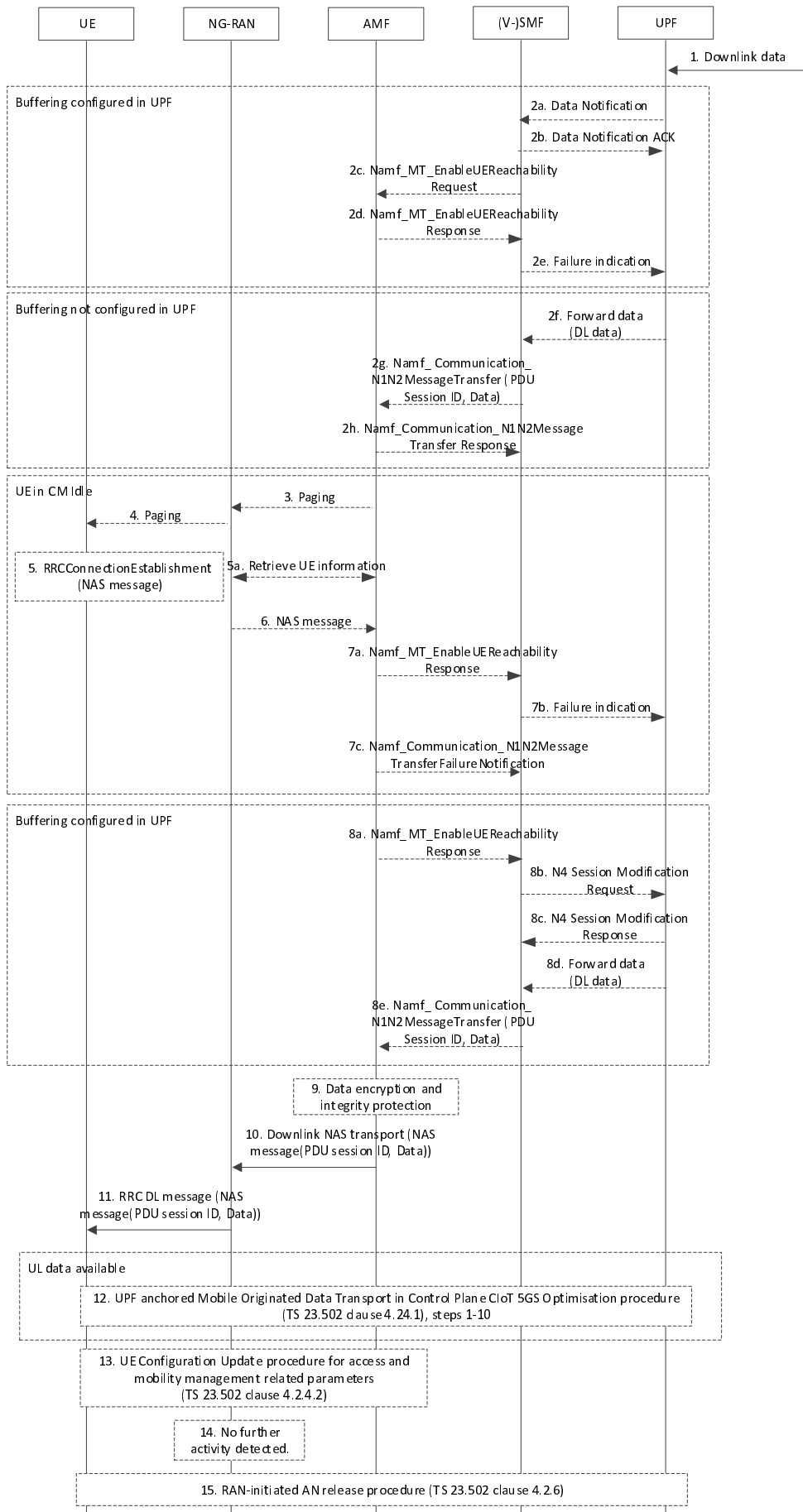


Figure 4.24.2-1: Mobile Terminated Data Transport in Control Plane CIoT 5GS Optimisation

1. Downlink data is received by the UPF. If buffering is configured in the UPF, then the flow continues in step 2a, otherwise the flow continues in step 2f.
- 2a. [conditional] If this is the first downlink packet to be buffered and SMF has instructed the UPF to report the arrival of first downlink packet to be buffered, then the UPF sends a Data Notification to the SMF.
- 2b. [conditional] The SMF sends a Data Notification ACK to the UPF.
- 2c. [conditional] The SMF sends a Namf\_MT\_EnableUEReachability request to the AMF.

The SMF determines whether Extended Buffering applies based on local policy and the capability of the UPF. If Extended Buffering applies, the SMF includes "Extended Buffering support" indication in Namf\_MT\_EnableUEReachability request.

- 2d. [conditional] If AMF determines the UE is unreachable (e.g. if the UE is in MICO mode or the UE is configured for extended idle mode DRX), then the AMF rejects the request from the SMF with an indication that the UE is not reachable. If the SMF included Extended Buffering support indication, the AMF indicates the Estimated Maximum Wait time in the response message. If the UE is in MICO mode, the AMF determines the Estimated Maximum Wait time based on the next expected periodic registration timer update expiration or by implementation. If the UE is configured for extended idle mode DRX, the AMF determines the Estimated Maximum Wait time based on the start of next PagingTime Window. The AMF stores an indication that the SMF has been informed that the UE is unreachable.
- 2e. [conditional] If the SMF receives an "Estimated Maximum Wait time" from the AMF and Extended buffering applies, the SMF sends a failure indication to the UPF with an Extended Buffering time and optionally a DL Buffering Suggested Packet Count. The Extended Buffering time is determined by the SMF and should be larger or equal to the Estimated Maximum Wait time received from the AMF. The DL Buffering Suggested Packet Count parameter is determined by the SMF and, if available, the Suggested Number of Downlink Packets parameter may be considered. The procedure stops after this step.
- 2f. [conditional] If buffering is not configured in the UPF, then the UPF forwards the downlink data to the (V-)SMF in non-roaming and LBO cases. In the home-routed roaming case, the H-UPF forwards the data to the V-UPF and then to the V-SMF.
- 2g. [conditional] The SMF determines whether Extended Buffering applies based on local policy and the capability of the SMF.

If user data is received in step 2f and Extended buffering is not configured for the SMF, then (V-)SMF compresses the header if header compression applies to the PDU session and creates the downlink user data PDU that is intended as payload in a NAS message. The (V-)SMF forwards the downlink user data PDU and the PDU session ID to the AMF using the Namf\_Communication\_N1N2MessageTransfer service operation. If Extended Buffering applies, then (V-)SMF keeps a copy of the downlink data.

If user data is received in step 2f and Extended Buffering applies, the SMF includes "Extended Buffering support" indication in Namf\_Communication\_N1N2Message Transfer.

- 2h. [conditional] AMF responds to SMF.

If AMF determines that the UE is reachable for the SMF, then the AMF informs the SMF. Based on this, the SMF deletes the copy of the downlink data.

If AMF determines the UE is unreachable for the SMF (e.g. if the UE is in MICO mode or the UE is configured for extended idle mode DRX), then the AMF rejects the request from the SMF. The AMF may include in the reject message an indication that the SMF need not trigger the Namf\_Communication\_N1N2MessageTransfer Request to the AMF, if the SMF has not subscribed to the event of the UE reachability.

If the SMF included Extended Buffering support indication, the AMF indicates the Estimated Maximum Wait time, in the reject message, for the SMF to determine the Extended Buffering time. If the UE is in MICO mode, the AMF determines the Estimated Maximum Wait time based on the next expected periodic registration timer update expiration or by implementation. If the UE is configured for extended idle mode DRX, the AMF determines the Estimated Maximum Wait time based on the start of next PagingTime Window. The AMF stores an indication that the SMF has been informed that the UE is unreachable.

If the SMF receives an "Estimated Maximum Wait time" from the AMF and Extended Buffering in SMF applies, the SMF store the DL Data for the Extended Buffering time. The Extended Buffering time is determined

by the SMF and should be larger or equal to the Estimated Maximum Wait time received from the AMF. The SMF does not send any additional Namf\_Communication\_N1N2MessageTransfer message if subsequent downlink data packets are received.

3. [Conditional] If the UE is in CM Idle, the AMF sends a paging message to NG-RAN. If available, the AMF may include the WUS Assistance Information in the N2 Paging message(s).
4. [Conditional] If NG-RAN received a paging message from AMF and UE and NG-RAN support WUS, then:
  - if the NGAP Paging message contains the *Assistance Data for Recommended Cells* IE (see TS 38.413 [10]), then NG-RAN shall only broadcast the UE's Wake Up Signal in the last used cell;
  - else (i.e. the *Assistance Data for Recommended Cells* IE is not included in the NGAP Paging message) NG-RAN should not broadcast the UE's Wake Up Signal.

NG-RAN performs paging. If the WUS Assistance Information is included in the N2 Paging message, the NG-eNB takes it into account when paging the UE (see TS 36.300 [46]).

5. [Conditional] If the UE receives paging message, it responds with a NAS message sent over RRC Connection Establishment.
- 5a. [Conditional] In the NB-IoT case, during Step 5, the NG-RAN, based on configuration, may retrieve the NB-IoT UE Priority and the Expected UE Behaviour Parameters from the AMF, if not previously retrieved. Based on such parameters, the NG-RAN may apply prioritisation between requests from different UEs before triggering step 6 and throughout the RRC connection. The NG-RAN may retrieve additional parameters (e.g. UE Radio Capabilities).
6. [Conditional] The NAS message is forwarded to the AMF.
- 7a. [Conditional] AMF to SMF: Namf\_MT-EnableUERachability Response.

If the SMF used the MT\_EnableUERachability request in step 2c and the UE has not responded to paging then the AMF sends a response to the SMF indicating that the request failed.
- 7b. [Conditional] SMF to UPF: If the SMF has received a Namf\_MT-EnableUERachability response from the AMF indicating that the request failed, the SMF indicates to the UPF to discard the buffered data and the procedure stops after this step.
- 7c. [Conditional] AMF to SMF: Namf\_Communication\_N1N2Transfer Failure Notification.

If the SMF used the Namf\_Communication\_N1N2MessageTransfer service operation in step 2g and the UE has not responded to paging, the AMF sends a failure notification to the SMF based on which the SMF discards the buffered data. The procedure stops after this step.
- 8a. [Conditional] AMF to SMF: Namf\_MT-EnableUERachability Response.

If the SMF used the MT\_EnableUERachability request in step 2c, then the AMF indicates to the SMF that the UE is reachable.
- 8b. [Conditional] SMF to UPF: N4 Session Modification Request.

If the SMF received an indication from the AMF that the UE is reachable, then the SMF indicates to the UPF to deliver buffered data to the SMF.
- 8c. [Conditional] UPF to SMF: N4 Session Modification Response.
- 8d. [Conditional] Buffered data is delivered to the SMF.
- 8e. [Conditional] (V-)SMF compresses the header if header compression applies to the PDU session and creates the downlink user data PDU that is intended as payload in a NAS message. The (V-)SMF forwards the downlink user data PDU and the PDU session ID to the AMF using the Namf\_Communication\_N1N2MessageTransfer service operation.
9. The AMF creates a DL NAS transport message with the PDU session ID and the downlink user data PDU received from the SMF. The AMF ciphers and integrity protects the NAS transport message.

10. The AMF sends the DL NAS transport message to NG-RAN.
11. NG-RAN delivers the NAS payload over RRC to the UE.
12. While the RRC connection is established further uplink and downlink data can be exchanged. In order to send uplink data, the procedure continues as per steps 1-10 of the UPF anchored Mobile Originated Data Transport in Control Plane CIoT 5GS Optimisation procedure (clause 4.24.1).
13. If the AMF has paged the UE to trigger the NAS procedure as in step 3-6, the AMF shall initiate the UE configuration update procedure as defined in clause 4.2.4.2 to assign a new 5G-GUTI.
14. [Conditional] If no further activity is detected by NG-RAN, then NG-RAN triggers the AN release procedure.
15. [Conditional] The UE's logical NG-AP signalling connection and RRC signalling connection are released according to clause 4.2.6.

NOTE: The details of the NGAP messages to be used for this procedure are specified in TS 38.413 [10].

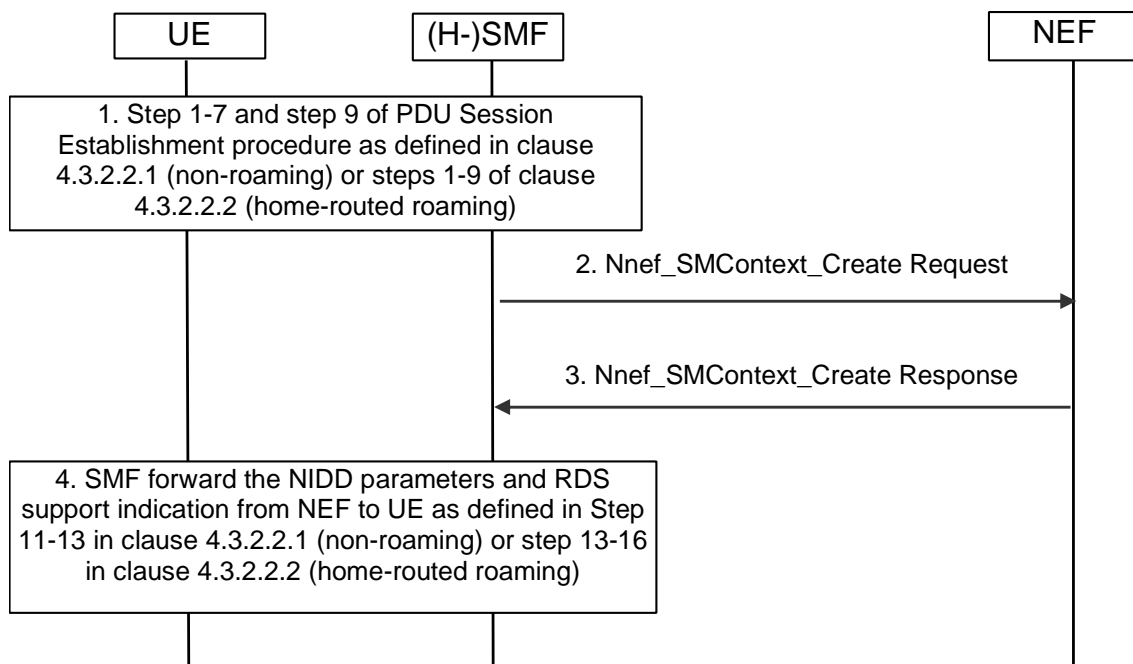
## 4.25 Procedures for NEF based Non-IP Data Delivery

### 4.25.1 General

Non-IP Data Delivery (NIDD) it is a means for delivering data via a PDU Sessions of type "Unstructured". The subsequent clauses describe the procedures necessary to support NEF based NIDD.

### 4.25.2 SMF-NEF Connection Establishment

When the UE performs the PDU Session establishment with PDU Session type of "Unstructured" and the subscription information corresponding to the UE requested DNN includes the "NEF Identity for NIDD" (NEF ID), then the SMF initiates a SMF-NEF Connection establishment procedure towards the NEF corresponding to the "NEF ID" for that DNN / S-NSSAI Combination.



**Figure 4.25.2-1: SMF-NEF Connection procedure**

1. Steps 1-7 and step 9 of clause 4.3.2.2.1 for UE-requested PDU Session Establishment Procedure for non-roaming scenarios or steps 1-9 of clause 4.3.2.2.2 for UE-requested PDU Session Establishment Procedure for



home-routed roaming scenarios. The (H-)SMF receives the Session Management Subscription data for the corresponding SUPI, DNN and S-NSSAI that is associated with NEF Identity for NIDD and NIDD information such GPSI and AF ID.

2. If the subscription information corresponding to DNN and S-NSSAI includes the "NEF Identity for NIDD" (NEF ID), the SMF shall create a PDU session towards the NEF. The SMF invokes Nnef\_SMContext\_Create Request (User Identity, PDU Session ID, SMF ID, NIDD information, S-NSSAI, DNN, [RDS support indication], [Small Data Rate Control parameters], [Small Data Rate Control Status], [Serving PLMN Rate Control parameters]) message towards the NEF. The RDS support indication is included if the UE capability to support Reliable Data Service (RDS) is included in the PCO in the PDU Session Establishment Request message. The SMF provides Small Data Rate Control parameters to the NEF for PDU Session, if required. The SMF provides the Small Data Rate Control Status to the NEF, if received from the AMF. If the Serving PLMN intends to enforce Serving PLMN Rate Control (see clause 5.31.14.2 of TS 23.501 [2]) for this PDU session then the SMF shall provide Serving PLMN Rate Control parameters to NEF for limiting the rate of downlink control plane data packets.

If no AF has previously performed the NIDD Configuration procedure with the NEF for the User Identity received in step 2, then the NEF initiates the NIDD Configuration procedure (see clause 4.25.3) before step 3.

3. The NEF creates an NEF PDU session Context and associates it with User Identity and PDU session ID. The NEF invokes Nnef\_SMContext\_Create Response (Cause, [RDS support indication], [Extended Buffering Support indication], [NIDD parameters]) towards the SMF confirming establishment of the PDU session to the NEF for the UE. If NEF supports and allows use of RDS, it includes the RDS support indication to SMF and the SMF includes it in the PCO. If NEF supports Extended Buffering, NEF includes Extended Buffering Support indication in the response and subscribes for mobility-related events with the AMF to receive an indication when the UE becomes reachable. The NIDD parameters (e.g. maximum packet size) are sent to the SMF, if available.
4. Steps 11-13 of clause 4.3.2.2.1 for UE-requested PDU Session Establishment Procedure for non-roaming scenarios or steps 13-16 of clause 4.3.2.2.2 for UE requested PDU Session Establishment Procedure for home-routed roaming scenarios.

### 4.25.3 NIDD Configuration

Figure 4.25.3-1 illustrates the procedure for configuring necessary information for data delivery via the NIDD API.

The NIDD Configuration procedure can be NEF initiated or AF triggered: in the former case the procedure starts at step 1, in the latter case it starts at step 2.

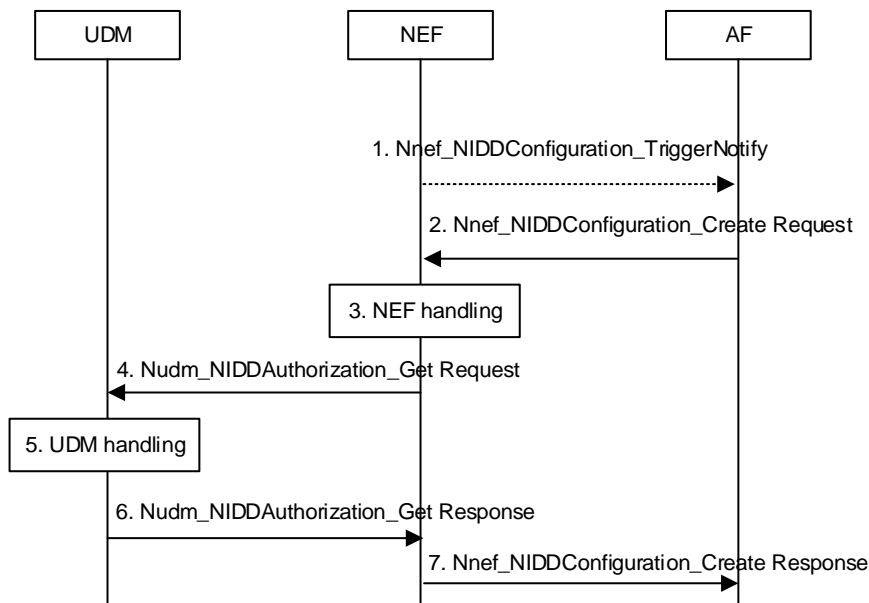


Figure 4.25.3-1: NIDD Configuration procedure

1. [Optional] If the NEF requires a NIDD configuration with a given AF, then the NEF sends a Nnef\_NIDDConfiguration\_TriggerNotify (GPSI, AF ID, NEF ID) message to the AF for asking the Nnef\_NIDDConfiguration\_Create Request for the UE identified by the GPSI.
2. The AF sends a Nnef\_NIDDConfiguration\_Create Request message (GPSI or External Group Identifier, AF ID, NIDD Duration, T8 Destination Address, Requested Action, TLTRI, Reliable Data Service Configuration, MTC Provider Information) to the NEF.

Reliable Data Service Configuration is an optional parameter that is used to configure the Reliable Data Service (as defined in clause 5.31.6 of TS 23.501 [2]) including port numbers for originator application(s) and receiver application(s). TLTRI is included in the request if the Requested Action is set to "Update" or "Cancel", otherwise TLTRI is not included in the request and the NEF assigns a TLTRI to the NIDD Configuration.

NOTE 1: It is up to the AF to determine whether and if NIDD Duration can be set to never expire.

NOTE 2: The AF is expected to be configured to use the same NEF as the one selected by the SMF during the UE's establishment of the PDU Session used for NEF based NIDD.

NOTE 3: When more than one AF is associated with a PDU Session, the parameters that are provided in step 2 can be provisioned in the NEF based on operator policy or configuration. In which case, any parameters that are provided in step 2 that conflict with the provisioned values are ignored.

3. If the Requested Action is set to "Cancel" it indicates that the purpose of the request is to cancel the transaction identified by TLTRI and the flow proceeds to step 7. If the Requested Action is set to "Update", the purpose of the transaction is to update the parameters associated with the configuration (i.e. Reliable Data Service). Otherwise, the request is for a new NIDD configuration and the NEF stores the received GPSI or External Group Identifier, AF ID, T8 Destination Address and NIDD Duration. If either the AF is not authorised to perform this request (e.g. based on policies, if the SLA does not allow for it) or the Nnef\_NIDDConfiguration\_Create Request is malformed, the NEF performs step 7 and provides a Cause value appropriately indicating the error. Depending on the configuration, the NEF may change the NIDD Duration.
4. The NEF sends an Nudm\_NIDDAuthorisation\_Get Request (GPSI or External Group Identifier, S-NSSAI, DNN, AF ID, MTC Provider Information, NIDD Duration, Update Notification Address) message to the UDM to authorise the NIDD configuration request for the received External Group Identifier or GPSI.

NOTE 4: The NEF uses the AF ID, External Group Identifier or GPSI that was obtained in step 2 to determine what DNN will be used to enable transfer of unstructured data between the UE and the AF. This determination is based on local policies.

NOTE 5: The MTC Provider Information in step 2 is an optional parameter. The NEF should validate the provided MTC Provider Information and may override it to a NEF selected MTC Provider Information based on configuration. How the NEF determines the MTC Provider Information, if not present in step 2, is left to implementation (e.g. based on the requesting AF).

5. The UDM examines the Nudm\_NIDDAuthorisation\_Get Request message.

If the authorisation is successful and if an External Group Identifier was included in step 4, the UDM maps the External Group Identifier to an Internal-Group Identifier and a list of GPSIs and maps GPSIs to SUPIs.

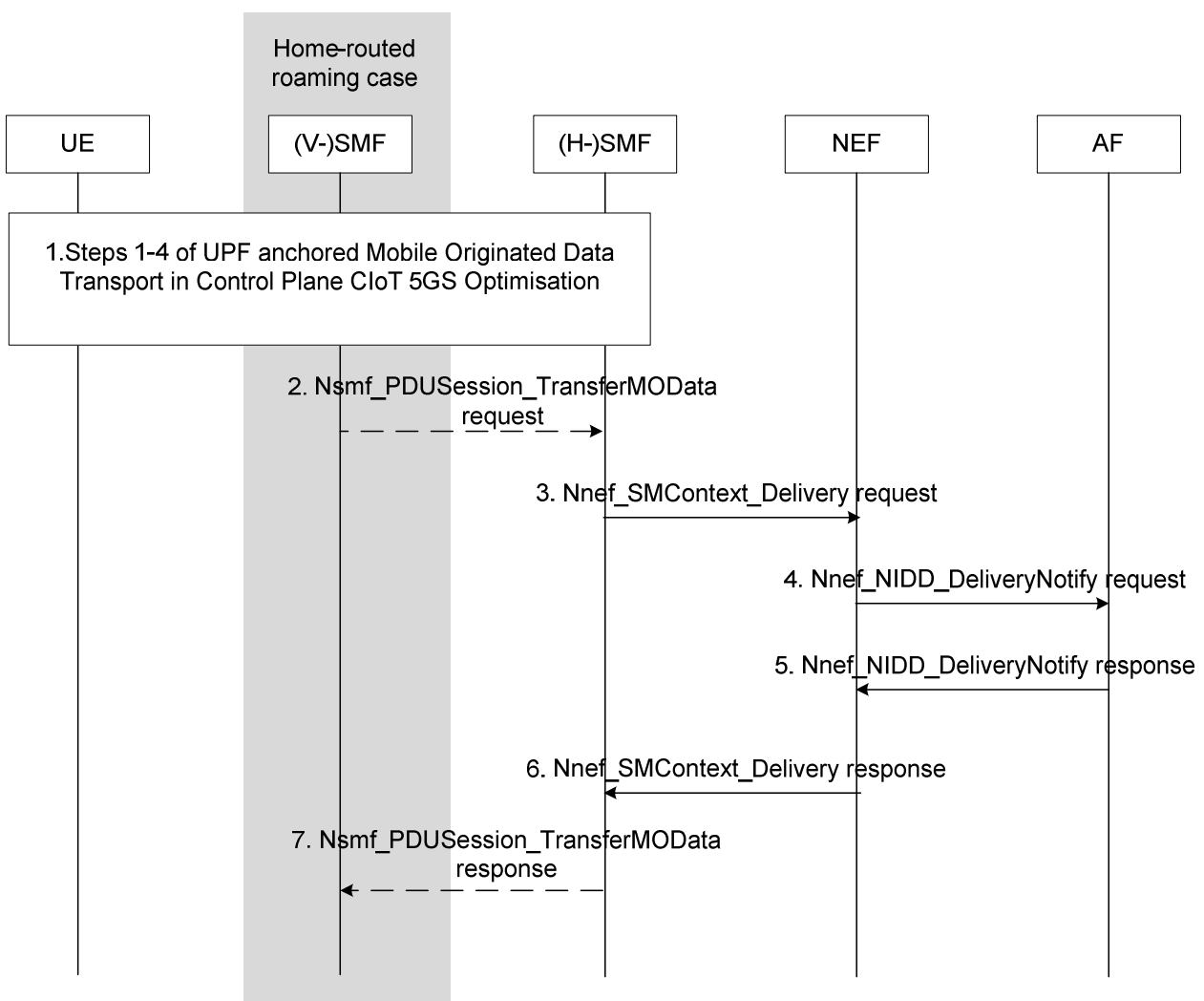
NOTE 6: If External Group Identifier was included in step 4, how the UDM selects a GPSI when multiple GPSIs are associated with the same SUPI is left to implementation, e.g. based on the MTC Provider Information (if received) or the default GPSI (if not received).

6. The UDM sends an Nudm\_NIDDAuthorisation\_Get Response (single value or list of (SUPI and GPSI), Result) message to the NEF to acknowledge acceptance of the Nudm\_NIDDAuthorisation\_Get Request. If the UDM determines that the list size exceeds the message capacity, the UDM shall segment the list and send it in multiple messages (for details on segmentation, see TS 29.503 [52]). The SUPI(s) and, if available, the GPSI(s) (when Nnef\_NIDDConfiguration\_Create Request contains an GPSI) are returned by the UDM in this response. This allows the NEF to correlate the AF request received in step 2 of this procedure with the SMF-NEF Connection to be established for each UE or each group member UE. Depending on the configuration (e.g. based on DNN), the UDM may change the NIDD Duration and include the updated value of the NIDD Duration in the response to the NEF.
7. The NEF sends a Nnef\_NIDDConfiguration\_Create Response (TLTRI, Maximum Packet Size, Reliable Data Service Indication and Cause) message to the AF to acknowledge acceptance of the

Nnef\_NIDDConfiguration\_Create Request. If the NIDD Configuration was accepted, the NEF assigns a TLTRI to the NIDD Configuration and sends it to the AF. The NEF creates an association between the TLTRI, GPSI or External Group Identifier, SUPI and PDU session ID which is received from the SMF in step 2 of the SMF-NEF Connection procedure in clause 4.25.1. In the MT NIDD procedure, the NEF will use TLTRI and either GPSI or External Group Identifier to determine the SUPI(s) and PDU session ID(s) of PDU Session(s) for delivering unstructured data. In the MO NIDD procedure, the NEF will use the SUPI(s) and PDU session ID(s) to obtain the TLTRI, GPSI. The Reliable Data Service Indication indicates if the Reliable Data Service is enabled in the NIDD configuration. The Maximum Packet Size is the maximum NIDD packet size. The response may include an updated value of the NIDD Duration.

### 4.25.4 NEF Anchored Mobile Originated Data Transport

Figure 4.25.4-1 illustrates the NEF Anchored Mobile Originated Data Transport procedure.



**Figure 4.25.4-1: NEF Anchored Mobile Originated Data Transport procedure**

1. The UE sends a NAS message with unstructured data according to steps 1-4 of the procedure for UPF anchored Mobile Originated Data Transport in Control Plane ClIoT 5GS Optimisation (see clause 4.24.1). The Reliable Data Service header is included if the Reliable Data Service is enabled.
2. [Conditional] In the case of home-routed roaming the V-SMF sends the Nsmf\_PDUSession\_TransferMODData request to the H-SMF including MO small data.

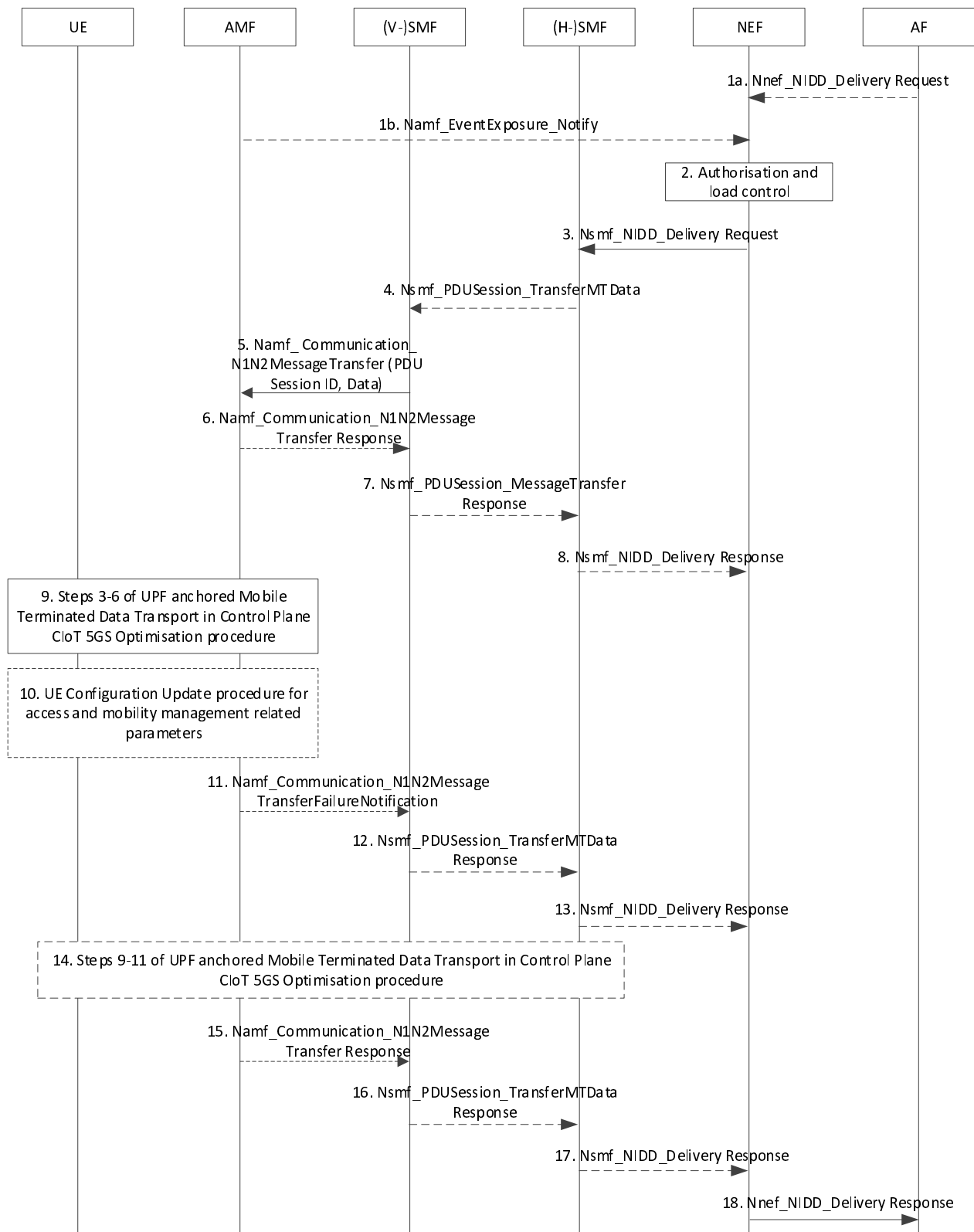
3. The (H-)SMF sends the Nnef\_SMContext\_Delivery Request (User Identity, PDU session ID, unstructured data) message to the NEF.
4. When the NEF receives the unstructured data and finds an NEF PDU Session context and the related T8 Destination Address, then it sends the unstructured data to the AF that is identified by the T8 Destination address in a Nnef\_NIDD\_DeliveryNotify Request (GPSI, unstructured data, Reliable Data Service Configuration). If no T8 Destination address is associated with the UE's PDN connection, the data is discarded, the Nnef\_NIDD\_DeliveryNotify Request is not sent and the flow continues at step 6. The Reliable Data Service Configuration is used to provide the AF with additional information such as indicate if an acknowledgement was requested and port numbers for originator application and receiver application, when the Reliable Data Service is enabled.

**Editor's note:** It is left to Stage 3 whether or not the NEF aggregates Nnef\_NIDD\_DeliveryNotify Request messages to the AF.

5. The AF responds to the NEF with a Nnef\_NIDD\_DeliveryNotify Response (Cause).
6. The NEF sends Nnef\_SMContext\_Delivery Response to the SMF. If the NEF cannot deliver the data, e.g. due to missing AF configuration, the NEF sends an appropriate error code to the SMF.
7. [Conditional] In the case of home-routed roaming, the H-SMF responds to the V-SMF with a Nsmf\_PDUSession\_TransferMOData (Result Indication) Response.

#### 4.25.5 NEF Anchored Mobile Terminated Data Transport

Figure 4.25.5-1 illustrates the procedure using which the AF sends unstructured data to a given user as identified via External Identifier or MSISDN.



**Figure 4.25.5-1: NEF Anchored Mobile Terminated Data Transport**

1a. If AF has already activated the NIDD service for a given UE and has downlink unstructured data to send to the UE, the AF sends a Nnef\_NIDD\_Delivery Request (GPSI, TLTRI, unstructured data, Reliable Data Service Configuration) message to the NEF. Reliable Data Service Configuration is an optional parameter that is used to configure the Reliable Data Service, it may be used to indicate if a Reliable Data Service acknowledgement is requested and port numbers for originator application and receiver application.

- 1b. AMF indicates to NEF that the UE has become reachable. Based on this the NEF re-starts delivering buffered unstructured data to the UE.
2. The NEF determines the 5GS QoS Flow Context based on the DNN associated with the NIDD configuration and the User Identity. If an NEF 5GS QoS Flow Context corresponding to the GPSI included in step 1 is found, then the NEF checks if the AF is authorised to send data and if it does not exceed its quota or rate. If these checks fail, then steps 3-15 are skipped and an appropriate error code is returned in step 17.
3. The NEF forwards the unstructured data to the (H-)SMF using Nsmf\_NIDD\_Delivery Request. If NEF has indicated support of Extended Buffering in Nnef\_SMContext\_Create Response during SMF-NEF connection establishment, then NEF keeps a copy of the data.
4. In the roaming case, the H-SMF sends the Nsmf\_PDUSession\_TransferMTData to the V-SMF including MT small data.
5. The (V-)SMF determines whether Extended Buffering applies based on local policy and based on whether NEF has indicated support of Extended Buffering in Nnef\_SMContext\_Create Response during SMF-NEF connection establishment. (V-)SMF compresses the header if header compression applies and forwards the data and the PDU session ID to the AMF using the Namf\_Communication\_N1N2MessageTransfer service operation. If Extended Buffering applies, then (V-SMF) includes "Extended Buffering support" indication in Namf\_Communication\_N1N2Message Transfer.
6. If AMF determines the UE is unreachable for the SMF (e.g. if the UE is in MICO mode or the UE is configured for extended idle mode DRX), then the AMF rejects the request from the SMF. The AMF may include in the reject message an indication that the SMF need not trigger the Namf\_Communication\_N1N2MessageTransfer Request to the AMF, if the SMF has not subscribed to the event of UE reachability.

If the SMF included Extended Buffering support indication, the AMF indicates the Estimated Maximum Wait time, in the reject message, for the SMF to determine the Extended Buffering time. If the UE is in MICO mode, the AMF determines the Estimated Maximum Wait time based on the next expected periodic registration timer update expiration or by implementation. If the UE is configured for extended idle mode DRX, the AMF determines the Estimated Maximum Wait time based on the start of next PagingTime Window. The AMF stores an indication that the SMF has been informed that the UE is unreachable.

7. In the roaming case V-SMF sends Nsmf\_PDUSession\_TransferMTData (Result Indication) response to H-SMF. If the V-SMF receives an "Estimated Maximum Wait time" from the AMF and Extended Buffering applies, the V-SMF also passes the "Estimated Maximum Wait time" to the H-SMF.
8. If the (H-)SMF receives a failure indication, (H-)SMF also sends a failure indication to NEF. If (H-)SMF has received the "Estimated Maximum Wait time" and Extended Buffering applies, the (H-)SMF includes Extended Buffering time in the failure indication. The Extended Buffering time is determined by the (H-)SMF and should be larger or equal to the Estimated Maximum Wait time. The NEF stores the DL data for the Extended Buffering time. The NEF does not send any additional Nsmf\_NIDD\_Delivery Request message if subsequent downlink data packets are received. The procedures stop at this step.
9. If the AMF determines the UE to be reachable in Step 5, then Steps 3 to 6 of the UPF anchored Mobile Terminated Data Transport in Control Plane CIoT 5GS Optimisation procedure (clause 4.24.2) apply.  
  
If the Reliable Data Service header indicates that the acknowledgement is requested, then the UE shall respond with an acknowledgement to the DL data that was received.
10. If the AMF has paged the UE to trigger the NAS procedure in step 9, the AMF shall initiate the UE configuration update procedure as defined in clause 4.2.4.2 to assign a new 5G-GUTI.
11. If the UE has not responded to paging, the AMF sends a failure notification to the (V-)SMF. Otherwise the procedure continues at step 13.
12. In the roaming case, if V-SMF has received a failure notification from AMF, then V-SMF sends Nsmf\_PDUSession\_TransferMTData (Result Indication) response to H-SMF.
13. If (H-)SMF receives a failure notification, then SMF indicates to the NEF that the requested Nsmf\_NIDD\_Delivery has failed. If Extended Buffering applies, then NEF purges the copy of the data. The procedure continues at step 17.

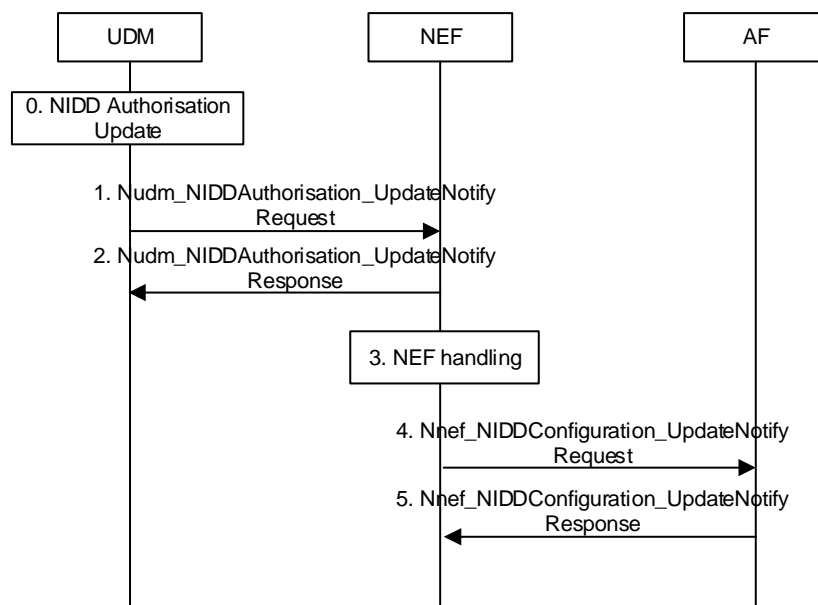
14. Steps 9 to 11 of the UPF anchored Mobile Terminated Data Transport in Control Plane CIoT 5GS Optimisation procedure (clause 4.24.2) apply.
15. AMF informs (V-)SMF that data has been forwarded.
16. In the roaming case, V-SMF sends Nsmf\_PDUSession\_TransferMTData (Result Indication) response to H-SMF that the data has been forwarded.
17. (H-)SMF indicates to NEF that the data has been forwarded. If Extended Buffering applies then NEF purges the copy of the data.
18. The NEF sends a Nnef\_NIDD\_Delivery Response (cause) to the AF.

The Reliable Data Service Acknowledgement Indication is used to indicate if an acknowledgement was received from the UE for the MT NIDD. If the Reliable Data Service was requested in step 1, then the Nnef\_NIDD\_Delivery Response is sent to the AF after the acknowledgement is received from the UE or, if no acknowledgment is received, then the Nnef\_NIDD\_Delivery Response is sent to the AF with a cause value indicating that no acknowledgement was received.

## 4.25.6 NIDD Authorization Update

Figure 4.25.6-1 illustrates the procedure for updating or revoking an existing NIDD Authorization.

The UDM may initiate the NIDD Authorization Update procedure with the NEF to send updated Authorization information to the NEF.



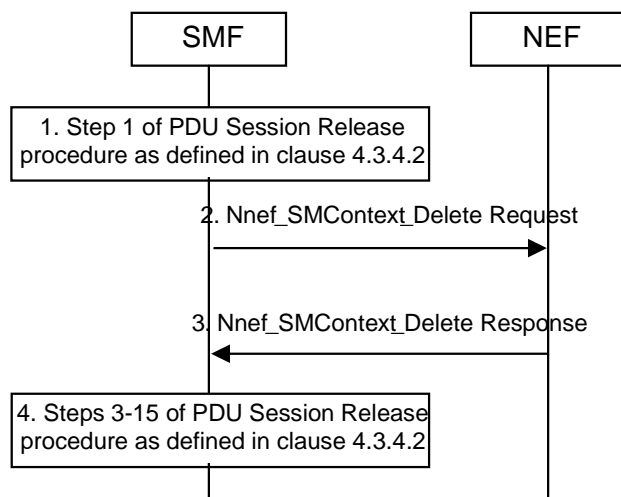
**Figure 4.25.6-1: NIDD Authorization Update procedure**

0. UDM provided a successful authorization for a NIDD configuration request as defined in clause 4.25.3. The NIDD authorization is modified in UDM (e.g. subscription withdrawal, DNN used for NIDD service is removed from the UE subscription) before expiration of the NIDD Duration previously authorized.
1. The UDM sends an NIDD Authorization Update information using Nudm\_NIDDAuthorisation\_UpdateNotify Request (SUPI, GPSI, S-NSSAI, DNN, Result, Cause, NIDD Duration) message to the NEF to update an user's NIDD authorization.
2. The NEF sends Nudm\_NIDDAuthorisation\_UpdateNotify Response message to the UDM to acknowledge the authorization update.
3. If the authorization is removed, the NEF should initiate the SMF-NEF Connection release procedure as specified in the clause 4.25.8.

4. The NEF informs the AF that the user's authorisation status has changed by sending Nnef\_NIDDConfiguration\_UpdateNotify Request (GPSI, TLTRI, Result, Cause, NIDD Duration) message to the AF to update a user's NIDD authorization.
5. The AF responds to the NEF with Nnef\_NIDDConfiguration\_UpdateNotify Response message.

#### 4.25.7 SMF Initiated SMF-NEF Connection Release procedure

When the PDU Session Release is initiated and if a NEF has been selected as anchor of the Control Plane CIoT 5GS Optimisation enabled PDU session which is Unstructured PDU Session Type as described in the clause 4.3.4.2, then the SMF initiates a SMF-NEF Connection Release procedure towards the NEF corresponding to the "NEF ID" for that DNN / S-NSSAI Combination.



**Figure 4.25.7-1: SMF Initiated SMF-NEF Connection Release procedure**

1. The SMF performs Step 1 of PDU Session Release Procedure as described in clause 4.3.4.2.
2. If a NEF has been selected as anchor of the Control Plane CIoT 5GS Optimisation enabled PDU session which is Unstructured PDU Session Type as described in clause 4.3.2.2, the SMF initiates the SMF-NEF Connection release for this PDU Session by sending Nnef\_SMContext\_Delete Request (User Identity, PDU Session ID, S-NSSAI, DNN, Release Cause) message to the NEF.
3. The NEF deletes the NEF PDU Session Context associated with the User Identity and the PDU session ID. The NEF sends Nnef\_SMContext\_Delete Response (Cause, [Small Data Control Rate Status], [APN Rate Control Status]) to the SMF confirming release of the SMF-NEF session for the UE. The NEF includes Small Data Rate Control Status if PDU Session used Small Data Rate Control.
4. Steps 3-15 of PDU Session Release Procedure as described in clause 4.3.4.2.

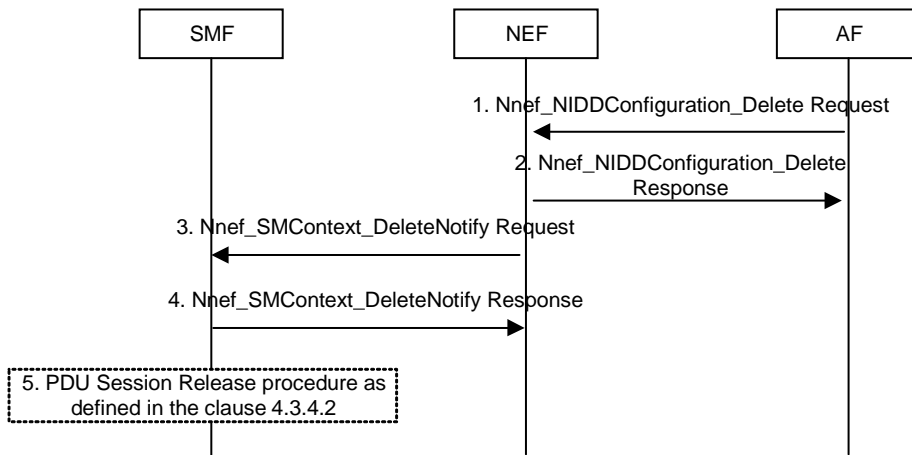
#### 4.25.8 NEF Initiated SMF-NEF Connection Release procedure

NEF initiates a SMF-NEF connection release procedure in the following cases:

- when a NIDD Authorization Update Request from the UDM indicates that the User is no longer authorized for NIDD, or
- failure of AF or failure of AF connection, or
- based on a request from the AF.

Figure 4.25.8-1 illustrates the NEF Initiated SMF-NEF Connection Release procedure based on a request from AF.

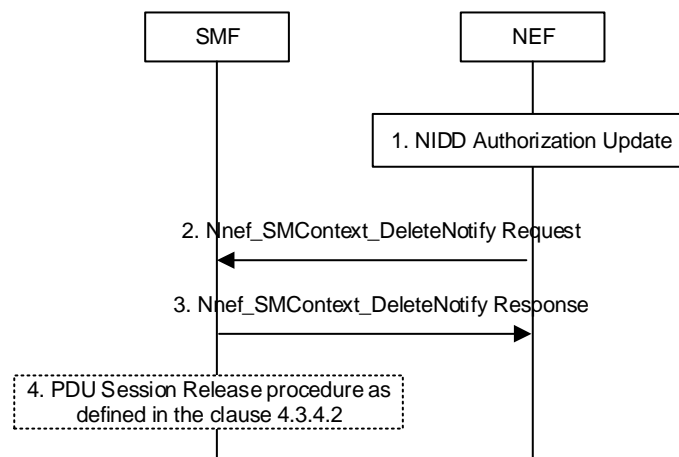




**Figure 4.25.8-1: NEF Initiated SMF-NEF Connection Release procedure on the AF request**

1. AF may indicate that a User's NIDD SMF-NEF connection is no longer needed by invoking Nnef\_NIDDConfiguration\_Delete Request (TLTRI) toward NEF.
2. The NEF deletes the NEF PDU session Context associated with the TLTRI and acknowledges the deletion of the NIDD configuration by invoking Nnef\_NIDDConfiguration\_Delete Response to the AF.
3. The NEF notifies the deletion of the SM context information by invoking Nnef\_SMContext\_DeleteNotify Request toward the SMF.
4. The SMF acknowledges the notification by invoking Nnef\_SMContext\_DeleteNotify Response to the NEF.
5. If the PDU session is not longer needed, the SMF performs steps 2-11 of PDU Session Release Procedure (see clause 4.3.4.2).

Figure 4.25.8-2 illustrates the NEF Initiated SMF-NEF Connection Release procedure based on the NIDD Authorization Update.

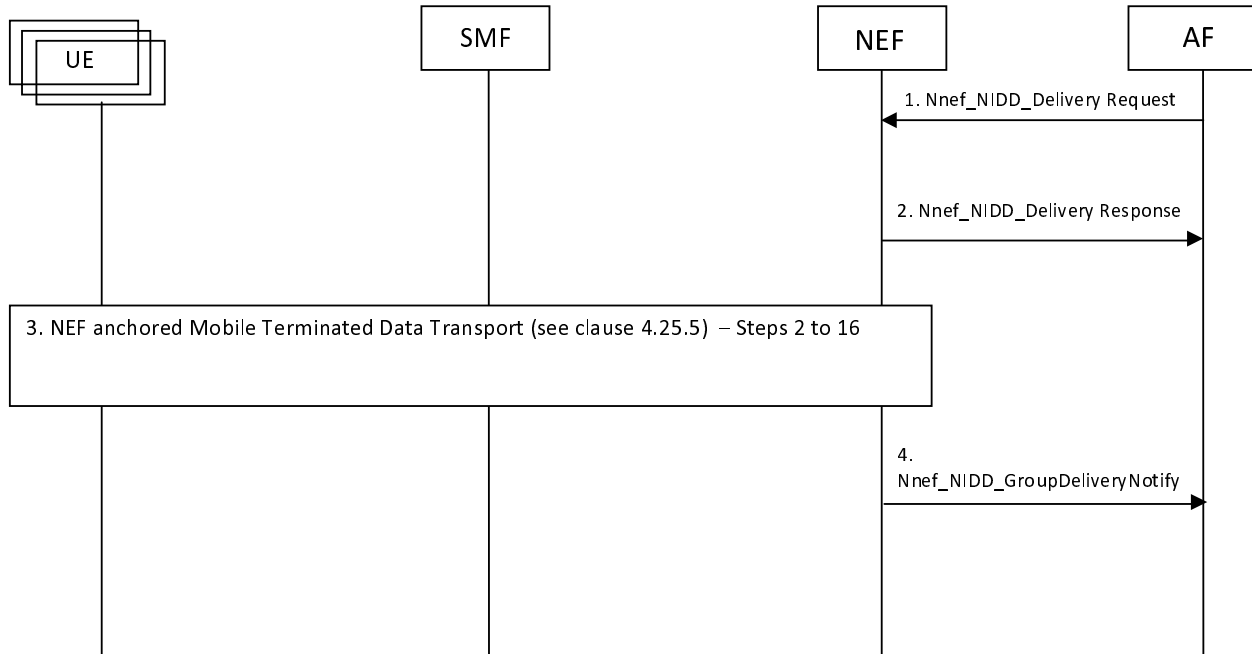


**Figure 4.25.8-2: NEF Initiated SMF-NEF Connection Release procedure on the NIDD Authorization Update**

1. On NIDD Authorization Update by UDM, NEF may determine that it needs to release the corresponding SMF-NEF Connection.
2. The NEF deletes the corresponding NEF PDU session Context and notifies the deletion of the SM context information by invoking Nnef\_SMContext\_DeleteNotify Request toward the SMF.
3. The SMF acknowledges the notification by invoking Nnef\_SMContext\_DeleteNotify Response to the NEF.
4. If the PDU session is not longer needed, the SMF performs steps 2-11 of PDU Session Release Procedure (see clause 4.3.4.2).

## 4.25.9 NEF Anchored Group NIDD via NEF anchored unicast MT data

Figure 4.25.9-1 illustrates the procedure by which the AF can send a Group NIDD addressed to External Group Identifier. It is a pre-requisite assumption that the NEF has already resolved the mapping of External Group Identifier to individual SUPIs with the help of UDM during NIDD Configuration procedure as specified in clause 4.25.3. Standalone MT NIDD procedure specified in clause 4.25.5 is re-used by NEF to unicast the MT data to each UE.



**Figure 4.25.9-1: NEF Anchored Group NIDD via NEF anchored unicast data**

1. If AF has already used the NIDD Configuration procedure of clause 4.25.3 to activate the NIDD service for a group of UEs and has unstructured data to send to the group identified by an External Group Identifier, the AF sends a Nnef\_NIDD\_Delivery Request (External Group Identifier, TLTRI, unstructured data, Reliable Data Service Configuration) message to the NEF. Reliable Data Service Configuration is an optional parameter that is used to configure the Reliable Data Service. When unstructured data is sent to an External Group Identifier, the AF shall not request acknowledgement in the Reliable Data Service Configuration.
2. Based on the existing NIDD configuration of the UE Group (see clause 4.25.3), the NEF sends a single Nnef\_NIDD\_Delivery Response to AF to acknowledge the acceptance of the Group NIDD delivery request in step 1.
3. The NEF uses the NEF anchored Mobile Terminated Data Transport procedure that is specified in steps 2-16 in clause 4.25.5 to send the same MT NIDD to each UE in the group.
4. After executing step 3 for all UEs in the group, the NEF sends aggregated response in Nnef\_NIDD\_GroupDeliveryNotify message. If some target UEs were not reachable due to UE power saving, then the NEF does not buffer the MT NIDD, but it may include indication on the expected reachability of those UEs in its response to AF in this step. If the delivery towards certain UE failed, the NEF may include the cause value.

## 4.26 Network Function/NF Service Context Transfer Procedures

### 4.26.1 General

Network Function/NF Service Context Transfer Procedures allow transfer of Service Context of a NF/NF Service from a Source NF/NF Service Instance to the Target NF/NF Service Instance, e.g. before the Source NF/NF Service can gracefully close its NF/NF Service. If SMF sets are deployed this applies from an SMF instance within an SMF set to an SMF instance of another SMF set.

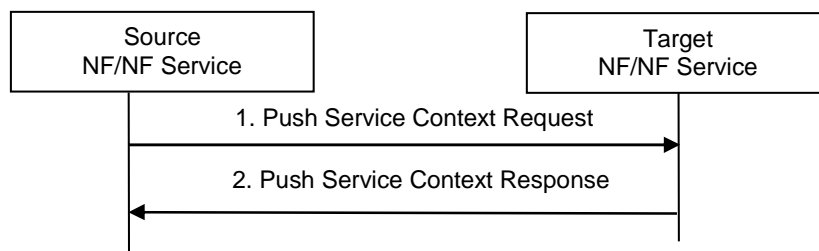
A request (push procedure, see clause 4.26.2) or response (pull procedure, see clause 4.26.3) from a Source NF/NF Service Instance to a Target NF/NF Service Instance contains either

- the context being transferred, e.g. SM context (direct mode); or
- optionally, an endpoint address from which Target NF/NF Service Instance can retrieve the context, see TS 29.501 [62] (indirect mode).

It assumes that access to a given context endpoint address can be restricted to single Target NF/NF Service Instance.

NOTE: Which procedures need to be executed for indirect mode is part of the specific context transfer procedures as specified in clause 4.26.5.

## 4.26.2 NF/NF Service Context Transfer Push Procedure

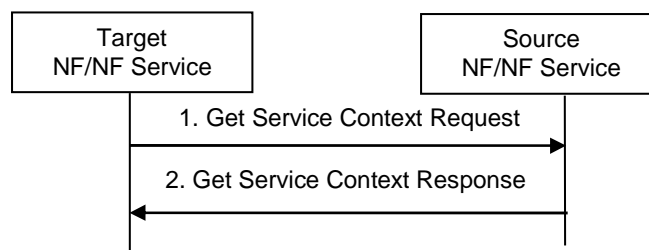


**Figure 4.26.2-1: NF/NF Service Context Push procedure**

1. When triggered, the Source NF/NF Service acting as NF Service Consumer sends its Context (e.g. UE Context or SM context) to the Target NF/NF Service acting as NF Service producer. This may trigger several other procedures that ensure all necessary NF/NF Services are being updated and set up with necessary information about the new context location.
2. The NF Service Consumer receives the response indicating the result of the operation (successful or not successful). When all procedures have been executed successfully the Target NF/NF Service can continue to serve the original NF Service Consumers of the Source NF/NF Service, which e.g. can be shut down gracefully.

NOTE: After resumption of a new service transaction, it may be necessary to contact the UE using existing procedures.

## 4.26.3 NF/NF Service Context Transfer Pull procedure



**Figure 4.26.3-1: NF/NF Service Context Pull procedure**

1. When triggered, the Target NF/NF Service as an NF Service Consumer requests a Context (e.g. UE context or SM context) from the Source NF as a NF Service Producer. This may trigger several other procedures that ensure all necessary NF/NF services are being updated and set up with necessary information about the new context location.

NOTE 1: Which procedures need to be executed and what information needs to be updated is part of the specific context transfer procedures as specified in clause 4.26.5.

2. The NF Service Consumer receives the Context and the operation was successful. When all procedures have been executed successfully the Target NF/NF Service can continue to serve the original NF Service Consumers of the Source NF/NF Service, which e.g. can be shut down gracefully.

NOTE 2: After resumption of a new service transaction, it may be necessary to contact the UE using existing procedures.

## 4.26.4 Context Transfer due to decommissioning

In the case of decommissioning, the Old NF may inform NRF that it is about to be decommissioned. NRF will in this case not include the NF profile of the Old NF in any discovery result from the NF/NF service discovery procedure. The NRF will also notify any consumers subscribed to changes to this resource.

## 4.26.5 SMF Service Context Transfer procedures

### 4.26.5.1 General

This clause lists the context-specific transfer procedures between different SMF Sets supporting the same DNN/S-NSSAI pair supported for SM Contexts (i.e. SMF contexts).

### 4.26.5.2 I-SMF Context Transfer procedure

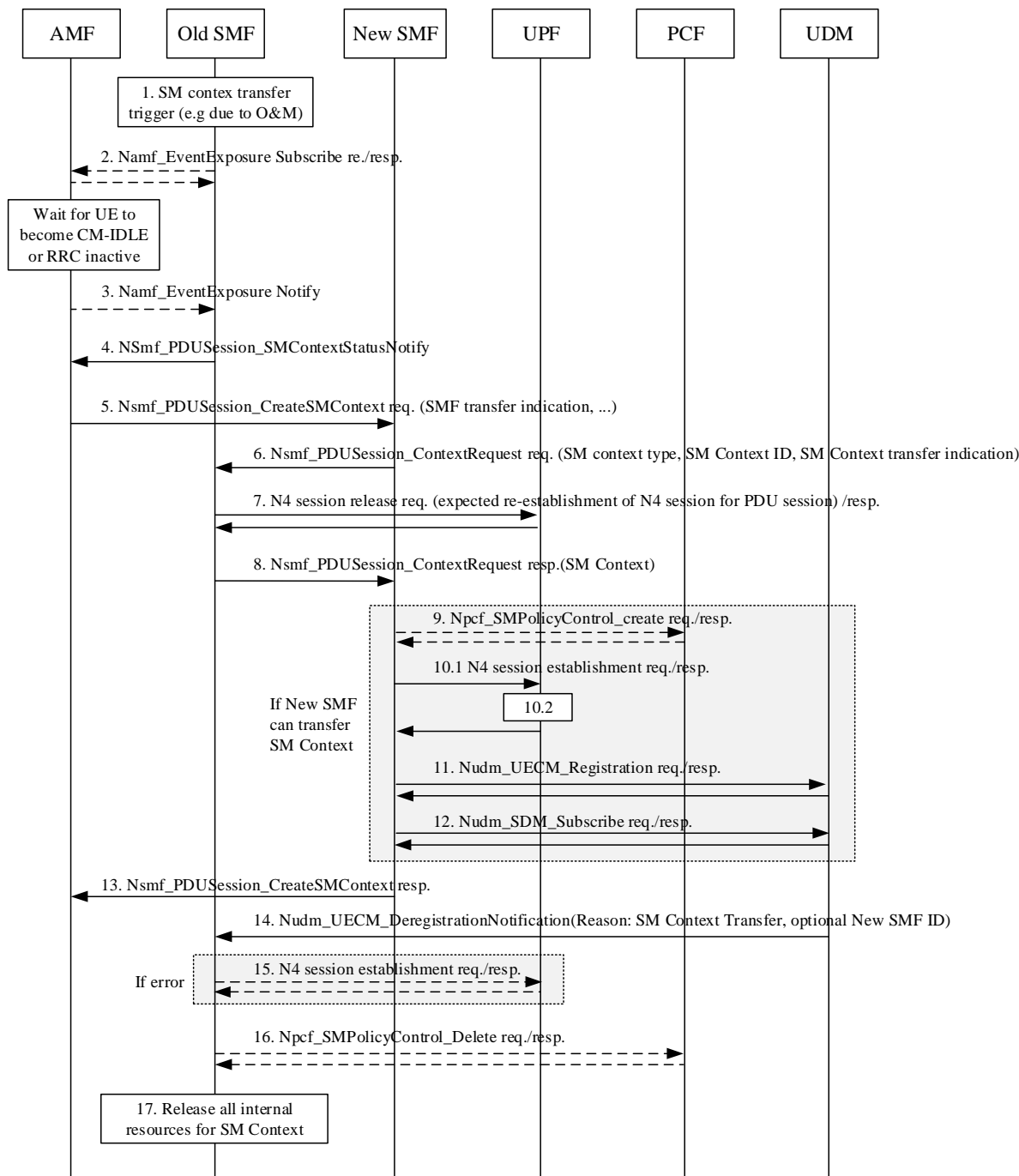
Old I-SMF triggered from O&M procedure sends Nsmf\_PDUSession\_SMContextStatusNotify (I-SMF transfer indication, New SMF ID or SMF set ID) to AMF.

Steps 2-25 in clause 4.23.4.3 follows, where in step 2 AMF selects the indicated I-SMF, or selects the I-SMF from the indicated SMF set.

### 4.26.5.3 SMF Context Transfer procedure, LBO or no Roaming, no I-SMF

In the case of dynamic IP address assignment (IPv4 address and/or IPv6 prefix), the procedure in figure 4.26.4.1.1-1 assumes that, if the UE IP address is received from Old SMF, the control of the IP address(es) assigned by Old SMF is moved to New SMF by O&M procedures. New SMF is in full control of the concerned IP address(es) when the transfer is complete.

NOTE 1: If UPF has the IP point of presence from the DNN, the same UPF is used.



**Figure 4.26.4.1.1-1: Context transfer of a PDU session**

1. SM context transfer is triggered, e.g. by OAM to Old SMF including SUPI, PDU session ID and New SMF ID or SMF set ID. The SMF selection by using SMF set ID not applicable when the IP range is managed by SMF.
2. [Conditional - depending on current subscription] Old SMF subscribes to events when UE status becomes CM-IDLE or CM-CONNECTED with RRC inactive state (Namf\_EventExposure\_Subscribe).
3. [Conditional - depending on the event] The AMF detects the monitored event occurs and sends the event report by means of Namf\_EventExposure\_Notify message, to Old SMF.
4. From Old SMF to AMF Nsmf\_PDUSession\_SMContextStatusNotify (SMF transfer indication, Old SMF ID, New SMF ID or SMF set ID from Step 1, PDU Session ID, SUPI, SM Context ID).

5. AMF, or SCP if delegated discovery is used, uses New SMF ID or SMF set ID to select New SMF and sends Nsmf\_PDUSession\_CreateSMContext request (PDU Session ID, Old SMF ID, SM Context ID in Old SMF, UE location info, Access Type, RAT Type, Operation Type, SMF transfer indication). The same PDU Session ID as received in step 4 is used. If the AMF receives the service request from the UE for the PDU session(s) affected by this procedure the AMF delays the transaction with the SMF until the step 13 completes. If the AMF receives the UE context transfer request from the other AMF due to the UE mobility, the AMF defers the response until the step 13 completes. Also, to avoid infinite waiting time, the AMF starts a locally configured guard timer upon sending the request to the SMF and the AMF decides the procedure has failed at expiry of the guard timer.

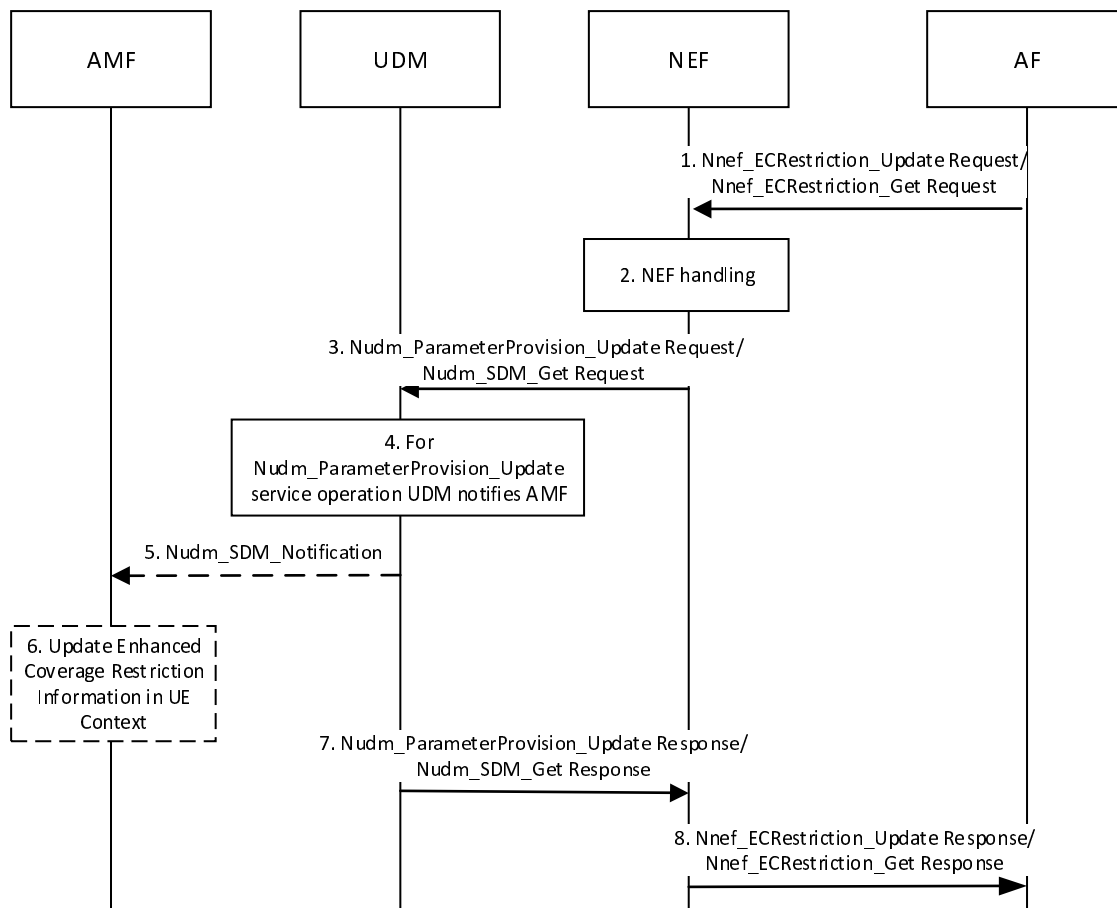
NOTE 2: Either delay or failure of the SM Context transfer may incur timeout or failure in UE procedure(s).

6. From New SMF to Old SMF Nsmf\_PDUSession\_ContextRequest request (SM Context type, SM Context ID, SMF transfer indication). If New SMF is not capable to transfer this SM Context (e.g. it is not responsible for the IP range), steps 9 to 12 are skipped.
7. Old SMF releases the N4 session with the UPF by sending a flag notifying the UPF about the expected re-establishment of the N4 session for the same PDU session. Based on this, if supported, the UPF should delay the release of the N4 session up to step 10.2 to allow for uninterrupted packet handling until the N4 session is re-established by New SMF.
8. From Old SMF to New SMF Nsmf\_PDUSession\_ContextRequest response (SM Context or endpoint address where New SMF can retrieve SM Context). The SM Context includes the IP address(es) if the PDU session is of type IPv4, IPv6 or IPv4v6, or the Ethernet MAC address(es) if the PDU session is of type Ethernet as well as the UPF to be selected by New SMF. Old SMF starts a timer to monitor the SMF context transferring process.
9. [Conditional] If dynamic PCC is used for the PDU Session, New SMF sets up a new policy association towards PCF.
  - 10.1. UPF receives a N4 session establishment request for the same PDU session from step 7. The parameters from step 8 and, if applies, step 9 are used.
  - 10.2. New SMF performs a full re-establishment of the N4 session, establishing a new N4 session. All information related to the N4 session of Old SMF that is not used by the N4 session of New SMF is removed from UPF if not already done.
11. New SMF registers to UDM. The information stored at the UDM includes SUPI, SMF identity and the associated DNN and PDU Session ID.
12. New SMF subscribes to subscription changes for the UE.
13. From New SMF to AMF: Nsmf\_PDUSession\_CreateSMContext response. If this response indicates a redirect (e.g. another SMF in the set), the procedure moves to step 5 with the indicated endpoint address as target.
14. UDM notifies Old SMF that it is deregistered for the PDU Session by sending Nudm\_UECM\_DeregistrationNotification, optionally including New SMF ID
15. [Conditional] If 14 was not received and the timer from step 8 expires, Old SMF re-establishes the N4 session. The UPF may for the purpose use the information stored in step 7. In this case, the procedure ends here.
16. [Conditional] If Nudm\_UECM\_DeregistrationNotification in step 14 was received, Old SMF removes its policy association with PCF. Any changes to the QoS rules need to be sent to the UE when it becomes active.
17. Old SMF releases any internal resources corresponding to the indicated PDU session. Subscribers to SMContextStatusNotify for the transferred SM context are notified of the context transfer and optionally of the new location of the transferred SM context.

## 4.27 Procedures for Enhanced Coverage Restriction Control via NEF

### 4.27.1 General

The support for Enhanced Coverage Restriction Control via NEF enables AF to query status of Enhanced Coverage Restriction or enable/disable Enhanced Coverage Restriction per individual UEs. Figure 4.27.1-1 shows the procedure for Enhanced Coverage Restriction Control via NEF.



**Figure 4.27.1-1: Enhanced Coverage Restriction Control via NEF**

1. The AF may enable or disable Enhanced Coverage Restriction or query the status of Enhanced Coverage Restriction by sending the Nnef\_ECRestriction\_Update Request or Nnef\_ECRestriction\_Get Request respectively. Both the service operations require GPSI and AF Identifier as required input and optionally MTC Provider Information.
2. Based on operator policies, if the AF is not authorized to perform the request (e.g. if the SLA does not allow for it) or if the AF has exceeded its quota or rate of submitting Enhanced Coverage Requests, the NEF performs Step 8 and provides a cause value appropriately indicating the failure result.
3. The NEF sends the Nudm\_ParameterProvision\_Update Request to update the subscription data for Enhanced Coverage Restriction. The NEF sends the Nudm\_SDM\_Get Request service operation to query the status of Enhanced Coverage Restriction.
4. The UDM checks the GPSI and examines whether any included parameters are in the range acceptable by the operator, whether Enhanced Coverage Restriction is supported by the serving NF (i.e. AMF in this case). If this check fails, the UDM provides a cause value indicating the reason for failure condition to the NEF in step 7

In the case of Nudm\_ParameterProvision\_Update Request, the UDM sets the Enhanced Coverage Restriction information to the appropriate value and procedure continues to step 5.

In the case of Nudm\_SDM\_Get Request, the UDM may retrieve the status of Enhanced Coverage Restriction information from UDR using Nudr\_DM\_Query Request and skip steps 5 and 6.

5. The UDM sends Nudm\_SDM\_Notification and provide AMF with updates Enhanced Coverage Restriction information.
6. The AMF updates the Enhanced Coverage Restriction information stored in the UE context. The AMF will transfer Enhanced Coverage Restriction information stored as part of its UE context during AMF change.

NOTE: UE is informed of the updated Enhanced Coverage Restriction information at the next Registration procedure or based on the local policy the network can de-register the UE indicating re-registration is required.

7. The UDM sends the Nudm\_ParameterProvision\_Update Response or Nudm\_SDM\_Get Response to the NEF.
8. The NEF sends the Nnef\_ECRestriction\_Update Response or Nnef\_ECRestriction\_Get Response to the AF.

---

## 5 Network Function Service procedures

### 5.1 Network Function Service framework procedures

#### 5.1.1 Network Function Service Discovery

The network function (NF) within the core network may expose its capability as service via its service based interfaces, which can be re-used by other NFs. Unless the expected NF information is locally configured on requester NF, e.g. the expected NF is in the same PLMN, the NF service discovery is implemented via the NF discovery.

### 5.2 Network Function services

#### 5.2.1 General

#### 5.2.2 AMF Services

##### 5.2.2.1 General

The following table shows the AMF Services and AMF Service Operations.



Table 5.2.2.1-1: List of AMF Services

Service Name	Service Operations	Operation Semantic	Known Consumer(s)
Namf_Communication	UEContextTransfer	Request/ Response	Peer AMF
	CreateUEContext	Request/ Response	Peer AMF
	RelocateUEContext	Request/ Response	Peer AMF
	CancelRelocationUEContext	Request/ Response	Peer AMF
	ReleaseUEContext	Request/ Response	Peer AMF
	RegistrationStatusUpdate	Request/ Response	Peer AMF
	N1MessageNotify	Subscribe / Notify	PCF, LMF, Peer AMF
	N1N2MessageSubscribe		PCF
	N1N2MessageUnSubscribe		PCF
	N1N2MessageTransfer	Request/ Response	SMF, SMSF, PCF, LMF
	N1N2TransferFailureNotification	Subscribe / Notify	SMF, SMSF, PCF, LMF
	N2InfoSubscribe	Subscribe / Notify	NOTE 1
	N2InfoUnSubscribe		NOTE 1
	N2InfoNotify		AMF, LMF
	EBIAssignment	Request/Response	SMF
	AMFStatusChangeSubscribe	Subscribe / Notify	SMF, PCF, NEF, SMSF, UDM
	AMFStatusChangeUnSubscribe	Subscribe / Notify	SMF, PCF, NEF, SMSF, UDM
	AMFStatusChangeNotify	Subscribe / Notify	SMF, PCF, NEF, SMSF, UDM
	NonUeN2MessageTransfer	Request/Response	Peer AMF, CBCF, PWS-IWF, LMF
	NonUeN2InfoSubscribe	Subscribe / Notify	CBCF, PWS-IWF
NonUeN2InfoUnSubscribe	CBCF, PWS-IWF		
NonUeN2InfoNotify	CBCF, PWS-IWF, LMF		
Namf_EventExposure	Subscribe	Subscribe / Notify	NEF, SMF, UDM, NWDAF, LMF
	Unsubscribe	Subscribe / Notify	NEF, SMF, UDM, NWDAF, LMF
	Notify	Subscribe / Notify	NEF, SMF, UDM, NWDAF, LMF
Namf_MT	EnableUEReachability	Request/Response	SMSF, SMF
	ProvideDomainSelectionInfo	Request/Response	UDM
Namf_Location	ProvidePositioningInfo	Request/Response	GMLC
	EventNotify	Subscribe / Notify	GMLC
	ProvideLocationInfo	Request/Response	UDM
	CancelLocation	Request/Response	GMLC

NOTE 1: In this Release of the specification no known consumer is identified to use this service operation.

## 5.2.2.2 Namf\_Communication service

### 5.2.2.2.1 General

**Service description:** This service enables an NF to communicate with the UE through N1 NAS messages or with the AN (both UE and non UE specific). The service operations defined below allow the NF to communicate with the UE and the AN. The following are the key functionalities of this NF service.

- Provide service operations for transporting N1 messages to the UE;
- Allow NFs to subscribe and unsubscribe for notifications of specific N1 messages from the UE;
- Allow NFs to subscribe and unsubscribe for notifications about specific information from AN;
- Provide service operations for initiating N2 messages towards the AN;
- Security Context Management; and
- UE information management and transfer (including its security context).

#### 5.2.2.2.2 Namf\_Communication\_UEContextTransfer service operation

**Service operation name:** Namf\_Communication\_UEContextTransfer

**Description:** Provides the UE context to the consumer NF.

**Input, Required:** 5G-GUTI or SUPI, Access Type, Reason.

**Input, Optional:** Integrity protected message from the UE that triggers the context transfer.

**Output, Required:** The UE context of the identified UE or only the SUPI and an indication that the Registration Request has been validated. The UE context is detailed in table 5.2.2.2.2-1.

**Output, Optional:** Mobile Equipment Identifier (if available), Allowed NSSAI, Mapping Of Allowed NSSAI.

See clause 4.2.2.2.2 for example of usage of this service operation. If the consumer NF sent an integrity protected message from the UE, the AMF uses it to verify whether this request is permitted to retrieve the UE context of the UE. If it is permitted, the AMF provides UE context to the consumer NF in the Namf\_Communication\_UEContextTransfer response. The following table illustrates the UE Context:

**Table 5.2.2.2.2-1: UE Context in AMF**

Field	Description
SUPI	SUPI (Subscription Permanent Identifier) is the subscriber's permanent identity in 5GS.
Routing Indicator	UE's Routing Indicator that allows together with SUCI/SUPI Home Network Identifier to route network signalling to AUSF and UDM instances capable to serve the subscriber
AUSF Group ID	The AUSF Group ID for the given UE.
UDM Group ID	The UDM Group ID for the UE.
PCF Group ID	The PCF Group ID for the UE.
SUPI-unauthenticated-indicator	This indicates whether the SUPI is unauthenticated.
GPSI	The GPSI(s) of the UE. The presence is dictated by its storage in the UDM.
5G-GUTI	5G Globally Unique Temporary Identifier.
PEI	Mobile Equipment Identity
Internal Group ID-list	List of the subscribed internal group(s) that the UE belongs to.
UE Specific DRX Parameters	UE specific DRX parameters for E-UTRA and NR.
UE Specific DRX Parameters for NB-IoT	UE Specific DRX Parameters for NB-IoT
UE MM Network Capability	Indicates the UE MM network capabilities.
5GMM Capability	Includes other UE capabilities related to 5GCN or interworking with EPS.
Events Subscription	List of the event subscriptions by other CP NFs. Indicating the events being subscribed as well as any information on how to send the corresponding notifications
LTE-M Indication	Indicates if the UE is a Category M UE. This is based on indication provided by the NG-RAN or by the MME at EPS to 5GS handover.
MO Exception Data Counter	MO Exception Data Counter used for Small Data Rate Control purposes, see clause 5.31.14.3 of TS 23.501 [2].
AMF-Associated Expected UE Behaviour parameters	Indicates per UE the Expected UE Behaviour Parameters and their corresponding validity times as specified in clause 4.15.6.3.
<b>For the AM Policy Association:</b>	
AM Policy Information	Information on AM policy provided by PCF. Includes the Policy Control Request Triggers and the Policy Control Request Information. Includes the authorized RFSP and the authorized Service Area Restrictions.
PCF ID	The identifier of the PCF for AM Policy. In roaming, the identifier of V-PCF (NOTE 2).
<b>For the UE Policy Association:</b>	
Trigger Information	The Policy Control Request Triggers on UE policy provided by PCF.
PCF ID(s)	The identifier of the PCF for UE Policy. In roaming, the identifiers of both V-PCF and H-PCF (NOTE 1) (NOTE 2).
<b>Other information</b>	
Subscribed RFSP Index	An index to specific RRM configuration in the NG-RAN that is received from the UDM.
RFSP Index in Use	An index to specific RRM configuration in the NG-RAN that is currently in use.
UE-AMBR in serving network	The UE-AMBR that has been sent to RAN (e.g. based on subscribed UE-AMBR from UDM or UE-AMBR received from PCF)
MICO Mode Indication	Indicates the MICO Mode for the UE.
Extended idle mode DRX Parameters	Negotiated extended idle mode DRX parameters.
Active Time Value for MICO mode	UE specific Active Time value allocated by AMF for MICO mode handling.
Strictly Periodic Registration Timer Indication	An indication that UE shall perform the Periodic Registration Update in a strictly periodic time, see clause 5.31.7.5 of TS 23.501 [2].
Voice Support Match Indicator	An indication whether the UE radio capabilities are compatible with the network configuration. The AMF uses it as an input for setting the IMS voice over PS Session Supported Indication over 3GPP access.
Homogenous Support of IMS Voice over PS Sessions	Indicates per UE if "IMS Voice over PS Sessions" is homogeneously supported in all TAs in the serving AMF or homogeneously not supported, or, support is non-homogeneous/unknown, see clause 5.16.3.3 of TS 23.501 [2].
UE Radio Capability for Paging Information	Information used by the NG-RAN to enhance the paging towards the UE (see clause 5.4.4.1 of TS 23.501 [2]).
Information On Recommended Cells And RAN nodes For Paging	Information sent by the NG-RAN and used by the AMF when paging the UE to help determining the NG-RAN nodes to be paged as well as to provide the information on recommended cells to each of these NG-RAN nodes, in order to optimize the probability of successful paging while minimizing the signalling load on the radio path.
UE Radio Capability Information	Information sent by the NG-RAN node and stored in the AMF. The AMF sends this information to the NG-RAN node within the UE context during transition to CM-CONNECTED state, except for NB-IoT when NB-IoT specific UE Radio Access Capability are sent instead.

Field	Description
UE Radio Capability ID	Pointer that uniquely identifies a set of UE Radio Capabilities in UCMF as defined in TS 23.501 [2].
NB-IoT specific UE Radio Access Capability Information	NB-IoT specific UE radio access capabilities.
WUS Assistance Information	Assistance information for determining the WUS group (see TS 23.501 [2]).
SMSF Identifier	The Identifier of the SMSF serving the UE in RM-REGISTERED state.
SMSF Address	The Address of the SMSF serving the UE in RM-REGISTERED state. (see clause 4.13.3.1).
SMS Subscription	Indicates subscription to any SMS delivery service over NAS irrespective of access type.
SEAF data	Master security information received from AUSF.
Last used EPS PLMN ID	The identifier of the last used EPS PLMN.
Paging Assistance Data for CE capable UE	Paging Assistance Data for Enhanced Coverage level and cell ID provided by the last NG-RAN the UE was connected to.
Enhanced Coverage Restricted Information	Specifies per PLMN whether CE mode B is restricted for the UE, or both CE mode A and CE mode B are restricted for the UE, or both CE mode A and CE mode B are not restricted for the UE.
NB-IoT Enhanced Coverage Restricted Information	Specifies per PLMN whether the Enhanced Coverage is restricted or not for the UE.
Service Gap Time	Used to set the Service Gap timer for Service Gap Control (see clause 5.31.16 of TS 23.501 [2]).
Running Service Gap expiry time	The time of expiry of a currently running Service Gap Timer (see clause 5.31.16 of TS 23.501 [2]).
NB-IoT UE Priority	Numerical value used by the NG-RAN to prioritise between UEs accessing via NB-IoT.
List of Small Data Rate Control Statuses	List of Small Data Rate Control Statuses by DNN and S-NSSAI for the released PDU Sessions, see clause 5.31.14.3 of TS 23.501 [2].
List of APN Rate Control Statuses	Indicates for each APN, the APN Rate Control Status (see clause 4.7.7.3 of TS 23.401 [13]) received from an MME when mobility from EPC to 5GC occurs. This information is provided to the MME during 5GC to EPC mobility.
<b>For each access type level context within the UE access and mobility context:</b>	
Access Type	Indicates the access type for this context.
RM State	Registration management state.
Registration Area	Current Registration Area (a set of tracking areas in TAI List).
TAI of last Registration	TAI of the TA in which the last Registration Request was initiated.
User Location Information	Information on user location.
Mobility Restrictions	Mobility Restrictions restrict mobility handling or service access of a UE. It consists of RAT restriction, Forbidden area, Service area restrictions and Core Network type restriction. It may also contain an Allowed CAG list and, optionally an indication whether the UE is only allowed to access 5GS via CAG cells.
Security Information for CP	As defined in TS 33.501 [15].
Security Information for UP	As defined in TS 33.501 [15].
Allowed NSSAI	Allowed NSSAI consisting of one or more S-NSSAIs for serving PLMN in the present Registration Area.
Mapping Of Allowed NSSAI	Mapping Of Allowed NSSAI is the mapping of each S-NSSAI of the Allowed NSSAI to the S-NSSAIs of the Subscribed S-NSSAIs.
S-NSSAIs subject to Network Slice-Specific Authentication and Authorization	Subscribed S-NSSAIs which are subject to NSSAA procedure. Also including the status, i.e. result, of the NSSAA if already executed or whether the S-NSSAI is pending the completion of an NSSAA procedure.
Inclusion of NSSAI in RRC Connection Establishment Allowed by HPLMN	[Only for 3GPP access] it defines whether the UDM has indicated that the UE is allowed to include NSSAI in the RRC connection Establishment in clear text.
Access Stratum Connection Establishment NSSAI Inclusion Mode	Defines what NSSAI, if any, to include in the Access Stratum connection establishment as specified in clause 5.15.9 of TS 23.501 [2].
CM state for UE connected via N3IWF/TNGF	Identifies the UE CM state (CM-IDLE, CM-CONNECTED) for UE connected via N3IWF/TNGF
N2 address information for N3IWF/TNGF	Identifies the N3IWF/TNGF to which UE is connected. Exists only if CM state for UE connected via N3IWF/TNGF is CM-CONNECTED.
AMF UE NGAP ID	Identifies the UE association over the NG interface within the AMF as defined in TS 38.413 [10]. This parameter exists only if CM state for the respective Access Type is CM-CONNECTED.
RAN UE NGAP ID	Identifies the UE association over the NG interface within the NG-RAN node as defined in TS 38.413 [10]. This parameter exists only if CM state for the respective Access Type is CM-CONNECTED.
Network Slice Instance(s)	The Network Slice Instances selected by 5GC for this UE.

Field	Description
URRP-AMF information	UE Reachability Request Parameter contains a list of URRP-AMF flags and associated authorised NF IDs. Each URRP-AMF flag indicates whether direct UE reachability notification has been authorised by the HPLMN towards the associated NF ID or not.
SoR Update Indicator for Initial Registration	An indication whether the UDM requests the AMF to retrieve SoR information when the UE performs NAS Registration Type "Initial Registration".
SoR Update Indicator for Emergency Registration	An indication whether the UDM requests the AMF to retrieve SoR information when the UE performs NAS Registration Type "Emergency Registration".
Charging Characteristics	The Charging Characteristics as defined in Annex A of TS 32.256 [71].
<b>For each PDU Session level context:</b>	
S-NSSAI(s)	The S-NSSAI(s) associated to the PDU Session.
DNN	The associated DNN for the PDU Session.
Network Slice Instance id	The network Slice Instance information for the PDU Session
PDU Session ID	The identifier of the PDU Session.
SMF Information	The associated SMF identifier and SMF address for the PDU Session. When an I-SMF is used, this additionally include the information correspond to an I-SMF.
Access Type	The current access type for this PDU Session (for a MA PDU Session this may correspond to information indicating 2 Access Type).
EBI-ARP list	The allocated EBI and associated ARP pairs for this PDU session.
5GSM Core Network Capability	The UEs 5GSM Core Network Capability as defined in clause 5.4.4b of TS 23.501 [2].
SMF derived CN assisted RAN parameters tuning	These are PDU Session specific parameters received from the SMF and used by the AMF to derive the Core Network assisted RAN parameters tuning.
NOTE 1: The AMF transfers the PCF ID to the SMF during PDU Session Establishment. The SMF may select the PCF identified by the PCF ID as described in clause 6.3.7.1 of TS 23.501 [2]. In HR roaming case, the AMF transfers the identifier of H-PCF as described in clause 4.3.2.2.2. In LBO roaming case, the AMF transfers the identifier of V-PCF as described in clause 4.3.2.2.1.	
NOTE 2: The PCF ID in AM Policy Association information and the PCF ID in UE Policy Association Information should be the same in non-roaming case. The V-PCF ID in AM Policy Association information and the V-PCF ID in UE Policy Association Information should be the same in roaming case.	

### 5.2.2.2.3 Namf\_Communication\_RegistrationStatusUpdate service operation

**Service operation name:** Namf\_Communication\_RegistrationStatusUpdate

**Description:** This service operation is used by the consumer NF to inform the AMF that a prior UE context transfer has resulted in the UE successfully registering with it. The UE context is marked inactive in the AMF.

**Input, Required:** 5G-GUTI, Status.

**Input, Optional:** PDU Session ID(s) (indicates the PDU Session(s) to be released), PCF reselected indicator (indicates that new AMF has selected a new PCF to handle the AM Policy association and/or the UE Policy association).

**Output, Required:** None.

**Output, Optional:** None.

See clause 4.2.2.2.2 step 10 for example usage of this service operation. When the AMF receives this request, it marks the UE context information as inactive since the UE context has been successfully transferred to the peer NF and the UE has successfully registered there. The AMF receives information about whether the AM Policy Association Information and/or the UE Policy Association Information in the UE context will be used or not (i.e. new AMF may select a different PCF and then create a new AM Policy Association and/or a new UE Policy Association). The AMF sends a Namf\_Communication\_RegistrationStatusUpdate response to the consumer NF.

NOTE 2: Whether notification Ack need a separate message or be realized in the transport layer will be determined in TS 29.518 [18].

### 5.2.2.2.4 Namf\_Communication\_N1MessageNotify service operation

**Service operation name:** Namf\_Communication\_N1MessageNotify

**Description:** AMF notifies the N1 message received from the UE to a destination CN NF.

**Input, Required:** AMF ID (GUAMI), N1 Message(s)

**Input, Optional:** local time zone, UE's current location, AN access information (e.g. AN type AN N2 terminating point, CAG Identifier(s) of the CAG cell), Allowed NSSAI, Mapping Of Allowed NSSAI, SUPI, MM Context, LMF identification.

**Output, Required:** None.

**Output, Optional:** None.

The destination NF type to be notified is determined based on one of the following:

- The N1 message type is always known to be consumed by one particular NF type; or
- An NF had explicitly subscribed for the particular N1 message type to be notified towards it.

**NOTE:** Whether notification Ack need a separate message or be realized in the transport layer will be determined in TS 29.518 [18].

The optional AN access information (if available), SUPI, MM Context, Allowed NSSAI and Mapping Of Allowed NSSAI parameters are included if the service operation is invoked towards a peer AMF.

#### 5.2.2.2.5 Namf\_Communication\_N1N2MessageSubscribe service operation

**Service operation name:** Namf\_Communication\_N1N2MessageSubscribe.

**Description:** An NF can subscribe with the AMF to get notified of a particular N1 message type or a specific N2 information type about the UE.

**Input, Required:** CN NF ID, N1 Message Type

**Input, Optional:** SUPI.

**Output, Required:** None.

**Output, Optional:** None.

The consumer NF invokes the Namf\_Communication\_N1MessageSubscribe service operation (NF ID, N1 message type or N2 information type to subscribe) on the AMF. The consumer NF shall provide a SUPI for UE associated N1 message subscriptions. If the consumer NF is allowed to subscribe for the type of N1/N2 message requested, the AMF creates a binding for the consumer NF to deliver subsequent Namf\_Communication\_N1MessageNotify or Namf\_Communication\_N2InfoNotify towards that NF.

**NOTE:** Whether Subscription Ack need a separate message or be realized in the transport layer will be determined in TS 29.518 [18].

#### 5.2.2.2.6 Namf\_Communication\_N1N2MessageUnSubscribe service operation

**Service operation name:** Namf\_Communication\_N1N2MessageUnSubscribe.

**Description:** An NF can unsubscribe with the AMF to stop notifying a particular N1 message type or a specific N2 information type about the UE.

**Input, Required:** CN NF ID, N1 Message Type

**Input, Optional:** None.

**Output, Required:** None.

**Output, Optional:** None.

The consumer NF invokes the Namf\_Communication\_N1MessageUnSubscribe service operation (NF ID, N1 message type or N2 information type to subscribe) on the AMF. The AMF deletes the binding for the consumer NF for the requested N1 message type.

NOTE: Whether UnSubscribe Ack need a separate message or be realized in the transport layer will be determined in TS 29.518 [18].

#### 5.2.2.2.7 Namf\_Communication\_N1N2MessageTransfer service operation

**Service operation name:** Namf\_Communication\_N1N2MessageTransfer.

**Description:** CN NF request to transfer downlink N1 and/or N2 message to the UE and/or AN through the AMF.

**Input, Required:** CN NF ID, Message type (N1 or N2 or both), Message Container (s) where at least one of the message containers (N1 or N2) is required.

**Input, Optional:** last message indication, Session ID, Paging Policy Indicator, ARP, Area of validity for the N2 SM information, 5QI, N1N2TransferFailure Notification Target Address, type of N2 SM information, type of N2 NRPPa information, Extended Buffering Support. MA PDU session Accepted indication, target access type (3GPP access or non-3GPP access), selected alternative H-SMF ID.

Namf\_Communication\_N1N2MessageTransfer supports the transfer of only one N2 message. N2 SM information and N2 NRPPa information are mutually exclusive.

**Output, Required:** Result indication.

**Output, Optional:** Redirection information, Estimated Maximum wait time.

If the UE is in CM-IDLE state, the AMF initiates the network triggered service request procedure as specified in clause 4.2.3.3 and responds to the consumer NF with a result indication, "attempting to reach UE". Otherwise, the AMF responds to the consumer NF, with a Namf\_Communication\_N1N2MessageTransfer response, providing a result indication of whether the AMF was able to successfully transfer the N1 and/or the N2 message towards the UE and/or the AN. A result indication of "N1/N2 transfer success" does not mean that N1 message is successfully received by the UE. It only means that the AMF is able to successfully send the N1 or N2 message towards the AN.

The "Area of validity for the N2 SM information", if included is used by the AMF to determine whether the N2 SM information provided by the consumer NF can be used towards the AN based on the current location of the UE. If the location of the UE is outside the "Area of validity for the N2 SM information" indicated, the AMF shall not send the N2 SM information to the AN.

If the consumer NF knows that a specific downlink N1 message is the last message to be transferred in this transaction, the consumer NF shall include the last message indication in the Namf\_Communication\_N1N2MessageTransfer service operation so that the AMF knows that the no more downlink N1 message need to be transferred for this transaction.

The CN NF is implicitly subscribed to be notified of N1N2TransferFailure by providing the N1N2TransferFailure Notification Target Address. When AMF detects that the UE fails to respond to paging or the AMF determines the UE is temporarily unreachable e.g. due to extended idle mode DRX or MICO mode, the AMF invokes the Namf\_Communication\_N1N2TransferFailureNotification to provide the failure notification to the location addressed by N1N2TransferFailure Notification Target Address.

The "Extended Buffering applies" indication, if included, is used by the AMF to include "Estimated Maximum Wait time" in Namf\_Communication\_N1N2 TransferFailureNotification if invoked due to the UE being unreachable.

If the result of the service operation fails, the AMF shall set the corresponding cause value in the result indication which can be used by the NF consumer for further action. If the related UE is not served by AMF and the AMF knows which AMF is serving the UE, the AMF provides redirection information which can be used by the consumer NF to resend UE related message to the AMF that serves the UE.

If the consumer NF is a SMF and he request includes N2 SM information, the SMF indicates the type of N2 SM information. If the consumer NF is a LMF and the request includes N2 NRPPa information, the LMF indicates the type of N2 NRPPa information.

NOTE: The actual N2 SM information or N2 NRPPa information is not interpreted by the AMF.

The selected alternative H-SMF ID information may be provided as described in clause 4.3.2.2.2.

The Small Data Rate Control Status is included if a PDU Session is being released and the UPF or NEF provided Small Data Rate Control Status when the PDU Session was released for the AMF to store.



For the usage of MA PDU session Accepted indication and target access type (3GPP access or non-3GPP access) see clauses 4.22.2, 4.22.3, 4.22.6.3 and 4.22.9.4.

#### 5.2.2.2.7A Namf\_Communication\_N1N2TransferFailureNotification service operation

**Service operation name:** Namf\_Communication\_N1N2TransferFailureNotification.

**Description:** The AMF uses this notification to inform the NF service consumer that initiated an earlier Namf\_Communication\_N1N2MessageTransfer, that the AMF failed to deliver the N1 message to the UE as the UE failed to respond to paging.

**Input, Required:** Cause, N1N2MessageTransfer Notification Target Address.

**Input, Optional:** Estimated Maximum wait time.

**Output, Required:** None.

**Output, Optional:** None.

#### 5.2.2.2.8 Namf\_Communication\_N2InfoSubscribe service operation

**Service operation name:** Namf\_Communication\_N2InfoSubscribe.

**Description:** An NF invokes this service operation to subscribe for the delivery of information contained in a specific N2 message type.

**Input, Required:** CN NF ID, N2 information type to be subscribed.

**Input, Optional:** None.

**Output, Required:** None.

**Output, Optional:** None.

#### 5.2.2.2.9 Namf\_Communication\_N2InfoUnsubscribe service operation

**Service operation name:** Namf\_Communication\_N2InfoUnSubscribe.

**Description:** An NF can invoke this service operation to unsubscribe for the delivery of information contained in a specific N2 message type.

**Input, Required:** CN NF ID, N2 information type to unsubscribe.

**Input, Optional:** None.

**Output, Required:** None.

**Output, Optional:** None.

The consumer NF invokes the Namf\_Communication\_N2InfoUnSubscribe service operation (CN NF ID, N2 information type to unsubscribe) on the AMF. The AMF deletes the binding for the consumer NF to for the requested information to unsubscribe.

#### 5.2.2.2.10 Namf\_Communication\_N2InfoNotify service operation

**Service operation name:** Namf\_Communication\_N2InfoNotify.

**Description:** The AMF uses this service operation to notify a particular N2 message information towards the NFs that have subscribed (implicitly or explicitly) for the specific information. This service operation is also used to redirect the N2 message to the AMF that are serving the UE.

**Input, Required:** AMF ID (GUAMI), N2 information.

**Input, Optional:** Indication of the I-SMF change/removal.

**Output, Required:** None.

**Output, Optional:** None.

#### 5.2.2.2.11 Namf\_Communication\_CreateUEContext service operation

**Service operation name:** Namf\_Communication\_CreateUEContext

**Description:** This service operation is used by a source AMF to create the UE context in a target AMF during handover procedures.

**Input, Required:** 5G-GUTI, UE context of the identified UE. As described in Table 5.2.2.2.1-1, the UE context may include the SUPI, DRX parameters, AM policy information, UE Radio Capability ID, PCF ID, UE network capability, used N1 security context information, event subscriptions by other consumer NF and the list of SM PDU Session IDs along with the SMF handling the PDU Session, N2 information including source to target RAN transparent container, Endpoint information of S-AMF to receive N2 information notification about handover complete.

**Input, Optional:** allocated EBI information, PCF ID, MS Classmark 2, STN-SR, C MSISDN and the Supported Codec IE.

**Output, Required:** Cause, N2 information including Target to Source transparent container, N2 SM information (PDU Sessions failed to be setup list and the N3 DL forwarding information), handle for the UE context created, PCF ID.

**Output, Optional:** None.

#### 5.2.2.2.12 Namf\_Communication\_ReleaseUEContext service operation

**Service operation name:** Namf\_Communication\_ReleaseUEContext

**Description:** This service operation is used by a source AMF to release the UE context in a target AMF during handover cancel procedures.

**Input, Required:** Handle of the UE context.

**Input, Optional:** None.

**Output, Required:** Cause.

**Output, Optional:** None.

#### 5.2.2.2.13 Namf\_Communication\_EBIAssignment service operation

**Service operation name:** Namf\_Communication\_EBIAssignment.

**Description:** The consumer NF uses this service operation to request a bunch of EPS Bearer IDs for a PDU Session and optionally indicate to the AMF the list of EBI(s) to be released.

**Inputs, Required:** SUPI, PDU Session ID, ARP list.

**Input, Optional:** Released EBI list.

**Outputs, Required:** None.

**Outputs, Optional:** a list of <ARP, EBI> pair, <ARP, Cause> pair.

The consumer NF invokes the Namf\_Communication\_EBIAssignment service operation when it determines that one or more EPS Bearer IDs are required for EPS QoS mapping for a PDU Session. The ARP list indicates the number of the requested EBIs and the corresponding ARP. The AMF uses the ARP list (including ARP priority level, the pre-emption capability and the pre-emption vulnerability) and the S-NSSAI to prioritize the EBI request, AMF can revoke the EBI from an ongoing lower priority PDU Session, if the maximum number of EBIs have been reached and a session with a higher priority requests an EBI. The AMF responds the consumer NF with a cause which indicates whether the assignment is successful or not. If the assignment is successful, the AMF provides a list of <ARP, EBI> pair to the consumer NF.

If the consumer NF determines that some EBIs are not needed, the consumer NF indicates the EBI(s) that can be released in the Released EBI list.

#### 5.2.2.2.14 Namf\_Communication\_AMFStatusChangeSubscribe service operation

**Service operation name:** Namf\_Communication\_AMFStatusChangeSubscribe

**Description:** This service operation is used by an NF to subscribe for AMF Status Change notification.

**Input, Required:** GUAMI(s).

**Input, Optional:** None.

**Output, Required:** None.

**Output, Optional:** None.

See clause 5.21.2.2 of TS 23.501 [2] for the example usage of this service operation. The GUAMI(s) is used to identify the AMF.

#### 5.2.2.2.15 Namf\_Communication\_AMFStatusChangeUnSubscribe service operation

**Service operation name:** Namf\_Communication\_AMFStatusChangeUnSubscribe

**Description:** This service operation is used by an NF to unsubscribe for AMF Status Change notification.

**Input, Required:** GUAMI(s).

**Input, Optional:** None.

**Output, Required:** None.

**Output, Optional:** None.

See clause 5.21.2.2 of TS 23.501 [2] for the example usage of this service operation. The GUAMI(s) is used to identify the AMF.

#### 5.2.2.2.16 Namf\_Communication\_AMFStatusChangeNotify service operation

**Service operation name:** Namf\_Communication\_AMFStatusChangeNotify

**Description:** Report AMF Status change (e.g. AMF unavailable) notification to subscribed NFs.

**Input, Required:** GUAMI(s).

**Input, Optional:** Target AMF(s) Name associated with the indicated GUAMI.

**Output, Required:** None.

**Output, Optional:** None.

See clause 5.21.2.2 of TS 23.501 [2] for the example usage of this service operation. The GUAMI(s) is used to identify the AMF. For network deployment without UDSF case, the target AMF Name which is to serve the user of the indicated GUAMI is also included.

#### 5.2.2.2.17 Namf\_Communication\_NonUeN2MessageTransfer service operation

**Service operation name:** Namf\_Communication\_NonUeN2MessageTransfer

**Description:** NF Service Consumer requests to transfer a non-UE specific message to NG-RAN node(s) via N2.

**Input, Required:** N2 Message Container.

**Input, Optional:** TAI List, RAT Selector (ng-eNB or gNB), Global RAN Node List, Send Write-Replace-Warning-Indication, Send Stop-Warning-Indication.

**Output, Required:** N2 Information Transfer Result.

**Output, Optional:** PWS Result Data.

PWS Result Data is included when parts of a PWS received message have not been comprehended or were missing, or if the message contained logical errors. It may contain the Unknown Tracking Area List which may be present in the associated PWS response message.

#### 5.2.2.2.18 Namf\_Communication\_NonUeN2InfoSubscribe service operation

**Service operation name:** Namf\_Communication\_NonUeN2InfoSubscribe

**Description:** The NF Service Consumer invokes this service operation to subscribe to the delivery of non-UE specific information from the NG-RAN node sent via N2 to the AMF.

**Input, Required:** NF Service Consumer ID, N2 information type to be subscribed.

**Input, Optional:** None.

**Output, Required:** None.

**Output, Optional:** None.

#### 5.2.2.2.19 Namf\_Communication\_NonUeN2InfoUnSubscribe service operation

**Service operation name:** Namf\_Communication\_NonUeN2InfoUnSubscribe

**Description:** The NF Service Consumer invokes this service operation to unsubscribe to stop notifying non-UE specific N2 information.

**Input, Required:** Subscription Correlation Id.

**Input, Optional:** None.

**Output, Required:** None.

**Output, Optional:** None.

#### 5.2.2.2.20 Namf\_Communication\_NonUeN2InfoNotify service operation

**Service operation name:** Namf\_Communication\_NonUeN2InfoNotify

**Description:** The AMF uses this service operation to notify a particular event towards the NF Service Consumer that has subscribed for the specific information. The AMF receives messages for such events from NG-RAN via N2.

**Input, Required:** N2 information.

**Input, Optional:** None.

**Output, Required:** None.

**Output, Optional:** None.

#### 5.2.2.2.21 Namf\_Communication\_RelocateUEContext service operation

**Service operation name:** Namf\_Communication\_RelocateUEContext

**Description:** This service operation is used by an initial AMF to relocate the UE context in a target AMF during EPS to 5GS handover (per N26) procedures.

**Input, Required:** UE context of the identified UE, information to reach the MME about this UE (MME Control Plane F-TEID, MME addressing information), content of the N26 Forward Relocation Request (including the Source to Target RAN Transparent Container and the identification of target RAN), PDU Session ID and the S-NSSAI associated with corresponding N2 SM Information received from SMF, PDU Session ID and its associated S-NSSAI of the VPLMN value for each PDU Session, the corresponding S-NSSAI of HPLMN value for home routed PDU Session(s).

As described in Table 5.2.2.2.2-1, the UE context may include the SUPI, DRX parameters, AM policy information, UE Radio Capability ID, PCF ID, UE network capability, used N1 security context information, event subscriptions by other consumer NF, Allowed NSSAI received from NSSF and the list of SM PDU Session IDs with the corresponding SMF handling the PDU Session, the S-NSSAI of the VPLMN and the S-NSSAI of HPLMN for home routed PDU Session(s).

**Input, Optional:** This may contain following optional information within the UE context: allocated EBI information, MS Classmark 2, STN-SR, C MSISDN and the Supported Codec IE.

**Output, Required:** Cause, handle for the UE context created.

**Output, Optional:** None.

#### 5.2.2.2.22 Namf\_Communication\_CancelRelocateUEContext service operation

**Service operation name:** Namf\_Communication\_CancelRelocateUEContext

**Description:** This service operation is used by an initial AMF to cancel the relocation of the UE context in a target AMF during EPS to 5GS handover (per N26) with AMF reallocation procedures.

**Input, Required:** Handle of the UE context.

**Input, Optional:** None.

**Output, Required:** Cause.

**Output, Optional:** None.

#### 5.2.2.3 Namf\_EventExposure service

##### 5.2.2.3.1 General

**Service description:** This service enables an NF to subscribe and get notified about an Event ID.

Following UE access and mobility information event are considered (Event ID is defined in clause 4.15.1 and Table 4.15.3.1-1):

- Location Report (TAI, Cell ID, N3IWF/TNGF node, UE local IP address and optionally UDP source port number);
- UE moving in or out of a subscribed "Area Of Interest" as described in clauses 5.3.4.4 and 5.6.11 of TS 23.501 [2];
- Number of UEs served by the AMF and located in "Area Of Interest";
- Time zone changes (UE Time zone);
- Access Type changes (3GPP access or non-3GPP access);
- Registration state changes (Registered or Deregistered);
- Connectivity state changes (IDLE or CONNECTED);
- UE loss of communication;
- UE reachability status;
- UE indication of switching off SMS over NAS service;
- Subscription Correlation ID change (implicit subscription);
- UE Type Allocation code (TAC);
- Frequent mobility re-registration;
- Subscription Correlation ID addition (implicit subscription); and

- User State Information in 5GS, as described in clause 5.4.4 of TS 23.632 [68].

Event Filters are used to specify the conditions to match for notifying the event (i.e. "List of Parameter values to match"). If there are no conditions to match for a specific Event ID, then the Event Filter is not provided. The following table provides some examples on how the conditions to match for event reporting can be specified for various Event IDs for AMF exposure.

**NOTE:** The conditions to match can be set based on AMF-associated expected UE Behaviour parameter(s) to only notify the event when the UE's behaviour deviates from its expected UE behaviour as described in TS 23.288 [50].

**Table 5.2.2.3.1-1: Example of Event Filters for AMF exposure events**

Event ID	Event Filter (List of Parameter Values to Match)
Location Report	<Parameter Type = LocationFilter, Value = TA1>
UE moving in or out of Area of Interest	<Parameter Type = TAI, Value = TA1> <Parameter Type = S-NSSAI, Value = S-NSSAI1> <Parameter Type = NSI ID, Value = NSI ID1> <Parameter Type = PRA ID, Value = PRA ID value>
Access Type	<Parameter Type=AN Type, Value=3GPP Access">
Location	<Parameter Type=TAI, Value=wildcard> (to report any TAI change)
Location	<Parameter Type=TAI Value=abnormal> (to report only when the TAI deviates from expected values based on Expected UE Moving Trajectory).
Reachability Filter	Applicable to the event UE reachability. Value = UE reachability status change or UE reachable for DL traffic. Absence of this parameter in UE reachability event request is interpreted as "UE reachability status change".

The following service operations are defined for the Namf\_EventExposure service:

- Namf\_EventExposure\_Subscribe.
- Namf\_EventExposure\_UnSubscribe.
- Namf\_EventExposure\_Notify.

#### 5.2.2.3.2 Namf\_EventExposure\_Subscribe service operation

**Service operation name:** Namf\_EventExposure\_Subscribe.

**Description:** The consumer NF uses this service operation to subscribe to or modify event reporting for one UE, a group of UE(s) or any UE.

**Input, Required:** NF ID, Target of Event Reporting: UE(s) ID (SUPI or Internal Group Identifier or indication that any UE is targeted), ((set of) Event ID(s) defined in clause 5.2.2.3.1, Notification Target Address (+ Notification Correlation ID))s, Event Reporting Information defined in Table 4.15.1-1.

**Input, Optional:** (Event Filter (s) associated with each Event ID; Event Filter (s) are defined in clause 5.2.2.3.1, Subscription Correlation ID (in the case of modification of the event subscription), Expiry time, Idle Status Indication request (if UE reachability or Availability after DDN failure reporting is requested).

**Output, Required:** When the subscription is accepted: Subscription Correlation ID (required for management of this subscription), Expiry time (required if the subscription can be expired based on the operator's policy).

**Output, Optional:** First corresponding event report is included, if available (see clause 4.15.1).

The NF consumer subscribes to the event notification by invoking Namf\_EventExposure to the AMF. The AMF allocates an Subscription Correlation ID for the subscription and responds to the consumer NF with the Subscription Correlation ID. UE ID identifies the UE, SUPI and/or GPSI. Event ID (see clause 4.15.1) identifies the events that the NF consumer is interested in. The Subscription Correlation ID is unique within the AMF Set.

The ((set of) Event ID(s), Notification Target Address (+ Notification Correlation ID)) helps the Event Receiving NF to co-relate a notification against a corresponding event subscription for the indicated Event ID.

In the case that the NF consumer subscribes to the AMF on behalf of other NF, the NF consumer include the Notification Target Address(+Notification Correlation ID) of other NF for the Event ID which is to be notified to other NF directly and the Notification Target Address(+Notification Correlation ID) of itself for the Subscription Correlation ID change event. Each Notification Target Address(+ Notification Correlation ID) is associated with the related (set of) Event ID(s).When the Subscription Correlation ID change due to the AMF reallocation, the notification is sent to NF consumer which triggers this subscription.

Event filter may include "AN type(s)" as part of the list of parameter values to match and it indicates to subscribe the event per Access Type.

Event receiving NF ID identifies the NF that shall receive the event reporting.

When the consumer NF needs to modify an existing subscription previously created by itself in the AMF, it invokes Namf\_EventExposure\_Subscribe service operation which contains the Subscription Correlation ID and the new Event Filters with Event ID to the AMF.

#### 5.2.2.3.3 Namf\_EventExposure\_UnSubscribe service operation

**Service operation name:** Namf\_EventExposure\_UnSubscribe.

**Description:** The NF consumer uses this service operation to unsubscribe for a specific event for one UE, group of UE(s), any UE.

**Input, Required:** Subscription Correlation ID.

**Input, Optional:** None.

**Output, Required:** Operation execution result indication.

**Output, Optional:** None.

The NF consumer unsubscribes the event notification by invoking Namf\_EventExposure\_Unsubscribe (Subscription Correlation ID) to the AMF.

#### 5.2.2.3.4 Namf\_EventExposure\_Notify service operation

**Service operation name:** Namf\_EventExposure\_Notify.

**Service operation description:** Provides the previously subscribed event information to the NF Consumer which has subscribed to that event before.

**Input, Required:** AMF ID (GUAMI), Notification Correlation Information, Event ID, corresponding UE(s) (SUPI(s) and if available GPSI(s)), time stamp.

**Input, Optional:** Event specific parameter list, Idle Status Indication (time when UE returned to Idle, Active Time, Periodic Update Timer, eDRX cycle, suggested number of DL packets).

**Output, Required:** None.

**Output, Optional:** None.

When the AMF detects a UE access and mobility event corresponding to a Subscription, it invokes Namf\_EventExposure\_Notify service operation to the NF consumer(s) which has subscribed to the UE mobility event before. The event is notified towards the consumers for which the Event filters (which may include "AN type(s)") match. The Notification Target Address (+ Notification Correlation ID) indicates to the Event Receiving NF the specific event notification subscription. The event specific parameter indicates the type of mobility event and related information, e.g. Registration Area Update/new Registration Area.

The optional event specific parameter list provides the values that matched for generating the event notification. The parameter values to match are specified during the event subscription (see clause 5.2.2.3.2). For example if the event type reported is "AN change", the event specific parameter list contains the value of the new AN.

## 5.2.2.4 Namf\_MT service

### 5.2.2.4.1 General

**Service description:** It provides a NF the service to request information related to capabilities that make sure UE is reachable to send MT signalling or data to a target UE. The following are the key functionalities of this NF service

- paging UE if UE is in IDLE state and respond other NF after the UE enters CM-CONNECTED state.
- response to the requester NF if UE is in CONNECTED state.
- providing the terminating domain selection information for IMS voice to the consumer NF.

### 5.2.2.4.2 Namf\_MT\_EnableUEReachability service operation

**Service operation name:** Namf\_MT\_EnableUEReachability.

**Description:** The consumer NF uses this service operation to request enabling UE reachability.

**Inputs, Required:** NF ID, UE ID.

**Inputs, Optional:** Extended Buffering Support.

**Outputs, Required:** Result indication.

**Outputs, Optional:** Redirection information, Estimated Maximum wait time.

See clause 4.13.3.6 and clause 4.24.2 for details on the usage of this service operation.

The consumer NF does not need to know UE state. The AMF accepts the request and respond the consumer NF immediately if UE is in CM-CONNECTED state. If the UE is in CM-IDLE state, the AMF may page the UE and respond to the consumer NF after the UE enters CM-CONNECTED state.

If the result of the service operation fails, the AMF shall set the corresponding cause value in the result indication which can be used by the NF consumer for further action. If the related UE is not served by the AMF and the AMF knows which AMF is serving the UE, the AMF provides redirection information which can be used by the NF consumer to resend UE related message to the AMF that serves the UE.

### 5.2.2.4.3 Namf\_MT\_ProvideDomainSelectionInfo

**Service operation name:** Namf\_MT\_ProvideDomainSelectionInfo.

**Description:** Provides the UE information for terminating domain selection of IMS voice to the consumer NF.

**Input, Required:** SUPI.

**Input, Optional:** None.

**Output, Required:** Success/Failure indication.

**Output, Optional:** Indication of supporting IMS voice over PS Session or not, Time stamp of the last radio contact with the UE, Current RAT type.

## 5.2.2.5 Namf\_Location service

### 5.2.2.5.1 General

**Service description:** This service enables an NF to request location information for a target UE. The following are the key functionalities of this NF service.

- Allow NFs to request the current or last known geodetic and optionally civic location of a target UE.
- Allow NFs to be notified of event information related to emergency sessions or deferred UE location.



- Allow NFs to request Network Provided Location Information (NPLI) and/or local time zone corresponding to the location of a target UE.
- Allow NFs to request a deferred geodetic and optionally civic location of a target UE for Periodic, Triggered and UE Available Location Events.
- Allow NFs to cancel an ongoing session for periodic or triggered location of a target UE.

#### 5.2.2.5.2 Namf\_Location\_ProvidePositioningInfo service operation

**Service operation name:** Namf\_Location\_ProvidePositioningInfo

**Description:** Provides UE positioning information to the consumer NF.

**Input, Required:** UE Identification (SUPI or PEI), Client Type.

**Input, Optional:** Location QoS, Supported GAD shapes, UE Privacy Requirements, LCS Client Identification, Deferred location type, Deferred location parameters, Notification Target address, Notification Correlation ID, service type.

**Output, Required:** Success/Failure indication

**Output, Optional:** Geodetic Location, Civic Location, Position Methods Used, Failure Cause.

See steps 4 and 10 of clause 6.1.1, steps 5, 14, 18 and 22 of clause 6.1.2 and steps 5 and 6 of clause 6.3.1 of TS 23.273 [51], for examples of usage of this service operation.

#### 5.2.2.5.3 Namf\_Location\_EventNotify service operation

**Service operation name:** Namf\_Location\_EventNotify

**Description:** Provides UE location related event information related to emergency sessions or deferred location to the consumer NF.

**Input, Required:** Type of location related event (e.g. emergency session initiation, deferred location for the UE available event, activation of location for periodic or triggered location, mobility of a target UE to a new AMF or MME for a deferred location), UE Identification (SUPI or PEI).

**Input, Optional:** GPSI, Geodetic Location, Civic Location, Position methods used, Notification Target address, Notification Correlation ID, address of a new AMF or MME or MSC server Identity for 5G-SRVCC as specified in TS 23.216 [74].

**Output, Required:** None.

**Output, Optional:** None.

See steps 5 and 8 of clause 6.10.1 and step 19 of clause 6.3.1 of TS 23.273 [51] and clause 6.5.4 of TS 23.216 [74] for examples of usage of this service operation.

#### 5.2.2.5.4 Namf\_Location\_ProvideLocationInfo service operation

**Service operation name:** Namf\_Location\_ProvideLocationInfo

**Description:** Provides Network Provided Location Information (NPLI) of a target UE to the consumer NF.

**Input, Required:** UE Identification (SUPI).

**Input, Optional:** 5GS Location Information Request, Current Location Request, RAT type Requested, Local Time Zone Request.

**Output, Required:** Success/Failure indication.

**Output, Optional:** 5GS Location Information (Cell Identity, Tracking Area Identity, Geographical/Geodetic Information, Current Location Retrieved, Age of Location Information, Current RAT Type), Local Time Zone, Failure

Cause. In the case of non-3GPP access: a UE local IP address (used to reach the N3IWF/TNGF) and optionally UDP source port number (if NAT is detected).

#### 5.2.2.5.5 Namf\_Location\_CancelLocation service operation

**Service operation name:** Namf\_Location\_CancelLocation

**Description:** Cancels an ongoing deferred location of a target UE to the consumer NF.

**Input, Required:** UE Identification (SUPI), Notification Target address, Notification Correlation ID.

**Input, Optional:** None.

**Output, Required:** Success/Failure indication.

**Output, Optional:** None.

See steps 4 and 10 of clause 6.3.3 of TS 23.273 [51] for examples of usage of this service operation.

### 5.2.3 UDM Services

#### 5.2.3.1 General

The following table illustrates the UDM Services and Service Operations.

**Table 5.2.3.1-1: NF services provided by UDM**

NF service	Service Operations	Operation Semantics	Example Consumer(s)
Subscriber Data Management (SDM)	Get	Request/Response	AMF, SMF, SMSF, NEF
	Subscribe	Subscribe/Notify	AMF, SMF, SMSF, NEF
	Unsubscribe	Subscribe/Notify	AMF, SMF, SMSF, NEF
	Notification	Subscribe/Notify	AMF, SMF, SMSF, NEF, GMLC
	Info	Request/Response	AMF, NEF
UE Context Management (UECM)	Registration	Request/Response	AMF, SMF, SMSF
	DeregistrationNotification	Subscribe/Notify	AMF
	Deregistration	Request/Response	AMF, SMF, SMSF
	Get	Request/Response	NEF, SMSF, GMLC, NWDAF
	Update	Request/Response	AMF, SMF
	PCscfRestoration	Subscribe/Notify	AMF, SMF
UE Authentication	Get	Request/Response	AUSF
	ResultConfirmation	Request/Response	AUSF
EventExposure	Subscribe	Subscribe/Notify	NEF (NOTE), NWDAF
	Unsubscribe		NEF (NOTE), NWDAF
	Notify		NEF (NOTE), NWDAF
Parameter Provision	Update	Request/Response	NEF, AMF
	Create	Request/Response	NEF
	Delete	Request/Response	NEF
	Get	Request/Response	NEF
NIDDAuthorisation	Get	Request/Response	NEF
	UpdateNotify	Subscribe/Notify	NEF
NOTE: Other NFs are allowed to consume the service based on roaming agreement or operator policy.			

### 5.2.3.2 Nudm\_UECM (UECM) service

#### 5.2.3.2.1 Nudm\_UECM\_Registration service operation

**Service operation name:** Nudm\_UECM\_Registration

**Description:** Register UE's serving NF (if NF Type is AMF, SMSF) or Session's serving NF (if NF Type is SMF) on the UDM. This operation implies the following:

- The authorization, if applicable, to register the NF service consumer in UDM for the UE (e.g. based on UE roaming/RAT restrictions applicable when NF type is AMF). If this is successful, the NF service consumer is set as a serving NF for the corresponding UE/Session context.
- When the consumer is AMF or SMF, it is implicitly subscribed to be notified when it is deregistered in UDM. This notification is done by means of Nudm\_UECM\_DeregistrationNotification operation.
- When the consumer is AMF or SMF, it may optionally use this operation to subscribe to be notified of the need for P-CSCF Restoration. This notification is done by means of Nudm\_UECM\_PCscfRestoration operation. For more information regarding P-CSCF restoration procedures see TS 23.380 [38].

**Inputs, Required:** NF ID, SUPI, NF Type, Access Type (if NF Type is AMF, SMSF), RAT Type (if NF Type is AMF), PDU Session ID (if NF Type is SMF). If NF Type is SMF: DNN or Indication of Emergency Services, S-NSSAI, SMF+PGW-C FQDN for S5/S8 if the PDU Session supports EPS interworking, Serving PLMN ID. If NF type is AMF and Access Type is 3GPP access: Registration type. If NF type is SMSF: SMSF MAP address and/or Diameter address, Serving PLMN ID.

**Inputs, Optional:** PEI (conditional, condition stated below), P-CSCF Restoration notification information, GUAMI, NID (e.g. if NF Type is AMF; see clause 5.18 of TS 23.501 [2]), backup AMF(s) (if NF Type is AMF), "Homogeneous Support of IMS Voice over PS Sessions" indication (if NF Type is AMF), UE SRVCC capability (if NF Type is AMF), indication that access is from ePDG (shall be sent if NF Type is SMF and PDU Session is setup via S2b), VGMLC ID (if NF type is AMF and information is available in AMF). Backup AMF(s) sent only once by the AMF to the UDM in its first interaction with the UDM.

**Outputs, Required:** Result indication.

**Outputs, Optional:** None.

If the PEI was retrieved by the AMF (either from the UE or another AMF), AMF shall provide it to the UDM using Nudm\_UECM\_Registration in order to ensure that the UDM always has the latest PEI available e.g. for reporting event Change of SUPI-PEI association.

See step 14a of clause 4.2.2.2.2 for an example usage of this service operation.

#### 5.2.3.2.2 Nudm\_UECM\_DeregistrationNotification service operation

**Service operation name:** Nudm\_UECM\_DeregistrationNotification.

**Description:** UDM notifies the NF consumer which has previously registered (using Nudm\_UECM\_Registration operation) has been deregistered in the UDM. As a result, the consumer is no longer registered in UDM as a serving NF for that UE.

NOTE: This notification corresponds to an implicit subscription.

**Inputs, Required:** SUPI, Access Type, PDU Session ID, serving NF deregistration reason.

**Inputs, Optional:** NF ID in the case of SM Context Transfer.

**Outputs, Required:** None.

**Outputs, Optional:** None.

See step 14d of clauses 4.2.2.2.2 and 4.26.5.3 for an example usage of this service operation. The serving NF deregistration reason tells the reason for sending the deregistration notification to the consumer NF.

The reason for AMF deregistration can be one of the following:

- UE Initial Registration.
- UE Registration area change.
- Subscription Withdrawn.
- 5GS to EPS Mobility.

The reason for SMF deregistration can be one of the following:

- SMF Context Transfer.

#### 5.2.3.2.3 Nudm\_UECM\_Deregistration service operation

**Service operation name:** Nudm\_UECM\_Deregistration.

**Description:** The NF consumer requests the UDM to delete the information related to the NF in the UE context. When the consumer is AMF, this implies that the subscriptions to be notified when the NF is deregistered in UDM (i.e. Nudm\_UECM\_DeregistrationNotification) are also removed.

**Inputs, Required:** SUPI, NF type, Access Type, PDU Session Id (if NF Type is SMF).

- Access Type is included only when the NF type indicates AMF or SMSF.

**Inputs, Optional:** None.

**Outputs, Required:** Result Indication.

**Outputs, Optional:** None.

#### 5.2.3.2.4 Nudm\_UECM\_Get service operation

**Service operation name:** Nudm\_UECM\_Get.

**Description:** The NF consumer requests the UDM to get the NF ID or SMS address of the NF serving the UE.

**Inputs, Required:** UE ID, NF Type.

**Inputs, Optional:** Access Type.

- Access Type is included when the NF type indicates SMSF.

**Outputs, Required:** NF ID or SMS address of the NF corresponding to the NF type requested by NF consumer. If the NF Type requested by NF consumer is AMF, the Access Type corresponding to the AMF is also included.

**Outputs, Optional:** SUPI or GPSI or both.

#### 5.2.3.2.5 Nudm\_UECM\_Update service operation

**Service operation name:** Nudm\_UECM\_Update.

**Description:** Consumer updates some UE related information (e.g. UE capabilities, Intersystem continuity context, SMF+PGW-C FQDN for S5/S8 interface).

**Inputs, Required:** NF ID, SUPI, NF type, UE context information.

**Inputs, Optional:** "Homogeneous Support of IMS Voice over PS Sessions" indication (if NF Type is AMF), SMF+PGW-C FQDN for S5/S8 interface (if NF Type is SMF).

**Outputs, Required:** Result Indication.

**Outputs, Optional:** None.

#### 5.2.3.2.6 Nudm\_UECM\_PCscfRestoration service operation

**Service operation name:** Nudm\_UECM\_PCscfRestoration.

**Description:** UDM notifies the AMF and/or SMF(s) which indicated during registration in UDM to be notified of the need for P-CSCF Restoration.

**Inputs, Required:** SUPI.

**Inputs, Optional:** None.

**Outputs, Required:** None.

**Outputs, Optional:** None.

### 5.2.3.3 Nudm\_SubscriberDataManagement (SDM) Service

#### 5.2.3.3.1 General

Subscription data types used in the Nudm\_SubscriberDataManagement Service are defined in Table 5.2.3.3.1-1 below.

**Table 5.2.3.3.1-1: UE Subscription data types**

Subscription data type	Field	Description
Access and Mobility Subscription data (data needed for UE Registration and Mobility Management)	GPSI List	List of the GPSI (Generic Public Subscription Identifier) used both inside and outside of the 3GPP system to address a 3GPP subscription (see NOTE 9).
	Internal Group ID-list	List of the subscribed internal group(s) that the UE belongs to.
	Subscribed-UE-AMBR	The Maximum Aggregated uplink and downlink MBRs to be shared across all Non-GBR QoS Flows according to the subscription of the user.
	Subscribed S-NSSAIs	The Network Slices that the UE subscribes to. In the roaming case, it indicates the subscribed Network Slices applicable to the Serving PLMN.
	Default S-NSSAIs	The Subscribed S-NSSAIs marked as default S-NSSAI. In the roaming case, only those applicable to the Serving PLMN.
	S-NSSAIs subject to Network Slice-Specific Authentication and Authorization	The Subscribed S-NSSAIs marked as subject to NSSAA. When present, the GPSI list shall include at least one GPSI.
	UE Usage Type	As defined in clause 5.15.7.2 of TS 23.501 [2].
	RAT restriction	3GPP Radio Access Technology(ies) not allowed the UE to access.
	Forbidden area	Defines areas in which the UE is not permitted to initiate any communication with the network.
	Service Area Restriction	Indicates Allowed Areas in which the UE is permitted to initiate communication with the network and Non-allowed areas in which the UE and the network are not allowed to initiate Service Request or SM signalling to obtain user services.
	Core Network type restriction	Defines whether UE is allowed to connect to 5GC and/or EPC for this PLMN.
	CAG information	The CAG information includes Allowed CAG list and, optionally an indication whether the UE is only allowed to access 5GS via CAG cells as defined in clause 5.30.3 of TS 23.501 [2].
	CAG information Subscription Change Indication	When present, indicates to the serving AMF that the CAG information in the subscription data changed and the UE must be updated.
	RFSP Index	An index to specific RRM configuration in the NG-RAN.
	Subscribed Periodic Registration Timer	Indicates a subscribed Periodic Registration Timer value, which may be influenced by e.g. network configuration parameter as specified in clause 4.15.6.3a.
	Subscribed Active Time	Indicates a subscribed active time value, which may be influenced by e.g. network configuration parameter as specified in clause 4.15.6.3a.
	MPS priority	Indicates the user is subscribed to MPS as indicated in clause 5.16.5 of TS 23.501 [2].
	MCX priority	Indicates the user is subscribed to MCX as indicated in clause 5.16.6 of TS 23.501 [2].
	AMF-Associated Expected UE Behaviour parameters	Information on expected UE movement and communication characteristics. See clause 4.15.6.3
	Steering of Roaming	List of preferred PLMN/access technology combinations or HPLMN indication that no change of the "Operator Controlled PLMN Selector with Access Technology" list stored in the UE is needed (see NOTE 3). Optionally includes an indication that the UDM requests an acknowledgement of the reception of this information from the UE.

	SoR Update Indicator for Initial Registration	An indication whether the UDM requests the AMF to retrieve SoR information when the UE performs Registration with NAS Registration Type "Initial Registration".
	SoR Update Indicator for Emergency Registration	An indication whether the UDM requests the AMF to retrieve SoR information when the UE performs Registration with NAS Registration Type "Emergency Registration".
	Network Slicing Subscription Change Indicator	When present, indicates to the serving AMF that the subscription data for network slicing changed and the UE configuration must be updated.
	Tracing Requirements	Trace requirements about a UE (e.g. trace reference, address of the Trace Collection Entity, etc.) is defined in TS 32.421 [39].
	Inclusion of NSSAI in RRC Connection Establishment Allowed	When present, it is used to indicate that the UE is allowed to include NSSAI in the RRC connection Establishment in clear text for 3GPP access.
	Service Gap Time	Used to set the Service Gap timer for Service Gap Control (see clause 5.31.16 of TS 23.501 [2]).
	Subscribed DNN list	List of the subscribed DNNs for the UE (NOTE 1). Used to determine the list of LADN available to the UE as defined in clause 5.6.5 of TS 23.501 [2].
	UDM Update Data	Includes a set of parameters (e.g. updated Default Configured NSSAI and/or updated Routing Indicator) to be delivered from UDM to the UE via NAS signalling as defined in clause 4.20 (NOTE 3).  Optionally includes an indication that the UDM requests an acknowledgement of the reception of this information from the UE and an indication for the UE to re-register.
	NB-IoT UE priority	Numerical value used by the NG-RAN to prioritise between UEs accessing via NB-IoT.
	Enhanced Coverage Restriction	Specifies whether CE mode B is restricted for the UE, or both CE mode A and CE mode B are restricted for the UE, or both CE mode A and CE mode B are not restricted for the UE.
	NB-IoT Enhanced Coverage Restriction	Indicates whether Enhanced Coverage for NB-IoT UEs is restricted or not.
	IAB-Operation allowed	Indicates that the subscriber is allowed for IAB-operation as specified in clause 5.35.2 of TS 23.501 [2].
	Charging Characteristics	It contains the Charging Characteristics as defined in Annex A of TS 32.256 [71]. This information, when provided, shall override any corresponding predefined information at the AMF.
	Extended idle mode DRX cycle length	Indicates a subscribed extended idle mode DRX cycle length value.
Slice Selection Subscription data (data needed for Slice Selection as described in clause 4.2.2.2.3 and in clause 4.11.0a.5)	Subscribed S-NSSAIs	The Network Slices that the UE subscribes to. In roaming case, it indicates the subscribed network slices applicable to the serving PLMN.
	Default S-NSSAIs	The Subscribed S-NSSAIs marked as default S-NSSAI. In the roaming case, only those applicable to the Serving PLMN.
	S-NSSAIs subject to Network Slice-Specific Authentication and Authorization	The Subscribed S-NSSAIs marked as subject to NSSAA.
SMF Selection Subscription data (data needed for SMF Selection as described in clause 6.3.2 of	SUPI	Key
	<b>SMF Selection Subscription data contains one or more S-NSSAI level subscription data:</b>	
	S-NSSAI	Indicates the value of the S-NSSAI.
	Subscribed DNN list	List of the subscribed DNNs for the UE (NOTE 1).



TS 23.501 [2])	Default DNN	The default DNN if the UE does not provide a DNN (NOTE 2).
	LBO Roaming Information	Indicates whether LBO roaming is allowed per DNN, or per (S-NSSAI, subscribed DNN).
	Interworking with EPS indication list	Indicates whether EPS interworking is supported per (S-NSSAI, subscribed DNN).
	Same SMF for Multiple PDU Sessions to the same DNN and S-NSSAI	Indication whether the same SMF for multiple PDU Sessions to the same DNN and S-NSSAI is required.
	Invoke NEF indication	When present, indicates, per S-NSSAI and per DNN, that NEF based infrequent small data transfer shall be used for the PDU Session (see NOTE 8).
	SMF information for static IP address/prefix	When static IP address/prefix is used, this may be used to indicate the associated SMF information per (S-NSSAI, DNN).
UE context in SMF data	SUPI	Key.
	PDU Session Id(s)	List of PDU Session Id(s) for the UE.
	<b>For emergency PDU Session Id:</b>	
	Emergency Information	The SMF+PGW-C FQDN for emergency session used for interworking with EPC.
	<b>For each non-emergency PDU Session Id:</b>	
	DNN	DNN for the PDU Session.
	SMF	Allocated SMF for the PDU Session. Includes SMF IP Address and SMF NF Id.
	SMF+PGW-C FQDN	The S5/S8 SMF+PGW-C FQDN used for interworking with EPS (see NOTE 5).
SMS Management Subscription data (data needed by SMSF for SMSF Registration)	SMS parameters	Indicates SMS parameters subscribed for SMS service such as SMS teleservice, SMS barring list
	Trace Requirements	Trace requirements about a UE (e.g. trace reference, address of the Trace Collection Entity, etc.) is defined in TS 32.421 [39]. This information is only sent to a SMSF in HPLMN.
SMS Subscription data (data needed in AMF)	SMS Subscription	Indicates subscription to any SMS delivery service over NAS irrespective of access type.
UE Context in SMSF data	SMSF Information	Indicates SMSF allocated for the UE, including SMSF address and SMSF NF ID.
	Access Type	3GPP or non-3GPP access through this SMSF
Session Management Subscription data (data needed for PDU Session Establishment)	GPSI List	List of the GPSI (Generic Public Subscription Identifier) used both inside and outside of the 3GPP system to address a 3GPP subscription.
	Internal Group ID-list	List of the subscribed internal group(s) that the UE belongs to.
	Trace Requirements	Trace requirements about a UE (e.g. trace reference, address of the Trace Collection Entity, etc...) is defined in TS 32.421 [39]. This information is only sent to a SMF in the HPLMN or one of its equivalent PLMN(s).
	<b>Session Management Subscription data contains one or more S-NSSAI level subscription data:</b>	
	S-NSSAI	Indicates the value of the S-NSSAI.
	Subscribed DNN list	List of the subscribed DNNs for the S-NSSAI (NOTE 1).
	<b>For each DNN in S-NSSAI level subscription data:</b>	
	DNN	DNN for the PDU Session.
	Framed Route information	Set of Framed Routes. A Framed Route refers to a range of IPv4 addresses / IPv6 Prefixes to associate with a PDU Session established on this (DNN, S-NSSAI). See NOTE 4.
	Allowed PDU Session Types	Indicates the allowed PDU Session Types (IPv4, IPv6, IPv4v6, Ethernet and Unstructured) for the DNN, S-NSSAI. See NOTE 6.

Default PDU Session Type	Indicates the default PDU Session Type for the DNN, S-NSSAI.
Allowed SSC modes	Indicates the allowed SSC modes for the DNN, S-NSSAI.
Default SSC mode	Indicate the default SSC mode for the DNN, S-NSSAI.
Interworking with EPS indication	Indicates whether interworking with EPS is supported for this DNN and S-NSSAI.
5GS Subscribed QoS profile	The QoS Flow level QoS parameter values (5QI and ARP) for the DNN, S-NSSAI (see clause 5.7.2.7 of TS 23.501 [2]).
Charging Characteristics	It contains Charging Characteristics as defined in Annex A, clause A.1 of TS 32.255 [45]. This information, when provided, shall override any corresponding predefined information at the SMF.
Subscribed-Session-AMBR	The maximum aggregated uplink and downlink MBRs to be shared across all Non-GBR QoS Flows in each PDU Session, which are established for the DNN, S-NSSAI.
Static IP address/prefix	Indicate the static IP address/prefix for the DNN, S-NSSAI.
User Plane Security Policy	Indicates the security policy for integrity protection and encryption for the user plane.
PDU Session continuity at inter RAT mobility	Provides for this DNN, S-NSSAI how to handle a PDU Session when UE the moves to or from NB-IoT. Possible values are: maintain the PDU session; disconnect the PDU session with a reactivation request; disconnect PDU session without reactivation request; or to leave it to local VPLMN policy.
NEF Identity for NIDD	When present, indicates, per S-NSSAI and per DNN, the identity of the NEF to anchor Unstructured PDU Session. When not present for the S-NSSAI and DNN, the PDU session terminates in UPF (see NOTE 8).
NIDD information	Information such as External Group Identifier, External Identifier, MSISDN, or AF ID used for SMF-NEF Connection.
SMF-Associated Expected UE Behaviour parameters	Parameters on expected characteristics of a PDU Session their corresponding validity times as specified in clause 4.15.6.3.
Suggested number of downlink packets	Parameters on expected PDU session characteristics as specified in clauses 4.15.3.2.3b and 4.15.6.3a.
ATSSS information	Indicates whether MA PDU session establishment is allowed.
Secondary authentication indication	Indicates that whether the Secondary authentication/authorization (as defined in clause 5.6 of TS 23.501 [2]) is required for PDU Session Establishment as specified in clause 4.3.2.3.
DN-AAA server UE IP address allocation indication	Indicates that whether the SMF is required to request the UE IP address from the DN-AAA server (as defined in clause 5.6 of TS 23.501 [2]) for PDU Session Establishment as specified in clause 4.3.2.3.
DN-AAA server addressing information.	If at least one of secondary DN-AAA authentication, DN-AAA authorization or DN-AAA UE IP address allocation is required by subscription data, the subscription data may also contain DN-AAA server addressing information.
Identifier translation	SUPI Corresponding SUPI for input GPSI.

	(Optional) MSISDN	Corresponding GPSI (MSISDN) for input GPSI (External Identifier). This is optionally provided for legacy SMS infrastructure not supporting MSISDN-less SMS. The presence of an MSISDN should be interpreted as an indication to the NEF that MSISDN shall be used to identify the UE when sending the SMS to the SMS-SC via T4.
	GPSI	Corresponding GPSI for input SUPI and Application Port ID.
Intersystem continuity Context	(DNN, PGW FQDN) list	For each DNN, indicates the SMF+PGW-C which support interworking with EPC.
LCS privacy (data needed by GMLC)	LCS privacy profile data	Provides information for LCS privacy classes and Location Privacy Indication (LPI) as defined in clause 5.4.2 of TS 23.273 [51]
LCS mobile origination (data needed by AMF)	LCS Mobile Originated Data	When present, indicates to the serving AMF which LCS mobile originated services are subscribed as defined in clause 7.1 of TS 23.273 [51].
UE reachability	UE reachability information	Provides, per PLMN, the list of NF IDs or the list of NF sets or the list of NF types authorized to request notification for UE's reachability (NOTE 7).
V2X Subscription data (see TS 23.287 [73])	NR V2X Services Authorization	Indicates whether the UE is authorized to use the NR sidelink for V2X services as Vehicle UE, Pedestrian UE, or both.
	LTE V2X Services Authorization	Indicates whether the UE is authorized to use the LTE sidelink for V2X services as Vehicle UE, Pedestrian UE, or both.
	NR UE-PC5-AMBR	AMBR of UE's NR sidelink (i.e. PC5) communication for V2X services.
	LTE UE-PC5-AMBR	AMBR of UE's LTE sidelink (i.e. PC5) communication for V2X services.
<p>NOTE 1: The Subscribed DNN list can include a wildcard DNN.</p> <p>NOTE 2: The default DNN shall not be a wildcard DNN.</p> <p>NOTE 3: The Steering of Roaming information and UDM Update Data are protected using the mechanisms defined in TS 33.501 [15].</p> <p>NOTE 4: Framed Route information and Framed Route(s) are defined in TS 23.501 [2].</p> <p>NOTE 5: Depending on the scenario PGW-C FQDN may be for S5/S8, or for S2b (ePDG case).</p> <p>NOTE 6: The Allowed PDU Session Types configured for a DNN which supports interworking with EPC should contain only the PDU Session Type corresponding to the PDN Type configured in the APN that corresponds to the DNN.</p> <p>NOTE 7: Providing a list of NF types or a list of NF sets may be more appropriate for some deployments, e.g. in highly dynamic NF lifecycle management deployments.</p> <p>NOTE 8: For a S-NSSAI and a DNN, the "Invoke NEF Indication" shall be present in the SMF selection subscription data if and only if the "NEF Identity for NIDD" Session Management Subscription Data includes a NEF Identity. When the "NEF Identity for NIDD" Session Management Subscription Data includes a NEF Identity for a S-NSSAI and DNN, the "Control Plane Only Indicator" will always be set for PDU Sessions to this S-NSSAI and DNN (see clause 5.31.4.1 of TS 23.501 [2]).</p> <p>NOTE 9: When multiple GPSIs are included in the GPSI list, any GPSI in the list can be used in NSSAA procedures.</p>		

**Table 5.2.3.3.1-2: Group Subscription data types**

Subscription data type	Field	Description
Group Identifier translation	External Group Identifier	Identifies external group of UEs that the UE belongs to as defined in TS 23.682 [23].
	Internal Group Identifier	Identifies internal group of UEs that the UE belongs to as defined in TS 23.501 [2].
	SUPI list	Corresponding SUPI list for input External Group Identifier.
Group Data (NOTE 1)	Internal Group Identifier	Internal identifiers of the group of UEs that the Group Data belongs to.
	Group data	In the case of 5G VN related groups the content of this information is defined in clause 4.15.6.3b.

Subscription data type	Field	Description
NOTE 1: Group Data within Group Subscription Data can be managed using the Shared Data feature defined in TS 29.503 [52]. In that case, Shared Data is identified using Shared Data identifier and can contain additional information than the one defined in this table.		

At least a mandatory key is required for each Subscription Data Type to identify the corresponding data. Depending on the use case, for some Subscription Data Types it is possible to use one or multiple sub keys to further identify the corresponding data, as defined in Tables 5.2.3.3.1-3 and 5.2.3.3.1-4 below.

**Table 5.2.3.3.1-3: UE Subscription data types keys**

Subscription Data Types	Data Key	Data Sub Key
Access and Mobility Subscription data	SUPI	Serving PLMN ID and optionally NID
SMF Selection Subscription data	SUPI	Serving PLMN ID and optionally NID
UE context in SMF data	SUPI	S-NSSAI
SMS Management Subscription data	SUPI	Serving PLMN ID and optionally NID
SMS Subscription data	SUPI	Serving PLMN ID and optionally NID
UE Context in SMSF data	SUPI	-
Session Management Subscription data	SUPI	S-NSSAI
		DNN
		Serving PLMN ID and optionally NID
Identifier translation	GPSI	-
	SUPI	Application Port ID
Slice Selection Subscription data	SUPI	Serving PLMN ID and optionally NID
Intersystem continuity Context	SUPI	DNN
LCS privacy	SUPI	-
LCS mobile origination	SUPI	-
UE reachability	SUPI	-
V2X Subscription data	SUPI	-

**Table 5.2.3.3.1-4: Group Subscription data types keys**

Subscription Data Types	Data Key	Data Sub Key
Group Identifier translation	External Group Identifier	-
	Internal Group Identifier	-
Group Data	Internal Group Identifier	-

Wireline access specific subscription data parameters are specified in TS 23.316 [53].

#### 5.2.3.3.2 Nudm\_SDM\_Get service operation

**Service Operation name:** Nudm\_SDM\_Get

**Description:** Consumer NF gets the subscription data indicated by the subscription data type input from UDM. The UDM shall check the requested consumer is authorized to get the specific subscription data requested. In the case of NF consumer is SMF, the subscriber data may contain e.g. Allowed PDU Session Type(s), Allowed SSC mode(s), default 5QI/ARP, Subscribed S-NSSAI(s).

**Inputs, Required:** NF ID, Subscription data type(s), Key for each Subscription data type(s).

**Inputs, Optional:** Data Sub Key(s), SoR Update Indicator, AF Identifier (for AF authorisation by the UDM).

If the AMF already has subscription data for the UE but the SoR Update Indicator in the UE context requires the AMF to retrieve SoR information depending on the NAS Registration Type ("Initial Registration" or "Emergency Registration"), the AMF shall include SoR update indicator in the Nudm\_SDM\_Get depending on the NAS Registration type.

**Outputs, Required:** The consumer NF gets the requested subscription data.

**Outputs, Optional:** None.

#### 5.2.3.3.3 Nudm\_SDM\_Notification service operation

**Service or service operation name:** Nudm\_SDM\_Notification

**Description:** The UDM notifies NF consumer of the updates of Subscription Data indicated by the "subscription data Type" input and additional UDM-related parameters.

**Inputs, Required:** Subscription data type(s), Key for each Subscription data type(s).

**Inputs, Optional:** None.

**Outputs, Required:** Result Indication.

The UDM invokes this service operation under the following cases:

- When the subscription data is updated at the UDM, the updated subscription information is notified to the serving NF that has subscribed for the specific subscription data type to be notified.
- When the UDM needs to deliver Steering of Roaming information to a UE.
- When the UDM needs to deliver UDM Update Data to a UE (e.g. a new Routing Indicator or Default Configured NSSAI to the UE).

If the updated subscription information is related to session management the subscriber data may contain e.g. Allowed PDU Session Type(s), Allowed SSC mode(s), default 5QI/ARP.

**Outputs, Optional:** Redirection information.

If the NF consumer is AMF and if the result of the service operation fails, AMF shall set corresponding cause value in result indication which can be used by the UDM for further action. If the related UE is not served by the AMF and the AMF knows which AMF is serving the UE, the AMF provides redirection information which can be used by the UDM to resend UE related message to the AMF that serves the UE.

#### 5.2.3.3.4 Nudm\_SDM\_Subscribe service operation

**Service operation name:** Nudm\_SDM\_Subscribe

**Description:** The NF consumer subscribes for updates to Subscription Data indicated by the 'subscription data type' input. The UDM shall check the requested consumer is authorized to subscribe to requested updates.

**Inputs, Required:** Subscription data type(s), Key for each Subscription data type(s).

**Inputs, Optional:** Data Sub Key(s), Immediate Report Indication.

**Outputs, Required:** None.

**Outputs, Optional:** Subscription Data.

#### 5.2.3.3.5 Nudm\_SDM\_Unsubscribe service operation

**Service operation name:** Nudm\_SDM\_Unsubscribe

**Description:** The NF consumer unsubscribes from updates to Subscription Data indicated by the 'subscription data type' input.

**Inputs, Required:** Subscription data type(s), Key for each Subscription data type(s).

**Inputs, Optional:** If the NF type is SMF: DNN, S-NSSAI.

**Outputs, Required:** None.

**Outputs, Optional:** None.

#### 5.2.3.3.6 Nudm\_SDM\_Info service operation

**Service Operation name:** Nudm\_SDM\_Info

**Description:** Consumer NF provides UDM with information about the status of the subscription data management procedures. This service operation is used for:

- providing acknowledgement from the UE to UDM about successful delivery of Steering of Roaming information via the AMF as defined in TS 23.122 [22].
- providing acknowledgement from the UE to UDM about successful Network Slicing Configuration subsequent to delivery of the Network Slicing Subscription Change Indication via the AMF.
- providing acknowledgement from the UE to UDM about successful delivery of UDM Update Data via the AMF as defined in clause 4.20.
- providing acknowledgement from the AMF to UDM that the delivery of the UDM Update Data has failed as defined in clause 4.20.

**Inputs, Required:** SUPI, Info (e.g. UE acknowledgment of SoR information from UDM via AMF, UE acknowledgement of successful Network Slicing Configuration subsequent to delivery of the Network Slicing Subscription Change Indication via the AMF, UE acknowledgment of UDM Update Data from UDM via AMF, failed transmission of UDM Update Data from UDM via AMF, failed transmission of SoR information from UDM via AMF).

**Inputs, Optional:** None.

**Outputs, Required:** None.

**Outputs, Optional:** None.

#### 5.2.3.3.7 Void

### 5.2.3.4 Nudm\_UEAuthentication Service

#### 5.2.3.4.1 General

This service is used by the requester NF to get authentication data and provide UDM with the result of the authentication procedure success.

#### 5.2.3.4.2 Nudm\_UEAuthentication\_Get service operation

See TS 33.501 [15].

#### 5.2.3.4.3 Nudm\_UEAuthentication\_ResultConfirmation service operation

See TS 33.501 [15].

### 5.2.3.5 Nudm\_EventExposure service

#### 5.2.3.5.1 General

See clause 4.15.3.1.

### 5.2.3.5.2 Nudm\_EventExposure\_Subscribe service operation

**Service operation name:** Nudm\_EventExposure\_Subscribe

**Description:** The NF consumer subscribes to receive an event, or if the subscription is already defined in UDM, then the subscription is updated.

**NF Consumers:** NEF.

**Inputs, Required:** Target of Event Reporting: UE(s) ID (SUPI or GPSI, Internal Group Identifier or External Group Identifier, or indication that any UE is targeted), Event filter containing the Event Id(s) (see clause 4.15.3.1) and Event Reporting Information defined in Table 4.15.1-1.

**Inputs, Optional:** Expiry time, DNN, S-NSSAI, traffic descriptor identifying the source of the downlink IP or Ethernet traffic (for Availability after DDN Failure and downlink data delivery status events), MTC Provider Information, Idle Status Indication request (if UE reachability or Availability after DDN failure reporting is requested).

For configuration of monitoring events applicable to both EPC and 5GC, a combined SCEF+NEF indicates that the monitoring event is also applicable to EPC (i.e. the event must be reported both by 5GC and EPC) and may include a SCEF address (i.e. if the event needs to be configured in a serving node in the EPC and the corresponding notification needs to be sent directly to the SCEF).

**Outputs, Required:** Operation execution result indication. When the subscription is accepted: Subscription Correlation ID, Expiry time (required if the subscription can be expired based on the operator's policy).

**Outputs, Optional:** First corresponding event report is included, if corresponding information is available (see clause 4.15.1), Number of UE if the External Group Identifier and Maximum Number of Reports are included in the inputs.

Number of UEs indicates the number of UEs within the group identified by the External Group Identifier. The NEF uses this value to determine whether the monitoring event has been reported for all group member UEs.

### 5.2.3.5.3 Nudm\_EventExposure\_Unsubscribe service operation

**Service operation name:** Nudm\_EventExposure\_Unsubscribe

**Description:** the consumer deletes the subscription of an event if already defined in UDM.

**Inputs, Required:** Subscription Correlation ID.

**Outputs, Required:** Operation execution result indication.

### 5.2.3.5.4 Nudm\_EventExposure\_Notify service operation

**Service operation name:** Nudm\_EventExposure\_Notify

**Description:** UDM reports the event to the consumer that has previously subscribed.

**Inputs, Required:** Event ID, Notification Correlation Information, time stamp.

**Inputs, Optional:** Event specific parameters list.

**Outputs, Required:** None.

### 5.2.3.6 Nudm\_ParameterProvision service

#### 5.2.3.6.1 General

This service is for allowing NEF to provision of information which can be used for the UE in 5GS.

Parameter Provision data types used in the Nudm\_ParameterProvision Service are defined in Table 5.2.3.6.1-1 below.

**Table 5.2.3.6.1-1: Parameter Provision data types**

Parameter Provision data type	Description
Expected UE Behaviour parameters	See clause 4.15.6.3
Network Configuration parameters	See clause 4.15.6.3a
5G VN group configuration data	5G VN Group Data and 5G VN Group membership management parameters for the 5G VN Group. See clause 4.15.6.3b and clause 4.15.6.3c
Location Privacy Indication parameters	Location Privacy Indication parameters of the "LCS privacy" Data Subset of the Subscription Data. See clause 5.2.3.3.1 and clause 7.1 of TS 23.273 [51].
Enhanced Coverage Restriction Information	See clause 4.27.1 and clause 5.31.12 of TS 23.501 [2].

At least a mandatory key is required for each Parameter Provision Data Type to identify the corresponding data as defined in Table 5.2.3.6.1-2.

**Table 5.2.3.6.1-2: Parameter Provision data types keys**

Parameter Provision Data Types	Data Key	Data Sub Key
Expected UE Behaviour parameters	GPSI or External Group ID	-
Network Configuration parameters	GPSI	-
5G VN group data	External Group Identifier	-
5G VN group membership management parameters	External Group Identifier	-
Location Privacy Indication parameters.	GPSI	-
Enhanced Coverage Restriction Information	GPSI	-

### 5.2.3.6.2 Nudm\_ParameterProvision\_Update service operation

**Service operation name:** Nudm\_ParameterProvision\_Update.

**Description:** The consumer updates the UE related information (e.g. Expected UE Behaviour, Network Configuration parameters, Location Privacy Indication parameters, Enhanced Coverage Restriction Information) or 5G VN group related information (5G VN group data, 5G VN membership management).

**Inputs, Required:** AF ID, Transaction Reference ID(s).

**Inputs, Optional:** GPSI or SUPI, External Group ID, at least one of the Expected UE Behaviour parameters or at least one of the Network Configuration parameters or 5G VN group related information, MTC Provider Information, Validity Time or Location Privacy Indication parameters or Enhanced Coverage Restriction Information.

**Outputs, Required:** Transaction Reference ID(s), Operation execution result indication.

**Outputs, Optional:** Transaction specific parameters, if available.

### 5.2.3.6.3 Nudm\_ParameterProvision\_Create service operation

**Service operation name:** Nudm\_ParameterProvision\_Create

**Description:** The consumer creates a Network Configuration with one or more parameters, or a 5G VN group related information (e.g. 5G VN group data, 5G VN membership management).

**Inputs, Required:** AF ID, Transaction Reference ID(s).

**Inputs, Optional:** GPSI, External Group ID, one or multiple Network Configuration parameters, or for 5G VN group creation, External Group ID and 5G VN group related information, MTC Provider Information.

**Outputs, Required:** Transaction Reference ID(s), Operation execution result indication.



**Outputs, Optional:** Transaction specific parameters, if available; Internal Group ID if the inputs include a new 5G VN configuration.

#### 5.2.3.6.4 Nudm\_ParameterProvision\_Delete service operation

**Service operation name:** Nudm\_ParameterProvision\_Delete

**Description:** The consumer deletes one or more previously created Network Configuration parameters, or a 5G VN group.

**Inputs, Required:** AF ID, Transaction Reference ID(s).

**Inputs, Optional:** GPSI, External Group ID, for 5G VN group deletion or Network Configuration of Parameters.

**Outputs, Required:** Transaction Reference ID(s), Operation execution result indication.

**Outputs, Optional:** None.

#### 5.2.3.6.5 Nudm\_ParameterProvision\_Get service operation

**Service operation name:** Nudm\_ParameterProvision\_Get

**Description:** The consumer gets the UE related information (e.g. Expected UE Behaviour, Network Configuration parameters).

**Inputs, Required:** GPSI, AF ID, requested information (e.g. Expected UE Behaviour, Network Configuration parameters).

**Inputs, Optional:** None.

**Outputs, Required:** Requested data, Operation execution result indication.

**Outputs, Optional:** None.

#### 5.2.3.7 Nudm\_NIDDAuthorisation service

##### 5.2.3.7.1 General

See clause 4.25.3.

##### 5.2.3.7.2 Nudm\_NIDDAuthorisation\_Get service operation

**Service operation name:** Nudm\_NIDDAuthorisation\_Get

**Description:** The consumer requests authorisation for NIDD Configuration.

**Inputs, Required:** GPSI or External Group Identifier, DNN, S-NSSAI, MTC Provider Information, Update Notification Address).

**Inputs, Optional:** NIDD Duration.

**Outputs, Required:** Single value or list of (SUPI, GPSI), Result.

**Outputs, Optional:** NIDD Duration.

##### 5.2.3.7.3 Nudm\_NIDDAuthorisation\_UpdateNotify service operation

**Service operation name:** Nudm\_NIDDAuthorisation\_UpdateNotify

**Description:** This service operation is used by the UDM to notify the NIDD Authorization Update to NF consumer.

**Inputs, Required:** SUPI, GPSI, DNN, S-NSSAI, Result.

**Inputs, Optional:** Cause (e.g. subscription withdrawal, DNN used for NIDD service is removed from the UE subscription), NIDD Duration.

**Outputs, Required:** None.

## 5.2.4 5G-EIR Services

### 5.2.4.1 General

The following table illustrates the 5G-EIR Service.

**Table 5.2.4-1: NF services provided by 5G-EIR**

NF service	Service Operations	Operation Semantics	Example Consumer(s)
N5g-eir_EquipmentIdentityCheck	Get	Request/Response	AMF

### 5.2.4.2 N5g-eir\_EquipmentIdentityCheck service

#### 5.2.4.2.1 General

**Service Description:** This service is provided by the 5G-EIR to check the PEI and check whether the PEI is in the prohibited list or not. The service can be consumed by AMF. The service operations provided within this service are depicted as below.

#### 5.2.4.2.2 N5g-eir\_EquipmentIdentityCheck\_Get service operation

**Service operation name:** N5g-eir\_EquipmentIdentityCheck\_Get

**Description:** Check the PEI and determine whether the subscriber is allowed to use the equipment.

**Inputs, Required:** PEI, SUPI.

**Inputs, Optional:** none

**Outputs, Required:** PEI checking result

**Outputs, Optional:** none

## 5.2.5 PCF Services

### 5.2.5.1 General

The following table illustrates the PCF Services.

Table 5.2.5.1-1: NF services provided by PCF

Service Name	Service Operations	Operation Semantics	Example Consumer (s)
Npcf_AMPolicyControl	Create	Request/Response	AMF
	Update	Request/Response	AMF
	UpdateNotify	Subscribe/Notify	AMF
	Delete	Request/Response	AMF
Npcf_Policy Authorization	Create	Request/Response	AF, NEF
	Update	Request/Response	AF, NEF
	Delete	Request/Response	AF, NEF
	Notify	Subscribe/Notify	AF, NEF, NWDAF
	Subscribe		AF, NEF, NWDAF
Unsubscribe	AF, NEF, NWDAF		
Npcf_SMPolicyControl	Create	Request/Response	SMF
	UpdateNotify	Subscribe/Notify	SMF
	Update	Request/Response	SMF
	Delete	Request/Response	SMF
Npcf_BDTPolicyControl	Create	Request/Response	NEF
	Update	Request/Response	NEF
	Notify		NEF
Npcf_UEPolicyControl	Create	Request/Response	AMF, V-PCF
	Update	Request/Response	AMF, V-PCF
	UpdateNotify	Subscribe/Notify	AMF, V-PCF
	Delete	Request/Response	AMF, V-PCF
Npcf_EventExposure	Subscribe	Subscribe/Notify	NEF, NWDAF
	Unsubscribe		
	Notify		

## 5.2.5.2 Npcf\_AMPolicyControl service

### 5.2.5.2.1 General

**Service description:** NF Service Consumer, e.g. AMF, can create and manage a AM Policy Association in the PCF through which the NF Service Consumer receives AM policy control information for a UE identified by a SUPI.

As part of this service, the PCF may provide the NF Service Consumer, e.g. AMF, with AM policy information for a SUPI that may contain:

- Access and mobility related policy information as defined in clause 6.5 of TS 23.503 [20]. In the case of roaming, this information is provided by V-PCF;
- Policy Control Request Trigger of AM Policy Association. When such a Policy Control Request Trigger condition is met the NF Service Consumer, e.g. shall contact PCF and provide information on the Policy Request Trigger condition that has been met. In the case of roaming, the V-PCF may subscribe to AMF.

At Npcf\_AMPolicyControl\_Create, the NF Service Consumer, e.g. AMF requests the creation of a corresponding "AM Policy Association" with the PCF (Npcf\_AMPolicyControl\_Create) and provides relevant parameters about the UE context to the PCF. When the PCF has created the AM Policy Association, the PCF may provide policy information as defined above.

When a Policy Control Request Trigger condition is met the NF Service Consumer, e.g. AMF requests the update (Npcf\_AMPolicyControl\_Update) of the AM Policy Association by providing information on the condition(s) that have been met. The PCF may provide updated policy information to the NF Service Consumer.

The PCF may at any time provide updated policy information (Npcf\_AMPolicyControl\_UpdateNotify);

At UE deregistration the NF Service Consumer, e.g. AMF requests the deletion of the corresponding AM Policy Association.

#### 5.2.5.2.2 Npcf\_AMPolicyControl\_Create service operation

**Service operation name:** Npcf\_AMPolicyControl\_Create

**Description:** NF Service Consumer can request the creation of an AM Policy Association and by providing relevant parameters about the UE context to the PCF.

**Inputs, Required:** SUPI.

**Inputs, Optional:** Information provided by the AMF as defined in 6.2.1.2 of TS 23.503 [20], such as Access Type, Permanent Equipment Identifier, GPSI, User Location Information, UE Time Zone, Serving Network (PLMN ID, or PLMN ID and NID, see clause 5.34 of TS 23.501 [2]), RAT type, List of subscribed Service Area Restrictions, subscribed RFSP Index, the Allowed NSSAI, GUAMI, backup AMF(s) (if NF Type is AMF). Backup AMF(s) are sent only once by the AMF to the PCF in its first interaction with the PCF.

**Outputs, Required:** AM Policy Association ID.

**Outputs, Optional:** The requested Access and mobility related policy information as defined in clause 6.5 of TS 23.503 [20] and Policy Control Request Trigger of AM Policy Association.

See clause 4.2.2.2.2 (step 16) for the detail usage of this service operation for AMF. In step 16, the AMF requests the PCF to apply operator policies for the UE.

See clause 4.16.1.2 (steps 2 and 3) for the detail usage of this service operation for AMF. In step 2, the AMF requests the PCF to apply operator policies for the UE; in step 3, the PCF acknowledges AMF with requested policy.

#### 5.2.5.2.3 Npcf\_AMPolicyControl\_UpdateNotify service operation

**Service operation name:** Npcf\_AMPolicyControl\_UpdateNotify

**Description:** Provides to the NF Service Consumer, e.g. AMF, updated AM related Policy information for the AM Policy Association as defined in clause 6.5 of TS 23.503 [20].

NOTE: This notification corresponds to an implicit subscription.

**Inputs, Required:** AM Policy Association ID.

**Inputs, Optional:** Access and Mobility related information or indication of AM Policy Association termination.

**Outputs, Required:** Success or failure.

**Outputs, Optional:** None.

See clause 4.16.2.2 for the usage of this service operation.

#### 5.2.5.2.4 Npcf\_AMPolicyControl\_Delete service operation

**Service operation name:** Npcf\_AMPolicyControl\_Delete

**Description:** Provides means for the NF Consumer to delete the AM Policy Association.

**Inputs, Required:** AM Policy Association ID.

**Inputs, Optional:** None.

**Outputs, Required:** Success or Failure.

**Outputs, Optional:** None.

See clause 4.16.3.2 (step 2 and 3) for the detail usage of this service operation for AMF. In step 2, the AMF initiates the AM Policy Association Termination procedure; in step 3 the PCF deletes the AM Policy Association for this AM Policy Association ID.

#### 5.2.5.2.5 Npcf\_AMPolicyControl\_Update service operation

**Service operation name:** Npcf\_AMPolicyControl\_Update.

**Description:** NF Service Consumer, e.g. AMF can request the update of the AM Policy Association to receive updated Policy information for the UE context when the policy control request trigger is met or the AMF is relocated due to the UE mobility and the old PCF is selected.

**Inputs, Required:** AM Policy Association ID.

**Inputs, Optional:** Information on the Policy Control Request Trigger condition that has been met as defined in clause 6.1.2.5 of TS 23.503 [20], GUAMI(s) (if NF Type is AMF).

**Outputs, Required:** Success or not.

**Outputs, Optional:** Policy information for the UE context as defined in clause 5.2.5.2.1.

See clause 4.16.2.1 for the usage of this service operation.

### 5.2.5.3 Npcf\_PolicyAuthorization Service

#### 5.2.5.3.1 General

**Service description:** This service is to authorise an AF request and to create policies as requested by the authorized AF for the PDU Session to which the AF session is bound. Additionally this service allows an AF to exchange Ethernet port management information with DS-TT and NW-TT. This service allows the NF consumer to subscribe/unsubscribe the notification of events, which are defined in clause 6.1.3.18 of TS 23.503 [20].

#### 5.2.5.3.2 Npcf\_PolicyAuthorization\_Create service operation

**Service operation name:** Npcf\_PolicyAuthorization\_Create

**Description:** Authorize the request and optionally determines and installs SM Policy Control Data according to the information provided by the NF Consumer or provides Ethernet Port Management Information Container for Ethernet ports on DS-TT or NW-TT, or Bridge Management Information Container.

**Inputs, Required:** UE (IP or MAC) address, identification of the application session context.

**Inputs, Optional:** UE identity if available, DNN if available, S-NSSAI if available, Media type, Media format, bandwidth requirements, sponsored data connectivity if applicable, flow description, Application Identifier, AF Communication Service Identifier, AF Record Identifier, Flow status, Priority indicator, emergency indicator, Application service provider, resource allocation outcome, AF Application Event Identifier, a list of DNAI(s) and corresponding routing profile ID(s) or N6 traffic routing information, AF Transaction Id, Early and/or late notifications about UP path management events, temporal validity condition and spatial validity condition as described in clause 5.6.7 in 23.501 [2], Background Data Transfer Reference ID, priority sharing indicator as described in clause 6.1.3.15 of TS 23.503 [20], pre-emption control information as described in clause 6.1.3.15 of TS 23.503 [20], Port Management Information Container and related port number, Bridge Management Information Container, TSN AF parameters provided by the TSN AF to the PCF as described in clause 6.1.3.23 of TS 23.503 [20], QoS parameter(s) to be measured, Reporting frequency, Target of reporting as described in clause 6.1.3.21 of TS 23.503 [20], Alternative Service Requirements (containing one or more QoS reference parameters in a prioritized order).

**Outputs, Required:** Success or Failure (reason for failure, e.g. as defined in clauses 6.1.3.16 and 6.1.3.10 of TS 23.503 [20]).

**Outputs, Optional:** The service information that can be accepted by the PCF.

#### 5.2.5.3.3 Npcf\_PolicyAuthorization\_Update service operation

**Service operation name:** Npcf\_PolicyAuthorization\_Update

**Description:** Provides updated information to the PCF.

**Inputs, Required:** Identification of the application session context.

**Inputs, Optional:** Media type, Media format, bandwidth requirements, sponsored data connectivity if applicable, flow description, Application Identifier, AF Communication Service Identifier, AF Record Identifier, Flow status, Priority indicator, Application service provider, resource allocation outcome, AF Application Event Identifier, a list of DNAI(s)

and corresponding routing profile ID(s) or N6 traffic routing information, AF Transaction Id, Early and/or late notifications about UP path management events, temporal validity condition and spatial validity condition as described in clause 5.6.7 in 23.501 [2], Background Data Transfer Reference ID, priority sharing indicator as described in clause 6.1.3.15 of TS 23.503 [20], pre-emption control information as described in clause 6.1.3.15 of TS 23.503 [20], Port Management Information Container and related port number, Bridge Management Information Container, TSN AF parameters provided by the TSN AF to the PCF as described in clause 6.1.3.23 of TS 23.503 [20], QoS parameter(s) to be measured, Reporting frequency, Target of reporting as described in clause 6.1.3.21 of TS 23.503 [20].

**Outputs, Required:** Success or Failure (reason for failure, e.g. as defined in clause 6.1.3.16 of TS 23.503 [20]).

**Outputs, Optional:** The service information that can be accepted by the PCF.

Provides updated application level information and communicates with Npcf\_SMPolicyControl service to determine and install the policy according to the information provided by the NF Consumer. Updates an application context in the PCF.

#### 5.2.5.3.4 Npcf\_PolicyAuthorization\_Delete service operation

**Service operation name:** Npcf\_PolicyAuthorization\_Delete

**Description:** Provides means for the NF Consumer to delete the context of application level session information.

**Inputs, Required:** Identification of the application session context.

**Inputs, Optional:** None.

**Outputs, Required:** None.

**Outputs, Optional:** None.

#### 5.2.5.3.5 Npcf\_PolicyAuthorization\_Notify service operation

**Service operation name:** Npcf\_PolicyAuthorization\_Notify

**Description:** provided by the PCF to notify NF consumers of the subscribed events.

**Inputs, Required:** Event ID.

The events that can be subscribed are defined in clause 6.1.3.18 of TS 23.503 [20].

**Inputs, Optional:** Event information (defined on a per Event ID basis) are defined in clause 6.1.3.18 of TS 23.503 [20], Notification Correlation Information (information to identify the application session).

Notification Correlation Information is mandatory except in the case of the new 5GS Bridge information detected event if no AF session exists between the PCF and the AF.

**Outputs, Required:** Operation execution result indication.

**Outputs, Optional:** None.

#### 5.2.5.3.6 Npcf\_PolicyAuthorization\_Subscribe service operation

**Service operation name:** Npcf\_PolicyAuthorization\_Subscribe

**Description:** provided by the PCF for NF consumers to explicitly subscribe the notification of events.

**Inputs, Required:** (Set of) Event ID(s) as specified in Npcf\_PolicyAuthorization\_Notify service operation, target of PCF event reporting (defined below), NF ID, Event Reporting Information defined in Table 4.15.1-1 (only the Event Reporting mode and the immediate reporting flag when applicable), Notification Target Address (+ Notification Correlation ID).

The target of PCF event reporting the subscription for an individual AF session: An UE IP address (IPv4 address or IPv6 prefix) optionally together with a (DNN, S-NSSAI) or with a UE ID (SUPI or GPSI).

**Inputs, Optional:** Event Filter, Subscription Correlation ID (in the case of modification of the event subscription).

**Outputs, Required:** When the subscription is accepted: Subscription Correlation ID.

**Outputs, Optional:** None.

#### 5.2.5.3.7 Npcf\_PolicyAuthorization\_Unsubscribe service operation

**Service operation name:** Npcf\_PolicyAuthorization\_Unsubscribe

**Description:** Enable NF consumers to explicitly unsubscribe the notification of PCF events related to Npcf\_PolicyAuthorization\_Subscribe operation.

**Inputs, Required:** Subscription Correlation.

**Inputs, Optional:** None.

**Outputs, Required:** Success or Failure.

**Outputs, Optional:** None.

#### 5.2.5.4 Npcf\_SMPolicyControl service

##### 5.2.5.4.1 General

**Service description:** NF Service Consumer, e.g. SMF can create and manage a SM Policy Association in the PCF through which the NF Service Consumer receives policy information for a PDU Session.

As part of this service, the PCF may provide the NF Service Consumer, e.g. SMF with policy information about the PDU Session that may contain:

- PDU Session related policy information as defined in clause 6.4 of TS 23.503 [20].
- PCC rule information as defined in clause 6.3 of TS 23.503 [20].
- Policy Control Request Trigger information i.e. a set of Policy Request Trigger(s) as defined in clause 6.1.3.5 of TS 23.503 [20]. When a Policy Control Request Trigger condition is met the NF Service Consumer, e.g. SMF shall contact the PCF and provide information on the Policy Control Request Trigger condition that has been met.

At PDU Session establishment the NF Service Consumer, e.g. SMF requests the creation of a corresponding SM Policy Association with the PCF (Npcf\_SMPolicyControl\_Create) and provides relevant parameters about the PDU Session to the PCF.

- When the PCF has created the "SM Policy Association, the PCF may provide policy information as defined above.

When a Policy Control Request Trigger condition is met the NF Service Consumer, e.g. SMF requests the update(Npcf\_SMPolicyControl\_Update) of the SM Policy Association by providing information on the condition(s) that have been met. The PCF may provide updated policy information to the NF Service Consumer.

The PCF may at any time provide updated policy information (Npcf\_SMPolicyControl\_UpdateNotify).

At PDU Session Release the NF Service Consumer, e.g. SMF requests the deletion of the corresponding SM Policy Association.

##### 5.2.5.4.2 Npcf\_SMPolicyControl\_Create service operation

**Service operation name:** Npcf\_SMPolicyControl\_Create.

**Description:** The NF Service Consumer can request the creation of a SM Policy Association and provide relevant parameters about the PDU Session to the PCF.

**Inputs, Required:** SUPI (or PEI in the case of emergency PDU Session without SUPI), PDU Session id, DNN, S-NSSAI and RAT Type.

**Inputs, Optional:** Information provided by the SMF as defined in clause 6.2.1.2 of TS 23.503 [20], such as Access Type, the IPv4 address and/or IPv6 prefix, PEI, GPSI, User Location Information, UE Time Zone, Serving Network (PLMN ID, or PLMN ID and NID, see clause 5.34 of TS 23.501 [2]), Charging Characteristics information, Session AMBR, subscribed default QoS information, Trace Requirements and Internal Group Identifier (see clause 5.9.7 of TS 23.501 [2]), DN Authorization Profile Index, Framed Route information. MA PDU Request indication, MA PDU Network-Upgrade Allowed indication, ATSSS capabilities of the MA PDU Session, QoS constraints from the VPLMN (see clause 4.3.2.2.2).

Framed Route information is defined in Table 5.2.3.3.1-1.

**NOTE:** If SMF receives the DN authorized Session AMBR from the DN-AAA at PDU session establishment, it includes the DN authorized Session AMBR within the Session-AMBR, instead of the subscribed Session AMBR received from the UDM, in the request.

W-5GAN specific PDU session information provided by the SMF is specified in TS 23.316 [53].

**Outputs, Required:** SM Policy Association ID defined in TS 29.512 [57]. Success or Failure.

**Outputs, Optional:** Policy information for the PDU Session as defined in clause 5.2.5.4.1.

See clause 4.16.4 for the detail usage of this service operation.

See clauses 4.22.2.1 and 4.22.3 for detailed usage of this service operation for ATSSS.

#### 5.2.5.4.3 Npcf\_SMPolicyControl\_UpdateNotify service operation

**Service operation name:** Npcf\_SMPolicyControl\_UpdateNotify

**Description:** Provides to the NF Service Consumer, e.g. SMF updated Policy information for the PDU Session evaluated based on the information previously provided by the SMF, AF, CHF, UDR and NWDAF, as defined in clause 6.2.1.2 of TS 23.503 [20],

**Inputs, Required:** SM Policy Association ID.

**Inputs, Optional:** Policy information for the PDU Session as defined in clause 5.2.5.4.1.

**Outputs, Required:** Success or Failure.

**Outputs, Optional:** None.

See clause 4.16.5.2 for the usage of this service operation.

#### 5.2.5.4.4 Npcf\_SMPolicyControl\_Delete service operation

**Service operation name:** Npcf\_SMPolicyControl\_Delete

**Description:** The NF Service Consumer can request the deletion of the SM Policy Association and of the associated resources.

**Inputs, Required:** SM Policy Association ID.

**Inputs, Optional:** 5G SRVCC indication.

**Outputs, Required:** Success or Failure.

**Outputs, Optional:** None.

See clause 4.16.6 for the usage of this service operation.

When the PDU session for IMS is released due to PS to CS handover for 5G SRVCC, SMF indicate the 5G SRVCC indication received from AMF to PCF.

#### 5.2.5.4.5 Npcf\_SMPolicyControl\_Update service operation

**Service operation name:** Npcf\_SMPolicyControl\_Update.



**Description:** The NF Service Consumer can request the update of the SM Policy Association to receive updated Policy information for the PDU Session.

**Inputs, Required:** SM Policy Association ID.

**Inputs, Optional:** Information on the Policy Control Request Trigger condition, as defined in clause 6.1.3.5 of TS 23.503 [20], that has been met such as Access Type, (new or removed) IPv4 address and/or IPv6 network prefix, User Location Information, UE Time Zone, Serving Network, RAT type, Session AMBR, or subscribed default QoS information, DN Authorization Profile Index, 5GS bridge information [Bridge ID, DS-TT MAC address, port number of DS-TT port, UE-DS-TT Residence Time], Port Management Information Container and the related port number, Bridge Management Information Container, QoS Monitoring report, MA PDU Request indication, MA PDU Network-Upgrade Allowed indication, ATSSS capabilities of the MA PDU Session, QoS constraints from the VPLMN (see clause 4.3.2.2.2).

W-5GAN specific PDU session information provided by the SMF is specified in TS 23.316 [53].

**Outputs, Required:** Success or not.

**Outputs, Optional:** Policy information for the PDU Session as defined in clause 5.2.5.4.1.

See clause 4.16.5.1 for the usage of this service operation.

NOTE: When this service operation is invoked by SMF, race conditions apply, which are defined in TS 29.513 [47].

## 5.2.5.5 Npcf\_BDTPolicyControl Service

### 5.2.5.5.1 General

**Service description:** This service provides background data transfer policy, which includes the following functionalities:

- Get background data transfer policies based on the request via NEF from AF; and
- Update background data transfer based on the selection provided by AF.

#### 5.2.5.5.2 Npcf\_BDTPolicyControl\_Create service operation

**Service operation name:** Npcf\_BDTPolicyControl\_Create

**Description:** This service is to create the background data transfer policy.

**Inputs, Required:** ASP identifier, Volume per UE, Number of UEs, Desired time window.

**Inputs, Optional:** S-NSSAI, DNN, Internal Group Identifier, Network Area Information, Request for notification, MAC address or IP 3-tuple of Application server.

**Outputs, Required:** one or more background data transfer policies, Background Data Transfer Reference ID.

**Outputs, Optional:** None.

#### 5.2.5.5.3 Npcf\_BDTPolicyControl\_Update service operation

**Service operation name:** Npcf\_BDTPolicyControl\_Update

**Description:** This service is to update the background data transfer policy to the PCF.

**Inputs, Required:** ASP identifier, background data transfer policy, Background Data Transfer Reference ID.

**Inputs, Optional:** Stop notification.

**Outputs, Required:** None

**Outputs, Optional:** None.

#### 5.2.5.5.4 Npcf\_BDTPolicyControl\_Notify service operation

**Service operation name:** Npcf\_BDTPolicyControl\_Notify

**Description:** This service operation sends the BDT warning notification to the NF consumer.

**Inputs, Required:** Background data transfer reference ID.

**Inputs, Optional:** Network Area Information, Time window, list of candidate Background Data Transfer policies.

**Outputs, Required:** None.

**Outputs, Optional:** None.

#### 5.2.5.6 Npcf\_UEPolicyControl Service

##### 5.2.5.6.1 General

**Service description:** NF Service Consumer, e.g. AMF, may create and manage a UE Policy Association in the PCF through which the NF Service Consumer receives Policy Control Request Trigger of UE Policy Association.

The association allows (V-)PCF to provide UE policy information to the UE transparently through the NF Service Consumer using NAS TRANSPORT message to carry:

- UE policy information as defined in clause 6.6 of TS 23.503 [20]. In the case of roaming, the URSP rules are provided by H-PCF and the ANDSP rules may be provided by V-PCF or H-PCF or both.

As part of this service, the PCF may provide the NF Service Consumer, e.g. AMF, with policy information about the UE that may contain:

- Policy Control Request Trigger of UE Policy Association. When such a Policy Control Request Trigger condition is met, the NF Service Consumer, e.g. AMF, shall contact PCF and provide information on the Policy Request Trigger condition that has been met. In the case of roaming, the V-PCF may subscribe to AMF or the H-PCF may subscribe to AMF via V-PCF.

At Npcf\_UEPolicyControl\_Create, the NF Service Consumer, e.g. AMF, requests the creation of a corresponding "UE Policy Association" with the PCF (Npcf\_UEPolicyControl\_Create) and provides relevant parameters about the UE context to the PCF. When the PCF has created the UE Policy Association, the PCF may provide policy information as defined above.

When a Policy Control Request Trigger condition is met, the NF Service Consumer, e.g. AMF, requests the update (Npcf\_UEPolicyControl\_Update) of the UE Policy Association by providing information on the condition(s) that have been met. The PCF may provide updated policy information to the NF Service Consumer.

During the AMF relocation, if the target AMF receives the PCF ID from source AMF and the target AMF decides to contact with the PCF identified by the PCF ID based on the local policies, the target AMF requests the update (Npcf\_UEPolicyControl\_Update) of the UE Policy Association. If a Policy Control Request Trigger condition is met, the information matching the trigger condition may also be provided by the target AMF. The PCF may provide updated policy information to the target AMF.

The PCF may at any time provide updated policy information (Npcf\_UEPolicyControl\_UpdateNotify).

At UE deregistration the NF Service Consumer, e.g. AMF, requests the deletion of the corresponding UE Policy Association.

##### 5.2.5.6.2 Npcf\_UEPolicyControl\_Create service operation

**Service operation name:** Npcf\_UEPolicyControl\_Create

**Description:** NF Service Consumer can request the creation of a UE Policy Association by providing relevant parameters about the UE context to the PCF.

**Inputs, Required:** Notification endpoint, SUPI.

**Inputs, Optional:** H-PCF ID (if the NF service producer is V-PCF and AMF is NF service consumer), information provided by the AMF as define in 6.2.1.2 of TS 23.503 [20], such as Access Type, Permanent Equipment Identifier, GPSI, User Location Information, UE Time Zone, Serving Network (PLMN ID, or PLMN ID and NID, see clause 5.34 of TS 23.501 [2]), RAT type, UE policy information including the list of PSIs, OS id and Internal Group (see TS 23.501 [2])

**Outputs, Required:** Success or Failure, UE Policy Association ID.

**Outputs, Optional:** Policy Control Request Trigger of UE Policy Association. In the case of H-PCF is producer, UE policy information (see clause 5.2.5.6.1).

#### 5.2.5.6.3 Npcf\_UEPolicyControl\_UpdateNotify service operation

**Service operation name:** Npcf\_UEPolicyControl\_UpdateNotify

**Description:** Provides to the NF Service Consumer updated Policy information for the UE context evaluated based on the information previously provided by the PCF.

NOTE: This notification corresponds to an implicit subscription.

**Inputs, Required:** Notification endpoint, UE Policy Association ID.

**Inputs, Optional:** Policy Control Request Trigger of UE Policy Association. In the case of H-PCF is producer, UE Access and PDU session related information as defined in clause 5.2.5.1.

**Outputs, Required:** Success or failure.

**Outputs, Optional:** None.

#### 5.2.5.6.4 Npcf\_UEPolicyControl\_Delete service operation

**Service operation name:** Npcf\_UEPolicyControl\_Delete

**Description:** Provides means for the NF Consumer to delete the UE policy control association.

**Inputs, Required:** UE Policy Association ID.

**Inputs, Optional:** None.

**Outputs, Required:** Success or Failure.

**Outputs, Optional:** None.

#### 5.2.5.6.5 Npcf\_UEPolicyControl\_Update service operation

**Service operation name:** Npcf\_UEPolicyControl\_Update

**Description:** NF Service Consumer, e.g. AMF can request the update of the UE Policy Association to receive updated Policy information for the UE context.

**Inputs, Required:** UE Policy Association ID.

**Inputs, Optional:** Information on the UE policy related Policy Control Request Trigger condition that has been met, as defined in Table 6.1.2.5-1 of TS 23.503 [20].

**Outputs, Required:** Success or Failure.

**Outputs, Optional:** Policy Control Request Trigger of UE Policy Association. In the case of H-PCF is producer, UE related policy information.

## 5.2.5.7 Npcf\_EventExposure service

### 5.2.5.7.1 General

**Service description:** This service enables an NF to subscribe and get notified about PCF events for a group of UE(s) or any UE accessing a combination of (DNN, S-NSSAI).

The events can be subscribed by a NF consumer are described in clause 6.1.3.18 of TS 23.503 [20].

The following service operations are defined for the Npcf\_EventExposure service:

- Npcf\_EventExposure\_Subscribe.
- Npcf\_EventExposure\_UnSubscribe.
- Npcf\_EventExposure\_Notify.

### 5.2.5.7.2 Npcf\_EventExposure\_Subscribe service operation

**Service operation name:** Npcf\_EventExposure\_Subscribe.

**Description:** The consumer NF uses this service operation to subscribe to or modify event reporting for a group of UE(s) or any UE accessing a combination of (DNN, S-NSSAI).

**NF Consumers:** NEF.

**Inputs, Required:** NF ID, Target of Event Reporting (Internal Group Identifier or indication that any UE accessing a combination of (DNN, S-NSSAI) is targeted, (set of) Event ID(s) defined in clause 5.2.5.7.1, Notification Target Address (+ Notification Correlation ID) and Event Reporting Information defined in Table 4.15.1-1.

**Inputs, Optional:** Event Filter (s) associated with each Event ID, Expiry time.

**Outputs, Required:** Operation execution result indication. When the subscription is accepted: Subscription Correlation ID, Expiry time (required if the subscription can be expired based on the operator's policy).

**Outputs, Optional:** First corresponding event report is included, if corresponding information is available (see clause 4.15.1).

The NF consumer subscribes to the event notification by invoking Npcf\_EventExposure to the PCF. The PCF allocates a Subscription Correlation ID for the subscription and responds to the consumer NF with the Subscription Correlation ID. Event receiving NF ID identifies the NF that shall receive the event reporting.

### 5.2.5.7.3 Npcf\_EventExposure\_Unsubscribe service operation

**Service operation name:** Npcf\_EventExposure\_Unsubscribe.

**Description:** The NF consumer uses this service operation to unsubscribe for a specific event for a group of UE(s) or any UE accessing a combination of (DNN, S-NSSAI).

**Inputs, Required:** Subscription Correlation ID.

**Input, Optional:** None.

**Outputs, Required:** Operation execution result indication.

**Output, Optional:** None.

### 5.2.5.7.4 Npcf\_EventExposure\_Notify service operation

**Service operation name:** Npcf\_EventExposure\_Notify.

**Description:** This service operation reports the event to the consumer that has previously subscribed.

**Inputs, Required:** Event ID, corresponding UE ID (GPSI), Notification Correlation Information, time stamp.

**Inputs, Optional:** None.

**Outputs, Required:** None.

## 5.2.6 NEF Services

### 5.2.6.1 General

The following table shows the NEF Services and Service Operations:

**Table 5.2.6.1-1: NF Services provided by the NEF**

Service Name	Service Operations	Operation Semantics	Example Consumer(s)
<b>Nnef_EventExposure</b>	Subscribe	Subscribe/Notify	AF, NWDAF
	Unsubscribe		AF, NWDAF
	Notify		AF, NWDAF
<b>Nnef_PFDManagement</b>	Fetch	Request/Response	SMF
	Subscribe	Subscribe/Notify	SMF
	Notify		SMF
	Unsubscribe		SMF
	Create	Request/Response	AF
	Update	Request/Response	AF
	Delete	Request/Response	AF
<b>Nnef_ParameterProvision</b>	Update	Request/Response	AF
	Create	Request/Response	AF
	Delete	Request/Response	AF
	Get	Request/Response	AF
<b>Nnef_Trigger</b>	Delivery	Request/Response	AF
	DeliveryNotify	Subscribe/Notify	AF
<b>Nnef_BDTPNegotiation</b>	Create	Request/Response	AF
	Update	Request/Response	AF
	Notify		AF
<b>Nnef_TrafficInfluence</b>	Create	Request/Response	AF
	Update	Request/Response	AF
	Delete	Request/Response	AF
	Get	Request/Response	AF
	Notify	Subscribe/Notify	AF
	AppRelocationInfo	Subscribe/Notify	AF
<b>Nnef_ChargeableParty</b>	Create	Request/Response	AF
	Update	Request/Response	AF
	Notify	Request/Response	AF
<b>Nnef_AFsessionWithQoS</b>	Create	Request/Response	AF
	Notify	Request/Response	AF
	Update	Request/Response	AF
	Revoke	Request/Response	AF
<b>Nnef_MSISDN-less_MO_SMS</b>	Notify	Notify	AF
<b>Nnef_ServiceParameter</b>	Create	Request/Response	AF
	Update	Request/Response	AF
	Delete	Request/Response	AF
	Get	Request/Response	AF
<b>Nnef_APISupportCapability</b>	Subscribe	Subscribe/Notify	AF
	Unsubscribe	Subscribe/Notify	AF
	Notify	Subscribe/Notify	AF
<b>Nnef_NIDDConfiguration</b>	Create	Request/Response	AF
	TriggerNotify	Subscribe/Notify	AF
	UpdateNotify	Subscribe/Notify	AF
	Delete	Request/Response	AF
<b>Nnef_NIDD</b>	Delivery	Request/Response	AF
	DeliveryNotify	Subscribe/Notify	AF

	GroupDeliveryNotify	Notify	AF
<b>Nnef_SMContext</b>	Create	Request/Response	SMF
	Delete	Request/Response	SMF
	DeleteNotify	Subscribe/Notify	SMF
	Delivery	Request/Response	SMF
<b>Nnef_AnalyticsExposure</b>	Subscribe	Subscribe/Notify	AF
	Unsubscribe		AF
	Notify		AF
	Fetch	Request/Response	AF
<b>Nnef_UCMFProvisioning</b>	Create	Request/Response	AF
	Delete	Request/Response	AF
	Update	Request/Response	AF
<b>Nnef_ECRestriction</b>	Get	Request/Response	AF
	Update	Request/Response	AF
<b>Nnef_ApplyPolicy</b>	Create	Request/Response	AF
	Update	Request/Response	AF
	Delete	Request/Response	AF
<b>Nnef_Location</b>	LocationUpdateNotify	Notify	AF

## 5.2.6.2 Nnef\_EventExposure service

### 5.2.6.2.1 General

See clause 4.15.3.1 and clause 4.15.2a.

In order to support the NWDAF to collect data from the AF via the NEF, the Event IDs associated with available data to be collected from the AF are defined in clause 5.2.19.2.1, which can be subscribed by the NWDAF. The Event filters for the specific Event IDs as defined in clause 5.2.19.2.1 can also be used for collecting data from the AF via the NEF.

### 5.2.6.2.2 Nnef\_EventExposure\_Subscribe operation

**Service operation name:** Nnef\_EventExposure\_Subscribe

**Description:** the consumer subscribes to receive an event, or if the event is already defined in NEF, then the subscription is updated.

**Inputs, Required:** (Set of) Event ID(s) as specified in clause 4.15.3.1 or Npcf\_PolicyAuthorization\_Notify and Naf\_EventExposure\_Subscribe service operation, Target of Event Reporting (GPSI, SUPI, External Group Identifier, or Internal Group Identifier), Event Reporting Information defined in Table 4.15.1-1, Notification Target Address (+ Notification Correlation ID), MTC Provider Information.

**Inputs, Optional:** Event Filter, (set of) Application Identifier(s), Subscription Correlation ID (in the case of modification of the event subscription), Expiry time, Idle Status Indication request (if UE reachability or Availability after DDN failure reporting is requested).

**Outputs, Required:** When the subscription is accepted: Subscription Correlation ID, Expiry time (required if the subscription can be expired based on the operator's policy).

**Outputs, Optional:** First corresponding event report is included, if available (see clause 4.15.1).

### 5.2.6.2.3 Nnef\_EventExposure\_Unsubscribe service operation

**Service operation name:** Nnef\_EventExposure\_Unsubscribe

**Description:** the NF consumer deletes an event if already defined in NEF.

**Inputs, Required:** Subscription Correlation ID.

**Outputs, Required:** Operation execution result indication.



#### 5.2.6.2.4 Nnef\_EventExposure\_Notify service operation

**Service operation name:** Nnef\_EventExposure\_Notify

**Description:** NEF reports the event to the consumer that has previously subscribed.

**Inputs, Required:** Event ID, Notification Correlation Information, time stamp.

**Inputs, Optional:** Event information (defined on a per Event ID basis).

**Outputs, Required:** Operation execution result indication.

#### 5.2.6.3 Nnef\_PFDManagement service

##### 5.2.6.3.1 General

The service provides the capability to create, update or remove PFDs via the NEF (PFDF). See clause 4.18 for the detailed procedures.

##### 5.2.6.3.2 Nnef\_PFDManagement\_Fetch service operation

**Service operation name:** Nnef\_PFDManagement\_Fetch

**Description:** Provides the PFDs for Application Identifier to the NF Consumer.

**Inputs, Required:** Application Identifier(s).

**Inputs, Optional:** None.

**Outputs, Required:** Application Identifier, PFDs.

##### 5.2.6.3.3 Nnef\_PFDManagement\_Subscribe service operation

**Service operation name:** Nnef\_PFDManagement\_Subscribe

**Description:** provided by the NEF (PFDF) for NF consumers to explicitly subscribe the notification of changes of PFDs for Application Identifier.

**Inputs, Required:** Application Identifier(s).

**Inputs, Optional:** None.

**Outputs, Required:** None.

##### 5.2.6.3.4 Nnef\_PFDManagement\_Notify service operation

**Service operation name:** Nnef\_PFDManagement\_Notify

**Description:** Provides Update PFDs for Application Identifier to the NF Consumer.

**Inputs, Required:** Application Identifier(s), PFDs.

**Inputs, Optional:** None.

**Outputs, Required:** None.

##### 5.2.6.3.5 Nnef\_PFDManagement\_Unsubscribe service operation

**Service operation name:** Nnef\_PFDManagement\_Unsubscribe

**Description:** Provides by the NEF (PFDF) for NF Consumer to explicitly unsubscribe the notification of events.

**Inputs, Required:** Application Identifier(s).

**Inputs, Optional:** None.

**Outputs, Required:** None

#### 5.2.6.3.6 Nnef\_PFDManagement\_Create service operation

**Service operation name:** Nnef\_PFDManagement\_Create

**Description:** The consumer requests PFD management to create PFDs.

**Inputs, Required:** AF ID, External Application Identifier and one or more sets of PFDs.

**Inputs, Optional:** Allowed Delay.

**Outputs, Required:** Transaction Reference ID.

#### 5.2.6.3.7 Nnef\_PFDManagement\_Update service operation

**Service operation name:** Nnef\_PFDManagement\_Update

**Description:** The consumer requests PFD management to update PFDs.

**Inputs, Required:** Transaction Reference ID, one or more sets of PFDs.

**Inputs, Optional:** Allowed Delay.

**Outputs, Required:** None.

#### 5.2.6.3.8 Nnef\_PFDManagement\_Delete service operation

**Service operation name:** Nnef\_PFDManagement\_Delete

**Description:** The consumer requests PFD management to delete the PFDs.

**Inputs, Required:** Transaction Reference ID.

**Inputs, Optional:** None.

**Outputs, Required:** None.

#### 5.2.6.4 Nnef\_ParameterProvision service

##### 5.2.6.4.1 General

This service is for allowing external party to provision of information which can be used for the UE in 5GS.

##### 5.2.6.4.2 Nnef\_ParameterProvision\_Update service operation

**Service operation name:** Nnef\_ParameterProvision\_Update

**Description:** The consumer updates the UE related information (e.g. Expected UE Behaviour, Network Configuration parameters, Location Privacy Indication parameters) or 5G VN Group related information (e.g. 5G VN group data, 5G VN membership management).

**Inputs, Required:** AF ID, Transaction Reference ID.

**Inputs, Optional:** GPSI, External Group ID at least one of the Expected UE Behaviour parameters or at least one of the Network Configuration parameters or 5G VN related information, Validity Time or Location Privacy Indication parameters, MTC Provider Information.

**Outputs, Required:** Operation execution result indication.

**Outputs, Optional:** Transaction specific parameters, if available.

#### 5.2.6.4.3 Nnef\_ParameterProvision\_Create service operation

**Service operation name:** Nnef\_ParameterProvision\_Create

**Description:** The consumer creates a 5G VN group.

**Inputs, Required:** AF ID, Transaction Reference ID.

**Inputs, Optional:** GPSI, External Group ID for 5G VN group creation, External Group ID, 5G VN group related information (e.g. 5G VN group data, 5G VN membership management), MTC Provider Information.

**Outputs, Required:** Operation execution result indication.

**Outputs, Optional:** Transaction specific parameters, if available.

#### 5.2.6.4.4 Nnef\_ParameterProvision\_Delete service operation

**Service operation name:** Nnef\_ParameterProvision\_Delete

**Description:** The consumer deletes a 5G VN group.

**Inputs, Required:** AF ID, Transaction Reference ID.

**Inputs, Optional:** External Group ID.

**Outputs, Required:** Operation execution result indication.

**Outputs, Optional:** None.

#### 5.2.6.4.5 Nnef\_ParameterProvision\_Get service operation

**Service operation name:** Nnef\_ParameterProvision\_Get

**Description:** The consumer gets the UE related information (e.g. Expected UE Behaviour, Network Configuration parameters).

**Inputs, Required:** GPSI, AF ID, requested information (e.g. Expected UE Behaviour, Network Configuration parameters).

**Inputs, Optional:** None.

**Outputs, Required:** Requested data, Operation execution result indication.

**Outputs, Optional:** None.

#### 5.2.6.5 Nnef\_Trigger service

##### 5.2.6.5.1 General

See clause 4.13.2.

##### 5.2.6.5.2 Nnef\_Trigger\_Delivery service operation

**Service operation name:** Nnef\_Trigger\_Delivery

**Description:** the consumer requests that a trigger be sent to an application on a UE and subscribes to be notified about result of the trigger delivery attempt.

**Inputs, Required:** GPSI, AF ID, Trigger Reference Number, Application Port ID

**Inputs, Optional:** Validity Period, Priority, Trigger Payload.

**Outputs, Required:** Transaction Reference ID, Cause.

### 5.2.6.5.3 Nnef\_Trigger\_DeliveryNotify service operation

**Service operation name:** Nnef\_Trigger\_DeliveryNotify

**Description:** NEF reports the status of the trigger delivery to the consumer (failure or success).

NOTE: This notification corresponds to an implicit subscription by Nnef\_Trigger\_Delivery service operation.

**Inputs, Required:** Transaction Reference ID, Delivery Report.

**Inputs, Optional:** None.

**Outputs, Required:** None.

### 5.2.6.6 Nnef\_BDTPNegotiation service

#### 5.2.6.6.1 General

See clause 4.16.7.

#### 5.2.6.6.2 Nnef\_BDTPNegotiation\_Create service operation

**Service operation name:** Nnef\_BDTPNegotiation\_Create.

**Description:** The consumer requests a background data transfer policy.

**Inputs, Required:** ASP Identifier, Volume per UE, Number of UEs, Desired time window.

**Inputs, Optional:** External Group Identifier, Network Area Information, Request for notification, MAC address or IP 3-tuple of Application server.

**Outputs, Required:** Background Data Transfer Reference ID, one or more background data transfer policies.

**Output, Optional:** None.

#### 5.2.6.6.3 Nnef\_BDTPNegotiation\_Update service operation

**Service operation name:** Nnef\_BDTPNegotiation Update.

**Description:** the consumer requests the selected background data transfer policy to be set.

**Inputs, Required:** Background Data Transfer Reference ID, background data transfer policy.

**Inputs, Optional:** Stop notification.

**Outputs, Required:** None.

**Outputs, Optional:** None.

#### 5.2.6.6.4 Nnef\_BDTPNegotiation\_Notify service operation

**Service operation name:** Nnef\_BDTPNegotiation\_Notify

**Description:** NEF sends the BDT warning notification to the NF consumer.

**Inputs, Required:** Background data transfer reference ID.

**Inputs, Optional:** Network Area Information, Time window, list of candidate Background DataTransfer policies.

**Outputs, Required:** None.

**Outputs, Optional:** None.

## 5.2.6.7 Nnef\_TrafficInfluence service

### 5.2.6.7.1 General

**Service description:** This service provides:

- Request authorization of NF Service Consumer requests.
- Request parameter mapping from NF Service Consumer requests to 5GC parameters and vice versa as described in clause 5.6.7 of TS 23.501 [2].
- NF Service Consumer request routing (forwarding) to actual NF Service Producer to influence traffic routing decisions as described in clause 5.6.7 of TS 23.501 [2].

### 5.2.6.7.2 Nnef\_TrafficInfluence\_Create operation

**Service operation name:** Nnef\_TrafficInfluence\_Create

**Description:** Authorize the request and forward the request for traffic influence.

**Inputs, Required:** AF Transaction Id.

The AF Transaction Id refers to the request.

**Inputs, Optional:** The address (IP or Ethernet) of the UE if available, GPSI if available, DNN if available, S-NSSAI if available, External Group Identifier if available, application identifier or traffic filtering information, AF-Service-Identifier, a list of DNAI(s) and corresponding routing profile ID(s) or N6 traffic routing information, Indication of traffic correlation, Indication of application relocation possibility, Indication of UE IP address preservation, Early and/or late notifications about UP path management events, Temporal validity condition and Spatial validity condition as described in clause 5.6.7 of TS 23.501 [2].

**Outputs, Required:** Operation execution result indication.

**Outputs, Optional:** None.

### 5.2.6.7.3 Nnef\_TrafficInfluence\_Update operation

**Service operation name:** Nnef\_TrafficInfluence\_Update

**Description:** Authorize the request and forward the request to update the traffic influence.

**Inputs, Required:** AF Transaction Id.

The AF Transaction Id identifies the NF Service Consumer request to be updated.

**Inputs, Optional:** Same optional information as in Nnef\_TrafficInfluence\_Create Input.

**Outputs, Required:** Operation execution result indication.

**Outputs, Optional:** None.

### 5.2.6.7.4 Nnef\_TrafficInfluence\_Delete operation

**Service operation name:** Nnef\_TrafficInfluence\_Delete

**Description:** Authorize the request and forward the request to delete(s) request for traffic influence.

**Inputs, Required:** AF Transaction Id.

The AF Transaction Id identifies the NF Service Consumer request for traffic influence to be deleted.

**Inputs, Optional:** None.

**Outputs, Required:** Operation execution result indication.

**Outputs, Optional:** None.

#### 5.2.6.7.4A Nnef\_TrafficInfluence\_Get operation

**Service operation name:** Nnef\_TrafficInfluence\_Get

**Description:** Get the current traffic influence parameters.

**Inputs, Required:** AF Transaction Id.

The AF Transaction Id refers to the request.

**Inputs, Optional:** The address (IP or Ethernet) of the UE if available, GPSI if available, DNN if available, S-NSSAI if available, External Group Identifier if available, application identifier or traffic filtering information, AF-Service-Identifier, a list of DNAI(s) and corresponding routing profile ID(s) or N6 traffic routing information.

**Outputs, Required:** Operation execution result indication, requested data.

**Outputs, Optional:** None.

#### 5.2.6.7.5 Nnef\_TrafficInfluence\_Notify operation

**Service operation name:** Nnef\_TrafficInfluence\_Notify

**Description:** Forward the notification of UP path management event report to AF.

**Known NF Service Consumers:** AF.

**Inputs, Required:** AF Transaction Id, Event ID.

The AF Transaction Id identifies the AF request for traffic influence that the event report is related to. The event may be the UP path management event defined in clause 5.6.7 of TS 23.501 [2].

**Inputs, Optional:** Event information (defined on a per Event ID basis).

**Outputs, Required:** Operation execution result indication.

**Outputs, Optional:** None.

#### 5.2.6.7.6 Nnef\_TrafficInfluence\_AppRelocationInfo operation

**Service operation name:** Nnef\_TrafficInfluence\_AppRelocationInfo

**Description:** Forward the acknowledgement to the notification of UP path management event report to SMF.

**Inputs, Required:** Notification Correlation Information, cause code.

Cause code indicates whether the acknowledgement is a positive response or a negative response.

**Inputs, Optional:** N6 traffic routing information as described in clause 5.6.7 of TS 23.501 [2].

**Outputs, Required:** None.

**Outputs, Optional:** None.

#### 5.2.6.8 Nnef\_ChargeableParty service

##### 5.2.6.8.1 General

See clauses 4.15.6.4 and 4.15.6.5.

##### 5.2.6.8.2 Nnef\_ChargeableParty\_Create service operation

**Service operation name:** Nnef\_ChargeableParty Create

**Description:** The consumer requests to become the chargeable party for a data session for a UE.

**Inputs, Required:** AF Identifier, UE address (i.e. IP address or MAC address), Flow description(s), Sponsor Information, Sponsoring Status.

**Inputs, Optional:** Time period, traffic volume, Background Data Transfer Reference ID.

**Outputs, Required:** Transaction Reference ID, result.

**Output (optional):** None.

#### 5.2.6.8.3 Nnef\_ChargeableParty\_Update service operation

**Service operation name:** Nnef\_ChargeableParty Update

**Description:** The consumer can change the chargeable party of a data session for a UE.

**Inputs, Required:** AF Identifier, Transaction Reference ID, Sponsoring Status.

**Inputs, Optional:** Time period, traffic volume, Background Data Transfer Reference ID.

**Outputs, Required:** Transaction Reference ID, result.

**Output (optional):** None.

#### 5.2.6.8.4 Nnef\_ChargeableParty\_Notify service operation

**Service operation name:** Nnef\_ChargeableParty Notify

**Description:** NEF reports the bearer level event(s) to the consumer.

**Inputs, Required:** Event reports.

**Inputs, Optional:** None.

**Outputs, Required:** None.

**Output (optional):** None.

#### 5.2.6.9 Nnef\_AFsessionWithQoS service

##### 5.2.6.9.1 General

See clause 4.15.6.6.

This service is also used to support subscription and notification of QoS Monitoring for URLLC, as described in clause 5.33.3.2 of TS 23.501 [2].

##### 5.2.6.9.2 Nnef\_AFsessionWithQoS\_Create service operation

**Service operation name:** Nnef\_AFsessionWithQoS Create

**Description:** The consumer requests the network to provide a specific QoS for an AF session.

**Inputs, Required:** AF Identifier, UE address (i.e. IP address or MAC address), Flow description(s), QoS Reference.

**Inputs, Optional:** time period, traffic volume, Alternative Service Requirements (containing one or more QoS reference parameters in a prioritized order), QoS parameter(s) to be measured, Reporting frequency, Target of reporting as described in clause 6.1.3.21 of TS 23.503 [20].

**Outputs, Required:** Transaction Reference ID, result.

**Output (optional):** None.

### 5.2.6.9.3 Nnef\_AFsessionWithQoS\_Notify service operation

**Service operation name:** Nnef\_AFsessionWithQoS Notify

**Description:** NEF reports the QoS Flow level event(s) to the consumer.

**Inputs, Required:** Reports of the events as defined in clause 6.1.3.18 of TS 23.503 [20].

**Inputs, Optional:** When the event report is for QoS Monitoring for URLLC, includes Packet delay for UL, DL, or round trip of the single UP path or two UP paths in the case of redundant transmission, as defined in clause 5.33.3.2 of TS 23.501 [2].

**Outputs, Required:** None.

**Output (optional):** None.

### 5.2.6.9.4 Nnef\_AFsessionWithQoS\_Revoke service operation

**Service operation name:** Nnef\_AFsessionWithQoS Revoke

**Description:** The consumer requests the network to revoke the AF session with requested QoS or the AF session with requested QoS including Alternative Service Requirements.

**Inputs, Required:** Transaction Reference ID.

**Inputs, Optional:** None.

**Outputs, Required:** Transaction Reference ID, result.

**Output (optional):** None.

### 5.2.6.9.5 Nnef\_AFsessionWithQoS\_Update service operation

**Service operation name:** Nnef\_AFsessionWithQoS Update

**Description:** The consumer requests the network to update the Service Requirement(s) and/or additional Alternative Service Requirement(s) for an AF session.

**Inputs, Required:** Transaction Reference ID.

**Inputs, Optional:** Flow description, QoS reference, time period, traffic volume, Alternative Service Requirements (containing one or more QoS reference parameters in a prioritized order), QoS parameter(s) to be measured, Reporting frequency, Target of reporting as described in clause 6.1.3.21 of TS 23.503 [20].

**Outputs, Required:** Result.

**Output (optional):** None.

### 5.2.6.10 Nnef\_MSISDN-less\_MO\_SMS service

#### 5.2.6.10.1 General

See clause 4.13.7.

#### 5.2.6.10.2 Nnef\_MSISDN-less\_MO\_SMSNotify service operation

**Service operation name:** Nnef\_MSISDN-less\_MO\_SMSNotify

**Description:** NEF delivers to the SMS Payload to the AF. The NEF shall determine the notification destination URL of the AF based on configured information on the mapping of SME addresses to destination URLs.

**Inputs, Required:** SMS payload, GPSI and Application Port ID.

**Inputs, Optional:** None.



**Outputs, Required:** None.

### 5.2.6.11 Nnef\_ServiceParameter service

#### 5.2.6.11.1 General

This service is for allowing external party to provision of service specific parameters which can be used for the UE in 5GS. The detailed information is described in clause 4.15.6.7.

#### 5.2.6.11.2 Nnef\_ServiceParameter\_Create operation

**Service operation name:** Nnef\_ServiceParameter\_Create

**Description:** The consumer stores service specific parameters in the UDR via the NEF.

**Inputs, Required:** Service Descriptor (e.g. the combination of DNN and S-NSSAI, an AF-Service-Identifier or an application identifier)

**Inputs, Optional:** Service Parameters and Target UE identifiers (e.g. the address (IP or Ethernet) of the UE if available, GPSI if available, External Group Identifier if available)

**Outputs, Required:** Transaction Reference ID, operation execution result indication.

**Outputs, Optional:** None.

#### 5.2.6.11.3 Nnef\_ServiceParameter\_Update operation

**Service operation name:** Nnef\_ServiceParameter\_Update

**Description:** The consumer updates service specific parameters in the UDR via the NEF.

**Inputs, Required:** Service Descriptor (e.g. the combination of DNN and S-NSSAI, an AF-Service-Identifier or an application identifier), Transaction Reference ID.

**Inputs, Optional:** Service Parameters and Target UE identifiers (e.g. the address (IP or Ethernet) of the UE if available, GPSI if available, External Group Identifier if available).

**Outputs, Required:** Operation execution result indication.

**Outputs, Optional:** None.

#### 5.2.6.11.4 Nnef\_ServiceParameter\_Delete operation

**Service operation name:** Nnef\_ServiceParameter\_Delete

**Description:** The consumer deletes service specific parameters from the UDR via the NEF.

**Inputs, Required:** Service Descriptor (e.g. the combination of DNN and S-NSSAI, an AF-Service-Identifier or an application identifier), Transaction Reference ID.

**Inputs, Optional:** Target UE identifiers (e.g. the address (IP or Ethernet) of the UE if available, GPSI if available, External Group Identifier if available).

**Outputs, Required:** Operation execution result indication.

**Outputs, Optional:** None.

#### 5.2.6.11.5 Nnef\_ServiceParameter\_Get operation

**Service operation name:** Nnef\_ServiceParameter\_Get

**Description:** The consumer retrieves service specific parameters in the UDR via the NEF.

**Inputs, Required:** Service Descriptor (e.g. the combination of DNN and S-NSSAI, an AF-Service-Identifier or an application identifier).

**Inputs, Optional:** Service Parameters and Target UE identifiers (e.g. the address (IP or Ethernet) of the UE if available, GPSI if available, External Group Identifier if available).

**Outputs, Required:** Transaction Reference ID, operation execution result indication, requested data.

**Outputs, Optional:** None.

## 5.2.6.12 Nnef\_APISupportCapability service

### 5.2.6.12.1 General

In order to support interworking with EPC, the NEF is integrated with SCEF as a combined SCEF+NEF node for network exposure as defined in clause 5.17.5 of TS 23.501 [2].

The common services provided by SCEF+NEF may become unavailable because the UE is now being served by a node (e.g. MME) or NF (e.g. AMF) that does not support that service. If the availability or expected level of support of a service API associated with a UE changes, for example due to a mobility between 5GC and EPC, the AF can be made aware of the change via this service.

This service consists of Subscribe, Unsubscribe, Notify service operations. It supports informing AF of the availability or expected level of support of a given service via a response to the One-time report type subscribe request of the AF or via a notification to the Continuous report type subscription of the AF.

### 5.2.6.12.2 Nnef\_APISupportCapability\_Subscribe service operation

**Service operation name:** Nnef\_APISupportCapability\_Subscribe

**Description:** The AF subscribes to receive notification about the availability or expected level of support of a service API for a UE or a group of UEs.

**Inputs, Required:** UE ID or External Group ID, Report Type (One-time report or Continuous report).

**Inputs, Optional:** Duration of Reporting, callback URI.

**Outputs, Required:** Operation execution result indication. When the subscription is accepted: Subscription Correlation ID, API indication.

### 5.2.6.12.3 Nnef\_APISupportCapability\_Notify service operation

**Service operation name:** Nnef\_APISupportCapability\_Notify

**Description:** The AF is notified about the availability or expected level of support of a service API for a UE or a group of UEs if it has subscribed to receive it.

**Inputs, Required:** API Indication, UE ID or External Group ID.

**Inputs, Optional:** None.

**Outputs, Required:** Operation execution result indication.

### 5.2.6.12.4 Nnef\_APISupportCapability\_Unsubscribe service operation

**Service operation name:** Nnef\_APISupportCapability\_Unsubscribe

**Description:** The AF unsubscribes to receive notification about the availability or expected level of support of a service API for a UE or a group of UEs.

**Inputs, Required:** UE ID or External Group ID.

**Inputs, Optional:** None.

**Outputs, Required:** Operation execution result indication.

### 5.2.6.13 Nnef\_NIDDConfiguration service

#### 5.2.6.13.1 General

See clause 4.25.3.

#### 5.2.6.13.2 Nnef\_NIDDConfiguration\_Create service operation

**Service operation name:** Nnef\_NIDDConfiguration\_Create

**Description:** This service operation is used by the consumer to request NIDD Configuration between NF consumer and NEF to support NIDD via NEF.

**Inputs, Optional:** Reliable Data Service Configuration, Requested Action, TLTRI, NIDD Duration.

**Inputs, Required:** GPSI or External Group Identifier, AF ID, T8 Destination Address, MTC Provider Information).

**Outputs, Required:** TLTRI, Reliable Data Service Indication, Maximum Packet Size, Cause.

**Outputs, Optional:** NIDD Duration.

#### 5.2.6.13.3 Nnef\_NIDDConfiguration\_TriggerNotify service operation

**Service operation name:** Nnef\_NIDDConfiguration\_TriggerNotify

**Description:** NEF triggers NIDD Configuration Create Request if there is no NIDD Configuration between NF consumer and NEF.

**Inputs, Required:** GPSI, AF ID, NEF ID.

**Outputs, Required:** None.

#### 5.2.6.13.4 Nnef\_NIDDConfiguration\_UpdateNotify service operation

**Service operation name:** Nnef\_NIDDConfiguration\_UpdateNotify

**Description:** This service operation is used by the NEF to notify NF consumer the NIDD Configuration Update due to NIDD Authorization Update.

**Inputs, Required:** GPSI, TLTRI, Result.

**Inputs, Optional:** Cause, NIDD Duration.

**Outputs, Required:** None.

#### 5.2.6.13.5 Nnef\_NIDDConfiguration\_Delete service operation

**Service operation name:** Nnef\_NIDDConfiguration\_Delete

**Description:** This service operation is used by the NF consumer to request NIDD Configuration delete between NF consumer and NEF to support NIDD via NEF.

**Inputs, Required:** TLTRI.

**Outputs, Required:** Cause.

### 5.2.6.14 Nnef\_NIDD service

#### 5.2.6.14.1 General

See clauses 4.25.4, 4.25.5 and 4.25.9.

#### 5.2.6.14.2 Nnef\_NIDD\_Delivery service operation

**Service operation name:** Nnef\_NIDD\_Delivery

**Description:** This service operation is used by the NF consumer to deliver the unstructured data between NF consumer and NEF to support NIDD via NEF.

**Inputs, Required:** User Identity or External Group Identifier, unstructured data, TLTRI (Optional), Reliable Data Service Configuration (Optional), MO Exception Data Counter.

**Outputs, Required:** Cause.

#### 5.2.6.14.3 Nnef\_NIDD\_DeliveryNotify service operation

**Service operation name:** Nnef\_NIDD\_DeliveryNotify

**Description:** This service operation is used by the NEF to forward the unstructured data to NF consumer to support NIDD via NEF.

**Inputs, Required:** User Identity, unstructured data, TLTRI (Optional), Reliable Data Service Configuration (Optional).

**Outputs, Required:** Cause.

#### 5.2.6.14.4 Nnef\_NIDD\_GroupDeliveryNotify service operation

**Service operation name:** Nnef\_NIDD\_GroupDeliveryNotify

**Description:** This service operation is used by the NEF to inform the AF of the aggregated response of Group MT NIDD operation.

**Inputs, Required:** The TLTRI that was provided when the Nnef\_NIDD\_Delivery operation was invoked with an External Group Identifier, External Identifier list with associated with the External Group Identifier and cause values.

**Inputs, Optional:** Re-transmission Time(s).

**Outputs, Required:** None.

#### 5.2.6.15 Nnef\_SMContext service

##### 5.2.6.15.1 General

The service provides the capability to create, update or release the SMF-NEF Connection. See clause 4.25.2 for the detailed procedure.

##### 5.2.6.15.2 Nnef\_SMContext\_Create service operation

**Service operation name:** Nnef\_SMContext\_Create

**Description:** This service operation is used by the consumer to request connection establishment between NF consumer and NEF to support NIDD via NEF.

**Inputs, Required:** User Identity, PDU session ID, NIDD information, S-NSSAI, DNN.

**Inputs, Optional:** RDS support indication, Serving PLMN Rate Control parameters, Small Data Rate Control parameters and Small Data Control Status.

**Outputs, Required:** Cause.

**Outputs, Optional:** Extended Buffering Support, NIDD Parameters, RDS support indication.

##### 5.2.6.15.3 Nnef\_SMContext\_Delete service operation

**Service operation name:** Nnef\_SMContext\_Delete

**Description:** This service operation is used by the NF consumer to request SMF-NEF Connection release between NF consumer and NEF to support NIDD via NEF.

**Inputs, Required:** User Identity, PDU Session ID, NEF ID, S-NSSAI, DNN, Release Cause.

**Outputs, Required:** Cause.

**Outputs, Optional:** Small Data Rate Control Status, APN Rate Control Status.

#### 5.2.6.15.4 Nnef\_SMContext\_DeleteNotify service operation

**Service operation name:** Nnef\_SMContext\_DeleteNotify

**Description:** This service operation is used by the NEF to notify NF consumer that the SMF-NEF Connection for NIDD via NEF is no longer valid.

**Inputs, Required:** User Identity, PDU session ID, S-NSSAI, DNN, Reason of the SMF-NEF connection release

**Inputs, Optional:** Small Data Rate Control Status, APN Rate Control Status.

**Outputs, Required:** Cause.

#### 5.2.6.15.5 Nnef\_SMContext\_Delivery service operation

**Service operation name:** Nnef\_SMContext\_Delivery

**Description:** This service operation is used by the NF consumer to deliver the unstructured data between NF consumer and NEF to support NIDD.

**Inputs, Required:** User Identity, PDU session ID, unstructured data.

**Outputs, Required:** Cause.

#### 5.2.6.16 Nnef\_AnalyticsExposure service

##### 5.2.6.16.1 General

This service is for allowing NF Service Consumer to ask analytics information as specified in TS 23.288 [50].

##### 5.2.6.16.2 Nnef\_AnalyticsExposure\_Subscribe operation

**Service operation name:** Nnef\_AnalyticsExposure\_Subscribe

**Description:** The NF consumer subscribes or modifies an existing subscription on analytics information.

**Inputs, Required:** (Set of) Analytic ID(s), Analytic Filter Information, Target of Analytic Reporting (UEs (e.g. GPSI), External Group Identifier, any UEs), Analytic Reporting Information, Notification Target Address (+ Notification Correlation ID). These input parameters are detailed in TS 23.288 [50].

**Inputs, Optional:** Subscription Correlation ID (in the case of modification of the analytic subscription), Expiry time, slice specific information, Geographical area.

NOTE 1: When the Analytics ID is set to "User Data Congestion", the input parameters are defined in TS 23.288 [50].

NOTE 2: The Geographical area could be provided as e.g. shapes (e.g. polygons, circles, etc.) or civic addresses (e.g. streets, districts, etc.) as referenced by OMA Presence API.

**Outputs, Required:** When the subscription is accepted: Subscription Correlation ID, Expiry time (required if the subscription can be expired based on the operator's policy).

**Outputs, Optional:** First corresponding analytic report is included, if available.

### 5.2.6.16.3 Nnef\_AnalyticsExposure\_Unsubscribe service operation

**Service operation name:** Nnef\_AnalyticsExposure\_Unsubscribe

**Description:** The NF consumer unsubscribes to an existing subscription on analytics information.

**Inputs, Required:** Subscription Correlation ID.

**Outputs, Required:** Operation execution result indication.

### 5.2.6.16.4 Nnef\_AnalyticsExposure\_Notify service operation

**Service operation name:** Nnef\_AnalyticsExposure\_Notify

**Description:** NEF reports the analytics to the NF consumer that has previously subscribed.

**Inputs, Required:** Analytic ID(s), Notification Correlation Information, Analytic information (defined on a per Analytic ID basis). These input parameters are detailed in TS 23.288 [50].

**Inputs, Optional:** Timestamp of analytics generation, Probability assertion, specified in TS 23.288 [50].

**Outputs, Required:** Operation execution result indication.

### 5.2.6.16.5 Nnef\_AnalyticsExposure\_Fetch service operation

**Service operation name:** Nnef\_AnalyticsExposure\_Fetch

**Description:** The NF consumer requests analytics information.

**Inputs Required:** Analytic ID, Analytic Filter Information, Target of Analytic Reporting (UE (e.g. GPSI), External Group Identifier, any UEs), Analytic Reporting Information. These input parameters are detailed in TS 23.288 [50].

**Inputs, Optional:** Slice specific information, Geographical area.

NOTE 1: When the Analytics ID is set to "User Data Congestion", the input parameters are defined in TS 23.288 [50].

NOTE 2: The Geographical area could be provided as e.g. shapes (e.g. polygons, circles, etc.) or civic addresses (e.g. streets, districts, etc.) as referenced by OMA Presence API.

**Outputs Required:** Analytic information (defined on a per Analytic ID basis) specified in TS 23.288 [50].

**Outputs, Optional:** Timestamp of analytics generation, Probability assertion, specified in TS 23.288 [50].

## 5.2.6.17 Nnef\_UCMFProvisioning service

### 5.2.6.17.1 General

This service is for allowing external party to provision the UCMF with UCMF dictionary entries for Manufacturer-assigned UE Radio Capability IDs.

### 5.2.6.17.2 Nnef\_UCMFProvisioning\_Create operation

**Service operation name:** Nnef\_UCMFProvisioning\_Create

**Description:** The consumer creates a UCMF dictionary entry (or more entries) for a Manufacturer-assigned UE Radio Capability ID via the NEF. For each UE Radio Capability ID the following inputs are provided:

- a) a UE radio access capability set with respective Coding format or the UE radio access capability set in both TS 36.331 [16] and TS 38.331 [12] coding formats and each RATs' UE Radio Capability for Paging; and
- b) the related UE model(s) IMEI/TAC value(s) the UE radio capability ID applies to.

**Inputs, Required:** (list of) [UE Radio Capability ID, set(s) of UE Radio Access Capability set and UE Radio Capability for Paging and respective Coding format(s), (List of) IMEI/TAC value(s)].

**Inputs, Optional:** None.

**Outputs, Required:** None.

**Outputs, Optional:** None.

The Coding format(s) indicates the format of the respective UE radio access capabilities as defined in TS 36.331 [16] or TS 38.331 [12].

#### 5.2.6.17.3 Nnef\_UCMFProvisioning\_Delete operation

**Service operation name:** Nnef\_UCMFProvisioning\_Delete

**Description:** The consumer deletes a UCMF dictionary entry for a Manufacturer-assigned UE Radio Capability ID via the NEF. The consumer provides a (list of) UE radio capability ID value(s) to be deleted or it may provide the IMEI/TAC values for which the associated UE radio capability ID entries shall be no longer used.

**Inputs, Required:** UE Radio Capability ID(s) of the UCMF dictionary entry(ies) to be deleted or IMEI/TAC(s) that no longer use associated UE radio Capability ID(s).

**Inputs, Optional:** None.

**Outputs, Required:** None.

**Outputs, Optional:** None.

#### 5.2.6.17.4 Nnef\_UCMFProvisioning\_Update operation

**Service operation name:** Nnef\_UCMFProvisioning\_Update

**Description:** The consumer updates the list of IMEI/TAC values a UCMF dictionary entry(or a list of entries) applies to for a Manufacturer-assigned UE Radio Capability ID via the NEF. For each UE Radio Capability ID provided, (a list of) UE model(s) IMEI/TAC value(s) to be added or removed to the related UCMF entry is provided.

**Inputs, Required:** Update Type (one of "Add IMEI/TAC Values" or "Remove IMEI/TAC Values") and:

- If Update Type is "Add IMEI/TAC Values", the (list of) UE Radio Capability ID(s) of the UCMF dictionary entry(ies) to be updated and the related additional (list of) IMEI/TAC(s); or
- If Update Type is "Remove IMEI/TAC Values", the (list of) UE Radio Capability ID(s) of the UCMF dictionary entry(ies) to be updated and the related (list of) IMEI/TAC(s) to be removed.

**Inputs, Optional:** None.

**Outputs, Required:** None.

**Outputs, Optional:** None.

#### 5.2.6.18 Nnef\_ECRestriction service

##### 5.2.6.18.1 General

This service is for allowing the AF to query status of Enhanced Coverage Restriction or enable/disable Enhanced Coverage Restriction per individual UE.

##### 5.2.6.18.2 Nnef\_ECRestriction\_Get service operation

**Service operation name:** Nnef\_ECRestriction\_Get

**Description:** The consumer query the status of Enhanced Coverage Restriction information.

**Inputs, Required:** GPSI, AF Identifier.

**Inputs, Optional:**

**Outputs, Required:** Operation execution result indication.

**Outputs, Optional:** Enhanced Coverage Restriction information.

#### 5.2.6.18.3 Nnef\_ECRestriction\_Update service operation

**Service operation name:** Nnef\_ECRestriction\_Update

**Description:** The consumer enables or disables the Enhanced Coverage Restriction.

**Inputs, Required:** GPSI, AF Identifier, Enhanced Coverage Restriction information.

**Inputs, Optional:** MTC Provider Information.

**Outputs, Required:** Operation execution result indication.

**Outputs, Optional:**

#### 5.2.6.19 Nnef\_ApplyPolicy service

##### 5.2.6.19.1 General

The service provides the capability to apply a previously negotiated Background Data Transfer Policy to a UE or a group of UEs. See clause 4.15.6.8 for the detailed procedure.

##### 5.2.6.19.2 Nnef\_ApplyPolicy\_Create service operation

**Service operation name:** Nnef\_ApplyPolicy Create

**Description:** The consumer requests to apply a policy to the UE.

**Inputs, Required:** AF Identifier, External Identifier or External Group ID, Background Data Transfer Reference ID for a previously negotiated policy of a background data transfer.

**Inputs, Optional:** None.

**Outputs, Required:** Transaction Reference ID, result.

**Output (optional):** None.

##### 5.2.6.19.3 Nnef\_ApplyPolicy\_Update service operation

**Service operation name:** Nnef\_ApplyPolicy Update

**Description:** The consumer requests to update a policy to the UE.

**Inputs, Required:** Transaction Reference ID, Background Data Transfer Reference ID for a previously negotiated policy of a background data transfer.

**Inputs, Optional:** None.

**Outputs, Required:** Result.

**Output (optional):** None.

##### 5.2.6.19.4 Nnef\_ApplyPolicy\_Delete service operation

**Service operation name:** Nnef\_ApplyPolicy Delete

**Description:** The consumer requests to delete a policy to the UE.



**Inputs, Required:** Transaction Reference ID.

**Inputs, Optional:** None.

**Outputs, Required:** Result.

**Output (optional):** None.

5.2.6.20      Void

5.2.6.21      Nnef\_Location service

5.2.6.21.1      General

The service provides the capability to deliver UE location to AF.

5.2.6.21.2      Nnef\_Location\_LocationUpdateNotify service operation

**Service operation name:** Nnef\_Location\_LocationUpdateNotify

**Description:** Provides UE location information to the consumer NF.

**Inputs, Required:** Identity of the AF, UE identifier (GPSI), event causing the location estimate (5GC-MO-LR), location estimate, age of location estimate, accuracy indication, LCS QoS class.

**Inputs, Optional:** Service identity.

**Outputs, Required:** Success/Failure indication.

**Output (optional):** Failure Cause (in the case of failure indication provided).

5.2.6A      Void

## 5.2.7 NRF Services

### 5.2.7.1 General

The following table shows the NRF Services and Service Operations:

**Table 5.2.7.1-1: NF services provided by the NRF**

Service Name	Service Operations	Operation Semantics	Example Consumer(s)
Nnrf_NFManagement	NFRegister	Request/Response	AMF, SMF, UDM, AUSF, NEF, PCF, SMSF, NSSF, UPF, BSF, CHF, NWDAF, P-CSCF, HSS, UDR, SCP
	NFUpdate	Request/Response	AMF, SMF, UDM, AUSF, NEF, PCF, SMSF, NSSF, UPF, BSF, CHF, NWDAF, P-CSCF, HSS, UDR, SCP
	NFDeregister	Request/Response	AMF, SMF, UDM, AUSF, NEF, PCF, SMSF, NSSF, UPF, BSF, CHF, NWDAF, P-CSCF, HSS, UDR, SCP
	NFStatusSubscribe	Subscribe/Notify	AMF, SMF, PCF, NEF, NSSF, SMSF, AUSF, CHF, NRF, NWDAF, I-CSCF, S-CSCF, IMS-AS, SCP, UDM
	NFStatusNotify		AMF, SMF, PCF, NEF, NSSF, SMSF, AUSF, CHF, NWDAF, I-CSCF, S-CSCF, IMS-AS, SCP, UDM
	NFStatusUnSubscribe		AMF, SMF, PCF, NEF, NSSF, SMSF, AUSF, CHF, NRF, NWDAF, I-CSCF, S-CSCF, IMS-AS, SCP, UDM
Nnrf_NFDiscovery	Request	Request/Response	AMF, SMF, PCF, NEF, NSSF, SMSF, AUSF, CHF, NRF, NWDAF, I-CSCF, S-CSCF, IMS-AS, SCP, UDM, AF (NOTE 2)
Nnrf_AccessToken	Get	Request/Response	AMF, SMF, PCF, NEF, NSSF, SMSF, AUSF, UDM, NWDAF, I-CSCF, S-CSCF, IMS-AS, HSS

NOTE 1: HSS\_IMS services are defined in TS 23.228 [55].

NOTE 2: The AF is a trusted AF by an operator.

### 5.2.7.2 Nnrf\_NFManagement service

#### 5.2.7.2.1 General

#### 5.2.7.2.2 Nnrf\_NFManagement\_NFRegister service operation

**Service Operation name:** Nnrf\_NFManagement\_NFRegister.

**Description:** Registers the consumer NF in the NRF by providing the NF profile of the consumer NF to NRF and NRF marks the consumer NF available.

**Inputs, Required:** NF type, NF instance ID, FQDN or IP address of NF, Names of supported NF services (if applicable) and PLMN ID e.g. if NF needs to be discovered by other PLMNs.

NOTE 1: for the UPF, the addressing information within the NF profile corresponds to the N4 interface.

NOTE 2: For the purpose of the Nnrf\_NFManagement service, the SCP is treated by the NRF in the same way as NFs. Specifically, the SCP is designated with a specific NF type and NF instance ID. However, the SCP does not support services and related NF profile parameters do not apply (e.g. NF Set ID, NF service set ID, Endpoint Address(es) of instance(s) of supported service(s)), see clause 6.2.6.3 of TS 23.501 [2].

**Inputs, Optional:**

- If the consumer NF stores Data Set(s) (e.g. UDR): Range(s) of SUPIs, range(s) of GPSIs, range(s) of external group identifiers, Data Set Identifier(s).
- If the consumer is BSF: Range(s) of (UE) IPv4 addresses or Range(s) of (UE) IPv6 prefixes, IP domain list as described in clause 6.1.6.2.21 of TS 29.510 [37].

NOTE 3: Range of SUPI(s) is limited in this release to a SUPI type of IMSI as defined in TS 23.003 [33].

- If the consumer is UDM, UDR, PCF or AUSF, they can include UDM Group ID, UDR Group ID, PCF Group ID, AUSF Group ID respectively.
- For UDM and AUSF, Routing Indicator.
- If the consumer is AMF, it includes list of GUAMI(s). In addition, AMF may include list of GUAMI(s) for which it can serve as backup for failure/maintenance.
- If the consumer is CHF, it may include Range(s) of SUPIs, Range(s) of GPSIs, or Range(s) of PLMNs as defined in TS 32.290 [42].
- If the consumer is CHF, primary CHF instance and the secondary CHF instance pair. If the CHF does not provide NF set ID or NF Service Set ID, it shall provide a primary CHF instance and the secondary CHF instance pair and otherwise it may do so.
- If the consumer is P-CSCF, the P-CSCF IP address(es) to be provided to the UE by SMF.
- If the consumer is HSS, IMPI range, IMPU range, HSS Group ID (as defined in TS 23.228 [55]) can be used as optional input parameters.
- For the UPF Management: UPF Provisioning Information as defined in clause 4.17.6.
- S-NSSAI(s) and the associated NSI ID(s) (if available).
- DNN(s) if the consumer is PCF or BSF.DNN(s) per S-NSSAI if the consumer is SMF or UPF.
- Information about the location of the NF consumer (operator specific information, e.g. geographical location, data centre).
- TAI(s).
- NF Set ID.
- NF Service Set ID.
- If the consumer is PCF or SMF, it includes the MA PDU Session capability to indicate if the NF instance supports MA PDU session or not.
- If the consumer is PCF, it includes the DNN replacement capability to indicate if the NF instance supports DNN replacement or not.
- If the consumer is NWDAF, it includes Analytics ID(s) and NWDAF Serving Area information. Details about NWDAF specific information are described in clause 6.3.13 of TS 23.501 [2].
- If the consumer is NEF, it may include Event ID(s) supported by AFs, Application Identifier(s) supported by AFs, range(s) of External Identifiers, or range(s) of External Group Identifiers, or the domain names served by the NEF.
- Notification endpoint for default subscription for each type of notification that the NF is interested in receiving.
- Endpoint Address(es) of instance(s) of supported service(s).
- NF capacity information.
- NF priority information.
- If consumer is NF, SCP domain the NF belongs to.
- If the consumer is SCP, it may include:

- SCP domain(s) the SCP belongs to.
- Remote PLMNs reachable through SCP.
- Endpoint addresses or Address Domain(s) (e.g. IP Address or FQDN ranges) accessible via the SCP.
- NF sets of NFs served by the SCP.

**Outputs, Required:** Result indication.

**Outputs, Optional:** None.

See clause 5.21.2.1 of TS 23.501 [2], the AMF registers itself to NRF.

#### 5.2.7.2.3 Nnrf\_NFManagement\_NFUpdate service operation

**Service Operation name:** Nnrf\_NFManagement\_NFUpdate.

**Description:** Provides the updated NF profile of NF consumer to NRF.

**Inputs, Required:** NF instance ID.

**Inputs, Optional:** If replacing the full NF profile, the full NF profile shall be provided. If updating parts of the NF profile, the NF profile elements that needs to be updated shall be provided.

**Outputs, Required:** Result indication.

**Outputs, Optional:** None.

See clause 5.21.2.1 of TS 23.501 [2], the AMF adds or updates the associated GUAMI(s).

#### 5.2.7.2.4 Nnrf\_NFManagement\_NFDeregister service operation

**Service Operation name:** Nnrf\_NFManagement\_NFDeregister

**Description:** Inform the unavailability of NF consumer to NRF.

**Inputs, Required:** NF Instance ID, Reason indication.

**Inputs, Optional:** None.

**Outputs, Required:** Result indication.

**Outputs, Optional:** None.

See clause 5.21.2.2 of TS 23.501 [2], the AMF deregister itself from NRF.

#### 5.2.7.2.5 Nnrf\_NFManagement\_NFStatusSubscribe service operation

**Service Operation name:** Nnrf\_NFManagement\_NFStatusSubscribe.

**Description:** Consumer can subscribe to be notified of the following:

- Newly registered NF along with its NF services.
- Updated NF profile.
- Deregistered NF.

**Inputs, Required:** callback URI.

**Inputs, Optional:**

- PLMN ID of the target NF/NF service, in the case of the subscription to the status of NF/NF service instance(s) in home PLMN from the serving PLMN.
- Validity Time, in case to indicate the time instant after which the subscription becomes invalid.

- For updated NF profile subscription, conditions that trigger a notification from NRF. Includes monitored attributes in the NF profile (changes trigger a notification) or unmonitored attributes in the NF profile (changes do not trigger a notification)
- The following parameters are mutually exclusive:
  - NF Type (if NF status of a specific NF type is to be monitored).
  - NF Instance ID or NF Instance ID list (if NF status of a specific NF instance or a list of NF instance is to be monitored).
  - NF Service name (if NF status for NF which exposes a given NF service is to be monitored).
  - NF Set (if NF status of a set of NF Instances belonging to a certain NF Set is to be monitored).
  - NF Service Set (if the status of a set of NF Service Instances belonging to a certain NF Service Set is to be monitored).
  - NF Group (if the NF status of NF Instances identified by a NF (UDM, AUSF, PCF, CHF, HSS or UDR) Group Identity is to be monitored).
  - SCP Domain (if the status of NF or SCP instances belonging to a certain SCP domain is to be monitored).
  - For the UPF Management defined in clause 4.17.6: UPF Provisioning Information as defined in that clause.
  - For AMF, Consumer may include list of GUAMI(s), or AMF Set or AMF Region.
  - S-NSSAI(s) and the associated NSI ID(s) (if available).
  - For NWDAF, Consumer may include Analytics ID(s) and TAI(s). Details about NWDAF discovery and selection are described in clause 6.3.13 of TS 23.501 [2].
  - For NEF, Consumer may include Event ID(s) provided by AF.

**Outputs, Required:** When the subscription is accepted: Subscription Correlation ID (required for management of this subscription), Validity Time.

**Outputs, Optional:** None.

NOTE: Alternatively, other means such as OA&M can also be used to subscribe for NF status.

#### 5.2.7.2.6 Nnrf\_NFManagement\_NFStatusNotify service operation

**Service Operation name:** Nnrf\_NFManagement\_NFStatusNotify.

**Description:** NRF notifies subscribed consumers of the following:

- Newly registered NF along with its NF services.
- Updated NF profile.
- Deregistered NF.

**Inputs, Required:** Notification Event type; NF instance ID; for newly registered NF, NF profile; for updated NF, NF profile or NF profile changes.

NOTE: See clause 6.1.6.3.6 of TS 29.510 [37] for the detailed use of Notification Event type.

**Inputs, Optional:** None.

**Outputs, Required:** None.

**Outputs, Optional:** None.

#### 5.2.7.2.7 Nnrf\_NFManagement\_NFStatusUnsubscribe service operation

**Service Operation name:** Nnrf\_NFManagement\_NFStatusUnsubscribe.

**Description:** Consumer can unsubscribe from being notified of newly registered NF along with its NF services and other events types described in the Nnrf\_NFManagement\_NFStatusSubscribe service operation (see clause 5.2.7.2.5).

**Inputs, Required:** Subscription Correlation ID.

**Inputs, Optional:** None.

**Outputs, Required:** Operation execution result indication.

**Outputs, Optional:** None.

NOTE: Alternatively, other means such as OA&M can also be used to unsubscribe for NF status.

### 5.2.7.3 Nnrf\_NFDiscovery service

#### 5.2.7.3.1 General

**Service description:** This service enables one NF or SCP to discover a set of NF instances with specific NF service or a target NF type or one or more SCPs. The service also enables one NF service or SCP to discover a specific NF service. The service operations defined below allow the NF/NF services or SCP to communicate with NRF.

This service also enables an SCP to discover SCPs.

NOTE: For the purpose of the Nnrf\_NFDiscovery service, the SCP is treated in the same way as NFs. It is designated with a specific NF type. However, the SCP does not support services.

#### 5.2.7.3.2 Nnrf\_NFDiscovery\_Request service operation

**Service operation name:** Nnrf\_NFDiscovery\_Request

**Description:** provides the IP address or FQDN of the expected NF instance(s) and, if present in NF profile, the Endpoint Address(es) of NF service instance(s) to the NF service consumer or SCP.

**Inputs, Required:** one or more target NF service Name(s), NF type of the target NF, NF type of the NF service consumer.

If the NF service consumer intends to discover an NF service producer providing all the standardized services, it provides a wildcard NF service name.

**Inputs, Optional:**

- S-NSSAI and the associated NSI ID (if available), DNN, target NF/NF service PLMN ID, NRF to be used to select NFs/services within HPLMN, Serving PLMN ID, the NF service consumer ID, preferred target NF location, TAI.

NOTE 1: For network slicing the NF service consumer ID is a required input.

- FQDN for the S5/S8 interface of the SMF+PGW-C, to discover the N11/N16 interface of the SMF+PGW-C in the case of EPS to 5GS mobility.
- If the target NF stores Data Set(s) (e.g. UDR, BSF): SUPI, IMPI, IMPU, Data Set Identifier(s). (UE) IPv4 address, IP domain or (UE) IPv6 Prefix.

NOTE 2: If the request includes a subscriber identifier the NRF may need to use the association between the supplied subscriber identifier and the appropriate NF Group ID as described in clause 6.3.1 of TS 23.501 [2] to determine the applicable set of NF instances for the response.

NOTE 3: The (UE) IPv4 address or (UE) IPv6 Prefix is provided for BSF discovery: in that case the NRF looks up for a match within one of the Range(s) of (UE) IPv4 addresses or Range(s) of (UE) IPv6 prefixes provided by BSF(s) as part of the invocation of Nnrf\_NFManagement\_NFRegister operation. The NRF is not meant to store individual (UE) IPv4 addresses or (UE) IPv6 prefixes.

- If the target NF is UDM or AUSF, the request may include the UE's Routing Indicator.
- If the target NF is AMF, the request may include:

- AMF region, AMF Set, GUAMI and Target TAI(s).
- If the target NF is UDR or UDM or AUSF or PCF, the request may include UDR Group ID or UDM Group ID or AUSF Group ID or PCF Group ID respectively.

NOTE 4: It is assumed that the corresponding NF service consumer is either configured with the corresponding Group ID or it received it via earlier Discovery output.

- If the target NF is UDM, the request may include SUPI, GPSI, Internal Group ID and External Group ID.  
If the target NF is UPF, the request may include SMF Area Identity, UE IPv4 Address/IPv6 Prefix, supported ATSSS steering functionality

NOTE 5: The (UE) IPv4 address or (UE) IPv6 Prefix is provided for UPF discovery: in that case the NRF looks up for a match within one of the Range(s) of (UE) IPv4 addresses or Range(s) of (UE) IPv6 prefixes provided by UPF as part of the invocation of Nnrf\_NFManagement\_NFRegister operation. The NRF is not meant to store individual (UE) IPv4 addresses or (UE) IPv6 prefixes.

NOTE 6: Discovering UPF at PDU Session Establishment time and creating the N4 association assumes full connectivity between SMF and UPFs.

- If the target NF is CHF, the request may include SUPI or GPSI as specified in TS 32.290 [42].
- If the target NF is PCF or SMF, the request may include the MA PDU Session capability to indicate that a NF instance supporting MA PDU session capability is requested.
- If the target NF is PCF, the request may include the DNN replacement capability to indicate that a NF instance supporting DNN replacement capability is preferred.
- If the target NF is NWDAF, the request may include Analytics ID(s) and TAI(s). Details about NWDAF discovery and selection are described in clause 6.3.13 of TS 23.501 [2].
- If the target NF is HSS, the request may include IMPI and/or IMPU and/or HSS Group ID.
- If the NF service consumer needs to discover NF service producer instance(s) within an NF instance, the request includes the target NF Instance ID and NF Service Set ID of the producer.
- If the NF service consumer needs to discover NF service producer instance(s) in an equivalent NF Service Set within an NF Set, the request includes the identification of the equivalent NF service Set and NF Set ID of producer.

NOTE 7: TS 29.510 [37] specifies the mechanism to identify equivalent NF Service Sets.

- If the NF service consumer needs to discover NF service producer instance(s) in the NF Set, the request includes the target NF Set ID of the producer.
- If the target NF is SMF, the request may include:
  - the UE location (TAI); or
  - TAI list.
- If the target NF is P-CSCF, the request may include UE location information, UE IP address/IP prefix, Access Type.
- If the target NF is NEF, the request may include Event ID(s) provided by AF and optional AF identification as described in clause 6.2.2.3 of TS 23.288 [50]. When the consumer is an AF, the request may include an External Identifier, External Group Identifier, or a domain name.
- If the target NF is SMF, the request may include the Control Plane CIoT 5GS Optimisation Indication or User Plane CIoT 5GS Optimisation Indication.
- If the target NF is SCP, the request may include information about:
  - SCP domain(s).
  - Remote PLMN reachable through SCP.

- Endpoint addresses or Address Domain(s) (e.g. IP Address or FQDN ranges) accessible via the SCP.
- NF sets of NFs served by the SCP.

**Outputs, Required:** A set of NF instances, a validity period for the discovery result, containing per NF Instance: NF type, NF instance ID, FQDN or IP address(es) of the NF instance and if applicable, a list of services instances, where each service instance has a service name, a NF service instance ID and optionally Endpoint Address(es)

Endpoint Address(es) may be a list of IP addresses or an FQDN for the NF service instance.

NOTE 8: SCPs does not have any service instances.

**Outputs, Optional:** Per NF instance, other information in the NF profile listed in clause 6.2.6 of TS 23.501 [2] related to the NF instance, such as:

- NF load information.
- NF capacity information.
- NF priority information.
- If the target NF stores Data Set(s) (e.g. UDR): Range(s) of SUPIs, range(s) of GPSIs, range(s) of external group identifiers, Data Set Identifier(s). If the target NF is BSF or P-CSCF: Range(s) of (UE) IPv4 addresses or Range(s) of (UE) IPv6 prefixes.

NOTE 9: Range of SUPI(s) is limited in this release to a SUPI type of IMSI as defined in TS 23.003 [33].

- If the target NF is UDM, UDR, PCF or AUSF, they can include UDM Group ID, UDR Group ID, PCF Group ID, AUSF Group ID respectively.
- If the target NF is HSS, it can include HSS Group ID.
- For UDM and AUSF, Routing Indicator.
- If the target NF is AMF, it includes list of GUAMI(s). In addition, it may include list of GUAMI(s) for which it can serve as backup for failure/maintenance.
- If the target NF is CHF, it includes primary CHF instance and the secondary CHF instance pair(s), if configured in CHF instance profile.
- For the UPF Management: UPF Provisioning Information as defined in clause 4.17.6.
- S-NSSAI(s) and the associated NSI ID(s) (if available).
- Information about the location of the target NF (operator specific information, e.g. geographical location, data centre).
- TAI(s).
- PLMN ID.
- If the target is PCF or SMF, it includes the MA PDU Session capability to indicate if the NF instance supports MA PDU session or not.
- If the target is PCF, it includes the DNN replacement capability to indicate if the NF instance supports DNN replacement or not.
- If the target NF is NWDAF, it includes the Analytics ID(s) and NWDAF Serving Area information. Details about NWDAF specific information are described in clause 6.3.13 of TS 23.501 [2].
- NF Set ID.
- NF Service Set ID.
- If the target NF is SMF, it may include the SMF(s) Service Area.

NOTE 10: If no SMF Service Area is provided, the AMF assumes that a SMF can serve the whole PLMN.



- If the target NF is P-CSCF, it includes P-CSCF FQDN(s) or IP address(es) and optional Access Type(s) associated with each P-CSCF.
- If the target NF is NEF, it may include Event ID(s) provided by AF.
- SCP domain the NF belongs to.

NOTE 11: Only one SCP domain is registered in NF profile for an NF.

- If the target is SCP:
  - SCP domain(s).
  - Remote PLMNs reachable through SCP.
  - Endpoint addresses or Address Domain(s) (e.g. IP Address or FQDN ranges) accessible via the SCP.
  - NF sets of NFs served by the SCP.

See clause 4.17.4 and 4.17.5 for details on the usage of this service operation.

## 5.2.7.4 Nnrf\_AccessToken\_service

### 5.2.7.4.1 General

This service provides OAuth2 2.0 Access Tokens for NF to NF authorization as defined in TS 33.501 [15].

### 5.2.7.4.2 Nnrf\_AccessToken\_Get Service Operation

See TS 33.501 [15].

## 5.2.8 SMF Services

### 5.2.8.1 General

The following table shows the SMF Services and SMF Service Operations.

**Table 5.2.8.1-1: NF services provided by the SMF**

Service Name	Service Operations	Operation Semantics	Example Consumer(s)
Nsmf_PDUSession	Create	Request/Response	V-SMF/I-SMF
	Update	Request/Response	V-SMF/I-SMF, H-SMF
	Release	Request/Response	V-SMF/I-SMF
	CreateSMContext	Request/Response	AMF
	UpdateSMContext	Request/Response	AMF
	ReleaseSMContext	Request/Response	AMF
	SMContextStatusNotify	Subscribe/Notify	AMF
	StatusNotify	Subscribe/Notify	V-SMF/I-SMF
	ContextRequest	Request/Response	AMF, V-SMF/I-SMF, SMF
	ContextPush	Request/Response	SMF
	SendMOData	Request/Response	AMF
	TransferMOData	Request/Response	V-SMF/I-SMF
TransferMTData	Request/Response	SMF, H-SMF	
Nsmf_EventExposure	Subscribe	Subscribe/Notify	NEF, AMF, NWDAF
	Unsubscribe		NEF, AMF, NWDAF
	Notify		NEF, AMF, NWDAF
	AppRelocationInfo		AF
Nsmf_NIDD	Delivery	Request/Response	NEF

## 5.2.8.2 Nsmf\_PDUSession Service

### 5.2.8.2.1 General

**Service description:** This service operates on the PDU Sessions. The following are the key functionalities of this NF service:

- (between AMF and SMF) Creation / Deletion / Modification of AMF-SMF interactions for PDU Sessions;

The resource handled between AMF and SMF via Create / Update / Release SM context operations corresponds to the AMF-SMF association for a PDU Session;

When the AMF has got no association with an SMF to support a PDU Session, the AMF creates such association via the Nsmf\_PDUSession\_CreateSMContext operation. The context created is identified via the SM Context ID. Otherwise (e.g. at hand-over between 3GPP and Non 3GPP access) the AMF uses the Nsmf\_PDUSession\_UpdateSMContext operation.

NOTE 1: In TS 29.502 [36] SM Context ID is referred to as smContextRef for N11 and pduSessionRef and pduSessionUri for N16.

When the UE is handed-over from an (old) AMF towards another (new) AMF, the old AMF provides the new AMF with the SMF addressing information corresponding to the AMF-SMF association related with each PDU Session of that UE. The new AMF can thus further act upon the association with the SMF via Nsmf\_PDUSession\_UpdateSMContext and Nsmf\_PDUSession\_ReleaseSMContext operations. This may take place:

- at inter AMF change due to AMF planned maintenance or due to AMF failure described in clause 5.21.2 of TS 23.501 [2];
- at inter AMF mobility in CM-CONNECTED state described in clause 4.9.1.3;
- at inter AMF mobility in CM-IDLE state described in clause 4.2.2.2.
- (between AMF and SMF) Passing MO Small Data from AMF to SMF in clause 4.24.1.
- (between V-SMF and H-SMF) Creation / Deletion / Modification of PDU Sessions;
- (between V-SMF/I-SMF and (H-)SMF) Transferring MO Small Data from V-SMF/I-SMF to (H-)SMF in clause 4.25.4.
- (between V-SMF/I-SMF and (H-)SMF) Transferring MT Small Data from (H-)SMF to V-SMF/I-SMF in clause 4.24.5.

Even though the V-SMF creates the PDU Session resource onto the H-SMF, each of the V-SMF and of the H-SMF needs to be able to modify a PDU Session and/or to ask for PDU Session Release. Thus, at Nsmf\_PDUSession\_Create, V-SMF informs the H-SMF about addressing information for its corresponding PDU Session resource, allowing H-SMF to use later on the Nsmf\_PDUSession\_Update and Nsmf\_PDUSession\_Release and Nsmf\_PDUSession\_StatusNotify operations.

NOTE 2: The PDU Session resource in V-SMF is created when the AMF requests to create SM context of this PDU Session

NOTE 3: H-SMF also informs the consumer (V-SMF) about addressing information about its PDU Session resource, but this is part of normal resource creation operation in REST and not specific to this service.

### 5.2.8.2.2 Nsmf\_PDUSession\_Create service operation

**Service operation name:** Nsmf\_PDUSession\_Create.

**Description:** Create a new PDU Session in the H-SMF or SMF or create an association with an existing PDN connection in the home SMF+PGW-C.

**Input, Required:** SUPI, V-SMF ID or I-SMF ID, V-SMF SM Context ID or I-SMF SM Context ID, DNN, V-CN Tunnel Info or I-UPF Tunnel Info, addressing information allowing the H-SMF to request the V-SMF to issue further operations about the PDU Session or addressing information allowing the SMF to request the I-SMF to issue further

operations about the PDU Session, Serving Network (PLMN ID, or PLMN ID and NID, see clause 5.18 of TS 23.501 [2]).

**Input, Optional:** S-NSSAI, PCO, Requested PDU Session Type, 5GSM Core Network Capability, Requested SSC mode, PDU Session ID, Number Of Packet Filters, UE location information, subscription get notified of PDU Session status change, PEI, GPSI, AN type, PCF ID, PCF Group ID, DNN Selection Mode, UE's Routing Indicator or UDM Group ID for the UE, Always-on PDU Session Requested, Control Plane ClIoT 5GS Optimisation Indication, information provided by V-SMF related to charging in home routed scenario (see TS 32.255 [45]), AMF ID, EPS Bearer Status, extended NAS-SM timer indication, DNAI list supported by I-SMF (from I-SMF to SMF), HO Preparation Indication, MA PDU request indication, MA PDU Network-Upgrade Allowed indication, Indication on whether the UE is registered in both accesses; QoS constraints from the VPLMN (see clause 4.3.2.2.2).

**Output, Required:** Result Indication and if success a SM Context ID and in addition: QFI(s), QoS Profile(s), Session-AMBR, QoS Rule(s), QoS Flow level QoS parameters if any for the QoS Flow(s) associated with the QoS rule(s), H-CN Tunnel Info or PSA UPF Tunnel Info, Enable pause of charging indication, Selected PDU Session Type and SSC mode.

**Output, Optional:** PDU Session ID, S-NSSAI, Cause, PCO, UE IP address, IPv6 Prefix allocated to the PDU Session, information needed by V-SMF in the case of EPS interworking such as the PDN Connection Type, EPS bearer context(s), linked EBI, Reflective QoS Timer, Always-on PDU Session Granted, information provided by H-SMF related to charging in home routed scenario (see TS 32.255 [45]), DNAI(s) of interest for this PDU Session (from SMF to I-SMF), indication of multi-homing support (from SMF to I-SMF). MA PDU session Accepted indication, Indication on whether Small Data Rate Control applies or not.

The V-SMF SM Context ID in the Input provides addressing information allocated by the V-SMF (to be used for service operations towards the V-SMF for this PDU Session).

The I-SMF SM Context ID in the Input provides addressing information allocated by the I-SMF (to be used for service operations towards the I-SMF for this PDU Session).

See clause 4.3.2.2.2, clause 4.11.1.2.2, clause 4.11.1.3.3 and clause 4.24 for details on the usage of this service operation.

See clauses 4.22.2.2 and 4.22.3 for detailed usage of this service operation for ATSSS.

### 5.2.8.2.3 Nsmf\_PDUSESSION\_Update service operation

**Service operation name:** Nsmf\_PDUSESSION\_Update.

**Description:** Update the established PDU Session.

This service operation is invoked by the V-SMF towards the H-SMF in the case of UE or serving network requested PDU Session Modification in order for the V-SMF to transfer the PDU Session Modification request. It can also be invoked by the V-SMF to indicate to the H-SMF that the access type of the PDU session can be changed.

This service operation is invoked by the I-SMF towards the SMF in the case of UE or serving network requested PDU Session Modification in order for the I-SMF to transfer the PDU Session Modification request. It can also be invoked by the I-SMF to indicate to the SMF that the access type of the PDU session can be changed. This service operation is also invoked by the I-SMF towards the SMF to insert or remove ULCL or BP controlled by the I-SMF or to report usage offloaded via UL CL or BP controlled by I-SMF.

This service operation is invoked by the H-SMF towards the V-SMF for both UE initiated and HPLMN initiated PDU Session Modification and PDU Session Release cases in order to have the SM PDU Session Modification request or SM PDU Session Release request sent to the UE. It can also be invoked by the H-SMF towards the V-SMF to release the 5GC and 5G-AN resources in e.g. handover from 5GC-N3IWF to EPS and from 5GS to EPC/ePDG, wherein the UE is not notified.

This service operation is invoked by the SMF towards the I-SMF for both UE initiated and SMF/PCF initiated PDU Session Modification and PDU Session Release cases in order to have the SM PDU Session Modification request or SM PDU Session Release request sent to the UE. It can also be invoked by the SMF towards the I-SMF to release the 5GC and 5G-AN resources in e.g. handover from 5GC-N3IWF to EPS and from 5GS to EPC/ePDG, wherein the UE is not notified. This service operation is also invoked by the SMF towards the I-SMF to provide updated N4 information or updated DNAI list of interest for this PDU Session when SMF receives updated PCC rules.

This service operation is invoked by the V-SMF or I-SMF and the H-SMF or SMF in the case of PDU Session Establishment authentication/authorization by a DN-AAA server defined in clause 4.3.2.3: it is used to carry DN Request Container information between the DN-AAA server and the UE.

**Input, Required:** SM Context ID.

**Input, Optional:** UE location information (ULI), UE Time Zone, AN type, indication of PDU Session Release, H-SMF SM Context ID (from H-SMF to V-SMF) or SMF SM Context ID (from SMF to I-SMF), QoS Rule and QoS Flow level QoS parameters if any for the QoS Flow associated with the QoS rule (from H-SMF to V-SMF or from SMF to I-SMF), EPS bearer context(s) and Linked EBI (from H-SMF to V-SMF or from SMF to I-SMF), N9 Tunnel Info (from V-SMF to H-SMF or from I-SMF to SMF), Information requested by UE for e.g. QoS (from V-SMF to H-SMF or from I-SMF to SMF), 5GSM Core Network Capability, Information necessary for V-SMF or I-SMF to build SM Message towards the UE (from H-SMF to V-SMF or from SMF to I-SMF), Trigger PDU release indication (V-SMF to H-SMF or from I-SMF to SMF), Start Pause of Charging indication, Stop Pause of Charging indication, DN Request Container information, indication that the UE shall not be notified, EBI Allocation Parameters (ARP list), Secondary RAT usage data, indication that the access type of the PDU session can be changed (V-SMF to H-SMF or from I-SMF to SMF) or from SMF to I-SMF), extended NAS-SM timer indication, DNAI list supported by I-SMF (from I-SMF to SMF), indication of multi-homing support (from SMF to I-SMF), indication of ULCL or BP insertion (from I-SMF to SMF), indication of ULCL or BP removal (from I-SMF to SMF), IPv6 prefix @local PSA (from I-SMF to SMF), DNAI(s) supported by local PSA (from I-SMF to SMF), Tunnel info of ULCL or BP (from I-SMF to SMF), N4 information (from I-SMF to SMF or from SMF to I-SMF), Handover Complete Indication, Relocation Cancel Indication, MA PDU request indication, MA PDU Network-Upgrade Allowed indication, Indication on whether the UE is registered in both accesses, MA PDU session Accepted indication, access for MA PDU Session Release, access type for GBR QoS flow, Indication of access unavailability (with access type), QoS Monitoring Indication (from SMF to I-SMF), QoS Monitoring reporting frequency (from SMF to I-SMF), QoS monitoring policy (from SMF to I-SMF), QoS Monitoring Result from (I-SMF to SMF).

**Output, Required:** Result indication, <ARP, Cause> pair.

**Output, Optional:** UE location information, AN Type, SM information from UE (from V-SMF to H-SMF or from I-SMF to SMF), list of Rejected QoS Flows (from V-SMF to H-SMF or from I-SMF to SMF), a list of <ARP, EBI> pair, Secondary RAT Usage Data, DNAI(s) of interest for this PDU Session (from SMF to I-SMF), N4 Information (from SMF to I-SMF), QFI(s), QoS Profile(s), Session-AMBR, QoS Rule(s), QoS Flow level QoS parameters if any for the QoS Flow(s) associated with the QoS rule(s), EPS bearer context(s), linked EBI, DNAI(s) of interest for this PDU Session.

The H-SMF SM Context ID in the Input provides addressing information allocated by the H-SMF (to be used for service operations towards the H-SMF for this PDU Session).

The SMF SM Context ID in the Input provides addressing information allocated by the SMF (to be used for service operations towards the SMF for this PDU Session).

See clause 4.3.3.3 for an example usage of this service operation.

See clauses 4.22.6.3, 4.22.7, 4.22.8.3 and 4.22.10.3 for detailed usage of this service operation for ATSSS.

#### 5.2.8.2.4 Nsmf\_PDUSession\_Release service operation

**Service operation name:** Nsmf\_PDUSession\_Release.

**Description:** It causes the immediate and unconditional deletion of the resources associated with the PDU Session. This service operation is used by V-SMF to request the H-SMF or used by I-SMF to request the SMF to release the resources related to a PDU Session for the serving network initiated PDU release case (e.g. implicit De-registration of UE in the serving network).

**Input, Required:** SM Context ID.

**Input, Optional:** Secondary RAT Usage Data, N4 information.

**Output, Required:** Result Indication.

**Output, Optional:** Small Data Rate Control Status, APN Rate Control Status.

See clause 4.3.4.3 for an example usage of this service operation.

#### 5.2.8.2.5 Nsmf\_PDUSession\_CreateSMContext service operation

**Service operation name:** Nsmf\_PDUSession\_CreateSMContext.

**Description:** It creates an AMF-SMF association to support a PDU Session.

**Input, Required:** SUPI or PEI, DNN, AMF ID (AMF Instance ID), RAT Type, Serving Network (PLMN ID, or PLMN ID and NID, see clause 5.18 of TS 23.501 [2]).

**Input, Optional:** PEI, S-NSSAI(s), PDU Session Id, N1 SM container, UE location information, UE Time Zone, AN type, H-SMF identifier/address, list of alternative H-SMF(s) if available, old PDU Session ID (if the AMF also received an old PDU Session ID from the UE as specified in clause 4.3.5.2), Subscription For PDU Session Status Notification, Subscription for DDN Failure Notification, NEF Correlation ID, indication that the SUPI has not been authenticated, PCF ID, PCF Group ID, DNN Selection Mode, UE PDN Connection Context, GPSI, UE presence in LADN service area, GUAMI, backup AMF(s) (if NF Type is AMF), Trace Requirements, Control Plane ClIoT 5GS Optimisation indication, Small Data Rate Control Status, APN Rate Control Status. Backup AMF(s) sent only once by the AMF to the SMF in its first interaction with the SMF, UE's Routing Indicator or UDM Group ID for the UE, EPS Bearer Status, Target ID (for EPS to 5GS handover), "Invoke NEF" flag, additional following for SM context transfer: SMF transfer indication, Old SMF ID, SM context ID in old SMF (see clause 4.26.5.3), HO Preparation Indication, indication of no NG-RAN change. MA PDU request indication, MA PDU Network-Upgrade Allowed indication, Indication on whether the UE is registered in both accesses.

**Output, Required:** Result Indication and if successful SM Context ID.

**Output, Optional:** Cause, PDU Session ID, N2 SM information, N1 SM container, S-NSSAI(s).

When the PDU Session is for Emergency services for a UE without USIM, the AMF provides the PEI and not the SUPI as identifier of the UE. When the PDU Session is for Emergency services of an unauthenticated UE with an USIM, the AMF shall provide both the SUPI and the PEI and shall provide an indication that the SUPI has not been authenticated.

See clause 4.3.2.2.1, clause 4.3.2.2.2, clause 4.11.1.2.2 and clause 4.11.1.3.3 for details on the usage of this service operation.

See clauses 4.22.2.1 and 4.22.3 for detailed usage of this service operation for ATSSS.

#### 5.2.8.2.6 Nsmf\_PDUSession\_UpdateSMContext service operation

**Service operation name:** Nsmf\_PDUSession\_UpdateSMContext.

**Description:** It allows to update the AMF-SMF association to support a PDU Session and/or to provide SMF with N1/N2 SM information received from the UE or from the AN, or allows to establish forwarding tunnel between UPFs controlled by different SMFs (e.g. by UPF controlled by old I-SMF and UPF controlled by new I-SMF).

**Input, Required:** SM Context ID.

**Input, Optional:** N1 SM container received from the UE, N2 SM information received from the AN (e.g. N3 addressing information, notification indicating that the QoS targets cannot be fulfilled for a QFI, Secondary RAT Usage Data), Operation Type (e.g. UP activate, UP deactivate, UP To Be Switched), Serving GW Address(es) and Serving GW DL TEID(s) for data forwarding during HO from 5GS to EPS, UE location information, AN type, UE Time Zone, H-SMF identifier/address, EBI(s) to be revoked, PDU Session(s) to be re-activated, Direct Forwarding Flag, ARP list, S-NSSAI, Data Forwarding Tunnel (setup/release), UE presence in LADN service area, Target ID, Target AMF ID, GUAMI, backup AMF(s) (if NF Type is AMF), Indication of Access Type can be changed, RAT Type. Backup AMF(s) sent only once by the AMF to the SMF in its first interaction with the SMF. Release indication and release cause, forwarding tunnel information, Handover Complete Indication, Relocation Cancel Indication. MA PDU request indication, MA PDU Network-Upgrade Allowed indication, Indication on whether the UE is registered in both accesses, access on which signalling was received, Subscription to DDN Failure Notification, NEF Correlation ID, MO Exception Data Counter, access for MA PDU Session Release.

**Output, Required:** Result Indication.

**Output, Optional:** PDU Session ID, Cause, released EBI list, allocated EBI information, N2 SM information (e.g. QFI, UE location information, notification indication indicating that the QoS targets cannot be fulfilled), N1 SM container to be transferred to the AN/UE, type of N2 SM information. MA PDU session Accepted indication.

See clause 4.3.3.2 and clause 4.3.3.3 for an example usage of this service operation.

See clause 4.9.1.2.2 for the usage of the "UP To Be Switched" Operation Type.

For the use of the "EBI(s) to be revoked" information, see clause 4.11.1.4.1.

For the use of the "Direct Forwarding Flag", see clause 4.11.1.2.2.2.

For the use of the "Indication of Access Type can be changed", see clause 4.2.3.2.

For the use of "release indication and release cause", see clause 4.3.4.2.

For the use of the "forwarding tunnel information", see clause 4.23.4.3.

If the consumer NF is AMF and the SMF determines that some EBIs are not needed, the SMF will put the EBIs back in the released EBI list.

If the consumer NF is AMF and Inter-system mobility happens, the SMF sends allocated EBI information to AMF.

If the ARP of QoS flow is changed, the SMF uses this operation to update EBI-ARP information in the AMF.

If the AMF does not have PDU Session ID, the PDU Session ID is not required for Input and is required for Output.

If consumer NF is AMF and SMF includes N2 SM information in the Output, the SMF indicates type of N2 SM information.

The Small Data Rate Control Status is included if a PDU Session is being released and the UPF or NEF provided Small Data Rate Control Status for the AMF to store. APN Rate Control Status is included if a PDU Session is being released and the UPF or NEF provided APN Rate Control Status for the AMF to store.

NOTE: The N2 SM information is not interpreted by the AMF.

See clauses 4.22.6.3, 4.22.9 and 4.22.10.2 for detailed usage of this service operation for ATSSS.

#### 5.2.8.2.7 Nsmf\_PDUSession\_ReleaseSMContext service operation

**Service operation name:** Nsmf\_PDUSession\_ReleaseSMContext.

**Description:** It allows to release the AMF-SMF association for a certain PDU Session because the PDU Session has been released.

**Input, Required:** SM Context ID.

**Input, Optional:** UE location information, AN type, UE Time Zone, N2 SM Info (Secondary RAT Usage Data), V-SMF only, I-SMF only.

**Output, Required:** Result Indication.

**Output, Optional:** Cause, Small Data Rate Control Status, APN Rate Control Status.

See clause 4.3.4.2 and clause 4.3.4.3 for an example usage of this service.

If the consumer NF is AMF and the PDU Session indicated by the PDU Session ID had been assigned some EBIs, the AMF locally determines that the corresponding EBI(s) are released.

For the use of the "V-SMF only" indication, see clause 4.11.1.2.

For the use of the "I-SMF only" indication, see clause 4.23.7.3.

#### 5.2.8.2.8 Nsmf\_PDUSession\_SMContextStatusNotify service operation

**Service operation name:** Nsmf\_PDUSession\_SMContextStatusNotify.

**Description:** This service operation is used by the SMF to notify its consumers about the status of an SM context related to a PDU Session (e.g. PDU Session Release due to local reasons within the SMF, PDU Session handover to a different system or access type, SMF context transfer). The SMF may use this service operation to update the SMF derived CN assisted RAN parameters tuning in the AMF. The SMF may report the DDN Failure with NEF Correlation ID to the AMF.

**Input, Required:** Status information.

**Input, Optional:** Cause, SMF derived CN assisted RAN parameters tuning, New SMF ID for SM Context Transfer (see clause 4.26.5.3) or SMF set ID, Small Data Rate Control Status, APN Rate Control Status, DDN Failure detected in (I-/V-)SMF.

**Output, Required:** Result Indication.

**Output, Optional:** None.

#### 5.2.8.2.9 Nsmf\_PDUSession\_StatusNotify service operation

**Service operation name:** Nsmf\_PDUSession\_StatusNotify.

**Description:** This service operation is used by the SMF to notify its consumers about the status of a PDU Session (e.g. PDU Session is released due to local reasons within the H-SMF, PDU Session handover to a different system or access type).

**Input, Required:** Status information.

**Input, Optional:** Cause, Small Data Rate Control Status, APN Rate Control Status.

**Output, Required:** Result Indication.

**Output, Optional:** None.

#### 5.2.8.2.10 Nsmf\_PDUSession\_ContextRequest service operation

**Service operation name:** Nsmf\_PDUSession\_ContextRequest.

**Description:** This service operation is used by the NF Consumer to request for SM Context (e.g. during EPS IWK, HO, SM Context transfer indication), or during mobility procedure with I-SMF (or V-SMF) changes or may be triggered by OAM.

**Input, Required:** SM Context ID, SM context type.

**Input, Optional:** Target MME Capability, EBI list not to be transferred, PDU Session ID (include PDU Session ID when available), SMF transfer indication, indication of no NG-RAN change.

**Output, Required:** One of the following:

- SM Context Container.
- Endpoint where SM Context can be retrieved.

**Output, Optional:** Small Data Rate Control Status.

The SM context type indicates the type of SM context to be requested, e.g. PDN Connection Context, 5G SM Context or both. If the SM context type is PDN Connection Context, the SM Context included in the SM Context container is the PDN Connection Context. If the SM context type is all, the SM Context included in the SM Context container includes both the PDN Connection Context and the 5G SM Context.

Table 5.2.8.2.10-1 illustrates the SM Context that may be transferred between I-SMF(s) or between V-SMF(s) in home-routed roaming case.

**Table 5.2.8.2.10-1: SM Context of a PDU Session transferred between I-SMF(s) or between V-SMF(s)**

Field	Description
SUPI	SUPI (Subscription Permanent Identifier) is the subscriber's permanent identity in 5GS.
Trace Requirements	Trace reference: Identifies a record or a collection of records for a particular trace.
	Trace type: Indicates the type of trace
	OMC identity: Identifies the OMC that shall receive the trace record(s).
S-NSSAI	The S-NSSAI of the PDU Session for the serving PLMN.
HPLMN S-NSSAI	The S-NSSAI of the PDU Session for the HPLMN (Home-Routed PDU Session)
Network Slice Instance id	The network Slice Instance information for the PDU Session
DNN	The associated DNN for the PDU Session.
AMF Information	The associated AMF instance identifier and GUAMI.
Access Type	The current access type for this PDU Session.
RAT Type	RAT Type for this PDU Session.
PDU Session ID	The identifier of the PDU Session.
H-SMF Information or SMF Information	The associated H-SMF identifier and H-SMF address for the HR PDU Session ( applies only for a V-SMF), or the SMF identifier and SMF address for PDU Session (applies for I-SMF).
Context ID of the PDU Session in H-SMF or Context ID of the PDU Session in SMF	The context ID of the PDU Session in H-SMF or in SMF.
Forwarding Indication	An indication on whether forwarding tunnel needs be established in order to forward buffered DL data.
Uplink Tunnel Info of UPF controlled by the SMF / H-SMF	The Tunnel Information to be used to send UL traffic towards the UPF controlled by the SMF / H-SMF that interfaces the UPF controlled by the I-SMF.
Tunnel Info of NG-RAN	The N3 Tunnel Information in the NG-RAN for the PDU Session. This information is transferred if the target I/V-SMF indicates no NG-RAN change
<b>For each QoS Flow in the PDU Session:</b>	
5G QoS Identifier (5QI)	Identifier for the authorized QoS parameters for the service data flow.
ARP	The Allocation and Retention Priority for the service data flow consisting of the priority level, the pre-emption capability and the pre-emption vulnerability
GFBR	Guaranteed Flow Bit Rate (GFBR) - UL and DL
MFBR	Maximum Flow Bit Rate (MFBR) - UL and DL
Priority Level	Indicates a priority in scheduling resources among QoS Flows.
Averaging Window	Represents the duration over which the guaranteed and maximum bitrate shall be calculated.
Maximum Data Burst Volume	Denotes the largest amount of data that is required to be transferred within a period of 5G-AN PDB.
Reflective QoS Control	Indicates to apply reflective QoS for the SDF in the TFT.
QoS Notification Control (QNC)	Indicates whether notifications are requested from 3GPP RAN when the GFBR can no longer (or can again) be guaranteed for a QoS Flow during the lifetime of the QoS Flow.
Maximum Packet Loss Rate	Maximum Packet Loss Rate - UL and DL.
<b>Mapped EPS Bearer Context for Each QFI to support interworking with EPS:</b>	
EPS Bearer Id	An EPS bearer identity uniquely identifies an EPS bearer for one UE accessing via E-UTRAN
Mapped EPS Bearer QoS	ARP, GBR, MBR, QCI.
PGW-U tunnel Information	PGW-U S5/S8 GTP-U tunnel IP address and TEID information.
TFT	Traffic Flow Template

### 5.2.8.2.11 Nsmf\_PDUSession\_ContextPush service operation

**Service operation name:** Nsmf\_PDUSession\_ContextPushRequest

**Description:** This service operation is used by the SMF as Service Consumer to push one SM Context to a another SMF as NF Service Producer. It may be triggered by OAM.

**Input, Required:** One of the following:

- SM Context of identified PDU session.



- Endpoint where SM Context of identified PDU session can be retrieved.

The SM context includes SM context in I-SMF(or V-SMF) and SM context in SMF (or H-SMF) separately.

See Table 5.2.8.2.10-1 for single SM Context stored in I-SMF or V-SMF that may be transferred to another SMF instance.

**Editor's note:** The SM context stored in SMF(or H-SMF) is to be defined.

**Output, Required:** Result Indication.

**Output, Optional:** Cause.

See clause 4.26.2 for an example usage of this service operation.

#### 5.2.8.2.12 Nsmf\_PDUSession\_SendMOData service operation

**Service operation name:** Nsmf\_PDUSession\_SendMOData

**Description:** When the AMF has received MO Small Data from the UE in NAS procedure, this service operation allows the AMF to send the MO Small Data to the SMF.

**Input, Required:** SM Context ID, N1 container received from the UE.

**Input, Optional:** AN type, MO Exception Data Counter.

**Output, Required:** Result Indication.

**Output, Optional:** Cause.

See clause 4.24.1 for an example usage of this service operation.

#### 5.2.8.2.13 Nsmf\_PDUSession\_TransferMOData service operation

**Service operation name:** Nsmf\_PDUSession\_TransferMOData

**Description:** When the V-SMF/I-SMF has received MO Small Data from AMF, this service operation allows the V-SMF/I-SMF to forward the MO Small Data to the (H-)SMF.

**Input, Required:** SM Context ID, MO Small Data.

**Input, Optional:** MO Exception Data Counter.

**Output, Required:** Result Indication.

**Output, Optional:** Cause.

See clause 4.25.4 for an example usage of this service operation.

#### 5.2.8.2.14 Nsmf\_PDUSession\_TransferMTData service operation

**Service operation name:** Nsmf\_PDUSession\_TransferMTData

**Description:** When the (H-)SMF has received MT Small Data from the NEF, this service operation allows the (H-)SMF to send the MT Small Data to the V-SMF/I-SMF.

**Input, Required:** SM Context ID, MT Small Data.

**Input, Optional:** None.

**Output, Required:** Result Indication.

**Output, Optional:** Cause, Estimated Maximum Wait time.

See clause 4.24.5 for an example usage of this service operation.

### 5.2.8.3 Nsmf\_EventExposure Service

#### 5.2.8.3.1 General

**Service description:** This service provides events related to PDU Sessions towards consumer NF. The service operations exposed by this service allow other NFs to subscribe and get notified of events happening on PDU Sessions. The following are the key functionalities of this NF service.

- Allow consumer NFs to Subscribe and unsubscribe for an Event ID on PDU Session(s);
- Allow the NWDAF to collect data for network data analytics as specified in TS 23.288 [50];
- Notifying events on the PDU Session to the subscribed NFs; and
- Allow consumer NFs to acknowledge or respond to an event notification.

The following events can be subscribed by a NF consumer (Event ID is defined in clause 4.15.1):

- UE IP address / Prefix allocation/change: The event notification may contain a new UE IP address / Prefix or an indication of which UE IP address / Prefix has been released.
- PDU Session Establishment and/or PDU Session Release.

The event notification may contain following information:

- PDU Session Type.
- DNN.
- UE IP address/Prefix.
- UP path change: a notification corresponding to this event is sent when the UE IP address / Prefix and / or DNAI and /or the N6 traffic routing information has changed.

The event notification may contain following information:

- the type of notification ("EARLY" or "LATE").
- for both the source and target UP path between the UE and the DN, the corresponding information is provided when it has changed:
  - DNAI.
  - UE IP address / Prefix.
  - N6 traffic routing information.

NOTE 1: UP path change notification, DNAI and N6 traffic routing information are further described in clause 5.6.7 of TS 23.501 [2].

- QoS Monitoring for URLLC: the event notification may contain the QoS Monitoring report as described in clause 5.33.3.2 of TS 23.501 [2].
- Change of Access Type; The event notification contains the new Access Type for the PDU Session.
- PLMN change; The event notification contains the new PLMN Identifier for the PDU Session.
- Downlink data delivery status. The event notification contains the status of downlink data buffering in the core network including:
  - First downlink packet per source of the downlink IP traffic in extended buffering and Estimated maximum wait time.
  - First downlink packet per source of the downlink IP traffic discarded.
  - First downlink packet per source of the downlink IP traffic transmitted after previous buffering and/or discarding of corresponding packet(s).

- QFI allocation: The event notification is sent when a new QoS flow is established within a PDU session and contains:
  - If the Target of Event Reporting is a PDU session, both the allocated QFI and either one of the following (Application Identifier or IP Packet Filter Set or Ethernet Packet Filter Set). The DNN, S-NSSAI corresponding to the PDU session are also sent.
  - If the Target of Event Reporting is a SUPI, both the allocated QFI and either one of the following (Application Identifier or IP Packet Filter Set or Ethernet Packet Filter Set) for each PDU session ID established for this SUPI. The DNN, S-NSSAI corresponding to each PDU session are also sent.
  - If the Target of Event Reporting is an Internal-Group-Id or any UE, multiple instances of the tuple (allocated QFI and either one of the following (Application Identifier or IP Packet Filter Set or Ethernet Packet Filter Set). PDU session ID, SUPI). The DNN, S-NSSAI corresponding to each PDU session are also sent.

When the consumer NF is the NWDAF, the event QFI allocation is used to collect data for Observed Service Experience analytics and UE communication analytics as specified in TS 23.288 [50].

Event Filters are used to specify the conditions to match for notifying the events (i.e. "List of Parameter values to match"). If there are no conditions to match for a specific Event ID, then the Event Filter is not provided. The following table provides as an example how the conditions to match for event reporting can be specified for various Event IDs for SMF exposure.

**Table 5.2.8.3.1-1: Example of Event Filters for SMF exposure events**

Event ID for SMF exposure	Event Filter (List of Parameter Values to Match)
DNAI Change	None
PDU Session Release	None
PDU Session Establishment	
QoS Monitoring for URLLC	None
QFI allocation	<Parameter Type = DNN, Value = DNN1> <Parameter Type = S-NSSAI, Value = S-NSSAI1>
QFI allocation	<Parameter Type = Application Identifier, Value = Application Identifier1>

The target of SMF event reporting may correspond to a PDU Session ID, an UE ID (SUPI) an Internal Group Identifier or an indication that any UE is targeted (e.g. on a specific DNN).

When acknowledgment is expected the SMF also provides Notification Correlation Information to the consumer NF in the event notification.

The consumer NF may provide the following event-specific information when acknowledging an event notification:

- For UP path change event:
- N6 traffic routing information related to the target DNAI.

NOTE 2: Acknowledgement to a UP path change event notification is further described in clause 5.6.7 of TS 23.501 [2].

### 5.2.8.3.2 Nsmf\_EventExposure\_Notify service operation

**Service operation name:** Nsmf\_EventExposure\_Notify

**Description:** Report UE PDU Session related event(s) to the NF which has subscribed to the event report service.

**Input Required:** Event ID, Notification Correlation Information, UE ID (SUPI and if available GPSI), PDU Session ID, time stamp.

**Input, Optional:** Event specific parameter list as described in clause 5.2.8.3.1.

**Output Required:** Result Indication.

**Output, Optional:** Redirection information.

When the SMF detects the event subscribed by the NF consumer, the SMF reports the subscribed event together with the Notification Target Address (+ Notification Correlation ID) to the Event Receiving NF.

The optional event specific parameter list provides the values that matched for generating the event notification. The parameter values to match are specified during the event subscription (see clause 5.2.8.3.3).

See clause 4.3.6.3 for details on usage of this service operation toward Application Function.

If the NF consumer is AMF and the result of the service operation fails, the AMF shall set corresponding cause value in result indication which can be used by the SMF for further action. If the related UE is not served by the AMF and the AMF knows which AMF is serving the UE, the AMF provides redirection information which can be used by the SMF to resend UE related message to the AMF that serves the UE.

**NOTE:** In the case of UP plane path, as described in clause 4.3.6.2, this notification can be the result of an implicit subscription of the NEF/AF by the PCF as part of setting PCC rule(s) via the Npcf\_SMPolicyControl service (see clause 5.2.5.4).

#### 5.2.8.3.2A Nsmf\_EventExposure\_AppRelocationInfo service operation

**Service operation name:** Nsmf\_EventExposure\_AppRelocationInfo

**Description:** Acknowledge the notification from the SMF regarding UE PDU Session related event(s).

**Input Required:** Notification Correlation Information, cause code.

The Notification Correlation Information is provided by the SMF in the event notification.

Cause code indicates this acknowledgement is positive or negative.

**Input, Optional:** Event specific parameter list as described in clause 5.2.8.3.1.

**Output Required:** None.

**Output, Optional:** None.

See clause 4.3.6.3 for details on usage of this service operation toward Application Function.

#### 5.2.8.3.3 Nsmf\_EventExposure\_Subscribe service operation

**Service operation name:** Nsmf\_EventExposure\_Subscribe.

**Description:** This service operation is used by an NF to subscribe or modify a subscription for event notifications on a specified PDU Session or for all PDU Sessions of one UE, group of UE(s) or any UE.

**Input, Required:** NF ID, Target of Event Reporting as defined in clause 5.2.8.3.1, (set of) Event ID(s) defined in clause 5.2.8.3.1, Notification Target Address (+ Notification Correlation ID), Event Reporting Information defined in Table 4.15.1-1.

**Input, Optional:** Event Filter(s) associated with each Event ID; Event Filter(s) are defined in clause 5.2.8.3.1, Subscription Correlation ID (in the case of modification of the event subscription), Expiry time.

**Output, Required:** When the subscription is accepted: Subscription Correlation ID (required for management of this subscription), Expiry time (required if the subscription can be expired based on the operator's policy).

**Output, Optional:** First corresponding event report is included, if available (see clause 4.15.1).

Notification Target Address (+ Notification Correlation ID) is used to correlate Notifications sent by SMF with this subscription.

#### 5.2.8.3.4 Nsmf\_EventExposure\_UnSubscribe service operation

**Service operation name:** Nsmf\_EventExposure\_UnSubscribe.

**Description:** This service operation is used by an NF to unsubscribe event notifications.

**Input, Required:** Subscription Correlation ID.

**Input, Optional:** None.

**Output, Required:** None.

**Output, Optional:** None.

## 5.2.8.4 Nsmf\_NIDD Service

### 5.2.8.4.1 General

This service is used for NIDD transfer between SMF and another NF. See clause 4.25.5.

### 5.2.8.4.2 Nsmf\_NIDD\_Delivery service operation

**Service operation name:** Nsmf\_NIDD\_Delivery

**Description:** This service operation is used by the NF consumer to deliver the unstructured data between NF consumer and SMF to support NIDD via NEF.

**Inputs Required:** User Identity, PDU Session ID, unstructured data, Reliable Data Service Configuration (Optional).

**Inputs, Optional:** None.

**Outputs Required:** Cause.

**Outputs, Optional:** Extended Buffering Time.

## 5.2.9 SMSF Services

### 5.2.9.1 General

The following table illustrates the SMSF Services.

**Table 5.2.9.1-1: List of SMSF Services**

Service Name	Service Operations	Operation Semantics	Example Consumer(s)
Nsmsf_SMSService	Activate	Request/Response	AMF
	Deactivate	Request/Response	AMF
	UplinkSMS	Request/Response	AMF

### 5.2.9.2 Nsmsf\_SMSService service

#### 5.2.9.2.1 General

This service allows AMF to authorize SMS and activate SMS for the served user on SMSF.

#### 5.2.9.2.2 Nsmsf\_SMSService\_Activate service operation

**Service operation name:** Nsmsf\_SMSService\_Activate.

**Description:** Authorize whether the specified UE is allowed to activate SMS service, or add connectivity for SMS over new Access Type.

**Concurrent use:** None.

**Inputs, Required:** SUPI, NF ID, RAT Type.

**Inputs, Optional:** GPSI, Time Zone, one or more Access Type(s), GUAMI, backup AMF(s) (if NF Type is AMF). Backup AMF(s) sent only once by the AMF to the SMSF in its first interaction with the SMSF, UE's Routing Indicator or UDM Group ID for the UE.

**Outputs, Required:** SMS service activation result.

**Outputs, Optional:** None.

#### 5.2.9.2.3 Nsmsf\_SMSservice\_Deactivate service operation

**Service operation name:** Nsmsf\_SMSservice\_Deactivate.

**Description:** Remove SMS service authorization from SMSF for a given service user, or with Access Type included, remove connectivity for SMS over the affected Access Type.

**Concurrent use:** None.

**Inputs, Required:** SUPI.

**Inputs, Optional:** Access Type.

**Outputs, Required:** SMS service deactivation result.

**Outputs, Optional:** None.

#### 5.2.9.2.4 Nsmsf\_SMSservice\_UplinkSMS service operation

**Service operation name:** Nsmsf\_SMSservice\_UplinkSMS.

**Description:** transmit uplink SMS message from consumer NF to SMSF.

**Concurrent use:** None.

**Inputs, Required:** SUPI, SMS payload.

**Inputs, Optional:** GPSI, UE Time Zone, UE Location Information (ULI).

**Outputs, Required:** SMS message transmission result.

**Outputs, Optional:** None.

## 5.2.10 AUSF Services

### 5.2.10.1 General

The following table illustrates the AUSF Services.

**Table 5.2.10.1-1: List of AUSF Services**

Service Name	Service Operations	Operation Semantics	Example Consumer(s)
Nausf_UEAuthentication	Authenticate	Request/Response	AMF
Nausf_SoRProtection	Protect	Request/Response	UDM
Nausf_UPUProtection	Protect	Request/Response	UDM

### 5.2.10.2 Nausf\_UEAuthentication service

#### 5.2.10.2.1 General

**Service Description:** the AUSF provides UE authentication service to the requester NF. For AKA based authentication, this operation can be also used to recover from synchronization failure situations.

5.2.10.2.2 Nausf\_UEAuthentication\_Authenticate service operation

See TS 33.501 [15].

5.2.10.2.3 Void

5.2.10.3 Nausf\_SoRProtection service

5.2.10.3.1 General

**Service Description:** The AUSF provides the Steering of Roaming information protection service to the requester NF.

5.2.10.3.2 Nausf\_SoRProtection Protect service operation

See TS 33.501 [15].

5.2.10.4 Nausf\_UPUProtection service

5.2.10.4.1 General

**Service Description:** The AUSF provides the UE Parameters Update protection service to the requester NF.

5.2.10.4.2 Nausf\_UPUProtection Protect service operation

See TS 33.501 [15].

5.2.10.5 Void

## 5.2.11 NWDAF Services

The NWDAF services are defined in TS 23.288 [50].

5.2.11.1 Void

5.2.11.2 Void

5.2.11.3 Void

## 5.2.12 UDR Services

5.2.12.1 General

The following Data Set Identifiers shall be considered in this release: Subscription Data, Policy Data, Application data and Data for Exposure. The corresponding Data Subset Identifiers and Data (Sub)Key(s) are defined in Table 5.2.12.2.1-1.

The set of Data Set Identifiers shall be extensible to cater for new identifiers as well as for operator specific identifiers and related data to be consumed.

The following table illustrates the UDR Services.

**Table 5.2.12.1-1: NF services provided by UDR**

<b>NF service</b>	<b>Service Operations</b>	<b>Operation Semantics</b>	<b>Example Consumer(s)</b>
Data Management (DM)	Query	Request/Response	UDM, PCF, NEF
	Create	Request/Response	NEF
	Delete	Request/Response	NEF
	Update	Request/Response	UDM, PCF, NEF
	Subscribe	Subscribe/Notify	UDM, PCF, NEF
	Unsubscribe		UDM, PCF, NEF
	Notify		UDM, PCF, NEF
GroupIDmap	Query	Request/Response	NRF, SCP

The following table shows the Exposure data that may be stored in the UDR along with a time stamp using Data Management (DM) Service:

**NOTE:** When the data in Table 5.2.12.1-2 need to be monitored in real time, they should be monitored directly at the originating NF (e.g. registration state changes may be monitored via the Namf\_EventExposure service) and not use the stored information from UDR if it is not the latest. It is expected that such dynamically changing information (e.g. UE reachability status) is used for statistical purpose and analytics.



Table 5.2.12.1-2: Exposure data stored in the UDR

Category	Information	Description	Data key	Data Sub key
Access and mobility information	UE location	Gives the Location or the last known location of a UE (e.g. Tai, Cell Id... both 3GPP and non-3GPP access location)	SUPI or GPSI	
	UE time zone	Current time zone for the UE	SUPI or GPSI	
	UE Access type	3GPP access or non-3GPP access	SUPI or GPSI	
	UE RAT type	Determined as defined in clause 5.3.2.3 of TS 23.501 [2]. The values are defined in TS 29.571 [70]	SUPI or GPSI	
	UE registration state	Registered or Deregistered	SUPI or GPSI	
	UE connectivity state	IDLE or CONNECTED	SUPI or GPSI	
	UE reachability status	It indicates if the UE is reachable for sending either SMS or downlink data to the UE, which is detected when the UE transitions to CM-CONNECTED state or when the UE will become reachable for paging, e.g. Periodic Registration Update timer	SUPI or GPSI	
	UE SMS over NAS service status	SMS over NAS supported or not in the UE	SUPI or GPSI	
	UE Roaming status	It indicates UE's current roaming status (the serving PLMN and/or whether the UE is in its HPLMN)	SUPI or GPSI	
	UE Current PLMN	Current PLMN for the UE	SUPI or GPSI	
Session management information	UE IP address	UE IP address	SUPI or GPSI	PDU session ID or DNN
	PDU session status	Active / released	SUPI or GPSI	PDU session ID or DNN or UE IP address
	DNAI	DNAI	SUPI or GPSI	PDU session ID or DNN or UE IP address
	N6 traffic routing information	N6 traffic routing information	SUPI or GPSI	PDU session ID or DNN or UE IP address

## 5.2.12.2 Nudr\_DataManagement (DM) service

### 5.2.12.2.1 General

The operations defined for Nudr\_DM service use following set of parameters defined in this clause:

- Data Set Identifier: uniquely identifies the requested set of data within the UDR (see clause 4.2.5).
- Data Subset Identifier: it uniquely identifies the data subset within each Data Set Identifier. As specified in the procedures in clause 4, e.g. subscription data can consist of subsets particularised for specific procedures like mobility, session, etc.
- Data Keys defined in Table 5.2.12.2.1-1

For Nudr\_DM\_Subscribe and Nudr\_DM\_Notify operations:

- The Target of Event Reporting is made up of a Data Key and possibly a Data Sub Key both defined in Table 5.2.12.2.1-1. When a Data Sub Key is defined in the table but not present in the Nudr\_DM\_Subscribe this means that all values of the Data Sub Key are targeted.

- The Data Set Identifier plus (if present) the (set of) Data Subset Identifier(s) corresponds to a (set of) Event ID(s) as defined in clause 4.15.1

An NF Service Consumer may include an indicator when it invokes Nudr\_DM Query/Create/Update service operation to subscribe the changes of the data, to avoid a separate Nudr\_DM\_Subscribe service operation.

Depending on the use case, it is possible to use a Data Key and/or one or multiple Data sub keys to further identify the corresponding data, as defined in Table 5.2.12.2.1-1 below.

**Table 5.2.12.2.1-1: Data keys**

Data Set	Data Subset	Data Key	Data Sub Key
Subscription Data (see clause 5.2.3.3.1)	Access and Mobility Subscription data	SUPI	Serving PLMN ID and optionally NID
	SMF Selection Subscription data	SUPI	Serving PLMN ID and optionally NID
	UE context in SMF data	SUPI	PDU Session ID or DNN
	SMS Management Subscription data	SUPI	Serving PLMN ID and optionally NID
	SMS Subscription data	SUPI	Serving PLMN ID and optionally NID
	Session Management Subscription data	SUPI	S-NSSAI
			DNN
			Serving PLMN ID and optionally NID
	Slice Selection Subscription data	SUPI	Serving PLMN ID and optionally NID
	Group Data (NOTE 4)	Internal Group Identifier or External Group Identifier	-
	Identifier translation	GPSI SUPI	Application Port ID
	Intersystem continuity Context	SUPI	DNN
	LCS privacy	SUPI	-
	LCS mobile origination	SUPI	-
	UE reachability	SUPI	-
	Group Identifier Translation	Internal Group Identifier or External Group Identifier	-
UE context in SMSF data	SUPI	-	
V2X Subscription data	SUPI	-	
Application data	Packet Flow Descriptions (PFDs)	Application Identifier	-
	AF traffic influence request information (See clause 5.6.7 and clause 6.3.7.2 of TS 23.501 [2])	AF transaction internal ID	S-NSSAI and DNN and/or Internal Group Identifier or SUPI
		S-NSSAI and DNN and/or Internal Group Identifier or SUPI	
	Background Data Transfer (NOTE 3)	Internal Group Identifier or SUPI	
Service specific information (See clause 4.15.6.7)	S-NSSAI and DNN or Internal Group Identifier or SUPI		
Policy Data	UE context policy control data (See clause 6.2.1.3 of TS 23.503 [20])	SUPI	
	PDU Session policy control data (See clause 6.2.1.3 of TS 23.503 [20])	SUPI	S-NSSAI
			DNN
	Policy Set Entry data (See clause 6.2.1.3 of TS 23.503 [20])	SUPI (for the UDR in HPLMN)	
		PLMN ID (for the UDR in VPLMN)	
	Remaining allowed Usage data (See clause 6.2.1.3 of TS 23.503 [20])	SUPI	S-NSSAI
			DNN
Sponsored data connectivity profiles (See clause 6.2.1.6 of TS 23.503 [20])	Sponsor Identity		
Background Data Transfer data (See clause 6.2.1.6 of TS 23.503 [20])	Background Data Transfer Reference ID. (NOTE 2)		

Exposure Data (see clause 5.2.12.1)	Access and Mobility Information	None. (NOTE 1) SUPI or GPSI	PDU Session ID or UE IP address or DNN
	Session Management information	SUPI or GPSI	
NOTE 1: Retrieval of the stored Background Data Transfer References for all ASP identifiers in the UDR requires Data Subset but no Data Key or Data Subkey(s).			
NOTE 2: Update of a Background Data Transfer Reference in the UDR requires a Data key to refer to a Background Data Transfer Reference as input data.			
NOTE 3: The Background Data Transfer includes the Background Data Reference ID and the ASP id that requests to apply the Background Data Reference ID to the UE(s). Furthermore, the Background Data Transfer includes the relevant information received from the AF as defined in clause 6.1.2.4 of TS 23.503 [20].			
NOTE 4: Group Data includes 5G VN group configuration and any other data related to a group stored in the UDR.			

The content of the UDR storage for (Data Set Id= Application Data, Data Subset Id = AF TrafficInfluence request information) is specified in clause 5.6.7, Table 5.6.7-1 of TS 23.501 [2]. This information is written by the NEF and read by the PCF(s). PCF(s) may also subscribe to changes onto this information.

#### 5.2.12.2.2 Nudr\_DM\_Query service operation

**Service operation name:** Nudr\_DM\_Query.

**Description:** NF service consumer requests a set of data from UDR.

**Inputs, Required:** Data Set Identifier, Data Key(s).

**Inputs, Optional:** Data Subset Identifier(s), Data Sub Key(s) (for each Data Subset, see clause 5.2.12.2.1).

**Outputs, Required:** Requested data.

**Outputs, Optional:** None.

#### 5.2.12.2.3 Nudr\_DM\_Create service operation

**Service operation name:** Nudr\_DM\_Create.

**Description:** NF service consumer intends to insert a new data record into the UDR, e.g. a NF service consumer intends to insert a new application data record into the UDR.

**Inputs, Required:** Data Set Identifier, Data Key(s).

**Inputs, Optional:** Data Subset Identifier(s), Data Sub Key(s) (for each Data Subset, see clause 5.2.12.2.1).

**Outputs, Required:** Result.

**Outputs, Optional:** None.

#### 5.2.12.2.4 Nudr\_DM\_Delete service operation

**Service operation name:** Nudr\_DM\_Delete.

**Description:** NF service consumer intends to delete user data stored in the UDR, e.g. a NF service consumer intends to delete an application data record.

**Inputs, Required:** Data Set Identifier, Data Key(s).

**Inputs, Optional:** Data Subset Identifier(s), Data Sub Key(s) (for each Data Subset, see clause 5.2.12.2.1).

**Outputs, Required:** Result.

**Outputs, Optional:** None.

#### 5.2.12.2.5 Nudr\_DM\_Update service operation

**Service operation name:** Nudr\_DM\_Update.

**Description:** NF service consumer intends to update stored data in the UDR.

**Inputs, Required:** Data Set Identifier, Data Key(s), Data.

**Inputs, Optional:** Data Subset Identifier(s), Data Sub Key(s) (for each Data Subset, see clause 5.2.12.2.1).

**Outputs, Required:** Result.

**Outputs, Optional:** None.

#### 5.2.12.2.6 Nudr\_DM\_Subscribe service operation

**Service operation name:** Nudr\_DM\_Subscribe.

**Description:** NF service consumer performs the subscription to notification to data modified in the UDR. The events can be changes on existing data, addition of data.

**Inputs, Required:** Data Set Identifier as defined in clause 5.2.12.2.1, Notification Target Address (+ Notification Correlation ID), Event Reporting Information defined in Table 4.15.1-1.

**Inputs, Optional:** Target of Event Reporting as defined in clause 5.2.12.2.1, Data Subset Identifier(s) as defined in clause 5.2.12.2.1, Data Key(s), Subscription Correlation ID (in the case of modification of the event subscription).

**Outputs, Required:** When the subscription is accepted: Subscription Correlation ID.

**Outputs, Optional:** None.

#### 5.2.12.2.7 Nudr\_DM\_Unsubscribe service operation

**Service operation name:** Nudr\_DM\_Unsubscribe

**Description:** NF service consumer performs the un-subscription to notification to data modified in the UDR. The events can be changes on existing data, addition of data.

**Inputs, Required:** Subscription Correlation ID.

**Inputs, Optional:** None.

**Outputs, Required:** Result.

**Outputs, Optional:** None.

#### 5.2.12.2.8 Nudr\_DM\_Notify service operation

**Service operation name:** Nudr\_DM\_Notify.

**Description:** UDR notifies NF service consumer(s) about modification of data, when data in the UDR is added, modified or deleted and an NF needs to be informed about this, due to a previous subscription to notifications procedure or due to a local configuration policy in the UDR.

**Inputs, Required:** Notification Correlation Information, Data Set Identifier as defined in clause 5.2.12.2.1, Target of Event Reporting as defined in clause 5.2.12.2, Updated Data.

**Inputs, Optional:** Data Subset Identifier as defined in clause 5.2.12.2.1.

**Outputs, Required:** Result.

**Outputs, Optional:** None.

### 5.2.12.3 Nudr\_GroupIDmap service

#### 5.2.12.3.1 General

The Nudr\_GroupIDmap service allows an NF consumer to retrieve a NF group ID corresponding to a subscriber identifier.

#### 5.2.12.3.2 Nudr\_GroupIDmap\_query service operation

**Service Operation name:** Nudr\_GroupIDmap\_query

**Description:** Provides towards the invoking NF the NF Group ID corresponding to the supplied subscriber identifier.

**Inputs, Required:**

- NF Type (e.g. HSS).
- Subscriber Identifier.
- Subscriber Identifier Type (at least one of {IMPI, IMPU, SUPI, GPSI}).

**Inputs, Optional:** None.

**Outputs, Required:** NF Group ID.

**Outputs, Optional:** None.

### 5.2.13 BSF Services

#### 5.2.13.1 General

The following table shows the BSF Services and Service Operations:

**Table 5.2.13.1-1: NF services provided by the BSF**

Service Name	Service Operations	Operation Semantics	Example Consumer(s)
Nbsf_management	Register	Request/Response	PCF
	Deregister	Request/Response	PCF
	Discovery	Request/Response	NEF, AF, NWDAF
	Update	Request/Response	PCF

#### 5.2.13.2 Nbsf\_Management service

##### 5.2.13.2.1 General

The Nbsf provides the Nbsf Management Register, Nbsf Management Remove and the Nbsf Management Discovery service operations.

##### 5.2.13.2.2 Nbsf\_Management\_Register service operation

**Service Operation name:** Nbsf\_Management\_Register

**Description:** Registers the tuple (UE address(es), SUPI, GPSI, DNN, S-NSSAI, PCF address(es), PCF instance id, PCF Set ID) for a PDU Session.

**Inputs, Required:** UE address(es), PCF address(es).

UE address can contain IP address/prefix or MAC address as defined in TS 23.501 [2]. It can optionally include Framed Route information. W-5GAN specific UE IP address information is specified in TS 23.316 [53].

Framed Route information is defined in Table 5.2.3.3.1-1.

NOTE: For TSN scenarios the UE address contains the DS-TT port MAC address.

**Inputs, Optional:** DNN, SUPI, GPSI, S-NSSAI, PCF instance ID and PCF Set ID, level of Binding (see clause 6.3.1.0 of TS 23.501 [2]).

**Outputs, Required:** Result indication, Binding Identifier for a PDU Session.

**Outputs, Optional:** None.

#### 5.2.13.2.3 Nbsf\_Management\_Deregister service operation

**Service Operation name:** Nbsf\_Management\_Deregister

**Description:** Removes the binding information for a PDU Session.

**Inputs, Required:** Binding Identifier for a PDU Session.

W-5GAN specific UE IP address information are specified in TS 23.316 [53].

**Inputs, Optional:**

**Outputs, Required:** Result indication.

**Outputs, Optional:** None.

#### 5.2.13.2.4 Nbsf\_Management\_Discovery service operation

**Service Operation name:** Nbsf\_Management\_discovery

**Description:** Discovers the PCF and PCF set selected for the tuple (UE address(es), SUPI, GPSI, DNN, S-NSSAI).

**Inputs, Required:** UE address (i.e. IP address or MAC address), DNN [Conditional], S-NSSAI [Conditional].

NOTE: For TSN scenarios the UE address contains the DS-TT port MAC address.

**Inputs, Optional:** SUPI, GPSI.

**Outputs, Required:** PCF address(es), PCF instance ID [Conditional, if available] and PCF Set ID [Conditional, if available], level of Binding [Conditional, if available] (see clause 6.3.1.0 of TS 23.501 [2]).

**Outputs, Optional:** None.

#### 5.2.13.2.5 Nbsf\_Management\_Update service operation

**Service Operation name:** Nbsf\_Management\_Update

**Description:** Replaces the list of UE address(es) for a PDU Session.

**Inputs, Required:** Binding Identifier for the PDU Session.

UE address can contain IP address/prefix or Ethernet address as defined in TS 23.501 [2].

NOTE: For TSN scenarios the UE address contains the DS-TT port MAC address.

**Inputs, Optional:** UE address(es), PCF id, PCF address(es).

**Outputs, Required:** Result indication.

**Outputs, Optional:** None.

### 5.2.14 UDSF Services

#### 5.2.14.1 General

The following table illustrates the UDSF Services.



Table 5.2.14-1: NF Services provided by UDSF

NF service	Service Operations	Operation Semantics	Example Consumer(s)
Unstructured Data Management	Query	Request/Response	Any NF
	Create	Request/Response	Any NF
	Delete	Request/Response	Any NF
	Update	Request/Response	Any NF

NOTE: Nudsf is different compared to other service-based interfaces due to dynamic data access performance requirements.

## 5.2.14.2 Nudsf\_UnstructuredDataManagement service

### 5.2.14.2.1 General

#### 5.2.14.2.2 Nudsf\_UnstructuredDataManagement\_Query service operation

**Service operation name:** Nudsf\_UnstructuredDataManagement\_Query.

**Description:** NF service consumer intends to query data from UDSF.

**Inputs, Required:** Data Identifier.

Data Identifier uniquely identifies the data to be retrieved from the UDSF

**Inputs, Optional:** None.

**Outputs, Required:** Requested data.

**Outputs, Optional:** None.

#### 5.2.14.2.3 Nudsf\_UnstructuredDataManagement\_Create service operation

**Service operation name:** Nudsf\_UnstructuredDataManagement\_Create.

**Description:** NF service consumer intends to insert a new user data record into the UDSF, e.g. AMF stores the context for registered UE(s) in the UDSF.

**Inputs, Required:** Data Identifier, Data.

Data Identifier uniquely identifies the data, which is created in the UDSF.

**Inputs, Optional:** None

**Outputs, Required:** Result.

**Outputs, Optional:** None.

#### 5.2.14.2.4 Nudsf\_UnstructuredDataManagement\_Delete service operation

**Service operation name:** Nudsf\_UnstructuredDataManagement\_Delete.

**Description:** NF service consumer intends to delete user data stored in the UDSF, e.g. when AMF deletes the context for unregistered UE(s) in the UDSF.

**Inputs, Required:** Data Identifier.

**Inputs, Optional:** None.

Data Identifier uniquely identifies the data to be deleted within the UDSF.

**Outputs, Required:** Result.

**Outputs, Optional:** None.

#### 5.2.14.2.5 Nudsf\_UnstructuredDataManagement\_Update service operation

**Service operation name:** Nudsf\_UnstructuredDataManagement\_Update.

**Description:** NF service consumer intends to update stored data in the UDSF.

**Inputs, Required:** Data Identifier, Data.

Data Identifier uniquely identifies the data, which is updated in the UDSF.

**Inputs, Optional:** None.

**Outputs, Required:** Result.

**Outputs, Optional:** None.

### 5.2.15 LMF Services

LMF services are defined in clause 8.3 of TS 23.273 [51].

### 5.2.16 NSSF Services

#### 5.2.16.1 General

The following table illustrates the NSSF Services.

**Table 5.2.16.1-1: NF Services provided by NSSF**

Service Name	Service Operations	Operation Semantics	Example Consumer(s)
Nnssf_NSSelection	Get	Request/Response	AMF, NSSF in a different PLMN, SMF
Nnssf_NSSAIAvailability	Update	Request/Response	AMF
	Subscribe	Subscribe/Notify	AMF
	Unsubscribe		AMF
	Notify		AMF
	Delete	Request/Response	AMF

NOTE: The SMF uses the Nnssf\_NSSelection\_Get service operation during EPS interworking.

#### 5.2.16.2 Nnssf\_NSSelection service

##### 5.2.16.2.1 Nnssf\_NSSelection\_Get service operation

**Service operation name:** Nnssf\_NSSelection\_Get

**Description:** This service operation enables Network Slice selection in both the Serving PLMN and HPLMN. It also enables the NSSF to provide to the AMF the Allowed NSSAI and the Configured NSSAI for the Serving PLMN.

It may be invoked during Registration procedure, during inter-PLMN mobility procedure, during PDU Session Establishment procedure or during UE Configuration Update procedure. When invoked during Registration procedure it may possibly trigger AMF re-allocation. When invoked during PDU Session Establishment procedure it may be invoked in the VPLMN or in the HPLMN. When invoked during UE Configuration Update procedure or inter-PLMN mobility procedure it may be invoked in the Serving PLMN.

NOTE 1: The list of events, which trigger invoking of the Nnssf\_NSSelection\_Get service operation, is not exhaustive.

NOTE 2: The NSSF can determine the serving network and Access Type from the TAI, as described in TS 29.571 [70].

**Inputs, Required:** None.

**Inputs, Conditional Required:**

If this service operation is invoked during Registration procedure for Network Slice selection or UE Configuration Update procedure, then the following inputs are required:

- Subscribed S-NSSAI(s) with the indication if marked as default S-NSSAI, PLMN ID of the SUPI, TAI, NF type of the NF service consumer, Requester ID.

If this service operation is invoked to derive the S-NSSAI for the serving PLMN (as described in clause 4.11.1.3.3), the following inputs are required:

- S-NSSAIs for the HPLMN associated with established PDN connection, PLMN ID of the SUPI, NF type of the NF service consumer, Requester ID.

If this service operation is invoked by target AMF during inter-PLMN mobility procedure, the following inputs are required:

- S-NSSAIs for the HPLMN, PLMN ID of the SUPI, TAI.

If this service operation is invoked during PDN Connection Establishment in the Serving PLMN in EPS by a SMF+PGW-C, the following inputs are required:

- Subscribed S-NSSAIs for the UE, PLMN ID of the SUPI, NF type of the NF service consumer, Requester ID.

If this service operation is invoked during PDU Session Establishment procedure in the Serving PLMN then the following inputs are required:

- S-NSSAI, non-roaming/LBO roaming/HR roaming indication, PLMN ID of the SUPI, TAI, NF type of the NF service consumer, Requester ID.

**Inputs, Optional:**

If this service operation is invoked during Registration procedure for Network Slice selection or UE Configuration Update procedure, then the following inputs are provided if available:

- Requested NSSAI, Mapping Of Requested NSSAI, Default Configured NSSAI Indication, Allowed NSSAI for current Access Type, Allowed NSSAI for the other Access Type and the corresponding Mapping Of Allowed NSSAIs for current Access Type and other Access Type.

If this service operation is invoked during PDU Session Establishment procedure, then the following input is optional:

- HPLMN S-NSSAI that maps to the S-NSSAI from the Allowed NSSAI of the Serving PLMN.

**Outputs, Conditional Required:**

If this service operation is invoked during Registration procedure for Network Slice selection or UE Configuration Update procedure, then one or more of the following outputs are required:

- Allowed NSSAI, Configured NSSAI; Target AMF Set or, based on configuration, the list of candidate AMF(s).

If this service operation is invoked during inter-PLMN mobility procedure, then one or more of the following outputs are required:

- Allowed NSSAI.

If this service operation is invoked to derive the S-NSSAI for the serving PLMN (as described in clause 4.11.1.3.3), the following output is required:

- S-NSSAIs for the HPLMN associated with established PDN connection, Mapping of S-NSSAIs associated with established PDN connection in the Serving PLMN.

If this service operation is invoked during PDN Connection Establishment in the Serving PLMN in EPS by a SMF+PGW-C, the following outputs are required:

- Subscribed S-NSSAIs for the UE, Mapping of S-NSSAIs associated with the subscribed S-NSSAIs for the UE in the Serving PLMN.

If this service operation is invoked during PDU Session Establishment procedure then the following outputs are required:

- The NRF to be used to select NFs/services within the selected Network Slice instance.

#### **Outputs, conditional Optional:**

If this service operation is invoked during UE Registration procedure or UE Configuration Update procedure, then one or more of the following outputs are optional:

- Mapping Of Allowed NSSAI, Mapping Of Configured NSSAI, NSI ID(s) associated with the Network Slice instances of the Allowed NSSAI, NRF(s) to be used to select NFs/services within the selected Network Slice instance(s) and NRF to be used to determine the list of candidate AMF(s) from the AMF Set, rejected S-NSSAI with cause of rejection.

If this service operation is invoked during inter-PLMN mobility procedure, then the following output is optional:

- Mapping Of Allowed NSSAI.

If this service operation is invoked during PDU Session Establishment procedure, then the following output is optional:

- NSI ID associated with the S-NSSAI provided in the input.

### 5.2.16.3 Nnssf\_NSSAIAvailability service

#### 5.2.16.3.1 General

**Service description:** This service enables to update the AMFs and the NSSF on the availability of S-NSSAIs on a per TA basis.

NOTE: The NSSF can determine the serving network and Access Type from the TAI, as described in TS 29.571 [70].

#### 5.2.16.3.2 Nnssf\_NSSAIAvailability\_Update service operation

**Service operation name:** Nnssf\_NSSAIAvailability\_Update

**Description:** This service operation enables the AMF to update the NSSF with the S-NSSAIs the AMF supports per TA and get the availability of the S-NSSAIs per TA for the S-NSSAIs the AMF supports.

**Inputs, Required:** Supported S-NSSAIs per TAI.

The supported S-NSSAIs per TAI, is a list of TAIs and for each TAI the S-NSSAIs supported by the AMF.

**Inputs, Optional:** None.

**Outputs, Required:** A list of TAIs and, for each TAI, the S-NSSAIs supported by the AMF and 5G-AN and authorized by the NSSF for the TAI.

**Outputs, Optional:** For each TAI, a list of S-NSSAIs restricted per PLMN for the TAI.

#### 5.2.16.3.3 Nnssf\_NSSAIAvailability\_Notify service operation

**Service operation name:** Nnssf\_NSSAIAvailability\_Notify

**Description:** This service operation enables the NSSF to update the AMF with any S-NSSAIs restricted per TA and, if needed, subsequently lift any restriction per TA.

**Inputs, Required:** SubscriptionId, a list of TAIs and the S-NSSAIs for which the status is changed (restricted/unrestricted) per each TAI.

**Inputs, Optional:** None.

**Outputs, Required:** None.

**Outputs, Optional:** None.

#### 5.2.16.3.4 Nssf\_NSSAIAvailability\_Subscribe service operation

**Service operation name:** Nssf\_NSSAIAvailability\_Subscribe

**Description:** This service operation enables a NF Service Consumer (e.g. AMF) to subscribe to a notification of any changes in status of the NSSAI availability information (e.g. S-NSSAIs available per TA and the restricted S-NSSAI(s) per PLMN in that TA in the serving PLMN of the UE) upon this is updated by another AMF.

**Inputs, Required:** Callback URI of the NF Service Consumer, list of TAIs supported by the NF service consumer, event to be subscribed.

**Inputs, Optional:** Expiry time.

**Outputs, Required:** SubscriptionID,

**Outputs, Conditional Required:** Expiry time (if present in the request, may be included in the response based on operator's policy and taking into account the expiry time present in the request (i.e. should be less than or equal to that value); if not present in the request, may be included in the response based on operator's policy. Whatever the case, if not included in the response, this means that the subscription is valid without an expiry time).

**Outputs, Optional:** A list of TAIs and, for each TAI, the S-NSSAIs supported by the AMF and 5G-AN and authorized by the NSSF for the TAI and a list of S-NSSAIs restricted per PLMN for the TAI.

#### 5.2.16.3.5 Nssf\_NSSAIAvailability\_Unsubscribe service operation

**Service operation name:** Nssf\_NSSAIAvailability\_Unsubscribe

**Description:** This service operation enables a NF Service Consumer (e.g. AMF) to unsubscribe to a notification of any previously subscribed changes to the NSSAI availability information.

**Inputs, Required:** SubscriptionId.

**Inputs, Optional:** None.

**Outputs, Required:** None.

**Outputs, Optional:** None.

#### 5.2.16.3.6 Nssf\_NSSAIAvailability\_Delete service operation

**Service operation name:** Nssf\_NSSAIAvailability\_Delete

**Description:** This service operation enables a NF service consumer (e.g. AMF) to delete the NSSAI availability information stored for the NF service consumer in the NSSF.

**Inputs, Required:** NfId.

**Inputs, Optional:** None.

**Outputs, Required:** None.

**Outputs, Optional:** None.

## 5.2.17 CHF Spending Limit Control Service

### 5.2.17.1 General

The following table illustrates the CHF Services defined in this specification. The other services of CHF are defined in clause 6.2 of TS 32.290 [42].

**Table 5.2.17.1-1: CHF Services**

Service Name	Service Operations	Operation Semantics	Example Consumer(s)
Nchf_SpendingLimitControl	Subscribe	Subscribe/Notify	PCF
	Unsubscribe		PCF
	Notify		PCF

### 5.2.17.2 Nchf\_SpendingLimitControl service

#### 5.2.17.2.1 General

**Service description:** This service enables transfer of policy counter status information relating to subscriber spending limits from CHF to the NF consumer.

#### 5.2.17.2.2 Nchf\_SpendingLimitControl Subscribe service operation

**Service operation name:** Nchf\_SpendingLimitControl\_Subscribe

**Description:** Subscribe to notification of changes in the status of the policy counters available at the CHF and retrieval of the status of the policy counters for which subscription is accepted by CHF.

**Inputs, Required:** SUPI (for the Initial Spending Limit request), SubscriptionCorrelationId (for the Intermediate Spending Limit report), Event Id "policy counter status change", Event Filter Information "List of policy counter identifier (s)".

**Inputs, Optional:** Notification Correlation Target (required for the Initial Spending Limit request), Event Filter Information "List of policy counter identifier (s)", Event Reporting Information (continuous reporting).

**Outputs, Required:** Status of the requested subscribed policy counters to the subscriber in the Event Information.

**Outputs, Optional:** Pending policy counter statuses and their activation times, for all policy counter(s) available for this subscriber. If list of policy counter identifier(s) was provided, the CHF returns only the pending policy counter statuses and their activation times, per required policy counter identifier in the Event Information, SubscriptionCorrelationId.

#### 5.2.17.2.3 Nchf\_SpendingLimitControl Unsubscribe service operation

**Service operation name:** Nchf\_SpendingLimitControl\_Unsubscribe

**Description:** Cancel the subscription to status changes for all the policy counters available at the CHF.

**Inputs, Required:** SubscriptionCorrelationId.

**Inputs, Optional:** None.

**Outputs, Required:** Success or Failure.

**Outputs, Optional:** None.

#### 5.2.17.2.4 Nchf\_SpendingLimitControl Notify service operation

**Service operation name:** Nchf\_SpendingLimitControl\_Notify

**Description:** Notify the change of the status of the subscribed policy counters available at the CHF. Alternatively, it can be used by the CHF to provide one or more pending statuses for a subscribed policy counter together with the time they have to be applied. Alternatively, it is also used by the CHF to notify the removal of a subscriber from the CHF system, so that the NF consumer can terminate the subscriptions of all the policy counters of the subscriber.

**Inputs, Required:** Notification Target Address, SUPI.

**Inputs, Optional:** policy counter status as Event Information, Pending policy counter statuses and their activation times as Event Information. Subscriber removal from the CHF system as Event Information.

**Outputs, Required:** Success or Failure.

**Outputs, Optional:** None.

## 5.2.18 UCMF Services

### 5.2.18.1 General

The following table illustrates the UCMF Services.

**Table 5.2.18.1-1: NF services provided by UCMF**

Service Name	Service Operations	Operation Semantics	Example Consumer(s)
Nucmf_Provisioning	Create	Request/Response	AF, NEF
	Delete	Request/Response	AF, NEF
	Update	Request/Response	AF, NEF
Nucmf_UECapabilityManagement	Resolve	Request/Response	AMF
	Assign	Request/Response	AMF
	Subscribe	Subscribe/Notify	AMF
	Unsubscribe	Subscribe/Notify	AMF
	Notify	Subscribe/Notify	AMF

### 5.2.18.2 Nucmf\_Provisioning service

#### 5.2.18.2.1 Nucmf\_Provisioning\_Create service operation

**Service operation name:** Nucmf\_Provisioning\_Create

**Description:** The consumer creates a UCMF dictionary entry (or more entries) for a Manufacturer-assigned UE Radio Capability ID(s). For each UE Radio Capability ID the following inputs are provided:

- a) a UE radio access capability set with respective coding format or the UE radio access capability set in both TS 36.331 [16] and TS 38.331 [12] coding formats and each RATs' UE Radio Capability for Paging; and
- b) the related UE model(s) IMEI/TAC value(s) the UE radio capability ID applies to.

**Inputs, Required:** (list of) [UE Radio Capability ID(s), set(s) of UE radio access capability set and UE Radio Capability for Paging and respective Coding format(s), (list of) IMEI/TAC value(s)].

**Inputs, Optional:** None.

**Outputs, Required:** None.

**Outputs, Optional:** None.

The Coding format(s) indicates the format of the respective UE radio access capabilities as defined in TS 36.331 [16] or TS 38.331 [12]. The UCMF dictionary entry shall not contain UTRAN radio capabilities.

#### 5.2.18.2.2 Nucmf\_Provisioning\_Delete service operation

**Service operation name:** Nucmf\_Provisioning\_Delete

**Description:** The consumer deletes a UCMF dictionary entry(s) for a Manufacturer-assigned UE Radio Capability ID(s). The consumer provides a (list of) UE radio capability ID value(s) to be deleted or it may provide the IMEI/TAC values for which the associated UE radio capability ID entries shall be no longer used.

**Inputs, Required:** UE Radio Capability ID(s) of the UCMF dictionary entry(s) to be deleted or IMEI/TAC that no longer use associated UE radio Capability ID(s).

**Inputs, Optional:** None.

**Outputs, Required:** None.

**Outputs, Optional:** None.

### 5.2.18.2.3 Nucmf\_Provisioning\_Update service operation

**Service operation name:** Nucmf\_Provisioning\_Update

**Description:** The consumer updates the list of IMEI/TAC values a UCMF dictionary entry (or a list of entries) applies to for a Manufacturer-assigned UE Radio Capability ID. For each UE Radio Capability ID provided, (a list of) UE model(s) IMEI/TAC value(s) to be added or removed to the related UCMF entry is provided.

**Inputs, Required:** Update Type (one of "Add IMEI/TAC Values" or "Remove IMEI/TAC Values") and:

- If Update Type is "Add IMEI/TAC Values", the (list of) UE Radio Capability ID(s) of the UCMF dictionary entry(ies) to be updated and the related additional (list of) IMEI/TAC(s); or
- If Update Type is "Remove IMEI/TAC Values", the (list of) UE Radio Capability ID(s) of the UCMF dictionary entry(ies) to be updated and the related (list of) IMEI/TAC(s) to be removed.

**Inputs, Optional:** None.

**Outputs, Required:** None.

**Outputs, Optional:** None.

## 5.2.18.3 Nucmf\_UECapabilityManagement Service

### 5.2.18.3.1 Nucmf\_UECapabilityManagement Resolve service operation

**Service Operation name:** Nucmf\_UECapabilityManagement\_Resolve

**Description:** Consumer NF gets the UE Radio Access Capability and one or more UE Radio Capability for Paging corresponding to a specific UE Radio Capability ID (either Manufacturer-assigned or PLMN-assigned) and Coding Format.

**Inputs, Required:** UE Radio Capability ID, Coding format.

**Inputs, Optional:** None.

**Outputs, Required:** UE Radio Access Capability, one or more UE Radio Capability for Paging.

**Outputs, Optional:** None.

The Coding format indicates the format as defined in TS 36.331 [16] or TS 38.331 [12] of the UE Radio Access Capability expected by the NF in output. When the Coding Format is TS 36.331 [16], the UCMF shall provide the UE Radio Capability for Paging for E-UTRA. When the Coding Format is TS 38.331 [12], the UCMF shall provide the UE Radio Capability for Paging for NR and, if the PLMN supports E-UTRA connected to 5GC, shall provide the UE Radio Capability for Paging for E-UTRA.

### 5.2.18.3.2 Nucmf\_UECapabilityManagement\_Assign service operation

**Service or service operation name:** Nucmf\_UECapabilityManagement\_Assign

**Description:** The NF consumer sends to the UCMF:



- the UE Radio Access Capability (and its Coding Format); or
- the UE Radio Access Capability and each RATs' UE Radio Capability for Paging in both TS 36.331 [16] and TS 38.331 [12] coding formats;

and obtains a PLMN-assigned UE Radio Capability ID in return.

**Inputs, Required:** UE Radio Access Capability(s), Coding format(s), IMEI/TAC.

**Inputs, Optional:** One or more UE Radio Capability for Paging.

**Outputs, Required:** UE Radio Capability ID.

**Outputs, Optional:** None.

The AMF does not send NB-IoT Radio Access Capability to the UCMF.

The Coding format indicates the format of the UE Radio Access Capability as defined in TS 36.331 [16] or TS 38.331 [12].

#### 5.2.18.3.3 Nucmf\_UECapabilityManagement\_Subscribe service operation

**Service operation name:** Nucmf\_UECapabilityManagement\_Subscribe

**Description:** The NF consumer subscribes for updates to UCMF dictionary entries and provides the coding format in which UE Radio Access Capability is expected by NF. The UCMF shall check the requested consumer is authorized to subscribe to requested updates.

**Inputs, Required:** Coding format.

**Inputs, Optional:** None.

**Outputs, Required:** None.

**Outputs, Optional:** None.

The Coding format indicates the format of the UE Radio Access Capability as defined in TS 36.331 [16] or TS 38.331 [12].

#### 5.2.18.3.4 Nucmf\_UECapabilityManagement\_Unsubscribe service operation

**Service operation name:** Nucmf\_UECapabilityManagement\_Unsubscribe

**Description:** The NF consumer unsubscribes from updates to UCMF dictionary entries.

**Inputs, Required:** None.

**Inputs, Optional:** None.

**Outputs, Required:** None.

**Outputs, Optional:** None.

#### 5.2.18.3.5 Nucmf\_UECapabilityManagement\_Notify service operation

**Service Operation name:** Nucmf\_UECapabilityManagement\_Notify

**Description:** Producer NF provides notifications about changes in UCMF to subscribed consumer NF.

**Inputs, Required:** Notification Type ("creation", "deletion", "Added IMEI/TAC in Manufacturer Assigned operation requested list", "Removed IMEI/TAC from Manufacturer Assigned operation requested list", "Removed UE Radio Capability ID from Manufacturer Assigned operation requested list").

**Inputs, Optional:** If Notification Type is set to "creation": One or more UCMF dictionary entries, each UCMF dictionary entry consisting of a UE Radio Capability ID and the corresponding UE Radio Access Capability. If Notification Type is set to "deletion": One or more UE Radio Capability IDs. If Notification Type is set to "Added

IMEI/TAC in Manufacturer Assigned operation requested list" or "Removed IMEI/TAC from Manufacturer Assigned operation requested list", one or more IMEI/TACs, if Notification type is "Removed UE Radio Capability ID from Manufacturer Assigned operation requested list, one or more PLMN assigned UE radio Capability IDs.

**Outputs, Required:** None.

**Outputs, Optional:** None.

The Manufacturer Assigned operation requested list is defined in clause 5.11.3a of TS 23.401 [13] and clause 5.4.4.1a of the present document.

## 5.2.19 AF Services

### 5.2.19.1 General

The following table illustrates the AF Services.

**Table 5.2.19.1-1: Services provided by AF**

Service Name	Service Operations	Operation Semantics	Example Consumer(s)
Naf_EventExposure	Subscribe	Subscribe/Notify	NEF, NWDAF
	Unsubscribe		NEF, NWDAF
	Notify		NEF, NWDAF

NOTE: In this release of the specification, Naf\_EventExposure service is only used for analytics as described in TS 23.288 [50].

### 5.2.19.2 Naf\_EventExposure service

#### 5.2.19.2.1 General

**Service description:** This service enables consumer NF to subscribe and get notified of events.

The events can be subscribed by a NF consumer are described in TS 23.288 [50].

The following service operations are defined for the Naf\_EventExposure service:

- Naf\_EventExposure\_Subscribe.
- Naf\_EventExposure\_Unsubscribe.
- Naf\_EventExposure\_Notify.

The following events can be subscribed by a NF consumer (Event ID is defined in clause 4.15.1):

- Service Experience information, as defined in clause 6.4.2 of TS 23.288 [50].
- UE Mobility information, as defined in clause 6.7.2.2 of TS 23.288 [50].
- UE Communication information, as defined in clause 6.7.3.2 of TS 23.288 [50].
- Exceptions information, as defined in clause 6.7.5.2 of TS 23.288 [50].

Event Filters are used to specify the conditions to match for notifying the event (i.e. "List of Parameter values to match"). If there are no conditions to match for a specific Event ID, then the Event Filter is not provided. The following table provides some examples on how the conditions to match for event reporting can be specified for various Event IDs for AF exposure.

**Table 5.2.19.2.1-1: Example of Event Filters for AF exposure events**

Event ID for AF exposure	Event Filter (List of Parameter Values to Match)
Exceptions information	<Parameter Type = Exception ID, Value = Exception ID1>
Service Experience information	<Parameter Type = TAI, Value = TAI1>
Service Experience information	<Parameter Type = geographic zone identifier, Value = geographic zone identifier1>

### 5.2.19.2.2 Naf\_EventExposure\_Subscribe service operation

**Service operation name:** Naf\_EventExposure\_Subscribe

**Description:** The consumer NF subscribes the event to collect AF data for UE(s), group of UEs, or any UE, or updates the subscription which is already defined in AF.

**Input, Required:** Target of Event Reporting: external UE ID(s), External Group Identifier, or indication that any UE is targeted, (set of) Event ID(s), Notification Target Address (+ Notification Correlation ID) and Event Reporting Information as defined in Table 4.15.1-1, Expiry time.

**Input, Optional:** NF ID, Event Filter(s) associated with each Event ID, (set of) Application Identifier(s), Subscription Correlation ID (in the case of modification of the existing subscription).

NOTE: In the case of untrusted AF, NEF ID is used as NF ID.

**Output, Required:** Operation execution result indication. When the subscription is accepted: Subscription Correlation ID.

**Output, Optional:** First corresponding event report is included, if corresponding information is available (see clause 4.15.1).

### 5.2.19.2.3 Naf\_EventExposure\_Unsubscribe service operation

**Service operation name:** Naf\_EventExposure\_Unsubscribe

**Description:** The consumer NF unsubscribes for a specific event.

**Input, Required:** Subscription Correlation ID.

**Input, Optional:** None.

**Output, Required:** Operation execution result indication.

**Output, Optional:** None.

### 5.2.19.2.4 Naf\_EventExposure\_Notify service operation

**Service operation name:** Naf\_EventExposure\_Notify

**Description:** The AF provides the previously subscribed event information to the consumer NF which has subscribed to that event before.

**Input, Required:** Notification Correlation Information, Event ID, corresponding UE(s) (external UE ID(s), External Group Identifier, or indication of any UE), time stamp.

**Input, Optional:** Event specific parameter list.

**Output, Required:** None.

**Output, Optional:** None.

## 5.2.20 NSSAAF services

### 5.2.20.1 General

The following table illustrates the NSSAAF Services.

**Table 5.2.20-1: List of NSSAAF Services**

Service Name	Service Operations	Operation Semantics	Example Consumer(s)
Nnssaaf_NSSAA	Authenticate	Request/Response	AMF
	Re-AuthenticationNotification	Notify	AMF
	RevocationNotification	Notify	AMF

### 5.2.20.2 Nnssaaf\_NSSAA service

#### 5.2.20.2.1 General

**Service Description:** The NSSAAF provides Network Slice- Specific Authentication and Authorization (NSSAA) service to the requester NF by relaying EAP messages towards a AAA-S or AAA-P and performing related protocol conversion as needed. It also provides notification to the current AMF where the UE is of the need to re-authenticate and re-authorize the UE or to revoke the UE authorization. The AMF to receive the notification is implicitly subscribed and it is found in the UDM by providing the UE GPSI.

#### 5.2.20.2.2 Nnssaaf\_NSSAA\_Authenticate service operation

See TS 33.501 [15].

#### 5.2.20.2.3 Nnssaaf\_NSSAA\_Re-AuthenticationNotification service operation

See TS 33.501 [15].

#### 5.2.20.2.4 Nnssaaf\_NSSAA\_RevocationNotification service operation

See TS 33.501 [15].

---

# Annex A (informative): Drafting rules and conventions for NF services

## A.1 General

This informative Annex provides drafting rules and conventions followed in this technical specification (and TS 23.501 [2]) for the definition of NF services offered over the service-based interfaces.

---

## A.2 Naming

### A.2.1 Service naming

Each NF service provided by a service-based interface shall be named and referred to according to the following nomenclature:

- *Nnfname\_ServiceName*, where *Nnfname* is the service-based interface where the NF service is invoked. See clause 4.2.5 of TS 23.501 [2] for the list of service-based interfaces in the 5GS Architecture.

Example (illustrative): *Namf\_Registration*.

### A.2.2 Service operation naming

If a service contains multiple independent operations, each operation shall be named and referred to according to the following nomenclature:

- *Nnfname\_ServiceName\_ServiceOperation[Method]*, where the *ServiceName* represents the actual NF service. The *ServiceOperation* itself defines the available service functionality which can be addressed by a specific operation. The *Method(s)* is/are the action(s), how the *ServiceOperation* can be used. It can be created, read, updated or deleted.

Example (illustrative): *Namf\_Session\_Registration[Create]*, *Namf\_Session\_Registration[Delete]*

In general, this operation naming structure for the given example is depicted in a tree-structure diagram:

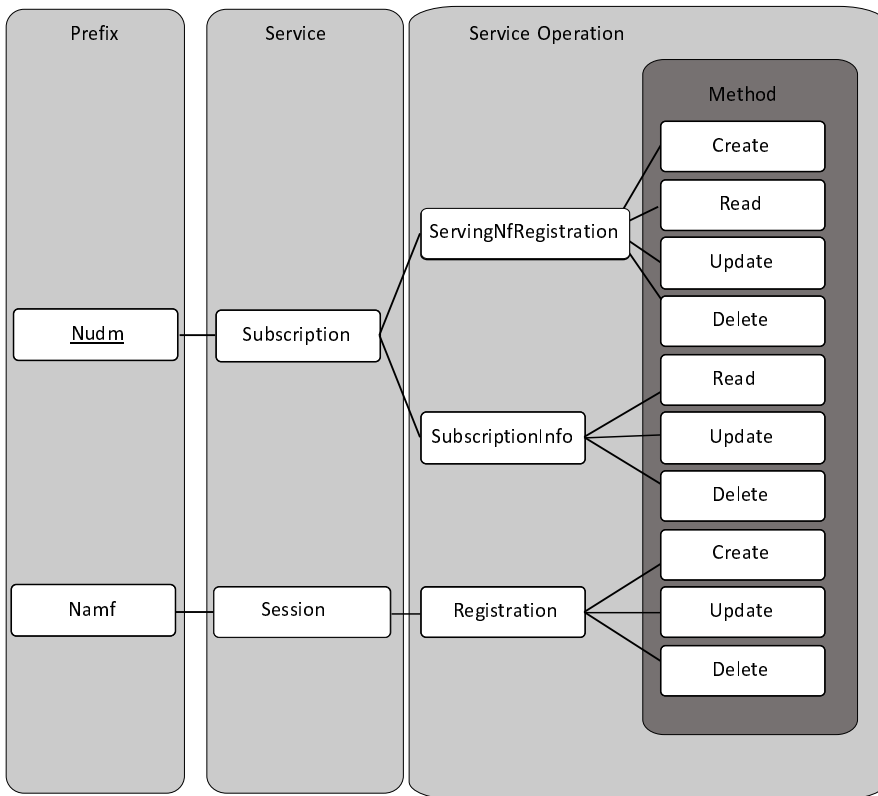


Figure A.2.2-1: Service Operation Naming and its Methods

### A.3 Representation in an information flow

Invoking a service or service operation within an information flow is represented using a disaggregated representation (see figure A.3-1).

The disaggregated representations on figure A.3-1 shall be used as follows:

- The <step> represents the actual step number in the information flow e.g. "7."
- Representation a) shall be used when the step is required.
- Representation b) shall be used when the step is optional or conditional.

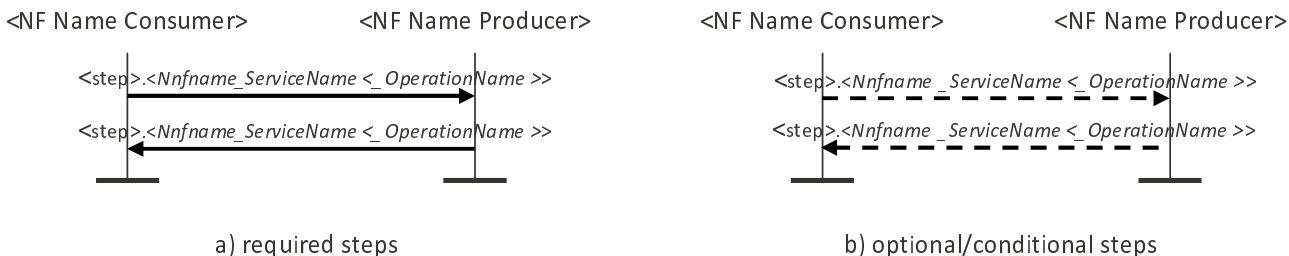


Figure A.3-1: Disaggregated representation of a NF service or service operation in information flows

NOTE: Depending on the information flow, the order of NF Producer and NF Consumer can be reversed.

---

## A.4 Reference to services and service operations in procedures

Whenever a procedure needs to refer to the service or service operation of a service-based interface, the naming in clause A.2 shall be used, using italic font. Unless otherwise obvious in the text, the NF Consumer of the service or service operation shall be indicated within parenthesis after the service or service operation name.

- <Nfname\_ServiceName<\_OperationName>> (<NF Name Consumer>)

Example: e.g. *Namf\_Registration\_RelocationRequest (AMF)*

---

## A.5 Service and service operation description template

The description of a service or service operation in this specification shall be done according to the following template.

NOTE: The heading level should follow that of the actual clause where the service is specified.

**X.x** <Nfname\_ServiceName<\_OperationName>>

**X.x.1** **Description**

**Service or service operation name:** <Nfname\_ServiceName<\_OperationName>>.

**Description:** <short descriptive text>.

**Known NF Consumers:** <list of NFs>.

**Inputs, Required:** <list of parameters> -- *Parameters required from NF Consumer for successful completion of the service or service operation. Parameters required for the operation of the underlying protocol shall not be listed.*

**Inputs, Optional:** <list of parameters> -- *Additional parameters that may be provided by NF Consumer for execution of the service or service operation. Parameters required for the operation of the underlying protocol shall not be listed.*

**Outputs, Required:** <list of parameters>, <Nfname\_ServiceNameX<\_OperationNameY >>, <Other> -- *Parameters provided to NF Consumer and/or service triggered upon successful completion of the service and/or other (e.g. procedure triggered). Parameters required for the operation of the underlying protocol shall not be listed.*

**Outputs, Optional:** <list of parameters> -- *Additional parameters provided to NF Consumer upon successful completion of the service or service operation. Parameters required for the operation of the underlying protocol shall not be listed.*

**X.x.2** **Service/service operation information flow**

<Information flow of the service or service operation offered by NF Producer to NF Consumer over the NF Producer service-based interface>.

NOTE: This information flow can require invoking other services. In this case, the invoked services are represented as described in clause A.3.

---

## A.6 Design Guidelines for NF services

Clause 7.1.1 of TS 23.501 [2] defines the criteria for defining the NF services. The following clauses identify the design guidelines that shall be considered for identifying the NF services.

### A.6.1 Self-Containment

The following design guidelines are used for identifying self-contained NF services.

- Each NF service operates on its own set of context(s). A context refers to a state or a software resource or an internal data storage. The NF service operations can create, read, update or delete the context(s).
- Any direct access of a context(s) owned by a NF service is be made by the service operations of that NF service. Services provided by the same NF can communicate internally within the NF.

## A.6.2 Reusability

The following design guidelines are used for specifying NF services to be reusable.

- NF service operations are specified such that other NF can potentially invoke them in future, if required.
- The service operations may be usable in multiple system procedures specified in clause 4 of this specification.
- Using clause 4 of the current document, the system procedures in which the NF service operations can be used are considered and based on that the parameters for the NF service operations are clearly listed.

NOTE: It is possible that, when mapping an end to end call flow to service based architecture, one step in the call flow may map to multiple NF service operation invocations. This specification clearly identifies each NF service operation invocation in the call flow. Protocol optimization of multiple NF service operation invocations are left for TS 29.500 [17] consideration.

## A.6.3 Use Independent Management Schemes

The mechanisms for independent management schemes are not in scope of this specification.



---

## Annex B (informative): Drafting Rules for Information flows

The following drafting rules are recommended for information flows specified in this specification in order to ensure that the Control Plane network functions can be supported with service based interfaces:

1. Information flows should describe the end to end functionality. NF services in clause 5 shall only be derived from the information flows in clause 4.
2. Information flows should strive to use type of interactions such as REQUEST/RESPONSE (e.g. location request, location response), SUBSCRIBE/NOTIFY between Core CP NFs. Any other type of interactions described should have justifications for its use.
3. Information flows should also ensure readability thus the semantics of the REQUEST/RESPONSE should still be maintained (for instance, we need to indicate PDU Session request, PDU Session response and Subscribe for UE location reporting/Notify UE location reporting) for readers and developers to understand the need for a certain transaction.

NOTE: As stated in TS 23.501 [2], service based interface is not supported for N1, N2, N4. Thus, the rules are not meant for those interfaces.

---

## Annex C (informative): Generating EPS PDN Connection parameters from 5G PDU Session parameters

This annex specifies how to generate the EPS PDN connection parameters from the 5G PDU Session parameters in SMF+PGW-C.

When the SMF+PGW-C is requested to set up/modify either a PDN connection or a PDU session supporting interworking between EPS and 5GS, the SMF+PGW-C generates the PDN Connection parameters from the PDU session parameters.

When the SMF+PGW-C generates the PDN Connection parameters based on the PDU Session parameters, the following rules hold:

- PDN type: the PDN type is set to IPv4, IPv6 or IPv4v6 if the PDU Session Type is IPv4, IPv6 or IPv4v6, respectively. The PDN Type is set to Ethernet if the MME, SGW and UE support Ethernet PDN Type, otherwise the PDN type is set to Non-IP for Ethernet and Unstructured PDU Session Types
- EPS bearer ID: the EBI is requested from the AMF during the establishment of a QoS Flow as described in clause 4.11.1.4.1 for PDU Sessions supporting interworking between EPS and 5GS. The EBI is obtained from MME during the establishment of an EPS Bearer (that is triggered by an establishment of a QoS Flow) as defined in TS 23.401 [13] for PDN Connections hosted by SMF+PGW-C. The association between EBI and QoS Flow is stored by the SMF.
- APN-AMBR: APN-AMBR is set according to operator policy (e.g. taking the Session AMBR into account).
- EPS QoS parameters (including ARP, QCI, GBR and MBR):

If QoS Flow is mapped to one EPS bearer, ARP, GBR and MBR of the EPS Bearer is set to the ARP, GFBR and MFBR of the corresponding QoS Flow, respectively. For standardized 5QIs, the QCI is one to one mapped to the 5QI. For non-standardized 5QIs, the SMF+PGW-C derives the QCI based on the 5QI and operator policy.

A GBR QoS Flow is mapped 1 to 1 to a GBR dedicated EPS Bearer if an EBI has been assigned. After mobility to EPS traffic flows corresponding to GBR QoS Flow for which no EBI has been assigned will continue flowing on the default EPS bearer if it does not have assigned TFT.

If multiple QoS Flows are mapped to one EPS bearer, the EPS bearer parameters are set based on operator policy, e.g. EPS bearer QoS parameters are set according to the highest QoS of all mapped QoS Flows.

After mobility to EPS traffic flows corresponding to Non-GBR QoS Flows for which no EBI has been assigned will continue flowing on the default EPS Bearer if it does not have assigned TFT.

---

## Annex D (normative): UE Presence in Area of Interest

### D.1 Determination of UE presence in Area of Interest by AMF

If RRC Inactive state applies to NG-RAN and the AMF has requested NG-RAN location reporting for the Area Of Interest and UE is in CM-CONNECTED state, the AMF determines the UE presence of Area of Interest as the reported value from the NG-RAN.

If RRC Inactive state applies to NG-RAN and the AMF has requested N2 Notification, the AMF determines the UE presence in Area Of Interest as follows:

- IN:
  - if the UE is inside the Area Of Interest service area and if the UE is in CM-CONNECTED with RRC Connected state; or

NOTE 1: The above is valid e.g. under the condition that Area Of Interest border coincides with NG-RAN node service area border or RAN Notification Area.

- if the UE is inside a Registration Area which is contained within the Area Of Interest.
- OUT:
  - if the UE is outside the Area Of Interest in CM-CONNECTED with RRC Connected state; or

NOTE 2: The above is valid e.g. under the condition that Area Of Interest border coincides with NG-RAN node service area border or RAN Notification Area.

- if UE is inside a Registration Area which does not contain any part of Area Of Interest.
- UNKNOWN:
  - if none of above conditions for IN or OUT is met.

Otherwise, AMF determines the UE presence of Area Of Interest as follows:

- IN:
  - if the UE is inside the Area Of Interest service area and if the UE is in CM-CONNECTED state; or
  - if the UE is inside a Registration Area which is contained within the Area Of Interest.
- OUT:
  - if the UE is outside the Area Of Interest in CM-CONNECTED; or
  - if UE is inside a Registration Area which does not contain any part of Area Of Interest.
- UNKNOWN:
  - if none of above conditions for IN or OUT is met.

---

### D.2 Determination of UE presence in Area of Interest by NG-RAN

If the AMF has requested for the Area of Interest, NG-RAN determines the UE presence of Area Of Interest as follows:

- IN:
  - if the UE is inside the Area Of Interest and the UE is in RRC Connected state; or
  - if the UE is inside an RNA which is contained within the Area Of Interest.
- OUT:
  - if the UE is outside the Area Of Interest in RRC Connected state; or
  - if UE is inside an RNA which does not contain any part of Area Of Interest.
- UNKNOWN:
  - if none of above conditions for IN or OUT is met.

# Annex E (normative): Delegated SMF and PCF discovery in the Home Routed and specific SMF Service Areas scenarios

## E.0 Overview

This Annex describes the option where the SCP is involved in the SMF and PCF selection for following cases:

- PDU Session to be established in Home Routed mode,
- PDU Session requiring an I-SMF as defined in clause
- PCF discovery in the Roaming scenario

NOTE: No similar Annex is foreseen to describe the discovery and selection of other NF involving the SCP.

## E.1 Delegated SMF discovery in the Home Routed scenario

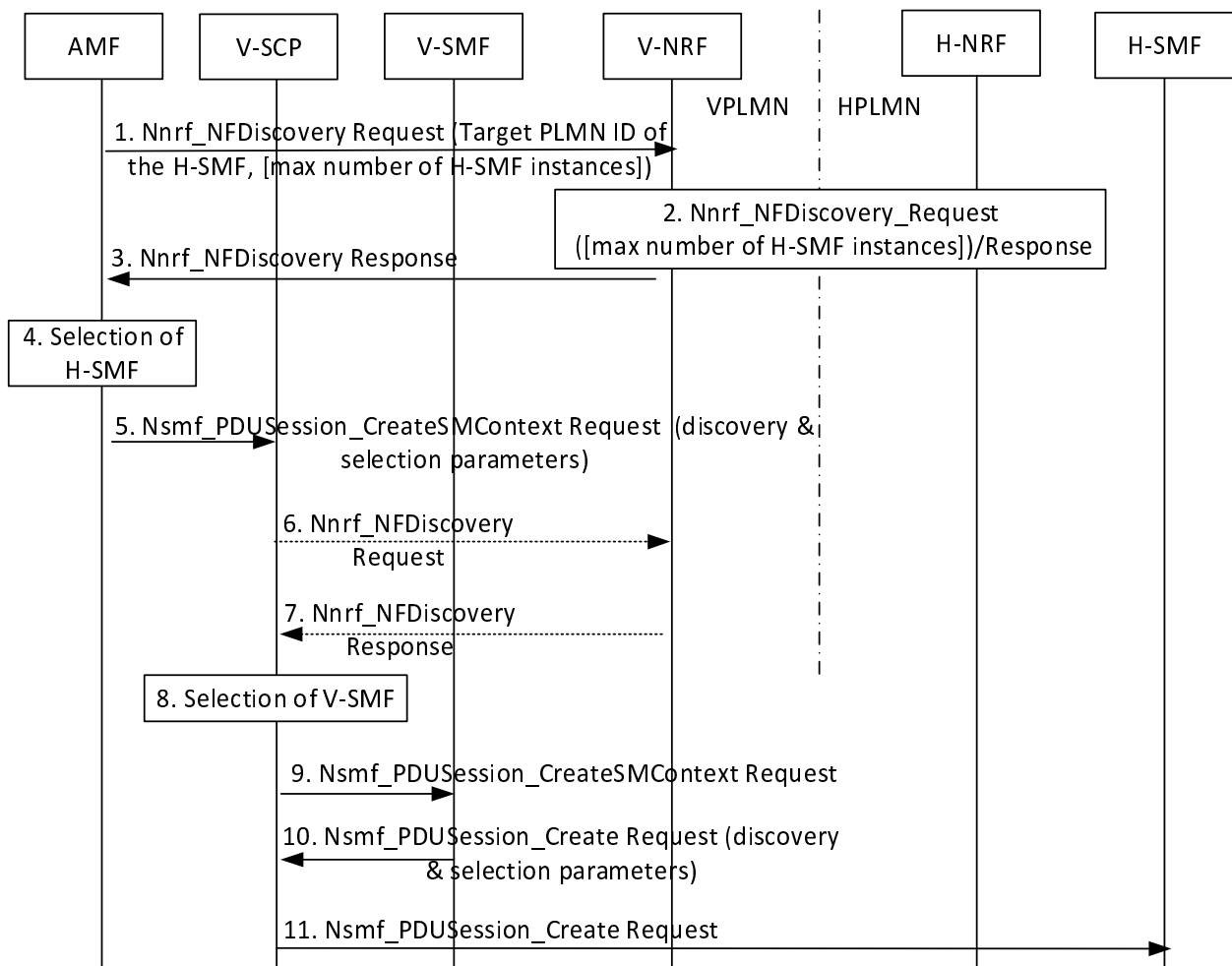


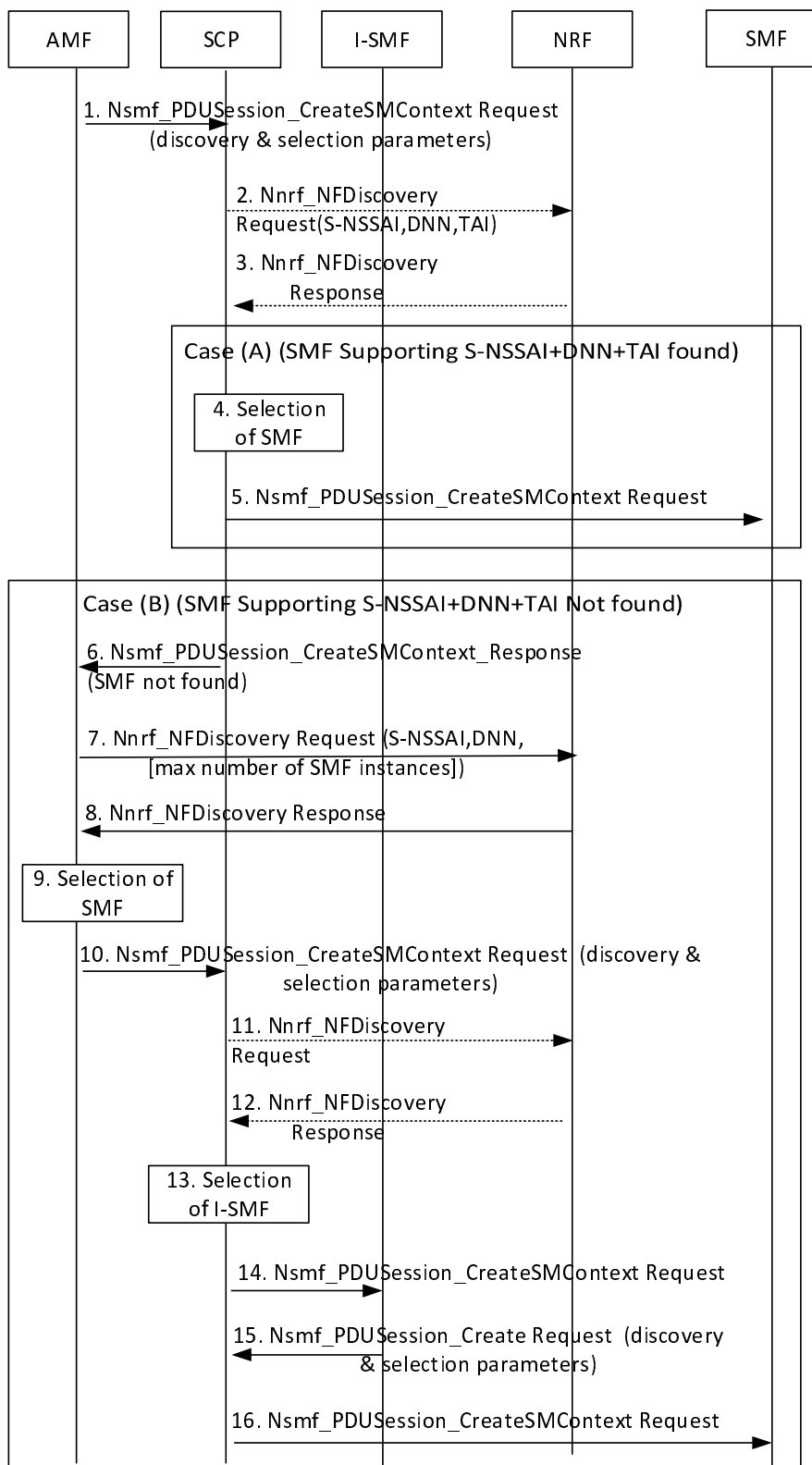
Figure E.1: Delegated Discovery of SMF in the Home Routed Scenario

1. The AMF sends Nnrf\_NFDiscovery Request to the V-NRF. The AMF may indicate the maximum number of H-SMF instances to be returned by the NRF.

2. The NRF in VPLMN and NRF in HPLMN interact using the Nnrf\_NFDiscovery service. See step 2 in clause 4.17.5.
  3. The AMF gets Nnrf\_NFDiscovery service response with one or more profile(s) of SMF(s) in HPLMN.
  4. The AMF selects an SMF instance in HPLMN (H-SMF endpoint).
  5. The AMF builds a Nsmf\_PDUSession\_CreateSMContext Request that includes the endpoint (e.g. URI) of the selected H-SMF in the body of the request. If the AMF supports delegated SMF discovery and is configured to apply it, the AMF sends the Nsmf\_PDUSession\_CreateSMContext Request with Discovery & Selection parameters to the selected SCP in the VPLMN. Discovery & Selection parameters include S-NSSAI, UE location (TAI), i.e. parameter for V-SMF selection.
  6. [Optional] The SCP in VPLMN sends Nnrf\_NFDiscovery Request to the V-NRF using Discovery & Selection parameters received from AMF.
  7. [Optional] The SCP in VPLMN gets Nnrf\_NFDiscovery service response with profile(s) of SMF(s) in VPLMN.
  8. The SCP in VPLMN selects an SMF instance in VPLMN (V-SMF), which supports the Discovery & Selection parameters received earlier from the AMF.
  9. The SCP in VPLMN forwards the Nsmf\_PDUSession\_CreateSMContext Request received from the AMF to the selected SMF instance in VPLMN.
  10. If the V-SMF does not support delegated SMF discovery or is not configured to apply it (Case A), the V-SMF sends Nsmf\_PDUSession\_Create Request directly to the H-SMF. Otherwise (Case B), the V-SMF sends the Nsmf\_PDUSession\_Create Request to the SCP in VPLMN but adds Discovery & Selection parameter set to H-SMF endpoint received from the AMF. In both cases, the V-SMF uses the received endpoint (e.g. URI) of the selected H-SMF to construct the target destination to be addressed.
- NOTE: The Nsmf\_PDUSession\_Create Request sent by the V-SMF in Case A and in Case B is the same apart from the Discovery & Selection parameter. The Nsmf\_PDUSession\_Create Request received by the H-SMF in Case A and in Case B is the same.
11. The SCP in VPLMN sends a Nsmf\_PDUSession\_Create Request to the selected SMF instance in HPLMN indicated in step 10.

When the V-SMF responds to AMF with Nsmf\_PDUSession\_CreateSMContext Response as in clause 4.3.2.2.2 in step 3b, if the AMF has not stored the SMF Service Area for the V-SMF, the AMF shall obtain the SMF Service Area for the concerned V-SMF from the NRF using the Nnrf\_NFManagement\_NFStatusSubscribe service operation.

## E.2 Delegated I-SMF discovery



**Figure E.2: Delegated Discovery of I-SMF**

The following impacts are applicable to clause 4.23.5 (PDU Session Establishment procedure) to support delegated SMF discovery:

1. If the AMF supports delegated SMF discovery and is configured to apply it, the AMF sends an Nsmf\_PDUSession\_CreateSMContext Request together with discovery and selection parameters to a SCP. The discovery and selection parameters include S-NSSAI, DNN, TAI that corresponds to the UE location required SMF capability (e.g. support of ATSSS).
2. [Optional] The SCP sends an Nnrf\_NFDDiscovery Request to the NRF. The request includes discovery and selection parameters received from AMF in step 1.
3. [Optional] The SCP gets Nnrf\_NFDDiscovery service response. The response may include one or more profile(s) of SMF(s).

Depending on the available information, the SCP may either execute steps in Case A or in Case B.

Case A There are, either in the NRF response or discovered by the SCP, one or more SMF instances that support Discovery and selection criteria set by the AMF.

4. The SCP selects an SMF instance.
5. The SCP forwards the Nsmf\_PDUSession\_CreateSMContext Request to the selected SMF instance.

Case B There is, either in the NRF response or discovered by the SCP, no SMF instance that supports Discovery and selection criteria set by the AMF.

6. The SCP returns an Nsmf\_PDUSession\_CreateSMContext Response to the AMF with an error 'NF not found'
7. The AMF sends Nnrf\_NFDDiscovery Request to the NRF. The AMF may indicate the maximum number of SMF instances to be returned by the NRF.
8. The AMF gets Nnrf\_NFDDiscovery service response with one or more profile(s) of SMF(s).
9. The AMF selects an SMF instance endpoint.
10. The AMF builds a Nsmf\_PDUSession\_CreateSMContext Request that contains the endpoint (e.g. URI) of the selected SMF in the body of the request. If the AMF supports delegated SMF discovery and is configured to apply it, the AMF sends the Nsmf\_PDUSession\_CreateSMContext Request to a SCP together with Discovery and selection parameters that include S-NSSAI, TAI that corresponds to the UE location, i.e. parameter for I-SMF selection.
11. [Optional] The SCP sends an Nnrf\_NFDDiscovery Request to the NRF. The request includes Discovery and selection parameters received from AMF (including the TAI that corresponds to the UE location).
12. [Optional] The SCP gets Nnrf\_NFDDiscovery service response. The response may include one or more profile(s) of I-SMF(s).
13. The SCP selects an I-SMF instance that supports the TAI.
14. The SCP forwards the Nsmf\_PDUSession\_CreateSMContext Request received from the AMF to the selected I-SMF instance.
15. If the I-SMF does not support delegated SMF discovery or is not configured to apply it (Case A), the I-SMF sends Nsmf\_PDUSession\_Create Request directly to the SMF. Otherwise (Case B), the I-SMF sends the Nsmf\_PDUSession\_Create Request to the SCP but adds Discovery & Selection parameter set to the SMF endpoint received from AMF. In both cases the I-SMF uses the received endpoint (e.g. URI) of the selected SMF to construct the target destination to be addressed.

NOTE: The Nsmf\_PDUSession\_Create Request sent by the I-SMF in Case A and in Case B is the same apart from the Discovery & Selection parameter. The Nsmf\_PDUSession\_Create Request received by the SMF in Case A and in Case B is the same.

16. The SCP forwards the Nsmf\_PDUSession\_Create Request to the selected SMF instance indicated in step 15.

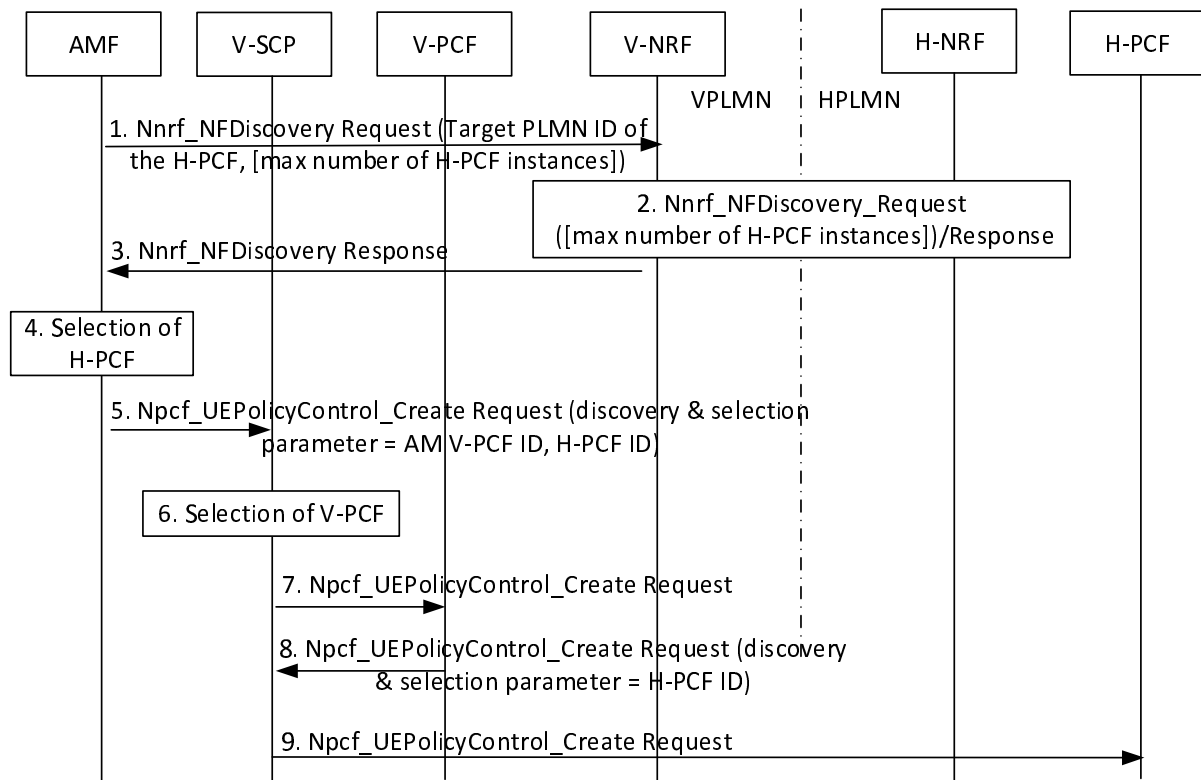
The procedure continues as described in clause 4.3.2.2.2 from Step 7.

Difference comparing to procedure defined in clause 4.3.2.2.2, the V-SMF and V-UPF are replaced by I-SMF and I-UPF and H-SMF and H-UPF are replaced by SMF and UPF(PSA) respectively. Also only the S-NSSAI with the value defined by the serving PLMN is sent to the SMF.



When the I-SMF responds to AMF with Nsmf\_PDUSession\_CreateSMContext Response as in clause 4.3.2.2.2 in Step 3b, if the AMF has not stored the SMF Service Area for the I-SMF, the AMF shall obtain the SMF Service Area for the concerned I-SMF from the NRF using the Nnrf\_NFManagement\_NFStatusSubscribe service operation.

### E.3 Delegated PCF discovery in the Roaming scenario



**Figure E.3: Delegated Discovery of PCF in the Home Routed Scenario**

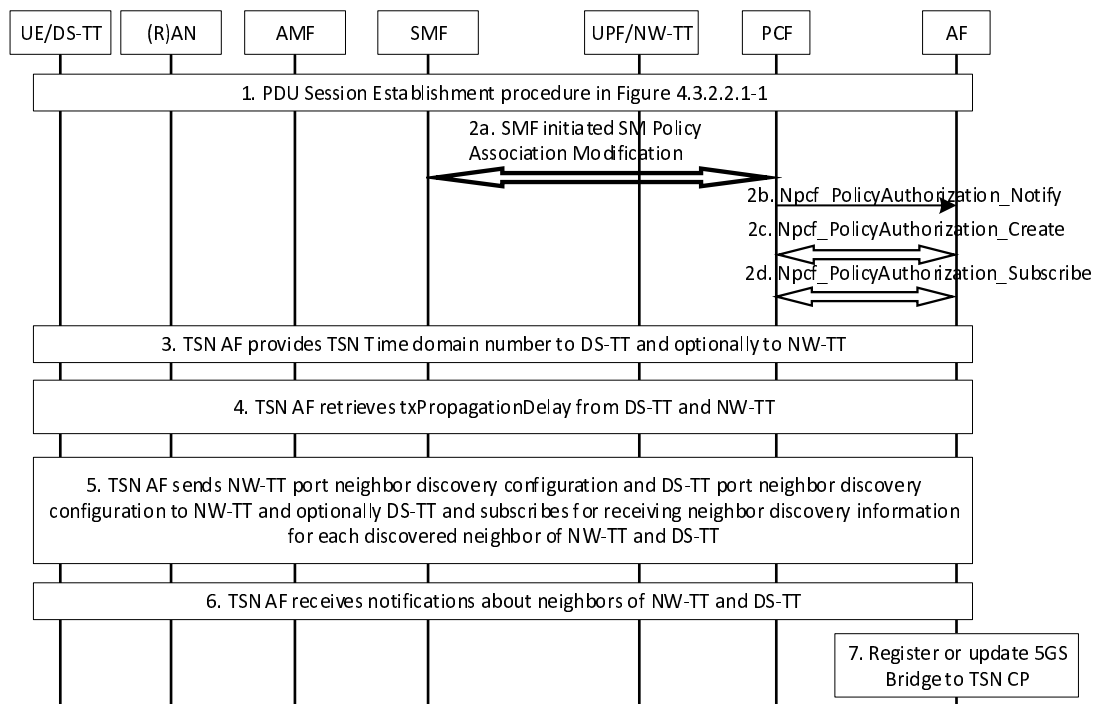
1. The AMF sends Nnrf\_NFDiscovery Request to the V-NRF in order to discover a PCF in HPLMN. The AMF may indicate the maximum number of H-PCF instances to be returned by the NRF.
2. The NRF in VPLMN and NRF in HPLMN interact using the Nnrf\_NFDiscovery service. See step 2 in clause 4.17.5.
3. The AMF gets Nnrf\_NFDiscovery service response with one or more profile(s) of PCF(s) in HPLMN.
4. The AMF selects a PCF instance in HPLMN.
5. The AMF builds a Npcf\_UEPolicyControl Request that contains the H-PCF ID in the body of the request. If the AMF supports delegated PCF discovery and is configured to apply it, the AMF forwards the Npcf\_UEPolicyControl Request to the selected SCP in VPLMN together with Discovery & Selection parameter set to V-PCF instance ID.
6. The SCP in VPLMN selects the corresponding (V-)PCF instance for UE policy association based on Discovery & Selection parameter received from the AMF.
7. The SCP in VPLMN forwards the Npcf\_UEPolicyControl Request to the selected PCF instance in VPLMN.
8. If the V-PCF does not support delegated PCF discovery or is not configured to apply it (Case A), the V-PCF sends Npcf\_UEPolicyControl Request to the selected PCF instance. Otherwise (Case B), the V-PCF sends the Npcf\_UEPolicyControl Request to a SCP in VPLMN but adds Discovery & Selection parameter set to H-PCF ID.

9. The SCP in VPLMN sends an Npcf\_UEPolicyControl Request to the selected PCF instance in HPLMN indicated in step 8.

## Annex F (informative): Information flows for 5GS integration with TSN

This annex defines the procedures for 5GS integration with TSN fully-centralized model as defined in IEEE Std 802.1Qcc-2018 [65], it includes 5GS Bridge information reporting and 5GS Bridge configuration.

### F.1 5GS Bridge information reporting



**Figure F.1-1: 5GS Bridge information reporting**

Identities of 5GS Bridge and UPF/NW-TT ports are pre-configured on the UPF based on deployment. The SMF requests the UPF/NW-TT to measure and report the clock drift between the TSN GM time and 5GS GM time for one or more TSN time domains.

1. PDU Session Establishment as defined clause 4.3.2.2.1-1 is used to establish a PDU Session serving for TSC.

During this procedure, the SMF selects a UPF, which supports functions as defined in clause 5.28.1 of TS 23.501 [2], for the PDU Session.

During this procedure, the SMF receives the UE-DS-TT residence time, DS-TT MAC address for this PDU Session and port management capabilities from the DS-TT/UE in PDU Session Establishment request and receives the allocated port number for DS-TT Ethernet port and Bridge ID in N4 Session Establishment Response message. The UPF allocates the port number for DS-TT, Bridge ID after receiving N4 Session Establishment Request message.

2. The SMF sends the information received in step 1 to the TSN AF via PCF to establish/modify the 5GS Bridge. The Npcf\_PolicyAuthorization\_Notify message in step 2b is delivered via the pre-configured AF session as described in clause 4.16.5.1. The TSN AF stores the binding relationship between 5GS Bridge ID, MAC address of the DS-TT Ethernet port and also updates 5GS bridge delay as defined in clause 5.27.5 of TS 23.501 [2] for future configuration. The TSN AF requests creation of a new AF session associated with the MAC address of the DS-TT Ethernet port using the Npcf\_PolicyAuthorization\_Create operation (step 2c) and subscribes for TSN events over the newly created AF session using the Npcf\_PolicyAuthorization\_Subscribe operation (step 2d).

Using the 5GS Bridge ID received in step 2b the TSN AF subscribes with the NW-TT for receiving bridge management information changes for the 5GS bridge indicated by the 5GS Bridge ID as described in clause 5.28.3.1 of TS 23.501 [2].

After receiving a Bridge Management Information Container (BMIC) containing the NW-TT port numbers, the TSN AF subscribes with the NW-TT for receiving NW-TT port management information changes for the NW-TT port indicated by each of the NW-TT port numbers as described in clause 5.28.3.1 of TS 23.501 [2].

The TSN AF can use any PDU Session to subscribe with the NW-TT for bridge or port management information notifications. Similarly, the UPF can use any PDU Session to send bridge or port management information notifications.

3. If DS-TT has indicated support for the TSN Time domain number in the port management capabilities, TSN AF provides the TSN Time domain number to DS-TT. Optionally, TSN AF provides the TSN Time domain number to NW-TT.
4. If supported according to the port management capabilities received from DS-TT, TSN AF retrieves txPropagationDelay and Traffic Class table from DS-TT. TSN AF also retrieves txPropagationDelay and Traffic Class table from NW-TT.

**NOTE:** It is assumed that distribution of TSN GM time towards NW-TT and DS-TT for the TSN time domain is activated before TSN AF retrieves txPropagationDelay so that DS-TT and NW-TT can convert txPropagationDelay from 5GS time to TSN time before reporting txPropagationDelay to TSN AF.

5. If DS-TT supports neighbor discovery according to the port management capabilities received from DS-TT, then TSN AF:
  - provides DS-TT port neighbor discovery configuration to DS-TT to configure and activate the LLDP agent in DS-TT;
  - subscribes to receive Neighbor discovery information for each discovered neighbor of DS-TT (see Table 5.28.3.1-1 of TS 23.501 [2]).

If DS-TT does not support neighbor discovery, then TSN AF:

- provides DS-TT port neighbor discovery configuration to NW-TT to configure and activate the LLDP agent in NW-TT to perform neighbor discovery on behalf of DS-TT;
- subscribes to receive Neighbor discovery information for each discovered neighbor of DS-TT from NW-TT (see Table 5.28.3.1-1 of TS 23.501 [2]).

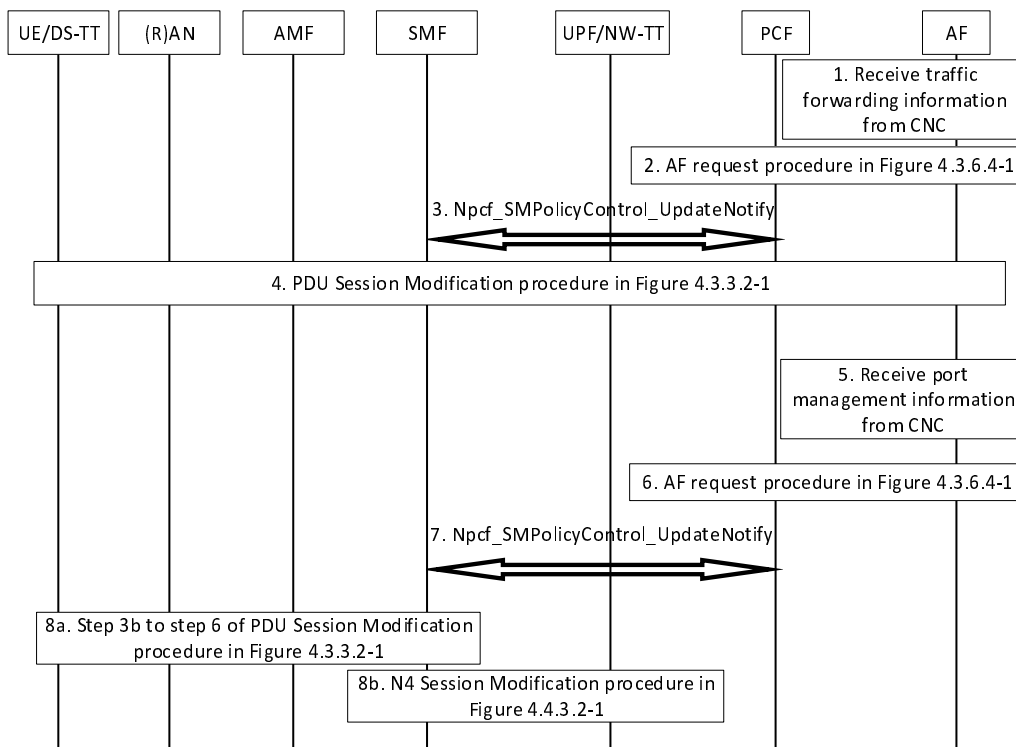
TSN AF:

- writes NW-TT port neighbor discovery configuration to NW-TT to configure and activate the LLDP agent in NW-TT;
  - subscribes to receive Neighbor discovery information for each discovered neighbor of NW-TT (see Table 5.28.3.1-1 of TS 23.501 [2]).
6. TSN AF receives notifications from DS-TT (If DS-TT supports neighbour discovery) and NW-TT on discovered neighbors of DS-TT and NW-TT.
  7. The TSN AF constructs the above received information as 5GS Bridge information and sends them to the CNC to register a new TSN Bridge or update an existing TSN Bridge.

---

## F.2 5GS Bridge configuration

For 5GS integrating with fully-centralized model TSN network, the CNC provides TSN information to the AF.



**Figure F.2-1: 5GS Bridge information configuration**

1. CNC provides per-stream filtering and policing parameters according to clause 8.6.5.1 of IEEE Std 802.1Q [66] to AF and the AF uses them to derive TSN QoS information and related flow information. The CNC provides the forwarding rule to AF according to clause 8.8.1 of IEEE Std 802.1Q [66]. The TSN AF uses this information to identify the DS-TT MAC address of corresponding PDU session.

2. The AF determines the MAC address of a PDU Session based on the previous stored associations, then triggers an AF request procedure. The AF request includes the DS-TT MAC address of the PDU session.

Based on the information received from the CNC, 5GS bridge delay information and the UE-DS-TT residence time, the TSN AF determines the TSN QoS information and TSC Assistance Container for one or more TSN streams and sends them to the PCF. The TSN AF also provides Service Data Flow Filter containing Flow description also includes Ethernet Packet Filters.

3. When PCF receives the AF request, the PCF finds the correct SMF based on the DS-TT MAC address of the PDU session and notifies the SMF via Npcf\_SMPolicyControl\_UpdateNotify message.

After mapping the received TSN QoS parameters for TSN streams to 5GS QoS, the PCF triggers Npcf\_SMPolicyControl\_UpdateNotify message to update the PCC rule to the SMF. The PCC rule includes the Ethernet Packet Filters, the 5GS QoS profile along with TSC Assistance Container.

4. SMF may trigger the PDU Session Modification procedure to establish/modify a QoS Flow to transfer the TSN streams. During this procedure, the SMF provides the information received in PCC rules to the UPF via N4 Session Modification procedure.

Upon reception of the TSC Assistance Container, the SMF determine the TSCAI for QoS flow and sends the TSCAI along with the QoS profile to the NG RAN.

5. If needed, the CNC provides additional information (e.g. the gate control list as defined in clause 8.6.8.4 of IEEE Std 802.1Q-2018 [66]) to the TSN AF.

6. The AF determines the MAC address of a PDU Session for the configured port based on the previous stored associations, this is used to deliver the Port Management information to the correct SMF that manages the port via PCF. The AF triggers an AF request procedure. The AF request includes the DS-TT MAC address (i.e. the MAC address of the PDU Session), TSN QoS Parameters, Port Management information Container and the related port number as defined in clause 5.28.3 of TS 23.501 [2]. The port number is used by SMF to decide whether the configured port is in DS-TT or NW-TT.

NOTE: When TSN AF needs to convey 5GS Bridge- or NW-TT port-specific information to the NW-TT/UPF, the TSN AF chooses an arbitrary AF Session related to the corresponding 5GS bridge and sends the 5GS Bridge-specific information inside a Bridge Management Information Container (BMIC) or NW-TT Port Management Information Container (NW-TT PMIC) as specified in TS 23.501 [2].

7. The PCF determines the SMF based on the MAC address received in the AF request, the PCF maps the TSN QoS information provided by the AF to PCC rules as described in clause 5.28.4 of TS 23.501 [2]. The PCF includes the TSC Assistance Container received from the AF with the PCC rules and forwards it to the SMF. The PCF transparently transports the received Port Management information Container and related port number to SMF via Npcf\_SMPolicyControl\_UpdateNotify message.
- 8a. If the SMF decides the port is on DS-TT based on the received port number, the SMF transports the received Port Management information Container to the UE/DS-TT in PDU Session Modification Request message.
- 8b. If the SMF decides the port is on NW-TT based on the received port number, the SMF transports the received Port Management information Container to the UPF/NW-TT in N4 Session Modification Request message. SMF provides the Ethernet Packet Filters as part of the N4 Packet Detection rule to the UPF/NW-TT.

If the UPF sends a Clock Drift Report to the SMF as described in clause 5.27.2 of TS 23.501 [2], the SMF adjusts the Burst Arrival Time and Periodicity from a TSN grandmaster clock to the 5G clock and sends the updated TSCAI to NG-RAN.

## Annex G (informative): Change history

Change history							
Date	Meeting	TDoc	CR	Rev	Cat	Subject/Comment	New version
2017-09	SP#77	SP-170735	-	-	-	MCC Editorial Update for presentation to TSG SA#77 for information	1.0.0
2017-09	SA2#122 E					Correcting implementation issues of S2-176821 and additional clean-up.	1.2.0
2017-12	SP-78	SP-170932	-	-	-	MCC Editorial Update for presentation to TSG SA#78 for Approval	2.0.0
2017-12	SP-78	-	-	-	-	MCC Editorial Update after TSG SA#78 Approval	15.0.0
2018-03	SP-79	SP-180092	0001	5	F	Corrections on the specification of Network Exposure services	15.1.0
2018-03	SP-79	SP-180101	0002	2	F	Corrections to PDU session establishment / modification procedure	15.1.0
2018-03	SP-79	SP-180101	0003	1	F	Clean-up of the registration procedure	15.1.0
2018-03	SP-79	SP-180090	0005	3	F	Using NRF for UPF discovery	15.1.0
2018-03	SP-79	SP-180101	0006	4	F	Allowed NSSAI and Access Type	15.1.0
2018-03	SP-79	SP-180101	0008	2	F	Corrections to the Inter-system mobility procedures	15.1.0
2018-03	SP-79	SP-180101	0009	1	F	QoS clarifications for EPC interworking	15.1.0
2018-03	SP-79	SP-180101	0010	-	F	EPS bearer ID allocation update	15.1.0
2018-03	SP-79	SP-180090	0011	1	F	Correction of Npcf_BDTPolicyControl service operation (Backround data transfer)	15.1.0
2018-03	SP-79	SP-180095	0012	-	C	Multiple request of Location Reporting for Area of Interest	15.1.0
2018-03	SP-79	SP-180101	0013	1	F	SMF behaviour based on LADN notification	15.1.0
2018-03	SP-79	SP-180101	0014	-	F	Clarification on Internal Event Exposure	15.1.0
2018-03	SP-79	SP-180101	0015	-	F	Clarification on 5G-GUTI in EPS to 5GS Mobility Registration Procedure using N26	15.1.0
2018-03	SP-79	SP-180101	0016	-	F	Adding missing text about UE policies related to Service Request including the List Of Allowed PDU Sessions	15.1.0
2018-03	SP-79	SP-180101	0019	1	F	Update of NEF service for background data transfer	15.1.0
2018-03	SP-79	SP-180101	0020	1	F	Update of NEF service for PFD management	15.1.0
2018-03	SP-79	SP-180101	0021	-	F	Clarification on handover applicability between 3GPP and non-3GPP accesses	15.1.0
2018-03	SP-79	SP-180101	0022	-	F	Clarification on paging when it is related with both 3GPP and non-3GPP PDU Session	15.1.0
2018-03	SP-79	SP-180101	0023	1	F	Sending EBI to the NG-RAN	15.1.0
2018-03	SP-79	SP-180101	0024	1	F	Indirect data forwarding in home routed roaming case	15.1.0
2018-03	SP-79	SP-180101	0025	1	F	Interaction between SMF and UPF during the inter-system change	15.1.0
2018-03	SP-79	SP-180101	0026	1	F	Direct forwarding flag for handover from EPS to 5GS	15.1.0
2018-03	SP-79	SP-180101	0027	1	F	Update to N2 Handover procedure	15.1.0
2018-03	SP-79	SP-180101	0029	1	F	Clarification on keeping NAS signalling connection	15.1.0
2018-03	SP-79	SP-180093	0030	1	F	Clarification on SMS related Subscription data	15.1.0
2018-03	SP-79	SP-180101	0032	-	F	Clarification related to Subscription data type	15.1.0
2018-03	SP-79	SP-180101	0033	2	F	Clarification on PCF association	15.1.0
2018-03	SP-79	SP-180101	0034	-	F	Slicing handling for EPS to 5GS Mobility without N26	15.1.0
2018-03	SP-79	SP-180101	0035	-	F	Keeping EBI transfer alignment	15.1.0
2018-03	SP-79	SP-180101	0036	-	F	Clarification on the Emergency HO indication for EPS fallback	15.1.0
2018-03	SP-79	SP-180102	0037	-	F	Alignment of Namf_MT_EnableUEReachability service operation	15.1.0
2018-03	SP-79	SP-180102	0038	-	F	Mobility from EPC to 5GC	15.1.0
2018-03	SP-79	SP-180095	0040	-	C	Clarification on PDU Session Release timer provided to the UE for 'SSC mode 3'	15.1.0
2018-03	SP-79	SP-180102	0041	1	F	Generalize exposure of Mobility Events from AMF	15.1.0
2018-03	SP-79	SP-180102	0042	2	F	Align the UE location presence status of LADN Session into Network Triggered Service Request procedure	15.1.0
2018-03	SP-79	SP-180102	0043	-	F	Correction on AF influence on traffic routing	15.1.0
2018-03	SP-79	SP-180102	0044	-	F	Correction to RAN Initiated QoS Flow Mobility Procedure for Dual Connectivity	15.1.0
2018-03	SP-79	SP-180102	0045	-	F	Clarification on UDM service consumption order of UECM and SDM	15.1.0
2018-03	SP-79	SP-180102	0046	-	F	Cleanup of the service request procedure	15.1.0
2018-03	SP-79	SP-180091	0047	-	F	UE-specific DRX parameter negotiation between UE and AMF	15.1.0
2018-03	SP-79	SP-180102	0048	-	F	Update of handover cancel procedure	15.1.0
2018-03	SP-79	SP-180091	0049	1	F	Control of the Messages triggering Paging at AMF	15.1.0
2018-03	SP-79	SP-180102	0050	-	F	Clarification for Area of validity in NW triggered SR procedure	15.1.0
2018-03	SP-79	SP-180091	0051	2	F	Revision on Service Request procedure	15.1.0
2018-03	SP-79	SP-180093	0052	1	F	Correction on Notification control for GBR QoS flow	15.1.0
2018-03	SP-79	SP-180093	0053	-	F	Reflective QoS Timer transmission during PDU Session establishment	15.1.0
2018-03	SP-79	SP-180102	0054	-	F	Correction on Policy association procedure during AMF relocation	15.1.0
2018-03	SP-79	SP-180102	0055	-	F	PCF selection for AMF during inter NG-RAN node N2 based handover	15.1.0
2018-03	SP-79	SP-180102	0056	1	F	Correction on PCF selection in SMF	15.1.0
2018-03	SP-79	SP-180091	0057	-	F	Update Paging Policy Differentiation in Network triggered Service Request procedure	15.1.0
2018-03	SP-79	SP-180102	0058	3	F	NEF service definitions for AF influence	15.1.0
2018-03	SP-79	SP-180102	0059	2	F	Update Handover procedures in clause 4.11.1.2	15.1.0
2018-03	SP-79	SP-180102	0060	2	F	Clean up of FFSs in 4.11.1.2.2	15.1.0



2018-03	SP-79	SP-180102	0061	3	F	A new annex for generating EPS PDN Connection parameters from 5G PDU Session parameters	15.1.0
2018-03	SP-79	SP-180102	0062	-	F	SMSF address deactivation and activation in AMF	15.1.0
2018-03	SP-79	SP-180102	0063	-	F	Correction on SMSF Nsmf_SMSservice_Activate service operation	15.1.0
2018-03	SP-79	SP-180102	0065	-	F	Resolution of ENs in Service Request procedures	15.1.0
2018-03	SP-79	SP-180096	0066	-	D	Editorial correction to clause 4.12.8	15.1.0
2018-03	SP-79	SP-180102	0067	-	F	Nudm SDM service Subscription Data types updates	15.1.0
2018-03	SP-79	SP-180102	0068	-	F	Replace PUI with GPSI	15.1.0
2018-03	SP-79	SP-180102	0069	-	F	Traffic mapping information that disallows UL packets	15.1.0
2018-03	SP-79	SP-180093	0070	1	F	Add Nocs_SpendingLimitControl service, service operations and information flows	15.1.0
2018-03	SP-79	SP-180102	0071	-	F	Correction/cleanup of IMS Emergency support	15.1.0
2018-03	SP-79	SP-180091	0072	-	F	Idle and connected state terminology cleanup	15.1.0
2018-03	SP-79	SP-180102	0073	1	F	LCS Correction of identities	15.1.0
2018-03	SP-79	SP-180103	0074	-	F	Slice selection cleanup	15.1.0
2018-03	SP-79	SP-180103	0075	1	F	Proposed resolution of Editor's Notes on clause 4.16	15.1.0
2018-03	SP-79	SP-180103	0076	1	F	Alignment of terminology and general cleanup	15.1.0
2018-03	SP-79	SP-180103	0078	1	F	Application Trigger procedure updates	15.1.0
2018-03	SP-79	SP-180103	0079	-	F	Specification of AN Parameters for Non-3GPP Access	15.1.0
2018-03	SP-79	SP-180103	0080	-	F	Clarifying inclusion of TAU messages in Registration Request	15.1.0
2018-03	SP-79	SP-180103	0082	2	F	Call flow for the PDU session setup for emergency with Emergency Service Support indicator	15.1.0
2018-03	SP-79	SP-180103	0083	1	F	NF Service Discovery	15.1.0
2018-03	SP-79	SP-180103	0085	1	F	Update 5GS and EPS handover procedures	15.1.0
2018-03	SP-79	SP-180103	0087	1	F	Operation type in Nsmf_PDUSession_UpdateSMContext Request	15.1.0
2018-03	SP-79	SP-180103	0088	1	F	Corrections of PDU session establishment procedure	15.1.0
2018-03	SP-79	SP-180103	0089	1	F	Correction on Secondary authorization/authentication procedure	15.1.0
2018-03	SP-79	SP-180103	0090	1	F	N4 reporting for PDU Session Inactivity	15.1.0
2018-03	SP-79	SP-180103	0091	1	F	Update PDU Session Modification procedures	15.1.0
2018-03	SP-79	SP-180103	0092	1	F	Correction on DNN management	15.1.0
2018-03	SP-79	SP-180103	0094	1	F	Mobility Restrictions when Roaming	15.1.0
2018-03	SP-79	SP-180103	0097	1	F	Change to Required Inputs for Update service operation	15.1.0
2018-03	SP-79	SP-180103	0098	3	F	Delivery of UE Access and PDU session related information by the PCF to the UE	15.1.0
2018-03	SP-79	SP-180093	0099	3	F	Interworking without N26 corrections	15.1.0
2018-03	SP-79	SP-180103	0100	1	F	Different Corrections of text and references	15.1.0
2018-03	SP-79	SP-180103	0101	2	F	Cleaning up binding in BSF after PDU session termination	15.1.0
2018-03	SP-79	SP-180103	0104	1	F	Updates of NSSF Services	15.1.0
2018-03	SP-79	SP-180090	0105	4	F	Selection mode transfer over N11 and N16 (wildcard DNN)	15.1.0
2018-03	SP-79	SP-180103	0106	7	F	Update to PCF-SMF interface ( Npcf_SMPolicyControl service)	15.1.0
2018-03	SP-79	SP-180092	0107	1	F	Correcting the support of charging Characteristics	15.1.0
2018-03	SP-79	SP-180103	0108	1	F	Handling of mapped EPS QoS parameters in IWK with EPC	15.1.0
2018-03	SP-79	SP-180103	0109	3	F	Alignment of non-3GPP & 3GPP registration procedures	15.1.0
2018-03	SP-79	SP-180090	0110	1	F	Network sharing PLMN handling	15.1.0
2018-03	SP-79	SP-180103	0111	3	F	Move 5GS related impact from TS 23.401 to TS 23.502	15.1.0
2018-03	SP-79	SP-180104	0112	-	F	Fixes for Emergency Services using Fallback procedure	15.1.0
2018-03	SP-79	SP-180104	0113	1	F	Fixes for UDM/UDR services	15.1.0
2018-03	SP-79	SP-180104	0114	1	F	EPS Interworking - Fixes for 5GS to EPS Mobility	15.1.0
2018-03	SP-79	SP-180104	0115	1	F	EPS Interworking - EPS Bearer ID allocation for HR session	15.1.0
2018-03	SP-79	SP-180104	0116	1	F	EPS Interworking - Fixes for 5GS->EPS HO	15.1.0
2018-03	SP-79	SP-180104	0117	1	F	EPS Interworking - Fixes for EPS->5GS HO	15.1.0
2018-03	SP-79	SP-180104	0118	2	F	EPS Interworking - Fixes for EPS to 5GS Mobility	15.1.0
2018-03	SP-79	SP-180104	0121	1	F	Update Nnrf_NFDISCOVERY service based on the UE IP address	15.1.0
2018-03	SP-79	SP-180104	0122	3	F	Update of Npcf_SMPolicyControl service	15.1.0
2018-03	SP-79	SP-180104	0125	3	F	Update to PCF-AMF interface and Npcf_AMPOLICYCONTROL service	15.1.0
2018-03	SP-79	SP-180104	0127	1	F	Correction on 5GS to EPS handover using N26 interface	15.1.0
2018-03	SP-79	SP-180104	0128	2	F	Nudm SDM service operations input parameter update	15.1.0
2018-03	SP-79	SP-180092	0129	2	F	Nudr_DM service operations input parameter update	15.1.0
2018-03	SP-79	SP-180104	0131	-	F	Nudm_SDM 'Access and Mobility Subscription data' update	15.1.0
2018-03	SP-79	SP-180104	0132	1	F	MME and AMF registration in HSS+UDM	15.1.0
2018-03	SP-79	SP-180104	0136	-	F	Clarification on SMSF registration/deregistration with UDM	15.1.0
2018-03	SP-79	SP-180104	0137	1	F	Clarification on AMF registration with UDM for Registration procedure for untrusted non-3GPP access	15.1.0
2018-03	SP-79	SP-180104	0138	2	F	Clarification on Location reporting procedures	15.1.0
2018-03	SP-79	SP-180104	0139	1	F	Correction to handovers between 3GPP and non-3GPP	15.1.0
2018-03	SP-79	SP-180104	0140	1	F	Clarification and alignment on the NG-RAN behavior for EPS/RAT fallback	15.1.0
2018-03	SP-79	SP-180104	0142	2	F	Clarification on how the AMF initiates inter or intra system handover to E-UTRAN connect to both EPC and 5GC.	15.1.0
2018-03	SP-79	SP-180104	0143	1	F	Clarification on the SM EPS bearer context from v-SMF	15.1.0
2018-03	SP-79	SP-180104	0144	1	F	Modification on the EBI revocation and ARP change	15.1.0
2018-03	SP-79	SP-180104	0147	-	F	Fixing the wrong usage of 'relocation'	15.1.0

2018-03	SP-79	SP-180104	0148	-	F	Corrections to NRF and NSSF services	15.1.0
2018-03	SP-79	SP-180104	0149	1	F	Correction of handover procedure from 4G to 5G in Single Registration mode	15.1.0
2018-03	SP-79	SP-180105	0151	-	F	Correction to UE Registration	15.1.0
2018-03	SP-79	SP-180105	0152	-	F	Corrections to SMF selection	15.1.0
2018-03	SP-79	SP-180092	0153	1	F	UE support for Multi-homed IPv6 PDU Session	15.1.0
2018-03	SP-79	SP-180105	0154	-	F	Adding the missing GPSI parameter in SMF	15.1.0
2018-03	SP-79	SP-180105	0155	2	F	Transparent relay between V-SMF and H-SMF in case of different feature support	15.1.0
2018-03	SP-79	SP-180105	0156	-	F	Preservation of GBR QoS Flows upon redirection	15.1.0
2018-03	SP-79	SP-180093	0157	2	F	Handling of UE Core Network Capability and indication of UE support for Handover Attach to NG-RAN	15.1.0
2018-03	SP-79	SP-180105	0158	3	F	Clarification on NSSAI configuration	15.1.0
2018-03	SP-79	SP-180093	0159	1	F	UE assisted UE policies calculation in PCF	15.1.0
2018-03	SP-79	SP-180105	0160	1	F	Correction of used Registration Type	15.1.0
2018-03	SP-79	SP-180105	0163	1	F	Re-use of definitions and abbreviations specified in TS 23.503.	15.1.0
2018-03	SP-79	SP-180105	0166	1	F	Correction to the UE Requested PDU Session Establishment via Untrusted non-3GPP Access Procedure	15.1.0
2018-03	SP-79	SP-180105	0167	1	F	Correction for UE location in Xn based HO procedure	15.1.0
2018-03	SP-79	SP-180105	0168	3	F	Clarification of UDR usage in policy related procedures	15.1.0
2018-03	SP-79	SP-180105	0170	2	F	Correction of UDR usage in MM related procedures	15.1.0
2018-03	SP-79	SP-180105	0171	2	F	Correction of UDR usage in specific service related procedures	15.1.0
2018-03	SP-79	SP-180105	0172	2	F	Correction for the invocation of Nudm_UECM_Deregistration service operation	15.1.0
2018-03	SP-79	SP-180105	0175	2	F	Correction of UDR usage in SM related procedures	15.1.0
2018-03	SP-79	SP-180105	0176	1	F	Clarification on handover procedure for home-routed roaming scenario	15.1.0
2018-03	SP-79	SP-180105	0177	-	F	Correction to inter NG-RAN node N2 based handover	15.1.0
2018-03	SP-79	SP-180105	0179	1	F	Correction on N4 Session Modification Request in Handover procedure	15.1.0
2018-03	SP-79	SP-180105	0180	1	F	Correction on Service Request procedure when UE establishes a signalling connection only	15.1.0
2018-03	SP-79	SP-180105	0181	1	F	Clarify how to send end marker during HO procedure	15.1.0
2018-03	SP-79	SP-180105	0183	-	F	Aligning TS 23.502 onto TS 29.244 about PPD.	15.1.0
2018-03	SP-79	SP-180092	0184	2	F	User plane security policy	15.1.0
2018-03	SP-79	SP-180105	0185	-	F	Service Request procedure corrections	15.1.0
2018-03	SP-79	SP-180105	0186	1	F	New cause for UP reactivation failure in Service Request procedure	15.1.0
2018-03	SP-79	SP-180105	0187	2	F	Rejection of UP activation during the Registration procedure	15.1.0
2018-03	SP-79	SP-180105	0188	2	F	Activating a Background Data Transfer Policy	15.1.0
2018-03	SP-79	SP-180106	0189	1	F	P-CSCF Discovery for IMS in 5GC using IP-CAN method	15.1.0
2018-03	SP-79	SP-180106	0191	-	F	Clarification on modification of the set of network slices for a UE	15.1.0
2018-03	SP-79	SP-180106	0192	1	F	Location reporting procedure for LADN in RRC Inactive state - TS 23.502	15.1.0
2018-03	SP-79	SP-180106	0193	3	F	Exposure of Mobility Events from AMF	15.1.0
2018-03	SP-79	SP-180106	0195	1	F	Clarification on AMF behaviour due to Subscriber Data Change in UDM	15.1.0
2018-03	SP-79	SP-180095	0199	1	B	Supporting 3GPP PS Data Off in 5GS	15.1.0
2018-03	SP-79	SP-180106	0203	1	F	Clarifications on EPS to 5GS handover procedure using N26	15.1.0
2018-03	SP-79	SP-180106	0204	1	F	Request Type in PDN connectivity request for SRM interworking	15.1.0
2018-03	SP-79	SP-180106	0205	1	F	Alignment CR for Application Function influence on traffic routing procedure	15.1.0
2018-03	SP-79	SP-180106	0206	1	F	PDU session ID in PDU session management procedure	15.1.0
2018-03	SP-79	SP-180106	0209	1	F	UE context removal in UDM during deregistration procedure	15.1.0
2018-03	SP-79	SP-180096	0210	1	D	Correction on non-3GPP Service request procedure	15.1.0
2018-03	SP-79	SP-180106	0211	2	F	Indication for Non-geographically selected AMF	15.1.0
2018-03	SP-79	SP-180106	0212	1	F	Updating Network Triggered Service Request to support selective re-activation of PDU session over non-3GPP access	15.1.0
2018-03	SP-79	SP-180106	0213	1	F	Editorial corrections in clause 4.2.3.3 Network Triggered Service Request	15.1.0
2018-03	SP-79	SP-180090	0215	1	F	Capturing impacts to 23.401 procedure for interworking with 5GC	15.1.0
2018-03	SP-79	SP-180106	0216	1	F	Clean up for PCC related flows	15.1.0
2018-03	SP-79	SP-180106	0219	-	F	Editorial modifications in procedures related to PDU session anchor addition or removal	15.1.0
2018-03	SP-79	SP-180106	0223	1	F	S-NSSAI in the PDU Session Establishment Accept for roaming scenario	15.1.0
2018-03	SP-79	SP-180106	0226	-	F	Clarification on Nnwdaf_EventsSubscription_Unsubscribe service operation	15.1.0
2018-03	SP-79	SP-180106	0227	-	F	Clarification on Network data analytics procedure	15.1.0
2018-03	SP-79	SP-180106	0228	2	F	Slicing configuration update	15.1.0
2018-03	SP-79	SP-180125	0229	1	B	Addition of PDU Session type IPv4v6	15.1.0
2018-03	SP-79	SP-180106	0230	1	F	Update of Reachability procedures	15.1.0
2018-03	SP-79	SP-180093	0234	2	C	EPS Fallback for voice further enhancements	15.1.0

2018-03	SP-79	SP-180106	0235	1	F	Clarification on Use of List of Parameter Values to Match in Event Filters	15.1.0
2018-03	SP-79	SP-180106	0236	2	F	Clarification on the services for External Parameter Provisioning	15.1.0
2018-03	SP-79	SP-180106	0237	-	F	Correction to PDU Session Establishment procedure	15.1.0
2018-03	SP-79	SP-180106	0238	1	F	EPS bearer context handling for N26 case	15.1.0
2018-06	SP-80	SP-180491	0182	3	F	TS 23.502: Xn handover and slice unavailability	15.2.0
2018-06	SP-80	SP-180482	0241	1	F	Correction of description related to PFD management	15.2.0
2018-06	SP-80	SP-180484	0245	-	F	Deregistration procedure correction	15.2.0
2018-06	SP-80	SP-180480	0247	1	F	Clarification on NG-RAN location reporting procedure	15.2.0
2018-06	SP-80	SP-180489	0249	-	F	TS 23.502: Perform authentication before Context Acknowledgement during 5GS to EPS Idle mode mobility using N26 interface	15.2.0
2018-06	SP-80	SP-180482	0251	6	F	Correction of UE configuration update procedure	15.2.0
2018-06	SP-80	SP-180481	0254	2	F	Clarifications on Nudr interactions between PCF and UDR	15.2.0
2018-06	SP-80	SP-180484	0255	-	F	Editorial corrections	15.2.0
2018-06	SP-80	SP-180484	0258	1	F	EPS to 5GS Mobility - Handling PDN connections that are not subject to service continuity	15.2.0
2018-06	SP-80	SP-180487	0259	1	F	P-GW-C+SMF Registration in the UDM for the purpose of EPS interworking	15.2.0
2018-06	SP-80	SP-180482	0261	1	F	Context retrieval for the purpose of EPS interworking	15.2.0
2018-06	SP-80	SP-180491	0262	-	F	Voice fallback during roaming scenarios	15.2.0
2018-06	SP-80	SP-180486	0263	1	F	NF Discovery via the NRF	15.2.0
2018-06	SP-80	SP-180487	0265	-	F	Nudm_UEAuthentication Service clarification	15.2.0
2018-06	SP-80	SP-180483	0266	-	D	Correction to figure caption errors in handover procedures	15.2.0
2018-06	SP-80	SP-180479	0268	3	F	Propose to add the network Requested PDU Session Release procedure via Untrusted non-3GPP access	15.2.0
2018-06	SP-80	SP-180483	0269	-	F	Correction to NEF service	15.2.0
2018-06	SP-80	SP-180481	0270	2	F	Clarify related description for Network Sharing and Interworking	15.2.0
2018-06	SP-80	SP-180481	0271	2	F	Clarifications to Registration and UE triggered Service Request procedure	15.2.0
2018-06	SP-80	SP-180489	0273	1	F	The interaction between PCF and AF	15.2.0
2018-06	SP-80	SP-180480	0274	1	F	Clarification on MT SMS domain selection by SMSF	15.2.0
2018-06	SP-80	SP-180483	0275	2	F	Correction to CN-initiated selective deactivation of UP connection of an existing PDU Session	15.2.0
2018-06	SP-80	SP-180479	0276	3	F	Clarification of the mapping relation between PDU session ID and access type in the AMF.	15.2.0
2018-06	SP-80	SP-180489	0277	1	F	TS 23.502: Clean-up for the RRC Inactive related procedure	15.2.0
2018-06	SP-80	SP-180482	0279	2	F	Cleanup to PCF selection in AMF and SMF	15.2.0
2018-06	SP-80	SP-180484	0280	1	F	Description of Policy Association	15.2.0
2018-06	SP-80	SP-180489	0281	2	F	Wildcard DNN management	15.2.0
2018-06	SP-80	SP-180479	0284	-	F	Clarification on HO procedure	15.2.0
2018-06	SP-80	SP-180479	0285	-	F	Clarification of Data Notification in service request procedure	15.2.0
2018-06	SP-80	SP-180484	0286	5	F	Correlation between EBI and QFI	15.2.0
2018-06	SP-80	SP-180479	0287	3	F	Clarification on Data Keys for Application data	15.2.0
2018-06	SP-80	SP-180491	0288	1	F	Updates on Subscribe Service Operation	15.2.0
2018-06	SP-80	SP-180489	0289	-	F	Alignment on the IMS voice over PS session supported indication	15.2.0
2018-06	SP-80	SP-180480	0290	1	F	Clarification on RAT fallback	15.2.0
2018-06	SP-80	SP-180479	0293	-	F	Clarification on AMF deregistration by UDM in N26 based interworking from 5GS to EPS	15.2.0
2018-06	SP-80	SP-180480	0296	-	F	Clarification on Network-initiated Deregistration	15.2.0
2018-06	SP-80	SP-180488	0297	-	F	Selective deactivation of UP connection for non-3GPP PDU Session	15.2.0
2018-06	SP-80	SP-180485	0300	5	F	Lack of S-NSSAI or DNN in the PDU Session Establishment Request	15.2.0
2018-06	SP-80	SP-180485	0302	1	F	Interactions with the DN-AAA that are not for authentication	15.2.0
2018-06	SP-80	SP-180481	0303	1	F	Clarification to handling of packet filters at PDU Session Modification	15.2.0
2018-06	SP-80	SP-180485	0304	1	F	LADN Signalling to SMF	15.2.0
2018-06	SP-80	SP-180484	0305	2	F	Corrections on UE configuration update procedure.	15.2.0
2018-06	SP-80	SP-180482	0308	2	F	CN tunnel handling during IRAT handover	15.2.0
2018-06	SP-80	SP-180489	0310	1	F	Subscription status notification for Event Exposure service	15.2.0
2018-06	SP-80	SP-180487	311	1	F	Removal of editor's notes in clause 4.12	15.2.0
2018-06	SP-80	SP-180480	0312	-	F	Clarification on SMF selection	15.2.0
2018-06	SP-80	SP-180480	0313	2	F	Clarification on policy provision in roaming case	15.2.0
2018-06	SP-80	SP-180479	0317	1	F	Authentication related services.	15.2.0
2018-06	SP-80	SP-180486	0318	5	F	Network slicing information as the service input parameter of BSF service operations	15.2.0
2018-06	SP-80	SP-180490	0319	1	F	Mobility Event Subscribe Service operation correction	15.2.0
2018-06	SP-80	SP-180491	0320	6	F	Update on AMF service operation to support query for terminating domain selection for IMS voice	15.2.0
2018-06	SP-80	SP-180483	0322	-	F	Correction on Nsmsf_SMSService_Activate service operation	15.2.0
2018-06	SP-80	SP-180482	0323	1	F	Correction of Provision parameters flow	15.2.0
2018-06	SP-80	SP-180482	0325	2	F	Consolidation of UE Network Capabilities	15.2.0
2018-06	SP-80	SP-180488	0326	-	F	Removal of one step SMS procedure	15.2.0

2018-06	SP-80	SP-180481	0327	1	F	Clarifications on Nudr interactions between PCF and UDR	15.2.0
2018-06	SP-80	SP-180491	0328	2	F	Update Nudr_DataManagement (DM) service for data subscription	15.2.0
2018-06	SP-80	SP-180489	0329	-	F	Terminology cleanup	15.2.0
2018-06	SP-80	SP-180484	0331	1	F	Corrections to Service Request procedure	15.2.0
2018-06	SP-80	SP-180481	0334	1	F	Clarification on the use of shared AMF Pointer value	15.2.0
2018-06	SP-80	SP-180480	0335	3	F	Clarification on NGAP UE-TNLA-binding per UE Release procedure	15.2.0
2018-06	SP-80	SP-180488	0336	1	F	ReAuthentication by an external DN-AAA server	15.2.0
2018-06	SP-80	SP-180491	0337	5	F	Updates to SMF Event Exposure	15.2.0
2018-06	SP-80	SP-180487	0340	1	F	Policy related update in the PDU Session Establishment procedure	15.2.0
2018-06	SP-80	SP-180488	0341	1	F	Remove PCF as the consumer of Namf_EventExposure and Nsmf_EventExposure services	15.2.0
2018-06	SP-80	SP-180485	0342	3	F	Indirect Data forwarding for N2 HO	15.2.0
2018-06	SP-80	SP-180486	0345	1	F	N4 modification inserted during PDU Session Modification procedure	15.2.0
2018-06	SP-80	SP-180490	0347	-	F	Update of PDU Session Establishment Procedure	15.2.0
2018-06	SP-80	SP-180483	0349	-	F	Correction to N2 handover preparation	15.2.0
2018-06	SP-80	SP-180488	0352	2	F	Setting indirect data forwarding flag	15.2.0
2018-06	SP-80	SP-180478	0353	-	F	23.502: Alignment of terminologies regarding PDU Session	15.2.0
2018-06	SP-80	SP-180489	0354	2	F	TS 23.502 Clarification on Internal-Group identifier	15.2.0
2018-06	SP-80	SP-180489	0355	2	F	TS 23.502 Clarification on Access and mobility related policy	15.2.0
2018-06	SP-80	SP-180489	0356	1	F	TS 23.502 Clarification on AMF Subscription Correlation ID	15.2.0
2018-06	SP-80	SP-180478	0357	6	F	Additional DataSet and Datakey	15.2.0
2018-06	SP-80	SP-180489	0359	2	F	TS23.502 Remove access independent event trigger in Nsmf_EventExposure Service	15.2.0
2018-06	SP-80	SP-180488	0360	4	F	S-NSSAI check in Network Triggered Service Request	15.2.0
2018-06	SP-80	SP-180483	0362	1	F	Correction to User Plane Security Enforcement	15.2.0
2018-06	SP-80	SP-180483	0363	1	F	Correction to handover procedures	15.2.0
2018-06	SP-80	SP-180477	0365	-	D	Corrections on namings of SMF Service Operations	15.2.0
2018-06	SP-80	SP-180484	0366	1	F	Corrections to the selective deactivation of UP connection	15.2.0
2018-06	SP-80	SP-180481	0369	4	F	Clarification on the EBI assignment, PDU session ID list in Registration and PDU session correlation.	15.2.0
2018-06	SP-80	SP-180486	0370	1	F	Modification on SMF registration after EPS to 5GS mobility	15.2.0
2018-06	SP-80	SP-180487	0371	2	F	Proposal on the EPS Qos parameters on N7	15.2.0
2018-06	SP-80	SP-180483	0374	-	F	Correction to Nnwdaf_EventsSubscription_Notify (related to nw slice)	15.2.0
2018-06	SP-80	SP-180480	0376	1	F	Clarification on Nbsf_Management_Deregister service operation	15.2.0
2018-06	SP-80	SP-180481	0377	2	F	Clarification on Nnwdaf_Analytics_Info service	15.2.0
2018-06	SP-80	SP-180483	0378	1	F	Correction to indirect forwarding at intra 5GS N2 HO	15.2.0
2018-06	SP-80	SP-180485	0380	1	F	Local deactivation of MICO mode	15.2.0
2018-06	SP-80	SP-180484	0382	1	F	Dual registration interworking procedure	15.2.0
2018-06	SP-80	SP-180484	0383	8	F	EBI allocation and slicing interworking with EPS	15.2.0
2018-06	SP-80	SP-180490	0384	2	F	Tunnel Info reservation at the UPF for sessions interworked with EPC	15.2.0
2018-06	SP-80	SP-180483	0388	1	F	Correction to Nnef_TrafficInfluence service description	15.2.0
2018-06	SP-80	SP-180487	0389	3	F	Relaying of Nnef_TrafficInfluence requests to the PCF	15.2.0
2018-06	SP-80	SP-180484	0392	1	F	Corrections to PFD management	15.2.0
2018-06	SP-80	SP-180487	0393	2	F	Registration procedure update	15.2.0
2018-06	SP-80	SP-180485	0394	2	F	Handling of maximum supported data rate per UE for integrity protection	15.2.0
2018-06	SP-80	SP-180486	0395	1	F	NF/NF service Discovery across PLMNs	15.2.0
2018-06	SP-80	SP-180486	0396	1	F	NF/NF service Status Subscribe/Notify Flows	15.2.0
2018-06	SP-80	SP-180487	0397	-	F	Nudm service update to support Steering of Roaming	15.2.0
2018-06	SP-80	SP-180484	0400	2	F	Deregistration procedure for SMS over NAS	15.2.0
2018-06	SP-80	SP-180487	0401	-	F	Nudm service update to support P-CSCF Restoration	15.2.0
2018-06	SP-80	SP-180482	0402	1	F	Correction on Location continuity procedure	15.2.0
2018-06	SP-80	SP-180485	0403	1	F	IPsec SAs in tunnel mode	15.2.0
2018-06	SP-80	SP-180481	0404	1	F	Clarify GUTI aspects for single-registration mode UEs for interworking without N26	15.2.0
2018-06	SP-80	SP-180489	0406	1	F	Transaction reference ID usage in NEF NBI	15.2.0
2018-06	SP-80	SP-180483	0407	2	F	Correction to UE Radio Capability handling	15.2.0
2018-06	SP-80	SP-180488	0408	-	F	Resolving EN related to subscription data	15.2.0
2018-06	SP-80	SP-180488	0409	-	F	Resolving EN related to paging priority	15.2.0
2018-06	SP-80	SP-180485	0410	1	F	Handling of Configured NSSAIs in Roaming Scenarios - 23.502	15.2.0
2018-06	SP-80	SP-180488	0411	1	F	Slicing information and RFSP	15.2.0
2018-06	SP-80	SP-180487	0412	1	F	QoS rule structure improvement	15.2.0
2018-06	SP-80	SP-180476	0415	3	B	Exposure Data	15.2.0
2018-06	SP-80	SP-180484	0416	-	F	EPS to 5GS Mobility	15.2.0
2018-06	SP-80	SP-180485	0417	1	F	Fixes for HO Procedure - Handling MT Signalling from SMF.	15.2.0
2018-06	SP-80	SP-180478	0418	3	F	AMF Context Retrieval upon relocation	15.2.0
2018-06	SP-80	SP-180487	0419	-	F	NRF Service Operations	15.2.0
2018-06	SP-80	SP-180484	0420	2	F	EPS Bearer ID allocation for Home routed case	15.2.0
2018-06	SP-80	SP-180490	0422	1	F	UDM-AUSF Discovery	15.2.0
2018-06	SP-80	SP-180479	0423	2	F	AS Security Setup	15.2.0

2018-06	SP-80	SP-180481	0425	2	F	Clarification on the roaming aspects of SMF related policy	15.2.0
2018-06	SP-80	SP-180479	0428	2	F	Clarification on AN parameter in Service Request	15.2.0
2018-06	SP-80	SP-180482	0431	1	F	Correction on Non-3GPP Registration procedure	15.2.0
2018-06	SP-80	SP-180490	0432	4	F	UE presence of Area Of Interest (Restructuring)	15.2.0
2018-06	SP-80	SP-180486	0439	1	F	Missing S-NSSAI and the associated NSI ID in Nnrf_NFManagement_service	15.2.0
2018-06	SP-80	SP-180488	0440	1	F	Removing Editor's note about How NWDAF services work while roaming	15.2.0
2018-06	SP-80	SP-180482	0445	3	F	CN type indicator in Emergency Service Fallback procedure	15.2.0
2018-06	SP-80	SP-180482	0446	2	F	Correct Nudr_DM service operation usage by NEF	15.2.0
2018-06	SP-80	SP-180488	0447	-	F	Resolving EN related to Exposure with bulk subscription	15.2.0
2018-06	SP-80	SP-180486	0448	1	F	Mobility restrictions	15.2.0
2018-06	SP-80	SP-180488	0449	2	F	S-NSSAI of VPLMN when HO from 4G to 5G	15.2.0
2018-06	SP-80	SP-180485	0451	2	F	How Peer CP NF sends notification to target/new AMF after AMF planned removal	15.2.0
2018-06	SP-80	SP-180478	0452	1	F	AF influence on traffic routing for Ethernet type PDU Session	15.2.0
2018-06	SP-80	SP-180479	0457	1	F	Clarification of maximum number of reports and maximum duration of reporting	15.2.0
2018-06	SP-80	SP-180478	0458	1	F	Align Namf_Communication_N1N2TransferFailure service operation	15.2.0
2018-06	SP-80	SP-180490	0460	2	F	UDR storage for Nnef_TrafficInfluence from AF	15.2.0
2018-06	SP-80	SP-180491	0461	2	F	Update to AMF policy association modification procedure	15.2.0
2018-06	SP-80	SP-180489	0463	1	F	Support for UAC Access Identity in Visited PLMNs	15.2.0
2018-06	SP-80	SP-180488	0464	-	F	SMF exemption to NAS level congestion control for high priority access	15.2.0
2018-06	SP-80	SP-180488	0465	-	F	SMF Selection Subscriber Data clarification	15.2.0
2018-06	SP-80	SP-180479	0466	1	F	Clarification on Emergency services Fallback	15.2.0
2018-06	SP-80	SP-180490	0467	1	F	Update of the Handover procedure considering the ongoing inter NG-RAN node handover	15.2.0
2018-06	SP-80	SP-180491	0468	-	F	Update of the Network Triggered Service Request procedure for some clarifications	15.2.0
2018-06	SP-80	SP-180485	0469	2	F	Including GUAMI in RRC message of related procedures	15.2.0
2018-06	SP-80	SP-180480	0470	3	F	Clarification on Mobility related parameters of UE Context in AMF	15.2.0
2018-06	SP-80	SP-180482	0473	2	F	CN tunnel handling for IRAT Idle mobility	15.2.0
2018-06	SP-80	SP-180480	0474	2	F	Clarification on SMSF checking SMS management subscription data	15.2.0
2018-06	SP-80	SP-180481	0476	1	F	Clarification on UE configuration update procedure	15.2.0
2018-06	SP-80	SP-180487	0477	2	F	PCF selection during the AMF relocation	15.2.0
2018-06	SP-80	SP-180486	0480	5	F	MT-SMS over NAS re-transmission upon delivery failure on one Access Type	15.2.0
2018-06	SP-80	SP-180478	0481	1	F	Allowed NSSAI RAN awareness	15.2.0
2018-06	SP-80	SP-180490	0486	2	F	UE radio capability handling in the 5GS	15.2.0
2018-06	SP-80	SP-180478	0487	1	F	Adding number of supported packet filters in PDU Session Modification	15.2.0
2018-06	SP-80	SP-180491	0492	1	F	Update Registration procedures	15.2.0
2018-06	SP-80	SP-180482	0496	1	F	Correction of having multiple S-NSSAIs for a single PDU session	15.2.0
2018-06	SP-80	SP-180486	0497	3	F	Network slicing subscription change and update of UE configuration	15.2.0
2018-06	SP-80	SP-180490	0498	2	F	UE support of SMS and SMS subscription	15.2.0
2018-06	SP-80	SP-180488	0499	2	F	Removal of RAT Type from UE-associated N2 signalling	15.2.0
2018-06	SP-80	SP-180482	0501	2	F	Clarifying use-cases of network triggered service request	15.2.0
2018-06	SP-80	SP-180481	0502	1	F	Clarifying UE Reachability Notification Procedure	15.2.0
2018-06	SP-80	SP-180483	0505	2	F	Correction to identifiers in Registration procedure	15.2.0
2018-06	SP-80	SP-180483	0506	-	F	Correction to Figure 4.3.5.7-1: Simultaneous change of Branching Point or UL CL and additional PSA for a PDU Session	15.2.0
2018-06	SP-80	SP-180483	0507	-	F	Correction to UDR Data Set Identifiers considered in this release	15.2.0
2018-06	SP-80	SP-180490	0508	-	F	UE Policies in a UE Policy Container	15.2.0
2018-06	SP-80	SP-180480	0509	-	F	Clarification on single outstanding Service Request	15.2.0
2018-09	SP-81	SP-180717	0390	5	F	Discovering SMF instance at EPS to 5GS interworking	15.3.0
2018-09	SP-81	SP-180717	0489	4	F	AMF-PCF Association termination	15.3.0
2018-09	SP-81	SP-180717	0512	1	F	Change OCS to CHF in TS 23.502	15.3.0
2018-09	SP-81	SP-180717	0513	1	F	Correction to SMF registration of PDU Session ID	15.3.0
2018-09	SP-81	SP-180717	0514	-	F	Correction to handling of DNNs not supported by the network	15.3.0
2018-09	SP-81	SP-180717	0516	-	F	Mandatory valid lifetime configuration for old IP prefix in multi-homing	15.3.0
2018-09	SP-81	SP-180717	0517	4	F	Temporary identifier usage at interworking	15.3.0
2018-09	SP-81	SP-180717	0518	1	F	Requested NSSAI in Network Initiated Change of Network slices	15.3.0
2018-09	SP-81	SP-180717	0519	1	F	Network Slicing Subscription Change Indication	15.3.0
2018-09	SP-81	SP-180717	0520	2	F	Triggers for Network Triggered Service Request and UE Activity procedure	15.3.0
2018-09	SP-81	SP-180717	0521	-	F	5GS to EPS Mobility without N26	15.3.0
2018-09	SP-81	SP-180717	0522	1	F	EPS to 5GS mobility with N26	15.3.0
2018-09	SP-81	SP-180717	0525	7	F	Handling of subscription restrictions for mobility from EPS to 5GS	15.3.0
2018-09	SP-81	SP-180717	0526	2	F	Update of parameter in call flow and service operation for NSI ID	15.3.0
2018-09	SP-81	SP-180717	0527	-	F	Corrections to AF influence on traffic routing	15.3.0

2018-09	SP-81	SP-180724	0530	2	B	Support of tracing in 5GS signalling: SM related signalling and data	15.3.0
2018-09	SP-81	SP-180724	0531	2	B	Support of tracing in 5GS signalling: SMSF related signalling and data	15.3.0
2018-09	SP-81	SP-180717	0532	1	B	User Location Information added in N2 UE Context Release Complete	15.3.0
2018-09	SP-81	SP-180717	0533	1	F	Clarification to UE Configuration Update	15.3.0
2018-09	SP-81	SP-180717	0534	-	F	Clarification on CN-initiated selective deactivation of UP connection	15.3.0
2018-09	SP-81	SP-180717	0535	1	F	Clarification on UE configuration update procedure	15.3.0
2018-09	SP-81	SP-180717	0539	-	F	Alignment on Namf_EventExposure_Subscribe service operation	15.3.0
2018-09	SP-81	SP-180718	0540	7	F	PCF added as consumer of EventExposure service of AMF and SMF	15.3.0
2018-09	SP-81	SP-180718	0543	2	F	Correction on Connection Resume procedure	15.3.0
2018-09	SP-81	SP-180718	0544	1	F	Correction on signalling message holding during HO	15.3.0
2018-09	SP-81	SP-180718	0546	1	F	Clarification on UE Capability Match Request procedure	15.3.0
2018-09	SP-81	SP-180717	0547	-	D	Fixing clause number	15.3.0
2018-09	SP-81	SP-180718	0548	1	F	Service Accept to complete Service Request	15.3.0
2018-09	SP-81	SP-180718	0549	3	F	TS 23.502 Clarification on N2 based handover	15.3.0
2018-09	SP-81	SP-180718	0550	4	F	TS23.502 Clarifications on Xn based handover	15.3.0
2018-09	SP-81	SP-180717	0555	-	D	Editorial Fixes to the UECM Text	15.3.0
2018-09	SP-81	SP-180718	0557	2	F	Termination of the AM Policy Association	15.3.0
2018-09	SP-81	SP-180718	0561	2	F	Adding N28 session termination procedure and updates to CHF services	15.3.0
2018-09	SP-81	SP-180718	0563	-	F	Update to Registration procedure with AMF relocation	15.3.0
2018-09	SP-81	SP-180717	0565	2	D	Correction of UE configuration update procedure	15.3.0
2018-09	SP-81	SP-180717	0569	1	C	Indirect data forwarding for interworking with N26	15.3.0
2018-09	SP-81	SP-180718	0576	2	F	UE Context in SMSF data	15.3.0
2018-09	SP-81	SP-180718	0577	1	F	UE context in SMF data	15.3.0
2018-09	SP-81	SP-180718	0579	-	F	TS 23.502: Mobility Restriction List Clean up	15.3.0
2018-09	SP-81	SP-180718	0582	5	F	Default S-NSSAI correction and NSSF service update	15.3.0
2018-09	SP-81	SP-180718	0585	2	F	Subscription of selecting the same SMF and UPF	15.3.0
2018-09	SP-81	SP-180718	0586	2	F	N16 communication failure	15.3.0
2018-09	SP-81	SP-180718	0587	4	F	Clarification on UPF tunnel change	15.3.0
2018-09	SP-81	SP-180718	0588	3	F	Data handling in UPF during IRAT handover	15.3.0
2018-09	SP-81	SP-180718	0590	1	F	5GS to EPS Mobility	15.3.0
2018-09	SP-81	SP-180718	0591	1	F	Registration type for Nudm_UECM_Registration	15.3.0
2018-09	SP-81	SP-180718	0592	1	F	Correction to AS Security Context	15.3.0
2018-09	SP-81	SP-180718	0594	1	F	Peer NF association of GUAMI with a given UE	15.3.0
2018-09	SP-81	SP-180718	0595	1	F	23.502: 5G AN Parameters sent during Service Request	15.3.0
2018-09	SP-81	SP-180718	0597	2	F	Correction on AMF and UDM service table	15.3.0
2018-09	SP-81	SP-180718	0599	1	F	RRC Inactive to EPC mobility	15.3.0
2018-09	SP-81	SP-180719	0600	1	F	Homogeneous Support of IMS Voice over PS Sessions indication	15.3.0
2018-09	SP-81	SP-180719	0601	2	F	Clarification on the PDU session handling in EPS to 5GS handover with N26	15.3.0
2018-09	SP-81	SP-180719	0602	1	F	Clarification on the target MME capability from AMF to SMF for 5GS to EPS mobility	15.3.0
2018-09	SP-81	SP-180719	0604	1	F	Handling LADN service area during handovers	15.3.0
2018-09	SP-81	SP-180719	0605	1	F	Clarification on N3IWF key delivery during registration procedure	15.3.0
2018-09	SP-81	SP-180719	0606	1	F	Clarification on representation of Aol for NG-RAN location reporting procedure	15.3.0
2018-09	SP-81	SP-180719	0607	2	F	MT SMS failure recovery	15.3.0
2018-09	SP-81	SP-180719	0608	1	F	Add monitoring event cancellation call flows	15.3.0
2018-09	SP-81	SP-180719	0609	1	F	Nudm_EventExposure_Subscribe and unsubscribe service operation correction	15.3.0
2018-09	SP-81	SP-180719	0610	-	F	Time stamp in Namf, Nsmf and Nnef EventExposure_Notify service operations	15.3.0
2018-09	SP-81	SP-180719	0611	1	F	Corrections to NRF services description	15.3.0
2018-09	SP-81	SP-180719	0612	9	F	SBI friendly UE policy delivery procedure	15.3.0
2018-09	SP-81	SP-180719	0613	1	F	Correction to handover from 5GS to EPS	15.3.0
2018-09	SP-81	SP-180719	0615	2	F	Correction on inter-PLMN mobility	15.3.0
2018-09	SP-81	SP-180719	0616	1	F	Update to PDN connection establishment	15.3.0
2018-09	SP-81	SP-180719	0617	3	F	Clarification on Nbsf_Management_Update service operation	15.3.0
2018-09	SP-81	SP-180719	0618	-	F	Nudm service update to support protection of Steering of Roaming	15.3.0
2018-09	SP-81	SP-180719	0619	-	F	5GS-EPS interworking for Multi-homed IPv6 PDU Session	15.3.0
2018-09	SP-81	SP-180719	0620	2	F	Clafication on retrieval of the security context from old AMF	15.3.0
2018-09	SP-81	SP-180717	0621	2	B	Missing NEF services.	15.3.0
2018-09	SP-81	SP-180719	0623	-	F	Clarifications about MOBIKE and N3IWF certificate	15.3.0
2018-09	SP-81	SP-180719	0626	-	F	Corrections to N4 session and N4 node procedures	15.3.0
2018-09	SP-81	SP-180719	0627	1	F	Solving wrong references, service names or service operation names in NF services description	15.3.0
2018-09	SP-81	SP-180719	0628	-	F	Incorrect service operation names for NEF services	15.3.0
2018-09	SP-81	SP-180719	0630	2	F	Correction to NRF service operations and procedures	15.3.0
2018-09	SP-81	SP-180719	0631	1	F	Correction to Event Exposure operations	15.3.0

2018-09	SP-81	SP-180720	0633	1	F	Clarifications on AF influence on traffic routing procedures	15.3.0
2018-09	SP-81	SP-180720	0634	2	F	Corrections to UE Requested PDU Session Establishment	15.3.0
2018-09	SP-81	SP-180720	0635	-	F	Corrections related to SM on Hand-Over procedures	15.3.0
2018-09	SP-81	SP-180720	0636	1	F	Replace wrong Figure 4.16.4-1: SM Policy Association Establishment	15.3.0
2018-09	SP-81	SP-180720	0637	-	F	Optionality of Network area information	15.3.0
2018-09	SP-81	SP-180720	0638	-	F	Location Service, alignment procedures and NF Services	15.3.0
2018-09	SP-81	SP-180720	0639	1	F	Core Network type restriction on EPC in 5GS subscription data	15.3.0
2018-09	SP-81	SP-180720	0640	2	F	Indirect Forwarding Flag	15.3.0
2018-09	SP-81	SP-180720	0641	1	F	Storing FQDN for S5/S8 interface of the SMF+PGW-C in UDM	15.3.0
2018-09	SP-81	SP-180720	0644	1	F	Impacts on Update Location in 5GS to EPS Interworking without N26	15.3.0
2018-09	SP-81	SP-180720	0646	-	F	Resolving Editor's notes related to N2 messages	15.3.0
2018-09	SP-81	SP-180720	0647	-	F	Resolving Editor's note related to Session Management	15.3.0
2018-09	SP-81	SP-180720	0648	-	F	Resolving Editor's note related to Security	15.3.0
2018-09	SP-81	SP-180720	0651	-	F	Correction for UE requested LADN Information	15.3.0
2018-09	SP-81	SP-180720	0653	-	F	Clarification on ANDSP support	15.3.0
2018-09	SP-81	SP-180720	0654	1	F	Clarification on N26 based interworking procedures	15.3.0
2018-09	SP-81	SP-180720	0655	1	F	Corrections on Area Of Interest	15.3.0
2018-09	SP-81	SP-180720	0657	3	F	Signalling Configured NSSAIs valid for any PLMN usage in the Registration procedure	15.3.0
2018-09	SP-81	SP-180720	0658	1	F	SMS support used in different meanings	15.3.0
2018-09	SP-81	SP-180720	0660	2	F	NEF notification event correction	15.3.0
2018-09	SP-81	SP-180720	0662	1	F	Exposure with bulk subscription correction	15.3.0
2018-09	SP-81	SP-180720	0663	-	F	Removal of duplicated call flow	15.3.0
2018-09	SP-81	SP-180720	0664	1	F	NEF service operation correction	15.3.0
2018-09	SP-81	SP-180720	0667	1	F	Updates to NF service framework and NRF services for CHF discovery and selection	15.3.0
2018-09	SP-81	SP-180721	0668	-	F	Correction to service name for UE Subscriber Data Update Notification	15.3.0
2018-09	SP-81	SP-180721	0670	1	F	Correction to the procedure of PFD Retrieval by the SMF	15.3.0
2018-09	SP-81	SP-180721	0671	2	F	Removal of Binding information storage in UDR	15.3.0
2018-09	SP-81	SP-180721	0673	2	F	Further corrections to identifiers in Registration procedure	15.3.0
2018-09	SP-81	SP-180721	0674	-	F	Correction to Configured NSSAI for the HPLMN	15.3.0
2018-09	SP-81	SP-180721	0675	1	F	Correction to emergency registered	15.3.0
2018-09	SP-81	SP-180721	0676	-	F	Correction of wrong reference	15.3.0
2018-09	SP-81	SP-180721	0678	1	F	Corrections to Service Request	15.3.0
2018-09	SP-81	SP-180721	0679	1	F	Core Network assistance information in N2 message	15.3.0
2018-09	SP-81	SP-180721	0682	3	F	Correction to unsubscribe the monitoring event for a group	15.3.0
2018-09	SP-81	SP-180721	0683	2	F	OAuth2 Authorization Service	15.3.0
2018-09	SP-81	SP-180721	0686	-	F	23.502: UDM Service Operations	15.3.0
2018-09	SP-81	SP-180721	0689	1	F	23.502: N2 Tracing Requirements	15.3.0
2018-09	SP-81	SP-180721	0690	2	F	23.502: AMF-AMF Tracing Requirements	15.3.0
2018-09	SP-81	SP-180721	0691	1	F	23.502: AUSF, UDM, UDR Discovery	15.3.0
2018-09	SP-81	SP-180721	0692	2	F	23.502: UE Context removal correction	15.3.0
2018-09	SP-81	SP-180721	0693	1	F	23.502: NRF in different domains	15.3.0
2018-09	SP-81	SP-180721	0694	4	F	Default IPsec tunnel for a PDU Session	15.3.0
2018-09	SP-81	SP-180721	0695	2	F	Clarification on List Of PDU Sessions To Be Activated	15.3.0
2018-09	SP-81	SP-180721	0697	3	F	Correction to Service Request QoS when changing between non-3GPP and 3GPP accesses	15.3.0
2018-09	SP-81	SP-180721	0699	4	F	Clarification for QoS flow associated with the default QoS rule	15.3.0
2018-09	SP-81	SP-180721	0702	3	F	Update to registration procedure with AMF relocation	15.3.0
2018-09	SP-81	SP-180721	0704	1	F	The interaction between AF and PCF	15.3.0
2018-09	SP-81	SP-180721	0705	2	F	Storage of UE Policy in VPLMN	15.3.0
2018-09	SP-81	SP-180721	0706	2	F	TS 23.502 Clarification on Namf_Communication_N2InfoNotify	15.3.0
2018-09	SP-81	SP-180722	0707	2	F	TS23.502 Removal of Nnef_PFDManagement_Create service operation	15.3.0
2018-09	SP-81	SP-180722	0708	-	F	Clarifications on Registration, UE triggered SR and UCU procedures	15.3.0
2018-09	SP-81	SP-180722	0709	2	F	Clarifications on Registration and SR procedures	15.3.0
2018-09	SP-81	SP-180722	0710	2	F	Update Registration procedures for SMS over NAS	15.3.0
2018-09	SP-81	SP-180722	0712	1	F	Correction on the PDN connection IE and S-NSSAI during 4G->5G interworking with N26.	15.3.0
2018-09	SP-81	SP-180722	0715	2	F	EBI allocation for interworking	15.3.0
2018-09	SP-81	SP-180722	0718	1	F	NGAP session management procedure handling	15.3.0
2018-09	SP-81	SP-180722	0720	-	F	Correction on security for interworking	15.3.0
2018-09	SP-81	SP-180722	0721	2	F	Registration triggered by UE Configuration Update	15.3.0
2018-09	SP-81	SP-180722	0722	2	F	UE Configuration for MM policy	15.3.0
2018-09	SP-81	SP-180722	0723	2	F	LMF Service Update	15.3.0
2018-09	SP-81	SP-180722	0724	3	F	Clarification on terminology in NF service framework procedures	15.3.0
2018-09	SP-81	SP-180722	0726	-	F	Update Network-initiated Deregistration	15.3.0
2018-09	SP-81	SP-180791	0714	2	F	Clarification on the AMF store the DNN and SMF+PGW-C to UDM+HSS without N26	15.3.0
2018-12	SP-82	SP-181088	0642	6	F	Handling of AMF registration in UDM for non-3GPP access	15.4.0

2018-12	SP-82	SP-181088	0643	1	F	Handling of Notify Request in EPC	15.4.0
2018-12	SP-82	SP-181091	0645	2	F	Use of Nudm service operations in EPS to 5GS mobility without N26	15.4.0
2018-12	SP-82	SP-181087	0652	3	F	Correction for Registration procedure for LADN – Triggering Condition	15.4.0
2018-12	SP-82	SP-181089	0661	4	F	IWK support for handover of PDU sessions without UP	15.4.0
2018-12	SP-82	SP-181091	0730	5	C	Update of Default Configured NSSAI and other UE parameters via Control Plane Solution from UDM to AMF with Direct NAS Transport to UE	15.4.0
2018-12	SP-82	SP-181090	0731	3	C	Support for partial ciphering of initial NAS messages	15.4.0
2018-12	SP-82	SP-181084	0734	2	F	Aligning Nnrf_NFManagement with 23.501 and stage 3, 29.510	15.4.0
2018-12	SP-82	SP-181084	0735	1	F	Aligning discovery with stage 3	15.4.0
2018-12	SP-82	SP-181084	0736	-	F	Alignment of AMF identity transfer in LCS procedures	15.4.0
2018-12	SP-82	SP-181088	0737	2	F	EPS Fallback, RAT Fallback and PCC	15.4.0
2018-12	SP-82	SP-181087	0738	1	F	Correction to UE context transfer upon registration via another access type	15.4.0
2018-12	SP-82	SP-181088	0739	3	F	Handover from 5GC-N3IWF to EPS	15.4.0
2018-12	SP-82	SP-181088	0740	3	F	Handover from EPC/ePDG to 5GS	15.4.0
2018-12	SP-82	SP-181088	0741	1	F	Corrections to EPS to 5GS mobility for idle-mode mobility	15.4.0
2018-12	SP-82	SP-181087	0742	3	F	Corrections to 5GS to EPS handover using N26	15.4.0
2018-12	SP-82	SP-181087	0743	3	F	Corrections to EPS to 5GS handover	15.4.0
2018-12	SP-82	SP-181084	0745	4	F	Npcf_EventExposure service for bulk subscription	15.4.0
2018-12	SP-82	SP-181088	0746	1	F	Interactions with PCF - Interworking	15.4.0
2018-12	SP-82	SP-181086	0749	1	F	Correcting the interaction needed for the NSSF service	15.4.0
2018-12	SP-82	SP-181087	0752	-	F	Correction on TAU during 5GS to EPS handover using N26 interface	15.4.0
2018-12	SP-82	SP-181089	0753	1	F	PCF interaction during IWK when UE is in EPS	15.4.0
2018-12	SP-82	SP-181085	0755	1	F	Clarification on signalling connection release condition in Registration procedure	15.4.0
2018-12	SP-82	SP-181085	0756	2	F	Clarification on PDU Session activation and deactivation	15.4.0
2018-12	SP-82	SP-181090	0757	2	F	TS23.502 Clarification on UE policy service and AM policy service	15.4.0
2018-12	SP-82	SP-181091	0759	1	F	Using TCP for reliable NAS transport between UE and N3IWF	15.4.0
2018-12	SP-82	SP-181090	0762	2	F	RRC Inactive state assistance information provisioning to NG-RAN	15.4.0
2018-12	SP-82	SP-181084	0765	1	F	Adding RAN Status Transfer to N2 HO	15.4.0
2018-12	SP-82	SP-181089	0767	5	F	Network controlled NSSAI for SR-related Access Stratum connection establishment	15.4.0
2018-12	SP-82	SP-181090	0768	1	F	Replace PCRF+PCF with PCF in interworking with EPC scenarios	15.4.0
2018-12	SP-82	SP-181089	0770	1	F	Priority indication over SBA interfaces via Message Priority header	15.4.0
2018-12	SP-82	SP-181086	0772	-	F	Correcting known consumers of Namf service	15.4.0
2018-12	SP-82	SP-181091	0773	2	F	Updates from UEPolicyControl introduction	15.4.0
2018-12	SP-82	SP-181090	0774	1	F	Secondary Re-authentication update	15.4.0
2018-12	SP-82	SP-181085	0775	3	F	Clarification on interworking with N26 interface	15.4.0
2018-12	SP-82	SP-181087	0777	1	F	Correction to the monitoring event subscription to a group	15.4.0
2018-12	SP-82	SP-181087	0779	1	F	Correction to UE Policy Association procedure	15.4.0
2018-12	SP-82	SP-181086	0782	5	F	Clarification on the delivery of EBI to UE and RAN	15.4.0
2018-12	SP-82	SP-181085	0783	4	F	CHF Selection	15.4.0
2018-12	SP-82	SP-181084	0784	1	F	AF subscribed events	15.4.0
2018-12	SP-82	SP-181087	0785	2	F	Correction to AM Policy Association Termination in registration procedure	15.4.0
2018-12	SP-82	SP-181084	0786	3	F	Alignment for always-on PDU sessions	15.4.0
2018-12	SP-82	SP-181084	0788	-	F	Adding Subscribed DNN list in Access and Mobility subscription data	15.4.0
2018-12	SP-82	SP-181088	0790	4	F	EPS Interworking: Single versus Dual Registration with the UDM	15.4.0
2018-12	SP-82	SP-181088	0791	1	F	EPS bearer mapping for 5GS to EPS mobility with N26	15.4.0
2018-12	SP-82	SP-181090	0792	1	F	Registration Procedure – fix UDM registration	15.4.0
2018-12	SP-82	SP-181086	0793	3	F	Clarification on the PDU Session handover procedure with the User Plane Security Enforcement	15.4.0
2018-12	SP-82	SP-181091	0795	3	F	Update the UCU procedure with operator-defined access category definitions	15.4.0
2018-12	SP-82	SP-181086	0796	1	F	Clarification on the AMF store the DNN and SMF+PGW-C to UDM+HSS	15.4.0
2018-12	SP-82	SP-181088	0799	2	F	Efficient delivery of UE Policies	15.4.0
2018-12	SP-82	SP-181091	0800	1	F	Update the general description of Nnef_PFDManagement service	15.4.0
2018-12	SP-82	SP-181089	0801	1	F	Monitoring input parameter correction	15.4.0
2018-12	SP-82	SP-181091	0802	1	F	Update of SMS service operation parameters for 3GPP specific encoding	15.4.0
2018-12	SP-82	SP-181089	0803	-	F	NRF Service Update	15.4.0
2018-12	SP-82	SP-181087	0806	4	F	Correction of UE Configuration Update	15.4.0
2018-12	SP-82	SP-181088	0807	1	F	Handling of NF location during discovery	15.4.0
2018-12	SP-82	SP-181088	0808	1	F	Corrections to event exposure information flows and Nudm_EventExposure service description	15.4.0
2018-12	SP-82	SP-181089	0809	2	C	MCS Access and Mobility Subscription Data	15.4.0
2018-12	SP-82	SP-181089	0813	1	F	PDU Session Modification due to QoS Flow creation	15.4.0
2018-12	SP-82	SP-181090	0814	2	F	SMF storing FQDN for the S5/S8 interface of the SMF+PGW-C for N3GPP PDU Session	15.4.0



2018-12	SP-82	SP-181088	0815	2	F	Handling of N3GPP access registration in interworking between EPS and 5GS using N26.	15.4.0
2018-12	SP-82	SP-181090	0816	2	F	UE Identifier provided during Registration Procedure	15.4.0
2018-12	SP-82	SP-181090	0817	1	F	Selective deactivation for always-on PDU sessions	15.4.0
2018-12	SP-82	SP-181084	0818	3	F	5G-TMSI reallocation and RRC Inactive	15.4.0
2018-12	SP-82	SP-181089	0819	1	F	QoS Flow deletion	15.4.0
2018-12	SP-82	SP-181090	0823	1	F	Registration procedure with different Registration types	15.4.0
2018-12	SP-82	SP-181088	0824	2	F	EPS to 5GS with network slices	15.4.0
2018-12	SP-82	SP-181084	0825	3	F	AUSF and UDM selection in 5GC NFs	15.4.0
2018-12	SP-82	SP-181090	0827	3	F	Registration procedure updates due to UE Policy Control Service	15.4.0
2018-12	SP-82	SP-181088	0828	1	F	Include GPSI in Npcf-SMPolicyControl Create message	15.4.0
2018-12	SP-82	SP-181085	0830	2	F	Clarification on DNN not subscribed in AMF	15.4.0
2018-12	SP-82	SP-181085	0831	-	F	Clarification on ANDSP support indication in UE Policy Container	15.4.0
2018-12	SP-82	SP-181085	0832	1	F	Clarification on rejected S-NSSAIs and cause in Registration and UCU procedure	15.4.0
2018-12	SP-82	SP-181085	0835	1	F	Clarification on Event Reporting information for Npcf_PolicyAuthorization service	15.4.0
2018-12	SP-82	SP-181086	0836	1	F	Clarification on UE Policy Control Request Triggers	15.4.0
2018-12	SP-82	SP-181087	0837	1	F	Correction to interworking procedures without N26	15.4.0
2018-12	SP-82	SP-181089	0838	-	F	Indirect forwarding timer for N2 HO	15.4.0
2018-12	SP-82	SP-181085	0841	1	F	Clarification on Registration with AMF re-allocation	15.4.0
2018-12	SP-82	SP-181089	0842	1	F	PDN Disconnection handling	15.4.0
2018-12	SP-82	SP-181086	0843	2	F	Clarification on SMF registration to UDM+HSS	15.4.0
2018-12	SP-82	SP-181089	0845	1	F	OSID storage	15.4.0
2018-12	SP-82	SP-181085	0846	1	F	Clarification on PDU Session procedures (AMF awareness of N2 information type)	15.4.0
2018-12	SP-82	SP-181085	0847	1	F	Clarification on ID provision to RAN in registration procedure	15.4.0
2018-12	SP-82	SP-181088	0848	-	F	Deletion of AN tunnel info from Handover Notify message in the EPS-to-5GS handover procedure	15.4.0
2018-12	SP-82	SP-181090	0849	-	F	Removal of PPI from N2 SM information	15.4.0
2018-12	SP-82	SP-181087	0850	1	F	Correction to handover from EPS to 5GS	15.4.0
2018-12	SP-82	SP-181089	0852	1	F	Non-accepted PDU session in N2 based HO	15.4.0
2018-12	SP-82	SP-181086	0854	2	F	Clarification on the PDN connection release during N26 mobility	15.4.0
2018-12	SP-82	SP-181090	0857	-	F	Storing SMSF address in the UDR	15.4.0
2018-12	SP-82	SP-181084	0859	2	F	Addition of URRP in UE context in the MM context	15.4.0
2018-12	SP-82	SP-181088	0860	1	F	Event subscription clarification	15.4.0
2018-12	SP-82	SP-181085	0861	1	F	Charging related information in Nsmf_PDUSession_Create service operation	15.4.0
2018-12	SP-82	SP-181087	0862	1	F	Correction to network requested PDU Session Release due to a change of the set of network slices for a UE	15.4.0
2018-12	SP-82	SP-181088	0863	-	B	Data Volume Reporting for Option 4/7 - Procedure updates	15.4.0
2019-01	-	-	-	-	-	Editorial correction to replace '-' with 'o' due to CR implementation error.	15.4.1
2019-03	SP-83	SP-190157	0868	1	F	Avoiding unnecessary authentication for SR-mode UEs during EPS-5GS mobility	15.5.0
2019-03	SP-83	SP-190157	0869	3	F	PDU Session Release with User Plane Deactivated	15.5.0
2019-03	SP-83	SP-190157	0870	1	F	DL Data Buffering in the SMF for the PDU Session with UP Deactivated	15.5.0
2019-03	SP-83	SP-190157	0871	4	F	Registration Procedure Update with Inter PLMN AMF Reallocation	15.5.0
2019-03	SP-83	SP-190157	0873	1	F	Data Types for parameters within UE Parameter Update via Control Plane Solution	15.5.0
2019-03	SP-83	SP-190157	0874	1	F	Adding SM Context ID in relevant clauses	15.5.0
2019-03	SP-83	SP-190157	0876	1	F	Corrections to N4 procedure for PFD management	15.5.0
2019-03	SP-83	SP-190157	0879	1	F	Support of piggybacking of NAS SM message while configuring a DRB	15.5.0
2019-03	SP-83	SP-190157	0880	1	F	SMF register in UDM	15.5.0
2019-03	SP-83	SP-190157	0881	3	F	Alignment with stage 3 for EPS interworking indications	15.5.0
2019-03	SP-83	SP-190157	0884	-	F	Correction to UECM_Update service operation for status change of EPS interworking support	15.5.0
2019-03	SP-83	SP-190157	0886	6	F	EBI allocation when access type of PDU Session is changed from N3GPP to 3GPP. Revocation of EBI when access type of PDU Session is changed from 3GPP to N3GPP	15.5.0
2019-03	SP-83	SP-190157	0888	3	F	Remove PEI from the required input of Npcf_AMPolicyControl service operations	15.5.0
2019-03	SP-83	SP-190157	0889	2	F	Correction to UE parameters update procedure	15.5.0
2019-03	SP-83	SP-190157	0893	1	F	Clarification on Policy related procedures	15.5.0
2019-03	SP-83	SP-190157	0901	-	F	AMF awareness of N2 information type (LMF case)	15.5.0
2019-03	SP-83	SP-190157	0904	1	F	List of equivalent PLMNs in Registration accept missing	15.5.0
2019-03	SP-83	SP-190157	0907	2	F	Retrieval of Policy Control Subscription information for validation of URSP rules	15.5.0
2019-03	SP-83	SP-190157	0909	1	F	Events subscribed using the Npcf_PolicyAuthorization Service	15.5.0
2019-03	SP-83	SP-190157	0910	2	F	Correction to the Initial NAS message protection	15.5.0

2019-03	SP-83	SP-190157	0911	-	F	Remove BSF from the UDR consumer list	15.5.0
2019-03	SP-83	SP-190157	0913	-	F	Add AMF as consumer for UpdateNotify Service Operation for Npcf_UEPolicyControl Service	15.5.0
2019-03	SP-83	SP-190157	0914	1	F	Corrections to UE Policy Association Establishment procedure	15.5.0
2019-03	SP-83	SP-190157	0915	1	F	Corrections to UE Policy Association Modification initiated by the AMF procedure	15.5.0
2019-03	SP-83	SP-190157	0916	-	F	Corrections to UE Policy Association Modification initiated by the PCF procedure	15.5.0
2019-03	SP-83	SP-190158	0923	6	F	Procedure for DN authorization profile index	15.5.0
2019-03	SP-83	SP-190158	0925	1	F	Correction on current HO procedures	15.5.0
2019-03	SP-83	SP-190158	0927	1	F	Presence of Reference ID in Location Reporting Control	15.5.0
2019-03	SP-83	SP-190158	0930	1	F	Clarification on missing condition of UE Policy Association Establishment	15.5.0
2019-03	SP-83	SP-190158	0933	2	F	Network Slice update clarification	15.5.0
2019-03	SP-83	SP-190158	0934	3	F	Clarification on Mobility Restriction	15.5.0
2019-03	SP-83	SP-190158	0935	2	F	Clarification of the PDU Session establishment and release procedure	15.5.0
2019-03	SP-83	SP-190158	0936	-	F	IP address/Prefix(es) kept for 5G to 4G mobility	15.5.0
2019-03	SP-83	SP-190158	0939	1	F	Correction on UE policy delivery	15.5.0
2019-03	SP-83	SP-190158	0943	1	F	Correction to UE initiated service request procedure	15.5.0
2019-03	SP-83	SP-190158	0944	1	F	Correction to Xn handover for network sharing	15.5.0
2019-03	SP-83	SP-190158	0947	-	F	Clarification on the UE Capability Match Request procedure	15.5.0
2019-03	SP-83	SP-190158	0953	1	F	Correcting references for routing rules configuration	15.5.0
2019-03	SP-83	SP-190158	0954	-	F	Correction for EPS to 5GS Mobility	15.5.0
2019-03	SP-83	SP-190158	0956	1	F	Correction on monitoring event for 'availability after DDN failure'.	15.5.0
2019-03	SP-83	SP-190158	0960	3	F	Fixes for DC secondary RAT charging report procedure	15.5.0
2019-03	SP-83	SP-190158	0961	1	F	Selection of a combo PGW+SMF at EPC attachment via WLAN access	15.5.0
2019-03	SP-83	SP-190158	0981	4	F	Correction of the handling of QoS flows at 5GS to EPS mobility	15.5.0
2019-03	SP-83	SP-190158	0982	1	F	UE presence in restricted area indication during inter NG-RAN node N2 based handover	15.5.0
2019-03	SP-83	SP-190158	0988	1	F	Correction for Annex C	15.5.0
2019-03	SP-83	SP-190158	0995	2	F	Informing EPS about Emergency case during Emergency Service Fallback	15.5.0
2019-03	SP-83	SP-190158	0996	-	F	Corrections to PDUSession_SMContextStatusNotify and PDUSession_StatusNotify	15.5.0
2019-03	SP-83	SP-190158	0997	2	F	Corrections to N3GPP handover scenarios	15.5.0
2019-03	SP-83	SP-190158	1000	-	F	UE Identity during the Registration procedure	15.5.0
2019-03	SP-83	SP-190158	1006	2	F	Clarification on Location continuity for handover of emergency session	15.5.0
2019-03	SP-83	SP-190159	1010	4	F	Correction of the change of access in home routed roaming scenario	15.5.0
2019-03	SP-83	SP-190159	1025	2	F	Correction on UE Requested PDU Session Establishment for Home Routed roaming	15.5.0
2019-03	SP-83	SP-190159	1030	4	F	UE Configuration Update Procedure Correction	15.5.0
2019-03	SP-83	SP-190159	1032	2	F	Handling proposal in case of UPF selection failure	15.5.0
2019-03	SP-83	SP-190159	1034	1	F	Correction to Exposure with bulk subscription procedure	15.5.0
2019-03	SP-83	SP-190159	1037	3	F	Slice interworking HR mode update	15.5.0
2019-03	SP-83	SP-190159	1038	2	F	Clarification on UE Behaviour for PDN Connection Handover Failure to 5GS	15.5.0
2019-03	SP-83	SP-190159	1042	1	F	UE identifier during Initial Registration	15.5.0
2019-03	SP-83	SP-190159	1045	-	F	Target ID in Nsmf_PDUSession_CreateSMContext for EPS to 5GS handover	15.5.0
2019-03	SP-83	SP-190159	1063	1	F	Correction the terms on Secondary authentication/authorization of the PDU Session Establishment	15.5.0
2019-03	SP-83	SP-190159	1065	1	F	Xn based handover with I-UPF insertion	15.5.0
2019-03	SP-83	SP-190159	1067	3	F	EPS bearer synchronization when move from EPC to 5GC(UE deletes the bearer locally)	15.5.0
2019-03	SP-83	SP-190159	1069	2	F	Register SMF+PGW-C to HSS+UDM	15.5.0
2019-03	SP-83	SP-190159	1075	2	F	Clarification on missing condition of UE Policy Association Termination	15.5.0
2019-03	SP-83	SP-190159	1076	1	F	Clarification on missing condition of AM Policy Association Establishment and Termination	15.5.0
2019-03	SP-83	SP-190159	1084	1	F	Correction on SMSF address registration in UDM	15.5.0
2019-03	SP-83	SP-190159	1087	1	F	Clarification on NG-RAN behaviour on Periodic RNAU procedure	15.5.0
2019-03	SP-83	SP-190159	1088	2	F	Clarification on PDU Session modification and release procedure	15.5.0
2019-03	SP-83	SP-190159	1099	1	F	Corrections on routing rule	15.5.0
2019-03	SP-83	SP-190159	1100	-	F	Correction to AM policy association related procedure	15.5.0
2019-03	SP-83	SP-190159	1101	3	F	Correction to policy related definition in the registration procedure	15.5.0
2019-03	SP-83	SP-190159	1103	1	F	EPS Fallback Initial Context Setup	15.5.0
2019-03	SP-83	SP-190159	1108	1	F	Update the procedure for the change of SSC mode 3 PDU Session Anchor with multiple PDU sessions	15.5.0

2019-03	SP-83	SP-190230	1119	-	F	Removal of UPF_Management Service	15.5.0
2019-03	SP-83	SP-190173	0866	9	B	Introduction of ATSSS Procedures including Multi-Access PDU Session Establishment	16.0.0
2019-03	SP-83	SP-190166	0872	3	B	Small Data over NAS PDU Session Management	16.0.0
2019-03	SP-83	SP-190171	0877	6	B	Procedure updates for solution 1 in 23.725 for user plane redundancy	16.0.0
2019-03	SP-83	SP-190171	0878	2	B	Procedure for solution 11 in 23.725 for Ethernet anchor relocation	16.0.0
2019-03	SP-83	SP-190167	0894	2	B	Procedures for Trusted Non-3GPP Access	16.0.0
2019-03	SP-83	SP-190199	0895	1	F	eNS IDLE mobility	16.0.0
2019-03	SP-83	SP-190174	0903	2	B	eSBA communication schemas related to discovery and selection	16.0.0
2019-03	SP-83	SP-190171	0905	2	B	Update procedure of 23.502 to adopt solution 4 in 23.725	16.0.0
2019-03	SP-83	SP-190171	0906	2	B	Introduction of TR 23.725 solution 6 for UL CL relocation	16.0.0
2019-03	SP-83	SP-190166	0918	4	B	Procedures for CIoT Management of Enhanced Coverage	16.0.0
2019-03	SP-83	SP-190166	0924	2	B	Introduction of the MSISDN-less MO SMS Service	16.0.0
2019-03	SP-83	SP-190166	0928	3	B	Enhance Idle mode mobility using N26 interface procedure to support NAS-SM data transfer via SCEF+NEF	16.0.0
2019-03	SP-83	SP-190172	0929	3	B	Adding reference to new TS 23.288 in TS 23.502	16.0.0
2019-03	SP-83	SP-190168	0932	2	F	Update to LCS related definitions	16.0.0
2019-03	SP-83	SP-190164	0937	2	B	Procedures related to ETSUN	16.0.0
2019-03	SP-83	SP-190166	0942	3	B	Extended connected time value for enhancing MICO mode	16.0.0
2019-03	SP-83	SP-190162	0946	2	B	Adding 5G SRVCC description to 23.502	16.0.0
2019-03	SP-83	SP-190174	0957	5	B	eSBA communication schema Model C	16.0.0
2019-03	SP-83	SP-190170	0962	3	B	NEF service for service specific parameter provisioning	16.0.0
2019-03	SP-83	SP-190166	0964	4	B	Procedures for solution 14 to key issue 9	16.0.0
2019-03	SP-83	SP-190164	0967	2	B	KI-#5 specific AF influence on traffic routing	16.0.0
2019-03	SP-83	SP-190174	0968	4	B	Bindings between the consumer and producer	16.0.0
2019-03	SP-83	SP-190172	0970	5	B	Use of analytics for background data transfer	16.0.0
2019-03	SP-83	SP-190166	0971	8	B	Introduction of small data transfer in Control Plane CIoT 5GS Optimisation	16.0.0
2019-03	SP-83	SP-190166	0972	10	B	Procedure of NEF based Non-IP Data Delivery	16.0.0
2019-03	SP-83	SP-190166	0973	2	B	Expected UE Behaviour parameters for CIoT	16.0.0
2019-03	SP-83	SP-190166	0974	5	B	MICO Mode Management for Expected Application Behaviour	16.0.0
2019-03	SP-83	SP-190166	0975	2	B	Procedures for Inter-RAT mobility support to and from NB-IoT	16.0.0
2019-03	SP-83	SP-190166	0976	2	B	CIoT Procedures for CN Selection and Steering	16.0.0
2019-03	SP-83	SP-190166	0977	5	B	External parameters provisioning to the 5GS	16.0.0
2019-03	SP-83	SP-190166	0978	4	B	Extend existing procedures for external parameters provisioning in 5GS	16.0.0
2019-03	SP-83	SP-190169	0987	2	B	5GLAN group management procedures	16.0.0
2019-03	SP-83	SP-190172	0992	2	B	Update of TS 23.502 for BDT notification	16.0.0
2019-03	SP-83	SP-190173	0993	1	B	Updates to Nnrf services to include MA PDU session capability	16.0.0
2019-03	SP-83	SP-190171	1001	2	B	PDU Session Management Procedure to support URLLC	16.0.0
2019-03	SP-83	SP-190166	1002	2	B	Session Management Procedure for Control Plane CIoT 5GS Optimisation	16.0.0
2019-03	SP-83	SP-190164	1003	2	B	Nsmf_PDUSession_ContextRequest service operation Update	16.0.0
2019-03	SP-83	SP-190167	1009	2	B	PDU Session establishment for Trusted Non-3GPP Access	16.0.0
2019-03	SP-83	SP-190172	1013	3	B	Addition of Event Reporting Information Parameters for network data analytics	16.0.0
2019-03	SP-83	SP-190166	1015	2	F	Application function notification of downlink data delivery status (HLCom)	16.0.0
2019-03	SP-83	SP-190166	1016	2	F	Including MICO with Extended Connected time in relevant procedures	16.0.0
2019-03	SP-83	SP-190166	1017	2	B	Introducing eDRX parameters to procedures	16.0.0
2019-03	SP-83	SP-190193	1023	2	B	TS 23.502: Introducing Non-public network - CAG	16.0.0
2019-03	SP-83	SP-190169	1024	2	B	TS 23.502: Introducing Non-public network	16.0.0
2019-03	SP-83	SP-190175	1027	2	B	Support PDN type Ethernet at 5GS to EPS mobility with N26	16.0.0
2019-03	SP-83	SP-190167	1039	2	B	Support of full Frame Routing feature	16.0.0
2019-03	SP-83	SP-190168	1043	2	F	LCS Event Exposure using NEF	16.0.0
2019-03	SP-83	SP-190168	1046	-	F	Remove LMF Service Descriptions	16.0.0
2019-03	SP-83	SP-190166	1055	2	B	Support for Reliable Data Service	16.0.0
2019-03	SP-83	SP-190164	1056	1	B	Addition of UE IP address Allocation by UPF	16.0.0
2019-03	SP-83	SP-190172	1060	2	B	NEF service for NWDAF analytics	16.0.0
2019-03	SP-83	SP-190171	1064	2	B	Update HO procedure of 23.502 to adopt solution 4 in 23.725	16.0.0
2019-03	SP-83	SP-190164	1071	4	B	ETSUN: N2 based handover procedures	16.0.0
2019-03	SP-83	SP-190164	1072	3	B	ETSUN: UL CL/BP Insertion, AN release, Selective deactivation procedures	16.0.0
2019-03	SP-83	SP-190199	1074	1	B	eNS: Update handover from 4G to 5G via N26	16.0.0
2019-03	SP-83	SP-190167	1078	2	B	UDM data for wireline access characteristics	16.0.0
2019-03	SP-83	SP-190172	1080	2	B	CR for TS 23.502 Updating NRF Services	16.0.0
2019-03	SP-83	SP-190164	1092	2	B	ETSUN Xn handover	16.0.0
2019-03	SP-83	SP-190162	1093	1	B	Adding AMF reporting UE SRVCC capability	16.0.0

2019-03	SP-83	SP-190171	1107	3	B	Activating UP path based on AF response	16.0.0
2019-03	SP-83	SP-190166	1110	2	B	Procedures for Service Gap Control	16.0.0
2019-03	SP-83	SP-190166	1115	2	B	Procedure of availability after DDN failure notification for multiple AFs	16.0.0
2019-03	SP-83	SP-190171	1116	3	B	Updates to 4.3.6, based on TR Sol#13	16.0.0
2019-04	-	-	-	-	-	MCC editorial style and formatting corrections	16.0.1
2019-04	-	-	-	-	-	MCC correction moving clause 4.21.2 to 4.17.11 and renaming clause 4.17.11 to 4.17.12 for readability purposes	16.0.2
2019-06	SP-84	SP-190420	0979	5	B	Adding network status exposure capability with optional use of analytics	16.1.0
2019-06	SP-84	SP-190410	1073	4	F	eSBA NF Registration via SCP	16.1.0
2019-06	SP-84	SP-190408	1111	2	B	Introduction of inter-UE QoS differentiation for NB-IoT using NB-IoT UE Priority	16.1.0
2019-06	SP-84	SP-190410	1120	9	F	Resolving the EN in Bindings between the consumer and producer	16.1.0
2019-06	SP-84	SP-190416	1124	7	B	Update ATSSS performance measurement Procedures	16.1.0
2019-06	SP-84	SP-190425	1128	3	B	Introduction of RACS: UCMF services	16.1.0
2019-06	SP-84	SP-190419	1129	1	B	SMF discovery of P-CSCF	16.1.0
2019-06	SP-84	SP-190419	1130	3	B	HSS instances registration and discovery in NRF	16.1.0
2019-06	SP-84	SP-190420	1131	3	F	Correction for background data transfer in TS 23.502	16.1.0
2019-06	SP-84	SP-190400	1133	2	A	Corrections of Npcf_UEPolicyControl Service	16.1.0
2019-06	SP-84	SP-190400	1135	4	A	UE Policy association procedures correction	16.1.0
2019-06	SP-84	SP-190408	1136	2	C	Header Compression for CP Clot 5GS Optimisation	16.1.0
2019-06	SP-84	SP-190412	1138	5	B	UP connection Deactivation for URLLC PDU Session	16.1.0
2019-06	SP-84	SP-190420	1140	6	B	Removal of Editor's note and update the specification for BDT warning notification in TS 23.502	16.1.0
2019-06	SP-84	SP-190422	1141	5	B	Transfer of N4 information for local traffic switching from SMF to I-SMF	16.1.0
2019-06	SP-84	SP-190430	1144	1	F	Procedure updates for 5G LAN group management	16.1.0
2019-06	SP-84	SP-190413	1145	2	F	SMF determining support of Ethernet PDN Type	16.1.0
2019-06	SP-84	SP-190400	1148	-	A	Corrections to procedure of 5GS to EPS Mobility without N26	16.1.0
2019-06	SP-84	SP-190413	1149	2	F	SMF determining EPS interworking support	16.1.0
2019-06	SP-84	SP-190400	1150	2	C	EPS interworking support indication from AMF to SMF for N3GPP PDU Session	16.1.0
2019-06	SP-84	SP-190406	1151	2	F	PFD provisioning procedure	16.1.0
2019-06	SP-84	SP-190410	1152	-	F	Network Slicing and delegated discovery	16.1.0
2019-06	SP-84	SP-190400	1156	2	A	Remove note on skipping subscription for UE Policy Delivery Result	16.1.0
2019-06	SP-84	SP-190415	1158	2	B	Registration Procedure Update for Trusted non-3GPP access	16.1.0
2019-06	SP-84	SP-190416	1161	2	F	Clarification on MA PDU Session Establishment for HR roaming	16.1.0
2019-06	SP-84	SP-190408	1164	2	F	TS23.502, Clarification of header compression and other editorial update	16.1.0
2019-06	SP-84	SP-190400	1167	3	A	Correction to N2 AMF Mobility Request	16.1.0
2019-06	SP-84	SP-190410	1168	2	F	Update of NRF services for supporting indirect communication	16.1.0
2019-06	SP-84	SP-190412	1171	1	F	Correction to the user plane redundancy handling	16.1.0
2019-06	SP-84	SP-190410	1172	1	F	NF/NF service status subscribe/notify update	16.1.0
2019-06	SP-84	SP-190415	1173	1	B	Session binding information in wireline access	16.1.0
2019-06	SP-84	SP-190419	1174	1	B	Support for IMS functionality using Npcf services	16.1.0
2019-06	SP-84	SP-190416	1176	-	B	Adding ATSSS steering capabilities to UPF provisioning information	16.1.0
2019-06	SP-84	SP-190408	1179	3	B	MTC Provider Information clarification	16.1.0
2019-06	SP-84	SP-190408	1180	1	B	NEF based NIDD procedure with home routed traffic	16.1.0
2019-06	SP-84	SP-190408	1182	2	C	Report count per Event type	16.1.0
2019-06	SP-84	SP-190408	1183	2	B	Service Gap corrections	16.1.0
2019-06	SP-84	SP-190408	1184	7	B	Updates of CP and UP Clot 5GS optimisation procedures	16.1.0
2019-06	SP-84	SP-190415	1185	2	F	PDU Session establishment and modification via trusted non-3GPP access	16.1.0
2019-06	SP-84	SP-190416	1190	2	F	UE Requested PDU Session Establishment with Network Modification to MA PDU Session	16.1.0
2019-06	SP-84	SP-190427	1191	1	F	Correction of not resolved non-normative statements	16.1.0
2019-06	SP-84	SP-190409	1194	-	B	Extension of AMF Services Operations for eLCS	16.1.0
2019-06	SP-84	SP-190409	1196	4	B	UDM SM Data for eLCS	16.1.0
2019-06	SP-84	SP-190400	1198	1	A	Correction to the provisioning of the UE Integrity Protection Data Rate capability	16.1.0
2019-06	SP-84	SP-190427	1202	2	F	S-NSSAIs of UE Context transfer during inter PLMN mobility	16.1.0
2019-06	SP-84	SP-190412	1203	5	C	Update procedures related to redundant transmission	16.1.0
2019-06	SP-84	SP-190400	1207	1	A	Add missing description on UE Policy Information	16.1.0
2019-06	SP-84	SP-190400	1209	1	A	Correction to UCU procedure and Policy related service	16.1.0
2019-06	SP-84	SP-190400	1214	1	F	Clarification on PDU Session deactivation	16.1.0
2019-06	SP-84	SP-190416	1215	6	B	PDU Session Modification for ATSSS	16.1.0
2019-06	SP-84	SP-190416	1216	2	B	Registration and Service Request for ATSSS	16.1.0
2019-06	SP-84	SP-190416	1217	1	B	PDU Session Release for ATSSS	16.1.0
2019-06	SP-84	SP-190408	1223	-	B	Update to NIDD configuration service and procedures	16.1.0

2019-06	SP-84	SP-190421	1224	5	B	Slice Specific Authentication and Authorization with multiple registrations in the same PLMN	16.1.0
2019-06	SP-84	SP-190400	1225	1	A	Clarification on Mobility Restriction	16.1.0
2019-06	SP-84	SP-190427	1226	1	F	Correction to UE Activity Procedure	16.1.0
2019-06	SP-84	SP-190400	1227	1	A	EPS bearer synchronization when move from EPC to 5GC(Network deletes bearer locally)	16.1.0
2019-06	SP-84	SP-190400	1228	3	A	Resource released at the V-SMF/V-UPF	16.1.0
2019-06	SP-84	SP-190400	1229	1	A	Correction to EPS to 5GS mobility procedure without N26	16.1.0
2019-06	SP-84	SP-190422	1230	1	B	LADN PDU Session handling in ETSUN scenario	16.1.0
2019-06	SP-84	SP-190421	1231	5	B	eNS IDLE mobility for AMF reallocation	16.1.0
2019-06	SP-84	SP-190408	1232	1	F	Update to NIDD delivery service and procedures	16.1.0
2019-06	SP-84	SP-190408	1233	2	B	Adding NIDD authorization update service and procedures	16.1.0
2019-06	SP-84	SP-190408	1234	1	B	Adding NIDD SMF-NEF Connection Release service and procedures	16.1.0
2019-06	SP-84	SP-190427	1236	1	F	Correction on unsuccessful MT SMS delivery attempt and UE Activity Notification	16.1.0
2019-06	SP-84	SP-190422	1237	7	B	I-SMF relocation with I-UPF as an ULCL or BP	16.1.0
2019-06	SP-84	SP-190420	1239	1	B	Adding NF load information inside NFprofile	16.1.0
2019-06	SP-84	SP-190400	1243	1	F	Correction on Non-3GPP Registration procedure	16.1.0
2019-06	SP-84	SP-190401	1245	2	A	Correction for 5GS AM Policy Framework	16.1.0
2019-06	SP-84	SP-190401	1247	2	A	Correction for 5GS SM Policy Framework	16.1.0
2019-06	SP-84	SP-190401	1249	2	A	Correction for 5GS UE Policy Framework	16.1.0
2019-06	SP-84	SP-190401	1251	3	A	Clarification on the PDU session re-establish without N26	16.1.0
2019-06	SP-84	SP-190401	1253	4	A	Clarification on the 5G to 4G idle mobility with N26 for sync	16.1.0
2019-06	SP-84	SP-190420	1256	6	B	CR for adding Naf_EventExposure services	16.1.0
2019-06	SP-84	SP-190430	1258	9	B	Provisioning of 5G LAN group configuration parameters	16.1.0
2019-06	SP-84	SP-190410	1260	2	F	Indirect communication without delegated discovery - corrections	16.1.0
2019-06	SP-84	SP-190531	1262	1	A	Correcting AMF behaviour for Service Request that is not integrity protected	16.1.0
2019-06	SP-84	SP-190413	1263	3	F	Registration Update with complete attach	16.1.0
2019-06	SP-84	SP-190408	1264	-	F	Correction to the NIDD Configuration procedure	16.1.0
2019-06	SP-84	SP-190412	1265	2	C	Update PDU Session Establishment procedure regarding solution 4 in 23.725	16.1.0
2019-06	SP-84	SP-190413	1278	3	F	Corrections on some MM procedures	16.1.0
2019-06	SP-84	SP-190401	1279	5	A	SMF actions on rejection of PDU Session session or QoS flows during Handover and Service Request procedures	16.1.0
2019-06	SP-84	SP-190408	1282	2	F	Correction of NEF service operation information flow	16.1.0
2019-06	SP-84	SP-190408	1285	1	B	Service Gap Control Capability Indication in UE's MM Core Network Capability	16.1.0
2019-06	SP-84	SP-190408	1286	5	F	Correction of Control Plane Clot 5GS Optimisation	16.1.0
2019-06	SP-84	SP-190422	1289	4	B	Removal invalid NOTE in Registration procedure	16.1.0
2019-06	SP-84	SP-190410	1292	5	F	SCP and NRF interaction	16.1.0
2019-06	SP-84	SP-190412	1294	2	F	Clarification on Nsmf_EventExposure_AppRelocationInfo service operation	16.1.0
2019-06	SP-84	SP-190401	1296	3	A	Correction to change of SSC mode 3 PDU session anchor	16.1.0
2019-06	SP-84	SP-190420	1298	3	C	Updating TS 23.502 with extensions to NRF Services	16.1.0
2019-06	SP-84	SP-190427	1302	-	F	NW Slicing Subscription Change Indication during AMF Relocation	16.1.0
2019-06	SP-84	SP-190410	1305	8	B	NF Service Context Transfer Procedures	16.1.0
2019-06	SP-84	SP-190408	1306	4	B	Extended buffering for HLCom	16.1.0
2019-06	SP-84	SP-190404	1307	3	A	Updating LCS procedures for location reporting for multiple cells	16.1.0
2019-06	SP-84	SP-190401	1309	-	A	Removing unnecessary PDU release during inter-system handover	16.1.0
2019-06	SP-84	SP-190413	1310	1	C	Introduce Nbsf_Management_Update service operation	16.1.0
2019-06	SP-84	SP-190425	1313	1	B	Introducing RACS for handover procedure	16.1.0
2019-06	SP-84	SP-190430	1316	1	C	Network sharing aspects for SNPNS	16.1.0
2019-06	SP-84	SP-190401	1318	1	A	AF session with required QoS procedure	16.1.0
2019-06	SP-84	SP-190417	1321	1	C	Adding Support for Indicating Serialization Format in RDS	16.1.0
2019-06	SP-84	SP-190412	1323	1	F	Generalized text for redundant user planes in RAN	16.1.0
2019-06	SP-84	SP-190413	1324	3	C	DNN replacement	16.1.0
2019-06	SP-84	SP-190410	1325	3	B	SMF context transfer	16.1.0
2019-06	SP-84	SP-190410	1326	1	F	NF Set ID, NF Service Set ID in 23.502	16.1.0
2019-06	SP-84	SP-190413	1328	3	F	Serving 4G only UEs by SMF+PGW-C	16.1.0
2019-06	SP-84	SP-190420	1329	1	C	Adding new event in Namf_EventExposure for Network Performance Analysis	16.1.0
2019-06	SP-84	SP-190401	1331	2	A	Corrections to 3GPP and N3GPP Emergency Sessions Handover Procedures	16.1.0
2019-06	SP-84	SP-190422	1339	1	C	I-SMF notification of Access Type change to the SMF	16.1.0
2019-06	SP-84	SP-190422	1340	-	C	Service area of SMF(s) not transferred between AMF(s)	16.1.0
2019-06	SP-84	SP-190418	1342	2	C	S6b optional for ePDG connected to 5GS	16.1.0
2019-06	SP-84	SP-190401	1344	-	A	Release EPS bearer resources in SGW when EPS to 5GS handover finished	16.1.0
2019-06	SP-84	SP-190408	1345	2	F	Correction to the Release Assistance Information use	16.1.0

2019-06	SP-84	SP-190401	1349	1	A	Correction to the provisioning of the Number Of Packet Filters	16.1.0
2019-06	SP-84	SP-190425	1350	2	B	Introduction of RACS	16.1.0
2019-06	SP-84	SP-190430	1351	2	F	Adding 5GLAN N19 tunnel management	16.1.0
2019-06	SP-84	SP-190422	1353	2	F	Clarification on V-SMF changes in Roaming scenario and NRF Service update	16.1.0
2019-06	SP-84	SP-190416	1355	2	F	Network Triggered Service Request for MA PDU Session	16.1.0
2019-06	SP-84	SP-190408	1360	4	B	Introduction of UP Clot 5GS optimisation procedures	16.1.0
2019-06	SP-84	SP-190427	1361	1	F	Use of IMEI and IMEISV	16.1.0
2019-06	SP-84	SP-190427	1364	1	F	Correction of optional parameters in Registration Request	16.1.0
2019-06	SP-84	SP-190416	1366	3	B	Reporting of Access Availability	16.1.0
2019-06	SP-84	SP-190425	1369	2	B	Assignment of UE Radio Capability ID using NAS	16.1.0
2019-06	SP-84	SP-190408	1370	1	F	Update to the UE Subscription Data Types Keys for MSISDN-less MO SMS	16.1.0
2019-06	SP-84	SP-190420	1371	2	B	Description regarding NEF support of data retrieval from external party	16.1.0
2019-06	SP-84	SP-190427	1374	1	F	Subscription Segmentation in PCF and UDR	16.1.0
2019-06	SP-84	SP-190427	1375	1	C	Serving PLMN UE-AMBR control	16.1.0
2019-06	SP-84	SP-190420	1376	1	C	NWDAF-assisted expected UE behavioural parameters provisioning	16.1.0
2019-06	SP-84	SP-190415	1378	2	B	Procedures for devices not supporting NAS over WLAN access	16.1.0
2019-06	SP-84	SP-190415	1379	1	B	Remaining procedures for trusted Non-3GPP access	16.1.0
2019-06	SP-84	SP-190408	1383	1	B	Procedure for Enhanced Coverage Restriction Control via NEF	16.1.0
2019-06	SP-84	SP-190431	1386	2	B	Adding Support for Delivering Background Data Transfer Policies to the UE	16.1.0
2019-06	SP-84	SP-190408	1388	1	B	Establishing N3 data transfer when Control Plane Optimisation is enabled	16.1.0
2019-06	SP-84	SP-190419	1389	3	B	Adding NF Group ID association functionality to UDR	16.1.0
2019-06	SP-84	SP-190408	1396	1	B	Extended buffered data forwarding for Idle mode mobility between EPS and 5GS	16.1.0
2019-06	SP-84	SP-190401	1398	2	A	Non-allowed area exemption for PS data off status change	16.1.0
2019-06	SP-84	SP-190402	1404	1	A	Fallback to CS domain if VoNR and VoLTE emergency calls not supported	16.1.0
2019-06	SP-84	SP-190420	1405	-	F	CR to update Nnef_EventExposure services	16.1.0
2019-06	SP-84	SP-190419	1406	2	B	NRF service enhancement to support P-CSCF discovery	16.1.0
2019-06	SP-84	SP-190402	1408	1	A	Correction to Registration with AMF relocation	16.1.0
2019-06	SP-84	SP-190422	1409	2	B	Service operation clarification and resource release	16.1.0
2019-06	SP-84	SP-190422	1410	1	C	Xn based inter NG-RAN handover clarification and removal of intermediate SMF	16.1.0
2019-06	SP-84	SP-190422	1411	2	C	Branching Point or UL CL controlled by I-SMF	16.1.0
2019-06	SP-84	SP-190421	1412	1	B	AMF reallocation for the mobility from EPS to 5GS	16.1.0
2019-06	SP-84	SP-190425	1413	2	B	PLMN-assigned capability ID deletion	16.1.0
2019-06	SP-84	SP-190412	1416	2	F	Correction on the late notification procedures of simultaneous change of Branching Point/ULCL and additional PSA for a PDU session	16.1.0
2019-06	SP-84	SP-190412	1417	2	F	Update procedures related with always-on PDU session for URLLC service	16.1.0
2019-06	SP-84	SP-190420	1420	2	C	Updating NEF and NRF Services to Support AF Available Data Registration as described in TS23.288	16.1.0
2019-06	SP-84	SP-190431	1422	2	B	PDU session management for Background Data Transfer	16.1.0
2019-06	SP-84	SP-190402	1424	3	A	Correction to background data transfer policy procedure and related services	16.1.0
2019-06	SP-84	SP-190408	1425	-	B	Removal of editor's notes on new service operation for data transport in Clot CP 5GS Optimisation	16.1.0
2019-06	SP-84	SP-190408	1426	3	B	AS RAI Handling at AN release procedure	16.1.0
2019-06	SP-84	SP-190408	1428	1	B	Procedures for Small Data Rate Control	16.1.0
2019-06	SP-84	SP-190415	1431	1	B	Sending Location information for trusted N3GPP from TNAP to TNGF	16.1.0
2019-06	SP-84	SP-190413	1433	3	F	Clarification on Network-initiated Deregistration	16.1.0
2019-06	SP-84	SP-190408	1435	1	F	Resolution of Editor's Note on classification of Suggested Number of Downlink Packets	16.1.0
2019-06	SP-84	SP-190412	1437	1	C	Update PDU Session Modification procedure regarding solution 4	16.1.0
2019-06	SP-84	SP-190408	1438	1	B	Missing Monitoring Event functionality	16.1.0
2019-06	SP-84	SP-190408	1439	2	B	monitoring procedures involving I-NEF	16.1.0
2019-06	SP-84	SP-190402	1441	-	A	Clarification on event ID of NEF event exposure service operation	16.1.0
2019-06	SP-84	SP-190427	1447	1	F	Clarification to mapping of non-GBR QoS Flows to EPS Bearers	16.1.0
2019-06	SP-84	SP-190408	1449	1	F	Control Plane Only Indication during PDU session establishment	16.1.0
2019-06	SP-84	SP-190402	1450	1	F	Capturing 23.402 impacts for 5GS interworking	16.1.0
2019-06	SP-84	SP-190402	1452	1	A	Correction on usage of Direct Forwarding Path Availability during handovers	16.1.0
2019-06	SP-84	SP-190402	1455	-	A	Missing operations for Nnssf_NSSAIAvailability service	16.1.0
2019-06	SP-84	SP-190402	1456	-	A	Clarification on S-NSSAI for PDU session	16.1.0
2019-06	SP-84	SP-190402	1457	-	A	Corrections to data forwarding during inter-system HO	16.1.0

2019-06	SP-84	SP-190463	1457	-	A	Correction for NF authorized to request notification for UE reachability	16.1.0
2019-06	SP-84	REMOVED	1324	3	C	Removal of postponed CR from v16.1.0, added in error. DNN replacement	16.1.1
2019-06	SP-84	SP-190413	1415	1	A	Addition of CR missed in error in v16.1.0: Correction on procedure of simultaneous change of BP/ULCL and additional PSA	16.1.1
2019-09	SP-85	MCC	1234	1	B	Correction of implementation of clauses 5.2.6.15.3 and 5.2.6.15.4	16.2.0
2019-09	SP-85	SP-190608	1126	4	B	QoS Monitoring to assist URLLC Service	16.2.0
2019-09	SP-85	SP-190618	1322	2	F	Removing NID from 5GS to EPS handover procedure description	16.2.0
2019-09	SP-85	SP-190621	1324	7	C	DNN replacement	16.2.0
2019-09	SP-85	SP-190605	1373	2	F	NIDD Configuration Procedure Update for RDS and Maximum Packet Size	16.2.0
2019-09	SP-85	SP-190607	1382	4	B	Procedures and call flows for SMF Delegated Discovery and Selection in HR and specific SMF Service Areas scenarios and PCF Delegated Discovery and Selection	16.2.0
2019-09	SP-85	SP-190621	1391	4	F	Clarification on the target CN handling in Emergency Service Fallback	16.2.0
2019-09	SP-85	SP-190610	1392	2	F	MA-PDU Session Management	16.2.0
2019-09	SP-85	SP-190607	1393	10	B	Service Context Transfer Support via indirect Transfer	16.2.0
2019-09	SP-85	SP-190605	1429	1	F	Stateless IPv6 Address Autoconfiguration for Control Plane Clot 5GS Optimisation	16.2.0
2019-09	SP-85	SP-190610	1442	3	B	Update the MA PDU session establishment procedure	16.2.0
2019-09	SP-85	SP-190615	1445	7	B	Enhancements to QoS Handling for V2X Communication Over Uu Reference Point	16.2.0
2019-09	SP-85	SP-190612	1459	-	F	Removal of Level of aggregation from Event Reporting Information Parameters	16.2.0
2019-09	SP-85	SP-190605	1461	2	F	NAS RAI corrections	16.2.0
2019-09	SP-85	SP-190617	1463	3	F	PLMN assigned Radio Capability ID transfer during Inter PLMN mobility	16.2.0
2019-09	SP-85	SP-190618	1464	3	C	Introducing support for Ethernet port management	16.2.0
2019-09	SP-85	SP-190618	1466	1	F	5G LAN group management procedure corrections	16.2.0
2019-09	SP-85	SP-190622	1468	1	F	Specification of SMF behaviour at PDU Session setup and modification failure	16.2.0
2019-09	SP-85	SP-190607	1469	3	F	On set identifiers at Nnrf_NFDisccovery_Request	16.2.0
2019-09	SP-85	SP-190606	1473	-	C	MO-LR Subscription data to AMF at registration	16.2.0
2019-09	SP-85	SP-190606	1475	-	C	Location privacy setting from AF	16.2.0
2019-09	SP-85	SP-190621	1479	3	F	Replacement of VPLMN by serving PLMN where appropriate	16.2.0
2019-09	SP-85	SP-190605	1481	3	F	Update to downlink data delivery status event to support PCC and HR roaming	16.2.0
2019-09	SP-85	SP-190621	1483	2	F	Clarification on UE context removal and PDU Session release in General Registration	16.2.0
2019-09	SP-85	SP-190621	1484	2	F	DNN Configuration for interworking with EPS	16.2.0
2019-09	SP-85	SP-190605	1485	-	F	Aligning Terminology referring to the Clot 5GS Optimisations	16.2.0
2019-09	SP-85	SP-190617	1486	1	C	Corrections of PLMN assigned Capability signalling	16.2.0
2019-09	SP-85	SP-190621	1487	3	F	UEs not supporting 5GC NAS connected to SMF+PGW-C	16.2.0
2019-09	SP-85	SP-190621	1488	1	F	Handover from EPC/ePDG to 5GS	16.2.0
2019-09	SP-85	SP-190621	1493	2	B	CN identifier coordination	16.2.0
2019-09	SP-85	SP-190622	1494	-	F	Correction of AN Release procedure	16.2.0
2019-09	SP-85	SP-190621	1495	1	F	Correction of Network Slice selection information	16.2.0
2019-09	SP-85	SP-190605	1496	-	F	Follow-on indication in initial registration for Service Gap	16.2.0
2019-09	SP-85	SP-190601	1498	-	A	Discrepancy with TS 33.501 with respect to Secondary Authentication	16.2.0
2019-09	SP-85	SP-190608	1499	2	F	Failure handling for redundancy based on dual connectivity	16.2.0
2019-09	SP-85	SP-190617	1501	1	B	Optimised sending of PEI in 5GS	16.2.0
2019-09	SP-85	SP-190621	1504	1	F	Erroneous implementation of CR1263R3 and further clarification	16.2.0
2019-09	SP-85	SP-190864	1659	-	F	Clarifications to Slice-Specific Authentication and Authorisation	16.2.0
2019-09	SP-85	SP-190622	1507	1	F	S6b optional for ePDG connected to 5GS	16.2.0
2019-09	SP-85	SP-190605	1510	3	F	UE Indication of support for the User Plane Clot Optimisation in RRC Message when RAT Type is not NR	16.2.0
2019-09	SP-85	SP-190605	1511	-	F	Corrections on setting the Invoke NEF Flag during PDU Session Establishment	16.2.0
2019-09	SP-85	SP-190621	1512	2	F	Correction on Intra-5GC HO description	16.2.0
2019-09	SP-85	SP-190622	1514	1	F	Avoiding EPS to 5GS handover for voice	16.2.0
2019-09	SP-85	SP-190622	1518	1	F	End Marker for the PDU session of HR roaming	16.2.0
2019-09	SP-85	SP-190614	1519	1	F	ETSUN: End Marker handling	16.2.0
2019-09	SP-85	SP-190614	1520	-	F	UL-CL/BP change control	16.2.0
2019-09	SP-85	SP-190621	1523	2	F	Correction on emergency service fallback	16.2.0
2019-09	SP-85	SP-190617	1524	2	F	NB-IoT and other RATs capabilities coexistence	16.2.0
2019-09	SP-85	SP-190601	1528	3	A	Correction to setting up an AF session with required QoS	16.2.0
2019-09	SP-85	SP-190619	1529	2	F	Correction to the Background Data Transfer policy determination and usage	16.2.0

2019-09	SP-85	SP-190608	1530	1	F	Update of AN release procedure for URLLC service	16.2.0
2019-09	SP-85	SP-190622	1532	1	F	Correction on NRF Service Consumer	16.2.0
2019-09	SP-85	SP-190614	1535	3	F	Corrections to clause 4.23 (ETSUN)	16.2.0
2019-09	SP-85	SP-190607	1539	4	F	Update SM context transfer procedure	16.2.0
2019-09	SP-85	SP-190612	1541	3	F	Clarifications to AMF and SMF Event Exposure Services	16.2.0
2019-09	SP-85	SP-190611	1545	1	F	NF Group resolution by SCP	16.2.0
2019-09	SP-85	SP-190601	1551	2	A	Location Reporting signalling load	16.2.0
2019-09	SP-85	SP-190621	1554	1	F	Correction of optional parameters	16.2.0
2019-09	SP-85	SP-190605	1556	1	F	Conditions to use CP or UP Clot	16.2.0
2019-09	SP-85	SP-190621	1557	1	F	Nudm_SDM_Get consumer NFs	16.2.0
2019-09	SP-85	SP-190614	1559	2	F	IWK IDLE mode mobility using N26 interface with I-SMF/I-UPF	16.2.0
2019-09	SP-85	SP-190621	1561	1	F	Enabling AF data synchronization	16.2.0
2019-09	SP-85	SP-190601	1563	1	A	Update CN-initiated selective deactivation of UP connection of an existing PDU Session procedure	16.2.0
2019-09	SP-85	SP-190605	1565	2	F	Corrections to N3 data transfer establishment procedures	16.2.0
2019-09	SP-85	SP-190621	1570	1	F	N2 AMF Mobility: Alignment with TS 29.413	16.2.0
2019-09	SP-85	SP-190610	1572	1	F	N2 AMF Mobility: Alignment with TS 29.413	16.2.0
2019-09	SP-85	SP-190619	1573	1	F	New Nnef_ApplyPolicy service operation	16.2.0
2019-09	SP-85	SP-190622	1581	1	F	UDR information for network functions authorized to request notifications on UE's reachability	16.2.0
2019-09	SP-85	SP-190605	1583	3	F	Clarification on NEF discovery by an AF	16.2.0
2019-09	SP-85	SP-190618	1591	1	F	Adding NID as input for policy decisions	16.2.0
2019-09	SP-85	SP-190612	1595	2	D	CR for editorial corrections on Nnf_EventExposure_Subscribe service	16.2.0
2019-09	SP-85	SP-190607	1597	2	F	Update of context transfer procedures	16.2.0
2019-09	SP-85	SP-190618	1600	3	B	TSC Update to Service Operations to Support TSC	16.2.0
2019-09	SP-85	SP-190622	1603	1	F	PDU Session Establishment for TSC	16.2.0
2019-09	SP-85	SP-190609	1605	1	F	Clarification on QoS resource release in trusted non-3GPP access	16.2.0
2019-09	SP-85	SP-190610	1607	2	F	Handling of access addition - Option 2	16.2.0
2019-09	SP-85	SP-190610	1611	4	B	EPS interworking for MA PDU	16.2.0
2019-09	SP-85	SP-190601	1614	1	A	Corrections for support of Static IP Address	16.2.0
2019-09	SP-85	SP-190605	1620	-	F	Clarification of Service Gap Control Capability indication	16.2.0
2019-09	SP-85	SP-190610	1622	1	F	De-activating user-plane resources over one access	16.2.0
2019-09	SP-85	SP-190614	1624	1	F	Correction on PDU Session Release/Modification related to ETSUN	16.2.0
2019-09	SP-85	SP-190608	1625	1	F	Clarification and correction to AF response	16.2.0
2019-09	SP-85	SP-190608	1626	-	F	Correction on the AF subscribed notification procedures of session & service continuity and UP path management scenarios	16.2.0
2019-09	SP-85	SP-190605	1629	-	F	Update the SMF discovery and selection regarding the Control Plane/User Plane Clot 5GS Optimisations	16.2.0
2019-09	SP-85	SP-190605	1630	1	F	Clarification on the buffered data delivery	16.2.0
2019-09	SP-85	SP-190609	1633	2	F	Deregistration procedure for trusted non-3GPP access	16.2.0
2019-09	SP-85	SP-190618	1639	3	B	Burst Arrival Time Clock Reference Adjustment Procedure	16.2.0
2019-09	SP-85	SP-190618	1642	4	B	Procedures for 5GS Bridge information reporting and configuration	16.2.0
2019-09	SP-85	SP-190605	1643	1	F	Clarification on Preferred Network Behaviour for Clot 5GS Optimisations	16.2.0
2019-09	SP-85	SP-190605	1644	1	F	RAI Terminology Alignment on Clot 5GS Optimisations	16.2.0
2019-09	SP-85	SP-190605	1646	-	F	Clarification on Service Operation for Extended Buffering Support	16.2.0
2019-09	SP-85	SP-190612	1652	2	F	Updating the inputs related to BSF discovery	16.2.0
2019-09	SP-85	SP-190614	1655	-	F	Correction to clause 4.23.9.3	16.2.0
2019-09	SP-85	SP-190613	1656	-	B	MCC implementation correction CR: Slice Specific Authentication and Authorization with multiple registrations in the same PLMN	16.2.0
2019-12	SP-86	SP-191069	1372	2	B	Identification of LTE-M (eMTC) traffic	16.3.0
2019-12	SP-86	SP-191075	1380	4	F	Aligning Trusted and Untrusted Non-3GPP Access with respect to the Additional QoS Information	16.3.0
2019-12	SP-86	SP-191076	1465	2	F	Registration procedure updates for W-AGF interactions	16.3.0
2019-12	SP-86	SP-191071	1470	5	F	Binding when a consumer later becomes a producer	16.3.0
2019-12	SP-86	SP-191070	1474	1	F	Add VGMLC ID to UE context data in Nudm_CM_Registration	16.3.0
2019-12	SP-86	SP-191080	1477	6	F	BDT renegotiation upon expected network performance change	16.3.0
2019-12	SP-86	SP-191069	1482	8	F	Corrections to Availability after DDN Failure event	16.3.0
2019-12	SP-86	SP-191069	1516	3	F	Monitoring Event Subscription and Network Configuration correction	16.3.0
2019-12	SP-86	SP-191088	1546	3	F	Correction to deletion of PLMN-assigned UE Radio Capability ID	16.3.0
2019-12	SP-86	SP-191069	1555	2	F	Group reporting guard time correction	16.3.0
2019-12	SP-86	SP-191069	1587	3	F	Support for PDN Connectivity Status monitoring event	16.3.0
2019-12	SP-86	SP-191071	1601	1	F	UDR Group ID Mapping service	16.3.0
2019-12	SP-86	SP-191077	1616	2	F	Subscription information check for ATSSS	16.3.0
2019-12	SP-86	SP-191080	1617	3	F	Nnef_NetworkStatus service	16.3.0
2019-12	SP-86	SP-191080	1627	4	F	Support of abnormal behaviour analytics	16.3.0
2019-12	SP-86	SP-191076	1635	1	F	NULL encryption for trusted non-3GPP access	16.3.0
2019-12	SP-86	SP-191069	1645	3	F	Corrections to Small Data Rate Control and Exception Reporting	16.3.0
2019-12	SP-86	SP-191071	1647	1	F	NRF Discovery Service Update	16.3.0
2019-12	SP-86	SP-191075	1661	1	F	Correction of PEI(IMEISV) in Registration procedures	16.3.0



2019-12	SP-86	SP-191069	1668	1	F	Clarification on provisioning of NIDD related identifiers	16.3.0
2019-12	SP-86	SP-191082	1670	3	F	Correction to N16a for the transfer of N4 requests from SMF / responses from local UPF	16.3.0
2019-12	SP-86	SP-191075	1675	4	F	Clarification on Registration with AMF re-allocation	16.3.0
2019-12	SP-86	SP-191075	1678	-	F	Rename of Accumulated Usage data	16.3.0
2019-12	SP-86	SP-191091	1679	3	F	Clarification on DNN replacement	16.3.0
2019-12	SP-86	SP-191075	1680	2	F	Missing Date subset in UDR	16.3.0
2019-12	SP-86	SP-191091	1682	1	F	clarification on N6 traffic routing information for Ethernet type PDU Session	16.3.0
2019-12	SP-86	SP-191077	1686	2	F	ATSSS Capability for PCF	16.3.0
2019-12	SP-86	SP-191077	1687	2	F	Update on Home-Routed roaming	16.3.0
2019-12	SP-86	SP-191073	1691	1	C	Update on services/procedures for QoS Monitoring	16.3.0
2019-12	SP-86	SP-191075	1697	-	F	Corrections on Registration, UCU and AN release procedures	16.3.0
2019-12	SP-86	SP-191082	1698	2	F	Clarification on IPv6 Router Advertisement message in ETSUN	16.3.0
2019-12	SP-86	SP-191091	1701	1	F	Corrections on Nsmf_PDUSession Notify services	16.3.0
2019-12	SP-86	SP-191091	1703	-	F	End marker in service request procedure	16.3.0
2019-12	SP-86	SP-191091	1704	2	F	Correction to Service Request procedure	16.3.0
2019-12	SP-86	SP-191091	1705	1	F	Correction of message in EBI allocation	16.3.0
2019-12	SP-86	SP-191077	1708	1	F	23502 Clarification of Access Availability report via N4	16.3.0
2019-12	SP-86	SP-191091	1709	1	F	Add secondary authentication parameter in subscription data	16.3.0
2019-12	SP-86	SP-191091	1710	2	F	Corrections to N26 based Interworking Procedures	16.3.0
2019-12	SP-86	SP-191080	1712	-	F	Correction of NEF Event Exposure	16.3.0
2019-12	SP-86	SP-191080	1713	-	F	UDM Discovery by Internal Group ID	16.3.0
2019-12	SP-86	SP-191091	1715	4	F	SMS Correction to handle SMS-Termination when a UE is not able to receive SMS	16.3.0
2019-12	SP-86	SP-191091	1716	1	F	SMS Clarification	16.3.0
2019-12	SP-86	SP-191091	1718	1	F	UEs not supporting 5GC NAS connected to SMF+PGW-C	16.3.0
2019-12	SP-86	SP-191091	1719	-	F	Correction on UDM registration and deregistrion service operations by SMF and alignment with stage 3	16.3.0
2019-12	SP-86	SP-191091	1720	2	F	PCF selection for multiple PDU Sessions to the same DNN and S-NSSAI	16.3.0
2019-12	SP-86	SP-191069	1721	2	F	Correction of UDM subscription to Nsmf_EventExposure	16.3.0
2019-12	SP-86	SP-191073	1726	-	F	Establish redundant N3/N9 transmission for an existing QoS Flow	16.3.0
2019-12	SP-86	SP-191069	1727	1	F	Extended NAS timers for CE mode B	16.3.0
2019-12	SP-86	SP-191069	1728	2	F	NIDD procedure corrections	16.3.0
2019-12	SP-86	SP-191092	1729	3	F	Addressing open issues for Ethernet port management	16.3.0
2019-12	SP-86	SP-191091	1735	1	F	Session activation in registration procedure	16.3.0
2019-12	SP-86	SP-191082	1736	4	F	ETSUN:SM Context	16.3.0
2019-12	SP-86	SP-191082	1737	1	F	ETSUN: Update procedures	16.3.0
2019-12	SP-86	SP-191071	1738	-	F	Correction of PCF discovery via BSF to consider eSBA binding principles	16.3.0
2019-12	SP-86	SP-191091	1739	1	F	Update to Clause 5.2.5.2.2 Npcf_AMPolicyControl_Create service operation	16.3.0
2019-12	SP-86	SP-191078	1762	-	F	UDR service for mapping IMS Public Identity to HSS Group ID for HSS selection	16.3.0
2019-12	SP-86	SP-191071	1766	1	F	Correction on SM context transfer procedure	16.3.0
2019-12	SP-86	SP-191077	1767	4	F	Updating AMF/SMF/PCF service operations for ATSSS	16.3.0
2019-12	SP-86	SP-191075	1768	1	F	Clarification on fallback procedures	16.3.0
2019-12	SP-86	SP-191077	1769	5	F	Corrections for MA PDU session handling	16.3.0
2019-12	SP-86	SP-191077	1770	2	F	Corrections to interworking with EPS for ATSSS	16.3.0
2019-12	SP-86	SP-191091	1771	2	F	PCF selection for DNN replacement	16.3.0
2019-12	SP-86	SP-191071	1774	-	F	Update to delegated discovery procedure with binding indication	16.3.0
2019-12	SP-86	SP-191069	1775	2	F	Clarification on MAC AS RAI in 5GC	16.3.0
2019-12	SP-86	SP-191069	1779	2	F	Correction to DDD status event with SMF buffering	16.3.0
2019-12	SP-86	SP-191080	1782	2	F	List the Event IDs in the AF services and the NEF services	16.3.0
2019-12	SP-86	SP-191084	1784	2	F	Update to service specific parameter provisioning procedure	16.3.0
2019-12	SP-86	SP-191091	1785	2	F	AF session with QoS - Flow description	16.3.0
2019-12	SP-86	SP-191069	1791	2	F	N3 tunnel info handling during Suspend and Resume procedure	16.3.0
2019-12	SP-86	SP-191086	1793	1	F	IAB node Registration procedure	16.3.0
2019-12	SP-86	SP-191092	1799	1	F	Removing NID from Xn based inter NG-RAN handover procedure	16.3.0
2019-12	SP-86	SP-191081	1801	-	F	TS 23.502: Correction of UE Identity in NSSAA role	16.3.0
2019-12	SP-86	SP-191091	1803	1	F	Clarification on the CN tunnel information in relocation response.	16.3.0
2019-12	SP-86	SP-191091	1804	3	F	adding direct forwarding during HO between EPS and 5GS	16.3.0
2019-12	SP-86	SP-191069	1807	1	F	AMF and SMF merging subscription parameters	16.3.0
2019-12	SP-86	SP-191069	1808	4	F	Correction of Small Data Rate Control interworking	16.3.0
2019-12	SP-86	SP-191069	1809	2	F	Group NIDD corrections	16.3.0
2019-12	SP-86	SP-191069	1810	2	F	Monitoring event triggers	16.3.0
2019-12	SP-86	SP-191092	1812	1	F	Implement traffic correlation indicaiton of AF influence	16.3.0
2019-12	SP-86	SP-191088	1814	4	F	removing requirement that TAC+SV is used to identify UE model in manufacturer assigned ID	16.3.0
2019-12	SP-86	SP-191081	1815	4	F	On NSSAA	16.3.0
2019-12	SP-86	SP-191071	1817	1	F	Correction of the SMF Context Transfer procedure and services	16.3.0

2019-12	SP-86	SP-191071	1819	3	F	Update of the binding procedures	16.3.0
2019-12	SP-86	SP-191080	1824	3	F	Event Id on QFI allocation	16.3.0
2019-12	SP-86	SP-191091	1826	3	F	Clarification on handover failure between 3GPP and non-3GPP accesses	16.3.0
2019-12	SP-86	SP-191057	1834	2	A	UE IPv4 Address/IPv6 Prefix as query parameters for UPF discovery using NRF	16.3.0
2019-12	SP-86	SP-191091	1835	2	F	Incorrect service reference for SMF provisioning	16.3.0
2019-12	SP-86	SP-191091	1836	-	F	Missing AUSF Service	16.3.0
2019-12	SP-86	SP-191091	1837	-	F	Missing reference to UE Parameters Update via UDM Control Plane Procedure	16.3.0
2019-12	SP-86	SP-191091	1842	2	F	Correcting small issues in failure cases at UE mobility	16.3.0
2019-12	SP-86	SP-191091	1846	2	F	SMS transmission in Expected UE Behaviour parameters	16.3.0
2019-12	SP-86	SP-191073	1847	1	F	5G URLLC Handling PDU Session Failure - 23.502	16.3.0
2019-12	SP-86	SP-191071	1849	1	F	Clarification on SMF identifier in HR roaming	16.3.0
2019-12	SP-86	SP-191088	1853	3	F	RAC ID during inter-PLMN handover case	16.3.0
2019-12	SP-86	SP-191071	1855	5	C	Consumer/Producer binding for subscribe/notify	16.3.0
2019-12	SP-86	SP-191091	1859	2	F	Correction to the access authentication for untrusted non-3GPP access	16.3.0
2019-12	SP-86	SP-191076	1860	2	F	TWIF co-located with UPF	16.3.0
2019-12	SP-86	SP-191076	1861	2	F	TNGF co-located with UPF	16.3.0
2019-12	SP-86	SP-191082	1865	1	F	Relation between mobility events and control local offload in ETSUN cases	16.3.0
2019-12	SP-86	SP-191059	1867	2	F	MO EDT for User Plane CloT 5GS Optimisation	16.3.0
2019-12	SP-86	SP-191069	1868	3	F	Enforcing maximum UP resources activation of 2 PDU sessions for NB-IoT	16.3.0
2019-12	SP-86	SP-191092	1870	2	F	5G LAN group management procedure corrections	16.3.0
2019-12	SP-86	SP-191075	1871	2	D	SMF IP Change Event Clarification	16.3.0
2019-12	SP-86	SP-191091	1872	4	F	SoR support for different registration types	16.3.0
2019-12	SP-86	SP-191091	1874	2	F	Event Id for SMSF Registration Notification Events	16.3.0
2019-12	SP-86	SP-191115	1875	2	F	Correction to EPS-5GS idle mobility with N26	16.3.0
2019-12	SP-86	SP-191077	1880	2	F	Applicability of UP Security Policy to a MA PDU Session	16.3.0
2019-12	SP-86	SP-191081	1881	2	F	Correction on pending NSSAA indication to UE	16.3.0
2019-12	SP-86	SP-191091	1883	2	F	NR-U secondary RAT usage report	16.3.0
2019-12	SP-86	SP-191072	1885	-	F	Clarification on SRVCC indication during PDU session release	16.3.0
2019-12	SP-86	SP-191073	1887	2	F	Clarification on URLLC support in Session Modification Procedure	16.3.0
2019-12	SP-86	SP-191082	1888	1	F	Clarification on the L-PSA handling during HO/SR in ETSUN case.	16.3.0
2019-12	SP-86	SP-191080	1889	1	F	Add NWDAF as consumer of NF Services	16.3.0
2019-12	SP-86	SP-191088	1890	2	F	Clarification on UCMF service	16.3.0
2019-12	SP-86	SP-191088	1891	2	F	Supporting bulk dictionary entries creation and deletion for UCMF service	16.3.0
2019-12	SP-86	SP-191091	1893	-	F	Correction to NAI used for registration via trusted non-3GPP access	16.3.0
2019-12	SP-86	SP-191091	1894	3	F	EBI management for QoS flow	16.3.0
2019-12	SP-86	SP-191082	1897	2	F	IRAT Mobility procedure with I-SMF involved	16.3.0
2019-12	SP-86	SP-191093	1899	-	F	Propose updated to Application Data in UDR	16.3.0
2019-12	SP-86	SP-191092	1900	2	F	Group Subscription Data and Group Identifiers in Nudm and Nudr services	16.3.0
2019-12	SP-86	SP-191077	1902	-	F	Reporting of Access Availability	16.3.0
2019-12	SP-86	SP-191080	1905	-	F	Update to Naf_EventExposure_Subscribe service operation	16.3.0
2019-12	SP-86	SP-191091	1907	3	F	Clarification on Policy Control Request Triggers	16.3.0
2019-12	SP-86	SP-191091	1908	2	F	SMF selection for Static IP address	16.3.0
2019-12	SP-86	SP-191071	1909	-	F	PCF Set support	16.3.0
2019-12	SP-86	SP-191085	1911	-	F	Event Id for UserStatus Retrieval Events	16.3.0
2019-12	SP-86	SP-191069	1916	1	F	Small Data transfer for CP CloT	16.3.0
2019-12	SP-86	SP-191084	1917	1	F	Corrections to handling of Alternative QoS Profiles	16.3.0
2019-12	SP-86	SP-191063	1918	2	F	Enhancements to QoS Handling for V2X Communication Over Uu Reference Point	16.3.0
2019-12	SP-86	SP-191073	1923	-	F	Correction on Xn-based HO procedure regarding N3/N9 redundant transmission	16.3.0
2019-12	SP-86	SP-191084	1924	2	F	Revoke Alternative Service Requirement request	16.3.0
2019-12	SP-86	SP-191069	1927	1	F	Corrections to Small Data Rate Control in PDU Session Establishment Procedure	16.3.0
2019-12	SP-86	SP-191069	1929	1	F	Corrections to RDS Configuration in the PDU Session Establishment procedure	16.3.0
2019-12	SP-86	SP-191060	1931	-	F	Availability after DDN Failure event with UPF buffering procedure	16.3.0
2019-12	SP-86	SP-191081	1934	3	F	Service used for slice-specific re-authentication and revocation	16.3.0
2019-12	SP-86	SP-191081	1936	2	F	Addition of NSSAA Services	16.3.0
2019-12	SP-86	SP-191092	1940	2	F	Support for Untrusted Non-3GPP access for SNPN	16.3.0
2019-12	SP-86	SP-191091	1941	4	F	Use of EPS/RAT fallback for VoWiFi session	16.3.0
2019-12	SP-86	SP-191063	1943	1	C	Signalling updated QoS parameters to the UE	16.3.0
2019-12	SP-86	SP-191081	1944	2	F	NSSAA at mobility	16.3.0
2019-12	SP-86	SP-191080	1946	-	F	Corrections to Nnrf service operations for NWDAF	16.3.0
2019-12	SP-86	SP-191082	1947	2	F	Minor corrections related with ETSUN	16.3.0

2019-12	SP-86	SP-191075	1950	-	F	Adding missing interactions in PDU session release	16.3.0
2019-12	SP-86	SP-191070	1952	-	F	Add AMF as consumer for Nudm_ParametersProvision_Update Service Operation	16.3.0
2020-03	SP-87E	SP-200077	1582	2	F	23.502 Supporting for AF providing UE IP address(es) for 5G VN group PDU sessions	16.4.0
2020-03	SP-87E	SP-200063	1590	6	F	Idle mode mobility with data forwarding	16.4.0
2020-03	SP-87E	SP-200063	1667	3	F	Corrections on Extended Buffering	16.4.0
2020-03	SP-87E	SP-200077	1673	7	F	UPF reporting the time comparison	16.4.0
2020-03	SP-87E	SP-200060	1685	4	A	Correction on UE Policy Association Establishment procedure	16.4.0
2020-03	SP-87E	SP-200077	1763	2	F	Adding Information about serving network to Nsmf_PDUSession service	16.4.0
2020-03	SP-87E	SP-200079	1773	4	F	UE IDLE over N3GPP responding to indication of DL data when access is available	16.4.0
2020-03	SP-87E	SP-200063	1776	2	F	Correction to UE context in AMF for Power Saving Function	16.4.0
2020-03	SP-87E	SP-200077	1792	4	F	Adding Information about serving network to Nudm and Nudr services	16.4.0
2020-03	SP-87E	SP-200077	1796	7	F	Support of CAG ID privacy	16.4.0
2020-03	SP-87E	SP-200077	1797	4	F	NID parameter for SNPN N3IWF deployments	16.4.0
2020-03	SP-87E	SP-200072	1825	6	F	IWK IDLE mode mobility using N26 interface with I-SMF/I-UPF and data forwarding	16.4.0
2020-03	SP-87E	SP-200069	1840	4	F	Correction on MA PDU Session Release	16.4.0
2020-03	SP-87E	SP-200079	1878	3	F	AMF registering in UDM and HSS+UDM cancelling the old serving node at initial Registration	16.4.0
2020-03	SP-87E	SP-200069	1906	2	F	Clarification on Access type for ATSSS	16.4.0
2020-03	SP-87E	SP-200063	1930	6	F	DDD status event with UPF buffering procedure	16.4.0
2020-03	SP-87E	SP-200068	1950	2	F	Access type and RAT type per Non-3GPP accesses	16.4.0
2020-03	SP-87E	SP-200071	1953	5	F	Release PDU sessions due to revocation from AAA server or re-auth failure	16.4.0
2020-03	SP-87E	SP-200077	1956	4	F	PNI-NPN CAG Configuration Update	16.4.0
2020-03	SP-87E	SP-200079	1957	2	F	Update to Emergency Services Fallback	16.4.0
2020-03	SP-87E	SP-200065	1959	3	F	Binding for notification reselection corrections	16.4.0
2020-03	SP-87E	SP-200079	1960	3	F	Update Alternative Service Requirement request	16.4.0
2020-03	SP-87E	SP-200065	1961	4	F	Applicability of binding indication	16.4.0
2020-03	SP-87E	SP-200065	1962	4	F	Additional Usage scenarios for binding when a consumer later becomes a producer	16.4.0
2020-03	SP-87E	SP-200072	1963	1	F	Clean up of I/V/SMF selection	16.4.0
2020-03	SP-87E	SP-200072	1964	1	F	ETSUN corrections	16.4.0
2020-03	SP-87E	SP-200079	1966	2	F	Correction on EPS Fallback procedure	16.4.0
2020-03	SP-87E	SP-200069	1969	2	F	AMF decision for the network convert MA PDU	16.4.0
2020-03	SP-87E	SP-200069	1970	3	F	Corrections on interworking with EPS	16.4.0
2020-03	SP-87E	SP-200079	1973	2	F	Missing Non-UE N2 Message Services Operations	16.4.0
2020-03	SP-87E	SP-200079	1976	3	F	Alignment with stage 3 on Immediate Report for Nudm_SDM_Subscribe	16.4.0
2020-03	SP-87E	SP-200060	1978	2	F	Emergency service at EPC-5GC interworking	16.4.0
2020-03	SP-87E	SP-200079	1980	5	F	Not supporting 15 EPS bearers at 5GS to EPS mobility	16.4.0
2020-03	SP-87E	SP-200072	1981	2	F	Correction to Handover Procedures	16.4.0
2020-03	SP-87E	SP-200079	1982	1	F	AMF awareness of emergency Registration/PDU Session at inter-CN node change	16.4.0
2020-03	SP-87E	SP-200063	1983	3	F	Availability after DDN Failure in 5GC	16.4.0
2020-03	SP-87E	SP-200063	1984	1	F	Availability after DDN Failure event with UPF buffering	16.4.0
2020-03	SP-87E	SP-200063	1985	2	F	NEF service update for NIDD	16.4.0
2020-03	SP-87E	SP-200065	1986	4	F	Correction of PCF discovery via BSF to consider eSBA producer binding indication principles - BSF Services (23.502)	16.4.0
2020-03	SP-87E	SP-200079	1987	1	F	Adding the N4 association setup procedure initiated by UPF	16.4.0
2020-03	SP-87E	SP-200079	1988	3	F	Use of EPS/RAT fallback for VoWiFi session	16.4.0
2020-03	SP-87E	SP-200072	1989	-	F	Correction of 5GS to EPS Idle mode mobility using N26 interface with I-SMF removal	16.4.0
2020-03	SP-87E	SP-200067	1992	1	F	Update dynamic CN PDB to NG-RAN during Xn handover	16.4.0
2020-03	SP-87E	SP-200079	1994	1	F	Update to Network triggered SR procedure	16.4.0
2020-03	SP-87E	SP-200079	1995	1	F	Corrections on registration with AMF relocation	16.4.0
2020-03	SP-87E	SP-200079	1996	1	F	Correction of the CN tunnel info at the target side	16.4.0
2020-03	SP-87E	SP-200065	1997	2	F	Update the binding indication for subscription	16.4.0
2020-03	SP-87E	SP-200072	1998	1	F	Different N3/N9 tunnel information	16.4.0
2020-03	SP-87E	SP-200063	2001	1	F	Small Data Rate Control enforcement corrections	16.4.0
2020-03	SP-87E	SP-200063	2003	1	F	Addition of eDRX parameter to subscription data types	16.4.0
2020-03	SP-87E	SP-200063	2004	1	F	Correction of Nsmf_SendMODData parameter list	16.4.0
2020-03	SP-87E	SP-200067	2007	2	F	Alternative QoS Profile corrections	16.4.0
2020-03	SP-87E	SP-200070	2008	2	F	Clarification of the BDT policy re-negotiation procedure	16.4.0
2020-03	SP-87E	SP-200063	2013	-	F	Extended Buffering Control in the SMF	16.4.0
2020-03	SP-87E	SP-200069	2015	3	F	Corrections for ATSSS support when roaming	16.4.0
2020-03	SP-87E	SP-200069	2016	1	F	Corrections to SMF service operations for ATSSS	16.4.0
2020-03	SP-87E	SP-200069	2017	-	F	Corrections to PCF service operations for ATSSS	16.4.0

2020-03	SP-87E	SP-200069	2018	1	F	Corrections for SMF-PCF interactions for ATSSS	16.4.0
2020-03	SP-87E	SP-200072	2019	1	F	Non N26 based Interworking Procedures with I-SMF	16.4.0
2020-03	SP-87E	SP-200079	2021	2	F	Add AMF Charging Characteristics	16.4.0
2020-03	SP-87E	SP-200060	2023	2	A	Corrections on SMF Charging Characteristics	16.4.0
2020-03	SP-87E	SP-200079	2024	-	F	Correction about the DN Information	16.4.0
2020-03	SP-87E	SP-200063	2025	1	B	WUS assistance information procedures	16.4.0
2020-03	SP-87E	SP-200079	2026	2	F	Clarification on the EPS fallback reporting	16.4.0
2020-03	SP-87E	SP-200077	2030	2	F	Item#4 Update the Annex F.2 5GS Bridge configuration.	16.4.0
2020-03	SP-87E	SP-200074	2034	-	F	RAC ID during inter-PLMN handover case	16.4.0
2020-03	SP-87E	SP-200063	2035	-	F	Update to Nnef_SMCContext_Create service operation	16.4.0
2020-03	SP-87E	SP-200072	2039	-	F	End marker indication in SR procedure	16.4.0
2020-03	SP-87E	SP-200077	2041	4	F	#1_Procedures for support of 5G VN group communication	16.4.0
2020-03	SP-87E	SP-200267	2043	4	F	Procedure update for PDU Session establishment and Bridge based information reporting	16.4.0
2020-03	SP-87E	SP-200069	2045	2	F	Service operation to notify unavailability of non-3GPP access	16.4.0
2020-03	SP-87E	SP-200079	2047	1	F	Clarification on the result of Namf_Communication_N1N2MessageTransfer service	16.4.0
2020-03	SP-87E	SP-200079	2048	3	F	EBI revocation of QoS flow of default QoS rule	16.4.0
2020-03	SP-87E	SP-200063	2049	1	F	NAS signalling of CP Relocation Indication Truncated 5G-S-TMSI Parameters Procedures	16.4.0
2020-03	SP-87E	SP-200063	2050	2	F	Correction for non MO-Exception Data cause signalling	16.4.0
2020-03	SP-87E	SP-200063	2052	1	F	Add Serving PLMN rate control in the PDU Session Establishment	16.4.0
2020-03	SP-87E	SP-200063	2054	-	F	Clarification on Enhanced Coverage Restriction	16.4.0
2020-03	SP-87E	SP-200064	2055	1	F	UE LCS Privacy Profile Update	16.4.0
2020-03	SP-87E	SP-200064	2056	1	F	NEF service to support location transfer	16.4.0
2020-03	SP-87E	SP-200079	2059	6	F	Correction to UE configuration update procedure conditions for re-registration	16.4.0
2020-03	SP-87E	SP-200079	2063	1	F	Correction on the usage of SUPI and PDU Session ID	16.4.0
2020-03	SP-87E	SP-200067	2064	1	F	Correction on PDU Session Modification procedure regarding redundant transmission	16.4.0
2020-03	SP-87E	SP-200074	2066	2	F	UCMF provisioning correction	16.4.0
2020-03	SP-87E	SP-200079	2068	1	D	Correction on PDU Session Modification procedure	16.4.0
2020-03	SP-87E	SP-200065	2069	2	F	Update of the binding procedures with Routing Binding Indication	16.4.0
2020-03	SP-87E	SP-200063	2072	1	F	Update to AMF exposure of mobility events for extended buffering in NEF	16.4.0
2020-03	SP-87E	SP-200079	2082	-	F	Clarification on the CN tunnel info allocation and release	16.4.0
2020-03	SP-87E	SP-200079	2083	1	F	QoS Flows reestablished during EPS Fallback	16.4.0
2020-03	SP-87E	SP-200079	2084	-	F	Reachability Event Correction	16.4.0
2020-03	SP-87E	SP-200070	2088	-	F	Adding two new event IDs for AMF event exposure.	16.4.0
2020-03	SP-87E	SP-200070	2089	-	F	Updates to AMF event exposure and event filters	16.4.0
2020-03	SP-87E	SP-200079	2090	-	F	Incorrect service operation Namf_Communication_RegistrationCompleteNotify	16.4.0
2020-03	SP-87E	SP-200077	2091	1	F	Updating the UE with new CAG information	16.4.0
2020-03	SP-87E	SP-200077	2092	1	F	Correct the transfer of the bridge delay related parameters	16.4.0
2020-03	SP-87E	SP-200077	2093	1	F	Correct the-the NW-TT port related	16.4.0
2020-03	SP-87E	SP-200079	2095	1	F	Corrections on EPS fallback and RAT fallback for IMS voice	16.4.0
2020-03	SP-87E	SP-200069	2096	1	F	Indication of network ATSSS capability in Registration procedures	16.4.0
2020-03	SP-87E	SP-200069	2098	1	F	MA PDU Session Modification when UE is registered to different PLMNs over 3GPP access and non-3GPP access	16.4.0
2020-03	SP-87E	SP-200070	2099	-	F	SMF services for data collection	16.4.0
2020-03	SP-87E	SP-200069	2100	-	D	Rapporteur Submission - Editorial update for ATSSS	16.4.0
2020-03	SP-87E	SP-200069	2104	1	F	Correction on Network Modification to MA PDU Session	16.4.0
2020-03	SP-87E	SP-200074	2107	1	D	Editorial updates in RACS clauses	16.4.0
2020-03	SP-87E	SP-200077	2108	1	F	Clarification on CAG ID provided by NG-RAN to AMF.	16.4.0
2020-03	SP-87E	SP-200079	2109	-	F	Clarification on the EPS fallback reporting during Transfer of PDU session used for IMS voice from non-3GPP access to 5GS.	16.4.0
2020-03	SP-87E	SP-200079	2113	1	F	Corrections for CN tunnel info allocation and release	16.4.0
2020-03	SP-87E	SP-200072	2115	1	F	Corrections for Registration and Service Request	16.4.0
2020-03	SP-87E	SP-200065	2117	1	F	Updated resource information alignment with CT4	16.4.0
2020-03	SP-87E	SP-200072	2118	1	F	ETSUN related CR for non-FASMO corrections	16.4.0
2020-03	SP-87E	SP-200067	2121	-	F	Clarification on the target AF for late notification	16.4.0
2020-03	SP-87E	SP-200079	2122	1	F	AFsessionWithQoS update	16.4.0
2020-03	SP-87E	SP-200079	2123	-	F	Updates to the AFsessionWithQoS setup	16.4.0
2020-03	SP-87E	SP-200081	2127	1	F	Support of inter-RAT HO from NR SA to EN-DC	16.4.0
2020-03	SP-87E	SP-200063	2129	1	F	corrections for handling of I-NEF routing configuration during inter PLMN mobility	16.4.0
2020-03	SP-87E	SP-200063	2130	1	F	N4 session level reporting for discard and buffered DL traffic detection	16.4.0
2020-03	SP-87E	SP-200068	2134	-	F	Adding procedures for devices that do not support 5G NAS over WLAN access	16.4.0
2020-03	SP-87E	SP-200077	2137	1	F	clarification on Port Management Information Container toward SMF	16.4.0
2020-03	SP-87E	SP-200065	2138	1	F	Routing binding indication correction	16.4.0

2020-03	SP-87E	SP-200072	2139	1	F	Local PSA release correction	16.4.0
2020-03	SP-87E	SP-200077	2142	1	F	Correcting procedure of NEF service operations information flow and adding parameters of 5G VN group data	16.4.0
2020-03	SP-87E	SP-200079	2145	-	F	Update of steering of roaming information for different registration types	16.4.0
2020-03	SP-87E	SP-200079	2146	1	F	NSSAI in the HO request during inter RAT/EPS interworking	16.4.0
2020-03	SP-87E	SP-200077	2150	1	F	Update for Bridge Delay information reporting and QoS mapping	16.4.0
2020-03	SP-87E	SP-200065	2151	1	F	Updating NRF services based on NF profile	16.4.0
2020-03	SP-87E	SP-200065	2152	1	F	Update of NF Status Subscribe/Unsubscribe services with PLMN ID	16.4.0
2020-03	SP-87E	SP-200065	2153	-	F	Update of context transfer procedures	16.4.0
2020-03	SP-87E	SP-200069	2155	1	F	Supporting EPS interworking with ATSSS	16.4.0
2020-03	SP-87E	SP-200079	2157	1	F	Procedures update due to removal of TEID allocation by SMF	16.4.0
2020-03	SP-87E	SP-200071	2160	1	F	NSSAA procedure clarification	16.4.0
2020-03	SP-87E	SP-200081	2162	1	F	Addition of PSCell information in PDU Session modification	16.4.0
2020-03	SP-87E	SP-200079	2163	1	F	Inclusion of Requested NSSAI in AN Parameters	16.4.0
2020-03	SP-87E	SP-200069	2166	-	F	User-plane resources establishment over the second access for Home-routed Roaming MA PDU session establishment	16.4.0
2020-07	SP-88E	SP-200433	2081	2	F	Support of ETSUN and ATSSS	16.5.0
2020-07	SP-88E	SP-200428	2097	2	F	MA PDU Session Release when UE is registered to different PLMNs over 3GPP access and non-3GPP access	16.5.0
2020-07	SP-88E	SP-200552	2110	1	F	Corrections on known consumers of AMF related services	16.5.0
2020-07	SP-88E	SP-200433	2112	1	F	Handover of a PDU Session procedure between untrusted non-3GPP and 3GPP access	16.5.0
2020-07	SP-88E	SP-200433	2174	1	F	Support of ETSUN within and between PLMN(s)	16.5.0
2020-07	SP-88E	SP-200551	2175	1	F	V-SMF may apply VPLMN policies related with the SLA with the HPLMN	16.5.0
2020-07	SP-88E	SP-200551	2176	-	F	Remove un-necessary End Marker Indication in invocations of Nsmf_PDUSESSION_Update Request	16.5.0
2020-07	SP-88E	SP-200422	2177	1	F	Corrections for Availability after DDN Failure event with UPF buffering	16.5.0
2020-07	SP-88E	SP-200437	2178	-	F	Common Network Exposure	16.5.0
2020-07	SP-88E	SP-200424	2182	-	F	Update of PCF address(es) for a PDU session in the BSF	16.5.0
2020-07	SP-88E	SP-200427	2183	1	F	Handover of a PDU Session procedure between 3GPP and trusted non-3GPP access	16.5.0
2020-07	SP-88E	SP-200422	2184	1	F	Specify the new service Nsmf_PDUSESSION_MessageTransfer	16.5.0
2020-07	SP-88E	SP-200552	2186	-	F	Corrections for AF Session with QoS procedure	16.5.0
2020-07	SP-88E	SP-200428	2188	-	F	Handling of mobility in case ATSSS is not supported in target AMF	16.5.0
2020-07	SP-88E	SP-200436	2190	1	F	UE radio capability for 5GS and IWK	16.5.0
2020-07	SP-88E	SP-200439	2194	1	F	QoS container vs. TSCAI input container	16.5.0
2020-07	SP-88E	SP-200439	2195	1	F	Removing NID from Xn based inter NG-RAN HO procedure	16.5.0
2020-07	SP-88E	SP-200439	2196	1	F	Correct the transfer of the NW-TT port's Port Management Container	16.5.0
2020-07	SP-88E	SP-200431	2197	1	F	Support of data collection for any UE	16.5.0
2020-07	SP-88E	SP-200428	2199	-	F	Clarification on MA PDU Session re-activation	16.5.0
2020-07	SP-88E	SP-200551	2203	1	F	Clarification on PDU session establishment without S-NSSAI indication	16.5.0
2020-07	SP-88E	SP-200422	2204	-	F	Correction to handling of Service Gap timer for regulatory prioritized services	16.5.0
2020-07	SP-88E	SP-200428	2205	1	F	MPTCP functionality information	16.5.0
2020-07	SP-88E	SP-200425	2206	-	F	Packet delay of RAN for QoS Monitoring	16.5.0
2020-07	SP-88E	SP-200424	2208	2	F	Enablers for multiple SCPs (23.502)	16.5.0
2020-07	SP-88E	SP-200432	2210	1	F	Removal of service area for UE registration with empty Allowed NSSAI due to pending NSSAA	16.5.0
2020-07	SP-88E	SP-200439	2211	1	F	Adding CAG information in Registration Accept message	16.5.0
2020-07	SP-88E	SP-200551	2212	1	F	Nudm_UECM_Get input parameter correction	16.5.0
2020-07	SP-88E	SP-200551	2213	-	F	UE reachability for SMS	16.5.0
2020-07	SP-88E	SP-200432	2214	1	F	Correction of NSSAA procedure and Registration procedure	16.5.0
2020-07	SP-88E	SP-200422	2216	-	F	Small data rate control enforcement of normal and exception data	16.5.0
2020-07	SP-88E	SP-200424	2217	1	F	Corrections to Binding for Indirect Communication without delegated discovery	16.5.0
2020-07	SP-88E	SP-200551	2218	1	F	Emergency call enhancements for 4G only UE	16.5.0
2020-07	SP-88E	SP-200609	2219	3	F	Update PDU Session release when Control Plane Only indication is not applicable	16.5.0
2020-07	SP-88E	SP-200422	2220	1	F	Change of the restriction of enhanced coverage in UE Configuration Update procedure	16.5.0
2020-07	SP-88E	SP-200439	2224	1	F	Bridge Delay Clarification	16.5.0
2020-07	SP-88E	SP-200428	2225	1	F	Corrections on ATSSS capabilities	16.5.0
2020-07	SP-88E	SP-200428	2227	1	F	Clarifications on Network initiated service request procedure	16.5.0
2020-07	SP-88E	SP-200431	2228	1	F	Event filters for data collection	16.5.0
2020-07	SP-88E	SP-200440	2230	1	F	URSP info provision for xBDT	16.5.0
2020-07	SP-88E	SP-200436	2231	-	F	Support of multiple coding formats	16.5.0
2020-07	SP-88E	SP-200431	2232	1	F	Correction on AMF TAC event for newly detected UEs	16.5.0
2020-07	SP-88E	SP-200428	2234	1	F	MA PDU session establishment in home-routed roaming	16.5.0

2020-07	SP-88E	SP-200431	2236	1	F	Remove the Nnef_NetworkStatus service	16.5.0
2020-07	SP-88E	SP-200431	2239	1	F	Updates to AMF event exposure and event filters	16.5.0
2020-07	SP-88E	SP-200552	2242	1	F	Clarification on Npcf_BDTPolicyControl	16.5.0
2020-07	SP-88E	SP-200433	2243	-	F	Xn based handover for home routed roaming scenario	16.5.0
2020-07	SP-88E	SP-200422	2244	1	F	Correction of NEF-based NIDD procedures	16.5.0
2020-07	SP-88E	SP-200552	2247	1	F	EBI of default EPS bearer	16.5.0
2020-07	SP-88E	SP-200552	2248	2	F	CN tunnel info allocation for non roaming and LBO case	16.5.0
2020-07	SP-88E	SP-200433	2250	-	F	PDU Session release and Deregistration procedure correction	16.5.0
2020-07	SP-88E	SP-200433	2251	1	F	Pause of Charging	16.5.0
2020-07	SP-88E	SP-200433	2252	-	F	Correction to Policy Update Procedures with I-SMF	16.5.0
2020-07	SP-88E	SP-200551	2256	1	F	Fix the incorrect figure and description in 5GS - EPS HO.	16.5.0
2020-07	SP-88E	SP-200433	2257	1	F	Clarification on CN tunnel for EPS during the I-SMF insertion	16.5.0
2020-07	SP-88E	SP-200439	2258	1	F	Alignment on the Trigger for SMF and clarification on the NW-TT port(s) for PDU session	16.5.0
2020-07	SP-88E	SP-200439	2259	1	F	Removing the duplication and incorrect part in the Annex F	16.5.0
2020-07	SP-88E	SP-200439	2261	1	F	Corrections for 5GS Bridge information reporting and configuration	16.5.0
2020-07	SP-88E	SP-200436	2263	-	F	Use correct term for IMEI/TAC in UCMF Services	16.5.0
2020-07	SP-88E	SP-200423	2267	1	F	Update Nudm_UECM_Get and Nudm_EventExposure_Subscribe service operation	16.5.0
2020-07	SP-88E	SP-200432	2271	1	F	Defer Network Slice-Specific Re-authentication and Re-authorization procedure for UE in CM-IDLE	16.5.0
2020-07	SP-88E	SP-200551	2272	1	F	Correction on List Of PDU Sessions To Be Activated	16.5.0
2020-07	SP-88E	SP-200432	2276	-	F	Correction on the value of S-NSSAIs for NSSAA	16.5.0
2020-07	SP-88E	SP-200420	2279	1	A	Correction on Deregistration procedures for SMS over NAS	16.5.0
2020-07	SP-88E	SP-200551	2280	1	F	Reordering DL data during SR procedure	16.5.0
2020-07	SP-88E	SP-200552	2282	1	F	Correction on deregistration procedure	16.5.0
2020-07	SP-88E	SP-200437	2283	1	F	User State Information in 5GS	16.5.0
2020-07	SP-88E	SP-200425	2287	1	F	Clarification on the late notification for the target AF	16.5.0
2020-07	SP-88E	SP-200432	2289	1	F	Usage of NSSAA status at N2 based handover	16.5.0
2020-07	SP-88E	SP-200420	2291	1	F	5G-GUTI in the Access Network parameters	16.5.0
2020-07	SP-88E	SP-200424	2292	1	F	Update of Nnrf_NFManagement_NFRegister service operation	16.5.0
2020-07	SP-88E	SP-200427	2293	-	F	Sending the IP address of TNGF to UE	16.5.0
2020-07	SP-88E	SP-200432	2296	1	F	PDU session release in NSSAA procedure	16.5.0
2020-07	SP-88E	SP-200439	2298	-	F	Notify the information of the detected bridge and detected port to the TSN AF	16.5.0
2020-07	SP-88E	SP-200422	2300	1	F	UE specific DRX for NB-IoT in 5GC	16.5.0
2020-07	SP-88E	SP-200422	2301	-	F	PDU session modification when Restriction of use of Enhanced Coverage changes	16.5.0
2020-07	SP-88E	SP-200431	2303	-	F	AF event filter for service experience area of interest	16.5.0
2020-07	SP-88E	SP-200431	2304	-	F	NEF event exposure correction	16.5.0
2020-07	SP-88E	SP-200439	2305	1	F	Updating call flow with Ethernet Filters	16.5.0
2020-07	SP-88E	SP-200551	2306	1	F	Clarification of TEID allocation by UPF	16.5.0
2020-07	SP-88E	SP-200439	2307	1	F	SMF to request the UE IP address from the DN-AAA server based on subscription information	16.5.0
2020-07	SP-88E	SP-200431	2237	2	F	Correction of BDT policy re-negotiation procedure	16.5.0
2020-07	SP-88E	SP-200439	2297	3	F	Missing important assumptions on how Npcf_PolicyAuthorization_Notify is used in TSN context	16.5.0
2020-07	SP-88E	SP-200420	2311	1	A	Presence of PEI in Nudm_UECM_Registration Request	16.5.0
2020-07	SP-88E	SP-200422	2312	1	F	Network Parameters Configuration by Parameter Provisioning and Event Exposure Subscription	16.5.0
2020-07	SP-88E	SP-200434	2313	-	F	Alignment with RAN stage 3 on Alternative QoS Profile	16.5.0
2020-07	SP-88E	SP-200432	2316	-	F	Replacing AUSF by NSSAAF to support NSSAA	16.5.0
2020-07	SP-88E	SP-200516	2317	1	F	Clarification on Registration with AMF re-allocation	16.5.0
2020-07	SP-88E	SP-200551	2318	1	B	Alignment CR for DAPS HO	16.5.0
2020-07	SP-88E	SP-200427	2319	1	F	Correction on Framed Route information reporting	16.5.0
2020-07	SP-88E	SP-200422	2320	-	F	Removal of I-NEF	16.5.0
2020-07	SP-88E	SP-200551	2321	1	F	Missing parameters in Namf_Communication_NonUeN2MessageTransfer	16.5.0
2020-07	SP-88E	SP-200433	2322	1	F	Interworking between ETSUN and URLLC/TSN	16.5.0
2020-08	SP-88E	-	-	-	-	Removal of postponed CR2317R1: Clarification on Registration with AMF re-allocation	16.5.1
2020-09	SP-89E	SP-200685	2326	1	F	Registration procedure across ePLMNs	16.6.0
2020-09	SP-89E	SP-200680	2328	-	F	Missing N2 SM information from initial AMF to target AMF	16.6.0
2020-09	SP-89E	SP-200686	2330	1	F	Remove un-necessary End Marker Indication in invocations of Nsmf_PDUSession_Update Request (missing part)	16.6.0
2020-09	SP-89E	SP-200680	2331	-	F	removal of editor's note	16.6.0
2020-09	SP-89E	SP-200680	2333	1	F	GPSI for NSSAA	16.6.0
2020-09	SP-89E	SP-200682	2334	-	F	V2X Subscription Data	16.6.0
2020-09	SP-89E	SP-200671	2336	1	A	SMF aware of UE Reachability after N1N2MessageTransfer error due to UE unreachable	16.6.0
2020-09	SP-89E	SP-200688	2338	1	F	Addressing wording comments from IEEE LS response on TSN support	16.6.0

2020-09	SP-89E	SP-200673	2340	-	F	Clarification on use of N2 message in PDU Session establishment for Control Plane CloT 5GS Optimization	16.6.0
2020-09	SP-89E	SP-200686	2341	-	F	UE user plane integrity protection mandatory at full rate	16.6.0
2020-09	SP-89E	SP-200679	2342	1	F	Re-ordering of interactions in the BDT policy re-negotiation procedure	16.6.0
2020-09	SP-89E	SP-200689	2344	1	F	Correction to the procedure for future background data transfer procedure	16.6.0
2020-09	SP-89E	SP-200686	2345	-	F	WUS system support for 5GC	16.6.0
2020-09	SP-89E	SP-200679	2346	1	F	Time in trajectories of Expected UE Behaviour	16.6.0
2020-09	SP-89E	SP-200674	2349	1	F	Routing Binding indication without delegated discovery	16.6.0
2020-09	SP-89E	SP-200682	2356	-	F	Clarification on UE policy related description	16.6.0
2020-09	SP-89E	SP-200688	2357	1	F	Removal of HO triggered by MRL	16.6.0
2020-09	SP-89E	SP-200681	2361	1	F	Clarification on End marker	16.6.0
2020-09	SP-89E	SP-200681	2362	-	F	Corrections on link local address and CN tunnel info provision	16.6.0
2020-09	SP-89E	SP-200676	2364	-	F	Correcting UE Id in the Access Network parameters	16.6.0
2020-09	SP-89E	SP-200686	2367	-	F	Corrections on DAPS HO Procedure	16.6.0
2020-09	SP-89E	SP-200671	2368	1	A	Correction on Deregistration procedures for SMS over NAS	16.6.0
2020-09	SP-89E	SP-200673	2370	-	F	Procedure Clarifications for multiple UP resource support for an NB-IoT UE	16.6.0
2020-09	SP-89E	SP-200673	2371	1	F	Procedure Clarifications for CloT optimisations during mobility to and from non-3GPP access	16.6.0
2020-09	SP-89E	SP-200673	2372	1	F	Correction to interaction between the SMF and UPF for Availability after DDN failure event	16.6.0
2020-09	SP-89E	SP-200673	2373	1	F	Procedures to Redirect UE via service reject to align with CT1	16.6.0
2020-09	SP-89E	SP-200676	2374	-	F	Adding emergency registration procedure for trusted non-3GPP access	16.6.0
2020-09	SP-89E	SP-200676	2375	1	F	Adding handover procedure between EPS and 5GC-TNGF	16.6.0
2020-09	SP-89E	SP-200676	2376	1	F	Clarification on Identifiers of N5CW devices	16.6.0
2020-09	SP-89E	SP-200671	2380	1	A	Stage 3 alignment on UE reachability event	16.6.0
2020-09	SP-89E	SP-200688	2382	-	F	Alignment with RAN specification on adding PLMN+CAG information in paging message	16.6.0
2020-09	SP-89E	SP-200688	2386	1	F	GUTI clarification for UE registration in an SNPN	16.6.0
2020-09	SP-89E	SP-200688	2388	1	F	Clarify Ethernet Frames handling for Ethernet PDU session	16.6.0
2020-09	SP-89E	SP-200674	2389	1	F	Clarifications on SCP registration and discovery procedures	16.6.0
2020-09	SP-89E	SP-200688	2390	-	F	23.502 - Resolution of open items related to IEEE LS	16.6.0
2020-09	SP-89E	SP-200686	2392	1	F	Correction of NSSAI in the Registration procedure and Service Request procedure	16.6.0
2020-09	SP-89E	SP-200679	2393	-	F	Location event filter for trusted AF	16.6.0
2020-09	SP-89E	SP-200674	2394	1	F	Correction on Nnrf_NFManagement_NFStatusSubscribe service operation	16.6.0
2020-09	SP-89E	SP-200674	2395	1	F	Correction on Nnrf_NFManagement_NFStatusNotify service operation	16.6.0
2020-09	SP-89E	SP-200688	2396	1	F	Moving NW-TT ports from BMI into BMIC	16.6.0
2020-09	SP-89E	SP-200673	2398	1	F	PCC control for DDD status and availability after DDN failure events	16.6.0
2020-12	SP-90E	SP-200946	2332	-	F	Handling of AAA-S address in NSSAA	16.7.0
2020-12	SP-90E	SP-200951	2358	2	F	QoS related parameters to be updated during Handover	16.7.0
2020-12	SP-90E	SP-200958	2383	2	F	NSSAA re-authentication by AAA-S	16.7.0
2020-12	SP-90E	SP-200959	2400	2	F	Corrections to MME Emergency Configuration Data for enable the selection of different emergency gateways based on UE capabilities	16.7.0
2020-12	SP-90E	SP-200945	2405	1	A	Clarification on Emergency Services Fallback	16.7.0
2020-12	SP-90E	SP-200959	2406	1	F	Correction on EPS fallback with emergency service	16.7.0
2020-12	SP-90E	SP-200959	2407	1	F	Correction on EPS fallback for voice service	16.7.0
2020-12	SP-90E	SP-200953	2411	1	F	Replacing Bridge Address with Bridge ID	16.7.0
2020-12	SP-90E	SP-200958	2412	-	F	Correction to Nnssaaf_NSSAA_Notify service	16.7.0
2020-12	SP-90E	SP-200959	2414	1	F	QoS control in V-SMF	16.7.0
2020-12	SP-90E	SP-200959	2415	-	F	UE Context in AMF Data	16.7.0
2020-12	SP-90E	SP-200947	2419	1	F	Correction on Enhanced Coverage Restriction	16.7.0
2020-12	SP-90E	SP-200947	2421	-	F	Event Configuration Synchronization between 4G&5G	16.7.0
2020-12	SP-90E	SP-200959	2424	1	F	Clarification on Registration with AMF re-allocation	16.7.0
2020-12	SP-90E	SP-200957	2425	-	F	Clarifications for the BDT policy negotiation procedure	16.7.0
2020-12	SP-90E	SP-200959	2426	-	F	Correction of Registration procedure for untrusted non-3GPP access	16.7.0
2020-12	SP-90E	SP-200959	2428	1	F	Handling of UE parameters update and Steering of Roaming procedure when UE is not reachable or when acknowledgement from UE is not received	16.7.0
2020-12	SP-90E	SP-200959	2430	1	F	S-NSSAI handling at the Inter PLMN mobility	16.7.0
2020-12	SP-90E	SP-200959	2431	1	F	Correction on Location Report	16.7.0
2020-12	SP-90E	SP-200947	2433	1	F	Correction on header compression for CP Optimisation	16.7.0
2020-12	SP-90E	SP-200953	2434	1	F	Clarification on UPF report Bridge ID	16.7.0
2020-12	SP-90E	SP-200959	2435	1	F	Corrections for PDU Session Release Procedure in 5GC	16.7.0
2020-12	SP-90E	SP-200959	2438	1	F	Voice fallback triggered by PDU session resource setup	16.7.0
2020-12	SP-90E	SP-201100	2439	2	A	Removal of SMSF registration notification flag	16.7.0

2020-12	SP-90E	SP-200945	2442	1	A	Stage 3 alignment on correction of UE Context Transfer payload in case of UE initial registration	16.7.0
2020-12	SP-90E	SP-200945	2444	1	A	Correction of Network Triggered Service Request for UE in CM-CONNECTED	16.7.0
2020-12	SP-90E	SP-200945	2446	1	A	Stage 3 alignment on clarification of Registration Status Update for PCF for UE Policy	16.7.0
2020-12	SP-90E	SP-200947	2448	1	F	Clarifications for GUTI re-allocation	16.7.0
2020-12	SP-90E	SP-200959	2449	1	F	Correction to AN Release procedure	16.7.0
2020-12	SP-90E	SP-201127	2450	2	F	Fixing Redirection for EPS Fallback indication	16.7.0
2020-12	SP-90E	SP-200953	2451	1	F	Use of NSSF Services for SNPN	16.7.0
2020-12	SP-90E	SP-200954	2452	-	F	Correction on Trusted Non-3GPP access	16.7.0
2020-12	SP-90E	SP-201141	2453	2	F	QoS parameter handling for PDU session transfer between 3GPP and non-3GPP access	16.7.0
2020-12	SP-90E	SP-200959	2454	1	F	General cleanup of specification	16.7.0
2021-01	SP-90E	-	-	-	-	MCC correction: Removal of postponed 23.502 CR2413R1 from implementation	16.7.1
2021-03	SP-91E	-	-	-	-	MCC clean-up of numerous typos before CR Implementation	16.8.0
2021-03	SP-91E	SP-210055	2418	2	F	UE availability after DDN failure and DDD status events handling with V-SMF and I-SMF	16.8.0
2021-03	SP-91E	SP-210055	2422	2	F	Correction to Network Configuration Parameter handling	16.8.0
2021-03	SP-91E	SP-210075	2456	1	F	Corrections on EPS to 5GS Handover with AMF re-allocation	16.8.0
2021-03	SP-91E	SP-210082	2457	-	F	EBI allocation for Emergency PDU Sessions	16.8.0
2021-03	SP-91E	SP-210082	2458	1	F	Correcting AMF specifications related with the FQDN for the S5/S8 interface of the SMF+PGW-C	16.8.0
2021-03	SP-91E	SP-210082	2459	1	F	Add steps for releasing resources for indirect forwarding in Handover Cancel	16.8.0
2021-03	SP-91E	SP-210082	2460	-	F	Corrections on Inter NG-RAN node N2 Handover Procedure description	16.8.0
2021-03	SP-91E	SP-210082	2473	1	F	Uplink packet filter handling to avoid packet drops	16.8.0
2021-03	SP-91E	SP-210082	2475	2	F	Handling of DN-AAA interactions in case of EPS IWK	16.8.0
2021-03	SP-91E	SP-210053	2480	1	A	Supplement DNN to the input parameter of Nnrf_NFManagement_NFRegister service operation	16.8.0
2021-03	SP-91E	SP-210055	2483	1	F	Roaming status monitoring event clarification	16.8.0
2021-03	SP-91E	SP-210082	2485	1	F	Correction of Inter-AMF mobility with group monitoring	16.8.0
2021-03	SP-91E	SP-210082	2487	1	F	QoS control in the VPLMN	16.8.0
2021-03	SP-91E	SP-210075	2488	1	F	PDU Session ID and Configured S-NSSAI handling during EPS to 5GS HO with AMF reallocation	16.8.0
2021-03	SP-91E	SP-210055	2489	1	F	MTC Provider Information handling	16.8.0
2021-03	SP-91E	SP-210082	2492	1	F	Configuration of SMF+PGW-C identity in Emergency Configuration Data	16.8.0
2021-03	SP-91E	SP-210082	2493	1	F	Correction to handling of alternative H-SMF in home routed roaming	16.8.0
2021-03	SP-91E	SP-210243	2495	-	F	PFD provisioning correction to exclude pre-configuration	16.8.0
2021-03	SP-91E	SP-210245	2515	1	F	Clarification on MA PDU session for LADN	16.8.0
2021-03	SP-91E	SP-210244	2516	-	F	Correction on switching an existing PDU Session between non-3GPP access and 3GPP access	16.8.0
2021-03	SP-91E	SP-210243	2524	-	F	Delete the duplicated SoR item in UE Subscription data	16.8.0
2021-03	SP-91E	SP-210082	2535	1	F	Home Routed PDU Session Establishment	16.8.0
2021-03	SP-91E	SP-210082	2537	-	F	NGAP TNLA Binding correction	16.8.0
2021-03	SP-91E	SP-210082	2544	1	F	Alignment with stage 3 for location reporting	16.8.0
2021-03	SP-91E	SP-210082	2545	1	F	NGAP UE-TNLA-binding update	16.8.0
2021-03	SP-91E	SP-210057	2546	-	F	Remove EN for authorization in Indirect Communication and Delegated Discovery	16.8.0
2021-03	SP-91E	SP-210076	2548	1	F	QoS parameter handling for PDU session transfer between 3GPP and non-3GPP access	16.8.0
2021-03	SP-91E	SP-210055	2556	-	F	Clarification on session transfer between non-3GPP access and 3GPP access during the CPSR	16.8.0
2021-03	SP-91E	SP-210079	2561	1	F	Immediate Suspension	16.8.0
2021-03	SP-91E	SP-210055	2574	1	F	Downlink data report by UPF	16.8.0
2021-03	SP-91E	SP-210056	2576	1	F	Update of AMF event exposure service	16.8.0
2021-03	SP-91E	SP-210243	2598	1	F	Incorrect linkage of unreachable to lack of paging response	16.8.0
2021-06	SP-92E	SP-210343	2465	4	F	Solving interworking to 5GS with N26 issue due to UE's N1 mode capability disabling/enabling	16.9.0
2021-06	SP-92E	SP-210324	2617	-	A	Delete NSI ID via N7 interface	16.9.0
2021-06	SP-92E	SP-210329	2643	2	F	Support of AF change	16.9.0
2021-06	SP-92E	SP-210334	2721	1	F	New service operation of Namf_Communication_CancelRelocateUEContext	16.9.0
2021-06	SP-92E	SP-210326	2744	1	F	Group event clarification and event transfer between AMFs	16.9.0
2021-06	SP-92E	SP-210331	2763	1	F	Removal of Notification Control from the Additional QoS Information	16.9.0
2021-06	SP-92E	SP-210329	2766	-	F	N9 forwarding tunnel between source and target ULCL	16.9.0
2021-06	SP-92E	SP-210330	2768	1	F	CHF discovery via NRF	16.9.0
2021-06	SP-92E	SP-210336	2786	1	F	Registration with AMF relocation considering CAG	16.9.0
2021-06	SP-92E	SP-210336	2791	-	F	Correction of reference for TSN AF parameters	16.9.0



2021-06	SP-92E	SP-210333	2792	1	F	Clarify the BDT warning procedure with degraded Network performance	16.9.0
2021-06	SP-92E	SP-210334	2810	1	F	Simultaneous change of ULCL/BP and PSA	16.9.0
2021-06	SP-92E	SP-210334	2825	-	F	Add NG-RAN N3 Tunnel information in SM context	16.9.0
2021-06	SP-92E	SP-210327	2842	1	F	NIDD configuration correction	16.9.0
2021-06	SP-92E	SP-210331	2853	1	F	Handover of a PDU Session procedure between 3GPP and trusted non-3GPP access in deployments topologies with specific SMF Service Areas	16.9.0
2021-06	SP-92E	SP-210328	2868	1	F	Handling of UTRAN UE radio capabilities	16.9.0
2021-09	SP-93E	SP-210902	2751	2	A	Correction to EPS bearer ID transfer	16.10.0
2021-09	SP-93E	SP-210909	2812	3	F	L-PSA release during mobility procedure with I-SMF removal	16.10.0
2021-09	SP-93E	SP-210910	2890	1	F	Handling of UE Radio Capability for Paging	16.10.0
2021-09	SP-93E	SP-210934	2897	-	F	Removal of Reliable Data Service Serialization Indications	16.10.0
2021-09	SP-93E	SP-210911	2923	1	F	Update PCF service operation	16.10.0
2021-09	SP-93E	SP-210903	2940	1	F	Correction of the Notification of User Plane Management Events procedure	16.10.0
2021-09	SP-93E	SP-210909	2971	1	F	Source I-SMF release for PDU Session not requested for handover	16.10.0
2021-09	SP-93E	SP-210903	2992	1	F	Initial event reporting during event subscription	16.10.0
2021-09	SP-93E	SP-210903	3057	1	F	Session Management Subscription data for EPS/5GS interworking	16.10.0
2021-09	SP-93E	SP-210903	3059	1	F	Inter-AMF mobility with group monitoring	16.10.0
2021-09	SP-93E	SP-210902	3062	1	A	Dual Access Type SMS registration	16.10.0
2021-09	SP-93E	SP-210904	3064	-	F	5GS Idle Status Indication	16.10.0
2021-09	SP-93E	SP-210904	3066	-	F	Device Triggering parameter correction	16.10.0
2021-09	SP-93E	SP-210903	3074	-	F	Update on EventExposure Subscribe services	16.10.0
2021-09	SP-93E	SP-210911	3095	1	F	clarification for 5GS Bridge available event	16.10.0
2021-09	SP-93E	SP-210903	3117	-	F	RAN-triggered PDU Session Release	16.10.0
2021-12	SP-94E	SP-211276	3226	1	F	V-SMF change at inter-PLMN mobility	16.11.0
2021-12	SP-94E	SP-211278	3241	1	F	RID Update for SNPN UEs	16.11.0
2021-12	SP-94E	SP-211278	3255	1	F	correction for CAG restrictions with emergency services	16.11.0
2021-12	SP-94E	SP-211279	3262	1	F	AMF re-allocation during inter PLMN mobility	16.11.0
2021-12	SP-94E	SP-211274	3294	1	F	Providing UE's address to AMF during registration via trusted Non-3GPP access	16.11.0
2021-12	SP-94E	SP-211279	3298	1	F	Layer below IPsec to enable NAT traversal for TNGF/N3IWF access	16.11.0
2021-12	SP-94E	SP-211278	3302	1	F	Include TSN time domain into bridge information reporting procedure	16.11.0
2021-12	SP-94E	SP-211279	3310	-	F	Corrections to procedures for Handover of a PDU Session between 3GPP and untrusted non-3GPP access	16.11.0
2021-12	SP-94E	SP-211273	3315	-	F	Update the location service operations to add service identity and service type	16.11.0
2022-03	SP-95E	SP-220047	3224	2	F	Mapping TSCAI between TSN GM clock and 5GS clock	16.12.0
2022-03	SP-95E	SP-220045	3230	2	F	Service Request and PCF interaction	16.12.0
2022-03	SP-95E	SP-220046	3336	1	F	Handover of a PDU Session from 3GPP to untrusted non-3GPP access (I-SMF case)	16.12.0
2022-03	SP-95E	SP-220045	3344	1	F	Data forwarding indication during HO	16.12.0
2022-03	SP-95E	SP-220045	3375	1	F	UP path change notification to the AF	16.12.0
2022-03	SP-95E	SP-220046	3386	1	F	Mobility between HPLMN and VPLMN	16.12.0
2022-03	SP-95E	SP-220044	3409	-	F	Missing QoS Monitoring report in the Npcf_SMPolicyControl_Update service	16.12.0
2022-06	SP-96	SP-220391	3319	2	F	AMF interaction with GMLC at SRVCC for an Emergency session	16.13.0
2022-06	SP-96	SP-220391	3468	1	F	Clarification of NIDD Authorization	16.13.0
2022-06	SP-96	SP-220389	3478	1	A	Correction on N2 based handover procedure	16.13.0
2022-06	SP-96	SP-220391	3486	1	F	Correction of the Signalling Based Tracing support	16.13.0
2022-09	SP-97E	SP-220771	3521	1	F	Clarification on RAN sharing in case of SNPN	16.14.0
2022-09	SP-97E	SP-220769	3537	1	F	Clarification on NAS PDU delivery during PDU Session modification	16.14.0
2022-09	SP-97E	SP-220771	3540	1	F	Correction on 5G VN group management	16.14.0
2022-09	SP-97E	SP-220893	3542	1	F	Removal of EAP Re-authentication	16.14.0
2022-12	SP-98E	SP-221063	3559	1	F	3GPP PS Data Off status in PDU Session Establishment	16.15.0
2023-06	SP-100	SP-230455	3873	1	F	Clarification on roaming scenario of N5CW device	16.16.0
2023-06	SP-100	SP-230447	4123	1	F	Reinstating definition of Nnrf_NFManagement_NFStatusUnsubscribe service operation	16.16.0

## History

<b>Document history</b>		
V16.5.0	July 2020	Publication (withdrawn)
V16.5.1	September 2020	Publication
V16.6.0	October 2020	Publication
V16.7.0	January 2021	Publication (withdrawn)
V16.7.1	January 2021	Publication
V16.8.0	April 2021	Publication
V16.9.0	July 2021	Publication
V16.10.0	September 2021	Publication
V16.11.0	January 2022	Publication
V16.12.0	March 2022	Publication
V16.13.0	July 2022	Publication
V16.14.0	September 2022	Publication
V16.15.0	January 2023	Publication
V16.16.0	July 2023	Publication