

ETSI TS 123 221 V9.4.0 (2010-06)

Technical Specification

**Digital cellular telecommunications system (Phase 2+);
Universal Mobile Telecommunications System (UMTS);
LTE;
Architectural requirements
(3GPP TS 23.221 version 9.4.0 Release 9)**



Reference

RTS/TSGS-0223221v940

Keywords

GSM, LTE, UMTS

ETSI

650 Route des Lucioles
F-06921 Sophia Antipolis Cedex - FRANCE

Tel.: +33 4 92 94 42 00 Fax: +33 4 93 65 47 16

Siret N° 348 623 562 00017 - NAF 742 C
Association à but non lucratif enregistrée à la
Sous-Préfecture de Grasse (06) N° 7803/88

Important notice

Individual copies of the present document can be downloaded from:

<http://www.etsi.org>

The present document may be made available in more than one electronic version or in print. In any case of existing or perceived difference in contents between such versions, the reference version is the Portable Document Format (PDF). In case of dispute, the reference shall be the printing on ETSI printers of the PDF version kept on a specific network drive within ETSI Secretariat.

Users of the present document should be aware that the document may be subject to revision or change of status. Information on the current status of this and other ETSI documents is available at

<http://portal.etsi.org/tb/status/status.asp>

If you find errors in the present document, please send your comment to one of the following services:

http://portal.etsi.org/chaicor/ETSI_support.asp

Copyright Notification

No part may be reproduced except as authorized by written permission.
The copyright and the foregoing restriction extend to reproduction in all media.

© European Telecommunications Standards Institute 2010.
All rights reserved.

DECT[™], **PLUGTESTS**[™], **UMTS**[™], **TIPHON**[™], the TIPHON logo and the ETSI logo are Trade Marks of ETSI registered for the benefit of its Members.

3GPP[™] is a Trade Mark of ETSI registered for the benefit of its Members and of the 3GPP Organizational Partners.

LTE[™] is a Trade Mark of ETSI currently being registered

for the benefit of its Members and of the 3GPP Organizational Partners.

GSM[®] and the GSM logo are Trade Marks registered and owned by the GSM Association.

Intellectual Property Rights

IPRs essential or potentially essential to the present document may have been declared to ETSI. The information pertaining to these essential IPRs, if any, is publicly available for **ETSI members and non-members**, and can be found in ETSI SR 000 314: "*Intellectual Property Rights (IPRs); Essential, or potentially Essential, IPRs notified to ETSI in respect of ETSI standards*", which is available from the ETSI Secretariat. Latest updates are available on the ETSI Web server (<http://webapp.etsi.org/IPR/home.asp>).

Pursuant to the ETSI IPR Policy, no investigation, including IPR searches, has been carried out by ETSI. No guarantee can be given as to the existence of other IPRs not referenced in ETSI SR 000 314 (or the updates on the ETSI Web server) which are, or may be, or may become, essential to the present document.

Foreword

This Technical Specification (TS) has been produced by ETSI 3rd Generation Partnership Project (3GPP).

The present document may refer to technical specifications or reports using their 3GPP identities, UMTS identities or GSM identities. These should be interpreted as being references to the corresponding ETSI deliverables.

The cross reference between GSM, UMTS, 3GPP and ETSI identities can be found under <http://webapp.etsi.org/key/queryform.asp>.

Contents

Intellectual Property Rights	2
Foreword.....	2
Foreword.....	5
1 Scope	6
2 References	6
3 Definitions, symbols and abbreviations	7
3.1 Definitions	7
3.2 Symbols.....	8
3.3 Abbreviations	8
4 3GPP system domains and subsystems	9
4.1 Allowed network and terminal configurations	9
4.2 Circuit switched (CS) core network domain	9
4.2.1 Iu mode to Iu mode handover for circuit switched services	9
4.2.2 A mode to Iu mode handover for CS services	10
4.2.3 General principles for use of CS-MGW resources	10
4.2.4 Transcoder location.....	10
4.3 Packet Switched (PS) core network domain.....	10
4.4 IP Multimedia subsystem (IMS)	10
4.5 Cross Core Network Domain Requirements	10
4.6 UTRAN	10
4.7 GERAN	11
4.8 E-UTRAN	11
5 IP addressing	11
5.1 IP version issues	11
5.2 Interoperability between IPv4 and IPv6 networks.....	11
5.2.1 IPv4/IPv6 Mobile connecting to IPv4 and IPv6 networks	11
5.2.2 IPv6 only Mobile connecting to IPv4 network	12
5.2.3 IPv6 Mobile connected to an IPv6 Device via an IPv4 network.....	13
5.3 Address management	13
5.4 IP addressing and routing for access to IM-subsystem services.....	14
5.5 Simultaneous access to multiple services	15
5.6 UE support of IPv6.....	16
6 Mobility management.....	16
6.1 Introduction	16
6.2 Location management and mobility management concept overview.....	17
6.2.1 Non-combined procedures.....	17
6.2.2 Use of combined procedures.....	19
6.3 Description of the location management and mobility management concept - area concepts	19
6.3.1 Introduction.....	19
6.3.2 Location areas	19
6.3.3 Tracking and Routing areas	19
6.3.3a Support of Iu and A/Gb mode of operation in GERAN Cells	19
6.3.3a.1 Overview.....	19
6.3.3a.2 Interface selection in GERAN Cells	20
6.3.3a.2.1 Basic principles for MS controlled Cell/Mode selection/re-selection	21
6.3.3a.2.2 Basic principles for network controlled Mode selection/re-selection	21
6.3.4 RAN internal areas.....	21
6.3.5 Relationship between the different areas	21
6.3.5a Restriction of subscribers" access.....	22
6.3.6 Hierarchical tracking concept	23
6.4 Relationship between MM and SM states for an UE.....	23
6.5 Requirement in case of temporarily loss of coverage of packet UE.....	24

6.6	MM functionality in different UE service states	24
6.7	The RRC state machine	25
6.8	Relationship between CS and PS service states and RRC state for an UE	26
6.9	Service registration and location update	27
6.9.1	Introduction	27
6.9.2	Location area update	27
6.9.3	Tracking and Routing area update	27
6.9.4	Combined updates	28
6.10	Paging initiated by CN	28
6.11	Signalling connection establishment	28
6.11a	CS Domain Signalling Requirements (in particular relating to handover)	28
6.12	Relations between SRNS relocation and location registration	28
6.13	Requirements on identifiers for UMTS and GSM	30
6.14	Use of MM system information	30
6.15	Signalling procedures	31
6.15.1	Idle mode procedures	31
6.15.1.1	Location Area update	31
6.15.1.2	Routing Area Update	33
6.15.1.2A	Tracking Area Update	33
6.15.1.3	Periodic registration towards both CN nodes without use of Gs or SGs	33
6.15.1.4	Periodic registration with use of Gs or SGs	33
6.15.1.5	UE initiated combined detach procedure when using Gs or SGs	33
6.15.1.6	Forbidden LA/RA	33
6.15.2	SRNS Relocation	33
6.16	RAN coordination	33
7	Call control	34
7.1	General Aspects	34
7.2	Domain selection for mobile terminated calls from the PSTN/CS domain	34
7.2.1	Introduction	34
7.2.2	Calls directed to the CS domain	35
7.2.3	Calls directed to the IMS	35
7.2a	Domain selection for UE originating sessions / calls	35
7.2b	Access Domain Selection for terminating sessions	37
7.2c	Domain Selection for UE originating SMS	38
7.3	Routing sessions from the IMS to the CS Domain	38
8	Support of IM CN Subsystem services	38
8.1	Context activation and registration	38
8.2	Location management	40
8.2.1	Registration concepts for a subscriber roaming into CS domain	40
8.3	IMS Emergency sessions	42
8.3.1	GPRS/EPS considerations for UE recognized IMS Emergency Sessions	42
8.3.2	Emergency Calls in absence of UICC for GPRS/EPS Access	42
9	Efficient use of radio resource	42
Annex A (informative): Guidance for CSFB and IMS enabled UE implementations in E-UTRAN		43
A.1	General	43
A.2	IMS PS Voice preferred	43
A.2.1	EPS Attach	43
A.2.2	Combined EPS/IMSI attach	44
A.3	CS Voice preferred	45
A.4	IMS PS Voice only	46
A.5	CS Voice only	46
Annex B (informative): Change history		48
History		49

Foreword

This Technical Specification has been produced by the 3rd Generation Partnership Project (3GPP).

The contents of the present document are subject to continuing work within the TSG and may change following formal TSG approval. Should the TSG modify the contents of the present document, it will be re-released by the TSG with an identifying change of release date and an increase in version number as follows:

Version x.y.z

where:

- x the first digit:
 - 1 presented to TSG for information;
 - 2 presented to TSG for approval;
 - 3 or greater indicates TSG approved document under change control.
- y the second digit is incremented for all changes of substance, i.e. technical enhancements, corrections, updates, etc.
- z the third digit is incremented when editorial only changes have been incorporated in the document.

1 Scope

This document covers the architectural requirements for 3GPP systems based on UTRAN, E-UTRAN and Iu mode GERAN. In particular it details the high level requirements for the Circuit Switched (CS) Domain and the stage 2 procedures that span more than one domain/subsystem. The reference model to which these procedures apply can be found within TS 23.002 [1]. In addition, A mode to Iu mode handover for CS services is addressed. Detailed architectural requirements within the subsystems are contained within the remainder of the 23 series of specifications e.g. the requirements for the Packet Switched (PS) domain are contained within TS 23.060 [2], TS 23.401 [27] and the requirements for the Bearer Independent CS Core Network are contained in TS 23.205[14].

2 References

The following documents contain provisions which, through reference in this text, constitute provisions of the present document.

- References are either specific (identified by date of publication, edition number, version number, etc.) or non-specific.
- For a specific reference, subsequent revisions do not apply.
- For a non-specific reference, the latest version applies. In the case of a reference to a 3GPP document (including a GSM document), a non-specific reference implicitly refers to the latest version of that document *in the same Release as the present document*.

- [1] 3GPP TS 23.002: "Network Architecture".
- [2] 3GPP TS 23.060: "General Packet Radio Service (GPRS) Service description; Stage 2".
- [3] 3GPP TS 23.012: "Location management procedures".
- [5] 3GPP TS 25.331: "Radio Resource Control (RRC) Protocol Specification".
- [6] 3GPP TS 25.301: "Radio interface protocol architecture".
- [7] 3GPP TS 25.303: "UE functions and inter-layer procedures in connected mode".
- [8] 3GPP TR 21.905: "3G Vocabulary".
- [9] 3GPP TS 25.413: "UTRAN Iu interface RANAP signalling".
- [10] 3GPP TS 25.410: "UTRAN Iu Interface: General Aspects and Principles".
- [11] 3GPP TS 23.228: "IP Multimedia Subsystem – Stage 2".
- [12] 3GPP TS 43.051: "GERAN Overall Description".
- [13] 3GPP TS 23.153: "Out of Band Transcoder Control - Stage 2".
- [14] 3GPP TS 23.205: "Bearer Independent CS Core Network – Stage 2".
- [15] 3GPP TR 25.931: "UTRAN Functions, examples on signalling procedures".
- [16] RFC 2766: "Network Address Translation - Protocol Translation (NAT-PT)", G. Tsirtsis, P. Srisuresh. February 2000.
- [17] RFC 2893: "Transition Mechanisms for IPv6 Hosts and Routers", R. Gilligan, E. Nordmark, August 2000.
- [17a] RFC 3041: "Privacy Extensions for Stateless Address Autoconfiguration in IPv6", T. Narten, R. Daves, January 2001.
- [18] 3GPP TS 25.401 "UTRAN Overall Description".

- [19] 3GPP TS 25.304: "UE Procedures in Idle Mode and Procedures for Cell Reselection in Connected Mode".
- [20] 3GPP TS 45.008: "Radio subsystem link control".
- [21] RFC3316: "IPv6 for Some Second and Third Generation Cellular Hosts", June 2002.
- [22] 3GPP TS 24.007: "Digital cellular telecommunications system (Phase 2+); Mobile radio interface signalling layer 3 General aspects".
- [23] 3GPP TS 24.229 "IP Multimedia Call Control Protocol based on SIP and SDP".
- [24] 3GPP TS 23.008: "Organisation of subscriber data".
- [25] 3GPP TS 24.008: "Mobile radio interface Layer 3 specification; Core network protocols; Stage 3".
- [26] 3GPP TR 23.981 "Interworking aspects and migration scenarios for IPv4 based IMS implementations".
- [27] 3GPP TS 23.401: "General Packet Radio Service (GPRS) enhancements for Evolved Universal Terrestrial Radio Access Network (E-UTRAN) access".
- [28] 3GPP TS 36.300: "Evolved Universal Terrestrial Radio Access (E-UTRA) and Evolved Universal Terrestrial Radio Access (E-UTRAN); Overall description; Stage 2".
- [29] 3GPP TS 36.331: "Evolved Universal Terrestrial Radio Access (E-UTRA); Radio Resource Control (RRC); Protocol specification".
- [30] 3GPP TS 23.272: "Circuit Switched Fallback in Evolved Packet System; Stage 2".
- [31] 3GPP TS 23.292: "IP Multimedia Subsystem (IMS) Centralized Services".
- [32] 3GPP TS 23.237: "IP Multimedia Subsystem (IMS) Service Continuity".
- [33] 3GPP TS 23.167: "IP Multimedia Subsystem (IMS) emergency sessions".
- [34] 3GPP TS 24.301: "Non-Access-Stratum (NAS) protocol for Evolved Packet System (EPS); Stage 3".

3 Definitions, symbols and abbreviations

3.1 Definitions

For the purposes of the present document, the terms defined in TR 21.905 [8] apply, in addition, the following terms apply:

In Iu mode: see TR 21.905 [8].

In A/Gb mode: see TR 21.905 [8].

RAN: within this document, the term RAN (Radio Access Network) is used to refer to UTRAN and/or GERAN in Iu mode and/or E-UTRAN.

3.2 Symbols

For the purposes of the present document, the following symbols apply:

3.3 Abbreviations

For the purposes of the present document, the following abbreviations apply:

ATM	Asynchronous Transfer Mode
CM	Connection Management
CN	Core Network
CS	Circuit Switched
CSCF	Call/Session Control Function
CSFB	Circuit Switched Fallback
CS-MGW	Circuit Switched Media Gateway
DHCP	Dynamic Host Configuration Protocol
EPS	Evolved Packet System
E-UTRAN	Evolved UMTS Terrestrial Radio Access Network
GERAN	GSM/EDGE Radio Access Network
GGSN	Gateway GPRS Support Node
GPRS	General Packet Radio Service
GTP	GPRS Tunnelling Protocol
HLR	Home Location Register
IM	IP Multimedia
IMS	IP Multimedia Subsystem
IMSI	International Mobile Subscriber Identity
IP	Internet Protocol
IPSec	IP Security protocol
LA	Location Area
LAC	Location Area Code
LAN	Local Area Network
LLC	Logical Link Control
LM	Location Management
MAP	Mobile Application Part
MGCF	Media Gateway Control Function
MGW	Media Gateway
MM	Mobility Management
MME	Mobility Management Entity
MRF	Media Resource Function
MSC	Mobile Switching Centre
NAT	Network Address Translator
NGN	Next Generation Networks
OoBTC	Out of Band Transcoder Control
P-GW	PDN Gateway
PDA	Personal Digital Assistant
PDP	Packet Data Protocol
PLMN	Public Land Mobile Network
PS	Packet Switched
RA	Routing Area
RAC	Routing Area Code
RAI	Routing Area Identifier
RAN	Radio Access Network
RANAP	Radio Access Network Application Part
RLC	Radio Link Control
RNC	Radio Network Controller
RNTI	Radio Network Temporary Identifier
RRC	Radio Resource Control
S-GW	Serving Gateway
SGSN	Serving GPRS Support Node
SGW	Signalling gateway
SIP	Session Initiation Protocol

SRNS	Serving Radio Network Subsystem
SS7	Signalling System No. 7
STM	Synchronous Transfer Mode
SRNS	Serving Radio Network Subsystem
TCP	Transmission Control Protocol
TMSI	Temporary Mobile Station Identifier
TrFO	Transcoder Free Operation
UDP	User Datagram Protocol
UE	User Equipment
UMTS	Universal Mobile Telecommunications System
URA	UTRAN Registration Area
UTRAN	UMTS Terrestrial Radio Access Network
VHE	Virtual Home Environment
VLR	Visited Location Register

4 3GPP system domains and subsystems

4.1 Allowed network and terminal configurations

A 3GPP network is divided into a radio AN and a CN, which are connected via an open interface over the Iu or S1 or A/Gb reference point(s). The A/Gb mode is not further described in this specification. Furthermore, the core network is from a functional point of view divided into a PS Domain, IM Subsystem and a CS Domain (see TS 23.002 [1]). Any deployment of the IM subsystem requires a PS domain.

The following network configurations shall be allowed:

- networks which provide the functionality of CS Domain and PS Domain (and optionally IM Subsystem);
- networks which only provide the functionality of the CS Domain (only with GERAN or UTRAN access);
- networks which only provide the functionality of the PS Domain (and optionally IM Subsystem).

The following terminal configurations shall be allowed:

- terminals which are able to access both to the CS Domain and PS Domain (and optionally IM Subsystem);
- terminals which are only able to access to the PS Domain (and optionally IM Subsystem);
- terminals which are only able to access to the CS Domain.

It shall be noted that a terminal which is only able to access to e.g. the PS Domain supports only mobility management, protocols etc. of that domain. The different configurations given above shall not prevent CS-type services from being delivered over the PS domain.

4.2 Circuit switched (CS) core network domain

4.2.1 Iu mode to Iu mode handover for circuit switched services

For Iu mode to Iu mode Inter-MSC Hand-Over / SRNS relocation the MAP E interface transporting RANAP messages shall be used. Alternatively, in the case of intra-PLMN handover, the GSM to UMTS inter-system handover or SRNS relocation between two MSC-areas may be executed as intra-MSC inter-system handover or SRNS relocation respectively. In such a case this will be performed by utilising a direct SCCP connection between the target RNC located in the target MSC-area and the MSC server already involved in the call.

For handover of circuit-switched services involving the change of CN equipment (only CS-MGW or CS-MGW and MSC-server) the anchor principle shall be applied.

- The first MSC Server involved in a call will become the Anchor MSC Server for this call during and after handover, and will remain in the call until the call is released. Every subsequent handover (Intra and Inter) will be controlled by this MSC Server.

- The first CS-MGW involved in a call will become the Anchor CS-MGW for this call during and after handover, and will remain in the call until the call is released. The Nc interface is anchored in the CS-MGW, the correlation between CS-MGW to PSTN and the CS-MGW to RAN remain fixed until the call is released.

4.2.2 A mode to Iu mode handover for CS services

For A mode to Iu mode inter-system Inter-MSC Hand-Over (GSM to UMTS) the MAP E interface transporting BSSMAP messages shall be used. As a network option, in the case of intra-PLMN inter-system handover from A mode to Iu mode, the handover between two MSC-areas may be executed as:

- intra-MSC handover, if the serving BSS is connected to the Anchor MSC; or
- subsequent intra-MSC handover or subsequent inter-MSC handover back to the Anchor MSC Server, if the serving BSS is connected to an MSC-B. The decision between these two alternatives is implementation and network configuration dependent.

The procedure will be performed by utilising a direct SCCP connection between the target RNC located in the target MSC-area and the Anchor MSC or MSC-B, respectively.

4.2.3 General principles for use of CS-MGW resources

The following principles for use of CS-MGW resources apply:

1. it shall not be necessary to have the CS-MGW co-located with the MSC Server;
2. the CS-MGW resources need not be associated with any particular MSC Server (see note 1);
3. it shall be possible for any MSC Server to request resources of any CS-MGW in the network (see note 1);
4. it shall be possible for an RNC to connect to the CS-MGW indicated by the MSC server;

Note 1: For points 2 and 3 above, issues related to O&M procedures such as where notification of restart of a CS-MGW should be sent to, need to be considered. Extensions to H.248 may be required.

The specification of the Bearer Independent CS CN which uses the CS-MGW is in TS 23.205 [14].

4.2.4 Transcoder location

The transcoders are located in the core network. They may be located in the CS-MGW at the border to the RAN (i.e. the CS-MGW at the Iu interface) or at the CS-MGW at the edge of the core network (e.g. at the edge towards the PSTN/ISDN), TS 23.153 [13].

4.3 Packet Switched (PS) core network domain

The requirements for the GPRS PS domain are in TS 23.060 [2] and for the EPS PS domain in TS 23.401 [27].

4.4 IP Multimedia subsystem (IMS)

The requirements for the IMS are in TS 23.228 [11].

4.5 Cross Core Network Domain Requirements

The specifications shall support the option of IP transport for the MAP and CAP based interfaces

4.6 UTRAN

The requirements for the UTRAN are in the 3GPP 25-series of specifications. An overview can be found in TS 25.401 [18].

4.7 GERAN

The requirements for the GERAN are in TS 43.051 [12]

4.8 E-UTRAN

The requirements for the E-UTRAN are in the 3GPP 36-series of specifications. An overview can be found in TS 36.300 [28].

5 IP addressing

5.1 IP version issues

The EPS/UMTS/GSM architecture shall support IPv4 / IPv6 based on the statements below.

- IP transport between network elements of the IP Connectivity services (between RNC, SGSN, GGSN, eNodeB, MME, S-GW, and P-GW) and IP transport for the CS Domain: both IPv4 and IPv6 are options for IP Connectivity.
- IM CN subsystem elements (UE to CSCF and the other elements e.g. MRF):
 - The architecture should make optimum use of IPv6.
 - 3GPP specifications design the IM CN subsystem elements and interfaces to support both IPv4 and IPv6. In the case the UE supports IPv4, the guidelines and recommendations in TR 23.981 [26] should be followed.
 - The UE may support IPv4 only, IPv6 only or both for the connection to the IM CN subsystem. In the case the UE supports IPv4, the guidelines and recommendations in TR 23.981 [26] should be followed.
 - According to the procedures defined in TS 23.060 [23] and/or TS 23.401 [27], when a UE is assigned an IPv6 prefix, it can change the global IPv6 address it is currently using via the mechanism defined in RFC 3041 [16a], or similar means.
- Access to existing data services (Intranet, Internet,...):
- The UE can access IPv4 and IPv6 based services.

5.2 Interoperability between IPv4 and IPv6 networks

Since the UE can access both IPv4 and IPv6 based services, situations may arise where interworking is needed to interoperate with IPv4 and IPv6 networks. This clause describes three different interworking scenarios: UE is IPv4 and IPv6 capable, IPv6 only UE, and IPv6 UE connected via IPv4 network to an IPv6 device. These scenarios are examples of IPv6 and IPv4 interworking. The scenarios presented below only considered cases of a Transition Gateway (TrGW) for generic services and specialist services may require additional functionality at the application level.

5.2.1 IPv4/IPv6 Mobile connecting to IPv4 and IPv6 networks

An installation where the UE has both IPv4 and IPv6 stacks is shown in Figure 5-1. As depicted, the terminal connects to the IPv4 device directly using an IPv4 PDP or EPS Bearer Context. Hence, the UE appears to be a standard IPv4 node to the external IPv4 network. This scenario does not need any specific transition support from the network. However, it requires both versions of IP at the UE. The GGSN/P-GW in this scenario may be different for the IPv6 and the IPv4 connections unless IPv4/v6 PDP or EPS Bearer Contexts are used. With GGSN/P-GW is meant either a GGSN or a P-GW..

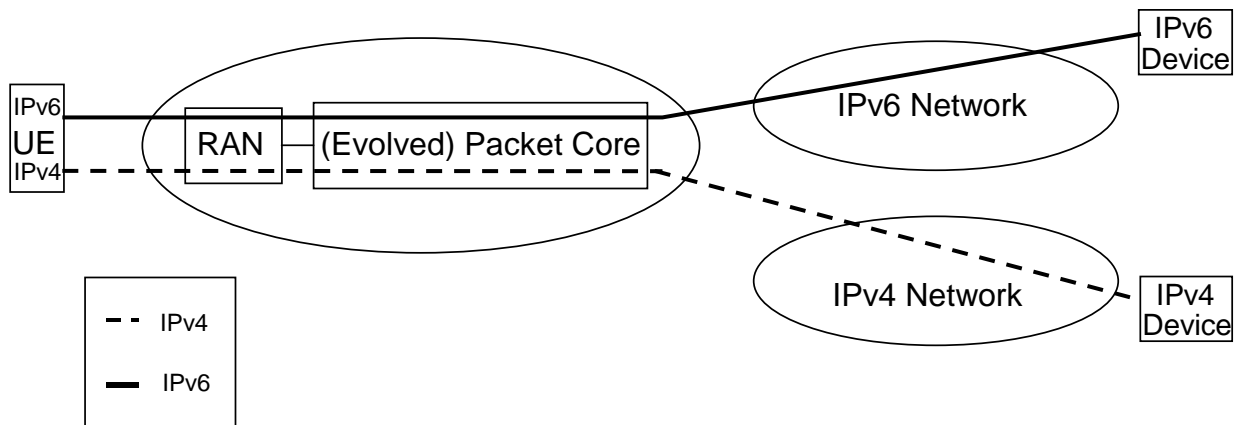

Figure 5-1: UE with IPv4 and IPv6 capability connecting to IPv4 and IPv6 networks

5.2.2 IPv6 only Mobile connecting to IPv4 network

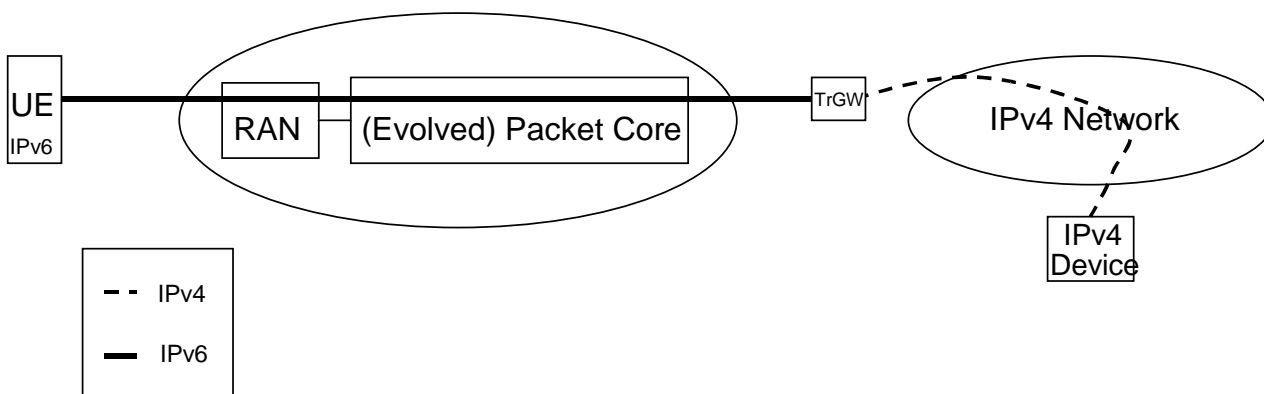

Figure 5-2: IPv6 only mobile connecting to IPv4 data services

Figure 5-2 shows an IPv6 only terminal connected to an IPv4 device. The UE is using an IPv6 PDP or EPS Bearer Context for access to a Transition Gateway (TrGW) that translates the IPv6 packets to IPv4 and vice versa. The TrGW may be implemented as a Network Address Translation – Protocol Translation (NAT-PT) [16] to convert IPv6 traffic coming from the UE to IPv4 traffic and vice versa.

NAT-PT is a combination of NAT-like address translation and IP header conversion as described in [16]. NAT-PT uses a pool of IPv4 addresses for assignment to IPv6 nodes on a dynamic basis as sessions are initiated across v4-v6 boundaries. NAT-PT binds addresses in the v6 network with addresses in the v4 network to provide transparent routing of packets traversing address realms. This requires no changes to end nodes and IP packet routing is completely transparent to them. It does, however, require NAT-PT to track the sessions it supports and mandates that inbound and outbound packets pertaining to a session traverse the same NAT-PT device.

5.2.3 IPv6 Mobile connected to an IPv6 Device via an IPv4 network

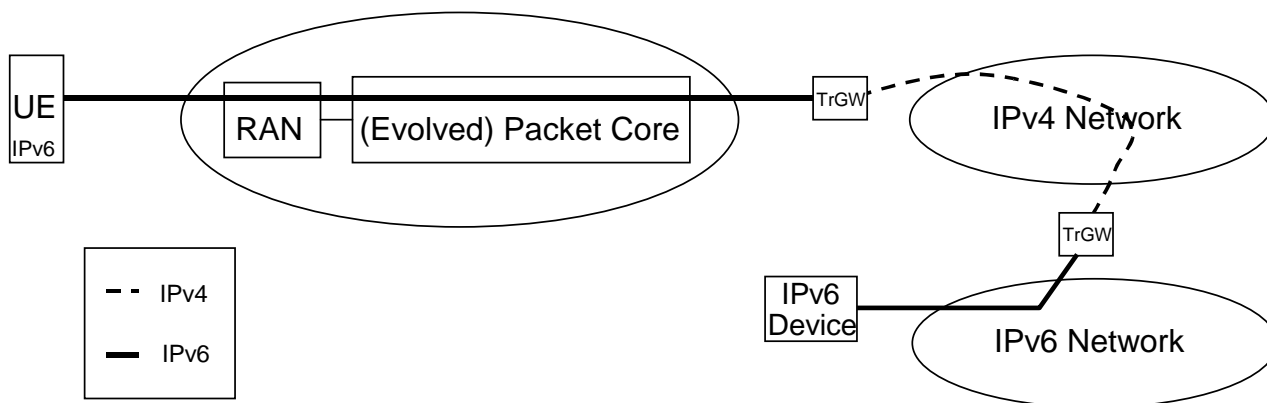

Figure 5-3: IPv6 mobile connected to an IPv6 device via an IPv4 network

Figure 5-3 shows a case where an IPv4 network lies between two IPv6 domains. The IPv6 domains can be interconnected using IETF standard mechanisms such as automatic or configured tunnelling of IPv6 over IPv4 [17].

5.3 Address management

A 3GPP network may be implemented as a number of logically separate IP networks which contain different parts of the overall system. Each of these elements is referred to as an "IP Addressing Domain". Within an "IP Addressing Domain" it is required that the nodes within the domain are part of a consistent non-overlapping IP-address space. It is also required that IP packets may be routed from any node in the domain to any other node in the domain using conventional IP routing. In a real implementation an IP Addressing Domain may be a physically separate IP network or an IP VPN.

IP Addressing Domains may be interconnected at various points. At these points of interconnect gateways, firewalls or NATs may be present. It is not guaranteed that IP packets from one IP Addressing Domain can be directly routed to any interconnected IP Addressing Domain. Rather inter-Domain traffic may be handled via firewalls or tunnels. This implies that different IP Addressing Domains can have different (and possibly overlapping) address spaces.

Figure 5-4 below shows an example of the IP Addressing Domains involved in PS-domain and IP-subsystem services.

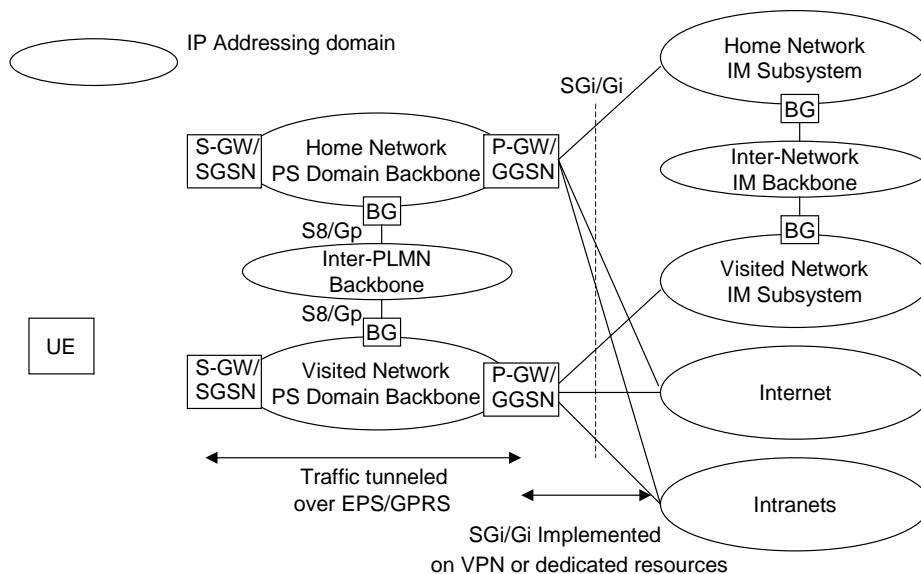

Figure 5-4: IP Addressing Domains Involved In PS-Domain and IM Services

Though 3GPP networks can use different IP Addressing Domains as shown above, it is possible that several different IP Addressing Domains fall under a common co-operative management regime. In this case the different IP Addressing

Domains may be implemented as a single administrative domain at the operator's discretion, thus using a common IP-address space.

A UE accessing services in either an IM subsystem, the Internet, or an external Intranet, or a combination of these service domains within the same IP network, requires an IP address that is part of the target network's IP Addressing Domain. For each of these IP networks, the IP address is linked to a specific PDP or EPS Bearer context, or set of PDP or EPS Bearer contexts sharing this IP address via a single APN.

When the UE establishes the PDP or EPS Bearer context to access an IP network, it may use an existing PDP or EPS Bearer context if it has an active context with a compatible IP addressing domain and quality of service profile.

5.4 IP addressing and routing for access to IM-subsystem services

This clause deals with a UE accessing IM CN subsystem services via EPS or GPRS.

A UE accessing IM CN Subsystem services requires an IP address that is logically part of the IM CN subsystem IP Addressing Domain. This is established using an appropriate PDP or EPS Bearer context. It is possible to connect to a P-GW/GGSN either in the VPLMN or the HPLMN. For routing efficiency this context may benefit from being connected through a P-GW/GGSN in the visited network. The connection between the UE and the IM CN subsystem (where the P-GW/GGSN is either in the Home or the Visited network) is shown below:

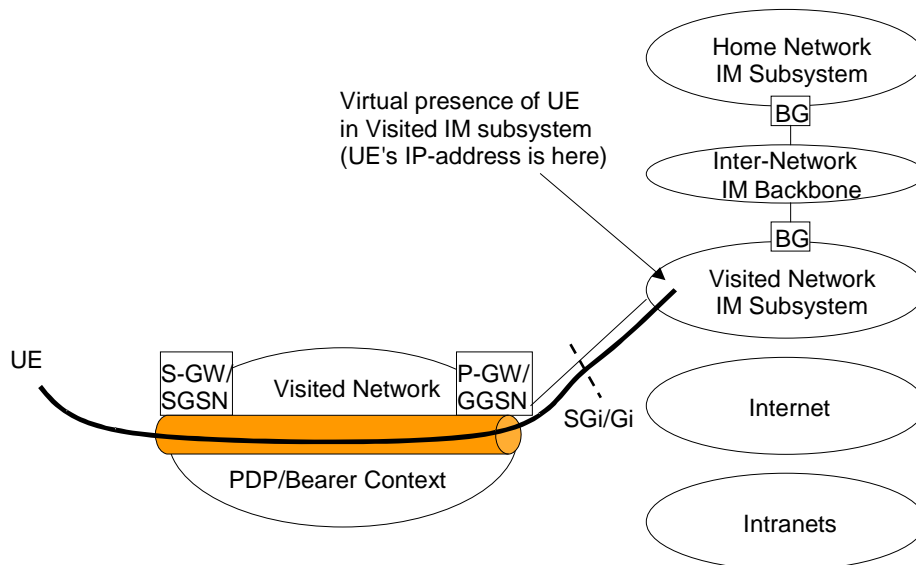

Figure 5-5: UE Accessing IM Subsystem Services with P-GW/GGSN in the Visited network via Visited Network IM subsystem

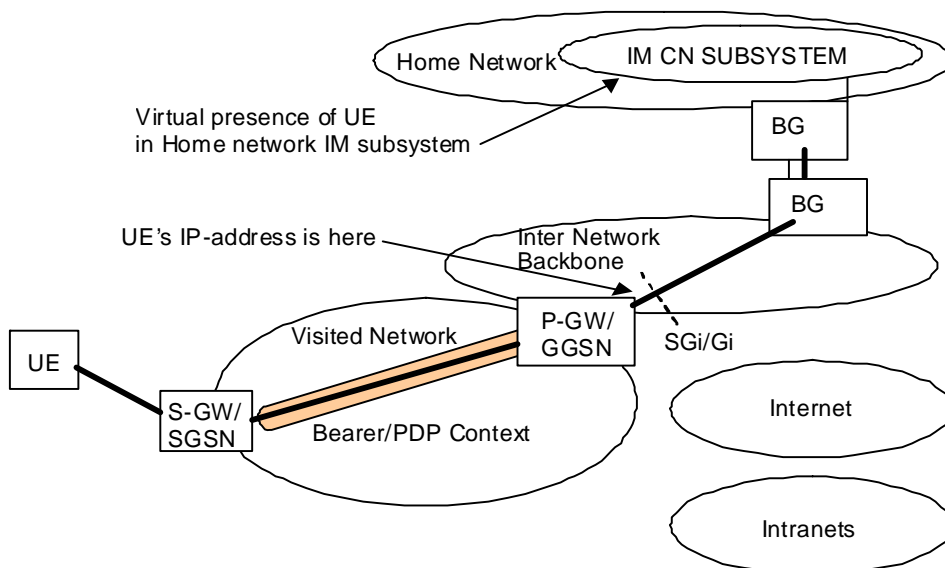

Figure 5-5a.1: UE Accessing IM Subsystem Services with P-GW/GGSN in the Visited network

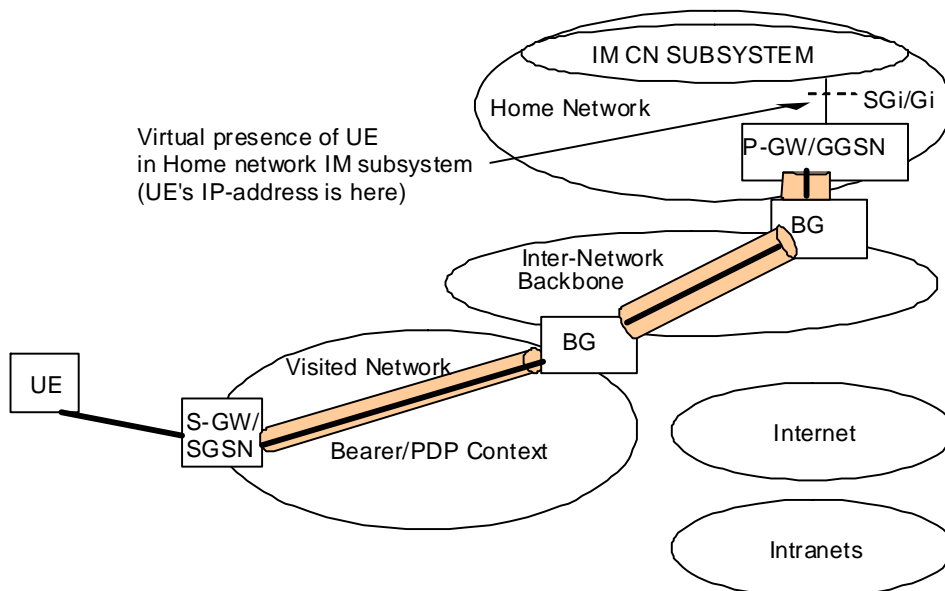

Figure 5-5a: UE Accessing IM CN subsystem Services with P-GW/GGSN in the Home network

The ability of the User plane and the Control Plane for a single IMS session being able to pass through different P-GWs/GGSNs is not defined in this release.

5.5 Simultaneous access to multiple services

A UE can have multiple services active simultaneously. When the services are part of different IP addressing domains, separate EPS Bearer or PDP contexts and IP addresses are required. The UE shall support multiple IP addresses when simultaneous EPS Bearer or PDP contexts are activated that require separate IP addresses for different addressing domains.

Figure 5-6 shows an example of a connection between a UE and an Internet/Intranet service that is not available in the Visited Network with a simultaneous connection to the Visited Network's IM Subsystem. In this example, there may be two IPv6 addresses allocated, or one IPv4 address allocated for internet/Intranet access and one IPv6 address for IM subsystem access.

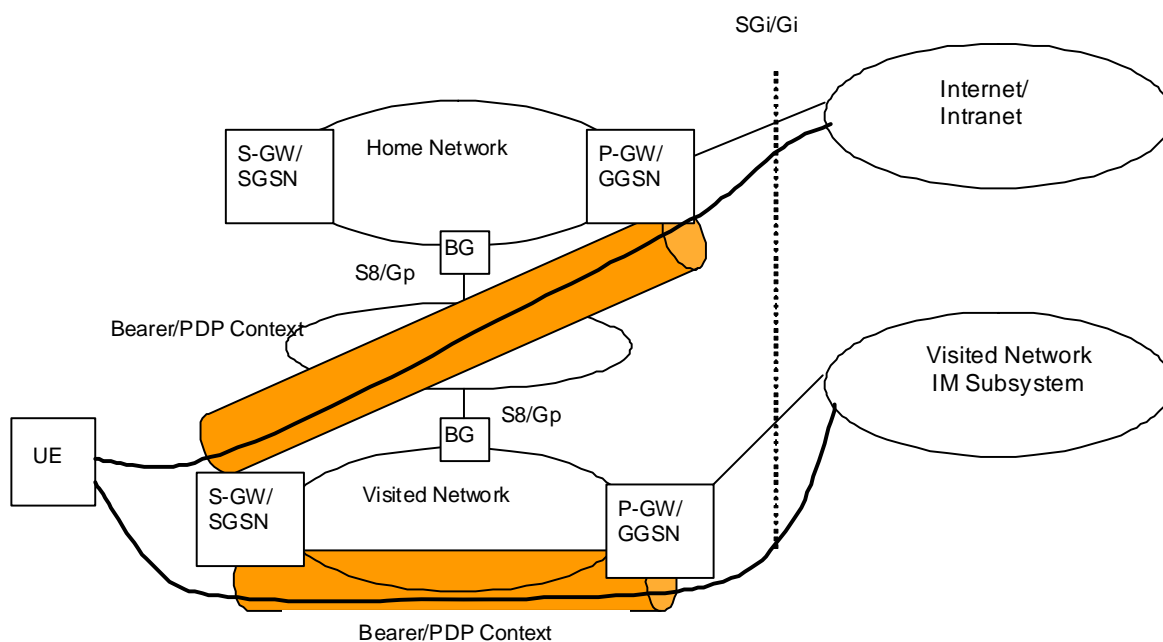

Figure 5-6: UE Accessing Home Internet/Intranet Services and Visited Network IM CN Subsystem Services

5.6 UE support of IPv6

The set of IPv6 functionality a 3GPP UE will require is dependent on the services (IMS, Packet Streaming etc.) it will use.

As a minimum, a 3GPP UE shall comply with the Basic IP group of specifications as defined in RFC 3316 [21]. This IPv6 functionality is sufficient to provide compatibility towards IPv6 entities external to 3GPP.

A 3GPP UE shall follow the recommendations for the IP Security set of functions in RFC 3316 [21] when a specific service requires such functions.

According to the procedures defined in TS 23.060 [2] and in TS 23.401 [27], when a UE is assigned an IPv6 prefix, it can change the global IPv6 address it is currently using via the mechanism defined in RFC 3041 [17a], or similar means, without updating the PS domain. Any application that requires full IP address knowledge shall provide a mechanism to get the latest IPv6 address when the IPv6 address in the UE has been changed. An example of such means is defined in TS 23.228 [11].

NOTE: RFC 3316 [21] does not make any recommendations on preferred transition and interoperability mechanisms between IPv4 and IPv6.

6 Mobility management

6.1 Introduction

From a Mobility Management point of view, the CN encompasses two domains, a CS domain and a PS domain. The UTRAN and the GERAN can be connected either to both these CN domains or to one of the CN domains. The E-UTRAN connects with the PS domain only.

A single RRC connection (between RAN and UE) shall carry all user plane and signalling flows to/from a UE. This is regardless of where in the CN they originate/terminate.

The 3GPP specifications for UTRAN and GSM in Iu mode shall support compatibility with GSM networks in A/Gb mode from the point of view of roaming and handover. The 3GPP specifications for EPS support compatibility with

GSM networks and with UMTS from the point of view of roaming and handover. For the LM/MM functionality point of view this implies among other things the following:

- IMSI shall be used as the common user identity in the two CN domains;
- common MAP signalling is applied to networks supporting either Iu or A/Gb mode or both.
- radio network parameters and radio resource management should be isolated in the RAN.

The LM/MM techniques used should minimise radio resource usage of the RAN.

6.2 Location management and mobility management concept overview

6.2.1 Non-combined procedures

From a LM/MM point of view, the CN consists of two domains, a CS domain and a PS domain or one of these domains.

Each domain has its own service state machine. An UE, that is supporting both CS services and PS services, has a CS service state machine and a PS service state machine. The two peers of the service state machine are working independently to each other, although associated to the same UE. The UE-CN signalling aims to keep the peer entities synchronised.

As an introduction, figure 6.1 gives an overview of the UE registration and connection principles for the CN consisting of two separate PS and CS service nodes.

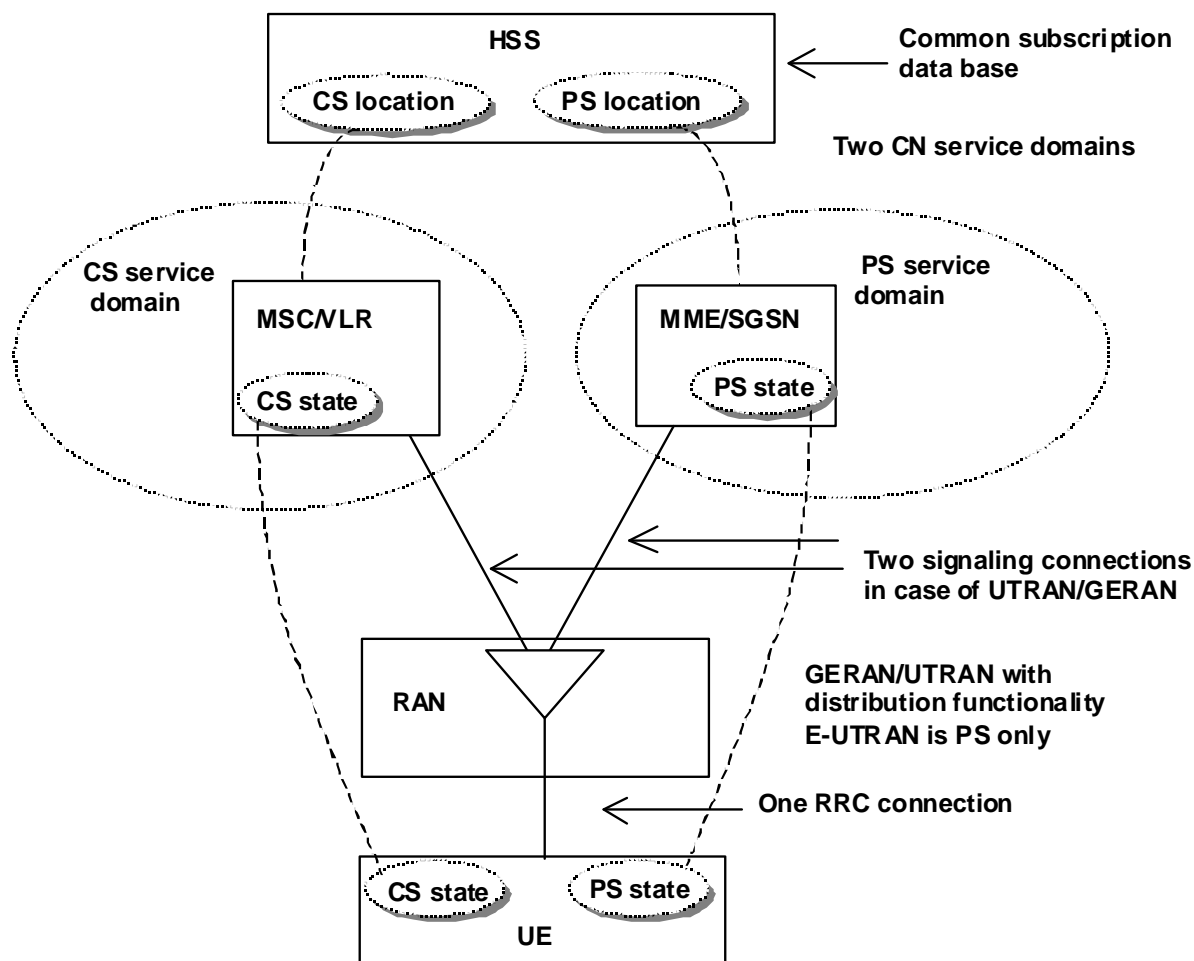

Figure 6.1: Overview of the UE registration and connection principles

The CN consists of both a CS domain with MSC/VLR, 3G_MSC/VLR, as the main serving node and an PS domain with SGSN/GGSN, 3G_SGSN, 3G_GGSN, MME, S-GW and P-GW as the main serving nodes.

The main PS service states are PS-DETACHED, PS-IDLE and PS-CONNECTED. The main CS service states are CS-DETACHED, CS-IDLE and CS-CONNECTED. For the respective domain there are specific related MM system information controlling the MM functionality of the UE.

When the UE is attached to PS it may be registered with SGSN and MME in parallel.

The aim of the RAN is to offer one unified set of radio bearers which can be used for bursty packet traffic and for traditional telephony traffic. Therefore, only one logical control channel structure is used for all kind of traffic. The radio resource handling is RAN internal functionality and the CN does not define the type of radio resource allocated.

The UTRAN and the E-UTRAN Radio Resource Control (RRC) has two modes, RRC Connected mode and RRC Idle mode. The RRC mode describes which identity is used to identify the UE. In RRC Idle mode the UE is identified by a CN associated identity. In RRC Connected mode the UE is assigned a Radio Network Temporary Identity to be used as UE identity on common transport channels. When the UE is allocated dedicated UTRAN transport channels, it uses the inherent addressing provided by these transport channels.

In PS-CONNECTED state the UE is in RRC Connected mode. In CS-CONNECTED state the UE is in RRC Connected mode.

For the mobility functionality, different area concepts are used. Tracking Areas (TAs), Location Areas (LAs) and Routing Areas (RAs) are used in the CN. UTRAN Registration Areas and Cell Areas are used in the Iu based RAN. LAs are related to CS services. TAs and RAs are related to PS services.

When "Intra Domain Connection of RAN Nodes to Multiple CN Nodes" is not used, one LA is handled by one CN node. With "Intra Domain Connection of RAN Nodes to Multiple CN Nodes" one LA may be handled by multiple CN nodes. For an UE that is registered in a LA, this implies that the UE is registered in the specific CN node handling this specific LA.

When "Intra Domain Connection of RAN Nodes to Multiple CN Nodes" is not used, one RA is handled by one CN node. With "Intra Domain Connection of RAN Nodes to Multiple CN Nodes" one RA may be handled by multiple CN nodes. One TA may be handled by multiple CN nodes. For an UE that is registered in a TA or RA, this implies that the UE is registered in the specific CN node handling this specific TA or RA.

LA is used by the 3G_MSC/VLR for paging the UE. RA is used by the SGSN for paging the UE. TA is used by the MME for paging the UE. UTRAN Registration Areas and Cell Areas are only visible in the UTRAN and used in RRC-Connected mode. The relations between LA, TA and RA are described in clause 4.3.2.

In RRC Idle mode it is the broadcast MM system information (e.g. information about the present LA, present TA or present RA) that determines when the UE initiates a location registration procedure towards the CN. An UE crossing an LA border, in state CS-IDLE and RRC Idle mode, shall initiate LA update towards the MSC. An UE crossing an RA border, in state PS-IDLE and RRC Idle mode, shall initiate RA update towards the SGSN. An UE crossing a TA border to a TA that is not registered with the MME, in state ECM Idle or ECM Connected, shall initiate TA update towards the MME.

In UTRAN RRC Connected mode, the UE receives the MM system information on the established RRC connection. (i.e. the broadcast MM system information is not used by the UE in the UTRAN RRC connected mode). In E-UTRAN RRC Connected mode, the UE receives the broadcast MM system information and uses it. An UE receiving information indicating a new LA, in state CS-IDLE and RRC Connected mode, shall initiate LA update towards the MSC. An UE receiving information indicating a new RA, in state PS-IDLE and RRC Connected mode, shall initiate RA update towards the SGSN. An UE receiving information indicating a new TA that is not registered with the MME shall initiate TA update towards the MME. An UE in state CS-CONNECTED and RRC Connected mode, shall not initiate LA update towards the CN.

In CS-DETACHED mode the UE shall not initiate any LA update and this independent of the RRC mode. In PS-DETACHED mode the UE shall not initiate any TA or RA updates and this independent of the RRC mode.

In addition to normal location registration when changing registration area, the UE may (network options) perform CS periodic registration when in CS-IDLE state and PS periodic registration when in PS-IDLE state. The respective periodic registration may be on/off on LA respective TA or RA level.

On the MM level, IMSI and CS related TMSI are used as UE identities in the CS domain, and IMSI and PS related TMSI are used as UE identities in the PS domain. The IMSI is the common UE identity for the two CN domains (CS and PS).

A signalling connection between the UE and the CN refers to a logical connection consisting of an RRC connection between UE and RAN and an Iu or S1 signalling connection between the RAN and the CN node. The CS domain related signalling between RAN and CN applies to UTRAN only. The CS domain related signalling and PS domain related signalling uses one common RRC connection and two Iu signalling connections ("two RANAP instances"), i.e. one Iu signalling connection for the CS domain and one Iu signalling connection for the PS domain.

6.2.2 Use of combined procedures

The use of separated PS and CS mobility mechanisms within the UE and within the CN can lead to non-optimal usage of the radio resource (for example a UE in PS idle and CS idle state would perform both LA updates (for the CS mechanism) and TA or RA updates (for PS mechanisms)).

To offer flexibility in the provision of MM, combined mechanisms can be used for LM purposes as well as for attach/detach status purposes.

A UE can perform combined update mechanisms. A CN should allow combined update operations (operator option). UEs should support the use of both combined and separate mechanisms.

NOTE: The support of this feature by all UEs will also ease evolution of MM in the future.

The RAN does not co-ordinate MM procedures that are logically between the CN and the MS. This includes: LM, authentication, temporary identity management and equipment identity check.

6.3 Description of the location management and mobility management concept - area concepts

6.3.1 Introduction

For the mobility functionality five different area concepts are used. LA and RA in the CN as well as UTRAN Registration Area, GERAN Registration Area and Cell areas in the RAN.

6.3.2 Location areas

For CS services, the CN uses LA. LA is used e.g. at CN initiated paging related to CS services. A CS service related temporary identity, CS-TMSI, may be allocated to the UE. This temporary identity is then unique within a LA.

6.3.3 Tracking and Routing areas

For PS services, the CN uses TA or RA. TA or RA is used e.g. at CN initiated paging related to PS services. A PS service related temporary identity, P-TMSI or S-TMSI, may be allocated to the UE. The P-TMSI is then unique within an RA. The S-TMSI is then unique within one or multiple TAs.

6.3.3a Support of Iu and A/Gb mode of operation in GERAN Cells

6.3.3a.1 Overview

A GERAN capable cell may belong to the same LA/RA for both modes of operation (figure 6.2a). In the case of a combined CN node supporting both Iu and A/Gb mode MSs, a single LA/RA identity for MSs in either mode shall be broadcasted in the cell since the same LAI and RAI will be used in both modes of operation.

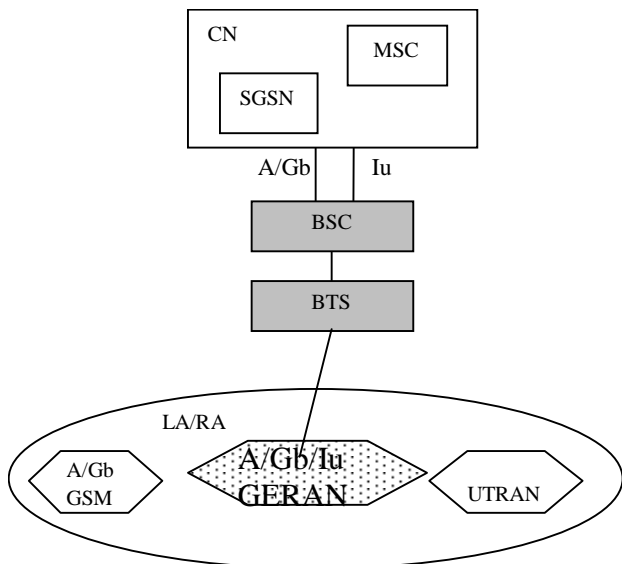

Figure 6.2a: Combined Iu/A/Gb Cell with Combined CN nodes

It is also possible for GERAN capable cell to support both A/Gb and Iu mode of operation without any restriction on combined CN nodes (figure 6.2b). In order to support this GERAN capable cells need to support the possibility to broadcast both LA/RA identities for MSs in Iu mode and for MSs in A/Gb mode. The existing LAI/RAI will be used for mobiles operating in A/Gb mode while the LAI/RAI for Iu mode will be used for mobiles operating in Iu mode. The reason for this is that the LA and RA cannot in this case overlap the both CNs.

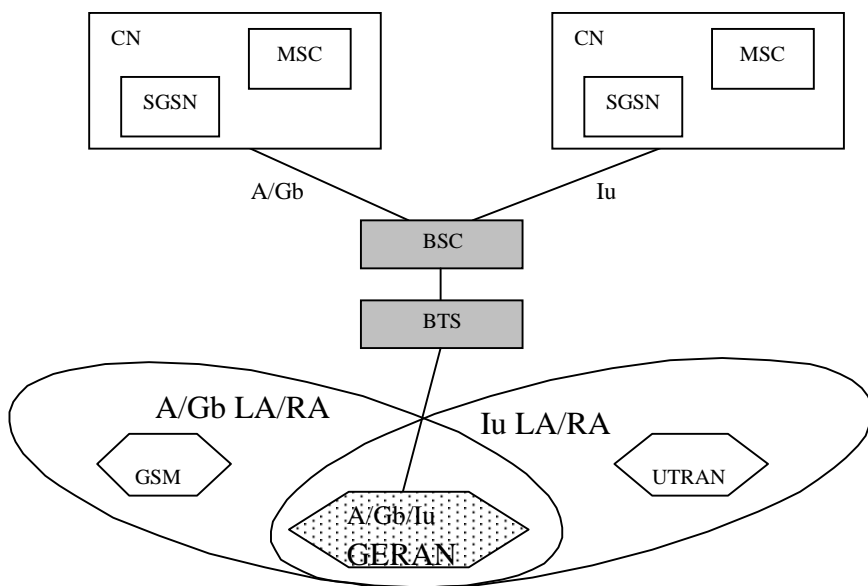

Figure 6.2b: Combined A/Gb/Iu Cell

6.3.3a.2 Interface selection in GERAN Cells

The MS shall be able to derive the mode supported in cell from the information broadcasted.

The support of different modes of operation in the MS shall be indicated in the MS Classmark and/or the MS Radio Access Capabilities.

6.3.3a.2.1 Basic principles for MS controlled Cell/Mode selection/re-selection

The procedures for MS controlled cell selection/re-selection are done according to UMTS/GSM principles and procedures outlined in TS 25.304 [19] and TS 45.008 [20]. This means that a GERAN cell will be selected regardless which mode it supports. The cell selection is based on radio criteria and not service.

If a GERAN cell is selected and it is both Iu and A/Gb capable, an Iu and A/Gb capable mobile station shall select Iu mode of operation by default.

NOTE: The above text outlines the default mechanism of mode of operation selection and does not prohibit the introduction of a more flexible solution, which avoids unnecessary mode of operation changes, at a later stage

6.3.3a.2.2 Basic principles for network controlled Mode selection/re-selection

The procedures for network-controlled cell selection/re-selection are done according to UMTS/GSM principles. When a cell/mode change is ordered by the network, the mode of operation to apply will be indicated by the network.

6.3.4 RAN internal areas

RAN internal areas are used by the UTRAN when the terminal is in RRC-Connected mode (see clause 6.7). The areas are used at e.g. RAN initiated paging. RAN internal area updating is a radio network procedure and the RAN internal area structure should not be visible outside the RAN. In RRC connected mode, the UE position is known on cell level or on URA/GRA level. RNTI is used as a temporary UE identifier used within the RAN and allocated at RRC connection establishment.

6.3.5 Relationship between the different areas

The following area relations exist (see figure 6.3):

- there need not be any relation between URA/GRA and LA respectively between URA/GRA and RA. The URA concept is defined in TS 25.331 [5] and the GRA concept is defined in TS 43.051 [12];
- one RA consists of a number of cells belonging to RNCs that are connected to the same CN node;
- one LA consists of a number of cells belonging to RNCs that are connected to the same CN node;
- one TA consists of a number of cells belonging to eNodeBs that are connected to the same CN node;
- one RA is handled by only one CN serving node, i.e. one combined MSC+SGSN or one 3G_SGSN, unless "Intra Domain Connection of RAN Nodes to Multiple CN Nodes" is used;
- one LA is handled by only one CN serving node, i.e. one combined MSC + SGSN or one 3G_MSC/VLR, unless "Intra Domain Connection of RAN Nodes to Multiple CN Nodes" is used.

There is no relation between TAs and LA/RAs. However, related configurations may be useful for certain services, e.g. for CS Fallback.

The GSM defined relations between LA and RA applies i.e. the following relations between LA and RA are possible:

- RA and LA is equal;
- one RA is a subset of one, and only one, LA, meaning that a RA do not span more than one LA.

The mapping between one LA and RNCs is handled within the MSC/VLR owning this LA. The mapping between one RA and RNCs is handled within the SGSN owning this RA. The mapping between LA and cells respective between RA and cells is handled within RNC.

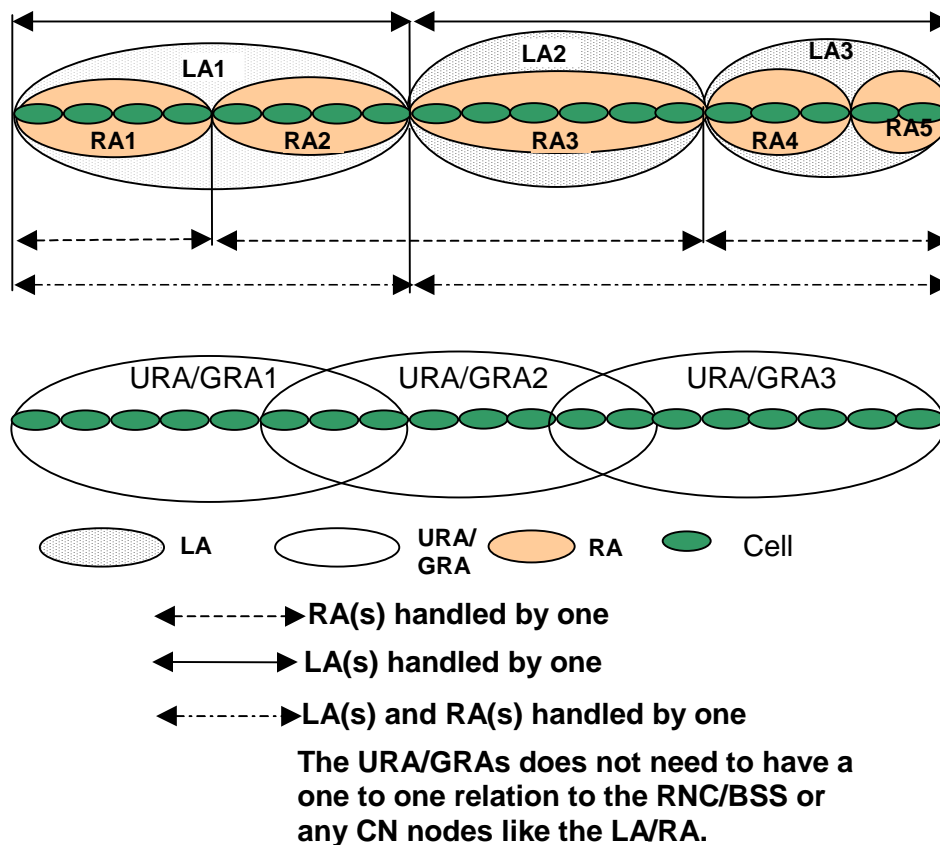

Figure 6.3: Relationship between different areas

6.3.5a Restriction of subscribers' access

Operators shall be able to restrict their subscriber's access between E-UTRAN, GERAN and UTRAN radio access, via administrative procedures based on subscription information.

In order for the restriction to apply, the network cells shall be organized so that each LA and RA contains either UTRAN or GERAN cells only. TAs apply to E-UTRAN only. Based on the subscription information and the LA/RA/TA information available in the VLR/SGSN/MME, subscriber's access may be rejected during LA/RA/TA update procedure.

NOTE: In order for this feature to work, both serving and home network operators need to have configured the feature.

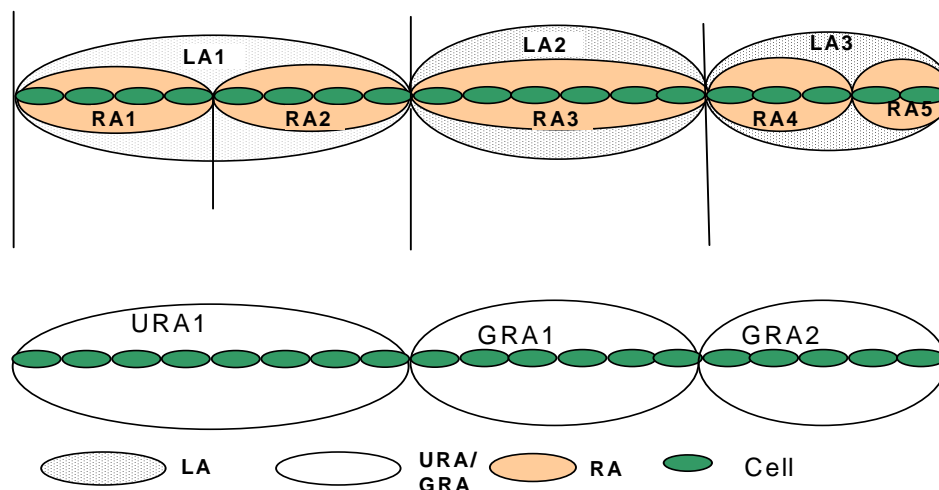

Access restriction can be applied for the above scenario

Figure 6.3a: Example scenario between different areas for restriction

The HSS shall provide the MSC/MSC server/VLR and SGSN with the following information about the subscriber's access restriction set by the operator, as specified in TS 23.008 [24]:

- Subscriber GERAN only
- Subscriber UTRAN only

For *Subscriber GERAN only* or *Subscriber UTRAN only*, the UE shall be notified of the access restriction using the existing procedures for network rejection of Location Update and Attachment, as defined in TS 24.008 [25] and the existing cause values for these procedures.

E-UTRAN access may be restricted by not accepting MME registrations at HSS.

6.3.6 Hierarchical tracking concept

This concept applies to UTRAN access only. A packet UE (in RRC connected mode) is tracked at the cell level by RNC during an active connection.

A packet UE (in RRC connected mode) is tracked at the URA level by RNC when no data are actively transfer, and the probability of data transfer is quite high.

A packet UE (in PS-Idle state) is tracked at the RA level by SGSN when no data is actively transferred and the probability of data transfer is quite low. The network operator can optimise paging and updating load by controlling the size of the different areas and the probability of data transfer (controlled by the RRC_connection_release timer). For example, one operator can decide that URA/GRA are small, and that RRC connection are released after a relatively short time of inactivity, so that most attached packet UE are tracked in the RA level (optimum for packet UE mainly using client-server type of service).

Another operator can decide that URA/GRA are large, and that RRC connection are released only if RRC connection is lost, so that most attached packet UE are tracked at the URA level.

The procedure for the releasing of the RRC connection can be found in TS 23.060 [2] under the Iu release procedure. The URA update procedures can be found in TS 25.331 [5] and GRA update procedures can be found in TS 43.051 [12].

6.4 Relationship between MM and SM states for an UE

When a UE is attached to PS service, it may have, but need not have, some EPS Bearer/PDP context established with GERAN or UTRAN Access. With E-UTRAN access a PS attached UE has at least one EPS Bearer context established.

If the UE has no EPS Bearer/PDP context established (SM-Inactive), no radio access bearer are established for PS service. The UE is in RRC connected mode, only if the state is CS-CONNECTED state or PS-CONNECTED state (i.e. only a PS signalling connection is established).

If the UE has at least one EPS Bearer/PDP context established (SM-Active), the UE can be in PS-CONNECTED state or in PS-IDLE state.

NOTE: The EPS Bearer/PDP context status is not modified by the release of the RRC connection, except if the release of the connection is due to an RRC failure which do not permit to maintain the negotiated QoS (e.g. a real time connection).

6.5 Requirement in case of temporarily loss of coverage of packet UE

A packet attached UE using non-real time bearer shall not lose its EPS Bearer/PDP context in case of temporarily loss of coverage. Within the network, it shall be possible to use timers to detect when a UE has been out of coverage for a long period of time and, dependent upon operator policy, to then remove unused EPS Bearer/PDP context(s).

6.6 MM functionality in different UE service states

CS service states and related MM functionality:

- CS-DETACHED: The UE is not reachable by the network for CS services. The UE does not initiate LA updates at LA changes and no periodic CS service updates;
- CS-IDLE: The UE is reachable by paging for CS services. The UE initiates LA updates at LA changes. The UE may initiate periodic CS service updates and this depends on the CS periodic update state of the present LA;
- CS-CONNECTED: The UE has a signalling connection for CS services established between the UE and the CN. The UE does not initiate LA update (even not when the present LA changes) and no periodic CS service updates.

PS service states and related MM functionality:

- PS-DETACHED: The UE is not reachable by the network for PS services. The UE does not initiate TA/RA updates at TA/RA changes and no periodic PS service updates;
- PS-IDLE: The UE is reachable by paging for PS services. The UE initiates TA/RA updates at TA/RA changes. The UE may initiate periodic PS service updates and this depends on the PS periodic update state of the present TA/RA;
- PS-CONNECTED: The UE has a signalling connection for PS services established between the UE and the CN. The UE initiates TA/RA update when RAI in MM system information changes. No periodic PS service updates.

There can also be a NULL state. In the UE, this state corresponds to power off or possibly a "no SIM" condition. In the CN, the NULL state correspond to CS-DETACHED and PS-DETACHED.

For each state transition there can be several events that triggers the transition. Some of them are described below.

NOTE: Some of these can coincide, e.g. moving from CS-IDLE to CS-DETACHED and moving from PS-IDLE to PS-DETACHED.

Moving from CS-IDLE to CS-CONNECTED:

The state transition from CS-IDLE to CS-CONNECTED is performed when a signalling connection is established between UE and CN for CS services. In GSM this state transition is triggered by the message CM_SERVICE_REQUEST or PAGE_RESPONSE.

Moving from CS-CONNECTED to CS-IDLE:

The state transition from CS-CONNECTED to CS-IDLE is performed when the signalling connection for CS services is released, e.g. at call release and no other CS service is ongoing. A radio link failure can also trigger this state transition.

Moving from CS-IDLE to CS-DETACHED:

The transition from CS-IDLE to CS-DETACHED can be triggered by some action from the user of the UE but an expiring timer in the network could also trigger it. The UE is marked as CS_DETACHED in the CN and then as a consequence no CS service establishment is possible.

Moving from PS-IDLE to PS-CONNECTED:

The state transition from PS-IDLE to PS-CONNECTED is performed when a signalling connection is established between UE and CN for PS services.

Moving from PS-CONNECTED to PS-IDLE:

The state transition from PS-CONNECTED to PS-IDLE is performed when the signalling connection for PS services is released, e.g. at release of a PS service, no other PS service is ongoing and at release of the RRC connection in case of very low level of activity. A radio link failure can also trigger this state transition.

Moving from PS-IDLE to PS-DETACHED:

The transition from PS-IDLE to PS-DETACHED can be triggered by some action from the user of the UE but an expiring timer in the network could also trigger it. The UE is marked as PS_DETACHED in the CN and then as a consequence no PS service establishment is possible.

6.7 The RRC state machine

The UTRAN RRC state machine is a description model of how the UE and the RAN co-operate regarding RRC functionality. The RRC state describes the state of the UE in the RAN. Here follows a brief description of the UTRAN RRC state machine, for more information see TS 25.301 [6] and TS 25.303 [7]. The E-UTRAN RRC state machine is described in TS 36.331 [29].

NOTE: RRC idle mode and RRC connected mode refer to the UE idle mode and UE connected mode respectively in TS 25.301 [6] and TS 25.303 [7].

The RRC state machine exists as peer entities, one in the UE and one in RAN. Apart from transient situations and error cases they are synchronised. Figure 6.4 illustrates the main modes/states of the RRC state machine.

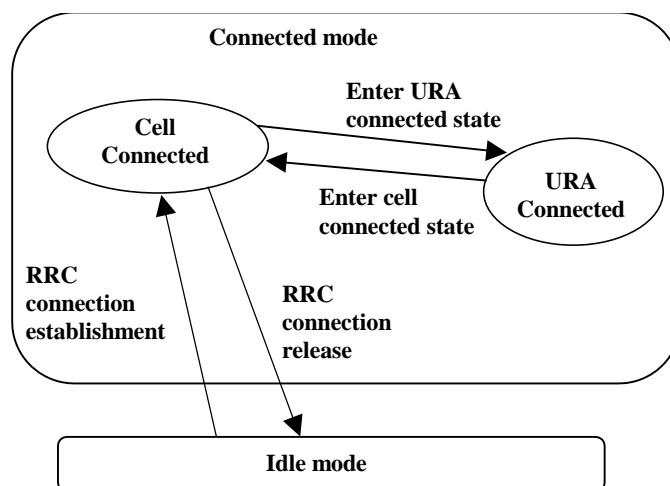

Figure 6.4: RRC modes, main RRC states and main mode/state transitions

RRC-Idle_mode:

In the Idle mode there is no connection established between UE and RAN. There is no signalling between RAN and the UE except for system information that is sent from RAN down link on a Broadcast channel to the UE. The UE can also receive paging messages with a CN identity on the PCH. There is no information on the UE stored in RAN in this state.

RRC-Connected_mode:

In the Connected mode the main states are Cell Connected state and URA connected state. In this mode there is one RNC that is acting as Serving RNC (SRNC), and an RRC connection is established between the UE and this SRNC.

- When the UE position is known on cell level, the UE is in the cell connected state. When in cell connected state, the RRC connection mobility is handled by handover procedures.
- When the UE position is known on URA level, the UE is in the URA connected state. The URA contains a set of cells. URA updating procedures provides the mobility functionality in this state. In URA connected state no dedicated radio resources are used.

6.8 Relationship between CS and PS service states and RRC state for an UE

This clause describes the relationship for the UTRAN. In E-UTRAN the RRC operates for PS services only despite some extensions for supporting the provision of CS services via GERAN/UTRAN.

During non-transient conditions the following relations are valid between service states and RRC modes for an UE:

- when in either CS-CONNECTED state or PS-CONNECTED state, or in both CS-CONNECTED state and PS-CONNECTED state, then the UE is in RRC connected mode;
- when in neither CS-CONNECTED state nor PS-CONNECTED state, then the UE is in RRC idle mode.

Figure 6.5 and figure 6.6 illustrate two examples on the relations between the UTRAN RRC states and CS/PS service states.

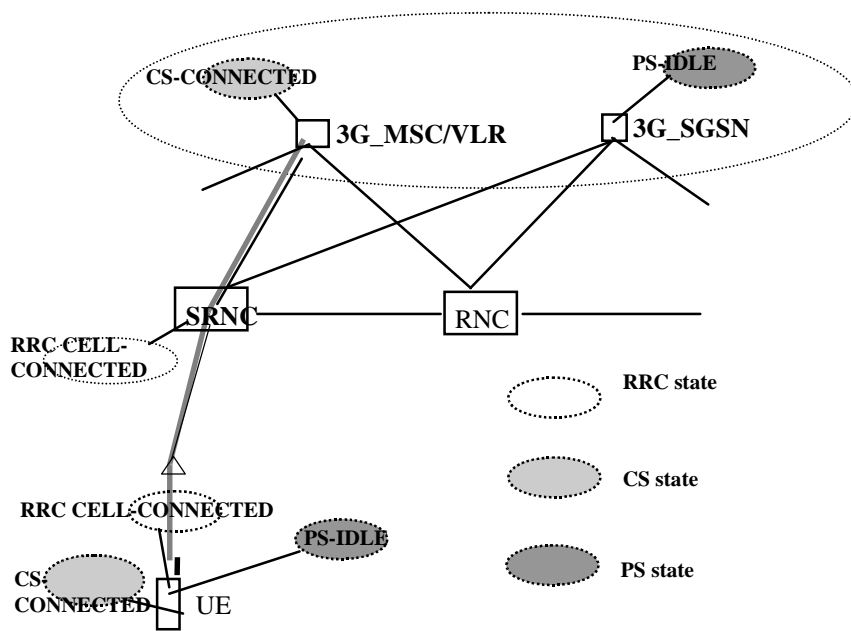

Figure 6.5: UE in CS-CONNECTED state and PS-IDLE state

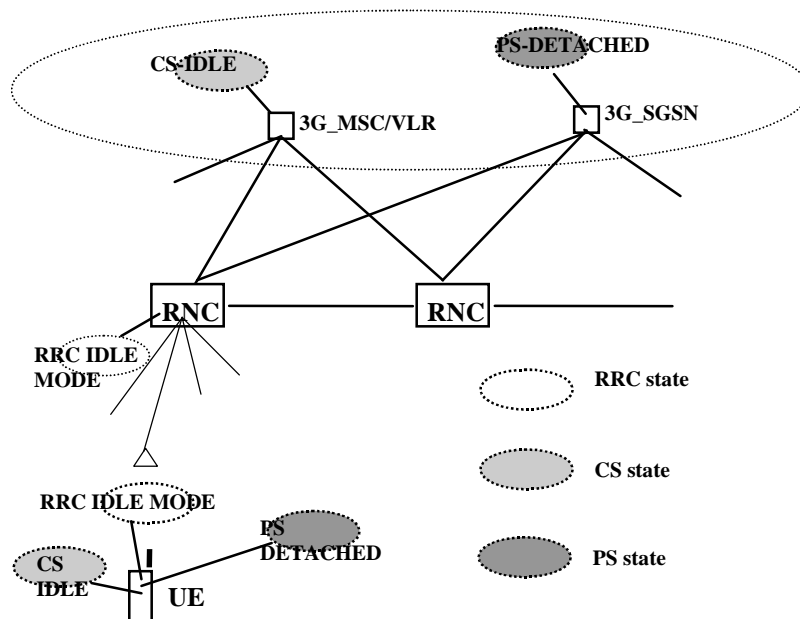

Figure 6.6: UE in CS-IDLE state and PS-DETACHED state

6.9 Service registration and location update

6.9.1 Introduction

Service registration (attach) in the respective CN domain is done initially (after UE being detached due to e.g. power off). When a registration area is changed a location update is performed. In addition, periodic registration can be performed. Here follows descriptions of when the respective CN registration area is changed.

NOTE: It is not here defined which different registration procedures that are needed.

6.9.2 Location area update

LA update is initiated by the UE to inform the CS domain of the CN that the UE has entered a new LA. In case the new LA is in an area served by another CN node, the LA update also triggers the registration of the subscriber in the new CN node and a location update for CS services towards the HLR/HSS.

LA update is only initiated by the UE when the UE is in state CS-IDLE, and this independently of the PS state. If the UE is CS-IDLE but RRC connected, which means that the UE is in PS-CONNECTED state, LA update is initiated by the UE when it receives information indicating a new LA.

6.9.3 Tracking and Routing area update

TA/RA update is initiated by the UE to inform the PS domain of the CN that the UE has entered a new TA/RA. In case the new TA/RA is in an area served by another CN node, the TA/RA update also triggers the registration of the subscriber in the new CN node and a location update for PS services towards the HSS.

TA/RA update is initiated by the UE when the UE is in state PS-IDLE, and this independently of the CS state. If the UE is PS-IDLE but UTRAN RRC connected, which means that the UE is in CS-CONNECTED state, RA update is initiated by the UE when it receives information indicating a new RA.

When the UE is in PS-CONNECTED state the UE initiates TA/RA update when TAI/RAI in MM system information changes.

6.9.4 Combined updates

The GSM radio interface combined procedures and their support via the Gs interface is the starting point for the support of combined updates. With E-UTRAN access combined update procedures may be used by MME and MSC.

6.10 Paging initiated by CN

A CN node requests paging only for UE in CS-IDLE state or PS IDLE state. Paging from a CN node is done independent of the service state of the UE in the other CN domain type.

CS and PS paging is co-ordinated within the UTRAN. Details on how the co-ordination is achieved and the parameters to be provided by the CN are specified in TS 25.413 [9]. The procedures required between the UTRAN and UE are in TS 25.331 [5].

6.11 Signalling connection establishment

A signalling connection between the UE and a CN node refers here to a logical connection consisting of an RRC connection between UE and the RAN and an S1 or Iu signalling connection between the RAN and the CN node. The signalling connection is used for transfer of higher layer (MM, CM) information between the UE and the CN node.

At a service request to one of the CN domain types and when no such connection exists towards the applicable CN domain type, the UE shall request establishment of a new signalling connection.

If no RRC connection exists, this is established in conjunction with (before) the transfer of the signalling establishment request. At the RRC connection establishment, an UE context is built up in the SRNC.

If an RRC connection is already established, the UE shall send the signalling establishment request using that RRC connection.

At reception of the signalling establishment request, the RAN will establish an S1 or Iu connection towards the CN node indicated by the CN service domain type received from UE.

6.11a CS Domain Signalling Requirements (in particular relating to handover)

Correct operation of the Call Control, Mobility Management and Call Independent Supplementary Service protocols requires that downlink messages from the MSC shall be delivered in the correct order and shall not be lost, duplicated or delivered in error.

The RAN and Iu/A interfaces shall provide this functionality in all cases except for when the Iu/A interface SCCP connection is being changed, e.g. at SRNS relocation or inter-BSC (external) handover.

When the SCCP connection is being changed, the MSC shall buffer downlink CC, MM and CISS messages. Specifically, the MSC shall buffer messages from these protocols after transmission of a (BSSMAP) Handover Command or RANAP-Relocation Command message and until receipt of a Handover Complete, Relocation Complete, Handover Failure or Relocation Cancel message.

In the uplink, the UE is responsible for delivering the CS domain messages across the radio interface. Once the message has been received by part of the network, it is the network's responsibility to deliver the message to the MSC. This can result in duplicate message delivery to the CN. The RAN shall ensure that the protocol used between UE and RAN permits any duplicate messages that are delivered to the CN, to be correctly discarded by N(SD) mechanism specified in TS 24.007 [22] for the uplink CC, MM and CISS messages.

6.12 Relations between SRNS relocation and location registration

This clause clarifies the need for separate handling of MM registration area (LA and RA) information in RRC idle mode respective in RRC connected mode. The following example illustrates relations between SRNC relocation, registration

area (LA/RA) change and LA/RA updates. As shown in the example, this is equally applicable for a combined MSC + SGSN as well as the 3G-MSC/VLR and 3G-SGSN.

NOTE 1: The example is based on the assumptions that one RNC can set up Iu connections to only one 3G_MSC/VLR (or combined MSC+SGSN) and only one 3G_SGSN (or combined MSC+SGSN), and that the CN node is configured to only send page to the RNC(s) that is controlling cells within the relevant LA/RA.

Preconditions (see figure 6.7):

- LA1 is handled by 3G_MSC/VLR1 and LA2 is handled by 3G_MSC/VLR2 ;
- RA1 is handled by 3G_SGSN1 and RA2 is handled by 3G_SGSN2 ;
- UE is registered in LA1 in 3G_MSC/VLR1 and in RA1 in 3G_SGSN1;
- the UE is in PS-CONNECTED state and a signalling connection exists between UE and 3G_SGSN1;
- the UE is in CS-IDLE state and no signalling connection exists between UE and 3G_MSC/VLR1;
- RNC1 is acting as SRNC and RNC2 is acting as DRNC;
- UE is in RRC cell connected state and with dedicated channels established to cells within both RNC1 and RNC2. UE does not listening to the PCH;
- the registration area information sent to the UE indicates LA1 and RA1.

The UE can always (at least in normal working states) identify the present available registration area (LA respective RA) associated with the respective CN domain. The determination of the present area differs depending on the state of the UE. For UE in RRC idle mode (UE with no ongoing communication with the network) it is the cell selection mechanism in the UE that is used. For UE in RRC connected mode it is the RAN that determines the area (although a change can implicit be initiated by the UE).

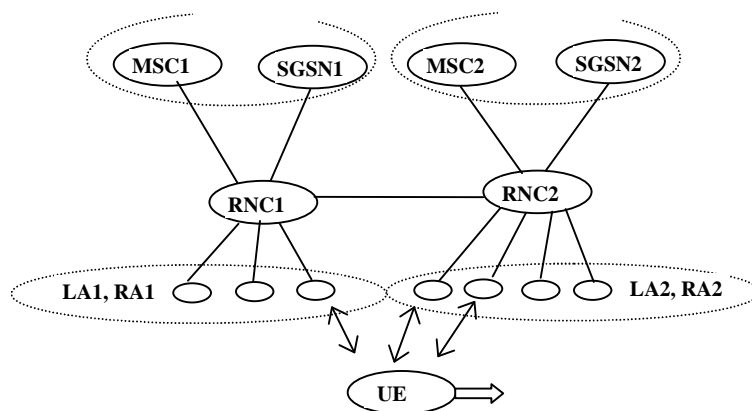

Figure 6.7: Illustration of the preconditions in the described example

In figure 6.7 MSC stands for 3G_MSC/VLR and SGSN for 3G_SGSN.

The UE moves now further towards the right, leaving the coverage area of cells controlled by RNC1, and resulting in that the UE has dedicated channel(s) established to cell(s) within only RNC2. This can result in the following sequence of events:

- the SRNC (RNC1) can decide to perform an SRNC relocation resulting in that the RNC2 becomes SRNC. In this example, the change of SRNC also implies a change of SGSN with an update of the UE location registration for the PS domain;
- after this SRNC relocation or combined with this procedure, the MM registration area information sent to the UE is changed and indicates now LA2 and RA2;

NOTE 2: The MM registration area information need not be sent for every SRNS relocation, nor does it preclude MM registration area information being sent in other occasions.

- the UE initiates a LA update, which results in a registration change from LA1 in 3G_MSC/VLR1 to LA2 in 3G_MSC/VLR2 and results in changed MM registration information.

NOTE 3: The area information can not be changed to indicate LA2 unless SRNC relocation has been performed, because the LA update signalling is sent from the UE, by using the established RRC connection to SRNC, and then to the 3G_MSC/VLR to which the SRNC belongs.

6.13 Requirements on identifiers for UMTS and GSM

- 1a) The format of the UMTS Location Area Identifier and UMTS TMSI shall not prevent a dual mode GSM-UMTS mobile which was last location updated over the GSM radio interface (i.e. has a GSM LAI and GSM TMSI), from performing a location update (or other signalling) over the UMTS radio interface to a UMTS MSC.
- 1b) The format of the UMTS Location Area Identifier and UMTS TMSI shall not prevent a dual mode GSM-UMTS mobile which was last location updated over the UMTS radio interface (i.e. has a UMTS LAI and UMTS TMSI), from performing a location update (or other signalling) over the GSM radio interface to a GSM MSC.
- 1c) The format of the UMTS Routing Area Identifier and UMTS P-TMSI shall not prevent a dual mode GSM-UMTS mobile which was last routing area updated over the GSM radio interface (i.e. has a GSM RAI and GSM P-TMSI), from performing a routing area update (or other signalling) over the UMTS radio interface to a UMTS SGSN.
- 1d) The format of the UMTS Routing Area Identifier and UMTS P-TMSI shall not prevent a dual mode GSM-UMTS mobile which was last routing area updated over the UMTS radio interface (i.e. has a UMTS RAI and UMTS P-TMSI), from performing a routing area update (or other signalling) over the GSM radio interface to a GSM SGSN.
- 2) The standard shall support means by which an operator can configure GSM and UMTS cells to be members of the same registration area (i.e. the mobile can receive paging from whichever cell it is camped on and does not need to location update (or routing update) just because the mobile has changed from a UMTS to a GSM cell).
- 3a) The standard shall support means by which an operator can allocate GSM and UMTS LAIs which enable GSM MSCs to be able to contact UMTS MSCs and vice versa.
- 3b) The standard shall support means by which an operator can allocate GSM and UMTS RAIs which enable GSM SGSNs to be able to contact UMTS SGSNs and vice versa.
 - 4) The standard shall support means by which an operator can ensure that the IMSI does not need to be sent over the radio interface when the mobile station moves from a GSM cell to a UMTS cell (and vice-versa).
 - 5) The standard shall support means by which an operator can ensure that the IMSI does not need to be sent over the radio interface when a USIM is moved from a UMTS mobile station to a GSM mobile station (and vice-versa).
- 6) The standard need not support means by which an operator can ensure that the IMSI is not sent over the radio interface when a GSM SIM is moved from a GSM mobile station to a UMTS mobile station (and vice-versa).

6.14 Use of MM system information

In each cell the network broadcasts MM system information on the broadcast channel. The "current MM system information" is used by the MM functionality in the UE respecting the rules for the UE service state of the respective MM state machine, see clause 6.6. The "current MM system information" is identified as follows:

- In RRC idle mode, when the UE camps on one cell, it receives all MM system information valid for this cell on the broadcast channel of the cell. The received MM system information is then the "current MM system information";
- In UTRAN RRC connected mode, the SRNS shall control the current MM system information valid for the UE. e.g. at SRNS relocation, the new SRNS may send applicable MM system information to the UE. The established RRC connection shall be used for transferring any new MM system information to the UE. The UE shall use any new MM system information received from the SRNC on the established RRC connection as the "current MM system information";

NOTE: The MM system information need not necessarily be sent for every SRNSs relocation, nor does it preclude MM system information being sent on other occasions.

- In E-UTRAN RRC connected mode, the UE receives all MM system information valid for this cell on the broadcast channel of the cell. The received MM system information is then the "current MM system information";
- At the RRC connection establishment, the UE uses the broadcasted MM system information of the cell where the establishment is made as the "current MM system information";
- When the UE leaves the RRC connected mode and enters RRC idle mode, the UE uses the broadcasted MM system information of the chosen cell, which is determined by the UE idle mode cell selection/re-selection process that is then performed, as the "current MM system information".

6.15 Signalling procedures

6.15.1 Idle mode procedures

The signalling procedures shown in the following clauses do not represent the complete set of possibilities, nor do they mandate this kind of operation. This document specifies a set of elementary procedures for each interface, which can be combined in different ways in an implementation. Therefore these sequences are merely examples of a typical implementation. By default the combined procedures as defined in TS 23.060 [2] or TS 23.272 [30] are also applicable when using Gs or SGs.

The list of parameters should be regarded as examples of possible information carried by the messages and not as a complete list.

6.15.1.1 Location Area update

Figure 6.8 shows location registration when changing LA including change of 3G-MSC/VLR and when the UE is in MM idle state towards the 3G_MSC/VLR.

The illustrated transfer of MM signalling to/from the UE uses an established RRC connection. This RRC connection can have been established beforehand due to ongoing interwork between UE and 3G-SGSN or be established only for this location registration procedure towards the 3G_MSC/VLR.

For each indicated MM message sent in this case to/from UE, the CN discriminator indicates 3G_MSC/VLR.

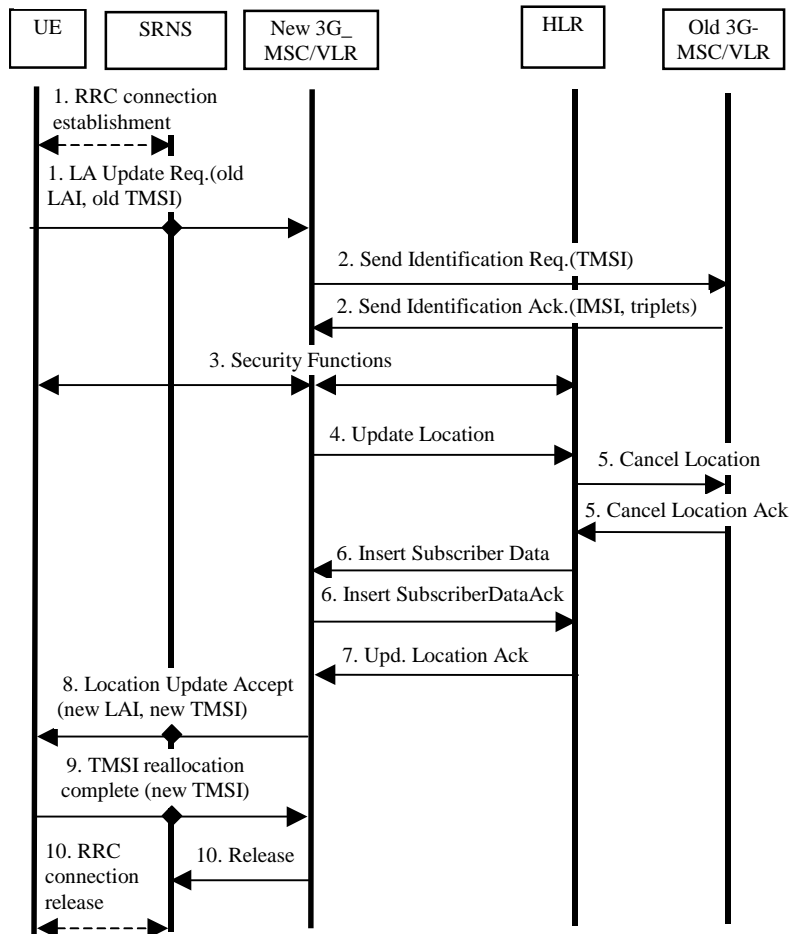

Figure 6.8: Interface information transfer for location update when changing VLR area

- 1 The RRC connection is established, if not already done. The UE sends the initial message LA Update Request (old TMSI, old LAI, etc.) to the new 3G_MSC/VLR. The old TMSI and LAI are those that were assigned to the UE. The SRNS transfers the message to the 3G_MSC/VLR

NOTE: The sending of this message to 3G_MSC/VLR also implies establishment of a signalling connection between SRNS and 3G_MSC/VLR for the concerned UE.

The RAN shall add the RAC and the LAC of the cell where the message was received before passing the message to the MSC.

2. The new 3G_MSC/VLR sends an Send Identification Request (old TMSI) to the old 3G_MSC/VLR to get the IMSI for the UE. (The old LAI received from UE is used to derive the old 3G_MSC/VLR identity/address.) The old 3G_MSC/VLR responds with Send Identification Ack. (IMSI and Authentication triplets).
3. Security functions may be executed.
4. The new 3G_MSC/VLR inform the HLR of the change of 3G_MSC/VLR by sending Update Location (IMSI, MSC address, VLR number) to the HLR.
5. The HLR cancels the context in the old 3G_MSC/VLR by sending Cancel Location (IMSI). The old 3G_MSC/VLR removes the context and acknowledges with Cancel Location Ack.
6. The HLR sends Insert Subscriber Data (IMSI, subscription data) to the new 3G_MSC/VLR. The new 3G_MSC/VLR acknowledges with Insert Subscriber Data Ack.
7. The HLR acknowledges the Update Location by sending Update Location Ack. to the new 3G_MSC/VLR.
8. The new 3G_MSC/VLR validates the UE presence in the new LA. If due to regional, national or international restrictions the UE is not allowed to attach in the LA or subscription checking fails, then the new 3G_MSC/VLR

rejects the LA update with an appropriate cause. If all checks are successful, then the new 3G_MSC/VLR responds to the UE with LA Update Accept (new TMSI, new LAI).

9. The UE acknowledges the new TMSI with a TMSI reallocation Complete. (TMSI can optionally be reallocated with the TMSI reallocation procedure).
10. When the location registration procedure is finished, the 3G_MSC/VLR can release the signalling connection towards the SRNS for the concerned UE. The SRNS shall then release the RRC connection if there is no signalling connection between 3G_SGSN and SRNS for the UE.

6.15.1.2 Routing Area Update

The routing area update procedure is detailed in TS 23.060 [2].

6.15.1.2A Tracking Area Update

The tracking area update procedure is detailed in TS 23.401 [27].

6.15.1.3 Periodic registration towards both CN nodes without use of Gs or SGs

Periodic registration for the CS domain is specified in TS 23.012 [3]. Periodic registration for the PS domain is covered in TS 23.060 [2] and in TS 23.401 [27].

6.15.1.4 Periodic registration with use of Gs or SGs

Periodic registration for the PS domain with use of Gs or SGs is covered in TS 23.060 [2] or in TS 23.272 [30]. Only TA/RA Updates are required from the UE to the SGSN or MME.

6.15.1.5 UE initiated combined detach procedure when using Gs or SGs

UE initiated Combined Detach Procedure when using Gs or SGs is specified in TS 23.060 [2] or in TS 23.272 [30]. The UE indicates which form of detach is required, i.e., PS Detach only, CS Detach only or combined Detach.

6.15.1.6 Forbidden LA/RA

The CN (SGSN and MSC/VLR) shall not send the COMMON Id message with SNA information to the UTRAN when the attach request, LA update, or RA update are rejected.

6.15.2 SRNS Relocation

SRNS relocation is UTRAN related functionality covered in TS 25.413 [9] and TS 23.060 [2].

NOTE: Examples of RAN signalling are given in TR 25.931 [15].

6.16 RAN coordination

This applies to UTRAN only. The RAN coordinates the resource allocation of an UE attached to both PS and CS services. The UTRAN shall reject or downgrade a connection which cannot be granted, see TS 23.060 [2]. The cause might be congestion on the radio interface, or the existence of other connections between this UE and the other CN.

The RAN uses the IMSI to identify a UE. The IMSI is transferred from the CN to the RAN with the common ID procedure. When an Iu connection is established, the CN shall perform the RANAP common ID procedure toward RAN as soon as the UE is identified (IMSI). The IMSI is only stored in the RAN for the duration of the RRC Connection.

There are two functions that are co-ordinated.

- 1) Paging coordination is described in 5.9.1 of TS 25.410 [10]; and
- 2) Relocation coordination that is described in 8.7.5 in TS 25.413 [9].

7 Call control

7.1 General Aspects

The following technical requirements are applied to support multimedia in GSM/UMTS.

- 1) GSM/UMTS shall enable the provisioning of multimedia services and multivendor interworking between UE and network.
- 2) Handover and roaming to and from GSM shall be supported provided GSM is capable of supporting the ongoing media service.
- 3) For multimedia services the standardized multimedia protocol shall be run transparently via a PDP-context or a CS connection established using GSM SM/CC . This allows transparent hand-over and roaming between GSM and UMTS provided that GSM supports the QoS requirements.
- 4) SIP from the IETF shall be the multimedia call control supported over the PS domain, where the network functional entities for multimedia support are within the PLMN.

NOTE: Other multimedia protocols can be supported e.g. H.323 transparently over the PS domain . In these cases, the multimedia functional entities shall be outside of the PLMN. Support of terminating calls for these protocols are outside the scope of these specifications.

- 5) H.324M shall be supported within the CS domain.

Figure 7.1 illustrates the realisation of the multimedia service based on requirement 3. 'Multimedia Protocol' indicates the functionality either inside the communicating user's terminal or a server (e.g. SIP server). It is essentially a control function both for user plane and control plane for the multimedia communication.

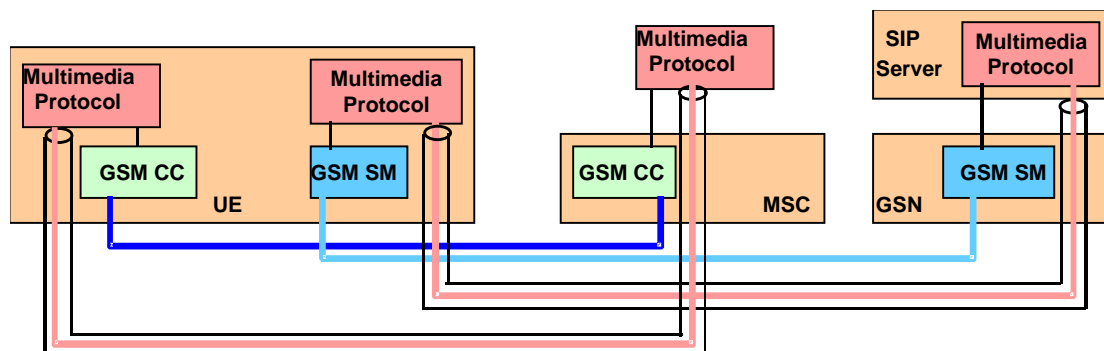

Figure 7.1: Support of multimedia making use of GSM SM/CC

7.2 Domain selection for mobile terminated calls from the PSTN/CS domain

7.2.1 Introduction

It is an operator's decision whether mobile terminated calls from the PSTN/CS domain are routed first to the CS domain, or to the IMS subsystem. Both options may co-exist within one operator's network.

The ability to select whether the CS domain or the IMS will provide the services is termed the Service Domain Selection (SDS) (see clause 7.2.2) and whether the CS domain or the IMS/IP-CAN is used to communicate call termination from the network and the UE is termed access domain selection (ADS) (see clauses 7.2a and 7.2b).

7.2.2 Calls directed to the CS domain

When the mobile terminated call set-up arrives at a G-MSC server or G-MSC, then that call may be subject to service domain selection to determine whether the terminating call is to be delivered to the CS domain or the IMS is used to provide the services for the user. The G-MSC Server or G-MSC interrogates the HSS for routing information. The HSS decides on the way the call shall be treated next (e.g. IM CN subsystem, CS domain (e.g. the subscriber is roaming in a legacy network), service platform involvement). According to the decision, the HSS returns information that will make the G-MSC progress the call towards an MGCF (for onward handling in the IMS), a VMSC or to provide further processing (e.g. invoke CAMEL G-MSC processing).

SDS may take into account for terminating calls whether the user is roaming or not, user preferences, service subscription and operator policy.

7.2.3 Calls directed to the IMS

When the mobile terminated call set-up arrives at a MGCF, then the MGCF passes the session to an I-CSCF which interrogates the HSS for routing information. The HSS returns information that will enable the I-CSCF to progress the call towards an S-CSCF. From the S-CSCF the session may be re-directed to the CS domain or may continue in the IMS upon instruction from the access domain selection functionality (see clause 7.2b).

7.2a Domain selection for UE originating sessions / calls

For UE originating calls, the UE performs access domain selection. The UE shall be able to take following factors into account for access domain selection decision:

- The state of the UE in the circuit switched domain. This state information shall be included: Detached, Attached.
- The state of the UE in the IMS. The state information shall include: Registered, Unregistered.
- The domain used by an existing session / call for the same service.
- User preferences and any available operator policy.
- The "IMS voice over PS session supported indication" as defined in TS 23.060 [2] and TS 23.401 [27].
- Whether the UE is expected to behave in a "Voice centric" or "Data Centric" way
- UE capability of supporting IMS PS voice.
- Indications the network may have provided to the UE in combined EPS/IMSI attach/TAU, e.g. "SMS-only" indication or "CSFB Not Preferred" indication as defined in TS 23.272 [30]

The service domain selection functionality will decide whether the call is serviced in the CS domain or the IMS. Service domain selection functionality may take into account for originating calls whether the user is roaming or not, user preferences, service subscription and operator policy. If the UE is configured for Voice over IMS, the service domain selection functionality should take the "IMS voice over PS session supported indication" into account and should only initiate IMS voice calls (with the voice bearer in the PS domain) using the RAT where the "IMS voice over PS session supported indication" applies and indicates support. The "IMS voice over PS session supported indication" applies to E-UTRAN when received in E-UTRAN, and applies to UTRAN when either received in GERAN or UTRAN.

To allow for appropriate domain selection for originating voice calls, a CSFB and/or IMS/CS-voice capable UE is set to behave as "Voice centric" or "Data centric" in E-UTRAN:

- A UE set to "Voice centric" shall always try to ensure that Voice service is possible. A CSFB and an IMS/CS-voice capable UE set to "Voice centric" unable to obtain voice service in E-UTRAN (e.g. CSFB and IMS voice are not supported or the configured preferences on how to handle voice services prevent usage of any available voice services), shall disable the E-UTRAN capability, which results in re-selecting GERAN or UTRAN. The E-UTRAN capability is re-enabled by the UE under the conditions described in TS 24.301 [34]. A voice centric CSFB capable UE that receives "CSFB Not Preferred" or "SMS-only" indication as a result of combined EPS/IMSI attach or combined TA/LA Update procedures and unable to obtain voice services over IMS shall disable the E-UTRAN capability, which results in re-selecting GERAN or UTRAN.

- A UE set to "Data centric" does not disable the E-UTRAN capability if voice services cannot be obtained. Upon receiving combined EPS/IMSI attach accept or combined TA/LA Update accept with "SMS-only" indication, a data centric UE stays in the current RAT and is not allowed to use CSFB. Upon receiving combined EPS/IMSI attach accept or combined TA/LA Update accept with "CSFB Not Preferred" indication, a data centric UE stays in the current RAT and is allowed to use CSFB.

As specified in TS 23.401 [27] and TS 23.060 [2], a CSFB and/or IMS capable UE indicates in Attach/RAU/TAU Request whether it is set to "Voice centric" or "Data centric" and it indicates its configured preferences on how the UE is supposed to handle voice services in E-UTRAN. Depending on operator's configuration, this information can be used by the network to choose the RFSP Index in use, see clause 4.3.6 in 23.401 [27] and clause 5.3.5 in TS 23.060 [2] for examples of how RFSP Index can be used for selective idle mode camping.

To allow for appropriate domain selection for originating voice calls, the following applies for a CSFB and IMS capable UE in E-UTRAN:

- It should be possible to provision UEs with the following HPLMN operator preferences on how a UE that is both CSFB and IMS capable is supposed to handle voice services (See Annex A for examples on UE behaviour for each configuration):
 - CS Voice only: the UE will use only the CS domain (possibly using IMS signalling, see TS 23.292 [31]) to originate voice calls and it will not attempt to initiate voice sessions over IMS using a PS bearer. The UE attempts combined EPS/IMSI attach or combined TA/LA Update procedures. If combined EPS/IMSI attach or combined TA/LA Update fail to register the IMSI in the CS domain or succeed with an "SMS-only" indication or succeed with a "CSFB Not Preferred" indication, the UE behaves as described for "voice centric" or "data centric" according to its setting.
 - CS Voice preferred, IMS PS Voice as secondary: if CS voice is available the UE will use the CS domain (possibly using IMS signalling, see TS 23.292 [31]) to originate and terminate voice calls. The UE attempts combined EPS/IMSI attach or combined TA/LA Update procedures (as defined in TS 23.272 [30]). If combined EPS/IMSI attach or combined TA/LA Update procedures fail to register the IMSI in the CS domain or succeed with an "SMS-only" indication or succeed with a "CSFB Not Preferred" indication, the UE attempts to use voice over IMS to originate voice calls. If the UE fails to use IMS for voice e.g. due to "IMS voice over PS session supported indication" indicates voice is not supported, the UE behaves as described for "voice centric" or "data centric" according to its setting.
 - IMS PS Voice preferred, CS Voice as secondary: if IMS voice is available the UE will use IMS to originate and terminate voice sessions. The UE may attempt combined EPS/IMSI attach with or without "SMS only", combined TA/LA Update with or without "SMS only" or EPS attach/TAU procedures. If the UE fails to use IMS for voice, e.g. due to "IMS voice over PS session supported indication" indicates voice is not supported (in Attach accept or subsequent TAU accept), then the UE uses the CS domain (as defined in TS 23.272 [30]), possibly using IMS signalling (see TS 23.292 [31]). If not already performed, the UE attempts combined TA/LA Update procedures. If the combined TA/LA Update procedures fail to register the IMSI in the CS domain or succeed with an "SMS-only" indication or succeed with a "CSFB Not Preferred" indication and the UE has failed to use IMS for voice, the UE behaves as described for "voice centric" or "data centric" according to its setting.

NOTE 1: Whether to perform combined EPS/IMSI attach/combined TA/LA Update or EPS attach/TAU for the case of "IMS PS Voice preferred" is to be evaluated in each release of the specifications.

- IMS PS Voice only: the UE will use IMS to originate voice sessions and will not attempt CS Voice. The UE may attempt combined EPS/IMSI attach with "SMS only", combined TA/LA Update with "SMS only" or EPS attach/TAU. If the UE fails to use IMS for voice, e.g. due to "IMS voice over PS session supported indication" indicates voice is not supported on E-UTRAN, the UE behaves as described for "voice centric" or "data centric" according to its setting.

To allow for appropriate domain selection for originating voice calls, the following CS/IMS voice preference setting applies for a CS and IMS capable UE in UTRAN:

- It should be possible to provision UEs with the following HPLMN operator preferences on how a CS/IMS enabled UE is supposed to handle voice services:
 - CS Voice only: the UE will not attempt to initiate voice sessions over IMS using a PS bearer. This does not preclude the use of IMS signalling to control a CS bearer (see TS 23.292 [31]);

- CS Voice preferred, IMS PS Voice as secondary: the UE will try to use the CS domain (possibly using IMS signalling, see TS 23.292 [31]) to originate voice calls;
- IMS PS Voice preferred, CS Voice as secondary: the UE will try to use IMS to originate voice sessions. If the UE fails to use IMS for voice e.g. due to "IMS voice over PS session supported indication" indicates voice is not supported (in Attach accept or subsequent RAU accept), then the UE will use the CS domain to originate voice calls, possibly using IMS signalling (see TS 23.292 [31]).

NOTE 2: The above CS/IMS voice preference setting for UTRAN is only applicable for the selection of domain for the voice media i.e. the existing mobility procedure is not changed due to these settings.

In limited service state, a UE should always camp on a RAT which is likely to support emergency calls.

The TS 23.167 [33] describes when an emergency call is to be initiated in the CS domain or using IMS. When the CS domain is to be used the following applies:

- A CSFB/IMS enabled UE which is registered in the CS domain, e.g. using CSFB procedures or using above-mentioned selection principles, shall initiate emergency call attempts in the CS domain by using available CS domain procedures.
- A CS Voice capable UE which is not registered in the CS domain shall initiate emergency calls in the CS domain by autonomously switching to a RAT which supports the CS domain (e.g. GERAN or UTRAN).

7.2b Access Domain Selection for terminating sessions

Terminating Access Domain Selection (T-ADS) selects CS access and/or one or more PS access network(s) to be used to deliver a terminating session to the UE.

For IMS Service Centralization and Continuity enabled networks, T-ADS is a functionality located in the IMS. The UE enhanced for IMS Service Centralization and Continuity is able to assist the T-ADS.

For IMS Service Centralization and Continuity users, T-ADS is performed as specified in TS 23.292 [31] and TS 23.237 [32].

Prior to responding to a session request requesting one or more media (i.e. bi-directional speech media) bearers in the PS domain, the UE shall determine, based on the PS domain's access network capabilities including the information whether IMS voice over PS Session is supported (as specified in TS 23.060 [2] and TS 23.401 [27]) (if indicated), user preferences and operator policy, whether the media bearers can be accepted on the PS domain. If the media bearers cannot be accepted, then the UE shall perform SDS.

For terminating sessions:

- T-ADS is always performed after the terminating services.

The T-ADS may take the following factors (but not limited to) into account for the selection decision:

- The state of the UE in the circuit switched domain. This state information shall be included: Detached, Attached.
- The state of the UE in the IMS. The state information shall include: Registered, Unregistered.
- The UE capabilities.
- The access network capabilities including the information whether IMS voice over PS Session is supported (as specified in TS 23.060 [2] and TS 23.401 [27]) by the 3GPP access network that had the most recent radio contact with the UE.
- The domains / access types used by an existing session.
- The media components included in the incoming session.
- User preferences and operator policy.

7.2c Domain Selection for UE originating SMS

To allow for appropriate domain selection for SMS delivery, the following applies for an IMS capable UE which supports SMS over IP networks:

- It should be possible to provision UEs with the following HPLMN operator preferences on how an IMS enabled UE is supposed to handle SMS services:
 - SMS is not to be invoked over IP networks: the UE does not attempt to deliver SMS over IP networks. The UE attempts to deliver SMS over NAS signalling.
 - SMS is preferred to be invoked over IP networks: the UE attempts to deliver SMS over IP networks. If delivery of SMS over IP networks is not available, the UE attempts to deliver SMS over NAS signalling.

7.3 Routing sessions from the IMS to the CS Domain

If the IMS Service Centralization and Continuity is not used and if a subscriber is subscribed to both the CS domain and the IMS, then there may arise the need to route sessions that arrived in the IMS to the CS domain using a number related to the subscriber's MS-ISDN. All sessions which are forwarded from the IMS to the CS domain shall enter the CS domain through a G-MSC or G-MSC Server. The G-MSC or G-MSC Server will handle the session as a mobile terminating call.

If the IMS Service Centralization and Continuity is used, the routing of the session from IMS to CS shall be done according to TS 23.292 [31].

8 Support of IM CN Subsystem services

8.1 Context activation and registration

The IP address is allocated to UE either by GPRS specific signalling when a PDP context is activated using the PDP Context Activation Procedure, or some other means e.g. by DHCP. The UE shall use IP addresses assigned to it for, but not limited to, the following:

- the exchange of application level signalling (e.g., registration, CC) with the S-CSCF from the access network currently used,
- application level registration to IM CN subsystem as an address used to reach the UE
- an address used to reach the UE for multimedia sessions.

The P-CSCF is located either in the Home network or in the Visited Network.

In the following flow, a description of the order in which the registration procedure is executed and how the IP address is allocated is shown. Figure 8.1 shows the procedures performed during the GPRS and application level registration.

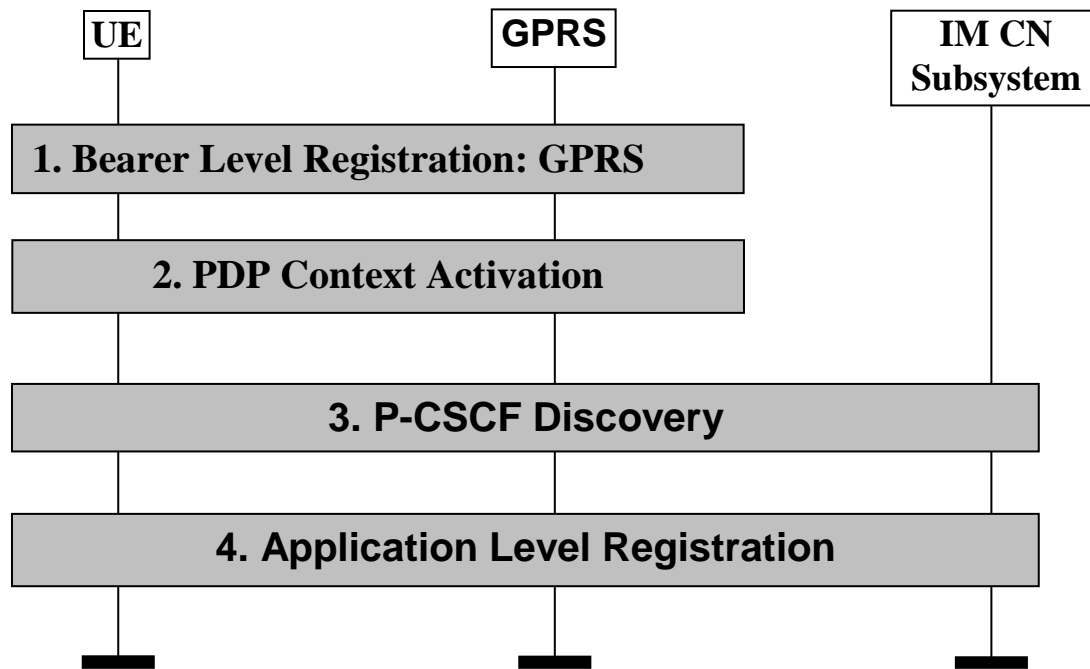

Figure 8.1: Registration

The following steps are performed:

1. the bearer level registration is performed (e.g. when the terminal is switched on or upon explicit indication from the user).
2. the PDP context activation is done. The UE has two options:
 - activate a PDP context using the PDP Context Activation Procedure and obtain a new IP address (e.g. if the UE does not have any existing PDP context active or desires to use a different IP address)
 - activate an additional PDP context using the Secondary PDP Context Activation Procedure and re-using the IP address of the linked already active PDP contexts.
3. UE performs the P-CSCF discovery procedure, where the UE discovers a P-CSCF [11].

There can be time gaps between these procedures and the following one. For instance, the UE may perform PDP context activation and the P-CSCF discovery, but not the application level registration. The UE may use the activated PDP context for other types of signalling, e.g. for P-CSCF discovery.

4. UE performs application level registration by providing the IP address obtained at step 2 to the P-CSCF selected at step 3. The IP address used for signalling purposes is allocated in association with PDP context activation and not on an incoming call basis.

The discovered P-CSCF forwards the registration on to the UE's home network where a S-CSCF [11] is assigned and the registration takes place. This registration associates the P-CSCF with the UE.

From the S-CSCF point of view, the P-CSCF is where the UE is reachable for mobile-terminated session control signalling and any other type of mobile terminated IMS signalling.

Whether the procedures are activated individually by the UE or some of them are performed automatically depends on implementation of the terminal and on the UE's configuration. For instance, the multimedia application in the UE could start the application level registration and steps 2-4 would have to be executed in response to support the operation initiated by the application. Interaction with the UE may happen during these steps.

8.2 Location management

8.2.1 Registration concepts for a subscriber roaming into CS domain

Figure 8.2 shows the registration concept for a subscriber, who access IM services in the home network, roaming into a CS domain.

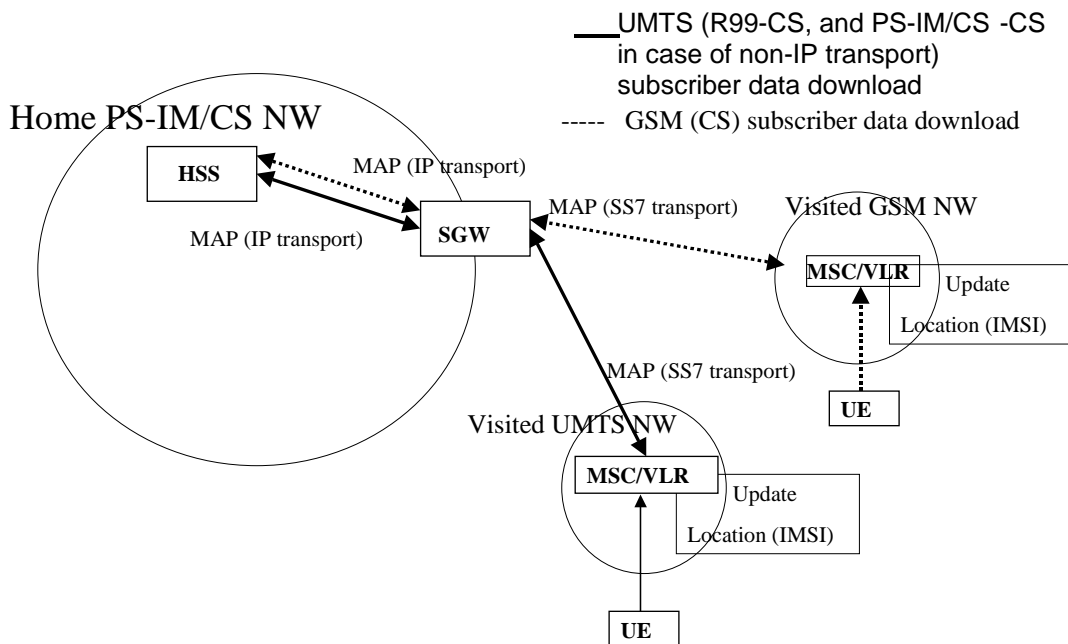

Figure 8.2: A roaming model for registration in a CS domain

NOTE: The above figure shows one configuration where the Signalling Gateway (SGW) is needed. Other configurations are possible as well (see TS 23.002 [1]).

The detailed message sequence chart for a subscriber roaming into a CS domain and accessing an IM application is shown in figure 8.3.

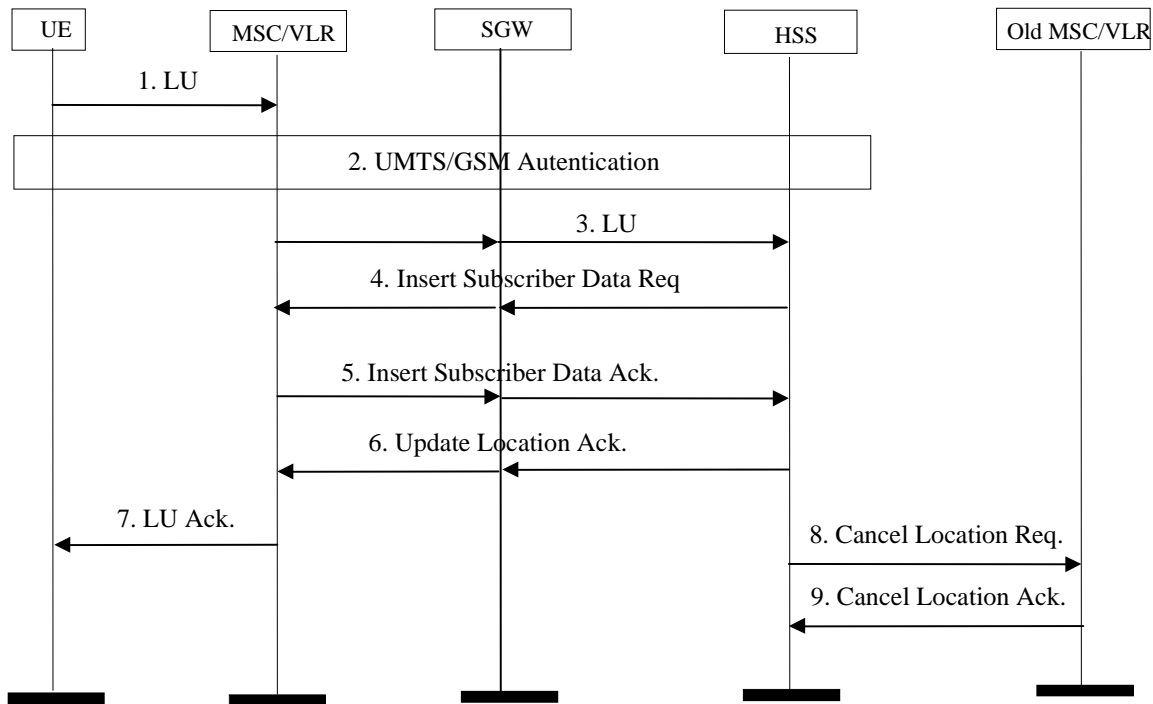

Figure 8.3: Message sequence for roaming into a CS domain

1. The UE initiates the Location Update procedure with the MSC/VLR of the visited network. The LU message contains the IMSI of the subscriber.
2. The authentication is performed as per the existing 3GPP specifications for the CS domain.
3. The MSC/VLR initiates the MAP Location Update procedure towards the HSS of the user via SGW. The HSS stores the VLR address etc. The message contains IMSI and other parameters as defined in the 3GPP specifications for the CS domain. The SGW performs SS7 transport to/from IP conversion.
4. The HSS provides the subscriber data for the roaming user to VLR by sending MAP Insert Subscriber Data message via SGW. The message contains IMSI and other necessary parameters as defined in the 3GPP specification for both Iu and A/Gb mode. The message is passed through the SGW transparently while the SS7 to/from IP conversion is performed in SGW.
5. The serving VLR then acknowledges the receipt of the subscriber data to the HSS via SGW.
6. The HSS acknowledges the completion of location updating procedure to the MSC/VLR via SGW.
7. The MSC/VLR acknowledges the completion of location updating procedure to the UE.
8. The HSS sends the MAP Cancel Location message to the old MSC/VLR (optional procedure).
9. Location cancellation is acknowledged to the HSS by the old MSC/VLR.

NOTE 1: The steps 8 and 9 above assume that the UE was previously registered to a CS domain .

NOTE 2: The MAP messages between the MSC/VLR and HSS are passed transparently via SGW. The SGW does not interpret the MAP messages in anyway, but performs only the lower level conversion between SS7 and IP. This is in accordance with the TS 23.002 [1] for SGW.

8.3 IMS Emergency sessions

8.3.1 GPRS/EPS considerations for UE recognized IMS Emergency Sessions

Requirements for GPRS and EPS functions for support of IMS emergency services are defined in TS 23.060 [2], TS 23.401 [27] and in TS 23.167 [33].

8.3.2 Emergency Calls in absence of UICC for GPRS/EPS Access

Requirements for GPRS and EPS functions for support of IMS emergency services are defined in TS 23.060 [2], TS 23.401 [27] and in TS 23.167 [33].

9 Efficient use of radio resource

This clause captures the technical requirements to ensure efficient use of the radio resource in the UMTS access network. The radio resource is considered to be a scarce resource and therefore every opportunity shall be taken to optimize its use.

For UTRAN it shall be possible to re-apply PS domain pre-release 5 mechanisms for efficient use of radio resource.

Additional requirements for efficient use of the radio spectrum for release 5 SIP signalling include the following:

- UMTS shall support mechanisms to optimize transport of SIP signalling packets over the radio interface, typically by compressing the SIP signalling messages and by compressing the IP and transport layer protocol headers that carry these SIP messages.
- The chosen solution(s) shall be extensible to facilitate the incorporation of new and improved compression algorithms in a backward compatible way as they become available.
- The chosen solution(s) should work in roaming scenarios.
- Application specific compression shall minimize impacts on existing UMTS release e.g. it could be defined between the UE and associated application server, e.g. at the SIP Client and at the first SIP Proxy.

Support of SIP signalling compression is mandatory in the UE and P-CSCF for IMS. The actual usage of compression is optional but highly preferable and is subject to operator policies. See TS 24.229 [23] for more details.

Annex A (informative): Guidance for CSFB and IMS enabled UE implementations in E-UTRAN

A.1 General

This annex provides some examples on how the CSFB and IMS capable UE which supports E-UTRAN can make use of the following indications/settings prior to accessing E-UTRAN:

- "CS Voice only", "IMS PS Voice only", "prefer CS Voice with IMS PS Voice as secondary", or "prefer IMS PS Voice with CS Voice as secondary", and
- "Voice centric" or "Data centric".

A.2 IMS PS Voice preferred

A.2.1 EPS Attach

The following figure A.2.1-1 illustrates the UE behaviour when performing non-combined EPS/IMS attach, with the setting of: "prefer IMS PS Voice with CS Voice as secondary".

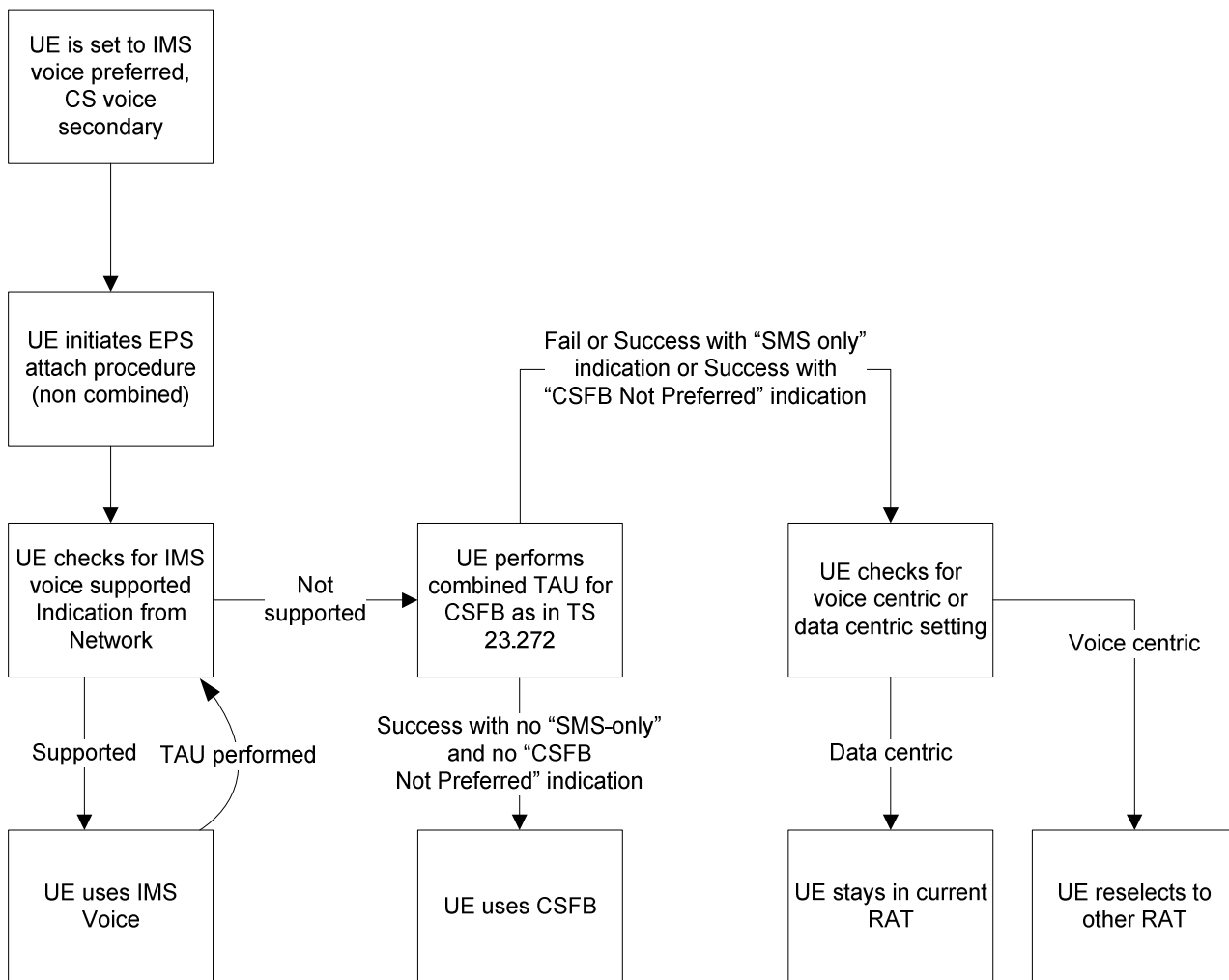

Figure A.2.1-1: UE behaviour for IMS PS Voice preferred with CS Voice as secondary, non combined EPS/IMSI attach

A.2.2 Combined EPS/IMSI attach

The following figure A.2.2-1 illustrates the UE behaviour when performing combined EPS/IMSI attach, with the setting of: "prefer IMS PS Voice with CS Voice as secondary".

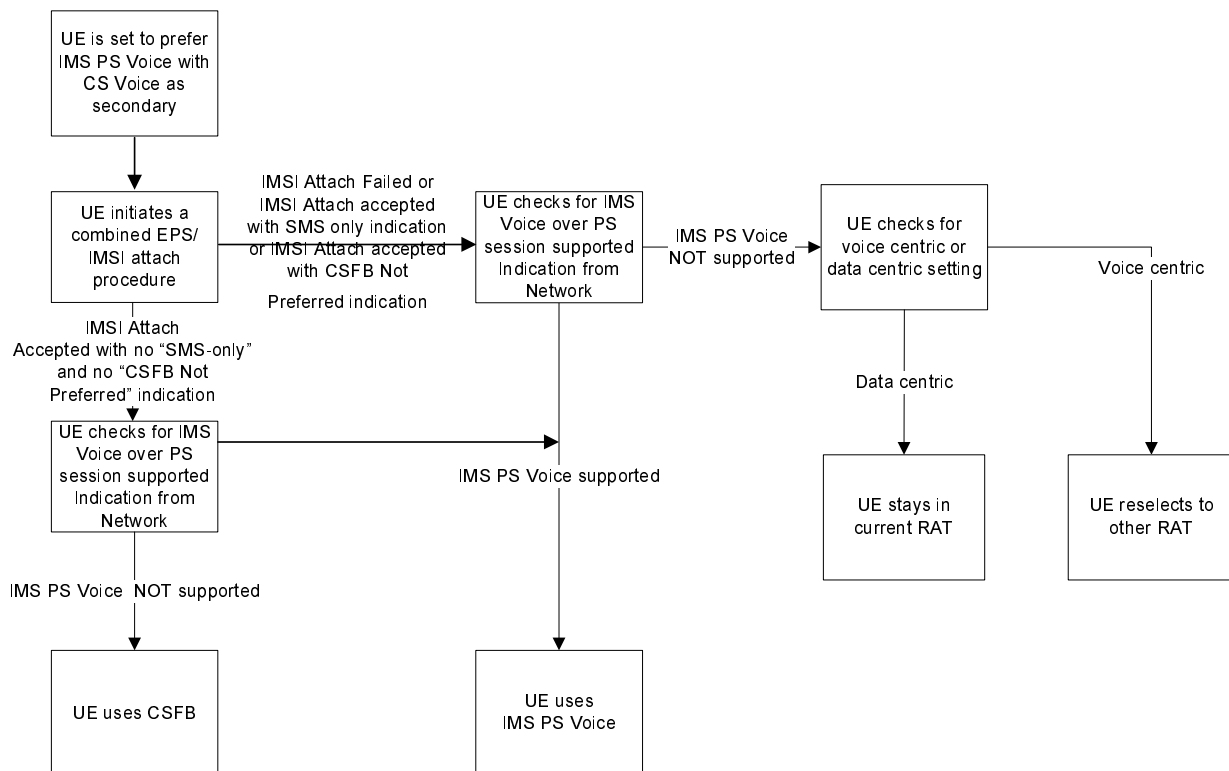

Figure A.2.2-1: UE behaviour for IMS PS Voice preferred with CS Voice as secondary, combined EPS/IMSI attach

A.3 CS Voice preferred

The following figure A.2.1-1 illustrates the UE behaviour with the setting of: "prefer CS Voice with IMS PS Voice as secondary".

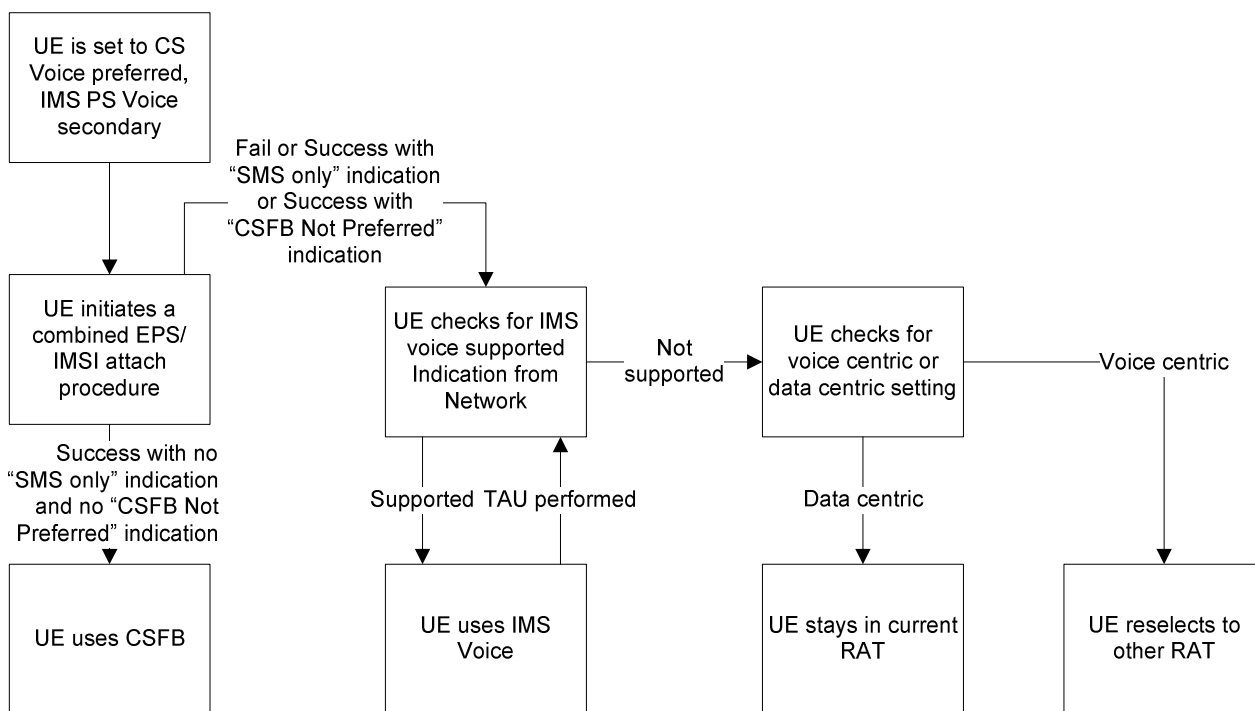

Figure A.3-1: UE behaviour for CS Voice preferred with IMS PS Voice as secondary

A.4 IMS PS Voice only

The following figure A.4.1-illustrates the UE behaviour with the setting of: "IMS PS Voice only".

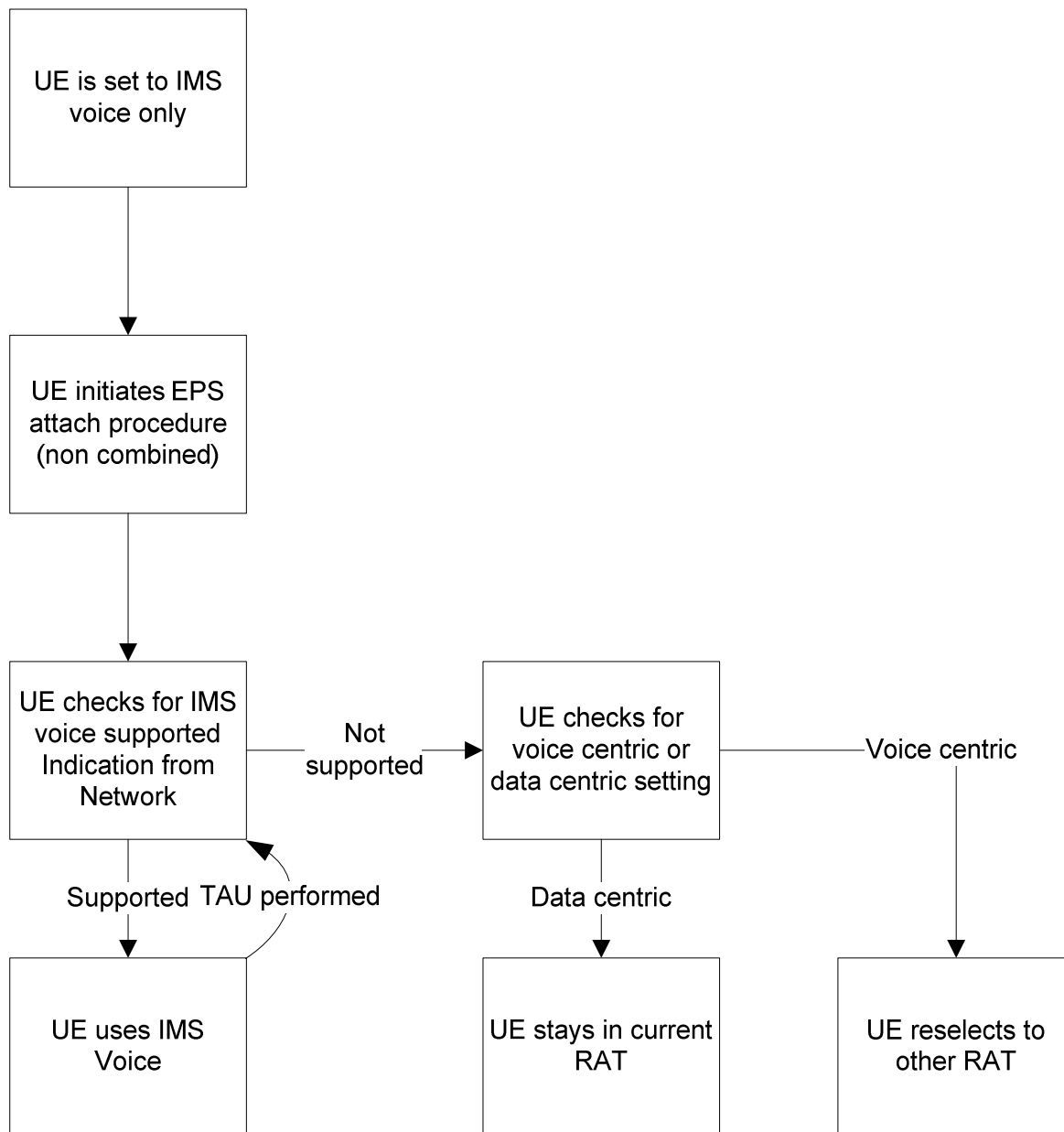

Figure A.4-1: UE behaviour for IMS PS Voice only

A.5 CS Voice only

The following figure A.5.1-illustrates the UE behaviour with the setting of: "CS Voice only".

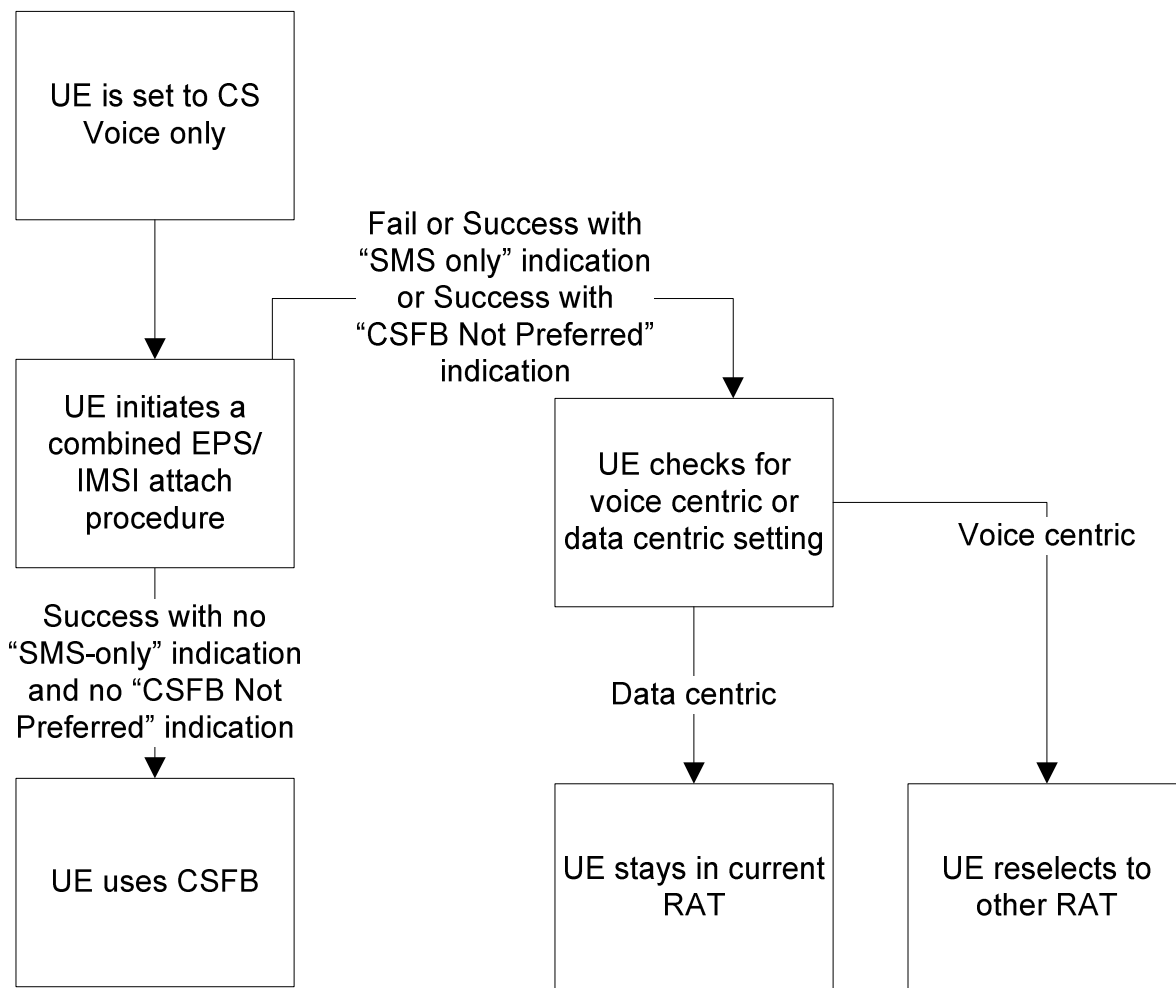

Figure A.5-1: UE behaviour for CS Voice only

Annex B (informative): Change history

Change history								
Date	TSG #	TSG Doc.	CR	Rev	Cat	Subject/Comment	Old	New
03/2003	SA#19	SP-030171	039	1	D	Re-organization of IMS specifications to better reflect aspects of interoperability and commonality between IP Multimedia Systems using different IP-Connectivity Access Networks	5.7.0	6.0.0
09/2003	SA#21	SP-030378	041		A	Combination of service domains	6.0.0	6.1.0
03/2004	SA#23	SP-040036	046		A	Interaction between Shared Network in Connected mode, reject of Mobility Management procedures and Common Id	6.1.0	6.2.0
03/2004	SA#23	SP-040036	044	2	B	Include administrative restriction subscription parameter	6.1.0	6.2.0
06/2004	SA#24	SP-040318	047	2	F	Handling of PDP Contexts	6.2.0	6.3.0
06/2004	SA#24	SP-040318	048	1	C	IPv4 based IMS	6.2.0	6.3.0
03/2006	SA#31	SP-060131	0051	1	B	Support of PS domain IMS emergency calls	6.3.0	7.0.0
03/2007	SA#35	SP-070101	0053	4	C	Clarification on Domain Selection	7.0.0	7.1.0
12/2007	SA#38	SP-070897	0054	3	C	Removal of GPRS specific support for Emergency	7.1.0	7.2.0
03/2008	SA#39	SP-080110	0057	2	C	Any IP version support	7.2.0	8.0.0
06/2008	SA#40	SP-080374	0060	1	B	Allowing P-CSCF from a different network than GGSN	8.0.0	8.1.0
09/2008	SA#41	SP-080587	0061	1	B	General Updates of Architectural Requirements to cover EPS	8.1.0	8.2.0
12/2008	SA#42	SP-080817	0063	-	F	Correction of temporary loss of coverage section	8.2.0	8.3.0
12/2008	SA#42	SP-080807	0064	2	F	Alignment of ADS requirements	8.2.0	8.3.0
06/2009	SA#44	SP-090330	0065	8	F	CS domain and IM CN Subsystem selection principles	8.3.0	8.4.0
06/2009	SA#44	SP-090354	0066	1	F	CS domain and IM CN Subsystem selection principles	8.4.0	9.0.0
09/2009	SA#45	SP-090601	0067	-	F	Adding references to applicable specifications for support of emergency	9.0.0	9.1.0
09/2009	SA#45	SP-090583	0070	1	A	Clarification of UE behavior for voice domain selection	9.0.0	9.1.0
09/2009	SA#45	SP-090583	0072	1	A	Consideration of UE capability during domain selection	9.0.0	9.1.0
09/2009	SA#45	SP-090641	0085	4	A	Interaction of CSFB with SMS over SGs	9.0.0	9.1.0
09/2009	SA#45	SP-090609	0087	3	F	Voice Domain Selection for lu mode	9.0.0	9.1.0
12/2009	SA#46	SP-090772	0105	2	A	Domain selection for SMS	9.1.0	9.2.0
12/2009	SA#46	SP-090794	0096	-	F	Cleanup of domain selection principles	9.1.0	9.2.0
12/2009	SA#46	SP-090794	0098	1	F	Enabling LTE capability of the voice centric UE	9.1.0	9.2.0
12/2009	SA#46	SP-090794	0103	3	F	UE behaviour when configured with "IMS PS Voice only" setting	9.1.0	9.2.0
03/2010	SA#47	SP-100147	0108	4	F	Support for IMS voice over PS indicator for T-ADS	9.2.0	9.3.0
03/2010	SA#47	SP-100129	0110	2	A	Alignment of UE TADS with 3GPP TS 23.292 and correcting T-ADS	9.2.0	9.3.0
06/2010	SA#48	SP-100330	0114	1	D	Correction of wrong reference in TS 23.221	9.3.0	9.4.0
06/2010	SA#48	SP-100330	0116	1	F	Definitions for voice domain preferences	9.3.0	9.4.0

History

Document history		
V9.2.0	January 2010	Publication
V9.3.0	March 2010	Publication
V9.4.0	June 2010	Publication