

ETSI TS 123 108 V18.0.0 (2024-05)



**Digital cellular telecommunications system (Phase 2+) (GSM);
Universal Mobile Telecommunications System (UMTS);
Mobile radio interface layer 3 specification,
core network protocols;
Stage 2
(3GPP TS 23.108 version 18.0.0 Release 18)**



Reference

RTS/TSGC-0123108vi00

Keywords

GSM,UMTS

ETSI

650 Route des Lucioles
F-06921 Sophia Antipolis Cedex - FRANCE

Tel.: +33 4 92 94 42 00 Fax: +33 4 93 65 47 16

Siret N° 348 623 562 00017 - APE 7112B
Association à but non lucratif enregistrée à la
Sous-Préfecture de Grasse (06) N° w061004871

Important notice

The present document can be downloaded from:

<https://www.etsi.org/standards-search>

The present document may be made available in electronic versions and/or in print. The content of any electronic and/or print versions of the present document shall not be modified without the prior written authorization of ETSI. In case of any existing or perceived difference in contents between such versions and/or in print, the prevailing version of an ETSI deliverable is the one made publicly available in PDF format at www.etsi.org/deliver.

Users of the present document should be aware that the document may be subject to revision or change of status.

Information on the current status of this and other ETSI documents is available at

<https://portal.etsi.org/TB/ETSIDeliverableStatus.aspx>

If you find errors in the present document, please send your comment to one of the following services:

<https://portal.etsi.org/People/CommitteeSupportStaff.aspx>

If you find a security vulnerability in the present document, please report it through our
Coordinated Vulnerability Disclosure Program:

<https://www.etsi.org/standards/coordinated-vulnerability-disclosure>

Notice of disclaimer & limitation of liability

The information provided in the present deliverable is directed solely to professionals who have the appropriate degree of experience to understand and interpret its content in accordance with generally accepted engineering or other professional standard and applicable regulations.

No recommendation as to products and services or vendors is made or should be implied.

No representation or warranty is made that this deliverable is technically accurate or sufficient or conforms to any law and/or governmental rule and/or regulation and further, no representation or warranty is made of merchantability or fitness for any particular purpose or against infringement of intellectual property rights.

In no event shall ETSI be held liable for loss of profits or any other incidental or consequential damages.

Any software contained in this deliverable is provided "AS IS" with no warranties, express or implied, including but not limited to, the warranties of merchantability, fitness for a particular purpose and non-infringement of intellectual property rights and ETSI shall not be held liable in any event for any damages whatsoever (including, without limitation, damages for loss of profits, business interruption, loss of information, or any other pecuniary loss) arising out of or related to the use of or inability to use the software.

Copyright Notification

No part may be reproduced or utilized in any form or by any means, electronic or mechanical, including photocopying and microfilm except as authorized by written permission of ETSI.

The content of the PDF version shall not be modified without the written authorization of ETSI.

The copyright and the foregoing restriction extend to reproduction in all media.

© ETSI 2024.
All rights reserved.

Intellectual Property Rights

Essential patents

IPRs essential or potentially essential to normative deliverables may have been declared to ETSI. The declarations pertaining to these essential IPRs, if any, are publicly available for **ETSI members and non-members**, and can be found in ETSI SR 000 314: "*Intellectual Property Rights (IPRs); Essential, or potentially Essential, IPRs notified to ETSI in respect of ETSI standards*", which is available from the ETSI Secretariat. Latest updates are available on the ETSI Web server (<https://ipr.etsi.org/>).

Pursuant to the ETSI Directives including the ETSI IPR Policy, no investigation regarding the essentiality of IPRs, including IPR searches, has been carried out by ETSI. No guarantee can be given as to the existence of other IPRs not referenced in ETSI SR 000 314 (or the updates on the ETSI Web server) which are, or may be, or may become, essential to the present document.

Trademarks

The present document may include trademarks and/or tradenames which are asserted and/or registered by their owners. ETSI claims no ownership of these except for any which are indicated as being the property of ETSI, and conveys no right to use or reproduce any trademark and/or tradename. Mention of those trademarks in the present document does not constitute an endorsement by ETSI of products, services or organizations associated with those trademarks.

DECT™, **PLUGTESTS™**, **UMTS™** and the ETSI logo are trademarks of ETSI registered for the benefit of its Members. **3GPP™** and **LTE™** are trademarks of ETSI registered for the benefit of its Members and of the 3GPP Organizational Partners. **oneM2M™** logo is a trademark of ETSI registered for the benefit of its Members and of the oneM2M Partners. **GSM®** and the GSM logo are trademarks registered and owned by the GSM Association.

Legal Notice

This Technical Specification (TS) has been produced by ETSI 3rd Generation Partnership Project (3GPP).

The present document may refer to technical specifications or reports using their 3GPP identities. These shall be interpreted as being references to the corresponding ETSI deliverables.

The cross reference between 3GPP and ETSI identities can be found under <https://webapp.etsi.org/key/queryform.asp>.

Modal verbs terminology

In the present document "**shall**", "**shall not**", "**should**", "**should not**", "**may**", "**need not**", "**will**", "**will not**", "**can**" and "**cannot**" are to be interpreted as described in clause 3.2 of the [ETSI Drafting Rules](#) (Verbal forms for the expression of provisions).

"**must**" and "**must not**" are **NOT** allowed in ETSI deliverables except when used in direct citation.

Contents

Intellectual Property Rights	2
Legal Notice	2
Modal verbs terminology.....	2
Foreword.....	5
Introduction	5
1 Scope	6
1.1 Scope of the Technical Specification	6
1.2 Application to the interface structures.....	6
1.3 Structure of layer 3 procedures.....	6
1.4 Test procedures	6
1.5 Use of logical channels.....	7
1.6 Overview of control procedures	7
1.6.1 List of procedures	7
1.7 Applicability of implementations	9
1.7.1 Voice Group Call Service (VGCS) and Voice Broadcast Service (VBS).....	9
1.7.2 General Packet Radio Service (GPRS)	9
2 References	10
2.1 Definitions and abbreviations.....	12
2.1.1 Random values.....	13
2.2.2 Vocabulary.....	13
3 Radio Resource management procedures.....	13
4 Elementary procedures for Mobility Management.....	13
5 Elementary procedures for circuit-switched Call Control.....	13
6 Support for packet services	13
7 Examples of structured procedures	13
7.1 General	13
7.1.1 Paging request.....	14
7.1.2 Immediate assignment	14
7.1.3 Service request and contention resolution	14
7.1.4 Authentication.....	15
7.1.5 Ciphering mode setting.....	15
7.1.6 Transaction phase	15
7.1.6.1 Channel mode modify	15
7.1.7 Channel release	16
7.2 Abnormal cases	16
7.3 Selected examples	16
7.3.1 Location updating	17
7.3.2 Mobile originating call establishment.....	18
7.3.3 Mobile terminating call establishment.....	22
7.3.4 Call clearing.....	24
7.3.5 DTMF protocol control.....	26
7.3.6 Handover	27
7.3.7 In-call modification.....	28
7.3.8 Call re-establishment	28
7.3.9 Network initiated mobile originating call \$(CCBS)\$	29
8 Handling of unknown, unforeseen, and erroneous protocol data.....	33
9 Message functional definitions and contents.....	34
10 General message format and information elements coding.....	34
11 List of system parameters.....	34

Annex A (informative): **Change History**35
History36

Foreword

This Technical Specification (TS) has been produced by the 3rd Generation Partnership Project (3GPP).

The present document specifies the procedures used at the radio interface core network protocols within the 3rd generation mobile telecommunications system and the digital cellular telecommunications system.

The contents of the present document are subject to continuing work within the TSG and may change following formal TSG approval. Should the TSG modify the contents of the present document, it will be re-released by the TSG with an identifying change of release date and an increase in version number as follows:

Version x.y.z

where:

- x the first digit:
 - 1 presented to TSG for information;
 - 2 presented to TSG for approval;
 - 3 or greater indicates TSG approved document under change control.
- y the second digit is incremented for all changes of substance, i.e. technical enhancements, corrections, updates, etc.
- z the third digit is incremented when editorial only changes have been incorporated in the document.

Introduction

The present document includes references to features which are not part of the Phase 2+ Release 96 of the GSM Technical specifications. All subclauses which were changed as a result of these features contain a marker (see table below) relevant to the particular feature.

1 Scope

The present document specifies the procedures used at the radio interface (Reference Point Um, see 3GPP TS 24.002 [15]) for Call Control (CC), Mobility Management (MM), and Session Management (SM).

When the notations for "further study" or "FS" or "FFS" are present in the present document they mean that the indicated text is not a normative portion of this standard.

These procedures are defined in terms of messages exchanged over the control channels of the radio interface. The control channels are described in 3GPP TS 44.003 [16].

The structured functions and procedures of this protocol and the relationship with other layers and entities are described in general terms in 3GPP TS 24.007 [20].

1.1 Scope of the Technical Specification

The procedures currently described in the present document are for the call control of circuit-switched connections, session management for GPRS services, mobility management and radio resource management for circuit-switched and GPRS services.

3GPP TS 24.010 [21] contains functional procedures for support of supplementary services.

3GPP TS 24.011 [22] contains functional procedures for support of point-to-point short message services.

3GPP TS 24.012 [23] contains functional description of short message - cell broadcast.

3GPP TS 44.060 [76] contains procedures for radio link control and medium access control (RLC/MAC) of packet data physical channels.

3GPP TS 44.018 [80] contains the procedures for the RR protocol.

3GPP TS 24.008 [81] contains the procedures for the CN protocols.

3GPP TS 44.071 [23a] contains functional descriptions and procedures for support of location services.

NOTE: "layer 3" includes the functions and protocols described in this Technical Specification. The terms "data link layer" and "layer 2" are used interchangeably to refer to the layer immediately below layer 3.

1.2 Application to the interface structures

The layer 3 procedures apply to the interface structures defined in 3GPP TS 44.003 [16]. They use the functions and services provided by layer 2 defined in 3GPP TS 44.005 [18] and 3GPP TS 44.006 [19]. 3GPP TS 24.007 [20] gives the general description of layer 3 including procedures, messages format and error handling.

1.3 Structure of layer 3 procedures

A building block method is used to describe the layer 3 procedures.

The basic building blocks are "elementary procedures" provided by the protocol control entities of the three sublayers, i.e. radio resource management, mobility management and connection management sublayer.

Complete layer 3 transactions consist of specific sequences of elementary procedures. The term "structured procedure" is used for these sequences.

1.4 Test procedures

Test procedures of the GSM radio interface signalling are described in 3GPP TS 51.010 [39] and 3GPP TS 51.02x series.

1.5 Use of logical channels

The logical control channels are defined in 3GPP TS 45.002 [32]. In the following those control channels are considered which carry signalling information or specific types of user packet information:

- i) Broadcast Control CHannel (BCCH): downlink only, used to broadcast Cell specific information;
- ii) Synchronization CHannel (SCH): downlink only, used to broadcast synchronization and BSS identification information;
- iii) Paging CHannel (PCH): downlink only, used to send page requests to Mobile Stations (MSs);
- iv) Random Access CHannel (RACH): uplink only, used to request a Dedicated Control CHannel;
- v) Access Grant CHannel (AGCH): downlink only, used to allocate a Dedicated Control CHannel;
- vi) Standalone Dedicated Control CHannel (SDCCH): bi-directional;
- vii) Fast Associated Control CHannel (FACCH): bi-directional, associated with a Traffic CHannel;
- viii) Slow Associated Control CHannel (SACCH): bi-directional, associated with a SDCCH or a Traffic CHannel;
- ix) Cell Broadcast CHannel (CBCH): downlink only used for general (not point to point) short message information.
- x) Notification CHannel (NCH): downlink only, used to notify mobile stations of VBS (Voice Broadcast Service) calls or VGCS (Voice Group Call Service) calls.

Two service access points are defined on signalling layer 2 which are discriminated by their Service Access Point Identifiers (SAPI) (see 3GPP TS 44.006 [19]):

- i) SAPI 0: supports the transfer of signalling information including user-user information;
- ii) SAPI 3: supports the transfer of user short messages.

Layer 3 selects the service access point, the logical control channel and the mode of operation of layer 2 (acknowledged, unacknowledged or random access, see 3GPP TS 44.005 [18] and 3GPP TS 44.006 [19]) as required for each individual message.

1.6 Overview of control procedures

1.6.1 List of procedures

The following procedures are specified in the Technical Specification:

- a) Clause 4 specifies elementary procedures for Mobility Management:
 - mobility management common procedures (subclause 4.3);
 - TMSI reallocation procedure (subclause 4.3.1);
 - authentication procedure (subclause 4.3.2);
 - identification procedure (subclause 4.3.3);
 - IMSI detach procedure (subclause 4.3.4);
 - abort procedure (subclause 4.3.5);
 - MM information procedure (subclause 4.3.6);
 - mobility management specific procedures (subclause 4.4);
 - location updating procedure (subclause 4.4.1);
 - periodic updating (subclause 4.4.2);

- IMSI attach procedure (subclause 4.4.3);
 - generic location updating procedure (subclause 4.4);
 - connection management sublayer service provision;
 - mobility management connection establishment (subclause 4.5.1);
 - mobility management connection information transfer phase (subclause 4.5.2);
 - mobility management connection release (subclause 4.5.3);
 - GPRS specific mobility management procedures (subclause 4.7);
 - GPRS attach procedure (subclause 4.7.3);
 - GPRS detach procedure (subclause 4.7.4);
 - GPRS routing area updating procedure (subclause 4.7.5);
 - GPRS common mobility management procedures (subclause 4.7);
 - GPRS P-TMSI reallocation procedure (subclause 4.7.6);
 - GPRS authentication and ciphering procedure (subclause 4.7.7);
 - GPRS identification procedure (subclause 4.7.8);
 - GPRS information procedure (subclause 4.7.12);
- b) Clause 5 specifies elementary procedures for circuit switched Call Control comprising the following elementary procedures:
- mobile originating call establishment (subclause 5.2.1);
 - mobile terminating call establishment (subclause 5.2.2);
 - signalling procedures during the active state (subclause 5.3);
 - user notification procedure (subclause 5.3.1);
 - call rearrangements (subclause 5.3.2);
 - DTMF protocol control procedure (subclause 5.5.7);
 - in-call modification (subclause 5.3.4);
 - call clearing initiated by the mobile station (subclause 5.4.3);
 - call clearing initiated by the network (subclause 5.4.4);
 - miscellaneous procedures;
 - in-band tones and announcements (subclause 5.5.1);
 - status enquiry procedure (subclause 5.5.3);
 - call re-establishment procedure (subclause 5.5.4);
- d) Clause 6 specifies elementary procedures for session management:
- GPRS session management procedures (subclause 6.1);
 - PDP context activation (subclause 6.1.1);
 - PDP context modification (subclause 6.1.2);
 - PDP context deactivation (subclause 6.1.3);

- anonymous PDP context activation (subclause 6.1.4);
- anonymous PDP context deactivation (subclause 6.1.5).

The elementary procedures can be combined to form structured procedures. Examples of such structured procedures are given in clause 7. This part of the Technical Specification is only provided for guidance to assist implementations.

Clause 8 specifies actions to be taken on various error conditions and also provides rules to ensure compatibility with future enhancements of the protocol.

1.7 Applicability of implementations

The applicability of procedures of this technical specification for the mobile station is dependent on the services and functions which are to be supported by a mobile station.

1.7.1 Voice Group Call Service (VGCS) and Voice Broadcast Service (VBS)

For mobile stations supporting the Voice Group Call Service or the Voice Broadcast Service, it is explicitly mentioned throughout this technical specification if a certain procedure is applicable only for such a service and, if necessary, how mobile stations not supporting such a service shall behave.

For VGCS and VBS, the following possible mobile station implementations exist:

- support of listening to voice broadcast calls (VBS listening);
- support of originating a voice broadcast call (VBS originating);
- support of listening to voice group calls (VGCS listening);
- support of talking in voice group calls (VGCS talking. This always includes the implementation for VGCS listening);
- support of originating a voice group call (VGCS originating. This always includes the implementation for VGCS talking).

Apart from the explicitly mentioned combinations, all possible combinations are optional and supported by this technical specification.

The related terms are used in this technical specification, if information on these implementation options is required.

1.7.2 General Packet Radio Service (GPRS)

For mobile stations supporting the General Packet Radio Service (GPRS), it is explicitly mentioned throughout the technical specification if a certain procedure is applicable only for such a service and, if necessary, how mobile stations not supporting such a service shall behave.

A GPRS MS may operate in one of the following MS operation modes, see 3GPP TS 23.060 [74]:

- MS operation mode A;
- MS operation mode B; or
- MS operation mode C.

The MS operation mode depends on the services that the MS is attached to, i.e., only GPRS or both GPRS and non-GPRS services, and upon the MS's capabilities to operate GPRS and other GSM services simultaneously. Mobile stations that are capable to operate GPRS services are referred to as GPRS MSs.

NOTE: Other GSM technical specifications may refer to the MS operation modes A, B, and C as GPRS class-A MS, GPRS class-B MS, and GPRS class-C MS.

It should be noted that it is possible that for a GPRS MS, the GMM procedures currently described in the ETS do not support combinations of VGCS, VBS and GPRS. The possible interactions are not studied yet.

2 References

The following documents contain provisions which, through reference in this text, constitute provisions of the present document.

- References are either specific (identified by date of publication, edition number, version number, etc.) or non-specific.
- For a specific reference, subsequent revisions do not apply.
- For a non-specific reference, the latest version applies. In the case of a reference to a 3GPP document (including a GSM document), a non-specific reference implicitly refers to the latest version of that document *in the same Release as the present document*.

- [1] Void.
- [2] Void.
- [2a] 3GPP TR 21.905 "Vocabulary for 3GPP Specifications"
- [3] Void.
- [4] Void.
- [5] Void.
- [6] Void.
- [7] Void.
- [8] Void.
- [9] Void
- [10] Void.
- [11] Void.
- [12] Void.
- [12a] Void.
- [13] Void.
- [14] Void.
- [15] 3GPP TS 24.002: "GSM-UMTS Public Land Mobile Network (PLMN) access reference configuration".
- [16] 3GPP TS 44.003: "Mobile Station - Base Station System (MS - BSS) interface; Channel structures and access capabilities".
- [17] Void.
- [18] 3GPP TS 44.005: "Data Link (DL) layer; General aspects".
- [19] 3GPP TS 44.006: "Mobile Station - Base Station System (MS - BSS) interface; Data Link (DL) layer specification".
- [20] 3GPP TS 24.007: "Mobile radio interface signalling layer 3; General aspects".

- [21] 3GPP TS 24.010: "Mobile radio interface layer 3; Supplementary services specification; General aspects".
- [22] 3GPP TS 24.011: "Point-to-Point (PP) Short Message Service (SMS) support on mobile radio interface".
- [23] 3GPP TS 24.012: "Short Message Service Cell Broadcast (SMSCB) support on the mobile radio interface".
- [23a] 3GPP TS 44.071: "Location Services (LCS); Mobile radio interface layer 3 specification".
- [23b] Void.
- [24] Void.
- [25] Void.
- [26] Void.
- [27] Void.
- [28] Void.
- [29] Void.
- [30] Void.
- [31] Void.
- [32] 3GPP TS 45.002: "Multiplexing and multiple access on the radio path".
- [33] Void.
- [34] Void.
- [35] Void.
- [36] Void.
- [37] Void.
- [38] Void.
- [39] 3GPP TS 51.010: "Mobile Station (MS) conformance specification".
- [40] Void.
- [41] Void.
- [42] Void.
- [43] Void.
- [44] Void.
- [45] Void.
- [46] Void.
- [47] Void.
- [48] Void.
- [49] Void.
- [50] Void.
- [51] Void.

[52]	Void.
[53]	Void.
[54]	Void.
[55]	Void.
[56]	Void.
[57]	Void.
[58]	Void.
[59]	Void.
[60]	Void.
[61]	Void.
[62]	Void.
[63]	Void.
[64]	Void.
[65]	Void.
[66]	Void.
[67]	Void.
[68]	Void.
[69]	Void.
[70]	Void.
[71]	Void.
[72]	Void.
[73]	Void.
[74]	3GPP TS 23.060: "General Packet Radio Service (GPRS); Service Description; Stage 2".
[75]	Void.
[76]	3GPP TS 44.060: "General Packet Radio Service (GPRS); Mobile Station (MS) - Base Station System (BSS) interface; Radio Link Control/Medium Access Control (RLC/MAC) protocol".
[77]	Void.
[78]	Void.
[79]	Void.
[80]	3GPP TS 44.018: "Mobile radio interface layer 3 specification; Radio Resource Control Protocol".
[81]	3GPP TS 24.008: "Mobile radio interface Layer 3 specification; Core network protocols; Stage 3".

2.1 Definitions and abbreviations

For the purposes of the present document, the abbreviations defined in 3GPP TR 21.905 [2a] apply.

2.1.1 Random values

For the RR protocol see 3GPP TS 44.018 and for the CN protocols see 3GPP TS 24.008 [81].

2.2.2 Vocabulary

For the RR protocol see 3GPP TS 44.018 [80] and for the CN protocols see 3GPP TS 24.008 [81].

3 Radio Resource management procedures

See 3GPP TS 44.018 [80].

4 Elementary procedures for Mobility Management

See 3GPP TS 24.008 [81].

5 Elementary procedures for circuit-switched Call Control

See 3GPP TS 24.008 [81].

6 Support for packet services

See 3GPP TS 24.008 [81].

7 Examples of structured procedures

Clause 7 is informative.

7.1 General

Clause 7 contains examples of how the network may group together the elementary procedures (i.e. the procedures defined in clauses 3 to 5) in order to provide normal service.

The layer 3 signalling at the radio interface may be divided into so-called structured procedures which consist of specific combinations of elementary procedures. In subclause 7.3, selected examples of structured procedures are described. A structured procedure consists of (not necessarily all) components shown in figure 7.1. These components are characterized by the purpose of their use in structured procedures and their message flow in the following subclauses 7.1.1 to 7.1.7.

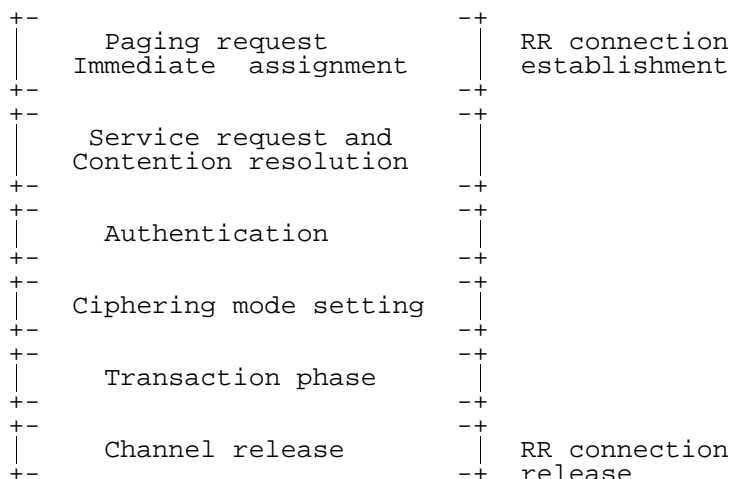

Figure 7.1/3GPP TS 23.108: Components of structured procedures

7.1.1 Paging request

The paging procedure is used to locate a mobile station to which a connection shall be established.

Upon receipt of a PAGING REQUEST message the addressed mobile station initiates the immediate assignment procedure.

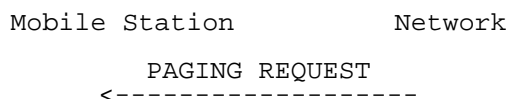

Figure 7.2/3GPP TS 23.108: Paging request

7.1.2 Immediate assignment

The immediate assignment procedure is always initiated by the mobile station. It may be triggered by a paging request or by a mobile originating service request.

The mobile station sends a CHANNEL REQUEST message on the Random Access Channel. The network responds with an IMMEDIATE ASSIGNMENT message which causes the mobile station to seize the indicated dedicated channel.

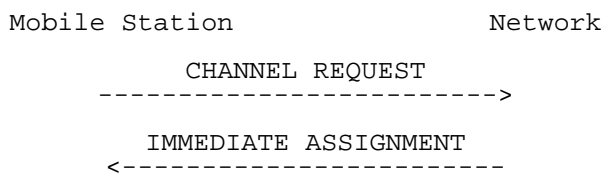

Figure 7.3/3GPP TS 23.108: Immediate assignment

7.1.3 Service request and contention resolution

The initial service request message (a PAGING RESPONSE, LOCATION UPDATING REQUEST, IMSI DETACH, CM SERVICE REQUEST, or CM RE-ESTABLISHMENT REQUEST message) is sent by the mobile station to the network piggy-backed in the L2 SABM frames establishing the main signalling link. Its purpose is:

- to provide non-confidential information relevant to the service requested for the RR and MM sublayer in the network;

- in particular to identify the user in the network without jeopardising the confidentiality of the user's identity; this is achieved by using as mobile identity the TMSI, which was never before transmitted un-encrypted over the radio interface;
- to allow for contention resolution;
- optionally, in the CM SERVICE REQUEST message to inform the network of the priority level associated with the call.

Contention resolution provides a resolution process when more than one MS try to seize a channel allocated during the immediate assignment procedure (because they happened to use the same random reference at the same time during random access). This is achieved by the network including in a L2 UA frame the same information field as that one received in the L2 SABM frame to which the UA frame responds. By comparing the two information fields the MS can verify whether it was the originator of the L2 establishment, because the service request contains the mobile identity.

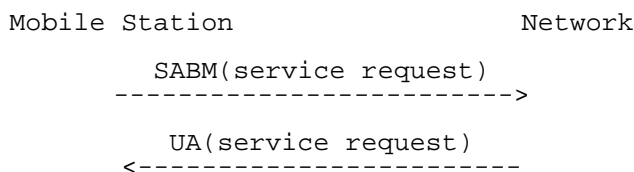

Figure 7.4/3GPP TS 23.108: Service request and contention resolution

7.1.4 Authentication

The purpose of authentication is to validate the identity provided by the mobile station . It is initiated by the network. The authentication procedure also provides the mobile station with information from which a new ciphering key can be derived. The network decides whether or not to use authentication. This may depend on the context.

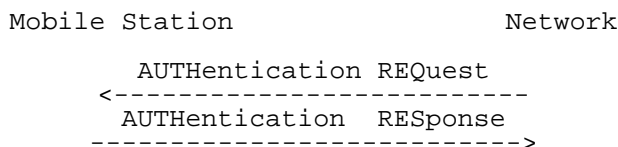

Figure 7.5/3GPP TS 23.108: Authentication

7.1.5 Ciphering mode setting

Ciphering mode setting is initiated by the network. Its purpose is to instruct the mobile station whether or not to use ciphering and which algorithm to use.

Where ciphering is used, this procedure synchronizes the start of ciphering at the mobile station and in the network.

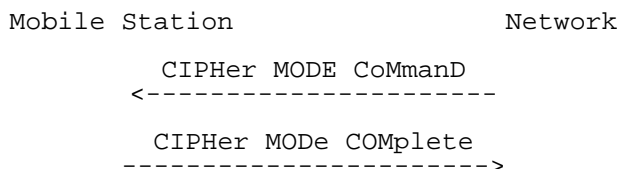

Figure 7.6/3GPP TS 23.108: Ciphering mode setting

7.1.6 Transaction phase

A variety of elementary procedures described in clauses 3 to 5 may be performed during the transaction phase. In this subclause, only the channel mode modify procedure is characterized.

7.1.6.1 Channel mode modify

The channel mode modify procedure may be used when a traffic channel has been assigned e.g.:

- during the in-call modification procedure in order that the channel mode of the TCH be changed to that one requested by call control;
- during call establishment with very early assignment in order that the channel mode of the TCH be changed from signalling only to the mode requested by call control;
- during the active phase of a data call in order that the speed of the data transmission be changed.

The channel mode modify procedure is initiated by the network sending a CHANNEL MODE MODIFY message and completed by the mobile station changing the mode of the TCH and sending back a CHANNEL MODE MODIFY ACKNOWLEDGE message.

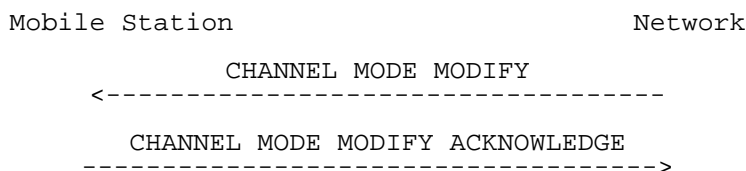

Figure 7.7/3GPP TS 23.108: Channel mode change

7.1.7 Channel release

Once the transaction phase has been completed, the channel is released by the channel release procedure. The data link layer is released explicitly as described in 3GPP TS 44.006 [19]. After the channel release is completed, the radio resources which were in use may be reallocated by the network.

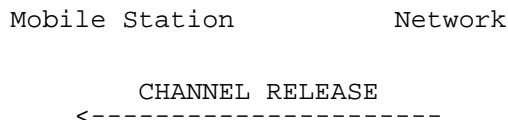

Figure 7.8/3GPP TS 23.108 Channel release

7.2 Abnormal cases

Abnormal cases are not described in the examples of clause 7. They may arise from:

- a) failure at a lower layer (e.g. loss of radio connection);
- b) failure of an elementary procedure;
- c) errors in an elementary procedure.

7.3 Selected examples

The following examples are considered:

- location updating;
- mobile originating call establishment;
 - a) without OACSU (early assignment);
 - b) with OACSU;
 - c) with very early assignment;
- mobile terminating call establishment;
 - a) without OACSU (early assignment);
 - b) with OACSU;

- call clearing:
 - a) network initiated;
 - b) mobile initiated;
- DTMF protocol control.
- handover:
 - a) between finely synchronized cells;
 - b) between non-synchronized cells;
 - c) handover failure, where reconnection of the old channel is possible;
- in-call modification;
- call re-establishment;
- network initiated MO call, e.g. CCBS Recall \$(CCBS)\$:
 - a) assignment before A party alerting;
 - b) assignment before B party alerting;
 - c) assignment after A and B party alerting.

7.3.1 Location updating

The location updating procedure is always initiated by the mobile station e.g. when it finds itself in a different location area from the one in which it was registered before. The cases where the procedure is triggered are described in clause 4.

The procedure is shown in figure 7.9/3GPP TS 23.108. The network may decide whether to allocate a new TMSI during location updating, and this option is reflected in this example.

The mobile station initiates immediate assignment, service request using the LOCATION UPDATING REQUEST message, and contention resolution.

The network requires authentication (this again is an option).

As the network intends to allocate a new TMSI, it should activate ciphering. The network includes the new TMSI in the LOCATION UPDATING ACCEPT message (it could also use the explicit TMSI reallocation procedure, see clause 4). The mobile station sends a TMSI REALLOCATION COMPLETE message to the network to acknowledge the receipt of the new TMSI. Upon receipt of the TMSI REALLOCATION COMPLETE message the network initiates the channel release if no further transactions are scheduled.

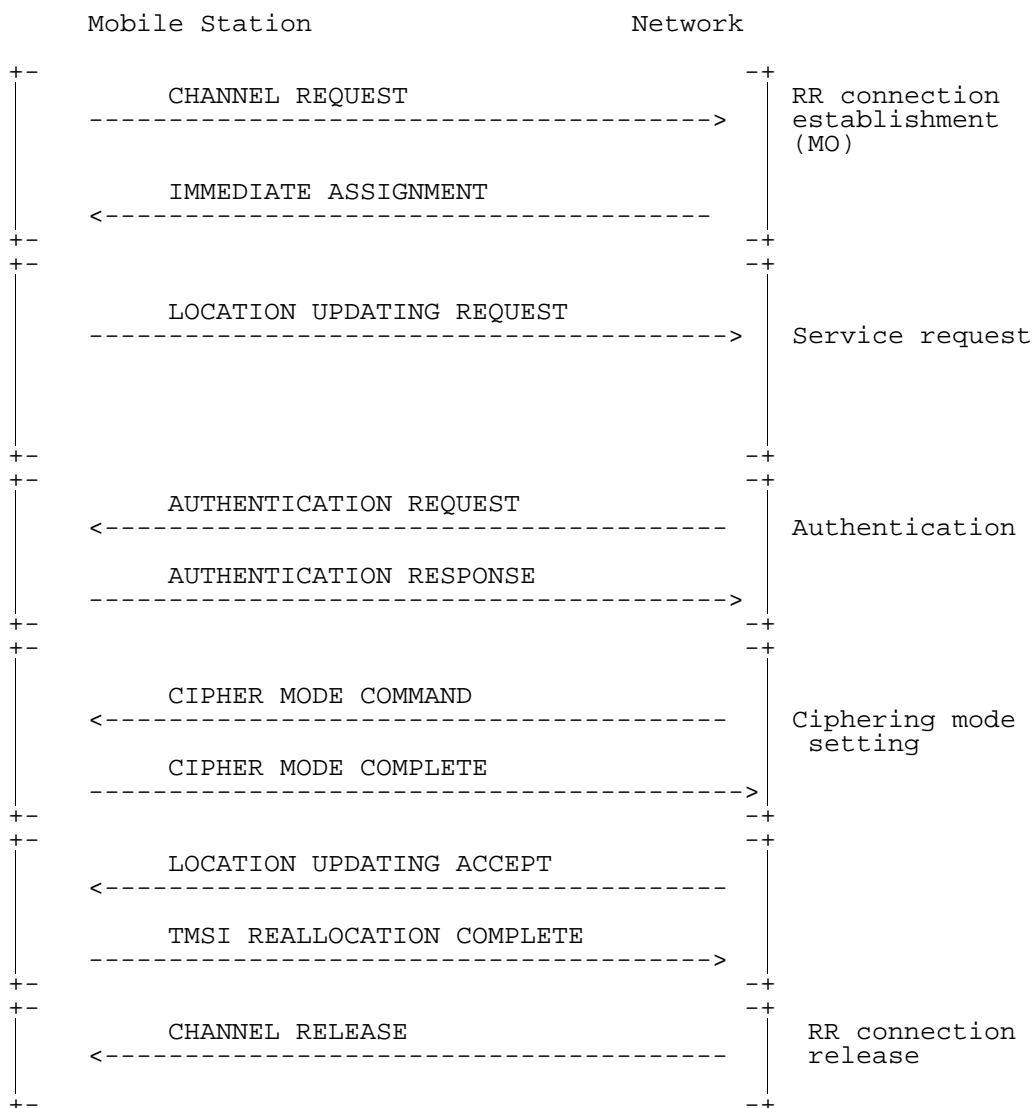

Figure 7.9/3GPP TS 23.108: Location updating: successful case

7.3.2 Mobile originating call establishment

The mobile station initiates immediate assignment, service request using the CM SERVICE REQUEST message, and contention resolution. The network may initiate authentication and may start the ciphering mode setting.

After sending the CIPHERING MODE COMPLETE message, the mobile station initiates call establishment by sending the SETUP message to the network. The network answers with a CALL PROCEEDING message.

a) Non-OACSU option (early assignment):

With this option the network allocates a traffic channel to the mobile station before it initiates call establishment in the fixed network.

If call queuing is applied, it may cause variable delay in the traffic channel assignment.

When user alerting has been initiated at the called side, an ALERTING message is sent to the mobile station. The network may optionally instruct the MS to attach the user connection at this stage of the call, by means of the progress indicator information element set to the value #1 or #8 (if the ringing tone will be sent by the remote end) in the ALERTING message. In that case, an alerting ringing tone has to be generated by the network.

NOTE: The speech codec is transparent for supervisory tones.

A CONNECT message and its acknowledgement CONNECT ACKNOWLEDGE complete the call establishment when the called party has answered.

The mobile originating call setup with early assignment is shown in figure 7.10a/3GPP TS 23.108.

b) OACSU option (late assignment):

The network determines when the traffic channel is to be assigned. The assignment may be performed at any time after call establishment has been initiated in the fixed network. In the following the case is considered where the network will only allocate a traffic channel after the called party has answered the call (late assignment).

As in a) an ALERTING message is sent to the mobile station when user alerting has been initiated at the called side. If the ringing tone is needed, it has to be generated locally at the mobile station as no traffic channel is allocated. When the called party has answered, the network will initiate the channel assignment procedure in order to allocate a traffic channel to the mobile station. If call queuing is applied, it may cause variable delay in the traffic channel assignment. Once the channel assignment has been completed the network will send a CONNECT message to the mobile station. The MS attaches then the user connection. The CONNECT ACKNOWLEDGE message will complete the call setup.

The mobile originating call setup with late assignment is shown in figure 7.10b/3GPP TS 23.108.

c) Very early assignment:

The network assigns the traffic channel at the earliest possible moment, i.e. in the immediate assignment procedure. The mode of the traffic channel is changed from signalling only to the mode necessary for the call by means of the channel mode change procedure. An appropriate moment for that change is after the network has sent the CALL PROCEEDING message, when the call is established towards the called user.

With this option, call queuing is never applied.

The further establishment of the call is as in a).

The mobile originating call setup with very early assignment is shown in figure 7.10c/3GPP TS 23.108.

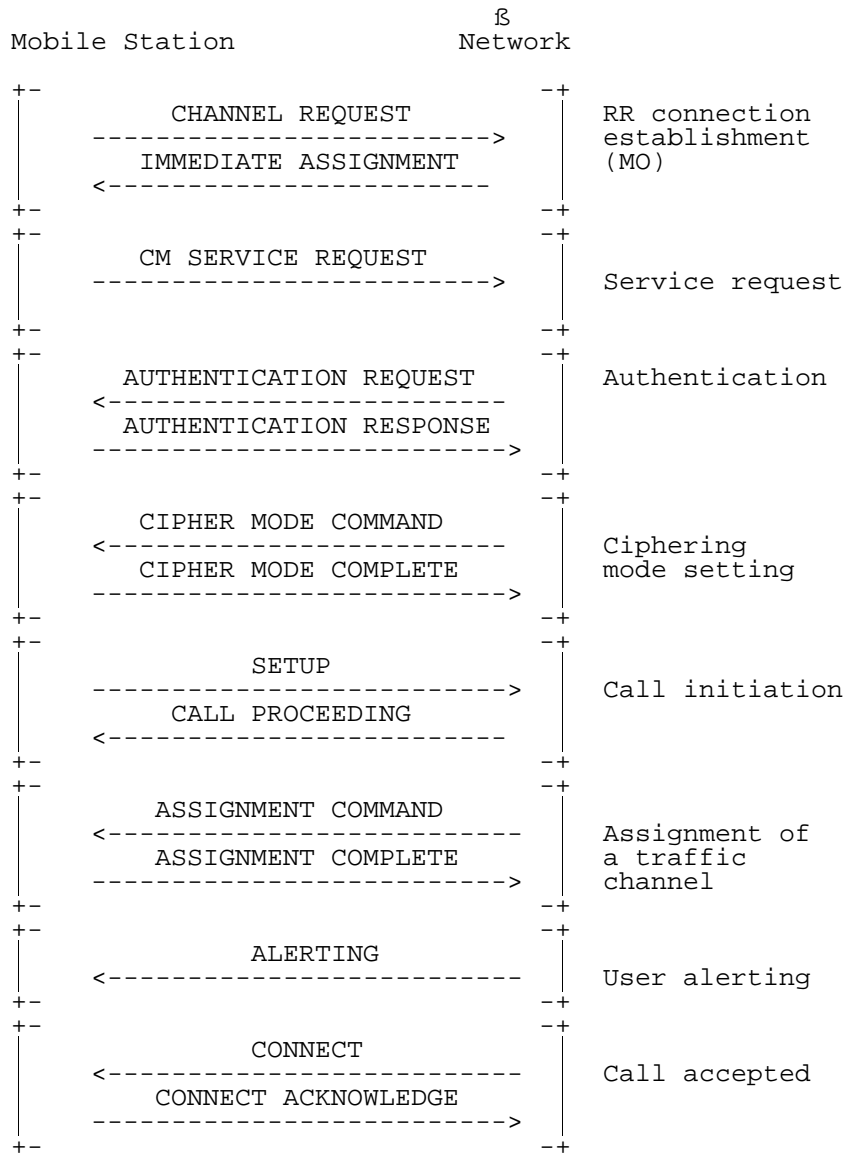

Figure 7.10a/3GPP TS 23.108: Mobile originating call establishment without OACSU (early assignment)

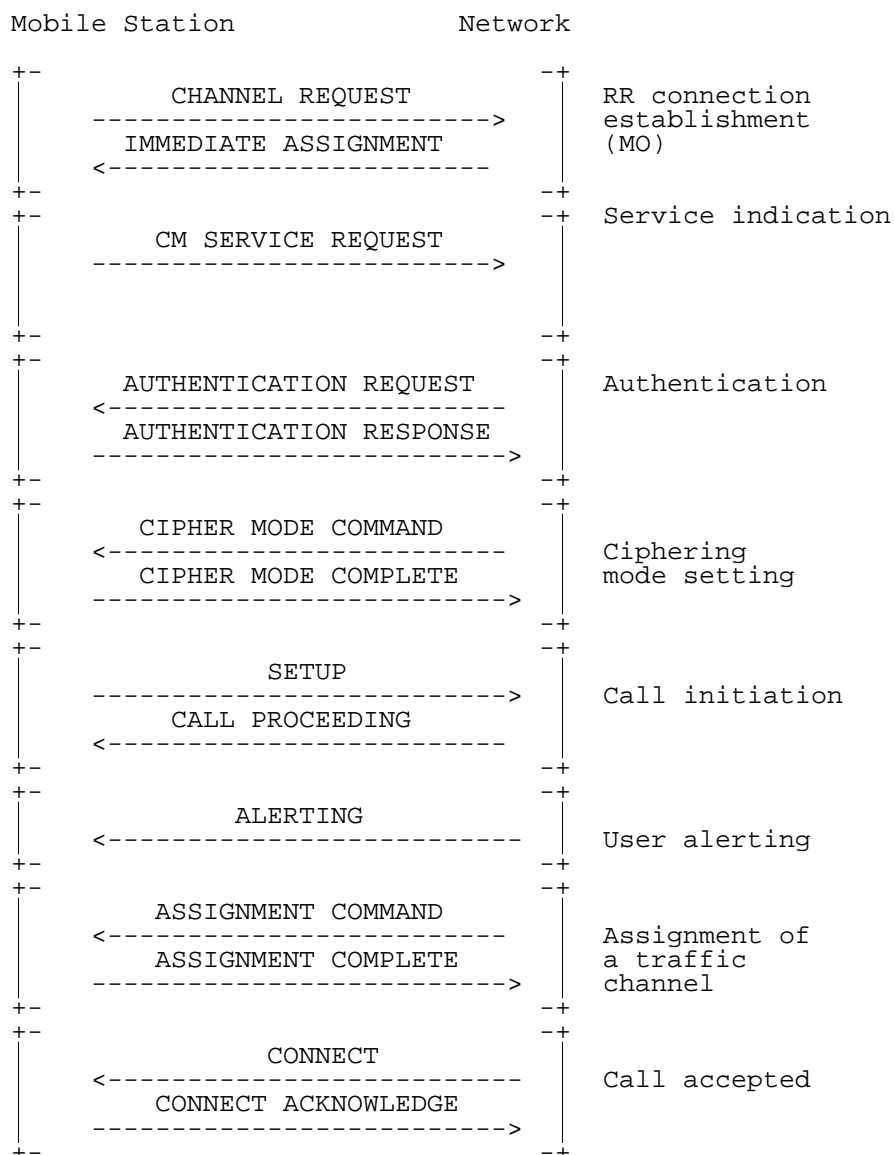

Figure 7.10b/3GPP TS 23.108: Mobile originating call establishment with OACSU (late assignment)

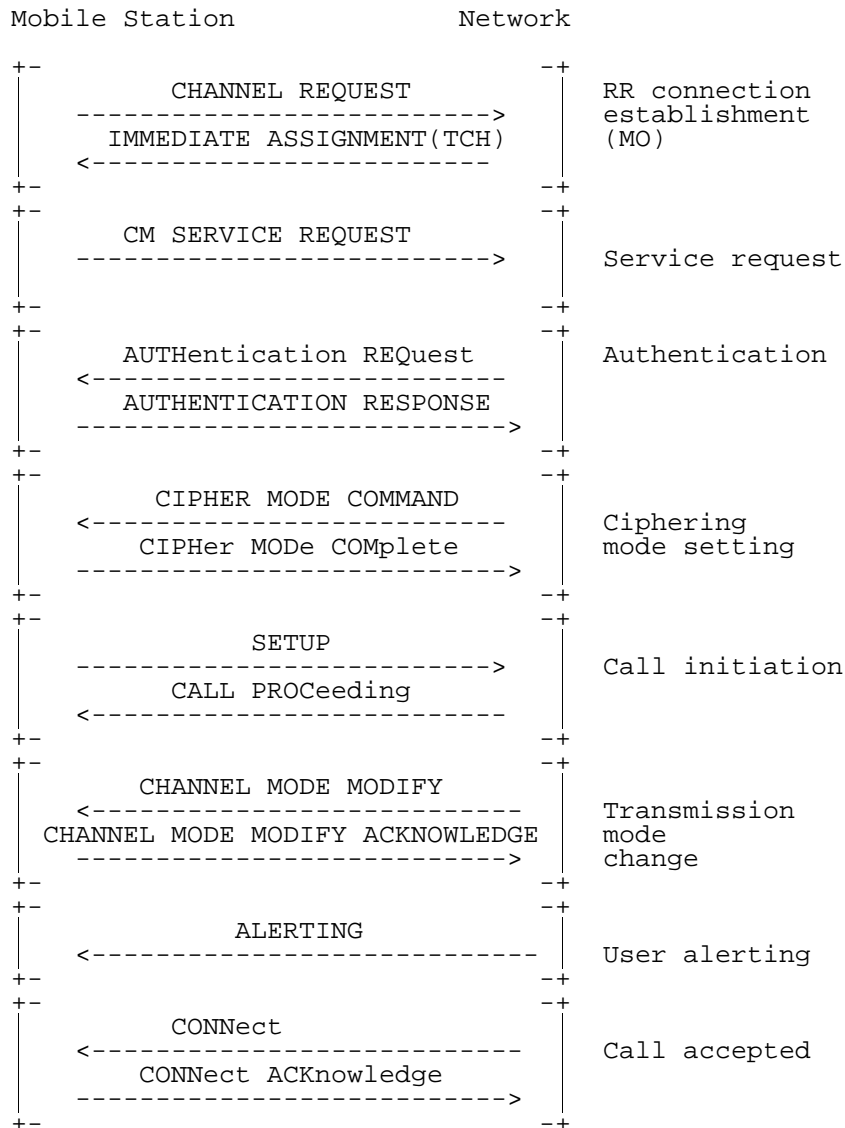

Figure 7.10c/3GPP TS 23.108: Mobile originating call establishment with very early assignment

7.3.3 Mobile terminating call establishment

Mobile terminating call establishment is initiated by the network sending a PAGING REQUEST message (see figure 7.11a/3GPP TS 23.108). Upon receiving this message the mobile station initiates the immediate assignment procedure and responds to the network by sending the PAGING RESPONSE message within a layer 2 SABM frame. The network returns a layer 2 UA frame containing the same information field as was sent in the SABM frame.

Authentication and ciphering are treated by the network in the same way as defined for the mobile originating call establishment (subclause 7.3.2). After ciphering has been started, the network sends a SETUP message to the mobile station. The capability of the mobile station (at that time) to accept the call is confirmed when the mobile station returns a CALL CONFIRMED message to the network.

a) Non-OACSU option (early assignment):

With this option the network initiates the assignment of a traffic channel upon receiving the CALL CONFIRMED message.

The signal IE is not included in the SETUP message, therefore user alerting is initiated only after a traffic channel has been allocated. An ALERTING message will be sent to the network.

When the called user answers, the mobile station sends a CONNECT message to the network. Upon receiving the CONNECT message the network completes the through connection of the communication path and sends a CONNECT ACK message to the mobile station.

b) OACSU option (late assignment):

In that option, the signalling IE is included in the SETUP message. Consequently, user alerting is initiated as soon as the MS has accepted the call.

The network determines when the traffic channel is to be assigned. The assignment may be performed at any time after user alerting has been initiated. In the following the case is considered where the network will only allocate a traffic channel to the mobile station after having received the CONNECT message sent from the mobile station (see figure 7.11b).

Upon receiving the ASSIGNMENT COMPLETE message from the mobile station, the network completes the through connection of the communication path and sends a CONNECT ACKNOWLEDGE message to the mobile station.

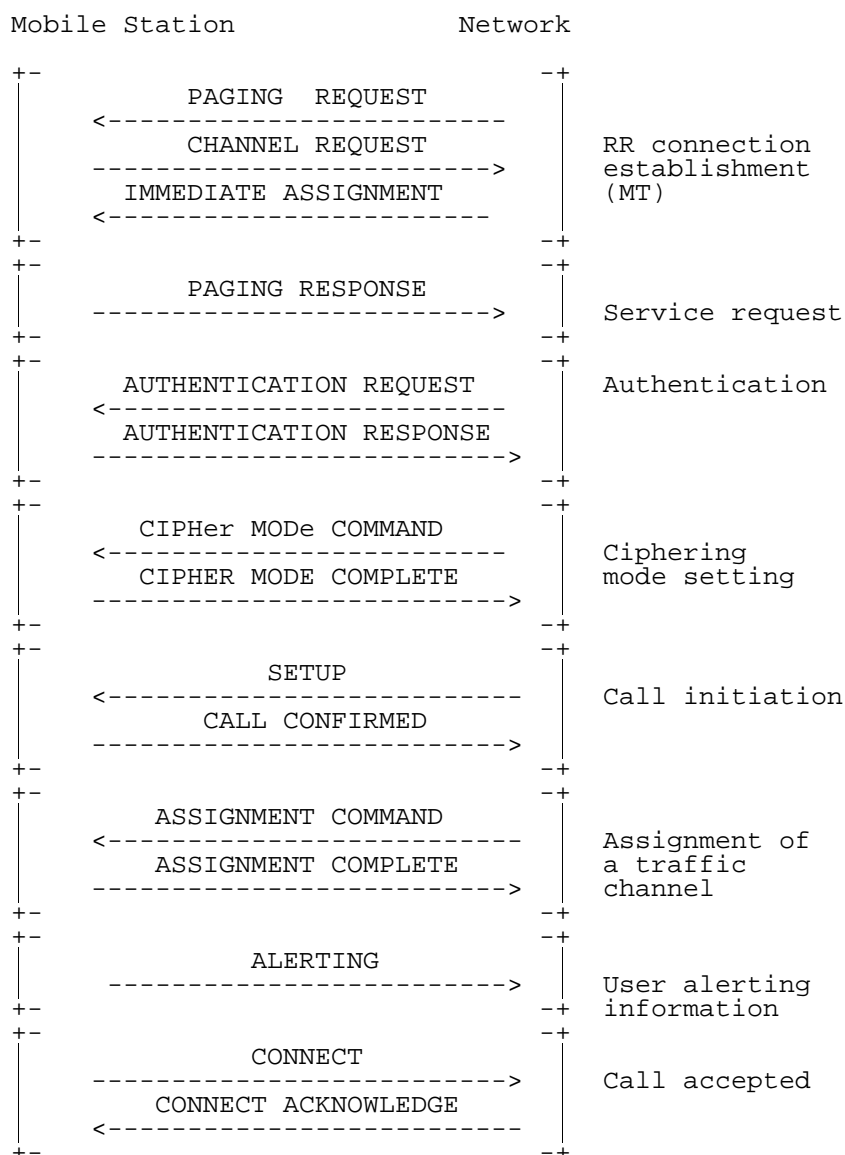

Figure 7.11a/3GPP TS 23.108: Mobile terminating: call establishment without OACSU (early assignment)

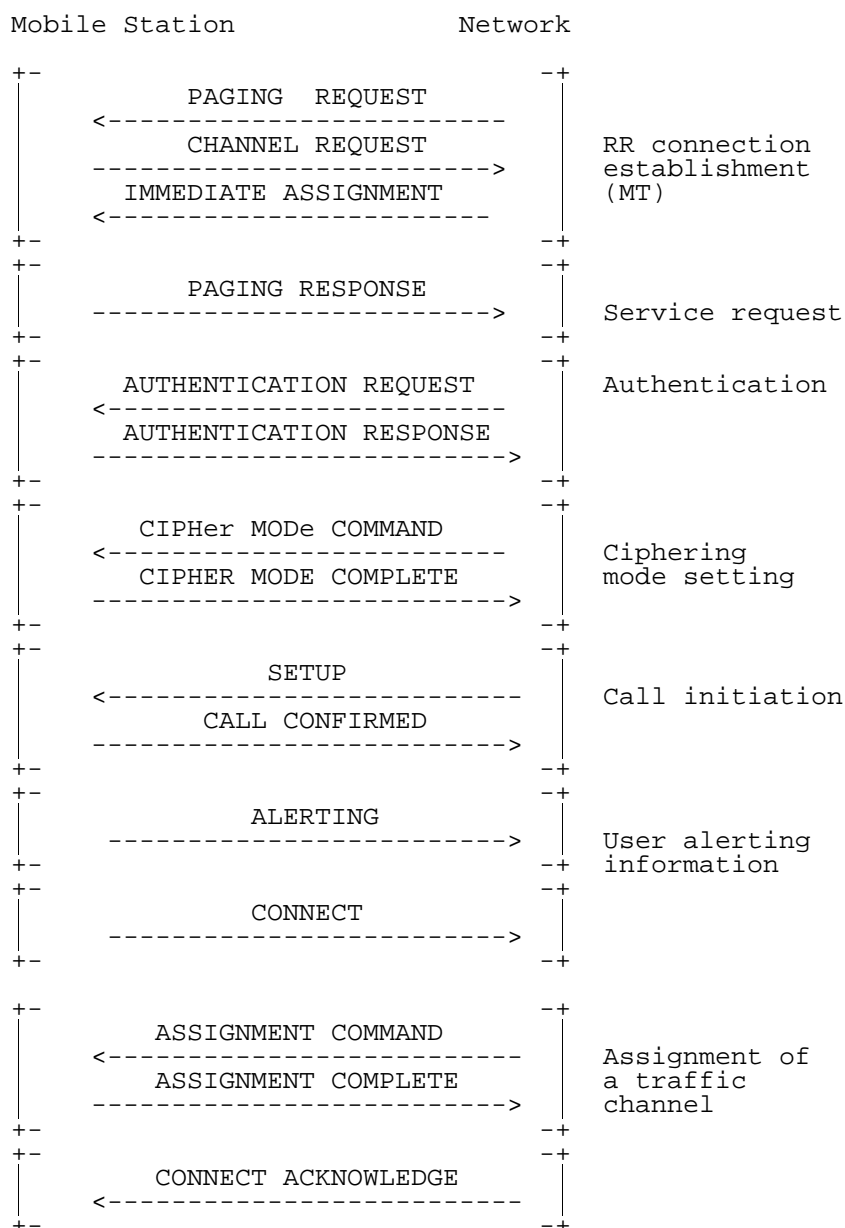

Figure 7.11b/3GPP TS 23.108: Mobile terminating: call establishment with OACSU (late assignment)

7.3.4 Call clearing

a) initiated by the network

The network initiates the clearing of a call by sending a DISCONNECT message to the mobile station (see also subclause 5.4.4).

Upon receiving the DISCONNECT message from the network the mobile station sends a RELEASE message to the network.

Upon receiving the RELEASE message from the mobile station, the network sends a RELEASE COMPLETE to the mobile station and, if the traffic channel is longer needed (e.g. last activity on the traffic channel), performs the channel release procedure as described in subclause 7.1.7.

Upon receiving the RELEASE COMPLETE message and if the cleared call was the last activity on the traffic channel, the mobile station waits for the release of the channel which is always initiated by the network.

When there exist multiple traffic channels in the Multicall environment the network does not release (i.e. retains) a traffic channel even if the cleared call was the last activity on the traffic channel under the condition as follows;

- a waiting call exists and the mobile station does not indicate to the network which bearer will be used for accepting the waiting call yet; and
- there exists no retained bearer for the waiting call.

When the mobile station receives SETUP message with Signal IE indicating Call Waiting, which means the network cannot provide any additional traffic channel, then:

- the MS shall not request a new SI value before releasing any other call (that leads to release any other bearers than the retained bearer);
- If the mobile station indicates the different SI value from the retained bearer after releasing any other calls (that leads to release any other bearer than the retained bearer), the network allocates a new TCH for the call, and releases the retained bearer.

Call clearing initiated by the network is shown in figure 7.12a.

b) initiated by the mobile station:

The mobile station initiates the clearing of a call by sending a DISCONNECT message to the network (see also subclause 5.4.3).

Upon receiving the DISCONNECT message from the mobile station the network sends a RELEASE message to the mobile station.

Upon receiving the RELEASE message from the network, the mobile station sends a RELEASE COMPLETE to the network, which, if the traffic channel is no longer needed (e.g. last activity on the traffic channel), performs the channel release procedure as described in subclause 7.1.6.

When there exist multiple traffic channels in the Multicall environment the network does not release (i.e. retains) a traffic channel even if the cleared call was the last activity on the traffic channel under the condition as follows:

- a waiting call exists and the mobile station does not indicate to the network which bearer will be used for accepting the waiting call yet; and
- there exists no retained bearer for the waiting call.

When the mobile station receives SETUP message with Signaling IE indicating Call Waiting, which means network cannot provide any additional traffic channel, then:

- The MS shall not request a new SI value before releasing any other call (that leads to release any other bearers than the retained bearer);
- If the mobile station indicates the different SI value from the retained bearer after releasing any other calls (that leads to release any other bearer than the retained bearer), the network allocates a new TCH for the call, and releases the retained bearer.

Call clearing initiated by the mobile station is shown in figure 7.12b.

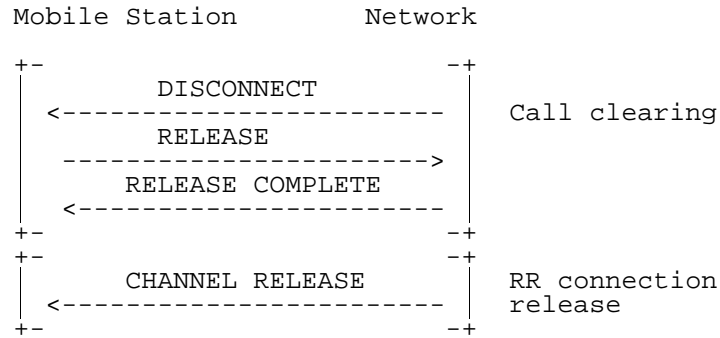

a) Call clearing initiated by the network

Figure 7.12a/3GPP TS 23.108: Call clearing

a)

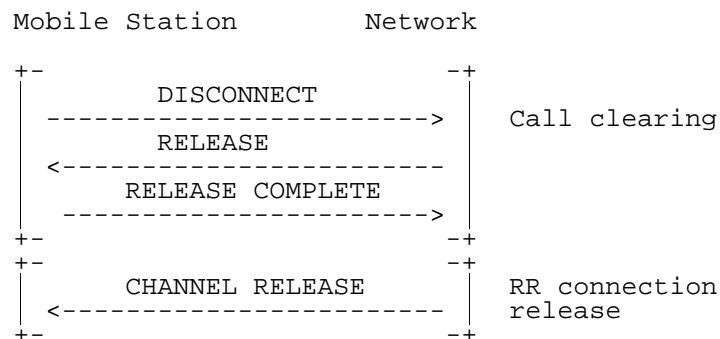

b) Call clearing initiated by the MS

Figure 7.12b/3GPP TS 23.108: Call clearing

7.3.5 DTMF protocol control

Figure 7.13 shows the structured procedure for DTMF protocol control.

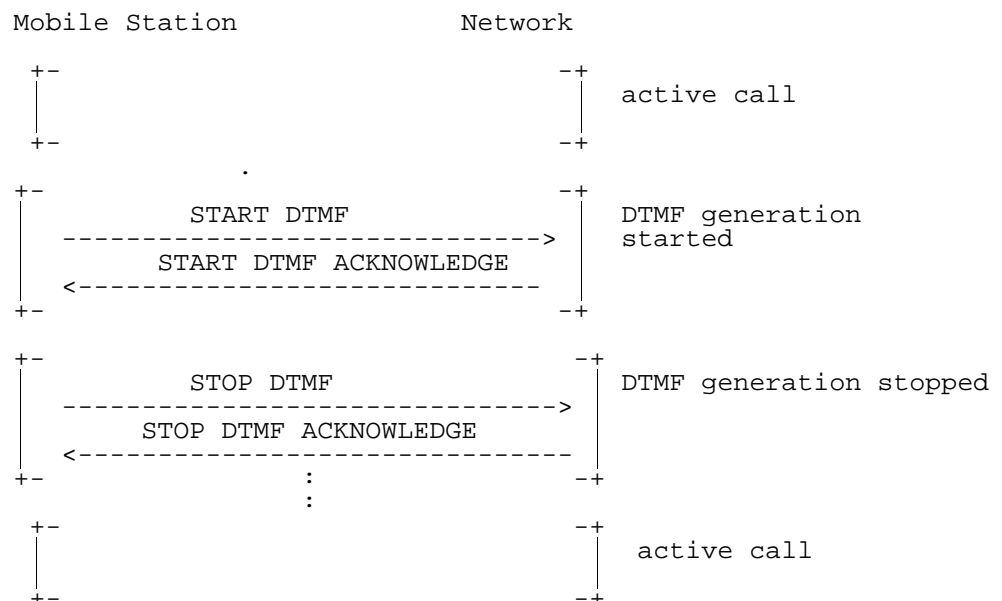
**Figure 7.13/3GPP TS 23.108: DTMF protocol control**

7.3.6 Handover

Figure 7.14 shows the structured procedure for handover to a finely synchronized cell, successful case.

Figure 7.15 shows the structured procedure for handover to a non-synchronized cell, successful case.

Figure 7.16 shows the structured procedure for handover failure, and reconnection to the old traffic channel.

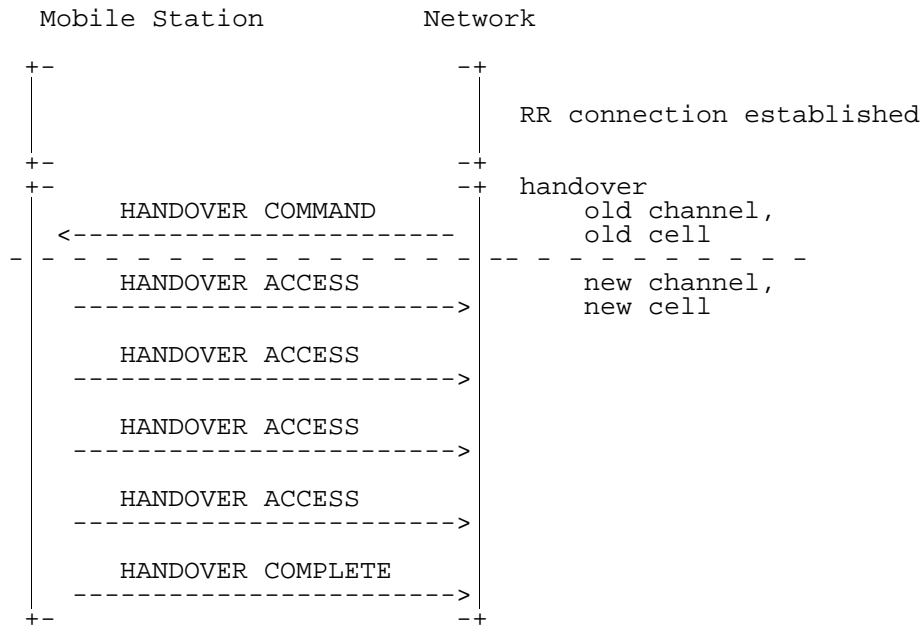

Figure 7.14/3GPP TS 23.108: Handover to a finely synchronized cell, successful case

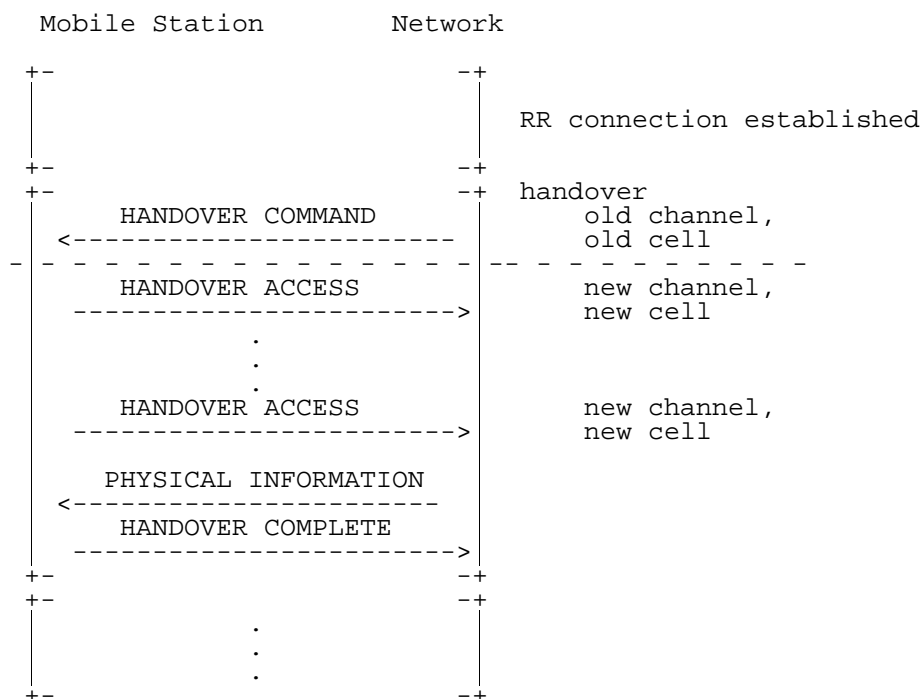

Figure 7.15/3GPP TS 23.108: Handover to a non-synchronized cell, successful case

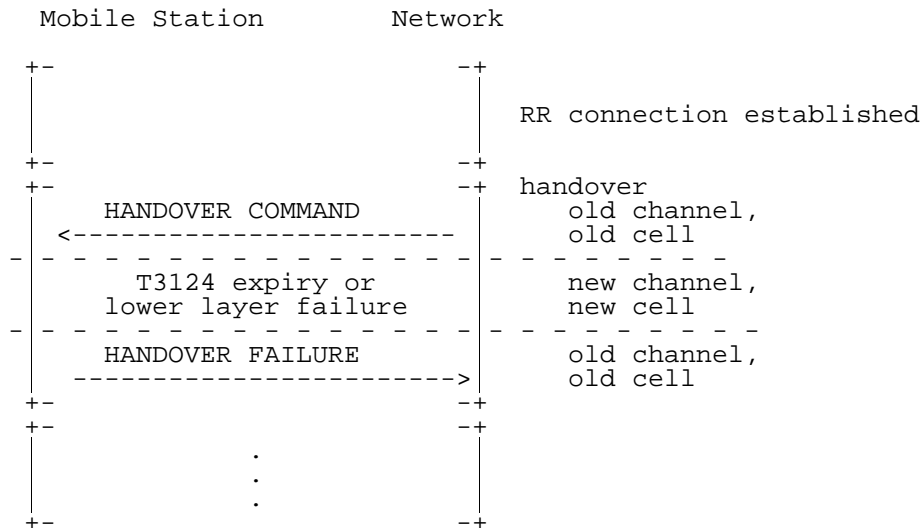

Figure 7.16/3GPP TS 23.108: Handover failure, reconnection to the old traffic channel

7.3.7 In-call modification

Figure 7.17/3GPP TS 23.108 shows the structured procedure for in-call modification.

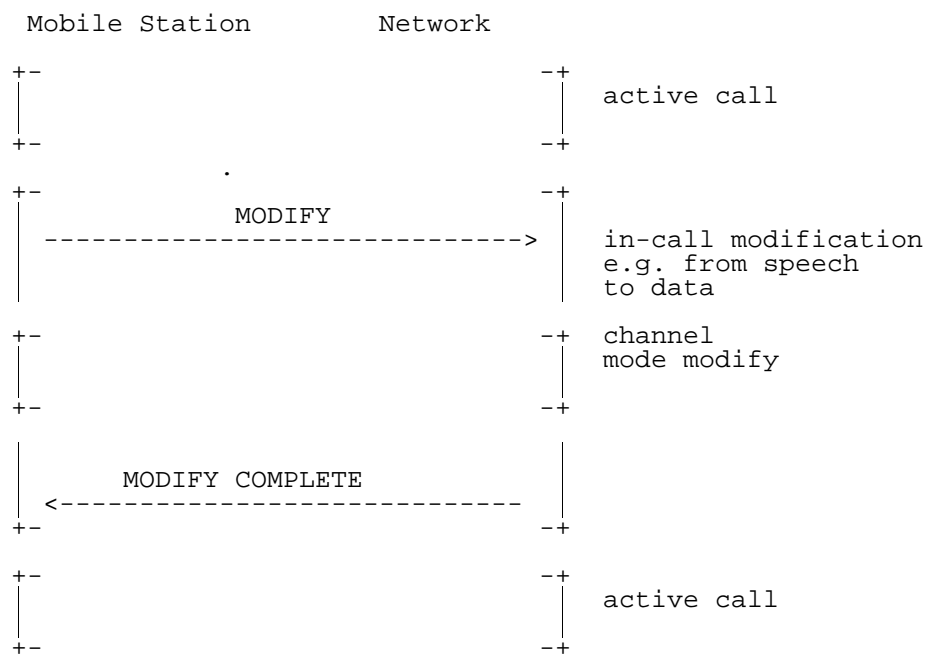

Figure 7.17/3GPP TS 23.108: In-call modification

7.3.8 Call re-establishment

Figure 7.18/3GPP TS 23.108 shows the structured procedure for call re-establishment.

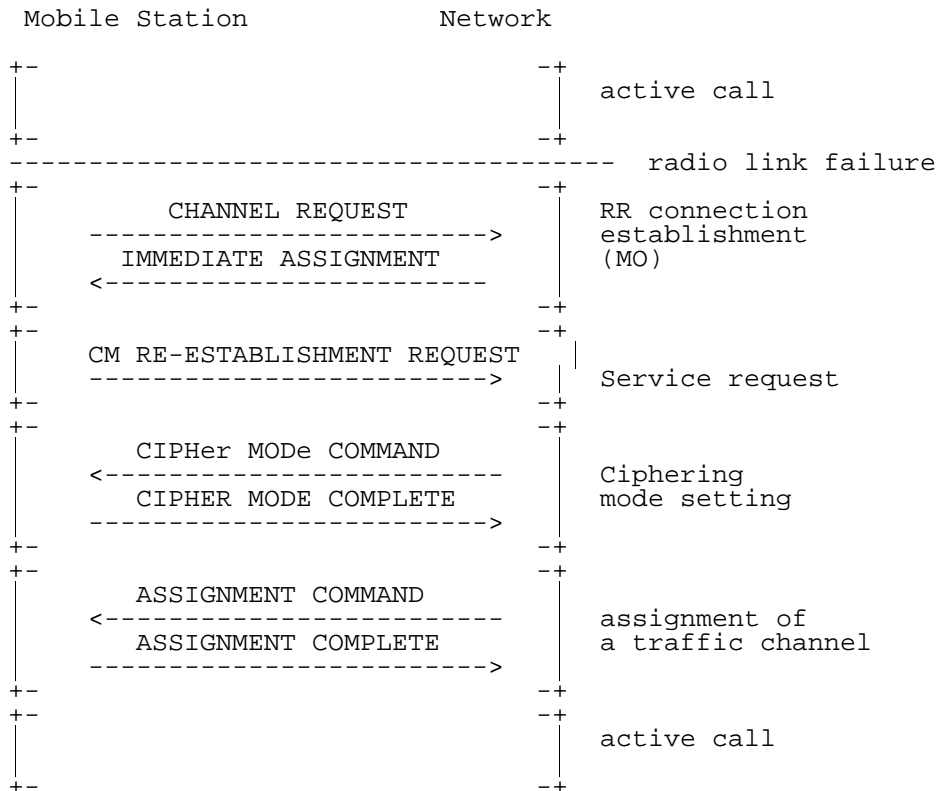

Figure 7.18/3GPP TS 23.108: Call re-establishment

7.3.9 Network initiated mobile originating call \$(CCBS)\$

Network initiated mobile originating call establishment (which is used, for example, for CCBS Service) is initiated by the network sending a PAGING REQUEST message. Upon receiving this message the mobile station initiates the immediate assignment procedure and responds to the network by sending the PAGING RESPONSE message within a layer 2 SABM frame. The network returns a layer 2 UA frame containing the same information field as was sent in the SABM frame.

Authentication and ciphering are treated by the network in the same way as defined for the mobile originating call establishment (subclause 7.3.2). After ciphering has been started, the network sends a CM SERVICE PROMPT message, indicating that the CM protocol is to be started, to the mobile station. The basic capability of the mobile station to accept any form of recall service is confirmed when the mobile station returns a START CC message to the network.

a) assignment before A party alerting:

With this option the network allocates a traffic channel to the mobile station before the mobile station alerts its user.

The network responds to the START CC message with a CC-ESTABLISHMENT message. The MS answers with a CC-ESTABLISHMENT CONFIRMED message indicating the wanted channel characteristics. The network then initiates traffic channel assignment.

When the traffic channel has been assigned, the network indicates a pending recall by sending a RECALL message.

If the calling user accepts the recall, a SETUP message is sent to the network. The network responds with a CALL PROCEEDING message and initiates call establishment in the fixed network.

When user alerting has been initiated at the called side, an ALERTING message is sent to the mobile station. The network may optionally instruct the MS to attach the user connection at this stage of the call, by means of the progress indicator information element set to the value #1 or #8 (if the ringing tone will be sent by the remote end) in the ALERTING message. In that case, an alerting ringing tone has to be generated by the network.

NOTE 1: The speech codec is transparent for supervisory tones.

A CONNECT message and its acknowledgement CONNECT ACKNOWLEDGE complete the call establishment when the called party has answered.

The network initiated mobile originating call establishment with assignment before A part alerting is shown in figure 7.19/3GPP TS 23.108.

b) assignment before B party alerting:

With this option the network allocates a traffic channel to the mobile station after the mobile station has alerted its user and after its user has accepted the recall but before the network initiates call establishment in the fixed network.

The network responds to the START CC message with a CC-ESTABLISHMENT message. The MS answers with a CC-ESTABLISHMENT CONFIRMED message indicating the wanted channel characteristics.

The network indicates a pending recall by sending a RECALL message. If the calling user accepts the recall, a SETUP message is sent to the network. The network responds with a CALL PROCEEDING message and initiates traffic channel assignment.

When the traffic channel has been assigned, the network initiates call establishment in the fixed network.

When user alerting has been initiated at the called side, an ALERTING message is sent to the mobile station. The network may optionally instruct the MS to attach the user connection at this stage of the call, by means of the progress indicator information element set to the value #1 or #8 (if the ringing tone will be sent by the remote end) in the ALERTING message. In that case, an alerting ringing tone has to be generated by the network.

NOTE 2: The speech codec is transparent for supervisory tones.

A CONNECT message and its acknowledgement CONNECT ACKNOWLEDGE complete the call establishment when the called party has answered.

The network initiated mobile originating call establishment with assignment before B party alerting is shown in figure 7.20/3GPP TS 23.108.

c) assignment after A and B party alerting

With this option, the network determines when the traffic channel is to be assigned. The assignment may be performed at any time after call establishment has been initiated in the fixed network. In the following, the case is considered where the network will only allocate a traffic channel after the called party has answered the call (late assignment).

The network responds to the START CC message with a CC-ESTABLISHMENT. The MS answers with a CC-ESTABLISHMENT CONFIRMED message indicating the wanted channel characteristics.

The network indicates a pending recall by sending a RECALL message. If the calling user accepts the recall, a SETUP message is sent to the network. The network responds with a CALL PROCEEDING message and initiates call establishment in the fixed network.

As in a) and b) an ALERTING message is sent to the mobile station when user alerting has been initiated at the called side. If the ringing tone is needed, it has to be generated locally at the mobile station as no traffic channel is allocated. When the called party has answered, the network will initiate the channel assignment procedure in order to allocate a traffic channel to the mobile station. Once the channel assignment has been completed the network will send a CONNECT message to the mobile station. The MS attaches then the user connection. The CONNECT ACKNOWLEDGE message will complete the call setup.

The network initiated mobile originating call establishment with assignment after A and B party alerting is shown in figure 7.21/3GPP TS 23.108.

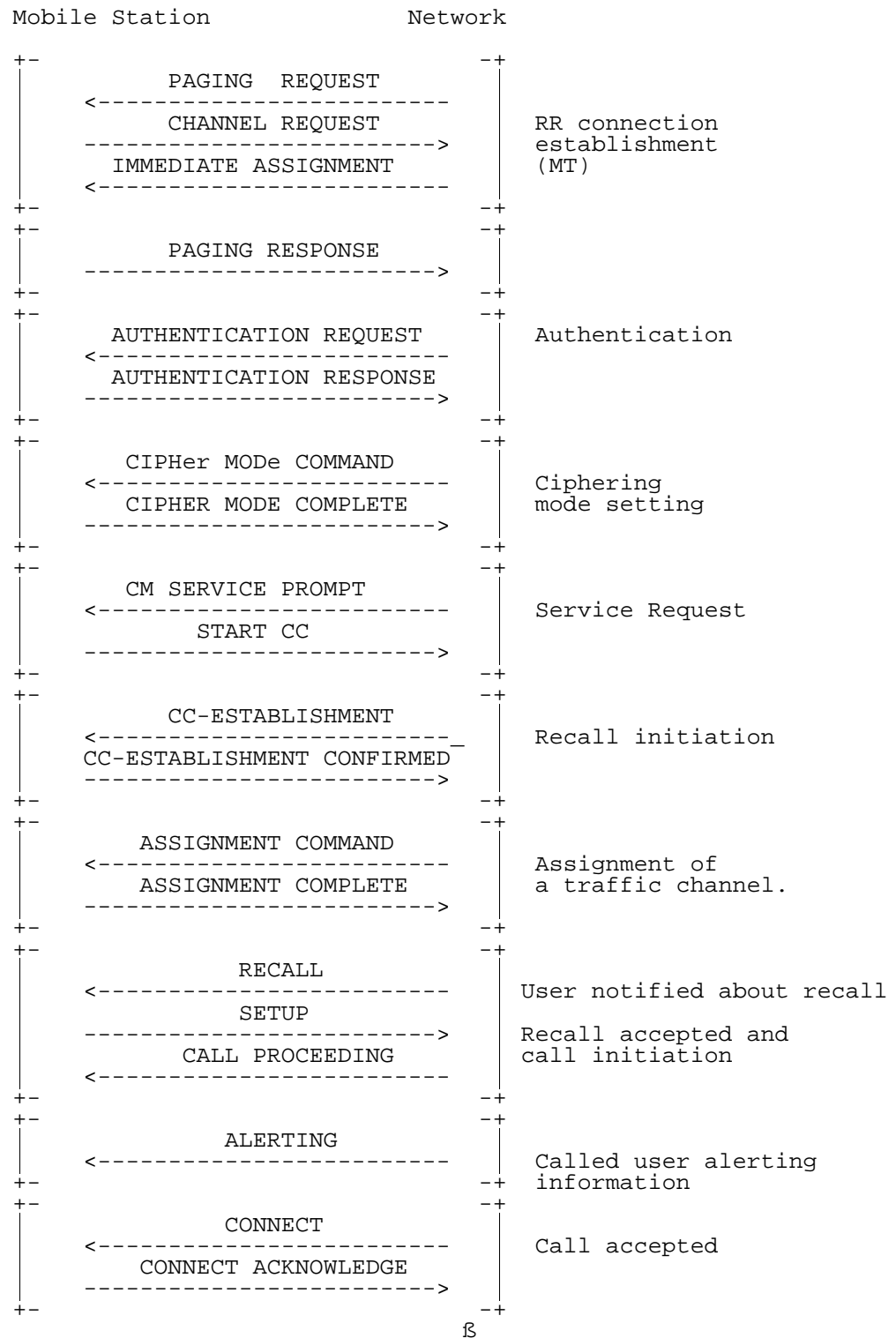

Figure 7.19/3GPP TS 23.108: Network initiated mobile originating call establishment with assignment before A party alerting

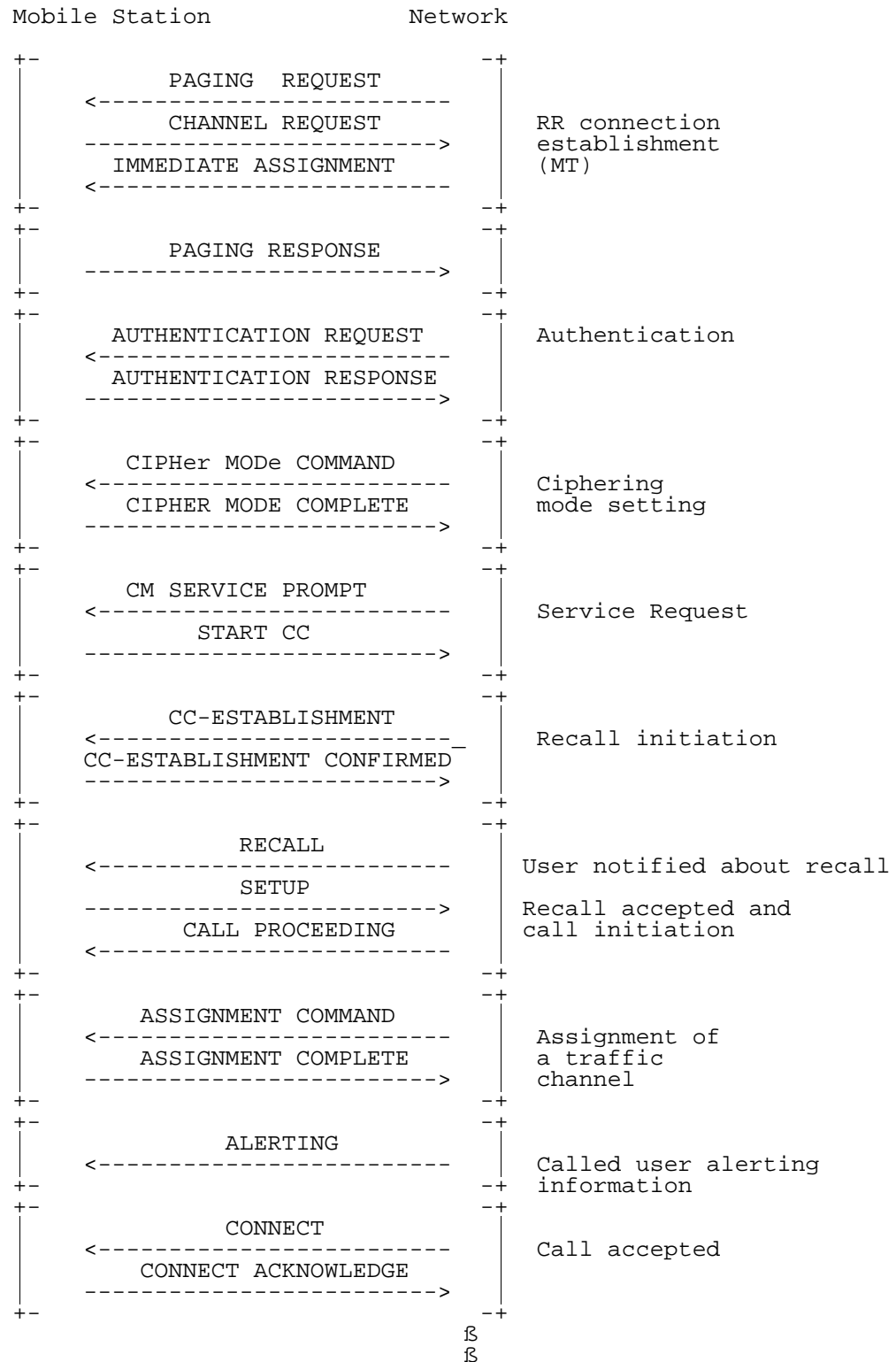

Figure 7.20/3GPP TS 23.108: Network initiated mobile originating call establishment with assignment before B party alerting

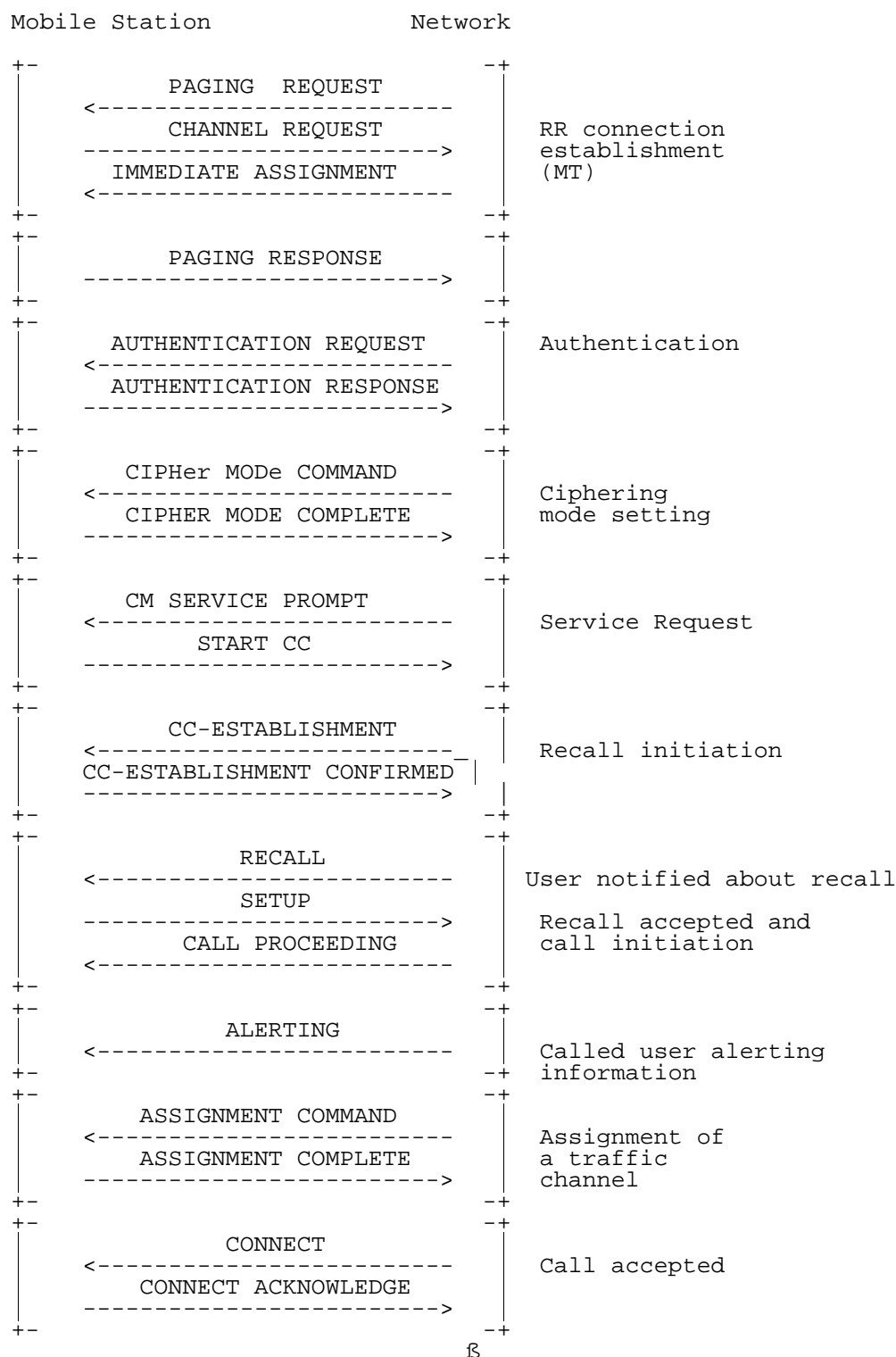

Figure 7.21/3GPP TS 23.108: Network initiated mobile originating call establishment with assignment after A and B party alerting

8 Handling of unknown, unforeseen, and erroneous protocol data

For the RR protocol see 3GPP TS 44.018 [80] and for the CN protocols see 3GPP TS 24.008 [81].

9 Message functional definitions and contents

For the RR protocol see 3GPP TS 44.018 [80] and for the CN protocols see 3GPP TS 24.008 [81].

10 General message format and information elements coding

For the RR protocol see 3GPP TS 44.018 [80] and for the CN protocols see 3GPP TS 24.008 [81].

11 List of system parameters

For the RR protocol see 3GPP TS 44.018 [80] and for the CN protocols see 3GPP TS 24.008 [81].

Annex A (informative): Change History

Based on 3GPP TS 04.08 version 7.1.1 and inclusion of CRs:

Tdoc	SPEC	CR	REV	VERS	SUBJECT	CAT	NEW_VERS
P-99-510	24.008	A371	2	7.1.0	BCIE modifications due to EDGE	B	8.0.0
P-99-523	24.008	A515	1	7.1.0	Split of 24.008 in RR and CN parts (Clause 7, "L3	F	8.0.0
P-99-388	24.008	A562		7.1.0	CR to 24.008 due to EDGE SMG2 EDGE WS	B	8.0.0
P-99-523	24.008	A567	1	7.1.0	Split of 24.008 in RR and CN parts	F	8.0.0
P-99-390	24.008	A592	1	7.1.0	GSM 400 and Mobile Station Classmark	B	8.0.0
P-99-523	24.008	A611	1	7.1.0	Split of 24.008 in RR and CN parts	F	8.0.0
P-99-523	24.008	A613	1	7.1.0	Split of 24.008 in RR and CN parts	F	8.0.0
P-99-512	24.008	A621	2	7.1.0	IE Daylight saving time	B	8.0.0
P-99-461	24.008	A687		7.1.0	Transfer of the LSA Information to the MS	B	8.0.0
				3.0.0	Transferred to TSGN / June 1999		
NP-99446	23.108	002		3.0.0	mirror R99 LCS CR	A	3.1.0
NP-00095	23.108	004		3.1.0	Clarification on timing to release TCH	C	3.2.0
				3.2.0	NP-11: upgrade to Rel-4		4.0.0
					NP-15: withdrawn		
				4.0.0	NP-16: approved for Rel-5; MCC editorials & corrections to references		5.0.0
				5.0.0	Rel-6 published after CN#26		6.0.0
				6.0.0	Upgraded to Rel-7 by MCC		7.0.0
				7.0.0	Upgraded to Rel-8 by MCC		8.0.0
				8.0.0	Upgraded to Rel-9 by MCC		9.0.0
				9.0.0	Upgraded to Rel-10 by MCC		10.0.0
CP-110695	23.108	0005		10.0.0	Refence update for TS 23.108	F	11.0.0
				11.0.0	Upgraded to Rel-12 by MCC		12.0.0
				12.0.0	Upgraded to Rel-13 by MCC		13.0.0

Change history							
Date	Meeting	TDoc	CR	Rev	Cat	Subject/Comment	New version
2017-03	CT-75	-	-	-	-	Update to Rel-14 version (MCC)	14.0.0
2018-06	SA-80	-	-	-	-	Update to Rel-15 version (MCC)	15.0.0
2020-07	SA-88e	-	-	-	-	Update to Rel-16 version (MCC)	16.0.0
2022-03	SA-95e	-	-	-	-	Update to Rel-17 version (MCC)	17.0.0
2024-03	-	-	-	-	-	Update to Rel-18 version (MCC)	18.0.0

History

Document history		
V18.0.0	May 2024	Publication