

ETSI TS 123 093 V3.1.0 (2000-01)

Technical Specification

**Digital cellular telecommunications system (Phase 2+) (GSM);
Universal Mobile Telecommunications System (UMTS);
Technical realization of Completion of Calls to Busy
Subscriber (CCBS) - Stage 2
(3G TS 23.093 version 3.1.0 Release 1999)**



Reference

DTS/TSGN-SS23093U

Keywords

GSM, UMTS

ETSI

Postal address

F-06921 Sophia Antipolis Cedex - FRANCE

Office address

650 Route des Lucioles - Sophia Antipolis
Valbonne - FRANCE
Tel.: +33 4 92 94 42 00 Fax: +33 4 93 65 47 16
Siret N° 348 623 562 00017 - NAF 742 C
Association à but non lucratif enregistrée à la
Sous-Préfecture de Grasse (06) N° 7803/88

Internet

secretariat@etsi.fr
Individual copies of this ETSI deliverable
can be downloaded from
<http://www.etsi.org>
If you find errors in the present document, send your
comment to: editor@etsi.fr

Important notice

This ETSI deliverable may be made available in more than one electronic version or in print. In any case of existing or perceived difference in contents between such versions, the reference version is the Portable Document Format (PDF). In case of dispute, the reference shall be the printing on ETSI printers of the PDF version kept on a specific network drive within ETSI Secretariat.

Copyright Notification

No part may be reproduced except as authorized by written permission.
The copyright and the foregoing restriction extend to reproduction in all media.

© European Telecommunications Standards Institute 2000.
All rights reserved.

Intellectual Property Rights

IPRs essential or potentially essential to the present document may have been declared to ETSI. The information pertaining to these essential IPRs, if any, is publicly available for **ETSI members and non-members**, and can be found in SR 000 314: "*Intellectual Property Rights (IPRs); Essential, or potentially Essential, IPRs notified to ETSI in respect of ETSI standards*", which is available from the ETSI Secretariat. Latest updates are available on the ETSI Web server (<http://www.etsi.org/ipr>).

Pursuant to the ETSI IPR Policy, no investigation, including IPR searches, has been carried out by ETSI. No guarantee can be given as to the existence of other IPRs not referenced in SR 000 314 (or the updates on the ETSI Web server) which are, or may be, or may become, essential to the present document.

Foreword

This Technical Specification (TS) has been produced by the ETSI 3rd Generation Partnership Project (3GPP).

The present document may refer to technical specifications or reports using their 3GPP identities or GSM identities. These should be interpreted as being references to the corresponding ETSI deliverables. The mapping of document identities is as follows:

For 3GPP documents:

3G TS | TR nn.nnn "<title>" (with or without the prefix 3G)

is equivalent to

ETSI TS | TR 1nn nnn "[Digital cellular telecommunications system (Phase 2+) (GSM);] Universal Mobile Telecommunications System; <title>

For GSM document identities of type "GSM xx.yy", e.g. GSM 01.04, the corresponding ETSI document identity may be found in the Cross Reference List on www.etsi.org/key

Contents

Foreword	5
1 Scope.....	6
2 Normative references	6
3 Definitions and abbreviations	6
3.1 Definitions	6
3.2 Abbreviations.....	7
4 General.....	7
4.1 Overview.....	7
4.2 Architecture	7
4.2.1 Architectural overview during roaming	8
5 Handling of completion of calls to busy subscriber.....	9
5.1 CCBS Timers.....	9
5.2 Information flows	10
5.3 Activation	14
5.4 Deactivation.....	15
5.5 Interrogation	16
5.6 Messages and their contents.....	17
5.6.1 Information elements used in the messages	17
5.6.1.1 Call Information information element	17
5.6.1.2 AddressOfB information element.....	17
5.6.1.3 CCBS Description information element.....	17
5.6.2 Messages between MS and MSC	18
5.6.3 Messages between MSC and VLR (B-interface)	19
5.6.3.1 Messages between MSC and VLR in the originating network.....	19
5.6.3.2 Messages between MSC and VLR in the destination network.....	21
5.6.4 Messages between VLR and HLR (D-interface).....	22
5.6.4.1 Messages between VLR and HLR in the originating network	22
5.6.4.2 Messages between VLR and HLR in the destination network	24
5.6.5 Messages between MSC and HLR (C-interface)	25
5.6.6 Messages between MSC - MSC (E-interface).....	25
5.6.7 Existing parameters containing CCBS specific information	25
6 Monitoring and CCBS Call Reporting.....	26
6.1 Monitoring.....	26
6.1.1 Overview	26
6.1.2 Monitoring Subscriber B-state information.....	26
6.1.3 Monitoring Subscriber A state information:.....	26
6.2 MSC/VLR Monitoring Model	27
6.2.1 Subscriber status.....	27
6.2.1.1 Idle.....	28
6.2.1.2 Not Idle.....	28
6.2.1.3 Not Reachable	28
6.2.2 Reporting of subscriber state transitions	29
6.2.2.1 Start Reporting of Monitoring Events	29
6.2.2.2 Stop Reporting of Monitoring Events.....	29
6.3 CCBS Call Reporting.....	30
6.3.1 Overview	30
6.3.2 Originating Network (A-side)	30
6.3.3 Destination Network (B-side)	30
6.3.3.1 Interaction of Event Reporting and CCBS Call Report.....	30
6.4 Location Update.....	30
7 Mobility	31
7.1 Mobility during Activation	31
7.2 Number used within CCBS Call	31

7.3	MS does Location Update.....	31
7.4	Mobility during CCBS Call in the destination network.....	31
8	Interaction with other supplementary services	32
8.1	Call forwarding unconditional (CFU).....	32
8.2	Call forward on busy (CFB)	32
8.3	Call forwarding on no reply (CFNRy).....	32
8.4	Call forwarding on MS not reachable (CFNRc)	32
8.5	Call Waiting (CW).....	33
8.6	Multiparty service (MPTY)	33
8.7	Closed user group (CUG)	33
8.8	Advice Of Charge (AoC).....	33
8.9	Barring of all outgoing calls (BAOC).....	33
8.10	Barring of outgoing international calls (BOIC)	33
8.11	Barring of outgoing international calls except those directed to the home PLMN country (BOIC-exHC)	33
8.12	Barring of all incoming calls (BAIC)	33
8.13	Barring of incoming calls when roaming outside the home PLMN country (BIC-Roam)	34
8.14	Completion of calls to busy subscriber (CCBS)	34
9	Interaction with other network features	35
9.1	Customised Applications for Mobile network Enhanced Logic (CAMEL).....	35
9.2	Support of Optimal Routeing (SOR)	35
10	Interworking with other networks.....	36
10.1	Interworking with network entities not supporting CCBS.....	36
10.1.1	CCBS not supported by MSC A.....	36
10.1.2	CCBS not supported by HLR B	36
10.1.3	CCBS not supported by MSC B.....	37
11	Network entity functions	38
11.1	Originating Network Processes.....	38
11.1.1	Processes and procedures in MSC/VLR.....	38
11.1.2	Processes and procedures in HLR.....	60
11.2	Destination Network Processes.....	91
11.2.1	Procedures in GMSC.....	91
11.2.2	Processes and procedures in HLR.....	97
11.2.3	Procedures in MSC/VLR	127
11.3	Processes and procedures common in originating and destination network entities.....	139
12	Information stored in the HLRs	155
12.1	Originating Network Data	155
12.2	Destination Network Data	155
12.3	Transfer of information from HLR to VLR.....	156
13	State transition model	157
13.1	State transition model for the CCBS service in the originating network	157
13.2	State transition model for the CCBS service in the destination network	157
13.3	State transition model for a CCBS Request.....	158
13.4	Information stored in the VLRs	159
Annex A (Informative): Message flow diagrams showing a successful CCBS request		160
Annex A: Change history		163
History.....		164

Foreword

This Technical Specification has been produced by the 3GPP.

This specification gives the stage 2 description of the Completion of Calls to Busy Subscriber (CCBS) supplementary service within the 3GPP system.

The contents of the present document are subject to continuing work within the TSG and may change following formal TSG approval. Should the TSG modify the contents of this TS, it will be re-released by the TSG with an identifying change of release date and an increase in version number as follows:

Version 3.y.z

where:

- x the first digit:
 - 1 presented to TSG for information;
 - 2 presented to TSG for approval;
 - 3 Indicates TSG approved document under change control.
- y the second digit is incremented for all changes of substance, i.e. technical enhancements, corrections, updates, etc.
- z the third digit is incremented when editorial only changes have been incorporated in the specification;

1 Scope

This Technical Specification gives the stage 2 description of the Completion of Calls to Busy Subscriber (CCBS) supplementary service.

2 Normative references

References may be made to:

- a) specific versions of publications (identified by date of publication, edition number, version number, etc.), in which case, subsequent revisions to the referenced document do not apply; or
- b) all versions up to and including the identified version (identified by "up to and including" before the version identity); or
- c) all versions subsequent to and including the identified version (identified by "onwards" following the version identity); or
- d) publications without mention of a specific version, in which case the latest version applies.

A non-specific reference to an ETS shall also be taken to refer to later versions published as an EN with the same number.

- | | |
|------|---|
| [1] | TR 21.905: "3G Vocabulary". |
| [2] | TS 22.030: "Man Machine Interface (MMI) of the Mobile Station (MS)". |
| [3] | TS 22.093: "Completion of calls to busy subscriber (CCBS) supplementary services - Stage 1". |
| [4] | TS 23.011: "Technical realization of supplementary services - General Aspects". |
| [5] | TS 23.018: "Basic Call Handling - Technical Realization". |
| [6] | TS 23.078: "Customised Applications for Mobile network Enhanced Logic (CAMEL) - Stage 2". |
| [7] | TS 23.079: "Support for Optimal Routeing (SOR) - Technical Realization". |
| [8] | TS 24.008: "Mobile radio interface layer 3 specification; Core Network Protocols Stage3". |
| [9] | TS 29.002: "Mobile Application Part (MAP) specification". |
| [10] | ETS 300 358: "ISDN Completion of Calls to Busy Subscriber (CCBS) supplementary service; Functional capabilities and information flows". |

3 Definitions and abbreviations

3.1 Definitions

Destination B: The entity addressed in the original call set up, which is busy when first called by subscriber A. Similarly, MSC B, VLR B and HLR B are the network elements pertaining to Destination B when Destination B is a GSM mobile.

Originating queue: The queue that manages CCBS requests for a subscriber, when that subscriber is the originator of those CCBS Requests.

SSAP: Supplementary Service Application Part. SSAP is the protocol used for CCBS procedures on the interface between the originating and destination network. Communication across this interface is performed using SCCP Connectionless Signalling (Refer to ETS 300 358).

Subscriber A: The user of MS A, requesting CCBS. Similarly, MSC A, VLR A and HLR A are the network elements pertaining to Subscriber A.

Subscriber B: The user of destination B, who may not necessarily subscribe to CCBS.

Subscriber C: The user of MS C, who is the forwarded-to-party when call forwarding applies. Similarly, MSC C, VLR C and HLR C are the network elements pertaining to Subscriber C.

Target queue: The queue that manages CCBS requests for a subscriber, when that subscriber is the target of CCBS Requests.

Timers: For each of the service timers, the location, start and stop conditions and action on expiry are given - Refer to subclause 5.1.

3.2 Abbreviations

Abbreviations used in this specification are listed in TR 21.905.

4 General

4.1 Overview

The CCBS service allows a calling subscriber A, encountering a NDUB destination B, to be notified when destination B becomes idle and to have the network automatically generate a CCBS call to destination B, if subscriber A desires. Subscriber A may make distinct CCBS requests for calls to the same destination B for different basic services.

4.2 Architecture

Figure 4.2.1 is an architectural overview of the CCBS service when interworking between the originating and the destination networks involved. The originating network may be a mobile network or a fixed network and the destination network may also be a mobile network or a fixed network.

The call related signalling for CCBS is performed on ISUP links on the following interfaces:

VMSC A - GMSC B;

VMSC A - DLE;

OLE - GMSC B;

whereas the specific CCBS procedures are performed via the SSAP protocol, which is signalled on the following interfaces:

HLR A - HLR B;

HLR A - DLE;

OLE - HLR B.

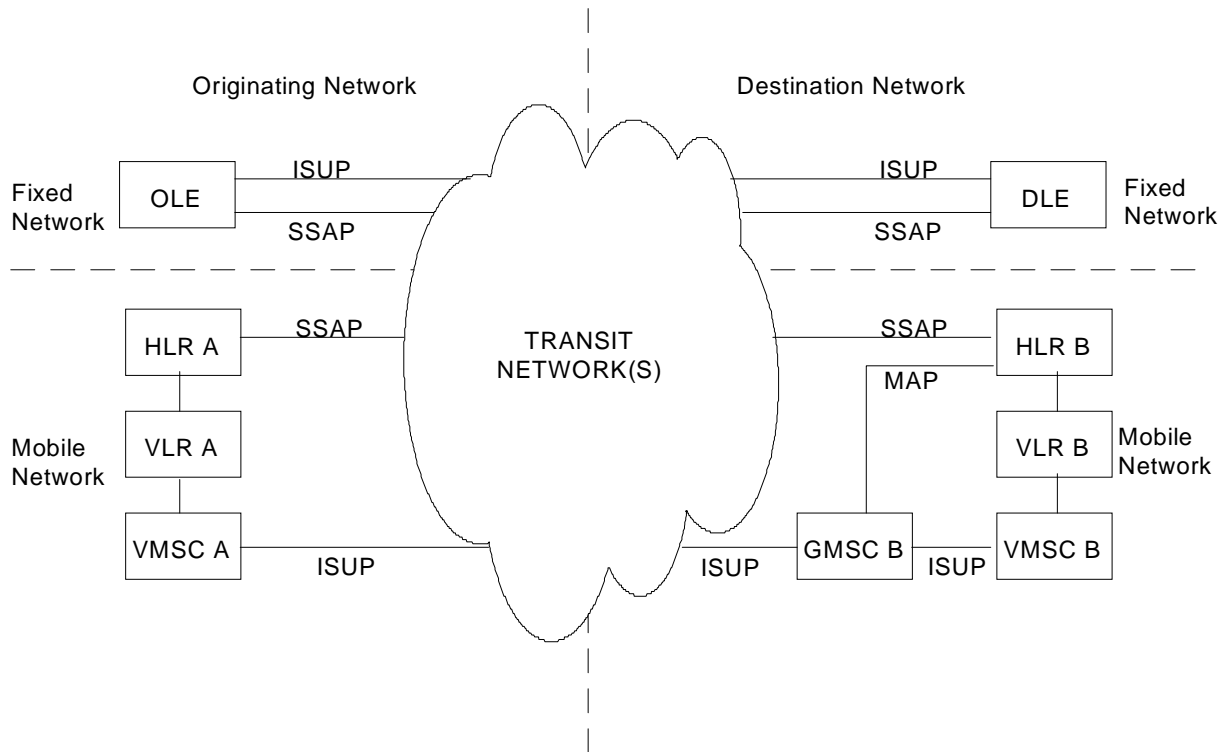

Figure 4.2.1: Architectural overview showing common point of interworking

4.2.1 Architectural overview during roaming

Either the originating subscriber A or the destination subscriber B or both may be located outside of their HPLMNs during the CCBS service. When all the involved networks support CCBS service the normal handling described in this specification applies. When some network entities do not support CCBS service refer to clause 10 where the exceptions are described in more detail.

The signalling between different networks described in the subclause 4.2 applies also during roaming. HLR A and HLR B belongs always to the HPLMN of the subscriber whereas VLR A and MSC A and GMSC, VLR B and MSC B respectively may belong to a HPLMN or VPLMN. Refer to TS 23.018 where call handling in the mobile network is described in more detail.

5 Handling of completion of calls to busy subscriber

Registration and erasure of CCBS are not applicable. Activation and Invocation of CCBS are intrinsic parts of the operation of the service, and are described in this section.

5.1 CCBS Timers

The timers used to control the operation of CCBS can be considered to consist of two groups i.e. the timers which operate on a per subscriber basis (see table 1) and the service duration timers (T3 and T7) which operate on a per CCBS Request basis (see table 2).

Table 1: CCBS Service Timers

Timer	Name	Value	Run At	Started	Stopped	Expiry
T1	Retention	>15s	MSC A	Busy (CCBS Possible) sent to MS A	CCBS Request received from MS A	Discard retained information
T4	Recall	20-30s	MSC A	CCBS Recall sent to MS A and MS A is idle	Subscriber A initiates CCBS setup or rejects CCBS Recall	Cancel request
T8	Destination idle guard	0-15s	HLR B	Event Report received from VLR B indicating destination B is idle	Event Report received from VLR B indicating destination B is no longer idle	Inform originating network that Destination B is free
T9	Recall B	40-55s	HLR B	Remote User Free sent to the A-side	Request cancelled, completed or suspended	Cancel request
T10	CCBS notification	20-30s	MSC A	CCBS Recall sent to MS A and MS A is not idle	Subscriber A initiates CCBS setup, rejects CCBS Recall or requests suspension	Suspend request
T11	CCBS resume	20-25s	HLR A	HLR A receives a resume request and there are more than one suspended request in subscriber A's queue	Remote User Free received from destination network	Resume next suspended request in queue
T12	CCBS Call Guard	20-30s	HLRA	HLRA receives a CCBS RUF Ack and starts to wait CCBS Call Report	CCBS Call Report received	Cancel request

Table 2: Service Duration Timers

Timer	Name	Value	Run At	Started	Stopped	Expiry
T3	Originating service duration	15-45m	HLR A	Acknowledgement to CCBS Request received from destination network	Request cancelled or completed	Cancel request
T7	Terminating service duration	>45m	HLR B	HLR B acknowledges successful activation of a CCBS Request	Request cancelled or completed	Cancel request

5.2 Information flows

Figures 5.2.1 and 5.2.2 show the flow of information between network elements for a mobile to mobile call for the following:

Figure 5.2.1: Successful CCBS request, destination B busy when request made, subscriber A free when destination B becomes free.

Figure 5.2.2: Subscriber A is not idle when destination B becomes free.

Figures 5.2.3 and 5.2.4 show the flow of information between network elements for a mobile to fixed call for the same situations described in figures 5.2.1 and 5.2.2 respectively.

Each information flow diagram has been divided where appropriate into four distinct phases of operation. These are as follows:

- (1) Pre-conditions (Initial Call encountering NDUB and CCBS possible in the destination network). The detailed description of the basic call handling can be found in TS 23.018;
- (2) Activation;
- (3) Invocation;
- (4) Operation (CCBS Call Set-up).

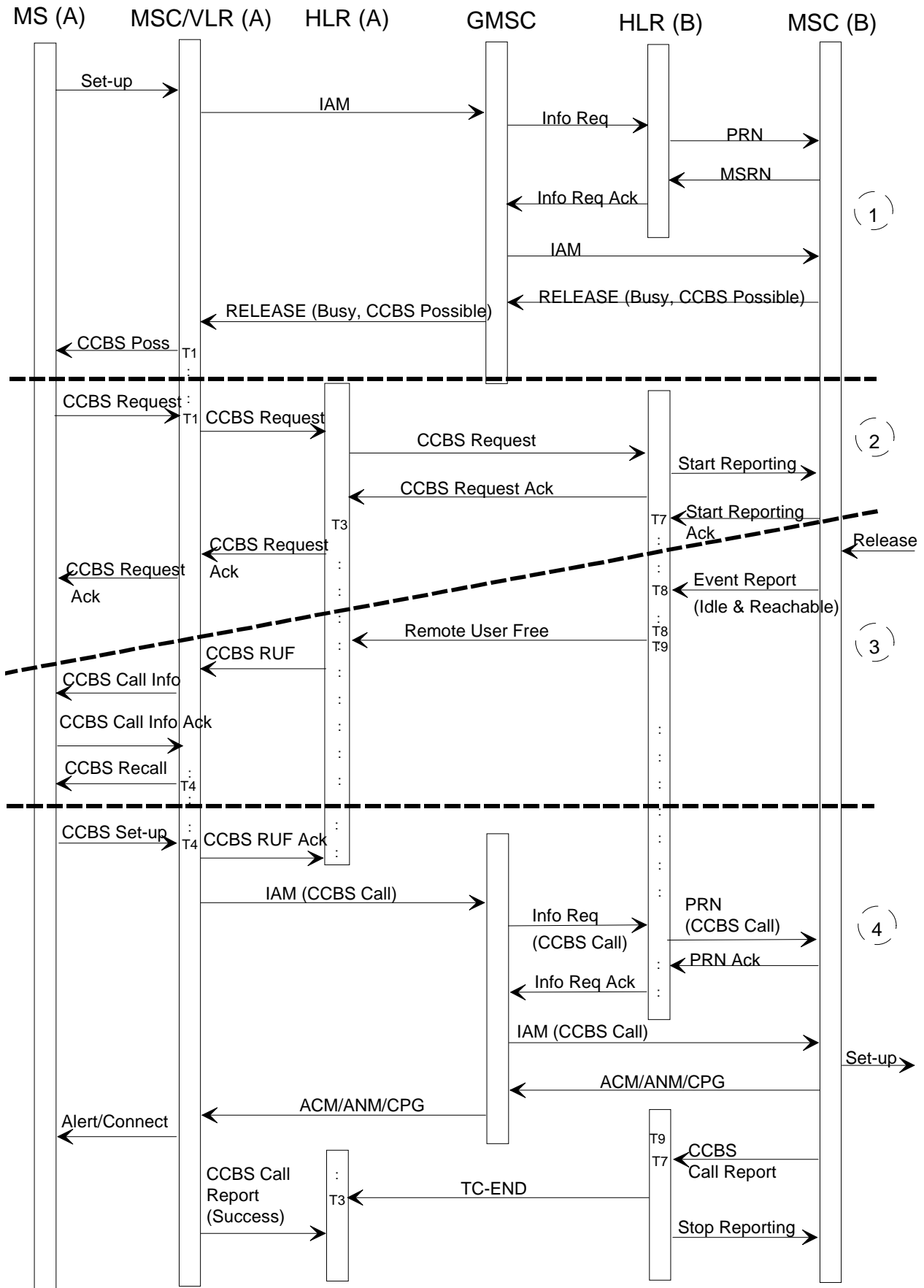
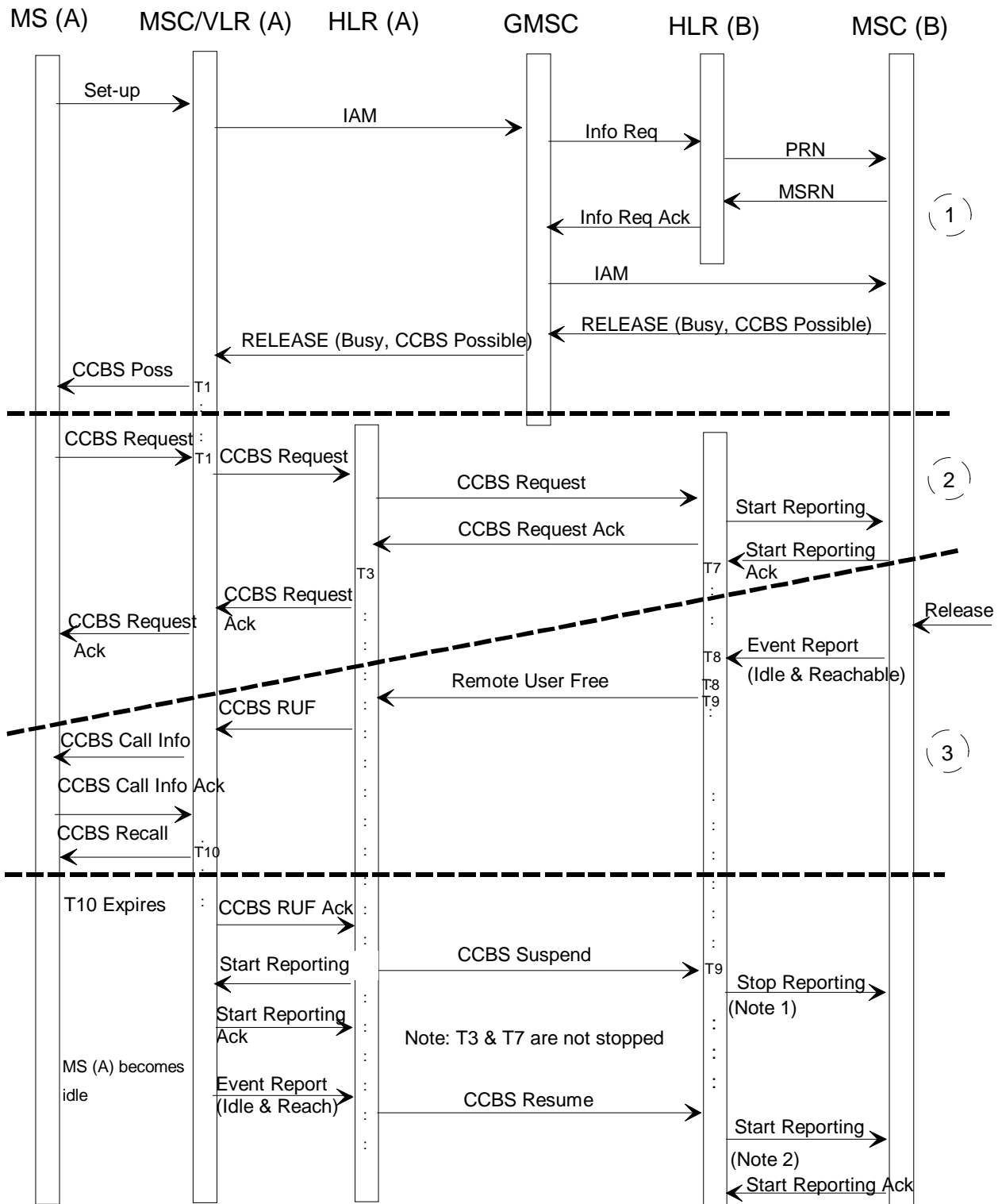

Figure 5.2.1: Successful CCBS request. Destination B busy when request activated, subscriber A free when destination B becomes free (mobile-to-mobile)



Note 1 : Stop Reporting is sent if there are only suspended requests in the queue

Note 2 : Start Reporting is sent if MSC B is not monitoring destination B

Figure 5.2.2: Subscriber A not idle when destination B becomes free (mobile-to-mobile); Processing of a single request

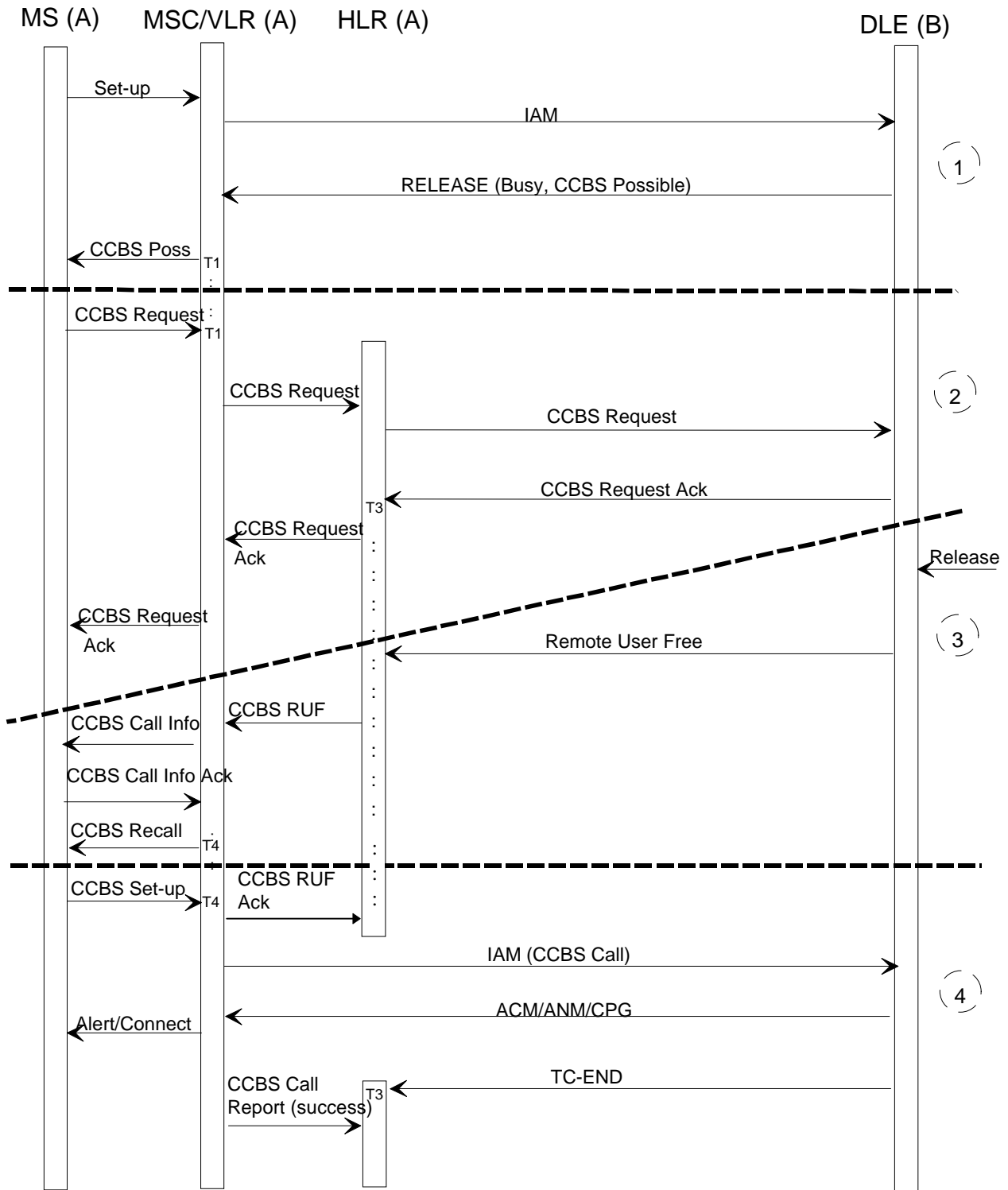

Figure 5.2.3: Successful CCBS request. Destination B busy when request activated, subscriber A free when destination B becomes free (mobile-to-fixed)

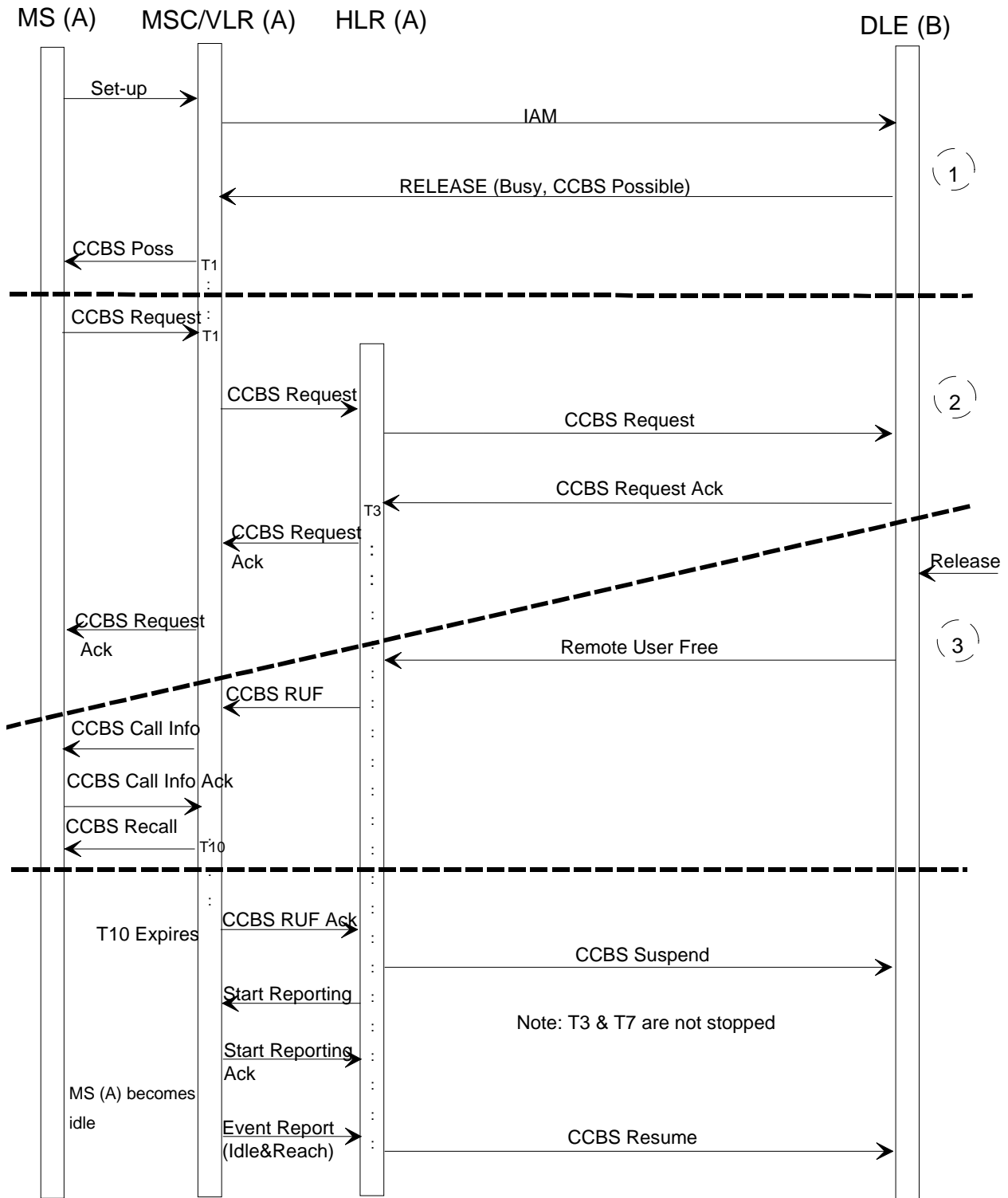

Figure 5.2.4: Subscriber A not idle when destination B becomes free (mobile-to-fixed)

5.3 Activation

Activation of a CCBS Request is carried out by subscriber A. VLR A is considered to be transparent during the activation operation.

The information flows shown in figures 5.2.1 to 5.2.4 inclusive show the information flow for the activation process.

5.4 Deactivation

Subscriber A may deactivate CCBS in any of the following ways:

- Deactivate all outstanding CCBS requests; or
- Deactivate a specific CCBS Request.

The different deactivation operations are identified by different MMI commands as specified in TS 22.030.

Deactivation of CCBS requests by subscriber A shall be performed at HLR A.

To deactivate all outstanding CCBS requests, the Deactivate CCBS operation request shall contain the SS-Code only.

To deactivate a specific CCBS request, the Deactivate CCBS operation request shall contain the following parameters:

- SS-Code;
- CCBS Index.

On receipt of the deactivation request, HLR A shall cancel the CCBS request, i.e. remove all record of a CCBS request from the subscriber A's originating CCBS queue and instruct the destination B network to cancel the corresponding CCBS request in the destination CCBS queue of subscriber B. HLR A shall return a result indicating whether the deactivation attempt was successful or not.

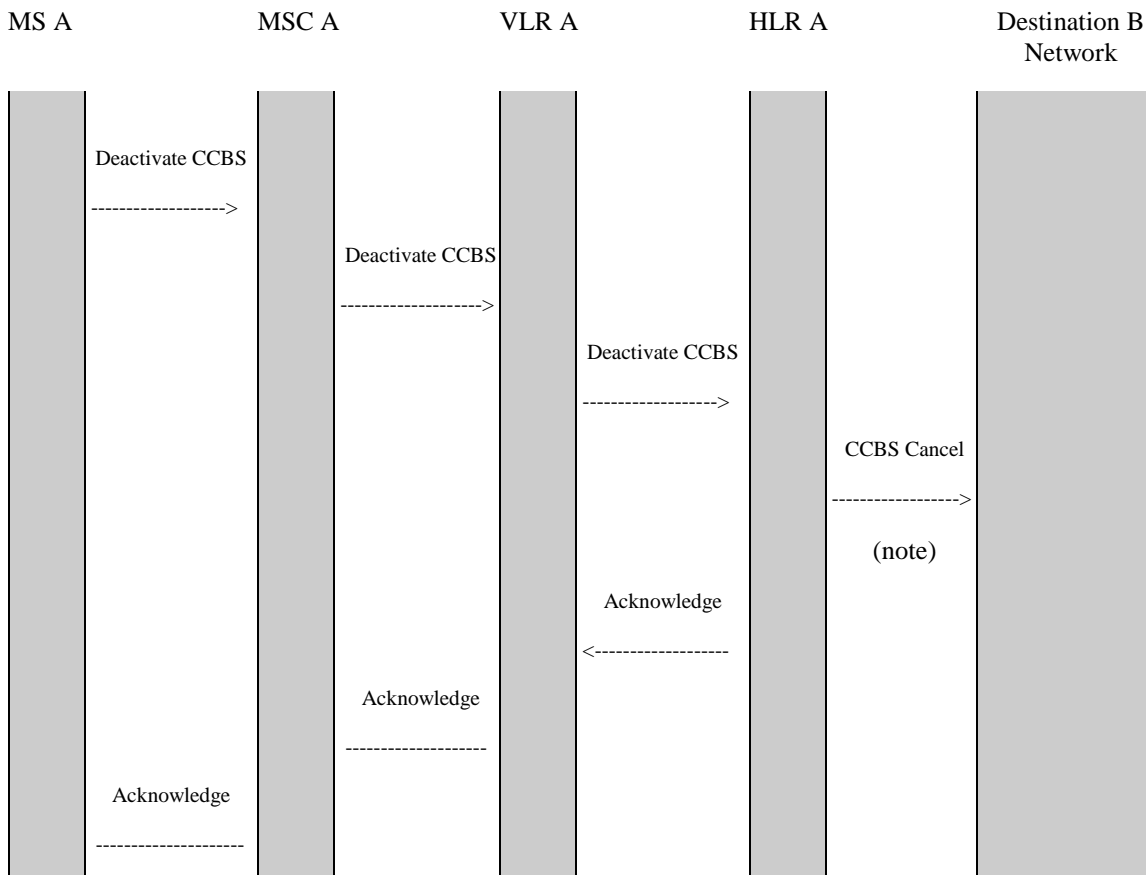

NOTE: CCBS Cancel shall be sent for each CCBS Request that is cancelled in HLR A.

Figure 5.4.1: Successful deactivation of all CCBS Requests/a specific CCBS request

NOTE: In the case where a subscriber attempts to perform a deactivation operation but the subscriber is not provisioned with the CCBS service then, the subscriber shall receive an indication that the CCBS service is not provisioned for him.

5.5 Interrogation

Interrogation of CCBS shall be carried by request to HLR A. HLR A then returns the required information or error to MS A, see figure 5.5.1. MSC A and VLR A are considered to be transparent during the interrogation operation.

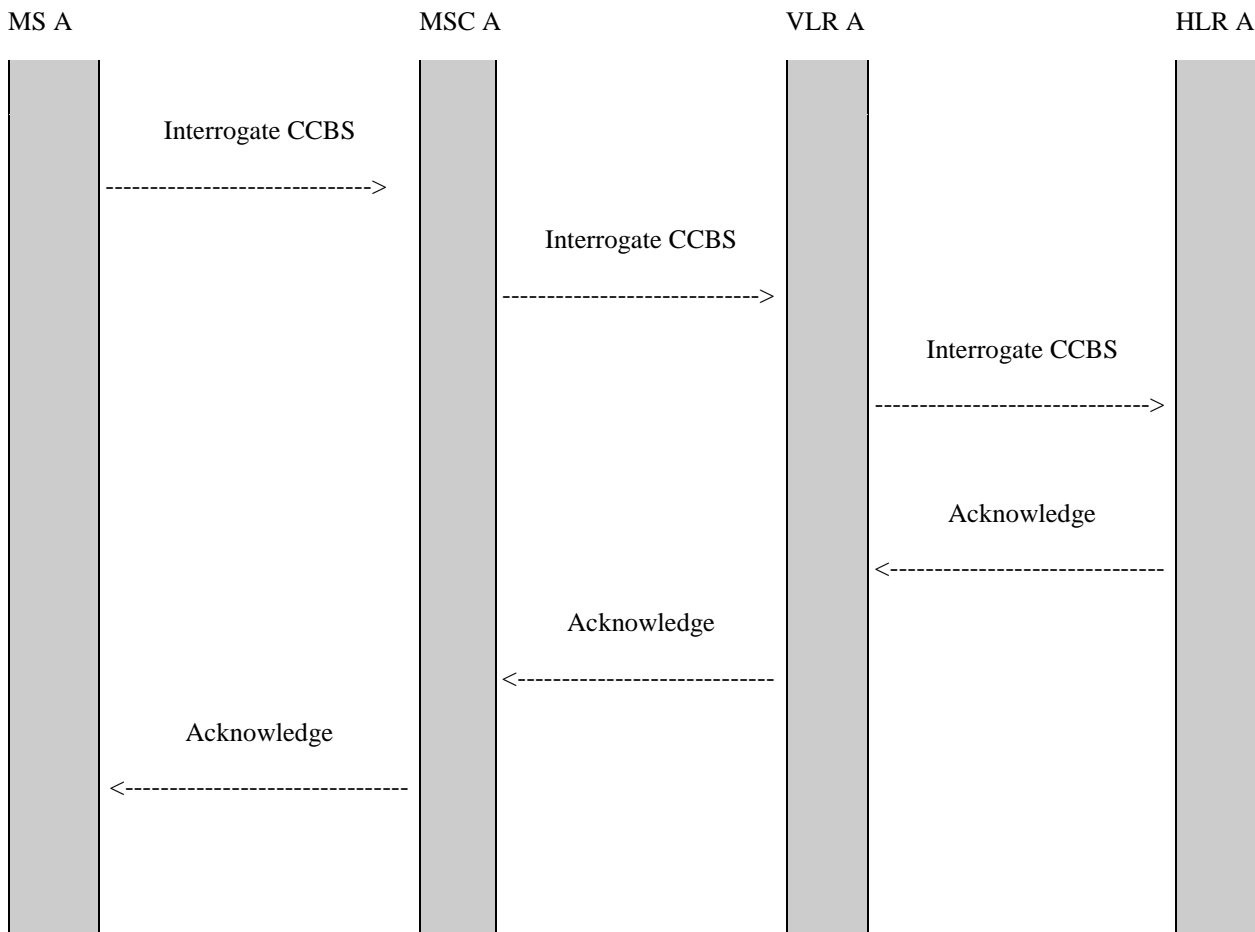

Figure 5.5.1: General interrogation of completion of calls to busy subscriber

The Interrogate CCBS operation request shall contain the SS-Code only.

In response to a general interrogation, MS A shall be given the AddressOfB, BasicServiceCode and CCBS index for each CCBS Request in the queue. The entries shall be ordered in the chronological order, the oldest entry shall be presented first.

If there are no CCBS Requests in the queue, MS A shall be given an indication that no entries exist in the queue.

NOTE: In the case where a subscriber attempts to perform an interrogation operation but the subscriber is not provisioned with the CCBS service then, the subscriber shall receive an indication that the CCBS service is not provisioned for him.

5.6 Messages and their contents

This clause contains the detailed description of the information flows used by CCBS.

Each Information Element, IE is marked as (M) Mandatory, (C) Conditional or (O) Optional. A mandatory information element shall always be present. A conditional information shall be present if certain conditions are fulfilled; if those conditions are not fulfilled it shall be absent. An optional information element may be present or absent, at the discretion of the application at the sending entity. This categorisation is a functional classification, i.e., stage 2 information and not a stage 3 classifications to be used for the protocol.

The stage 2 and stage 3 message and information element names are not necessarily identical.

5.6.1 Information elements used in the messages

In this clause constructed information elements are described.

5.6.1.1 Call Information information element

Call Information information element is formed in the MSC A during the CCBS activation. This information element contains unmodified copy of the SETUP message received from the MS A. If CCBS Request is activated, the Call Information is stored in the HLR A. During CCBS Recall Call Information is relayed back to the MS. Refer to SETUP Container information element defined in TS 24.008.

5.6.1.2 AddressOfB information element

AddressOfB information element is formed in the MSC A during the CCBS activation. It contains the number of the destination B dialled by the A-user.

Table 5.6.1.2: Structure of AddressOfB information element

Parent Information Element	Child Information element name	Information element Required	Information element description
AddressOfB	B subscriber number, B subscriber subaddress	M C	The number of the destination B dialled by the A-user; Shall be present if it was dialled by the A-user; otherwise shall be absent

5.6.1.3 CCBS Description information element

CCBS Description information element is formed in the HLR A during the CCBS activation.

Table 5.6.1.3: Structure of CCBS Description information element

Parent Information Element	Child Information element name	Information element Required	Information element description
CCBS Description	CCBS Index, AddressOfB, BasicServiceGroup	M M M	CCBS Index (range 1 - 5) identifies the request in the network. The structure of the AddressOfB is defined in table 5.6.1.2; BasicServiceGroup related to the original call.

5.6.2 Messages between MS and MSC

These messages are used in the originating network.

Table 5.6.2: Messages between MS and MSC

Message	Message sender	Information element name	Information element Required	Information element description
CCBS POSSIBLE	MSC	-	-	This message contains no information elements.
CCBS REQUEST	MS	-	-	This message contains no information elements.
CCBS REQUEST ACK	MSC	CCBS Index, AddressOfB, BasicServiceGroup	M O O	CCBS Index (range 1 - 5) identifies the request in the network. The structure of the AddressOfB is defined in table 5.6.1.2 BasicServiceGroup related to the original call.
CCBS REQUEST ERROR	MSC	Error	M	The information element can take the following values: - Short term denial - Long term denial
DEACTIVATE CCBS	MS	CCBS Index	C	If CCBS Index is present the corresponding request shall be deleted, otherwise all requests shall be deleted.
DEACTIVATE CCBS ACK	MSC	DeactivateResult	M	The information element can take the following values: - Success - Not Provisioned
INTERROGATE CCBS	MS	-	-	This message contains no information elements.
INTERROGATE CCBS ACK	MSC	List(1-5) of CCBS Description; No Entries; Not Provisioned	C C C	The list shall contain one entry for each CCBS Request for which the HLR stores data or; the queue is empty or; CCBS is not provisioned for the subscriber Exactly one of these information elements shall be present. The structure of the CCBS Description is defined in table 5.6.1.3.
CCBS CALL INFO	MSC	Call Information	M	The content of the Call Information is defined in the subclause 5.6.1.1.
CCBS CALL INFO ACK	MS	GSM BC	M	GSM BC indicates the BC the MS prefers to use. The network may allocate a traffic channel accordingly.
CCBS CALL INFO ERROR	MS	Error	M	The information element can take the following values: - Incompatible Terminal
CCBS RECALL	MSC	CCBS Description, Alerting Pattern	M, C	The structure of the CCBS Description is defined in table 5.6.1.3. Alerting Pattern shall be present if it was received in the CCBS RUF message
CCBS SETUP	MS	-	-	The content of the message is the same as the MO Set-up message has. Refer to TS 24.008.
CCBS RECALL REJECT	MS	Cause	M	The MS shall indicate the reason of CCBS Recall rejection. The information element can take the following values: - Recall Rejected by the user - UDUB - ACMmax exceeded

5.6.3 Messages between MSC and VLR (B-interface)

5.6.3.1 Messages between MSC and VLR in the originating network

These messages are used in the originating network. Some messages are used also in the terminating network. They are marked accordingly.

Table 5.6.3.1: Messages between MSC and VLR in the originating network

Message	Message sender	Information element name	Information element Required	Information element description
CALL END	MSC	-	-	This message contains no information elements. The message is used also in the terminating network.
CCBS CALL DELIVERY	MSC	Outcome	M	The information element indicates whether CCBS Call was successful or failure. It can take the following values: - Success; - Failure; - NDUB; - Busy; - Absent Subscriber.. The message is used also in the terminating network.
CCBS REQUEST	MSC	-	-	This message contains no information elements
CCBS REQUEST ACK	VLR	CCBS Index, AddressOfB, BasicServiceGroup	M O O	CCBS Index (range 1 - 5) identifies the request in the network. The structure of the AddressOfB is defined in table 5.6.1.2 BasicServiceGroup related to the original call.
CCBS REQUEST ERROR	VLR	Error	M	The information element can take the following values: - Short term denial; - Long term denial.
COMPLETE RECALL	VLR	Call Information	M	The content of the Call Information is defined in the subclause 5.6.1.1.
COMPLETE RECALL ACK	MSC	-	-	This message contains no information elements
COMPLETE RECALL NEGATIVE RESPONSE	MSC	Negative Response	M	The negative information element can take the following values: - Absent Subscriber; - Incompatible Terminal; - Radio Congestion.
DEACTIVATE CCBS	MSC	CCBS Index	C	If CCBS Index is present the corresponding request shall be deleted, otherwise all requests shall be deleted.
DEACTIVATE CCBS ACK	VLR	DeactivateResult	M	The information element can take the following values: - Success; - Not Provisioned.
INTERROGATE CCBS	MSC	-	-	This message contains no information elements

Table 5.6.3.1: Messages between MSC and VLR in the originating network, cont.

Message	Message sender	Information element name	Information element Required	Information element description
INTERROGATE CCBS ACK	VLR	List(1-5) of CCBS Description; No Entries; Not Provisioned	C C C	The list shall contain one entry for each CCBS Request for which the HLR stores data; or the queue is empty; or CCBS is not provisioned for the subscriber. Exactly one of these information elements shall be present. The structure of the CCBS Description is defined in table 5.6.1.3.
NOT IDLE	MSC	-	-	This message contains no information elements. The message is used also in the terminating network.
PAGE MS FOR RECALL	VLR	Location area ID, TMSI	M O	Location area in which the MS is to be paged TMSI to be broadcast to identify the MS
PAGE MS FOR RECALL NEGATIVE RESPONSE	MSC	Negative Response	M	The negative information element can take the following values: - Unknown LAI; - Absent Subscriber; - Busy Subscriber.
PROCESS ACCESS REQUEST	MSC	-	-	Refer to TS 23.018
RADIO FAILURE	MSC	-	-	This message contains no information elements. The message is used also in the terminating network.
RECALL	VLR	CCBS Description Alerting Pattern	M C	The structure of the CCBS Description is defined in table 5.6.1.3. Alerting Pattern shall be present if it was received in the CCBS RUF message
RECALL ACK	MSC	Cause	M	The information element can take the following values: - Accept; - Rejected; - T4 Expiry; - T10 Expiry; - Radio Failure; - UDUB, busy; - UDUB, idle; - Incompatible terminal.
SEARCH FOR MS MSC FOR RECALL	VLR	-	-	This message contains no information elements
SEARCH FOR MS MSC FOR RECALL ACK	MSC	-	-	This message contains no information elements
SEARCH FOR MS MSC FOR RECALL NEGATIVE RESPONSE	MSC	Negative Response	M	The negative information element can take the following values: - Absent Subscriber; - Busy Subscriber;
SEND INFO FOR OUTGOING CALL	MSC	-	-	Refer to TS 23.018
START STATUS ENQUIRY	VLR	-	-	This message contains no information elements. The message is used also in the terminating network.
STATUS ENQUIRY RESULT	MSC	Status	M	The information element can take the following vales: - CCBS Idle; - CCBS Not Idle. The message is used also in the terminating network.
STOP STATUS ENQUIRY	VLR	-	-	This message contains no information elements. The message is used also in the terminating network.

5.6.3.2 Messages between MSC and VLR in the destination network

These messages are used in the destination network. Some messages are used also in the originating network. They are marked accordingly.

Table 5.6.3.2: Messages between MSC and VLR in the destination network

Message	Message sender	Information element name	Information element Required	Information element description
CALL END	MSC	-	-	Refer to table 5.6.3.1
CCBS CALL DELIVERY	MSC	-	-	Refer to table 5.6.3.1
START STATUS ENQUIRY	VLR	-	-	Refer to table 5.6.3.1
STATUS ENQUIRY RESULT	MSC	-	-	Refer to table 5.6.3.1
STOP STATUS ENQUIRY	VLR	-	-	Refer to table 5.6.3.1
RADIO FAILURE	MSC	-	-	Refer to table 5.6.3.1
NOT IDLE	MSC	-	-	Refer to table 5.6.3.1
COMPLETE CALL	VLR	- Indicator	- C	Refer to TS 23.018 In addition: The information element shall be present if the call is CCBS Call; otherwise it shall be absent.
PROCESS CALL WAITING	VLR	- Indicator	- C	Refer to TS 23.018 In addition: The information element shall be present if the call is CCBS Call; otherwise it shall be absent.
SEND INFO FOR INCOMING CALL ACK	VLR	- CCBS Target	- C	Refer to TS 23.018 In addition: The information element shall be present if the B subscriber can be target of CCBS request; otherwise it shall be absent.
SEND INFO FOR INCOMING CALL NEGATIVE RESPONSE	VLR	- CCBS Target	- C	Refer to TS 23.018 In addition: The information element shall be present if the B subscriber can be target of CCBS request; otherwise it shall be absent.

5.6.4 Messages between VLR and HLR (D-interface)

5.6.4.1 Messages between VLR and HLR in the originating network

These messages are used between VLR - HLR in the originating network. Some messages are used also in the destination network. They are marked accordingly.

Table 5.6.4.1: Messages between VLR and HLR in the originating network

Message	Message sender	Information element name	Information element Required	Information element description
CCBS REQUEST	VLR	Call Information	M	The content of the Call Information is defined in the subclause 5.6.1.1. ISDN BC derived for the initial call.
		ISDN BC	M	
		ISDN HLC	C	Shall be present if ISDN HLC was present in the initial call; otherwise shall be absent.
		ISDN LLC	C	Shall be present if ISDN LLC was present in the initial call; otherwise shall be absent.
		Presentation Indicator	C	Shall be present if CLIR was invoked for the initial call; otherwise shall be absent.
		Translated B No	M	The number used for routing purposes stored in international E.164 format.
		CAMEL Invoked	C	Shall be present if MO CAMEL was invoked in the initial call; otherwise shall be absent.
		Basic Service Group	M	GSM Elementary Basic Service Group which corresponds to the basic service used for initial call set-up
CCBS REQUEST ACK	HLR	AddressOfB	M	The structure of the AddressOfB is defined in table 5.6.1.2 The structure of the AddressOfB is defined in table 5.6.1.2 BasicServiceGroup related to the original call.
		CCBS Index	M	
		Basic Service Group	O	
CCBS REQUEST ERROR	HLR	Error	M	The information element can take the following values: - Short term denial; - Long term denial;
CCBS RUF	HLR	Call Information	M	The content of the Call Information is defined in the subclause 5.6.1.1. The content of the CCBS Description is defined in table 5.6.1.3.
		CCBS Description	M	
		Translated B No	M	The number used for routing purposes in international E.164 format.
		Replace B No	C	The information element shall be present if the HLR instructs the MSC to replace the destination B number with the translated B number; otherwise it shall be absent.
		Alerting Pattern	C	Alerting Pattern shall be present if the HLR has determined an alerting category or an alerting level for the CCBS recall
CCBS RUF ACK	VLR	Result	M	The information element indicates whether CCBS Recall was accepted. It can take the following values: - RUF Accepted; - RUF Rejected; - T4 Expiry; - T10 Expiry; - UDUB, idle; - UDUB, busy.
CCBS RUF ERROR	VLR	Error	M	The information element indicates the reason why CCBS Recall could not be successfully delivered. It can take the following values: - IMSI Detached; - Restricted Area; - No Page Response; - Incompatible Terminal; - Absent Subscriber; - Radio Failure; - Ccomp Busy; - System Failure.

Table 5.6.4.1: Messages between VLR and HLR in the originating network, cont.

Message	Message sender	Information element name	Information element Required	Information element description
EVENT REPORT	VLR	Status	M	The information element contains subscriber status. It can take the following values: - CCBS Idle; - CCBS Not Idle; - CCBS Not Reachable. The message is used also in the terminating network.
EVENT REPORT ACK	HLR	-	-	This message contains no information elements The message is used also in the terminating network.
EVENT_REPORT_ERROR	HLR	Error	M	The information element contains no application specific error values. The message is used also in the terminating network.
START REPORTING	HLR	-	-	This message contains no information elements. The message is used also in the terminating network.
START REPORTING ACK	VLR	Status	M	The information element contains subscriber status. It can take the following values: - CCBS Idle; - CCBS Not Idle; - CCBS Not Reachable. The message is used also in the terminating network.
START REPORTING ERROR	VLR	Error	M	The information element contains no application specific error values. The message is used also in the terminating network.
CONTINUE MONITORING	HLR	-	-	This message contains no information elements. The message is used also in the terminating network.
STOP REPORTING	HLR	-	-	This message contains no information elements. The message is used also in the terminating network.
CCBS CALL REPORT	VLR	Mode Outcome Status	M M C	The information element indicates the reporting mode. It can take the following values : - A; - B. The information element indicates the outcome of the CCBS Call. It can take the following values: - Success; - Busy (only for mode A); - NDUB (only for mode B) - Failure. The information element contains subscriber status. It is set only for mode B. It can take the following values: - CCBS Idle; - CCBS Not Idle; - CCBS Not Reachable. The message is used also in the terminating network.
CCBS CALL REPORT ACK	HLR	-	-	This message contains no information elements. The message is used also in the terminating network.
CCBS CALL REPORT ERROR	HLR	Error	M	The information element contains no application specific error values. The message is used also in the terminating network.
DEACTIVATE CCBS	VLR	CCBS Index	C	If CCBS Index is present the corresponding request shall be deleted, otherwise all requests shall be deleted.
DEACTIVATE CCBS ACK	HLR	DeactivateResult	M	The information element can take the following values: - Success; - Not Provisioned.
DEACTIVATE CCBS ERROR	HLR	Error	M	The information element contains no application specific error values.

Table 5.6.4.1: Messages between VLR and HLR in the originating network, cont.

Message	Message sender	Information element name	Information element Required	Information element description
INTERROGATE CCBS	VLR	-	-	This message contains no information elements.
INTERROGATE CCBS ACK	HLR	List(1-5) of CCBS Description; No Entries; Not Provisioned	C C C	The list shall contain one entry for each CCBS Request for which the HLR stores data or; the queue is empty or; CCBS is not provisioned for the subscriber. Exactly one of these information elements shall be present. The structure of the CCBS Description is defined in table 5.6.1.3.
INTERROGATE CCBS ERROR	HLR	Error	M	The information element contains no application specific error values.

5.6.4.2 Messages between VLR and HLR in the destination network

These messages are used between VLR - HLR in the destination network. Some messages are used also in the originating network. They are marked accordingly.

Table 5.6.4.2: Messages between VLR and HLR in the destination network

Message	Message sender	Information element name	Information element Required	Information element description
EVENT REPORT	VLR	-	-	Refer to table 5.6.4.1
EVENT REPORT ACK	HLR	-	-	Refer to table 5.6.4.1
EVENT REPORT ERROR	HLR	-	-	Refer to table 5.6.4.1
START REPORTING	HLR	-	-	Refer to table 5.6.4.1
START REPORTING ACK	VLR	-	-	Refer to table 5.6.4.1
START REPORTING ERROR	VLR	-	-	Refer to table 5.6.4.1
CONTINUE MONITORING	HLR	-	-	Refer to table 5.6.4.1
STOP REPORTING	HLR	-	-	Refer to table 5.6.4.1
CCBS CALL REPORT	VLR	-	-	Refer to table 5.6.4.1
CCBS CALL REPORT ACK	HLR	-	-	Refer to table 5.6.4.1
CCBS CALL REPORT ERROR	HLR	-	-	Refer to table 5.6.4.1
PROVIDE ROAMING NUMBER	HLR	- CCBS Call Reporting Request	- C	Refer to TS 23.018 In addition: The information element shall be present for CCBS Call roaming number enquiry; otherwise it shall be absent.

5.6.5 Messages between MSC and HLR (C-interface)

Table 5.6.5: Messages between MSC and HLR

Message	Message sender	Information element name	Information element Required	Information element description
SEND ROUTING INFO	MSC	- CCBS Supported CCBS Call Indicator	- C C	Refer to TS 23.018 In addition: The information element shall be present if GMSC supports CCBS; otherwise it shall be absent. The information element shall be present, if SRI is for CCBS Call; otherwise it shall be absent.
SEND ROUTING INFO_ACK	HLR	- CCBS Target Keep CCBS Call Indicator	- C C	Refer to TS 23.018 In addition: The information element shall be present if the call is forwarded on busy and the subscriber B can be target of CCBS requests; otherwise it shall be absent. The information element shall be present if the VMSC supports CCBS and SRI enquiry was for CCBS Call; otherwise it shall be absent.
SEND ROUTING INFO NEGATIVE RESPONSE	HLR	- Negative Response	- -	Refer to TS 23.018 New value(s) for existing parameter(s): - Busy_CCBS_Possible; - Busy_CCBS_Not_Possible.

5.6.6 Messages between MSC - MSC (E-interface)

Table 5.6.6: Messages between MSC and MSC

Message	Message sender	Information element name	Information element Required	Information element description
RESUME CALL HANDLING	MSC	- CCBS Target	- C	Refer to TS 23.079 In addition: The information element shall be present if the call is forwarded on busy and the subscriber B can be target of CCBS requests; otherwise it shall be absent.

5.6.7 Existing parameters containing CCBS specific information

Mobile Station Classmark 2 (refer to TS 24.008 contains information whether “Network initiated MO CM connection request” is supported or not. This information is vital for the recall mechanism.

CC capabilities (refer to TS 24.008) contains information whether “Prolonged Clearing Procedures” are supported or not. This information is vital for the activation mechanism.

SS-Code and SS-Status (refer to TS 29.002) contains information whether CCBS service is provisioned to the subscriber. Both originating and destination CCBS service have their own SS-Code.

6 Monitoring and CCBS Call Reporting

6.1 Monitoring

6.1.1 Overview

Monitoring is the process where the subscriber state is observed and reported. When monitoring is started, the current subscriber state is reported and any subsequent changes of subscriber state are reported until monitoring is stopped.

Monitoring subscriber state information will be necessary against MS B and may also be necessary against MS A.

For both these cases the monitoring functionality is located in the appropriate serving VMSC/VLR and is controlled from the appropriate HLR. The actions on the A-side and B-side for monitoring are completely independent and the following description is generic to cover either case. The HLR sends an explicit Start Reporting signal to the VLR to initiate monitoring. The VLR acknowledges the request confirming that monitoring has started and indicates the current status of the subscriber state in the VMSC/VLR. The VLR will continue to send an Event Report to the HLR whenever the appropriate subscriber state transition event occurs. The HLR sends an explicit Stop Reporting signal to the VLR when reporting on the subscriber state transitions is no longer required.

6.1.2 Monitoring Subscriber B-state information

The CCBS service requires monitoring of the subscriber state at the called destination network (B-side). This monitoring enables the HLR B to be aware of any transition of subscriber state in VMSC/VLR B while there is an active CCBS Request in the HLR B queue. The basic service operation is that, when the destination B subscriber state becomes Idle, the HLR B is informed and a Remote User Free indication is sent towards the originating A network at the appropriate time. If subsequently to that event the destination B subscriber state becomes not Idle or not reachable, then the HLR B is informed by the VMSC/VLR B in order that it can take an appropriate action towards HLR A, e.g. defer sending of the Remote User Free indication.

6.1.3 Monitoring Subscriber A state information:

Monitoring Subscriber A state information will be necessary if the Remote User Free indication from Destination B network cannot be acted upon because e.g. MS A is not idle or not reachable and leads to the CCBS request being suspended. The service action in this event is that, when the subscriber state subsequently becomes Idle, the HLR A is informed and a Resume indication is sent towards the destination B network at the appropriate time.

6.2 MSC/VLR Monitoring Model

The Monitoring model represents the information related to the status of the subscriber connection in the MSC/VLR. A generic monitoring model is used in the MSC/VLR covering the needs of both subscriber A and subscriber B state information for CCBS. The MSC/VLR monitoring model for CCBS is shown in figure 6.2.1. Note that state transitions reported to the HLR are shown as solid lines.

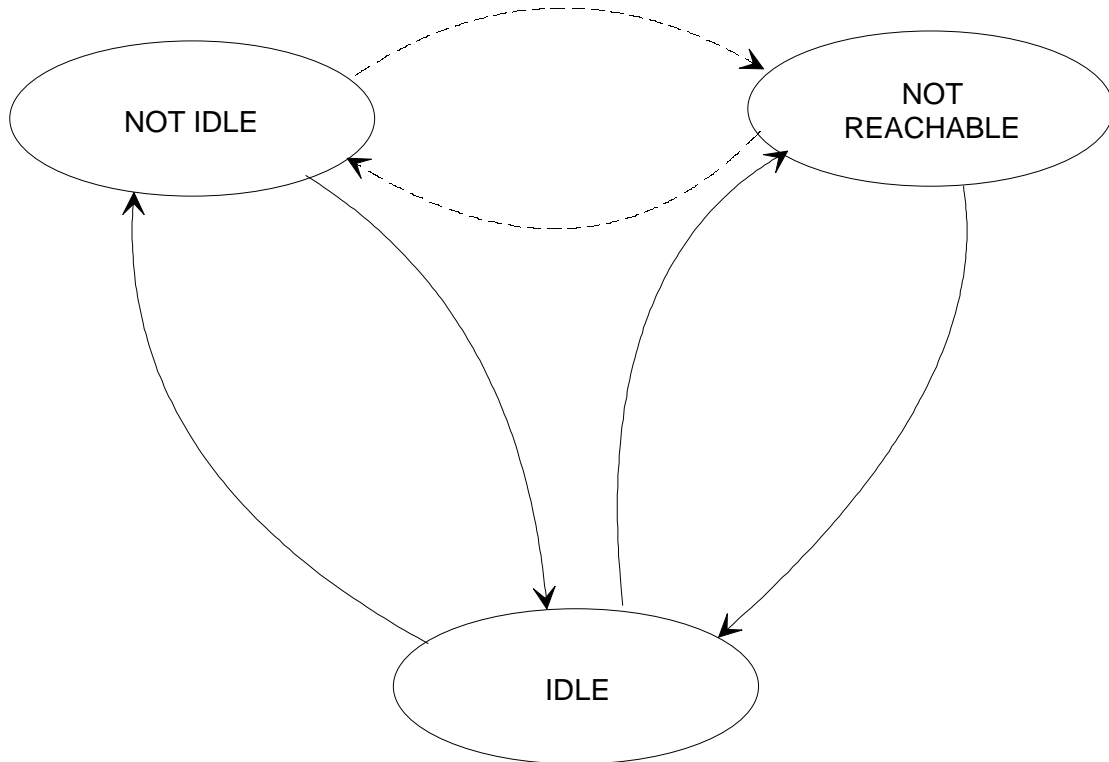

Figure 6.2.1: MSC/VLR Monitoring Model

6.2.1 Subscriber status

The monitoring model in the MSC/VLR makes use of the three subscriber states described in table 6.2.1.

NOTE: Refer to TS 23.078 for equivalent subscriber state description.

Table 6.2.1: Subscriber States

Subscriber states	Description (for monitoring purposes)	Notes
IDLE	The state of the MS is neither "NOT IDLE" nor "NOT REACHABLE"	"Assumed Idle"
NOT IDLE	The MS is engaged on a transaction for a MO or MT circuit switched call	"CAMEL busy"
NOT REACHABLE	The MSC/VLR can determine from its internal data that the MS is not reachable e.g. IMSI detached, Restricted Area, No Page Response.	"Network Determined Not Reachable"

For each subscriber state a description can be found on the entry events, functions and exit events.

6.2.1.1 Idle

Entry events:

- Indication of last call released (Mobile Originated or Mobile Terminated);
- Indication of radio link failure;
- Indication of MS activity related to e.g. MO-SMS, MT-SMS and CISS;
- IMSI Attached;
- Location Update.

Functions:

- Events leading to a transition to the Not Idle or Not Reachable subscriber state are awaited.

Exit events:

- A Mobile Originated Set-up message is received from the MS for first (and only) call;
- A Mobile Terminated Set-up message is sent to the MS for first (and only) call.
- IMSI Detached;
- Roaming in LA not allowed;
- No Page Response;
- An exception condition is encountered e.g. Cancel Location indication received.

6.2.1.2 Not Idle

Entry events:

- A Mobile Originated Set-up message is received from the MS for first (and only) call;
- A Mobile Terminated Set-up message is sent to the MS for first (and only) call.

Functions:

- Events leading to a transition to the Idle or Not Reachable subscriber state are awaited.

Exit events:

- Indication of last call released (Mobile Originated or Mobile Terminated);
- Indication of radio link failure;
- An exception condition is encountered e.g. Cancel Location indication received.

6.2.1.3 Not Reachable

Entry events:

- IMSI Detached;
- Roaming in LA not allowed;
- No Page Response.

Functions:

- Events leading to a transition to the Idle or Not Idle subscriber state are awaited.

Exit events:

- Indication of MS activity related to e.g. MO-SMS, MT-SMS and CISS;
- IMSI Attached;
- Location Update;
- A Mobile Originated Set-up message is received from the MS for first (and only) call;
- A Mobile Terminated Set-up message is sent to the MS for first (and only) call;
- An exception condition is encountered e.g. Cancel Location indication received.

6.2.2 Reporting of subscriber state transitions

Transitions between subscriber states are reported from the MSC/VLR, while monitoring in the MSC/VLR is on going. The table 6.2.2 indicates which transitions are monitored in the MSC/VLR and whether these are reported to the HLR for the CCBS service. An appropriate Event Report signal is sent from the VLR to the HLR when a relevant state transition occurs. The Event Report signal includes a status parameter which reflects the subscriber state information.

Table 6.2.2: Reporting of Subscriber States Transitions

Subscriber state transition event	Event reporting HLR informed	Event report Subscriber status
IDLE to NOT IDLE	Yes	CCBS Not Idle
IDLE to NOT REACHABLE	Yes	CCBS Not Reachable
NOT IDLE to IDLE	Yes	CCBS Idle
NOT IDLE to NOT REACHABLE	No	-
NOT REACHABLE to IDLE	Yes	CCBS Idle
NOT REACHABLE to NOT IDLE	No	-

6.2.2.1 Start Reporting of Monitoring Events

When a Start Reporting signal is received from the HLR, the VLR shall acknowledge the request confirming that monitoring has started and indicate the current status of the subscriber state in the MSC/VLR. The VLR shall subsequently continue to send the Event Reports indicated in table 6.2.2 whenever the appropriate subscriber state transition event occurs.

Note where a single user has a CCBS request activated against him and has an outstanding CCBS request suspended against someone else, (i.e. is effectively both destination B and CCBS subscriber A) reporting on both A-side and B-side is required. In this case, the VLR shall only send a single Event Report as indicated in table 6.2.2 whenever the appropriate subscriber state transition event occurs. The HLR shall not send another Start Reporting signal to the VLR if monitoring is already ongoing in the MSC/VLR for either A-side or the B-side.

6.2.2.2 Stop Reporting of Monitoring Events

When a Stop Reporting signal is received from the HLR, the VLR shall stop sending the Event Reports.

6.3 CCBS Call Reporting

6.3.1 Overview

As well as monitoring of the subscriber state, it is also necessary to report the result of the CCBS Call. The basic reporting requirements are as follows from both the A-side and the B-side.

CCBS Call Reporting - A-side:

The CCBS service logic in the originating network HLR A requires a report on the outcome of the CCBS Call resulting from the acceptance of the CCBS Recall by Subscriber A. The VLR A sends a CCBS Call Report to the HLR A indicating the outcome of the CCBS call processing in MSC/VLR A when e.g. an address complete message (ACM) is received from the destination B network. CCBS Call Reporting on the A-side is completely independent of any monitoring of subscriber state information. The sending of CCBS Call Report is required even when there is no monitoring ongoing in the MSC/VLR.

CCBS Call Reporting- B-side:

The CCBS service logic in the destination network HLR B requires a report on the outcome of CCBS Call processing in the MSC/VLR B. The HLR B initiates the CCBS call outcome reporting in the VLR when the VLR is normally queried to provide routing information for mobile terminated calls (by including an CCBS indicator in the PRN message). The VLR B sends a CCBS Call Report to the HLR B indicating the outcome of the CCBS call processing and the new status of the subscriber state in the MSC/VLR B when e.g. MS B is alerted to the CCBS Call.

6.3.2 Originating Network (A-side)

When a CCBS RUF signal is received by the VLR, CCBS processing in the MSC/VLR leads to a CCBS Recall signal being sent to the MS. When the response to the CCBS Recall is received, the VLR shall subsequently send a CCBS Call Report when the relevant processing for the outgoing CCBS call to the destination network is completed as shown in the SDLs for MSC/VLR A.

6.3.3 Destination Network (B-side)

When an initiate CCBS Call Reporting Request signal (B-side) is received by the VLR in the Provide Roaming Number message, the VLR shall subsequently send a CCBS Call Report when the relevant processing of the incoming CCBS call is completed as shown in the SDLs for MSC/VLR B.

6.3.3.1 Interaction of Event Reporting and CCBS Call Report

Reporting on subscriber state transitions will be ongoing in the MSC/VLR B when a report on the CCBS call outcome is required.

When a subscriber state transition from IDLE to NOT IDLE occurs due to an incoming CCBS call, an Event Report shall not be sent. Instead, a CCBS Call Report (containing CCBS call outcome information and the status) shall be sent to the HLR B. After the CCBS Call Report has been sent, normal Event Reporting will continue i.e. the VLR shall subsequently send only the Event Reports indicated in table 6.2.2 when the next appropriate subscriber state transition event occurs.

6.4 Location Update

The MS may roam to a new MSC/VLR area while monitoring is ongoing in the previous MSC/VLR. When the VLR receives a Cancel Location signal from the HLR due to normal mobility management procedures, any ongoing CCBS related activities associated with the subscriber shall cease.

If the A-side monitoring is ongoing when the HLR receives a Location Update request from the new VLR, the Location Update signal is considered to indicate that the subscriber state is idle and the appropriate CCBS process in the HLR is informed. The normal mobility management procedures will lead to a Cancel Location signal being sent to the old VLR causing the Event Reporting to stop.

If the B-side monitoring is ongoing when the HLR receives a Location Update request from the new VLR, the normal mobility management procedures are followed. On successful completion of Location Update procedure, the HLR shall send a Start Reporting signal to the new VLR. If during the handling of the normal Location Updating procedure, it is detected that the new MSC/VLR does not support CCBS, the HLR shall not send a Start Reporting signal to the new VLR.

NOTE: There is no impact to the MS due to CCBS monitoring, i.e. normal Location Update procedures apply.

7 Mobility

The handling for CCBS specific mobility is described below.

7.1 Mobility during Activation

In order to allow the activation of CCBS when the call is released, the CC connection towards the MS shall be kept, to avoid any problems of mobility with the MS A.

Therefore the MSC shall maintain the CC connection with the MS A while T1 is running and until either T1 expires or the MSC sends a CCBS REQUEST ACK or CCBS REQUEST ERROR to the MS. After MSC has sent CCBS REQUEST ACK or CCBS REQUEST ERROR, the MSC A shall release the CC connection with MS.

7.2 Number used within CCBS Call

The activating MSC A shall store the originally dialled number in the Call Information container. The TranslatedBNo parameter shall contain destination B address stored in international E.164 format.

If the MS A is registered outside of the HPLMN during the initial call or when Remote_User_Free is received from the destination B network the HLR A may request the recall MSC A to change the number used for CCBS Call to the TranslatedBNo instead. Refer to the SDLs for originating MSC/VLR.

If CAMEL service was activated in the original call the HLR A shall not request to change the number used for the CCBS Call.

7.3 MS does Location Update

CCBS does place extra requirements for the Location Update procedure in the HLR when MS is monitored. Refer to subclause 6.4.

7.4 Mobility during CCBS Call in the destination network

If MS registers to non-supporting network special handling has to be applied. Refer to subclause 10.1.3.

8 Interaction with other supplementary services

TS 22.093 specifies a number of interactions between CCBS and other supplementary services. Additional details of how these interactions apply are as follows.

8.1 Call forwarding unconditional (CFU)

If a call to destination B is forwarded to subscriber C by CFU and MS C is NDUB, the GMSC shall inform MSC A that CCBS is not possible when it releases the call. Refer to Process MT_GMSC (see TS 23.018) for further details.

If destination B activates CFU after subscriber A has activated a CCBS Request against destination B, HLR B shall not process CCBS Requests in the queue which are related to the relevant Basic Service Group, except that T7 shall continue for each CCBS Request in the destination B queue. If T7 expires for a particular request, HLR B shall cancel the request, as described in the SDLs shown in figure 11.2.2.1.

If MSC B is monitoring MS B when CFU is activated by destination B and all the CCBS Requests in the destination B queue subsequently become "Active and Quiescent", then HLR B shall send "Stop Reporting" to MSC B. If destination B deactivates CFU resulting in one or more requests becoming "Active and Operative" in the destination B queue then, HLR B shall send "Start Reporting" to MSC B if monitoring is not already ongoing.

A CCBS Call shall be forwarded without the CCBS call Indicator.

8.2 Call forward on busy (CFB)

If a call to destination B is forwarded to subscriber C by CFB and MS C is NDUB, the forwarding switch (GMSC or VMSC) shall inform MSC A that CCBS is possible when it releases the call. Refer to Process MT_GMSC or Process ICH_MSC (see TS 23.018) for further details.

If destination B activates CFB after subscriber A has activated a CCBS Request against destination B, HLR B shall continue to process CCBS Requests in the queue. If a CCBS Call subsequently arrives at MSC B and MS B is NDUB, a network provider option exists as to whether:

- the CCBS call shall be treated as when MS B is busy for the CCBS call, without CFB active; or
- the CCBS call shall be forwarded without the CCBS call Indicator.

8.3 Call forwarding on no reply (CFNRy)

If a call to destination B is forwarded to subscriber C by CFNRy and MS C is NDUB, the forwarding switch (VMSC) shall inform MSC A that CCBS is not possible when it releases the call. Refer to Process MT_GMSC or Process ICH_MSC (see TS 23.018) for further details

If destination B activates CFNRy after subscriber A has activated a CCBS Request against destination B, HLR B shall continue to process CCBS Requests in the queue.

A CCBS call shall be forwarded without the CCBS call Indicator.

8.4 Call forwarding on MS not reachable (CFNRc)

If a call to destination B is forwarded to subscriber C by CFNRc and MS C is NDUB, the forwarding switch (GMSC or VMSC) shall inform MSC A that CCBS is not possible when it releases the call. Refer to Process MT_GMSC or Process_ICH_MSC (see TS 23.018) for further details.

If destination B activates CFNRc after subscriber A has activated a CCBS Request against destination B, HLR B shall continue to process CCBS Requests in the queue.

The CCBS call shall be forwarded without the CCBS call Indicator.

8.5 Call Waiting (CW)

No impact.

8.6 Multiparty service (MPTY)

No impact.

8.7 Closed user group (CUG)

No impact.

8.8 Advice Of Charge (AoC)

If subscriber A accepts a "CCBS Recall" indication but ACMmax exceeds, then MSC A shall cancel the associated request and shall not establish the CCBS Call.

8.9 Barring of all outgoing calls (BAOC)

If subscriber A accepts a "CCBS Recall" indication but MSC A detects that BAOB is active and operative, then MSC A shall cancel the associated request and shall not establish the CCBS Call.

8.10 Barring of outgoing international calls (BOIC)

If subscriber A accepts a "CCBS Recall" indication but the CCBS Call would be an international call and MSC A detects that BOIC is active and operative, then MSC A shall cancel the associated request and shall not establish the CCBS Call.

8.11 Barring of outgoing international calls except those directed to the home PLMN country (BOIC-exHC)

If subscriber A accepts a "CCBS Recall" indication but the CCBS Call would be an international call except to the home PLMN country and MSC A detects that BOIC-exHC is active and operative, then MSC A shall cancel the associated request and shall not establish the CCBS Call.

8.12 Barring of all incoming calls (BAIC)

If a CCBS Request arrives at HLR B and HLR B detects that BAIC is active and operative for the relevant Basic Service Group, then HLR B shall not accept the activation attempt and shall indicate short term denial in the response.

If MSC B is monitoring MS B when BAIC is activated by destination B then all the CCBS Requests in the destination B queue subsequently become "Active and Quiescent" and HLR B shall send "Stop Reporting" to MSC B. If destination B deactivates BAIC resulting in one or more requests becoming "Active and Operative" in the destination B queue then, HLR B shall send "Start Reporting" to MSC B if monitoring is not already ongoing.

If barring of all incoming calls becomes active and operative for a particular Basic Service Group for destination B, such that a CCBS call from subscriber A is not permitted, HLR B shall cancel the associated request related to the Basic Service Group and select the next non-suspended request in the queue for processing for other Basic Service Groups.

8.13 Barring of incoming calls when roaming outside the home PLMN country (BIC-Roam)

If a CCBS Request arrives at HLR B and HLR B detects that BIC-Roam is active and operative for the relevant Basic Service Group, then HLR B shall not accept the activation attempt and shall indicate short term denial in the response.

If MSC B is monitoring MS B when BIC-Roam is activated by destination B then all the CCBS Requests in the destination B queue subsequently become "Active and Quiescent" and HLR B shall send "Stop Reporting" to MSC B. If destination B deactivates BIC-Roam resulting in one or more requests becoming "Active and Operative" in the destination B queue then, HLR B shall send "Start Reporting" to MSC B if monitoring is not already ongoing.

If barring of incoming calls when roaming outside the home PLMN country becomes active and operative for a particular Basic Service Group for destination B, such that a CCBS call from subscriber A is not permitted, HLR B shall cancel the associated request related to the Basic Service Group and select the next non-suspended request in the queue for processing for other Basic Service Groups.

8.14 Completion of calls to busy subscriber (CCBS)

Subscriber A may have successfully activated one or more CCBS requests against different destinations B, and also have one or more CCBS requests successfully activated against him by different subscribers. In this case, HLR A shall co-ordinate the different requests.

Checking for an identical CCBS request already existing shall include checks in both directions, i.e. if subscriber A activates a CCBS Request against destination B, HLR A shall check subscriber A's originating queue for any previous requests activated by subscriber A against destination B for the same basic service group. HLR A shall also check subscriber A's target queue for any requests activated by destination B against subscriber A for the same basic service group.

9 Interaction with other network features

TS 22.093 specifies a number of interactions between CCBS and other network features.

9.1 Customised Applications for Mobile network Enhanced Logic (CAMEL)

For a terminating CAMEL based service which changes the destination B address for the original call which subsequently encounters NDUB, the GMSC shall inform originating network that CCBS is not possible when it releases the call.

If an originating CAMEL based service determines for a CCBS Call a different destination B Address than for the original call, the CCBS Call shall be released and the associated CCBS Request shall be cancelled.

If the CAMEL based service requests a call set-up to an alternative destination after the original call has met Busy, CCBS Possible condition, the CCBS activation shall be allowed if the alternative call set-up also encounters Busy condition.

9.2 Support of Optimal Routeing (SOR)

The CCBS supporting GMSC shall include CCBS Supported indicator to the SRI message.

If HLR B receives a request for routeing information when destination B is blocked (i.e. the HLR B is waiting for an SRI for a CCBS call set-up) and the SRI does not include a CCBS call indicator nor CCBS supported in the GMSC indicator and the request is from a GMSC not in the same PLMN as HLR B, then HLR B shall return an SRI negative response indicating OR not allowed. This will force the GMSC to route the call to a GMSC in the same PLMN as HLR B (see TS 23.079).

The GMSC in HPLMN B should be able to include the CCBS Call indicator in the non-OR SRI, and the CCBS call set-up will proceed, although it won't be optimally routed.

If the HLR receives an SRI indicating a CCBS-capable GMSC but not a CCBS call while awaiting SRI for a CCBS call, it can treat the request as if the B-subscriber were busy, regardless of where the GMSC is.

10 Interworking with other networks

The point of interworking shall be the interface between HLR A and HLR B. The flow of information across this interface shall be identical to that between exchanges for the ISDN version of CCBS.

Interworking with ISDNs which support the ISDN version of CCBS is therefore available without further modification.

Interworking with networks other than ISDNs, e.g. private networks, is not specified here, but is not precluded.

CCBS shall be able to interwork through networks which do not support CCBS. In this situation, the CCBS service may fail.

10.1 Interworking with network entities not supporting CCBS

CCBS requires support of the service by the following entities for it to operate as specified above:

- MS A;
- MSC A;
- VLR A;
- HLR A;
- GMSC;
- HLR B;
- MSC B;
- VLR B.

The following shows the actions required to cover the situations where these entities do not support CCBS. Note that the situation is further complicated by mobility. For example, MSC A may support CCBS when the initial request is made, but if subscriber A has changed location, the new MSC A may not support CCBS.

It is assumed that the entities support the service at the points in the call where actions are initiated by them, and that an entity which receives an indication for the CCBS service but does not support it can indicate its lack of support to the sending entity.

10.1.1 CCBS not supported by MSC A

HLR A knows whether the MSC A supports CCBS or not through the transfer of subscriber data.

MS B becomes idle

When HLR A receives the "Remote User Free" indication for a particular CCBS Request and detects that the MSC A where MS A is currently registered does not support CCBS, then HLR A shall suspend the corresponding CCBS Request and shall send "CCBS Suspend" to HLR B. When MS A registers in a different MSC which supports CCBS, HLR A shall resume the corresponding CCBS Request and shall send "CCBS Resume" to HLR B, continuing as if MS A had become free.

10.1.2 CCBS not supported by HLR B

Initial call encounters busy

If an MSC B that supports CCBS recognises that HLR B does not support CCBS then "CCBS Not Possible" will be generated in the CCBS diagnostic.

10.1.3 CCBS not supported by MSC B

HLR B knows whether the MSC B supports CCBS or not through the transfer of subscriber data.

CCBS Request

If MSC B does not support CCBS, HLR B acknowledge the request and start T7. No processing of the destination B queue and subsequently no monitoring of destination B will be possible until destination B registers in a supporting MSC.

CCBS Call set-up

If HLR B knows that MSC B does not support CCBS the HLR B shall delete the corresponding CCBS Request and shall request a Roaming No without including the CCBS Call indicator in the request. Within Send Routeing Info Ack the HLR shall inform the GMSC to remove CCBS Call Indicator from the IAM message.

After a "Remote User Free" has been sent from MSC B but before the CCBS call set-up is completed, destination B may register in an MSC which does not support the service. MSC B shall accept the CCBS call, but MSC B will not be able to inform HLR B of the successful completion of the CCBS call, so the request will remain active in HLR B until the recall B timer (T9) expires and the request is cancelled.

11 Network entity functions

The following SDL diagrams describe the various processes and procedures within individual network entities for handling CCBS. The SDL diagrams are as follows:

11.1 Originating Network Processes

11.1.1 Processes and procedures in MSC/VLR

Figure 11.1.1.1: Process MSC_CCBS_Recall_Manager

This process controls the CCBS Recall handling in the MSC and controls timers T4 and T10

Figure 11.1.1.2: Process VLR_CCBS_Recall_Manager

This process controls the CCBS Recall handling in the VLR and reports the result of the Recall directly to the HLR.

Figure 11.1.1.3: Process OCH_CCBS_VLR

This process controls the CCBS Call Setup in the VLR

Figure 11.1.1.4: Procedure CCBS_Check_OG_Call

This procedure checks whether the outgoing call meets various conditions set by the CCBS supplementary service. If CCBS is not implemented Pass exit shall be taken.

Figure 11.1.1.5: Procedure CCBS_Check_If_CCBS_Possible

This procedure is called when Release message is received from the destination network. It checks whether CCBS activation is possible.

Figure 11.1.1.6: Procedure CCBS_Activation_MSC

If CCBS activation is possible this procedure is called. It handles the dialogue between MS and MSC and MSC and HLR respectively.

Figure 11.1.1.7: Procedure Page_MS_MSC_For_Recall

During CCBS recall this procedure handles paging of the MS if the location area id is known.

Figure 11.1.1.8: Procedure Search_For_MS_MSC_For_Recall

During CCBS recall this procedure handles paging of the MS on MSC side if the location area id is not known.

Figure 11.1.1.9: Procedure Search_For_MS_VLR_Recall

During CCBS recall this procedure handles paging of the MS on VLR side if the location area id is not known.

Figure 11.1.1.10: Procedure Complete_Recall_MSC

During CCBS recall this procedure handles early channel allocation and establish CC connection with the MS.

Figure 11.1.1.11: Procedure CCBS_OCH_Report_Success

This procedure is called when CCBS call is successfully delivered to the destination network. The procedure informs HLR of successful call delivery.

Figure 11.1.1.12: Procedure CCBS_OCH_Report_Failure

This procedure is called when CCBS call delivery failed to the destination network. The procedure informs HLR of call delivery failure.

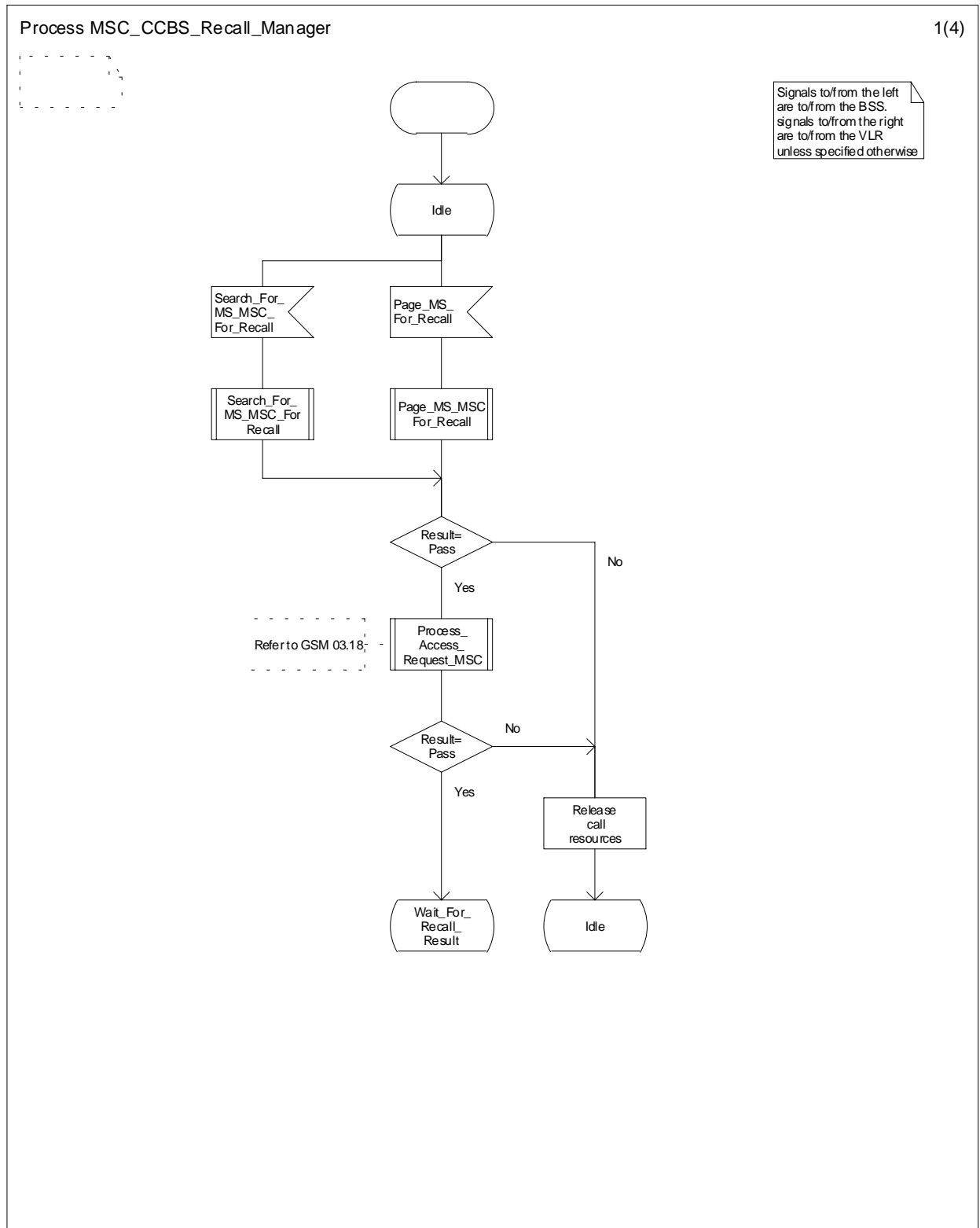

Figure 11.1.1.1: Process MSC_CCBS_Recall_Manager (sheet 1 of 4)

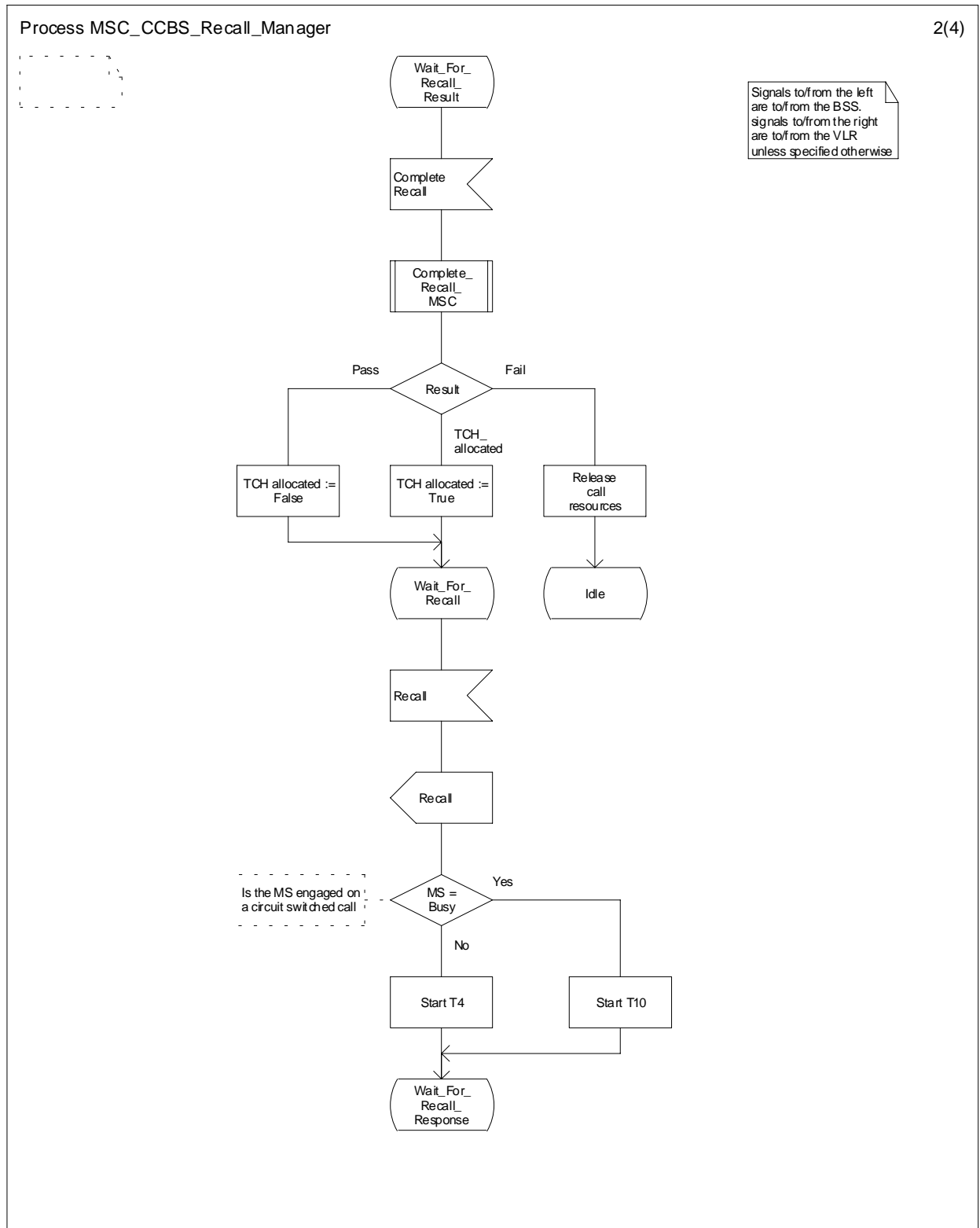

Figure 11.1.1.1: Process MSC_CCBS_Recall_Manager (sheet 2 of 4)

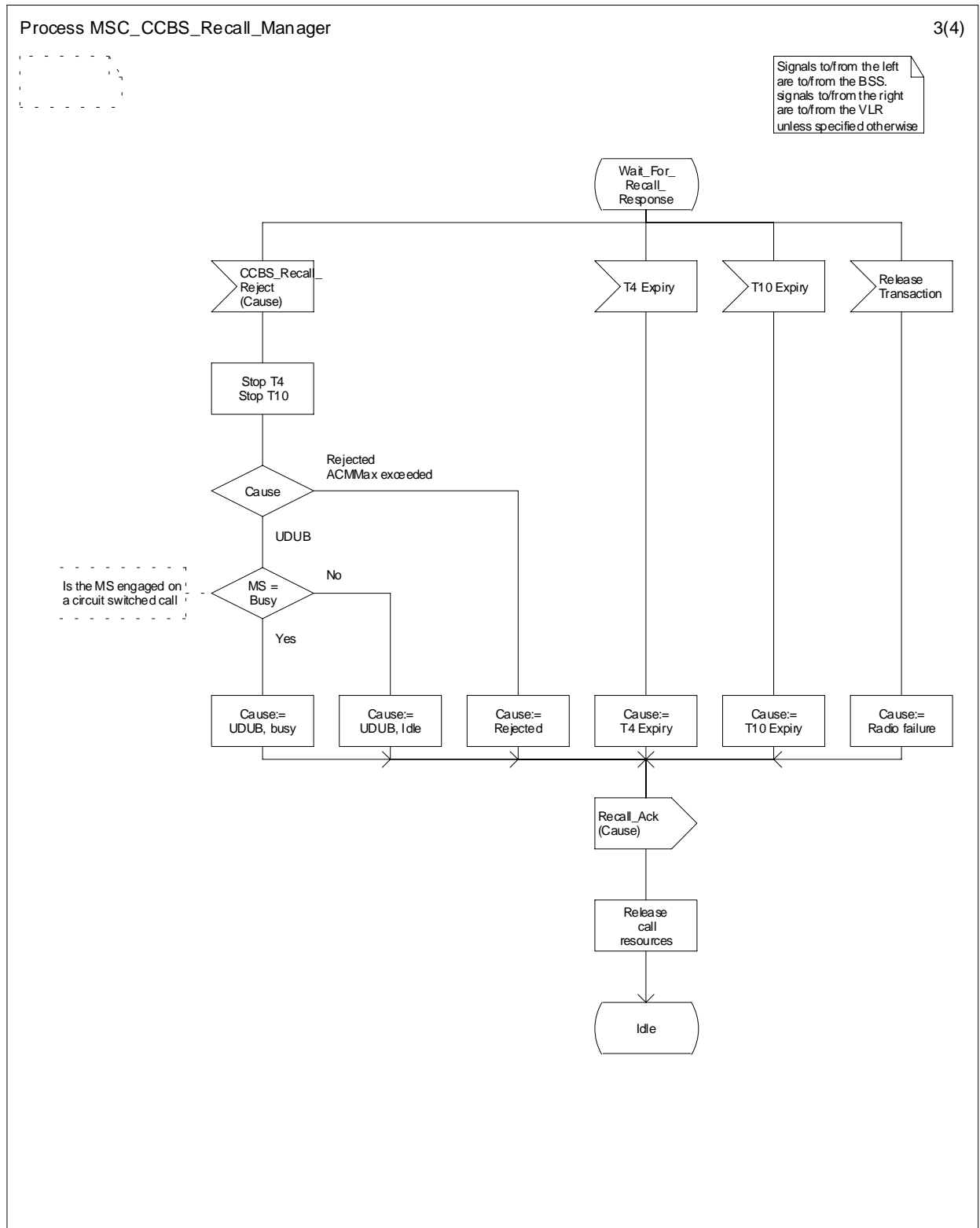

Figure 11.1.1.1: Process MSC_CCBS_Recall_Manager (sheet 3 of 4)

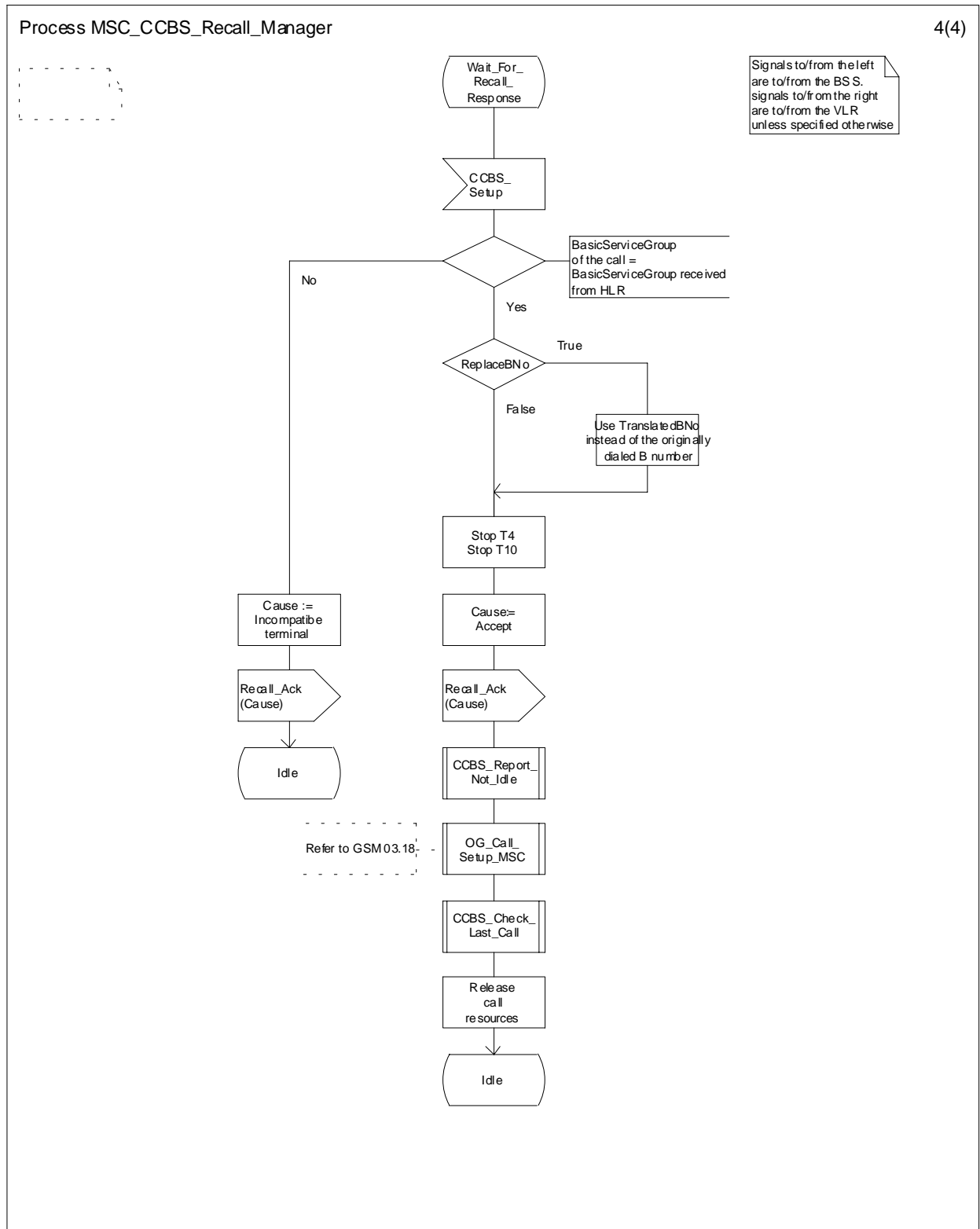

Figure 11.1.1.1: Process MSC_CCBS_Recall_Manager (sheet 4 of 4)

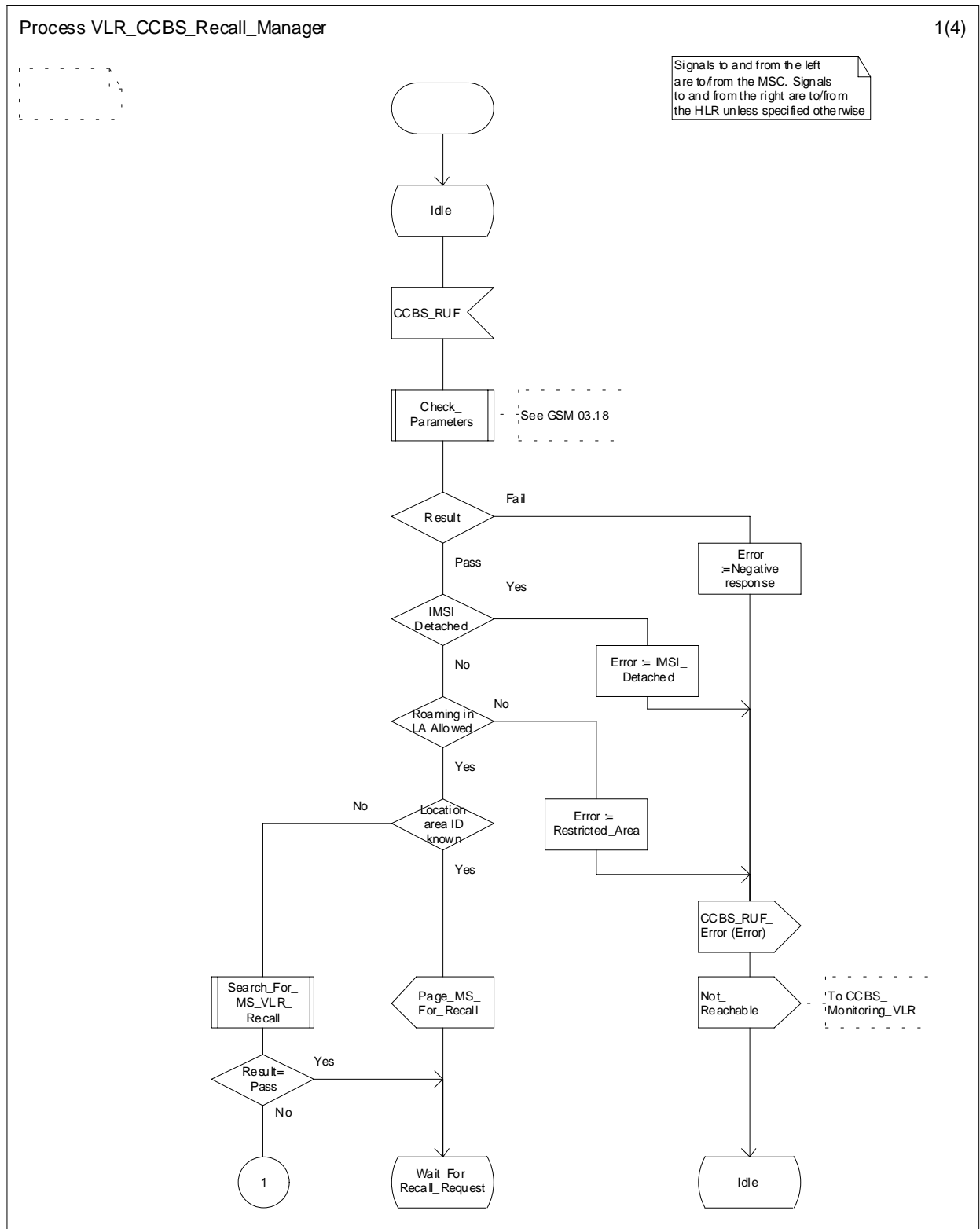

Figure 11.1.1.2: Process VLR_CCBS_Recall_Manager (sheet 1 of 4)

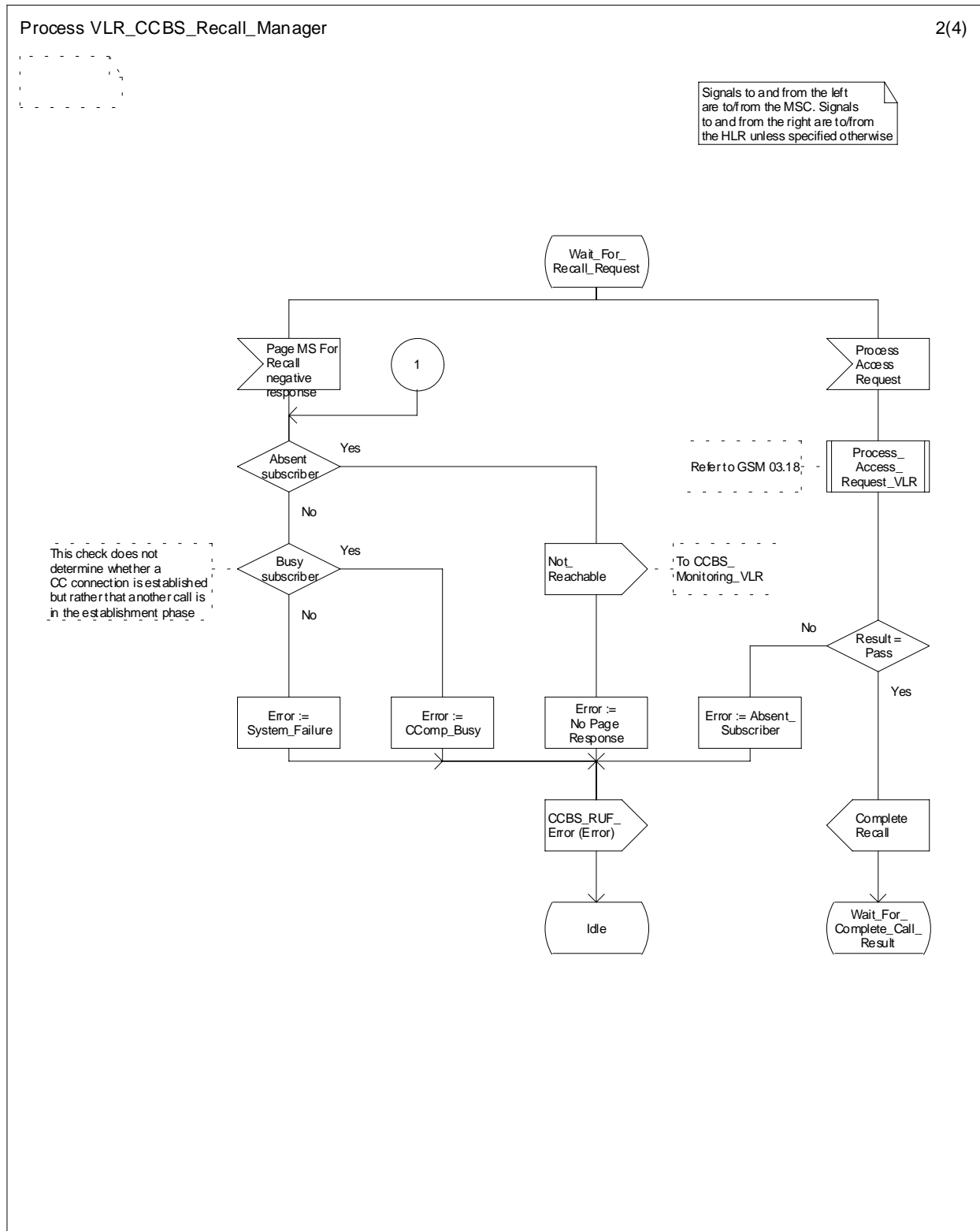

Figure 11.1.1.2: Process VLR_CCBS_Recall_Manager (sheet 2 of 4)

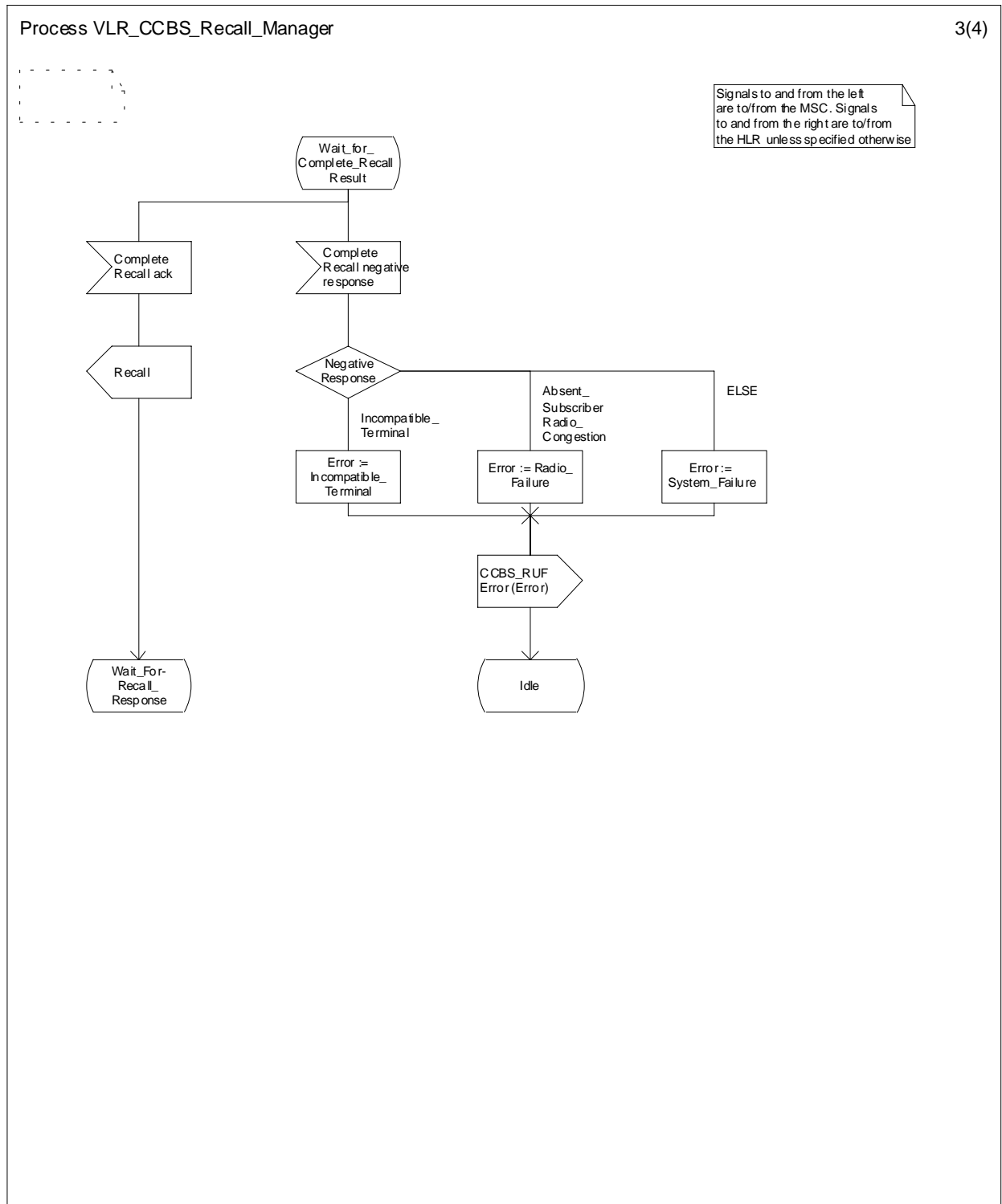

Figure 11.1.1.2: Process VLR_CCBS_Recall_Manager (sheet 3 of 4)

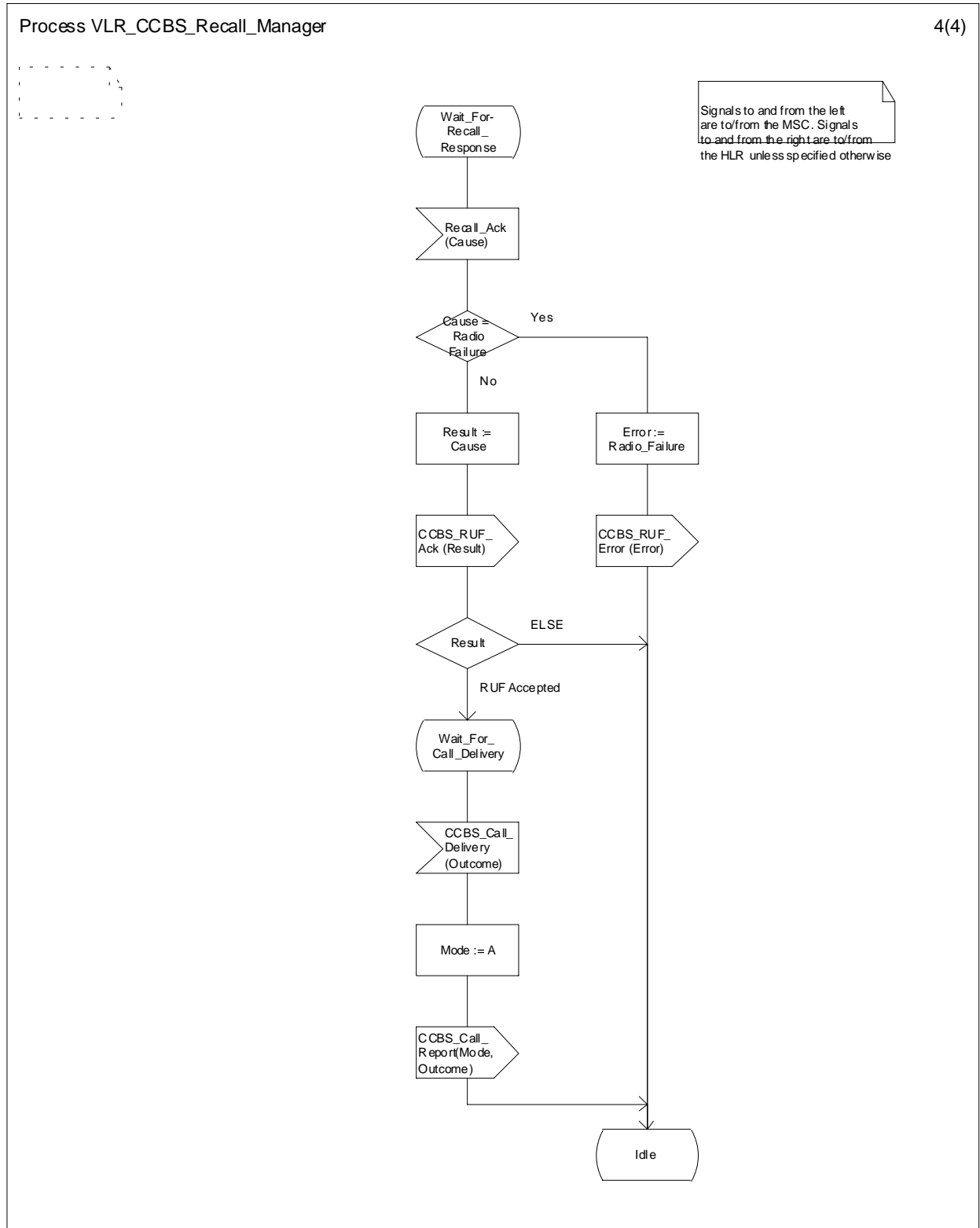

Figure 11.1.1.2: Process VLR_CCBS_Recall_Manager (sheet 4 of 4)

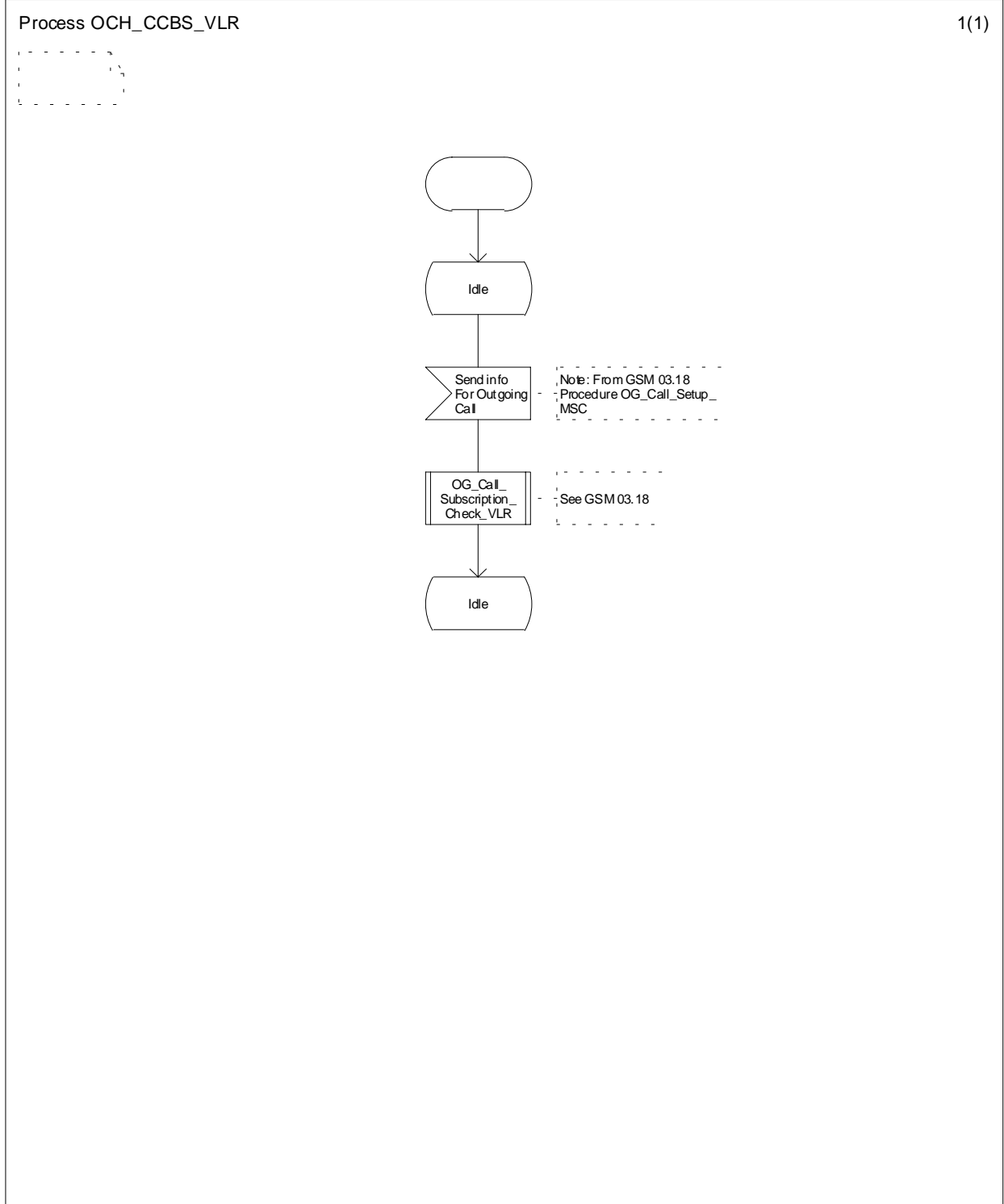

Figure 11.1.1.3: Process OCH_CCBS_VLR

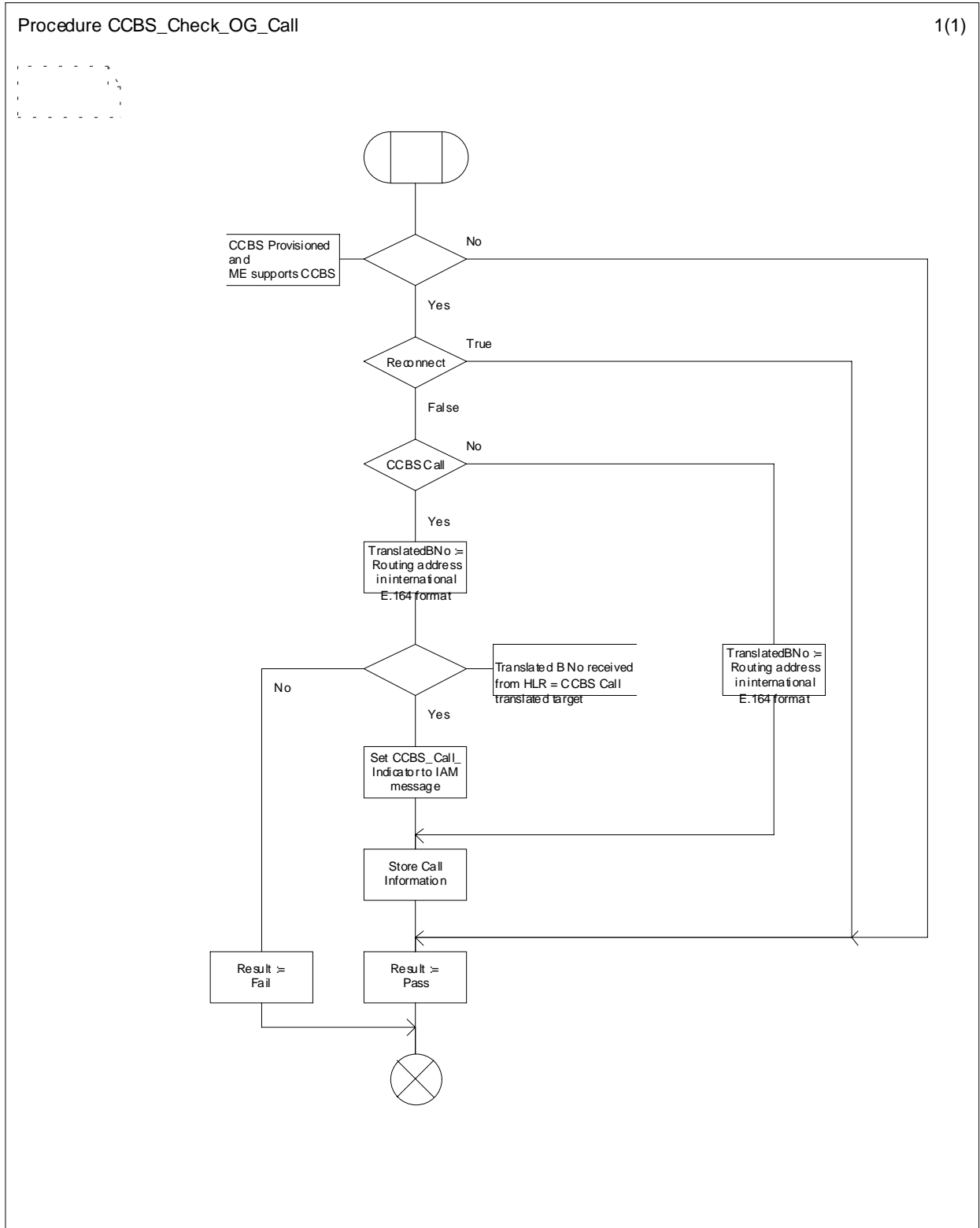

Figure 11.1.1.4: Procedure CCBS_Check_OG_Call

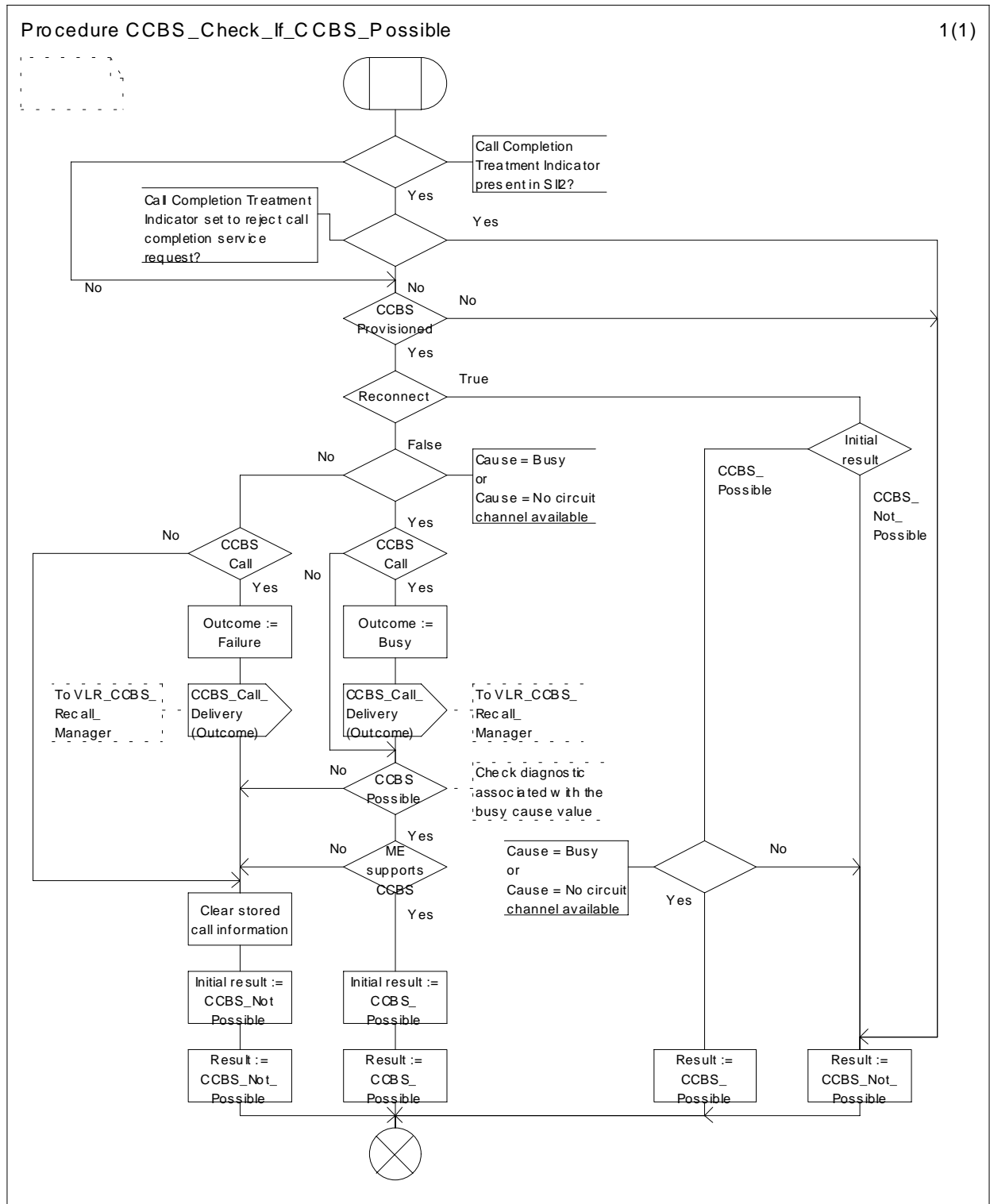

Figure 11.1.1.5: Procedure CCBS_Check_If_CCBS_Possible

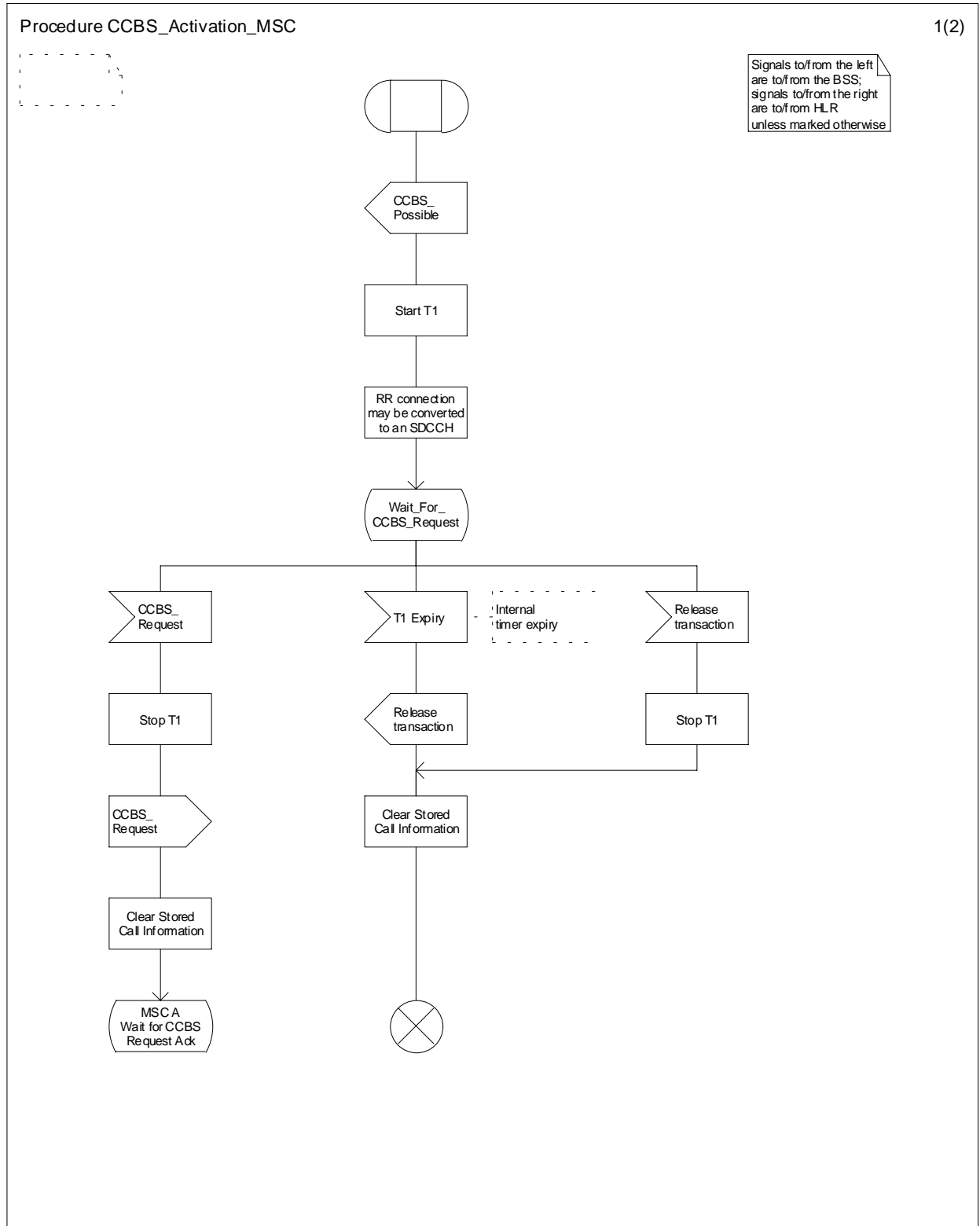

Figure 11.1.1.6: Procedure CCBS_Activation_MSC (sheet 1 of 2)

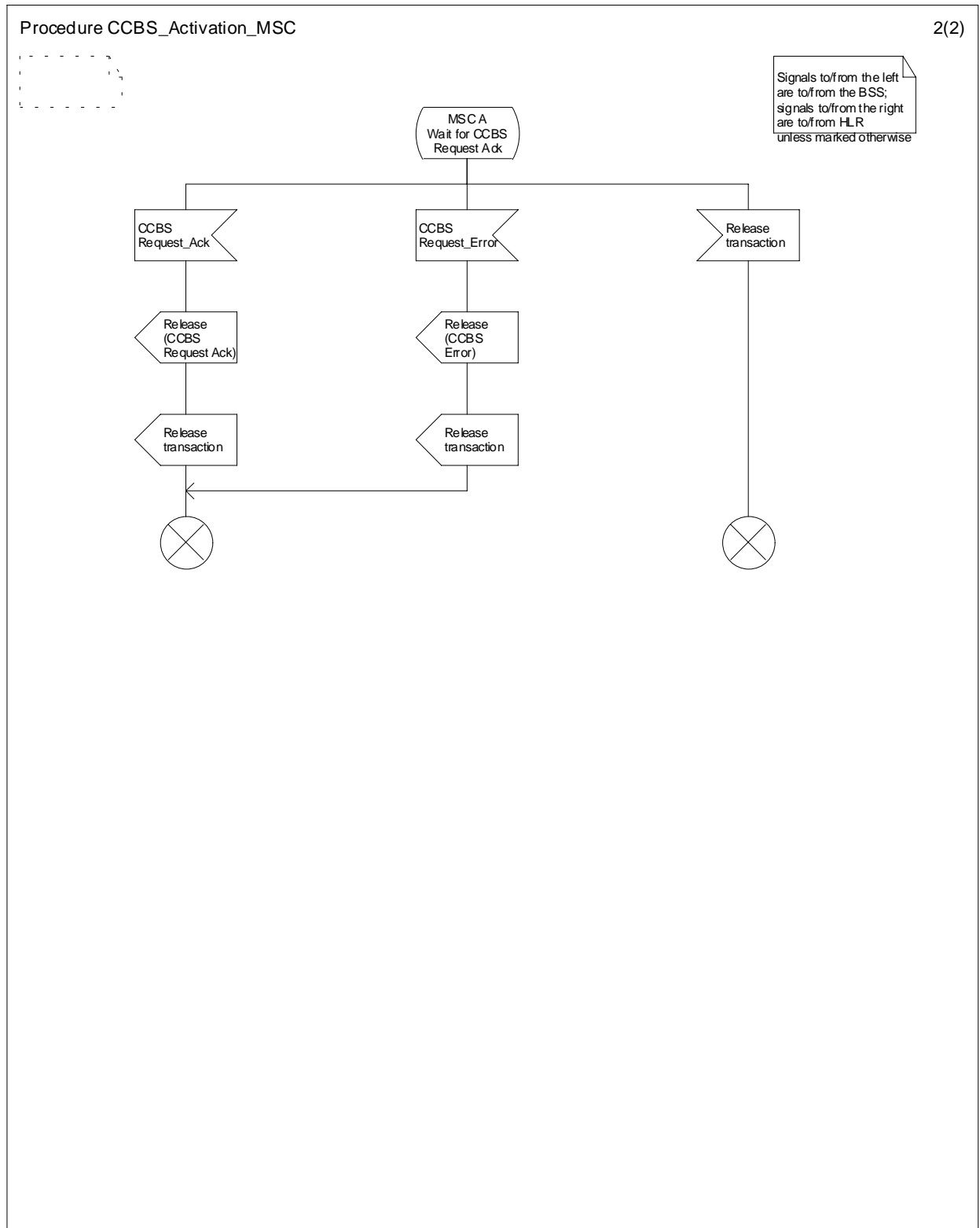

Figure 11.1.1.6: Procedure CCBS_Activation_MSC (sheet 2 of 2)

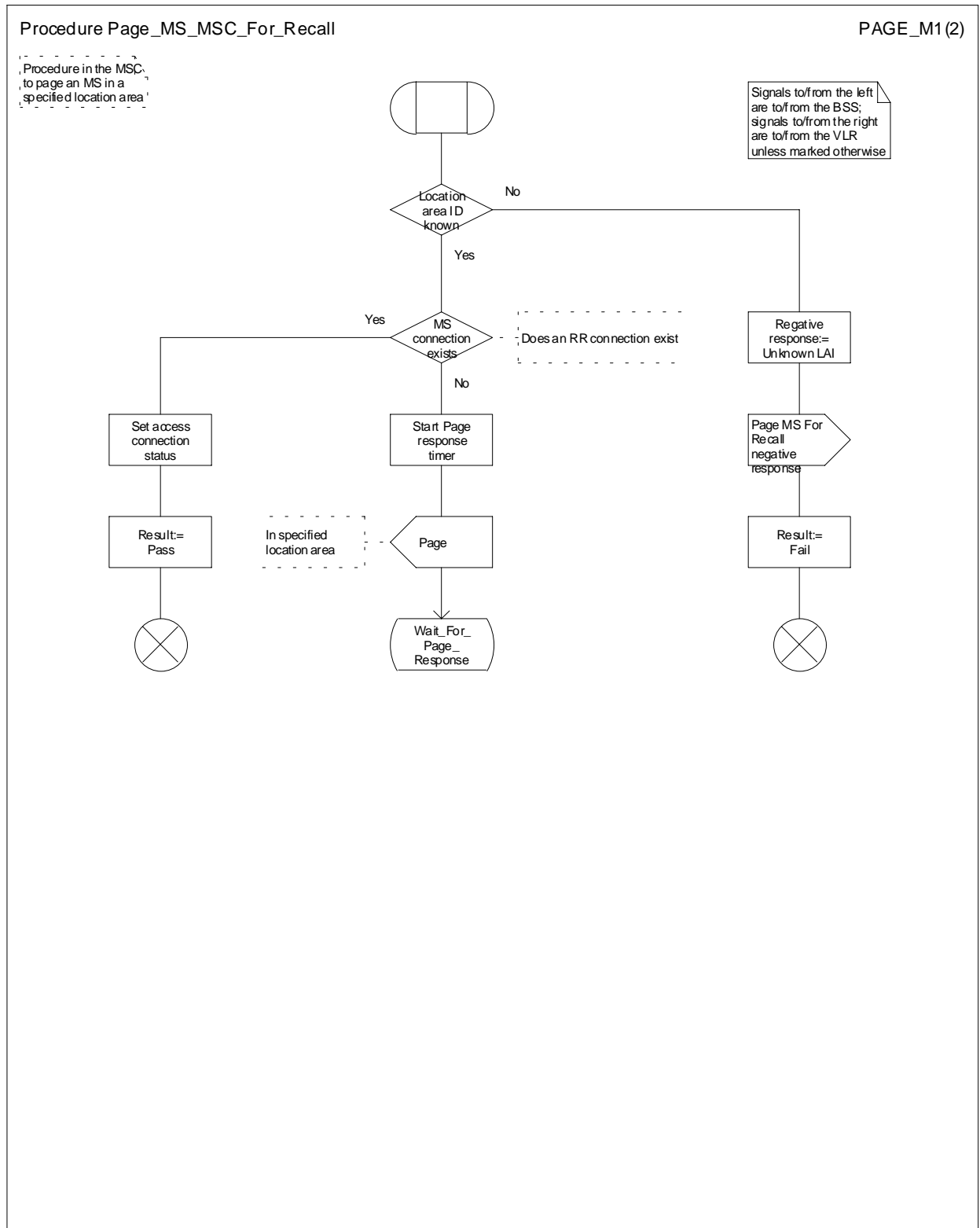

Figure 11.1.1.7: Procedure Page_MS_MSC_For_Recall (sheet 1 of 2)

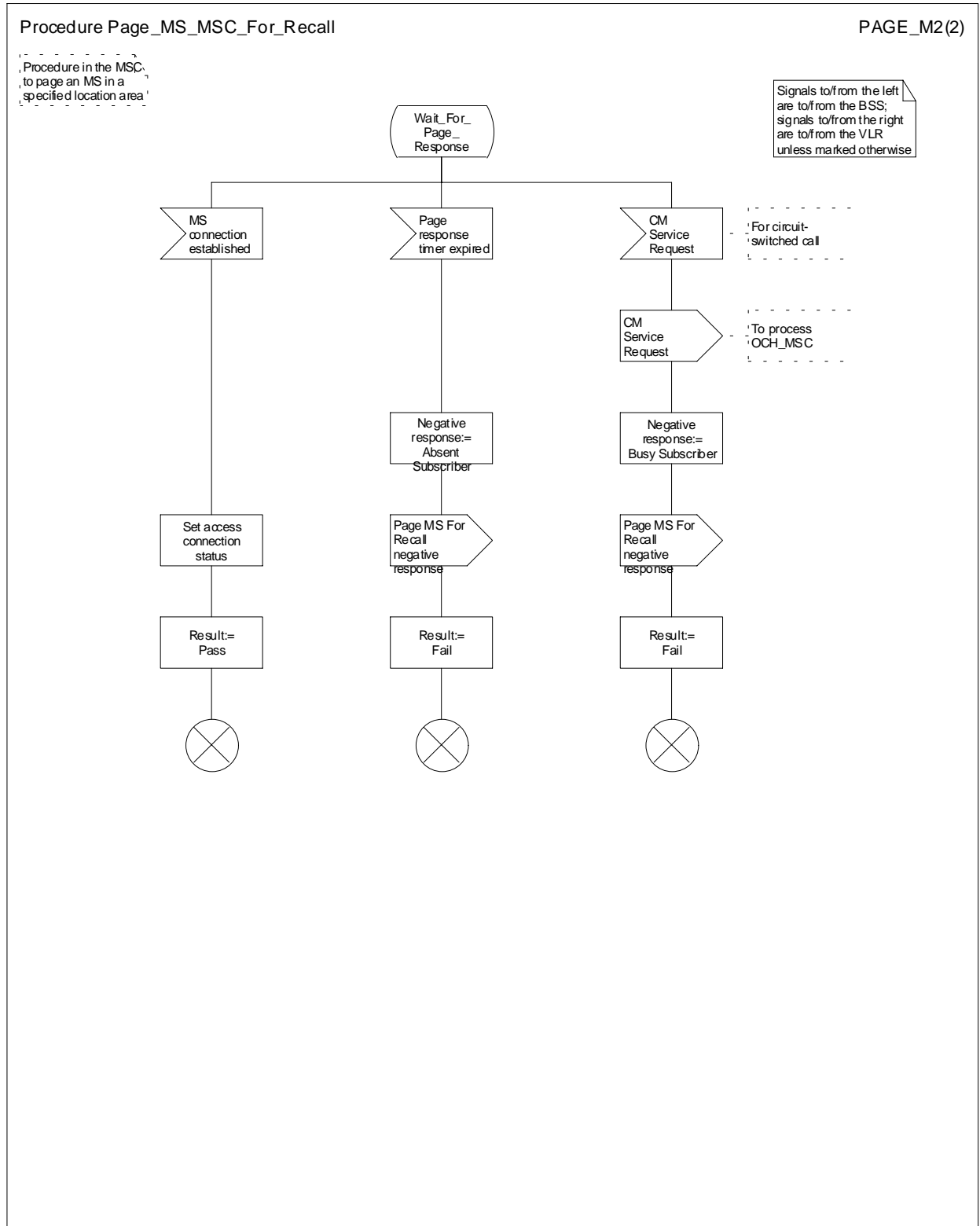

Figure 11.1.1.7: Procedure Page_MS_MSC_For_Recall (sheet 2 of 2)

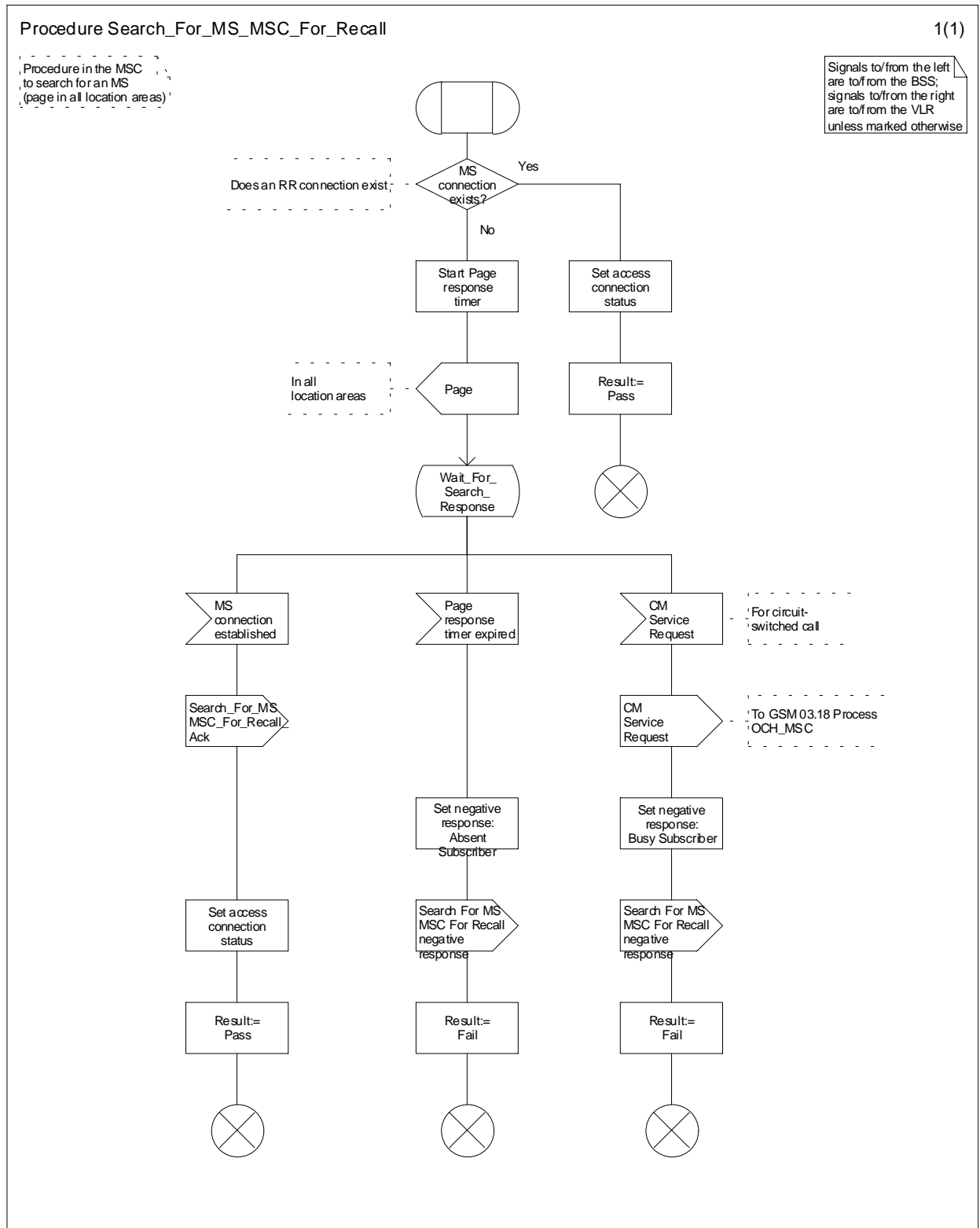

Figure 11.1.1.8: Procedure Search_For_MS_MSC_For_Recall

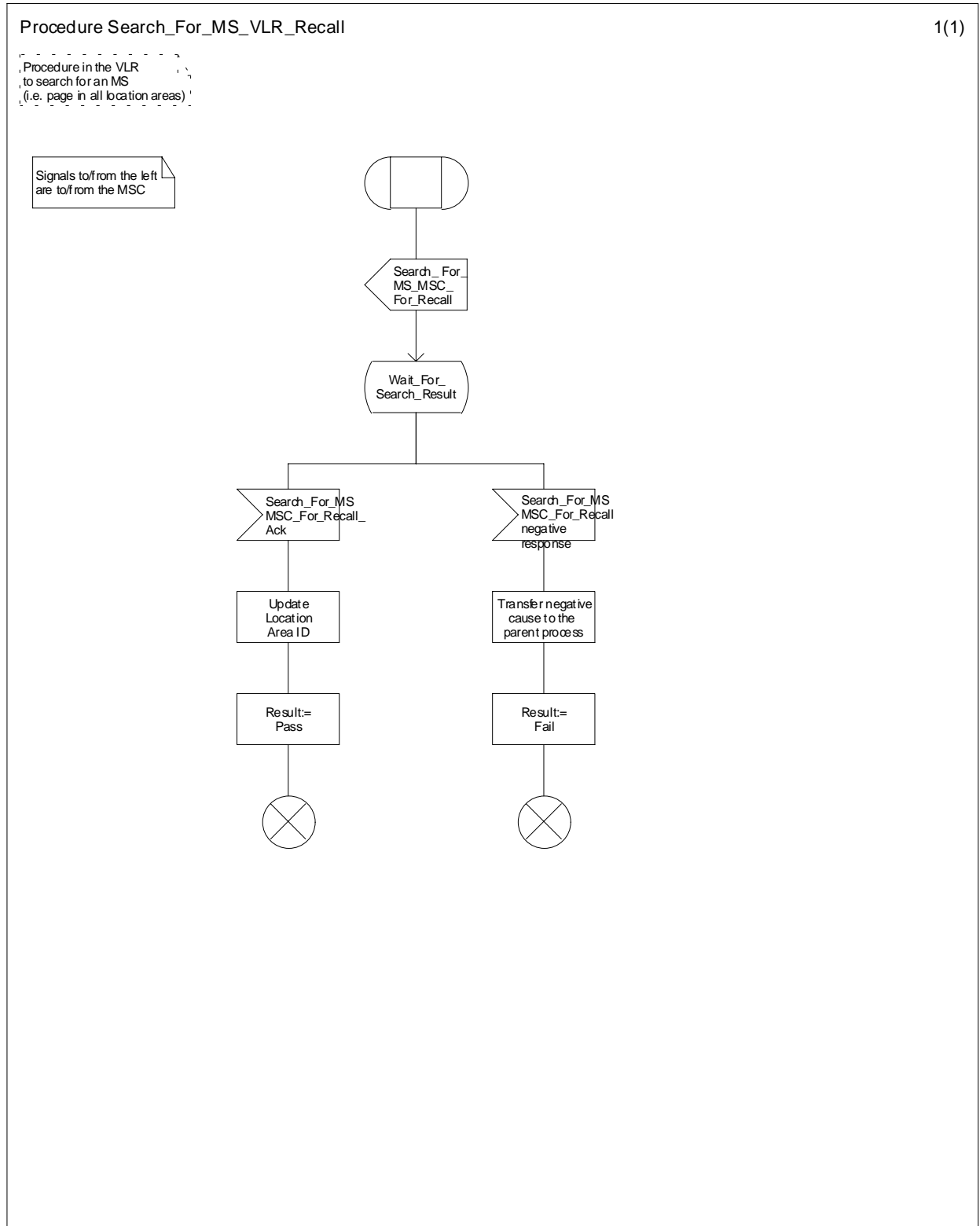

Figure 11.1.1.9: Procedure Search_For_MS_VLR_Recall

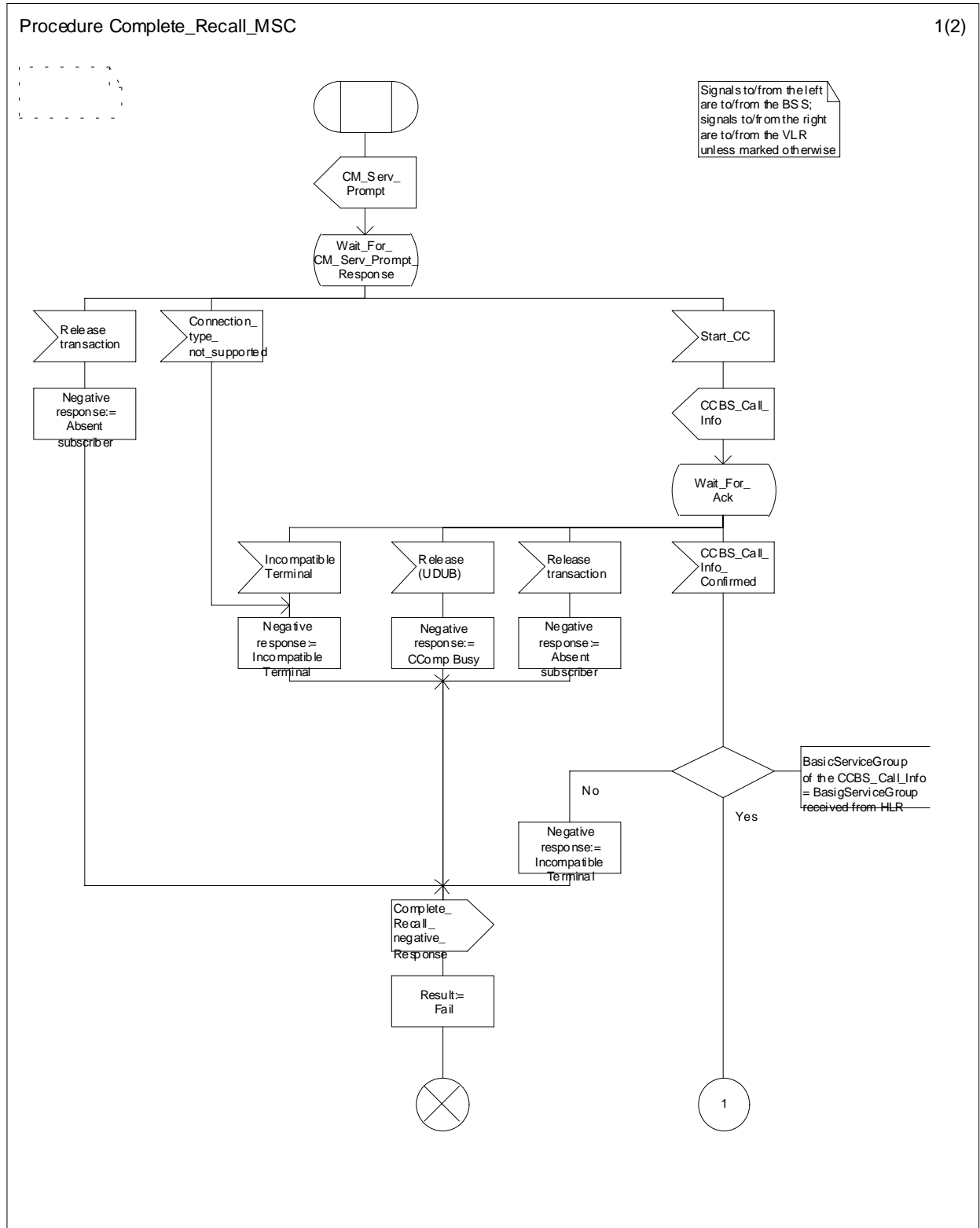

Figure 11.1.10: Procedure Complete_Recall_MSC (sheet 1 of 2)

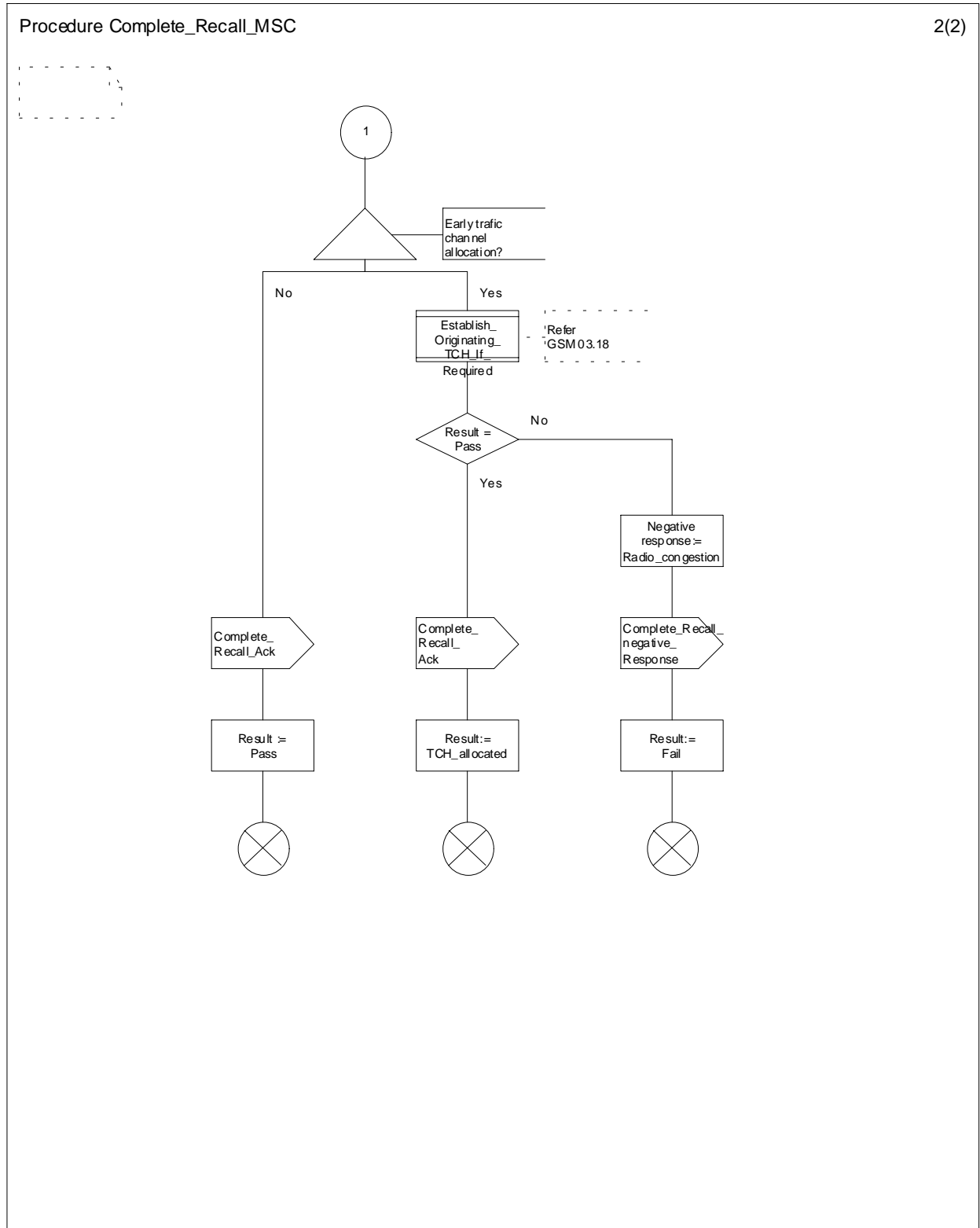

Figure 11.1.1.10: Procedure Complete_Recall_MSC (sheet 2 of 2)

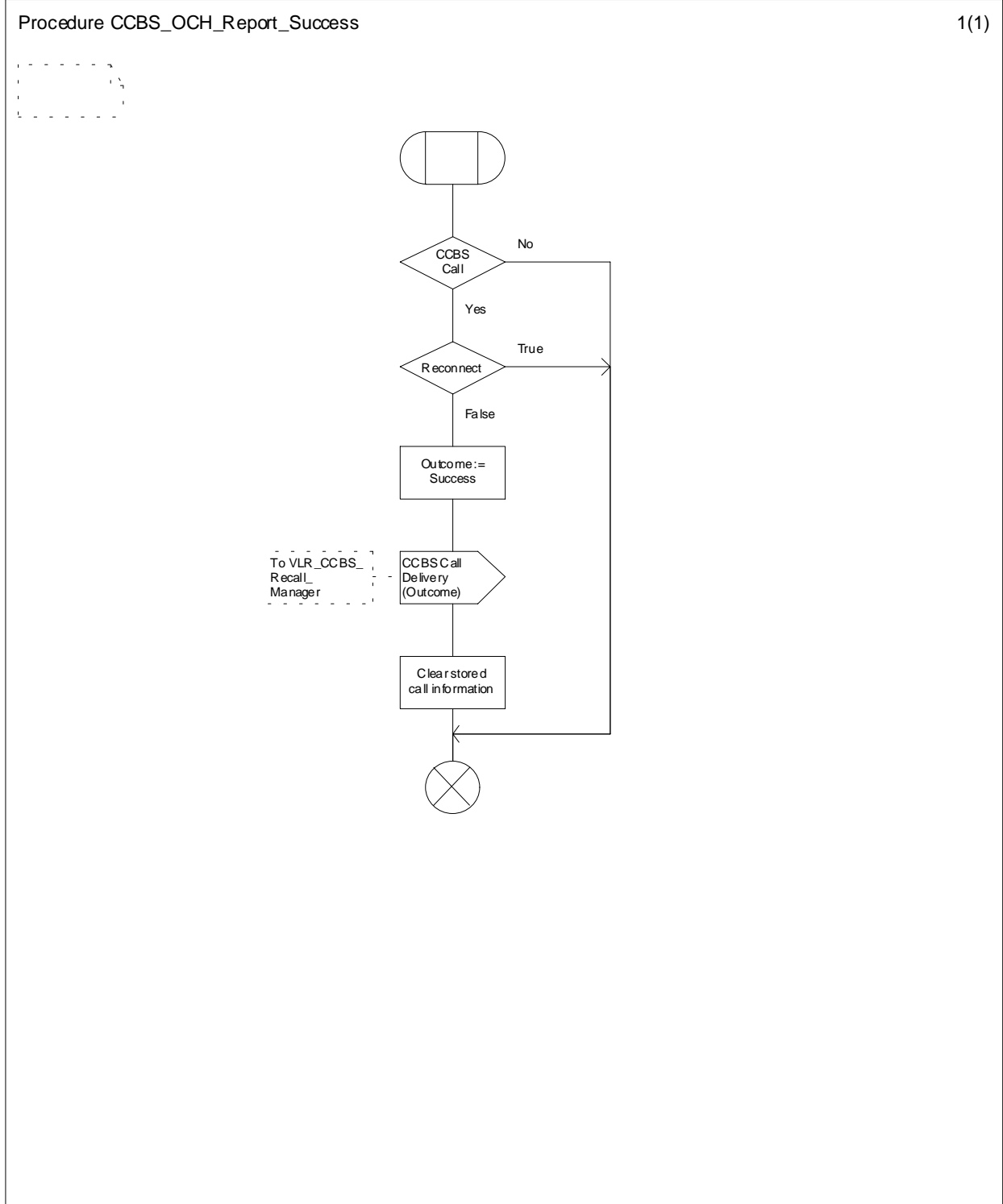

Figure 11.1.1.11: Procedure CCBS_OCH_Report_Success

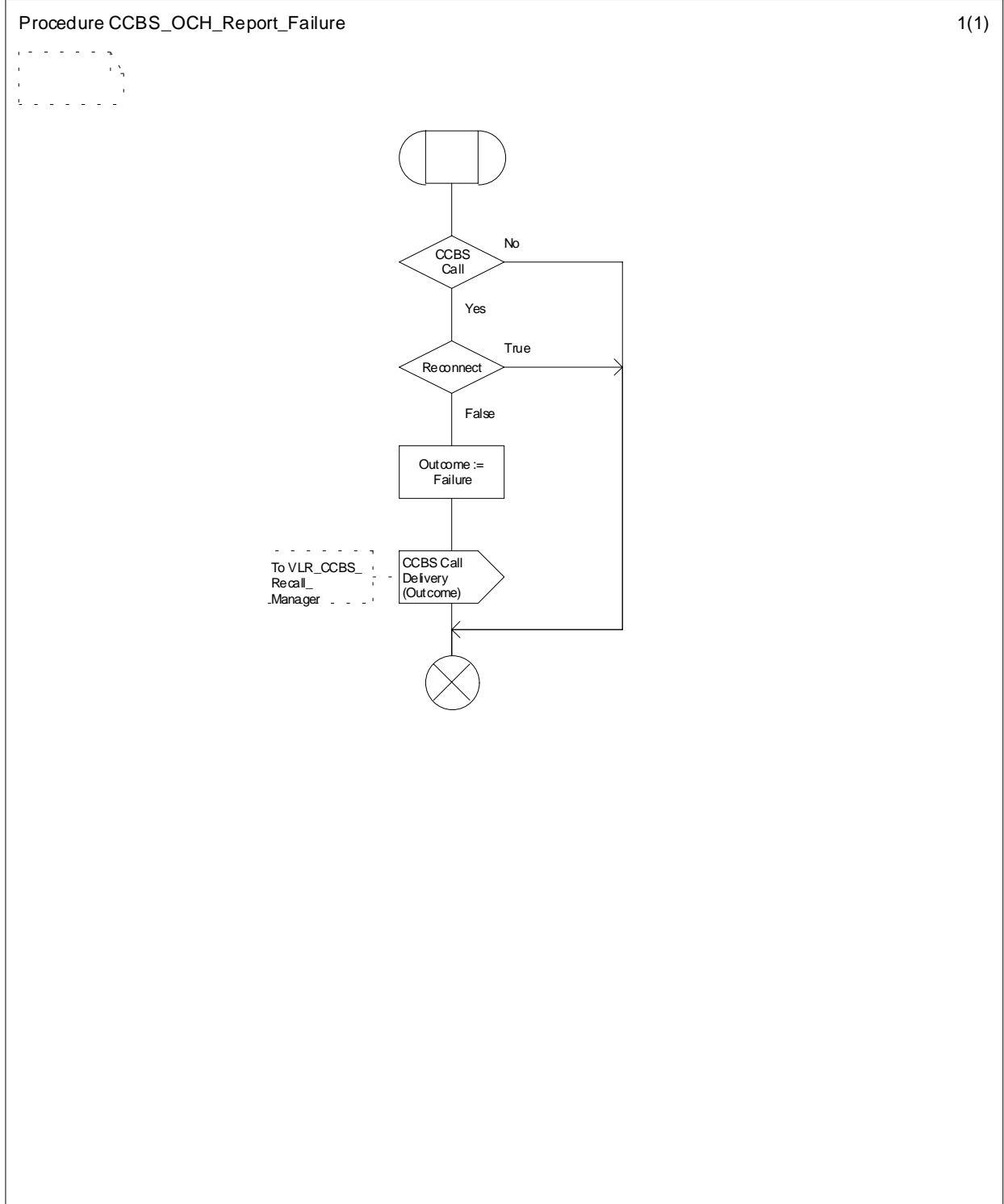

Figure 11.1.1.12: Procedure CCBS_OCH_Report_Failure

11.1.2 Processes and procedures in HLR

Figure 11.1.2.1: Block diagram of HLRA processes

Figure 11.1.2.2: Process HLRA_Request_Manager

This process is in charge of the user interface procedures and queue handling, i.e. whether the request to processed is present in the queue or not.

The process has three states, "Idle", "Operative" and "Operative Resuming". In the "Idle" state the queue is empty and the only actions to queue are creation of new request and interrogation of the queue. In other states activation, interrogation and deactivation procedures similarly, that is why they are grouped under "*" state.

Whenever the first request is created the process changes it's state to "Operative", in this state there are request(s) in the queue and none of them are suspended.

When HLRA_Request reports of suspension the process changes it's state to "Operative Resuming" and the HLRA_Resume is started with correct trigger signal i.e. idle indication from MSC or recall end is waited.

Only NET suspended request can be selected and resumed, USER type suspended requests remain as suspended until they are marked as NET suspended. This happens when idle indication is received from the MSC.

The resuming process is paused if there is new suspended request with cause code Not reach i.e. The resuming starts again when idle condition is met again or there is a new recall with successful outcome i.e. the recall ends without Not Reach indication.

The resuming process will be stopped, if there are no suspended requests in the queue any more. The process changes it's state to normal "Operative" or "Idle" state.

Figure 11.1.2.3: Process HLRA_Request

This process is created during the activation of service and contains all related data. The process has five different states, "Wait_For_Answer", "Active", "Recall", "Suspended" and "Frozen". During its creation the process sends CCBS_Request via SSAP interface to destination network B containing all call related data as well originating networks retention capabilities.

In the "Wait_For_Answer" state process receives response from destination network which is further relayed to the HLRA_Request_Manager. In case of positive acknowledgement destination network returns info whether the retention is supported in both networks.

In "Active" state process waits recall from destination network, however process can vanish if operation timer T3 expires or explicit deletion is received from the user or destination network. In case of deletion the process informs the queue. When the recall arrives the process transits to the "Recall" state.

In the "Recall" state process waits the recall outcome, either positive or negative. Depending of the recall outcome the request can be deleted, retained or suspended. If the request is to be retained the process transits back to the "Active" state. If the request is suspended due to the T10 expiry, CCBS_Busy condition or the MS is not reachable the process transits to the suspended state.

If the request is deleted during "Recall" due SSAP_Cancel, T3 expiry or explicit deletion the queue is updated immediately and the request changes it's state to "Recall Deleted" where it waits the recall to end.

In the "Suspended" state actions the request can be resumed if the MS is known to be CCBS_Idle or the request can be deleted due to the explicit deletion or timer T3 expiry.

The request is placed in "Frozen" state whenever it receives Remote User Free indication from the destination network and the request can't be fulfilled due service interaction or lack of support in MSCVLR. The request shall indicate suspended back to the destination network and stay in the queue. If the service becomes later possible, the request will revert back "Active" state and indicate resumed to the destination network.

Whenever the state of the process is changed, the new state is stored and the procedure CCBS_Notify_SS_Invocation is called.

Figure 11.1.2.4: Process HLRA_Recall_Manager

This process has two different states, "Idle" and "CCBS_Busy".

The process let's only one individual process to be in recall state in a time and have a dialogue open to the MSC and it changes it's state to "CCBS_Busy". In this state other requests are suspended immediately and marked as NET suspended with cause code = Busy.

In "CCBS_Busy" state the process waits recall reporting from the MSC. Possible inputs from the MSC are CCBS_RUF_Ack, CCBS_RUF_Error and CCBS_Call_Report. CCBS_Call_Report can be received if the subscriber has accepted the recall, otherwise the process changes it's state back to "Idle". If the process receives Query_State request from the HLRA_Resume during the recall the process informs the resume process whether a recall is being processed.

Figure 11.1.2.5: Process HLRA_Resume

The process has four different states, "Idle", "Resume pending", "Wait For Selection" and "Resuming". The process is started when a request is suspended. For the first suspended request it is also set the trigger point i.e. when it is correct to send out selection request for resuming. Two triggers are provided, A_Idle from the monitoring process and Recall_End from the recall handling. If the trigger is set to A_Idle the monitoring process is also started.

When the process is started and correct trigger is set the process waits in the "Resume pending" state to receive a permission to start resuming. When the permission is received the process asks for the first NET request to resumed. If A_Idle signal is received from the monitoring process the resuming process asks the queue manager to set all suspended requests as NET type in order to allow the selection.

When there are no active suspended request in the queue any more the resuming process is stopped i.e. when the "Deleted" signal in the HLRA_Request_Manager is handled.

Figure 11.1.2.6: Process HLRA_Monitoring

Monitoring process has two different states, "Idle" and "Monitoring". Reception of "A_Query" signal transits the process to "Monitoring" state. In this state the process reports "Idle" condition to the resuming process and starts the monitoring again in the MSC if location update or restore data happens.

Figure 11.1.2.7: Procedure HLRA_CCBS_Check_Interactions

This procedure checks whether the Remote User Free indication can be delivered to the MSCVLR or not.

Figure 11.1.2.8: Procedure CCBS_Notify_SS_Invocation

This procedure is called by the process HLRA_Request whenever there is a change of state. The procedure informs the gsmSCF of the state change if the SS-CSI applicable to CCBS is stored in the HLR.

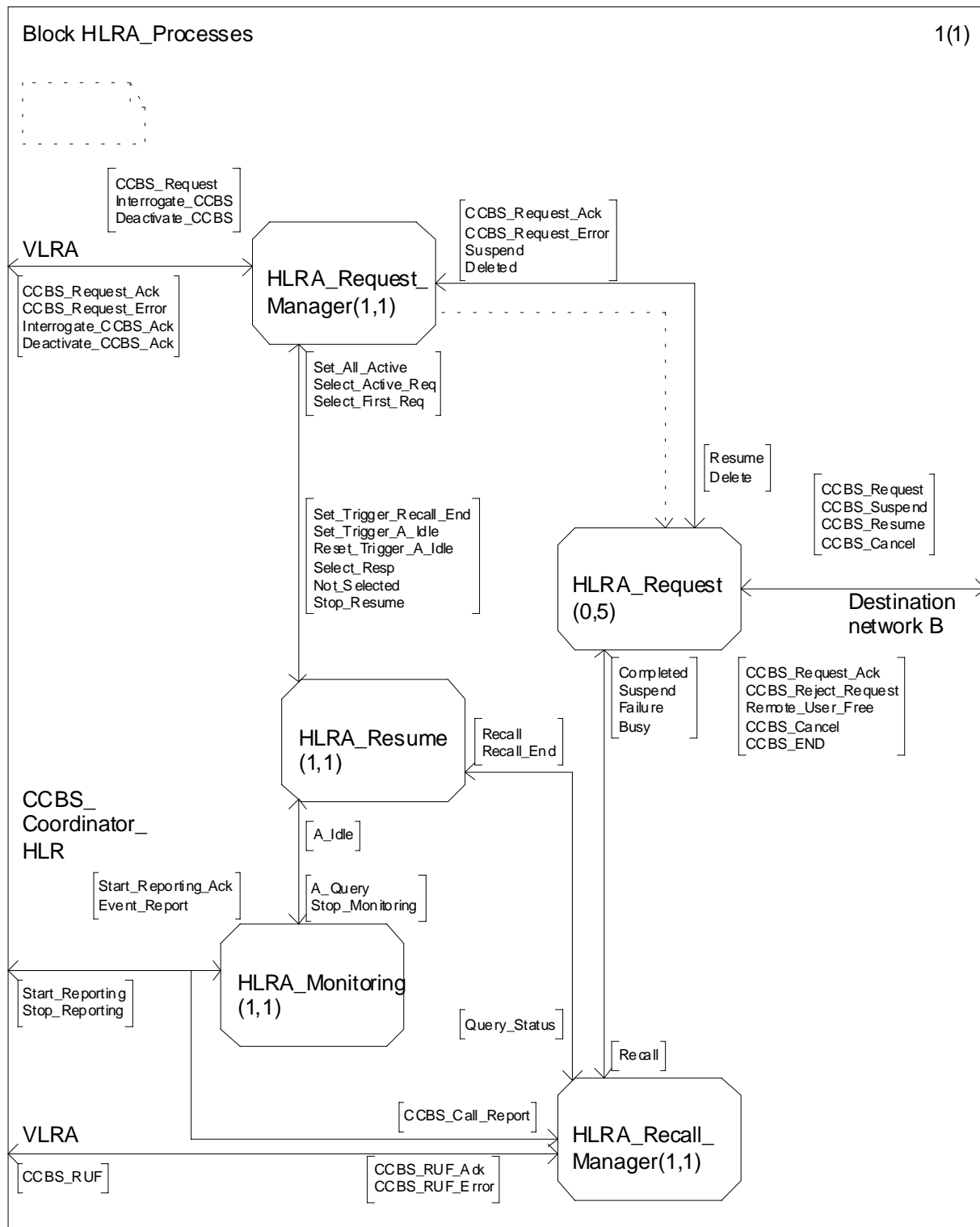

Figure 11.1.2.1: HLRA Processes

NOTE: Figure 11.1.2.1 is one possible method of implementing queue processing in HLR A. Manufacturers are not constrained to follow the implementation given in figure 11.1.2.1. However, the external behaviour of HLR A shall appear to be the same.

Description of above signals:**Relation HLRA_Request_Manager and HLRA_Request**

CCBS_Request_Ack signal is acknowledgement of a successful activation from the individual request to the queue manager.

CCBS_Request_Error signal is sent if the destination networks queue is full or the destination networks queue size is set to zero. The individual request is deleted from the originating side.

Suspend is used within HLRA_Request and HLRA_Request_Manager. The queue shall update it's internal information.

Delete is used within HLRA_Request_Manager and HLRA_Request. The queue manager instructs the individual request the request to die.

Deleted is used within HLRA_Request_Manager and HLRA_Request. The individual request informs the queue of its expiry.

Resume is used within HLRA_Request_Manager and HLRA_Request. The individual request is resumed and it shall inform the destination network of the resumption.

Relation HLRA_Request_Manager and HLRA_Resume

Set_Trigger_Recall_End is used within the HLRA_Request_Manager and HLRA_Resume. If resuming is not ongoing this signal set the resuming process to the "ResumePending" state and query is sent to the recall process.

Set_Trigger_A_Idle is used within the HLRA_request_manager and HLRA_resume. If resuming is not ongoing this signal set the resuming process to the "ResumePending" state. In all cases this causes "A_Query" signal to be sent.

Reset_Trigger_A_Idle is used within the HLRA_request_manager and HLRA_resume. This signal sets the resuming process to the "ResumePending" state and causes "A_Query" signal to be sent.

Select_Resp is used within the HLRA_request_manager and HLRA_resume. This signal informs the resuming process to start T11.

Not_Selected is used within the HLRA_request_manager and HLRA_resume. This signal informs the resuming process that the selection was not done and the process will transit to "ResumePending" state.

Stop_Resume is used within the HLRA_request_manager and HLRA_resume. This signal informs the resuming process to stop it's actions and stop the monitoring also.

Set_All_Active is used within the HLRA_Resume and HLRA_request_manager. This signal informs the queue to set all suspended requests as NET suspended and later on they can be resumed.

Select_Active_Req is used within the HLRA_Resume and HLRA_request_manager. This signal informs the queue to select first NET suspended request to be resumed. If successful the request process will return "Select_Resp", otherwise "Not_Selected".

Select_First_Req is used within the HLRA_Resume and HLRA_request_manager. This signal informs the queue to select first suspended request to be resumed. If successful the request process will return "Select_Resp", otherwise "Not_Selected".

Relation HLRA_Recall_Manager and HLRA_Request

Recall is used within HLRA_Request and HLRA_Recall_Manager. It contains all call related data in order to form the CCBS_Call.

Completed is used within the HLRA_Recall_Manager and HLRA_Request. It informs the request of successful CCBS_Call and causes the request to vanish.

Failure is used within the HLRA_Recall_Manager and HLRA_Request. It informs the request of unsuccessful CCBS_Call and causes the request to vanish.

Busy is used within the HLRA_Recall_Manager and HLRA_Request. It informs the request of unsuccessful CCBS_Call and causes the request to vanish if retention is not supported.

Suspend is used within HLRA_Recall_Manager and HLRA_Request. The request shall change it's state and report the suspension to the queue manager.

Relation HLRA_Monitoring and HLRA_Resume

A_Query is used within HLRA_Resume and HLRA_Monitoring. It instruct the HLRA_Monitoring to start it's actions and return the idle condition when possible.

A_Idle is used within HLRA_Monitoring and HLRA_Resume. It informs the resuming process that the subscriber is now CCBS_Idle and not CCBS_Busy.

Stop_Monitoring is used with HLRA_Resume and HLRA_Monitoring. It instructs the monitoring process to stop it's actions and stop the monitoring from VLR also.

Location_Update/Restore_Data events are tracked and external reporting is started again.

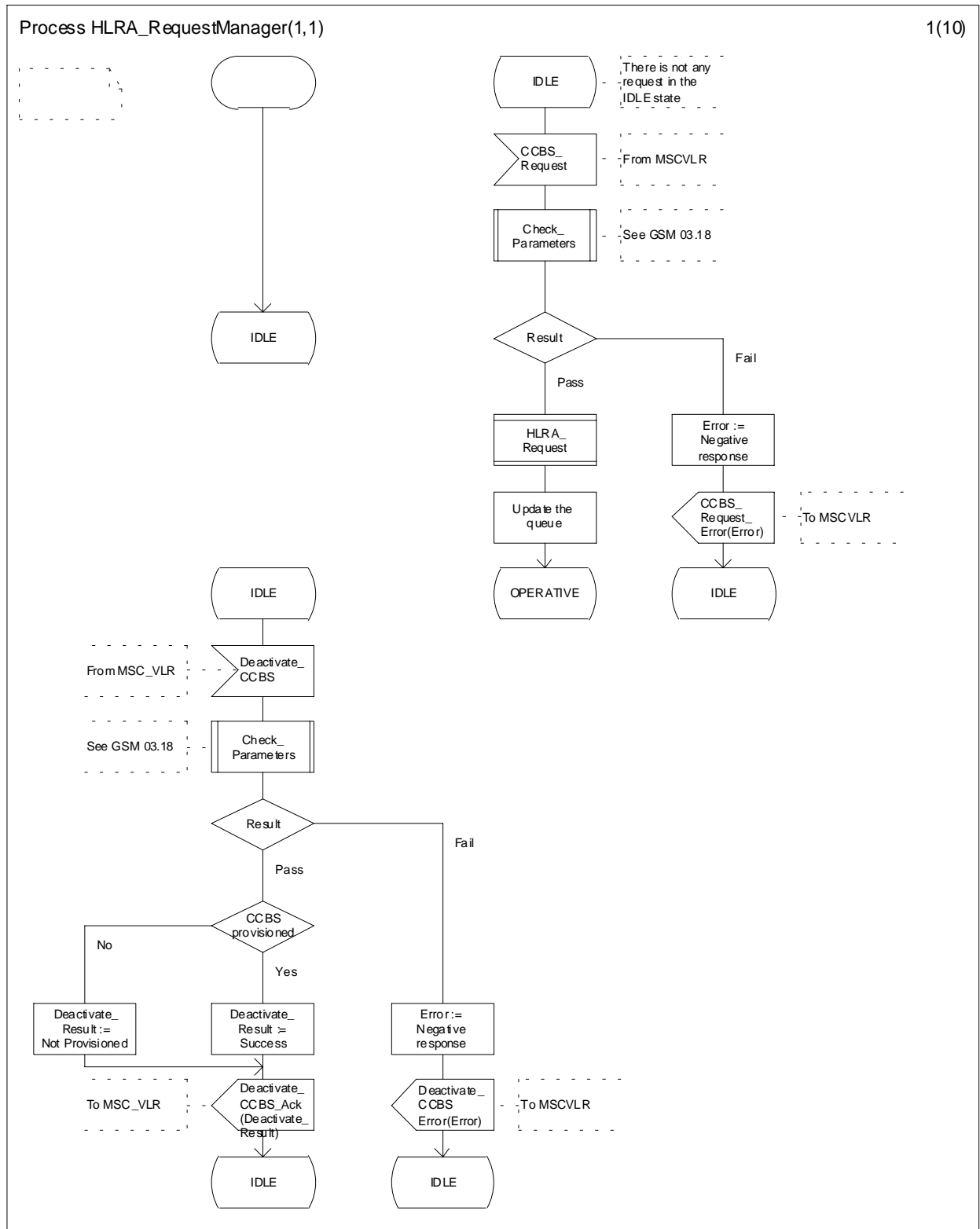

Figure 11.1.2.2: Process HLRA_Request_Manager (sheet 1 of 10)

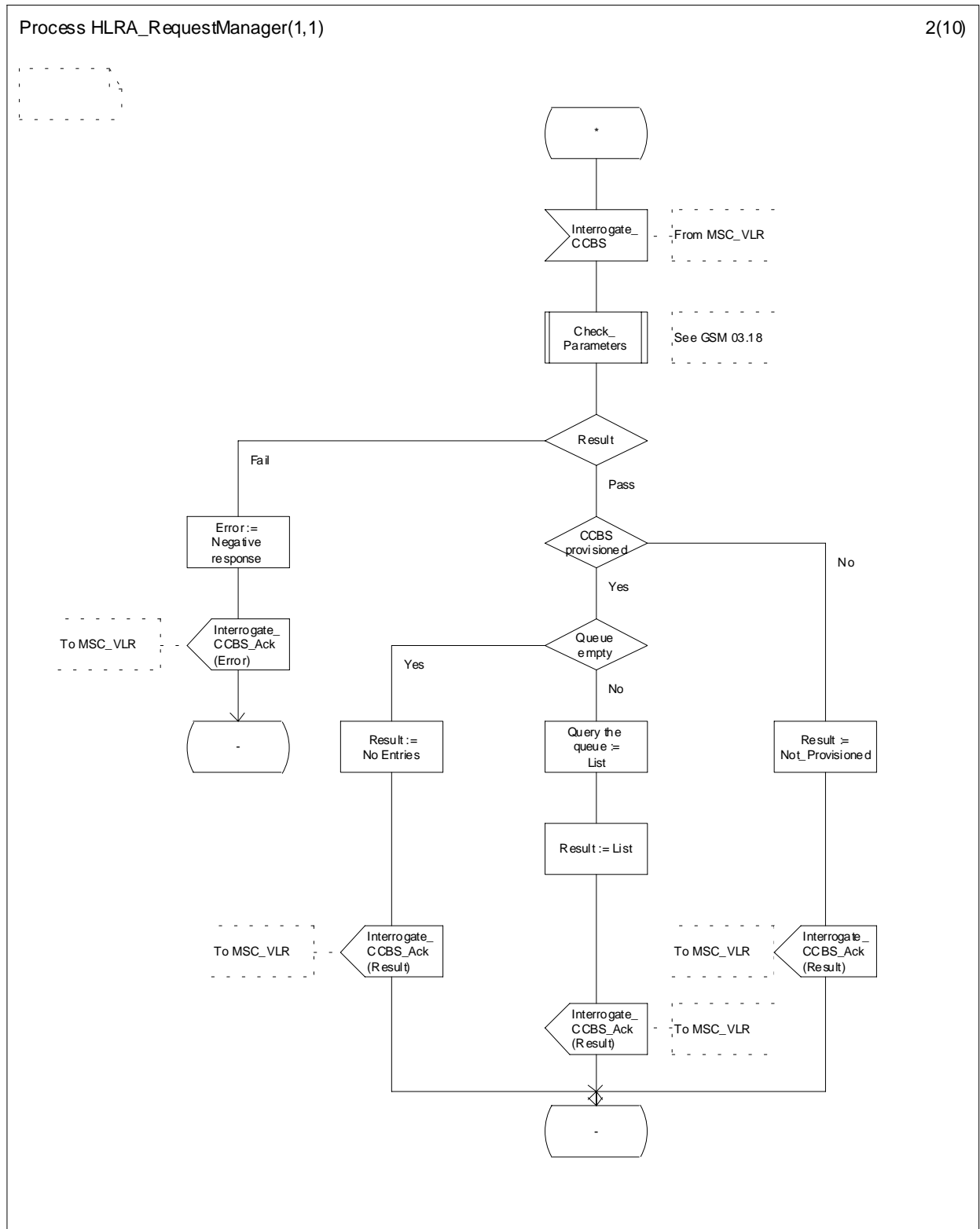

Figure 11.1.2.2: Process HLRA_Request_Manager (sheet 2 of 10)

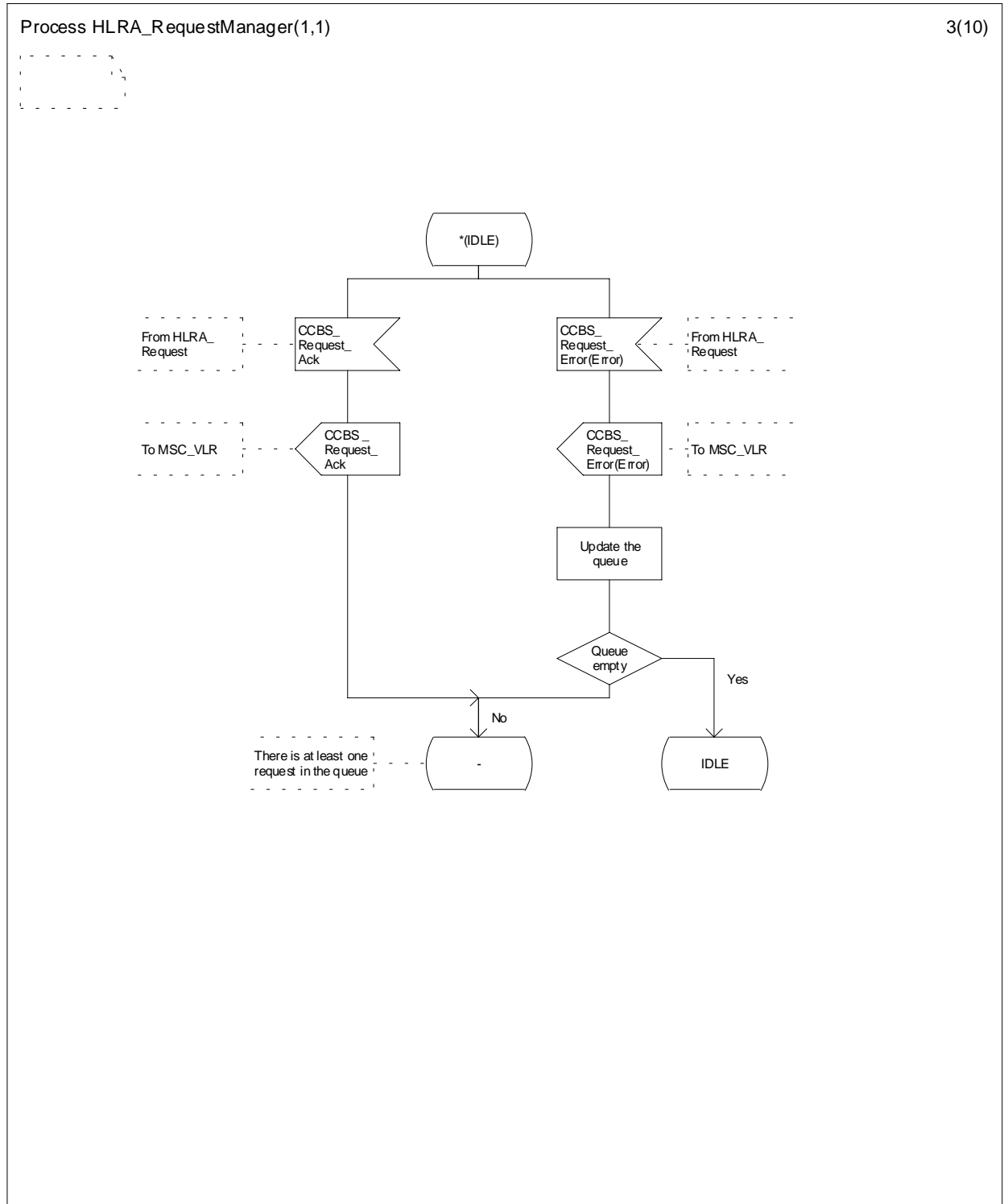

Figure 11.1.2.2: Process HLRA_Request_Manager (sheet 3 of 10)

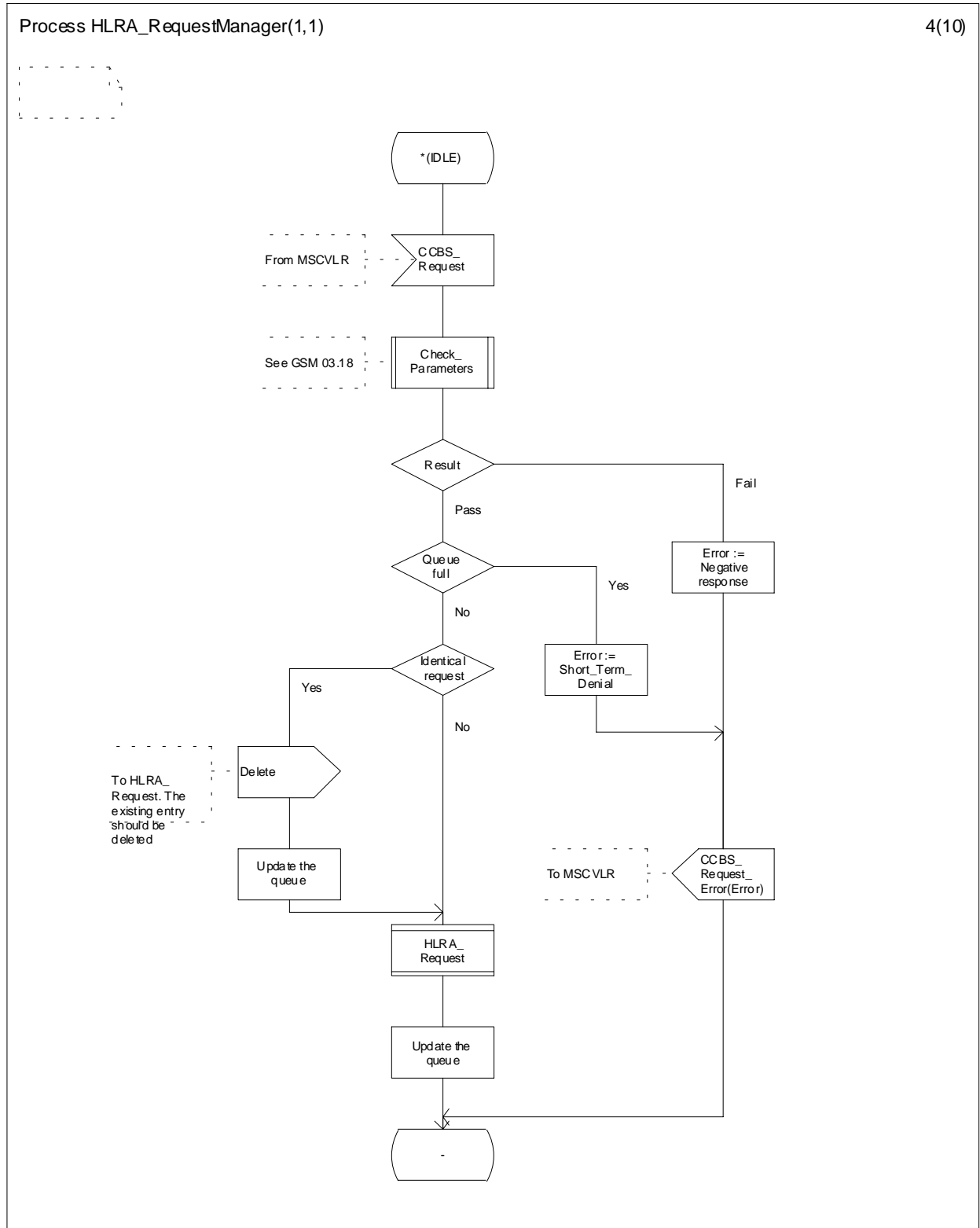

Figure 11.1.2.2: Process HLRA_Request_Manager (sheet 4 of 10)

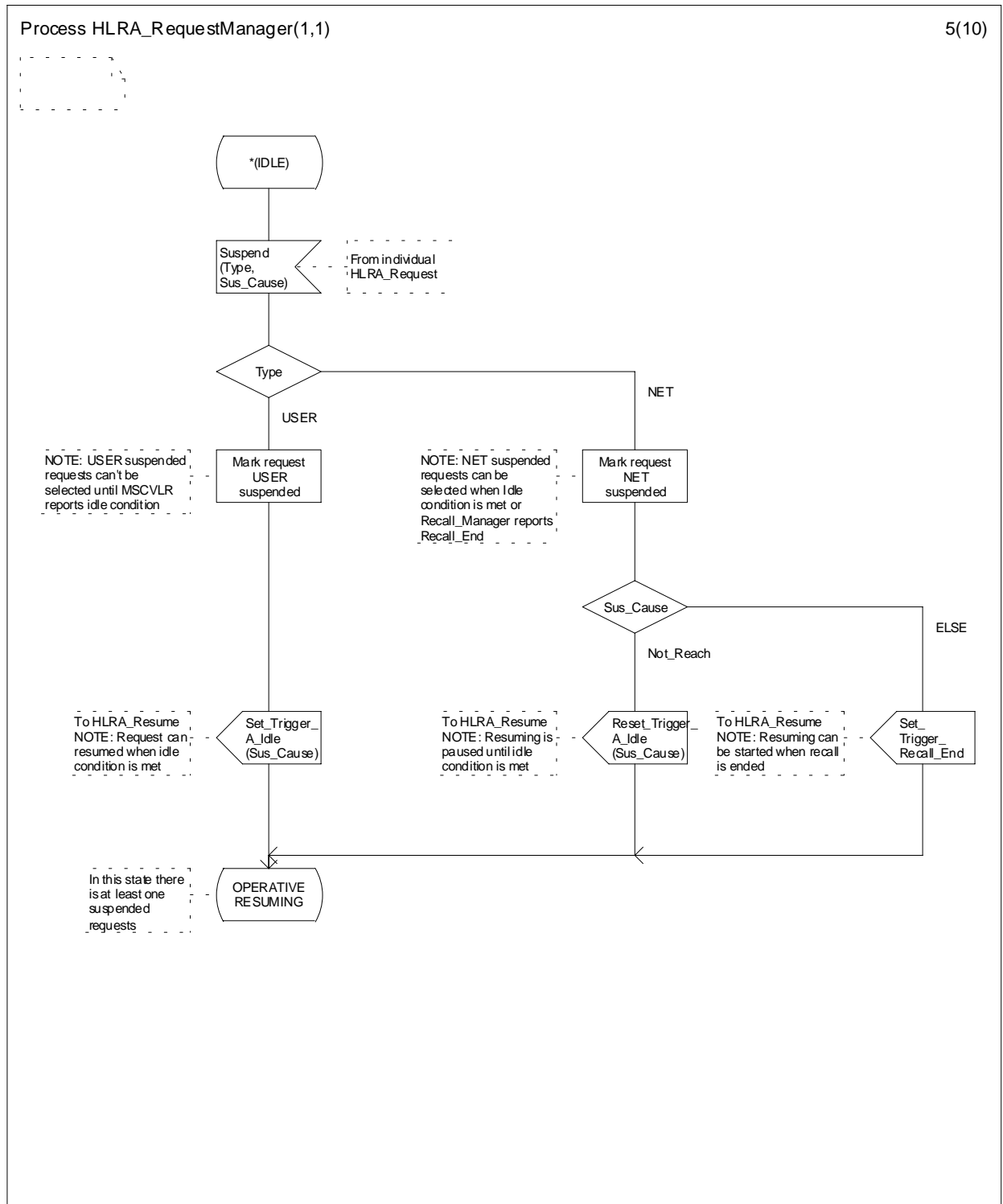

Figure 11.1.2.2: Process HLRA_Request_Manager (sheet 5 of 10)

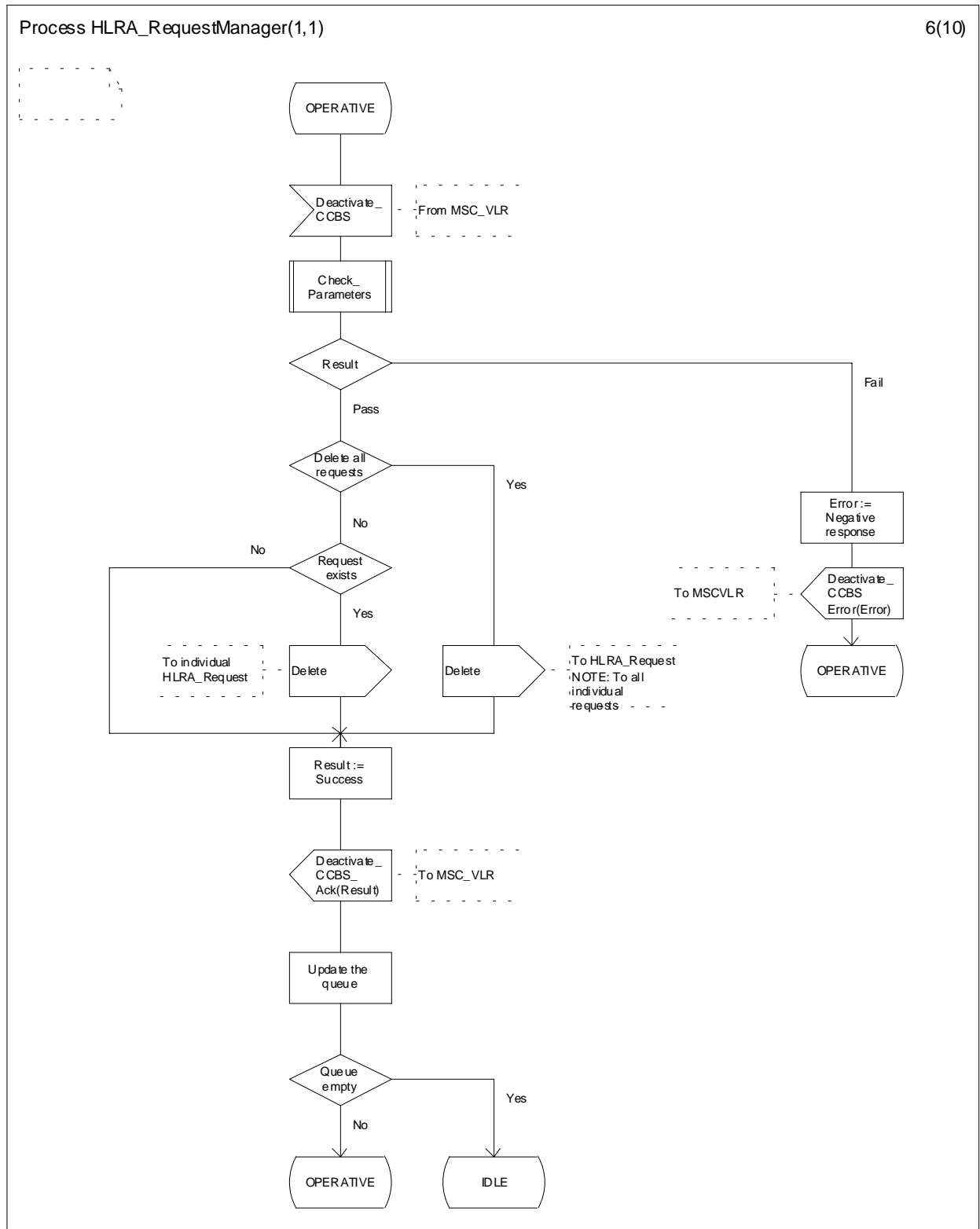

Figure 11.1.2.2: Process HLRA_Request_Manager (sheet 6 of 10)

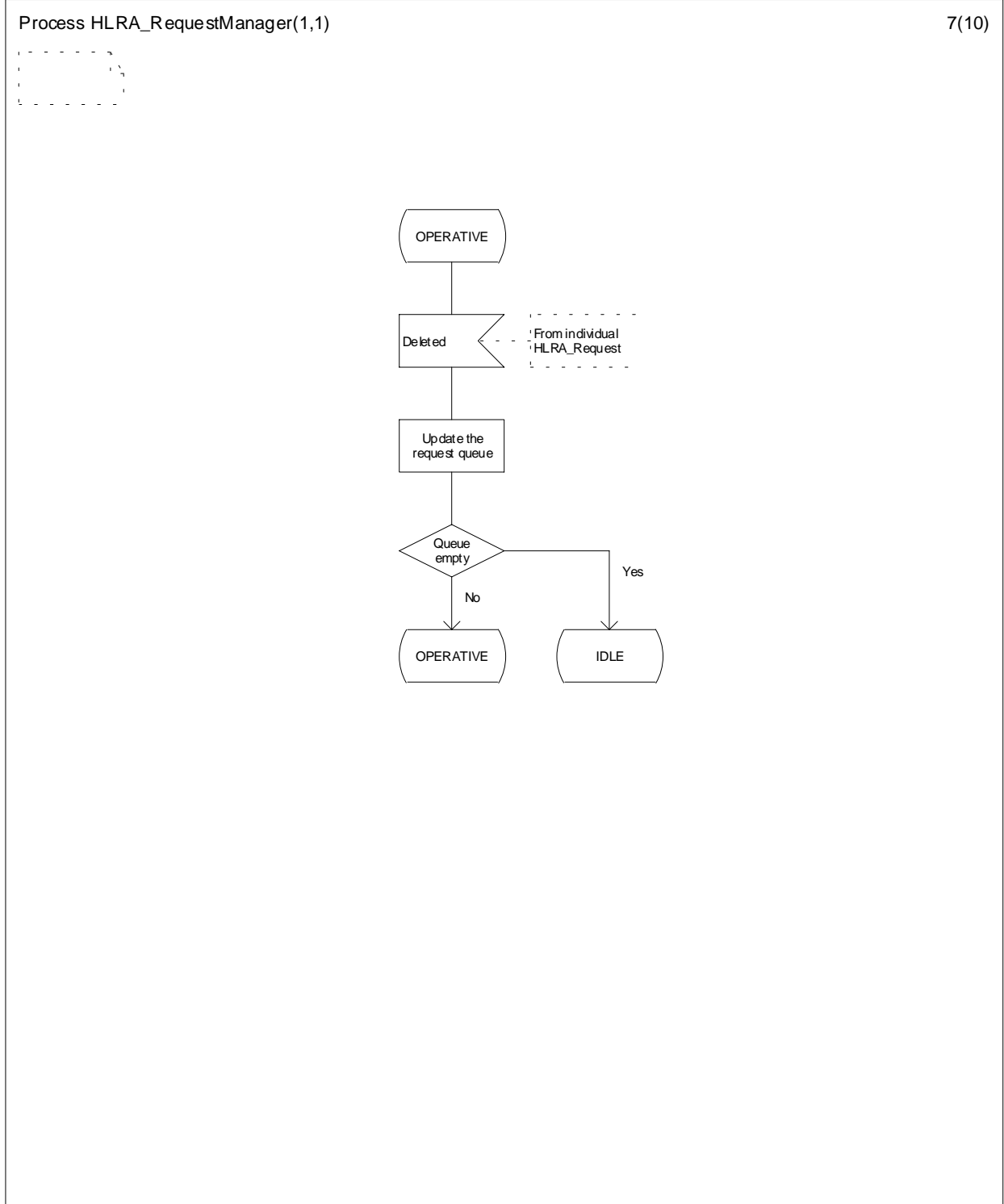

Figure 11.1.2.2: Process HLRA_Request_Manager (sheet 7 of 10)

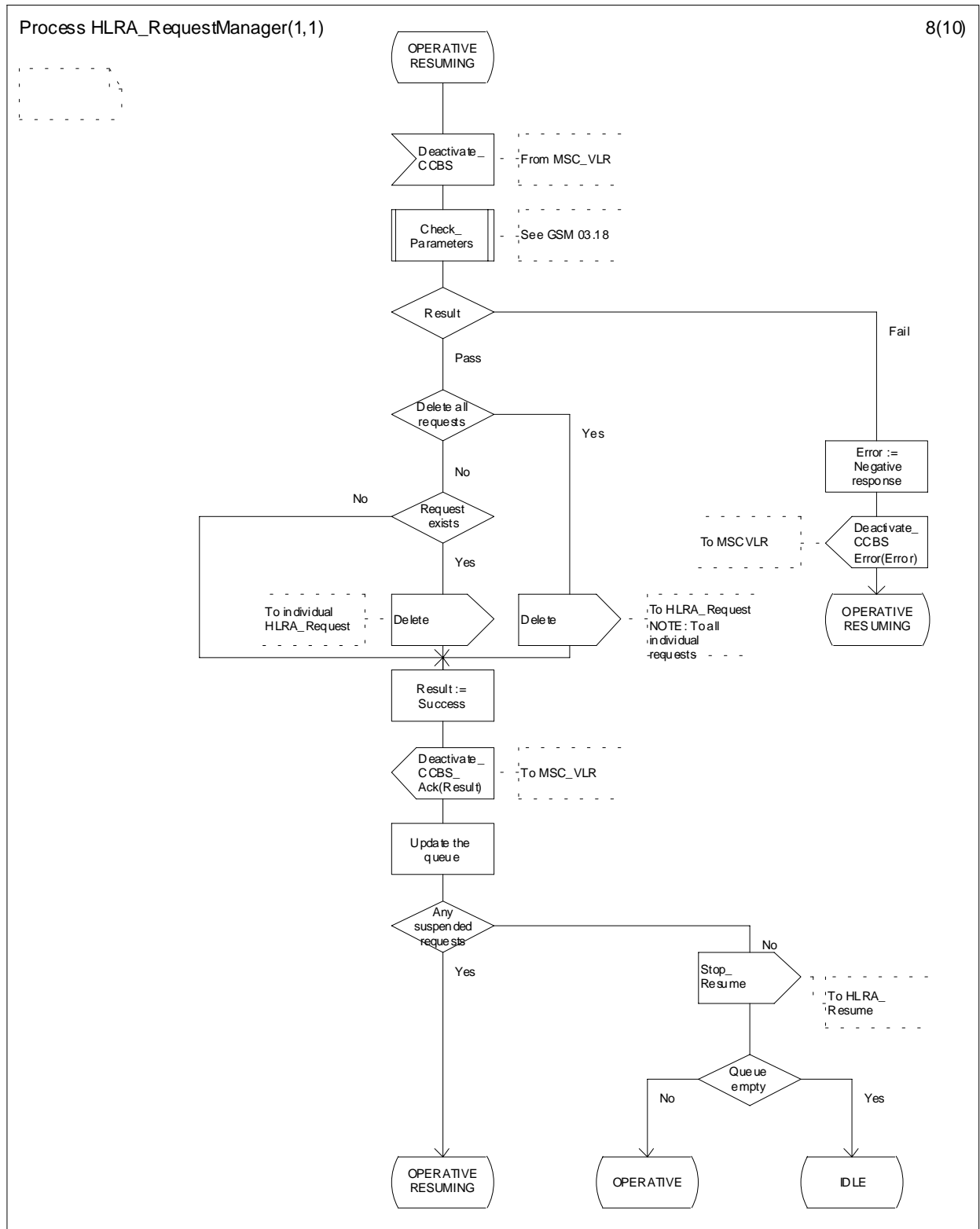

Figure 11.1.2.2: Process HLRA_Request_Manager (sheet 8 of 10)

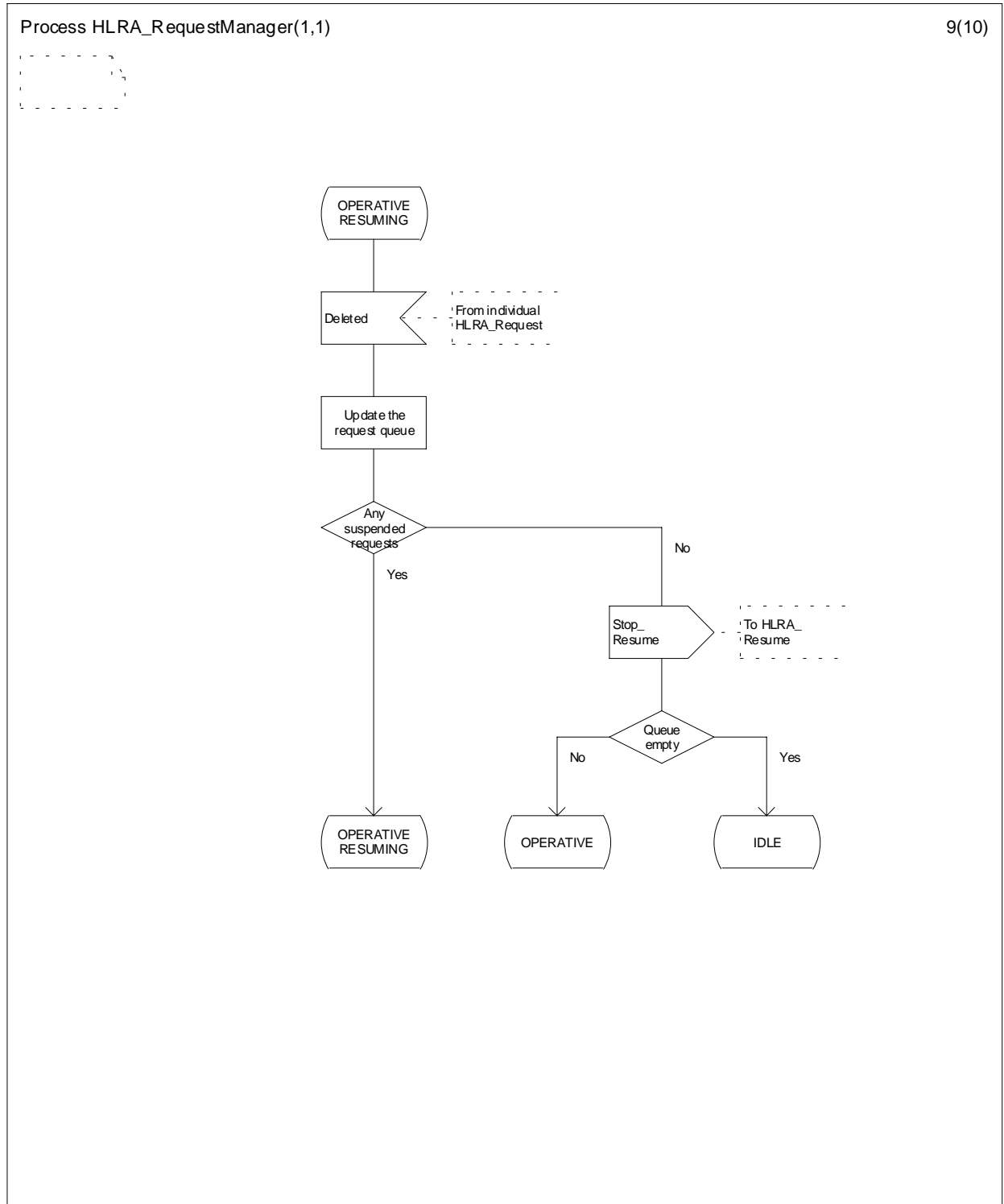

Figure 11.1.2.2: Process HLRA_Request_Manager (sheet 9 of 10)

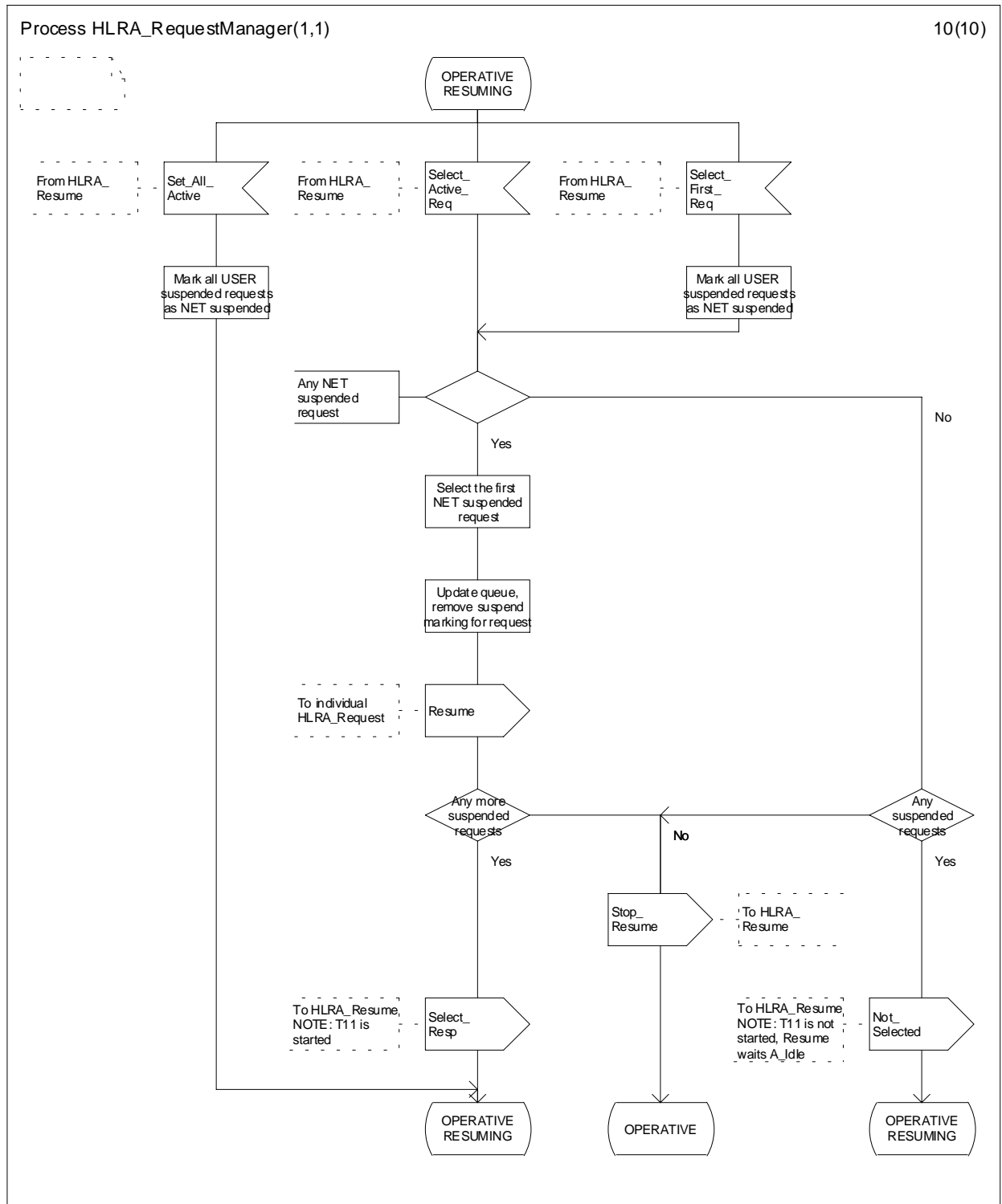

Figure 11.1.2.2: Process HLRA_Request_Manager (sheet 10 of 10)

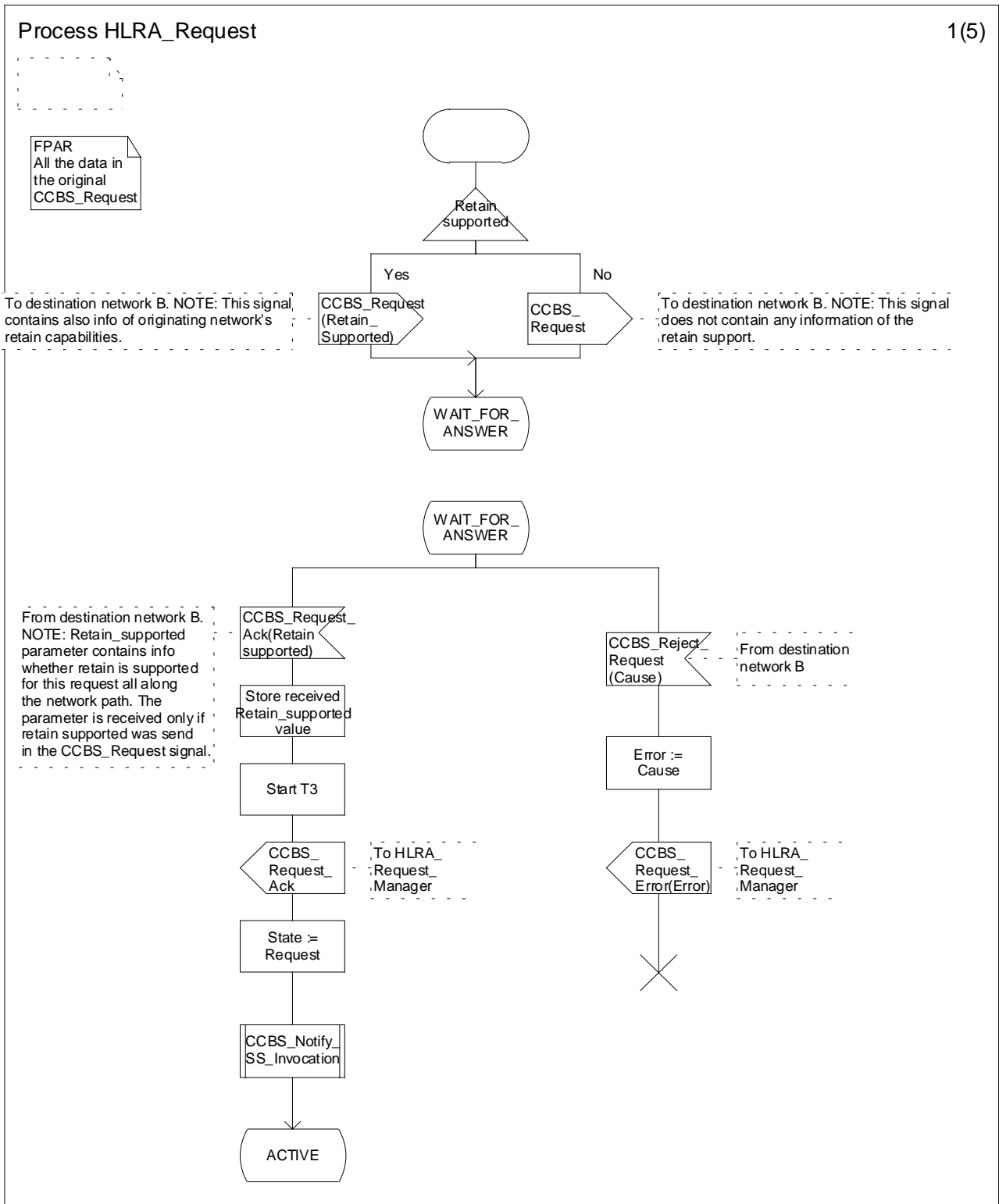

Figure 11.1.2.3: Process HLRA_Request (sheet 1 of 5)

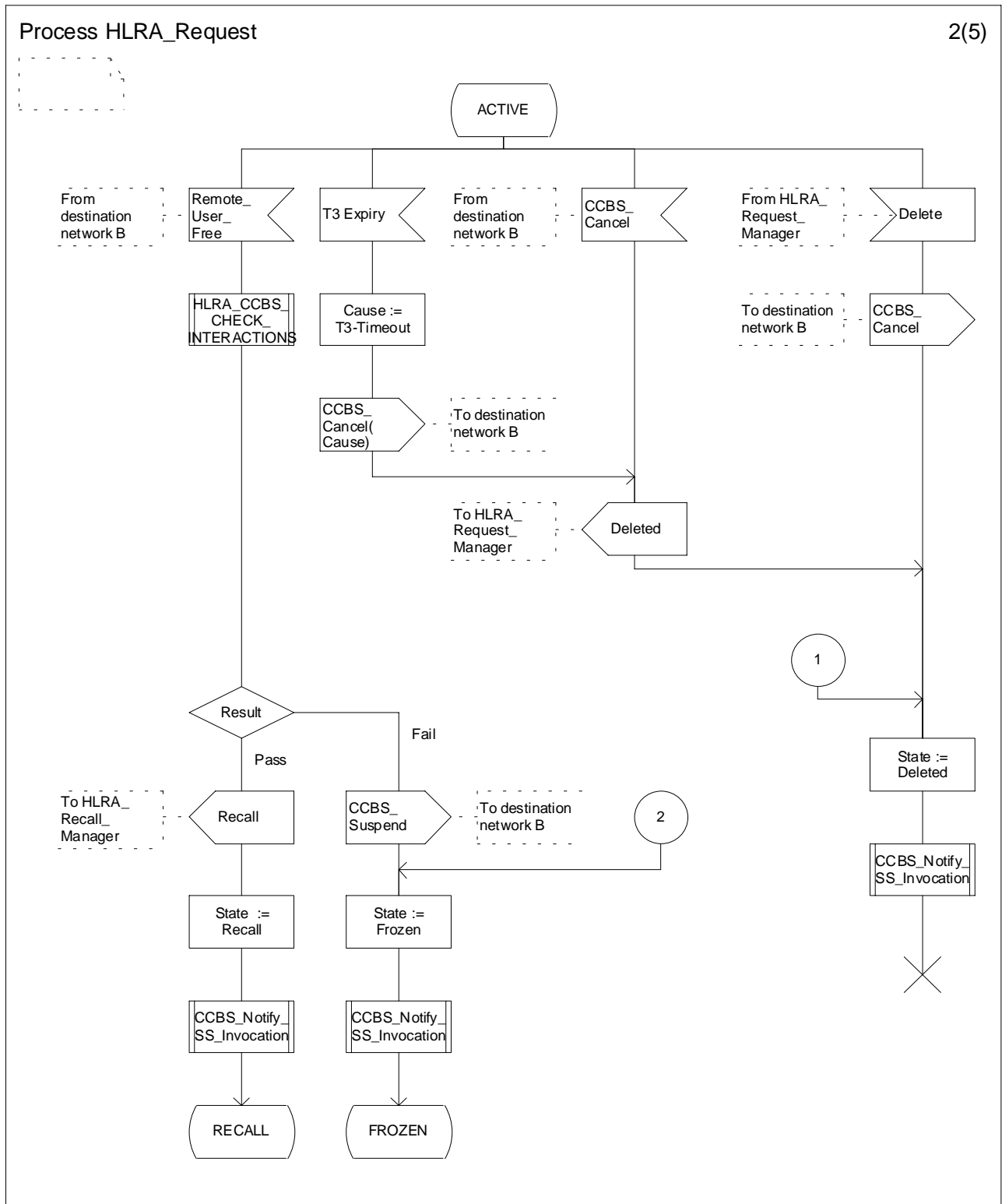

Figure 11.1.2.3: Process HLRA_Request (sheet 2 of 5)

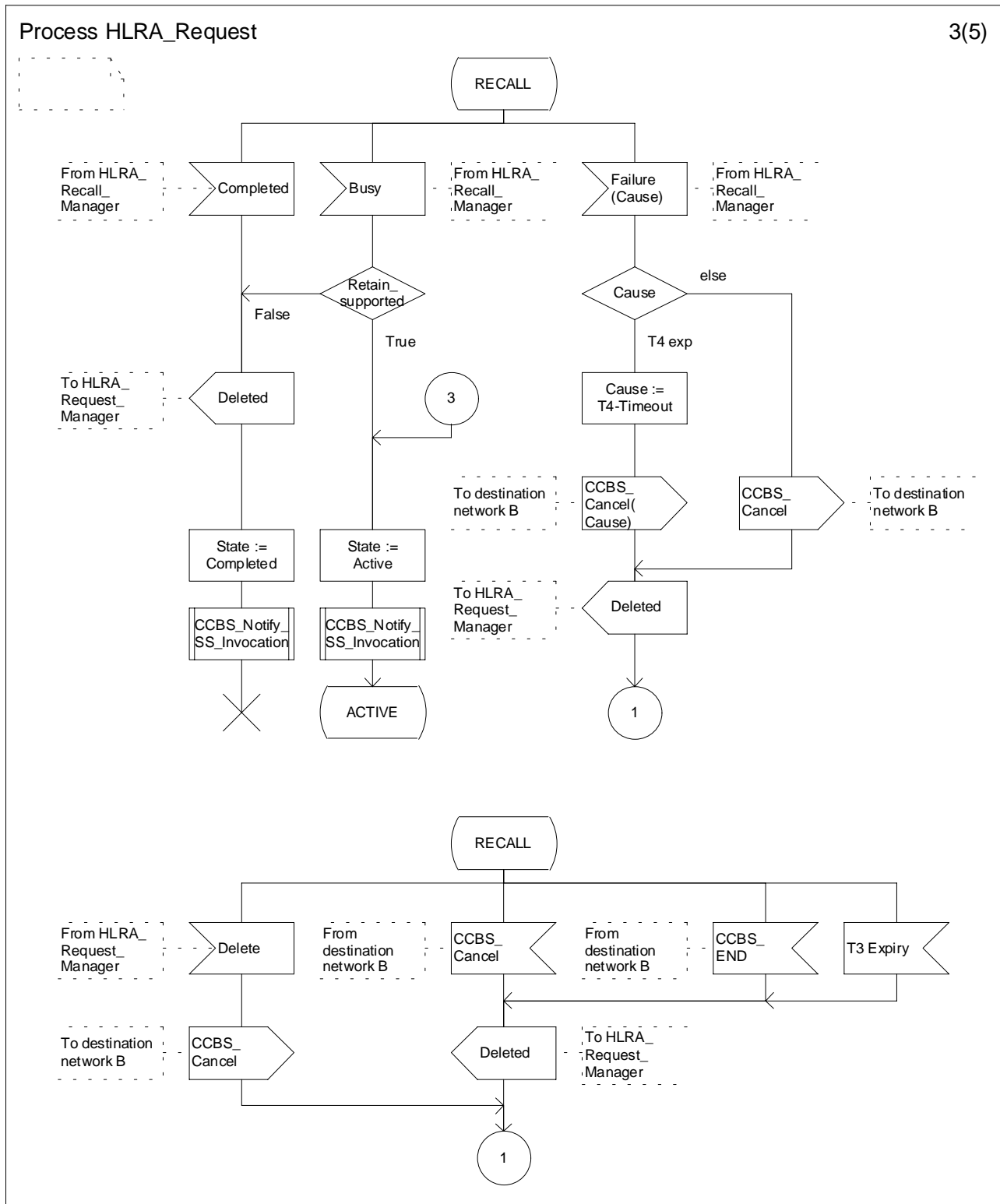

Figure 11.1.2.3: Process HLRA_Request (sheet 3 of 5)

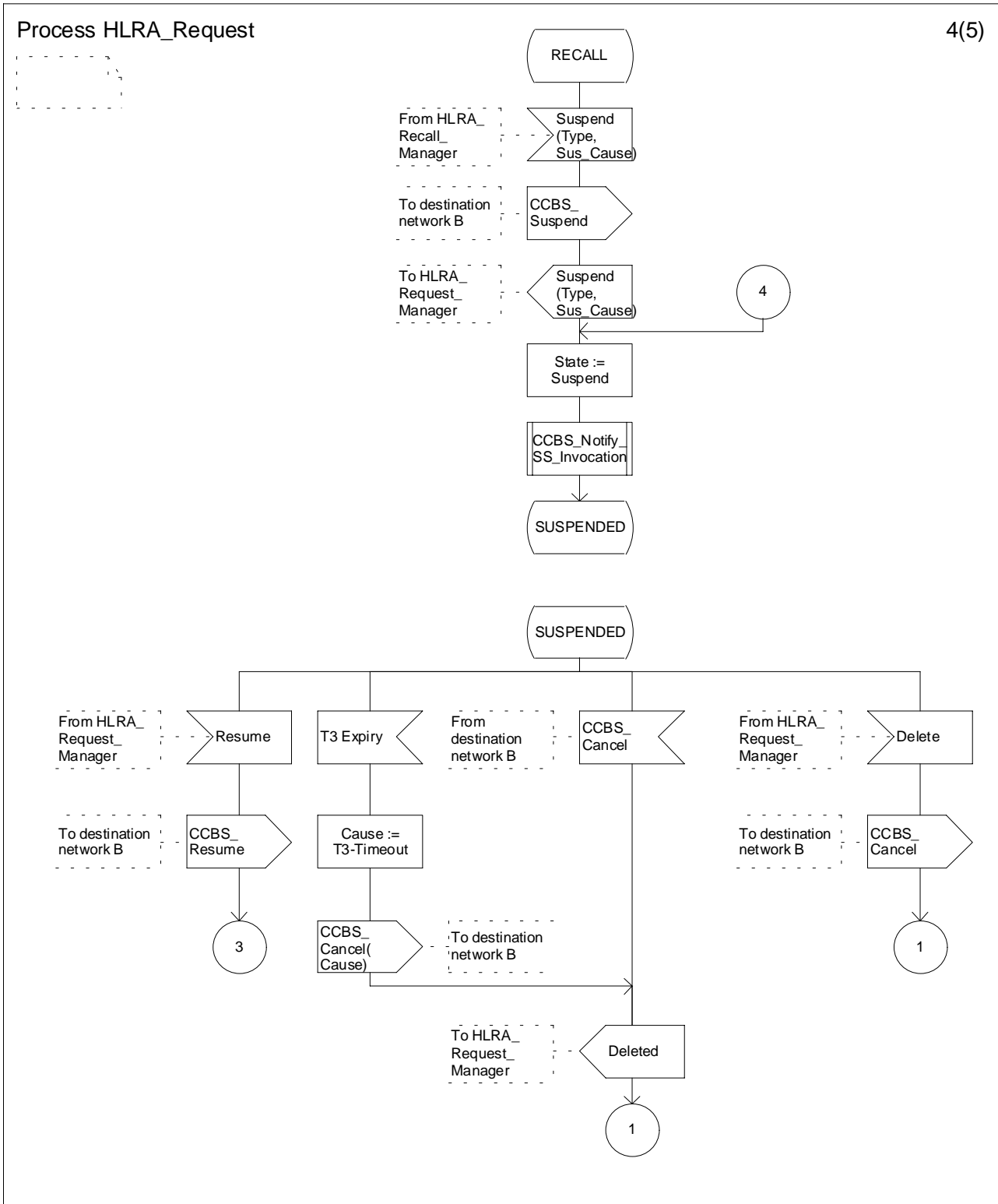

Figure 11.1.2.3: Process HLRA_Request (sheet 4 of 5)

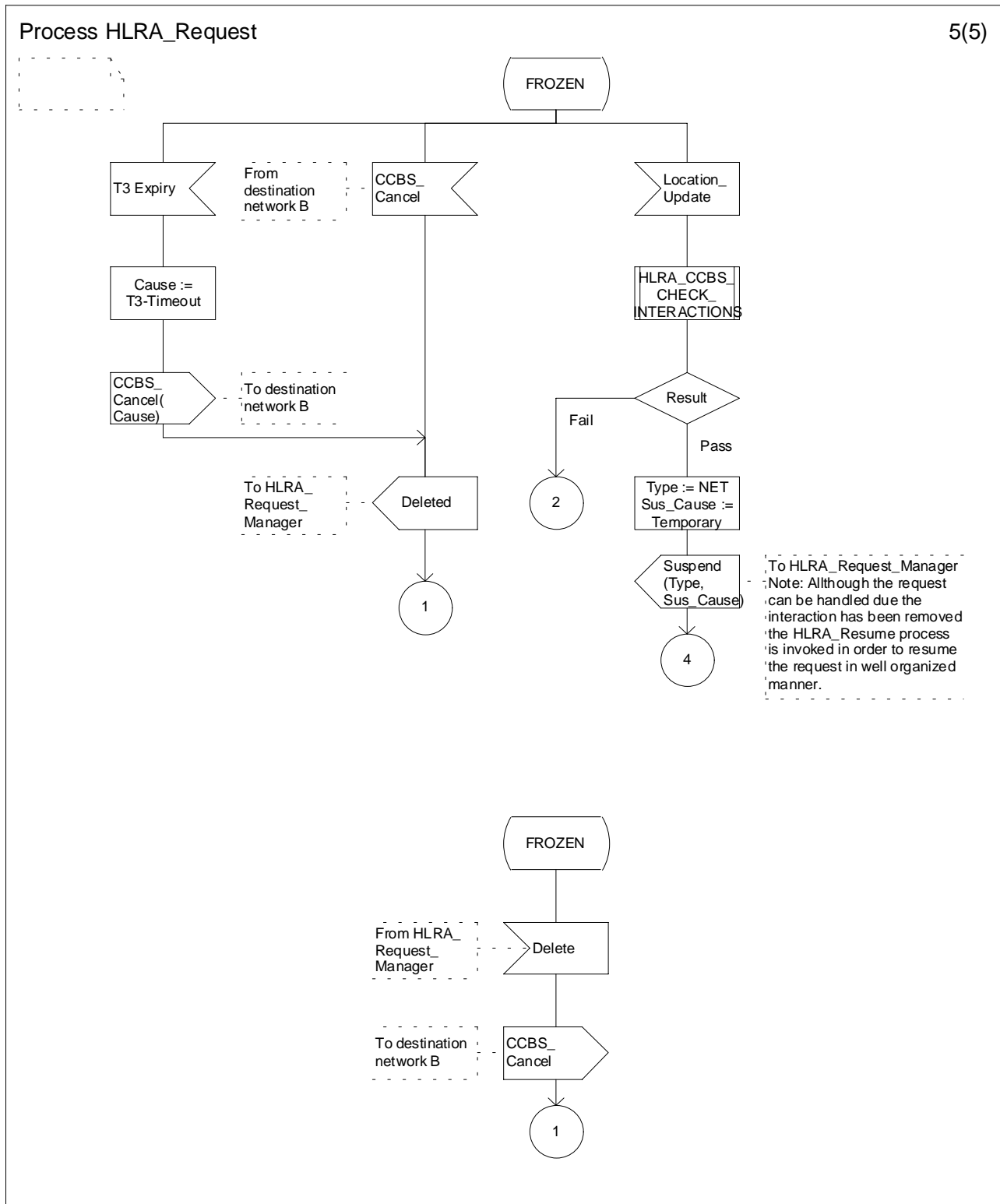

Figure 11.1.2.3: Process HLRA_Request (sheet 5 of 5)

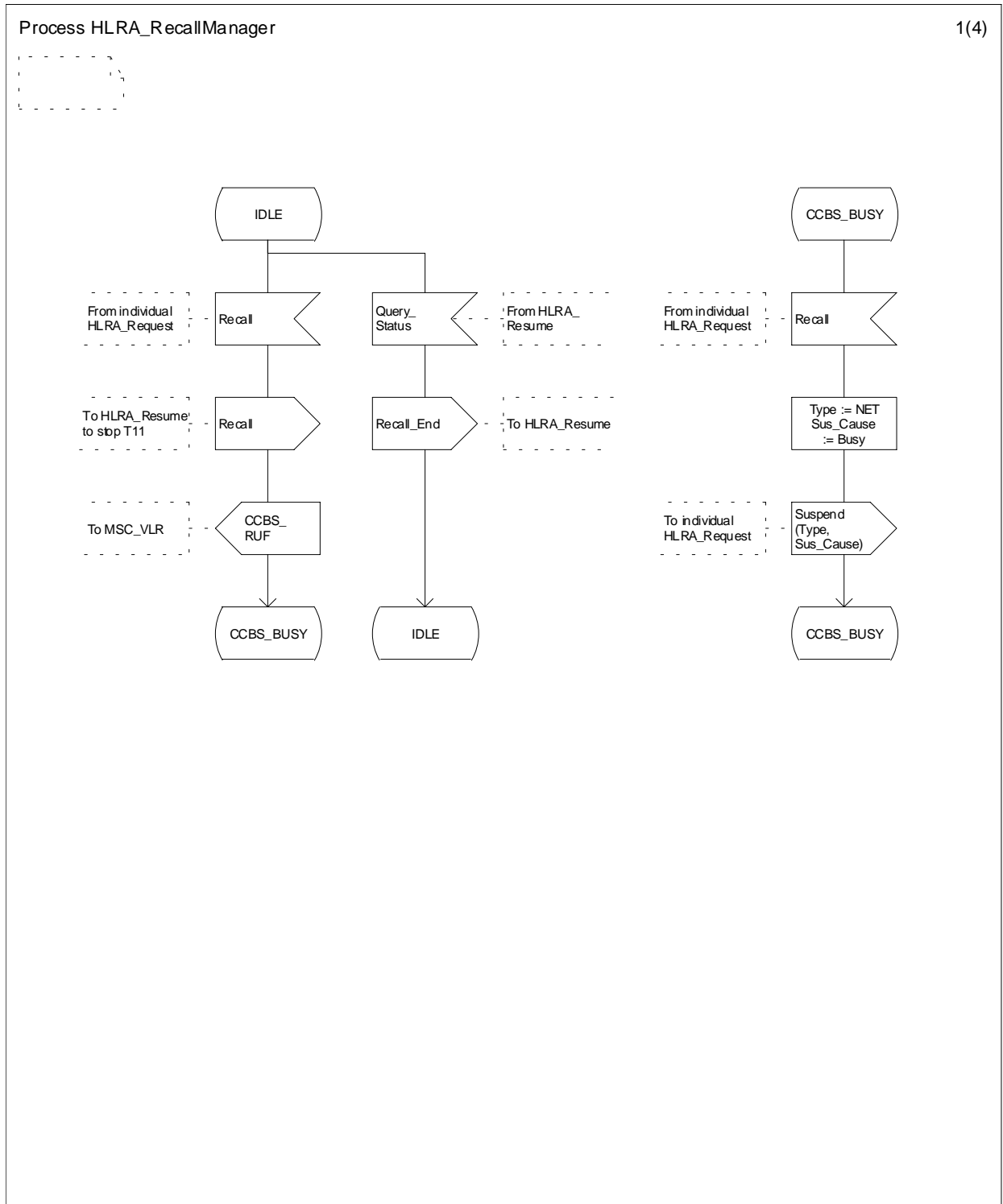

Figure 11.1.2.4: Process HLRA_Recall_Manager (sheet 1 of 4)

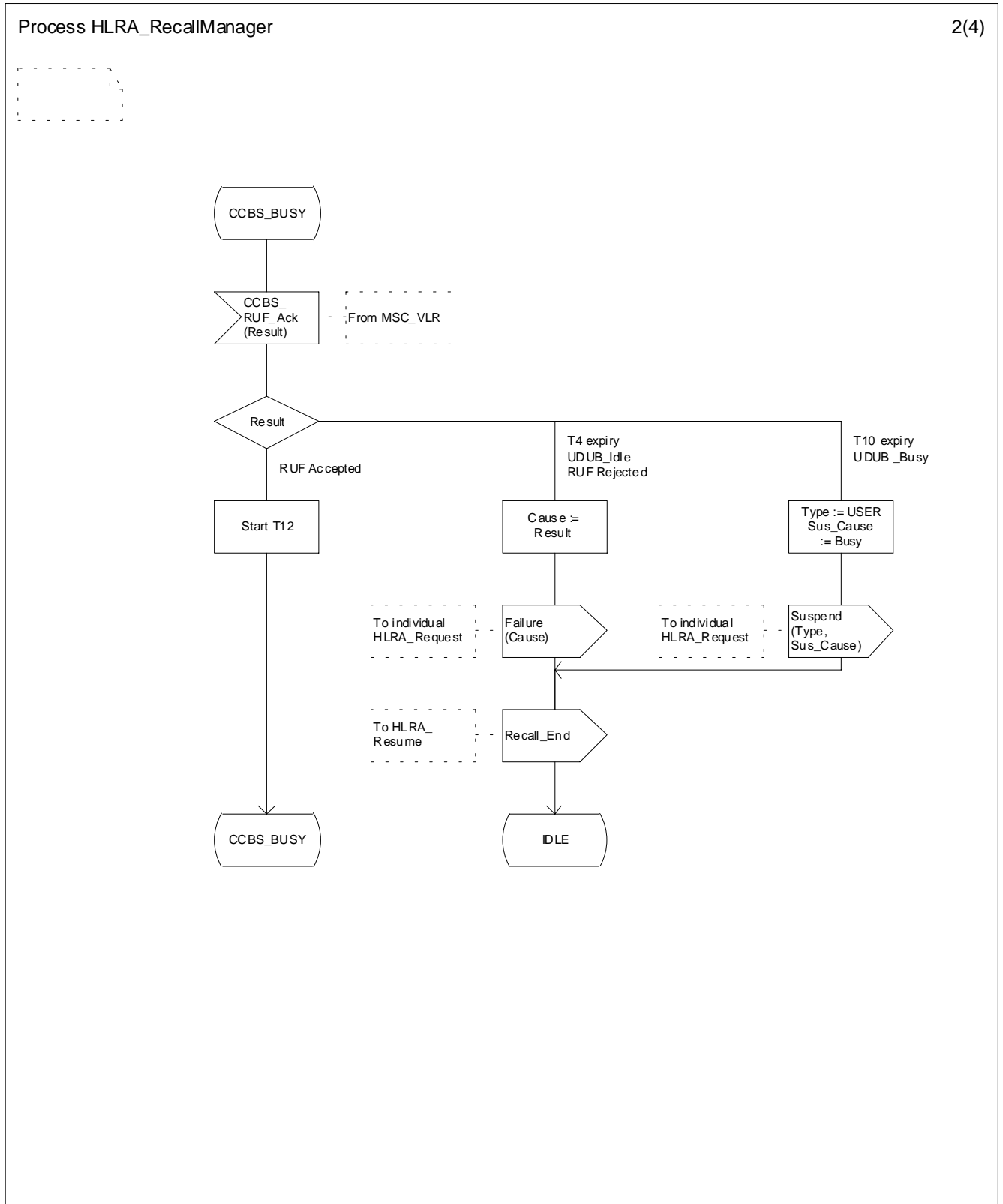

Figure 11.1.2.4: Process HLRA_Recall_Manager (sheet 2 of 4)

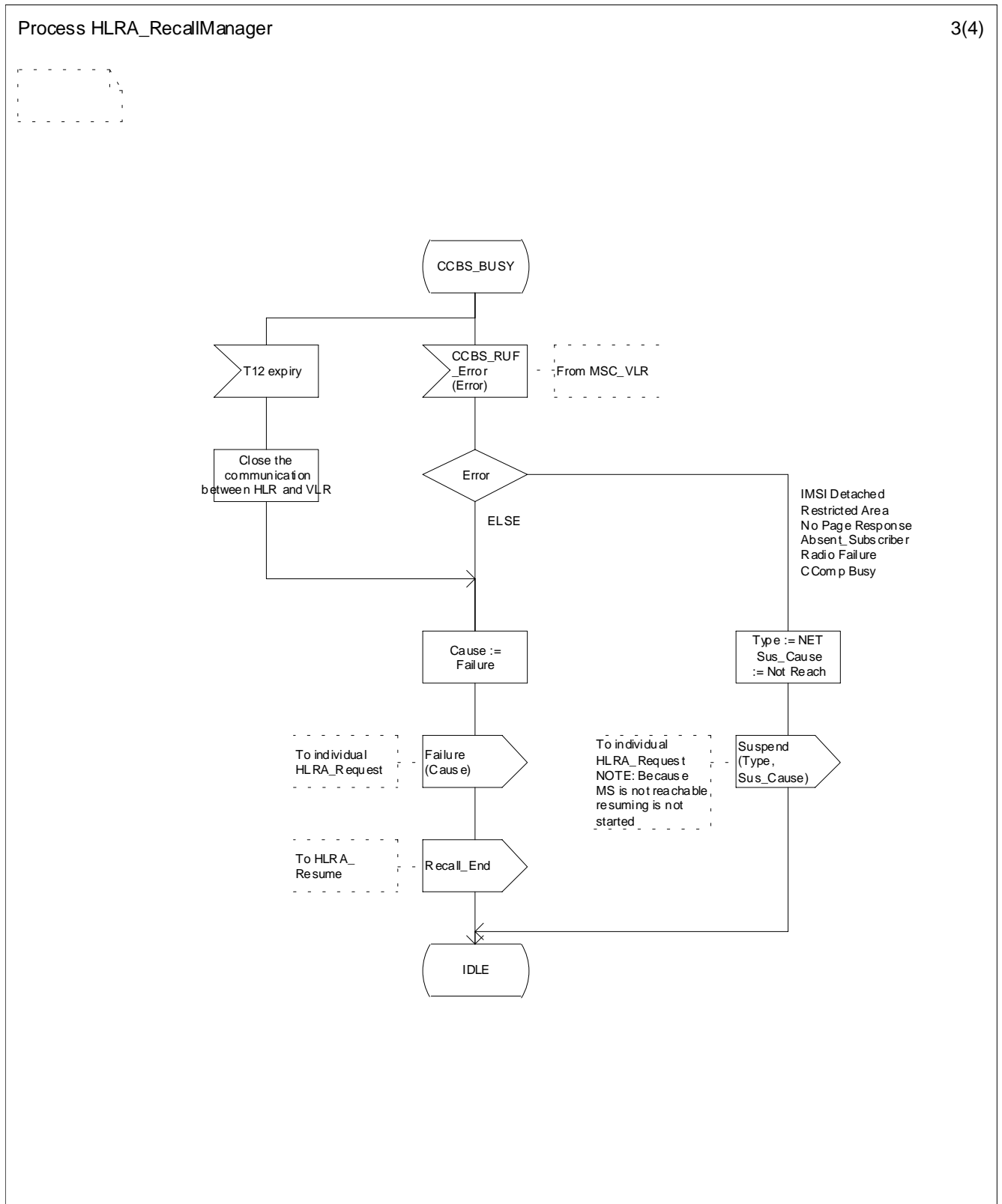

Figure 11.1.2.4: Process HLRA_Recall_Manager (sheet 3 of 4)

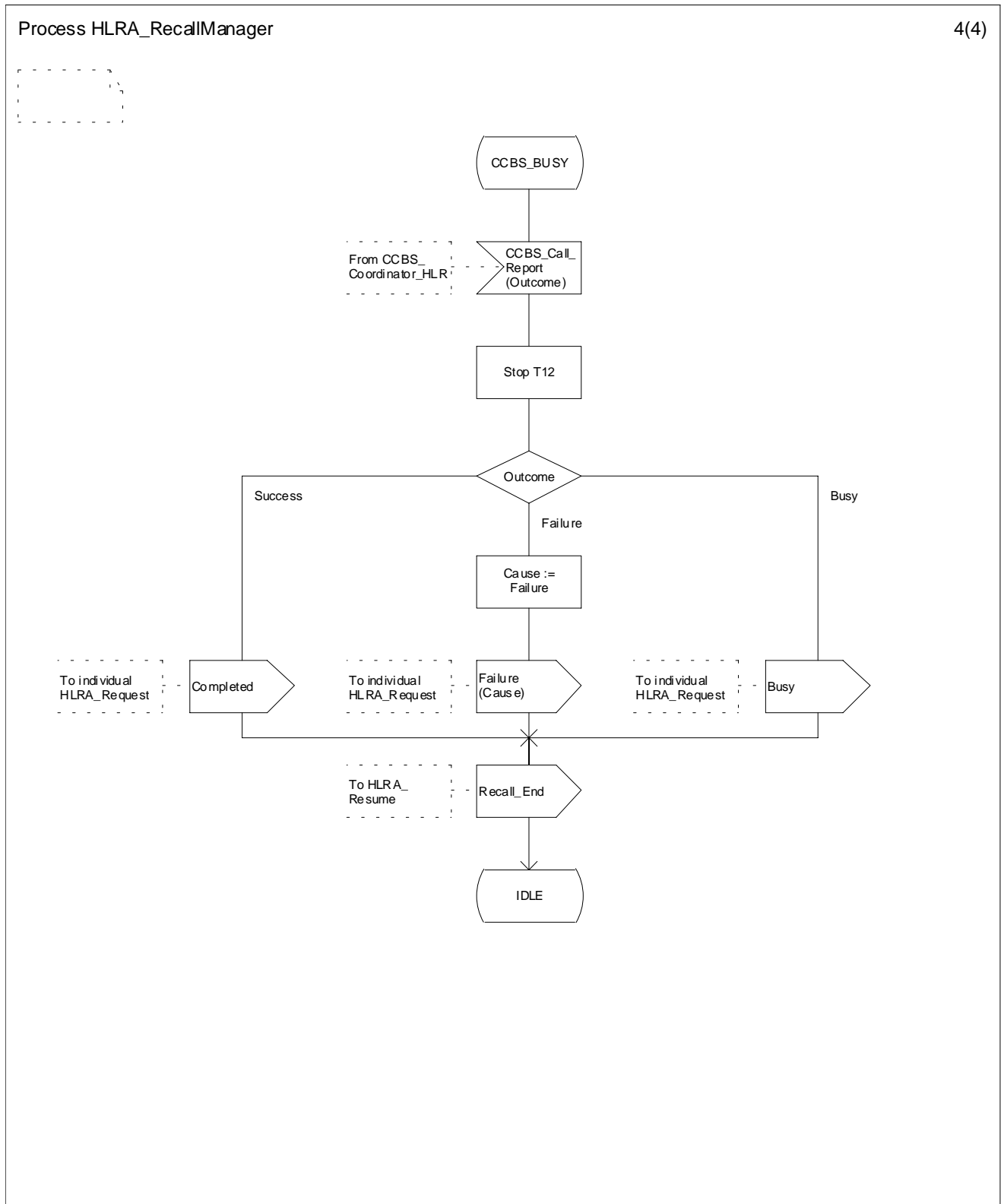

Figure 11.1.2.4: Process HLRA_Recall_Manager (sheet 4 of 4)

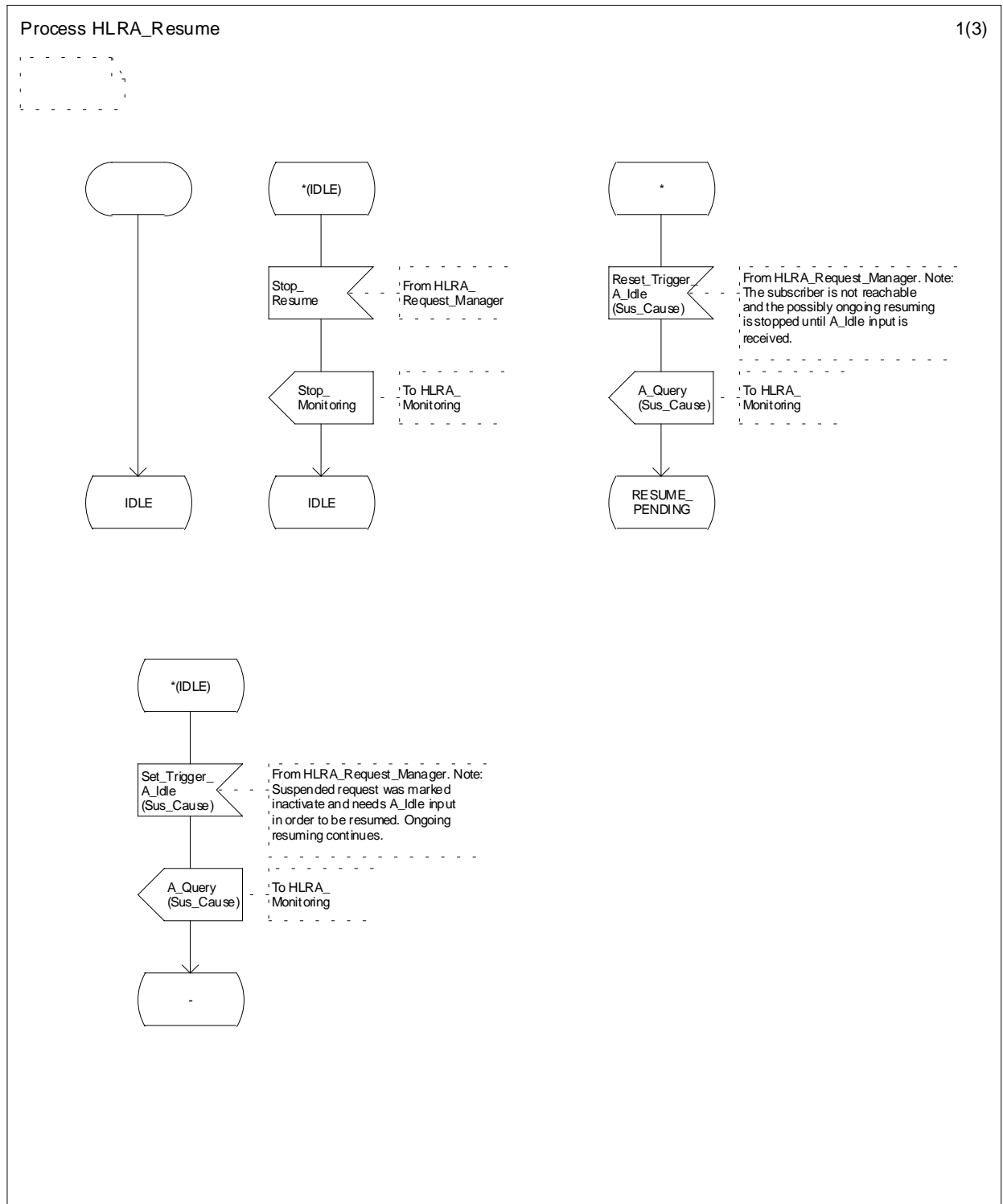

Figure 11.1.2.5: Process HLRA_Resume (sheet 1 of 3)

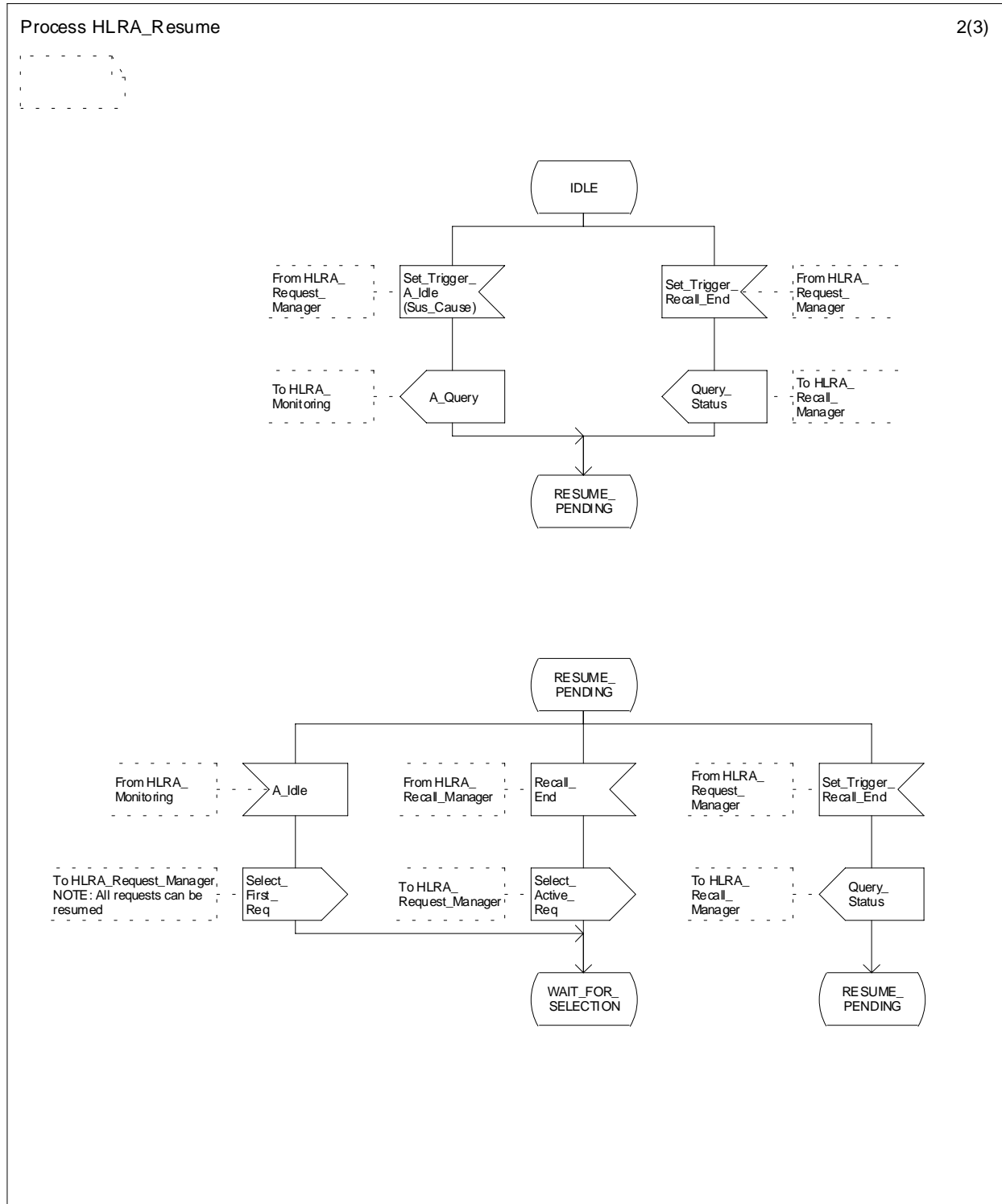

Figure 11.1.2.5: Process HLRA_Resume (sheet 2 of 3)

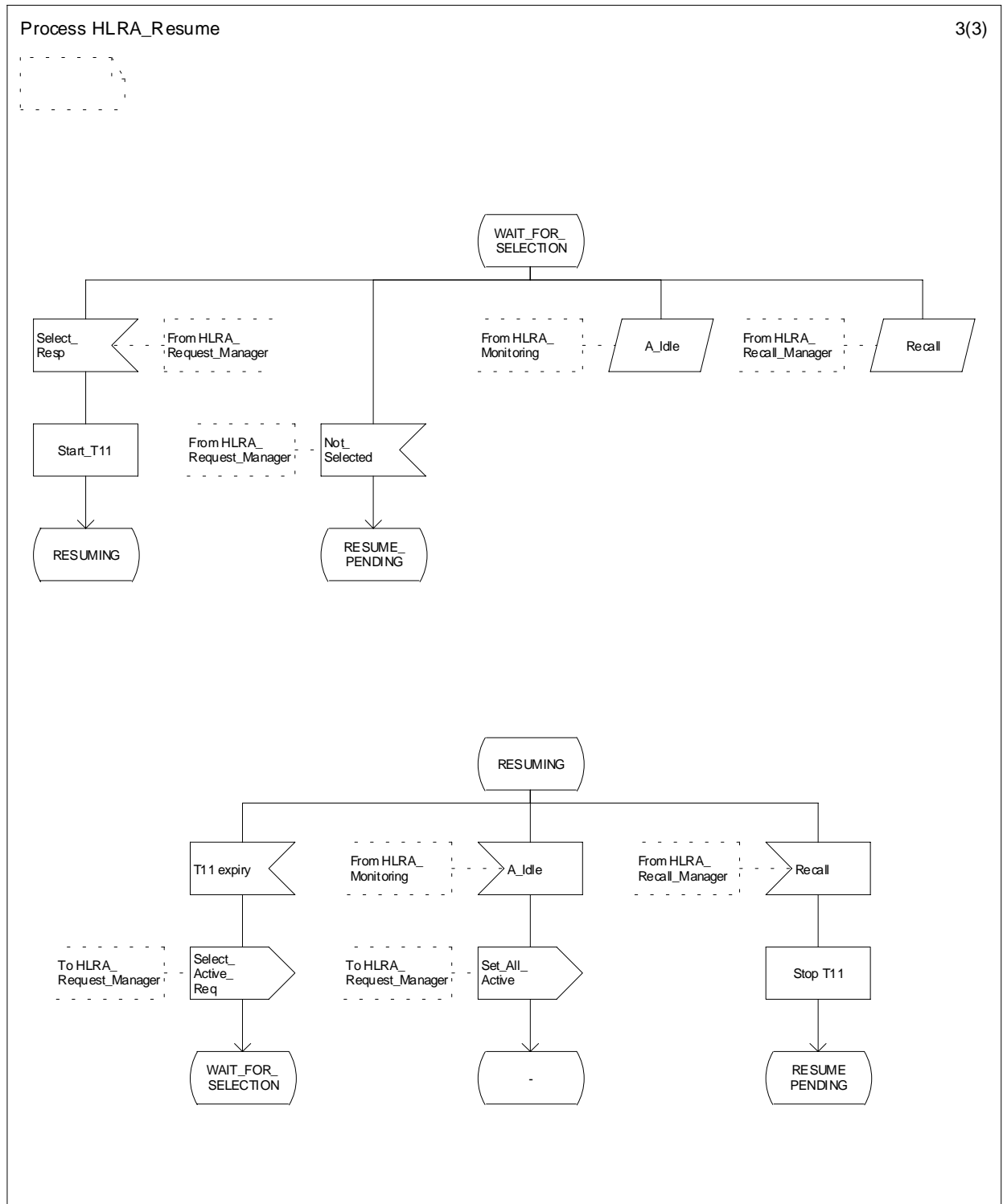

Figure 11.1.2.5: Process HLRA_Resume (sheet 3 of 3)

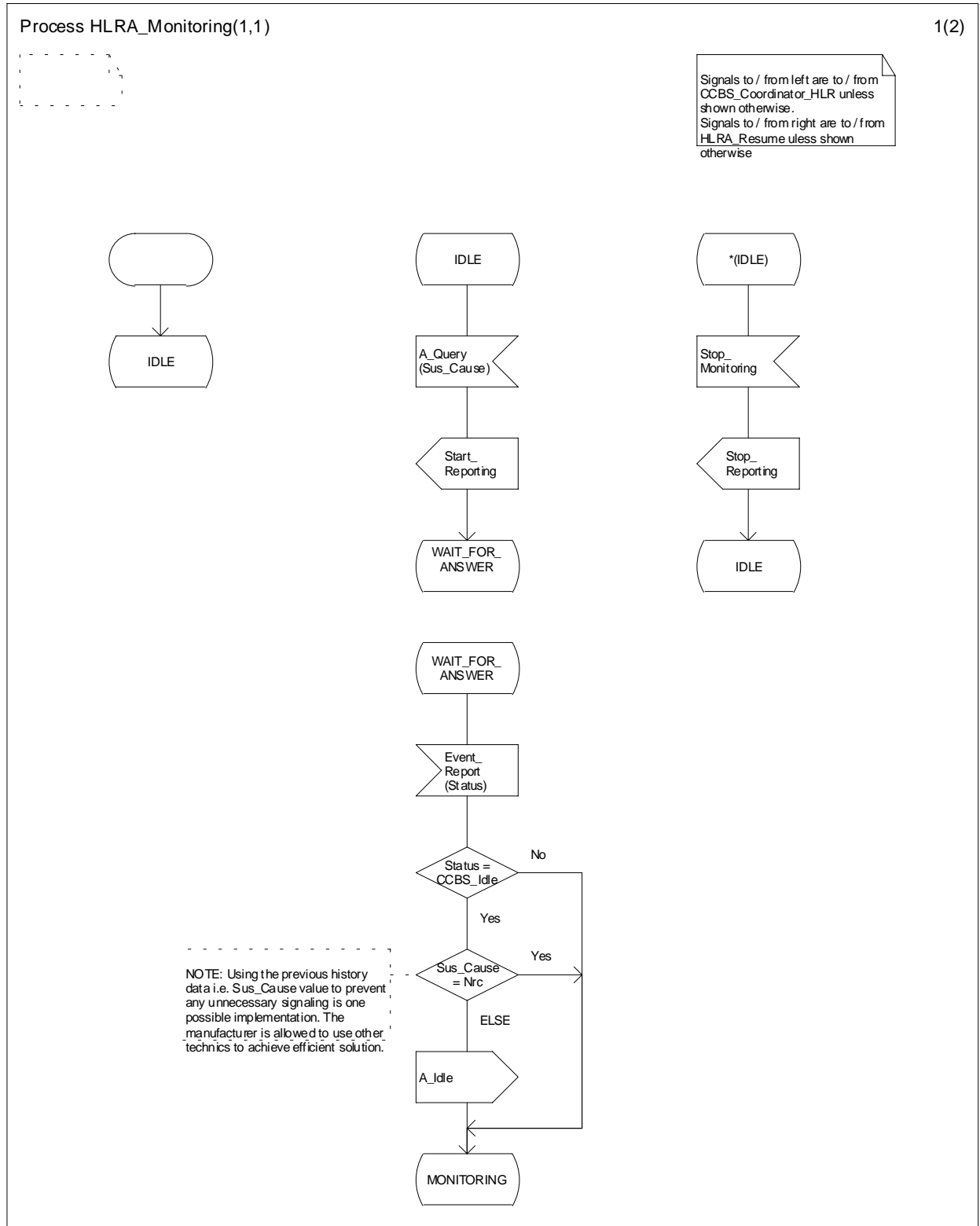

Figure 11.1.2.6: Process HLRA_Monitoring (sheet 1 of 2)

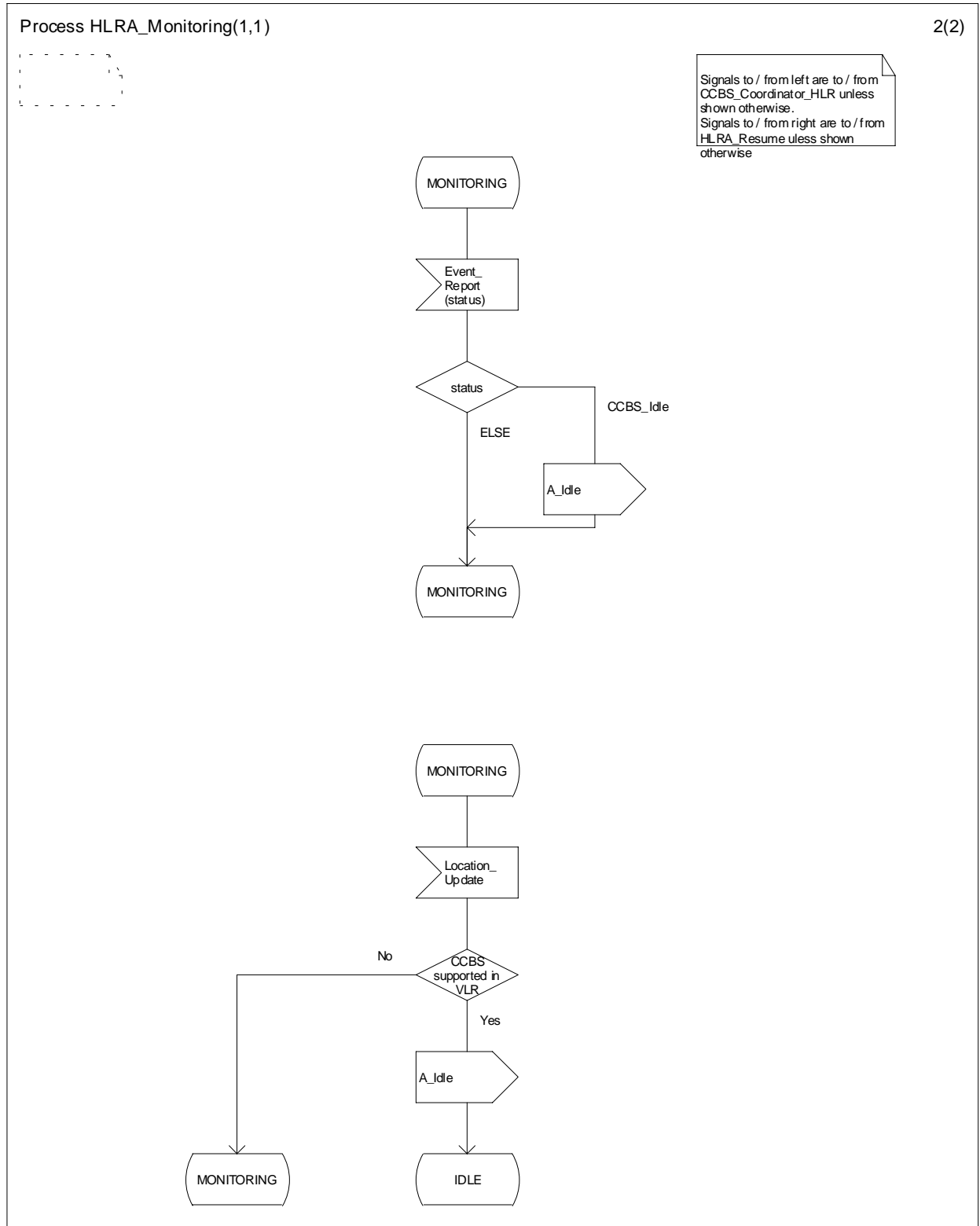

Figure 11.1.2.6: Process HLRA_Monitoring (sheet 2 of 2)

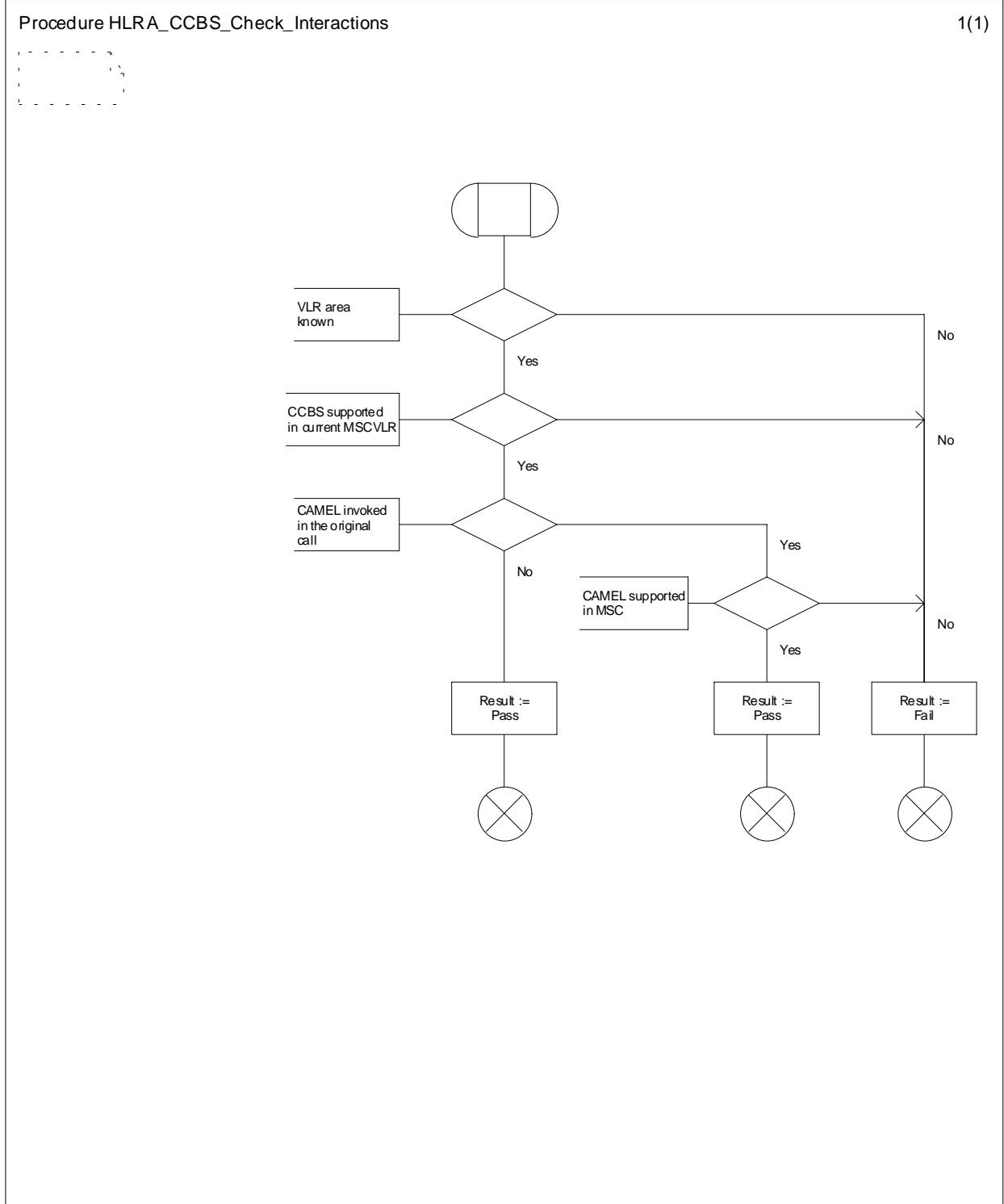

Figure 11.1.2.7: Procedure HLRA_CCBS_Check_Interactions

Procedure CCBS_Notify_SS_Invocation

1(1)

Procedure in the MSC to notify the gsmSCF of the CCBS invocation

Signals to/from the left are to/from the gsmSCF.

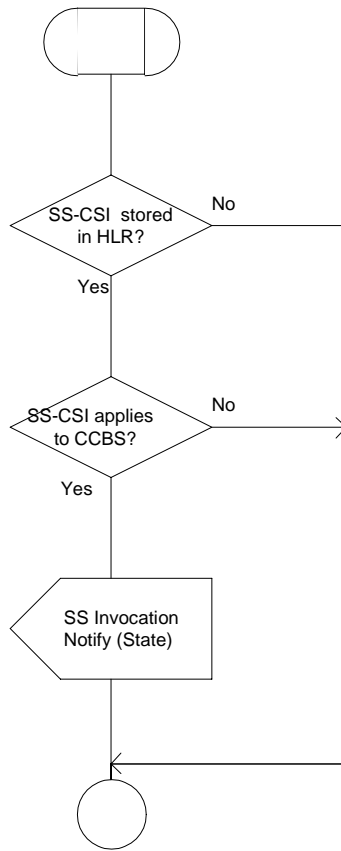

Figure 11.1.2.8: Procedure CCBS_Notify_SS_Invocation

11.2 Destination Network Processes

11.2.1 Procedures in GMSC

Figure 11.2.1.1: Procedure CCBS_MT_GMSC_Check_CCBS_Call

This procedure checks from the IAM message whether the call is CCBS call. If that is the case the CCBS Call parameter is set to the Send Routing Info message. This functionality shall be applied only to the initial call leg. The procedure initialises also the CCBS Possible variable as True, the variable is accessible to all CCBS specific procedures in the GMSC.

Figure 11.2.1.2: Procedure CCBS_MT_GMSC_Check_CCBS_Indicators

This procedure sets the CCBS_Call indicator to the outgoing IAM message when needed. This functionality shall be applied only to the initial call leg.

Figure 11.2.1.3: Procedure CCBS_MT_GMSC_Remove_Indicators_Store_FWT

This procedure removes CCBS_Call indicator from the forwarded IAM message and also stores the forwarding type. It also checks whether subscriber B can be target of CCBS Requests and stores that information for later use.

Figure 11.2.1.4: Procedure CCBS_MT_GMSC_Remove_Indicators

This procedure removes CCBS_Call indicator from the outgoing IAM message. CCBS activation is not possible for this call because T-CSI modified destination address.

Figure 11.2.1.5: Procedure CCBS_MT_GMSC_Check_CCBS_Possible

This procedure contains the core logic to handle various interactions with CAMEL, OR and received Release message content. The procedure alters CCBS specific global variable CCBS Target which controls setting of the diagnostic field in the Release message towards the originating network.

Global variables Reconnect and Resume Call are specific to CAMEL and OR interaction respectively. They are initialised and updated in the process MT_GMSC or MT_CF_MSC, refer to TS 23.018.

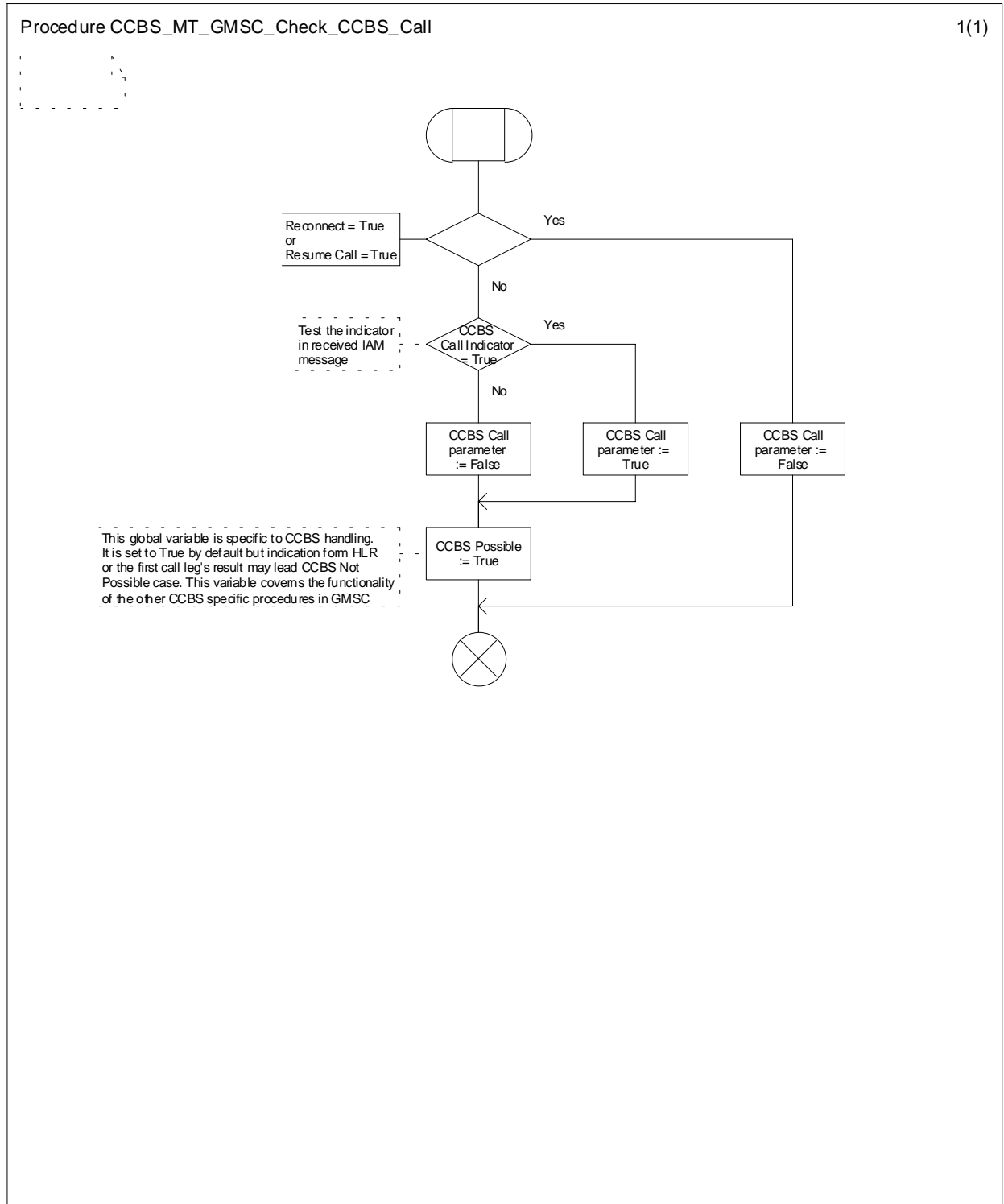

Figure 11.2.1.1: Procedure CCBS_MT_GMSC_Check_CCBS_Call

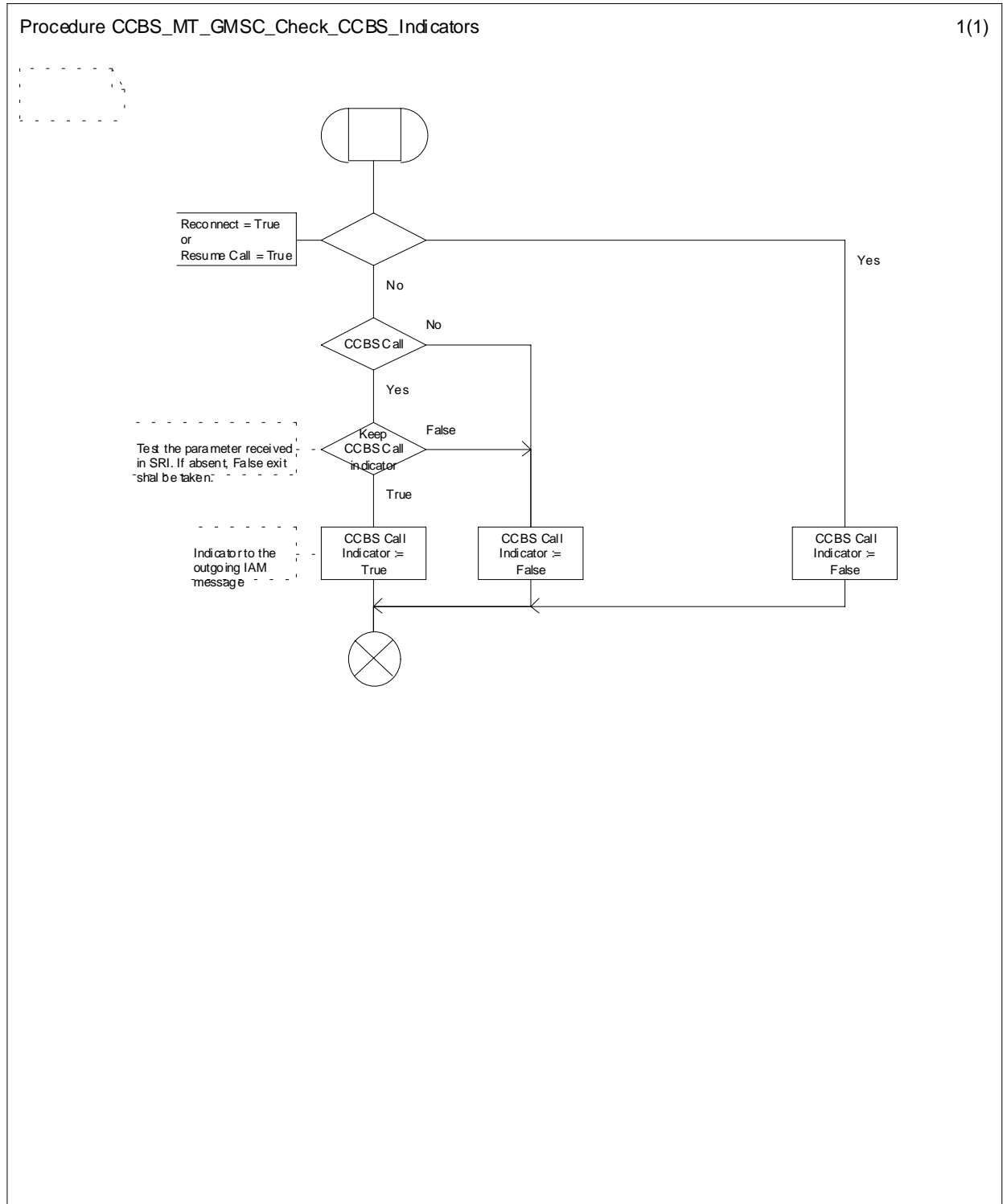

Figure 11.2.1.2: Procedure CCBS_MT_GMSC_Check_CCBS_Indicators

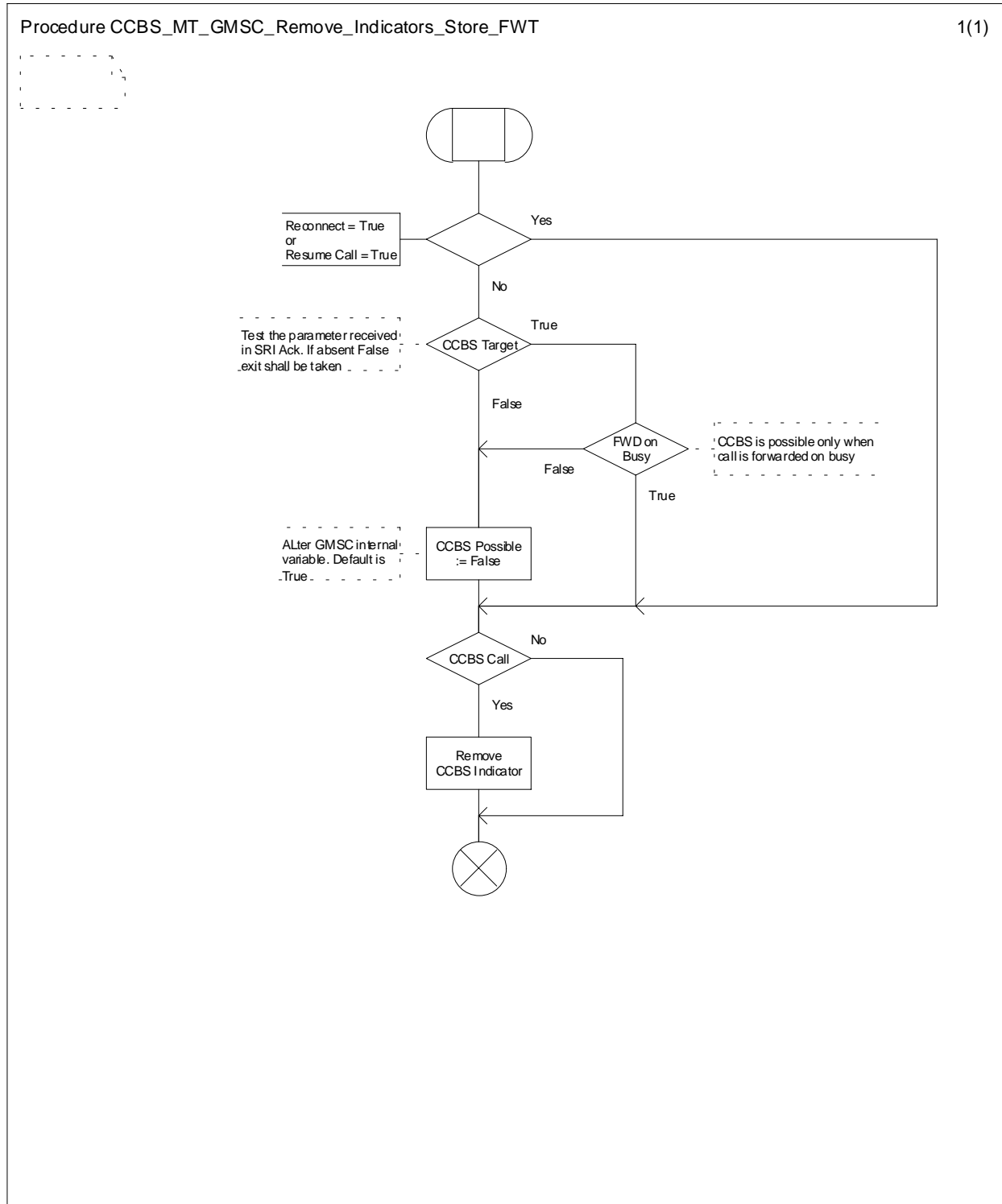

Figure 11.2.1.3: Procedure CCBS_MT_GMSC_Remove_Indicators_Store_FWT

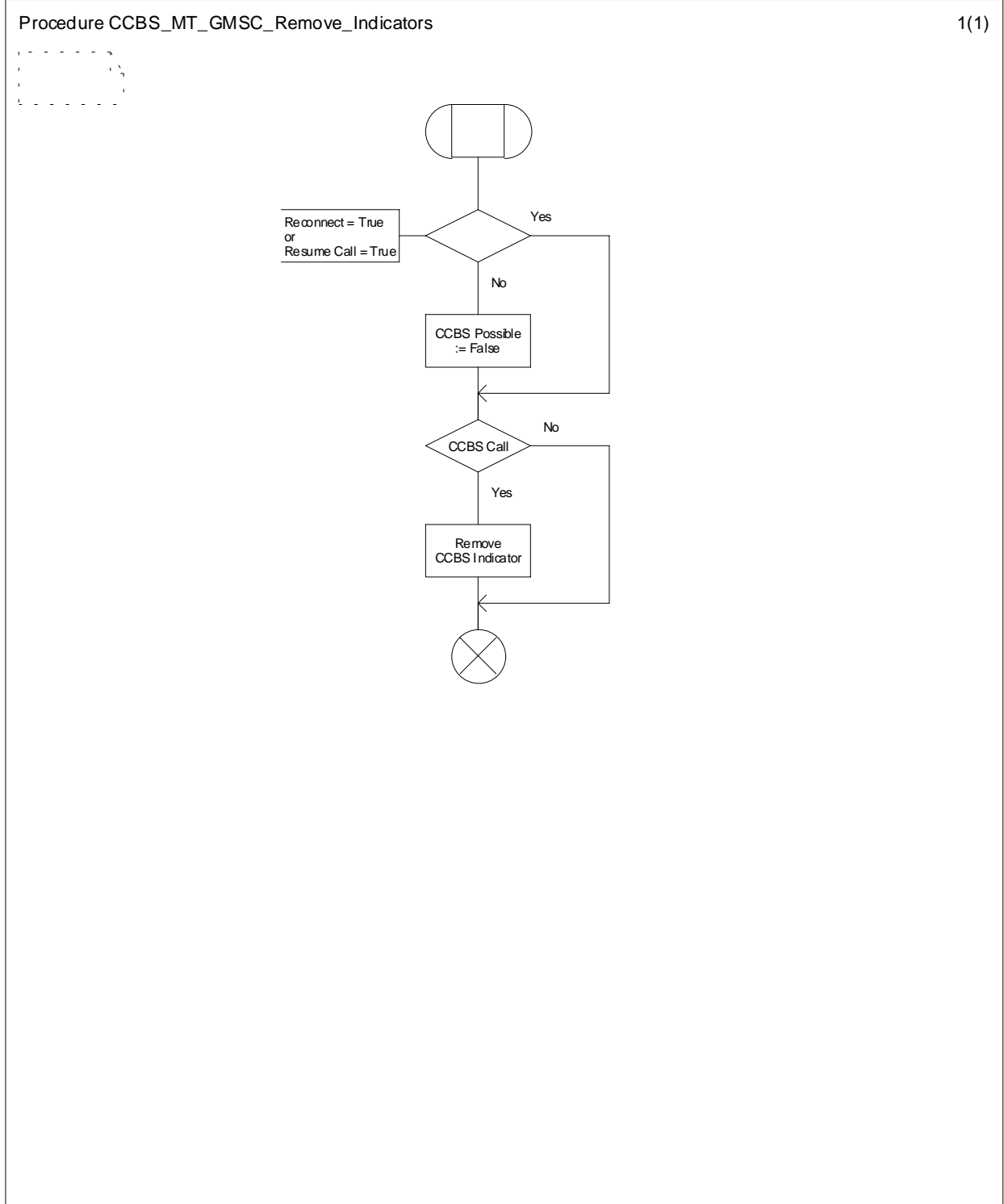

Figure 11.2.1.4: Procedure CCBS_MT_GMSC_Remove_Indicators

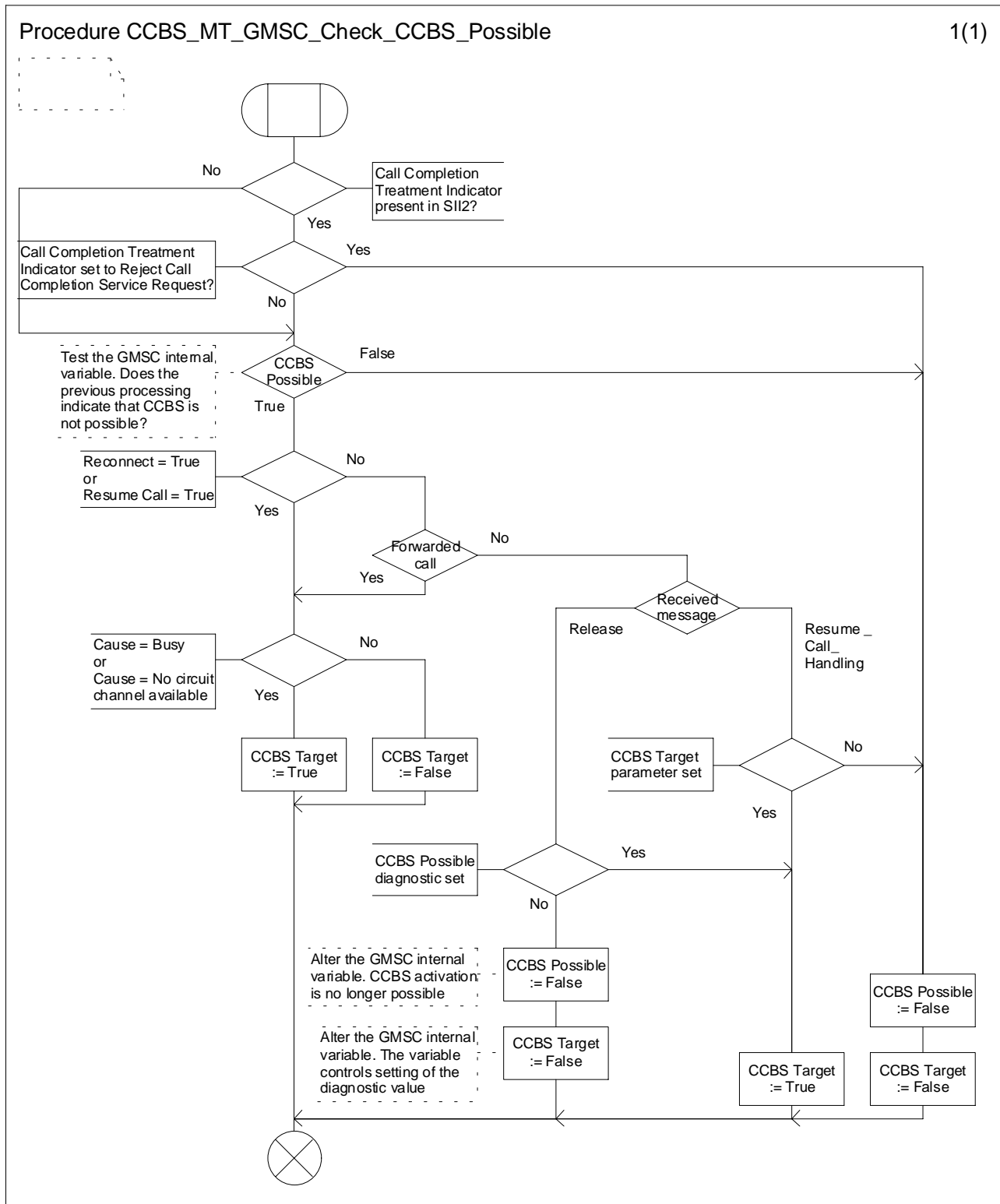

Figure 11.2.1.5: Procedure CCBS_MT_GMSC_Check_CCBS_Possible

11.2.2 Processes and procedures in HLR

Figure 11.2.2.1: Block diagram of HLRB_processes

Figure 11.2.2.2: Process HLRB_Request_Manager

This process has the task of controlling the queue and determining whether requests to be processed are present in the queue or not.

The process has two states "idle" and "active". In the "idle" state there are no "operative" requests in the queue i.e. there are only suspended requests or no requests at all. In the "active" state there is at least one "operative" request in the queue which needs processing. A transition from "idle" to "active" will trigger this process to start the process "HLRB_Recall_Manager". Only a transition from "active" to "idle" will result in this process stopping the process "HLRB_Recall_Manager".

Figure 11.2.2.3: Process HLRB_Request

This process represents an individual CCBS request on the destination side. Reception of signals on the external interface (SSAP signalling) are handled by this process.

Retention is handled by this process. The individual request is informed by the Recall manager process about the outcome of the CCBS Call. The individual request is in charge to decide on whether it will stay in the destination queue (retention) or not according to its data stored.

T7 expiry is controlled by the individual request in that way, that it remembers T7 expiry when it is the selected request (i.e. a CCBS Recall has been initiated for this request). The event is detected after the CCBS Recall when retention has kept the request in the queue.

Figure 11.2.2.4: Process HLRB_Recall Manager

This process is in charge of the recall handling. It is started and stopped by the process "HLRB_Request_Manager" depending on whether there are operative requests in the terminating queue or not.

As soon as this process is started, it will start the process "HLRB_Monitoring" and wait for a response from this process. The response indicates that user B is idle guarded i.e. a CCBS Recall can be initiated. Hence, the process asks the request manager for selection of an individual request from the terminating queue.

When an individual process is selected, the process initiates a CCBS Recall via the individual request (since the external interface is tied to the individual request), starts T9 and takes over control of the blocking function while waiting for the CCBS Call. Control of blocking is done by sending the signal "Recall_Block" to process "HLRB_Blocking".

While waiting for the outcome of the CCBS Call, the process will be informed either by the selected individual request in the case of negative outcome (suspension or cancellation, both hidden to the process), or by process "HLRB_Monitoring" in the case the CCBS Call has reached the terminating PLMN.

Figure 11.2.2.5: Process HLRB_Monitoring

This process takes care of monitoring events received from MSC/VLR and detects potential conditions for initiating a CCBS Recall.

The process is controlled by the "HLRB_Recall_Manager" process which was formerly in charge of detecting the recall condition.

When the process is started, it invokes the monitoring function in the MSC/VLR and awaits the first event report. The process keeps track of the subscriber state changes by running a state machine which reflects the subscriber states. When there is a transition from subscriber state "not idle" to "idle", then T8 is started. As soon as T8 expires, the process changes state again in order to remember that the subscriber is now idle guarded and a recall could be initiated

Whether a CCBS Recall is initiated or not depends on whether the process "HLRB_Recall_Manager" has asked for this information by sending a "B_Query" signal to the monitoring process. The process "HLRB_Monitoring" gives this information only if the "B_Query" signal has been received. This is done by sending the signal "B_Guarded" to the Recall Manager and it is only done once per request. The monitoring process keeps track on whether a query was received or not by appropriate state changes.

As the monitoring process is in charge for the idle guard function, it also controls the blocking of incoming calls during the idle guard time (T8). Hence, when the recall manager process has sent a "B_Query" (i.e. a CCBS request needs to be processed) then the monitoring process starts the corresponding blocking along with T8. The blocking is only stopped if T8 does not expire. If T8 expires, then blocking is still needed for the following CCBS Recall. The responsibility for controlling the blocking (i.e. switching it off) is given to the recall manager process.

Figure 11.2.2.6: Process HLRB_Blocking

This process controls the CCBS Call delivery reporting when the processes are in the proper state. This means that the reporting functionality of the outcome of the CCBS Call is not blindly triggered whenever there is a terminating CCBS Call.

The process has three different states: "idle", "Blocking" and "Recall Blocking". The "Idle" state reflects the case when blocking is disabled. In the "Blocking" state all incoming calls are blocked (e.g. while T8 is running). The "Recall Blocking" state allows one CCBS Call to pass, which will trigger the CCBS Call delivery reporting in the MSC/VLR via the TS 23.018 process "SRI_HLR". When this happens, the process will automatically change back to state "Blocking" as no other CCBS Call is expected for now.

When the process has detected that destination B is idle, it will start the blocking. Hence, the blocking process will change state to "Blocking". As soon as the process "HLRB_Recall_Manager" has initiated a CCBS Recall, it will cause a state change in the blocking process to state "Recall Blocking". When the CCBS Call is received, "result = OK" indication in signal "SRI_Received_Ack" will trigger the reporting mechanism for CCBS Call delivery via a PRN request in the TS 23.018 process "SRI_HLR"

Figure 11.2.2.7: Procedure HLRB_CCBS_Check_Interactions

This procedure checks whether the request is frozen due to the supplementary service interactions.

Figure 11.2.2.8: Procedure CCBS_Handling_HLR

This procedure is called during Send Routeing Info message handling in the HLR. If blocking is active only CCBS Calls can proceed, others will fail with busy or forward indication. For CCBS Call CCBS Call Indicator is set to the Provide Roaming Number message.

Figure 11.2.2.9: Procedure CCBS_Report_PRN_Failure

This procedure is called if Provide Roaming Number returns an error. For CCBS call is then generated an internal call report.

The handling of multiple requests in HLR B can be further clarified by the diagram shown in figure 11.2.2.1.

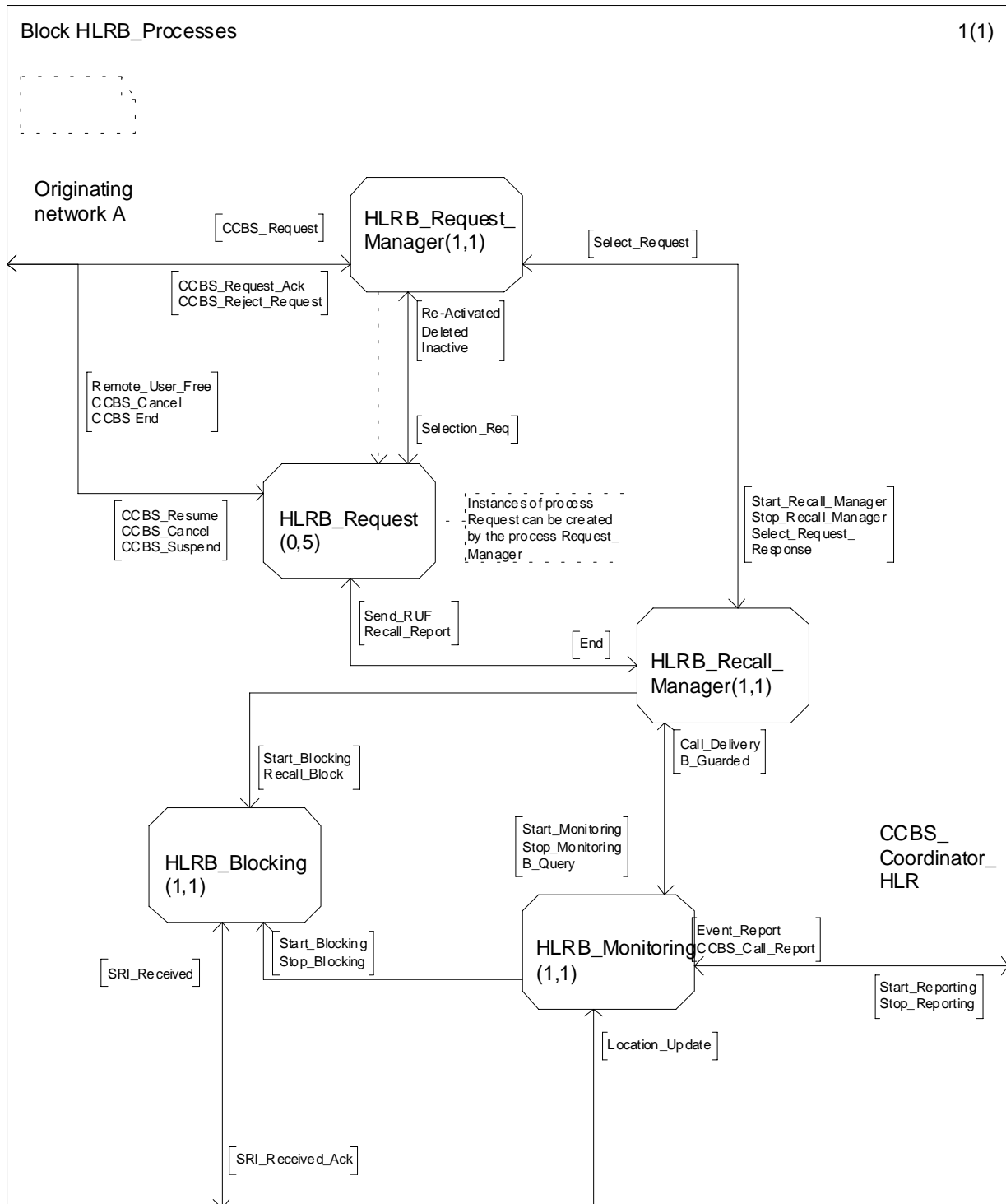

Figure 11.2.2.1: HLRB_Processes

Description of above signals

Relation Originating Network and HLRB_Request_Manager

CCBS_Request: When the originating network attempts to activate CCBS, it sends a CCBS_Request message to HLRB Request Manager.

CCBS_Request_Ack: When the HLRB_Request_Manager acknowledges the activation, it sends CCBS_Request Ack to originating network.

CCBS_Reject: If the HLRB_Request_Manager does not accept the activation attempt, it sends CCBS_Reject to the originating network indicating long term or short term denial.

Relation Originating Network and HLRB_Request

CCBS_Suspend: If the originating network suspends a CCBS Request, it sends CCBS_Suspend to HLRB Request.

CCBS_Resume: When a request that was suspended is now resumed, the originating network sends a CCBS_Resume message to HLRB Request.

CCBS_Cancel: When a request is cancelled in the originating network, it sends a CCBS Cancel message to HLRB Request.

Remote_User_Free: HLRB_Request sends Remote_User_Free to the originating network to inform the originating network that destination B is now idle.

CCBS_Cancel: If a CCBS Request is cancelled in the destination network, HLRB_Request sends CCBS_Cancel to the originating network.

TC_END: If a CCBS Call is successfully delivered to destination B, then HLRB_Request ends the dialogue with the originating network by sending a TC_END message.

Relation HLRB_Request_Manager and HLRB_Request

Selection_Request: Once destination B is idle guarded, then the HLRB_Request_Manager will select the first non-suspended request in the queue for processing by sending "Select_Request" to HLRB_Request.

Inactive: When a CCBS Request is either suspended or unselectable due to the supplementary service interaction, HLRB_Request informs HLRB_Request_Manager so that the queue status can be updated.

Re-Activated: When either a suspended CCBS Request is resumed or the supplementary service interaction with the request ends, then HLRB_Request informs HLRB_Request_Manager so that the queue status can be updated.

Deleted: When a CCBS Request is cancelled, then HLRB_Request informs HLRB_Request_Manager so that the queue status can be updated.

Relation HLRB_Recall_Manager and HLRB_Blocking

Stop_Blocking: When the Recall manager process is stopped by the Request Manager process or the Recall manager receives an 'End' signal from the Request manager, the Recall manager sends "Stop_Blocking" to HLRB_Blocking.

Recall_Block: When a "Send RUF" signal is sent to HLRB_Request, the HLRB_Recall_Manager also sends "Recall Block" to HLRB_Blocking so that one CCBS Call can be delivered to destination B, but other normal incoming calls are blocked.

Relation HLRB_Recall_Manager and HLRB_Request_Manager

Select_Request: On reception of a "B_Guarded" signal, the Recall manager sends "Select_Request" to the Request manager. The Request manager then selects the first non-suspended request in the queue for processing.

Start_Recall_Manager: When a CCBS Request is successfully activated, the Request manager sends "Start_Recall_Manager" to HLRB_Recall_Manager which subsequently causes the recall manager process to start the monitoring process.

Stop_Recall_Manager: The Request manager can stop the Recall manager process by sending a "Stop_Recall_Manager" signal

Select_Request_Response: When the Request manager has selected a request for processing it sends a response to the recall manager causing the recall manager to initiate a CCBS Recall.

Relation HLRB_Recall_Manager and HLRB_Request

Send_RUF: The Recall manager requests the individual process to send a Remote User Free indication to the originating network by sending a "Send_RUF" signal to the individual process.

Recall_Report: The Recall manager informs the individual process of the result of processing a CCBS Recall by sending a "Recall Report" signal.

END: When a CCBS Request is suspended or cancelled the HLRB_Request process sends an "End" signal to the Recall Manager process.

Relation HLRB_Recall_Manager and HLRB_Monitoring

Start_Monitoring: When the Recall manager process is started by the Request manager process, the Recall manager sends "Start_Monitoring" to the HLRB_Monitoring process to request the status of destination B

Stop_Monitoring: When the Recall manager process is stopped by the Request manager process, the Recall manager sends "Stop_Monitoring" to the HLRB_Monitoring process.

B_Query: HLRB_Recall_Manager requests the HLRB_monitoring process to get informed when destination B has become idle guarded.

Relation HLRB_Monitoring and HLRB_Recall_Manager

B_Guarded: HLRB_Monitoring informs the HLRB_Recall_Manager that destination B has become idle guarded.

Call_Delivery: HLRB_Monitoring informs the HLRB_Recall_Manager about the delivery of the CCBS call.

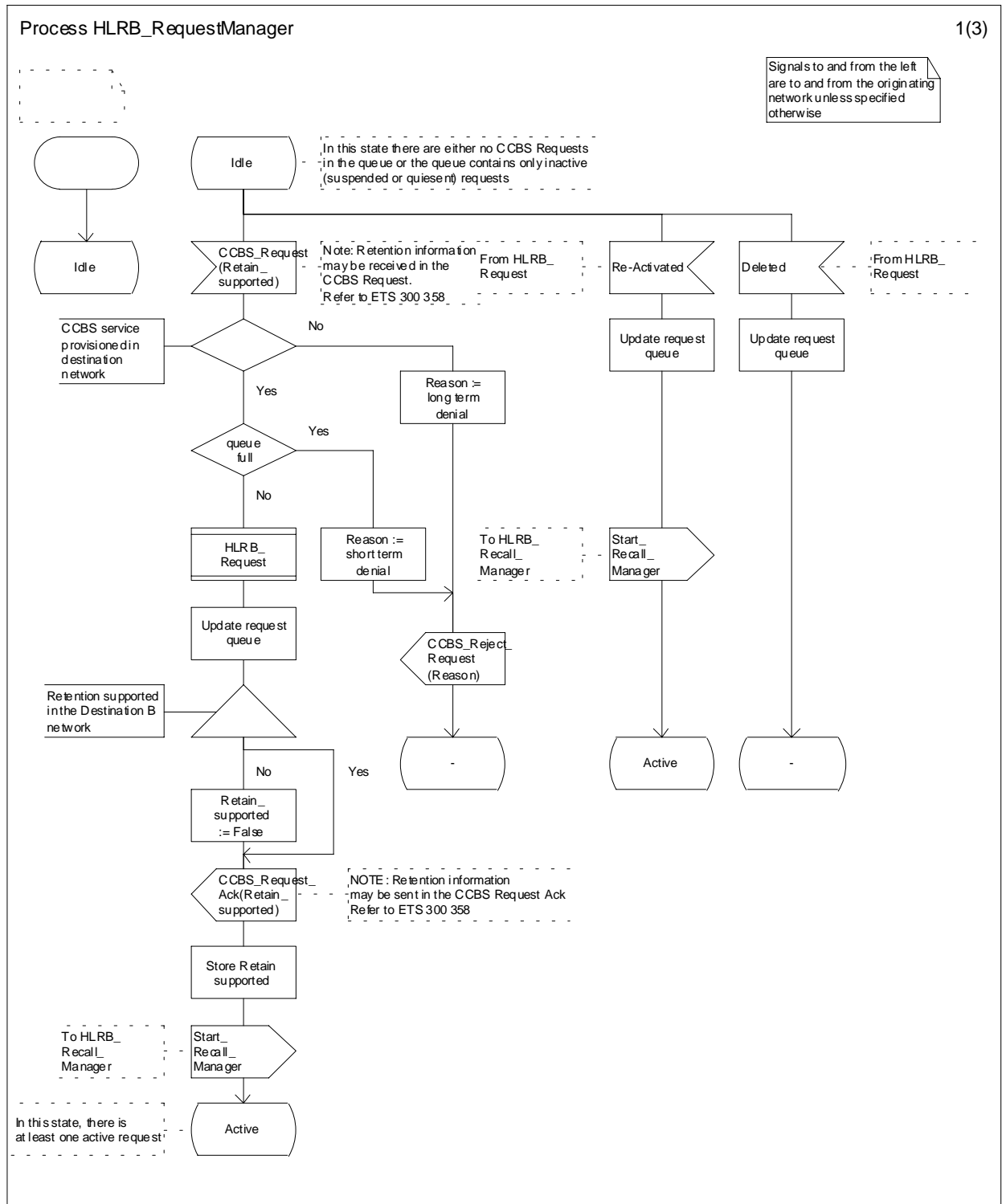

Figure 11.2.2.2: Process HLRB_REQUEST_MANAGER (sheet 1 of 3)

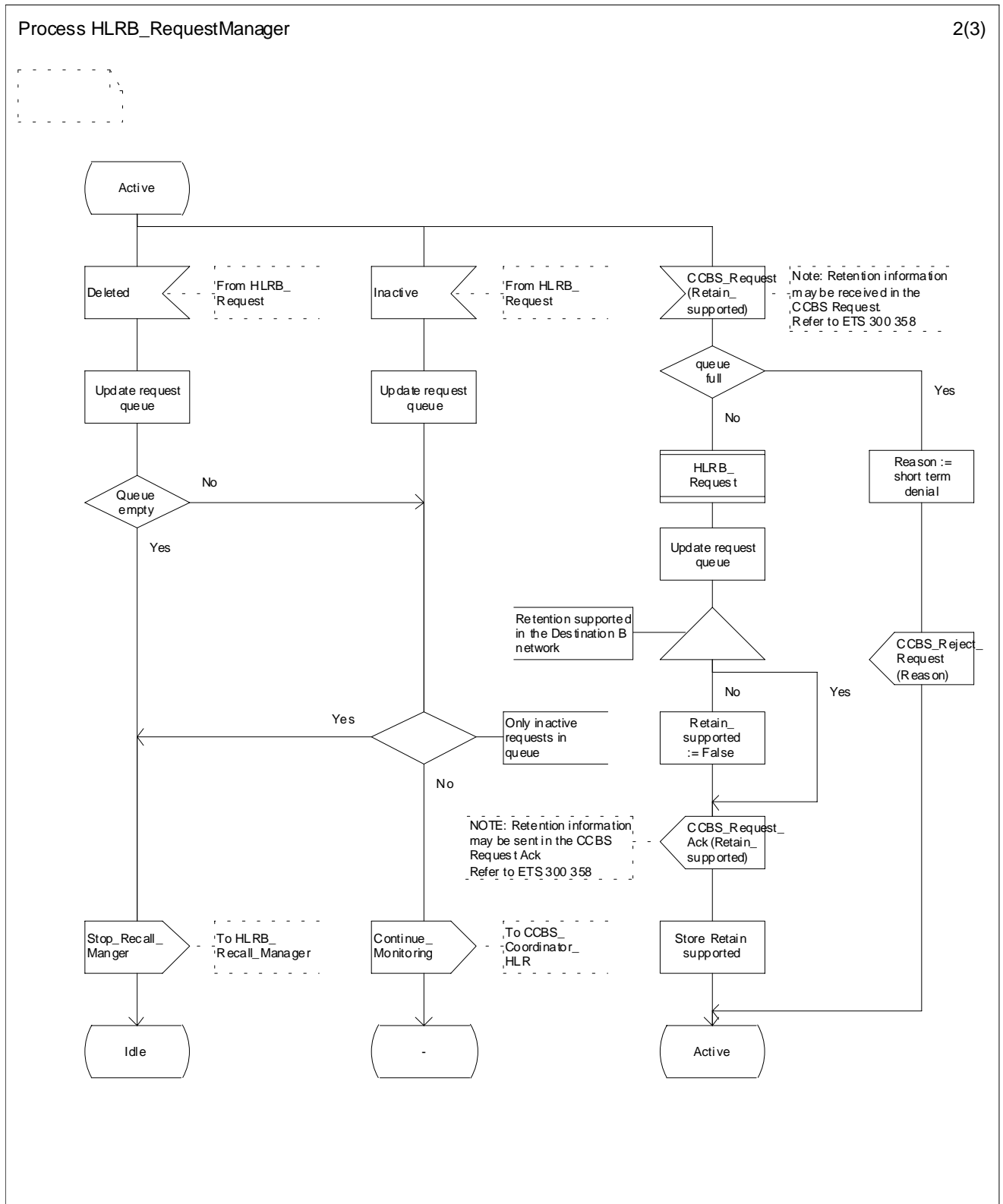

Figure 11.2.2.2: Process HLRB_REQUEST_MANAGER (sheet 2 of 3)

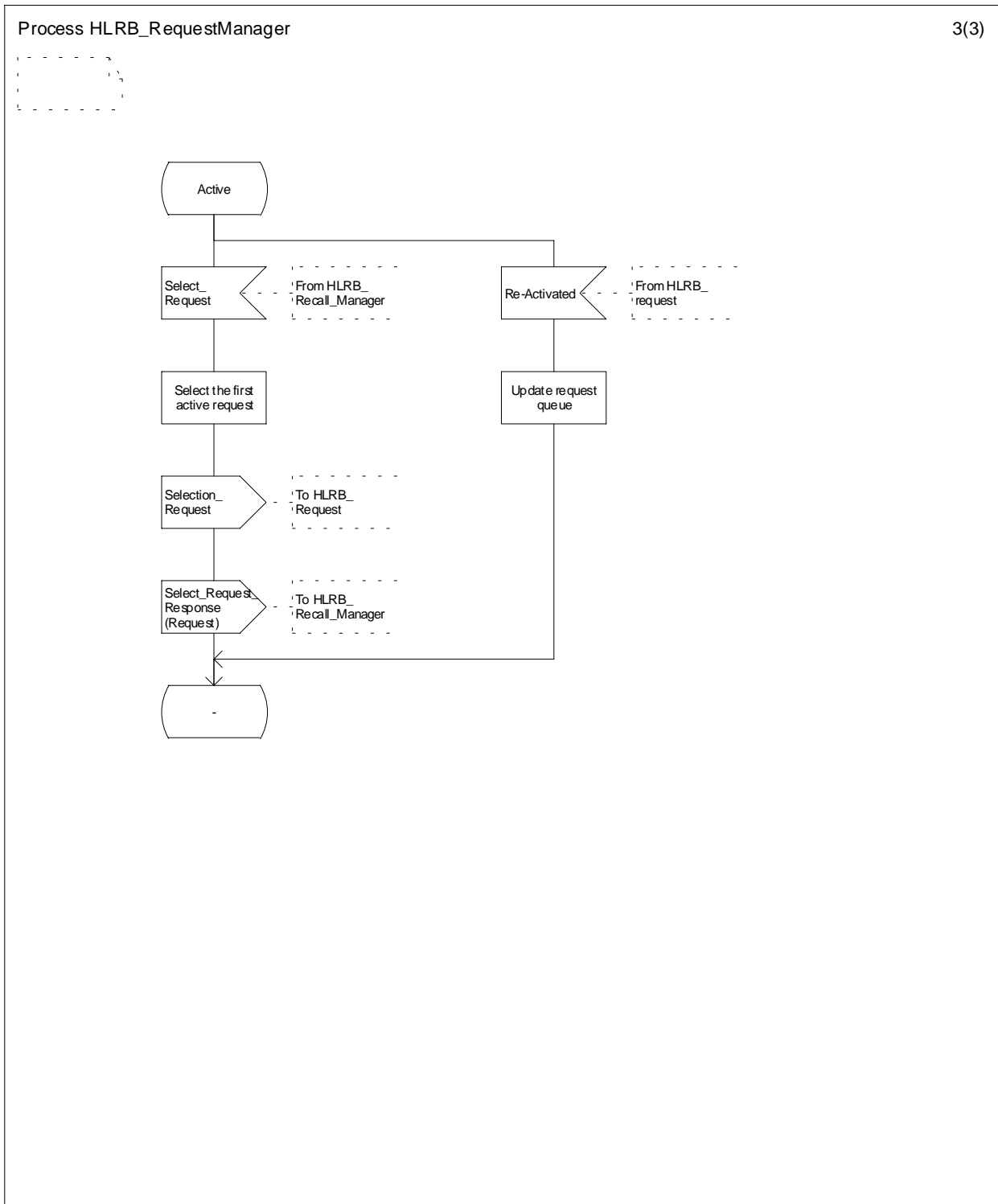

Figure 11.2.2.2: Process HLRB_REQUEST_MANAGER (sheet 3 of 3)

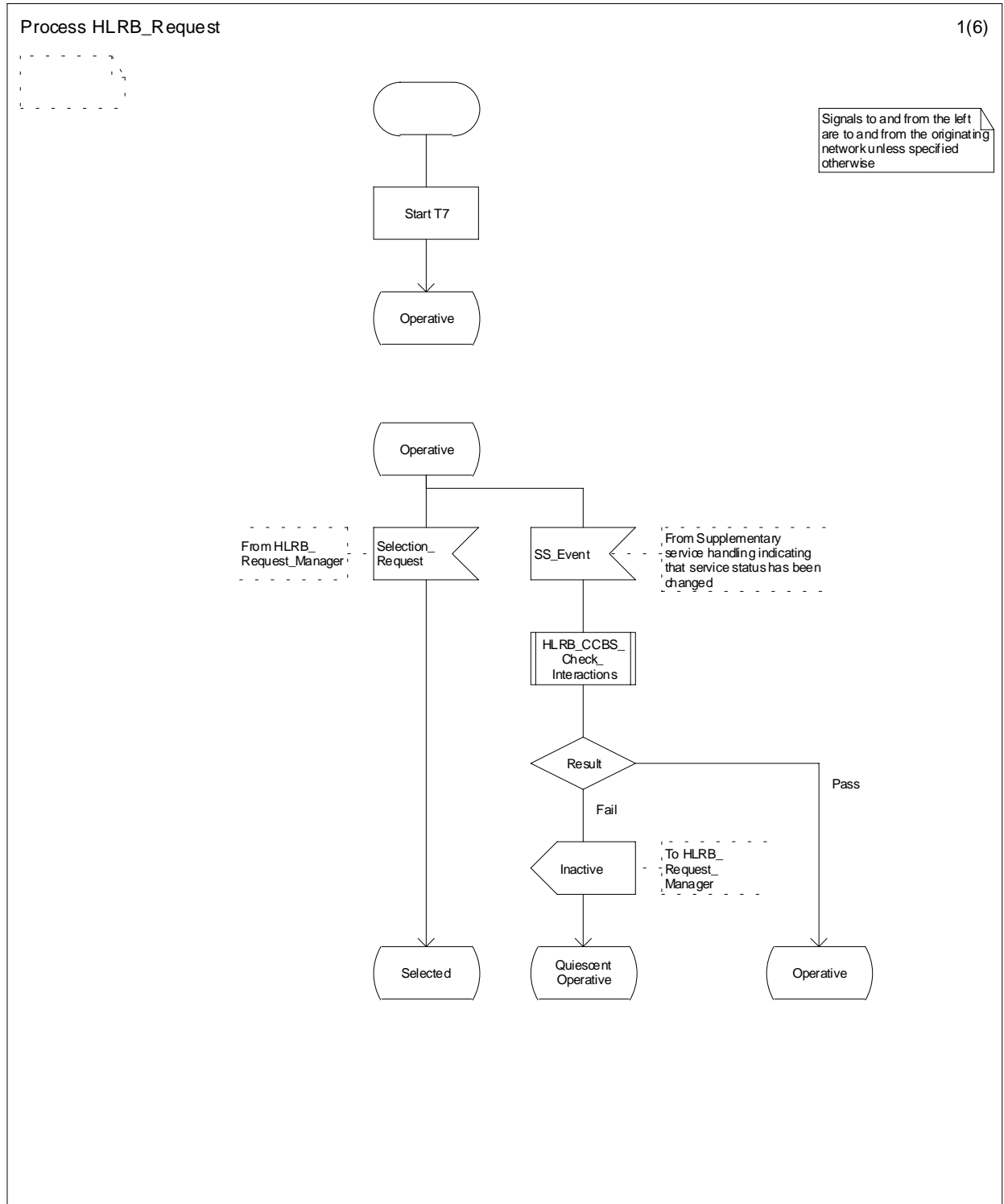

Figure 11.2.2.3: Process HLRB_REQUEST (sheet 1 of 6)

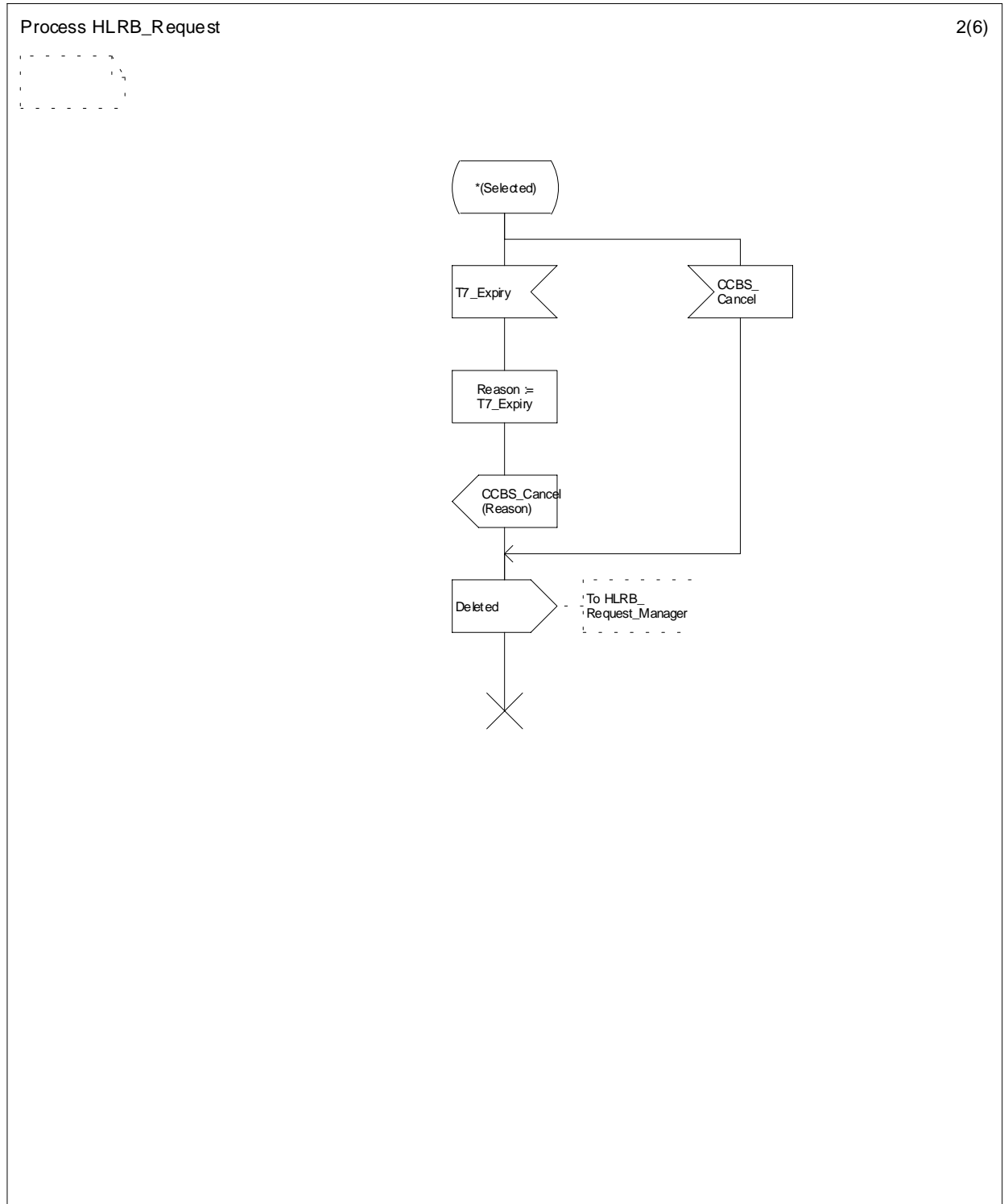

Figure 11.2.2.3: Process HLRB_REQUEST (sheet 2 of 6)

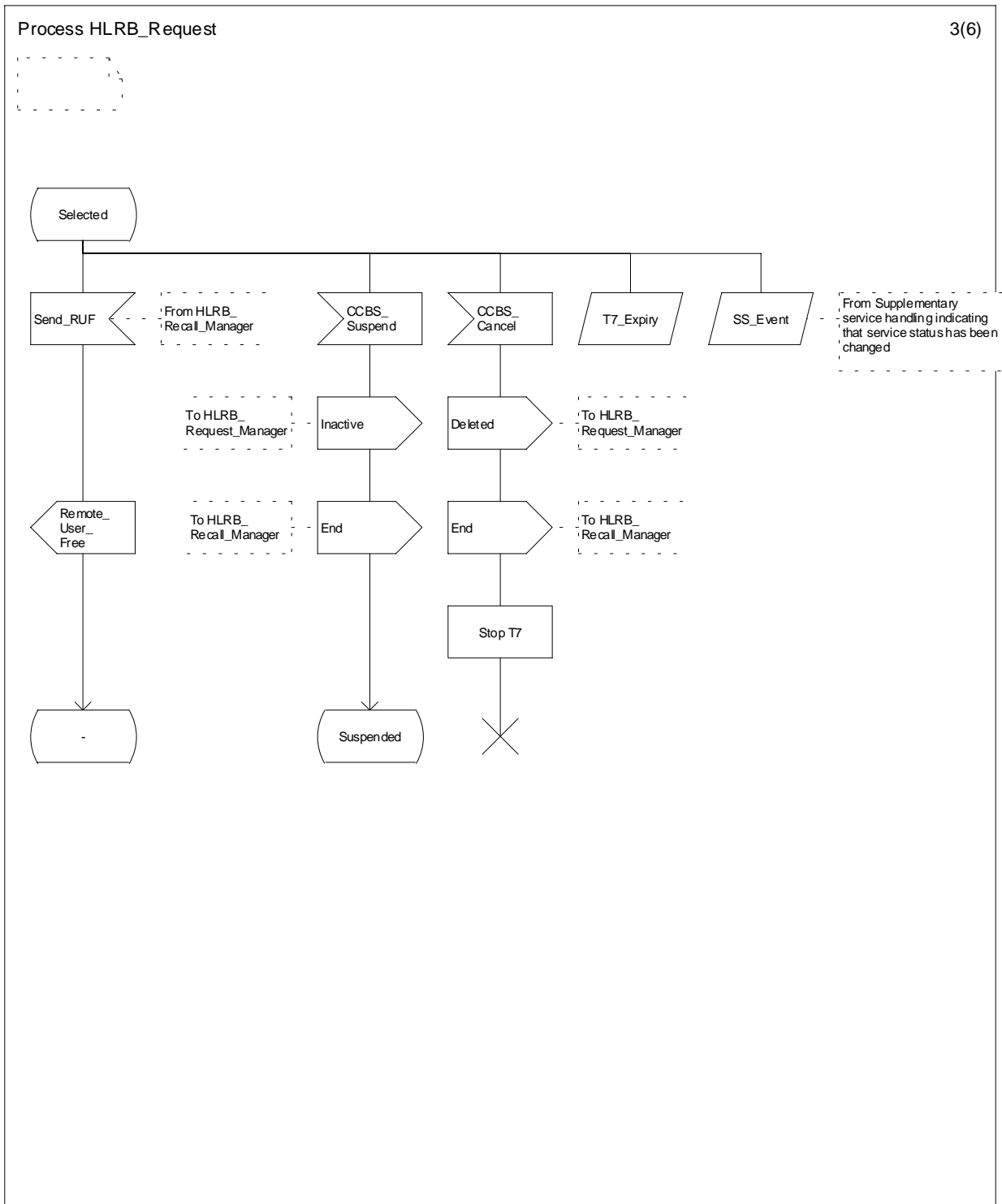

Figure 11.2.2.3: Process HLRB_REQUEST (sheet 3 of 6)

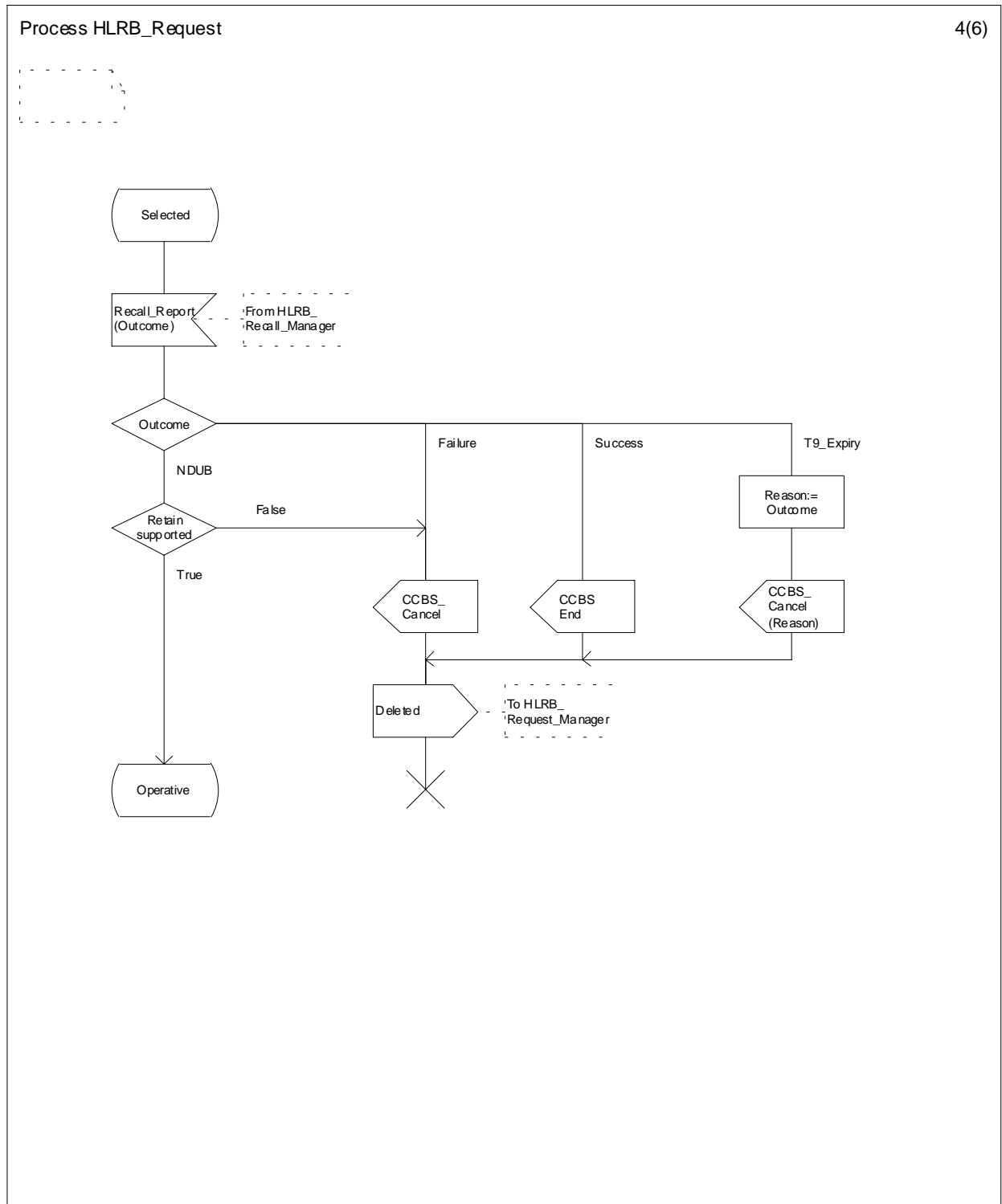

Figure 11.2.2.3: Process HLRB_REQUEST (sheet 4 of 6)

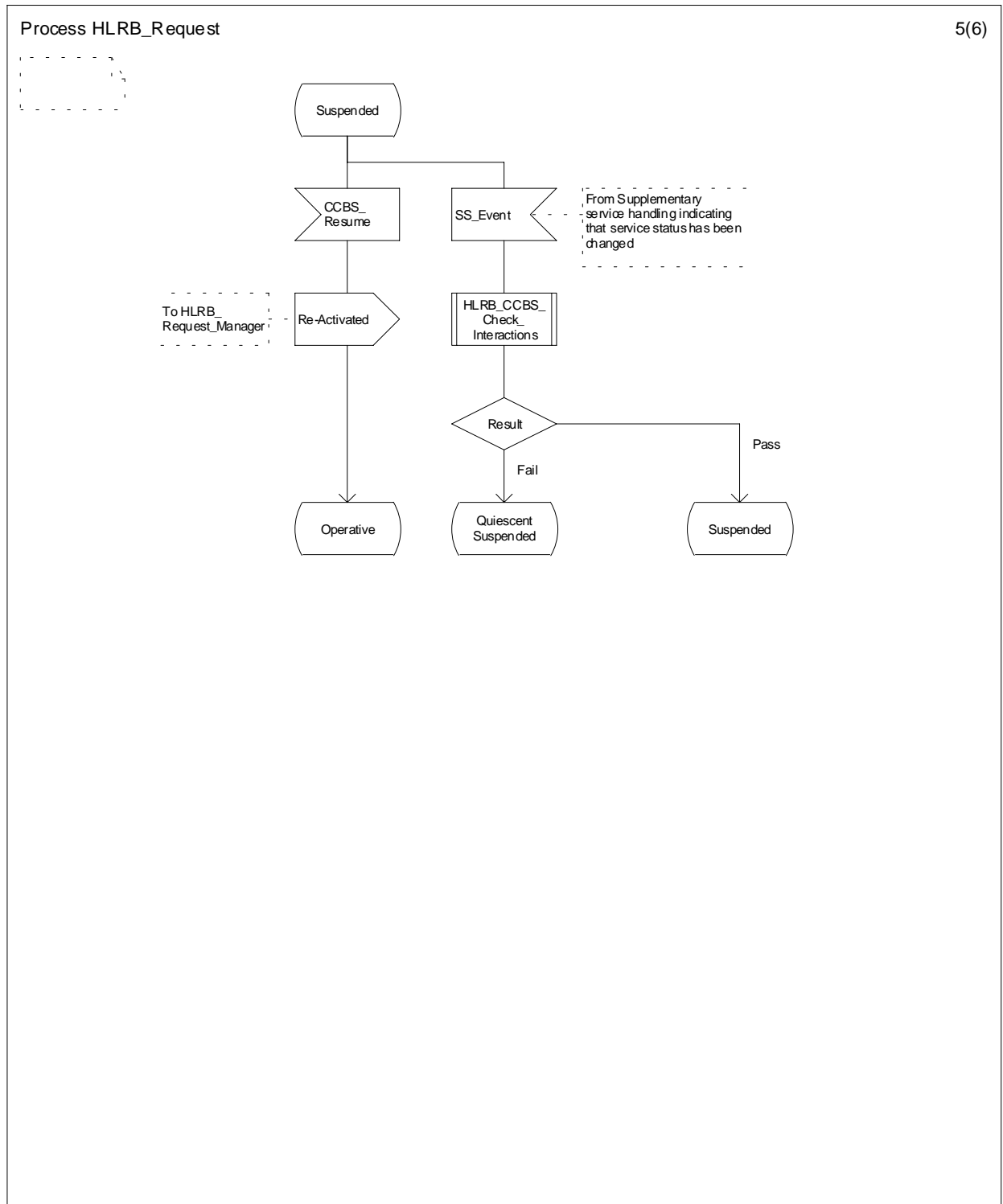

Figure 11.2.2.3: Process HLRB_REQUEST (sheet 5 of 6)

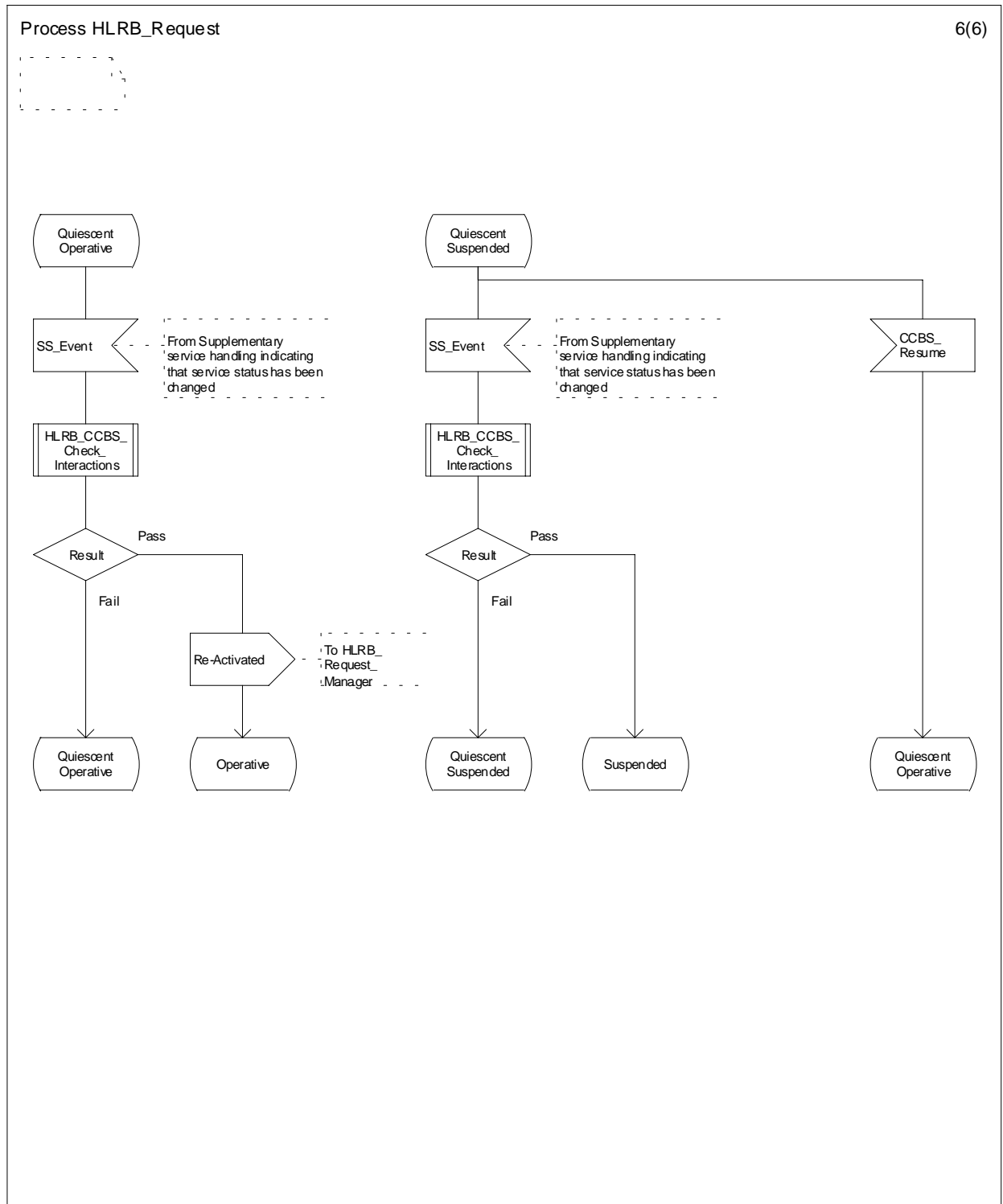

Figure 11.2.2.3: Process HLRB_REQUEST (sheet 6 of 6)

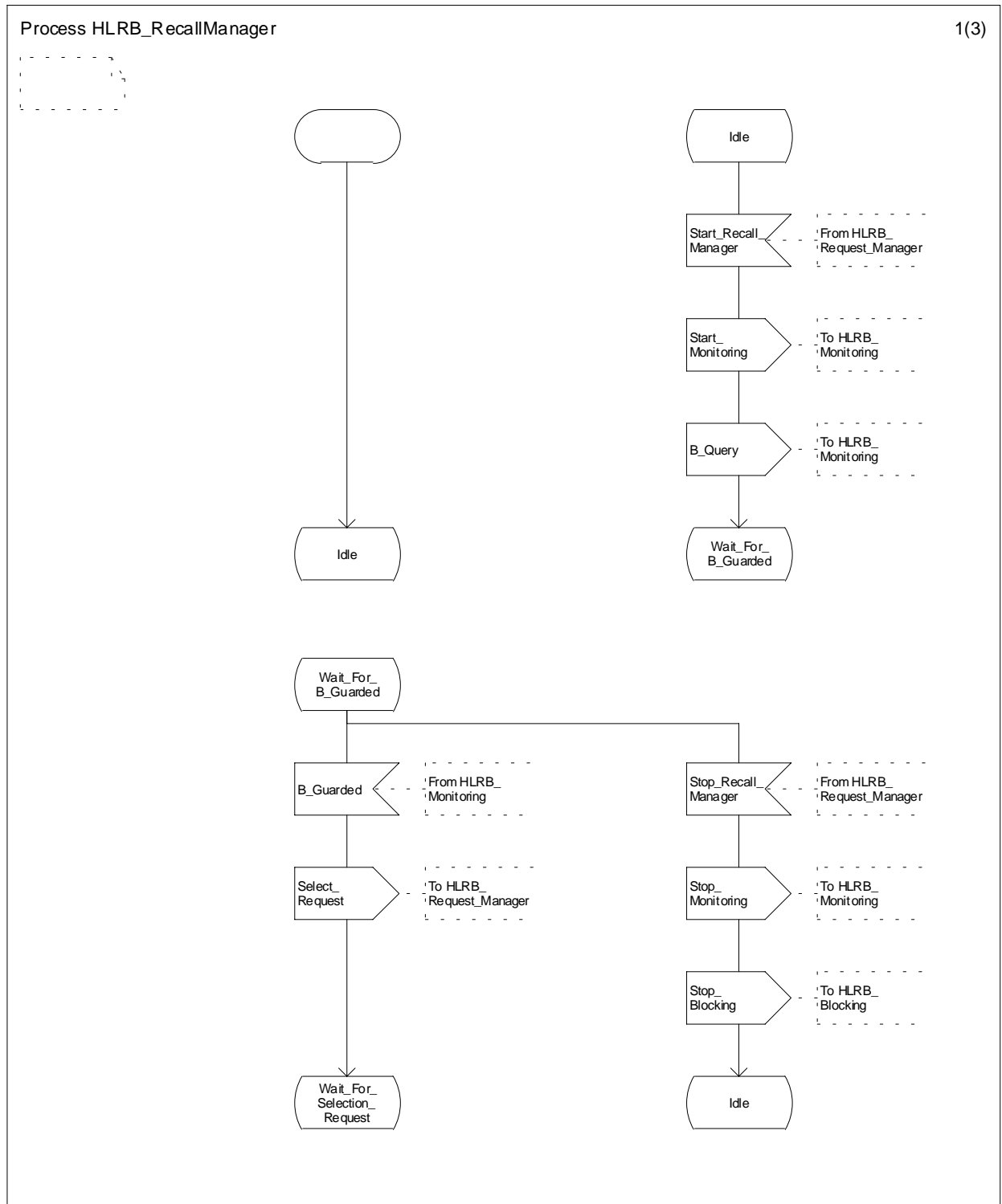

Figure 11.2.2.4: Process HLRB_RECALL_MANAGER (sheet 1 of 3)

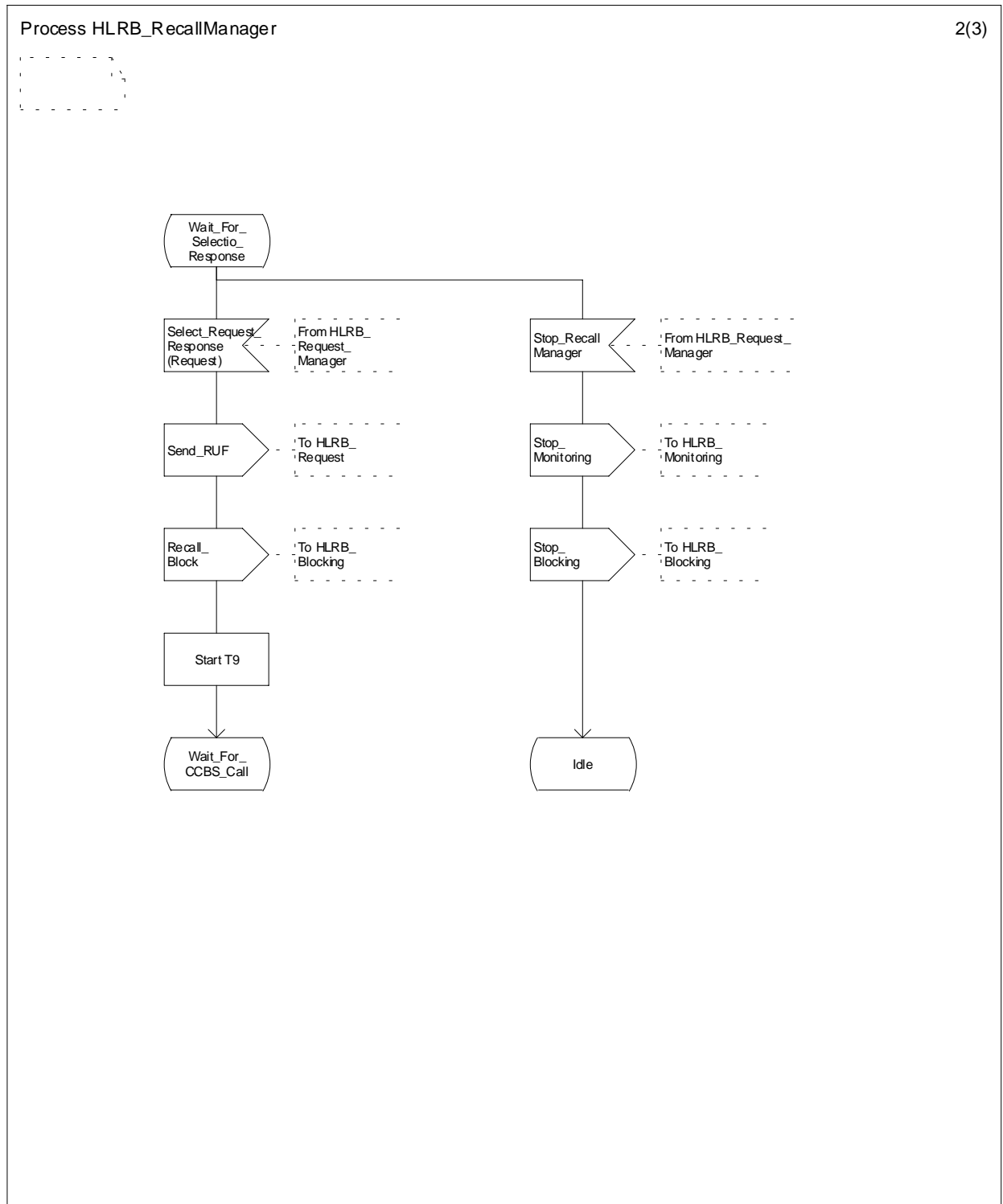

Figure 11.2.2.4: Process HLRB_RECALL_MANAGER (sheet 2 of 3)

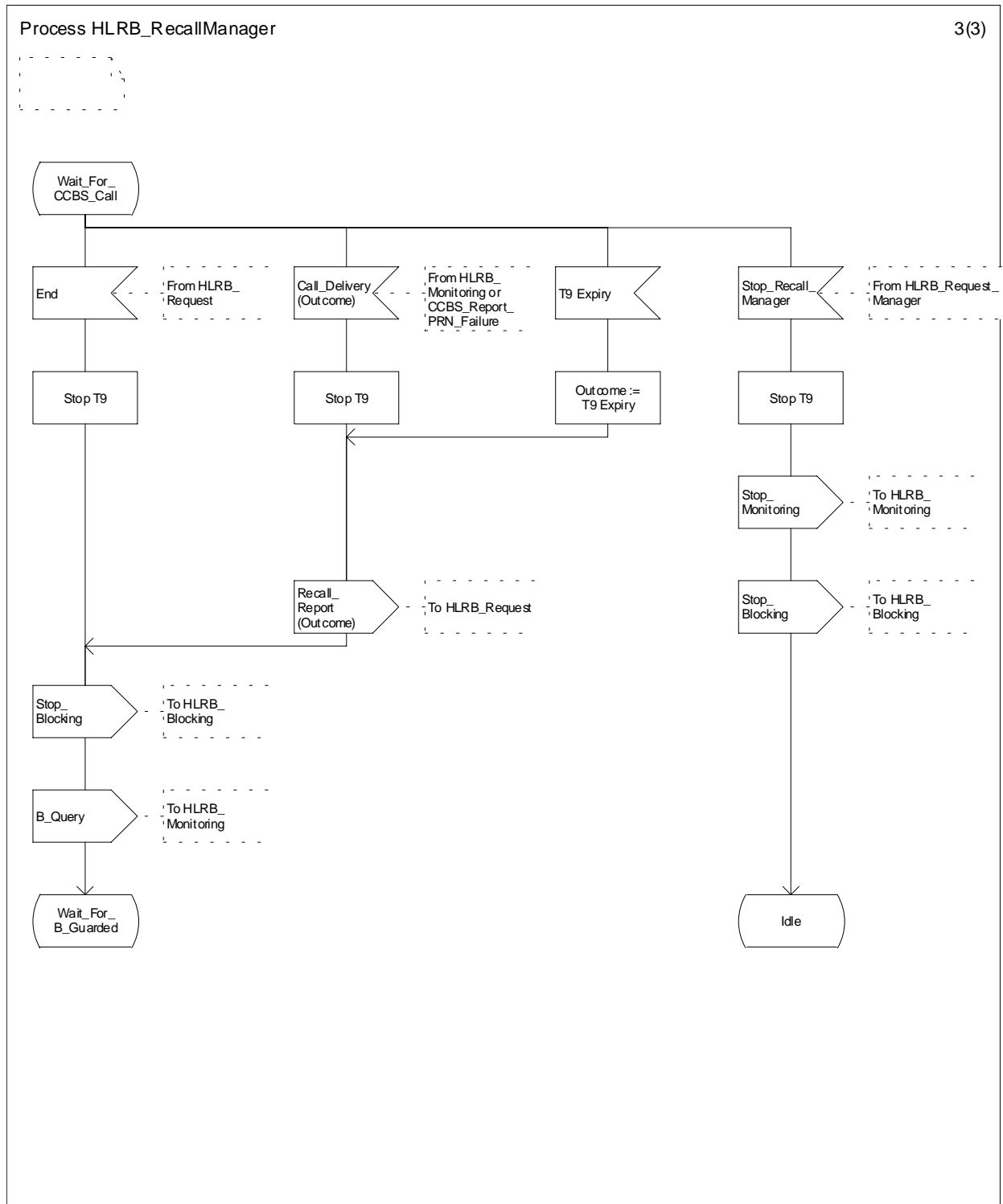

Figure 11.2.2.4: Process HLRB_RECALL_MANAGER (sheet 3 of 3)

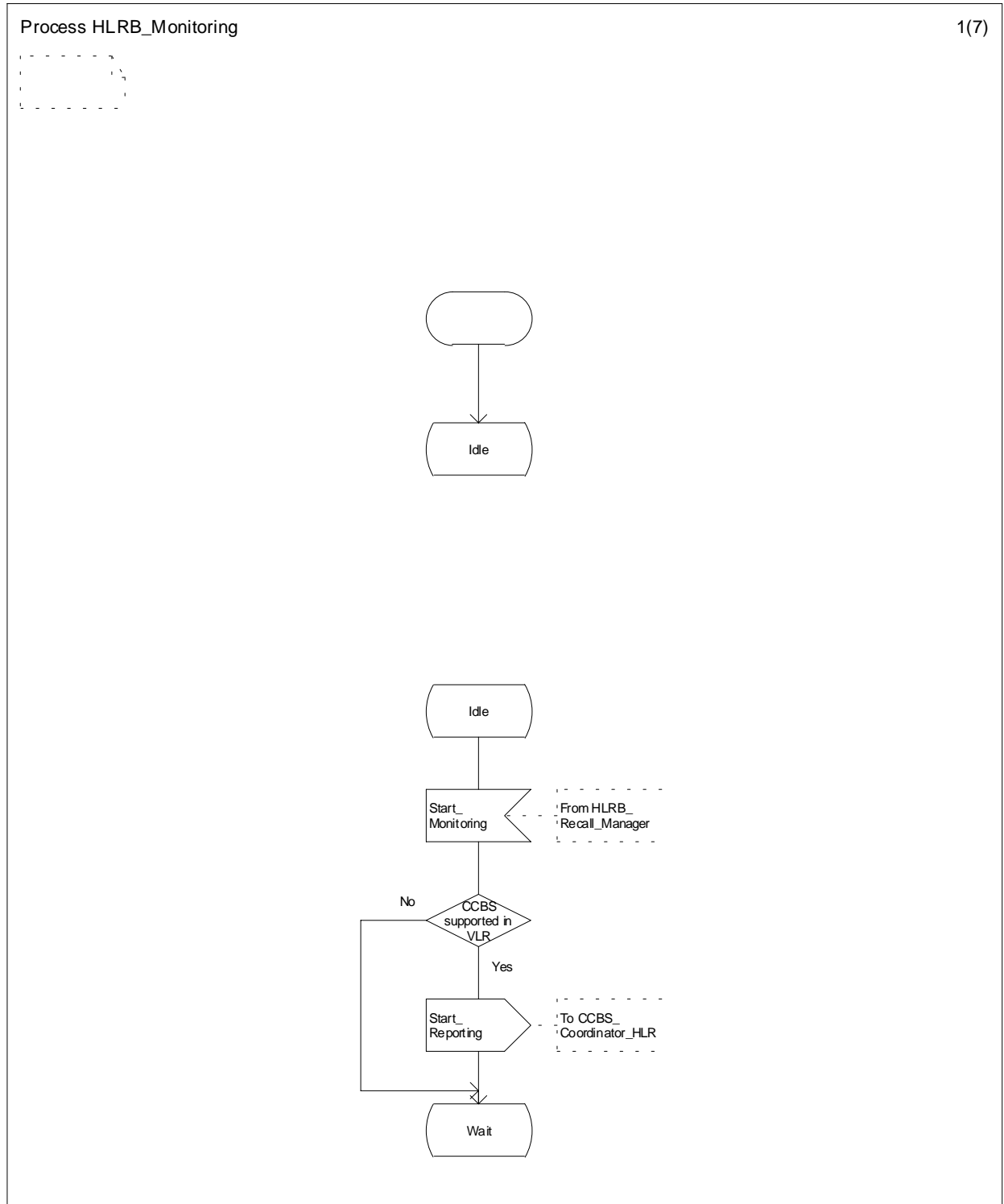

Figure 11.2.2.5: Process HLRB_MONITORING (sheet 1 of 7)

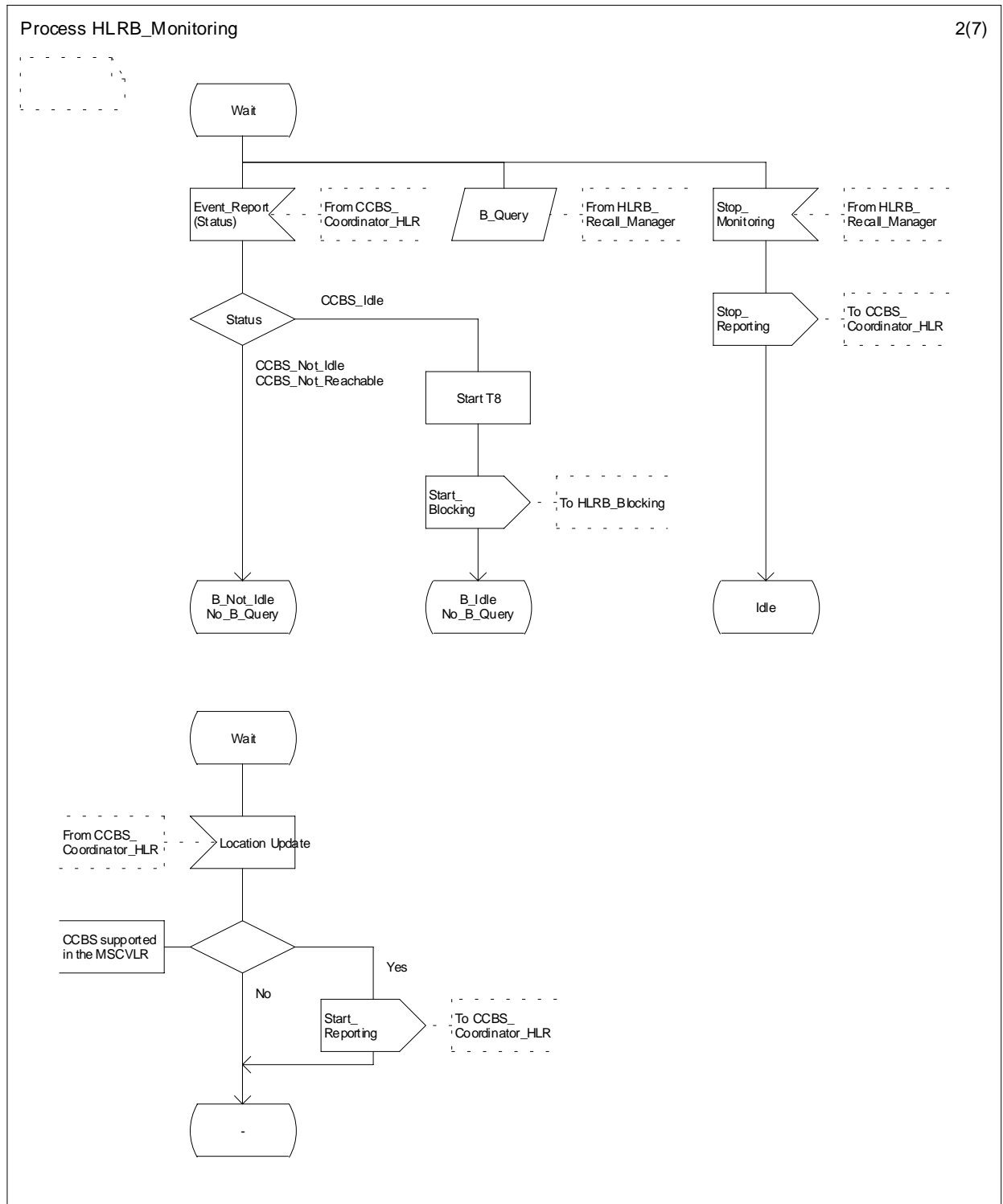

Figure 11.2.2.5: Process HLRB_MONITORING (sheet 2 of 7)

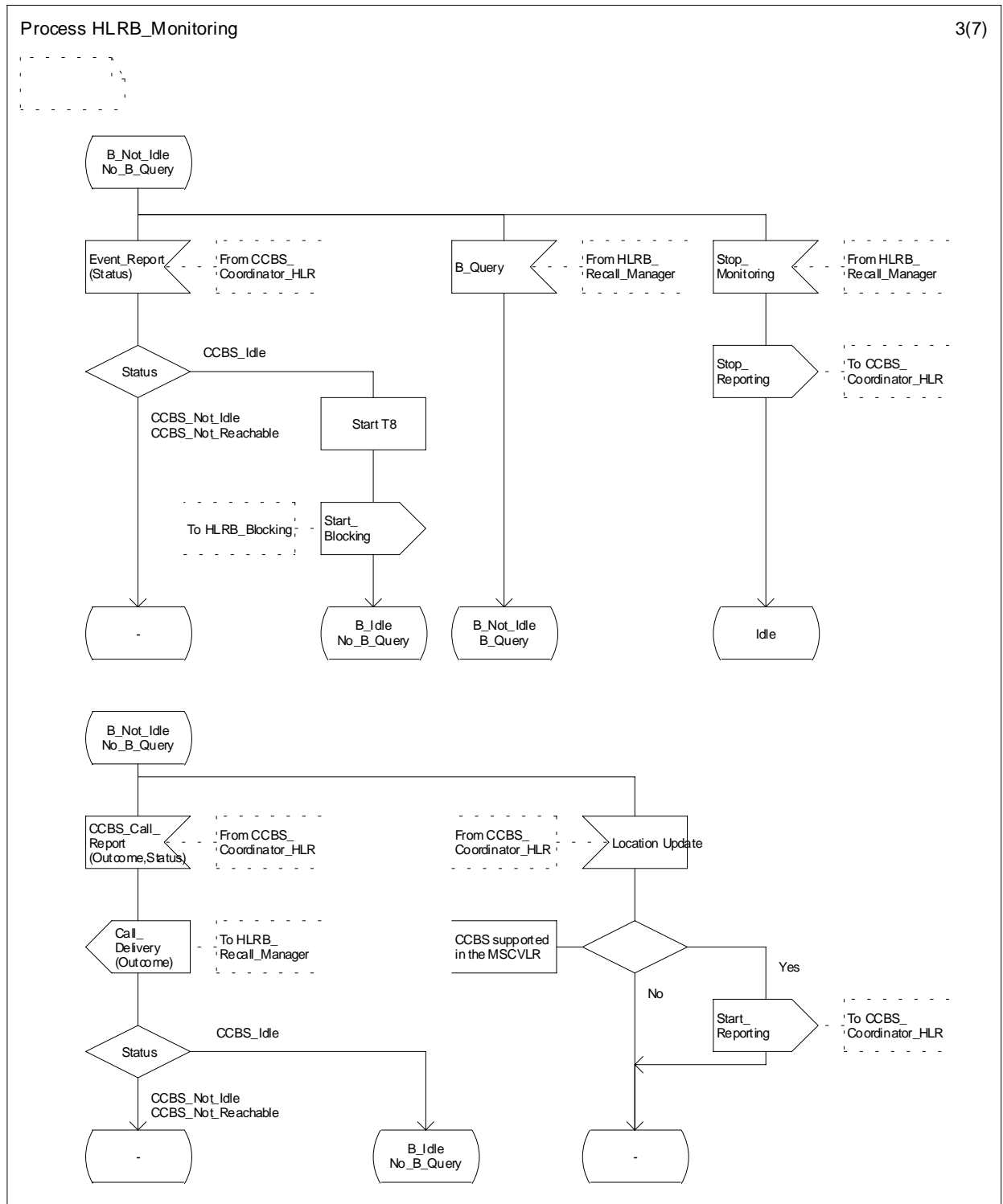

Figure 11.2.2.5: Process HLRB_MONITORING (sheet 3 of 7)

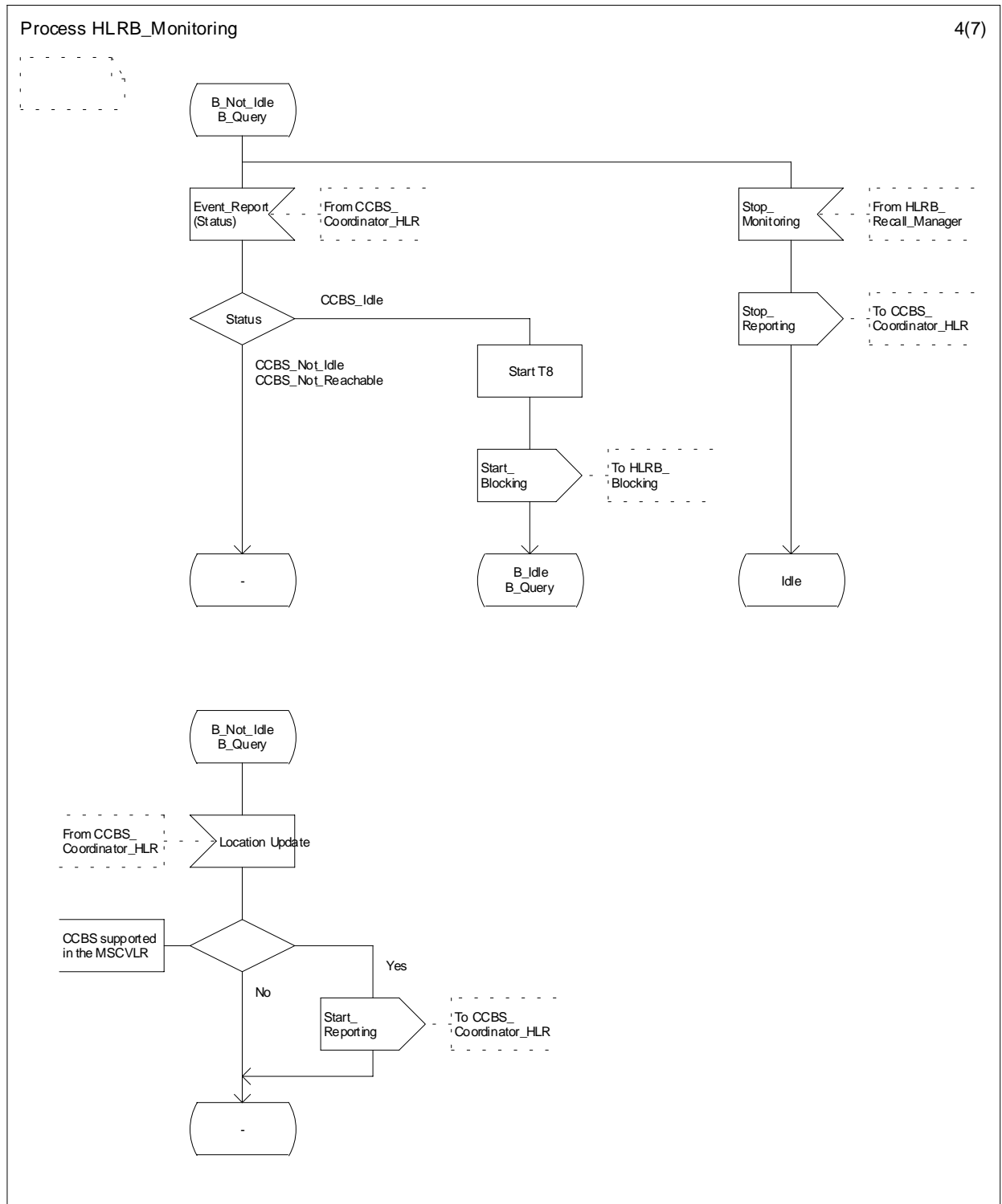

Figure 11.2.2.5: Process HLRB_MONITORING (sheet 4 of 7)

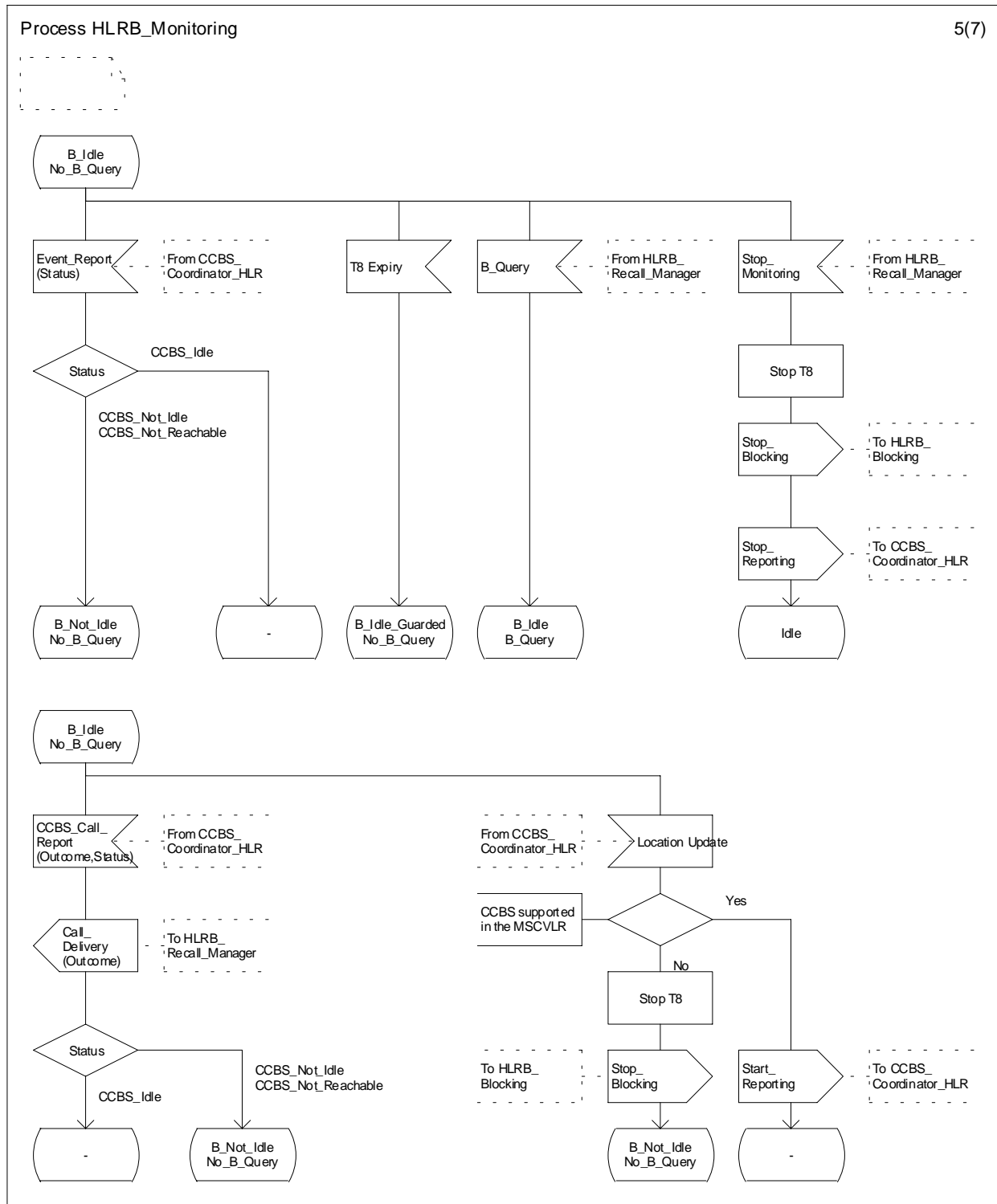

Figure 11.2.2.5: Process HLRB_MONITORING (sheet 5 of 7)

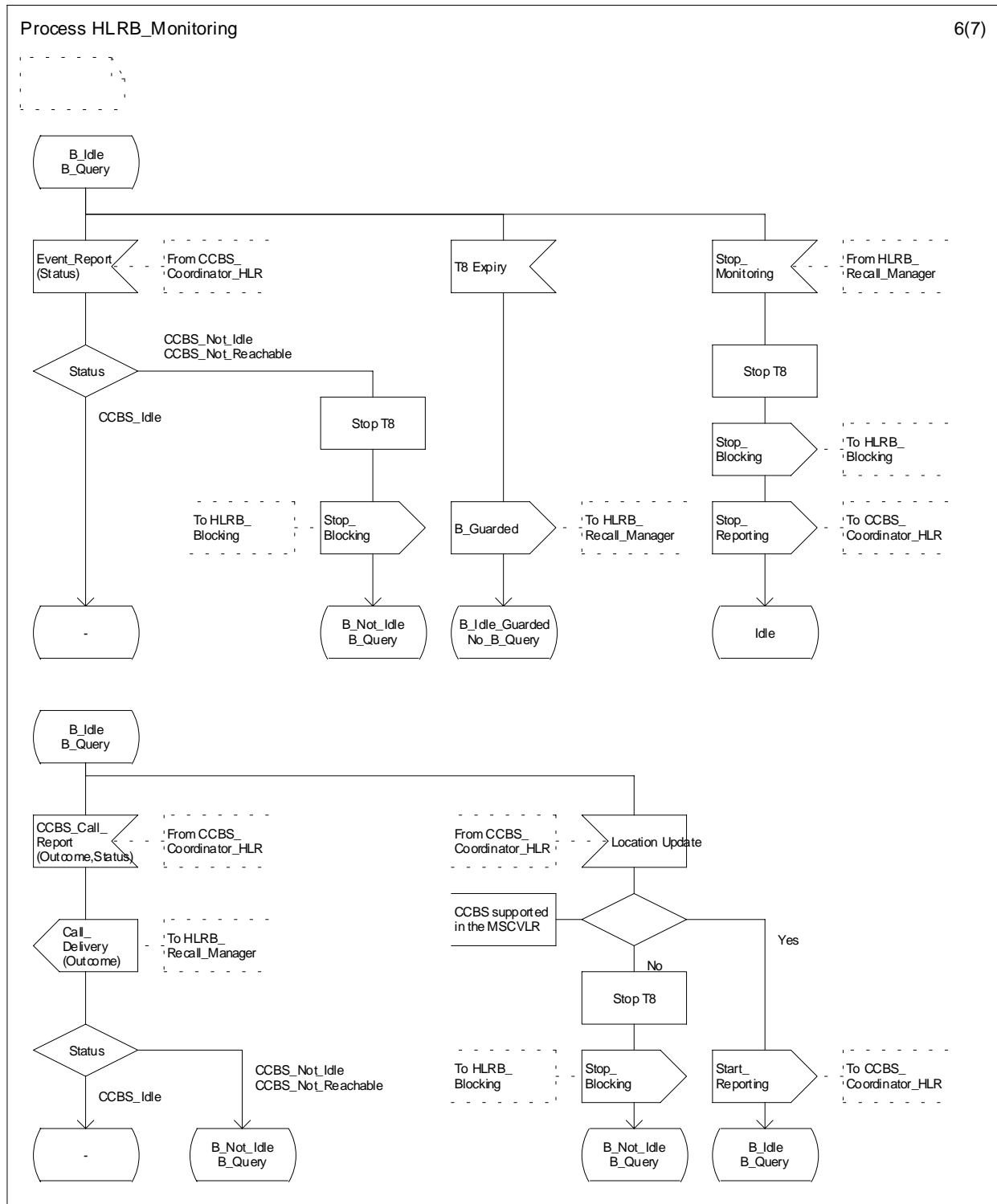

Figure 11.2.2.5: Process HLRB_MONITORING (sheet 6 of 7)

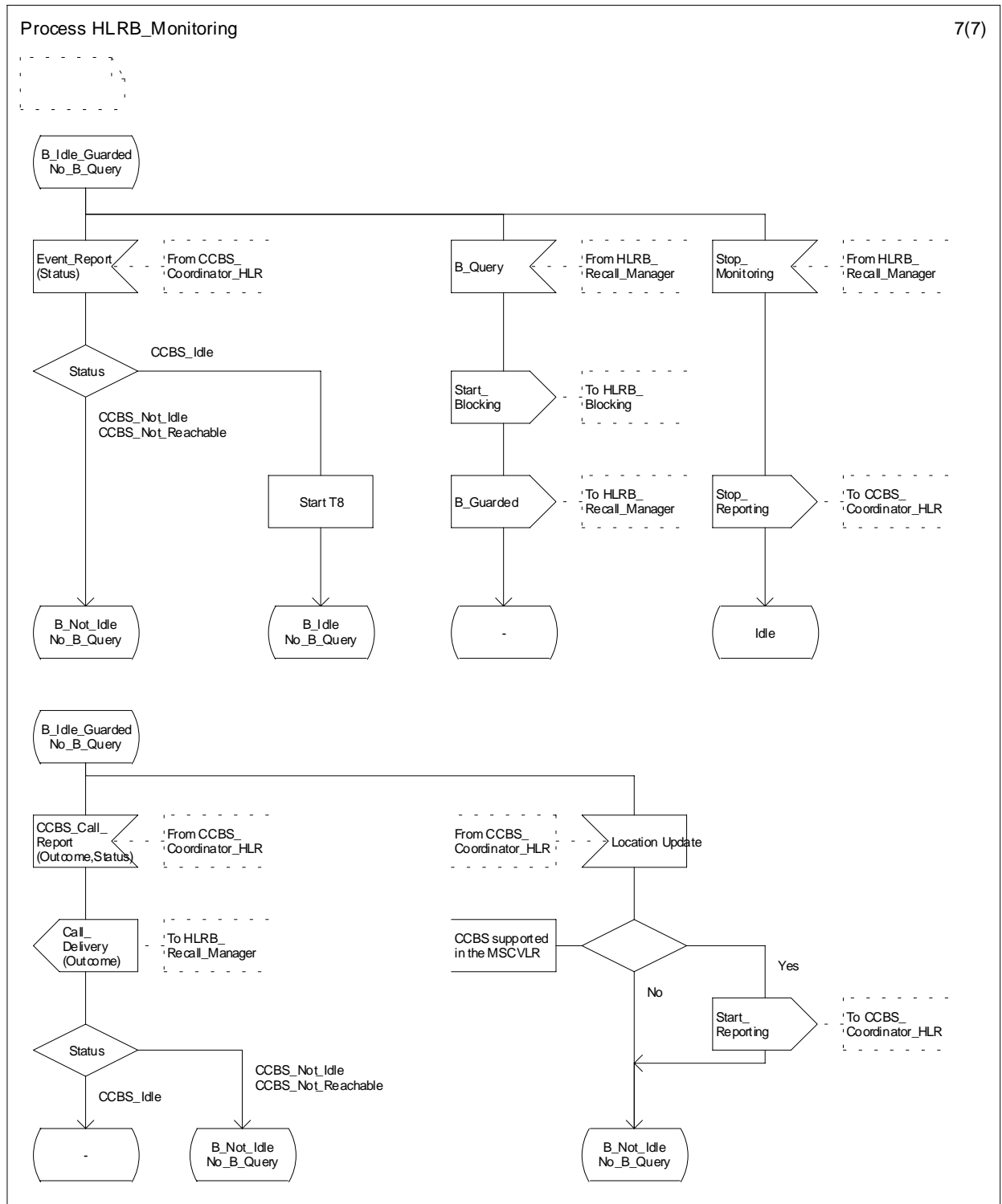

Figure 11.2.2.5: Process HLRB_MONITORING (sheet 7 of 7)

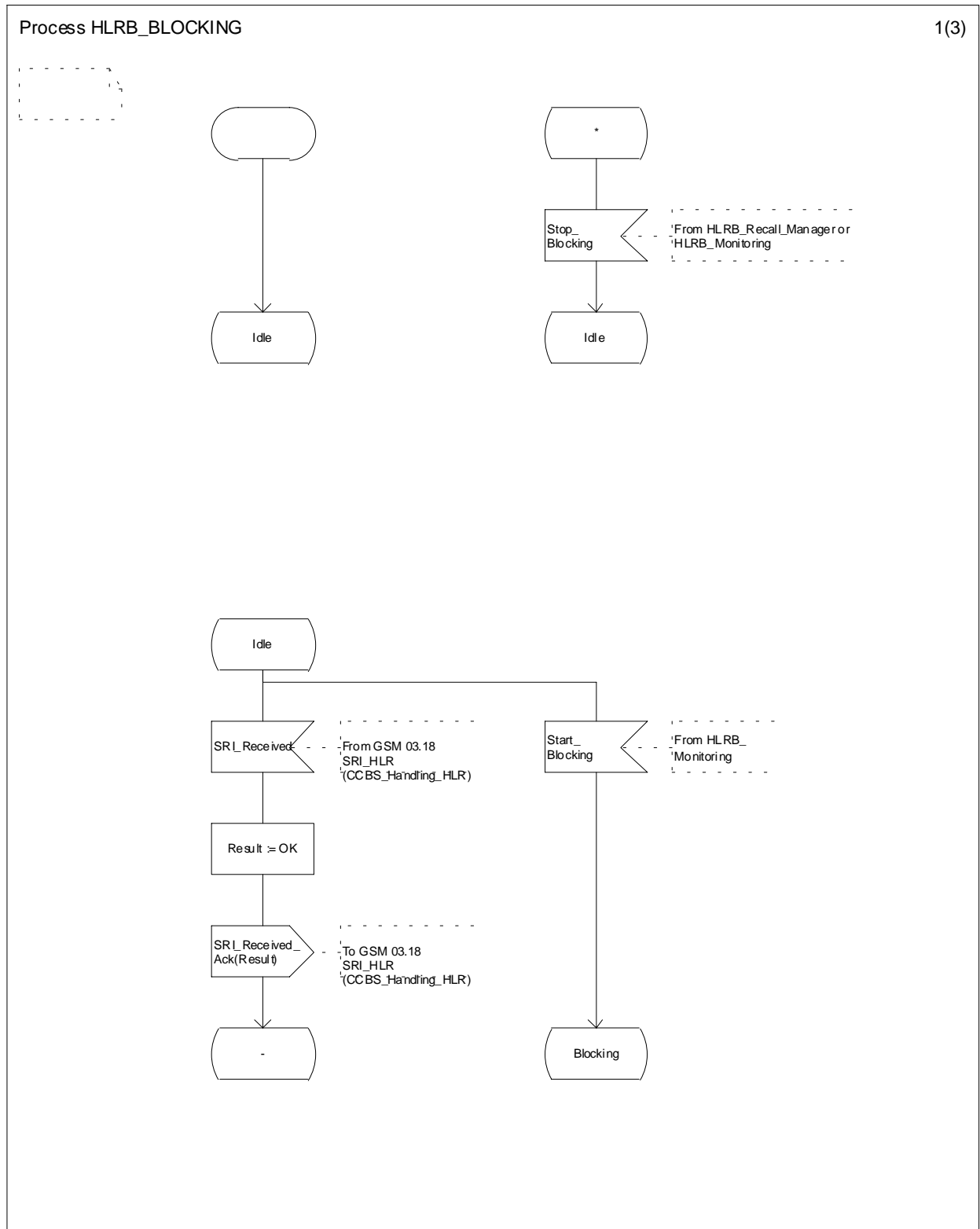

Figure 11.2.2.6: Process HLRB_BLOCKING (sheet 1 of 3)

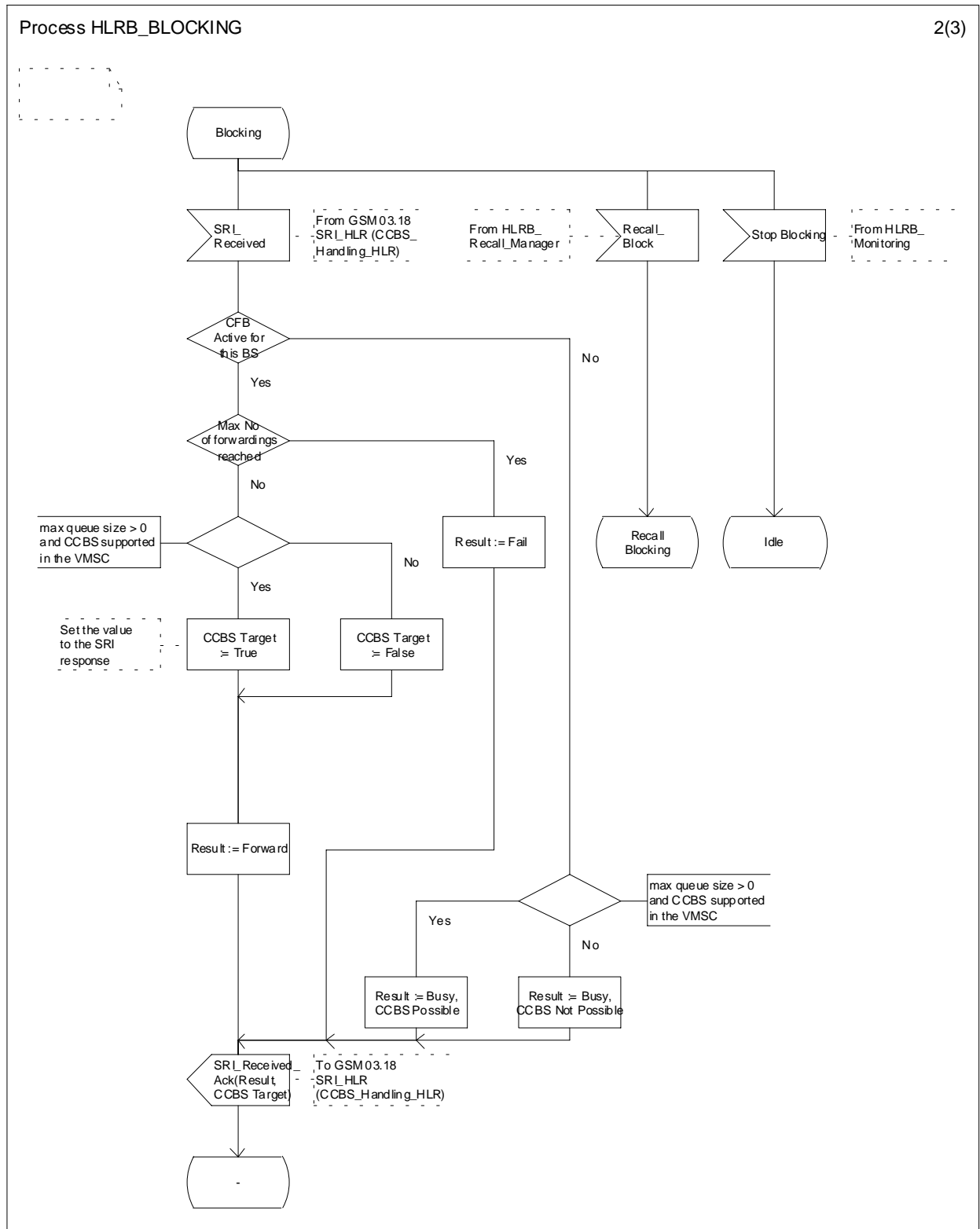

Figure 11.2.2.6: Process HLRB_BLOCKING (sheet 2 of 3)

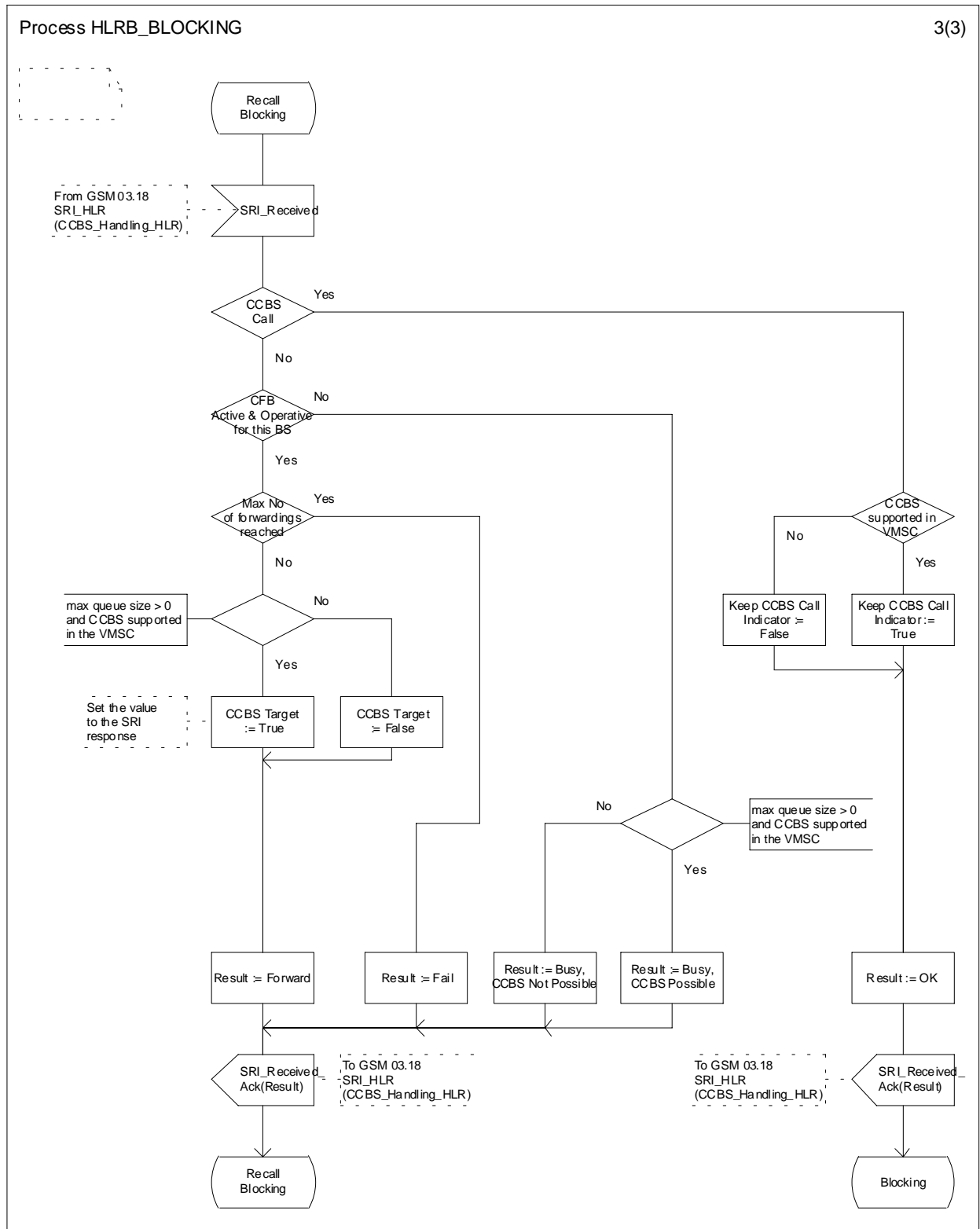

Figure 11.2.2.6: Process HLRB_BLOCKING (sheet 3 of 3)

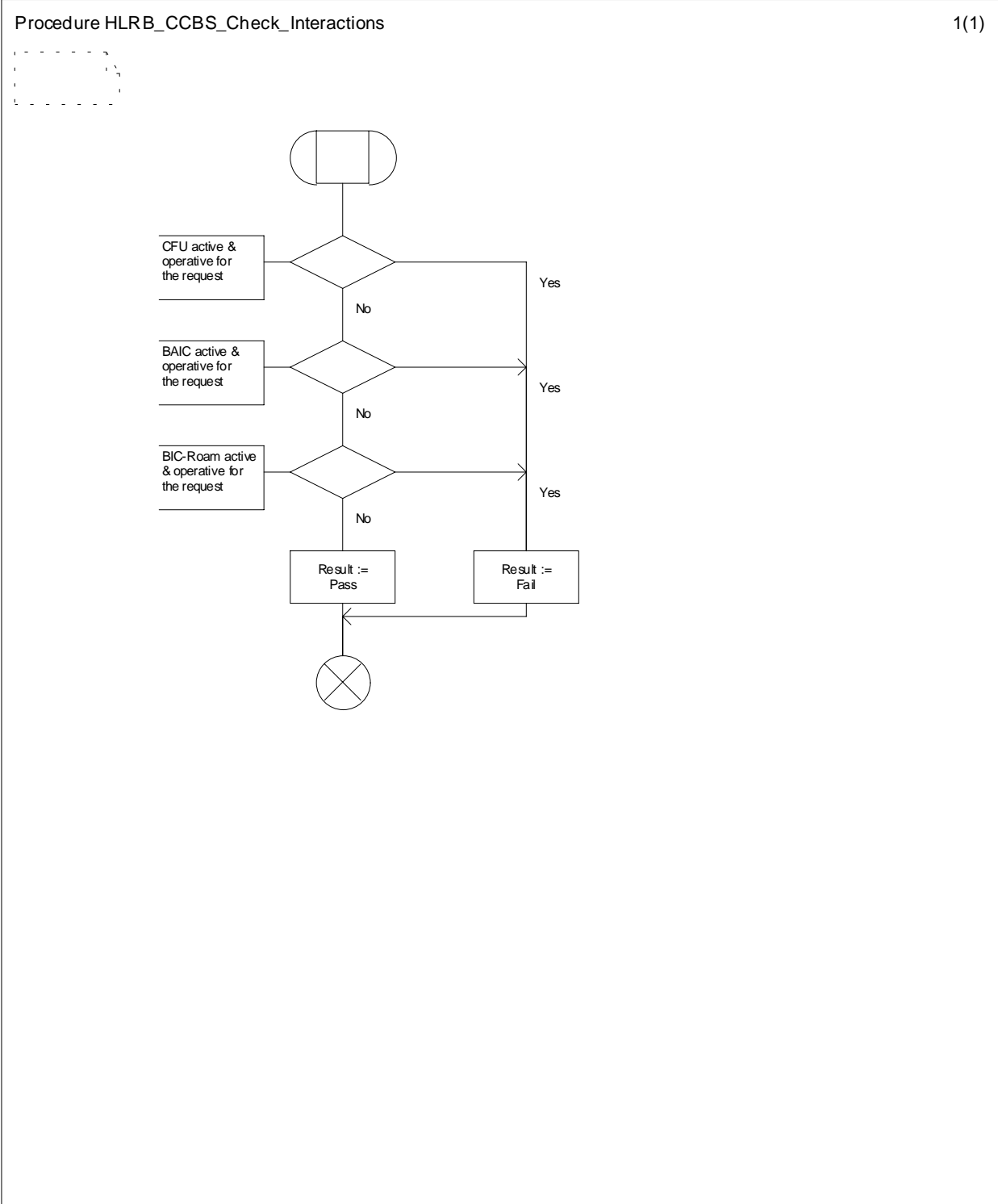

Figure 11.2.2.7: Procedure HLRB_Check_Interactions

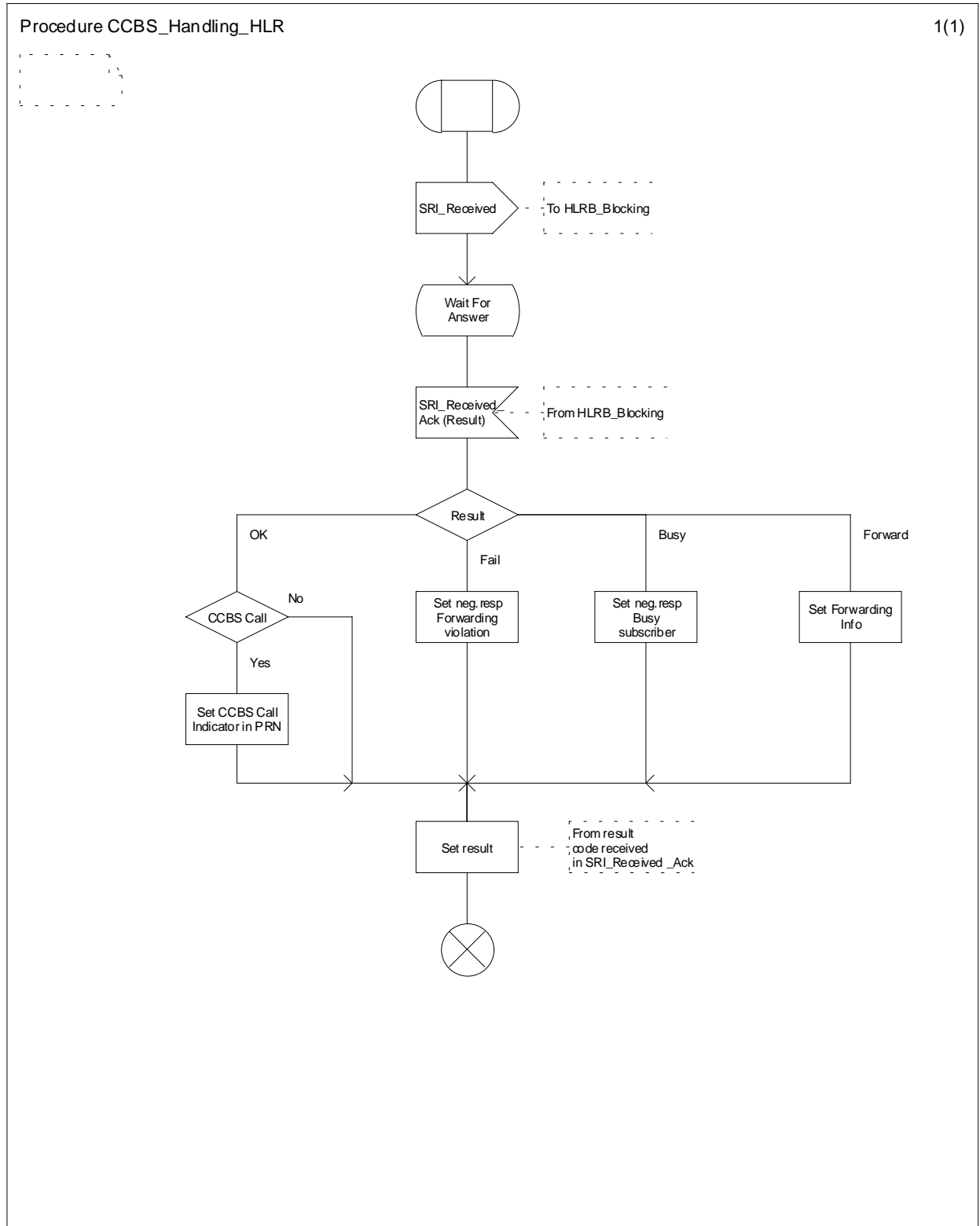

Figure 11.2.2.8: Procedure CCBS_Handling_HLR

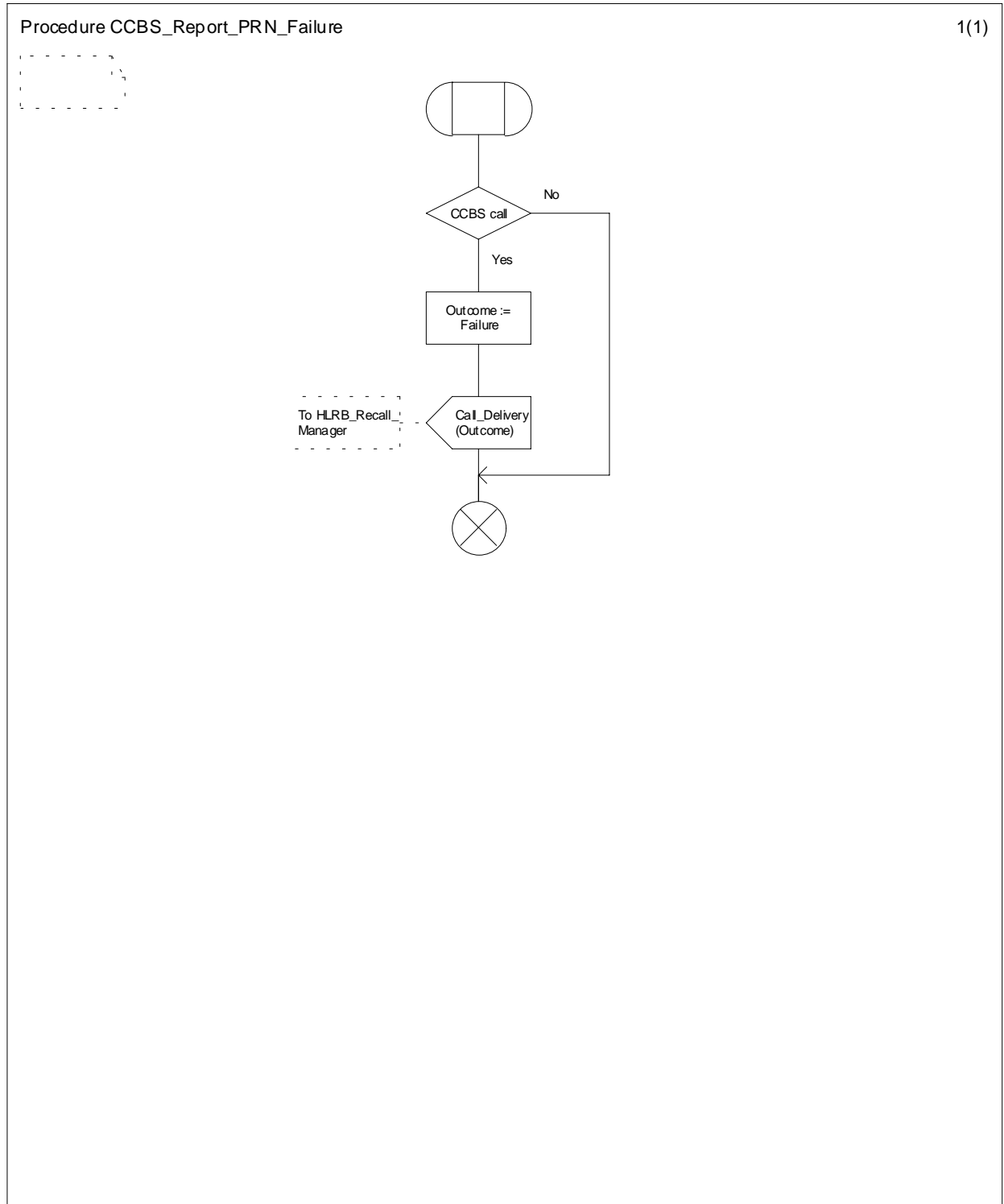

Figure 11.2.2.9: Procedure CCBS_Report_PRN_Failure

11.2.3 Procedures in MSC/VLR

Figure 11.2.3.1: Procedure CCBS_MT_MSC_Check_Forwarding

This procedure is called to set the CCBS Target variable. That variable is used in later phase to set the correct diagnostic value to the Release message.

Figure 11.2.3.2: Procedure CCBS_Handle_PRN

This procedure is called to store CCBS call indicator when roaming number is reserved in the VLR.

Figure 11.2.3.3: Procedure CCBS_ICH_Set_CCBS_Call_Indicator

This procedure is called when VLR receives Send Info For Incoming Call message. If MSRN is related to the CCBS call, CCBS call indicator is set for call handling.

Figure 11.2.3.4: Procedure CCBS_ICH_MSC_Report_Failure

This procedure is called when CCBS call fails in the destination MSC and the reason is detected in the MSC side.

Figure 11.2.3.5: Procedure CCBS_ICH_VLR_Report_Failure

This procedure is called when CCBS call fails in the destination MSC and the reason is detected in the VLR side.

Figure 11.2.3.6: Procedure CCBS_ICH_Report_Not_Reachable

This procedure is called when call fails in the destination MSC with special cause of Not_Reachable. On normal call Not_Reachable message is sent to the monitoring process, on CCBS call subscriber is reported being absent.

Figure 11.2.3.7: Procedure CCBS_ICH_Handle_NDUB

This procedure is called when call encounters NDUB condition in the destination MSC. It is a network option to forward the call or release the call.

Figure 11.2.3.8: Procedure CCBS_ICH_Handle_UDUB

This procedure is called when call encounters UDUB condition in the destination MSC.

Figure 11.2.3.9: Procedure CCBS_ICH_MSC_Report_Success

This procedure is called when CCBS call is successfully delivered in the destination MSC and the event is detected in the MSC side.

Figure 11.2.3.10: Procedure CCBS_ICH_VLR_Report_Success

This procedure is called when CCBS call is successfully delivered in the destination MSC and the event is detected in the VLR side.

Figure 11.2.3.11: Procedure CCBS_ICH_Set_CCBS_Target

This procedure is called if when a call encounters busy condition in the destination MSC. If busy cause is NDUB and the user has elected to be target of CCBS requests, CCBS Target is set to True.

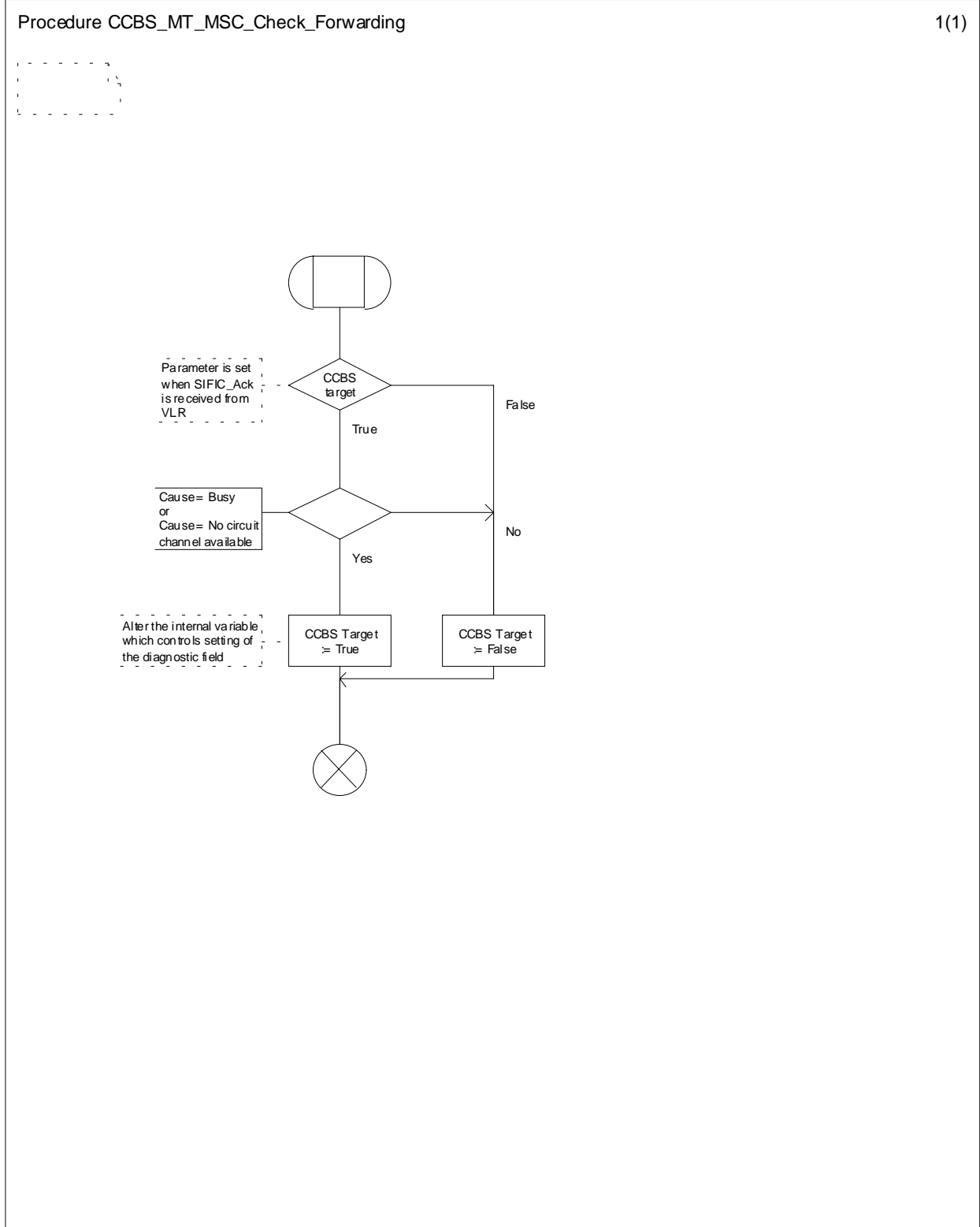

Figure 11.2.3.1: Procedure CCBS_MT_MSC_Check_Forwarding

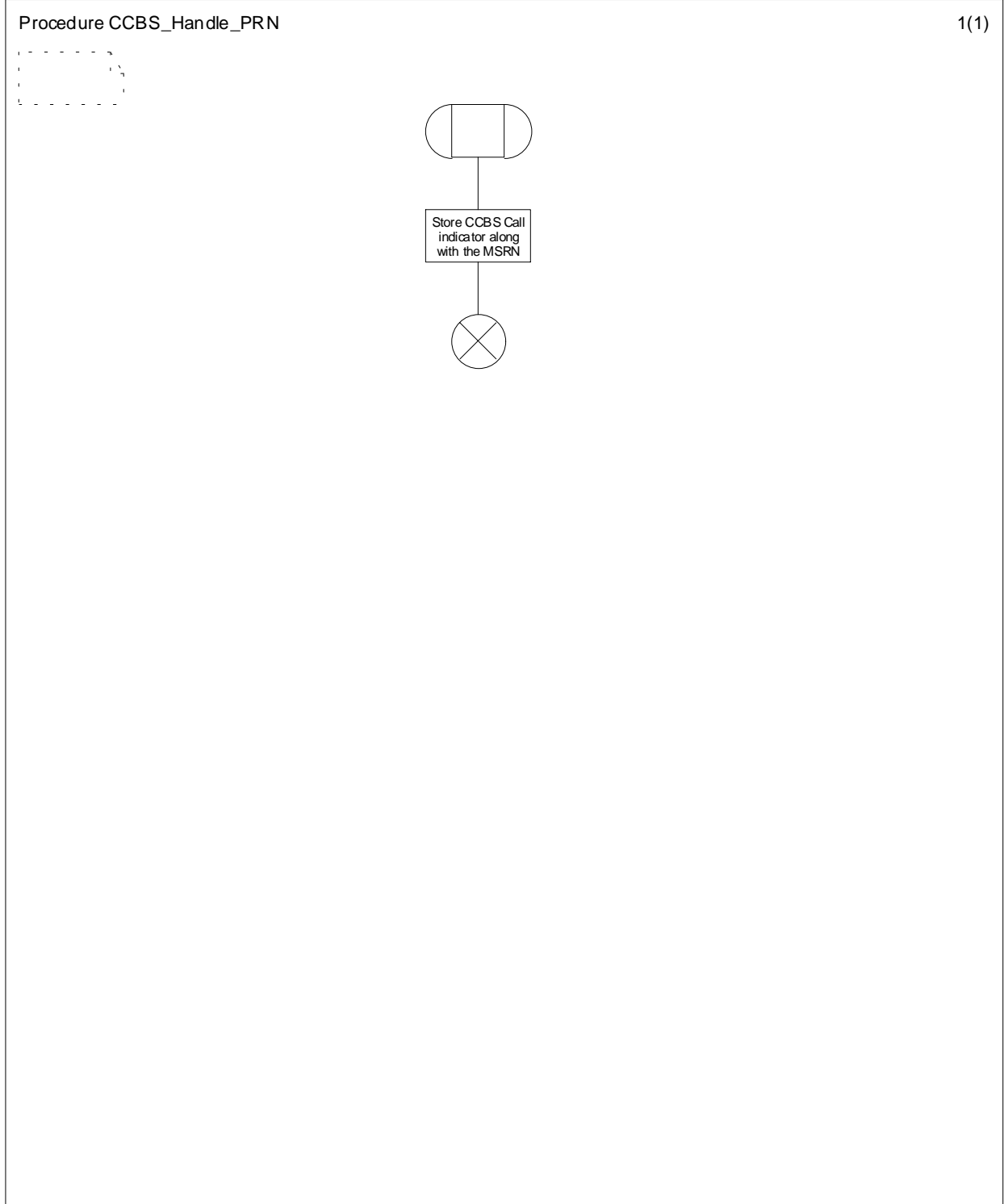

Figure 11.2.3.2: Procedure CCBS_Handle_PRN

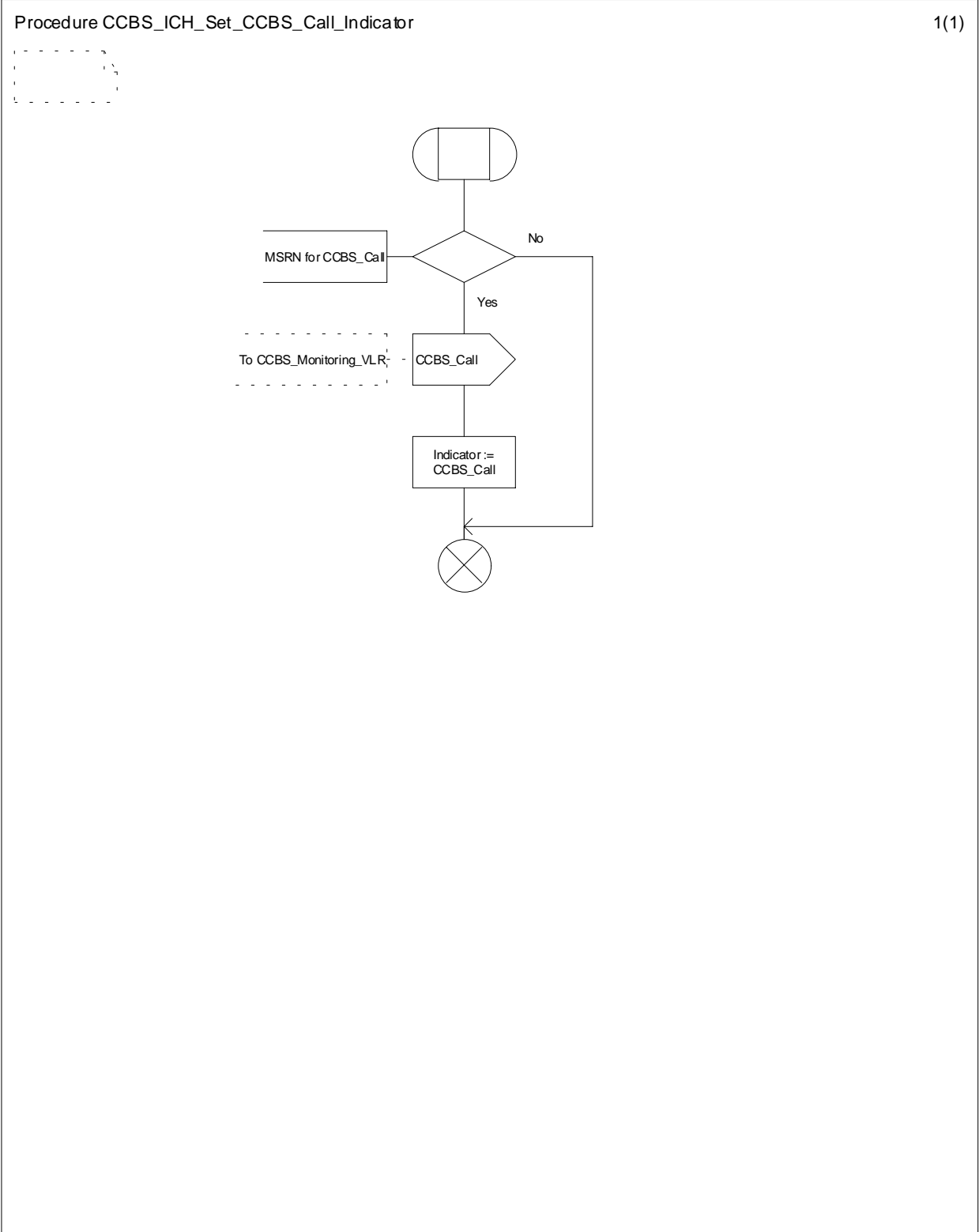

Figure 11.2.3.3: Procedure CCBS_ICH_Set_CCBS_Call_Indicator

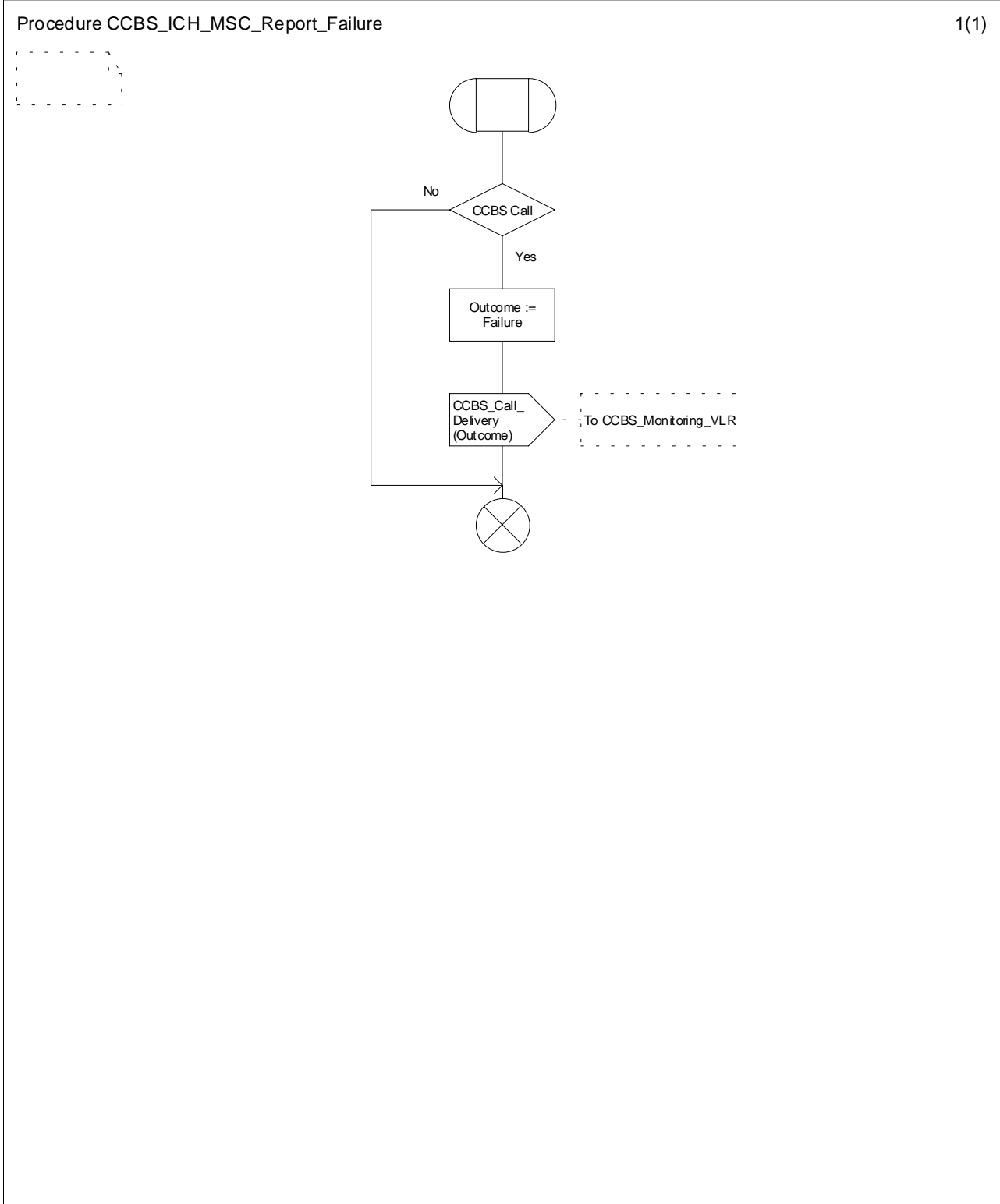

Figure 11.2.3.4: Procedure CCBS_ICH_MSC_Report_Failure

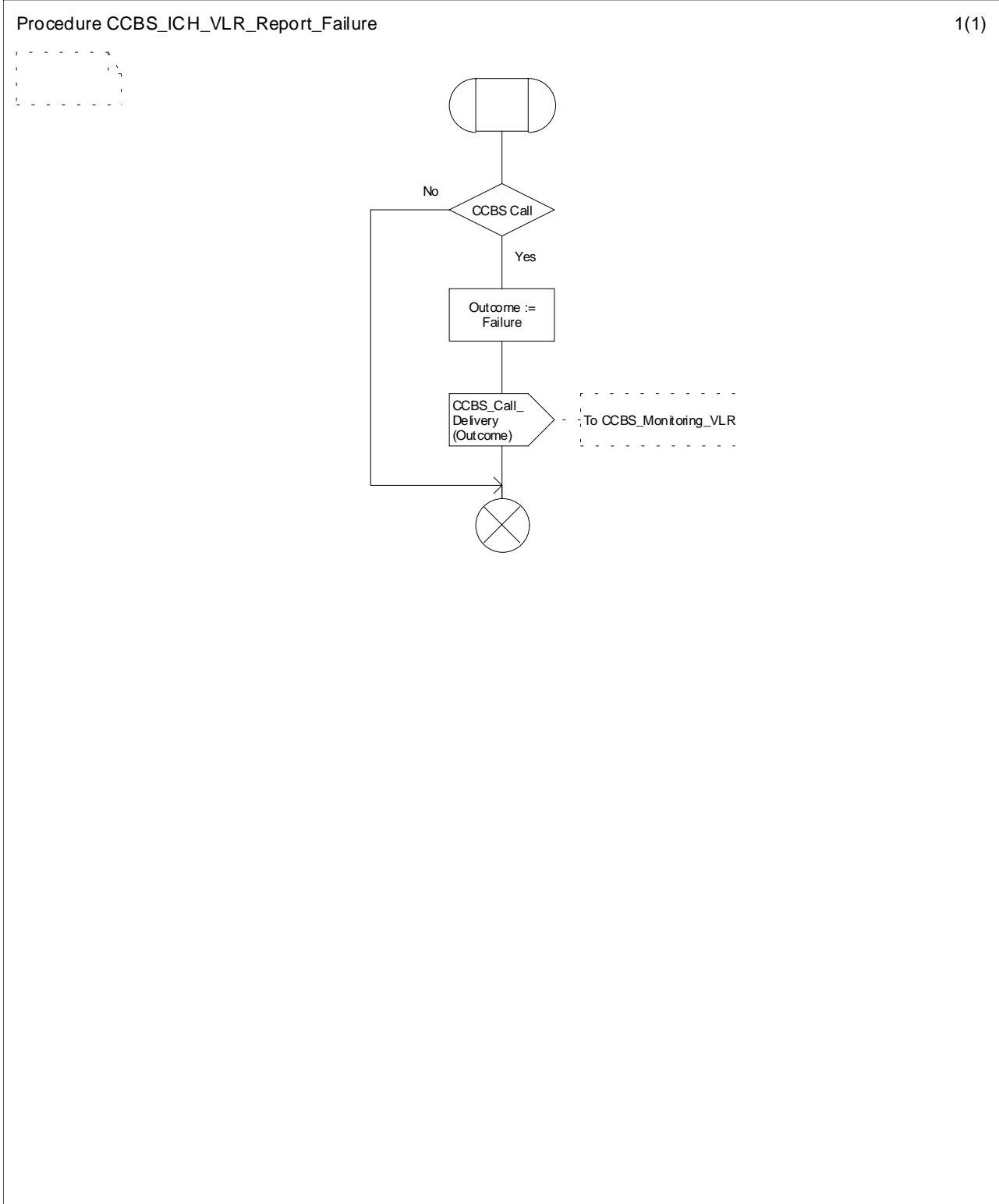

Figure 11.2.3.5: Procedure CCBS_ICH_VLR_Report_Failure

Procedure CCBS_ICH_Report_Not_Reachable

1(1)

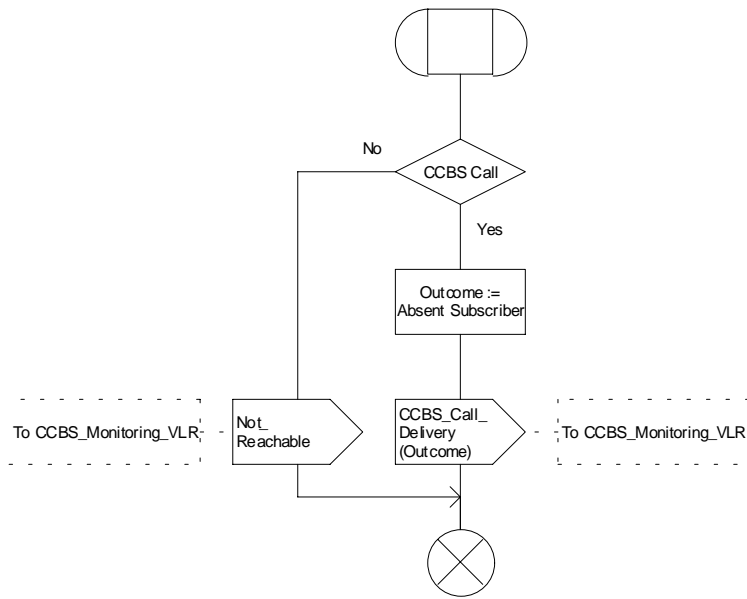
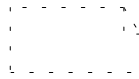

Figure 11.2.3.6: Procedure CCBS_ICH_Report_Not_Reachable

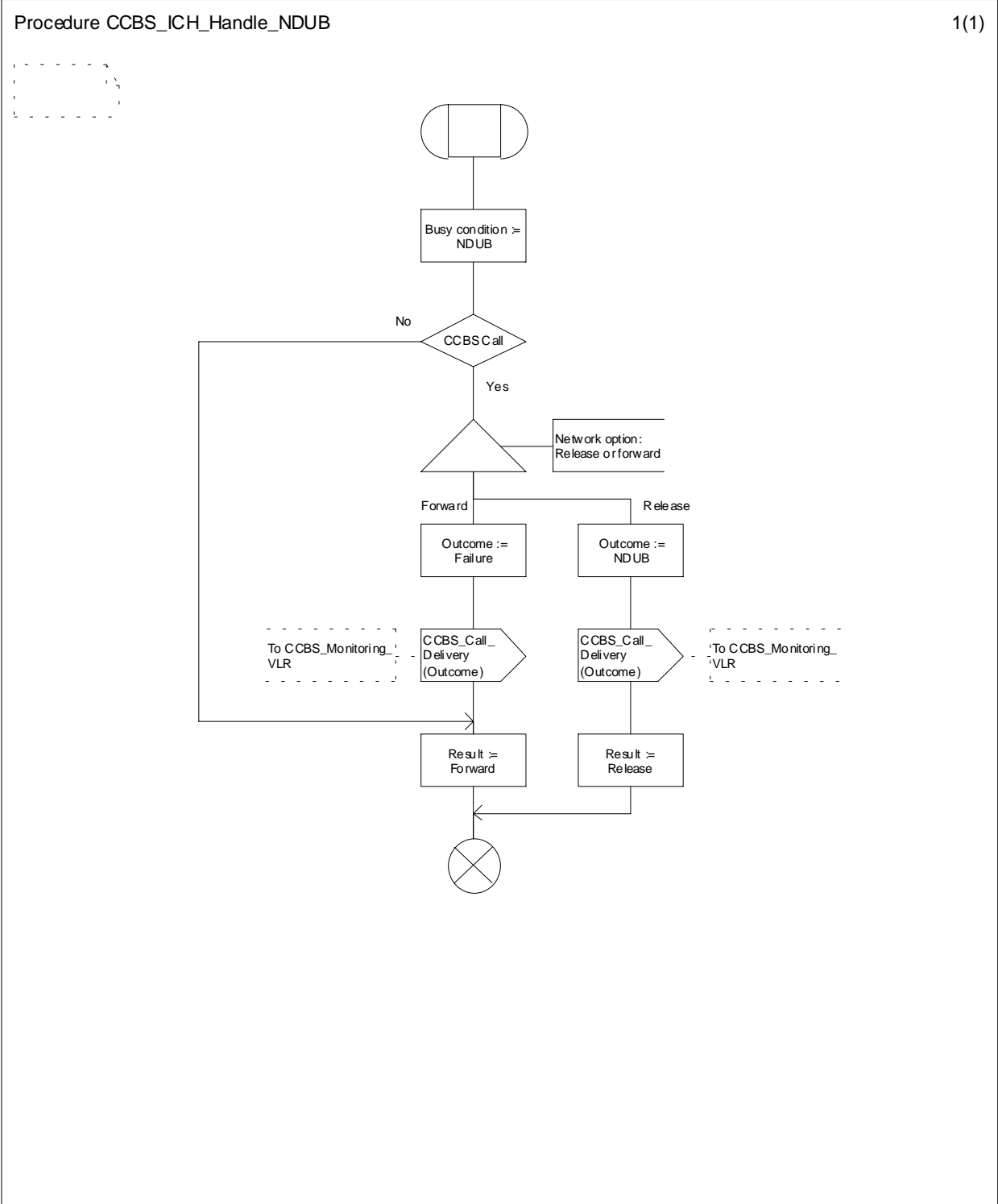

Figure 11.2.3.7: Procedure CCBS_ICH_Handle_NDUB

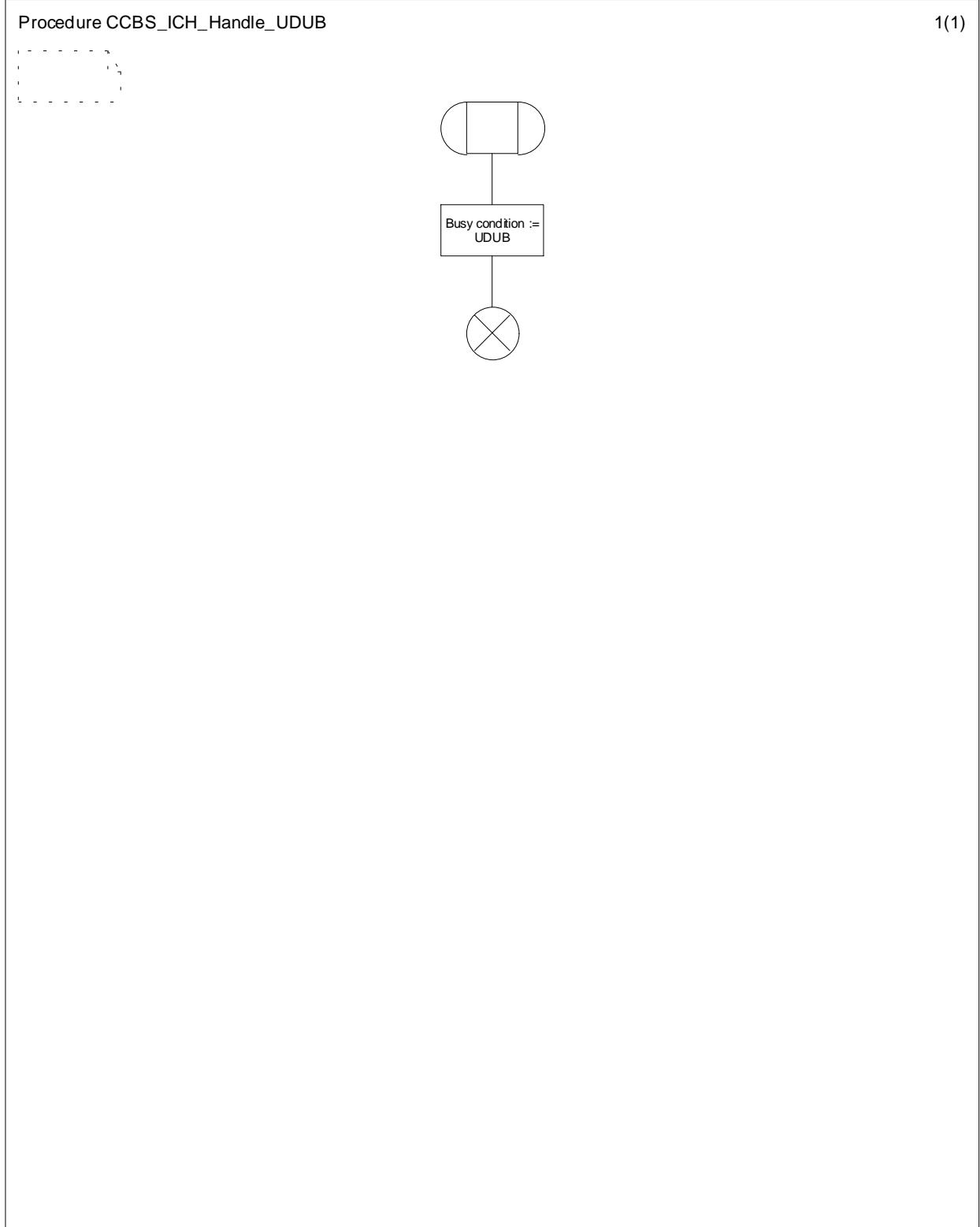

Figure 11.2.3.8: Procedure CCBS_ICH_Handle_UDUB

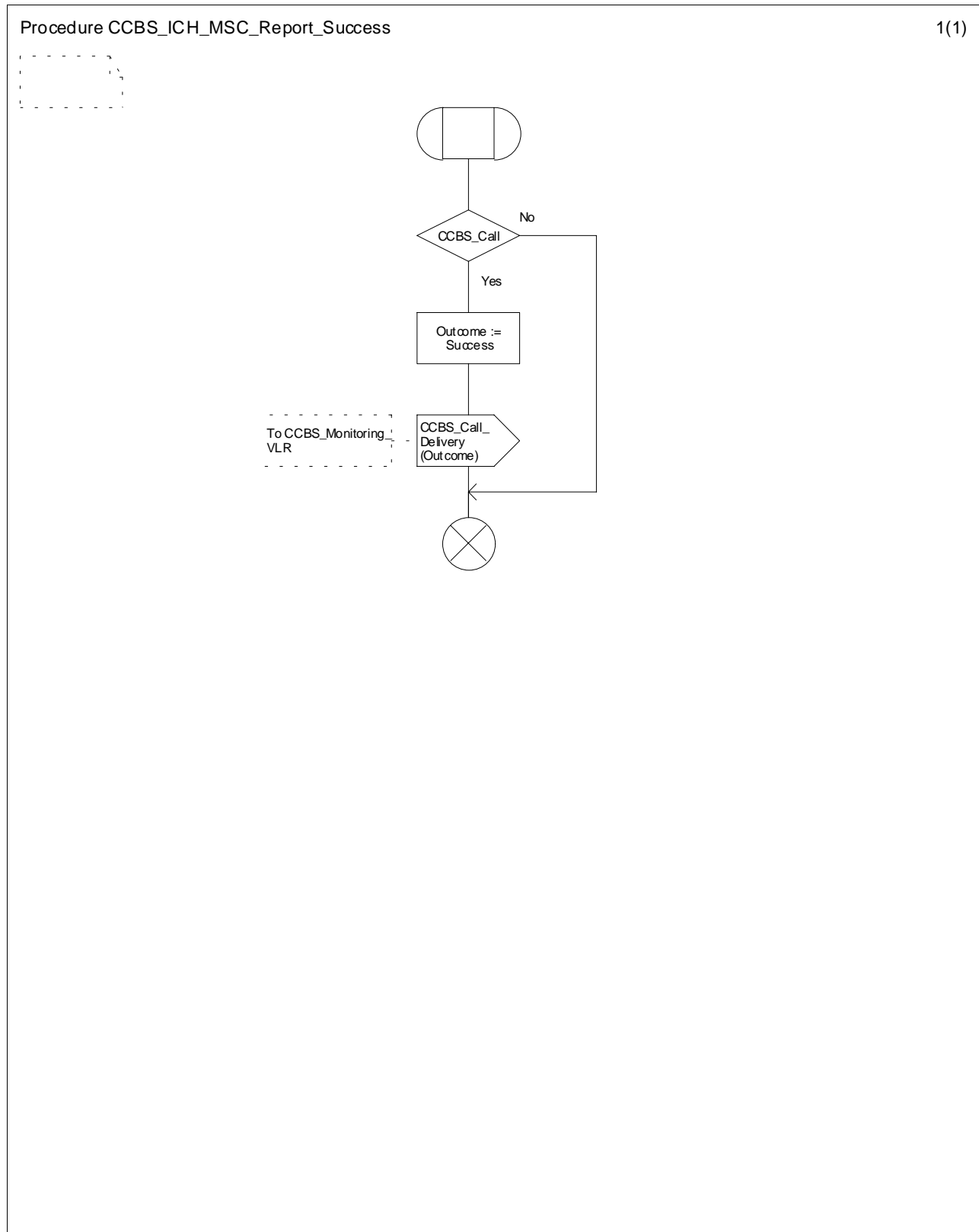

Figure 11.2.3.9: Procedure CCBS_ICH_MSC_Report_Success

Procedure CCBS_ICH_VLR_Report_Success

1(1)

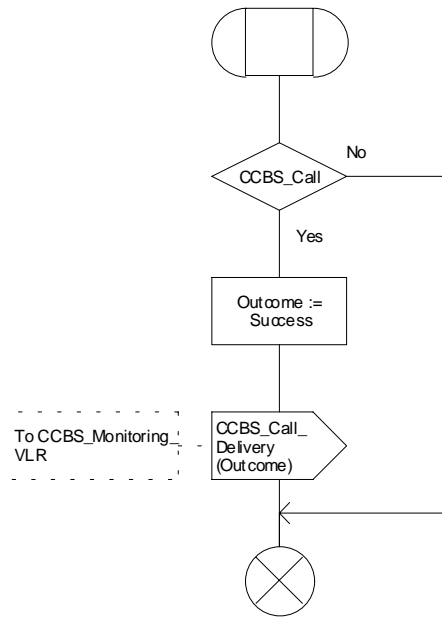

Figure 11.2.3.10: Procedure CCBS_ICH_VLR_Report_Success

Procedure CCBS_ICH_Set_CCBS_Target

1(1)

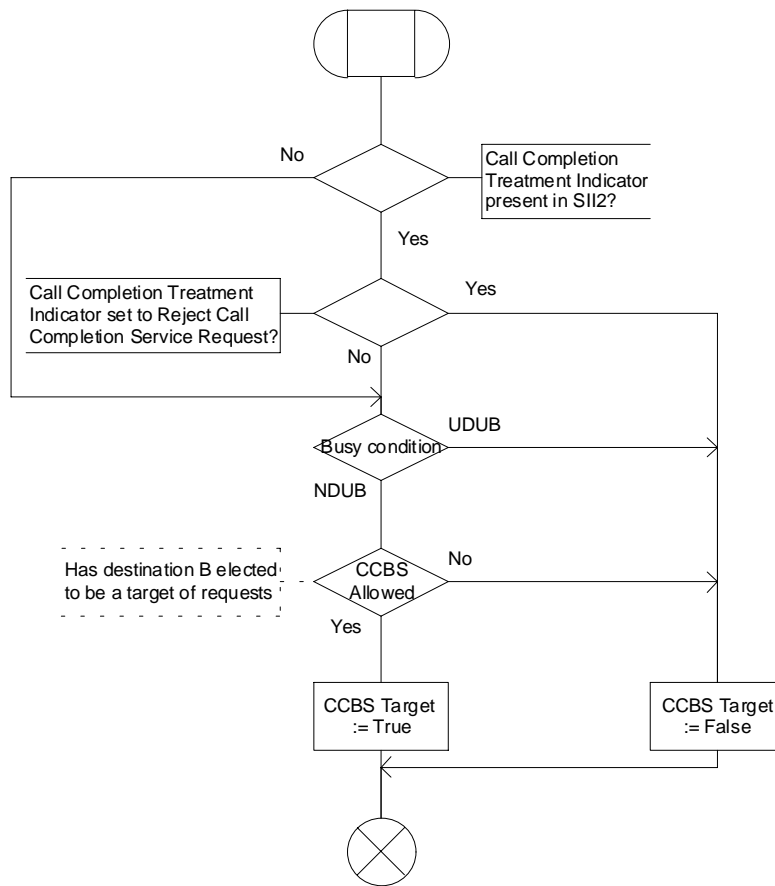

Figure 11.2.3.11: Procedure CCBS_ICH_Set_CCBS_Target

11.3 Processes and procedures common in originating and destination network entities

Figure 11.3.1: Process CCBS_Monitoring_VLR

This process is responsible for monitoring the subscriber in VLR and also controls the MSC monitoring process.

Figure 11.3.2: Process CCBS_Monitoring_MSC

This process is responsible for monitoring subscriber in MSC.

Figure 11.3.3: Process CCBS_Coordinator_HLR

This process co-ordinates HLRA and HLRB monitoring interaction. Start and Stop Reporting messages are sent only once towards MSC, CCBS_Call_Report messages are directed to correct queue and Status information is distributed to both queues when needed.

Figure 11.3.4: Procedure CCBS_Set_Diagnostic_For_Release

This procedure is called to set the diagnostic field to the Release message. The diagnostic is set according to the internal CCBS Target variable.

Figure 11.3.5: Procedure CCBS_Report_Not_Idle

This procedure is called when either MO or MT setup is received or sent to the MS. It informs the VLR monitoring process that the MS is engaged with a call.

Figure 11.3.6: Procedure CCBS_Report_MS_Activity

This procedure is called when Process_Access_Request is successfully performed. It informs the VLR monitoring process and may cause transition to the Idle state.

Figure 11.3.7: Procedure CCBS_Check_Last_Call

This procedure is called when a call is ending. If the call is the last CC connection to the MS, that is reported to the VLR monitoring process.

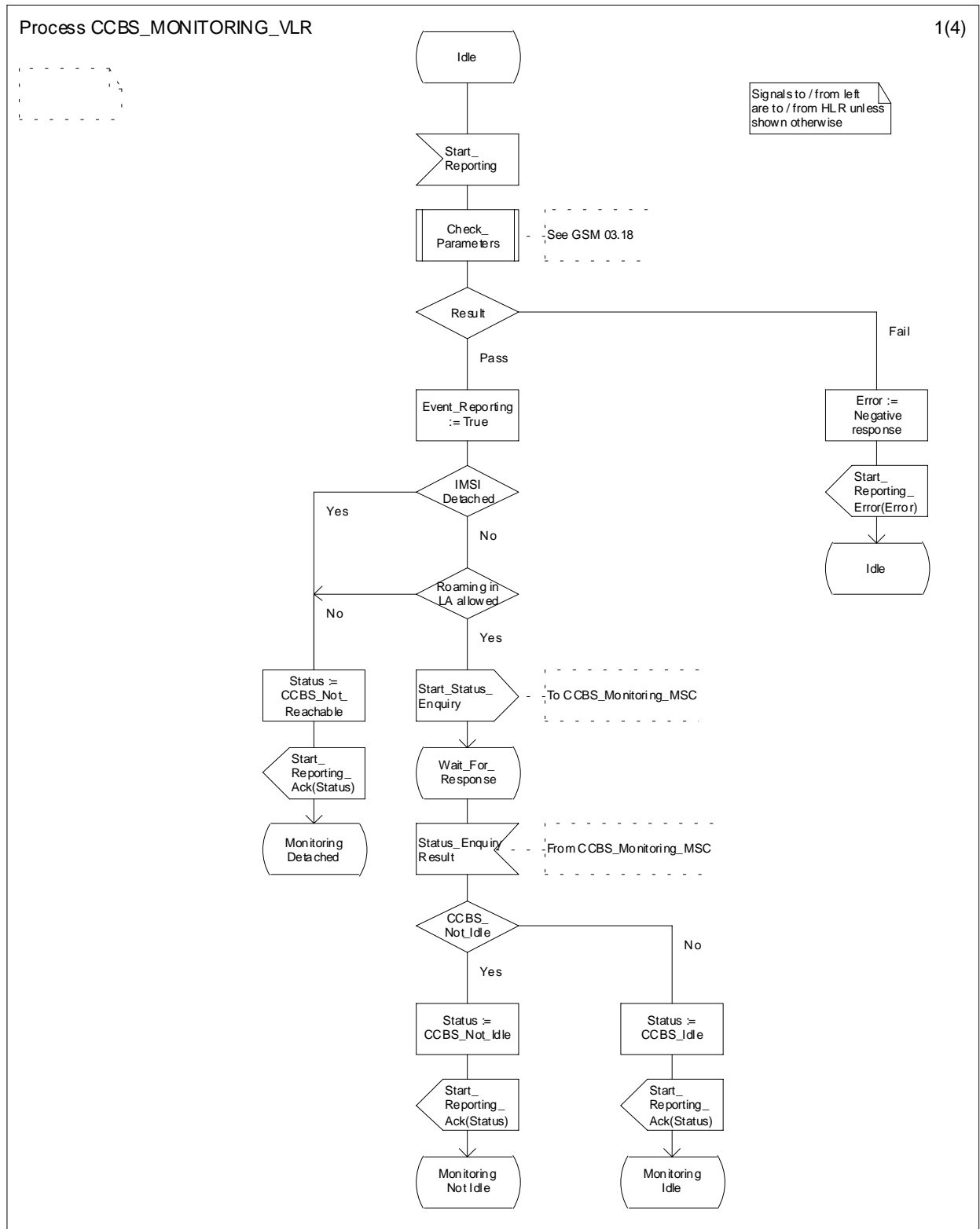

Figure 11.3.1: Process CCBS_Monitoring_VLR (sheet 1 of 4)

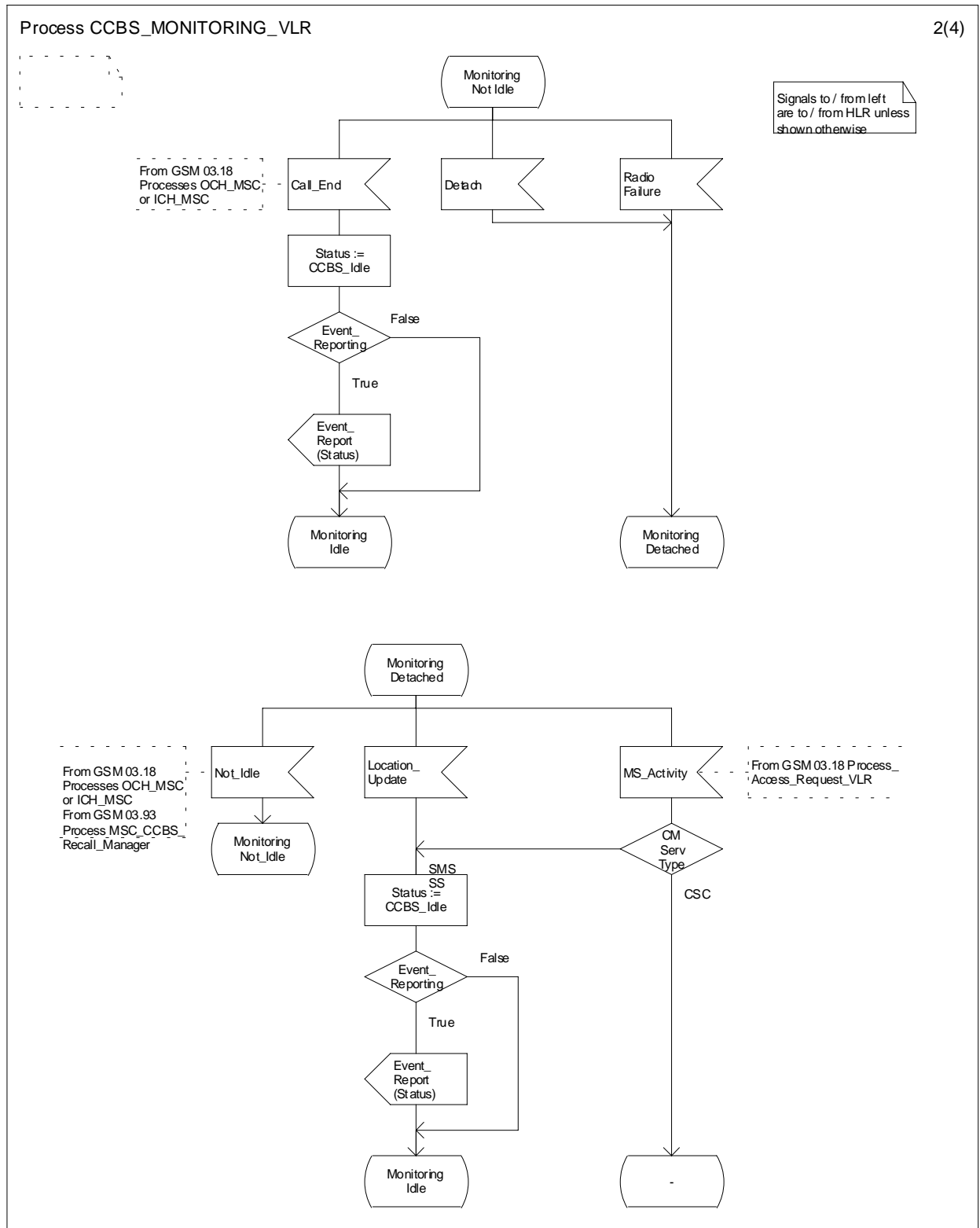

Figure 11.3.1: Process CCBS_Monitoring_VLR (sheet 2 of 4)

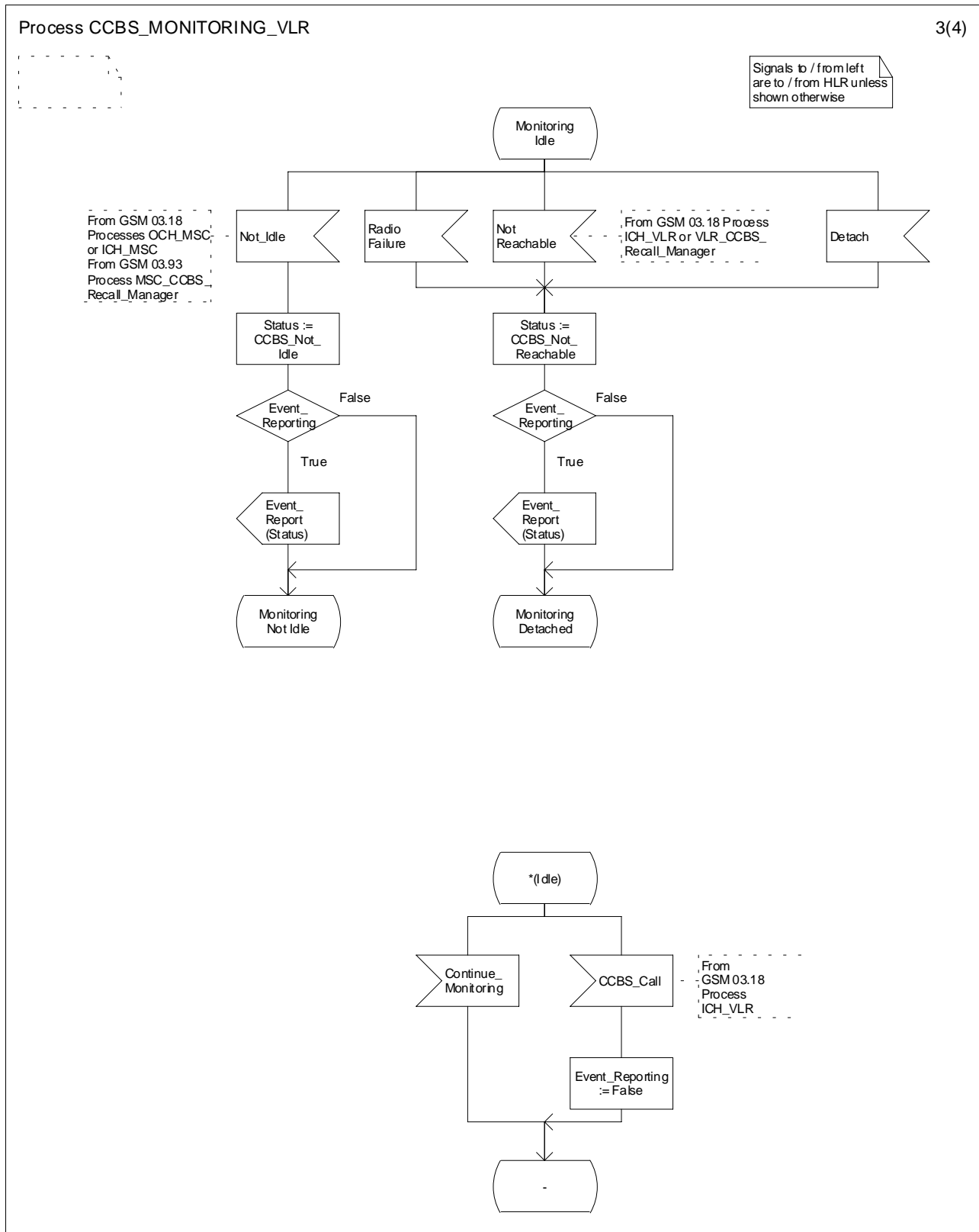

Figure 11.3.1: Process CCBS_Monitoring_VLR (sheet 3 of 4)

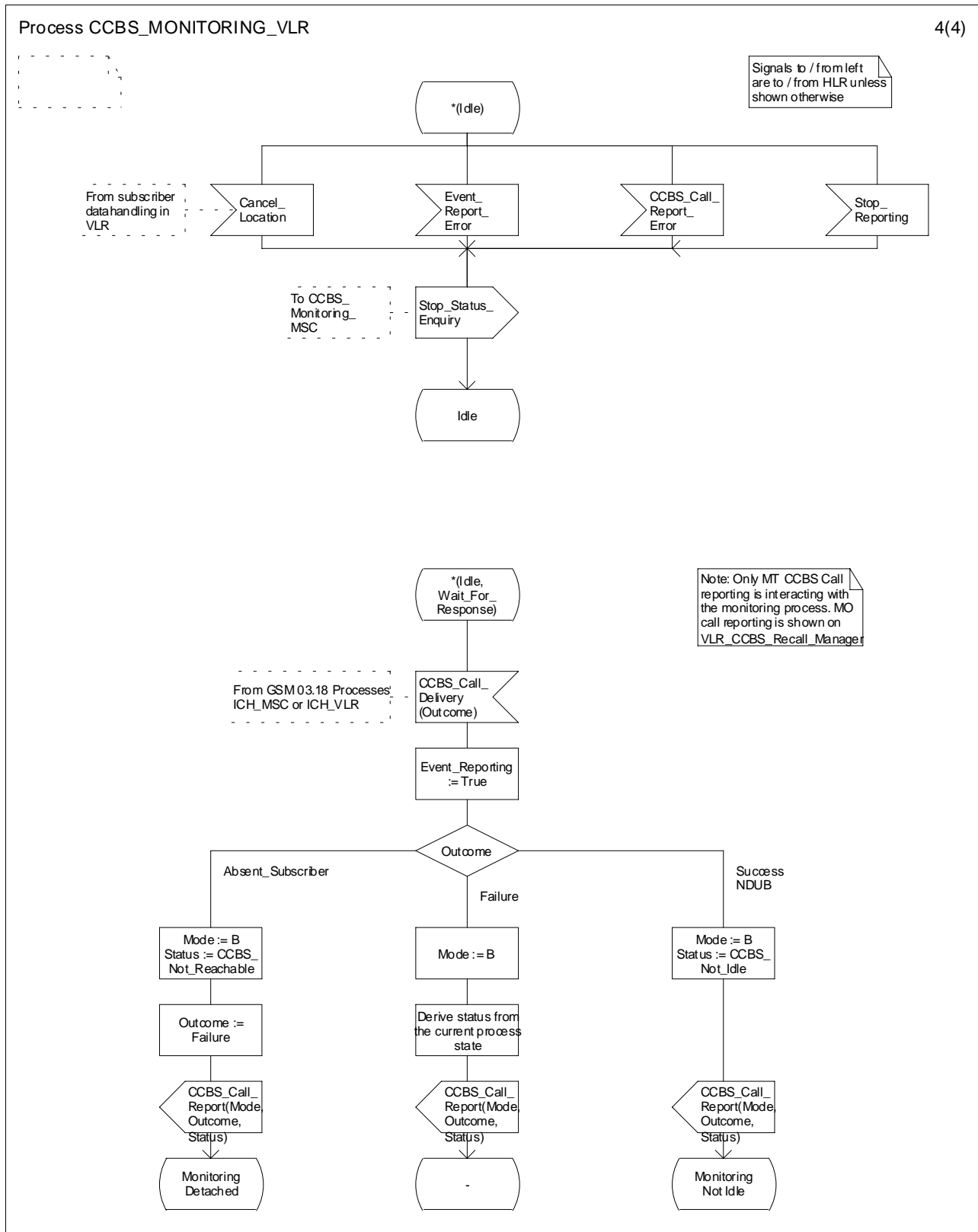

Figure 11.3.1: Process CCBS_Monitoring_VLR (sheet 4 of 4)

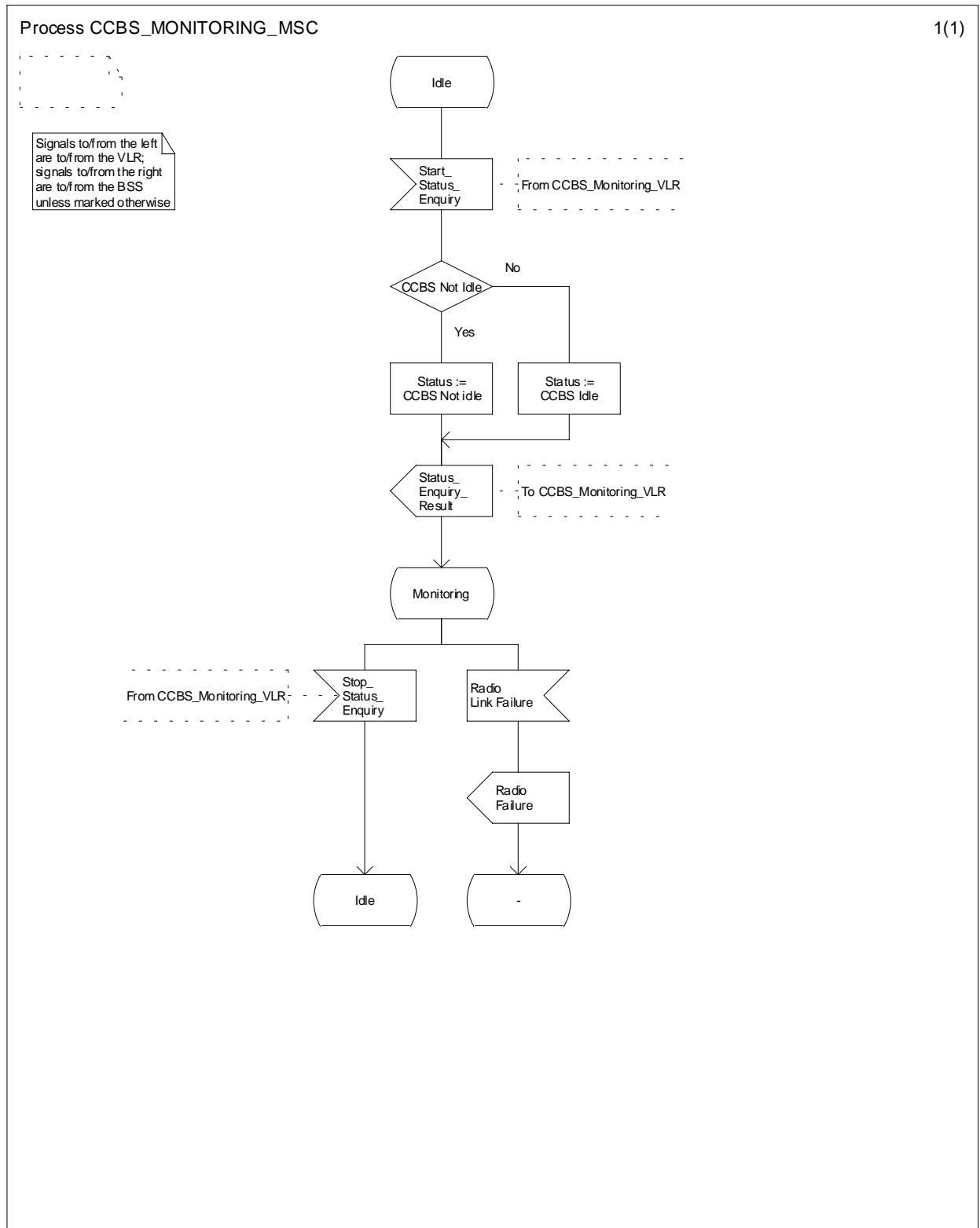

Figure 11.3.2: Process CCBS_Monitoring_MSC

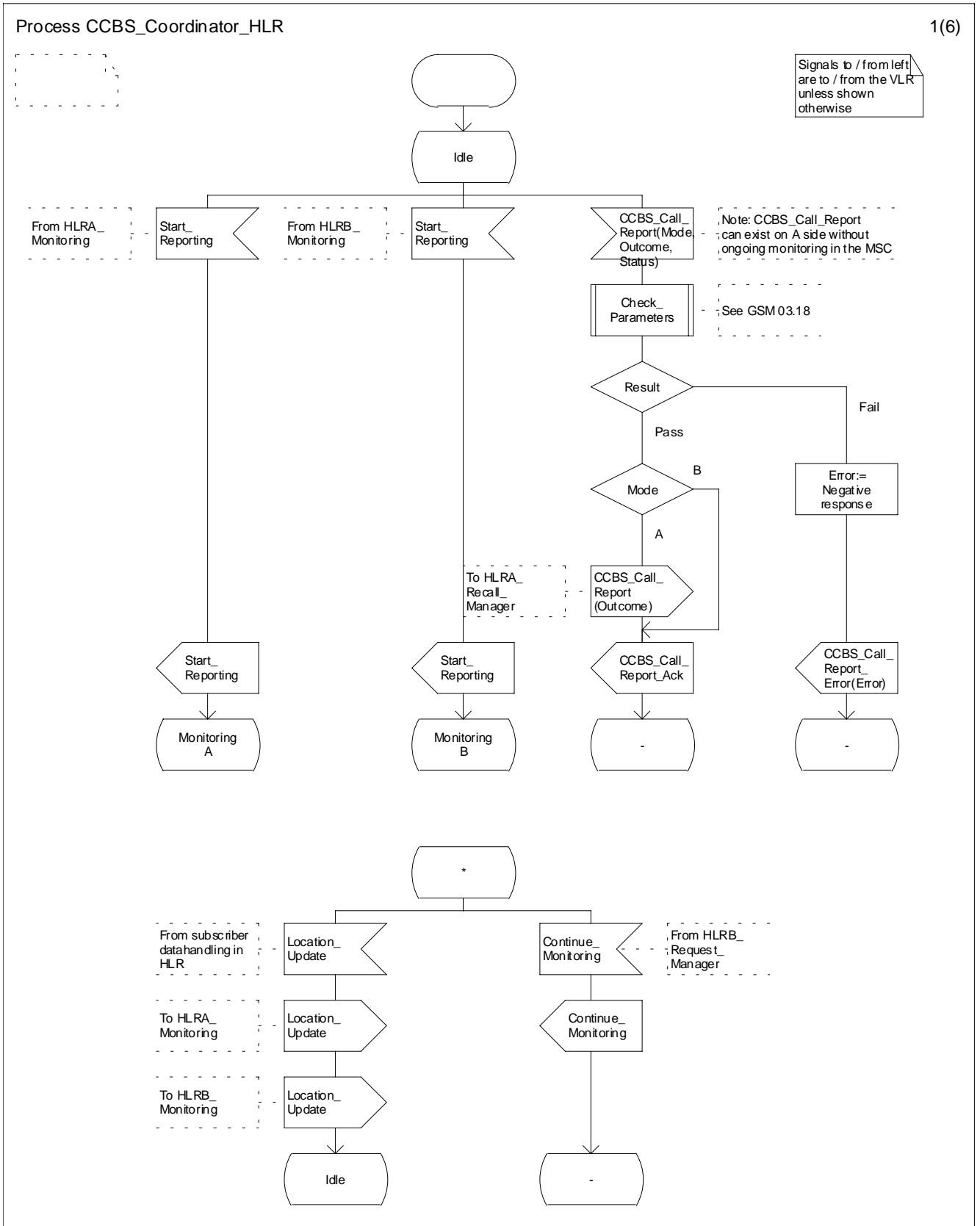

Figure 11.3.3: Process CCBS_Coordinator_HLR (sheet 1 of 6)

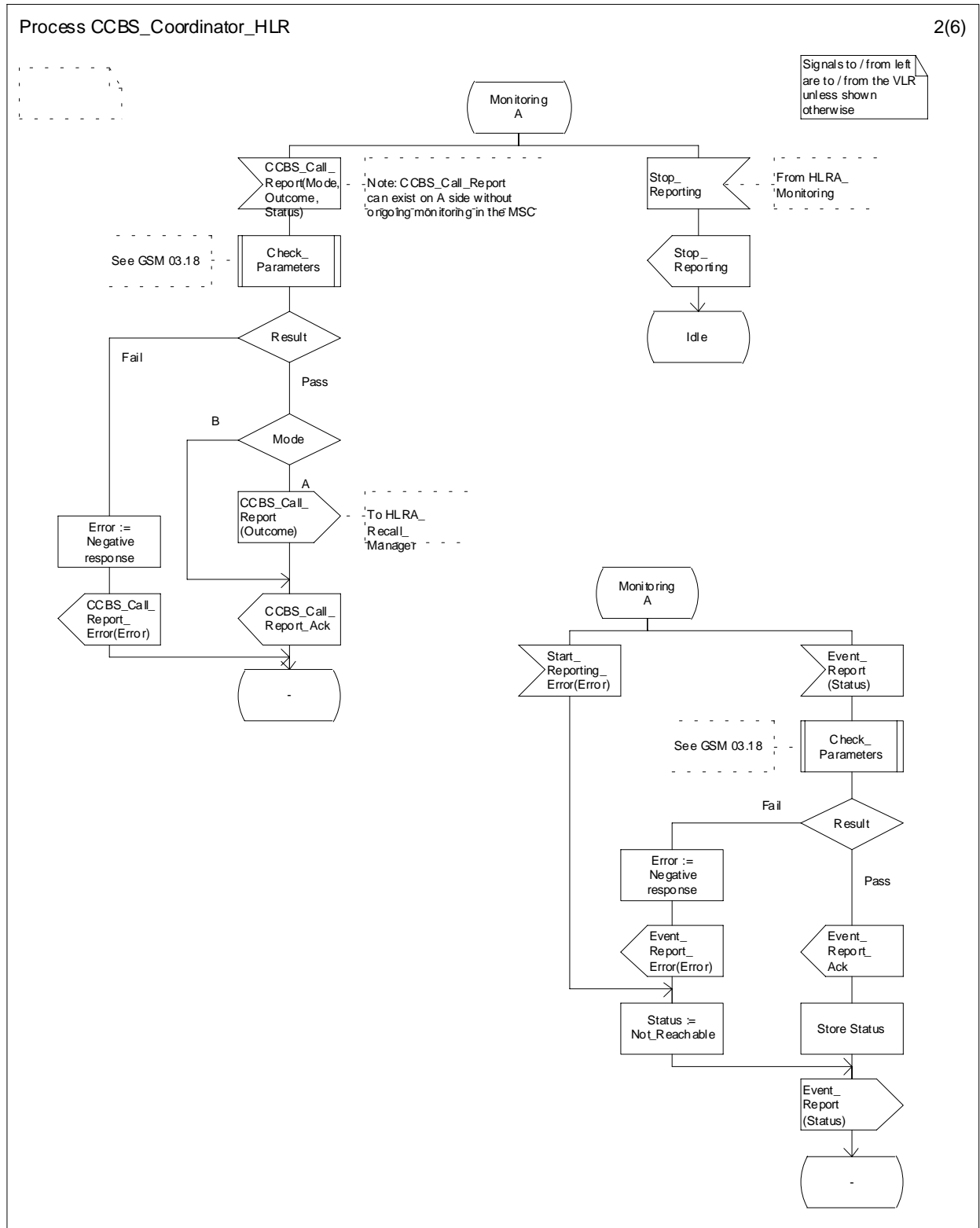

Figure 11.3.3: Process CCBS_Coordinator_HLR (sheet 2 of 6)

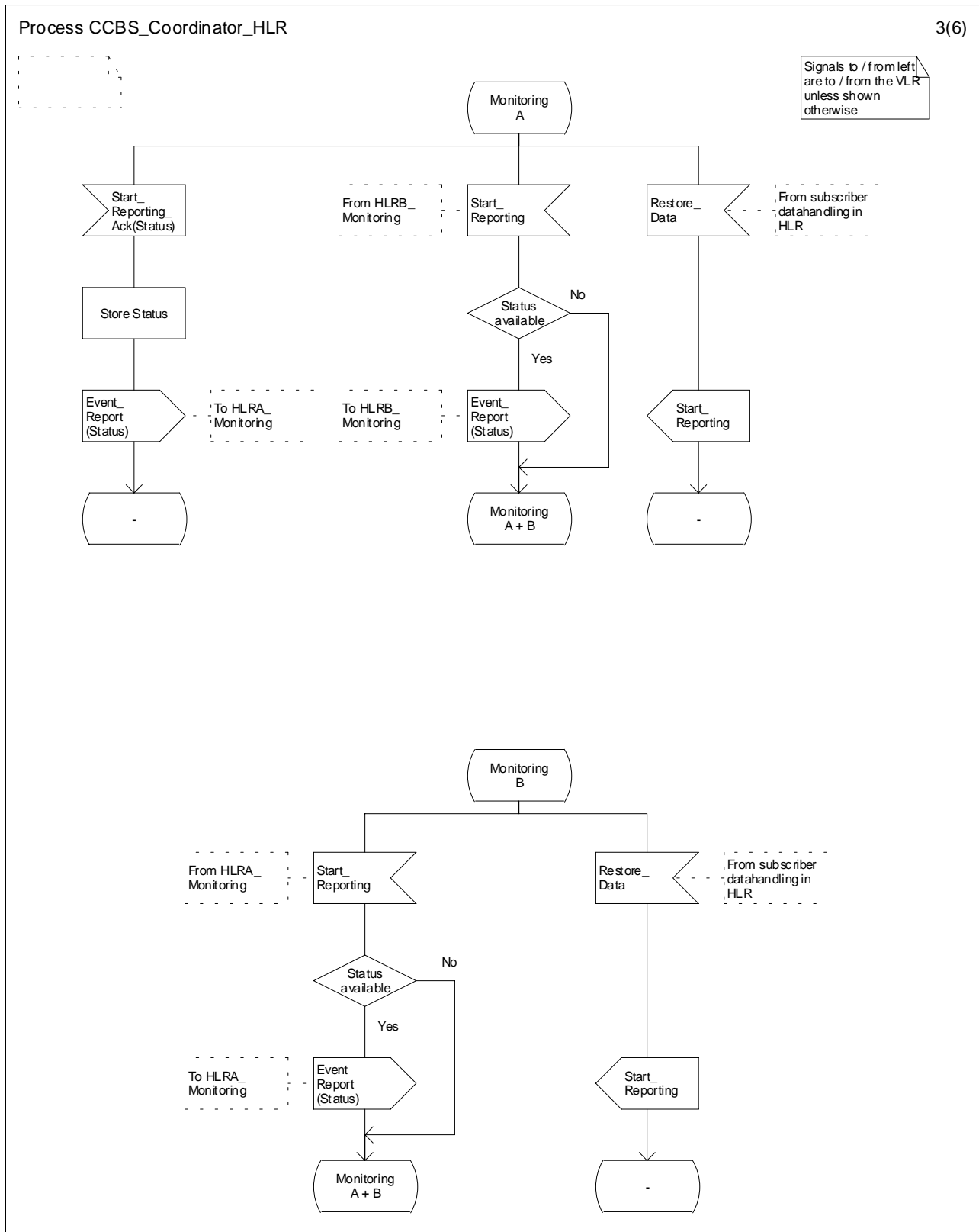

Figure 11.3.3: Process CCBS_Coordinator_HLR (sheet 3 of 6)

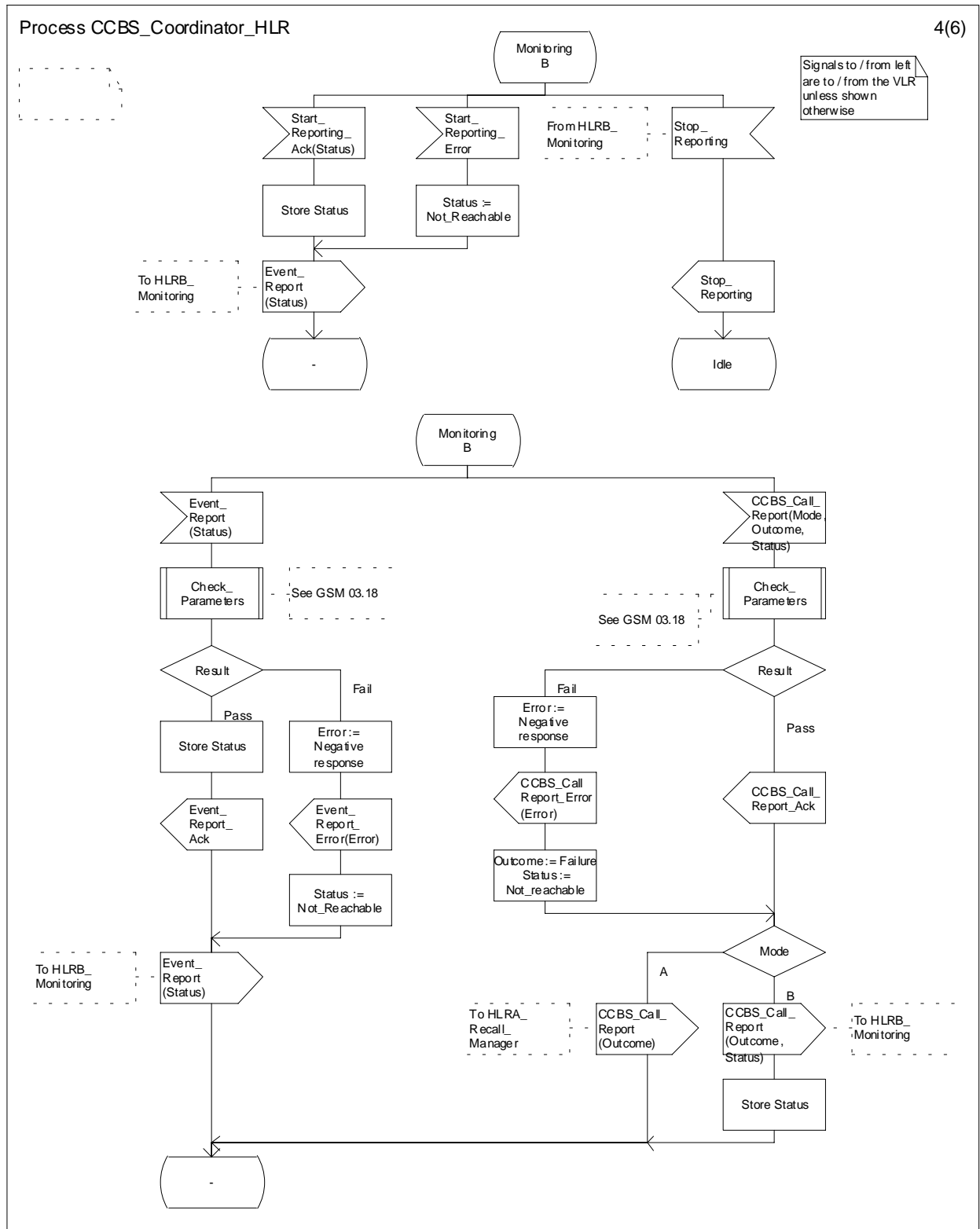

Figure 11.3.3: Process CCBS_Coordinator_HLR (sheet 4 of 6)

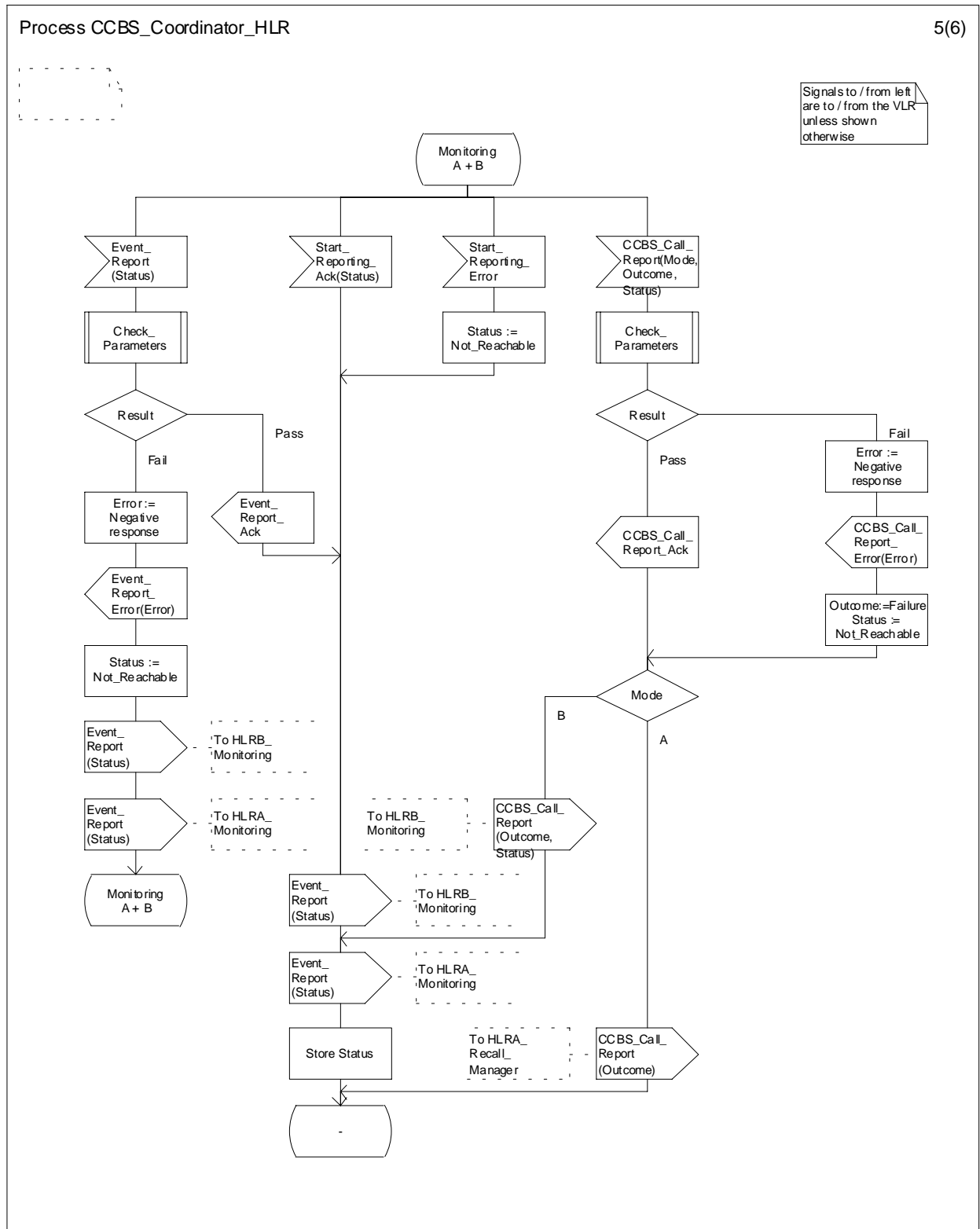

Figure 11.3.3: Process CCBS_Coordinator_HLR (sheet 5 of 6)

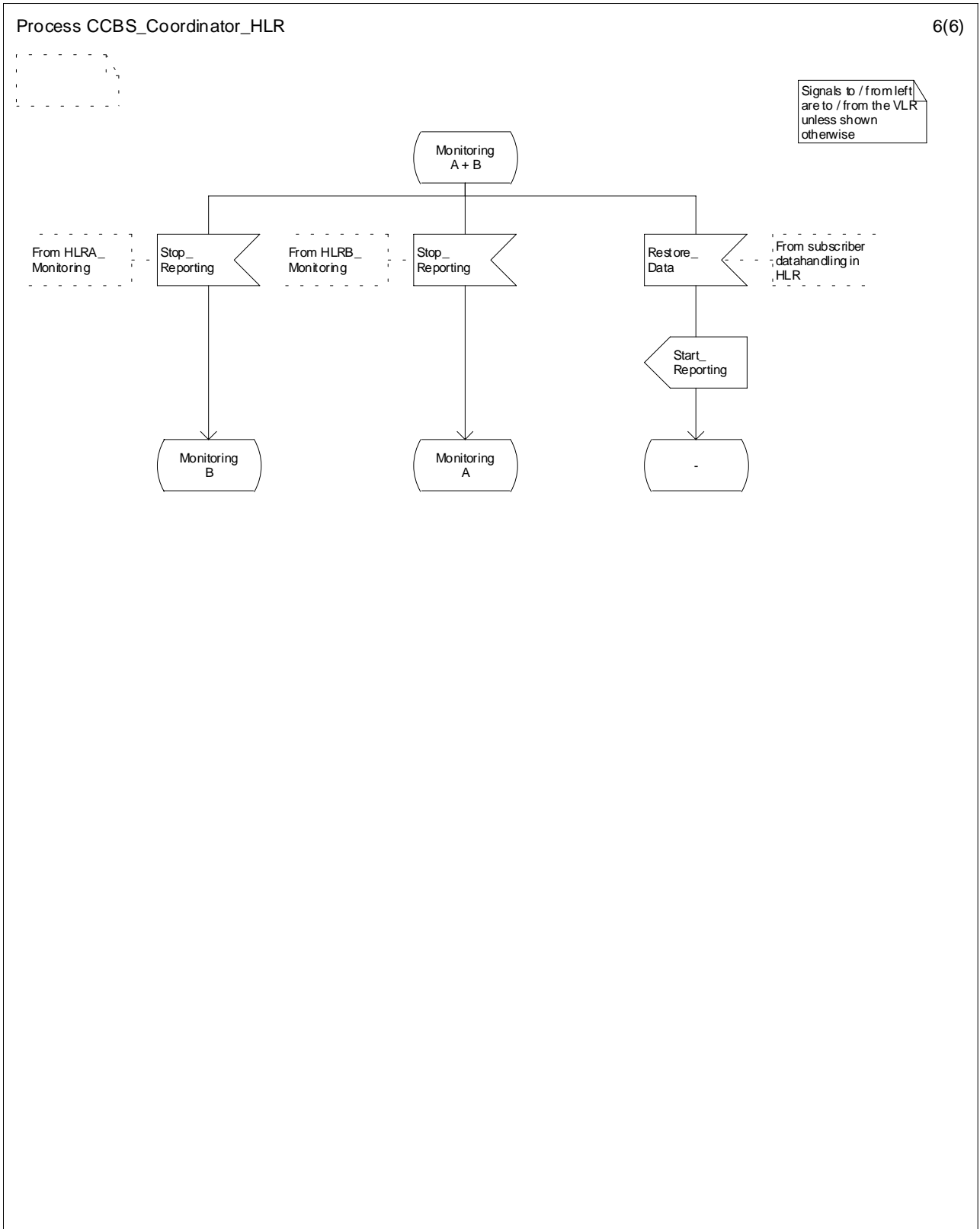

Figure 11.3.3: Process CCBS_Coordinator_HLR (sheet 6 of 6)

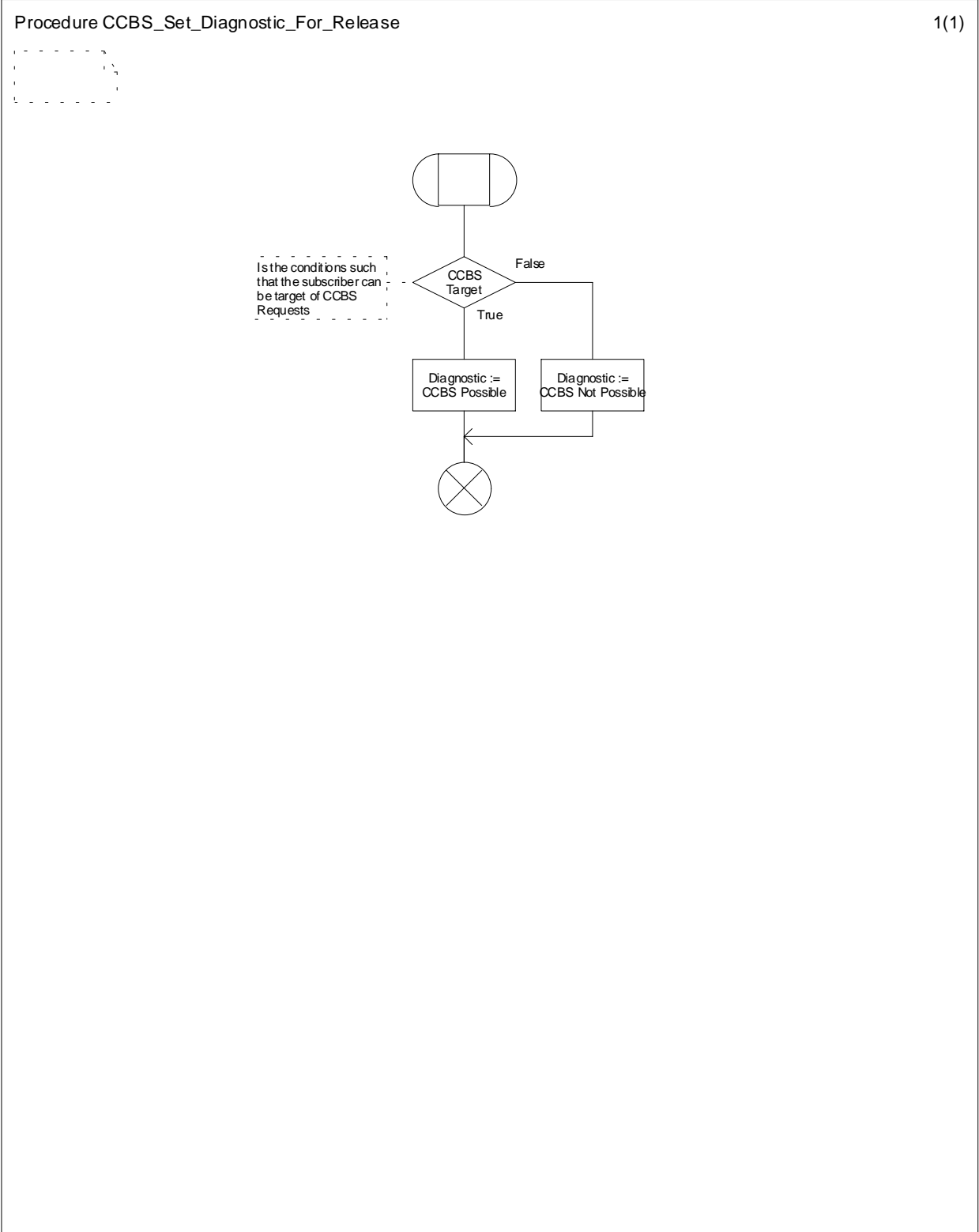

Figure 11.3.4: Procedure CCBS_Set_Diagnostic_For_Release

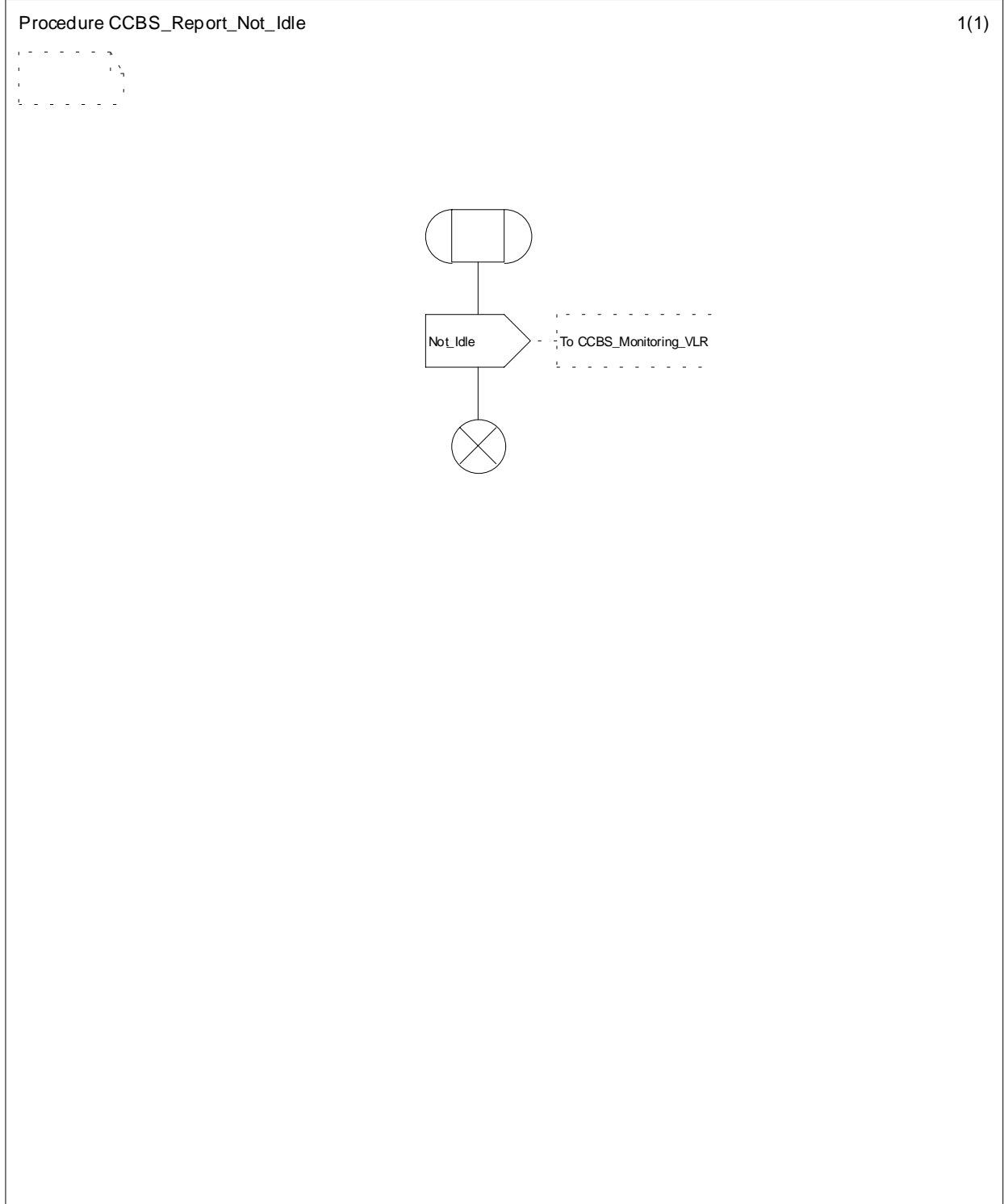

Figure 11.3.5: Procedure CCBS_Report_Not_Idle

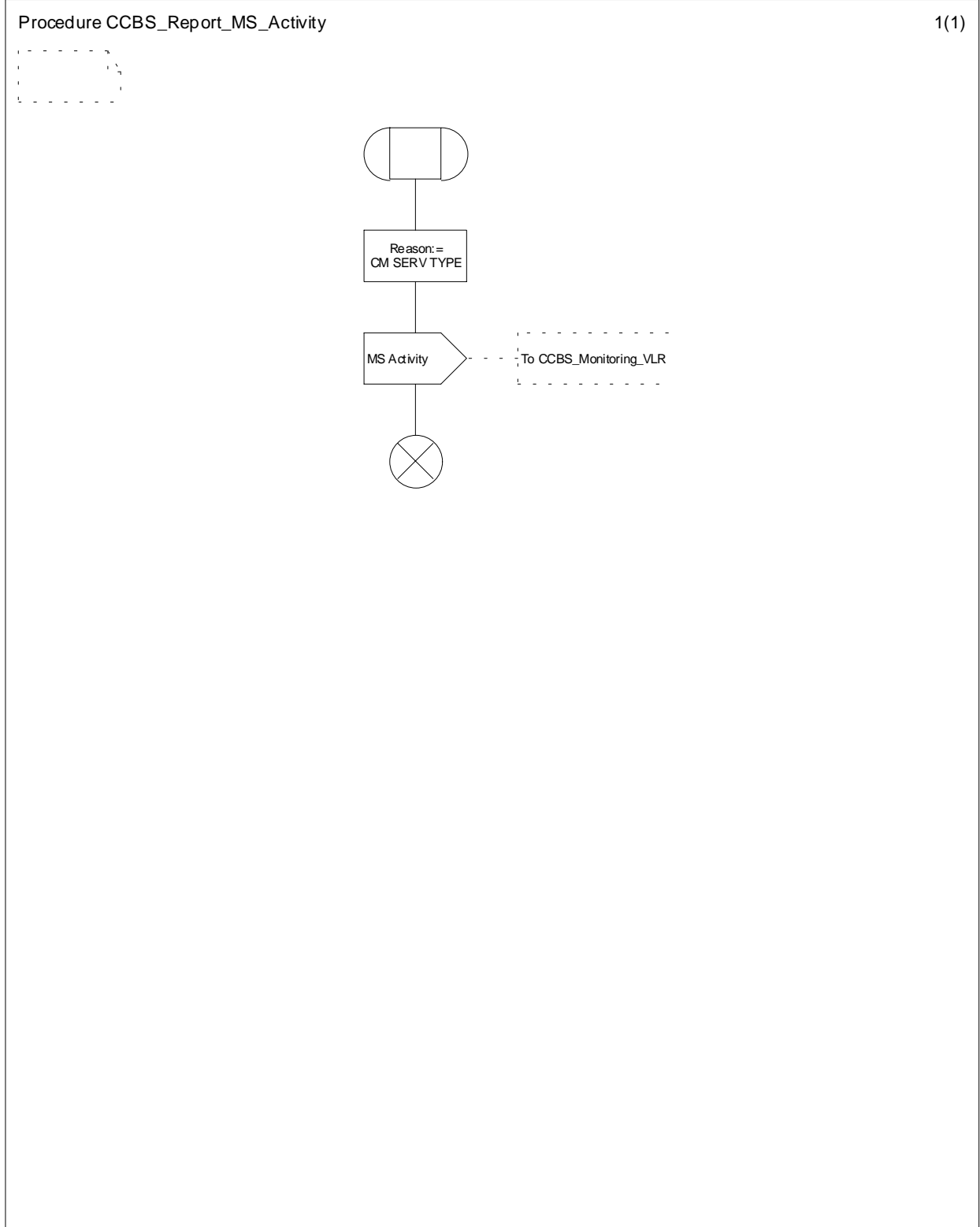

Figure 11.3.6: Procedure CCBS_Report_MS_Activity

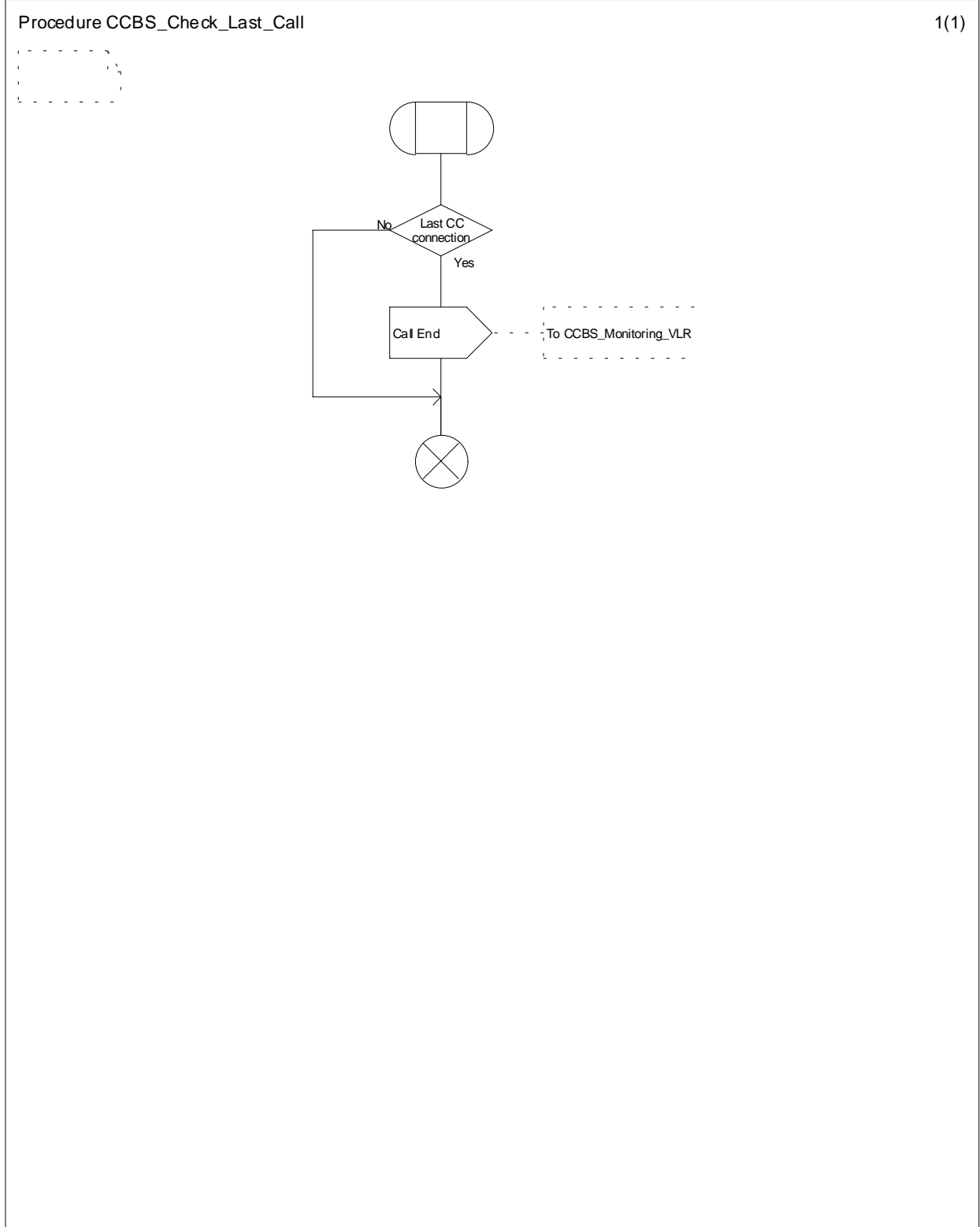

Figure 11.3.7: Procedure CCBS_Check_Last_Call

12 Information stored in the HLRs

Note that a given subscriber may be both the originator and the target of CCBS requests; a given HLR may therefore be required to store both the data for HLR A and the data for HLR B against a given subscriber.

12.1 Originating Network Data

The following logical states are applicable for the CCBS service in the originating network (refer to TS 23.011 for an explanation of the notation):

Provisioning State	Registration State	Activation State	HLR Induction State
(Not Provisioned,	Not Applicable,	Not Active,	Not Induced)
(Provisioned,	Not Applicable,	Active and Operative	Not Induced)

The logical state shall be on a per subscriber basis and hence the same for all basic service groups.

The HLR shall store the logical state of the CCBS service (which shall be one of the valid states listed above) on a per subscriber basis. The HLR shall store the following information for each CCBS Request that is successfully activated by subscriber A:

- AddressOfB;
- Basic Service Group;
- CCBS Call Information;
- Translated Number;
- Retention supported by destination network (if HLR A supports retention);
- CCBS Index;
- CAMEL Invoked.

The HLR shall store for the served subscriber as the originator of CCBS requests:

- The parameter "Max Queue Size",
- This parameter takes a value in the range 1 to 5.

12.2 Destination Network Data

The following logical states are applicable for the CCBS service in the destination network (refer to TS 23.011 for an explanation of the notation):

Provisioning State	Registration State	Activation State	HLR Induction State
(Not Provisioned,	Not Applicable,	Not Active,	Not Induced)
(Provisioned,	Not Applicable,	Active and Operative,	Not Induced)

The logical state shall be on a per subscriber basis and hence the same for all basic service groups.

The HLR shall store the logical state of the CCBS service (which shall be one of the valid states listed above) on a per subscriber basis.

The HLR shall store the following information for each CCBS Request that is successfully activated against User B :

- Basic Service Group;
- Retention supported by originating network (if HLR B supports retention).

The HLR shall store on a per subscriber basis:

The parameter "Number of terminating CCBS Requests"

This parameter takes a value in the range 1 to 5.

12.3 Transfer of information from HLR to VLR

If the provisioning state for CCBS supplementary service is "Provisioned" then, when the subscriber registers on a VLR, the HLR shall send that VLR information about the logical state of CCBS supplementary service.

If the logical state of CCBS supplementary service is changed while a subscriber is registered on a VLR, then the HLR shall inform the VLR of the new logical state of CCBS supplementary service.

Both originating and destination network CCBS supplementary service logical states are updated independently of each other to the VLR.

13 State transition model

13.1 State transition model for the CCBS service in the originating network

Figure 13.1.1 shows the successful cases of transition between the applicable logical states of the CCBS service in the originating network. The state changes may be caused by actions of the service provider or the network.

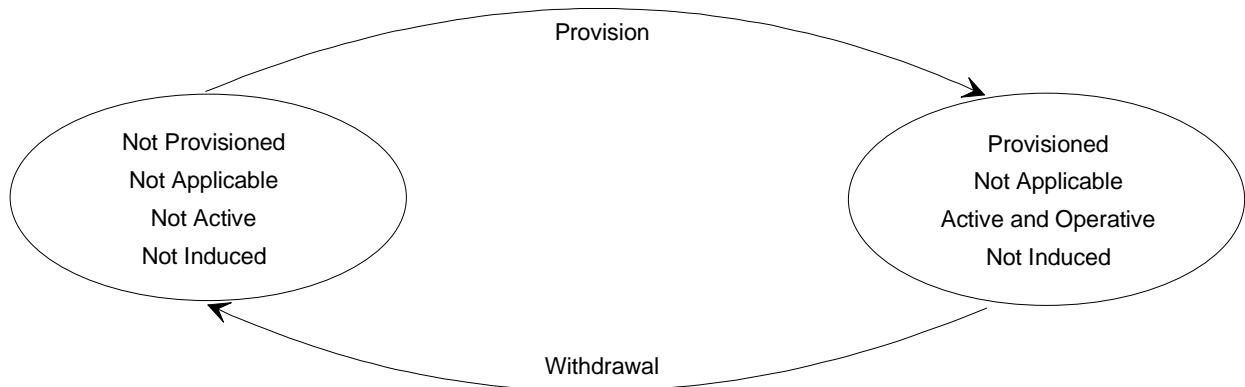

Figure 13.1.1: State Transition Model for CCBS Service in the originating network

13.2 State transition model for the CCBS service in the destination network

Figure 13.2.1 shows the successful cases of transition between the applicable logical states of the CCBS service in the destination network. The state changes may be caused by actions of the service provider or the network.

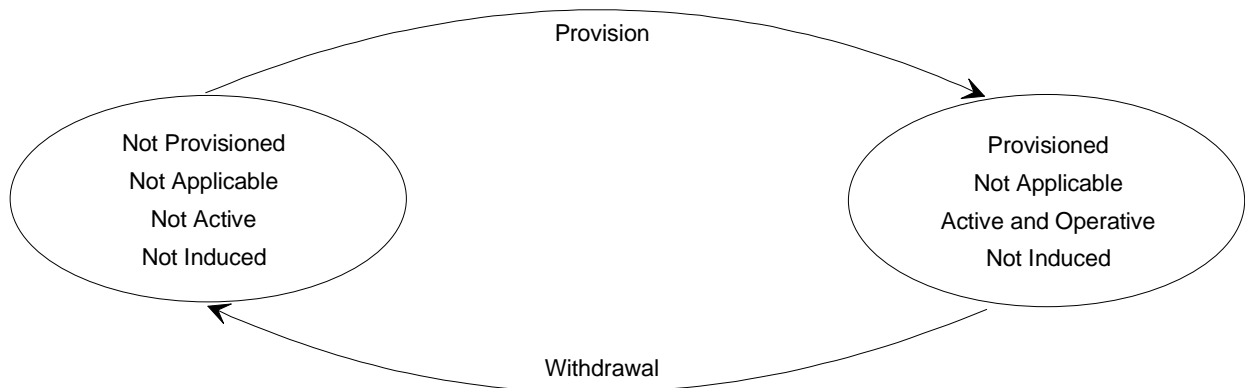

Figure 13.2.1: State Transition Model for CCBS Service in the destination network

13.3 State transition model for a CCBS Request

Figure 13.3.1 shows the successful cases of transition between the applicable logical states of a CCBS Request. The state changes may be caused by actions of the served subscriber or the network.

Each subscriber can be considered to have a set of n requests, where n is the maximum number of CCBS requests allowed for a subscriber as an originator.

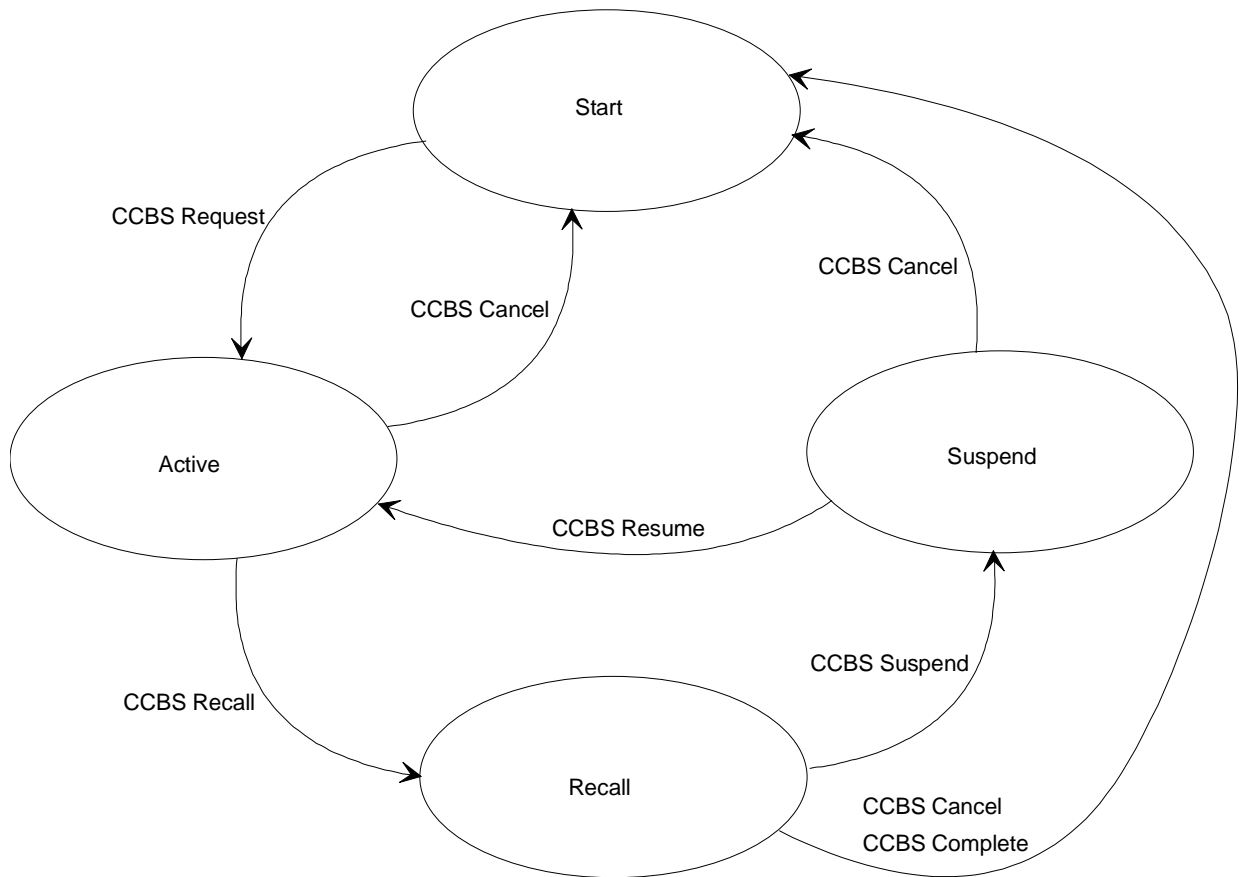

Figure 13.3.1: State Transition Model for a CCBS Request in Originating Network

On provision of the CCBS service, all requests transit to the "Start" state

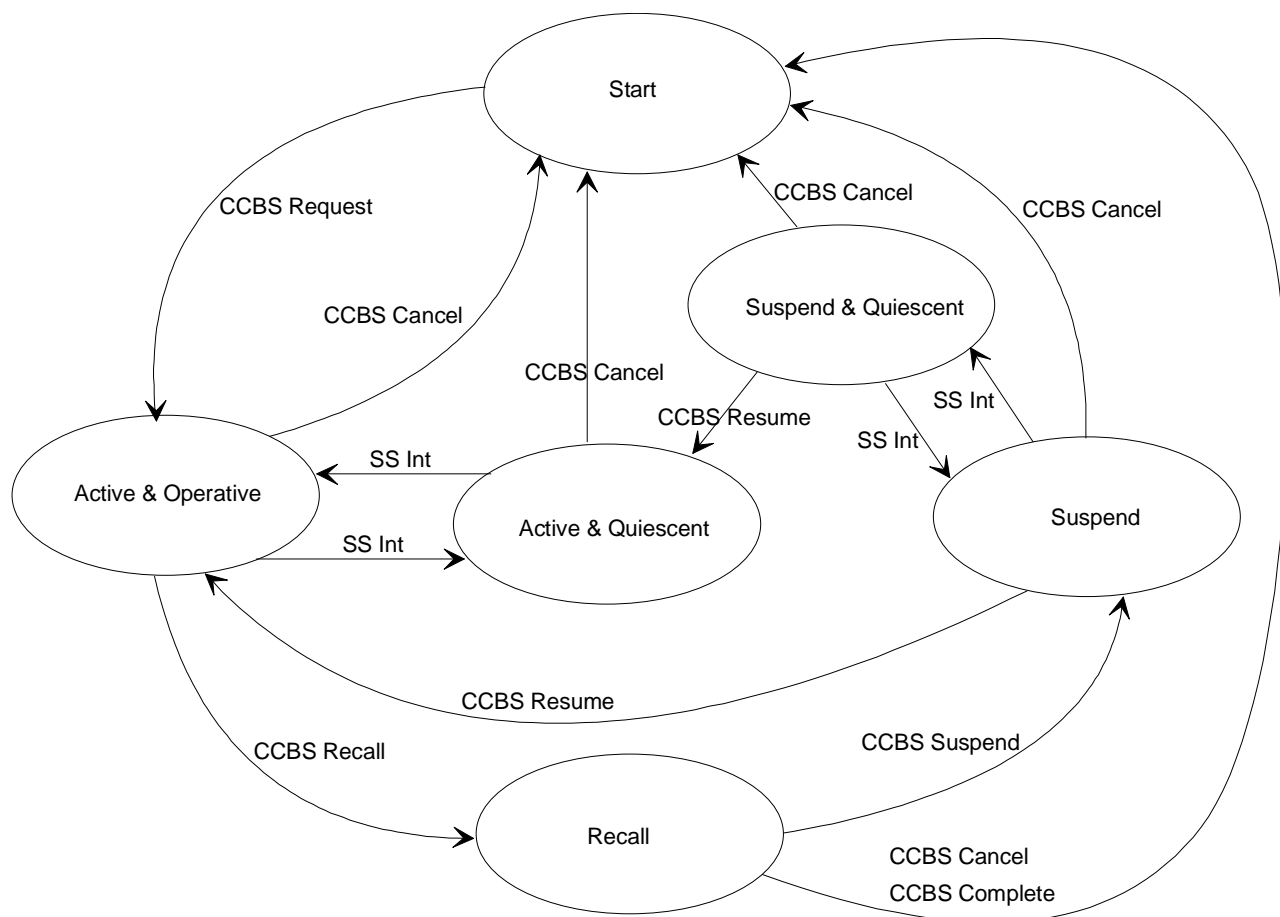

Figure 13.3.2: State Transition Model for a CCBS Request in Destination Network

13.4 Information stored in the VLRs

Originating Network Data

For the CCBS service in the originating network the VLR shall store the service state information received from HLR.

Destination Network Data

For the CCBS service in the destination network the VLR shall store the service state information received from HLR.

Annex A (Informative): Message flow diagrams showing a successful CCBS request

The following message flow diagrams show a successful CCBS request. Destination B busy when request activated, subscriber A free when destination B becomes free (mobile-to-mobile).

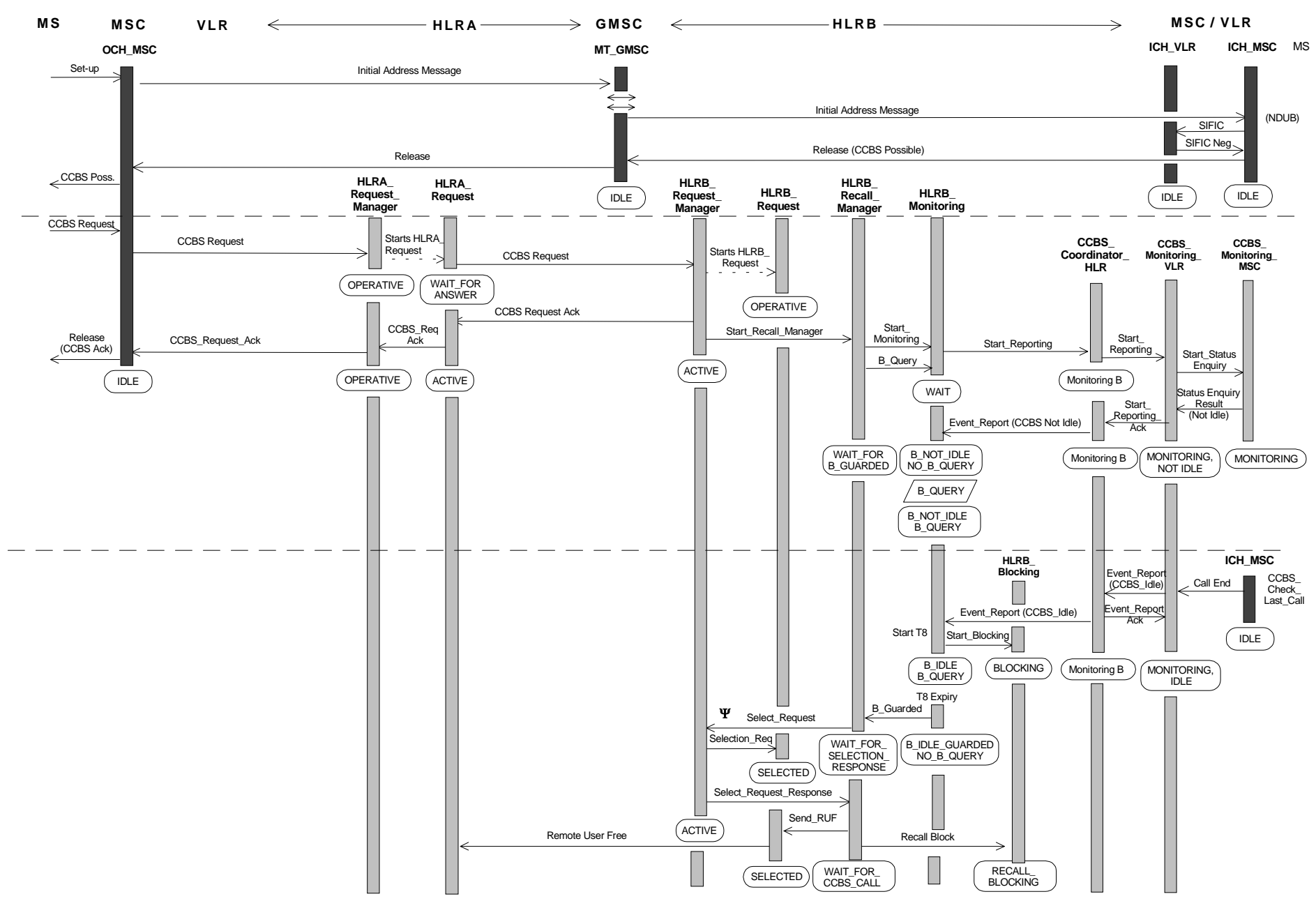

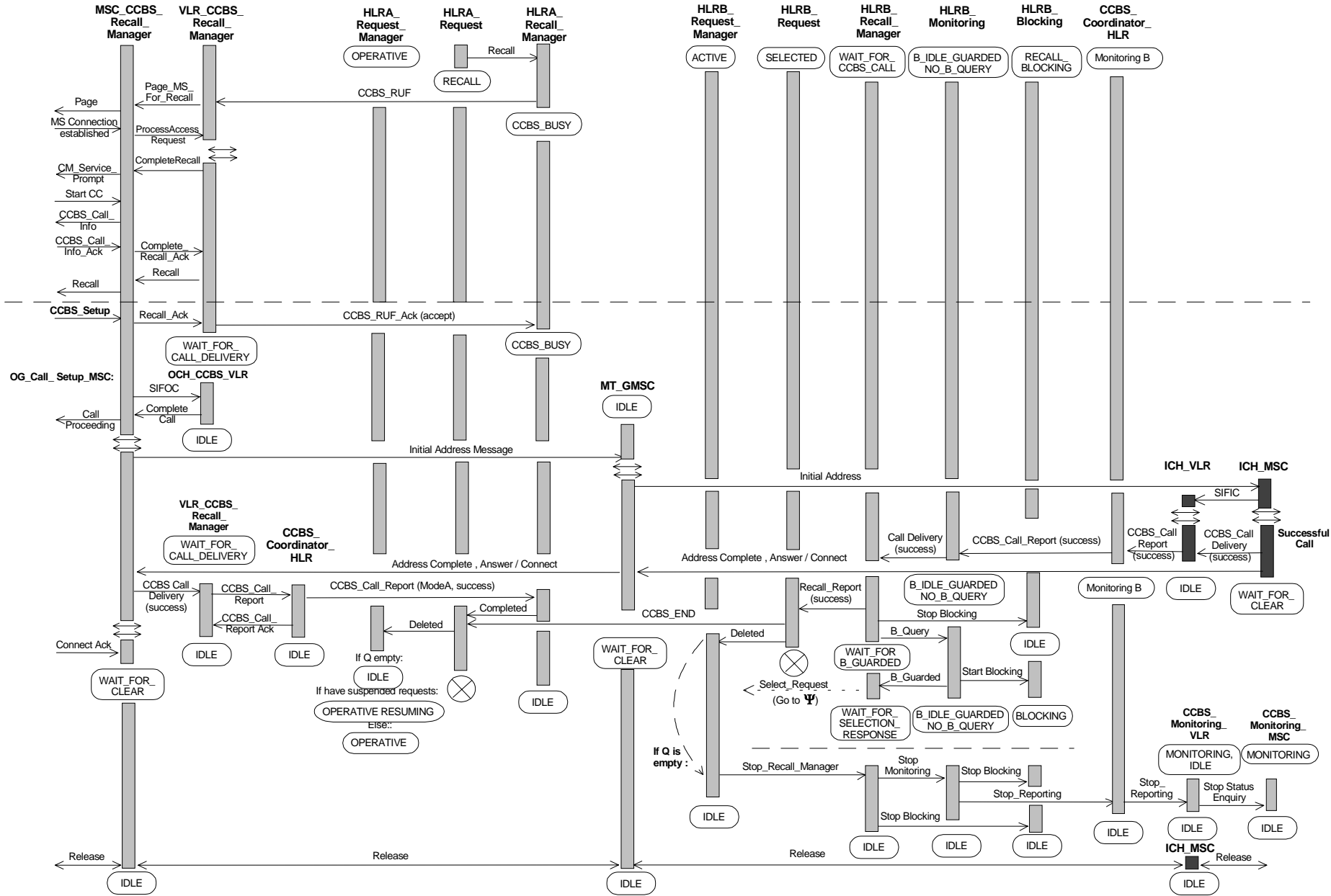

Annex A: Change history

Change history						
TSG CN#	Spec	Version	CR	<Phase>	New Version	Subject/Comment
Apr 1999	GSM 03.93	6.2.0				Transferred to 3GPP CN1
CN#03	23.093				3.0.0	Approved at CN#03
CN#06	23.093	3.0.0	001r3	R99	3.1.0	Approved at CN#06
CN#06	23.093	3.0.0	002r3	R99	3.1.0	Approved at CN#06

History

Document history		
V3.1.0	January 2000	Publication