

ETSI TS 123 040 V8.5.0 (2009-06)

Technical Specification

**Digital cellular telecommunications system (Phase 2+);
Universal Mobile Telecommunications System (UMTS);
LTE;
Technical realization of Short Message Service (SMS)
(3GPP TS 23.040 version 8.5.0 Release 8)**



Reference

RTS/TSGC-0123040v850

Keywords

GSM, LTE, UMTS

ETSI

650 Route des Lucioles
F-06921 Sophia Antipolis Cedex - FRANCE

Tel.: +33 4 92 94 42 00 Fax: +33 4 93 65 47 16

Siret N° 348 623 562 00017 - NAF 742 C
Association à but non lucratif enregistrée à la
Sous-Préfecture de Grasse (06) N° 7803/88

Important notice

Individual copies of the present document can be downloaded from:

<http://www.etsi.org>

The present document may be made available in more than one electronic version or in print. In any case of existing or perceived difference in contents between such versions, the reference version is the Portable Document Format (PDF). In case of dispute, the reference shall be the printing on ETSI printers of the PDF version kept on a specific network drive within ETSI Secretariat.

Users of the present document should be aware that the document may be subject to revision or change of status. Information on the current status of this and other ETSI documents is available at

<http://portal.etsi.org/tb/status/status.asp>

If you find errors in the present document, please send your comment to one of the following services:

http://portal.etsi.org/chaicor/ETSI_support.asp

Copyright Notification

No part may be reproduced except as authorized by written permission.
The copyright and the foregoing restriction extend to reproduction in all media.

© European Telecommunications Standards Institute 2009.
All rights reserved.

DECT™, **PLUGTESTS™**, **UMTS™**, **TIPHON™**, the TIPHON logo and the ETSI logo are Trade Marks of ETSI registered for the benefit of its Members.

3GPP™ is a Trade Mark of ETSI registered for the benefit of its Members and of the 3GPP Organizational Partners.

LTE™ is a Trade Mark of ETSI currently being registered

for the benefit of its Members and of the 3GPP Organizational Partners.

GSM® and the GSM logo are Trade Marks registered and owned by the GSM Association.

Intellectual Property Rights

IPRs essential or potentially essential to the present document may have been declared to ETSI. The information pertaining to these essential IPRs, if any, is publicly available for **ETSI members and non-members**, and can be found in ETSI SR 000 314: *"Intellectual Property Rights (IPRs); Essential, or potentially Essential, IPRs notified to ETSI in respect of ETSI standards"*, which is available from the ETSI Secretariat. Latest updates are available on the ETSI Web server (<http://webapp.etsi.org/IPR/home.asp>).

Pursuant to the ETSI IPR Policy, no investigation, including IPR searches, has been carried out by ETSI. No guarantee can be given as to the existence of other IPRs not referenced in ETSI SR 000 314 (or the updates on the ETSI Web server) which are, or may be, or may become, essential to the present document.

Foreword

This Technical Specification (TS) has been produced by ETSI 3rd Generation Partnership Project (3GPP).

The present document may refer to technical specifications or reports using their 3GPP identities, UMTS identities or GSM identities. These should be interpreted as being references to the corresponding ETSI deliverables.

The cross reference between GSM, UMTS, 3GPP and ETSI identities can be found under <http://webapp.etsi.org/key/queryform.asp>.

Contents

Intellectual Property Rights	2
Foreword.....	2
Foreword.....	9
Introduction	9
1 Scope	10
2 References	10
2.1 Definitions and abbreviations.....	12
2.1.1 Definitions	12
2.1.2 Abbreviations.....	15
3 Services and service elements	15
3.1 Basic services	15
3.2 Short Message Service elements	16
3.2.0 Introduction.....	16
3.2.1 Validity-Period	16
3.2.2 Service-Centre-Time-Stamp	16
3.2.3 Protocol-Identifier.....	17
3.2.4 More-Messages-to-Send	17
3.2.5 Delivery of Priority and non-Priority Messages	17
3.2.6 Messages-Waiting.....	18
3.2.7 Alert-SC.....	21
3.2.7a MT Correlation ID.....	21
3.2.8 Options concerning MNRG, MNRF, UNRI, MNRR-MS, MNRR-SGSN, UNRR, MCEF and MWD	22
3.2.9 Status report capabilities.....	23
3.2.10 Reply Path.....	24
3.3 Unsuccessful short message TPDU transfer SC -> MS.....	24
3.3.1 Errors occurring during transfer of TPDU to MS	24
3.3.2 Errors occurring after TPDU arrives at MS	24
3.4 Unsuccessful short message TPDU transfer MS -> SC.....	26
3.4.1 Errors occurring during transfer of TPDU to SC.....	26
3.4.2 Errors occurring after TPDU arrives at SC.....	26
3.5 Use of Supplementary Services in combination with the Short Message Service.....	26
3.6 Applicability of Operator Determined Barring to the Short Message Service	27
3.7 Multiple short message transfer.....	27
3.8 SMS and Internet Electronic Mail interworking	27
3.8.1 Basic Format.....	27
3.8.2 Optional Fields.....	28
3.8.2.1 Subject.....	28
3.8.2.2 Real Name.....	28
3.8.2.3 Optional Control Flag	28
3.8.3 Text concatenation	29
3.8.4 Alternative characters for Internet email addresses in MO SMS.....	29
3.9 SMS COMPRESSION	29
3.10 Enhanced Messaging Service	30
3.10.1 Text formatting	30
3.10.2 Pictures	31
3.10.3 Animations.....	31
3.10.4 Sound	31
3.10.5 vCard and vCalendar	31
3.10.6 WVG (Wireless Vector Graphics) Object	31
3.10.6.1 Overview of WVG Graphical Primitives	32
4 Network architecture	32
4.1 Basic network structure	32

4.2	Transfer on reference point 3	33
5	Service Centre and PLMN interconnection.....	34
5.1	Service centre connection.....	34
5.2	Routing requirements	34
5.2.1	Mobile terminated short message	34
5.2.2	Mobile originated short message	34
6	Service Centre functionality	34
6.1	Service Centre capabilities	34
6.2	SC functional requirements	35
6.2.1	Subaddressing support	35
6.3	SC EMS Extended Object Data Request Command Feature	35
7	MS functionality.....	36
7.1	MS capabilities	36
7.2	MS configuration.....	36
8	Node functionality	37
8.1	Node functionality related to SM MT	37
8.1.1	Functionality of the SMS-GMSC	37
8.1.2	Functionality of the MSC	39
8.1.3	Functionality of the SGSN.....	39
8.1.4	Functionality of the SMS Router	40
8.1.5	Functionality of the IP-SM-GW	41
8.2	Node functionality related to SM MO.....	42
8.2.1	Functionality of the MSC	42
8.2.2	Functionality of the SMS-IWMSC	42
8.2.3	Functionality of the SGSN.....	43
8.2.4	Functionality of the IP-SM-GW	43
8.3	SMS-IWMSC functionality related to alerting.....	43
9	Protocols and protocol architecture	43
9.1	Protocol element features	44
9.1.1	Octet and Bit transmission order.....	44
9.1.2	Numeric and alphanumeric representation	44
9.1.2.1	Integer representation.....	44
9.1.2.2	Octet representation	45
9.1.2.3	Semi-octet representation.....	45
9.1.2.4	Alphanumeric representation	46
9.1.2.5	Address fields.....	46
9.2	Service provided by the SM-TL	48
9.2.1	General.....	48
9.2.2	PDU Type repertoire at SM-TL.....	48
9.2.2.1	SMS-DELIVER type	49
9.2.2.1a	SMS-DELIVER-REPORT type.....	51
9.2.2.2	SMS-SUBMIT type	53
9.2.2.2a	SMS-SUBMIT-REPORT type.....	55
9.2.2.3	SMS-STATUS-REPORT type.....	57
9.2.2.4	SMS-COMMAND type	59
9.2.3	Definition of the TPDU parameters.....	60
9.2.3.1	TP-Message-Type-Indicator (TP-MTI).....	60
9.2.3.2	TP-More-Messages-to-Send (TP-MMS).....	60
9.2.3.3	TP-Validity-Period-Format (TP-VPF)	61
9.2.3.4	TP-Status-Report-Indication (TP-SRI).....	61
9.2.3.5	TP-Status-Report-Request (TP-SRR).....	61
9.2.3.6	TP-Message-Reference (TP-MR)	61
9.2.3.7	TP-Originating-Address (TP-OA).....	62
9.2.3.8	TP-Destination-Address (TP-DA).....	62
9.2.3.9	TP-Protocol-Identifier (TP-PID).....	62
9.2.3.10	TP-Data-Coding-Scheme (TP-DCS).....	64
9.2.3.11	TP-Service-Centre-Time-Stamp (TP-SCTS)	64
9.2.3.12	TP-Validity-Period (TP-VP)	65
9.2.3.12.1	TP-VP (Relative format)	65

9.2.3.12.2	TP-VP (Absolute format)	65
9.2.3.12.3	TP-VP (Enhanced format)	65
9.2.3.13	TP-Discharge-Time (TP-DT)	66
9.2.3.14	TP-Recipient-Address (TP-RA)	66
9.2.3.15	TP-Status (TP-ST)	66
9.2.3.16	TP-User-Data-Length (TP-UDL)	67
9.2.3.17	TP-Reply-Path (TP-RP)	68
9.2.3.18	TP-Message-Number (TP-MN)	68
9.2.3.19	TP-Command-Type (TP-CT)	68
9.2.3.20	TP-Command-Data-Length (TP-CDL)	68
9.2.3.21	TP-Command-Data (TP-CD)	69
9.2.3.22	TP-Failure-Cause (TP-FCS)	69
9.2.3.23	TP-User-Data-Header-Indicator (TP-UDHI)	70
9.2.3.24	TP-User Data (TP-UD)	70
9.2.3.24.1	Concatenated Short Messages	74
9.2.3.24.2	Special SMS Message Indication	75
9.2.3.24.3	Application Port Addressing 8 bit address	77
9.2.3.24.4	Application Port Addressing 16 bit address	77
9.2.3.24.5	SMSC Control Parameters	78
9.2.3.24.6	UDH Source Indicator	79
9.2.3.24.7	(U)SIM Toolkit Security Headers	79
9.2.3.24.8	Concatenated short messages, 16-bit reference number	79
9.2.3.24.9	Wireless Control Message Protocol	80
9.2.3.24.10	Enhanced Messaging Service	81
9.2.3.24.10.1	EMS Coding	81
9.2.3.24.10.1.1	Text Formatting	81
9.2.3.24.10.1.2	Predefined Sound	83
9.2.3.24.10.1.3	User Defined Sound	83
9.2.3.24.10.1.4	Predefined Animation	83
9.2.3.24.10.1.5	Large Animation	83
9.2.3.24.10.1.6	Small Animation	83
9.2.3.24.10.1.7	Large Picture	84
9.2.3.24.10.1.8	Small Picture	84
9.2.3.24.10.1.9	Variable Picture	84
9.2.3.24.10.1.10	User Prompt Indicator	84
9.2.3.24.10.1.11	Standard WVG Object	85
9.2.3.24.10.1.12	Character Size WVG Object	85
9.2.3.24.10.1.13	Extended Object	86
9.2.3.24.10.1.14	Reused Extended Object	88
9.2.3.24.10.1.15	Compression Control	88
9.2.3.24.10.1.15.1	LZSS Implementation for EMS extended object compression	90
9.2.3.24.10.1.15.2	Data Compression	92
9.2.3.24.10.1.15.3	Data De-compression	92
9.2.3.24.10.1.15.4	Test Vectors	93
9.2.3.24.10.1.16	Object Distribution Indicator	93
9.2.3.24.10.1.17	Reply Address Element	93
9.2.3.24.10.1.18	Extended Object Data Request Command	94
9.2.3.24.10.2.1	Example of Basic text formatting and predefined EMS coding	94
9.2.3.24.10.2.2	Example of User defined Objects EMS coding	95
9.2.3.24.10.2.3	Concatenation of SMS messages	95
9.2.3.24.10.3	EMS Formats	96
9.2.3.24.10.3.1	Sounds	96
9.2.3.24.10.3.2	Pictures	96
9.2.3.24.10.3.3	Animation	97
9.2.3.24.11	RFC 822 E-Mail Header	97
9.2.3.24.12	Hyperlink format element	99
9.2.3.24.13	Enhanced Voice Mail Information	100
9.2.3.24.13.1	Enhanced Voice Mail Notification	100
9.2.3.24.13.2	Enhanced Voice Mail Delete Confirmation	103
9.2.3.24.14	Identification of a directory number within the User Data Field	105
9.2.3.24.15	National Language Single Shift	105
9.2.3.24.16	National Language Locking Shift	106

9.2.3.25	TP-Reject-Duplicates (TP-RD)	106
9.2.3.26	TP-Status-Report-Qualifier (TP-SRQ)	106
9.2.3.27	TP-Parameter-Indicator (TP-PI)	106
9.3	Service provided by the SM-RL	107
9.3.1	General	107
9.3.2	Protocol element repertoire at SM-RL	107
9.3.2.1	RP-MO-DATA	108
9.3.2.2	RP-MT-DATA	108
9.3.2.3	RP-ACK	108
9.3.2.4	RP-ERROR	108
9.3.2.5	RP-ALERT-SC	109
9.3.2.6	RP-SM-MEMORY-AVAILABLE	109
10	Fundamental procedures within SMS	109
10.1	Short message mobile terminated	110
10.2	Short message mobile originated	124
10.3	Alert transfer	132
11	Mapping of error causes between RP layers	135
11.1	Mobile Terminated short message transfer	135
11.2	Memory available notification	136
11.3	Mobile Originated short message transfer	136
Annex A (informative):	Protocol stacks for interconnecting SCs and MSCs	138
Annex B (informative):	Information now contained in 3GPP TS 23.038 [9]	139
Annex C (informative):	Short message information flow	140
Annex D (informative):	Mobile Station reply procedures	157
D.1	Introduction	157
D.2	The scope of applicability	157
D.3	Terminology	157
D.4	The reply path requesting procedure	157
D.5	The reception of an original MT SM	158
D.6	The submission of the reply MO SM	158
D.7	Usage of SCs for replying	158
D.8	Replying possibilities for Phase 1 mobile stations	159
D.9	The resulting service for originating SMEs	159
Annex E (normative):	Extended Object Format Type	160
E.1	Predefined Sound	160
E.2	iMelody	160
E.3	Black and white bitmap	160
E.4	2-bit greyscale bitmap	160
E.5	6-bit colour bitmap	161
E.6	Predefined animation	161
E.7	Black and white bitmap animation	161
E.8	2-bit greyscale bitmap animation	162
E.9	6-bit colour bitmap animation	162
E.10	vCard	163

E.11	vCalendar	163
E.12	Data Format Delivery Request.....	163
E.13	Standard WVG Object.....	163
E.14	Polyphonic melody.....	164
Annex F (informative) : Compression methods for EMS.....		165
F.1	LZSS compression	165
F.1.1	Introduction	165
F.1.2	LZSS Basic Algorithm	165
F.1.3	Informative Example.....	166
Annex G (normative): WVG (Wireless Vector Graphics) data format.....		168
G.1	Introduction	168
G.1.1	Standard and Character Size WVG elements	168
G.1.2	Compression methods	168
G.1.3	Coordinate Systems.....	169
G.1.3.1	Compact Coordinate System.....	169
G.1.3.2	Flat Coordinate System.....	171
G.1.3.3	Coordinate values	171
G.1.4	Color schemes	171
G.1.5	Rendering model	172
G.2	Graphical elements.....	172
G.2.1	Line elements	172
G.2.1.1	Polyline.....	172
G.2.1.2	Circular Polyline.....	172
G.2.1.3	Bezier Polyline.....	173
G.2.1.4	Auto-closure of a line	173
G.2.2	Polygon elements	173
G.2.3	Simple shape elements	173
G.2.3.1	Ellipse	173
G.2.3.2	Rectangle	173
G.2.4	Special shape elements.....	174
G.2.5	Text element.....	174
G.2.6	Group elements	175
G.2.7	Reuse element	175
G.2.8	Animation elements.....	175
G.2.8.1	Simple animation elements.....	175
G.2.8.2	Standard Animation Element.....	177
G.2.9	Frame Element	177
G.2.10	Local Element	177
G.2.11	Extended Element.....	177
G.3	Element attributes.....	178
G.4	Element Transform.....	178
G.5	Character Size WVG Element.....	178
G.6	Data Format BNF.....	179
G.7	Web Safe Color Palette	196
Annex H (informative): Development Guidelines for Creation of Polyhony Using SP-MIDI.....		198
H.1.	Running status	198
H.2	File type considerations.....	198
H.3	File size reduction	198
H.4	Restrictions.....	199

Annex I (informative): **Change history**200
History202

Foreword

This Technical Specification (TS) has been produced by the 3rd Generation Partnership Project (3GPP).

The contents of the present document are subject to continuing work within the TSG and may change following formal TSG approval. Should the TSG modify the contents of the present document, it will be re-released by the TSG with an identifying change of release date and an increase in version number as follows:

Version x.y.z

where:

- x the first digit:
 - 1 presented to TSG for information;
 - 2 presented to TSG for approval;
 - 3 or greater indicates TSG approved document under change control.
- y the second digit is incremented for all changes of substance, i.e. technical enhancements, corrections, updates, etc.
- z the third digit is incremented when editorial only changes have been incorporated in the document.

Introduction

The Short Message Service (SMS) provides a means of sending messages of limited size to and from GSM/UMTS mobiles. The provision of SMS makes use of a Service Centre, which acts as a store and forward centre for short messages. Thus a GSM/UMTS PLMN needs to support the transfer of short messages between Service Centres and mobiles.

Mobile originated messages shall be transported from an MS to a Service Centre. These may be destined for other mobile users, or for subscribers on a fixed network. Mobile terminated messages shall be transported from a Service Centre to an MS. These may be input to the Service Centre by other mobile users (via a mobile originated short message) or by a variety of other sources, e.g. speech, telex, or facsimile.

1 Scope

The present document describes the Short Message Service (SMS) for GSM/UMTS networks. It defines:

- the services and service elements;
- the network architecture;
- the Service Centre functionality;
- the SMS Router functionality;
- the MSC functionality (with regard to the SMS);
- the SGSN functionality (with regard to the SMS);
- the routing requirements;
- the protocols and protocol layering;

for the Mobile Originated and Mobile Terminated Short Message Service Teleservices, as specified in 3GPP TS 22.003 [2] and 3GPP TS 22.105 [32].

The use of radio resources for the transfer of short messages between the MS and the MSC or the SGSN is described in 3GPP TS 24.011 [13].

The network aspects of Short Message Service provision are outside the scope of the present document (i.e. the provision of network connectivity between the PLMN subsystems). There is no technical restriction within the present document for the transfer of short messages between different PLMNs. Any such restriction is likely to be subject to commercial arrangements and PLMN operators must make their own provision for interworking or for preventing interworking with other PLMNs as they see fit.

The required and assumed network service offered to the higher layers is defined in the present document.

2 References

The following documents contain provisions which, through reference in this text, constitute provisions of the present document.

- References are either specific (identified by date of publication, edition number, version number, etc.) or non-specific.
- For a specific reference, subsequent revisions do not apply.
- For a non-specific reference, the latest version applies. In the case of a reference to a 3GPP document (including a GSM document), a non-specific reference implicitly refers to the latest version of that document *in the same Release as the present document*.

- [1] void
- [2] 3GPP TS 22.003: "Circuit Teleservices supported by a Public Land Mobile Network (PLMN)".
- [3] 3GPP TS 22.004: "General on supplementary services".
- [4] 3GPP TS 22.041: "Operator Determined Barring (ODB)".
- [5] 3GPP TS 23.002: "Network architecture".
- [6] 3GPP TS 23.008: "Organization of subscriber data".
- [7] 3GPP TS 23.011: "Technical realization of supplementary services".
- [8] 3GPP TS 23.015: "Technical realization of Operator Determined Barring (ODB)".

- [9] 3GPP TS 23.038: "Alphabets and language-specific information".
- [10] 3GPP TS 23.041: "Technical realization of Cell Broadcast Service (CBS)".
- [11] 3GPP TS 43.047: "Example protocol stacks for interconnecting Service Centre(s) (SC) and Mobile-services Switching Centre(s) (MSC)".
- [12] 3GPP TS 44.008: "Mobile radio interface layer 3 specification".
- [13] 3GPP TS 24.011: "Point-to-Point (PP) Short Message Service (SMS) support on mobile radio interface".
- [14] 3GPP TS 27.005: "Use of Data Terminal Equipment - Data Circuit terminating Equipment (DTE - DCE) interface for Short Message Service (SMS) and Cell Broadcast Service (CBS)".
- [15] 3GPP TS 29.002: "Mobile Application Part (MAP) specification".
- [16] 3GPP TS 51.011 Release 4 (version 4.x.x): "Specification of the Subscriber Identity Module - Mobile Equipment (SIM- ME) interface".
- [17] CCITT Recommendation E.164 (Blue Book): "The international public telecommunication numbering plan".
- [18] CCITT Recommendation E.163 (Blue Book): "Numbering plan for the international telephone service".
- [19] CCITT Recommendation Q.771: "Specifications of Signalling System No.7; Functional description of transaction capabilities".
- [20] CCITT Recommendation T.100 (Blue Book): "International information exchange for interactive videotex".
- [21] CCITT Recommendation T.101 (Blue Book): "International interworking for videotex services".
- [22] CCITT Recommendation X.121 (Blue Book): "International numbering plan for public data networks".
- [23] CCITT Recommendation X.400 (Blue Book): "Message handling services: Message handling system and service overview".
- [24] ISO/IEC10646: "Universal Multiple-Octet Coded Character Set (USC); UCS2, 16 bit coding".
- [25] 3GPP TS 22.022: "Personalisation of Mobile Equipment (ME); Mobile functionality specification".
- [26] 3GPP TS 23.042: "Compression Algorithm for Text Messaging Services".
- [27] 3GPP TS 23.060: "General Packet Radio Service (GPRS); Service description; Stage 2".
- [28] 3GPP TS 31.115: "Secured packet structure for (U)SIM toolkit application".
- [29] 3GPP TR 21.905: "Vocabulary for 3GPP Specifications".
- [30] 3GPP TS 31.102: "Characteristics of the USIM application".
- [31] 3GPP TS 31.101: "UICC – Terminal interface; Physical and logical characteristics".
- [32] 3GPP TS 22.105: "Services and Service Capabilites".
- [33] Infrared Data Association. Specifications for Ir Mobile Communications (IrMC). iMelody.
- [34] IETF RFC 822: "Standard for the format of ARPA Internet text messages".
- [35] void

- [36] "vCard - The Electronic Business Card", version 2.1, The Internet Mail Consortium (IMC), September 18, 1996, [URL:http://www.imc.org/pdi/vcard-21.doc](http://www.imc.org/pdi/vcard-21.doc).
- [37] "vCalendar - the Electronic Calendaring and Scheduling Format", version 1.0, The Internet Mail Consortium (IMC), September 18, 1996, [URL:http://www.imc.org/pdi/vcal-10.doc](http://www.imc.org/pdi/vcal-10.doc)
- [38] Scalable Polyphony MIDI Specification, MIDI Manufacturers Association (2002); <http://www.midi.org>
- [39] Scalable Polyphony MIDI Device 5-to-24 Note Profile for 3GPP, MIDI Manufacturers Association (2002); <http://www.midi.org>
- [40] The Complete MIDI 1.0 Detailed Specification, Incorporating all Recommended Practices, MIDI Manufacturers Association, Document version 96.1, 1996; <http://www.midi.org>
- [41] 3GPP TS 23.097: Multiple Subscriber Profile (MSP) (Phase 2) - Stage 2
- [42] 3GPP TS 23.204: "Support of SMS over generic 3GPP IP access; Stage 2".
- [43] IETF RFC 3261: "SIP: Session Initiation Protocol".
- [44] IETF RFC 3428: "Session Initiation Protocol (SIP) Extension for Instant Messaging".

2.1 Definitions and abbreviations

2.1.1 Definitions

For the purposes of the present document, the following terms and definitions apply:

NOTE 1: The term "mobile station" (MS) in the present document is synonymous with the term "user equipment" (UE) in UMTS terminology as defined in 3GPP TR 21.905 [29].

active MS: switched-on mobile station with a SIM/UICC see 3GPP TS 31.101 [31] module attached

alert-SC: service element provided by a GSM/UMTS PLMN to inform an SC which has previously initiated unsuccessful short message delivery attempt(s) to a specific MS, that the MS is now recognized by the PLMN to have recovered operation

status report: SC informing the originating MS of the outcome of a short message submitted to an SME

Gateway MSC For Short Message Service (SMS-GMSC): function of an MSC capable of receiving a short message from an SC, interrogating an HLR for routing information and SMS info, and delivering the short message to the VMSC or the SGSN of the recipient MS

Interworking MSC For Short Message Service (SMS-IWMSC): function of an MSC capable of receiving a short message from within the PLMN and submitting it to the recipient SC

IP-Short-Message-Gateway (IP-SM-GW): function responsible for protocol interworking between the IP-based UE and the SC

Messages-Waiting (MW): service element that makes a PLMN store information (Messages-Waiting-Indication), listing those SCs that have made unsuccessful short message delivery attempts to MSs in that PLMN

Messages-Waiting-Indication (MWI): data to be stored in the HLR and VLR with which an MS is associated, indicating that there is one or more messages waiting in a set of SCs to be delivered to the MS (due to unsuccessful delivery attempt(s))

Messages-Waiting-Data (MWD): part of the MWI to be stored in the HLR. MWD consists of an address list of the SCs which have messages waiting to be delivered to the MS

Mobile-services Switching Centre (MSC): exchange which performs switching functions for mobile stations located in a geographical area designated as the MSC area

Mobile-Station-Memory-Capacity-Exceeded-Flag (MCEF): part of the MWI to be stored in the HLR

NOTE 2: MCEF is a Boolean parameter indicating if the address list of MWD contains one or more entries because an attempt to deliver a short message to an MS has failed with a cause of MS Memory Capacity Exceeded

Mobile-Station-Not-Reachable-Flag (MNRF): part of the MWI to be stored in the VLR and the HLR

NOTE 3: MNRF is a Boolean parameter indicating if the address list of MWD contains one or more entries because an attempt to deliver a short message to an MS has failed with a cause of Absent Subscriber.

Mobile-station-Not-Reachable-for-GPRS (MNRG): part of the MWI to be stored in the SGSN and the HLR

NOTE 4: MNRG is a Boolean parameter indicating if the address list of MWD contains one or more entries because an attempt to deliver a short message to an MS has failed with a cause of Absent Subscriber.

Mobile-Station-Not-Reachable-via-the-MS-Reason (MNRR-MS): part of the MWI in the HLR which stores the reason for an MS being absent when an attempt to deliver a short message to an MS fails at the MSC with a cause of Absent Subscriber

Mobile-Station-Not-Reachable-via-the-SGSN-Reason (MNRR-SGSN): part of the MWI in the HLR which stores the reason for an MS being absent when an attempt to deliver a short message to an MS fails at the SGSN with a cause of Absent Subscriber

More-Messages-To-Send (MMS): information element offering an MS receiving a short message from an SC the information whether there are still more messages waiting to be sent from that SC to the MS

NOTE 5: The TP-MMS element (conveyed in the Transfer layer) is copied into the RP-MMS element (conveyed in the Relay layer). It is possible with Phase 2 and later versions of MAP (3GPP TS 29.002 [15]) for the RP-MMS element to keep an SM transaction open between the SMS-GMSC and the MS in the case where there are more-messages-to-send. Earlier versions of MAP support the transport of the TP-MMS element.

priority: service element enabling the SC or SME to request a short message delivery attempt to an MS irrespective of whether or not the MS has been identified as temporarily absent

protocol-identifier: information element by which the originator of a short message (either an SC or an MS) may refer to a higher layer protocol

receiving MS: the mobile station to which an MT SM is destined.

reply path procedure: mechanism which allows an SME to request that an SC should be permitted to handle a reply sent in response to a message previously sent from that SME to another SME

NOTE 6: This may happen even though the SC may be unknown to the SME which received the initial message.

report: response from either the network or the recipient upon a short message being sent from either an SC or an MS

NOTE 7: A report may be a delivery report, which confirms the delivery of the short message to the recipient, or it may be a failure report, which informs the originator that the short message was never delivered and the reason why.

When issued by the Service Centre, the delivery report confirms the reception of the Short Message by the SC, and not the delivery of the Short Message to the SME.

When issued by the Mobile Station, the delivery report confirms the reception of the Short Message by the Mobile Station, and not the delivery of the Short Message to the user.

replace short message type: range of values in the Protocol Identifier which allows an indication to be sent with a short message (MT or MO) that the short message is of a particular type allowing the receiving MS or the SC to replace an existing message of the same type held in the SC, the ME or on the SIM/UICC, provided it comes:

- in MT cases: from the same SC and originating address;
- in MO cases: from the same MS.

sending MS: the mobile station from which an MO SM is sourced.

Service Centre (SC): function responsible for the relaying and store-and-forwarding of a short message between an SME and an MS

NOTE 8: The SC is not a part of the GSM/UMTS PLMN, however MSC and SC may be integrated.

Serving GPRS Support Node (SGSN): exchange which performs packet switching functions for mobile stations located in a geographical area designated as the SGSN area

short message: information that may be conveyed by means of the Short Message Service

NOTE 9: As described in the present document.

Short Message Entity (SME): entity which may send or receive Short Messages

NOTE 10: The SME may be located in a fixed network, an MS, or an SC.

SMS-STATUS-REPORT: short message transfer protocol data unit informing the receiving MS of the status of a mobile originated short message previously submitted by the MS, i.e. whether the SC was able to forward the message or not, or whether the message was stored in the SC for later delivery

SMS-COMMAND: short message transfer protocol data unit which enables an MS to invoke an operation at the SC

NOTE 11: An MS may then, for example, delete a short message, cancel a TP-Status-Report-Request, enquire about the status of a short message or request another function to be performed by the SC.

NOTE 12: The type of operation is indicated by the TP-Command-Type and the particular SM to operate on is indicated by the TP-Message-Number and the TP-Destination-Address. Receipt of an SMS-COMMAND is confirmed by an RP-ACK or RP-ERROR. In the case of certain SMS-COMMANDs, an SMS-STATUS-REPORT may be sent, where the outcome of the SMS-COMMAND is passed in its TP-Status field.

SMS-DELIVER: short message transfer protocol data unit containing user data (the short message), being sent from an SC to an MS

SMS-SUBMIT: short message transfer protocol data unit containing user data (the short message), being sent from an MS to an SC

Service-Centre-Time-Stamp (SCTS): information element offering the recipient of a short message the information of when the message arrived at the SM-TL entity of the SC

NOTE 13: The time of arrival comprises the year, month, day, hour, minute, second and time zone.

UE-Not-Reachable-for-IP (UNRI): part of the MWI to be stored in the IP-SM-GW and the HSS/HLR

NOTE 14: UNRI is a Boolean parameter indicating if the address list of MWD contains one or more entries because an attempt to deliver a short message to an UE has failed with a cause of Absent Subscriber.

UE-Not-Reachable-Reason (UNRR): part of the MWI in the HSS/HLR which stores the reason for an UE being absent when an attempt to deliver a short message to an UE fails at the IP-SM-GW.

Validity-Period (VP): information element enabling the originator MS to indicate the time period during which the originator considers the short message to be valid.

For the purposes of the present document, the following terms and definitions given in 3GPP TS 23.038 [9] apply:

National Language Identifier
National Language Locking Shift Table
National Language Single Shift Table

2.1.2 Abbreviations

For the purposes of the present document, the abbreviations defined in 3GPP TR 21.905 [29] and the following apply:

SM MO	Short Message Mobile Originated
SM MT	Short Message Mobile Terminated
SM-AL	Short Message Application Layer
SM-LL	Short Message Lower Layers
SM-RL	Short Message Relay Layer
SM-RP	Short Message Relay Layer Protocol
SM-RS	Short Message Relay Service
SM-TL	Short Message Transfer Layer
SM-TP	Short Message Transfer Layer Protocol
SM-TS	Short Message Transfer Service
SSN	Sub-System Number
TPDU	Transfer protocol data unit

3 Services and service elements

The SMS provides a means to transfer short messages between a GSM/UMTS MS and an SME via an SC. The SC serves as an interworking and relaying function of the message transfer between the MS and the SME.

The present document describes only the short message services between the MS and SC. It may, however, refer to possible higher layer applications.

3.1 Basic services

The Short Message Service comprise two basic services:

- SM MT (Short Message Mobile Terminated);
- SM MO (Short Message Mobile Originated).

SM MT denotes the capability of the GSM/UMTS system to transfer a short message submitted from the SC to one MS, and to provide information about the delivery of the short message either by a delivery report or a failure report with a specific mechanism for later delivery; see figure 1.

SM MO denotes the capability of the GSM/UMTS system to transfer a short message submitted by the MS to one SME via an SC, and to provide information about the delivery of the short message either by a delivery report or a failure report. The message shall include the address of that SME to which the SC shall eventually attempt to relay the short message; see figure 2.

The text messages to be transferred by means of the SM MT or SM MO contain up to 140 octets.

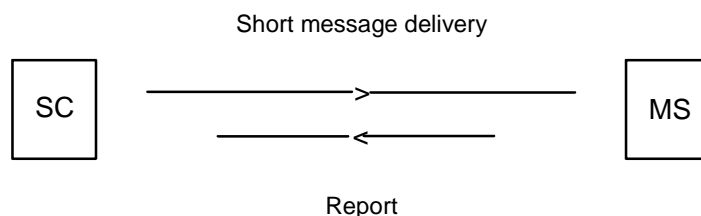

Figure 1: The Short Message Service mobile terminated

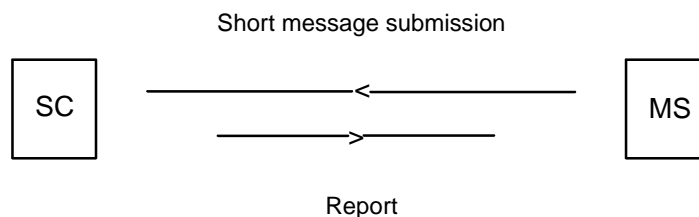

Figure 2: The Short Message Service mobile originated

An active MS shall be able to receive a short message TPDU (SMS-DELIVER) at any time, independently of whether or not there is a speech or data call in progress. A report shall always be returned to the SC; either confirming that the MS has received the short message, or informing the SC that it was impossible to deliver the short message TPDU to the MS, including the reason why.

An active MS shall be able to submit a short message TPDU (SMS-SUBMIT) at any time, independently of whether or not there is a speech or data call in progress. A report shall always be returned to the MS; either confirming that the SC has received the short message TPDU, or informing the MS that it was impossible to deliver the short message TPDU to the SC, including the reason why.

NOTE: When the transmission or reception of a short message coincide with a change of state in the MS, i.e. from busy to idle or from idle to busy, or during a handover, the short message transfer may be aborted.

It is also possible for two short messages to be received in sequence having the same originating address and identification, i.e. message reference number (MO) or SC Timestamp (MT). Such a situation may be due to errors at the RP or CP layers (e.g. during inter MSC handover) where it may be a duplicated message or otherwise it may be a valid new message.

The receiving entity should therefore make provision to check other parameters contained in the short message to decide whether the second short message is to be discarded.

3.2 Short Message Service elements

3.2.0 Introduction

The SMS comprises 8 elements particular to the submission and reception of messages:

- Validity-Period;
- Service-Centre-Time-Stamp;
- Protocol-Identifier;
- More-Messages-to-Send;
- Priority;
- Messages-Waiting;
- Alert-SC.
- MT Correlation ID.

3.2.1 Validity-Period

The Validity-Period is the information element which gives an MS submitting an SMS-SUBMIT to the SC the possibility to include a specific time period value in the short message (TP-Validity-Period field, see clause 9). The TP-Validity-Period parameter value indicates the time period for which the short message is valid, i.e. for how long the SC shall guarantee its existence in the SC memory before delivery to the recipient has been carried out.

3.2.2 Service-Centre-Time-Stamp

The Service-Centre-Time-Stamp is the information element by which the SC informs the recipient MS about the time of arrival of the short message at the SM-TL entity of the SC. The time value is included in every SMS-DELIVER (TP-Service-Centre-Time-Stamp field, see clause 9) being delivered to the MS.

3.2.3 Protocol-Identifier

The Protocol-Identifier is the information element by which the SM-TL either refers to the higher layer protocol being used, or indicates interworking with a certain type of telematic device.

The Protocol-Identifier information element makes use of a particular field in the message types SMS-SUBMIT, SMS-SUBMIT-REPORT for RP-ACK, SMS-DELIVER DELIVER, SMS-DELIVER-REPORT for RP-ACK, SMS_STATUS_REPORT and SMS-COMMAND TP-Protocol-Identifier (TP-PID).

3.2.4 More-Messages-to-Send

The More-Messages-to-Send is the information element by which the SC informs the MS that there is one or more messages waiting in that SC to be delivered to the MS. The More-Messages-to-Send information element makes use of a Boolean parameter in the message SMS-DELIVER, TP-More-Messages-to-Send (TP-MMS).

3.2.5 Delivery of Priority and non-Priority Messages

Priority is the information element provided by an SC or SME to indicate to the PLMN whether or not a message is a priority message.

Delivery of a non-priority message shall not be attempted if the MS has been identified as temporarily absent (see clause 3.2.6).

Delivery of a non-priority message shall be attempted if the MS has not been identified as temporarily absent irrespective of whether the MS has been identified as having no free memory capacity (see clause 3.2.6).

Delivery of a priority message shall be attempted irrespective of whether or not the MS has been identified as temporarily absent, or having no free memory capacity.

3.2.6 Messages-Waiting

The Messages-Waiting is the service element that enables the PLMN to provide the HLR, SGSN and VLR with which the recipient MS is associated with the information that there is a message in the originating SC waiting to be delivered to the MS. The service element is only used in case of previous unsuccessful delivery attempt(s) due to temporarily absent mobile or MS memory capacity exceeded. This information, denoted the Messages-Waiting-Indication (MWD), consists of Messages-Waiting-Data (MWD), the Mobile-station-Not-Reachable-for-GPRS (MNRG), the UE-Not-Reachable-for-IP (UNRI), the Mobile-Station-Not-Reachable-Flag (MNRF), the Mobile-Not-Reachable-via-the-MSC-Reason (MNRR-MSC), the Mobile-Not-Reachable-via-the-SGSN-Reason (MNRR-SGSN), the UE Not Reachable-Reason (UNRR) and the Mobile-Station-Memory-Capacity-Exceeded-Flag (MCEF) located in the HLR; the Mobile-station-Not Reachable-for-GPRS (MNRG) located in the SGSN, and the Mobile-Station-Not-Reachable-Flag (MNRF) located in the VLR. Figure 3 shows an example.

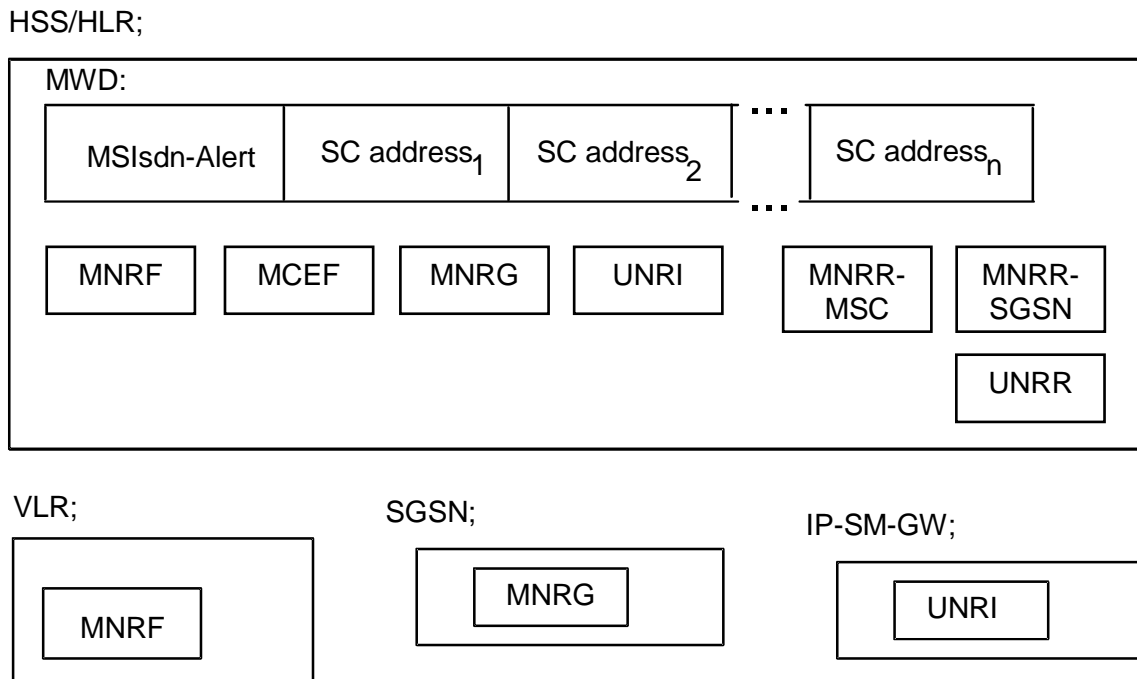

Figure 3: Example of how information on one MS can be put in relation to SC(s) in order to fulfil the requirement of Alert-SC mechanism

The MWD shall contain a list of addresses (SC-Addr) of SCs which have made previous unsuccessful delivery attempts of a message (see clause 5). In order to be able to send alert messages to every SC which has made unsuccessful delivery attempts to an MS, the HLR shall store the MSIsdn-Alert (see clause 3.2.7) together with references to the SC addresses. The requirements placed upon the HLR are specified in GSM TS 03.08 [6]. The description of how the HLR is provided with SC and MS address information is given in 3GPP TS 29.002 [15].

The Mobile-Station-Memory-Capacity-Exceeded-Flag (MCEF) within the HLR is a Boolean parameter with the value TRUE an attempt to deliver a short message to an MS has failed with a cause of MS Memory Capacity Exceeded, and with the value FALSE otherwise.

The Mobile-station-Not Reachable-for-GPRS (MNRG) within the HLR and the SGSN is a Boolean parameter with the value TRUE when an attempt to deliver a short message to an MS has failed with a cause of Absent Subscriber, and with the value FALSE otherwise (except as described in note 1 below).

The Mobile-Station-Not-Reachable-Flag (MNRF) within the HLR and the VLR is a Boolean parameter with the value TRUE when the list MWD contains one or more list elements because an attempt to deliver a short message to an MS has failed with a cause of Absent Subscriber, and with the value FALSE otherwise.

The UE-Not-Reachable-for-IP (UNRI) within the HLR/HSS and IP-SM-GW is a Boolean parameter with the value TRUE when the list MWD contains one or more list elements because an attempt to deliver a short message to an UE has failed with a cause of Absent Subscriber, and with the value FALSE otherwise.

The Mobile-Station-Not-Reachable-via-the-MSC-Reason (MNRR-MSC) within the HLR stores the reason for the MS being absent when an attempt to deliver a short message to an MS fails at the MSC with the cause Absent Subscriber. The HLR updates the MNRR-MSC with the reason for absence when an absent subscriber diagnostic information is received from the SMS-GMSC and the MNRF is set. The HLR clears the MNRR-MSC when the MNRF is cleared. If the MNRF is set due to a failure at the MSC with cause Absent Subscriber and information pertaining to the absence of the MS is not available from the SMS-GMSC, the MNRR-MSC shall remain in a cleared state. The MNRR-MSC shall either be in a cleared state or contain one of the following reasons:

No Paging Response via the MSC;

IMSI Detached.

The Mobile-Station-Not-Reachable-via-the-SGSN-Reason (MNRR-SGSN) within the HLR stores the reason for the MS being absent when an attempt to deliver a short message to an MS fails at the SGSN with the cause Absent Subscriber. The HLR updates the MNRR-SGSN with the reason for absence when an absent subscriber diagnostic information is received from the GMSC and the MNRG is set. The HLR clears the MNRR-SGSN when the MNRG is cleared. If the MNRG is set due to a failure at the SGSN with cause Absent Subscriber and information pertaining to the absence of the MS is not available from the GMSC, the MNRR-SGSN shall remain in a cleared state. The MNRR-SGSN shall either be in a cleared state or contain one of the following reasons:

No Paging Response via the SGSN;

GPRS Detached.

NOTE 1: The MNRG can also be set in the HLR and in the SGSN after an unsuccessful attempt to invoke the network requested PDP-Context Activation procedure. In this case, no SC address is stored in MWD list (see 3GPP TS 23.060 [27]).

NOTE 2: When a short message delivery attempt fails at the HLR due to Roaming being Restricted, the MS being deregistered in HLR or the MS being Purged the absent subscriber diagnostic reason is returned to the SC, however the reason is not stored in the MNRR-MSC or MNRR-SGSN.

The UE-Station-Not-Reachable-Reason (UNRR) within the HSS/HLR stores the reason for the UE being absent when an attempt to deliver a short message to an UE fails at the IP-SM-GW with the cause Absent Subscriber. The HSS/HLR updates the UNRR with the reason for absence when an absent subscriber diagnostic information is received from the IP-SM-GW and the UNRI is set. The HSS/HLR clears the UNRR when the UNRI is cleared. If the UNRI is set due to a failure at the IP-SM-GW with cause Absent Subscriber, the UNRR shall remain in a cleared state. The UNRR shall either be in a cleared state or contain one of the following reasons:

No Response via the IP-SM-GW;

UE deregistered.

The MWD, MCEF, MNRR-MSC, MNRR-SGSN, MNRG, MNRF, UNRI and UNRR are updated in the following way:

- 1a) When a mobile terminated short message delivery fails at the MSC due to the MS being temporarily absent (i.e. either IMSI DETACH flag is set or there is no response from the MS to a paging request via the MSC), the SC address is inserted into the MWD list (if it is not already present), the MNRF is set (if it is not already set) and the MNRR-MSC is updated (if the information is available), as described in clause 10.
- 1b) When a mobile terminated short message delivery fails at the SGSN due to the MS being temporarily absent (i.e. either GPRS DETACH flag is set or there is no response from the MS to a paging request via the SGSN), the SC address is inserted into the MWD list (if it is not already present), the MNRG is set (if it is not already set) and the MNRR-SGSN is updated (if the information is available), as described in clause 10.
- 1c) When a mobile terminated short message delivery fails at the MSC due to the MS memory capacity being exceeded, the SC address is inserted into the MWD list (if it is not already present), the MCEF is set (if it is not already set), the MNRF is cleared and the MNRR-MSC is cleared.
- 1d) When a mobile terminated short message delivery fails at the SGSN due to the MS memory capacity being exceeded, the SC address is inserted into the MWD list (if it is not already present), the MCEF is set (if it is not already set), the MNRG is cleared and the MNRR-SGSN is cleared.

- 1e) When a mobile terminated short message delivery fails due to the UE memory capacity via the IP-SM-GW being exceeded, the SC address is inserted into the MWD list (if it is not already present), the MCEF is set (if it is not already set), the UNRI is cleared and the UNRR is cleared.
- 1f) If the MSISdn used by the SC to address the recipient MS for alerting purposes is different from the MSISdn-Alert of the MS (see clause 3.2.7), the HLR returns the MSISdn-Alert to the SC within the failure report, see "1c Failure report" in figures 15 and 16.
- 2a) When either the HLR or VLR detects that the MS has recovered operation (e.g. has responded to a paging request over MSC), the HLR directly or on request of the VLR shall clear MNRF and MNRR via the MSC. Then, if with a non empty MWD list and the MCEF clear, the HLR shall invoke operations to alert the SCs within the MWD (see clause 3.2.7 and clause 10). After each SC is alerted by the HLR, the address for that SC shall be deleted from the MWD. If the MCEF is set in the HLR, the HLR shall not invoke operations to alert the SCs within the MWD and data are not cleared from the MWD.
- 2b) When either the HLR or SGSN detects that the MS has recovered operation (e.g. has responded to a paging request via the SGSN), the HLR directly or on request of the SGSN shall clear MNRG and MNRR via the SGSN. Then, if with a non empty MWD list and the MCEF clear, the HLR shall invoke operations to alert the SCs within the MWD (see clause 3.2.7 and clause 10). After each SC is alerted by the HLR, the address for that SC is deleted from the MWD. If the MCEF is set in the HLR, the HLR shall not invoke operations to alert the SCs within the MWD and data are not cleared from the MWD.
- 2c) When the HLR/HSS detects that the UE has recovered operation (i.e. registered) or the IP-SM-GW indicates the UE's availability, the HLR/HSS shall clear the UNRI and UNRR via the IP-SM-GW. Then, if with a non empty MWD list and the MCEF clear, the HLR/HSS shall invoke operations to alert the SCs within the MWD (see clause 3.2.7 and clause 10). After each SC is alerted by the HLR/HSS, the address for that SC is deleted from the MWD. If the MCEF is set in the HLR/HSS, the HLR/HSS shall not invoke operations to alert the SCs within the MWD and data are not cleared from the MWD.
- 2d) When the HLR receives (via the MSC and the VLR) a notification that the MS (with a non-empty MWD and the MCEF set in the HLR) has memory capacity available to receive one or more short messages, the HLR shall invoke operations to alert the SCs within the MWD (see clause 3.2.7 and clause 10). Once the Alert SC operations have been invoked, the MNRF is cleared in the VLR and the MCEF, MNRF and MNRR-MS are cleared in the HLR. After each SC is alerted by the HLR, the address for that SC is deleted from the MWD.
- 2e) When the HLR receives (via the SGSN) a notification that the MS (with a non-empty MWD and the MCEF set in the HLR) has memory capacity available to receive one or more short messages, the HLR shall invoke operations to alert the SCs within the MWD (see clause 3.2.7 and clause 10). Once the Alert SC operations have been invoked, the MNRG is cleared in the SGSN and the MCEF, MNRG and MNRR-SGSN are cleared in the HLR. After each SC is alerted by the HLR, the address for that SC is deleted from the MWD.
- 2f) When the HLR/HSS receives (via the IP-SM-GW) a notification that the UE (with a non-empty MWD and the MCEF set in the HLR/HSS) has memory capacity available to receive one or more short messages, the HLR/HSS shall invoke operations to alert the SCs within the MWD (see clause 3.2.7 and clause 10). Once the Alert SC operations have been invoked, the UNRI and UNRR are cleared in the HLR/HSS. After each SC is alerted by the HLR/HSS, the address for that SC is deleted from the MWD.
- 2g) When the HLR receives from the SMS-GMSC a notification that a short message has been successfully delivered from an SC to an MS via the MSC for which the MCEF is set and the MWD are not empty, the HLR shall invoke operations to alert other SCs within the MWD (see clause 3.2.7 and clause 10). Once the Alert SC operations have been invoked, the MCEF, MNRF and MNRR-MS are cleared in the HLR. After each SC is alerted by the HLR, the address for that SC is deleted from the MWD. The SC which successfully delivered the message is also deleted from the MWD, if present.
- 2h) When the HLR receives from the SMS-GMSC a notification that a short message has been successfully delivered from an SC to an MS via the SGSN for which the MCEF is set and the MWD are not empty, the HLR shall invoke operations to alert other SCs within the MWD (see clause 3.2.7 and clause 10). Once the Alert SC operations have been invoked, the MCEF, MNRG and MNRR-SGSN are cleared in the HLR. After each SC is alerted by the HLR, the address for that SC is deleted from the MWD. The SC which successfully delivered the message is also deleted from the MWD, if present.
- 2i) When the HLR receives (via the MSC and the VLR, or the SGSN) a notification that the MS has memory capacity available to receive one or more short messages but the MCEF is not set and the MWD are empty, the HLR acknowledges the notification but does not alert any service centre.

NOTE 3: The HLR can be in a situation where the MWD list is empty but where either MNRF or MNRG (with the related MNRR-MS or MNRR-SGSN) is still set. This enables the HLR to return the correct address (MS or SGSN address) at the next Send Routing Information Request from the SMS-GMSC.

NOTE 4: If the SMS delivery failed on first attempt via the MS or the SGSN (see cases 1a for IMSI Detach and 1b for GPRS Detach), and is successful on the second attempt (see cases 2e and 2f), the SC address shall not be inserted into the MWD list

3.2.7 Alert-SC

The Alert-SC is the service element, which may be provided by some GSM/UMTS PLMNs, to inform the SC that an MS:

- 1) to which a delivery attempt has failed because the MS is not reachable or because the MS memory capacity was exceeded; and
- 2) which is now recognized by the PLMN:
 - a) to have resumed operation (e.g. to have responded to a paging request); or
 - b) to have memory newly available (which implies that the mobile is reachable).

is again ready to receive one or more short messages. The SC may - on reception of an Alert-SC - initiate the delivery attempt procedure for the queued messages destined for this MS.

To each MS there may be allocated several MSIsdns. When the HLR is to alert an SC that an MS is again attainable it shall use a specific MSIsdn value for this purpose; in the present document called MSIsdn-Alert.

NOTE 5: Repeated delivery attempts from the SC may be of two types:

- i) A repeated delivery attempt because the SC has been informed that the MS is active and available to receive short messages.
- ii) An autonomous repeated delivery attempt by the SC.

The application of these two options is defined by the providers of the SC and the network.

3.2.7a MT Correlation ID

The MT Correlation ID is a service element used only when the HPLMN of the receiving MS is using an SMS Router or an IP-SM-GW. It is used to correlate a Forward SM operation to a previous Info Retrieval operation.

Use of the MT Correlation ID enhances security. By analysing the Correlation ID received in a Forward Short message operation, it can be easily checked from where the associated Info Retrieval operation originated, thus resulting in detection of "fake" and "spoofed" SMs.

The MT Correlation ID is used in place of the IMSI in the IMSI IE at the protocol layer. Hence, its structure is defined to be exactly the same as this element.

NOTE: Using an MT Correlation ID in place of the real IMSI has the added benefit of enhancing subscriber privacy in that the full IMSI is not shared with the HPLMN of the sending MS.

The MT Correlation ID shall be composed as shown in figure 3a below.

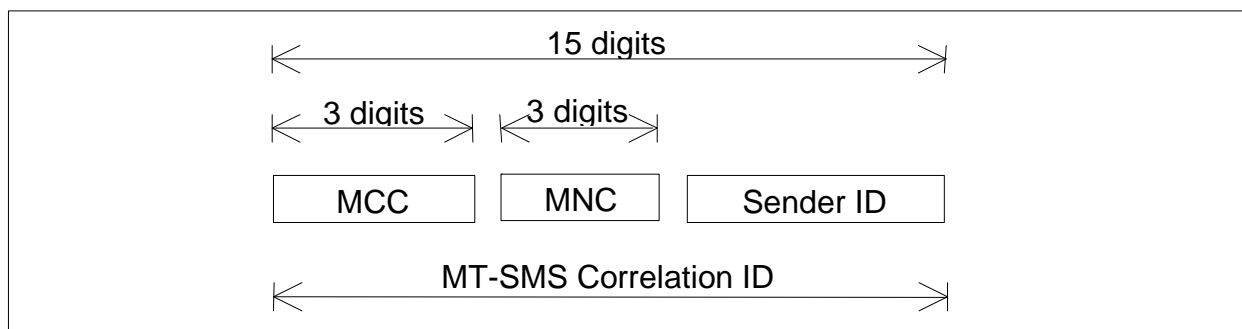

Figure 3a: Structure of the MT Correlation ID

The MT Correlation ID is composed of three parts:

- 1) Mobile Country Code (MCC) of the HPLMN of the receiving MS. It consists of three decimal digits.
- 2) Mobile Network Code (MNC) of the HPLMN of the receiving MS. It consists of three decimal digits. If the MNC of the HPLMN of the receiving MS is 2 digits only in length, the first digit of the MSIN shall be appended to the right-hand side.
- 3) Sender ID. It consists of nine decimal digits and shall be unique for its lifetime. For security purposes, its value shall be a number allocated at random, rather than sequentially.

An example of the MT Correlation ID is:

Sender ID: 569123006

IMSI in use: 234151234567890

Where:

MCC = 234;

MNC = 15;

MSIN = 1234567890,

Which gives the MT Correlation ID: 234151569123006.

3.2.8 Options concerning MNRG, MNRF, UNRI, MNRR-MS, MNRR-SGSN, UNRR, MCEF and MWD

Setting the Mobile-Station-Not-Reachable-Flag (MNRF) in the VLR is mandatory. Setting the Mobile-station-Not-Reachable-for-GPRS (MNRG) in the SGSN is mandatory. It is mandatory for the VLR or the SGSN to send the "MS Reachable" message (see clause 10) to the HLR when the MS has been detected as becoming active and then to clear MNRF in the VLR or the MNRG in SGSN.

The Messages-Waiting-Data (MWD), the Mobile-Station-Not-Reachable-Flag (MNRF), the Mobile-station-Not-Reachable-for-GPRS (MNRG), the Mobile-Station-Not-Reachable-via-the-MS-Reason (MNRR-MS), the Mobile-Station-Not-Reachable-via-the-SGSN-Reason (MNRR-SGSN), and the Mobile-Station-Memory-Capacity-Exceeded-Flag (MCEF) within the HLR are optional, but if one is implemented all must be implemented (except MNRG and MNRR-SGSN if the HLR does not support GPRS). This is linked to the transmission of the "Alert SC" message.

The following describes what happens when a delivery fails.

Case 1: MWD, MNRF, MNRG, UNRI, MNRR-MS, MNRR-SGSN, UNRR, and MCEF are implemented in the HLR.

In the case of a delivery failure (to an MS) with cause Absent Subscriber, the SMS-GMSC requests the HLR to add, if needed, a new entry in the MWD with cause Absent Subscriber. This new entry contains the SC address. The HLR sets its copy of the MNRF, MNRG or both and updates the MNRR-MS, MNRR-SGSN or both (if the information is available). The SC is notified of the failure, the reason for the MS being absent and also of the MWD setting in the HLR within the Report message (see clause 10).

If a delivery through an IP-SM-GW fails (to an MS) with cause Mobile Station Memory Capacity Exceeded via the SGSN, IP-SM-GW, or the MSC, the IP-SM-GW requests the HSS to add, if needed, a new entry in the MWD with cause Mobile Station Memory Capacity Exceeded. This new entry contains the SC address. The HLR sets the MCEF and resets MNRF, MNRG, or UNRI. The SC is notified of the failure and also of the MWD setting in the HLR within the Report message (see clause 10).

In the case of a delivery failure (to an MS) with cause Mobile Station Memory Capacity Exceeded via the SGSN or the MSC, the SMS-GMSC or SMS Router requests the HLR to add, if needed, a new entry in the MWD with cause Mobile Station Memory Capacity Exceeded. This new entry contains the SC address. The HLR sets the MCEF and resets MNRF or MNRG. The SC is notified of the failure and also of the MWD setting in the HLR within the Report message (see clause 10).

If the HLR indicates that it is able to store the SC address, then the SC shall receive an Alert SC message when the MS becomes active.

If the HLR indicates that it is unable to store the SC address (e.g. because MWD is full), then the only way to ensure delivery is for the SC to try to retransmit the message periodically.

When the HLR receives the MS Reachable message, if the MCEF is clear it sends an Alert SC message to the concerned SC, updates MWD and clears MNRF (if the MS is reachable via the MSC) or MNRG (if the MS is reachable via the SGSN) or UNRI (if the MS is reachable via the IP-SM-GW).

When the HLR receives the MS Memory Capacity Available message, it sends an Alert SC message to the concerned SC, updates MWD, clears the MCEF and clears MNRF (if the MS is reachable via the MSC), UNRI (if the UE is reachable via the IP-SM-GW) or MNRG (if the MS is reachable via the SGSN).

Case 2: MWD, MNRF, MNRG, MNRR-MS, MNRR-SGSN and MCEF are not implemented in the HLR.

NOTE: HLRs supporting SMSIP and having implemented MWD, MNRF, MNRG, MNRR, MCEF shall also implement UNRI and UNRR

In the case of a delivery failure, the SC is notified that the HLR is unable to store its address in the MWD. In case of a delivery failure (to a MS) with cause Absent Subscriber, the SC is notified of the reason for the MS being absent (if the information is available). The SC must retransmit the short message periodically in order to ensure delivery.

The HLR discards the MS Reachable message received from the VLR or SGSN without any failure or error report.

The HLR discards the MS Memory Capacity Available message received from the MS via the MSC and the VLR or SGSN without any failure or error report.

3.2.9 Status report capabilities

The SMS also offers to the SC the capabilities of informing the MS of the status of a previously sent mobile originated short message. The status of the message can be:

- Successfully delivered to the SME;
- The SC was not able to forward the message to the SME. The reason can be an error of permanent or temporary nature. Permanent errors can be e.g. validity period expired, invalid SME address. Errors of temporary nature can be e.g. SC-SME connection being down, SME temporarily unavailable.

This is achieved by the SC returning a status report TPDU (SMS-STATUS-REPORT) to the originating MS when the SC has concluded the status of the short message. The status report may be initiated by a status report request within the mobile originated short message. The status report TPDU is treated as an SMS-DELIVER TPDU by the SC when it comes to delivery procedures e.g. the alerting mechanism.

The SC may also return to a non-MS SME the status of a mobile terminated short message. This is however outside the scope of the present document.

The status report capabilities of the SMS are optional, i.e. the choice of whether to offer status report or not is left to the SC operator.

For reasons of resilience and/or load sharing architecture of SMSC's by network operators, the SMSC address (the RP-OA) used by the SMSC to send the Status Report to the MS cannot be guaranteed to be the same SMSC address (RP-DA) used by the MS to submit the SM to which the Status Report refers. Where an MS wishes to implement a check that these addresses correlate, a means of disabling the correlation check shall be provided at the MS through MMI.

3.2.10 Reply Path

Reply Path specified in the present document provides a way of both requesting and indicating a service centre's commitment to deliver a reply from the replying MS to the originating SME.

Annex D deals with MS procedures, which in general are outside the scope of GSM/UMTS specifications. However, for advanced use of the SMS, including both application level protocols and human responses, it is of vital importance to guarantee that a reply-supporting MS is able to reply on every SM, to every SME capable of receiving such reply short messages.

3.3 Unsuccessful short message TPDU transfer SC -> MS

Unsuccessful message transfer SC -> MS may be caused by a variety of different errors. The description of the occurrence of the different errors and how to handle and transfer the error indications is given in GSM 44.008 [12], 3GPP TS 24.011 [13] and 3GPP TS 29.002 [15].

The different error indications which the SMS-GMSC shall be capable of returning to the SC following an unsuccessful short message TPDU transfer SC -> MS, are given in table 1. In some cases, additional diagnostic information may be provided.

3.3.1 Errors occurring during transfer of TPDU to MS

These errors are generally due to barring or unsupported service in the PLMN or MS. An error indication is returned to the SC from the SMS-GMSC, but further diagnostic information from the MS shall not be available.

3.3.2 Errors occurring after TPDU arrives at MS

These errors may occur due to the MS not supporting optional short message service features, or in connection with a short message application. An error indication shall be returned to the SC from the SMS-GMSC. Additionally, a TPDU (SMS-DELIVER-REPORT) containing diagnostic information may be conveyed from the MS to the originating SC, transparently through the PLMN, by means defined in 3GPP TS 24.011 [13] and 3GPP TS 29.002 [15]. The sending of the diagnostic information is optional at the MS, but when it is sent, the PLMN shall convey the information to the SC, and the SC shall support reception of the information.

Table 1: Error indications related to mobile terminated short message transfer which may be transferred to the originating SC

Error indication	S ¹⁾	Meaning
Unknown subscriber	P	The PLMN rejects the short message TPDU because there is not allocated an IMSI or a directory number for the mobile subscriber in the HLR (see 3GPP TS 29.002 [15]).
Teleservice not provisioned	P	The PLMN rejects the short message TPDU because the recipient MS has no SMS subscription (see 3GPP TS 29.002 [15]).
Call barred	T	The PLMN rejects the short message TPDU due to barring of the MS (see 3GPP TS 29.002 [15], description of the Barring supplementary service, 3GPP TS 22.004 [3] and 3GPP TS 23.011[7]), description of Call barred due to Unauthorised Message Originator, 3GPP TS 29.002 [15], and description of Operator Determined Barring, 3GPP TS 22.041 [4] and 3GPP TS 23.015 [8]).
Facility not supported	T	The VPLMN rejects the short message TPDU due to no provision of the SMS in the VPLMN (see 3GPP TS 29.002 [15]).
Absent subscriber	T	<p>The PLMN rejects the short message TPDU because</p> <ul style="list-style-type: none"> - there was no paging response via the SGSN, MSC or both; (see GSM 44.008 [12] & 3GPP TS 29.002 [15]) - the IMSI GPRS or both records are marked detached (see 3GPP TS 29.002 [15]); - the MS is subject to roaming restrictions (see "Roaming not allowed", 3GPP TS 29.002 [15]); - deregistered in the HLR. The HLR does not have an MSC, SGSN or both numbers stored for the target MS, (see 3GPP TS 29.002 [15]); - Unidentified subscriber (see 3GPP TS 29.002 [15]); - MS purged (see 3GPP TS 29.002 [15]). <p>(The reasons for absence are assigned integer values in table 1a. The appropriate integer value is sent with the absent subscriber error indication as defined in 3GPP TS 29.002 [15])</p>
MS busy for MT SMS	T	<p>The PLMN rejects the short message TPDU because of congestion encountered at the visited MSC or the SGSN. Possible reasons include any of the following events in progress:</p> <ul style="list-style-type: none"> - short message delivery from another SC; - IMSI or GPRS detach - Location Update or Inter SGSN Routing Area Update; - paging; - emergency call; - call setup.
SMS lower layers capabilities not provisioned	T	The PLMN rejects the short message TPDU due to MS not being able to support the Short Message Service. The short message transfer attempt is rejected either due to information contained in the class-mark, or the MSC not being able to establish connection at SAPI = 3 (see GSM 44.008 [12] and 3GPP TS 29.002 [15]).
Error in MS	T	The PLMN rejects the short message TPDU due to an error occurring within the MS at reception of a short message, e.g. protocol error.
Illegal Subscriber	P	The PLMN rejects the short message TPDU because the MS failed authentication.
Illegal Equipment	P	The PLMN rejects the short message TPDU because the IMEI of the MS was black-listed in the EIR.
System failure	T	The PLMN rejects the short message TPDU due to network or protocol failure others than those listed above (see 3GPP TS 29.002 [15]).
Memory Capacity Exceeded	T	The MS rejects the short message since it has no memory capacity available to store the message.

1) : Status (Permanent or Temporary)

The relation between the two sets of error indications is given in the table 1. Each error is classified as either "Temporary" or "Permanent". This classification gives an indication of whether or not it is probable that the MS becomes attainable within a reasonable period, and so provides the recommended action to be taken by the SC, i.e. either to store the message for later transfer, or to discard it.

**Table 1a: Assignment of values to reasons for absence
(values must be in the range of 0 to 255, see 3GPP TS 29.002 [15])**

Values	Reason for absence
0	- no paging response via the MSC
1	- IMSI detached
2	- roaming restriction
3	- deregistered in the HLR for non GPRS
4	- MS purged for non GPRS
5	- no paging response via the SGSN
6	- GPRS detached
7	- deregistered in the HLR for GPRS
8	- MS purged for GPRS
9	- Unidentified subscriber via the MSC
10	- Unidentified subscriber via the SGSN
11	- deregistered in the HSS/HLR for IMS
12	- no response via the IP-SM-GW
All 'non GPRS' reasons (except for roaming restriction) can be combined with all 'GPRS' reasons and vice-versa	
All other integer values are reserved.	

3.4 Unsuccessful short message TPDU transfer MS -> SC

The error indications related to mobile originated short message transfer which may be transferred to the originating MS are given in 3GPP TS 24.011 [13]. In some cases, additional diagnostic information may be provided.

3.4.1 Errors occurring during transfer of TPDU to SC

These errors are generally due to barring or unsupported service in the PLMN. An error indication is returned to the MS from the MSC or the SGSN, but further diagnostic information from the SC shall not be available.

3.4.2 Errors occurring after TPDU arrives at SC

These errors may occur due to the SC not supporting optional short message service features, or in connection with a short message application. An error indication shall be returned to the MS from the MSC or from the SGSN. Additionally, a TPDU (SMS-SUBMIT-REPORT) containing diagnostic information may be conveyed from the SC to the originating MS, transparently through the PLMN, as defined in 3GPP TS 29.002 [15] and 3GPP TS 24.011 [13]. The sending of the diagnostic information is optional at the SC, but when it is sent, the PLMN shall convey the information to the MS, and the MS shall support reception of the information.

NOTE: The SMS-SUBMIT-REPORT is part of the negative acknowledgement to the mobile originated short message, and is not part of the status report capabilities described in clause 3.2.9.

3.5 Use of Supplementary Services in combination with the Short Message Service

Only a sub-set of the Supplementary Services defined in 3GPP TS 22.004 [3] and 3GPP TS 23.011 [7] may be used in combination with the Short Message Service. This sub-set comprises the following Supplementary Services:

All the 5 Barring services.

3.6 Applicability of Operator Determined Barring to the Short Message Service

The network feature Operator Determined Barring (see 3GPP TS 22.041 [4]) applies to the Short Message Service.

If a short message fails due to operator determined barring then an appropriate error cause is returned to the originator.

3.7 Multiple short message transfer

To avoid the need for a mobile to be paged, authenticated etc. for each message waiting in the Service Centre, the SC may indicate to the SMS-GMSC that there are more messages to send. When this indication is given, MAP procedures are invoked such that this indication is passed to the VMSC, and the VMSC does not release the MS until all short messages waiting in the SC have been transferred.

3.8 SMS and Internet Electronic Mail interworking

The interworking between Internet electronic mail and SMS is offered in both directions which enables new and old mobiles to send/receive Internet electronic mails via SMS. The interworking is according to the following procedures:

- An SMS message which is required to interwork with Internet email may have its TP-PID value set for Internet electronic mail;

NOTE: There is an alternative mechanism described in subclause 9.2.3.24 providing full RFC 822 [34] internet electronic mail interworking.

- Either single or concatenated SMS can be used to transport the email;
- Concatenation may be achieved by the TPUDH mechanism, in which case the concatenation is carried out at a lower level to the formats specified in subclauses 3.8.1 and 3.8.2. Alternatively, concatenation may be achieved using the text-based means described below;
- Email cc fields are not supported;
- Where multiple fields are present, additional spaces may be inserted by the sender to improve presentation of the message. Spaces may not be inserted into the actual email address (e.g. user@domain1.domain2).

3.8.1 Basic Format

The basic format for transferring email in either direction consists of the following:

MT SMS:

[<from-address><space>]<message>

MO SMS:

[<to-address><space>]<message>

where [] denote optional fields and <> delimit fields.

The to-address or from address may take the form:

user@domain1.domain2

or

User Name <user@domain1.domain2>

In the latter case the angle brackets <> are part of the address and are actually transmitted.

Depending on the nature of the gateway, the destination/origination address is either derived from the content of the SMS TP-OA or TP-DA field, or the TP-OA/TP-DA field contains a generic gateway address and the to/from address is added at the beginning as shown above.

Multiple addresses may be identified in MO messages by separating each address by a comma like this:

```
address1,address2,address3<space><message>
```

It is optional for the receiving gateway to support this. If the receiving gateway does not support multiple messages then it shall reject the original message by returning an appropriate error in a text message.

3.8.2 Optional Fields

The following further optional fields are supported. An email <-> SMS gateway may insert additional spaces in the MT message for presentation to the user, and must accept additional spaces in the MO message from the user.

3.8.2.1 Subject

The subject is placed between the address and the message, delimited by round brackets () or preceded by ##, for example:

```
[<to-address>](<subject><message>
```

or

```
[<to-address>]##<subject>#<message>
```

An MO message may contain either format. An MT message may contain either format. Developers must ensure that both forms are supported for full compatibility.

3.8.2.2 Real Name

The Real Name field contains the real name of the sender and is used only in MO messages. The SC or email gateway shall generate an email message according to standard email procedures containing Real Name <user@domain1.domain2> (the angle brackets being part of the address and hence transmitted). If a subject is to be included with the Real Name then only the ## prefix is used.

The syntax is:

```
[<to-address>]#<real-name>[##<subject>]#<message>
```

3.8.2.3 Optional Control Flag

An optional control flag may be added to the start of the message in MO messages only. This consists of a single character <CF> following a # symbol as follows:

```
[#<CF>#][<to-address>]<space><message>
```

This may also be used in combination with the above fields. It is intended for use where a particular SC or email gateway specific function is required to be invoked. For example, the control flag #A# might add a particular (pre-stored) signature to the end of the message or #R# might change the from-address to a pre-stored value or #5# might add the text "Please phone me at the office". All of these functions are open for definition by Service Centre or email gateway operators.

3.8.3 Text concatenation

If the concatenation mechanism described in subclause 9.2.3.24.1 is not supported by the transmitting or receiving entity, the following textual concatenation mechanism may be used. The first message is ended with a + sign, and each subsequent message start and end with + signs until the final message which starts with a + sign but does not end with a + sign.

```
<message1>+  
+<message2>+  
+<message3>
```

Any header fields placed on the front of an MO or MT message are not added to the second and subsequent messages.

This provides a simple mechanism which is completely backward compatible. There is no indication of the number of messages and should a message be lost by the system or arrive out of sequence then the original message cannot be reconstructed. Therefore, wherever possible the concatenation mechanism specified in subclause 9.2.3.24.1 should be used instead.

3.8.4 Alternative characters for Internet email addresses in MO SMS.

It is difficult or impossible to generate some characters on a mobile phone and so the following alternatives may be used:

@ may be replaced by *
_ (underscore) may be replaced by \$

3.9 SMS COMPRESSION

Short Messages may be compressed in accordance with the compression algorithm described in 3GPP TS 23.042 [26].

Compression and Decompression may take place between SME's or between an SME and the SC.

The compression only applies to the TP-User-Data part of the TPDU and excludes any TP-User-Data-Header which may be present. The Compression Header (see 3GPP TS 23.042 [26]) must commence at the first octet of the TP-User-Data field immediately following any TP-User-Data-Header field which may be present.

The TP-UDL value must be set in accordance with that value defined for the compressed TP-User-Data case in clause 9.2.3.16.

The TP-DCS parameter indicates whether or not a short message is compressed. If the TP-DCS parameter indicates that the short message is compressed then the alphabet encoding values (bits 2 and 3 in 3GPP TS 23.038 [9]) must be ignored by the receiving entity.

In the case where a short message after compression is greater than 140 octets (including the Compression Header and Footer (see 3GPP TS 23.042 [26]) and any TP-User-Data-Header which may be present) then the sending entity must concatenate the short message in the normal way as described in clause 9.2.3.24.1 if it wishes to continue to send the short message. Only the first segment of the concatenated short message must contain the Compression Header defined in 3GPP TS 23.042 [26]. All segments other than the final segment must be 140 octets in length. Only the final segment contains the Compression Footer (see 3GPP TS 23.042 [26]).

For mobile terminated compressed messages, where the MMI or the Message Class indicated in the TP-DCS requires the message to be stored in the MS then the MS shall store the compressed message as received. In the case where the MS is capable of decompression then the MS may display the decompressed message. Such an MS may optionally store the message in decompressed form subject to the MS being configured to do this via MMI. However, prior to storing the message in decompressed form, the MS may have to create a concatenated SM and carry out component modification on the TP-UDL and TP-DCS values to indicate the correct length values and that the message is no longer compressed. Transfer of messages direct from the radio interface or those stored in the MS to a TE is according to the procedure defined in 3GPP TS 27.005 [14] and is independent of whether the message is compressed or uncompressed.

For mobile originated compressed messages, an MS capable of compression may compress a short message generated within the MS itself prior to sending it to the radio interface. An MS capable of compression may optionally compress an uncompressed message received from a TE subject to the MS being configured to do this via MMI. In such a case the MS would have to carry out component modification on the TP-UDL and TP-DCS values to indicate the correct length values and that the message is compressed. A TE may send a message (compressed or uncompressed) to the MS using the procedures defined in 3GPP TS 27.005 [14]. The MS shall store the compressed message as received and/or transfer it directly to the radio interface.

In addition for the compression method described above, it may be possible to compress certain Information Elements of the User Data Header of a TPDU. The compression method is defined in subclause 9.2.3.24.10.1.13.

3.10 Enhanced Messaging Service

The Enhanced Messaging Service (EMS) is based upon the standard SMS, but with formatting added to the text. The formatting may permit the message to contain animations, pictures, melodies, formatted text, and vCard and vCalendar objects. Objects may be mixed together into one message. This clause overviews the supported features. The coding mechanisms and formats are specified in subclause 9.2.3.24.10.

The following sub clauses describe a number of features of EMS. The data formats in the features below shall be supported (ie the UE shall behave in a predictable manner when receiving such data) but the features are supported subject to the capabilities of the UE. However, it is highly recommended that all of these features are implemented otherwise interoperability problems at the application level may result.

3.10.1 Text formatting

The following text formatting features are supported:

Alignment

- Left
- Centre
- Right
- Default (Language dependent)

Font size

- Normal
- Large
- Small

Style

- Normal
- **Bold**
- *Italic*
- Underlined
- ~~Strikethrough~~
- Text Colour
- Text Background Colour

3.10.2 Pictures

Basic Pictures

It is possible to include either a small (16*16 pixels), large (32*32 pixels) or pictures of variable size. These pictures have neither animation nor grey scale; they are plain black and white. All pictures are user defined.

Extended Pictures

It is possible to include extended pictures. These pictures may be black and white, greyscale or colour bit maps. The picture size is a maximum of 255 x 255 pixels. These pictures may be transmitted in a compressed form.

3.10.3 Animations

Predefined

There are number of predefined animations. These animations are not sent as animation over the air interface, only the identification of them. As soon as the position of the animation in the SM data is reached, the animation corresponding to the received number shall be displayed in a manner which is manufacturer specific.

User Defined

The user-defined animations consist of 4 pictures and there are two different sizes of these animations. The picture size of the small animations are 8*8 pixels and the large 16*16 pixels. These animations are sent over the air interface.

Extended Animations

It is possible to include extended animations. These may be black and white, greyscale or colour bit maps. The maximum size of a single animated frame is 255 x 255 pixels. The repetition of these animations may be controlled by the originator. These animations may be transmitted in a compressed form.

3.10.4 Sound

Predefined

There are a number of predefined sounds. These sounds are not transferred over the air interface, only the identification of them. There are 10 different sounds that can be added in the message, and as soon as the sound mark is in focus (on the display), the sound will be played.

User Defined

The sender can define own melodies according to the iMelody format [33]. These melodies are transferred in the SM and can take up to 128 bytes.

Extended Sounds

Monophonic melodies may be transferred using the iMelody format [33]. These may be transmitted in a compressed form.

3.10.5 vCard and vCalendar

A message may contain vCard and vCalendar objects as specified in [36][37]. These may be transmitted in a compressed form.

3.10.6 WVG (Wireless Vector Graphics) Object

A message may contain one or more WVG objects. A WVG object is a vector graphics picture or animation and is scalable. Two subtypes of WVG objects are supported; Standard WVG object and Character Size WVG object. Actual display size of a Standard WVG object depends on display screen size and MMI implementation on terminals. A Character Size WVG object has a height that equals or is similar to the height of message text but with variable width. Character Size WVG object may be edited in the same way as standard text, e.g. insertion deletion and text wrapping.

3.10.6.1 Overview of WVG Graphical Primitives

The WVG element is used to describe vector graphics objects. The vector graphics format is used to allow the creation of small pictures which may include simple animation or the creation small handwritten sketches. WVG makes use of the following graphical primitives (full detail is listed in annex G.2) These primitives can be used to describe a compact drawing.

List of Graphical Primitives:

- Polylines (G.2.1)
 - Simple Line Polyline (G.2.1.1)
 - Circular Polyline (G.2.1.2)
 - Bezier lines (G.2.1.3)
- Polygons (G.2.2)
 - Arbitrary Polygon (G.2.2)
 - Regular Polygon (G.2.4)
 - Star Shaped Polygon (G.2.4)
 - Regular Grid Element (G.2.4)
- Ellipses (G.2.3.1)
- Rectangles (G.2.3.2)
- Text Element (G.2.5)
- Grouping Element (G.2.6)
- Reuse Element (G.2.7)
- Animations Elements (G.2.8)
- Frame Element (G.2.9)
- Local Element (G.2.10)

4 Network architecture

4.1 Basic network structure

The exchange of messages between an MS and an SME involves the entities shown in figure 4.

The architecture for providing SMS over a generic IP CAN is described in 3GPP TS 23.204 [42] (see subclause 5).

The basic network structure of the SMS is depicted in figure 5.

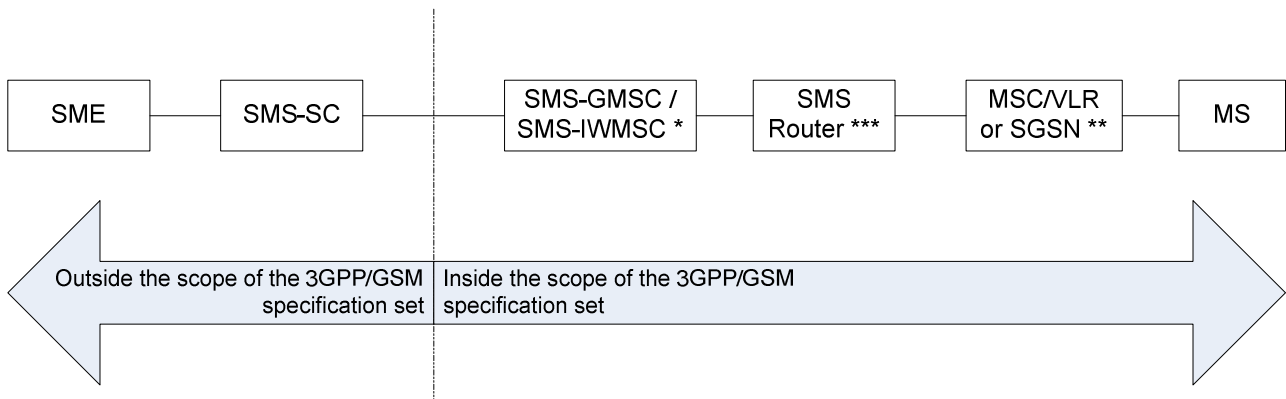

- *): SMS-GMSC when the short message is transferred from the SC to the MS, SMS-IWMSC when the short message is transferred from the MS to the SC. The SC may be integrated with the SMS-GMSC/SMS-IWMSC.
- **): SGSN is used in place of the MSC for SMS transfer over GPRS.
- ***): The SMS Router is an optional functional entity, and is used only in the MT case.

Figure 4: Entities involved in the provision of SM MT and SM MO

The reference points of figure 5 support the short message transfer in the following way:

- message transfer on reference point 1 is described in clause 5;
- the operations performed on reference points 2 and 4 are described in 3GPP TS 29.002 [15];
- message transfer on reference point 3 is described in subclause 4.2;
- message transfer on reference point 5 is supported by the protocol described in 3GPP TS 24.011 [13].

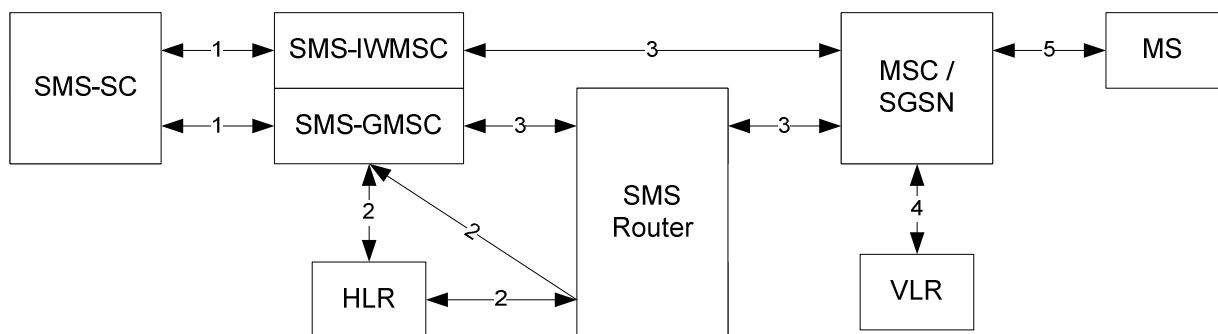

- NOTE 1: Reference point 4 is not used for SMS transfer via the SGSN
- NOTE 2: The SMS Router is an optional entity that may be present in the MT case only. If it is not present, reference point 3 extends from the SMS-GMSC directly to the MSC/SGSN.

Figure 5: The main network structure serving as a basis for the short message transfer

4.2 Transfer on reference point 3

Reference point 3 is used to support communications between:

- MSC <-> SMS-GMSC / SMS-IWMSC;
- SGSN <-> SMS-GMSC / SMS-IWMSC;
- SMS Router <-> SMS-GMSC;
- SMS Router <-> MSC;
- SMS Router <-> SGSN.

If any of the above two end nodes are in the same PLMN, the definition of this reference point is left to the operators. For example, this reference point may use:

- PSPDN; or
- CCITT SS no 7 (according to 3GPP TS 29.002 [15]).

If any of the above two end nodes are in different PLMNs, this reference point shall use CCITT SS no 7 according to 3GPP TS 29.002 [15], unless otherwise bilaterally agreed.

5 Service Centre and PLMN interconnection

The present document deals with the SC only with regard to the interchange of messages between SC and MS. Only the requirements put upon the SC by the SMS functionality are specified in the present document.

5.1 Service centre connection

One SC may be connected to several PLMNs, and may be connected to several MSCs (SMS-GMSCs or SMS-IWMSCs) within one and the same PLMN.

The SC is addressed from the mobile by an E.164 [17] number in the numbering plan of the PLMN to which the SC is connected. This E.164 [17] number shall uniquely identify the SC to that PLMN.

There may be an intermediate network between the PLMN and the SC; in this case the PLMN must autonomously make a connection to the SC using the SC address in this intermediate network.

No mandatory protocol between the SC and the MSC below the transfer layer is specified by GSM/UMTS; this is a matter for agreement between SC and PLMN operators. However, annex A provides an example protocol stack which could be used.

5.2 Routing requirements

5.2.1 Mobile terminated short message

The SC sends the short message to the SMS-GMSC. The SMS-GMSC interrogates the HLR to retrieve routing information necessary to forward the short message, and then sends the message to the relevant MSC or SGSN, transiting other networks if necessary and transiting an SMS Router in the HPLMN of the receiving MS if this is deployed. The MSC or SGSN then sends the short message to the MS.

5.2.2 Mobile originated short message

The MS sends the short message to the MSC or the SGSN. The MS shall always address the required SC by an E.164 [17] address. The visited PLMN shall route the message to the appropriate SMS-IWMSC in the SC's PLMN, transiting other networks if necessary.

As an operator option, the SMS-IWMSC may interrogate the HLR to retrieve the recipient's IMSI in order to check that an SMS Interworking agreement exists between the two networks.

6 Service Centre functionality

In the present document, only the SC functionality related to the short message service between the SC and the MS is specified.

6.1 Service Centre capabilities

The SC should be capable of:

- submitting a short message to an MS, retaining the responsibility of the message until
 - 1) the report has been received; or
 - 2) the Validity-Period expires.
- receiving a report from the PLMN;
- receiving a short message from an MS;
- returning a report to the PLMN for a previously received short message.

6.2 SC functional requirements

The detailed functionality of the SC is outside the scope of the present document, and is for the SC operator to define. However, the following functional requirements are mandatory for all SCs in order to support the SM-TP (see clause 9) towards the PLMN:

- 1) To identify each SMS-DELIVER sent to an MS in a unique way, a time stamp value is included in the field TP-Service-Centre-Time-Stamp, TP-SCTS, of the SMS-DELIVER. The time stamp gives the time when the message arrived at the SC with the accuracy of a second. If two or more messages to the same MS arrive at the SC within one second, the SC shall modify the time stamp of those messages in such a way that:
 - a) all messages to the MS contain different time stamps;
 - b) the modification of the time stamps is kept to a minimum.
- 2) The SC is only allowed to have one outstanding SMS-DELIVER (i.e. a message for which a report has not been received) to a specific MS at a given time.
- 3) The SC shall be able to initiate overwriting of short messages previously received by the SC if requested by the same originating address (MS or any other source) by use of the same message type.

6.2.1 Subaddressing support

Support for subaddressing is an optional functional requirement for an SC. If it is supported, subaddressing information shall be conveyed from SME to SME according the following rules:

- A SME may send a SM with '*'s or '#'s included in the TP-DA field. The first '#' encountered in TP-DA indicates where the address for SC routing purposes is terminated. Additional '*'s or '#'s can be present in the following digits, and all these digits including the first '#' are subaddress digits.
- When the SC receives a SM to convey with such a subaddress information, it should deliver the SM to the destination SME with the same subaddress digits copied in the TP-OA field.

This subaddressing mechanism does not apply when the TON is alphanumeric

Example:

SME with number 987654321 sends a SM with TP-DA = 1234#56#789*

SME with number 1234 will receive the SM with TP-OA = 987654321#56#789*

6.3 SC EMS Extended Object Data Request Command Feature

An SME has the ability of determining which data formats within the Extended Object IE are supported by a specific terminal. The SC has the option of supporting this feature using an SMS-DELIVER PDU. This SMS-DELIVER PDU shall contain the EMS Data Format Delivery Request IE, and be marked for automatic deletion by the mobile station.

7 MS functionality

In the present document, only the MS functionality related to the short message service between the SC and the MS is specified.

7.1 MS capabilities

The MS, when equipped for SMS, should be capable of:

- submitting a short message TPDU to an SC, retaining the responsibility of the message until:
 - 1) the report arrives from the network; or
 - 2) a timer expires.
- receiving a short message TPDU from an SC;
- returning a delivery report to the network for a previously received short message;
- receiving a report from the network;
- notifying the network when it has memory capacity available to receive one or more short messages when it has previously rejected a short message because its memory capacity was exceeded;
- notifying the SC when a short message is intended to replace a short message the MS has previously submitted to the same destination address.

It is recommended that an MS supporting both replying and automatic SC selection (as specified in clause D.2 of annex D) follows procedures specified in annex D when replying to MT short messages with MO short messages.

It is recommended that an MS supporting a capability for requesting a reply path follows procedures specified in annex D.

7.2 MS configuration

The reference configuration is assumed as in figure 6, i.e. only the case where the terminal is integrated in the MS is considered.

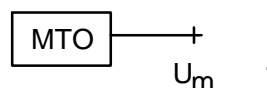

Figure 6: Reference configuration of the MS which apply to the SMS

NOTE: It is foreseen that a terminal interface may be offered, e.g. for higher layer protocols, memory capacity reasons or to be able to type in mobile originated messages. This terminal interface is regarded as an implementation option, although, where offered, it must be based upon an R- or S-reference point. 3GPP TS 27.005 [14] provides an example based on the R reference point.

8 Node functionality

The overall requirements to the MSC, SMS-GMSC, SMS-IWMSC, SGSN and SMS Router with respect to handling of the Short Message Service is to cater for the routing and necessary intermediate buffering of the short messages.

8.1 Node functionality related to SM MT

8.1.1 Functionality of the SMS-GMSC

When receiving a short message TPDU from the SC, the SMS-GMSC is responsible for the following operations:

- reception of the short message TPDU;
- inspection of the parameters.

NOTE 1: The SMS-GMSC may be identical to the MSC.

if parameters are incorrect:

- returning the appropriate error information to the SC in a failure report (see clauses 9 and 10);

if errors are not found within parameters:

- interrogating the HLR ("sendRoutingInfoForShortMsg", see clause 10); retrieving routing information or possible error information;

if HLR is returning error information:

- returning the appropriate error information to the SC in a failure report (see clauses 9 and 10);

if no errors are indicated by the HLR:

- transferring the short message TPDU to the MSC or SGSN using the routing information obtained from the HLR ("forwardShortMessage", see clause 10);

NOTE 2: In case where two addresses (SGSN and MSC) are received from HLR, the SMS-GMSC may choose (operator dependant) via which nodes (SGSN or MSC) the SMS is first to be sent. The SMS delivery via the SGSN is normally more radio resource efficient than the SMS delivery via the MSC.

if one address (SGSN or MSC) is received from HLR:

- When receiving the report associated with the short message from the MSC or SGSN (positive or negative outcome of "forwardShortMessage", see clause 10), the SMS-GMSC is responsible for the following operations;

if the report indicates successful delivery:

- notifying the HLR of the successful delivery via the MSC or the SGSN, which shall cause the HLR to alert any service centres whose addresses are stored in the MWD for the MS;
- creating and sending the successful report to the SC;

if the report is a failure report indicating "absent subscriber" via the MSC or the SGSN (see clause 3.3):

- requesting the HLR to insert the address of the originating SC into the MWD (if implemented) with cause Absent Subscriber ("SM_DeliveryReportStatus", see clauses 9 and 10);
- informing the HLR of the reason for the MS being absent via the MSC or the SGSN (if this information is available);
- establishing, where necessary, a link with the addressed SC (see clause 5);
- creating and sending the negative report to the SC which should include the reason for the MS being absent (if this information is available) so that the SC may adjust any retry algorithm appropriately (see clauses 9 and 10);

if the report is a failure report indicating "MS memory capacity exceeded" via the MSC or the SGSN (see clause 3.3):

- requesting the HLR to insert the address of the originating SC into the MWD (if implemented) with cause MS Memory Capacity Exceeded via the MSC or the SGSN ("SM_DeliveryReportStatus", see clauses 9 and 10);
- establishing, where necessary, a link with the addressed SC (see clause 5);
- creating and sending the report to the SC (see clauses 9 and 10).

if two addresses (SGSN and MSC) are received from HLR:

- When receiving the first report associated with the short message from the MSC or SGSN (positive or negative outcome of "forwardShortMessage", see clause 10), the SMS-GMSC is responsible for the following operations:

if the first report indicates successful delivery:

- notifying the HLR of the successful delivery via the MSC or the SGSN, which shall cause the HLR to alert any service centres whose addresses are stored in the MWD for the MS;
- creating and sending the successful report to the SC;

if the first report is a failure report indicating:

- Unidentified subscriber;
 - Facility not supported;
 - Absent subscriber with indication: GPRS or IMSI Detach;
 - System failure;
 - Unexpected data value;
 - Data missing;
 - GPRS connection suspended (see 3GPP TS 29.002 [15]);
 - SM Delivery Failure with indication: equipment Not SM Equipped;
- transferring the short message TPDU to the second path using the routing information obtained from HLR.

if the second report indicates successful delivery:

- notifying the HLR of the successful delivery of the second transfer via the MSC or SGSN, which shall cause the HLR to alert any service centres whose addresses are stored in the MWD for the MS;
- notifying the HLR of the unsuccessful delivery at first transfer only with cause "absent subscriber";
- notifying the HLR of the reason for the MS being absent via the MSC or the SGSN (if this information is available);
- establishing, when necessary, a link with the addressed SC (see clause 5);
- creating and sending the successful report to the SC;

if the second report is a failure report:

- requesting the HLR to insert the address of the originating SC into the MWD (if implemented) only if at least one of the first or second report failed due to "MS Memory Capacity Exceeded" or "Absent Subscriber" ("SM_DeliveryReportStatus", see clauses 9 and 10);
- notifying the HLR only with the causes "Absent Subscriber", "Memory Capacity Exceeded" via the MSC or the SGSN, or both;
- notifying the HLR of the reason for the MS being absent via the MSC, SGSN or both (if this information is available);
- establishing, where necessary, a link with the addressed SC (see clause 5);

- creating and sending the negative report to the SC with errors from first and second path (see clauses 9 and 10).

8.1.2 Functionality of the MSC

When receiving a short message TPDU from the SMS-GMSC ("forwardShortMessage", see clause 10), the MSC is responsible for the following operations:

- reception of the short message TPDU;
- retrieving information from the VLR ("sendInfoFor-MT-SMS", see clause 10); location area address and, when appropriate, error information;

if errors are indicated by the VLR:

- returning the appropriate error information to the SMS-GMSC in a failure report (negative outcome of "forwardShortMessage" see clauses 10 and 11);

if no errors are indicated by the VLR:

- transferring the short message to the MS (see 3GPP TS 24.011 [13]).

When receiving a confirmation that the message is received by the MS (see 3GPP TS 24.011 [13]):

- relaying the delivery confirmation to the SMS-GMSC in a delivery report (positive outcome of "forwardShortMessage", see clauses 10 and 11).

When receiving a failure report of the short message transfer to the MS (see 3GPP TS 24.011 [13]):

- returning the appropriate error information to the SMS-GMSC in a failure report (negative outcome of "forwardShortMessage", see clause 10).

When receiving a notification from the MS that it has memory available to receive one or more short messages (see 3GPP TS 24.011 [13]):

- relaying the notification to the VLR ("mSMemoryCapacityAvailable", see clause 10);

if errors are indicated by the VLR:

- returning the appropriate error information to the MS in a failure report (negative outcome of "ReadyForSM", see clauses 10 and 11).

When there is an ongoing MT-SMS transfer to the MS (see 3GPP TS 24.011 [13]), or other busy condition for MT-SMS, the MSC has the option to store the TPDU in a queue for a short time (which must be shorter than the supervision timer defined in 3GPP TS 29.002 [15]). The maximum time that a message may be queued is related to the permitted delay for the MSC to respond to the SMS-GMSC. When the MS becomes available for MT-SMS transfer, the stored TPDUs are delivered to the MS on a first-in first-out basis. If a message is not successfully transferred to the MS within the permitted time, the MSC returns an appropriate error to the SMS-GMSC.

8.1.3 Functionality of the SGSN

When receiving a short message TPDU from the SMS-GMSC ("forwardShortMessage", see clause 10), the SGSN is responsible for the following operations:

- reception of the short message TPDU;

if errors are detected by the SGSN:

- returning the appropriate error information to the SMS-GMSC in a failure report (negative outcome of "forwardShortMessage" see clauses 10 and 11);

if no errors are detected by the SGSN:

- transferring the short message to the MS (see 3GPP TS 24.011 [13]).

When receiving a confirmation that the message is received by the MS (see 3GPP TS 24.011 [13]):

- relaying the delivery confirmation to the SMS-GMSC in a delivery report (positive outcome of "forwardShortMessage", see clauses 10 and 11).

When receiving a failure report of the short message transfer to the MS (see 3GPP TS 24.011 [13]):

- returning the appropriate error information to the SMS-GMSC in a failure report (negative outcome of "forwardShortMessage", see clause 10).

When receiving a notification from the MS that it has memory available to receive one or more short messages (see 3GPP TS 24.011 [13]):

if errors are detected by the SGSN:

- returning the appropriate error information to the MS in a failure report (negative outcome of "ReadyForSM", see clauses 10 and 11).

if no errors are detected by the SGSN:

- notifying the HLR of memory available in the MS via the SGSN with "ReadyForSM" (see clauses 10 and 11).

When the MS is becoming reachable again (see GSM 44.008 [12]):

- notifying the HLR of MS being reachable via the SGSN (and via the MSC if any) with "ReadyForSM" (see clauses 10).

When there is an ongoing MT-SMS transfer to the MS (see 3GPP TS 24.011 [13]), or other busy condition for MT-SMS, the SGSN has the option to store the TPDU in a queue for a short time (which must be shorter than the supervision timer defined in 3GPP TS 29.002 [15]). The maximum time that a message may be queued is related to the permitted delay for the SGSN to respond to the SMS-GMSC. When the MS becomes available for MT-SMS transfer, the stored TPDU's are delivered to the MS on a first-in first-out basis. If a message is not successfully transferred to the MS within the permitted time, the SGSN returns an appropriate error to the SMS-GMSC.

8.1.4 Functionality of the SMS Router

When receiving a routing information retrieval ("sendRoutingInfoForShortMsg", see clause 10), the SMS Router is responsible for the following operations:

- interrogating the HLR ("sendRoutingInfoForShortMsg", see clause 10); retrieving routing information or possible error information. This interrogation may be omitted if a parameter within the "sendRoutingInfoForShortMsg" explicitly indicates that delivery of a short message is not intended and only MCC+MNC are requested.

if HLR is returning error information:

- forwarding the returned error information transparently to the SMS-GMSC;

if no errors are indicated by the HLR:

- creating an MT Correlation ID;
- storing against the MT Correlation ID: the IMSI, the MSC address and/or the SGSN address. The address of the SMS-GMSC and the destination MSISDN may also be stored. Creating an MT Correlation ID and storing these data against the MT Correlation ID may be omitted if a parameter within the "sendRoutingInfoForShortMsg" explicitly indicates that delivery of a short message is not intended;
- forwarding the returned information to the SMS-GMSC populating the IMSI IE with the MT Correlation ID and either:
 - a) the MSC address and/or SGSN address with the address of the SMS Router; or

NOTE 1: In this case if two addresses (SGSN and MSC) are received from HLR, the SMS-GMSC chooses (operator dependant) via which node (SGSN or MSC) the SM is first to be sent, not the SMS Router.

- b) the address of the SMS Router. In this case the SMS Router delivers the SM as described in 3GPP TS 23.204 [42] for the IP-SM-GW. This option is mandatory when the SMS Router is deployed together with an IP-SM-GW.

NOTE 2: In this case if two addresses (SGSN and MSC) are received from HLR, the SMS Router chooses via which node (SGSN or MSC) the SM is first to be sent, i.e. the SMS Router delivers the SM as an IP-SM-GW.

If a parameter within the "sendRoutingInfoForShortMsg" explicitly indicates that delivery of a short message is not intended and that only IMSI or only MCC+MNC are requested, the IMSI IE may be populated with IMSI or MCC+MNC+dummy MSIN, respectively, and the MSC address and/or SGSN address with a dummy network node address.

if HLR is returning an Inform-Service-Centre information:

- forwarding the received information transparently to the SMS-GMSC.

When receiving a short message TPDU from the SMS-GMSC ("forwardShortMessage", see clause 10), the SMS Router is responsible for the following operations:

- receiving the short message TPDU;
- checking validity of the MT Correlation ID received in the IMSI field

The MT Correlation ID shall be considered invalid if the MT Correlation ID is unknown. Optionally, the MT Correlation ID may also be considered invalid if the CC and NDC of the address of the SMS-GMSC from which the forwardShortMessage was received is different from the CC and NDC of the SMS-GMSC address stored above i.e. the forwardShortMessage has originated from a different network than that which issued the sendRoutingInfoForShortMsg.

If the received MT Correlation ID is deemed invalid by the SMS Router:

- returning the error "System failure" to the SMS-GMSC in a failure report (negative outcome of "forwardShortMessage" see clauses 10 and 11).

If the received MT Correlation ID is deemed valid by the SMS Router:

- transferring the short message TPDU to the MSC (if the called party SSN in the received message is for MSC) or to the SGSN (if the called party SSN in the received message is for SGSN) using the stored routing information and replacing the MT Correlation ID with the stored IMSI (obtained from the HLR, above);
- support for service execution, lawful interception, and number portability if required; and
- forwarding the delivery confirmation or failure report from the MSC or SGSN (which may have originally come from the MS) transparently to the SMS-GMSC.

8.1.5 Functionality of the IP-SM-GW

The IP-SM-GW is described in 3GPP TS 23.204 [42], it provides:

- protocol interworking for delivery of short message between the IP-based UE and the SMSC;
- delivery of the SM to the MSC/SGSN if needed as described in 3GPP TS 23.204 [42]; and
- support for service execution, lawful interception, and number portability if required.

8.2 Node functionality related to SM MO

8.2.1 Functionality of the MSC

When receiving a short message TPDU from the MS, the MSC is responsible for the following operations:

- reception of the short message TPDU (see 3GPP TS 24.011 [13]);
- retrieving information from the VLR ("sendInfoForMO-SMS", see clause 10); the MSISDN of the MS and, when appropriate, error information. The retrieval of information from the VLR is followed by the VLR investigating the MNRF (to be used in the alerting procedure, see clause 10)

if errors are indicated by the VLR:

- returning the appropriate error information to the MS in a failure report (negative outcome of "sendInfoForMO-SMS" see clauses 10 and 11);

if no errors are indicated by the VLR:

- inspection of the RP-DA parameter;

if parameters are incorrect:

- returning the appropriate error information to the MS in a failure report (see 3GPP TS 24.011 [13]);

if no parameter errors are found:

NOTE: The SMS-IWMSC may be identical to the MSC.

- transferring the short message TPDU to the SMS-IWMSC ("forwardShortMessage", see clause 10).

When receiving the report of the short message from the SMS-IWMSC (positive or negative outcome of the "forwardShortMessage", see clause 10), the MSC is responsible for the following operations:

- relaying the report to the MS (see 3GPP TS 24.011 [13]).

8.2.2 Functionality of the SMS-IWMSC

When receiving a short message TPDU from the MSC, IP-SM-GW or SGSN ("forwardShortMessage", see clause 10), the SMS-IWMSC is responsible for the following operations:

- reception of the short message TPDU;
- optionally, interrogating the HLR ("sendRoutingInfoForShortMsg", see clause 10); retrieving the recipient's IMSI in order to check for the existence of an SMS Interworking agreement before establishing a link with the addressed SC;

if HLR returns error information:

- returning the appropriate error information to the MSC or SGSN in a failure report (negative outcome of "forwardShortMessage", see clause 10);

if no errors are indicated by the HLR:

- inspecting the IMSI parameter and ignoring the other routing information;

if the received parameter is unacceptable to the SMS-IWMSC (due to lack of an SMS Interworking agreement):

- returning SM Delivery Failure with indication: invalid SME-address to the MSC or SGSN;

if the parameter is acceptable to the SMS-IWMSC (due to the existence of an SMS Interworking agreement) or the SMS-IWMSC didn't apply the optional HLR interrogation:

- establishing, where necessary, a link with the addressed SC (see clause 5);

- transferring the short message TPDU to the SC (if the address is valid);

if a report associated with the short message is received from the SC, the SMS-IWMSC is responsible for the following operations:

- relaying of the report to the MSC or SGSN (positive or negative outcome of "forwardShortMessage", see clause 10);

if a report associated with the short message is not received from the SC before a timer expires or if the SC address is invalid, the SMS-IWMSC is responsible for the following operations:

- returning the appropriate error information to the MSC or SGSN in a failure report (negative outcome of "forwardShortMessage", see clause 10).

The value of the timer is dependent on the protocol between the SC and the SMS-IWMSC.

8.2.3 Functionality of the SGSN

When receiving a short message TPDU from the MS, the SGSN is responsible for the following operations:

- reception of the short message TPDU (see 3GPP TS 24.011 [13]);
- inspection of the RP-DA parameter;

if parameters are incorrect:

- returning the appropriate error information to the MS in a failure report (see 3GPP TS 24.011 [13]);

if no parameter errors are found:

- transferring the short message TPDU to the SMS-IWMSC ("forwardShortMessage", see clause 10).

When receiving the report of the short message from the SMS-IWMSC (positive or negative outcome of the "forwardShortMessage", see clause 10), the SGSN is responsible for the following operations:

- relaying the report to the MS (see 3GPP TS 24.011 [13]).

8.2.4 Functionality of the IP-SM-GW

Successful SM MO delivery procedure with IP-SM-GW is described in 3GPP TS 23.204 [42] (see subclause 6.3).

8.3 SMS-IWMSC functionality related to alerting

When receiving an alert from the HLR ("alertServiceCentre", see clause 10), the SMS-IWMSC is responsible for the following operations:

- inspect the SC address;
- generate an RP-Alert-SC (see clause 9);
- transferring the RP-Alert-SC to the SC.

NOTE: If the SC address is not valid, then no further action shall be taken.

9 Protocols and protocol architecture

The protocol layers of the SMS are structured as shown in figure 7.

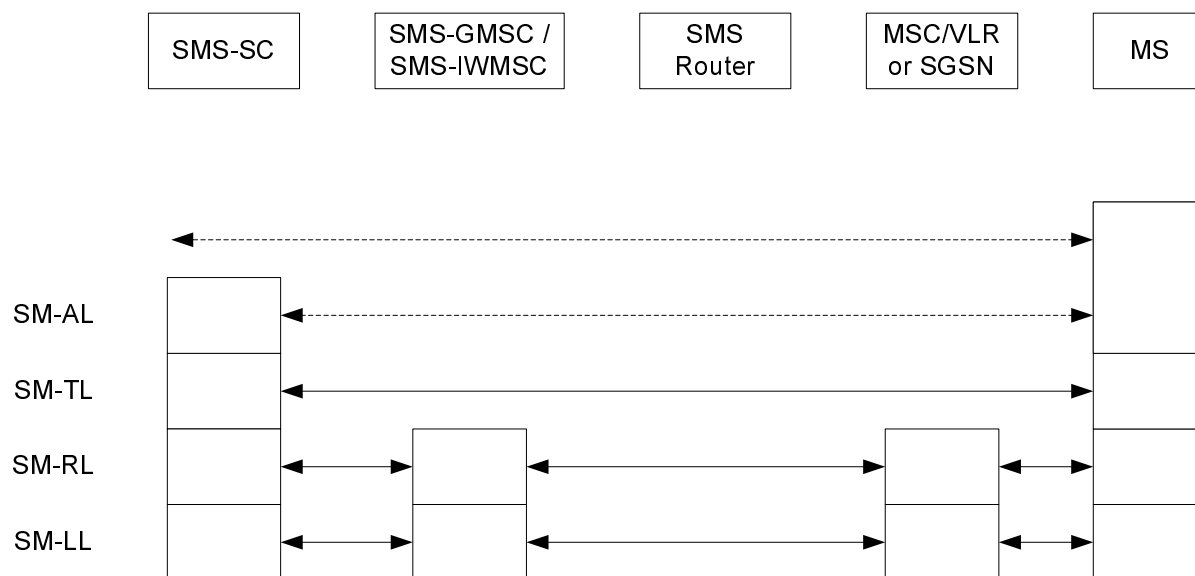

NOTE: The SMS Router is an optional functional entity, and is used only in the MT case.

Figure 7: Protocol layer overview for the Short Message Service

The present document specifies the protocol at the SM-TL, the service offered by the SM-TL at the MS and the SC, and the service offered by the SM-RL at the SC.

Note that while normally SM-TL terminates at the SC in SM MO, the SMS-IWMSC may inspect TP-DA in SMS-SUBMIT for the purpose of checking the existence of an SMS interworking agreement (see clause 8.2.2).

9.1 Protocol element features

9.1.1 Octet and Bit transmission order

The octets are transmitted according to their individual numbering; the octet with the lowest number being transmitted first. The bits within each octet are transmitted according to their individual numbering also; the bits with the lowest internal number being transmitted first.

9.1.2 Numeric and alphanumeric representation

For parameters within the TPDUs, there are four ways of numeric representation: Integer representation, octet, semi-octet and alphanumeric representation.

9.1.2.1 Integer representation

Wherever the bits from a number of octets, complete or in fractions, are to represent an integer, the interpretation shall be according to the following:

- 1) Between octets: the octets with the lowest octet numbers shall contain the most significant bits, i.e. the byte order shall be big endian.
- 2) Within an octet: the bits with the highest bit numbers shall be the most significant.

Below is given an example of octet and bit representation and transmission order of an integer represented field.

Let the 2 rightmost bits of octet no 5, the complete octet no 6 and 7, and the 3 leftmost bits of octet no 8 represent an integer, as shown in figure 8.

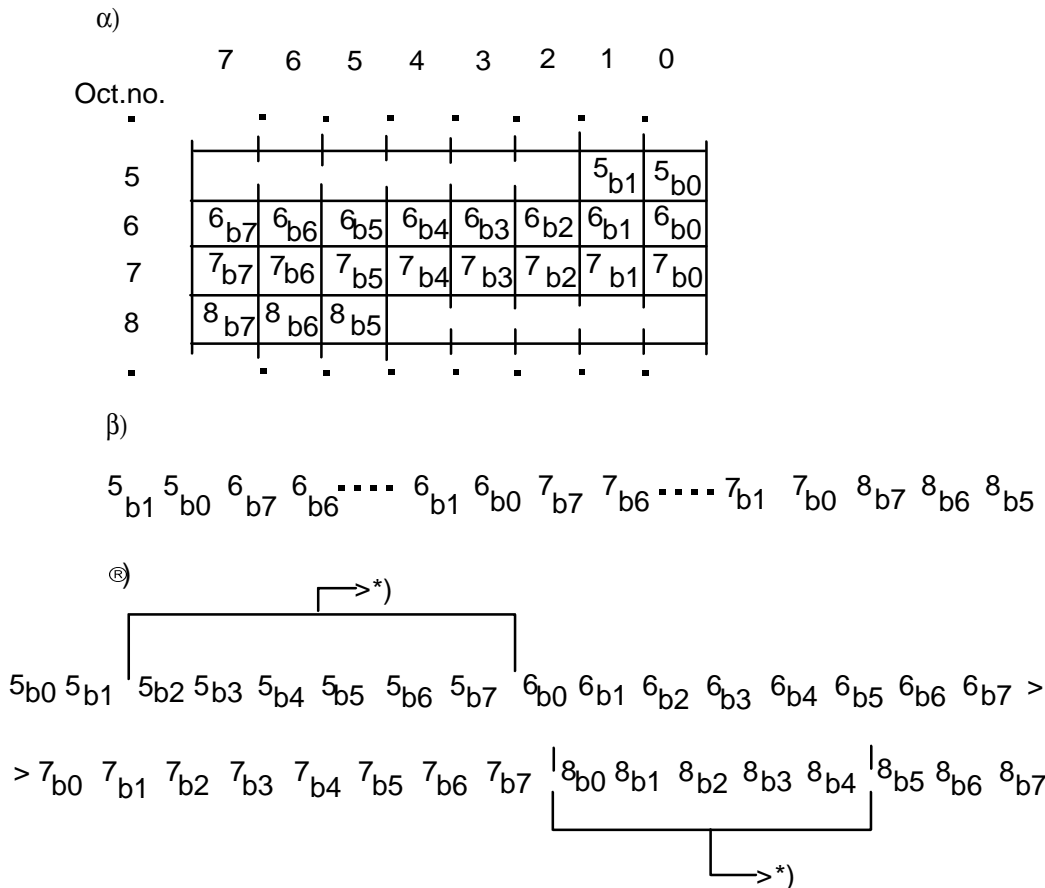

*) : Bits not representing the integer.

Figure 8: 21 bits from the octets 5, 6, 7, and 8 in a short message α) shall represent an integer as shown in β), and shall be transmitted in an order as shown in γ)

9.1.2.2 Octet representation

A field which is octet represented, shall always consist of a number of complete octets. Each octet within the field represents one decimal digit. The octets with the lowest octet numbers shall contain the most significant decimal digits.

9.1.2.3 Semi-octet representation

A field which is semi-octet represented, shall consist of a number of complete octets and - possibly - one half octet. Each half octet within the field represents one decimal digit. The octets with the lowest octet numbers shall contain the most significant decimal digits. Within one octet, the half octet containing the bits with bit numbers 0 to 3, shall represent the most significant digit.

In the case where a semi-octet represented field comprises an odd number of digits, the bits with bit numbers 4 to 7 within the last octet are fill bits and shall always be set to "1111".

If a mobile receives an address field containing non-integer information in the semi-octets other than "1111" (e.g. 1110) it shall display the semi-octet as the representation given in GSM 44.008 [12] under "called BCD number", viz 1010="*", 1011="#", 1100="a", 1101="b", 1110="c". In the event of a discrepancy between the values quoted here and the values specified in GSM 44.008[12] then GSM 44.008 [12] shall take precedence. If a mobile receives "1111" in a position prior to the last semi-octet then processing shall commence with the next semi-octet and the intervening semi-octet shall be ignored.

Within each semi octet, the bits with the highest bit numbers shall be the most significant.

Below is given an example:

Octet no:

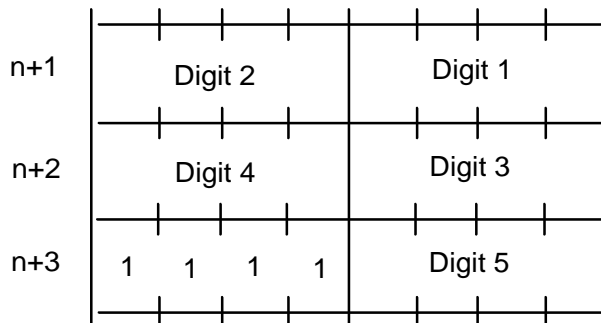

9.1.2.4 Alphanumeric representation

A field which uses alphanumeric representation shall consist of a number of 7-bit characters represented as the default alphabet defined in 3GPP TS 23.038 [9].

9.1.2.5 Address fields

Address fields used by SM-RL are specified in 3GPP TS 24.011 [13] and 3GPP TS 29.002 [15].

Each address field of the SM-TL consists of the following sub-fields: An Address-Length field of one octet, a Type-of-Address field of one octet, and one Address-Value field of variable length; as shown below:

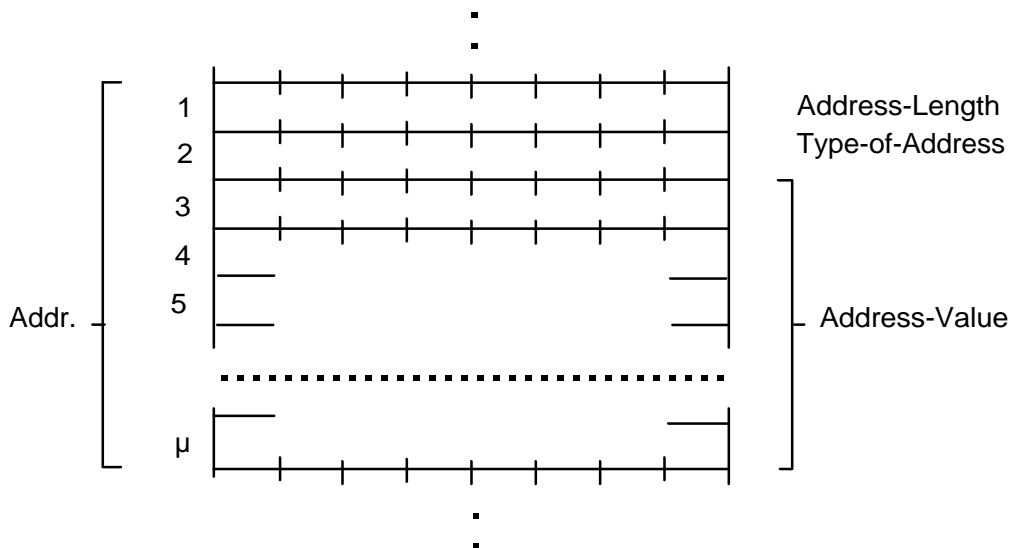

The Address-Length field is an integer representation of the number of useful semi-octets within the Address-Value field, i.e. excludes any semi octet containing only fill bits.

The Type-of-Address field format is as follows:

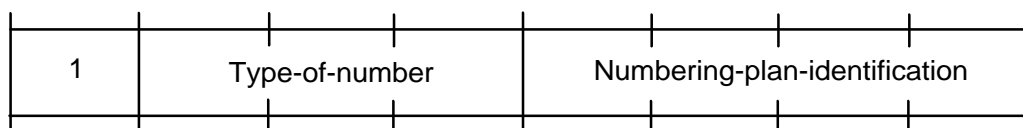

Type-of-number:

Bits 6 5 4

0 0 0	Unknown ¹⁾
0 0 1	International number ²⁾
0 1 0	National number ³⁾
0 1 1	Network specific number ⁴⁾
1 0 0	Subscriber number ⁵⁾
1 0 1	Alphanumeric, (coded according to 3GPP TS 23.038 [9] GSM 7-bit default alphabet)
1 1 0	Abbreviated number
1 1 1	Reserved for extension

The MS shall interpret reserved values as "Unknown" but shall store them exactly as received.

The SC may reject messages with a type of number containing a reserved value or one which is not supported.

Reserved values shall not be transmitted by an SC conforming to this version of the specification.

- 1) "Unknown" is used when the user or network has no a priori information about the numbering plan. In this case, the Address-Value field is organized according to the network dialling plan, e.g. prefix or escape digits might be present.
- 2) The international format shall be accepted also when the message is destined to a recipient in the same country as the MSC or as the SGSN.
- 3) Prefix or escape digits shall not be included.
- 4) "Network specific number" is used to indicate administration/service number specific to the serving network, e.g. used to access an operator.
- 5) "Subscriber number" is used when a specific short number representation is stored in one or more SCs as part of a higher layer application. (Note that "Subscriber number" shall only be used in connection with the proper PID referring to this application).

Numbering-plan-identification

Bits 3 2 1 0

0 0 0 0	Unknown
0 0 0 1	ISDN/telephone numbering plan (E.164 [17]/E.163[18])
0 0 1 1	Data numbering plan (X.121)
0 1 0 0	Telex numbering plan
0 1 0 1	Service Centre Specific plan ¹⁾
0 1 1 0	Service Centre Specific plan ¹⁾
1 0 0 0	National numbering plan
1 0 0 1	Private numbering plan
1 0 1 0	ERMES numbering plan (ETSI DE/PS 3 01-3)
1 1 1 1	Reserved for extension

All other values are reserved.

- 1) "Service Centre specific number" is used to indicate a numbering plan specific to External Short Message Entities attached to the SMSC.

For Type-of-number = 101 bits 3,2,1,0 are reserved and shall be transmitted as 0000. Note that for addressing any of the entities SC, MSC, SGSN or MS, Numbering-plan-identification = 0001 shall always be used. However, for addressing the SME, any specified Numbering-plan-identification value may be used.

The MS shall interpret reserved values as "Unknown" but shall store them exactly as received.

The SC may reject messages with a type of number containing a reserved value or one which is not supported.

Reserved values shall not be transmitted by an SC conforming to this version of the specification.

Within the Address-Value field, either a semi-octet or an alphanumeric¹⁾ representation applies.

The maximum length of the full address field (Address-Length, Type-of-Address and Address-Value) is 12 octets.

1) Applies only to addressing at the SM-TL.

9.2 Service provided by the SM-TL

9.2.1 General

The Short Message Transfer Layer (SM-TL) provides a service to the Short Message Application Layer (SM-AL). This service enables the SM-AL to transfer short messages to its peer entity, receive short messages from its peer entity and receive reports about earlier requests for short messages to be transferred.

In order to keep track of messages and reports about those messages, primitives between the SM-AL and SM-TL contain a Short Message Identifier (SMI), which is a reference number for the message associated with the primitive. This Short Message Identifier is mapped to and from the Short Message Identifier used between the SM-TL and the Short Message Relay Layer (SM-RL). The Short Message Identifier is not carried between entities and therefore a given message may have different SMIs at the MS and SC sides (see clause 9.3.1 below).

The SM-TL communicates with its peer entity by the protocol described in the following clauses.

9.2.2 PDU Type repertoire at SM-TL

The SM-TL comprises the following six PDUs:

SMS-DELIVER, conveying a short message from the SC to the MS;

SMS-DELIVER-REPORT, conveying;

a) a failure cause (if necessary);

b) information as part of a positive or negative acknowledgement to an SMS-DELIVER or SMS-STATUS-REPORT;

SMS-SUBMIT, conveying a short message from the MS to the SC;

SMS-SUBMIT-REPORT, conveying;

a) a failure cause (if necessary);

b) information as part of a positive or negative acknowledgement to an SMS-SUBMIT or SMS-COMMAND;

SMS-STATUS-REPORT, conveying a status report from the SC to the MS;

SMS-COMMAND, conveying a command from the MS to the SC.

9.2.2.1 SMS-DELIVER type

Basic elements of the SMS-DELIVER type:

Abbr.	Reference	P1)	R2)	Description
TP-MTI	TP-Message-Type-Indicator	M	2b	Parameter describing the message type.
TP-MMS	TP-More-Messages-to-Send	M	b	Parameter indicating whether or not there are more messages to send
TP-RP	TP-Reply-Path	M	b	Parameter indicating that Reply Path exists.
TP-UDHI	TP-User-Data-Header-Indicator	O	b	Parameter indicating that the TP-UD field contains a Header
TP-SRI	TP-Status-Report-Indication	O	b	Parameter indicating if the SME has requested a status report.
TP-OA	TP-Originating-Address	M	2-12o	Address of the originating SME.
TP-PID	TP-Protocol-Identifier	M	o	Parameter identifying the above layer protocol, if any.
TP-DCS	TP-Data-Coding-Scheme	M	o	Parameter identifying the coding scheme within the TP-User-Data.
TP-SCTS	TP-Service-Centre-Time-Stamp	M	7o	Parameter identifying time when the SC received the message.
TP-UDL	TP-User-Data-Length	M	l	Parameter indicating the length of the TP-User-Data field to follow.
TP-UD	TP-User-Data	O	3)	

- 1) Provision; Mandatory (M) or Optional (O).
- 2) Representation; Integer (I), bit (b), 2 bits (2b), Octet (o), 7 octets (7o), 2-12 octets (2-12o).
- 3) Dependent on the TP-DCS.

Layout of SMS-DELIVER:

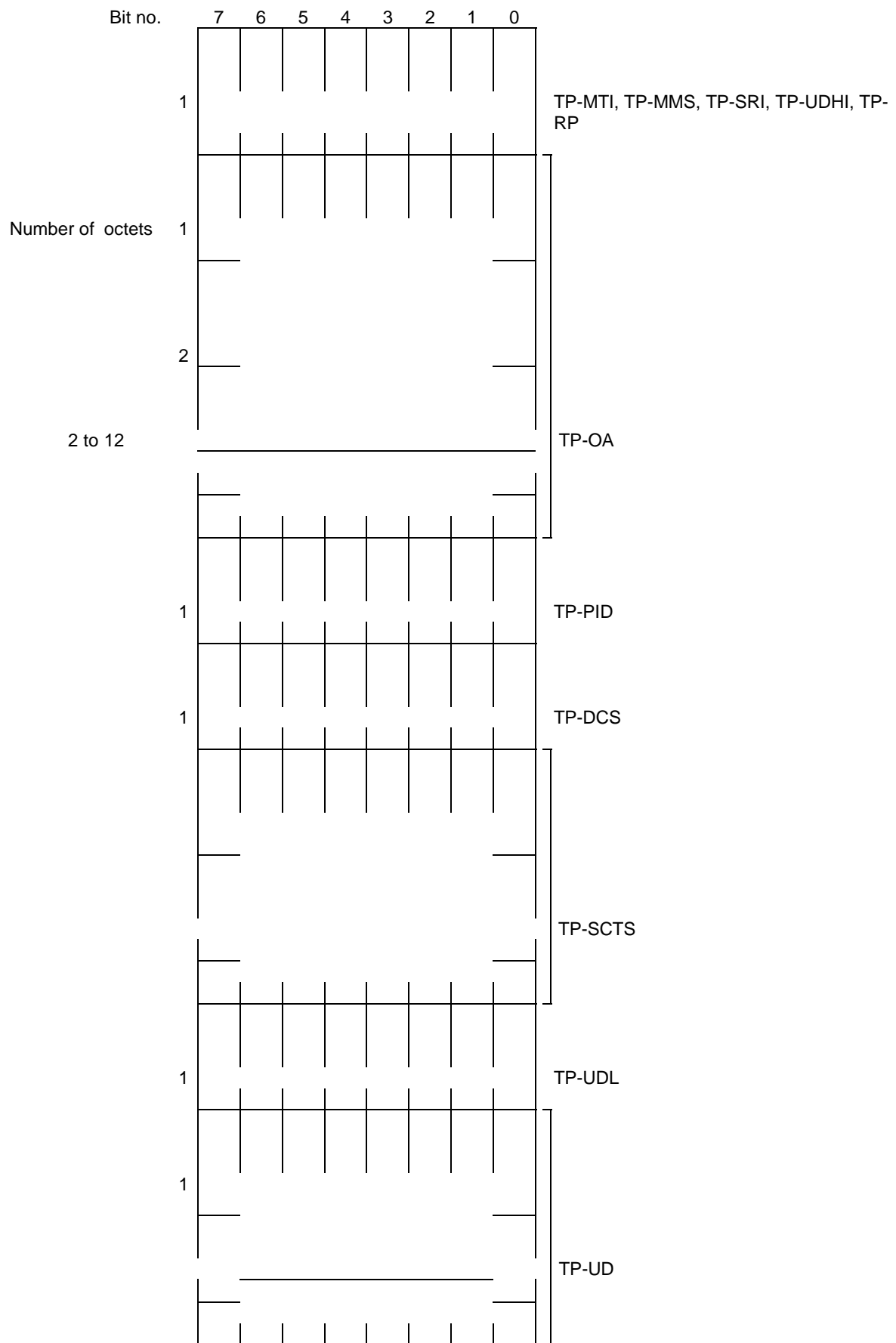

NOTE: Any unused bits shall be set to zero by the sending entity and shall be ignored by the receiving entity.

9.2.2.1a SMS-DELIVER-REPORT type

An SMS-DELIVER-REPORT TPDU is carried as a RP-User-Data element within an RP-ERROR PDU and is part of the negative acknowledgement to an SMS-DELIVER or SMS-STATUS-REPORT.

An SMS-DELIVER-REPORT TPDU is also carried as a RP-User-Data element within an RP-ACK PDU and is part of a positive acknowledgement to a SMS-DELIVER or SMS-STATUS REPORT.

(i) SMS-DELIVER-REPORT for RP-ERROR

Basic elements of the SMS-DELIVER-REPORT type:

Abbr.	Reference	p1)	p2)	Description
TP-MTI	TP-Message-Type-Indicator	M	2b	Parameter describing the message type
TP-UDHI	TP-User-Data-Header-Indication	O	b	Parameter indicating that the TP-UD field contains a Header
TP-FCS	TP-Failure-Cause	M	I	Parameter indicating the reason for SMS-DELIVER failure
TP-PI	TP-Parameter-Indicator	M	o	Parameter indicating the presence of any of the optional parameters which follow
TP-PID	TP-Protocol-Identifier	O	o	see clause 9.2.3.9
TP-DCS	TP-Data-Coding-Scheme	O	o	see clause 9.2.3.10
TP-UDL	TP-User-Data-Length	O	o	see clause 9.2.3.16
TP-UD	TP-User-Data	O	3) 4)	see clause 9.2.3.24

- 1) Provision: Mandatory (M) or Optional (O).
- 2) Representation: Integer (I), bit (b), 2bits (2b), octet (o).
- 3) Dependent upon the TP-DCS.
- 4) The TP-User-Data field in the SMS-DELIVER-REPORT is only available for use by the MT.

Layout of SMS-DELIVER-REPORT:

Number of Octets	Bit Number								
	7	6	5	4	3	2	1	0	
1									TP-MTI, TP-UDHI
1									TP-FCS
1									TP-PI
0,1									TP-PID
0,1									TP-DCS
0,1									TP-UDL
0 to 158									TP-UD

Bits 7 and 5 - 2 in octet 1 are presently unused and the sender shall set them to zero. If any of these bits is non-zero, the receiver shall not examine the other field and shall treat the TP-Failure-Cause as "Unspecified error cause".

(ii) SMS-DELIVER-REPORT for RP-ACK

Basic elements of the SMS-DELIVER-REPORT type:

Abbr	Reference	p1)	p2)	Description
TP-MTI	TP-Message Type Indicator	M	2b	Parameter describing the message type
TP-UDHI	TP-User-Data-Header-Indication	O	b	Parameter indicating that the TP-UD field contains a Header
TP-PI	TP-Parameter-Indicator	M	o	Parameter indicating the presence of any of the optional parameters which follow
TP-PID	TP-Protocol-Identifier	O	o	see clause 9.2.3.9
TP-DCS	TP-Data-Coding-Scheme	O	o	see clause 9.2.3.10
TP-UDL	TP-User-Data-Length	O	o	see clause 9.2.3.16
TP-UD	TP-User-Data	O	3) 4)	see clause 9.2.3.24

- 1) Provision: Mandatory (M) or Optional (O).
- 2) Representation: Integer (I), Bit (b), 2 bits (2b), octet (o).
- 3) Dependent upon the TP-DCS.
- 4) The TP-User-Data field in the SMS-DELIVER-REPORT is only available for use by the MT.

Layout of SMS-DELIVER-REPORT:

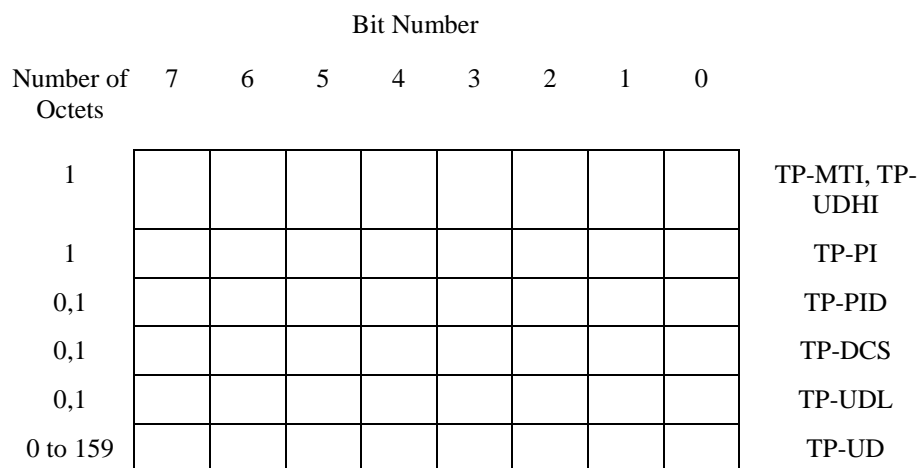

Bits 7 and 5 - 2 in octet 1 are presently unused in the SMS-DELIVER-REPORT and the sender shall set them to zero. If any of these bits is non-zero, the receiver shall ignore them.

9.2.2.2 SMS-SUBMIT type

Basic elements of the SMS-SUBMIT type:

Abbr.	Reference	p1)	p2)	Description
TP-MTI	TP-Message-Type-Indicator	M	2b	Parameter describing the message type.
TP-RD	TP-Reject-Duplicates	M	b	Parameter indicating whether or not the SC shall accept an SMS-SUBMIT for an SM still held in the SC which has the same TP-MR and the same TP-DA as a previously submitted SM from the same OA
TP-VPF	TP-Validity-Period-Format	M	2b	Parameter indicating whether or not the TP-VP field is present.
TP-RP	TP-Reply-Path	M	b	Parameter indicating the request for Reply Path.
TP-UDHI	TP-User-Data-Header-Indicator	O	b	Parameter indicating that the TP-UD field contains a Header.
TP-SRR	TP-Status-Report-Request	O	b	Parameter indicating if the MS is requesting a status report.
TP-MR	TP-Message-Reference	M	I	Parameter identifying the SMS-SUBMIT.
TP-DA	TP-Destination-Address	M	2-12o	Address of the destination SME.
TP-PID	TP-Protocol-Identifier	M	o	Parameter identifying the above layer protocol, if any.
TP-DCS	TP-Data-Coding-Scheme	M	o	Parameter identifying the coding scheme within the TP-User-Data.
TP-VP	TP-Validity-Period	O	o/7o	Parameter identifying the time from where the message is no longer valid.
TP-UDL	TP-User-Data-Length	M	I	Parameter indicating the length of the TP-User-Data field to follow.
TP-UD	TP-User-Data	O	3)	

- 1) Provision; Mandatory (M) or Optional (O).
- 2) Representation; Integer (I), bit (b), 2 bits (2b), Octet (o), 7 octets (7o), 2-12 octets (2-12o).
- 3) Dependent on the TP-DCS.

Layout of SMS-SUBMIT:

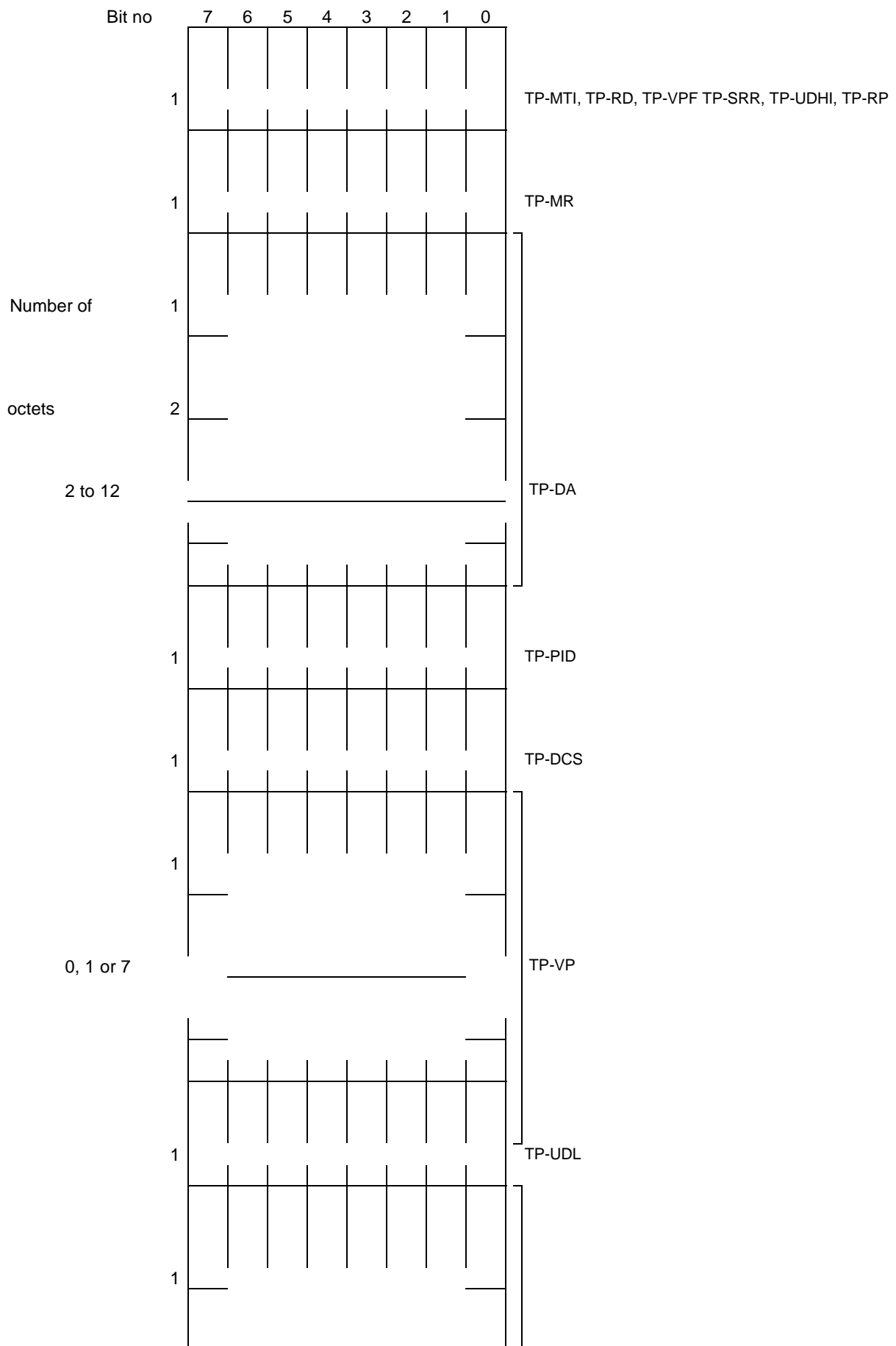

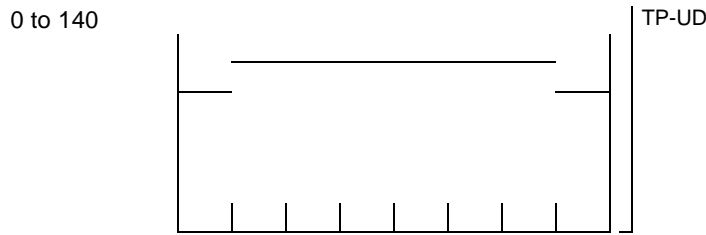

NOTE: Any unused bits shall be set to zero by the sending entity and shall be ignored by the receiving entity.

9.2.2.2a SMS-SUBMIT-REPORT type

An SMS-SUBMIT-REPORT TPDU is carried as a RP-User-Data element within an RP-ERROR PDU and is part of the negative acknowledgement to an SMS-SUBMIT or SMS-COMMAND.

An SMS-SUBMIT-REPORT TPDU is also carried as a RP-User-Data element with an RP-ACK PDU and is part of a positive acknowledgement to a SMS-SUBMIT or SMS-COMMAND.

(i) SMS-SUBMIT-REPORT for RP-ERROR

Basic elements of the SMS-SUBMIT-REPORT type:

Abbr.	Reference	p1)	p2)	Description
TP-MTI	TP-Message-Type-Indicator	M	2b	Parameter describing the message type
TP-UDHI	TP-User-Data-Header-Indication	O	b	Parameter indicating that the TP-UD field contains a Header
TP-FCS	TP-Failure-Cause	M	l	Parameter indicating the reason for SMS-SUBMIT failure
TP-PI	TP-Parameter-Indicator	M	o	Parameter indicating the presence of any of the optional parameters which follow
TP-SCTS	TP-Service-Centre-Time-Stamp	M	7o 5)	Parameter identifying the time when the SC received the SMS-SUBMIT See clause 9.2.3.11
TP-PID	TP-Protocol-Identifier	O	o	See clause 9.2.3.9
TP-DCS	TP-Data-Coding-Scheme	O	o	see clause 9.2.3.10
TP-UDL	TP-User-Data-Length	O	o	see clause 9.2.3.16
TP-UD	TP-User-Data	O	3) 4)	see clause 9.2.3.24

- 1) Provision: Mandatory (M) or Optional (O).
- 2) Representation: Integer (I), bit (b), 2bits (2b), octet (o).
- 3) Dependent upon the TP-DCS.
- 4) The TP-User-Data field in the SMS-SUBMIT-REPORT is only available for use by the SC.
- 5) This same time value shall also be carried in the SMS-STATUS-REPORT relating to a particular SM. See clause 9.2.2.3. This shall allow the submitting SME to associate a particular SMS-SUBMIT with a subsequent SMS-STATUS-REPORT by correlating the TP-SCTS values.

Layout of SMS-SUBMIT-REPORT:

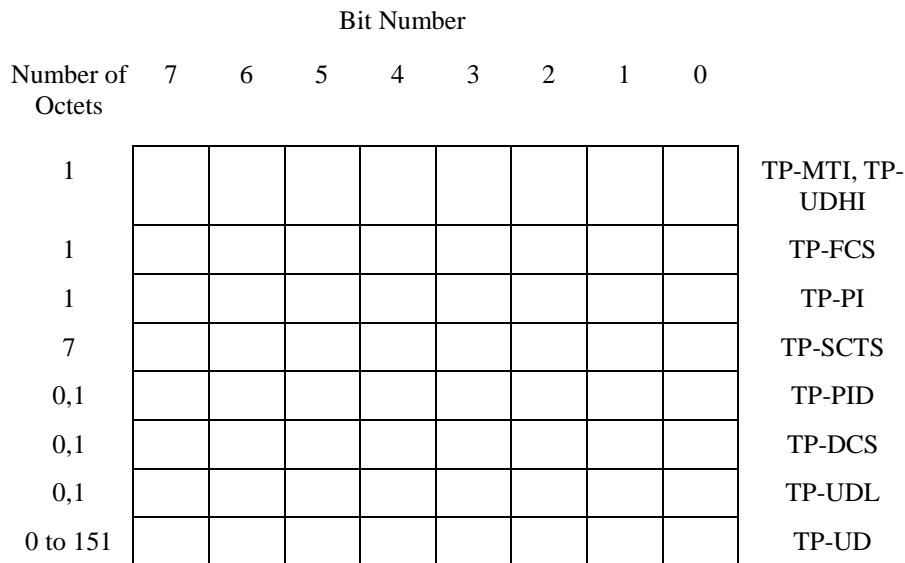

Bits 7 and 5 - 2 in octet 1 are presently unused and the sender shall set them to zero. If any of these bits is non-zero, the receiver shall not examine the other field and shall treat the TP-Failure-Cause as "Unspecified error cause".

(ii) SMS-SUBMIT-REPORT for RP-ACK

Basic elements of the SMS-SUBMIT_REPORT type:

Abbr	Reference	p1)	p2)	Description
TP-MTI	TP-Message Type-Indicator	M	2b	Parameter describing the message type
TP-UDHI	TP-User-Data-Header-Indication	O	b	Parameter indicating that the TP-UD field contains a Header
TP-PI	TP-Parameter-Indicator	M	o	Parameter indicating the presence of any of the optional parameters which follow
TP-SCTS	TP-Service-Centre-Time-Stamp	M	7o 5)	Parameter identifying the time when the SC received the SMS-SUBMIT See clause 9.2.3.11
TP-PID	TP-Protocol-Identifier	O	o	See clause 9.2.3.9
TP-DCS	TP-Data-Coding-Scheme	O	o	see clause 9.2.3.10
TP-UDL	TP-User-Data-Length	O	o	see clause 9.2.3.16
TP-UD	TP-User-Data	O	3) 4)	see clause 9.2.3.24

- 1) Provision: Mandatory (M) or Optional (O).
- 2) Representation: Integer (I), Bit (B), 2bits (2b), octet (o).
- 3) Dependent upon the TP-DCS.
- 4) The TP-User-Data field in the SMS-SUBMIT-REPORT is only available for use by the SC.
- 5) This same time value shall also be carried in the SMS-STATUS-REPORT relating to a particular SM. See clause 9.2.2.3. This shall allow the submitting SME to associate a particular SMS-SUBMIT with a subsequent SMS-STATUS-REPORT by correlating the TP-SCTS values.

Layout of SMS-SUBMIT REPORT

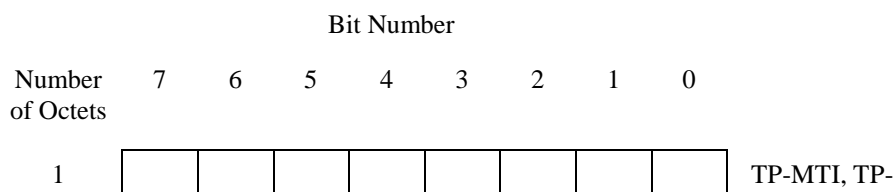

								UDHI
1								TP-PI
7								TP-SCTS
0,1								TP-PID
0,1								TP-DCS
0,1								TP-UDL
0 to 152								TP-UD

Bits 7 and 5 - 2 in octet 1 are presently unused in the SMS-SUBMIT-REPORT and the sender shall set them to zero. If any of these bits is non-zero, the receiver shall ignore them.

9.2.2.3 SMS-STATUS-REPORT type

Basic elements of the SMS-STATUS-REPORT type:

Abbr.	Reference	P1)	R2)	Description
TP-MTI	TP-Message-Type-Indicator	M	2b	Parameter describing the message type
TP-UDHI	TP-User-Data-Header-Indication	O	b	Parameter indicating that the TP-UD field contains a Header
TP-MMS	TP-More-Messages-to-Send	M	b	Parameter indicating whether or not there are more messages to send
TP-SRQ	TP-Status-Report-Qualifier	M	b	Parameter indicating whether the previously submitted TPDU was an SMS-SUBMIT or an SMS-COMMAND
TP-MR	TP-Message-Reference ³⁾	M	l	Parameter identifying the previously submitted SMS-SUBMIT or SMS-COMMAND
TP-RA	TP-Recipient-Address	M	2-12o	Address of the recipient of the previously submitted mobile originated short message
TP-SCTS	TP-Service-Centre-Time-Stamp	M	7o	Parameter identifying time when the SC received the previously sent SMS-SUBMIT
TP-DT	TP-Discharge-Time	M	7o	Parameter identifying the time associated with a particular TP-ST outcome
TP-ST	TP-Status	M	o	Parameter identifying the status of the previously sent mobile originated short message
TP-PI	TP-Parameter-Indicator	O 4)	o	Parameter indicating the presence of any of the optional parameters which follow
TP-PID	TP-Protocol-Identifier	O	o	see clause 9.2.3.9. TP-PID of original SMS-SUBMIT
TP-DCS	TP-Data-Coding-Scheme	O	o	see clause 9.2.3.10
TP-UDL	TP-User-Data-Length	O	o	see clause 9.2.3.16
TP-UD	TP-User-Data	O	5)	see clause 9.2.3.24

- 1) Provision: Mandatory (M) or Optional (O).
- 2) Representation: Integer (I), bit (b), 2 bits (2b), Octet (o), 7 octets (7o), 2-12 octets (2-12o).
- 3) Where the SMS-STATUS-REPORT is the result of an SMS-COMMAND and the TP-Command-Type was an Enquiry, the TP-MR returned in the SMS-STATUS-REPORT shall be the TP-MN which was sent in the SMS-COMMAND (i.e. the TP-MR of the previously submitted SM to which the Enquiry refers).
- 4) Mandatory if any of the optional parameters following TP-PI is present, otherwise optional.
- 5) TP-UD contains information related to a SMS-DELIVER; can contain information transported in the TP-UD of SMS-DELIVER-REPORT, and information inserted by the SMSC. The length of the TP-UD field is limited and might not be long enough to fit information both from the original receiving terminal (as included into the SMS-DELIVER-REPORT) and information added by the SMSC. In these cases the former information has higher priority, and the latter shall be truncated.

Layout of SMS-STATUS-REPORT:

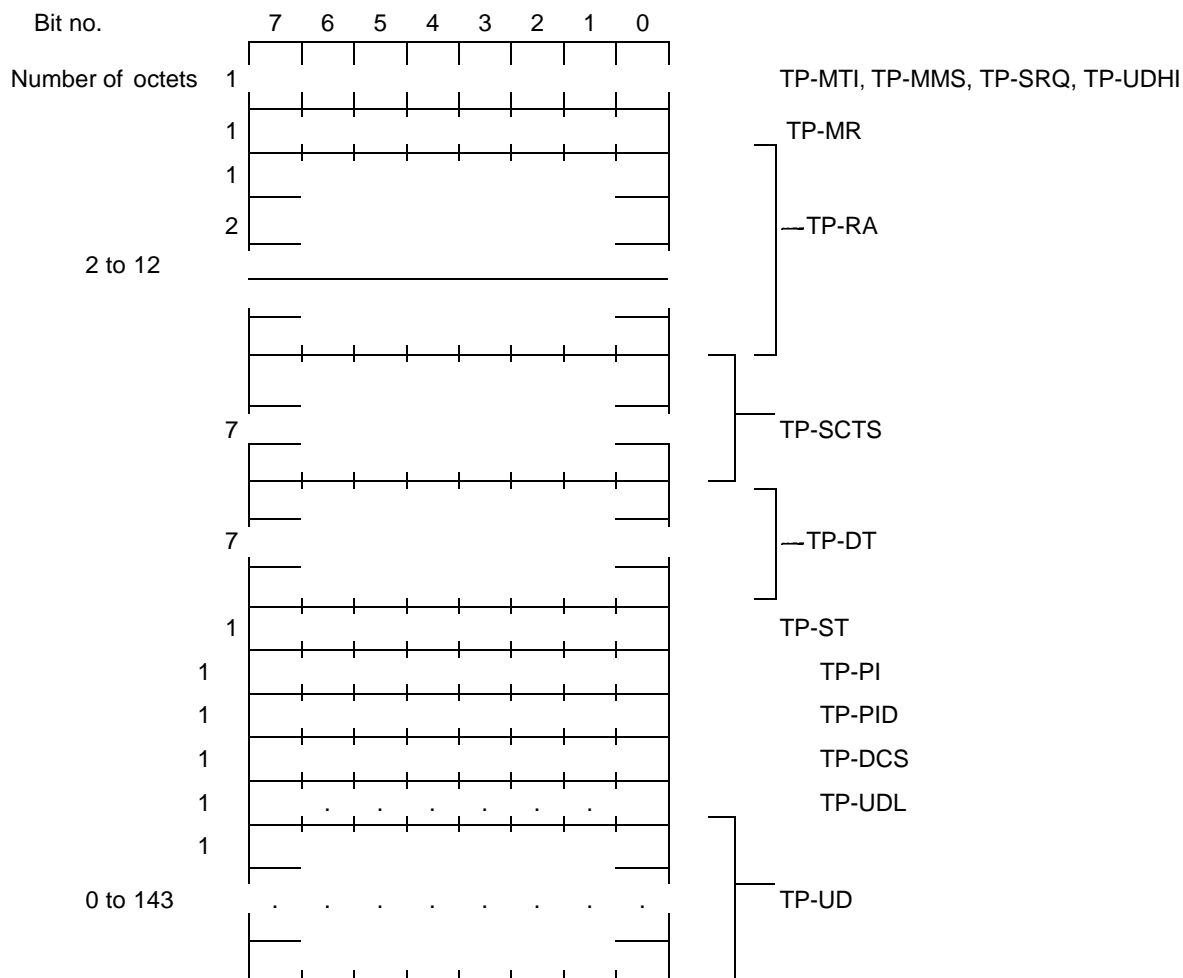

NOTE: Any unused bits shall be set to zero by the sending entity and shall be ignored by the receiving entity.

The maximum guaranteed length of TP-UD is 131 octets. In order to achieve the maximum stated above (143 octets), the TP-RA field must have a length of 2 octets and TP-PID and TP-DCS must not be present.

9.2.2.4 SMS-COMMAND type

Basic elements of the SMS-COMMAND type:

Abbr.	Reference	P1)	R2)	Description
TP-MTI	TP-Message-Type-Indicator	M	2b	Parameter describing the type
TP-UDHI	TP-User-Data-Header-Indication	O	b	Parameter indicating that the TP-CD field contains a Header
TP-SRR	TP-Status-Report- Request	O	b	Parameter indicating if the SMS Command is requesting a status report.
TP-MR	TP-Message Reference	M	l	Parameter identifying the SMS-COMMAND
TP-PID	TP-Protocol- Identifier	M	o	Parameter identifying the above layer protocol, if any
TP-CT	TP-Command-Type	M	o	Parameter specifying which operation is to be performed on a SM
TP-MN	TP-Message-Number	M ³⁾	o	Parameter indicating which SM in the SC to operate on
TP-DA	TP-Destination-Address	M ⁴⁾	2-12o	Parameter indicating the Destination Address to which the TP-Command refers
TP-CDL	TP-Command-Data-Length	M	o	Parameter indicating the length of the TP-CD field in octets
TP-CD	TP-Command-Data	O	o	Parameter containing user data

- 1) Provision: Mandatory (M) or Optional (O).
- 2) Representation: Integer (I), bit (b), 2bits (2b), octet (o).
- 3) For TP-Command-Types which are not for a specific SM this field shall be ignored when received. Its value is of no concern but the field must be present to maintain the structure.
- 4) For certain TP-Command-Types which operate on a specific SM (e.g. Enquire, Delete etc.) the full TP-DA must be specified. For TP-Command-Types which do not operate on a specific SM, the address length must be set to zero indicating that the Address-Value fields are not present. The Type-of-Address field must be present (see 9.1.2.5) and shall be set to zero and ignored.

Layout of SMS-COMMAND:

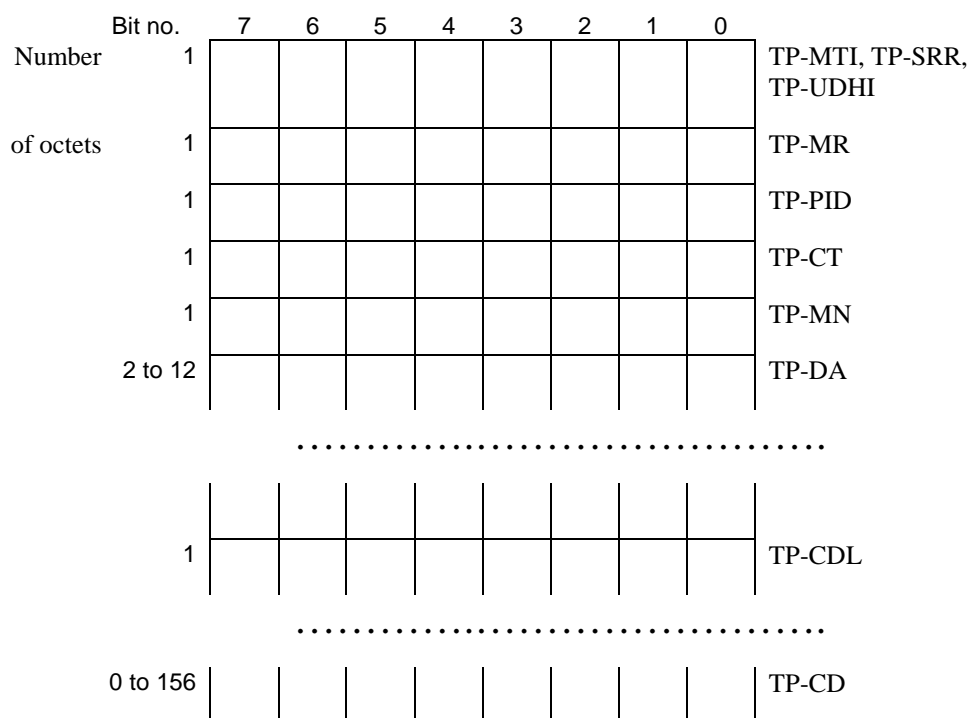

NOTE: The maximum guaranteed length of TP-CD is 146 octets. In order to achieve the maximum stated above (156 octets), the TP-DA field must have a length of 2 octets.

9.2.3 Definition of the TPDU parameters

9.2.3.1 TP-Message-Type-Indicator (TP-MTI)

The TP-Message-Type-Indicator is a 2-bit field, located within bits no 0 and 1 of the first octet of all PDUs which can be given the following values:

bit1	bit0	Message type
0	0	SMS-DELIVER (in the direction SC to MS)
0	0	SMS-DELIVER REPORT (in the direction MS to SC)
1	0	SMS-STATUS-REPORT (in the direction SC to MS)
1	0	SMS-COMMAND (in the direction MS to SC)
0	1	SMS-SUBMIT (in the direction MS to SC)
0	1	SMS-SUBMIT-REPORT (in the direction SC to MS)
1	1	Reserved

If an MS receives a TPDU with a "Reserved" value in the TP-MTI it shall process the message as if it were an "SMS-DELIVER" but store the message exactly as received.

9.2.3.2 TP-More-Messages-to-Send (TP-MMS)

The TP-More-Messages-to-Send is a 1-bit field, located within bit no 2 of the first octet of SMS-DELIVER and SMS-STATUS-REPORT, and to be given the following values:

Bit no 2:	0	More messages are waiting for the MS in this SC
	1	No more messages are waiting for the MS in this SC

NOTE: In the case of SMS-STATUS-REPORT this parameter refers to messages waiting for the mobile to which the status report is sent. The term message in this context refers to SMS-messages or status reports.

9.2.3.3 TP-Validity-Period-Format (TP-VPF)

The TP-Validity-Period-Format is a 2-bit field, located within bit no 3 and 4 of the first octet of SMS-SUBMIT, and to be given the following values:

bit4	bit3	
0	0	TP-VP field not present
1	0	TP-VP field present - relative format
0	1	TP-VP field present - enhanced format
1	1	TP-VP field present - absolute format

Any unsupported value may be rejected by the SC by returning the "TP-VPF not supported" TP-FCS value in the SMS Submit Report for RP-Error.

9.2.3.4 TP-Status-Report-Indication (TP-SRI)

The TP-Status-Report-Indication is a 1-bit field, located within bit no. 5 of the first octet of SMS-DELIVER, and to be given the following values:

Bit no. 5: 0	A status report shall not be returned to the SME
1	A status report shall be returned to the SME

9.2.3.5 TP-Status-Report-Request (TP-SRR)

The TP-Status-Report-Request is a 1-bit field, located within bit no. 5 of the first octet of SMS-SUBMIT and SMS-COMMAND, and to be given the following values:

Bit no. 5: 0	A status report is not requested
1	A status report is requested

9.2.3.6 TP-Message-Reference (TP-MR)

The TP-Message-Reference field gives an integer representation of a reference number of the SMS-SUBMIT or SMS-COMMAND submitted to the SC by the MS. The MS increments TP-Message-Reference by 1 for each SMS-SUBMIT or SMS-COMMAND being submitted. The value to be used for each SMS-SUBMIT is obtained by reading the Last-Used-TP-MR value from the SMS Status data field in the (U)SIM (see GSM TS 51.011 [16] and 3GPP TS 31.102 [30]) and incrementing this value by 1. After each SMS-SUBMIT has been submitted to the network, the Last-Used-TP-MR value in the (U)SIM is updated with the TP-MR that was used in the SMS-SUBMIT operation. The reference number may possess values in the range 0 to 255. The value in the TP-MR assigned by the MS is the same value which is received at the SC.

In the case where no response or an RP-ERROR with an appropriate cause value (see 3GPP TS 24.011 [13]) is received in response to an SMS-SUBMIT, then the MS shall automatically repeat the SMS-SUBMIT but must use the same TP-MR value and set the TP-RD bit to 1 (see 9.2.3.25). The number of times the MS automatically repeats the SMS-SUBMIT shall be in the range 1 to 3 but the precise number is an implementation matter. The automatic repeat mechanism should be capable of being disabled through MMI.

If all automatic attempts fail (or in the case of no automatic attempts the first attempt fails), the user shall be informed. The failed message shall be stored in the mobile in such a way that the user can request a retransmission using the same TP-MR value, without the need to re-enter any information. Such storage need only be provided for a single failed message, i.e. the one most recently attempted.

The SC should discard an SMS-SUBMIT which has the TP-RD bit set to a 1 and which has the same TP-MR value as the previous SMS-SUBMIT received from the same originating address. In the case of a discarded SMS-SUBMIT, the SC should respond with an RP-ERROR, in which case the RP-ERROR shall include a SMS-SUBMIT-REPORT with TP-FCS indicating "SM Rejected – Duplicate SM". In some cases, for backward compatibility with earlier phases and versions of this specification, the SC may be configured to respond with an RP-ACK.

The SMS-STATUS-REPORT also contains a TP-Message-Reference field. The value sent to the MS shall be the same as the TP-Message-Reference value generated by the MS in the earlier SMS-SUBMIT or SMS-COMMAND to which the status report relates.

9.2.3.7 TP-Originating-Address (TP-OA)

The TP-Originating-Address field is formatted according to the formatting rules of address fields.

The first '#' encountered in TP-OA indicates where the address for SMSC routing purposes is terminated. Additional '*'s or '#'s can be present in the following digits, and all these digits including the first '#' are subaddress digits.

9.2.3.8 TP-Destination-Address (TP-DA)

The TP-Destination-Address field is formatted according to the formatting rules of address fields.

The first '#' encountered in TP-DA indicates where the address for SMSC routing purposes is terminated. Additional '*'s or '#'s can be present in the following digits, and all these digits including the first '#' are subaddress digits.

9.2.3.9 TP-Protocol-Identifier (TP-PID)

The TP-Protocol-Identifier parameter serves the purposes indicated in clause 3.2.3. It consists of one octet, and the bits in the octet are used as follows:

The MS shall interpret reserved, obsolete, or unsupported values as the value 00000000 but shall store them exactly as received.

The SC may reject messages with a TP-Protocol-Identifier containing a reserved value or one which is not supported.

bits	usage
7 6	
0 0	Assigns bits 0..5 as defined below
0 1	Assigns bits 0..5 as defined below
1 0	reserved
1 1	Assigns bits 0-5 for SC specific use

In the case where bit 7 = 0 and bit 6 = 0,

bit 5 indicates telematic interworking:

value = 0 : no interworking, but SME-to-SME protocol

value = 1 : telematic interworking

In the case of telematic interworking, the following five bit patterns in bits 4..0 are used to indicate different types of telematic devices:

4.. 0	
00000	implicit - device type is specific to this SC, or can be concluded on the basis of the address
00001	telex (or teletex reduced to telex format)
00010	group 3 telefax
00011	group 4 telefax
00100	voice telephone (i.e. conversion to speech)
00101	ERMES (European Radio Messaging System)
00110	National Paging system (known to the SC)
00111	Videotex (T.100 [20] /T.101 [21])
01000	teletex, carrier unspecified
01001	teletex, in PSPDN
01010	teletex, in CSPDN
01011	teletex, in analog PSTN
01100	teletex, in digital ISDN
01101	UCI (Universal Computer Interface, ETSI DE/PS 3 01-3)
01110..01111	(reserved, 2 combinations)
10000	a message handling facility (known to the SC)
10001	any public X.400-based message handling system
10010	Internet Electronic Mail
10011..10111	(reserved, 5 combinations)
11000..11110	values specific to each SC, usage based on mutual agreement between the SME and the SC (7 combinations available for each SC)

11111 A GSM/UMTS mobile station. The SC converts the SM from the received TP-Data-Coding-Scheme to any data coding scheme supported by that MS (e.g. the default).

If bit 5 has value 1 in an SMS-SUBMIT PDU, it indicates that the SME is a telematic device of a type which is indicated in bits 4..0, and requests the SC to convert the SM into a form suited for that device type. If the destination network is ISDN, the SC must also select the proper service indicators for connecting to a device of that type.

If bit 5 has value 1 in an SMS-DELIVER PDU, it indicates that the SME is a telematic device of a type which is indicated in bits 4..0.

If bit 5 has value 0 in an SMS-DELIVER PDU, the value in bits 4..0 identifies the SM-AL protocol being used between the SME and the MS.

Note that for the straightforward case of simple MS-to-SC short message transfer the Protocol Identifier is set to the value 0.

In the case where bit 7 = 0, bit 6 = 1, bits 5..0 are used as defined below

5 .. .0	
000000	Short Message Type 0
000001	Replace Short Message Type 1
000010	Replace Short Message Type 2
000011	Replace Short Message Type 3
000100	Replace Short Message Type 4
000101	Replace Short Message Type 5
000110	Replace Short Message Type 6
000111	Replace Short Message Type 7
001000..011101	Reserved
011110	Enhanced Message Service (Obsolete)
011111	Return Call Message
100000..111011	Reserved
111100	ANSI-136 R-DATA
111101	ME Data download
111110	ME De-personalization Short Message
111111	(U)SIM Data download

A short message type 0 indicates that the ME must acknowledge receipt of the short message but shall discard its contents. This means that

- the MS shall be able to receive the type 0 short message irrespective of whether there is memory available in the (U)SIM or ME or not,
- the MS shall not indicate the receipt of the type 0 short message to the user,
- the short message shall neither be stored in the (U)SIM nor ME.

The Replace Short Message feature is optional for the ME and the (U)SIM but if implemented it shall be performed as described here.

For MT short messages, on receipt of a short message from the SC, the MS shall check to see if the associated Protocol Identifier contains a Replace Short Message Type code.

If such a code is present, then the MS shall check the originating address and replace any existing stored message having the same Protocol Identifier code and originating address with the new short message and other parameter values. If there is no message to be replaced, the MS shall store the message in the normal way. The MS may also check the SC address as well as the Originating Address. However, in a network which has multiple SCs, it is possible for a Replace Message type for a SM to be sent via different SCs and so it is recommended that the SC address should not be checked by the MS unless the application specifically requires such a check.

If a Replace Short Message Type code is not present then the MS shall store the message in the normal way.

In MO short messages the SC reacts similarly but only the address of the originating MS or any other source is checked.

A Return Call Message indicates to the MS to inform the user that a call (e.g. a telephone call) can be established to the address specified within the TP-OA. The RP-OA contains the address of the SC as usual. The message content (if present) gives displayable information (e.g. the number of waiting voice messages). The message is handled in the same way as all other messages of the Replace Short Message Types.

The ME De-personalization Short Message is a ME-specific message which instructs the ME to de-personalities the ME (see 3GPP TS 22.022 [25]). The TP-DCS shall be set to Uncompressed, Default Alphabet, and Message Class 1 (ME-specific), which corresponds to a bit coding of 00010001. The TP-UD field contains de-personalization information coded according to 3GPP TS 22.022 [25]. This information shall not be displayed by an ME which supports the scheme. The acknowledgement to this message is a SMS-DELIVER-REPORT for RP-ACK in which the TP-User-Data shall be coded according to 3GPP TS 22.022 [25].

(U)SIM Data download is a facility whereby the ME must pass the short message in its entirety including all SMS elements contained in the SMS deliver to the (U)SIM using the mechanism described in GSM TS 51.011 [16] and 3GPP TS 31.102 [30]. The DCS shall be set to message class 2. The entire user data field is available for (U)SIM Data download. If the DCS is not set to message class 2 then the message shall be handled in the normal way by the ME. However it has to be noted that MEs based on releases of this specification earlier than REL-5 may allow only 8 bit message class 2 with bit coding 11110110 or 00010110 for (U)SIM Data download.

ME Data download is a facility whereby the ME shall process the short message in its entirety including all SMS elements contained in the SMS deliver to the ME. The DCS should normally be set to message class 1. If the DCS is set to message class 1 and no application in the ME exists, which is able to process the short message, the ME may discard the short message. The entire user data field is available for ME data download. The TPDU parameters required for the SMS-DELIVER should be passed transparently by all involved SCs, so no TPDU parameter in the entire short message is modified, other than the changes required to convert an SMS-SUBMIT into an SMS-DELIVER.

ANSI-136 R-DATA is a facility whereby the ME must pass the short message in its entirety, including all elements contained in the SMS DELIVER, to the (U)SIM using the mechanism described in GSM TS 11.14 [16] and 3GPP TS 31.102 [30]. The DCS shall be set to message class 2. If the DCS is not set to message class 2 then the message shall be handled in the normal way by the ME. However it has to be noted that MEs based on releases of this specification earlier than REL-5 may allow only 8 bit message class 2 with bit coding 11110110 or 00010110 for ANSI-136 R-DATA.

9.2.3.10 TP-Data-Coding-Scheme (TP-DCS)

The TP-Data-Coding-Scheme is defined in 3GPP TS 23.038 [9].

9.2.3.11 TP-Service-Centre-Time-Stamp (TP-SCTS)

The TP-Service-Centre-Time-Stamp field is given in semi-octet representation, and represents the local time in the following way:

	Year:	Month:	Day:	Hour:	Minute:	Second:	Time Zone
Digits: (Semi-octets)	2	2	2	2	2	2	2

The Time Zone indicates the difference, expressed in quarters of an hour, between the local time and GMT. In the first of the two semi-octets, the first bit (bit 3 of the seventh octet of the TP-Service-Centre-Time-Stamp field) represents the algebraic sign of this difference (0: positive, 1: negative).

The Service-Centre-Time-Stamp, and any other times coded in this format that are defined in the present document, represent the time local to the sending entity.

If the MS has knowledge of the local time zone, then any time received (e.g. Service-Centre-Time-Stamp) at the MS may be displayed in the local time rather than the time local to the sending entity. Messages shall be stored as received without change to any time contained therein.

The Time Zone code enables the receiver to calculate the equivalent time in GMT from the other semi-octets in the Service-Centre-Time-Stamp, or indicate the time zone (GMT, GMT+1H etc.), or perform other similar calculations as required by the implementation. The value contained in the Time Zone field must take into account daylight saving time, such that when the sending entity changes from regular (winter) time to daylight saving (summer) time, there is a

change to the value in the Time Zone field, for example in the UK the winter setting is 00000000 and the summer setting is 01000000.

If the MS receives a non-integer value in the SCTS, it shall assume that the digit is set to 0 but shall store the entire field exactly as received.

9.2.3.12 TP-Validity-Period (TP-VP)

9.2.3.12.1 TP-VP (Relative format)

The TP-Validity-Period comprises 1 octet in integer representation, giving the length of the validity period, counted from when the SMS-SUBMIT is received by the SC.

The representation of time is as follows:

TP-VP value	Validity period value
0 to 143	$(\text{TP-VP} + 1) \times 5 \text{ minutes}$ (i.e. 5 minutes intervals up to 12 hours)
144 to 167	$12 \text{ hours} + ((\text{TP-VP} - 143) \times 30 \text{ minutes})$
168 to 196	$(\text{TP-VP} - 166) \times 1 \text{ day}$
197 to 255	$(\text{TP-VP} - 192) \times 1 \text{ week}$

9.2.3.12.2 TP-VP (Absolute format)

The TP-Validity Period comprises 7 octets in semi octet representation giving the absolute time of the validity period termination.

The representation of time is identical to the representation of the TP-Service-Centre-Time-Stamp.

9.2.3.12.3 TP-VP (Enhanced format)

The TP-Validity Period comprises 7 octets. The presence of all octets is mandatory although they may not all be used. The first octet indicates the way in which the following 6 octets are used. Any reserved/unused bits or octets must be set to zero.

Octet 1 TP-VP functionality indicator

bit 7 Extension bit

Set to 1 if the TP-VP functionality indicator is to be extended to another octet. A setting of 0 indicates that there are no more TP-VP functionality indicator extension octets to follow.

Any such extension octet shall immediately follow the previous TP-VP functionality indicator.

bit 6 Single shot SM.

Set to 1 if the SC is required to make up to one delivery attempt. The TP-Validity Period, where present, shall be applicable to the Single shot SM.

bits 5, 4, 3 Reserved

bits 2, 1, 0 Validity Period Format.

Value bits 2 1 0

0 0 0	No Validity Period specified
0 0 1	Validity Period is as specified for the relative case. The following octet contains the TP-VP value as described in 9.2.3.12.1
0 1 0	Validity period is relative in integer representation and the following octet contains the TP-VP value in the range 0 to 255 representing 0 to 255 seconds. A TP-VP value of zero is undefined and reserved for future use.
0 1 1	Validity period is relative in semi-octet representation. The following 3 octets contain the relative time in Hours, Minutes and Seconds giving the length of the validity period counted from when the SMS-SUBMIT is received by the SC. The representation of time uses the same representation as the Hours, Minutes and Seconds in the TP-Service-Centre-Time-Stamp.
1 0 0	Reserved
1 0 1	Reserved
1 1 0	Reserved
1 1 1	Reserved

The SC shall reject any Unsupported/ Reserved values received by returning the 'TP-VP not supported' TP-FCS value in the Submit SM Report for RP-Error.

9.2.3.13 TP-Discharge-Time (TP-DT)

The TP-Discharge-Time field indicates the time at which a previously submitted SMS-SUBMIT was successfully delivered to or attempted to deliver to the recipient SME or disposed of by the SC.

In the case of "transaction completed" the time shall be the time of the completion of the transaction. In the case of "SC still trying to transfer SM" the time shall be the time of the last transfer attempt. In the case of "permanent or temporary error - SC not making any more transfer attempts" the time shall be the time of either the last transfer attempt or the time at which the SC disposed of the SM according to the Status outcome in TP-ST.

The TP-Discharge-Time is given in semi-octet representation in a format identical to the TP-SCTS.

9.2.3.14 TP-Recipient-Address (TP-RA)

The TP-Recipient-Address field indicates the address of the SME that was the destination of the previously submitted mobile originated short message being subject to the status report. The field is formatted according to the formatting rules of address fields.

9.2.3.15 TP-Status (TP-ST)

The TP-Status field indicates the status of a previously submitted SMS-SUBMIT and certain SMS COMMANDS for which a Status -Report has been requested. It consists of one octet and the bits in the octet are used as follows.

The MS shall interpret any reserved values as "Service Rejected" (01100011) but shall store them exactly as received.

bits	value/usage
7	0 Bits 0..6 as defined below:
6....0	Indicate whether the previously submitted short message was successfully forwarded to the SME, or whether an error condition has been encountered, as follows:
	Short message transaction completed
0000000	Short message received by the SME
0000001	Short message forwarded by the SC to the SME but the SC is unable to confirm delivery
0000010	Short message replaced by the SC
0000011..0001111	Reserved
0010000..0011111	Values specific to each SC

Temporary error, SC still trying to transfer SM

0100000	Congestion
0100001	SME busy
0100010	No response from SME
0100011	Service rejected
0100100	Quality of service not available
0100101	Error in SME
0100110..0101111	Reserved
0110000..0111111	Values specific to each SC

Permanent error, SC is not making any more transfer attempts

1000000	Remote procedure error
1000001	Incompatible destination
1000010	Connection rejected by SME
1000011	Not obtainable
1000100	Quality of service not available
1000101	No interworking available
1000110	SM Validity Period Expired
1000111	SM Deleted by originating SME
1001000	SM Deleted by SC Administration
1001001	SM does not exist (The SM may have previously existed in the SC but the SC no longer has knowledge of it or the SM may never have previously existed in the SC)
1001010..1001111	Reserved
1010000..1011111	Values specific to each SC

Temporary error, SC is not making any more transfer attempts

1100000	Congestion
1100001	SME busy
1100010	No response from SME
1100011	Service rejected
1100100	Quality of service not available
1100101	Error in SME
1100110..1101001	Reserved
1101010..1101111	Reserved
1110000..1111111	Values specific to each SC

bits	value/usage
7	1 Bits 0..6 reserved

9.2.3.16 TP-User-Data-Length (TP-UDL)

If the TP-User-Data is coded using the GSM 7 bit default alphabet, the TP-User-Data-Length field gives an integer representation of the number of septets within the TP-User-Data field to follow. If the 7bit default-alphabet extension mechanism is used within the TP-User-Data (see 3GPP TS 23.038 [9]), the actual number of characters in the message shall be less than the number of septets. If a TP-User-Data-Header field is present, then the TP-User-Data-Length value is the sum of the number of septets in the TP-User-Data-Header field (including any padding) and the number of septets in the TP-User-Data field which follows. See figure 9.2.3.24 (a). If the TP-User-Data is coded using 8-bit data, the TP-User-Data-Length field gives an integer representation of the number of octets within the TP-User-Data field to follow. If a TP-User-Data-Header field is present, then the TP-User-Data-Length value is the sum of the number of octets in the TP-User-Data-Header field and the number of octets in the TP-User-Data field which follows. See figure 9.2.3.24 (b).

If the TP-User-Data is coded using UCS2 [24] data, the TP-User-Data-Length field gives an integer representation of the number of octets within the TP-User-Data field to follow. If a TP-User-Data-Header field is present, then the TP-User-Data-Length value is the sum of the number of octets in the TP-User-Data-Header field and the number of octets in the TP-User-Data field which follows. See figure 9.2.3.24 (b).

If the TP-User-Data is coded using compressed GSM 7 bit default alphabet or compressed 8 bit data or compressed UCS2 [24] data, the TP-User-Data-Length field gives an integer representation of the number of octets after compression within the TP-User-Data field to follow. If a TP-User-Data-Header field is present, then the TP-User-Data-Length value is the sum of the number of uncompressed octets in the TP-User-Data-Header field and the number of octets in the compressed TP-User-Data field which follows. See figure 9.2.3.24 (c).

For other Data Coding Schemes, see 3GPP TS 23.038 [9]. If this field is zero, the TP-User-Data field shall not be present.

9.2.3.17 TP-Reply-Path (TP-RP)

The TP-Reply-Path is a 1-bit field, located within bit no 7 of the first octet of both SMS-DELIVER and SMS-SUBMIT, and to be given the following values:

Bit no 7:	0	TP-Reply-Path parameter is not set in this SMS-SUBMIT/DELIVER
	1	TP-Reply-Path parameter is set in this SMS-SUBMIT/DELIVER

Please refer to annex D for details about the Reply procedures.

9.2.3.18 TP-Message-Number (TP-MN)

The TP-Message-Number is an 8-bit field allowing an MS to refer uniquely to an SM in the SC which that MS has previously submitted. The TP-MN value is the TP-MR value of a previously submitted SM.

9.2.3.19 TP-Command-Type (TP-CT)

The TP-Command-Type is an 8-bit field specifying the type of operation that the SC is to perform. It has the following values:

Value (bit 7 .. 0)	Command Description	Status Report Request Value
00000000	Enquiry relating to previously submitted short message	1
00000001	Cancel Status Report Request relating to previously submitted short message	0
00000010	Delete previously submitted Short Message	0
00000011	Enable Status Report Request relating to previously submitted short message	0
0000100..00011111	Reserved	unspecified
11100000..11111111	Values specific for each SC	1 or 0

The SC shall return an RP-Error with an appropriate TP-Failure-Cause for any TP-Command value which is reserved, unsupported or invalid or the actioning of the command has failed.

The SC shall return an RP-ACK if the actioning of the Command has succeeded.

A successful Enquiry shall result in the SC sending a SMS-STATUS-REPORT for the SM to which the Enquiry refers. In the case where the SC has a number of SMs which have the same TP-MR, the same TP-DA and have come from the same originating address the SC shall send a SMS-STATUS-REPORT for each SM.

In the case where a TP-Command is to Delete a previously submitted short message, the SC shall send a Status Report indicating that the SM has been deleted if the original Submit SM request requested a status Report.

9.2.3.20 TP-Command-Data-Length (TP-CDL)

The TP-Command-Data-Length field is used to indicate the number of octets contained within the TP-Command-Data-field. If this field is set to zero, the TP-Command-Data field shall not be present.

9.2.3.21 TP-Command-Data (TP-CD)

The TP-Command-Data field contains data relating to the operation requested by the MS which is to be performed at the SC. The maximum length of this field is 157 octets. The usage and provision of the optional TP-Command-Data field shall be determined by the function selected by the TP-Command-Type field.

9.2.3.22 TP-Failure-Cause (TP-FCS)

The TP-Failure-Cause field is used to report the reason for failure to transfer or process a short message. It consists of a single octet used as follows:

TP-FCS Value (Hex)	Meaning	When used	
		MO	MT
00 - 7F	Reserved		
80 - 8F	TP-PID errors		
80	Telematic interworking not supported	x	
81	Short message Type 0 not supported	x	x
82	Cannot replace short message	x	x
83 - 8E	Reserved		
8F	Unspecified TP-PID error	x	x
90 - 9F	TP-DCS errors		
90	Data coding scheme (alphabet) not supported	x	
91	Message class not supported		x
92 - 9E	Reserved		
9F	Unspecified TP-DCS error	x	x
A0 - AF	TP-Command Errors		
A0	Command cannot be actioned	x	
A1	Command unsupported	x	
A2 - AE	Reserved		
AF	Unspecified TP-Command error	x	
B0	TPDU not supported	x	x
B1 - BF	Reserved		
C0	SC busy	x	
C1	No SC subscription	x	
C2	SC system failure	x	
C3	Invalid SME address	x	
C4	Destination SME barred	x	
C5	SM Rejected-Duplicate SM	x	
C6	TP-VPF not supported	x	
C7	TP-VP not supported	x	
C8 - CF	Reserved		
D0	(U)SIM SMS storage full		x
D1	No SMS storage capability in (U)SIM		x
D2	Error in MS		x
D3	Memory Capacity Exceeded		x
D4	(U)SIM Application Toolkit Busy		x
D5	(U)SIM data download error		x
D6 - DF	Reserved		
E0 - FE	Values specific to an application	x	x
FF	Unspecified error cause	x	x

NOTE: Any reserved codes which are received should be treated as an unspecified error cause. MT and MO refer to the overall mobile terminated and mobile originated services; not the direction of transmission of TP-FCS.

9.2.3.23 TP-User-Data-Header-Indicator (TP-UDHI)

The TP-User-Data-Header-Indicator is a 1 bit field within bit 6 of the first octet of the following six PDUs:

- SMS-SUBMIT,
- SMS-SUBMIT-REPORT,
- SMS-DELIVER,
- SMS-DELIVER-REPORT,
- SMS-STATUS-REPORT,
- SMS-COMMAND.

TP-UDHI has the following values.

- | | | |
|-----------|---|--|
| Bit no. 6 | 0 | The TP-UD field contains only the short message |
| | 1 | The beginning of the TP-UD field contains a Header in addition to the short message. |

9.2.3.24 TP-User Data (TP-UD)

The length of the TP-User-Data field is defined in the PDU's of the SM-TL (see clause 9.2.2).

The TP-User-Data field may comprise just the short message itself or a Header in addition to the short message depending upon the setting of TP-UDHI.

Where the TP-UDHI value is set to 0 the TP-User-Data field comprises the short message only, where the user data can be 7 bit (default alphabet) data, 8 bit data, or 16 bit (UCS2 [24]) data.

Where the TP-UDHI value is set to 1 the first octets of the TP-User-Data field contains a Header in the following order starting at the first octet of the TP-User-Data field.

Irrespective of whether any part of the User Data Header is ignored or discarded, the MS shall always store the entire TPDU exactly as received.

FIELD	LENGTH
Length of User Data Header	1 octet
Information-Element-Identifier "A"	1 octet
Length of Information-Element "A"	1 octet
Information-Element "A" Data	0 to "n" octets
Information-Element-Identifier "B"	1 octet
Length of Information-Element "B"	1 octet
Information-Element "B" Data	0 to "n" octets
Information-Element-Identifier "X"	1 octet
Length of Information-Element "X"	1 octet
Information-Element "X" Data	0 to "n" octets

The diagram below shows the layout of the TP-User-Data-Length and the TP-User-Data for uncompressed GSM 7 bit default alphabet data. The UDHL field is the first octet of the TP-User-Data content of the Short Message.

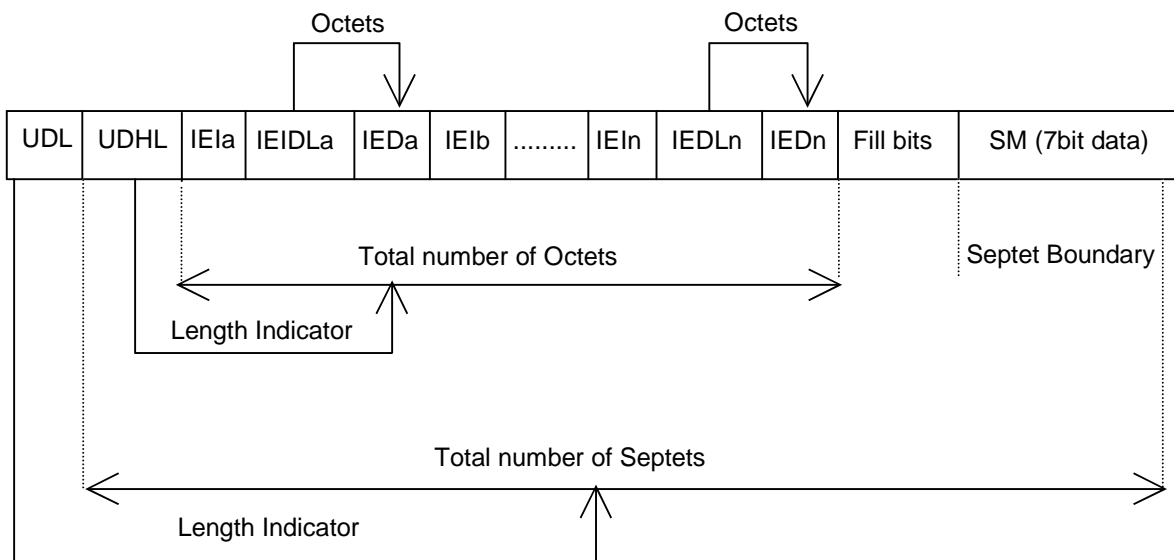

Figure 9.2.3.24 (a)

The diagram below shows the layout of the TP-User-Data-Length and the TP-User-Data for uncompressed 8 bit data or uncompressed UCS2 data. The UDHL field is the first octet of the TP-User-Data content of the Short Message.

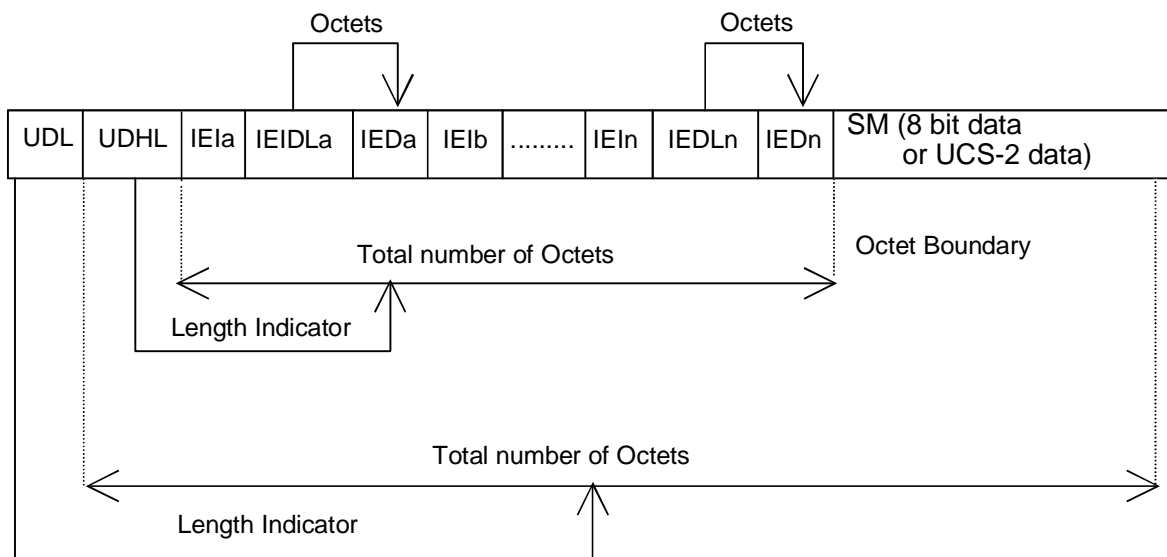

Figure 9.2.3.24 (b)

The diagram below shows the layout of the TP-User-Data-Length and the TP-User-Data for compressed GSM 7 bit default alphabet data, compressed 8 bit data or compressed UCS2 data. The UDHL field is the first octet of the TP-User-Data content of the Short Message.

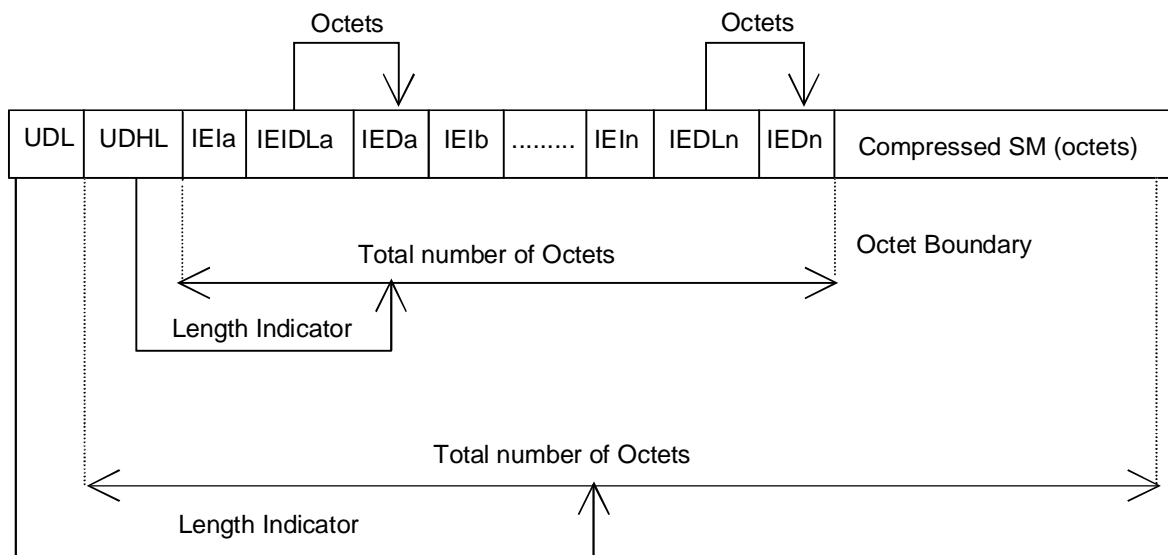

Figure 9.2.3.24 (c)

The definition of the TP-User-Data-Length field which immediately precedes the "Length of User Data Header" is unchanged and shall therefore be the total length of the TP-User-Data field including the Header, if present. (see 9.2.3.16).

The "Length-of-Information-Element" fields shall be the integer representation of the number of octets within its associated "Information-Element-Data" field which follows and shall not include itself in its count value.

The "Length-of-User-Data-Header" field shall be the integer representation of the number of octets within the "User-Data-Header" information fields which follow and shall not include itself in its count or any fill bits which may be present (see text below).

Information Elements may appear in any order and need not follow the order used in the present document. Information Elements are classified into 3 categories as described below.

- SMS Control – identifies those IEIs which have the capability of dictating SMS functionality.
- EMS Control – identifies those IEIs which manage EMS Content IEIs.
- EMS Content – identifies those IEIs containing data of a unique media format.

It is permissible for certain IEs to be repeated within a short message, or within a concatenated message. There is no restriction on the repeatability of IEs in the EMS Content classification. The repeatability of SMS Control and EMS Control IEs is determined on an individual basis. See the IE table below for the repeatability of each IE.

In the event that IEs determined as not repeatable are duplicated, the last occurrence of the IE shall be used. In the event that two or more IEs occur which have mutually exclusive meanings (e.g. an 8bit port address and a 16bit port address), then the last occurring IE shall be used.

If the length of the User Data Header is such that there are too few or too many octets in the final Information Element then the whole User Data Header shall be ignored.

If any reserved values are received within the content of any Information Element then that part of the Information Element shall be ignored.

The support of any Information Element Identifier is optional unless otherwise stated.

The Information Element Identifier octet shall be coded as follows:

VALUE (hex)	MEANING	Classification	Repeatability
00	Concatenated short messages, 8-bit reference number	SMS Control	No
01	Special SMS Message Indication	SMS Control	Yes
02	Reserved	N/A	N/A
03	Value not used to avoid misinterpretation as <LF> character	N/A	N/A
04	Application port addressing scheme, 8 bit address	SMS Control	No
05	Application port addressing scheme, 16 bit address	SMS Control	No
06	SMSC Control Parameters	SMS Control	No
07	UDH Source Indicator	SMS Control	Yes
08	Concatenated short message, 16-bit reference number	SMS Control	No
09	Wireless Control Message Protocol	SMS Control	Note 3
0A	Text Formatting	EMS Control	Yes
0B	Predefined Sound	EMS Content	Yes
0C	User Defined Sound (iMelody max 128 bytes)	EMS Content	Yes
0D	Predefined Animation	EMS Content	Yes
0E	Large Animation (16*16 times 4 = 32*4 =128 bytes)	EMS Content	Yes
0F	Small Animation (8*8 times 4 = 8*4 =32 bytes)	EMS Content	Yes
10	Large Picture (32*32 = 128 bytes)	EMS Content	Yes
11	Small Picture (16*16 = 32 bytes)	EMS Content	Yes
12	Variable Picture	EMS Content	Yes
13	User prompt indicator	EMS Control	Yes
14	Extended Object	EMS Content	Yes
15	Reused Extended Object	EMS Control	Yes
16	Compression Control	EMS Control	No
17	Object Distribution Indicator	EMS Control	Yes
18	Standard WVG object	EMS Content	Yes
19	Character Size WVG object	EMS Content	Yes
1A	Extended Object Data Request Command	EMS Control	No
1B-1F	Reserved for future EMS features (see subclause 3.10)	N/A	N/A
20	RFC 822 E-Mail Header	SMS Control	No
21	Hyperlink format element	SMS Control	Yes
22	Reply Address Element	SMS Control	No
23	Enhanced Voice Mail Information	SMS Control	No
24	National Language Single Shift	SMS Control	No
25	National Language Locking Shift	SMS Control	No
26 – 6F	Reserved for future use	N/A	N/A
70 – 7F	(U)SIM Toolkit Security Headers	SMS Control	Note 1
80 – 9F	SME to SME specific use	SMS Control	Note 2
A0 – BF	Reserved for future use	N/A	N/A
C0 – DF	SC specific use	SMS Control	Note 2
E0 – FF	Reserved for future use	N/A	N/A
Note 1:	The functionality of these IEIs is defined in 3GPP TSG 31.115 [28], and therefore, the repeatability is not within the scope of this document and will not be determined here.		
Note 2:	The functionality of these IEIs is used in a proprietary fashion by different SMSC vendors, and therefore, are not within the scope of this technical specification.		
Note 3:	The functionality of these IEIs is defined by the WAP Forum and therefore the repeatability is not within the scope of this document and will not be determined here.		

A receiving entity shall ignore (i.e. skip over and commence processing at the next information element) any information element where the IEI is Reserved or not supported. The receiving entity calculates the start of the next information element by looking at the length of the current information element and skipping that number of octets.

The SM itself may be coded as 7, 8 or 16 bit data.

If 7 bit data is used and the TP-UD-Header does not finish on a septet boundary then fill bits are inserted after the last Information Element Data octet up to the next septet boundary so that there is an integral number of septets for the entire TP-UD header. This is to ensure that the SM itself starts on an septet boundary so that an earlier Phase mobile shall be capable of displaying the SM itself although the TP-UD Header in the TP-UD field may not be understood.

It is optional to make the first character of the SM itself a Carriage Return character encoded according to the default 7 bit alphabet so that earlier Phase mobiles, which do not understand the TP-UD-Header, shall over-write the displayed TP-UD-Header with the SM itself.

If 16 bit (USC2) data is used then padding octets are not necessary. The SM itself shall start on an octet boundary.

If 8 bit data is used then padding is not necessary. An earlier Phase mobile shall be able to display the SM itself although the TP-UD header may not be understood.

It is also possible for mobiles not wishing to support the TP-UD header to check the value of the TP-UDHI bit in the SMS-Deliver PDU and the first octet of the TP-UD field and skip to the start of the SM and ignore the TP-UD header.

9.2.3.24.1 Concatenated Short Messages

This facility allows short messages to be concatenated to form a longer message.

In the case of uncompressed 8-bit data, the maximum length of the short message within the TP-UD field is 134 (140-6) octets.

In the case of uncompressed GSM 7 bit default alphabet data, the maximum length of the short message within the TP-UD field is 153 (160-7) characters. A character represented by an escape-sequence shall not be split in the middle.

In the case of 16 bit uncompressed USC2 data, the maximum length of the short message within the TP-UD field is 67 ((140-6)/2) characters. A UCS2 character shall not be split in the middle; if the length of the User Data Header is odd, the maximum length of the whole TP-UD field is 139 octets.

In the case of compressed GSM 7 bit default alphabet data, 8 bit data or UCS2 the maximum length of the compressed short message within the TP-UD field is 134 (140-6) octets including the Compression Header and Compression Footer, both or either of which may be present (see clause 3.9).

The maximum length of an uncompressed concatenated short message is 39015 (255*153) default alphabet characters, 34170 (255*134) octets or 17085 (255*67) UCS2 characters.

The maximum length of a compressed concatenated message is 34170 (255*134) octets including the Compression Header and Compression Footer (see clause 3.9 and figure 9.2.3.24.1(a) below).

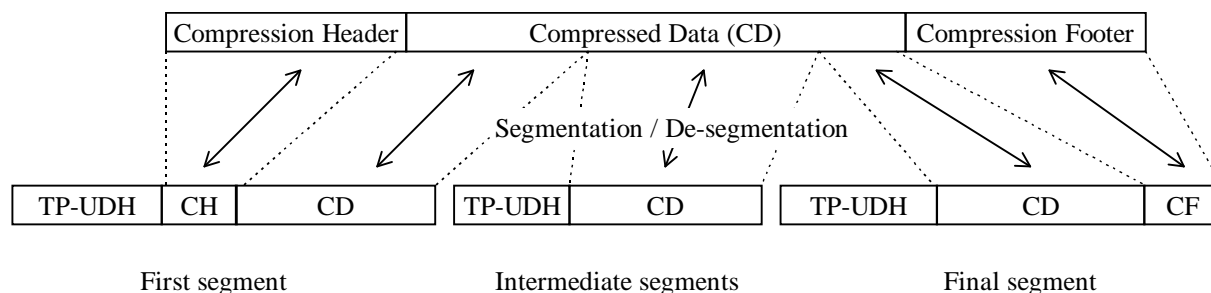

Figure 9.2.3.24.1 (a): Concatenation of a Compressed short message

The Information-Element-Data field contains information set by the application in the SMS-SUBMIT so that the receiving entity is able to re-assemble the short messages in the correct order. Each concatenated short message contains a reference number which together with the originating address and Service Centre address allows the receiving entity to discriminate between concatenated short messages sent from different originating SMEs and/or SCs. In a network which has multiple SCs, it is possible for different segments of a concatenated SM to be sent via different SCs and so it is recommended that the SC address should not be checked by the MS unless the application specifically requires such a check.

The TP elements in the SMS-SUBMIT PDU, apart from TP-MR, TP-SRR, TP-UDL and TP-UD, should remain unchanged for each SM which forms part of a concatenated SM, otherwise this may lead to irrational behaviour. TP-MR must be incremented for every segment of a concatenated message as defined in clause 9.2.3.6. A SC shall handle segments of a concatenated message like any other short message. The relation between segments of a concatenated message is made only at the originator, where the message is segmented, and at the recipient, where the message is reassembled. SMS-COMMANDs identify messages by TP-MR and therefore apply to only one segment of a

concatenated message. It is up to the originating SME to issue SMS-COMMANDs for all the required segments of a concatenated message.

The Information-Element-Data octets shall be coded as follows.

Octet 1 Concatenated short message reference number.

This octet shall contain a modulo 256 counter indicating the reference number for a particular concatenated short message. This reference number shall remain constant for every short message which makes up a particular concatenated short message.

Octet 2 Maximum number of short messages in the concatenated short message.

This octet shall contain a value in the range 0 to 255 indicating the total number of short messages within the concatenated short message. The value shall start at 1 and remain constant for every short message which makes up the concatenated short message. If the value is zero then the receiving entity shall ignore the whole Information Element.

Octet 3 Sequence number of the current short message.

This octet shall contain a value in the range 0 to 255 indicating the sequence number of a particular short message within the concatenated short message. The value shall start at 1 and increment by one for every short message sent within the concatenated short message. If the value is zero or the value is greater than the value in octet 2 then the receiving entity shall ignore the whole Information Element.

The IEI and associated IEI length and IEI data shall be present in every segment of the concatenated SM.

9.2.3.24.2 Special SMS Message Indication

There are three levels of "Message Waiting" indication provided within the present document. The first level is to set the Protocol Identifier to "Return Call message", which indicates that a message is waiting and relies on the text of the message to supply the detail. The second level uses the Data Coding Scheme with or without Return Call Message (see 3GPP TS 23.038 [9]) to indicate the type of message waiting and whether there are some messages or no messages. The third level is described here, and provides the maximum detail level for analysis by the mobile, i.e. an indication of the number and type of messages waiting in systems connected to the PLMN.

This information shall be stored by the ME in the Message Waiting Indication Status on the SIM (see 3GPP TS 51.011 [16]) or USIM (see 3GPP TS 31.102 [30]) when present or otherwise should be stored in the ME. In case there are multiple records of EF_{MWIS} this information shall be stored within the record according to the profile if available – or otherwise within the first record.

The number of messages shall be stored in Message Waiting Indication Status and an indicator should be shown if the number of messages is non-zero or removed if the number of messages is zero. The ME may also provide some MMI to indicate and access the actual number of messages waiting. Text may be included by the SMS Service Centre for backward compatibility with the earliest Phase mobiles and the Data Coding Scheme may also be used to convey this information in parallel for backward compatibility with "middle" Phase mobiles (which support the use of Data Coding Scheme for Message Waiting Indication but not the use of TP-UDH for Message Waiting Indication).

The information-Element octets shall be coded as follows:

Octet 1 Message Indication type and Storage.

Bit 7 Indicates whether or not the message shall be stored.

Bit 7

0 Discard message after updating indication

1 Store message after updating indication

In the event of a conflict between this setting and the setting of the Data Coding Scheme (see 3GPP TS 23.038 [9]) then the message shall be stored if either the DCS indicates this, or Octet 1 above indicates this.

Bits 0 and 1 indicate the basic message indication type.

00	Voice Message Waiting
01	Fax Message Waiting
10	Electronic Mail Message Waiting
11	Extended Message Type Waiting (equivalent to "other" in 3GPP TS 23.038 [9])

Bits 432 indicate the extended message indication type.

000	No extended message indication type.
001	Video Message Waiting

Other values of bits 432 where bits 0 and 1 are '11' are Reserved for future use in the present document.

Values of bits 432 where bits 0 and 1 are '00', '01' or '10' are Reserved for future use in the present document.

NOTE: Values using bits 432 where bits 0 and 1 are '11' should be exhausted before using the remaining codespace due to existing early implementations erroneously using parts of this codespace.

Bits 6 and 5 indicate the profile ID of the Multiple Subscriber Profile (see 3GPP TS 23.097 [41]).

00	profile ID 1
01	profile ID 2
10	profile ID 3
11	profile ID 4

Terminals should be capable of receiving any values in octet 1, including those marked as Reserved. Terminals may add the Message Count of all unknown Message Waiting Indication types received within the same TP-UDH and indicate this result to the user.

Octet 2 Message Count.

This octet shall contain a value in the range 0 to 255 indicating the number of messages of the type specified in Octet 1 waiting. The value 255 shall be taken to mean 255 or greater. In the event of a conflict between this setting and the setting of the Data Coding Scheme (see 3GPP TS 23.038 [9]) then the Message Count in the TP-UDH shall override the indication in the TP-DCS.

If more than one type of message is required to be indicated within one SMS message, then further octets must be used, as in the following example:

- [00] TP-UDL [1E] (30 decimal septets)
- [01] Length of TP-UDH [08]
- [02] IEI = Special SMS Message Indication [01]
- [03] Length = 02
- [04] Octet 1 = Voice Mail, do not store [00]
- [05] Octet 2 = 04 Messages
- [06] IEI = Special SMS Message Indication [01]
- [07] Length = 02
- [08] Octet 1 = Fax Mail, Store [81]
- [09] Octet 2 = 02 Messages
- + 5 Fill bits
- + 19 seven-bit character message text

The Total number of bits is 210.

In the case where this IEI is to be used in a concatenated SM then the IEI, its associated IEI length and IEI data shall be contained in the first segment of the concatenated SM. The IEI, its associated IEI length and IEI data should also be contained in every subsequent segment of the concatenated SM although this is not mandatory. However, in the case

where these elements are not contained in every subsequent segment of the concatenated SM and where an out of sequence segment delivery occurs or where the first segment is not delivered then processing difficulties may arise at the receiving entity which may result in the concatenated SM being totally or partially discarded.

9.2.3.24.3 Application Port Addressing 8 bit address

This facility allows short messages to be routed to one of multiple applications, using a method similar to TCP/UDP ports in a TCP/IP network. An application entity is uniquely identified by the pair of TP-DA/TP-OA and the port address. The port addressing is transparent to the transport, and also useful in Status Reports.

The total length of the IE is 2 octets:

octet 1 Destination port.

This octet contains a number indicating the receiving port, i.e. application, in the receiving device.

octet 2 Originator port.

This octet contains a number indicating the sending port, i.e. application, in the sending device.

The port range is up to 255 using 8 bit addressing space. The Integer value of the port number is presented as in 3GPP TS 23.040 clause 9.1.2.1.

VALUE (port number)	MEANING
0 - 239	Reserved
240 - 255	Available for allocation by applications

A receiving entity shall ignore (i.e. skip over and commence processing at the next information element) any information element where the value of the Information-Element-Data is Reserved or not supported.

In the case where this IE is to be used in a concatenated SM then the IEI, its associated IEI length and IEI data shall be contained in the first segment of the concatenated SM. The IEI, its associated IEI length and IEI data shall also be contained in every subsequent segment of the concatenated SM.

9.2.3.24.4 Application Port Addressing 16 bit address

This facility allows short messages to be routed to one of multiple applications, using a method similar to TCP/UDP ports in a TCP/IP network. An application entity is uniquely identified by the pair of TP-DA/TP-OA and the port address. The port addressing is transparent to the transport, and also useful in Status Reports.

The total length of the IE is 4 octets:

octet 1,2 Destination port.

These octets contain a number indicating the receiving port, i.e. application, in the receiving device.

octet 3,4 Originator port.

These octets contain a number indicating the sending port, i.e. application, in the sending device.

The port range is up to 65535 using 16 bit addressing space. The Integer value of the port number is presented as in 3GPP TS 23.040 clause 9.1.2.1.

VALUE (port number)	MEANING
0 - 15999	UDP/TCP port numbers assigned by IANA without the need to refer to 3GPP. For the procedure, use and assignment of port numbers in this range – refer to the IANA database. (http://www.IANA.com/). See Note 1.
16000 - 16999	Available for allocation by SMS applications without the need to refer to 3GPP or IANA. See Note 2.
17000 - 49151	UDP/TCP port numbers assigned by IANA. For the procedure, use and assignment of port numbers in this range – refer to the IANA database. (http://www.IANA.com/). See Note 1.

49152 – 65535 Reserved for future allocation by 3GPP. For a port number in this range an application must be made to 3GPP.

NOTE 1: The value used for this field by a particular application is the same value that the application would use when using a UDP or a TCP transport. Therefore, applications that register a UDP or TCP port with the IANA need to use the same registered value for this field. UDP and TCP ports are registered separately. Therefore, it is necessary to check the application since the fact that a particular TCP port is registered (e.g., for HTTP) does not mean that its corresponding UDP port will be also registered for the same application.

NOTE 2: There is a risk of port numbers in this range having conflicting applications. If it is desirable to avoid such a conflict then an application for a port number in the range 49152 – 65535 is to be made to 3GPP.

A receiving entity shall ignore (i.e. skip over and commence processing at the next information element) any information element where the value of the Information-Element-Data is Reserved or not supported.

In the case where this IE is to be used in a concatenated SM then the IEI, its associated IEI length and IEI data shall be contained in the first segment of the concatenated SM. The IEI, its associated IEI length and IEI data shall also be contained in every subsequent segment of the concatenated SM.

9.2.3.24.5 SMSC Control Parameters

The facility enables the SMS protocol headers to be expanded using a flexible method. It may be used to control the SMSC, but is also passed transparently to the receiving mobile. The Information Element must be present in every short message affected by it, i.e. in every short message in a concatenated message.

The Information Element data octets shall be coded as follows:

octet 1 Selective Status Report.

This facility is used to control the creation of Status Reports, depending on the error code of the particular message. It is also used by the sending entity to request inclusion of the original UDH into the Status Report. In this case the original UDH must be separated from the rest of the UDH using the Source Indicator. The TP-SRR must be set in order for the Selective Status Report to be enabled. The bits are defined as follows:

bit 0

- 0 No Status Report for short message transaction completed
- 1 Status Report for short message transaction completed

bit 1

- 0 No Status Report for permanent error when SC is not making any more transfer attempts
- 1 Status Report for permanent error when SC is not making any more transfer attempts

bit 2

- 0 No Status Report for temporary error when SC is not making any more transfer attempts
- 1 Status Report for temporary error when SC is not making any more transfer attempts

bit 3

- 0 No Status Report for temporary error when SC is still trying to transfer SM
- 1 Status Report for temporary error when SC is still trying to transfer SM

bits 4 and 5

reserved for future use.

bit 6

0 No activation

1 A Status Report generated by this Short Message, due to a permanent error or last temporary error, cancels the SRR of the rest of the Short Messages in a concatenated message. This feature can only be used where a SC is aware of the segmentation of a concatenated SM and is therefore an implementation matter.

bit 7

0 Do not include original UDH into the Status Report

1 Include original UDH into the Status Report

9.2.3.24.6 UDH Source Indicator

The facility is used to separate the UDH of the original message, a UDH created by the SMSC, and a UDH provided by the original receiving entity. The Source Indicator is placed in front of the content inserted by the source. The indicated content (one or more Information-Elements) ends at the next UDH-Source-Indicator, or at the end of the UDH. The Separator is intended to be used especially in Status Reports, but can also be used by the SMSC to add information into Short Message (for example Message waiting). The default content for a UDH in a SMS-DELIVERY is the headers inserted by the sending device, and the default content for a UDH in a SMS-STATUS-REPORT is the headers copied from the SMS-DELIVERY-REPORT.

Values of octet:

01 The following part of the UDH is created by the original sender (valid in case of Status Report)

02 The following part of the UDH is created by the original receiver (valid in case of Status Report)

03 The following part of the UDH is created by the SMSC (can occur in any message or report)

In the case where this IEI is to be used in a concatenated SM then the IEI, its associated IEI length and IEI data shall be contained in the first segment of the concatenated SM. The IEI, its associated IEI length and IEI data should also be contained in every subsequent segment of the concatenated SM although this is not mandatory. However, in the case where these elements are not contained in every subsequent segment of the concatenated SM and where an out of sequence segment delivery occurs or where the first segment is not delivered then processing difficulties may arise at the receiving entity which may result in the concatenated SM being totally or partially discarded.

9.2.3.24.7 (U)SIM Toolkit Security Headers

There are no IEI data values associated with these IEI values and so the associated Length of Information element field is present but set to zero.

These IEI values implicitly define that a Security Header is always present at the start of the TP-User-Data field which immediately follows the TP-User-Data-Header. Details of the Security Header will be found in TS 31.115 [28].

In the case where a concatenated message contains a Security Header then the Security Header will only be present in the first segment of a concatenated message.

In the case where SMS compression is applied to a TP-User-Data field which contains a Security Header then the SMS compression header (3GPP TS 23.042 [26]) shall immediately precede the Security Header.

9.2.3.24.8 Concatenated short messages, 16-bit reference number

This facility is an enhanced variant of the Concatenated Short Message facility (see clause 9.2.3.24.1). The enhancement is a 16-bit reference number, instead of the short 8-bit reference number. The larger reference number reduces the probability that two different concatenated messages are mistakenly sent with identical reference numbers to a receiver. Except for the size of the reference number this facility is identical to the Concatenated Short Message facility (see clause 9.2.3.24.1).

In the case of uncompressed 8-bit data, the maximum length of the short message within the TP-UD field is 133 (140-7) octets.

In the case of uncompressed GSM 7 bit default alphabet data, the maximum length of the short message within the TP-UD field is 152 (160-8) characters. A character represented by an escape-sequence shall not be split in the middle.

In the case of 16 bit uncompressed USC2 data, the maximum length of the short message within the TP-UD field is 66 ((140-7)/2) characters. A UCS2 character shall not be split in the middle; if the length of the User Data Header is odd, the maximum length of the whole TP-UD field is 139 octets.

In the case of compressed GSM 7 bit default alphabet data, 8 bit data or UCS2 the maximum length of the compressed short message within the TP-UD field is 133 (140-7) octets including the Compression Header and Compression Footer, both or either of which may be present (see clause 3.9).

The relation between compression and concatenation is the same as for Concatenated Short Messages (see clause 9.2.3.24.1).

The Information-Element-Data field contains information set by the application in the SMS-SUBMIT so that the receiving entity is able to re-assemble the short messages in the correct order. Each concatenated short message contains a reference number which together with the originating address and Service Centre address allows the receiving entity to discriminate between concatenated short messages sent from different originating SMEs and/or SCs. In a network which has multiple SCs, it is possible for different segments of a concatenated SM to be sent via different SCs and so it is recommended that the SC address should not be checked by the MS unless the application specifically requires such a check.

The TP elements in the SMS-SUBMIT PDU, apart from TP-MR, TP-UDL and TP-UD, should remain unchanged for each SM which forms part of a concatenated SM, otherwise this may lead to irrational behaviour. TP-MR must be incremented for every segment of a concatenated message as defined in clause 9.2.3.6. A SC shall handle segments of concatenated message like any other short message. The relation between segments of a concatenated message is made at the originator, where the message is segmented, and at the recipient, where the message is reassembled. SMS-COMMANDs identify messages by TP-MR and therefore apply to only one segment of a concatenated message. It is up to the originating SME to issue SMS-COMMANDs for all the required segments of a concatenated message.

The Information-Element-Data octets shall be coded as follows:

Octet 1-2 Concatenated short messages, 16-bit reference number.

This octet shall contain a modulo 65536 counter indicating the reference number for a particular enhanced concatenated short message. This reference number shall remain constant for every short message which makes up a particular enhanced concatenated short message.

Octet 3 Maximum number of short messages in the enhanced concatenated short message.

This octet shall contain a value in the range 0 to 255 indicating the total number of short messages within the concatenated short message. The value shall start at 1 and remain constant for every short message which makes up the enhanced concatenated short message. If the value is zero then the receiving entity shall ignore the whole Information Element.

Octet 4 Sequence number of the current short message.

This octet shall contain a value in the range 0 to 255 indicating the sequence number of a particular short message within the concatenated short message. The value shall start at 1 and increment by one for every short message sent within the concatenated short message. If the value is zero or the value is greater than the value in octet 3 then the receiving entity shall ignore the whole Information Element.

The IEI and associated IEI length and IEI data shall be present in every segment of the concatenated SM.

9.2.3.24.9 Wireless Control Message Protocol

The Wireless Control Message Protocol (WCMP) is part of the WAP suite of protocols; an open standard specified by the WAP Forum Ltd.

The protocol specifies a set of messages that can be used by the receiver to notify the sender if an error occurs. This can be due to routing problems, no application listening at the destination port number, or due to insufficient buffer capacity. The error messages can be used by the sender to avoid retransmitting packets, that can not be properly handled

at the receiver. WCMP can also be used for diagnostics and informational purposes. WCMP messages are usually generated by a datagram transport layer or a management entity.

The Information-Element-Data octet(s) shall be coded as follows:

Octet 1-n Protocol Data Unit of WCMP.

This octet(s) shall contain a WCMP protocol data unit.

In the case where this IE is to be used in a concatenated SM then the IEI, its associated IEI length and IEI data shall be contained in the first segment of the concatenated SM. The IEI, its associated IEI length and IEI data shall also be contained in every subsequent segment of the concatenated SM.

9.2.3.24.10 Enhanced Messaging Service

9.2.3.24.10.1 EMS Coding

Enhanced Messaging is based on standard mechanism in GSM SMS messaging. The first mechanism is called **user data header** (TP-UDH), which makes it possible to include binary data in a normal SM prior the text message itself (clause 9.2.3.24). The binary data is in the TP-UD field (message), which means that it steals a part of the 140 bytes. Each object within the SM shall be identified by a IE in the TP-UD Header. The IE will contain a **octet** (refer to clause 9.2.3.24.10.1) that identifies the absolute position of the object within and from the beginning of the SM data. In case of formatting text, an additional octet will give the number of characters for which the formatting applies. Next mechanism that is used is **concatenation**, see clause 9.2.3.24.1. This mechanism permits longer messages than 140 bytes, in fact 255 messages a 140 bytes each can be concatenated to one message up to about 38k bytes.

EMS IEs of the same type may occur more than once in a single message or one segment of a concatenated SM.

9.2.3.24.10.1.1 Text Formatting

The Information-Element-Data octet(s) shall be coded as follows:

Octet 1 Start position of the text formatting. Set to the number of characters after the formatting shall be applied from the beginning of the SM data.

This octet shall be coded as an integer value in the range 0 (beginning of the SM data) to the maximum number of characters included in the SM data of one single SM or one segment of a concatenated SM.

Octet 2 Text formatting length. Gives the number of formatted characters or sets a default text formatting.

This octet shall be coded as an integer value in the range 1 to the maximum number of characters for which the formatting applies in one single SM or one segment of a concatenated SM.

A text formatting length value of 0 indicates that the text format shall be used as a default text format for the current SM. The default text format shall be used for all text in a concatenated SM unless temporarily overridden by a text formatting IE with a non-zero text format length field.

It shall be possible to re-define the default text formatting to be applied to all subsequent text in the current SM by sending a new Text Format IE with text format length zero.

Conflicting overlapping text formatting instructions shall be resolved by applying the formatting instructions in their sequential order.

Octet 3 formatting mode value coded as following:

Octet 3: Bit 7 Bit 6 Bit 5 Bit 4 Bit 3 Bit 2 Bit 1 Bit 0

Bit 1	Bit 0	*Alignment
0	0	Left
0	1	Center
1	0	Right
1	1	Language dependent (default)

*in case formatting text is inserted on the same line as previous non formatting text or with a different mode value, the alignment value shall be set to the same value as the previous formatted predefined object.

Alignment may affect object placement.

Bit 3	Bit 2	Font Size
0	0	Normal (default)
0	1	Large
1	0	Small
1	1	<i>reserved</i>

Bit 4	Style bold
1	Bold on
0	Bold off

Bit 5	Style <i>Italic</i>
1	Italic on
0	Italic off

Bit 6	Style <u>Underlined</u>
1	Underlined on
0	Underlined off

Bit 7	Style Strikethrough
1	Strikethrough on
0	Strikethrough off

If bit 4,5,6 and 7 are set to 0, it will mean normal style (default).

Octet 4 Text Colour.

This Octet may be omitted by setting the IED length accordingly.

Bits 0..3 define the Text Foreground Colour

Bits 4..7 define the Text Background Colour

Each colour is defined in a semi octet according to the table below. The actual colours displayed may vary between ME's depending on the display device used.

The colour values defined are simple primary and secondary colours plus four levels of grey. Bright colours have a higher intensity than dark colours.

Nibble Value (msb...lsb)	Colour
0000	Black
0001	Dark Grey
0010	Dark Red
0011	Dark Yellow
0100	Dark Green
0101	Dark Cyan
0110	Dark Blue
0111	Dark Magenta
1000	Grey

1001	White
1010	Bright Red
1011	Bright Yellow
1100	Bright Green
1101	Bright Cyan
1110	Bright Blue
1111	Bright Magenta

9.2.3.24.10.1.2 Predefined Sound

The Information-Element-Data octet(s) shall be coded as follows.

Octet 1 position indicating in the SM data the instant after which the sound shall be played. It will be set to the number of characters from the beginning of the SM data after which the sound shall be played.

This octet shall be coded as an integer value in the range 0 (beginning of the SM data) to the maximum number of characters included in the SM data of one single SM or one segment of a concatenated SM.

Octet 2 sound number. Shall be encoded as a integer value.

9.2.3.24.10.1.3 User Defined Sound

The Information-Element-Data octet(s) shall be coded as follows.

Octet 1 position indicating in the SM data the instant the after which the sound shall be played (refer to clause 9.2.3.24.10.1.2).

Octet 2-n Protocol Data Unit as described in clause 9.2.3.24.10.3.1.

This octet(s) shall contain a User Defined Sound.

9.2.3.24.10.1.4 Predefined Animation

The Information-Element-Data octet(s) shall be coded as follows:

Octet 1 position indicating in the SM data the instant the animation shall be displayed. Set to the number of characters from the beginning of the SM data after which the animation shall be displayed.

This octet shall be coded as an integer value in the range 0 (beginning of the SM data) to the maximum number of characters included in the SM data of one single SM or one segment of a concatenated SM.

Octet 2 animation number. Shall be encoded as an integer value.

9.2.3.24.10.1.5 Large Animation

The Information-Element-Data octet(s) shall be coded as follows:

Octet 1 position indicating the instant the animation shall be displayed in the SM data (refer clause 9.2.3.24.10.1.4).

Octet 2-n Protocol Data Unit as described in clause 9.2.3.24.10.3.3.

This octet(s) shall contain a Large Animation.

9.2.3.24.10.1.6 Small Animation

The Information-Element-Data octet(s) shall be coded as follows:

Octet 1 position indicating the instant the animation shall be displayed in the SM data (refer clause 9.2.3.24.10.1.4).

Octet 2-n Protocol Data Unit as described in clause 9.2.3.24.10.3.3.

This octet(s) shall contain a Small Animation.

9.2.3.24.10.1.7 Large Picture

The Information-Element-Data octet(s) shall be coded as follows:

Octet 1 position indicating in the SM data the instant the picture shall be displayed. Set to the number of characters from the beginning of the SM data after which the picture shall be displayed. This octet shall be coded as an integer value in the range 0 (beginning of the SM data) to the maximum number of characters included in the SM data of one single SM or one segment of a concatenated SM.

Octet 2-n Protocol Data Unit as described in 9.2.3.24.10.3.2.

This octet(s) shall contain a Large Picture.

9.2.3.24.10.1.8 Small Picture

The Information-Element-Data octet(s) shall be coded as follows:

Octet 1 position indicating in the SM data the instant the picture shall be displayed in the SM data (refer clause 9.2.3.24.10.1.7).

Octet 2-n Protocol Data Unit as described in clause 9.2.3.24.10.3.2.

This octet(s) shall contain a Small Picture.

9.2.3.24.10.1.9 Variable Picture

The Information-Element-Data octet(s) shall be coded as follows:

Octet 1 position indicating in the SM data the instant the picture shall be displayed in the SM data (refer clause 9.2.3.24.10.1.7).

Octet 2 Horizontal dimension of the picture.

This octet shall contain the horizontal number of 8 pixels i.e. this value shall be multiplied by 8 to get the whole number of horizontal pixels.

Octet 3 Vertical dimension of the picture.

This octet shall contain the vertical number of pixels.

Octet 4-n Protocol Data Unit as described in clause 9.2.3.24.10.3.2.

This octet(s) shall contain a Variable Picture line by line from top left to bottom right.

The values of the horizontal and vertical dimensions must be chosen properly by the sending entity. If the calculated size of this IE exceeds the limits of a single SM or segment it shall be discarded by the receiving entity.

Examples of EMS coding

All IE values in the TP-UD are hexadecimal values.

9.2.3.24.10.1.10 User Prompt Indicator

With the User Prompt Indicator a sending entity is able to indicate to the receiving entity, that the following object is intended to be handled at the time of reception, e.g. by means of user interaction. The object may be a picture, an animation, a User Defined Sound or a combination of these.

For example the User Prompt Indicator may be used when sending an operators logo to the ME that should be displayed instead of the operators name in standby mode.

When receiving the object the user shall be prompted to accept or discard the object. After this user interaction the SM may be discarded.

The User Prompt Indicator IE shall immediately precede the corresponding object IE(s).

If a User Prompt Indicator IE is not followed by a corresponding object IE it shall be discarded.

The Information-Element-Data octet(s) shall be coded as follows:

Octet 1 Number of corresponding objects.

This octet shall contain the number of corresponding objects as an integer value.

Where Octet 1 indicates that the User Prompt Indicator refers to more than one object, the ME should check the validity of the objects referenced for stitching together. The objects should be considered for stitching if they are either Images (Small, Large, Variable Pictures) or User Defined Sounds, and all of the objects referenced by the User Prompt Indicator IE are of the same type. Animations, Text formatting and pre-defined sound IE's are not suitable for stitching.

User defined sounds may be stitched by concatenating the data contained within each User Defined Sound IE into a single melody object, this may be achieved by ignoring the iMelody header and footer information of the second and subsequent User Defined Sound IE's referenced from the User Prompt Indicator.

Images may be joined along their vertical edges, to form a single "wide" image, the resulting image will have a width equal to the sum of the widths of all the images defined in the User Prompt Indicator.

9.2.3.24.10.1.11 Standard WVG Object

The Standard WVG object as defined by IEI 18 is structured as follows:

Octet 1 position indicating in the SM data the instant the object shall be displayed in the SM data

Octet 2..n Standard WVG object bit stream

The unused bits in the last octet will be filled with 0

The detailed data format and attributes of Standard WVG object are defined in Annex G.

The bit order is defined as follows:

The octet with a smaller octet number stores the bits appearing in the front position in the bit stream; the most significant bit in an octet stores the first bit in position in a 8-bit segment in the bit stream.

A Standard WVG object may or may not have fixed size. In either case, display size should be determined by the terminal implementation. Recommended display size is a largest possible size on terminal screen while aspect ratio shall be maintained.

9.2.3.24.10.1.12 Character Size WVG Object

The Character Size WVG object as defined by IEI 19 is structured as follows:

Octet 1 position indicating in the SM data the instant the object shall be displayed in the SM data

Octet 2..n Character Size WVG bit stream

The unused bits in the last octet will be filled with 0

The detailed data format and attributes of Character Size WVG object are defined in Annex G.

The bit order is defined as follows:

The octet with a smaller octet number stores the bits appearing in the front position in the bit stream; the most significant bit in an octet stores the first bit in position in a 8-bit segment in the bit stream.

A Character Size WVG object is a small graphics similar to the size of a typed character. The display height for a Character Size WVG object is decided by the terminal implementation. Recommended Character Size WVG object height is to be similar to the message text font height. The width of a Character Size WVG object is variable depending on the aspect ratio defined in the object. Character Size WVG objects can appear more than one time in one message.

Example:

Dad, I ♥ you!

In the above example, the “heart” is a Character Size WVG object at the position in between the letter “I” and “y”.

In the above example, there are 4 Character Size WVG objects, each representing a Chinese character.

9.2.3.24.10.1.13 Extended Object

The Extended Object allows an extended code range for format types. The Extended Object may extend across segment boundaries of a concatenated short message. Octets 1 through 7 of the first Extended Object IE shall be contained in a single segment. A single segment may include one or more Extended Object IEs.

If multiple SMs are concatenated and at least one of them contains an Extended Object information element, then concatenation of the SMs shall be done using the 'Concatenated short messages, 16-bit reference number', versus the 'Concatenated short messages, 8-bit reference number' information element. The re-assembly of the Extended Object segments shall be done according to the sequence number of the associated Concatenation IE.

One or more Extended Objects may be compressed using a compression algorithm as indicated in the Compression Control IE (see clause 9.2.3.24.10.1.13).

An SME implementing the Extended Object IE shall be capable of interpreting an uncompressed concatenated message composed of at least **min_eo_msg** short messages which have been received. According to current content provider requirements and handset manufacturer constraints, variable **min_eo_msg** is set to 8.

The first Extended Object IE of an Extended Object contains a reference number, length, control data, type and position. The subsequent Extended Object IEs shall only contain Extended Object data as illustrated in Figure 9.2.24.10.11.

The IE length is variable.

- | | | | | | | | | | | | | | | | |
|------------|--|-------|---------------------|---|-------------------------|---|--------------------------------------|-------|-----------------------|---|----------------------------------|---|---|----------|----------|
| Octet 1 | Extended Object reference number.
A modulo 256 counter indicating the reference number for the Extended Object. Two different Extended Objects in a single concatenated message shall have different reference numbers. | | | | | | | | | | | | | | |
| Octet 2..3 | Extended Object length in number of octets (integer representation) as shown in Figure 9.2.3.24.10.1.11. | | | | | | | | | | | | | | |
| Octet 4 | Control data. <table border="0" style="margin-left: 20px;"> <tr> <td style="vertical-align: top;">Bit 0</td> <td>Object distribution</td> </tr> <tr> <td style="vertical-align: top;">0</td> <td>Object may be forwarded</td> </tr> <tr> <td style="vertical-align: top;">1</td> <td>Object shall not be forwarded by SMS</td> </tr> <tr> <td style="vertical-align: top;">Bit 1</td> <td>User Prompt Indicator</td> </tr> <tr> <td style="vertical-align: top;">0</td> <td>Object shall be handled normally</td> </tr> <tr> <td style="vertical-align: top;">1</td> <td>Object shall be handled as a User Prompt (see 9.2.3.24.10.1.10)</td> </tr> <tr> <td style="vertical-align: top;">Bit 2..7</td> <td>reserved</td> </tr> </table> <p>Any reserved values shall be set to 0.</p> | Bit 0 | Object distribution | 0 | Object may be forwarded | 1 | Object shall not be forwarded by SMS | Bit 1 | User Prompt Indicator | 0 | Object shall be handled normally | 1 | Object shall be handled as a User Prompt (see 9.2.3.24.10.1.10) | Bit 2..7 | reserved |
| Bit 0 | Object distribution | | | | | | | | | | | | | | |
| 0 | Object may be forwarded | | | | | | | | | | | | | | |
| 1 | Object shall not be forwarded by SMS | | | | | | | | | | | | | | |
| Bit 1 | User Prompt Indicator | | | | | | | | | | | | | | |
| 0 | Object shall be handled normally | | | | | | | | | | | | | | |
| 1 | Object shall be handled as a User Prompt (see 9.2.3.24.10.1.10) | | | | | | | | | | | | | | |
| Bit 2..7 | reserved | | | | | | | | | | | | | | |
| Octet 5 | Extended Object Type.
This octet indicates the format of the Extended Object from the table below.
If the value is reserved or if the associated format is not supported then the receiving entity shall ignore the Extend Object. | | | | | | | | | | | | | | |

Format Type	Format Description
0x00	Predefined sound as defined in annex E.
0x01	iMelody as defined in annex E.
0x02	Black and white bitmap as defined in annex E.
0x03	2-bit greyscale bitmap as defined in annex E.
0x04	6-bit colour bitmap as defined in annex E.
0x05	Predefined animation as defined in annex E.
0x06	Black and white bitmap animation as defined in annex E.
0x07	2-bit greyscale bitmap animation as defined in annex E.
0x08	6-bit colour bitmap animation as defined in annex E.
0x09	vCard as defined in annex E.
0x0A	vCalendar as defined in annex E.
0x0B	Standard WVG object as defined in annex E
0x0C	Polyphonic melody as defined in annex E.
0x0D.. 0xFE	Reserved
0xFF	Data Format Delivery Request as defined in annex E.

Octet 6..7 Extended Object Position (integer representation).

The Extended Object Position indicates the absolute character position within the message text after which the object shall be played or displayed. The absolute character position relates to the entire text within the concatenated message, the first character is numbered character 1.

NOTE: Although this is an absolute value, for concatenated messages, it is suggested the positions used are those that lie within the text of short message segments that have the sequence number equal to or higher than the one that contains the Extended Object IE.

If more than one Extended Object is located at the same position then they may be played or displayed in sequence or simultaneously.

Octet 8..n Extended Object Data.

This sequence of octets is structured as illustrated in the figure below and defined annex E. This figure illustrates the construction of a number of SMs containing a large Extended Object which crosses a SM boundary and is encoded into 2 SM TPDUs. The figure illustrates only the User Data field of the SM (TPDUs). For a description of concatenation of SM refer to Figures 9.2.3.24 (a, b and c)

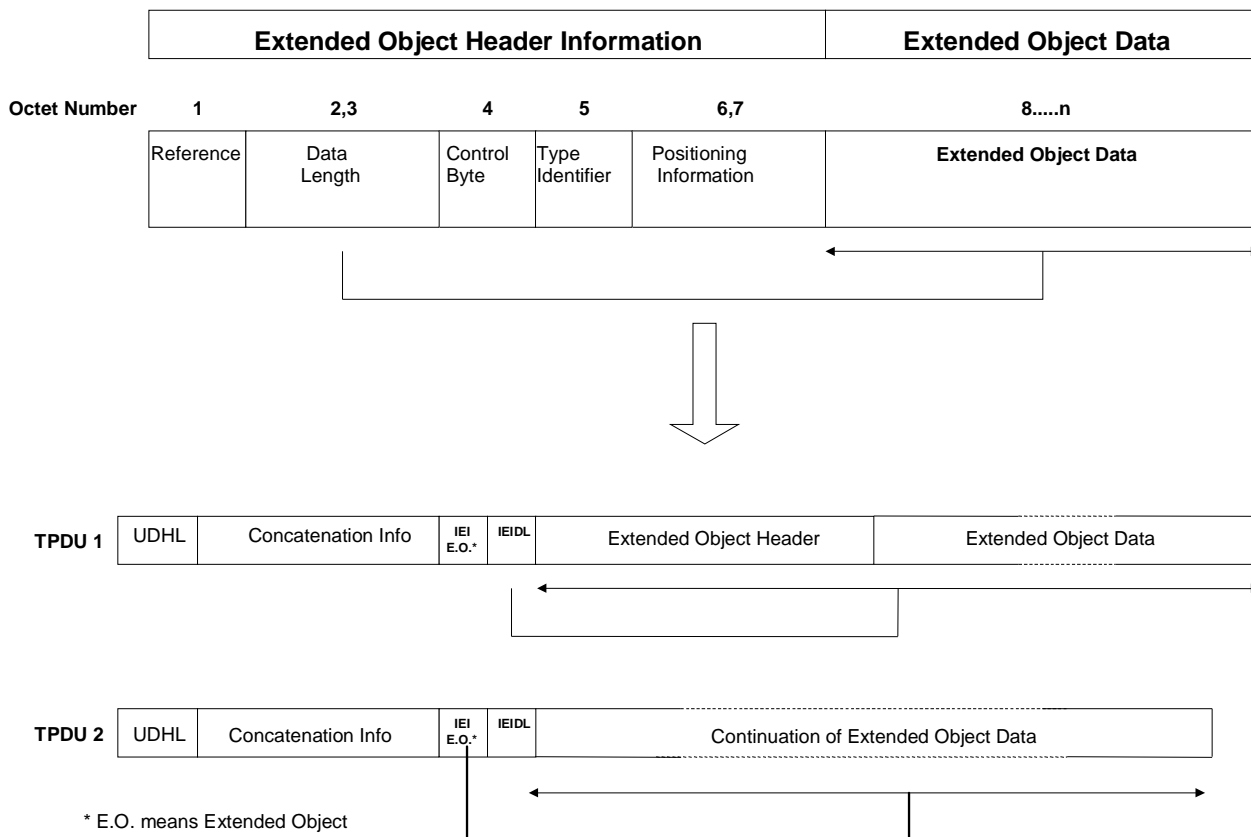

Figure 9.2.3.24.10.1.13

9.2.3.24.10.1.14 Reused Extended Object

This facility is used to reuse an Extended Object in a message which has already been defined in the same message.

Octet 1 Reference number of the Extended Object to be reused.

NOTE: The suggested reference numbers are those of Extended Objects that are contained in short messages that have the sequence number equal to or lower than the one that contains the Reused Extended Object IE.

Octet 2..3 indicates in the concatenated message the absolute character position after which the object shall be played or displayed.

NOTE: Although this is an absolute value, for concatenated messages, the suggested positions that lie within the text of short message segments that have the sequence number equal to or higher than the one that contains the Extended Object IE.

9.2.3.24.10.1.15 Compression Control

This information element is used to indicate a compressed octet sequence. The compression control is only used in association with one or more Extended Objects and/or Reused Extended Objects. The compressed data may extend across sequential short messages within a concatenated short message as illustrated by Figure 9.2.24.10.1.15. The first Compression Control IE of a compressed data sequence contains one octet of Compression Information and a 2-octet length field.

The SME shall support decompression if the Extended Object IE is implemented. An SME implementing the Extending Object IE shall be capable of decompressing a received stream for which the original uncompressed information fits into 1 to **min_eo_msg** messages. An SME may be capable of decompressing a received stream for which the original uncompressed information fits into more than **min_eo_msg** short messages. Variable **min_eo_msg** is defined in clause 9.2.3.24.10.1.11.

The IE length is variable.

Octet 1 Compression information.

Bits 0..3 represent the compression algorithm and bits 4..7 represent compression algorithm specific parameters.

Bit 0..3 Compression algorithm

0000 LZSS Compression according to clause 9.2.3.24.10.1.15.1

Bit 4..7 Shall be set 0.

0001..1111 reserved for future use; reserved bits shall be transmitted 0.

Bit 4..7 reserved

Octets 2..3 Length of the compressed data in octets (integer representation).
The length indicates the length of the compressed data that may extend across several compression control IEs.

Octets 4..n Compressed data may contain one or more compressed Extended Objects. Figure 9.2.3.24.10.1.15 is an example and illustrates the assembly of a series of SM TPDUs from a sequence of concatenated and compressed extended objects. Each Extended Object is preceded by its IEI (Extended Object or Reused Extended Object). A series of Extended Objects is then compressed into a single buffer and this is split into several SM TPDUs as illustrated.

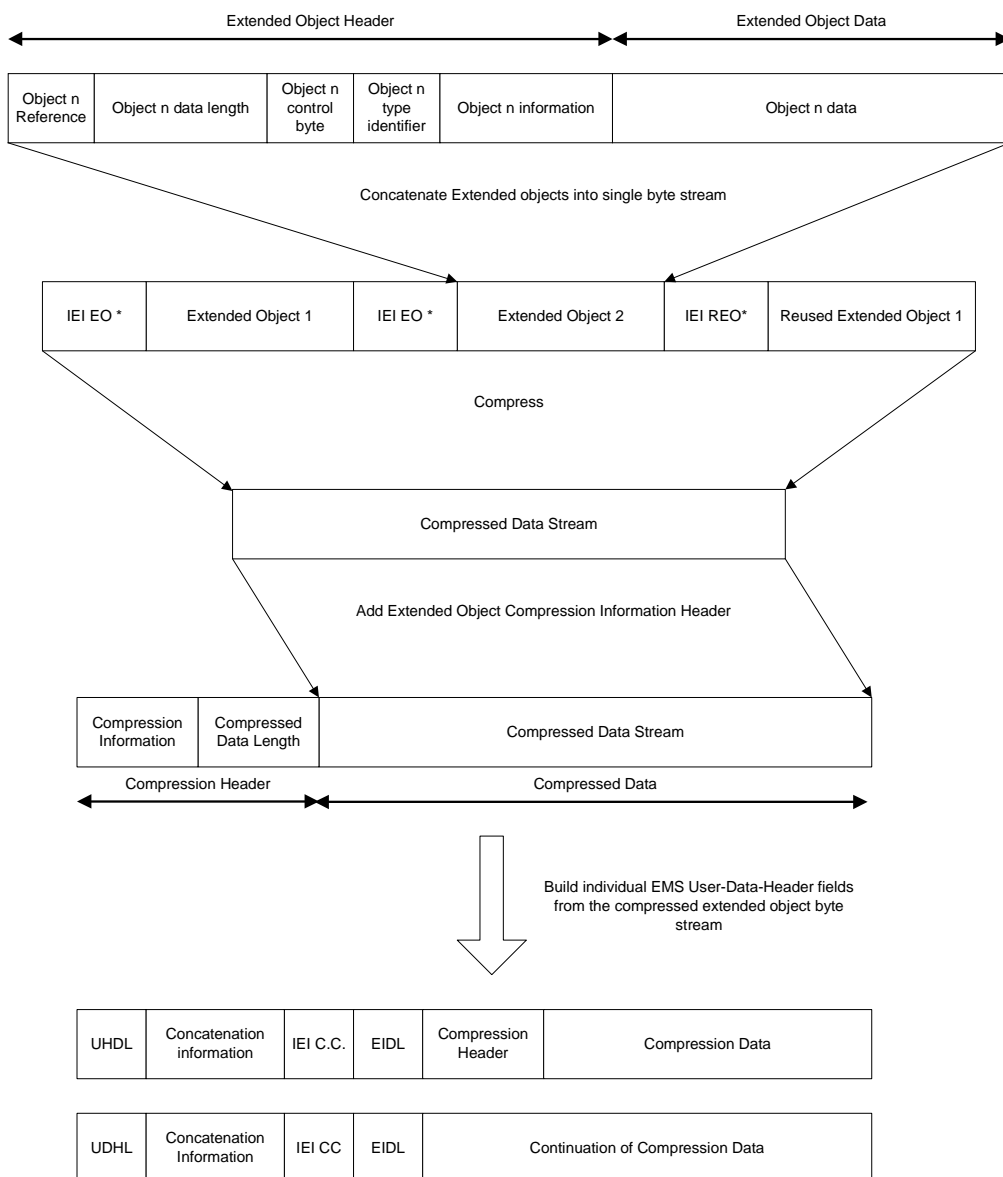

*E.O Means Extended Object.
 *R.E.O means Reused Extended Object.
 C.C. means compression.

Figure 9.2.3.24.10.1.15

9.2.3.24.10.1.15.1 LZSS Implementation for EMS extended object compression

LZSS compression uses two tokens to identify either literal strings (byte-sequences) or references to repeated sequences. These tokens (for EMS extended-object compression) are described in this clause of the document. A more general introduction to LZSS compression together with an informative example (based upon the tokens described below) is provided in Annex F (informative).

The compressed data stream consists of any combination of literal data blocks and slice descriptor sequences.

The format of the compressed data stream is illustrated as follows: -

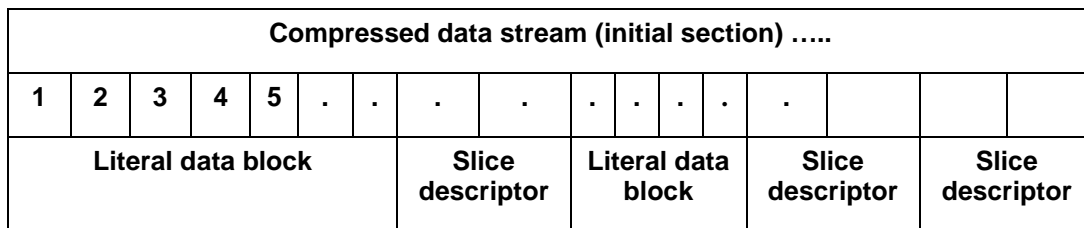

Figure 9.2.3.24.10.1.15.1.a LZSS compressed data format

This diagram represents the structure of a compressed byte stream using LZSS. The stream contains a mixture of literal octets from the input buffer and slice descriptors representing the re-occurrence of an octet sequence together with a length and index for the matching octet sequence. The initial octets of a compressed buffer will always be a sequence of literal octets. The structures of the literal data blocks and slice descriptors are given below.

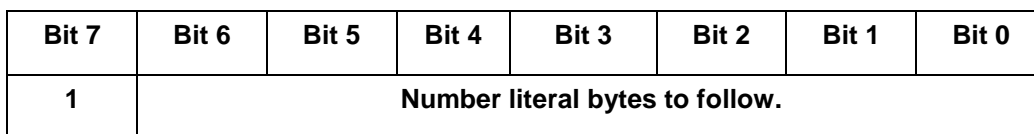

Figure 9.2.3.24.10.1.15.1.b Literal block identifier

When literal octets are written into the compression buffer (for instance during the initial phases of compression) they are preceded by a literal block identifier. The most significant bit (bit 7) of this block shall be set 1. Bits 6-0 indicate the length of the literal block which follows (up to 127 octets). If no match can be found in an octet sequence of greater than 127 octets then 2 (or more) literal blocks shall be written sequentially.

Octet 1								Octet 2							
Bit 15	Bit 14	Bit 13	Bit 12	Bit 11	Bit 10	Bit 9	Bit 8	Bit 7	Bit 6	Bit 5	Bit 4	Bit 3	Bit 2	Bit 1	Bit 0
0	Slice Length							Slice Offset							

Figure 9.2.3.24.10.1.15.1.c Slice Descriptor

As can be seen from the above table, the slice descriptor sequence length is two octets, hence only repeating slices of data longer than two octets are extracted. The “slice length” is contained in the descriptor high octet and describes a data slice length of up to 63 octets. The “slice offset index” to the start of the slice is contained in the lower 9 bits and limits the window to 511 octets. The “slice offset index” gives the start position of the source slice measured backwards from the current writing position in the output decoded message data buffer, expressed as a positive number.

9.2.3.24.10.1.15.2 Data Compression

The compressed data output stream is constructed by repeating the following process until the end of the input data buffer is reached.

The input data buffer is scanned, from the current reading position (minus 1) through to a position 511 bytes back from current reading position (the window) looking for the maximum (but limited to 63 octets) length matching data slice contained that matches the data starting at the current reading position (the look ahead buffer).

If no matching data slice, longer than two octets, is found then the input data octet at the current reading position is written to a literal buffer. Both the current reading position in the input data buffer and the current writing position in the output data buffer are incremented by one.

If a matching slice is found then a slice descriptor is written to the output data buffer at the current writing position in the output data buffer and the current writing position is incremented by two. The current reading position in the input data buffer is incremented by the length of the newly found matching data slice.

If the next read octet results in a matching slice being found then the literal buffer is written out. The literal block header, containing a count of the number of literals in the block, is written out first. (If more than 127 literal octets exist in the literal buffer, then it is split into multiple blocks).

The above sequence is repeated until the current reading position reaches the end of the input data buffer.

When encoding (compressing), it is the input data buffer, up to the current reading position, that is used to search for already known matching data slices, as this represents, and is equal to, the reconstructed output data buffer of the decoder at the receiving end.

9.2.3.24.10.1.15.3 Data De-compression

The following sequence is repeated until the end of the input data buffer.

The data octet at the current reading position in the input data buffer is tested for either 0 or 1 in bit 7.

If the bit is set (bit 7 = 1), then the number of literal octets that follow is determined from the lower 7 bits of the header octet (this one).

The literal octet block is written to the output data buffer at the current writing position and both the output data writing position and the input data reading position pointers are incremented by the block size.

If the bit is clear (bit 7 = 0), then the “slice length” and “slice offset index” are extracted from the two octet slice descriptor.

The data slice is copied from within the output data buffer to the end of the output data buffer, where the start of the source slice is at a position “slice offset index” back from the current output data writing position and the destination start position of the slice is the current output buffer writing position. The input data buffer reading position is incremented by two and the output data writing position is incremented by the “slice length”.

9.2.3.24.10.1.15.4 Test Vectors

In order to assist implementers of the compression algorithm described in this specification, a suite of test vectors and 'help' information are available in electronic format. The test vectors are supplied with this specification.

These test vectors provide checks for most of the commonly expected parameter value variants in this specification and may be updated as the need arises.

In addition Annex F contains an introduction to LZ-type compression algorithms and also has a brief informative example.

9.2.3.24.10.1.16 Object Distribution Indicator

This facility allows a level of control to be requested over the distribution of objects contained within selected information elements in short messages.

If no Object Distribution Indicator is specified for an information element in which an object is received, then that object may be freely distributed.

If a MS provides facilities to modify an object, then the Distribution Attributes (see below) shall be maintained; i.e. an object that is not allowed to be distributed cannot become so after modification.

The use of the Object Distribution Indicator in conjunction with a TE is beyond the scope of the present document.

Where the Object Distribution Indicator is applied to object IE's that are also addressed by an IE which affects or controls them in some other way (such as User Prompt Indicator IE (see clause 9.2.3.24.10.1.10)), then it shall precede all of the IE's including the other controlling IE's.

Octet 1 Number of Information Elements.

This octet specifies the number of information elements from 1-255 for which the Distribution Attributes in the next octet shall apply. The affected objects shall be contained in Information Elements immediately following this IE and may be contained in subsequent short message segments within a concatenated short message.

If the Object Distribution Indicator is applied to the same object IE's as addressed by an IE which affects or controls them in some other way (such as the User Prompt Indicator IE), then value of this field shall reflect the total number of all the object IE's and all of the controlling IE's.

If set to 0 the Distribution Attributes shall apply to all information elements until either the end of the message or another Object Distribution Indicator IE is received.

Octet 2 Distribution Attributes.

Bit 0

0 the associated object(s) may be forwarded

1 the associated object(s) shall not be forwarded by SMS

bit 1..7

reserved for future use.

9.2.3.24.10.1.17 Reply Address Element

Only one alternate Reply Address Element can be integrated in a message. In the case the Reply Address Element is part of a Concatenated SM this IE shall occur in its first segment only.

Octet 1..n Alternate Reply Address encoded as specified for address fields in clause 9.1.2.5

When this IE is received in a message, replies to this message should take place by default using the address specified in this IE instead of the regular message TP-OA.

NOTE: Despite the fact that MMI aspects of the ME are out of the scope of the present document, it must be mentioned that this mechanism might open the door to potential abuse. It is desirable that the user is made aware in some way that the reply address of the incoming message is different from the originator's one, and that the user is presented with the original TP-OA address to identify the sender of the SM .

9.2.3.24.10.1.18 Extended Object Data Request Command

There is no data element associated with this IE. The associated Information Element Length field is present but set to zero.

Upon receiving this IE in an SMS-DELIVER PDU, if an MS supports this request and the corresponding response, it shall respond with an SMS-DELIVER-REPORT PDU containing a Data Format Delivery Request as defined in the Extended Object IE. This SMS-DELIVER PDU may be discarded.

9.2.3.24.10.2.1 Example of Basic text formatting and predefined EMS coding

An example of the basic concept of coding is given as follows:

TP-UDHI=1

SMS User Data Header: UDHL=05, IEI=0A, IEDL=03, IED₁=0F, IED₂=12, IED₃=10

SMS User Data: This is a text with bold option on following with normal text.

Should be displayed as:

This is a text with bold option on following with normal text.

It is also possible to add predefined sounds in the message.

Example:

TP-UDHI=1

SMS User Data Header: UDHL=08, IEI=0B, IEDL=02, IED₁=09,<sound5>, IEI=0B, IEDL=2, IED₁=1C, <sound7>

SMS User Data: This is a message with two different sounds.

The sound nr5 shall be played after the 9th received character ("a") and sound nr7 shall be played after the 28th received character ("e").

9.2.3.24.10.2.2 Example of User defined Objects EMS coding

Example of a message including one small picture is coded as follows:

TP UDHI=1

SMS User Data Header: UDHL=24, IEI=11, IEIDL=22, IED₁=08, <  (small picture 32bytes)>

SMS User Data: Hello!<CR><LF><CR><LF>One small picture in here

Should be displayed as:

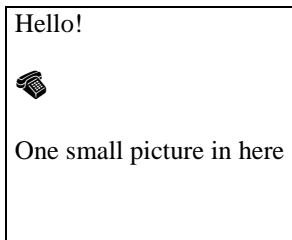

If the message starts with <CR>, then the "unreadable" data in an old terminal will be overwritten by the text, and the user will not see any strange characters. It is possible to insert the same picture several times in the same message. In that case, the TP-UD header shall contain as many IE as the number of occurrences contained in the SM or one segment of a concatenated message. Using defined elements will normally imply that more than one SM is required and therefore concatenation is required.

9.2.3.24.10.2.3 Concatenation of SMS messages

Concatenated messages are required in most cases required when using several types of EMS elements, since it is only possible to send one large picture/large animation/melody in one single SM. After including either of these elements, there are only 4 (or 9 if no concatenation is used) characters left to the text part, and this is usually too little.

If one or more objects are embedded in one segment of a concatenated message, the IE octet indicating its/their position within the SM data cannot be set to a value that would refer to a position in the next segment(s) so that received segments should be processed before all of them have been received. It means that a formatting text that could not be conveyed in one segment shall be split in as many segments as necessary. In that case, the IE relating to the formatting shall be repeated in all the segments in which it will apply.

Example of a message including 2 Large Pictures, 4 Small animations and 2 User defined Melodies together with some text.

The EMS message: <Large Picture1> <User Defined Melody 1> Hello All, This is a real Enhanced Message <Small Animation 1>. I can send <Small Animation 2> and receive <Small Animation 3> really advanced EMS messages <Animation 4> Isn't it impressive? /Lars <User Defined Melody2> <Large Picture 2>

This EMS message has to use concatenated messages and the SM will typically contain the following data:

SM	User Data Header	User Data
1	IEI=10 (Large Picture) IED ₁ =00 (beginning of the SM) <Large Picture 1 (128 bytes)>	[<CR><LF>]
2	IEI=0C (User Defined Sound) IED ₁ =00 (beginning of the SM) <User Melody 1 (129bytes max)>	Hello
3	IEI=0F (Small Animation) IED ₁ =24 (36 th position) <Small Animation 1 (32 bytes)> IEI=0F (Small Animation) IED ₁ =2F (47 th position) <Small Animation 2 (32 bytes)>	All, This is a real Enhanced Message. I can send and
4	IEI=0F (Small Animation) IED ₁ =07 (7 th position) <Small Animation 3 (32 bytes)> IEI=0F (Small Animation) IED ₁ =25 (37 th position) <Small Animation 4 (32 bytes)>	receive really advanced EMS messages. Isn't it impressive? /Lars.
5	IEI=0C (User Defined Sound) IED ₁ =00 (beginning of the SM) <User Melody 1 (128 bytes max)>	[<CR><LF>]
6	IEI=10 (Large Picture) IED ₁ =00 (beginning of the SM) <Large Picture 2 (128 bytes)>	

9.2.3.24.10.3 EMS Formats

9.2.3.24.10.3.1 Sounds

Predefined Sounds

There are a number of fixed predefined sounds. Each sound nr corresponds to a specific sound according to the table below. The presentations of these sounds are manufacturer specific.

Sound nr	Description
0	Chimes high
1	Chimes low
2	Ding
3	TaDa
4	Notify
5	Drum
6	Claps
7	FanFar
8	Chord high
9	Chord low

User defined sounds

The user defined sounds are coded according to the iMelody format[33]. The maximum length of a sound is 128 bytes.

9.2.3.24.10.3.2 Pictures

Pictures are coded from upper left to lower right and in each byte the most significant bit represent the pixel at the left. The pictures are plain black and white, no colours or grey scales are supported. The bitvalue "0" represents a white pixel and the bitvalue "1" represents a black pixel.

Example 16*16 picture

Byte 1	Byte 2
Byte 3	Byte 4
...	...
...	...
Byte 31	Byte 32

9.2.3.24.10.3.3 Animation

Predefined

There are a number of predefined animations. Each animation nr corresponds to a specific animation according to the table below. The way of displaying the animation is manufacturer specific.

Animation nr	Description
0	I am ironic, flirty
1	I am glad
2	I am sceptic
3	I am sad
4	WOW!
5	I am crying
6	I am winking
7	I am laughing
8	I am indifferent
9	In love/Kissing
10	I am confused
11	Tongue hanging out
12	I am angry
13	Wearing glasses
14	Devil

User Defined

Animations are coded as 4 sequential pictures, with the first picture sent first.

9.2.3.24.11 RFC 822 E-Mail Header

This information element is used to indicate the existence of an RFC 822 Internet electronic mail in the data part of the short message. Both, E-Mail Header and (optional) E-Mail Body shall be parts of the SM's data and shall be compliant with the syntax specified in RFC 822 [34]. The character set used for encoding of E-Mail Header and E-Mail body, however, shall be according to 3GPP TS 23.038 [9]. Encoding of E-Mail Header and E-Mail Body shall be done using the same character set.

In compliance with RFC 822 [34] the E-Mail Header shall always be located at the very beginning of the SM's data part. It shall always be present in the "unfolded" format as it is specified in RFC 822 [34]. Not the <CRLF> character defined in RFC 822 [34] but the <LF> character according to 3GPP TS 23.038 [9] shall be used for the separation of different E-Mail Header fields.

If an RFC 822 E-Mail Body exists, it shall immediately follow the E-Mail Header in the SM's data part.

NOTE 1: The null line defined in RFC 822 for the separation of E-Mail Header and E-Mail Body may be discarded.

NOTE 2: The sending of extended SMTP headers is allowed and the MS should not reject the message if there are header fields in the email header part that are not specified in RFC 822.

In case of an RFC 822 E-Mail Header exceeding the data part of a single SM, concatenation shall be used. In this case the E-Mail Header starts in the first segment of a concatenated SM and continues in one or several subsequent segments. The RFC 822 E-Mail Body shall immediately follow the final fraction of the RFC 822 E-Mail Header and may also be spread over several segments of the concatenated SM.

In case where this IEI is to be used in a concatenated SM then the IEI, its associated IEDL, and IED fields shall be contained in the first segment of the concatenated SM and shall also be contained in every subsequent segment of the concatenated SM.

The Information-Element-Data octet shall be coded as follows:

Octet 1 RFC 822 E-Mail Header length indicator.

This octet shall indicate the length of the RFC 822 E-Mail Header that is located at the beginning of the data part of the SM. In case of an E-Mail Header exceeding the data part of a single SM, this octet shall indicate the length of that fraction of the RFC 822 E-Mail Header that is located at the beginning of the data part of the current segment of the concatenated SM.

If the user data is coded using the GSM 7 bit default alphabet, this IED octet shall give an integer representation of the number of septets within (that fraction of) the RFC 822 E-Mail Header that is located at the beginning of the data part of the current (segment of the concatenated) SM. See figure 9.2.3.24.11 (a).

If the user data is coded using 8-bit data, this IED octet shall give an integer representation of the number of octets within (that fraction of) the RFC 822 E-Mail Header that is located at the beginning of the data part of the current (segment of the concatenated) SM. See figure 9.2.3.24.11 (b).

If the user data is coded using UCS2 [24] data, this IED octet shall give an integer representation of the number of UCS2 characters (consisting of 2 octets) within (that fraction of) the RFC 822 E-Mail Header that is located at the beginning of the data part of the current (segment of the concatenated) SM. See figure 9.2.3.24.11 (c).

NOTE 3: If the user data is coded using compressed GSM 7 bit default alphabet or compressed 8 bit data or compressed UCS2 [24] data the RFC 822 E-Mail Header length indicator's value shall be based on the amount of uncompressed data, i.e. before compression is performed.

The diagram below shows the layout of the IED for GSM 7 bit default alphabet data.

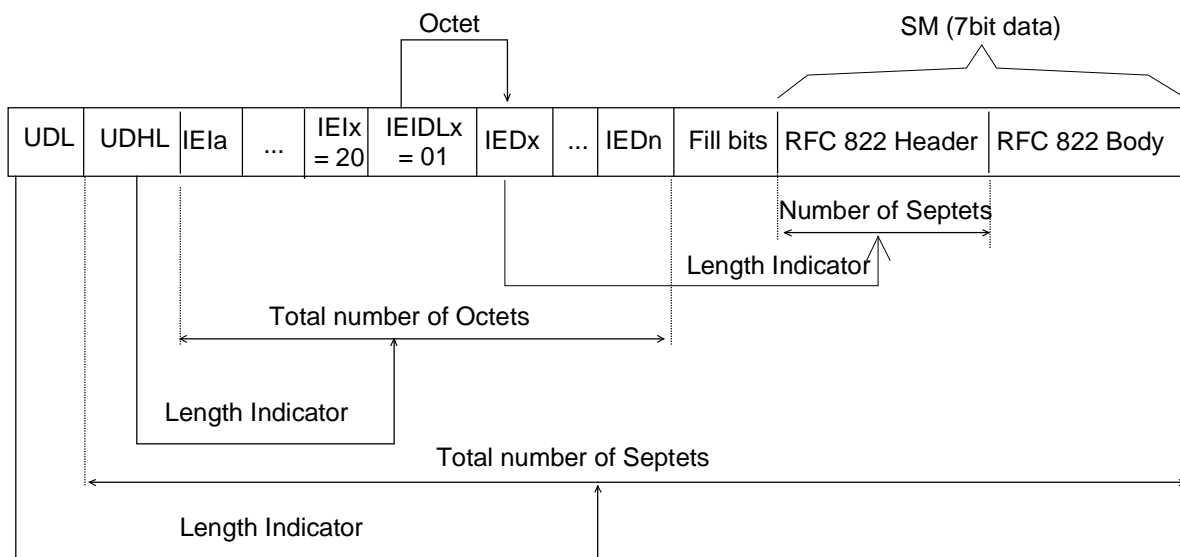

Figure 9.2.3.24.11 (a)

The diagram below shows the layout of the IED for 8 bit data.

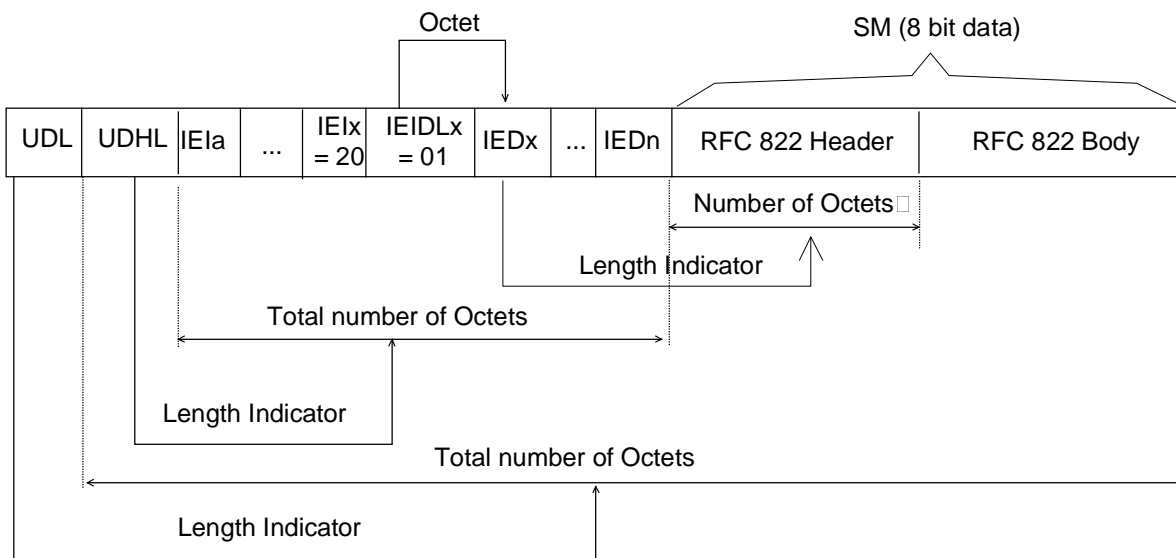

Figure 9.2.3.24.11 (b)

The diagram below shows the layout of the IED for UCS2 data.

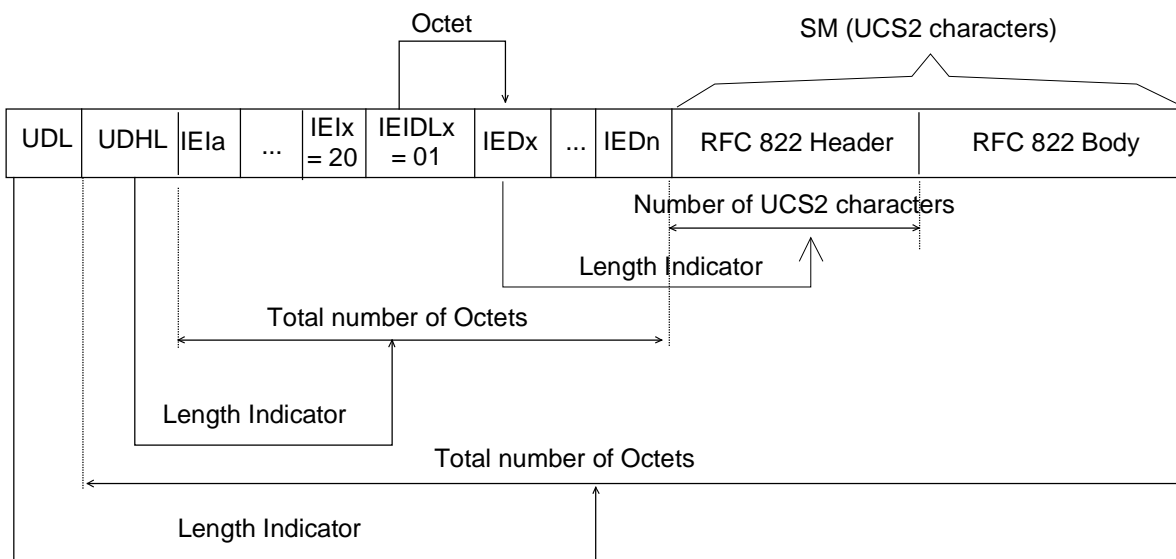

Figure 9.2.3.24.11 (c)

9.2.3.24.12 Hyperlink format element

A hyperlink format element shall be structured as follows:

Octet 1 and 2 Absolute Element Position (integer representation).

The Absolute Element Position indicates the absolute character position within the message text. The absolute character position relates to the entire text within the concatenated message, the first character is numbered character 1.

Octet 3 Hyperlink Title length: an integer representation of the number of characters in the hyperlink title.

Octet 4 URL length: an integer representation of the number of characters in the URL.

A space character shall be inserted between the hyperlink title and the URL. The hyperlink title can be a mixture of text, animations and pictures. Elements (text, animations and pictures) for which the position is included in the range [Absolute hyperlink position...Absolute hyperlink position+hyperlink title length] are part of the hyperlink title. The string of text in the range [Absolute hyperlink position+hyperlink title length+1...Absolute hyperlink position+hyperlink title length+1+URL length] is to be interpreted as a URL.

9.2.3.24.13 Enhanced Voice Mail Information

Enhanced Voice Mail Information allows a Voice Mail system to convey to a mobile subscriber, comprehensive information regarding individual voice mail messages and mailbox status.

Enhanced Voice Mail Information has two types of Information Element Data

- Enhanced Voice Mail Notification which conveys to the MS information regarding newly deposited Voice Mail messages and Voice Mailbox Status
- Enhanced Voice Mail Delete Confirmation which allows an MS to maintain Voice mailbox status information synchronisation between the MS and the Voice Mailbox in the event of Voice Mail Message deletion.

The first 'bit' of the Enhanced Voice Mail Information Element Data is known as Enhanced Voice Mail PDU Type and discriminates between whether the Enhanced Voice Mail Information PDU is an Enhanced Voice Mail Notification or an Enhanced Voice Mail Delete Confirmation.

9.2.3.24.13.1 Enhanced Voice Mail Notification

The Enhanced Voice Mail Notification Information Element Data has the following format where the parameters are in strict order following the IEDL. The Enhanced Voice Mail Notification IEI and its associated IEDL and IED shall be complete within a single UDH.

In the event of a contradiction between Enhanced Voice Mail Notification and either the DCS (23.038) [9] indicating Voicemail Message Waiting or the Special SMS Message Indication (9.2.3.24.2) indicating Voice Message Waiting or both then the Enhanced Voice Mail Notification specified here shall take precedence.

Parameter	Parameter Length	Mandatory/Optional/Conditional
ENHANCED_VOICE_MAIL_PDU_TYPE	Bit 0 Octet 1	M
RESERVED_FOR_FUTURE_USE	Bit 1 Octet 1	M
MULTIPLE_SUBSCRIBER_PROFILE	Bits 2..3 Octet 1	M
SM_STORAGE	Bit 4 Octet 1	M
VM_MAILBOX_ALMOST_FULL	Bit 5 Octet 1	M
VM_MAILBOX_FULL	Bit 6 Octet 1	M
VM_MAILBOX_STATUS_EXTENSION_INDICATOR	Bit 7 Octet 1	M
VM_MAILBOX_ACCESS_ADDRESS	Octets 2... n+2 (NOTE 2)	M
NUMBER_OF_VOICE_MESSAGES	Bits 0..7 Octet n+3	M
NUMBER_OF_VM_NOTIFICATIONS	Bits 0..4 Octet n+4	M
RESERVED_FOR_FUTURE_USE	Bits 5..7 Octet n+4	M
VM_MAILBOX_STATUS_EXTENSION_LENGTH	1 Octet (NOTE 3)	C
VM_MAILBOX_STATUS_EXTENSION_DATA	1 or more Octets (NOTE 3)	C
VM_MESSAGE_ID (NOTE 1)	Bits 0..15 Octets n+5..n+6	M
VM_MESSAGE_LENGTH (NOTE 1)	Bits 0..7 Octet n+7	M
VM_MESSAGE_RETENTION_DAYS (NOTE 1)	Bits 0..4 Octet n+8	M
RESERVED_FOR_FUTURE_USE (NOTE 1)	Bit 5 Octet n+8	M
VM_MESSAGE_PRIORITY_INDICATION (NOTE 1)	Bit 6 Octet n+8	M
OCTET_VM_MESSAGE_EXTENSION_INDICATOR (NOTE 1)	Bit 7 Octet n+8	M
VM_MESSAGE_CALLING_LINE_IDENTITY (NOTE 1)	Octets n+9.. n+9+m (NOTE 2)	M
VM_MESSAGE_EXTENSION_LENGTH (NOTE 1)	1 Octet (NOTE 3)	C
VM_MESSAGE_EXTENSION_DATA (NOTE 1)	1 or more Octets (NOTE 3)	C
NOTE 1: This sequence of parameters are repeated a number of times according to the number of Voice Mail notifications conveyed in this IE.		
NOTE 2: 'n' and 'm' denote the number of octets required for the VM_MAILBOX_ACCESS_ADDRESS and the VM_CALLING_LINE_IDENTITY as appropriate including the Address-Length, Type-of-address and Address-value (see 9.1.2.5).		
NOTE 3: The Conditional Octets are excluded from the Octet count in the table in this release because no extensions are defined in this release.		

ENHANCED_VOICE_MAIL_PDU_TYPE	This parameter shall be set to 0 to specify that the following Information Element Data Parameters is an Enhanced Voice Mail Notification.
RESERVED_FOR_FUTURE_USE	This parameter is set to 0 and is reserved for future use.
MULTIPLE_SUBSCRIBER_PROFILE	This parameter shall indicate the Multiple Subscriber Profile (see 3GPP TS 23.097 [41]):
	00 profile ID 1
	10 profile ID 2
	01 profile ID 3
	11 profile ID 4
SM_STORAGE	This parameter shall be set to 0 to indicate that this SM shall be discarded after evaluating its contents; otherwise it shall be set to a 1 to indicate to the MS that this SM shall be stored in the ME or the USIM.
VM_MAILBOX_ALMOST_FULL	This parameter shall be set to 1 if the Voice Mailbox in the Voice Mail system is almost full; otherwise this field shall be set to 0. The point at which the voice mailbox is considered almost full is Voice Mail System specific.
VM_MAILBOX_FULL	This parameter shall be set to 1 if the Voice Mailbox in the Voice Mail system is full; otherwise this field shall be set to 0.

VM_MAILBOX_STATUS_EXTENSION_INDICATOR	In this release, this parameter shall be set to 0. This parameter shall be set to 1 to indicate that a VM_MAILBOX_STATUS_EXTENSION_LENGTH parameter is present in this PDU.
VM_MAILBOX_ACCESS_ADDRESS	This parameter shall contain the Voice Mailbox number. It shall be coded according to section 9.1.2.5. In case of contradiction between this parameter and the Mailbox Dialing Numbers stored on (U)SIM this parameter shall take precedence and the MS may try to update EF _{MBDN} on (U)SIM.
NUMBER_OF_VOICE_MESSAGES	This octet shall contain a value in the range 0 to 255 indicating the current number of Voice Mail messages that are unread. The value 255 shall be taken to mean 255 or greater. The NUMBER_OF_VOICE_MESSAGES shall be stored on the (U)SIM in accordance with the procedure for storage of Message Waiting Indication Status described in Special SMS Message Indication (9.2.3.24.2).
NUMBER_OF_VM_NOTIFICATIONS	This parameter has a range 0 to 15. This parameter shall indicate the number of specific Voice Message notifications to follow within this IE.
RESERVED_FOR_FUTURE_USE	This parameter shall be set to 0 and is reserved for future use.
VM_MAILBOX_STATUS_EXTENSION_LENGTH	This parameter shall be set to the number of additional octets that immediately follow. This parameter has a value in the range 0 to 255. The presence of this parameter is conditional on the setting of VM_MAILBOX_STATUS_EXTENSION_INDICATOR in this PDU.
VM_MAILBOX_STATUS_EXTENSION_DATA	This parameter comprises a number of additional octets allowing additional VM mailbox generic status parameters to be conveyed in this PDU. Additional octets are not defined in this release but may be defined later by 3GPP. This parameter is conditional on the presence of VM_MAILBOX_EXTENSION_LENGTH
VM_MESSAGE_ID	This parameter shall be set to the message ID of the Voice Mail message in this specific Voice Message notification. This parameter is binary and has a range 0 to 65535, modulus 65536. It is the responsibility of the Voice Mail system to set this parameter to uniquely identify a Voice Mail message within the modulus.
VM_MESSAGE_LENGTH	This parameter shall be set to the length of the Voice Mail message in this notification in seconds. This parameter has a range 0 to 255. For voice mail messages that are longer than 255 seconds, this parameter shall be set to its maximum 255.
VM_MESSAGE_RETENTION_DAYS	This parameter shall be set to the number of days after which the specific Voice Mail message in this notification is anticipated to be automatically deleted from the Voice Mail system timed from the GSM Timestamp (TP-SCTS 9.2.3.11) for this Enhanced Voice Mail Notification. This parameter has a range 0 to 31. For Voice Mail messages that have a longer retention time than 31 days, this parameter shall be set to its maximum 31.

NOTE: The GSM Timestamp is the time that the SC received the SM from the Voice Mail system which is not necessarily the time that the voice message was deposited into the Voice Mail system.

RESERVED_FOR_FUTURE_USE	This parameter is set to 0 and is reserved for future use.
VM_MESSAGE_PRIORITY_INDICATION	This parameter shall be set to 1 to indicate that the specific Voice Mail message in this notification held in the Voice Mailbox is urgent; otherwise the parameter shall be set to 0.
VM_MESSAGE_EXTENSION_INDICATOR	In this release, this parameter shall be set to 0. This parameter shall be set to a 1 to indicate that a VM_MESSAGE_EXTENSION_LENGTH parameter is present in this PDU.
VM_MESSAGE_CALLING_LINE_IDENTITY	This parameter shall contain the address to be used by the mobile subscriber to contact the originator of the specific Voice Mail message in this notification. Where the CLI is not available then the coding of this parameter shall indicate that there is no address. i.e The length indicator in this parameter shall be set to 0. This parameter coding shall comply with the the SM-TL address format specified in 9.1.2.5 above.
VM_MESSAGE_EXTENSION_LENGTH	This parameter shall be set to the number of additional octets that immediately follow. This parameter has a value in the range 0 to 255. The presence of this parameter is conditional on the setting of VM_MESSAGE_EXTENSION_INDICATOR in this PDU.
VM_MESSAGE_EXTENSION_DATA	This parameter comprises a number of additional octets allowing additional voicemail message specific parameters to be conveyed in this PDU. Additional octets are not defined in this release but may be defined later by 3GPP. This parameter is conditional on the presence of VM_MESSAGE_EXTENSION_LENGTH.

9.2.3.24.13.2 Enhanced Voice Mail Delete Confirmation

The Enhanced Voice Mail Delete Confirmation Information Element Data contains synchronization information. A Voice Mail system may send an Enhanced Voice Mail Delete Confirmation in order to indicate to the ME that certain voice mail messages that have been deleted and to indicate the updated status of the Voice Mailbox.

The Enhanced Voice Mail Delete Confirmation Information Element Data has the following format where the parameters are in strict order following the IEDL. The Enhanced Voice Mail Delete Confirmation IEI and its associated IEDL and IED shall be complete within a single UDH.

Parameter	Parameter Length	Mandatory/Conditional /Optional
ENHANCED_VOICE_MAIL_PDU_TYPE	Bit 0 Octet 1	M
RESERVED_FOR_FUTURE_USE	Bit 1 Octet 1	M
MULTIPLE_SUBSCRIBER_PROFILE	Bits 3..2 Octet 1	M
SM_STORAGE	Bit 4 Octet 1	M
VM_MAILBOX_ALMOST_FULL	Bit 5 Octet 1	M
VM_MAILBOX_FULL	Bit 6 Octet 1	M
VM_MAILBOX_STATUS_EXTENSION_INDICATOR	Bit 7 Octet 1	M
VM_MAILBOX_ACCESS_ADDRESS	Octets 2..n+2 (NOTE 2)	M
NUMBER_OF_VOICE_MESSAGES	Bits 0..7 Octet n+3	M
NUMBER_OF_VM_DELETES	Bits 0..4 Octet n+4	M
RESERVED_FOR_FUTURE_USE	Bits 5..7 Octet n+4	M
VM_MAILBOX_STATUS_EXTENSION_LENGTH	1 Octet (NOTE 3)	C
VM_MAILBOX_STATUS_EXTENSION_DATA	1 or more Octets (NOTE 3)	C
VM_MESSAGE_ID (NOTE 1)	Octets n+5..n+6	M
RESERVED_FOR_FUTURE_USE (NOTE 1)	Bits 0..6 Octet n+7	M
VM_MESSAGE_EXTENSION_INDICATOR (NOTE 1)	Bit 7 Octet n+7	M
VM_MESSAGE_EXTENSION_LENGTH (NOTE 1)	1 Octet (NOTE 3)	C
VM_MESSAGE_EXTENSION_DATA (NOTE 1)	1 or more Octets (NOTE 3)	C
NOTE 1: This sequence of parameters are repeated a number of times according to the number of Voice Mail Delete Confirmations conveyed in this IE.		
NOTE 2: 'n' denotes the number of octets required for the VM_MAILBOX_ACCESS_ADDRESS including the Address-Length, Type-of-address and Address-value (see 9.1.2.5).		
NOTE 3: The Conditional Octets are excluded from the Octet count in the table in this release because no extensions are defined in this release.		

ENHANCED_VOICE_MAIL_PDU_TYPE	This parameter shall be set to 1 to specify that the following Information Element Data is an Enhanced Voice Mail Delete Confirmation.
RESERVED_FOR_FUTURE_USE	This parameter is set to 0 and is reserved for future use.
MULTIPLE_SUBSCRIBER_PROFILE	See clause 9.2.3.24.13.1
SM_STORAGE	See clause 9.2.3.24.13.1
VM_MAILBOX_ALMOST_FULL	See clause 9.2.3.24.13.1
VM_MAILBOX_FULL	See clause 9.2.3.24.13.1
VM_MAILBOX_STATUS_EXTENSION_INDICATOR	In this release, this parameter shall be set to 0. This parameter shall be set to 1 to indicate that a VM_MAILBOX_STATUS_EXTENSION_LENGTH parameter is present in this PDU.
VM_MAILBOX_ACCESS_ADDRESS	See clause 9.2.3.24.13.1
NUMBER_OF_VOICE_MESSAGES	See clause 9.2.3.24.13.1
NUMBER_OF_VM_DELETES	This parameter has a range 0 to 63. This parameter shall indicate the number of VM_MESSAGE_ID's that follow in this IE
RESERVED_FOR_FUTURE_USE	This parameter is set to 0 and is reserved for future use.
VM_MAILBOX_STATUS_EXTENSION_LENGTH	This parameter shall be set to the number of additional octets that immediately follow. This parameter has a value in the range 0 to 255. The presence of this parameter is conditional on the setting of VM_MAILBOX_STATUS_EXTENSION_INDICATOR in this PDU.

VM_MAILBOX_STATUS_EXTENSION_DATA	This parameter comprises a number of additional octets allowing additional VM mailbox generic status parameters to be conveyed in the PDU. Additional octets are not defined in this release but may be defined later by 3GPP. This parameter is conditional on the presence of VM_MAILBOX_EXTENSION_LENGTH
VM_MESSAGE_ID	This parameter shall be set to the message ID of the specific voice mail message(s) whose deletion is being confirmed. The range of this parameter is defined in clause 9.2.3.24.13.1 and for a specific voice mail message the value of this parameter shall be identical to that used for the VM Notification. This parameter is repeated according to the number of voice mail message deletions being confirmed.
RESERVED_FOR_FUTURE_USE	This parameter is set to 0 and is reserved for future use. This parameter is repeated according to the number of voice mail message deletions being confirmed.
VM_MESSAGE_EXTENSION_INDICATOR	In this release, this parameter shall be set to 0. This parameter shall be set to a 1 to indicate that a VM_MESSAGE_EXTENSION_LENGTH parameter is present in this PDU.
VM_MESSAGE_EXTENSION_LENGTH	This parameter shall be set to the number of additional octets that immediately follow. This parameter has a value in the range 0 to 255. The presence of this parameter is conditional on the setting of VM_MESSAGE_EXTENSION_INDICATOR in this PDU
VM_MESSAGE_EXTENSION_DATA	This parameter comprises a number of additional octets allowing additional voicemail message specific parameters to be conveyed in this PDU. Additional octets are not defined in this release but may be defined later by 3GPP. This parameter is conditional on the presence of VM_MESSAGE_EXTENSION_LENGTH

9.2.3.24.14 Identification of a directory number within the User Data Field

A directory number may, as an optional feature, be identified within the User Data Field.

This allows, for example, a receiving entity to automatically identify a string of digits in the User Data Field as being a telephone number in order to facilitate easy call back by user action.

This shall be implemented by enclosing the directory number in inverted commas (character 0100010 from the 7 bit default alphabet in 3GPP TS 23.038 [9] or its equivalent in other character sets).

Unspecified address formats or International address formats (using + symbol) may be used for the directory number.

Spaces may be included with the directory number inside the inverted commas. E.g. "+1 234 567 8901"

The User Data Field displayed to the recipient may contain more than one directory number, in which case it is for the user to select the one required.

9.2.3.24.15 National Language Single Shift

This information element is used to indicate which National Language Single Shift Table is used instead of the GSM 7 bit default alphabet extension table specified in 3GPP TS 23.038 [9].

The total length of the IE is 1 octet:

octet 1 National Language Identifier.

The National Language Identifier values and Language tables are defined in 3GPP TS 23.038 [9].

A receiving entity shall ignore (i.e. skip over and commence processing at the next information element) this information element if the value of the National Language Identifier is not described in 3GPP TS 23.038 [9].

If this IE is duplicated within different segments of a concatenated message then a receiving entity shall process each segment individually.

If this IE is not included within a segment of a concatenated message then the receiving entity shall use the GSM 7 bit default alphabet extension table for this segment.

In the event that this IE is duplicated within one segment of a concatenated message or a single message then a receiving entity shall use the last occurrence of the IE.

In the event that this IE is received within a single message or a segment of a concatenated message, in which the DCS has indicated UCS-2 encoding, then the receiving entity shall ignore this IE.

9.2.3.24.16 National Language Locking Shift

This information element is used to indicate which National Language Locking Shift Table is used instead of the GSM 7 bit default alphabet specified in 3GPP TS 23.038 [9].

This IE is coded in the same way as the National Language Single Shift IE in subclause 9.2.3.24.15.

A receiving entity shall ignore (i.e. skip over and commence processing at the next information element) this information element if the value of the National Language Identifier is not described in 3GPP TS 23.038 [9].

If this IE is duplicated within different segments of a concatenated message then a receiving entity shall process each segment individually.

If this IE is not included within a segment of a concatenated message then the receiving entity shall use the GSM 7 bit default alphabet table for this segment.

In the event that this IE is duplicated within one segment of a concatenated message or a single message then a receiving entity shall use the last occurrence of the IE.

In the event that this IE is received within a single message or a segment of a concatenated message, in which the DCS has indicated UCS-2 encoding, then the receiving entity shall ignore this IE.

9.2.3.25 TP-Reject-Duplicates (TP-RD)

The TP-Reject-Duplicates is a 1 bit field located within bit 2 of the first octet of SMS-SUBMIT and has the following values.

Bit no. 2:	0	Instruct the SC to accept an SMS-SUBMIT for an SM still held in the SC which has the same TP-MR and the same TP-DA as a previously submitted SM from the same OA.
	1	Instruct the SC to reject an SMS-SUBMIT for an SM still held in the SC which has the same TP-MR and the same TP-DA as the previously submitted SM from the same OA. In this case the response returned by the SC is as specified in 9.2.3.6..

9.2.3.26 TP-Status-Report-Qualifier (TP-SRQ)

The TP-Status-Report-Qualifier is a 1 bit field located within bit 5 of the first octet of SMS-STATUS-REPORT and has the following values

Bit no. 5:	0	The SMS-STATUS-REPORT is the result of a SMS-SUBMIT.
	1	The SMS-STATUS-REPORT is the result of an SMS-COMMAND e.g. an Enquiry.

9.2.3.27 TP-Parameter-Indicator (TP-PI)

The TP-Parameter-Indicator comprises a number of octets between 1 and n where each bit when set to a 1 indicates that a particular optional parameter is present in the fields which follow. The TP-PI is present as part of the RP-User-Data in

the RP-ACK or the RP-ERROR as indicated in clauses 9.2.2.1a and 9.2.2.2a or the RP-DATA as indicated in clause 9.2.2.3.

The structure of the TP-PI is as follows:

Octet 1:

bit 7	bit 6	bit 5	bit 4	bit 3	bit 2	bit 1	bit 0
Extension bit	Reserved	Reserved	Reserved	Reserved	TP-UDL	TP-DCS	TP-PID

The most significant bit in octet 1 and any other TP-PI octets which may be added later is reserved as an extension bit which when set to a 1 shall indicate that another TP-PI octet follows immediately afterwards.

If the TP-UDL bit is set to zero then by definition neither the TP-UDL field or the TP-UD field can be present. If the TP-UDL bit is set to "1" but the TP-DCS bit is set to "0" then the receiving entity shall for TP-DCS assume a value of 0x00, i.e. the 7bit default alphabet.

If a Reserved bit is set to "1" then the receiving entity shall ignore the setting. The setting of this bit shall mean that additional information will follow the TP-User-Data, so a receiving entity shall discard any octets following the TP-User-Data.

9.3 Service provided by the SM-RL

9.3.1 General

The Short Message Relay Layer (SM-RL) provides a service to the Short Message Transfer Layer (SM-TL). This service enables the SM-TL to send Transfer Protocol Data Units (TPDUs) to its peer entity, receive TPDUs from its peer entity and receive reports about earlier requests for TPDUs to be transferred.

In order to keep track of TPDUs and reports about those TPDUs, primitives between the SM-TL and SM-RL contain a Short Message Identifier (SMI), which is a reference number for the TPDU associated with the primitive. This Short Message Identifier is not carried via the SM-RL protocol of clause 9.3.2. It is carried via the relay layer service between the SC and GMSC. It is also carried by SM-RL of 3GPP TS 24.011 [13], between the visited MSC and MS. The parameter is not carried by MAP but is mapped to and from the TCAP dialogue Identifier (see CCITT Recommendation Q.771, "Blue Book" [19]) at the GMSC and the visited MSC (therefore the Message Identifier at the SC/GMSC interface is not the same as at the visited MSC/MS interface).

The SM-RL communicates with its peer entity by the protocol described in the following clauses.

9.3.2 Protocol element repertoire at SM-RL

Different protocols are required between different pairs of SM-RL entities. Those are described in other GSM/UMTS specifications. This clause gives a survey of the different information elements which have to be conveyed between those entities. (Note that the notation of the protocol and information elements may vary between different GSM/UMTS specifications).

The SM-RL comprises the following 6 protocol elements:

RP-MO-DATA	for transferring a TPDU from MS to SC
RP-MT-DATA	for transferring a TPDU from SC to MS
RP-ACK	for acknowledging an RP-MO-DATA, an RP-MT-DATA or an RP-SM-MEMORY-AVAILABLE
RP-ERROR	for informing of an unsuccessful RP-MO-DATA or an RP-MT-DATA transfer attempt
RP-ALERT-SC	for alerting the SC that the MS has recovered operation (information sent from the HLR to the SC)
RP-SM-MEMORY-AVAILABLE	for notifying the network that the MS has memory available to accept one or more short messages (information sent from the MS to the HLR)

9.3.2.1 RP-MO-DATA

Basic elements of the RP-MO-DATA type.

Abbr.	Reference	p1)	Description
RP-OA	RP-Originating-Address	++-	Address of the originating MS.
RP-DA	RP-Destination-Address	--+	Address of the destination SC.
RP-UD	RP-User-Data	+++	Parameter containing the TPDU

- 1) Provision on the links SC<->MSC, MSC<->MSC or MSC<->SGSN, and MSC<->MS or SGSN<->MS indicated by "xxx", where x may be either "+" or "-", dependent on whether the parameter is mandatory or not on the respective link.

9.3.2.2 RP-MT-DATA

Basic elements of the RP-MT-DATA type.

Abbr.	Reference	p1)	Description
RP-PRI	RP-Priority-Request	+--	Parameter indicating whether or not the short message transfer should be stopped if the originator SC address is already contained in the MWD.
RP-MMS	RP-More-Messages-To-Send	OO-	Parameter indicating that there are more messages waiting in the SC
RP-OA	RP-Originating-Address	+++	Address of the originating SC.
RP-DA	RP-Destination-Address	++-	Address of the destination MS.
RP-UD	RP-User-Data	+++	Parameter containing the TPDU
RP-MTI	RP-Message Type Indicator	O--	Parameter indicating if the TPDU is a SMS Deliver or a SMS Status Report ²⁾
RP-SMEA	RP-originating SME-Address	O--	Address of the originating SME ²⁾

- 1) Provision on the links SC<->MSC, MSC<->MSC or MSC<->SGSN, and MSC<->MS or SGSN<->MS indicated by "xxx", where x may be "+", "-" or "O", dependent on whether the parameter is mandatory, not present or optional on the respective link.
- 2) These information elements may be included in the "Send Routing Information for SM" sent by the SMS-GMSC to the HLR.

When transmitted, the RP-SMEA shall take the TP-OA value.

When transmitted, the RP-MTI shall be given the following values:

- 0 SMS Deliver.
- 1 SMS Status Report.

This may be used by the HLR to distinguish the two cases in order not to apply any filtering mechanism based on the RP-SMEA value in case of a SMS-Status Report transmission.

9.3.2.3 RP-ACK

The RP-ACK contains the RP-User-Data which is a parameter containing the TPDU (see subclauses 9.2.2.1a and 9.2.2.2a).

9.3.2.4 RP-ERROR

Basic elements of the RP-ERROR type.

Abbr.	Reference	p1)	Description
RP-MSI	RP-MW-Set-Indication	+--	Parameter indicating whether or not the MWI has been up-dated. 2)
RP-CS	RP-Cause	+++	Parameter identifying the error type. The RP-Cause parameter gives the reason why a short message transfer attempt fails. In practice three relay layer protocols are used - SC to GMSC/IWMSC (see GSM TS 43.047 [11]), MAP (see 3GPP TS 29.002 [15]) and via the radio interface (see 3GPP TS 24.011 [13])
RP-MSIsdn	RP-international--MS-ISDN-number	+--	MSIsdn-Alert of the MS, see clause 3.2.7 3)
RP-UD	RP-User-Data	OO O	Parameter containing a TPDU

- 1) Provision on the links SC<->MSC, MSC<->MSC or MSC<->SGSN, and MSC<->MS or SGSN<->MS indicated by "xxx", where x may be "+", "-" or "O" dependent on whether the parameter is mandatory, not present or optional on the respective link.
- 2) Only present when the RP-ERROR is transferred from the SMS-GMSC to the SC.
- 3) Only present when the RP-MT-DATA transfer attempt failed because the MS is not reachable or because the MS memory capacity was exceeded and the MSIsdn-Alert is different from the MSIsdn used by the SC to address the recipient MS.

9.3.2.5 RP-ALERT-SC

Basic elements of the RP-ALERT-SC type:

Abbr.	Reference	p1)	Description
RP-MSIsdn	RP-International-MS-ISDN-Number	M	MSIsdn of the MS.

- 1) Provision; Mandatory (M).

9.3.2.6 RP-SM-MEMORY-AVAILABLE

Basic elements of the RP-SM-MEMORY-AVAILABLE type:

Abbr.	Reference	p1)	Description
RP-IMSI	RP-International-Mobile-Subscriber-Identity	++-	IMSI of the MS.

- 1) Provision on the links HLR<->VLR or HLR<->SGSN, VLR<->MSC and MSC<->MS or SGSN<->MS indicated by "xxx", where x may be either "+" or "-", dependent on whether the parameter is mandatory or not present on the respective link.

10 Fundamental procedures within SMS

The procedures for providing SMS over a generic IP CAN is described in 3GPP TS 23.204 [42] (see subclause 6).

The SMS comprises 3 fundamental procedures:

- 1) Short message mobile terminated. This procedure consists of all necessary operations to:
 - a) transfer a short message or status report from the SC to the MS;
 - b) return a report to the SC, containing the result of the message transfer attempt.
- 2) Short message mobile originated. This procedure consists of all necessary operations to:
 - a) transfer a short message from the MS to the SC;

- b) return a report to the MS, containing the result of the message transfer attempt.
- 3) Transfer of an Alert. This procedure consists of all necessary operations for an HLR or a VLR to initiate a transfer of an Alert to a specific SC, informing the SC that the MS has recovered operation.

3GPP TS 29.002 [15] defines operations necessary for the provision of the Short Message Service. The operations defined in clause 10 describe the requirement that the Short Message Service puts upon the network functionality. If discrepancies exist in nomenclature, it is the 3GPP TS 29.002 [15] that shall be the reference.

Annex C indicates the flow of primitives and parameters during the short message transfer between the SC and the MS. Both the Mobile terminated and the Mobile originated cases are covered.

10.1 Short message mobile terminated

The entities involved in this procedure are depicted in figure 14.

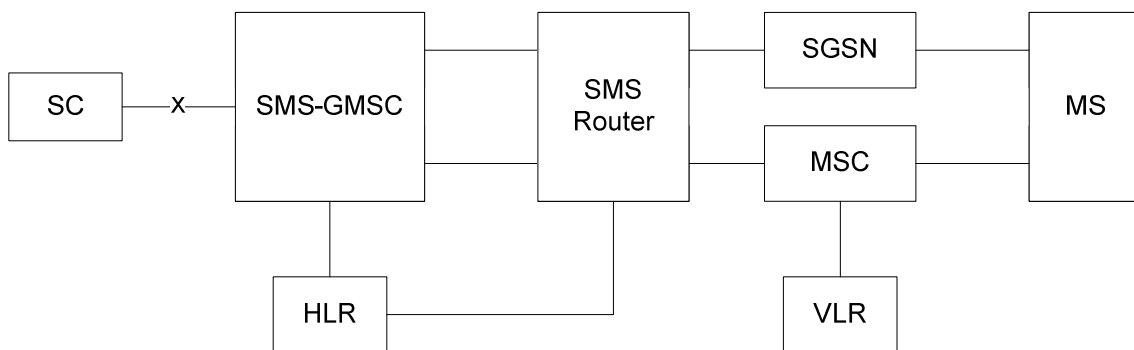

- NOTE 1: The SMS Router is an optional entity. If it is not present, the two interfaces extending from the right side of the SMS-GMSC extend directly to the SGSN and MSC, respectively.
- NOTE 2: Since the short message mobile terminated procedure covers the functionality required at SM-RL for transferring TPDUs from SC to MS, the procedure described covers both short message (SMS-DELIVER) and status report (SMS-STATUS-REPORT) transfer. The term "short message transfer" therefore, in this clause, covers both cases.

Figure 14: Interfaces involved in the Short message mobile terminated procedure. GSM TS 43.002 [5]. X is the interface between an MSC and an SC as defined in clause 5

In figure 15, sequence diagrams are shown for the following basic situations of short message mobile terminated transfer attempt:

- Successful short message transfer via the MSC or the SGSN;
- Successful short message transfer via the SMS Router, and the MSC or SGSN;
- Short message transfer attempt failing due to error at the SMS-GMSC;
- Short message transfer attempt failing due to negative outcome of HLR information retrieval;
- Short message transfer attempt via the SMS Router failing due to negative outcome of HLR information retrieval;
- Short message transfer attempt failing due to error at the MSC or SGSN;
- Short message transfer attempt failing due to negative outcome of VLR information retrieval;
- Short message transfer attempt failing due to erroneous message transfer on the radio path;
- Short message transfer attempt failing over the first path (e.g. SGSN) and succeeding over the second path (e.g. MSC);
- Short message transfer attempt via the SMS Router failing over the first path (e.g. SGSN) and succeeding over the second path (e.g. MSC);

- Short message transfer attempt failing over the first path (e.g. SGSN) and over the second path (e.g. MSC).

References to the relevant specifications of the different operations are given in clause 4.

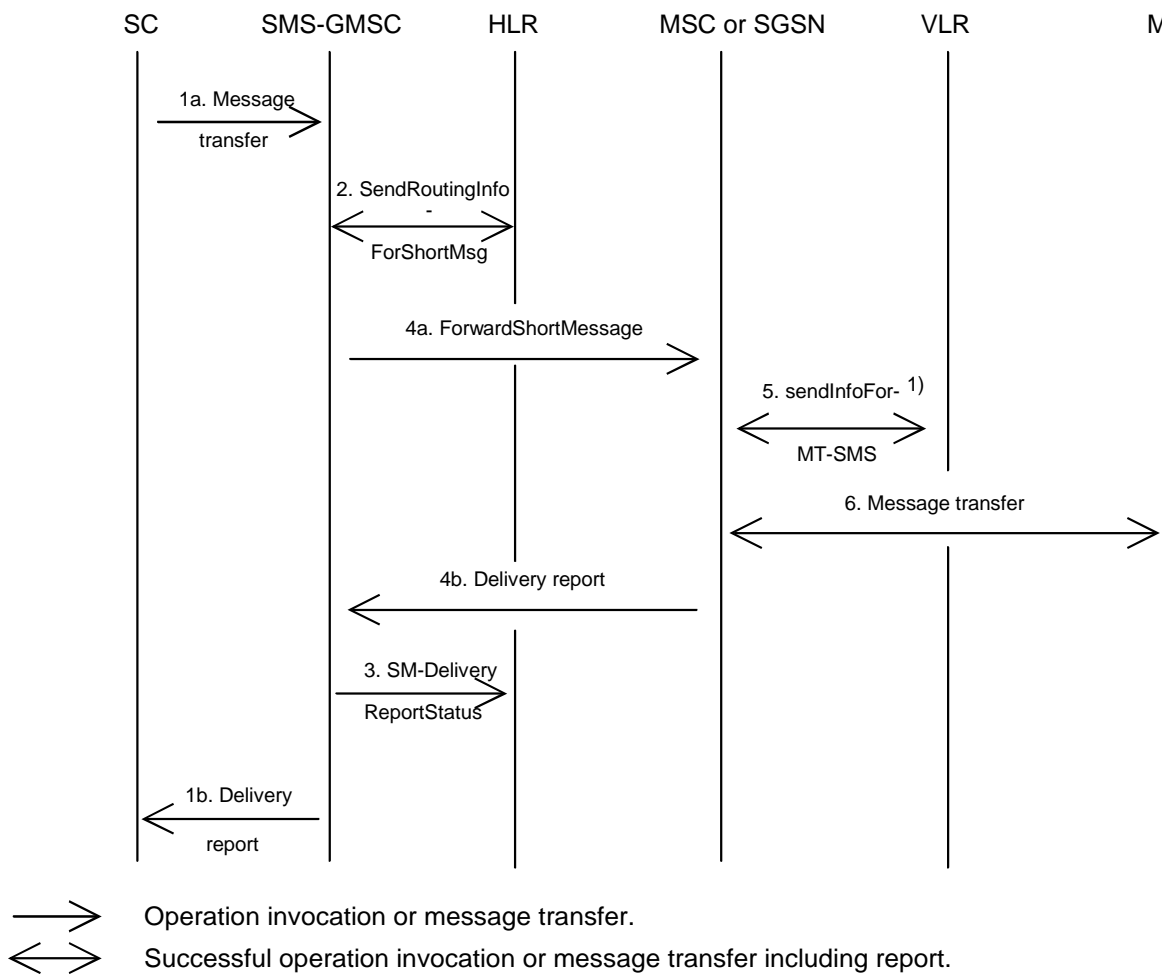

NOTE 1): This operation is not used by the SGSN.

Figure 15a): Successful short message transfer attempt via the MSC or the SGSN

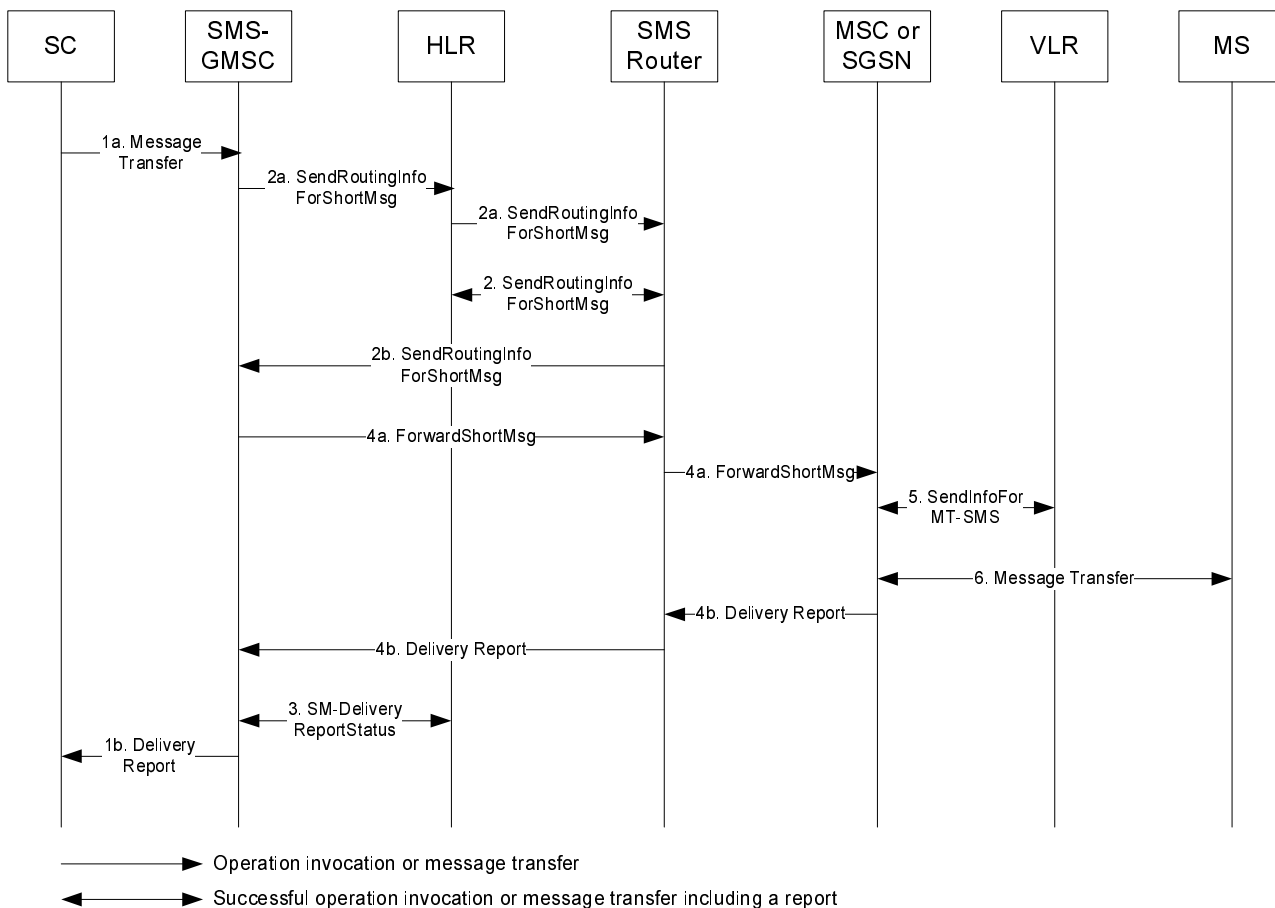

NOTE 1: Operation 5 is not used by the SGSN.

Figure 15a): Successful short message transfer attempt via the SMS Router, and the MSC or SGSN



Figure 15b): Short message transfer attempt failing due to error at the SMS-GMSC

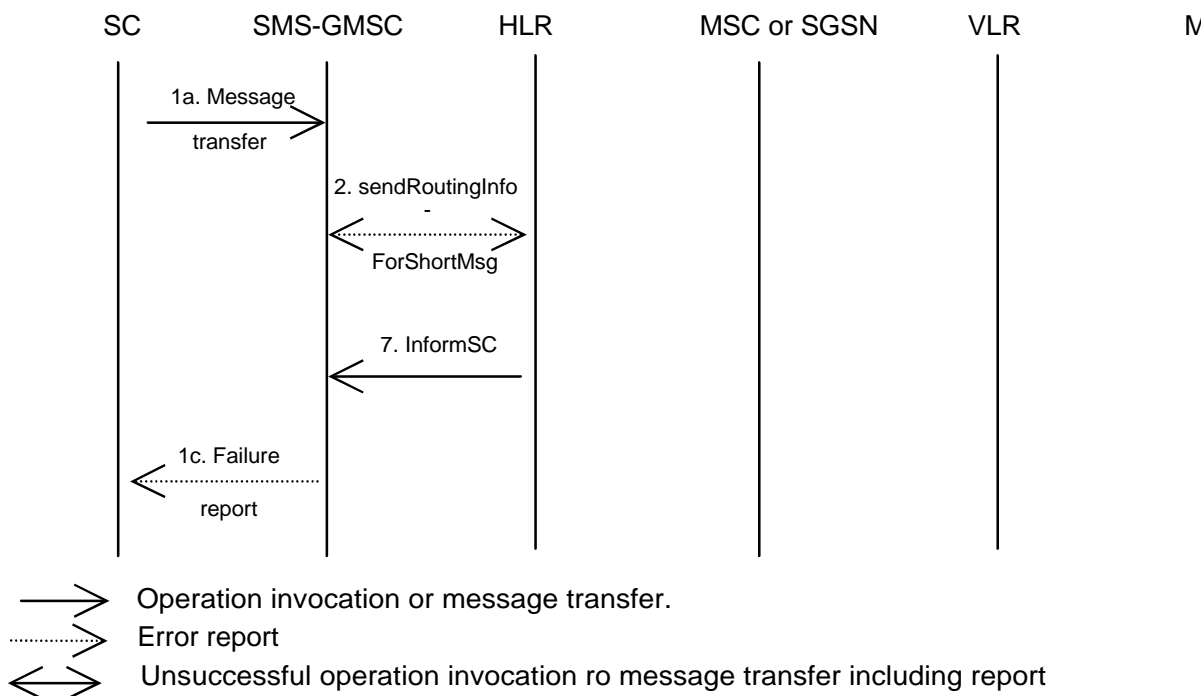

Figure 15c): Short message transfer attempt failing due to negative outcome of HLR information retrieval

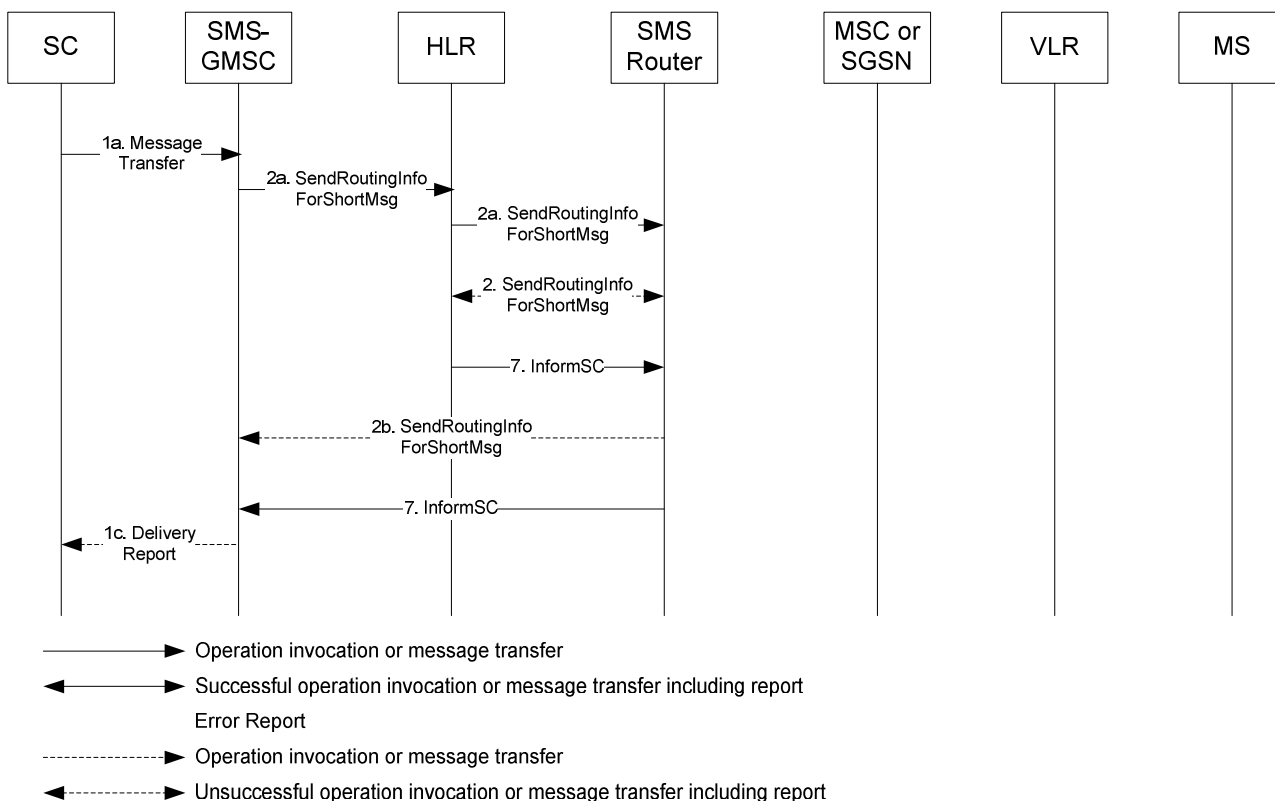
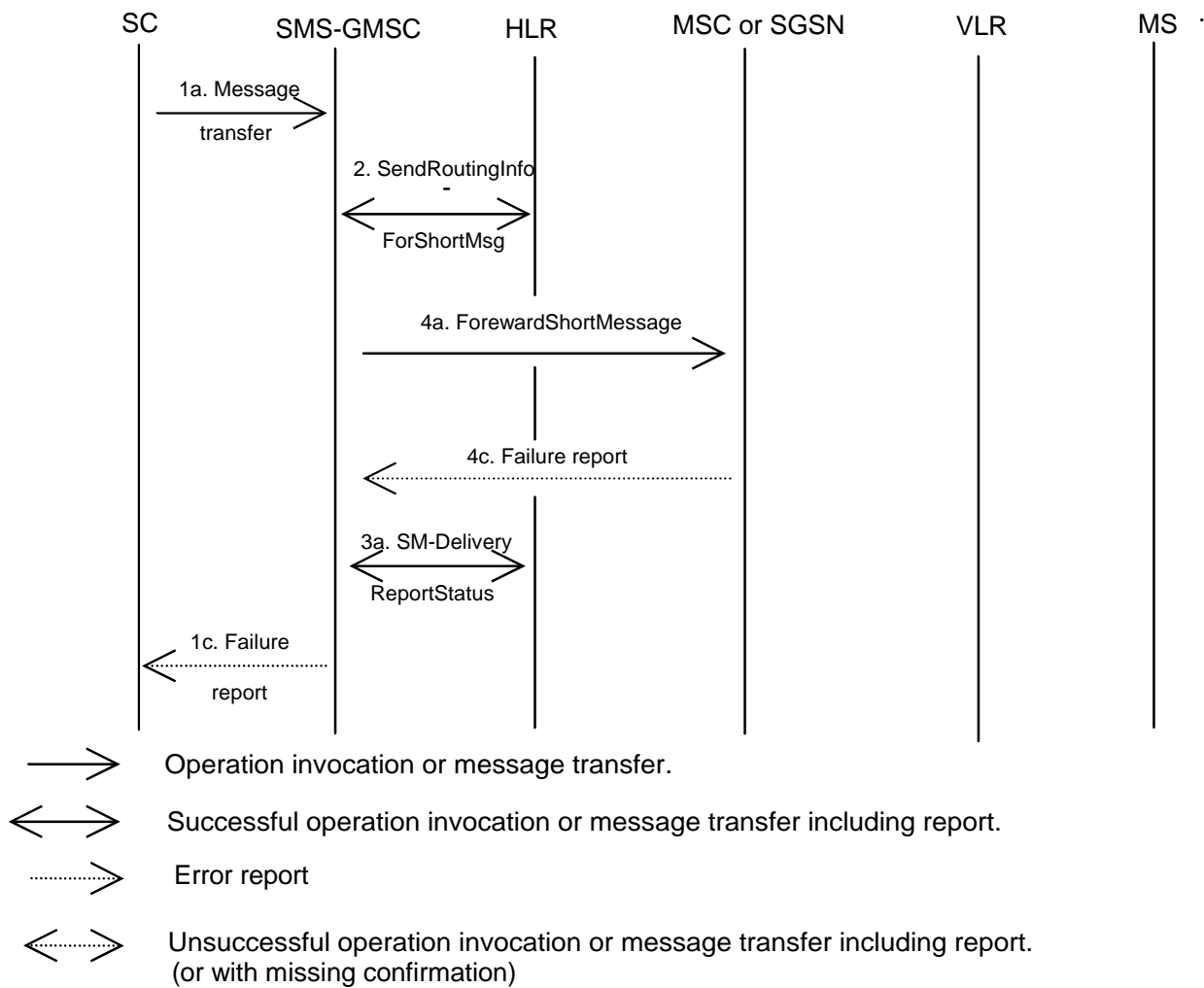
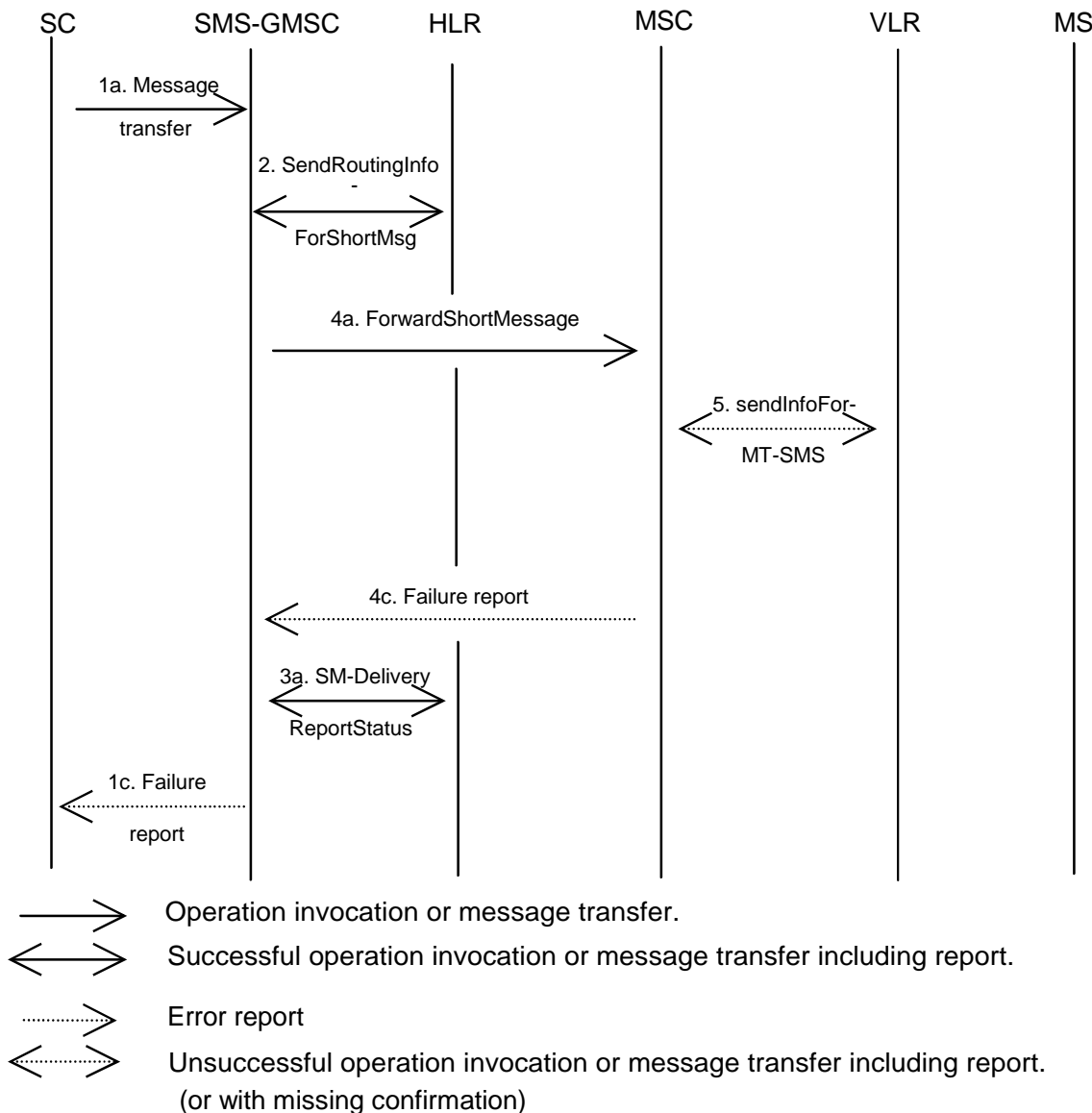

Figure 15ca) Short message transfer attempt via the SMS Router failing due to negative outcome of HLR information retrieval



NOTE: If an SMS Router is present, the message flow in 15aa is used, except that a 4c Failure Report message is transparently transferred to the SMS-GMSC from the MSC or SGSN by the SMS Router instead of a 4b Delivery Report.

Figure 15d): Short message transfer attempt failing due to error at the MSC or SGSN



NOTE: If an SMS Router is present, the message flow in 15aa is used, except that a 4c Failure Report message is transparently transferred to the SMS-GMSC from the MSC or SGSN by the SMS Router instead of a 4b Delivery Report.

Figure 15e): Short message transfer attempt failing due to negative outcome of VLR information retrieval

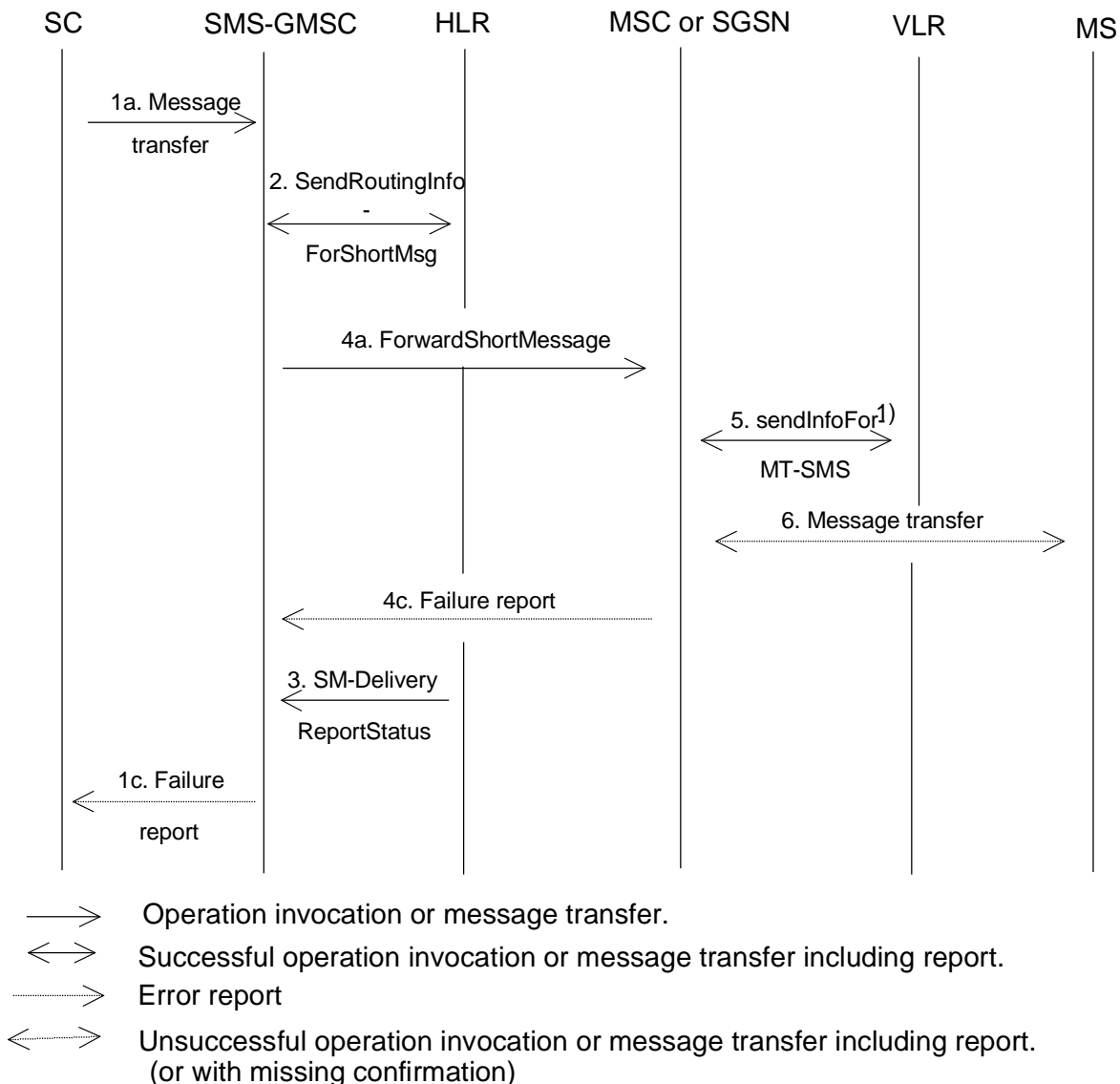

NOTE 1: This operation is not used by the SGSN.

NOTE 2: If an SMS Router is present, the message flow in 15aa is used, except that a 4c Failure Report message is transparently transferred to the SMS-GMSC from the MSC or SGSN by the SMS Router instead of a 4b Delivery Report.

Figure 15f): Short message transfer attempt failing due to erroneous message transfer on the radio path

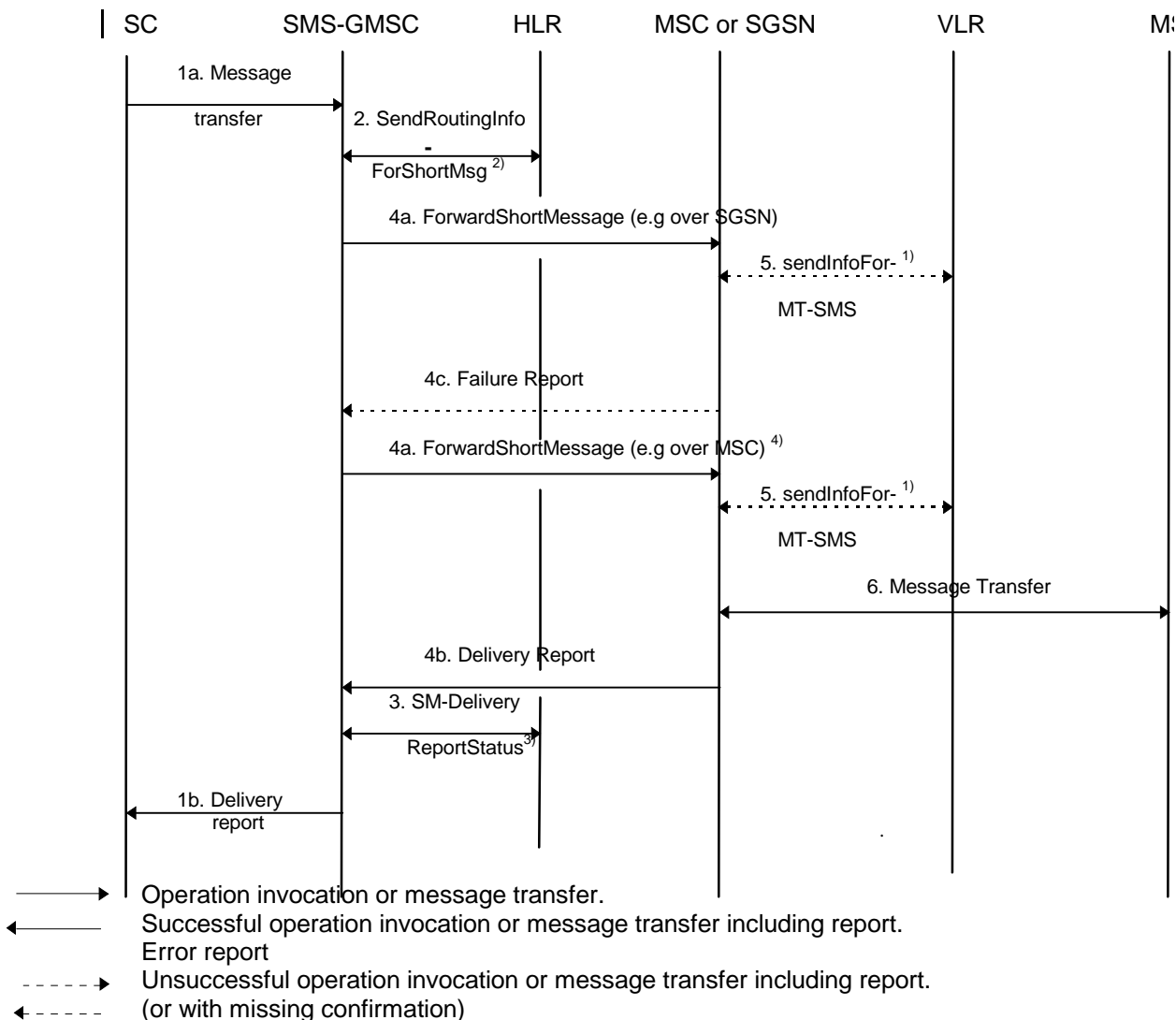

NOTE 1: This operation is not used by the SGSN.

NOTE 2: Two addresses (SGSN and MSC) are received from HLR.

NOTE 3: Both successful transfer over second path and unsuccessful transfer over first path (e.g. Absent subscriber) are sent to HLR.

NOTE 4: The SMS transfer towards the second path is only triggered by the reception of some MAP errors on the first path as described in sub-clause 8.1.1.

Figure 15g): Short message transfer attempt failing over the first path (e.g. SGSN) and succeeding over the second path (e.g. MSC)

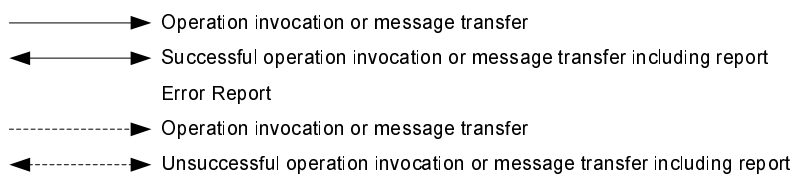
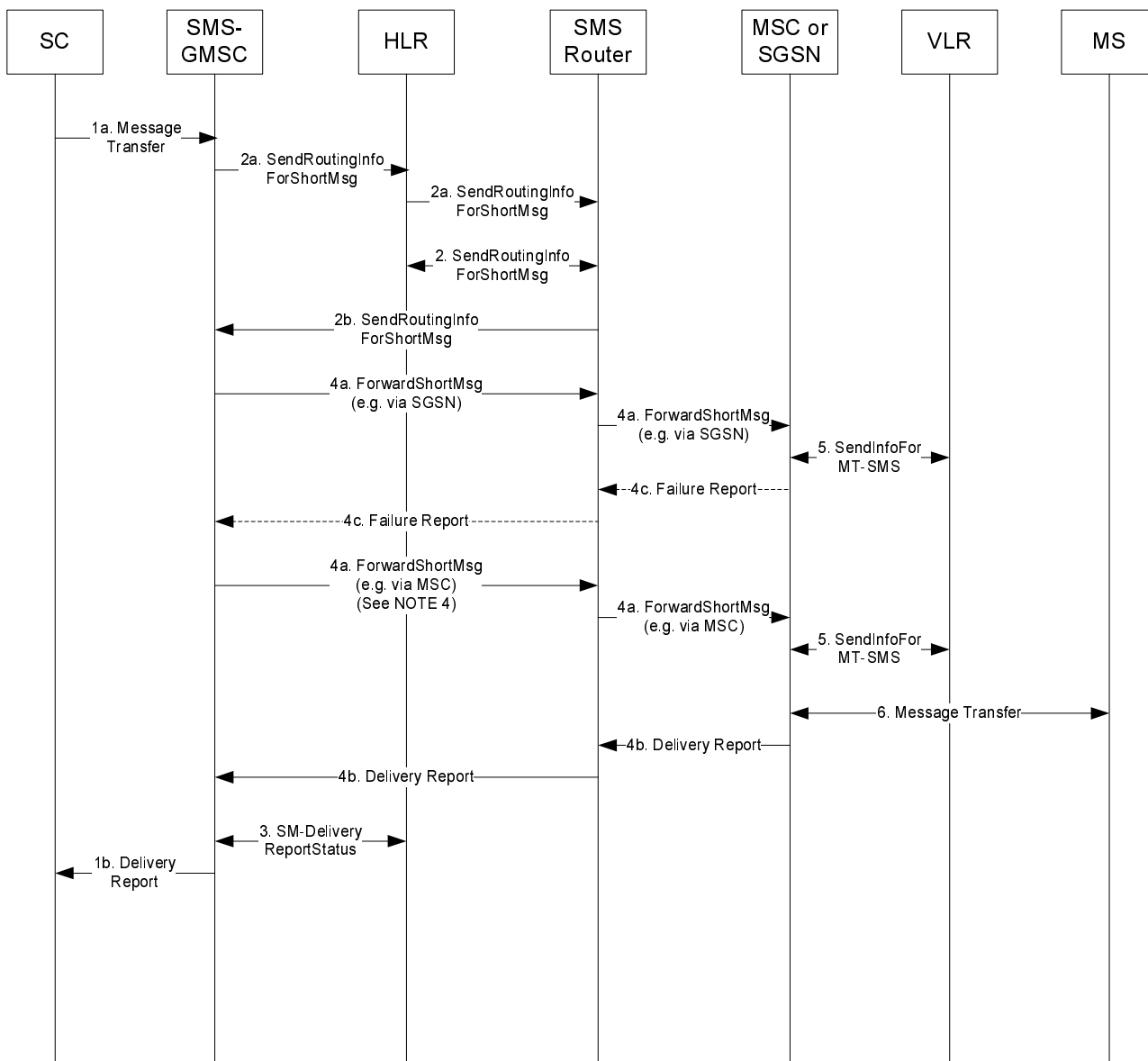

NOTE 1: Operation 5 is not used by the SGSN.

NOTE 2: In Operation 2b, two addresses are received from the SMS Router by the SMS-GMSC. Both contain the address of the SMS Router, however, each address identifies delivery to the MS via the MSC or via the SGSN.

NOTE 3: In Operation 3, both successful transfer over second path and unsuccessful transfer over first path (e.g. Absent subscriber) are sent to the HLR.

NOTE 4: The SMS transfer towards the second path is only triggered by the reception of some MAP errors on the first path as described in sub-clause 8.1.1.

Figure 15ga): Short message transfer attempt via the SMS Router failing over the first path (e.g. SGSN) and succeeding over the second path (e.g. MSC)

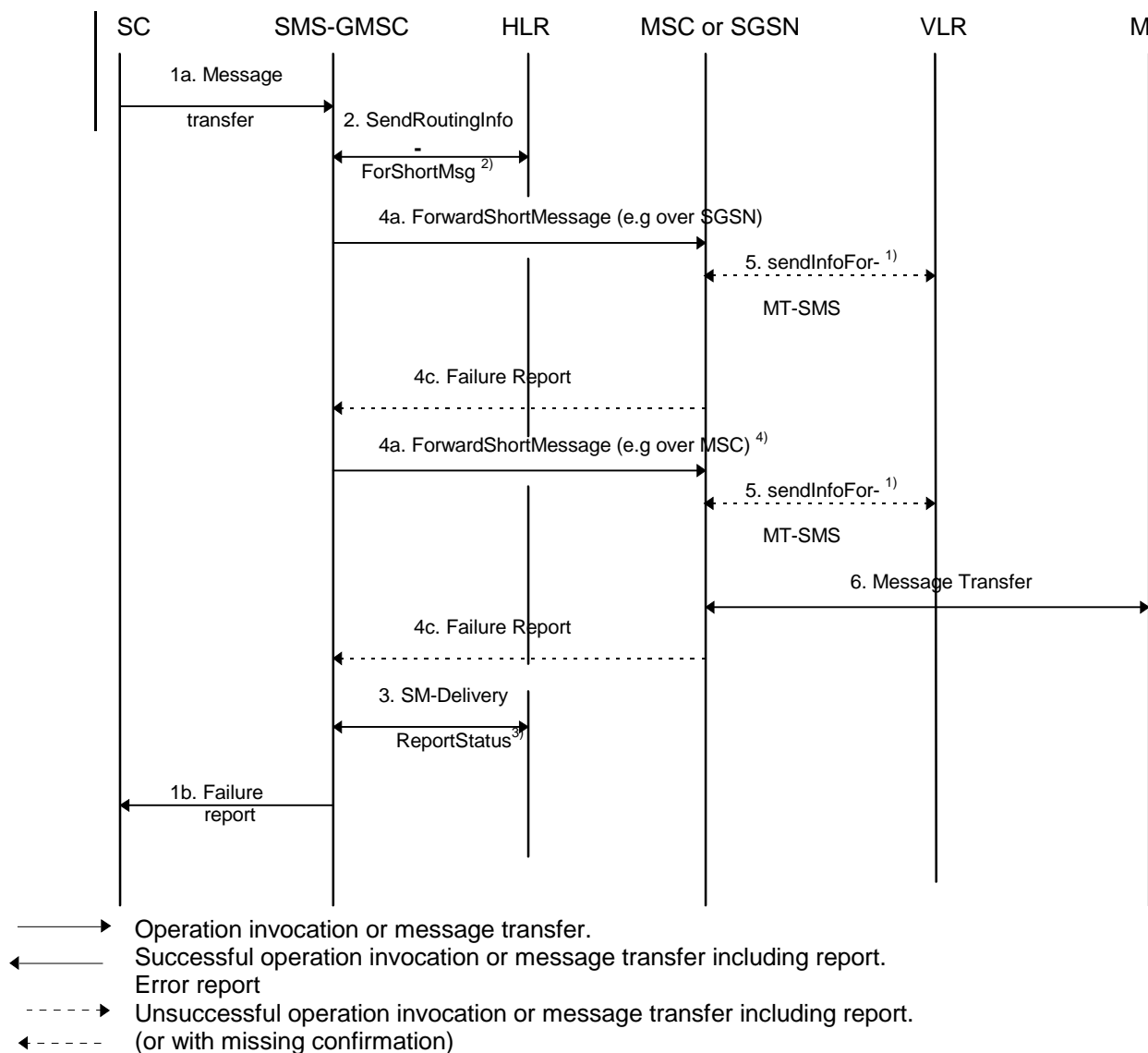

NOTE 1: This operation is not used by the SGSN.

NOTE 2: Two addresses (SGSN and MSC) are received from HLR.

NOTE 3: Unsuccessful transfer over the second path (e.g. MemoryCapacityExceeded) and over the first path (e.g. Absent subscriber) are sent to HLR.

NOTE 4: The SMS transfer towards the second path is only triggered by the reception of some MAP errors on the first path as described in clause 8.1.1.

NOTE 5: If an SMS Router is present, the message flow in 15ga is used, except that a 4c Failure Report message is transparently transferred to the SMS-GMSC from the MSC or SGSN by the SMS Router instead of a 4b Delivery Report.

Figure 15h): Short message transfer attempt failing over the first path (e.g. SGSN) and over the second path (e.g. MSC)

Operation 1: Message transfer SC -> SMS-GMSC.

This operation is used to transfer a short message from an SC to an SMS-GMSC.

The operation consists of:

- the transfer of a message containing the TPDU from the SC to the SMS-GMSC (see "1a. Message transfer" in figure 15); and
- the return of either a "Failure report" (see 1c. in figure 15) or a "Delivery report" (see 1b. in figure 15).

"Failure report" is returned to the SC when the SMS-GMSC has received indication from another entity (MSC, SGSN or HLR) the procedure was unsuccessful. The error indications which the SMS-GMSC may receive from the MSC,

SGSN, HLR, VLR or MS enable the SMS-GMSC to return one of the error indications given in clause 3.3 back to the SC.

Operation 2: sendRoutingInfoForShortMsg.

The operation is an interrogation of the HLR by the SMS-GMSC or the SMS Router to retrieve information necessary to deliver the short message.

The result may contain the MSC, SGSN, both MSC and SGSN addresses, or the address of the SMS Router. It shall also indicate which address belongs to the MSC and the SGSN, however, it shall not indicate if the address belongs to an SMS Router (as the SMS Router poses as either an MSC or an SGSN or both to the SMS-GMSC).

Operation 3: SM-DeliveryReportStatus.

The operation provides a means for the SMS-GMSC to request the HLR to add an SC address to the MWD, and is activated when the SMS-GMSC receives an absent subscriber indication from the MSC, SGSN or both, and/or when the SMS-GMSC receives a failure report for a short message transfer with cause MS Memory Capacity Exceeded via the MSC or SGSN. The Return Result optionally contains the MSISdn-Alert.

This operation is also activated at successful delivery short message when the MNRF, MNRG or both are set in HLR.

The operation consists of:

- the transfer of a message, containing the MSISDN of the MS to which the short message was addressed, the SC-address, the successful outcome and/or the causes (Absent Subscriber, MS memory capacity exceeded or both) for updating the MWD, from the SMS-GMSC to the HLR (see 3. in figure 15).

Operation 4: forwardShortMessage.

The operation provides a means for the SMS-GMSC to transfer a short message to the MSC or to the SGSN at which the MS is currently located, via an SMS Router if deployed by the HPLMN of the receiving MS.

The operation works in tandem with the forwarding of the short message from the MSC or from the SGSN to the MS. Thus, the outcome of the operation comprises either success, i.e. that the message has been delivered to the MS; or a failure that may be caused by several reasons, e.g. failure in the transfer SMS-GMSC -> MSC or SMS-GMSC -> SGSN, MS being detached, or no paging response.

It should be noted that the MNRG setting is implicitly carried out in the SGSN when the message transfer is denied due to GPRS DETACH.

Operation 5: sendInfoForMT-SMS.

The operation provides a means for the MSC to retrieve subscriber information from VLR for mobile terminated short message transfer. The operation may be associated with an authentication procedure, as shown in figure 16. Unsuccessful retrieval (e.g. absent subscriber) is indicated by a cause indication to the SMS-GMSC.

An overall depiction of how operation 5 interacts with signalling on the radio path is given in figure 16.

It should be noted that the MNRF setting is implicitly carried out when the message transfer is denied due to IMSI DETACH.

NOTE: This operation is not used by the SGSN.

Operation 6: Message transfer MSC -> MS.

The operation is used to transfer a short message from the MSC to the MS.

If the transfer is not successful, e.g. due to the MS losing radio coverage after having successfully authenticated, a failure report (RP-ERROR) is returned to the SMS-GMSC. In this case, MWD and MCEF in the HLR shall be updated only for the case where the transfer fails with cause MS Memory Capacity Exceeded.

If the MS notifies the network that the MS has been unable to accept a short message because its memory capacity has been exceeded, then the ME shall set the memory capacity Exceeded Notification flag if present.

Operation 7: InformSC.

The operation is used to transfer the MSISdn-Alert from the HLR to the SMS-GMSC if the error Absent Subscriber or a positive result is given as an answer to the operation SendRoutingInfoForSM.

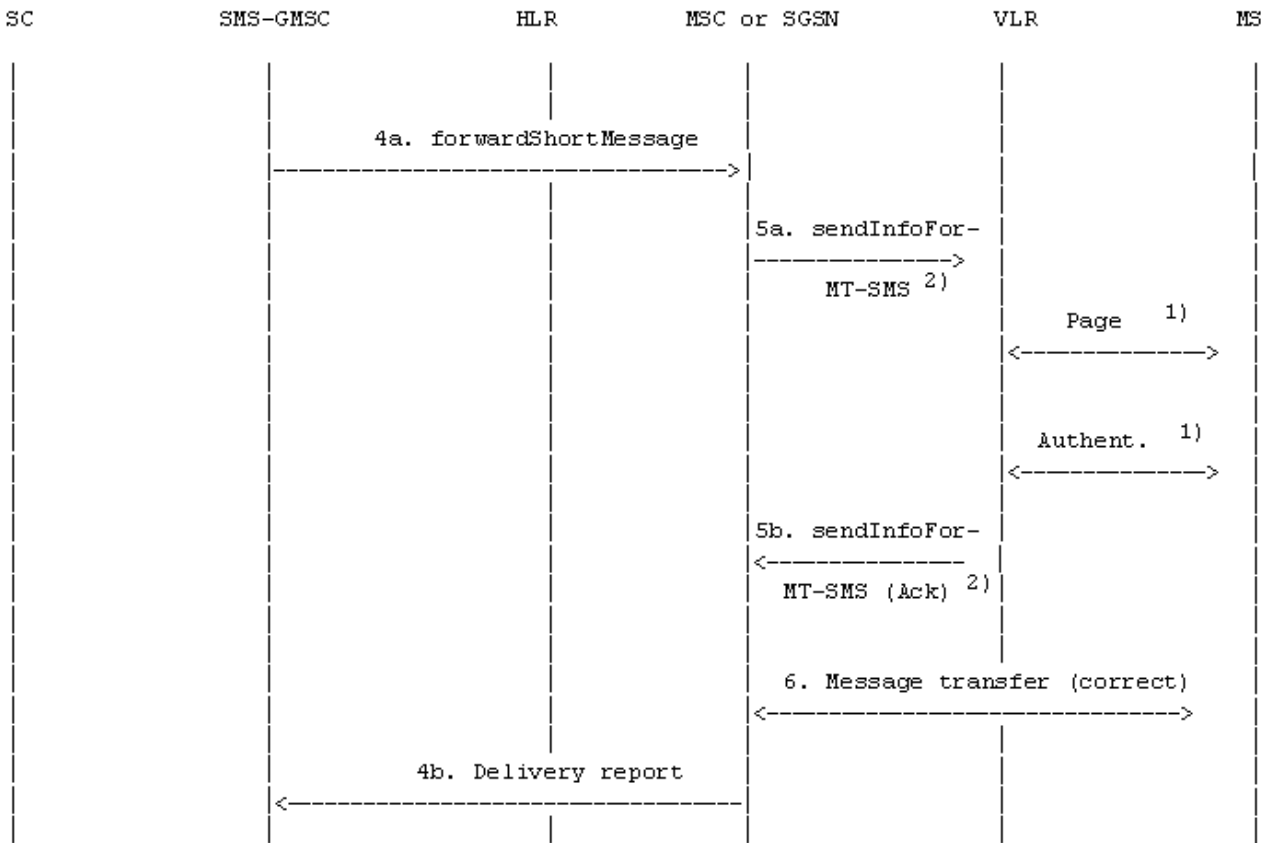

-----> : Operation invocation or message transfer
 <----- : Successful operation invocation or message transfer incl. report

NOTE 1: Described in GSM 44.008 [12] and 3GPP TS 29.002 [15].
 If the SGSN is used, Paging and Authentication are performed from SGSN.

NOTE 2: This operation is not used by the SGSN.

NOTE 3: If an SMS Router is present, the message 4a forwardShortMessage and 4b Delivery report are transparently transferred from/to the SMS-GMSC to/from the MSC or SGSN by the SMS Router.

Figure 16a): "Send information for MT SMS" procedure; error free case

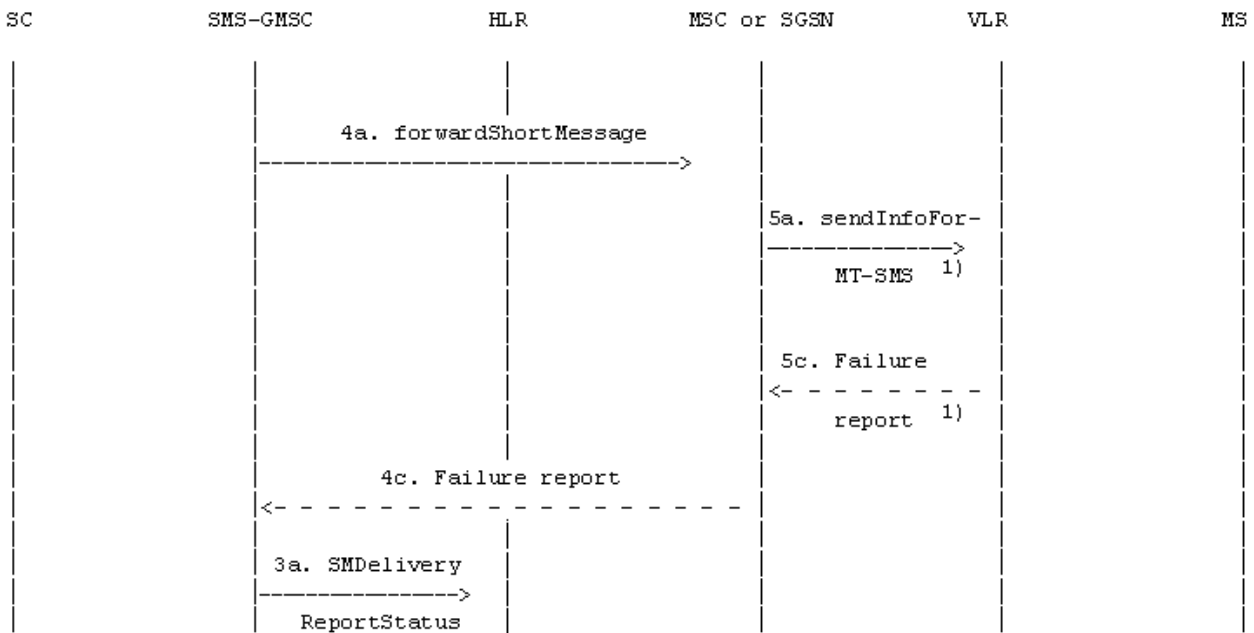

----- : Operation invocation or message transfer
 - - - -> : Error report

NOTE 1: The GPRS DETACH information is in the SGSN. This operation is not used by the SGSN.

NOTE 2: If an SMS Router is present, the message 4a forwardShortMessage and 4c Failure report are transparently transferred from/to the SMS-GMSC to/from the MSC or SGSN by the SMS Router.

Figure 16b): "Send information for MT SMS" procedure; erroneous case: absent subscriber (e.g. IMSI DETACH or GPRS DETACH)

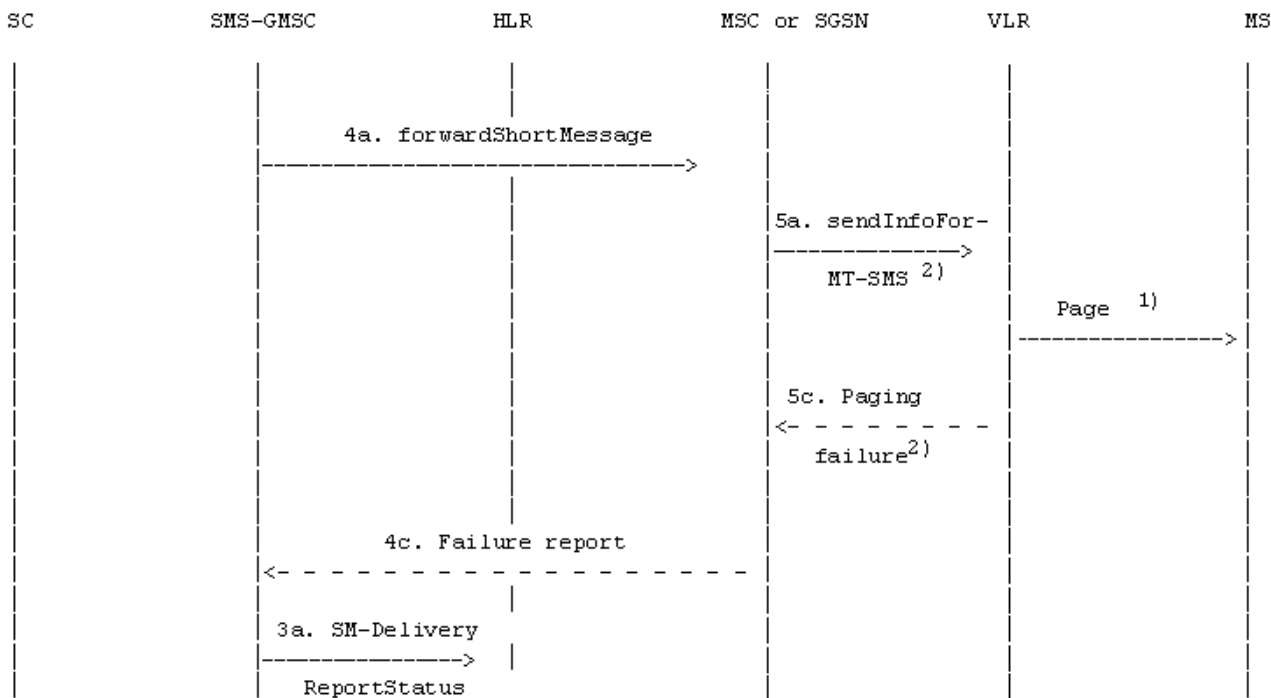

----- : Operation invocation or message transfer
 - - - -> : Error report

NOTE 1: Described in GSM 44.008 [12] and 3GPP TS 29.002 [15].
 If the SGSN is used, Paging is performed from SGSN.

NOTE 2: This operation is not used by the SGSN.

NOTE 3: If an SMS Router is present, the message 4a forwardShortMessage and 4c Failure report are transparently transferred from/to the SMS-GMSC to/from the MSC or SGSN by the SMS Router.

Figure 16c): "Send information for MT SMS" procedure; erroneous case: Absent subscriber (e.g. no paging response)

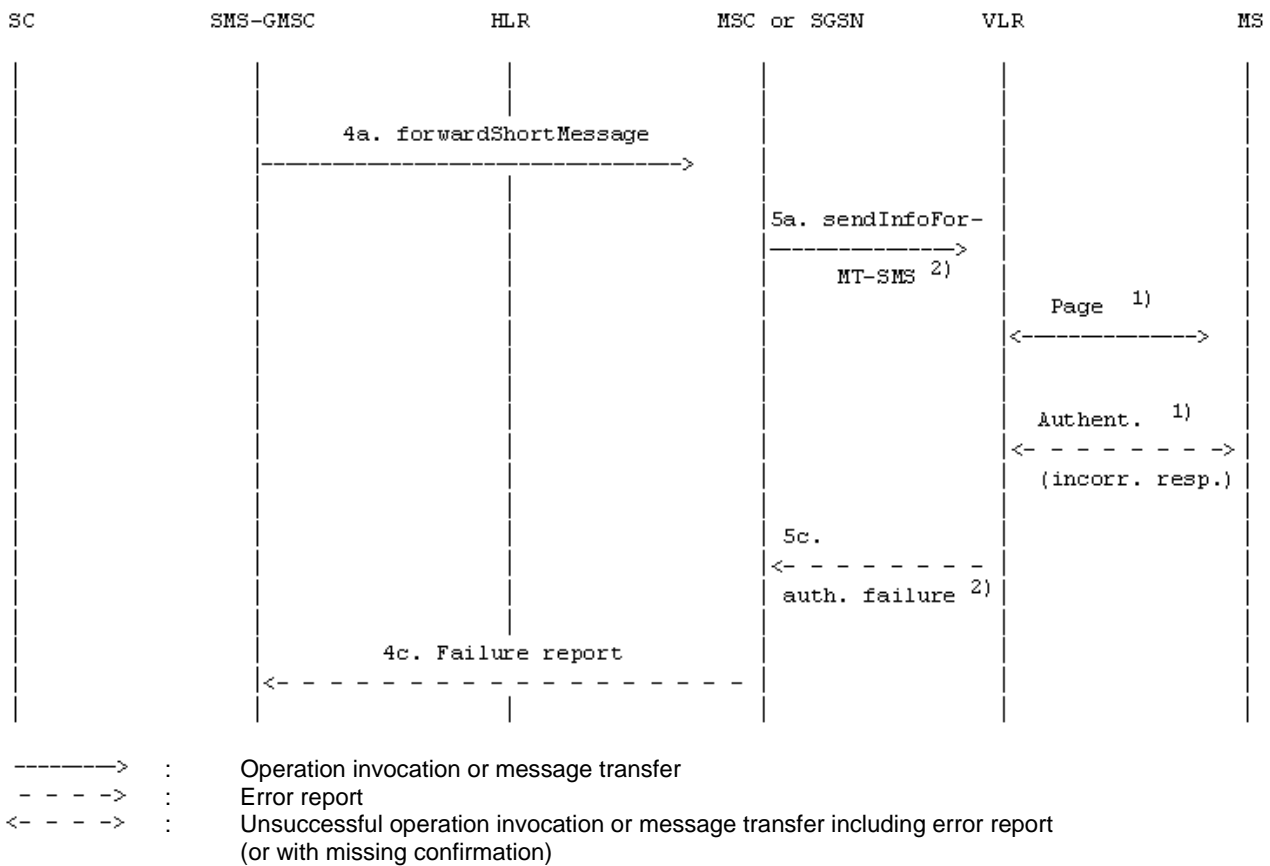

NOTE 1: Described in GSM 44.008 [12] and 3GPP TS 29.002 [15].
 If the SGSN is used, Paging and Authentication are performed from SGSN.
 NOTE 2: This operation is not used by the SGSN.
 NOTE 3: If an SMS Router is present, the message 4a forwardShortMessage and 4c Failure report are transparently transferred from/to the SMS-GMSC to/from the MSC or SGSN by the SMS Router.

Figure 16d): "Send information for MT SMS" procedure; incorrect authentication

10.2 Short message mobile originated

The entities involved in this procedure is depicted in figure 17.

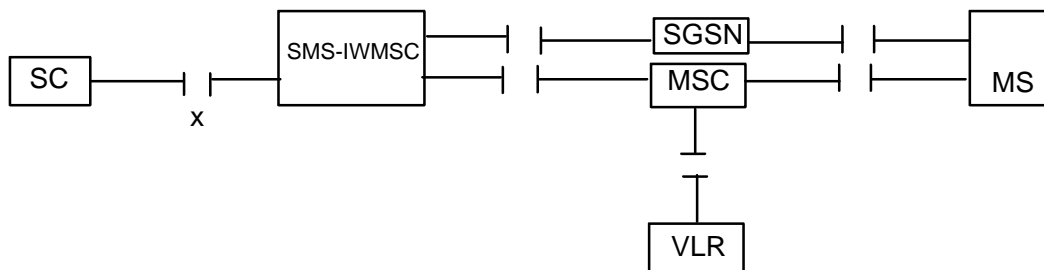

Figure 17: Interfaces involved in the Short message mobile originated procedure

GSM TS 43.002 [5]. X is the interface between an MSC or an SGSN and an SC as defined in clause 5.

Note that since the short message mobile originated procedure covers the functionality required at SM-RL for transferring TPDU's from SC to MS, the procedure described covers both short message (SMS-SUBMIT) and command (SMS-COMMAND) transfer. The term "short message transfer" therefore in this clause, covers both cases.

In figure 18, sequence diagrams for the following basic situations of short message mobile terminated transfer attempt:

- Successful short message transfer;
- Short message transfer attempt failing due to error at the MSC or SGSN;
- Short message transfer attempt failing due to negative outcome of VLR information retrieval;
- Short message transfer attempt failing due to error at the SMS-IWMSC;
- Short message transfer attempt failing due to error at the SC;
- Short Message transfer attempt successful due to the existence of an SMS Interworking agreement;
- Short Message transfer attempt failing due to non-existence of an SMS Interworking agreement;
- Short Message transfer attempt failing due to negative outcome of HLR information retrieval.

References to the relevant specifications of the different operations are given in clause 4.

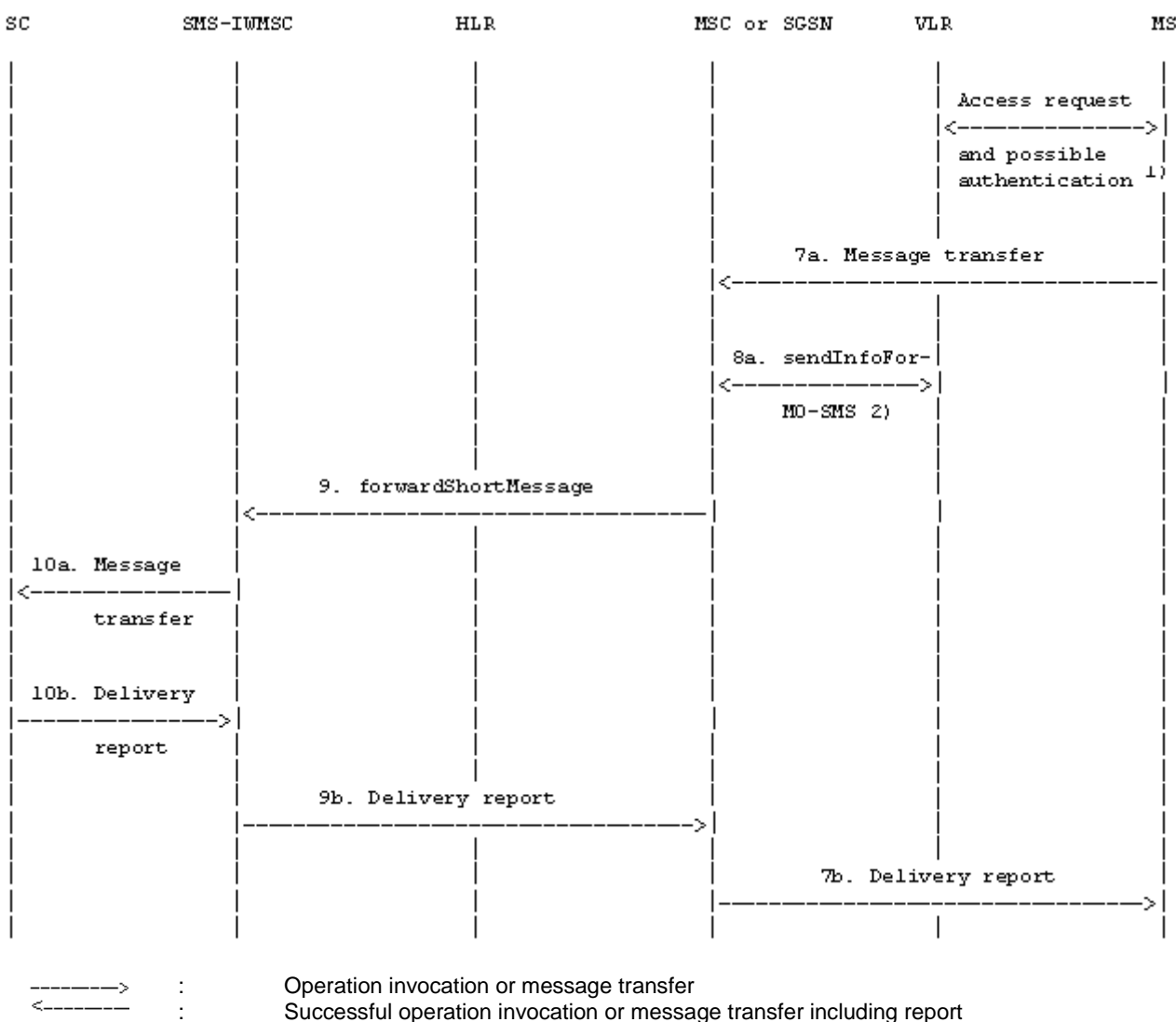
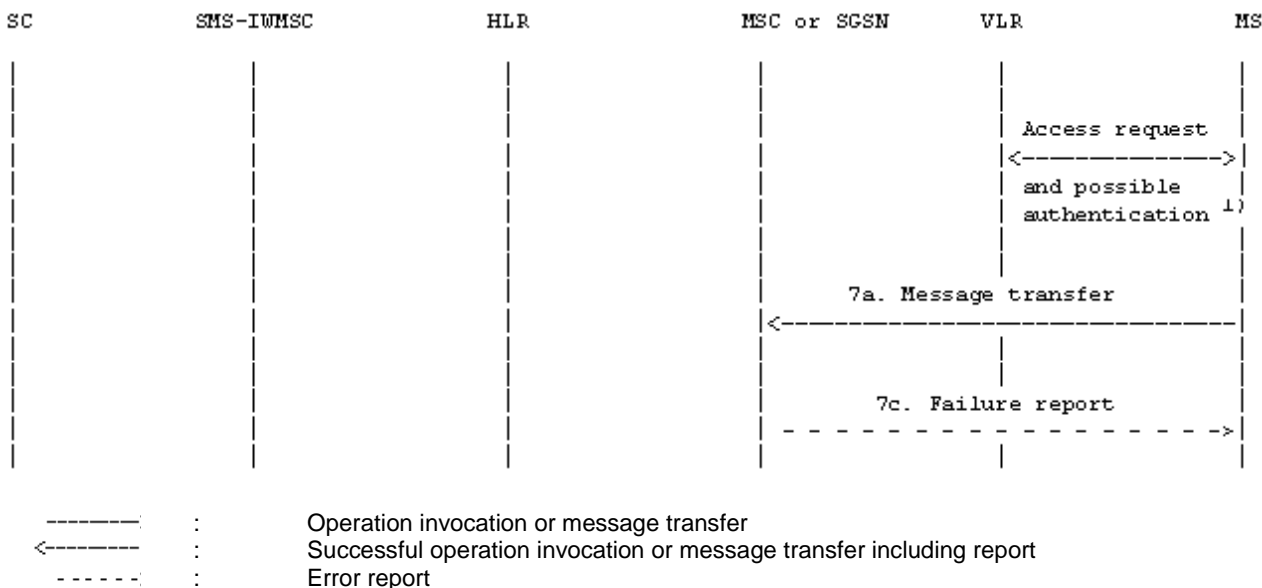
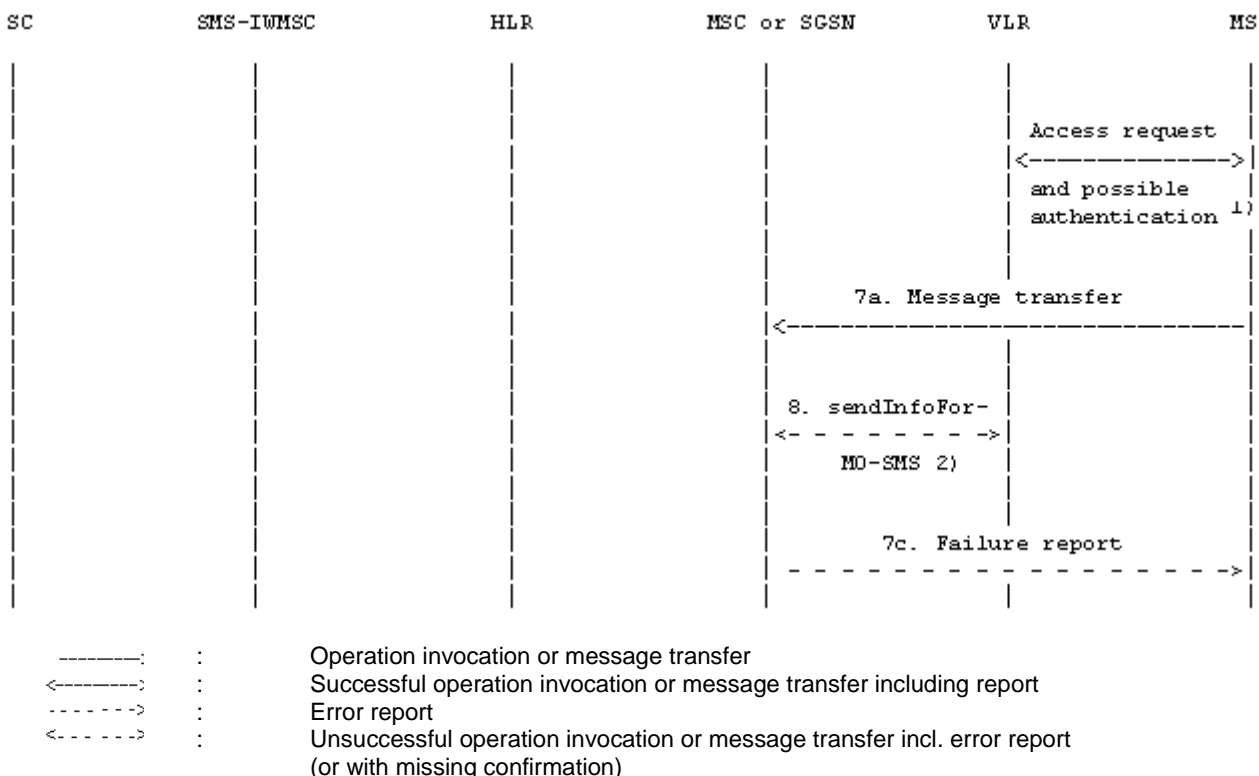

Figure 18a): Successful short message transfer attempt



NOTE 1): Described in GSM 44.008 [12] and 3GPP TS 29.002 [15].

Figure 18b): Short message transfer attempt failing due to error at the MSC or SGSN



NOTE 1): Described in GSM 44.008 [12] and 3GPP TS 29.002 [15].

NOTE 2): This operation is not used by the SGSN.

Figure 18c): Short message transfer attempt failing due to negative outcome of VLR information retrieval

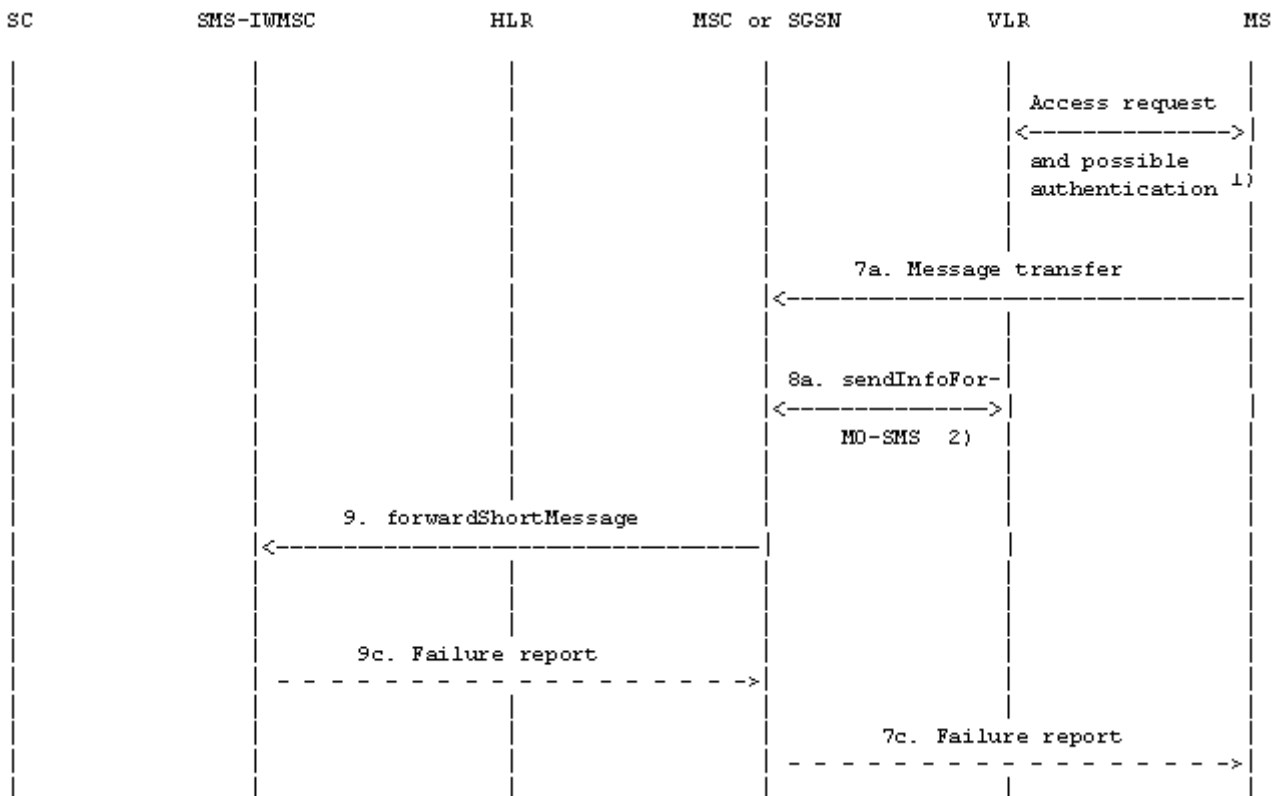

----- : Operation invocation or message transfer
 <----- : Successful operation invocation or message transfer including report
 - - - - - : Error report

NOTE 1): Described in GSM 44.008 [12] and 3GPP TS 29.002 [15].

NOTE 2): This operation is not used by the SGSN.

Figure 18d): Short message transfer attempt failing due to error at the SMS-IW MSC

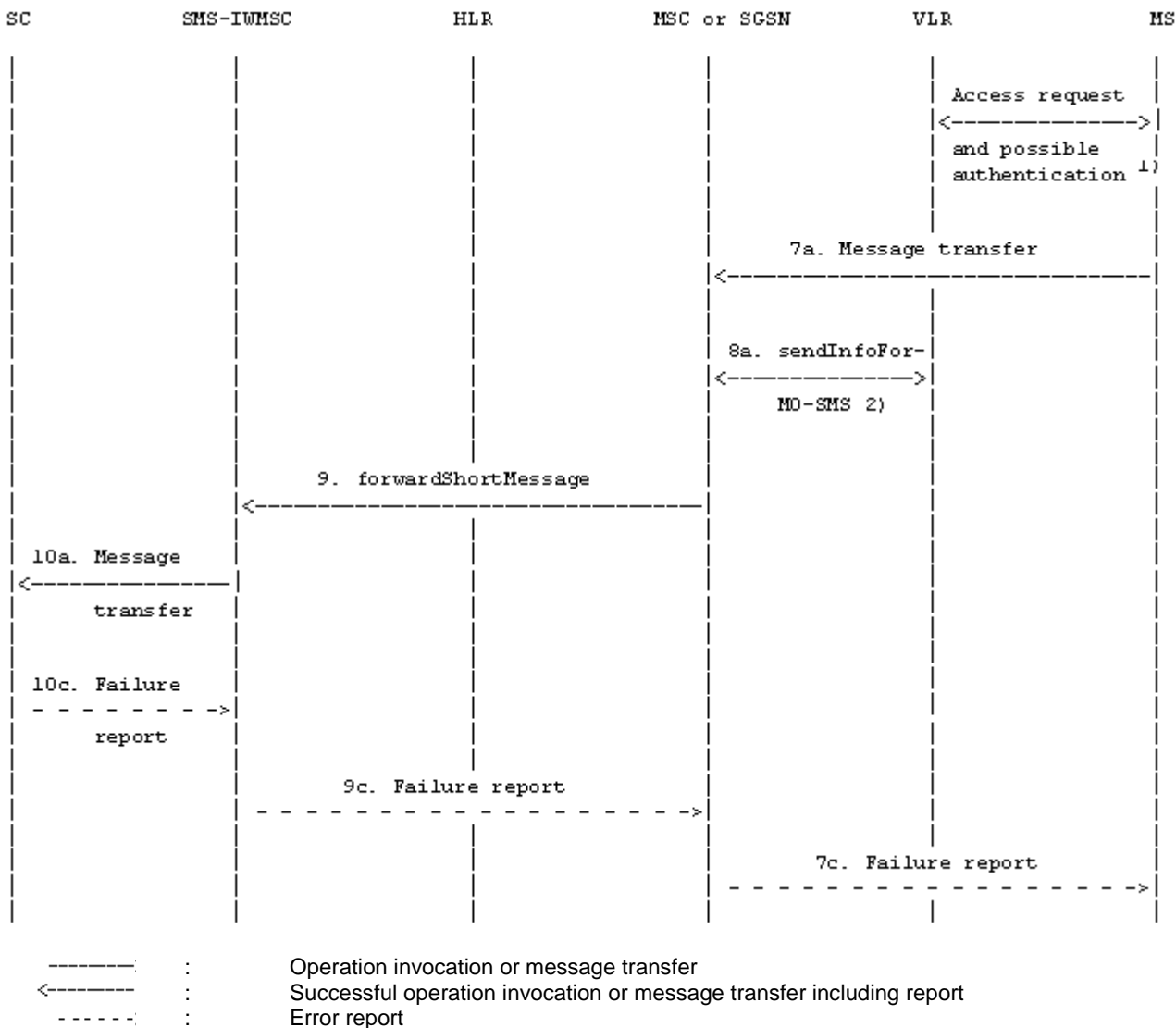

NOTE 1): Described in GSM 44.008 [12] and 3GPP TS 29.002 [15].

NOTE 2): This operation is not used by the SGSN.

Figure 18e): Short message transfer attempt failing due to error at the SC

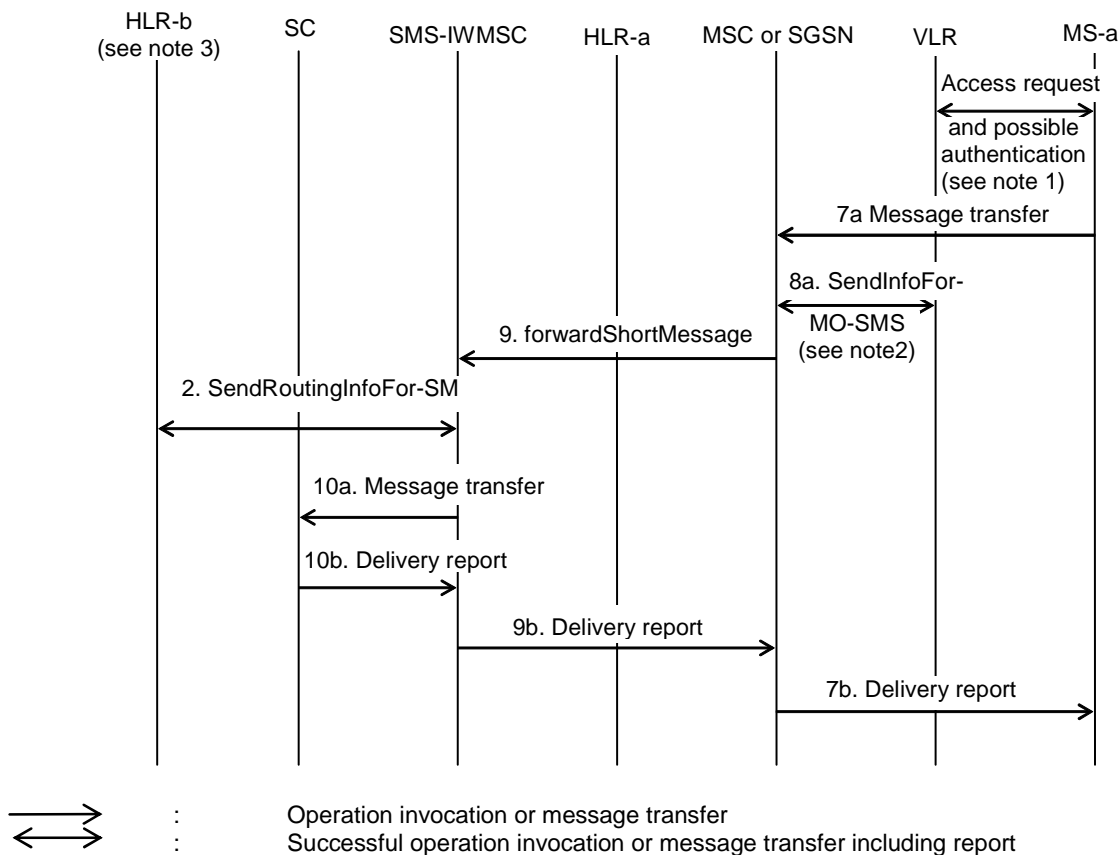

NOTE 1: Described in 3GPP TS 44.008 [12] and 3GPP TS 29.002 [15].

NOTE 2: This operation is not used by the SGSN.

NOTE 3: HLR that terminated user belongs to.

After completing operation 2, SMS-IWMSC could check whether SMS interworking agreement exists or not based on IMSI. In this figure 18f case, there is an SMS interworking agreement between operators.

Figure 18f): Short Message transfer Successful due to the existence of an SMS Interworking agreement

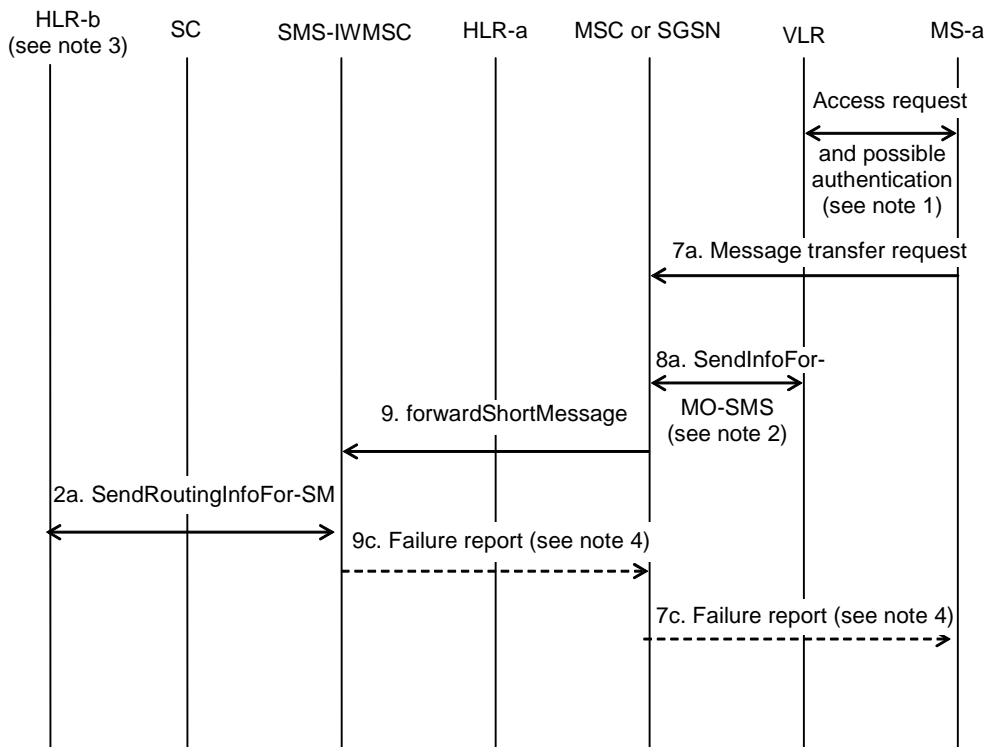

: Operation invocation or message transfer
 : Successful operation invocation or message transfer including report
 : Error report

NOTE 1: Described in 3GPP TS 44.008 [12] and 3GPP TS 29.002 [15].

NOTE 2: This operation is not used by the SGSN.

NOTE 3: HLR that terminated user belongs to.

NOTE 4: The lack of an SMS interworking agreement can not be conveyed in the Failure Report as a specific indication.

After completing operation 2, SMS-IWMSC could check whether SMS interworking agreement exists or not based on IMSI. In this figure18g case, there is no SMS Interworking agreement between operators.

Figure 18g): Short Message transfer attempt failing due to non-existence of an SMS Interworking agreement

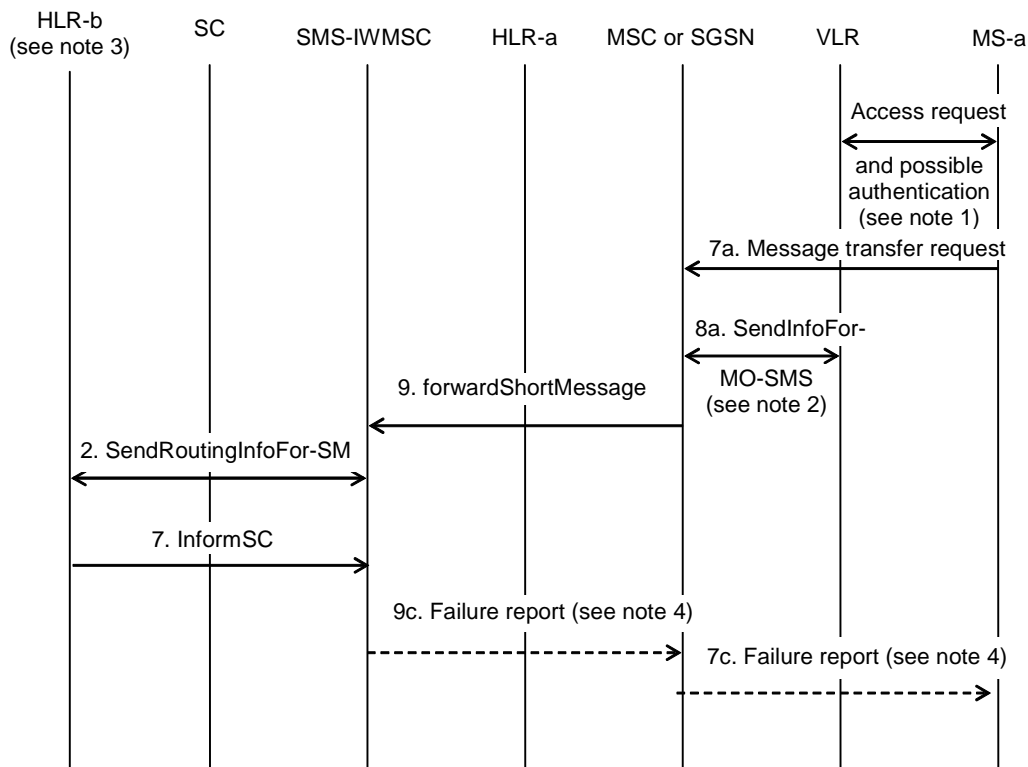

: Operation invocation or message transfer
 : Successful operation invocation or message transfer including report
 : Error report

- NOTE 1: Described in 3GPP TS 44.008 [12] and 3GPP TS 29.002 [15].
- NOTE 2: This operation is not used by the SGSN.
- NOTE 3: HLR that terminated user belongs to.
- NOTE 4: The lack of an SMS interworking agreement can not be conveyed in the Failure Report as a specific indication.

If SMS-IWMSC receives an informSC Message, then this message shall be ignored by the SMS-IWMSC.

Figure 18h: Short Message transfer attempt failing due to negative outcome of HLR information retrieval

If a failure report is indicated by the HLR after invocation of the "sendRoutingInfoForShortMsg" operation, the SMS-IWMSC shall return the appropriate error information to the MSC/SGSN with the error cause coded as follows:

Return error from SendRoutingInfoForSM	Error mapping to ForwardShortMessage
system Failure	system Failure
data Missing	system Failure
Unexpected Data Value	system Failure
facility Not supported	SM Delivery Failure cause: invalid SME-address
unknown Subscriber	SM Delivery Failure cause: invalid SME-address
teleservice Not provisioned	SM Delivery Failure cause: invalid SME-address
Call barred	SM Delivery Failure cause: invalid SME-address
Absent Subscriber SM	SM Delivery Failure cause: invalid SME-address

Operation 2: sendRoutingInfoForShortMsg.

The operation is an interrogation of the HLR by the SMS-IWMSC to retrieve information necessary to forward the short message.

The outcome of the operation comprises either success, where the result contains the IMSI for terminated UE, or failure, which may be caused by several reasons.

Operation 7: Message transfer MS -> MSC or MS -> SGSN.

The operation is used to transfer a short message from the MS to the MSC or to the SGSN.

Operation 8: sendInfoForMO-SMS.

The operation provides a means for the MSC to verify from the VLR that the mobile originated short message transfer does not violate supplementary services invoked or restrictions imposed using the network feature Operator Determined Barring.

A successful VLR response carries the MSISdn of the originating MS being transferred to the SC at SM-RL.

NOTE: This operation is not used by SGSN.

Operation 9: forwardShortMessage.

The operation provides a means for the MSC or for the SGSN to transfer a short message to the SMS-IWMSC.

The procedure is required if the serving MSC or SGSN cannot access the SC directly, e.g. because it has no connection to SC (see clause 5).

The procedure works in tandem with the forwarding of the short message from the SMS-IWMSC to the SC. Thus, the outcome of the operation comprises either success, i.e. that the message has been delivered to the SC; or a failure that may be caused by several reasons, e.g. failure in the transfer MSC --> SMS-IWMSC or SGSN --> SMS-IWMSC, SC does not comply.

Operation 10: Message transfer SMS-IWMSC -> SC.

The operation is used to transfer a short message from an SMS-IWMSC to an SC, and consists of:

- the transfer of a message containing the TPDU from the SMS-IWMSC to the SC (see "10a. Message transfer" in figure 18); and
- the return of either a "Failure report" (see 10c. in figure 18) or a "Delivery report" (see 10b. in figure 18).

"Failure report" is returned to the MS when the SMS-IWMSC has received indication from the network or the SC that the procedure was unsuccessful.

10.3 Alert transfer

The entities involved in this procedure are depicted in figure 19.

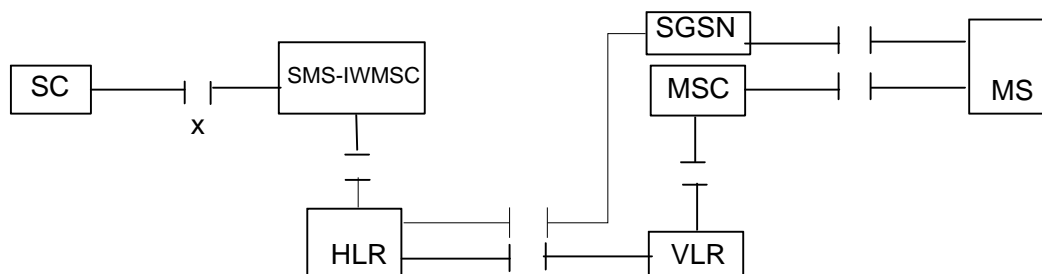

Figure 19: Interfaces involved in the Alert procedure. X is the interface between an SC and an MSC as defined in clause 5

This procedure consists of the operations shown in figure 20.

Three cases are distinguished:

- the MS becomes reachable when the MNRF, MNRG or both are set but the MCEF is not set (figure 20a);
- the MS becomes reachable when the MNRF, MNRG or both, and the MCEF are set (figure 20b);
- the MS notifies the network that it has memory available to receive one or more short messages when the MCEF is set (figure 20c).

The operations between MSC and VLR, between HLR and VLR or SGSN and between HLR and SMS-IWMSC are specified in 3GPP TS 29.002 [15]. The operation between MS and MSC or SGSN is specified in 3GPP TS 24.011 [13]. References to specifications of other operations are given in clause 4.

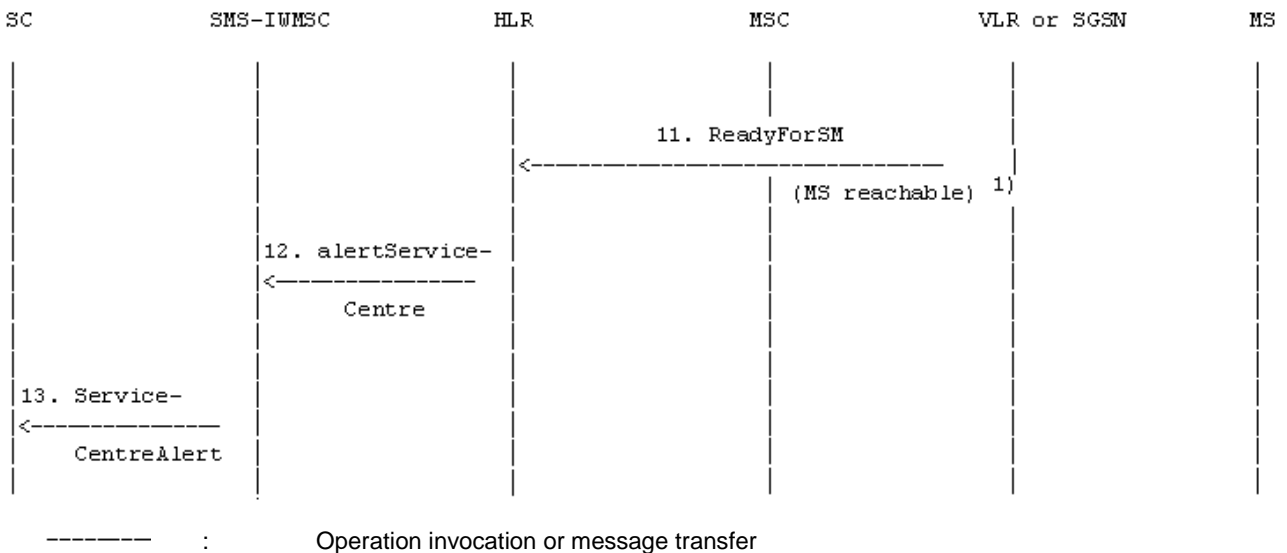

NOTE 1): In case ReadyForSM is sent by the SGSN, the reason may be MS reachable via the SGSN, or MS reachable via the SGSN and the MSC (see 3GPP TS 23.060 [27]).

Figure 20a: The alert procedure when the MS becomes reachable, MNRF, MNRG or both are set and MCEF is not set

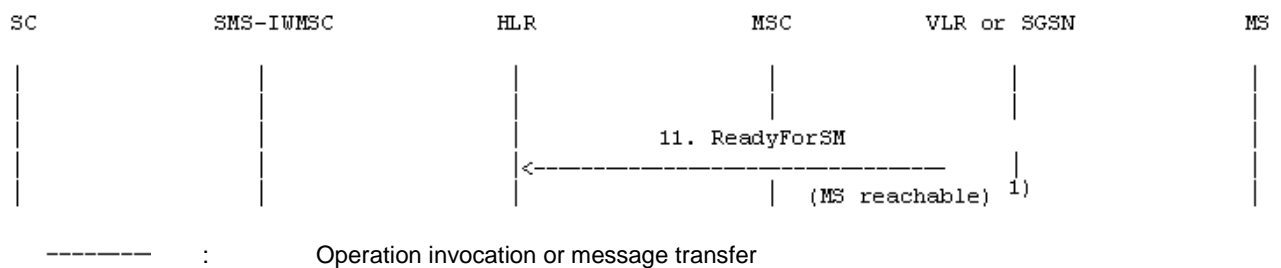

NOTE 1): In case ReadyForSM is sent by the SGSN, the reason may be MS reachable via the SGSN, or MS reachable via the SGSN and the MSC (see 3GPP TS 23.060 [27]).

Figure 20b: The alert procedure when the MS becomes reachable, MNRF, MNRG or both are set and MCEF is set

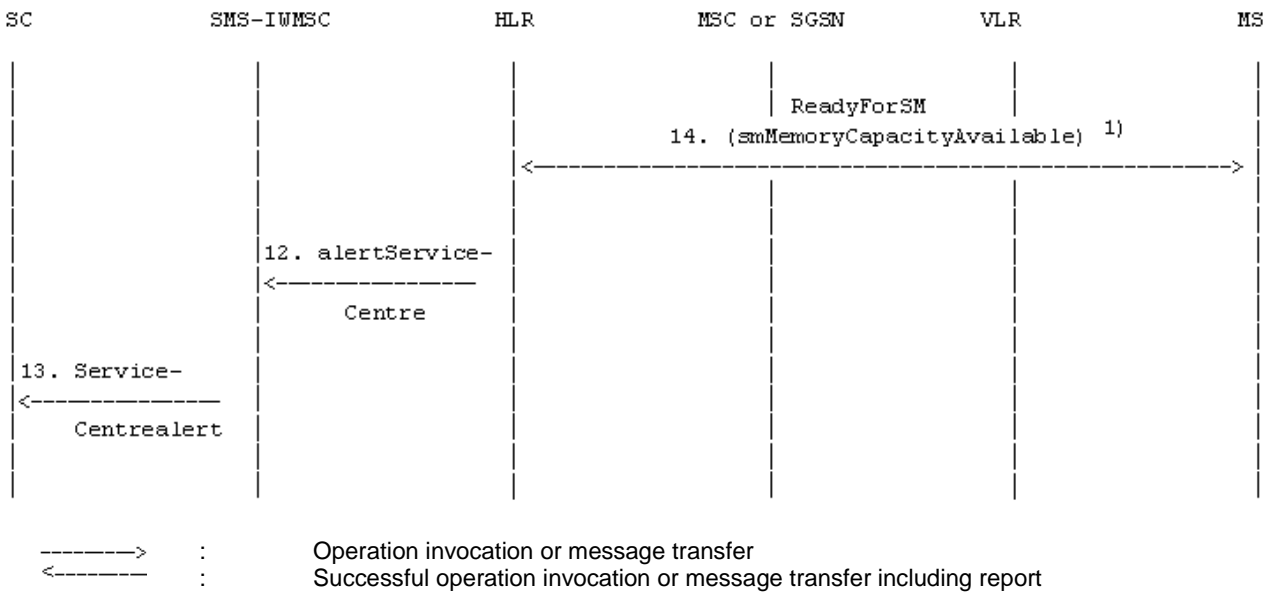

NOTE 1): Described in 3GPP TS 24.011 [13] and 3GPP TS 29.002 [15].

Figure 20c: The alert procedure when the MS notifies the network that it has memory available to receive one or more short messages and MCEF is set

Operation 11: ReadyForSM (MS reachable).

The operation provides a means to transfer alert information from VLR or SGSN to HLR.

The procedure is activated when the VLR or the SGSN detects that the MS is active, i.e. when the MS responds to a paging request.

Operation 12: alertServiceCentre.

The operation provides a means to transfer alert information from HLR to MSC.

Operation 13: ServiceCentrealert.

The operation provides a means to transfer alert information from an SMS-IWMSC to an SC.

The operation consists of transfer of a message ("RP-ALERT-SC") from the SMS-IWMSC to the SC.

Operation 14: ReadyForSM (smMemoryCapacityAvailable).

The operation provides a means for the MS to notify the network that it has memory available to receive one or more short messages.

The following applies if the memory capacity available notification flag is implemented in the (U)SIM.

The operation consists of transfer of a message ("RP-SM-MEMORY-AVAILABLE") from the MS to the HLR, and the return of an acknowledgement to the MS. When the MS rejects a short message due to lack of available memory capacity the need to transfer notification shall be stored in the (U)SIM. After a attempt to transfer the RP-SM-Memory-Available message the following applies:

If the MS receives a positive acknowledgement it shall unset the memory capacity exceeded notification flag in the (U)SIM and exit this procedure.

If the MS receives a negative acknowledgement indicating a permanent failure condition (as specified in 3GPP TS 24.011 [13]) it shall unset the memory capacity exceeded notification flag in the (U)SIM and exit the procedure.

If the MS receives a negative acknowledgement indicating a temporary failure condition (as specified in 3GPP TS 24.011 [13]) or receives no acknowledgement or an indication of failure by lower layers, it shall repeat the attempt to transfer the message in accordance with procedures defined in 3GPP TS 24.011 [13]. If these repeat

procedures fail, the mobile shall unset the memory capacity exceeded notification flag in the (U)SIM and exit this procedure.

If memory capacity has become available because memory is cleared, the value of the memory capacity exceeded notification flag is read. If the flag is set, the MS notifies the network that memory capacity is now available as described above.

When the mobile is powered up or the SIM/UICC is inserted, the mobile shall check the memory capacity exceeded notification flag in the (U)SIM; if the flag is set and the (U)SIM has memory available to receive a short message the mobile shall attempt to notify the network that it has memory available, as described above.

11 Mapping of error causes between RP layers

This clause describes the interworking between the relay layers on the radio interface (i.e. between the servicing MSC/SGSN and the mobile station), and within the network (i.e. between servicing MSC/SGSN, VLR, HLR, or GMSC).

11.1 Mobile Terminated short message transfer

If errors are indicated by the VLR after invocation of the "sendInfoFor-MT-SMS" operation, the appropriate error information is returned to the SMS-GMSC in a failure report as specified in 3GPP TS 29.002 [15] (negative outcome of "forwardShortMessage" see clause 10).

If errors are detected by the MSC or by the SGSN during the transfer on the radio interface, or by the IP-SM-GW, the error cause returned in the return error of the MAP procedure ForwardShortMessage shall be set as follows:

Failure at the MSC , SGSN or IP-SM-GW	Return error to be included in the MAP-proc
RP-ERROR message with error cause: 22 Memory capacity exceeded Other error causes	SM_DeliveryFailure with cause "MemoryCapacityExceeded" ¹⁾ SM_DeliveryFailure with cause "equipmentProtocolError" ¹⁾
CP or lower layer error (e.g. RR, layer 2 failure) ²⁾ Mobile has no SM capability	SM_DeliveryFailure with cause "equipmentProtocolError" ¹⁾ SM_DeliveryFailure with cause "equipmentNotSM-Equipped" ¹⁾ ⁰
TR1N timeout ²⁾ MNSMS-error-ind (No SAPI 3)	SM_DeliveryFailure with cause "equipmentProtocolError" ¹⁾
SIP transport error (e.g. SIP failure response message or transaction timeout)	SM_DeliveryFailure with cause "equipmentProtocolError" ¹⁾
¹⁾ For definition of MAP error SM_DeliveryFailure and its parameter "cause" see 3GPP TS 29.002 [15]. ²⁾ The error causes of the RP-ERROR message, the CP layer and timer TR1N are defined in 3GPP TS 24.011 [13]. ³⁾ The failure response codes for the SIP MESSAGE request are defined in IETF RFC 3428 [44], and the failure response codes for SIP transaction timeout in IETF RFC 3261 [43].	

11.2 Memory available notification

If errors are indicated by the HLR (via the VLR, the IP-SM-GW, or the SGSN) after invocation of the "ReadyForSM" operation, the MSC, the IP-SM-GW, or the SGSN shall return the appropriate error information to the MS in a failure report (i.e. a RP-ERROR message) containing the following error cause:

Return error from ReadyForSM (Alert Reason is "memory available")	Cause value in the RP-ERROR message
DataMissing	38 Network out of order
UnexpectedDataValue	38 Network out of order
UnknownSubscriber	30 Unknown Subscriber
FacilityNotSupported	69 Requested facility not implemented
System Failure	38 Network out of order
Local or lower layer failure (e.g. reject condition, timer expired or transaction abort)	38 Network out of order

NOTE: The coding and the use of the RP-ERROR message is specified in 3GPP TS 24.011 [13].

11.3 Mobile Originated short message transfer

If errors are indicated by the VLR after invocation of the "sendInfoForMO-SMS" operation.(see clause 10), the MSC shall return the appropriate error information to the MS in a failure report (i.e. a RP-ERROR message) containing the following error cause:

Return error from SendInfoForMO-SMS	Cause value in the RP-ERROR message
DataMissing	38 Network out of order
UnexpectedDataValue	38 Network out of order
TeleserviceNotProvisioned	50 Requested facility not subscribed
CallBarred	
- barringServiceActive	10 Call barred
- operatorBarring	8 Operator determined barring

NOTE: The coding and the use of the RP-ERROR message is specified in 3GPP TS 24.011 [13]. The operation SendInfoForMO-SMS is not used by the SGSN.

If errors are indicated by the SMS-IW MSC (negative outcome of the "forwardShortMessage"), the MSC, the IP-SM-GW, or the SGSN shall send a failure report (i.e. a RP-ERROR message) to the MS, with the error cause coded as follows:

Return error from ForwardShortMessage	Cause value in the RP-ERROR message
System Failure	38 Network out of order
FacilityNotSupported	69 Requested facility not implemented
UnexpectedDataValue	38 Network out of order
SM-DeliveryFailure cause: unknownSC	1 Unassigned number
SM-DeliveryFailure cause: SC-Congestion	42 Congestion
SM-DeliveryFailure cause: invalidSME-Addr (NOTE 1)	21 Short message transfer rejected
SM-DeliveryFailure cause: subscriberNotSC-Subscriber	28 Unidentified subscriber
Local or lower layer failure (e.g. reject condition, timer expired or transaction abort)	38 Network out of order
NOTE 1: This cause includes the case when the outcome of optional HLR interrogation is unacceptable (see clause 8.2.2)	

NOTE: The coding and the use of the RP-ERROR message is specified in 3GPP TS 24.011 [13].

Annex A (informative): Protocol stacks for interconnecting SCs and MSCs

No mandatory protocol between the Service Centre (SC) and the Mobile Switching Centre (MSC) below the transfer layer is specified by GSM/UMTS specifications; this is a matter of agreement between SC and PLMN operators.

Some example protocols are provided in GSM TS 43.047 [11] to assist SC and PLMN operators. These are based on the following principles, which SC and PLMN operators are recommended to follow even if they choose not to use one of the examples given in GSM TS 43.047 [11]:

The protocol(s) between SC and MSC below transfer layer should:

- a) provide the service defined for SM-RL (see subclause 9.3);
- b) be based on widely accepted telecommunications protocols in the public domain;
- c) permit open interconnection.

Annex B (informative): Information now contained in 3GPP TS 23.038 [9]

Annex B held information that is now contained in 3GPP TS 23.038 [9].

Annex C (informative): Short message information flow

The diagrams in this annex describe the flow of primitives and parameters during the short message transfer. These diagrams refer to specifications 3GPP TS 23.040, 3GPP TS 24.011 [13] and 3GPP TS 29.002 [15]. The parameters in dotted lines are optional. The abbreviations used in diagrams are listed below. The relevant specifications are given in parentheses. (*) stands for a common GSM/UMTS abbreviations and (-) for a general abbreviation.

CM	Call Management (*)
CS	CauSe (-)
DA	Destination Address (-)
DCS	Data Coding Scheme (3GPP TS 23.040)
DI	Dialogue Identifier TCAP
GMSCA	Gateway MSC Address
GPRS	General Packet Radio Services 3GPP TS 23.060 [27])
HLR	Home Location Register (*)
IMSI	International Mobile Subscriber Identity (*)
MAL	MSISdn-Alert (3GPP TS 23.040)
MMS	More Messages to Send (3GPP TS 23.040)
MR	Message Reference (3GPP TS 23.040)
MS	Mobile Station (*)
MSC	Mobile services Switching Centre (*)
MSCA	MSC Address
MSI	Mobile waiting Set Indication (3GPP TS 23.040)
MSISdn	Mobile Station ISDN number (*)
MSM	More Short Messages (3GPP TS 29.002 [15])
MSRN	Mobile Station Roaming Number (*)
MT	Message Type (3GPP TS 24.011[13])
MTI	Message Type Indicator (3GPP TS 24.011[13])
MWS	Message Waiting Set (3GPP TS 23.040)
OA	Originating Address (-)
OC	Operation Code (3GPP TS 29.002 [15])
PCI	Protocol Control Information (-)
PDI	Protocol DIscriminator (*)
PRI	PRiority (3GPP TS 23.040)
RCT	ReCeption Time (3GPP TS 23.040)
REA	REcipient Address (3GPP TS 23.040)
RL	ReLay function (3GPP TS 24.011[13])
RP	Reply Path (3GPP TS 23.040)
SC	Service Centre (3GPP TS 23.040)
SCA	Service Centre Address (3GPP TS 23.040)
SCTS	Service Centre Time Stamp (3GPP TS 23.040)
SGSN	Serving GPRS Support Node (3GPP TS 23.060 [27])
SM	Short Message (3GPP TS 23.040)
SM-AL	Short Message Application Layer (3GPP TS 23.040)
SME	Short Message Entity (3GPP TS 23.040)
SMI	Short Message Identifier (3GPP TS 23.040) □
SM-RL	Short Message Relay Layer (3GPP TS 23.040, 24.011[13])
SMS-GMSC	Short Message Service Gateway MSC (3GPP TS 23.040)
SMS-IWMSC	Short Message Service Interworking MSC (3GPP TS 23.040)
SoR	Status of Report (3GPP TS 23.040)
SM-TL	Short Message Transfer Layer (3GPP TS 23.040)
SRI	Status Report Indication (3GPP TS 23.040)
SRR	Status Report Request (3GPP TS 23.040)
TCAP	Transaction Capabilities Application Part (-)
TID	Transaction Identifier (*)
UD	User Data (-)
UDL	User Data Length (3GPP TS 23.040)
VLR	Visitor Location Register (*)
VP	Validity Period (3GPP TS 23.040)
VPF	Validity Period Format (3GPP TS 23.040)

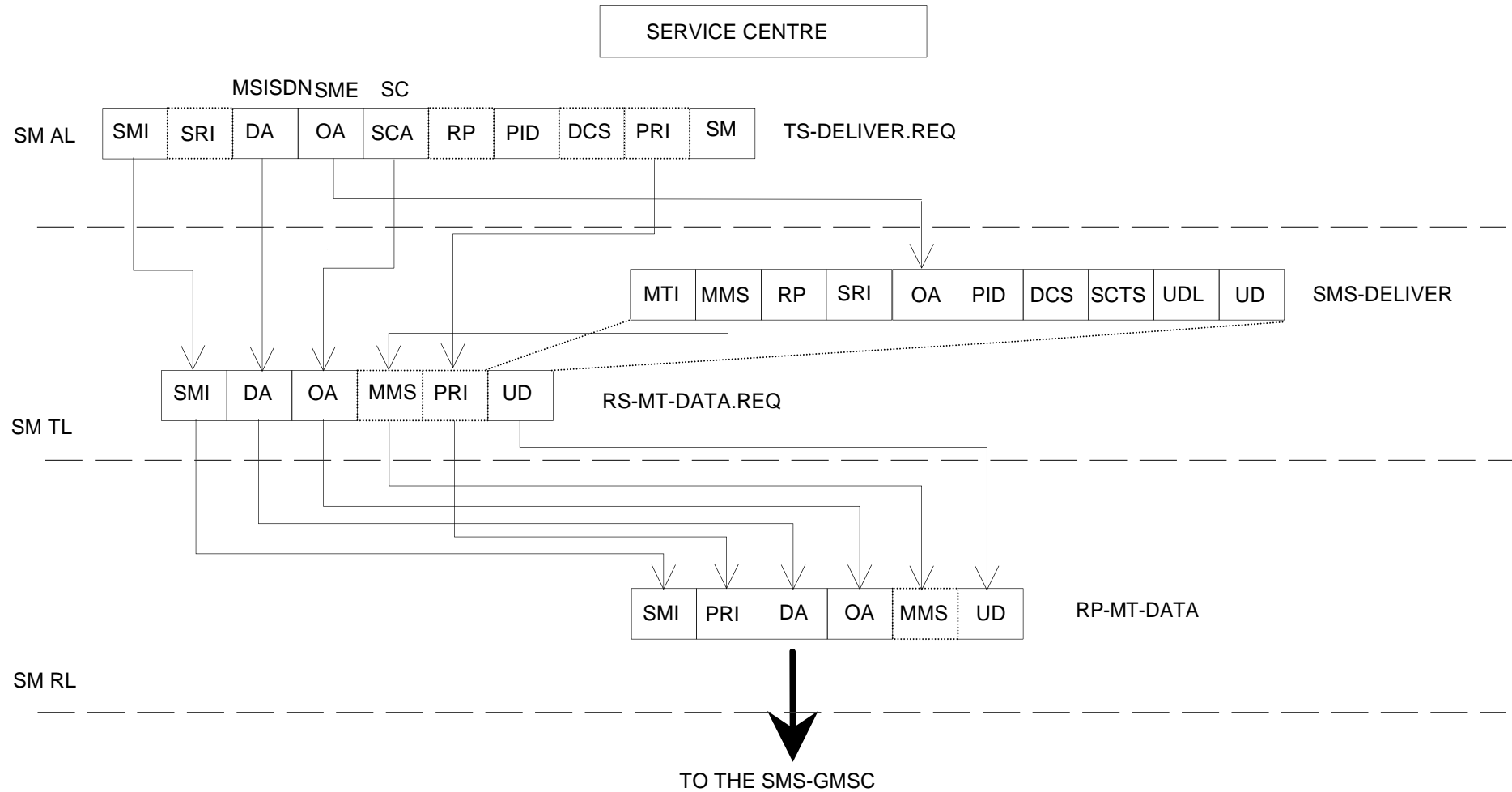

NOTE: SMI is not carried via SM-RL of clause 9.3.5 but is carried via the relay service between the SC and GMSC (see clause 9.3.4.1).

Figure C.1: Mobile terminated short message

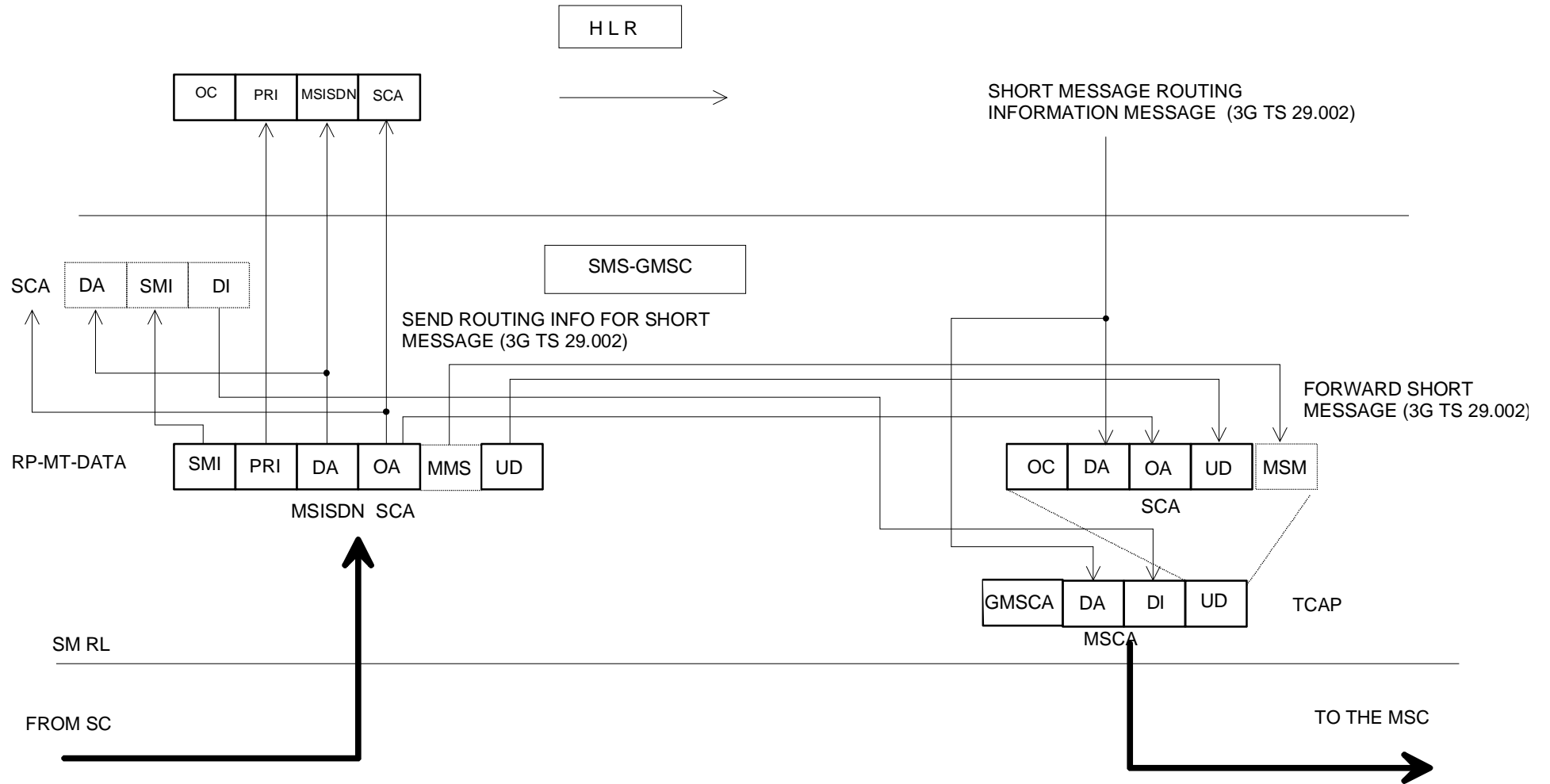

NOTE: A sequence of short messages shall have MMS set to 1 in each RP-MT-DATA except the last (last shall have MMS set to 0). Each RP-MT-DATA shall be carried via FORWARD SHORT MESSAGE via TCAP and shall be assigned the same Dialogue Identifier as previous RP-MT-DATAS in the sequence.

Figure C.2: Mobile terminated short message

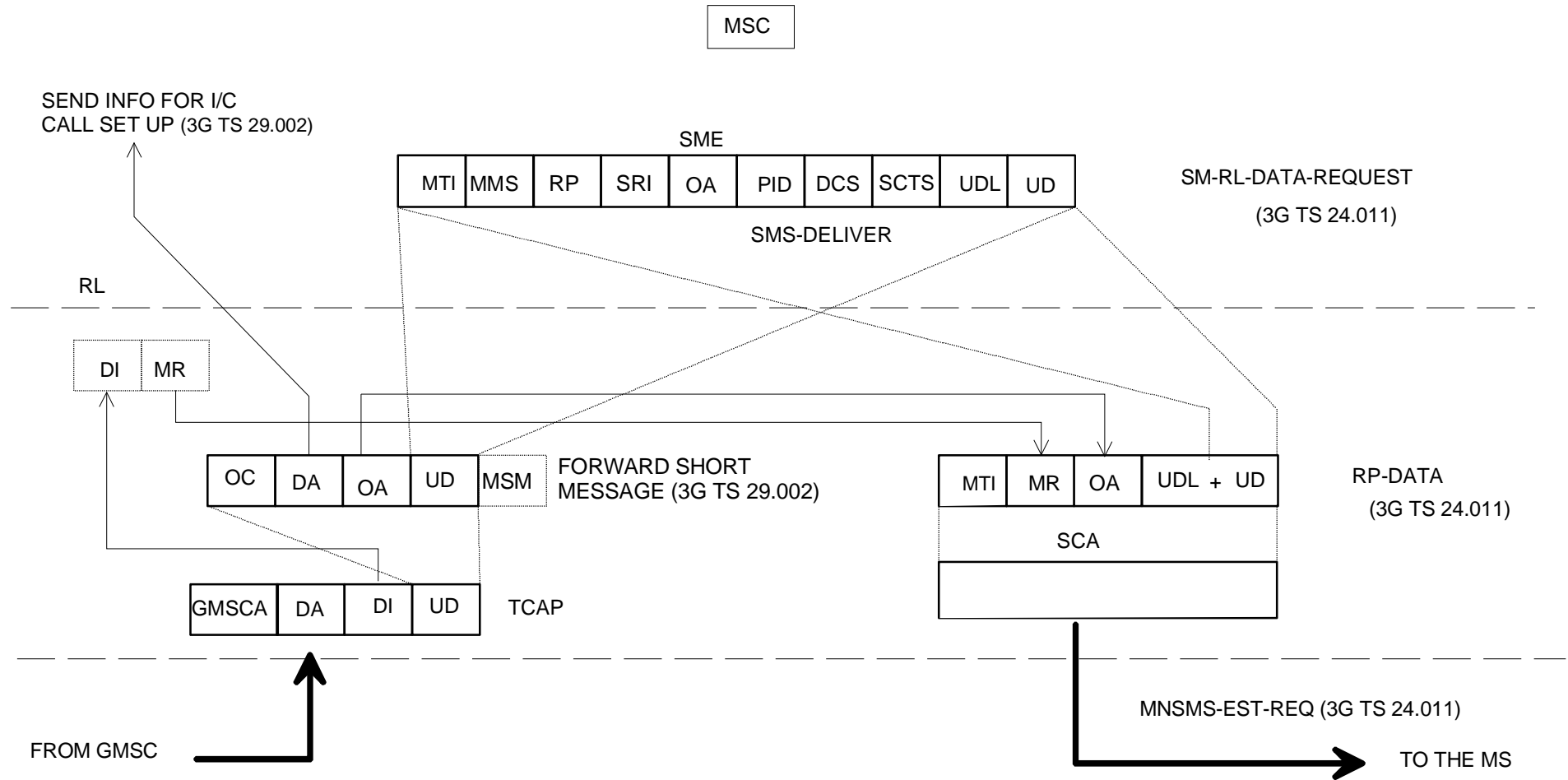

NOTE: MR is of local significance to the MSC/MS interface and is not the value supplied to the MSC.

Figure C.3: Mobile terminated short message

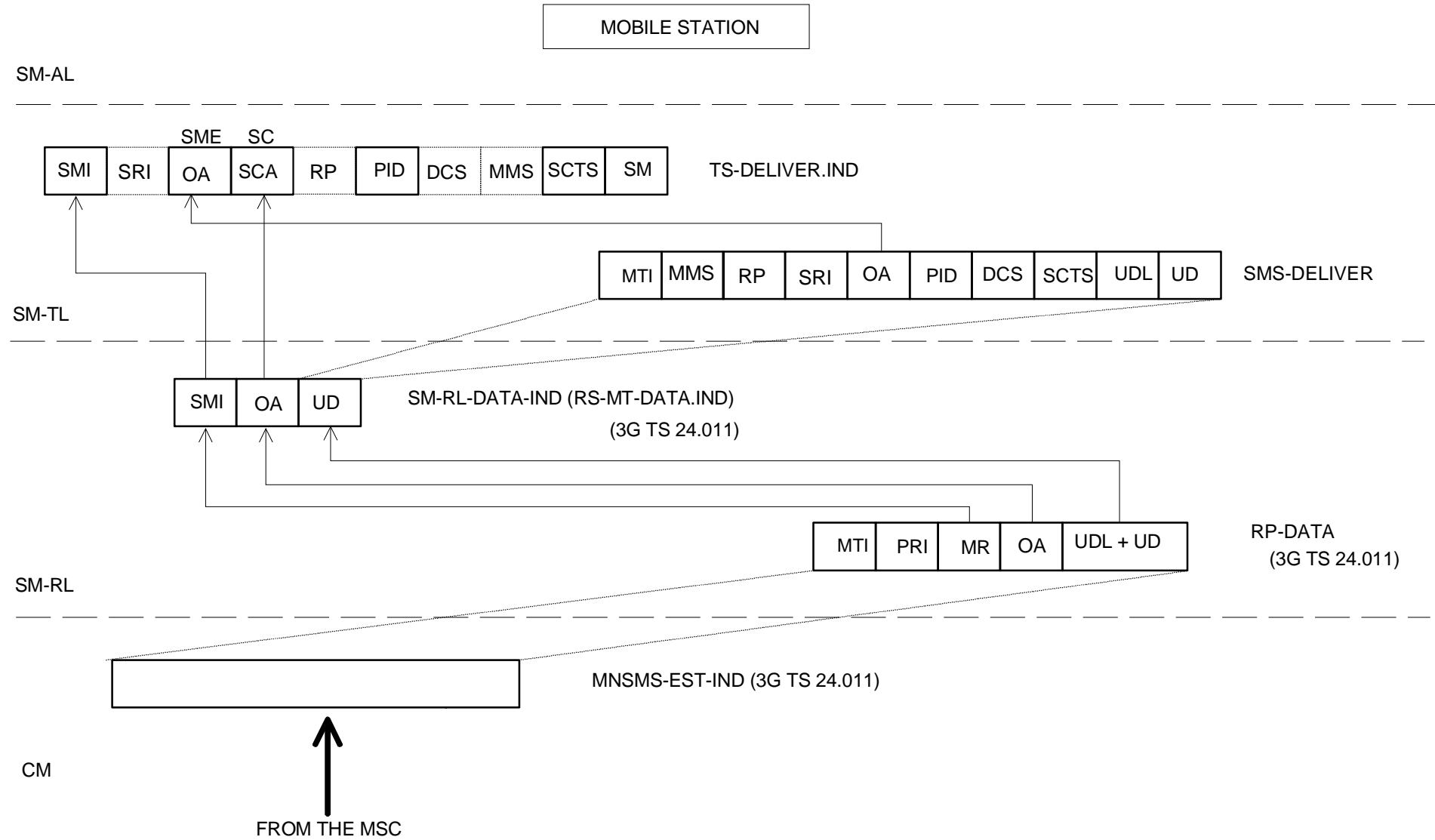

Figure C.4: Mobile terminated short message

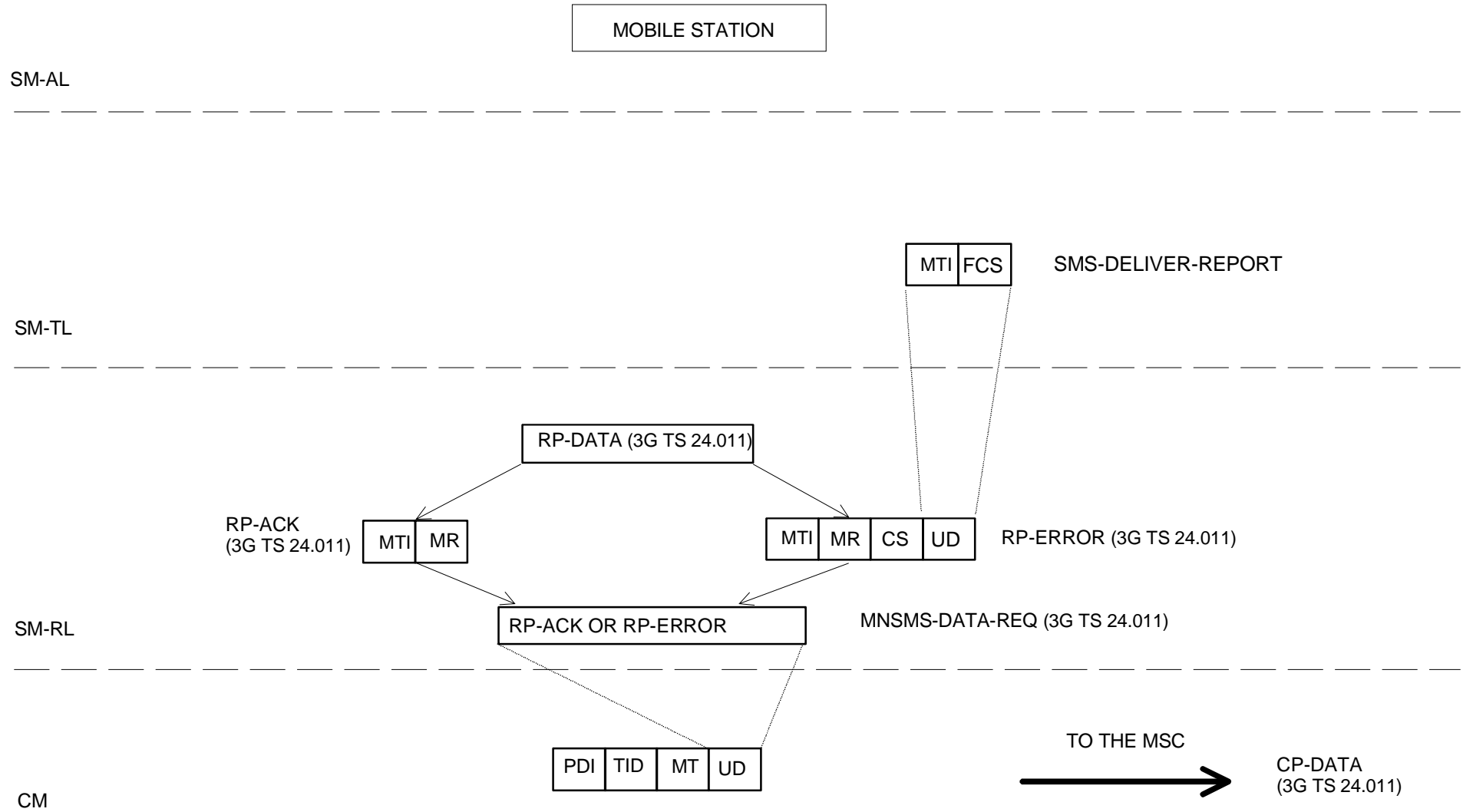
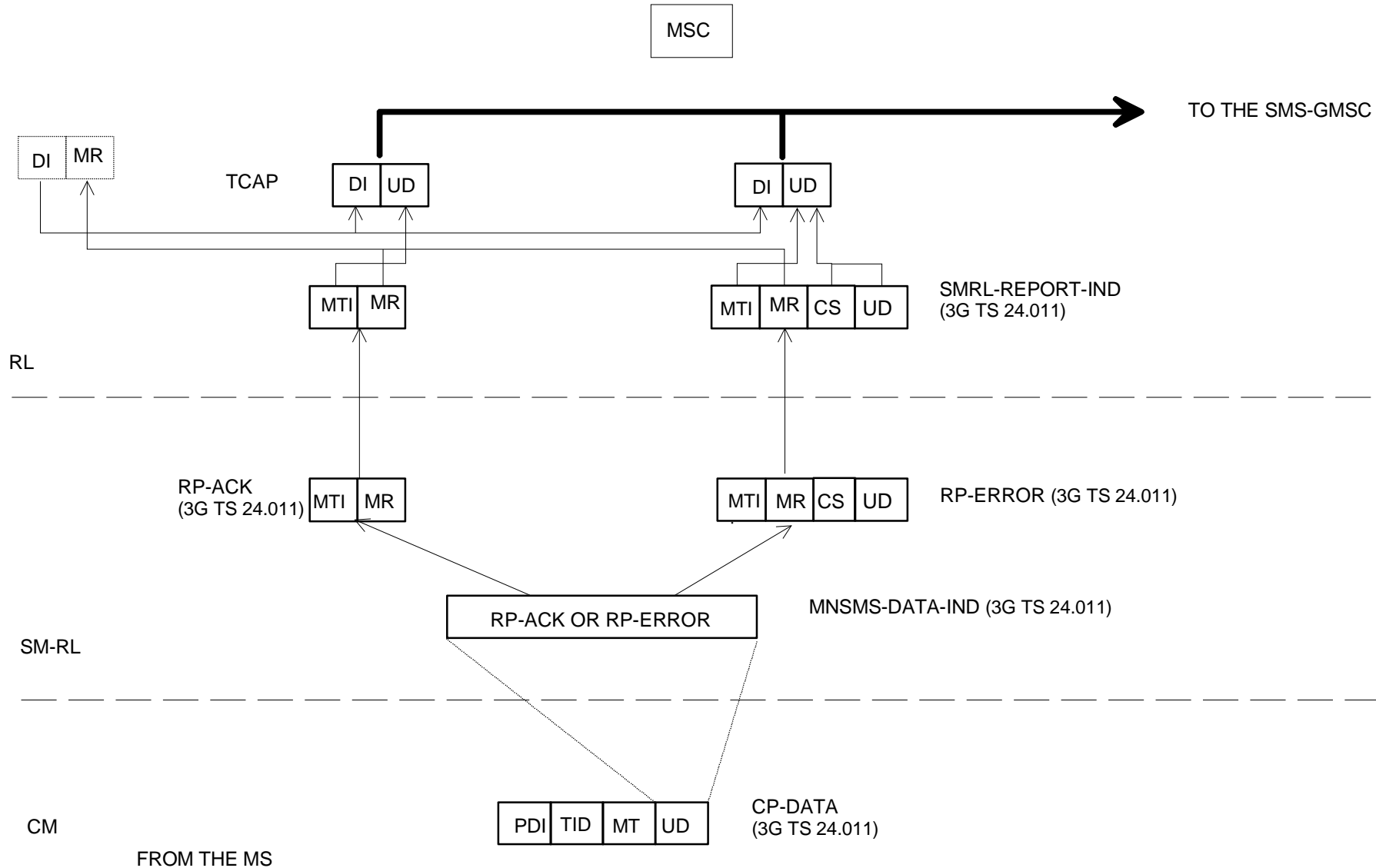
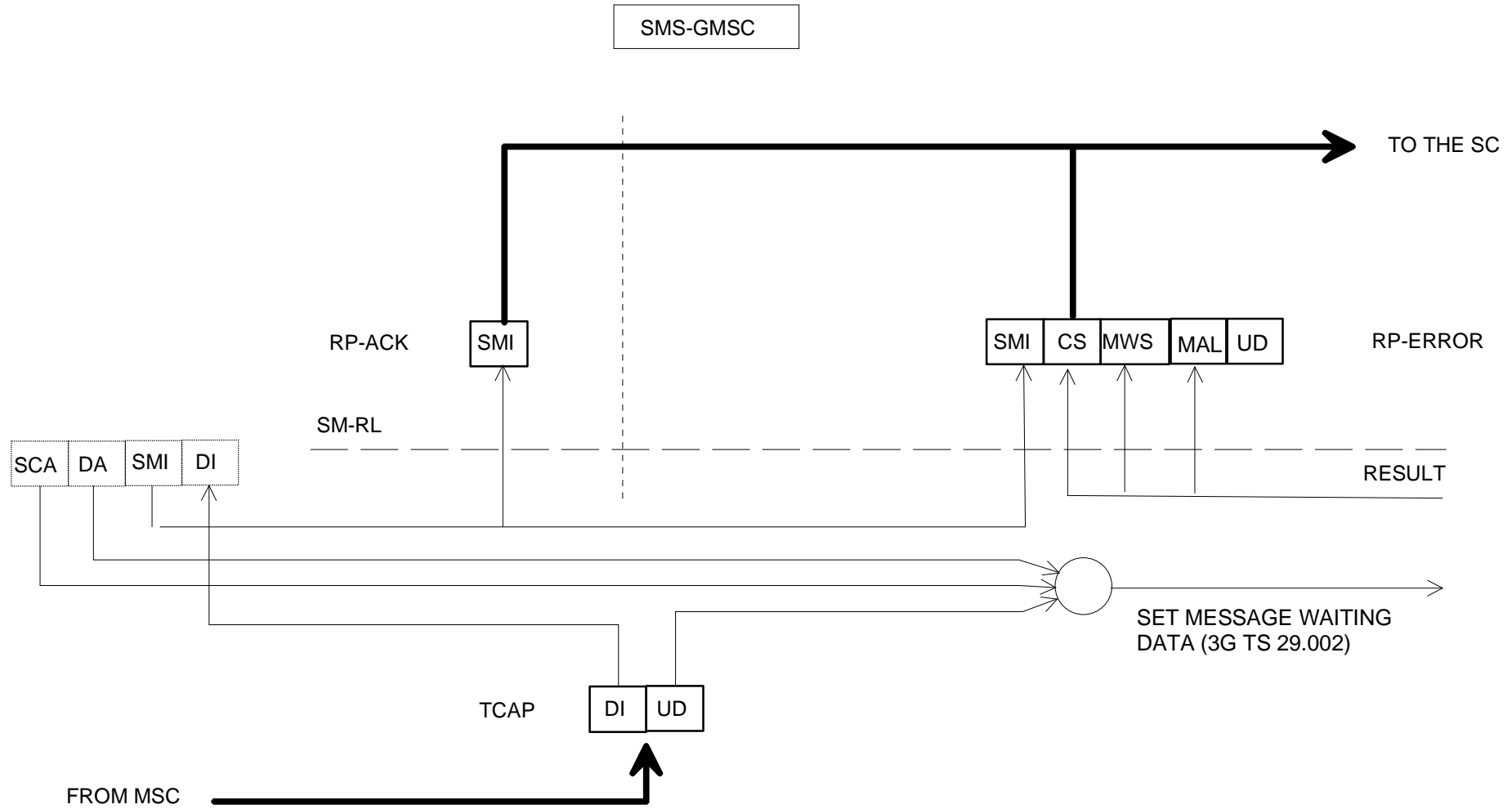

Figure C.5: Acknowledgement in the MT case



NOTE: The cause carried via UD of TCAP is not the cause supplied via RP-ERROR but is the cause resulting from application of the mapping specified by table 8.5 of 24.011[13].

Figure C.6: Acknowledgement in the MT case



NOTE 1: The MAP operation "SetMessageWaitingData" is invoked only if a cause "Absent Subscriber" is carried in TCAP UD.
 NOTE 2: The cause delivered to the SC is not necessarily the cause carried via TCAP but is one of the set specified by table 03.40/1.

Figure C.7: Acknowledgement in the MT case

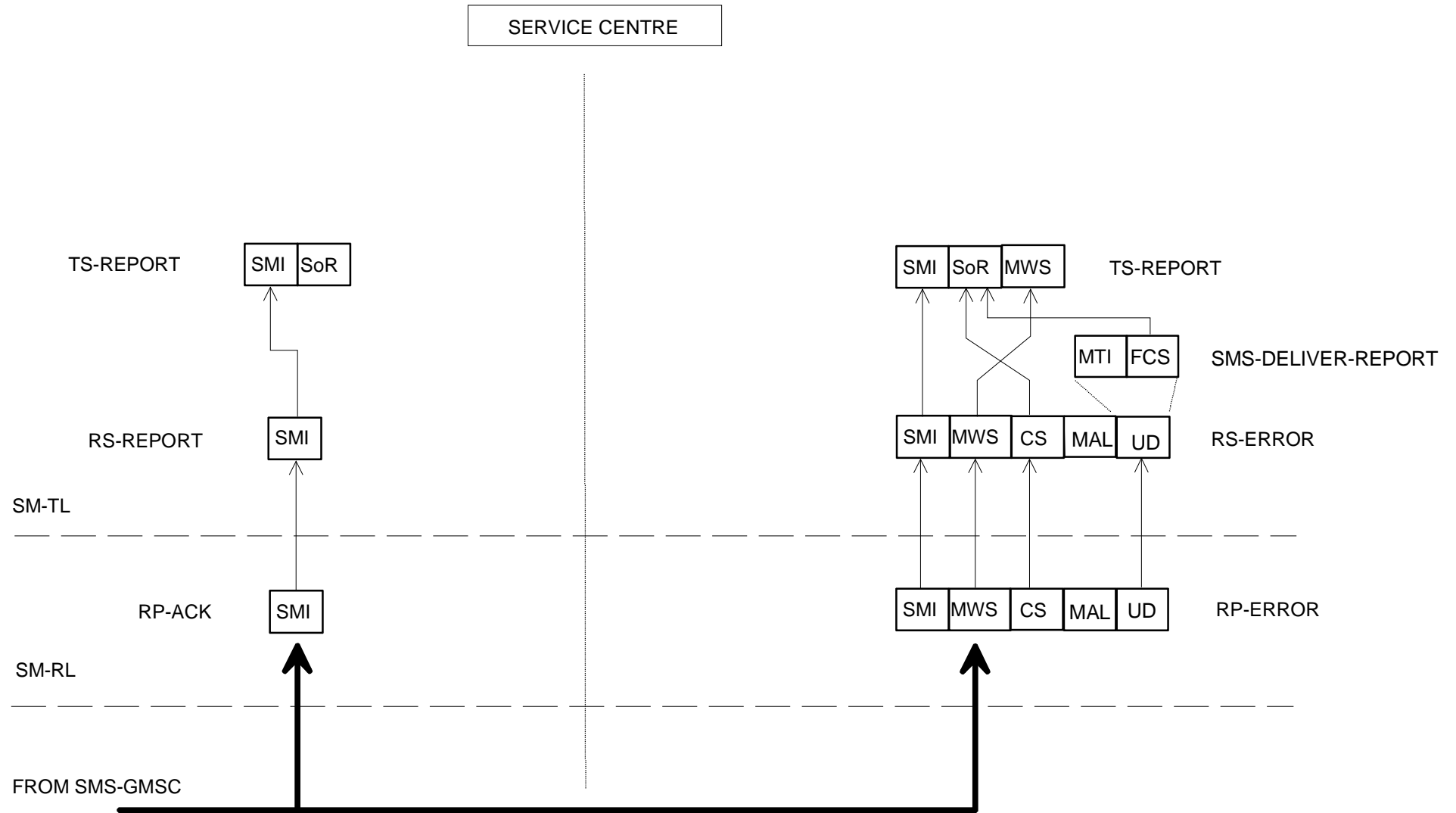
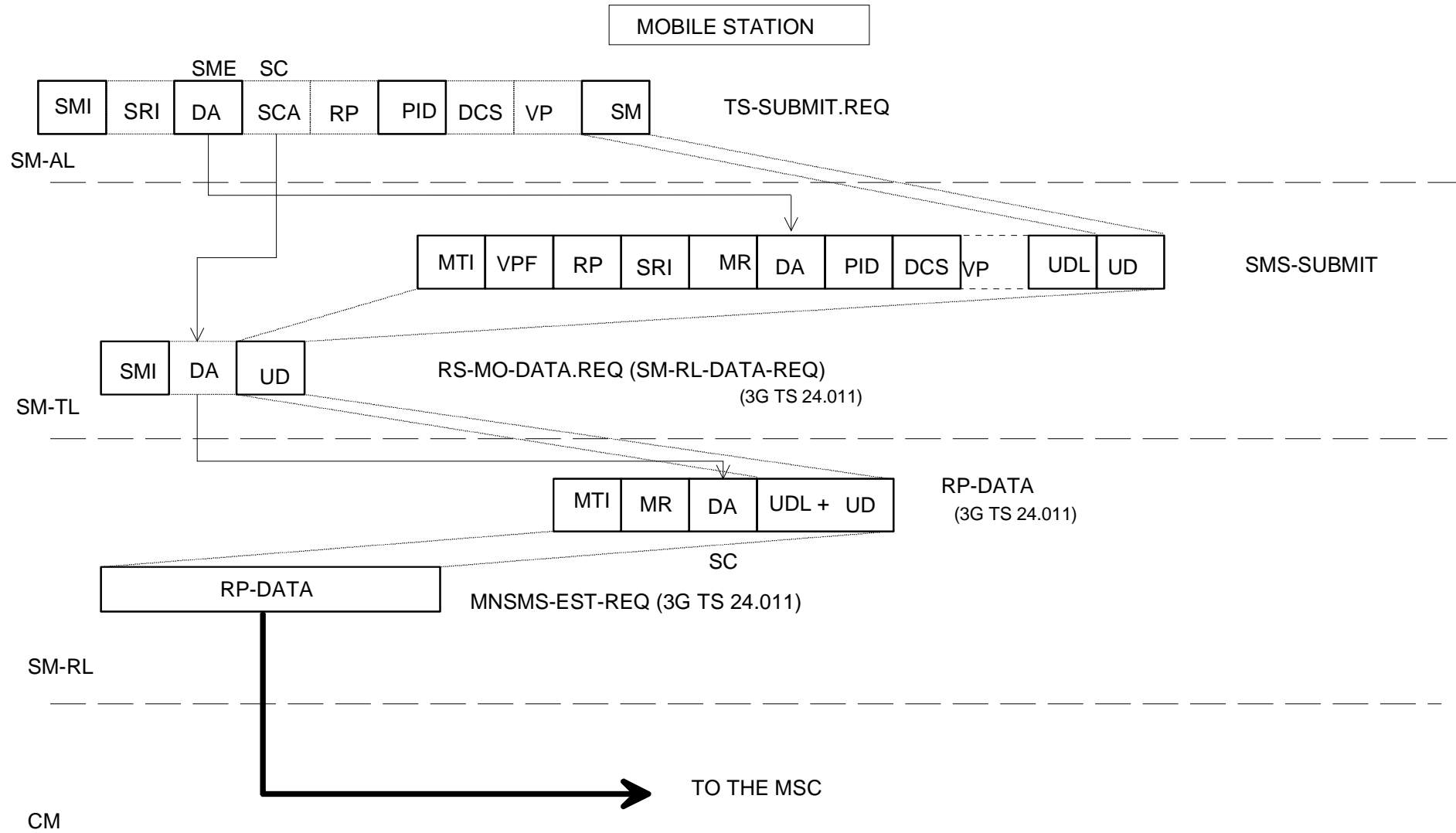

Figure C.8: Acknowledgement in the MT case



NOTE: The mapping of SMI to MR by the MS is a local matter.

Figure C.9: Mobile originated short message

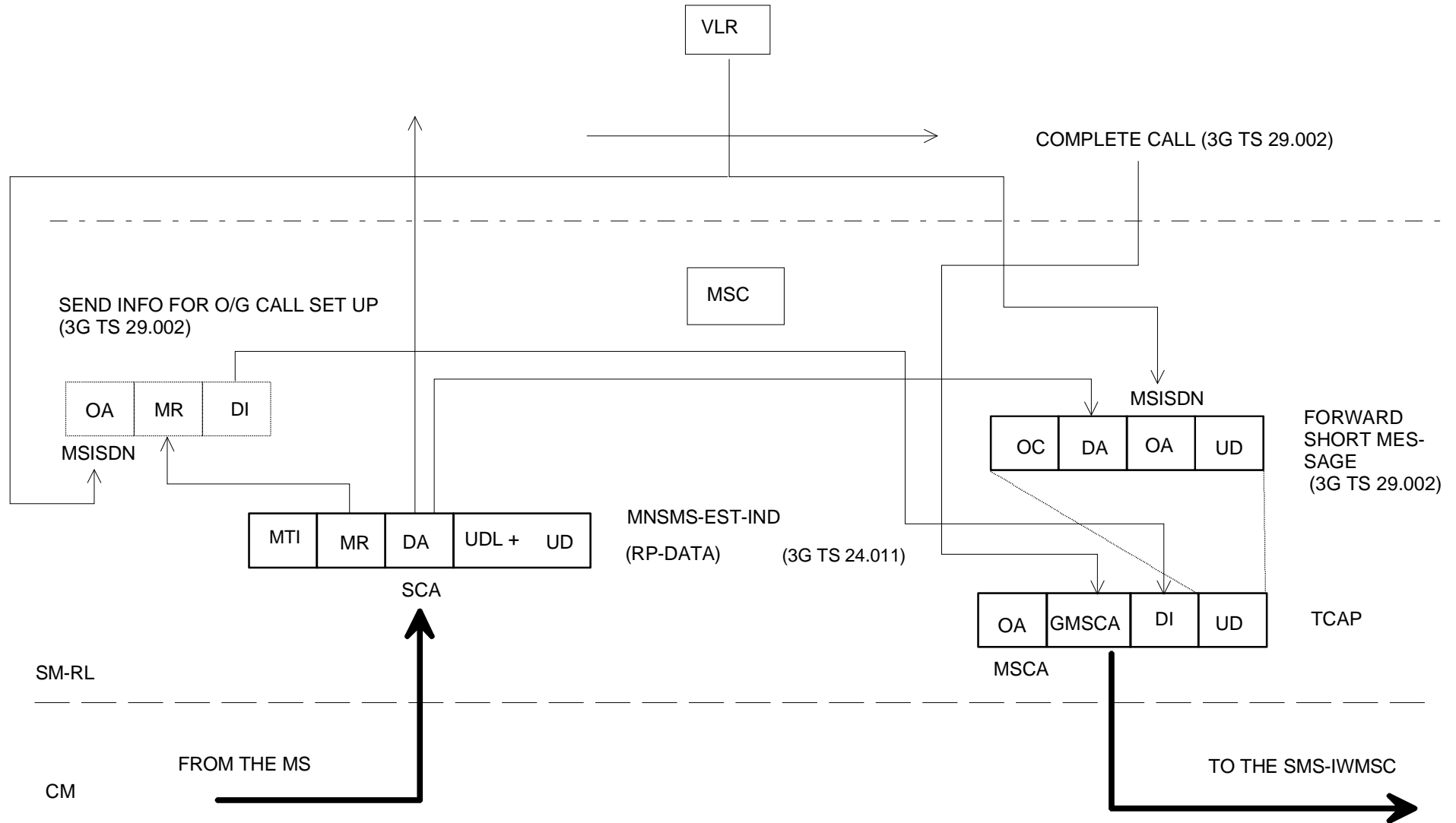
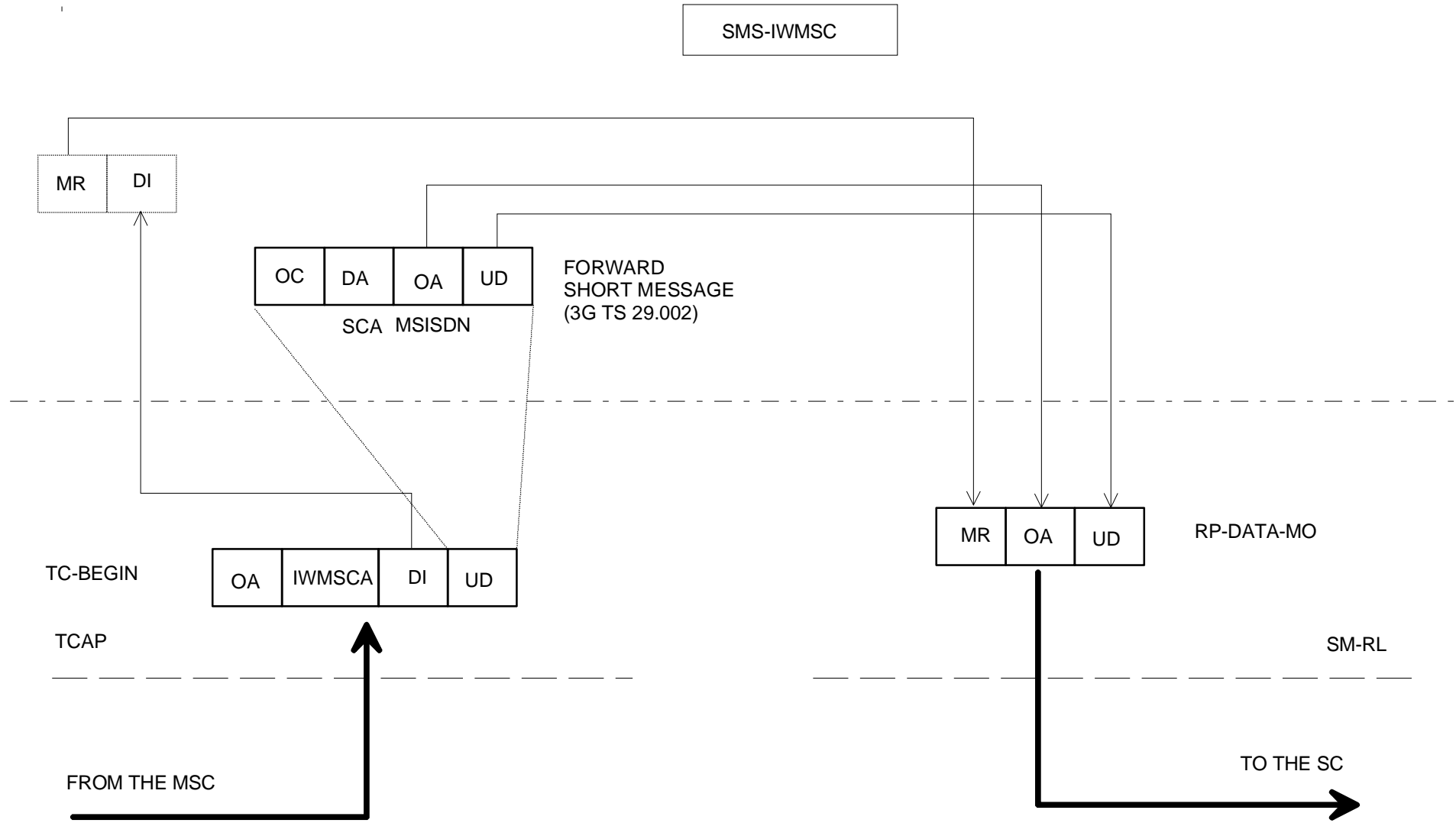

Figure C.10: Mobile originated short message



NOTE: MR is of local significance to the IW MSC/SC interface and is not the value supplied by the MS via the MS/MSC interface.

Figure C.11: Mobile originated short message

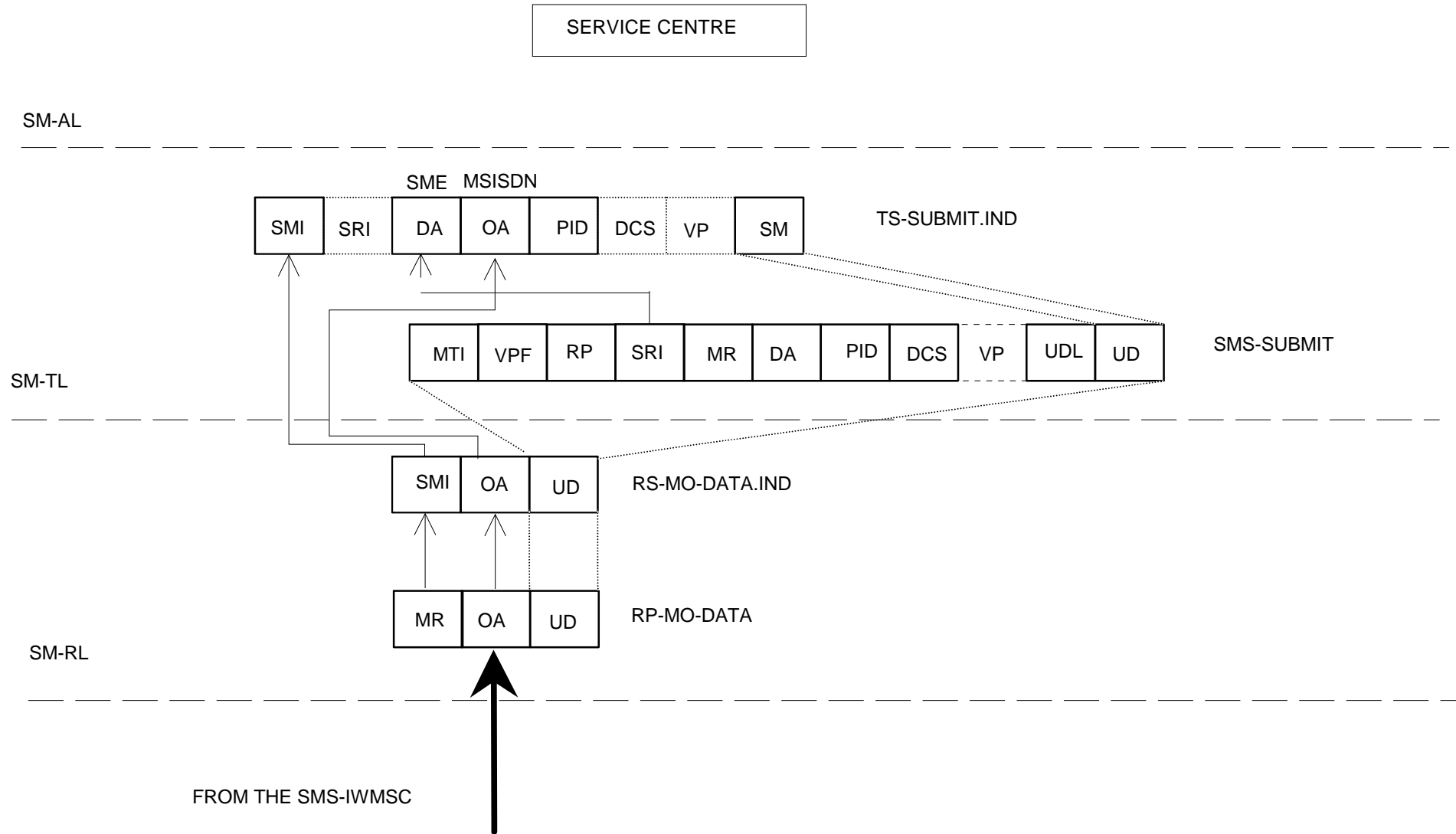

Figure C.12: Mobile originated short message

SERVICE CENTRE

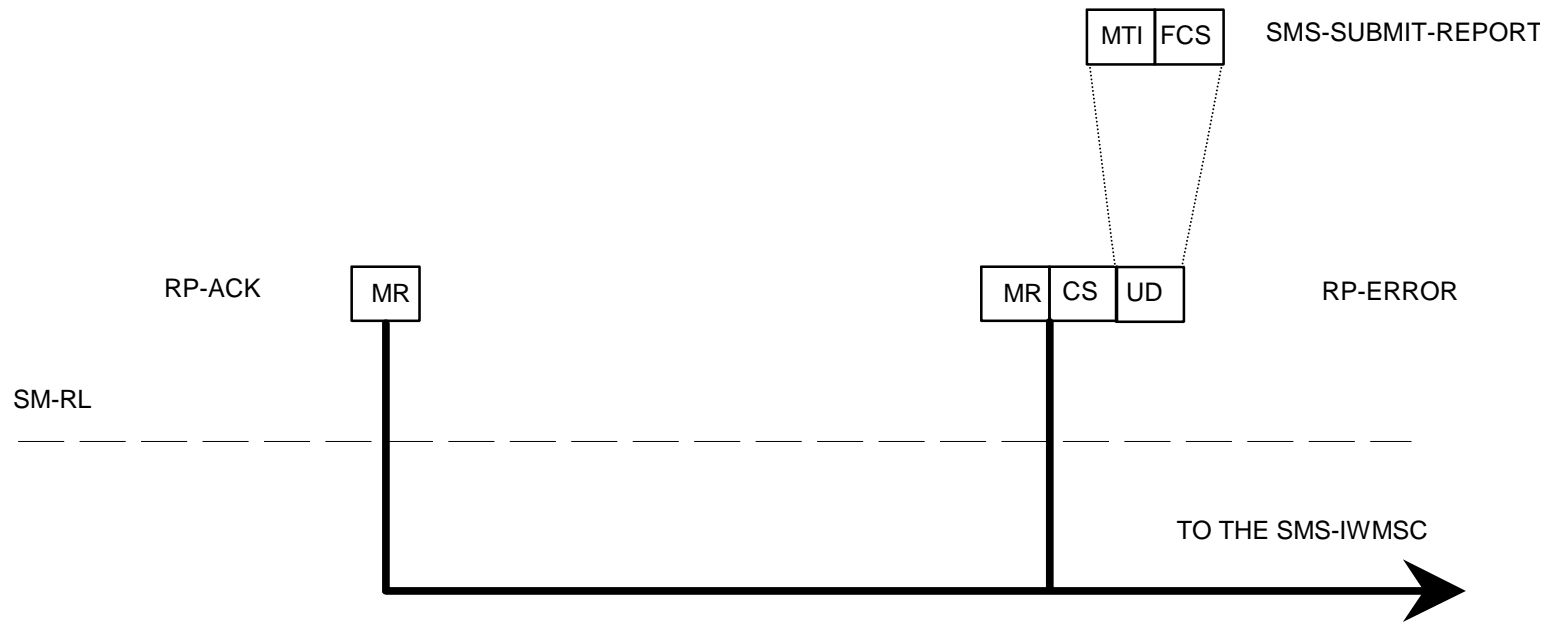

Figure C.13: Acknowledgement in the MO case

SMS-IWMSC

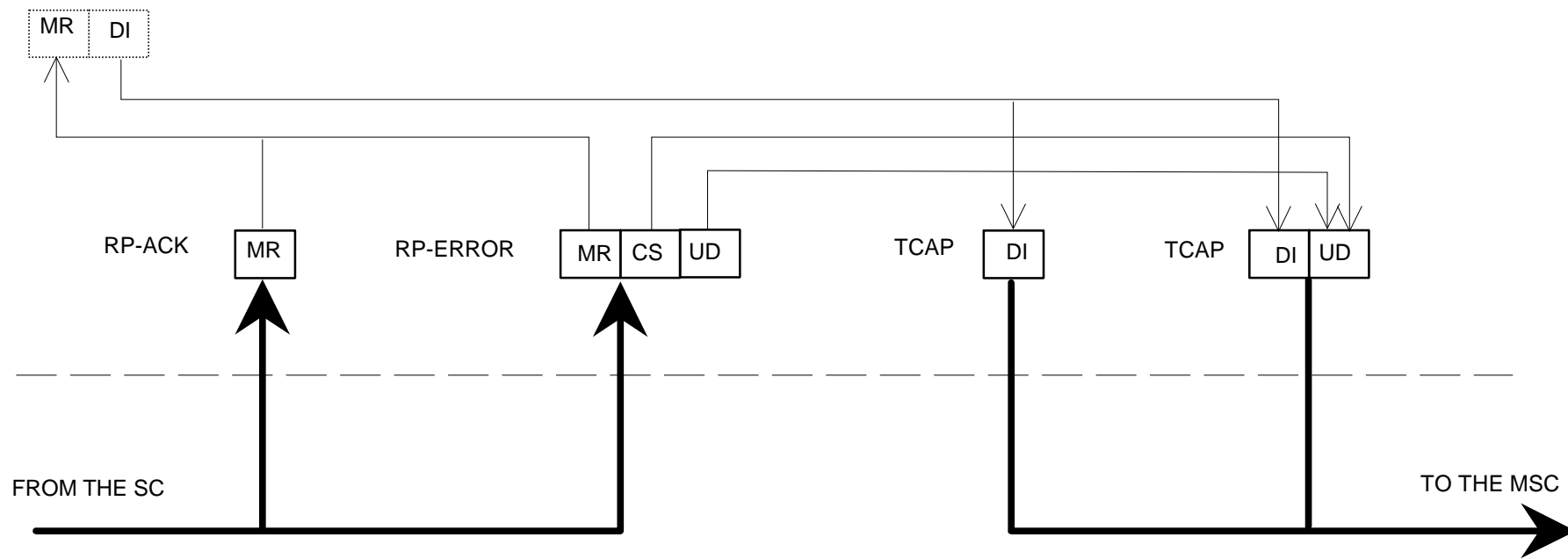

Figure C.14: Acknowledgement in the MO case

MSC

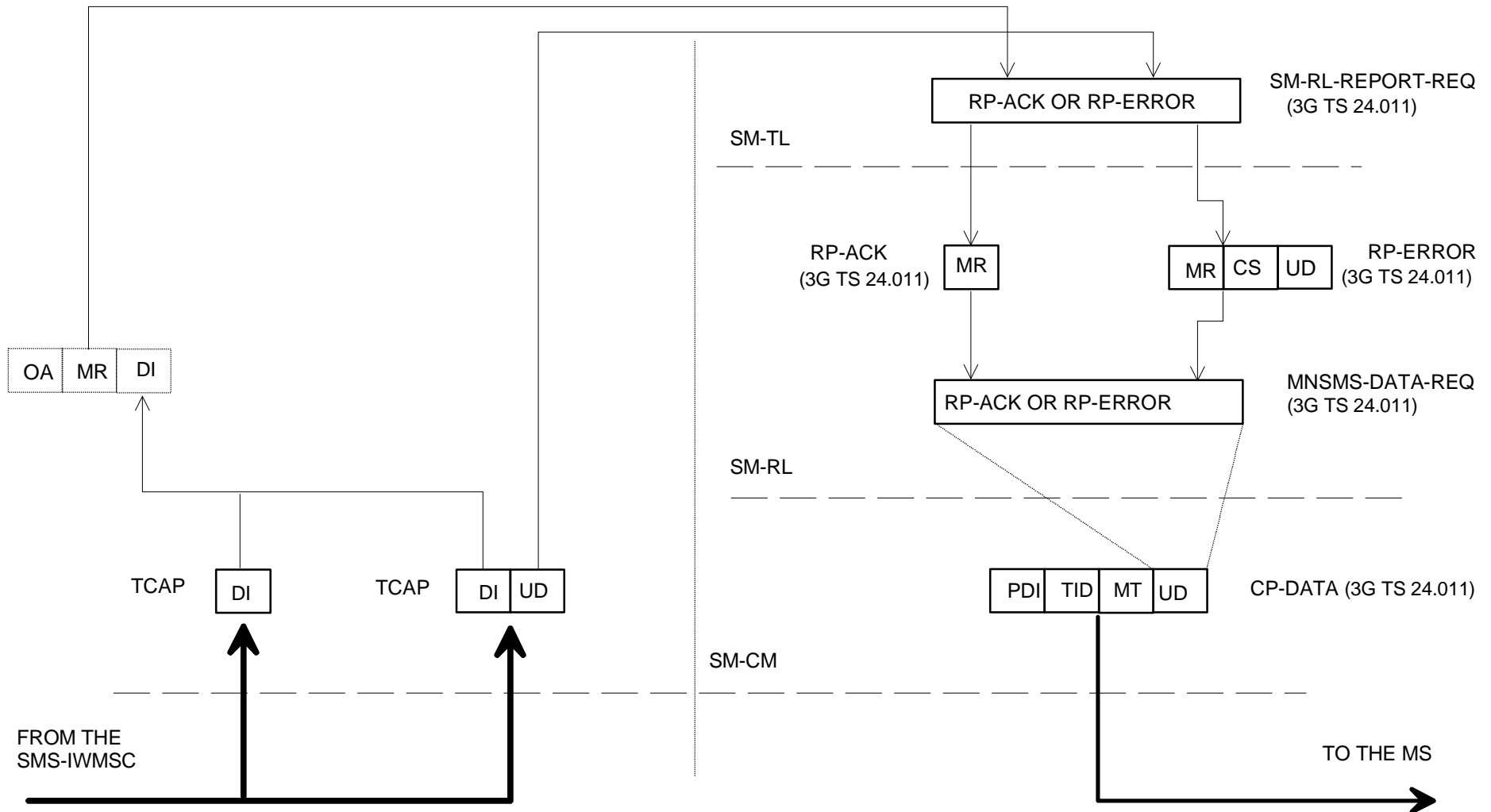

Figure C.15: Acknowledgement in the MO case

MOBILE STATION

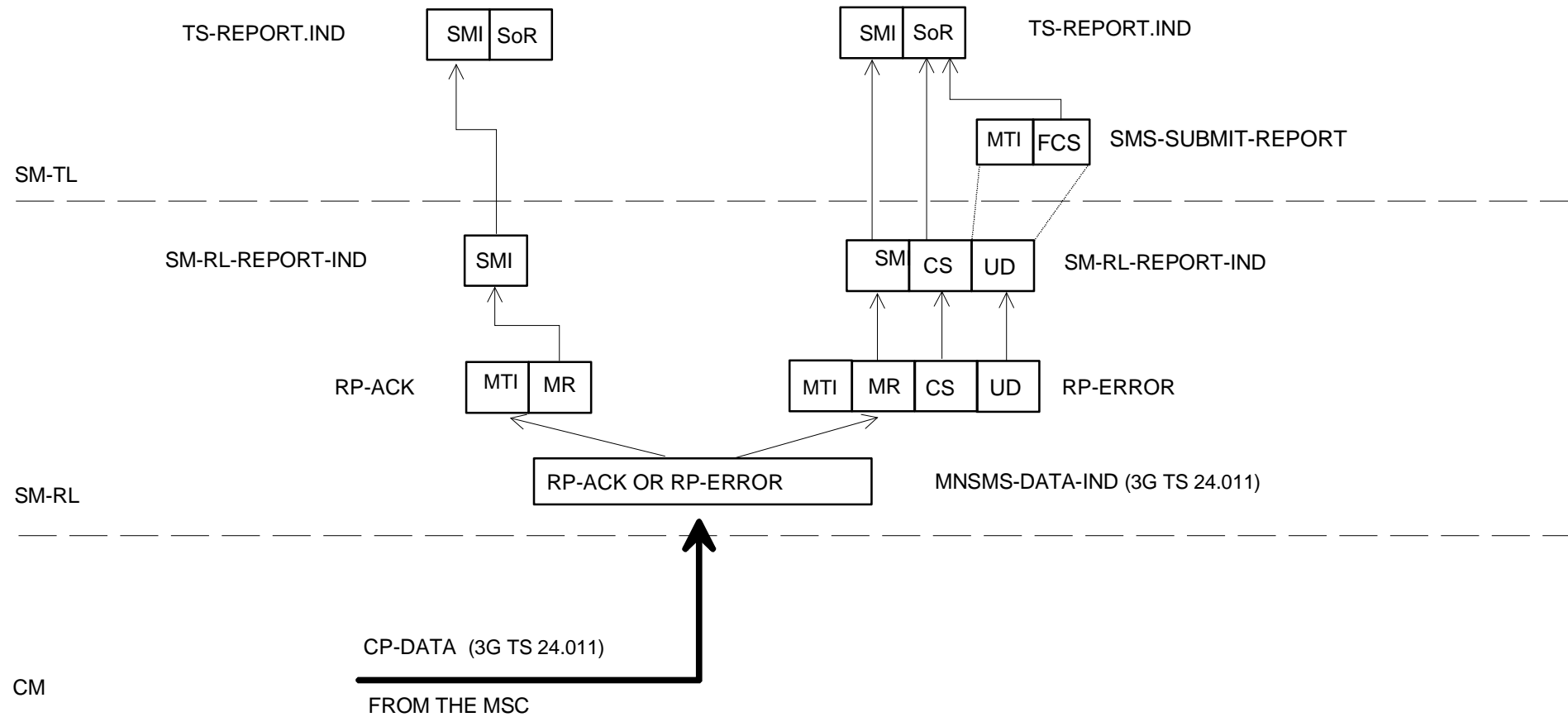

Figure C.16: Acknowledgement in the MO case

Annex D (informative): Mobile Station reply procedures

D.1 Introduction

The reply procedures specified in this annex should be followed by a mobile station when replying to a short message, i.e. when generating a MO SM in response to a received MT SM, addressed to the originator of that MT SM. The main purpose of this annex is to specify how the MS selects the service centre for delivering that MO SM: an arbitrary SME may only be reached by submitting the reply SM to a specific SC, known to be able of delivering to that SME.

D.2 The scope of applicability

The reply procedures in clauses 5 and 6 of this annex should be followed by every MS which fulfils the following criteria:

- 1) The MS automatically selects the value for the RP-Destination-Address parameter in RP-MO-DATA, or the MS has the SC address within the SM-RL entity. (That is to say: the human user is not obliged to manually key in the SC address for every MO short message).
- 2) The MS or an application within it supports some form of replying to a MT SM with a MO SM. (That is to say: in the process of generating the reply MO SM, any reference whatsoever, implicit or explicit, is made to the original MT SM).
- 3) The replying support of (2) is to be equally available towards every SME.

When an SME submits an SM to an SC for delivery, it may request that the SC sets the TP-Reply-Path parameter in the SM to be delivered. If the submitting SME is an MS, the reply path requesting procedure; in clause 4 of this annex may be applied. However, an SC may support the reply procedures without supporting the reply path requesting procedure; in that case, the SC sets the TP-Reply-Path parameter on another basis, which must be the case if the SM originates from an SME which is not an MS.

D.3 Terminology

An originating SME submits an original SM to an original SC, which delivers the original MT SM to a replying MS. The replying MS sends back a reply MO SM, a MO SM which is generated (automatically or by human operations) in response to the original MT SM, and which is addressed to the originating SME.

If the originating SME is an MS, the original MT SM is submitted within an SMS-SUBMIT PDU; we say that reply path is requested if the TP-Reply-Path parameter is set in the SMS-SUBMIT PDU of the original MT SM.

We say that reply path exists if the TP-Reply-Path parameter was set in the SMS-DELIVER PDU of the original MT SM; we say that reply path does not exist otherwise.

The replying MS may have a default SC which is normally used for delivering all the MO short messages originated from the replying MS. Alternatively, a human user or automatic application may specify a selected SC for delivering a particular SM (thus the term selected SC refers to an SC address selected for one short message only).

D.4 The reply path requesting procedure

The discussion in this clause applies to cases when the originating SME is a mobile station only. The reply procedures discussed in the clauses to follow this one are independent of the type of the originating SME.

The reply path is requested by the originating SME (an MS) by setting the TP-Reply-Path parameter in the SMS SUBMIT PDU of the original SM. If the original SC supports reply path requesting for the originating SME (an MS), it shall take notice of the TP-Reply-Path parameter in the SMS-SUBMIT PDU and set the TP-Reply-Path parameter in the SMS-DELIVER PDU of the original MT SM towards the replying MS. Hence, reply path exists for the replying MS towards the originating SME (an MS).

D.5 The reception of an original MT SM

When a replying MS receives an original MT SM, it then has:

- 1) originating SME = TP-Originating-Address in the SMS-DELIVER PDU,
- 2) original SC = RP-Originating-Address in RPS-MT-DATA, and
- 3) reply path exists/reply path does not exist = TP-Reply-Path in SMS-DELIVER PDU (set/not set).

D.6 The submission of the reply MO SM

According to clause 5, the replying MS knows if:

- a) reply path exists; or
- b) reply path does not exist.

We then specify that when submitting the reply MO SM, the replying MS should use parameters as follows:

- 1) TP-Destination-Address in SMS-SUBMIT PDU = originating SME,
- 2a) If reply path exists:

RP-Destination-Address in RP-MO-DATA = original SC,

- 2b) If reply path does not exist:

RP-Destination-Address in RS-MO-DATA = selected SC or default SC or original SC,

- 3a) If reply path exists:

after submitting one reply MO SM, the reply path does not exist any more.

In case (2b), it is allowed to use the original SC or the default SC, but then there is no guarantee that the original/default SC shall deliver the reply MO SM. (The original SC may refuse to deliver, if the replying MS is not its subscriber; the default SC may be unable to deliver, if it has no access path to the originating SME.)

Requirement (3a) states that the case (a), reply path exists, holds for one reply MO SM only (per original MT SM).

D.7 Usage of SCs for replying

The specification in this annex supports the following way of replying.

The original MT SM and the reply MO SM are delivered by the same SC, the original SC. This principle maximizes the probability that the SC can e.g. route the reply MO SM to the proper data network for reaching the originating SME; this principle is a must, if the originating SME is integrated within the original SC.

If the original SC by any means whatsoever knows that it is both willing and able to deliver one (potential) reply MO SM, it may indicate this fact by setting the TP-Reply-Path parameter in the original MT SM. The original SC thus commits itself to delivering one reply MO SM; let us call this reply delivery commitment.

One reason for the SC to make the reply delivery commitment may be the reply path requesting procedure specified in clause 4 on this annex.

The reply path commitment is not valid forever, but the original SC may have e.g. a time limit for maintaining this commitment.

D.8 Replying possibilities for Phase 1 mobile stations

The Phase 2 mobile stations should support the procedures in this annex (if they fulfil the criteria in clause 2 of it). Yet, Phase 1 mobile stations, too, may apply steps (1) and (2a) in clause 6 of this annex, i.e. reply via the original SC, automatically or manually (by choosing selected SC = original SC), despite the fact that the TP-Reply-Path parameter shall be ignored by them. The delivery of the reply MO SM cannot be guaranteed in this case, yet the possibility of delivery may be improved (especially if the originating SME is not an MS).

D.9 The resulting service for originating SMEs

As the consequence of the replying procedures specified in this annex, all SMEs and applications within them may assume that replying from all mobile stations is always possible, provided that the mobile stations do support the proper replying mechanism itself (human response in context with the original MT SM, automatic replying by an application, application level protocols, etc.).

Annex E (normative): Extended Object Format Type

E.1 Predefined Sound

The predefined sound as integrated in the Extended Object IE is structured as follows:

Octet 8 Sound number as defined in table of subclause 9.2.3.24.10.3.1.

E.2 iMelody

An iMelody object [33] can be integrated in an Extended Object IE with the following structure:

Octet 8..n iMelody object coded according to the iMelody format [33].

E.3 Black and white bitmap

The user-defined black and white bitmap as integrated in the Extended Object IE is structured as follows:

Octet 8 Horizontal dimension of picture.
 This octet shall contain the horizontal number of pixels

Octet 9 Vertical dimension of picture.
 This octet shall contain the vertical number of pixels.

Octet 10..n Picture data, pixel by pixel from top left to bottom right. The picture data is encoded as a continuous sequence of bits. There shall be no fill bits at the end of each row of data, Fill bits may only be used in the last octet of the picture data if needed. The fill bits in the last octet shall be ignored. Within each octet the MSB represents the leftmost pixel.

The colour values are encoded as follows:

Bit Value	Colour
0	White
1	Black

E.4 2-bit greyscale bitmap

The user-defined 2-bit greyscale bitmap as integrated in the Extended Object IE is structured as follows:

Octet 8 Horizontal dimension of picture.
 This octet shall contain the horizontal number of pixels

Octet 9 Vertical dimension of picture.
 This octet shall contain the vertical number of pixels.

Octet 10..n Picture data, pixel by pixel from top left to bottom right. The picture data is encoded as a continuous sequence of bits. There shall be no fill bits at the end of each row of data, Fill bits may only be used in the last octet of the picture data. The fill bits in the last octet shall be ignored. The pair of bits at the MSB represents the leftmost pixel of the four defined in an octet.

The colour values are encoded as follows:

Bit Value	Colour
00	Black
01	Dark Grey
10	Light Grey
11	White

E.5 6-bit colour bitmap

The user-defined 6-bit colour bitmap as integrated in the Extended Object IE is structured as follows:

- Octet 8 Horizontal dimension of picture.
This octet shall contain the horizontal number of pixels
- Octet 9 Vertical dimension of picture.
This octet shall contain the vertical number of pixels.
- Octet 10..n.

Picture data, pixel by pixel from top left to bottom right. The picture data is encoded as a continuous sequence of bits. There shall be no fill bits at the end of each row of data, Fill bits may only be used in the last octet of the picture data. The fill bits in the last octet shall be ignored.

Each pixel colour is represented by 6-bits of data, giving a total of 64 colours. (2 bits of data define the levels of each red, green and blue). The overall pixel colour is a composite of the three RGB values.

The first pair of bits of picture data define the level of red of the topmost, leftmost pixel, the next pair of bits the level of green for this pixel, and the third pair the level of blue for the pixel. The first bit of a pair defining a colour level is the MSB. This is illustrated below.

Octet 1							
Bit 7	Bit 6	Bit 5	Bit 4	Bit 3	Bit 2	Bit 1	Bit 0
MSB Red Pixel 1	LSB Red Pixel 1	MSB Green Pixel 1	LSB Green Pixel 1	MSB Blue Pixel 1	LSB Blue Pixel 1	MSB Red Pixel 2	LSB Red Pixel 2

Octet 2							
Bit 7	Bit 6	Bit 5	Bit 4	Bit 3	Bit 2	Bit 1	Bit 0
MSB Green Pixel 2	LSB Green Pixel 2	MSB Blue Pixel 2	LSB Blue Pixel 2	MSB Red Pixel 3	LSB Red Pixel 3	MSB Green Pixel 3	LSB Green Pixel 3

E.6 Predefined animation

The predefined animation as integrated in the Extended Object IE is structured as follows:

- Octet 8 Animation number as defined in table of subclause 9.2.3.24.10.3.3.

E.7 Black and white bitmap animation

The user-black and white animation is integrated in the Extended Object IE is structured as follows:

- Octet 8 Horizontal dimension of picture.
This octet shall contain the horizontal number of pixels.
- Octet 9 Vertical dimension of picture.
This octet shall contain the vertical number of pixels.
- Octet 10 The number of frames in the animation.

Octet 11 Animation control byte.

Bits	Meaning
7 – 4	Frame display. The value (in tenths of a second) that is requested between each frame: 0000 1 tenth (i.e. 0.1s) 1111 16 tenths (i.e. 1.6 s)
3 – 0	Repeat value. The requested number of repetitions of the animation: 0000 Unlimited repetition 0001 1 repetition 1111 15 repetitions

Octet 12..n Contains a series of bitstreams encoding 1 bit pixel depth bitmaps as defined in F.3. If a frame in the animation would require fill bits (as described in F.3) these shall be contained at the end of the frame such that the bit-stream for the next frame begins on an octet boundary.

E.8 2-bit greyscale bitmap animation

The user-black and white animation is integrated in the Extended Object IE is structured as follows:

- Octet 8 Horizontal dimension of picture.
This octet shall contain the horizontal number of pixels.
- Octet 9 Vertical dimension of picture.
This octet shall contain the vertical number of pixels.
- Octet 10 The number of frames in the animation.
- Octet 11 Animation control byte.

Bits	Meaning
7 – 4	Frame display. The value (in tenths of a second) that is requested between each frame: 0000 1 tenth (i.e. 0.1s) 1111 16 tenths (i.e. 1.6 s)
3 – 0	Repeat value. The requested number of repetitions of the animation: 0000 Unlimited repetition 0001 1 repetition 1111 15 repetitions

Octet 12..n Contains a series of bitstreams encoding 2 bit pixel depth bitmaps as defined in F.4. If a frame in the animation would require fill bits (as described in F.4) these shall be contained at the end of the frame such that the bit-stream for the next frame begins on an octet boundary.

E.9 6-bit colour bitmap animation

The user-black and white animation is integrated in the Extended Object IE is structured as follows:

- Octet 8 Horizontal dimension of picture.
This octet shall contain the horizontal number of pixels.
- Octet 9 Vertical dimension of picture.
This octet shall contain the vertical number of pixels.
- Octet 10 The number of frames in the animation.
- Octet 11 Animation control byte.

Bits	Meaning
7 – 4	Frame display. The value (in tenths of a second) that is requested between each frame: 0000 1 tenth (i.e. 0.1s) 1111 16 tenths (i.e. 1.6 s)
3 – 0	Repeat value. The requested number of repetitions of the animation: 0000 Unlimited repetition 0001 1 repetition 1111 15 repetitions

Octet 12..n Contains a series of bitstreams encoding 6 bit pixel depth bitmaps as defined in F.5. If a frame in the animation would require fill bits (as described in F.5) these shall be contained at the end of the frame such that the bit-stream for the next frame begins on an octet boundary.

E.10 vCard

A vCard object [36] can be integrated in a Extended Object IE with the following structure:

Octet 8..n vCard object as defined in [36]. The UTF-8 encoding is used instead of the default 7-bit ASCII. For certain vCard properties, other encoding can be used by setting the CHARSET property parameter to the appropriate character set.

E.11 vCalendar

A vCalendar object [37] can be integrated in a Extended Object IE with the following structure:

Octet 8..n vCalendar object as defined in [37]. The UTF-8 encoding is used instead of the default 7-bit ASCII. For certain vCalendar properties, other encoding can be used by setting the CHARSET property parameter to the appropriate character set.

E.12 Data Format Delivery Request

This Data Format Delivery Request is an optional feature used by an SME to indicate which Extended Object data formats, listed in subclause 9.2.3.24.10.1.11, it is requesting for delivery. This Data Format Delivery Request may be included by an SME in a MO SM containing other EMS related data, or in a MO SM independently. Processing of this data format is optional in a MT short message.

The information in this data format represents an extensible bit field with the first bit being mapped to the first Extended Object (EO) data format defined in the table in subclause 9.2.3.24.10.1.11.

Octet 8

Bit 0: If set to 1 indicates support for EO data format 00

Bit 1: If set to 1 indicates support for EO data format 01

Bit 2: If set to 1 indicates support for EO data format 02

.....

.....

Octet n

Bit 0: If set indicates support for EO data format $((n - 8) * 8)$

Bit 1: If set indicates support for EO data format $((n - 8) * 8) + 1$

Bit 2: If set indicates support for EO data format $((n - 8) * 8) + 2$

.....

Any unused bits in the last octet shall be set to zero.

E.13 Standard WVG Object

The Standard WVG object as defined by Format Type 0x0B in the Extended Object IE is as follows.

Octet 8..n Standard WVG object bit stream

The unused bits in the last octet will be filled with 0

The detailed data format and attributes of Standard WVG object are defined in Annex G.

The bit order is defined as follows:

The octet with a smaller octet number stores the bits appearing in the front position in the bit stream; the most significant bit in an octet stores the first bit in position in a 8-bit segment in the bit stream.

A Standard WVG object may or may not have fixed size. In either case, display size should be determined by the terminal implementation. Recommended display size is a largest possible size on terminal screen while aspect ratio shall be maintained.

E.14 Polyphonic melody

A Polyphonic melody can be integrated as an extended object in one or more short messages. Informative guidelines for the creation of polyphony content using SP-MIDI [38] are listed in Annex H.

However, in order to guarantee the interoperability with legacy mobile devices which are not able to interpret specific SP-MIDI content, the following considerations shall be taken into account for content creation:

- When content is not provided in SP-MIDI format the presence of the MIP table in polyphonic extended objects is not mandatory. Since a receiving SME supporting polyphonic extended objects may decide to ignore and skip the content of a MIP message by implementing its own note stealing or channel masking strategy when played. However, when SP-MIDI format data is present and the message is stored and subject to potential forwarding, the specific SP-MIDI content shall be kept as received by the SME.
- the additional rhythm channel as specified in subclause 3.2 in [38] might not be supported by the receiving SME.

Octet 8..n SMF as defined in [38], [40]

Annex F (informative) : Compression methods for EMS

F.1 LZSS compression

F.1.1 Introduction

The LZSS compression algorithm is one of a number of compression algorithms generally referred to as “Dictionary Methods”. These algorithms rely upon the fact that (in general) an input data buffer will contain repeating “patterns” or matching sequences of bytes.

The algorithms fall into 2 groups. Systems like LZ78 and LZ77 scan an input buffer and construct a “dictionary” of the most commonly occurring byte sequences or “phrases”. This dictionary is pre-pended with the compressed data and the compressed data comprises an array of indices into the dictionary.

A second set is a modification of this in that the data dictionary is implicit in the uncompressed data buffer. All are based upon an algorithm developed and published in 1977 by Abraham Lempel and Jakob Ziv [LZ77](#). A refinement of this algorithm, which is the basis for practically all the later methods in this group, is the [LZSS](#) algorithm developed in 1982 by Storer and Szymanski. These methods try to find if the character sequence currently being compressed has already occurred earlier in the input data and then, instead of repeating it, output only a pointer to the earlier occurrence. This is illustrated in the following diagram:

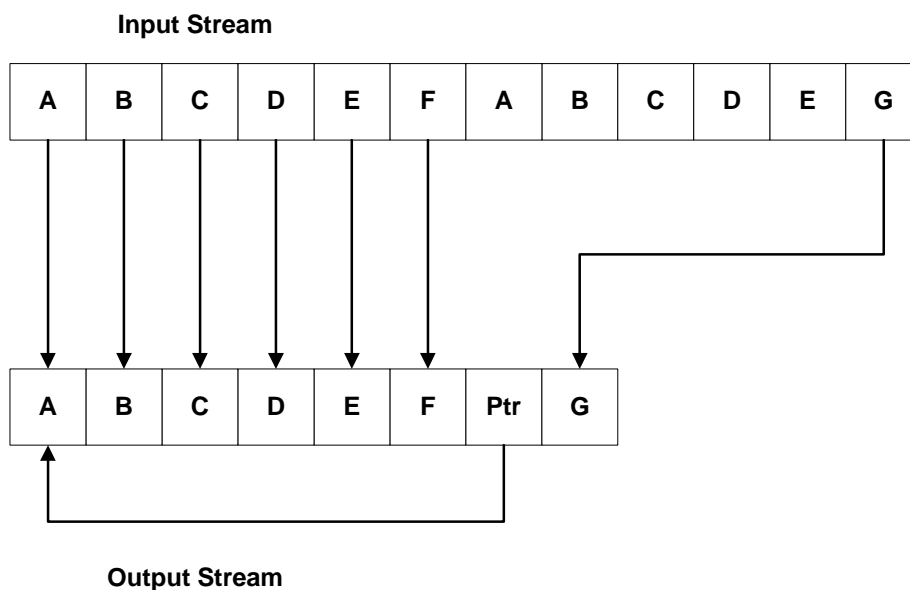

Figure F.1 Illustration of “Implicit Dictionary” compression methods

F.1.2 LZSS Basic Algorithm

The algorithm searches the window (a buffer moving back from the current position in the input data). It searches for the longest match with the beginning of the look-ahead buffer (a buffer moving forward from the current position in the input data) and outputs a pointer to that match. This pointer indicates a position and length of that data match. It is referred to here as a “Slice Descriptor”.

Since it is possible that not even a one-character match can be found, the output cannot contain just pointers. Accordingly at times it is necessary to write literal octets into the output buffer. A block of literal octets is preceded by a “Literal Block Identifier” which indicates the length of the literal octet sequence that follows.

F 1.3 Informative Example.

The following is provided as an informative example using the input buffer shown below.

1	2	3	4	5	6	7	8	9	10	11	12	13	14	15	16
0x01	0x02	0x03	0x01	0x02	0x03	0x04	0x01	0x02	0x03	0x01	0x02	0x03	0x01	0x02	0x03

Figure F.2 Sample input buffer (16 octets long)

Step 1:

Starting position is byte 1 in the input buffer. For octets 1 to 3 there are no octet matches in the window for the look-ahead buffer. So write a literal octet sequence of 3 octets following a literal block header.

1	2	3	4
0x83	0x01	0x02	0x03

Figure F.3 Output buffer after initial literal block is written

Step 2:

Current position is octet 4. Examining the look-ahead buffer and the window a 3 octet match is found beginning 3 octets before (octet 1) and of 3 octets in length. A 2 octet slice descriptor is added to the output buffer. The current position moves to octet 7 of the input buffer.

1	2	3	4	5	6
0x83	0x01	0x02	0x03	0x06	0x03

Figure F.4 Output buffer after the first slice descriptor is written

Step 3:

Current position is octet 7 in the input buffer (0x04). There are no matches in the window for this value so a 2 octet literal sequence is written to the end of the output buffer. The current position moves to octet 8 of the input buffer.

1	2	3	4	5	6	7	8
0x83	0x01	0x02	0x03	0x06	0x03	0x81	0x04

Figure F.5 Second literal block is written into output buffer

Step 4:

Current position is octet 8 of the input buffer. Comparing the window with the look-ahead buffer reveals a octet match from the current position with octets 1 to 6 of the input buffer. That is a 6 octet sequence beginning 7 octets back from the current position.. A two-octet slice descriptor for this match is added to the output buffer. The current position moves to octet 14 of the input buffer (6 octets further on).

1	2	3	4	5	6	7	8	9	10
0x83	0x01	0x02	0x03	0x06	0x03	0x81	0x04	0x0 C	0x0 7

Figure F.6 Octet match slice descriptor is written into output buffer

Step 5:

Current position is octet 14 of the input buffer. Comparing the window with the look-ahead buffer reveals another 3 octet sequence match (0x01, 0x02, 0x03). This octet sequence occurs several times in the window within the 511 octets that the slice descriptor allows. Therefore several different (but valid) slice descriptors could be written (this would be implementation dependent). However in this example we will reference the initial 3 octets of the input buffer and write a slice descriptor indicating a 3 octet match beginning 13 octets behind the current position.

1	2	3	4	5	6	7	8	9	10	11	12
0x83	0x01	0x02	0x03	0x06	0x03	0x81	0x04	0x0 C	0x0 7	0x0 6	0x0 D

Figure F.7 Octet match slice descriptor is written into output buffer: the final output buffer

Annex G (normative): WVG (Wireless Vector Graphics) data format

WVG (Wireless Vector Graphics) is a compact binary data format for vector graphics. WVG data is represented by a bit stream, composed of a header, codec parameters and graphical elements. The bit representation of the drawing and contained graphical elements is designed such that the bit stream can be optimized for smallest possible size.

G.1 Introduction

G.1.1 Standard and Character Size WVG elements

A Standard WVG element is defined by the complete WVG specification. Using a set of the WVG specification with a set of default values, a simplified vector graphics can be used to represent a simple and small vector graphics or glyph. Character Size WVG elements can be included in normal text to represent a handwritten character or symbols that are not supported by character coding system and the font library.

G.1.2 Compression methods

A combination of compression methods is used in the WVG to achieve the best compression ratio for simple vector graphics and animations. They include:

- **switchable linear or non-linear coordination system:** when graphical elements in a drawing are not evenly distributed, the representation of coordinates can be optimized using a non-linear coordinate system (uneven coordinates)
- **bit packing:** variable number of bits to represent a number. The number of bits used in WVG can vary from 1 bit to 16 bits.
- **local envelope:** use a dedicated coordinate system to describe elements in a small area using relatively small coordinate numbers
- **variable resolution:** in coordinates, sizes, angles, scale and etc, different resolutions can be used for a graphical element to save the number of bits needed for representing a value.
- **palettes:** color and element ID can be mapped using a palette defined in the drawing header. This also saves the number of bits for representing a color value and an element ID.
- **default values:** many values can be omitted to use default values. E.g. when no color scheme is defined, the data describes a mono drawing
- **default animation timing:** in addition to standard time based animation, WVG uses a simplified animation model. In Simple Animation mode, no timing is needed for describing animations. Instead, a cycle is defined to describe the timing for these animations.

G.1.3 Coordinate Systems

There are two coordinate systems used in WVG, namely Compact Coordinate System and Flat Coordinate System.

G.1.3.1 Compact Coordinate System

In compact coordinate system, a drawing area is defined as rectangle area called envelope. There are two types of envelopes, global envelope and local envelope. The global envelope is a base area in which the drawing is contained. There is only one global envelope. A local envelope is a square area completely or partially within the global envelope. There is no specific global envelope size specified in the data format. The physical display size is decided at rendering time.

The aspect ratio and orientation are defined in the data header and should be maintained when the drawing is displayed.

Aspect ratios include 1:1, 4:3, 16:9 up to 1024: 729 (height:width), in both portrait and landscape orientation. Aspect ratio for Characters Size WVG elements only has landscape orientation.

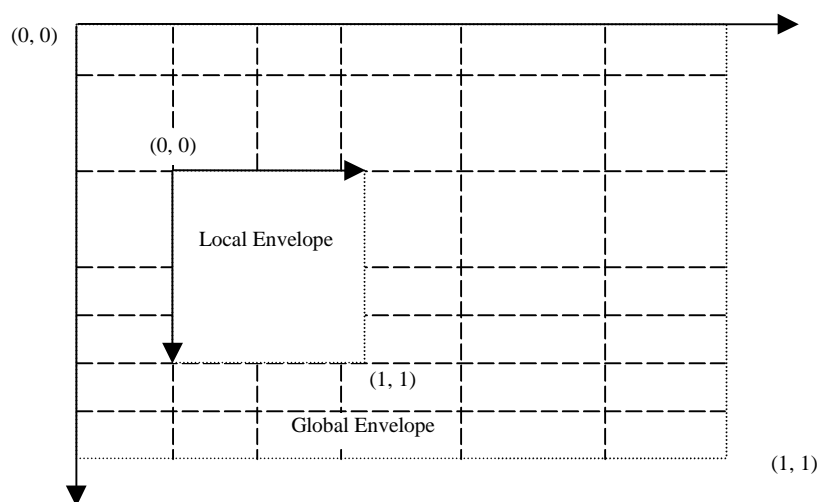

In Compact Coordinate System, coordinates are restricted to certain positions which are the cross points of a grid. The grid is defined in the WVG data header, set by a group of parameters. The grid lines along with x axis or y axis may be unevenly distributed.

The global grid can be described using a curve shown above.

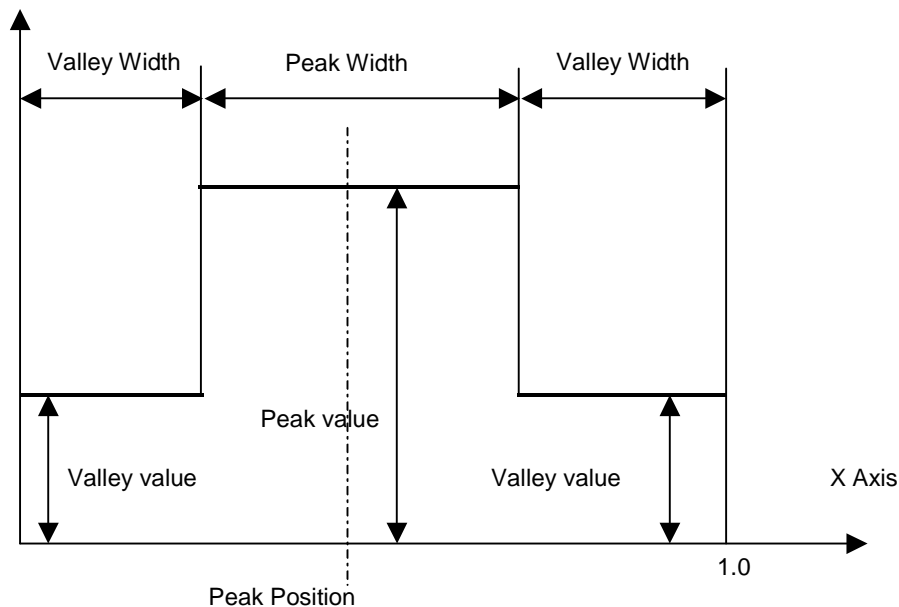

There are one peak and two valleys in the curve. The definition of the curve is:

- peak position: the central position of a peak;
- peak value: a value equal or larger than 1,0;
- peak width: a value less than 1,0.

All valleys should have the same value.

The total area enclosed by the curve and the x-axis from 0,0 to 1,0 is always equating to 1,0.

The curve can be uniquely defined by peak position, peak value and peak width. Once the parameters are determined, other values such as valley value can be calculated. Once a curve is given, grid line positions can be calculated according to the following function:

$$\int_0^{X_k} d(x) dx = \frac{k}{n-1}$$

Where X_k is the position of the k^{th} grid line, where n is total number of grid lines. $d(x)$ is the curve function described in the present document.

In standard WVG, the curve parameters are preset as follows.

Variable parameters:

- number of grid lines: 15, 31, 63 or 127;
- peak value: 1,0, 1,5, 2,0 and 2,5;
- peak position: 13 options from 0,0 (0/12), 0,083333 (1/12), 0,166667 (2/12) to 1,0 (12/12);
- peak width: 0,3, 0,4, 0,5 and 0,6.

When a portion of a peak exceeds the global envelope only the part within the global envelope is valid.

For Character Size WVG or glyph, the parameters are set as follows.

Predefined parameters:

- peak width: 0,4.

Variable parameters:

- number of grid lines: 7, 15, 31 or 63;
- peak value: 1,0 or 1,5;
- peak position: 0,3333 (1/3), 0,5, 0,6667 (2/3).

When using relative coordinates in Compact Coordinate System (refer to clause G 1.3.3), some elements may be specified with specific resolution, which is independent of the global resolution. There are 8 predefined resolutions available for "re-definition resolution", there are 1/27, 1/38, 1/48, 1/64, 1/85, 1/128 and 1/160 of the length of the shorter global envelope edge. Re-definition of resolution only applies to elements in global scope.

G.1.3.2 Flat Coordinate System

The Flat Coordinate System is a 16 bit signed coordinate system with the top left coordinate of the screen being defined as $(x=0,y=0)$ and the bottom right coordinate being described as $(x=2^{15}, y = 2^{15})$. Note that this expresses the dynamic range of the coordinate system, however it does not mean that all drawings are of this size.

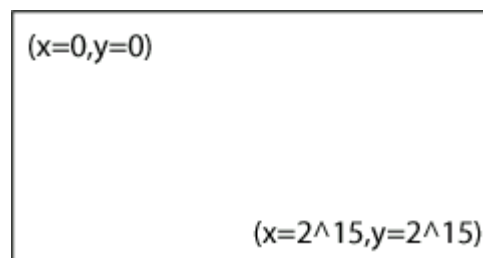

G.1.3.3 Coordinate values

Coordinate values may be represented using two methods: absolute coordinate and relative coordinate.

Absolute Coordinate: an absolute coordinate is a pair of x and y coordinate number. In WVG Compact Coordinate System, absolute coordinate values are the coordinate grid line numbers and are always positive.

Relative Coordinate: the relative coordinate is used only in lines and transform. If the start point is defined by an absolute coordinate, subsequent points can be described by relative coordinates, which are relative grid units from the previous point. A relative coordinate is signed, and it may be positive or negative. A relative coordinate may be used in both global and local coordinate systems. A relative coordinate may exceed the scope of the local envelope that defines the start point of the line.

G.1.4 Color schemes

WVG supports the following color schemes.

- Black and white (2 Colors): black and white color.
- 2-bit grayscales: four grayscales are defined as (0,0,0), (85,85,85), (170,170,170) and (255,255,255) in 24-bit RGB color format.
- 4 default colors.
- 6-bit RGB color: it is similar to 24-bit RGB color definition but uses only 2 bits to represent a single color, in which value 0, 1, 2 and 3 represent 8-bit color value 0, 85, 170 and 255 respectively.
- 6-bit RGB color using 2nd palette.
- 8-bit websafe color.

- 12-bit and 24-bit RGB color.

There are 2 optional drawing pens in WVG, stroke pen and fill pen. Stroke pen and fill pen can be specified with one of the colors defined using the scheme. When the stroke pen is not defined, BLACK should be used for strokes. When the fill pen is not defined, no fill should be applied.

G.1.5 Rendering model

WVG uses painter model. The elements appears in the later position in the WVG bit stream will overrides the overlapped portion of the elements which appear in the front in the bit stream.

G.2 Graphical elements

WVG defines a set of graphical and animation elements. Among them, line, shape and text elements are the building blocks to form a drawing. These elements can be transformed, grouped and animated. There are also special elements that are auxiliary.

G.2.1 Line elements

There are 3 types of lines: polyline, circular polyline and bezier polyline. A polyline can represent a dot when there is only a start point defined.

A line element has its reference point at the starting point. A reference point of an element specifies the location of the element.

G.2.1.1 Polyline

Polyline is a set of straight lines connecting a sequence of points. When there is only one point, it is defined as a dot.

G.2.1.2 Circular Polyline

Circular Polyline is a line that contains at least one circular curve segment. The curve segment connects two adjacent points by a circular arc. The curve segment is determined by the two adjacent points and a curve offset (the perpendicular distance from the center of the line connecting the adjacent points to the circular arc).

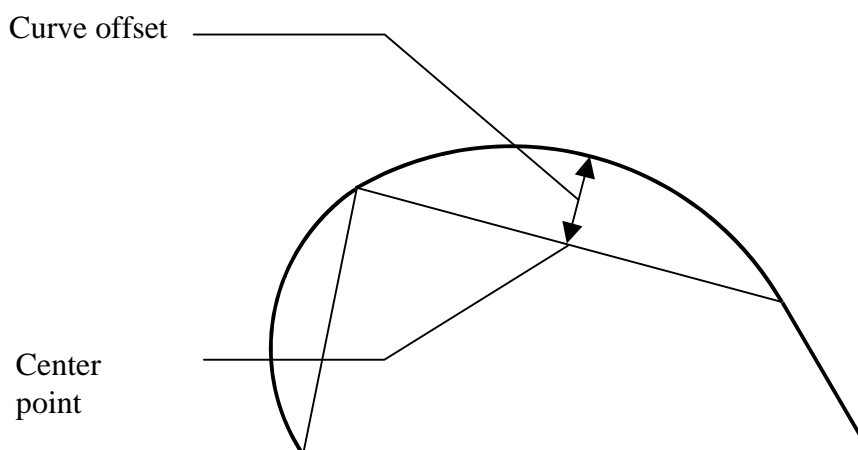

Curve offset values are within the range $-0,5$ to $0,5$, inclusive. A value of $0,5$ or $-0,5$ identifies that the curve offset equals half of length of the connecting line. The value indicates that the curve is close to a half circle. A positive value indicates that the curve is at the left side of the base line viewed from the curve direction. A negative value indicates that the curve is at the right side of the base line viewed from the curve direction.

G.2.1.3 Bezier Polyline

A Bezier Polyline contains one or more off curve control points in between on curve points. Bezier curves can be filled to create curved shapes and are common in generalized font representations.

All line elements have direction from the start point to the end point.

Color fill may apply to a line. Refer to clause G.2.1.4.

G.2.1.4 Auto-closure of a line

When a line is specified with the fill attribute, the line is considered as a closed line, which connects the start point and the end point using a straight line. The enclosed area of a closed line can be used for color fill.

The enclosed area is based on nonzero fill rule. Following are two examples in which the light color indicates the enclosed area.

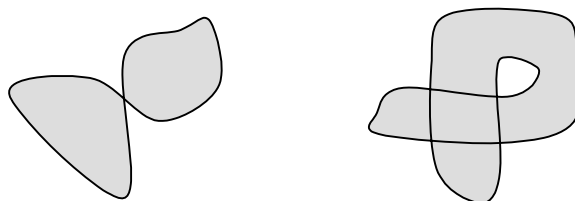

G.2.2 Polygon elements

Polygon elements are closed representations of polyline, circular polyline and Bezier polyline elements. Polygons may have separate line and fill colors or may not be filled at all.

Polygon elements use the nonzero fill rule for enclosed areas and can be used for color fill.

A polygon element has its reference point at the starting point.

G.2.3 Simple shape elements

Simple Shapes are rectangles and ellipses. A simple shape is defined by width, height, center point, and angle of rotation. The angle parameter defines how much the shape should be rotated about its center from a horizontal axis drawn through its center. Note that angle units are specified in the main header.

G.2.3.1 Ellipse

Ellipses are defined by their major axis, minor axis, center and angle of rotation. Circles are considered a special case of ellipse in which the major and minor axis are the same length.

G.2.3.2 Rectangle

Rectangles are represented by their center, width, height, and rotation angle. Squares are considered special rectangles in which the width and height are identical.

When the "round corner" indicator is set, the corner of the rectangle should be rounded. There is no specific radius of the round corner is defined. The recommended radius of the rounded corner should be 20% of the length of the shorter edge of the rectangle or the square.

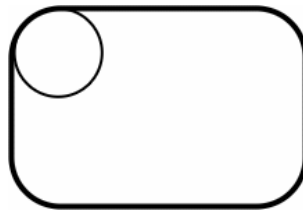

A simple shape element has its reference point at its center.

G.2.4 Special shape elements

There are 3 types of special shapes. These shapes are Regular Polygons, Stars, and Grids. Each shape has a reference point that determines its position for the purpose of transformations such as detailed in G2,8,1 and G,4. Shapes may have other parameters. These shapes include:

- **Regular polygon:** a regular polygon has equal length of all its edges. In its original position, the bottom edge of the regular polygon should be aligned horizontally. A rotate angle can be optionally specified. Regular polygon parameters include the number of vertex, the diameter of the reference circle and angle of rotation.

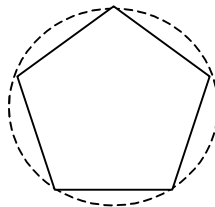

- **Star:** a star is defined by the number of corner vertex, the diameter of the reference circle, vertex angle and angle of rotation. In its original position, the bottom edge, which formed by two vertexes of the star, should be aligned horizontally. A rotate angle can be optionally specified. Vertex angles are predefined as 0, 36, 60, 90 degrees.

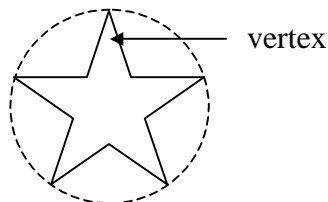

If the vertex angle is 0, a single line from center to vertex shall be drawn.

- **Grid:** a grid is a number of evenly distributed perpendicular lines. Its parameters include height, width, angle and number of rows and columns (up to 16).

A special shape element has its reference point at its center.

G.2.5 Text element

WVG supports text display inside the drawing. However it supports only the default font. To avoid inconsistency on different terminals, it is recommended to use vector based font. Text can be placed in a drawing with position, font size and rotate angle. Like other elements, text has attributes of line style, line color, line width. It can also be animated.

Control characters are ignored when the text is rendered except for the CR (Carriage Return). The CR indicates the text followed by should be displayed at the next line position. Multi-line text should be left aligned. There is no character

spacing and line spacing defined. Recommended character spacing is 10% of the text height. Recommended line spacing is 20% of the text height.

A text element has its reference point at top-left corner.

G.2.6 Group elements

A set of elements can be grouped together.

The Group element is used to mark the start and end of grouped elements. A group of elements starts with a Group element which has the end-group indicator off, followed by a list of elements in the group, and ends with an Group element which has the end-group indicator on. Groups can be nested. Implementation must support at least 2 levels of nested group.

Group (start)

Element 1

Element 2

.....

Group (start)

Element a

Element b

.....

Group (end)

Element n

Element n+1

.....

Group (end)

G.2.7 Reuse element

Reuse element can be used to display an element or a group of elements with a transform and/or changed attributes and/or display an array. Whether a reuse element references a group or a basic element depends on the element type that the `element_index` in the reuse element points to. When reuse array is specified, the referenced element or group of elements is duplicated in rows and columns. The reference point of a reused array is at the reference point of the top-left element in the array.

G.2.8 Animation elements

There are two types of animation elements, Simple Animation Element and Standard Animation Element. In the data format, a simple animation element is followed by another element or a group element that the animation applies to. A standard animation element has pointer or index that points to another element or a group element.

G.2.8.1 Simple animation elements

Simple animation is defined for WVG. All animation timing is based on an "Animation Cycle". WVG animation is repetitive. After completion of playing one cycle, a subsequent cycle play commences immediately.

There are two types of animation cycles defined, short cycle and long cycle. The time length of animation cycles are not defined. The time length of a long cycle should be twice the length of a short cycle. Recommended short cycle should collapses for 1 second and long cycle pay for 2 seconds.

There are two types of animations.

Visibility: an element can be visible or invisible during a specific cycle segments. A short cycle is divided into 4 time segments equally and a long cycle is divided into 8 time segments equally.

In the following example, a visibility for short cycle animation is defined. The element to be animated will blink following the pattern defined in the Visibility field below. Bit 1 indicates the element should be displayed during the time segment. Bit 0 indicates it should not be displayed during the time segment.

0	1	0	1
---	---	---	---

In the following example, a visibility for long cycle animation is defined. The element to be animated will blink following the pattern defined in the visibility field below.

1	0	1	0	1	1	1	1
---	---	---	---	---	---	---	---

Round Rotation: an element can be rotated at clockwise or counter-clockwise directions.

Transform: a start and an end transform can be applied to an element to describe the start and end position of a rotate, a scale, a translate animation or any combination of these action. When a transform element is omitted, it defaults to use the element's original position. An animation element must include at least one transform element. The animated element can also be a group to allow the animation action applied to a group of elements.

In simple animation, a transform from start position to end position should be completed in one cycle. A bounced flag can be turned on to allow "bouncing" animation. A bounced transform transforms the element from start position to end position in one cycle.

Transform in a short cycle:

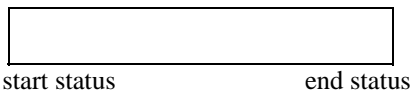

Bounced Transform in a short cycle:

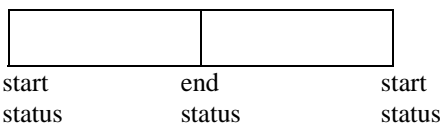

Transform in a long cycle:

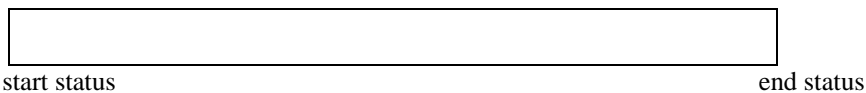

Bounced Transform in a long cycle:

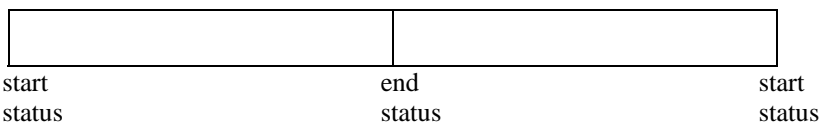

Visibility and transform animation can be applied to the same element.

G.2.8.2 Standard Animation Element

A Standard Animation Element contains animation information such as begin transform position, end transform position, begin color, end color, begin time, end time, etc. This allows one animation element to represent a series of related images, which results in significant compression of the data stream. The WVG player interpolates between the beginning state and end state to achieve animation.

Animation elements are not allowed inside groups. Animation rotation ranges from 0 to 360 degrees in both clockwise and counter-clockwise directions.

G.2.9 Frame Element

Frame Element is as a marker of the start of a new frame. All elements before a frame element belong to previous frame. The delay between two frames is defined as an infinite time interval. This means says that once a frame marker is reached, the elements that have been displayed on the screen at this time will stay on the screen until the user requests that the next frame should be displayed. The idea is that one can have multiple "pages" of graphics, such as a multi-page cartoon. The user can then study the first page and when finish can press a button (or trigger some other event) to see the next page of the cartoon. The mechanism of the user event is not defined and is left up to the application developer.

Here are parameters of a frame element:

- keep last frame contents (or not). Zero means not keeping last frame contents, otherwise all the contents of previous frame will be kept.
- fill in a new background color (or not). Zero means no new fill color is needed for this frame, otherwise a new background color will be used.
- new background color.

A frame element cannot appear in an element group. Reuse and animation elements can not apply to a frame element.

G.2.10 Local Element

This element defines the size and position of a local envelope.

The local envelope is a square area whose top-left corner is defined as the origin for its x and y-axis. The number of grid lines are pre-defined to 7, 15, 31 and 63. The resolution is constant in a local grid which is pre-defined at 1/27, 1/32, 1/48, 1/64, 1/85, 1/128, and 1/160 of the local envelope width. Actual envelope size can be determined by number of grid lines and grid resolution. The position of the local envelope is determined by the local envelope origin that falls at a coordinate within the global envelope.

A local element cannot appear in between another local start and local end element.

G.2.11 Extended Element

The Extended Element is defined to create objects which are not part of the base parsing level of defined objects in the present document and as a future proof method of expansion as defined by 3GPP technical committees. The extended element is intended for resolving problems in the current release. It may also be possible to use the extended element for potential enhancements in future releases. If the decoder encounters an extended element and the extended element type is unrecognized, it can gracefully skip this element by seeking past it in the bitstream, and continuing decoding at the next element in the bitstream.

An extended element contains the size of the extended element, the extended element type, and a series of bytes representing the payload data. The size field represents the payload data size in bytes. Note that when reading the payload data, bit alignment should be assumed (not byte alignment).

G.3 Element attributes

Each element has a number of attributes such as pen color, fill color and line width used for stroking. The following elements Line, polygon, shape and text elements have the listed attributes.

- Line width: 3 levels (fine, medium, thick). Default is fine.
- Line style: 4 types (solid, dash, dot and reserved). Default is solid.
- Pencolor and fill color.

Line Width:

There are 4 line width settings defined, namely "No Line", "Fine", "Medium" and "Thick". No specific width is defined for "Fine", "Medium" and "Thick". Recommended line widths are 1% or one pixel, 2% and 4% of the shorter dimension of the drawing. Line width for "Fine", "Medium" and "Thick" should be at least 1 pixel. E.g., in a 120 x 80 pixel screen, the line width may appear as 1 pixel, 2 pixels and 3 pixels.

Line Type:

Dash Line: a dash line should start with a solid segment of the line. The length of the solid segments is recommended to be 4 to 6 times of the line width. The space between two solid segments is recommended to be 3-4 times of the line width.



Dotted Line: a dotted line is a string of circular dot on the path of a line. It is recommended that the diameter of rounded dot is same as the line width. The space between two dots shall be between 1 to 2 dot diameters.



Line Cap:

Line cap is Circular.

Line Joint:

Line joint is Round for line joint.

G.4 Element Transform

The Transform element is used to scale, rotate, or translate any single element or group of elements. Multiple transforms may be applied in succession to any element by standard matrix concatenation. The transform element may be included in Group, Reuse and Animation elements and applied to line, polygon, shape, text and group elements. The sequence of applying transform operations is scale->rotate->translate.

G.5 Character Size WVG Element

The character size WVG, or glyph is a subset variation of WVG. Character Size WVG uses a compact coordinate system with a half resolution global grid (7, 15, 31 and 63 grid lines), default color (monochrome), line elements (polyline, circular polyline and Bezier polyline) and a simplified drawing header.

G.6 Data Format BNF

The following notation is used in the present document for BNF syntax:

<>	Enclose term names
	Separates alternatives (exclusive OR)
[]	Square brackets enclose optional items in syntax descriptions.
{ }	{ } Term enclosed is used zero or more times
()	() Enclose groups of alternative terms
...	From ... to
;	Start with comments
0	Bit value 0 in bit stream
1	Bit value 1 in bit stream
' '	Terminator described by enclosed text

Notes for reading the BNF:

NOTE 1: The bit value appearing at the left in the BNF indicates it is arranged in the front in the bit stream.

NOTE 2: Notation 00...11 is equivalent to (00 | 01 | 10 | 11).

NOTE 3: Notation (0 | 1 <val>) is used in the BNF in many occurrences for optionally omitting a value. In this example, it indicates either a specific value <val> can be used, or it can be omitted when default value can be used. The bit value 0 or 1 indicates if <val> is specified.

NOTE 4: Signed integers use Two's Complement representation.

WVG (Wireless Vector Graphics)

<WVG> ::= (0 <character size WVG>) | (1 <standard WVG>)

<character size WVG> ::= <character size WVG header> <line elements>

<standard WVG> ::= <standard WVG header> <elements>

Common

<text code mode> ::= 0 | 1 ; 0 for 7-bit GSM character set. 1 for 16-bit UCS-2

<string length> ::= 'unsigned 8-bit integer' ; number of GSM or UCS-2 characters
; GSM extension characters are counted as one character
; <string length> = 0 means null string

<char> ::= 'unsigned 7 bit integer' ; 7-bit GSM character value
; Extension table are supported but the Another Extension; and the
; Page Break are not supported.

| 'unsigned 16 bit integer' ; 16-bit UCS-2 value
; CR is supported but other control characters are not supported
; (ignored when processed).

<mask> := 0 | 1 ; 0 for false, 1 for true

<hint> := 0 | 1 ; 0 for false, 1 for true

Character Size WVG Header

<character size WVG header> ::= (0 (<aspect ratio> <line element mask> <relative use>

<parameters X-0> <parameters Y-0>))

; standard header

| (1 (<line element mask> <relative use> <MaxXYInBits0>))

; compact header. In this case, x and y grid are same,

; default peak value 1.0, default aspect ratio 1:1.

; Note: character size WVG always use compact coordinate mode

<line element mask> ::= <mask> ; true for at least one polyline element in the drawing

<mask> ; true for at least one circular polyline element in the drawing

<mask> ; true for at least one Bezier polyline element in the drawing

<relative use> ::= 0 | 1 ; 0 for all points use absolute coordinates,

; 1 for at least one point uses relative coordinate (offset mode)

<parameters X-0> ::= <MaxXInBits0> <peak description>

<parameters Y-0> ::= <MaxYInBits0> <peak description>

<MaxXInBits0> ::= <bits indicator >

<MaxYInBits0> ::= <bits indicator >

<MaxXYInBits0> ::= <bits indicator >

<bits indicator> ::= 00...11 ; 00 for 3 bits (max value 7), 01 for 4 bits (max value 15)

; 10 for 5 bits (max value 31), 11 for 6 bits (max value 63)

<peak description> ::= 00...11 ; 00: peak value 1.0, no peak position required

; 01: peak value 1.5, peak position 0.5

; 10: peak value 1.5, peak position 0.3333

; 11: peak value 1.5, peak position 0.6667

Character Size WVG Elements

<line elements> ::= <number of line elements> <line element> { <line element> }

<number of line elements> ::= 'unsigned 7-bit integer' ; maximum 127 elements

<line element> ::= <line header>

(<polyline element> | <circular polyline element> | <Bezier polyline element>)

<line header> ::= <line element type> [<point mode>] ; appear when <relative use> = 1

<line element type> ::= ; empty, when <line element mask> = 100, 010 or 100

0 | 1 ; when <line element mask> = 011, 110, 110 or 101

; 0 for the first element with mask value 1 in the <line element mask>

; 1 for the second element with mask value 1 in <line element mask>

00..11 ; 00 for polyline, 01 for circular polyline, 10 for Bezier polyline

; (when <line element mask> = 111)

<point mode> ::= 0 | (1 <offset bit use>) ; 0 for use of absolute coordinate for <Next Point>

; 1 for using relative coordinate (offset mode) for <Next Point>

Standard WVG Header

<standard WVG header> ::= <general info> <color configuration> <codec parameters> <animation settings>
 <general info> ::= <version> 0 | (1 <text code mode> <author string> <title string> <time stamp>)
 <version> ::= 0000...1111
 <author string> ::= 0 | (1 <string length> <char> { <char> })
 <title string> ::= 0 | (1 <string length> <char> { <char> })
 <time stamp> ::= 0 | (1 <year> <month> <day> <hour> <minute> <second>)
 <year> ::= 'signed_13_bit_integer'
 <month> ::= 'unsigned_4_bit_integer' ; range 1-12
 <day> ::= 'unsigned_5_bit_integer' ; range 1-31
 <hour> ::= 'unsigned_5_bit_integer' ; range 0-23
 <minute> ::= 'unsigned_6_bit_integer' ; range 0-59
 <second> ::= 'unsigned_6_bit_integer' ; range 0-59

Color

<color configuration> ::= <color scheme> <default colors>

<color scheme> ::=	00	; black and white
	010	; 2-bit gray scale
	011	; 2-bit predefined color. 4 color value 00, 01, 10, 11 are
		; mapped to RGB color (255,255,255), (255,0,0),
		; (0,255,0) and (0,0,255) respectively
	100	; 6-bit RGB color
	101	; websafe color
	1100 <6-bit color palette>	; 6-bit RGB color using 2nd color palette
	1101 <8-bit color palette>	; websafe color using 2nd palette
	1110	; for 12 bits color mode
	1111	; for 24 bits color mode

<6-bit color palette> ::= 00000...11111 ; A value equal to "number of color" - 1.

;

Maximum 32 color entries

{<6-bit RGB color>} ; specify color value from 0 to "number of color"-1

<8-bit color palette> ::= 0000000...1111111 ; A value equal to "number of color" - 1.

Maximum 128 color entries

{ <8-bit websafe color> } ; specify color value from 0 to "number of color"-1

; Note: the decoder will decide number of bits used by <indexed

; RGB/websafe color> <indexed color> use 1 to 7 bits if <number of

; color> is 2, 3...4, 5...8, 9...16, 17...32, 33...64, 65...128.

<draw color> ::= **<b/w color>** *; when color scheme is 00*
 | **<grayscale>** *; when color scheme is 010*
 | **<2-bit predefined color>** *; when color scheme is 011*
 | **<6-bit RGB color>** *; when color scheme is 100*
 | **<8-bit websafe color>** *; when color scheme is 101*
 | **<indexed RGB color>** *; when color scheme is 1100*
 | **<indexed websafe color>** *; when color scheme is 1101*
 | **<12 bit RGB color>** *; when color scheme is 1110*
 | **<24 bit RGB color>** *; when color scheme is 1111*

<b/w color> ::= 0 | *; white*

1 *; black*

<grayscale> ::= 00...11 *; 00 for 24-bit RGB color (0,0,0), 01 for 24-bit RGB color (85,85,85)*
; 10 for 24-bit RGB color (170,170,170), 11 for 24-bit RGB color (255,255,255)

<2-bit predefined color> ::= 00...11 *; 00 for 24-bit RGB color (255,255,255), 01 for 24-bit RGB color (255,0,0)*
; 10 for 24-bit RGB color (0,255,0), 11 for 24-bit RGB color (0,0,255)

<6-bit RGB color> ::= <2-bit R> <2-bit G> <2-bit B>

<indexed RGB color> ::= (0 | 1) | 00...11 | 000...111 | 0000...1111 | 00000...11111
; map to 6-bit RGB color value defined in <6-bit color palette>

<8-bit websafe color> ::= 00000000...11111111

; See G.7 for websafe color palette definition

<indexed websafe color> ::= (0 | 1) | 00...11 | 000...111 | 0000...1111 |
00000...11111 | 000000...111111 | 0000000...1111111
; map to 8-bit websafe color value defined in <8-bit color palette>

<2-bit R> ::= <2-bit color value> *; Red color value*

<2-bit G> ::= <2-bit color value> *; green color value*

<2-bit B> ::= <2-bit color value> *; blue color value*

<2-bit color value> ::= 00...11 *; 00, 01, 10 and 11 for color value 0, 85, 170 and 255*
; defined in 0-255 color range respectively

<12-bit RGB color> ::= <4-bit R> <4-bit G> <4-bit B> *;*

<4-bit R> ::= <4-bit color value> *; Red color value*

<4-bit G> ::= <4-bit color value> *; green color value*

<4-bit B> ::= <4-bit color value> *; blue color value*

<4-bit color value> ::= 0000...1111 *; multiply by 17 to convert to 8 bit color value*

<24-bit RGB color> ::= <8-bit R> <8-bit G> <8-bit B> *;*

<8-bit R> ::= <8-bit color value> *; Red color value*

<8-bit G> ::= <8-bit color value> ; green color value
 <8-bit B> ::= <8-bit color value> ; blue color value
 <8-bit color value> ::= 00000000...11111111 ; intensity value of color value

<default colors> := (0 | (1 <default line color>)) ; use black when first bit is 0
 (0 | (1 <default fill color>)) ; use black when first bit is 0
 (0 | (1 <background color>)) ; use white when first bit is 0
 ; If above color(s) are not
 ; specified, use BLACK as <default line color> and <default fill color>, and use
 ; WHITE as <background color>.

<default line color> ::= <draw color>

<default fill color> ::= <draw color>

<background color> ::= <draw color>

Codec Parameters

<codec parameters> ::= <element mask> <attribute mask> <generic parameters>

<coordinate parameters>

<coordinate parameters> ::= (0 <flat coordinate parameters>) ; flat coordinate mode
 | (1 <compact coordinate parameters>) ; compact coordinate mode

<element mask> ::= <mask> ; true for at least one local envelope element in the drawing
 <mask> ; true for at least one polyline element in the drawing
 <mask> ; true for at least one circular polyline element in the drawing
 <mask> ; true for at least one Bezier polyline element in the drawing
 <mask> ; true for at least one simple shape element in the drawing
 <mask> ; true for at least one reuse element in the drawing
 <mask> ; true for at least one group element in the drawing
 <mask> ; true for at least one animation element in the drawing
 (0 | (1 ; extension bit. 1 for rare masks are followed by
 <mask> ; true for at least one polygon element in the drawing
 <mask> ; true for at least one special shape element in the drawing
 <mask> ; true for at least one frame element in the drawing
 <mask> ; true for at least one text element in the drawing
 <mask> ; true for at least one extended element in the drawing
) ; The decoder should decide how many bits to be used by <element type>
) ; according to number of "1"s in the <element mask>. Number of bits
 ; used by <element type> can be 0 (if only one "1" in <element mask>),

; 1 (if 2 "1"s), 2 (if 3 or 4 "1"s), 3 (if 5-8 "1"s) or 4 (if more than 8
 ; "1"s). Value of <element type> that is to represent a specific element
 ; type is same as the order of the specific mask in the <element mask>
 ; that represents this type of element. For example, if <element mask> is
 ; 011000010, <element type> will use 2 bits and value 00, 01, 10
 ; (11 is not used) represent polyline, circular polyline and animation
 ; elements respectively.
 ; Note that <mask> for local envelope has no meanings when in flat
 ; coordinate mode but still
 ; exists

<attribute masks> ::= <line type mask> <line width mask> <line color mask> <fill mask>

<line type mask> ::= <mask> ; true when at least one element uses line type attribute

<line width mask> ::= <mask> ; true when at least one element uses line width attribute

<fill mask> ::= <mask> ; true when at least one element uses fill attribute

<line color mask> ::= <mask> ; true when at least one element uses line color

Generic Parameters

<generic parameters> ::= (0 | (1 <angle resolution> <angle in bits>) ; 0 for default (22.5 degree, 3 bits)

(0 | (1 <scale resolution> <scale in bits>) ; 0 for default (1/4, 3 bits)

(0 | (1 <index in bits>) ; 0 for default (both 3 bits)

[<curve offset in bits>]

; <curve offset in bits> appear when <mask> for <circular polyline element>

; or <polygon element> is true

<angle resolution> ::= 00...11 ; 00 for angle unit is 1.40625 degree; 01 for angle unit is 5.625 degree

; 10 for angle unit is 11.25 degree; 11 for angle unit is 22.5 degree

<angle in bits> ::= 000...111 ; number of bits used by <angle value> is from 1 to 8 bits

<angle value> ::= 'signed angleInBits+1-bit integer'

; angle unit is decided by <angle resolution>

; 0 degree is defined as positive direction of the X axis and

; positive angle value is clockwise.

; -180 degree is represented by maximum negative digit

<scaleresolution> ::= 00..11 ; 00 for 1/4 as scale unit. 01 for 1/16 as scale unit

; 10 for 1/64 as scale unit; 11 for 1/256 as scale unit

<scale in bits> ::= 0000...1111 ; number of bits used by <scale value> is from 1 to 16 bits

<scale value> ::= 'signed scaleInBits+1-bits integer'

; scale unit is decided by <scale resolution>

; negative scale value means scaling at

; opposite direction

<index in bits> ::= 0000...1111 *; number of bits used by <index> are from 1 to 16 bits*

<index> ::= <index value>

<index value> ::= 'unsigned IndexInBits+1-bit integer'

<curve offset in bits> ::= 0 | 1 *; 0 for using 4 bits (15 levels)*

; 1 for using 5 bits (31 levels)

Compact Coordinate Parameters

<compact coordinate parameters> ::= <aspect ratio> <TransXYInBits1>

<parameters X-1> <parameters Y-1> <redefine resolution hint>

<aspect ratio> ::= 00 | *; aspect ratio = 1:1*

((01 *; aspect ratio = 4:3*

| 10 *; aspect ratio = 16:9*

| 1100 *; aspect ratio = 64:27*

| 1101 *; aspect ratio = 256:81*

| 1110 *; aspect ratio = 1024:243*

| 1111 *; aspect ratio = 4096:729*

) [<display orientation>] *; <display orientation> appears in standard WVG*

) *; character size WVG uses landscape only*

<display orientation > ::= 0 | 1 *; 0 for landscape, 1 for portrait*

<parameters X-1> ::= <MaxXInBits1> <coordinate parameters>

<parameters Y-1> ::= <MaxYInBits1> <coordinate parameters>

<coordinate parameters> ::= 00 | (<peak value> <peak position> <peak width>)

; peak value default to 1.0 when 00 is defined

<MaxXInBits1> ::= 00...11 *; Number of bits used by <X>.*

; This determines the number of grid lines in the X direction.

<MaxYInBits1> ::= 00...11 *; Number of bits used by <Y>.*

; This determines the number of grid lines in the Y direction.

; 00 for 15, 01 for 31, 10 for 63, 11 for 127

<peak value> ::= 01...11 *; 01 for 1.5, 10 for 2.0, 11 for 2.5*

<peak position> ::= 0000...1100 *; 0-12. Peak position = value/12 from envelope left.*

| 1101 *; reserved*

| 1110 *; reserved*

| 1111 *; reserved*

<peak width> ::= 00...11 *; 00 for 0.3, 01 for 0.4, 10 for 0.5, 11 for 0.6*

; <peak width> value are to the scale of total global envelope width.

; 10 (0.5) and 11 (0.6) are not allowed when <peak value> is 11 (2.5)

; 11 (0.6) is not allowed when <peak value> is 10 (2.0)

<redefine resolution hint> ::= <hint> ; true when at least one element uses 'redefine resolution' attribute

<TransXYInBits1> ::= 00..11 ; number of bits to encode translation and center of transform

; 00 for 5 bits, 01 for 6 bits, 10 for 7 bits, 11 for 8 bits

; In global scope and at X axis, it uses unit of (global envelope width/ (number of X grid lines -1))

; In global scope and at Y axis, it uses unit of (global envelope height/ (number of Y grid lines -1))

; In local scope, its unit is same as local coordinate unit.

Flat Coordinate Parameters

<flat coordinate parameters> ::= <drawing width> (0 | 1 (<drawing height>)) ; 0 means height = width

<MaxXInBits2><MaxYInBits2> <XYAllPositive>

<TransXYInBits2> <NumPointsInBits>

<OffsetXInBitsLevel1> <OffsetYInBitsLevel1>

<OffsetXInBitsLevel2> <OffsetYInBitsLevel2>

<drawing width> ::= 'unsigned 16-bit integer'

<drawing height> ::= 'unsigned 16-bit integer'

<MaxXInBits2> ::= 'unsigned_4_bit_integer'

; number of bits to encode X coordination

<MaxYInBits2> ::= 'unsigned_4_bit_integer'

; number of bits to encode Y coordination

<XYAllPositive> ::= 'unsigned_1_bit_integer'

; 0 means not all x/y are positive

; 1 means all x/y are positive

<TransXYInBits2> ::= 'unsigned_4_bit_integer' ; number of bits to encode translation and center of transform

<OffsetXInBitsLevel1> ::= 'unsigned_4_bit_integer'

<OffsetYInBitsLevel1> ::= 'unsigned_4_bit_integer'

<OffsetXInBitsLevel2> ::= 'unsigned_4_bit_integer'

<OffsetYInBitsLevel2> ::= 'unsigned_4_bit_integer'

<NumPointsInBits> ::= 'unsigned_4_bit_integer'

Animation Settings

<animation settings> ::= [<animation mode>] ; appear when <animation element> exist

<animation mode> ::= 0 | 1 ; 0 for simple animation; 1 for standard animation

Element

<elements> := <number of elements> <element> { <element> }

<number of elements> ::= (0 'unsigned 7-bit integer')

| (1 'unsigned 15-bit integer')

<element> := <element type> (<basic element> |

<frame element> | <group element> | <re-use element> |
 <animation element> | <extended element> | <local envelope element>)
 <element type> ::= | 0...1 | 00..11 | 000...111 | 0000...1111 ; empty is allowed
 ; decided by <element mask>. Please refer to <element mask>
 <animation element> := <simple animation element> | <standard animation element>
 ; if <animation mode> is 0, all animation elements in the drawing are <simple animation element>
 ; if <animation mode> is 1, all animation elements in the drawing are <standard animation element>
 <basic element> ::= <basic element header> (<polyline element> | <circular polyline element>
 | <Bezier polyline element> | <polygon element> | <simple shape element>
 | <special shape element> | <text element>)

Basic Element Header

<basic element header> ::= (<offset bit use> ; when in flat coordinate mode
 | <resolution and offset bit>) ; when in compact coordinate mode
 [0 | (1<attributes set>)] ; appears when <attribute masks> does not equal
 ; to 0000
 ; 0 for using default attributes defined in <drawing header>
 ; 1 for using the following specific attributes

<Offset Bit Use> ::= <Offset X Use><Offset Y Use>

<Offset X Use> ::= 0 | 1

; when in compact coordinate mode, 0 means offset X will use 3 bits.,

; 1 means use 4 bits

; when in flat coordinate mode, 0 means offset X will use <OffsetXInBitsLevel1>.,

; 1 means use <OffsetXInBitsLevel2>

<Offset Y Use> ::= 0 | 1

; when in compact coordinate mode, 0 means offset X will use 3 bits,

; 1 means use 4 bits

; when in flat coordinate mode, 0 means offset X will use <OffsetYInBitsLevel1>.,

; 1 means use <OffsetYInBitsLevel2>

<resolution and offset bit> ::= (0 | (1<offset bit use>)

; only when <redefine resolution hint> is false or in local scope

; 0 for absolute coordinate, 1 for relative coordinates

| (0 (0 | (1<offset bit use>))

; when <redefine resolution hint> is true and in global scope

; 0 for absolute coordinate, 1 for relative coordinates

| (1 <coordinate resolution> <offset bit use>)

; when *<redefine resolution hint>* is true and in global scope
 ; *redefine resolution, always use relative coordinates*

<coordinate resolution> ::= 000...111 ; *decide the grid line interval by a scale of width*
 ; *or height of the global envelope whichever is short.*
 ; *0-7 for 1/27, 1/32, 1/38, 1/48, 1/64,*
 ; *1/85, 1/128 and 1/160 respectively*

Element Attributes

<attribute set> ::= [*<line type>*] ; *appear when <line type mask> is true*
 [*<line width>*] ; *appear when <line width mask> is true*
 [0 | (1 *<line color>*)] ; *appear when <line color mask> is true and*
 ; *<line width> is not zero*
 ; *0 for <default line color>, 1 for specified color*
 [0 | (1 ; *0 for no fill; 1 for with fill*
 (0 | (1 *<fill color>*)) ; *0 for <default fill color>, 1 for specified color*
) ; *appear when <fill mask> is true*
] ; *Note: line type and line width are not used by <text element> but*
 ; *still exist here. If not filled, then background of text output will*
 ; *be transparent. If filled, then fill color will be used as text background.*

<line width> ::= 00...11 ; *00 for no line, 01 for Fine, 10 for medium, 11 for thick*
 ; *00 is only valid with fill*

<line type> ::= 00...11 ; *0 for solid, 1 for dash line, 2 for dotted line*

<fill color > ::= *<draw color>*

<line color> ::= *<draw color>*

<OverrideAttributeSet> ::= 0 | (1 *<line type>*)

0 | (1 *<line width>*)

0 | (1 *<line color>*)

0 | (1 *<fill>*)

0 | (1 *<fill color>*)

; *0 for no overriding, 1 for overriding with specified attribute*

<fill> ::= 0 | 1 ; *0 means no fill, 1 means fill*

Transform

<Transform> ::= *<TranslateX><TranslateY>*

0 | (1 *<Angle>* *<ScaleX><ScaleY>* *<CX><CY>*) ; *optional other transforms*

<Angle> ::= 0 | (1 *<Angle Value>*) ; *0 means angle will use default value which is 0*

<TranslateX> ::= 0 | (1 <TranslateX Value>); 0 means translate x will use default value which is 0
 <TranslateX Value> ::= 'signed_TransXYInBits2_bit integer' ; when in flat coordinate mode
 | 'signed_TransXYInBits1+5 bit integer' ; when in compact coordinate mode
 <TranslateY> ::= 0 | (1 <TranslateY Value>); 0 means translate y will use default value which is 0
 <TranslateY Value> ::= 'signed_TransXYInBits2_bit integer' ; when in flat coordinate mode
 | 'signed_TransXYInBits1+5-bit integer' ; when in compact coordinate mode
 <ScaleX> ::= 0 | (1 <Scale value>) ; 0 means scale will use default value which is 1.0
 <ScaleY> ::= 0 | (1 <Scale value>) ; 0 means scale will use default value which is same as
 ; absolute value of <ScaleX>
 <CX> ::= 0 | (1 <CX value>) ; translation of rotation and scale center; 0 means it will use default
 ; value which is at the left border of the drawing (x=0 in the flat
 ; coordinate system or the global envelope)
 <CX value> ::= 'signed_TransXYInBits2_bit integer' ; when in flat coordinate mode
 | <X> ; when in compact coordinate mode
 <CY> ::= 0 | (1 <CY value>) ; 0 means it will use default value which is
 ; (y=0 in the flat coordinate system or the global envelope)
 <CY value> ::= 'signed_TransXYInBits2_bit integer' ; when in flat coordinate mode
 | <Y> ; when in compact coordinate mode

Polyline Element

<polyline element> ::= [<numberOfPoints>] <First Point> { <Next Point> } [<point terminator>]
 ; specifies a start point, zero or many intermediate points and an end point.
 ; <numberOfPoints> appears only when in flat coordinate mode
 ; <point terminator> appears only when in compact coordinate mode
 <point terminator> ::= 111...111111 ; Absolute mode in character size WVG. Same number of
 ; bits of <MaxXInBits0> or <MaxXYInBits0>
 | 1111...1111111 ; Absolute mode in standard WVG. Same number of bits of
 ; <MaxXInBits1> or <MaxLocalXYInBits>
 | (100 | 1000) ; Offset mode (relative).
 ; use 100 when <Offset X Use> = 0
 ; use 1000 when <Offset X Use> = 1

Circular Polyline Element

<circular polyline element> ::= <curve hint> [<numberOfPoints>] <FirstPoint> <curve offset> <point>
 { <curve offset> <NextPoint> } [<offset terminator>]
 ; <numberOfPoints> appears only when use

; flat coordinate mode

; <offset terminator> appears only when use

; compact coordinate mode

<curve hint> ::= <hint>

<curve offset> ::= (0 | (1 <curve offset value>)) ; when <curve hint> is true
 | <curve offset value> ; when <curve hint> is false

<offset value> ::= 'signed 4-bit integer' ; when <curve offset in bits> = 0
 ; or in character size WVG

| 'signed 5-bit integer' ; when <curve offset in bits> = 1

; Curve offset ratio $r = e/L$

; Where e is actual curve offset (can be positive or negative),

; L is distance between adjacent nodes

; We use a signed integer value v to represent. $v = \text{round}(r*k)$;

; Where $k = 2^n - 2$ (n is number of bits used for <offset value>)

<offset terminator> ::= (1 <curve offset bits>) ; when <curve hint> is true

| <curve offset bits> ; when <curve hint> is false

<curve offset bits> ::= 1000 ; when <curve offset in bits> = 0

| 10000 ; when <curve offset in bits> = 1

Bezier Polyline Element

<Bezier polyline element> ::= [<NumberOfPoints>]

<First Point> { <OnCurve> <Next Point> } [1 <point terminator>]

; Same data format for PolyBezCurve, and PolygonBezCurve

; <numberOfPoints> appears only when in flat coordinate mode

; "1 <point terminator>" appears only when in compact coordinate mode

<NumberOfPoints> ::= 'unsigned_NumberOfPointsInBits_bit integer'

<OnCurve> ::= 0 | 1

; 0 – off curve

; 1 – on curve

NOTE: Only cubic and quadratic Bezier curves are supported. It means only one or two successive off-curve points are allowed. The first point of a curve must be on-curve. The last point must also be on-curve if it is Bezier polyline but is not necessary for Bezier polygon.

Polygon Element

Polygon element is actually a closed polyline (including circular and Bezier polyline)

<polygon element> ::= (00 <polyline element>) | (01 <circular polyline element>)

| (10 <Bezier polyline element>)

Simple Shape Element

<simple shape element> ::= (0 <rectangle element>) | (1 <ellipse element>)

<rectangle element> ::= <Point><Width><Height><rounded flag> <Angle>

<ellipse element> ::= <Point><Width><Height> <Angle>

<Width> ::= <X> | <Offset X> ; <Offset X> is used when <Offset Bit Use> exists in the <basic element header>

; if the element is in global scope in compact coordinate mode, use unit of

; (global envelope width/ (number of X grid lines -1))

<Height> ::= 0 | (1 <HeightValue>) ; 0 means the height is same as width, height will not be encoded

<HeightValue> ::= <Y> | <Offset Y>

; <Offset Y> is used when <Offset Bit Use> exists in the <basic element header>

; if the element is in global scope in compact coordinate mode, use unit of

; (global envelope height/ (number of Y grid lines -1))

<rounded flag> ::= 0 | 1 ; 0 for straight corner, 1 for rounded corner

Special Shape Element

<special shape element> ::= <point> <angle>

00 (<vertex> <diameter> ; regular polygon

| 01 (<vertex> <vertex angle> <diameter> ; star

| 10 (<rectangle size> <rows> <columns>) ; grid

| 11 ; not used

<diameter> ::= <X> | <Offset X> ; diameter of circle or vertex

; <Offset X> is used when <Offset Bit Use> exists in the <basic element header>

; if the element is in global scope in compact coordinate mode, use unit of

; (global envelope width/ (number of X grid lines -1))

<rectangle size> ::= <width> <height>

<vertex> ::= 000...111 ; number of vertex = <vertex> + 3

<vertex angle> ::= 00...11 ; 00 for 0 degree, 01 for 36 degree

; 10 for 60 degree, 11 for 90 degree

<rows> ::= 0000...1111 ; rows = <rows> + 1

<columns> ::= 0000...1111 ; columns = <columns> + 1

Text Element

<text element> ::= <point> <angle> <text code mode> <string length> { <char> }

; <point> is top-left corner of the text.

 ::= <Y> | <Offset Y> ; <Offset Y> is used when <Offset Bit Use> exists in the <basic element

; header>

; if the element is in global scope in compact coordinate mode, use unit of

; (global envelope height/ (number of Y grid lines -1))

Local Envelope Element

<local envelope element> ::= (0 <local envelope description> <point>)

 ; local start

 ; <point> is top- left corner of the local envelope in global coordinates.

 ; Elements in the local envelope scope use local coordinates and measurements

 | 1 ; local end

<local envelope description> ::= <coordinate resolution> <MaxLocalXYInBits>

<MaxLocalXYInBits> ::= 00...11

 ; 00 for 3 bits(max value 7), 01 for 4 bits (max value 15),

 ; 10 for 5 bits (max value 31), 11 for 6 bits (max value 63)

Group Element

<group element> ::= (0 (0 | (1 <transform>)) <display>) ; start of group. Transform is optional
 | 1 ; end of group

<display> ::= 0 | 1

 ; 0 – no display when render; 1 – display when render

Re-use Element

<re-use element> ::= <element index> ; point to the element to be re-used

 ; only <basic element>, <group element> and

 ; <re-use element> can be reused

 <transform> ; re-use with transformation

 0 | (1 <array parameter>) ; array. It should be performed as the last step

 0 | (1 <OverrideAttributeSet>)

<element index> ::= <index value> ; the element sequence number in whole drawing. Start from 0.

<array parameter> ::= <columns> [<array width>] <rows> [<array height>]

 ; <array height> indicates whole height of the array, appears when <rows> is non-zero

 ; element interval at X direction equals to <width>/<columns>

 ; <array width> indicates whole width of the array, appears when <columns> is non-zero

 ; element interval at Y direction equals to <height>/<rows>

 ; The top left element in the array is at the position specified in <transform>

<array width> ::= <X>

 ; if the element is in globale scope in compact coordinate mode, use unit of
 ; (global envelope width/ (number of X grid lines –1))

<array height> ::= 0 | (1 <Y>)

 ; 0 means the height is same as width, height will not be encoded

 ; if the element is in globale scope in compact coordinate mode, use unit of

 ; (global envelope height/ (number of Y grid lines –1))

Frame Element

<Frame> ::= <KeepLastFrameContentFlag><HasFilledColorFlag>[< fill color >]

; <fill color> is new background color for the frame

<KeepLastFrameContentFlag> ::= 'unsigned 1-bit integer'

; keep the image of the last frame on the screen, or clear it

; value 0 - Do not keep last frame content.

; value 1 - Keep last frame content.

<HasFilledColorFlag> ::= 'unsigned 1-bit integer'

; value 0 - no filled color

; value 1 - has filled color

Simple Animation Element

<simple animation element> ::= <cycle type>

(0 | (1 <visibility parameter>)

(0 | (1 <transform>) *; begin transform*

(0 | (1 <transform>) *; end transform*

(0 | 1) *; 0 for no bouncing. 1 for bouncing*

<rotation direction>

<round rotation flag>

<round rotation flag> ::= 0 | 1 *; 0 for no round rotation.*

; 1 for round rotation and will override angles defined in <transform>

<cycle type> ::= 0 | 1 *; 0 indicates short animation cycle; 1 indicates long animation cycle*

<visibility parameter> ::= <visibility timing>

<visibility timing> ::= 0000...1111 | 00000000...11111111

; One blinking cycle is divided into four equal time steps for short

; animation cycle or eight steps for long animation cycle. <visibility timing> is a map of time steps in

; which 0 represents invisible and 1 represents visible. Note that in above map, consequence time steps

; is from left to right, or from first order to later order in bit stream.

<rotation direction> ::= 0 | 1 *; 1 for clockwise rotating. 0 for counter-clockwise rotating*

NOTE: For all individual values in the transform, linear interpolation is used.

Standard Animation Element

<standard animation element> ::= <element index> <BeginTransform><EndTransform><Rotation Direction>

<Round> ::= 0 | 1 (1 <BeginColor><EndColor>) <BeginTime><Duration><ExistAfter>

<BeginTransform> ::= 0 | (1 <Transform>) ; *begin position*
 ;0 – means use (start from) default transform:
 ; Angle=0, TranslateX=0, TranslateY=0, ScaleX=256, ScaleY=256, Cx=0, Cy=0
 ;1 – means Transform follows

<EndTransform> ::= 0 | (1 <Transform>) ; *end position*
 ;0 – means use (end at) default transform
 ; Angle=0, TranslateX=0, TranslateY=0, ScaleX=256, ScaleY=256, Cx=0, Cy=0
 ;1 – means Transform follows

<Rotation Direction> ::= 0 | 1 ;0 – counter clockwise
 ;1 – clockwise

<Round> ::= 0 | 1 ;0 – no rotation
 ;1 – rotate 360 degrees

<BeginColor> ::= (0 | (1 <line color>)) (0 | (1 <fill color>))
 ;0 – use default colors
 ;1 – use specified colors

<EndColor> ::= (0 | (1 <line color>)) (0 | (1 <fill color>))
 ;0 – use default colors
 ;1 – use specified colors

<BeginTime> ::= 'unsigned 12-bit integer' ; <BeginTime> is in units of 10ms

<Duration> ::= 'unsigned 12-bit integer' ; <Duration> is in units of 10ms

<ExistAfter> ::= 0 | (1 <AnimationRepeat>) ; 0 – animation element will disappear after the animation is finished
 ; 1 – animation element will persist after the animation is finished

<AnimationRepeat> ::= 0 | (1 <Bouncing>) ; 0 – no repeat, animated element will stay
 ; at <EndTransform>

<Bouncing> ::= 0 | 1 ; 1 – animation will repeat, duration will be <Duration>
 ; 0 – no bouncing, animation will repeat as from begin
 ; position to end position
 ; 1 – repeat with bouncing. Animation will be
 ; repeated as end position ->
 ; begin position, then begin position->end position,
 ; then end position->begin position ...

NOTE: For all individual values in the transform, linear interpolation is used. Similarly, color interpolation uses linear RGB color space. Out of range color values are allowed.

Extended Element

<Extended> ::= <SizeOfSize><Size><ExtendedElementType>{<payload>}

<SizeOfSize> ::= 'unsigned_5_bit integer'
 ; the bit size of the Size field

<Size> ::= 'unsigned-<SizeOfSize>-bit integer'
 ; size of extended element data after ExtendedElementType, in bytes

<ExtendedElementType> ::= 'unsigned_8_bit integer'

; element type of extended element

<payload> ::= 'unsigned_8_bit integer'

; encoded extended element data. The size should be the same as the Size field of Extended, above.

Position and Measurement

<First Point> ::= <point> *; first point of a polyline or polygon (including circular and Bezier polygons)*

<Next Point> ::= <point> | *; when use absolute mode*

<Offset> *; when use offset mode*

; in flat coordinate system, only offset mode is used.

<point> ::= <X> <Y>

<X> ::= 'signed MaxXInBits2-bit integer' *; when in flat coordinate mode and <XYAllPositive> = 0*

| 'unsigned MaxXInBits2-bit integer' *; when in flat coordinate mode and <XYAllPositive> = 1*

| 'unsigned MaxXInBits1+4-bit integer' *; when in compact coordinate mode and in global scope*

| 'unsigned MaxLocalXYInBits+3-bit integer' *; when in compact coordinate mode and in local scope*

| 'unsigned MaxXInBits0+3-bit integer' *; when in character size WVG (use standard header)*

| 'unsigned MaxXYBits0+3-bit integer' *; when in character size WVG (use compact header)*

<Y> ::= 'signed MaxYInBits2-bit integer' *; when in flat coordinate mode and <XYAllPositive> = 0*

| 'unsigned MaxYInBits2-bit integer' *; when in flat coordinate mode and <XYAllPositive> = 1*

| 'unsigned MaxYInBits1+4-bit integer' *; when in compact coordinate mode and in global scope*

| 'unsigned MaxLocalXYInBits+3-bit integer' *; when in compact coordinate mode and in local scope*

| 'unsigned MaxYInBits0+3-bit integer' *; when in character size WVG (use standard header)*

| 'unsigned MaxXYBits0+3-bit integer' *; when in character size WVG (use compact header)*

; Note: in compact coordinate mode, <X> and <Y> do not use the maximum number of the unsigned integer

<Offset> ::= <Offset X> <Offset Y>

<Offset X> ::= <signed offset X> *; when used by <Next Point>*

| <unsigned offset X> *; when used in other cases*

<Offset Y> ::= <signed offset Y> *; when used by <Next Point>*

| <unsigned offset Y> *; when used in other cases*

<signed offset X> = 'signed OffsetXInBitsLevel1-bit integer'

; when in flat coordinate mode and <offset bit use> = 0

| 'signed OffsetXInBitsLevel2-bit integer'

; when in flat coordinate mode and <offset bit use> = 1

| 'signed 3-bit integer' *; when in compact coordinate mode and <offset bit use> = 0*

| 'signed 4-bit integer' *; when in compact coordinate mode and <offset bit use> = 0*

<signed offset Y> = 'signed OffsetYInBitsLevel1-bit integer'

; when in flat coordinate mode and <offset bit use> = 0

| 'signed OffsetYInBitsLevel2-bit integer'

;when in flat coordinate mode and <offset bit use> = 1

| 'signed 3-bit integer' *;when in compact coordinate mode and <offset bit use> = 0*

| 'signed 4-bit integer' *;when in compact coordinate mode and <offset bit use> = 0*

<unsigned offset X> ::= 'unsigned OffsetXInBitsLevel1-bit integer'

;when in flat coordinate mode and <offset bit use> = 0

| 'unsigned OffsetXInBitsLevel2-bit integer'

;when in flat coordinate mode and <offset bit use> = 1

| 'unsigned 3-bit integer' *;when in compact coordinate mode and <offset bit use> = 0*

| 'unsigned 4-bit integer' *;when in compact coordinate mode and <offset bit use> = 1*

<unsigned offset Y> ::= 'unsigned OffsetYInBitsLevel1-bit integer'

;when in flat coordinate mode and <offset bit use> = 0

| 'unsigned OffsetYInBitsLevel2-bit integer'

;when in flat coordinate mode and <offset bit use> = 1

| 'unsigned 3-bit integer' *;when in compact coordinate mode and <offset bit use> = 0*

| 'unsigned 4-bit integer' *;when in compact coordinate mode and <offset bit use> = 1*

G.7 Web Safe Color Palette

Web safe color palette can be defined as in following C syntax using 24-bit RGB color (in form of {red, blue, green}).
The first index of the array indicates value of <8-bit websafe color>

```
int websafePalette[256][3] =
{
  { 255, 255, 255 }, { 255, 204, 255 }, { 255, 153, 255 }, { 255, 102, 255 },
  { 255, 51, 255 }, { 255, 0, 255 }, { 255, 255, 204 }, { 255, 204, 204 },
  { 255, 153, 204 }, { 255, 102, 204 }, { 255, 51, 204 }, { 255, 0, 204 },
  { 255, 255, 153 }, { 255, 204, 153 }, { 255, 153, 153 }, { 255, 102, 153 },
  { 255, 51, 153 }, { 255, 0, 153 }, { 204, 255, 255 }, { 204, 204, 255 },
  { 204, 153, 255 }, { 204, 102, 255 }, { 204, 51, 255 }, { 204, 0, 255 },
  { 204, 255, 204 }, { 204, 204, 204 }, { 204, 153, 204 }, { 204, 102, 204 },
  { 204, 51, 204 }, { 204, 0, 204 }, { 204, 255, 153 }, { 204, 204, 153 },
  { 204, 153, 153 }, { 204, 102, 153 }, { 204, 51, 153 }, { 204, 0, 153 },
  { 153, 255, 255 }, { 153, 204, 255 }, { 153, 153, 255 }, { 153, 102, 255 },
  { 153, 51, 255 }, { 153, 0, 255 }, { 153, 255, 204 }, { 153, 204, 204 },
  { 153, 153, 204 }, { 153, 102, 204 }, { 153, 51, 204 }, { 153, 0, 204 },
  { 153, 255, 153 }, { 153, 204, 153 }, { 153, 153, 153 }, { 153, 102, 153 },
  { 153, 51, 153 }, { 153, 0, 153 }, { 102, 255, 255 }, { 102, 204, 255 },
  { 102, 153, 255 }, { 102, 102, 255 }, { 102, 51, 255 }, { 102, 0, 255 },
  { 102, 255, 204 }, { 102, 204, 204 }, { 102, 153, 204 }, { 102, 102, 204 },
  { 102, 51, 204 }, { 102, 0, 204 }, { 102, 255, 153 }, { 102, 204, 153 },
  { 102, 153, 153 }, { 102, 102, 153 }, { 102, 51, 153 }, { 102, 0, 153 },
  { 51, 255, 255 }, { 51, 204, 255 }, { 51, 153, 255 }, { 51, 102, 255 },
  { 51, 51, 255 }, { 51, 0, 255 }, { 51, 255, 204 }, { 51, 204, 204 },
  { 51, 153, 204 }, { 51, 102, 204 }, { 51, 51, 204 }, { 51, 0, 204 },
  { 51, 255, 153 }, { 51, 204, 153 }, { 51, 153, 153 }, { 51, 102, 153 },
  { 51, 51, 153 }, { 51, 0, 153 }, { 0, 255, 255 }, { 0, 204, 255 },
  { 0, 153, 255 }, { 0, 102, 255 }, { 0, 51, 255 }, { 0, 0, 255 },
```

{ 0, 255, 204 }, { 0, 204, 204 }, { 0, 153, 204 }, { 0, 102, 204 },
{ 0, 51, 204 }, { 0, 0, 204 }, { 0, 255, 153 }, { 0, 204, 153 },
{ 0, 153, 153 }, { 0, 102, 153 }, { 0, 51, 153 }, { 0, 0, 153 },
{ 255, 255, 102 }, { 255, 204, 102 }, { 255, 153, 102 }, { 255, 102, 102 },
{ 255, 51, 102 }, { 255, 0, 102 }, { 255, 255, 51 }, { 255, 204, 51 },
{ 255, 153, 51 }, { 255, 102, 51 }, { 255, 51, 51 }, { 255, 0, 51 },
{ 255, 255, 0 }, { 255, 204, 0 }, { 255, 153, 0 }, { 255, 102, 0 },
{ 255, 51, 0 }, { 255, 0, 0 }, { 204, 255, 102 }, { 204, 204, 102 },
{ 204, 153, 102 }, { 204, 102, 102 }, { 204, 51, 102 }, { 204, 0, 102 },
{ 204, 255, 51 }, { 204, 204, 51 }, { 204, 153, 51 }, { 204, 102, 51 },
{ 204, 51, 51 }, { 204, 0, 51 }, { 204, 255, 0 }, { 204, 204, 0 },
{ 204, 153, 0 }, { 204, 102, 0 }, { 204, 51, 0 }, { 204, 0, 0 },
{ 153, 255, 102 }, { 153, 204, 102 }, { 153, 153, 102 }, { 153, 102, 102 },
{ 153, 51, 102 }, { 153, 0, 102 }, { 153, 255, 51 }, { 153, 204, 51 },
{ 153, 153, 51 }, { 153, 102, 51 }, { 153, 51, 51 }, { 153, 0, 51 },
{ 153, 255, 0 }, { 153, 204, 0 }, { 153, 153, 0 }, { 153, 102, 0 },
{ 153, 51, 0 }, { 153, 0, 0 }, { 102, 255, 102 }, { 102, 204, 102 },
{ 102, 153, 102 }, { 102, 102, 102 }, { 102, 51, 102 }, { 102, 0, 102 },
{ 102, 255, 51 }, { 102, 204, 51 }, { 102, 153, 51 }, { 102, 102, 51 },
{ 102, 51, 51 }, { 102, 0, 51 }, { 102, 255, 0 }, { 102, 204, 0 },
{ 102, 153, 0 }, { 102, 102, 0 }, { 102, 51, 0 }, { 102, 0, 0 },
{ 51, 255, 102 }, { 51, 204, 102 }, { 51, 153, 102 }, { 51, 102, 102 },
{ 51, 51, 102 }, { 51, 0, 102 }, { 51, 255, 51 }, { 51, 204, 51 },
{ 51, 153, 51 }, { 51, 102, 51 }, { 51, 51, 51 }, { 51, 0, 51 },
{ 51, 255, 0 }, { 51, 204, 0 }, { 51, 153, 0 }, { 51, 102, 0 },
{ 51, 51, 0 }, { 51, 0, 0 }, { 0, 255, 102 }, { 0, 204, 102 },
{ 0, 153, 102 }, { 0, 102, 102 }, { 0, 51, 102 }, { 0, 0, 102 },
{ 0, 255, 51 }, { 0, 204, 51 }, { 0, 153, 51 }, { 0, 102, 51 },
{ 0, 51, 51 }, { 0, 0, 51 }, { 0, 255, 0 }, { 0, 204, 0 },
{ 0, 153, 0 }, { 0, 102, 0 }, { 0, 51, 0 }, { 17, 17, 17 },
{ 34, 34, 34 }, { 68, 68, 68 }, { 85, 85, 85 }, { 119, 119, 119 },
{ 136, 136, 136 }, { 170, 170, 170 }, { 187, 187, 187 }, { 221, 221, 221 },
{ 238, 238, 238 }, { 192, 192, 192 }, { 128, 0, 0 }, { 128, 0, 128 },
{ 0, 128, 0 }, { 0, 128, 128 }, { 0, 0, 0 }, { 0, 0, 0 },
{ 0, 0, 0 }, { 0, 0, 0 }, { 0, 0, 0 }, { 0, 0, 0 },
{ 0, 0, 0 }, { 0, 0, 0 }, { 0, 0, 0 }, { 0, 0, 0 },
{ 0, 0, 0 }, { 0, 0, 0 }, { 0, 0, 0 }, { 0, 0, 0 },
{ 0, 0, 0 }, { 0, 0, 0 }, { 0, 0, 0 }, { 0, 0, 0 },
{ 0, 0, 0 }, { 0, 0, 0 }, { 0, 0, 0 }, { 0, 0, 0 }
};

Annex H (informative): Development Guidelines for Creation of Polyphony Using SP-MIDI

While Scalable Polyphony-MIDI (SP-MIDI) [38] is a full-featured standard for synthesizing music, using a few guidelines SP-MIDI [38, 39] can be optimized for wireless devices. These guidelines can be grouped as optimizing individual notes, and to minimize the overall size of a melody.

H.1. Running status

In the Musical Instrument Digital Interface (MIDI) standard, a key-on or a key-off event will use at most three bytes each, cf. [40]. However, in case several key events occur on the same MIDI-channel, running status can be used. In principle running status means that the first byte of, e.g. key-on is omitted. In addition, the key-on event having a velocity of zero is equivalent to the key-off event. Thus, combining running status and using key-on with zero velocity, as the key-off event will reduce the number of bytes needed to encode key events.

EXAMPLE: Without running status, the sequence

91 2E 23 8E, 91 2B 50 8E, 81 2E 64 00, 81 2B 64 00

means “Key 2E ON” Velocity 23 MIDI Ch 1”, “Key 2B ON Velocity 50 MIDI Ch 1”, “Key 2E OFF Velocity 64 MIDI Ch 1”, “Key 2B OFF Velocity 64 MIDI Ch 1”. Using running status will reduce the sequence into

91 2E 23 8E, 2B 50 8E, 2E 00 00, 2B 00 00,

That is, the command byte is omitted and velocity zero is used for key off.

H.2 File type considerations

The SP-MIDI content can be stored in, a Standard MIDI File (SMF) of type 0 or type 1 [40]. In a type 0 SMF, one header chunk and one track chunk is used. In a type 1 SMF one header chunk and several track chunks are used. SMF type 2 should not be used

H.3 File size reduction

In general it is more efficient to store the MIDI data as a type 1 file. The increased efficiency is reached if each track contains one MIDI channel and one instrument (This is often the case). Evidently, running status can be applied on each individual track reducing the track size. To further reduce the size of the file use one track per used MIDI channel. That is, if a temple/conductor track exists merge it with the first instrument track. Remove, all meta events which are not necessary, e.g. "track name", "lyric". To summarize, the following measures can be taken in order to reduce the SMF:

- 1) use SMF type 1 (or check if type 1 is smaller than type 0 and use the smallest);
- 2) use running status;
- 3) one and only one instrument per track. Try not to change channels;
- 4) do not change tempo in the middle of the music, i.e., only set tempo once;
- 5) use beat, instead of SMPTE, to set tempo;
- 6) copyright is on automatically;
- 7) remove controller messages, which are optional according to [39];

8) turn off the options below:

- sequence Number - MIDI sequence ids;
- text - embedded text for anything;
- sequence / track name;
- instrument name;
- lyric;
- marker - for synchronization purposes;
- cue point;
- midi channel presix - associate channels with all events following;
- sequencer-specific settings.

Items 1 to 3 above optimize the notes, while items 4 to 8 optimize the overall melody. The above measures will provide an SMF, which is ready for compression. However, prior to compression the composer/content author can consider to use few values for key velocity and thereby increasing the redundancy of the file.

H.4 Restrictions

Content creators should not expect the full support for the following features:

- MIDI message channel pressure;
- MIDI message pitch bend;
- individual stereophonic panoramic (pan) as expressed in table 5 in [39];
- MIDI message master volume.

Content creators should not expect a time granularity better than 5ms to be supported by the SME.

To ensure interoperability, the first value of the MIP table should be no more than 6 voices.

Annex I (informative): Change history

TSG	TSG TDoc	Vers	CR	Rev	Ph	Cat	Subject	New Vers	Work Item
T#4	TP-99126	2.0.0	New				Creation of 3GPP 23.040 v3.0.0 out of GSM 03.40 v7.1.0	3.0.0	
T#4	TP-99124	3.0.0	001		R99	A	Clarification concerning SMSC address checking in the MS for concatenated messages and replace message types	3.1.0	TEI
T#4	TP-99146	3.0.0	002		R99	A	Guidance regarding the SMSC address in a Status Report	3.1.0	TEI
T#5	TP-99177	3.1.0	003		R99	A	Change to reserved port number range for SMS	3.2.0	TEI
T#5	TP-99177	3.1.0	004		R99	B	New TP-PID value for delivery of ANSI-136 Short Messages	3.2.0	SMS
T#5	TP-99177	3.1.0	005		R99	D	IEI values in concatenated SM's	3.2.0	SMS
T#6	TP-99237	3.2.0	007		R99	F	Adaptations for UMTS	3.3.0	TEI
T#6	TP-99237	3.2.0	006		R99	C	Duplicate messages	3.3.0	TEI
T#6	TP-99237	3.2.0	008		R99	A	Concatenated Short Message	3.3.0	TEI
T#7	TP-000024	3.3.0	009		R99	B	Enhancement of the Message Content in SMS	3.4.0	MMS
T#7	TP-000024	3.3.0	010		R99	B	Multiple Information Elements	3.4.0	TEI
T#7	TP-000024	3.3.0	011		R99	B	SMS E-MAIL PARAMETERS	3.4.0	TEI
-	-	3.4.0	-	-	R99	-	Editorial graphics update to make visible	3.4.1	-
T#8	TP-000073	3.4.1	012		R99	F	Alignment in Enhanced Messaging Service	3.5.0	EMS
T#8	TP-000073	3.4.1	014		R99	F	Correction to text on SMS TimeZone	3.5.0	TEI
T#8	TP-000073	3.4.1	015		R99	F	Correction of TP-PID	3.5.0	TEI
T#8	TP-000074	3.5.0	013		Rel4	B	Addition of numbering plan value for Service Centre Specific Addresses	4.0.0	TEI
T#9	TP-000144	4.0.0	016		Rel4	F	Presence of TP-PI	4.1.0	SMS TEI
T#9	TP-000144	4.0.0	017		Rel4	D	Big endian integer representation	4.1.0	SMS TEI
T#9	TP-000144	4.0.0	018		Rel4	B	SMS Address fields section needs clarification	4.1.0	SMS TEI
T#9	TP-000144	4.0.0	019		Rel4	B	User prompt indication	4.1.0	SMS TEI
T#11	TP-010029	4.1.0	020		Rel4	C	Predefined animations for EMS	4.2.0	TEI4
T#11	TP-010029	4.1.0	021		Rel4	C	Message Waiting Indication Status storage on the USIM	4.2.0	UICC1-CPHS
T#12	TP-010128	4.2.0	023		Rel4	F	Clarification of User Prompt Indicator	4.3.0	TEI4
T#12	TP-010128	4.2.0	025		Rel4	F	Clarification of Email Addressing for Email – SMS Interworking	4.3.0	TEI4
T#12	TP-010128	4.2.0	026		Rel4	F	Removal of duplicated values in TP-PID section	4.3.0	TEI4
T#12	TP-010128	4.2.0	027		Rel4	F	Application Port Addressing Clarification	4.3.0	TEI4
T#12	TP-010128	4.3.0	022		Rel5	B	Addition of text and background colour	5.0.0	MESS5-EMS
T#12	TP-010128	4.3.0	024		Rel5	B	Object Distribution Indicator	5.0.0	MESS5-EMS
T#12	TP-010149	4.3.0	028	1	Rel5	B	Extended Objects in EMS	5.0.0	MESS5-EMS
T#13	TP-010194	5.0.0	029		Rel5	B	Hyperlink Information Element	5.1.0	TEI5
T#13	TP-010194	5.0.0	031		Rel5	A	Removal of EMS PID	5.1.0	TEI5
T#13	TP-010194	5.0.0	033		Rel5	B	EMS Delivery Request	5.1.0	TEI5
T#14	TP-010280	5.1.0	034		Rel5	F	Correction of Data Format Delivery Request	5.2.0	TEI5
T#14	TP-010280	5.1.0	035		Rel5	F	Information Element Classification	5.2.0	TEI5
T#14	TP-010280	5.1.0	036		Rel5	F	Clarification of LZSS compression for "EXTENDED OBJECTS" in EMS	5.2.0	MESS5_E MS
T#14	TP-010280	5.1.0	037		Rel5	F	Extended Object Positioning	5.2.0	TEI5
T#14	TP-010280	5.1.0	040		Rel5	F	Correction on SMS Information Element Data Length	5.2.0	TEI5
T#15	TP-020015	5.2.0	041		Rel5	B	Wireless Vector Graphics in EMS	5.3.0	MESS5_E MS
T#15	TP-020079	5.2.0	042	1	Rel5	B	Polyphonic Extended Object	5.3.0	MESS5_E MS
T#15	TP-020015	5.2.0	045		Rel5	A	MO-SMS duplicate message response	5.3.0	TEI5
T#15	TP-020015	5.2.0	046	1	Rel5	B	Subaddressing scheme for SMS	5.3.0	TEI5
T#15	TP-020015	5.2.0	047		Rel5	B	Alternate Reply Address Element	5.3.0	TEI5
T#15	TP-020015	5.2.0	048		Rel5	C	Extended Object Data Request Command	5.3.0	MESS5_E MS
T#16	TP-020104	5.3.0	049		Rel5	F	Clarification of bit value combinations within TP-PI	5.4.0	TEI5
T#16	TP-020104	5.3.0	050		Rel5	F	References to the TP-RD bit	5.4.0	TEI5
T#16	TP-020104	5.3.0	051		Rel5	F	TP-DCS values for SIM data download	5.4.0	TEI5
T#16	TP-020104	5.3.0	054		Rel5	C	Clarification of the requirement for type 0 Short Messages	5.4.0	TEI5

T#16	TP-020104	5.3.0	055		Rel5	F	Occurrence of the Reply Address Element	5.4.0	TEI5
T#16	TP-020104	5.3.0	056		Rel5	F	WVG Corrections and Clarifications	5.4.0	MESS5-EMS
T#16	TP-020104	5.3.0	057		Rel5	F	WVG Corrections and Clarifications	5.4.0	MESS5-EMS
T#16	TP-020104	5.3.0	058		Rel5	F	WVG Clarifications for websafe color	5.4.0	MESS5-EMS
T#16	TP-020104	5.3.0	059		Rel5	F	Add repeat and bouncing to Standard Animation for consistency with Simple Animation	5.4.0	MESS5-EMS
T#16	TP-020104	5.3.0	060		Rel5	F	Allow angle applied to special shape grid for consistency with other special shape elements	5.4.0	MESS5-EMS
T#17	TP-020204	5.4.0	061		Rel5	F	Error in MS example error	5.5.0	TEI5
T#17	TP-020204	5.5.0	062		Rel6	F	Identification of a directory number in the User Data Field	6.0.0	TEI6
T#17		6.0.0					Addition of compression_test_vectors.zip to the specification zip-file	6.0.1	
T#20	TP-030114	6.0.1	063		Rel6	F	Reserved values in TP-Status	6.1.0	TEI6
T#20	TP-030114	6.0.1	067		Rel6	A	Missing SMSs over MSC even if the MS is capable of such sending	6.1.0	TEI6
T#21	TP-030173	6.1.0	068		Rel6	C	Videomail message waiting indication in TP-UDH	6.2.0	TEI6
T#23	TP-040049	6.2.0	070		Rel6	A	Correction of error message for MAP_ForwardShortMessage	6.3.0	TEI5
T#23	TP-040059	6.2.0	071	1	Rel6	C	Procedure for confirming the existence of an SMS interworking agreement	6.3.0	TEI6
T#24	TP-040096	6.3.0	072	1	Rel6	B	Enhanced Voice Mail Information	6.4.0	TEI6
T#24	TP-040094	6.3.0	073		Rel6	F	Optional IEI's	6.4.0	TEI6
T#25	TP-040200	6.4.0	076	1	Rel6	B	Special Message Indication – introduction of Multiple Subscriber Profiles	6.5.0	TEI4, TEI6
T#25	TP-040171	6.4.0	077		Rel6	F	Enhanced Voice Mail Information – access number priority	6.5.0	TEI6
CT#30	CP-050545	6.5.0	082	1	Rel-6	F	Reference corrections	6.6.0	TEI6
CT#31	CP-060113	6.6.0	0084	-	Rel-6	F	Correction of reference [28]	6.7.0	TEI6
CT#33	CP-060457	6.7.0	0087		Rel-6	F	Max user data length in GSM 7bit concatenated uncompressed message with 16 bit reference number	6.8.0	TEI6
2006-10		6.8.0					Adds compression test vectors file (identical to those of v6.6.0).	6.8.1	
2007-03	CP-070145	6.8.1	0088	2	Rel-7	B	Addition of capability to route MT-SMs via the HPLMN of the receiving MS	7.0.0	SMSviaH
2007-03	CP-070154	6.8.1	0091	-	Rel-7	F	Mapping of SIP error codes to RP-ERROR	7.0.0	SMSIP
2007-03	CP-070154	6.8.1	0090	1	Rel-7	B	SMS over IP	7.0.0	SMSIP
2007-03	CP-070155	6.8.1	0089	1	Rel-7	F	MNRR correction	7.0.0	TEI7
2007-03		7.0.0					Version 7.0.1 created by MCC (Figure 3 was the area of overlapping CRs- "MNRR" box split according to CR#0089r1)	7.0.1	
2007-12	CP-070815	7.0.1	0092	1	Rel-8	C	SMS Router Optimization	8.0.0	TEI8
2008-03	CP-080137	8.0.0	0094		Rel-8		language specific extension of the GSM7 alphabet	8.1.0	TEI8
2008-06	CP-080337	8.1.0	0100	1	Rel-8	A	Correction to clearing of mobile not reachable flags	8.2.0	TEI
2008-09	CP-080536	8.2.0	0101	1	Rel-8	F	SMS 16 bit port addressing. Clarification of IANA's role	8.3.0	TEI8
2008-09		8.2.0					Editorial corrections by MCC	8.3.0	
2009-03	CP-090122	8.3.0	0104	1	Rel-8	A	SM termination correction	8.4.0	SMSIP
2009-03					Rel-8		Editorial cleanup by MCC	8.4.0	
2009-06	CP-090413	8.4.0	0107		Rel-8	F	UE reachability notification from IP-SM-GW	8.5.0	SAES

History

Document history		
V8.2.0	October 2008	Publication
V8.3.0	October 2008	Publication
V8.4.0	March 2009	Publication
V8.5.0	June 2009	Publication