

ETSI TS 103 916 V2.1.1 (2024-01)



TECHNICAL SPECIFICATION

**Intelligent Transport Systems (ITS);  
Parking Availability Service;  
Release 2**

---

**Reference**

DTS/ITS-001960

---

**Keywords**

automotive, ITS, safety, service, transport

**ETSI**

---

650 Route des Lucioles  
F-06921 Sophia Antipolis Cedex - FRANCE

Tel.: +33 4 92 94 42 00 Fax: +33 4 93 65 47 16

Siret N° 348 623 562 00017 - APE 7112B  
Association à but non lucratif enregistrée à la  
Sous-Préfecture de Grasse (06) N° w061004871

---

**Important notice**

The present document can be downloaded from:

<https://www.etsi.org/standards-search>

The present document may be made available in electronic versions and/or in print. The content of any electronic and/or print versions of the present document shall not be modified without the prior written authorization of ETSI. In case of any existing or perceived difference in contents between such versions and/or in print, the prevailing version of an ETSI deliverable is the one made publicly available in PDF format at [www.etsi.org/deliver](http://www.etsi.org/deliver).

Users of the present document should be aware that the document may be subject to revision or change of status.

Information on the current status of this and other ETSI documents is available at

<https://portal.etsi.org/TB/ETSIDeliverableStatus.aspx>

If you find errors in the present document, please send your comment to one of the following services:

<https://portal.etsi.org/People/CommitteeSupportStaff.aspx>

If you find a security vulnerability in the present document, please report it through our  
Coordinated Vulnerability Disclosure Program:

<https://www.etsi.org/standards/coordinated-vulnerability-disclosure>

---

**Notice of disclaimer & limitation of liability**

The information provided in the present deliverable is directed solely to professionals who have the appropriate degree of experience to understand and interpret its content in accordance with generally accepted engineering or other professional standard and applicable regulations.

No recommendation as to products and services or vendors is made or should be implied.

No representation or warranty is made that this deliverable is technically accurate or sufficient or conforms to any law and/or governmental rule and/or regulation and further, no representation or warranty is made of merchantability or fitness for any particular purpose or against infringement of intellectual property rights.

In no event shall ETSI be held liable for loss of profits or any other incidental or consequential damages.

Any software contained in this deliverable is provided "AS IS" with no warranties, express or implied, including but not limited to, the warranties of merchantability, fitness for a particular purpose and non-infringement of intellectual property rights and ETSI shall not be held liable in any event for any damages whatsoever (including, without limitation, damages for loss of profits, business interruption, loss of information, or any other pecuniary loss) arising out of or related to the use of or inability to use the software.

---

**Copyright Notification**

No part may be reproduced or utilized in any form or by any means, electronic or mechanical, including photocopying and microfilm except as authorized by written permission of ETSI.

The content of the PDF version shall not be modified without the written authorization of ETSI.

The copyright and the foregoing restriction extend to reproduction in all media.

© ETSI 2024.  
All rights reserved.

# Contents

Intellectual Property Rights .....	6
Foreword.....	6
Modal verbs terminology.....	6
Introduction .....	6
1 Scope .....	8
2 References .....	8
2.1 Normative references .....	8
2.2 Informative references.....	9
3 Definition of terms, symbols, and abbreviations.....	9
3.1 Terms.....	9
3.2 Symbols.....	10
3.3 Abbreviations .....	10
4 PAS contextual introduction .....	11
4.1 Background .....	11
4.2 General information about parking place .....	13
4.2.1 Introduction.....	13
4.2.2 Parking place organizational aspects .....	13
4.2.3 Services provided by the PAS.....	16
4.2.4 Related POIs .....	16
5 PAS functional description.....	16
5.1 Introduction .....	16
5.2 PAS in the ITS architecture .....	16
5.2.0 Overview .....	16
5.2.1 Vehicle Parking Information.....	17
5.2.2 Parking Space Reservation and Payment.....	18
5.2.3 Related user' services Reservation and Payment .....	18
5.3 PAS functional architecture.....	18
5.4 Interfaces of the PAS.....	19
5.4.0 Overview .....	19
5.4.1 Parking Availability basic service interfaces in the facilities layer (IF-OFa) .....	19
5.4.2 Interface to the ITS Application (IF-App) .....	20
5.4.3 Interface to the ITS-S networking and transport layer (IF-N&T).....	20
5.4.3.1 Networking & Transport Layer.....	20
5.4.3.2 Interface to GeoNetworking/BTP stack .....	20
5.4.3.3 Interface to the IPv6 stack and the combined IPv6/GeoNetworking stack .....	21
5.4.4 Interface to the ITS-S management plan (IF-Mng).....	21
5.4.5 Interface to the ITS-S security functions (IF-Sec) .....	21
5.5 PAS Operational requirements .....	21
5.5.1 Functional Requirements Basic Service Management.....	21
5.5.2 Minimum Performance Requirements.....	22
6 POIM-PA dissemination .....	23
6.1 Introduction .....	23
6.2 POIM-PA transmission method .....	23
6.3 Frequency/Periodicity range of POIM-PAs .....	24
6.4 Transmitting POIM-PAs .....	24
6.5 Triggering conditions .....	24
6.6 Multi-Channel Operation (MCO), congestion control and service announcement .....	24
6.6.1 Introduction.....	24
6.6.2 Interface to MCO_FAC .....	25
6.7 Security constraints .....	26
6.7.1 Introduction.....	26
6.7.2 Service Specific Permission (SSP) .....	26

6.7.3	General priority constraints.....	27
7	POIM-PA Format Specification.....	27
7.1	Introduction.....	27
7.2	General Structure of a POIM-PA PDU.....	27
7.3	ITS PDU header.....	28
7.4	POIM PDU payload.....	28
7.5	POIM-PA PDU Containers.....	29
7.5.1	Management container.....	29
7.5.2	GeneralParkingPlace container.....	29
7.5.3	ParkingStatus container.....	29
7.5.4	ParkingSupplyCapabilities container.....	30
7.5.5	RelatedPOIs container.....	30
7.6	POIM-PA formatting and decoding.....	31
8	Protocol operation of the PAS.....	31
8.1	Introduction.....	31
8.2	Originating ITS-S operation.....	31
8.2.1	Protocol data setting rules.....	31
8.2.2	Protocol data.....	31
8.2.3	General protocol operation.....	32
8.3	Receiving ITS-S operation.....	33
8.3.1	Protocol data setting rules.....	33
8.3.2	General protocol operation.....	33
8.3.3	Exceptions handling.....	33
8.4	PAS protocol flowcharts.....	34
<b>Annex A (normative): Generic POIM Concept and ASN.1 modules .....</b>		<b>35</b>
A.1	Structure of a POIM PDU.....	35
A.1.1	Overview.....	35
A.1.2	POI Block Management Container.....	36
A.1.3	Related POI Info Block Container.....	36
A.1.4	POIM-PA.....	36
A.2	POIM - ASN.1 modules.....	36
A.3	POIM-PA ASN.1 module.....	37
<b>Annex B (informative): Specification of POIM and POIM-PA in readable format .....</b>		<b>38</b>
<b>Annex C (informative): Examples of PAS Parking place profiling .....</b>		<b>39</b>
C.1	Introduction.....	39
C.2	Passengers cars and small utility vehicles parking place available at no cost.....	39
C.3	Passengers cars and small utility vehicles paid parking place.....	39
C.4	Individually targeted parking spaces.....	39
C.5	Park & Ride facility.....	40
C.6	Lorries/Trucks and Coaches parking place.....	40
C.7	Queue trucks parking place dynamic management.....	40
C.8	Limited time parking place.....	41
<b>Annex D (informative): Pre-Standardization Studies .....</b>		<b>42</b>
D.1	Introduction.....	42
D.2	PAS link with the Valet Parking Service.....	42
D.3	PAM Request needs.....	44
D.4	Park & Ride facility.....	45

D.5	Lorries/Trucks and Coaches parking.....	46
D.6	Decentralized PAS initiated by a vehicle .....	46
D.7	Added information in POIM-PA considering the parking access by unconnected vehicles .....	46
History	.....	48

---

# Intellectual Property Rights

## Essential patents

IPRs essential or potentially essential to normative deliverables may have been declared to ETSI. The declarations pertaining to these essential IPRs, if any, are publicly available for **ETSI members and non-members**, and can be found in ETSI SR 000 314: "*Intellectual Property Rights (IPRs); Essential, or potentially Essential, IPRs notified to ETSI in respect of ETSI standards*", which is available from the ETSI Secretariat. Latest updates are available on the ETSI Web server (<https://ipr.etsi.org/>).

Pursuant to the ETSI Directives including the ETSI IPR Policy, no investigation regarding the essentiality of IPRs, including IPR searches, has been carried out by ETSI. No guarantee can be given as to the existence of other IPRs not referenced in ETSI SR 000 314 (or the updates on the ETSI Web server) which are, or may be, or may become, essential to the present document.

## Trademarks

The present document may include trademarks and/or tradenames which are asserted and/or registered by their owners. ETSI claims no ownership of these except for any which are indicated as being the property of ETSI, and conveys no right to use or reproduce any trademark and/or tradename. Mention of those trademarks in the present document does not constitute an endorsement by ETSI of products, services or organizations associated with those trademarks.

**DECT™**, **PLUGTESTS™**, **UMTS™** and the ETSI logo are trademarks of ETSI registered for the benefit of its Members. **3GPP™** and **LTE™** are trademarks of ETSI registered for the benefit of its Members and of the 3GPP Organizational Partners. **oneM2M™** logo is a trademark of ETSI registered for the benefit of its Members and of the oneM2M Partners. **GSM®** and the GSM logo are trademarks registered and owned by the GSM Association.

---

# Foreword

This Technical Specification (TS) has been produced by ETSI Technical Committee Intelligent Transport Systems (ITS).

---

# Modal verbs terminology

In the present document "**shall**", "**shall not**", "**should**", "**should not**", "**may**", "**need not**", "**will**", "**will not**", "**can**" and "**cannot**" are to be interpreted as described in clause 3.2 of the [ETSI Drafting Rules](#) (Verbal forms for the expression of provisions).

"**must**" and "**must not**" are **NOT** allowed in ETSI deliverables except when used in direct citation.

---

# Introduction

The present document specifies the Parking Availability Service (PAS) and how an ITS station (ITS-S) can disseminate to other ITS-Ss information about the static and dynamic status of a parking place and its offered parking spaces. As many types of POIs can be of interest to road users, the present document specifies also a generic approach enabling the development of further specifications targeting other types of POIs.

The PAS increases awareness among ITS-Ss by sharing information about the availability of parking spaces corresponding to the relevant vehicle type and locally related services.

The Parking Availability Message (POIM-PA) is composed of the generic POI information blocks (POIM) and of the specific Parking Availability information blocks (PA) enabling the interoperable sharing of basic information about the disseminating ITS-S (required for the interpretation of the transmitted data), its available parking resources and services, their availability status, and local availability related POIs. POIM-PAs are generated periodically or when judged necessary as determined by POIM-PA generation rules.

The present document is the first Release 2 version as a basis for future Release 2 versions of the PA facilities layer service: future versions of the present document will specify PA service in a way allowing the ETSI ITS release 2 facilities layer standard structure focusing on ITS facilities layer functionalities and to be used with different security and lower layer technologies.

Support to Automated Valet Parking (AVP) in the PA service is not covered in the normative part of the present document. However, annex D of the present document provides an informative pre-standardization study of supporting AVP in the PA service for possible normative work in future releases.

---

# 1 Scope

The present document specifies the facility layer service responsible for the generation of dynamic parking availability information in various transport environments (on street, off street, in parking facilities and park & ride stations). The dissemination is intended from a roadside or any other appropriate node, for example a central station.

---

## 2 References

### 2.1 Normative references

References are either specific (identified by date of publication and/or edition number or version number) or non-specific. For specific references, only the cited version applies. For non-specific references, the latest version of the referenced document (including any amendments) applies.

Referenced documents which are not found to be publicly available in the expected location might be found at <https://docbox.etsi.org/Reference/>.

NOTE: While any hyperlinks included in this clause were valid at the time of publication, ETSI cannot guarantee their long term validity.

The following referenced documents are necessary for the application of the present document.

- [1] [ETSI TS 102 894-2](#): "Intelligent Transport Systems (ITS); Users and applications requirements; Part 2: Applications and facilities layer common data dictionary; Release 2".
- [2] [ETSI TS 103 141](#): "Intelligent Transport Systems (ITS); Facilities layer function; Multi-Channel Operation (MCO) for Cooperative ITS (C-ITS); Release 2".
- [3] [ETSI TS 103 836-5-1](#): "Intelligent Transport Systems (ITS); Vehicular Communications; GeoNetworking; Part 5: Transport Protocols; Sub-part 1: Basic Transport Protocol; Release 2".
- [4] [ETSI TS 103 836-4-1](#): "Intelligent Transport Systems (ITS); Vehicular Communications; GeoNetworking; Part 4: Geographical addressing and forwarding for point-to-point and point-to-multipoint communications; Sub-part 1: Media-Independent Functionality; Release 2".
- [5] [ETSI TS 103 097](#): "Intelligent Transport Systems (ITS); Security; Security header and certificate formats; Release 2".
- [6] [Recommendation ITU-T X.691/ISO/IEC 8825-2 \(1997-12\)](#): "Information technology - ASN.1 encoding rules: Specification of Packed Encoding Rules (PER)".
- [7] [ETSI TS 102 940](#): "Intelligent Transport Systems (ITS); Security; ITS communications security architecture and security management; Release 2".
- [8] [ETSI TS 103 836-6-1](#): "Intelligent Transport Systems (ITS); Vehicular Communications; GeoNetworking; Part 6: Internet Integration; Sub-part 1: Transmission of IPv6 Packets over GeoNetworking Protocols; Release 2".



## 2.2 Informative references

References are either specific (identified by date of publication and/or edition number or version number) or non-specific. For specific references, only the cited version applies. For non-specific references, the latest version of the referenced document (including any amendments) applies.

**NOTE:** While any hyperlinks included in this clause were valid at the time of publication, ETSI cannot guarantee their long term validity.

The following referenced documents are not necessary for the application of the present document but they assist the user with regard to a particular subject area.

- [i.1] TS 16157-6: "Intelligent transport systems - DATEX II data exchange specifications for traffic management and information - Part 6: Parking publications" (produced by CEN).
- [i.2] ETSI TS 101 556-1: "Intelligent Transport Systems (ITS); Infrastructure to Vehicle Communication; Electric Vehicle Charging Spot Notification Specification".
- [i.3] ETSI TS 101 556-2: "Intelligent Transport Systems (ITS); Infrastructure to Vehicle Communication; Part 2: Communication system specification to support application requirements for Tyre Information System (TIS) and Tyre Pressure Gauge (TPG) interoperability".
- [i.4] ETSI TS 101 556-3: "Intelligent Transport Systems (ITS); Infrastructure to Vehicle Communications; Part 3: Communications system for the planning and reservation of EV energy supply using wireless networks".
- [i.5] ISO 23374-1: "Intelligent transport systems -- Automated Valet Parking System (AVPS) -- Part 1: System framework, requirements for automated driving and for communications interface".
- [i.6] ETSI TR 103 300-1: "Intelligent Transport Systems (ITS); Vulnerable Road Users (VRU) awareness; Part 1: Use Cases definition; Release 2".
- [i.7] ETSI TS 103 300-2: "Intelligent Transport Systems (ITS); Vulnerable Road Users (VRU) awareness; Part 2: Functional Architecture and Requirements definition; Release 2".

---

## 3 Definition of terms, symbols, and abbreviations

### 3.1 Terms

For the purposes of the present document, the terms given in TS 16157-6 [i.1] and the following apply:

**authority:** entity which has the right and ability to perform certain tasks on a subject vehicle

**NOTE 1:** Within the present document, authority can be transferred between the user and the service provider and does not exist among the two at the same time. One always has priority regarding the management and operation of the Subject Vehicle.

**NOTE 2:** A secured authority transfer procedure needs to be specified when accessing and leaving a parking which provides services requiring such authority transfer.

**destination:** location within the operation zone to which a subject vehicle is transferred to

**NOTE:** For automated vehicle the destination needs to specify the reference location line used to position the subject vehicle according to its parking orientation.

**drop-off area:** location within the operation zone where the user leaves its vehicle and hands it over authority to the service provider

**main user service:** service that includes the provision of information on available parking spaces, the possible reservation, and guidance to park for an authorized category of vehicles

**operation zone:** geographical area within a parking place where automated driving can be performed by the automated valet parking service

NOTE 1: An operation zone can be shared between automated Subject Vehicle and human driven subject vehicle.

NOTE 2: Operation zone may contain information other than the two-dimensional geographic area, such as maximum vehicle height or floor marking information.

**path:** planned sequence of way points for a vehicle to follow

NOTE: A path is determined based on the physical size and moving capabilities (e.g. turning radius) of the subject vehicle.

**pick-up area:** location within the operation zone where the user retrieves its vehicle and recovers its complete usage

**related user service:** service which can be provided locally to the user to facilitate its mobility or assist in the maintenance and operation of its vehicle

NOTE 1: A related user service can be provided at the parking place level (e.g. vehicle washing, vehicle Tyre Pressure Monitoring and adjustment, fuel or hydrogen supply, etc.) or at a parking space level (electrical vehicle charging).

NOTE 2: Information on available related user services, their reservations and payment can also be part of related user services.

**route:** planned itinerary for a vehicle, in the operation zone, from its point of origin to its destination

**service provider:** role of an organization that receives/hands over authority with users for a given parking main or related service

**subject vehicle:** vehicle which is the subject of a particular main or related service delivered during a parking operation

**user of a particular service:** individual service recipient that hands over/retrieves authority to/from service provider

## 3.2 Symbols

Void.

## 3.3 Abbreviations

For the purposes of the present document, the abbreviations given in ETSI TR 103 300-1 [i.6], ETSI TS 103 300-2 [i.7] and the following apply:

AVP	Automated Valet Parking
AVPS	Automated Valet Parking System
BTP	Basic Transport Protocol
CCH	Control Channel
CDD	Common Data Dictionary
FCP	Functional Configuration Profile
FL-SDU	Facilities-Layer - Service Data Unit
IF-App	Interface of the Facility to Application
IF-OFa	Interface of the Facility to Other Facilities
IF-Mng	Interface of the Facility to the Management plan
IF-N&T	Interface of the Facility to the Network & Transport layers
IF-Sec	Interface of the Facility to the Security protocol
ITS	Intelligent Transport Systems
ITS-S	ITS Station
MAC	Medium Access Control
MAPEM	MAP (topology) Extended Message
MCI	MCO Control Information
MCO	Multi-Channel Operation
MIB	Management Information Base
PA	Public Availability

PAS	Parking Availability Service
POIM	Point Of Interest Message
PCI	Protocol Control Information
POIM-PA	Point Of Interest Message - for Parking Availability
POI	Point Of Interest
PoTi	Position and Time
PT	Public Transport
VRU	Vulnerable Road User

---

## 4 PAS contextual introduction

### 4.1 Background

Mobility services are users' value-added services which support the mobility of users in their various mobility activities contexts. These services are necessary to maintain the user' mobility system operational (e.g. its vehicle), to facilitate the transition between various transport modalities, and to support the transition of the user toward other users' offered services which are of interest to them (Point Of Interest (POI)).

Point Of Interest are multiple and are related to the user activity and its present needs.

Parking places are often associated to these various points of interest as users need to park their vehicles when accessing a new service facility (e.g. hotel, restaurant, public transport station, rest area, energy supply station, etc.).

In a parking area, it is possible to access other services which can be supplied by specific related POIs. For example:

- A Valet Parking (human or automated) which may take in charge the vehicle to park it or take care of it for requested other services (e.g. energy loading, washing, tyres pressure gauging and refiling, goods transfer, etc.).
- An Energy supply station (petrol/gas, hydrogen, electric, etc.) which can be at the level of the parking place or at the level of parking space (e.g. electrical supply (connected or inductive)) ETSI TS 101 556-1 [i.2] and ETSI TS 101 556-3 [i.4].
- A vehicle tyres pressure gauge and filing system, see ETSI TS 101 556-2 [i.3], enabling to control vehicles tyres pressure and adjust their pressures when necessary.
- A vehicle washing system.
- Vehicle security system (e.g. for trucks and their payload).
- Mobility Services which are required for Park & Rides.
- Etc.

These services can be identified as related services to the parking services.

Vehicle parking is a process which contains a functional pipeline as shown in Figure 1.

This process starts with the provisioning of information about the parking location, its main and related user' services and other features which are relevant to users for accessing and use supplied services.

The present document focuses only on the provisioning of this information via a Parking Availability Service (PAS) basic service located at the facilities layer level of the ITS Station (ITS-S).

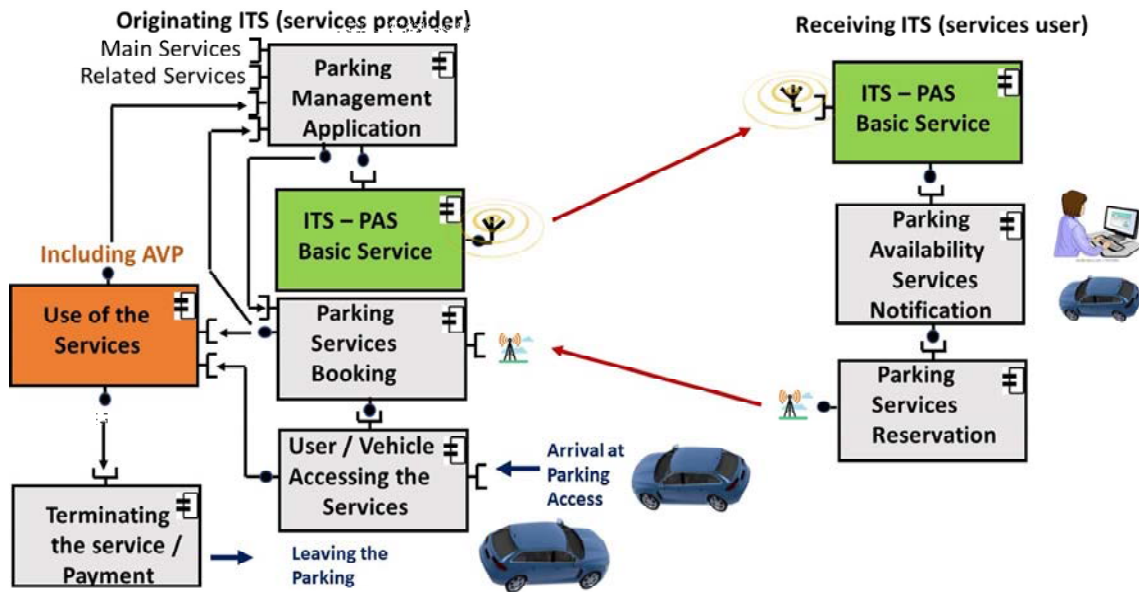

**Figure 1: Functional pipeline of the whole parking management process**

Parking place and related services information are provided via standard Point Of Interest Message - for Parking Availability (POIM-PA) which can be broadcasted or directly addressed to vehicles according to the communication profile which is selected by the PAS basic service (e.g. local ad-hoc network or cellular access).

The present document is a generic standard developed to cover several parking profiles (like use cases), starting with an initial proposal which can be progressively extended to cover all parking profiles which will be developed in Europe.

The parking service process includes the following functions:

- The parking management application which monitors and controls the main and related parking services and their use relatively to booking and users/vehicles accesses.
- The ITS PAS basic service which is distributed at the level of the originating parking ITS-S and receiving vehicles ITS-Ss.
- The parking availability services notification, providing necessary information to the user (human or vehicle) for taking a decision (reservation/selection or searching for another parking).
- The parking services reservation if the user decides to use some of the proposed available services. The reservation can be accompanied with a prepayment covering some delay for the user arrival time (e.g. one hour).
- The parking service booking at the level of the parking, consecutive to a received reservation from a user.
- The start of the parking services (booked or not) when the user is arriving at the level of the parking vehicle access.
- The use of the selected parking services.
- The termination of the user selected services with its final payment.

NOTE 1: Accessing the parking services is related to the use or not of a valet parking (human or automated). When a valet parking is used, a vehicle driving control transition protocol needs to be executed to switch the vehicle control from the user to the parking management at the user arrival time and back from the parking management to the user at the user departing time.

Parking reservation and payment can be provided by proprietary procedures via a WEB site or other proprietary means which can be identified at the level of the POIM-PA.

A given parking place may include several parking sub-places, parking areas and parking identified areas. A typical example is a highway rest area (campus level) which can include a parking sub-place at no cost for passenger vehicles and a truck parking sub-place including a parking identified area for dangerous goods transportation. In such case, each parking place, parking sub-place, parking area and parking identified area can be considered individually at the level of the PAS (e.g. one POIM-PA per parking type).

Parking identified areas can be used to regroup together parking identified spaces offering the same characteristics, users' services, and restrictions. For example:

- Parking identified areas dedicated to passengers' Electrical Vehicles reloading, with a free access (without a reservation), with a cost related to the provided electrical energy (i.e. PISIDxx).
- Parking identified areas dedicated to passengers' Electrical Vehicles' reloading with a free access, with a cost but reserved to disabled people (i.e. PISIDxy).
- Parking identified areas dedicated to AVP without reservation (i.e. PISIDyy).
- Parking identified areas dedicated to AVP with reservation (i.e. PISIDyz).
- Etc.

NOTE 2: To respect the maximum amount of resources limit consumed at the access layer, for large parking places, the POIM-PA can be limited to provide information only for a part of the parking place (e.g. each parking sub-place, parking area or parking identified areas).

Parking spaces can be nested in another POI place (e.g. airport terminal, train station, hotel, etc.) and then be managed by the local POI place authority. Such organization can lead to integrate the provision of parking availability information directly in the POIM related to the considered POI place.

## 4.2 General information about parking place

### 4.2.1 Introduction

A parking place can be divided into several elements (sub-place, parking areas, parking identified areas) facilitating users' and vehicles' accesses to relevant parking spaces.

Each element of a parking place, a parking sub-place, a parking identified area is constituted of the following facilities:

- Vehicular access.
- Pedestrian access (optionally including disabled accesses).
- Specific areas (i.e. parking identified areas) regrouped into sub-places or parking areas.
- Supplementary facilities which enable the location of equipment or services to be defined in the place.
- Parking spaces.
- Related POIs located in the vicinity of the parking place.

All these parking facilities are organized to provide parking spaces and services which are identified in terms of characteristics and availability to ease the selection of the users and then enables a possible reservation when available.

### 4.2.2 Parking place organizational aspects

The present document considers parking organizations which are represented in Figure 2, respecting the example of place hierarchy as provided in TS 1657-6 [i.1].

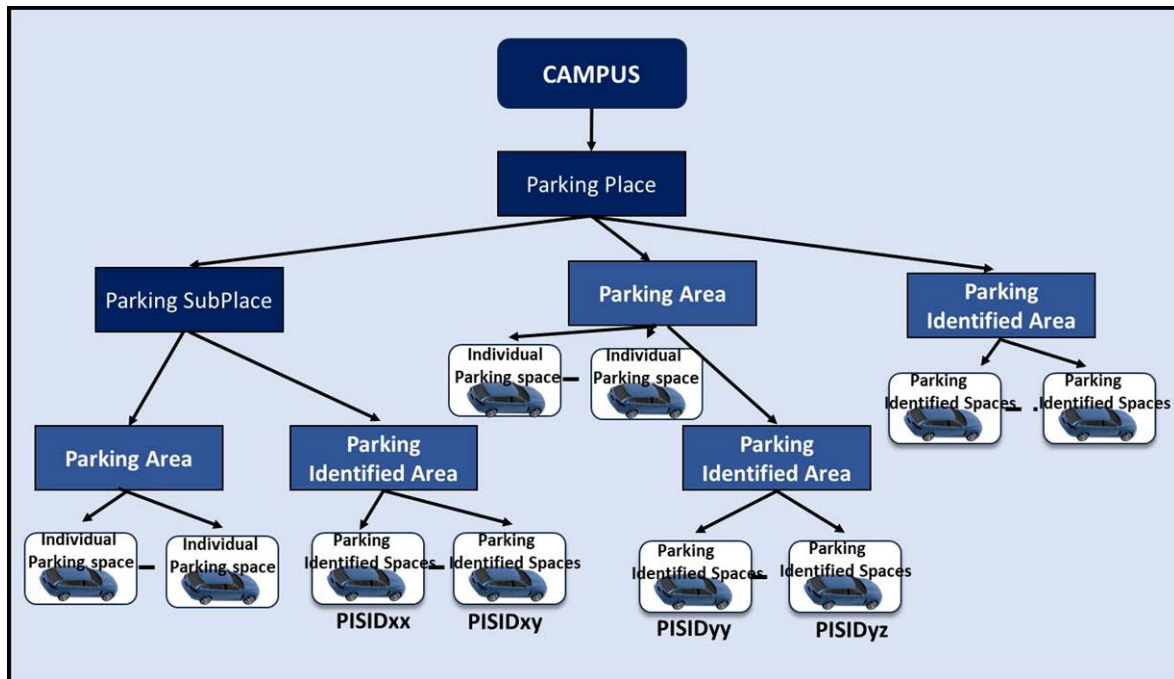

**Figure 2: Example of place hierarchy**

A given parking place may include several parking sub-places, parking areas and parking identified areas. A typical example is a highway rest area (campus level) which can include a parking sub-place at no cost for passenger vehicles and a truck parking sub-place including a parking identified area for dangerous goods transportation. In such case, each parking place, parking sub-place, parking area and parking identified area can be considered individually at the level of the PAS (e.g. one POIM-PA per parking type).

Parking identified areas can be used to regroup together parking identified spaces offering the same characteristics, users' services, and restrictions. For example:

- Parking identified areas dedicated to passengers' Electrical Vehicles reloading, with a free access (without a reservation), with a cost related to the provided electrical energy (i.e. PISIDxx).
- Parking identified areas dedicated to passengers' Electrical Vehicles' reloading with a free access, with a cost but reserved to disabled people (i.e. PISIDxy).
- Parking identified areas dedicated to AVP without reservation (i.e. PISIDyy).
- Parking identified areas dedicated to AVP with reservation (i.e. PISIDyz).
- Etc.

**NOTE:** To respect the maximum amount of resources limit consumed at the access layer level, for large parking places, the POIM-PA can be limited to provide information only for a part of the parking place (e.g. each parking sub-place, parking area or parking identified areas).

Parking spaces can be nested in another POI place (e.g. airport terminal, train station, hotel, etc.) and then be managed by the local POI place authority. Such organization can lead to integrate the provision of parking availability information directly in the POIM related to the considered POI place.

A parking place is mainly constituted of the following elements:

- Parking place location, layout, and structure:
  - The parking place can be in open air along one or several streets, it can be in a building comprising several parking levels or can be in an open space organized to park vehicles.
  - The parking place can be nested in another POI (e.g. a Public Transport (PT) station such as an airport or a train station). In such case, a parking reservation and payment could be considered when booking/purchasing a PT travel.

- The parking place can be divided into several sub-places which can be assigned to different vehicle's types.

**EXAMPLE:** In a rest area campus accessible via a motorway, it would be possible to identify a sub-place assigned to passengers' cars and a sub-place assigned to trucks and coaches.

- Available parking space types:
  - A parking place and sub-place is composed of parking spaces which may offer a diversity of services to their users associated to the vehicle parking (see Figure 3) and may differ in their characteristics (e.g. size).
  - The concept of "parking identified area" [i.1] enables to regroup together parking spaces which have the same characteristics, offer the same users services, and present the same restrictions. Each parking identified space needs to have an assigned identifier (e.g. PISIDxx) which fully describes the parking space type including its layout (type of accepted vehicles), local services (e.g. E.V reloading, reserved to disabled people, facilities for vehicle loading/unloading, etc.) and restrictions (only accessible on reservation, payable, parking time limit, etc.).

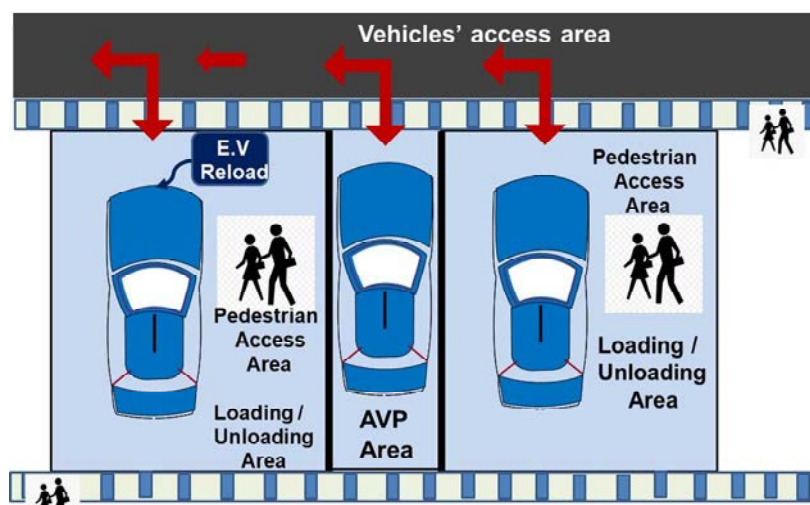

**Figure 3: Example of a multipurpose parking space**

Common characteristics to be consistently available to parking place and parking spaces:

- Vehicular accesses:
  - The vehicular access comprises the possible routes which are available for authorized vehicles from the various parking entries to reach an assigned parking space. It also comprises the possible routes which are available for authorized vehicles to leave the parking by existing exits and to move in the parking to access to supplementary facilities and available related POIs. These routes can be described in a parking digital map.
- Pedestrian access:
  - The pedestrian access comprises the possible routes which are available to pedestrians (optionally including disabled people) to move in the parking place after leaving their vehicle and for their vehicle retrieval. The pedestrian access may also include the description of the routes used to reach local related POIs and other facilities such as the parking payment and the route to emergency issues.
- Locally related POIs:
  - They are POIs (e.g. vehicle washing, energy stations, etc.) which are locally available and may be accessible to parking place users.
- When available, a valet parking is also a service which will be available at the parking place level and/or at the level of parking identified space (e.g. parking identified spaces dedicated to AVP).

### 4.2.3 Services provided by the PAS

The Parking Availability Service (PAS) provides real time generic information about the Parking Place, its management, the aggregated status of the parking place, its detailed status (e.g. per space) and Related POIs.

Other optional information can be provided according to the parking profile being considered.

The provided information can be pushed by the parking management to vehicles either within predefined periods of time or upon detection of a user need.

### 4.2.4 Related POIs

Related POIs can be part of the parking when restricted to parking users and directly available only after accessing to the parking place.

But other Related POIs (outside the parking place), can also be locally, publicly available to a parking place user.

It would be complex and inefficient to provide detailed information about all locally available POIs in a POIM-PA, but the PAS may provide information about the links available for the interested user to access detailed information about the POIs which are related to its local stay while parking its vehicle.

---

## 5 PAS functional description

### 5.1 Introduction

The Parking Availability Service (PAS) is an ITS-S service which provides static and dynamic real time information about parking spaces such as detailed information for single parking spaces and the availability of parking services (such as vehicle parking, parking space reservation, payment modalities and contacts and parking space related Valet Parking).

This information is provided via a standard message Point Of Interest Message - for Parking Availability (POIM-PA) which can be locally broadcasted, or more systematically addressed to vehicles on a contractual basis (unicast pushing mode).

### 5.2 PAS in the ITS architecture

#### 5.2.0 Overview

Figure 4 presents the main components of the ITS-S architecture that directly impact the PAS operation.



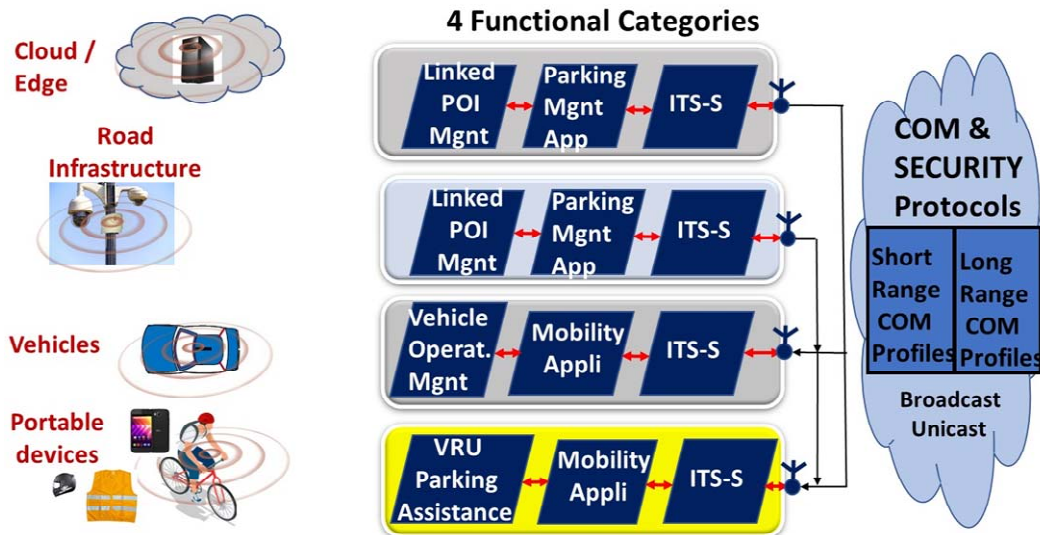

**Figure 4: Functional categories**

Figure 4 shows 4 functional categories:

- VRU portable devices.
- Vehicles (human driven and automated).
- Road Infrastructure.
- In the Cloud or at the edge of the Cloud.

According to the ITS architecture implementation, the Parking management application can be realized in a central system located in the Cloud or at the edge of the Cloud or it can be realized at the parking level located along the roadside.

A road user can be in a vehicle (or it can be the vehicle itself in case of an automated vehicle) or it can be a Vulnerable Road User (e.g. bicyclist or motorcyclist).

The Communication Technology being used depends on the respective locations of the originating ITS-S and receiving ITS-Ss:

- When the originating ITS-S is in the Cloud or at the edge of the Cloud, a cellular network connected to Internet shall be used.
- If the originating ITS-S is in the parking along the road infrastructure, an ad-hoc local area network (short range profile) can be used.

The PAS located in the ITS-S is under the control of an ITS mobility application (i.e. Parking Management) which is acting either as a mobility service provider or as a mobility service user depending on the considered functional category.

### 5.2.1 Vehicle Parking Information

Vehicle parking information is provided to potential users of the parking either via locally broadcast messages or from a central system (unicast push mode).

They are real time information which provide available parking capabilities and associated management information necessary to select a parking space, optionally make a parking space reservation, prepayment, and final payment at the end of the parking main used service.

## 5.2.2 Parking Space Reservation and Payment

After a real time, reception of the parking availability information, the potential user of the main service can initiate a reservation based on received information. If the parking is subject to a payment, the reservation can be secured by a prepayment so authorizing the user to arrive and use the reserved parking space with a delay being covered by the prepayment.

If a parking space reservation is possible, the "reservation type" may be optionally specified (see the parking reservation type in ASN.1). If there is no common reservation type, this means that a reservation is not possible. If a parking space can be reserved, booking contact information shall be provided for the user to be able to reserve a parking space.

**NOTE:** Even if information is provided by the PAS for parking reservation and payment, these services access are out of the scope of the present specification.

## 5.2.3 Related user' services Reservation and Payment

A limited number of related users' services which are associated to the navigation of vehicles, people and goods inside the parking can be the object of the communication about their availability, payment, and reservation information.

For paid services, a reservation can be achieved on basis of communicated information. The reservation and payment of related user' services can be achieved as for the parking space reservation and payment.

**NOTE:** As for parking space reservation and payment, these related user' services reservation and payment are also out of the scope of the present specification.

## 5.3 PAS functional architecture

The PAS is distributed in ITS-Stations facilities layers which are originating POIMs-PA, and which are receiving POIMs-PA for the supply of the service to customers.

Typically, the originating ITS-S is located at the level of a Roadside equipment or at the level of a central system, while the receiving ITS-Ss are located at the level of vehicles which may be human driven or fully automatized (including VRUs vehicles).

Then, the interactions between originating ITS-S and receiving ITS-S are achieved via standard Point Of Interest Messages - for Parking Availability (POIMs-PA) which are exchanged using standard network communication profiles.

Standard network communication profiles include wireless ad-hoc local area networks such as the ITS-G5 and the LTE V2X (CP5) and long-range network including wireless cellular networks for their access (e.g. 5G).

Figure 5 provides a representation of a functional architecture which is necessary to support the PAS.

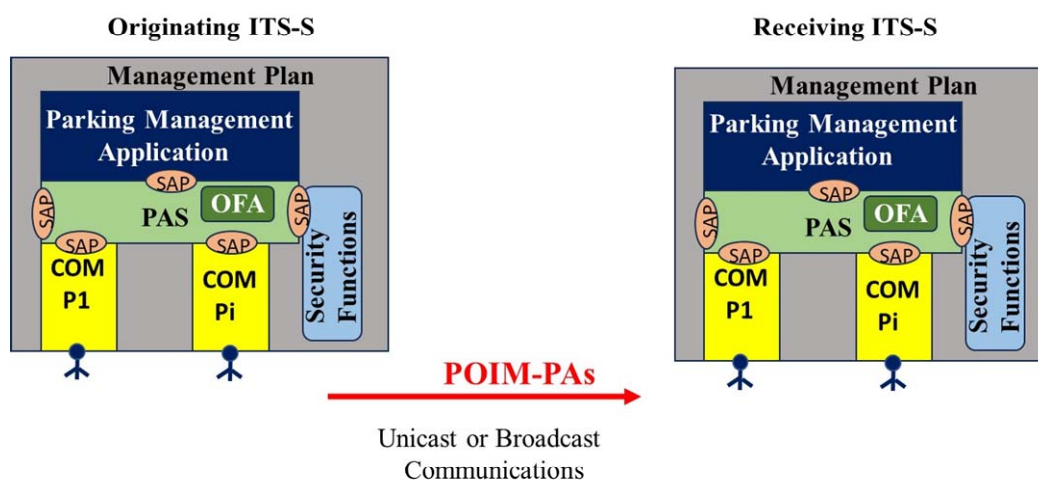

**Figure 5: Functional architecture supporting PAS**

Several Communication Profiles may be available. Their usages are left at the discretion of the ITS-S implementation.

Other Facilities (OFA) includes the facilities which need to be interfaced with the PAS. This includes the Multi-Channel Operation (MCO), if supported.

## 5.4 Interfaces of the PAS

### 5.4.0 Overview

The PAS is managed by the Parking Management Application at the level of the service providers and by a mobility support application at the level of the service users.

PAS is a real time information service which provides the availability of parking services and other related mobility services either directly (e.g. valet parking, Electrical Vehicle charging, etc.) or indirectly via related POI application addresses.

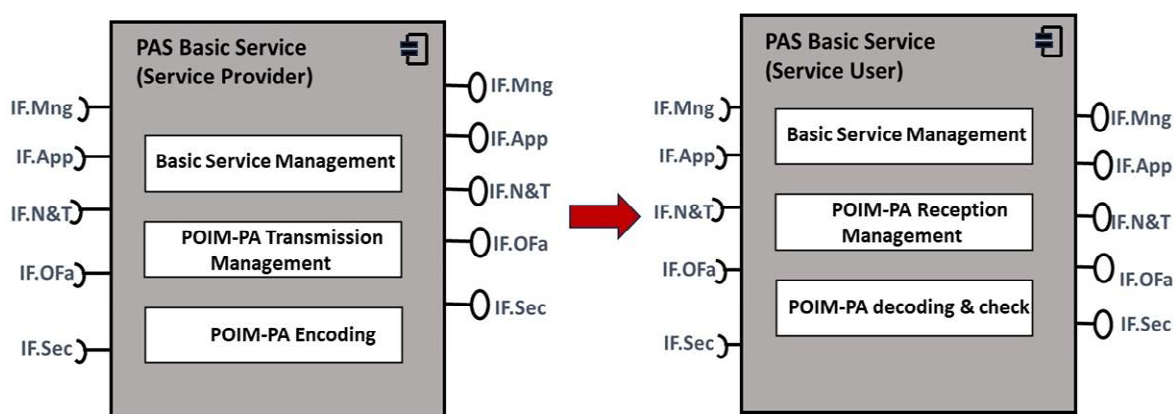

**Figure 6: Summary of the PAS functions and interfaces**

#### At service provider level:

Depending on the ITS-S communication profiles availability, the PAS may use the communication broadcast mode or the unicast mode to disseminate POIMs-PA to users.

#### At service user level:

The user may receive parking availability information if needed and may use it to select a parking space with or without a reservation.

The clauses below describe the interfaces shown in Figure 6.

### 5.4.1 Parking Availability basic service interfaces in the facilities layer (IF-OFa)

The interactions between the PAS and other facilities layer entities in the ITS-S architecture are used to obtain information for the generation of the POIM-PA and for storing information related to Parking. The interfaces for these interactions are described in Table 1.

**Table 1: PAS basic service interfaces (IF.OFa)**

Interfaced functionality	Parameters
PoTi	Information of the positioning and timing are sent to the PAS basic service, i.e. the position of the ITS-S and time information as specified in ETSI TS 102 894-2 [1].
MCO	If the ITS-S supports MCO, the PAS shall exchange information with the MCO facility (MCO-FAC) via the interface IF-MCO specified in ETSI TS 103 141 [2] using the interface IF.OFa depicted in figure 6. This interface can be used to configure the default MCO settings for the generated POIM-PA and can also be used to configure the MCO parameters on a per message basis. More operational details are provided in clause 6.6 of the present document.
HMI support	The interactions between the PAS and the HMI support function of the facilities layer are necessary for the exchange of information (parameters, data elements) to be used for the management of the PAS and the provisioning of data elements in POIMs-PA. The HMI support function can forward input data from the touchscreen or button in the device of the user to PAS. This interaction is not necessary for fully automated vehicles.
LDM	LDM/POIM-PA data are exchanged via the interface between LDM and the PAS basic service.
Other application support facilities	Information to trigger the transmission of POIM-PA messages are sent to the PAS by the relevant application. The PAS forwards received messages to the relevant applications.

## 5.4.2 Interface to the ITS Application (IF-App)

An ITS application is a function of the ITS application layer that implements the application logic of one or more-use cases.

The Parking Management application provides data frames and data elements which are used to build the POIMs-PA. Received POIMs-PA contents are provided to the Parking Management application after validation by the PAS.

## 5.4.3 Interface to the ITS-S networking and transport layer (IF-N&T)

### 5.4.3.1 Networking & Transport Layer

If the ITS-S does not support the MCO, the PAS shall exchange information with the ITS Networking & Transport layer via the interface IF.N&T, as depicted in Figure 6.

At the originating ITS-S, the PAS shall provide the POIM-PA embedded in a Facility-layer Service Data Unit (FL-SDU) together with Protocol Control Information (PCI) to the ITS Networking & Transport Layer. At the receiving ITS-S, the ITS Networking & Transport Layer passes the received POIM-PA to the PAS, if available.

The data set that shall be passed between the PAS and the ITS Networking & Transport Layer for the originating and receiving ITS-S is specified in Table 2.

**Table 2: Data passed between PAS basic service and the ITS Networking & Transport layers**

Category	Data	Data requirement	Mandatory/Optional
Data passed from the PAS to the ITS networking & transport layer	POIM-PA	{ <i>poim-pa</i> } as specified in annex A.	Mandatory
	PCI	Depending on the protocol stack applied in the networking and transport layer as specified in clause 5.4.3.2 or 5.4.3.3.	Mandatory
Data passed from the ITS networking & transport layer to the PAS	Received POIM-PA	{ <i>Poim-pa</i> } as specified in annex A.	Mandatory

### 5.4.3.2 Interface to GeoNetworking/BTP stack

If the GeoNetworking/BTP protocol stack is used, and GeoNetworking is used as the network layer, the PCI being passed from PAS to GeoNetworking/BTP stack shall comply with Table 5 in clause 6.6.2.

### 5.4.3.3 Interface to the IPv6 stack and the combined IPv6/GeoNetworking stack

If the PAS uses the IPv6 stack or the combined IPv6/GeoNetworking stack for POIM-PA dissemination, ETSI TS 103 836-6-1 [8] shall be applied.

NOTE 1: The specification of the interface between the PAS and the IPv6 stack is out of the scope of the present document.

NOTE 2: If IP-based transport is used to transfer the facility layer POIM-PA between interconnected actors, security constraints as outlined in clause 6.7 may not be applicable. In this case trust enforcement among the participating actors, e.g. using mutual authentication, and authentication of information can be based on other standard IT security methods, such as IPSec, DTLS, TLS or other VPN solutions that provide an end-to-end secure communication path between known actors.

NOTE 3: Security methods, sharing methods and other transport related information, such as messaging queuing protocols, transport layer protocol, ports to use, etc. can be agreed among interconnected actors.

When the POIM-PA dissemination makes use of the combined IPv6/GeoNetworking stack, the interface between the PAS and the combined IPv6/GeoNetworking stack may be identical to the interface between the PAS and IPv6 stack.

### 5.4.4 Interface to the ITS-S management plan (IF-Mng)

The PAS of an originating ITS-S obtains configuration parameters and other control information from the Management Information Base (MIB) located in the management plan via the IF Mng interface, as depicted in Figure 6.

### 5.4.5 Interface to the ITS-S security functions (IF-Sec)

The PAS may exchange primitives with the Security entity of the ITS-S using the IF Sec interface provided by the Security entity as depicted in Figure 6.

As POIM-PA are originated by static ITS-S located in a central station or in a parking, the ITS-S ID does not need to be changed.

If the receiving ITS-S PAS detects an originating ITS-S misbehaviour, this one shall be signalled to the Security entity via the IF Sec interface, as depicted in Figure 6.

## 5.5 PAS Operational requirements

### 5.5.1 Functional Requirements Basic Service Management

The PAS is managed in cooperation between the PAS provider (Roadside equipment or a central system) and PAS users of the service which can be vehicles controlled by human (SAE levels 0 to 3) or which can be fully automated vehicles (SAE level 4 and 5) or motorized VRUs searching for a dedicated parking.

The PAS is triggered by a parking management application which provides the service.

At the level of the service provider, the POIMs-PA dissemination is controlled via several triggering conditions relatively to the type of ITS communication profile being used:

- **Continuous broadcast from a Roadside Unit:** In this case, the POIM-PA is continuously broadcasted at a predefined frequency which can be adjusted according to the used channel congestion management. Local users are then constantly receiving the broadcasted POIMs-PA and then filter them according to their local mobility application needs.
- **Push unicast mode from a central station:** The unicast mode is used by long range communication systems, in this case directly addressing a user which has a service contract with the parking management service operator. Then, the dissemination of POIMs-PA to the user is under the initiative of the service operator which may infer, according to some received information, that the user needs to be informed about local parking' availabilities.

**POIM-PA Decoding & check:**

At the level of the service user ITS-S, the POIM-PA decoding function shall extract the relevant data elements contained in the received POIM-PA. These data elements are then communicated to the POIM-PA reception management function after checking its relevance and verifying that it is not the object of a cyberattack. After decoding the received message, this one is checked in terms of correctness (compliance to the standard), integrity, consistency, and plausibility. Then the message relevance is verified. If the message is expected by the ITS Application of the receiving ITS-S, this one can be provided to the POIM-PA Reception Management. If not, the received message is discarded.

**POIM-PA Reception Management:**

POIMs-PA are received by potential users of the Parking Availability Service. Received POIMs-PA are then analysed in terms of consistency, integrity, and plausibility to verify that the message cannot be at the origin of a cyberattack. After the POIM-PA checking operation, its relevance relative to the local ITS Application is checked to verify that the received message is of interest to it. If this is the case, the POIM-PA is transferred to the receiving ITS Application either directly or via the Local Dynamic Map (LDM). This interaction between the POIM-PA Reception Management and the ITS Application is left to the discretion of the ITS-S supplier implementation.

If a cyberattack risk is detected or if the message is not relevant, this one shall be discarded.

**POIM-PA Encoding:**

Before transmission, the POIM-PA shall be encoded in respect of the standard message structure, semantic and syntaxes. When the message is ready to be transmitted, the relevant transport port is selected according to the communication profile which is used. All data elements are gathered from an application database which contains a description of available parking main design features, services, and current states as well as a description of associated services and related POIs/mobility services.

**POIM-PA Transmission Management:**

The POIM-PA transmission is triggered by the service provider parking management application according to the selected communication profile which is available and the preferred communication mode.

The communication mode can be:

- The broadcast mode when the ITS-S type is a roadside unit station. The broadcast period is comprised between 1 to 10 seconds according to the used ITS channel occupation state (see clause 6.3).
- The unicast mode (push) when the ITS-S type is a central station.

## 5.5.2 Minimum Performance Requirements

The PAS provides real time information relatively to the availability of the main and related services proposed by a parking manager.

Then, the minimum performance requirements are related to the quality of the supplied information in terms of its reality, so avoiding false positive and false negative information as well as in terms of timeliness (end-to-end latency time) relatively to the user urgency needs to park.

As some provided information can be dynamically changing (e.g. during peak hours), the only way for the user to secure its needs is to reserve a parking service or set of services corresponding to it. This can only be done if the response provided by the service provider is short regarding the occurrence of the user need.

The End-to-End (E2E) latency time is relative to the communication mode which is used according to the selected communication profile. Table 3 provides the maximum E2E latency time requirements relatively to selected communication mode.

**Table 3: Maximum E2E latency time requirements relatively to selected communication mode**

Communication Mode	Transmission Triggering Conditions	Reception	Max E2E Maximum latency time	Comments
Continuous broadcast	Service provider application	All users present in the wireless ad-hoc local area network covered area	1 to 10 seconds according to information dynamic evolutions and network load	False positive and false negative are related to the selected time-period of broadcasting
Pushed unicast	Push unicast is triggered by the service provider when this one considers that the addressed user needs to receive updated parking availability information	The addressed user receives an unsolicited parking availability information which can be repeated according to parking load evolution	During peak hours, the maximum latency time between repeated unicast messages needs to be adjusted between 1 to 10 seconds	The latency time can be measured by comparing the message reception time value to the time stamp value provided in the POIM-PA
NOTE: During peak hours, it is then recommended to select the maximum time-period of 1 second excepted if the used channel is saturated.				

Maximum latency time value is related to the value of the time- period between consecutive messages. If the time-period is one second, the maximum latency time shall be less than one second. If the time-period is 10 seconds, the maximum latency time shall be less than ten seconds.

False positive and false negative information are likely during peak hours, especially if the time-period between two consecutive messages is 10 seconds and the latency time is also 10 seconds. This means that for 20 seconds, receiving vehicle(s) could not receive an updated information.

## 6 POIM-PA dissemination

### 6.1 Introduction

Parking Availability Messages (POIMs-PA) are composed of containers (mandatory and optional) which transport information (data elements) which are considered necessary for the receiving ITS-S to select an appropriate parking and act (e.g. reservation) to secure a parking space.

POIMs-PA transmission and reception are achieved according to available communication profiles and their selection of the local parking management application.

The transmission of a POIM-PA is under the control of the parking management application (Mobility support application) which triggers it after providing specified information which are required according to parking types.

POIMs-PA are securely transmitted in a predefined communication channel which is assigned according to the selected communication profile.

### 6.2 POIM-PA transmission method

The POIM-PA transmission method is depending on:

- The locally available communication profiles which are discovered by the communication management.
- The preferred communication profile(s) selected by the application. If several communication profiles are selected by the application a preference order can be provided.

Based on these two types of information, the PAS management selects one transmission method and initiates the POIM-PA transmission as soon as the POIM-PA is built from the encoding function.

The POIM-PA transmission is initiated after providing the transport port number corresponding to the communication profile which is selected.

## 6.3 Frequency/Periodicity range of POIM-PAs

The frequency/periodicity of the POIM-PA is only relevant for broadcast mode. It shall be programmed between a periodicity to 1 to 10 seconds (between 0,1 to 1 hertz of Frequency). Then  $T_{GenPoim-pa}$  is limited to  $T_{GenPoim-paMin} \leq T_{GenPam} \leq T_{GenPoim-paMax}$ . With:

$$T_{GenPoim-paMin} = 1 \text{ second and } T_{GenPoim-paMax} = 10 \text{ seconds.}$$

The periodicity can be adjusted according to the congestion level control received from the communication management plan.

When the unicast mode is used, the POIM-PA is addressed to one specified ITS-S. With the objective to ensure a good reception of the POIM-PA, several contiguous POIMs-PA can be sent to the addressed ITS-S. However, in such case, their time interval is left to the discretion of the implementation as depending on the dynamic evolution of the parking occupation.

## 6.4 Transmitting POIM-PAs

The POIM-PA is then transmitted by the Communication profile protocol stack which has been selected.

An ad-hoc local area network communication profile identifies automatically the ITS channel to be used according to the selected technology (ITS-G5, LTE-V2X) and the type of service requesting the transmission (e.g. mobility service). Of course, the channel selection can be modified under control of the multi-channel operation (if available) considered here below.

A long range (cellular) communication profile is conditioned by the local availability of the service provided by the telecom operator under contract. If the service is locally available, this one will be automatically discovered and then the POIM-PA can be transmitted in the frequency band assigned to the contracted telecom operator for the available cellular generation (e.g. 4G or 5G).

## 6.5 Triggering conditions

The POIM-PA transmission is triggered by the Parking Management Application according to the communication profile and its communication mode capabilities which have been selected.

## 6.6 Multi-Channel Operation (MCO), congestion control and service announcement

### 6.6.1 Introduction

Multi-Channel Operation (MCO) is a cross-layer functionality that enables the use of multiple radio channels in Cooperative Intelligent Transport Systems (C-ITS). The Facilities layer functionalities and its interface are specified in ETSI TS 103 141 [2].

MCO service needs to exchange information with the ITS application and other ITS-S functional layers. Exchanged information are related to:

- The standard access technologies which are locally available.
- The ITS application requirements (in the present document, the mobility application requirements).
- The monitoring of the channel load and then the possibility of changing the ITS channel in case of congestion.
- The necessity for ITS Stations to know in real time the ITS channel which is used for a given ITS application and its known limitations.



POI Availability service supports the POI management mobile application by providing real time information to ITS users during their mobility. But the users are facing many types of POIs which can be of interest to them. So, the question is whether it is possible to assign one or several ITS channel(s) (one per retained access technology) to mobile applications including POIs management.

The monitoring of the assigned channel(s), signalling a congestion detection may require proposing a new ITS channels sharing strategy (e.g. using another channel to transfer POIM-PA in case of congestion of the assigned channel). In such case, the new channel which can be used should be identified and the transfer organized properly to maintain the interoperability of cooperative ITS-S. The service announcement can be used for this purpose.

Generally, the service announcement is used to inform ITS-S about ITS channels which are used by applications and then their supporting services. As it is assumed that the CCH (Control Channel) used for road safety applications is always available, the service announcement should preferably use this channel. However, if POIs are managed one by one, this could create the risk of overloading the CCH with many service announcements and then reducing drastically the available bandwidth remaining for road safety applications. Consequently, the mobility services announcements require a global strategy not specific to a particular POI.

The ITS application is informed by the MCO of the resources' limits (maximum number of resources in kilobits per second that can be consumed at the facility layer by the FCP in each of the channels indicated in the channel list).

The ITS application is then required to adjust the size of the transmitted POIM-PA to respect the access layer resources limits taking into account the overhead added by the communication and security protocols.

## 6.6.2 Interface to MCO\_FAC

If the ITS-S supports MCO, the PAS shall exchange information with the MCO\_FAC via the interface IF.MCO specified in ETSI TS 103 141 [2] which is a facility layer function accessible via IF.OFa interface (see Figure 6). This interface can be used to configure the default MCO settings for generated POIM-PAs and can also be used to configure the MCO parameters on a per message basis.

If the ITS-S supports MCO, the PAS shall provide the POIM-PA embedded in a Facility-Layer Service Data Unit (FL-SDU) together with protocol control information (PCI) to the MCO\_FAC. In addition, it can also provide MCO Control Information (MCI) following ETSI TS 103 141 [2] to configure the MCO parameters of the POIM-PA being provided. At the receiving ITS-S, the MCO\_FAC shall pass the received POIM-PA to the PAS.

The data set that is passed between the PAS and the MCO\_FAC for the originating and receiving ITS-S is specified in Table 4.

**Table 4: Data exchanged between the PAS and the MCO\_FAC**

Category	Data	Data requirement	Mandatory/Conditional /Optional
Data passed from the PAS to the MCO_FAC	POIM-PA	(poim-pa) as specified in clause A.3.	Mandatory
	PCI	Depending on the protocol stack applied in the networking and transport layers as specified in Table 5.	Mandatory
	MCI	MCO parameters configuration. Needed if the default MCO parameters have not been configured or want to be overwritten for a specific POIM-PA.	Conditional
Data passed from the MCO_FAC to the PAS	Received POIM-PA	(poim-pa) as specified in clause A.3.	Mandatory

If the GeoNetworking/BTP stack is used and the GeoNetworking is used as the network layer protocol, the PCI being passed from the PAS to the GeoNetworking/BTP stack shall comply with Table 5.

Table 5: PCI from PAS to GeoNetworking/BTP at the originating ITS-S

Category	Data	Data requirement	Mandatory/Conditional/Optional
Data passed from the PAS to GeoNetworking/BTP	BTP type	BTP header type B ETSI TS 103 836-5-1 [3], clause 7.2.2	Conditional. The data shall be passed if the value is not provided by the ITS-S configuration, e.g. defined in a Management Information Base (MIB) or if the value is different from the default value as set in the MIB.
	Destination port	As specified in ETSI TS 103 836-5-1 [3]	Conditional. The data shall be passed if the value is not provided by the ITS-S configuration, e.g. defined in a Management Information Base (MIB) or if the value is different from the default value as set in the MIB.
	Destination port info	As specified in ETSI TS 103 836-5-1 [3]	Conditional. The data shall be passed if the value is not provided by the ITS-S configuration, e.g. defined in a Management Information Base (MIB) or if the value is different from the default value as set in the MIB.
	GN Packet transport type	GeoNetworking SHB	Conditional. The data shall be passed if the value is not provided by the ITS-S configuration, e.g. defined in a Management Information Base (MIB) or if the value is different from the default value as set in the MIB.
	GN Communication profile	Unspecified, ITS-G5 or LTE-V2X	Conditional The data shall be passed if the value is not provided by the ITS-S configuration, e.g. defined in a Management Information Base (MIB) or if the value is different from the default value as set in the MIB.
	GN Security profile	SECURED or UNSECURED	Conditional. The data shall be passed if the value is not provided by the ITS-S configuration, e.g. defined in a Management Information Base (MIB) or if the value is different from the default value as set in the MIB.
	GN Traffic Class	As defined in ETSI TS 103 836-4-1 [4].	Mandatory.
	GN Maximum packet lifetime	It shall not exceed 1 000 ms	Mandatory.
	Length	Length of the POIM-PA	Mandatory.

## 6.7 Security constraints

### 6.7.1 Introduction

If an ITS station uses the trust model according to ETSI TS 102 940 [7] and ITS certificates according to ETSI TS 103 097 [5], clause 6.7.2 shall apply.

For other scenarios, the trust model, and the mechanism for trust enforcement for inter-connected ITS stations can be agreed among participating actors.

### 6.7.2 Service Specific Permission (SSP)

POIM-PAs shall be signed using private keys associated to Authorization Tickets that contain SSPs of type BitmapSsp as specified in ETSI TS 103 097 [5].

The SSP for the POIM-PA shall be of CHOICE BitmapSsp. It is defined by a variable number of octets and shall correspond to the octet scheme illustrated in Figure 7. This octet scheme allows SSP format to accommodate current and future versions of the present document.

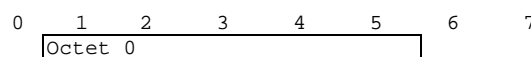

**Figure 7: Format for SSP Octet Scheme (BitmapSsp)**

The SSP has a maximum length as specified in ETSI TS 103 097 [5]. The first octet shall reflect the version of the SSP (see Table 6). In the current version of the present document, the SSP field contains only the SSP version byte.

**Table 6: Octet Scheme for POIM-PA SSPs**

Octet #	Description	Value
0	SSP version control	1

### 6.7.3 General priority constraints

If the GeoNetworking/BTP stack is used, the priority constraint shall be as given by the Traffic Class as specified in ETSI TS 103 836-4-1 [4].

---

## 7 POIM-PA Format Specification

### 7.1 Introduction

POI Messages for Parking Availability (POIMs-PA) belong to the POIM class and as such shall respect the POIM PDU generic structure which is described in clause A.1 of the present document.

A POIM-PA is composed of containers (mandatory and optional) which transport information (data elements) being considered necessary for the receiving ITS-S to select an appropriate parking and act (e.g. reservation) to secure a parking space.

POIMs-PA transmission and reception are achieved according to available communication profiles and the selection of the local parking management application.

The transmission of POIMs-PA is under the control of the parking management application (Mobility support application) which triggers them after providing specified information which are required according to parking types.

POIMs-PA are securely transmitted in a predefined communication channel which is assigned according to the selected communication profile.

### 7.2 General Structure of a POIM-PA PDU

The general structure of the POIM-PA PDU is provided in Figure 8. The PAS is a POI which starts with the POIM PDU header and is composed of several mandatory and optional containers.

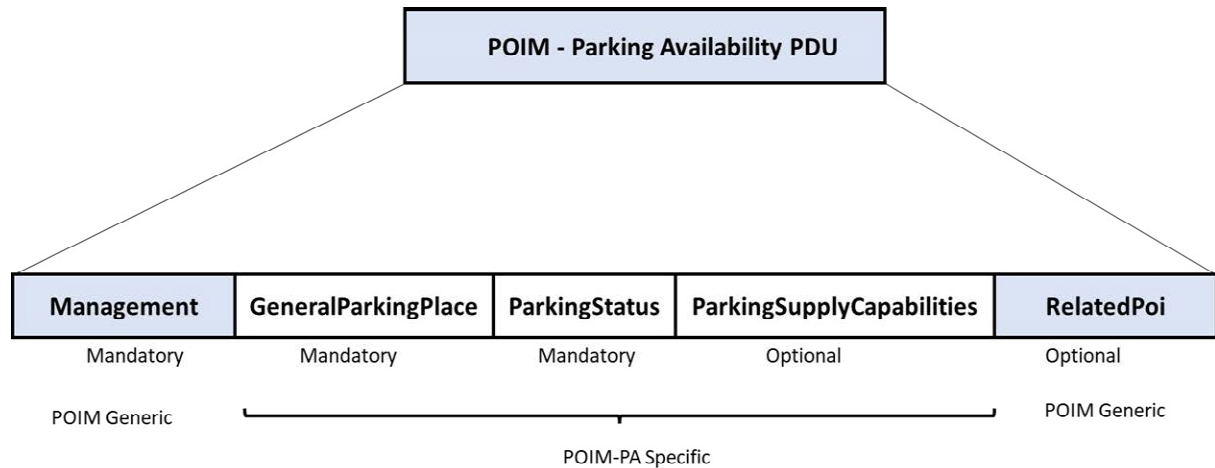

**Figure 8: General structure of the POIM-PA PDU**

The **Management** container is a generic POIM container is a mandatory container and contains data elements which are specified in clause 7.5.1.

The **GeneralParkingPlace** container is a mandatory container and contains general information about the parking place which are specified in clause 7.5.2.

The **ParkingStatus** is mandatory and contains an aggregated status of the parking place which is specified in clause 7.5.3.

The **ParkingSupplyCapabilities** is optional and contains a detailed status of available parking supply capabilities which are specified in clause 7.5.4.

The **RelatedPOI** is optional and contains one or several related POI(s) links enabling the access to these related POI(s) if judged necessary by the service user. Related POI data elements are specified in clause 7.5.5.

NOTE: The specification of protocol and message for accessing a related POI are out of the scope of the present document.

## 7.3 ITS PDU header

The ITS PDU header is a common POIM header that includes the information of the protocol version (1 for this initial version), the message type (3 for POIs) and the ITS-S ID of the originating ITS-S.

This container is part of the POIM PDU Information Block and the ASN.1 coding of the ITS PDU header is provided in annex A of the present document.

## 7.4 POIM PDU payload

The POIM PDU payload is constituted of POI Information Blocks which are imported from the CDD relatively to the considered POI type.

A list of wrapped POI information blocks, each with its type identifier is then provided. Each POI Information Block contains the block type and the block content.

The first POI information block provides the POI Type (value 1 for the parking availability). The POI content is then defined by the POI Type.

Then, a generic management container is added, and a generic Related POIs container can be optionally added.

For more details see clauses A.1 and A.2.

## 7.5 POIM-PA PDU Containers

### 7.5.1 Management container

This container is generic to all POI types and contains:

- The service provider Identifier.
- The block Identification number (Identifier 2B).
- The Timestamp (ITS timestamp).
- The linked Ivims (optional).
- The linked Mapems (optional).

The ASN.1 coding of the management information is provided in annex A.

### 7.5.2 GeneralParkingPlace container

The general parking place container contains the following information:

- The geographical position of the parking place (mandatory).
- The name of the parking place (mandatory).
- The opening periods (optional).
- The address of the parking place (optional).
- The phone number of the parking place (optional).
- The WEB Site link of the parking place (optional).

For more details see the clause A.3.

### 7.5.3 ParkingStatus container

This container provides aggregated dynamic information relatively to the status of the parking facility.

It includes the following information:

- Current status of the parking place:
  - This information contains DFs and DEs which provide the overall status of the parking place:
    - Parking place status (open or closed).
- Current occupancy of the entire parking place:
  - This optional information provides the current occupancy of the entire parking facility. This component is only representative if the entire facility has areas and spaces of the same type. e.g. personal car parking spaces:
    - Parking place overall occupancy (%), freeSpaces, totalSpaces.
    - Parking place status occupancy (%), freeSpaces, totalSpaces per grouping of:
      - Vehicle type, e.g. truck/Coach or passenger car or motorcycle.
      - Load type, e.g. dangerous goods.
      - Reservation type, e.g. electric charging.

- Fee type, e.g. hourly, or flat fee.
- Occupancy type, e.g. queue parking.

#### 7.5.4 ParkingSupplyCapabilities container

This container mainly focuses on parking spaces which enable the parking of one vehicle (in some cases multiple vehicles) and may provide supplementary facilities such as the location of equipment (e.g. the provisioning of electrical energy, security equipment, etc.) or services (e.g. access to disabled people, loading/off-loading goods, space reservation, etc.). Single parking space information (for reservation, Orientation, Boundary for automated driving function, Status (free, free until, occupied, occupied until, reserved until, etc.), occupancy rules (unlimited, limited, forced stay, forced departure)) can be included using one of the following options:

- freeSpacesPosition: the optional list of positions of free spaces.
- freeSpacesId: the optional list of Ids of free spaces.
- spacesBasic: the optional basic information about none, some, or all parking spaces within the area.
- spacesDetailed: the optional detailed information about none, some, or all parking spaces within the area.

Parking areas presenting the same parking space characteristics in terms of:

- Allowed Vehicle Categories: the categories of vehicles that are allowed in the parking area.
- Not Allowed Engine Characteristics: the optional characteristic(s) of engines that are not allowed in the parking area.
- Allowed Load Types: the optional load type(s) that are allowed in the parking area.
- Not allowed Load Types: the optional load type(s) that are not allowed in the parking area.
- Height Restriction: the optional applicable vehicle height restriction.
- Reservation Type: the optional parking reservation type(s) associated to the parking area.
- Pricing Information: the optional pricing information applicable to the parking area.
- Payment Information: the optional payment information applicable to the parking area.
- Booking Contact Information: the optional booking contact information applicable to the parking area.
- Access Characteristics: the optional access information to the area.

#### 7.5.5 RelatedPOIs container

This optional container is generic to all POI types and contains a list of RelatedPoiInfoBlock and represents a common container to refer to other POI Information Blocks. Each Related POI Information Block contains the following information:

- poiInfoBlockType: The type of Related POI Information Blocks.
- poiInfoBlockContent: provided by the service provider. Contained information shall enable the user to access to information of identified Related POIs via provided reference links (e.g. WEB site URL, Phone number).
- serviceProviderId: Identifier of the organization that provided the related POI Information Block.
- timestamp: Optional timestamp of the generation or last change of the related POI Information Block.

For more details see the clause A.2.

## 7.6 POIM-PA formatting and decoding

The POIM-PA format shall be as specified in clause A.3 of the present document.

DEs and DFs that are not defined in the present document shall be imported from the ETSI Common Data Dictionary ETSI TS 102 894-2 [1] as specified in annex A.

Unaligned Packet Encoding Rules (PER) as defined in Recommendation ITU-T X.691/ISO/IEC 8825-2 [6] shall be used from POIM-PA encoding and decoding.

---

# 8 Protocol operation of the PAS

## 8.1 Introduction

The PAS is under the control of one Parking Management application which is distributed in an originating ITS-S and in a receiving ITS-S.

Several operation protocols are available according to the communication profile being used at the level of ITS-Ss:

- Continuous broadcast of POIMs-PA which is available at the level of ITS-S having this broadcasting capability (e.g. Roadside Equipment).
- Pushed unicast of POIMs-PA which is available at the level of ITS-S mainly using the unicast mode (e.g. central systems). Such protocol operation is based on a contractual service which specify the triggering conditions for the central system to provide the PAS.

## 8.2 Originating ITS-S operation

### 8.2.1 Protocol data setting rules

At the originating ITS-S level, the communication protocol and its associated data are selected at ITS-S initialization time (switching-on) and may be adjusted according to the local availability evolutions of the ITS-S communication capabilities.

When several communication capabilities (e.g. communication profiles) are simultaneously available at the level of ITS-S, the Parking Management Application choses the communication profile(s) which shall be used.

If several communication profiles are accepted, a priority order may be communicated.

The network management plan may dynamically update the selected communication profile according to the availability of local communication capabilities of the ITS-S (and in some cases according to the congestion level of the used channel(s)), trying always to respect as much as possible the initial choices provided by the Parking Management Application.

### 8.2.2 Protocol data

Relevant protocol data are provided at initialization time and before a change of communication profile.

If a change of communication profile involves a change in the security profile or/and in the application profile, the security protocol data or/and application protocol data need also to be adjusted.

General protocol data to be set are provided in communication and security technical specifications in relation to available standard technologies (ad-hoc local area network, and cellular).

Protocol data which are specific to this PAS are:

- Selected Communication profile(s):
  - The network management plan is constantly monitoring the state of locally available network communication capabilities. Based on the result of this monitoring process, the parking management application may select the communication profile(s) to be used to provide parking availability information. If several communication profiles are simultaneously available and chosen by the application, a preference order shall be provided by the application.
- Selected Operation Protocol:
  - According to the communication profile being used, several communication protocols can be available. Then, the parking management application may select the one which seems to be the more appropriate to it.
- Continuous Broadcasting of PAMs:
  - Continuous broadcasting of POIMs-PA can be selected by the parking management application and consists of continuously broadcasting POIMs-PA at a predefined frequency in the range of 1 to 0.1 hertz (periodicity between 1 to 10 seconds).
- Addressing PAM (push mode):
  - For ITS-S only equipped with unicast communication, the push mode consists for the parking management application located at the level of a central ITS-S to push POIMs-PA to customer vehicles requiring information about parking availability. The information is then pushed to customers according to decision criteria under the responsibility of the parking management application.

### 8.2.3 General protocol operation

Figure 9 provides an overview of the communication protocol operation at the level of an originating ITS-S.

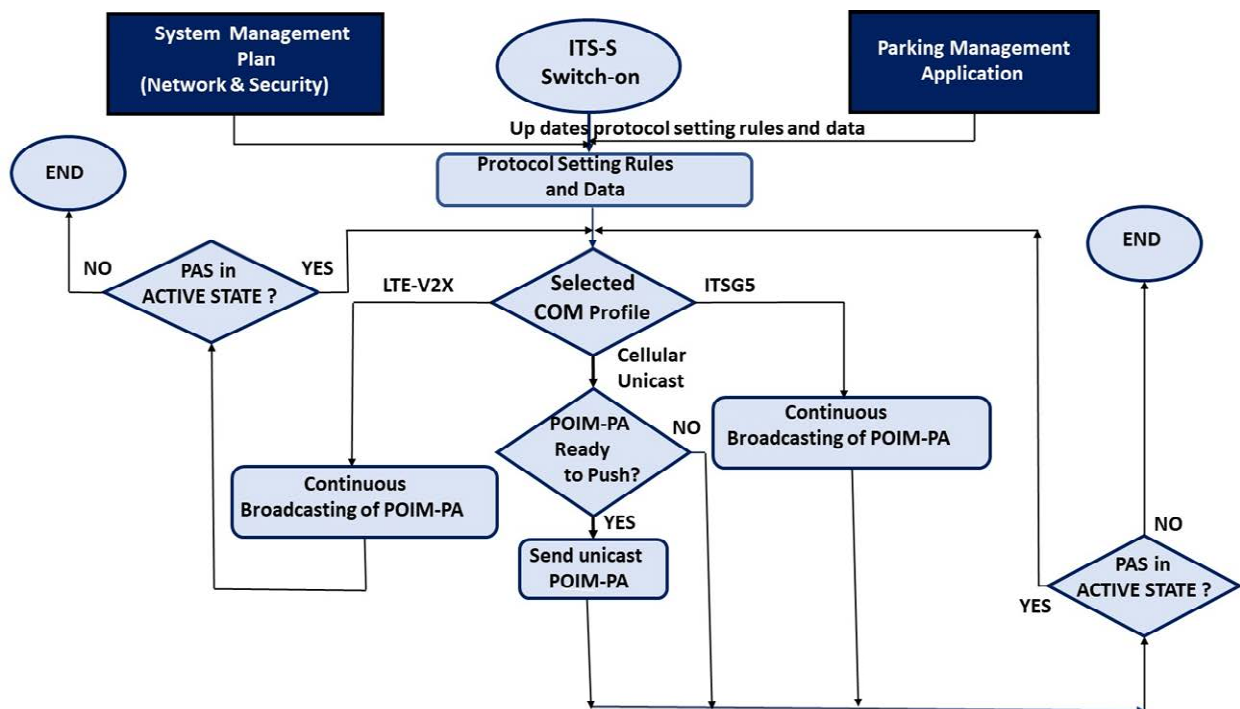

Figure 9: General protocol operation at level of the Originating ITS-S



## 8.3 Receiving ITS-S operation

### 8.3.1 Protocol data setting rules

At the receiving ITS-S level, the communication protocol and its associated data are selected at ITS-S initialization time (switching-on) and may be adjusted according to the local availability evolutions of the ITS-S communication capabilities.

ITS-S receive POIMs-PA which are broadcasted or addressed to it.

Upon reception of POIMs-PA, the ITS-S shall check the consistency, integrity of received messages. They may also check the plausibility of received data elements and then the relevance of received messages relatively to their parking needs.

### 8.3.2 General protocol operation

Figure 10 provides an overview of the communication protocol operation at the level of a receiving ITS-S.

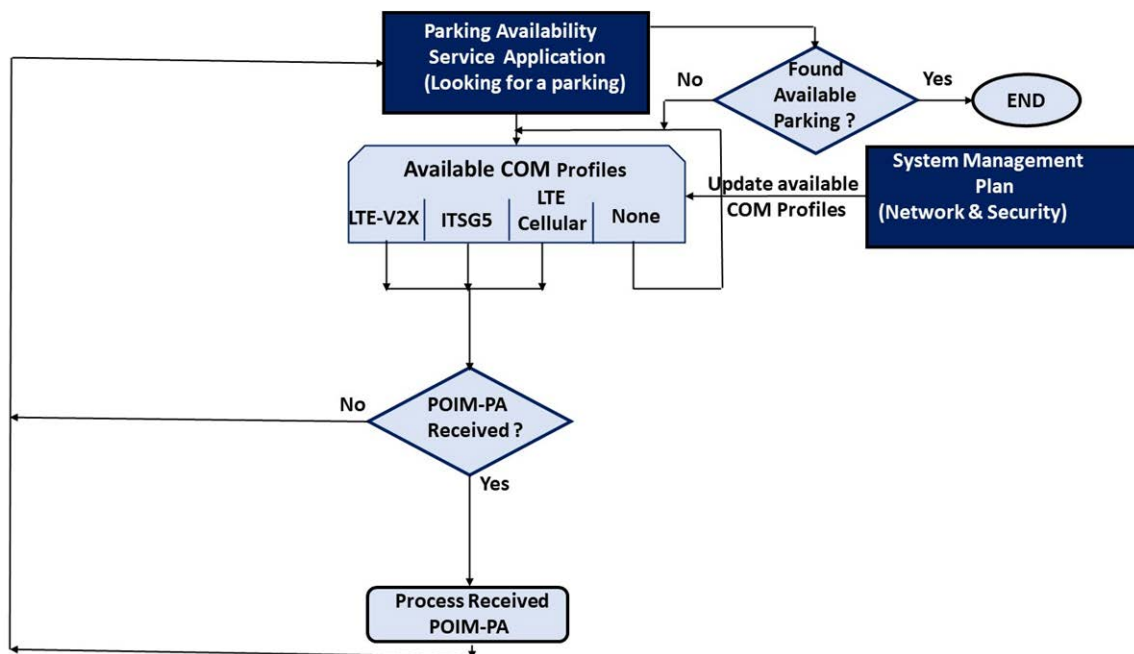

Figure 10: General protocol operation at the level of a receiving ITS-S

### 8.3.3 Exceptions handling

Exceptions can be originating from the communication system or the security system. Other parts of the ITS may also lead to some exceptions if defectives.

#### Communication exceptions:

Communication with the Parking Management Application requires the presence at the level of the receiving ITS-S of at least one relevant standard communication network (local ad-hoc network or global network via cellular). If this is not the case, the receiving ITS-S will not have the capability to receive POIMs-PA. In such case, a watchdog timer can be initiated when waiting for the detection of the local presence of a relevant network. Hence if the time elapses, a network defect information can be sent to the Parking Availability Service Application which may act accordingly.

### Security exceptions:

During the received POIM-PA processing, the facilities layer may detect a cyberattack or misbehaviour of a remote system. In such case, the received message shall be immediately destructed, optionally after being communicated to a relevant security system for analyses. The originating system identity of the cyberattack/misbehaviour shall be signalled to relevant security authorities.

## 8.4 PAS protocol flowcharts

The PAS flow chart is represented in Figure 11.

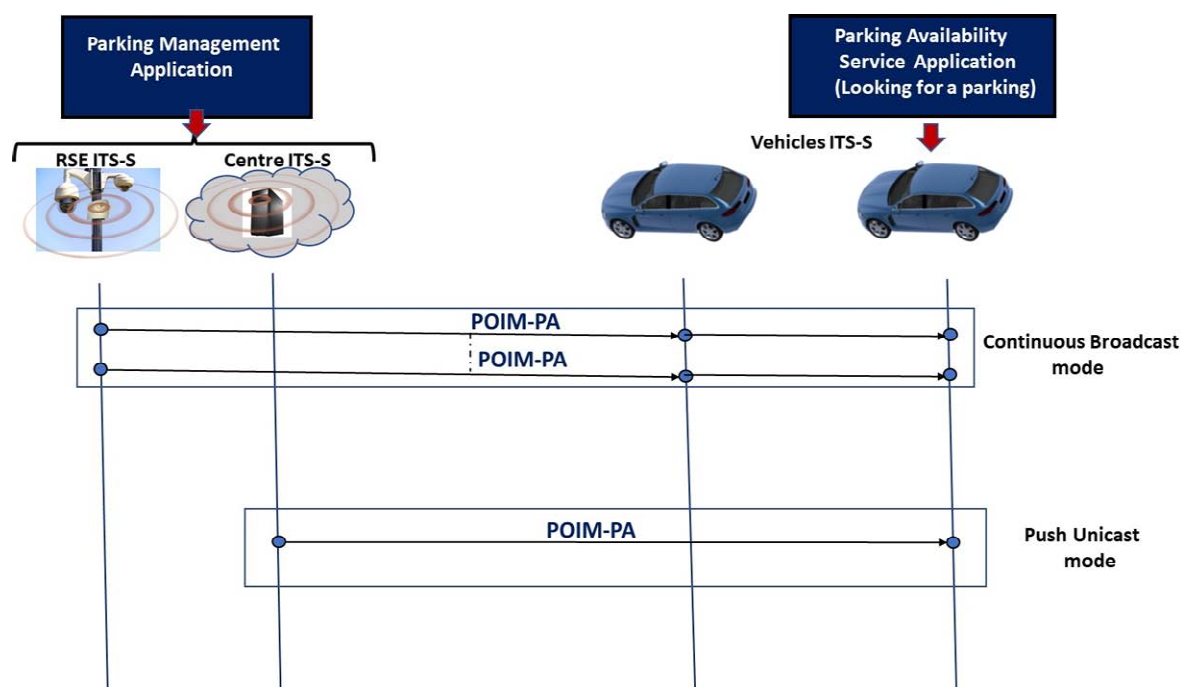

Figure 11: PAS flow chart overview

The 2 communication modes are considered:

- **Continuous Broadcast:**
  - In this communication mode a broadcasting ITS-S (e.g. a RoadSide Equipment (RSE)) is continuously broadcasting POIMs-PA at a predefined frequency. Vehicles ITS-Ss being in the communication range of the RSE receive POIMs-PA and may process them if needed. Results are passed to the local application for use.
- **Push Unicast:**
  - In this communication mode, a centre operating a parking management application monitors the evolution of customers connected cooperative vehicles and may decide to address POIMs-PA to vehicles which are supposed to have a need to park. Algorithm and criteria used by the central application to decide addressing a POIM-PA to a given vehicle is fully under the responsibility of the parking management authority.

# Annex A (normative): Generic POIM Concept and ASN.1 modules

## A.1 Structure of a POIM PDU

### A.1.1 Overview

A POIM is a PDU composed of one common ITS PDU header and multiple POIM Blocks, which together constitute the POIM-PA payload. Each POI Information Block can be generated and processed independently from the other, whilst linkage between the POI Information Blocks is possible.

The general structure of a POIM is illustrated in Figure A.1.

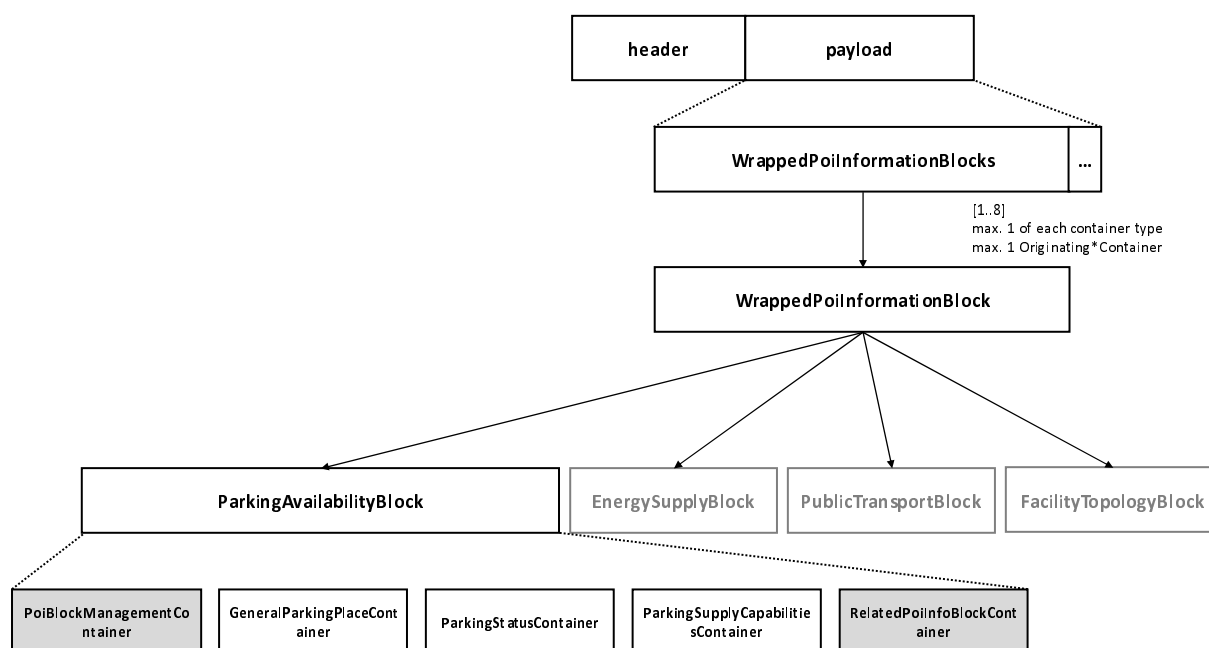

**Figure A.1: General Structure of a POIM**

The component *header* is a common header for facility layer PDUs.

The component *payload* represents the POIM payload and consists of a list of POI Information Blocks wrapped in a structure called *WrappedPoiInformationBlocks* that includes the type identifier of the Information Blocks and the Information Block itself.

POI Information Blocks can be defined for Point-of-Interest specific aspects, i.e. aspects related to a specific location that are useful or interesting such as: parking availability, energy supply, public transport, etc.

Each POI Information Block shall consist of:

- A POI Block Management Container which has the same format for all POI Information Blocks.
- One or more Information Block specific containers.
- An optional Related POI Info Block Container which has the same format for all POI Information Blocks.

Each container is composed of a sequence of components, their component type being either a Data Element (DE) or a Data Frame (DF). A component is either optional or mandatory in the POIM Format. If not specified as optional in the ASN.1 specification of the present document, a component is considered as mandatory.

## A.1.2 POI Block Management Container

The POI Block Management Container provides basic information which is necessary to process the other information in the POI Information Block.

The POI Block Management Container shall contain the following components:

- 1) *serviceProviderId* to uniquely identify the POI information issuer.
- 2) *blockIdentificationNumber* to uniquely identify the POI Information Block.
- 3) *timestamp* to identify the time at which the POI Block was generated.

The POI Block Management Container may contain the components *linkedIvims* or *linkedMapems* to link the POI Information Block with IVIMs and/or MAPEMs.

## A.1.3 Related POI Info Block Container

The Related POI Info Block Container provides information related to the POI Information Block which is contained in other Information Blocks. The Related POI Info Block Container shall contain a list of DF *RelatedPoiInfoBlock* pointing to other Information Blocks as applicable.

*RelatedPoiInfoBlock* shall contain the components *RelatedPoiInfoBlock*, *serviceProviderId* *blockIdentificationNumber*.

*RelatedPoiInfoBlock* may contain the component *timestamp* of the related Related Poi Info Block to refer to one specific update of the block.

## A.1.4 POIM-PA

In the present document the POIM is instantiated as a POIM for Parking Availability, abbreviated as POIM-ParkingAvailability or POIM-PA.

A POIM-PA shall contain the *ParkingAvailabilityBlock* and may contain other blocks that will be defined in later versions of the present document.

---

## A.2 POIM - ASN.1 modules

This clause provides the normative ASN.1 modules (see Recommendation ITU-T X.691/ISO/IEC 8825-2 [6]) containing the syntactical specification of the POIM PDU. Its containers, the data frames and data elements are defined in the present document.

The semantical specification of the POIM components, its containers, the data frames, and the data elements are contained in the same modules, in the form of ASN.1 comments. For readability, the same semantical specifications are presented in a different format in annex B.

The POIM-PDU-Description module is identified by the Object Identifier {itu-t (0) identified-organization (4) etsi (0) itsDomain (5) wg1 (1) poi(103916) poim(0) major-version-1 (1) minor-version-1 (1)}. The module can be downloaded as a file as indicated in Table A.1. The associated SHA-256 cryptographic hash digest of the referenced file offers a mean to verify the integrity of that file.

**Table A.1: POIM PDU Description ASN.1 module information**

Module Name	POIM-PDU-Descriptions
OID	{itu-t (0) identified-organization (4) etsi (0) itsDomain (5) wg1 (1) poi (103916) poim (0) major-version-1 (1) minor-version-1 (1)}
Link	<a href="https://forge.etsi.org/rep/ITS/asn1/poim_ts103916/-/raw/v2.1.1/POIM-PDU-Description.asn">https://forge.etsi.org/rep/ITS/asn1/poim_ts103916/-/raw/v2.1.1/POIM-PDU-Description.asn</a>
SHA-256 hash	e7ba7a1a7c4c95be51902a1485c2f45136435eafb66eaa1be14e58f2bcc99e3e

The POIM-CommonContainers module is identified by the Object Identifier {itu-t (0) identified-organization (4) etsi (0) itsDomain (5) wg1 (1) poi(103916) common(99) major-version-1 (1) minor-version-1 (1)}. The module can be downloaded as a file as indicated in Table A.2. The associated SHA-256 cryptographic hash digest of the referenced file offers a means to verify the integrity of that file.

**Table A.2: POIM CommonContainers ASN.1 module information**

Module Name	POIM-CommonContainers
OID	{itu-t (0) identified-organization (4) etsi (0) itsDomain (5) wg1 (1) poi (103916) common (99) major-version-1 (1) minor-version-1 (1)}
Link	<a href="https://forge.etsi.org/rep/ITS/asn1/poim_ts103916/-/raw/v2.1.1/POIM-CommonContainers.asn">https://forge.etsi.org/rep/ITS/asn1/poim_ts103916/-/raw/v2.1.1/POIM-CommonContainers.asn</a>
SHA-256 hash	d1d6a1257d13348de89b79c205d11048280ba8037c33df834648e6d1d95055c0

## A.3 POIM-PA ASN.1 module

This clause provides the normative ASN.1 modules (see Recommendation ITU-T X.691/ISO/IEC 8825-2 [6]) containing the syntactical specification of the *ParkingAvailabilityBlock*, its containers, data frames, and data elements defined in the present document. This module, together with modules specified in clause A.2 provides the POIM-PA specification.

The semantical specification of the *ParkingAvailabilityBlock* components, its containers, the data frames, and the data elements are contained in the same module, in the form of ASN.1 comments. For readability, the same semantical specification is presented in a different format in annex B.

The POIM-ParkingAvailability module is identified by the Object Identifier {itu-t (0) identified-organization (4) etsi (0) itsDomain (5) wg1 (1) poi(103916) parkingAvailability(1) major-version-1 (1) minor-version-1 (1)}. The module can be downloaded as a file as indicated in Table A.3. The associated SHA-256 cryptographic hash digest of the referenced file offers a mean to verify the integrity of that file.

**Table A.3: POIM ParkingAvailability ASN.1 module information**

Module Name	POIM-PDU-Descriptions
OID	{itu-t (0) identified-organization (4) etsi (0) itsDomain (5) wg1 (1) poi (103916) parkingAvailability (1) major-version-1 (1) minor-version-1 (1)}
Link	<a href="https://forge.etsi.org/rep/ITS/asn1/pa_ts103916/-/raw/v2.1.1/POIM-ParkingAvailability.asn">https://forge.etsi.org/rep/ITS/asn1/pa_ts103916/-/raw/v2.1.1/POIM-ParkingAvailability.asn</a>
SHA-256 hash	dd05938e201c7f10a3aaf2021f4983e5d481e0401d413b62203a253db97e6966

---

## Annex B (informative): Specification of POIM and POIM-PA in readable format

The specification of POIM, POIM-PA and their components is available at the following URLs:

- [https://forge.etsi.org/rep/ITS/asn1/poim\\_ts103916/-/tree/v2.1.1/docs](https://forge.etsi.org/rep/ITS/asn1/poim_ts103916/-/tree/v2.1.1/docs)

---

## Annex C (informative): Examples of PAS Parking place profiling

### C.1 Introduction

POIs profiling corresponds to the description of POIs use cases which may require new mandatory or optional information. The related specification will therefore need to be updated accordingly. Clauses below present some possible parking related use cases/parking profiles (list not exhaustive).

Some parking profiles are well covered by this specification while some others need an update of the present document to fully satisfy their functional requirements.

Clauses C.2 and C.3 profiles are covered by the present document, clause C.4 profile can be partially covered but requires limiting the message size according to link layer constraints. Clauses C.6 and C.7 profiles are partially covered but may require in the future the addition of security and safety containers.

---

### C.2 Passengers cars and small utility vehicles parking place available at no cost

This parking availability profile focuses on the parking of passengers' cars and small utility vehicles at no parking cost.

However, parking spaces may offer facilities or services which may be optionally paying. Parking space reservation is not possible, and the parking occupancy rules can be variable.

---

### C.3 Passengers cars and small utility vehicles paid parking place

This parking availability profile focuses on the parking of passengers' cars and small utility vehicles which require the payment of a parking fee. A parking space can be reserved and in such case a pre-payment can be required to secure the reservation. Other facilities and services can be added (at no cost or to be paid).

---

### C.4 Individually targeted parking spaces

Parking spaces are managed individually to satisfy users' needs (nearest a loading/off-loading position, reducing the itinerary or using a relevant itinerary for disabled people, reducing the transition time in case of multimodal transportation, etc.).

In case of a large parking place, providing all individual (single) parking spaces characteristics would lead to very big POIMs-PA exceeding the communication capacity of the MAC layer of ad-hoc local networks and then requiring a fragmentation and re-construction of big messages at the level of the parking management application. Moreover, such approach would unnecessarily overload the assigned communication channel.

Consequently, to avoid the dissemination of big POIMs-PA which would be unnecessarily consuming the available ITS bandwidth and then lead to the assigned channel saturation, it seems necessary to develop a solution which only enables the dissemination of information which are useful to users.

One solution is the collection of users' needs via POI Request Messages clearly identifying which is the targeted individual parking spaces which would be satisfying a given user' need.

This solution and associated use cases are discussed in clause D.3 of the present document.

---

## C.5 Park & Ride facility

Park & Ride facility is a parking profile which combines two types of POI places:

- a Parking POI place; and
- a Transport POI place.

The Transport POI place can be either considered as nested (integrated) in the POI place or as being a Related Parking place (independent of the Transport place).

One user objective is to reduce as much as possible the transition time between the parking place and the relevant transportation platform where its transportation mean is waiting before departure or arrival.

In large transportation places such as an international airport or a central train station, many parking places can be available. This is typically one situation which would greatly benefit from the POIM-PA Request indicating the targeted transport platform interesting the user. In such case, the parking management application may propose available parking spaces which would drastically reduce the transition time between the parking place and the targeted transportation relevant platform while optimizing the size of the POIM-PA.

This parking profile needs more study, in particular regarding the transition mode (walking, using a shuttle, etc.) between the parking place and the transportation place when both are not integrated.

---

## C.6 Lorries/Trucks and Coaches parking place

Coaches which are used to transport groups of passengers for long distance travels will need to stop periodically for the comfort of passengers and the security of the drivers. Safety and security are of high importance during these stops and related POIs (toilets, snacks, cafeteria, etc.) are often requested by users.

Lorries and trucks have also particular requirements in terms of security and safety . This is the case, for the transported goods (dangerous or expensive).

Such parking profile needs more study to identify the relevant security/safety information to be provided as well as the relevant related POIs.

---

## C.7 Queue trucks parking place dynamic management

Trucks can be parked according to dynamic management process. Queue parking place is an example which can be encountered on highway (see Figure C.1).



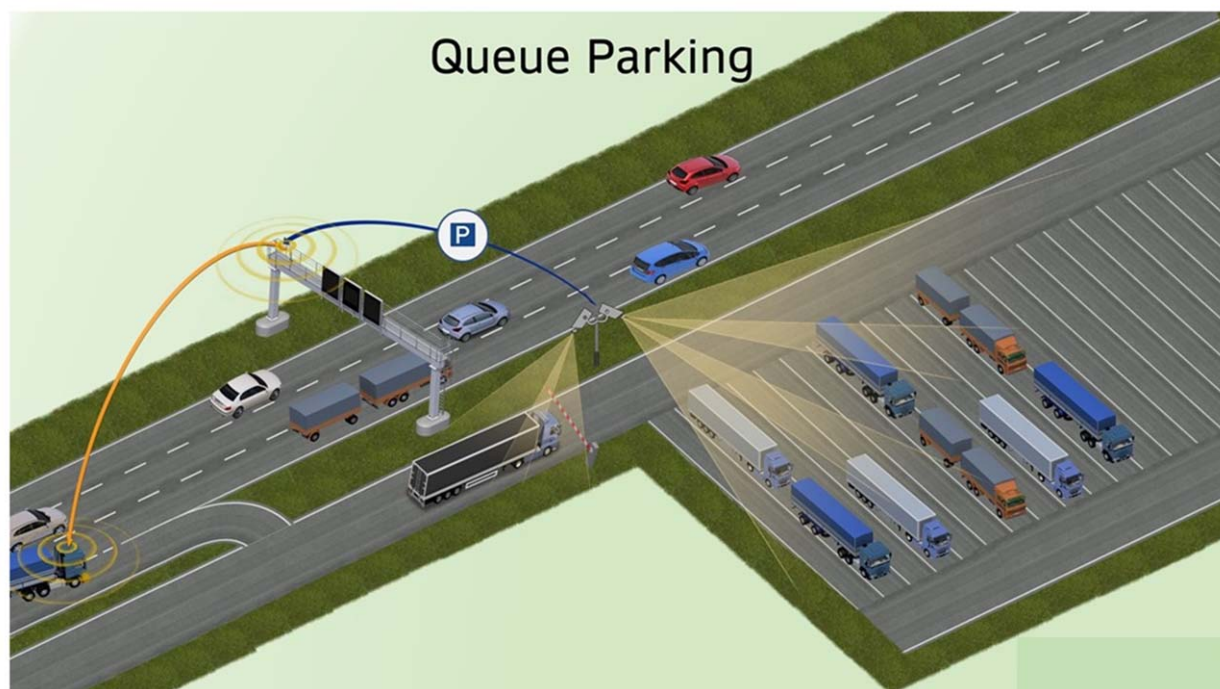

**Figure C.1: Queue parking dynamic management**

In this dynamic management process, trucks are parking in queues, one after the other. Each truck will need to have an earlier time of departure that all the trucks behind it.

## C.8 Limited time parking place

Parking profiles having strict occupation rules which limit the parking time or the parking period.

Some examples of occupation rules are:

- Available only during a predefined period.
- Car sharing, limited to the collection or release of passengers.
- Delivery, limited to the pick-up or delivery of goods.
- Valet Parking Drop-Off and Pick-Up, limited to the transition between the vehicle control and the valet parking.
- Quick drop, limited to a quick drop of passengers.
- Event, parking authorized only during a programmed event.
- Prohibited/permitted only at particular time.
- Seasonable Heterogeneous, depending on seasons.
- Only on Request.
- Etc.

Not respecting the rules may lead to a punishment under the form of a fine or the removal of the vehicle.

This parking profile requires some further studies.

## Annex D (informative): Pre-Standardization Studies

### D.1 Introduction

This pre-standardization studies annex provides initial pre-study results relative to subjects which are not mature enough to be integrated in the present document.

### D.2 PAS link with the Valet Parking Service

Valet Parking is a well-known service which is associated with vehicle parking.

During the parking process, this is a key activity when accessing and leaving the parking because a vehicle is then given to a human or an information system to transfer the vehicle between two or more positions in the parking. This will need to be securely achieved with a high level of confidence and in full safety relatively to other users of the parking.

A Valet parking related service container can be optionally integrated into the POIM-PA as shown in Figure D.1.

Valet Parking is a service for parking a subject vehicle in an assigned parking space. However, before parking the subject vehicle, the Valet Parking can be requested to enable other user services being proposed at the parking identified area level (e.g. car washing, energy supply, tyres check-up and refilling, etc.). This means that the Valet Parking may have to follow a planned itinerary passing by the POIs offering the requested services (washing station, energy supply station, tyres check-up and refilling station, etc.).

This sequence of Valet Parking operations is under the responsibility of the parking management system based on the selected related services requested by the user.

**NOTE:** Parking space type for valet parking may be strictly limited to the maximum authorized dimensions of the parked vehicles. In case of Electrical Vehicles, the electrical charging can be achieved by inductive means under the parked vehicle.

As for the vehicle parking, Valet parking can be used to retrieve the parked vehicle and drive it to a pick-up parking space where the vehicle can be given back to its owner.

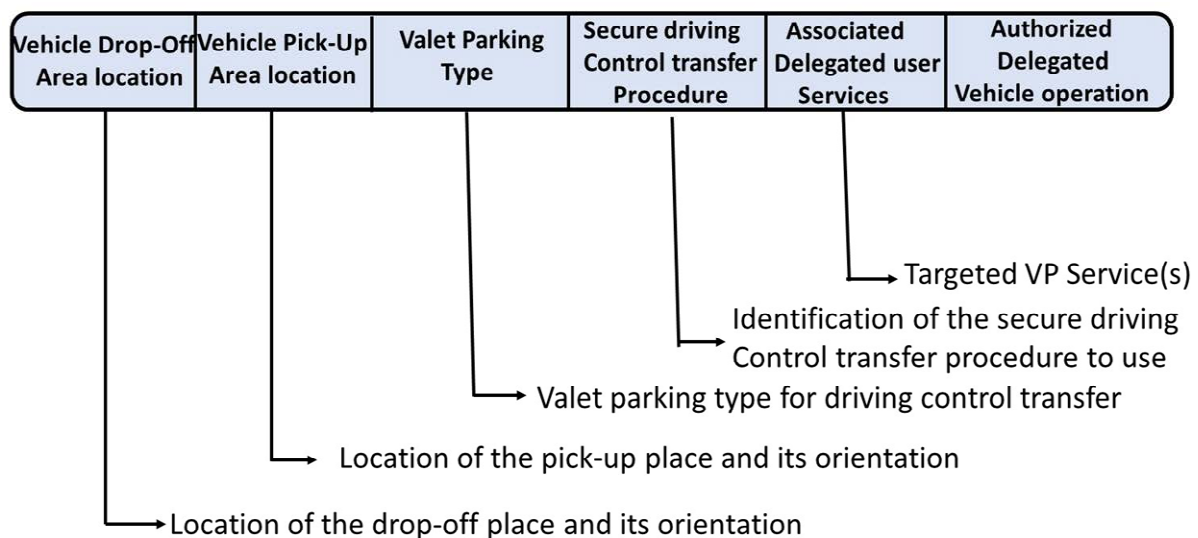

**Figure D.1: Proposed structure and content of the valet parking associated user service container in POIM**

The data elements contained in this container are strongly influenced by the type of valet parking and the driving mode of the vehicle when accessing or leaving the parking.

Several categories of Valet Parking can be identified:

- **Human Valet Parking:** The vehicle is controlled by a human driver which take it from the drop-off area when accessing the parking and drive it to the pick-up area upon request of its owner. In this case, the transition procedure is proprietary to the parking management.
- **Robotized Valet Parking:** In this case, the vehicle is up-loaded on a specialized vehicle from the drop-off area and transported to an assigned parking space. Then the opposite manoeuvre of transporting the vehicle from the assigned parking space to a pick-up area is achieved upon request of the owner when retrieving its vehicle.
- **ISO 23374-1 AVPS Type1 [i.5]:** After a secured vehicle driving transfer to the parking management system, the subject vehicle system carries out most of the operation functions. Only portions of the destination assignment function are allocated to the parking management system. However, the subject vehicle needs the parking management system support to discover its itinerary to reach its destination (i.e. Parking digital map) and security/traffic rules to respect in the parking area.
- **ISO 23374-1 AVPS Type 2 [i.5]:** The parking management system carries out most of the operation functions (tele-operation of the subject vehicle). This is achieved after a secured vehicle driving transfer to the parking management system and remains until a secure vehicle driving transfer to the user (human driver or automated vehicle driving) is achieved.
- **ISO 23374-1 AVPS Type 3 [i.5]:** The functional allocation is balanced between the two operation sub-systems (parking management system and subject vehicle system).

Driving mode transition occurs when the subject vehicle accesses the parking and leaves the parking (see Figure D.2).

The driving mode transition matrix represented in Figure D.2 identifies the various possible situations for vehicle driving control transfer at arrival and departure time of the subject vehicle.

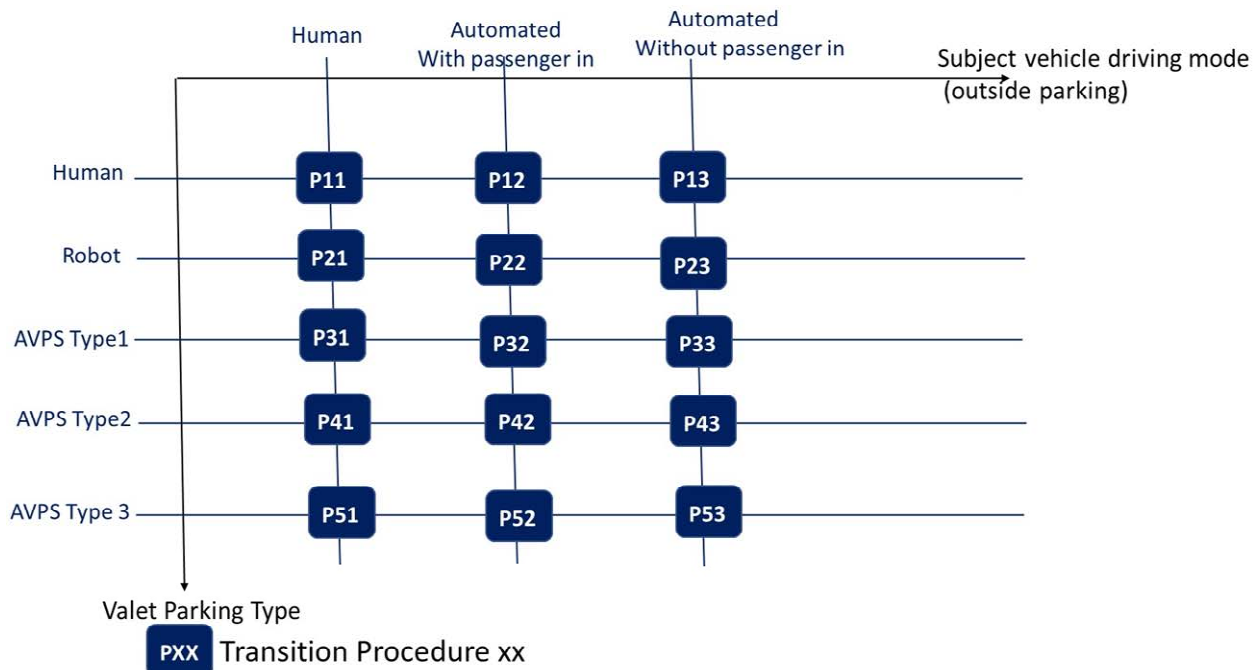

**Figure D.2: Driving mode transition matrix**

In the two driving control transfer situations (Vehicle driving control transfer at arrival and at departure time) the driving mode transition procedure will have to be specified. However, in some situations this could be achieved using private driving mode transition procedures (e.g. when a human or a robot is involved).

Driving mode procedure standardization could be necessary when the subject vehicle is in an automated driving mode and the valet parking is of the AVP type. In such case, the driving mode transition procedure will include:

- A secured driving mode transfer procedure authorizing the parking management system to teleoperate the automated subject vehicle according to the AVPS type when the subject vehicle accesses the parking. Then securely restitution of the driving control to the subject vehicle when this one leaves the parking.
- The identification of authorized control operations on the automated subject vehicle when this one is teleoperated by the parking management system. Authorized teleoperations are relative to the programmed services which are requested by the subject vehicle (e.g. longitudinal/lateral control, actions on the doors, energy tank lock, opening rear boot door, etc.).
- The identification of linked POIs (associated services at parking level) which can be optionally requested by the user.

If the subject vehicle is in an automated driving mode and transports passengers (humans or animals), before the transfer of the driving mode control to the parking management, it will have to be ensured that all passengers (including animals) have securely left the vehicle in the drop-off area space which is the more appropriate for them (e.g. at an appropriate public transport station level in case of park & Ride). Then if an AVP service is used, the subject vehicle is led to its assigned parking space by this service after passing by local related POIs sequence which may have been requested by the user.

The opposite procedure is followed when the user is recovering its vehicle. This one is led to the pick-up area by the AVP service and then passengers/driver can access it as soon as the vehicle control is given back to the subject vehicle.

The start and release of the valet parking service is controlled by service triggering conditions:

- At the subject vehicle arrival:
  - When the secured driving mode transfer procedure has been properly executed at the level of the drop-off area.
- At the user departing time:
  - The transfer of the subject vehicle from its assigned parking space to the pick-up area needs to be triggered by the user which signals its arrival in the parking. Several means may be used (phone call, electronic mail, SMS, at reservation planning, etc.). A user authentication procedure needs to be set-up (e.g. electronic signature).

Further studies are required before the introduction of this service in a future version of the PAS.

---

## D.3 PAM Request needs

For service efficiency purpose and for optimization of the ITS frequency spectrum usage by POI services there should be the possibility from the service user to be able to precise its parking needs using a POIM-PA Request message.

### Service efficiency

Several parking profiles (use cases) may take advantage of precisely knowing the intent of the user with the objective to indicate him the most available parking spaces facilitating or reducing its transition time from the assigned parking space to its local destination. The following parking profiles are non-exhaustive examples of such need:

- For disabled people, particular itinerary can be reserved for them to reach their intended destination (e.g. for reaching a transportation platform or a shopping centre). It is then required to assign a parking space which is the nearest possible to this itinerary.
- For heavy goods delivery or loading, it is necessary to find a parking space as close as possible to the goods transfer area.
- For Park & Ride, it is necessary to reduce the transition time to find a parking space nearest the transport platform targeted by the user (e.g. airport departure/arrival terminal, train station departure/arrival platform, relevant bus stop, etc.).

Many other situations may require that the user precises its intent.

### ITS frequency spectrum optimization

As identified in clause 4.1, many POI types could be considered in the future leading to a consequent ITS bandwidth consumption at the level of assigned ITS channels.

Regarding Parking Availability, this is particularly true at the level of ad-hoc local networks when there are big parking places proposing thousands of single parking spaces which cannot be only described in a POIM-PA if it is required to respect the maximum MAC payload constraints of a few thousand bytes.

Not respecting the maximum MAC payload would lead to fragment the POIM-PA at the level of the parking management application and reconstitute it at the level of the receiving parking management application.

Such type of fragmentation operation should be avoided and requires that the parking management application decomposes a large parking place in several sub-places and parking identified areas to guarantee the respect of the maximum MAC payload size.

Consequently, it is proposed to further study the specification of an optional POIM-PA Request Message containing user' intents for parking profiles which may require it.

---

## D.4 Park & Ride facility

As indicated in annex C of the present document, the park and ride parking profile consider two types of POIs (e.g. a parking place and a transport place).

For parking places nested in the transport place, the transition from the parking place to the transport place can be simple. However, for big transport places such as airports or central train/bus stations, the transition may require following a particular route either walking or using transition shuttle (see Figure D.3).

New optional information block/containers can be added to inform about available transition modes from the parking place to the transport place according to the identified transport platform.

Further studies are required to specify optionally additional information to respond to Park & Ride facility profile.

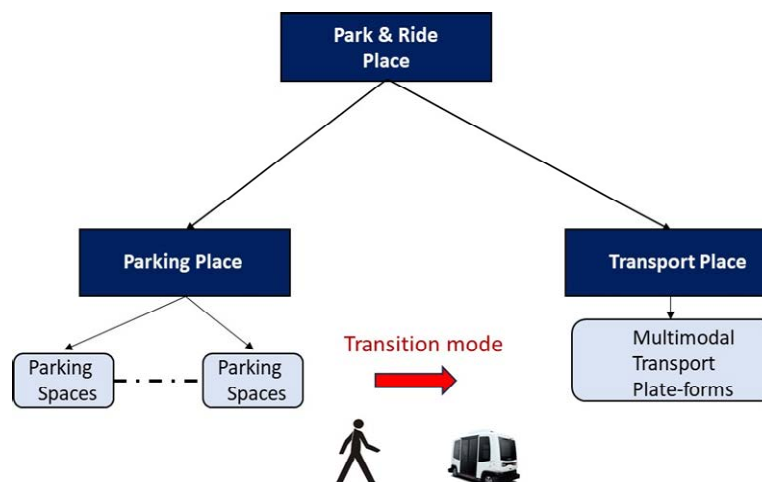

Figure D.3: Transition from a parking place to a transport place

## D.5 Lorries/Trucks and Coaches parking

Lorries/trucks and Coaches parking places are the object of dedicated security and road safety E.C attentions.

ESPOG is a European organization which supported the European Union in the development of official standard for truck parking areas in the E.U.

Parking Safety, Parking security and Parking related POIs are of particular importance for Trucks/Lorries and Coaches and need to be carefully studied to identify the information which could be added in POIMs-PA.

## D.6 Decentralized PAS initiated by a vehicle

As shown in Figure D.4, a stationary vehicle may signal its departure, so releasing one parking space for another vehicle which is looking for a parking space. Since such information is only related to one parking space whose main characteristics could be identified, the POIM-PA is not the appropriate message. In this case signalling could take place via a DENM since the use case (a stationary vehicle leaves its parking space) represents a road hazard.

A vehicle which leaves a parking space may also be supported by the Manoeuvre Coordination Service (MCS) which may facilitate the manoeuvre coordination of the departing vehicle (subject vehicle) and other vehicles (target vehicles) which are moving locally. In such case, the manoeuvre cost can be beneficial for two vehicles, the subject vehicle which may leave safely the parking space and another vehicle which is looking for a parking space.

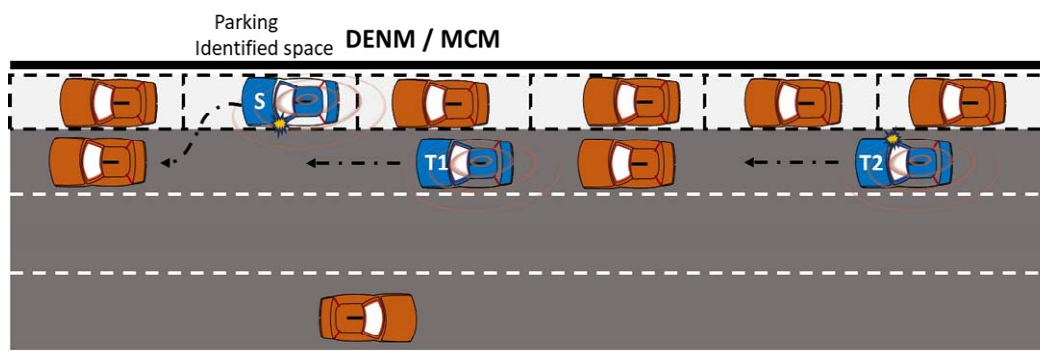

Figure D.4: Stationary vehicle signalling its departure from a identified parking space

## D.7 Added information in POIM-PA considering the parking access by unconnected vehicles

Unconnected vehicles will be pre-dominating over cooperative ones during a long period of time.

This situation can lead to a quick saturation of a parking place during peak hours because a lack of information to be provided to unconnected vehicles which could be queuing in front of the entry barrier remaining closed.

A possible reservation of relevant parking identified spaces is a solution for cooperative vehicles to keep the possibility to park in a parking identified area which remains only accessible to them via a reservation procedure.

Figure D.5 presents a situation where a parking place is saturated (including an identified parking area only accessible via a reservation) and where vehicles are queuing to find a relevant parking space.

- The exceeded number of vehicles finding a free space more than the remained free spaces

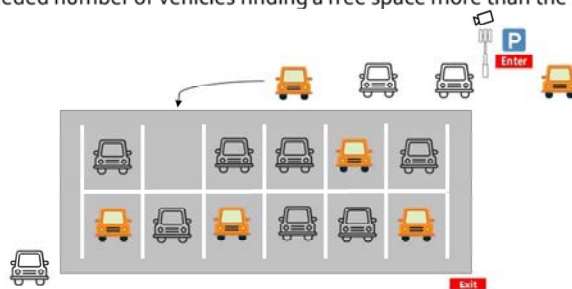

- The number of vehicles waiting for parking in front of the entrance and the expected waiting time to park in the parking place

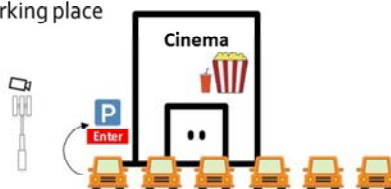

**Figure D.5: Saturated parking place with a waiting queue at its main entry**

Additional data elements could be added in the POIM-PA to signal such situation and provide complementary information related to estimated average waiting time which could be derived from previous similar situations (statistics).

---

## History

<b>Document history</b>		
V2.1.1	January 2024	Publication