

ETSI TS 103 636-4 V1.2.1 (2021-04)



TECHNICAL SPECIFICATION

**DECT-2020 New Radio (NR);
Part 4: MAC layer;
Release 1**

Reference

RTS/DECT-00364

Keywords

DECT-2020, IMT-2020, MAC, NR

ETSI

650 Route des Lucioles
F-06921 Sophia Antipolis Cedex - FRANCE

Tel.: +33 4 92 94 42 00 Fax: +33 4 93 65 47 16

Siret N° 348 623 562 00017 - APE 7112B
Association à but non lucratif enregistrée à la
Sous-Préfecture de Grasse (06) N° w061004871

Important notice

The present document can be downloaded from:

<http://www.etsi.org/standards-search>

The present document may be made available in electronic versions and/or in print. The content of any electronic and/or print versions of the present document shall not be modified without the prior written authorization of ETSI. In case of any existing or perceived difference in contents between such versions and/or in print, the prevailing version of an ETSI deliverable is the one made publicly available in PDF format at www.etsi.org/deliver.

Users of the present document should be aware that the document may be subject to revision or change of status.

Information on the current status of this and other ETSI documents is available at

<https://portal.etsi.org/TB/ETSIDeliverableStatus.aspx>

If you find errors in the present document, please send your comment to one of the following services:

<https://portal.etsi.org/People/CommitteeSupportStaff.aspx>

Notice of disclaimer & limitation of liability

The information provided in the present deliverable is directed solely to professionals who have the appropriate degree of experience to understand and interpret its content in accordance with generally accepted engineering or other professional standard and applicable regulations.

No recommendation as to products and services or vendors is made or should be implied.

No representation or warranty is made that this deliverable is technically accurate or sufficient or conforms to any law and/or governmental rule and/or regulation and further, no representation or warranty is made of merchantability or fitness for any particular purpose or against infringement of intellectual property rights.

In no event shall ETSI be held liable for loss of profits or any other incidental or consequential damages.

Any software contained in this deliverable is provided "AS IS" with no warranties, express or implied, including but not limited to, the warranties of merchantability, fitness for a particular purpose and non-infringement of intellectual property rights and ETSI shall not be held liable in any event for any damages whatsoever (including, without limitation, damages for loss of profits, business interruption, loss of information, or any other pecuniary loss) arising out of or related to the use of or inability to use the software.

Copyright Notification

No part may be reproduced or utilized in any form or by any means, electronic or mechanical, including photocopying and microfilm except as authorized by written permission of ETSI.

The content of the PDF version shall not be modified without the written authorization of ETSI.

The copyright and the foregoing restriction extend to reproduction in all media.

© ETSI 2021.
All rights reserved.

Contents

Intellectual Property Rights	6
Foreword.....	6
Modal verbs terminology.....	6
1 Scope	7
2 References	7
2.1 Normative references	7
2.2 Informative references.....	7
3 Definition of terms, symbols and abbreviations.....	8
3.1 Terms.....	8
3.2 Symbols.....	8
3.3 Abbreviations	8
4 General	9
4.1 Introduction	9
4.2 MAC Architecture	9
4.2.1 General.....	9
4.2.2 MAC Structure.....	10
4.2.3 Identities	11
4.2.3.1 Network ID	11
4.2.3.2 Long Radio Device ID (Long RD ID).....	11
4.2.3.3 Short Radio Device ID (Short RD ID)	12
4.3 Service	12
4.3.1 Services provided to upper layers	12
4.3.2 Services expected from physical layer.....	13
4.4 Functions	13
4.5 Channel Structure	13
4.5.1 Logical and Transport Channels	13
4.5.2 Mapping Physical layer packet.....	14
4.6 Order of transmission and figure numbering conventions.....	14
5 MAC Layer Procedures.....	15
5.1 Spectrum Management Procedures	15
5.1.1 General.....	15
5.1.2 Operating Channel(s) and Subslot(s) selection	15
5.1.3 Last Minute Scan	16
5.1.4 Selecting RD for association.....	16
5.1.5 Beacons Transmissions	17
5.1.6 Power control.....	18
5.2 Broadcast Procedure.....	18
5.2.1 General.....	18
5.2.2 Broadcast procedure initialization	19
5.2.3 Broadcast transmission	19
5.3 Random Access procedure	19
5.3.1 General.....	19
5.3.2 Announcing Random access resources	20
5.3.3 Random Access transmission	20
5.3.4 Random Access response.....	21
5.4 Scheduled access data transfer	22
5.5 HARQ Operation.....	23
5.5.1 General.....	23
5.5.2 Receiver Operation	23
5.6 Multiplexing and assembly.....	24
5.7 Mobility Procedures	25
5.8 Association procedure	25
5.8.1 General.....	25
5.8.2 Sending beacon for association.....	26

5.8.3	Association initiation	26
5.8.4	Sending association request	27
5.8.5	Association response.....	27
5.8.6	Association Release	28
5.9	Security Procedures	28
5.9.1	Mode 1	28
5.9.1.1	General	28
5.9.1.2	Integrity protection.....	28
5.9.1.3	Ciphering.....	29
5.10	Reconfiguration.....	31
6	Protocol Data Units, formats and parameters.....	31
6.1	General	31
6.2	Physical Header Field.....	32
6.2.1	General.....	32
6.2.2	Coding of Feedback info.....	34
6.3	MAC PDU	37
6.3.1	General.....	37
6.3.2	MAC Header type.....	37
6.3.3	MAC Common header.....	38
6.3.3.1	DATA MAC PDU header	38
6.3.3.2	Beacon Header	38
6.3.3.3	Unicast Header.....	38
6.3.3.4	RD Broadcasting Header.....	39
6.3.4	MAC multiplexing header	39
6.4	MAC Messages and Information Elements (IEs)	42
6.4.1	General.....	42
6.4.2	MAC messages	42
6.4.2.1	General	42
6.4.2.2	Network Beacon message	42
6.4.2.3	Cluster Beacon message.....	43
6.4.2.4	Association Request message.....	44
6.4.2.5	Association Response message	46
6.4.2.6	Association Release message	47
6.4.2.7	Reconfiguration Request message	47
6.4.2.8	Reconfiguration Response message	48
6.4.2.9	Additional MAC message	49
6.4.3	MAC information elements	49
6.4.3.1	MAC Security Info IE.....	49
6.4.3.2	Route Info IE.....	50
6.4.3.3	Resource allocation IE	50
6.4.3.4	Random Access Resource IE	52
6.4.3.5	RD Capability IE.....	53
6.4.3.6	Neighbouring IE.....	53
6.4.3.7	Broadcast Indication IE.....	54
6.4.3.8	Padding IE.....	55
6.4.3.9	Group Assignment IE.....	56
7	Variables, and Timers.....	56
7.1	General	56
7.2	Variables.....	57
7.3	Timers	58
Annex A (normative): MAC Layer Requirements for Radio Device Classes.....		59
A.1	Introduction	59
A.2	Radio Device Class (1.1.1.A).....	59
A.2.1	Modes	59
A.2.2	System Operation	59
A.2.3	Security	59
A.2.4	Feedback Info Formats	59

Annex B (normative): Data Link Layer Operation60
B.1 Segmentation.....60
B.2 Routing PDU in Mesh operation61
Annex C (informative): Change History63
History64

Intellectual Property Rights

Essential patents

IPRs essential or potentially essential to normative deliverables may have been declared to ETSI. The declarations pertaining to these essential IPRs, if any, are publicly available for **ETSI members and non-members**, and can be found in ETSI SR 000 314: "*Intellectual Property Rights (IPRs); Essential, or potentially Essential, IPRs notified to ETSI in respect of ETSI standards*", which is available from the ETSI Secretariat. Latest updates are available on the ETSI Web server (<https://ipr.etsi.org/>).

Pursuant to the ETSI Directives including the ETSI IPR Policy, no investigation regarding the essentiality of IPRs, including IPR searches, has been carried out by ETSI. No guarantee can be given as to the existence of other IPRs not referenced in ETSI SR 000 314 (or the updates on the ETSI Web server) which are, or may be, or may become, essential to the present document.

Trademarks

The present document may include trademarks and/or tradenames which are asserted and/or registered by their owners. ETSI claims no ownership of these except for any which are indicated as being the property of ETSI, and conveys no right to use or reproduce any trademark and/or tradename. Mention of those trademarks in the present document does not constitute an endorsement by ETSI of products, services or organizations associated with those trademarks.

DECT™, **PLUGTESTS™**, **UMTS™** and the ETSI logo are trademarks of ETSI registered for the benefit of its Members. **3GPP™** and **LTE™** are trademarks of ETSI registered for the benefit of its Members and of the 3GPP Organizational Partners. **oneM2M™** logo is a trademark of ETSI registered for the benefit of its Members and of the oneM2M Partners. **GSM®** and the GSM logo are trademarks registered and owned by the GSM Association.

Foreword

This Technical Specification (TS) has been produced by ETSI Technical Committee Digital Enhanced Cordless Telecommunications (DECT).

The present document is part 4 of a multi-part deliverable. Full details of the entire series can be found in part 1 [1].

Modal verbs terminology

In the present document "**shall**", "**shall not**", "**should**", "**should not**", "**may**", "**need not**", "**will**", "**will not**", "**can**" and "**cannot**" are to be interpreted as described in clause 3.2 of the [ETSI Drafting Rules](#) (Verbal forms for the expression of provisions).

"**must**" and "**must not**" are **NOT** allowed in ETSI deliverables except when used in direct citation.

1 Scope

The present document is one of the parts of the specification of the DECT-2020 New Radio (NR).

The present document specifies Medium Access Control (MAC) layer and interaction between MAC layer and physical layer and higher layers.

2 References

2.1 Normative references

References are either specific (identified by date of publication and/or edition number or version number) or non-specific. For specific references, only the cited version applies. For non-specific references, the latest version of the referenced document (including any amendments) applies.

Referenced documents which are not found to be publicly available in the expected location might be found at <https://docbox.etsi.org/Reference>.

NOTE: While any hyperlinks included in this clause were valid at the time of publication, ETSI cannot guarantee their long term validity.

The following referenced documents are necessary for the application of the present document.

- [1] ETSI TS 103 636-1: "DECT-2020 New Radio (NR); Part 1: Overview; Release 1".
- [2] ETSI TS 103 636-2: "DECT-2020 New Radio (NR); Part 2: Radio reception and transmission requirements; Release 1".
- [3] ETSI TS 103 636-3: "DECT-2020 New Radio (NR); Part 3: Physical layer; Release 1".
- [4] FIPS PUB 197: "Advanced Encryption Standard (AES)".
- [5] NIST Special Publication 800-38B: "Recommendation for Block Cipher Modes of Operation: The CMAC Mode for Authentication".

2.2 Informative references

References are either specific (identified by date of publication and/or edition number or version number) or non-specific. For specific references, only the cited version applies. For non-specific references, the latest version of the referenced document (including any amendments) applies.

NOTE: While any hyperlinks included in this clause were valid at the time of publication, ETSI cannot guarantee their long term validity.

The following referenced documents are not necessary for the application of the present document but they assist the user with regard to a particular subject area.

- [i.1] ETSI EN 300 175 (all parts): "Digital Enhanced Cordless Telecommunications (DECT); Common Interface (CI)".

3 Definition of terms, symbols and abbreviations

3.1 Terms

For the purposes of the present document, the following terms apply:

Fixed Termination point (FT): operational mode of RD where RD initiates coordinates local radio resources, provides information how other RDs may connect and communicate with it

operating channel: single continuous part of radio spectrum with a defined bandwidth where RDs transmits and/or receives as defined in ETSI TS 103 636-2 [2]

Portable Termination point (PT): operational mode of RD where RD selects another RD, which is in FT mode, for association

radio device: device with radio transmission and reception capability which can operate in FT and/or PT mode

resource: variable length time unit defined in subslot(s) or slot(s) in single operating channel that RD is using for transmission or reception of physical layer packet

NOTE: Resource can be contentious or contention free, i.e. scheduled.

slot: unit of a radio frame as defined in ETSI TS 103 636-3 [3], clause 4

subslot: unit of a radio frame as defined in ETSI TS 103 636-3 [3], clause 4

NOTE: Subslots in the frame are numbered in increasing order and the first subslot of radio frame is number 0.

3.2 Symbols

For the purposes of the present document, the following symbols apply:

0x	Value in hexadecimals
β	Fourier transform scaling factor as defined in ETSI TS 103 636-3 [3]
μ	Subcarrier scaling factor as defined in ETSI TS 103 636-3 [3]
RSSI-1	RSSI-1 measurement as defined in ETSI TS 103 636-2 [2]
RSSI-2	RSSI-2 measurement as defined in ETSI TS 103 636-2 [2]

3.3 Abbreviations

For the purposes of the present document, the abbreviations given in ETSI TS 103 636-1 [1] and the following apply.

NOTE: An abbreviation defined in the present document takes precedence over the definition of the same abbreviation, if any, in ETSI TS 103 636-1 [1].

ACK	Acknowledgement
BCC	Broadcast Control
BCCH	Broadcast Control Channel
BLER	Block Error Ratio
BS	Buffer Size
BSC	Beacon Scanning Control
CCC	Connection Configuration Control
CCCH	Common Control Channel
CQI	Channel Quality Indicator
DCCH	Dedicated Control Channel
DCH	Dedicated Channel
DF	Data Field

NOTE: As defined in ETSI TS 103 636-3 [3].

DTCH	Dedicated Traffic Channel
------	---------------------------

FT Fixed Termination point
 GI Guard Interval

NOTE: As defined in ETSI TS 103 636-3 [3].

HARQ Hybrid Automatic Repeat reQuest
 HPC Hyper Packet Counter
 IE Information Element
 ID IDentity
 LBT Listen Before Talk
 LRC Local Radio Control
 MCS Modulation and Coding Scheme
 MIC Message Integrity Code

NOTE: Same as Message Authentication Code.

MIMO Multiple Input Multiple Output
 MSB Most Significant Bit
 MTCH Multicast (Broadcast) Traffic Channel
 MUX Multiplexing
 NACK Negative Acknowledgement
 OFDM Orthogonal Frequency Division Multiplexing
 PCC Physical Control Channel
 PCCH Paging Common Channel
 PCH/BCH Paging and Broadcast Channel
 PDC Physical Data Channel
 PDU Protocol Data Unit
 PT Portable Termination point
 PTC Paging Transmission Control
 RAC Random Access Control
 RACH Random Access Channel
 RD Radio Device
 RSSI Received Signal Strength Indicator
 SDU Service Data Unit
 SFN System Frame Number
 STF Synchronization Training Field

NOTE: As defined in ETSI TS 103 636-3 [3].

4 General

4.1 Introduction

The objective of this clause is to describe the MAC protocol layer architecture, used identities, used transport channels and mapping MAC PDU into physical layer packet.

4.2 MAC Architecture

4.2.1 General

This clause describes a model of the MAC i.e. it does not specify or restrict implementations.

4.2.2 MAC Structure

The overall MAC structure is depicted in Figure 4.2.2-1. MAC provides DTCH and MTCH logical channels for transferring higher layer data. The flow of the higher layer data and MAC internal message to physical channels is depicted with black solid lines. The grey dashed line corresponds MAC internal control interfaces between MAC function and MAC control entity.

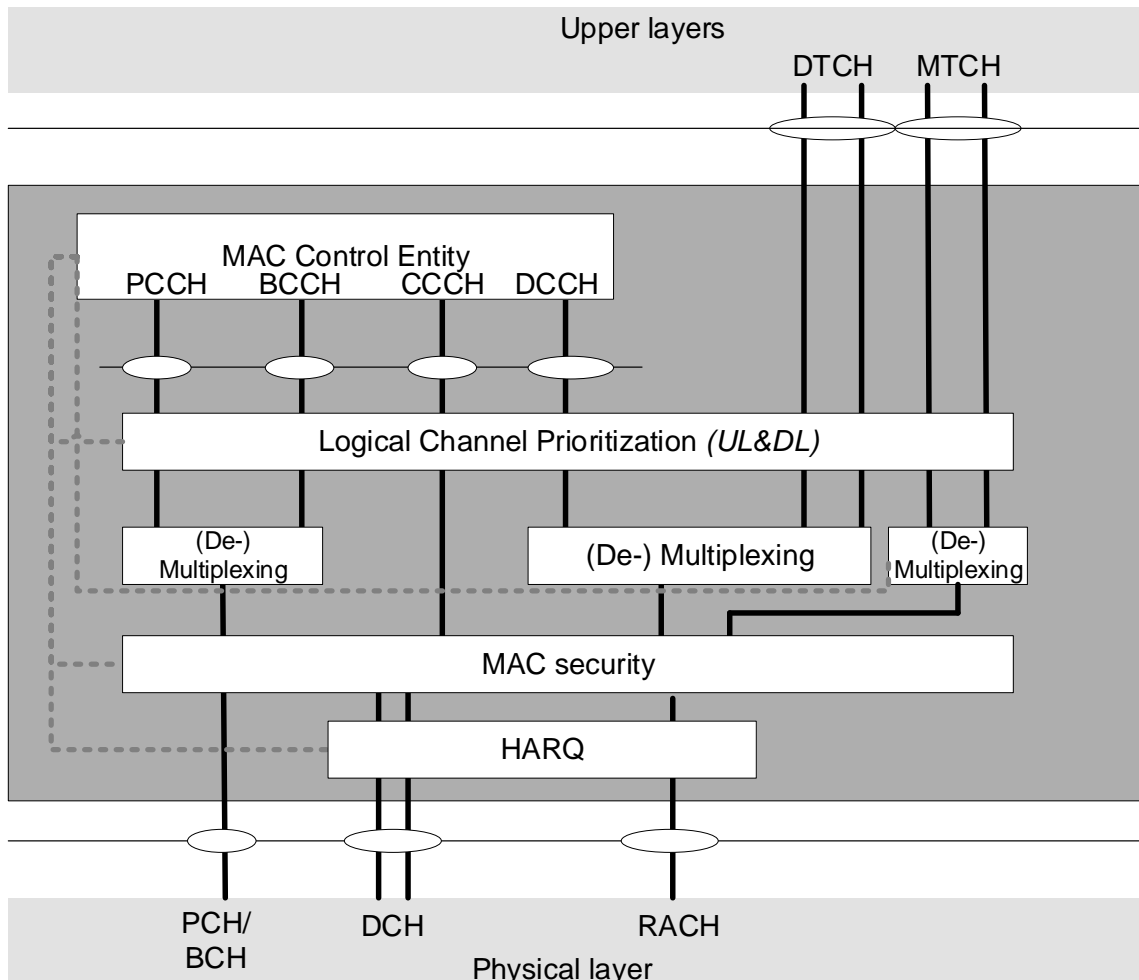

Figure 4.2.2-1: MAC structure overview

The MAC layer of the Radio Device (RD) handles transmission and reception of the following transport channels:

- Paging and Broadcast Channel (PCH/BCH);
- Dedicated Channel (DCH);
- Random Access Channel (RACH).

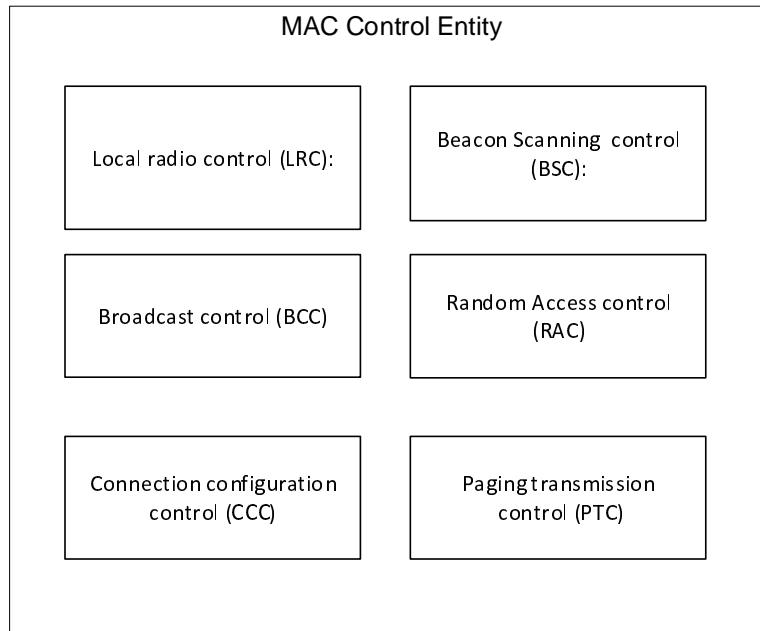

Figure 4.2.2-2: MAC control Entity

The MAC control entity is depicted in Figure 4.2.2-2 and described in clause 4.4.

4.2.3 Identities

4.2.3.1 Network ID

Network ID has length of 32 bits, and first 24 MSB bits are used to identify a DECT-2020 network uniquely from other DECT-2020 networks. The 8 LSB bits of the network are selected locally to minimize collision with other networks.

The network ID is transmitted periodically in a beacon frame as plain text enabling other RDs to detect which network the transmitted beacon belongs to.

The last 8 LSB bits of the network ID are transmitted in PHY control field of the packet as defined in clause 6.2.

The 24 MSB bits of the network ID are provided to PHY layer to initialize the PDC scrambling sequence in clause 7.6.6 of ETSI TS 103 636-3 [3].

The network ID can be set to any other value than 0x00000000.

NOTE: Network ID should be set in such a manner that maximum likelihood for a unique identity for a network is obtained due to randomness of 2 power of 32.

4.2.3.2 Long Radio Device ID (Long RD ID)

Long radio device ID has length of 32 bits, and it identifies radio device uniquely in single DECT-2020 network. The coding of the Long RD ID is defined in Table 4.2.3.2-1. An RD obtains the Long RD ID as part of authentication process over DECT-2020 system or via manually provision or by using other communication channel.

The Long RD ID is used:

- in association procedure to recognize associating RDs uniquely;
- in MAC layer security procedures;
- in packet routing in mesh system operation to identify original source and final target receiver of the routed data packet.

Table 4.2.3.2-1: Use of Long RD ID address space

Address type	Address field	Comment
Reserved address	0x00000000	Shall not be used as it is considered as not defined.
Backend address	0xFFFFFFFF	Indicates that packet is to be delivered out from DECT-2020 system, i.e. to backend system.
Broadcast address	0xFFFFFFFF	This address can be used to indicate that packet needs to be received by all RDs in the system when performing packet routing.
Long RD ID	0x00000001-0xFFFFFFFF	This address space is used to identify radio device uniquely in DECT-2020 systems.
Multicast address	0x00000001-0xFFFFFFFF	The system configuration defines range of address that are used as multicast address in the given system. A multicast group can use any of those addresses. When receiver address of the packet is multicast group the packet is intended to all members of that group. An RD can be part of one or multiple multicast group.

The Long RD ID is transmitted in MAC PDU to:

- identify the receiver and the transmitter of the packet in association procedure for exchanging Short RD IDs; or
- when transmitter of the frame considers that there is potential confusion on Short RD IDs.

When RD is initiating authentication over DECT-2020 network the RD can use random value or application defined value as Long RD ID from Long RD ID space defined in Table 4.2.3.2-1, if no valid Long RD ID value is available from previous authentication procedures.

4.2.3.3 Short Radio Device ID (Short RD ID)

Short radio device ID has length of 16 bits, and it identifies radio device locally in DECT-2020 network. The coding of the Short RD ID is defined in Table 4.2.3.3-1.

The Short RD ID is used in PHY control field as in transmitter or receiver fields to identify transmitter and receiver of the packet.

The Short RD ID is exchanged during association procedure between RDs performing association so that linkage between Short RD ID and Long RD ID is obtained by both associating RD. Each radio device randomly selects Short RD ID value that it uses in association.

Table 4.2.3.3-1: Use of Short RD ID address space

Address type	Address field	Comment
Reserved address	0x0000	Shall not be used as it is considered as not defined
Short RD ID	0x0001-0xFFFF	This address space is used to identify RD in PHY control field
Broadcast address	0xFFFF	This address can be used to indicate that transmission is broadcast frame

4.3 Service

4.3.1 Services provided to upper layers

The MAC layer provides the following services to upper layers:

- data transfer;
- radio resource allocation.

4.3.2 Services expected from physical layer

The MAC layer expects the following services from the physical layer:

- data transfer services in physical layer packets;
- measurements.

4.4 Functions

The MAC layer supports the following control functions in MAC control entity:

- Local Radio Control (LRC): This function is overall in charge of radio resource in local coordination area, when RD coordinates local radio resources, i.e. operates as FT.
- Paging Transmission Control (PTC): This function controls paging message transmission when RD coordinates local radio resources, i.e. operates as FT.
- Broadcast Control (BCC): This functionality controls Beacon and other broadcast/multicast transmission.
- Random Access Control (RAC): This functionality is in charge of random access transmission.
- Beacon Scanning Control (BSC): This function controls scanning operation.
- Connection Configuration Control (CCC): This functionality controls multiplexing, mapping data to transport channel, MCS, HARQ configuration, MAC security and handovers with LRC.

The MAC layer supports the following transmission functions:

- paging and broadcast signalling;
- control signalling;
- radio resource management by channel selection and channel access procedures;
- logical channel prioritization;
- mapping between logical channels and transport channels;
- multiplexing of MAC SDUs from one or different logical channels onto MAC PDU to be delivered to the physical layer on transport channels;
- demultiplexing of MAC SDUs to one or different logical channels from transport blocks MAC PDU delivered from the physical layer via transport channels;
- error correction through HARQ;
- MAC layer security by providing integrity protection and ciphering.

4.5 Channel Structure

4.5.1 Logical and Transport Channels

The MAC layer provides data transfer services on logical channels. To accommodate different kinds of data transfer services, multiple types of logical channels are defined i.e. each supporting transfer of a particular type of information.

Each logical channel type is defined by what type of information is transferred. MAC has set of internal logical channels and logical channels to higher layers.

The MAC layer has the control and traffic channels listed in Table 4.5.1-1.

Table 4.5.1-1: Logical channels provided by MAC

Logical channel name	Acronym	Available for higher layers	Control channel	Traffic channel
Broadcast Control Channel	BCCH		X	
Paging Control Channel	PCCH		X	
Common Control Channel	CCCH		X	
Dedicated Control Channel	DCCH		X	
Dedicated Traffic Channel	DTCH	X		X
Multicast Traffic Channel	MTCH	X		X

The MAC sublayer uses the transport channels listed in Table 4.5.1-2.

Table 4.5.1-2: Transport channels used by MAC

Transport channel name	Acronym	Downlink	Uplink
Paging and Broadcast Channel	PCH/BCH	X	
Dedicated Channel	DCH	X	X
Random Access Channel	RACH	X	X

Logical channels can be mapped as described in Table 4.5.1-3.

Table 4.5.1-3: Channel mapping

Transport channel \ Logical channel	PCH/BCH	DCH	RACH
BCCH	X		
PCCH	X		
CCCH			X
DCCH	X	X	X
DTCH		X	X
MTCH	X		X

4.5.2 Mapping Physical layer packet

In packet transmission transport channels are mapped to Physical Data Channel (PDC) carried in physical layer packet. Additionally, MAC provides the number of used spatial streams, and content of the Physical Layer Control Field to physical layer. The Physical Layer Control Field is mapped to Physical Control Channel (PCC) of the physical layer packet.

4.6 Order of transmission and figure numbering conventions

The transmission order is Big endian and left to right:

- A list of octets is transmitted 1st octet first.
- For each octet, bites are numbered 0 to 7 according to transmission order. Bit 0 is transmitted first (ascending transmission order).
- When bits are numbered in any other MAC structure, they are also numbered according to transmission order.

Whenever an octet or other container represents a numeric quantity the left most bit in the diagram and thus, the first to be transmitted, is the high order or most significant bit.

For octets, the bit labelled 0 is the most significant bit and bit 7 is the least significant bit.

When referring to the bits of a numerical value, ordinal numbers starting by 1st can be used to refer to the bits. 1st bit means the most significant bit, 2nd bit means the second MSB (note that if the value is placed in an octet the first bit is transmitted in bit 0). Last bit, 2nd last, 3rd last, etc. can be used to refer to the 3 least significant bits of the number.

NOTE: The transmission order (endianness and bit transmission order) is identical to DECT (ETSI EN 300 175 [i.1], parts 1 to 8). However the numbering convention in figures (bit numbering in octets carrying numeric values) has been reversed to follow generally accepted conventions.

5 MAC Layer Procedures

5.1 Spectrum Management Procedures

5.1.1 General

An RD shall support the set of cognitive radio spectrum management features, defined in clause 5.1.

In each connection between two RDs, one RD is in FT-mode and the other RD is in PT-mode. The RD in FT-mode coordinates local radio resources and provides information how other RDs may connect and communicate with it, whereas the RD in PT-mode performs functions based on information provided by the RD in FT mode.

The radio resource coordination in an FT-mode RD is performed with the following functions:

- Operating carrier(s) and subslot(s) selection by using a background scan as defined in clause 5.1.2.
- Transmitting beacon(s) to enable other RDs to identify, measure and initiate association with the RD, as defined in clause 5.1.5.
- Providing and configuring radio communication parameters of the connections with associated RDs.
- Selecting optimum power level as defined in clause 5.1.6.

An RD in PT-mode operates based on information provided by RDs in FT-mode and performs following functions:

- Selecting RD for association as defined in clause 5.1.4.
- Performing configured measurements before initiating transmissions to an RD in FT-mode as defined in clause 5.1.4 or clause 5.7.
- Selecting optimum power level as defined in clause 5.1.6.

A single RD can operate both in FT and PT modes simultaneously, i.e. in FT mode coordinate radio resources for other RDs connecting to it as well as in PT mode be connected to another RD, which operate in FT mode.

5.1.2 Operating Channel(s) and Subslot(s) selection

When an RD initiates FT-mode operation, the RD shall initiate background scan process for finding the operating channels and subslots, which are fulfilling the operating conditions.

The background scan may be done in any order on supported band(s) and channel(s). For each channel the RD shall measure at least duration of variable *SCAN_MEAS_DURATION* and obtain the RSSI-1 value for each measured subslot.

In each measured subslot on the channel the RD shall consider whether the subslot is "free", "possible" or "busy". The subslot status is considered as:

- "free" if $\max(\text{RSSI-1}) \leq \text{RSSI_THRESHOLD_MIN}$;
- "possible" if $\text{RSSI_THRESHOLD_MIN} < \max(\text{RSSI-1}) \leq \text{RSSI_THRESHOLD_MAX}$;
- "busy" if $\max(\text{RSSI-1}) > \text{RSSI_THRESHOLD_MAX}$.

within the duration of measured subslot.

The RD may stop the background scan process and initiate beacon transmission as defined in clause 5.2, if the number "free" or "possible" subslots is $\geq \text{SCAN_SUITABLE}$ at *SCAN_MEAS_DURATION* at least on one channel and the number of "free" or "possible" measured subslots is sufficient for operation of the RD.

After measuring the supported channels, the RD should select operating channel(s) or consecutive operating channels in following manner:

- select any channel or consecutive channels where all subslots are "free", if such is found;
- select the channel or consecutive channels that has the lowest number of "busy" subslots; and:
 - if multiple channels or consecutive channels have the same number of "busy" subslots;
 - select the channel or consecutive channels that has the lowest number of "possible" subslots.

After selecting the operating channel(s) the RD shall start timer *scanStatusValid*. The RD shall consider the scan valid until timer *scanStatusValid* expires.

If *DECT_PROTECTED* is TRUE the RD may start the timer *dectProTime* (subtracting the age of the measurement of this channel) and consider status of "free" or "possible" subslot is valid until *dectProTime* expires.

The RD shall exclude subslots measured as "busy" or subslots not having valid "free" or "possible" status in resource announcements in the beacon message. The RD may measure a subslot previously measured as "busy" at any time to check whether it can be considered as "free" or "possible".

The RD may re-start the timer *scanStatusValid* when the RD has updated measurement results of all the "free" and "possible" subslots, without a need to measure those subslot(s) on which the RD is transmitting to or the RD is receiving transmission on it, i.e. any transmission that it is coordinating.

The RD may re-initiate the Operating Channel(s) and Subslot(s) selection procedure at any time. The RD should re-initiate Operating Channel(s) and Subslot(s) selection procedure when number of busy subslots \geq *CHANNEL_LOADED* at *SCAN_MEAS_START*, or the number of "free" or "possible" measured subslots is not sufficient for operation of the RD.

5.1.3 Last Minute Scan

When variable *DECT_PROTECTED* is true and timer *dectProTime* is not running, the RD shall consider that subslot status is no longer valid for a given slot, which is not in use by the RD.

The RD shall update the status of a subslot on given carrier by performing RSSI-1 measurement on 1 and/or 0,5 frames before the slot and update subslots status "free", "possible" or "busy" as defined in clause 5.1.2. before announcing resource available for transmission or before initiating its own transmission on the subslot.

When performing measurements the RD may:

- start timer *dectProTime*.

5.1.4 Selecting RD for association

When an RD desires to establish connection with another RD it scans frequency channels to detected network and/or cluster beacon messages containing desired network ID(s).

When an RD detects network beacon(s) from another RD, RD may:

- Initiate reception of cluster beacon based on information obtained from network beacon.

When an RD detects cluster beacons from another RD, RD shall:

- Evaluate radio quality by RSSI-2 measurement from the detected beacon whether it meets the minimum quality level for radio connection.

The minimum quality level is defined as:

- $RSSI-2 \geq MIN_SENSITIVITY_LEVEL + MIN_QUALITY$
- If the RD has detected multiple beacons from different RDs, which all meets the minimum quality level for radio connection:
 - If the detected beacon(s) contains the route info IE:
 - the RD should select the RD that broadcast smallest route cost value for association.
 - Else:
 - The RD should select the RD that provides highest RSSI-2 value for association.
- If none of the detected cluster beacons meet the minimum quality level, the RD may:
 - initiate association to RD providing highest RSSI-2 value; or
 - continue scanning frequency channels to detect network and cluster beacon messages.

5.1.5 Beaconing Transmissions

To enable other RDs to identify, measure and initiate association with the RD, an RD in FT mode initiates the transmission of the beacon messages. The identification of the RD and the network is done by Network ID and Long RD ID included in MAC Common header of the MAC PDU carrying beacon message.

There exists two types beacon messages that are transmitted periodically by the FT:

- Network Beacon message, clause 6.4.2.2.
- Cluster Beacon message, clause 6.4.2.3.

The transmission periods of the Network and Cluster Beacon messages can be different.

The Network Beacon message is used to allow RDs to find network rapidly. The Network Beacon message can be transmitted on limited set of channel(s) to reduce other RDs search time. When RD is detecting the Network Beacon message the RDs measures RSSI-2 for RD selection for association, clause 5.1.4, and for Mobility, clause 5.7, purposes.

The Network Beacon message indicates the operating channel of the RD in FT mode and next transmission timing of the Cluster Beacon message as illustrated in Figure 5.1.5-1.

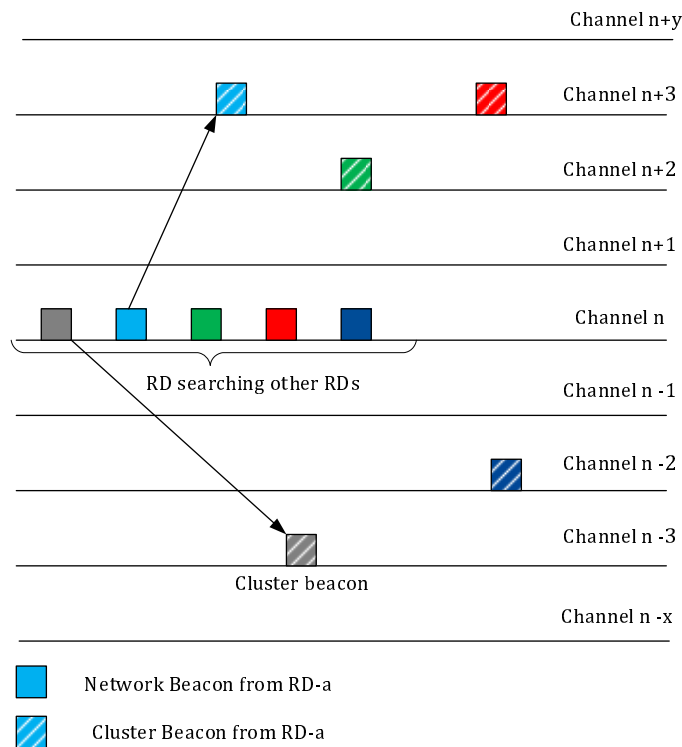

**Figure 5.1.5-1: Examples of Network and Cluster Beacon transmissions
(Different colours represent different RDs sending Network and Cluster Beacon messages)**

The Cluster Beacon message is used to provide frame and slot timing used by the RD in FT mode. The Cluster Beacon provides the parameters for initiating association with the RD and it is used to coordinate radio resources in the cluster. The MAC PDU carrying Cluster Beacon Message can be amended with additional optional IEs.

All beacon messages transmission are done as defined in clause 5.2.

5.1.6 Power control

When transmitting broadcast messages the transmission power of the RD can be configured to the RD or the RD can independently adjust the used TX power.

When transmitting unicast message the used TX power shall be the minimum that provides the target BLER of the single transmission of the transmitted MAC PDU on selected MCS.

In all case the used TX power shall be equal or less than maximum allowed by the regulations in given operating channel.

5.2 Broadcast Procedure

5.2.1 General

Broadcast procedure provides means for an RD to broadcast messages for different purposes. These purposes are:

- broadcasting beacon messages;
- broadcasting signalling or application data for all other RDs of the network; or
- broadcasting signalling or application data for multicast group of the network.

5.2.2 Broadcast procedure initialization

An RD may start sending broadcast message after it has selected operating channel(s) and timer *scanStatusValid* is running or it has selected other RD for association.

For initiating broadcast transmission the RD shall:

- if *DECT_PROTECTED* is TRUE and *dectProTime* is not running:
 - take actions defined in clause 5.1.3;
- select the resource that is "free" or "possible";
- take actions in clause 5.2.3.

5.2.3 Broadcast transmission

The RD shall set the content of the broadcast transmission as follows:

- if the message is a beacon message:
 - use Physical Layer Control Field: Type 1;
- else:
 - use Physical Layer Control Field: Type 2 and set Receiver Identity to broadcast ID;
- if MAC security is used:
 - set MAC Security to 10 in MAC header Type and include Security Info in Common MAC header.

5.3 Random Access procedure

5.3.1 General

Resources for random access transmission per operating channel are broadcasted in beacons by RDs. Random access transmission and resources are defined by following parameters:

- **RACH resources slots:** Indicates slot index of the first and last slot in a frame for RACH resources.
- **Repetition:** Defines how often RACH resources are repeated in coming frames.
- **RACH Period:** Defines how many frames RACH allocation is valid after the frame where beacon was transmitted.
- **Maximum Random Access TX time:** Defines the maximum Packet length for single RACH transmission.
- **Response Window:** Time window when RACH response can be expected by RD sending Random access transmission. If not received the transmitting RD considers that RACH transmission failed.
- **CW_MIN:** Defines the minimum value where the *CW_CURRENT* can be reduced.
- **CW_MAX:** Defines the maximum value where the *CW_CURRENT* can be increased.

NOTE: Allowed parameter value ranges for above parameters are operating band specific with possible default values.

Slots indicated as random access resources are divided into multiple start positions where the transmission can be initiated. Start positions are counted from the beginning of a random access slot, and are 0, 1, 2, 3... times the duration of STF and GI field, with given μ -factor as defined in ETSI TS 103 636-3 [3]. The random access resource partition to start positions is depicted in Figure 5.3.1-1.

Transmissions to random access resources are controlled by Listen Before Talk (LBT) protocol, with exponential back off delay. The timer *rachBackOff* is started with random value picked by the RD and it has uniform distribution between 0 and *CW_CURRENT*, taking values multiple of STF and GI with given μ -factor as defined in ETSI TS 103 636-3 [3]. Transmission to the random access is allowed after timer *rachBackOff* expires and channel is detected as "free" or "possible" at least *MINIMUM_LBT_PERIOD* before this. The channel is considered as "free" or "possible" based on thresholds defined in clause 5.1.2. The *MINIMUM_LBT_PERIOD* is the duration of STF, a GI before the start position with given μ -factor as defined in ETSI TS 103 636-3 [3].

The LBT and random delay is depicted in Figure 5.3.1-1.

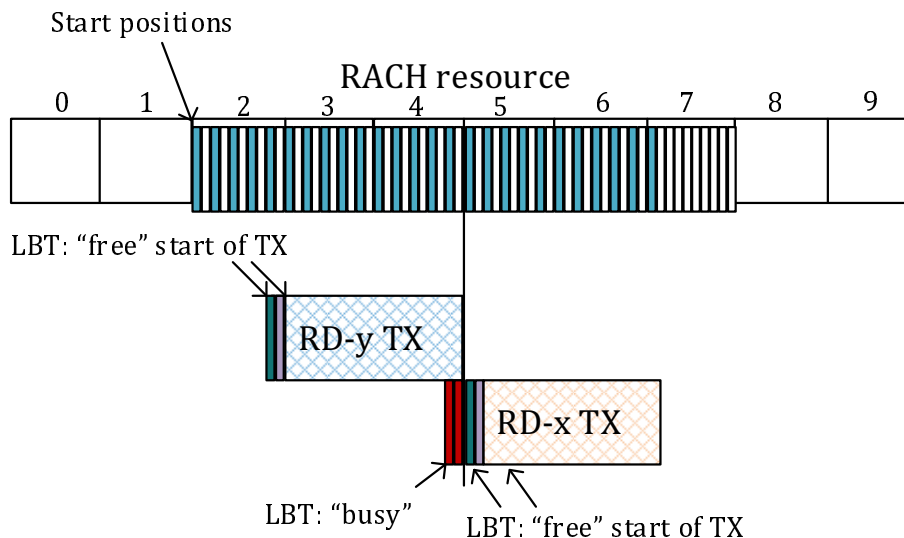

Figure 5.3.1-1: Random Access transmissions

5.3.2 Announcing Random access resources

An RD may start announcing random access resources in beacon. Before announcing resources, the RD should evaluate local interference conditions and select resources where interference is below "busy level" as defined in clause 5.1.2.

If variable *DECT_PROTECTED* is TRUE and timer *dectProTime* is not running, before announcing random access resources in a beacon message the RD shall:

- check one frame advance whether resources to be announced are "free", or "possible" as defined in clause 5.1.2;
- remove all slots that are measured as "busy".

After announcing random access resources the RD should detect transmission as defined in clause 5.5:

- for all detected transmissions send random access response and HARQ feedback in RACH response window.

During reception of random access resource, RD may measure slots whether resources are "free", "possible" or "busy" from other systems transmissions for updating random access resources. When performing measurements the RD may:

- start timer *dectProTime*;
- update next announced random access resources based on measurement result.

5.3.3 Random Access transmission

Before transmitting to random access resource the RD shall:

- obtain random access parameters listed in clause 5.3.1;

- if random access resource IE contains *dectProtime* field:
 - start timer *dectProtime* with value provided in *dectProtime* field;
- use Physical Layer Control Field: Type 2;
- select the highest MCS and highest available number of spatial streams that maximizes throughput;
- set feedback info bits accordingly;
- prepare MAC PDU for transmission as defined in clause 5.6;
- pick random value between 0 and *CW_CURRENT*, and start timer *rachBackOff* with the value;
- keep *rachBackOff* running during random access resources;
- if timer *dectProtime* will expire before random access transmission:
 - consider obtained random access resources as invalid and defer the random access transmission; or
 - RD may:
 - perform RSSI-1 measurement on subslot(s) of the random access resource and update subslot(s) status "free", "possible" or "busy" as defined in clause 5.1.2;
 - exclude subslots that are measured as "busy" from random access resources and consider remaining measured random access resources as valid; and
 - start time *dectProtime*.
- at least *MINIMUM_LBT_PERIOD* before the *rachBackOff* expires, measure channel whether it is "free" or "possible" for transmission;
- if channel is detected as "free" or "possible" as defined in clause 5.1.2, and prepared MAC PDU fits to remaining random access resources:
 - initiate random access transmission;
- if channel is detected "busy" as defined in clause 5.1.2:
 - measure channel until it is detected as "free" as defined in clause 5.1.2, during random access resources;
 - if channel is detected as "free" or "possible" and prepared MAC PDU fits into remaining random access resources:
 - initiate random access transmission;
 - else:
 - defer random access transmission to next occurrence of random access resources.

NOTE: After transmitting to random access the RD may re-initiate random access transmission procedure to same random access resources.

5.3.4 Random Access response

After performing random access transmission the RD should receive a response within in indicated as random access response window.

If the RD does not receive response message as PHY control indicating neither ACK nor NACK is detected during random access response window:

- considers that there was collision in the transmission;

- if *CW_CURRENT* is less than *CW_MAX*:
 - double the value of *CW_CURRENT*;
- initiate new random access procedure as defined in clause 5.3.3.

If the RD receives responses message as PHY control indicating neither ACK nor NACK is detected during random access response window:

- consider that there was no collision;
- set the *CW_CURRENT* to *CW_MIN*;
- if random access response message CRC of the DATA part fails:
 - initiate new random access transmission as defined in clause 5.3.3 and include HARQ feedback as defined in clause 5.5;
- if random access response message CRC of the Data part is OK:
 - act based on received message and include HARQ feedback as defined in clause 5.5;
 - if received message includes resource allocation for transmission:
 - use allocated resources for next transmission;
 - else:
 - initiate new random access transmission as defined in clause 5.3.3.

If the RD receives broadcast message containing Broadcast Indication IE (see clause 6.4.3.7) indicating Random Access response and RD finds its own Short RD ID from the Broadcast Indication IE during random access response window:

- consider that random access transmission was successful;
- set the *CW_CURRENT* to *CW_MIN*;
- if Broadcast Indication IE indicates that MAC PDU transmitted in random access message was successfully decoded:
 - clear the MAC PDU from the TX buffer;
- else:
 - initiate re-transmission of the MAC PDU;
- if received MAC PDU includes resource allocation:
 - use allocated resources for next (re)transmission;
- else if MAC buffers are empty:
 - procedure ends;
- else:
 - initiate new random access transmission as defined in clause 5.3.3.

5.4 Scheduled access data transfer

The schedule access data transfer is performed by using pre-assigned resources. The FT part of the communication assigns the resources for RD to transmit and receive. The RD shall:

- receive all resources configured as *receive* as follows:
 - perform HARQ operation as defined in clause 5.5;

- maintain reception of beacon messages, if RD is not able to receive beacon due to scheduled reception or transmission resource:
 - operations on scheduled resource take precedence;
- transmit on resource configured as *transmit* scheduled resource as follows:
 - use Physical Layer Control Field: Type 2;
 - select the highest MCS and highest available number of spatial streams that maximizes throughput;
 - set feedback info bits;
 - prepare MAC PDU as defined in clause 5.6;
 - if MAC security is used:
 - take actions defined in clause 5.9;
 - if RD does not have any valid MAC SDUs or MAC IEs or pending HARQ processes or other PHY feedback, the RD should:
 - defer to the transmission to that resource.

5.5 HARQ Operation

5.5.1 General

RD shall support HARQ combining based on physical layer control field signalling. Based on packet coding result an RD sends ACK or NACK feedback in physical control field of the frame. The processing time for creating the feedback is two subslots, resulting that feedback shall be included in transmission at subslot $n+3$ or next transmitted packet after that, where n indicates the subslot where the reception of the packet ended. High layer signalling can be used to delay HARQ feedback signalling.

5.5.2 Receiver Operation

An RD performing reception:

- If PHY Control field is not decodable:
 - no transmission is detected by the PHY layer, i.e. signal level is so low that received energy is considered noise or below detection threshold or CRC of the PHY layer fails:
 - ignore the resource - RD does not generate negative or positive feedback.
- If MAC PDU is received with PHY Control Field with Header Format: 000:
 - if the PHY Control Field indicates with short network ID and receiver ID that the data is intended to it:
 - decode the PHY control bits to define the MCS, Packet length, Transmission mode, HARQ process number, Redundancy version and New data indication status;
 - if New Data Indication defines that the transmitted information is a retransmission of ongoing HARQ process:
 - combine the received transmission with the existing data in the buffer belonging to the same HARQ process buffer;
 - attempt to decode the DATA part;
 - if the CRC of the DATA part is correct:
 - transmit a positive acknowledgement (ACK) to the transmitter using the physical layer feedback bits in next packet transmission; and

- process the MAC PDU further;
- if the CRC of the DATA part is indicating incorrect reception:
 - transmit a negative acknowledgement (NACK) to the transmitter using the physical layer feedback bits in next packet transmission; and
 - store the received packet (in soft symbols) in the HARQ process buffer;
- else:
 - ignore the received packet - MAC does not generate ACK or NACK feedback message.
- If MAC PDU is received by correct RD with PHY Control Field with Header Format: 001:
 - if the PHY Control Field indicates with short network ID and receiver ID that the data is intended to it:
 - decode the PHY control bits to define the MCS, Packet length, Transmission mode;
 - attempt to decode the DATA part;
 - if the CRC of the DATA part is correct:
 - process the MAC PDU further;
 - if the CRC of the DATA part is indicating incorrect reception:
 - ignore received DATA part;
 - else:
 - ignore the received packet.

5.6 Multiplexing and assembly

The RD shall perform multiplexing to MAC PDU as follows:

- calculate maximum MAC PDU size based on available resource, selected MCS, TX power and highest available number of spatial streams;
- obtain maximum MAC PDU content size by taking into account:
 - MAC header type;
 - MAC Common header;
 - if security is used:
 - security info if included;
 - MIC;
- fill MAC PDU content in following order:
 - all MAC message(s);
 - individual MAC IE(s);
 - all MAC SDUs from higher layer signalling flow;
 - all MAC SDUs from user plain data flow in priority order;
 - if MAC PDU content is not full:
 - include padding into MAC PDU content to obtain next possible packet length;
- set used MCS, transmission power, number of streams and packet length fields in PHY control field 1.

5.7 Mobility Procedures

Radio Device mobility is based on RSSI-2 measurement and RD reselection decision to change association from previous RD in FT mode to another RD in FT mode. The RD may initiate and complete association to target RD in FT mode before releasing the association from source RD in FT mode. Additionally, an RD may maintain association to multiple RDs simultaneously.

The RD in PT mode and associated with other RD should perform mobility procedures as follows:

- scan supported channel periodically to detect network and cluster beacons from other RDs;
- when detecting network or cluster beacon perform RSSI-2 measurement on the detected beacon;
- if $RSSI-2_{detected} > RSSI-2_{Own} + RELATIVE_QUALITY$:
 - associate *countToTrigger* for the detected RD and decrease the counter *countToTrigger* by 1;
- else:
 - reset the *countToTrigger* to value stored in variable *COUNT_TO_TRIGGER* obtained from cluster beacon;
- if *countToTrigger* is zero, consider RD for target RD for mobility:
 - receive cluster beacon from the RD, and if it enables association:
 - initiate association towards RD as defined in clause 5.8;
- else:
 - maintain scanning for detecting other RDs and measure detected RD in its next cluster beacon interval.

NOTE 1: RD may release the association to source RD before or after completing the association.

NOTE 2: Additionally the RD may fail to send Association Release message to source due to loss of radio connection.

NOTE 3: RD may stop measuring detected other RD, if RSSI-2 value of the detected RD low compared to existing RD. This is left to implementation. Criteria for stopping measurement can be e.g. $RSSI-2_{detected} < RSSI-2_{Own} - 6$ dB.

5.8 Association procedure

5.8.1 General

Figure 5.8.1-1 presents the association signalling procedure. The purpose of association signalling is to initiate unicast data exchange between two RDs. Single RD may have active association to multiple other RDs simultaneously. When association is established, it is maintained until it is explicitly released by either party.

NOTE: The explicit release may not always be possible due to radio conditions, mobility, or due to other reasons.

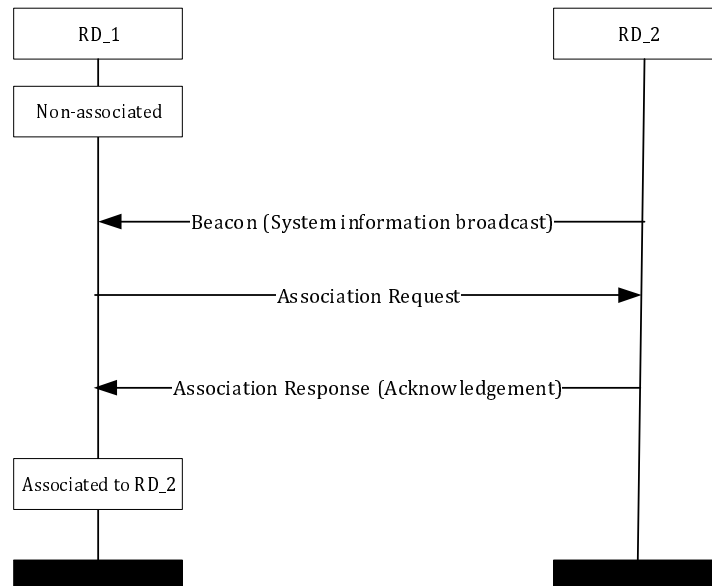

Figure 5.8.1-1: Association signalling

5.8.2 Sending beacon for association

The RD_2 enables association procedure by broadcasting beacon frames as defined in clause 5.2.1. The reception of beacon allows other RDs to associate with RD_2. The beacon frame has at least following parameters:

- Control Header type 1 is used.
- Short RD ID of the RD_2 is included in PHY control field of the beacon frame as transmitter address of the frame.
- The rest of the PHY control field are set accordingly.
- Network ID and Long RD ID of the RD_2 is included in Beacon Header, clause 6.3.3.2, of the MAC PDU and transmitted as plain text.

The beacon content of the MAC PDU can be transmitted as plain text without MIC or ciphered with inclusion of the MIC provided by MAC security.

If beacon content is sent plain text the RD_2 provides association for any other RDs that may or may not have MAC security key(s) available from authentication with backend.

If beacon content is ciphered the association is only possible for RD that have already MAC security keys available.

5.8.3 Association initiation

RD_1 initiates the association procedure by performing following actions:

- generate Short RD ID as random value:
 - the RD_1 uses random value generation so that all values available in 2 power of 16 have equal probability to be obtained from the process;
- exclude reserved values (Table 4.2.3.3-1) from selection;
- scan radio environment to detect possible other RDs for association as defined in clause 5.1.2:
 - during this process it may detect multiple DECT-2020 frames (Unicast or broadcast);
- if it detects same short RD value as it has randomly allocated in first step:
 - perform random Short RD ID allocation again;

- if detects suitable other RD for association:
 - send Association Request message to detected RD.

5.8.4 Sending association request

The RD sends Association Request frame as CCCH message as follows:

- uses parameters provided in Beacon;
- uses actions defined clause 5.3;
- set Short RD ID in PHY control field of the frame as transmitter address of the frame;
- set receiver address of the PHY control field as the Short RD ID of the RD_2;
- include its own Long RD ID and receivers Long RD ID in Unicast Header, clause 6.3.3.3, of the MAC PDU, to be transmitted as plain text;
- if beacon was ciphered and/or RD has MAC security keys available:
 - ciphered and integrity protect the rest of the MAC PDU part as defined in clause 5.9;
- if beacon was not ciphered and RD does not have MAC security keys:
 - send association request without ciphering and integrity;
- after sending the association request frame:
 - initiate reception of the association response frame as instructed by the beacon frame.

5.8.5 Association response

When RD_2 receives the association request it performs following actions for sending response:

- considers if it can accept association;
- checks whether it has knowledge if the indicated Short RD ID is in use by another RD with different Long RD ID.

If RD_2 can accept the association request, it sends Association Response Frame as CCCH message by setting:

- set Short RD ID of it is own as the transmitter ID in PHY control field of the frame;
- set to Short RD ID of the RD_2 as receiver address of the frame in PHY control field;
- includes Long RD ID of the RD_2, received from association request to, and its own Long RD ID into, Unicast Header (see clause 6.3.3.3), of the MAC PDU of the frame;
- include set of association parameters how to communication may continue;
- if the association request was ciphered and integrity protected, RD_2 uses ciphering and integrity protection to the MAC PDU.

If RD_2 cannot accept association, it sends Association Response as above with cause and timer *rejectTime* to inform association request is rejected to the RD_1.

When RD_1 receives Association Response:

- if association request is accepted and RD-1 can operate with provided configuration in association response:
 - start using provided configuration and consider association successful;
 - procedure ends;

- else if RD-1 cannot operate with provided configuration in association response:
 - send association release as defined in clause 5.8.6;
- if association response is rejected:
 - RD shall consider association failed;
 - RD shall prohibit sending new association request to RD-2 until timer *rejectTime* is expired;
 - RD-1 should initiate RD selection for association procedure as defined in clause 5.1.4.

5.8.6 Association Release

When an RD wants to release association with other RD, the RD sends Association Release message. The RD can send the Association Release at any time. When Physical layer confirms the transmission of MAC PDU containing Association Release message, the RD shall:

- consider association as released;
- clear all configurations, buffers and timers regarding this association.

When an RD receives Association Release Message from another RD, the RD shall:

- consider association as released;
- clear all configurations, buffers and timers regarding this association.

5.9 Security Procedures

5.9.1 Mode 1

5.9.1.1 General

Mode 1, uses AES-128 for ciphering with integrity protection to provide confidentiality and message authentication of a MAC PDU as defined in FIPS PUB 197 [4].

For Mode 1 the RD shall have two keys, one for integrity protection and another for encryption.

The Mode 1 uses secret keys for both ciphering and integrity protection. The method is transparent for the method used for RD authentication and key distribution.

The both integrity and encryption process is initiated by the RD when receiving a MAC PDU than contains the MAC security Info IE, clause 6.4.3.1. The security Info IE is used to synchronize the initialization vector between two RDs. The security Info IE can be received in beacon message or from unicast MAC PDU.

5.9.1.2 Integrity protection

The Mode 1 integrity protection of the messages is obtained by using the message integrity code (MIC) that is added to end of the MAC PDU as shown in Figure 6.3.1-1. The MIC is calculated by using CMAC (OMAC-1) message authentication algorithm as defined in NIST Special Publication 800-38B [5].

When RD is transmitting the MAC PDU and Mode 1 security is applied, the RD shall:

- construct the MAC PDU, including MAC header type, MAC common header, and add all MAC SDUs by using MAC mux header into MAC PDU;
- generate MIC from complete MAC PDU;
- truncate the MIC to 5 octets and amend it to the end of MAC PDU;
- take actions defined in clause 5.9.1.3 for ciphering the data.

When RD has received MAC PDU that indicated in MAC header that security is applied RD shall:

- verify received MIC:
 - if MIC is correct:
 - RD shall process the MAC PDU further;
 - else:
 - discard the complete MAC PDU.

5.9.1.3 Ciphering

For Mode 1, uses AES-128 counter mode (CTR) for encryption as defined in FIPS PUB 197 [4]. The initialization vector (IV) for the counter is defined in Table 5.9.1.3-1.

Table 5.9.1.3-1: Initialization vector

Bits	Definition
0 to 11	PSN: (Packet sequence number), transmitted in MAC PDU. Set to zero when MAC PDU packet contains one time HPC.
12 to 31	Ciphering engine internal byte counter. Increased by one at every 16 byte ciphred block. Set to zero for the first 16 byte block of the MAC PDU.
32 to 63 (octets: 4 to 7)	Long RD-ID of the transmitter.
64 to 95 (octets: 8 to 11)	Long RD ID of the receiver.
96 to 127 (octets: 12 to 15)	HPC: (Hyper packet counter).

When RD is transmitting the MAC PDU, and Mode 1 security is applied, the RD shall:

- if the MAC PDU is transmitted with DATA MAC PDU header or Unicast Header:
 - if MAC PDU sequence number is 0;
 - increment HPC by one;
 - use MAC PDU sequence number as PSN;
 - if RD is sending one or multiple MAC IE as plain text:
 - indicate the presence of Security info IE in MAC Header Type;
 - cipher MAC PDU from Security info IE onwards including MIC;
 - else if RD is initiating security or re-synchronizing the HPC:
 - increase the HPC at least by one from previously used value and include Security info IE into MAC PDU;
 - indicate the presence of Security info IE in MAC Header Type and set Security IV type to resynchronizing HPC;
 - cipher MAC PDU from Security info IE onwards including MIC;
 - else if RD is detecting IV synchronization error, and is not able to send re-synchronizing the HPC:
 - increase the HPC at least by one from previously used value and include Security info IE into MAC PDU;
 - indicate the presence of Security info IE in MAC header type and set Security IV type to One time HPC with HPC request;
 - cipher MAC PDU from Security info IE onwards including MIC;

- else:
 - indicate that MAC security is applied in MAC Header Type;
- cipher MAC PDU from MAC Common header onwards including MIC;
- procedure ends;
- if the MAC PDU is transmitted with Beacon header, or RD Broadcasting Header:
 - increment HPC at least one from previously used value;
 - set the PSN to zero;
 - if RD is initiating or re-synchronizing the HPC:
 - set Security IV type to resynchronizing HPC;
 - include Security info IE with HPC into MAC PDU;
 - indicate the presence of Security info IE in MAC header type;
 - cipher MAC PDU from Security info IE onwards including MIC;
 - procedure ends.

When RD is receiving the MAC PDU, and Mode 1 security is applied, the RD shall:

- if the MAC PDU is received with DATA MAC PDU header or Unicast Header:
 - if MAC PDU sequence number is 0;
 - increment HPC by one;
 - use MAC PDU sequence number as PSN;
 - if Security info IE is present in MAC Header Type and set Security IV type to initiating security or resynchronizing HPC:
 - obtain HPC from the Security info;
 - use obtained HPC for receiving and transmitting future MAC PDUs;
 - decipher MAC PDU from Security info IE onwards including MIC using;
 - else if Security info IE is present in MAC header type:
 - decipher MAC PDU from Security info IE onwards including MIC;
 - else:
 - decipher MAC PDU from MAC Common header onwards including MIC;
 - take actions defined in clause 5.9.1.2.
- if the MAC PDU is received with Beacon header, or RD Broadcasting Header:
 - set the PSN to zero;
 - obtain HPC from the Security info;
 - if is set to Security IV type to resynchronizing HPC:
 - use obtained HPC for receiving and transmitting future MAC PDUs;
 - decipher MAC PDU from Security info IE onwards including MIC using HPC and PSN;
 - take actions defined in clause 5.9.1.2.

5.10 Reconfiguration

When an RD receives the reconfiguration request message the RD shall:

- consider received configuration and whether it can support it;
- if RD can support configuration the RD shall:
 - send reconfiguration response message indicating that configuration is accepted;
 - consider new configuration to be valid after physical layer confirms that reconfiguration response has been send;
- if RD cannot support received configuration the RD shall:
 - send reconfiguration response message including configuration that it can support;
 - consider new configuration to be valid after physical layer confirms that reconfiguration response has been send.

When an RD receives the reconfiguration response message the RD shall:

- if reconfiguration response message indicates that configuration included in reconfiguration request message is completely accepted:
 - consider new configuration to be valid immediately;
- if reconfiguration response message contain new configuration parameters:
 - if RD can support configuration the received reconfiguration response:
 - consider new configuration to be valid immediately;
 - else:
 - initiate transmission of association release message with release cause "incompatible configuration".

6 Protocol Data Units, formats and parameters

6.1 General

MAC protocol has two separate parts in physical layer packet for transmitting and receiving information. The first part is Physical Header Field, clause 6.2 and second part is MAC PDU, clause 6.3.

Both Physical Header Field and MAC PDU are a bit strings that are byte aligned (i.e. multiple of 8 bits) in length. In figures and tables in clause 6, bit strings are represented the most significant bit in the leftmost bit of the first line of the table, the least significant bit is the rightmost bit on the last line of the table, and more generally the bit string is to be read from left to right and then in the reading order of the lines. The bit order of each parameter field within a Physical Header Field and a MAC PDU is represented with the first and most significant bit in the leftmost bit and the last and least significant bit in the rightmost bit.

6.2 Physical Header Field

6.2.1 General

In packet transmission MAC layer defines the number of antennas used for transmission, and the transmission format of the physical layer frame and sets the content of physical layer control field of the frame. Physical layer supports two (2) different sizes of physical layer control field. Different sizes are:

- Type 1: 40 bits
- Type 2: 80 bits

The information coding for each type is as defined in Tables 6.2.1-1, 6.2.1-2 and 6.2.1-2a and presented in Figure 6.2.1-1 and Figure 6.2.1-2.

Physical layer amends content with 16-bit CRC and performs physical layer transmission procedure as defined in ETSI TS 103 636-3 [3].

Table 6.2.1-1: Physical Layer Control Field: Type 1, Header Format: 000

Control channel field	#bits	Explanation
Header Format	3	Defines the format of the control header Type 1. Bits are set to 000.
Packet length type	1	Indicates whether transmission length is indicated in subslots or slots: If set to 0, the length is given in subslots. If set to 1 the length is given in slots.
Packet length	4	The length of packet transmission in subslot or slots. Packet length is signalled numerical value plus one subslot or slot. The length of the subslot is 5 OFDM symbols as defined in ETSI TS 103 636-3 [3].
Short Network ID	8	Short network ID of the RD as defined in clause 4.2.3.1.
Transmitter Identity	16	Short RD ID of the RD as defined in clause 4.2.3.3.
Transmit Power	4	Defines the used TX power as defined in Table 6.2.1-3.
Reserved	1	Reserved. Set to zero by the transmitter. The Receiver shall ignore this bit.
DF MCS	3	Defines the MCS of the transmission as defined in ETSI TS 103 636-3 [3].

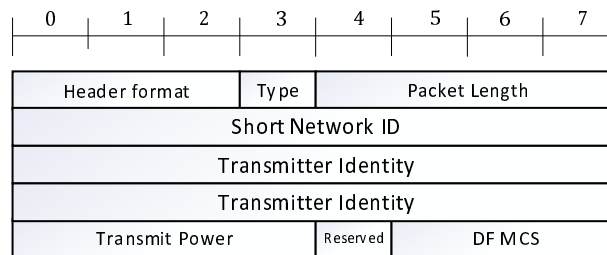

Figure 6.2.1-1: Physical Layer Control Field: Type 1

Table 6.2.1-2: Physical Layer Control Field: Type 2, Header Format: 000

Control channel field	#bits	Explanation
Header Format	3	Defines the format of the control header Type 2. Bits are set to 000.
Packet length type	1	Indicates whether transmission length is indicated in subslots or slots: If set to 0, the length is given in subslots. If set to 1 the length is given in slots.
Packet length	4	The length of packet transmission in subslot or slots. Packet length is signalled numerical value plus one subslot or slot. The length of the subslot is 5 OFDM symbols as defined in ETSI TS 103 636-3 [3].
Short Network ID	8	Short network ID of the RD as defined in clause 4.2.3.1.
Transmitter Identity	16	Short RD ID of the RD as defined in clause 4.2.3.3.
Transmit Power	4	Defines the used TX power as defined in Table 6.2.1-3.
DF MCS	4	Defines the MCS of the transmission as defined in ETSI TS 103 636-3 [3].
Receiver Identity	16	Short RD ID of receiver RD, or broadcast ID as defined in clause 4.2.3.3.
Number of Spatial Streams	2	Number of spatial streams of the data field as defined in Table 6.2.1-4.
DF Redundancy Version	2	Defines the redundancy version number of the transmission as defined in clause 6.1.5.3 of ETSI TS 103 636-3 [3].
DF New data Indication	1	Transmitter toggles this bit to control whether receiver combines this transmission with previous content of the HARQ process.
DF HARQ Process Number	3	HARQ process number of this transmission.
Feedback format	4	Defines the coding of the feedback info as defined in Table 6.2.2-1.
Feedback info	12	Feedback information in clause 6.2.2.

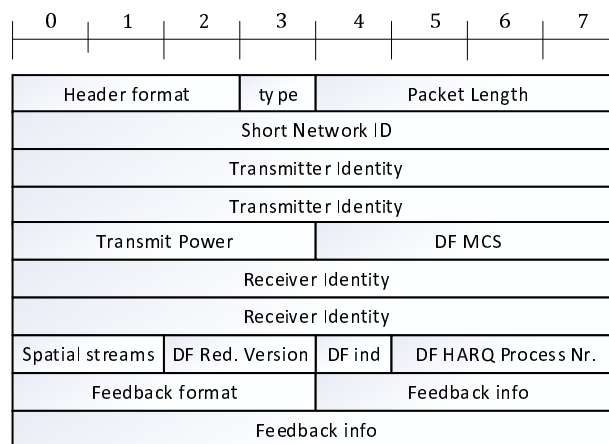

Figure 6.2.1-2: Physical Layer Control Field: Type 2

Table 6.2.1-2a: Physical Layer Control Field: Type 2, Header Format: 001

Control channel field	#bits	Explanation
Header Format	3	Defines the format of the control header Type 2. Bits are set to 001. Indicating that transmitter does not request HARQ feedback for DF of this packet.
Packet length type	1	Indicates whether transmission length is indicated in subslots or slots: If set to 0, the length is given in subslots. If set to 1 the length is given in slots.
Packet length	4	The length of packet transmission in subslot or slots. Packet length is signalled numerical value plus one subslot or slot. The length of the subslot is 5 OFDM symbols as defined in ETSI TS 103 636-3 [3].
Short Network ID	8	Short network ID of the RD as defined in clause 4.2.3.1.
Transmitter Identity	16	Short RD ID of the RD as defined in clause 4.2.3.3.
Transmit Power	4	Defines the used TX power as defined in Table 6.2.1-3.
DF MCS	4	Defines the MCS of the transmission as defined in ETSI TS 103 636-3 [3].
Receiver Identity	16	Short RD ID of receiver RD, or broadcast ID as defined in clause 4.2.3.3.
Number of Spatial Streams	2	Number of spatial streams of the data field as defined in Table 6.2.1-4.
Reserved	6	Reserved. Set to zero by the transmitter. The receiver shall ignore these bits.
Feedback format	4	Defines the coding of the feedback info as defined in Table 6.2.2-1.
Feedback info	12	Feedback information in clause 6.2.2.
NOTE: When packet transmission is done with this version of the Physical Layer Control Field: Type 2 the DF Redundancy Version is set to 0.		

Table 6.2.1-3: Transmit Power

Bit field	TX Power [dBm]
0000	-40
0001	-30
0010	-20
0011	-13
0100	-6
0101	-3
0110	0
0111	3
1000	6
1001	10
1010	14
1011	19
1100	23
1101	26
1110	29
1111	> 32

Table 6.2.1-4: Number of Spatial Streams

Bit field	Transmission mode
00	Single spatial stream
01	Two spatial streams
10	Four spatial streams
11	Eight Spatial streams

6.2.2 Coding of Feedback info

The coding the feedback info is indicated with Feedback format field in Table 6.2.2-1.

Table 6.2.2-1: Feedback format for 12-bit Feedback Info

Bit field	Feedback format
0000	No feedback. Receiver shall ignore feedback info bits
0001	Format 1, table 6.2.2-2a
0010	Format 2, table 6.2.2-2b
0011	Format 3, table 6.2.2-2c
0100	Format 4, table 6.2.2-2d
0101	Format 5, table 6.2.2-2e
0110 to 1110	Reserved
1111	Escape

Table 6.2.2-2a: Feedback info format 1

Field	#bits	Explanation
HARQ Process number	3	Indicates the process of the HARQ feedback.
Transmission feedback	1	If set to 0, the feedback is Negative Acknowledgement (NACK). If set to 1 the feedback is positive Acknowledgement (ACK).
Channel Quality Indicator (CQI)	4	Channel quality indicator, as defined in Table 6.2.2-3.
Buffer Status	4	Buffer status as define in Table 6.2.2-4.

Table 6.2.2-2b: Feedback info format 2

Field	#bits	Explanation
Channel Quality Indicator (CQI)	4	Channel quality indicator, as defined in Table 6.2.2-3.
Buffer Status	4	Buffer status as define in Table 6.2.2-4.
MIMO Feedback	1	Bit coding: 0: Single layer. 1: Dual layers.
Codebook index	3	Codebook index as defined in Table 6.3.4-1 for single layer, or Table 6.3.4-3 for dual layer for dual layer in ETSI TS 103 636-3 [3].

Table 6.2.2-2c: Feedback info format 3

Field	#bits	Explanation
HARQ Process number	3	Indicates the process of the HARQ feedback.
Transmission feedback	1	If set to 0, the feedback is Negative Acknowledgement (NACK). If set to 1 the feedback is positive Acknowledgement (ACK).
HARQ Process number	3	Indicates the process of the HARQ feedback.
Transmission feedback	1	If set to 0, the feedback is Negative Acknowledgement (NACK). If set to 1 the feedback is positive Acknowledgement (ACK).
Channel Quality Indicator (CQI)	4	Channel quality indicator, as defined in Table 6.2.2-3.

Table 6.2.2-2d: Feedback info format 4

Field	#bits	Explanation
HARQ feedback bitmap	8	HARQ feedback bitmap, where bit position indicates the process number. 1 st bit is process 0, and 8 th bit is for process 7. Process where data has been successfully decoded and ACK has not sent is set to 1. Otherwise bit is set 0.
Channel Quality Indicator (CQI)	4	Channel quality indicator, as defined in Table 6.2.2-3.

Table 6.2.2-2e: Feedback info format 5

Field	#bits	Explanation
HARQ Process number	3	Indicates the process of the HARQ feedback.
Transmission feedback	1	If set to 0, the feedback is Negative Acknowledgement (NACK). If set to 1 the feedback is positive Acknowledgement (ACK).
MIMO Feedback	2	Bit coding: 00: Single layer, codebook index included. 01: Dual layers, codebook index included. 10: Four layers, codebook index included. 11: Reserved.
Codebook index	6	Codebook index as defined in Table 6.3.4-2 for single layer, or Table 6.3.4-4 for dual layers or Table 6.3.4-5 for four layers for four-layers, in ETSI TS 103 636-3 [3].

The coding of the Channel Quality Indicator (CQI) is presented in Table 6.2.2-3. The RD shall select the index in such a manner that BLER does not exceed 10 % with indicated MCS in given channel conditions. The MCS values are defined in Annex A of ETSI TS 103 636-3 [3]. The index out of range is indicated even when decoding of MCS-0 is not possible with 10 % BLER.

Table 6.2.2-3: Channel Quality Indicator

Bit field	Modulation
0000	Out of Range
0001	MCS-0
0010	MCS-1
0011	MCS-2
0100	MCS-3
0101	MCS-4
0110	MCS-5
0111	MCS-6
1000	MCS-7
1001	MCS-8
1010	MCS-9
1011	MCS-10
1100	MCS-11
1101 to 1111	Reserved

The coding of the buffer status is presented in Table 6.2.2-4. When included in the feedback info, the RD shall report the remaining available data in its MAC buffer after MAC PDU included in data field indicated in this physical header field.

Table 6.2.2-4: Buffer Status

Bit field	Buffer Size (BS) value [bytes]
0000	BS = 0
0001	0 < BS ≤ 16
0010	16 < BS ≤ 32
0011	32 < BS ≤ 64
0100	64 < BS ≤ 128
0101	128 < BS ≤ 256
0110	256 < BS ≤ 512
0111	512 < BS ≤ 1 024
1000	2 048 < BS ≤ 4 096
1001	4 096 < BS ≤ 8 192
1010	8 192 < BS ≤ 16 384
1011	16 384 < BS ≤ 32 768
1100	32 768 < BS ≤ 65 536
1101	65 536 < BS ≤ 131 072
1110	131 072 < BS ≤ 262 144
1111	BS > 262 144

6.3 MAC PDU

6.3.1 General

Basic MAC PDU structure is depicted in Figure 6.3.1-1 presenting also parts of the MAC PDU are that ciphered and are covered by integrity protection if MAC layer security is used. The MAC PDU contains following parts:

- MAC header type, clause 6.3.2;
- MAC Common header, clause 6.3.3;
- one or more MAC SDU that is included in MAC PDU with MAC multiplexing header, clause 6.3.4;
- Message Integrity Code MIC, clause 5.9.1.

The first byte of the MAC PDU is the MAC header type in Figure 6.3.1-1, and the first bit of MAC Header type is the bit zero in Figure 6.3.2-1.

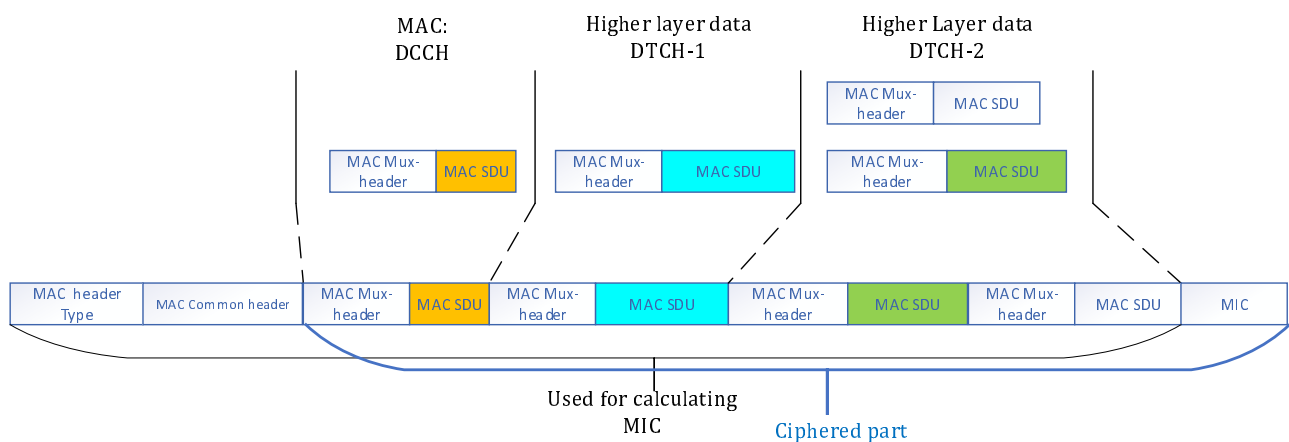

Figure 6.3.1-1: MAC PDU: MAC multiplexing with security ciphering and integrity protection

MAC PDU always follows this general format for all transport channels (PCH/BCH, DCH, or RACH).

6.3.2 MAC Header type

The MAC header type field has length of a single octet. The bits of the octet are defined as shown in Figure 6.3.2-1. The version bits shall be set to 00. The MAC security info is defined in Table 6.3.2-1. The MAC header type field is defined in Table 6.3.2-2.



Figure 6.3.2-1: MAC header Type

Table 6.3.2-1: MAC Security

Value	Definition
00	MAC security not used for this MAC PDU.
01	MAC security used and MAC Security IE not present. MAC PDU sequence number used as PSN for security. Ciphared part starts immediately after MAC Common header.
10	MAC security used and MAC Security Info IE is in MAC PDU. The ciphared part starts immediately after MAC Security info.
11	Reserved.

Table 6.3.2-2: MAC header Type field

Value	Definition
0000	DATA MAC PDU header as defined in Figure 6.3.3.1-1
0001	Beacon Header as defined in Figure 6.3.3.2-1
0010	Unicast Header as defined in Figure 6.3.3.3-1
0011	RD Broadcasting Header as defined in Figure 6.3.3.4-1
1111	Escape

After the MAC header type field the MAC Common header is included.

6.3.3 MAC Common header

6.3.3.1 DATA MAC PDU header

The DATA MAC PDU header, MAC Common header, has single 12-bit sequence number as shown in Figure 6.3.3.1-1. The receiver may perform duplicate detection and packet re-ordering after HARQ re-transmission based on the sequence number. When reset bit is set to 1, the receiver shall consider this PDU as first PDU in MAC re-ordering function.

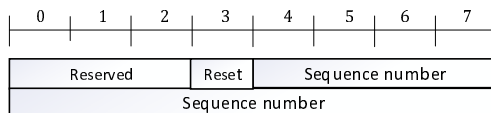

Figure 6.3.3.1-1: DATA MAC PDU

6.3.3.2 Beacon Header

The Beacon Header, MAC Common header, has the first 24 MSB of Network ID in first 3 octets, followed by 4 octets for Transmitter Address as shown in Figure 6.3.3.2-1. The RD sets the Transmitter Address to its own Long RD ID when transmitting the frame.

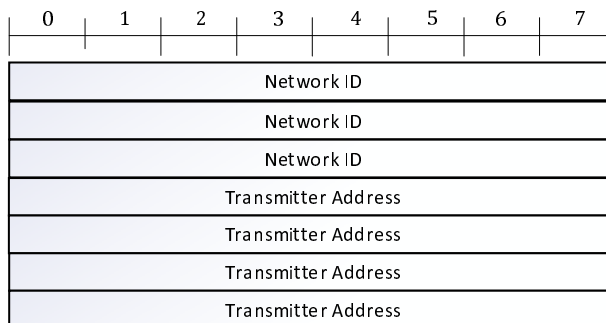

Figure 6.3.3.2-1: Beacon Header

6.3.3.3 Unicast Header

The Unicast Header, MAC Common header, has single 12-bit sequence number as first octet. The receiver may perform duplicate detection and packet re-ordering after HARQ re-transmission based on the sequence number. When reset bit is set to 1, the receiver shall consider this PDU as first PDU in MAC re-ordering function.

The next 4 octets are the Receiver Address, followed by 4 octets of Transmitter Address as shown in Figure 6.3.3.3-1. The RD set the Receiver Address to targeted receiver's Long RD ID value and sets the Transmitter Address to its own Long RD ID when transmitting the frame. The header type provides association between 16 bit Short RD ID and Long RD ID.

RD shall use this header type for:

- association signalling defined in clause 5.8;
- association signalling due to mobility;
- re-establishment of the connection after being out of service;
- re-synchronizing MAC security.

RD may use this header type for any user plane packet if transmitter of the MAC PDU desires to include full address in MAC PDU.

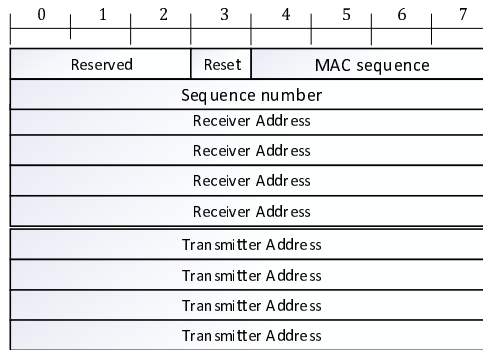

Figure 6.3.3.3-1: Unicast Header

6.3.3.4 RD Broadcasting Header

The RD Broadcasting Header, MAC Common header, has single 12-bit sequence number as first octet. The receiver may perform reordering and duplicate detection based on the sequence number. When reset bit is set to 1, the receiver shall consider this PDU as first PDU in MAC re-ordering function.

The next 4 octets are the Transmitter Address as shown in Figure 6.3.3.4-1.

The RD sets the Transmitter Address to its own Long RD ID when transmitting the frame.

RD shall use this header type for:

- broadcast user plane messages to all other RDs in the same network without previous association or reception of beacon with Long RD ID.

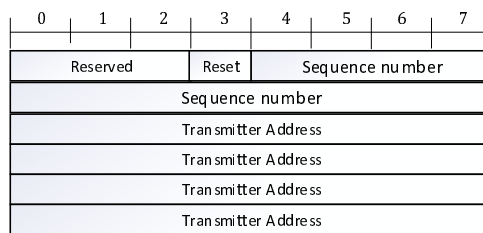

Figure 6.3.3.4-1: RD Broadcasting Header

6.3.4 MAC multiplexing header

MAC multiplexing multiple MAC SDUs into single MAC PDU by adding MAC Multiplex header (MAC Mux header) into MAC SDU. The header includes one octet information, with two fields: MAC Extension (MAC_Ext) and IE Type, and optional one or two octet length field. The length field indicates the length of the MAC SDU in octets. The 8 bit length can indicate SDU length between 0 and 255 octets and 16 bit length can indicate SDU length between 0 and 65 535 octets.

Different MAC MUX-header options are shown in Figure 6.3.4-1.

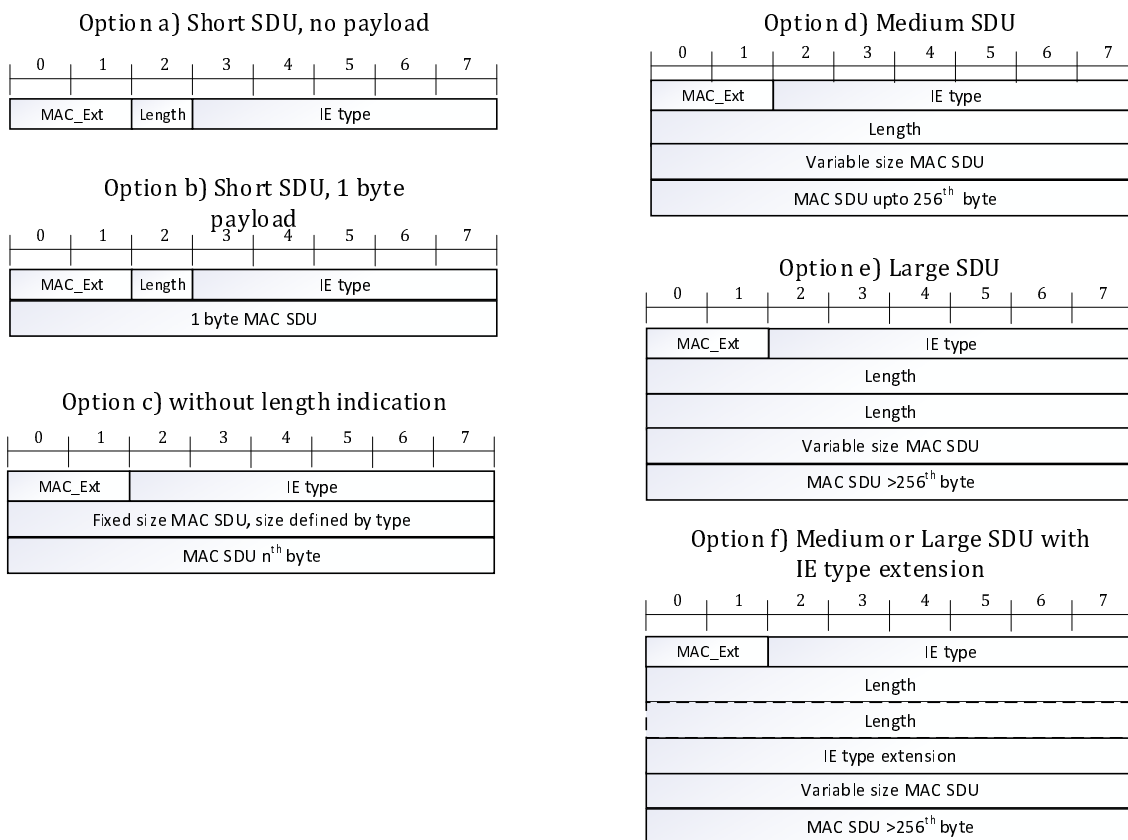

Figure 6.3.4-1: MAC multiplexing PDU with different header options

Table 6.3.4-1: MAC extension field encoding

Value	Definition
00	No length field included in IE header. The IE type defines the length of the IE payload.
01	8 bit length included indicating the length of the IE payload.
10	16 bit length included indicating the length of the IE payload.
11	Short IE, one bit length field included in IE header. The IE payload size is 0 when length bit (bit 2) is set to 0, or 1 byte when length bit (bit 2) is set to 1, shown in Figure 6.3.4-1 option a) and option b).

IE type field indicates content type of the MAC SDU as defined in Table 6.3.4-2. The code point 11110 is reserved for proprietary extensions and code point 11111 for future extensions.

Table 6.3.4-2: IE type field encoding for MAC Extension field encoding 00, 01, 10

Value	Definition
000000	Padding IE
000001	Higher layer signalling - flow 1
000010	Higher layer signalling - flow 2
000011	User plane data - flow 1
000100	User plane data - flow 2
000101	User plane data - flow 3
000110	User plane data - flow 4
000111	Routing PDU, clause B.2
001000	Network Beacon message
001001	Cluster Beacon message
001010	Association Request message
001011	Association Response message
001100	Association Release message
001101	Reconfiguration Request message
001110	Reconfiguration Response message
001111	Additional MAC messages
010000	Security Info IE
010001	Route Info IE
010010	Resource allocation IE
010011	Random Access Resource IE
010100	RD capability IE
010101	Neighbouring IE
010110	Broadcast Indication IE
010111	Group Assignment IE
011000 to 111101	Reserved
111110	Escape
111111	IE type extension. There is additional 1 byte IE type extension field after one or two byte length field. Length includes the length of payload and the extension.

For the MAC extension field encoding 11 and payload length 0 the IE types are defined in Table 6.3.4-3. The code point 11110 is reserved for proprietary extensions. The actual IE content does not exist as it has zero length.

Table 6.3.4-3: IE type field encoding for MAC extension field encoding 11 and payload length 0 byte

Value	Definition
00000	Padding IE
00001 to 01111	Reserved
10000	Security Info IE
10001 to 11101	Reserved
11110	Escape
11111	Reserved

For the MAC extension field encoding 11 and payload length 1 the IE types are defined in Table 6.3.4-4. The code point 11110 is reserved for proprietary extensions.

Table 6.3.4-4: IE type field encoding for MAC extension field encoding 11 and payload length of 1 byte

Value	Definition
00000	Padding IE
00001 to 11101	Reserved
11110	Escape
11111	Reserved

6.4 MAC Messages and Information Elements (IEs)

6.4.1 General

The following clauses present the content of the different MAC messages and MAC information elements IEs. Only the content of each IE is presented without MAC multiplexing header.

A MAC IE can be multiplexed with MAC messages other MAC IEs or with MAC SDU containing higher layer signalling, user plane data flow or Routing PDU in single MAC PDU. Receiver may process all received MAC messages or MAC IE received in single MAC PDU in any order.

The bit coding for fields with multiple possible values shall follow that coding where first listed value is coded all zeros and next value is coded as value 1, and so on.

EXAMPLE: If given values are: 50 ms, 100 ms, 500 ms, 1 000 ms, and bitfield size is 2 bits, values would be coded to bit as: 00: 50 ms, 01: 100 ms, 10: 500 ms and 11: 1 000 ms.

All fields or bits or code values marked as reserved in any IE, are reserved for future use. Receiver shall ignore these fields or bits. Transmitter shall set the reserved bits or bits in reserved fields to zero. If receiver receives field with code value that is reserved, it shall consider that IE is incorrect and not act on this IE.

6.4.2 MAC messages

6.4.2.1 General

The following clauses present the content of the different MAC messages.

6.4.2.2 Network Beacon message

The network beacon message is used to announce the presence of a network and indicate the cluster beacon transmission timing, periodicity, and operating channel.

The network beacon is always transmitted with Beacon Header, clause 6.3.3.2, and if MAC security is applied to the network beacon the MAC Security Info, clause 6.4.3.1, is present.

The Network beacon message contains always the information Network Beacon IE presented in Figure 6.4.2.2-1 followed by other optional IEs. The coding of the Network Beacon IE is defined in Table 6.4.2.2-1.

When operating in Mesh mode the RD shall include Route Info (see clause 6.4.3.2) into Network beacon message.

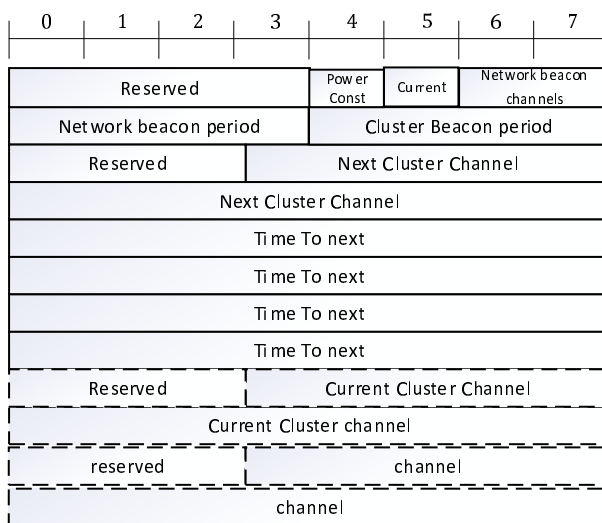

Figure 6.4.2.2-1: Network Beacon Message IE

Table 6.4.2.2-1: Network beacon IE field definitions

Field	Bits	Definition
Power const	1	0: The RD operating in FT mode does not have power constrains. 1: The RD operating in FT mode has power constrains.
Current	1	0: The current cluster channel is the same as next cluster channel. The current cluster channel field is not included. 1: The current cluster channel is not same as next cluster channel. The current cluster channel field is included.
Network Beacon channels	2	Number of additional Network beacon channels included in the end of the network beacon IE. RD should also scan these channels to detect possible other RDs.
Network Beacon period	4	Indicates the network beacon period in ms. Coded values: 50 ms, 100 ms, 500 ms, 1 000 ms, 1 500 ms, 2 000 ms, 4 000 ms. Rest are reserved.
Cluster Beacon period	4	Indicates the Cluster beacon transmission period in ms. Coded values: 10 ms, 50 ms, 100 ms, 500 ms, 1 000 ms, 1 500 ms, 2 000 ms, 4 000 ms, 8 000 ms, 16 000 ms, 32 000 ms. Rest are reserved.
Next Cluster Channel	13	Operating channel of the cluster for next cluster beacon period. Field gives absolute the carrier centre frequency as defined in ETSI TS 103 636-2 [2].
Time to Next	32	Time in microseconds until the next beacon period starts.
Additional Network Beacon Channels	13	Additional network channel(s) of the network to detect Network Beacon messages. Field gives absolute the carrier centre frequency as defined in ETSI TS 103 636-2 [2].

6.4.2.3 Cluster Beacon message

The Cluster Beacon message is used to provide frame and slot timing for the cluster, announce radio parameters and radio resources so that other RDs may communicate the RD in FT mode.

When RD receives the Cluster Beacon message, it considers that transmission of the physical layer packet containing cluster beacon message was initiated at first symbol of the slot 0 in a radio frame if not indicated by Frame Offset Field. If Frame Offset is present the RD considers that frame started indicated number of subslots earlier.

The System Frame Number (SFN) provides the frame count.

The cluster beacon message is always transmitted with Beacon Header, clause 6.3.3.2, and if MAC security is applied to the network beacon the MAC Security Info, clause 6.4.3.1, is present.

The cluster beacon message contains always the information Cluster Beacon IE presented in Figure 6.4.2.3-1 followed by the Random Access Resource IE. After these IEs other optional IEs may follow.

The coding of the Cluster Beacon IE is defined in Table 6.4.2.3-1.

When operating in Mesh mode the RD shall include Route Info (see clause 6.4.3.2) into Cluster beacon message.

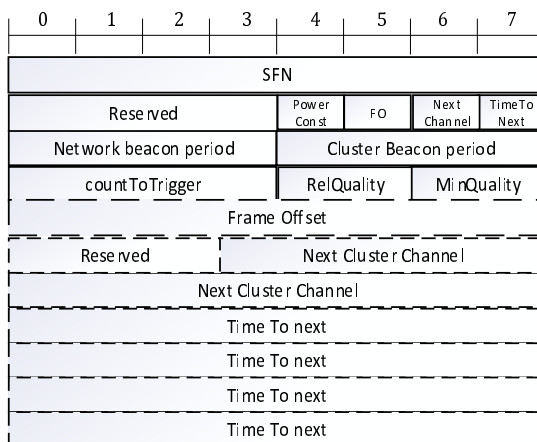

Figure 6.4.2.3-1: Cluster Beacon Message IE

Table 6.4.2.3-1: Cluster beacon IE field definitions

Field	Bits	Definition
SFN	8	Current System Frame number.
Power const	1	As defined in Table 6.4.2.2-1.
FO	1	0: Frame Offset field is not present. 1: Frame Offset field is not present.
Next Channel	1	0: The cluster channel in for next cluster beacon period is the same as current cluster channel. The next cluster channel field is not included. 1: The cluster channel in for next cluster beacon period is different as current cluster channel. The next cluster channel field is included.
TimeToNext	1	0: The next cluster beacon is transmitted based on Cluster beacon period. The Time to next field is not present. 1: The next cluster beacon is transmitted in time location. The Time to next field is present.
Network Beacon period	4	As defined in Table 6.4.2.2-1.
Cluster Beacon period	4	As defined in Table 6.4.2.2-1.
countToTrigger	4	Provides COUNT_TO_TRIGGER value for RD initiated mobility, with following coding: Coded values: 1 times, 2 times, 3 times, 4 times, 5 times, 6 times, 7 times, 8 times, 16 times, 24 times, 32 times, 40 times, 48 times, 64 times, 128 times, 256 times. Reserved.
RelQuality	2	Provides <i>RELATIVE_QUALITY</i> threshold for RD initiate mobility. Coded values: 0 dB, 3 dB, 6 dB, 9 dB.
minQuality	2	Provides <i>MIN_QUALITY</i> threshold for RD's initial FT selection. Coded values: 0 dB, 3 dB, 6 dB, 9 dB.
Frame Offset	8 or 16	The 8 bits version is used when $\mu \leq 4$, and the 16 bits version is used when $\mu > 4$, ETSI TS 103 636-3 [3]. Indicates how many subslot the cluster beacon is delayed from the start of the frame.
Next Cluster Channel	13	As defined in Table 6.4.2.2-1.
Time to next	32	As defined in Table 6.4.2.2-1.

6.4.2.4 Association Request message

The association request message is used by an RD to initiate communication with another RD as defined in clause 5.8.3.

The association request message is sent on Random access resources and transmitted with Unicast Header, clause 6.3.3.2, and if MAC security is applied to the network beacon the MAC Security Info, clause 6.4.3.1, is present.

The association request message contains always the information Association Request IE presented in Figure 6.4.2.4-1. After association request the RD includes the RD capability IE in MAC PDU. After these IEs other optional IEs may follow. The coding of the Association Request IE is defined in Table 6.4.2.4-2.

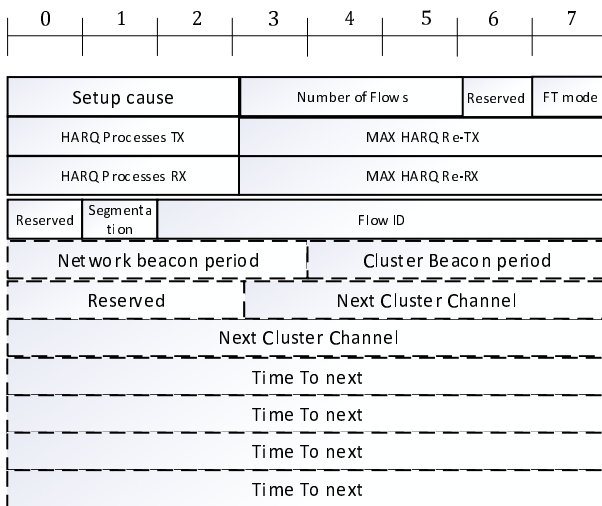

Figure 6.4.2.4-1: Association Request Message IE

Table 6.4.2.4-1: Association Request IE field definitions

Field	Bits	Definition
Setup cause	3	RD indicates the setup cause of the association as decoded in Table 6.4.2.5-1.
Number flows	3	RD indicates how many different flows it would like to setup. There shall be as many segmentation field and flow IDs included as indicated in this field. Code Value: 111 is reserved and shall not be set.
FT mode	1	0: RD operates only in PT Mode. 1: RD operates also in FT mode. RD shall include Network Beacon period, Cluster beacon Period, Next Cluster channel and Time to Next fields.
HARQ Process TX	3	Number of HARQ processes the RD is requesting to use for its transmission.
MAX HARQ RE-TX	5	The maximum HARQ re-transmission delay that RD use in its transmissions. Coded Values: 0,105 ms, 0,2 ms, 0,4 ms, 0,8 ms, 1 ms, 2 ms, 4 ms, 6 ms, 8 ms, 10 ms, 20 ms, 30 ms, 40 ms, 50 ms, 60 ms, 70 ms, 80 ms, 90 ms, 100 ms, 120 ms, 140 ms, 160 ms, 180 ms, 200 ms, 24 ms, 280 ms, 320 ms, 360 ms, 400 ms, 450 ms, 500 ms, notDefined.
HARQ Process RX	3	Number of HARQ processes the RD is requesting to use for its reception.
MAX HARQ RE-RX	5	The maximum HARQ re-transmission delay that RD expects in reception. Coded Values: 0,105 ms, 0,2 ms, 0,4 ms, 0,8 ms, 1 ms, 2 ms, 4 ms, 6 ms, 8 ms, 10 ms, 20 ms, 30 ms, 40 ms, 50 ms, 60 ms, 70 ms, 80 ms, 90 ms, 100 ms, 120 ms, 140 ms, 160 ms, 180 ms, 200 ms, 24 ms, 280 ms, 320 ms, 360 ms, 400 ms, 450 ms, 500 ms, notDefined.
Segmentation	1	0: Transparent mode is request for the flow in following flow ID, Annex B. 1: Segmentation mode is used for the request flow in following flow ID, Annex B.
Flow ID	5	ID of the flow to be established, from Table 6.3.4-2. Higher layer signalling, or Flow 1-4 or Routing PDU.
Network Beacon period	4	As defined in Table 6.4.2.2-1.
Cluster Beacon period	4	As defined in Table 6.4.2.2-1.
Next Cluster Channel	13	As defined in Table 6.4.2.2-1.
Time to next	32	As defined in Table 6.4.2.2-1.

Table 6.4.2.4-2: Association Setup Cause IE

Bit coding	Definition
000	Initial association.
001	Association to request new set of flows.
010	Association due to mobility.
011	Re-association after error: Lost of connection, Security error, other error.
100	Change of own operating channel. Only when RD operates also in FT mode.
101	Change operating mode. Associated originally in PT mode, but started to operate in FT mode, or changing from PT mode only.
110	Other reason.
110 to 111	Reserved.

6.4.2.5 Association Response message

The association response message is used by an RD to accept or reject the association request as defined in clause 5.8.5.

The association response message is transmitted with Unicast Header, clause 6.3.3.2, and if MAC security is applied to the network beacon the MAC Security Info, clause 6.4.3.1, is present.

The association response message contains always the first octet of the Association response IE presented in Figure 6.4.2.5-1. The ACK/NACK bit indicates whether the association is accepted or not. If RD rejects the association request the association response includes only rejection cause and rejectTime fields in second octet.

In case that RD accepts the association request the RD can indicate whether it can support HARQ configuration provided in association request or whether association response include new HARQ configuration. Then RD indicates if it can support all flows or part of the flows that was requested in association request. If RD can support only part of the flows it includes the flow IDs that it has established.

The Group bit is used to indicate whether to associated RD is associated to Group with given Resource TAG. The Group ID and Resource TAG is used to indicate pre-allocated resources in group assignment IE.

After the association response message the RD includes the RD capability IE into MAC PDU. After these IEs other optional IEs may follow. The message may include Resource allocation IE enabling scheduled connection between to RDs.

The coding of the Association Response message is defined in Table 6.4.2.5-2.

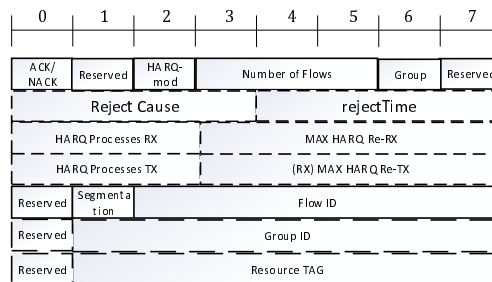

Figure 6.4.2.5-1: Association Response Message IE

Table 6.4.2.5-1: Association Response IE field definitions

Field	Bits	Definition
ACK/NACK	1	0: Association rejected. the reject cause is coded in second octet of the message, as defined in Table 6.4.2.6-1. Bits 1-7 of the first octet is ignored by the receiver. 1: Association Accepted.
HARQ-mod	1	0: HARQ configuration accepted as configured in association request. HARQ fields are not present. 1: HARQ configuration present.
Number of flows	3	RD indicates how many different flows it can accept. There shall be as many segmentation fields and flow IDs included as indicated in this field to indicate accepted flow ID and use of segmentation. Value Coding: 111, All flows accepted as configured in association request.
Group	1	0: Group ID and Resource TAG not included. 1: Group ID and Resource TAG included.
HARQ Process RX	3	Number of HARQ processes the RD is accepting to use for its reception.
MAX HARQ RE-RX	5	The maximum number of HARQ re-transmission the RD expects in reception.
HARQ Process TX	3	Number of HARQ processes the RD is accepting to use for its transmission.
MAX HARQ RE-TX	5	The maximum number of HARQ re-transmission the RD may use in its transmissions.
Segmentation	1	0: Transparent mode is for the request flow in following flow ID, Annex B. 1: Segmentation mode is used for the request flow in following flow ID, Annex B.
Flow ID	5	ID of the flow that has been accepted, from Table 6.3.4-2. Higher layer signalling, or Flow 1-4 or Routing PDU.

Table 6.4.2.5-2: Reject Cause and rejectTime

Field	Bits	Definition
Reject Cause	4	Cause of the rejection. Coded values: <i>No sufficient radio capacity, No sufficient HW capacity, Conflict with Short-RD ID detected, Non-secured association request are not accepted, Other reason, Other values are reserved</i>
rejectTimer	4	Time how long other RD shall prohibit sending new association request to this RD. Coded values: 0 s, 5 s, 10 s, 30 s, 60 s, 120 s, 180 s, 300 s, 600 s, other values are reserved.

6.4.2.6 Association Release message

The association release message is used by an RD to release association with another RD as defined in clause 5.8.6.

The coding of the Association Release message is defined in Figure 6.4.2.6-1 and in Table 6.4.2.6-1.

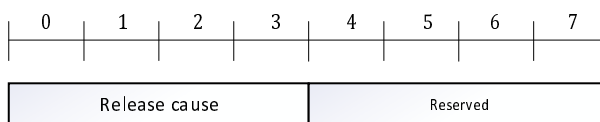

Figure 6.4.2.6-1: Association Release Message IE

Table 6.4.2.6-1: Association Release IE field definitions

Field	Bits	Definition
Release Cause	4	Defines the cause of the association release. Value coding: connection termination, mobility, long Inactivity, incompatible configuration, No sufficient HW/memory resource, No sufficient radio resources, bad radio quality, security error, other error, other reason, reserved.

6.4.2.7 Reconfiguration Request message

The reconfiguration request message is a generic message structure used by an RD to initiate modification of the radio configuration parameters during existing association.

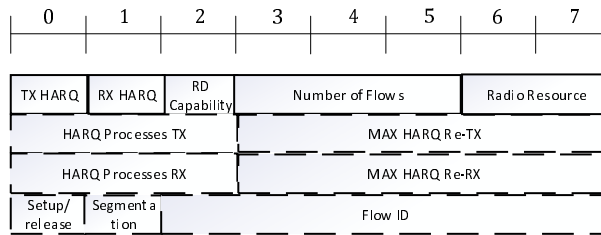

Figure 6.4.2.7-1: Reconfiguration Request Message IE

Table 6.4.2.7-1: Association Response IE field definitions

Field	Bits	Definition
TX HARQ	1	0: HARQ TX configuration is not requested to be modified. 1: HARQ TX configuration is requested to be modified. HARQ Process TX and MAX HARQ RE-TX fields are present.
RX HARQ	1	0: HARQ RX configuration is not requested to be modified. 1: HARQ RX configuration is requested to be modified. HARQ Process RX and MAX HARQ RE-RX fields are present.
RD Capability	1	0: Ignore. 1: The RD capability is changed. The RD capability IE, clause 6.4.3.5 included after the reconfiguration message.
Number of flows	3	RD indicates how many different flows request to be modified. There shall be as many setup/release, segmentation field and flow IDs included as indicated in this field.
Radio Resource	2	Change in radio resources. Value coding: No Change, Requesting More resources, Requesting less resources, Resource allocation IE included after reconfiguration message.
HARQ Process TX	3	As defined in Table 6.4.2.4-2.
MAX HARQ RE-RX	5	As defined in Table 6.4.2.4-2.
HARQ Process RX	3	As defined in Table 6.4.2.4-2.
MAX HARQ RE-TX	5	As defined in Table 6.4.2.4-2.
Setup/Release	1	0: The flow indicated in Flow ID is for setup or reconfiguration. 1: The flow indicated in Flow ID is released.
Segmentation	1	As defined in Table 6.4.2.4-2.
Flow ID	6	As defined in Table 6.4.2.4-2.

6.4.2.8 Reconfiguration Response message

The reconfiguration response message is response message to reconfiguration request used by an RD to accept radio configuration parameters during existing association.

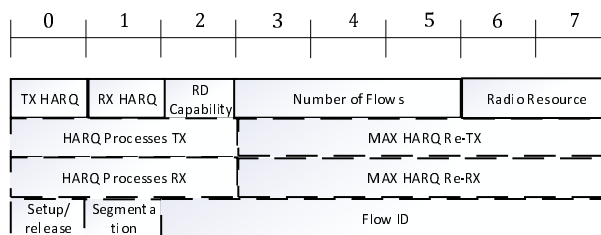

Figure 6.4.2.8-1: Reconfiguration Request Message IE

Table 6.4.2.8-1: Association Response IE field definitions

Field	Bits	Definition
TX HARQ	1	0: HARQ TX configuration is accepted, or were not modified in reconfiguration request. 1: HARQ TX configuration is not accepted. HARQ Process TX and MAX HARQ RE-TX fields are present.
RX HARQ	1	0: HARQ RX configuration is accepted or were not modified in reconfiguration request. 1: HARQ RX configuration is not accepted. HARQ Process RX and MAX HARQ RE-RX fields are present.
RD Capability	1	0: Ignore. 1: The RD indicates that its capability is changed. The RD capability IE, clause 6.4.3.5 included after the reconfiguration message.
Number of flows	3	RD indicates how many different modifications of flows it can accept. RD shall accept always all releases. There shall be as many segmentation field and flow IDs included as indicated in this field to indicate accepted flow ID and use of segmentation. Value Coding: 111, All flows accepted as configured in association request.
Radio Resource	2	Change in radio resources. Value coding: No Change, Requesting More resources, Requesting less resources, Resource allocation IE included after reconfiguration message.
HARQ Process TX	3	As defined in Table 6.4.2.4-2.
MAX HARQ RE-RX	5	As defined in Table 6.4.2.4-2.
HARQ Process TX	3	As defined in Table 6.4.2.4-2.
MAX HARQ RE-TX	5	As defined in Table 6.4.2.4-2.
Setup/Release	1	0: The flow indicated in Flow ID is for setup or reconfiguration. 1: The flow indicated in Flow ID is released.
Segmentation	1	As defined in Table 6.4.2.4-2.
Flow ID	6	As defined in Table 6.4.2.4-2.

6.4.2.9 Additional MAC message

This MAC multiplexing header codepoint is reserved for future provisions of different additional MAC messages.

6.4.3 MAC information elements

6.4.3.1 MAC Security Info IE

The MAC security info is presented in Figure 6.4.3.1-1. The version field indicates the security mode as defined in Table 6.4.3.1-1. The key index indicates currently used key. The transmitter shall indicate increase the key index by one when taking a new key in use. The security IV type coding is depending on the security version, and for Mode 1 it is defined in Table 6.4.3.1-2.

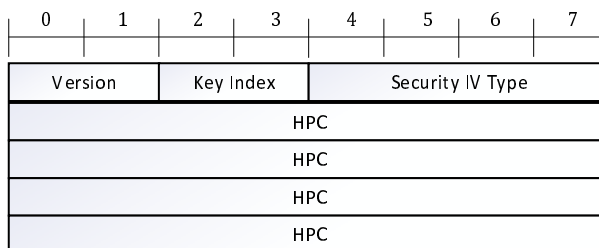

Figure 6.4.3.1-1: MAC Security Info

Table 6.4.3.1-1: Version

Value	Definition
00	Mode 1
01	Reserved
10	Reserved
11	Reserved

Table 6.4.3.1-2: Security IV type for Mode 1

Value	Definition
0000	One time HPC.
0001	Resynchronizing HPC. Initiate Mode -1 security by using this HPC value in both uplink and downlink communication.
0010	One time HPC, with HPC request.
0011-1111	Reserved.

6.4.3.2 Route Info IE

In mesh system operation RD transmitting beacon(s) includes route info IE in a beacon frame. The route info IE contains following parameters:

- *sink address*;
- *route cost*;
- *Application sequence number*.

Sink address is set to the Long RD ID (32 bits) of the FT (RD having the internet connection), where the routing tree is originally formed.

The calculation of *route cost* is left to RD implementation, as detailed calculation can be dependent on multiple factors. However, it shall be set such that the following rules are fully filled:

- *Route cost* is between values 0 and 255 (i.e. 8 bits) where smaller value means lower cost and value is linearly increasing.
- *Route cost* is always increased at a minimum of one (1) at each hop in mesh network.

The *application sequence number* provides identification sequence number for network level application data that needs to be distributed in the DL direction to all members of the mesh network. The application sequence number is used by the RD associated to its next hop to identify whether the application data has changed compared to its current application data. If the sequence number is increased, the RD requests the application data, from its next hop, i.e. RD to which it is associated.

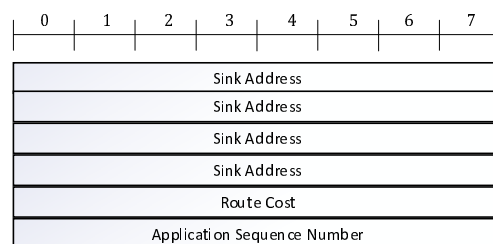

Figure 6.4.3.2-1: Route Info IE

6.4.3.3 Resource allocation IE

The resource allocation IE is used to allocate resources for scheduled transmissions and reception. The RD operating in FT mode includes this IE in beacon message or in unicast message.

The content of the IE is presented in Figure 6.4.3.3-1. The minimum content of the resource allocation IE is 1 first octet of the IE. When resource Allocation Type is set to 00 - release all scheduled resources, the IE has a length of one octet, otherwise the length of IE is 3 octets in minimum. The presence of optional parts is indicated by the Resource allocation bit map in the first octet. The coding of the bit map is presented in Table 6.4.3.3-1.

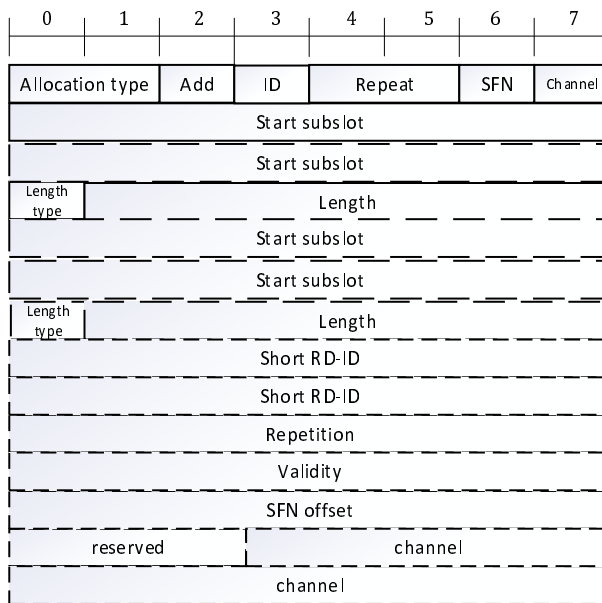

Figure 6.4.3.3-1: Resource allocation IE

Table 6.4.3.3-1: Resource allocation bitmap

Field	Value	Definition
Allocation Type	00	The receiving RD shall release all previously allocated scheduled resources. No other IEs are present. Other bits in the bitmap shall be ignored by the RD.
	01	Downlink allocation. The RD receiving this IE shall receive indicated resources.
	10	Uplink allocation. The RD receiving this IE shall use indicated resources for transmission.
	11	IE includes both downlink and uplink resource. The first start subslot and length are indicating DL resources.
Add	0	Resource allocation is new or replaces previous allocation.
	1	Resource allocation is additional allocation for existing allocation.
ID	0	Short RD-ID is not present. IE is sent as unicast message.
	1	Short RD-ID is present. IE is sent in beacon. Short RD-ID identifies who received the allocation.
Repeat	00	Resource allocation is single allocation and repetition and validity fields are not present.
	01	Resource allocation is repeating in following frames with periodicity indicated in Repetition field, until validity expires indicated in validity field.
	10	Resource allocation is repeating in following subslots with periodicity indicated in Repetition field, until validity expires indicated in validity field.
	11	Use of specific repeated resource is allowed after reception of Group ID and assignment Tag from the Group Assignment IE.
SFN	0	Resource allocation is immediately valid from this frame onwards. The SFN offset field is not present in the IE.
	1	Resource allocation is valid from the frame indicated in SFN offset field onwards.
Channel	0	The resource allocation(s) is valid for the channel where the IE is received. The channel field is not present in the IE.
	1	The channel where resource allocation(s) is valid is indicated in channel field of the IE.

Start subslot: 8 bits or 16 bits. The start subslot indicates the first subslot where the resource allocation is valid in the frame. The 8 bits version is used when $\mu \leq 4$, and the 16 bits version is used when $\mu > 4$, ETSI TS 103 636-3 [3].

Length type: 1 bit. Indicates whether length is indicated in subslots or in slots. When set to 0, the length is given in subslots.

Length: 7 bits. The length of the resource allocation in subslots or in slots. The transmitter can split the resource allocation to multiple physical layer packet transmissions.

Repetition: 8 bits. Indicates the repetition of the resource allocation in frames or in subslots.

SFN offset: 8 bits. Indicates the SFN value when the resource allocation is valid.

Validity: 8 bits. Indicates how long the resource allocation is valid in frames. The value 0xFF indicates that allocation is permanent and valid until explicitly removed.

Channel: 13 bits. Indicates the absolute the carrier centre frequency as defined in ETSI TS 103 636-2 [2].

6.4.3.4 Random Access Resource IE

The random access resource IE is used to allocate resources for random access transmission and provide necessary configuration to operate on random access resources. The RACH resource IE has 5 octets of mandatory content.

The present of the optional parts are indicated by the RACH Resource allocation bit map in first octet. The coding of the bitmap is presented in Table 6.4.3.4-1.

Table 6.4.3.4-1: RACH Resource allocation bitmap

Field	Value	Definition
Reserved	NA	Reserved for future use. The field shall be ignored by the receiver.
Protime	0	Timer dectProtime not present in the RACH resource allocation IE.
	1	Timer dectProtime present in the RACH resource allocation IE.
Repeat		All values Coded as defined in Table 6.4.3.1-1.
SFN		All values Coded as defined in Table 6.4.3.1-1.
Channel	0	The resource allocation(s) is valid for the channel where the IE is received. The channel field is not present in the IE.
	1	The channel where resource allocation(s) is valid is indicated in channel field of the IE.
Chan_2	0	The random access response is sent on the same channel as the random access message.
	1	The separate channel field is included in the end of the IE to indicate the channel for Random access response message.

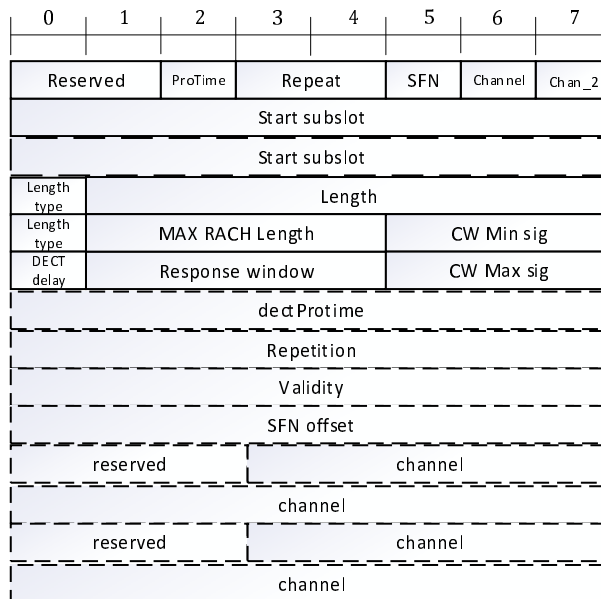

Figure 6.4.3.4-1: Random Access Resource IE

Start subslot: 8 bits or 16 bits. The start subslot indicates the first subslot where the RACH resource allocation is valid in the frame. The 8 bits version is used when $\mu \leq 4$, and the 16 bits version is used when $\mu > 4$, ETSI TS 103 636-3 [3].

Length type: 1 bit. As defined in clause 6.4.3.3.

Length: 7 bits. The length of the random access resource allocation in subslots or in slots.

Length type: 1 bit. As defined in clause 6.4.3.3.

MAX RACH Length: The maximum length of single random access transmission.

CWmin_sig: 3 bits. Taking values: 0, 1, 2, 3 ..., 7. The configured $CW_MIN = 8 \times CWmin_sig$.

DECT_Delay: 1 bit. If set 0 the response window starts from subslot $n+3$, where n indicates the subslot where the transmission of the Random Access packet ended. If set to 1 the response window starts 0,5 frames after the start of the frame where the Random access transmission was initiated.

Response window: Defines the response window length in subslots.

CWmax_sig: 3 bits. Taking values: 0, 1, 2, 3 ..., 7. The configured $CW_MAX = 256 \times CWmax_sig$.

dectProttime: 8 bits. Time in frames how long the transmission to RACH resources can be done without last minute scan.

Repetition: As defined in clause 6.4.3.3.

Validity: As defined in clause 6.4.3.3.

SFN offset: As defined in clause 6.4.3.3.

Channel: As defined in clause 6.4.3.3.

6.4.3.5 RD Capability IE

The RD Capability IE is used to indicate RD's capabilities to another RD. This IE is present in association request and association response messages. When RD selects Physical layer transmission format it shall not exceed capabilities of receiving RD.

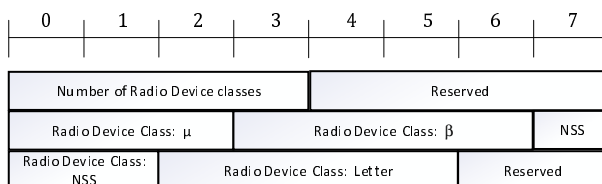

Figure 6.4.3.5-1: RD Capability IE

Table 6.4.3.5-1: Association Response IE field definitions

Field	Bits	Definition
Number of Radio Device Classes	4	Indicates how many different radio device classes are included. The radio device class is constructed from ($\mu, \beta, NSS, Letter, reserved$) fields. Thus complete 2 octets are always repeated.
Radio Device Class: μ	3	RD indicates the supported subcarrier scaling factor μ , in ETSI TS 103 636-3 [3]. Coded Values: 1, 2, 4, 8, rest are served.
Radio Device Class: β	4	RD indicates the supported Fourier transform scaling factor β , in ETSI TS 103 636-3 [3]. Coded Values: 1, 2, 4, 8, 12, 16, rest are served.
Radio Device Class: NSS	3	RD indicates the supported spatial stream transmission capabilities, in ETSI TS 103 636-3 [3]. Coded Values: 1, 2, 4, 8, rest are served.
Radio Device Class: Letter	5	RD indicates the supported capability letter, in ETSI TS 103 636-3 [3]. Coded Values: A, B, C, D, E, rest are served.

6.4.3.6 Neighbouring IE

The Neighbouring IE is used to indicate other RD presence of neighbouring RD in FT mode. The IE is optional and can be multiplexed in unicast MAC PDUs or Network or Cluster beacon messages.

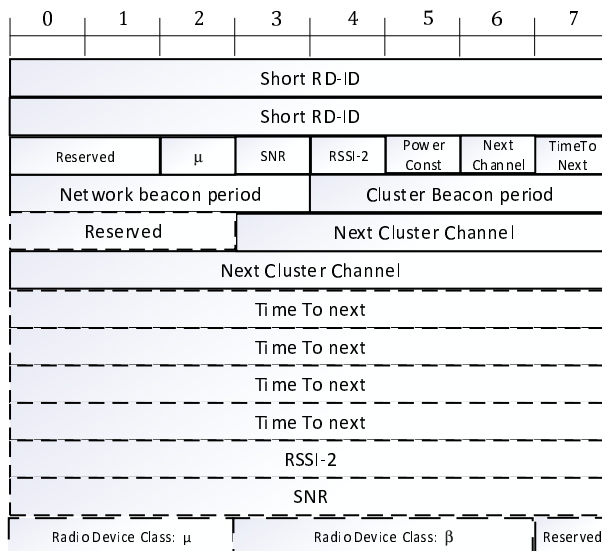

Figure 6.4.3.6-1: Neighbouring IE

Table 6.4.3.6-1: Neighbouring IE field definitions

Field	Bits	Definition
Short-RD ID	16	The Short-RD ID of the indicated RD.
μ	1	0: Radio device class signalling is not present. The indicated RD operates with same μ and β factor as the RD sending this IE. 1: Radio device class signalling is present. The indicated RD operates with the indicated μ and β factor.
SNR	1	0: SNR measurement result not present. 1: SNR measurement result, measured by the RD sending this IE, from indicated RD is present.
RSSI-2	1	0: RSSI-2 measurement result not present. 1: RSSI-2 measurement result, measured by the RD sending this IE, from indicated RD is present.
Power Const	1	Power constrain information from indicated RD as defined in Table 6.4.2.2-1.
Next Channel	1	As defined in Table 6.4.2.3-1.
TimeToNext	1	As defined in Table 6.4.2.3-1.
Next Cluster Channel	13	Indicated RDs cluster beacon channel as defined in Table 6.4.2.2-1.
Time to next	32	Time until start of the Indicated RDs cluster beacon period as defined in Table 6.4.2.2-1.

6.4.3.7 Broadcast Indication IE

The Broadcast indication IE is used to address a RD with broadcast message, and it can be repeated multiple times in a MAC PDU. The Broadcast indication IE can be used for paging, or for random access response message. The IE can be included into cluster beacon or transmitted in as broadcast message.

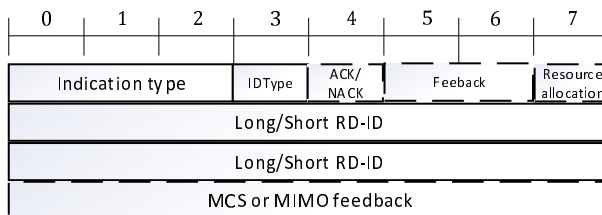

Figure 6.4.3.7-1: Broadcast Indication IE

Table 6.4.3.7-1: Broadcast Indication IE field definitions

Field	Bits	Definition
Indication type	3	Provides the type of the indication that is send to all RDs listed in the IE. Value coding: Paging, Random access response, Other values are reserved.
IDType	1	Indicates the ID type used to identify different RDs. Valued coding: Short RD-ID, Long RD-ID. For Random access response Short RD-ID shall be used.
ACK/NACK	1	Present when indication Type is Random access response. Otherwise, the field is set to reserved. 0: Indicates that MAC PDU in Random access message was incorrectly received. 1: Indicates that MAC PDU in Random access message was correctly received.
Feedback	2	Present when indication Type is Random access response. Otherwise, the field is set to reserved. Indicates the coding of the MCS or MIMO Feedback bits. Value coding: no feedback, MCS, MIMO_2_antenna, MIMO_4_antenna.
Resource Allocation	1	Indicates whether resource allocation IE for the RD follows in this MAC PDU. 0: No present. 1: IE follows.
Long/Short RD-ID	16/32	Short RD-ID or Long RD-ID of an RD.
MCS or MIMO Feedback	8	If Feedback field indicates MCS, this field indicates Channel quality indicator. The first 4 MSB bits are set to reserved and the 4 LSB bits contain the Channel quality, as defined in Table 6.2.2-3. If feedback indicates the MIMO_2_antenna, this field provides MIMO feedback for two transmit antennas. The four MSB bits of the field are severed. The fifth (5 th) MSB provides the number of layers: Single layer, dual layer. The 3 LBS bits provides Codebook index as defined in Table 6.3.4-1 for single layer, or Table 6.3.4-3 for dual layer for dual layer in ETSI TS 103 636-3 [3]. If feedback indicates the MIMO_4_antenna, this field provides MIMO feedback for four transmit antennas. The two MSB bits of the field provides the number of layers: Single layer, dual layers, four layers, reserved. The 6 LBS bits provides Codebook index as defined in Table 6.3.4-2 for single layer, or Table 6.3.4-4 for dual layers or Table 6.3.4-5 for four layers, in ETSI TS 103 636-3 [3].

6.4.3.8 Padding IE

The Padding IE is used to fil up the MAC PDU to next allowed MAC PDU size supported by the physical layer, when other MAC message, MAC IE or higher layer SDU are not available or do not fit into available space. The location of the padding IE is thus the last part of MAC PDU or just before MIC when MAC security is used. When security is used the padding IE will be ciphered and used as part of MIC calculation as any other IE. The receiver shall ignore the content of the padding IE.

Padding IE is used as follows:

- if one octet of padding is needed:
 - indicate in MAC extension field: 011 (one bit length present), set length to zero and set IE type: 00000 (padding);
- else, if two octets of padding are needed:
 - indicate in MAC extension field: 11 (one bit length present), set length to one and set IE type: 00000 (padding);
- else:
 - indicate in MAC extension field: 01 (on octet length present), set IE type: 000000 (padding), and set length to indicate number of padding octets;

- include number indicated octets of arbitrary data into padding IE.

6.4.3.9 Group Assignment IE

The Group assignment IE is used to assign pre-configured resources to several RDs with single broadcast message. The Group triggers the previously configured resource configuration to be valid after indicated SFN offset and to be until validity time, with given with repetition.

Single (1 bit): when set to 1 the bit indicates in Group Assignment that there is only single Resource TAG present and all resource repetitions are assigned to a single RD. Otherwise the index of the Resource TAG present in the Group IE provides the index of the repeat resource.

For clarity the first Resource TAG, the first instance of the configured resource allocation after SFN offset, and second Resource TAG the first repetition and show on.

If number of resource TAGs is less than number of resources repetitions in resource allocation, those repetitions are considered as not assigned.

The Resource TAG value: 111 1111 (0x7F) is considered as broadcast and all members of the groups shall receive the given resource.

Direct (1 bit): indicates whether direction of the pre-assignment resources is inverted.

When it is set to 0, the assignment follows definition of Resource allocation IE in Table 6.4.3.1-1.

If Direct bit is set to 1 the direction is inverted.

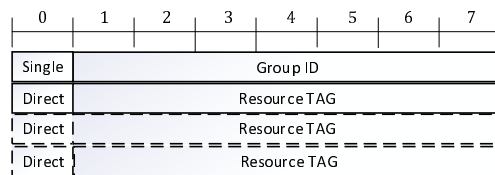

Figure 6.4.3.9-1: Group Assignment IE

Table 6.4.3.9-1: Group Assignment IE field definitions

Field	Bits	Definition
Single	1	0: Multiple resource assignments follows for a group. 1: Single resource assignment for the group member.
Group ID	7	Provides the Group ID for which the resource assignment is valid.
Direct	1	0: Indicates that assignment follows Resource allocation direction as defined in Table 6.4.3.1-1. 1: Indicates that Resource allocation direction is inverted from definition provided in Table 6.4.3.1-1.
Resource TAG	7	Provides the Resource TAG value. The index position of the resource TAG indicated index to repeated resource which RD having the TAG value consider to be valid for it. Value: 111 1111 (0x7F) indicates that resource is broadcast for all members of the group.

7 Variables, and Timers

7.1 General

Variables, and timers are general and shall be applied in all operating bands.

The set of variables, constants and timers are operating band specific values and shall be applied on each indicated band with band specific values. The use of these variables, constants and timers on other bands is not prohibited.

7.2 Variables

Table 7.2-1: Channel selection and Mobility variables

Variable	Default value on Operating Band 1 in ETSI TS 103 636-2 [2]	Default value on other Operating Bands in ETSI TS 103 636-2 [2]	Definition
<i>DECT_PROTECTED</i>	TRUE	NA	Defines when specific channel selection rules apply.
<i>SCAN_MEAS_DURATION</i>	24 slots	NA	The minimum measurement time for a single operating channel to obtain RSSI-1 value for each measured subslot.
<i>RSSI_THRESHOLD_MIN</i>	-85 dBm	NA	The RSSI-1 threshold when a slot is slot as "free".
<i>RSSI_THRESHOLD_MAX</i>	-52 dBm - MAX TX power of the RD	-40 dBm - MAX TX power of the RD	The RSSI-1 threshold when a slot is considered as "busy".
<i>SCAN_SUITABLE</i>	75 %	NA	Threshold when an operating channel can be considered fulfilling operating conditions.
<i>CHANNEL_LOADED</i>	80 %	NA	Threshold when operating channel load is so high that RD should start Operating Channel(s) and Subslot(s) selection.
<i>SCAN_MEAS_START</i>	8 s	NA	Defines duration how long the Channel load is evaluated.
<i>NETWORK_BEACON_PRERIOD</i>	Always signalled	Always signalled	Defines the Network Beacon transmission period of an RD in FT mode.
<i>CLUSTER_BEACON_PERIOD</i>	Always signalled	Always signalled	Defines the Cluster Beacon transmission period of an RD in FT mode.
<i>COUNT_TO_TRIGGER</i>	Always signalled	Always signalled	Defines the threshold how many times the target RD in FT mode needs to be measured better than current FT for mobility event.
<i>REL_QUALITY</i>	Always signalled	Always signalled	Defines the relative quality that target RD in FT mode needs to be better than current FT for mobility event.
<i>MIN_QUALITY</i>	Always signalled	Always signalled	Defines the minimum quality above sensitivity that RD in FT mode needs to be for association.
<i>NEXT_CLUSTER_CHANNEL</i>	Always signalled	Always signalled	Defines the next cluster channel of an RD in FT mode.

Table 7.2-2: Random Access variables

Variable	Default value on Operating Band 1 in ETSI TS 103 636-2 [2]	Default value on Operating Band in ETSI TS 103 636-2 [2]	Definition
<i>CW_CURRENT</i>	Dynamic	Dynamic	Defines the current upper edge of the window where random delay for initiating RACH transmission is selected.
<i>CW_MAX</i>	Always signalled	Always signalled	The maximum upper edge of the window where random delay for initiating RACH transmission is selected.
<i>CW_MIN</i>	Always signalled	Always signalled	The minimum upper edge of the window where random delay for initiating RACH transmission is selected.
<i>MINIMUM_LBT_PERIOD</i>	Duration of STF plus GI	Duration of STF plus GI	Defines the minimum LBT time that channel needs to be measured free before initiating transmission.

7.3 Timers

Table 7.3-1: Timers

Timer	Value on Operating Band 1 in ETSI TS 103 636-2 [2]	Value on Operating Band in ETSI TS 103 636-2 [2]
<i>dectProTime</i>	Dynamic	NA
<i>scanStatusValid</i>	300 s	600 s
<i>rachBackOff</i>	Dynamic	Dynamic
<i>countToTrigger</i>	Always signalled	Always signalled
<i>timeToNext</i>	Always signalled	Always signalled

Annex A (normative): MAC Layer Requirements for Radio Device Classes

A.1 Introduction

Radio device class shall define a set of MAC functionalities that are supported by the RD.

A.2 Radio Device Class (1.1.1.A)

A.2.1 Modes

Radio device shall support operation in FT-mode and PT-mode simultaneously.

The RD shall support transmission of Network Beacon and Cluster Beacon messages.

A.2.2 System Operation

Radio Device shall support Mesh system operation, including transmission and reception of Route Info IE, and Routing PDU.

A.2.3 Security

Radio Device shall support MAC Security Mode 1.

A.2.4 Feedback Info Formats

Radio Device shall support Feedback Info Format 1 and Feedback Info Format 3.

Annex B (normative): Data Link Layer Operation

B.1 Segmentation

Each user plane data flow or routing PDU can operate in either transparent mode or in segmentation mode. In transparent mode the segmentation operation does not introduce any protocol header to the higher layer SDU.

When segmentation mode is configured to the user plane data flow(s) or routing PDU, the RD adds segmentation header to user plane data flow SDU or routing PDU. When complete SDU is included the header contains following fields:

- SI: Segmentation indication as defined in Table B.1-1.
- Sequence number that is increased every higher layer SDU.

When SDU is segmented the RD adds segmentation offset.

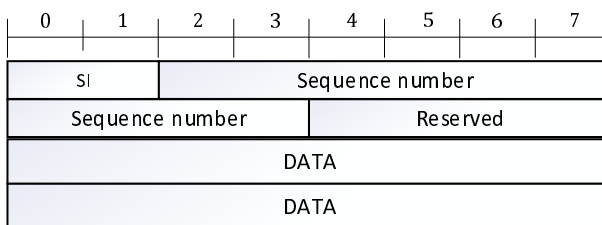

Figure B.1-1: Segmentation PDU, for complete SDU

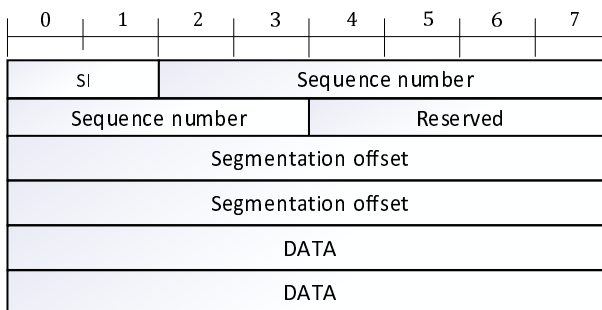

Figure B.1-2: Segmentation PDU, for SDU Segment

Table B.1-1: SI coding

Value	Description
00	Data field contains complete higher layer SDU
01	Data field contains the first segment of higher layer SDU
10	Data field contains the last segment of higher layer SDU
11	Data field contains neither the first nor last segment of higher layer SDU

The Segmentation offset field indicates the position of the higher layer SDU segment in bytes within the original higher layer SDU. The first byte of the original higher layer SDU is referred by the segmentation offset field value "0000000000000000", i.e. numbering starts at zero.

B.2 Routing PDU in Mesh operation

PDU format for routing is depicted in Figure B.2-1. The first octet is used for indicating to the receiver that the PDU is for routing operation.

The first octet after multiplexing header is a routing bitmap field where each bit has specific meaning as defined in Table B.2-1. After the bit field, 32-bit source and destination address are present, for both fields Long RD IDs, defined in clause 4.2.3.1, are used. After the address fields 8-bit hop counter field is present, that has different encoding depending on routing bitmap field as shown Table B.2-2.

After the bitmap field payload, i.e. high layer data is included into payload part of the PDU. There is no separate length field as the size of the routing header can be determined in decoding phase and lower layer (MAC/PHY) will support This PDU structure is provided to MAC layer for transmission procedure.

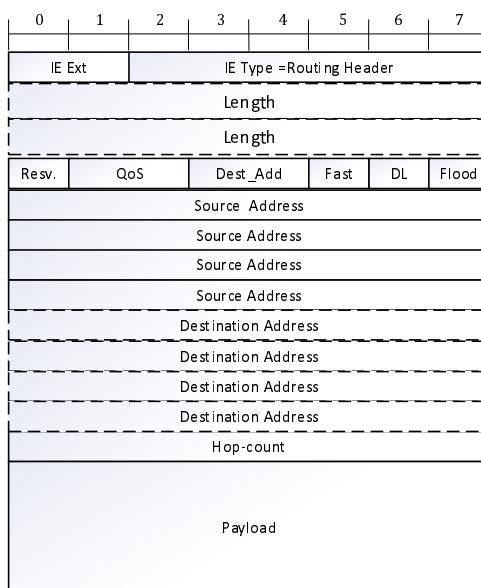

Figure B.2-1: PDU structure for routing

Table B.2-1: A routing bitmap field - bit definition

Bit field name	Values	Description
Resv.	0	Reserved for future use.
QoS	00 - Low priority data 01 - High priority data 10 - Reserved 11 - Reserved	Quality of Service of the packet.
Dest_Add	00 - Destination address is present 01 - Destination address is broadcast 10 - Destination address is backend address 11 - Reserved	When set to 01, the destination address field is omitted and data is known to be sent to address 0xFFFFFFFF. When set to 10, the destination address field is omitted, and data is known to be sent to address 0xFFFFFFFFE.
Fast	0 - bit is not set 1 - bit is set	When set to 1, the data is sent only as unacknowledged broadcast to unicast address.
DL	0 - bit is not set 1 - bit is set	When set to 1, the data is in DL direction.
Flood	0 - bit is not set 1 - bit is set	0 = Packet uses hop-by-hop routing, 1 = Packet uses flood (send to every known node) routing.

Table B.2-2: Coding of Hop count

Flood bit set	Hop count bits	Description
0	0-8 bits, cumulative hop count.	When packet is transmitted by MAC layer to next hop the value increased by 1.
1	4 MSB bits for hop limit, 4 LSB bits for hop counter.	The original source of the packet sets the maximum number of hops that packet is flooded. When packet is transmitted by MAC layer to next hop the value increased by 1. If the hop limit equals to hop counter the packet is no longer flooded.

Annex C (informative): Change History

Date	Version	Information about changes
July 2020	1.1.1	First publication of the TS
December 2020	1.1.2	Implemented Change Requests: DECT(20)000330r2 Small corrections to 103 636-4 DECT(20)000349r2 Clarification on bit encoding of PHY header TS103.636-4 DECT(20)000360 Security IE and routing IE correction These CRs were approved DECT#88 Version 1.1.2 prepared by the Rapporteur

History

Document history		
V1.1.1	July 2020	Publication
V1.2.1	April 2021	Publication