

ETSI TS 103 636-3 V1.3.1 (2021-12)



TECHNICAL SPECIFICATION

**DECT-2020 New Radio (NR);
Part 3: Physical layer;
Release 1**

Reference

RTS/DECT-00372

Keywordschannel coding, DECT, DECT-2020, IMT-2020,
modulation, NR, OFDM, physical layer, radio**ETSI**650 Route des Lucioles
F-06921 Sophia Antipolis Cedex - FRANCE

Tel.: +33 4 92 94 42 00 Fax: +33 4 93 65 47 16

Siret N° 348 623 562 00017 - APE 7112B
Association à but non lucratif enregistrée à la
Sous-Préfecture de Grasse (06) N° w061004871

Important notice

The present document can be downloaded from:

<http://www.etsi.org/standards-search>

The present document may be made available in electronic versions and/or in print. The content of any electronic and/or print versions of the present document shall not be modified without the prior written authorization of ETSI. In case of any existing or perceived difference in contents between such versions and/or in print, the prevailing version of an ETSI deliverable is the one made publicly available in PDF format at www.etsi.org/deliver.

Users of the present document should be aware that the document may be subject to revision or change of status.

Information on the current status of this and other ETSI documents is available at

<https://portal.etsi.org/TB/ETSIDeliverableStatus.aspx>

If you find errors in the present document, please send your comment to one of the following services:

<https://portal.etsi.org/People/CommitteeSupportStaff.aspx>

Notice of disclaimer & limitation of liability

The information provided in the present deliverable is directed solely to professionals who have the appropriate degree of experience to understand and interpret its content in accordance with generally accepted engineering or other professional standard and applicable regulations.

No recommendation as to products and services or vendors is made or should be implied.

No representation or warranty is made that this deliverable is technically accurate or sufficient or conforms to any law and/or governmental rule and/or regulation and further, no representation or warranty is made of merchantability or fitness for any particular purpose or against infringement of intellectual property rights.

In no event shall ETSI be held liable for loss of profits or any other incidental or consequential damages.

Any software contained in this deliverable is provided "AS IS" with no warranties, express or implied, including but not limited to, the warranties of merchantability, fitness for a particular purpose and non-infringement of intellectual property rights and ETSI shall not be held liable in any event for any damages whatsoever (including, without limitation, damages for loss of profits, business interruption, loss of information, or any other pecuniary loss) arising out of or related to the use of or inability to use the software.

Copyright Notification

No part may be reproduced or utilized in any form or by any means, electronic or mechanical, including photocopying and microfilm except as authorized by written permission of ETSI.

The content of the PDF version shall not be modified without the written authorization of ETSI.

The copyright and the foregoing restriction extend to reproduction in all media.

© ETSI 2021.
All rights reserved.

Contents

Intellectual Property Rights	6
Foreword.....	6
Modal verbs terminology.....	6
1 Scope	7
2 References	7
2.1 Normative references	7
2.2 Informative references.....	7
3 Definition of terms, symbols and abbreviations.....	7
3.1 Terms.....	7
3.2 Symbols.....	8
3.3 Abbreviations	8
4 Physical layer principles.....	9
4.1 General description of Physical layer.....	9
4.2 Multiple access	10
4.3 Numerologies	10
4.4 Frame structure.....	11
4.5 Physical resources	12
5 Physical layer transmissions.....	15
5.1 Transmission packet structure	15
5.2 Physical resource mapping	16
5.2.1 Guard Interval (GI)	16
5.2.2 Synchronization Training Field (STF).....	16
5.2.3 Demodulation Reference Signal (DRS).....	17
5.2.4 Physical Control Channel (PCC)	17
5.2.5 Physical Data Channel (PDC).....	18
5.3 Transport block size	19
6 Generic procedures.....	20
6.1 Channel coding, rate-matching and interleaving	20
6.1.1 Overview	20
6.1.2 CRC calculation.....	20
6.1.3 Code block segmentation.....	20
6.1.4 Channel coding	22
6.1.4.1 Introduction.....	22
6.1.4.2 Turbo coding	22
6.1.4.2.1 Turbo encoder.....	22
6.1.4.2.2 Trellis termination for turbo encoder.....	23
6.1.4.2.3 Turbo code internal interleaver.....	24
6.1.5 Rate matching	25
6.1.5.1 Rate matching for turbo coded transport channels	25
6.1.5.2 Sub-block interleaver	25
6.1.5.3 Bit collection, selection and transmission	26
6.1.6 Code block concatenation.....	27
6.2 Pseudo-random sequence generation.....	28
6.3 Modulation	28
6.3.1 Symbol mapping	28
6.3.1.1 Overview	28
6.3.1.2 BPSK.....	28
6.3.1.3 QPSK	28
6.3.1.4 16-QAM.....	29
6.3.1.5 64-QAM.....	29
6.3.1.6 256-QAM.....	29
6.3.1.7 1024-QAM.....	29
6.3.2 Spatial multiplexing	29

6.3.3	Transmit stream mapping	30
6.3.3.1	Transmit stream mapping for spatial multiplexing and for single antenna	30
6.3.3.2	Transmit diversity precoding	30
6.3.4	Beamforming and antenna port mapping.....	32
6.3.5	OFDM signal generation	35
6.3.6	Cyclic prefix insertion	35
7	Transmission encoding.....	35
7.1	Transmitter block diagram	35
7.2	Transmission modes	36
7.3	Synchronization Training Field (STF) beamforming	37
7.4	Demodulation Reference Signal (DRS) beamforming	37
7.5	Physical Control Channel (PCC) encoding	37
7.5.1	Overall description.....	37
7.5.2	CRC calculation	38
7.5.2.1	Parity bit calculation	38
7.5.2.2	CRC Masking for MIMO closed loop.....	38
7.5.2.3	CRC Masking for beamforming.....	38
7.5.2.4	CRC attachment	38
7.5.3	Channel coding & rate matching	38
7.5.4	Scrambling	38
7.5.5	Symbol mapping.....	38
7.5.6	Spatial multiplexing	38
7.5.7	Transmit stream mapping	38
7.5.8	Beamforming	39
7.5.9	Subcarrier mapping.....	39
7.6	Physical Data Channel (PDC) encoding.....	39
7.6.1	Overall description.....	39
7.6.2	CRC calculation.....	39
7.6.3	Code block segmentation.....	39
7.6.4	Channel coding & rate matching	39
7.6.5	Code block concatenation.....	40
7.6.6	Scrambling	40
7.6.7	Symbol mapping.....	40
7.6.8	Spatial multiplexing	40
7.6.9	Transmit stream mapping	40
7.6.10	Beamforming and antenna port mapping.....	40
7.6.11	Subcarrier mapping.....	40
Annex A (normative):	Modulation and coding schemes.....	41
Annex B (normative):	Physical layer requirements for radio device classes.....	42
B.1	Introduction	42
B.2	Radio device class (μ , β , NSS, A) = (1.1.1.A)	42
B.2.1	Transmission bandwidth.....	42
B.2.2	Transmission modes	42
B.2.3	Modulation and coding scheme	42
B.2.3.1	Modulation and coding	42
B.2.3.2	Hybrid ARQ processes	42
B.2.3.3	Soft buffer size.....	42
B.2.3.4	Code block segment size.....	42
Annex C (informative):	Examples of transport block sizes and maximum achievable data rates	43
C.1	Introduction	43
C.2	Single slot transmission, single spatial stream	43
C.3	Dual slot transmission, single spatial stream.....	46
C.4	Quad slot transmission, single spatial stream.....	48

Annex D (informative): **Change History**50
History51

Intellectual Property Rights

Essential patents

IPRs essential or potentially essential to normative deliverables may have been declared to ETSI. The declarations pertaining to these essential IPRs, if any, are publicly available for **ETSI members and non-members**, and can be found in ETSI SR 000 314: "*Intellectual Property Rights (IPRs); Essential, or potentially Essential, IPRs notified to ETSI in respect of ETSI standards*", which is available from the ETSI Secretariat. Latest updates are available on the ETSI Web server (<https://ipr.etsi.org/>).

Pursuant to the ETSI Directives including the ETSI IPR Policy, no investigation regarding the essentiality of IPRs, including IPR searches, has been carried out by ETSI. No guarantee can be given as to the existence of other IPRs not referenced in ETSI SR 000 314 (or the updates on the ETSI Web server) which are, or may be, or may become, essential to the present document.

Trademarks

The present document may include trademarks and/or tradenames which are asserted and/or registered by their owners. ETSI claims no ownership of these except for any which are indicated as being the property of ETSI, and conveys no right to use or reproduce any trademark and/or tradename. Mention of those trademarks in the present document does not constitute an endorsement by ETSI of products, services or organizations associated with those trademarks.

DECT™, **PLUGTESTS™**, **UMTS™** and the ETSI logo are trademarks of ETSI registered for the benefit of its Members. **3GPP™** and **LTE™** are trademarks of ETSI registered for the benefit of its Members and of the 3GPP Organizational Partners. **oneM2M™** logo is a trademark of ETSI registered for the benefit of its Members and of the oneM2M Partners. **GSM®** and the GSM logo are trademarks registered and owned by the GSM Association.

Foreword

This Technical Specification (TS) has been produced by ETSI Technical Committee Digital Enhanced Cordless Telecommunications (DECT).

The present document is part 3 of a multi-part deliverable covering the DECT-2020 New Radio (NR) technology. Full details of the entire series can be found in part 1 [1].

DECT-2020 NR is recognized in Recommendation ITU-R M.2150 [i.1] as a component RIT fulfilling the IMT-2020 requirements of the IMT-2020 use scenarios URLLC and mMTC. The Set of Radio Interface Technology (SRIT) called "DECT 5G SRIT" is involving 3GPP NR and DECT-2020 NR.

Modal verbs terminology

In the present document "**shall**", "**shall not**", "**should**", "**should not**", "**may**", "**need not**", "**will**", "**will not**", "**can**" and "**cannot**" are to be interpreted as described in clause 3.2 of the [ETSI Drafting Rules](#) (Verbal forms for the expression of provisions).

"**must**" and "**must not**" are **NOT** allowed in ETSI deliverables except when used in direct citation.

1 Scope

The present document is one of the parts of the specification of the DECT-2020 New Radio (NR).

The present document specifies the Physical layer and interaction between PHY and MAC layer.

2 References

2.1 Normative references

References are either specific (identified by date of publication and/or edition number or version number) or non-specific. For specific references, only the cited version applies. For non-specific references, the latest version of the referenced document (including any amendments) applies.

Referenced documents which are not found to be publicly available in the expected location might be found at <https://docbox.etsi.org/Reference>.

NOTE: While any hyperlinks included in this clause were valid at the time of publication, ETSI cannot guarantee their long term validity.

The following referenced documents are necessary for the application of the present document.

- [1] ETSI TS 103 636-1: "DECT-2020 New Radio (NR); Part 1: Overview; Release 1".
- [2] ETSI TS 103 636-2: "DECT-2020 New Radio (NR); Part 2: Radio reception and transmission requirements; Release 1".
- [3] ETSI TS 103 636-4: "DECT-2020 New Radio (NR); Part 4: MAC layer; Release 1".

2.2 Informative references

References are either specific (identified by date of publication and/or edition number or version number) or non-specific. For specific references, only the cited version applies. For non-specific references, the latest version of the referenced document (including any amendments) applies.

NOTE: While any hyperlinks included in this clause were valid at the time of publication, ETSI cannot guarantee their long term validity.

The following referenced documents are not necessary for the application of the present document but they assist the user with regard to a particular subject area.

- [i.1] Recommendation ITU-R M.2150: "Detailed specifications of the terrestrial radio interfaces of International Mobile Telecommunications-2020 (IMT-2020)".
-

3 Definition of terms, symbols and abbreviations

3.1 Terms

Void.

3.2 Symbols

For the purposes of the present document, the following symbols apply:

\forall	Mathematical notation for "for all"
\wedge	Mathematical notation for "and"
$\lfloor x \rfloor$	Mathematical notation for "floor of x" i.e. rounding towards zero
$\lceil x \rceil$	Mathematical notation for "ceiling of x" i.e. rounding towards infinity
β	Fourier transform scaling factor
μ	Subcarrier scaling factor
Δ_f^μ	Subcarrier spacing for given subcarrier scaling factor
$f_s^{\mu,\beta}$	Sample frequency
k_{OCC}^β	Occupied subcarriers for given transform scaling factor
$B_{DFT}^{\mu,\beta}$	Nominal bandwidth
$B_{TX}^{\mu,\beta}$	Transmission bandwidth
GI^μ	Guard interval for given subcarrier scaling factor
M_{symb}^{stream}	Number of modulated symbols in a spatial stream
M_{symb}	Number of modulated symbols
N_{CP}^β	Cyclic Prefix size for given transform scaling factor
N_{DFT}^β	Discrete Fourier Transform size for given Fourier transform scaling factor
N_{OCC}^β	Number of occupied subcarriers for given Fourier transform scaling factor
N_{symb}^{SLOT}	Number OFDM symbols in a slot
$N_{subslot}^{SLOT}$	Number of subslots in a slot
N_{slot}^{FRAME}	Number of slots in a frame
N_{symb}^{PACKET}	Number of OFDM symbols in a transmission packet
N_{TX}	Number of transmission antennas
N_{TX}^{eff}	Effective number of transmission antennas
N_{TS}	Number of transmit streams
N_{SS}	Number of spatial streams
N_{bps}	Number of bits per symbol for given modulation
T_{frame}	Duration of a frame
T_{slot}	Duration of a slot
$T_s^{\mu,\beta}$	Sample time interval
T_{symb}^μ	Duration of OFDM symbol for given subcarrier scaling factor

3.3 Abbreviations

For the purposes of the present document, the abbreviations given in ETSI TS 103 636-1 [1] and the following apply:

NOTE: An abbreviation defined in the present document takes precedence over the definition of the same abbreviation, if any, in ETSI TS 103 636-1 [1].

ARQ	Automatic Repeat reQuest
BPSK	Binary Phase Shift Keying
CP	Cyclic Prefix
CRC	Cyclic Redundancy Check
DC	Zero or DC Subcarrier
DECT	Digital Enhanced Cordless Telecommunications
DF	Data Field
DFT	Discrete Fourier Transform
DRS	Demodulation Reference Signal
FDMA	Frequency Division Multiple Access
GF	Galois Field
GI	Guard Interval
HARQ	Hybrid ARQ
MAC	Medium Access Control
OFDM	Orthogonal Frequency Division Multiplexing

PCC	Physical Control Channel
PCCC	Parallel Concatenated Convolutional Code
PDC	Physical Data Channel
PDU	Protocol Data Unit
PHY	Physical layer
QAM	Quadrature Amplitude Modulation
QPSK	Quadrature Phase Shift Keying
RD	Radio Device
SAP	Service Access Point
SS	Spatial Stream
STF	Synchronization Training Field
TDD	Time Division Duplex
TDMA	Time Division Multiple Access
TS	Transmit Stream
TX	Transmission

4 Physical layer principles

4.1 General description of Physical layer

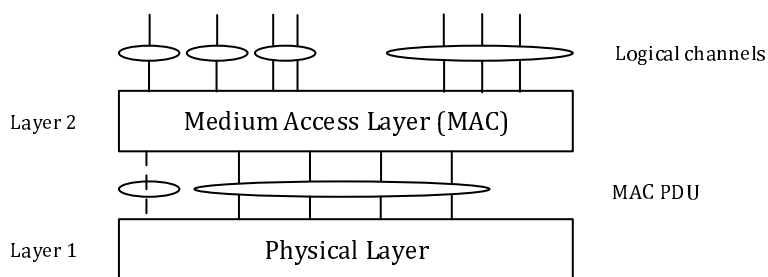

Figure 4.1-1: Radio interface protocol architecture around the Physical layer

Figure 4.1-1 shows the DECT-2020 radio interface protocol architecture around the Physical layer (PHY). The physical layer interfaces the Medium Access Control (MAC) layer. The circles between different layer/sub-layers indicate Service Access Points (SAPs). The physical layer offers Physical Control Channel (PCC) and Physical Data Channel (PDC) to transmit MAC PDU(s). Different physical channels are characterized by how the information is transferred over the radio interface within single transmission packet.

The physical layer performs the following functions in order to provide the data transport service:

- Error detection on the physical channels and indication to higher layers
- FEC encoding/decoding of the physical channels
- Hybrid ARQ soft-combining
- Rate matching of the coded physical channel data to physical channels
- Mapping of the coded physical channel data onto physical channels
- Modulation and demodulation of physical channels
- Frequency and time synchronization
- Radio characteristics measurements and indication to higher layers
- Multiple Input Multiple Output (MIMO) antenna processing
- Transmit Diversity (TX diversity)
- Beamforming

The physical channels defined are:

- the Physical Control Channel (PCC);
- the Physical Data Channel (PDC).

The modulation schemes supported are:

- BPSK;
- QPSK;
- 16-QAM;
- 64-QAM;
- 256-QAM; and
- 1024-QAM.

The channel coding scheme for transport blocks in all physical channels is Turbo Coding with a coding rate of $R=1/3$, two 8-state constituent encoders and a turbo code internal interleaver. Trellis termination is used for the turbo coding. Before the turbo coding, transport blocks are segmented into byte aligned segments with a maximum codeblock size. Error detection is supported by the use of 16 or 24 bit CRC as specified for a given physical channel.

4.2 Multiple access

The multiple access scheme for the DECT-2020 physical layer is based on Time Division Duplex (TDD) combined with Frequency Division Multiple Access (FDMA) and Time Division Multiple Access (TDMA). The physical layer operates with non-overlapping channels in frequency domain and non-overlapping transmission slots in time domain. Radio channel spacing is defined in ETSI TS 103 636-2 [2].

The modulation within the transmitted packets is Orthogonal Frequency Division Multiplexing (OFDM) with a Cyclic Prefix (CP).

Both frame duration (10 ms) and slot duration (0,41667 ms) ensure coexistence with legacy DECT systems.

4.3 Numerologies

In the present document, unless otherwise noted, the size of various fields in the time domain are expressed in terms of basic parameters. Subcarrier spacing is defined by the subcarrier scaling factor μ , resulting either in 27 kHz, 54 kHz, 108 kHz or 216 kHz OFDM subcarriers spacing Δ_f^μ . In addition, the Fourier transform scaling factor β can be set to allow different transmission bandwidths for each configuration of the subcarrier spacing. The numerologies listed in table 4.3-1 support multiple throughput and latency configurations for the network. In the table $B_{DFT}^{\mu,\beta}$ denotes the nominal bandwidth, $B_{TX}^{\mu,\beta}$ denotes the transmission bandwidth consisting of N_{OCC}^β occupied subcarriers and the empty DC carrier in the center of the transmission bandwidth, $T_s^{\mu,\beta}$ denotes the critical sample rate, N_{DFT}^β the Fourier transform size, N_{CP}^β denotes the cyclic prefix size in samples.

Table 4.3-1: Supported transmission numerologies

		β	$B_{DFT}^{\mu,\beta}$ [kHz]	$T_s^{\mu,\beta}$	N_{DFT}^{β}	N_{CP}^{β}	N_{OCC}^{β}	$B_{TX}^{\mu,\beta}$ [kHz]		
μ	1	1	1 728	5,7870E-07	64	8	56	1 539		
	Δ_f^{μ} [kHz]	27	2	3 456	2,8935E-07	128	16	112	3 051	
		T_{sym}^{μ} [us]	41,667	4	6 912	1,4468E-07	256	32	224	6 075
	$N_{sym}^{SLOT,\mu}$		10	8	13 824	7,2338E-08	512	64	448	12 123
			$N_{subslot}^{SLOT,\mu}$	2	12	20 736	4,8225E-08	768	96	672
	GI^{μ} [us]	18,52	16	27 648	3,6169E-08	1 024	128	896	24 219	
		<hr/>								
μ	2	1	3 456	2,8935E-07	64	8	56	3 078		
	Δ_f^{μ} [kHz]	54	2	6 912	1,4468E-07	128	16	112	6 102	
		T_{sym}^{μ} [us]	20,833	4	13 824	7,2338E-08	256	32	224	12 150
	$N_{sym}^{SLOT,\mu}$		20	8	27 648	3,6169E-08	512	64	448	24 246
			$N_{subslot}^{SLOT,\mu}$	4	12	41 472	2,4113E-08	768	96	672
	GI^{μ} [us]	20,83	16	55 296	1,8084E-08	1 024	128	896	48 438	
		<hr/>								
μ	4	1	6 912	1,4468E-07	64	8	56	6 156		
	Δ_f^{μ} [kHz]	108	2	13 824	7,2338E-08	128	16	112	12 204	
		T_{sym}^{μ} [us]	10,417	4	27 648	3,6169E-08	256	32	224	24 300
	$N_{sym}^{SLOT,\mu}$		40	8	55 296	1,8084E-08	512	64	448	48 492
			$N_{subslot}^{SLOT,\mu}$	8	12	82 944	1,2056E-08	768	96	672
	GI^{μ} [us]	10,42	16	110 592	9,0422E-09	1 024	128	896	96 876	
		<hr/>								
μ	8	1	13 824	7,2338E-08	64	8	56	12 312		
	Δ_f^{μ} [kHz]	216	2	27 648	3,6169E-08	128	16	112	24 408	
		T_{sym}^{μ} [us]	5,208	4	55 296	1,8084E-08	256	32	224	48 600
	$N_{sym}^{SLOT,\mu}$		80	8	110 592	9,0422E-09	512	64	448	96 984
			$N_{subslot}^{SLOT,\mu}$	16	12	165 888	6,0282E-09	768	96	672
	GI^{μ} [us]	10,42	16	221 184	4,5211E-09	1 024	128	896	193 752	

4.4 Frame structure

The radio frame has a duration of $T_{frame} = 10\text{ ms}$ and consists of $N_{slot}^{FRAME} = 24$ slots with a slot duration of $T_{slot} = 0,41667\text{ ms}$ as depicted in figure 4.4-1.

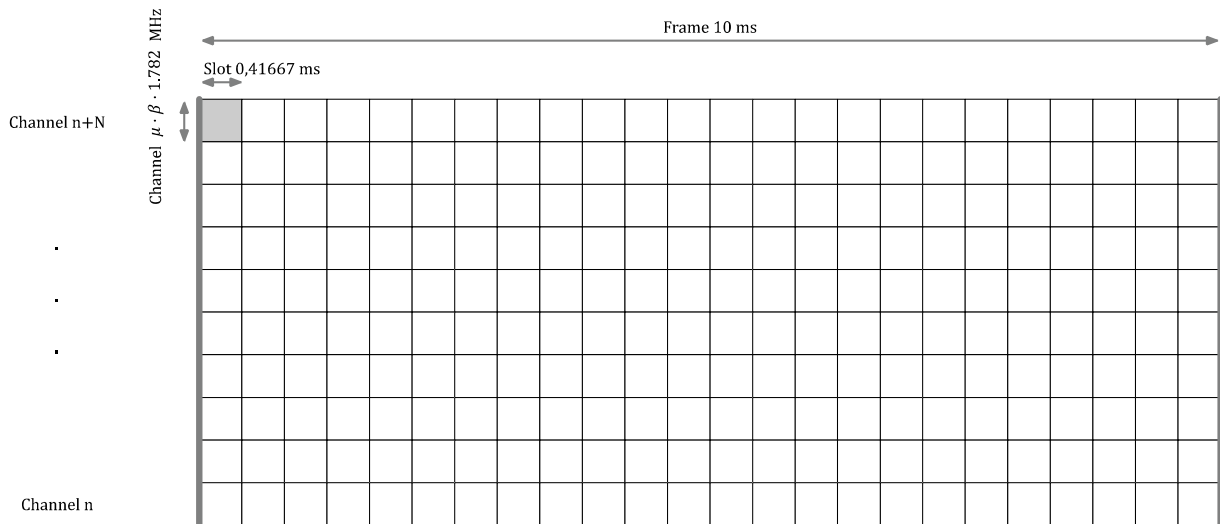

Figure 4.4-1: DECT-2020 frame structure

Each slot consists of $N_{sym}^{SLOT,\mu} = 10, 20, 40$ or 80 OFDM symbols depending on subcarrier scaling factor μ . Slot is further divided into $N_{subslot}^{SLOT,\mu}$ subslots according to the table 4.3-1 for each subcarrier scaling μ . Packet transmission duration is integer multiple of subslots.

Basic channel width is 1,728 MHz. Multiple adjacent basic channels can be aggregated with β and μ to form a wider transmission bandwidth ranging from 1,728 MHz to 221,184 MHz. Channel raster and numbering is specified in ETSI TS 103 636-2 [2].

4.5 Physical resources

Physical resources are mapped to frequency domain OFDM symbol $(s, k, l)_\beta$, where s may denote either transmit stream or spatial stream index, k denotes the subcarrier index and l denotes the OFDM symbol position in the time domain relative to the start of the transmission packet as depicted in figure 4.5-1. The occupied subcarriers indices are:

$$k_{occ}^\beta = \left[-\frac{N_{occ}^\beta}{2}, \dots, -1, 1, \dots, \frac{N_{occ}^\beta}{2} \right]$$

The remaining subcarriers are the guard bands and the zero carrier (or DC carrier) which are not used for data transmission. Example of resource mappings are depicted in figures 4.5-2 and 4.5-3.

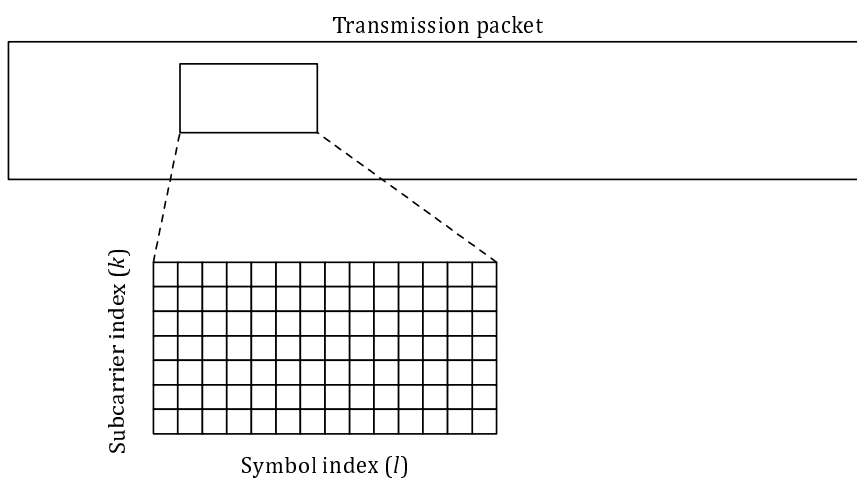

Figure 4.5-1: Resource grid and indexing

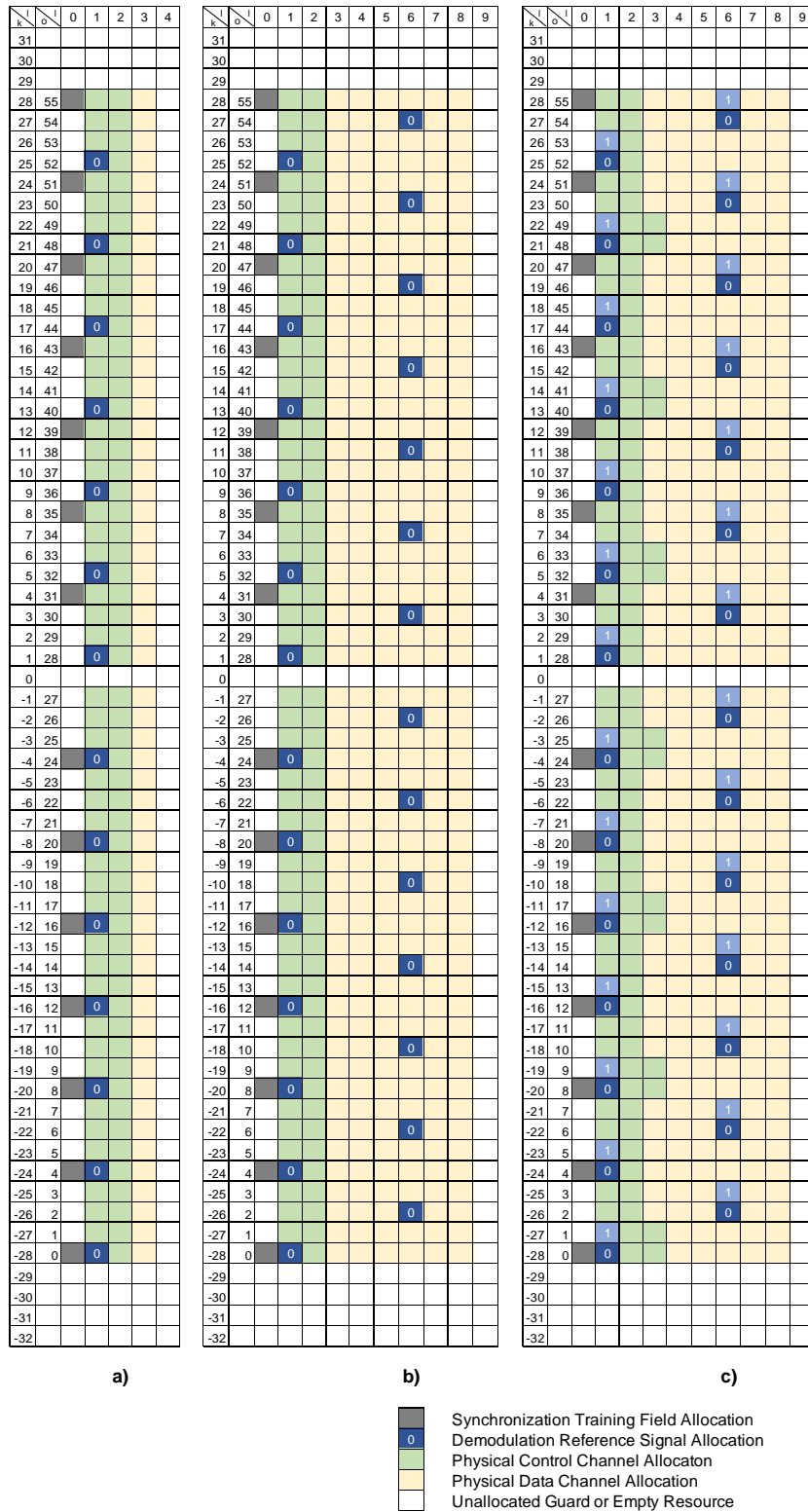

Figure 4.5-2: Resource mapping for $(\mu, \beta) = (*, 1)$
a) Transmission from single effective antenna of one subslot duration
b) Transmission from single effective antenna of two subslots duration
c) Transmission from two effective antennas of two subslots duration

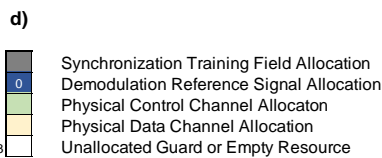
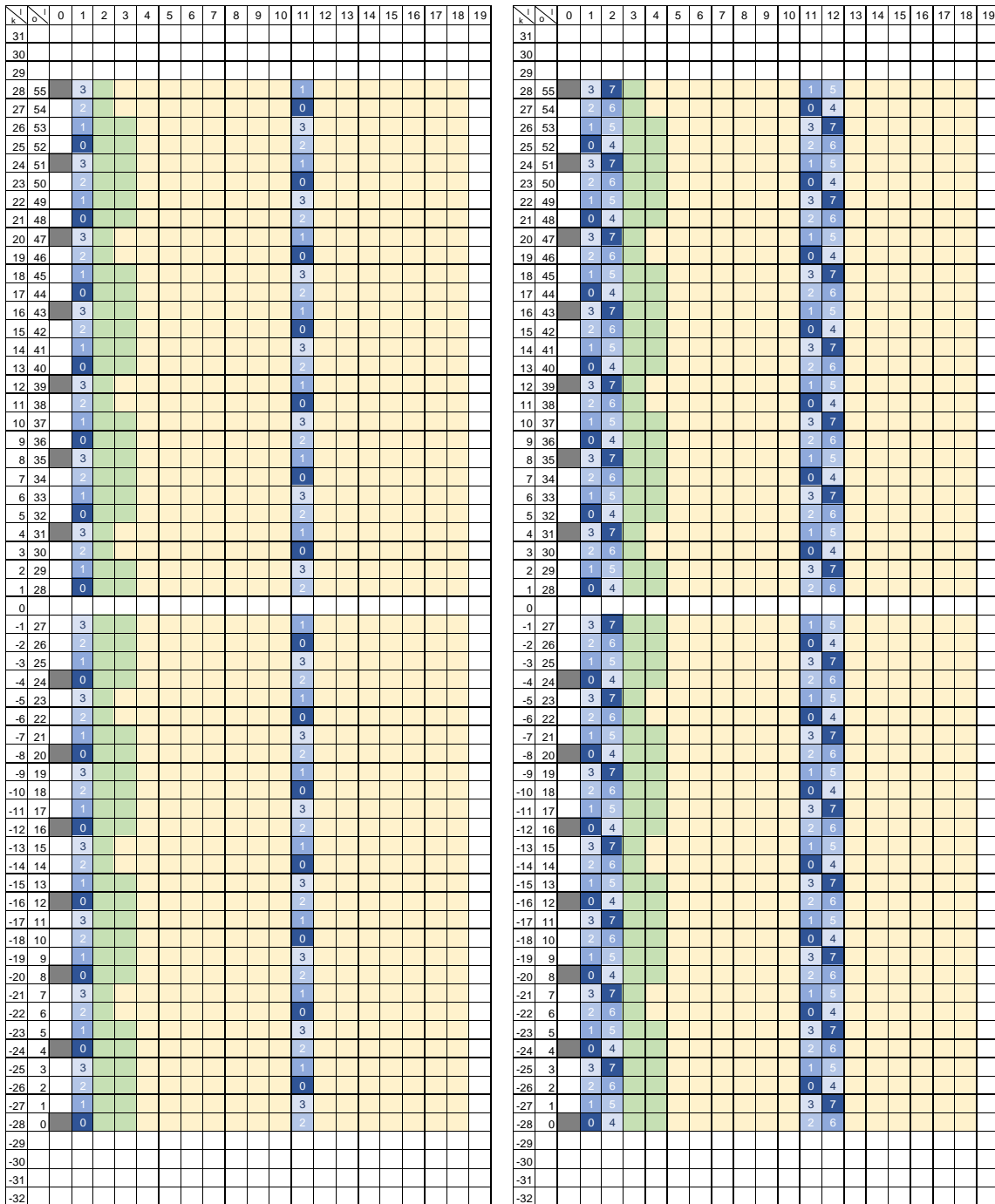

Figure 4.5-3: Resource mapping for $(\mu, \beta) = (*, 1)$
d) Transmission from four effective antennas of four subslots duration
e) Transmission from eight effective antennas of four subslots duration

5 Physical layer transmissions

5.1 Transmission packet structure

DECT-2020 transmission packet consists of Synchronization Training Field (STF), Data Field (DF) and Guard Interval (GI) as depicted in figures 5.1-1, 5.1-2 and 5.1-3. OFDM symbol length T_{symb}^μ is dependent on the subcarrier scaling factor μ as shown in table 4.3-1. STF transmission starts at transmission allocation boundary. SFT is purposefully constructed to create time domain repetitive pattern for receiver gain, timing and frequency acquisition. DF carries Demodulation Reference Signal (DRS), Physical Control Channel (PCC) and Physical Data Channel (PDC). GI in the end of the packet allows transmission-reception and reception-transmission turnaround and to avoid overlapping transmissions from adjacent TDMA timeslots.

Transmission packet length in OFDM symbols is:

$$\begin{aligned} \text{if } PacketLengthType = 0 &\Rightarrow N_{symb}^{PACKET} = PacketLength * N_{symb}^{SLOT,\mu} / N_{subslot}^{SLOT,\mu} \\ \text{if } PacketLengthType = 1 &\Rightarrow N_{symb}^{PACKET} = PacketLength * N_{symb}^{SLOT,\mu} \end{aligned}$$

depending whether *PacketLengthType* in Physical Header ETSI TS 103 636-4 [3], clause 6.2.1 indicates that the packet length is specified in terms of slots or subslots. The transmission packet length contains GI duration.

For $N_{TX}^{eff} \geq 4$ transmission length should be at least three subslots (15 OFDM symbols) to accomodate second set of demodulation reference signals for time variant channel and frequency error estimation.

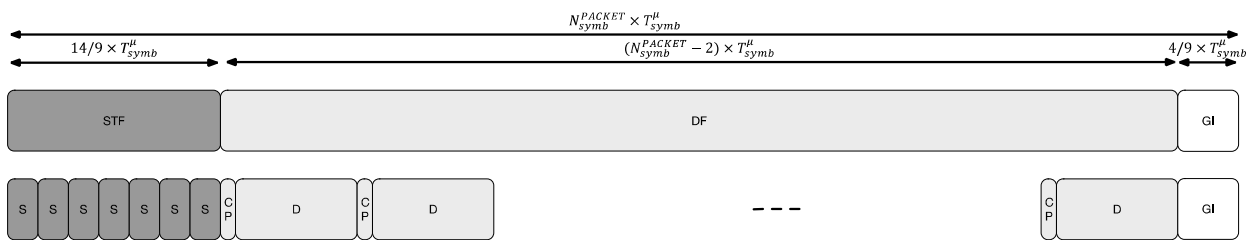

Figure 5.1-1: Packet structure for $\mu = \{1\}$

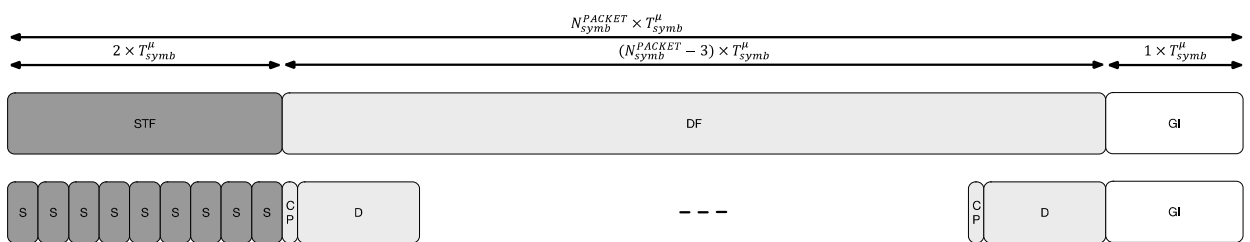

Figure 5.1-2: Packet structure for $\mu = \{2, 4\}$

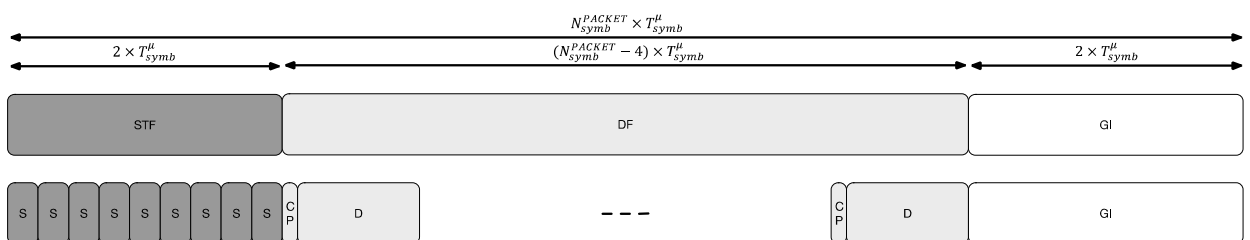

Figure 5.1-3: Packet structure for $\mu = \{8\}$

NOTE: For the highest subcarrier scaling the 4-bit packet length specifier allows packet length scaling from 5 to 80 OFDM symbols when packet length is specified in subslots, and up to 1 280 OFDM symbols when length is specified in slots.

5.2 Physical resource mapping

5.2.1 Guard Interval (GI)

GI in the end of the packet allows transmission-reception and reception-transmission turnaround and to avoid overlapping transmissions from adjacent timeslots. Guard intervals are of length $GI^{\mu=1} = \frac{4}{9} \cdot T_{symbol}^{\mu}$, $GI^{\mu=\{2,4\}} = 1 \cdot T_{symbol}^{\mu}$ and $GI^{\mu=8} = 2 \cdot T_{symbol}^{\mu}$ for subcarrier scaling factors $\mu = \{1,2,4,8\}$, respectively. Guard interval duration in μs is listed in table 4.3-1 for each subcarrier scaling.

5.2.2 Synchronization Training Field (STF)

Synchronization training signal is mapped into frequency domain subcarriers:

$$(t, k_i, l) = (0, k_{occ}^{\beta} [i \cdot 4], 0), \forall i = 0, \dots, \frac{N_{occ}^{\beta}}{8} - 1$$

and

$$(t, k_i, l) = \left(0, k_{occ}^{\beta} \left[\frac{N_{occ}^{\beta}}{2} + 3 + \left(i - \frac{N_{occ}^{\beta}}{8}\right) \cdot 4 \right], 0 \right), \forall i = \frac{N_{occ}^{\beta}}{8}, \dots, \frac{N_{occ}^{\beta}}{4} - 1$$

Thus, synchronization training is always in transmit stream $t = 0$ and in OFDM symbol $l = 0$ on every fourth subcarrier starting from the lowest occupied negative subcarrier but excluding the DC carrier.

EXAMPLE: The occupied STF subcarriers for DFT size 64 are [-28, -24, -20, -16, -12, -8, -4, 4, 8, 12, 16, 20, 24, 28] as depicted in figure 4.5-2.

Synchronization training data symbols are defined as:

$$y_i^{STF,(0)} = y^{(0),\beta} \left[\left(i + 2 \cdot \log_2(N_{TX}^{eff}) \right) \bmod \frac{N_{occ}^{\beta}}{4} \right], \forall i = 0, \dots, \frac{N_{occ}^{\beta}}{4} - 1$$

where N_{TX}^{eff} is the effective number of transmit antennas, which equals to the number of transmit streams $N_{TX}^{eff} = N_{TS}$. The STF base sequences are defined as:

$$y^{(0),\beta=1} = \{0 - 1j, 0 - 1j, -1 + 0j, -1 + 0j, 0 + 1j, 0 - 1j, 0 + 1j, 0 - 1j, 0 - 1j, 0 + 1j, 0 + 1j, -1 - 0j, 0 - 1j, -1 + 0j\}$$

$$y^{(0),\beta=2} = \{-1, -1, 1, 1, 1, -1, 1, 1, 1, 1, -1, -1, 1, -1, 1, 1, 1, -1, 1, 1, -1, 1, 1, 1, -1, 1, 1, -1, 1, 1, -1\}$$

$$y^{(0),\beta=4} = \{y^{(0),\beta=2}, y^{(0),\beta=2}\}$$

$$y^{(0),\beta=8} = \{y^{(0),\beta=4}, y^{(0),\beta=4}\}$$

$$y^{(0),\beta=12} = \{y^{(0),\beta=4}, y^{(0),\beta=4}, y^{(0),\beta=4}\}$$

$$y^{(0),\beta=16} = \{y^{(0),\beta=8}, y^{(0),\beta=8}\}$$

NOTE: Single effective transmit antenna is signalled with base sequence $y^{(0),\beta}$ transmitted as it is, two effective transmit antennas transmit the base sequence as a two steps, four effective transmit antennas transmit the base sequence as four steps, and eight effective transmit antennas transmit the base sequence as six steps cyclically rotated versions.

5.2.3 Demodulation Reference Signal (DRS)

Demodulation reference signals are allocated to the transmit streams according to the number of transmit streams N_{TS} . DRS is transmitted on the resources:

$$(t, k_i, l) = (t, k_{OCC}^\beta [i \cdot 4 + (t + (n \bmod 2) \cdot 2) \bmod 4], 1 + \lfloor t/4 \rfloor + n \cdot N_{step}),$$

$$\forall i = 0, \dots, \frac{N_{OCC}^\beta}{4} - 1, n = 0, \dots, \left\lfloor \frac{N_{PACKET}^{symb}}{N_{step}} \right\rfloor - 1$$

$$N_{step} = \begin{cases} 5, & \text{if } N_{TX}^{eff} \leq 2 \\ 10, & \text{if } N_{TX}^{eff} \geq 4 \end{cases}$$

where t is the transmit stream index.

EXAMPLE: Thus the pilot carriers for DFT size of 64 and for $t = 0$ are [-28, -24, -20, -16, -12, -8, -4, 1, 5, 9, 13, 17, 21, 25], for OFDM symbols $1 + n \cdot N_{step} \forall n \bmod 2 = 0$ and [-26, -22, -18, -14, -10, -6, -2, 3, 7, 11, 15, 19, 23, 27] for $1 + n \cdot N_{step} \forall n \bmod 2 = 1$ as depicted in figure 4.5-2.

Signal transmitted on DRS subcarrier k_i is:

$$y_i^{DRS,(t)} = \begin{cases} y^\beta [4 \cdot i + t \bmod 4] & \forall i = 0, \dots, N_{OCC}^\beta/4 - 1 \wedge t \leq 4 \\ -y^\beta [4 \cdot i + t \bmod 4] & \forall i = 0, \dots, N_{OCC}^\beta/4 - 1 \wedge t > 4 \end{cases}$$

where the base sequences are defined as:

$$y^{\beta=1} = \{1, 1, 1, 1, -1, 1, 1, -1, -1, 1, 1, 1, -1, 1, -1, 1, 1, -1, 1, -1, 1, 1, 1, 1, -1, 1, -1, 1, -1, 1, 1, 1, -1, 1, -1, 1, 1, 1, 1, -1, 1, -1, -1, 1, 1, -1, -1, -1, -1, 1, -1, -1, -1, -1, -1, 1, 1, 1, -1, 1, 1, -1, -1, 1, -1, -1, -1\}$$

$$y^{\beta=2} = \{y^{\beta=1}, y^{\beta=1}\}$$

$$y^{\beta=4} = \{y^{\beta=2}, y^{\beta=2}\}$$

$$y^{\beta=8} = \{y^{\beta=4}, y^{\beta=4}\}$$

$$y^{\beta=12} = \{y^{\beta=4}, y^{\beta=4}, y^{\beta=4}\}$$

$$y^{\beta=16} = \{y^{\beta=8}, y^{\beta=8}\}$$

5.2.4 Physical Control Channel (PCC)

PCC is mapped to spatial stream 0 to the $N_{subc}^{PCC} = 98$ subcarriers starting from OFDM symbol $l = 1$ and to the subcarriers which are not already occupied by DRS in any transmit stream. The procedure for subcarrier allocation for PCC is defined with steps:

- 1) Start from OFDM symbol $l = 1$ and set $N_{subc}^{unalloc} = 98$.
- 2) Starting from the lowest subcarrier of the OFDM symbol l , select the subcarriers which are not allocated for DRS and denote them by $k_{(0,l)}, k_{(1,l)}, \dots, k_{(U-1,l)}$, where U is the number of such unoccupied carriers.
- 3) If $U < N_{subc}^{unalloc}$ go to 4) else go to 5) to spread the remaining allocation as widely as possible across the transmission bandwidth.
- 4) Allocate all the available subcarriers in symbol l to PCC:
 - a) Add all subcarriers $k_{(0,l)}, k_{(1,l)}, \dots, k_{(U-1,l)}$ to the set of subcarriers k_l^{PCC} allocated to PCC.
 - b) Proceed to the next OFDM symbol by setting $l = l + 1$ and subtracting already allocated subcarriers $N_{subc}^{unalloc} = N_{subc}^{unalloc} - U$.
 - c) Jump to 2).

- 5) Assign $R^{PCC} = 7$ to be the number of rows of the matrix. The rows of the matrix are numbered $0, 1, 2, \dots, R^{PCC} - 1$ from top to bottom.
- 6) Determine the number of columns of the matrix C^{PCC} by:

$$C^{PCC} = U/R^{PCC}$$

The columns of rectangular matrix are numbered $0, 1, 2, \dots, C^{PCC} - 1$ from left to right.

- 7) Then, the subcarrier indices are written into the $(R^{PCC} \times C^{PCC})$ matrix row by row starting with bit $k_{(0,l)}$ in column 0 of row 0:

$$\begin{bmatrix} k_{(0,l)} & k_{(1,l)} & k_{(2,l)} & \dots & k_{(C^{PCC}-1,l)} \\ k_{(C^{PCC},l)} & k_{(C^{PCC}+1,l)} & k_{(C^{PCC}+2,l)} & \dots & k_{(2C^{PCC},l)} \\ \vdots & \vdots & \vdots & \ddots & \vdots \\ k_{((R^{PCC}-1) \times C^{PCC},l)} & k_{((R^{PCC}-1) \times C^{PCC}+1,l)} & k_{((R^{PCC}-1) \times C^{PCC}+2,l)} & \dots & k_{(R^{PCC} \times C^{PCC}-1,l)} \end{bmatrix}$$

- 8) The $N_{subc}^{unalloc}$ subcarriers are read from the matrix column by column starting from row 0 of column 0 to the set of PCC subcarriers k_l^{PCC} . Thus, allocation order is $k_{(0,l)}, k_{(C^{PCC},l)}, \dots, k_{((R^{PCC}-1) \times C^{PCC},l)}, k_{(1,l)}, k_{(C^{PCC}+1,l)}, \dots$, until all N_{subc}^{PCC} are allocated.

EXAMPLE: Examples of subcarrier allocations for PCC are depicted in figures 4.5-2 and 4.5-3.

Modulated data is mapped to the set of subcarriers k^{PCC} starting from lowest OFDM symbol index l and from lowest subcarrier index available for that OFDM symbol, filling the subcarriers first in frequency direction and then proceeding to the next OFDM symbol.

NOTE: Symbol mapping order is independent of allocation order. Thus, the list of allocated subcarriers is used in sorted order from lowest to highest for each OFDM symbol.

5.2.5 Physical Data Channel (PDC)

The remaining subcarriers of DF which are not allocated for DRS in any transmit stream or PCC in spatial stream 0 are allocated for PDC.

The length of DF in OFDM symbols is given by:

$$N_{symp}^{DF} = N_{symp}^{PACKET} - N_{symp}^{GI+STF}$$

where $N_{symp}^{GI+STF} = 2$ for $\mu = \{1\}$, $N_{symp}^{GI+STF} = 3$ for $\mu = \{2, 4\}$ and $N_{symp}^{GI+STF} = 4$ for $\mu = 8$. The number of DRS subcarriers N_{subc}^{DRS} in a packet is given by:

$$N_{subc}^{DRS} = N_{TX}^{eff} \cdot \frac{N_{OCC}^{\beta}}{4} \cdot \left\lfloor \frac{N_{symp}^{PACKET}}{N_{step}} \right\rfloor$$

where:

$$N_{step} = \begin{cases} 5, & \text{if } N_{TX}^{eff} \leq 2 \\ 10, & \text{if } N_{TX}^{eff} \geq 4 \end{cases}$$

The number of PDC subcarriers N_{subc}^{PDC} is then given by:

$$N_{subc}^{PDC} = N_{symp}^{DF} \cdot N_{OCC}^{\beta} - N_{subc}^{DRS} - N_{subc}^{PCC}$$

Modulated data is mapped to the set of subcarriers k^{PDC} starting from lowest OFDM symbol index l and from lowest subcarrier index available for that OFDM symbol, filling the subcarriers first in frequency direction and then proceeding to the next OFDM symbol.

5.3 Transport block size

With number of subcarriers N_{subc}^{PDC} available for transmission transport block size N_{bits}^{TB} is calculated as follows.

Supported Modulation and Coding Schemes (MCS) are defined in table A-1. For a MCS carrying N_{bps} bits per symbol and coding rate R , maximum number of bits which can be carried by the PDC is given by:

$$N_{bits}^{PDC} = \lfloor N_{ss} \cdot N_{subc}^{PDC} \cdot N_{bps} \cdot R \rfloor,$$

where the number of subcarriers available for PDC transmission N_{subc}^{PDC} for given packet size is calculated according to clause 5.2.5 and N_{ss} is the number of parallel spatial streams.

Set the CRC length of the TBS and individual code block segments as:

$$L = 24$$

Set maximum turbo encoder code block size according to the RD class specified in Annex B either to:

$$Z = 2\,048$$

or:

$$Z = 6\,144$$

If $N_{bits}^{PDC} \leq 512$, set:

$$M = 8$$

Else if $N_{bits}^{PDC} \leq 1\,024$, set:

$$M = 16$$

Else if $N_{bits}^{PDC} \leq 2\,048$, set:

$$M = 32$$

Else:

$$M = 64$$

Calculate the largest multiple of M not greater than N_{bits}^{PDC} as:

$$N_M = \left\lfloor \frac{N_{bits}^{PDC}}{M} \right\rfloor \times M$$

If $N_M \leq Z$, set:

$$N_{bits}^{TB} = N_M - L$$

Else transport block will be segmented. Calculate the number of code block segments:

$$C = \left\lceil \frac{N_M - L}{Z} \right\rceil$$

To get the transport block size subtract the transport block CRC length and individual codeblock CRC lengths:

$$N_{bits}^{TB} = N_M - (C + 1) \times L$$

NOTE: With this definition of transport block size the number of filler bits in clause 6.1.3 is always 0.

6 Generic procedures

6.1 Channel coding, rate-matching and interleaving

6.1.1 Overview

Data and control streams from/to MAC layer are encoded/decoded to offer physical layer packet services over the radio transmission link. Channel coding scheme is a combination of error detection, error correction, rate matching and interleaving.

6.1.2 CRC calculation

Denote the input bits to the CRC computation by $a_0, a_1, a_2, a_3, \dots, a_{A-1}$, and the parity bits by $p_0, p_1, p_2, p_3, \dots, p_{L-1}$. A is the size of the input sequence and L is the number of parity bits. The parity bits are generated by one of the following cyclic generator polynomials:

- $g_{\text{CRC24A}}(D) = [D^{24} + D^{23} + D^{18} + D^{17} + D^{14} + D^{11} + D^{10} + D^7 + D^6 + D^5 + D^4 + D^3 + D + 1]$; and
- $g_{\text{CRC24B}}(D) = [D^{24} + D^{23} + D^6 + D^5 + D + 1]$ for a CRC length $L = 24$; and
- $g_{\text{CRC16}}(D) = [D^{16} + D^{12} + D^5 + 1]$ for a CRC length $L = 16$.

The encoding is performed in a systematic form, which means that in GF(2), the polynomial:

$$a_0 D^{A+23} + a_1 D^{A+22} + \dots + a_{A-1} D^{24} + p_0 D^{23} + p_1 D^{22} + \dots + p_{22} D^1 + p_{23}$$

yields a remainder equal to 0 when divided by the corresponding length-24 CRC generator polynomial, $g_{\text{CRC24A}}(D)$ or $g_{\text{CRC24B}}(D)$, the polynomial:

$$a_0 D^{A+15} + a_1 D^{A+14} + \dots + a_{A-1} D^{16} + p_0 D^{15} + p_1 D^{14} + \dots + p_{14} D^1 + p_{15}$$

yields a remainder equal to 0 when divided by $g_{\text{CRC16}}(D)$.

The bits after CRC attachment are denoted by $b_0, b_1, b_2, b_3, \dots, b_{B-1}$, where $B = A + L$. The relation between a_k and b_k is:

$$\begin{aligned} b_k &= a_k & \text{for } k = 0, 1, 2, \dots, A-1 \\ b_k &= p_{k-A} & \text{for } k = A, A+1, A+2, \dots, A+L-1. \end{aligned}$$

6.1.3 Code block segmentation

The input bit sequence to the code block segmentation is denoted by $b_0, b_1, b_2, b_3, \dots, b_{B-1}$, where $B > 0$. If B is larger than the maximum code block size Z , segmentation of the input bit sequence is performed, and an additional CRC sequence of $L = 24$ bits is attached to each code block. The maximum code block size is:

- $Z = 2\,048$ or $6\,144$ as defined in Annex B for each Radio Device Class.

If the number of filler bits F calculated below is not 0, filler bits are added to the beginning of the first block.

Note that if $B < 40$, filler bits are added to the beginning of the code block.

The filler bits shall be set to $\langle \text{NULL} \rangle$ at the input to the encoder.

Total number of code blocks C is determined by:

if $B \leq Z$

$$L = 0$$

$$\text{Number of code blocks: } C = 1$$

$$B' = B$$

else

$$L = 24$$

Number of code blocks: $C = \lceil B/(Z - L) \rceil$.

$$B' = B + C \cdot L$$

end if

The bits output from code block segmentation, for $C \neq 0$, are denoted by $c_{r0}, c_{r1}, c_{r2}, c_{r3}, \dots, c_{r(K_r-1)}$, where r is the code block number, and K_r is the number of bits for the code block number r .

Number of bits in each code block (applicable for $C \neq 0$ only):

First segmentation size: K_+ = minimum K in table 6.1.4.2.3-1 such that $C \cdot K \geq B'$

if $C = 1$

the number of code blocks with length K_+ is $C_+ = 1$, $K_- = 0$, $C_- = 0$

else if $C > 1$

Second segmentation size: K_- = maximum K in table 6.1.4.2.3-1 such that $K < K_+$

$$\Delta_K = K_+ - K_-$$

$$\text{Number of segments of size } K_-: C_- = \left\lfloor \frac{C \cdot K_+ - B'}{\Delta_K} \right\rfloor$$

$$\text{Number of segments of size } K_+: C_+ = C - C_-$$

end if

Number of filler bits: $F = C_+ \cdot K_+ + C_- \cdot K_- - B'$

for $k = 0$ to $F-1$ -- Insertion of filler bits

$$c_{0k} = \langle \text{NULL} \rangle$$

end for

$k = F$

$s = 0$

for $r = 0$ to $C-1$

if $r < C_-$

$$K_r = K_-$$

else

$$K_r = K_+$$

end if

while $k < K_r - L$

$$c_{rk} = b_s$$

$$k = k + 1$$

$$s = s + 1$$

end while

if $C > 1$

The sequence $c_{r0}, c_{r1}, c_{r2}, c_{r3}, \dots, c_{r(K_r-L-1)}$ is used to calculate the CRC parity bits $p_{r0}, p_{r1}, p_{r2}, \dots, p_{r(L-1)}$ according to clause 6.1.2 with the generator polynomial $g_{\text{CRC24B}}(D)$. For CRC calculation it is assumed that filler bits, if present, have the value 0.

while $k < K_r$

$$c_{rk} = p_{r(k+L-K_r)}$$

$$k = k + 1$$

end while

end if

$$k = 0$$

end for

6.1.4 Channel coding

6.1.4.1 Introduction

The bit sequence input for a given code block to channel coding is denoted by $c_0, c_1, c_2, c_3, \dots, c_{K-1}$, where K is the number of bits to encode. After encoding the bits are denoted by $d_0^{(i)}, d_1^{(i)}, d_2^{(i)}, d_3^{(i)}, \dots, d_{D-1}^{(i)}$, where D is the number of encoded bits per output stream and i indexes the encoder output stream. The relation between c_k and $d_k^{(i)}$ and between K and D is dependent on the channel coding scheme.

6.1.4.2 Turbo coding

6.1.4.2.1 Turbo encoder

The scheme of turbo encoder is a Parallel Concatenated Convolutional Code (PCCC) with two 8-state constituent encoders and one turbo code internal interleaver. The coding rate of turbo encoder is 1/3. The structure of turbo encoder is illustrated in figure 6.1.4.2.1-1.

The transfer function of the 8-state constituent code for the PCCC is:

$$G(D) = \left[1, \frac{g_1(D)}{g_0(D)} \right],$$

where:

$$g_0(D) = 1 + D^2 + D^3,$$

$$g_1(D) = 1 + D + D^3.$$

The initial value of the shift registers of the 8-state constituent encoders shall be all zeros when starting to encode the input bits.

The output from the turbo encoder is:

$$d_k^{(0)} = x_k$$

$$d_k^{(1)} = z_k$$

$$d_k^{(2)} = z'_k$$

for $k = 0, 1, 2, \dots, K - 1$.

If the code block to be encoded is the 0-th code block and the number of filler bits is greater than zero, i.e. $F > 0$, then the encoder shall set $c_k = 0, k = 0, \dots, (F-1)$ at its input and shall set $d_k^{(0)} = \langle NULL \rangle, k = 0, \dots, (F-1)$ and $d_k^{(1)} = \langle NULL \rangle, k = 0, \dots, (F-1)$ at its output.

The bits input to the turbo encoder are denoted by $c_0, c_1, c_2, c_3, \dots, c_{K-1}$, and the bits output from the first and second 8-state constituent encoders are denoted by $z_0, z_1, z_2, z_3, \dots, z_{K-1}$ and $z'_0, z'_1, z'_2, z'_3, \dots, z'_{K-1}$, respectively. The bits output from the turbo code internal interleaver are denoted by $c'_0, c'_1, \dots, c'_{K-1}$, and these bits are to be the input to the second 8-state constituent encoder.

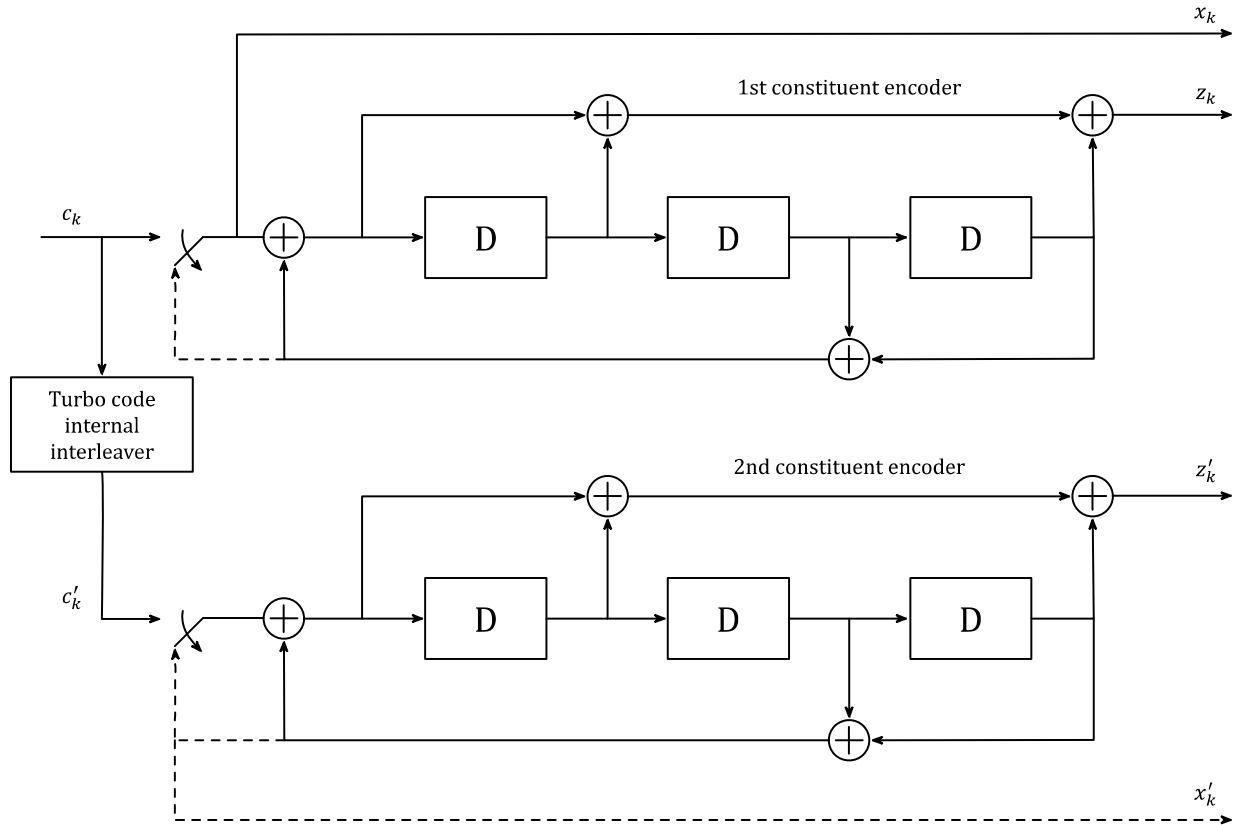

Figure 6.1.4.2.1-1: Structure of rate 1/3 turbo encoder (dotted lines apply for trellis termination only)

6.1.4.2.2 Trellis termination for turbo encoder

Trellis termination is performed by taking the tail bits from the shift register feedback after all information bits are encoded. Tail bits are padded after the encoding of information bits.

The first three tail bits shall be used to terminate the first constituent encoder (upper switch of figure 6.1.4.2.1-1 in lower position) while the second constituent encoder is disabled. The last three tail bits shall be used to terminate the second constituent encoder (lower switch of figure 6.1.4.2.1-1 in lower position) while the first constituent encoder is disabled.

The transmitted bits for trellis termination shall then be:

$$d_K^{(0)} = x_K, d_{K+1}^{(0)} = z_{K+1}, d_{K+2}^{(0)} = x'_K, d_{K+3}^{(0)} = z'_{K+1}$$

$$d_K^{(1)} = z_K, d_{K+1}^{(1)} = x_{K+2}, d_{K+2}^{(1)} = z'_K, d_{K+3}^{(1)} = x'_{K+2}$$

$$d_K^{(2)} = x_{K+1}, d_{K+1}^{(2)} = z_{K+2}, d_{K+2}^{(2)} = x'_{K+1}, d_{K+3}^{(2)} = z'_{K+2}$$

6.1.4.2.3 Turbo code internal interleaver

The bits input to the turbo code internal interleaver are denoted by c_0, c_1, \dots, c_{K-1} , where K is the number of input bits. The bits output from the turbo code internal interleaver are denoted by $c'_0, c'_1, \dots, c'_{K-1}$.

The relationship between the input and output bits is as follows:

$$c'_i = c_{\Pi(i)}, i = 0, 1, \dots, (K-1), i=0, 1, \dots, (K-1)$$

where the relationship between the output index i and the input index $\Pi(i)$ satisfies the following quadratic form:

$$\Pi(i) = (f_1 \cdot i + f_2 \cdot i^2) \bmod K$$

The parameters f_1 and f_2 depend on the block size K and are summarized in table 6.1.4.2.3-1.

Table 6.1.4.2.3-1: Turbo code internal interleaver parameters

i	K	f_1	f_2	i	K	f_1	f_2	i	K	f_1	f_2	i	K	f_1	f_2
1	40	3	10	48	416	25	52	95	1 120	67	140	142	3 200	111	240
2	48	7	12	49	424	51	106	96	1 152	35	72	143	3 264	443	204
3	56	19	42	50	432	47	72	97	1 184	19	74	144	3 328	51	104
4	64	7	16	51	440	91	110	98	1 216	39	76	145	3 392	51	212
5	72	7	18	52	448	29	168	99	1 248	19	78	146	3 456	451	192
6	80	11	20	53	456	29	114	100	1 280	199	240	147	3 520	257	220
7	88	5	22	54	464	247	58	101	1 312	21	82	148	3 584	57	336
8	96	11	24	55	472	29	118	102	1 344	211	252	149	3 648	313	228
9	104	7	26	56	480	89	180	103	1 376	21	86	150	3 712	271	232
10	112	41	84	57	488	91	122	104	1 408	43	88	151	3 776	179	236
11	120	103	90	58	496	157	62	105	1 440	149	60	152	3 840	331	120
12	128	15	32	59	504	55	84	106	1 472	45	92	153	3 904	363	244
13	136	9	34	60	512	31	64	107	1 504	49	846	154	3 968	375	248
14	144	17	108	61	528	17	66	108	1 536	71	48	155	4 032	127	168
15	152	9	38	62	544	35	68	109	1 568	13	28	156	4 096	31	64
16	160	21	120	63	560	227	420	110	1 600	17	80	157	4 160	33	130
17	168	101	84	64	576	65	96	111	1 632	25	102	158	4 224	43	264
18	176	21	44	65	592	19	74	112	1 664	183	104	159	4 288	33	134
19	184	57	46	66	608	37	76	113	1 696	55	954	160	4 352	477	408
20	192	23	48	67	624	41	234	114	1 728	127	96	161	4 416	35	138
21	200	13	50	68	640	39	80	115	1 760	27	110	162	4 480	233	280
22	208	27	52	69	656	185	82	116	1 792	29	112	163	4 544	357	142
23	216	11	36	70	672	43	252	117	1 824	29	114	164	4 608	337	480
24	224	27	56	71	688	21	86	118	1 856	57	116	165	4 672	37	146
25	232	85	58	72	704	155	44	119	1 888	45	354	166	4 736	71	444
26	240	29	60	73	720	79	120	120	1 920	31	120	167	4 800	71	120
27	248	33	62	74	736	139	92	121	1 952	59	610	168	4 864	37	152
28	256	15	32	75	752	23	94	122	1 984	185	124	169	4 928	39	462
29	264	17	198	76	768	217	48	123	2 016	113	420	170	4 992	127	234
30	272	33	68	77	784	25	98	124	2 048	31	64	171	5 056	39	158
31	280	103	210	78	800	17	80	125	2 112	17	66	172	5 120	39	80
32	288	19	36	79	816	127	102	126	2 176	171	136	173	5 184	31	96
33	296	19	74	80	832	25	52	127	2 240	209	420	174	5 248	113	902
34	304	37	76	81	848	239	106	128	2 304	253	216	175	5 312	41	166
35	312	19	78	82	864	17	48	129	2 368	367	444	176	5 376	251	336
36	320	21	120	83	880	137	110	130	2 432	265	456	177	5 440	43	170
37	328	21	82	84	896	215	112	131	2 496	181	468	178	5 504	21	86
38	336	115	84	85	912	29	114	132	2 560	39	80	179	5 568	43	174
39	344	193	86	86	928	15	58	133	2 624	27	164	180	5 632	45	176
40	352	21	44	87	944	147	118	134	2 688	127	504	181	5 696	45	178
41	360	133	90	88	960	29	60	135	2 752	143	172	182	5 760	161	120
42	368	81	46	89	976	59	122	136	2 816	43	88	183	5 824	89	182
43	376	45	94	90	992	65	124	137	2 880	29	300	184	5 888	323	184
44	384	23	48	91	1 008	55	84	138	2 944	45	92	185	5 952	47	186
45	392	243	98	92	1 024	31	64	139	3 008	157	188	186	6 016	23	94
46	400	151	40	93	1 056	17	66	140	3 072	47	96	187	6 080	47	190
47	408	155	102	94	1 088	171	204	141	3 136	13	28	188	6 144	263	480

6.1.5 Rate matching

6.1.5.1 Rate matching for turbo coded transport channels

The rate matching for turbo coded transport channels is defined per coded block and consists of interleaving the three information bit streams $d_k^{(0)}$, $d_k^{(1)}$ and $d_k^{(2)}$, followed by the collection of bits and the generation of a circular buffer as depicted in figure 6.1.5.1-1. The output bits for each code block are transmitted as described in clause 6.1.5.3.

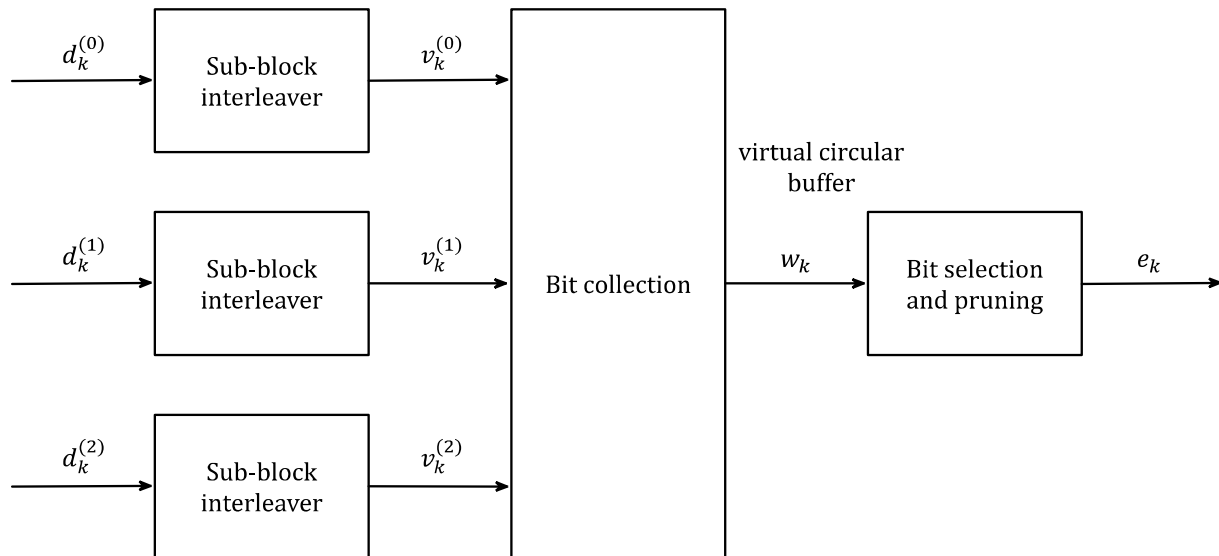

Figure 6.1.5.1-1: Rate matching for turbo coded transport channels

The bit stream $d_k^{(0)}$ is interleaved according to the sub-block interleaver defined in clause 6.1.5.2 with an output sequence defined as $v_0^{(0)}, v_1^{(0)}, v_2^{(0)}, \dots, v_{K_{\Pi}-1}^{(0)}$ and where K_{Π} is defined in clause 6.1.5.2.

The bit stream $d_k^{(1)}$ is interleaved according to the sub-block interleaver defined in clause 6.1.5.2 with an output sequence defined as $v_0^{(1)}, v_1^{(1)}, v_2^{(1)}, \dots, v_{K_{\Pi}-1}^{(1)}$.

The bit stream $d_k^{(2)}$ is interleaved according to the sub-block interleaver defined in clause 6.1.5.2 with an output sequence defined as $v_0^{(2)}, v_1^{(2)}, v_2^{(2)}, \dots, v_{K_{\Pi}-1}^{(2)}$.

The sequence of bits e_k for transmission is generated according to clause 6.1.5.3.

6.1.5.2 Sub-block interleaver

The bits input to the block interleaver are denoted by $d_0^{(i)}, d_1^{(i)}, d_2^{(i)}, \dots, d_{D-1}^{(i)}$, where D is the number of bits. The output bit sequence from the block interleaver is derived as follows:

- 1) Assign $C_{subblock}^{TC} = 32$ to be the number of columns of the matrix. The columns of the matrix are numbered 0, 1, 2, ..., $C_{subblock}^{TC} - 1$ from left to right.
- 2) Determine the number of rows of the matrix $R_{subblock}^{TC}$, by finding minimum integer $R_{subblock}^{TC}$ such that:

$$D \leq (R_{subblock}^{TC} \times C_{subblock}^{TC})$$

The rows of rectangular matrix are numbered 0, 1, 2, ..., $R_{subblock}^{TC} - 1$ from top to bottom.

- 3) If $(R_{subblock}^{TC} \times C_{subblock}^{TC}) > D$, then $N_D = (R_{subblock}^{TC} \times C_{subblock}^{TC} - D)$ dummy bits are padded such that $y_k = \langle NULL \rangle$ for $k = 0, 1, \dots, N_D - 1$. Then, $y_{N_D+k} = d_k^{(i)}$, $k = 0, 1, \dots, D-1$, and the bit sequence y_k is written into the $(R_{subblock}^{TC} \times C_{subblock}^{TC})$ matrix row by row starting with bit y_0 in column 0 of row 0:

$$\begin{bmatrix} y_0 & y_1 & y_2 & \cdots & y_{C_{subblock}^{TC}-1} \\ y_{C_{subblock}^{TC}} & y_{C_{subblock}^{TC}+1} & y_{C_{subblock}^{TC}+2} & \cdots & y_{2C_{subblock}^{TC}-1} \\ \vdots & \vdots & \vdots & \ddots & \vdots \\ y_{(R_{subblock}^{TC}-1) \times C_{subblock}^{TC}} & y_{(R_{subblock}^{TC}-1) \times C_{subblock}^{TC}+1} & y_{(R_{subblock}^{TC}-1) \times C_{subblock}^{TC}+2} & \cdots & y_{(R_{subblock}^{TC} \times C_{subblock}^{TC}-1)} \end{bmatrix}$$

For $d_k^{(0)}$ and $d_k^{(1)}$:

- 4) Perform the inter-column permutation for the matrix based on the pattern $\langle P(j) \rangle_{j \in \{0, 1, \dots, C_{subblock}^{TC}-1\}}$ that is shown in table 6.1.5.2-1, where $P(j)$ is the original column position of the j -th permuted column. After permutation of the columns, the inter-column permuted $(R_{subblock}^{TC} \times C_{subblock}^{TC})$ matrix is equal to:

$$\begin{bmatrix} y_{P(0)} & y_{P(1)} & y_{P(2)} & \cdots & y_{P(C_{subblock}^{TC}-1)} \\ y_{P(0)+C_{subblock}^{TC}} & y_{P(1)+C_{subblock}^{TC}} & y_{P(2)+C_{subblock}^{TC}} & \cdots & y_{P(C_{subblock}^{TC}-1)+C_{subblock}^{TC}} \\ \vdots & \vdots & \vdots & \ddots & \vdots \\ y_{P(0)+(R_{subblock}^{TC}-1) \times C_{subblock}^{TC}} & y_{P(1)+(R_{subblock}^{TC}-1) \times C_{subblock}^{TC}} & y_{P(2)+(R_{subblock}^{TC}-1) \times C_{subblock}^{TC}} & \cdots & y_{P(C_{subblock}^{TC}-1)+(R_{subblock}^{TC}-1) \times C_{subblock}^{TC}} \end{bmatrix}$$

- 5) The output of the block interleaver is the bit sequence read out column by column from the inter-column permuted $(R_{subblock}^{TC} \times C_{subblock}^{TC})$ matrix. The bits after sub-block interleaving are denoted by: $v_0^{(i)}, v_1^{(i)}, v_2^{(i)}, \dots, v_{K_{\Pi}-1}^{(i)}$, where $v_0^{(i)}$ corresponds to $y_{P(0)}, v_1^{(i)}$ to $y_{P(0)+C_{subblock}^{TC}} \dots$ and $K_{\Pi} = (R_{subblock}^{TC} \times C_{subblock}^{TC})$.

For $d_k^{(2)}$:

- 6) The output of the sub-block interleaver is denoted by $v_0^{(2)}, v_1^{(2)}, v_2^{(2)}, \dots, v_{K_{\Pi}-1}^{(2)}$, where $v_k^{(2)} = y_{\pi(k)}$ and where:

$$\pi(k) \xrightarrow{\leftarrow} \left(P \left(\left\lfloor \frac{k}{R_{subblock}^{TC}} \right\rfloor \right) + C_{subblock}^{TC} \times (k \bmod R_{subblock}^{TC}) + 1 \right) \bmod K_{\Pi}$$

The permutation function P is defined in table 6.1.5.2-1.

Table 6.1.5.2-1: Inter-column permutation pattern for sub-block interleaver

Number of columns $C_{subblock}^{TC}$	Inter-column permutation pattern $\langle P(0), P(1), \dots, P(C_{subblock}^{TC}-1) \rangle$
32	$\langle 0, 16, 8, 24, 4, 20, 12, 28, 2, 18, 10, 26, 6, 22, 14, 30, 1, 17, 9, 25, 5, 21, 13, 29, 3, 19, 11, 27, 7, 23, 15, 31 \rangle$

6.1.5.3 Bit collection, selection and transmission

The circular buffer of length $K_w = 3K_{\Pi}$ for the r -th coded block is generated as follows:

$$w_k = v_k^{(0)} \text{ for } k = 0, \dots, K_{\Pi} - 1$$

$$w_{K_{\Pi}+2k} = v_k^{(1)} \text{ for } k = 0, \dots, K_{\Pi} - 1$$

$$w_{K_{\Pi}+2k+1} = v_k^{(2)} \text{ for } k = 0, \dots, K_{\Pi} - 1$$

Denote the soft buffer size for the transport block by N_{IR} bits and the soft buffer size for the r -th code block by N_{cb} bits. The size N_{cb} is obtained as follows, where C is the number of code blocks computed in clause 6.1.3:

$$N_{cb} = \min \left(\left\lfloor \frac{N_{IR}}{C} \right\rfloor, K_w \right),$$

where N_{IR} is equal to:

$$N_{IR} = \left\lfloor \frac{N_{soft}}{\min(M_{DL_HARQ}, M_{limit})} \right\rfloor$$

Where N_{soft} is the total number of soft channel bits according to the Radio Device class category defined in Annex A.

$M_{\text{DL_HARQ}}$ is the maximum number of DL HARQ processes according to the Radio Device class category defined in Annex B.

M_{limit} is a constant equal to 8.

Denoting by E the rate matching output sequence length for the r -th coded block, and rv_{idx} the redundancy version number for this transmission ($rv_{idx} = 0, 1, 2$ or 3), the rate matching output bit sequence is e_k , $k = 0, 1, \dots, E - 1$.

Define by $G = N_{\text{sub}bc}^{PDC} \cdot N_{SS} \cdot N_{bps}$ the total number of bits available for the transmission of one transport block.

Set $G' = G / (N_{SS} \cdot N_{bps}) = N_{\text{sub}bc}^{PDC}$ where N_{bps} is equal to 1 for BPSK, 2 for QPSK, 4 for 16-QAM, 6 for 64-QAM, 8 for 256-QAM and 10 for 1024-QAM, and where:

- N_{SS} is equal to the number of spatial layers a transport block is mapped onto

Set $\gamma = G' \bmod C$, where C is the number of code blocks computed in clause 6.1.3.

if $r \leq C - \gamma - 1$

$$\text{set } E = N_{SS} \cdot N_{bps} \cdot \lceil G'/C \rceil = N_{SS} \cdot N_{bps} \cdot \lceil N_{\text{sub}bc}^{PDC}/C \rceil$$

else

$$\text{set } E = N_{SS} \cdot N_{bps} \cdot \lceil G'/C \rceil = N_{SS} \cdot N_{bps} \cdot \lceil N_{\text{sub}bc}^{PDC}/C \rceil$$

end if

Set $k_0 = R_{\text{sub}block}^{TC} \cdot \left(2 \cdot \left\lceil \frac{N_{cb}}{8 \cdot R_{\text{sub}block}^{TC}} \right\rceil \cdot rv_{idx} + 2 \right)$, where $R_{\text{sub}block}^{TC}$ is the number of rows defined in clause 6.1.5.2.

Set $k = 0$ and $j = 0$

while $\{k < E\}$

if $w_{(k_0+j) \bmod N_{cb}} \neq \langle \text{NULL} \rangle$

$$e_k = w_{(k_0+j) \bmod N_{cb}}$$

$$k = k + 1$$

end if

$$j = j + 1$$

end while

6.1.6 Code block concatenation

The input bit sequence for the code block concatenation block are the sequences e_{rk} , for $r = 0, \dots, C - 1$ and $k = 0, \dots, E_r - 1$. The output bit sequence from the code block concatenation block is the sequence f_k for $k = 0, \dots, G - 1$.

The code block concatenation consists of sequentially concatenating the rate matching outputs for the different code blocks. Therefore,

set $k = 0$ and $r = 0$

while $r < C$

Set $j = 0$

while $j < E_r$

$$f_k = e_{rj}$$

$$k = k + 1$$

$$j = j + 1$$

end while

$$r = r + 1$$

end while

6.2 Pseudo-random sequence generation

Generic pseudo random sequence is defined by a length 31 Gold sequence. The output sequence $g(n)$ of length N_{PN} where $n = 0, 1, \dots, N_{PN} - 1$ is defined by:

$$\begin{aligned} g(n) &= (x_1(n + N_C) + x_1(n + N_C)) \bmod 2 \\ x_1(n + 31) &= (x_1(n + 3) + x_1(n)) \bmod 2 \\ x_2(n + 31) &= (x_2(n + 3) + x_2(n + 2) + x_2(n + 1) + x_2(n)) \bmod 2 \end{aligned} ,$$

where $N_C = 1\ 600$ and the first m-sequence shall be initialized with:

$$x_1(0) = 1, x_1(n) = 0, \forall n = \{1, 2, \dots, 30\}$$

The initialization of the second m-sequence $x_2(n)$ is denoted by:

$$g_{init} = \sum_{i=0}^{30} x_2(i) \cdot 2^i,$$

with the value depending on the application sequence.

6.3 Modulation

6.3.1 Symbol mapping

6.3.1.1 Overview

The modulation mapper takes binary digits, 0 or 1, as input and produces complex-valued modulation symbols as output.

6.3.1.2 BPSK

In case of BPSK modulation, bit $d(i)$ is mapped to complex-valued modulation symbol $x(i)$ according to:

$$\begin{aligned} x(i) &= \frac{1}{\sqrt{2}} \{ (1 - 2 * d(i)) \\ &\quad + j(1 - 2 * d(i)) \} \end{aligned}$$

6.3.1.3 QPSK

In case of QPSK modulation, pair of bits, $d(i)$, $d(i + 1)$ are mapped to complex-valued modulation symbols $x(i)$ according to:

$$\begin{aligned} x(i) &= \frac{1}{\sqrt{2}} \{ (1 - 2 * d(i)) \\ &\quad + j(1 - 2 * d(i + 1)) \} \end{aligned}$$

6.3.1.4 16-QAM

In case of 16-QAM modulation, quadruplets of bits, $d(i)$, $d(i + 1)$, $d(i + 2)$, $d(i + 3)$ are mapped to complex-valued modulation symbols $x(i)$ according to:

$$x(i) = \frac{1}{\sqrt{10}} \left\{ (1 - 2 * d(i)) \left(2 - (1 - 2 * d(i + 2)) \right) \right. \\ \left. + j (1 - 2 * d(i + 1)) \left(2 - (1 - 2 * d(i + 3)) \right) \right\}$$

6.3.1.5 64-QAM

In case of 64-QAM modulation, hexuplets of bits, $d(i)$, $d(i + 1)$, $d(i + 2)$, $d(i + 3)$, $d(i + 4)$, $d(i + 5)$, are mapped to complex-valued modulation symbols $x(i)$ according to:

$$x(i) = \frac{1}{\sqrt{42}} \left\{ (1 - 2 * d(i)) \left(4 - (1 - 2 * d(i + 2)) \left(2 - (1 - 2 * d(i + 4)) \right) \right) \right. \\ \left. + j (1 - 2 * d(i + 1)) \left(4 - (1 - 2 * d(i + 3)) \left(2 - (1 - 2 * d(i + 5)) \right) \right) \right\}$$

6.3.1.6 256-QAM

In case of 256-QAM modulation, octuplets of bits, $d(i)$, $d(i + 1)$, $d(i + 2)$, $d(i + 3)$, $d(i + 4)$, $d(i + 5)$, $d(i + 6)$, $d(i + 7)$ are mapped to complex-valued modulation symbols $x(i)$ according to:

$$x(i) = \frac{1}{\sqrt{170}} \left\{ (1 - 2 * d(i)) \left(8 - (1 - 2 * d(i + 2)) \left(4 - (1 - 2 * d(i + 4)) \left(2 - (1 - 2 * d(i + 6)) \right) \right) \right) \right. \\ \left. + j (1 - 2 * d(i + 1)) \left(8 - (1 - 2 * d(i + 3)) \left(4 - (1 - 2 * d(i + 5)) \left(2 - (1 - 2 * d(i + 7)) \right) \right) \right) \right\}$$

6.3.1.7 1024-QAM

In case of 1024-QAM modulation, decuplets of bits, $d(i)$, $d(i + 1)$, $d(i + 2)$, $d(i + 3)$, $d(i + 4)$, $d(i + 5)$, $d(i + 6)$, $d(i + 7)$, $d(i + 8)$, $d(i + 9)$ are mapped to complex-valued modulation symbols $x(i)$ according to:

$$x(i) = \frac{1}{\sqrt{682}} \left\{ (1 - 2 * d(i)) \left(16 - (1 - 2 * d(i + 2)) \left(8 - (1 - 2 * d(i + 4)) \left(4 - (1 - 2 * d(i + 6)) \left(2 - (1 - 2 * d(i + 8)) \right) \right) \right) \right) \right. \\ \left. + j (1 - 2 * d(i + 1)) \left(16 - (1 - 2 * d(i + 3)) \left(8 - (1 - 2 * d(i + 5)) \left(4 - (1 - 2 * d(i + 7)) \left(2 - (1 - 2 * d(i + 9)) \right) \right) \right) \right) \right\}$$

6.3.2 Spatial multiplexing

The modulated transport block to spatial stream multiplexing shall be done according to table 6.3.2-1, where the complex valued modulation symbols $x(i)$, $i = 0, \dots, M_{\text{sybm}}$ is mapped to the modulated symbol in spatial stream $x^{(s)}(i)$, $i = 0, \dots, M_{\text{sybm}}^{\text{stream}}$ for stream s and $M_{\text{sybm}}^{\text{stream}} = M_{\text{sybm}} / N_{\text{SS}}$. The number of spatial streams is less than or equal to the number of antenna ports used for the transmission of the channel.

Table 6.3.2-1: Modulated transport block to spatial stream mapping

Number of spatial streams	Modulated transport block to spatial stream mapping
1	$x^{(0)}(i) = x(i)$
2	$x^{(0)}(i) = x(2i)$ $x^{(1)}(i) = x(2i + 1)$
4	$x^{(0)}(i) = x(4i)$ $x^{(1)}(i) = x(4i + 1)$ $x^{(2)}(i) = x(4i + 2)$ $x^{(3)}(i) = x(4i + 3)$
8	$x^{(0)}(i) = x(8i)$ $x^{(1)}(i) = x(8i + 1)$ $x^{(2)}(i) = x(8i + 2)$ $x^{(3)}(i) = x(8i + 3)$ $x^{(4)}(i) = x(8i + 4)$ $x^{(5)}(i) = x(8i + 5)$ $x^{(6)}(i) = x(8i + 6)$ $x^{(7)}(i) = x(8i + 7)$

6.3.3 Transmit stream mapping

6.3.3.1 Transmit stream mapping for spatial multiplexing and for single antenna

If transmit diversity is not used the precoding matrix is identity matrix, thus:

$$y^{(s)}(i) = x^{(s)}(i), i = 0, \dots, M_{\text{symbol}}^{\text{stream}} - 1, s = 0, \dots, N_{\text{SS}}$$

where $y^{(s)}(i)$ denotes transmission in transmit stream index s and $x^{(s)}(i)$ is modulated symbol for spatial stream index s and time index i and number of transmit streams $N_{\text{TS}} = N_{\text{SS}}$.

6.3.3.2 Transmit diversity precoding

When transmit diversity is used the pair of symbols $[x^{(0)}(2i), x^{(0)}(2i + 1)]^T, i = 0, \dots, M_{\text{symbol}}^{\text{stream}}/2 - 1$ of spatial stream 0 shall be precoded according to:

$$\begin{bmatrix} y^{(0)}(2i) \\ \vdots \\ y^{(N_{\text{TS}}-1)}(2i) \\ y^{(0)}(2i + 1) \\ \vdots \\ y^{(N_{\text{TS}}-1)}(2i + 1) \end{bmatrix} = Y_i \begin{bmatrix} \text{Re}\{x^{(0)}(2i)\} \\ \text{Re}\{x^{(0)}(2i + 1)\} \\ \text{Im}\{x^{(0)}(2i)\} \\ \text{Im}\{x^{(0)}(2i + 1)\} \end{bmatrix}, i = 0, \dots, M_{\text{symbol}}^{\text{stream}} - 1$$

where $y^{(t)}(l)$ is the transmit diversity precoded transmission in transmit stream t and index l and $x^{(s)}(l)$ is modulated symbol for spatial stream index s and time index l . The precoding matrices Y_i are given by tables 6.3.3.2-1 to 6.3.3.2-3 for index i and for each transmit diversity scheme.

Table 6.3.3.2-1: Precoding matrix Y_i for two antenna transmit diversity using two transmit streams

Y_i
$\begin{bmatrix} 1 & 0 & j & 0 \\ 0 & -1 & 0 & j \\ 0 & 1 & 0 & j \\ 1 & 0 & -j & 0 \end{bmatrix}$

Table 6.3.3.2-2: Precoding matrix Y_i for four antenna transmit diversity using four transmit streams

index $i \bmod 6$	Y_i (ordered from left to right in increasing order of index)			
	0 - 3	$\begin{bmatrix} 1 & 0 & j & 0 \\ 0 & -1 & 0 & j \\ 0 & 0 & 0 & 0 \\ 0 & 0 & 0 & 0 \\ 0 & 1 & 0 & j \\ 1 & 0 & -j & 0 \\ 0 & 0 & 0 & 0 \\ 0 & 0 & 0 & 0 \end{bmatrix}$	$\begin{bmatrix} 0 & 0 & 0 & 0 \\ 0 & 0 & 0 & 0 \\ 1 & 0 & j & 0 \\ 0 & -1 & 0 & j \\ 0 & 0 & 0 & 0 \\ 0 & 0 & 0 & 0 \\ 0 & 1 & 0 & j \\ 1 & 0 & -j & 0 \end{bmatrix}$	$\begin{bmatrix} 1 & 0 & j & 0 \\ 0 & 0 & 0 & 0 \\ 0 & -1 & 0 & j \\ 0 & 0 & 0 & 0 \\ 0 & 1 & 0 & j \\ 0 & 0 & 0 & 0 \\ 1 & 0 & -j & 0 \\ 0 & 0 & 0 & 0 \end{bmatrix}$
4 - 5	$\begin{bmatrix} 1 & 0 & j & 0 \\ 0 & 0 & 0 & 0 \\ 0 & 0 & 0 & 0 \\ 0 & -1 & 0 & j \\ 0 & 1 & 0 & j \\ 0 & 0 & 0 & 0 \\ 0 & 0 & 0 & 0 \\ 1 & 0 & -j & 0 \end{bmatrix}$	$\begin{bmatrix} 0 & 0 & 0 & 0 \\ 1 & 0 & j & 0 \\ 0 & -1 & 0 & j \\ 0 & 0 & 0 & 0 \\ 0 & 0 & 0 & 0 \\ 0 & 1 & 0 & j \\ 1 & 0 & -j & 0 \\ 0 & 0 & 0 & 0 \end{bmatrix}$	-	-

The same precoding or beamforming is applied to PCC, PDC, DRS and STF transmit streams for the precoding to be transparent to the receiver.

Single antenna transmission precoding matrix is identity matrix $W = 1$.

Open loop MIMO and transmit diversity transmissions can be done with any orthogonal precoding matrix which is transparent to the receiver.

The precoding matrix W are given by tables 6.3.4-1 to 6.3.4-5 for each closed loop codebook index applicable for given transmission.

Channel sounding packet shall always be transmitted with identity precoding matrix, thus using codebook index 0 of tables 6.3.4-3, 6.3.4-5 and 6.3.4-6.

Table 6.3.4-1: Precoding matrix W for single transmit stream transmission using two antenna ports

Codebook index	W (ordered from left to right in increasing order of index)							
	0 - 5	$\begin{bmatrix} 1 \\ 0 \end{bmatrix}$	$\begin{bmatrix} 0 \\ 1 \end{bmatrix}$	$\frac{1}{\sqrt{2}} \begin{bmatrix} 1 \\ 1 \end{bmatrix}$	$\frac{1}{\sqrt{2}} \begin{bmatrix} 1 \\ -1 \end{bmatrix}$	$\frac{1}{\sqrt{2}} \begin{bmatrix} 1 \\ j \end{bmatrix}$	$\frac{1}{\sqrt{2}} \begin{bmatrix} 1 \\ -j \end{bmatrix}$	-

Table 6.3.4-2: Precoding matrix W for single transmit stream transmission using four antenna ports

Codebook index	W (ordered from left to right in increasing order of index)							
	0 - 7	$\begin{bmatrix} 1 \\ 0 \\ 0 \\ 0 \end{bmatrix}$	$\begin{bmatrix} 0 \\ 1 \\ 0 \\ 0 \end{bmatrix}$	$\begin{bmatrix} 0 \\ 0 \\ 1 \\ 0 \end{bmatrix}$	$\begin{bmatrix} 0 \\ 0 \\ 0 \\ 1 \end{bmatrix}$	$\frac{1}{\sqrt{2}} \begin{bmatrix} 1 \\ 0 \\ 1 \\ 0 \end{bmatrix}$	$\frac{1}{\sqrt{2}} \begin{bmatrix} 1 \\ 0 \\ -1 \\ 0 \end{bmatrix}$	$\frac{1}{\sqrt{2}} \begin{bmatrix} 1 \\ 0 \\ j \\ 0 \end{bmatrix}$
8 - 15	$\frac{1}{\sqrt{2}} \begin{bmatrix} 0 \\ 1 \\ 1 \\ 0 \end{bmatrix}$	$\frac{1}{\sqrt{2}} \begin{bmatrix} 0 \\ 1 \\ 0 \\ -1 \end{bmatrix}$	$\frac{1}{\sqrt{2}} \begin{bmatrix} 0 \\ 1 \\ 0 \\ j \end{bmatrix}$	$\frac{1}{\sqrt{2}} \begin{bmatrix} 0 \\ 1 \\ 0 \\ -j \end{bmatrix}$	$\frac{1}{2} \begin{bmatrix} 1 \\ 1 \\ 1 \\ 1 \end{bmatrix}$	$\frac{1}{2} \begin{bmatrix} 1 \\ 1 \\ 1 \\ j \end{bmatrix}$	$\frac{1}{2} \begin{bmatrix} 1 \\ 1 \\ -1 \\ -1 \end{bmatrix}$	$\frac{1}{2} \begin{bmatrix} 1 \\ 1 \\ -j \\ -j \end{bmatrix}$
16 - 23	$\frac{1}{2} \begin{bmatrix} 1 \\ j \\ 1 \\ j \end{bmatrix}$	$\frac{1}{2} \begin{bmatrix} 1 \\ j \\ j \\ -1 \end{bmatrix}$	$\frac{1}{2} \begin{bmatrix} 1 \\ j \\ -1 \\ -j \end{bmatrix}$	$\frac{1}{2} \begin{bmatrix} 1 \\ j \\ -j \\ 1 \end{bmatrix}$	$\frac{1}{2} \begin{bmatrix} 1 \\ -1 \\ 1 \\ -1 \end{bmatrix}$	$\frac{1}{2} \begin{bmatrix} 1 \\ -1 \\ j \\ -j \end{bmatrix}$	$\frac{1}{2} \begin{bmatrix} 1 \\ -1 \\ -1 \\ 1 \end{bmatrix}$	$\frac{1}{2} \begin{bmatrix} 1 \\ -1 \\ -j \\ j \end{bmatrix}$
24 - 27	$\frac{1}{2} \begin{bmatrix} 1 \\ -j \\ 1 \\ -j \end{bmatrix}$	$\frac{1}{2} \begin{bmatrix} 1 \\ -j \\ j \\ 1 \end{bmatrix}$	$\frac{1}{2} \begin{bmatrix} 1 \\ -j \\ -1 \\ j \end{bmatrix}$	$\frac{1}{2} \begin{bmatrix} 1 \\ -j \\ -j \\ -1 \end{bmatrix}$	-	-	-	-

Table 6.3.4-3: Precoding matrix W for dual transmit stream transmission using two antenna ports

Codebook index	W (ordered from left to right in increasing order of index)		
	0 - 2	$\frac{1}{\sqrt{2}} \begin{bmatrix} 1 & 0 \\ 0 & 1 \end{bmatrix}$	$\frac{1}{2} \begin{bmatrix} 1 & 1 \\ 1 & -1 \end{bmatrix}$

Table 6.3.4-4: Precoding matrix W for dual transmit stream transmission using four antenna ports

Codebook index	W (ordered from left to right in increasing order of index)			
	0 - 3	$\frac{1}{\sqrt{2}} \begin{bmatrix} 1 & 0 \\ 0 & 1 \\ 0 & 0 \\ 0 & 0 \end{bmatrix}$	$\frac{1}{\sqrt{2}} \begin{bmatrix} 1 & 0 \\ 0 & 0 \\ 0 & 1 \\ 0 & 0 \end{bmatrix}$	$\frac{1}{\sqrt{2}} \begin{bmatrix} 1 & 0 \\ 0 & 0 \\ 0 & 0 \\ 0 & 1 \end{bmatrix}$
4 - 7	$\frac{1}{\sqrt{2}} \begin{bmatrix} 0 & 0 \\ 1 & 0 \\ 0 & 0 \\ 0 & 1 \end{bmatrix}$	$\frac{1}{\sqrt{2}} \begin{bmatrix} 0 & 0 \\ 0 & 0 \\ 1 & 0 \\ 0 & 1 \end{bmatrix}$	$\frac{1}{2} \begin{bmatrix} 1 & 0 \\ 0 & 1 \\ 1 & 0 \\ 0 & -j \end{bmatrix}$	$\frac{1}{2} \begin{bmatrix} 1 & 0 \\ 0 & 1 \\ 1 & 0 \\ 0 & j \end{bmatrix}$
8 - 11	$\frac{1}{2} \begin{bmatrix} 1 & 0 \\ 0 & 1 \\ -j & 0 \\ 0 & 1 \end{bmatrix}$	$\frac{1}{2} \begin{bmatrix} 1 & 0 \\ 0 & 1 \\ -j & 0 \\ 0 & -1 \end{bmatrix}$	$\frac{1}{2} \begin{bmatrix} 1 & 0 \\ 0 & 1 \\ -1 & 0 \\ 0 & -j \end{bmatrix}$	$\frac{1}{2} \begin{bmatrix} 1 & 0 \\ 0 & 1 \\ -1 & 0 \\ 0 & j \end{bmatrix}$
12 - 15	$\frac{1}{2} \begin{bmatrix} 1 & 0 \\ 0 & 1 \\ j & 0 \\ 0 & 1 \end{bmatrix}$	$\frac{1}{2} \begin{bmatrix} 1 & 0 \\ 0 & 1 \\ j & 0 \\ 0 & -1 \end{bmatrix}$	$\frac{1}{2\sqrt{2}} \begin{bmatrix} 1 & 1 \\ 1 & 1 \\ 1 & -1 \\ 1 & -1 \end{bmatrix}$	$\frac{1}{2\sqrt{2}} \begin{bmatrix} 1 & 1 \\ 1 & 1 \\ j & -j \\ j & -j \end{bmatrix}$
16 - 19	$\frac{1}{2\sqrt{2}} \begin{bmatrix} 1 & 1 \\ j & j \\ 1 & -1 \\ j & -j \end{bmatrix}$	$\frac{1}{2\sqrt{2}} \begin{bmatrix} 1 & 1 \\ j & j \\ j & -j \\ -1 & 1 \end{bmatrix}$	$\frac{1}{2\sqrt{2}} \begin{bmatrix} 1 & 1 \\ -1 & -1 \\ 1 & -1 \\ -1 & 1 \end{bmatrix}$	$\frac{1}{2\sqrt{2}} \begin{bmatrix} 1 & 1 \\ -1 & -1 \\ j & -j \\ -j & j \end{bmatrix}$
20 - 21	$\frac{1}{2\sqrt{2}} \begin{bmatrix} 1 & 1 \\ -j & -j \\ 1 & -1 \\ -j & j \end{bmatrix}$	$\frac{1}{2\sqrt{2}} \begin{bmatrix} 1 & 1 \\ -j & -j \\ j & -j \\ 1 & -1 \end{bmatrix}$	-	-

Table 6.3.4-5: Precoding matrix W for four transmit stream transmission using four antenna ports

Codebook index	W (ordered from left to right in increasing order of index)			
	0 - 3	$\frac{1}{2} \begin{bmatrix} 1 & 0 & 0 & 0 \\ 0 & 1 & 0 & 0 \\ 0 & 0 & 1 & 0 \\ 0 & 0 & 0 & 1 \end{bmatrix}$	$\frac{1}{2\sqrt{2}} \begin{bmatrix} 1 & 1 & 0 & 0 \\ 0 & 0 & 1 & 1 \\ 1 & -1 & 0 & 0 \\ 0 & 0 & 1 & -1 \end{bmatrix}$	$\frac{1}{2\sqrt{2}} \begin{bmatrix} 1 & 1 & 0 & 0 \\ 0 & 0 & 1 & 1 \\ j & -j & 0 & 0 \\ 0 & 0 & j & -j \end{bmatrix}$
4	$\frac{1}{4} \begin{bmatrix} 1 & 1 & 1 & 1 \\ 1 & -1 & 1 & -1 \\ j & j & -j & -j \\ j & -j & -j & j \end{bmatrix}$	-	-	-

Table 6.3.4-6: Precoding matrix W for eight transmit stream transmission using eight antenna ports

Codebook index	W (ordered from left to right in increasing order of index)							
	0	$\frac{1}{2\sqrt{2}} \begin{bmatrix} 1 & 0 & 0 & 0 & 0 & 0 & 0 & 0 \\ 0 & 1 & 0 & 0 & 0 & 0 & 0 & 0 \\ 0 & 0 & 1 & 0 & 0 & 0 & 0 & 0 \\ 0 & 0 & 0 & 1 & 0 & 0 & 0 & 0 \\ 0 & 0 & 0 & 0 & 1 & 0 & 0 & 0 \\ 0 & 0 & 0 & 0 & 0 & 1 & 0 & 0 \\ 0 & 0 & 0 & 0 & 0 & 0 & 1 & 0 \\ 0 & 0 & 0 & 0 & 0 & 0 & 0 & 1 \end{bmatrix}$						

6.3.5 OFDM signal generation

$$q_{n,l}^{(p)} = \frac{1}{\sqrt{N_{OCC,l}}} \sum_k z_{k,l}^{(p)} \exp(j(2\pi \cdot k/N_{DFT}^\beta) \cdot n), k = 0, \dots, N_{DCT}, n = 0, \dots, N_{DCT}$$

where l is the OFDM symbol index, $N_{OCC,l}$ is number of occupied subcarriers for OFDM symbol l , N_{DFT}^β is the discrete Fourier transform size for the scaling factor β , and $z_{k,l}^{(p)}$ is the frequency domain signal to be transformed and $q_{n,l}^{(p)}$ is the corresponding time domain signal for antenna port p . Sum of the transmit power over all transmit chains shall be normalized to 1,0 for each OFDM symbol l .

NOTE 1: Power scaling due to the transmit diversity or spatial multiplexing is built in to the precoding matrices.

NOTE 2: Number of occupied subcarriers is four times lower for STF symbol than for the other symbols, i.e. $4 \cdot N_{OCC,0} = N_{OCC,i}, i \neq 0$.

6.3.6 Cyclic prefix insertion

Cyclic prefixes for each of the Fourier transform scaling β is $1/8$ of the N_{DFT}^β for all OFDM symbols except for the OFDM symbol 0 of the transmission packet.

For OFDM symbol 0 of the transmission packet the cyclic prefix shall equal to $3/4 \cdot N_{DFT}^\beta$ when subcarrier scaling factor $\mu = 1$ or $5/4 \cdot N_{DFT}^\beta$ when subcarrier scaling factor $\mu = \{2, 4, 8\}$.

NOTE: STF signal is defined in frequency domain for OFDM symbol 0. The cyclic prefix definitions above with frequency domain definition of STF together create 7 or 9 repetitions of $1/4 \cdot N_{DFT}^\beta$ long base sequence.

7 Transmission encoding

7.1 Transmitter block diagram

High level transmitter block diagram is depicted in figure 7.1-1. N_{SS} denotes the number of spatial streams. For PCC the number of spatial streams is fixed to one. The number of spatial streams for PDC is signalled within the Physical Header as specified ETSI TS 103 636-4 [3], clause 6.2.1. N_{TX}^{eff} is the effective number of transmit antennas. The effective number of transmit antennas is signalled with cyclic rotation of STF base sequence as defined in clause 5.2.2. Number of transmit streams N_{TS} can be appropriately deduced from N_{TX}^{eff} and N_{SS} according to the table 7.2-1. The additional degrees of freedom beyond N_{TX}^{eff} can be used for beamforming and the actual number of transmit antennas N_{TX} does not need to be known to the receiver.

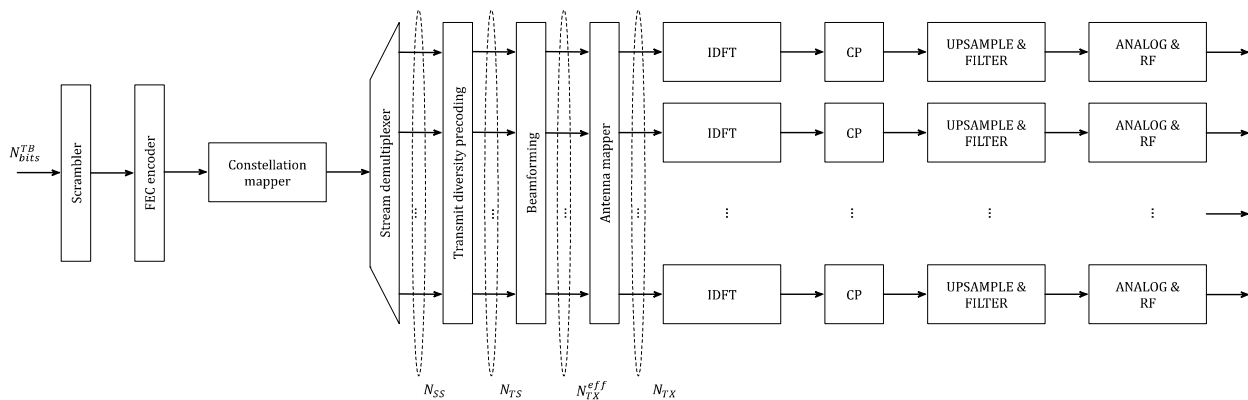

Figure 7.1-1: Transmitter Block Diagram

7.2 Transmission modes

Transmission modes available for transmitting a packet are listed in table 7.2-1. The transmission mode is signalled with:

- Cyclic rotation of STF sequence as specified in clause 5.2.2 for the number of effective transmit antennas N_{TX}^{eff} .
- Physical header field containing the number of spatial streams N_{SS} signalled as specified in ETSI TS 103 636-4 [3].
- XOR-masking the CRC of the PCC as specified in clause 7.5.2.2 for closed loop transmission.
- XOR-masking the CRC of the PCC as specified in clause 7.5.2.3 for beamformed (precoded) transmission:
 - When precoding matrix is identity matrix the CRC of the PCC shall **NOT** be XOR-masked.
 - When precoding something else than identity matrix the CRC of the PCC shall be XOR-masked.

Closed loop transmission are beamformed according to the clause 6.3.4 and beamforming matrix shall be uniformly applied to all fields of the transmission: STF, DRS, PCC and PDC.

Open loop transmissions can be beamformed according to the clause 6.3.4 or with any other orthogonal beamforming matrix as long as the beamforming is transparent to the receiver and the beamforming is uniformly applied to all fields of transmission: STF, DRS, PCC and PDC.

NOTE: When transmission is not beamformed and it is signalled appropriately, receiver may use the channel estimates for channel sounding purposes. When transmission is beamformed the receiver sees composite of beamforming and channel response matrix.

Table 7.2-1: Transmission modes and transmission mode signalling
CL - Closed Loop (True/False), BF - Beamformed (True/False), N_{TX} - Number of antenna ports

Radio device class N_{SS} capability = 1 as defined in Annex B									
PDC					PCC				
Transmission mode signalling	N_{TX}^{eff}	N_{SS}	CL	BF	Effective transmission mode	N_{TS}	N_{TX}	Effective transmission mode	BF
Single antenna	1	1	F	F	Single antenna	1	1	Single antenna	F
Radio device class N_{SS} capability = 2 as defined in Annex B									
PDC					PCC				
Transmission mode signalling	N_{TX}^{eff}	N_{SS}	CL	BF	Effective transmission mode	N_{TS}	N_{TX}	Effective transmission mode	BF
Transmit diversity	2	1	F	T/F	2 x 1 TxDiv	2	2	2 x 1 TxDiv	T/F
MIMO open loop	2	2	F	T/F	2 x 2 MIMO	2	2	2 x 1 TxDiv	T/F
MIMO closed loop	1	1	T	T/F	Single antenna	1	2	Single antenna	T/F
MIMO closed loop	2	2	T	T/F	2 x 2 MIMO	2	2	2 x 1 TxDiv	T/F
Radio device class N_{SS} capability = 4 as defined in Annex B									
PDC					PCC				
Transmission mode signalling	N_{TX}^{eff}	N_{SS}	CL	BF	Effective transmission mode	N_{TS}	N_{TX}	Effective transmission mode	BF
Transmit diversity	4	1	F	T/F	4 x 1 TxDiv	4	4	4 x 1 TxDiv	T/F
MIMO open loop	4	4	F	T/F	4 x 4 MIMO	4	4	4 x 1 TxDiv	T/F
MIMO closed loop	1	1	T	T/F	Single antenna	1	4	Single antenna	T/F
MIMO closed loop	2	2	T	T/F	2 x 2 MIMO	2	4	2 x 1 TxDiv	T/F
MIMO closed loop	4	4	T	T/F	4 x 4 MIMO	4	4	4 x 1 TxDiv	T/F
Radio device class N_{SS} capability = 8 as defined in Annex B									
PDC					PCC				
Transmission mode signalling	N_{TX}^{eff}	N_{SS}	CL	BF	Effective transmission mode	N_{TS}	N_{TX}	Effective transmission mode	BF
Transmit diversity	8	1	F	T/F	8 x 1 TxDiv	8	8	8 x 1 TxDiv	T/F
MIMO open loop	8	8	F	T/F	8 x 8 MIMO	8	8	8 x 1 TxDiv	T/F

7.3 Synchronization Training Field (STF) beamforming

Synchronization training field symbols $y_i^{STF,(0)}$ from transmit stream 0 as specified in clause 5.2.2 are beamformed with beamforming matrix defined in clause 6.3.4 for transmission as:

$$\begin{bmatrix} z^{(0)}(i) \\ \vdots \\ z^{(N_{TX}-1)}(i) \end{bmatrix} = W \begin{bmatrix} y^{STF,(0)}(i) \\ 0 \\ \vdots \\ 0 \end{bmatrix},$$

where the number of rows in the transmit stream vector is according to the number of transmit streams for the selected transmission mode.

7.4 Demodulation Reference Signal (DRS) beamforming

Demodulation reference symbols $y_i^{DRS,(t)}$ from transmit stream t as specified in clause 5.2.3 are beamformed with beamforming matrix defined in clause 6.3.4 for transmission as:

$$\begin{bmatrix} z^{(0)}(i) \\ \vdots \\ z^{(N_{TX}-1)}(i) \end{bmatrix} = W \begin{bmatrix} y^{DRS,(0)}(i) \\ \vdots \\ y^{DRS,(N_{TS}-1)}(i) \end{bmatrix},$$

where the number of rows in the transmit stream vector is according to the number of transmit streams for the selected transmission mode.

7.5 Physical Control Channel (PCC) encoding

7.5.1 Overall description

High level description of PCC encoding procedure is depicted in figure 7.5.1-1. Number of physical control channel payload bits N_{bits}^{PCC} is either 40 or 80 bits depending on the control channel format. The physical control channel is transmitted on $N_{sub}^{PCC} = 98$ subcarriers. The receiver shall blind decode both transport block sizes and select the one with a CRC match.

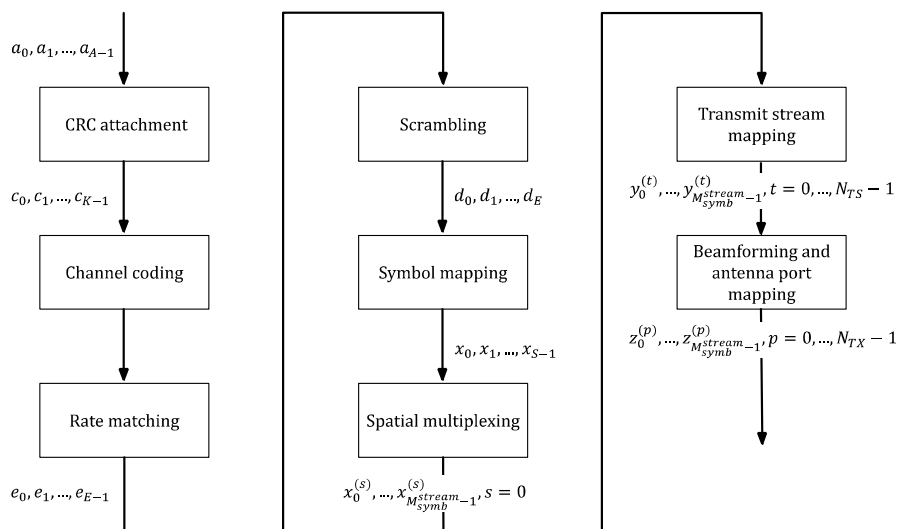

Figure 7.5.1-1: Physical control channel encoding

7.5.2 CRC calculation

7.5.2.1 Parity bit calculation

Physical control channel bits are a_0, a_1, \dots, a_{A-1} , where $A = N_{bits}^{PCC}$ and the 16 Parity bits p_0, p_1, \dots, p_{15} for the PCC are generated by using polynome $g_{CRC16}(D)$ according to the clause 6.1.2.

7.5.2.2 CRC Masking for MIMO closed loop

The 16 parity bits p_0, p_1, \dots, p_{15} are XOR masked with bitmask 0x5555 for signalling closed loop transmission.

7.5.2.3 CRC Masking for beamforming

The 16 parity bits p_0, p_1, \dots, p_{15} are XOR masked with bitmask 0xAAAA for signalling beamformed transmission.

7.5.2.4 CRC attachment

CRC attachment is defined in clause 6.1.2. The bits after CRC attachment are denoted by c_0, c_1, \dots, c_{K-1} , where $K = A + L$, where $L = 16$.

7.5.3 Channel coding & rate matching

The bit sequence c_0, c_1, \dots, c_{K-1} is channel encoded using the turbo encoder defined in clause 6.1.4 and rate matched to transmission on $N_{subc}^{PCC} = 98$ subcarriers with $N_{bps} = 2$ for QPSK modulation and with single spatial stream $N_{SS} = 1$ as specified in clause 6.1.5. For all PCC transmissions redundancy version number $rv_{idx} = 0$.

The bits after channel encoding are denoted by e_0, e_1, \dots, e_{E-1} , where $E = N_{subc}^{PCC} N_{bps}$.

7.5.4 Scrambling

The block channel encoded bits e_0, e_1, \dots, e_{E-1} , shall be scrambled with a sequence prior to CRC attachment, resulting in a block of scrambled bits:

$$d(i) = (e(i) + g(i)) \bmod 2$$

where the scrambling sequence $g(i)$ is given by clause 6.2. The scrambling sequence shall be initialized with $g_{init} = 0x44454354$.

7.5.5 Symbol mapping

Bit sequence by d_0, d_1, \dots, d_{E-1} is mapped into complex valued QPSK modulation symbols x_0, x_1, \dots, x_{S-1} as defined in clause 6.3.1.2. The length of the modulated symbol vector is $S = N_{subc}^{PCC}$.

7.5.6 Spatial multiplexing

Modulated symbols x_0, x_1, \dots, x_{S-1} are mapped to 0th spatial stream according to clause 6.3.2, thus:

$$x^{(0)}(i) = x(i)$$

where $i = 0, \dots, S - 1$ and $S = N_{subc}^{PCC}$.

7.5.7 Transmit stream mapping

Modulated symbols $x^{(0)}(i)$ from spatial stream 0 in case of single antenna transmission or spatial multiplexing are mapped directly to corresponding transmit stream as specified in clause 6.3.3.1 or in case of transmit diversity precoded as specified in clause 6.3.3.2 producing output $y^{(t)}(i)$, $i = 0, \dots, S$, where $S = N_{subc}^{PCC}$ and transmit streams $t = 0, \dots, N_{TS} - 1$ according to the transmission mode.

7.5.8 Beamforming

The modulated symbols $y^{(t)}(i)$, $i = 0, \dots, S$ from transmit streams $t = 0, \dots, N_{TS} - 1$ are beamformed according to the transmit mode as specified in clause 6.3.4 to produce PCC transmission $z^{(p)}(i)$, $i = 0, \dots, S$ on antenna port $p = 0, \dots, N_{TX}$.

7.5.9 Subcarrier mapping

Beamformed symbols $z^{(p)}(i)$, $i = 0, \dots, N_{sub}^{PCC}$, $p = 0, \dots, N_{TX} - 1$ are mapped into $N_{sub}^{PCC} = 98$ subcarriers as defined in clause 5.2.4.

7.6 Physical Data Channel (PDC) encoding

7.6.1 Overall description

PDC encoding procedure is depicted in figure 7.6.1-1.

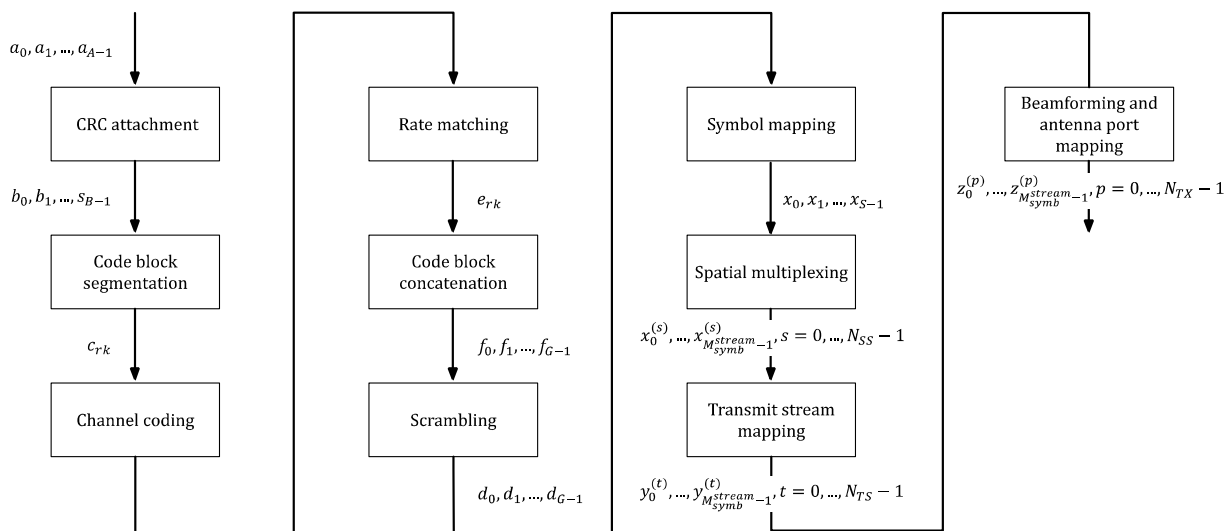

Figure 7.6.1-1: Physical Data Channel Encoding

7.6.2 CRC calculation

Physical data channel bits are a_0, a_1, \dots, a_{A-1} , where the length of transport block is given by clause 5.3 according to the transmission allocation.

Parity bits for the transport block are generated by using the polynomial $g_{CRC24A}(D)$ according to the clause 6.1.2. The bits after CRC attachment are denoted by b_0, b_1, \dots, b_{B-1} , where $B = A + L$, where $L = 24$.

7.6.3 Code block segmentation

Transport block is segmented into C independently turbo encoded blocks, each individually protected with 24-bit CRC as specified in clause 6.1.3.

7.6.4 Channel coding & rate matching

Each of the code block segments are individually channel coded and rate matched as specified in clause 6.1.4 and clause 6.1.5. All non-HARQ transmissions shall use redundancy version index $rv_{idx} = 0$.

7.6.5 Code block concatenation

Code block segments are concatenated according to clause 6.1.6.

7.6.6 Scrambling

The channel encoded and concatenated codeblocks f_0, f, \dots, f_{G-1} , where $G = N_{ss} \cdot N_{subc}^{PDC} \cdot N_{bps}$ shall be scrambled resulting in a block of scrambled bits:

$$d(i) = (f(i) + g(i)) \bmod 2$$

where the scrambling sequence $g(i)$ is given by clause 6.2.

If transmission is using Physical Layer Control Field: Type 2 as specified in ETSI TS 103 636-4 [3], clause 6.2 the scrambling sequence shall be initialized with 24 MSB bits of the NetworkID ETSI TS 103 636-4 [3], clause 4.2.3:

$$g_{init} = (\text{Network ID} \gg 8) \& 0x00ffff$$

If transmission is using Physical Layer Control Field: Type 1 as specified in ETSI TS 103 636-4 [3], clause 6.2 the scrambling sequence shall be initialized with 8 LSB bits of the Network ID ETSI TS 103 636-4 [3], clause 4.2.3:

$$g_{init} = \text{Network ID} \& 0x00000ff$$

7.6.7 Symbol mapping

Bit sequence by d_0, d_1, \dots, d_{S-1} is mapped into complex valued modulation symbols x_0, x_1, \dots, x_{S-1} as defined in clause 6.3.1 according to the MCS selected for the transport block. The length of the modulated symbol vector is $S = N_{subc}^{PDC} \cdot N_{SS}$.

7.6.8 Spatial multiplexing

Modulated symbols x_0, x_1, \dots, x_{S-1} are mapped to spatial streams $x_i^{(0)}, \dots, x_i^{(N_{SS}-1)}$ according to clause 6.3.2 for the selected transmission mode, where $S = N_{subc}^{PDC} \cdot N_{SS}$ and $i = 0, \dots, N_{subc}^{PDC} - 1$.

7.6.9 Transmit stream mapping

Modulated symbols from spatial stream mapping $x_i^{(0)}, \dots, x_i^{(N_{SS}-1)}$ are precoded to $y_i^{(0)}, \dots, y_i^{(N_{TS}-1)}$ according to the transmission mode, where N_{TS} is the number of transmit streams and $i = 0, \dots, N_{subc}^{PDC} - 1$.

For single antenna transmission the mapping is specified in clause 6.3.3.1.

For transmit diversity transmission is precoded is specified in clause 6.3.3.2.

For spatially multiplexed transmissions the mapping is specified in clause 6.3.3.1.

7.6.10 Beamforming and antenna port mapping

The modulated symbols $y_i^{(t)}$, $i = 0, \dots, N_{subc}^{PDC}$ from transmit streams $t = 0, \dots, N_{TS} - 1$ are beamformed according to the transmit mode as specified in clause 6.3.4 to produce PDC transmission $z_i^{(p)}$, $i = 0, \dots, N_{subc}^{PDC}$ on antenna ports $p = 0, \dots, N_{TX} - 1$.

7.6.11 Subcarrier mapping

Beamformed symbols $z_i^{(p)}$, $i = 0, \dots, N_{subc}^{PDC}$, $p = 0, \dots, N_{TX} - 1$ are mapped into N_{subc}^{PDC} subcarriers as defined in clause 5.2.5.

Annex A (normative): Modulation and coding schemes

Modulation and coding schemes are listed in table A-1, where N_{bps} denotes the number of bits per modulation symbol and R denotes the coding rate.

Table A-1: Modulation and coding schemes

MCS Index	Modulation	N_{bps}	R
0	BPSK	1	1/2
1	QPSK	2	1/2
2	QPSK	2	3/4
3	16-QAM	4	1/2
4	16-QAM	4	3/4
5	64-QAM	6	2/3
6	64-QAM	6	3/4
7	64-QAM	6	5/6
8	256-QAM	8	3/4
9	256-QAM	8	5/6
10	1024-QAM	10	3/4
11	1024-QAM	10	5/6

Annex B (normative): Physical layer requirements for radio device classes

B.1 Introduction

Radio device class shall be defined with tuple (μ, β, N_{SS}, A) for subcarrier scaling factor, Fourier transform scaling, number of spatial streams. In addition to first three fields, in the fourth field of the tuple encodes a device class variant with a letter A, B, ..., etc. restricting the supported modulation and coding schemes and MAC capabilities. Capabilities of lower device category shall be supported by higher device category individually in all dimensions of the device category definition except in the first " μ " dimension.

B.2 Radio device class $(\mu, \beta, N_{SS}, A) = (1.1.1.A)$

B.2.1 Transmission bandwidth

Device shall support subcarrier scaling factor $\mu = 1$ and Fourier transform scaling factor $\beta = 1$. See clause 4.3.

B.2.2 Transmission modes

Device shall support all transmission modes that can be received with single transmission antenna. See clause 7.2.

B.2.3 Modulation and coding scheme

B.2.3.1 Modulation and coding

Device shall support MCS from 0 to 4. See Annex A.

B.2.3.2 Hybrid ARQ processes

Device shall support at least $M_{DL_HARQ} = 8$ HARQ processes with at least $M_{DL_HARQ}^{connection} = 2$ processes per connection. See clause 6.1.5.

B.2.3.3 Soft buffer size

Device shall support $N_{soft} = 25\ 344$ byte soft buffer size. See clause 6.1.5.

B.2.3.4 Code block segment size

Device shall support maximum code block size $Z = 2\ 048$. See clause 6.1.3.

Annex C (informative): Examples of transport block sizes and maximum achievable data rates

C.1 Introduction

In this annex just a few examples of Transport Block Sizes (TBS) and achievable peak datarates are listed. Short transmission packet suffers relatively more of synchronization, channel training and control channel overheads compared to long packets which can be seen by comparing examples of clauses C.2 to C.4, which list TBS lengths and peak dataretes for single slot, dual slot and quad slot transmissions. The transport block size depends on:

- 1) transmission length which can range from single subslot up to sixteen slot transmission with subslot (5 OFDM symbol) granularity;
- 2) modulation and coding scheme;
- 3) number of transmission streams; and
- 4) system bandwidth.

Number of unique transmission configurations is high. Therefore, listing them all here is impractical. Use clause 5.3 to derive TBS for transmission configuration and calculate achievable data rate using transmission duration and transmission duty-cycle.

C.2 Single slot transmission, single spatial stream

Table C.2-1: Transport block sizes (in bits) for single slot transmission and single spatial stream with maximum turbo code block size of 2 048 bits

	μ	$\beta \backslash \text{MCS}$	0	1	2	3	4	5	6	7	8	9	10	11							
			TRANSPORT BLOCK SIZES																		
1			1	136	296	456	616	936	1 256	1 416	1 576	1 896	2 040	2 296	2 552						
			2	344	712	1 064	1 448	2 104	2 872	3 256	3 576	4 320	4 832	5 408	6 048						
			4	760	1 544	2 296	3 064	4 640	6 152	6 984	7 752	9 328	10 328	11 672	12 928						
			8	1 576	3 128	4 768	6 344	9 584	12 800	14 440	16 040	19 256	21 408	24 136	26 776						
			12	2 360	4 832	7 240	9 712	14 568	19 448	21 920	24 368	29 248	32 464	36 576	40 624						
			16	3 192	6 472	9 776	12 992	19 576	26 096	29 376	32 656	39 176	43 544	49 040	54 496						
			2			1	368	760	1 160	1 544	2 296	3 064	3 512	3 896	4 640	5 216	5 856	6 472			
						2	808	1 640	2 424	3 256	4 960	6 600	7 496	8 304	9 968	11 096	12 480	13 888			
						4	1 704	3 384	5 088	6 792	10 264	13 696	15 464	17 168	20 576	22 920	25 776	28 608			
						8	3 448	6 920	10 392	13 888	20 896	27 864	31 400	34 872	41 840	46 528	52 344	58 160			
						12	5 216	10 456	15 720	20 960	31 528	42 032	47 336	52 600	63 080	70 112	78 912	87 688			
						16	6 984	14 016	21 024	28 056	42 160	56 200	63 272	70 304	84 344	93 760	105 456	117 176			
						4			1	904	1 832	2 680	3 640	5 472	7 304	8 176	9 136	10 968	12 160	13 760	15 272
									2	1 864	3 704	5 600	7 496	11 288	15 016	16 912	18 808	22 600	25 136	28 248	31 400
									4	3 768	7 560	11 416	15 208	22 856	30 504	34 384	38 176	45 824	50 936	57 328	63 720
									8	7 624	15 336	23 048	30 696	46 144	61 504	69 216	76 928	92 312	102 624	115 448	128 232
12	11 480	23 048							34 616	46 208	69 344	92 504	104 072	115 640	138 800	154 224	173 528	192 808			
16	15 400	30 824							46 272	61 696	92 632	123 480	138 992	154 416	185 288	205 912	231 648	257 384			
8									1	1 928	3 832	5 792	7 688	11 608	15 464	17 424	19 384	23 240	25 840	29 120	32 360
									2	3 896	7 816	11 736	15 656	23 560	31 400	35 384	39 304	47 144	52 408	58 968	65 552
									4	7 880	15 784	23 688	31 592	47 464	63 272	71 240	79 144	94 976	105 520	118 752	131 960
									8	15 848	31 720	47 592	63 464	95 272	127 040	142 976	158 848	190 592	211 792	238 296	264 800
			12	23 816	47 656				71 496	95 336	143 104	190 784	214 688	238 552	286 232	318 040	357 840	397 616			
			16	31 784	63 592				95 400	127 232	190 912	254 552	286 424	318 232	381 872	424 312	477 384	530 432			

Table C.2-2: Single channel maximum throughput for single slot transmission with single spatial stream with maximum turbo code block size of 2 048 bits

	μ	$\beta \backslash \text{MCS}$	DATARATE (Mbps)															
			0	1	2	3	4	5	6	7	8	9	10	11				
1	1	1	0,326	0,710	1,094	1,478	2,246	3,014	3,398	3,782	4,550	4,896	5,510	6,125				
		2	0,826	1,709	2,554	3,475	5,050	6,893	7,814	8,582	10,368	11,597	12,979	14,515				
		4	1,824	3,706	5,510	7,354	11,136	14,765	16,762	18,605	22,387	24,787	28,013	31,027				
		8	3,782	7,507	11,443	15,226	23,002	30,720	34,656	38,496	46,214	51,379	57,926	64,262				
		12	5,664	11,597	17,376	23,309	34,963	46,675	52,608	58,483	70,195	77,914	87,782	97,498				
		16	7,661	15,533	23,462	31,181	46,982	62,630	70,502	78,374	94,022	104,506	117,696	130,790				
		2	2	1	0,883	1,824	2,784	3,706	5,510	7,354	8,429	9,350	11,136	12,518	14,054	15,533		
				2	1,939	3,936	5,818	7,814	11,904	15,840	17,990	19,930	23,923	26,630	29,952	33,331		
				4	4,090	8,122	12,211	16,301	24,634	32,870	37,114	41,203	49,382	55,008	61,862	68,659		
				8	8,275	16,608	24,941	33,331	50,150	66,874	75,360	83,693	100,416	111,667	125,626	139,584		
				12	12,518	25,094	37,728	50,304	75,667	100,877	113,606	126,240	151,392	168,269	189,389	210,451		
				16	16,762	33,638	50,458	67,334	101,184	134,880	151,853	168,730	202,426	225,024	253,094	281,222		
				4	4	1	2,170	4,397	6,432	8,736	13,133	17,530	19,622	21,926	26,323	29,184	33,024	36,653
						2	4,474	8,890	13,440	17,990	27,091	36,038	40,589	45,139	54,240	60,326	67,795	75,360
						4	9,043	18,144	27,398	36,499	54,854	73,210	82,522	91,622	109,978	122,246	137,587	152,928
						8	18,298	36,806	55,315	73,670	110,746	147,610	166,118	184,627	221,549	246,298	277,075	307,757
12	27,552					55,315	83,078	110,899	166,426	222,010	249,773	277,536	333,120	370,138	416,467	462,739		
16	36,960					73,978	111,053	148,070	222,317	296,352	333,581	370,598	444,691	494,189	555,955	617,722		
8	8					1	4,627	9,197	13,901	18,451	27,859	37,114	41,818	46,522	55,776	62,016	69,888	77,664
						2	9,350	18,758	28,166	37,574	56,544	75,360	84,922	94,330	113,146	125,779	141,523	157,325
						4	18,912	37,882	56,851	75,821	113,914	151,853	170,976	189,946	227,942	253,248	285,005	316,704
						8	38,035	76,128	114,221	152,314	228,653	304,896	343,142	381,235	457,421	508,301	571,910	635,520
		12	57,158			114,374	171,590	228,806	343,450	457,882	515,251	572,525	686,957	763,296	858,816	954,278		
		16	76,282			152,621	228,960	305,357	458,189	610,925	687,418	763,757	916,493	1 018,349	1 145,722	1 273,037		

Table C.2-3: Transport block sizes (in bits) for single slot transmission and single spatial stream with maximum turbo code block size of 6 144 bits

	μ	$\beta \backslash \text{MCS}$	TRANSPORT BLOCK SIZES															
			0	1	2	3	4	5	6	7	8	9	10	11				
1	1	1	136	296	456	616	936	1 256	1 416	1 576	1 896	2 088	2 344	2 600				
		2	344	712	1 064	1 448	2 152	2 920	3 304	3 624	4 392	4 904	5 480	6 096				
		4	760	1 544	2 344	3 112	4 712	6 200	7 032	7 800	9 400	10 424	11 768	13 024				
		8	1 576	3 176	4 840	6 392	9 656	12 896	14 560	16 160	19 400	21 576	24 328	26 992				
		12	2 408	4 904	7 288	9 784	14 688	19 592	22 088	24 560	29 488	32 728	36 864	40 960				
		16	3 240	6 520	9 848	13 088	19 720	26 288	29 616	32 920	39 488	43 880	49 424	54 928				
		2	2	1	368	760	1 160	1 544	2 344	3 112	3 560	3 944	4 712	5 288	5 928	6 520		
				2	808	1 640	2 472	3 304	5 032	6 648	7 544	8 376	10 040	11 192	12 576	13 984		
				4	1 704	3 432	5 160	6 840	10 360	13 792	15 584	17 312	20 744	23 112	25 968	28 848		
				8	3 496	6 968	10 488	13 984	21 064	28 080	31 640	35 160	42 176	46 888	52 752	58 616		
				12	5 288	10 552	15 840	21 128	31 768	42 368	47 720	53 008	63 584	70 664	79 536	88 384		
				16	7 032	14 112	21 192	28 272	42 496	56 632	63 776	70 856	85 016	94 504	106 296	118 088		
				4	4	1	904	1 832	2 728	3 688	5 544	7 352	8 248	9 208	11 064	12 256	13 856	15 392
						2	1 864	3 752	5 672	7 544	11 384	15 136	17 056	18 952	22 792	25 328	28 464	31 640
						4	3 816	7 608	11 512	15 328	23 048	30 744	34 648	38 464	46 184	51 344	57 784	64 224
						8	7 672	15 456	23 240	30 936	46 504	61 984	69 768	77 552	93 032	103 440	116 360	129 240
12	11 576					23 240	34 904	46 568	69 896	93 224	104 888	116 552	139 904	155 448	174 896	194 344		
16	15 520					31 064	46 632	62 176	93 352	124 464	140 096	155 640	186 752	207 544	233 472	259 424		
8	8					1	1 928	3 880	5 864	7 736	11 704	15 584	17 568	19 528	23 432	26 032	29 360	32 600
						2	3 944	7 864	11 832	15 776	23 752	31 640	35 672	39 616	47 528	52 816	59 448	66 080
						4	7 928	15 904	23 880	31 832	47 848	63 776	71 816	79 768	95 720	106 360	119 688	133 016
						8	15 968	31 960	47 976	63 968	96 040	128 048	144 104	160 096	192 104	213 472	240 168	266 888
		12	24 008			48 040	72 072	96 104	144 232	192 296	216 392	240 424	288 488	320 560	360 672	400 760		
		16	32 024			64 096	96 168	128 240	192 424	256 568	288 680	320 752	384 896	427 672	481 152	534 632		

Table C.2-4: Single channel maximum throughput for single slot transmission with single spatial stream with maximum turbo code block size of 6 144 bits

		μ	$\beta \backslash \text{MCS}$	0	1	2	3	4	5	6	7	8	9	10	11
				0	1	2	3	4	5	6	7	8	9	10	11
DATARATE (Mbps)	1	1		0,326	0,710	1,094	1,478	2,246	3,014	3,398	3,782	4,550	5,011	5,626	6,240
		2		0,826	1,709	2,554	3,475	5,165	7,008	7,930	8,698	10,541	11,770	13,152	14,630
		4		1,824	3,706	5,626	7,469	11,309	14,880	16,877	18,720	22,560	25,018	28,243	31,258
		8		3,782	7,622	11,616	15,341	23,174	30,950	34,944	38,784	46,560	51,782	58,387	64,781
		12		5,779	11,770	17,491	23,482	35,251	47,021	53,011	58,944	70,771	78,547	88,474	98,304
		16		7,776	15,648	23,635	31,411	47,328	63,091	71,078	79,008	94,771	105,312	118,618	131,827
	2	1		0,883	1,824	2,784	3,706	5,626	7,469	8,544	9,466	11,309	12,691	14,227	15,648
		2		1,939	3,936	5,933	7,930	12,077	15,955	18,106	20,102	24,096	26,861	30,182	33,562
		4		4,090	8,237	12,384	16,416	24,864	33,101	37,402	41,549	49,786	55,469	62,323	69,235
		8		8,390	16,723	25,171	33,562	50,554	67,392	75,936	84,384	101,222	112,531	126,605	140,678
		12		12,691	25,325	38,016	50,707	76,243	101,683	114,528	127,219	152,602	169,594	190,886	212,122
		16		16,877	33,869	50,861	67,853	101,990	135,917	153,062	170,054	204,038	226,810	255,110	283,411
	4	1		2,170	4,397	6,547	8,851	13,306	17,645	19,795	22,099	26,554	29,414	33,254	36,941
		2		4,474	9,005	13,613	18,106	27,322	36,326	40,934	45,485	54,701	60,787	68,314	75,936
		4		9,158	18,259	27,629	36,787	55,315	73,786	83,155	92,314	110,842	123,226	138,682	154,138
		8		18,413	37,094	55,776	74,246	111,610	148,762	167,443	186,125	223,277	248,256	279,264	310,176
12			27,782	55,776	83,770	111,763	167,750	223,738	251,731	279,725	335,770	373,075	419,750	466,426	
16			37,248	74,554	111,917	149,222	224,045	298,714	336,230	373,536	448,205	498,106	560,333	622,618	
8	1		4,627	9,312	14,074	18,566	28,090	37,402	42,163	46,867	56,237	62,477	70,464	78,240	
	2		9,466	18,874	28,397	37,862	57,005	75,936	85,613	95,078	114,067	126,758	142,675	158,592	
	4		19,027	38,170	57,312	76,397	114,835	153,062	172,358	191,443	229,728	255,264	287,251	319,238	
	8		38,323	76,704	115,142	153,523	230,496	307,315	345,850	384,230	461,050	512,333	576,403	640,531	
	12		57,619	115,296	172,973	230,650	346,157	461,510	519,341	577,018	692,371	769,344	865,613	961,824	
	16		76,858	153,830	230,803	307,776	461,818	615,763	692,832	769,805	923,750	1 026,413	1 154,765	1 283,117	

C.3 Dual slot transmission, single spatial stream

Table C.3-1: Transport block sizes (in bits) for dual slot transmission and single spatial stream with maximum turbo code block size of 2 048 bits

	μ	$\beta \setminus \text{MCS}$	0	1	2	3	4	5	6	7	8	9	10	11
			TRANSPORT BLOCK SIZES	1	1	400	824	1 256	1 672	2 488	3 320	3 768	4 128	5 024
2	872	1 768			2 616	3 512	5 280	7 048	7 944	8 880	10 648	11 864	13 312	14 824
4	1 800	3 576			5 408	7 240	10 904	14 568	16 400	18 232	21 920	24 368	27 416	30 504
8	3 640	7 368			11 096	14 760	22 240	29 632	33 360	37 088	44 504	49 488	55 688	61 824
12	5 536	11 096			16 720	22 280	33 488	44 672	50 320	55 880	67 064	74 544	83 896	93 184
16	7 432	14 888			22 344	29 824	44 800	59 736	67 256	74 736	89 648	99 640	112 104	124 568
2	1	904		1 832	2 680	3 640	5 472	7 304	8 176	9 136	10 968	12 160	13 760	15 272
	2	1 864		3 704	5 600	7 496	11 288	15 016	16 912	18 808	22 600	25 136	28 248	31 400
	4	3 768		7 560	11 416	15 208	22 856	30 504	34 384	38 176	45 824	50 936	57 328	63 720
	8	7 624		15 336	23 048	30 696	46 144	61 504	69 216	76 928	92 312	102 624	115 448	128 232
	12	11 480		23 048	34 616	46 208	69 344	92 504	104 072	115 640	138 800	152 224	173 528	192 808
	16	15 400		30 824	46 272	61 696	92 632	123 480	138 992	154 416	185 288	205 912	231 648	257 384
4	1	1 960		3 896	5 856	7 816	11 800	15 720	17 680	19 640	23 624	26 224	29 504	32 784
	2	3 960		7 944	11 928	15 912	23 880	31 848	35 832	39 880	47 848	53 152	59 800	66 448
	4	7 944		15 976	24 008	32 040	48 104	64 168	72 200	80 232	96 296	107 056	120 392	133 792
	8	16 040		32 168	48 296	64 360	96 616	128 808	144 936	161 064	193 256	214 752	241 640	268 464
	12	24 136	48 296	72 520	96 680	145 064	193 448	217 672	241 832	290 216	322 472	362 824	403 112	
	16	32 232	64 488	96 744	129 000	193 576	258 088	290 408	322 664	387 176	430 256	484 008	537 784	
8	1	3 960	8 008	12 056	16 104	24 200	32 296	36 344	40 392	48 488	53 920	60 632	67 384	
	2	8 072	16 208	24 368	32 464	48 784	65 040	73 200	81 360	97 616	108 504	122 096	135 624	
	4	16 272	32 592	48 912	65 232	97 936	130 576	146 960	163 280	195 920	217 736	244 920	272 128	
	8	32 656	65 360	98 064	130 768	196 240	261 624	294 392	327 096	392 504	436 136	490 656	545 176	
	12	49 040	98 128	147 216	196 304	294 520	392 672	441 824	490 912	589 064	654 536	736 392	818 224	
	16	65 424	130 896	196 344	261 816	392 800	523 744	589 256	654 728	785 648	873 000	982 104	1 091 208	

Table C.3-2: Single channel maximum throughput for dual slot transmission with single spatial stream with maximum turbo code block size of 2 048 bits

	μ	$\beta \setminus \text{MCS}$	0	1	2	3	4	5	6	7	8	9	10	11
			DATARATE (Mbps)	1	1	0,480	0,989	1,507	2,006	2,986	3,984	4,522	4,954	6,029
2	1,046	2,122			3,139	4,214	6,336	8,458	9,533	10,656	12,778	14,237	15,974	17,789
4	2,160	4,291			6,490	8,688	13,085	17,482	19,680	21,878	26,304	29,242	32,899	36,605
8	4,368	8,842			13,315	17,712	26,688	35,558	40,032	44,506	53,405	59,386	66,826	74,189
12	6,643	13,315			20,064	26,736	40,186	53,606	60,384	67,056	80,477	89,453	100,675	111,821
16	8,918	17,866			26,813	35,789	53,760	71,683	80,707	89,683	107,578	119,568	134,525	149,482
2	1	1,085		2,198	3,216	4,368	6,566	8,765	9,811	10,963	13,162	14,592	16,512	18,326
	2	2,237		4,445	6,720	8,995	13,546	18,019	20,294	22,570	27,120	30,163	33,898	37,680
	4	4,522		9,072	13,699	18,250	27,427	36,605	41,261	45,811	54,989	61,123	68,794	76,464
	8	9,149		18,403	27,658	36,835	55,373	73,805	83,059	92,314	110,774	123,149	138,538	153,878
	12	13,776		27,658	41,539	55,450	83,213	111,005	124,886	138,768	166,560	185,069	208,234	231,370
	16	18,480		36,989	55,526	74,035	111,158	148,176	166,790	185,299	222,346	247,094	277,978	308,861
4	1	2,352		4,675	7,027	9,379	14,160	18,864	21,216	23,568	28,349	31,469	35,405	39,341
	2	4,752		9,533	14,314	19,094	28,656	38,218	42,998	47,856	57,418	63,782	71,760	79,738
	4	9,533		19,171	28,810	38,448	57,725	77,002	86,640	96,278	115,555	128,467	144,470	160,550
	8	19,248		38,602	57,955	77,232	115,939	154,570	173,923	193,277	231,907	257,702	289,968	322,157
	12	28,963	57,955	87,024	116,016	174,077	232,138	261,206	290,198	348,259	386,966	435,389	483,734	
	16	38,678	77,386	116,093	154,800	232,291	309,706	348,490	387,197	464,611	516,307	580,810	645,341	
8	1	4,752	9,610	14,467	19,325	29,040	38,755	43,613	48,470	58,186	64,704	72,758	80,861	
	2	9,686	19,450	29,242	38,957	58,541	78,048	87,840	97,632	117,139	130,205	146,515	162,749	
	4	19,526	39,110	58,694	78,278	117,523	156,691	176,352	195,936	235,104	261,283	293,904	326,554	
	8	39,187	78,432	117,677	156,922	235,488	313,949	353,270	392,515	471,005	523,363	588,787	654,211	
	12	58,848	117,754	176,659	235,565	353,424	471,206	530,189	589,094	706,877	785,443	883,670	981,869	
	16	78,509	157,075	235,613	314,179	471,360	628,493	707,107	785,674	942,778	1 047,600	1 178,525	1 309,450	

Table C.3-3: Transport block sizes (in bits) for dual slot transmission and single spatial stream with maximum turbo code block size of 6 144 bits

		μ	$\beta \setminus \text{MCS}$	TRANSPORT BLOCK SIZES										
				0	1	2	3	4	5	6	7	8	9	10
1	1	1	400	824	1 256	1 672	2 536	3 368	3 816	4 200	5 096	5 608	6 328	7 032
		2	872	1 768	2 664	3 560	5 352	7 096	7 992	8 952	10 744	11 960	13 408	14 944
		4	1 800	3 624	5 480	7 288	11 000	14 688	16 544	18 376	22 088	24 560	27 632	30 744
		8	3 688	7 416	11 192	14 880	22 408	29 872	33 624	37 376	44 840	49 872	56 120	62 304
		12	5 608	11 192	16 864	22 472	33 752	45 032	50 704	56 312	67 592	75 120	84 568	93 928
		16	7 480	15 008	22 536	30 064	45 160	60 216	67 784	75 312	90 368	100 432	112 992	125 552
	2	1	904	1 832	2 728	3 688	5 544	7 352	8 248	9 208	11 064	12 256	13 856	15 392
		2	1 864	3 752	5 672	7 544	11 384	15 136	17 056	18 952	22 792	25 328	28 464	31 640
		4	3 816	7 608	11 512	15 328	23 048	30 744	34 648	38 464	46 184	51 344	57 784	64 224
		8	7 672	15 456	23 240	30 936	46 504	61 984	69 768	77 552	93 032	103 440	116 360	129 240
		12	11 576	23 240	34 904	46 568	69 896	93 224	104 888	116 552	139 904	155 448	174 896	194 344
		16	15 520	31 064	46 632	62 176	93 352	124 464	140 096	155 640	186 752	207 544	233 472	259 424
	4	1	1 960	3 944	5 928	7 864	11 896	15 840	17 824	19 784	23 816	26 416	29 744	33 048
		2	4 008	7 992	12 024	16 032	24 072	32 088	36 120	40 192	48 232	53 584	60 280	66 976
		4	7 992	16 096	24 200	32 280	48 488	64 672	72 776	80 856	97 064	107 896	121 352	134 848
		8	16 160	32 408	48 680	64 864	97 384	129 816	146 088	162 336	194 792	216 456	243 560	270 576
12		24 328	48 680	73 096	97 448	146 216	194 984	219 400	243 752	292 520	325 016	365 704	406 304	
16		32 472	64 992	97 512	130 008	195 112	260 128	292 712	325 208	390 248	433 664	487 848	542 032	
8	1	4 008	8 056	12 152	16 224	24 392	32 536	36 632	40 704	48 872	54 352	61 112	67 912	
	2	8 120	16 352	24 560	32 728	49 168	65 568	73 776	82 008	98 384	109 368	123 056	136 704	
	4	16 416	32 856	49 296	65 760	98 704	131 608	148 112	164 576	197 456	219 464	246 864	274 288	
	8	32 920	65 888	98 832	131 800	197 776	263 688	296 720	329 688	395 600	439 592	494 544	549 496	
	12	49 424	98 896	148 368	197 840	296 848	395 792	445 328	494 800	593 720	659 720	742 200	824 704	
	16	65 952	131 928	197 904	263 880	395 920	527 872	593 912	659 912	791 864	879 912	989 880	1 099 848	

Table C.3-4: Single channel maximum throughput for single slot transmission with single spatial stream with maximum turbo code block size of 6 144 bits

		μ	$\beta \setminus \text{MCS}$	DATARATE (Mbps)										
				0	1	2	3	4	5	6	7	8	9	10
1	1	1	0,480	0,989	1,507	2,006	3,043	4,042	4,579	5,040	6,115	6,730	7,594	8,438
		2	1,046	2,122	3,197	4,272	6,422	8,515	9,590	10,742	12,893	14,352	16,090	17,933
		4	2,160	4,349	6,576	8,746	13,200	17,626	19,853	22,051	26,506	29,472	33,158	36,893
		8	4,426	8,899	13,430	17,856	26,890	35,846	40,349	44,851	53,808	59,846	67,344	74,765
		12	6,730	13,430	20,237	26,966	40,502	54,038	60,845	67,574	81,110	90,144	101,484	112,714
		16	8,976	18,010	27,043	36,077	54,192	72,259	81,341	90,374	108,442	120,518	135,590	150,662
	2	1	1,085	2,198	3,274	4,426	6,653	8,822	9,898	11,050	13,277	14,707	16,627	18,470
		2	2,237	4,502	6,806	9,053	13,661	18,163	20,467	22,742	27,350	30,394	34,157	37,968
		4	4,579	9,130	13,814	18,394	27,658	36,893	41,578	46,157	55,421	61,613	69,341	77,069
		8	9,206	18,547	27,888	37,123	55,805	74,381	83,722	93,062	111,638	124,128	139,632	155,088
		12	13,891	27,888	41,885	55,882	83,875	111,869	125,866	139,862	167,885	186,538	209,875	233,213
		16	18,624	37,277	55,958	74,611	112,022	149,357	168,115	186,768	224,102	249,053	280,166	311,309
	4	1	2,352	4,733	7,114	9,437	14,275	19,008	21,389	23,741	28,579	31,699	35,693	39,658
		2	4,810	9,590	14,429	19,238	28,886	38,506	43,344	48,230	57,878	64,301	72,336	80,371
		4	9,590	19,315	29,040	38,736	58,186	77,606	87,331	97,027	116,477	129,475	145,622	161,818
		8	19,392	38,890	58,416	77,837	116,861	155,779	175,306	194,803	233,750	259,747	292,272	324,691
12		29,194	58,416	87,715	116,938	175,459	233,981	263,280	292,502	351,024	390,019	438,845	487,565	
16		38,966	77,990	117,014	156,010	234,134	312,154	351,254	390,250	468,298	520,397	585,418	650,438	
8	1	4,810	9,667	14,582	19,469	29,270	39,043	43,958	48,845	58,646	65,222	73,334	81,494	
	2	9,744	19,622	29,472	39,274	59,002	78,682	88,531	98,410	118,061	131,242	147,667	164,045	
	4	19,699	39,427	59,155	78,912	118,445	157,930	177,734	197,491	236,947	263,357	296,237	329,146	
	8	39,504	79,066	118,598	158,160	237,331	316,426	356,064	395,626	474,720	527,510	593,453	659,395	
	12	59,309	118,675	178,042	237,408	356,218	474,950	534,394	593,760	712,464	791,664	890,640	989,645	
	16	79,142	158,314	237,485	316,656	475,104	633,446	712,694	791,894	950,237	1 055,894	1 187,856	1 319,818	

C.4 Quad slot transmission, single spatial stream

Table C.4-1: Transport block sizes (in bits) for quad slot transmission and single spatial stream with maximum turbo code block size of 2 048 bits

μ	β \ MCS	0	1	2	3	4	5	6	7	8	9	10	11
		TRANSPORT BLOCK SIZES											
1	1	920	1 864	2 744	3 704	5 600	7 496	8 432	9 392	11 288	12 544	14 144	15 720
	2	1 928	3 832	5 792	7 688	11 608	15 464	17 424	19 384	23 240	25 840	29 120	32 360
	4	3 896	7 816	11 736	15 656	23 560	31 400	35 384	39 304	47 144	52 408	58 968	65 552
	8	7 880	15 784	23 688	31 592	47 464	63 272	71 240	79 144	94 976	105 520	118 752	131 960
	12	11 864	23 752	35 640	47 528	71 368	95 144	107 120	119 008	142 784	158 656	178 512	198 368
	16	15 848	31 720	47 592	63 464	95 272	127 040	142 976	158 848	190 592	211 792	238 296	264 800
2	1	1 960	3 896	5 856	7 816	11 800	15 720	17 680	19 640	23 624	26 224	29 504	32 784
	2	3 960	7 944	11 928	15 912	23 880	31 848	35 832	39 880	47 848	53 152	59 800	66 448
	4	7 944	15 976	24 008	32 040	48 104	64 168	72 200	80 232	96 296	107 056	120 392	133 792
	8	16 040	32 168	48 296	64 360	96 616	128 808	144 936	161 064	193 256	214 752	241 640	268 464
	12	24 136	48 296	72 520	96 680	145 064	193 448	217 672	241 832	290 216	322 472	362 824	403 112
	16	32 232	64 488	96 744	129 000	193 576	258 088	290 408	322 664	387 176	430 256	484 008	537 784
4	1	4 024	8 072	12 160	16 208	24 368	32 528	36 576	40 688	48 848	54 240	61 056	67 832
	2	8 112	16 336	24 496	32 720	49 104	65 488	73 712	81 936	98 320	109 272	122 928	136 584
	4	16 336	32 784	49 232	65 680	98 576	131 472	147 896	164 344	197 240	219 184	246 584	274 024
	8	32 848	65 808	98 768	131 640	197 560	263 392	296 352	329 312	395 144	439 120	494 000	548 840
	12	49 360	98 768	148 216	197 624	296 480	395 336	444 808	494 192	593 048	658 968	741 376	823 744
	16	65 872	131 768	197 688	263 584	395 464	527 280	593 240	659 160	790 976	878 880	988 752	1 098 624
8	1	8 176	16 400	24 688	32 912	49 424	65 936	74 224	82 448	98 960	109 952	123 736	137 480
	2	16 464	33 040	49 616	66 128	99 256	132 344	148 920	165 496	198 580	220 632	248 288	275 856
	4	33 104	66 256	99 384	132 536	198 880	265 160	298 376	331 528	397 808	442 016	497 304	552 568
	8	66 320	132 664	199 008	265 352	398 128	530 816	597 224	663 592	796 280	884 760	995 400	1 106 016
	12	99 512	199 072	298 632	398 192	597 352	796 472	896 096	995 656	1 194 752	1 327 528	1 493 496	1 659 464
	16	132 728	265 480	398 256	531 008	796 600	1 062 128	1 194 944	1 327 720	1 593 224	1 770 272	1 991 592	2 212 888

Table C.4-2: Single channel maximum throughput for quad slot transmission with single spatial stream with maximum turbo code block size of 2 048 bits

μ	β \ MCS	0	1	2	3	4	5	6	7	8	9	10	11
		DATARATE (Mbps)											
1	1	0,552	1,118	1,646	2,222	3,360	4,498	5,059	5,635	6,773	7,526	8,486	9,432
	2	1,157	2,299	3,475	4,613	6,965	9,278	10,454	11,630	13,944	15,504	17,472	19,416
	4	2,338	4,690	7,042	9,394	14,136	18,840	21,230	23,582	28,286	31,445	35,381	39,331
	8	4,728	9,470	14,213	18,955	28,478	37,963	42,744	47,486	56,986	63,312	71,251	79,176
	12	7,118	14,251	21,384	28,517	42,821	57,086	64,272	71,405	85,670	95,194	107,107	119,021
	16	9,509	19,032	28,555	38,078	57,163	76,224	85,786	95,309	114,355	127,075	142,978	158,880
2	1	1,176	2,338	3,514	4,690	7,080	9,432	10,608	11,784	14,174	15,734	17,702	19,670
	2	2,376	4,766	7,157	9,547	14,328	19,109	21,499	23,928	28,709	31,891	35,880	39,869
	4	4,766	9,586	14,405	19,224	28,862	38,501	43,320	48,139	57,778	64,234	72,235	80,275
	8	9,624	19,301	28,978	38,616	57,970	77,285	86,962	96,638	115,954	128,851	144,984	161,078
	12	14,482	28,978	43,512	58,008	87,038	116,069	130,603	145,099	174,130	193,483	217,694	241,867
	16	19,339	38,693	58,046	77,400	116,146	154,853	174,245	193,598	232,306	258,154	290,405	322,670
4	1	2,414	4,843	7,296	9,725	14,621	19,517	21,946	24,413	29,309	32,544	36,634	40,699
	2	4,867	9,802	14,698	19,632	29,462	39,293	44,227	49,162	58,992	65,563	73,757	81,950
	4	9,802	19,670	29,539	39,408	59,146	78,883	88,738	98,606	118,344	131,510	147,950	164,414
	8	19,709	39,485	59,261	78,984	118,536	158,035	177,811	197,587	237,086	263,472	296,400	329,304
	12	29,616	59,261	88,930	118,574	177,888	237,202	266,885	296,515	355,829	395,381	444,826	494,246
	16	39,523	79,061	118,613	158,150	237,278	316,368	355,944	395,496	474,586	527,328	593,251	659,174
8	1	4,906	9,840	14,813	19,747	29,654	39,562	44,534	49,469	59,376	65,971	74,242	82,488
	2	9,878	19,824	29,770	39,677	59,554	79,406	89,352	99,298	119,136	132,379	148,973	165,514
	4	19,862	39,754	59,630	79,522	119,328	159,096	179,026	198,917	238,685	265,210	298,382	331,541
	8	39,792	79,598	119,405	159,211	238,877	318,490	358,334	398,155	477,768	530,856	597,240	663,610
	12	59,707	119,443	179,179	238,915	358,411	477,883	537,658	597,394	716,851	796,517	896,098	995,678
	16	79,637	159,288	238,954	318,605	477,960	637,277	716,966	796,632	955,934	1 062,163	1 194,955	1 327,733

Table C.4-3: Transport block sizes (in bits) for quad slot transmission and single spatial stream with maximum turbo code block size of 6 144 bits

		μ	$\beta \backslash \text{MCS}$	0	1	2	3	4	5	6	7	8	9	10	11
				TRANSPORT BLOCK SIZES											
TRANSPORT BLOCK SIZES	1	1	1	920	1 864	2 792	3 752	5 672	7 544	8 504	9 464	11 384	12 640	14 240	15 840
			2	1 928	3 880	5 864	7 736	11 704	15 584	17 568	19 528	23 432	26 032	29 360	32 600
			4	3 944	7 864	11 832	15 776	23 752	31 640	35 672	39 616	47 528	52 816	59 448	66 080
			8	7 928	15 904	23 880	31 832	47 848	63 776	71 816	79 768	95 720	106 360	119 688	133 016
			12	11 960	23 944	35 928	47 912	71 944	95 912	107 960	119 944	143 912	159 904	179 928	199 952
			16	15 968	31 960	47 976	63 968	96 040	128 048	144 104	160 096	192 104	213 472	240 168	266 888
	2	2	1	1 960	3 944	5 928	7 864	11 896	15 840	17 824	19 784	23 816	26 416	29 744	33 048
			2	4 008	7 992	12 024	16 032	24 072	32 088	36 120	40 192	48 232	53 584	60 280	66 976
			4	7 992	16 096	24 200	32 280	48 488	64 672	72 776	80 856	97 064	107 896	121 352	134 848
			8	16 160	32 408	48 680	64 864	97 384	129 816	146 088	162 336	194 792	216 456	243 560	270 576
			12	24 328	48 680	73 096	97 448	146 216	194 984	219 400	243 752	292 520	325 016	365 704	406 304
			16	32 472	64 992	97 512	130 008	195 112	260 128	292 712	325 208	390 248	433 664	487 848	542 032
	4	4	1	4 072	8 120	12 256	16 352	24 560	32 792	36 864	41 024	49 232	54 672	61 536	68 360
			2	8 184	16 480	24 688	32 984	49 488	66 016	74 288	82 584	99 088	110 136	123 888	137 664
			4	16 480	33 048	49 616	66 208	99 344	132 504	149 072	165 640	198 800	220 912	248 528	276 184
			8	33 112	66 336	99 536	132 696	199 120	265 480	298 704	331 904	398 264	442 576	497 912	553 184
12			49 744	99 536	149 392	199 184	298 832	398 456	448 312	498 104	597 752	664 176	747 232	830 248	
16			66 400	132 824	199 248	265 672	398 584	531 456	597 944	664 368	797 216	885 840	996 576	1 107 312	
8	8	1	8 248	16 544	24 880	33 176	49 808	66 464	74 800	83 096	99 728	110 816	124 720	138 560	
		2	16 608	33 304	50 000	66 656	100 048	133 400	150 096	166 792	200 144	222 384	250 256	278 040	
		4	33 368	66 784	100 176	133 592	200 464	267 272	300 728	334 144	400 952	445 520	501 240	556 936	
		8	66 848	133 720	200 592	267 464	401 272	535 016	601 952	668 824	802 568	891 768	1 003 272	1 114 752	
		12	100 304	200 656	300 984	401 336	602 080	802 760	903 176	1 003 528	1 204 208	1 338 016	1 505 304	1 672 568	
		16	133 784	267 592	401 400	535 208	802 888	1 070 528	1 204 400	1 338 208	1 605 824	1 784 264	2 007 336	2 230 384	

Table C.4-4: Single channel maximum throughput for quad slot transmission with single spatial stream with maximum turbo code block size of 6 144 bits

		μ	$\beta \backslash \text{MCS}$	0	1	2	3	4	5	6	7	8	9	10	11
				DATARATE (Mbps)											
DATARATE (Mbps)	1	1	1	0,552	1,118	1,675	2,251	3,403	4,526	5,102	5,678	6,830	7,584	8,544	9,504
			2	1,157	2,328	3,518	4,642	7,022	9,350	10,541	11,717	14,059	15,619	17,616	19,560
			4	2,366	4,718	7,099	9,466	14,251	18,984	21,403	23,770	28,517	31,690	35,669	39,648
			8	4,757	9,542	14,328	19,099	28,709	38,266	43,090	47,861	57,432	63,816	71,813	79,810
			12	7,176	14,366	21,557	28,747	43,166	57,547	64,776	71,966	86,347	95,942	107,957	119,971
			16	9,581	19,176	28,786	38,381	57,624	76,829	86,462	96,058	115,262	128,083	144,101	160,133
	2	2	1	1,176	2,366	3,557	4,718	7,138	9,504	10,694	11,870	14,290	15,850	17,846	19,829
			2	2,405	4,795	7,214	9,619	14,443	19,253	21,672	24,115	28,939	32,150	36,168	40,186
			4	4,795	9,658	14,520	19,368	29,093	38,803	43,666	48,514	58,238	64,738	72,811	80,909
			8	9,696	19,445	29,208	38,918	58,430	77,890	87,653	97,402	116,875	129,874	146,136	162,346
			12	14,597	29,208	43,858	58,469	87,730	116,990	131,640	146,251	175,512	195,010	219,422	243,782
			16	19,483	38,995	58,507	78,005	117,067	156,077	175,627	195,125	234,149	260,198	292,709	325,219
	4	4	1	2,443	4,872	7,354	9,811	14,736	19,675	22,118	24,614	29,539	32,803	36,922	41,016
			2	4,910	9,888	14,813	19,790	29,693	39,610	44,573	49,550	59,453	66,082	74,333	82,598
			4	9,888	19,829	29,770	39,725	59,606	79,502	89,443	99,384	119,280	132,547	149,117	165,710
			8	19,867	39,802	59,722	79,618	119,472	159,288	179,222	199,142	238,958	265,546	298,747	331,910
12			29,846	59,722	89,635	119,510	179,299	239,074	268,987	298,862	358,651	398,506	448,339	498,149	
16			39,840	79,694	119,549	159,403	239,150	318,874	358,766	398,621	478,330	531,504	597,946	664,387	
8	8	1	4,949	9,926	14,928	19,906	29,885	39,878	44,880	49,858	59,837	66,490	74,832	83,136	
		2	9,965	19,982	30,000	39,994	60,029	80,040	90,058	100,075	120,086	133,430	150,154	166,824	
		4	20,021	40,070	60,106	80,155	120,278	160,363	180,437	200,486	240,571	267,312	300,744	334,162	
		8	40,109	80,232	120,355	160,478	240,763	321,010	361,171	401,294	481,541	535,061	601,963	668,851	
		12	60,182	120,394	180,590	240,802	361,248	481,656	541,906	602,117	722,525	802,810	903,182	1 003,541	
		16	80,270	160,555	240,840	321,125	481,733	642,317	722,640	802,925	963,494	1 070,558	1 204,402	1 338,230	

Annex D (informative): Change History

Date	Version	Information about changes
July 2020	1.1.1	First publication of the TS
October 2020	1.1.2	Implemented Change Requests: DECT(20)000309r1 DRS correction DECT(20)000310r1 Precoding correction DECT(20)000311r1 Scrambling correction DECT(20)000312r1 STF correction These CRs were approved DECT-Telco 2.11.2020 Version 1.1.2 prepared by the Rapporteur
November 2020	1.1.3	Implemented Change Requests: DECT(20)000332 Transmission Bandwidth Correction This CR was approved in DECT-Telco 16.11.2020 Version 1.1.3 prepared by the Rapporteur
March 2021	1.1.4	Implemented Change Requests: DECT(21)000063 ETSI_TS_103_636-3_Physical_Layer_Editorial_Corrections This CR was approved in DECT#89 Plenary Version 1.1.4 prepared by the Rapporteur
April 2021	1.2.1	Publication of the TS version 1.2.1
November 2021	1.2.2	Implemented Change Requests: DECT(21)000305 These CRs were approved DECT#92-Plenary Version 1.2.2 prepared by the Rapporteur
November 2021	1.2.3	Added reference to Recommendation ITU-R M.2150 and description to Foreword Version 1.2.3 prepared by the Rapporteur
November 2021	1.2.4	Corrected informative reference Version 1.2.4 prepared by the Rapporteur

History

Document history		
V1.1.1	July 2020	Publication
V1.2.1	April 2021	Publication
V1.3.1	December 2021	Publication