

ETSI TS 103 021-2 V1.2.2 (2004-11)

Technical Specification

**Access and Terminals (AT);
Harmonized basic attachment requirements for Terminals for
connection to analogue interfaces of the Telephone Networks;
Update of the technical contents of
TBR 021, EN 301 437, TBR 015, TBR 017;
Part 2: Basic transmission and protection of
the network from harm**



Reference

RTS/AT-010125

Keywords

access, POTS, PSTN, terminal

ETSI

650 Route des Lucioles
F-06921 Sophia Antipolis Cedex - FRANCE

Tel.: +33 4 92 94 42 00 Fax: +33 4 93 65 47 16

Siret N° 348 623 562 00017 - NAF 742 C
Association à but non lucratif enregistrée à la
Sous-Préfecture de Grasse (06) N° 7803/88

Important notice

Individual copies of the present document can be downloaded from:

<http://www.etsi.org>

The present document may be made available in more than one electronic version or in print. In any case of existing or perceived difference in contents between such versions, the reference version is the Portable Document Format (PDF). In case of dispute, the reference shall be the printing on ETSI printers of the PDF version kept on a specific network drive within ETSI Secretariat.

Users of the present document should be aware that the document may be subject to revision or change of status. Information on the current status of this and other ETSI documents is available at

<http://portal.etsi.org/tb/status/status.asp>

If you find errors in the present document, please send your comment to one of the following services:

http://portal.etsi.org/chaicor/ETSI_support.asp

Copyright Notification

No part may be reproduced except as authorized by written permission.
The copyright and the foregoing restriction extend to reproduction in all media.

© European Telecommunications Standards Institute 2004.
All rights reserved.

DECTTM, **PLUGTESTS**TM and **UMTS**TM are Trade Marks of ETSI registered for the benefit of its Members.
TIPHONTM and the **TIPHON logo** are Trade Marks currently being registered by ETSI for the benefit of its Members.
3GPPTM is a Trade Mark of ETSI registered for the benefit of its Members and of the 3GPP Organizational Partners.

Contents

Intellectual Property Rights	5
Foreword.....	5
1 Scope	6
2 References	6
3 Definitions and abbreviations.....	6
3.1 Definitions	6
3.2 Abbreviations	8
4 Requirements.....	8
4.1 Impedance unbalance about earth	8
4.1.1 Quiescent state	8
4.1.2 Loop steady state	9
4.1.2.1 Longitudinal Conversion Loss	9
4.1.2.2 Output Signal Balance.....	9
4.2 Sending level limitations	9
4.2.1 Mean sending level	9
4.2.2 Instantaneous voltage.....	10
4.2.3 Sending level in a 10 Hz bandwidth	10
4.2.4 Sending level between 4,3 kHz and 200 kHz	11
4.2.5 Sending level from 200 kHz to 30 MHz	11
4.3 Power feeding limitations.....	12
4.4 Automatically repeated call attempts	13
Annex A (informative): Test methods.....	14
A.1 General	14
A.1.1 Acoustic environment for tests.....	14
A.1.2 Powered state.....	14
A.2 Details for testing of voice stimulated TE.....	14
A.2.1 Voice signal to be used during tests	14
A.2.1.1 Type of test signal.....	14
A.2.1.2 Levels.....	15
A.2.2 Electro-acoustic interfaces.....	15
A.2.2.1 Handset	15
A.2.2.2 Hands-free.....	15
A.2.2.3 Headset	15
A.2.2.4 Other interfaces.....	16
A.3 Feeding bridge.....	16
A.4 Test methods	16
A.4.1 Impedance unbalance about earth	16
A.4.1.1 Quiescent state	16
A.4.1.2 Loop steady state	17
A.4.1.2.1 Longitudinal Conversion Loss (LCL)	17
A.4.1.2.2 Output Signal Balance.....	18
A.4.2 Sending level limitations	19
A.4.2.1 Mean sending level	19
A.4.2.2 Instantaneous voltage.....	20
A.4.2.3 Sending level in a 10 Hz bandwidth	21
A.4.2.4 Sending level between 4,3 kHz and 200 kHz	22
A.4.2.5 Sending level from 200 kHz to 30 MHz	23
A.4.3 Power feeding limitations.....	24
A.4.4 Automatically repeated call attempts	25
Annex B (informative): Requirements Table (RT)	26

B.1	Guidance for completion of the RT	26
B.1.1	Condition table	26
B.1.2	Requirements table	26
History	28

Intellectual Property Rights

IPRs essential or potentially essential to the present document may have been declared to ETSI. The information pertaining to these essential IPRs, if any, is publicly available for **ETSI members and non-members**, and can be found in ETSI SR 000 314: "*Intellectual Property Rights (IPRs); Essential, or potentially Essential, IPRs notified to ETSI in respect of ETSI standards*", which is available from the ETSI Secretariat. Latest updates are available on the ETSI Web server (<http://webapp.etsi.org/IPR/home.asp>).

Pursuant to the ETSI IPR Policy, no investigation, including IPR searches, has been carried out by ETSI. No guarantee can be given as to the existence of other IPRs not referenced in ETSI SR 000 314 (or the updates on the ETSI Web server) which are, or may be, or may become, essential to the present document.

Foreword

This Technical Specification (TS) has been produced by ETSI Technical Committee Access and Terminals (AT).

The present document is a minor editorial update of the first version to include text which was omitted from tables B.1 and B.2.

The present document is part 2 of a multi-part deliverable covering technical updates to the TBRs, as identified below:

Part 1: "General aspects";

Part 2: "Basic transmission and protection of the network from harm";

Part 3: "Basic Interworking with the Public Telephone Network".

NOTE: Standardizes the aspects of interworking with the network. This part 3 only applies to TE intended for switched networks.

1 Scope

The present document is a part of a multi-part deliverable. It specifies basic compatibility and interoperability aspects, including basic transmission, which are applicable to all Terminal Equipment (TE) intended to be connected to analogue interfaces of public or private, switched or non switched telephone networks. The present document is applicable to a TE which is capable of accessing an analogue telephone network line at the Network Termination Point (NTP).

The present document is intended to ensure that no harm occurs to the network.

2 References

The following documents contain provisions which, through reference in this text, constitute provisions of the present document.

- References are either specific (identified by date of publication and/or edition number or version number) or non-specific.
- For a specific reference, subsequent revisions do not apply.
- For a non-specific reference, the latest version applies.

Referenced documents which are not found to be publicly available in the expected location might be found at <http://docbox.etsi.org/Reference>.

- [1] ITU-T Recommendation G.117: "Transmission aspects of unbalance about earth".
- [2] ITU-T Recommendation P.59: "Artificial conversational speech".
- [3] ITU-T Recommendation G.101: "The transmission plan".
- [4] ITU-T Recommendation P.64: "Determination of sensitivity/frequency characteristics of local telephone systems".
- [5] ITU-T Recommendation P.51: "Artificial mouth".
- [6] ITU-T Recommendation P.340: "Transmission characteristics and speech quality parameters of hands-free terminals".
- [7] ITU-T Recommendation P.38: "Transmission characteristics of Operator Telephone Systems (OTS)".
- [8] ETSI TS 103 021-1: "Access and Terminals (AT); Harmonized basic attachment requirements for Terminals for connection to analogue interfaces of the Telephone Networks; Update of the technical contents of TBR 021, EN 301 437, TBR 015, TBR 017; Part 1: General Aspects".

3 Definitions and abbreviations

3.1 Definitions

For the purposes of the present document, the following terms and definitions apply:

connection to earth: all the following points, as applicable, are connected to the earth point during measurement:

- a point in the TE which is intended to be connected to mains earth (in practice this might be carried out by connecting to the earth of the mains source which is supplying the TE);
- connector points which are intended to be connected to earth during the normal operation of the apparatus.

dBV: absolute voltage level expressed in decibels with respect to 1 V

longitudinal conversion loss: As described in ITU-T Recommendation G.117 [1], clause 4.1.3.

loop state: state where the TE draws sufficient DC current to activate the exchange

loop steady state: loop state excluding the transitions from and to quiescent state

Network Termination Point (NTP): physical point at the boundary of the Telephone Network intended to accept the connection of a TE

NOTE: See figure 1.

Output Signal Balance (OSB): As described in ITU-T Recommendation G.117 [1], clause 4.3.1.

peak to peak voltage: difference between the maximum and minimum voltage during any 10 ms window

quiescent state: state where the TE draws insufficient DC current to activate the exchange

Reference Impedance Z_R : complex impedance made up of 270 Ω in series with a parallel combination of 750 Ω and 150 nF

NOTE: This is shown in figure A.1 of TS 103 021-1 [8].

Telephone Network (TN): telecommunication network mainly exchanging voice band signals

NOTE: TN is a general term for PSTN, non-switched leased lines and Private telephone networks.

Terminal Connection Point (TCP): point of the TE intended to be connected to the Telephone Network

NOTE: An adapter may be required between the terminal and the existing national network termination point in individual countries. Such an adapter is outside the scope of the present document (see figure 1).

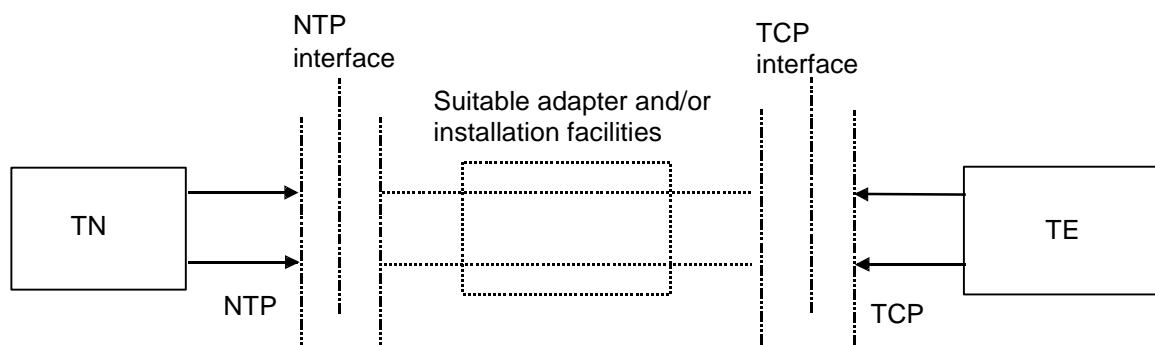

Figure 1: Terminal connection point and network termination point

Terminal Equipment (TE): equipment intended to be connected to the TN; i.e.:

- to be connected directly to the termination (NTP) of a TN; or
- to interwork with a TN being connected directly or indirectly to the NTP;
- in order to send, process or receive information. The system of connection may be wire, radio, optical or other electromagnetic system.

NOTE: TE intended to be connected to public networks may be subject to particular regulatory treatment, whereas TE intended to be connected to private networks are usually not subject to particular regulatory treatment.

3.2 Abbreviations

For the purposes of the present document, the following abbreviations apply:

AC	Alternating Current
DC	Direct Current
DTMF	Dual Tone Modulation Frequency
HFRP	Hands-Free Reference Point
ICP	Installation Connection Point
LCL	Longitudinal Conversion Loss
MRP	Mouth Reference Point
NTP	Network Termination Point
OSB	Output Signal Balance
PSTN	Public Switched Telephone Network
rms	root mean square
TCP	Terminal Connection Point
TE	Terminal Equipment
TN	Telephone Network

4 Requirements

4.1 Impedance unbalance about earth

4.1.1 Quiescent state

Justification: Protection of the network from harm. Unbalance may cause crosstalk.

The impedance unbalance about earth is expressed as the Longitudinal Conversion Loss (LCL) in this clause.

Requirement: The Longitudinal Conversion Loss when the AC termination of the TE is 600 Ω shall be at least the values given in table 1 and figure 2.

Table 1: Unbalance about earth

Frequency range	Minimum value
50 Hz to 600 Hz	40 dB
600 Hz to 3 400 Hz	46 dB
3 400 Hz to 3 800 Hz	40 dB

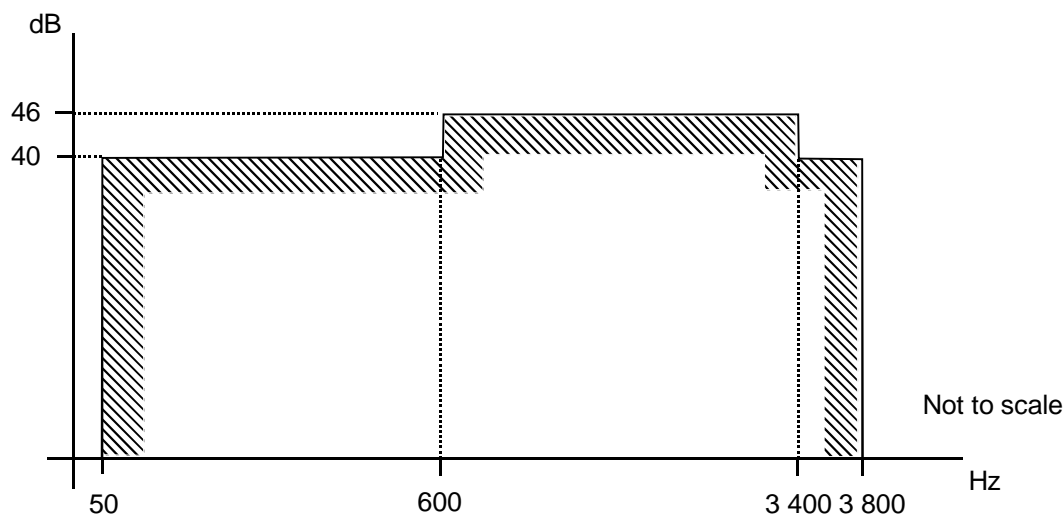

Figure 2: Unbalance about earth

Test: The test shall be conducted according to clause A.4.1.1.

4.1.2 Loop steady state

Justification: Protection of the network from harm. Unbalance may cause crosstalk.

The impedance unbalance about earth is expressed as Longitudinal Conversion Loss (LCL) when the TE is in the receiving mode and Output Signal Balance (OSB) when in the transmitting mode.

The requirements during the loop steady state apply when the TE has been in the loop state for a minimum of 1,2 s with a line feeding current which can be obtained when the TE is connected to a source of 50 V DC in series with a resistor within the range of 2 800 Ω to 400 Ω . For the purpose of conducting the test of clauses A.4.1.2 and A.4.2 including all clauses the maximum feed resistance of 2 800 Ω shall be replaced by 2 300 Ω for TE declared to be intended for use only on lines providing a loop current of 18 mA or greater.

4.1.2.1 Longitudinal Conversion Loss

Requirement: The LCL when the AC termination of the TE is 600 Ω shall be at least the values given in table 1 and figure 2.

Test: The test shall be conducted according to clause A.4.1.2.1.

4.1.2.2 Output Signal Balance

Requirement: The OSB when the AC termination of the TE is 600 Ω shall be at least the values given in table 1 and figure 2.

Test: This requirement will only be completely tested at frequencies where the unbalance level exceeds -70 dBV with the test method shown in clause A.4.1.2.2. Measurement results below -70 dBV will only be noted as compliant, no value will be registered. Voice TE is stimulated by a Pseudo Speech Signal at a level defined in clause A.2.1.2, table A.1, column "Nominal".

4.2 Sending level limitations

These requirements apply to all states except during loop disconnect dialling and register recall signalling. It also does not apply to transient conditions (seizing and releasing the line), which are not considered states.

Justification: Protection of the network from harm is assured by limiting the signal sent by the TE so that the interfering effects of the signal can be predicted and avoided.

4.2.1 Mean sending level

This requirement does not apply to DTMF signals.

Requirement: The mean sending level in the frequency range 200 Hz to 3 800 Hz over a one-minute period shall not be greater than -9,7 dBV when the TE interface is terminated with the reference impedance Z_R .

Test: The test shall be conducted according to clause A.4.2.1. Voice TE is stimulated by a pseudo speech signal at a level defined in clause A.2.1.2, table A.1, column "Nominal".

4.2.2 Instantaneous voltage

Requirement: The peak to peak voltage in the frequency range 200 Hz to 3 800 Hz shall not exceed 5 V_{pp} when the TE interface is terminated with the reference impedance Z_R .

NOTE: It is recognized that due to the statistical nature of speech signals, the peak to peak voltage level could under some circumstances of real use exceed 5 V. It is recommended that when stimulated with the pseudo speech signal at a level of +10 dBPa, the peak to peak voltage measured in the frequency band 100 Hz to 20 kHz should not exceed 8,0 V when the TE interface is terminated with the reference impedance Z_R .

Test: The test shall be conducted according to clause A.4.2.2. Voice terminal is stimulated by a pseudo speech signal at a level defined in clause A.2.1.2, table A.1, column "5 V_{pp}".

4.2.3 Sending level in a 10 Hz bandwidth

This requirement does not apply to DTMF signals and Voice TE.

Requirement: the voltage within a 10 Hz bandwidth centred at any point in the frequency range 30 Hz to 4 300 Hz, and wholly contained within that frequency band, shall not exceed the limits given in table 2 and figure 3 when the TE interface is terminated with the reference impedance Z_R .

Table 2: Voltage in a 10 Hz bandwidth

Points	Frequency	Sending level
A	0,03 kHz	-33,7 dBV
B	0,1 kHz	-10,7 dBV
C	0,2 kHz	-6,7 dBV
D	3,8 kHz	-6,7 dBV
E	3,9 kHz	-10,7 dBV
F	4,0 kHz	-16,7 dBV
G	4,3 kHz	-29,7 dBV

NOTE: Limits for intermediate frequencies can be found by drawing a straight line between the break points on a logarithmic (Hz) - linear (dB) scale.

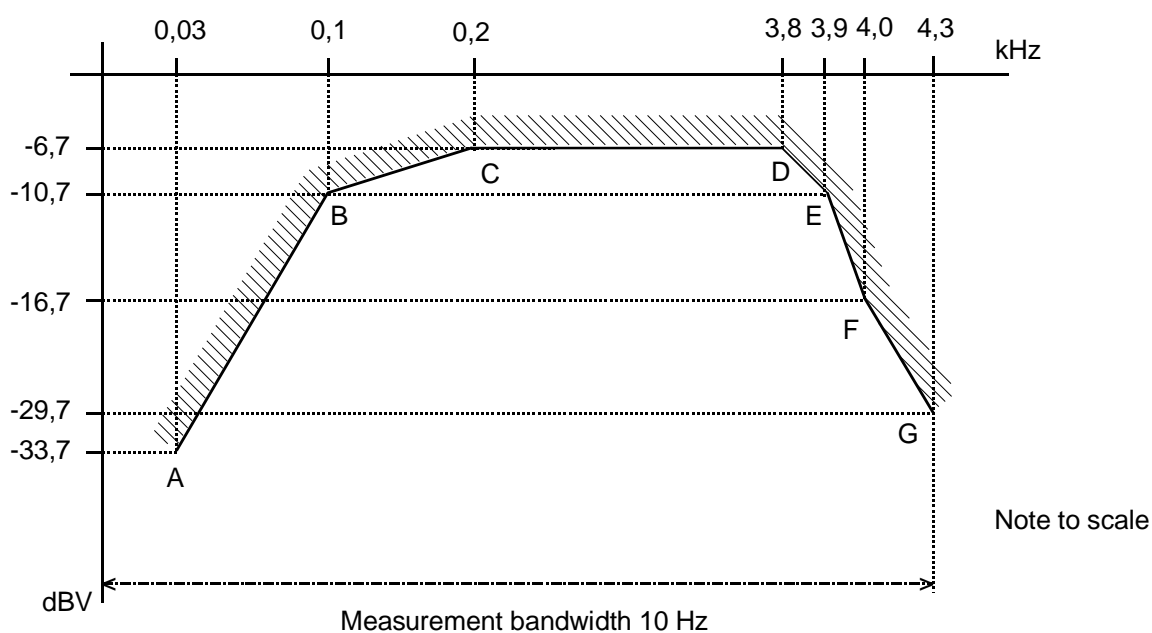

NOTE: The test shall be conducted according to clause A.4.2.3.

Figure 3: Voltage level in a 10 Hz bandwidth

4.2.4 Sending level between 4,3 kHz and 200 kHz

Requirement: the total voltage level in a bandwidth, defined in table 3, wholly contained within the frequency range 4,3 kHz to 200 kHz, arising from normal operation of the TE when terminated with Z_R , shall not exceed the limits shown in table 3 and figure 4.

During tone (DTMF) signalling the limits given in table 3 and figure 4 do not apply and are replaced by the following:

- in the range 4,3 kHz to 20 kHz, the individual level of any single frequency component shall not exceed -35,7 dBV;
- in the range 20 kHz to 200 kHz, the individual level of any single frequency component shall not exceed -40,7 dBV.

NOTE: "Normal operation of the TE" is defined in the test, see clause A.1.2.

Table 3: Sending level between 4,3 kHz and 200 kHz

Points	Frequency range	Sending level in a specified bandwidth	Measurement bandwidth
G to H	4,3 kHz to 6,0 kHz	-15 dBV	300 Hz
H to I	6,0 kHz to 8,9 kHz	-15 dBV decreasing to -44 dBV	300 Hz
I to J	8,9 kHz to 12 kHz	-44 dBV decreasing to -58,5 dBV	300 Hz
J to K	12 kHz to 200 kHz	-58,5 dBV	1 kHz

NOTE: Limits for intermediate frequencies can be found by drawing a straight line between the break points on a logarithmic (Hz) - linear (dBV) scale.

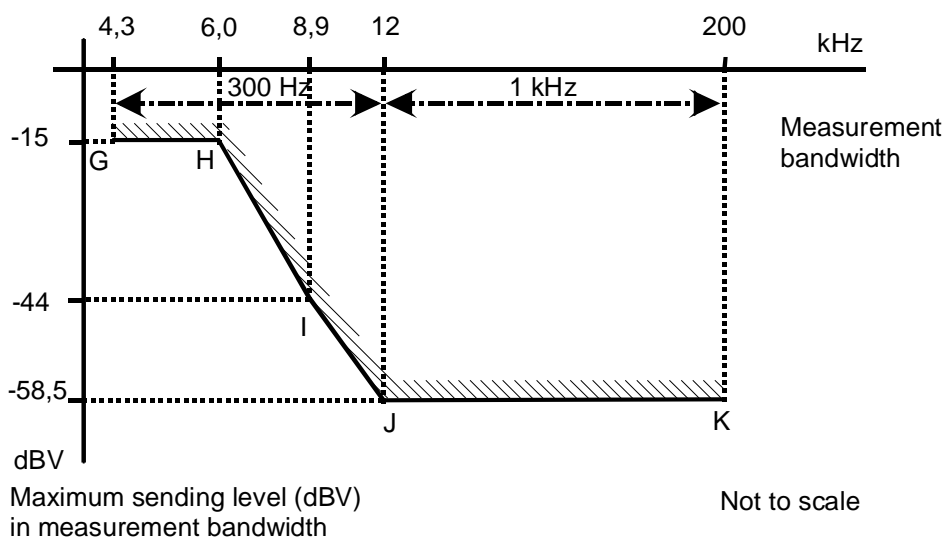

Figure 4: Sending level between 4,3 kHz and 200 kHz

Test: The test shall be conducted according to clauses A.4.2.4. Voice terminal equipment is stimulated by a Pseudo Speech Signal at a level defined in clause A.2.1.2, table A.1, column "Nominal".

4.2.5 Sending level from 200 kHz to 30 MHz

Justification: To ensure a better coexistence with the other access and local communications systems (e.g. to avoid crosstalk within the same access cable).

Requirement: The total voltage level in a bandwidth, defined in table 1, wholly contained within the frequency range 200 kHz to 30 MHz, arising from normal operation of the TE and when terminated with Z_{RHF} , shall not exceed the limits shown in table 1 and figure 1.

NOTE: "Normal operation of the TE" is defined in the test, see clause A.1.2.

Table 4: Maximum sending between 200 kHz and 30 MHz

Points	Frequency range	Maximum sending level U in a specified bandwidth	Spectral Voltage U/ \sqrt{B}	Measurement bandwidth B	Reference Impedance
A to B	0,2 MHz to 0,5 MHz	-60 dBV	-100 dBV/ $\sqrt{\text{Hz}}$	10 kHz	Z_{RHF}
B to C	0,5 MHz to 3 MHz	-60 dBV	-100 dBV/ $\sqrt{\text{Hz}}$	10 kHz	Z_{RHF}
B to C	0,5 MHz to 3 MHz	-60 dBV	-120 dBV/ $\sqrt{\text{Hz}}$	1 MHz	Z_{RHF}
C to D	3 MHz to 30 MHz	-60 dBV	-120 dBV/ $\sqrt{\text{Hz}}$	1 MHz	Z_{RHF}

NOTE: A voltage of 1 V, equals 0 dBV, and causes a power of +2,2 dBm in 600 Ω , +8,7 dBm in 135 Ω and +9,2 dBm in 120 Ω .

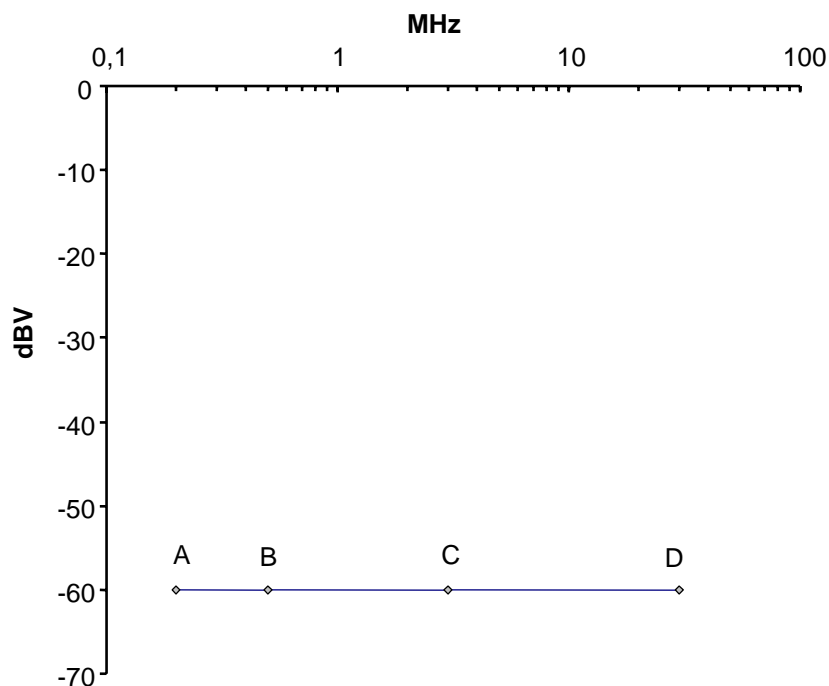

Figure 5: Maximum sending between 200 kHz and 30 MHz

Test: The test shall be conducted according to clauses A.4.2.5.

4.3 Power feeding limitations

Justification: To prevent harm to the network.

Requirement: The TE shall not feed DC power to the network interface.

Test: The test shall be conducted according to clause A.4.3.

4.4 Automatically repeated call attempts

Justification: Protection of the TN from harm is achieved by restricting automatically repeated call attempts from the TE.

Requirement: The TE shall not automatically initiate an internally generated repeat call attempt less than 5 s after the termination of the previous call attempt in the same repeat attempt sequence. The previous call attempt is considered to be terminated when the TE returns to the quiescent state. There shall be no more than 15 repeated call attempts in a repeated call attempt sequence.

NOTE: Although the present document permits repeat call attempts to be made after an interval of 5 s, the interval between repeat call attempts, in most practical applications, will usually be set to a value considerably greater than this so as to provide an appropriate compromise between the rate of redialling and the likelihood of the repeat call attempt being successful. Where this interval is user adjustable, TE supplier's are recommended to provide guidance to users on how to select a setting that would best suit the types of applications for which the TE is intended (e.g. taking into account the typical holding times for calls).

Test: The test shall be conducted according to clause A.4.4.

Annex A (informative): Test methods

A.1 General

Refer to clause A.1 of TS 103 021-1 [8].

A.1.1 Acoustic environment for tests

The characteristics of the acoustic environment shall be such that they will have a negligible effect on the measurements being made and the repeatability of results should only be dependant on the technical properties of the acoustically stimulated terminal.

A.1.2 Powered state

Tests shall be carried out with the TE powered on, under normal operating conditions defined by the supplier.

A.2 Details for testing of voice stimulated TE

A.2.1 Voice signal to be used during tests

A.2.1.1 Type of test signal

Pink Noise: For the purpose of the present document the pink noise test signal, adjusted at the relevant Reference Point, shall be band limited to the frequency range 200 Hz to 3 800 Hz.

There are two recommended methods of achieving this, the choice of which depends upon the filtering technique used.

- a) Where analogue filters are used the slopes of the band limiting filter shall be at least 24 dB/octave and the out-of-band attenuation shall be at least 25 dB (see figure A.1). The 1/3 octave spectrum of electrically generated pink noise shall be equalized to within ± 1 dB, while acoustically generated pink noise shall be equalized (in free field) to within ± 3 dB.

NOTE 1: When measured with 1/3 octave bandwidth at standard frequencies, an ideal filtered pink noise signal will be attenuated 1,1 dB at 200 Hz and 0,9 dB at 4 kHz compared to a non-filtered pink noise signal.

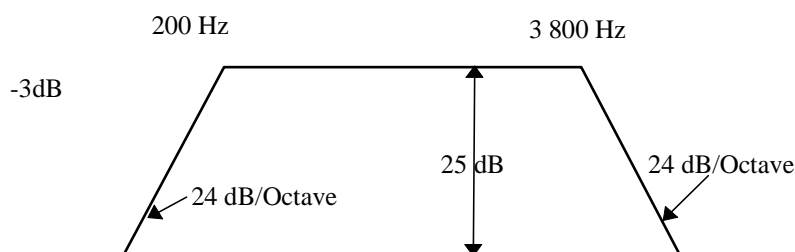

Figure A.1: Response for the band-limiting filter

- b) Where digital filters are used the detail of a) above applies, but with the 3 dB attenuation points set at 225 Hz and 3 563 Hz instead of 200 Hz and 3 800 Hz.

Speech Test Signal: This shall be band-limited pink noise (see definition above) that is continuously modulated to be ON for a period of $250 \text{ ms} \pm 5 \text{ ms}$ and OFF for a period of $150 \text{ ms} \pm 5 \text{ ms}$. The signal level specified refers to the level of the signal during the ON period.

Pseudo Speech Signal: This shall be a Speech Test Signal (see definition above) with 11 cycles and then followed by a period of $5,6 \text{ s} \pm 20 \text{ ms}$ OFF giving an activity ratio of approximately 28 %.

NOTE 2: The total OFF time after the 11th ON burst will be 5,75 s.

NOTE 3: The timing tolerances given above will result in a tolerance for the r.m.s. level of $\pm 0,1 \text{ dB}$.

This Pseudo Speech Signal is repeated for as long as is necessary for any measurements to be made.

Where the Supplier declares that the Pseudo Speech Signal is not appropriate for the intended use of the TE, an alternative test signal may be specified by the Supplier providing that the overall activity ratio during a one minute period shall be within the range of 23 % to 33 %. Any alternative signal shall be adjusted to give the same r.m.s. level over a one minute period as the level for the pseudo speech signal.

NOTE 4: The activity factor of 28 % can be found in ITU-T Recommendation P.59 [2].

A.2.1.2 Levels

Table A.1: Input signal levels (ON)

Stimulating point	Stimulated point	Nominal	5 Vpp
Analogue NTP simulator	TCP	-12 dBVemf	-7 dBVemf
Digital (NTP or TCP or other)	TCP or ICP or other	-12,5 dBm0	-7,5 dBm0
Analogue TCP simulator	ICP	-4 dBVemf	+1 dBVemf
MRP of a handset or headset	Microphone	-4,7 dBPa	+0 dBPa
HFRP of a handsfree	Microphone	-28,7 dBPa	-24 dBPa

NOTE 1: Analogue interfaces (PSTN-TCP and ICP) shall be stimulated with generators presenting a source impedance of Z_R . Equalization and level calibration of the pink noise signal shall be done with the generator disconnected from the load.

NOTE 2: dBm0 is the level expressed in dB with respect to the 0dBr Point as referred to in ITU-T Recommendation G.101 [3]. In the present document this is used together with the stimulation of digital interfaces.

A.2.2 Electro-acoustic interfaces

A.2.2.1 Handset

Mouth Reference Point (MRP): Generally the appropriate Mouth Reference Point from ITU-T Recommendation P.64 [4], shall be used. Where a supplier has declared that the ITU-T MRP would be inappropriate for the intended use of the TE, then the microphone positioning described by the supplier shall be applied.

A.2.2.2 Hands-free

Hands-Free Reference Point (HFRP): A point located on the axis of the artificial mouth, at 50 cm from the lip ring, where the level calibration is made in free field. It corresponds to the measurement point 11, as defined in ITU-T Recommendation P.51 [5]. Test arrangements should be based on ITU-T Recommendation P.340 [6].

A.2.2.3 Headset

For headsets the same measuring methods apply as for handsets. If the microphone positioning for testing is not defined by the manufacturer, it will correspond to the "corner of the mouth" position as defined in the ITU-T Recommendation P.38 [7], clause 1 (note).

A.2.2.4 Other interfaces

TE with other transducers arrangements will be tested in accordance with the manufacturer's instructions.

A.3 Feeding bridge

Refer to clause A.3 of TS 103 021-1 [8].

A.4 Test methods

A.4.1 Impedance unbalance about earth

A.4.1.1 Quiescent state

- **Requirement:** clause 4.1.1;
- **Purpose:** to ensure that the impedance unbalance about earth, expressed as Longitudinal Conversion Loss, meets the requirements.

Measurement principle:

- **Preamble:** set the TE in quiescent state;
- **Test state:** quiescent state.

Test configuration:

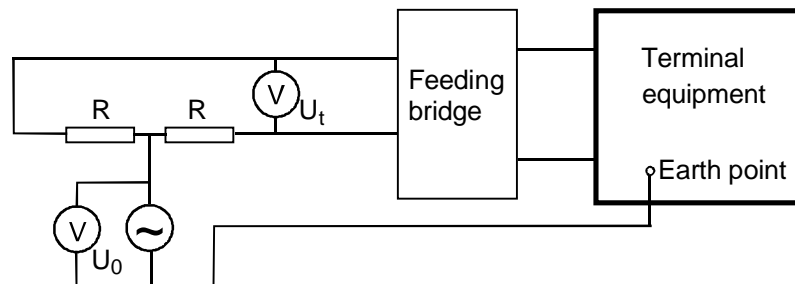

Figure A.2: Impedance balance about earth

DC feeding arrangement:

- feed voltage: 50 V. Feed resistance: 400 Ω . The test shall be made with both polarities.

Measurement points:

- the resistors R shall be 300 Ω .
- U_0 shall be a sinusoidal signal with a constant voltage of 0,775 V rms throughout the specified frequency range (50 Hz to 3 800 Hz in 1/3th octave steps). Measurement of the transverse voltage U_t shall be performed with a suitable frequency selective voltmeter.

Measurement execution:

- measure the voltage U_t across the specified frequency range. The test shall be carried out for both polarities of feeding.

Formal processing:

- the measured value of U_t is used to calculate the Longitudinal Conversion Loss by using the following formula at all the measurement points:

$$\text{Longitudinal Conversion Loss} = 20 \log_{10} \left| \frac{U_o}{U_t} \right| \text{ dB} .$$

Verdict:

- if the Longitudinal Conversion Loss is greater than or equal to the specified limits in table 1 and figure 2 then Pass; else Fail.

Guidance:

- The test generator output impedance should be less than 500 Ω ;
- The voltmeter input impedance should be greater than 100 k Ω .

A.4.1.2 Loop steady state

The maximum feed resistance of 2 800 Ω shall be replaced when appropriate by 2 300 Ω as stated in clause 4.1.2.

A.4.1.2.1 Longitudinal Conversion Loss (LCL)

- Requirement:** clause 4.1.2.1;
- Purpose:** to ensure that the impedance unbalance about earth, expressed as Longitudinal Conversion Loss, meets the requirements.

Measurement principle:

- Preamble: set the TE in loop state;
- Test state: loop state.

Test configuration:

Figure A.3: Loop steady state configuration

DC feeding arrangement:

- feed voltage: 50 V. Feed resistance: each of the following: 400 Ω , 850 Ω , 2 050 Ω , and 2 800 Ω . Polarity shall be switched between each feed resistance.

Measurement points:

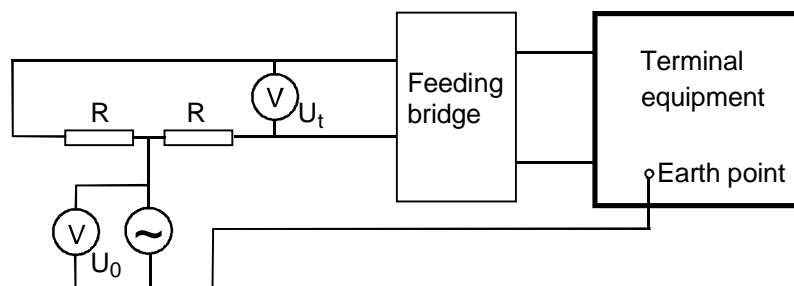
- the resistors R shall be 300 Ω .
- U_o shall be a sinusoidal signal with a constant voltage of 0,775 V throughout the specified frequency range (50 Hz to 3 800 Hz in 1/3th octave steps). Measurement of the transverse voltage U_t shall be performed with a suitable frequency selective voltmeter.

Measurement execution:

- measure the transversal voltage U_t across the specified frequency range for each of the feed conditions. Allow sufficient settling time at each feed condition to ensure that the measured value is stable to within $\pm 0,5\%$ for at least 0,2 s.

Formal processing:

- the measured value of U_t is used to calculate the Longitudinal Conversion Loss by using the following formula:

$$\text{Longitudinal Conversion Loss} = 20 \log_{10} \left| \frac{U_o}{U_t} \right| \text{ dB} .$$

Verdict:

- if the Longitudinal Conversion Loss is greater than the specified limit in table 1 and figure 2 then Pass; else Fail.

Guidance:

- the test sender output impedance should be less than 500 Ω . The voltmeter input impedance should be greater than 100 k Ω .

A.4.1.2.2 Output Signal Balance

- **Requirement:** clause 4.1.2.2;
- **Purpose:** to ensure that the impedance unbalance about earth, expressed as output signal balance, meets the requirements.

Measurement principle:

- **Preamble:** set the TE in loop state;
- **Test state:** loop state.

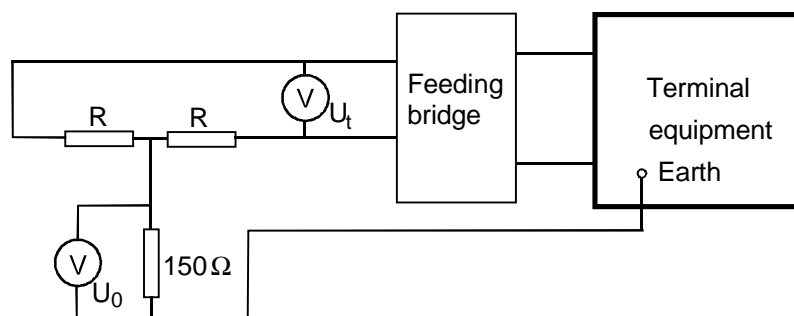
Test configuration:**Figure A.4: Output Signal Balance certification****DC feeding arrangement:**

- feed voltage: 50 V. Feed resistance: each of the following: 400 Ω , 850 Ω , 2 050 Ω , and 2 800 Ω . Polarity shall be switched between each feed resistance.

Measurement points:

- the resistors R shall be 300 Ω . Measurement of the voltages U_o and U_t shall be performed with a suitable frequency selective voltmeter.

Measurement execution:

- the TE is set in the loop state transmitting representative signals to line.

Formal processing:

- the measured values of U_o and U_t are used to calculate the OSB by using the following formula:

$$\text{Output Signal Balance} = 20 \log_{10} \left| \frac{U_t}{U_o} \right| \text{ dB};$$

- for frequencies at which U_o is less than -70 dBV the OSB is not calculated.

Verdict:

- if the OSB is greater than the specified limit in table 1 and figure 2 then Pass; else Fail. For frequencies at which U_o is less than -70 dBV there is no OSB requirement.

Guidance:

- the voltmeter input impedance should be greater than 100 k Ω .

A.4.2 Sending level limitations

The maximum feed resistance of 2 800 Ω shall be replaced when appropriate by 2 300 Ω as stated in clause 4.1.2.

A.4.2.1 Mean sending level

- Requirement:** clause 4.2.1;
- Purpose:** to check that the mean sending level in the frequency range 200 Hz to 3 800 Hz over a one-minute period shall not be greater than -9,7 dBV when the TE interface is terminated with the reference impedance Z_R .

Measurement principle:

- Preamble:** set the TE in loop state;
- Test state:** the TE shall be in loop state and sending representative signals continuously.

Test configuration:

Figure A.5: Mean sending level configuration

DC feeding arrangement:

- feed voltage: 50 V. Feed resistance: each of the following: 400 Ω , and 2 800 Ω . Polarity shall be switched between each feed resistance.

AC termination of TE:

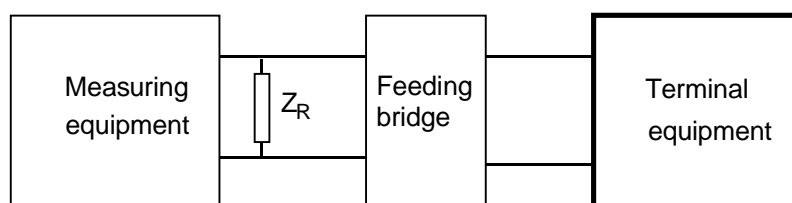
- Z_R

Measurement points:

- the TE is exercised to send to line representative combinations of its declared output capabilities.

Measurement execution:

- the TE shall be set in loop state, transmitting representative signals continuously. The mean sending level in the frequency range 200 Hz to 3 800 Hz transmitted across the termination points of the TE shall be determined over a one-minute period.

Formal processing:

- none.

Verdict:

- if the mean level over a one-minute period is less than or equal to -9,7 dBV then Pass; else Fail.

Guidance:

- TE with adjustable output level is set up in accordance with the supplier's instructions for intended use, or in the absence of instructions, is set to send at its maximum level. The TE is then operated in accordance with its intended use. For data equipment (e.g. modems), any output signal may be a test message consisting of a representative bit pattern or a scrambled signal. For answering machines or similar equipment where the output is derived from recorded speech, any recorded signal shall have been prepared in accordance with the supplier's instruction for intended use. See clause A.2.1 for Voice TE.

A.4.2.2 Instantaneous voltage

- **Requirement:** clause 4.2.2;
- **Purpose:** to check that the peak to peak voltage of the TE complies with clause 4.2.2.

Measurement principle:

- **Preamble:** set the TE in loop state;
- **Test state:** the TE shall be in loop state and sending representative signals.

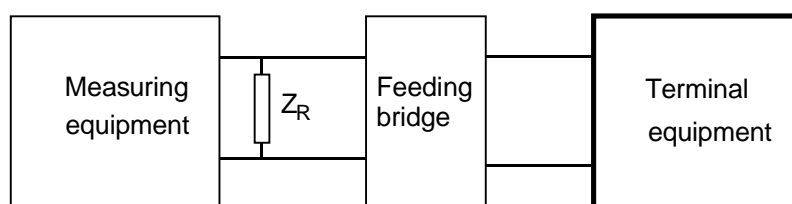
Test configuration:**Figure A.6: Instantaneous voltage configuration****DC feeding arrangement:**

- feed voltage: 50 V. Feed resistance: each of the following: 400 Ω and 2 800 Ω . Polarity shall be switched between each feed resistance.

AC termination of TE:

- Z_R .

Measurement points:

- the TE is exercised to send to the line:
 - representative combinations of its declared output capabilities;
 - DTMF signals.

Measurement execution:

- the TE shall be set in the loop state, transmitting representative signals. The peak to peak voltage transmitted across the termination points of the TE, shall be measured.

Formal processing:

- none.

Verdict:

- if the peak-to-peak voltage is not higher than 5,0 V then Pass; else Fail.

Guidance:

- TE with adjustable output level is set up in accordance with supplier's instructions to send at its maximum intended level. See clause A.2.1 for Voice TE.

A.4.2.3 Sending level in a 10 Hz bandwidth

- **Requirement:** clause 4.2.3;
- **Purpose:** to check that the TE complies with clause 4.2.3.

Measurement principle:

- **Preamble:** set the TE in loop state;
- **Test state:** the TE shall be in loop state and sending representative signals continuously.

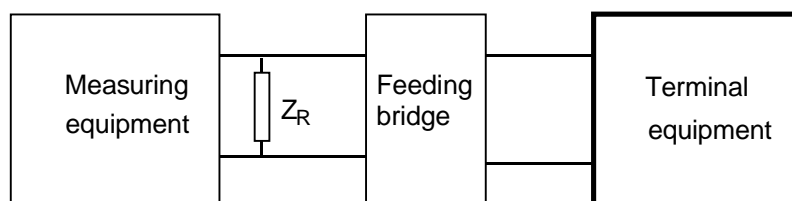
Test configuration:**Figure A.7: Sending level in 10 Hz bandwidth configuration****DC feeding arrangement:**

- feed voltage: 50 V. Feed resistance: each of the following: 400 Ω and 2 800 Ω . Polarity shall be switched between each feed resistance.

AC termination of TE:

- Z_R

Measurement points:

- the TE is exercised to send to line representative combinations of its declared output capabilities.

Measurement execution:

- the TE shall be set in loop state, transmitting representative signals continuously. The voltage level transmitted across the TCP shall be measured. It shall be determined whether the level within every 10 Hz bandwidth wholly contained in the frequency range 30 Hz to 4 300 Hz is less than or equal to the limits given in table 2 and figure 3. In the case of data equipment (e.g. modems) the level shall only be measured during the data transfer phase.

Formal processing:

- none.

Verdict:

- if the levels are according to table 2 and figure 3 then Pass; else Fail.

Guidance:

- TE with adjustable output level is set up in accordance with the supplier's instructions to send at its maximum intended level.

A.4.2.4 Sending level between 4,3 kHz and 200 kHz

- Requirement:** clause 4.2.4;
- Purpose:** to check that the TE complies with clause 4.2.4. in loop state.

Measurement principle:

- Preamble:** set the TE in transmitting mode;
- Test state:** the TE shall be sending representative signals continuously.

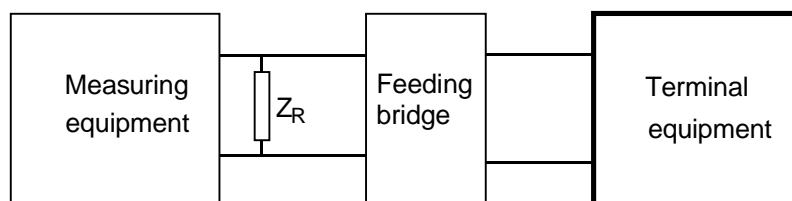
Test configuration:**Figure A.8: Sending level between 4,3 kHz and 200 kHz configuration****DC feeding arrangement:**

- feed voltage: 50 V. Feed resistance: each of the following: 400 Ω, and 2 800 Ω. Polarity shall be switched between each feed resistance.

AC termination of TE:

- Z_R .

Measurement points:

- the TE is made to send to line representative combinations of its declared capabilities.

Measurement execution:

- the TE is set to transmit representative signals continuously. The sending level across the termination points of the TE shall be measured. It is determined whether the level in a bandwidth defined in table 3, wholly contained in the frequency range 4,3 kHz to 200 kHz, is less than or equal to the limits of table 3 and figure 4. Where these limits are exceeded it is determined whether exceeding the limits is caused by tone signals having one or more single frequency component whose individual voltage level is less than or equal to -35,7 dBV in the range 4,3 kHz to 20 kHz and -40,7 dBV in the range 20 kHz to 200 kHz.

Formal processing:

- none.

Verdict:

- if the sending level complies with table 3 and figure 4 then Pass.
- if the only non-compliance with table 3 and figure 4 is due to a tone signal with one or more single frequency components whose individual levels are less than or equal to -35,7 dBV in the range 7,95 kHz to 20 kHz and -40,7 dBV in the range 20 kHz to 200 kHz then Pass; else, Fail.

Guidance:

- TE with adjustable output level is set up in accordance with supplier's instructions to send at its maximum level. See clause A.2.1. for Voice TE.

A.4.2.5 Sending level from 200 kHz to 30 MHz

- Requirement:** clause 4.2.5;
- Purpose:** to check that the TE complies with clause 4.2.5.

Measurement principle:

- Preamble:** set the TE in transmitting mode;
- Test state:** the TE shall be sending representative signals continuously.

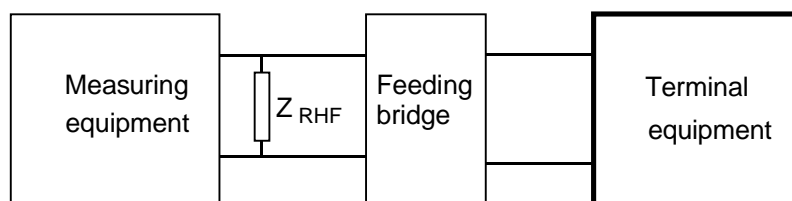
Test configuration:**Figure A.9: Sending level between 200 kHz and 30 MHz configuration****DC feeding arrangement:**

- feed voltage: 50 V. Feed resistance: each of the following: 400 Ω , and 2 800 Ω . Polarity shall be switched between each feed resistance.

AC termination of TE:

- Z_{RHF} .

Measurement points:

- the TE is made to send to line representative combinations of its declared capabilities.

Measurement execution:

- the TE is set to transmit representative signals continuously. The sending level across the termination points of the TE shall be measured. It is determined whether the level in a bandwidth defined in table 4, wholly contained in the frequency range 200 kHz to 30 MHz, is less than or equal to the limits of table 4 and figure 5.

Formal processing:

- none.

Verdict:

- if the sending level complies with table 4 and figure 5 then Pass.

Guidance:

- TE with adjustable output level is set up in accordance with supplier's instructions to send at its maximum level. See clause A.2.1. for Voice TE.

A.4.3 Power feeding limitations

- Requirement:** see clause 4.3;
- Purpose:** to verify that the TE does not feed the TN interface.

Measurement principle:

- by measuring the DC output current from the TE into a resistance of 300 Ω .

Test configuration:

- See figures A.10. or A.11.

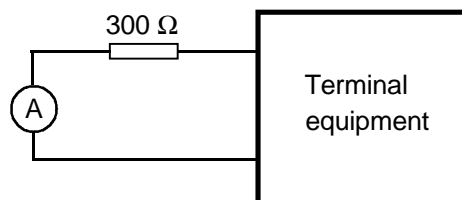
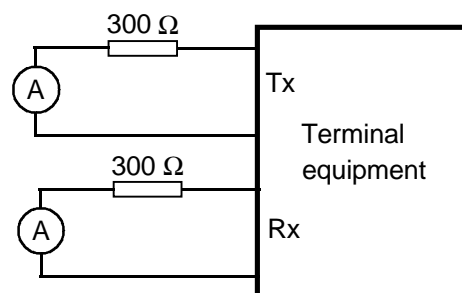
**Figure A.10: Power feeding test for 2 wire TE****Figure A.11: Power feeding test for 4 wire TE****Interface state:**

- powered.

Stimulus:

- none.

Monitor:

- the current through a resistance of 300 Ω after 5 s.

Result:

- the current through 300 Ω shall be less than 1 mA.

A.4.4 Automatically repeated call attempts

- **Requirement:** clause 4.4;
- **Purpose:** to check that the TE complies with clause 4.4.

Measurement principle:

- **Preamble:** set TE for automatic repeat call attempts to the same number. Set number of repeat call attempts to the maximum. Put TE in quiescent state;
- **Test state:** alternates between DTMF dialling, loop state and quiescent state.

Test configuration:

Figure A.12: Automatic repeated call attempts configuration

DC feeding arrangement:

- feed voltage: 50 V. Feed resistance: 850 Ω .

AC termination of TE:

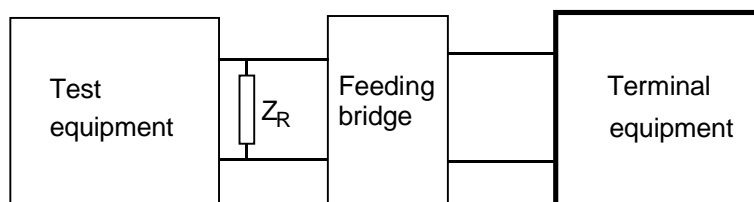
- Z_R .

Measurement execution:

- cause TE to dial out without subsequent successful connection. Monitor TE line terminals. Measure the duration of the shortest interval (t) between transition to the quiescent state and the loop state for the next automatically initiated, internally generated call attempt. Record the number of repeated call attempts.

Formal processing:

- none.

Verdict:

- if the interval (t) is greater than or equal to 5 s and if there is no more than 15 repeated call attempts in a call attempt sequence or if the TE does not make any repeated call attempt in the duration of the test then Pass; else Fail.

Guidance:

- if the interval between call attempts is user adjustable then it shall be set to the minimum interval in accordance with supplier's instructions.

Annex B (informative): Requirements Table (RT)

Notwithstanding the provisions of the copyright clause related to the text of the present document, ETSI grants that users of the present document may freely reproduce the RT proforma in this annex so that it can be used for its intended purposes and may further publish the completed RT.
--

B.1 Guidance for completion of the RT

B.1.1 Condition table

For the requirements, there is a table of condition questions.

The Reference column contains references in the form C.x where:

- C: means Condition;
- x: uniquely identifies the element of the table.

The Condition column contains a question, the answer to which determines whether the corresponding requirement(s) in the Requirements Table shall be mandatory.

The Status column identifies whether a "Yes" or "No" answer causes relevant requirements to be mandatory for the TE. The following codes are used:

- M: means that the relevant requirements are mandatory;
- N: means that the relevant requirements are not applicable.

The Support column is blank for the user to complete.

B.1.2 Requirements table

The Number column provides a unique identifier to each requirement.

The Reference column lists the clause reference in the present document where the requirement may be found.

The Requirement column gives the clause title of the relevant clause, supplemented by any additional information necessary to identify the requirement.

The Status column contains one of the following items:

- M: means that the requirement is mandatory;
- C.x: means that the requirement is mandatory if the relevant condition is met.

In some cases, two or more Conditions are included in the status column. The requirement shall be mandatory if the Boolean combination of them is true.

The Support column is blank for the user to complete.

Table B.1: Condition table

Reference	Condition	Status	Support (Y/N)	Comment
C.1.	Is the TE intended for 2-wire analogue leased lines?	If YES then M else N		
C.2.	Is the TE intended for 4-wire analogue leased lines?	If YES then M else N		
C.3.	Is the TE intended the connection to the PSTN	If YES then M else N		
C.4.	Is the TE intended to have a connection to earth?	If YES then M else N		
C.5.	Is the TE intended to be in loop state?	If YES then M else N		
C.6.	Is the TE intended for call answer?	If YES then M else N		
C.7.	Is the TE intended for call set-up?	If YES then M else N		
C.8.	Is the TE intended for dialling with DTMF?	If YES then M else N		
C.9.	Is the TE intended for automatic dialling with dial tone detection?	If YES then M else N		
C.10.	Is the TE intended for use in receiving mode?	If YES then M else N		
C.11.	Is the TE intended for use in transmitting mode?	If YES then M else N		
C.12.	Is the TE only intended to function on lines that provide more than 18mA of line current?	If YES then M else N		The test resistance of 2 800 Ω shall be replaced by 2 300 Ω
C.13.	Is the TE intended for making internally generated automatically repeated call attempts?	If YES then M else N		

Table B.2: Requirements table

No.	Reference	Requirement	Status	Support (Y/N)
R.1.	4.1.1	Impedance unbalance about earth - quiescent state	C.4	
R.2.	4.1.2.1	Longitudinal Conversion Loss	C.4 and C.5 and C.10	
R.3.	4.1.2.2	Output Signal Balance	C.4 and C.5 and C.11	
R.4.	4.2.1	Mean sending level	C.5 or C.10 or C.11	
R.5.	4.2.2	Instantaneous voltage	C.5 or C.10 or C.11	
R.6.	4.2.3	Sending level in a 10 Hz bandwidth	C.5 or C.10 or C.11	
R.7.	4.2.4	Sending level between 4,3 kHz and 200kHz	C.5 or C.10 or C.11	
R.8.	4.2.5	Sending level between 200 kHz and 30MHz	C.5 or C.10 or C.11	
R.9.	4.3	Power feeding limitations	M	
R.10.	4.4	Automatically repeated call attempts	C.13	

History

Document history		
V1.1.1	August 2003	Publication (Withdrawn)
V1.1.2	September 2003	Publication
V1.2.1	May 2004	Publication
V1.2.2	November 2004	Publication