

ETSI TS 102 221 V7.8.0 (2007-02)

Technical Specification

Smart Cards; UICC-Terminal interface; Physical and logical characteristics (Release 7)



Reference

RTS/SCP-T0266r8

Keywords

smart card

ETSI

650 Route des Lucioles
F-06921 Sophia Antipolis Cedex - FRANCE

Tel.: +33 4 92 94 42 00 Fax: +33 4 93 65 47 16

Siret N° 348 623 562 00017 - NAF 742 C
Association à but non lucratif enregistrée à la
Sous-Préfecture de Grasse (06) N° 7803/88

Important notice

Individual copies of the present document can be downloaded from:

<http://www.etsi.org>

The present document may be made available in more than one electronic version or in print. In any case of existing or perceived difference in contents between such versions, the reference version is the Portable Document Format (PDF). In case of dispute, the reference shall be the printing on ETSI printers of the PDF version kept on a specific network drive within ETSI Secretariat.

Users of the present document should be aware that the document may be subject to revision or change of status. Information on the current status of this and other ETSI documents is available at

<http://portal.etsi.org/tb/status/status.asp>

If you find errors in the present document, please send your comment to one of the following services:

http://portal.etsi.org/chaicor/ETSI_support.asp

Copyright Notification

No part may be reproduced except as authorized by written permission.
The copyright and the foregoing restriction extend to reproduction in all media.

© European Telecommunications Standards Institute 2007.
All rights reserved.

DECTTM, **PLUGTESTS**TM and **UMTS**TM are Trade Marks of ETSI registered for the benefit of its Members.
TIPHONTM and the **TIPHON logo** are Trade Marks currently being registered by ETSI for the benefit of its Members.
3GPPTM is a Trade Mark of ETSI registered for the benefit of its Members and of the 3GPP Organizational Partners.

Contents

Intellectual Property Rights	10
Foreword.....	10
Introduction	10
1 Scope	11
2 References	11
3 Definitions, symbols, abbreviations and coding conventions	12
3.1 Definitions	12
3.2 Symbols.....	14
3.3 Abbreviations	14
3.4 Coding conventions	16
4 Physical characteristics.....	16
4.1 ID-1 UICC.....	16
4.2 Plug-in UICC.....	17
4.3 Mini-UICC	17
4.4 Environmental conditions for card operation and storage	18
4.4.1 Specific UICC environmental conditions	18
4.4.1.1 Temperature range for specific UICC environmental conditions.....	18
4.4.1.2 High humidity	19
4.5 Contacts.....	19
4.5.1 Provision of contacts.....	19
4.5.1.1 Terminal.....	19
4.5.1.2 UICC	19
4.5.2 Contact activation and deactivation	19
4.5.3 Inactive contacts	19
4.5.4 Contact pressure.....	20
5 Electrical specifications of the UICC - Terminal interface	20
5.1 Class A operating conditions.....	20
5.1.1 Supply voltage Vcc (contact C1)	20
5.1.2 Reset (RST) (contact C2).....	21
5.1.3 Programming voltage Vpp (contact C6)	21
5.1.4 Clock CLK (contact C3).....	21
5.1.5 I/O (contact C7)	22
5.2 Class B operating conditions	22
5.2.1 Supply voltage Vcc (contact C1)	22
5.2.2 Reset (RST) (contact C2).....	22
5.2.3 Clock CLK (contact C3).....	23
5.2.4 I/O (contact C7)	23
5.3 Class C operating conditions	24
5.3.1 Supply voltage Vcc (contact C1)	24
5.3.2 Reset (RST) (contact C2).....	24
5.3.3 Clock CLK (contact C3).....	24
5.3.4 I/O (contact C7)	25
6 Initial communication establishment procedures	25
6.1 UICC activation and deactivation.....	25
6.2 Supply voltage switching	25
6.2.1 Supply voltage classes	26
6.2.2 Power consumption of the UICC during ATR.....	26
6.2.3 Application related electrical parameters.....	26
6.3 Answer To Reset content	27
6.3.1 Coding of historical bytes	27
6.3.2 Speed enhancement.....	28
6.3.3 Global Interface bytes	28

6.4	PPS procedure	28
6.5	Reset procedures	29
6.5.1	Cold reset	29
6.5.2	Warm reset	29
6.5.3	Reaction to resets	29
6.6	Clock stop mode	29
6.7	Bit/character duration and sampling time	29
6.8	Error handling	30
6.9	Compatibility	30
7	Transmission protocols	30
7.1	Physical layer	31
7.2	Data link layer	31
7.2.1	Character frame	32
7.2.1.1	Low impedance I/O line behaviour	32
7.2.2	Transmission protocol T = T = 0	33
7.2.2.1	Timing and specific options for characters in T = T = 0	33
7.2.2.2	Command header	33
7.2.2.3	Command processing	33
7.2.2.3.1	Procedure bytes	33
7.2.2.3.2	Status bytes	34
7.2.2.4	Error detection and correction	34
7.2.3	Transmission protocol T = T = 1	34
7.2.3.1	Timing and specific options for blocks sent with T = T = 1	35
7.2.3.1.1	Information field size	35
7.2.3.1.2	Character waiting integer	35
7.2.3.1.3	Character waiting time	35
7.2.3.1.4	Block waiting time	35
7.2.3.1.5	Block guard time	35
7.2.3.1.6	Waiting time extension	36
7.2.3.1.7	Error detection code	36
7.2.3.2	Block frame structure	36
7.2.3.2.1	Prologue field	36
7.2.3.2.2	Epilogue field	38
7.2.3.2.3	Block notations	38
7.2.3.3	Error free operation	38
7.2.3.4	Error handling for T = T = 1	39
7.2.3.4.1	Protocol initialization	39
7.2.3.4.2	Block dependent errors	39
7.2.3.5	Chaining	40
7.2.3.5.1	Rules for chaining	40
7.3	Transport layer	40
7.3.1	Transportation of an APDU using T = 0	40
7.3.1.1	Mapping of APDUs to TPDUs	41
7.3.1.1.1	Case 1	41
7.3.1.1.2	Case 2	42
7.3.1.1.3	Case 3	42
7.3.1.1.4	Case 4	43
7.3.1.1.5	Use of procedure bytes '61xx' and '6Cxx'	44
7.3.2	Transportation of a APDU using T = 1	45
7.3.2.1	Case 1	45
7.3.2.2	Case 2	45
7.3.2.3	Case 3	46
7.3.2.4	Case 4	46
7.4	Application layer	46
7.4.1	Exchange of APDUs	47
7.4.2	CAT layer	47
7.4.2.1	Proactive command	47
7.4.2.2	ENVELOPE Commands	48
8	Application and file structure	49
8.1	UICC application structure	49

8.2	File types	49
8.2.1	Dedicated files	49
8.2.2	Elementary files	50
8.2.2.1	Transparent EF	50
8.2.2.2	Linear fixed EF	50
8.2.2.3	Cyclic EF	50
8.2.2.4	BER-TLV structure EF	51
8.3	File referencing	51
8.4	Methods for selecting a file	51
8.4.1	SELECT by File Identifier referencing	52
8.4.2	SELECT by path referencing	53
8.4.3	Short File Identifier (SFI)	54
8.5	Application characteristics	54
8.5.1	Explicit application selection	54
8.5.1.1	SELECT by DF name	54
8.5.1.2	SELECT by partial DF name	55
8.5.2	Application session activation	55
8.5.3	Application session termination	55
8.5.4	Application session reset	56
8.5.5	Void	56
8.6	Reservation of file IDs	56
8.7	Logical channels	57
8.8	Shareable versus not-shareable files	58
9	Security features	58
9.1	Supported security features	58
9.2	Security architecture	59
9.2.1	Security attributes	59
9.2.2	Access mode	59
9.2.3	Security condition	59
9.2.4	Access rules	60
9.2.5	Compact format	60
9.2.6	Expanded format	61
9.2.7	Access rule referencing	61
9.3	Security environment	62
9.3.1	Definition of the security environment	62
9.3.2	Logical Channels and Security Environment	63
9.4	PIN definitions	63
9.4.1	Universal PIN	63
9.4.2	Application PIN	63
9.4.3	Local PIN	63
9.4.4	PINs and logical channels	64
9.5	PIN and key reference relation ship	64
9.5.1	Access condition mapping	64
9.5.2	PIN status indication	66
10	Structure of commands and responses	67
10.1	Command APDU structure	67
10.1.1	Coding of Class Byte	67
10.1.2	Coding of Instruction Byte	69
10.1.3	Coding of parameter bytes	69
10.1.4	Coding of Lc byte	69
10.1.5	Coding of data part	69
10.1.6	Coding of Le byte	70
10.2	Response APDU structure	70
10.2.1	Status conditions returned by the UICC	70
10.2.1.1	Normal processing	70
10.2.1.2	Postponed processing	70
10.2.1.3	Warnings	71
10.2.1.4	Execution errors	71
10.2.1.5	Checking errors	71
10.2.1.5.1	Functions in CLA not supported	71

10.2.1.5.2	Command not allowed.....	72
10.2.1.5.3	Wrong parameters	72
10.2.1.6	Application errors	72
10.2.2	Status words of the commands	73
10.3	Logical channels.....	74
11	Commands.....	74
11.1	Generic commands	74
11.1.1	SELECT.....	74
11.1.1.1	Functional description.....	74
11.1.1.2	Command parameters and data	74
11.1.1.3	Response Data.....	75
11.1.1.3.1	Response for MF, DF or ADF	76
11.1.1.3.2	Response for an EF.....	76
11.1.1.4	File control parameters.....	76
11.1.1.4.1	File size.....	76
11.1.1.4.2	Total file size	77
11.1.1.4.3	File Descriptor	77
11.1.1.4.4	File identifier	78
11.1.1.4.5	DF name	78
11.1.1.4.6	Proprietary information	79
11.1.1.4.7	Security attributes	83
11.1.1.4.8	Short file identifier	85
11.1.1.4.9	Life cycle status integer.....	85
11.1.1.4.10	PIN status template DO	85
11.1.2	STATUS	86
11.1.2.1	Functional description.....	86
11.1.2.2	Command parameters.....	86
11.1.3	READ BINARY	87
11.1.3.1	Functional description.....	87
11.1.3.2	Command parameters.....	87
11.1.4	UPDATE BINARY	87
11.1.4.1	Functional parameters	87
11.1.4.2	Command parameters and data	88
11.1.5	READ RECORD	88
11.1.5.1	Functional description.....	88
11.1.5.2	Command parameters.....	89
11.1.6	UPDATE RECORD	89
11.1.6.1	Functional description.....	89
11.1.6.2	Command parameters and data	90
11.1.7	SEARCH RECORD	90
11.1.7.1	Functional description.....	90
11.1.7.2	Command parameters and data	91
11.1.8	INCREASE.....	92
11.1.8.1	Functional description.....	92
11.1.8.2	Command parameters and data	92
11.1.9	VERIFY PIN	93
11.1.9.1	Functional description.....	93
11.1.9.1.1	PIN verification	93
11.1.9.1.2	PIN retry counter	93
11.1.9.2	Void.....	94
11.1.9.3	Command parameters.....	94
11.1.10	CHANGE PIN	94
11.1.10.1	Functional description.....	94
11.1.10.2	Command parameters.....	95
11.1.11	DISABLE PIN	95
11.1.11.1	Functional description.....	95
11.1.11.2	Command parameters.....	96
11.1.12	ENABLE PIN	96
11.1.12.1	Functional description.....	96
11.1.12.2	Command parameters.....	97
11.1.13	UNBLOCK PIN.....	97

11.1.13.1	Functional description.....	97
11.1.13.1.1	PIN unblocking.....	97
11.1.13.1.2	UNBLOCK PIN retry counter.....	98
11.1.13.2	Void.....	98
11.1.13.3	Command parameters.....	98
11.1.14	DEACTIVATE FILE.....	99
11.1.14.1	Functional description.....	99
11.1.14.2	Command parameters.....	99
11.1.15	ACTIVATE FILE.....	99
11.1.15.1	Functional description.....	99
11.1.15.2	Command parameters.....	100
11.1.16	AUTHENTICATE.....	100
11.1.16.1	Functional description.....	100
11.1.16.2	Command parameters and data	101
11.1.17	MANAGE CHANNEL.....	103
11.1.17.1	Functional description.....	103
11.1.17.2	Command parameters and data	103
11.1.18	GET CHALLENGE.....	104
11.1.18.1	Functional description.....	104
11.1.18.2	Command parameters and data	104
11.1.19	TERMINAL CAPABILITY	104
11.1.19.1	Functional description.....	104
11.1.19.2	Command parameters and data	105
11.1.19.2.1	Terminal power supply.....	105
11.1.19.2.2	Extended logical channels terminal support	105
11.2	CAT commands.....	106
11.2.1	TERMINAL PROFILE.....	106
11.2.1.1	Functional description.....	106
11.2.1.2	Command parameters and data	106
11.2.2	ENVELOPE.....	106
11.2.2.1	Functional description.....	106
11.2.2.2	Command parameters and data	106
11.2.3	FETCH.....	107
11.2.3.1	Functional description.....	107
11.2.3.2	Command parameters and data	107
11.2.4	TERMINAL RESPONSE.....	107
11.2.4.1	Functional description.....	107
11.2.4.2	Command parameters and data	108
11.3	Data Oriented commands	108
11.3.1	RETRIEVE DATA	109
11.3.1.1	Functional description.....	109
11.3.1.2	Command parameters and data	110
11.3.2	SET DATA	110
11.3.2.1	Functional description.....	110
11.3.2.2	Command parameters and data	111
12	Transmission oriented commands	112
12.1	T = 0 specific commands.....	112
12.1.1	GET RESPONSE.....	112
12.1.1.1	Functional description.....	112
12.1.1.2	Command parameters.....	112
13	Application independent files.....	113
13.1	EF _{DIR}	113
13.2	EF _{ICCID} (ICC Identification).....	114
13.3	EF _{P_L} (Preferred Languages).....	115
13.4	EF _{ARR} (Access Rule Reference)	115
14	Application independent protocol	116
14.1	File related procedures	116
14.1.1	Reading an EF.....	116
14.1.2	Updating an EF	116

14.1.3	Increasing an EF	116
14.2	PIN related procedures	117
14.2.1	PIN verification	117
14.2.2	PIN value substitution.....	117
14.2.3	PIN disabling	118
14.2.4	PIN enabling	118
14.2.5	PIN unblocking	118
14.3	Application selection procedures	118
14.3.1	Application selection by use of the EF _{DIR} file	118
14.3.2	Direct application selection.....	119
14.3.3	Direct application selection with partial AID	119
14.4	General application related procedures	119
14.4.1	Application session activation	119
14.4.2	UICC application interrogation.....	119
14.4.3	UICC application session termination	119
14.5	Miscellaneous procedures	119
14.5.1	UICC activation	119
14.5.2	UICC presence detection	119
14.5.3	UICC preferred language request	120
14.5.4	UICC logical channels	120
14.6	CAT related procedures.....	120
14.6.1	CAT Initialization procedure	120
14.6.2	Proactive polling	120
14.6.3	Support of commands	120
14.6.4	Support of response codes	120
14.6.5	Independence of applications and CAT tasks	120
14.6.6	Use of BUSY status response	121
14.6.7	Additional processing time	121
Annex A (normative):	UCS2 coding of Alpha fields for files residing on the UICC.....	122
Annex B (informative):	Main states of a UICC	124
Annex C (informative):	APDU protocol transmission examples.....	125
C.1	Exchanges Using T = 0	125
C.1.1	Case 1 command	125
C.1.2	Case 2 command	125
C.1.3	Case 3 command	126
C.1.4	Case 4 command	126
C.1.5	Case 2 commands Using the '61' and '6C' procedure bytes	126
C.1.6	Case 4 command Using the '61' procedure byte	127
C.1.7	Case 4 command with warning condition	127
Annex D (informative):	ATR examples	128
Annex E (informative):	Security attributes mechanisms and examples.....	130
E.1	Coding	130
E.2	Compact format.....	130
E.2.1	AM byte	130
E.2.2	SC byte	130
E.2.3	Examples	131
E.3	Expanded format	131
E.3.1	AM_DO.....	131
E.3.2	SC_DO	131
E.3.3	Access rule referencing	132
E.3.4	Examples	132
Annex F (informative):	Example of contents of EF_{ARR} '2F06'	133

F.1	Sample content of the EF _{ARR}	133
Annex G (informative): Access Rules Referencing (ARR).....		134
G.1	Sample content of EF _{ARR}	134
G.2	Example of access rule referencing with SE ID	137
Annex H (normative): List of SFI Values.....		138
H.1	List of SFI Values at the MF Level	138
Annex I (informative): Resets and modes of operation		139
Annex J (informative): Example of the use of PINs		140
J.1	Application having several ADFs	140
J.2	Two applications with two different security contexts.....	140
Annex K (informative): Examples of the PIN state transition on multi verification capable UICC		141
K.1	PIN state transition on the single logical channel	141
K.2	PIN state transition between logical channels	143
Annex L.1 (informative): Examples of SET DATA and RETRIEVE DATA usage.....		147
Annex L.2 (informative): Examples of RETRIEVE DATA usage with transport protocol T = 0 ...		149
Annex M (informative): Examples of ODD AUTHENTICATE instruction code usage		152
M.1:	Examples of ODD AUTHENTICATE instruction code usage at applicative level.....	152
M.2:	Examples of ODD AUTHENTICATE instruction code usage with transport protocol T = 0.....	153
Annex N (informative): Bibliography		156
Annex O (informative): Change history		157
History		160

Intellectual Property Rights

IPRs essential or potentially essential to the present document may have been declared to ETSI. The information pertaining to these essential IPRs, if any, is publicly available for **ETSI members and non-members**, and can be found in ETSI SR 000 314: "*Intellectual Property Rights (IPRs); Essential, or potentially Essential, IPRs notified to ETSI in respect of ETSI standards*", which is available from the ETSI Secretariat. Latest updates are available on the ETSI Web server (<http://webapp.etsi.org/IPR/home.asp>).

Pursuant to the ETSI IPR Policy, no investigation, including IPR searches, has been carried out by ETSI. No guarantee can be given as to the existence of other IPRs not referenced in ETSI SR 000 314 (or the updates on the ETSI Web server) which are, or may be, or may become, essential to the present document.

Foreword

This Technical Specification (TS) has been produced by ETSI Technical Committee Smart Card Platform (SCP).

It is based on work originally done in the 3GPP in TSG-terminals WG3.

The contents of the present document are subject to continuing work within TC SCP and may change following formal TC SCP approval. If TC SCP modifies the contents of the present document, it will then be republished by ETSI with an identifying change of release date and an increase in version number as follows:

Version x.y.z

where:

- x the first digit:
 - 0 early working draft;
 - 1 presented to TC SCP for information;
 - 2 presented to TC SCP for approval;
 - 3 or greater indicates TC SCP approved document under change control.
- y the second digit is incremented for all changes of substance, i.e. technical enhancements, corrections, updates, etc.
- z the third digit is incremented when editorial only changes have been incorporated in the document.

Introduction

The present document defines a generic Terminal/Integrated Circuit Card (ICC) interface.

The aim of the present document is to ensure interoperability between an ICC and a terminal independently of the respective manufacturer, card issuer or operator. The present document does not define any aspects related to the administrative management phase of the ICC. Any internal technical realization of either the ICC or the terminal is only specified where these are reflected over the interface.

Application specific details for applications residing on an ICC are specified in the respective application specific documents. The Universal Subscriber Identity Module (USIM)-application for 3G telecommunication networks is specified in TS 131 102 [2].

1 Scope

The present document specifies the interface between the UICC and the terminal.

The present document specifies:

- the requirements for the physical characteristics of the UICC;
- the electrical interface between the UICC and the terminal;
- the initial communication establishment and the transport protocols;
- the model which serves as a basis for the logical structure of the UICC;
- the communication commands and the procedures;
- the application independent files and protocols.

The administrative procedures and initial card management are not part of the present document.

2 References

The following documents contain provisions which, through reference in this text, constitute provisions of the present document.

- References are either specific (identified by date of publication and/or edition number or version number) or non-specific.
- For a specific reference, subsequent revisions do not apply.
- For a non-specific reference, the latest version applies.

Referenced documents which are not found to be publicly available in the expected location might be found at <http://docbox.etsi.org/Reference>.

NOTE: While any hyperlinks included in this clause were valid at the time of publication ETSI cannot guarantee their long term validity.

- [1] ETSI TS 123 038: "Digital cellular telecommunications system (Phase 2+); Universal Mobile Telecommunications System (UMTS); Alphabets and language-specific information (3GPP TS 23.038 version 6.1.0 Release 6)".
- [2] ETSI TS 131 102: "Universal Mobile Telecommunications System (UMTS); Characteristics of the USIM application (3GPP TS 31.102 version 6.9.0 Release 6)".
- [3] ETSI TS 101 220: "Smart Cards; ETSI numbering system for telecommunication application providers (Release 7)".
- [4] ETSI TS 102 223: "Smart Cards; Card Application Toolkit (CAT) (Release 7)".
- [5] ITU-T Recommendation E.118: "The international telecommunication charge card".
- [6] ISO 639 (all parts): "Codes for the representation of names of languages".
- [7] ISO/IEC 7810: "Identification cards - Physical characteristics".
- [8] ISO/IEC 7811-1: "Identification cards - Recording technique - Part 1: Embossing".
- [9] ISO/IEC 7816-1: "Identification cards - Integrated circuit(s) cards with contacts - Part 1: Physical characteristics".

- [10] ISO/IEC 7816-2: "Identification cards - Integrated circuit cards - Part 2: Cards with contacts - Dimensions and location of the contacts".
- [11] ISO/IEC 7816-3: "Identification cards - Integrated circuit cards - Part 3: Cards with contacts - Electrical interface and transmission protocols".
- [12] ISO/IEC 7816-4: "Identification cards - Integrated circuit cards - Part 4: Organization, security and commands for interchange".
- [13] Void.
- [14] Void.
- [15] Void.
- [16] Void.
- [17] ISO/IEC 10646: "Information technology - Universal Multiple-Octet Coded Character Set (UCS)".

3 Definitions, symbols, abbreviations and coding conventions

3.1 Definitions

For the purposes of the present document, the following terms and definitions apply:

1,8 V technology smart card: smart card operating at $1,8\text{ V} \pm 10\%$ and $3\text{ V} \pm 10\%$

1,8 V technology terminal: terminal operating the smart card - terminal interface at $1,8\text{ V} \pm 10\%$ and $3\text{ V} \pm 10\%$

3 V technology smart card: smart card operating at $3\text{ V} \pm 10\%$ and $5\text{ V} \pm 10\%$

3 V technology terminal: terminal operating the smart card - terminal interface at $3\text{ V} \pm 10\%$ and $5\text{ V} \pm 10\%$

access conditions: set of security attributes associated with a file

ADM: access condition to an EF which is under the control of the authority which creates this file

application DF: entry point to an application

application protocol: set of procedures required by the application

application: set of security mechanisms, files, data and protocols (excluding transmission protocols)

NOTE: An application can be a first level application and/or a second level application.

card session: link between the card and the external world starting with the ATR and ending with a subsequent reset or a deactivation of the card

CAT Application Toolkit procedures: see TS 102 223 [4]

channel session: link between the card and the external world during a card session on a given logical channel, starting with the opening of the logical channel and ending with the closure of the logical channel or the termination of the card session

class A operating conditions: terminal or a smart card operating at $5\text{ V} \pm 10\%$

class B operating conditions: terminal or a smart card operating at $3\text{ V} \pm 10\%$

class C operating conditions: terminal or a smart card operating at $1,8\text{ V} \pm 10\%$

current directory: latest MF, DF or ADF selected

current EF: latest EF selected

current file: current EF, if an EF is selected, else the current directory

data object: information coded as TLV objects, i.e. consisting of a Tag, a Length and a Value part

Dedicated File (DF): file containing access conditions and, optionally, Elementary Files (EFs) or other Dedicated Files (DFs)

directory: general term for MF, DF and ADF

Elementary File (EF): file containing access conditions and data and no other files

file identifier: 2 bytes which address a file in the UICC

file: directory or an organized set of bytes or records in the UICC

first level application: selectable application that is indicated in EF_{DIR} under the MF

EXAMPLE: A USIM application.

function: contains a command and a response pair

GSM session: part of the card session dedicated to the GSM operation

ID-1 UICC: UICC having the format of an ID-1 card

NOTE: See ISO/IEC 7816-1 [9].

Lc: length of command data sent by the application layer in a case 3 or 4 Command

Le: maximum length of data expected by the application layer in response to a case 2 or 4 Command

Lr: length of data sent back to the terminal by the UICC in response to a case 2 or 4 Command

Luicc: exact length of data available in the UICC to be returned in response to the case 2 or 4 Command received by the UICC

Master File (MF): unique mandatory file containing access conditions and optionally DFs and/or EFs

Mini-UICC: third format of UICC

multi-application capable terminal: terminal that can support more than one first level application with possibly separate user verification requirements for each application

multi-application card: card that can have more than one selectable application

multi-session card: card that supports more than one concurrent selectable application session during a card session

multi-verification capable UICC: card that can have more than one first level application and may support separate user verification requirements for each application

normal USIM operation: relating to general, PIN related, 3G and or GSM security and subscription related procedures

padding: one or more bits appended to a message in order to cause the message to contain the required number of bits or bytes

plug-in UICC: second format of UICC

proactive UICC: UICC which is capable of issuing commands to the terminal

NOTE: Part of CAT.

record number: number which identifies a record within an EF

record pointer: pointer which addresses one record in an EF

record: string of bytes within an EF handled as a single entity

second level application: application which can only be activated during the session of a first level application

NOTE: A second level application may have an AID. This AID shall not be stored in EF(DIR) unless it is also a first level application.

selectable application session: link between the application and the external world during a card session starting with the application selection and ending with de-selection or termination of the card session

selectable application: application that is selectable by an AID according to the process described in ISO/IEC 7816-4 [12] over the terminal-UICC interface

single verification capable UICC: card that only supports one user verification requirement for all first level applications

state H: high state on the I/O line (Vcc)

state L: low state on the I/O line (Gnd)

transport layer: layer responsible for transporting Secured Packets through the network

type 1 UICC: UICC which always enters the negotiable mode after a warm reset

type 2 UICC: UICC which always enters the specific mode after a warm reset

USIM session: selectable application session for a USIM application

3.2 Symbols

For the purposes of the present document, the following symbols apply:

Gnd	Ground
t_F	Fall time
t_R	Rise time
Vcc	Supply Voltage
V_{IH}	Input Voltage (high)
V_{IL}	Input Voltage (low)
V_{OH}	Output Voltage (high)
V_{OL}	Output Voltage (low)
V_{pp}	Programming Voltage

3.3 Abbreviations

For the purposes of the present document, the following abbreviations apply:

AC	Access Condition
ACK	ACKnowledge
ADF	Application Dedicated File
AID	Application IDentifier
ALW	ALWays
AM	Access Mode
AM-DO	Access Mode - Data Object
APDU	Application Protocol Data Unit
ARR	Access Rule Reference
AT	Authentication Template
ATR	Answer To Reset
BCD	Binary Coded Decimal
BER	Basic Encoding Rules
BER-TLV	Basic encoding rules - tag, length, value
BGT	Block Guard Time
BWT	Block Waiting Time
C-APDU	Command - APDU

CAT	Card Application Toolkit
CCT	Cryptographic Checksum Template
CLA	CLAss
CLK	CLocK
CRT	Control Reference Template
CT	Confidentiality Template
C-TPDU	Command-TPDU
CWI	Character Waiting Integer
CWT	Character Waiting Time
DAD	Destination Address
DER	Distinguished Encoding Rule
DF	Dedicated File
DO	Data Object
DST	Digital Signature Template
EDC	Error Detection Code byte
EF	Elementary File
EF _{DIR}	Elementary File DIRectory
etu	elementary time unit
f	frequency
FCP	File Control Parameters
Fi	clock rate conversion factor
FID	File IDentifier
GSM	Global System for Mobile communications
I/O	Input/Output
I-block	Information-block
ICC	Integrated Circuit Card
ID	IDentifier
IEC	International Electrotechnical Commission
IFS	Information Field Sizes
IFSC	Information Field Size for the UICC
IFSD	Information Field Size for the terminal
INF	INFormation field
INS	INStruction
ISO	International Organization for Standardization
LCSI	Life Cycle Status Information
LEN	LENgth
LRC	Longitudinal Redundancy Check
LSB	Least Significant Bit
ME	Mobile Equipment
MF	Master File
MSB	Most Significant Bit
NAD	Node ADdress byte
NEV	NEVer
OSI	Open System Interconnection
P1	Parameter 1
P2	Parameter 2
P3	Parameter 3
PCB	Protocol Control Byte
PDC	Personal Digital Cellular
PIN	Personal Identification Number
PPS	Protocol and Parameter Selection
PS	PIN Status
PS_DO	PIN Status_Data Object
R-APDU	Response-APDU
R-block	Receive-ready block
RFU	Reserved for Future Use
RST	ReSeT
R-TPDU	Response-TPDU
SAD	Source ADdress
S-block	Supervisory-Block
SC	Security Condition

SC_DO	Security Condition_Data Object
SE	Security Environment
SEID	Security Environment Identifier
SFI	Short (elementary) File Identifier
SIM	Subscriber Identity Module
SM	Secure Message
SMS	Short Message Service
SMS-PP	Short Message Service - Point to Point
TETRA	TErrestrial TRunked RAdio
TLV	Tag Length Value
TPDU	Transfer Protocol Data Unit
UCS2	Universal Character Set 2
UE	User Equipment
UICC	Universal Integrated Circuit Card
USIM	Universal Subscriber Identity Module
VPP	Programming power input, optional use by the card
WI	Waiting time Integer
WTX	Waiting Time eXtension
WWT	Work Waiting Time

3.4 Coding conventions

For the purposes of the present document, the following coding conventions apply:

- all lengths are presented in bytes, unless otherwise stated. Each byte is represented by bits b8 to b1, where b8 is the Most Significant Bit (MSB) and b1 is the Least Significant Bit (LSB). In each representation, the leftmost bit is the MSB.

In the UICC, all bytes specified as RFU shall be set to '00' and all bits specified as RFU shall be set to 0. If the GSM and/or USIM application exists on a UICC or is built on a generic telecommunications card, then other values may apply for the non-GSM or non-USIM applications. The values will be defined in the appropriate specifications for such cards and applications. These bytes and bits shall not be interpreted by a terminal in a GSM or 3G session.

The coding of all data objects in the present document is according to TS 101 220 [3]. All data objects are BER-TLV except if otherwise defined.

4 Physical characteristics

Three physical types of UICCs are currently specified by the present document. These are the "ID-1 UICC", the "Plug-in UICC" and the "Mini-UICC". At least one of the card sizes shall be supported by a terminal that is compliant to the present document.

The physical characteristics of all types of UICCs shall be in accordance with ISO/IEC 7816-1 [9] and ISO/IEC 7816-2 [10] unless otherwise specified by the present document. The following additional requirements shall be applied to ensure correct operation in a Telecom environment.

4.1 ID-1 UICC

The physical characteristics of the ID-1 UICC shall conform to ISO/IEC 7816-1 [9] and ISO/IEC 7816-2 [10].

The terminal shall accept embossed ID-1 UICCs. The embossing shall be in accordance with ISO/IEC 7811-1 [8] and ISO/IEC 7811-3 (see bibliography). The contacts of the ID-1 UICC shall be located on the front (embossed face, see ISO/IEC 7810 [7]) of the card.

4.2 Plug-in UICC

The Plug-in UICC shall have a width of 25 mm, a height of 15 mm, a thickness the same as an ID-1 UICC and a feature for orientation.

Annex A of ISO/IEC 7816-2 [10] applies with the location of the reference points adapted to the smaller size. The three reference points P1, P2 and P3 measure 7,5 mm, 3,3 mm and 20,8 mm, respectively, from 0. The values in figure 2 of ISO/IEC 7816-2 [10] are replaced by the corresponding values of figure 4.1.

The physical characteristics of the Plug-in UICC (Plug-in card) are defined in the present document.

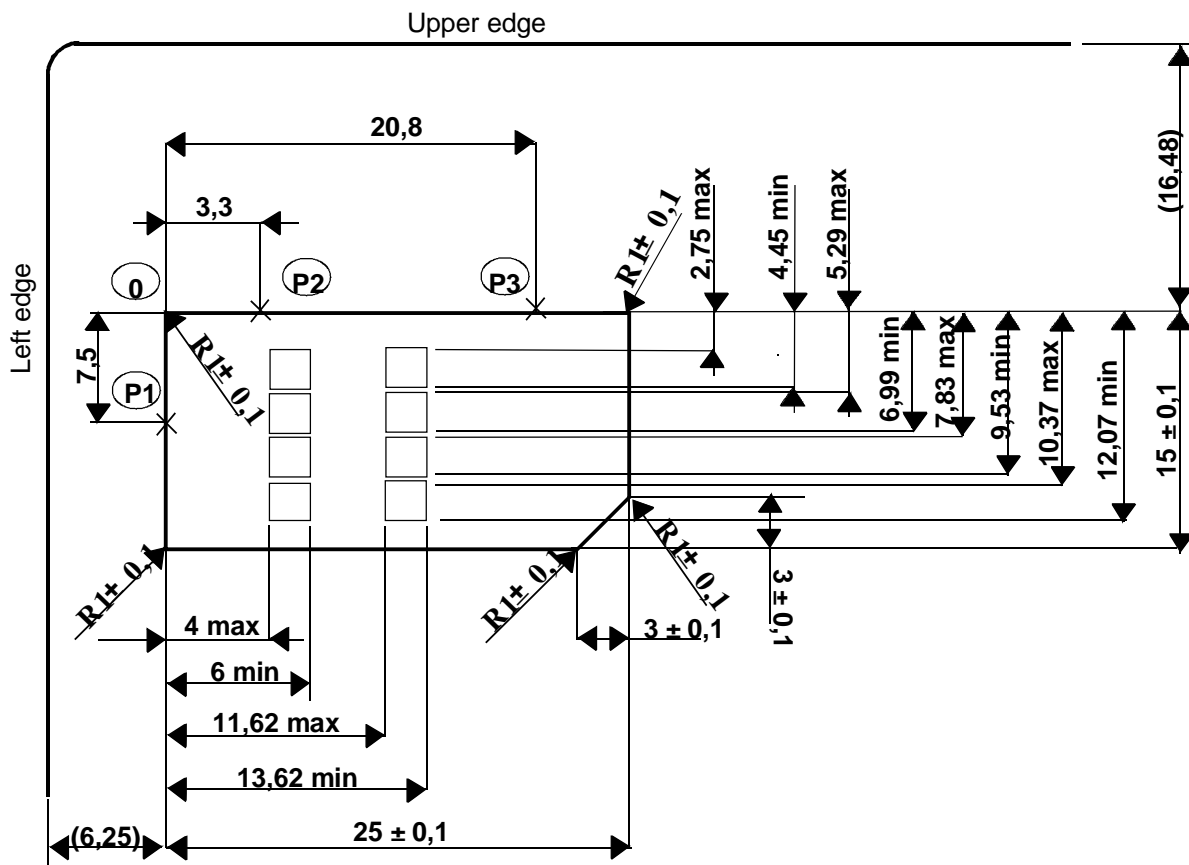

Figure 4.1: Plug-in UICC

4.3 Mini-UICC

The Mini-UICC shall have a width of 15 mm, a height of 12 mm, a thickness the same as an ID-1 UICC and a feature for orientation.

Annex A of ISO/IEC 7816-2 [10] applies with the location of the reference points adapted to the smaller size below figure 4.2. The values in figure 2 of ISO/IEC 7816-2 [10] are replaced by the corresponding values of figure 4.2.

The physical characteristics of the Mini-UICC are defined in the present document.

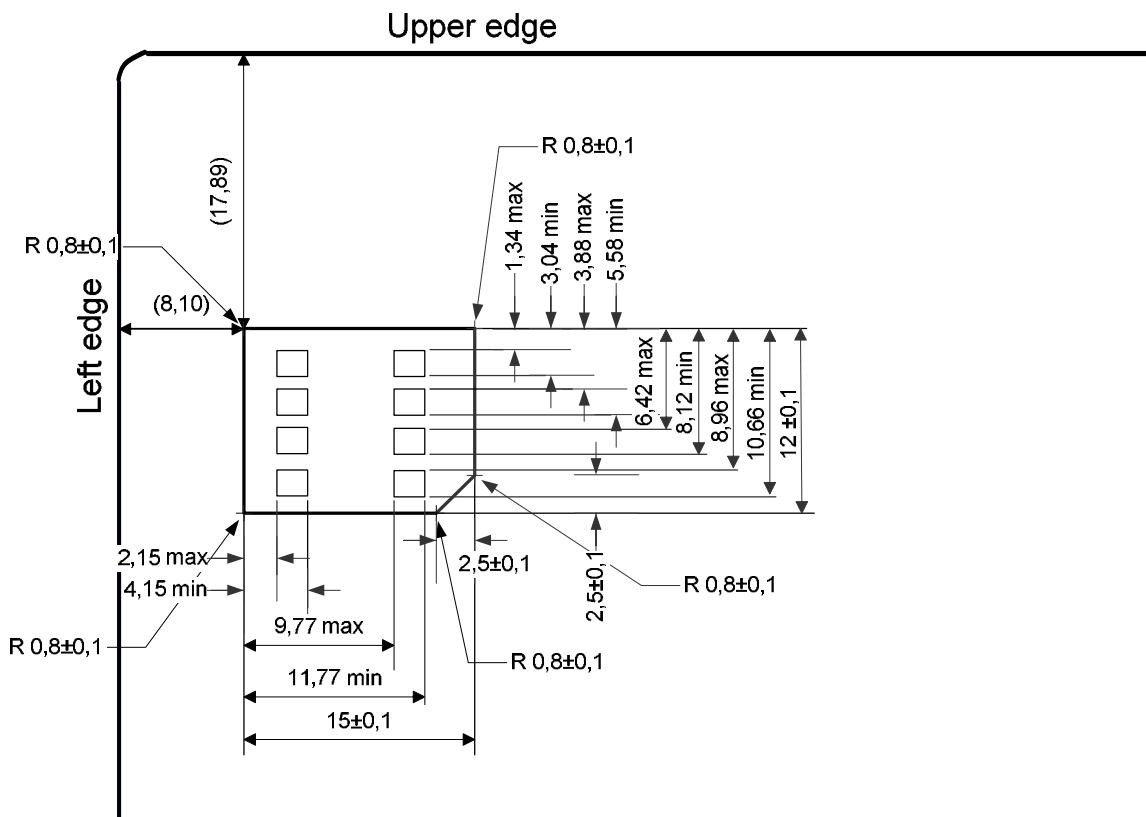

Figure 4.2: Mini-UICC

4.4 Environmental conditions for card operation and storage

The standard temperature range for storage and full operational use shall be between -25°C and +85°C.

4.4.1 Specific UICC environmental conditions

The support of specific UICC environmental conditions is optional for the UICC.

It is up to an application specification to specify the required specific environmental conditions to be supported by the UICC. If an application specification does not specify particular specific UICC environmental conditions then the UICC supports the standard environmental conditions for card operation and storage, as specified in the present document.

If the UICC supports specific environmental conditions, the indication mechanism, as specified in the present document, shall be supported.

4.4.1.1 Temperature range for specific UICC environmental conditions

The support of an extended temperature range is optional for the UICC.

The temperature ranges for full operational use and storage for specific UICC environmental conditions are defined in table 4.1.

Table 4.1: Temperature range for full operational use and storage for specific UICC environmental conditions

Temperature class	range
A	-40°C to +85°C ambient temperature range
B	-40°C to +105°C ambient temperature range
C	-40°C to +125°C ambient temperature range

4.4.1.2 High humidity

The support of the extended humidity condition is optional for the UICC.

A UICC supporting high humidity shall withstand the following equivalent environmental conditions for operation and storage:

- temperature: 85°C,
- relative humidity: from 90 % to 95 %,
- duration: 1 000 hours.

4.5 Contacts

4.5.1 Provision of contacts

4.5.1.1 Terminal

Contacting elements in the terminal in positions C4 and C8 are optional, and are not used by a Telecom application complying with the present document. They shall present a high impedance to the UICC. If it is determined that the UICC is a multi-application UICC, then these contacts may be used. Contact C6 need not be provided for Plug-in/Mini-UICC cards or any card if the terminal does not support class A operating conditions (see ISO/IEC 7816-3 [11]). If present, C6 shall present a high impedance to the UICC.

4.5.1.2 UICC

Contacts C4 and C8 need not be provided by the UICC. If provided, they shall not be connected internally in the UICC if the UICC only contains a Telecom application. Contact C6 shall not be bonded in the UICC for any function other than supplying Vpp. Contact C6 on a UICC not supporting class A operating conditions is RFU, see ISO/IEC 7816-3 [11].

4.5.2 Contact activation and deactivation

The terminal shall connect, activate and deactivate the UICC in accordance with the operating procedures specified in ISO/IEC 7816-3 [11].

For any voltage level, monitored during the activation sequence, or during the deactivation sequence following normal power-down, the order of the contact activation/deactivation shall be respected.

It is recommended that whenever possible, the deactivation sequence defined in ISO/IEC 7816-3 [11] should be followed by the terminal on all occasions when the terminal is powered down.

If the UICC clock is already stopped and is not restarted, the terminal may deactivate all the contacts in any order, provided that all signals reach low level before Vcc leaves high level. If the UICC clock is already stopped and is restarted before the deactivation sequence, then the deactivation sequence specified in ISO/IEC 7816-3 [11], clause 5.4 shall be followed.

When Vpp is connected to Vcc, as allowed in the present document for terminals supporting class A operation conditions only, then Vpp shall be activated and deactivated with Vcc, at the time of the Vcc activation/deactivation, as specified in the sequences of ISO/IEC 7816-3 [11], clauses 5.2 and 5.4.

4.5.3 Inactive contacts

The voltages on contacts C1, C2, C3, C6 and C7 of the terminal shall be in the range $0\text{ V} \pm 0,4\text{ V}$ referenced to ground (C5) when the terminal is switched off with the power source connected to the terminal. The measurement equipment shall have a resistance of 50 k Ω when measuring the voltage on C2, C3, C6 and C7. The resistance shall be 10 k Ω when measuring the voltage on C1.

4.5.4 Contact pressure

The contact pressure shall be large enough to ensure reliable and continuous contact (e.g. to overcome oxidization and to prevent interruption caused by vibration). The radius of any curvature of the contacting elements shall be greater than or equal to 0,8 mm over the contact area.

Under no circumstances shall the contact force exceed 0,5 N per contact.

Care shall be taken to avoid undue point pressure to the area of the UICC opposite to the contact area. Such pressure is potentially damaging to the components within the UICC.

5 Electrical specifications of the UICC - Terminal interface

The electrical specification in the present document covers the supply voltage range from 4,5 V to 5,5 V, 2,7 V to 3,3 V and 1,62 V to 1,98 V. For each state (V_{OH} , V_{IH} , V_{IL} and V_{OL}), a positive current is defined as flowing out of the entity (terminal or UICC) in that state. V_{pp} shall not be supported by the 3 V and 1,8 V technology terminal or the 3 V and 1,8 V technology UICC.

There are two states for the UICC while the power supply is on:

- the UICC is in operating state when it executes a command. This state also includes transmission of the command from the terminal, executing the command and sending the response back to the terminal;
- the UICC is in idle state at any other time. It shall retain all pertinent data during this state. In idle state, the clock may be stopped according to clause 6.6.

The clock duty cycle shall be between 40 % and 60 % of the period during stable operation. A clock cycle is defined at 50 % of V_{cc} from rising to rising edge or falling to falling edge. When switching clock frequencies terminals shall ensure that no pulse is shorter than 80 ns which is 40 % of the shortest allowed period.

When low impedance drivers are implemented on the I/O line, the I/O electrical circuit design shall insure that potential contention on the line will not result in any permanent damage of the terminal or the UICC. The terminal shall reduce the short circuit current on the I/O line by the means of a series resistor, the value shall be in the range of 47 Ω to 100 Ω .

5.1 Class A operating conditions

5.1.1 Supply voltage V_{cc} (contact C1)

The terminal shall operate the UICC within the following limits.

Table 5.1: Electrical characteristics of V_{cc} under normal operating conditions

Symbol	Minimum	Maximum	Unit
V_{cc}	4,5	5,5	V

The current consumption of the UICC shall not exceed the value given in the tables in clause 6.2.2 during the ATR (including activation and deactivation).

When the UICC is in idle state (see below) the current consumption of the card shall not exceed 200 μ A at 1 MHz and 25°C. If clock stop mode is enabled, then the current consumption shall also not exceed 200 μ A while the clock is stopped.

The terminal shall source the maximum current requirements defined above. It shall also be able to counteract spikes in the current consumption of the card up to a maximum charge of 40 nAs with no more than 400 ns duration and amplitude of at most 200 mA, ensuring that the supply voltage stays in the specified range.

NOTE: A possible solution would be to place a capacitor (e.g. 100 nF, ceramic) as close as possible to the contacting elements.

5.1.2 Reset (RST) (contact C2)

The terminal shall operate the UICC within the following limits.

Table 5.2: Electrical characteristics of RST under normal operating conditions

Symbol	Conditions	Minimum	Maximum	Unit
V_{OH}	$I_{OHmax} = +20 \mu A$	$V_{cc} - 0,7$	V_{cc} (see note)	V
V_{OL}	$I_{OLmax} = -200 \mu A$	0 (see note)	0,6	V
$t_R t_F$	$C_{out} = C_{in} = 30 pF$		400	μs
NOTE: To allow for overshoot, the voltage on RST shall remain between -0,3 V and $V_{cc} + 0,3$ V during dynamic operation.				

5.1.3 Programming voltage V_{pp} (contact C6)

The UICC shall not require any programming voltage on V_{pp} . The terminal need not provide contact C6. If the terminal provides contact C6, then, in the case the terminal supports an ID-1 UICC under class A operating conditions only, the same voltage shall be supplied on V_{pp} as on V_{cc} , while in the case of Plug-in UICC/Mini-UICC the terminal need not provide any voltage on C6. Contact C6 may be connected to V_{cc} in any terminal supporting only class A operating conditions but shall not be connected to ground.

5.1.4 Clock CLK (contact C3)

The terminal shall support 1 MHz to 5 MHz. The terminal shall supply the clock. No "internal clock" UICC shall be used.

The duty cycle shall be between 40 % and 60 % of the period during stable operation.

The terminal shall operate the UICC within the following limits.

Table 5.3: Electrical characteristics of CLK under normal operating conditions

Symbol	Conditions	Minimum	Maximum	Unit
V_{OH}	$I_{OHmax} = +20 \mu A$	$0,7 \times V_{cc}$	V_{cc} (see note)	V
V_{OL}	$I_{OLmax} = -200 \mu A$	0 (see note)	0,5	V
$t_R t_F$	$C_{out} = C_{in} = 30 pF$		9 % of period with a maximum of 0,5 μs	
NOTE: To allow for overshoot the voltage on CLK shall remain between -0,3 V and $V_{cc} + 0,3$ V during dynamic operation.				

5.1.5 I/O (contact C7)

Table 5.4 defines the electrical characteristics of the I/O (contact C7). The values given in the table allow the derivation of the values of the pull-up resistor in the terminal and the impedance of the drivers and receivers in the terminal and UICC.

Table 5.4: Electrical characteristics of I/O under normal operating conditions

Symbol	Conditions	Minimum	Maximum	Unit
V_{IH}	$I_{IHmax} = \pm 20 \mu A$ (see note 2)	$0,7 \times V_{CC}$	$V_{CC} + 0,3$	V
V_{IL}	$I_{ILmax} = +1 \text{ mA}$	-0,3	$0,15 \times V_{CC}$	V
V_{OH} (see note 1)	$I_{OHmax} = +20 \mu A$	3,8	V_{CC} (see note 3)	V
V_{OL}	$I_{OLmax} = -1 \text{ mA}$	0 (see note 3)	0,4	V
t_R t_F	$C_{out} = C_{in} = 30 \text{ pF}$		1 100 (see note 4)	μs ns

NOTE 1: It is assumed that a pull-up resistor is used in the interface device (recommended value: 20 k Ω).

NOTE 2: During static conditions (idle state) only the positive value can apply. Under dynamic operating conditions (transmission) short-term voltage spikes on the I/O line may cause a current reversal.

NOTE 3: To allow for overshoot the voltage on I/O shall remain between -0,3 V and $V_{CC} + 0,3 \text{ V}$ during dynamic operation.

NOTE 4: This value applies when the low impedance buffer is selected.

5.2 Class B operating conditions

5.2.1 Supply voltage V_{CC} (contact C1)

The terminal shall operate the UICC within the following limits.

Table 5.5: Electrical characteristics of V_{CC} under normal operating conditions

Symbol	Minimum	Maximum	Unit
V_{CC}	2,7	3,3	V

When the UICC is in idle state, the current consumption shall not exceed 200 μA at 1 MHz at +25°C. When the UICC is in clock stop mode, the current consumption shall not exceed 100 μA at +25°C.

The terminal shall be capable of sourcing the maximum current as defined in table 6.4. It shall also be able to counteract spikes in the current consumption of the card up to a maximum charge of 12 nAs with no more than 400 ns duration and an amplitude of at most 60 mA, ensuring that the supply voltage stays in the specified range.

5.2.2 Reset (RST) (contact C2)

The terminal shall operate the UICC within the following limits.

Table 5.6: Electrical characteristics of RESET (RST) under normal operating conditions

Symbol	Conditions	Minimum	Maximum	Unit
V_{OH}	$I_{OHmax} = +20 \mu A$	$0,8 \times V_{CC}$	V_{CC} (see note)	V
V_{OL}	$I_{OLmax} = -200 \mu A$	0 (see note)	$0,2 \times V_{CC}$	V
t_R t_F	$C_{in} = C_{out} = 30 \text{ pF}$		400	μs

NOTE: To allow for overshoot the voltage on RST should remain between -0,3 V and $V_{CC} + 0,3 \text{ V}$ during dynamic operations.

5.2.3 Clock CLK (contact C3)

The terminal shall support 1 MHz to 5 MHz. The terminal shall supply the clock. No "internal clock" UICC shall be used.

The duty cycle shall be between 40 % and 60 % of the period during stable operation.

The terminal shall operate the UICC within the following limits.

Table 5.7: Electrical characteristics of Clock (CLK) under normal operating conditions

Symbol	Conditions	Minimum	Maximum	Unit
V_{OH}	$I_{OHmax} = +20 \mu A$	$0,7 \times V_{cc}$	V_{cc} (see note)	V
V_{OL}	$I_{OLmax} = -20 \mu A$	0 (see note)	$0,2 \times V_{cc}$	V
t_R t_F	$C_{in} = C_{out} = 30 \text{ pF}$		50	ns
NOTE: To allow for overshoot the voltage on CLK should remain between -0,3 V and $V_{cc} + 0,3 \text{ V}$ during dynamic operations.				

5.2.4 I/O (contact C7)

Table 5.8 defines the electrical characteristics of the I/O (contact C7). The values given in the table allow the derivation of the values of the pull-up resistor in the terminal and the impedance of the drivers and receivers in the terminal and UICC.

Table 5.8: Electrical characteristics of I/O under normal operating conditions

Symbol	Conditions	Minimum	Maximum	Unit
V_{IH}	$I_{IHmax} = \pm 20 \mu A$ (see note 2)	$0,7 \times V_{cc}$	$V_{cc} + 0,3$	V
V_{IL}	$I_{ILmax} = +1 \text{ mA}$	-0,3	$0,2 \times V_{cc}$	V
V_{OH} (see note 1)	$I_{OHmax} = +20 \mu A$	$0,7 \times V_{cc}$	V_{cc} (see note 3)	V
V_{OL}	$I_{OLmax} = -1 \text{ mA}$	0 (see note 3)	0,4	V
t_R t_F	$C_{in} = C_{out} = 30 \text{ pF}$		1 100 (see note 4)	μs ns
NOTE 1: It is assumed that a pull-up resistor is used on the interface device (recommended value: 20 k Ω).				
NOTE 2: During static conditions (idle state) only the positive value can apply. Under dynamic operating conditions (transmissions) short-term voltage spikes on the I/O line may cause a current reversal.				
NOTE 3: To allow for overshoot the voltage on I/O shall remain between -0,3 V and $V_{cc} + 0,3 \text{ V}$ during dynamic operation.				
NOTE 4: This value applies when the low impedance buffer is selected.				

5.3 Class C operating conditions

5.3.1 Supply voltage Vcc (contact C1)

The terminal shall operate the UICC within the following limits.

Table 5.9: Electrical characteristics of Vcc under normal operating conditions

Symbol	Minimum	Maximum	Unit
Vcc	1,62	1,98	V

When the UICC is in idle state, the current consumption shall not exceed 200 μA at 1 MHz at +25°C. When the UICC is in clock stop mode, the current consumption shall not exceed 100 μA at +25°C.

The terminal shall be capable of sourcing the maximum current as defined in table 6.4. It shall also be able to counteract spikes in the current consumption of the card up to a maximum charge of 12 nAs with no more than 400 ns duration and an amplitude of at most 60 mA, ensuring that the supply voltage stays in the specified range.

5.3.2 Reset (RST) (contact C2)

The terminal shall operate the UICC within the following limits.

Table 5.10: Electrical characteristics of RESET (RST) under normal operating conditions

Symbol	Conditions	Minimum	Maximum	Unit
V _{OH}	I _{OHmax} = +20 μA	0,8 x Vcc	Vcc (see note)	V
V _{OL}	I _{OLmax} = -200 μA	0 (see note)	0,2 x Vcc	V
t _R t _F	C _{in} = C _{out} = 30 pF		400	μs

NOTE: To allow for overshoot the voltage on RST should remain between -0,3 V and Vcc + 0,3 V during dynamic operations.

5.3.3 Clock CLK (contact C3)

The terminal shall support 1 MHz to 5 MHz. The terminal shall supply the clock. No "internal clock" UICC shall be used.

The duty cycle shall be between 40 % and 60 % of the period during stable operation.

The terminal shall operate the UICC within the following limits.

Table 5.11: Electrical characteristics of Clock (CLK) under normal operating conditions

Symbol	Conditions	Minimum	Maximum	Unit
V _{OH}	I _{OHmax} = +20 μA	0,7 x Vcc	Vcc (see note)	V
V _{OL}	I _{OLmax} = -20 μA	0 (see note)	0,2 x Vcc	V
t _R t _F	C _{in} = C _{out} = 30 pF		50	ns

NOTE: To allow for overshoot the voltage on CLK should remain between -0,3 V and Vcc + 0,3 V during dynamic operations.

5.3.4 I/O (contact C7)

Table 5.12 defines the electrical characteristics of the I/O (contact C7). The values given in the table allow the derivation of the values of the pull-up resistor in the terminal and the impedance of the drivers and receivers in the terminal and UICC.

Table 5.12: Electrical characteristics of I/O under normal operating conditions

Symbol	Conditions	Minimum	Maximum	Unit
V_{IH}	$I_{IHmax} = \pm 20 \mu A$ (see note 2)	$0,7 \times V_{cc}$	$V_{cc} + 0,3$	V
V_{IL}	$I_{ILmax} = +1 \text{ mA}$	-0,3	$0,2 \times V_{cc}$	V
V_{OH} (see note 1)	$I_{OHmax} = +20 \mu A$	$0,7 \times V_{cc}$	V_{cc} (see note 3)	V
V_{OL}	$I_{OLmax} = -1 \text{ mA}$	0 (see note 3)	0,3	V
t_R t_F	$C_{in} = C_{out} = 30 \text{ pF}$		1 100 (see note 4)	μs ns

NOTE 1: It is assumed that a pull-up resistor is used on the interface device (recommended value: 20 k Ω).

NOTE 2: During static conditions (idle state) only the positive value can apply. Under dynamic operating conditions (transmissions) short-term voltage spikes on the I/O line may cause a current reversal.

NOTE 3: To allow for overshoot the voltage on I/O shall remain between -0,3 V and $V_{cc} + 0,3$ V during dynamic operation.

NOTE 4: This value applies when the low impedance buffer is selected.

6 Initial communication establishment procedures

6.1 UICC activation and deactivation

The terminal shall activate and deactivate the contacts of the UICC according to clause 4.4.2. During activation supply voltage switching, as defined in clause 6.2, shall take place prior to any further activity not related to the supply voltage switching.

6.2 Supply voltage switching

The terminal shall initially activate the UICC with the lowest voltage class available. If no ATR is received, the UICC shall be deactivated and activated with the next higher class, if supported by the terminal. If an ATR is received at the first applied voltage class, the contents of the ATR shall be analysed by the terminal. If the operating class used by the terminal is not supported by the UICC, the terminal shall deactivate the UICC and activate it with a supply voltage class indicated by the UICC. If the ATR is corrupted, the terminal shall perform the procedure at least 3 times using the same operating class before rejecting the UICC. In case of 3 consecutive corrupted ATRs, the terminal may activate the UICC with the next higher class. The terminal is restricted not to use but the next higher class in the retrieval attempt in this case.

6.2.1 Supply voltage classes

The supply voltage class shall be indicated in the ATR by the UICC (TA_i , $i > 2$).

Table 6.1: Supply voltage classes indicated in ATR

Symbol	Minimum	Maximum	Unit	Class	Encoding (Binary)
Vcc	4,5	5,5	V	A	xx xxx1
Vcc	2,7	3,3	V	B	xx xx1x
Vcc	1,62	1,98	V	C	xx x1xx
Vcc	RFU	RFU	V	D	xx 1xxx
Vcc	RFU	RFU	V	E	x1 xxxxx

NOTE: Class A and B values are according to ISO/IEC 7816-3 [11]. Class C and D are a further evolution of values specified in ISO/IEC 7816-3 [11]. It is possible to support a range of classes. The support shall be consecutive e.g. AB, BC. A combination like AC is not allowed.

6.2.2 Power consumption of the UICC during ATR

The maximum power consumption of the UICC during ATR is specified in tables 6.2a and 6.2b. The UICC power consumption during the ATR shall conform to the voltage class indicated in the ATR. If the UICC supports several supply voltage classes, each class shall conform to the corresponding maximum ATR power consumption, as specified in tables 6.2a and 6.2b. This is required because the terminal is not aware of the power consumption of the UICC until the ATR is received and an application is selected.

Table 6.2a: Power consumption that applies during ATR at maximum external clock frequency

Symbol	Voltage Class	Maximum	Unit
lcc	A	10	mA
lcc	B	7,5	mA
lcc	C	5	mA
lcc	D	RFU	mA
lcc	E	RFU	mA

Table 6.2b: Power consumption that applies during ATR at 4 MHz

Symbol	Voltage Class	Maximum	Unit
lcc	B	6	mA
lcc	C	4	mA
lcc	D	RFU	mA
lcc	E	RFU	mA

NOTE: 4 MHz is the maximum clock speed specified in GSM for 3 V and below.

6.2.3 Application related electrical parameters

The power consumption of a UICC depends upon the operating conditions and the application it is running. The power consumption of the UICC is restricted to the values indicated in tables 6.2a and 6.2b until an application is selected. An application is considered selected when the access condition is successfully verified. If no access condition is required for the application, the application is considered selected when an application related command is executed within the selected application. Selecting the application and performing a STATUS command is not considered to be the execution of an application command for these purposes.

The terminal retrieves the application power consumption requirements by selecting the application. It then gets back the application power consumption indication in the response of the SELECT command. It may as well issue a STATUS command within the application and get this information in the response of the command.

Table 6.3: Maximum power consumption of the UICC during the UICC session

Symbol	Voltage Class	Maximum	Unit
lcc	A	60	mA
lcc	B	50	mA
lcc	C	30	mA
lcc	D	RFU	mA
lcc	E	RFU	mA
NOTE: All values assume the maximum external clock.			

Applications may specify their own maximum power consumption values, up to the maximum specified in table 6.3.

If an application does not indicate its consumption, the terminal shall assume the maximum application power consumption is as specified in table 6.4.

The minimum power supply that the terminal shall be able to supply to the UICC during application session at maximum clock speed is specified in table 6.4.

Table 6.4: Minimum power supply by the terminal during the UICC session

Symbol	Voltage Class	Minimum	Unit
lcc	A	10	mA
lcc	B	10	mA
lcc	C	10	mA
lcc	D	RFU	mA
lcc	E	RFU	mA
NOTE: All values assume the maximum external clock.			

6.3 Answer To Reset content

The ATR is the first string of bytes sent from the UICC to the terminal after a reset has been performed. The ATR is defined in ISO/IEC 7816-3 [11].

The terminal shall be able to receive interface characters for transmission protocols other than T = 0 and T = 1, historical bytes and a check byte, even if only T = 0 and T = 1 are used by the terminal.

T = 15 global interface parameters shall be returned by the UICC.

NOTE: ATRs are listed in annex D of the present document.

6.3.1 Coding of historical bytes

The historical bytes indicate to the external world how to use the card. The information carried by the historical bytes of the UICC follows ISO/IEC 7816-4 [12].

The category indicator is the first byte sent by the UICC. Its value shall be '80' which means that the historical bytes are coded in COMPACT-TLV data objects.

The first information sent by the card shall be the "card data service" data object. This data object is introduced by tag '31'. The second information sent by the card shall be the "card capabilities" data object. This data object is introduced by tag '73'. The other data objects are optional.

6.3.2 Speed enhancement

The terminal and the UICC shall at least support $(F,D) = (512,8)$ and $(512,16)$ in addition to $(372,1)$, the default values. However, other values may also be supported. If the terminal requests PPS using values other than those above then the PPS procedure shall be initiated accordingly. The value of the transmission factors F and D is given by the UICC in TA_1 of the ATR.

To enable higher transmission speeds than the speeds allowed in ISO/IEC 7816-3 [11], table 6.5 includes an additional value for the D transmission factor that UICCs and terminals may choose to support:

- this additional DI value shall be associated to $FI = 1001$.

Table 6.5: Additional DI definition

DI	0111
Di	64

When this additional DI value is supported, the interface shall meet the additional requirements below, regardless of the operating conditions used.

Table 6.6: Complement to the I/O characteristics under normal operating conditions when $DI = 0111$ is supported

Symbol	Conditions	Minimum	Maximum	Unit
t_R t_F	$C_{in} = C_{out} = 30$ pF		400	ns
NOTE: To support the additional requirement above, the value of the pull-up resistor that is used on the interface device should be about 10 k Ω .				

6.3.3 Global Interface bytes

The global interface bytes are present after $T = 15$ indication in the ATR. The presence of global interface bytes is optional and the presence is indicated in the TD_i ($i > 1$) indicating $T = 15$. The content and coding of the first TA_i ($i > 2$) after $T = 15$ is defined in ISO/IEC 7816-3 [11]. The content and coding of the first TB_i ($i > 2$) after $T = 15$ is defined in the present document.

Table 6.7: Coding of the first TB_i ($i > 2$) after $T = 15$ of the ATR

b8	b7	b6	b5	b4	b3	b2	b1	Meaning
0	0	0	0	0	0	0	0	No additional global interface parameters supported
1	-	-	1	-	-	-	-	Low Impedance drivers and protocol available on the I/O line available (see clause 7.2.1)
NOTE: Any other value is RFU.								

6.4 PPS procedure

The terminal and the UICC shall support the PPS procedure in order to use transmission parameters other than the default values. The alternative parameters are indicated in the ATR. The interpretation of these parameters is according to ISO/IEC 7816-3 [11], and to the first TB_i ($i > 2$) after $T = 15$ in the ATR as defined in table 6.3 in clause 6.3. 3. For PPS1 the terminal shall select a value within the range indicated by the UICC as defined in ISO/IEC 7816-3 [11] and complemented in clause 6.3.2. For PPS2 the terminal shall select a value in accordance with the indication in the first TB_i ($i > 2$) after $T = 15$. PPS2 shall only be used if the first TB_i ($i > 2$) after $T = 15$ is present in the ATR. The coding for PPS2 is identical to that of the first TB_i ($i > 2$) after $T = 15$. The value selected depends upon the features supported by the terminal. The content of PPS2 is coded the same way as the first TB_i ($i > 2$) after $T = 15$. A terminal not supporting any of the features indicated in the first TB_i ($i > 2$) after $T = 15$ need not to support PPS2 in the PPS procedure.

When the terminal does not support or cannot interpret the values indicated by the card in character TA_1 of the ATR, it shall initiate at least one PPS procedure indicating in (F_i, D_i) the highest speed the terminal supports before issuing PPS using the default values $(372,1)$.

6.5 Reset procedures

Two types of resets are specified by the present document. Cold reset is the first reset occurring after activation of the contacts. Warm reset is any reset which is not a cold reset.

6.5.1 Cold reset

The cold reset is performed according to of ISO/IEC 7816-3 [11] and the UICC shall enter the negotiable mode. After a cold reset, the security status shall be reset.

6.5.2 Warm reset

The warm reset is performed according to of ISO/IEC 7816-3 [11] and the UICC shall enter either the negotiable or the specific mode. If the UICC enters the specific mode, it shall present the same protocol and interface parameters (Fi, Di) as in the session prior to the warm reset. The UICC shall respond with an identical ATR after every warm reset issued within the same session regardless of what application was active. After a warm reset, the security status shall be reset.

6.5.3 Reaction to resets

A UICC complying with the present document shall either be a "Type 1 UICC" or a "Type 2 UICC".

Figure 6.1 illustrates how the respective types of a UICC react to the cold or warm reset.

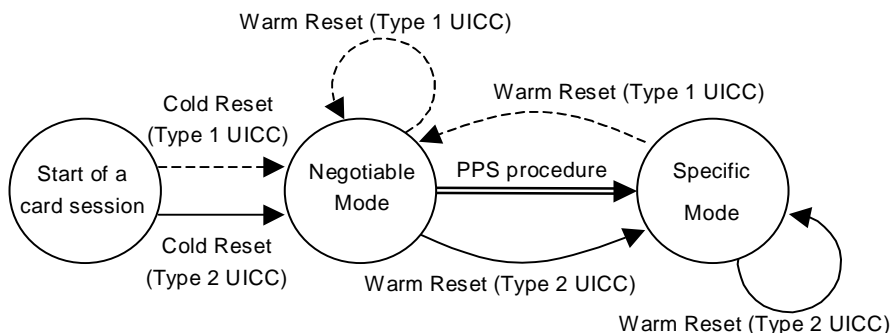

NOTE: See annex I for details.

Figure 6.1: Reaction to resets

6.6 Clock stop mode

The UICC shall support the clock stop procedure as defined in this clause. The clock stop mode is indicated in TA_i ($i > 2$) in $T = 15$ in the ATR, see ISO/IEC 7816-3 [11]. For a UICC supporting only class A operating conditions, clock stop mode "not allowed" may be indicated, see clause 6.3. If the UICC supports any other operating conditions even together with class A, clock stop mode shall be supported and the indication shall be set accordingly. The terminal shall follow this indication independently of operating conditions indicated by the card.

The terminal shall wait at least 1 860 clock cycles after having received the last character, including the guard time (2 etu), of the response before it switches off the clock (if it is allowed to do so). It shall wait at least 744 clock cycles before it sends the first command after having started the clock.

6.7 Bit/character duration and sampling time

The bit/character duration and sampling time specified in ISO/IEC 7816-3 [11], clause 6.3.2 are valid for all communications.

6.8 Error handling

If mandatory ATR characters (as defined in the present document) are not present in the ATR then it is up to the terminal to decide if a UICC has been activated or not, e.g. it is a card supporting an application not based on the present document.

If, from the terminal point of view, a UICC has been activated and the terminal has received an ATR with protocol errors then the terminal shall perform a Reset. ATR protocol errors are defined as where the ATR has indicated the presence of certain characters but they are not present. If mandatory UICC ATR characters (as specified in the present document) are absent and not indicated to be present then the terminal may consider this from an error handling point of view to be an ATR protocol error. The terminal shall not reject the UICC until at least three consecutive ATRs with protocol errors are received.

During the transmission of the ATR, the error detection and character repetition procedure specified in clause 7.2.2.4, is optional for the terminal. For the subsequent transmission on the basis of $T = 0$ this procedure is mandatory for the terminal.

For the UICC the error detection and character repetition procedure is mandatory for all communications using $T = 0$.

6.9 Compatibility

Terminals operating under class A operating conditions only and that are compliant to the electrical parameters defined in clause 5.1 shall operate with a 3 V Technology smart card according to the present document.

For compatibility with existing terminals, UICCs that are used in applications where the supply voltage class indication is based on the STATUS response procedure (see clause 6.2.3) shall support this procedure in addition to the supply voltage class indication in the ATR as defined in the present document.

In case the UICC does not support any supply voltage indication, the UICC shall be treated as a 5 V only card by the terminal.

7 Transmission protocols

This clause defines the transmission protocols used to exchange data between the terminal and the UICC. The structure and processing of commands initiated by the terminal for transmission control and for specific control in asynchronous half duplex transmission protocols will be described.

Two different protocols are defined, the character based protocol $T = T = 0$ and the block based protocol $T = T = 1$.

Both protocols $T = T = 0$ and $T = T = 1$ are mandatory for the terminal. The UICC shall support either $T = T = 0$ or $T = T = 1$ or both protocols. The protocols shall be supported as specified in the present document.

The protocol starts after either the answer to reset or a successful PPS exchange. Other parameters provided in the ATR and relevant to a specific protocol are defined in the respective parts of this clause.

The protocol applies a layering principle of the OSI-reference model. Four layers are considered. The layers are:

- the physical layer. The contained definitions are valid for $T = T = 0$ and $T = T = 1$;
- the data link layer, which consists of:
 - a character component;
 - a block component;
 - block identification;
 - send blocks;
 - detect transmission and sequence errors;
 - handle errors;
 - synchronize the protocol.
- the transport layer, which defines the transmission of application-oriented messages specific to each protocol.
- the application layer, which defines the exchange of messages according to an application protocol that is common to both protocols.

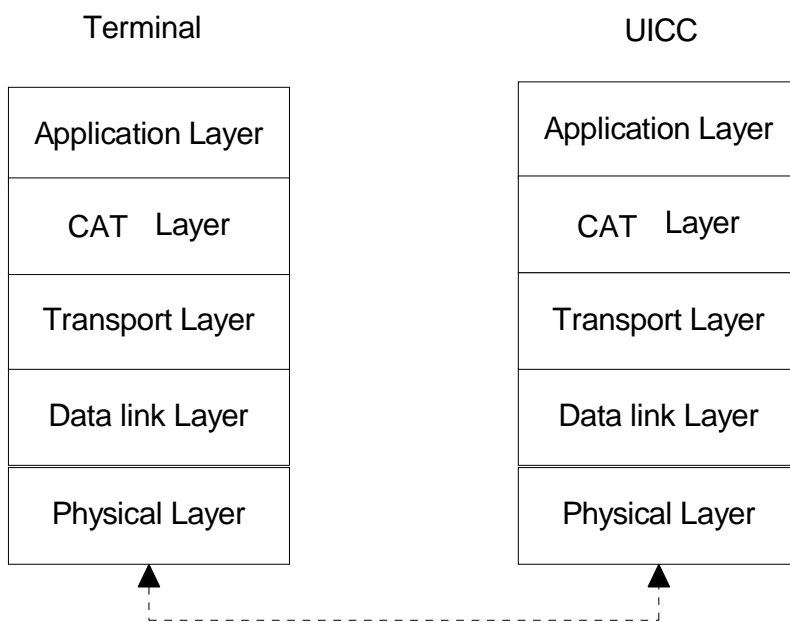

Figure 7.1: Layers

7.1 Physical layer

Both protocols $T = T = 0$ and $T = T = 1$ shall use the physical layer and character frame as defined in clause 7.2.1.

7.2 Data link layer

This clause describes the timing, specific options and error handling for the protocols $T = T = 0$ and $T = T = 1$.

7.2.1 Character frame

A character that is transmitted over the I/O line is embedded in a character frame.

Before the transmission of a character, the I/O line shall be in state H. Depending upon the convention used, the logical '1' in a character is either represented by state H on the I/O line, direct convention, or state L on the I/O line, inverse convention.

A character consists of 10 consecutive bits (see figure 7.2):

- 1 start bit in state L;
- 8 bits, which comprise the data byte;
- 1 even parity checking bit.

The parity bit is set, in a way, that there is an even number of bits set to '1' including the parity bit in the character frame.

The time origin is fixed as the mean between the last observation of state H and the first observation of state L. The receiver shall confirm the existence of a start bit before $0,7$ etu (receiver time). Then the subsequent bits shall be received at intervals of $(n + 0,5 \pm 0,2)$ etu (n being the rank of the bit). The start bit is bit 1.

Within a character, the time from the leading edge of the start bit to the trailing edge of the n th bit is $(n \pm 0,2)$ etu.

The interval between the leading edges of the start bits of two consecutive characters comprises the character duration ($10 \pm 0,2$) etu, plus a guardtime. Under error free transmission, during the guardtime both the UICC and the terminal shall be in reception mode (I/O line in state H), unless specified otherwise.

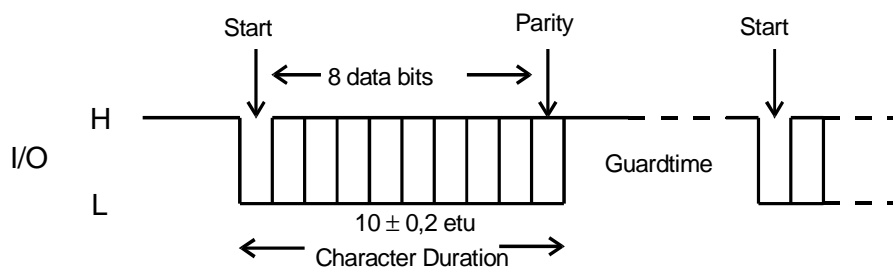

Figure 7.2: Character frame

The data shall always be passed over the I/O line with the most significant byte first. The order of bits within a byte (that is, whether the least significant or most significant bit is transferred first) is specified in character TS returned in the answer to reset (see ISO/IEC 7816-3 [11]).

7.2.1.1 Low impedance I/O line behaviour

If the low impedance driver on the I/O line has been selected, as the result of a successful PPS exchange, the following protocol on the I/O line applies.

The transmission state is defined as the period starting from the start bit of the first character to the end of the guardtime of the last character to transmit. During the transmission state the transmitter shall drive the I/O line to the desired level using the low impedance driver, with the exception of the error indication period, e.g. character guardtime of $T = T = 0$.

After reception of the last character in a command or response sequence when the communication direction is changed, the entity that is in turn to transmit, terminal or UICC, shall drive the I/O line to the high level using the low impedance driver during the interface inactivity period. During clock stop the terminal shall drive the I/O line to high state.

The interface inactivity period ends when the transmission of a new command or its response starts.

7.2.2 Transmission protocol T = T = 0

The T = T = 0 is a half-duplex asynchronous character based transmission protocol.

All commands using the protocol T = T = 0 are initiated from the terminal by sending a five byte header, which informs the UICC what to do. The terminal will always act as master and the UICC as a slave. The direction of the transmission is assumed to be known to both the UICC and the terminal.

7.2.2.1 Timing and specific options for characters in T = T = 0

The minimum interval between the leading edge of the start bits of two consecutive characters shall be at least 12 etu.

The maximum interval between the start leading edge of any character sent by the UICC and the start leading edge of the previous character sent either by the UICC or the terminal is the WWT. The value of the WWT shall not exceed $960 \times WI \times Fi/f$. WI is an integer received in the specific interface byte TC2. If no TC2 is available, default value of WI is 10. The clock rate conversion factor, Fi, and the baud rate conversion factor Di, may be indicated in TA1. If TA1 is absent the default values 372 and 1 respectively are used.

If the WWT is exceeded, the terminal shall initiate a deactivation within 960 etu.

7.2.2.2 Command header

A command is always initiated by the terminal which sends an instruction to the UICC in the form of a five byte-header called the command header. The command header comprises five consecutive bytes, CLA, INS, P1, P2, and P3.

These bytes together with any data to be sent with the command form the Command-Transport Protocol Data Unit (C-TPDU) for T = T = 0. The mapping of the C-APDU onto the C-TPDU is described in clause 7.3.

The terminal transmits the header to the UICC and waits for a procedure byte or a status byte.

7.2.2.3 Command processing

When the UICC has received the command header, a response containing a procedure byte or a status byte shall be sent to the terminal. Both the terminal and the UICC shall be able to keep track of the direction of the data flow and who has the access to the I/O-line.

7.2.2.3.1 Procedure bytes

The procedure byte indicates to the terminal what action it shall take next.

Procedure bytes are used to keep up the communication between the terminal and the UICC. They shall not be transmitted to the application layer.

The coding of the procedure byte and the action that shall be taken by the terminal is shown in table 7.1.

Table 7.1: Procedure byte coding

Byte	Value	Action
ACK	Equal to INS byte	All remaining data bytes shall be transferred by the terminal, or the terminal shall be ready to receive all remaining data bytes from the UICC.
	Equal to complement of INS byte ($\overline{\text{INS}}$)	The next data byte shall be transferred by the terminal, or the terminal shall be ready to receive the next data byte from the UICC.
NULL	'60'	The NULL-byte requests no further data transfer and the terminal shall only wait for a character conveying a procedure byte. This behaviour provides additional work waiting time as defined in this clause.
SW1	'61'	The terminal shall wait for a second procedure byte then send a GET RESPONSE command header to the UICC with a maximum length of 'XX', where 'XX' is the value of the second procedure byte (SW2).
	'6C'	The terminal shall wait for a second procedure byte then immediately repeat the previous command header to the UICC using a length of 'XX', where 'XX' is the value of the second procedure byte (SW2).

After these actions, the terminal shall wait for a further procedure byte or status word.

7.2.2.3.2 Status bytes

The status bytes SW1 SW2 form an end sequence indicating the status of the UICC at the end of a command. A normal ending of a command is indicating by SW1 SW2 = '90 00'.

Table 7.2: Status byte coding

Byte	Value	Action
SW1	'6X' or '9X' (except '60', '61', and '6C')	The terminal shall wait for a further status word (SW2). The terminal shall return the status words (together with any appropriate data) to the application layer and shall wait for another C-APDU.

7.2.2.4 Error detection and correction

The error detection and correction procedure is mandatory for T = T = 0 protocol except for the terminal during the ATR-procedure.

An error, from the receiver's point of view, is defined by an incorrect parity. The error is indicated on the I/O line, which is set to state L at $(10,5 \pm 0,2)$ etu after the leading edge of the start bit for the character. The I/O line shall be in state L for a maximum of 2 etu and a minimum of 1 etu. The transmitter shall check the I/O line for parity error indication at $(11 \pm 0,2)$ etu starting from the leading edge of the start bit, in the character being transmitted.

If the UICC or terminal as receiver detects a parity error in a character just received, it shall set the I/O line to state L at $(10,5 \pm 0,2)$ etu after the leading edge of the start bit for the character for a maximum of 2 etu to indicate the error to the sender (see figure 7.2).

If the transmitter detects an error indication at $(11 \pm 0,2)$ etu starting from the leading edge of the start bit, in the character being transmitted, the character shall be sent again after a minimum delay of 2 etu.

7.2.3 Transmission protocol T = T = 1

The T = T = 1 protocol is a half-duplex asynchronous block based transmission protocol. The protocol may be initiated as follows:

- after an ATR due to a cold reset;
- after an ATR due to a warm reset;
- after a successful PPS exchange.

The communication starts with a block sent by the terminal to the UICC. The right to send a block keeps alternating between the terminal and the UICC. A block is the smallest data unit, which can be sent and can contain either application data or transmission control data. A check of the received data might be performed before further processing of the received data.

7.2.3.1 Timing and specific options for blocks sent with $T = T = 1$

This clause defines options regarding timing, information field sizes and error detection parameters for blocks sent with $T = T = 1$.

7.2.3.1.1 Information field size

The IFSC defines the maximum length of the information field of blocks that can be received by the UICC. The default value of the IFSC is 32 bytes another value may be indicated in TA3 of the ATR.

The IFSD defines the maximum length of the information field of blocks that the terminal can receive. IFSD has a default value of 32 bytes and may be adjusted during the card session. The maximum value of the IFSD is 254 bytes.

7.2.3.1.2 Character waiting integer

CWI is used to calculate CWT and shall be in the range from 0 to 5. The value is set in bits b4 to b1 in TB3.

7.2.3.1.3 Character waiting time

CWT is defined as the maximum delay between the leading edges of two consecutive characters in the block.

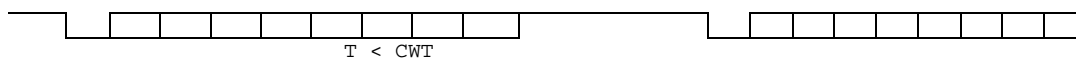

Figure 7.3: Character waiting time

The value of CWT may be calculated from the following equation: $CWT = (11 + 2^{CWI})$ etu.

7.2.3.1.4 Block waiting time

BWT is defined as the maximum delay between the leading edge of the last character of the block received by the card and the leading edge of the first character of the next block sent by the card.

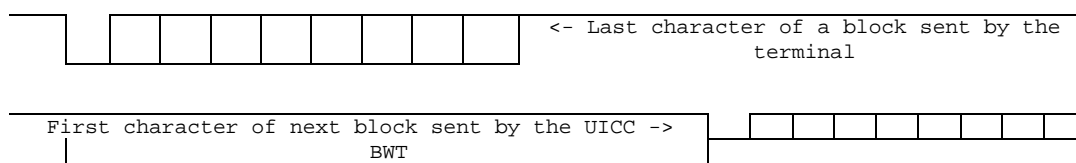

Figure 7.4: Block waiting time

BWT is used to detect an unresponsive card.

7.2.3.1.5 Block guard time

BGT is defined as the minimum delay between the leading edge of two consecutive characters sent in opposite directions. The value of BGT shall be 22 etu.

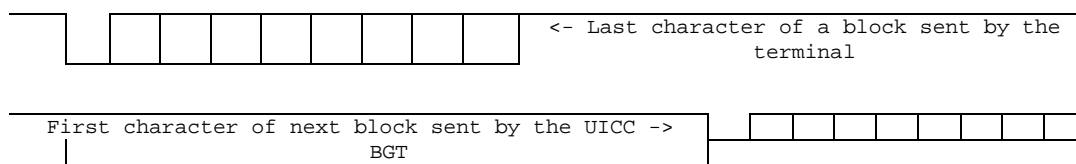

Figure 7.5: Block guard time

The delay between the last character of a block received by the UICC and the first character of the next block sent from the UICC shall be in the interval:

- $BGT < \text{delay} < BWT$.

7.2.3.1.6 Waiting time extension

WTX is a parameter used to ask for more time to process a command.

7.2.3.1.7 Error detection code

The parameter TC_i in the ATR is used to define which error detection code to use. LRC shall be used (b1 = 0). All other bits in TC_i are RFU and shall be set to 0.

7.2.3.2 Block frame structure

The protocol consists of blocks, which are transmitted between the terminal and the UICC. Each block has the following structure.

Table 7.3: Block frame structure

Prologue field			Information field	Epilogue field
NAD	PCB	LEN	INF	EDC
1 byte	1 byte	1 byte	0 byte to 254 bytes	1 byte

The prologue field and the epilogue field are mandatory. The Information field is optional.

7.2.3.2.1 Prologue field

The prologue field is divided into the following three mandatory fields:

- Node Address byte (NAD), 1 byte;
- Protocol Control Byte (PCB), 1 byte;
- Length (LEN), 1 byte.

7.2.3.2.1.1 Node address byte

The NAD-byte identifies the source and the intended destination of the block. The NAD may also be used to distinguish between different logical connections if they coexist as well as to provide Vpp state control (bit b8 and b4). Since b8 and b4 are not used, they shall be coded as '0'. Below is the structure of the NAD-byte.

Table 7.4: Node address byte

b8	b7	b6	b5	b4	b3	b2	b1
Unused	DAD			Unused	SAD		

In the first block sent from the terminal, a logical connection is set up based on the addresses in SAD and DAD. Subsequent blocks with an NAD containing the same pair of addresses are associated with the same logical connection.

Only the default value SAD = DAD = 0 shall be supported. All other combinations are RFU.

7.2.3.2.1.2 Protocol Control Byte

All information needed to control the transmission is transferred in the protocol control byte PCB. The coding of the PCB specifies the type of block. In the T = T = 1 protocol the following three different types of blocks are supported:

- Information block (I-block): which is used to transfer command and response APDUs;
- Receive-ready block (R-block): which is used to transfer acknowledgements;

- Supervisory block (S-block): which is used to send control information.

Tables 7.5 to 7.9 present the coding of the PCB for each block-type, starting with the I-block.

Table 7.5: Coding of PCB for an I-block

b8	b7	b6	b5	b4	b3	b2	b1
0	Sequence number, N(S)	Chaining, more-data bit, M	RFU				

Table 7.6: Coding of PCB for an R-block

b8	b7	b6	b5	b4	b3	b2	b1
1	0	0	Sequence number N(R)	See table 7.7			

Table 7.7: Bit b4 to b1 in the PCB for the R-block

b4	b3	b2	b1	Value	Meaning
0	0	0	0	'0'	Error free
0	0	0	1	'1'	EDC and/or parity error
0	0	1	0	'2'	Other errors
X	X	X	X	'X'	Other values are RFU

Table 7.8: Coding of PCB for an S-block

b8	b7	b6	b5	b4	b3	b2	b1
1	1	X	See table 7.9				

Table 7.9: Bits b5 to b1 of PCB for an S-block

b5	b4	b3	b2	b1	Value	Meaning
0	0	0	0	0	'0'	Resynchronization
0	0	0	0	1	'1'	Information field
0	0	0	1	0	'2'	Abortion
0	0	0	1	1	'3'	Extension of BWT
0	0	1	0	0	'4'	Error on VPP State (see note)
X	X	X	X	X	'X'	Other values are RFU
NOTE: Not used by UICCs and terminals conforming to the present document.						

The coding of b6 indicates whether it is a request (b6 = 0) or a response (b6 = 1).

7.2.3.2.1.3 Length

The length byte codes the number of bytes in the Information field of the block. The number of bytes in the information field may vary in the range from 0 byte to 254 bytes, depending on the type of block.

The value LEN = '00' indicates that the information field is absent and the value 'FF' is RFU.

7.2.3.2.1.4 Information field

The information field, INF, is optional and it depends on the type of the block what the field will be used for.

Table 7.10: Information field

Type of block	INF used for
I-block	Transfer command and response APDUs.
R-block	Not used.
S-block	Transfers non application related information: <ul style="list-style-type: none"> • INF shall be present (single byte) to adjust IFS with WTX; • INF shall be absent to signal error on VPP, or managing chain abortion or resynchronization.

7.2.3.2.2 Epilogue field

The epilogue field contains the Error Detection Code-byte (EDC), which transfers the error detection code of the transmitted block.

The LRC as defined in ISO/IEC 7816-3 [11] shall be used.

7.2.3.2.3 Block notations

7.2.3.2.3.1 I-block

The I-blocks are denoted as follows: I(N(S), M) where:

- N(S) is the send-sequence number of the block;
- M is the more-data bit used in the chaining function.

7.2.3.2.3.2 R-block

The R-block is denoted as follows: R(N(R)), where:

- N(R) is the number of the expected I-block.

7.2.3.2.3.3 S-block

S-blocks are always used in pairs. An S(request) is always followed by an S(response) block. The S-blocks are denoted as follows:

- S(RESYNCH request), a request of a resynchronization;
- S(RESYNCH response), an acknowledge of the resynchronization;
- S(IFS request), an offering of a maximum size of the information field;
- S(IFS response), an acknowledge on the information field;
- S(ABORT request), a request to abort the chain function;
- S(ABORT response), an acknowledge of the abortion of the chain function;
- S(WTX request), a request for an extension of the waiting time;
- S(WTX response), an acknowledge of the extension of the waiting time.

7.2.3.3 Error free operation

This clause describes the rules for error free operation with $T = T = 1$.

- The first block sent to the UICC shall be either an I-block with $N(S) = 0$ or an S-block.
- If a sender S sends $I(N_s(S), 0)$, the block is acknowledged by the receiver R with an $I(N_r(S), M)$. The contents of $I(N_r(S))$ indicate data transfer data and that the receiver is ready to receive the next block from the sender.

- If a sender S sends an $I(N_s(S), 1)$ it should be acknowledged by the receiver R with $R(N_r(R))$, where $N_s(S) \neq N_r(R)$, to indicate that the received block was correct and that the receiver is ready to receive the next block.
- The UICC might need more than BWT to process the previously received block, an S(WTX request) is sent by the UICC. The terminal shall acknowledge with an S(WTX response). The new allocated time starts at the leading edge of the last character of the S(WTX response).
- To change the value of IFSD, the terminal sends an S(IFS request). The request shall be acknowledged by the UICC with an S(IFS response) with the same INF. The new IFSD is assumed to be valid as long as no new S(IFS request) has been received by the UICC.
- When the receiver has received the number of characters as indicated in the value of the LEN and EDC the receiver returns the right to send.

7.2.3.4 Error handling for $T = T = 1$

This clause contains a description of the rules used to control the error handling for the $T = T = 1$ protocol.

The block component of the data link layer shall be able to handle errors like:

- BWT time-out;
- receive an invalid block, i.e. a block with parity errors, EDC error, invalid PCB, invalid length, lost synchronization or failure to receive relevant S(... response) after an S(... request).

Resynchronization of the protocol may be attempted at three consecutive levels. If one level is unsuccessful, then the next level is tried.

- For the terminal, the three levels are:
 - Retransmission of blocks.
 - Use of S(RESYNCH request).
 - Card reset or deactivation.
- For the UICC, the three levels are:
 - Retransmission of blocks.
 - Use of S(RESYNCH response).
 - Without action by the terminal, the UICC becomes unresponsive.

7.2.3.4.1 Protocol initialization

After an ATR due to a Warm reset or successful PPS procedure, the communication between the terminal and the UICC can be initiated. But if the terminal fails to receive an error-free block, in the beginning of the protocol, a maximum of two more successive attempts to receive the block is allowed before resetting or a deactivation of the card takes place.

If the response on the first block sent by the terminal is not sent within BWT, the terminal shall send an R(0).

When the protocol has been initiated and the first block received by the UICC is invalid, the UICC responses with an R(0).

If the terminal fails to receive an error-free block during a card-session, a maximum of two further attempts is allowed before an S(RESYNCH request) is sent.

7.2.3.4.2 Block dependent errors

When an I-block has been sent and a BWT time-out occurs or an invalid block has been received (with the terminal), an R-block is sent, which requests with its N(R) for the expected I-block with $N(S) = N(R)$.

When an R-block was sent and an invalid block is received or BWT time-out, the R-block shall be resent.

When an S(... request) has been sent and either a BWT time-out occurs (with the terminal) or the received response is not an S(... response), the S(... request) shall be resent. But if an S(... response) has been sent and either an invalid block is received or a BWT time-out occurs (with the terminal), an R-block shall be sent. The terminal shall not send an S(IFS request) before the R-block acknowledging a reception of the previous I-block sent by the card.

When the UICC sends an S(IFS request) and receives an invalid block, the S(IFS request) shall be resent maximum one extra time to receive an S(IFS response). After the second failure to receive an S(IFS response), the UICC shall stay in reception mode.

7.2.3.5 Chaining

Chaining allows the terminal or the UICC to transfer information, which is longer than IFSC or IFSD. If information longer than IFSC or IFSD is transferred, the information should be divided into pieces, each has a length \leq IFSC or IFSD. Each piece should be sent in an I-block using the chaining function.

The value of the M-bit in the PCB byte of the I-block controls the chaining function according to:

- M = 0, the block is not chained to the next block;
- M = 1, the block is chained to the next block, which shall be an I-block.

When a receiver receives a more-data I-block, an R(N(R)) shall be sent. N(R) = N(S) of the expected I-block. At least one chained block should follow.

A physical error, e.g. buffer overrun, in the UICC can cause an error in a chaining process. To abort a chain an S(ABORT request) can be sent by either the sender or the receiver. The request shall be answered with an S(ABORT response). When the S(ABORT response) has been received an R-block may be sent to either the terminal or the UICC to give back the right to send to either.

7.2.3.5.1 Rules for chaining

- When the terminal is the receiver, the terminal shall accept a sequence of chained I-blocks sent from the UICC. The length of each block is \leq IFSD.
- When the UICC is the receiver, the UICC shall accept a sequence of chained I-blocks sent from the terminal. The length of each block shall be equal to the value of IFSC except for the last block whose length can be any value in the range of 0 to IFSC.
- When the terminal is the sender, all I-blocks of a chain shall have LEN = IFSC bytes except for the last, which could have a value in the range of 0 to IFSC.
- When the UICC is the sender, all I-blocks of a chain shall have LEN \leq IFSD bytes per block.
- When the UICC is the receiver and receives block with LEN > IFSC, the block shall be rejected and acknowledged with an R-block with bits b1 to b4 in the PCB having a value of 2.

For reasons of efficiency, it is not recommended to send empty I-blocks.

7.3 Transport layer

This clause describes how the APDU are transported between the terminal and the UICC. For definition of the cases for Data in APDUs see clause 7.4.

7.3.1 Transportation of an APDU using T = 0

This clause describes the mapping of C-APDUs and R-APDUs for T = 0 protocol, the APDU exchange and the use of the GET RESPONSE command for case 2 and case 4.

7.3.1.1 Mapping of APDUs to TPDU

The mapping of the C-APDU onto the T = 0 command header is dependent upon the case of the command. The mapping of the data (if present) and status returned by the UICC onto the R-APDU is dependent upon the length of the data returned.

Procedure bytes '61XX' and '6CXX' are returned by the UICC to control exchanges between the transport layer of the terminal and the UICC, and should never be returned to the application layer of the terminal. Command processing in the UICC is not complete if it has returned procedure bytes '61XX' or '6CXX'.

Normal status on completion of processing a command is indicated if the UICC returns status words '9000' to the transport layer of the terminal. The transport layer of the terminal shall discontinue processing of a command (i.e. pass the R-APDU to the application layer and wait for a further C-APDU from the application layer) on receipt of any status words (but not on receipt of procedure bytes '61xx' and '6Cxx') from the UICC. For case 4 commands only, immediately following successful transmission of command data to the UICC, the transport layer of the terminal shall continue processing the command if warning status bytes ('62xx' or '63xx') or application related status bytes ('9xxx' except '9000') are received.

The following descriptions of the mapping of data and status returned by the UICC onto the R-APDU are for information, and apply only after the UICC has completed processing of the command, successfully or otherwise, and all data (if present) has been returned by the UICC under the control of '61XX' and '6CXX' procedure bytes. Detailed use of the INS, $\bar{I}NS$, and '60' procedure bytes is not described.

The status returned by the UICC shall relate to the most recently received command. Where a GET RESPONSE command is used to complete the processing of a case 2 or case 4 command, any status returned by the UICC after receipt of the GET RESPONSE command shall relate to GET RESPONSE command, not to the case 2 or case 4 command which it completes.

7.3.1.1.1 Case 1

The C-APDU is mapped onto the C-TPDU by assigning the value '00' to the body part (P3 = '00').

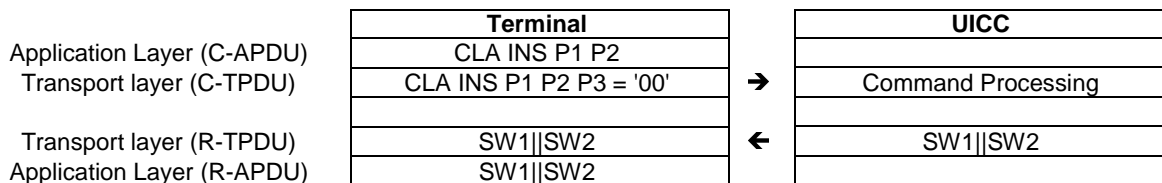

Figure 7.6

The flow of the exchange is as follows:

- 1) The transport layer of the terminal shall send the T = 0 command header to the UICC.
- 2) On receipt of the command header the UICC, under normal or abnormal processing, shall return status to the transport layer of the terminal.

The UICC shall analyse the T = 0 command header to determine whether it is processing a case 1 command or a case 2 command requesting all data up to the maximum length available.

- 3) On receipt of status from the UICC, the transport layer of the terminal shall discontinue processing of the command.

See annex C for details of the exchanges between the transport layer of the terminal and the UICC.

The status words returned to the transport layer of the terminal from the UICC after completion of processing of the command are mapped onto the mandatory trailer of the R-APDU without change.

7.3.1.1.2 Case 2

The C-APDU is mapped onto the C-TPDU without any change.

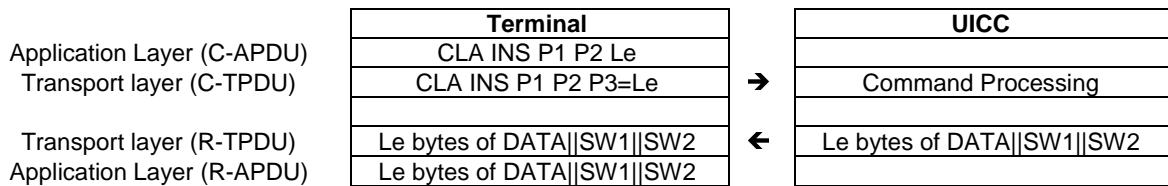

Figure 7.7

The flow of the exchange is as follows:

- 1) The transport layer of the terminal shall send the T = 0 command header to the UICC.
- 2) On receipt of the command header the UICC:
 - a) under normal processing shall return data and status to the transport layer of the terminal. The UICC shall use procedure bytes '6Cxx' (and if required, procedure bytes '61xx') to control the return of data (see below); or
 - b) under abnormal processing shall return status only to the transport layer of the terminal.
- 3) On receipt of the data (if present) and status from the UICC, the transport layer of the terminal shall discontinue processing the command.

See annex C for details of the exchanges between the transport layer of the terminal and the UICC, including use of the '61XX' and '6CXX' procedure bytes.

The R-TPDU is mapped onto the R-APDU without any change.

The data (if present) and status returned to the transport layer of the terminal from the UICC after completion of processing of the command are mapped onto the R-APDU as follows:

- The data returned (if present) is mapped onto the conditional body of the R-APDU. If no data is returned, the conditional body of R-APDU is left empty.
- The status returned is mapped onto the mandatory trailer of the R-APDU without change.

7.3.1.1.3 Case 3

The C-APDU is mapped onto the C-TPDU without any change. Lc is a value between 1 and 255.

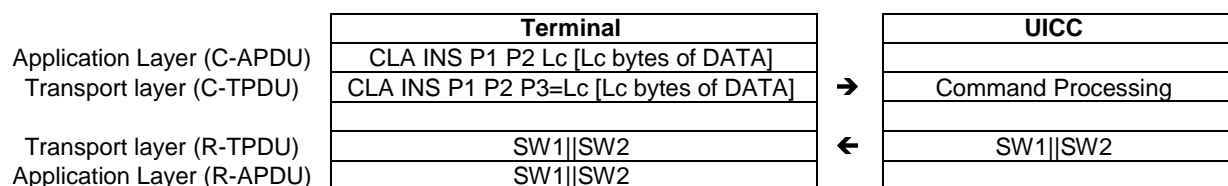

Figure 7.8

The flow of the exchange is as follows:

- 1) The transport layer of the terminal shall send the T = 0 command header to the UICC.
- 2) On receipt of the command header, if the UICC:
 - a) returns a procedure byte, the transport layer of the terminal shall send the data portion of the conditional body of the C-APDU to the UICC under the control of procedure bytes returned by the UICC; or
 - b) returns status, the transport layer of the terminal shall discontinue processing of the command.

- 3) If processing was not discontinued in step 2(b), the UICC shall return status following receipt of the conditional body of the C-APDU and completion of processing the command.
- 4) On receipt of status from the UICC, the transport layer of the terminal shall discontinue processing the command.

See annex C for details of the exchanges between the transport layer of the terminal and the UICC.

The status words returned to the transport layer of the terminal from the UICC after completion of processing of the command, or the status words returned by the UICC that caused the transport layer of the terminal to discontinue processing of the command, are mapped onto the R-APDU without change.

7.3.1.1.4 Case 4

The C-APDU is mapped onto the C-TPDU by cutting off the last byte (Le) of the body.

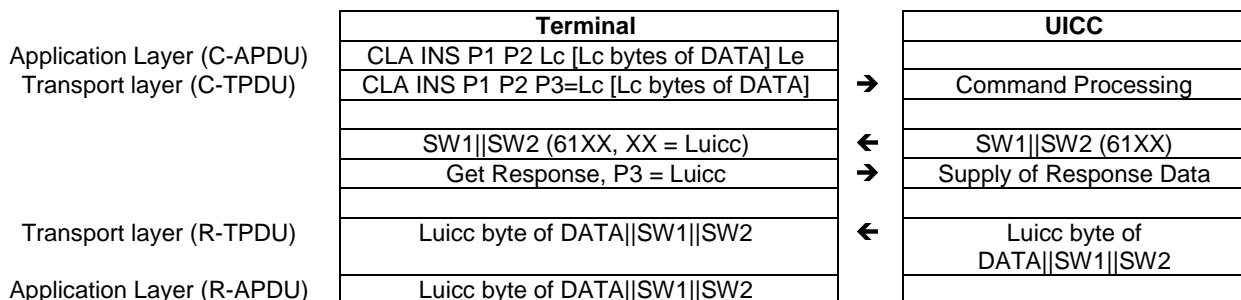

Figure 7.9

The flow of the exchange is as follows:

- 1) The transport layer of the terminal shall send the T = 0 command header to the UICC.
- 2) On receipt of the command header, if the UICC:
 - a) returns a procedure byte, the transport layer of the terminal shall send the data portion of the conditional body of the C-APDU to the UICC under the control of procedure bytes returned by the UICC; or
 - b) returns status, the transport layer of the terminal shall discontinue processing of the command.
- 3) If processing was not discontinued in step 2(b), following receipt of the conditional body of the C-APDU, the UICC:
 - a) under normal processing, shall return procedure bytes '61xx' to the transport layer of the terminal requesting the transport layer of the terminal to issue a GET RESPONSE command to retrieve the data from the UICC; or
 - b) under abnormal processing, shall return status only to the transport layer of the terminal.
- 4) On receipt of the procedure bytes or status returned in step 3, if the UICC:
 - a) returned '61xx' procedure bytes as in step 3(a), the transport layer of the terminal shall send a GET RESPONSE command header to the UICC with P3 set to a value less than or equal to the value contained in the 'xx' byte of '61xx' procedure bytes; or
 - b) returned status as in step 3(b) that indicates a warning ('62xx' or '63xx'), or which is application related ('9xxx' but not '9000'), the transport layer of the terminal shall send a GET RESPONSE command with Le = '00'; or
 - c) returned status as in step 3(b) other than that described in step 4(b), the transport layer of the terminal shall discontinue processing of the command.
- 5) If processing was not discontinued in step 4(c), the GET RESPONSE command shall be processed according to the rules for case 2 commands.

The first R-TPDU from the UICC indicates that the UICC performed the command correct and that the UICC has more data of length *Luicc* bytes to transfer. The first R-TPDU is mapped without any changes onto the R-APDU.

See annex C for details of the exchanges between the transport layer of the terminal and the UICC, including use of the '61XX' and '6CXX' procedure bytes.

7.3.1.1.5 Use of procedure bytes '61xx' and '6Cxx'

The UICC returns procedure bytes '61xx' and '6Cxx' to the transport layer of the terminal to indicate to it the manner in which it should retrieve the data requested by the command currently being processed. These procedure bytes are only used when processing case 2 and 4 commands using $T = 0$.

Procedure bytes '61xx' instruct the transport layer of the terminal to issue a GET RESPONSE command to the UICC. P3 of the GET RESPONSE command header is set to 'xx'.

Procedure bytes '6Cxx' instruct the transport layer of the terminal to immediately resend the previous command header setting P3 = 'xx'.

Usage of these procedure bytes during error free processing with case 2 and 4 commands is as follows. In the case of an error, the UICC may return status indicating error or warning conditions instead of the '61xx' or '6Cxx' response.

7.3.1.1.5.1 Case 2 commands

- 1) If the UICC receives a case 2 command header and $Le = '00'$ (with $Luicc < 256$ bytes) or $Le > Luicc$, it shall return:
 - a) procedure bytes '6C *Luicc*' instructing the transport layer of the terminal to immediately resend the command header with P3 = *Luicc*; or
 - b) status indicating a warning or error condition (but not SW1 SW2 = '90 00').
- 2) If the UICC receives a case 2 command header and $Le = '00'$ (with $Luicc = 256$ bytes) or $Le = Luicc$, it shall return:
 - a) data of length $Le (= Luicc)$ under the control of the INS, \overline{INS} , or '60' procedure bytes followed by the associated status; or
 - b) procedure bytes '61xx' instructing the transport layer of the terminal to issue a GET RESPONSE command with a maximum length of 'xx', 'xx' being less than *Luicc* (this could happen if the card buffer size is smaller than *Luicc*); or
 - c) status indicating a warning or error condition (but not SW1 SW2 = '90 00').
- 3) If the UICC receives a case 2 command header and $Le < Luicc$ it shall return:
 - a) data of length Le under the control of the INS, \overline{INS} , or '60' procedure bytes followed by procedure bytes '61xx' instructing the transport layer of the terminal to issue a GET RESPONSE command with a maximum length of 'xx'; or
 - b) status indicating a warning or error condition (but not SW1 SW2 = '90 00').

7.3.1.1.5.2 Case 4 commands

If the UICC receives a case 4 command, after processing the data sent with the C-APDU, it shall return:

- a) procedure bytes '61 xx' instructing the transport layer of the terminal to issue a GET RESPONSE command with a maximum length of 'xx'; or
- b) status indicating a warning or error condition (but not SW1 SW2 = '90 00').

The GET RESPONSE command so issued is then treated as described for case 2 commands.

7.3.2 Transportation of a APDU using T = 1

A C-APDU is sent from the application layer of the terminal to the transport layer of the terminal. The transport layer maps the C-APDU onto the INF of an I-block without change. The I-block is sent to the UICC. The Response data (if present) and the status are returned from the UICC to the transport layer of the terminal in the INF of an I-block. If the UICC returns a status which indicates:

- a warning ('62XX' or '63XX');
- an application condition ('9XXX'); or
- a successful execution of the command ('9000');

then it shall also return data (if available) associated with the processing of the command. No data shall be returned with any other status.

The contents of the INF of the I-block are mapped onto the R-APDU without change and returned to the application layer of the terminal. The transportation of APDU messages with T = 1 is mapped to the information of an I-block according to the four different cases described below. Each case is described in detail in clauses 7.3.2.1 to 7.3.2.4.

7.3.2.1 Case 1

C-APDU is mapped to the INF of the I-block without any changes:

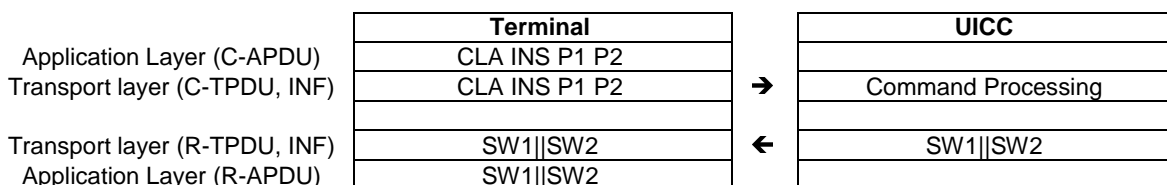

Figure 7.10

The response received from the INF in the I-block is mapped unchanged to the R-APDU.

7.3.2.2 Case 2

The C-APDU is mapped to the INF of an I-block without any changes.

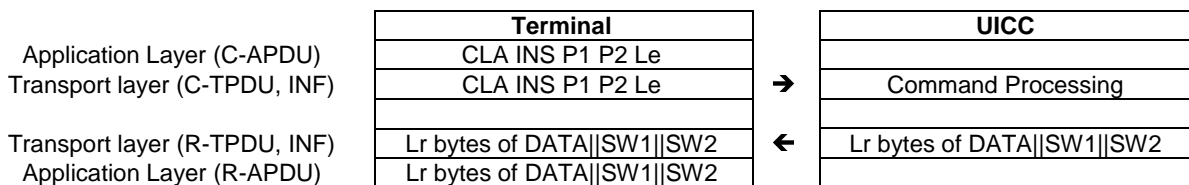

Figure 7.11

The R-APDU consists of either the INF of the I-block or the concatenation of the INF of successive I-blocks all received in the same response, which all shall be chained.

7.3.2.3 Case 3

The C-APDU is mapped without any changes to either an INF or is concatenated onto several successive I-blocks, which all shall be chained.

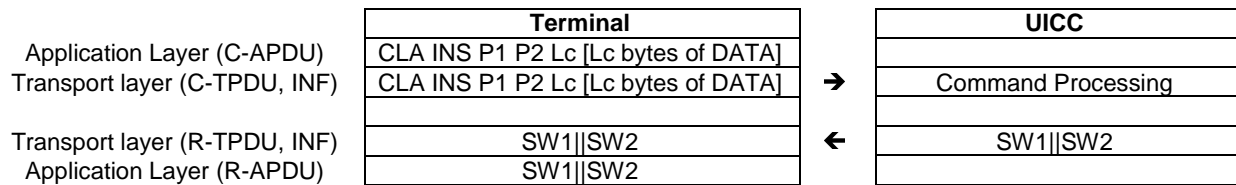

Figure 7.12

The INF of the I-block is mapped to the R-APDU without any changes.

7.3.2.4 Case 4

The C-APDU is mapped without any changes to either an INF or is concatenated onto several successive I-blocks, which all shall be chained.

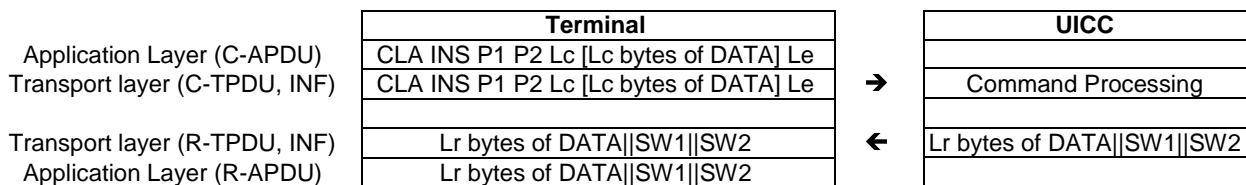

Figure 7.13

The response consists of either the INF of an I-block received in the response or the concatenation of INF of successive I-blocks in response, which all shall be chained.

7.4 Application layer

The application protocol consists of an ordered set of exchanges between the application layer and the transport layer of the terminal. Application protocols are defined in subsequent parts of the present document.

Each step in an application layer exchange consists of a command-response pair, where the application layer of the terminal sends a command to the UICC via the transport layer of the terminal, and the UICC processes it and sends a response to application layer of terminal using the transport layer of the UICC and the transport layer of terminal. Each specific command (C-APDU) has a specific response (R-APDU). The commands and responses are called command messages and response messages. The structure of the C-APDU can be found in clause 10.2. The structure of the R-APDU can be found in clause 10.2.

Both command and response messages may contain data. Thus, four cases shall be managed by the transmission protocols via the transport layer, as shown in table 7.11.

Table 7.11: Definition of cases for data in APDUs

Case	Command data	Response data
1	Absent	Absent
2	Absent	Present
3	Present	Absent
4	Present	Present

7.4.1 Exchange of APDUs

Figure 7.14 shows the principle exchange of command/response pairs.

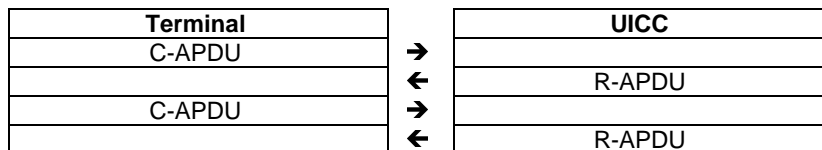

Figure 7.14

7.4.2 CAT layer

The CAT layer uses application status words to indicate:

- the availability of a proactive command for the terminal ('91XX');
- the usage of response data to an envelope command by the terminal (nominal '9000', warning '62XX' or '63XX', checking error '6FXX');
- the temporary unavailability of the CAT to handle an envelope command ('9300'), see clause 11.6.6.

7.4.2.1 Proactive command

Where the status word SW1-SW2 is equal to '9000', the card can reply '91XX' to indicate that a proactive command is pending. The terminal uses the FETCH C-APDU to get the pending proactive command. The terminal sends to the UICC the response of the proactive command execution with the TERMINAL RESPONSE C-APDU.

Even if the command to which the card replied with '91 XX' was sent on a logical channel different from the basic channel, the terminal shall send the FETCH and TERMINAL RESPONSE commands on the basic channel.

The mechanism, described hereafter for a case 4 C-APDU, is independent from the transport protocol.

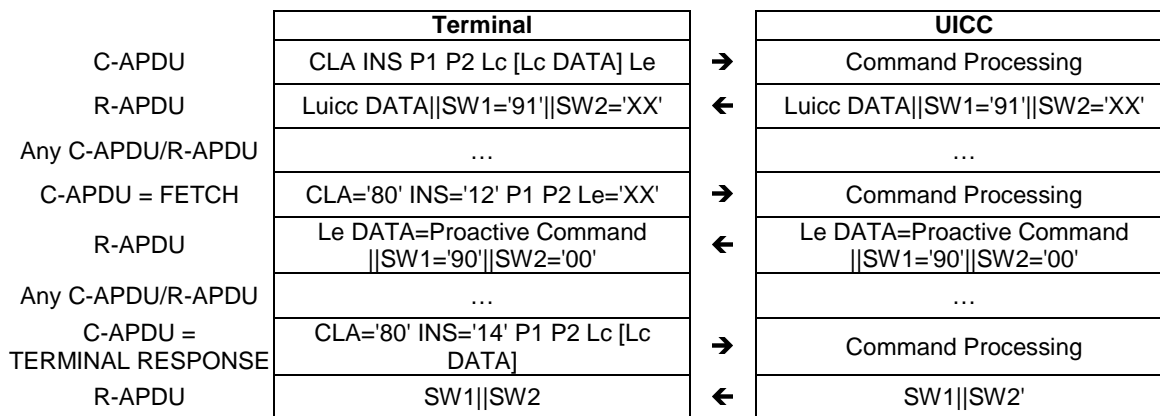

Figure 7.15

7.4.2.2 ENVELOPE Commands

The ENVELOPE C-APDU is used to transmit data to the CAT. For some BER-TLV (e.g. SMS-PP Data Download) contained in the body of this command, the card may send back data to be transmitted by the terminal on the acknowledgement channel (e.g. RP-ACK) or on the error channel (e.g. RP-ERROR). The BER-TLV data objects are defined in TS 102 223 [4] and in access technology dependent specifications.

This command is case 3 or 4 and is described hereafter for the different options.

Case 3: negative acknowledgement

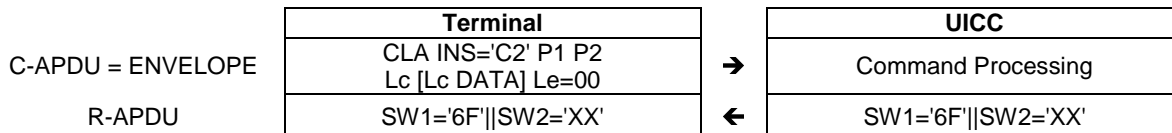

Figure 7.16

The terminal shall consider the status word received as a negative acknowledgement and use the error acknowledgement channel (e.g. RP-ERROR), when the status word present in the R-APDU is '6FXX'.

Case 4: positive acknowledgement

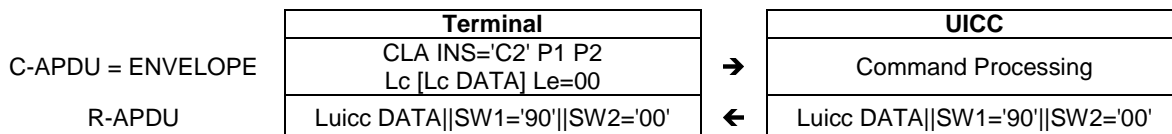

Figure 7.16a

The terminal shall consider the data field received as a positive acknowledgement and use the normal acknowledgement channel (e.g. RP-ACK) when the status word present in the R-APDU is '9000'.

Case 4: negative acknowledgement

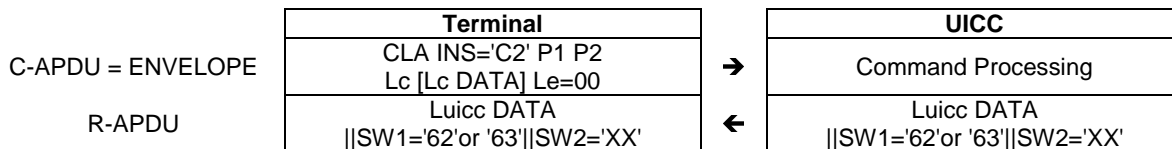

Figure 7.16b

The terminal shall consider the data field received as a negative acknowledgement and use the error acknowledgement channel (e.g. RP-ERROR), when the status word present in the R-APDU is either '62XX' or '63XX'.

8 Application and file structure

This clause describes the application and logical structure for the UICC.

8.1 UICC application structure

An example of organization of applications in the UICC is listed in figure 8.1.

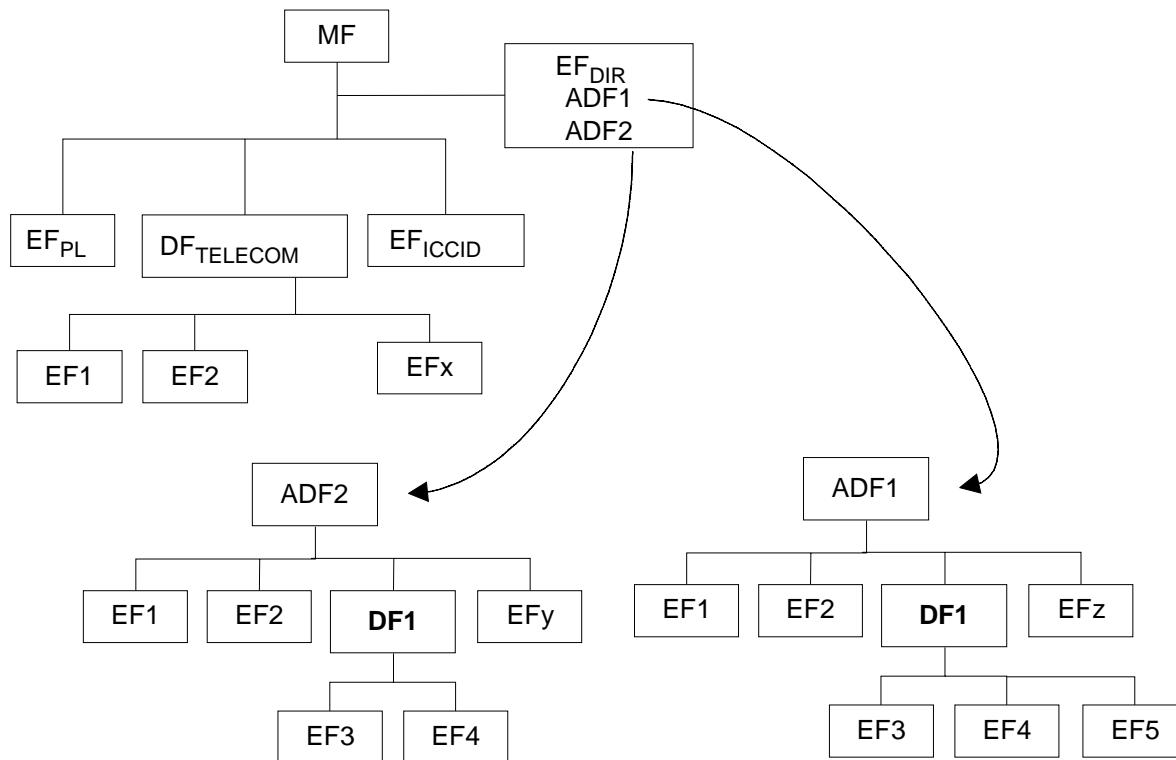

Figure 8.1: Example of an application structure

The present document does not impose any restrictions on the location of applications. All applications are uniquely identified by application identifiers that are obtained from EF_{DIR} . These application identifiers are used to select the application.

EF_{DIR} , EF_{PL} and EF_{ICCID} are all mandatory and reside directly under the Master File. See clause 13 for details.

$DF_{TELECOM}$ is optional. If present it resides under the MF and use the reserved FID '7F 10'. $DF_{TELECOM}$ contains application independent information.

8.2 File types

This clause defines the file types that apply to applications complying to the present document.

8.2.1 Dedicated files

A Dedicated File (DF) allows for a functional grouping of files. It can be the parent of DFs and/or EFs. DFs are referenced by file identifiers.

An Application DF (ADF) is a particular DF that contains all the DFs and EFs of an application.

8.2.2 Elementary files

8.2.2.1 Transparent EF

An EF with a transparent structure consists of a sequence of bytes. When reading or updating, the sequence of bytes to be acted upon is referenced by a relative address (offset), which indicates the start position (in bytes), and the number of bytes to be read or updated. The first byte of a transparent EF has the relative address '00 00'. The data length is indicated in the SELECT response of the EF.

8.2.2.2 Linear fixed EF

An EF with linear fixed structure consists of a sequence of records all having the same (fixed) length. The first record is record number 1. The length of a record as well as this value multiplied by the number of records are indicated in the SELECT response of the EF.

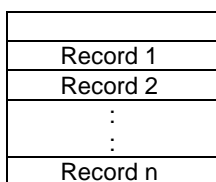

Figure 8.2: Structure of a linear fixed file

There are several methods to access records within an EF of this type:

- absolutely using the record number;
- when the record pointer is not set it shall be possible to perform an action on the first or the last record by using the NEXT or PREVIOUS mode;
- when the record pointer is set it shall be possible to perform an action on this record, the next record (unless the record pointer is set to the last record) or the previous record (unless the record pointer is set to the first record);
- by identifying a record using pattern search.

If an action following selection of a record is aborted (e.g. due to an unsuccessful execution of a command), then the record pointer shall remain set at the record at which it was set prior to the action.

It is not possible, at present, to have more than 254 records in a file of this type, and each record cannot be greater than 255 bytes.

8.2.2.3 Cyclic EF

Cyclic files are used for storing records in chronological order. When all records have been used for storage, then the next storage of data shall overwrite the oldest information.

An EF with a cyclic structure consists of a fixed number of records with the same (fixed) length. In this file structure there is a link between the last record (n) and the first record. When the record pointer is set to the last record n, then the next record is record 1. Similarly, when the record pointer is set to record 1, then the previous record is record n. The last updated record containing the newest data is record number 1, and the oldest data is held in record number n.

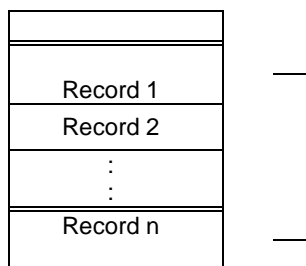

Figure 8.3: Structure of a cyclic file

For update operations only PREVIOUS record shall be used. For reading operations, the methods of addressing are Next, Previous, Current and Record Number.

If an action following selection of a record is aborted (e.g. due to an unsuccessful execution of a command), then the record pointer shall remain set at the record at which it was set prior to the action.

It is not possible, at present, to have more than 254 records in a file of this type, and each record cannot be greater than 254 bytes.

8.2.2.4 BER-TLV structure EF

A BER-TLV structure EF is seen at the interface as a set of data objects accessible by commands for handling data objects. The type of data objects in the EF is BER-TLV. A tag can only appear once in an EF.

8.3 File referencing

A File Identifier (FID) is used to address or identify a specific file. The FID consists of two bytes and shall be coded in hexadecimal notation.

FIDs shall be subject to the following conditions:

- the FID shall be assigned at the time of creation of the file concerned;
- no two files under the same parent shall have the same ID;
- the immediate children of the current DF, the parent DF or the immediate children of the parent DF shall not have the same FID.

A path is a concatenation of FIDs. The path starts from MF or the current DF, and ends with the identifier of the file itself. The order of the FIDs is always in the direction from father to child.

A Short File Identifier (SFI) is coded as 5 bits valued in the range from 1 to 30. No two files under the same parent shall have the same SFI.

A DF name is coded on 1 to 16 bytes. The DF name is the AID and shall be unique within a card.

The reserved FID '7FFF' can be used as a FID for the ADF of the current active application on a given logical channel.

8.4 Methods for selecting a file

After the UICC activation (as defined in clause 6.1) and the Answer To Reset (ATR), the Master File (MF) is implicitly selected and becomes the current directory. Each file may then be selected by using the SELECT function, using one of the 3 file referencing methods defined in this clause.

8.4.1 SELECT by File Identifier referencing

Selecting a DF, an ADF or the MF sets the current directory. After such a selection there is no current EF. Selecting an EF sets the current EF and the current directory remains the DF, ADF or MF, which is the parent of this EF. The current EF is always a child of the current directory. Only the ADF of the current application can be selected by FID.

Any application specific command shall only be operable if it is specific to the Current Directory.

The following files may be selected, by File Identifier (FID) referencing, from the last selected file:

- any file which is an immediate child of the current directory;
- any DF which is an immediate child of the parent of the current DF;
- the parent of the current directory;
- the current DF;
- the ADF of the current active application;
- the MF.

Figure 8.4 is an example of the logical structure for an application conforming to the present document.

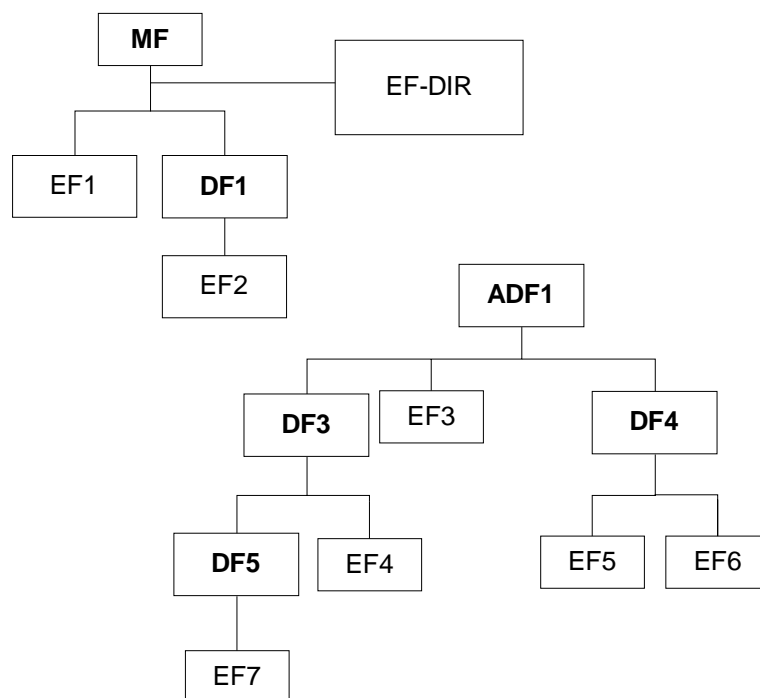

Figure 8.4: Example of a logical structure

Table 8.1 gives all the valid selections for an application complying to the present document for the logical structure in figure 8.4, if the FID is used. Reselection of the last selected file is also allowed but not shown. In this example, it is considered that the current application (ADF1) has been previously selected by DF name. Therefore ADF1 can be selected by using the FID '7FFF'.

Table 8.1: File selection

Last selected file	Valid selections
MF	ADF1, DF1, EF1, EF-DIR
DF1	MF, ADF1, EF2,
ADF1	MF, DF3, DF4, EF3
DF3	MF, ADF1, DF4, DF5, EF4
DF4	MF, ADF1, DF3, EF5, EF6
DF5	MF, ADF1, DF3, EF7
EF1	MF, ADF1, DF1, EF-DIR
EF2	MF, ADF1, DF1
EF3	MF, ADF1, DF3, DF4
EF4	MF, ADF1, DF3, DF4, DF5,
EF5	MF, ADF1, DF3, DF4, EF6
EF6	MF, ADF1, DF3, DF4, EF5
EF7	MF, ADF1, DF3, DF5

8.4.2 SELECT by path referencing

A file, DF or EF, may be referenced by path, as defined in clause 8.3. Table 8.2 contains examples of selection by path from figure 8.4. In this example, it is considered that the current application (ADF1) has been previously selected by DF name. The implicit FID of ADF1 '7FFF' is used in table 8.2 (see clause 8.3).

Table 8.2: Examples of file selection by path

Last selected DF	Beginning of the path	Example selections
any	MF	'EF1', 'EF-DIR', 'DF1', 'DF1 EF2'
any	MF	'7FFF DF3', '7FFF DF3 EF4', '7FFF DF3 DF5', '7FFF DF3 DF5 EF7' '7FFF DF4', '7FFF DF4 EF5', '7FFF DF4 EF6, '7FFF EF3'
DF1	Current DF	'EF2'
DF3	Current DF	'DF5', 'DF5 EF7', 'EF4'
DF4	Current DF	'EF5', 'EF6'
DF5	Current DF	'EF7'

In the case of 'select by path from MF", the terminal may use the special file-id '7FFF' (see clause 8.3) at the beginning of the path. It indicates that the path begins at the ADF of the current active application on this logical channel.

The following restrictions apply:

- In the case of "select by path from MF", the terminal shall not use the file identity of the MF (i.e. '3F00') at the beginning of the path.
- In the case of "select by path from current DF", the terminal shall not use the special file-ID '7FFF' at the beginning of the path.
- In the case of "select by path from MF" or "select by path from current DF", the terminal shall not use the file identity of the current DF.
- In the case of "select by path from MF" or "select by path from current DF", the terminal shall not use an empty data field.

8.4.3 Short File Identifier (SFI)

Any EF within a DF can be implicitly selected without giving a SELECT command by applying one of the following commands at the DF or ADF level and giving a Short File Identifier (SFI) as a part of the command:

- READ BINARY;
- UPDATE BINARY;
- READ RECORD;
- UPDATE RECORD;
- INCREASE;
- SEARCH RECORD;
- RETRIEVE DATA; or
- SET DATA.

Support of SFI for a specific file is indicated if the FCP of the file contains a TLV DO with tag '88'. If the length is 0 it indicates that the file does not support referencing by SFI. If the TLV DO is not present in the FCP it indicates that the 5 least significant bits of the FID are used as SFI.

When the READ RECORD command contains a valid SFI, it sets the file as the current EF and resets the current record pointer. Subsequent records are read with the READ RECORD command without SFI.

When the UPDATE RECORD command contains a valid SFI, it sets the file as the current EF and resets the current record pointer. Subsequent records are updated with the UPDATE RECORD command without SFI.

When the INCREASE command contains a valid SFI, it sets the file as the current EF and resets the current record pointer. Subsequent records are increased with the INCREASE command without SFI.

When the SEARCH RECORD command contains a valid SFI, it sets the file as the current EF and resets the current record pointer. Subsequent records are searched with the SEARCH RECORD command without SFI.

When the RETRIEVE DATA command contains a valid SFI, it sets the file as the current EF and resets the current tag pointer. If segmentation over several APDUs is used to retrieve long structures, subsequent RETRIEVE DATA commands shall be used without SFI.

When the SET DATA command contains a valid SFI, it sets the file as the current EF and resets the current tag pointer. If segmentation over several APDUs is used to set long structures, subsequent SET DATA commands shall be used without SFI.

8.5 Application characteristics

An application may be either explicitly or implicitly referenced.

An application is activated by explicit selecting it with the AID. This sets the application's ADF as the current ADF.

A current ADF can be referenced by FID with the implicit reference value '7FFF'.

8.5.1 Explicit application selection

8.5.1.1 SELECT by DF name

A selectable application, represented in the UICC by the AID, shall be referenced by a DF name coded on 1 byte to 16 bytes. Each name shall be unique within a UICC. A DF name can be used in the SELECT command to select a selectable application.

8.5.1.2 SELECT by partial DF name

A selectable application can also be selected using a partial DF name (when P1 = '04') using the P2 parameters first and only occurrence, next, previous or last as defined in ISO/IEC 7816-4 [12]. In this case, the DF name is right truncated. If several applications starting with the same byte content in the AID are present on the card, the application selected is depending upon the value specified in P2. If the "last" option is indicated in P2, the selected application is the last active application matching the partial DF name, even if it was during a previous card session.

Selection of an application using a partial DF name is optional for mono application cards, but a multi application card shall support it. The card shall indicate the support of this feature in the "card service data" and the "card capabilities" compact-TLV objects of the ATR historical bytes as specified in ISO/IEC 7816-4 [12].

The interpretation of next, previous and first is to be specified by the application. The application that is selected using these parameters shall match the partial DF name provided in the SELECT command. If the UICC does not support selection with partial DF name, the UICC shall respond with an appropriate response (e.g. command parameters not supported '6A86').

8.5.2 Application session activation

The application session is initiated when the terminal sends a SELECT command, with the application's AID, indicating in the command parameters that the application shall be activated.

An application may need an initialization procedure to be performed after its activation. This procedure is outside the scope of the present document but shall be described in the application specification. The procedure is used to bring the terminal and the application in the UICC to a well-defined state.

After having selected the application the UICC evaluates the security environment for this application. The SE is set according to the verification requirements for the application see table 9.1.

The verification status of the application PIN is updated according to the application's session activation procedure, as specified by the application.

The terminal may send to the UICC a specific STATUS command indicating that the initialization procedure of the application has been successfully executed.

There can only be one active selectable application session on a given logical channel. Therefore, in order to activate a new selectable application session in parallel to another, a new logical channel shall be opened.

A selectable application session may take place on several channel sessions.

8.5.3 Application session termination

An application may have a session termination procedure to be performed before the application is terminated. This procedure shall be described in the application specification. Before this procedure is executed, the terminal may send to the UICC a specific STATUS command indicating that the termination procedure of the application will start. After this termination procedure has been executed the terminal and the application are in a well-defined state.

An application session is then terminated if any of the following events occur on each logical channel that the application session has been activated on:

- Implicitly; if a SELECT by DF name command with an AID different from the currently active application is performed by the UICC, indicating in the command parameters that this new application shall be activated.
- Explicitly; if the application is reselected using the SELECT by DF name command with the AID corresponding to the currently active application, and indicating in the command parameters that the application shall be closed; The current directory, current EF and current application are the same as after the ATR on logical channel zero.
- If the logical channel is closed.

An application session is also terminated when the terminal performs a reset of the UICC.

The verification status of the application PIN is updated according to the application's session termination procedure, as specified by the application.

8.5.4 Application session reset

An application is reset if the application is reselected using the SELECT by DF name command with the AID corresponding to the currently active application, indicating in the command parameters that the application shall be activated.

Reset initializes the application session activation procedure. The security status of the application is updated according to the application's session activation procedure, as specified by the application.

8.5.5 Void

8.6 Reservation of file IDs

The following FIDs are reserved by the present document:

- ADF:
 - Operational use (implicit FID for the current ADF):
 - '7FFF'.
- Dedicated Files:
 - Administrative use:
 - '7F4X', '5F1X', '5F2X'.
 - Operational use:
 - '7F10' (DF_{TELECOM}), '7F20' (DF_{GSM}), '7F21' (DF_{DCS1800}), '7F22' (DF_{IS-41}), '7F23' (DF_{FP-CTS}), '7F24' (DF_{TIA/EIA-136}), '7F25' (DF_{TIA/EIA-95}) and '7F2X', where X ranges from '6' to 'F'.

NOTE: '7F80' (DF_{PDC}) is used for the Japanese PDC specification.

'7F90' (DF_{TETRA}) is used for the TETRA specification.

'7F31' (DF_{IDEN}) is used in the iDEN specification.

- Reserved under '7F10':
 - '5F50' (DF_{GRAPHICS}); '5F3A' (DF_{PHONEBOOK}).
- Elementary files:
 - Administrative use:
 - '6F XX' in the DFs '7F 4X'; '4F XX' in the DFs '5F 1X', '5F2X'.
 - '6F 1X' in the DFs '7F 10', '7F 20', '7F 21';
 - '4F 1X' in all 2nd level DFs;
 - '2F EX' in the MF '3F 00'.

- Operational use:
 - '6F 2X', '6F 3X', '6F 4X' in '7F 10' and '7F 2X';
 - '4F YX', where Y ranges from '2' to 'F' in all 2nd level DFs;
 - '2F05', '2F06' and '2F 1X' in the MF '3F 00'.
- Operational use ISO/IEC 7816-4 [12]:
 - '2F00' EF_{DIR}, '2F01' EF_{ATR} in the MF '3F00'.

In all the above, X ranges, unless otherwise stated, from '0' to 'F'.

8.7 Logical channels

Logical channels are defined in ISO/IEC 7816-4 [12]. The present document supports the first (i.e. CLA byte coded as in table 10.3) and the further (i.e. CLA byte coded as in table 10.4a) interindustry values for the CLA byte as defined in ISO/IEC 7816-4 [12], which support up to 19 logical channels in addition to the basic logical channel 0. Channel 0 is always available and open throughout the card session.

A UICC which supports logical channels indicates it in the ATR, together with the assignment methods and maximum number of logical channels it supports. The UICC supporting logical channels shall support:

- at least one channel in addition to the basic channel; and
- logical channel number assignment by the UICC.

Command interdependencies on one logical channel are independent of command interdependencies on another logical channel.

There is no interleaving of commands and their responses across logical channels; between the receipt of the command APDU and the sending of the response APDU to that command, only one logical channel is active.

In order to be accessed from several logical channels at the same time, a given file (EF, DF, ADF) shall be indicated as "shareable" in its file descriptor.

Applications are responsible for keeping data consistency (in the card and the terminal) when accessing the same file from different logical channels.

NOTE: Special attention should be given to cyclic files, e.g. when the file is read in one channel and updated in another.

A logical channel is opened by using a MANAGE CHANNEL command, in which the card assigns a channel number and returns it in the response.

The logical channel remains open until it is explicitly closed by a MANAGE CHANNEL command, or if the UICC is deactivated.

When the open function is performed from the basic channel, then after a successful open, the MF shall be implicitly selected as the current DF. When the open function is performed from a logical channel which is not the basic one, then after a successful open, the current DF of the logical channel from which the command was issued shall be selected as the current DF. In both cases, no current EF is selected in the new logical channel.

Parameters of the MANAGE CHANNEL command	Characteristics of the new channel	
	Current DF	ADF of current active application (referred to by the special '7FFF' file-ID)
CLA = 00 (from the basic channel)	MF	Undefined
CLA ≠ 00 (from the non-basic channel)	The same current DF as the one where the open channel is performed	ADF the application active in the logical channel where the open channel was performed

Once a new channel is opened, the current DF and the current EF are independent per each logical channel.

If the `MANAGE CHANNEL` command is performed on a DF or ADF that is not shareable, the card shall respond with an appropriate error message. The response shall indicate that the command is not allowed. No new channel is opened.

8.8 Shareable versus not-shareable files

A file (EF, DF or ADF) can be accessed (selected, read, updated, deleted, deactivated, activated, increased, searched, etc.) concurrently by different applications:

- by terminal applications through different logical channels,
- by UICC-based applications such as remote file management and toolkit applications.

The outcome of concurrent access is determined by the shareable/not-shareable bit in the file descriptor byte in the FCP of the accessed file as follows:

- If a file is indicated as shareable, then applications may perform authorized operations on the file independently of whether or not the file is the current file of any other application.
- If a file is indicated as not-shareable and is the current file of one application, then another application cannot perform any operation on the file regardless of authorization.

A consequence of the first rule is that if changes to a shareable file are permitted by the file's security conditions, then the file can be changed by one application while it is currently selected and being used by a second application. Descriptions of individual commands include the details of behaviour interaction in the shareable case.

A consequence of the second rule is that an application acquires exclusive access to a not-shareable file by successfully selecting it. Access by any other application, including an attempt to select the file, shall return the status word '6985' (Conditions of use not satisfied).

For the purpose of this clause, concurrent access to a file by two executing instances of a single application is considered to be accessed by two different applications.

For shareable files, file access shall be managed independently for each accessing application. In particular, a record-based file and a BER-TLV structure file shall have different pointers for each accessing application.

9 Security features

Every application that conforms to the present document may define security features in addition to the mandatory features defined in this clause.

9.1 Supported security features

A terminal that conforms to the present document and is designed for a multi-application UICC shall recognize the security attribute tags specified in the present document.

A single application terminal conforming to the present document shall support one of the access rules format specified in the present document. The application specifies which format is used.

A multi-application capable terminal that is designed to support a multi-verification capable UICC shall, from the security context point of view, support the usage of the level 1 verification requirements (PIN) and the level 2 verification requirements (PIN2). The coding is defined in table 9.3. The terminal shall, in addition, support the usage of a universal PIN as defined in the present document.

A multi-verification capable UICC conforming to the present document shall, from the security context point of view, support more than one level 1 user verification requirement (PIN). The specific key reference for the level 1 PIN is specified by each application in accordance with table 9.3. In addition, the application may specify a level 2 user verification requirement (PIN2). A multi-verification capable UICC shall support the use of a universal PIN. A multi-verification capable UICC shall support access rules defined in security attributes indicated in tag '8B' (i.e. referenced to expanded format).

A single verification capable UICC shall, from the security context point of view, support one level 1 user verification requirement (PIN) as defined in table 9.3. In addition the application may specify a level 2 user verification requirement as a second application verification requirement (PIN2). A single verification capable UICC may contain one or more selectable applications if there are no security aspects to be considered between the different selectable applications. From the security point of view only one level 1 verification requirement (PIN) is assigned to all ADFs/DFs and files on the UICC. In addition, a level 2 user verification requirement (PIN2) may be assigned for each application. From the security and access rules point of view the UICC is seen as a single application card. The coding of the level 1 and level 2 user verification requirement shall be according to table 9.3.

9.2 Security architecture

An application on a UICC conforming to the present document shall specify a level 1 key reference as the user verification (PIN). In addition the application may specify a level 2 key reference as a second user verification requirement (PIN2). The coding of the level 1 and level 2 user verification requirement shall be according to table 9.3. In addition, an application may specify the usage of a universal PIN as a replacement for the application PIN.

In order to perform commands other than SELECT and STATUS/GET RESPONSE, the security condition for the file shall be met. A security condition data object contains the conditions to be met in order to perform certain commands on a selected ADF/DF/EF.

If the UICC can not determine the access condition for the requested access to a file, then the requested access to this file shall not be granted and the card shall return an error status word '6982' (Security status not satisfied).

The security architecture consists of the following parts:

- Security attributes: a set of access rules.
- Access rules: consist of an access mode and one or more security conditions.
- Access Mode (AM): indicates to which operations (commands) the security condition applies.
- Security Condition (SC): contains references to the applicable key references (PINs).

Clauses 9.2.1 to 9.2.7 define the parts constituting the security architecture.

9.2.1 Security attributes

The security attributes are attached to an ADF/DF/EF and they are part of the FCP. The security attributes are indicated in the FCP using tag '8B', tag '8C' or tag 'AB' depending upon the format used, see ISO/IEC 7816-4 [12].

9.2.2 Access mode

The access mode byte/data object (AM byte/AM_DO) defines for which group/type of command(s) the security condition apply. The interpretation of the AM byte/AM_DO is file dependent (i.e. different for a DF/ADF and an EF), see ISO/IEC 7816-4 [12]. The command type/group is defined and coded according to ISO/IEC 7816-4 [12].

For instructions not belonging to a group as defined in ISO/IEC 7816-4 [12] the access rights can be indicated using AM_DO tags '81' to '8F'. The value of the tag defining the AM_DO indicates what description of the command exists in the definition list to follow in the value part of the data object. The coding of bit b4 to b1 in the AM_DO tag is defined in ISO/IEC 7816-4 [12].

The security conditions for bits not set to '1' in the AM byte are set to NEVER by default.

9.2.3 Security condition

The Security Condition (SC) indicates which security related procedures (user PIN verification) shall be satisfied before a command may be performed on a file. The SC is coded according to ISO/IEC 7816-4 [12].

9.2.4 Access rules

The access rule defines the security conditions for access to a file for each command/command group indicated in the AM-byte/AM_DO. The security condition is indicated in the SC-byte(s)/SC_DO(s) following the AM-byte/AM_DO. The access rule is coded by using one or more AM-bytes/AM_DOs each followed by one or more security conditions that are to be satisfied for the appropriate access.

The access rules may be coded in a compact or an expanded format. Furthermore, it is possible to combine one or more SCs to one AM such that at least one SC (the OR relation) shall be fulfilled before the command can be executed. It is possible to combine the SC such that more than one SC has to be fulfilled (the AND relation).

An access rule is a set of requirement(s) that shall be met in order to perform operations on a file. An access rule contains one or more security attributes, the AM byte/AM_DO in the attribute indicates what commands can be performed and the SC byte/SC_DO indicates what SC shall be met to be able to perform the commands indicated in the AM byte/AM_DO. The content of each AM byte (in compact format) or AM_DO (in expanded format) shall be unique within the same access rule. SC_DOs OR and AND relations shall contain at least two access conditions. The terminal shall ignore an AM/SC combination which is syntactically incorrect or with unknown instructions.

The CRT tags for SC_DOs are defined in ISO/IEC 7816-4 [12]. The SC required to perform commands indicated in the AM byte/AM_DO may be a simple condition or a logical OR or AND condition of several SC_DOs. The constructed TLV object containing AM bytes/AM_DOs and SC bytes/SC_DOs is an access rule. An access rule can be indicated in the FCP in one of the following ways:

- Tag '8C' Security attributes: Compact format.
- Tag 'AB' Security attributes: Expanded format.
- Tag '8B' Security attributes: Referenced to expanded format.

9.2.5 Compact format

The compact format is indicated by tag '8C' in the FCP. In the compact format an access rule consists of an AM byte and one or more SC bytes as defined in ISO/IEC 7816-4 [12].

The AM byte conveys two types of information. The interpretation of the AM byte itself (coded on b8), and the number of SC bytes following, this is equal to the number of bits set to '1' in bits b7 to b1 in the AM byte. If b8 in the AM byte is set to '0' the interpretation of bits b7 to b1 is as defined in ISO/IEC 7816-4 [12]. If b8 in the AM byte is set to '1' the usage of bits b7 to b4 is proprietary.

When multiple sets of an AM byte and one or more corresponding SC bytes are present in the value field they present an OR condition.

EXAMPLE 1: The access rule for READ always for an EF is coded using the compact format as follows.

Tag	L	AM	SC
'8C'	'02'	'01'	'00'

EXAMPLE 2: The access rule for UPDATE user PIN verification and READ always for an EF is coded using the compact format as follows.

Tag	L	AM	SC	SC
'8C'	'03'	'03'	'10'	'00'

9.2.6 Expanded format

The expanded format is indicated by tag 'AB' in the FCP. This tag indicates a constructed data object. In the expanded format an access rule consists of one AM_DO followed by a sequence of SC_DOs. The contents of the AM_DO is defined by the tag that it is indicated with, see ISO/IEC 7816-4 [12]. Tag '80' indicates that the AM_DO contains an AM byte. The sequence of SC_DOs following the AM-DO is relevant for all commands specified in the AM_DO. The different SC_DOs can form an OR or an AND condition as defined in ISO/IEC 7816-4 [12]. The information following tag 'AB' in the FCP can contain a lot of data if the rule is complex. This information is part of the FCP that is transmitted over the interface in the response to a SELECT or a STATUS command. The structure of the security attribute in expanded format is as follows.

Tag	length	AM_DO tag	AM_DO	SC_DO tag	SC_DO	AM_DO tag	AM_DO	SC_DO tag	SC_DO
'AB'		See ISO/IEC 7816-4 [12]		See ISO/IEC 7816-4 [12]		See ISO/IEC 7816-4 [12]		See ISO/IEC 7816-4 [12]	

An example using the expanded format coding is given in annex E.

9.2.7 Access rule referencing

Access rules may be shared between files in the UICC by referencing. This is accomplished by storing the security attributes in the expanded format in a linear fixed file, the Access Rule Reference(EF_{ARR}) in the UICC. The structure of the EF_{ARR} file is as follows.

Record Number (ARR)	Record Content (Access Rule)
'01'	AM_DO SC_DO ₁ SC_DO ₂ AM_DO SC_DO ₃ SC_DO ₄
'02'	AM_DO SC_DO ₁ AM_DO SC_DO ₅ SC_DO ₆

The referenced format is indicated in the FCP following tag '8B'. The access rule is stored in a file, EF_{ARR}. This file is a linear fixed file. Referencing is based on the following two methods:

- File ID and record number (File ID, record number).
- File ID, SE ID and record number (File ID, SE ID, record number).

The second possibility allows the usage of different access rules in different security environments. When referencing EF_{ARR} is based on the file ID, the rules for the location of the access rules are as follows:

- For an EF, if the EF(ARR) file with the file ID indicated in tag '8B' cannot be found in the current DF, the parent DF shall be searched for EF(ARR). This process shall continue until the EF(ARR) is found or until an ADF or the MF is reached;
- For a DF, if the EF(ARR) file with the file ID indicated in tag '8B' cannot be found in the parent DF, the grandparent DF shall be searched for EF(ARR). This process shall continue until the EF(ARR) is found or until an ADF or the MF is reached;
- For the MF or an ADF, the EF(ARR) file with the file ID indicated in tag '8B' shall be searched under the MF.

NOTE: There may be several EF_{ARR} containing access rules under the same DF. They are distinguished and referred to by their respective file-IDs.

The structure of the access rule referencing DO is as follows.

Tag	Length	Value
'8B'	'03'	File ID, record number
'8B'	'02' + n x '02'	File ID, SE ID _{n1} , Record number X, SE ID _{n2} , Record number Y, etc.

Each record in EF_{ARR} contains a sequence of AM_DOs followed by SC_DOs. The content of the record is the rule that applies for access to the selected file. The content of a sample EF_{ARR} file is given in annex F. The option with the SE ID referencing shall be used in an application where several security environments exist.

9.3 Security environment

The security environment is a mechanism to specify for the card system the security functions that are available to provide protection to commands for a specific application of the card according to ISO/IEC 7816-4 [12]. The security environment for a multi-application UICC is defined as a container for each activated application on the UICC. In case of a single application card the security environment is valid for the whole UICC. In the referenced format it is possible to indicate different access rules as a function of the SE that is in use.

9.3.1 Definition of the security environment

In case the referenced format contains SEID as the referencing method the terminal shall evaluate the SEID and perform the appropriate user verification accordingly.

The following properties are mapped to SE01 and SE00.

SE ID	Properties
'00'	(The global Application PIN is disabled AND the Universal PIN is disabled) OR (The global Application PIN is disabled AND the Universal PIN is enabled and used)
'01'	The global Application PIN is enabled OR (the global Application PIN is disabled AND the Universal PIN is enabled but not used)

The above requirements are derived from table 9.1. A multi-application capability UICC shall support the use of SE00 and SE01 in order to allow application verification requirement to be replaced by the Universal PIN. A multi-application capability terminal shall support SEID referencing in EF_{ARR}.

Table 9.1: PIN mapping into SE

PIN to verify			Universal PIN status	
			E	NE
APPL_PIN status	E		APPL_PIN SE01	APPL_PIN SE01
	NE	UUP	Universal_PIN SE00	NO PIN SE00
		DUUP	NO PIN SE01	NO PIN SE00
Key: UUP: Use Universal PIN (usage qualifier set to '08'). DUUP: Do not Use Universal PIN (usage qualifier set to '00').				

The Security Environment when no application is active on a given logical channel (SE_No_Active_Application) is set as follows: all application PINs assigned on the UICC are considered as APPL_PIN; if at least one of the application PINs is disabled, the SE is SE#00 except for the case where the Universal PIN is enabled but the default usage qualifier (see clause 9.5.2) is set to "do not use" as defined in table 9.1 (DUUP). This Security Environment is valid under the MF and under its child DFs/EFs as long as no application is active.

The Security Environment when an application is active on a given logical channel (SE_Active_Application) is determined as in table 9.1 with the APPL_PIN being the Application PIN of the active application. This Security Environment is valid under the ADF/MF and their child DFs/EFs.

9.3.2 Logical Channels and Security Environment

A UICC supporting logical channels has the security environment set during the application activation and is valid for the logical channel on which the application is activated. The security environment remains the same on this logical channel until a new application is selected or the status of the PIN status DO has changed, i.e. the application or universal PIN status has been changed from disabled to enabled or vice versa.

The security environment of an application running on a logical channel is inherited when a new channel is opened from the non-basic channel. It is evaluated as after the ATR and set as the SE_No_Active_Application when the new channel is opened from the basic channel.

Any command issued on a logical channel affecting the SE setting only affects the SE on the channel where the command was issued and other channels with inherited security from this channel. The SE change on a channel with inherited security also changes the SE on the channel from which the security status was inherited.

9.4 PIN definitions

The following clauses define the types of PIN that shall exist on a UICC, namely the Universal PIN and the application PIN, as well as other types of access conditions needed by the UICC/an application.

9.4.1 Universal PIN

A Universal PIN is a PIN that is used in a multi-application environment to allow several applications to share one common PIN. The Universal PIN is a global access condition that has been assigned a key reference value '11'. This key reference value shall not be used for anything else but to indicate the Universal PIN.

In order to give access to several applications on a multi-application UICC, a terminal conforming to the present document shall support the usage of the Universal PIN. A multi-application UICC according to the present document shall support the usage of a Universal PIN.

If an application allows the use of the Universal PIN as replacement PIN, the Universal PIN shall be part of the access condition for this application on a multi-application UICC that complies to the present document. In case of a single verification capable UICC the Universal PIN shall not be used.

The Universal PIN does not belong to any application, e.g. its verification status cannot be reset by the application activation or termination procedures.

9.4.2 Application PIN

An application PIN is a PIN that uses a global key reference (defined as level 1 in table 9.2) as defined in table 9.3. The application PIN allows access to any file on the UICC where it is referenced in the access rules. i.e. this PIN has global access rights with respect to files. It becomes an application PIN based on where it is assigned, and it belongs to the corresponding application Security Environment. An application, from the security context point of view, may consist of one or more ADFs/DFs. In this case the ADFs/DFs are seen as one application from the security and access rules point of view. All operations performed on a PIN (enable/disable/replace) covering several ADFs/DFs affects the applications where the PIN is used and the access rules where the corresponding key reference is used.

9.4.3 Local PIN

A local PIN is a PIN that uses a local key reference which is only valid within the ADF/DF where it is indicated in the FCP. It means that 2 ADFs can use the same local key reference number with two different values and two different status (enabled, disabled, verified, blocked), one for each ADF. The verification status of a local PIN is maintained when performing file selection. A local PIN shall be indicated in the FCP of child DFs. A local PIN is defined as level 2 in table 9.2 and coded as defined in table 9.3. A local PIN referenced in an ADF or a DF, which is not DF_{TELECOM}, does not give access to DF_{TELECOM}.

An ADF shall use only one application PIN and one local PIN. If replacement of the application PIN by the Universal PIN is authorized, the ADF shall also use the Universal PIN. Table 9.3 indicates how application PINs and local PINs shall be paired (the global key reference '01' is paired with the local key reference '81', the global key reference '02' is paired with the local key reference '82', etc.).

A local PIN can be assigned to a DF which is not part of an ADF. In this case, a key reference indicating a second application PIN as defined in table 9.3 shall be used.

9.4.4 PINs and logical channels

The PIN status of the Universal PIN and of application PINs is global in the UICC. The PIN status of local PINs exists within the ADF/DF where it is specified.

The PIN status of the Universal PIN, application PINs, and local PIN is independent from the logical channels. This means that when a PIN is verified in one logical channel, it is also verified in all other channels. Also when a PIN is enabled in one logical channel it is enabled in all other channels.

9.5 PIN and key reference relation ship

This clause describes the relationship between the user verification requirement (PIN) and referencing to a PIN in the VERIFY, CHANGE, DISABLE/ENABLE VERIFICATION and UNBLOCK commands.

9.5.1 Access condition mapping

Access condition mapping, using SC_DOs, is done using the expanded format with the entries coded as CRT values, i.e. tag 'A4' is used. The CRT is a constructed TLV DO containing a usage qualifier TLV DO (tag '95') and a Key reference TLV DO (tag '83').

The access condition groups are defined according to table 9.2. Each group is divided into several key references. The usage of a key reference shall be in accordance with the group definition in table 9.2.

Table 9.2: Access condition level coding

Level	Access condition
0	ALWays
1	User Verification (PIN)
2	(see note 1)
3 to 4	Reserved for Future Use
5 to 6	(see note 2)
7	NEVer
NOTE 1: This level is reserved for a second level of user verification (PIN2) that may be defined by an application.	
NOTE 2: Allocation of these levels and the respective requirements for their fulfilment are the responsibility of the appropriate administrative authority.	

The levels indicated in table 9.2 are used in the present document to refer to a specific group of access conditions.

A key reference shall only be assigned for the purpose as it is defined in table 9.3, e.g. a level 1 key reference is always to be used for an application or a set of applications that share the same access conditions. A level 2 key reference is only valid within the ADF/DF where it is indicated.

Table 9.3: PIN mapping into key references

CRT Tag	Len	Value						Access condition	Level
		Key Ref Tag	Len	Value	Usage Qualifier Tag	Len	Val		
'90'	'00'	-	-	-	-	-	-	ALW	0
'A4'	'06'	'83'	'01'	'01'	'95'	'01'	'08'	PIN Appl 1	1
'A4'	'06'	'83'	'01'	'02'	'95'	'01'	'08'	PIN Appl 2	
'A4'	'06'	'83'	'01'	'03'	'95'	'01'	'08'	PIN Appl 3	
'A4'	'06'	'83'	'01'	'04'	'95'	'01'	'08'	PIN Appl 4	
'A4'	'06'	'83'	'01'	'05'	'95'	'01'	'08'	PIN Appl 5	1
'A4'	'06'	'83'	'01'	'06'	'95'	'01'	'08'	PIN Appl 6	
'A4'	'06'	'83'	'01'	'07'	'95'	'01'	'08'	PIN Appl 7	
'A4'	'06'	'83'	'01'	'08'	'95'	'01'	'08'	PIN Appl 8	
'XX'	'06'	'83'	'01'	'09'	'95'	'01'	'08'	RFU	
'A4'	'06'	'83'	'01'	'0A'	'95'	'01'	'08'	ADM1	5
'A4'	'06'	'83'	'01'	'0B'	'95'	'01'	'08'	ADM2	
'A4'	'06'	'83'	'01'	'0C'	'95'	'01'	'08'	ADM3	
'A4'	'06'	'83'	'01'	'0D'	'95'	'01'	'08'	ADM4	
'A4'	'06'	'83'	'01'	'0E'	'95'	'01'	'08'	ADM5	
'A4'	'06'	'83'	'01'	'11'	'95'	'01'	'08'	PIN Universal PIN	1
'XX'	'06'	'83'	'01'	'12-1E'	'95'	'01'	'08'	RFU (Global)	3
'A4'	'06'	'83'	'01'	'81'	'95'	'01'	'08'	Second PIN Appl 1	2
'A4'	'06'	'83'	'01'	'82'	'95'	'01'	'08'	Second PIN Appl 2	
'A4'	'06'	'83'	'01'	'83'	'95'	'01'	'08'	Second PIN Appl 3	
'A4'	'06'	'83'	'01'	'84'	'95'	'01'	'08'	Second PIN Appl 4	
'A4'	'06'	'83'	'01'	'85'	'95'	'01'	'08'	Second PIN Appl 5	2
'A4'	'06'	'83'	'01'	'86'	'95'	'01'	'08'	Second PIN Appl 6	
'A4'	'06'	'83'	'01'	'87'	'95'	'01'	'08'	Second PIN Appl 7	
'A4'	'06'	'83'	'01'	'88'	'95'	'01'	'08'	Second PIN Appl 8	
'A4'	'06'	'83'	'01'	'89'	'95'	'01'	'08'	RFU	
'A4'	'06'	'83'	'01'	'8A'	'95'	'01'	'08'	ADM6	6
'A4'	'06'	'83'	'01'	'8B'	'95'	'01'	'08'	ADM7	
'A4'	'06'	'83'	'01'	'8C'	'95'	'01'	'08'	ADM8	
'A4'	'06'	'83'	'01'	'8D'	'95'	'01'	'08'	ADM9	
'A4'	'06'	'83'	'01'	'8E'	'95'	'01'	'08'	ADM10	
'XX'	'06'	'83'	'01'	'90-9E'	'95'	'01'	'08'	RFU (Local)	4
'97'	'00'	-	-	-	-	-	-	NEV	7

NOTE: The CRT value 'XX' for RFU key references is specified at the time when the value is taken into use.

A single verification capable UICC (from the security context point of view) shall use key reference '01' as PIN and key reference '81' as PIN2. A multi-verification capable UICC shall use key references in the range of '01' to '08' as PIN and may use key references in the range from '81' to '88' as PIN2. In addition a multi-verification capable UICC shall support the use of key reference '11' as a universal PIN, see clause 9.3.1 for the definition of a universal PIN. Multiple applications (from the security context point of view) on a UICC shall not share any key references except for key reference '11', which is used as the universal PIN.

9.5.2 PIN status indication

The status of a PIN that is used by an application for user verification is stored in the PS Template DO and shall be indicated in the FCP in a response to the SELECT or STATUS command issued at the application/DF level. The PIN status information is indicated in the FCP in the PS template DO using tag 'C6'. The PS template DO conveys two types of data, first the PS_DO indicated by tag '90' that indicates the status of the PIN(s) enabled/disabled. The PS_DO is followed by one or more key reference data objects indicated by tag '83'. The PIN status may be encoded over several bytes. For each bit set to '1' the corresponding key reference (PIN) is enabled. The PS_DO is coded using a bitmap list. Bit b8 in the most significant byte corresponds to the first key reference indicated by tag '83' following the PS_DO. Bits b7 to b1 are mapped to consecutive key references indicated by tag '83'. A key reference data object may be preceded by a usage qualifier data object. The usage qualifier data object indicated by tag '95' is mandatory for the universal PIN (see clause 9.4.1) and optional for other PINs. This usage qualifier indicates whether an enabled PIN needs to be verified for access. If there is no usage qualifier, or if the associated data object is empty, in front of a key reference, this indicates that this key reference does not support this feature, and it shall always be verified if enabled. The content of the PS_DO usage qualifier is defined in table 9.4. From table 9.4, the value to be used for user PIN verification is '08'. The usage qualifier of the Universal PIN is defined in the context of an application and may have different value in different applications.

The default usage qualifier of the Universal PIN after the ATR is set to "do not use" if all application PINs are enabled or if at least one of the applications where the application PIN is disabled has the Universal PIN usage qualifier set to "do not use". When no application is active on a given logical channel, the Universal PIN usage qualifier is evaluated as after the ATR.

Table 9.4: Usage qualifier coding for PS_DO

b8	b7	b6	b5	b4	b3	b2	b1	Meaning
0	0	0	0	0	0	0	0	the verification requirement is not used for verification
1	-	-	-	-	-	-	-	- use verification (DST, CCT) - use encipherment (CT) - use external authentication (AT)
-	1	-	-	-	-	-	-	- use computation (DST, CCT) - use decipherment (CT) - use internal authentication (AT)
-	-	1	-	-	-	-	-	- use SM response (CCT, CT, DST)
-	-	-	1	-	-	-	-	- use SM command (CCT, CT, DST)
-	-	-	-	1	-	-	-	- use the PIN for verification (Key Reference data user knowledge based)
-	-	-	-	-	1	-	-	- use user authentication, biometric based
-	-	-	-	-	-	x	x	RFU (default = 00)

The PS template DO is constructed as indicated in tables 9.5 and 9.6.

Table 9.5: PS Template DO structure

PS Template DO Tag	L	PS-DO Tag	L	V PS-byte(s)	Key-reference tag	L	V	Key-reference tag	L	V
'C6'		'90'			'83'	'01'		'83'	'01'	

Table 9.6: PS Template DO structure when PS_DO usage qualifier is used

PS Template DO Tag	L	PS-DO Tag	L	V PS-byte(s)	Usage Qualifier tag	L	V	Key-reference tag	L	V	Key-reference tag	L	V
'C6'		'90'			'95'	'01'		'83'	'01'		'83'	'01'	

10 Structure of commands and responses

This clause defines the command and response APDUs supported by the UICC.

10.1 Command APDU structure

This clause states a generic structure of an Application Protocol Data Unit (APDU) that is used by the application protocol on the top of the transmission protocol for sending a command to the card.

A command APDU consists of a header and a body part. The contents of the command APDU are depicted in table 10.1 where the header consists of the CLA, INS, P1 and P2 bytes that are mandatory for a command APDU and an optional body part that can contain the Lc, Data and Le. Parameters are further explained in clauses 10.1.1 to 10.1.6.

Table 10.1: Contents of command APDU

Code	Length	Description	Grouping
CLA	1	Class of instruction	Header
INS	1	Instruction code	
P1	1	Instruction parameter 1	
P2	1	Instruction parameter 2	
Lc	0 or 1	Number of bytes in the command data field	Body
Data	Lc	Command data string	
Le	0 or 1	Maximum number of data bytes expected in response of the command	

Four cases of C-APDU structure are possible as defined in table 10.2.

Table 10.2: Cases of C-APDUs

Case	Structure
1	CLA INS P1 P2
2	CLA INS P1 P2 Le
3	CLA INS P1 P2 Lc Data
4	CLA INS P1 P2 Lc Data Le

10.1.1 Coding of Class Byte

The present document supports the CLA defined in table 10.3 and table 10.17. In addition the command chaining, using b5 in class byte, as defined in ISO/IEC 7816-4 [12] is not supported (b5=0) in the present document. If the card supports the logical channel mechanism, the maximum number of available logical channels is indicated in the card capabilities data object of historical bytes of an ATR (refer to ISO/IEC 7816-4 [12]). If the card capabilities data object is missing, only the basic logical channel is supported.

An application on a UICC supporting logical channels utilizing secure messaging shall either exclude the class byte from the signature calculation for the message verification or set it to a default value. The terminal may change the logical channel on which the application is executed compared to the logical channel used for the secure messaging verification signature.

Table 10.3 specifies the coding of the class byte for the standard logical channels. Bit b5 is always set to 0. Bits b4 and b3 are used for indication of secure messaging format (see table 10.4a). Bits b2 and b1 indicate the logical channel used. Logical channels are numbered from 0 to 3 (standard logical channels).

Table 10.3: Coding of class byte for standard logical channels

b8	b7	b6	b5	b4	b3	b2	b1	Value	Meaning
0	0	0	0	-	-	-	-	'0X'	The coding is according to the first interindustry values of CLA byte defined in ISO/IEC 7816-4 [12]
1	0	1	0	-	-	-	-	'AX'	Coded as for '0X' unless stated otherwise
1	0	0	0	-	-	-	-	'8X'	Structured as for '0X', coding and meaning is defined in the present document
-	-	-	-	X	X	-	-	-	Secure Messaging indication (see table 10.4)
-	-	-	-	-	-	X	X	-	Logical channel number from 0 to 3 (see clause 10.3)

Table 10.4: Coding of Secure Messaging Indication for standard logical channels

b4	b3	Meaning
0	0	No SM used between terminal and card
0	1	Proprietary SM format
1	x	Secure messaging according to ISO/IEC 7816-4 [12] used
1	0	Command header not authenticated
1	1	Command header authenticated

Table 10.4a specifies the coding of the class byte for the extended logical channels. Bit b6 indicates secure messaging (see table 10.4b). Bit b5 is always set to 0. Bits b4 to b1 encode a number from zero to fifteen; this number plus four is the logical channel number from four to nineteen (extended logical channels).

Table 10.4a: Coding of class byte for extended logical channels

b8	b7	b6	b5	b4	b3	b2	b1	Value	Meaning
0	1	-	0	-	-	-	-	'01x0 xxxx'	The coding is according to the further interindustry values of CLA byte defined in ISO/IEC 7816-4 [12]
1	1	-	0	-	-	-	-	'11x0 xxxx'	Structured as for '01x0 xxxx', coding and meaning is defined in the present document
-	-	X	0						Secure Messaging indication (see table 10.Y)
-	-	-	0	X	X	X	X		Logical channel number from 4 to 19 (see clause 10.3)

Table 10.4b: Coding of Secure Messaging Indication for extended logical channels

b6	Meaning
0	No SM used between terminal and card
1	Command header not authenticated

By default no secure messaging is supported by the card(i.e. b4 = b3 = 0 in table 10.3, and b6 = 0 in table 10.4a), unless it is stated otherwise by an application.

10.1.2 Coding of Instruction Byte

Table 10.5 depicts coding of instruction byte of the commands.

Table 10.5: Coding of Instruction Byte of the Commands for a telecom application

COMMAND	CLA	INS
Command APDUs		
SELECT FILE	'0X' or '4X' or '6X'	'A4'
STATUS	'8X' or 'CX' or 'EX'	'F2'
READ BINARY	'0X' or '4X' or '6X'	'B0'
UPDATE BINARY	'0X' or '4X' or '6X'	'D6'
READ RECORD	'0X' or '4X' or '6X'	'B2'
UPDATE RECORD	'0X' or '4X' or '6X'	'DC'
SEARCH RECORD	'0X' or '4X' or '6X'	'A2'
INCREASE	'8X' or 'CX' or 'EX'	'32'
RETRIEVE DATA	'8X' or 'CX' or 'EX'	'CB'
SET DATA	'8X' or 'CX' or 'EX'	'DB'
VERIFY	'0X' or '4X' or '6X'	'20'
CHANGE PIN	'0X' or '4X' or '6X'	'24'
DISABLE PIN	'0X' or '4X' or '6X'	'26'
ENABLE PIN	'0X' or '4X' or '6X'	'28'
UNBLOCK PIN	'0X' or '4X' or '6X'	'2C'
DEACTIVATE FILE	'0X' or '4X' or '6X'	'04'
ACTIVATE FILE	'0X' or '4X' or '6X'	'44'
AUTHENTICATE	'0X' or '4X' or '6X'	'88', '89'
GET CHALLENGE	'0X' or '4X' or '6X'	'84'
TERMINAL CAPABILITY	'8X' or 'CX' or 'EX'	'AA'
TERMINAL PROFILE	'80'	'10'
ENVELOPE	'80'	'C2'
FETCH	'80'	'12'
TERMINAL RESPONSE	'80'	'14'
MANAGE CHANNEL	'0X' or '4X' or '6X'	'70'
Transmission oriented APDUs		
GET RESPONSE	'0X' or '4X' or '6X'	'C0'

10.1.3 Coding of parameter bytes

The value of the parameters P1 and P2 depends on the command. If the parameter is not used, the value is set to '00'. Coding of the parameter bytes is presented in the command definition clauses.

10.1.4 Coding of Lc byte

The number of data bytes present in the data field of the command APDU is presented in the parameter Lc. Lc is optional, in the command APDU, however if the Lc is present in the command APDU, data field consists of Lc subsequent bytes. The terminal may send from 1 byte to 255 bytes of command data.

10.1.5 Coding of data part

When present in a command or response APDU the structure of the data field is specific to each command.

10.1.6 Coding of Le byte

The maximum number of bytes expected in the data part of the response APDU is presented in the parameter Le, which is optional. This means that if the terminal does not expect any data in the response APDU Le is absent from the command APDU. However, if Le is present in the command APDU, the data field of the response APDU is expected to consist of Le bytes.

Le set to '00' indicates that the terminal expects to receive at most the maximum number of bytes, i.e. 256, in the response ADPU. The UICC may return any number of bytes in the range 1 to 256.

10.2 Response APDU structure

The response APDU consists of an optional data field and a mandatory status part divided into two bytes; SW1 and SW2. The number of bytes received in the response APDU is denoted Lr (length of the response data field). The structure of the response APDU is shown in table 10.6.

Table 10.6: Contents of Response APDU

Code	Length	Description
Data	Lr	Response data string
SW1	1	Status byte 1
SW2	1	Status byte 2

Coding of SW1 and SW2 is presented in clause 10.2.1.

10.2.1 Status conditions returned by the UICC

Status of the card after processing of the command is coded in the status bytes SW1 and SW2. This clause specifies the coding of the status bytes.

10.2.1.1 Normal processing

Table 10.7: Status byte coding - normal processing

SW1	SW2	Description
'90'	'00'	- Normal ending of the command
'91'	'XX'	- Normal ending of the command, with extra information from the proactive UICC containing a command for the terminal. Length 'XX' of the response data

10.2.1.2 Postponed processing

Table 10.8: Status byte coding - postponed processing

SW1	SW2	Error description
'93'	'00'	- SIM Application Toolkit is busy. Command cannot be executed at present, further normal commands are allowed

10.2.1.3 Warnings

Table 10.9: Status byte coding - warnings

SW1	SW2	Description
'62'	'00'	- No information given, state of non volatile memory unchanged
'62'	'81'	- Part of returned data may be corrupted
'62'	'82'	- End of file/record reached before reading Le bytes
'62'	'83'	- Selected file invalidated
'62'	'85'	- Selected file in termination state
'62'	'F1'	- More data available
'62'	'F2'	- More data available and proactive command pending
'62'	'F3'	- Authentication response data available
'63'	'F1'	- More data expected
'63'	'F2'	- More data expected and proactive command pending
'63'	'CX'	- Command successful but after using an internal update retry routine 'X' times - Verification failed, 'X' retries remaining (see note)
NOTE:		For the VERIFY PIN command, SW1SW2 indicates that the command was successful but the PIN was not correct and there are 'X' retries left. For all other commands it indicates the number of internal retries performed by the card to complete the command.

10.2.1.4 Execution errors

Table 10.10: Status byte coding - execution errors

SW1	SW2	Description
'64'	'00'	- No information given, state of non-volatile memory unchanged
'65'	'00'	- No information given, state of non-volatile memory changed
'65'	'81'	- Memory problem

10.2.1.5 Checking errors

Table 10.11: Status byte coding - checking errors

SW1	SW2	Description
'67'	'00'	- Wrong length
'67'	'XX'	- The interpretation of this status word is command dependent, except for SW2 = '00'
'6B'	'00'	- Wrong parameter(s) P1-P2
'6D'	'00'	- Instruction code not supported or invalid
'6E'	'00'	- Class not supported
'6F'	'00'	- Technical problem, no precise diagnosis
'6F'	'XX'	- The interpretation of this status word is command dependent, except for SW2 = '00'

10.2.1.5.1 Functions in CLA not supported

Table 10.12: Status byte coding - functions in CLA not supported

SW1	SW2	Description
'68'	'00'	- No information given
'68'	'81'	- Logical channel not supported
'68'	'82'	- Secure messaging not supported

10.2.1.5.2 Command not allowed

Table 10.13: Status byte coding - command not allowed

SW1	SW2	Description
'69'	'00'	- No information given
'69'	'81'	- Command incompatible with file structure
'69'	'82'	- Security status not satisfied
'69'	'83'	- Authentication/PIN method blocked
'69'	'84'	- Referenced data invalidated
'69'	'85'	- Conditions of use not satisfied
'69'	'86'	- Command not allowed (no EF selected)

10.2.1.5.3 Wrong parameters

Table 10.14: Status byte coding - wrong parameters

SW1	SW2	Description
'6A'	'80'	- Incorrect parameters in the data field
'6A'	'81'	- Function not supported
'6A'	'82'	- File not found
'6A'	'83'	- Record not found
'6A'	'84'	- Not enough memory space
'6A'	'86'	- Incorrect parameters P1 to P2
'6A'	'87'	- Lc inconsistent with P1 to P2
'6A'	'88'	- Referenced data not found

10.2.1.6 Application errors

Table 10.15: Status byte coding - application errors

SW1	SW2	Error description
'98'	'50'	- INCREASE cannot be performed, max value reached
'98'	'62'	- Authentication error, application specific

NOTE: Applications may define their own error codes.

10.2.2 Status words of the commands

Table 10.16 shows for each command the possible status conditions returned (marked by an asterisk *).

Table 10.16: Commands and status words

Status words	SELECT	STATUS	UPDATE BINARY	UPDATE RECORD	READ BINARY	READ RECORD	SEARCH RECORD	INCREASE	VERIFY PIN	CHANGE PIN	DISABLE PIN	ENABLE PIN	UNBLOCK PIN	DEACTIVATE FILE	ACTIVATE FILE	AUTHENTICATE	GET	CHALLENGE	TERMINAL PROFILE	ENVELOPE	FETCH	TERMINAL RESPONSE	MANAGE CHANNEL	RETRIEVE DATA	SET DATA	TERMINAL CAPABILITY
90 00	*	*	*	*	*	*	*	*	*	*	*	*	*	*	*	*	*	*	*	*	*	*	*	*	*	*
91 XX	*	*	*	*	*	*	*	*	*	*	*	*	*	*	*	*	*	*	*	*	*	*	*	*	*	*
93 00	*	*	*	*	*	*	*	*	*	*	*	*	*	*	*	*	*	*	*	*	*	*	*	*	*	*
98 50	*	*	*	*	*	*	*	*	*	*	*	*	*	*	*	*	*	*	*	*	*	*	*	*	*	*
98 62	*	*	*	*	*	*	*	*	*	*	*	*	*	*	*	*	*	*	*	*	*	*	*	*	*	*
62 00	*	*	*	*	*	*	*	*	*	*	*	*	*	*	*	*	*	*	*	*	*	*	*	*	*	*
62 81	*	*	*	*	*	*	*	*	*	*	*	*	*	*	*	*	*	*	*	*	*	*	*	*	*	*
62 82	*	*	*	*	*	*	*	*	*	*	*	*	*	*	*	*	*	*	*	*	*	*	*	*	*	*
62 83	*	*	*	*	*	*	*	*	*	*	*	*	*	*	*	*	*	*	*	*	*	*	*	*	*	*
62 85	*	*	*	*	*	*	*	*	*	*	*	*	*	*	*	*	*	*	*	*	*	*	*	*	*	*
62 F1	*	*	*	*	*	*	*	*	*	*	*	*	*	*	*	*	*	*	*	*	*	*	*	*	*	*
62 F2	*	*	*	*	*	*	*	*	*	*	*	*	*	*	*	*	*	*	*	*	*	*	*	*	*	*
62 F3	*	*	*	*	*	*	*	*	*	*	*	*	*	*	*	*	*	*	*	*	*	*	*	*	*	*
63 F1	*	*	*	*	*	*	*	*	*	*	*	*	*	*	*	*	*	*	*	*	*	*	*	*	*	*
63 F2	*	*	*	*	*	*	*	*	*	*	*	*	*	*	*	*	*	*	*	*	*	*	*	*	*	*
63 CX	*	*	*	*	*	*	*	*	*	*	*	*	*	*	*	*	*	*	*	*	*	*	*	*	*	*
64 00	*	*	*	*	*	*	*	*	*	*	*	*	*	*	*	*	*	*	*	*	*	*	*	*	*	*
65 00	*	*	*	*	*	*	*	*	*	*	*	*	*	*	*	*	*	*	*	*	*	*	*	*	*	*
65 81	*	*	*	*	*	*	*	*	*	*	*	*	*	*	*	*	*	*	*	*	*	*	*	*	*	*
67 XX	*	*	*	*	*	*	*	*	*	*	*	*	*	*	*	*	*	*	*	*	*	*	*	*	*	*
68 00	*	*	*	*	*	*	*	*	*	*	*	*	*	*	*	*	*	*	*	*	*	*	*	*	*	*
68 81	*	*	*	*	*	*	*	*	*	*	*	*	*	*	*	*	*	*	*	*	*	*	*	*	*	*
68 82	*	*	*	*	*	*	*	*	*	*	*	*	*	*	*	*	*	*	*	*	*	*	*	*	*	*
69 00	*	*	*	*	*	*	*	*	*	*	*	*	*	*	*	*	*	*	*	*	*	*	*	*	*	*
69 81	*	*	*	*	*	*	*	*	*	*	*	*	*	*	*	*	*	*	*	*	*	*	*	*	*	*
69 82	*	*	*	*	*	*	*	*	*	*	*	*	*	*	*	*	*	*	*	*	*	*	*	*	*	*
69 83	*	*	*	*	*	*	*	*	*	*	*	*	*	*	*	*	*	*	*	*	*	*	*	*	*	*
69 84	*	*	*	*	*	*	*	*	*	*	*	*	*	*	*	*	*	*	*	*	*	*	*	*	*	*
69 85	*	*	*	*	*	*	*	*	*	*	*	*	*	*	*	*	*	*	*	*	*	*	*	*	*	*
69 86	*	*	*	*	*	*	*	*	*	*	*	*	*	*	*	*	*	*	*	*	*	*	*	*	*	*
6A 80	*	*	*	*	*	*	*	*	*	*	*	*	*	*	*	*	*	*	*	*	*	*	*	*	*	*
6A 81	*	*	*	*	*	*	*	*	*	*	*	*	*	*	*	*	*	*	*	*	*	*	*	*	*	*
6A 82	*	*	*	*	*	*	*	*	*	*	*	*	*	*	*	*	*	*	*	*	*	*	*	*	*	*
6A 83	*	*	*	*	*	*	*	*	*	*	*	*	*	*	*	*	*	*	*	*	*	*	*	*	*	*
6A 84	*	*	*	*	*	*	*	*	*	*	*	*	*	*	*	*	*	*	*	*	*	*	*	*	*	*
6A 86	*	*	*	*	*	*	*	*	*	*	*	*	*	*	*	*	*	*	*	*	*	*	*	*	*	*
6A 87	*	*	*	*	*	*	*	*	*	*	*	*	*	*	*	*	*	*	*	*	*	*	*	*	*	*
6A 88	*	*	*	*	*	*	*	*	*	*	*	*	*	*	*	*	*	*	*	*	*	*	*	*	*	*
6B 00	*	*	*	*	*	*	*	*	*	*	*	*	*	*	*	*	*	*	*	*	*	*	*	*	*	*
6E 00	*	*	*	*	*	*	*	*	*	*	*	*	*	*	*	*	*	*	*	*	*	*	*	*	*	*
6F XX	*	*	*	*	*	*	*	*	*	*	*	*	*	*	*	*	*	*	*	*	*	*	*	*	*	*

The responses '91 XX', and '93 00' can only be given by a UICC to a terminal supporting CAT (see TS 102 223 [4]).

The behaviour of the terminal when receiving the response APDU from the ENVELOPE command with status word '6FXX', '62XX' and '63XX' is defined in clause 7.4.2.2.

10.3 Logical channels

Commands referring to a certain logical channel carry the respective logical channel number in:

- the two least significant bits of the CLA byte defined in table 10.3. Logical channels are numbered from 0 to 3. The basic logical channel (number 0) is permanently available.
- the four least significant bits of the CLA byte defined in table 10.4a. Logical channels are numbered from 4 to 19 (extended logical channels).

The MANAGE CHANNEL command shall be used to open and close a logical channel. The channel number is assigned by the UICC.

11 Commands

11.1 Generic commands

This clause lists the basic command and response APDU formats that are used by applications residing on a UICC. It is up to each application to determine which commands it uses. If an application does not support a command, it shall return the appropriate status word, see clause 10.2.

11.1.1 SELECT

11.1.1.1 Functional description

This function selects a file according to the methods described in clause 8.4. After a successful selection the record pointer and the current tag pointer are undefined.

Input:

- File ID, application ID, path or empty.

Output:

- If the selected file is the MF, a DF or an ADF:
 - File ID, total file size, PIN status and other application specific data.
- If the selected file is an EF:
 - File ID, file size, total file size, access conditions, invalidated/not invalidated indicator, structure of EF, length of the records in case of linear fixed structure or cyclic structure and reserved and maximum file size in case of BER-TLV structure.

11.1.1.2 Command parameters and data

Code	Value
CLA	As specified in clause 10.1.1
INS	As specified in clause 10.1.2
P1	Selection control, see table 11.1
P2	Selection control, see table 11.2
Lc	Length of subsequent data field or empty
Data	File ID, DF name, or path to file, according to P1
Le	Empty, '00', or maximum length of data expected in response

Table 11.1: Coding of P1

b8	b7	b6	b5	b4	b3	b2	b1	Meaning
0	0	0	0	0	0	0	0	Select DF, EF or MF by file id
0	0	0	0	0	0	0	1	Select child DF of the current DF
0	0	0	0	0	0	1	1	Select parent DF of the current DF
0	0	0	0	0	1	0	0	Selection by DF name (see note)
0	0	0	0	1	0	0	0	Select by path from MF
0	0	0	0	1	0	0	1	Select by path from current DF

NOTE: This is selection by AID.

Table 11.2: Coding of P2

b8	b7	b6	b5	b4	b3	b2	b1	Meaning
-	X	X	-	-	-	-	-	Application session control (see note 2)
-	0	0	-	-	-	-	-	- Activation/Reset
-	1	0	-	-	-	-	-	- Termination
0	-	-	0	0	1	-	-	Return FCP template
0	-	-	0	1	1	-	-	No data returned
-	-	-	-	-	-	X	X	Selection by AID control
-	-	-	-	-	-	0	0	- First or only occurrence
-	-	-	-	-	-	0	1	- Last occurrence
-	-	-	-	-	-	1	0	- Next occurrence
-	-	-	-	-	-	1	1	- Previous occurrence

NOTE 1: Whether the FCP information is returned or not depends on the type of APDU.
NOTE 2: This only applies when P1 indicates SELECT by DF name.

If P1 = '00' and the data field is empty, then P2 shall be set to '0C' ('No data returned'). Then the MF is set as the Current Directory.

To avoid ambiguities when P1 = '00', the following search order applies when selecting a file with a File ID (FID) as a parameter:

- immediate children of the current DF;
- the parent DF;
- the immediate children of the parent DF.

When P1 ≠ '04', bits b2 and b1 of P2 have no meaning and shall be set to 0.

When P1 = '04' (i.e. for selection by AID), a right truncated AID can be specified in the data field.

11.1.1.3 Response Data

Byte(s)	Description	Length
1	FCP template tag = '62'	1
2 (to 3)	Length of FCP template	1 or 2
3 to X+2 (or 4 to X+3)	FCP template	X

The response data contains the File Control Parameters (FCP) template of the selected file. The contents of the FCP depend on the selected file. See below for the list of TLV that are returned in each case.

In order to retrieve the entire FCP template, Le should be set to '00'.

The value part of the FCP template data object consists of data objects, as shown in clause 11.1.1.3.1. It is mandatory for data objects to be provided in the order given in the description of each response. New data objects can be added to the end of the response data. The terminal shall ignore data objects with tags it does not support.

11.1.1.3.1 Response for MF, DF or ADF

This clause lists the TLVs in the order returned when an MF, DF or ADF is selected.

Table 11.3: Response for MF, DF, or ADF with FCP template

Description	Tag	Clause	Status
File Descriptor	'82'	11.1.1.4.3	M
File Identifier	'83'	11.1.1.4.4	C1
DF name (AID)	'84'	11.1.1.4.5	C2
Proprietary information	'A5'	11.1.1.4.6	C3
Life Cycle Status Integer	'8A'	11.1.1.4.9	M
Security attributes	'8B', '8C' or 'AB'	11.1.1.4.7	C4
PIN Status Template DO	'C6'	11.1.1.4.10	M
Total file size	'81'	11.1.1.4.2	O
M: Mandatory. O: Optional. C1: The File identifier is mandatory for a DF or the MF. For an ADF the File identifier is optional. C2: DF name is mandatory for only ADF. C3: Proprietary information is mandatory for the MF. For a DF/ADF the Proprietary information is optional. C4: Exactly one shall be present.			

11.1.1.3.2 Response for an EF

This clause lists the TLVs in the order returned when an EF is selected.

Table 11.4: Response for an EF with FCP template

Description	Tag	Clause	Status
File Descriptor	'82'	11.1.1.4.3	M
File Identifier	'83'	11.1.1.4.4	M
Proprietary information	'A5'	11.1.1.4.6	O
Life Cycle Status Integer	'8A'	11.1.1.4.9	M
Security attributes	'8B', '8C' or 'AB'	11.1.1.4.7	C1
File size	'80'	11.1.1.4.1	M
Total file size	'81'	11.1.1.4.2	O
Short File Identifier (SFI)	'88'	11.1.1.4.8	O
M: Mandatory. O: Optional. C1: Exactly one shall be present.			

11.1.1.4 File control parameters

11.1.1.4.1 File size

Byte(s)	Description	Value	Length
1	Tag	'80'	1
2	Length	X, X ≥ 2	1
3 to X+24	Number of allocated data bytes in the file, excluding structural information		X

The most significant byte comes first in the value field.

For transparent EF, file size is the length of the body part of the EF, and for linear fixed or cyclic EF, it is the record length multiplied by the number of records of the EF. For a BER-TLV structure EF, file size is the memory used by the allocated data objects.

11.1.1.4.2 Total file size

Byte(s)	Description	Value	Length
1	Tag	'81'	1
2	Length	X, $X \geq 2$	1
3 to X+2	Number of allocated data bytes in the file, including structural information if any		X

The most significant byte comes first in the value field.

For an EF, the "total file size" represents the allocated memory for the content and the structural information (if any) of this EF.

For a BER-TLV structure EF, the structural information shall include any administrative overhead that is required to store the TLV objects in the file. If a reserved file size according to clause 11.1.1.4.6.Y is defined for the file, any memory space, that is allocated for the file accordingly, but is currently not used, shall be included in the total file size.

For a DF, the "total file size" represents the sum of the "total file sizes" of all the EFs and DFs contained in this DF plus the amount of available memory in this DF. The size of the structural information of the selected DF itself is not included.

11.1.1.4.3 File Descriptor

Byte(s)	Description	Status	Value	Length
1	Tag	M	'82'	1
2	Length	M	'02' or '05'	1
3	File descriptor byte (see table 11.5)	M		1
4	Data coding byte	M	'21'	1
5 to 6	Record length	C	'0001' to '00FF'	2
7	Number of records	C	'01' to 'FE'	1
M: Mandatory.				
C: These bytes are mandatory for linear fixed and cyclic files, otherwise they are not applicable.				

- File descriptor.

Contents: File descriptor specifies the file accessibility, and the file type and structure.

Coding: See table 11.5.

Table 11.5: File descriptor byte

b8	b7	B6	b5	b4	b3	b2	b1	Meaning
0	X	-	-	-	-	-	-	File accessibility
0	0	-	-	-	-	-	-	Not shareable file
0	1	-	-	-	-	-	-	Shareable file
0	-	X	X	X	-	-	-	File type
0	-	0	0	0	-	-	-	Working EF
0	-	0	0	1	-	-	-	Internal EF
0	-	0	1	0	-	-	-	RFU
0	-	0	1	1	-	-	-	
0	-	1	0	0	-	-	-	
0	-	1	0	1	-	-	-	
0	-	1	1	0	-	-	-	
0	-	1	1	1	0	0	0	DF or ADF
0	-	-	-	-	X	X	X	EF structure
0	-	Not all set to 1			0	0	0	No information given
0	-	-	-	-	0	0	1	Transparent structure
0	-	-	-	-	0	1	0	Linear fixed structure
0	-	-	-	-	0	1	1	RFU
0	-	-	-	-	1	0	0	
0	-	-	-	-	1	0	1	Cyclic structure
0	-	-	-	-	1	1	1	RFU
0	-	1	1	1	0	0	1	BER-TLV structure
1	X	X	X	X	X	X	X	RFU

- Data coding byte.

Coding: The data coding byte is coded according to ISO/IEC 7816-4 [12]. The actual value shall not be checked nor used by the terminal.

- Record length.

Contents: Record length specifies the length of a record when a record structured file has been selected.

Coding: The record length shall be present if a record structured file (i.e. for linear fixed or cyclic files) is selected. In this case it indicates the length the records on 2 bytes. Most significant byte comes first in the value field.

- Number of records.

Contents: Number of records specifies the number of records in a record structured file.

Coding: The number of records shall be present if a record structured file (i.e. for linear fixed or cyclic files) is selected. In this case it indicates the number of records on 1 byte.

11.1.1.4.4 File identifier

Byte(s)	Description	Value	Length
1	Tag	'83'	1
2	Length	'02'	1
3 to 4	File identifier		2

11.1.1.4.5 DF name

Byte(s)	Description	Value	Length
1	Tag	'84'	1
2	Length	$1 \leq X \leq 16$	1
3 to 2+X	DF name		X

DF name is a string of bytes, the AID, which is used to uniquely identify an application dedicated file in the card.

11.1.1.4.6 Proprietary information

This is a constructed TLV object.

Byte(s)	Description	Length
1	Proprietary information constructed Tag = 'A5'	1
2	Length	1
3 to 2+X	Proprietary data, constructed	X

The following TLV objects are defined for the proprietary template (tag 'A5'). Additional private TLV objects (bits b7 and b8 of the first byte of the tag set to '1') may be present after the TLV objects defined in this clause. For example, a manufacturer, issuer, or application provider specific TLV object may be present. If more than one TLV object with the same tag is indicated in this constructed TLV they shall be grouped together as the order in which they appear is used to specify the usage.

Description	Tag	Status	Clause
UICC characteristics	'80'	C1	11.1.1.4.6.1
Application power consumption	'81'	C2	11.1.1.4.6.2
Minimum application clock frequency	'82'	C3	11.1.1.4.6.3
Amount of available memory	'83'	C4	11.1.1.4.6.4
File details	'84'	C5	11.1.1.4.6.5
Reserved file size	'85'	C5	11.1.1.4.6.6
Maximum file size	'86'	C6	11.1.1.4.6.7
Supported system commands	'87'	C7	11.1.1.4.6.8
Specific UICC environmental conditions	'88'	C8	11.1.1.4.6.9
C1: The UICC characteristics are mandatory for the MF. C2: Application power consumption, is optional for ADFs. This TLV object shall not be present for the MF, an EF or DF. C3: This TLV object shall not be present for the MF, DF or an EF. For an ADF, it is optional. C4: This TLV object shall not be present for a transparent, linear fixed or cyclic EF. It is mandatory for BER-TLV structured EFs. For an ADF, DF or the MF, it is optional. C5: This TLV object shall only be present for BER-TLV structured EFs, for which it is mandatory. C6: This TLV object shall only be present for BER-TLV structured EFs, for which it is optional. C7: If the UICC supports system commands, then this TLV object is mandatory for the MF and optional for any other DF. C8: This TLV object shall be present for the MF only if the UICC supports specific UICC environmental conditions. It shall not be present for an ADF, DF or an EF.			

An application may supply more than one application power consumption or minimum application clock frequency Data Object (DO).

11.1.1.4.6.1 UICC characteristics

Byte(s)	Description	Value	Length
1	Tag	'80'	1
2	Length	'01'	1
3	UICC characteristics byte (see table 11.6)		1

Table 11.6: UICC characteristics byte

b8	b7	b6	b5	b4	b3	b2	b1	Meaning
-	-	-	-	X	X	-	1	Clock stop allowed
-	-	-	-	0	0	-	1	No preferred level
-	-	-	-	0	1	-	1	High level preferred
-	-	-	-	1	0	-	1	Low level preferred
-	-	-	-	1	1	-	1	RFU
-	-	-	-	X	X	-	0	Clock stop not allowed
-	-	-	-	0	0	-	0	Never
-	-	-	-	0	1	-	0	Unless at high level
-	-	-	-	1	0	-	0	Unless at low level
-	-	-	-	1	1	-	0	RFU
-	-	-	X	-	-	-	-	Supply voltage class A
-	-	X	-	-	-	-	-	Supply voltage class B
-	X	-	-	-	-	-	-	Supply voltage class C
X	-	-	-	-	-	X	-	RFU (shall be set to 0)

If bit b1 is coded '1', stopping the clock is allowed at high or low level. In this case bit b3 and b4 give information about the preferred level (high or low, respectively) at which the clock may be stopped.

If b1 is coded '0', the clock may be stopped only if the mandatory condition b3 = '1' (i.e. stop at high level) or b4 = '1' (i.e. stop at low level) is fulfilled. If all 3 bits are coded '0', then the clock shall not be stopped.

A supply voltage class, as defined in clause 6.2.1, is supported if the bit is coded as a '1'. If the voltage class is not supported the bit is coded as '0'.

11.1.1.4.6.2 Application power consumption

The application power consumption is indicated by tag '81' within the constructed TLV object. The first byte indicates the supply voltage at which the power consumption is measured. The coding of this byte is the same as for the supply voltage class indication in the ATR, see table 6.1. Unused bits are set to RFU. The second byte indicates the power consumption in mA. Bits b8 to b7 are RFU. Bits b6 to b1 indicates the power consumption of the application in mA. The power consumption is measured at the frequency indicated in the "Power consumption reference frequency" field for the application, averaged over 1 ms or at the maximum clock frequency supported by the UICC if no indication is given. The terminal shall ignore the application power consumption values '00' and 'FF'. A value higher than 3C shall not be interpreted by the terminal and is not to be used. The terminal may still accept the application.

The terminal shall evaluate the power consumption value given in the response. If the power supply class indicated in the response is not the currently used the terminal shall recalculate the value to the currently used supply voltage class. The terminal shall accept the application if the recalculated value is within the specification limits set for the currently used supply voltage class. The terminal may accept an application that exceeds the specified value if it can support the power consumption indicated by the application.

Byte(s)	Description	Value	Length
1	Tag	'81'	1
2	Length	'03'	1
3	Supply voltage class at which the power consumption is measured		1
4	Application power consumption	'01' to '3C'	1
5	Power consumption reference frequency	'0A' to 'FF'	1

The power consumption reference frequency is coded in Hexadecimal format. The resolution is 0,1 MHz, i.e. '0A' is 1 MHz and 'FE' is 25,4 MHz. The value 'FF' indicates that no reference frequency is indicated.

11.1.1.4.6.3 Minimum application clock frequency

The application minimum clock frequency is indicated by tag '82' within the constructed TLV object. This TLV object indicates to the terminal the minimum clock frequency required by the application. It is up to the application to specify a value that is required for commands or procedures to be executed within the required time. An application may indicate one or more application minimum clock frequencies if required. In case that more than one TLV object is indicated it is up to the application to specify for what purpose the different values are used, i.e. the order of the TLV objects within the constructed TLV is relevant.

Byte(s)	Description	Value	Length
1	Tag	'82'	1
2	Length	'01'	1
3	Application minimum clock frequency	'0A' to 'FF'	1

The minimum clock frequency is coded in Hexadecimal format. The resolution is 0,1 MHz, i.e. '0A' is 1 MHz and 'FE' is 25,4 MHz. If this TLV object is not present or the value is 'FF', no minimum application clock frequency is indicated.

11.1.1.4.6.4 Amount of available memory

Amount of memory which is available for DFs or EFs creation under the selected DF (and ADFs under the MF) or for creation of TLV objects in a BER-TLV structured EF.

Byte(s)	Description	Value	Length
1	Tag	'83'	1
2	Length	X, $X \geq 2$	1
3 to 2+X	Number of data bytes		X

The most significant byte comes first in the value field.

For BER-TLV structured EF this value shall be the maximum amount of bytes that is available in the EF for the next TLV object to be created. This shall include the space required for the tag and the length field. If a maximum file size is defined for the file, it shall not be exceeded, if an object is created with the indicated available size.

For example, if the amount of available memory is 100 bytes, it means that the terminal can store a TLV object with a 2 byte tag, 1 byte length, and 97 bytes of data.

11.1.1.4.6.5 File details

Indicator of the TLV coding supported by a BER TLV structured EF.

Byte(s)	Description	Value	Length
1	Tag	'84'	1
2	Length	1	1
3	File details value		1

- Coding of file access details value:

b8	b7	B6	b5	b4	b3	b2	b1	Meaning
-	-	-	-	-	-	-	1	DER coding only is supported
X	X	X	X	X	X	X	-	RFU

Additional bytes may be added to the value field in the future.

11.1.1.4.6.6 Reserved File size

Memory size which is reserved for this file and cannot be allocated by any other entity.

Byte(s)	Description	Value	Length
1	Tag	'85'	1
2	Length	X, $X \geq 2$	1
3 to 2+X	Number of data bytes		X

The most significant byte comes first in the value field.

The value shall include administrative overhead (if any) that is required to store TLV objects, but not the structural information for the file itself. Thus the actually usable file size calculated according to clause 11.1.1.4.1 may be smaller.

If no memory is reserved for the file, the value of the "Reserved File size" object is set to zero.

11.1.1.4.6.7 Maximum file size

File size that shall not be exceeded.

Byte(s)	Description	Value	Length
1	Tag	'86'	1
2	Length	X, $X \geq 2$	1
3 to 2+X	Number of data bytes		X

The most significant byte comes first in the value field.

The value shall include administrative overhead (if any) that is required to store TLV objects, but not the structural information for the file itself. Thus the actually usable file size calculated according to clause 11.1.1.4.1 may be smaller.

If no maximum file size is defined for the file, the maximum file size object is not present for a file, and all available memory of the UICC may be allocated to that file.

11.1.1.4.6.8 Supported system commands

Byte(s)	Description	Value	Length
1	Tag	'87'	1
2	Length	1	1
3	Supported commands		1

- Coding of Supported commands field:

b8	b7	B6	b5	b4	b3	b2	b1	Meaning
-	-	-	-	-	-	-	1	TERMINAL CAPABILITY is supported
-	-	-	-	-	-	-	0	TERMINAL CAPABILITY not supported
X	X	X	X	X	X	X	-	RFU

Additional bytes may be added to the value field in the future.

Applications on the UICC requiring more power than the minimum power consumption defined in table 6.4 may use the indication "TERMINAL CAPABILITY is supported" to request the terminal to indicate its capabilities with respect to support of additional power consumption using the TERMINAL CAPABILITY command. The use of this feature is up to the application to specify. If an application uses this mechanism it shall be used as specified in the present document.

11.1.1.4.6.9 Specific UICC environmental conditions

This TLV object indicates to the terminal the specific environmental conditions that the UICC supports. This TLV object is mandatory if the UICC supports specific UICC environmental conditions. It is up to the terminal whether to evaluate this object and how to behave.

Byte(s)	Description	Value	Length
1	Tag	'88'	1
2	Length	'01'	1
3	Specific UICC environmental conditions byte (see table 11.7a)		1

Table 11.7a: Specific UICC environmental conditions byte

b8	b7	b6	b5	b4	b3	b2	b1	Meaning
-	-	-	-	-	X	X	X	Temperature Class
					0	0	0	Standard temperature range
-	-	-	-	-	0	0	1	Temperature class A
-	-	-	-	-	0	1	0	Temperature class B
	-	-	-	-	0	1	1	Temperature class C
					1	X	X	RFU
-	-	-	-	X	-	-	-	High humidity
-	-	-	-	0	-	-	-	High humidity not supported
-	-	-	-	1	-	-	-	High humidity supported
X	X	X	X	-	-	-	-	RFU

11.1.1.4.7 Security attributes

11.1.1.4.7.1 Compact format

Byte(s)	Description	Value	Length
1	Tag	'8C'	1
2	Length	X	1
3	AM byte		1
4 to (X+2)	SC bytes		X-1

The value of the AM byte is defined in ISO/IEC 7816-4 [12]. The amount of SC bytes depends upon the value of the AM byte. There shall be a SC byte present for each bit set to '1' in the AM byte except for b8. The value of the SC byte is defined in ISO/IEC 7816-4 [12].

11.1.1.4.7.2 Expanded format

Byte(s)	Description	Value	Length	Comment
1	Tag	'AB'	1	
2	Length	V	1	
3	AM DO tag	'8X' (see note 1)	1	Security Rule #1
4	Length	X	1	
5 to (4+X)	AM_DO	(see note 2)	X	
5+X	SC_DO tag	(see note 2)	1	
6+X	Length	Y	1	
(7+X) to (6+X+Y)	SC_DO	(see note 2)	Y	
.....				
V+2-(4+W+Z)	AM DO tag	'8X' (see note 1)	1	Security Rule #N
V+2-(3+W+Z)	Length	W	1	
V+2-(2+W+Z) to V+2-(2+Z)	AM_DO	(see note 2)	W	
V+2-(1+Z)	SC_DO tag	(see note 2)	1	
V+2-Z	Length	Z	1	
V+2-(Z-1) to V+2	SC_DO	(see note 2)	Z	
NOTE 1: The value of 'X' is dependent on the usage of the AM_DO see ISO/IEC 7816-4 [12].				
NOTE 2: The value of the AM_DO and the SC_DO is defined in ISO/IEC 7816-4 [12].				

11.1.1.4.7.3 Referenced to expanded format

If the length of the data following tag '8B' = '03' the following definition applies.

Byte(s)	Description	Value	Length
1	Tag	'8B'	1
2	Length	3	1
3 to 4	EF _{ARR} File ID		2
5	EF _{ARR} Record number		1

If the length of the data following tag '8B' is '02' + X × '02' the following definition applies.

Byte(s)	Description	Value	Length
1	Tag	'8B'	1
2	Length	'02' + X × '02'	1
3 to 4	EF _{ARR} File ID		2
X+4	SEID		1
X+5	EF _{ARR} Record number		
NOTE: For each increment of X a new set of SEID and an EF _{ARR} Record numbers are introduced.			

11.1.1.4.8 Short file identifier

Byte(s)	Description	Value	Length
1	Tag	'88'	1
2	Length	'00' or '01'	1
3	Short file identifier		0 or 1

If the TLV is not present, the SFI value is the 5 least significant bits (bits b5 to b1) of the file identifier.

If the TLV is present but empty (i.e. length is 0), the SFI is not supported for the selected file.

If the length of the TLV is 1, the SFI value is indicated in the 5 most significant bits (bits b8 to b4) of the TLV value field. In this case, bits b3 to b1 shall be set to 0.

11.1.1.4.9 Life cycle status integer

Byte(s)	Description	Value	Length
1	Tag	'8A'	1
2	Length	1	1
3	Life Cycle Status Integer, see table 11.7b		1

Table 11.7b: Coding of life cycle status integer

b8	b7	b6	b5	b4	b3	b2	b1	Meaning
0	0	0	0	0	0	0	0	No information given
0	0	0	0	0	0	0	1	Creation state
0	0	0	0	0	0	1	1	Initialization state
0	0	0	0	0	1	-	1	Operational state - activated
0	0	0	0	0	1	-	0	Operational state - deactivated
0	0	0	0	1	1	-	-	Termination state
≠ 0				X	X	X	X	Proprietary
Any other value								RFU

11.1.1.4.10 PIN status template DO

This TLV object contains the PIN status information for a DF/ADF and which PINs are used for access to the DF/ADF and its children. PIN is indicated in this data object using the key reference tag '83' as defined in ISO/IEC 7816-4 [12]. The content of the constructed PIN status TLV Data Object tag 'C6' depends on the length (see below).

Byte(s)	Description	Value	Length
1	Tag	'C6'	1
2	Length		1
3	PS_DO tag	'90'	1
4	Length	X	1
X+4	PS_DO		X
X+5	Usage qualifier DO tag (see note 2)	'95'	1
X+6	Length	'01'	1
X+7	Usage qualifier, see clause 9.5.2		1
X+8	Key reference tag	'83'	1
X+9	Length	'01'	1
X+10	Key reference (PIN)	see table 9.3	1
NOTE 1: There may be one or more key reference data objects, each possibly preceded by a usage qualifier DO, following the PS_DO.			
NOTE 2: This TLV DO is mandatory if the Key reference DO value is '11' indicating the Universal PIN, otherwise it is optional.			

The usage qualifier DO indicates if the key reference data object (PIN) following it is to be used for verification or not. If this data object is present it shall precede the key reference data object it is associated with.

For the PS_DO coding see clause 9.5.2. For each bit set to '1' in the PS byte, the corresponding key reference in the PS Template, DO is enabled. The number of key reference tags (tag '83') indicates how many different PINs are used for access in the selected DF and its children.

11.1.2 STATUS

11.1.2.1 Functional description

This function returns information concerning the current directory or current application.

In addition, according to the application specification, it may be used to indicate to the application in the UICC that its session activation procedure has been successfully executed or that its termination procedure will be executed.

NOTE: These indications may be used to synchronize the applications in the terminal and in the UICC.

Input:

- None.

Output:

- One of the following:
 - FCP of the current directory.
 - The DF name TLV Data Object of the currently selected application.
 - No data returned.

11.1.2.2 Command parameters

Code	Value
CLA	As specified in clause 10.1.1
INS	As specified in clause 10.1.2
P1	Indication of application status (see table 11.8)
P2	See table 11.9
Le	Empty, '00', or maximum length of data expected in response

Table 11.8: Coding of P1

b8	b7	b6	b5	b4	b3	B2	b1	Meaning
0	0	0	0	0	0	0	0	No indication
0	0	0	0	0	0	0	1	Current application is initialized in the terminal
0	0	0	0	0	0	1	0	The terminal will initiate the termination of the current application

Table 11.9: Coding of P2

b8	b7	b6	b5	b4	b3	b2	b1	Meaning
0	0	0	0	0	0	0	0	Response parameters and data are identical to the response parameters and data of the SELECT command
0	0	0	0	0	0	0	1	The DF name TLV-object of the currently selected application is returned
0	0	0	0	1	1	0	0	No data returned
Any other value								RFU

11.1.3 READ BINARY

11.1.3.1 Functional description

This function reads a string of bytes from the current transparent EF. This function shall only be performed if the READ access condition for this EF is satisfied.

Input:

- Relative address and the length of the string.

Output:

- String of bytes.

11.1.3.2 Command parameters

Code	Value
CLA	As specified in clause 10.1.1
INS	As specified in clause 10.1.2
P1	See table 11.10
P2	Offset low
Lc	Not present
Data	Not present
Le	Number of bytes to be read

Table 11.10: Coding of P1

b8	B7	b6	b5	b4	b3	b2	b1	Meaning
0	X	X	X	X	X	X	X	b7 to b1 is the offset to the first byte to read - P2 is the low part of the offset
1	0	0	X	X	X	X	X	SFI referencing used, b1 to b5 are the SFI and P2 is the offset to the first byte to read

Response data:

Byte(s)	Description	Length
1 to Le	Data read	Le

11.1.4 UPDATE BINARY

11.1.4.1 Functional parameters

This function updates the current transparent EF with a string of bytes. This function shall only be performed if the UPDATE access condition for this EF is satisfied. An update can be considered as a replacement of the string already present in the EF by the string given in the update command.

Input:

- Relative address and the length of the string.
- String of bytes.

Output:

- None.

11.1.4.2 Command parameters and data

Code	Value
CLA	As specified in clause 10.1.1
INS	As specified in clause 10.1.2
P1	See table 11.10
P2	Offset low
Lc	Length of the subsequent data field
Data	String of data to be updated
Le	Not present

Coding of parameter P1 and P2 are identical to the coding of P1 and P2 in the READ BINARY command.

11.1.5 READ RECORD

11.1.5.1 Functional description

This function reads one complete record in the current linear fixed or cyclic EF. The record to be read is described by the modes below. This function shall only be performed if the READ access condition for this EF is satisfied. The record pointer shall not be changed by an unsuccessful READ RECORD function.

Four modes are defined:

CURRENT: The current record is read. The record pointer is not affected.

ABSOLUTE: The record given by the record number is read. The record pointer is not affected.

NEXT: The record pointer is incremented before the READ RECORD function is performed and the pointed record is read. If the record pointer has not been previously set within the selected EF, then READ RECORD (next) shall read the first record and set the record pointer to this record.

If the record pointer addresses the last record in a linear fixed EF, READ RECORD (next) shall not cause the record pointer to be changed, and no data shall be read.

If the record pointer addresses the last record in a cyclic EF, READ RECORD (next) shall set the record pointer to the first record in this EF and this record shall be read.

PREVIOUS: The record pointer is decremented before the READ RECORD function is performed and the pointed record is read. If the record pointer has not been previously set within the selected EF, then READ RECORD (previous) shall read the last record and set the record pointer to this record.

If the record pointer addresses the first record in a linear fixed EF, READ RECORD (previous) shall not cause the record pointer to be changed, and no data shall be read.

If the record pointer addresses the first record in a cyclic EF, READ RECORD (previous) shall set the record pointer to the last record in this EF and this record shall be read.

Input:

- Mode, record number (absolute mode only) and the length of the record.

Output:

- The record.

11.1.5.2 Command parameters

Code	Value
CLA	As specified in clause 10.1.1
INS	As specified in clause 10.1.2
P1	Record number
P2	Mode, see table 11.11
Lc	Not present
Data	Not present
Le	Number of bytes to be read

Table 11.11: Coding of P2

b8	b7	b6	b5	b4	b3	b2	b1	Meaning
0	0	0	0	0	-	-	-	Currently selected EF
X	X	X	X	X	-	-	-	Short File identifier (from 1 to 30)
-	-	-	-	-	0	1	0	Next record
-	-	-	-	-	0	1	1	Previous record
-	-	-	-	-	1	0	0	Absolute/current mode, the record number is given in P1 with P1='00' denoting the current record

For the modes "next" and "previous" P1 has no significance within the scope of the present document and shall be set to '00' by the terminal.

Response data:

Byte(s)	Description	Length
1 to Le	Data read	Le

11.1.6 UPDATE RECORD

11.1.6.1 Functional description

This function updates one specific, complete record in the current linear fixed or cyclic EF. This function shall only be performed if the UPDATE access condition for this EF is satisfied. The UPDATE can be considered as a replacement of the relevant record data of the EF by the record data given in the command. The record pointer shall not be changed by an unsuccessful UPDATE RECORD function.

The record to be updated is described by the modes below. Four modes are defined of which only PREVIOUS is allowed for cyclic files:

- CURRENT:** The current record is updated. The record pointer is not affected.
- ABSOLUTE:** The record given by the record number is updated. The record pointer is not affected.
- NEXT:** The record pointer is incremented before the UPDATE RECORD function is performed and the pointed record is updated. If the record pointer has not been previously set within the selected EF, then UPDATE RECORD (next) shall set the record pointer to the first record in this EF and this record shall be updated. If the record pointer addresses the last record in a linear fixed EF, UPDATE RECORD (next) shall not cause the record pointer to be changed, and no record shall be updated.

PREVIOUS: For a linear fixed EF the record pointer is decremented before the UPDATE RECORD function is performed and the pointed record is updated. If the record pointer has not been previously set within the selected EF, then UPDATE RECORD (previous) shall set the record pointer to the last record in this EF and this record shall be updated. If the record pointer addresses the first record in a linear fixed EF, UPDATE RECORD (previous) shall not cause the record pointer to be changed, and no record shall be updated.

For a cyclic EF the record containing the oldest data is updated, the record pointer is set to this record and this record becomes record number 1.

Input:

- Mode, record number (absolute mode only) and the length of the record.
- The data used for updating the record.

Output:

- None.

11.1.6.2 Command parameters and data

Code	Value
CLA	As specified in clause 10.1.1
INS	As specified in clause 10.1.2
P1	Record number
P2	Mode, see table 11.11
Lc	Length of the subsequent data field
Data	String of data to be updated
Le	Not present

Coding of parameter P2 is identical to the coding of P2 in READ RECORD command.

For the modes "next" and "previous" P1 has no significance and shall be set to '00' by the terminal.

11.1.7 SEARCH RECORD

11.1.7.1 Functional description

This function searches through a linear fixed or cyclic EF to find record(s) containing a specific pattern. This function shall only be performed if the READ access condition for this EF is satisfied. The search starts:

- either at the first byte of the record(s) (simple search); or
- from a given offset in the record(s); or
- from the first occurrence of a given byte in the record(s).

The response is either empty or contains the, up to the Le specified number of, record number(s) of the records that matches the search in the selected EF.

If one or more matches are found the record pointer shall be set to the first record where the search pattern was found.

Input:

- Search mode (simple/enhanced).
- Offset.
- Pattern.

Output:

- Either none, if Le is empty or no matches where found; or
- at most the number of record(s) number(s) defined in Le.

11.1.7.2 Command parameters and data

Code	Value
CLA	As specified in clause 10.1.1
INS	As specified in clause 10.1.2
P1	Record number ('00' indicates: current record)
P2	See table 11.12
Lc	Length of the subsequent data field
Data	- Simple search: search string - Enhanced search: search indication (2 bytes) followed by search string - Proprietary search: proprietary data
Le	Empty or maximum length of response data

Table 11.12: Coding of P2

b8	b7	b6	b5	b4	b3	b2	b1	Meaning
0	0	0	0	0	-	-	-	Currently selected EF
X	X	X	X	X	-	-	-	Short File Identifier
1	1	1	1	1	-	-	-	RFU
-	-	-	-	-	0	X	X	RFU (see note)
-	-	-	-	-	1	0	X	Simple search. Usage of P1 as a record number
-	-	-	-	-	1	0	0	Start forward search from record indicated in P1
-	-	-	-	-	1	0	1	Start backward search from record indicated in P1
-	-	-	-	-	1	1	0	Enhanced search - see table 11.13
-	-	-	-	-	1	1	1	Proprietary search

NOTE: This value is reserved by ISO/IEC 7816-4 [12].

Table 11.13: Coding of the first byte of the search indication for enhanced search mode

b8	b7	b6	b5	b4	b3	b2	b1	Meaning
0	0	0	0	0	-	-	-	The search starts in the record from the offset (absolute position) given in the second byte of the search indication
0	0	0	0	1	-	-	-	The search starts in the record after the first occurrence of the value contained in the second byte of the search indication
-	-	-	-	-	0	X	X	RFU (see note)
-	-	-	-	-	1	X	X	Usage of value of P1 as a record number
-	-	-	-	-	1	0	0	Start forward search form record indicated in P1
-	-	-	-	-	1	0	1	Start backward search form record indicated in P1
-	-	-	-	-	1	1	0	Start forward search from next record
-	-	-	-	-	1	1	1	Start backward search form previous record
Any other value								RFU

NOTE: This value is reserved by ISO/IEC 7816-4 [12].

For the modes "forward search from next record" and "backward search from previous record", P1 has no significance within the scope of the present document and shall be set to '00'.

Response data:

Byte(s)	Description	Length
0 to Le	Record number(s)	Le

NOTE: If Le is empty no record numbers will be returned.

11.1.8 INCREASE

11.1.8.1 Functional description

This function adds the value given by the terminal to the value of the last increased/updated record of the current cyclic EF, and stores the result into the oldest record. The record pointer is set to this record and this record becomes record number 1. This function can only be used if this EF has an INCREASE access condition assigned and this condition is fulfilled. The INCREASE access condition is indicated in the access rules using AM_DO tag '84'. Tag '84' indicates that the INS code for the INCREASE command is indicated as the value in the TLV object (instruction code '32'). The INCREASE command can only be used on files that refer to an access rule where this INS code is indicated as part of the rule.

The function does not perform the increase if the result would exceed the maximum value of the record (represented by all bytes set to 'FF').

Input:

- Value to be added.

Output:

- Value of the increased record.
- Value which has been added.

11.1.8.2 Command parameters and data

Code	Value
CLA	As specified in clause 10.1.1
INS	As specified in clause 10.1.2
P1	See table 11.14
P2	'00'
Lc	Length of the subsequent data field
Data	Value to be added
Le	Length of the response data

Table 11.14: Coding of P1

b8	b7	b6	b5	b4	b3	b2	b1	Meaning
0	0	0	0	0	0	0	0	Increase the currently selected EF
1	0	0	X	X	X	X	X	SFI referencing used, b1 to b5 are the SFI
NOTE: All other values are RFU.								

In this command, Lc is restricted to $0 < Lc < 128$ and the maximum record length is limited to 127 bytes.

Response data:

Byte(s)	Description	Length
1 to X	Value of the increased record	X
X + 1 to X + Lc	Value which has been added	Lc
NOTE: X denotes the length of the record.		

11.1.9 VERIFY PIN

11.1.9.1 Functional description

11.1.9.1.1 PIN verification

This function initiates the comparison in the UICC of the PIN verification data sent from the terminal with the PIN reference data stored in the card. The security status set as a result of the verification is valid regardless on which logical channel the verification is performed. The verification process is subject to the following conditions being fulfilled:

- PIN is not disabled;
- PIN is not blocked.

If the access condition for a function to be performed on the last selected file is PIN, then a successful verification of the relevant PIN is required prior to the use of the function on this file unless the PIN is disabled.

If the PIN presented is correct, the number of remaining PIN attempts for that PIN shall be reset to its initial value 3.

If the PIN presented is false, the number of remaining PIN attempts for that PIN shall be decremented, regardless on which logical channel the VERIFY PIN command was issued. The UICC shall return SW1 SW2 = '63C2' after the first false PIN presentation. The UICC shall return SW1 SW2 = '63C1' after the second consecutive false PIN presentation, not necessarily in the same card session. After the third consecutive false PIN presentation, not necessarily in the same card session, the respective PIN shall be blocked and the UICC shall return SW1 SW2 = '63C0'. Any subsequent VERIFY PIN command applied to this blocked PIN shall then return SW1 SW2 = '6983'. The access condition can never be fulfilled until the UNBLOCK PIN function has been successfully performed on the respective PIN.

Input:

- Indication PIN.

Output:

- None.

11.1.9.1.2 PIN retry counter

The VERIFY PIN with empty data field is used to retrieve the PIN retry counter from the UICC. This function is performed whether or not the relevant PIN is disabled or blocked (e.g. by 3 consecutive wrong PIN presentations).

The VERIFY PIN command is sent to the UICC with parameter P2 indicating the PIN for which the retry counter value is to be retrieved with an empty data field. The number of retries, if any, is indicated in the response by SW1 SW2 = '63CX', where X indicates the number of retries left.

A VERIFY PIN command with empty data field applied to a blocked PIN shall return SW1 SW2 = '63C0' or SW1 SW2 = '6983'.

Input:

- Empty.

Output:

- None.

11.1.9.2 Void

11.1.9.3 Command parameters

Code	Value
CLA	As specified in clause 10.1.1
INS	As specified in clause 10.1.2
P1	'00'
P2	Qualifier of the reference data, see table 11.15
Lc	Empty or '08'
Data	EMPTY or PIN value
Le	Not present

Table 11.15: Coding of P2

b8	b7	b6	b5	b4	b3	b2	b1	Meaning
0	0	0	0	0	0	0	0	Not supported
0	-	-	-	-	-	-	-	Global reference data (e.g. MF specific PIN)
1	-	-	-	-	-	-	-	Specific reference data (e.g. DF specific/application dependent PIN)
-	X	X	-	-	-	-	-	'00' (other values are RFU)
-	-	-	X	X	X	X	X	Reference data number ('01' to '1F')

The five least significant bits of parameter P2 specify the PIN key reference number (see clause 9.5.1).

Command data:

Byte(s)	Description	Length
1 to 8	PIN value	8

11.1.10 CHANGE PIN

11.1.10.1 Functional description

The Change PIN command is used to initiate the comparison of the verification data with the PIN, and then to conditionally replace the existing PIN with the new PIN sent to the UICC in the command. Once successfully changed on a logical channel, the new value is immediately available to all channels.

This function assigns a new value to the relevant PIN subject to the following conditions being fulfilled:

- PIN is not disabled;
- PIN is not blocked.

The old and new PIN shall be presented.

If the old PIN presented is correct, the number of remaining PIN attempts for that PIN shall be reset to its initial value 3 and the new value for the PIN becomes valid.

If the old PIN presented is false, the number of remaining PIN attempts for that PIN shall be decremented and the value of the PIN is unchanged. After 3 consecutive false PIN presentations, not necessarily in the same card session, the respective PIN shall be blocked and the access condition can never be fulfilled until the UNBLOCK PIN function has been performed successfully on the respective PIN.

Input:

- Indication of PIN, old PIN, new PIN.

Output:

- None.

11.1.10.2 Command parameters

Code	Value
CLA	As specified in clause 10.1.1
INS	As specified in clause 10.1.2
P1	'00'
P2	As specified for the VERIFY PIN command, see clause 11.1.9
Lc	Length of the subsequent data field = '10'
Data	Old PIN value, new PIN value
Le	Not present

NOTE: "Change PIN" is named "exchange reference data" in ISO/IEC 7816-4 [12].

Byte(s)	Description	Length
1 to 8	Old PIN value	8
9 to 16	New PIN value	8

11.1.11 DISABLE PIN

11.1.11.1 Functional description

The Disable PIN command is used to switch off the requirement to compare the PIN verification data with the PIN reference data. The command also allows an indication whether to use an alternative global key reference, if enabled, or not when the application PIN is disabled. For universal PIN definition see clause 9.4.1. Usage of an alternative global key reference for user verification is indicated in parameter P1. If an alternative global key reference is used as a replacement for the application PIN, the usage qualifier in the PS_DO template data object for the alternative global key reference is set to 'use' = '08'. The verification of the alternative global key reference shall be performed instead of the application PIN verification to get access to the application.

The UICC shall perform a validation of the SE after the successful execution of this command as the current SE may have changed and this shall affect the access to files.

NOTE 1: The access rules for the application must cater for the case that an alternative global key reference replaces the application PIN. It is the responsibility of the application to specify this.

The successful execution of this function has the effect that files protected by PIN are now accessible as if they were marked "ALWAYS", except in the case where the alternative global key reference is to be used as a replacement for the disabled PIN. In this case the access condition for files containing only a reference to the disabled PIN is the alternative global key reference. For files having more than one global key reference indicated in the access rules the access condition is "ALWAYS" after disabling on of the key references used in the access rules. The function DISABLE PIN shall not be executed by the selected application when PIN is already disabled or blocked.

NOTE 2: Every application must specify whether this function is applicable to all PINs defined for the application.

If the PIN presented is correct, the number of remaining PIN attempts shall be reset to its initial value 3 and PIN shall be disabled.

If the PIN presented is false, the number of remaining PIN attempts shall be decremented and PIN remains enabled. After 3 consecutive false PIN presentations, not necessarily in the same card session, the PIN shall be blocked and the access condition can never be fulfilled until the UNBLOCK PIN function has been successfully performed on PIN.

Input:

- PIN.

Output:

- None.

11.1.11.2 Command parameters

Code	Value
CLA	As specified in clause 10.1.1
INS	As specified in clause 10.1.2
P1	See table 11.16
P2	As specified for the VERIFY PIN command, see clause 11.1.9
Lc	Length of the subsequent data = '08'
Data	PIN value
Le	Not present

Table 11.16: Coding of P1

b8	b7	b6	b5	b4	b3	b2	b1	Meaning
0	0	0	0	0	0	0	0	Verification data present in data field
0	0	0	0	0	0	0	1	Reserved by ISO/IEC 7816-4 [12]
1	-	-	-	-	-	-	-	Verification data present, and use reference data number as verification replacement
-	X	X	-	-	-	-	-	'00' (other values are RFU)
-	-	-	X	X	X	X	X	Global key reference data number ('01' to '1F')

Command data:

Byte(s)	Description	Length
1 to 8	PIN value	8

11.1.12 ENABLE PIN

11.1.12.1 Functional description

The Enable PIN command is used to switch on the requirement to compare the PIN verification data with the PIN reference data. It is the reverse function of DISABLE PIN. If an alternative global key reference has been used as a replacement for the application PIN, the usage of the alternative global key reference as a replacement shall be disabled upon enabling the PIN for which the alternative global key reference has been a replacement (setting the usage qualifier in the PS_DO template data object for the alternative global key reference to do not use = '00').

The UICC shall perform a validation of the SE after the successful execution of this command as the current SE may have changed and this shall affect the access to files.

The function ENABLE PIN shall not be executed by the selected application when PIN is already enabled or blocked.

Every application shall specify whether this function is applicable to all PINs defined for the application.

If the PIN presented is correct, the number of remaining PIN attempts shall be reset to its initial value 3 and PIN shall be enabled.

If the PIN presented is false, the number of remaining PIN attempts shall be decremented and PIN remains disabled. After 3 consecutive false PIN presentations, not necessarily in the same card session, PIN shall be blocked and may optionally be set to "enabled". Once blocked, the PIN can only be unblocked using the UNBLOCK PIN function. If the PIN is blocked and "disabled", the access condition shall remain granted. If the PIN is blocked and "enabled", the access condition can never be fulfilled until the UNBLOCK PIN function has been successfully performed on PIN.

Input:

- PIN.

Output:

- None.

11.1.12.2 Command parameters

Code	Value
CLA	As specified in clause 10.1.1
INS	As specified in clause 10.1.2
P1	'00'
P2	As specified for the VERIFY PIN command, see clause 11.1.9
Lc	Length of the subsequent data = '08'
Data	PIN value
Le	Not present

Command data:

Byte(s)	Description	Length
1 to 8	PIN value	8

11.1.13 UNBLOCK PIN

11.1.13.1 Functional description

11.1.13.1.1 PIN unblocking

This function is used to reset the PIN retry counter to its initial value and then to conditionally set a new PIN value. This function may be performed whether or not the relevant PIN is blocked (e.g. by 3 consecutive wrong PIN presentations). This unblocking process is subject to the following condition being fulfilled:

- UNBLOCK PIN is not blocked.

If the UNBLOCK PIN presented is correct, the value of the PIN, presented together with the UNBLOCK PIN, is assigned to that PIN, the number of remaining UNBLOCK PIN attempts for that UNBLOCK PIN is reset to its initial value 10 and the number of remaining PIN attempts for that PIN is reset to its initial value 3. After a successful unblocking attempt the PIN is enabled and the relevant access condition level is satisfied the new PIN value is available for all channels.

If the presented UNBLOCK PIN is false, the number of remaining UNBLOCK PIN attempts for that UNBLOCK PIN, regardless on which logical channel the UNBLOCK PIN command was issued, shall be decremented. The UICC shall return SW1 SW2 = '63C9', '63C8', ..., '63C1' for up to the ninth consecutive false UNBLOCK PIN presentation, not necessarily in the same card session. After the tenth consecutive false UNBLOCK PIN presentation, not necessarily in the same card session, the respective UNBLOCK PIN shall be blocked and the UICC shall return SW1 SW2 = '63C0'. Any subsequent UNBLOCK PIN command applied to this blocked UNBLOCK PIN shall then return SW1 SW2 = '6983'. A false UNBLOCK PIN shall have no effect on the status of the respective PIN itself.

Input:

- Indication PIN, the UNBLOCK PIN and the new PIN.

Output:

- None.

11.1.13.1.2 UNBLOCK PIN retry counter

The UNBLOCK PIN command with empty data field is used to retrieve the UNBLOCK PIN retry counter from the UICC. This function may be performed whether or not the relevant PIN is blocked (e.g. by 3 consecutive wrong PIN presentations) and whether or not the UNBLOCK PIN is blocked.

The UNBLOCK PIN command is sent to the UICC with parameter P2 indicating the PIN for which the UNBLOCK PIN retry counter value is to be retrieved with an empty data field. The number of retries, if any, is indicated in the response by SW1 SW2 = '63CX', where X indicates the number of retries left.

An UNBLOCK PIN command with empty data field applied to a blocked UNBLOCK PIN shall return SW1 SW2 = '63C0' or SW1 SW2 = '6983'.

Input:

- Empty.

Output:

- None.

11.1.13.2 Void

11.1.13.3 Command parameters

Code	Value
CLA	As specified in clause 10.1.1
INS	As specified in clause 10.1.2
P1	'00'
P2	As specified for the VERIFY PIN command (see clause 11.1.9)
Lc	Empty or '10'
Data	Empty or UNBLOCK PIN value, new PIN value
Le	Not present

Command data:

Byte(s)	Description	Length
1 to 8	UNBLOCK PIN value	8
9 to 16	New PIN value	8

11.1.14 DEACTIVATE FILE

11.1.14.1 Functional description

This function initiates a reversible deactivation of an EF. After a DEACTIVATE FILE function the respective flag in the file LCSID_O shall be changed accordingly. This function shall only be performed if the DEACTIVATE FILE access condition for the EF is satisfied.

In case of successful execution of the command, the EF on which the command was applied becomes the current EF.

After an unsuccessful execution, the current EF and current DF shall remain the same as prior to the execution.

A deactivated file shall no longer be available within the selected application for any function except for the SELECT and the ACTIVATE FILE functions.

Input:

- File ID, path or empty.

Output:

- None.

11.1.14.2 Command parameters

Code	Value
CLA	As specified in clause 10.1.1
INS	As specified in clause 10.1.2
P1	selection control, see table 11.17
P2	00
Lc	Length of subsequent data field or empty
Data	File ID or path to file, according to P1
Le	Not present

Table 11.17: Coding of P1

b8	b7	b6	b5	b4	b3	b2	b1	Meaning
0	0	0	0	0	0	0	0	Select EF by file id
0	0	0	0	1	0	0	0	Select by path from MF
0	0	0	0	1	0	0	1	Select by path from current DF
NOTE: All other values are RFU.								

If P1 = P2 = '00' and the data field is empty, then the command applies on the current EF.

11.1.15 ACTIVATE FILE

11.1.15.1 Functional description

This function reactivates a deactivated EF. After an ACTIVATE FILE function the respective flag in the file LCSID_O shall be changed accordingly. This function shall only be performed if the ACTIVATE FILE access condition for the EF is satisfied.

In case of successful execution of the command, the EF on which the command was applied becomes the current EF.

After an unsuccessful execution, the current EF and current DF shall remain the same as prior the execution.

Input:

- File ID, path or empty.

Output:

- None.

11.1.15.2 Command parameters

Code	Value
CLA	As specified in clause 10.1.1
INS	As specified in clause 10.1.2
P1	As specified for the DEACTIVATE command (see clause 11.1.14.2)
P2	00
Lc	Length of subsequent data field or empty
Data	File ID or path to file, according to P1
Le	Not present

If P1 = P2 = '00' and the data field is empty, then the command applies on the current EF.

11.1.16 AUTHENTICATE

11.1.16.1 Functional description

An appropriate application shall be selected in the UICC before issuing this command. The function initiates the computation of authentication data by the UICC using a challenge sent from the terminal and a secret stored in the UICC. This command can be used with an EVEN or an ODD instruction (INS) code.

The EVEN instruction code can be used when the challenge data provided by the terminal is not TLV encapsulated data and the length of the challenge data provided by the terminal is less than 256 bytes.

The support of the ODD instruction code is application specific. It is used when challenge and response data is TLV encapsulated regardless of their length. Terminals and UICCs that do not support applications requiring TLV format do not have to support AUTHENTICATE command with ODD instruction code.

EVEN INS code

Input:

- Challenge data.

Output:

- Authentication and ciphering data.

ODD INS code

The authentication data and the authentication response data are encapsulated in BER-TLV objects structured as defined in clause 11.3 using tag '73' for BER-TLV structured data and tag '53' otherwise.

This command can chain successive blocks of authentication data, with a maximum size of 255 bytes each, required for one authentication operation using P1 to indicate the first/next block. The terminal performs the segmentation of the data, and the UICC the concatenation of the data. The first AUTHENTICATE APDU is sent with P1 indicating "First block of authentication data". Following AUTHENTICATE APDUs are sent with P1 indicating "Next block of authentication data". As long as the UICC has not received all segments of the authentication data it shall answer with SW1 SW2 '63 F1'. When all segments of the authentication data are received, the UICC shall calculate the authentication response and answer with SW1 SW2 '62 F3'.

The authentication response data is retrieved from the UICC using one or more separate AUTHENTICATE APDUs with the same chaining mechanism as for the authentication data. The UICC performs the segmentation of the data, and the terminal the concatenation of the response data. The first AUTHENTICATE APDU is sent with P1 indicating "First block of authentication response data". Following AUTHENTICATE APDUs are sent with P1 indicating "Next block of authentication response data". As long as the UICC has not sent all segments of the authentication response data it shall answer with SW1 SW2 '62 F1'. When all segments of the authentication response data are sent, the UICC shall answer with SW1 SW2 '90 00'.

The terminal may issue an AUTHENTICATE APDU indicating "retransmit previous block of authentication data" or "retransmit previous block of authentication response data". Except for P1 the terminal shall use the same parameters as in the previous command.

NOTE: This mechanism avoids repeating of a whole chain, if a problem is detected by the terminal after a substantial part of the segmented object was already transmitted.

If P1 indicates "First block of authentication data" or "Next block of authentication data":

Input:

- Authentication data encapsulated in a BER-TLV data object.

Output:

- None.

If P1 indicates "First block of authentication response data" or "Next block of authentication response data":

Input:

- None.

Output:

- Authentication response data encapsulated in a BER-TLV data object.

11.1.16.2 Command parameters and data

EVEN INS code

Code	Value
CLA	As specified in clause 10.1.1
INS	As specified in clause 10.1.2
P1	'00'
P2	See table 11.18
Lc	Length of the subsequent data field
Data	Authentication related data
Le	Length of the response data

NOTE 1: Parameter P1 = '00' indicates that no information on the algorithm is given. The algorithm is implicitly known in the context of the selected application.

Table 11.18: Coding of P2

b8	b7	b6	b5	b4	b3	b2	B1	Meaning
0	0	0	0	0	0	0	0	No information given
0	-	-	-	-	-	-	-	Global reference data (e.g. MF specific KEY)
1	-	-	-	-	-	-	-	Specific reference data (e.g. DF specific/application dependent KEY)
-	X	X	-	-	-	-	-	'00' (other values are RFU)
-	-	-	X	X	X	X	X	Reference data number ('01' to '1F')

NOTE 2: Parameter P2 = '00' indicates that no information on the key is given. The key is implicitly known in the context of the selected application.

Command data:

Byte(s)	Description	Length
1 to Lc	Authentication related data (see note)	Lc
NOTE: The command data must be specified by each application specific document.		

Response data (generic):

Byte(s)	Description	Length
1 to Le	Authentication related data (see note)	Le
NOTE: The response data must be specified by each application specific document.		

ODD INS code

P1 indicates "First block of authentication data" or "Next block of authentication data":

Code	Value
CLA	As specified in clause 10.1.1
INS	As specified in clause 10.1.2
P1	See table 11.18a
P2	See table 11.18
Lc	Length of the subsequent data field
Data	Authentication related data
Le	Not present

P1 indicates "First block of authentication response data" or "Next block of authentication response data":

Code	Value
CLA	As specified in clause 10.1.1
INS	As specified in clause 10.1.2
P1	See table 11.18a
P2	See table 11.18
Lc	Not present
Data	Not present
Le	Length of the response data

Table 11.18a: Coding of P1

b8	b7	b6	b5	b4	b3	b2	b1	Meaning
			0	0	0	0	0	Parameter P1 = 'XXX0 0000' indicates that no information on the algorithm is given. The algorithm is implicitly known in the context of the selected application.
			X	X	X	X	X	Reserved for information on the algorithm to be used by the authenticate command
1	0	0	-	-	-	-	-	First block of authentication data
0	0	0	-	-	-	-	-	Next block of authentication data
0	1	0	-	-	-	-	-	Retransmit previous block of authentication data
1	0	1	-	-	-	-	-	First block of authentication response data
0	0	1	-	-	-	-	-	Next block of authentication response data
0	1	1	-	-	-	-	-	Retransmit previous block of authentication response data

Command data

Byte(s)	Description	Length
1 to Lc	TLV encapsulated authentication related data, possibly segmented (see note)	Lc
NOTE: The command data must be specified by each application specific document.		

Response data (generic):

Byte(s)	Description	Length
1 to Le	TLV encapsulated authentication response related data, possibly segmented (see note)	Le
NOTE: The response data must be specified by each application specific document.		

11.1.17 MANAGE CHANNEL

11.1.17.1 Functional description

This command opens and closes logical channels. The open function opens a new logical channel other than the basic channel '0'. The UICC shall support channel number assignment by the UICC. If the **TERMINAL CAPABILITY** command with the tag '81' (Extended logical channels terminal support) is not sent by the terminal then the UICC shall not open more than 3 logical channels in addition to the basic channel. The UICC shall first assign channel numbers in the range 1 to 3 before assigning the extended logical channels number (i.e. from 4 to 19). The close function explicitly closes a logical channel. When a channel has been successfully closed, the channel can be reassigned. The basic logical channel '0' is always available and cannot be closed.

Input:

- None.

Output:

- None; or
- the channel number of the logical channel assigned by the UICC.

11.1.17.2 Command parameters and data

Code	Value
CLA	As specified in clause 10.1.1
INS	As specified in clause 10.1.2
P1	Logical channel operation code, see table 11.19
P2	See table 11.20
Lc	Not present
Data	Not present
Le	Not present or length of expected data

Table 11.19: Coding of P1

b8	b7	b6	b5	b4	b3	b2	b1	Meaning
0	0	0	0	0	0	0	0	Open logical channel
1	0	0	0	0	0	0	0	Close logical channel

NOTE: All other values are RFU.

Table 11.20: Coding of P2

b8	b7	b6	b5	b4	b3	b2	b1	Meaning
0	0	0	0	0	0	0	0	If P1='00': Logical channel to be internally assigned by the UICC If P1≠'00': reserved
0	0	0	0	0	0	0	1	Logical channel number 1
0	0	0	0	0	0	1	0	Logical channel number 2
0	0	0	0	0	0	1	1	Logical channel number 3
0	0	0	-	-	-	-	-	...
0	0	0	1	0	0	1	1	Logical channel number 19

NOTE 1: All other values are RFU.
NOTE 2: values '01', '02', '03', ... '13' are valid only with P1='80'.

Response data:

Byte(s)	Description	Length
1	Logical channel number	1

Response data shall only be returned if the value of the parameters P1-P2 of the command is '0000'.

11.1.18 GET CHALLENGE

11.1.18.1 Functional description

This function is used to create a random number. The generated random number is associated with the logical channel specified in the GET CHALLENGE command CLA. The maximum length of the random number returned by the UICC is specified by the Le parameter in the command parameters data.

The quality of the random number generated by this command is determined by the application and is outside the scope of the present document.

The generated random number may be used internally by the UICC in procedures specified by the application. The validity of the random number is at least for the next command, on the same logical channel, following the GET CHALLENGE command if not specified differently by the application. The random number referenced is always the latest generated on the logical channel specified in the CLA by the command referencing the usage of a generated random number.

Input:

- None.

Output:

- Random number.

11.1.18.2 Command parameters and data

Code	Value
CLA	As specified in clause 10.1.1
INS	As specified in clause 10.1.2
P1	'00'
P2	'00'
Lc	Not present
Data	Not present
Le	Maximum length of response data

Response data:

Byte(s)	Description	Length
1 to Lr	Random number	Lr

11.1.19 TERMINAL CAPABILITY

11.1.19.1 Functional description

This function is used to inform the UICC about terminal capability.

This command shall not be issued by the terminal if the Terminal capability mechanism is not indicated inside the supported system command field; see clause 11.1.1.4.6.8.

Input:

- Terminal capabilities

Output:

- None

11.1.19.2 Command parameters and data

Code	Value
CLA	As specified in clause 10.1.1
INS	As specified in clause 10.1.2
P1	'00'
P2	'00'
Lc	Length of the subsequent data field
Data	Command data
Le	Not present

Command data:

The command data are organized inside the constructed TLV object for terminal capability information:

Byte(s)	Description	Length
1	Terminal capability constructed Tag = 'A9'	1
2	Length	1
3 to 2+X	Proprietary data, constructed	X

The following TLV objects are defined for the terminal capability template (tag 'A9'). Additional private TLV objects (bits b7 and b8 of the first byte of the tag set to 1) may be present after the TLV objects defined in this clause.

Description	Tag	Clause
Terminal power supply	'80'	11.1.19.2.1
Extended logical channels terminal support	'81'	11.1.19.2.2

11.1.19.2.1 Terminal power supply

Terminals supporting applications requiring more power than the minimum power supply as defined in table 6.4 shall issue the TERMINAL CAPABILITY command with a terminal power supply TLV object during a new card session before the first application selection.

NOTE: It is recommended that terminals with minimum power supply capabilities also issue the TERMINAL CAPABILITY command with the terminal power supply TLV object before the first application selection.

The terminal power supply is indicated by tag '80' within the constructed TLV object. The first byte indicates the actual used supply voltage class. The coding of this byte is the same as for the supply voltage class indication in the ATR, see table 6.1. Unused bits are set to RFU. The second byte indicates the maximum available power supply in mA for the actual used supply voltage class.

Byte(s)	Description	Value	Length
1	Tag	'80'	1
2	Length	'03'	1
3	Actual used Supply voltage class		1
4	Maximum available power supply of the terminal	'0A' to '3C'	1
5	Actual used clock frequency	'0A' to 'FF'	1

The actual used clock frequency is coded in Hexadecimal format. The resolution is 0,1 MHz, i.e. '0A' is 1 MHz and 'FE' is 25,4 MHz. The value 'FF' indicates that no clock frequency is indicated.

11.1.19.2.2 Extended logical channels terminal support

Terminals supporting more logical channels than the standard logical channels shall indicate it to the UICC by issuing the TERMINAL CAPABILITY command with an extended logical channels terminal support TLV object during a new card session before the first application selection.

The present document only allows an extended logical channels terminal support TLV with zero length. In order to allow future extensions of this TLV, a UICC implemented according to the present document shall interpret any extended logical channels terminal support TLV as if it was sent with zero length.

The extended logical channels terminal support is indicated by tag '81' within the constructed TLV object.

Byte(s)	Description	Value	Length
1	Tag	'81'	1
2	Length	'00'	1

11.2 CAT commands

11.2.1 TERMINAL PROFILE

11.2.1.1 Functional description

This function is used by the terminal to transmit its CAT capabilities to the applications present on the UICC.

Input:

- Terminal profile, the structure of the data is defined in TS 102 223 [4].

Output:

- None.

11.2.1.2 Command parameters and data

Code	Value
CLA	As specified in clause 10.1.1
INS	As specified in clause 10.1.2
P1	'00'
P2	'00'
Lc	Length of the subsequent data field
Data	Structure and coding defined in TS 102 223 [4]
Le	Not present

11.2.2 ENVELOPE

11.2.2.1 Functional description

This function is used to transfer CAT information from the UE to the UICC.

Input:

- The structure of the data is defined in TS 102 223 [4].

Output:

- The structure of the data is defined in TS 102 223 [4].

11.2.2.2 Command parameters and data

Code	Value
CLA	As specified in clause 10.1.1
INS	As specified in clause 10.1.2
P1	'00'
P2	'00'
Lc	Length of the subsequent data field
Data	Structure and coding defined in TS 102 223 [4]

Le	Empty or maximum length of response data
----	--

Response data:

- Structure of the response data is defined in TS 102 223 [4] for CAT applications.

11.2.3 FETCH

11.2.3.1 Functional description

This function is used to transfer a proactive command from the UICC to the terminal (e.g. from a CAT application).

Input:

- None.

Output:

- Data string containing a proactive command for the terminal (e.g. a CAT command).

11.2.3.2 Command parameters and data

Code	Value
CLA	As specified in clause 10.1.1
INS	As specified in clause 10.1.2
P1	'00'
P2	'00'
Lc	Not present
Data	Not present
Le	Length of expected data

Response data:

- Structure of the response data is defined in TS 102 223 [4] for CAT applications.

11.2.4 TERMINAL RESPONSE

11.2.4.1 Functional description

This function is used to transfer from the terminal to the UICC the response to a previously fetched proactive command (e.g. a CAT command).

Input:

- Data string containing the response.

Output:

- None.

11.2.4.2 Command parameters and data

Code	Value
CLA	As specified in clause 10.1.1
INS	As specified in clause 10.1.2
P1	'00'
P2	'00'
Lc	Length of the subsequent data field
Data	Structure and coding defined in TS 102 223 [4]
Le	Not present

11.3 Data Oriented commands

This clause lists a group of data oriented command and response APDU formats that are used by applications residing on a UICC. It is up to each application to determine which commands it uses. If an application does not support a command, it shall return the appropriate status word, see clause 10.2.

The data transmitted is encapsulated in a BER-TLV data object structure and is formatted as follows:

Byte(s)	Description	Length
1 to T	BER-TLV Tag	$1 \leq T \leq 3$
T+1 to T+L	BER-TLV Length	$1 \leq L \leq 4$
T+L+1 to T+L+X	BER-TLV Value	X

The specific tag allocation scheme is beyond the scope of the present document.

However, the tag values, that shall be supported by the UICC and the terminal are defined as follows:

Tags of the context-specific class, coded on one to three bytes, shall be used for the TLV objects, i.e. tags shall be taken out of the following ranges:

- '80' to '9E' and '9F 1F' to '9F 7F' and '9F 81 XX' to '9F FF XX' with 'XX' from '00' to '7F' for primitive objects; and
- 'A0' to 'BE' and 'BF 1F' to 'BF 7F' and 'BF 81 XX' to 'BF FF XX' with 'XX' from '00' to '7F' for constructed objects.

Terminals shall take into account that each tag value can only exist once in a file and thus an unused tag has to be used to create a new object.

The tag '5C' as defined in ISO/IEC 7816-4 [12] is reserved to get the list of tags already allocated in a file. The value part of this TLV contains the concatenation of all top level tags of the BER-TLV objects allocated in the file. Tags contained in the value part of a constructed BER-TLV object shall not be included in the tag list. Tag '5C' shall not be considered as an allocated tag.

The length of the TLV objects shall be coded on one to four bytes:

Number of bytes	First byte	Following bytes	Encoded length value
1	'00' to '7F'	none	0 to 127
2	'81'	'80' to 'FF'	128 to 255
3	'82'	'01 00' to 'FF FF'	256 to 65 535
4	'83'	'01 00 00' to 'FF FF FF'	65 536 to 16 777 215

Even though the files are referred to as BER TLV structured files and the UICC internal encoding may be according to the BER, the length coding of the TLV objects used with the commands in this clause shall use the DER encoding defined here.

All following rules apply on each logical channel.

Multiple data oriented commands may be used to transfer a data object, identified by a tag, from/to the UICC. The data object, if needed, is divided into smaller components for transmission into several APDUs. If divided into several APDUs, P2 shall be set to "current EF" in all subsequent APDUs. The sender is in charge of performing the segmentation of the data, and the receiver is in charge of the concatenation of the data object. The transfer of a data object shall be initiated by a first APDU identified by P2 indicating "First Block". The transfer, if necessary, is continued by APDUs identified by P2 indicating "Next Block". The UICC shall answer with "more data available" or "more data expected" on any but the last block.

A data object transfer can be interleaved with any command not modifying the current EF or the current tag pointer. Any interleaved command that modifies the current EF or the current tag pointer shall abort an uncompleted data object transfer.

A successful APDU indicating "First Block" sets the current tag pointer and shall abort an uncompleted data object transfer. This applies for all tags defined in this clause, even if the new tag is the same as the previous one.

If the UICC answers with "more data available/expected and proactive command pending" and the terminal is able to handle a proactive session at this point of time, it sends any APDU command which does not interfere with the segmentation and which allows the card to answer with '91XX', or a FETCH command with Le equal to '00' to the card.

NOTE 1: This mechanism avoids blocking of the interface for proactive commands in case of a long sequence of segments.

The current tag pointer and its associated context (e.g. current offset in the data object) shall not be changed by an APDU resulting in an error status word. For the second and all following blocks the terminal may issue a SET or RETRIEVE DATA command indicating "retransmit previous block". The setting "retransmit previous block" is only allowed if the previous command did not result in an error status word. Except for P2 the terminal shall use the same parameters as in the previous command.

NOTE 2: This mechanism avoids repeating of a whole chain, if a problem is detected by the terminal after a substantial part of the segmented object was already transmitted.

11.3.1 RETRIEVE DATA

11.3.1.1 Functional description

This command retrieves a data object from the current BER-TLV structure EF. This function shall only be performed if the READ access condition for this EF is satisfied.

The rules for a data object transfer defined in clause 11.3 apply.

If the requested TLV object does not exist in the EF, the UICC shall answer with "referenced data not found".

If a current tag pointer associated with a SET DATA operation processed by another application points to the requested TLV object, the UICC shall answer with "conditions of use not satisfied".

NOTE 1: After the data object transfer (to retrieve it) is successfully completed, the object still cannot be replaced or deleted by another application as long as the current tag pointer points to it. To avoid unnecessary blocking situations, it is recommended that an application does not leave the current tag pointer on an object after retrieving it for an unnecessary amount of time. It can release the object by selecting a different file or re-selecting the same file.

If the tag of the object is not in the range specified in the present document, the UICC shall answer with "incorrect parameters in the data field".

NOTE 2: This allows for extensions in future releases by using tags of the application class to indicate more sophisticated retrieval features, while having a standardized reaction to these tags in UICCs according to this release.

The status word sent by the card after a successful RETRIEVE DATA command is '62F1' or '62F2' if more data is available.

NOTE 3: After a RETRIEVE DATA with P2 indicating First Block, if T = 0 protocol is used, the BER-TLV data object (or first part of it if segmented over several APDUs) to be sent by the card is lost if it is not retrieved by the terminal using a GET RESPONSE command.

Once a data object was fully retrieved, any subsequent RETRIEVE DATA command on this data object with parameter P2 set to "Next Block" shall be rejected with the status word '6A86'.

This command also allows retrieving the list of the tags allocated (data objects successfully completed) in the file. The tags of not yet completed SET DATA operations processed by other applications shall also be included in the list.

11.3.1.2 Command parameters and data

Code	Value
CLA	As specified in clause 10.1.1
INS	As specified in clause 10.1.2
P1	'00'
P2	See table 11.21
Lc	Length of subsequent data field if present
Data	Tag of requested object or empty
Le	Length of expected response data

Table 11.21: Coding of P2

b8	B7	b6	b5	b4	b3	b2	b1	Meaning
1	0	-	-	-	-	-	-	First block
0	0	-	0	0	0	0	0	Next block
0	1	-	0	0	0	0	0	Retransmit previous block
1	1	-	-	-	-	-	-	RFU
-	-	-	X	X	X	X	X	SFI
-	-	-	0	0	0	0	0	Current EF
Any other value								RFU

Command data:

- For P2 indicating first block of TLV: Tag value of TLV object that shall be retrieved.
- For P2 indicating next block or retransmit previous block, it is empty.
- The tag '5C' as defined in ISO/IEC 7816-4 [12] is used to get the list of tags allocated in the file.

Response data:

- For P2 encoding first block: BER-TLV data object or first part of it if segmented over several APDUs.
- For P2 encoding next block: if the previous RETRIEVE DATA command ended with "more data available", the next segment of the segmented TLV object is returned.
- For P2 encoding retransmit previous block: same data as in the previous command.

11.3.2 SET DATA

11.3.2.1 Functional description

If P2 indicates "first block", this command creates a new data object in the current BER-TLV structure EF or replaces an already existing data object with the same tag or deletes a data object. Space that is freed by such an operation shall be available for new objects. Subsequent commands with P2 indicating "next block" pass the remaining content of the data object being created or replaced to the card. If P2 indicates "retransmit previous block", the content sent with the previous command is updated.

This command shall only be performed if the UPDATE access condition for this EF is satisfied. The rules for a data object transfer defined in clause 11.3 apply.

When a transfer to create or replace an object is initiated, the first APDU identified by P2 indicating "First Block" shall at least contain the tag value and length of the value field of the BER-TLV data object. If the card returns '9000', '63F1' or '63F2' to this first APDU, it means that the length indicated in the BER-TLV is available on the card. The data object is then allocated in the file. If the length requested is not available, then the card shall return '6A84'.

If a current tag pointer associated with a SET or RETRIEVE DATA operation processed by another application points to the requested TLV object, the UICC shall answer with "conditions of use not satisfied".

NOTE 1: After the data object transfer (to create or replace it) is successfully completed, the object still cannot be retrieved, replaced or deleted by another application as long as the current tag pointer points to it. To avoid unnecessary blocking situations, it is recommended that an application does not leave the current tag pointer on an object after creating or replacing it for an unnecessary amount of time. It can release the object by selecting a different file or re-selecting the same file.

When a SET DATA command is successfully executed, the UICC shall return '9000' if it had received all expected data. It shall return '63F1' or '63F2' if data as indicated in the length of the TLV object is still missing.

A data object transfer is successfully completed when the number of bytes received matches the length indicated for the data object. After that, any subsequent SET DATA command on this data object with parameter P2 set to "Next block" shall be rejected with the status word '6A86'.

When a data object transfer is aborted, the data object with this tag shall no longer be available in the EF.

If the data sent with this command is greater than the length of the value field of the BER-TLV data object, the card shall return status word '6700', the data object is not updated and the data object transfer is not completed.

If the tag of the object is not in the range specified in the present document, the UICC shall answer with "incorrect parameters in the data field".

NOTE 2: This allows for extensions in future releases by using tags of the application class to indicate more sophisticated storage features, while having a standardized reaction to these tags in UICCs according to this release.

Deleting an object:

- If in a SET DATA command with P2 indicating "First Block", the data field only contains a tag field, i.e. the length and the value field of the BER-TLV data object are missing, the data object specified by the tag shall be deleted if present in the current context. Deleting a non-existent object shall not be considered as an error.
- If the data field contains a tag field and a length field with zero value, the object is not deleted, but a zero length object is created.

11.3.2.2 Command parameters and data

Code	Value
CLA	As specified in clause 10.1.1
INS	As specified in clause 10.1.2
P1	'00'
P2	See table 11.21
Lc	Length of the subsequent data field
Data	BER-TLV data object, or tag field only in case of deletion
Le	Not present

Command data:

- For P2 encoding first block: tag, length and nothing of the value field, or part or all of the value field of the object to create or replace. Tag only of the object to delete.
- For P2 encoding next block: next part of the value field of the object being created or replaced.
- For P2 encoding retransmit previous block: same data as in the previous command.

Response data:

- None.

12 Transmission oriented commands

This clause lists all transport specific commands. Currently there is only one such command.

12.1 T = 0 specific commands

12.1.1 GET RESPONSE

12.1.1.1 Functional description

The command is used to transmit APDUs from the card to the terminal, which otherwise could not be transferred by the protocol.

The response data depends on the preceding command. Response data is available when it is indicated in the procedure byte, see table 7.1, or status byte, see table 7.2. If the command GET RESPONSE is executed, it is required that it is executed immediately after the command it is related to (no other command shall come between the command/response pair and the command GET RESPONSE). If the sequence is not respected, the selected application shall send the status information "technical problem, no precise diagnosis" as a reaction to the GET RESPONSE.

The response data itself is defined in the clause for the corresponding command.

Because there is no interleaving of commands between logical channels, the terminal shall send the GET RESPONSE command on the same logical channel before sending a command APDU in another logical channel. Otherwise, the response is lost.

12.1.1.2 Command parameters

Table 12.1: Parameters for GET RESPONSE

Code	Value
CLA	As specified in clause 10.1.1
INS	As specified in clause 10.1.2
P1	'00'
P2	'00'
Lc	Not present
Data	Not present
Le	'00' or value of SW2 of the previous command

Response parameters and data:

- the response data is defined in each clause of the corresponding command.

NOTE: Since the MF is implicitly selected after UICC activation, GET RESPONSE is also allowed as the first command after activation for only GSM ME. 3G ME should send SELECT MF or STATUS command with FCP response.

13 Application independent files

13.1 EF_{DIR}

EF_{DIR} is a linear fixed file under the MF and is under the responsibility of the issuer.

Table 13.1: EF_{DIR} at MF-level

Identifier: '2F00'	Structure: Linear fixed	Mandatory	
SFI: Mandatory			
Record size: X bytes		Update activity: low	
Access Conditions:			
READ	ALW		
UPDATE	ADM		
DEACTIVATE	ADM		
ACTIVATE	ADM		
Bytes	Description	M/O	Length
1 to X	Application template TLV object	M	X bytes

The EF consists of one or more records, with each record able to hold one entry. Each entry in the EF_{DIR} is an application template Data Object (DO) as defined in ISO/IEC 7816-4 [12]. An application template DO is a constructed BER-TLV object with a maximum length of 127 bytes and has a mandatory AID DO. Within the scope of the present document, all other DOs are optional.

In table 13.2 the coding of the mandatory DOs and the optional DOs that has special meaning to the present document. All other DOs are according to ISO/IEC 7816-4 [12].

Table 13.2: Coding of an application template entry

Length	Description	Status
1	Application template tag = '61'	M
1	Length of the application template = '03'-'7F'	M
1	Application Identifier tag = '4F'	M
1	AID length = '01'-'10'	M
'01' to '10'	AID value. See TS 101 220 [3]	M
1	Application label tag = '50'	O
1	Application label length	O
note 1	Application label value	O
NOTE 1: The application label is a DO that contains a string of bytes provided by the application provider to be shown to the user for information, e.g. operator name. The value part of the application label shall be coded according to annex A. It is recommended that the number of bytes in the application label does not exceed 32.		
NOTE 2: Other DOs from ISO/IEC 7816-4 [12] may, at the application issuer's discretion, be present as well.		

13.2 EF_{ICCID} (ICC Identification)

This EF provides a unique identification number for the UICC.

Table 13.3: EF_{ICCID} at MF-level

Identifier: '2FE2'		Structure: transparent		Mandatory	
SFI: Optional					
File size: 10 bytes			Update activity: low		
Access Conditions:					
READ		ALW			
UPDATE		NEV			
DEACTIVATE		ADM			
ACTIVATE		ADM			
Bytes	Description			M/O	Length
1 to 10	Identification number			M	10 bytes

- Identification number:

Contents: according to ITU-T Recommendation E.118 [5].

Purpose: card identification number.

Coding: BCD, left justified and padded with 'F'. The order of digits is coded as below:

Byte 1:

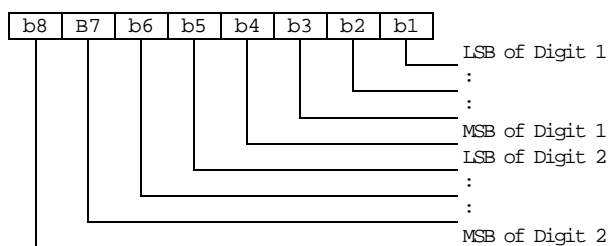

Byte 2:

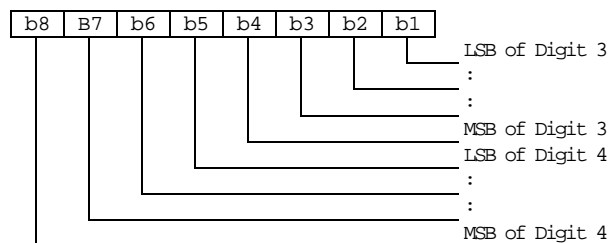

etc.

13.3 EF_{PL} (Preferred Languages)

This EF contains the codes for up to n languages. This information, determined by the user/operator, defines the preferred languages of the user, for the UICC, in order of priority.

Table 13.4: EF_{PL} at MF-level

Identifier: '2F 05'		Structure: transparent		Mandatory
SFI: Mandatory				
File size: 2n bytes		Update activity: low		
Access Conditions:				
READ		ALW		
UPDATE		PIN		
DEACTIVATE		ADM		
ACTIVATE		ADM		
Bytes	Description	M/O	Length	
1 to 2	1 st language code (highest prior)	M	2 bytes	
3 to 4	2 nd language code	O	2 bytes	
2n-1 to 2n	n th language code (lowest prior)	O	2 bytes	

Coding: each language code is a pair of alpha-numeric characters, defined in ISO 639 [6]. Each alpha-numeric character shall be coded on one byte using the SMS default 7-bit coded alphabet as defined in TS 123 038 [1] with bit 8 set to 0.

Unused language entries shall be set to 'FF FF'.

13.4 EF_{ARR} (Access Rule Reference)

This EF contains the access rules for files located under the MF in the UICC. If the security attribute tag '8B' is indicated in the FCP it contains a reference to a record in this file.

Table 13.5: EF_{ARR} at MF-level

Identifier: '2F06'		Structure: Linear fixed		Optional
SFI: Optional				
Record length: X bytes		Update activity: low		
Access Conditions:				
READ		ALW		
UPDATE		ADM		
DEACTIVATE		ADM		
ACTIVATE		ADM		
Bytes	Description	M/O	Length	
1 to X	Access Rule TLV data objects	M	X bytes	

This EF contains one or more records containing access rule information according to the referenced format as defined in ISO/IEC 7816-4 [12]. Each record represents an access rule. Unused bytes in the record are set to 'FF'.

14 Application independent protocol

14.1 File related procedures

14.1.1 Reading an EF

Reading of an EF can be done in two different ways.

- 1) If the short file identifiers are used the following procedure applies:
 - If short file identifiers are used, EFs that support SFI within the Current Directory can be read without explicitly selecting the EF. The terminal selects the DF or ADF and sends a READ command. This contains the short file identifier of the EF to be read and the location of the data to be read. If the access condition for READ is fulfilled, the application sends the requested data contained in the EF to the terminal. If the access condition is not fulfilled, no data will be sent and an error code will be returned.
- 2) If the short file identifiers are not used the following procedure applies:
 - The terminal selects the EF and sends a READ command. This contains the location of the data to be read. If the access condition for READ is fulfilled, the application sends the requested data contained in the EF to the terminal. If the access condition is not fulfilled, no data will be sent and an error code will be returned.

14.1.2 Updating an EF

Updating of an EF can be done in two different ways:

- 1) If the short file identifiers are used the following procedure applies:
 - If short file identifiers are used, EFs that support SFI within the Current Directory can be updated without explicitly selecting the EF. The terminal selects the DF or ADF and sends an UPDATE command. This contains the short file identifier of the EF and the location of the data to be updated and the new data to be stored. If the access condition for UPDATE is fulfilled, the application updates the selected EF by replacing the existing data in the EF with that contained in the command. If the access condition is not fulfilled, the data existing in the EF will be unchanged, the new data will not be stored, and an error code will be returned.
- 2) If the short file identifiers are not used the following procedure applies:
 - The terminal selects the EF and sends an UPDATE command. This contains the location of the data to be updated and the new data to be stored. If the access condition for UPDATE is fulfilled, the application updates the selected EF by replacing the existing data in the EF with that contained in the command. If the access condition is not fulfilled, the data existing in the EF will be unchanged, the new data will not be stored, and an error code will be returned.

14.1.3 Increasing an EF

Increasing of an EF can be done in two different ways:

- 1) If the short file identifiers are used the following procedure applies:
 - If short file identifiers are used, EFs that support SFI within the Current Directory can be increased without explicitly selecting the EF. The terminal selects the DF or ADF and sends an INCREASE command. This contains the short file identifier of the EF and the value which has to be added to the contents of the last updated/increased record. If the access condition for INCREASE is fulfilled, the application increases the existing value of the EF by the data contained in the command, and stores the result. If the access condition is not fulfilled, the data existing in the EF will be unchanged and an error code will be returned.

- 2) If the short file identifiers are not used the following procedure applies:
- The terminal selects the EF and sends an INCREASE command. This contains the value which has to be added to the contents of the last updated/increased record. If the access condition for INCREASE is fulfilled, the application increases the existing value of the EF by the data contained in the command, and stores the result. If the access condition is not fulfilled, the data existing in the EF will be unchanged and an error code will be returned.

NOTE: The identification of the data within an EF to be acted upon by the above procedures is specified within the command. For the procedures in clauses 14.1.1 and 14.1.2 this data may have been previously identified using a SEARCH RECORD command, e.g. searching for an alphanumeric pattern.

14.2 PIN related procedures

NOTE: The present document specifies only the generic behaviour of a PIN. An application may create a set of PINs each with a specific behaviour.

A successful completion of one of the following procedures grants the access right of the corresponding PIN for an application session. This right is valid for all files within the application protected by this PIN.

After a third consecutive unsuccessful completion of one of the following procedures associated to the same PIN, not necessarily in the same application session, the PIN becomes "blocked" and if the PIN status is set "enabled", the access right previously granted by this PIN is lost immediately.

An access right is not granted if any of the following procedures are aborted.

14.2.1 PIN verification

The terminal checks the PIN and the following procedures apply:

- If the PIN status is set "enabled" and the PIN is "blocked", the procedure ends and is finished unsuccessfully.
- If the PIN status is set "disabled" and the PIN is "blocked", the procedure ends and is finished successfully. The terminal shall, however, accept applications which do not grant access rights when the PIN status is set "disabled" and the PIN is "blocked". In that case terminal shall consider those applications as "blocked".
- If the PIN status is set "disabled" and the PIN is not "blocked", the procedure is finished successfully.
- If the PIN status is set "enabled" and the PIN is not "blocked", the terminal uses the VERIFY PIN function. If the PIN presented by the terminal is equal to the corresponding PIN stored in the application, the procedure is finished successfully. If the PIN presented by the terminal is not equal to the PIN which protects the application, the procedure ends and is finished unsuccessfully.

14.2.2 PIN value substitution

The terminal checks the PIN and the following procedures apply:

- If the PIN status is set "disabled" or the PIN is "blocked", the procedure ends and is finished unsuccessfully.
- If the PIN status is set "enabled" and the PIN is not "blocked", the terminal uses the CHANGE PIN function. If the old PIN presented by the terminal is equal to the PIN which protects the application, the new PIN presented by the terminal is stored instead of the old one and the procedure is finished successfully.
- If the old PIN presented by the terminal and the PIN which protects the application are not identical, the procedure ends and is finished unsuccessfully.

14.2.3 PIN disabling

PIN enabling and disabling/disabling and replacement may be disallowed by an application. If it is allowed then the following procedures shall be followed:

- If either the PIN status is set "disabled" or the PIN is "blocked", the procedure ends and is finished unsuccessfully.

Disabling and replacement:

- If the application PIN is not "blocked" and both the application PIN and the alternative global key reference statuses are set to "enabled", the terminal uses the DISABLE PIN function. If the PIN presented by the terminal is equal to the PIN which protects the application, the status of the PIN is set "disabled" and the usage qualifier of the alternative global key reference is set to "use" ('08') and the procedure is finished successfully. If the PIN presented by the terminal is not equal to the PIN which protects the application, the procedure ends and is finished unsuccessfully.

Disabling, no replacement:

- If the PIN is not "blocked" and the PIN status is set "enabled", the terminal uses the DISABLE PIN function. If the PIN presented by the terminal is equal to the PIN which protects the application, the status of the PIN is set "disabled" and the procedure is finished successfully. If the PIN presented by the terminal is not equal to the PIN which protects the application, the procedure ends and is finished unsuccessfully.

14.2.4 PIN enabling

PIN enabling and disabling may be disallowed by an application. If it is allowed then the following procedures shall be followed:

- If either the PIN status is set "enabled" or the PIN is "blocked", the procedure ends and is finished unsuccessfully.
- If the PIN status is set "disabled" and the PIN is not "blocked", the terminal uses the ENABLE PIN function. If the PIN presented by the terminal is equal to the PIN which is assigned to the application, the status of the PIN is set "enabled" and the procedure is finished successfully. If the PIN presented by the terminal is not equal to the PIN which protects the application, the procedure ends and is finished unsuccessfully.

14.2.5 PIN unblocking

The execution of the PIN unblocking procedure is independent of whether or not the PIN is "blocked".

The terminal checks if the UNBLOCK PIN is "blocked". If the UNBLOCK PIN is "blocked", the procedure ends and is finished unsuccessfully.

If the UNBLOCK PIN is not "blocked", the terminal uses the UNBLOCK PIN function. If the UNBLOCK PIN presented by the terminal is equal to the corresponding UNBLOCK PIN of the application, the relevant PIN becomes "unblocked" and the procedure is finished successfully. If the UNBLOCK PIN presented by the terminal is not equal to the corresponding UNBLOCK PIN of the application, the procedure ends and is finished unsuccessfully.

14.3 Application selection procedures

14.3.1 Application selection by use of the EF_{DIR} file

Application selection by use of the EF_{DIR} file is the procedure where the terminal reads the content of the EF_{DIR} file and presents the list of applications to the user whom can then make select one or more applications to activate.

The terminal performs the read procedure with EF_{DIR} and presents the applications that it supports to the user who may make a selection. If only one supported application is found this may be implicitly selected.

14.3.2 Direct application selection

An application may be selected, without reading the content of the EF_{DIR} file, by performing the SELECT procedure with the AID of the application to be selected.

14.3.3 Direct application selection with partial AID

See clause 8.5.1.2.

14.4 General application related procedures

14.4.1 Application session activation

The terminal performs the SELECT function with the AID of the selected application as a parameter.

If the SELECT function ends successfully the selected application's initialization procedure is executed. If the initialization procedure ends successfully the UICC enters the operation state. If the initialization procedure does not end successfully, the UICC remains in the application management state and sends an indication to the user that it was not possible to activate the selected application.

14.4.2 UICC application interrogation

The list of applications residing in the UICC can be read at anytime when the UICC is not inactive.

Request: The terminal performs the read procedure with EF_{DIR}.

14.4.3 UICC application session termination

An application session can be terminated at any time when the UICC is not inactive.

14.5 Miscellaneous procedures

14.5.1 UICC activation

After activation of the UICC, as defined in clause 4.5, the terminal requests the Preferred Language (EF_{PL}). If the terminal supports CAT, it shall perform the CAT initialization procedure. The terminal then performs an application selection procedure according to clause 14.3.

14.5.2 UICC presence detection

If an application present on the UICC has the requirement to ensure that the UICC has not been removed during a card session the following procedure applies. The terminal sends, at frequent intervals, a STATUS command on the UICC-terminal interface. The STATUS command shall be issued within a period of inactivity on the UICC-terminal interface. The period of inactivity and the conditions under which the presence detection takes place is specified by the applications active during the card session. Inactivity in this case is defined as starting at the end of the last communication or the last issued STATUS command. If no response data is received to this STATUS command the terminal shall take the appropriate actions after the work waiting time (T = 0) or block waiting time (T = 1) has expired as specified by the applications active. If the DF indicated in an error free response to a STATUS command is not the same as that which was indicated in the previous response, or accessed by the previous command, then the terminal shall take appropriate actions as specified by the applications active during the card session. This procedure shall be used in addition to a mechanical or other device used to detect the removal of a UICC.

14.5.3 UICC preferred language request

Request: The terminal performs the read procedure with EF_{PL}.

Update: The terminal performs the update procedure with EF_{PL}.

14.5.4 UICC logical channels

A UICC may offer the possibility to run several selectable applications in parallel. This is done with the logical channels mechanism. Only one selectable application can run at a given time in a given logical channel.

14.6 CAT related procedures

The higher level procedures, and contents and coding of the commands, are given in TS 102 223 [4]. Procedures relating to the transmission of commands and responses across the terminal-UICC interface are given in this clause. A UICC or terminal supporting CAT shall conform to the requirements given in this clause.

14.6.1 CAT Initialization procedure

A terminal supporting CAT shall send the TERMINAL PROFILE C-APDU. A UICC supporting CAT shall return the response status words (SW1 SW2) '90 00' or '91 XX'. If any other value is returned, the terminal shall assume that CAT is not supported. In case of proactive command pending, the terminal shall then start the proactive polling procedure with the default value.

14.6.2 Proactive polling

During idle mode the terminal shall send STATUS commands to the UICC at intervals no longer than the interval negotiated with the UICC (see TS 102 223 [4]). During a call the UICC presence detection applies. The default value for the proactive polling is the same as for the presence detection procedure.

14.6.3 Support of commands

A terminal supporting CAT shall support the commands TERMINAL PROFILE, ENVELOPE, FETCH and TERMINAL RESPONSE.

14.6.4 Support of response codes

A terminal supporting CAT shall support the response status words (SW1 SW2) '91 XX' and '93 00'. These responses shall never be used if the terminal does not support CAT.

14.6.5 Independence of applications and CAT tasks

Application and CAT operation shall be logically independent, both in the UICC and in the terminal. Specifically, this means:

- The currently selected EF and current record pointer in any active application shall remain unchanged, if still valid, as seen by the terminal, irrespective of any CAT activity.
- Between successive CAT related command-response pairs, other application (e.g. USIM) and UICC related command-response pairs can occur. The CAT task status shall remain unchanged by these command-response pairs.

14.6.6 Use of BUSY status response

If for any reason the CAT task of the UICC cannot process an ENVELOPE command issued by the terminal at present (e.g. other CAT processes are already running), the UICC can respond with a status response of '93 00'. The terminal may re-issue the command at a later stage.

The BUSY status response has no impact on e.g. USIM operation.

14.6.7 Additional processing time

The transport protocol provides a mechanism for the UICC to obtain additional processing time (i.e. NULL procedure byte for T = 0 and Work Waiting time extension (WTX) for T = 1) before supplying the response part of a command-response pair, during which time the terminal is unable to send further commands to the UICC.

If a CAT activity in the UICC runs for too long, this may prevent the terminal from sending e.g. USIM commands which are time-critical, e.g. INTERNAL AUTHENTICATE. A MORE TIME command is defined in TS 102 223 [4], which ensures that the USAT task in the UICC gets additional processing time, while at the same time freeing the UICC/terminal interface. The MORE TIME command should be used in preference to the transport protocol specific mechanisms for obtaining additional processing time.

Annex A (normative): UCS2 coding of Alpha fields for files residing on the UICC

If 16 bit UCS2 characters as defined in ISO/IEC 10646 [17] are used in an alpha field, the coding can take one of three forms. If the terminal supports UCS2 coding of alpha fields in the UICC, the terminal shall support all three coding schemes for character sets containing 128 characters or less; for character sets containing more than 128 characters, the terminal shall at least support the first coding scheme. If the alpha field record contains GSM default alphabet characters only, then none of these schemes shall be used in that record. Within a record, only one coding scheme, either the GSM default alphabet (see TS 123 038 [1]), or one of the three described below, shall be used.

- 1) If the first byte in the alpha string is '80', then the remaining bytes are 16 bit UCS2 characters, with the More Significant Byte (MSB) of the UCS2 character coded in the lower numbered byte of the alpha field, and the Less Significant Byte (LSB) of the UCS2 character is coded in the higher numbered alpha field byte, i.e. byte 2 of the alpha field contains the More Significant Byte (MSB) of the first UCS2 character, and byte 3 of the alpha field contains the Less Significant Byte (LSB) of the first UCS2 character (as shown below). Unused bytes shall be set to 'FF', and if the alpha field is an even number of bytes in length, then the last (unusable) byte shall be set to 'FF'.

EXAMPLE 1:

Byte 1	Byte 2	Byte 3	Byte 4	Byte 5	Byte 6	Byte 7	Byte 8	Byte 9
'80'	Ch1 _{MSB}	Ch1 _{LSB}	Ch2 _{MSB}	Ch2 _{LSB}	Ch3 _{MSB}	Ch3 _{LSB}	'FF'	'FF'

- 2) If the first byte of the alpha string is set to '81', then the second byte contains a value indicating the number of characters in the string, and the third byte contains an 8 bit number which defines bits 15 to 8 of a 16 bit base pointer, where bit 16 is set to zero, and bits 7 to 1 are also set to zero. These sixteen bits constitute a base pointer to a "half-page" in the UCS2 code space, to be used with some or all of the remaining bytes in the string. The fourth and subsequent bytes in the string contain codings as follows; if bit 8 of the byte is set to zero, the remaining 7 bits of the byte contain a GSM Default Alphabet character, whereas if bit 8 of the byte is set to one, then the remaining seven bits are an offset value added to the 16 bit base pointer defined earlier, and the resultant 16 bit value is a UCS2 code point, and completely defines a UCS2 character.

EXAMPLE 2:

Byte 1	Byte 2	Byte 3	Byte 4	Byte 5	Byte 6	Byte 7	Byte 8	Byte 9
'81'	'05'	'13'	'53'	'95'	'A6'	'XX'	'FF'	'FF'

In the above example:

- Byte 2 indicates that there are 5 characters in the string.
- Byte 3 indicates bits 15 to 8 of the base pointer, and indicates a bit pattern of 0hhh hhhh h000 0000 as the 16 bit base pointer number. Bengali characters for example start at code position 0980 (0000 1001 1000 0000), which is indicated by the coding '13' in byte 3 (shown by the bold digits).
- Byte 4 indicates GSM Default Alphabet character '53', i.e. 'S'.
- Byte 5 indicates a UCS2 character offset to the base pointer of '15', expressed in binary as follows 001 0101, which, when added to the base pointer value results in a sixteen bit value of 0000 1001 1001 0101, i.e. '0995', which is the Bengali letter KA.
- Byte 8 contains the value 'FF', but as the string length is 5, this is a valid character in the string, where the bit pattern 111 1111 is added to the base pointer, yielding a sixteen bit value of 0000 1001 1111 1111 for the UCS2 character (i.e. '09FF').

- 3) If the first byte of the alpha string is set to '82', then the second byte contains a value indicating the number of characters in the string, and the third and fourth bytes contain a 16 bit number which defines the complete 16 bit base pointer to a "half-page" in the UCS2 code space, for use with some or all of the remaining bytes in the string. The fifth and subsequent bytes in the string contain codings as follows; if bit 8 of the byte is set to zero, the remaining 7 bits of the byte contain a GSM Default Alphabet character, whereas if bit 8 of the byte is set to one, the remaining seven bits are an offset value added to the base pointer defined in bytes three and four, and the resultant 16 bit value is a UCS2 code point, and defines a UCS2 character.

EXAMPLE 3:

Byte 1	Byte 2	Byte 3	Byte 4	Byte 5	Byte 6	Byte 7	Byte 8	Byte 9
'82'	'05'	'05'	'30'	'2D'	'82'	'D3'	'2D'	'31'

In the above example:

- Byte 2 indicates that there are 5 characters in the string.
- Bytes 3 and 4 contain a sixteen bit base pointer number of '0530', pointing to the first character of the Armenian character set.
- Byte 5 contains a GSM Default Alphabet character of '2D', which is a dash "-".
- Byte 6 contains a value '82', which indicates it is an offset of '02' added to the base pointer, resulting in a UCS2 character code of '0532', which represents Armenian character Capital Ben.
- Byte 7 contains a value 'D3', an offset of '53', which when added to the base pointer results in a UCS2 code point of '0583', representing Armenian Character small Piwr.

Annex B (informative): Main states of a UICC

A UICC complying with the present document has the following states of operation:

- "Inactive" - In this state the UICC is powered off.
- "Application management" - In this state it is possible to start/end one or more application-session(s) as well as retrieve the list of applications in the UICC. This state can be entered at any time when the UICC is not in the inactive state and left when the PIN access condition for all the selected applications has been verified.
- "Operation" - This state is entered after the application session activation procedure for at least one application has ended successfully.

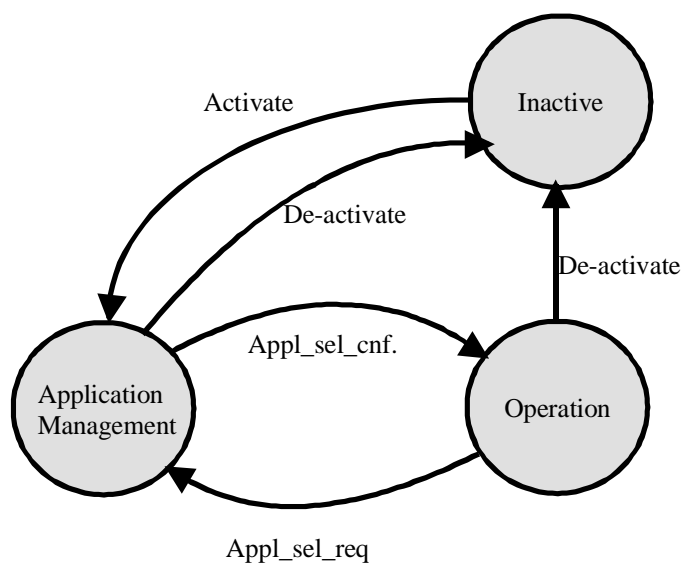

Figure B.1: UICC states

Annex C (informative): APDU protocol transmission examples

C.1 Exchanges Using T = 0

The following examples illustrate exchanges of data and procedure bytes between the terminal and the UICC.

Note the following:

- The use of procedure bytes '60' and $\overline{\text{INS}}$ is not illustrated.
- [Data(X)] means X bytes of data.
- Case 2 and 4 commands may have Le = '00' requesting the return of all data from the UICC up to the maximum available.

The examples in clauses C.1.1.1 to C.1.1.4 illustrate typical exchanges using case 1 to 4 commands. The examples in the clauses C.1.1.5 and C.1.1.6 illustrate the more extensive use of procedure bytes '61 XX' when used with cases 2 and 4 commands. The example in clause C.1.1.7 illustrates a warning condition with a case 4 command.

C.1.1 Case 1 command

A C-APDU of {CLA INS P1 P2} is passed from the terminal to the UICC (note that P3 of the C-TPDU is set to '00').

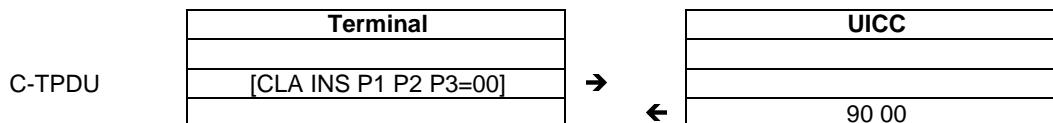

An R-APDU of {90 00} is returned from the UICC to the terminal.

C.1.2 Case 2 command

In this first example, a C-APDU of {CLA INS P1 P2 Le = 00} is passed from the terminal to the UICC with Luicc < 256 bytes.

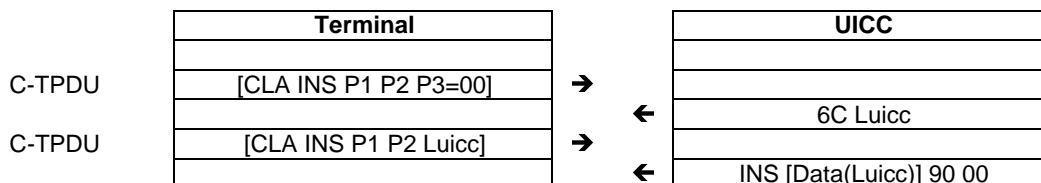

An R-APDU of {[Data(Luicc)] 90 00} is returned from the UICC to the terminal.

In this second example, a C-APDU of {CLA INS P1 P2 Le = 00} is passed from the terminal to the UICC with Luicc = 256 bytes.

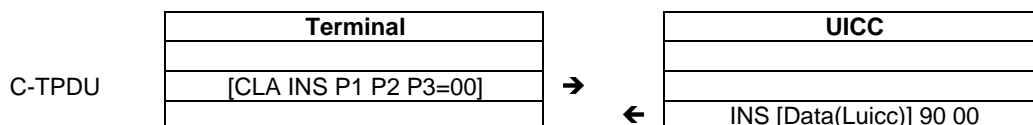

An R-APDU of {[Data(Luicc)] 90 00} is returned from the UICC to the terminal.

C.1.3 Case 3 command

A C-APDU of {CLA INS P1 P2 Lc [Data(Lc)]} is passed from the terminal to the UICC.

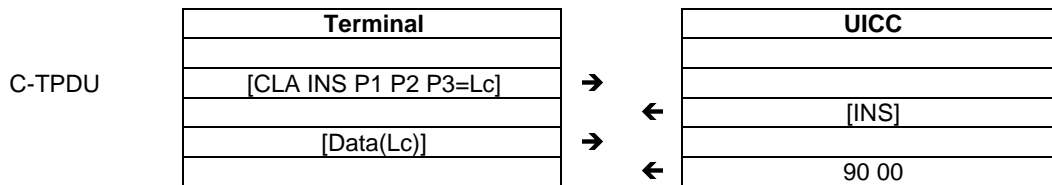

An R-APDU of {90 00} is returned from the UICC to the terminal.

C.1.4 Case 4 command

A C-APDU of {CLA INS P1 P2 Lc [Data (Lc)] Le = 00} is passed from the terminal to the UICC.

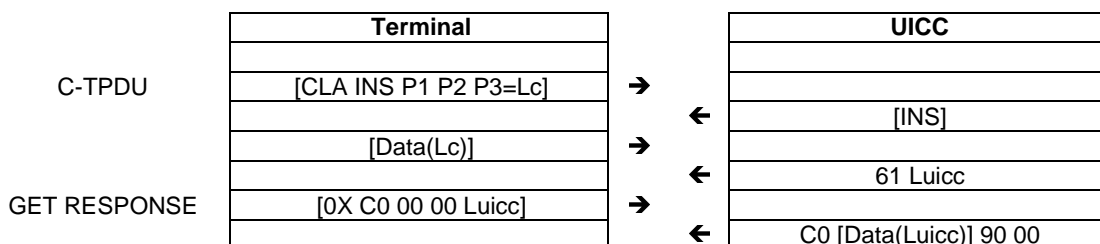

An R-APDU of {[Data(Luicc)] 90 00} is returned from the UICC to the terminal.

The GET RESPONSE command is sent on the same logical channel as the C-TPDU.

C.1.5 Case 2 commands Using the '61' and '6C' procedure bytes

A C-APDU of {CLA INS P1 P2 Le = 00} is passed from the terminal to the UICC with Luicc < 256 bytes.

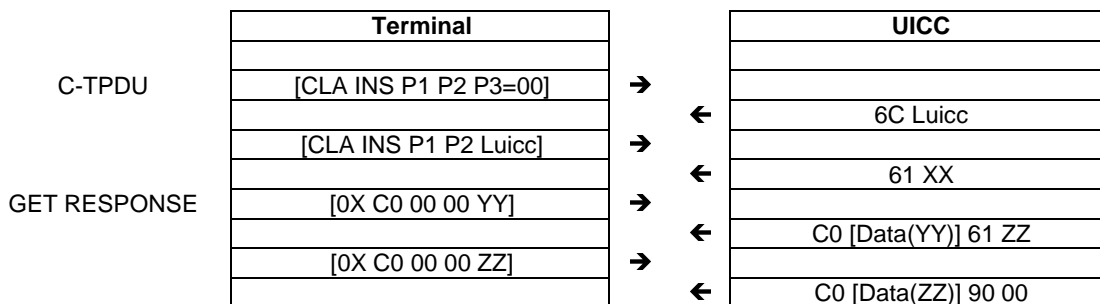

Where YY ≤ XX,

An R-APDU of {[Data(YY + ZZ)] 90 00} is returned from the UICC to the terminal.

The GET RESPONSE command is sent on the same logical channel as the C-TPDU.

C.1.6 Case 4 command Using the '61' procedure byte

A C-APDU of {CLA INS P1 P2 Lc [Data Lc] Le = 00} is passed from the terminal to the UICC.

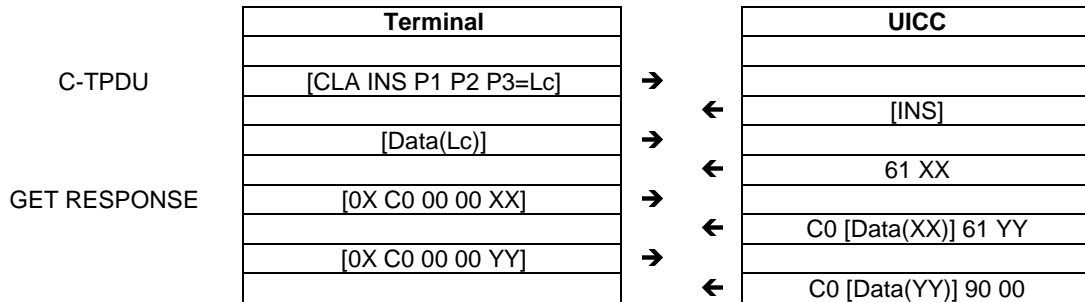

An R-APDU of {[Data(XX + YY)] 90 00} is returned from the UICC to the terminal.

The GET RESPONSE command is sent on the same logical channel as the C-TPDU.

C.1.7 Case 4 command with warning condition

A C-APDU of {CLA INS P1 P2 Lc [Data Lc] Le = 00} is passed from the terminal to the UICC.

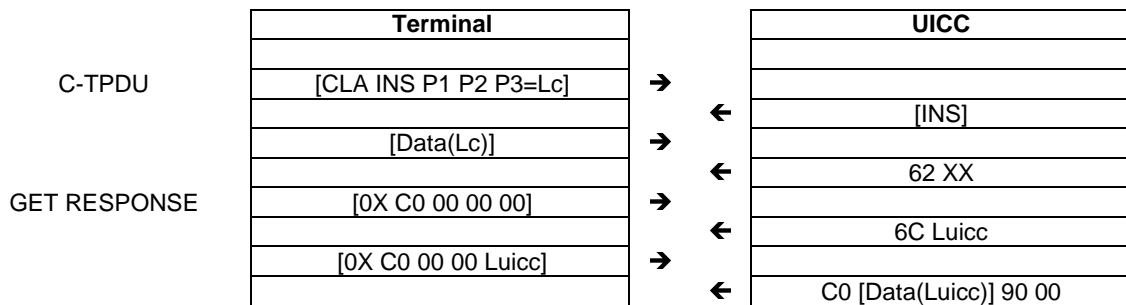

An R-APDU of {[Data(Luicc)] 62 XX} is returned from the terminal to the UICC containing the data returned together with the warning status bytes.

The GET RESPONSE command is sent on the same logical channel as the C-TPDU.

Annex D (informative): ATR examples

This annex gives examples of ATRs that can be returned by a UICC after a reset.

EXAMPLE 1: Cold reset for a T = 0 protocol only UICC.

Character	Value	Description
TS	'3B' or '3F'	Indicates direct or inverse convention
T0	'97'	TA1 and TD1 are present 7 bytes of historical bytes
TA1	'95'	Clock rate conversion factor FI=9 (F=512) Baud rate adjustment factor DI=5 (D=16)
TD1	'80'	TD2 only is present
TD2	'1F'	TA3 only is present Global interface bytes following
TA3	'42'	Clock stop supported (low electrical state) 3V UICC
T1	'80'	
T2	'31'	Card data services
T3	'A0'	SELECT by AID supported EFDIR present
T4	'73'	Card capabilities
T5	'BE'	SFI supported
T6	'21'	Data Coding Byte
T7	'15'	No extended Lc and Le 6 logical channels supported
TCK	'XX'	Check byte

EXAMPLE 2: Cold reset for a T = 0 and T = 1 protocol UICC.

Character	Value	Description
TS	'3B' or '3F'	Indicates direct or inverse convention
T0	'97'	TA1, and TD1 are present 7 bytes of historical bytes
TA1	'95'	Clock rate conversion factor FI=9 (F=512) Baud rate adjustment factor DI=5 (D=16)
TD1	'80'	Only TD2 is present Protocol T = 0 supported by UICC
TD2	'B1'	TA3, TB3 and TD3 are present Protocol T = 1 supported by UICC
TA3	'FE'	IFSC is 254 bytes long
TB3	'00'	Block Waiting Integer=0 Character Waiting Integer=0
TD3	'1F'	Only TA4 is present Global interface bytes following
TA4	'42'	Clock stop supported (low electrical state) 3V UICC
T1	'80'	
T2	'31'	Card data services
T3	'A0'	SELECT by AID supported EFDIR present
T4	'73'	Card capabilities
T5	'BE'	SFI supported
T6	'21'	Data Coding Byte
T7	'17'	No extended Lc and Le More than 8 logical channels supported
TCK	'XX'	Check byte

EXAMPLE 3: Warm reset (specific mode) and T = 1 protocol requested by the UICC.

Character	Value	Description
TS	'3B' or '3F'	Indicates direct or inverse convention
T0	'97'	TA1, and TD1 are present 7 bytes of historical bytes
TA1	'95'	Clock rate conversion factor FI=9 (F=512) Baud rate adjustment factor DI=5 (D=16)
TD1	'91'	TA2 and TD2 are present Protocol T = 1 supported by UICC
TA2	'81'	Protocol T = 1 used in specific mode Parameters indicated by the interface bytes, and card is not able to change mode
TD2	'B1'	TA3, TB3 and TD3 are present Protocol T = 1 supported by UICC
TA3	'FE'	IFSC is 254 bytes long
TB3	'00'	Block Waiting Integer=0 Character Waiting Integer=0
TD3	'1F'	Only TA4 is present Global interface bytes following
TA4	'42'	Clock stop supported (low electrical state)
T1	'80'	
T2	'31'	Card data services
T3	'A0'	SELECT by AID supported EF _{DIR} present
T4	'73'	Card capabilities
T5	'BE'	SFI supported
T6	'21'	Data Coding Byte
T7	'00'	No extended Lc and Le No Logical channels supported
TCK	'XX'	Check byte

Annex E (informative): Security attributes mechanisms and examples

E.1 Coding

Two codings are defined:

- a compact coding based on bitmaps;
- an expanded coding which is an extension of the compact coding with intermediate scope containing bitmap and TLV list management.

The security conditions for bits not set to '1' in the AM byte are set to NEVER by default.

E.2 Compact format

The compact format access rule is indicated by tag '8C' in the FCP. An access rule in this format is encoded with:

- an AM byte as defined in ISO/IEC 7816-4 [12];
- one or more SC bytes as defined in ISO/IEC 7816-4 [12].

E.2.1 AM byte

The AM byte conveys two types of information:

- interpretation of the AM byte itself;
- number of SC bytes in the access rule.

If b8 in the AM byte is set to '0' the AM byte is followed by a number of SC bytes equal to the number of bits set to '1' in the AM byte (excluding b8). Each SC bytes codes the conditions relevant to a set of commands, in the same order (b7 to b1) as in the AM byte. When b8 is set to '1' the usage of b7 to b4 is proprietary.

When multiple sets of an AM byte and one or more corresponding SC bytes are present in the value field of the DO, tag '8C', they represent an OR condition.

E.2.2 SC byte

The SC byte specifies which security mechanisms are necessary to conform to the access rules, see ISO/IEC 7816-4 [12]. The 4 most significant bits (b8 to b5) indicate the required security condition. An SE may be specified in bits b4 to b1. If an SE is specified, the mechanisms that may be defined in it for external authentication, user authentication and command protection shall be used, if indicated by bits b4 to b1.

If bit b8 is set to '1' all conditions in bits b7 to b5 shall be satisfied. If bit b8 is set to '0' at least one of the conditions set in bits b7 to b5 shall be satisfied. If b7 is set to '1', the CRT of the SE indicated in bits b4 to b1 describes whether secure messaging shall apply to the command APDU, the response APDU or both.

E.2.3 Examples

For EFs with the access condition ALW for READ and UPDATE the security attribute would look as follows:

Tag	L	AM	SC	SC
'8C'	'03'	'03'	'00'	'00'

For EFs with the access condition ALW for READ and NEV for all other access conditions the security attribute would look as follows:

Tag	L	AM	SC
'8C'	'02'	'01'	'00'

For EF_{DIR} and EF_{ICC} the access rule would be as follows. READ is set to ALW and UPDATE, DEACTIVATE and ACTIVATE is set to ADM. The ADM condition is indicated as a user authentication. The key reference is implicitly known.

Tag	L	AM	SC	SC	SC	SC
'8C'	'05'	'1B'	'90'	'90'	'90'	'00'

E.3 Expanded format

In the expanded format AM_DOs and SC_DOs are used to create the access rules. The expanded format access rule is indicated by tag 'AB' in the FCP. An access rule in this format is encoded with an AM_DO followed by a sequence of SC_DOs.

E.3.1 AM_DO

The AM_DO is defined in ISO/IEC 7816-4 [12]. The content of the AM_DO is defined by the tag value. Tag '80' indicates that the AM_DO contains an AM byte. Tags '81' to '8F' indicates that the AM_DO contains a command description. The content of the command description is dependent upon the tag value as defined in ISO/IEC 7816-4 [12]. Tag '9C' indicates that the AM_DO contains a proprietary state machine description.

When multiple sets of an AM_DO and one or more corresponding SC_DOs are present in the value field of the DO, tag 'AB', they represent an OR condition.

E.3.2 SC_DO

The SC_DO is defined in ISO/IEC 7816-4 [12]. The SC_DO definition contains an OR and an AND template. Several SC_DOs may be attached to a particular operation.

- If the SC_DOs are encapsulated in an OR template, then only one of the security conditions has to be fulfilled for the operation to be allowed.
- If the SC_DOs are not to be encapsulated in an OR template or if the SC_DOs are encapsulated in an AND template, then all security conditions shall be fulfilled before the operation is allowed.

E.3.3 Access rule referencing

Access rules in expanded format (AM_DOs and SC_DOs) may be stored in a linear fixed EF, each record contain one or more rules, as defined in ISO/IEC 7816-4 [12]. The access rule file may be an internal file, referenced implicitly, or may be referenced explicitly, e.g. by a file ID. The access rule stored in a file is indicated by tag '8B' in the FCP. The value of this DO contains at least one record number, called ARR. The DO can contain:

- A single byte containing the record number of the rule, valid if the access rule file is (implicitly) known.
- Three bytes containing two bytes with the File ID of the access rule file followed by one byte with the record number for the access rule.
- If the value filed is coded with a length of 2 + n x 2, for n > 1, it contains one or more SEID/ARR pairs, where the SEID codes the SE number on one byte. For each SE number, the access rules indicated in the ARR following its SE number are valid.

E.3.4 Examples

The access rule for EF_{PL} would look as follows. The READ and SEARCH access condition is ALWays. The UPDATE access condition is application1 PIN or application2 PIN.

Tag	L	AM_DO Tag	L	V	OR Tag	L	SC_DO Tag	L	Key Ref Tag	L	V	Usage Qualifier Tag	L	V	SC_DO Tag	L	Key Ref Tag	L	V	Usage Qualifier Tag	L	V	AM_DO Tag	L	V	SC_DO Tag	L
'AB'	'1A'	'80'	'01'	'02'	'A0'	'10'	'A4'	'06'	'83'	'01'	'01'	'95'	'01'	'08'	'A4'	'06'	'83'	'01'	'02'	'95'	'01'	'08'	'80'	'01'	'01'	'90'	'00'

Annex F (informative): Example of contents of EF_{ARR} '2F06'

F.1 Sample content of the EF_{ARR}

This clause contains an example of the contents of EF_{ARR} '2F06'.

Table F.1: Access rule references for files located at the MF level

ARR Record	Applicable	Access Condition	AM DO	LEN	Value	SCDO: CRT Tag	Security Condition	Len	Value					
									Key Ref Tag	Len	Value	Usage Qualifier Tag	Len	Value
01	EF	READ UPDATE/ DE-ACTIVATE/ ACTIVATE	'80' '80'	'01' '01'	'01' '1A'	'90' 'A4'	ALW Level 5	'00' '06'	'83'	'01'	'0X'	'95'	'01'	'YY'
02	EF	READ DEACTIVATE/ ACTIVATE	'80' '80'	'01' '01'	'01' '18'	'90' 'A4'	ALW Level 5	'00' '06'	'83'	'01'	'0X'	'95'	'01'	'YY'
03	EF	READ UPDATE DEACTIVATE/ ACTIVATE	'80' '80' '80'	'01' '01' '01'	'01' '02' '18'	'90' 'A4' 'A4'	ALW PIN Level 5	'00' '06' '06'	'83' '83'	'01' '01'	'01' '0X'	'95' '95'	'01' '01'	'01' 'YY'

The value X in table F.1 shall be according to level 5 in table 9.3. The value 'YY' in table F.1 shall be in accordance with ISO/IEC 7816-4 [12].

As an example, those records could be used as follows: the first record of EF_{ARR} can be the access rule of EF_{DIR}, the second record of EF_{ARR} can be the access rule of EF_{ICCID}, the third record of EF_{ARR} can be the access rule of EF_{PL}.

Annex G (informative): Access Rules Referencing (ARR)

G.1 Sample content of EF_{ARR}

This clause contains a set of access rule examples that are stored in EF_{ARR}. The access rules are referenced using tag '8B' in the FCP.

The following definitions apply:

- the application PIN is referred to as PIN Appl. 1 global (key reference '01');
- the UICC supports the usage of a universal PIN, see clause 9.4.1, that is referred to as UNIVERSAL PIN (key reference '11');
- the application PIN2 is referred to as Second PIN Appl.1 local (key reference '81');
- access condition ADM is referenced as Level 5/Level 6 (key reference 'YZ') where:
 - 'Y' = '0' for Level 5 and 'Y' = '8' for Level 6;
 - 'Z' = 'A' to 'E' for Level 5 and Level 6;
- the value 'XX' for the usage qualifier for key reference value 'YZ' is according to ISO/IEC 7816-4 [12].

Table G.1: Application Access Rule References

ARR Record	Applicable	Access Condition	AM DO	Len	Value	SCDO: CRT Tag	Security Condition	Len	Value											
									Key Ref Tag	Len	Value	Usage Qualifier Tag	Len	Value						
01	EF	READ	'80'	'01'	'01'	'90'	ALW	'00'	-	-	-	-	-	-						
02	EF	READ UPDATE DEACTIVATE/ E/ACTIVATE	'80'	'01'	'01'	'90'	ALW PIN Appl 1 global Level 5/Level 6	'00'	'83'	'01'	'01'	'95'	'01'	'08'						
			'80'	'01'	'02'	'A4'		'06'							'83'	'01'	'YZ'	'95'	'01'	'XX'
			'80'	'01'	'18'	'A4'		'06'												
03	EF	READ UPDATE/ DEACTIVATE/ E/ACTIVATE	'80'	'01'	'01'	'A4'	PIN Appl 1 global Level 5/Level 6	'06'	'83'	'01'	'01'	'95'	'01'	'08'						
			'80'	'01'	'1A"	'A4'		'06'							'83'	'01'	'YZ'	'95'	'01'	'XX'
04	EF	READ/UPDA TE DEACTIVATE/ E/ ACTIVATE	'80'	'01'	'03'	'A4'	PIN Appl 1 global Level 5/Level 6	'06'	'83'	'01'	'01'	'95'	'01'	'08'						
			'80'	'01'	'18'	'A4'		'06'							'83'	'01'	'YZ'	'95'	'01'	'XX'
05	EF	READ UPDATE DEACTIVATE/ E/ ACTIVATE	'80'	'01'	'01'	'A4'	PIN Appl 1 global PIN2 Appl 1 local Level 5/Level 6	'00'	'83'	'01'	'01'	'95'	'01'	'08'						
			'80'	'01'	'02'	'A4'		'06'							'83'	'01'	'81'	'95'	'01'	'08'
			'80'	'01'	'18'	'A4'		'06'												
06	EF	READ UPDATE/ DEACTIVATE/ E/ ACTIVATE	'80'	'01'	'01'	'90'	ALW Level 5/Level 6	'00'	'83'	'01'	'YZ'	'95'	'01'	'XX'						
			'80'	'01'	'1A"	'A4'		'06'												
07	EF	READ/UPDA TE/ ACTIVATE DEACTIVATE/ E	'80'	'01'	'13'	'A4'	PIN Appl 1 global Level 5/Level 6	'06'	'83'	'01'	'01'	'95'	'01'	'08'						
			'80'	'01'	'08'	'A4'		'06'							'83'	'01'	'YZ'	'95'	'01'	'XX'
08	EF	READ/UPDA TE/ ACTIVATE/	'80'	'01'	'1B'	'A4'	Level 5/Level 6	'06'	'83'	'01'	'YZ'	'95'	'01'	'XX'						

ARR Record	Applicable	Access Condition	AM DO	Len	Value	SCDO: CRT Tag	Security Condition	Len	Value					
									Key Ref Tag	Len	Value	Usage Qualifier Tag	Len	Value
		DEACTIVATE												
09	EF	READ/UPDATE DEACTIVATE/ ACTIVATE INCREASE	'80' '80' '84'	'01' '01' '01'	'03' '18' '32'	'A4' 'A4' 'A4'	PIN Appl 1 global Level 5/Level 6 PIN Appl 1 global	'06' '06' '06'	'83' '83' '83'	'01' '01' '01'	'01' 'YZ' '01'	'95' '95' '95'	'01' '01' '01'	'08' 'XX' '08'
10	EF	READ/UPDATE DEACTIVATE/ ACTIVATE INCREASE	'80' '80' '84'	'01' '01' '01'	'03' '18' '32'	'A4' 'A4' 'A4'	PIN Appl 1 global Level 5/Level 6 PIN2 Appl 1 global	'06' '06' '06'	'83' '83' '83'	'01' '01' '01'	'01' 'YZ' '81'	'95' '95' '95'	'01' '01' '01'	'08' 'XX' '08'
11	EF	READ UPDATE DEACTIVATE/ ACTIVATE	'80' '80' '80'	'01' '01' '01'	'01' '02' '18'	'90' 'A4' 'A4'	ALW Universal PIN Level 5/Level 6	'00' '06' '06'	'83' '83' '83'	'01' '01' '01'	'11' 'YZ' 'YZ'	'95' '95' '95'	'01' '01' '01'	'08' 'XX' '08'
12	EF	READ UPDATE/ DEACTIVATE/ ACTIVATE	'80' '80'	'01' '01'	'01' '1A"	'A4' 'A4'	Universal PIN Level 5/Level 6	'06' '06'	'83' '83'	'01' '01'	'11' 'YZ'	'95' '95'	'01' '01'	'08' 'XX'
13	EF	READ/UPDATE DEACTIVATE/ ACTIVATE	'80' '80'	'01' '01'	'03' '18'	'A4' 'A4'	Universal PIN Level 5/Level 6	'06' '06'	'83' '83'	'01' '01'	'11' 'YZ'	'95' '95'	'01' '01'	'08' 'XX'
14	EF	READ UPDATE DEACTIVATE/ ACTIVATE	'80' '80' '80'	'01' '01' '01'	'01' '02' '18'	'A4' 'A4' 'A4'	Universal PIN PIN2 Appl 1 local Level 5/Level 6	'00' '06' '06'	'83' '83' '83'	'01' '01' '01'	'11' '81' 'YZ'	'95' '95' '95'	'01' '01' '01'	'08' '08' 'XX'
15	EF	READ UPDATE/ DEACTIVATE/ ACTIVATE	'80' '80'	'01' '01'	'01' '1A"	'90' 'A4'	ALW Level 5/Level 6	'00' '06'	'83' '83'	'01' '01'	'YZ'	'95'	'01'	'XX'
16	EF	READ/UPDATE/ ACTIVATE DEACTIVATE	'80' '80'	'01' '01'	'13' '08'	'A4' 'A4'	Universal PIN Level 5/Level 6	'06' '06'	'83' '83'	'01' '01'	'11' 'YZ'	'95' '95'	'01' '01'	'08' 'XX'
17	EF	READ/UPDATE/ ACTIVATE/ DEACTIVATE	'80'	'01'	'1B'	'A4'	Level 5/Level 6	'06'	'83'	'01'	'YZ'	'95'	'01'	'XX'
18	EF	READ/UPDATE DEACTIVATE/ ACTIVATE INCREASE	'80' '80' '84'	'01' '01' '01'	'03' '18' '32'	'A4' 'A4' 'A4'	Universal PIN Level 5/Level 6 Universal PIN	'06' '06' '06'	'83' '83' '83'	'01' '01' '01'	'11' 'YZ' '11'	'95' '95' '95'	'01' '01' '01'	'08' 'XX' '08'
19	EF	READ/UPDATE DEACTIVATE/ ACTIVATE INCREASE	'80' '80' '84'	'01' '01' '01'	'03' '18' '32'	'A4' 'A4' 'A4'	Universal PIN Level 5/Level 6 PIN2 Appl 1 global	'06' '06' '06'	'83' '83' '83'	'01' '01' '01'	'11' 'YZ' '81'	'95' '95' '95'	'01' '01' '01'	'08' 'XX' '08'

Table G.2: DF_{Telecom} Access Rule References

ARR Record	Applicable	Access Condition	AM DO	L	V	SCDO CRT Tag	Security Condition	L	SCDO CRT Tag	L	Value						SCDO CRT Tag	L	Value					
											Key Ref Tag	L	V	Usage Qualifier Tag	L	V			Key Ref Tag	L	V	Usage Qualifier Tag	L	V
01	EF	READ	'80'	'01'	'01'	'90'	ALW	'00'			-	-	-	-	-	-	-	-	-	-	-	-		
02	EF	READ UPDATE DEACTIVATE/ ACTIVATE	'80' '80' '80'	'01' '01' '01'	'01' '02' '18'	'90' 'A0' 'A4'	ALW PIN Appl 1 global OR PIN Appl 2 Level 5	'00' '10' '06'	'A4'	'06'	'83' '83'	'01' '01'	'01' '0Z'	'95' '95'	'0' 1' '0' 1'	'08' 'XX'	'A4'	'0' 6'	'83' 1'	'0' 1'	'02'	'95'	'01'	'08'
03	EF	READ UPDATE/ DEACTIVATE/ ACTIVATE	'80' '80'	'01' '01'	'01' '1A"	'A0' 'A4'	PIN Appl 1 global OR PIN Appl 2 Level 5	'10' '06'	'A4'		'83' '83'	'01' '01'	'01' '0Z'	'95' '95'	'0' 1' '0' 1'	'08' 'XX'	'A4'	'0' 6'	'83' 1'	'0' 1'	'02'	'95'	'01'	'08'
04	EF	READ/UPD ATE DEACTIVATE/ ACTIVATE	'80' '80'	'01' '01'	'03' '18'	'A0' 'A4'	PIN Appl 1 global OR PIN Appl 2 Level 5	'10' '06'	'A4'		'83' '83'	'01' '01'	'01' '0Z'	'95' '95'	'0' 1' '0' 1'	'08' 'XX'	'A4'	'0' 6'	'83' 1'	'0' 1'	'02'	'95'	'01'	'08'
05	EF	READ UPDATE/ DEACTIVATE/ ACTIVATE	'80' '80'	'01' '01'	'01' '1A"	'90' 'A4'	ALW Level 5	'00' '06'			'83'	'01'	'0Z'	'95'	'0' 1'	'XX'								
06	EF	READ/ UPDATE/ ACTIVATE DEACTIVATE	'80' '80'	'01' '01'	'13' '08'	'A0' 'A4'	PIN Appl 1 global OR PIN Appl 2 Level 5	'10' '06'	'A4'		'83' '83'	'01' '01'	'01' '0Z'	'95' '95'	'0' 1' '0' 1'	'08' 'XX'	'A4'	'0' 6'	'83' 1'	'0' 1'	'02'	'95'	'01'	'08'
07	EF	READ/UPD ATE/ DEACTIVATE/ ACTIVATE	'80'	'01'	'1B'	'A4'	Level 5	'06'			'83'	'01'	'0Z'	'95'	'0' 1'	'XX'								

G.2 Example of access rule referencing with SE ID

This clause describes an example of the usage of the access rule referencing method using SE ID. Table G.1 is considered to be the EF(ARR) file for this example.

Assume an application uses PIN Application 1 Global as its application PIN. In addition, this application allows the replacement of its application PIN by the Universal PIN. EF(example) is an elementary file part of this application and has the following access conditions:

- READ: Always.
- UPDATE: PIN application 1 Global.
- ACTIVATE/DEACTIVATE: level 5 or 6.

The security attributes returned after the selection of EF(example) then contains a reference to record 2 of table G.1 for SE 01 and a reference to record 11 of table G.1 for SE 00.

Annex H (normative): List of SFI Values

This annex lists SFI values assigned in the present document.

H.1 List of SFI Values at the MF Level

File Identifier	SFI	Description
'2FE2'	'02'	ICC Identification (EF _{ICCI})
'2F05'	'05'	Preferred Languages (EF _{PL})
'2F06'	'06'	Access Rules Reference (EF _{ARR})
'2F00'	'1E'	Application Directory (EF _{DIR})

All other SFI values are reserved for future use.

Annex I (informative): Resets and modes of operation

This annex contains figures that illustrate selection and switching of modes of operation of the "Type 1 UICC" and "Type 2 UICC".

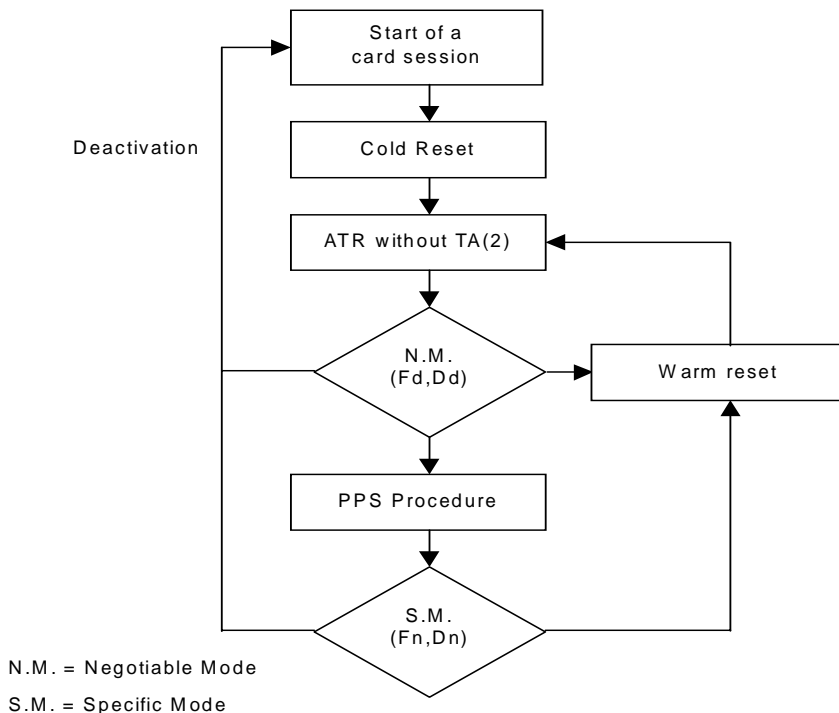

Figure I.1: Modes of operation of a "Type 1 UICC"

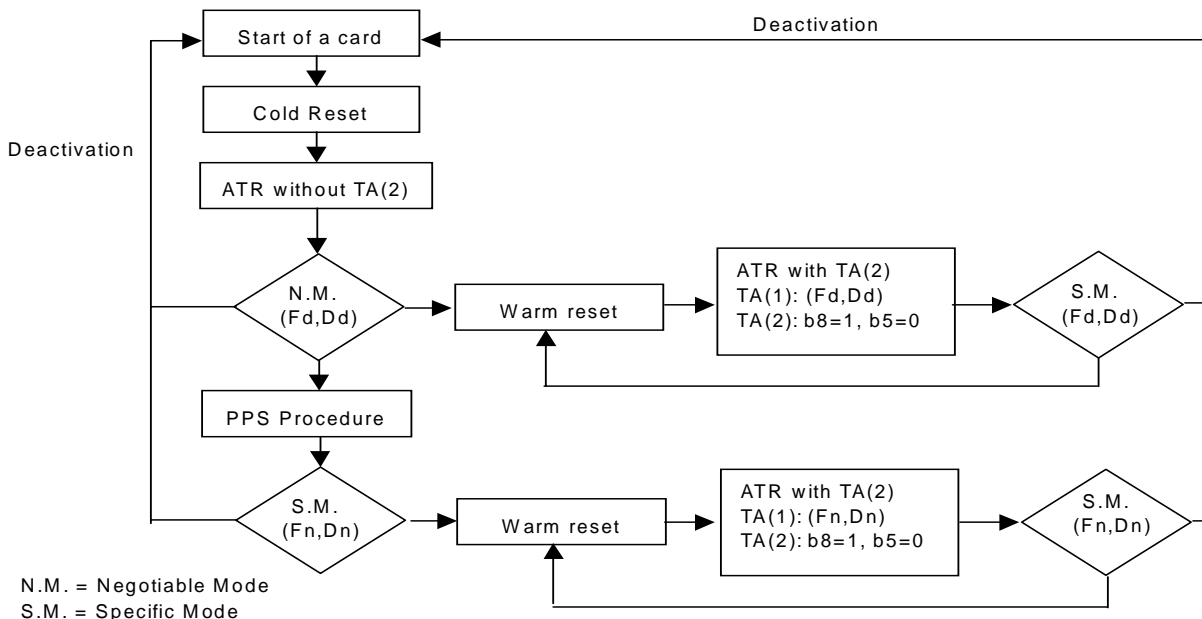

Figure I.2: Modes of operation of a "Type 2 UICC"

Annex J (informative): Example of the use of PINs

J.1 Application having several ADFs

From the security context point of view, 2 ADFs using the same application PIN are part of the same application. Each ADF then refers to the same local key reference number whose value and status is specific to each ADF. Figure J.1 illustrates it.

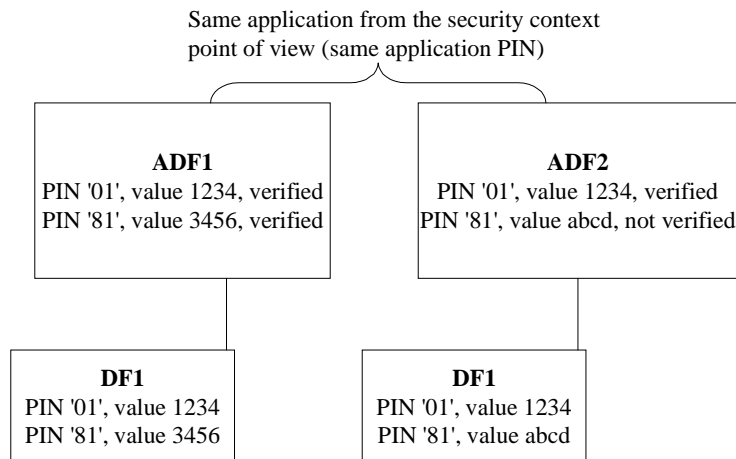

Figure J.1

J.2 Two applications with two different security contexts

From the security context point of view, two applications use two different application PINs. Then the local PINs of the applications use two different key reference numbers, each one paired with its associated application PIN. Figure J.2 illustrates this scenario.

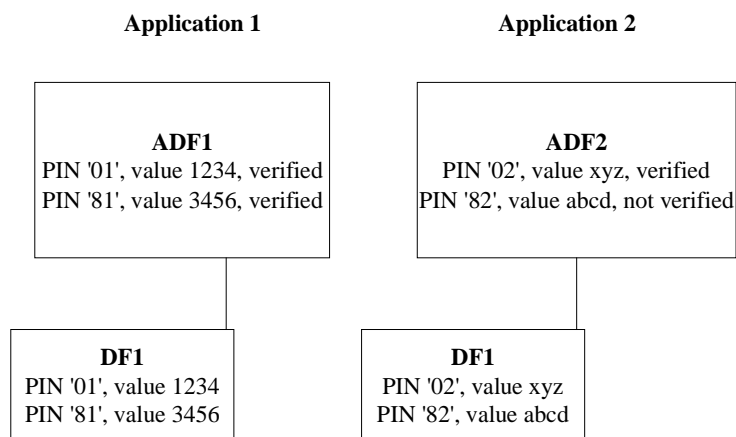

Figure J.2

Annex K (informative): Examples of the PIN state transition on multi verification capable UICC

This clause describes two examples of the global PIN state transition on a multi verification capable UICC.

In figure K.1, following global PINs and ADFs are assigned in the UICC:

- the global PIN, key reference '01', is referred to as an application PIN of ADF_A in SE (Security Environment) 01;
- the global PIN, key reference '02', is referred to as an application PIN of ADF_B in SE 01;
- the global PIN, key reference '11', is referred to as an universal PIN of both ADFs in SE 00;
- any files under MF, highlighted area, can refer to global PINs.

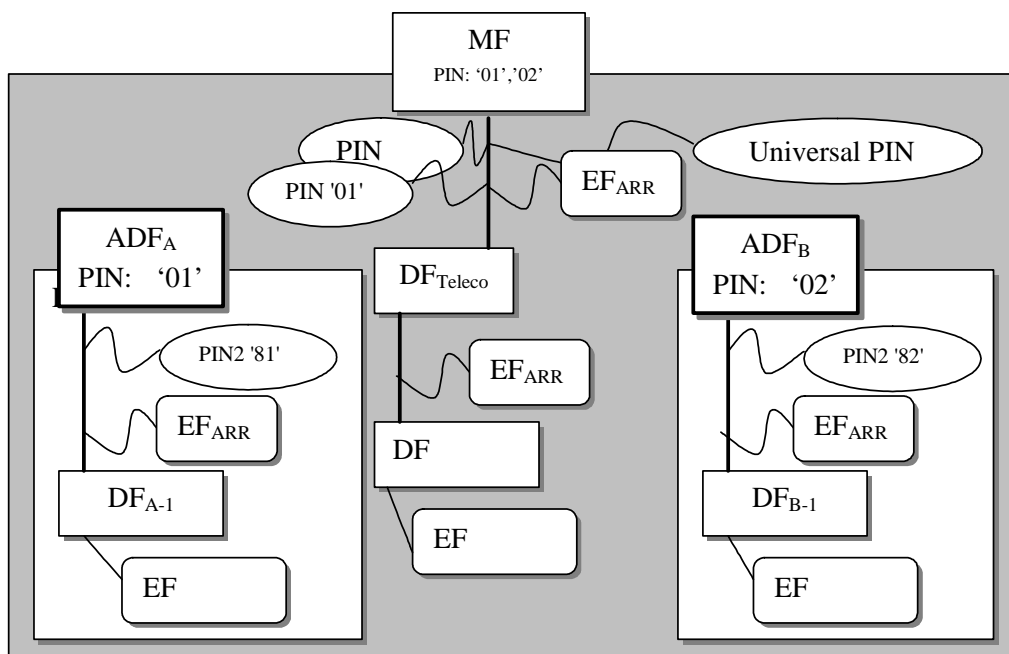

Figure K.1: Example of multi verification capable UICC

K.1 PIN state transition on the single logical channel

This clause describes global PIN state transition on a single-logical-channel scenario of the UICC illustrated in figure K.1.

The global PIN state transition contains:

- scenario on a logical channel;
- security status as PIN status and PIN verification state for PIN '11', '01' and '02';
- current ADF, DF and file;
- PIN status byte and usage qualifier for PIN '11' in PIN status DO;
- SE (Security Environment) ID.

Scenario	channel #0	Security status						logical channel #0							
		PIN status			PIN verification state			current			PIN status DO in the FCP				SE ID
		PIN '11'	PIN '01'	PIN '02'	PIN '11'	PIN '01'	PIN '02'				PIN '11'	PIN '01'	PIN '02'	PIN ('11')	
#1	ATR	E	E	E	N	N	N	—	MF	MF	E	E	E	'00'	01
#2	SELECT MF	↓	↓	↓	↓	↓	↓	—	↓	↓	↓	↓	↓	↓	↓
#3	SELECT by DF-name (A)	↓	↓	↓	↓	↓	↓	ADF (A)	ADF (A)	ADF (A)	↓	↓	—	↓	↓
#4	SELECT MF	↓	↓	↓	↓	↓	↓	↓	MF	MF	↓	↓	E	↓	↓
#5	DISABLE PIN ('01' → '11')	↓	D (R)	↓	↓	V	↓	↓	↓	↓	↓	D	↓	'08'	00
#6	VERIFY PIN ('11')	↓	↓	↓	V	↓	↓	↓	↓	↓	↓	↓	↓	↓	↓
#7	SELECT ADF ('7FFF')	↓	↓	↓	↓	↓	↓	↓	ADF (A)	ADF (A)	↓	↓	—	↓	↓
#8	SELECT by DF-name (B)	↓	↓	↓	↓	↓	↓	ADF (B)	ADF (B)	ADF (B)	↓	—	E	'00'	01
#9	SELECT MF	↓	↓	↓	↓	↓	↓	↓	MF	MF	↓	D	↓	↓	↓
#10	ATR	↓	↓	↓	N	↓	↓	—	↓	↓	↓	↓	↓	'08'	00
#11	SELECT MF	↓	↓	↓	↓	↓	↓	—	↓	↓	↓	↓	↓	↓	↓
#12	SELECT by DF-name (B)	↓	↓	↓	↓	↓	↓	ADF (B)	ADF (B)	ADF (B)	↓	—	↓	'00'	01
#13	SELECT by DF-name (A)	↓	↓	↓	↓	↓	↓	ADF (A)	ADF (A)	ADF (A)	↓	D	—	'08'	00

—: None, ↓: same status of the above, V: Verified, N: Not verified, E: Enabled, D: Disabled, R: Replaced

K.2 PIN state transition between logical channels

This clause describes PIN state transition on a two-logical-channels scenario of the UICC illustrated in figure x.1.

The global PIN state transition contains:

- scenario between two logical channels;
- security status as PIN status and PIN verification state for PIN '11', '01' and '02';
- on each logical channel,
- current ADF, DF and file;
- PIN status byte and usage qualifier for PIN '11' in PIN status DO;
- SE (Security Environment) ID.

Scenario	channel #0 channel #1		security status						logical channel #0					logical channel #1									
			PIN status			PIN verification state			current			PIN status DO in the FCP		SE ID	current			PIN status DO in the FCP		SE ID			
			PIN '11'	PIN '01'	PIN '02'	PIN '11'	PIN '01'	PIN '02'	ADF	DF	File	PIN status byte	usage qualifier		ADF	DF	File	PIN status byte	usage qualifier				
#1	ATR		E	E	E	N	N	N	—	MF	MF	E	E	E	'00'	01							
#2	SELECT MF		↓	↓	↓	↓	↓	↓	—	↓	↓	↓	↓	↓	↓	↓							
#3	SELECT by DF-name (A)		↓	↓	↓	↓	↓	↓	ADF (A)	ADF (A)	ADF (A)	↓	↓	—	↓	↓							
#4	SELECT MF		↓	↓	↓	↓	↓	↓	↓	MF	MF	↓	↓	E	↓	↓							
#5	DISABLE PIN ('01' → '11')		↓	D (R)	↓	↓	V	↓	↓	↓	↓	↓	D	↓	'08'	00							

	Scenario		security status						logical channel #0						logical channel #1									
			PIN status			PIN verification state			current			PIN status DO in the FCP			SE ID	current			PIN status DO in the FCP			SE ID		
			PIN '11'	PIN '01'	PIN '02'	PIN '11'	PIN '01'	PIN '02'	ADF	DF	File	PIN '11'	PIN '01'	PIN '02'		usage qualifier	ADF	DF	File	PIN '11'	PIN '01'		PIN '02'	usage qualifier
#6	VERIFY PIN ('11')		↓	↓	↓	V	↓	↓	↓	↓	↓	↓	↓	↓	↓	↓								
#7	SELECT ADF ('7FFF')		↓	↓	↓	↓	↓	↓	↓	ADF (A)	ADF (A)	↓	↓	—	↓	↓								
#8	MANAGE CH. (#0 → #1)		↓	↓	↓	↓	↓	↓	↓	↓	↓	↓	↓	—	↓	↓	—	MF	MF	E	D	E	'08'	00
#9		SELECT by DF-name (B)	↓	↓	↓	↓	↓	↓	↓	↓	↓	↓	↓	—	↓	↓	ADF (B)	ADF (B)	ADF (B)	↓	—	↓	'00'	01
#10		SELECT MF	↓	↓	↓	↓	↓	↓	↓	↓	↓	↓	↓	—	↓	↓	↓	MF	MF	↓	D	↓	↓	↓
#11	ATR		↓	↓	↓	N	↓	↓	—	MF	MF	↓	↓	E	↓	↓								
#12	SELECT MF		↓	↓	↓	↓	↓	↓	↓	↓	↓	↓	↓	↓	↓	↓								
#13		SELECT by DF-name (B)	↓	↓	↓	↓	↓	↓	ADF (B)	ADF (B)	ADF (B)	↓	—	↓	'00'	01								
#14	MANAGE CH. (#0 → #1)		↓	↓	↓	↓	↓	↓	↓	↓	↓	↓	—	↓	↓	↓	—	MF	MF	E	D	E	'08'	00
#15		SELECT by DF-name (A)	↓	↓	↓	↓	↓	↓	↓	↓	↓	↓	—	↓	↓	↓	ADF (A)	ADF (A)	ADF (A)	↓	↓	—	↓	↓
#16	DISABLE PIN ('02')		↓	↓	D	↓	↓	V	↓	↓	↓	↓	—	D	↓	↓	↓	↓	↓	↓	↓	—	↓	↓
#17	SELECT ADF ('7FFF')		↓	↓	↓	↓	↓	↓	↓	↓	↓	↓	—	↓	↓	↓	↓	↓	↓	↓	↓	—	↓	↓

Scenario		security status									logical channel #0					logical channel #1								
		PIN status			PIN verification state			current			PIN status DO in the FCP			SE ID	current			PIN status DO in the FCP			SE ID			
		PIN '11'	PIN '01'	PIN '02'	PIN '11'	PIN '01'	PIN '02'	ADF	DF	File	PIN '11'	PIN '01'	PIN '02'		usage qualifier	ADF	DF	File	PIN '11'	PIN '01'		PIN '02'	usage qualifier	
#18	ENABLE PIN ('01')	↓	E	↓	↓	↓	↓	↓	↓	↓	↓	—	↓	↓	↓	↓	↓	↓	↓	E	—	'00'	01	
#19	SELECT ADF ('7FFF')	↓	↓	↓	↓	↓	↓	↓	↓	↓	↓	—	↓	↓	↓	↓	↓	↓	↓	↓	—	↓	↓	
#20	DISABLE PIN ('01' → '11')	↓	D(R)	↓	↓	↓	↓	↓	↓	↓	↓	—	↓	↓	↓	↓	↓	↓	↓	D	—	'08'	00	
#21	SELECT ADF ('7FFF')	↓	↓	↓	↓	↓	↓	↓	↓	↓	↓	—	↓	↓	↓	↓	↓	↓	↓	↓	—	↓	↓	
#22	ATR	↓	↓	↓	↓	↓	↓	↓	—	MF	MF	↓	D	↓	↓	↓	↓	↓	↓	↓	↓	↓	↓	
#23	SELECT MF	↓	↓	↓	↓	↓	↓	↓	—	↓	↓	↓	↓	↓	↓	↓	↓	↓	↓	↓	↓	↓	↓	
#24	SELECT by DF-name (B)	↓	↓	↓	↓	↓	↓	↓	ADF (B)	ADF (B)	ADF (B)	↓	—	↓	↓	↓	↓	↓	↓	↓	↓	↓	↓	
#25	MANAGE CH. (#0 → #1)	↓	↓	↓	↓	↓	↓	↓	↓	↓	↓	↓	—	↓	↓	↓	—	MF	MF	E	D	D	'00'	01
#26	SELECT by DF-name (A)	↓	↓	↓	↓	↓	↓	↓	↓	↓	↓	↓	—	↓	↓	↓	ADF (A)	ADF (A)	ADF (A)	↓	↓	—	'08'	00
#27	ENABLE PIN ('02')	↓	↓	E	↓	↓	↓	↓	↓	↓	↓	↓	—	E	↓	↓	↓	↓	↓	↓	—	↓	↓	
#28	DISABLE PIN ('02' → '11')	↓	↓	D (R)	↓	↓	↓	↓	↓	↓	↓	↓	—	D	'08'	00	↓	↓	↓	↓	↓	—	↓	↓
#29	VERIFY PIN ('11')	↓	↓	↓	V	↓	↓	↓	↓	↓	↓	↓	—	↓	↓	↓	↓	↓	↓	↓	—	↓	↓	
#30	ATR	↓	↓	↓	N	↓	↓	↓	—	MF	MF	↓	D	↓	↓	↓	↓	↓	↓	↓	↓	↓	↓	

Scenario		security status							logical channel #0						logical channel #1										
		PIN status			PIN verification state				current			PIN status DO in the FCP			SE ID	current			PIN status DO in the FCP			SE ID			
		PIN '11'	PIN '01'	PIN '02'	PIN '11'	PIN '01'	PIN '02'	ADF	DF	File	PIN '11'	PIN '01'	PIN '02'	usage qualifier		ADF	DF	File	PIN '11'	PIN '01'	PIN '02'		usage qualifier	PIN ('11')	
#31	SELECT MF																								
#32	SELECT by DF-name (B)								ADF (B)	ADF (B)	ADF (B)		—												
#33	MANAGE CH. (#0 → #1)																—	MF	MF		E	D	D	'08'	00
#34	SELECT by DF-name (A)																ADF (A)	ADF (A)	ADF (A)				—		

NOTE: —: None, ↓: same status of the above, V: Verified, N: Not verified, E: Enabled, D: Disabled, R: Replaced.

Annex L.1 (informative): Examples of SET DATA and RETRIEVE DATA usage

Annex L.1 describes the sequences on APDU level, i.e. C-APDUs are given as

CLA INS P1 P2 {Lc DATA} {Le}

The presence of components enclosed in {...} depends on the case of the APDU.

The terminal stores some data in the object with tag 'A1' of length 45kB with interruption, good case.

Table L.1.1 SET DATA with interruption, good case

	Terminal		UICC
SET DATA (First Block)	[80 DB 00 80 Lc A1 82 B4 00 xx ... xx]	→	
SET DATA (Next Block)	[80 DB 00 00 Lc xx ... xx]	→	← 63 F1
AUTHENTICATE	[00 88 00 XX Lc YY...YY Le]	→	← 63 F1
SET DATA (Next Block)	[80 DB 00 00 Lc xx ... xx]	→	← [Data] 90 00
UPDATE BINARY on other logical channel	[01 D6 00 00 Lc xx ... xx]		← 63 F1
SET DATA (Next Block)	[80 DB 00 00 Lc xx ... xx]	→	← 90 00
...	...		← 63 F1
SET DATA (Next Block)	[80 DB 00 00 Lc xx ... xx]	→	← ...
			← 90 00

The terminal stores some data in the object with tag 'A1' of length 45kB with interruption, error case.

Table L.1.2 SET DATA with interruption, error case

	Terminal		UICC
SET DATA (First Block)	[80 DB 00 80 Lc A1 82 B4 00 xx ... xx]	→	
SET DATA (Next Block)	[80 DB 00 00 Lc xx ... xx]	→	← 63 F1
AUTHENTICATE	[00 88 00 XX Lc YY...YY Le]	→	← 63 F1
SET DATA (Next Block)	[80 DB 00 00 Lc xx ... xx]	→	← [Data] 90 00
UPDATE BINARY on same logical channel	[00 D6 81 00 Lc xx ... xx]		← 63 F1
SET DATA (Next Block)	[80 DB 00 00 Lc xx ... xx]	→	← 90 00
			← 6A 86

As a result of the error, the object with tag 'A1' is removed from the file.

The terminal retrieved the object with tag 'A2' with interruption (good case).

Table L.1.3 RETRIEVE DATA with interruption, good case

	Terminal		UICC
RETRIEVE DATA (First Block)	[80 CB 00 80 01 A2 Le]	→	
			←
RETRIEVE DATA (Next Block)	[80 CB 00 00 Le]	→	←
			←
AUTHENTICATE	[00 88 00 XX Lc YY YY Le]	→	←
			←
RETRIEVE DATA (Next Block)	[80 CB 00 00 Le]	→	←
			←
...	...		←
RETRIEVE DATA (Next Block)	[80 CB 00 00 Le]	→	←
			←

Annex L.2 (informative): Examples of RETRIEVE DATA usage with transport protocol T = 0

Annex L.2 describes the sequences on APDU and TPDU level.

C-APDUs are given as

CLA INS P1 P2 {Lc DATA} {Le}

C-TPDUs are given as

CLA INS P1 P2 P3 {DATA}

The presence of components enclosed in {...} depends on the case of the APDU or the type of the TPDU.

This clause gives examples of the usage of the RETRIEVE DATA command with transport protocol T = 0. The first example is based on the preconditions out of table L.1.3. Furthermore it is assumed that for the last block of the RETRIEVE DATA command only 64 additional data bytes are left to be retrieved to show the handling with the procedure byte '6C'. The second example shows the use of procedure byte '61' when a short object is retrieved.

Table L.2.1 RETRIEVE DATA with interruption, good case

	Terminal		UICC
RETRIEVE DATA (First Block) C-APDU:	[80 CB 00 80 01 A2 00]		
C-TPDU:	[80 CB 00 80 01]	→	
	[A2] (Tag)	→	← [CB] (INS)
Get Response	[00 C0 00 00 00]	→	← 62 F1 (SW1/2: 'Warning: more data available')
R-APDU:	[A2 len xx ... xx 62 F1]		← [C0] (INS) [A2 len xx ... xx] (256 Data bytes) + 90 00 (SW1/2 Normal ending of command)
RETRIEVE DATA (Next Block) C-APDU:	[80 CB 00 00 00]		
C-TPDU:	[80 CB 00 00 00]	→	
R-APDU:	[xx ... xx 62 F1]		← [CB] (INS) [xx ... xx] (256 Data bytes) + 62 F1 (SW1/2: 'more data available')
AUTHENTICATE C-APDU:	[00 88 00 81 22 YY YY...YY 33]		
C-TPDU:	[00 88 00 81 22]	→	
	[YY YY...YY] (Data)	→	← [88] (INS)
Get Response	[00 C0 00 00 33]	→	← 61 33 (SW1/2)
R-APDU:	[xx ... xx 90 00]		← [C0] (INS) [xx ... xx] (51 Data bytes) + 90 00 (SW1/2)
RETRIEVE DATA (Next Block) C-APDU:	[80 CB 00 00 00]		
C-TPDU:	[80 CB 00 00 00]	→	
R-APDU:	[xx ... xx 62 F1]		← [CB] (INS) [xx ... xx] (256 Data bytes) + 62 F1 (SW1/2: 'more data available')
...
RETRIEVE DATA (Next Block) C-APDU:	[80 CB 00 00 00] (see note)		
C-TPDU:	[80 CB 00 00 00]	→	
	[80 CB 00 00 40]		← 6C 40 (SW1/2: 'resend previous command with P3 equal to '40' – 64 additional Data bytes available')
R-APDU:	[xx ... xx 90 00]		← [CB] (INS) [xx ... xx] (64 Data bytes) + 90 00 (all data retrieved)

NOTE: Terminals are usually expected to skip this step, because they can calculate the correct length of the last command from the length field of the data object. However, the UICC has to support the given procedure.

Table L.2.2 RETRIEVE DATA, short object

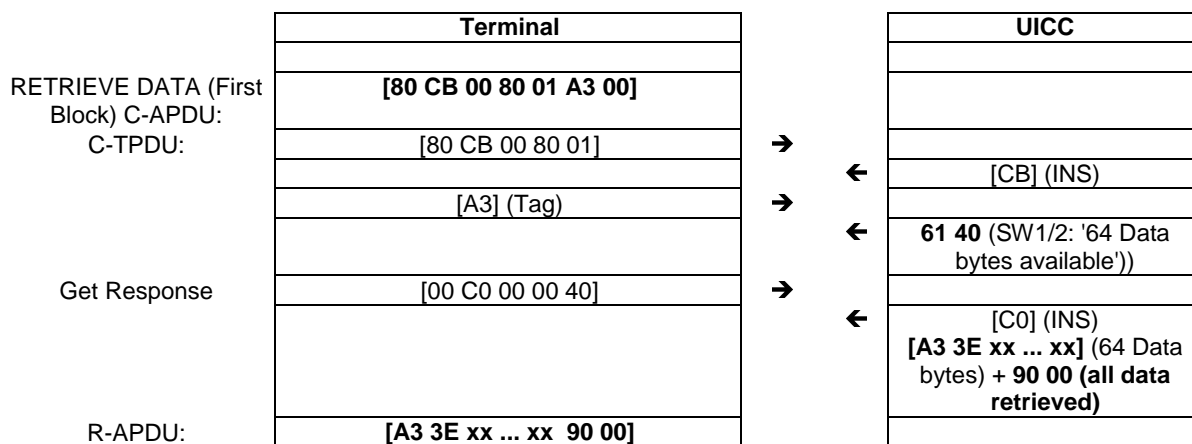

Annex M (informative): Examples of ODD AUTHENTICATE instruction code usage

M.1: Examples of ODD AUTHENTICATE instruction code usage at applicative level

Annex XX.1 describes the sequences on APDU level, i.e. C-APDUs are given as

CLA INS P1 P2 {Lc DATA} {Le}

The presence of components enclosed in {...} depends on the case of the APDU.

The terminal sends some data in the object with tag '53' and the answer received by the UICC is in the object with tag '53'. The security context used in the example is P2='00'. The challenge data is [xx ... xx] and the authentication response data is [yy ... yy].

In the first example the length of the challenge data is 200 bytes ('C8' hex) and the length of the response data is 100 bytes ('64' hex).

Table XX.1.1 ODD AUTHENTICATE with short data

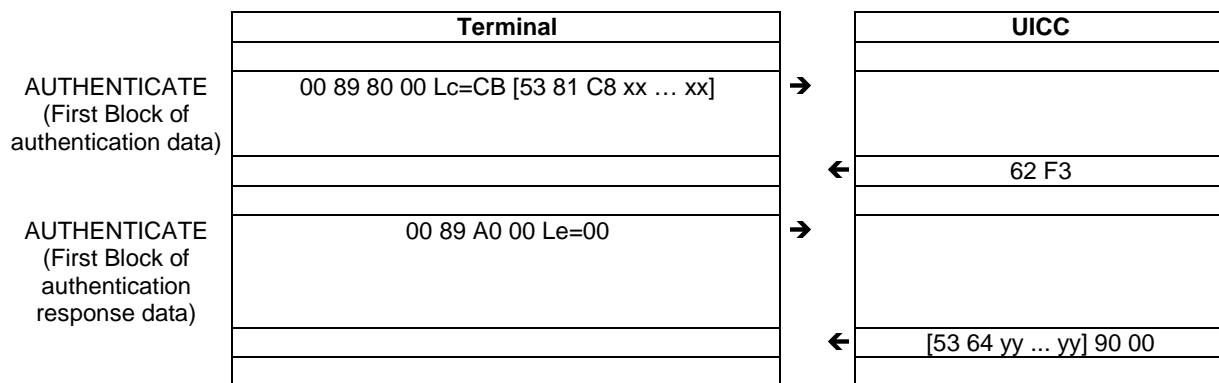

In the second example the length of the challenge data is 700 bytes ('02BC' hex) and the length of the response data is 600 bytes ('0258' hex).

Table XX.1.2 ODD AUTHENTICATE with extended data

	Terminal		UICC
AUTHENTICATE (First Block of authentication data)	00 89 80 00 Lc=FF [53 82 02 BC xx ... xx]	→	
AUTHENTICATE (Next Block of authentication data)	00 89 00 00 Lc=FF [xx ... xx]	→	← 63 F1
AUTHENTICATE (Next Block of authentication data)	00 89 00 00 Lc=C2 [xx ... xx]	→	← 63 F1
AUTHENTICATE (First Block of authentication response data)	00 89 A0 00 Le=00	→	← 62 F3
AUTHENTICATE (Next Block of authentication response data)	00 89 20 00 Le=00	→	← [53 82 02 58 yy ... yy] 62 F1
AUTHENTICATE (Next Block of authentication response data)	00 89 20 00 Le=5C	→	← [yy ... yy] 62 F1
			← [yy ... yy] 90 00

M.2: Examples of ODD AUTHENTICATE instruction code usage with transport protocol T = 0

Annex XX.2 describes the sequences on APDU and TPDU level.

C-APDUs are given as

CLA INS P1 P2 {Lc DATA} {Le}

C-TPDUs are given as

CLA INS P1 P2 P3 {DATA}

The presence of components enclosed in {...} depends on the case of the APDU or the type of the TPDU.

This clause gives examples of the usage of the ODD AUTHENTICATE command usage with transport protocol T = 0. The first example is based on the preconditions out of table XX.1.1. The second example is based on the preconditions out of table XX.1.2.

Table XX.2.1 ODD AUTHENTICATE with short data

	Terminal		UICC
AUTHENTICATE (First Block of authentication data)	00 89 80 00 Lc=CB [53 81 C8 xx ... xx]		
C-APDU:			
C-TPDU:	[00 89 80 00 CB]	→	
	[53 81 C8 xx ... xx] (200 Data bytes)	→	[89] (INS)
R-APDU:	[62 F3]	←	62 F3 (SW1/2: 'Warning: Authentication response data available')
AUTHENTICATE (First Block of authentication response data) C-APDU:	00 89 A0 00 Le=00		
C-TPDU:	[00 89 A0 00 00]	→	
	[00 89 A0 00 66]	→	6C 66 (SW1/2: '66 bytes available')
R-APDU:	[53 64 yy ... yy] [90 00]	←	[53 64 yy ... yy] 90 00

Table XX.2.1 ODD AUTHENTICATE with extended data

	Terminal		UICC
AUTHENTICATE (First Block of authentication data)	00 89 80 00 Lc=FF [53 82 02 BC xx ... xx]		
C-APDU:			
C-TPDU:	[00 89 80 00 FF]	→	
	[53 82 02 BC xx ... xx] (251 Data bytes)	→	[89] (INS)
R-APDU:	[62 F1]	←	63 F1 (SW1/2: 'Warning: more data expected')
AUTHENTICATE (Next Block of authentication data)	00 89 00 00 Lc=FF [xx ... xx]		
C-APDU:			
C-TPDU:	[00 89 00 00 FF]	→	
	[xx ... xx] (255 Data bytes)	→	[89] (INS)
R-APDU:	[63 F1]	←	63 F1 (SW1/2: 'Warning: more data expected')
AUTHENTICATE (Next Block of authentication data)	00 89 00 00 Lc=C2 [xx ... xx]		
C-APDU:			
C-TPDU:	[00 89 00 00 C2]	→	
	[xx ... xx] (194 Data bytes)	→	[89] (INS)
		←	62 F3 SW1/2: 'Warning: Authentication

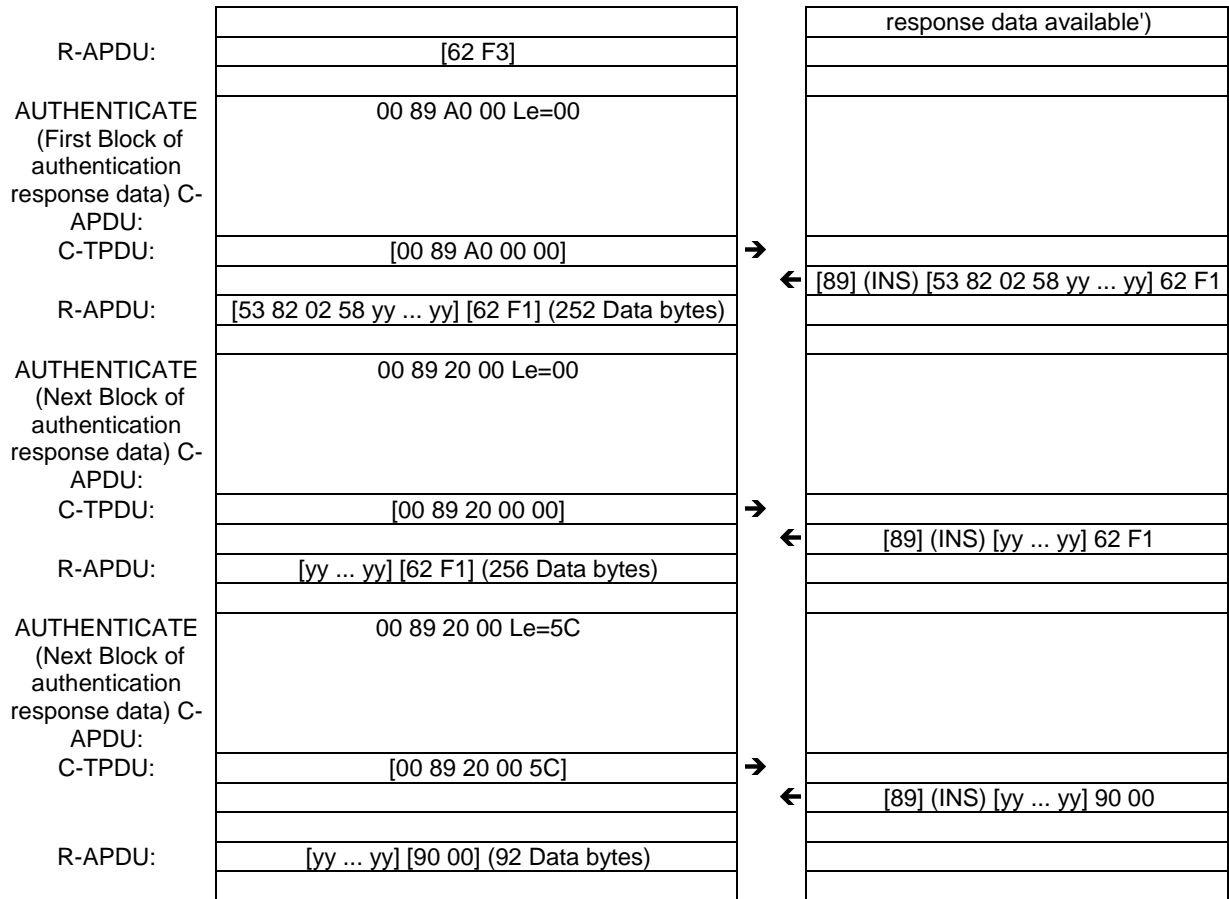

Annex N (informative): Bibliography

- ISO/IEC 7811-3: "Identification cards - Recording technique - Part 3: Location of embossed characters on ID-1 cards".

Annex O (informative): Change history

The table below indicates changes that have been incorporated into the present document since it was created by TC SCP.

Change history								
Date	Meeting	TC SCP Doc.	CR	Rv	Cat	Subject/Comment	Old	New
2000-08	SCP-02	9-00-0289	-		-	First draft created. Technical content is identical to 3GPP TS 31.101 V3.2.0		0.0.0
2000-08	SCP-02	9-00-0342	001		F	Correction and clarification of the provision of Contact C6	0.0.0	3.0.0
		9-00-0343	002		F	Clarifications of Electrical characteristics		
		9-00-0307	003		F	Clarification of the SELECT command with 'special' file-IDs		
		9-00-0293	004		F	Clarification of GET RESPONSE command usage		
		9-00-0346	005		F	ATR: Correction of Data Coding Byte		
		9-00-0348	006		F	Correction of the file descriptor information and PS Template DO		
		9-00-0352	007		F	Correction to S-Block dependent errors and T = 1 ATR example		
		9-00-0359	008		F	SELECT command response		
		9-00-0364	009		F	Clarifications and corrections to usage of SFI and reservation of file IDs		
		9-00-0366	010		F	Clarification of access rules and ADF		
		9-00-0367	011		F	Clarification of the location of EF(ARR).		
		9-00-0368	012		F	Clarifications to the SEARCH RECORD command		
		9-00-0369	013		F	Clarifications and corrections to clause 6		
		9-00-0373	014		F	Clarification to the INCREASE command		
		9-00-0374	015		F	Clarifications and corrections transmission protocols in clause 7		
		9-00-0375	016		F	Clarification to VERIFY PIN		
		9-00-0383	017		F	Application selection using partial DF name		
		9-00-0385	018		F	Correction of P1 of ACTIVATE and DEACTIVATE commands		
		9-00-0387	019		F	Definition of SFIs		
		9-00-0391	020		F	Collection of corrections and clarifications.		
		9-00-0393	021		F	Support of TERMINAL PROFILE by an UICC		
9-00-0394	022		F	Corrections to References and clarifications to definitions				
9-00-0396	023		F	Correction of PIN related procedure				
9-00-0397	024		F	Clarifications and corrections to the security architecture in clause 9				
9-00-0398	025		F	Alignment of table for commands and status words				
2000-12	SCP-03	9-00-0463	026		F	Clarification to the requirement for the warm reset	3.0.0	4.0.0
		9-00-0454	027		F	Corrections and clarifications on multi-verification capable UICC		
		9-00-0456	028		B	Changing UICC current consumption values for 3V and 1.8V for release 4		
		9-00-0459	029		F	Correction to SFI values		
		9-00-0467	030	1	F	Clarification of EFARR access conditions		
		9-00-0451	031		F	Correction of T = 1 ATR example		
		9-00-0452	032		F	Modification on using 'UICC characteristics byte' in FCP - TAG '80'		
		9-00-0453	033		F	Modification on using Proprietary information in FCP - TAG '81'		
		9-00-0465	034		F	Support for minimum clock frequency indication to the terminal		
9-00-0466	035		F	Correction of implicit MF selection				
2001-02	SCP-04	SCP-010041	037		A	Reservation of File ID '7F31' for iDEN Specifications	4.0.0	4.1.0
		SCP-010040	039		A	Clarification of selection by path		
		SCP-010054	043		A	Correction of the minimum pulse width during clock frequency switching		
		SCP-010056	045		A	Clarification of the access rules referencing		
		SCP-010060	047		A	Clarification on block dependent errors		
		SCP-010062	049		A	Indication of amount of available memory		
SCP-010063	050		A	Clarification of selection by path (empty data fields)				
2001-04	SCP-05	SCP-010121	051		B	Addition of GET CHALLENGE command	4.1.0	4.2.0
		SCP-010136	052	1	C	Applicability of commands to applications		
		SCP-010133	054		A	Correction to total file size for DFs		
		SCP-010139	055		B	Addition of logical channels		
		SCP-010145	056		B	Modification of security environment for logical channels		
2001-07	SCP-06	SCP-010177	058		A	Correction of EF(ARR) example in annex F	4.2.0	4.3.0
		SCP-010210	060		A	Clarification and correction regarding the Universal PIN		
2001-10	SCP-07	SCP-010293	064		F	Clarification on Local PIN status	4.3.0	4.4.0
		SCP-010295	066		A	Location of local PIN		
		SCP-010296	067		F	Correction regarding Logical Channels		
		SCP-010301	069		A	Correction of definition of application and second level application		
		SCP-010303	071		A	Addition of an example on Access Rule referencing		

Change history								
Date	Meeting	TC SCP Doc.	CR	Rv	Cat	Subject/Comment	Old	New
2002-01	SCP-08	SCP-010290	062		A	Clarification and correction regarding the Universal PIN and Global PINs	4.4.0	4.5.0
		SCP-010372	073		F	Correction to status words for the MANAGE CHANNEL command		
		SCP-010383	075		A	Inconsistency in the VERIFY PIN and UNBLOCK PIN commands definition		
		SCP-010385	076		A	Use of GET RESPONSE with case 2 and case 4 commands		
2002-03	SCP-09	SCP-020041	078		F	Correction of Errors in SELECT FILE by File Referencing Example	4.5.0	5.0.0
		SCP-020043	080		F	Correct SELECT command parameter definitions		
		SCP-020042	079		C	UICC presence detection procedure and usage modification		
2002-06	SCP-10	SCP-020184	087	1	F	Correction to status words for the commands STATUS, ACTIVATE FILE, DEACTIVATE FILE, GET CHALLENGE and MANAGE CHANNEL	5.0.0	5.1.0
		SCP-020158	084		F	Correction to Update Record		
			090		F	Correction of Procedure Byte '6Cxx' for case 2 commands with Le = '00'		
			093		F	SFI for EF(ICCID) and EF(ARR)		
			081		F	Additions to Abbreviations clause		
2002-09	SCP-11	SCP-020210	096		A	Status word 6700 for Select command	5.1.0	5.2.0
		SCP-020250	100	1	A	Corrections and clarifications to PIN handling		
		SCP-020210	103		F	Clarification of default SE and default Usage Qualifier		
		SCP-020253	106		A	Clarification of VERIFY PIN and UNBLOCK PIN		
2003-01	SCP-12	SCP-030050	109		F	Introduction of the reference to the CAT specification	5.2.0	6.0.0
		SCP-030050	115		F	Clarification of Proprietary Information field in FCP		
		SCP-030061	119		D	Remove UICC as an abbreviation to align with 3GPP TR 21.905		
		SCP-030059	112	1	F	Corrections and clarifications		
		SCP-030078	107	1	D	Refer to TLV Format Definitions in ETSI TS 101 220 [3] (this CR created Rel-6)		
2003-05	SCP-13	SCP-030111	120		D	Editorial Corrections on protocol definition	6.0.0	6.1.0
		SCP-030111	124		F	Clarification on use of '7FFF' for ADF selection		
		SCP-030111	131		F	Delete special FID '3FFF'		
2003-09	SCP-14	SCP-030293	132	1	C	Introduction of 85°C instead of 70°C as fully operational temperature	6.1.0	6.2.0
		SCP-030296	133	1	F	Clarification of application session termination		
		SCP-030297	136	1	C	Semantics of the Shareable/Not-Shareable Bit		
2003-12	SCP-15	SCP-030219	140		F	Correction of Security attributes length coding table	6.2.0	6.3.0
		SCP-030411	141	1	B	Introduction of a new Di factor on the card-terminal interface		
		SCP-030411	142		D	Informative annex on PIN state transition in multi verification capable UICC		
		SCP-030411	144		B	Addition of the warning status SW1/SW2='6285' indicating the selected DF is in termination state		
		SCP-030467	145	1	D	Correction to UICC status words		
2004-02	SCP-16	SCP-040055	135	2	B	Introduction of a third card size for the UICC	6.3.0	6.4.0
		SCP-040032	150		F	Clarification on the PPS procedure		
		SCP-040032	151		F	Alignments regarding tag 86		
2004-05	SCP-17	SCP-040237	155		F	Clarification of T = 0 description	6.4.0	6.5.0
		SCP-040237	156		F	Correction in the PIN state transition on the single logical channel table (annex K1)		
		SCP-040237	157		F	Clarification of status word '91xx' handling for Logical Channels		
		SCP-040237	159		F	Correction to UICC status words: Addition of 6985 for SELECT		
		SCP-040237	160		B	Introduction of low impedance driver on the I/O line		
2004-09	SCP-18	SCP-040316	161		B	Introduction of BER-TLV EFs (large files)	6.5.0	6.6.0
2004-11	SCP-19	SCP-040414	162		F	Clarification of sequence in PIN status template DO	6.6.0	6.7.0
		SCP-040414	163		F	Removing security attribute tag '86' as a possible tag within the FCP template		
		SCP-040414	168		A	Corrections to References and replacement of FCI with FCP		
		SCP-040414	173		A	Correction of description of response data structure for T = 1		
2004-11	SCP-19	SCP-040474	177	1	A	Delete status word '61XX' for T = 1	6.7.0	7.0.0
		SCP-040334	169		C	Clarification for response to SELECT		
2005-01	SCP-20	SCP-050014	181		A	Removing clause,8.5.5 on TS 102 221	7.0.0	7.1.0
		SCP-050014	180		A	Additional status word for commands capable to change the current file of a logical channel		
		SCP-050014	187		A	Consistent usage of terms in SET DATA command		
		SCP-050014	184		A	Clarification of TLV object state in case of erroneous SET DATA command		
		SCP-050014	186		A	Additional status word for RETRIEVE and SET DATA		
2005-06	SCP-21	SCP-050141	192		A	Correction on PIN verification status reset	7.1.0	7.2.0
		SCP-050142	203		A	Add definition for "current file"		
		SCP-050142	197		F	Modifications due to revision of ISO/IEC 7816 (all parts)		

Change history								
Date	Meeting	TC SCP Doc.	CR	Rv	Cat	Subject/Comment	Old	New
2005-09	SCP-22	SCP-050227	205		A	Removal of the extra guard time after the last character in a command sent to the UICC	7.2.0	7.3.0
		SCP-050273	210		A	Correction of ATR error handling		
		SCP-050274	211		D	Clarification for RETRIEVE DATA indicating 'First Block'		
2005-12	SCP-23	SCP-050460	213		A	Correction to the use of 'allocated' in the SET DATA command	7.3.0	7.4.0
			215		A	Clarification on tag pointer changes for BER-TLV structured files		
			217		A	Clarification on 'File Size' for BER-TLV structured EFs		
		SCP-050487	220		A	Coding of the first TBi (i > 2) after T = 15		
2006-03	SCP-25	SCP-060140	222		A	Clarification of presence of PPS2 in PPS request	7.4.0	7.5.0
2006-07	SCP-26	SCP-060244	223	2	B	Addition of specific UICC environmental conditions	7.5.0	7.6.0
		SCP-060255	221		D	Clarification of annex L for RETRIEVE DATA with transport protocol T = 0		
			222		B	Terminal capability indication mechanism		
		SCP-060282	218		B	Corrections related to clarifications on TERMINATE Commands		
2006-09	SCP-27	SCP-060441	225		A	Removal of retransmission of first block	7.6.0	7.7.0
		SCP-060467	228	1	A	Authenticate command with data message longer than what can be transported in a single command		
		SCP-060465	226	1	F	Corrections to the Terminal Capabilities command		
2007-01	SCP-29	SCP-070030	230		D	Addition of an annex on Authenticate command with data message longer than what can be transported in a single command	7.7.0	7.8.0
			231		F	Correction of incorrectly implemented CRs in REL-7		
			227	3	B	Extension of the number of logical channels		

History

Document history		
V7.0.0	December 2004	Publication
V7.1.0	May 2005	Publication
V7.2.0	August 2005	Publication
V7.3.0	October 2005	Publication
V7.4.0	January 2006	Publication
V7.5.0	May 2006	Publication
V7.6.0	August 2006	Publication
V7.7.0	October 2006	Publication
V7.8.0	February 2007	Publication