

# ETSI TS 101 348 V6.10.1 (2005-06)

---

*Technical Specification*

**Digital cellular telecommunications system (Phase 2+);  
General Packet Radio Service (GPRS);  
Interworking between the Public Land Mobile Network (PLMN)  
supporting GPRS and Packet Data Networks (PDN)  
(3GPP TS 09.61 version 6.10.1 Release 1997)**

---

**GSM**®  
GLOBAL SYSTEM FOR  
MOBILE COMMUNICATIONS

**3GPP**™

**ETSI** 

---

---

Reference

RTS/TSGC-030961v6a1

---

Keywords

GSM

**ETSI**

650 Route des Lucioles  
F-06921 Sophia Antipolis Cedex - FRANCE

Tel.: +33 4 92 94 42 00 Fax: +33 4 93 65 47 16

Siret N° 348 623 562 00017 - NAF 742 C  
Association à but non lucratif enregistrée à la  
Sous-Préfecture de Grasse (06) N° 7803/88

---

**Important notice**

Individual copies of the present document can be downloaded from:

<http://www.etsi.org>

The present document may be made available in more than one electronic version or in print. In any case of existing or perceived difference in contents between such versions, the reference version is the Portable Document Format (PDF). In case of dispute, the reference shall be the printing on ETSI printers of the PDF version kept on a specific network drive within ETSI Secretariat.

Users of the present document should be aware that the document may be subject to revision or change of status. Information on the current status of this and other ETSI documents is available at

<http://portal.etsi.org/tb/status/status.asp>

If you find errors in the present document, please send your comment to one of the following services:

[http://portal.etsi.org/chaicor/ETSI\\_support.asp](http://portal.etsi.org/chaicor/ETSI_support.asp)

---

**Copyright Notification**

No part may be reproduced except as authorized by written permission.  
The copyright and the foregoing restriction extend to reproduction in all media.

© European Telecommunications Standards Institute 2005.  
All rights reserved.

**DECT**<sup>TM</sup>, **PLUGTESTS**<sup>TM</sup> and **UMTS**<sup>TM</sup> are Trade Marks of ETSI registered for the benefit of its Members.  
**TIPHON**<sup>TM</sup> and the **TIPHON logo** are Trade Marks currently being registered by ETSI for the benefit of its Members.  
**3GPP**<sup>TM</sup> is a Trade Mark of ETSI registered for the benefit of its Members and of the 3GPP Organizational Partners.

---

## Intellectual Property Rights

IPRs essential or potentially essential to the present document may have been declared to ETSI. The information pertaining to these essential IPRs, if any, is publicly available for **ETSI members and non-members**, and can be found in ETSI SR 000 314: *"Intellectual Property Rights (IPRs); Essential, or potentially Essential, IPRs notified to ETSI in respect of ETSI standards"*, which is available from the ETSI Secretariat. Latest updates are available on the ETSI Web server (<http://webapp.etsi.org/IPR/home.asp>).

Pursuant to the ETSI IPR Policy, no investigation, including IPR searches, has been carried out by ETSI. No guarantee can be given as to the existence of other IPRs not referenced in ETSI SR 000 314 (or the updates on the ETSI Web server) which are, or may be, or may become, essential to the present document.

---

## Foreword

This Technical Specification (TS) has been produced by ETSI 3rd Generation Partnership Project (3GPP).

The present document may refer to technical specifications or reports using their 3GPP identities, UMTS identities or GSM identities. These should be interpreted as being references to the corresponding ETSI deliverables.

The cross reference between GSM, UMTS, 3GPP and ETSI identities can be found under <http://webapp.etsi.org/key/queryform.asp>.

# Contents

Intellectual Property Rights .....	2
Foreword.....	2
Foreword.....	5
1 Scope .....	6
2 References .....	6
3 Definitions, abbreviations and symbols .....	7
3.1 Definitions .....	7
3.2 Abbreviations .....	7
3.3 Symbols.....	8
4 Network characteristics .....	8
4.1 Key characteristics of PLMN .....	8
4.2 Key characteristics of PSDN .....	8
4.3 Key characteristics of IP Networks .....	8
5 Interworking Classifications.....	9
5.1 Service Interworking .....	9
5.2 Network Interworking .....	9
5.3 Numbering and Addressing .....	9
6 Access reference configuration .....	9
7 Interface to GPRS Bearer Services .....	9
8 Subscription checking .....	10
9 Screening .....	10
9.1 Network controlled screening.....	10
9.2 Subscription controlled screening .....	10
9.3 User controlled screening.....	10
10 Interworking with PSDN (X.75/X.25) .....	11
10.1 General .....	11
10.2 PSDN Interworking Models .....	11
10.2.1 X75 Interworking at the Gi Reference Point .....	11
10.2.1.1 Numbering and Addressing.....	12
10.2.1.2 Charging.....	12
10.2.2 X25 Interworking at the Gi Reference Point .....	12
10.2.2.1 Numbering and Addressing.....	14
10.2.2.2 Charging.....	14
10.3 User Facilities.....	14
10.4 The GPRS Interworking to PSDN Characteristics .....	14
11 Interworking with PDN (IP).....	14
11.1 General .....	14
11.2 PDN Interworking Model.....	14
11.2.1 Access to Internet, Intranet or ISP through GPRS .....	16
11.2.1.1 Transparent access to the Internet .....	16
11.2.1.2 Non Transparent access to an Intranet or ISP .....	17
11.3 Numbering and Addressing .....	20
11.4 Charging .....	20
11.5 Domain Name Server (DNS).....	20
11.6 Screening .....	20
12 Interworking between GPRS networks .....	20
12.1 Security Agreements .....	21
12.2 Routing protocol agreements.....	21

12.3	Charging agreements .....	21
13	Void .....	21
14	Void .....	22
15	Void .....	22
16	Usage of RADIUS on Gi interface .....	22
16.1	RADIUS Authentication .....	22
16.2	RADIUS Accounting .....	22
16.3	Authentication and accounting message flows .....	23
16.3.1	IP PDP type .....	23
16.3.2	Void .....	25
16.3.3	Accounting Update .....	25
16.3.4	AAA-Initiated PDP context termination .....	25
16.4	List of RADIUS attributes .....	26
16.4.1	Access-Request message (sent from the GGSN to AAA server) .....	26
16.4.2	Access-Accept (sent from AAA server to GGSN) .....	27
16.4.3	Accounting-Request START (sent from GGSN to AAA server) .....	28
16.4.4	Accounting Request STOP (sent from GGSN to AAA server) .....	29
16.4.5	Accounting Request ON (optionally sent from GGSN to AAA server) .....	30
16.4.6	Accounting Request OFF (optionally sent from GGSN to AAA server) .....	30
16.4.7	Sub-attributes of the 3GPP Vendor-Specific attribute .....	31
16.4.8	Accounting Request Interim-Update (sent from GGSN to AAA server) .....	38
16.4.9	Disconnect Request (optionally sent from AAA server to GGSN) .....	39
<b>Annex A (informative):</b>	<b>Change history .....</b>	<b>40</b>
History .....		41

---

# Foreword

This Technical Specification has been produced by the 3<sup>rd</sup> Generation Partnership Project (3GPP).

The contents of the present document are subject to continuing work within the TSG and may change following formal TSG approval. Should the TSG modify the contents of the present document, it will be re-released by the TSG with an identifying change of release date and an increase in version number as follows:

Version x.y.z

where:

- x the first digit:
  - 1 presented to TSG for information;
  - 2 presented to TSG for approval;
  - 3 or greater indicates TSG approved document under change control.
- y the second digit is incremented for all changes of substance, i.e. technical enhancements, corrections, updates, etc.
- z the third digit is incremented when editorial only changes have been incorporated in the document.

---

# 1 Scope

The present document defines the requirements for General Packet Radio Service (GPRS) interworking between a:

- a) PLMN and PSDN;
- b) PLMN and IP Networks;
- c) PLMN and PLMN.

---

# 2 References

The following documents contain provisions which, through reference in this text, constitute provisions of the present document.

- References are either specific (identified by date of publication, edition number, version number, etc.) or non-specific.
- For a specific reference, subsequent revisions do not apply.
- For a non-specific reference, the latest version applies. In the case of a reference to a 3GPP document (including a GSM document), a non-specific reference implicitly refers to the latest version of that document *in the same Release as the present document*.

- [1] 3GPP TR 01.04: "Abbreviations and acronyms".
- [2] 3GPP TS 02.60: "General Packet Radio Service (GPRS); Service Description; Stage 1".
- [3] 3GPP TS 03.60: "General Packet Radio Service (GPRS); Service Description; Stage 2".
- [4] 3GPP TS 03.61: "General Packet Radio Service (GPRS); Point to Multipoint Multicast Service Description; Stage 2".
- [5] 3GPP TS 03.62: "General Packet Radio Service (GPRS); Point to Multipoint Group Call Service Description; Stage 2".
- [6] 3GPP TS 03.64: "General Packet Radio Service (GPRS); Overall description of the GPRS radio interface; Stage 2".
- [7] 3GPP TS 04.60: "General Packet Radio Service (GPRS); Mobile Station (MS) - Base Station System (BSS) interface; Radio Link Control/Medium Access Control (RLC/MAC) protocol".
- [8] 3GPP TS 04.64: "General Packet Radio Service (GPRS); Mobile Station - Serving GPRS Support Node (MS-SGSN) Logical Link Control (LLC) layer specification".
- [9] 3GPP TS 04.65: "General Packet Radio Service (GPRS); Mobile Station (MS) - Serving GPRS Support Node (SGSN); Subnetwork Dependent Convergence Protocol (SNDTCP)".
- [10] 3GPP TS 07.60: "General Packet Radio Service (GPRS); Mobile Station (MS) supporting GPRS".
- [11] ITU-T Recommendation E.164: "The international public telecommunication numbering plan".
- [12] ITU-T Recommendation X.25: "Interface between Data Terminal Equipment (DTE) and Data Circuit-terminating Equipment (DCE) for terminals operating in the packet mode and connected to public data networks by dedicated circuit".
- [13] ITU-T Recommendation X.75: "Packet-switched signalling system between public networks providing data transmission services".
- [14] ITU-T Recommendation X.121: "International numbering plan for public data networks".
- [15] IETF RFC 768 (1980): "User Datagram Protocol" (STD 6).

- [16] IETF RFC 791 (1981): "Internet Protocol" (STD 5).
- [17] IETF RFC 792 (1981): "Internet Control Message Protocol" (STD 5).
- [18] IETF RFC 793 (1981): "Transmission Control Protocol" (STD 7).
- [19] IETF RFC 1034 (1987): "Domain names - concepts and facilities" (STD 7).
- [20] IETF RFC 1661 (1994): "The Point-to-Point Protocol (PPP)" (STD 51).
- [21] IETF RFC 2865 (2000): "Remote Authentication Dial In User Service (RADIUS)", C. Rigney, S. Willens, A. Rubens, W. Simpson.
- [22] IETF RFC 2866 (2000): "RADIUS Accounting", C. Rigney.
- [23] 3GPP TS 03.03: "Numbering, addressing and identification".
- [24] IETF RFC 2882 (2000): "Network Access Servers Requirements: Extended RADIUS Practices", D. Mitton.
- [25] IETF RFC 1035 (1987): "Domain names - implementation and specification".
- [26] IETF RFC 1771 (1995): "A Border Gateway Protocol 4 (BGP-4)".
- [27] IETF RFC 1825 (1995): "Security Architecture for the Internet Protocol".
- [28] IETF RFC 1826 (1995): "IP Authentication Header".
- [29] IETF RFC 1827 (1995): "IP Encapsulating Security Payload (ESP)".
- [30] 3GPP TS 04.08: " Mobile radio interface layer 3 specification ".
- [31] 3GPP TS 09.60: "General Packet Radio Service (GPRS); GPRS Tunnelling Protocol (GTP) across the Gn and Gp Interface ".

---

## 3 Definitions, abbreviations and symbols

### 3.1 Definitions

For the purposes of the present document, the terms and definitions given in 3GPP TS 02.60 [2] apply.

Terminology used in the present document is presented in 3GPP TS 01.04 [1]. For support of data services between GSM PLMN and other networks see 3GPP TS 09-series of specifications.

### 3.2 Abbreviations

For the purposes of the present document, the following abbreviations apply:

APN	Access Point Name
ATM	Asynchronous Transfer Mode
BG	Border Gateway
CHAP	Challenge Handshake Authentication Protocol
DHCP	Dynamic Host Configuration Protocol
DNIC	Data Network Identification Code
DNS	Domain Name Server
GGSN	Gateway GPRS Support Node
ICMP	Internet Control Message Protocol
IETF	Internet Engineering Task Force
IP	Internet Protocol
IPv4	Internet Protocol version 4
IPv6	Internet Protocol version 6



ISP	Internet Service Provider
LAPB	Link Access Protocol Balanced
MS	Mobile Station
MT	Mobile Terminal
PDN	Packet Data Network
PDU	Protocol Data Unit
PNIC	Pseudo Network Identification Code
PSDN	Packet Switched Data Network
RADIUS	Remote Authentication Dial In User Service
SGSN	Serving GPRS Support Node
SMDS	Switched Multimegabit Data Service
TCP	Transmission Control Protocol
TE	Terminal Equipment
UDP	User Datagram Protocol

### 3.3 Symbols

For the purposes of the present document, the following symbols apply:

Gb	Interface between an SGSN and a BSC.
Gi	Reference point between GPRS and an external packet data network.
Gn	Interface between two GSNs within the same PLMN.
Gp	Interface between two GSNs in different PLMNs. The Gp interface allows support of GPRS network services across areas served by the co-operating GPRS PLMNs.
Gs	Interface between an SGSN and MSC.
R	The reference point between a non-ISDN compatible TE and MT. Typically this reference point supports a standard serial interface.
Um	The interface between the MS and the GPRS fixed network part. The Um interface is the GPRS network interface for providing packet data services over the radio to the MS. The MT part of the MS is used to access the GPRS services through this interface.

---

## 4 Network characteristics

### 4.1 Key characteristics of PLMN

The GSM PLMN is fully defined in the GSM technical specifications. The GPRS related key characteristics are found in 3GPP TS 02.60 [2] and 3GPP TS 03.60 [3].

### 4.2 Key characteristics of PSDN

Packet Switched Data Networks (PSDNs) are defined in the relevant ITU-T Recommendation X series.

### 4.3 Key characteristics of IP Networks

The Internet is a conglomeration of networks utilising a common set of protocols. IP protocols are defined in the relevant IETF STD specifications and RFCs. The networks topologies may be based on LANs (e.g. ethernet), Point-to-Point leased lines, PSTN, ISDN, X.25 or WANs using switched technology (e.g. SMDS, ATM).

## 5 Interworking Classifications

### 5.1 Service Interworking

Service interworking is required when the Teleservice at the calling and called terminals are different. For GPRS, service interworking is not applicable at the Gi reference point.

### 5.2 Network Interworking

Network interworking is required whenever a PLMN is involved in communications with another network to provide end-to-end communications. The PLMN shall interconnect in a manner consistent with that of a normal Packet Data Network (type defined by the requirements e.g. IP, PSDN X.75). Interworking appears exactly like that of Packet Data Networks.

### 5.3 Numbering and Addressing

See 3GPP TS 03.03 [23] and the relevant sections for X.25 and IP addressing below.

## 6 Access reference configuration

Figure 1 shows the relationship between the MS, its terminal equipment and the GSM network in the overall GPRS environment.

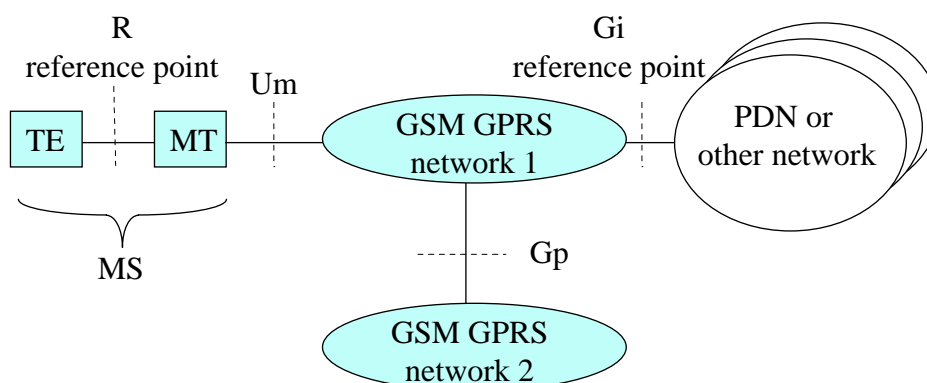
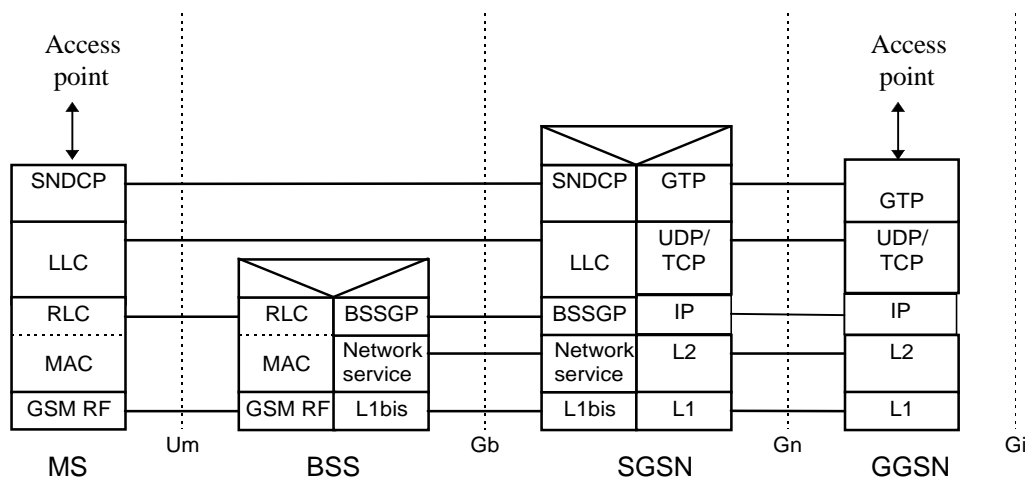

Figure 1: GPRS Access Interfaces and Reference Points

## 7 Interface to GPRS Bearer Services

Figure 2: Transmission Plane shows the relationship of the GPRS Bearer terminating at the SNDCP layer to the rest of the GPRS environment. It is shown for reference purposes only and detailed information can be found in 3GPP TS 03.60, 3GPP TS 04.64 [8] and 3GPP TS 04.65 [9].



NOTE: In the SGSN and GGSN UDP is mandatory. TCP is optional but recommended for X.25 services.

**Figure 2: GPRS Transmission Plane**

## 8 Subscription checking

Subscription is checked during the GPRS Attach procedure and also during the PDP Context Activation procedure as described in 3GPP TS 03.60 [3]. The GGSN implicitly checks its internal context related to the destination address for each mobile terminated packet. If there is a context associated with the PDP address the packet shall be forwarded to the MS, otherwise the packet shall be discarded or rejected depending on the implemented protocol.

## 9 Screening

Screening functions reside within the GPRS network and has three levels as described in 3GPP TS 02.60 [2] and 3GPP TS 03.60 [3]. Screening may be applicable for only certain protocols. Screening is outside the scope of GPRS standardisation, however, the following types of screening shall be supported.

### 9.1 Network controlled screening

The PLMN administration and/or the GPRS service provider shall set basic screening functionality, if applicable, (e.g. firewall) to reduce the risk of fraud and misuse. This is to ensure the integrity of the network and to protect subscribers.

### 9.2 Subscription controlled screening

This will not be in GPRS phase 1.

### 9.3 User controlled screening

This will not be in GPRS phase 1.

## 10 Interworking with PSDN (X.75/X.25)

### 10.1 General

GPRS shall support interworking with PSDN networks. The interworking may be either direct or through a transit network.

GPRS shall support both ITU-T Recommendation X.121 [14] and ITU-T Recommendation E.164 [11] addressing.

GPRS shall provide support for ITU-T Recommendation X.25 and ITU-T Recommendation X.75.

The GPRS TE's shall have addresses provided, and controlled, by their GPRS operator. The PSDN TE sends data to the GPRS TE by use of that TE's GPRS DNIC (Data Network Identification Code) or equivalent which uniquely identifies that GPRS network worldwide.

The GGSN for interworking with PSDNs is the access point of the GSM GPRS data network.

There are two models for PSDN interworking.

- X.75 over the Gi reference point.
- X.25 over the Gi reference point with the DCE located within the PSDN and the DTE located within the TE of the GPRS PLMN.

Both X.75 and X.25 access methods are supported when mobile users are resident on HPLMN or VPLMN. A roaming user may be allocated a dynamic address from the VPLMN.

### 10.2 PSDN Interworking Models

The two models of X.75 and X.25 represent the different scenarios for PSDN interworking with the GPRS network.

The model differences lie in the interconnection protocol over the Gi reference point.

#### 10.2.1 X75 Interworking at the Gi Reference Point

Figure 3 represents the case where X.75 is used as the interworking protocol, as used between interconnect X.25 PSDNs currently. The GPRS network will look like any other PSDN in all respects and uses X.75 addressing. Figure 4 shows the interconnecting protocol stacks to the GPRS bearer. The GPRS bearer is described in 3GPP TS 07.60 [10], which uses the protocols described in 3GPP TS 03.60 [3].

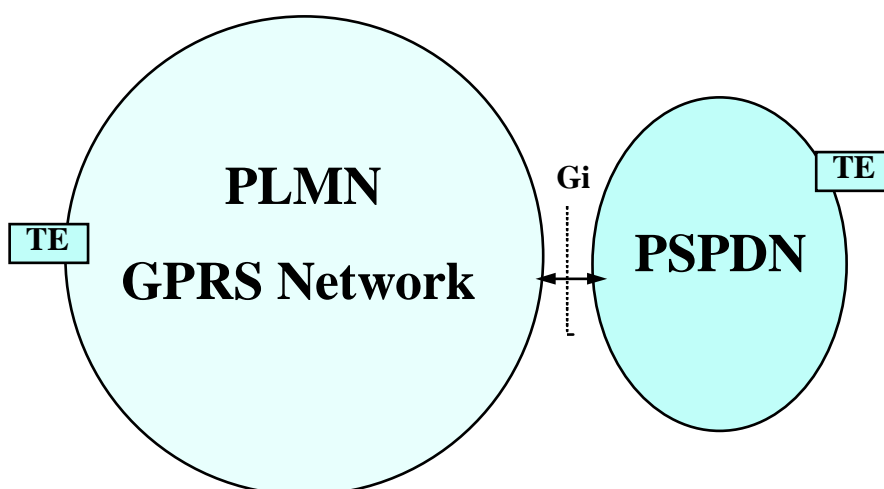
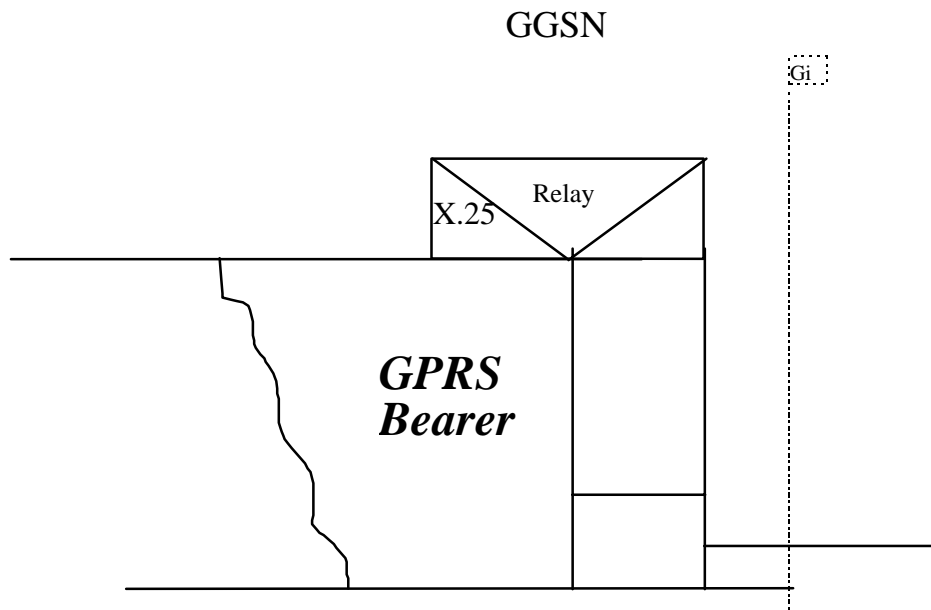

Figure 3: PSPDN Interworking with X.75 at Gi Reference Point



**Figure 4: The Protocol Stack for the X.75 Gi Reference Point**

#### 10.2.1.1 Numbering and Addressing

A PLMN GPRS network requires a DNIC or PNIC.

X.121 addresses allocated to subscribers belong to the PLMN operator.

#### 10.2.1.2 Charging

Charging of X.25 packets is done at the GGSN.

### 10.2.2 X25 Interworking at the Gi Reference Point

Figure 5 represents the case where X.25 is used as the interconnect protocol between a DCE and a DTE.

The DTE resides within the GPRS network. The DCE resides within the PSDN.

The GPRS Network is seen as part of the PSDN, as the Gi reference point is the interconnect point between the DCE and the DTE.

The protocol stack for this model is shown in figure 6.

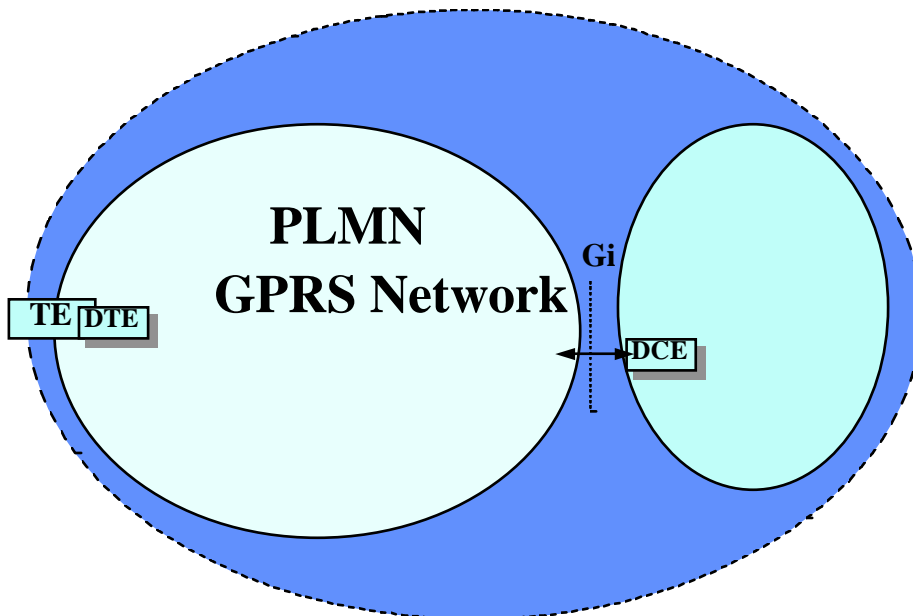

### Actual PSDN

NOTE: The PSDN can interwork at X.75 to other PSDN's

Figure 5: PSDN Interworking with X.25 over Gi Interface

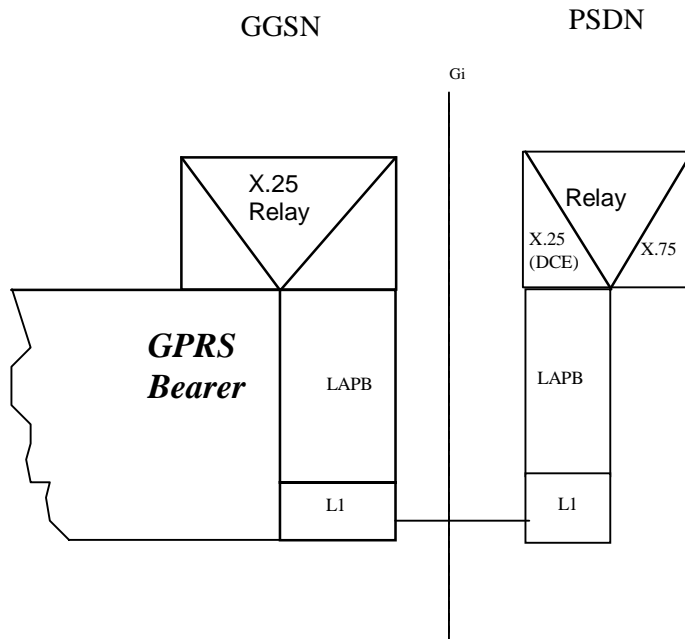

Figure 6: The Protocol Stack for the X.25 / Gi Reference point

Figure 6 shows the transmission plane only. In this case the GGSN shall resolve the association between the MS GPRS bearer and the X.25 DCE. L1 is left to operators to determine connection to other networks.

The X.25 Relay performs the following:

- mapping of logical channel numbers.

### 10.2.2.1 Numbering and Addressing

A fixed X.121 address for the MS may be allocated by the PSDN operator, and is integral to the PSDN numbering plan. A dynamic X.121 address can also be used which is assigned by the GPRS network at PDP context activation.

### 10.2.2.2 Charging

The charging information may be collected in the X.25 network, depending upon the agreement between the GPRS operator and the PSDN operator. The charging may also be collected in the GPRS network. If the VPLMN assigns the dynamic address, the charging of the GPRS and the external network shall be gathered and sent to the HPLMN.

## 10.3 User Facilities

The set of user facilities as defined in ITU-T Recommendation X.25 [12] may be supported.

As a minimum the following shall be supported:

- reverse charging;
- reverse charging acceptance;
- fast select restricted;
- fast select unrestricted;
- fast select acceptance.

## 10.4 The GPRS Interworking to PSDN Characteristics

Table 0 describes the differences in addressing, and user profile for each interconnect type. The static X.121 address in the following table indicates an address which is permanently allocated to the GPRS subscriber by the network operator. The dynamic X.121 address is assigned automatically on the PDP Context Activation procedure. The dynamic address is allocated from a free pool held in the GGSN. This is described in 3GPP TS 03.60 [3].

**Table 0: PSPDN GPRS Interconnection Characteristics**

Metric	X.75 - Stand Alone PSPDN X.25 - PSPDN Sub Network	
	Static X.121 address	Dynamic X.121 address
X.25 profile	User determined in X.25 DCE	Only Default Profiles allowed in X.25 DCE- Selected upon PDP context activation
X.28/X.29 PAD	Address in GGSN	Address in GGSN after PDP Context Activation

---

## 11 Interworking with PDN (IP)

### 11.1 General

GPRS shall support interworking with networks based on the Internet Protocol (IP). These interworked networks may be either intranets or the Internet.

### 11.2 PDN Interworking Model

When interworking with the IP networks, GPRS can operate IPv4 or IPv6. The interworking point with IP networks is at the Gi reference point as shown in figure 7.

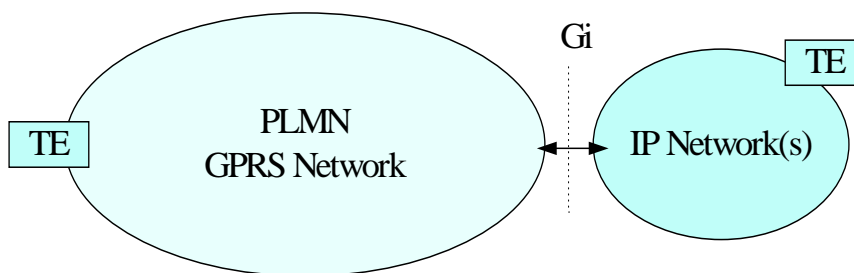

**Figure 7: IP network interworking**

The GGSN for interworking with the IP network is the access point of the GSM GPRS data network (see figure 8). In this case the GPRS network will look like any other IP network or subnetwork.

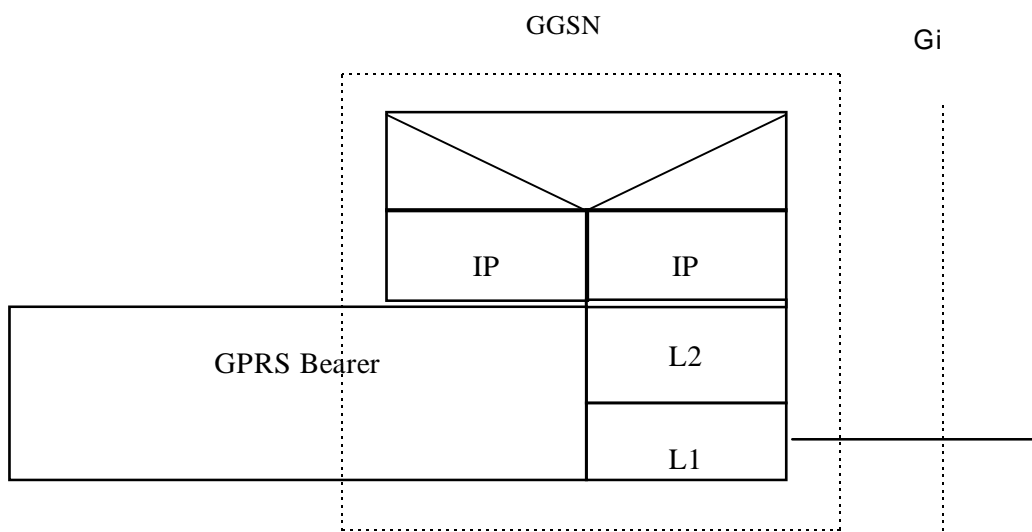

**Figure 8: The protocol stacks for the GiIP reference point**

Typically in the IP networks, the interworking with subnetworks is done via IP routers. The Gi reference point is between the GGSN and the external IP network. From the external IP network's point of view, the GGSN is seen as a normal IP router. The L2 and L1 layers are operator specific.

It is out of the scope of the present document to standardise the router functions and the used protocols in the Gi reference point.

Interworking with user defined ISPs and private/public IP networks is subject to interconnect agreements between the network operators.

No user data or header compression is done in the GGSN.

The following working assumptions are valid in the generic case:

- A firewall is configured by the GPRS operator. In general, all applications that are using IP as the underlying protocol are supported, but the GPRS operator may restrict their usage.
- A Domain Name Server is managed by the GPRS operator. Alternatively, the Domain Name Server can be managed by the external IP network operator.
- From the GPRS network's point of view, the allocation of a dynamic IP address is done by the GGSN as described in 3GPP TS 03.60 [3]. The GGSN may allocate these addresses by itself or use an external device such as an DHCP server. This external device may be operated by an external organisation such as an ISP or Intranet operator.



### 11.2.1 Access to Internet, Intranet or ISP through GPRS

The access to Internet, Intranet or ISP may involve specific functions such as : user authentication, user's authorization, end to end encryption between MS and Intranet/ISP, allocation of a dynamic address belonging to the PLMN/Intranet/ISP addressing space, etc.

For this purpose the GPRS PLMN may offer:

- either direct transparent access to the Internet; or
- a non transparent access to the Intranet/ISP. In this case the GPRS PLMN, i.e. the GGSN, takes part in the functions listed above.

#### 11.2.1.1 Transparent access to the Internet

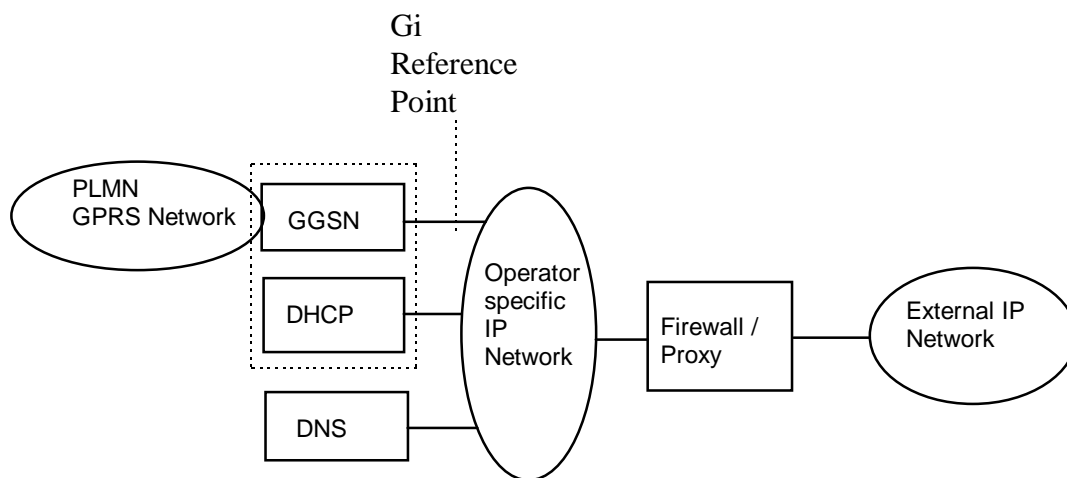

**Figure 9: Example of the PDN Interworking Model, transparent case**

In this case (see figure 9):

- The MS is given an address belonging to the operator addressing space. The address is given either at subscription in which case it is a static address or at PDP context activation in which case it is a dynamic address. This address is used for packet forwarding between the Internet and the GGSN and within the GGSN.
- The MS need not send any authentication request at PDP context activation and the GGSN need not take any part in the user authentication/authorization process.

The transparent case provides at least a basic ISP service. As a consequence of this it may therefore provide a bearer service for a tunnel to a private Intranet.

NB The remainder of this subclause deals with this specific case.

- The user level configuration may be carried out between the TE and the intranet, the GPRS network is transparent to this procedure.

The used protocol stack is depicted in figure 10.

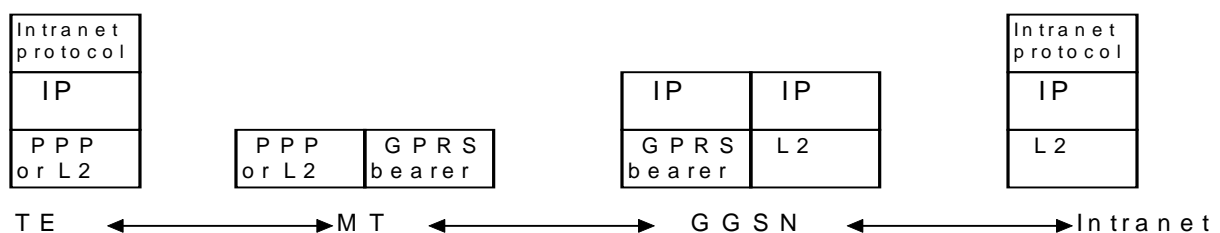

**Figure 10: Transparent access to an Intranet**

The communication between the GPRS PLMN and the Intranet may be performed over any network, even an insecure network e.g. the Internet. There is no specific security protocol between GGSN and the Intranet because security is ensured on an end to end basis between MS and the intranet by the "Intranet Protocol".

User authentication and encryption of user data are done within the "Intranet Protocol" if either of them is needed. This "Intranet Protocol" may also carry private (IP) addresses belonging to the address space of the Intranet.

An example of an "Intranet Protocol" is IPsec (see RFC 1825 [27]). If IPsec is used for this purpose then IPsec authentication header or security header may be used for user (data) authentication and for the confidentiality of user data (see RFC 1826 [28] and RFC 1827 [28]). In this case private IP tunnelling within public IP takes place.

### 11.2.1.2 Non Transparent access to an Intranet or ISP

In this case:

- the MS is given an address belonging to the Intranet/ISP addressing space. The address is given either at subscription in which case it is a static address or at PDP context activation in which case it is a dynamic address. This address is used for packet forwarding within the GGSN and for packet forwarding on the Intranet/ISP. This requires a link between the GGSN and an address allocation server, like Radius, DHCP, ..., belonging to the Intranet/ISP;
- the MS shall send an authentication request at PDP context activation and the GGSN requests user authentication from a server, like Radius, DHCP, ..., belonging to the Intranet/ISP;
- the protocol configuration options are retrieved (if requested by the MS at PDP context activation) from some server (Radius or DHCP, ...) belonging to the Intranet/ISP;
- the communication between the GPRS PLMN and the Intranet/ISP may be performed over any network, even an insecure e.g. the Internet. In case of an insecure connection between the GGSN and the Intranet/ISP there may be a specific security protocol in between. This security protocol is defined by mutual agreement between GPRS PLMN operator and Intranet/ISP administrator.

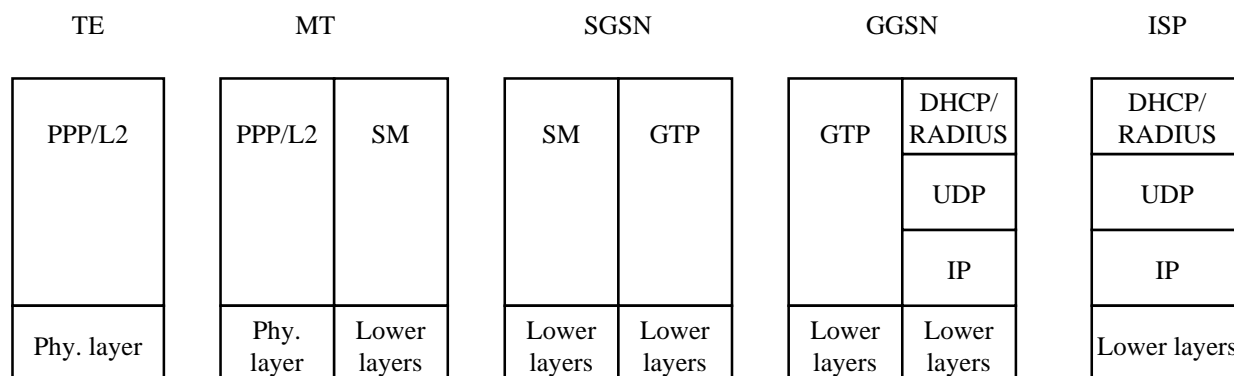

**Figure 11: Signalling plane of non transparent case**

The following description bullet items describe the signal flow.

- 1) The TE sends an AT-command to the MT to set up parameters and enter PPP mode. The MT responds with an AT-response.
- 2) LCP negotiates Maximum-Receive-Unit and authentication protocol. The negotiated authentication protocol is, either CHAP, PAP or 'none'. The MT shall try to negotiate for CHAP as first priority.
- 3) If the negotiated authentication protocol is either of CHAP or PAP, the TE authenticates itself towards the MT by means of that protocol. The MT stores the necessary authentication data and sends a forced positive acknowledgement of the authentication to the TE.
- 4) The TE requests IP configuration by sending the IPCP Configure-Request message to the MT indicating either the static IP address that shall be used or that an IP-address shall be dynamically allocated.

- 5) The MT sends the Activate PDP context request message to the SGSN, including the Protocol Configuration Options. The SGSN sends the Create PDP context req message to the chosen GGSN including the unmodified Protocol Configuration Options.
- 6) The GGSN deduces from the APN:
- the server(s) to be used for address allocation, authentication and protocol configuration options retrieval;
  - the protocol like Radius, DHCP, ... to be used with this / those server(s);
  - the communication and security feature needed to dialogue with this / those server(s) e.g. tunnel ,IPSec security association, dial-up connection (using possibly PPP), ....

As an example the GGSN may use one of the following options:

- RADIUS for authentication and IP-address allocation.. The RADIUS server responds with either an Access-Accept or an Access-Reject to the RADIUS client in the GGSN.
- RADIUS for authentication and DHCP for host configuration and address allocation. The RADIUS server responds with either an Access-Accept or an Access-Reject to the RADIUS client in the GGSN. After a successful authentication, the DHCP client discovers the DHCP server(s) in the ISP/Intranet and receives host configuration data.

If the received Protocol Configurations Options IE contains a PPP IPCP Configure-Request packet, the GGSN shall analyse all the contained IPCP options and their requested values. In accordance with the relevant PPP RFC 1661[20] the GGSN shall respond with the following messages:

- zero or one PPP IPCP Configure-Reject packet containing options not supported and options which values cannot be returned;
- zero or one PPP IPCP Configure-Nak packet containing options that are supported but has requested values that are incorrect/unsupported; and
- zero or one PPP IPCP Configure-Ack packet containing options that are supported and has requested values that are correct/supported.

Any returned PPP IPCP packets shall be contained in the Protocol Configurations Options IE.

- 7) The GGSN sends back to the SGSN a Create PDP Context Response message, containing the Protocol Configuration Options IE. The cause value shall be set according to the outcome of the host -authentication and -configuration. A PDP context activation shall not be rejected solely due to the presence of unsupported or incorrect PPP IPCP options or option values, received from the MS in the Protocol Configurations Options IE. The MS may however later decide to immediately deactivate the activated PDP context due to the information received in the Protocol Configurations Options IE received from the network.
- 8) Depending on the cause value received in the Create PDP Context Response the SGSN sends either an Activate PDP Context Accept or an Activate PDP Context Reject, to the MS.

If Protocol Configuration Options are received from the GGSN, the SGSN shall relay those to the MS. The MT sends either the configuration-ack packet (e.g. IPCP Configure Ack in PPP case), the configure-nak packet in case of dynamic address allocation (e.g. IPCP Configure Nak in PPP case), or a link Terminate request (LCP Terminate-Request in PPP case) back to the TE. In the case where a configure-nak packet was sent by the MT, a local negotiation may take place at the R reference point (i.e. the TE proposes the new value to the MT), after which a configuration-ack packet is sent to the TE.

- 9) In case a configuration-ack packet was sent to the TE, the link from the TE to the external ISP/Intranet is established and IP packets may be exchanged.

In case a link terminate request packet was sent to the TE, the TE and MT negotiates for link termination. The MT may then send a final AT-response to inform the TE about the rejected PDP Context activation.

A link terminate request packet (such as LCP Terminate-request in PPP case) causes a PDP context deactivation.

EXAMPLE: In the following example PPP is used as layer 2 protocol over the R reference point (figure 11a).

The MT acts as a PPP server and translates Protocol Configuration Options into SM message IEs. GTP carries this information unchanged to the GGSN which uses the information e.g. for DHCP or RADIUS authentication and host configuration. The result of the host authentication and configuration is carried via GTP to the SGSN which relays the information to the MT. The MT sends an IPCP Configure-Ack to the TE with the appropriate options included.

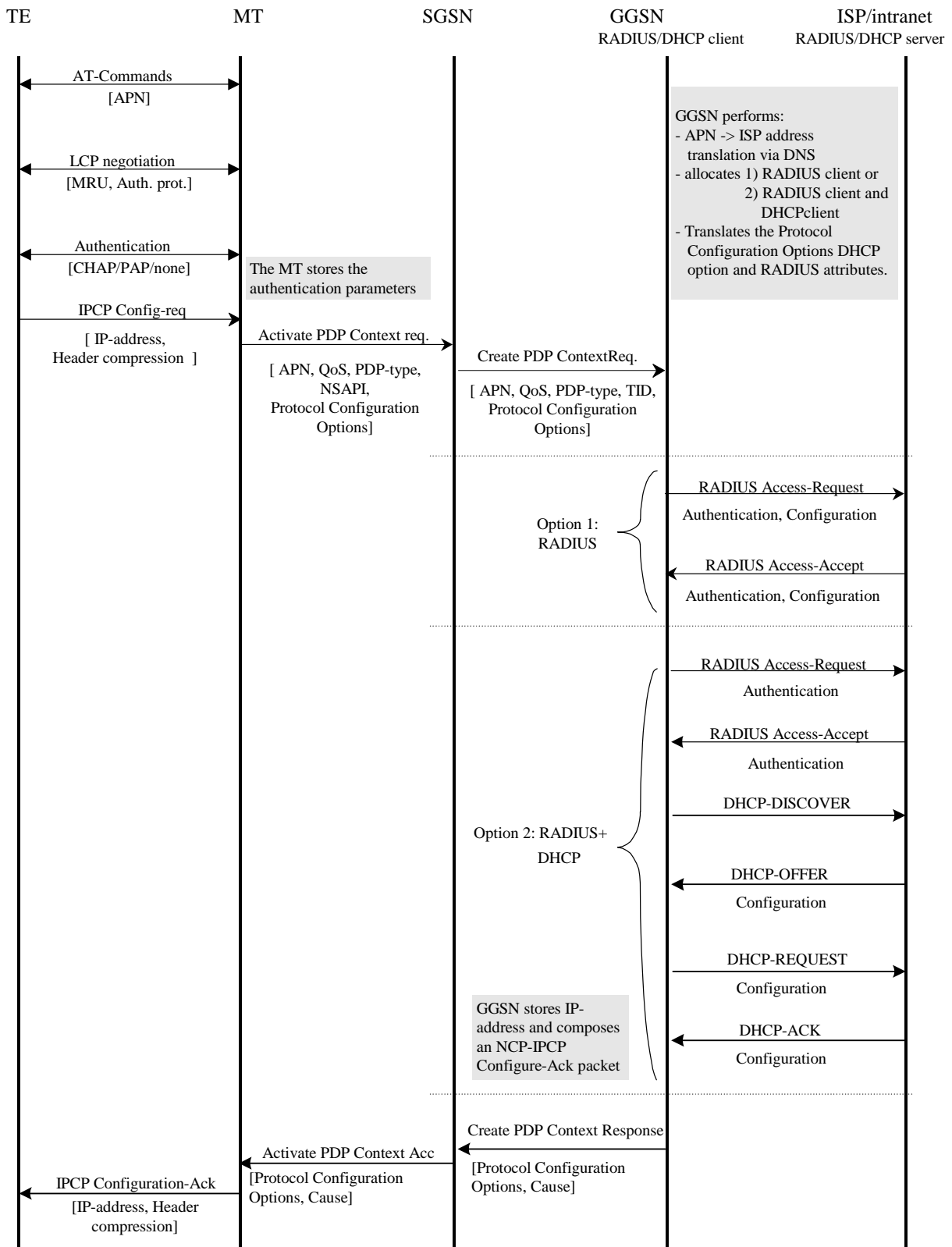

Figure 11a: Example where PPP is used as layer 2 protocol over the R reference point

## 11.3 Numbering and Addressing

In the case of interworking with the public IP networks (such as the Internet), the GPRS operator shall use public network addresses. These public addresses can be reserved from the responsible IP numbering body, or from an ISP with which the GPRS operator has an agreement. In the case of interworking with the private IP networks, the GPRS operator manages internally the subnetwork addresses.

The GPRS operator allocates the IP addresses for the subscribers in either of the following ways.

- The GPRS operator allocates a static IP address when the subscription record is built. The IP address is reserved from a pool of free IP addresses.
- The GPRS operator allocates (either on its own or in conjunction with an ISP) a dynamic IP address when the MS performs the PDP Context Activation procedure with dynamic address allocation as described in 3GPP TS 03.60 [3].

## 11.4 Charging

The GPRS operator may define the accuracy of the charging mechanism using one of the following categories:

- Every source/destination pair is logged separately.
- Source/destination pairs are logged to an accuracy of subnetworks.
- Source/destination pairs are logged to an accuracy of connection types (e.g. external data network, corporate network, another mobile).

## 11.5 Domain Name Server (DNS)

Provision of Domain Name services shall be provided by the GPRS operators in the transparent case and the ISP in the non transparent case. Domain name registration is handled by RIPE (Réseaux IP Européens) in Europe (DNS documentation is provided in RFC 1034 [19] and RFC 1035 [25]).

## 11.6 Screening

The way the GPRS operator is performing the operator controlled screening and the subscription controlled screening is out of the scope of the present document. These functions may be done, for example, in a firewall.

---

# 12 Interworking between GPRS networks

The primary reason for the interworking between the GPRS networks is to support roaming GPRS subscribers as described in 3GPP TS 03.60 [3]. The general model for GPRS network interworking is shown in figure 12.

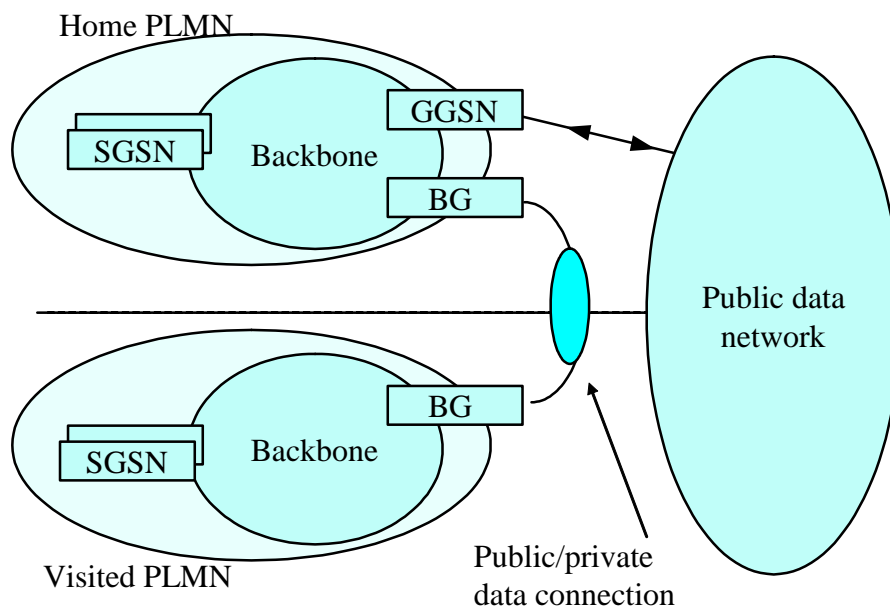

**Figure 12: General interworking between GPRS networks to support roaming subscribers**

For roaming subscribers that have a PDP address allocated from the HPLMN a forwarding route between the HPLMN and the VPLMN is created. This route is used for both mobile terminated and mobile originated data traffic. The communication is done via the BGs (Border Gateways) as described in 3GPP TS 03.60 [3].

The procedures to set the link between the SGSN in the VPLMN and the GGSN in the HPLMN is described in 3GPP TS 03.60 [3].

The inter-PLMN link may be any packet data network or dedicated link as described in 3GPP TS 03.60 [3]. The GPRS operators may have a dedicated inter-PLMN link to fulfil the QoS requirements of a certain protocol.

## 12.1 Security Agreements

Each GPRS operator may support IPsec (RFC 1825 [27]) and accompanying specifications for authentication (RFC 1826 [28]) and encryption (RFC 1827 [29]) as a basic set of security functionality in its border gateways. The GPRS operators may decide to use other security protocols based on bilateral agreements.

## 12.2 Routing protocol agreements

Each GPRS operator may support BGP (RFC 1771 [26]) as a basic set of routing functionality in its border gateways. The GPRS operators may decide to use other routing protocols based on bilateral agreements.

## 12.3 Charging agreements

Sharing the cost of the inter-PLMN link is subject to the agreement between the GPRS operators.

There may be a requirement to collect charging information in the Border Gateway (see figure 12) and this is down to the normal interconnect agreement between PLMN and PDN operators.

---

## 13 Void

**Figure 12: Void**

**Figure 13: Void**

Figure 14: Void

Figure 15: Void

---

## 14 Void

Figure 16: Void

Figure 17: Void

Figure 18: Void

Figure 19: Void

Figure 20: Void

---

## 15 Void

Figure 21: Void

---

## 16 Usage of RADIUS on Gi interface

A GGSN may, on a per APN basis, use RADIUS authentication to authenticate a user and RADIUS accounting to provide information to an AAA (Authentication, Authorization and Accounting) server.

### 16.1 RADIUS Authentication

RADIUS Authentication shall be used according to RFC2865 [21].

The RADIUS client function may reside in a GGSN. When the GGSN receives a Create PDP Context request message the RADIUS client function may send the authentication information to an authentication server, which is identified during the APN provisioning.

The authentication server checks that the user can be accepted. The response (when positive) may contain network information, such as an IP address for the user.

The information delivered during the Radius authentication can be used to automatically correlate the users identity (the MSISDN or IMSI) to the IP-address, assigned/confirmed by the GGSN or the authentication server respectively. The same procedure applies, in case of sending the authentication to a 'proxy' authentication server.

RADIUS Authentication is only applicable to the primary PDP context. When the GGSN receives an Access-Accept message from the authentication server it shall complete the PDP context activation procedure. If Access-Reject or no response is received, the GGSN shall reject the PDP Context Activation attempt with a suitable cause code, e.g. User Authentication failed.

### 16.2 RADIUS Accounting

RADIUS Accounting shall be used according to RFC 2866 [22].

The RADIUS accounting client function may reside in a GGSN. The RADIUS accounting client may send information to an accounting server, which is identified during the APN provisioning. The accounting server may store this information and use it to automatically identify the user. This information can be trusted because the GPRS network has authenticated the subscriber (i.e. SIM card and possibly other authentication methods).

RADIUS Accounting-Request Start and Stop messages may be used during both primary and secondary PDP context activation and deactivation procedures respectively.

The use of Accounting-Request STOP and in addition the Accounting ON and Accounting OFF messages may be used to ensure that information stored in the accounting server is synchronised with the GGSN information.

If the AAA server is used for IP address assignment, then, upon reception of a RADIUS Accounting-Request STOP message for all PDP contexts associated to a session defined by APN and IMSI or MSISDN, the AAA server may make the associated IP address available for assignment.

In order to avoid race conditions, the GGSN shall include a 3GPP Vendor-Specific sub-attribute "Session Stop indicator" when it sends the Accounting-Request STOP for the last PDP context of a PDP session and the PDP session is terminated (i.e. the IP address and all GTP tunnels can be released). The AAA server shall not assume the PDP session terminated until an Accounting-Request STOP with the Session Stop indicator is received.

## 16.3 Authentication and accounting message flows

### 16.3.1 IP PDP type

Figure 22 represents the RADIUS message flows between a GGSN and an Authentication, Authorization and Accounting (AAA) server.



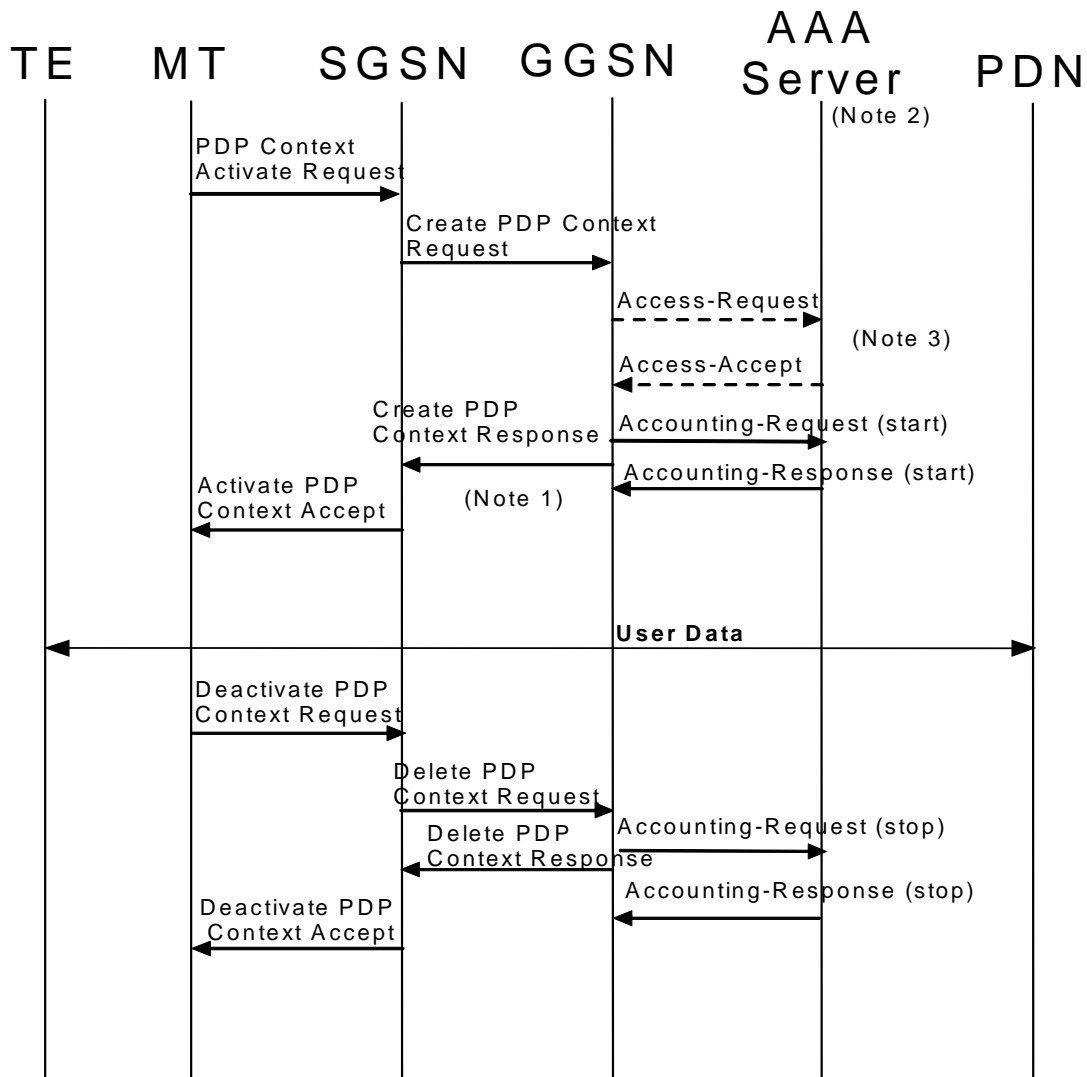

NOTE 1: If some external applications require RADIUS Accounting request (Start) information before they can process user packets, then the selected APN (GGSN) may be configured in such a way that the GGSN drops user data until the Accounting Response (START) is received from the AAA server. The GGSN may wait for the Accounting Response (START) before sending the CreatePDPContextResponse. The GGSN may reject the PDP context if the Accounting Response (START) is not received.

NOTE 2: Separate accounting and authentication servers may be used.

NOTE 3: The Access-Request message shall be used for primary PDP context only.

**Figure 22: RADIUS message flow for PDP type IP (successful user authentication case)**

When a GGSN receives a Create PDP Context Request message for a given APN, the GGSN may (depending on the configuration for this APN) send a RADIUS Access-Request to an AAA server. The AAA server authenticates and authorizes the user. If RADIUS is also responsible for IP address allocation the AAA server shall return the allocated IP address in the Access-Accept message.

Even if the GGSN was not involved in user authentication (e.g. transparent network access mode), it may send a RADIUS Accounting-Request START message to an AAA server. This message contains parameters, e.g. the tuple which includes the user-id and IP address, to be used by application servers (e.g. WAP gateway) in order to identify the user. This message also indicates to the AAA server that the user session has started.

If some external applications require RADIUS Accounting request (Start) information before they can process user packets, then the selected APN (GGSN) may be configured in such a way that the GGSN drops user data until the Accounting Response (START) is received from the AAA server. The GGSN may wait for the Accounting Response (START) before sending the CreatePDPContextResponse. The GGSN may reject the PDP context if the Accounting Response (START) is not received. The authentication and accounting servers may be separately configured for each APN.

When the GGSN receives a Delete PDP Context Request message and providing a RADIUS Accounting-Request START message was sent previously, the GGSN shall send a RADIUS Accounting-Request STOP message to the AAA server, which indicates the termination of this particular user session. The GGSN shall immediately send a Delete PDP context response, without waiting for an Accounting-Response STOP message from the AAA server.

The AAA server shall deallocate the IP address (if any) initially allocated to the subscriber, if there is no session for the subscriber.

Accounting-Request ON and Accounting-Request OFF messages may be sent from the GGSN to the AAA server to ensure the correct synchronization of the session information in the GGSN and the AAA server.

The GGSN may send an Accounting-Request ON message to the AAA server to indicate that a restart has occurred. The AAA server may then release the associated resources.

Prior to a scheduled restart, the GGSN may send Accounting-Request OFF message to the AAA server. The AAA server may then release the associated resources.

If an Access-Challenge is sent to the GGSN when an Access-Request message is pending and when IP PDP type is used, the GGSN shall silently discard the Access-Challenge message and it shall treat an Access-Challenge as though it had received an Access-Reject instead RFC 2865 [21].

### 16.3.2 Void

Figure 23: Void

### 16.3.3 Accounting Update

During the life of a PDP context some information related to this PDP context may change (i.e. SGSN address if a Inter-SGSN RA update occurs). Upon reception of an UpdatePDPContextRequest from the SGSN, the GGSN may send an Accounting Request Interim-Update to the AAA server to update the necessary information related to this PDP context (see figure 24). In such a case, the GGSN need not wait for the RADIUS AccountingResponse from the AAA server message before sending the UpdatePDPContextResponse to the SGSN. The GGSN may delete the PDP context if the AccountingResponse is not received from the AAA.

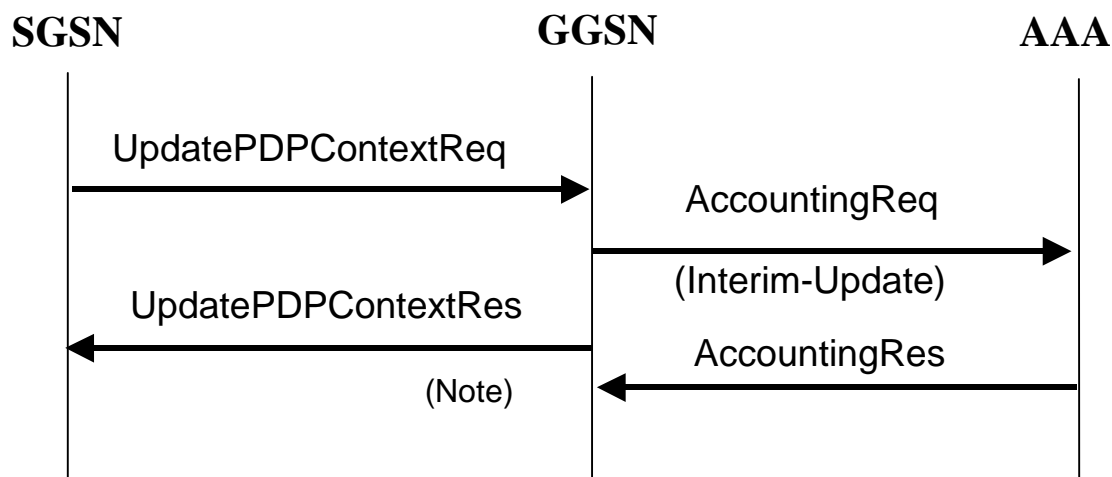

NOTE: As shown the GGSN need not wait for the RADIUS AccountingResponse from the AAA server message to send the UpdatePDPContextResponse to the SGSN. The GGSN may delete the PDP context if the AccountingResponse is not received from the AAA.

Figure 24: RADIUS for PDP context Update

### 16.3.4 AAA-Initiated PDP context termination

RADIUS is used as the protocol between the GGSN and a AAA server or proxy for applications (e.g. MMS) to deliver information related to GPRS user session. However some IP applications could need to interwork with the GGSN to

terminate a particular PDP context. For this purpose, the AAA server or proxy may send a RADIUS Disconnect Request to the GGSN. As depicted in figure 25, the GGSN may react by deleting the corresponding PDP context or silently discard the Disconnect Request message. For more information on RADIUS Disconnect, see RFC 2882 [24]. If the GGSN deletes the corresponding PDP context, it need not wait for the DeletePDPContextResponse from the SGSN before sending the RADIUS DisconnectResponse to the AAA server.

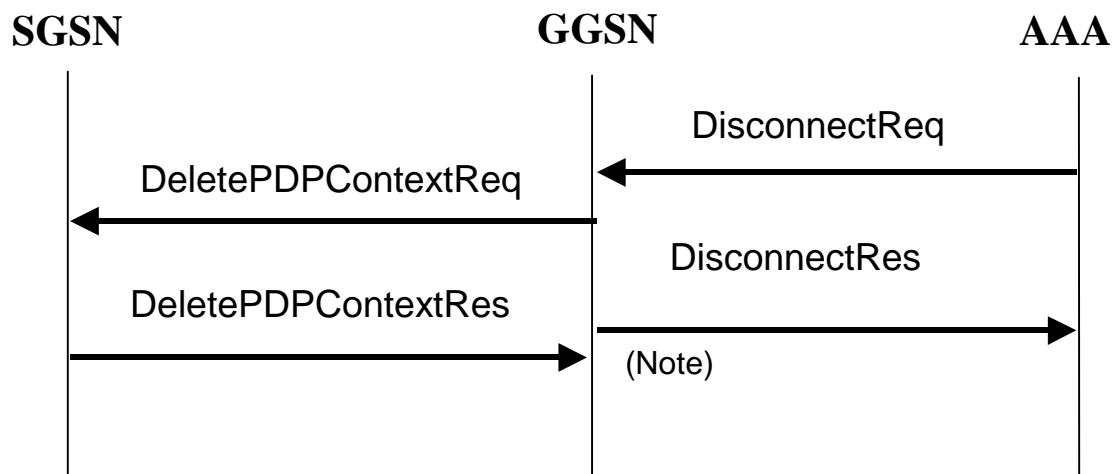

NOTE: As showed on figure 25, the GGSN need not wait for the DeletePDPContextResponse from the SGSN to send the RADIUS DisconnectResponse to the AAA server.

Figure 25: PDP Context deletion with RADIUS

## 16.4 List of RADIUS attributes

The following tables describe the actual content of the RADIUS messages exchanged between the GGSN and the AAA server. Other RADIUS attributes may be used as defined in RADIUS RFC(s). Unless otherwise stated, when the encoding scheme of an attribute is specified as UTF-8 encoding, this shall be interpreted as UTF-8 hexadecimal encoding.

### 16.4.1 Access-Request message (sent from the GGSN to AAA server)

The table 1 describes the attributes of the Access-Request message.

Table 1: The attributes of the Access-Request message

Attr #	Attribute Name	Description	Content	Presence Requirement
1	User-Name	Username is provided by the user (extracted from the Protocol Configuration Options (PCO) field of the Create PDP Context Request message). If no username is available a generic username, configurable on a per APN basis, shall be present.	String	Mandatory
2	User-Password	User password provided by the user if PAP is used (extracted from the PCO field of the Create PDP Context Request message). If no password is available a generic password, configurable on a per APN basis, shall be present.	String	Conditional Note 1
3	CHAP-Password	User password provided by the user if CHAP is used (extracted from the PCO field of the Create PDP Context Request message).	String	Conditional Note 2
4	NAS-IP-Address	IP address of the GGSN for communication with the AAA server.	IPv4	Conditional Note 3
32	NAS-Identifier	Hostname of the GGSN for communication with the AAA server.	String	Conditional Note 3
6	Service-Type	Indicates the type of service for this user	Framed	Optional
7	Framed-Protocol	Indicates the type of protocol for this user	7 (GPRS PDP)	Optional

Attr #	Attribute Name	Description	Content	Presence Requirement
			Context)	
8	Framed-IP-Address	IP address allocated for this user	IPv4	Conditional
9	Framed-IP-Netmask	Netmask for the user IP address	IPv4	Conditional
30	Called-Station-Id	Identifier for the target network	APN (UTF-8 encoded)	Mandatory
31	Calling-Station-Id	This attribute is the identifier for the MS, and it shall be configurable on a per APN basis.	MSISDN in international format according to 3GPP TS 03.03 [23], UTF-8 encoded decimal. Note that there are no leading characters in front of the country code.	Optional
60	CHAP-Challenge	Challenge if CHAP is used (extracted from the PCO field of the Create PDP Context Request message).	String	Conditional Note 2
61	NAS-Port-Type	Port type for the GGSN	As per RFC 2865 [21]	Optional
26/10415	3GPP Vendor-Specific	Sub-attributes according subclause 16.4.7	See subclause 16.4.7	Optional except sub-attribute 3 which is conditional
NOTE 1: Shall be present if PAP is used.				
NOTE 2: Shall be present if CHAP is used.				
NOTE 3: Either NAS-IP-Address or NAS-Identifier shall be present.				

## 16.4.2 Access-Accept (sent from AAA server to GGSN)

Table 2 describes the attributes of the Access-Accept message.

**Table 2: The attributes of the Access-Accept message**

Attr #	Attribute Name	Description	Content	Presence Requirement
1	User-Name	Username received in the Access-Request message or a substitute username provided by the AAA server. If the User-Name has been received in the Access-Accept message, this user-name shall be used in preference to the above	String	Optional
6	Service-Type	Indicates the type of service for this user	Framed	Optional
7	Framed-Protocol	Indicates the type of protocol for this user	7 (GPRS PDP Context)	Optional
8	Framed-IP-Address	IP address allocated for this user, if the AAA server is used to allocate IP address.	IPv4	Conditional
9	Framed-IP-Netmask	Netmask for the user IP address, if the AAA server is used to allocate IP netmask.	IPv4	Conditional
12	Framed-IP-MTU	MTU for the user towards this particular APN, MTU shall be less or equal to 1500	String	Optional
25	Class	Identifier to be used in all subsequent accounting messages.	String	Optional (Note)
27	Session-Timeout	Indicates the timeout value (in seconds) for the user session	32 bit unsigned Integer	Optional
28	Idle-Timeout	Indicates the timeout value (in seconds) for idle user session	32 bit unsigned Integer	Optional
26/311	MS- primary-DNS-server	Contains the primary DNS server address for this APN	Ipv4	Optional

Attr #	Attribute Name	Description	Content	Presence Requirement
26/311	MS-Secondary-DNS-Server	Contains the secondary DNS server address for this APN	IPv4	Optional
26/311	MS-Primary-NBNS-Server	Contains the primary NetBios name server address for this APN	IPv4	Optional
26/311	MS-Secondary-NBNS-Server	Contains the secondary NetBios server address for this APN	IPv4	Optional
NOTE: The presence of this attribute is conditional upon this attribute being received in the Access-Accept message.				

### 16.4.3 Accounting-Request START (sent from GGSN to AAA server)

Table 3 describes the attributes of the Accounting-Request START message.

**Table 3: The attributes of the Accounting-Request START message**

Attr #	Attribute Name	Description	Content	Presence Requirement
1	User-Name	Username provided by the user (extracted from the PCO field of the Create PDP Context Request message). If no username is available a generic username, configurable on a per APN basis, shall be present. If the User-Name has been received in the Access-Accept message, this user-name shall be used in preference to the above	String	Optional
4	NAS-IP-Address	GGSN IP address for communication with the AAA server.	IPv4	Conditional Note 1
32	NAS-Identifier	Hostname of the GGSN for communication with the AAA server.	String	Conditional Note 1
6	Service-Type	Indicates the type of service for this user	Framed	Optional
7	Framed Protocol	Indicates the type of protocol for this user	7 (GPRS PDP Context)	Optional
8	Framed-IP-Address	User IP address	IPv4	Mandatory
25	Class	Received in the access accept	String	Conditional (Note 2)
30	Called-Station-Id	Identifier for the target network	APN (UTF-8 encoded)	Mandatory
31	Calling-Station-Id	This attribute is the identifier for the MS, and it shall be configurable on a per APN basis.	MSISDN in international format according to 3GPP TS 03.03 [23], UTF-8 encoded decimal. Note that there are no leading characters in front of the country code.	Optional
40	Acct-Status-Type	Type of accounting message	START	Mandatory
41	Acct-Delay-Time	Indicates how many seconds the GGSN has been trying to send this record for, and can be subtracted from the time of arrival on the AAA server to find the approximate time (in seconds) of the event generating this Accounting-Request.	32 unsigned integer	Optional
44	Acct-Session-Id	User session identifier.	GGSN IP address and Charging-ID concatenated in a UTF-8 encoded hexadecimal. (Note 3)	Mandatory
45	Acct-Authentic	Authentication method	RADIUS or LOCAL	Optional

Attr #	Attribute Name	Description	Content	Presence Requirement
61	NAS-Port-Type	Port type for the GGSN	As per RFC 2865 [21]	Optional
26/10415	3GPP Vendor-Specific	Sub-attributes according subclause 16.4.7.	See subclause 16.4.7	Optional except sub-attribute 3 which is conditional

NOTE 1: Either NAS-IP-Address or NAS-Identifier shall be present.  
NOTE 2: The presence of this attribute is conditional upon this attribute being received in the Access-Accept message.  
NOTE 3: The GGSN IP address is the same as that used in the GCDRs.

## 16.4.4 Accounting Request STOP (sent from GGSN to AAA server)

Table 4 describes the attributes of the Accounting-Request STOP message.

**Table 4: The attributes of the Accounting-Request STOP message**

Attr #	Attribute Name	Description	Content	Presence Requirement
1	User-Name	Username provided by the user (extracted from the PCO field of the Create PDP Context Request message). If no username is available a generic username, configurable on a per APN basis, shall be present. If the User-Name has been received in the Access-Accept message, this user-name shall be used in preference to the above	String	Optional
4	NAS-IP-Address	IP address of the GGSN for communication with the AAA server.	IPv4	Conditional Note 1
32	NAS-Identifier	Hostname of the GGSN for communication with the AAA server.	String	Conditional Note 1
6	Service-Type	Indicates the type of service for this user	Framed	Optional
7	Framed Protocol	Indicates the type of protocol for this user	7 (GPRS PDP Context)	Optional
8	Framed-IP-Address	User IP address	IPv4	Mandatory
25	Class	Received in the access accept	String	Optional (Note 2)
30	Called-Station-Id	Identifier for the target network	APN (UTF-8 encoded)	Mandatory
31	Calling-Station-Id	This attribute is the identifier for the MS, and it shall be configurable on a per APN basis.	MSISDN in international format according to 3GPP TS 03.03 [23], UTF-8 encoded. Note that there are no leading characters in front of the country code.	Optional
40	Acct-Status-Type	Indicates the type of accounting request	STOP	Mandatory
41	Acct-Delay-Time	Indicates how many seconds the GGSN has been trying to send this record for, and can be subtracted from the time of arrival on the AAA server to find the approximate time of the event generating this Accounting-Request	Second	Optional
42	Acct-Input-Octets	GGSN counted number of octets sent by the user for the PDP context	32 bit unsigned integer	Optional
43	Acct-Output-Octets	GGSN counted number of octets received by the user for the PDP context	32 bit unsigned integer	Optional

Attr #	Attribute Name	Description	Content	Presence Requirement
44	Acct-Session-Id	User session identifier.	GGSN IP address and Charging-ID concatenated in a UTF-8 encoded hexadecimal. (Note 3)	Mandatory
45	Acct-Authentic	Authentication method	RADIUS or LOCAL	Optional
46	Acct-Session-Time	Duration of the session	Second	Optional
47	Acct-Input-Packets	GGSN counted number of packets sent by the user	Packet	Optional
48	Acct-Output-Packets	GGSN counted number of packets received by the user	Packet	Optional
49	Acct-Terminate-Cause	Indicate how the session was terminated	See RFC 2866 [22]	Optional
61	NAS-Port-Type	Port type for the GGSN	As per RFC 2865 [21]	Optional
26/10415	3GPP Vendor-Specific	Sub-attributes according to subclause 16.4.7.	See subclause 16.4.7	Optional except sub-attribute 3 which is conditional
NOTE 1: Either NAS-IP-Address or NAS-Identifier shall be present.				
NOTE 2: The presence of this attribute is conditional upon this attribute being received in the Access-Accept message.				
NOTE 3: The GGSN IP address is the same as that used in the GCDRs.				

## 16.4.5 Accounting Request ON (optionally sent from GGSN to AAA server)

Table 5 describes the attributes of the Accounting-Request ON message.

**Table 5: The attributes of the Accounting-Request ON message**

Attr #	Attribute Name	Description	Content	Presence Requirement
4	NAS-IP-Address	IP address of the GGSN for communication with the AAA server.	IPv4	Conditional Note
30	Called-Station-ID	Identifier for the target network.	APN (UTF-8 encoded)	Optional
32	NAS-Identifier	Hostname of the GGSN for communication with the AAA server.	String	Conditional Note
NOTE: Either NAS-IP-Address or NAS-Identifier shall be present.				

## 16.4.6 Accounting Request OFF (optionally sent from GGSN to AAA server)

Table 6 describes the attributes of the Accounting-Request OFF message.

**Table 6: The attributes of the Accounting-Request OFF message**

Attr #	Attribute Name	Description	Content	Presence Requirement
4	NAS-IP-Address	IP address of the GGSN for communication with the AAA server.	IPv4	Conditional Note
30	Called-Station-ID	Identifier for the target network.	APN (UTF-8 encoded)	Optional
32	NAS-Identifier	Hostname of the GGSN for communication with the AAA server.	String	Conditional Note
NOTE: Either NAS-IP-Address or NAS-Identifier shall be present.				

### 16.4.7 Sub-attributes of the 3GPP Vendor-Specific attribute

Table 7 describes the sub-attributes of the 3GPP Vendor-Specific attribute of the Access-Request, Accounting-Request START, Accounting-Request STOP and Accounting-Request Interim-Update messages.

**Table 7: The sub-attributes of the 3GPP Vendor-Specific attribute of the Access-Request, Accounting-Request START, Accounting-Request STOP and Accounting-Request Interim-Update messages**

Sub-attr #	Sub-attribute Name	Description	Presence Requirement	Associated attribute (Location of Sub-attr)
1	3GPP-IMSI	IMSI for this user	Optional	Access-Request, Accounting-Request START, Accounting-Request STOP, Accounting-Request Interim-Update
2	3GPP-Charging-Id	Charging ID for this PDP Context (this together with the GGSN-Address constitutes a unique identifier for the PDP context).	Optional	Access-Request, Accounting-Request START, Accounting-Request STOP, Accounting-Request Interim-Update
3	3GPP-PDP Type	Type of PDP context, i.e. IP	Conditional (mandatory if attribute 7 is present)	Access-Request, Accounting-Request START, Accounting-Request STOP, Accounting-Request Interim-Update
4	3GPP-CG-Address	Charging Gateway IP address	Optional	Access-Request, Accounting-Request START, Accounting-Request STOP, Accounting-Request Interim-Update
5	3GPP-GPRS-Negotiated-QoS-Profile	QoS profile applied by GGSN	Optional	Access-Request, Accounting-Request START, Accounting-Request STOP, Accounting-Request Interim-Update
6	3GPP-SGSN-Address	SGSN IP address that is used by the GTP control plane for the handling of control messages. It may be used to identify the PLMN to which the user is attached.	Optional	Access-Request, Accounting-Request START, Accounting-Request STOP, Accounting-Request Interim-Update



Sub-attr #	Sub-attribute Name	Description	Presence Requirement	Associated attribute (Location of Sub-attr)
7	3GPP-GGSN-Address	GGSN IP address that is used by the GTP control plane for the context establishment. It is the same as the GGSN IP address used in the GCDRs.	Optional	Access-Request, Accounting-Request START, Accounting-Request STOP, Accounting-Request Interim-Update
8	3GPP-IMSI-MCC-MNC	MCC and MNC extracted from the user's IMSI (first 5 or 6 digits, as applicable from the presented IMSI).	Optional	Access-Request, Accounting-Request START, Accounting-Request STOP, Accounting-Request Interim-Update
9	3GPP-GGSN- MCC-MNC	MCC-MNC of the network the GGSN belongs to.	Optional	Access-Request, Accounting-Request START, Accounting-Request STOP, Accounting-Request Interim-Update
10	3GPP-NSAPI	Identifies a particular PDP context for the associated PDN and MSISDN/IMSI from creation to deletion.	Optional	Access-Request, Accounting-Request START, Accounting-Request STOP, Accounting-Request Interim-Update
11	3GPP- Session-Stop-Indicator	Indicates to the AAA server that the last PDP context of a session is released and that the PDP session has been terminated.	Optional	Accounting Request STOP
12	3GPP- Selection-Mode	Contains the Selection mode for this PDP Context received in the Create PDP Context Request Message	Optional	Access-Request, Accounting-Request START, Accounting-Request STOP, Accounting-Request Interim-Update
18	3GPP-SGSN-MCC-MNC	MCC and MNC extracted from the RAI within the Create PDP Context Request or Update PDP Context Request message.	Optional	Access-Request, Accounting-Request START, Accounting-Request STOP, Accounting-Request Interim-Update

The RADIUS vendor Attribute is encoded as follows (as per RFC 2865 [21])

Octets	Bits						
	8	7	6	5	4	3	2
1	Type = 26						
2	Length = n						
3	Vendor id octet 1						
4	Vendor id octet 2						
5	Vendor id octet 3						
6	Vendor id octet 4						
7-n	String						

$n \geq 7$

3GPP Vendor Id = 10415

The string part is encoded as follows:

Octets	Bits						
	8	7	6	5	4	3	2
1	3GPP type =						
2	3GPP Length = m						
3-m	3GPP value						

$m \geq 2$  and  $m \leq 248$

The 3GPP specific attributes encoding is clarified below.

#### 1 - 3GPP-*IMSI*

Octets	Bits						
	8	7	6	5	4	3	2
1	3GPP type = 1						
2	3GPP Length = m						
3-m	IMSI digits 1-n (UTF-8 encoded)						

3GPP Type: 1

$n \leq 15$

Length:  $m \leq 17$

IMSI value: Text:

This is the UTF-8 encoded IMSI; The definition of IMSI shall be in accordance with 3GPP TS 03.03 [23] and 3GPP TS 09.60 [31]. There shall be no padding characters between the MCC and MNC, and between the MNC and MSIN. If the IMSI is less than 15 digits, the padding in the GTP information element shall be removed by the GGSN and not encoded in this sub-attribute.

**2 - 3GPP-Charging ID**

Octets	Bits							
	8	7	6	5	4	3	2	1
1	3GPP type = 2							
2	3GPP Length= 6							
3	Charging ID value Octet 1							
4	Charging ID value Octet 2							
5	Charging ID value Octet 3							
6	Charging ID value Octet 4							

3GPP Type: 2

Length: 6

Charging ID value: 32 bits unsigned integer

**3 - 3GPP-PDP type**

Octets	Bits							
	8	7	6	5	4	3	2	1
1	3GPP type = 3							
2	3GPP Length= 6							
3	PDP type octet 1							
4	PDP type octet 2							
5	PDP type octet 3							
6	PDP type octet 4							

3GPP Type: 3

Length: 6

PDP type value: Unsigned 32 bits integer

PDP type octet possible values:

0 = IP

**4 - 3GPP-Charging Gateway address**

Octets	Bits							
	8	7	6	5	4	3	2	1
1	3GPP type = 4							
2	3GPP Length= 6							
3	Charging GW addr Octet 1							
4	Charging GW addr Octet 2							
5	Charging GW addr Octet 3							
6	Charging GW addr Octet 4							

3GPP Type: 4

Length: 6

Charging GW address value: Address

### 5 - 3GPP-GPRS Negotiated QoS profile

Octets	Bits							
	8	7	6	5	4	3	2	1
1	3GPP type = 5							
2	3GPP Length= L							
3 -L	UTF-8 encoded QoS profile							

3GPP Type: 5

Length: 27 (release 99) or 11 (release 98)

QoS profile value: Text

UTF-8 encoded QoS profile syntax:

"<Release indicator> – <release specific QoS IE UTF-8 encoding>"

<Release indicator> = UTF-8 encoded number :

"98" = Release 98

"99" = Release 99

<release specific QoS profile UTF-8 encoding> = UTF-8 encoded QoS profile for the release indicated by the release indicator.

The UTF-8 encoding of a QoS IE is defined as follows: each octet is described by 2 UTF-8 encoded digits, defining its hexadecimal representation. The QoS profile definition is in 3GPP TS 04.08 [30].

The release 98 QoS profile data is 3 octets long, which then results in a 6 octets UTF-8 encoded string,

The release 99 QoS profile data is 11 octets long, which results in a 22 octets UTF-8 encoded string.

### 6 - 3GPP-SGSN address

Octets	Bits							
	8	7	6	5	4	3	2	1
1	3GPP type = 6							
2	3GPP Length= 6							
3	SGSN addr Octet 1							
4	SGSN addr Octet 2							
5	SGSN addr Octet 3							
6	SGSN addr Octet 4							

3GPP Type: 6

Length: 6

SGSN address value: Address

### 7 - 3GPP-GGSN address

Octets	Bits							
	8	7	6	5	4	3	2	1
1	3GPP type = 7							
2	3GPP Length= 6							
3	GGSN addr Octet 1							
4	GGSN addr Octet 2							
5	GGSN addr Octet 3							
6	GGSN addr Octet 4							

3GPP Type: 7

Length: 6

GGSN address value: Address

#### 8 - 3GPP-*IMSI MCC-MNC*

Octets	Bits							
	8	7	6	5	4	3	2	1
1	3GPP type = 8							
2	3GPP Length= n							
3	MCC digit1 (UTF-8 encoded)							
4	MCC digit2 (UTF-8 encoded)							
5	MCC digit3 (UTF-8 encoded)							
6	MNC digit1 (UTF-8 encoded)							
7	MNC digit2 (UTF-8 encoded)							
8	MNC digit3 if present (UTF-8 encoded)							

3GPP Type: 8

Length: n shall be 7 or 8 octets depending on the presence of MNC digit 3

MS address value: text

This is the UTF-8 encoding of the MS MCC-MNC values. In accordance with 3GPP TS 03.03 [23] and 3GPP TS 09.60 [31] the MCC shall be 3 digits and the MNC shall be either 2 or 3 digits. There shall be no padding characters between the MCC and MNC.

#### 9 - 3GPP-*GGSN MCC-MNC*

Octets	Bits							
	8	7	6	5	4	3	2	1
1	3GPP type = 9							
2	3GPP Length= n							
3	MCC digit1 (UTF-8 encoded)							
4	MCC digit2 (UTF-8 encoded)							
5	MCC digit3 (UTF-8 encoded)							
6	MNC digit1 (UTF-8 encoded)							
7	MNC digit2 (UTF-8 encoded)							
8	MNC digit3 if present (UTF-8 encoded)							

3GPP Type: 9

Length: n shall be 7 or 8 octets depending on the presence of MNC digit 3

GGSN address value: text

This is the UTF-8 encoding of the GGSN MCC-MNC values. In accordance with 3GPP TS 03.03 [23] and 3GPP TS 09.60 [31] the MCC shall be 3 digits and the MNC shall be either 2 or 3 digits. There shall be no padding characters between the MCC and MNC.

#### 10 - 3GPP-*NSAPI*

Octets	Bits							
	8	7	6	5	4	3	2	1
1	3GPP type = 10							
2	3GPP Length= 3							
3	NSAPI							

3GPP Type: 10

Length: 3

NSAPI value: text

It is the value of the NSAPI of the PDP context the RADIUS message is related to. It is encoded as its hexadecimal representation, using 1UTF-8 encoded digit.

### 11 - 3GPP-Session Stop Indicator

Octets	Bits							
	8	7	6	5	4	3	2	1
1	3GPP type = 11							
2	3GPP Length= 3							
3	1 1 1 1 1 1 1 1							

3GPP Type: 11

Length: 3

Value is set to all 1.

### 12 - 3GPP-Selection-Mode

Octets	Bits							
	8	7	6	5	4	3	2	1
1	3GPP type = 12							
2	3GPP Length= 1							
3	UTF-8 encoded Selection mode string							

3GPP Type: 12

Length: 3

Selection mode value: Text

The format of this attribute shall be a character string consisting of a single digit, mapping from the binary value of the selection mode in the Create PDP Context message (3GPP TS 09.60 [31]). Where 3GPP TS 09.60 [31] provides for interpretation of the value, e.g. map '3' to '2', this shall be done by the GGSN.

### 18 - 3GPP-SGSN MCC-MNC

Octets	Bits							
	8	7	6	5	4	3	2	1
1	3GPP type = 18							
2	3GPP Length= n							
3	MCC digit1 (UTF-8 encoded)							
4	MCC digit2 (UTF-8 encoded)							
5	MCC digit3 (UTF-8 encoded)							
6	MNC digit1 (UTF-8 encoded)							
7	MNC digit2 (UTF-8 encoded)							
8	MNC digit3 if present (UTF-8 encoded)							

3GPP Type: 18

Length: n shall be 7 or 8 octets depending on the presence of MNC digit 3

SGSN address value: text

This is the UTF-8 encoding of the RAI MCC-MNC values. In accordance with 3GPP TS 03.03 [23] and 3GPP TS 09.60 [31] the MCC shall be 3 digits and the MNC shall be either 2 or 3 digits. There shall be no padding characters between the MCC and MNC.

## 16.4.8 Accounting Request Interim-Update (sent from GGSN to AAA server)

Table 8 describes the attributes of the Accounting-Request Interim-Update message.

**Table 8: The attributes of the Accounting-Request Interim-Update message**

Attr #	Attribute Name	Description	Content	Presence Requirement
1	User-Name	Username provided by the user (extracted from the PCO field of the Create PDP Context Request message). If no username is available a generic username, configurable on a per APN basis, shall be present. If the User-Name has been received in the Access-Accept message, this user-name shall be used in preference to the above	String	Optional
4	NAS-IP-Address	IP address of the GGSN for communication with the AAA server.	IPv4	Conditional Note 1
32	NAS-Identifier	Hostname of the GGSN for communication with the AAA server.	String	Conditional Note 1
6	Service-Type	Indicates the type of service for this user	Framed	Optional
7	Framed Protocol	Indicates the type of protocol for this user	7 (GPRS PDP Context)	Optional
8	Framed-IP-Address	User IP address	IPv4	Mandatory
25	Class	Received in the access accept	String	Optional (Note 2)
30	Called-Station-Id	Identifier for the target network	APN (UTF-8 encoded)	Mandatory
31	Calling-Station-Id	This attribute is the identifier for the MS, and it shall be configurable on a per APN basis.	MSISDN in international format according to 3GPP TS 03.03 [23], UTF-8 encoded. Note that there are no leading characters in front of the country code.	Optional
40	Acct-Status-Type	Indicates the type of accounting request	Interim-Update	Mandatory
41	Acct-Delay-Time	Indicates how many seconds the GGSN has been trying to send this record for, and can be subtracted from the time of arrival on the AAA server to find the approximate time of the event generating this Accounting-Request	Second	Optional
42	Acct-Input-Octets	GGSN counted number of octets sent by the user for the PDP context	32 bit unsigned integer	Optional
43	Acct-Output-Octets	GGSN counted number of octets received by the user for the PDP context	32 bit unsigned integer	Optional
44	Acct-Session-Id	User session identifier.	GGSN IP address and Charging-ID concatenated in a UTF-8 encoded hexadecimal. (Note 3)	Mandatory
45	Acct-Authentic	Authentication method	RADIUS or LOCAL	Optional
46	Acct-Session-Time	Duration of the session	Second	Optional
47	Acct-Input-Packets	GGSN counted number of packets sent by the user	Packet	Optional

Attr #	Attribute Name	Description	Content	Presence Requirement
48	Acct-Output-Packets	GGSN counted number of packets received by the user	Packet	Optional
61	NAS-Port-Type	Port type for the GGSN	As per RFC 2865 [21]	Optional
26/10415	3GPP Vendor-Specific	Sub-attributes according to subclause 16.4.7.	See subclause 16.4.7	Optional except sub-attribute 3 which is conditional
NOTE 3: Either NAS-IP-Address or NAS-Identifier shall be present.				
NOTE 4: The presence of this attribute is conditional upon this attribute being received in the Access-Accept message.				
NOTE 3: The GGSN IP address is the same as that used in the GCDRs.				

## 16.4.9 Disconnect Request (optionally sent from AAA server to GGSN)

Table 9 describes the attributes of the Disconnect-Request message.

**Table 9: The attributes of the Disconnect-Request message**

Attr #	Attribute Name	Description	Content	Presence Requirement
1	User-Name	Username provided by the user (extracted from the PCO field of the Create PDP Context Request message). If no username is available a generic username, configurable on a per APN basis, shall be present. If the User-Name has been sent in the Access-Accept message, this user-name shall be used in preference to the above	String	Optional
8	Framed-IP-Address	User IP address	IPv4	Mandatory
44	Acct-Session-Id	User session identifier.	GGSN IP address and Charging-ID concatenated in a UTF-8 encoded hexadecimal. NOTE: The GGSN IP address is the same as that used in the GCDRs.	Mandatory



## Annex A (informative): Change history

Change history							
Date	TSG #	TSG Doc.	CR	Rev	Subject/Comment	Old	New
	s25	98-0101	A001		Access to an Intranet or ISP through GPRS	5.0.0	6.0.0
	s26	98-0292	A002		Authentication protocol when accessing an intranet or ISP through GPRS	6.0.0	6.1.0
	s26	98-0292	A003		Clarifications to Intranet/ISP Interworking section	6.0.0	6.1.0
	s26	98-0292	A004		Architecture Diagrams	6.0.0	6.1.0
	s26	98-0292	A005		Editorial review of 09.61	6.0.0	6.1.0
	s26				Correction of Word 95/97 problem (incomplete incorporation of CR A003 into V6.1.0)	6.1.0	6.2.0
	s27	98-0735	A006		Protocol Configuration Options at PDP context activation failure	6.2.0	6.3.0
	TSG#06	NP-99431	A015		Approved CR from TSG#6 incorporated:A012 IPCP negotiation at the GGSN for non-transparent IP	6.3.0	6.4.0
09-2001					Conversion to 3GPP layout and number	6.4.0	6.5.0
09-2001	TSG#13	NP-010530	A017	2	Standard method for information delivery (MSISDN; IP address...) between GPRS and external PDN using RADIUS	6.4.0	6.5.0
12-2001	TSG#14	NP-010572	A021	1	Correction to calling station id	6.5.0	6.6.0
12-2001	TSG#14	NP-010572	A023	1	Correction to 3GPP Vendor specify attribute 3GPP-IMSI	6.5.0	6.6.0
12-2001	TSG#14	NP-010572	A025		Correction to 3GPP vendor specific attributes containing MCC-MNC	6.5.0	6.6.0
12-2001	TSG#14	NP-010672	A027		Standard method for information update between GPRS and external PDN using RADIUS	6.5.0	6.6.0
12-2001	TSG#14	NP-010672	A030		Standard method for interworking between GPRS and external PDN using RADIUS	6.5.0	6.6.0
03-2002	TSG#15	NP-020080	A031		Change of associated attribute for 3GPP-NSAPI	6.6.0	6.7.0
06-2002	TSG#16	NP-020295	A035		Corrections to the 3GPP RADIUS attributes	6.7.0	6.8.0
06-2002	TSG#16	NP-020295	A037	1	Clarification on the Radius Flows	6.7.0	6.8.0
12-2002	TSG#18	NP-020613	A039	1	RADIUS enhancement for identification of VPLMN	6.8.0	6.9.0
03-2003	TSG#19	NP-030074	A047	1	Correction of References and specification Corrections	6.9.0	6.10.0
06-2005					Removal of company specific header of figure 22	6.10.0	6.10.1

---

## History

<b>Document history</b>		
V6.1.0	August 1998	Publication
V6.2.0	September 1998	Publication
V6.3.0	October 1998	Publication
V6.4.0	February 2001	Publication
V6.5.0	September 2001	Publication
V6.6.0	December 2001	Publication
V6.7.0	March 2002	Publication
V6.8.0	June 2002	Publication
V6.9.0	December 2002	Publication
V6.10.0	March 2003	Publication (Withdrawn)
V6.10.1	June 2005	Publication