

# ETSI TS 100 977 V8.14.0 (2007-06)

---

*Technical Specification*

**Digital cellular telecommunications system (Phase 2+);  
Specification of the Subscriber Identity Module -  
Mobile Equipment (SIM-ME) Interface  
(3GPP TS 11.11 version 8.14.0 Release 1999)**

---



---

Reference

RTS/TSGC-061111v8e0

---

Keywords

GSM

**ETSI**

650 Route des Lucioles  
F-06921 Sophia Antipolis Cedex - FRANCE

Tel.: +33 4 92 94 42 00 Fax: +33 4 93 65 47 16

Siret N° 348 623 562 00017 - NAF 742 C  
Association à but non lucratif enregistrée à la  
Sous-Préfecture de Grasse (06) N° 7803/88

---

**Important notice**

Individual copies of the present document can be downloaded from:

<http://www.etsi.org>

The present document may be made available in more than one electronic version or in print. In any case of existing or perceived difference in contents between such versions, the reference version is the Portable Document Format (PDF). In case of dispute, the reference shall be the printing on ETSI printers of the PDF version kept on a specific network drive within ETSI Secretariat.

Users of the present document should be aware that the document may be subject to revision or change of status. Information on the current status of this and other ETSI documents is available at

<http://portal.etsi.org/tb/status/status.asp>

If you find errors in the present document, please send your comment to one of the following services:

[http://portal.etsi.org/chaicor/ETSI\\_support.asp](http://portal.etsi.org/chaicor/ETSI_support.asp)

---

**Copyright Notification**

No part may be reproduced except as authorized by written permission.  
The copyright and the foregoing restriction extend to reproduction in all media.

© European Telecommunications Standards Institute 2007.  
All rights reserved.

DECT™, PLUGTESTS™ and UMTS™ are Trade Marks of ETSI registered for the benefit of its Members.  
TIPHON™ and the TIPHON logo are Trade Marks currently being registered by ETSI for the benefit of its Members.  
3GPP™ is a Trade Mark of ETSI registered for the benefit of its Members and of the 3GPP Organizational Partners.

---

## Intellectual Property Rights

IPRs essential or potentially essential to the present document may have been declared to ETSI. The information pertaining to these essential IPRs, if any, is publicly available for **ETSI members and non-members**, and can be found in ETSI SR 000 314: "*Intellectual Property Rights (IPRs); Essential, or potentially Essential, IPRs notified to ETSI in respect of ETSI standards*", which is available from the ETSI Secretariat. Latest updates are available on the ETSI Web server (<http://webapp.etsi.org/IPR/home.asp>).

Pursuant to the ETSI IPR Policy, no investigation, including IPR searches, has been carried out by ETSI. No guarantee can be given as to the existence of other IPRs not referenced in ETSI SR 000 314 (or the updates on the ETSI Web server) which are, or may be, or may become, essential to the present document.

---

## Foreword

This Technical Specification (TS) has been produced by ETSI 3rd Generation Partnership Project (3GPP).

The present document may refer to technical specifications or reports using their 3GPP identities, UMTS identities or GSM identities. These should be interpreted as being references to the corresponding ETSI deliverables.

The cross reference between GSM, UMTS, 3GPP and ETSI identities can be found under <http://webapp.etsi.org/key/queryform.asp>.

# Contents

Intellectual Property Rights .....	2
Foreword.....	2
Foreword.....	9
1 Scope .....	10
2 References .....	10
3 Definitions, abbreviations and symbols .....	12
3.1 Definitions .....	12
3.2 Abbreviations .....	13
3.3 Symbols.....	15
4 Physical characteristics.....	15
4.1 Format and layout.....	15
4.1.1 ID-1 SIM.....	15
4.1.2 Plug-in SIM .....	16
4.2 Temperature range for card operation .....	16
4.3 Contacts.....	16
4.3.1 Provision of contacts.....	16
4.3.2 Activation and deactivation .....	16
4.3.3 Inactive contacts .....	16
4.3.4 Contact pressure.....	17
4.4 Precedence.....	17
4.5 Static Protection .....	17
5 Electronic signals and transmission protocols.....	17
5.1 Supply voltage Vcc (contact C1).....	17
5.2 Reset (RST) (contact C2) .....	18
5.3 Programming voltage Vpp (contact C6).....	18
5.4 Clock CLK (contact C3).....	18
5.5 I/O (contact C7).....	18
5.6 States .....	19
5.7 Baudrate .....	19
5.8 Answer To Reset (ATR).....	19
5.8.1 Structure and contents.....	19
5.8.2 PPS procedure.....	21
5.8.3 Speed enhancement.....	22
5.9 Bit/character duration and sampling time .....	22
5.10 Error handling .....	22
6 Logical Model .....	23
6.1 General description.....	23
6.2 File identifier .....	23
6.3 Dedicated files.....	24
6.4 Elementary files.....	24
6.4.1 Transparent EF.....	24
6.4.2 Linear fixed EF .....	25
6.4.3 Cyclic EF .....	25
6.5 Methods for selecting a file .....	26
6.6 Reservation of file IDs .....	27
7 Security features .....	28
7.1 Authentication and cipher key generation procedure .....	28
7.2 Algorithms and processes.....	28
7.3 File access conditions.....	28
8 Description of the functions .....	29
8.1 SELECT .....	30

8.2	STATUS.....	30
8.3	READ BINARY.....	30
8.4	UPDATE BINARY.....	31
8.5	READ RECORD.....	31
8.6	UPDATE RECORD.....	32
8.7	SEEK.....	32
8.8	INCREASE.....	33
8.9	VERIFY CHV.....	33
8.10	CHANGE CHV.....	34
8.11	DISABLE CHV.....	34
8.12	ENABLE CHV.....	34
8.13	UNBLOCK CHV.....	35
8.14	INVALIDATE.....	35
8.15	REHABILITATE.....	35
8.16	RUN GSM ALGORITHM.....	36
8.17	SLEEP.....	36
8.18	TERMINAL PROFILE.....	36
8.19	ENVELOPE.....	36
8.20	FETCH.....	36
8.21	TERMINAL RESPONSE.....	37
9	Description of the commands.....	37
9.1	Mapping principles.....	37
9.2	Coding of the commands.....	40
9.2.1	SELECT.....	41
9.2.2	STATUS.....	43
9.2.3	READ BINARY.....	43
9.2.4	UPDATE BINARY.....	44
9.2.5	READ RECORD.....	44
9.2.6	UPDATE RECORD.....	44
9.2.7	SEEK.....	45
9.2.8	INCREASE.....	45
9.2.9	VERIFY CHV.....	46
9.2.10	CHANGE CHV.....	46
9.2.11	DISABLE CHV.....	46
9.2.12	ENABLE CHV.....	46
9.2.13	UNBLOCK CHV.....	47
9.2.14	INVALIDATE.....	47
9.2.15	REHABILITATE.....	47
9.2.16	RUN GSM ALGORITHM.....	47
9.2.17	SLEEP.....	47
9.2.18	GET RESPONSE.....	48
9.2.19	TERMINAL PROFILE.....	48
9.2.20	ENVELOPE.....	48
9.2.21	FETCH.....	48
9.2.22	TERMINAL RESPONSE.....	49
9.3	Definitions and coding.....	49
9.4	Status conditions returned by the card.....	50
9.4.1	Responses to commands which are correctly executed.....	51
9.4.2	Responses to commands which are postponed.....	51
9.4.3	Memory management.....	51
9.4.4	Referencing management.....	51
9.4.5	Security management.....	51
9.4.6	Application independent errors.....	52
9.4.7	Commands versus possible status responses.....	52
10	Contents of the Elementary Files (EF).....	53
10.1	Contents of the EFs at the MF level.....	53
10.1.1	EF <sub>ICCID</sub> (ICC Identification).....	53
10.1.2	EF <sub>ELP</sub> (Extended language preference).....	54
10.2	DFs at the GSM application level.....	55
10.3	Contents of files at the GSM application level.....	55

10.3.1	EF <sub>LP</sub> (Language preference) .....	55
10.3.2	EF <sub>IMSI</sub> (IMSI).....	56
10.3.3	EF <sub>Kc</sub> (Ciphering key Kc).....	57
10.3.4	EF <sub>PLMNsel</sub> (PLMN selector).....	57
10.3.5	EF <sub>HPPLMN</sub> (Higher Priority PLMN search period) .....	58
10.3.6	EF <sub>ACMmax</sub> (ACM maximum value) .....	59
10.3.7	EF <sub>SST</sub> (SIM service table) .....	60
10.3.8	EF <sub>ACM</sub> (Accumulated call meter).....	62
10.3.9	EF <sub>GID1</sub> (Group Identifier Level 1).....	63
10.3.10	EF <sub>GID2</sub> (Group Identifier Level 2).....	63
10.3.11	EF <sub>SPN</sub> (Service Provider Name).....	63
10.3.12	EF <sub>PUCT</sub> (Price per unit and currency table) .....	64
10.3.13	EF <sub>CBMI</sub> (Cell broadcast message identifier selection) .....	65
10.3.14	EF <sub>BCCH</sub> (Broadcast control channels) .....	65
10.3.15	EF <sub>ACC</sub> (Access control class).....	66
10.3.16	EF <sub>FPLMN</sub> (Forbidden PLMNs).....	67
10.3.17	EF <sub>LOCI</sub> (Location information) .....	67
10.3.18	EF <sub>AD</sub> (Administrative data).....	69
10.3.19	EF <sub>Phase</sub> (Phase identification).....	70
10.3.20	EF <sub>VGCS</sub> (Voice Group Call Service).....	71
10.3.21	EF <sub>VGCS</sub> (Voice Group Call Service Status) .....	72
10.3.22	EF <sub>VBS</sub> (Voice Broadcast Service).....	73
10.3.23	EF <sub>VBSS</sub> (Voice Broadcast Service Status).....	75
10.3.24	EF <sub>eMLPP</sub> (enhanced Multi Level Pre-emption and Priority) .....	75
10.3.25	EF <sub>AAeM</sub> (Automatic Answer for eMLPP Service).....	76
10.3.26	EF <sub>CBMID</sub> (Cell Broadcast Message Identifier for Data Download) .....	77
10.3.27	EF <sub>ECC</sub> (Emergency Call Codes).....	78
10.3.28	EF <sub>CBMIR</sub> (Cell broadcast message identifier range selection) .....	79
10.3.29	EF <sub>DCCK</sub> De-personalization Control Keys .....	80
10.3.30	EF <sub>CNL</sub> (Co-operative Network List).....	80
10.3.31	EF <sub>NIA</sub> (Network's Indication of Alerting) .....	81
10.3.32	EF <sub>KcGPRS</sub> (GPRS Ciphering key KcGPRS).....	82
10.3.33	EF <sub>LOCIGPRS</sub> (GPRS location information).....	82
10.3.34	EF <sub>SUME</sub> (SetUpMenu Elements) .....	84
10.3.35	EF <sub>PLMNwAcT</sub> (User controlled PLMN Selector with Access Technology).....	84
10.3.36	EF <sub>OPLMNwAcT</sub> (Operator controlled PLMN Selector with Access Technology) .....	86
10.3.37	EF <sub>HPLMNwAcT</sub> (HPLMN Selector with Access Technology).....	87
10.3.38	EF <sub>CPBCCH</sub> (CPBCCH Information) .....	87
10.3.39	EF <sub>InvScan</sub> (Investigation Scan) .....	88
10.3.40	Void .....	89
10.4	Contents of DFs at the GSM application level .....	89
10.4.1	Contents of files at the GSM SoLSA level .....	89
10.4.1.1	EF <sub>SAI</sub> (SoLSA Access Indicator).....	89
10.4.1.2	EF <sub>SLL</sub> (SoLSA LSA List) .....	90
10.4.1.3	LSA Descriptor files .....	92
10.4.2	Contents of files at the MExE level .....	93
10.4.2.1	EF <sub>MExE-ST</sub> (MExE Service table).....	93
10.4.2.2	EF <sub>ORPK</sub> (Operator Root Public Key).....	94
10.4.2.3	EF <sub>ARPK</sub> (Administrator Root Public Key).....	96
10.4.2.4	EF <sub>TPRPK</sub> (Third Party Root Public key) .....	96
10.4.2.5	Trusted Key/Certificates Data Files .....	97
10.5	Contents of files at the telecom level.....	97
10.5.1	EF <sub>ADN</sub> (Abbreviated dialling numbers).....	97
10.5.2	EF <sub>FDN</sub> (Fixed dialling numbers).....	101
10.5.3	EF <sub>SMS</sub> (Short messages) .....	101
10.5.4	Capability configuration parameters .....	102
10.5.4.1	EF <sub>CCP</sub> (Capability configuration parameters).....	102
10.5.4.2	EF <sub>ECCP</sub> (Extended Capability configuration parameters).....	103
10.5.5	EF <sub>MSISDN</sub> (MSISDN) .....	104
10.5.6	EF <sub>SMSP</sub> (Short message service parameters).....	104
10.5.7	EF <sub>SMSS</sub> (SMS status) .....	106

10.5.8	EF <sub>LND</sub> (Last number dialled).....	107
10.5.9	EF <sub>SDN</sub> (Service Dialling Numbers) .....	107
10.5.10	EF <sub>EXT1</sub> (Extension1) .....	108
10.5.11	EF <sub>EXT2</sub> (Extension2) .....	109
10.5.12	EF <sub>EXT3</sub> (Extension3) .....	110
10.5.13	EF <sub>BDN</sub> (Barred Dialling Numbers) .....	110
10.5.14	EF <sub>EXT4</sub> (Extension4) .....	111
10.5.15	EF <sub>SMSR</sub> (Short message status reports).....	111
10.5.16	EF <sub>CFMI</sub> (Comparison Method Information).....	112
10.6	DFs at the telecom level .....	112
10.6.1	Contents of files at the telecom graphics level.....	112
10.6.1.1	EF <sub>IMG</sub> (Image).....	112
10.6.1.2	Image Instance Data Files .....	114
10.7	Files of GSM .....	115
11	Application protocol.....	117
11.1	General procedures.....	119
11.1.1	Reading an EF.....	119
11.1.2	Updating an EF .....	119
11.1.3	Increasing an EF .....	120
11.2	SIM management procedures .....	120
11.2.1	SIM initialization .....	120
11.2.2	GSM session termination.....	122
11.2.3	Emergency Call Codes.....	122
11.2.4	Language preference .....	122
11.2.5	Administrative information request; .....	122
11.2.6	SIM service table request.....	122
11.2.7	SIM phase request.....	122
11.2.8	SIM Presence Detection and Proactive Polling .....	123
11.2.9	Extended Language preference.....	123
11.3	CHV related procedures .....	123
11.3.1	CHV verification .....	123
11.3.2	CHV value substitution.....	124
11.3.3	CHV disabling .....	124
11.3.4	CHV enabling .....	124
11.3.5	CHV unblocking.....	124
11.4	GSM security related procedures .....	124
11.4.1	GSM algorithms computation.....	124
11.4.2	IMSI request .....	125
11.4.3	Access control request .....	125
11.4.4	Higher Priority PLMN search period request .....	125
11.4.5	Location information .....	125
11.4.6	Cipher key.....	125
11.4.7	BCCH information.....	125
11.4.8	Forbidden PLMN.....	125
11.4.9	LSA information.....	125
11.4.10	GPRS Location information .....	125
11.4.11	GPRS Cipher key.....	125
11.5	Subscription related procedures .....	126
11.5.1	Dialling numbers .....	126
11.5.2	Short messages.....	128
11.5.3	Advice of Charge (AoC).....	129
11.5.4	Capability configuration parameters.....	129
11.5.5	PLMN selector.....	129
11.5.6	Cell broadcast message identifier .....	129
11.5.7	Group identifier level 1 .....	129
11.5.8	Group identifier level 2.....	130
11.5.9	Service Provider Name .....	130
11.5.10	Voice Group Call Services .....	130
11.5.11	Voice Broadcast Services .....	130
11.5.12	Enhanced Multi Level Pre-emption and Priority Service .....	130
11.5.13	Cell Broadcast Message range identifier .....	130

11.5.14	Depersonalisation Control Keys .....	131
11.5.15	Short message status report.....	131
11.5.16	Network's indication of alerting.....	131
11.5.17	User controlled PLMN Selector with Access Technology .....	131
11.5.18	Operator controlled PLMN Selector with Access Technology.....	131
11.5.19	HPLMN Selector with Access Technology .....	131
11.4.20	CPBCCCH information.....	132
11.5.21	Investigation Scan.....	132
11.5.22	Void .....	132
11.6	SIM Application Toolkit related procedures .....	132
11.6.1	Initialization procedure .....	132
11.6.2	Proactive polling .....	132
11.6.3	Support of commands .....	132
11.6.4	Support of response codes .....	132
11.6.5	Command-response pairs.....	133
11.6.6	Independence of normal GSM and SIM Application Toolkit tasks .....	133
11.6.7	Use of BUSY status response .....	133
11.6.8	Use of NULL procedure byte .....	133
11.6.9	Using the TERMINAL PROFILE, ENVELOPE, and TERMINAL RESPONSE commands.....	133
11.6.10	Using the FETCH command.....	133
11.6.11	Data Download via SMS-CB.....	134
11.6.12	Data Download via SMS-PP.....	134
11.6.13	Menu selection .....	134
11.6.14	Call Control .....	134
11.6.15	Proactive SIM .....	134
11.6.16	Mobile Originated Short Message control by SIM .....	134
11.6.17	SIM data download error .....	134
11.6.18	Image Request .....	134
11.7	MExE related procedures .....	135
11.7.1	MExE ST .....	135
11.7.2	Operator root public key .....	135
11.7.3	Administrator root public key.....	135
11.7.4	Third Party root public key(s).....	135
<b>Annex A (normative):</b>	<b>Plug-in SIM .....</b>	<b>136</b>
<b>Annex B (normative):</b>	<b>Coding of Alpha fields in the SIM for UCS2.....</b>	<b>137</b>
<b>Annex C (informative):</b>	<b>FDN/BDN Procedures .....</b>	<b>139</b>
<b>Annex D (informative):</b>	<b>Suggested contents of the EFs at pre-personalization .....</b>	<b>144</b>
<b>Annex E (informative):</b>	<b>SIM application Toolkit protocol diagrams .....</b>	<b>146</b>
<b>Annex F (informative):</b>	<b>Examples of coding of LSA Descriptor files for SoLSA .....</b>	<b>153</b>
<b>Annex G (normative):</b>	<b>Image Coding Schemes.....</b>	<b>154</b>
G.1	Basic Image Coding Scheme.....	154
G.2	Colour Image Coding Scheme .....	155
<b>Annex H (normative):</b>	<b>Coding of EFs for NAM and GSM-AMPS Operational Parameters.....</b>	<b>157</b>
H.1	Elementary File Definitions and Contents .....	157
H.1.1	EF <sub>MIN</sub> (Mobile Identification Number) .....	157
H.1.2	EF <sub>ACCOLC</sub> (Access Overload Class).....	158
H.1.3	EF <sub>SID</sub> (System ID Of Home System).....	158
H.1.4	EF <sub>IPC</sub> (Initial Paging Channel) .....	159
H.1.5	EF <sub>GPI</sub> (Group ID).....	159
H.1.6	EF <sub>S-ESN</sub> (SIM Electronic Serial Number).....	160
H.1.7	EF <sub>COUNT</sub> (Call Count).....	160
H.1.8	EF <sub>PSID</sub> (Positive/Favoured SID list) .....	161
H.1.9	EF <sub>NSID</sub> (Negative/Forbidden SID List) .....	162



H.1.10	EF <sub>SPL</sub> (Scanning Priority List).....	163
H.1.11	EF <sub>NETSEL</sub> (Network Selection Activation Flag).....	164
H.1.12	EF <sub>CSID</sub> (Current/Last Registered SID).....	165
H.1.13	EF <sub>REG-THRESH</sub> (Registration Threshold).....	165
H.1.14	EF <sub>CCCH</sub> (Current Control Channel) .....	165
H.1.15	EF <sub>LDCC</sub> (Latest DCC) .....	166
H.1.16	EF <sub>GSM-RECON</sub> (GSM Reconnect Timer).....	166
H.1.17	EF <sub>AMPS-2-GSM</sub> (AMPS to GSM Rescan Timing Table).....	167
H.1.18	EF <sub>*FCI</sub> (Feature Activation Codes).....	167
H.1.19	EF <sub>AMPS-UI</sub> (AMPS USAGE INDICATORS).....	168
H.2	Authentication Functionality.....	169
H.2.1	A-KEY (ANSI-41 Authentication Key) .....	169
H.2.2	SSD (Shared Secret Data) .....	169
H.3	Authentication commands.....	169
H.3.1	Generation of Authentication Signature Data and Cipherring Keys.....	170
H.3.2	Validation and Storage of Entered A-Key's .....	171
H.3.3	Ask Random Task .....	171
H.3.4	Update Shared Secret Data.....	172
H.3.5	Confirm Shared Secret Data.....	172
H.3.6	CMEA Encryption of Voice Channel Data Digits .....	173
H.3.7	SIM Status Codes.....	173
<b>Annex I (informative):</b>	<b>EF changes via Data Download or SIM Toolkit applications.....</b>	<b>174</b>
<b>Annex J (informative):</b>	<b>Change history .....</b>	<b>177</b>
History .....		180

---

# Foreword

This Technical Specification has been produced by the 3<sup>rd</sup> Generation Partnership Project (3GPP).

The contents of the present document are subject to continuing work within the TSG and may change following formal TSG approval. Should the TSG modify the contents of the present document, it will be re-released by the TSG with an identifying change of release date and an increase in version number as follows:

Version x.y.z

where:

- x the first digit:
  - 1 presented to TSG for information;
  - 2 presented to TSG for approval;
  - 3 or greater indicates TSG approved document under change control.
- y the second digit is incremented for all changes of substance, i.e. technical enhancements, corrections, updates, etc.
- z the third digit is incremented when editorial only changes have been incorporated in the document.

---

# 1 Scope

The present document defines the interface between the Subscriber Identity Module (SIM) and the Mobile Equipment (ME) for use during the network operation phase of GSM as well as those aspects of the internal organization of the SIM which are related to the network operation phase. This is to ensure interoperability between a SIM and an ME independently of the respective manufacturers and operators. The concept of a split of the Mobile Station (MS) into these elements as well as the distinction between the GSM network operation phase, which is also called GSM operations, and the administrative management phase are described in the TS 02.17 [6].

The present document defines:

- the requirements for the physical characteristics of the SIM, the electrical signals and the transmission protocols;
- the model which shall be used as a basis for the design of the logical structure of the SIM;
- the security features;
- the interface functions;
- the commands;
- the contents of the files required for the GSM application;
- the application protocol.

Unless otherwise stated, references to GSM also apply to DCS 1800 and PCS 1900.

The present document does not specify any aspects related to the administrative management phase. Any internal technical reallocation of either the SIM or the ME are only specified where these reflect over the interface. It does not specify any of the security algorithms which may be used.

The present document defines the SIM/ME interface for GSM Phase 2. While all attempts have been made to maintain phase compatibility, any issues that specifically relate to Phase 1 should be referenced from within the relevant Phase 1 specification.

---

# 2 References

The following documents contain provisions which, through reference in this text, constitute provisions of the present document.

- References are either specific (identified by date of publication, edition number, version number, etc.) or non-specific.
- For a specific reference, subsequent revisions do not apply.
- For a non-specific reference, the latest version applies. In the case of a reference to a 3GPP document (including a GSM document), a non-specific reference implicitly refers to the latest version of that document *in the same Release as the present document*.

- [1] not used
- [2] 3GPP TS 01.04: "Abbreviations and acronyms".
- [3] 3GPP TS 02.07: "Mobile Stations (MS) features".
- [4] 3GPP TS 02.09: " Security aspects".
- [5] 3GPP TS 22.011: " Service accessibility".
- [6] 3GPP TS 02.17: "Subscriber Identity Modules (SIM) Functional characteristics".
- [7] 3GPP TS 22.024: " Description of Charge Advice Information (CAI)".

- [8] 3GPP TS 02.30: "Man-Machine Interface (MMI) of the Mobile Station (MS)".
- [9] 3GPP TS 22.086: "Advice of charge (AoC) Supplementary Services - Stage 1".
- [10] 3GPP TS 23.003: "Numbering, addressing and identification".
- [11] 3GPP TS 03.20: "Security related network functions".
- [12] 3GPP TS 23.038: "Alphabets and language-specific information".
- [13] 3GPP TS 23.040: "Technical realization of the Short Message Service (SMS) Point-to-Point (PP)".
- [14] 3GPP TS 23.041: "Technical realization of Short Message Service Cell Broadcast (SMSCB)".
- [15] 3GPP TS 04.08: "Mobile radio interface layer 3 specification".
- [16] 3GPP TS 24.011: "Point-to-Point (PP) Short Message Service (SMS) support on mobile radio interface".
- [17] 3GPP TS 09.91: " Interworking aspects of the Subscriber Identity Module - Mobile Equipment (SIM - ME) interface between Phase 1 and Phase 2".
- [18] CCITT Recommendation E.118: "The international telecommunication charge card".
- [19] CCITT Recommendation E.164: "Numbering plan for the ISDN era".
- [20] CCITT Recommendation T.50: "International Alphabet No. 5". (ISO 646: 1983, "Information processing - ISO 7-bits coded characters set for information interchange".)
- [21] ISO/IEC 7810 (1995): "Identification cards - Physical characteristics".
- [22] ISO/IEC 7811-1 (1995): "Identification cards - Recording technique - Part 1: Embossing".
- [23] Void
- [24] ISO/IEC 7816-1 : "Identification cards - Integrated circuit cards Part 1: Card with contacts: Physical characteristics".
- [25] ISO/IEC 7816-2 : "Identification cards - Integrated circuit cards Part 2: Card with contacts: Dimensions and locations of the contacts".
- [26] ISO/IEC 7816-3: "Identification cards - Integrated circuit cards. Part 3: Cards with contacts: Electronic signals and transmission protocols".
- [27] 3GPP TS 11.14: "Specification of the SIM Application Toolkit for the Subscriber Identity Module - Mobile Equipment (SIM - ME) interface".
- [28] 3GPP TS 11.12: " Specification of the 3 Volt Subscriber Identity Module - Mobile Equipment (SIM - ME) interface".
- [29] 3GPP TS 22.022: "Personalization of Mobile Equipment (ME) Mobile functionality specification".
- [30] ISO 639 (1988): "Code for the representation of names of languages".
- [31] ISO/IEC 10646-1 (1993): "Information technology - Universal Multiple-Octet Coded Character Set (UCS) - Part 1: Architecture and Basic Multilingual Plane".
- [32] 3GPP TS 23.060: "General Packet Radio Service (GPRS); Service description; Stage 2".
- [33] 3GPP TS 23.073: "Support of Localised Service Area (SoLSA); Service description; Stage 2".
- [34] 3GPP TS 11.19: "Specification of the Cordless Telephony System Subscriber Identity Module for both Fixed Part and Mobile Station".
- [35] ISO/IEC 7816-4 : "Identification cards - Integrated circuit cards Part 4: Organization, security and commands for interchange".

- [36] TIA/EIA-136-005: "Introduction, Identification, and Semi-Permanent Memory, November 1998".
- [37] TIA/EIA-136-123-A: "Digital Control Channel Layer 3, November 1998".
- [38] TIA/EIA-136-140-A: "Analogue Control Channel, November 1998".
- [39] TIA/EIA-136-510-A: "Authentication, Encryption of Signaling Information/User Data and Privacy, November 1998".
- [40] ANSI TIA/EIA-41: "Cellular Radio Telecommunications Intersystem Operations".
- [41] EIA/TIA-553: "Mobile Station-Land Station Compatibility Specification".
- [42] 3GPP TS 22.067: "Enhanced Multi Level Pre-emption and Priority (eMLPP) Services - Stage 1".
- [43] TR45 AHAG "Common Cryptographic Algorithms, Revision C," October 27, 1998.
- [44] ETS 300.812: "Terrestrial Trunk Radio; Specification of the Subscriber Identity Module - Mobile Equipment (SIM - ME) interface".
- [45] 3GPP TS 03.22: "Functions related to Mobile Station (MS) in idle mode and group receive mode".
- [46] 3GPP TS 05.05: "Radio transmission and reception".
- [47] 3GPP TS 24.008: "Mobile Radio Interface Layer 3 specification, Core Network Protocols".
- [48] 3GPP TS 04.18: "Mobile radio interface layer 3 specification, Radio Resource Control Protocol".
- [49] 3GPP TS 04.60: "General Packet Radio Service (GPRS); Mobile Station (MS) - Base Station System (BSS) interface; Radio Link Control/ Medium Access Control (RLC/MAC) protocol".
- [50] 3GPP TS 23.057: "Mobile Station Application Execution Environment (MExE);Functional description; Stage 2".
- [51] 3GPP TS 23.122: "Technical Specification Group Core Network; NAS Functions related to Mobile Station (MS) in idle mode".
- [52] 3GPP TS 31.102: "Characteristics of the USIM application".

---

## 3 Definitions, abbreviations and symbols

### 3.1 Definitions

For the purposes of the present document, the following terms and definitions apply:

**access conditions:** set of security attributes associated with a file.

**application:** application consists of a set of security mechanisms, files, data and protocols (excluding transmission protocols).

**application protocol:** set of procedures required by the application.

**card session:** link between the card and the external world starting with the ATR and ending with a subsequent reset or a deactivation of the card.

**current directory:** latest MF or DF selected.

**current EF:** latest EF selected.

**data field:** obsolete term for Elementary File.

**Dedicated File (DF):** file containing access conditions and, optionally, Elementary Files (EFs) or other Dedicated Files (DFs).

**directory:** general term for MF and DF.

**Elementary File (EF):** file containing access conditions and data and no other files.

**file:** directory or an organized set of bytes or records in the SIM.

**file identifier:** 2 bytes which address a file in the SIM.

**GSM, DCS 1800 or PCS 1900 application:** set of security mechanisms, files, data and protocols required by GSM, DCS 1800 or PCS 1900.

**GSM session:** that part of the card session dedicated to the GSM operation.

**IC card SIM:** obsolete term for ID-1 SIM.

**ID-1 SIM:** SIM having the format of an ID-1 card (see ISO/IEC 7816-1 [24]).

**Master File (MF):** unique mandatory file containing access conditions and optionally DFs and/or EFs.

**normal GSM operation:** relating to general, CHV related, GSM security related and subscription related procedures.

**padding:** one or more bits appended to a message in order to cause the message to contain the required number of bits or bytes.

**plug-in SIM:** Second format of SIM (specified in clause 4).

**proactive SIM:** SIM which is capable of issuing commands to the ME. Part of SIM Application Toolkit (see clause 11).

**record:** string of bytes within an EF handled as a single entity (see clause 6).

**record number:** number which identifies a record within an EF.

**record pointer:** pointer which addresses one record in an EF.

**root directory:** obsolete term for Master File.

**SIM application toolkit procedures:** defined in TS 11.14 [27].

## 3.2 Abbreviations

For the purposes of the present document, the following abbreviations apply, in addition to those listed in TS 01.04 [2]:

A3	Algorithm 3, authentication algorithm; used for authenticating the subscriber
A38	A single algorithm performing the functions of A3 and A8
A5	Algorithm 5, cipher algorithm; used for enciphering/deciphering data
A8	Algorithm 8, cipher key generator; used to generate $K_c$
ACM	Accumulated Call Meter
ADM	Access condition to an EF which is under the control of the authority which creates this file
ADN	Abbreviated Dialling Number
AHAG	Ad-Hoc Authentication Group
A-Key	Authentication Key
ALW	ALWays
AMPS	Analogue Mobile Phone System
ANSI	American National Standards Institute
AoC	Advice of Charge
APDU	Application Protocol Data Unit
ATR	Answer To Reset
BCCH	Broadcast Control CHannel
BCD	Binary Coded Decimal
BDN	Barred Dialling Number
BTS	Base Transmitter Station
CB	Cell Broadcast
CBMI	Cell Broadcast Message Identifier

CCITT	The International Telegraph and Telephone Consultative Committee (now ITU Telecommunications Standardization sector)
CCP	Capability/Configuration Parameter
CHV	Card Holder Verification information; access condition used by the SIM for the verification of the identity of the user
CLA	CLAss
CNL	Co-operative Network List
CPBCCH	COMPACT Packet BCCH
CTS	Cordless Telephony System
DCK	De-personalization Control Keys
DCS	Digital Cellular System
DF	Dedicated File (abbreviation formerly used for Data Field)
DTMF	Dual Tone Multiple Frequency
ECC	Emergency Call Code
EF	Elementary File
EIA	Electronics Industries Alliance (North America)
eMLPP	enhanced Multi-Level Precedence and Pre-emption Service
ETSI	European Telecommunications Standards Institute
etu	elementary time unit
FDN	Fixed Dialling Number
GSM	Global System for Mobile communications
HPLMN	Home PLMN
IC	Integrated Circuit
ICC	Integrated Circuit(s) Card
ID	IDentifier
IEC	International Electrotechnical Commission
IMSI	International Mobile Subscriber Identity
ISO	International Organization for Standardization
Kc	Cryptographic key; used by the cipher A5
Ki	Subscriber authentication key; the cryptographic key used by the authentication algorithm, A3, and cipher key generator, A8
LAI	Location Area Information; information indicating a cell or a set of cells
lgth	The (specific) length of a data unit
LND	Last Number Dialed
LSA	Localised Service Area
LSA ID	Localised Service Area Identity
LSB	Least Significant Bit
MCC	Mobile Country Code
ME	Mobile Equipment
MF	Master File
MMI	Man Machine Interface
MNC	Mobile Network Code
MS	Mobile Station
MSB	Most Significant Bit
MSISDN	Mobile Station international ISDN number
NAM	Numeric Assignment Module
NET	NETwork
NEV	NEVer
NPI	Numbering Plan Identifier
OFM	Operational Feature Monitor
OPLMN	Operator Controlled PLMN (Selector List)
OTA	Over The Air
PDC	Personal Digital Communications
PIN/PIN2	Personal Identification Number / Personal Identification Number 2 (obsolete terms for CHV1 and CHV2, respectively)
PLMN	Public Land Mobile Network
PPS	Protocol and Parameter Select (response to the ATR)
PUK/PUK2	PIN Unblocking Key / PIN2 Unblocking Key (obsolete terms for UNBLOCK CHV1 and UNBLOCK CHV2, respectively)
RAND	A RANDom challenge issued by the network

RFU	Reserved for Future Use
SDN	Service Dialling Number
SID	System IDentity
SIM	Subscriber Identity Module
SMS	Short Message Service
SoLSA	Support of Localised Service Area
SRES	Signed RESponse calculated by a SIM
SSC	Supplementary Service Control string
SW1/SW2	Status Word 1 / Status Word 2
TETRA	TERrestrial Trunk RAdio
TIA	Telecommunications Industries Association (North America)
TMSI	Temporary Mobile Subscriber Identity
TON	Type Of Number
TP	Transfer layer Protocol
TPDU	Transfer Protocol Data Unit
TS	Technical Specification
UNBLOCK CHV1/2	value to unblock CHV1/CHV2
VBS	Voice Broadcast Service
VGCS	Voice Group Call Service
VPLMN	Visited PLMN

### 3.3 Symbols

For the purposes of the present document, the following symbols apply:

Vcc	Supply voltage
Vpp	Programming voltage
'0' to '9' and 'A' to 'F'	the sixteen hexadecimal digits

---

## 4 Physical characteristics

Two physical types of SIM are specified. These are the "ID-1 SIM" and the "Plug-in SIM".

The physical characteristics of both types of SIM shall be in accordance with ISO/IEC 7816-1,2 [24, 25] unless otherwise specified. The following additional requirements shall be applied to ensure proper operation in the GSM environment.

### 4.1 Format and layout

The information on the exterior of either SIM should include at least the individual account identifier and the check digit of the IC Card Identification (see clause 10, EF<sub>ICCID</sub>).

#### 4.1.1 ID-1 SIM

Format and layout of the ID-1 SIM shall be in accordance with ISO/IEC 7816-1,2 [24, 25].

The card shall have a polarization mark (see TS 02.07 [3]) which indicates how the user should insert the card into the ME.

The ME shall accept embossed ID-1 cards. The embossing shall be in accordance with ISO/IEC 7811 [22]. The contacts of the ID-1 SIM shall be located on the front (embossed face, see ISO/IEC 7810 [21]) of the card.

NOTE: Card warpage and tolerances are now specified for embossed cards in ISO/IEC 7810 [21].



## 4.1.2 Plug-in SIM

The Plug-in SIM has a width of 25 mm, a height of 15 mm, a thickness the same as an ID-1 SIM and a feature for orientation. See figure A.1 in normative annex A for details of the dimensions of the card and the dimensions and location of the contacts.

Annexes A.1 and A.2 of ISO 7816-1 [24] do not apply to the Plug-in SIM.

Annex A of ISO/IEC 7816-2 [25] applies with the location of the reference points adapted to the smaller size. The three reference points P1, P2 and P3 measure 7,5 mm, 3,3 mm and 20,8 mm, respectively, from 0. The values in table A.1 of ISO 7816-2 [25] are replaced by the corresponding values of figure A.1.

## 4.2 Temperature range for card operation

The temperature range for full operational use shall be between  $-25^{\circ}\text{C}$  and  $+70^{\circ}\text{C}$  with occasional peaks of up to  $+85^{\circ}\text{C}$ . "Occasional" means not more than 4 hours each time and not over 100 times during the life time of the card.

## 4.3 Contacts

### 4.3.1 Provision of contacts

ME: Contacting elements in the ME in positions C4 and C8 are optional, and are not used in the GSM application. They shall present a high impedance to the SIM card in the GSM application. If it is determined that the SIM is a multi-application ICC, then these contacts may be used. Contact C6 need not be provided for Plug-in SIMs.

SIM: Contacts C4 and C8 need not be provided by the SIM, but if they are provided, then they shall not be connected internally in the SIM if the SIM only contains the GSM application. Contact C6 shall not be bonded in the SIM for any function other than supplying  $V_{pp}$ .

### 4.3.2 Activation and deactivation

The ME shall connect, activate and deactivate the SIM in accordance with the Operating Procedures specified in ISO/IEC 7816-3 [26].

For any voltage level, monitored during the activation sequence, or during the deactivation sequence following soft power-down, the order of the contact activation/deactivation shall be respected.

NOTE 1: Soft Power switching is defined in TS 02.07 [3].

NOTE 2: It is recommended that whenever possible the deactivation sequence defined in ISO/IEC 7816-3 [26] should be followed by the ME on all occasions when the ME is powered down.

If the SIM clock is already stopped and is not restarted, the ME is allowed to deactivate all the contacts in any order, provided that all signals reach low level before  $V_{cc}$  leaves high level. If the SIM clock is already stopped and is restarted before the deactivation sequence, then the deactivation sequence specified in ISO/IEC 7816-3 [26] subclause 5.4 shall be followed.

When  $V_{pp}$  is connected to  $V_{cc}$ , as allowed by GSM (see clause 5), then  $V_{pp}$  will be activated and deactivated with  $V_{cc}$ , at the time of the  $V_{cc}$  activation/deactivation, as given in the sequences of ISO/IEC 7816-3 [26] subclauses 5.2 and 5.4.

$V_{cc}$  is powered when it has a value between 4,5 V and 5,5 V.

### 4.3.3 Inactive contacts

The voltages on contacts C1, C2, C3, C6 and C7 of the ME shall be between 0 and  $\pm 0,4$  volts referenced to ground (C5) when the ME is switched off with the power source connected to the ME. The measurement equipment shall have a resistance of 50 kohms when measuring the voltage on C2, C3, C6 and C7. The resistance shall be 10 kohms when measuring the voltage on C1.

### 4.3.4 Contact pressure

The contact pressure shall be large enough to ensure reliable and continuous contact (e.g. to overcome oxidation and to prevent interruption caused by vibration). The radius of any curvature of the contacting elements shall be greater than or equal to 0,8 mm over the contact area.

Under no circumstances may a contact force be greater than 0,5 N per contact.

Care shall be taken to avoid undue point pressure to the area of the SIM opposite to the contact area. Otherwise this may damage the components within the SIM.

## 4.4 Precedence

See TS 02.17 [6] for precedence.

## 4.5 Static Protection

Considering that the SIM is a CMOS device, the ME manufacturer shall take adequate precautions (in addition to the protection diodes inherent in the SIM) to safeguard the ME, SIM and SIM/ME interface from static discharges at all times, and particularly during SIM insertion into the ME.

---

# 5 Electronic signals and transmission protocols

Electronic signals and transmission protocols shall be in accordance with ISO/IEC 7816-3 [26] unless specified otherwise. The following additional requirements shall be applied to ensure proper operation in the GSM environment.

The choice of the transmission protocol(s), to be used to communicate between the SIM and the ME, shall at least include that specified and denoted by T=0 in ISO/IEC 7816-3 [26].

The values given in the tables hereafter are derived from ISO/IEC 7816-3 [26] with the following considerations:

- $V_{OH}$  and  $V_{OL}$  always refer to the device (ME or SIM) which is driving the interface.  $V_{IH}$  and  $V_{IL}$  always refer to the device (ME or SIM) which is operating as a receiver on the interface.
- this convention is different to the one used in ISO/IEC 7816-3 [26], which specifically defines an ICC for which its current conventions apply. The following clauses define the specific core requirements for the SIM, which provide also the basis for Type Approval. For each state ( $V_{OH}$ ,  $V_{IH}$ ,  $V_{IL}$  and  $V_{OL}$ ) a positive current is defined as flowing out of the entity (ME or SIM) in that state.

## 5.1 Supply voltage $V_{cc}$ (contact C1)

The SIM shall be operated within the following limits.

**Table 1: Electrical characteristics of  $V_{cc}$  under normal operating conditions**

Symbol	Minimum	Maximum	Unit
$V_{cc}$	4,5	5,5	V
$I_{cc}$		10	mA

The current consumption of the SIM shall not exceed the value given in table 1 during any state (including activation and deactivation as defined in subclause 4.3.2).

When the SIM is in idle state (see below) the current consumption of the card shall not exceed 200  $\mu$ A at 1 MHz and 25°C. If clock stop mode is allowed, then the current consumption shall also not exceed 200  $\mu$ A while the clock is stopped.

The ME shall source the maximum current requirements defined above. It shall also be able to counteract spikes in the current consumption of the card up to a maximum charge of 40 nAs with no more than 400 ns duration and an amplitude of at most 200 mA, ensuring that the supply voltage stays in the specified range.

NOTE: A possible solution would be to place a capacitor (e.g. 100 nF, ceramic) as close as possible to the contacting elements.

## 5.2 Reset (RST) (contact C2)

The ME shall operate the SIM within the following limits.

**Table 2: Electrical characteristics of RST under normal operating conditions**

Symbol	Conditions	Minimum	Maximum
$V_{OH}$	$I_{OHmax} = +20 \mu A$	$V_{cc}-0,7$	$V_{cc}$ (note)
$V_{OL}$	$I_{OLmax} = -200 \mu A$	0V (note)	0,6 V
$t_R t_F$	$C_{out} = C_{in} = 30 pF$		400 $\mu s$
NOTE: To allow for overshoot the voltage on RST shall remain between -0,3 V and $V_{cc}+0,3$ V during dynamic operation.			

## 5.3 Programming voltage $V_{pp}$ (contact C6)

SIMs shall not require any programming voltage on  $V_{pp}$ . The ME need not provide contact C6. If the ME provides contact C6, then, in the case of the ID-1 SIM the same voltage shall be supplied on  $V_{pp}$  as on  $V_{cc}$ , while in the case of Plug-in SIMs the ME need not provide any voltage on C6. Contact C6 may be connected to  $V_{cc}$  in any ME but shall not be connected to ground.

## 5.4 Clock CLK (contact C3)

The SIM shall support 1 MHz to 5 MHz. The clock shall be supplied by the ME. No "internal clock" SIMs shall be used.

If a frequency of 13/4 MHz is needed by the SIM to run the authentication procedure in the allotted time (see TS 03.20 [11]), or to process an ENVELOPE command used for SIM Data Download, bit 2 of byte 1 in the file characteristics shall be set to 1. Otherwise a minimum frequency of 13/8 MHz may be used.

The duty cycle shall be between 40 % and 60 % of the period during stable operation.

The ME shall operate the SIM within the following limits:

**Table 3: Electrical characteristics of CLK under normal operating conditions**

Symbol	Conditions	Minimum	Maximum
$V_{OH}$	$I_{OHmax} = +20 \mu A$	$0,7 \times V_{cc}$	$V_{cc}$ (note)
$V_{OL}$	$I_{OLmax} = -200 \mu A$	0 V (note)	0,5 V
$t_R t_F$	$C_{out} = C_{in} = 30 pF$		9 % of period with a maximum of 0,5 $\mu s$
NOTE: To allow for overshoot the voltage on CLK shall remain between -0,3 V and $V_{cc}+0,3$ V during dynamic operation.			

## 5.5 I/O (contact C7)

Table 4 defines the electrical characteristics of the I/O (contact C7). The values given in the table have the effect of defining the values of the pull-up resistor in the ME and the impedances of the drivers and receivers in the ME and SIM.

**Table 4: Electrical characteristics of I/O under normal operating conditions**

Symbol	Conditions	Minimum	Maximum
$V_{IH}$	$I_{IHmax} = \pm 20 \mu A$ (note 2)	$0,7 \times V_{CC}$	$V_{CC} + 0,3 V$
$V_{IL}$	$I_{ILmax} = +1 mA$	$-0,3 V$	$0,8 V$
$V_{OH}$ (note 1)	$I_{OHmax} = + 20 \mu A$	$3,8 V$	$V_{CC}$ (note 3)
$V_{OL}$	$I_{OLmax} = -1 mA$	$0 V$ (note 3)	$0,4 V$
$t_R$ $t_F$	$C_{out} = C_{in} = 30 pF$		$1 \mu s$
NOTE 1: It is assumed that a pull-up resistor is used in the interface device (recommended value: 20 kohms).			
NOTE 2: During static conditions (idle state) only the positive value can apply. Under dynamic operating conditions (transmission) short term voltage spikes on the I/O line may cause a current reversal.			
NOTE 3: To allow for overshoot the voltage on I/O shall remain between $-0,3 V$ and $V_{CC} + 0,3 V$ during dynamic operation.			

## 5.6 States

There are two states for the SIM while the power supply is on:

- the SIM is in operating state when it executes a command. This state also includes transmission from and to the ME;
- the SIM is in idle state at any other time. It shall retain all pertinent data during this state.

The SIM may support a clock stop mode. The clock shall only be switched off subject to the conditions specified in the file characteristics (see clause 9).

Clock stop mode. An ME of Phase 2 or later shall wait at least 1 860 clock cycles after having received the last character, including the guard time (2 etu), of the response before it switches off the clock (if it is allowed to do so). It shall wait at least 744 clock cycles before it sends the first command after having started the clock.

To achieve phase compatibility, the following procedure shall be adhered to:

- a SIM of Phase 2 or later shall always send the status information "normal ending of the command" after the successful interpretation of the command SLEEP received from a Phase 1 ME. An ME of Phase 2 or later shall not send a SLEEP command;
- a Phase 1 ME shall wait at least 744 clock cycles after having received the compulsory acknowledgement SW1 SW2 of the SLEEP command before it switches off the clock (if it is allowed to do so). It shall wait at least 744 clock cycles before it sends the first command after having started the clock.

## 5.7 Baudrate

The initial baudrate (during ATR) shall be:  $(\text{clock frequency})/372$ . Subsequent baudrate shall be:  $(\text{clock frequency})/372$  unless the PPS procedure has been successfully performed. In that case the negotiated baudrate shall be applied according to subclause 5.8.2.

## 5.8 Answer To Reset (ATR)

The ATR is information presented by the SIM to the ME at the beginning of the card session and gives operational requirements.

### 5.8.1 Structure and contents

The following table gives an explanation of the characters specified in ISO/IEC 7816-3 [26] and the requirements for their use in GSM. The answer to reset consists of at most 33 characters. The ME shall be able to receive interface characters for transmission protocols other than T=0, historical characters and a check byte, even if only T=0 is used by the ME.

Table 5: ATR

Character	Contents	sent by the card	a) evaluation by the ME b) reaction by the ME
1. Initial character TS	coding convention for all subsequent characters (direct or inverse convention)	always	a) always b) using appropriate convention
2. Format character T0	subsequent interface characters, number of historical characters	always	a) always b) identifying the subsequent characters accordingly
3. Interface character (global) TA1	parameters to calculate the work etu	optional	a) always if present b) if TA1 is not '11' or '01', PPS procedure shall be used (see subclause 5.8.2)
4. Interface character (global) TB1	parameters to calculate the programming voltage and current	optional	a) always if present b) if PI1 is not 0, then reject the SIM (in accordance with subclause 5.10)
5. Interface character (global) TC1	parameters to calculate the extra guardtime requested by the card; no extra guardtime is used to send characters from the card to the ME	optional	a) always if present b) if TC1 is neither 0 nor 255, then reject the SIM (in accordance with subclause 5.10); see the note after the table
6. Interface character TD1	protocol type; indicator for the presence of interface characters, specifying rules to be used for transmissions with the given protocol type	always, if T=15 indicated in TD <sub>i</sub> (i>1)	a) always if present b) identifying the subsequent characters accordingly
7. Interface character (specific) TA2	not used for protocol T=0	optional	a) optional b) -----
8. Interface character (global) TB2	parameter to calculate the programming voltage	never	the allowed value of TB1 above defines that an external programming voltage is not applicable
9. Interface character (specific) TC2	parameters to calculate the work waiting time	optional	a) always if present b) using the work waiting time accordingly
10. Interface character TD <sub>i</sub> (i>1)	protocol type; indicator for the presence of interface characters, specifying rules to be used for transmissions with the given protocol type	optional	a) always if present b) identifying the subsequent characters accordingly

(continued)

Table 5 (concluded): ATR

Character	Contents	sent by the card	a) evaluation by the ME b) reaction by the ME
11. Interface character  TA <sub>i</sub> , TB <sub>i</sub> , TC <sub>i</sub> (i>2)	characters which contain interface characters for other transmission protocols. If TD(i-1) indicates T=15, TA <sub>i</sub> is interpreted as global interface character	Always if TD(i-1) indicates T=15. Optional otherwise.	a) always  b) If T=15 is indicated in TD(i-1), TA <sub>i</sub> indicates: X1 clock stop indicator (b8 to b7) UI class indicator (b6 to b1)
12. Historical characters  T1,...,TK	contents not specified in ISO/IEC	optional	a) optional  b) -----
13. Check character  TCK	check byte (exclusive -ORing)	not sent if only T=0 is indicated in the ATR. If T=0 and T=15 are present and in all other cases, TCK shall be sent	a) optional  b) -----
NOTE: According to ISO/IEC 7816-3 [26], N=255 indicates that the minimum delay is 12 etu for the asynchronous half-duplex character transmission protocol. If '01' is indicated in TA1, PPS should be supported by the SIM to allow backward compatibility with existing MEs. For the interpretation of '01', see ISO/IEC 7816-3 [26].			

### 5.8.2 PPS procedure

Specifically related to this Technical Specification the PPS procedure according to ISO/IEC 7816-3 [26], is applied, only if TA1 is not equal to '11' or '01', as follows:

a) for MEs only supporting default speed (F=372, D=1)

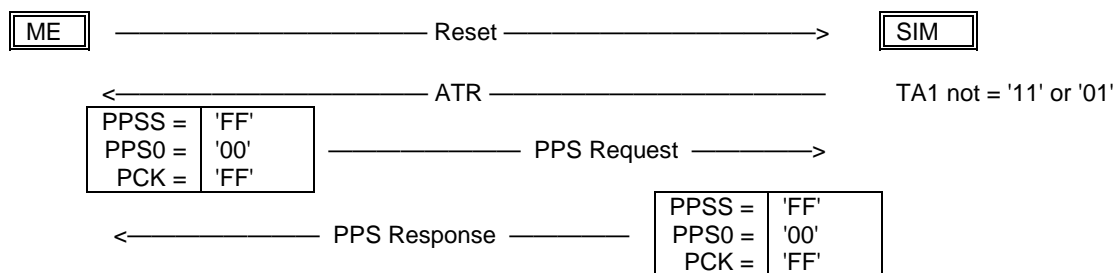
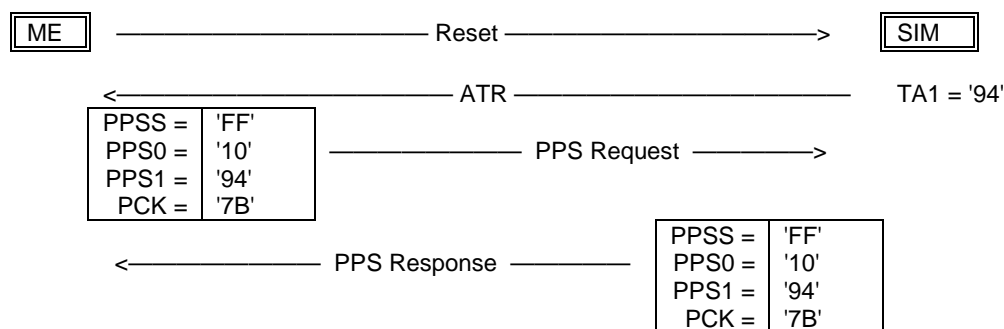

Figure 1: PPS procedure

PPS Request and PPS Response consist of the three (3) characters PPSS, PPSO and PCK of which PPSS is sent first. After this procedure the protocol T=0 and the parameters F=372, D=1 and N=0 shall be used.

b) for MEs only supporting enhanced speed (F=512, D=8)



**Figure 2: PPS procedure requesting enhanced speed values (F=512, D=8, see clause 5.8.3)**

PPS Request and PPS Response consist of the four (4) characters PPSS, PPS0, PPS1 and PCK, of which PPSS is sent first.

After this procedure, the protocol T=0 and the parameters F=512, D=8 and N=0 shall be used.

### 5.8.3 Speed enhancement

If speed enhancement is implemented, the ME and the SIM shall at least support F=512 and D=8 in addition to F=372 and D=1. However, other values may also be supported. If the ME requests PPS using values other than those above then the PPS procedure shall be initiated accordingly.

The SIM shall support the default value (F=372 and D=1). If the speed enhancement is supported by the SIM it is mandatory that F=512 and D=8 is supported. However, the value in TA1 may even indicate a faster speed (F=512 and D=16). The SIM may also support other values between the default value (F=372 and D=1) and the values indicated in TA1. The SIM shall offer the negotiable mode, to ensure backwards compatibility with existing MEs. In the negotiable mode the SIM will use default values even if other parameters are offered in the ATR if the PPS procedure is not initiated.

The ME shall support the default value (F=372 and D=1). If the speed enhancement is supported in the ME it is mandatory to support F=512 and D=8. The ME may additionally support other values.

If the SIM does not answer the PPS request within the initial waiting time the ME shall reset the SIM. After two failed PPS attempts using F=512 and D=8 or values indicated in TA1, (no PPS response from the SIM) the ME shall initiate PPS procedure using default values. If this also fails (no PPS response from the SIM) the ME may proceed using default values without requesting PPS.

If the SIM does not support the values requested by the ME, the SIM shall respond to the PPS request indicating the use of default values.

## 5.9 Bit/character duration and sampling time

The bit/character duration and sampling time specified in ISO/IEC 7816-3 [26], are valid for all communications.

## 5.10 Error handling

Following receipt of an ATR, which is not in accordance with this specification, e.g. because of forbidden ATR characters or too few bytes being transmitted, the ME shall perform a Reset. The ME shall not reject the SIM until at least three consecutive wrong ATRs are received.

During the transmission of the ATR and the protocol type selection, the error detection and character repetition procedure specified in ISO/IEC 7816-3 [26], is optional for the ME. For the subsequent transmission on the basis of T=0 this procedure is mandatory for the ME.

For the SIM the error detection and character repetition procedure is mandatory for all communications.

## 6 Logical Model

This clause describes the logical structure for a SIM, the code associated with it, and the structure of files used.

### 6.1 General description

Figure 3 shows the general structural relationships which may exist between files. The files are organized in a hierarchical structure and are of one of three types as defined below. These files may be either administrative or application specific. The operating system handles the access to the data stored in different files.

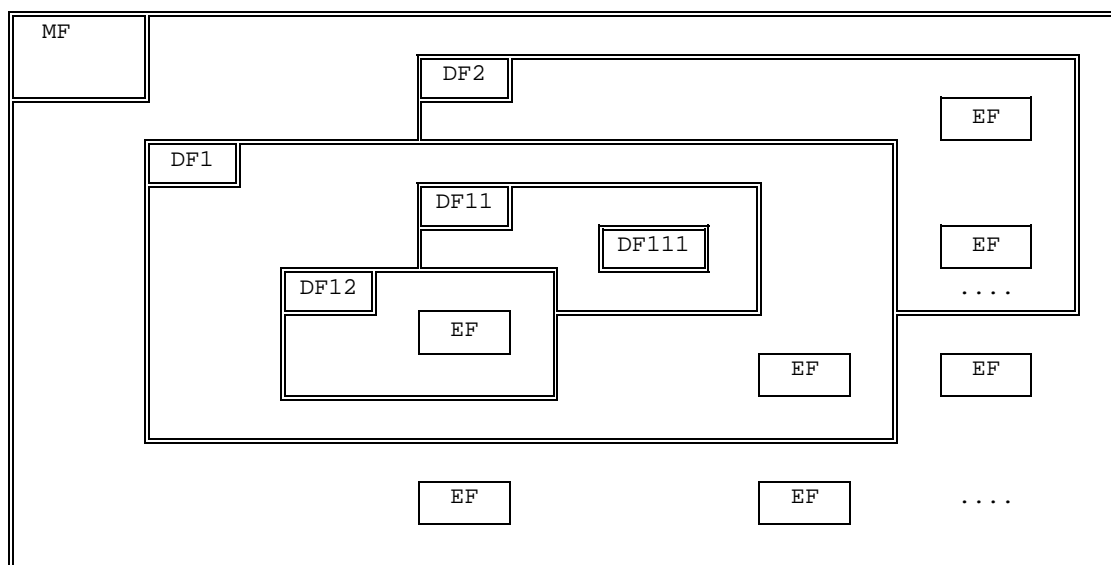

**Figure 3: Organization of memory**

Files are composed of a header, which is internally managed by the SIM, and optionally a body part. The information of the header is related to the structure and attributes of the file and may be obtained by using the commands GET RESPONSE or STATUS. This information is fixed during the administrative phase. The body part contains the data of the file.

### 6.2 File identifier

A file ID is used to address or identify each specific file. The file ID consists of two bytes and shall be coded in hexadecimal notation. They are specified in clause 10.

The first byte identifies the type of file, and for GSM is:

- '3F': Master File;
- '7F': 1<sup>st</sup> level Dedicated File;
- '5F': 2<sup>nd</sup> level Dedicated File;
- '2F': Elementary File under the Master File;
- '6F': Elementary File under a 1<sup>st</sup> level Dedicated File;
- '4F': Elementary File under 2<sup>nd</sup> level Dedicated File.

File IDs shall be subject to the following conditions:

- the file ID shall be assigned at the time of creation of the file concerned;
- no two files under the same parent shall have the same ID;



- a child and any parent, either immediate or remote in the hierarchy, e.g. grandparent, shall never have the same file ID.

In this way each file is uniquely identified.

## 6.3 Dedicated files

A Dedicated File (DF) is a functional grouping of files consisting of itself and all those files which contain this DF in their parental hierarchy (that is to say it consists of the DF and its complete "subtree"). A DF "consists" only of a header part.

Four 1<sup>st</sup> level DFs are defined in this specification:

- DF<sub>GSM</sub> which contains the applications for both GSM and/or DCS 1800;
- DF<sub>IS41</sub> which contains the applications for IS-41 as specified by ANSI T1P1;
- DF<sub>TELECOM</sub> which contains telecom service features;
- DF<sub>FP-CTS</sub> which contains the applications for the CTS fixed part (see TS 11.19 [34]).

All four files are immediate children of the Master File (MF) and may coexist on a multi-application card.

2<sup>nd</sup> level DFs are defined in this specification under DF<sub>GSM</sub>.

All 2<sup>nd</sup> level DFs are immediate children of the DF<sub>GSM</sub> and may coexist on a multi-application card.

## 6.4 Elementary files

An Elementary File (EF) is composed of a header and a body part. The following three structures of an EF are used by GSM.

A file is associated with attributes that depending of the file type indicates how data is to be accessed e.g. file size, record length etc. Although in the present document some files and data structures stored in a file are indicated as having a fixed length; when reading such structures the terminal shall derive the length of the structure from the attributes provided in the file information i.e. not use the fixed value specified for the file in the present document. Although the terminal is able to read the entire structure it should only use those elements from the structure which is recognised by the terminal.

### 6.4.1 Transparent EF

An EF with a transparent structure consists of a sequence of bytes. When reading or updating, the sequence of bytes to be acted upon is referenced by a relative address (offset), which indicates the start position (in bytes), and the number of bytes to be read or updated. The first byte of a transparent EF has the relative address '00 00'. The total data length of the body of the EF is indicated in the header of the EF.

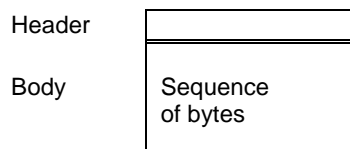

NOTE: This structure was previously referred to as "binary" in GSM.

**Figure 4: Structure of a transparent EF**

## 6.4.2 Linear fixed EF

An EF with linear fixed structure consists of a sequence of records all having the same (fixed) length. The first record is record number 1. The length of a record as well as this value multiplied by the number of records are indicated in the header of the EF.

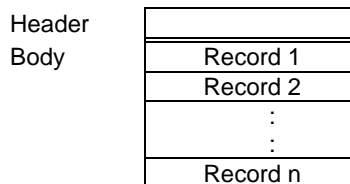

**Figure 5: Structure of a linear fixed file**

There are several methods to access records within an EF of this type:

- absolutely using the record number;
- when the record pointer is not set it shall be possible to perform an action on the first or the last record by using the NEXT or PREVIOUS mode;
- when the record pointer is set it shall be possible to perform an action on this record, the next record (unless the record pointer is set to the last record) or the previous record (unless the record pointer is set to the first record);
- by identifying a record using pattern seek starting:
  - forwards from the beginning of the file;
  - forwards from the record following the one at which the record pointer is set (unless the record pointer is set to the last record);
  - backwards from the end of the file;
  - backwards from the record preceding the one at which the record pointer is set (unless the record pointer is set to the first record).

If an action following selection of a record is aborted, then the record pointer shall remain set at the record at which it was set prior to the action. According to ISO/IEC 7816-4 [35] it is not possible to have more than 254 records in a file of this type, and each record can not be more than 255 bytes using the short command APDU format.

NOTE: This structure was previously referred to as "formatted" in GSM.

## 6.4.3 Cyclic EF

Cyclic files are used for storing records in chronological order. When all records have been used for storage, then the next storage of data shall overwrite the oldest information.

An EF with a cyclic structure consists of a fixed number of records with the same (fixed) length. In this file structure there is a link between the last record (n) and the first record. When the record pointer is set to the last record n, then the next record is record 1. Similarly, when the record pointer is set to record 1, then the previous record is record n. The last updated record containing the newest data is record number 1, and the oldest data is held in record number n.

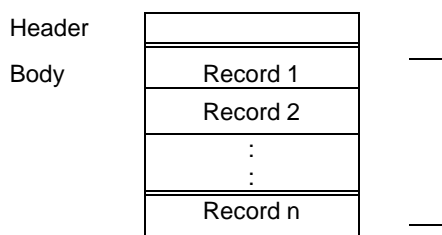

**Figure 6: Structure of a cyclic file**

For update operations only PREVIOUS record shall be used. For reading operations, the methods of addressing are Next, Previous, Current and Record Number.

After selection of a cyclic file (for either operation), the record pointer shall address the record updated or increased last. If an action following selection of a record is aborted, then the record pointer shall remain set at the record at which it was set prior to the action.

NOTE: It is not possible, at present, to have more than 255 records in a file of this type, and each record cannot be greater than 255 bytes.

## 6.5 Methods for selecting a file

After the Answer To Reset (ATR), the Master File (MF) is implicitly selected and becomes the Current Directory. Each file may then be selected by using the SELECT function in accordance with the following rules.

Selecting a DF or the MF sets the Current Directory. After such a selection there is no current EF. Selecting an EF sets the current EF and the Current Directory remains the DF or MF which is the parent of this EF. The current EF is always a child of the Current Directory.

Any application specific command shall only be operable if it is specific to the Current Directory.

The following files may be selected from the last selected file:

- any file which is an immediate child of the Current Directory;
- any DF which is an immediate child of the parent of the current DF;
- the parent of the Current Directory;
- the current DF;
- the MF.

This means in particular that a DF shall be selected prior to the selection of any of its EFs. All selections are made using the file ID.

The following figure gives the logical structure for the GSM application. GSM defines only two levels of DFs under the MF.

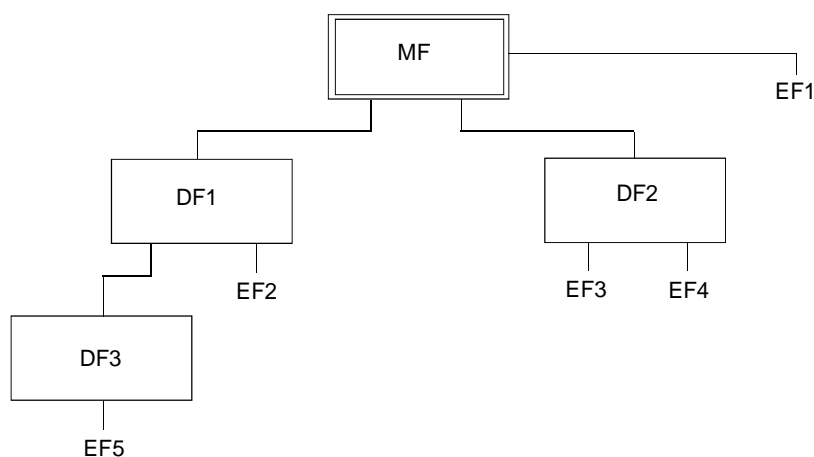

**Figure 7: Logical structure**

The following table gives the valid selections for GSM for the logical structure in figure 7. Reselection of the last selected file is also allowed but not shown.

Table 6: File selection

Last selected file	Valid Selections
MF	DF1, DF2, EF1
DF1	MF, DF2, DF3, EF2
DF2	MF, DF1, EF3, EF4
DF3	MF, DF1, EF5
EF1	MF, DF1, DF2
EF2	MF, DF1, DF2, DF3
EF3	MF, DF1, DF2, EF4
EF5	MF, DF1, DF3

## 6.6 Reservation of file IDs

In addition to the identifiers used for the files specified in the present document, the following file IDs are reserved for use by GSM.

Dedicated Files:

- administrative use:

'7F 4X', '5F1X', '5F2X'

- operational use:

'7F 10' (DF<sub>TELECOM</sub>), '7F 20' (DF<sub>GSM</sub>), '7F 21' (DF<sub>DCS1800</sub>), '7F 22' (DF<sub>IS-41</sub>), '7F 23' (DF<sub>FP-CTS</sub>) (see TS 11.19 [34]), '7F 24' (DF<sub>TIA/EIA-136</sub>), '7F 25' (DF<sub>TIA/EIA-95</sub>), and '7F 2X', where X ranges from '6' to 'F'.

NOTE: '7F 80' (DF<sub>PDC</sub>) is used in the Japanese PDC specification.

'7F 90' (DF<sub>TETRA</sub>) is used in the ETSI TETRA specification [44]

'7F 31' (DF<sub>IDEN</sub>) is used in the iDEN specification.

- reserved under '7F10':

'5F50' (DF<sub>GRAPHICS</sub>)

- reserved under '7F20':

'5F30' (DF<sub>IRIDIUM</sub>), '5F31' (DF<sub>Globalstar</sub>), '5F32' (DF<sub>ICO</sub>), '5F33' (DF<sub>ACeS</sub>), '5F3C' (DF<sub>MExE</sub>), '5F3X', where X ranges from '4' to 'B' and 'D' to 'F';

'5F40'(DF<sub>EIA/TIA-553</sub>), '5F4Y' where Y ranges from '1' to 'F';

'5F5X' where X ranges from '0' to 'F';

'5F60'(DF<sub>CTS</sub>), '5F6Y' where Y ranges from '1' to 'F';

'5F70' (DF<sub>SoLSA</sub>), '5F7Y' where Y ranges from '1' to 'F';

'5FYX' where Y ranges from '8' to 'F' and X from '0' to 'F'.

Elementary files:

- administrative use:

'6F XX' in the DFs '7F 4X'; '4F XX' in the DFs '5F 1X', '5F2X'

'6F 1X' in the DFs '7F 10', '7F 20', '7F 21';

'4F 1X' in all 2<sup>nd</sup> level DFs

'2F 01', '2F EX' in the MF '3F 00';

- operational use:

'6F 2X', '6F 3X', '6F 4X' in '7F 10' and '7F 2X';  
'4F YX', where Y ranges from '2' to 'F' in all 2<sup>nd</sup> level DFs.  
'2F 1X' in the MF '3F 00'.

In all the above, X ranges, unless otherwise stated, from '0' to 'F'.

---

## 7 Security features

The security aspects of GSM are described in the normative references TS 02.09 [4] and TS 03.20 [11]. This clause gives information related to security features supported by the SIM to enable the following:

- authentication of the subscriber identity to the network;
- data confidentiality over the radio interface;
- file access conditions.

### 7.1 Authentication and cipher key generation procedure

This subclause describes the authentication mechanism and cipher key generation which are invoked by the network. For the specification of the corresponding procedures across the SIM/ME interface see clause 11.

The network sends a Random Number (RAND) to the MS. The ME passes the RAND to the SIM in the command RUN GSM ALGORITHM. The SIM returns the values SRES and Kc to the ME which are derived using the algorithms and processes given below. The ME sends SRES to the network. The network compares this value with the value of SRES which it calculates for itself. The comparison of these SRES values provides the authentication. The value Kc is used by the ME in any future enciphered communications with the network until the next invocation of this mechanism.

A subscriber authentication key Ki is used in this procedure. This key Ki has a length of 128 bits and is stored within the SIM for use in the algorithms described below.

### 7.2 Algorithms and processes

The names and parameters of the algorithms supported by the SIM are defined in TS 03.20 [11]. These are:

- Algorithm A3 to authenticate the MS to the network;
- Algorithm A8 to generate the encryption key.

These algorithms may exist either discretely or combined (into A38) within the SIM. In either case the output on the SIM/ME interface is 12 bytes. The inputs to both A3 and A8, or A38, are Ki (128 bits) internally derived in the SIM, and RAND (128 bits) across the SIM/ME interface. The output is SRES (32 bits)/Kc (64 bits) the coding of which is defined in the command RUN GSM ALGORITHM in clause 9.

### 7.3 File access conditions

Every file has its own specific access condition for each command. The relevant access condition of the last selected file shall be fulfilled before the requested action can take place.

For each file:

- the access conditions for the commands READ and SEEK are identical;
- the access conditions for the commands SELECT and STATUS are ALWAYS.

No file access conditions are currently assigned by GSM to the MF and the DFs.

The access condition levels are defined in the following table:

**Table 7: Access condition level coding**

Level	Access Condition
0	ALWays
1	CHV1
2	CHV2
3	Reserved for GSM Future Use
4 to 14	ADM
15	NEVer

The meaning of the file access conditions is as follows:

**ALWAYS:** The action can be performed without any restriction;

**CHV1** (card holder verification 1): The action shall only be possible if one of the following three conditions is fulfilled:

- a correct CHV1 value has already been presented to the SIM during the current session;
- the CHV1 enabled/disabled indicator is set to "disabled";

NOTE: Some Phase 1 and Phase 2 SIMs do not necessarily grant access when CHV1 is "disabled" and "blocked".

- UNBLOCK CHV1 has been successfully performed during the current session;

**CHV2:** The action shall only be possible if one of the following two conditions is fulfilled:

- a correct CHV2 value has already been presented to the SIM during the current session;
- UNBLOCK CHV2 has been successfully performed during the current session;

**ADM:** Allocation of these levels and the respective requirements for their fulfilment are the responsibility of the appropriate administrative authority

The definition of access condition ADM does not preclude the administrative authority from using ALW, CHV1, CHV2 and NEV if required.

**NEVER:** The action cannot be performed over the SIM/ME interface. The SIM may perform the action internally.

Condition levels are not hierarchical. For instance, correct presentation of CHV2 does not allow actions to be performed which require presentation of CHV1. A condition level which has been satisfied remains valid until the end of the GSM session as long as the corresponding secret code remains unblocked, i.e. after three consecutive wrong attempts, not necessarily in the same card session, the access rights previously granted by this secret code are lost immediately. A satisfied CHV condition level applies to both DF<sub>GSM</sub> and DF<sub>TELECOM</sub>.

The ME shall determine whether CHV2 is available by using the response to the STATUS command. If CHV2 is "not initialized" then CHV2 commands, e.g. VERIFY CHV2, shall not be executable.

---

## 8 Description of the functions

This clause gives a functional description of the commands and their respective responses. Associated status conditions, error codes and their corresponding coding are specified in clause 9.

It shall be mandatory for all cards complying with this Standard to support all functions described in this Standard. The command GET RESPONSE which is needed for the protocol T=0 is specified in clause 9.

The following table lists the file types and structures together with the functions which may act on them during a GSM session. These are indicated by an asterisk (\*).

Table 8: Functions on files in GSM session

Function	File				
	MF	DF	EF transparent	EF linear fixed	EF cyclic
SELECT	*	*	*	*	*
STATUS	*	*	*	*	*
READ BINARY			*		
UPDATE BINARY			*		
READ RECORD				*	*
UPDATE RECORD				*	*
SEEK				*	
INCREASE					*
INVALIDATE			*	*	*
REHABILITATE			*	*	*

## 8.1 SELECT

This function selects a file according to the methods described in clause 6. After a successful selection the record pointer in a linear fixed file is undefined. The record pointer in a cyclic file shall address the last record which has been updated or increased.

Input:

- file ID.

Output:

- if the selected file is the MF or a DF:
  - file ID, total memory space available, CHV enabled/disabled indicator, CHV status and other GSM specific data;
- if the selected file is an EF:
  - file ID, file size, access conditions, invalidated/not invalidated indicator, structure of EF and length of the records in case of linear fixed structure or cyclic structure.

## 8.2 STATUS

This function returns information concerning the current directory. A current EF is not affected by the STATUS function. It is also used to give an opportunity for a pro-active SIM to indicate that the SIM wants to issue a SIM Application Toolkit command to the ME.

Input:

- none.

Output:

- file ID, total memory space available, CHV enabled/disabled indicator, CHV status and other GSM specific data (identical to SELECT above).

## 8.3 READ BINARY

This function reads a string of bytes from the current transparent EF. This function shall only be performed if the READ access condition for this EF is satisfied.

Input:

- relative address and the length of the string.

Output:

- string of bytes.

## 8.4 UPDATE BINARY

This function updates the current transparent EF with a string of bytes. This function shall only be performed if the UPDATE access condition for this EF is satisfied. An update can be considered as a replacement of the string already present in the EF by the string given in the update command.

Input:

- relative address and the length of the string;
- string of bytes.

Output:

- none.

## 8.5 READ RECORD

This function reads one complete record in the current linear fixed or cyclic EF. The record to be read is described by the modes below. This function shall only be performed if the READ access condition for this EF is satisfied. The record pointer shall not be changed by an unsuccessful READ RECORD function.

Four modes are defined:

**CURRENT:** The current record is read. The record pointer is not affected.

**ABSOLUTE:** The record given by the record number is read. The record pointer is not affected.

**NEXT:** The record pointer is incremented before the READ RECORD function is performed and the pointed record is read. If the record pointer has not been previously set within the selected EF, then READ RECORD (next) shall read the first record and set the record pointer to this record.

If the record pointer addresses the last record in a linear fixed EF, READ RECORD (next) shall not cause the record pointer to be changed, and no data shall be read.

If the record pointer addresses the last record in a cyclic EF, READ RECORD (next) shall set the record pointer to the first record in this EF and this record shall be read.

**PREVIOUS:** The record pointer is decremented before the READ RECORD function is performed and the pointed record is read. If the record pointer has not been previously set within the selected EF, then READ RECORD (previous) shall read the last record and set the record pointer to this record.

If the record pointer addresses the first record in a linear fixed EF, READ RECORD (previous) shall not cause the record pointer to be changed, and no data shall be read.

If the record pointer addresses the first record in a cyclic EF, READ RECORD (previous) shall set the record pointer to the last record in this EF and this record shall be read.

Input:

- mode, record number (absolute mode only) and the length of the record.

Output:

- the record.



## 8.6 UPDATE RECORD

This function updates one complete record in the current linear fixed or cyclic EF. This function shall only be performed if the UPDATE access condition for this EF is satisfied. The UPDATE can be considered as a replacement of the relevant record data of the EF by the record data given in the command. The record pointer shall not be changed by an unsuccessful UPDATE RECORD function.

The record to be updated is described by the modes below. Four modes are defined of which only PREVIOUS is allowed for cyclic files:

**CURRENT:** The current record is updated. The record pointer is not affected.

**ABSOLUTE:** The record given by the record number is updated. The record pointer is not affected.

**NEXT:** The record pointer is incremented before the UPDATE RECORD function is performed and the pointed record is updated. If the record pointer has not been previously set within the selected EF, then UPDATE RECORD (next) shall set the record pointer to the first record in this EF and this record shall be updated. If the record pointer addresses the last record in a linear fixed EF, UPDATE RECORD (next) shall not cause the record pointer to be changed, and no record shall be updated.

**PREVIOUS:** For a linear fixed EF the record pointer is decremented before the UPDATE RECORD function is performed and the pointed record is updated. If the record pointer has not been previously set within the selected EF, then UPDATE RECORD (previous) shall set the record pointer to the last record in this EF and this record shall be updated. If the record pointer addresses the first record in a linear fixed EF, UPDATE RECORD (previous) shall not cause the record pointer to be changed, and no record shall be updated.

For a cyclic EF the record containing the oldest data is updated, the record pointer is set to this record and this record becomes record number 1.

Input:

- mode, record number (absolute mode only) and the length of the record;
- the data used for updating the record.

Output:

- none.

## 8.7 SEEK

This function searches through the current linear fixed EF to find a record starting with the given pattern. This function shall only be performed if the READ access condition for this EF is satisfied. Two types of SEEK are defined:

**Type 1** The record pointer is set to the record containing the pattern, no output is available.

**Type 2** The record pointer is set to the record containing the pattern, the output is the record number.

NOTE: A Phase 1 SIM only executes type 1 of the SEEK function.

The SIM shall be able to accept any pattern length from 1 to 16 bytes inclusive. The length of the pattern shall not exceed the record length.

Four modes are defined:

- from the beginning forwards;
- from the end backwards;
- from the next location forwards;
- from the previous location backwards.

If the record pointer has not been previously set (its status is undefined) within the selected linear fixed EF, then the search begins:

- with the first record in the case of SEEK from the next location forwards; or
- with the last record in the case of SEEK from the previous location backwards.

After a successful SEEK, the record pointer is set to the record in which the pattern was found. The record pointer shall not be changed by an unsuccessful SEEK function.

Input:

- type and mode;
- pattern;
- length of the pattern.

Output:

- type 1: none;
- type 2: status/record number

## 8.8 INCREASE

This function adds the value given by the ME to the value of the last increased/updated record of the current cyclic EF, and stores the result into the oldest record. The record pointer is set to this record and this record becomes record number 1. This function shall be used only if this EF has an INCREASE access condition assigned and this condition is fulfilled (see bytes 8 and 10 in the response parameters/data of the current EF, clause 9). The SIM shall not perform the increase if the result would exceed the maximum value of the record (represented by all bytes set to 'FF').

Input:

- the value to be added.

Output:

- value of the increased record;
- value which has been added.

## 8.9 VERIFY CHV

This function verifies the CHV presented by the ME by comparing it with the relevant one stored in the SIM. The verification process is subject to the following conditions being fulfilled:

- CHV is not disabled;
- CHV is not blocked.

If the access condition for a function to be performed on the last selected file is CHV1 or CHV2, then a successful verification of the relevant CHV is required prior to the use of the function on this file unless the CHV is disabled.

If the CHV presented is correct, the number of remaining CHV attempts for that CHV shall be reset to its initial value 3.

If the CHV presented is false, the number of remaining CHV attempts for that CHV shall be decremented. After 3 consecutive false CHV presentations, not necessarily in the same card session, the respective CHV shall be blocked and the access condition can never be fulfilled until the UNBLOCK CHV function has been successfully performed on the respective CHV.

Input:

- indication CHV1/CHV2, CHV.

Output:

- none.

## 8.10 CHANGE CHV

This function assigns a new value to the relevant CHV subject to the following conditions being fulfilled:

- CHV is not disabled;
- CHV is not blocked.

The old and new CHV shall be presented.

If the old CHV presented is correct, the number of remaining CHV attempts for that CHV shall be reset to its initial value 3 and the new value for the CHV becomes valid.

If the old CHV presented is false, the number of remaining CHV attempts for that CHV shall be decremented and the value of the CHV is unchanged. After 3 consecutive false CHV presentations, not necessarily in the same card session, the respective CHV shall be blocked and the access condition can never be fulfilled until the UNBLOCK CHV function has been performed successfully on the respective CHV.

Input:

- indication CHV1/CHV2, old CHV, new CHV.

Output:

- none.

## 8.11 DISABLE CHV

This function may only be applied to CHV1. The successful execution of this function has the effect that files protected by CHV1 are now accessible as if they were marked "ALWAYS". The function DISABLE CHV shall not be executed by the SIM when CHV1 is already disabled or blocked.

If the CHV1 presented is correct, the number of remaining CHV1 attempts shall be reset to its initial value 3 and CHV1 shall be disabled.

If the CHV1 presented is false, the number of remaining CHV1 attempts shall be decremented and CHV1 remains enabled. After 3 consecutive false CHV1 presentations, not necessarily in the same card session, CHV1 shall be blocked and the access condition can never be fulfilled until the UNBLOCK CHV function has been successfully performed on CHV1.

Input:

- CHV1.

Output:

- none.

## 8.12 ENABLE CHV

This function may only be applied to CHV1. It is the reverse function of DISABLE CHV. The function ENABLE CHV shall not be executed by the SIM when CHV1 is already enabled or blocked.

If the CHV1 presented is correct, the number of remaining CHV1 attempts shall be reset to its initial value 3 and CHV1 shall be enabled.

If the CHV1 presented is false, the number of remaining CHV1 attempts shall be decremented and CHV1 remains disabled. After 3 consecutive false CHV1 presentations, not necessarily in the same card session, CHV1 shall be blocked and may optionally be set to "enabled". Once blocked, the CHV1 can only be unblocked using the UNBLOCK CHV function. If the CHV1 is blocked and "disabled", the access condition shall remain granted. If the CHV1 is blocked and "enabled", the access condition can never be fulfilled until the UNBLOCK CHV function has been successfully performed on CHV1.

## 8.13 UNBLOCK CHV

This function unblocks a CHV which has been blocked by 3 consecutive wrong CHV presentations. This function may be performed whether or not the relevant CHV is blocked.

If the UNBLOCK CHV presented is correct, the value of the CHV, presented together with the UNBLOCK CHV, is assigned to that CHV, the number of remaining UNBLOCK CHV attempts for that UNBLOCK CHV is reset to its initial value 10 and the number of remaining CHV attempts for that CHV is reset to its initial value 3. After a successful unblocking attempt the CHV is enabled and the relevant access condition level is satisfied.

If the presented UNBLOCK CHV is false, the number of remaining UNBLOCK CHV attempts for that UNBLOCK CHV shall be decremented. After 10 consecutive false UNBLOCK CHV presentations, not necessarily in the same card session, the respective UNBLOCK CHV shall be blocked. A false UNBLOCK CHV shall have no effect on the status of the respective CHV itself.

Input:

- indication CHV1/CHV2, the UNBLOCK CHV and the new CHV.

Output:

- none.

## 8.14 INVALIDATE

This function invalidates the current EF. After an INVALIDATE function the respective flag in the file status shall be changed accordingly. This function shall only be performed if the INVALIDATE access condition for the current EF is satisfied.

An invalidated file shall no longer be available within the application for any function except for the SELECT and the REHABILITATE functions unless the file status of the EF indicates that READ and UPDATE may also be performed.

Input:

- none.

Output:

- none.

## 8.15 REHABILITATE

This function rehabilitates the invalidated current EF. After a REHABILITATE function the respective flag in the file status shall be changed accordingly. This function shall only be performed if the REHABILITATE access condition for the current EF is satisfied.

If BDN is enabled (see subclause 11.5.1) then the REHABILITATE function shall not rehabilitate the invalidated EF<sub>IMSI</sub> and EF<sub>LOCI</sub> until the PROFILE DOWNLOAD procedure is performed indicating that the ME supports the "Call control by SIM" facility (see TS 11.14 [27]).

Input:

- none.

Output:

- none.

## 8.16 RUN GSM ALGORITHM

This function is used during the procedure for authenticating the SIM to a GSM network and to calculate a cipher key. The card runs the specified algorithms A3 and A8 using a 16 byte random number and the subscriber authentication key  $K_i$ , which is stored in the SIM. The function returns the calculated response SRES and the cipher key  $K_c$ .

The function shall not be executable unless  $DF_{GSM}$  or any sub-directory under  $DF_{GSM}$  has been selected as the Current Directory and a successful CHV1 verification procedure has been performed (see subclause 11.3.1).

Input:

- RAND.

Output:

- SRES,  $K_c$ .

The contents of  $K_c$  shall be presented to algorithm A5 by the ME in its full 64 bit format as delivered by the SIM.

## 8.17 SLEEP

This is an obsolete GSM function which was issued by Phase 1 MEs. The function shall not be used by an ME of Phase 2 or later.

## 8.18 TERMINAL PROFILE

This function is used by the ME to transmit to the SIM its capabilities concerning the SIM Application Toolkit functionality.

Input:

- terminal profile.

Output:

- none.

## 8.19 ENVELOPE

This function is used to transfer data to the SIM Application Toolkit applications in the SIM.

Input:

- data string.

Output:

- The structure of the data is defined in TS 11.14 [27].

## 8.20 FETCH

This function is used to transfer an Application Toolkit command from the SIM to the ME.

Input:

- none.

Output:

- data string containing an SIM Application Toolkit command for the ME.

## 8.21 TERMINAL RESPONSE

This function is used to transfer from the ME to the SIM the response to a previously fetched SIM Application Toolkit command.

Input:

- data string containing the response.

Output:

- none.

---

# 9 Description of the commands

This clause states the general principles for mapping the functions described in clause 8 onto Application Protocol Data Units which are used by the transmission protocol.

## 9.1 Mapping principles

An APDU can be a command APDU or a response APDU.

A command APDU has the following general format:

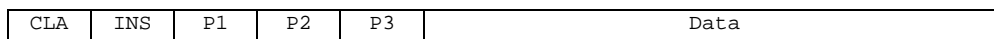

The response APDU has the following general format:

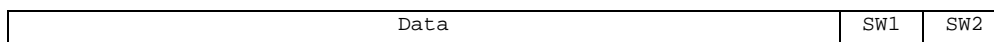

An APDU is transported by the T=0 transmission protocol without any change. Other protocols might embed an APDU into their own transport structure (ISO/IEC 7816-3 [26]).

The bytes have the following meaning:

- CLA is the class of instruction (ISO/IEC 7816-3 [26]), 'A0' is used in the GSM application;
- INS is the instruction code (ISO/IEC 7816-3 [26]) as defined in this subclause for each command;
- P1, P2, P3 are parameters for the instruction. They are specified in table 9. 'FF' is a valid value for P1, P2 and P3. P3 gives the length of the data element. P3='00' introduces a 256 byte data transfer from the SIM in an outgoing data transfer command (response direction). In an ingoing data transfer command (command direction), P3='00' introduces no transfer of data;
- SW1 and SW2 are the status words indicating the successful or unsuccessful outcome of the command.

For some of the functions described in clause 8 it is necessary for T=0 to use a supplementary transport service command (GET RESPONSE) to obtain the output data. For example, the SELECT function needs the following two commands:

- the first command (SELECT) has both parameters and data serving as input for the function;
- the second command (GET RESPONSE) has a parameter indicating the length of the data to be returned.

If the length of the response data is not known beforehand, then its correct length may be obtained by applying the first command and interpreting the status words. SW1 shall be '9F' and SW2 shall give the total length of the data. Other status words may be present in case of an error. The various cases are:

**Case 1: No input / No output****Case 2: No input / Output of known length**

NOTE: lgth='00' causes a data transfer of 256 bytes.

**Case 3: No Input / Output of unknown length**

GET RESPONSE

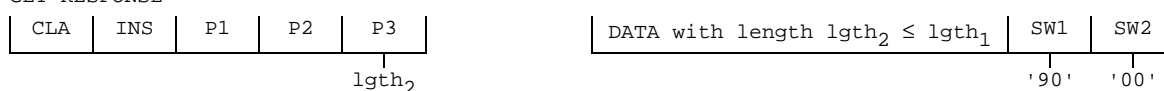
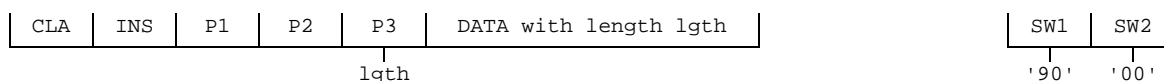
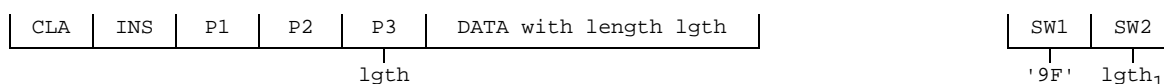
**Case 4: Input / No output****Case 5: Input / Output of known or unknown length**

GET RESPONSE

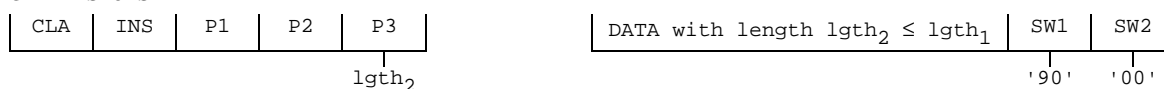

For cases 3 and 5, when SW1/SW2 indicates there is response data (i.e. SW1/SW2 = '9FXX'), then, if the ME requires to get this response data, it shall send a GET RESPONSE command as described in the relevant case above.

For case 5, in case of an ENVELOPE for SIM data download, SW1/SW2 may also indicate that there is response data with the value '9EXX', and the ME shall then send a GET RESPONSE command to get this response data.

If the GSM application is one of several applications in a multi-application card, other commands with CLA not equal to 'A0' may be sent by the terminal. This shall not influence the state of the GSM application.

The following diagrams show how the five cases of transmission protocol identified in the above diagrams can all be used to send pro-active SIM commands. For further information on the diagrams below see TS 11.14 [27].

**Case 1: No input / "OK" response with no output, plus additional command from SIM**

[Possible "normal GSM operation" command/response pairs]



NOTE: lgth<sub>1</sub>='00' causes a data transfer of 256 bytes.

**Case 2: No input / "OK" response with data of known length, plus additional command from SIM**



[Possible "normal GSM operation" command/response pairs]



NOTE: lgth='00' causes a data transfer of 256 bytes. The same applies to lgth<sub>1</sub>.

**Case 3: No Input / "OK" response with data of unknown length, plus additional command from SIM**



[Possible "normal GSM operation" command/response pairs]

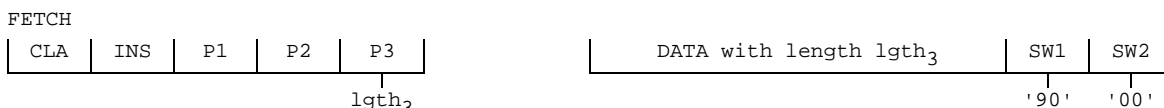

**Case 4: Input / "OK" response with no output data, plus additional command from SIM**

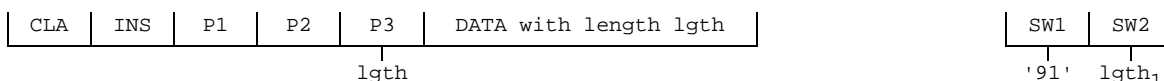

[Possible "normal GSM operation" command/response pairs]



**Case 5: Input / "OK" response with data of known or unknown length, plus additional command from SIM**

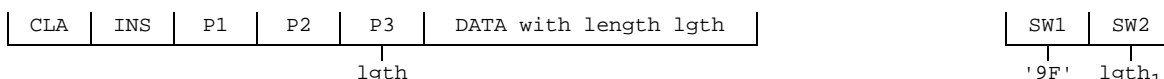



GET RESPONSE

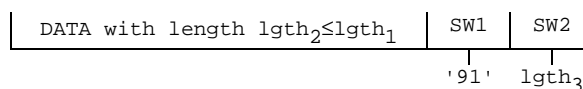
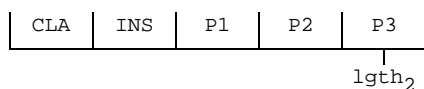

[Possible "normal GSM operation" command/response pairs]

FETCH

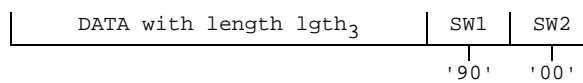
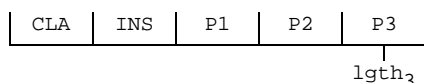

## 9.2 Coding of the commands

Table 9 below gives the coding of the commands. The direction of the data is indicated by (S) and (R), where (S) stands for data sent by the ME while (R) stands for data received by the ME. Offset is coded on 2 bytes where P1 gives the high order byte and P2 the low order byte. '00 00' means no offset and reading/updating starts with the first byte while an offset of '00 01' means that reading/updating starts with the second byte.

In addition to the instruction codes specified in table 9 the following codes are reserved:

GSM operational phase:

'1X' with X even, from X=6 to X=E.

Administrative management phase:

'2A', 'D0', 'D2', 'DE', 'C4', 'C6', 'C8', 'CA', 'CC', 'B4', 'B6', 'B8', 'BA' and 'BC'.

**Table 9: Coding of the commands**

COMMAND	INS	P1	P2	P3	S/R
SELECT	'A4'	'00'	'00'	'02'	S/R
STATUS	'F2'	'00'	'00'	lgth	R
READ BINARY	'B0'	offset high	offset low	lgth	R
UPDATE BINARY	'D6'	offset high	offset low	lgth	S
READ RECORD	'B2'	rec No.	mode	lgth	R
UPDATE RECORD	'DC'	rec No.	mode	lgth	S
SEEK	'A2'	'00'	type/mode	lgth	S/R
INCREASE	'32'	'00'	'00'	'03'	S/R
VERIFY CHV	'20'	'00'	CHV No.	'08'	S
CHANGE CHV	'24'	'00'	CHV No.	'10'	S
DISABLE CHV	'26'	'00'	'01'	'08'	S
ENABLE CHV	'28'	'00'	'01'	'08'	S
UNBLOCK CHV	'2C'	'00'	see note	'10'	S
INVALIDATE	'04'	'00'	'00'	'00'	-
REHABILITATE	'44'	'00'	'00'	'00'	-
RUN GSM ALGORITHM	'88'	'00'	'00'	'10'	S/R
SLEEP	'FA'	'00'	'00'	'00'	-
GET RESPONSE	'C0'	'00'	'00'	lgth	R
TERMINAL PROFILE	'10'	'00'	'00'	lgth	S
ENVELOPE	'C2'	'00'	'00'	lgth	S/R
FETCH	'12'	'00'	'00'	lgth	R
TERMINAL RESPONSE	'14'	'00'	'00'	lgth	S

NOTE: If the UNBLOCK CHV command applies to CHV1 then P2 is coded '00'; if it applies to CHV2 then P2 is coded '02'.

Definitions and codings used in the response parameters/data of the commands are given in subclause 9.3.

## 9.2.1 SELECT

COMMAND	CLASS	INS	P1	P2	P3
SELECT	'A0'	'A4'	'00'	'00'	'02'

Command parameters/data:

Byte(s)	Description	Length
1 - 2	File ID	2

Response parameters/data in case of an MF or DF:

Byte(s)	Description	Length
1 - 2	RFU	2
3 - 4	Total amount of memory of the selected directory which is not allocated to any of the DFs or EFs under the selected directory	2
5 - 6	File ID	2
7	Type of file (see subclause 9.3)	1
8 - 12	RFU	5
13	Length of the following data (byte 14 to the end)	1
14 - 34	GSM specific data	21

GSM specific data:

Byte(s)	Description	Length
14	File characteristics (see detail 1)	1
15	Number of DFs which are a direct child of the current directory	1
16	Number of EFs which are a direct child of the current directory	1
17	Number of CHVs, UNBLOCK CHVs and administrative codes	1
18	RFU	1
19	CHV1 status (see detail 2)	1
20	UNBLOCK CHV1 status (see detail 2)	1
21	CHV2 status (see detail 2)	1
22	UNBLOCK CHV2 status (see detail 2)	1
23	RFU	1
24 - 34	Reserved for the administrative management	$0 \leq \text{lgth} \leq 11$

Bytes 1 - 22 are mandatory and shall be returned by the SIM. Bytes 23 and following are optional and may not be returned by the SIM.

NOTE 1: Byte 35 and following are RFU.

NOTE 2: The STATUS information of the MF, DF<sub>GSM</sub> and DF<sub>TELECOM</sub> provide some identical application specific data, e.g. CHV status. On a multi-application card the MF should not contain any application specific data. Such data is obtained by terminals from the specific application directories. ME manufacturers should take this into account and therefore not use application specific data which may exist in the MF of a mono-application SIM.

Similarly, the VERIFY CHV command should not be executed in the MF but in the relevant application directory (e.g. DF<sub>GSM</sub>).

Detail 1: File characteristics

b8	b7	b6	b5	b4	b3	b2	b1
----	----	----	----	----	----	----	----

Clock stop (see below)

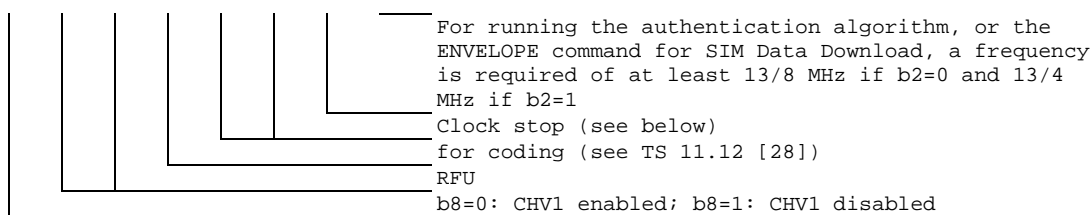

The coding of the conditions for stopping the clock is as follows:

Bit b1	Bit b3	Bit b4	
1	0	0	clock stop allowed, no preferred level
1	1	0	clock stop allowed, high level preferred
1	0	1	clock stop allowed, low level preferred
0	0	0	clock stop not allowed
0	1	0	clock stop not allowed, unless at high level
0	0	1	clock stop not allowed, unless at low level

If bit b1 (column 1) is coded 1, stopping the clock is allowed at high or low level. In this case columns 2 (bit b3) and 3 (bit b4) give information about the preferred level (high or low, respectively) at which the clock may be stopped.

If bit b1 is coded 0, the clock may be stopped only if the mandatory condition in column 2 (b3=1, i.e. stop at high level) or column 3 (b4=1, i.e. stop at low level) is fulfilled. If all 3 bits are coded 0, then the clock shall not be stopped.

Detail 2: Status byte of a secret code

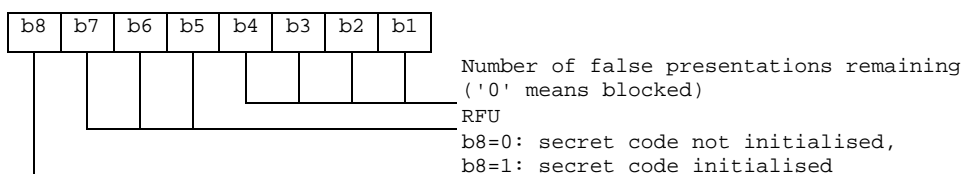

Response parameters/data in case of an EF:

Byte(s)	Description	Length
1 - 2	RFU	2
3 - 4	File size (for transparent EF: the length of the body part of the EF) (for linear fixed or cyclic EF: record length multiplied by the number of records of the EF)	2
5 - 6	File ID	2
7	Type of file (see 9.3)	1
8	see detail 3	1
9 - 11	Access conditions (see 9.3)	3
12	File status (see 9.3)	1
13	Length of the following data (byte 14 to the end)	1
14	Structure of EF (see 9.3)	1
15	Length of a record (see detail 4)	1
16 and following	RFU	-

Bytes 1-14 are mandatory and shall be returned by the SIM.

Byte 15 is mandatory in case of linear fixed or cyclic EFs and shall be returned by the SIM.

Byte 15 is optional in case of transparent EFs and may not be returned by the SIM.

Byte 16 and following (when defined) are optional and may not be returned by the SIM.

Detail 3: Byte 8

For transparent and linear fixed EFs this byte is RFU. For a cyclic EF all bits except bit 7 are RFU; b7=1 indicates that the INCREASE command is allowed on the selected cyclic file.

#### Detail 4: Byte 15

For cyclic and linear fixed EFs this byte denotes the length of a record. For a transparent EF, this byte shall be coded '00', if this byte is sent by the SIM.

## 9.2.2 STATUS

COMMAND	CLASS	INS	P1	P2	P3
STATUS	'A0'	'F2'	'00'	'00'	lgth

The response parameters/data are identical to the response parameters/data of the SELECT command in case of an MF or DF.

## 9.2.3 READ BINARY

COMMAND	CLASS	INS	P1	P2	P3
READ BINARY	'A0'	'B0'	offset high	offset low	lgth

Response parameters/data:

Byte(s)	Description	Length
1 - lgth	Data to be read	lgth

## 9.2.4 UPDATE BINARY

COMMAND	CLASS	INS	P1	P2	P3
UPDATE BINARY	'A0'	'D6'	offset high	offset low	lgth

Command parameters/data:

Byte(s)	Description	Length
1 - lgth	Data	lgth

## 9.2.5 READ RECORD

COMMAND	CLASS	INS	P1	P2	P3
READ RECORD	'A0'	'B2'	Rec.No.	Mode	lgth

Parameter P2 specifies the mode:

- '02' = next record;
- '03' = previous record;
- '04' = absolute mode/current mode, the record number is given in P1 with P1='00' denoting the current record.

For the modes "next" and "previous" P1 has no significance and shall be set to '00' by the ME. To ensure phase compatibility between Phase 2 SIMs and Phase 1 MEs, the SIM shall not interpret the value given by the ME.

Response parameters/data:

Byte(s)	Description	Length
1 - lgth	The data of the record	lgth

## 9.2.6 UPDATE RECORD

COMMAND	CLASS	INS	P1	P2	P3
UPDATE RECORD	'A0'	'DC'	Rec.No.	Mode	lgth

Parameter P2 specifies the mode:

- '02' = next record;
- '03' = previous record;
- '04' = absolute mode/current mode; the record number is given in P1 with P1='00' denoting the current record.

For the modes "next" and "previous" P1 has no significance and shall be set to '00' by the ME. To ensure phase compatibility between Phase 2 SIMs and Phase 1 MEs, the SIM shall not interpret the value given by the ME.

Command parameters/data:

Byte(s)	Description	Length
1 - lgth	Data	lgth

## 9.2.7 SEEK

COMMAND	CLASS	INS	P1	P2	P3
SEEK	'A0'	'A2'	'00'	Type/Mode	lgth

Parameter P2 specifies type and mode:

- 'x0' = from the beginning forward;
  - 'x1' = from the end backward;
  - 'x2' = from the next location forward;
  - 'x3' = from the previous location backward;
- with x='0' specifies type 1 and x='1' specifies type 2 of the SEEK command.

Command parameters/data:

Byte(s)	Description	Length
1 - lgth	Pattern	lgth

There are no response parameters/data for a type 1 SEEK. A type 2 SEEK returns the following response parameters/data:

Byte(s)	Description	Length
1	Record number	1

## 9.2.8 INCREASE

COMMAND	CLASS	INS	P1	P2	P3
INCREASE	'A0'	'32'	'00'	'00'	'03'

Command parameters/data:

Byte(s)	Description	Length
1 - 3	Value to be added	3

Response parameters/data:

Byte(s)	Description	Length
1 - X	Value of the increased record	X
X+1 - X+3	Value which has been added	3

NOTE: X denotes the length of the record.

## 9.2.9 VERIFY CHV

COMMAND	CLASS	INS	P1	P2	P3
VERIFY CHV	'A0'	'20'	'00'	CHV No.	'08'

Parameter P2 specifies the CHV:

- '01' = CHV1;
- '02' = CHV2.

Command parameters/data:

Byte(s)	Description	Length
1 - 8	CHV value	8

## 9.2.10 CHANGE CHV

COMMAND	CLASS	INS	P1	P2	P3
CHANGE CHV	'A0'	'24'	'00'	CHV No.	'10'

Parameter P2 specifies the CHV:

- '01' = CHV1;
- '02' = CHV2.

Command parameters/data:

Byte(s)	Description	Length
1 - 8	Old CHV value	8
9 - 16	New CHV value	8

## 9.2.11 DISABLE CHV

COMMAND	CLASS	INS	P1	P2	P3
DISABLE CHV	'A0'	'26'	'00'	'01'	'08'

Command parameters/data:

Byte(s)	Description	Length
1 - 8	CHV1 value	8

## 9.2.12 ENABLE CHV

COMMAND	CLASS	INS	P1	P2	P3
ENABLE CHV	'A0'	'28'	'00'	'01'	'08'

Command parameters/data:

Byte(s)	Description	Length
1 - 8	CHV1 value	8

## 9.2.13 UNBLOCK CHV

COMMAND	CLASS	INS	P1	P2	P3
UNBLOCK CHV	'A0'	'2C'	'00'	CHV No.	'10'

Parameter P2 specifies the CHV:

- 00 = CHV1;
- 02 = CHV2.

NOTE: The coding '00' for CHV1 differs from the coding of CHV1 used for other commands.

Command parameters/data:

Byte(s)	Description	Length
1 - 8	UNBLOCK CHV value	8
9 - 16	New CHV value	8

## 9.2.14 INVALIDATE

COMMAND	CLASS	INS	P1	P2	P3
INVALIDATE	'A0'	'04'	'00'	'00'	'00'

## 9.2.15 REHABILITATE

COMMAND	CLASS	INS	P1	P2	P3
REHABILITATE	'A0'	'44'	'00'	'00'	'00'

## 9.2.16 RUN GSM ALGORITHM

COMMAND	CLASS	INS	P1	P2	P3
RUN GSM ALGORITHM	'A0'	'88'	'00'	'00'	'10'

Command parameters/data:

Byte(s)	Description	Length
1 - 16	RAND	16

Response parameters/data:

Byte(s)	Description	Length
1 - 4	SRES	4
5 - 12	Cipher Key Kc	8

The most significant bit of SRES is coded on bit 8 of byte 1. The most significant bit of Kc is coded on bit 8 of byte 5.

## 9.2.17 SLEEP

COMMAND	CLASS	INS	P1	P2	P3
SLEEP	'A0'	'FA'	'00'	'00'	'00'

NOTE: This command is used by Phase 1 MEs only.

## 9.2.18 GET RESPONSE

COMMAND	CLASS	INS	P1	P2	P3
GET RESPONSE	'A0'	'C0'	'00'	'00'	lgth

The response data depends on the preceding command. Response data is available after the commands RUN GSM ALGORITHM, SEEK (type 2), SELECT, INCREASE, and ENVELOPE. If the command GET RESPONSE is executed, it is required that it is executed immediately after the command it is related to (no other command shall come between the command/response pair and the command GET RESPONSE). If the sequence is not respected, the SIM shall send the status information "technical problem with no diagnostic given" as a reaction to the GET RESPONSE.

Since the MF is implicitly selected after activation of the SIM, GET RESPONSE is also allowed as the first command after activation.

The response data itself is defined in the subclause for the corresponding command.

## 9.2.19 TERMINAL PROFILE

COMMAND	CLASS	INS	P1	P2	P3
TERMINAL PROFILE	'A0'	'10'	'00'	'00'	lgth

Command parameters/data:

length *lgth*. The structure of the command parameters is defined in TS 11.14 [27].

Response parameters/data:

none available

## 9.2.20 ENVELOPE

COMMAND	CLASS	INS	P1	P2	P3
ENVELOPE	'A0'	'C2'	'00'	'00'	lgth

Command parameters/data:

length *lgth*. The structure of the command parameters is defined in TS 11.14 [27].



Response parameters/data:

The structure of the data is defined in TS 11.14 [27].

### 9.2.21 FETCH

COMMAND	CLASS	INS	P1	P2	P3
FETCH	'A0'	'12'	'00'	'00'	lgth

Command parameters/data:

none.

Response parameters/data:

length lgth. The structure of the data is defined in TS 11.14 [27].

### 9.2.22 TERMINAL RESPONSE

COMMAND	CLASS	INS	P1	P2	P3
TERMINAL RESPONSE	'A0'	'14'	'00'	'00'	lgth

Command parameters/data:

length lgth. The structure of the command parameters is defined in TS 11.14 [27].

Response parameters/data:

none available.

## 9.3 Definitions and coding

The following definitions and coding are used in the response parameters/data of the commands.

### Coding

Each byte is represented by bits b8 to b1, where b8 is the most significant bit (MSB) and b1 is the least significant bit (LSB). In each representation the leftmost bit is the MSB.

### RFU

In a GSM specific card all bytes which are RFU shall be set to '00' and RFU bits to 0. Where the GSM application exists on a multiapplication card or is built on a generic telecommunications card (e.g. TE9) then other values may apply. The values will be defined in the appropriate specifications for such cards. These bytes and bits shall not be interpreted by an ME in a GSM session.

### File status

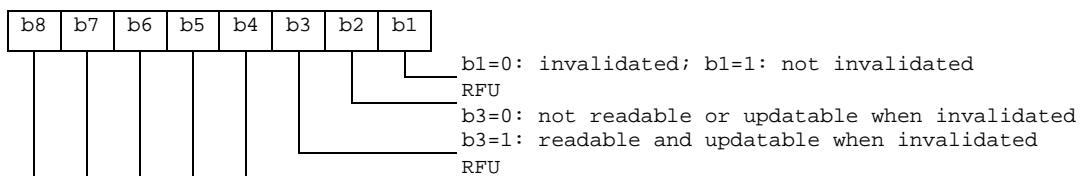

Bit b3 may be set to 1 in special circumstances when it is required that the EF can be read and updated even if the EF is invalidated, e.g. reading and updating the EF<sub>ADN</sub> when the FDN feature is enabled, or reading and updating the EF<sub>BDN</sub> when the BDN feature is disabled.

Structure of file

- '00' transparent;
- '01' linear fixed;
- '03' cyclic.

Type of File

- '00' RFU;
- '01' MF;
- '02' DF;
- '04' EF.

**Coding of CHVs and UNBLOCK CHVs**

A CHV is coded on 8 bytes. Only (decimal) digits (0-9) shall be used, coded in CCITT T.50 [20] with bit 8 set to zero. The minimum number of digits is 4. If the number of digits presented by the user is less than 8 then the ME shall pad the presented CHV with 'FF' before sending it to the SIM.

The coding of the UNBLOCK CHVs is identical to the coding of the CHVs. However, the number of (decimal) digits is always 8.

**Coding of Access Conditions**

The access conditions for the commands are coded on bytes 9, 10 and 11 of the response data of the SELECT command. Each condition is coded on 4 bits as shown in table 10.

**Table 10: Access conditions**

ALW	'0' *
CHV1	'1' *
CHV2	'2' *
RFU	'3'
ADM	'4'
.....	..
ADM	'E'
NEW	'F' *

Entries marked "\*" in the table above, are also available for use as administrative codes in addition to the ADM access levels '4' to 'E' (refer to subclause 7.3) if required by the appropriate administrative authority. If any of these access conditions are used, the code returned in the Access Condition bytes in the response data shall be the code applicable to that particular level.

Byte 9:

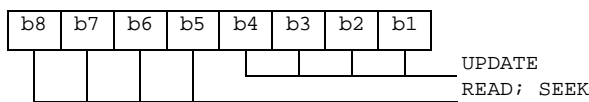

Byte 10:

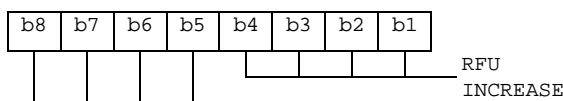

Byte 11:

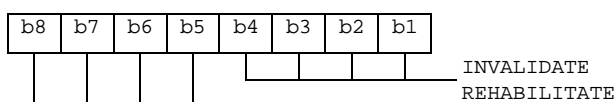

## 9.4 Status conditions returned by the card

This subclause specifies the coding of the status words SW1 and SW2.

### 9.4.1 Responses to commands which are correctly executed

SW1	SW2	Description
'90'	'00'	- normal ending of the command
'91'	'XX'	- normal ending of the command, with extra information from the proactive SIM containing a command for the ME. Length 'XX' of the response data
'9E'	'XX'	- length 'XX' of the response data given in case of a SIM data download error
'9F'	'XX'	- length 'XX' of the response data

### 9.4.2 Responses to commands which are postponed

SW1	SW2	Error description
'93'	'00'	- SIM Application Toolkit is busy. Command cannot be executed at present, further normal commands are allowed.

### 9.4.3 Memory management

SW1	SW2	Error description
'92'	'0X'	- command successful but after using an internal update retry routine 'X' times
'92'	'40'	- memory problem

### 9.4.4 Referencing management

SW1	SW2	Error description
'94'	'00'	- no EF selected
'94'	'02'	- out of range (invalid address)
'94'	'04'	- file ID not found - pattern not found
'94'	'08'	- file is inconsistent with the command

### 9.4.5 Security management

SW1	SW2	Error description
'98'	'02'	- no CHV initialized
'98'	'04'	- access condition not fulfilled - unsuccessful CHV verification, at least one attempt left - unsuccessful UNBLOCK CHV verification, at least one attempt left - authentication failed (see note)
'98'	'08'	- in contradiction with CHV status
'98'	'10'	- in contradiction with invalidation status
'98'	'40'	- unsuccessful CHV verification, no attempt left - unsuccessful UNBLOCK CHV verification, no attempt left - CHV blocked - UNBLOCK CHV blocked
'98'	'50'	- increase cannot be performed, Max value reached

NOTE: A Phase 1 SIM may send this error code after the third consecutive unsuccessful CHV verification attempt or the tenth consecutive unsuccessful unblocking attempt.

### 9.4.6 Application independent errors

SW1	SW2	Error description
'67'	'XX'	- incorrect parameter P3 (see note)
'6B'	'XX'##	- incorrect parameter P1 or P2 (see ##)
'6D'	'XX'##	- unknown instruction code given in the command
'6E'	'XX'##	- wrong instruction class given in the command
'6F'	'XX'##	- technical problem with no diagnostic given
NOTE 1: # These values of 'XX' are specified by ISO/IEC; at present the default value 'XX'='00' is the only one defined.		
NOTE 2: ## When the error in P1 or P2 is caused by the addressed record being out of range, then the return code '94 02' shall be used.		

NOTE: 'XX' gives the correct length or states that no additional information is given ('XX' = '00').

### 9.4.7 Commands versus possible status responses

The following table shows for each command the possible status conditions returned (marked by an asterisk \*).

**Table 11: Commands and status words**

Commands	OK				B u s y	Mem Sta	Refer. Status				Security Status					Application Independent Errors						
	9 0	9 1	9 E	9 F			9 3	9 2	9 2	9 4	9 4	9 4	9 4	9 8	9 8	9 8	9 8	9 8	9 8	6 7	6 B	6 D
	0	X	X	X	0	0	4	0	0	0	0	0	0	0	1	4	5	X	X	X	X	X
	0	X	X	X	0	X	0	0	2	4	8	2	4	8	0	0	0	X	X	X	X	X
Select Status	*	*		*			*	*		*								*	*		*	*
Update Binary	*	*				*	*	*		*		*	*	*				*	*		*	*
Update Record	*	*				*	*	*	*	*		*	*	*				*	*		*	*
Read Binary	*	*				*	*	*	*	*		*	*	*				*	*		*	*
Read Record	*	*				*	*	*	*	*		*	*	*				*	*		*	*
Seek	*			*		*	*	*	*	*		*	*	*				*	*		*	*
Increase				*		*	*	*	*	*		*	*	*		*		*	*		*	*
Verify CHV	*	*				*	*	*		*		*	*	*		*		*	*		*	*
Change CHV	*	*				*	*	*		*		*	*	*		*		*	*		*	*
Disable CHV	*	*				*	*	*		*		*	*	*		*		*	*		*	*
Enable CHV	*	*				*	*	*		*		*	*	*		*		*	*		*	*
Unblock CHV	*	*				*	*	*		*		*	*	*		*		*	*		*	*
Invalidate	*	*				*	*	*		*		*	*	*		*		*	*		*	*
Rehabilitate	*	*				*	*	*		*		*	*	*		*		*	*		*	*
Run GSM Algorithm				*			*			*		*	*					*	*		*	*
Sleep	*																	*	*		*	*
Get Response	*	*					*											*	*		*	*
Terminal Profile	*	*				*	*											*	*		*	*
Envelope	*	*	*	*	*	*	*											*	*		*	*
Fetch	*					*	*											*	*		*	*
Terminal Response	*	*				*	*											*	*		*	*

The responses '91 XX', and '93 00' and '9E XX' can only be given by a SIM supporting SIM Application Toolkit, to an ME also supporting SIM Application Toolkit.

For the SEEK command the response '91 XX' can be given directly after a Type 1 SEEK command. Following the Type 2 SEEK command the SIM can give the response '91 XX' only after the GET RESPONSE command.

## 10 Contents of the Elementary Files (EF)

This clause specifies the EFs for the GSM session defining access conditions, data items and coding. A data item is a part of an EF which represents a complete logical entity, e.g. the alpha tag in a EF<sub>ADN</sub> record.

EFs or data items having an unassigned value, or, which during the GSM session, are cleared by the ME, shall have their bytes set to 'FF'. After the administrative phase all data items shall have a defined value or have their bytes set to 'FF'. If a data item is 'deleted' during a GSM session by the allocation of a value specified in another GSM TS, then this value shall be used, and the data item is not unassigned; e.g. for a deleted LAI in EF<sub>LOCI</sub> the last byte takes the value 'FE' (TS 04.08 [15] refers).

EFs are mandatory (M) or optional (O). The file size of an optional EF may be zero. All implemented EFs with a file size greater than zero shall contain all mandatory data items. Optional data items may either be filled with 'F', or, if located at the end of an EF, need not exist.

When the coding is according to CCITT Recommendation T.50 [20], bit 8 of every byte shall be set to 0.

For an overview containing all files see figure 8.

### 10.1 Contents of the EFs at the MF level

There are only two EFs at the MF level.

#### 10.1.1 EF<sub>ICCID</sub> (ICC Identification)

This EF provides a unique identification number for the SIM.

Identifier: '2FE2'		Structure: transparent		Mandatory	
File size: 10 bytes			Update activity: low		
Access Conditions:					
READ		ALWAYS			
UPDATE		NEVER			
INVALIDATE		ADM			
REHABILITATE		ADM			
Bytes	Description	M/O	Length		
1 to 10	Identification number	M	10 bytes		

- Identification number

Contents:

according to CCITT Recommendation E.118 [18]. However, network operators who are already issuing Phase 1 SIM cards with an identification number length of 20 digits may retain this length.

Purpose:

card identification number.

Coding:

BCD, left justified and padded with 'F'; after padding the digits within a byte are swapped (see below). However, network operators who are already issuing Phase 1 SIM cards where the digits within a byte are not swapped may retain this configuration.

Byte 1:

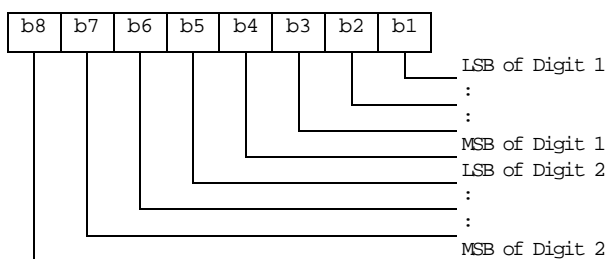

Byte 2:

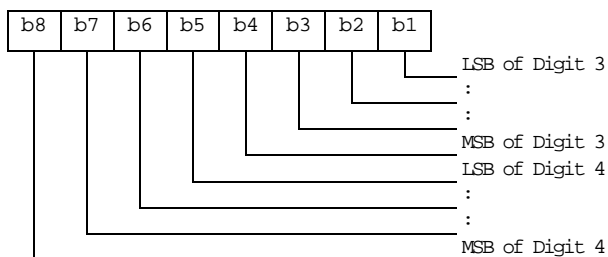

etc.

### 10.1.2 EF<sub>ELP</sub> (Extended language preference)

This EF contains the codes for up to n languages. This information, determined by the user/operator, defines the preferred languages of the user in order of priority. This information may be used by the ME for MMI purposes.

This information may also be used for the screening of Cell Broadcast messages in a preferred language, as follows.

When the CB Message Identifier capability is both allocated and activated, the ME selects only those CB messages the language of which corresponds to an entry in this EF or in EF<sub>LP</sub>, whichever of these EFs is used (see subclause 11.2.1). The CB message language is defined by the Data Coding Scheme (DCS: see TS 23.038 [12]) received with the CB message. The ME shall be responsible for translating the language coding indicated in the Data Coding Scheme for the Cell Broadcast Service (as defined in TS 23.038 [12]) to the language coding as defined in ISO 639 [30] if it is necessary to check the language coding in EF<sub>ELP</sub>.

Identifier: '2F 05'		Structure: transparent		Optional	
File size: 2n bytes			Update activity: low		
Access Conditions:					
READ		ALW			
UPDATE		CHV1			
INVALIDATE		ADM			
REHABILITATE		ADM			
Bytes	Description			M/O	Length
1 to 2	1 <sup>st</sup> language code (highest prior.)			O	2 bytes
3 to 4	2 <sup>nd</sup> language code			O	2 bytes
2n-1 to 2n	nth language code (lowest prior.)			O	2 bytes

Coding:

each language code is a pair of alpha-numeric characters, as defined in ISO 639 [30]. Each alpha-numeric character shall be coded on one byte using the SMS default 7-bit coded alphabet as defined in TS 23.038 [12] with bit 8 set to 0.

Unused language entries shall be set to 'FF FF'.

## 10.2 DFs at the GSM application level

For compatibility with other systems based on the GSM switching platform and for special GSM services, DFs may be present as child directories of DF<sub>GSM</sub>. The following have been defined:

DF <sub>IRIDIUM</sub>	'5F30'
DF <sub>GLOBALSTAR</sub>	'5F31'
DF <sub>ICO</sub>	'5F32'
DF <sub>ACeS</sub>	'5F33'
DF <sub>MEXE</sub>	'5F3C'
DF <sub>EIA/TIA-553</sub>	'5F40'
DF <sub>CTS</sub>	'5F60'
DF <sub>SoLSA</sub>	'5F70'

Only the contents of DF<sub>SoLSA</sub> and DF<sub>MEXE</sub> are specified in the present document. For details of the EFs contained in the DF<sub>CTS</sub>, see TS 11.19 [34].

## 10.3 Contents of files at the GSM application level

The EFs in the Dedicated File DF<sub>GSM</sub> contain network related information.

### 10.3.1 EF<sub>LP</sub> (Language preference)

This EF contains the codes for one or more languages. This information, determined by the user/operator, defines the preferred languages of the user in order of priority. This information may be used by the ME for MMI purposes.

This information may also be used for the screening of Cell Broadcast messages in a preferred language, as follows. When the CB Message Identifier capability is both allocated and activated, the ME selects only those CB messages the language of which corresponds to an entry in this EF or in EF<sub>ELP</sub>, whichever of these EFs is used (see subclause 11.2.1). The CB message language is defined by the Data Coding Scheme (DCS: see TS 23.038 [12]) received with the CB message. The ME shall be responsible for translating the language coding indicated in the Data Coding Scheme for the Cell Broadcast Service (as defined in TS 23.038 [12]) to the language coding as defined in ISO 639 [30] if it is necessary to check the language coding in EF<sub>ELP</sub>.

Identifier: '6F05'		Structure: transparent		Mandatory
File size: 1-n bytes		Update activity: low		
Access Conditions:				
READ		ALW		
UPDATE		CHV1		
INVALIDATE		ADM		
REHABILITATE		ADM		
Bytes	Description	M/O	Length	
1	1 <sup>st</sup> language code (highest prior.)	M	1 byte	
2	2 <sup>nd</sup> language code	O	1 byte	
n	n <sup>th</sup> language code (lowest prior.)	O	1 byte	

Coding: according to language codings contained in the Data Coding Scheme (see TS 23.038 [12]).

Using the command GET RESPONSE, the ME can determine the size of the EF.

### 10.3.2 EF<sub>IMSI</sub> (IMSI)

This EF contains the International Mobile Subscriber Identity (IMSI).

Identifier: '6F07'		Structure: transparent		Mandatory
File size: 9 bytes		Update activity: low		
Access Conditions:				
READ		CHV1		
UPDATE		ADM		
INVALIDATE		ADM		
REHABILITATE		CHV1		
Bytes	Description	M/O	Length	
1	length of IMSI	M	1 byte	
2 to 9	IMSI	M	8 bytes	

- length of IMSI

Contents:

The length indicator refers to the number of significant bytes, not including this length byte, required for the IMSI.

Coding: according to TS 04.08 [15].

- IMSI

Contents:

International Mobile Subscriber Identity.

Coding:

This information element is of variable length. If a network operator chooses an IMSI of less than 15 digits, unused nibbles shall be set to 'F'.

Byte 2:

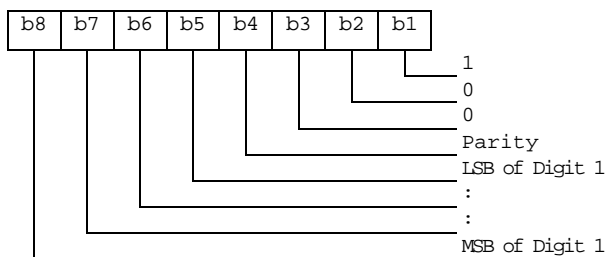

For the parity bit, see TS 04.08 [15].

Byte 3:

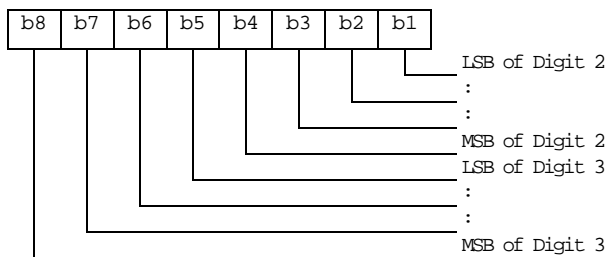

etc.



### 10.3.3 EF<sub>Kc</sub> (Cipherring key Kc)

This EF contains the cipherring key Kc and the cipherring key sequence number n.

Identifier: '6F20'		Structure: transparent		Mandatory
File size: 9 bytes		Update activity: high		
Access Conditions:				
READ		CHV1		
UPDATE		CHV1		
INVALIDATE		ADM		
REHABILITATE		ADM		
Bytes	Description	M/O	Length	
1 to 8	Cipherring key Kc	M	8 bytes	
9	Cipherring key sequence number n	M	1 byte	

- Cipherring key Kc

Coding:

The least significant bit of Kc is the least significant bit of the eighth byte. The most significant bit of Kc is the most significant bit of the first byte.

- Cipherring key sequence number n

Coding:

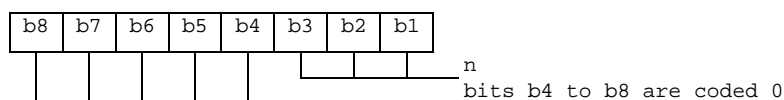

NOTE: TS 04.08 [15] defines the value of n=111 as "key not available". Therefore the value '07' and not 'FF' should be present following the administrative phase.

### 10.3.4 EF<sub>PLMNsel</sub> (PLMN selector)

This EF contains the coding for n PLMNs, where n is at least eight. This information determined by the user/operator defines the preferred PLMNs of the user in priority order.

Identifier: '6F30'		Structure: transparent		Optional
File size: 3n (n ≥ 8) bytes		Update activity: low		
Access Conditions:				
READ		CHV1		
UPDATE		CHV1		
INVALIDATE		ADM		
REHABILITATE		ADM		
Bytes	Description	M/O	Length	
1 to 3	1 <sup>st</sup> PLMN (highest priority)	M	3 bytes	
22 to 24	8 <sup>th</sup> PLMN	M	3 bytes	
25 to 27	9 <sup>th</sup> PLMN	O	3 bytes	
(3n-2) to 3n	n <sup>th</sup> PLMN (lowest priority)	O	3 bytes	

- PLMN

Contents:

Mobile Country Code (MCC) followed by the Mobile Network Code (MNC).

Coding:

according to TS 04.08 [15].

If storage for fewer than the maximum possible number  $n$  is required, the excess bytes shall be set to 'FF'.

For instance, using 246 for the MCC and 81 for the MNC and if this is the first and only PLMN, the contents reads as follows:

Bytes 1-3: '42' 'F6' '18'

Bytes 4-6: 'FF' 'FF' 'FF'

etc.

### 10.3.5 EF<sub>HPPLMN</sub> (Higher Priority PLMN search period)

This EF contains the interval of time between searches for a higher priority PLMN (see TS 22.011 [5]).

Identifier: '6F31'		Structure: transparent		Mandatory	
File size: 1 byte			Update activity: low		
Access Conditions:					
READ		CHV1			
UPDATE		ADM			
INVALIDATE		ADM			
REHABILITATE		ADM			
Bytes	Description			M/O	Length
1	Time interval			M	1 byte

- Time interval

Contents:

The time interval between two searches.

Coding:

The time interval is coded in integer multiples of  $n$  minutes. The range is from  $n$  minutes to a maximum value. The value '00' indicates that no attempts shall be made to search for any higher priority PLMN. The encoding is:

- '00': No higher priority PLMN search attempts
- '01':  $n$  minutes
- '02':  $2n$  minutes
- : : :
- 'YZ':  $(16Y+Z)n$  minutes (maximum value)

All other values shall be interpreted by the ME as a default period.

For specification of the integer timer interval  $n$ , the maximum value and the default period refer to TS 22.011 [5].

### 10.3.6 EF<sub>ACMmax</sub> (ACM maximum value)

This EF contains the maximum value of the accumulated call meter. This EF shall always be allocated if EF<sub>ACM</sub> is allocated.

Identifier: '6F37'		Structure: transparent		Optional	
File size: 3 bytes			Update activity: low		
Access Conditions:					
READ		CHV1			
UPDATE		CHV1/CHV2 (fixed during administrative management)			
INVALIDATE		ADM			
REHABILITATE		ADM			
Bytes	Description			M/O	Length
1 to 3	Maximum value			M	3 bytes

- Maximum value

Contents:

maximum value of the Accumulated Call Meter (ACM)

Coding:

First byte:

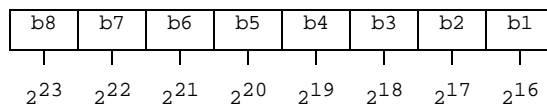

Second byte:

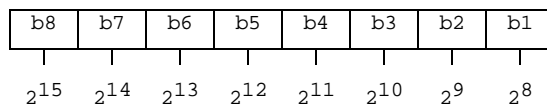

Third byte:

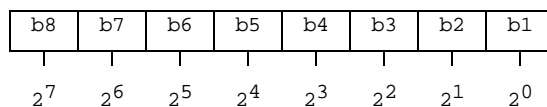

For instance, '00' '00' '30' represents  $2^5+2^4$ .

All ACM data is stored in the SIM and transmitted over the SIM/ME interface as binary.

ACMmax is not valid, as defined in TS 22.024 [7], if it is coded '000000'.

### 10.3.7 EF<sub>SST</sub> (SIM service table)

This EF indicates which services are allocated, and whether, if allocated, the service is activated. If a service is not allocated or not activated in the SIM, the ME shall not select this service.

Identifier: '6F38'		Structure: transparent		Mandatory
File size: X bytes, X ≥ 2		Update activity: low		
Access Conditions:				
READ		CHV1		
UPDATE		ADM		
INVALIDATE		ADM		
REHABILITATE		ADM		
Bytes	Description	M/O	Length	
1	Services n°1 to n°4	M	1 byte	
2	Services n°5 to n°8	M	1 byte	
3	Services n°9 to n°12	O	1 byte	
4	Services n°13 to n°16	O	1 byte	
5	Services n°17 to n°20	O	1 byte	
6	Services n°21 to n°24	O	1 byte	
7	Services n°25 to n°28	O	1 byte	
8	Services n°29 to n°32	O	1 byte	
etc.				
X	Services (4X-3) to (4X)	O	1 byte	

#### -Services

Contents:	Service n°1 :	CHV1 disable function
	Service n°2 :	Abbreviated Dialling Numbers (ADN)
	Service n°3 :	Fixed Dialling Numbers (FDN)
	Service n°4 :	Short Message Storage (SMS)
	Service n°5 :	Advice of Charge (AoC)
	Service n°6 :	Capability Configuration Parameters (CCP)
	Service n°7 :	PLMN selector
	Service n°8 :	RFU
	Service n°9 :	MSISDN
	Service n°10:	Extension1
	Service n°11:	Extension2
	Service n°12:	SMS Parameters
	Service n°13:	Last Number Dialed (LND)
	Service n°14:	Cell Broadcast Message Identifier
	Service n°15:	Group Identifier Level 1
	Service n°16:	Group Identifier Level 2
	Service n°17:	Service Provider Name
	Service n°18:	Service Dialling Numbers (SDN)
	Service n°19:	Extension3
	Service n°20:	RFU
	Service n°21:	VGCS Group Identifier List (EF <sub>VGCS</sub> and EF <sub>VGCSs</sub> )
	Service n°22:	VBS Group Identifier List (EF <sub>VBS</sub> and EF <sub>VBSs</sub> )
	Service n°23:	enhanced Multi-Level Precedence and Pre-emption Service
	Service n°24:	Automatic Answer for eMLPP
	Service n°25:	Data download via SMS-CB
	Service n°26:	Data download via SMS-PP
	Service n°27:	Menu selection
	Service n°28:	Call control
	Service n°29:	Proactive SIM
	Service n°30:	Cell Broadcast Message Identifier Ranges
	Service n°31:	Barred Dialling Numbers (BDN)
	Service n°32:	Extension4
	Service n°33:	De-personalization Control Keys
	Service n°34:	Co-operative Network List
	Service n°35:	Short Message Status Reports
	Service n°36:	Network's indication of alerting in the MS
	Service n°37:	Mobile Originated Short Message control by SIM
	Service n°38:	GPRS
	Service n°39:	Image (IMG)
	Service n°40:	SoLSA (Support of Local Service Area)
	Service n°41:	USSD string data object supported in Call Control
	Service n°42:	RUN AT COMMAND command
	Service n°43:	User controlled PLMN Selector with Access Technology

Service n 44:	Operator controlled PLMN Selector with Access Technology
Service n 45:	HPLMN Selector with Access Technology
Service n 46:	CPBCCCH Information
Service n 47:	Investigation Scan
Service n°48:	Extended Capability Configuration Parameters
Service n°49:	MExE
Service n°50:	Reserved and shall be ignored

For a phase 2 SIM, the EF shall contain at least two bytes which correspond to the Phase 1 services. Further bytes may be included, but if the EF includes an optional byte, then it is mandatory for the EF to also contain all bytes before that byte. Other services are possible in the future and will be coded on further bytes in the EF. The coding falls under the responsibility of ETSI.

NOTE 1: Service N°8 was used in Phase 1 for Called Party Subaddress. To prevent any risk of incompatibility Service N°8 should not be reallocated.

NOTE 2: As the BDN service relies on the Call Control feature, service n°31 (BDN) should only be allocated and activated if service n°28 (Call control) is allocated and activated.

Coding:

2 bits are used to code each service:

first bit = 1: service allocated

first bit = 0: service not allocated

where the first bit is b1, b3, b5 or b7;

second bit = 1: service activated

second bit = 0: service not activated

where the second bit is b2, b4, b6 or b8.

Service allocated means that the SIM has the capability to support the service. Service activated means that the service is available for the card holder (only valid if the service is allocated).

The following codings are possible:

- first bit = 0: service not allocated, second bit has no meaning;
- first bit = 1 and second bit = 0: service allocated but not activated;
- first bit = 1 and second bit = 1: service allocated and activated.

The bits for services not yet defined shall be set to RFU. For coding of RFU see subclause 9.3.

First byte:

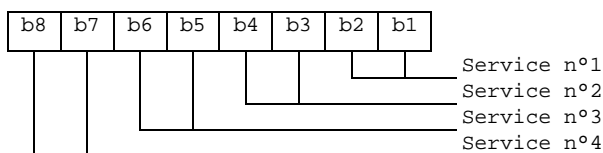

Second byte:

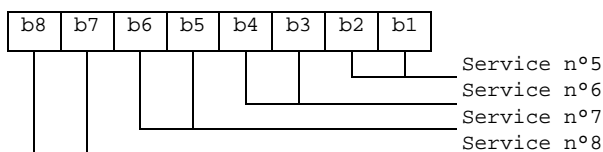

etc.

The following example of coding for the first byte means that service n°1 "CHV1-Disabling" is allocated but not activated:

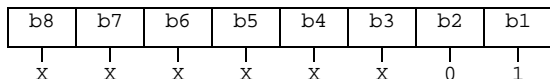

If the SIM supports the FDN feature (FDN allocated and activated) a special mechanism shall exist in the SIM which invalidates both EF<sub>IMSI</sub> and EF<sub>LOCI</sub> once during each GSM session. This mechanism shall be invoked by the SIM automatically if FDN is enabled. This invalidation shall occur at least before the next command following selection of either EF. FDN is enabled when the ADN is invalidated or not activated.

If the SIM supports the BDN feature (BDN allocated and activated) a special mechanism shall exist in the SIM which invalidates both EF<sub>IMSI</sub> and EF<sub>LOCI</sub> once during each GSM session and which forbids the REHABILITATE command to rehabilitate both EF<sub>IMSI</sub> and EF<sub>LOCI</sub> until the PROFILE DOWNLOAD procedure is performed indicating that the ME supports the "Call control by SIM" facility. This mechanism shall be invoked by the SIM automatically if BDN is enabled. The invalidation of EF<sub>IMSI</sub> and EF<sub>LOCI</sub> shall occur at least before the next command following selection of either EF. BDN is enabled when the EF<sub>BDN</sub> is not invalidated.

### 10.3.8 EF<sub>ACM</sub> (Accumulated call meter)

This EF contains the total number of units for both the current call and the preceding calls.

NOTE: The information may be used to provide an indication to the user for advice or as a basis for the calculation of the monetary cost of calls (see TS 22.086 [9]).

Identifier: '6F39'		Structure: cyclic		Optional	
Record length: 3 bytes			Update activity: high		
Access Conditions:					
READ		CHV1			
UPDATE		CHV1/CHV2 (fixed during administrative management)			
INCREASE		CHV1			
INVALIDATE		ADM			
REHABILITATE		ADM			
Bytes	Description	M/O	Length		
1 to 3	Accumulated count of units	M	3 bytes		

- Accumulated count of units

Contents: value of the ACM

Coding: see the coding of EF<sub>ACMmax</sub>

### 10.3.9 EF<sub>GID1</sub> (Group Identifier Level 1)

This EF contains identifiers for particular SIM-ME associations. It can be used to identify a group of SIMs for a particular application.

Identifier: '6F3E'		Structure: transparent		Optional
File size: 1 to n bytes		Update activity: low		
Access Conditions:				
READ		CHV1		
UPDATE		ADM		
INVALIDATE		ADM		
REHABILITATE		ADM		
Bytes	Description	M/O	Length	
1 to n	SIM group identifier(s)	O	n bytes	

### 10.3.10 EF<sub>GID2</sub> (Group Identifier Level 2)

This EF contains identifiers for particular SIM-ME associations. It can be used to identify a group of SIMs for a particular application.

Identifier: '6F3F'		Structure: transparent		Optional
File size: 1 to n bytes		Update activity: low		
Access Conditions:				
READ		CHV1		
UPDATE		ADM		
INVALIDATE		ADM		
REHABILITATE		ADM		
Bytes	Description	M/O	Length	
1 to n	SIM group identifier(s)	O	n bytes	

NOTE: The structure of EF<sub>GID1</sub> and EF<sub>GID2</sub> are identical. They are provided to allow the network operator to enforce different levels of security dependant on application.

### 10.3.11 EF<sub>SPN</sub> (Service Provider Name)

This EF contains the service provider name and appropriate requirements for the display by the ME.

Identifier: '6F46'		Structure: transparent		Optional
File Size: 17 bytes		Update activity: low		
Access Conditions:				
READ		ALWAYS		
UPDATE		ADM		
INVALIDATE		ADM		
REHABILITATE		ADM		
Bytes	Description	M/O	Length	
1	Display Condition	M	1 byte	
2 to 17	Service Provider Name	M	16 bytes	

- Display Condition

Contents: display condition for the service provider name in respect to the registered PLMN (see TS 02.07 [3]).

Coding: see below

Byte 1:

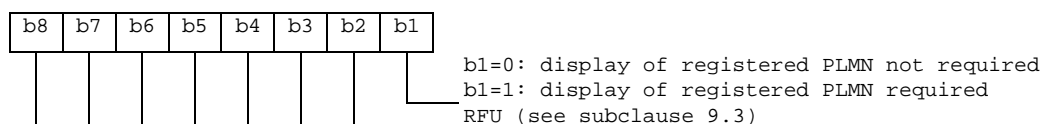

- Service Provider Name

Contents: service provider string to be displayed

Coding: the string shall use either

- the SMS default 7-bit coded alphabet as defined in TS 23.038 [12] with bit 8 set to 0. The string shall be left justified. Unused bytes shall be set to 'FF'; or
- one of the UCS2 code options defined in annex B.

### 10.3.12 EF<sub>PUCT</sub> (Price per unit and currency table)

This EF contains the Price per Unit and Currency Table (PUCT). The PUCT is Advice of Charge related information which may be used by the ME in conjunction with EF<sub>ACM</sub> to compute the cost of calls in the currency chosen by the subscriber, as specified in TS 22.024 [7]. This EF shall always be allocated if EF<sub>ACM</sub> is allocated.

Identifier: '6F41'		Structure: transparent		Optional
File size: 5 bytes		Update activity: low		
Access Conditions:				
READ		CHV1		
UPDATE		CHV1/CHV2 (fixed during administrative management)		
INVALIDATE		ADM		
REHABILITATE		ADM		
Bytes	Description	M/O	Length	
1 to 3	Currency code	M	3 bytes	
4 to 5	Price per unit	M	2 bytes	

- Currency code

Contents:

the alpha-identifier of the currency code.

Coding:

bytes 1, 2 and 3 are the respective first, second and third character of the alpha identifier. This alpha-tagging shall use the SMS default 7-bit coded alphabet as defined in TS 23.038 [12] with bit 8 set to 0.

- Price per unit

Contents:

price per unit expressed in the currency coded by bytes 1-3.

Coding:

Byte 4 and bits b1 to b4 of byte 5 represent the Elementary Price per Unit (EPPU) in the currency coded by bytes 1-3. Bits b5 to b8 of byte 5 are the decimal logarithm of the multiplicative factor represented by the absolute value of its decimal logarithm (EX) and the sign of EX, which is coded 0 for a positive sign and 1 for a negative sign.



Byte 4:

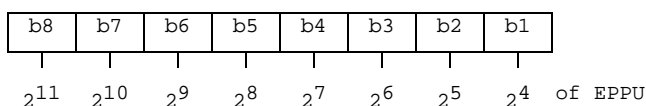

Byte 5:

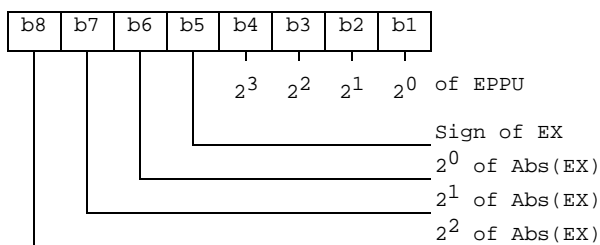

The computation of the price per unit value is made by the ME in compliance with TS 22.024 [7] by the following formula:

$$\text{price per unit} = \text{EPPU} * 10^{\text{EX}}$$

The price has to be understood as expressed in the coded currency.

### 10.3.13 EF<sub>CBMI</sub> (Cell broadcast message identifier selection)

This EF contains the Message Identifier Parameters which specify the type of content of the cell broadcast messages that the subscriber wishes the MS to accept.

Any number of CB Message Identifier Parameters may be stored in the SIM. No order of priority is applicable.

Identifier: '6F45'		Structure: transparent		Optional	
File size: 2n bytes			Update activity: low		
Access Conditions:					
READ		CHV1			
UPDATE		CHV1			
INVALIDATE		ADM			
REHABILITATE		ADM			
Bytes	Description			M/O	Length
1 to 2	CB Message Identifier 1			O	2 bytes
3 to 4	CB Message Identifier 2			O	2 bytes
2n-1 to 2n	CB Message Identifier n			O	2 bytes

- Cell Broadcast Message Identifier

Coding:

as in TS 23.041, "Message Format on BTS-MS Interface - Message Identifier".

Values listed show the types of message which shall be accepted by the MS.

Unused entries shall be set to 'FF FF'.

### 10.3.14 EF<sub>BCCH</sub> (Broadcast control channels)

This EF contains information concerning the BCCH according to TS 04.08 [15].

BCCH storage may reduce the extent of a Mobile Station's search of BCCH carriers when selecting a cell. The BCCH carrier lists in an MS shall be in accordance with the procedures specified in TS 04.08 [15]. The MS shall only store BCCH information from the System Information 2 message and not the 2bis extension message.

Identifier: '6F74'		Structure: transparent		Mandatory
File size: 16 bytes		Update activity: high		
Access Conditions:				
READ		CHV1		
UPDATE		CHV1		
INVALIDATE		ADM		
REHABILITATE		ADM		
Bytes	Description	M/O	Length	
1 to 16	BCCH information	M	16 bytes	

- BCCH information

Coding:

The information is coded as octets 2-17 of the "neighbour cells description information element" in TS 04.08 [15].

### 10.3.15 EF<sub>ACC</sub> (Access control class)

This EF contains the assigned access control class(es). TS 22.011 [5] refers. The access control class is a parameter to control the RACH utilization. 15 classes are split into 10 classes randomly allocated to normal subscribers and 5 classes allocated to specific high priority users. For more information see TS 22.011 [5].

Identifier: '6F78'		Structure: transparent		Mandatory
File size: 2 bytes		Update activity: low		
Access Conditions:				
READ		CHV1		
UPDATE		ADM		
INVALIDATE		ADM		
REHABILITATE		ADM		
Bytes	Description	M/O	Length	
1 to 2	Access control classes	M	2 bytes	

- Access control classes

Coding:

Each ACC is coded on one bit. An ACC is "allocated" if the corresponding bit is set to 1 and "not allocated" if this bit is set to 0. Bit b3 of byte 1 is set to 0.

Byte 1:

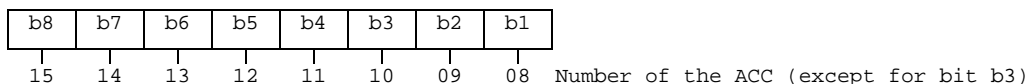

Byte 2:

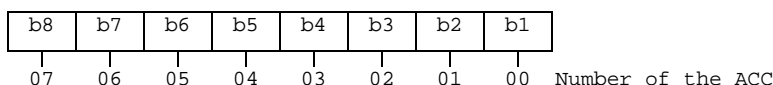

### 10.3.16 EF<sub>FPLMN</sub> (Forbidden PLMNs)

This EF contains the coding for four Forbidden PLMNs (FPLMN). It is read by the ME as part of the SIM initialization procedure and indicates PLMNs which the MS shall not automatically attempt to access.

A PLMN is written to the EF if a network rejects a Location Update with the cause "PLMN not allowed". The ME shall manage the list as follows.

When four FPLMNs are held in the EF, and rejection of a further PLMN is received by the ME from the network, the ME shall modify the EF using the UPDATE command. This new PLMN shall be stored in the fourth position, and the existing list "shifted" causing the previous contents of the first position to be lost.

When less than four FPLMNs exist in the EF, storage of an additional FPLMN shall not cause any existing FPLMN to be lost.

Dependent upon procedures used to manage storage and deletion of FPLMNs in the EF, it is possible, when less than four FPLMNs exist in the EF, for 'FFFFFF' to occur in any position. The ME shall analyse all the EF for FPLMNs in any position, and not regard 'FFFFFF' as a termination of valid data.

Identifier: '6F7B'		Structure: transparent		Mandatory	
File size: 12 bytes			Update activity: low		
Access Conditions:					
READ		CHV1			
UPDATE		CHV1			
INVALIDATE		ADM			
REHABILITATE		ADM			
Bytes	Description			M/O	Length
1 to 3	PLMN 1			M	3 bytes
4 to 6	PLMN 2			M	3 bytes
7 to 9	PLMN 3			M	3 bytes
10 to 12	PLMN 4			M	3 bytes

- PLMN

Contents:

Mobile Country Code (MCC) followed by the Mobile Network Code (MNC).

Coding:

according to TS 04.08 [15].

For instance, using 246 for the MCC and 81 for the MNC and if this is stored in PLMN 3 the contents is as follows:

Bytes 7-9: '42' 'F6' '18'

If storage for fewer than 4 PLMNs is required, the unused bytes shall be set to 'FF'.

### 10.3.17 EF<sub>LocI</sub> (Location information)

This EF contains the following Location Information:

- Temporary Mobile Subscriber Identity (TMSI);
- Location Area Information (LAI);
- TMSI TIME;
- Location update status.

See clause 11.1.2 for special requirements when updating EF<sub>LocI</sub>.

Identifier: '6F7E'		Structure: transparent		Mandatory
File size: 11 bytes		Update activity: high		
Access Conditions:				
READ		CHV1		
UPDATE		CHV1		
INVALIDATE		ADM		
REHABILITATE		CHV1		
Bytes	Description	M/O	Length	
1 to 4	TMSI	M	4 bytes	
5 to 9	LAI	M	5 bytes	
10	TMSI TIME	M	1 byte	
11	Location update status	M	1 byte	

- TMSI

Contents: Temporary Mobile Subscriber Identity

Coding: according to TS 04.08 [15].

Byte 1: first byte of TMSI

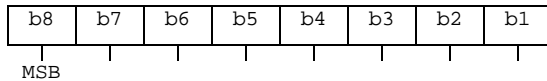

- LAI

Contents: Location Area Information

Coding: according to TS 04.08 [15].

Byte 5: first byte of LAI

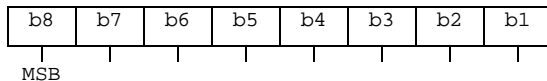

- TMSI TIME

Contents: Current value of Periodic Location Updating Timer (T3212).

This byte is used by Phase 1 MEs, but it shall not be used by Phase 2 MEs.

- Location update status

Contents: status of location update according to TS 04.08 [15].

Coding:

Byte 11:

Bits:	b3	b2	b1	
0	0	0	:	updated
0	0	1	:	not updated
0	1	0	:	PLMN not allowed
0	1	1	:	Location Area not allowed
1	1	1	:	reserved

Bits b4 to b8 are RFU (see subclause 9.3).

### 10.3.18 EF<sub>AD</sub> (Administrative data)

This EF contains information concerning the mode of operation according to the type of SIM, such as normal (to be used by PLMN subscribers for GSM operations), type approval (to allow specific use of the ME during type approval procedures of e.g. the radio equipment), cell testing (to allow testing of a cell before commercial use of this cell), manufacturer specific (to allow the ME manufacturer to perform specific proprietary auto-test in its ME during e.g. maintenance phases).

It also provides an indication of whether some ME features should be activated during normal operation as well as information about the length of the MNC, which is part of the International Mobile Subscriber Identity (IMSI).

Identifier: '6FAD'		Structure: transparent		Mandatory
File size: 3+X bytes			Update activity: low	
Access Conditions:				
READ		ALW		
UPDATE		ADM		
INVALIDATE		ADM		
REHABILITATE		ADM		
Bytes	Description	M/O	Length	
1	MS operation mode	M	1 byte	
2 to 3	Additional information	M	2 bytes	
4	length of MNC in the IMSI	O	1 byte	
5 to 3+X	RFU	O	(X-1) bytes	
NOTE: If X=0 no optional field is present; If X=1 byte 4 is present but no RFU field is present; When the RFU field is present (X ≥ 2) then byte 4 shall be present.				

- MS operation mode

Contents: mode of operation for the MS

Coding:

Initial value

- normal operation '00'
- type approval operations '80'
- normal operation + specific facilities '01'
- type approval operations + specific facilities '81'
- maintenance (off line) '02'
- cell test operation '04'

- Additional information

Coding:

- specific facilities (if b1=1 in byte 1);

Byte 2 (first byte of additional information):

b8	b7	b6	b5	b4	b3	b2	b1

RFU

Byte 3:

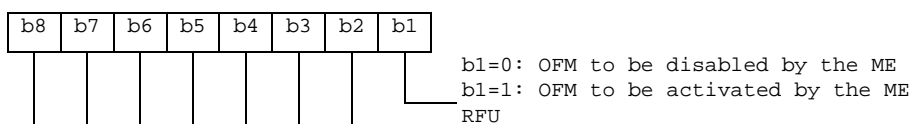

The OFM bit is used to control the Ciphering Indicator as specified in TS 02.07 [3]

- ME manufacturer specific information (if b2=1 in byte 1).
- Length of MNC in the IMSI :

Contents:

The length indicator refers to the number of digits, used for extracting the MNC from the IMSI

Coding:

Byte 4:

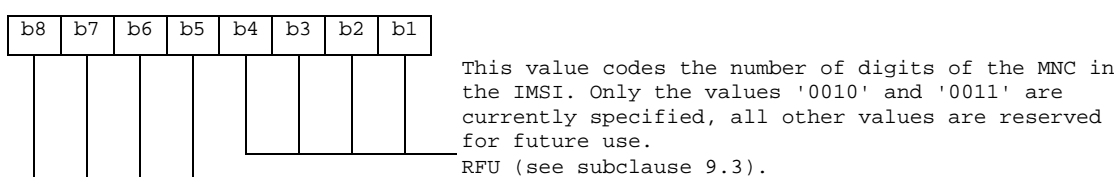

### 10.3.19 EF<sub>Phase</sub> (Phase identification)

This EF contains information concerning the phase of the SIM.

Identifier: '6FAE'		Structure: transparent		Mandatory	
File size: 1 byte			Update activity: low		
Access Conditions:					
READ		ALW			
UPDATE		ADM			
INVALIDATE		ADM			
REHABILITATE		ADM			
Bytes	Description			M/O	Length
1	SIM Phase			M	1 byte

- SIM Phase

Coding:

'00': phase 1

'02': phase 2

'03': phase 2 and PROFILE DOWNLOAD required (see TS 11.14 [27]).

All other codings are reserved for specification by ETSI TC SMG. Codings '04' to '0F' indicate that the SIM supports, as a minimum, the mandatory requirements defined in this specification.

This phase identification does not preclude a SIM to support some features of a phase later than the one indicated in EF<sub>Phase</sub>. For example : if EF<sub>Phase</sub> is coded '00', it may be assumed by the ME that some Phase 2 or Phase 2+ features are supported by this SIM; if EF<sub>Phase</sub> is coded '02' or '03', it may be assumed by the ME that some Phase 2+ features are supported by this SIM.

However, the services n°3 (FDN) and/or n°5 (AoC) shall only be allocated and activated in SIMs of phase 2 or later with EF<sub>Phase</sub> being coded '02' or greater. Similarly, service n°31 (BDN) shall only be allocated and activated in SIMs with EF<sub>Phase</sub> being coded '03' or greater.

If EF<sub>Phase</sub> is coded '03' or greater, an ME supporting SIM Application Toolkit shall perform the PROFILE DOWNLOAD procedure, as defined in TS 11.14 [27].

### 10.3.20 EF<sub>VGCS</sub> (Voice Group Call Service)

This EF contains a list of those VGCS group identifiers the user has subscribed to. The elementary file is used by the ME for group call establishment and group call reception.

Identifier: '6FB1'		Structure: transparent		Optional	
File size: 4n bytes (n <= 50)			Update activity: low		
Access Conditions:					
READ		CHV1			
UPDATE		ADM			
INVALIDATE		ADM			
REHABILITATE		ADM			
Bytes	Description			M/O	Length
1 to 4	Group ID 1			M	4 bytes
5 to 8	Group ID 2			O	4 bytes
:	:			:	:
(4n-3) to 4n	Group ID n			O	4 bytes

- Group ID

Contents: VGCS Group ID, according to TS 23.003 [10]

Coding:

The VGCS Group ID is of a variable length with a maximum length of 8 digits. Each VGCS Group ID is coded on four bytes, with each digit within the code being coded on four bits corresponding to BCD code. If a VGCS Group ID of less than 8 digits is chosen, then the unused nibbles shall be set to 'F'. VGCS Group ID Digit 1 is the most significant digit of the Group ID.

Byte 1:

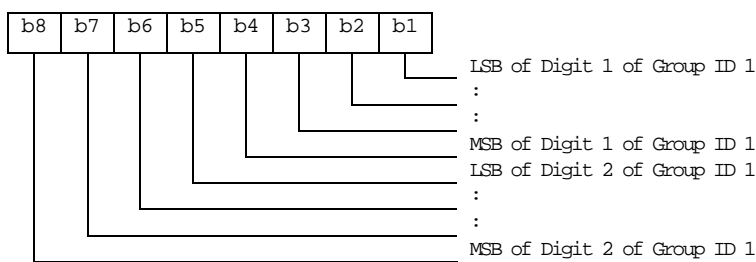

Byte 2:

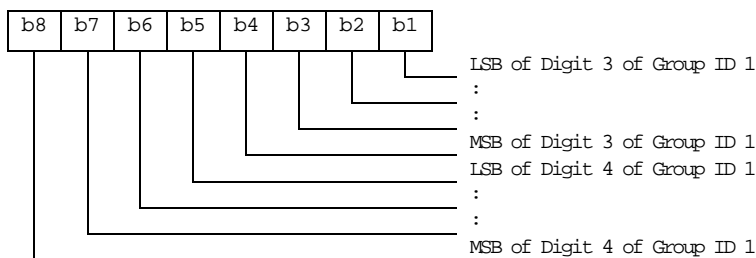

Byte 3:

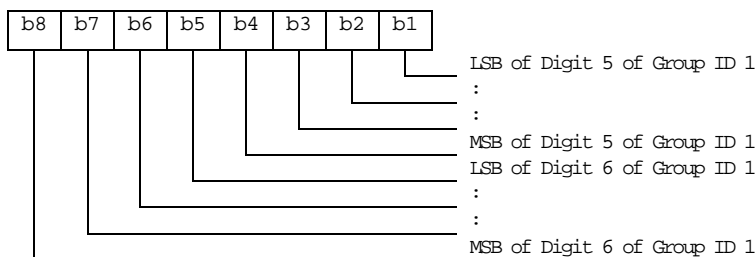

Byte 4:

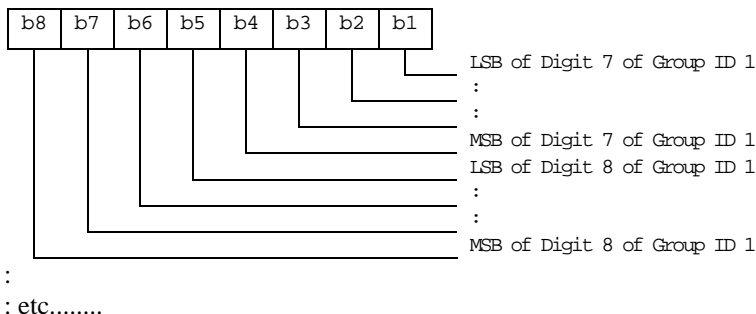

Byte (4n-3) to 4n:

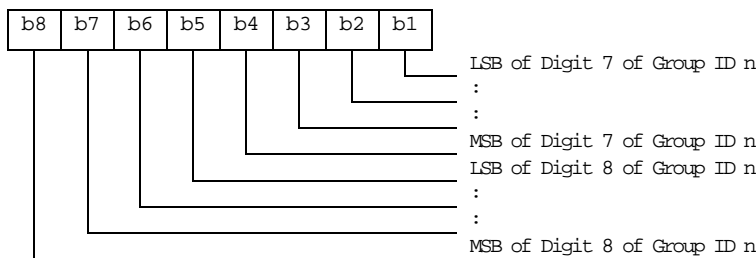

If storage for fewer than the maximum possible number *n* of VGCS Group IDs, is required, the excess bytes shall be set to 'FF'.

### 10.3.21 EF<sub>VGCS</sub> (Voice Group Call Service Status)

This EF contains the status of activation for the VGCS group identifiers. The elementary file is directly related to the EF<sub>VGCS</sub>. This EF shall always be allocated if EF<sub>VGCS</sub> is allocated.

Identifier: '6FB2'		Structure: transparent		Optional
File size: 7 bytes		Update activity: low		
Access Conditions:				
READ		CHV1		
UPDATE		ADM		
INVALIDATE		ADM		
REHABILITATE		ADM		
Bytes	Description	M/O	Length	
1 to 7	Activation/Deactivation Flags	M	7 bytes	

- Activation/Deactivation Flags

Contents: Activation/Deactivation Flags of the appropriate Group IDs

Coding:



bit = 0 means - Group ID deactivated

bit = 1 means - Group ID activated

Byte 1:

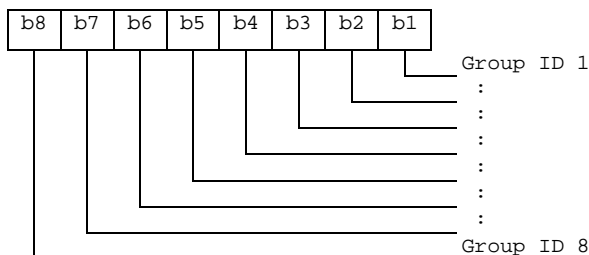

etc : : : : : : :

Byte 7:

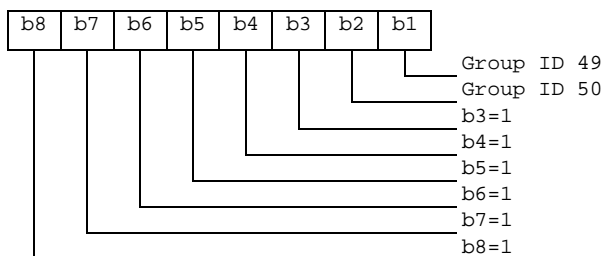

### 10.3.22 EF<sub>VBS</sub> (Voice Broadcast Service)

This EF contains a list of those VBS group identifiers the user has subscribed to. The elementary file is used by the ME for broadcast call establishment and broadcast call reception.

Identifier: '6FB3'		Structure: transparent		Optional	
File size: 4n bytes (n <= 50)			Update activity: low		
Access Conditions:					
READ		CHV1			
UPDATE		ADM			
INVALIDATE		ADM			
REHABILITATE		ADM			
Bytes	Description			M/O	Length
1 to 4	Group ID 1			M	4 bytes
5 to 2	Group ID 2			O	4 bytes
:	:			:	:
(4n-3) to 4n	Group ID n			O	4 bytes

- Group ID

Contents: VBS Group ID, according to TS 23.003 [10]

Coding:

The VBS Group ID is of a variable length with a maximum length of 8 digits. Each VBS Group ID is coded on four bytes, with each digit within the code being coded on four bits corresponding to BCD code. If a VBS Group ID of less than 8 digits is chosen, then the unused nibbles shall be set to 'F'. VBS Group ID Digit 1 is the most significant digit of the Group ID.

Byte 1:

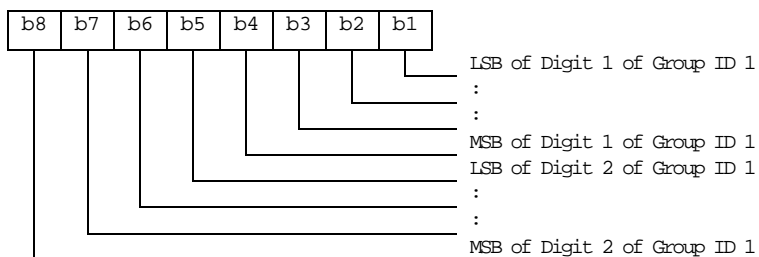

Byte 2:

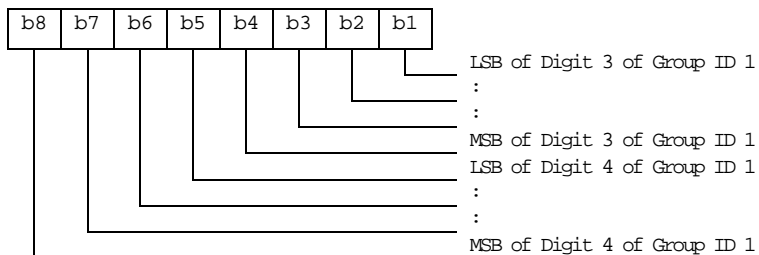

Byte 3:

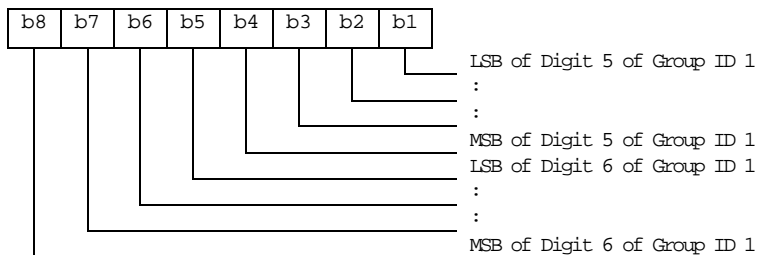

Byte 4:

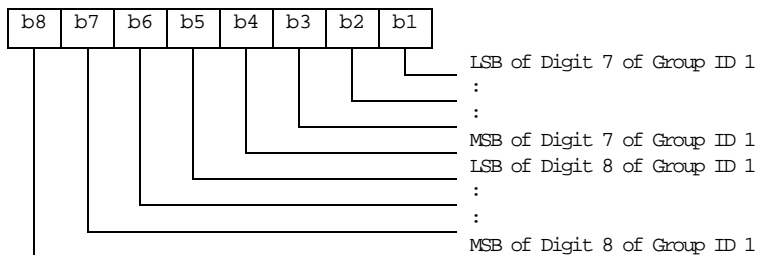

:  
: etc.....

Byte (4n-3) to 4n:

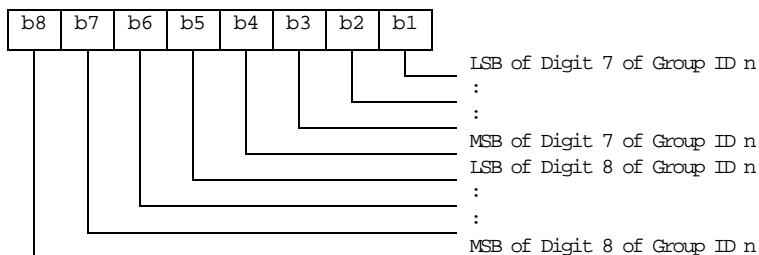

If storage for fewer than the maximum possible number  $n$  of VBS Group IDs, is required, the excess bytes shall be set to 'FF'.

### 10.3.23 EF<sub>VBSS</sub> (Voice Broadcast Service Status)

This EF contains the status of activation for the VBS group identifiers. The elementary file is directly related to the EF<sub>VBS</sub>. This EF shall always be allocated if EF<sub>VBS</sub> is allocated.

Identifier: '6FB4'		Structure: transparent		Optional	
File size: 7 bytes			Update activity: low		
Access Conditions:					
READ		CHV1			
UPDATE		ADM			
INVALIDATE		ADM			
REHABILITATE		ADM			
Bytes	Description			M/O	Length
1 to 7	Activation/Deactivation Flags			M	7 bytes

- Activation/Deactivation Flags

Contents: Activation/Deactivation Flags of the appropriate Group IDs

Coding:

see coding of EF<sub>VGCS</sub>

### 10.3.24 EF<sub>eMLPP</sub> (enhanced Multi Level Pre-emption and Priority)

This EF contains information about priority levels and fast call set-up conditions for the enhanced Multi Level Pre-emption and Priority service that which can be used by the subscriber.

Identifier: '6FB5'		Structure: transparent		Optional	
File size: 2 bytes			Update activity: low		
Access Conditions:					
READ		CHV1			
UPDATE		ADM			
INVALIDATE		ADM			
REHABILITATE		ADM			
Bytes	Description			M/O	Length
1	Priority levels			M	1 byte
2	Fast call set-up conditions			M	1 byte

- Priority levels

Contents: The eMLPP priority levels subscribed to.

Coding: Each eMLPP priority level is coded on one bit. Priority levels subscribed to have their corresponding bits set to 1. Priority levels not subscribed to have their corresponding bits set to 0. Bit b8 is reserved and set to 0.

Byte 1:

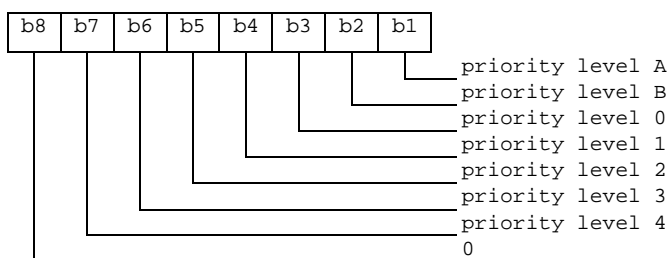

NOTE: Priority levels A and B can not be subscribed to (see TS 22.067 [42] for details).

EXAMPLE 1: If priority levels 0, 1 and 2 are subscribed to, EF<sub>eMLPP</sub> shall be coded '1C'.

- Fast call set-up conditions

Contents: For each eMLPP priority level, the capability to use a fast call set-up procedure.

Coding: Each eMLPP priority level is coded on one bit. Priority levels for which fast call set-up is allowed have their corresponding bits set to 1. Priority levels for which fast call set-up is not allowed have their corresponding bits set to 0. Bit b8 is reserved and set to 0.

Byte 2: fast call set-up condition for:

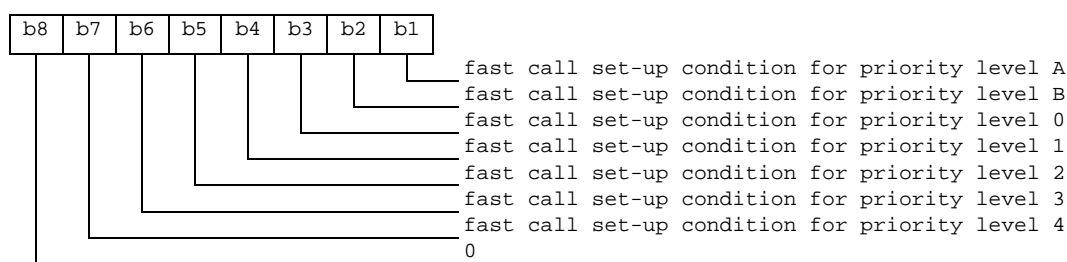

EXAMPLE 2: If fast call set-up is allowed for priority levels 0 and 1, then byte 2 of EF<sub>eMLPP</sub> is coded '0C'.

### 10.3.25 EF<sub>AAeM</sub> (Automatic Answer for eMLPP Service)

This EF contains those priority levels (of the Multi Level Pre-emption and Priority service) for which the mobile station shall answer automatically to incoming calls.

Identifier: '6FB6'		Structure: transparent		Optional
File size: 1 byte			Update activity: low	
Access Conditions:				
READ		CHV1		
UPDATE		CHV1		
INVALIDATE		ADM		
REHABILITATE		ADM		
Bytes	Description	M/O	Length	
1	Automatic answer priority levels	M	1 byte	

- Automatic answer priority levels

Contents:

For each eMLPP priority level, the capability for the mobile station to answer automatically to incoming calls (with the corresponding eMLPP priority level).

Coding:

Each eMLPP priority level is coded on one bit. Priority levels allowing an automatic answer from the mobile station have their corresponding bits set to 1. Priority levels not allowing an automatic answer from the mobile station have their corresponding bits set to 0. Bit b8 is reserved and set to 0.

Byte 1:

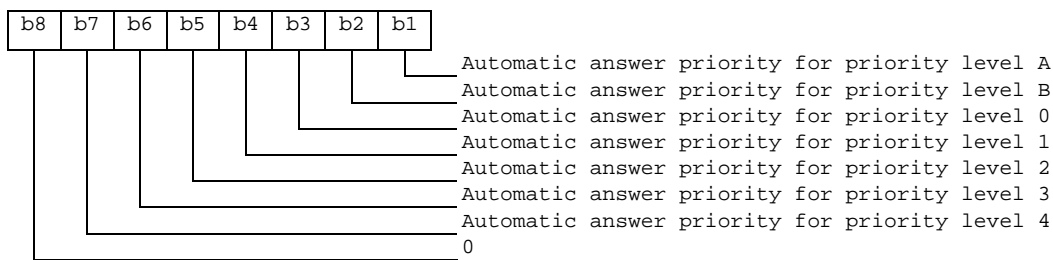

EXAMPLE: If automatic answer is allowed for incoming calls with priority levels A, 0 and 1, then EF<sub>AAeMLPP</sub> is coded '0D'.

### 10.3.26 EF<sub>CBMID</sub> (Cell Broadcast Message Identifier for Data Download)

This EF contains the message identifier parameters which specify the type of content of the cell broadcast messages which are to be passed to the SIM.

Any number of CB message identifier parameters may be stored in the SIM. No order of priority is applicable.

Identifier: '6F48'		Structure: transparent		Optional
File size: 2n bytes			Update activity: low	
Access Conditions:				
READ		CHV1		
UPDATE		ADM		
INVALIDATE		ADM		
REHABILITATE		ADM		
Bytes	Description	M/O	Length	
1 to 2	CB Message Identifier 1	O	2 bytes	
3 to 4	CB Message Identifier 2	O	2 bytes	
2n-1 to 2n	CB Message Identifier n	O	2 bytes	

- Cell Broadcast Message Identifier

Coding:

as in TS 23.041 [14]. Values listed show the identifiers of messages which shall be accepted by the MS to be passed to the SIM.

Unused entries shall be set to 'FF FF'.

### 10.3.27 EFecc (Emergency Call Codes)

This EF contains up to 5 emergency call codes.

Identifier: '6FB7'		Structure: transparent		Optional	
File size: 3n (n ≤ 5) bytes			Update activity: low		
Access Conditions:					
READ		ALW			
UPDATE		ADM			
INVALIDATE		ADM			
REHABILITATE		ADM			
Bytes	Description	M/O	Length		
1 to 3	Emergency Call Code 1	O	3 bytes		
4 to 6	Emergency Call Code 2	O	3 bytes		
(3n-2) to 3n	Emergency Call Code n	O	3 bytes		

- Emergency Call Code

Contents:

Emergency Call Code

Coding:

The emergency call code is of a variable length with a maximum length of 6 digits. Each emergency call code is coded on three bytes, with each digit within the code being coded on four bits as shown below. If a code of less than 6 digits is chosen, then the unused nibbles shall be set to 'F'.

Byte 1:

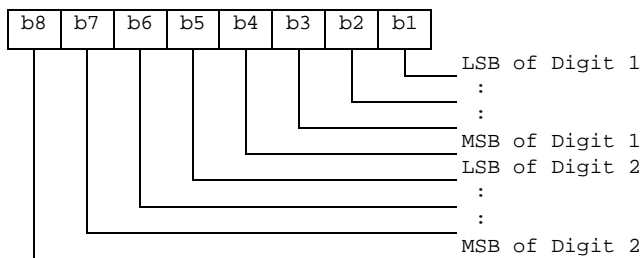

Byte 2:

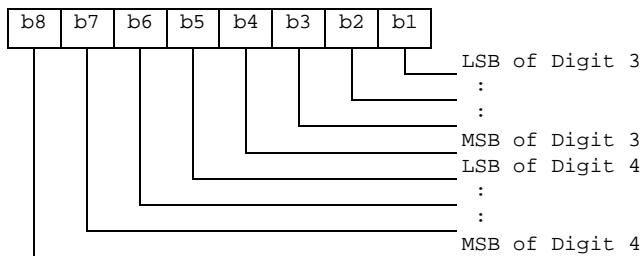

Byte 3:

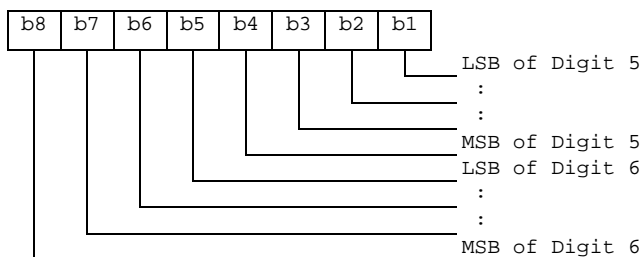

### 10.3.28 EF<sub>CBMIR</sub> (Cell broadcast message identifier range selection)

This EF contains ranges of cell broadcast message identifiers that the subscriber wishes the MS to accept.

Any number of CB Message Identifier Parameter ranges may be stored in the SIM. No order of priority is applicable.

Identifier: '6F50'		Structure: transparent		Optional
File size: 4n bytes		Update activity: low		
Access Conditions:				
READ		CHV1		
UPDATE		CHV1		
INVALIDATE		ADM		
REHABILITATE		ADM		
Bytes	Description	M/O	Length	
1 to 4	CB Message Identifier Range 1	O	4 bytes	
5 to 8	CB Message Identifier Range 2	O	4 bytes	
(4n-3) to 4n	CB Message Identifier Range n	O	4 bytes	

- Cell Broadcast Message Identifier Ranges

Contents:

CB Message Identifier ranges:

Coding:

bytes one and two of each range identifier equal the lower value of a cell broadcast range, bytes three and four equal the upper value of a cell broadcast range, both values are coded as in TS 23.041 [14] "Message Format on BTS-MS Interface - Message Identifier". Values listed show the ranges of messages which shall be accepted by the MS.

Unused entries shall be set to 'FF FF FF FF'.

### 10.3.29 EF<sub>DCK</sub> De-personalization Control Keys

This EF provides storage for the de-personalization control keys associated with the OTA de-personalization cycle of TS 22.022.

Identifier: '6F2C'		Structure: transparent		Optional
File size: 16 bytes		Update activity: low		
Access Conditions:				
READ		CHV1		
UPDATE		CHV1		
INVALIDATE		ADM		
REHABILITATE		ADM		
Bytes	Description	M/O	Length	
1 to 4	8 digits of network de-personalization control key	M	4 bytes	
5 to 8	8 digits of network subset de-personalization control key	M	4 bytes	
9 to 12	8 digits of service provider de-personalization control key	M	4 bytes	
13 to 16	8 digits of corporate de-personalization control key	M	4 bytes	

Empty control key records shall be coded 'FFFFFFF'.

### 10.3.30 EF<sub>CNL</sub> (Co-operative Network List)

This EF contains the Co-operative Network List for the multiple network personalization services defined in TS 22.022.

Identifier: '6F32'		Structure: transparent		Optional
File size: 6n bytes		Update activity: low		
Access Conditions:				
READ		CHV1		
UPDATE		ADM		
INVALIDATE		ADM		
REHABILITATE		ADM		
Bytes	Description	M/O	Length	
1 to 6	Element 1 of co-operative net list	O	6 bytes	
6n-5 to 6n	Element n of co-operative net list	O	6 bytes	

- Co-operative Network List

Contents:

PLMN network subset, service provider ID and corporate ID of co-operative networks.

Coding:

For each 6 byte list element



Byte 1 to 3 : PLMN (MCC + MNC) : according to TS 04.08 [15].

Byte 4:

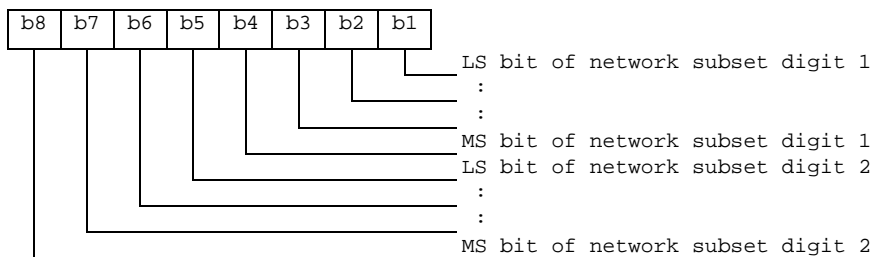

Byte 5:

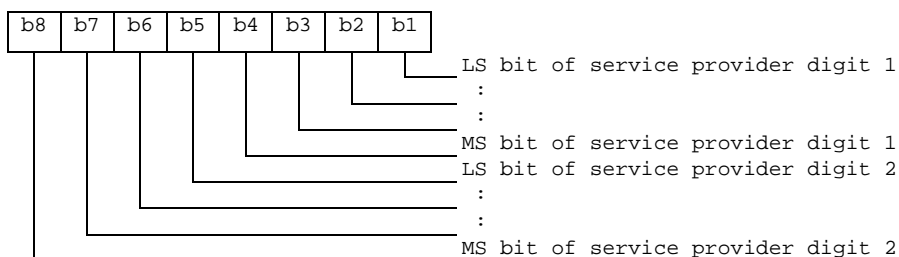

Byte 6:

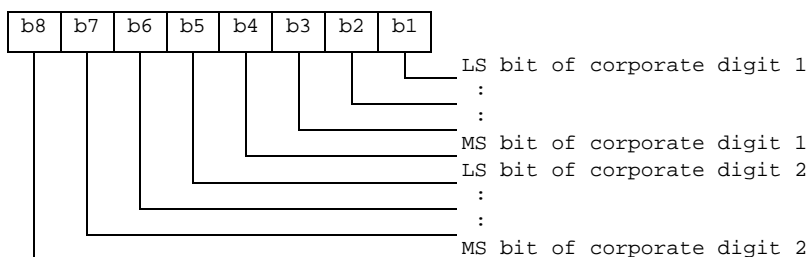

Empty fields shall be coded with 'FF'.

The end of the list is delimited by the first MCC field coded 'FFF'.

### 10.3.31 EF<sub>NIA</sub> (Network's Indication of Alerting)

This EF contains categories and associated text related to the Network's indication of alerting in the MS service defined in TS 02.07 [3].

Identifier: '6F51'		Structure: linear fixed		Optional
Record length : X+1 bytes		Update activity: low		
Access Conditions:				
READ		CHV1		
UPDATE		ADM		
INVALIDATE		ADM		
REHABILITATE		ADM		
Bytes	Description	M/O	Length	
1	Alerting category	M	1 byte	
2 to X+1	Informative text	M	X bytes	

- Alerting category

Contents:

category of alerting for terminating traffic.

Coding:

according to TS 04.08 [15]. Value 'FF' means that no information on alerting category is available.

- Informative text

Contents:

text describing the type of terminating traffic associated with the category.

Coding:

see the coding of the Alpha Identifier item of the EF<sub>ADN</sub> (subclause 10.5.1). The maximum number of characters for this informative text is indicated in TS 02.07 [3].

### 10.3.32 EF<sub>KcGPRS</sub> (GPRS Ciphering key KcGPRS)

This EF contains the ciphering key KcGPRS and the ciphering key sequence number n for GPRS (see TS 23.060 [32]).

Identifier: '6F52'		Structure: transparent		Optional
File size: 9 bytes		Update activity: high		
Access Conditions:				
READ		CHV1		
UPDATE		CHV1		
INVALIDATE		ADM		
REHABILITATE		ADM		
Bytes	Description	M/O	Length	
1 to 8	Ciphering key KcGPRS	M	8 bytes	
9	Ciphering key sequence number n for GPRS	M	1 byte	

- Ciphering key KcGPRS

Coding:

The least significant bit of KcGPRS is the least significant bit of the eighth byte. The most significant bit of KcGPRS is the most significant bit of the first byte.

- Ciphering key sequence number n for GPRS

Coding:

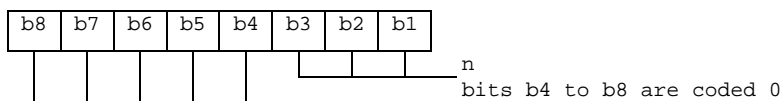

NOTE: TS 04.08 [15] defines the value of n=111 as "key not available". Therefore the value '07' and not 'FF' should be present following the administrative phase.

### 10.3.33 EF<sub>LOCIGPRS</sub> (GPRS location information)

This EF contains the following Location Information:

- Packet Temporary Mobile Subscriber Identity (P-TMSI);
- Packet Temporary Mobile Subscriber Identity signature value (P-TMSI signature value);
- Routing Area Information (RAI);
- Routing Area update status.

Identifier: '6F53'		Structure: transparent		Optional
File size: 14 bytes			Update activity: high	
Access Conditions: READ CHV1 UPDATE CHV1 INVALIDATE ADM REHABILITATE ADM				
Bytes	Description	M/O	Length	
1 to 4	P-TMSI	M	4 bytes	
5 to 7	P-TMSI signature value	M	3 bytes	
8 to 13	RAI	M	6 bytes	
14	Routing Area update status	M	1 byte	

- P-TMSI

Contents: Packet Temporary Mobile Subscriber Identity

Coding: according to TS 04.08 [15].

Byte 1: first byte of P-TMSI

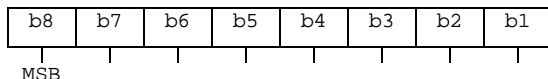

- P-TMSI signature value

Contents: Packet Temporary Mobile Subscriber Identity signature value

Coding: according to TS 04.08 [15].

Byte 5: first byte of P-TMSI signature value

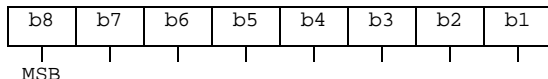

- RAI

Contents: Routing Area Information

Coding: according to TS 04.08 [15].

Byte 8: first byte of RAI

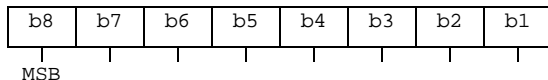

- Routing area update status

Contents: status of routing area update according to TS 04.08 [15].

Coding:

Byte 14:

Bits:	b3	b2	b1	
	0	0	0	: updated
	0	0	1	: not updated
	0	1	0	: PLMN not allowed
	0	1	1	: Routing Area not allowed

1 1 1 : reserved  
 Bits b4 to b8 are RFU (see subclause 9.3).

### 10.3.34 EF<sub>SUME</sub> (SetUpMenu Elements)

This EF contains Simple TLVs related to the menu title to be used by a SIM card supporting the SIM API when issuing a SET UP MENU proactive command.

Identifier: '6F54'		Structure: transparent		Optional
File size: X+Y bytes		Update activity: low		
Access Conditions:				
READ		ADM		
UPDATE		ADM		
INVALIDATE		ADM		
REHABILITATE		ADM		
Bytes	Description	M/O	Length	
1 - X	Title Alpha Identifier	M	X bytes	
1+X to X+Y	Title Icon Identifier	O	Y bytes	

- Title Alpha Identifier

Contents:

this field contains the Alpha Identifier Simple TLV defining the menu title text.

Coding:

according to TS 11.14 [27].

- Title Icon Identifier

Contents:

this field contains the Icon Identifier Simple TLV defining the menu title icon.

Coding:

according to GSM 11.14 [27].

If not present the field shall be set to 'FF'.

Unused bytes of this file shall be set to 'FF'.

### 10.3.35 EF<sub>PLMNwAcT</sub> (User controlled PLMN Selector with Access Technology)

This EF contains coding for n PLMNs, where n is at least eight. This information, determined by the user, defines the preferred PLMNs of the user in priority order. The EF also contains the Access Technologies for each PLMN in this list. (see TS 23.122 [51]).

Identifier: '6F60'		Structure: transparent		Optional
File size: 5n (n ≥ 8) bytes			Update activity: low	
Access Conditions:				
READ		CHV1		
UPDATE		CHV1		
INVALIDATE		ADM		
REHABILITATE		ADM		
Bytes	Description	M/O	Length	
1 to 3	1 <sup>st</sup> PLMN (highest priority)	M	3 bytes	
4 to 5	1 <sup>st</sup> PLMN Access Technology Identifier	M	2 bytes	
6 to 8	2 <sup>nd</sup> PLMN	M	3 bytes	
9 to 10	2 <sup>nd</sup> PLMN Access Technology Identifier	M	2 bytes	
:	:			
36 to 38	8 <sup>th</sup> PLMN	M	3 bytes	
39 to 40	8 <sup>th</sup> PLMN Access Technology Identifier	M	2 bytes	
41 to 43	9 <sup>th</sup> PLMN	O	3 bytes	
44 to 45	9 <sup>th</sup> PLMN Access Technology Identifier	O	2 bytes	
:	:			
(5n-4) to (5n-2)	N <sup>th</sup> PLMN (lowest priority)	O	3 bytes	
(5n-1) to 5n	N <sup>th</sup> PLMN Access Technology Identifier	O	2 bytes	

- PLMN

Contents:

Mobile Country Code (MCC) followed by the Mobile Network Code (MNC).

Coding:

according to TS 24.008 [47].

- Access Technologies

Contents: The Access Technologies of a PLMN that the MS will assume when searching for a listed PLMN.

Coding:

- 2 bytes are used to select the access technology where the meaning of each bit is as follows:
  - bit = 1: access technology selected;
  - bit = 0: access technology not selected.

Byte 5n-1:

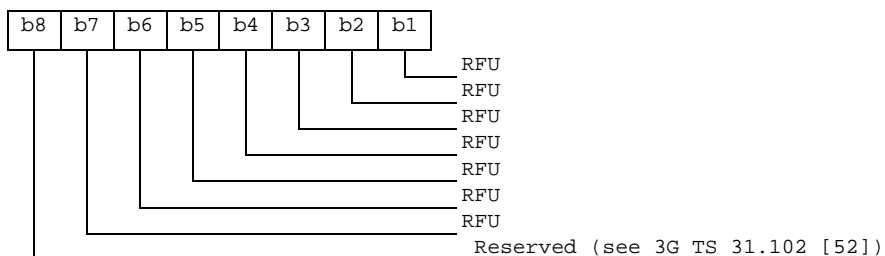

Byte 5n:

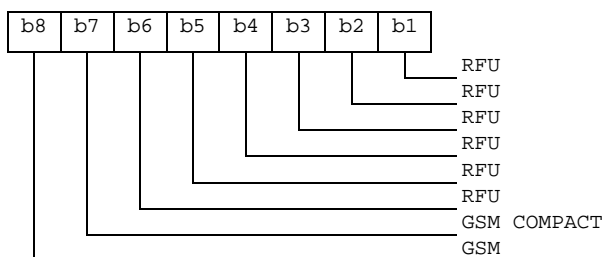

The RFU bits are coded with '0' in the bit positions.

### 10.3.36 EF<sub>OPLMNwAcT</sub> (Operator controlled PLMN Selector with Access Technology)

This EF contains coding for n PLMNs, where n is at least eight. This information, determined by the operator, defines the preferred PLMNs of the operator in priority order. The EF also contains the Access Technologies for each PLMN in this list (see TS 23.122 [51]).

Identifier: '6F61'		Structure: transparent		Optional
File size: 5n (n ≥ 8) bytes		Update activity: low		
Access Conditions:				
READ		CHV1		
UPDATE		ADM		
INVALIDATE		ADM		
REHABILITATE		ADM		
Bytes	Description	M/O	Length	
1 to 3	1 <sup>st</sup> PLMN (highest priority)	M	3 bytes	
4 to 5	1 <sup>st</sup> PLMN Access Technology Identifier	M	2 bytes	
:	:			
36 to 38	8 <sup>th</sup> PLMN	M	3 bytes	
39 to 40	8 <sup>th</sup> PLMN Access Technology Identifier	M	2 bytes	
41 to 43	9 <sup>th</sup> PLMN	O	3 bytes	
44 to 45	9 <sup>th</sup> PLMN Access Technology Identifier	O	2 bytes	
:	:			
(5n-4) to (5n-2)	N <sup>th</sup> PLMN (lowest priority)	O	3 bytes	
(5n-1) to 5n	N <sup>th</sup> PLMN Access Technology Identifier	O	2 bytes	

- PLMN

Contents:

Mobile Country Code (MCC) followed by the Mobile Network Code (MNC).

Coding:

according to TS 24.008 [47].

- Access Technologies

Contents: The Access Technologies of a PLMN that the MS will assume when searching for a listed PLMN.

Coding: See EF<sub>OPLMNwAcT</sub> for coding.

### 10.3.37 EF<sub>HPLMNwAcT</sub> (HPLMN Selector with Access Technology)

The HPLMN Selector with access technology data field shall contain the HPLMN code, or codes together with the respective access technology in priority order (see TS 23.122 [51]).

Identifier: '6F62'		Structure: transparent		Optional
File size: 5n (n ≥ 1) bytes		Update activity: low		
Access Conditions:				
READ		CHV1		
UPDATE		ADM		
INVALIDATE		ADM		
REHABILITATE		ADM		
Bytes	Description	M/O	Length	
1 to 3	1 <sup>st</sup> PLMN (highest priority)	M	3 bytes	
4 to 5	1 <sup>st</sup> PLMN Access Technology Identifier	M	2 bytes	
6 to 8	2 <sup>nd</sup> PLMN	O	3 bytes	
9 to 10	2 <sup>nd</sup> PLMN Access Technology Identifier	O	2 bytes	
:	:			
(5n-4) to (5n-2)	N <sup>th</sup> PLMN (lowest priority)	O	3 bytes	
(5n-1) to 5n	N <sup>th</sup> PLMN Access Technology Identifier	O	2 bytes	

- PLMN

Contents:

Mobile Country Code (MCC) followed by the Mobile Network Code (MNC).

Coding:

according to TS 24.008 [47].

- Access Technology

Contents: The Access Technology of the HPLMN that the MS will assume when searching for the HPLMN, in priority order. The first Access Technology in the list has the highest priority.

Coding: See EF<sub>PLMNwAcT</sub> for coding.

### 10.3.38 EF<sub>CPBCCH</sub> (CPBCCH Information)

This EF contains information concerning the CPBCCH according to TS 04.18 [48] and TS 03.22 [45].

CPBCCH storage may reduce the extent of a Mobile Station's search of CPBCCH carriers when selecting a cell. The CPBCCH carrier lists shall be in accordance with the procedures specified in TS 04.18 [48], TS 04.60 [49] and TS 03.22 [45]. The MS stores CPBCCH information from the System Information 19 message, Packet System Information 3, and Packet System Information 3 bis on the SIM. The same CPBCCH carrier shall never occur twice in the list.

Identifier: '6F63'		Structure: transparent		Optional
File size: 2n bytes		Update activity: high		
Access Conditions:				
READ		CHV1		
UPDATE		CHV1		
INVALIDATE		ADM		
REHABILITATE		ADM		
Bytes	Description	M/O	Length	
1 to 2	Element 1 of CPBCCH carrier list	M	2 bytes	
2n-1 to 2n	Element n of CPBCCH carrier list	M	2 bytes	

- Element in CPBCCH carrier list

Coding:

Byte 1: first byte of CPBCCH carrier list element

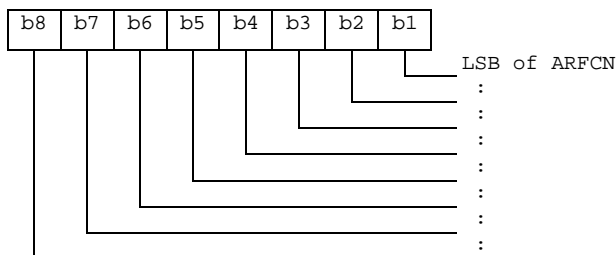

Byte 2: second byte of CPBCCH carrier list element

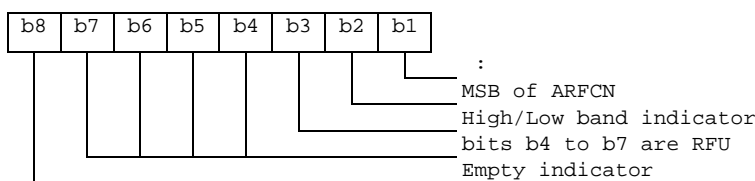

- ARFCN (10 bits) as defined in TS 05.05 [46].
- High/Low band indicator: If the ARFCN indicates possibly a channel in the DCS 1800 or a channel in the PCS 1900 band, if the bit is set to '1' the channel is in the higher band (GSM 1900). If the bit is set to '0', the lower band (GSM 1800) is indicated. If ARFCN indicates a unique channel, this indicator shall be set to '0'.
- Empty indicator: If this bit is set to '1', no CPBCCH carrier is stored in this position. If the Empty Indicator is set to '1', the content of the CPBCCH carrier field shall be ignored. The empty indicator shall also be used, and set to '1', if storage of fewer than maximum number n, of CPBCCH carrier fields is required.

### 10.3.39 EF<sub>InvScan</sub> (Investigation Scan)

This EF contains two flags used to control the investigation scan for higher prioritized PLMNs not offering voice services.

Identifier: '6F64'		Structure: transparent		Optional
File size: 1 byte		Update activity: low		
Access Conditions:				
READ		CHV1		
UPDATE		ADM		
INVALIDATE		ADM		
REHABILITATE		ADM		
Bytes	Description	M/O	Length	
1	Investigation scan flags	M	1 bytes	

- Investigation scan flags

Coding:

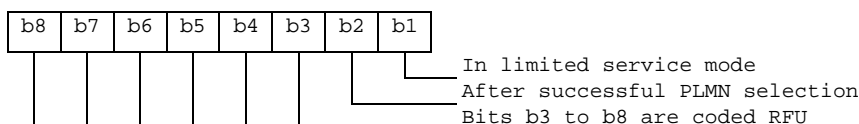



A '1' in a bit position indicates that the investigation scan shall be performed for the condition corresponding to that bit position and a '0' that it shall not be performed.

If this elementary file is not present, no investigation scan shall be performed.

### 10.3.40 Void

## 10.4 Contents of DFs at the GSM application level

### 10.4.1 Contents of files at the GSM SoLSA level

This subclause specifies the EFs in the dedicated file DF<sub>SoLSA</sub>. It only applies if the SoLSA feature is supported (see TS 23.073 [33]).

The EFs contain information about the users subscribed local service areas.

#### 10.4.1.1 EF<sub>SAI</sub> (SoLSA Access Indicator)

This EF contains the 'LSA only access indicator'. This EF shall always be allocated if DF<sub>SoLSA</sub> is present.

If the indicator is set, the network will prevent terminated and/or originated calls when the MS is camped in cells that are not included in the list of allowed LSAs in EF<sub>SLL</sub>. Emergency calls are, however, always allowed.

The EF also contains a text string which may be displayed when the MS is out of the served area(s).

Identifier: '4F30'		Structure: transparent		Optional
File size: X + 1 bytes		Update activity: low		
Access Conditions:				
READ		CHV1		
UPDATE		ADM		
INVALIDATE		ADM		
REHABILITATE		ADM		
Bytes	Description	M/O	Length	
1	LSA only access indicator	M	1 byte	
2 to X+1	LSA only access indication text	M	X bytes	

- LSA only access indicator

Contents: indicates whether the MS is restricted to use LSA cells only or not.

Coding:

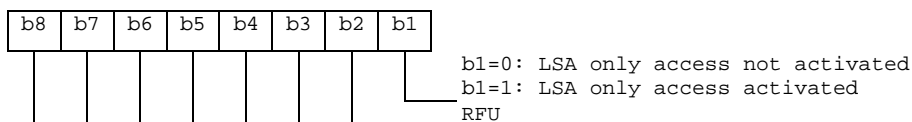

- LSA only access indication text

Contents: text to be displayed by the ME when it's out of LSA area.

Coding: the string shall use either

- the SMS default 7-bit coded alphabet as defined in TS 23.038 [12] with bit 8 set to 0. The alpha identifier shall be left justified. Unused bytes shall be set to 'FF'; or
- one of the UCS2 coded options as defined in annex B.

### 10.4.1.2 EF<sub>SLL</sub> (SoLSA LSA List)

This EF contains information describing the LSAs that the user is subscribed to. This EF shall always be allocated if DF<sub>SoLSA</sub> is present.

Each LSA is described by one record that is linked to a LSA Descriptor file. Each record contains information of the PLMN, priority of the LSA, information about the subscription and may also contain a text string and/or an icon that identifies the LSA to the user. The text string can be edited by the user.

Identifier: '4F31'		Structure: linear fixed		Optional
Record length: X + 10 bytes		Update activity: low		
Access Conditions:				
READ		CHV1		
UPDATE		CHV1		
INVALIDATE		ADM		
REHABILITATE		ADM		
Bytes	Description	M/O	Length	
1 to X	LSA name	O	X bytes	
X+1	Configuration parameters	M	1 byte	
X+2	RFU	M	1 byte	
X+3	Icon Identifier	M	1 byte	
X+4	Priority	M	1 byte	
X+5 to X+7	PLMN code	M	3 bytes	
X+8 to X+9	LSA Descriptor File Identifier	M	2 byte	
X+10	LSA Descriptor Record Identifier	M	1 byte	

#### - LSA name

Contents: LSA name string to be displayed when the ME is camped in the corresponding area, dependant on the contents of the LSA indication for idle mode field.

Coding: the string shall use either

- the SMS default 7-bit coded alphabet as defined in TS 23.038 [12] with bit 8 set to 0. The alpha identifier shall be left justified. Unused bytes shall be set to 'FF'; or
- one of the UCS2 coded options as defined in annex B.

#### - Configuration parameters

Contents: Icon qualifier, control of idle mode support and control of LSA indication for idle mode.

Coding:

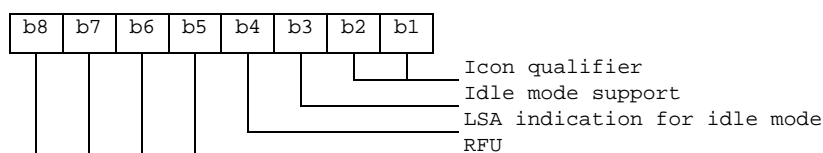

#### Icon qualifier:

Contents: The icon qualifier indicates to the ME how the icon is to be used.

- b2, b1: 00: icon is not to be used and may not be present  
 01: icon is self-explanatory, i.e. if displayed, it replaces the LSA name  
 10: icon is not self-explanatory, i.e. if displayed, it shall be displayed together with the LSA name  
 11: RFU

#### Idle mode support:

Contents: The idle mode support is used to indicate whether the ME shall favour camping on the LSA cells in idle mode.

b3 = 0: Idle mode support disabled  
b3 = 1: Idle mode support enabled

LSA indication for idle mode:

Contents: The LSA indication for idle mode is used to indicate whether or not the ME shall display the LSA name when the ME is camped on a cell within the LSA.

b4 = 0: LSA indication for idle mode disabled  
b4 = 1: LSA indication for idle mode enabled

Bits b5 to b8 are RFU (see subclause 9.3).

- Icon Identifier

Contents: The icon identifier addresses a record in EF<sub>IMG</sub>.

Coding: binary.

- Priority

Contents: Priority of the LSA which gives the ME the preference of this LSA relative to the other LSAs.

Coding:

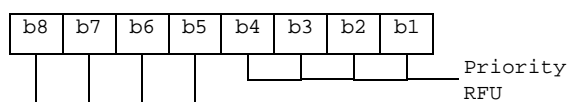

'0' is lowest priority, 'F' is highest.

- PLMN code

Contents: MCC + MNC for the LSA.

Coding: according to GSM 04.08 [15] and EF<sub>LOC1</sub>.

- LSA Descriptor File Identifier:

Contents: these bytes identify the EF which contains the LSA Descriptors forming the LSA.

Coding: byte X+8: high byte of the LSA Descriptor file;  
byte X+9: low byte of the LSA Descriptor file.

- LSA Descriptor Record Identifier:

Contents: this byte identifies the number of the first record in the LSA Descriptor file forming the LSA.

Coding: binary.

### 10.4.1.3 LSA Descriptor files

Residing under  $DF_{SoLSA}$ , there may be several LSA Descriptor files. These EFs contains one or more records again containing LSA Descriptors forming the LSAs. LSAs can be described in four different ways. As a list of LSA IDs, as a list of LAC + CIs, as a list of CIs or as a list of LACs. As the basic elements (LSA ID, LAC + CI, CI and LAC) of the four types of lists are of different length, they can not be mixed within one record. Different records may contain different kinds of lists within the EFs. Examples of codings of LSA Descriptor files can be found in annex F.

Identifier: '4FXX'		Structure: linear fixed		Optional
Record length: $n \cdot X + 2$ bytes		Update activity: low		
Access Conditions:				
READ		CHV1		
UPDATE		ADM		
INVALIDATE		ADM		
REHABILITATE		ADM		
Bytes	Description	M/O	Length	
1	LSA descriptor type and number	M	1 byte	
2 to $X+1$	1 <sup>st</sup> LSA Descriptor	M	X bytes	
$X+2$ to $2X+1$	2 <sup>nd</sup> LSA Descriptor	M	X bytes	
$(n-1) \cdot X + 2$ to $n \cdot X + 1$	$n^{\text{th}}$ LSA Descriptor	M	X bytes	
$n \cdot X + 2$	Record Identifier	M	1 byte	

- LSA descriptor type and number:

Contents: The LSA descriptor type gives the format of the LSA descriptor and the number of valid LSA Descriptors within the record.

Coding:

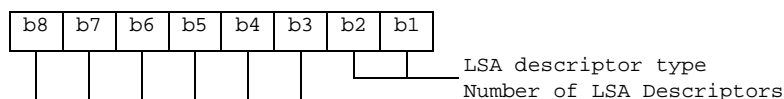

LSA descriptor type:

Contents: Gives the format of the LSA Descriptors.

b2, b1:     00: LSA ID.  
              01: LAC + CI  
              10: CI  
              11: LAC

Number of LSA Descriptors:

Contents: Gives the number of valid LSA Descriptors in the record.

Coding: binary, with b8 as MSB and b3 as LSB leaving room for 64 LSA Descriptors per record.

- LSA Descriptor

Contents: Dependant of the coding indicated in the LSA descriptor type:

- in case of LSA ID the field length 'X' is 3 bytes;
- in case of LAC + CI the field length 'X' is 4 bytes;
- in case of CI the field length 'X' is 2 bytes;
- in case of LAC the field length 'X' is 2 bytes.

Coding: according to TS 04.08 [15].

- Record Identifier:

Contents: This byte identifies the number of the next record containing the LSA Descriptors forming the LSA.

Coding: record number of next record. 'FF' identifies the end of the chain.

This file utilises the concept of chaining as for EF<sub>EXT1</sub>.

The identifier '4FXX' shall be different from one LSA Descriptor file to the other and different from the identifiers of EF<sub>SAI</sub> and EF<sub>SLL</sub>. For the range of 'XX', see subclause 6.6.

## 10.4.2 Contents of files at the MExE level

This subclause specifies the EFs in the dedicated file DFME<sub>XE</sub>. It only applies if support of MExE by the SIM is supported (see TS 23.057 [50]).

The EFs in the Dedicated File DFME<sub>XE</sub> contain execution environment related information.

### 10.4.2.1 EF<sub>MExE-ST</sub> (MExE Service table)

This EF indicates which MExE services are allocated, and whether, if allocated, the service is activated. If a service is not allocated or not activated in the SIM, the ME shall not select this service.

Identifier: '4F40'		Structure: transparent		Optional
File size: X bytes, X ≥ 1		Update activity: low		
Access Conditions:				
READ		CHV1		
UPDATE		ADM		
INVALIDATE		ADM		
REHABILITATE		ADM		
Bytes	Description	M/O	Length	
1	Services n°1 to n°4	M	1 byte	
2	Services n°5 to n°8	O	1 byte	
etc.				
X	Services (4X-3) to (4X)	O	1 byte	

-Services

Contents: Service n°1 : Operator root public key  
 Service n°2 : Administrator root public key  
 Service n°3 : Third party root public key  
 Service n°4 : RFU

Coding:

2 bits are used to code each service:

first bit = 1: service allocated

first bit = 0: service not allocated

where the first bit is b1, b3, b5 or b7;

second bit = 1: service activated

second bit = 0: service not activated

where the second bit is b2, b4, b6 or b8.

Service allocated means that the SIM has the capability to support the service. Service activated means that the service is available for the card holder (only valid if the service is allocated).

The following codings are possible:

- first bit = 0: service not allocated, second bit has no meaning;
- first bit = 1 and second bit = 0: service allocated but not activated;
- first bit = 1 and second bit = 1: service allocated and activated.

The bits for services not yet defined shall be set to RFU. For coding of RFU see subclause 9.3.

First byte:

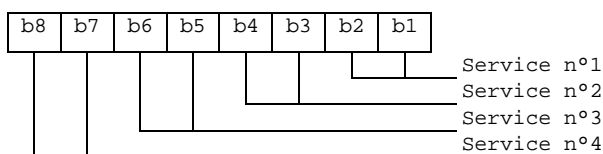

etc.

For an example of coding see sub-clause 10.3.7

### 10.4.2.2 EF<sub>ORPK</sub> (Operator Root Public Key)

This EF contains the descriptor(s) of certificates containing the Operator Root Public Key. This EF shall only be allocated if the operator wishes to verify applications and certificates in the MExE operator domain using a root public key held on the SIM. Each record of this EF contains one certificate descriptor.

For example, Operator may provide a second key for recover disaster procedure in order to limit OTA data to load.

Identifier: '4F41'		Structure: linear fixed		Optional
Record length : X + 10 bytes, X ≥ 1			Update activity: low	
Access Conditions:				
READ		CHV1		
UPDATE		ADM		
INVALIDATE		ADM		
REHABILITATE		ADM		
Bytes	Description	M/O	Length	
1	Parameters indicator	M	1 byte	
2	Flags	M	1 byte	
3	Type of certificate	M	1 byte	
4 to 5	Key/certificate file identifier	M	2 bytes	
6 to 7	Offset into key/certificate file	M	2 bytes	
8 to 9	Length of key/certificate data	M	2 bytes	
10	Key identifier length (X)	M	1 byte	
11 to 10+X	Key identifier	M	X bytes	

- Parameter indicator

Contents:

The parameter indicator indicates if record is full and which optional parameters are present

Coding: bit string

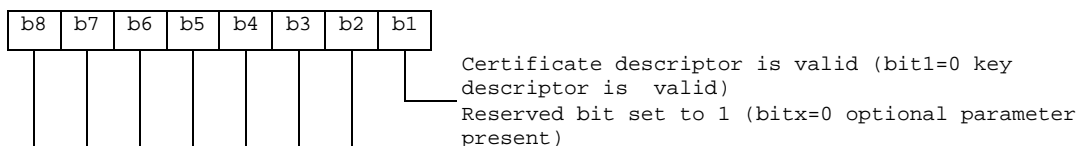

- Flags

Contents:

The authority flag indicates whether the certificate identify an authority (i.e. CA or AA) or not.

Coding: bit string

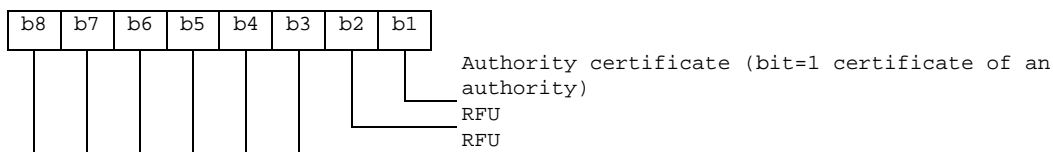

- Type of certificate  
 Contents:  
 This field indicates the type of certificate containing the key.  
 Coding: binary :  
 0 : WTLS  
 1 : X509  
 2 : X9.68  
 Other values are reserved for further use
  
- Key/certificate File Identifier  
 Contents:  
 these bytes identify an EF which is the key/certificate data file (see subclause 10.7.5), holding the actual key/certificate data for this record.  
 Coding:  
 byte 4: high byte of Key/certificate File Identifier;  
 byte 5: low byte of Key/certificate File Identifier.
  
- Offset into Key/certificate File  
 Contents:  
 these bytes specify an offset into the transparent key/certificate data File identified in bytes 4 and 5.  
 Coding:  
 byte 6: high byte of offset into Key/certificate Data File;  
 byte 7: low byte of offset into Key/certificate Data File
  
- Length of Key/certificate Data  
 Contents:  
 these bytes yield the length of the key/certificate data, starting at the offset identified in "Offset into Key/certificate File" field.  
 Coding:  
 byte 8: high byte of Key/certificate Data length;  
 byte 9: low byte of Key/certificate Data length.
  
- Key identifier length  
 Contents:  
 This field gives length of key identifier  
 Coding:  
 binary
  
- Key identifier  
 Contents:  
 This field provides a means of identifying certificates that contain a particular public key (chain building) and linking the public key to its corresponding private key. For more information about value and using see TS 23.057 [50].  
 Coding:  
 octet string
  
- Note: transparent key/certificate data longer than 256 bytes may be read using successive READ BINARY commands.

### 10.4.2.3 EF<sub>ARPK</sub> (Administrator Root Public Key)

This EF contains the descriptor(s) of certificates containing the Administrator Root Public Key. This EF shall only be allocated if the SIM issuer wishes to control the Third Party certificates on the terminal using an Administrator Root Public Key held on the SIM. Each record of this EF contains one certificate descriptor.

This file shall contain only one record.

Identifier: '4F42'		Structure: linear fixed		Optional
Record length: X + 10 bytes, X ≥ 1		Update activity: low		
Access Conditions:				
READ		CHV1		
UPDATE		ADM		
INVALIDATE		ADM		
REHABILITATE		ADM		
Bytes	Description	M/O	Length	
1	Parameters indicator	M	1 byte	
2	Flags	M	1 byte	
3	Type of certificate	M	1 byte	
4 to 5	Key/certificate file identifier	M	2 bytes	
6 to 7	Offset into key/certificate file	M	2 bytes	
8 to 9	Length of key/certificate data	M	2 bytes	
10	Key identifier length (X)	M	1 byte	
11 to 10+X	Key identifier	M	X bytes	

For contents and coding of all data items see the respective data items of the EF<sub>ORPK</sub> (sub-clause 10.4.2.1).

### 10.4.2.4 EF<sub>TPRPK</sub> (Third Party Root Public key)

This EF contains descriptor(s) of certificates containing the Third Party Root Public key (s). This EF shall only be allocated if the SIM issuer wishes to verify applications and certificates in the MExE Third Party domain using root public key(s) held on the SIM. This EF can contain one or more root public keys. Each record of this EF contains one certificate descriptor.

For example, an operator may provide several Third Party root public keys.

Identifier: '4F43'		Structure: linear fixed		Optional
Record length : X + Y + 11 bytes, X ≥ 1; Y ≥ 1		Update activity: low		
Access Conditions:				
READ		CHV1		
UPDATE		ADM		
INVALIDATE		ADM		
REHABILITATE		ADM		
Bytes	Description	M/O	Length	
1	Parameters indicator	M	1 byte	
2	Flags	M	1 byte	
3	Type of certificate	M	1 byte	
4 to 5	Key/certificate file identifier	M	2 bytes	
6 to 7	Offset into key/certificate file	M	2 bytes	
8 to 9	Length of key/certificate data	M	2 bytes	
10	Key identifier length (X)	M	1 byte	
11 to 10+X	Key identifier	M	X bytes	
11+X	Certificate identifier length (m)	M	1 byte	
12+X to 11+X+Y	Certificate identifier	M	Y bytes	



- Certificate identifier length  
Contents:  
This field gives length of certificate identifier  
Coding:  
binary
- Certificate identifier  
Contents:  
This field identify the issuer and provide a easy way to find a certificate. For more information about value and usage, see TS 23.057 [50].  
Coding:  
Octet string

For contents and coding of all other data items see the respective data items of the EF<sub>ORPK</sub> (sub-clause 10.7.1).

### 10.4.2.5 Trusted Key/Certificates Data Files

Residing under DF<sub>MEXE</sub>, there may be several key/certificates data files. These EFs containing key/certificates data shall have the following attributes:

Identifier: '4FXX'		Structure: transparent		Optional	
File size: Y bytes			Update activity: low		
Access Conditions:					
READ		CHV1			
UPDATE		ADM			
INVALIDATE		ADM			
REHABILITATE		ADM			
Bytes	Description			M/O	Length
1 to Y	Key/Certificates Data			M	Y bytes

Contents and coding:

Key/certificate data are accessed using the key/certificates descriptors provided by EF<sub>TPRPK</sub> (see sub-clause 10.4.2.4).

The identifier '4FXX' shall be different from one key/certificate data file to the other. For the range of 'XX', see sub-clause 6.6. The length Y may be different from one key/certificate data file to the other.

## 10.5 Contents of files at the telecom level

The EFs in the Dedicated File DF<sub>TELECOM</sub> contain service related information.

### 10.5.1 EF<sub>ADN</sub> (Abbreviated dialling numbers)

This EF contains Abbreviated Dialling Numbers (ADN) and/or Supplementary Service Control strings (SSC). In addition it contains identifiers of associated network/bearer capabilities and identifiers of extension records. It may also contain an associated alpha-tagging.

Identifier: '6F3A'		Structure: linear fixed		Optional
Record length: X+14 bytes			Update activity: low	
Access Conditions:				
READ		CHV1		
UPDATE		CHV1		
INVALIDATE		CHV2		
REHABILITATE		CHV2		
Bytes	Description	M/O	Length	
1 to X	Alpha Identifier	O	X bytes	
X+1	Length of BCD number/SSC contents	M	1 byte	
X+2	TON and NPI	M	1 byte	
X+3 to X+12	Dialling Number/SSC String	M	10 bytes	
X+13	Capability/Configuration Identifier	M	1 byte	
X+14	Extension1 Record Identifier	M	1 byte	

- Alpha Identifier

Contents:

Alpha-tagging of the associated dialling number.

Coding:

this alpha-tagging shall use either

- the SMS default 7-bit coded alphabet as defined in TS 23.038 [12] with bit 8 set to 0. The alpha identifier shall be left justified. Unused bytes shall be set to 'FF'; or
- one of the UCS2 coded options as defined in annex B.

NOTE 1: The value of X may be from zero to 241. Using the command GET RESPONSE the ME can determine the value of X.

- Length of BCD number/SSC contents

Contents:

this byte gives the number of bytes of the following two data items containing actual BCD number/SSC information. This means that the maximum value is 11, even when the actual ADN/SSC information length is greater than 11. When an ADN/SSC has extension, it is indicated by the extension1 identifier being unequal to 'FF'. The remainder is stored in the EF<sub>EXT1</sub> with the remaining length of the additional data being coded in the appropriate additional record itself (see subclause 10.5.10).

Coding:

according to TS 04.08 [15].

- TON and NPI

Contents:

Type of number (TON) and numbering plan identification (NPI).

Coding:

according to TS 04.08 [15]. If the Dialling Number/SSC String does not contain a dialling number, e.g. a control string deactivating a service, the TON/NPI byte shall be set to 'FF' by the ME (see note 2).

NOTE 2: If a dialling number is absent, no TON/NPI byte is transmitted over the radio interface (see TS 04.08 [15]). Accordingly, the ME should not interpret the value 'FF' and not send it over the radio interface.

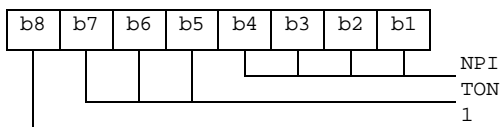

- Dialling Number/SSC String

Contents:

up to 20 digits of the telephone number and/or SSC information.

Coding:

according to TS 04.08 [15] , TS 02.30 [8] and the extended BCD-coding (see table 12). If the telephone number or SSC is longer than 20 digits, the first 20 digits are stored in this data item and the remainder is stored in an associated record in the EF<sub>EXT1</sub>. The record is identified by the Extension1 Record Identifier. If ADN/SSC require less than 20 digits, excess nibbles at the end of the data item shall be set to 'F'. Where individual dialled numbers, in one or more records, of less than 20 digits share a common appended digit string the first digits are stored in this data item and the common digits stored in an associated record in the EF<sub>EXT1</sub>. The record is identified by the Extension 1 Record Identifier. Excess nibbles at the end of the data item shall be set to 'F'.

Byte X+3

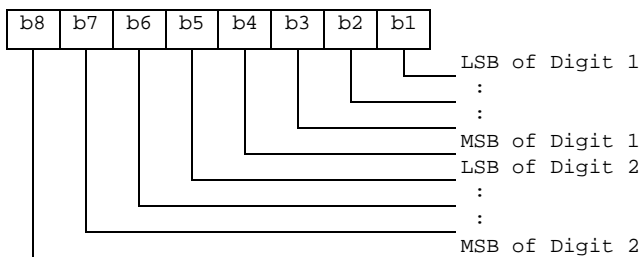

Byte X+4:

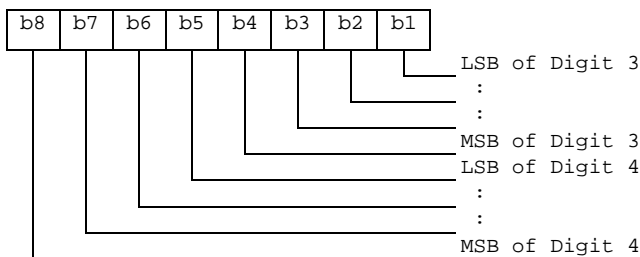

etc.

- Capability/Configuration Identifier

Contents:

capability/configuration identification byte. This byte identifies the number of a record in the EF<sub>CCP</sub> containing associated capability/configuration parameters required for the call. The use of this byte is optional. If it is not used it shall be set to 'FF'.

Coding:

binary.

- Extension1 Record Identifier

Contents:

extension1 record identification byte. This byte identifies the number of a record in the EF<sub>EXT1</sub> containing an associated called party subaddress or additional data. The use of this byte is optional. If it is not used it shall be set to 'FF'.

If the ADN/SSC requires both additional data and called party subaddress, this byte identifies the additional record. A chaining mechanism inside EF<sub>EXT1</sub> identifies the record of the appropriate called party subaddress (see subclause 10.5.10).

Coding:

binary.

NOTE 3: As EF<sub>ADN</sub> is part of the DF<sub>TELECOM</sub> it may be used by GSM and also other applications in a multi-application card. If the non-GSM application does not recognize the use of Type of Number (TON) and Number Plan Identification (NPI), then the information relating to the national dialling plan must be held within the data item dialling number/SSC and the TON and NPI fields set to UNKNOWN. This format would be acceptable for GSM operation and also for the non-GSM application where the TON and NPI fields shall be ignored.

EXAMPLE: SIM storage of an International Number using E.164 [19] numbering plan.

	TON	NPI	Digit field
GSM application	001	0001	abc...
Other application compatible with GSM	000	0000	xxx...abc...

where "abc..." denotes the subscriber number digits (including its country code), and "xxx..." denotes escape digits or a national prefix replacing TON and NPI.

NOTE 4: When the ME acts upon the EF<sub>ADN</sub> with a SEEK command in order to identify a character string in the alpha-identifier, it is the responsibility of the ME to ensure that the number of characters used as SEEK parameters are less than or equal to the value of X if the MMI allows the user to offer a greater number.

**Table 12: Extended BCD coding**

BCD Value	Character/Meaning
'0'	"0"
...	...
'9'	"9"
'A'	"*"
'B'	"#"
'C'	DTMF Control digit separator (TS 02.07 [3])
'D'	"Wild" value This will cause the MMI to prompt the user for a single digit (see TS 02.07 [3]).
'E'	Expansion digit ("Shift Key"). It has the effect of adding '10' to the following digit. The following BCD digit will hence be interpreted in the range of '10'-'1E'. The purpose of digits in this range is for further study.
'F'	Endmark e.g. in case of an odd number of digits

BCD values 'C', 'D' and 'E' are never sent across the radio interface.

NOTE 5: The interpretation of values 'D', 'E' and 'F' as DTMF digits is for further study.

NOTE 6: A second or subsequent 'C' BCD value will be interpreted as a 3 second PAUSE (see TS 02.07 [3]).

## 10.5.2 EF<sub>FDN</sub> (Fixed dialling numbers)

This EF contains Fixed Dialling Numbers (FDN) and/or Supplementary Service Control strings (SSC). In addition it contains identifiers of associated network/bearer capabilities and identifiers of extension records. It may also contain an associated alpha-tagging.

Identifier: '6F3B'		Structure: linear fixed		Optional
Record length: X+14 bytes		Update activity: low		
Access Conditions:				
READ		CHV1		
UPDATE		CHV2		
INVALIDATE		ADM		
REHABILITATE		ADM		
<hr/>				
Bytes	Description	M/O	Length	
1 to X	Alpha Identifier	O	X bytes	
X+1	Length of BCD number/SSC contents	M	1 byte	
X+2	TON and NPI	M	1 byte	
X+3 to X+12	Dialling Number/SSC String	M	10 bytes	
X+13	Capability/Configuration Identifier	M	1 byte	
X+14	Extension2 Record Identifier	M	1 byte	

For contents and coding of all data items see the respective data items of the EF<sub>ADN</sub> (subclause 10.5.1), with the exception that extension records are stored in the EF<sub>EXT2</sub>.

NOTE: The value of X (the number of bytes in the alpha-identifier) may be different to the length denoted X in EF<sub>ADN</sub>.

## 10.5.3 EF<sub>SMS</sub> (Short messages)

This EF contains information in accordance with TS 23.040 [13] comprising short messages (and associated parameters) which have either been received by the MS from the network, or are to be used as an MS originated message.

Identifier: '6F3C'		Structure: linear fixed		Optional
Record length: 176 bytes		Update activity: low		
Access Conditions:				
READ		CHV1		
UPDATE		CHV1		
INVALIDATE		ADM		
REHABILITATE		ADM		
Bytes	Description	M/O	Length	
1	Status	M	1 byte	
2 to 176	Remainder	M	175 bytes	

- Status

Contents:

Status byte of the record which can be used as a pattern in the SEEK command. For MS originating messages sent to the network, the status shall be updated when the MS receives a status report, or sends a successful SMS Command relating to the status report.

Coding:

b8	b7	b6	b5	b4	b3	b2	b1	
					X	X	0	free space
					X	X	1	used space
					0	0	1	message received by MS from network; message read
					0	1	1	message received by MS from network; message to be read
					1	1	1	MS originating message; message to be sent
								RFU (see subclause 9.3)

b8	b7	b6	b5	b4	b3	b2	b1	
			X	X	1	0	1	MS originating message; message sent to the network:
			0	0	1	0	1	status report not requested
			0	1	1	0	1	status report requested but not (yet) received;
			1	0	1	0	1	status report requested, received but not stored in EF-SMSR;
			1	1	1	0	1	status report requested, received and stored in EF-SMSR;
								RFU (see subclause 9.3)

- Remainder

Contents:

This data item commences with the TS-Service-Centre-Address as specified in TS 24.011 [16]. The bytes immediately following the TS-Service-Centre-Address contain an appropriate short message TPDU as specified in TS 23.040 [13], with identical coding and ordering of parameters.

Coding:

according to TS 23.040 [13] and TS 24.011 [16]. Any TP-message reference contained in an MS originated message stored in the SIM, shall have a value as follows:

message to be sent:	Value of the TP-message-reference: 'FF'
message sent to the network:	the value of TP-Message-Reference used in the message sent to the network.

Any bytes in the record following the TPDU shall be filled with 'FF'.

It is possible for a TS-Service-Centre-Address of maximum permitted length, e.g. containing more than 18 address digits, to be associated with a maximum length TPDU such that their combined length is 176 bytes. In this case the ME shall store in the SIM the TS-Service-Centre-Address and the TPDU in bytes 2-176 without modification, except for the last byte of the TPDU, which shall not be stored.

## 10.5.4 Capability configuration parameters

### 10.5.4.1 EF<sub>CCP</sub> (Capability configuration parameters)

This EF contains parameters of required network and bearer capabilities and ME configurations associated with a call established using an abbreviated dialling number, a fixed dialling number, an MSISDN, a last number dialled, a service dialling number or a barred dialling number.

For compatibility reasons, this file may be present for release 98 or earlier MEs in order to support Capability Configuration Parameters service.

Identifier: '6F3D'		Structure: linear fixed		Optional
Record length: 14 bytes		Update activity: low		
Access Conditions:				
READ		CHV1		
UPDATE		CHV1		
INVALIDATE		ADM		
REHABILITATE		ADM		
Bytes	Description	M/O	Length	
1 to 10	Bearer capability information element	M	10 bytes	
11 to 14	Bytes reserved - see below	M	4 bytes	

- Bearer capability information element

Contents and Coding:

- see TS 04.08 [15]. The Information Element Identity (IEI) shall be excluded. i.e. the first byte of the EF<sub>CCP</sub> record shall be Length of the bearer capability contents.
- Bytes 11-14 shall be set to 'FF' and shall not be interpreted by the ME.

#### 10.5.4.2 EF<sub>ECCP</sub> (Extended Capability configuration parameters)

This EF contains parameters of required network and bearer capabilities and ME configurations associated with a call established using an abbreviated dialling number, a fixed dialling number, an MSISDN, a last number dialled, a service dialling number or a barred dialling number.

The number of records of the EF<sub>ECCP</sub> shall be equal to the number of records of the EF<sub>CCP</sub>. Each record of the EF<sub>CCP</sub> shall have a corresponding record in the EF<sub>ECCP</sub> with the same record number.

If an ME has to update a record, then the ME shall update each record of both files, EF<sub>CCP</sub> with 10 bytes and EF<sub>ECCP</sub> with X bytes ( $X \geq 15$ ).

If an ME has to read a record, then the ME shall check the consistency between the record of the EF<sub>ECCP</sub> and the corresponding record of the EF<sub>CCP</sub> and update the record of the EF<sub>ECCP</sub> with the value of the corresponding record of the EF<sub>CCP</sub>.

Identifier: '6F4F'		Structure: linear fixed		Optional
Record length: X ( $X \geq 15$ )		Update activity: low		
Access Conditions:				
READ		CHV1		
UPDATE		CHV1		
INVALIDATE		ADM		
REHABILITATE		ADM		
Bytes	Description	M/O	Length	
1 to X	Bearer capability information element	M	X bytes	

- Bearer capability information element

Contents and Coding:

see TS 24.008 [47]. The Information Element Identity (IEI) shall be excluded, i.e. the first byte of the EF<sub>ECCP</sub> record shall be Length of the bearer capability contents.

Unused bytes are filled with 'FF'.

## 10.5.5 EF<sub>MSISDN</sub> (MSISDN)

This EF contains MSISDN(s) related to the subscriber. In addition it contains identifiers of associated network/bearer capabilities and identifiers of extension records. It may also contain an associated alpha-tagging.

Identifier: '6F40'		Structure: linear fixed		Optional
Record length: X+14 bytes		Update activity: low		
Access Conditions:				
READ		CHV1		
UPDATE		CHV1		
INVALIDATE		ADM		
REHABILITATE		ADM		
Bytes	Description	M/O	Length	
1 to X	Alpha Identifier	O	X bytes	
X+1	Length of BCD number/SSC contents	M	1 byte	
X+2	TON and NPI	M	1 byte	
X+3 to X+12	Dialling Number/SSC String	M	10 bytes	
X+13	Capability/Configuration Identifier	M	1 byte	
X+14	Extension1 Record Identifier	M	1 byte	

For contents and coding of all data items see the respective data items of EF<sub>ADN</sub>.

NOTE 1: If the SIM stores more than one MSISDN number and the ME displays the MSISDN number(s) within the initialization procedure then the one stored in the first record shall be displayed with priority.

NOTE 2: The value of X (the number of bytes in the alpha-identifier) may be different to the length denoted X in EF<sub>ADN</sub>.

## 10.5.6 EF<sub>SMSP</sub> (Short message service parameters)

This EF contains values for Short Message Service header Parameters (SMSP), which can be used by the ME for user assistance in preparation of mobile originated short messages. For example, a service centre address will often be common to many short messages sent by the subscriber.

The EF consists of one or more records, with each record able to hold a set of SMS parameters. The first (or only) record in the EF shall be used as a default set of parameters, if no other record is selected.

To distinguish between records, an alpha-identifier may be included within each record, coded on Y bytes.

The SMS parameters stored within a record may be present or absent independently. When a short message is to be sent from the MS, the parameter in the SIM record, if present, shall be used when a value is not supplied by the user.



Identifier: '6F42'		Structure: linear fixed		Optional
Record length: 28+Y bytes			Update activity: low	
Access Conditions:				
READ		CHV1		
UPDATE		CHV1		
INVALIDATE		ADM		
REHABILITATE		ADM		
Bytes	Description	M/O	Length	
1 to Y	Alpha-Identifier	O	Y bytes	
Y+1	Parameter Indicators	M	1 byte	
Y+2 to Y+13	TP-Destination Address	M	12 bytes	
Y+14 to Y+25	TS-Service Centre Address	M	12 bytes	
Y+26	TP-Protocol Identifier	M	1 byte	
Y+27	TP-Data Coding Scheme	M	1 byte	
Y+28	TP-Validity Period	M	1 byte	

Storage is allocated for all of the possible SMS parameters, regardless of whether they are present or absent. Any bytes unused, due to parameters not requiring all of the bytes, or due to absent parameters, shall be set to 'FF'.

- Alpha-Identifier

Contents:

Alpha Tag of the associated SMS-parameter.

Coding:

see subclause 10.5.1 (EF<sub>ADN</sub>).

NOTE: The value of Y may be zero, i.e. the alpha-identifier facility is not used. By using the command GET RESPONSE the ME can determine the value of Y.

- Parameter Indicators

Contents:

Each of the default SMS parameters which can be stored in the remainder of the record are marked absent or present by individual bits within this byte.

Coding:

Allocation of bits:

Bit number	Parameter indicated
1	TP-Destination Address
2	TS-Service Centre Address
3	TP-Protocol Identifier
4	TP-Data Coding Scheme
5	TP-Validity Period
6	reserved, set to 1
7	reserved, set to 1
8	reserved, set to 1

Bit value	Meaning
0	Parameter present
1	Parameter absent

- TP-Destination Address

Contents and Coding: As defined for SM-TL address fields in TS 23.040 [13].

- TP-Service Centre Address

Contents and Coding: As defined for RP-Destination address Centre Address in TS 24.011 [16].

- TP-Protocol Identifier

Contents and Coding: As defined in TS 23.040 [13].

- TP-Data Coding Scheme

Contents and Coding: As defined in TS 23.038 [12].

- TP-Validity Period

Contents and Coding: As defined in TS 23.040 [13] for the relative time format.

## 10.5.7 EF<sub>SMSS</sub> (SMS status)

This EF contains status information relating to the short message service.

The provision of this EF is associated with EF<sub>SMS</sub>. Both files shall be present together, or both absent from the SIM.

Identifier: '6F43'		Structure: transparent		Optional
File size: 2+X bytes		Update activity: low		
Access Conditions:				
READ		CHV1		
UPDATE		CHV1		
INVALIDATE		ADM		
REHABILITATE		ADM		
Bytes	Description	M/O	Length	
1	Last Used TP-MR	M	1 byte	
2	SMS "Memory Cap. Exceeded" Not. Flag	M	1 byte	
3 to 2+X	RFU	O	X bytes	

- Last Used TP-MR.

Contents:

the value of the TP-Message-Reference parameter in the last mobile originated short message, as defined in TS 23.040 [13].

Coding:

as defined in TS 23.040 [13].

- SMS "Memory Capacity Exceeded" Notification Flag.

Contents:

This flag is required to allow a process of flow control, so that as memory capacity in the MS becomes available, the Network can be informed. The process for this is described in TS 23.040 [13].

Coding:

b1=1 means flag unset; memory capacity available

b1=0 means flag set

b2 to b8 are reserved and set to 1.

## 10.5.8 EF<sub>LND</sub> (Last number dialled)

This EF contains the last numbers dialled (LND) and/or the respective supplementary service control strings (SSC). In addition it contains identifiers of associated network/bearer capabilities and identifiers of extension records. It may also contain associated alpha-tagging.

Identifier: '6F44'		Structure: cyclic		Optional
Record length: X+14 bytes		Update activity: low		
Access Conditions:				
READ		CHV1		
UPDATE		CHV1		
INCREASE		NEVER		
INVALIDATE		ADM		
REHABILITATE		ADM		
Bytes	Description	M/O	Length	
1 to X	Alpha Identifier	O	X bytes	
X+1	Length of BCD number/SSC contents	M	1 byte	
X+2	TON and NPI	M	1 byte	
X+3 to X+12	Dialling Number/SSC String	M	10 bytes	
X+13	Capability/Configuration Identifier	M	1 byte	
X+14	Extension1 Record Identifier	M	1 byte	

For contents and coding, see subclause 10.5.1 EF<sub>ADN</sub>.

The value of X in EF<sub>LND</sub> may be different to both the value of X in EF<sub>ADN</sub> and of X in EF<sub>FDN</sub>.

If the value of X in EF<sub>LND</sub> is longer than the length of the  $\alpha$ -tag of the number to be stored, then the ME shall pad the  $\alpha$ -tag with 'FF'. If the value of X in EF<sub>LND</sub> is shorter than the length of the  $\alpha$ -tag of the number to be stored, then the ME shall cut off excessive bytes.

## 10.5.9 EF<sub>SDN</sub> (Service Dialling Numbers)

This EF contains special service numbers (SDN) and/or the respective supplementary service control strings (SSC). In addition it contains identifiers of associated network/bearer capabilities and identifiers of extension records. It may also contain associated alpha-tagging.

Identifier: '6F49'		Structure: linear fixed		Optional
Record length: X+14 bytes		Update activity: low		
Access Conditions:				
READ		CHV1		
UPDATE		ADM		
INVALIDATE		ADM		
REHABILITATE		ADM		
Bytes	Description	M/O	Length	
1 to X	Alpha identifier	O	X bytes	
X+1	Length of BCD number/SSC contents	M	1 bytes	
X+2	TON and NPI	M	1 byte	
X+3 to X+12	Dialling Number/SSC String	M	10 bytes	
X+13	Capability/Configuration Identifier	M	1 byte	
X+14	Extension3 Record Identifier	M	1 byte	

For contents and coding of all data items see the respective data items of the EF<sub>ADN</sub> (subclause 10.5.1), with the exception that extension records are stored in the EF<sub>EXT3</sub>.

NOTE: The value of X (the number of bytes in the alpha-identifier) may be different to the length denoted X in EF<sub>ADN</sub>.

### 10.5.10 EF<sub>EXT1</sub> (Extension1)

This EF contains extension data of an ADN/SSC, an MSISDN, or an LND. Extension data is caused by:

- an ADN/SSC (MSISDN, LND) which is greater than the 20 digit capacity of the ADN/SSC (MSISDN, LND) Elementary File or where common digits are required to follow an ADN/SSC string of less than 20 digits. The remainder is stored in this EF as a record, which is identified by a specified identification byte inside the ADN/SSC (MSISDN, LND) Elementary File. The EXT1 record in this case is specified as additional data;
- an associated called party subaddress. The EXT1 record in this case is specified as subaddress data.

Identifier: '6F4A'		Structure: linear fixed		Optional
Record length: 13 bytes			Update activity: low	
Access Conditions:				
READ		CHV1		
UPDATE		CHV1		
INVALIDATE		ADM		
REHABILITATE		ADM		
Bytes	Description	M/O	Length	
1	Record type	M	1 byte	
2 to 12	Extension data	M	11 bytes	
13	Identifier	M	1 byte	

- Record type

Contents: type of the record

Coding:

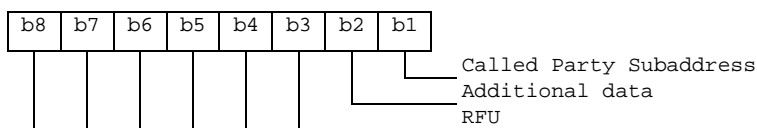

b3-b8 are reserved and set to 0;  
 a bit set to 1 identifies the type of record;  
 only one type can be set;  
 '00' indicates the type "unknown".

The following example of coding means that the type of extension data is "additional data":

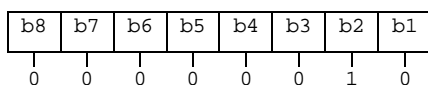

- Extension data

Contents: Additional data or Called Party Subaddress depending on record type.

Coding:

Case 1, Extension1 record is additional data:

The first byte of the extension data gives the number of bytes of the remainder of ADN/SSC (respectively MSISDN, LND). The coding of remaining bytes is BCD, according to the coding of ADN/SSC (MSISDN, LND). Unused nibbles at the end have to be set to 'F'. It is possible if the number of additional digits exceeds the capacity of the additional record to chain another record inside the EXT1 Elementary File by the identifier in byte 13.

Case 2, Extension1 record is Called Party Subaddress:

The subaddress data contains information as defined for this purpose in TS 04.08 [15]. All information defined in TS 04.08, except the information element identifier, shall be stored in the SIM. The length of this subaddress data can be up to 22 bytes. In those cases where two extension records are needed, these records are chained by the identifier field. The extension record containing the first part of the called party subaddress points to the record which contains the second part of the subaddress.

- Identifier

Contents: identifier of the next extension record to enable storage of information longer than 11 bytes.

Coding: record number of next record. 'FF' identifies the end of the chain.

EXAMPLE: Of a chain of extension records being associated to an ADN/SSC. The extension1 record identifier (Byte 14+X) of ADN/SSC is set to 3.

No of Record	Type	Extension Data	Next	Record
:	:	:	:	
:	:	:	:	
Record 3	'02'	xx .....xx	'06'	▶
Record 4	'xx'	xx .....xx	'xx'	
Record 5	'01'	xx .....xx	'FF'	◀
Record 6	'01'	xx .....xx	'05'	◀
:	:	:	:	
:	:	:	:	

In this example ADN/SSC is associated to additional data (record 3) and a called party subaddress whose length is more than 11 bytes (records 6 and 5).

### 10.5.11 EF<sub>EXT2</sub> (Extension2)

This EF contains extension data of an FDN/SSC (see EXT2 in subclause 10.5.2).

Identifier: '6F4B'		Structure: linear fixed		Optional
Record length: 13 bytes		Update activity: low		
Access Conditions:				
READ		CHV1		
UPDATE		CHV2		
INVALIDATE		ADM		
REHABILITATE		ADM		
Bytes	Description	M/O	Length	
1	Record type	M	1 byte	
2 to 12	Extension data	M	11 bytes	
13	Identifier	M	1 byte	

For contents and coding see subclause 10.5.10 EF<sub>EXT1</sub>.

## 10.5.12 EF<sub>EXT3</sub> (Extension3)

This EF contains extension data of an SDN (see EXT3 in subclause 10.5.9).

Identifier: '6F4C'		Structure: linear fixed		Optional
Record length: 13 bytes		Update activity: low		
Access Conditions:				
READ		CHV1		
UPDATE		ADM		
INVALIDATE		ADM		
REHABILITATE		ADM		
Bytes	Description	M/O	Length	
1	Record type	M	1 byte	
2 to 12	Extension data	M	11 bytes	
13	Identifier	M	1 byte	

For contents and coding see subclause 10.5.10 EF<sub>EXT1</sub>.

## 10.5.13 EF<sub>BDN</sub> (Barred Dialling Numbers)

This EF contains Barred Dialling Numbers (BDN) and/or Supplementary Service Control strings (SSC). In addition it contains identifiers of associated network/bearer capabilities and identifiers of extension records. It may also contain an associated alpha-tagging.

Identifier: '6F4D'		Structure: linear fixed		Optional
Record length: X+15 bytes		Update activity: low		
Access Conditions:				
READ		CHV1		
UPDATE		CHV2		
INVALIDATE		CHV2 / ADM (set at personalisation)		
REHABILITATE		CHV2 / ADM (set at personalisation)		
Bytes	Description	M/O	Length	
1 to X	Alpha Identifier	O	X bytes	
X+1	Length of BCD number/SSC contents	M	1 byte	
X+2	TON and NPI	M	1 byte	
X+3 to X+12	Dialling Number/SSC String	M	10 bytes	
X+13	Capability/Configuration Identifier	M	1 byte	
X+14	Extension4 Record Identifier	M	1 byte	
X+15	Comparison Method Pointer	M	1 byte	

For contents and coding of all data items, except for the Comparison Method Pointer, see the respective data items of the EF<sub>ADN</sub> (subclause 10.5.1), with the exception that extension records are stored in the EF<sub>EXT4</sub>. The Comparison Method Pointer refers to a record number in EF<sub>CM1</sub>.

NOTE: The value of X (the number of bytes in the alpha-identifier) may be different to the length denoted X in EF<sub>ADN</sub>.

### 10.5.14 EF<sub>EXT4</sub> (Extension4)

This EF contains extension data of an BDN/SSC (see EXT4 in subclause 10.5.13).

Identifier: '6F4E'		Structure: linear fixed		Optional
Record length: 13 bytes		Update activity: low		
Access Conditions:				
READ		CHV1		
UPDATE		CHV2		
INVALIDATE		ADM		
REHABILITATE		ADM		
Bytes	Description	M/O	Length	
1	Record type	M	1 byte	
2 to 12	Extension data	M	11 bytes	
13	Identifier	M	1 byte	

For contents and coding see subclause 10.5.10 EF<sub>EXT1</sub>.

### 10.5.15 EF<sub>SMSR</sub> (Short message status reports)

This EF contains information in accordance with TS 23.040 [13] comprising short message status reports which have been received by the MS from the network.

Each record is used to store the status report of a short message in a record of EF<sub>SMS</sub>. The first byte of each record is the link between the status report and the corresponding short message in EF<sub>SMS</sub>.

Identifier: '6F47'		Structure: linear fixed		Optional
Record length: 30 bytes		Update activity: low		
Access Conditions:				
READ		CHV1		
UPDATE		CHV1		
INVALIDATE		ADM		
REHABILITATE		ADM		
Bytes	Description	M/O	Length	
1	SMS record identifier	M	1	
2 to 30	SMS status report	M	29 bytes	

- SMS record identifier

Contents:

This data item identifies the corresponding SMS record in EF<sub>SMS</sub>, e.g. if this byte is coded '05' then this status report corresponds to the short message in record #5 of EF<sub>SMS</sub>.

Coding:

'00' - empty record

'01' - 'FF' - record number of the corresponding SMS in EF<sub>SMS</sub>.

- SMS status report

Contents:

This data item contains the SMS-STATUS-REPORT TPDU as specified in TS 23.040 [13], with identical coding and ordering of parameters.

Coding:

according to TS 23.040 [13]. Any bytes in the record following the TPDU shall be filled with 'FF'.

## 10.5.16 EF<sub>cmi</sub> (Comparison Method Information)

This EF contains a list of Comparison Method Identifiers and alpha-tagging associated with BDN entries (see EF<sub>BDN</sub>). This EF shall always be present if EF<sub>BDN</sub> is present.

Identifier: '6F58'		Structure: linear fixed		Optional	
Record length: X+1 bytes			Update activity: low		
Access Conditions:					
READ		CHV1			
UPDATE		ADM			
INVALIDATE		ADM			
REHABILITATE		ADM			
Bytes	Description			M/O	Length
1 to X	Alpha Identifier			M	X bytes
X+1	Comparison Method Identifier			M	1 byte

### - Alpha Identifier

Contents:

Alpha-tagging of the associated Comparison Method Identifier

Coding:

Same as the alpha identifier in EF<sub>ADN</sub>.

### - Comparison Method Identifier

Contents:

this byte describes the comparison method which is associated with a BDN record. Its interpretation is not specified but it shall be defined by the operators implementing the BDN feature.

Coding:

'00' - 'FE' = Comparison Method Identifier.

'FF' = Default method.

## 10.6 DFs at the telecom level

DFs may be present as child directories of DF<sub>TELECOM</sub>. The following has been defined.

DF<sub>GRAPHICS</sub> '5F50'

### 10.6.1 Contents of files at the telecom graphics level

The EFs in the Dedicated File DF<sub>GRAPHICS</sub> contain graphical information.

#### 10.6.1.1 EF<sub>img</sub> (Image)

Each record of this EF identifies instances of one particular graphical image, which graphical image is identified by this EF's record number.

Image instances may differ as to their size, having different resolutions, and the way they are coded, using one of several image coding schemes.



As an example, image  $k$  may represent a company logo, of which there are  $i$  instances on SIM, of various resolutions and perhaps encoded in several image coding schemes. Then, the  $i$  instances of the company's logo are described in record  $k$  of this EF.

Identifier: '4F20'		Structure: linear fixed		Optional
Record length: $9n+1$ or $9n+2$ bytes		Update activity: low		
Access Conditions:				
READ		CHV1		
UPDATE		ADM		
INVALIDATE		ADM		
REHABILITATE		ADM		
Bytes	Description	M/O	Length	
1	Number of Actual Image Instances	M	1 byte	
2 to 10	Descriptor of Image Instance 1	M	9 bytes	
11 to 19	Descriptor of Image Instance 2	O	9 bytes	
:				
$9(n-1) + 2$ to $9n + 1$	Descriptor of Image Instance $n$	O	9 bytes	
$9n + 2$	RFU	O	1 byte	

- Number of Actual Image Instances

Contents: this byte gives the number of actual image instances described in the following data items (i.e. unused descriptors are not counted).

Coding: binary

- Image Instance Descriptor

Contents: a description of an image instance

Coding: see below

#### Byte 1: Image Instance Width

Contents:

this byte specifies the image instance width, expressed in raster image points.

Coding:

binary.

#### Byte 2: Image Instance Height

Contents:

this byte specifies the image instance height, expressed in raster image points.

Coding:

binary.

#### Byte 3: Image Coding Scheme

Contents:

this byte identifies the image coding scheme that has been used in encoding the image instance.

Coding:

'11' - basic image coding scheme as defined in annex G;

'21' - colour image coding scheme as defined in annex G;

other values are reserved for future use.

#### Bytes 4 and 5: Image Instance File Identifier

##### Contents:

these bytes identify an EF which is the image instance data file (see subclause 10.6.1.2), holding the actual image data for this particular instance.

##### Coding:

byte 4: high byte of Image Instance File Identifier;

byte 5: low byte of Image Instance File Identifier.

#### Bytes 6 and 7: Offset into Image Instance File

##### Contents:

these bytes specify an offset into the transparent Image Instance File identified in bytes 4 and 5.

##### Coding:

byte 6: high byte of offset into Image Instance File;

byte 7: low byte of offset into Image Instance File

#### Bytes 8 and 9: Length of Image Instance Data

##### Contents:

these bytes yield the length of the image instance data, starting at the offset identified in bytes 6 and 7. For the colour image coding scheme, as defined in annex G, the length of image instance data excludes the CLUT.

##### Coding:

byte 8: high byte of Image Instance Data length;

byte 9: low byte of Image Instance Data length.

**NOTE:** Transparent image instance data longer than 256 bytes may be read using successive READ BINARY commands.

### 10.6.1.2 Image Instance Data Files

Residing under DF<sub>GRAPHICS</sub>, there may be several image instance data files. These EFs containing image instance data shall have the following attributes.

Identifier: '4FXX'		Structure: transparent		Optional
Record length: Y bytes		Update activity: low		
Access Conditions:				
READ		CHV1		
UPDATE		ADM		
INVALIDATE		ADM		
REHABILITATE		ADM		
Bytes	Description	M/O	Length	
1 to Y	Image Instance Data	M	Y bytes	

Contents and coding:

Image instance data are accessed using the image instance descriptors provided by  $EF_{IMG}$  (see subclause 10.6.1.1).

The identifier '4FXX' shall be different from one image instance data file to the other. For the range of 'XX', see subclause 6.6. The length Y may be different from one image instance data file to the other.

## 10.7 Files of GSM

This subclause contains a figure depicting the file structure of the SIM.  $DF_{GSM}$  shall be selected using the identifier '7F20'. If selection by this means fails, then DCS 1800 MEs shall, and optionally GSM MEs may then select  $DF_{GSM}$  with '7F21'.

NOTE 1: The selection of the GSM application using the identifier '7F21', if selection by means of the identifier '7F20' fails, is to ensure backwards compatibility with those Phase 1 SIMs which only support the DCS 1800 application using the Phase 1 directory  $DF_{DCS1800}$  coded '7F21'.

NOTE 2: To ensure backwards compatibility with those Phase 1 DCS 1800 MEs which have no means to select  $DF_{GSM}$  two options have been specified. These options are given in GSM 09.91 [17].

NOTE 3: The value '6F65' under  $DF_{GSM}$  was used in earlier versions of this specification, and should not be re-assigned in future versions.

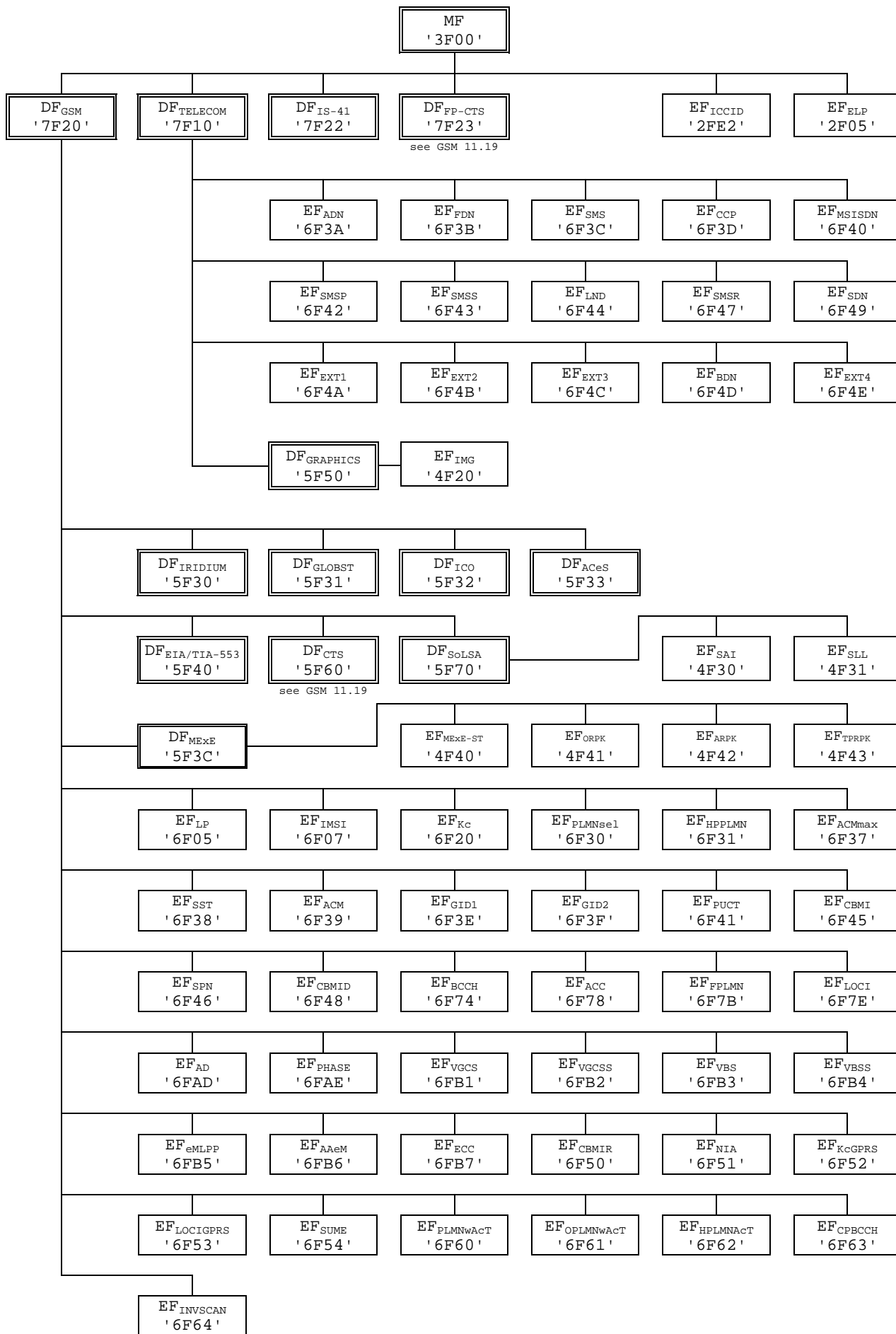

**Figure 8: File identifiers and directory structures of GSM**

---

## 11 Application protocol

When involved in GSM administrative management operations, the SIM interfaces with appropriate terminal equipment. These operations are outside the scope of this standard.

When involved in GSM network operations the SIM interfaces with an ME with which messages are exchanged. A message can be a command or a response.

- A GSM command/response pair is a sequence consisting of a command and the associated response.
- A GSM procedure consists of one or more GSM command/response pairs which are used to perform all or part of an application-oriented task. A procedure shall be considered as a whole, that is to say that the corresponding task is achieved if and only if the procedure is completed. The ME shall ensure that, when operated according to the manufacturer's manual, any unspecified interruption of the sequence of command/response pairs which realize the procedure, leads to the abortion of the procedure itself.
- A GSM session of the SIM in the GSM application is the interval of time starting at the completion of the SIM initialization procedure and ending either with the start of the GSM session termination procedure, or at the first instant the link between the SIM and the ME is interrupted.

During the GSM network operation phase, the ME plays the role of the master and the SIM plays the role of the slave.

The SIM shall execute all GSM and SIM Application Toolkit commands or procedures in such a way as not to jeopardise, or cause suspension, of service provisioning to the user. This could occur if, for example, execution of the RUN GSM ALGORITHM is delayed in such a way which would result in the network denying or suspending service to the user.

Some procedures at the SIM/ME interface require MMI interactions. The descriptions hereafter do not intend to infer any specific implementation of the corresponding MMI. When MMI interaction is required, it is marked "MMI" in the list given below.

Some procedures are not clearly user dependent. They are directly caused by the interaction of the MS and the network. Such procedures are marked "NET" in the list given below.

Some procedures are automatically initiated by the ME. They are marked "ME" in the list given below.

The list of procedures at the SIM/ME interface in GSM network operation is as follows:

General Procedures:

- |                    |    |
|--------------------|----|
| - Reading an EF    | ME |
| - Updating an EF   | ME |
| - Increasing an EF | ME |

SIM management procedures:

- |  |    |
|--|----|
| - SIM initialization                   | ME |
| - GSM session termination              | ME |
| - Emergency call codes request         | ME |
| - Extended language preference request | ME |
| - Language preference request          | ME |
| - Administrative information request   | ME |
| - SIM service table request            | ME |

- SIM phase request ME

## CHV related procedures:

- CHV verification MMI
- CHV value substitution MMI
- CHV disabling MMI
- CHV enabling MMI
- CHV unblocking MMI

## GSM security related procedures:

- GSM algorithms computation NET
- IMSI request NET
- Access control information request NET
- Higher Priority PLMN search period request NET
- Location Information NET
- GPRS Location Information NET
- Cipher key NET
- GPRS Cipher key NET
- BCCH information NET
- Forbidden PLMN information NET
- LSA information NET

## Subscription related procedures:

- Dialling Numbers (ADN, FDN, MSISDN, LND, SDN, BDN) MMI/ME
- Short messages (SMS) MMI
- Advice of Charge (AoC) MMI
- Capability Configuration Parameters (CCP) MMI
- PLMN Selector MMI
- HPLMN Selector with Access Technology MMI
- User controlled PLMN Selector with Access Technology MMI
- Operator controlled PLMN Selector with Access Technology MMI
- Investigation Scan request NET
- CPBCCCH information NET
- Cell Broadcast Message Identifier (CBMI) MMI
- Group Identifier Level 1 (GID1) MMI/ME
- Group Identifier Level 2 (GID2) MMI/ME
- Service Provider Name (SPN) ME
- Voice Group Call Service (VGCS) MMI/ME

- Voice Broadcast Service (VBS) MMI/ME
- Enhanced Multi Level Pre-emption and Priority (eMLPP) MMI/ME
- Depersonalisation Control Keys ME
- Short message status reports (SMSR) MMI
- Network's indication of alerting ME

SIM Application Toolkit related procedures:

- Data Download via SMS-CB (CBMID) NET
- Data Download via SMS-PP NET
- Menu selection MMI
- Call Control MMI/ME/NET
- Proactive SIM MMI/ME/NET
- Mobile Originated Short Message control by SIM MMI/ME/NET
- Image Request MMI/ME

MExE related procedures:

- Reading of MExE\_ST ME
- Reading of root public keys on the SIM (ORPK, ARPK,TPRPK) ME/NET

The procedures listed in subclause 11.2 are basically required for execution of the procedures in subclauses 11.3, 11.4 and 11.5. The procedures listed in subclauses 11.3 and 11.4 are mandatory (see TS 02.17 [6]). The procedures listed in subclause 11.5 are only executable if the associated services, which are optional, are provided in the SIM. However, if the procedures are implemented, it shall be in accordance with subclause 11.5.

If a procedure is related to a specific service indicated in the SIM Service Table, it shall only be executed if the corresponding bits denote this service as "allocated and activated" (see subclause 10.3.7). In all other cases this procedure shall not start.

## 11.1 General procedures

### 11.1.1 Reading an EF

The ME selects the EF and sends a READ command. This contains the location of the data to be read. If the access condition for READ is fulfilled, the SIM sends the requested data contained in the EF to the ME. If the access condition is not fulfilled, no data will be sent and an error code will be returned.

### 11.1.2 Updating an EF

The ME selects the EF and sends an UPDATE command. This contains the location of the data to be updated and the new data to be stored. If the access condition for UPDATE is fulfilled, the SIM updates the selected EF by replacing the existing data in the EF with that contained in the command. If the access condition is not fulfilled, the data existing in the EF will be unchanged, the new data will not be stored, and an error code will be returned.

In the case when updating EF<sub>LOC1</sub> with data containing the TMSI value and the card reports the error '92 40' (Memory Problem), the ME shall terminate GSM operation.

### 11.1.3 Increasing an EF

The ME selects the EF and sends an INCREASE command. This contains the value which has to be added to the contents of the last updated/increased record. If the access condition for INCREASE is fulfilled, the SIM increases the

existing value of the EF by the data contained in the command, and stores the result. If the access condition is not fulfilled, the data existing in the EF will be unchanged and an error code will be returned.

NOTE: The identification of the data within an EF to be acted upon by the above procedures is specified within the command. For the procedures in subclauses 11.1.1 and 11.1.2 this data may have been previously identified using a SEEK command, e.g. searching for an alphanumeric pattern.

## 11.2 SIM management procedures

Phase 2 MEs shall support all SIMs which comply with the mandatory requirements of Phase 1, even if these SIMs do not comply with all the mandatory requirements of Phase 2. Furthermore, Phase 2 MEs shall take care of potential incompatibilities with Phase 1 SIMs which could arise through use of inappropriate commands or misinterpretation of response data. Particular note should be taken of making a false interpretation of RFU bytes in a Phase 1 SIM having contradictory meaning in Phase 2; e.g. indication of EF invalidation state.

### 11.2.1 SIM initialization

After SIM activation (see subclause 4.3.2), the ME selects the Dedicated File DF<sub>GSM</sub> and optionally attempts to select EF<sub>ECC</sub>. If EF<sub>ECC</sub> is available, the ME requests the emergency call codes.

The ME requests the Extended Language Preference. The ME only requests the Language Preference (EF<sub>LP</sub>) if at least one of the following conditions holds:

- EF<sub>ELP</sub> is not available;
- EF<sub>ELP</sub> does not contain an entry corresponding to a language specified in ISO 639[30];
- the ME does not support any of the languages in EF<sub>ELP</sub>.

If both EFs are not available or none of the languages in the EFs is supported then the ME selects a default language. It then runs the CHV1 verification procedure.

If the CHV1 verification procedure is performed successfully, the ME then runs the SIM Phase request procedure.

For a SIM requiring PROFILE DOWNLOAD, then the ME shall perform the PROFILE DOWNLOAD procedure in accordance with TS 11.14 [27]. When BDN is enabled on a SIM, the PROFILE DOWNLOAD procedure is used to indicate to the SIM whether the ME supports the "Call Control by SIM" facility. If so, then the SIM is able to allow the REHABILITATE command to rehabilitate EF<sub>IMSI</sub> and EF<sub>LOCI</sub>.

If the ME detects a SIM of Phase 1, it shall omit the following procedures relating to FDN and continue with the Administrative Information request. The ME may omit procedures not defined in Phase 1 such as Higher Priority PLMN Search Period request.

For a SIM of Phase 2 or greater, GSM operation shall only start if one of the two following conditions is fulfilled:

- if EF<sub>IMSI</sub> and EF<sub>LOCI</sub> are not invalidated, the GSM operation shall start immediately;
- if EF<sub>IMSI</sub> and EF<sub>LOCI</sub> are invalidated, the ME rehabilitates these two EFs.

MEs without FDN capability but with Call control by SIM facility shall not rehabilitate EF<sub>IMSI</sub> and/or EF<sub>LOCI</sub> if FDN is enabled in the SIM and therefore have no access to these EFs. GSM operation will therefore be prohibited;

MEs without FDN capability and without Call control by SIM facility shall not rehabilitate EF<sub>IMSI</sub> and/or EF<sub>LOCI</sub> and therefore have no access to these EFs. GSM operation will therefore be prohibited.

It is these mechanisms which are used for control of services n°3 and n°31 by the use of SIMs for these services which always invalidate these two EFs at least before the next command following selection of either EF.

NOTE: When FDN and BDN are both enabled, and if the ME supports FDN but does not support the Call control by SIM facility, the rehabilitation of EF<sub>IMSI</sub> and EF<sub>LOCI</sub> will not be successful because of a restriction mechanism of the REHABILITATE command linked to the BDN feature.

When EF<sub>IMSI</sub> and EF<sub>LOCI</sub> are successfully rehabilitated, if the FDN capability procedure indicates that:



- i) FDN is allocated and activated in the SIM; and FDN is set "enabled", i.e. ADN "invalidated" or not activated; and the ME supports FDN; or
- ii) FDN is allocated and activated in the SIM; and FDN is set "disabled", i.e. ADN "not invalidated"; or
- iii) FDN is not allocated or not activated;

then GSM operation shall start.

In all other cases GSM operation shall not start.

Afterwards, the ME runs the following procedures, subject to the service being supported both by the ME and the SIM:

- Administrative Information request;
- SIM Service Table request;
- IMSI request;
- Access Control request;
- Higher Priority PLMN Search Period request;
- Investigation scan request;
- PLMN selector request;
- HPLMN Selector with Access Technology request;
- User controlled PLMN Selector with Access Technology request;
- Operator controlled PLMN Selector with Access Technology request;
- Location Information request;
- GPRS Location Information request;
- Cipher Key request;
- GPRS Cipher Key request;
- BCCH information request;
- CPBCCCH information request;
- Forbidden PLMN request;
- LSA information request;
- CBMID request;
- Depersonalisation Control Keys request;
- Network's indication of alerting request.

If the SIM service table indicates that the proactive SIM service is active, then from this point onwards, the ME, if it supports the proactive SIM service, shall send STATUS commands at least every 30s during idle mode as well as during calls, in order to enable the proactive SIM to respond with a command. The SIM may send proactive commands (see TS 11.14 [27]), including a command to change the interval between STATUS commands from the ME, when in idle mode. In-call requirements for STATUS for SIM Presence Detection are unchanged by this command.

After the SIM initialization has been completed successfully, the MS is ready for a GSM session.

## 11.2.2 GSM session termination

NOTE 1: This procedure is not to be confused with the deactivation procedure in subclause 4.3.2.

The GSM session is terminated by the ME as follows.

The ME runs all the procedures which are necessary to transfer the following subscriber related information to the SIM, subject to the service being supported both by the ME and the SIM:

- Location Information update;
- GPRS Location Information update;
- Cipher Key update;
- GPRS Cipher Key update;
- BCCH information update;
- CPBCCH information update;
- Advice of Charge increase;
- Forbidden PLMN update.

As soon as the SIM indicates that these procedures are completed, the ME/SIM link may be deactivated.

Finally, the ME deletes all these subscriber related information elements from its memory.

NOTE 2: If the ME has already updated any of the subscriber related information during the GSM Session, and the value has not changed until GSM session termination, the ME may omit the respective update procedure.

### 11.2.3 Emergency Call Codes

Request: The ME performs the reading procedure with  $EF_{ECC}$ .

Update: The ME performs the updating procedure with  $EF_{ECC}$ .

NOTE: The update procedure is only applicable when access conditions of ADM for update is set to ALW, CHV1 or CHV2.

### 11.2.4 Language preference

Request: The ME performs the reading procedure with  $EF_{LP}$ .

Update: The ME performs the updating procedure with  $EF_{LP}$ .

### 11.2.5 Administrative information request;

The ME performs the reading procedure with  $EF_{AD}$ .

### 11.2.6 SIM service table request

The ME performs the reading procedure with  $EF_{SST}$ .

### 11.2.7 SIM phase request

The ME performs the reading procedure with  $EF_{Phase}$ .

### 11.2.8 SIM Presence Detection and Proactive Polling

As an additional mechanism, to ensure that the SIM has not been removed during a card session, the ME sends, at frequent intervals, a STATUS command during each call. A STATUS command shall be issued within all 30 second periods of inactivity on the SIM-ME interface during a call. Inactivity in this case is defined as starting at the end of the last communication or the last issued STATUS command. If no response data is received to this STATUS command, then the call shall be terminated as soon as possible but at least within 5 seconds after the STATUS command has been

sent. If the DF indicated in response to a STATUS command is not the same as that which was indicated in the previous response, or accessed by the previous command, then the call shall be terminated as soon as possible but at least within 5 seconds after the response data has been received. This procedure shall be used in addition to a mechanical or other device used to detect the removal of a SIM.

If the ME supports the proactive SIM service, and the SIM has this service activated in its Service Table, then during idle mode the ME shall send STATUS commands to the SIM at intervals no longer than the interval negotiated with the SIM (see TS 11.14 [27]).

### 11.2.9 Extended Language preference

Request: The ME performs the reading procedure with EF<sub>ELP</sub>.

Update: The ME performs the updating procedure with EF<sub>ELP</sub>.

## 11.3 CHV related procedures

A successful completion of one of the following procedures grants the access right of the corresponding CHV for the GSM session. This right is valid for all files within the GSM application protected by this CHV.

After a third consecutive presentation of a wrong CHV to the SIM, not necessarily in the same GSM session, the CHV status becomes "blocked" and if the CHV is "enabled", the access right previously granted by this CHV is lost immediately.

An access right is not granted if any of the following procedures are unsuccessfully completed or aborted.

### 11.3.1 CHV verification

The ME checks the CHV status.

In the case of CHV1 the following procedure applies:

- if the CHV1 status is "blocked" and CHV1 is "enabled", the procedure ends and is finished unsuccessfully;
- if the CHV1 status is "blocked" but CHV1 is "disabled", the procedure ends and is finished successfully. The ME shall, however, accept SIMs which do not grant access rights when CHV1 is "blocked" and "disabled". In that case ME shall consider those SIMs as "blocked";
- if the CHV1 status is not "blocked" and CHV1 is "disabled", the procedure is finished successfully;
- if the CHV1 status is not "blocked" and CHV1 is "enabled", the ME uses the VERIFY CHV function. If the CHV1 presented by the ME is equal to the corresponding CHV1 stored in the SIM, the procedure is finished successfully. If the CHV1 presented by the ME is not equal to the corresponding CHV1 stored in the SIM, the procedure ends and is finished unsuccessfully.

In the case of CHV2 the following procedure applies:

- if the CHV2 status is "blocked", the procedure ends and is finished unsuccessfully;
- if the CHV2 status is not "blocked", the ME uses the VERIFY CHV function. If the CHV2 presented by the ME is equal to the corresponding CHV2 stored in the SIM, the procedure is finished successfully. If the CHV2 presented by the ME is not equal to the corresponding CHV2 stored in the SIM, the procedure ends and is finished unsuccessfully.

### 11.3.2 CHV value substitution

The ME checks the CHV status. If the CHV status is "blocked" or "disabled", the procedure ends and is finished unsuccessfully.

If the CHV status is not "blocked" and the enabled/disabled indicator is set "enabled", the ME uses the CHANGE CHV function. If the old CHV presented by the ME is equal to the corresponding CHV stored in the SIM, the new CHV presented by the ME is stored in the SIM and the procedure is finished successfully.

If the old CHV and the CHV in memory are not identical, the procedure ends and is finished unsuccessfully.

### 11.3.3 CHV disabling

Requirement: Service n°1 "allocated and activated".

The ME checks the CHV1 status. If the CHV1 status is "blocked", the procedure ends and is finished unsuccessfully.

If the CHV1 status is not "blocked", the ME reads the CHV1 enabled/disabled indicator. If this is set "disabled", the procedure ends and is finished unsuccessfully.

If the CHV1 status is not "blocked" and the enabled/disabled indicator is set "enabled", the ME uses the DISABLE CHV function. If the CHV1 presented by the ME is equal to the CHV1 stored in the SIM, the status of CHV1 is set "disabled" and the procedure is finished successfully. If the CHV1 presented by the ME is not equal to the CHV1 stored in the SIM, the procedure ends and is finished unsuccessfully.

### 11.3.4 CHV enabling

The ME checks the CHV1 status. If the CHV1 status is "blocked", the procedure ends and is finished unsuccessfully.

If the CHV1 status is not "blocked", the ME reads the CHV1 enabled/disabled indicator. If this is set "enabled", the procedure ends and is finished unsuccessfully.

If the CHV1 status is not "blocked" and the enabled/disabled indicator is set "disabled", the ME uses the ENABLE CHV function. If the CHV1 presented by the ME is equal to the CHV1 stored in the SIM, the status of CHV1 is set "enabled" and the procedure is finished successfully. If the CHV presented by the ME is not equal to the CHV1 stored in the SIM, the procedure ends and is finished unsuccessfully.

### 11.3.5 CHV unblocking

The execution of the CHV unblocking procedure is independent of the corresponding CHV status, i.e. being blocked or not.

The ME checks the UNBLOCK CHV status. If the UNBLOCK CHV status is "blocked", the procedure ends and is finished unsuccessfully.

If the UNBLOCK CHV status is not "blocked", the ME uses the UNBLOCK CHV function. If the UNBLOCK CHV presented by the ME is equal to the corresponding UNBLOCK CHV stored in the SIM, the relevant CHV status becomes "unblocked" and the procedure is finished successfully. If the UNBLOCK CHV presented by the ME is not equal to the corresponding UNBLOCK CHV stored in the SIM, the procedure ends and is finished unsuccessfully.

## 11.4 GSM security related procedures

### 11.4.1 GSM algorithms computation

The ME selects  $DF_{GSM}$  and uses the RUN GSM ALGORITHM function (see subclause 8.16). The response SRES-Kc is sent to the ME when requested by a subsequent GET RESPONSE command.

### 11.4.2 IMSI request

The ME performs the reading procedure with  $EF_{IMSI}$ .

### 11.4.3 Access control request

The ME performs the reading procedure with  $EF_{ACC}$ .

### 11.4.4 Higher Priority PLMN search period request

The ME performs the reading procedure with  $EF_{HPPLMN}$ .

### 11.4.5 Location information

Request: The ME performs the reading procedure with EF<sub>LOCI</sub>.

Update: The ME performs the updating procedure with EF<sub>LOCI</sub>.

### 11.4.6 Cipher key

Request: The ME performs the reading procedure with EF<sub>Kc</sub>.

Update: The ME performs the updating procedure with EF<sub>Kc</sub>.

### 11.4.7 BCCH information

Request: The ME performs the reading procedure with EF<sub>BCCH</sub>.

Update: The ME performs the updating procedure with EF<sub>BCCH</sub>.

### 11.4.8 Forbidden PLMN

Request: The ME performs the reading procedure with EF<sub>PLMN</sub>.

Update: The ME performs the updating procedure with EF<sub>PLMN</sub>.

### 11.4.9 LSA information

Request: The ME performs the reading procedure with EF<sub>SAI</sub>, EF<sub>SLL</sub> and its associated LSA Descriptor files.

Update: The ME performs the updating procedure with EF<sub>SLL</sub>.

### 11.4.10 GPRS Location information

Requirement: Service n°38 "allocated and activated".

Request: The ME performs the reading procedure with EF<sub>LOCIGPRS</sub>.

Update: The ME performs the updating procedure with EF<sub>LOCIGPRS</sub>.

### 11.4.11 GPRS Cipher key

Requirement: Service n°38 "allocated and activated".

Request: The ME performs the reading procedure with EF<sub>KcGPRS</sub>.

Update: The ME performs the updating procedure with EF<sub>KcGPRS</sub>.

## 11.5 Subscription related procedures

### 11.5.1 Dialling numbers

The following procedures may not only be applied to EF<sub>ADN</sub> and its associated extension files EF<sub>CCP</sub> and EF<sub>EXT1</sub> as described in the procedures below, but also to EF<sub>EDN</sub>, EF<sub>MSISDN</sub>, EF<sub>LND</sub>, EF<sub>BDN</sub> and EF<sub>SDN</sub> and their associated extension files. If these files are not allocated and activated, as denoted in the SIM service table, the current procedure shall be aborted and the appropriate EFs shall remain unchanged.

As an example, the following procedures are described as applied to ADN.

Requirement: Service n°2 "allocated and activated"

(Service n°3 for FDN,  
 Service n°9 for MSISDN,  
 Service n°13 for LND,  
 Service n°18 for SDN),  
 Service n°31 for BDN)

Update: The ME analyses and assembles the information to be stored as follows (the byte identifiers used below correspond to those in the description of the EFs in subclauses 10.5.1, 10.5.4 and 10.5.10):

- i) The ME identifies the Alpha-tagging, Capability/Configuration Identifier and Extension1 Record Identifier.
- ii) The dialling number/SSC string shall be analysed and allocated to the bytes of the EF as follows:
  - if a "+" is found, the TON identifier is set to "International";
  - if 20 or less "digits" remain, they shall form the dialling number/SSC string;
  - if more than 20 "digits" remain, the procedure shall be as follows:

Requirement:

Service n°10 "allocated and activated";  
 (Service n°10 applies also for MSISDN and LND);  
 Service n°11 for FDN;  
 Service n°19 for SDN;  
 Service n°32 for BDN).

The ME seeks for a free record in EF<sub>EXT1</sub>. If an Extension1 record is not marked as "free", the ME runs the Purge procedure. If an Extension1 record is still unavailable, the procedure is aborted.

The first 20 "digits" are stored in the dialling number/SSC string. The value of the length of BCD number/SSC contents is set to the maximum value, which is 11. The Extension1 record identifier is coded with the associated record number in the EF<sub>EXT1</sub>. The remaining digits are stored in the selected Extension1 record where the type of the record is set to "additional data". The first byte of the Extension1 record is set with the number of bytes of the remaining additional data. The number of bytes containing digit information is the sum of the length of BCD number/SSC contents of EF<sub>ADN</sub> and byte 2 of all associated chained Extension1 records containing additional data (see subclauses 10.5.1 and 10.5.10).

- iii) If a called party subaddress is associated to the ADN/SSC the procedure shall proceed as follows:

Requirement:

Service n°10 "allocated and activated"  
 (Service n°10 applies also for MSISDN and LND);  
 Service n°11 for FDN;  
 Service n°19 for SDN;  
 Service n°32 for BDN.)

If the length of the called party subaddress is less than or equal to 11 bytes (see TS 04.08 [15] for coding):

- the ME seeks for a free record in EF<sub>EXT1</sub>. If an Extension1 record is not marked as "free", the ME runs the Purge procedure. If an Extension1 record is still unavailable, the procedure is aborted;
- the ME stores the called party subaddress in the Extension1 record, and sets the Extension1 record type to "called party subaddress".

If the length of the called party subaddress is greater than 11 bytes (see TS 04.08 [15] for coding):

- the ME seeks for two free records in EF<sub>EXT1</sub>. If no such two records are found, the ME runs the Purge procedure. If two Extension1 records are still unavailable, the procedure is aborted;
- the ME stores the called party subaddress in the two Extension1 records. The identifier field in the Extension1 record containing the first part of the subaddress data is coded with the associated EF<sub>EXT1</sub> record number containing the second part of the subaddress data. Both Extension1 record types are set to "called party subaddress".

Once i), ii), and iii) have been considered the ME performs the updating procedure with EF<sub>ADN</sub>. If the SIM has no available empty space to store the received ADN/SSC, or if the procedure has been aborted, the ME advises the user.

NOTE 1: For reasons of memory efficiency the ME is allowed to analyse all Extension1 records to recognize if the additional or subaddress data to be stored is already existing in EF<sub>EXT1</sub>. In this case the ME may use the existing chain or the last part of the existing chain from more than one ADN (LND, MSISDN). The ME is only allowed to store extension data in unused records. If existing records are used for multiple access, the ME shall not change any data in those records to prevent corruption of existing chains.

- Erasure: The ME sends the identification of the information to be erased. The content of the identified record in EF<sub>ADN</sub> is marked as "free".
- Request: The ME sends the identification of the information to be read. The ME shall analyse the data of EF<sub>ADN</sub> (subclause 10.5.1) to ascertain, whether additional data is associated in EF<sub>EXT1</sub> or EF<sub>CCP</sub>. If necessary, then the ME performs the reading procedure on these EFs to assemble the complete ADN/SSC.
- Purge: The ME shall access each EF which references EF<sub>EXT1</sub> (EF<sub>EXT2</sub>) for storage and shall identify records in these files using extension data (additional data or called party subaddress). Note that existing chains have to be followed to the end. All referred Extension1 (Extension2) records are noted by the ME. All Extension1 (Extension2) records not noted are then marked by the ME as "free" by setting the whole record to 'FF'.

NOTE 2: Dependent upon the implementation of the ME, and in particular the possibility of erasure of ADN/SSC records by Phase 1 MEs, which have no knowledge of the EF<sub>EXT1</sub>, it is possible for Extension1 records to be marked as "used space" (not equal to 'FF'), although in fact they are no longer associated with an ADN/SSC record.

The following three procedures are only applicable to service n°3 (FDN).

FDN capability request. The ME has to check the state of service n°3, i.e. if FDN is "enabled" or "disabled". In case of enabled FDN, the ME has to switch to a restrictive terminal mode (see TS 02.07). To ascertain the state of FDN, the ME checks in EF<sub>SST</sub> whether or not ADN is activated. If ADN is not activated, service n°3 is enabled. If ADN is activated, the ME checks the response data of EF<sub>ADN</sub>. If EF<sub>ADN</sub> is invalidated, service n°3 is enabled. In all other cases service n°3 is disabled.

FDN disabling. The FDN disabling procedure requires that CHV2 verification procedure has been performed successfully and that ADN is activated. If not, FDN disabling procedure will not be executed successfully. To disable FDN capability, the ME rehabilitates EF<sub>ADN</sub>. The invalidate/rehabilitate flag of EF<sub>ADN</sub>, which is implicitly set by the REHABILITATE command, is at the same time the indicator for the state of the service n°3. If ADN is not activated, disabling of FDN is not possible and thus service n°3 is always enabled (see FDN capability request).

NOTE 3: If FDN is disabled (by rehabilitating EF<sub>ADN</sub>) using an administrative terminal then the FDN disabling procedure of this administrative terminal need also to rehabilitate EF<sub>IMSI</sub> and EF<sub>LOCI</sub> to ensure normal operation of the SIM in a phase 1 ME or a phase 2 ME which does not support FDN.

FDN enabling. The FDN enabling procedure requires that CHV2 verification procedure has been performed successfully. If not, FDN enabling procedure will not be executed successfully. To enable FDN capability, the ME invalidates EF<sub>ADN</sub>. The invalidate/rehabilitate flag of EF<sub>ADN</sub>, which is implicitly cleared by the INVALIDATE command, is at the same time the indicator for the state of the service n°3 (see FDN capability request). If ADN is not activated, service n°3 is always enabled.

Invalidated ADNs may optionally still be readable and updatable depending on the file status (see subclause 9.3)

The following three procedures are only applicable to service n°31 (BDN).

BDN capability request. The ME has to check the state of service n°31, i.e. if BDN is "enabled" or "disabled". BDN service is "enabled" only if service n°31 is allocated and activated, and EF<sub>BDN</sub> is not invalidated. In all other cases, the BDN service is "disabled".

BDN disabling. The BDN disabling procedure requires that CHV2 verification procedure has been performed successfully. If not, BDN disabling procedure will not be executed successfully. To disable BDN capability, the ME invalidates EF<sub>BDN</sub>. The invalidate/rehabilitate flag of EF<sub>BDN</sub>, which is implicitly cleared by the INVALIDATE command, is at the same time the indicator for the state of the service n°31 (see BDN capability request).

BDN enabling. The BDN enabling procedure requires that CHV2 verification procedure has been performed successfully. If not, BDN enabling procedure will not be executed successfully. To enable BDN capability, the ME rehabilitates EF<sub>BDN</sub>. The invalidate/rehabilitate flag of EF<sub>BDN</sub>, which is implicitly set by the REHABILITATE command, is at the same time the indicator for the state of the service n°31 (see BDN capability request).

Invalidated BDNs (when BDN capability is disabled) may optionally still be readable and updatable depending on the file status (see subclause 9.3).

## 11.5.2 Short messages

Requirement: Service n°4 "allocated and activated".

Request: The SIM seeks for the identified short message. If this message is found, the ME performs the reading procedure with EF<sub>SMS</sub>.

If service n°35 is "allocated and activated" and the status of the SMS is '1D' (status report requested, received and stored in EF<sub>SMSR</sub>), the ME performs the reading procedure with the corresponding record in EF<sub>SMSR</sub>. If the ME does not find a corresponding record in EF<sub>SMSR</sub>, then the ME shall update the status of the SMS with '15' (status report requested, received but not stored in EF<sub>SMSR</sub>).

If the short message is not found within the SIM memory, the SIM indicates that to the ME.

Update: The ME looks for the next available area to store the short message. If such an area is available, it performs the updating procedure with EF<sub>SMS</sub>.

If there is no available empty space in the SIM to store the received short message, a specific MMI will have to take place in order not to lose the message.

Erasure: The ME will select in the SIM the message area to be erased. Depending on the MMI, the message may be read before the area is marked as "free". After performing the updating procedure with EF<sub>SMS</sub>, the memory allocated to this short message in the SIM is made available for a new incoming message. The memory of the SIM may still contain the old message until a new message is stored in this area.

If service n°35 is "allocated and activated" and the status of the SMS is '1D' (status report requested, received and stored in EF<sub>SMSR</sub>), the ME performs the erasure procedure for EF<sub>SMSR</sub> with the corresponding record in EF<sub>SMSR</sub>.

## 11.5.3 Advice of Charge (AoC)

Requirement: Service n°5 "allocated and activated".

Accumulated Call Meter.

Request: The ME performs the reading procedure with EF<sub>ACM</sub>. The SIM returns the last updated value of the ACM.

Initialization: The ME performs the updating procedure with EF<sub>ACM</sub> using the new initial value.

Increasing: The ME performs the increasing procedure with EF<sub>ACM</sub> sending the value which has to be added.

Accumulated Call Meter Maximum Value.

Request: The ME performs the reading procedure with EF<sub>ACMmax</sub>.



Initialization: The ME performs the updating procedure with  $EF_{ACMmax}$  using the new initial maximum value.

Price per Unit and Currency Table (PUCT).

Request: The ME performs the reading procedure with  $EF_{PUCT}$ .

Update: The ME performs the updating procedure with  $EF_{PUCT}$ .

#### 11.5.4 Capability configuration parameters

Requirement: Service n°6 "allocated and activated".

Request: The ME performs the reading procedure with  $EF_{CCP}$ .

Update: The ME performs the updating procedure with  $EF_{CCP}$ .

Erasure: The ME sends the identification of the requested information to be erased. The content of the identified record in  $EF_{CCP}$  is marked as "free".

#### 11.5.5 PLMN selector

Requirement: Service n°7 "allocated and activated".

Request: The ME performs the reading procedure with  $EF_{PLMNse1}$ .

Update: The ME performs the updating procedure with  $EF_{PLMNse1}$ .

#### 11.5.6 Cell broadcast message identifier

Requirement: Service n°14 "allocated and activated".

Request: The ME performs the reading procedure with  $EF_{CBMI}$ .

Update: The ME performs the updating procedure with  $EF_{CBMI}$ .

#### 11.5.7 Group identifier level 1

Requirement: Service n°15 "allocated and activated".

Request: The ME performs the reading procedure with  $EF_{GID1}$ .

#### 11.5.8 Group identifier level 2

Requirement: Service n°16 "allocated and activated".

Request: The ME performs the reading procedure with  $EF_{GID2}$ .

#### 11.5.9 Service Provider Name

Requirement: Service n°17 "allocated and activated".

Request: The ME performs the reading procedure with  $EF_{SPN}$ .

#### 11.5.10 Voice Group Call Services

Requirement: Service n°21 "allocated and activated".

Voice Group Call Service

Request: The ME performs the reading procedure with  $EF_{VGCS}$ .

Voice Group Call Service Status

Request: The ME performs the reading procedure with  $EF_{VGCSS}$ .

Update: The ME performs the updating procedure with  $EF_{VGCSS}$ .

### 11.5.11 Voice Broadcast Services

Requirement: Service n°22 "allocated and activated".

#### Voice Broadcast Service

Request: The ME performs the reading procedure with  $EF_{VBS}$ .

#### Voice Broadcast Service Status

Request: The ME performs the reading procedure with  $EF_{VBSS}$ .

Update: The ME performs the updating procedure with  $EF_{VBSS}$ .

### 11.5.12 Enhanced Multi Level Pre-emption and Priority Service

Requirement: Service n°23 "allocated and activated".

#### Enhanced Multi Level Pre-emption and Priority

Request: The ME performs the reading procedure with  $EF_{eMLPP}$ .

#### Automatic Answer on eMLPP service

Request: The ME performs the reading procedure with  $EF_{AAeM}$ .

Update: The ME performs the updating procedure with  $EF_{AAeM}$ .

### 11.5.13 Cell Broadcast Message range identifier

Requirement: Service n°30 "allocated and activated".

Request: The ME performs the reading procedure with  $EF_{CBMIR}$ .

Update: The ME performs the updating procedure with  $EF_{CBMIR}$ .

### 11.5.14 Depersonalisation Control Keys

Requirement: Service n°33 "allocated and activated".

Request: The ME performs the reading procedure with  $EF_{DCK}$ .

### 11.5.15 Short message status report

Requirement: Service n°35 "allocated and activated".

Request: If the status of a stored short message indicates that there is a corresponding status report, the ME performs the seek function with  $EF_{SMSR}$  to identify the record containing the appropriate status report. The ME performs the reading procedure with  $EF_{SMSR}$ .

Update: If a status report is received, the ME first seeks within the SMS record identifiers of  $EF_{SMSR}$  for the same record number it used for the short message in  $EF_{SMS}$ . If such a record identifier is found in  $EF_{SMSR}$ , it is used for storage. If such a record identifier is not found, then the ME seeks for a free entry in  $EF_{SMSR}$  for storage. If no free entry is found the ME runs the Purge procedure with  $EF_{SMSR}$ . If there is still no free entry, the status report is not stored.

If the ME found an appropriate record in  $EF_{SMSR}$  for storage, it updates the record with the status report setting the record identifier in  $EF_{SMSR}$  to the appropriate record number of the short message in  $EF_{SMS}$ .

The status in EF<sub>SMS</sub> is updated accordingly (see subclause 10.5.3) by performing the update procedure with EF<sub>SMS</sub>.

**Erasure:** The ME runs the update procedure with EF<sub>SMSR</sub> by at least storing '00' in the first byte of the record. The ME may optionally update the following bytes with 'FF'.

**Purge:** The ME shall read the SMS record identifier (byte 1) of each record of EF<sub>SMSR</sub>. With each record the ME checks the corresponding short messages in EF<sub>SMS</sub>. If the status (byte 1) of the corresponding SMS is not equal '1D' (status report requested, received and stored in EF<sub>SMSR</sub>), the ME shall perform the erasure procedure with the appropriate record in EF<sub>SMSR</sub>.

### 11.5.16 Network's indication of alerting

**Requirement:** Service n°36 "allocated and activated".

**Request:** The ME performs the reading procedure with EF<sub>NIA</sub>.

### 11.5.17 User controlled PLMN Selector with Access Technology

**Requirement:** Service n°43 "allocated and activated".

**Request:** The ME performs the reading procedure with EF<sub>PLMNwAcT</sub>.

**Update:** The ME performs the updating procedure with EF<sub>PLMNwAcT</sub>.

### 11.5.18 Operator controlled PLMN Selector with Access Technology

**Requirement:** Service n°44 "allocated and activated".

**Request:** The ME performs the reading procedure with EF<sub>OPLMNwAcT</sub>.

### 11.5.19 HPLMN Selector with Access Technology

**Requirement:** Service n°45 "allocated and activated".

**Request:** The ME performs the reading procedure with EF<sub>HPLMNwAcT</sub>.

### 11.4.20 CPBCCCH information

**Requirement:** Service n°46 "allocated and activated".

**Request:** The ME performs the reading procedure with EF<sub>CPBCCCH</sub>.

**Update:** The ME performs the updating procedure with EF<sub>CPBCCCH</sub>.

### 11.5.21 Investigation Scan

**Requirement:** Service n°47 "allocated and activated".

**Request:** The ME performs the reading procedure with EF<sub>InvScan</sub>.

### 11.5.22 Void

## 11.6 SIM Application Toolkit related procedures

SIM Application Toolkit is an optional feature. The higher level procedures, and contents and coding of the commands, are given in TS 11.14 [27]. Procedures relating to the transmission of commands and responses across the SIM/ME

interface are given in this section. A SIM or ME supporting SIM Application Toolkit shall conform to the requirements given in this section.

### 11.6.1 Initialization procedure

A SIM supporting SIM Application Toolkit shall indicate this through relevant data in EF<sub>Phase</sub> and EF<sub>SST</sub>, as defined in the relevant sections above.

An ME supporting SIM Application Toolkit shall perform initialization as defined in the SIM Initialization section above.

### 11.6.2 Proactive polling

An ME supporting proactive SIM (part of SIM Application Toolkit) shall support the polling procedure as defined above.

### 11.6.3 Support of commands

A SIM or ME supporting SIM Application Toolkit shall support the commands TERMINAL PROFILE, ENVELOPE, FETCH and TERMINAL RESPONSE.

These commands shall never be used if either the SIM or ME does not support SIM Application Toolkit. Therefore standard SIMs and MEs do not need to support these commands.

### 11.6.4 Support of response codes

A SIM or ME supporting SIM Application Toolkit shall support the response status words (SW1 SW2) '91 XX', and '93 00' and '9E XX'. The SIM shall send '9E XX' only to an ME indicating in TERMINAL PROFILE that it supports the handling of these status words.

These responses shall never be used if either the SIM or ME does not support SIM Application Toolkit. Therefore standard SIMs and MEs do not need to support them.

### 11.6.5 Command-response pairs

Using the terminology where the ME issues a command and the SIM a response, ending in status words SW1 SW2, a command-response pair is considered as a single transaction. Each transaction is initiated by the ME and terminated by the SIM. One transaction must be completed before the next one can be initiated. This protocol applies to SIM Application Toolkit in the same way as it does to normal operation.

### 11.6.6 Independence of normal GSM and SIM Application Toolkit tasks

Normal GSM operation (relating to general, CHV related, GSM security related, and subscription related procedures) and SIM Application Toolkit operation shall be logically independent, both in the SIM and in the ME.

Specifically, this means:

- the currently selected EF and current record pointer in the normal GSM task shall remain unchanged, if still valid, as seen by the ME, irrespective of any SIM Application Toolkit activity;
- between successive SIM Application Toolkit related command-response pairs, other normal GSM related command-response pairs can occur. The SIM Application Toolkit task status shall remain unchanged by these command-response pairs.

### 11.6.7 Use of BUSY status response

If for any reason the SIM Application Toolkit task of the SIM cannot process an ENVELOPE command issued by the ME at present (e.g. other SIM Application Toolkit processes are already running, and this additional one would cause an overload), the SIM can respond with a status response of '93 00'. The ME may re-issue the command at a later stage.

The BUSY status response has no impact on normal GSM operation.

### 11.6.8 Use of NULL procedure byte

The NULL procedure byte provides a mechanism for the SIM to obtain more time before supplying the response part of a command-response pair, during which time the ME is unable to send further commands to the SIM.

If a SIM Application Toolkit activity in the SIM runs for too long, this may prevent the ME from sending "normal GSM" commands which are time-critical, e.g. RUN GSM ALGORITHM. A MORE TIME command is defined in TS 11.14 [27], which ensures that the SIM Application Toolkit task in the SIM gets more processing time, while at the same time freeing the SIM/ME interface. This should be used in preference to NULL procedure bytes ('60').

### 11.6.9 Using the TERMINAL PROFILE, ENVELOPE, and TERMINAL RESPONSE commands

These commands are part of the set used by SIM Application Toolkit. The use of these commands, the occasions where they are required, and the command and response parameters associated with the commands, are specified in TS 11.14 [27]. The ME completes the command parameters/data of the relevant command and sends the command to the SIM. The transmitted data is processed by the SIM in a specific way depending on the tag value in the command parameters.

A SIM or ME not supporting SIM Application Toolkit does not need to support these commands.

### 11.6.10 Using the FETCH command

This command is used by SIM Application Toolkit. The use of this command, the occasions where it is required, and the command and response parameters associated with the command, are specified in TS 11.14 [27]. It is similar in function to GET RESPONSE, in that it requests response parameters from the SIM, following a '91 XX' status response. The transmitted response data from the SIM is processed by the ME in a specific way depending on the tag value in the response parameters.

A SIM or ME not supporting SIM Application Toolkit does not need to support this command.

### 11.6.11 Data Download via SMS-CB

Requirement: Service n°25 "allocated and activated".

The ME shall perform the reading procedure with  $EF_{CBMID}$ . On receiving a cell broadcast message with an identifier which matches an identifier in  $EF_{CBMID}$ , the ME shall pass the CB message to the SIM using the ENVELOPE command. If a match is not found and service no. 14 is "allocated and activated", then the message identifier is checked against those in  $EF_{CBMI}$ .

### 11.6.12 Data Download via SMS-PP

Requirement: Service n°26 "allocated and activated".

The procedures and commands for Data Download via SMS-PP are defined in TS 11.14 [27].

### 11.6.13 Menu selection

Requirement: Service n°27 "allocated and activated".

The procedures and commands for Menu Selection are defined in TS 11.14 [27].

### 11.6.14 Call Control

Requirement: Service n°28 "allocated and activated".

The procedures and commands for Call Control are defined in TS 11.14 [27]. It is mandatory for the ME to perform the procedures if it has indicated that it supports Call Control in the TERMINAL PROFILE command. When BDN is enabled, the Call control facility of the ME is used by the SIM to support the BDN service.

### 11.6.15 Proactive SIM

Requirement: Service n°29 "allocated and activated".

The procedures and commands for Proactive SIM, at the application level, are defined in TS 11.14 [27].

### 11.6.16 Mobile Originated Short Message control by SIM

Requirement: Service n°37 "allocated and activated".

The procedures and commands for Mobile Originated Short Message control by SIM are defined in TS 11.14 [27]. It is mandatory for the ME to perform the procedures if it has indicated that it supports Mobile Originated Short Message control by SIM in the TERMINAL PROFILE command.

### 11.6.17 SIM data download error

In case of an ENVELOPE for SIM data download, the SIM can respond with the status words '9E XX' to indicate that response data is available. The ME shall use the GET RESPONSE command to get the response data. The ME shall then send transparently to the network this response data, using the error procedure of the transport mechanism.

### 11.6.18 Image Request

Requirement: Service n°39 "allocated and activated".

The ME sends the identification of the information to be read. The ME shall analyse the data of EF<sub>IMG</sub> (subclause 10.6.1.1) to identify the files containing the image's instances. If necessary, then the ME performs READ BINARY commands on these files to assemble the complete image instance data.

## 11.7 MExE related procedures

MExE is an optional feature. The higher level procedures, and contents and coding of the commands, are given in TS 23.057 [50]. Procedures relating to the transmission of commands and responses across the SIM/ME interface are given in this section. A SIM or ME supporting MExE shall conform to the requirements given in this section.

### 11.7.1 MExE ST

Requirement: Service n°49 (MExE) "allocated and activated".  
Request: The ME performs the reading procedure with EF<sub>MExE\_ST</sub>.

### 11.7.2 Operator root public key

Requirement: Service n°49 (MExE) "allocated and activated" and MExE ST service n°1 (EF<sub>ORPK</sub>) "allocated and activated".  
Request: The ME performs the reading procedure with EF<sub>ORPK</sub>. The ME shall analyse the data of EF<sub>ORPK</sub> (sub-clause 10.7.2) to identify the files containing the certificate instances. If necessary, then the ME performs READ BINARY commands on these files to assemble the complete certificate instance data.

### 11.7.3 Administrator root public key

Requirement: Service n°49 (MExE) "allocated and activated" and MExE ST service n°2 (EF<sub>ARPK</sub>) "allocated and activated".  
Request: The ME performs the reading procedure with EF<sub>ARPK</sub>. The ME shall analyse the data of EF<sub>ARPK</sub> (sub-clause 10.7.3) to identify the file containing the certificate instance. If necessary, then the ME performs READ BINARY commands on this file to assemble the complete certificate instance data.

### 11.7.4 Third Party root public key(s)

Requirement: Service n°49 (MExE) "allocated and activated" and MExE ST service n°3 (EF<sub>TPRPK</sub>) "allocated and activated".  
Request: The ME performs the reading procedure with EF<sub>TPRPK</sub>. The ME shall analyse the data of EF<sub>TPRPK</sub> (sub-clause 10.7.4) to identify the files containing the certificate instances. If necessary, then the ME performs READ BINARY commands on these files to assemble the complete certificate instance data.

# Annex A (normative): Plug-in SIM

This annex specifies the dimensions of the Plug-in SIM as well as the dimensions and location of the contacts of the Plug-in SIM. For further details of the Plug-in SIM see clause 4.

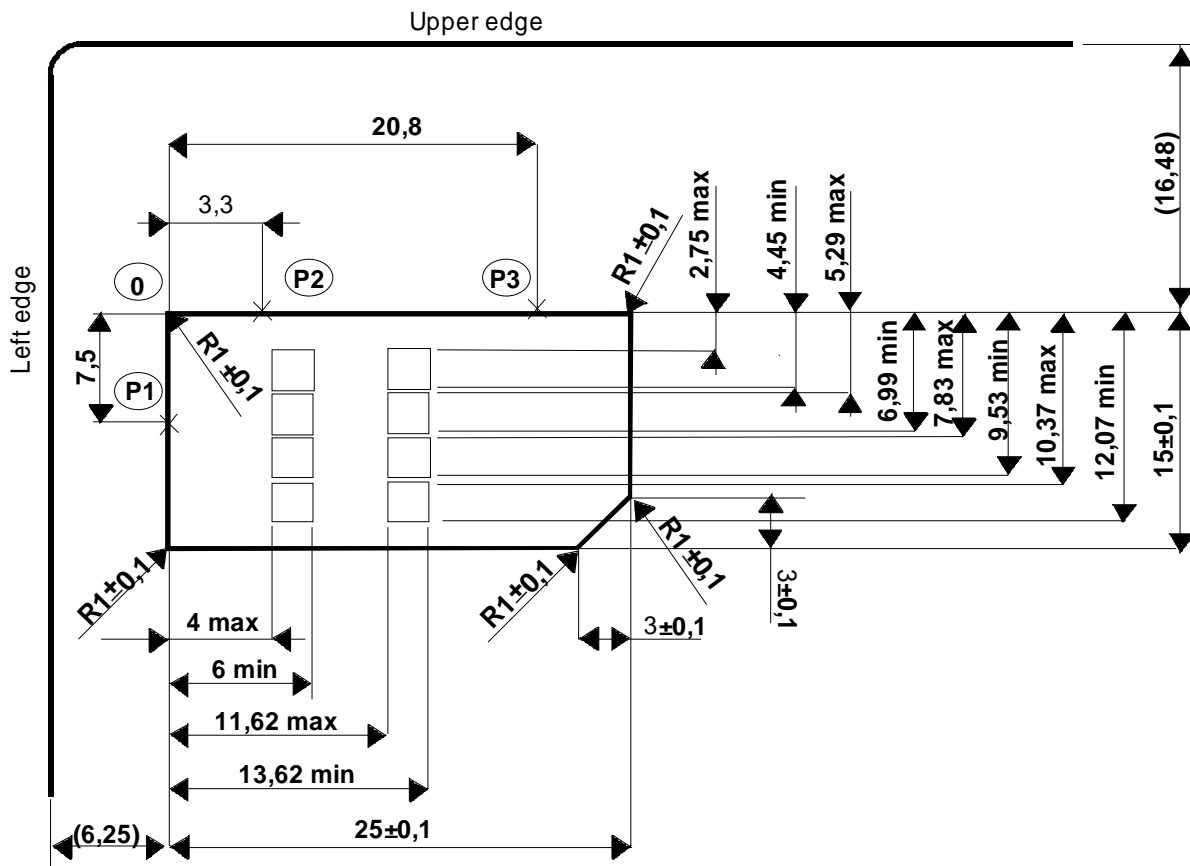

NOTE: The Plug-in SIM may be "obtained" by cutting away excessive plastic of an ID-1 SIM. The values in parenthesis in figure A.1 show the positional relationship between the Plug-in and the ID-1 SIM and are for information only.

Figure A.1: Plug-in SIM



## Annex B (normative): Coding of Alpha fields in the SIM for UCS2

If 16 bit UCS2 characters as defined in ISO/IEC 10646 [31] are being used in an alpha field, the coding can take one of three forms. If the ME supports UCS2 coding of alpha fields in the SIM, the ME shall support all three coding schemes for character sets containing 128 characters or less; for character sets containing more than 128 characters, the ME shall at least support the first coding scheme. If the alpha field record contains GSM default alphabet characters only, then none of these schemes shall be used in that record. Within a record, only one coding scheme, either GSM default alphabet, or one of the three described below, shall be used.

- 1) If the first octet in the alpha string is '80', then the remaining octets are 16 bit UCS2 characters, with the more significant octet (MSO) of the UCS2 character coded in the lower numbered octet of the alpha field, and the less significant octet (LSO) of the UCS2 character is coded in the higher numbered alpha field octet, i.e. octet 2 of the alpha field contains the more significant octet (MSO) of the first UCS2 character, and octet 3 of the alpha field contains the less significant octet (LSO) of the first UCS2 character (as shown below). Unused octets shall be set to 'FF', and if the alpha field is an even number of octets in length, then the last (unusable) octet shall be set to 'FF'.

### Example 1

Octet 1	Octet 2	Octet 3	Octet 4	Octet 5	Octet 6	Octet 7	Octet 8	Octet 9
'80'	Ch1 <sub>MSO</sub>	Ch1 <sub>LSO</sub>	Ch2 <sub>MSO</sub>	Ch2 <sub>LSO</sub>	Ch3 <sub>MSO</sub>	Ch3 <sub>LSO</sub>	'FF'	'FF'

- 2) If the first octet of the alpha string is set to '81', then the second octet contains a value indicating the number of characters in the string, and the third octet contains an 8 bit number which defines bits 15 to 8 of a 16 bit base pointer, where bit 16 is set to zero, and bits 7 to 1 are also set to zero. These sixteen bits constitute a base pointer to a "half-page" in the UCS2 code space, to be used with some or all of the remaining octets in the string. The fourth and subsequent octets in the string contain codings as follows; if bit 8 of the octet is set to zero, the remaining 7 bits of the octet contain a GSM Default Alphabet character, whereas if bit 8 of the octet is set to one, then the remaining seven bits are an offset value added to the 16 bit base pointer defined earlier, and the resultant 16 bit value is a UCS2 code point, and completely defines a UCS2 character.

### Example 2

Octet 1	Octet 2	Octet 3	Octet 4	Octet 5	Octet 6	Octet 7	Octet 8	Octet 9
'81'	'05'	'13'	'53'	'95'	'A6'	'XX'	'FF'	'FF'

In the above example;

- Octet 2 indicates there 5 characters in the string.
- Octet 3 indicates bits 15 to 8 of the base pointer, and indicates a bit pattern of 0hhh hhhh h000 0000 as the 16 bit base pointer number. Bengali characters for example start at code position 0980 (0000 1001 1000 0000), which is indicated by the coding '13' in octet 3 (shown by the italicised digits).
- Octet 4 indicates GSM Default Alphabet character '53', i.e. "S".
- Octet 5 indicates a UCS2 character offset to the base pointer of '15', expressed in binary as follows 001 0101, which, when added to the base pointer value results in a sixteen bit value of 0000 1001 1001 0101, i.e. '0995', which is the Bengali letter KA.
- Octet 8 contains the value 'FF', but as the string length is 5, this a valid character in the string, where the bit pattern 111 1111 is added to the base pointer, yielding a sixteen bit value of 0000 1001 1111 1111 for the UCS2 character (i.e. '09FF').

- 3) If the first octet of the alpha string is set to '82', then the second octet contains a value indicating the number of characters in the string, and the third and fourth octets contain a 16 bit number which defines the complete 16 bit base pointer to a "half-page" in the UCS2 code space, for use with some or all of the remaining octets in the string. The fifth and subsequent octets in the string contain codings as follows; if bit 8 of the octet is set to zero, the remaining 7 bits of the octet contain a GSM Default Alphabet character, whereas if bit 8 of the octet is set to one, the remaining seven bits are an offset value added to the base pointer defined in octets three and four, and the resultant 16 bit value is a UCS2 code point, and defines a UCS2 character.

### Example 3

Octet 1	Octet 2	Octet 3	Octet 4	Octet 5	Octet 6	Octet 7	Octet 8	Octet 9
'82'	'05'	'05'	'30'	'2D'	'82'	'D3'	'2D'	'31'

In the above example

- Octet 2 indicates there are 5 characters in the string.
- Octets 3 and 4 contain a sixteen bit base pointer number of '0530', pointing to the first character of the Armenian character set.
- Octet 5 contains a GSM Default Alphabet character of '2D', which is a dash "-".
- Octet 6 contains a value '82', which indicates it is an offset of '02' added to the base pointer, resulting in a UCS2 character code of '0532', which represents Armenian character Capital BEN.
- Octet 7 contains a value 'D3', an offset of '53', which when added to the base pointer results in a UCS2 code point of '0583', representing Armenian Character small PIWR.

# Annex C (informative): FDN/BDN Procedures

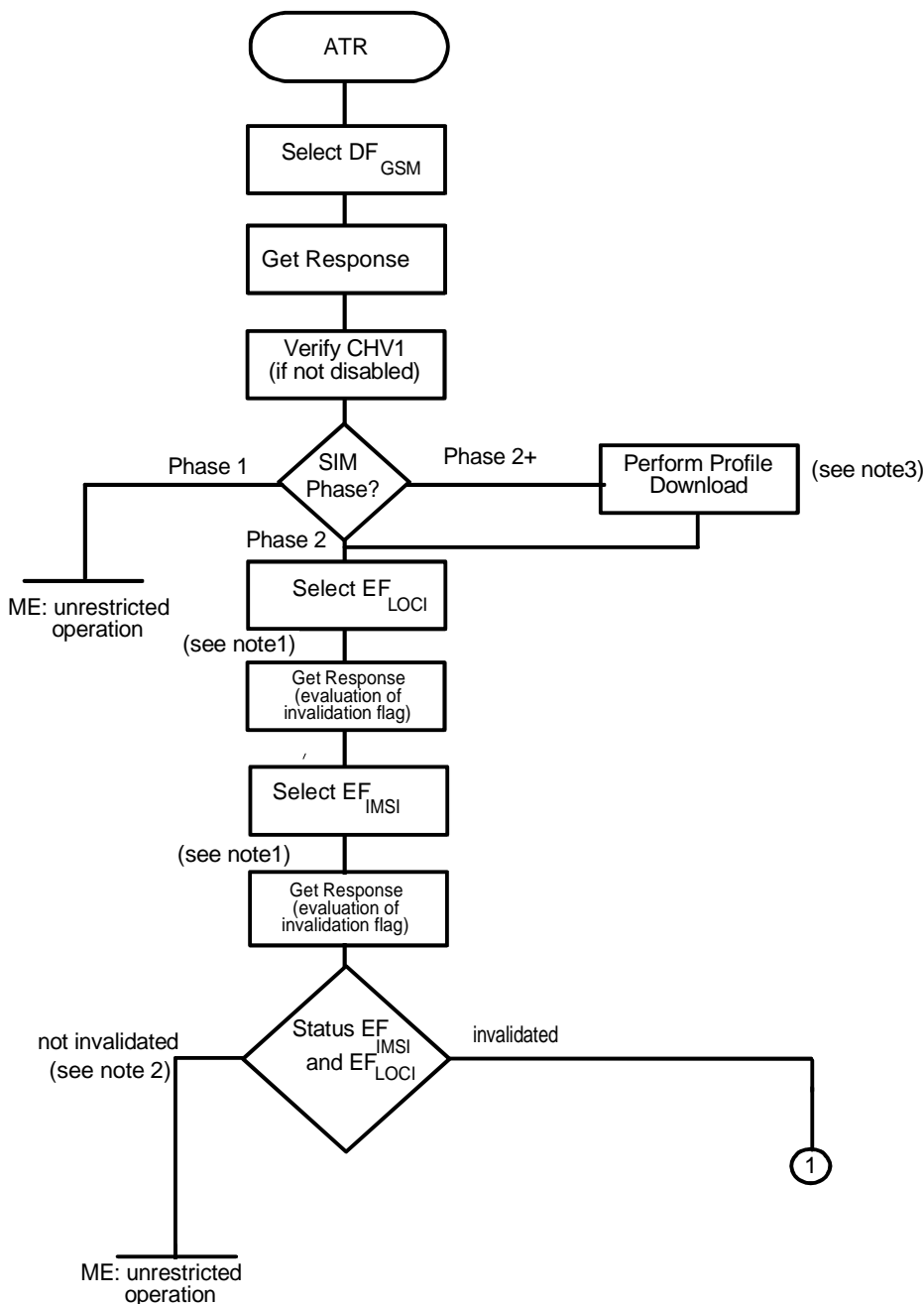

NOTE 1: In case of enabled FDN and/or enabled BDN, the EF has been invalidated by the SIM at no later than this stage.

NOTE 2: Invalidation of only one of the two EFs is not allowed for FDN and BDN.

NOTE 3: For SIMs with enabled BDN this procedure is used to check whether the ME supports the Call Control by the SIM facility.

**Figure C.1: Example of an Initialization Procedure of a FDN/BDN SIM (see subclause 11.2.1)**

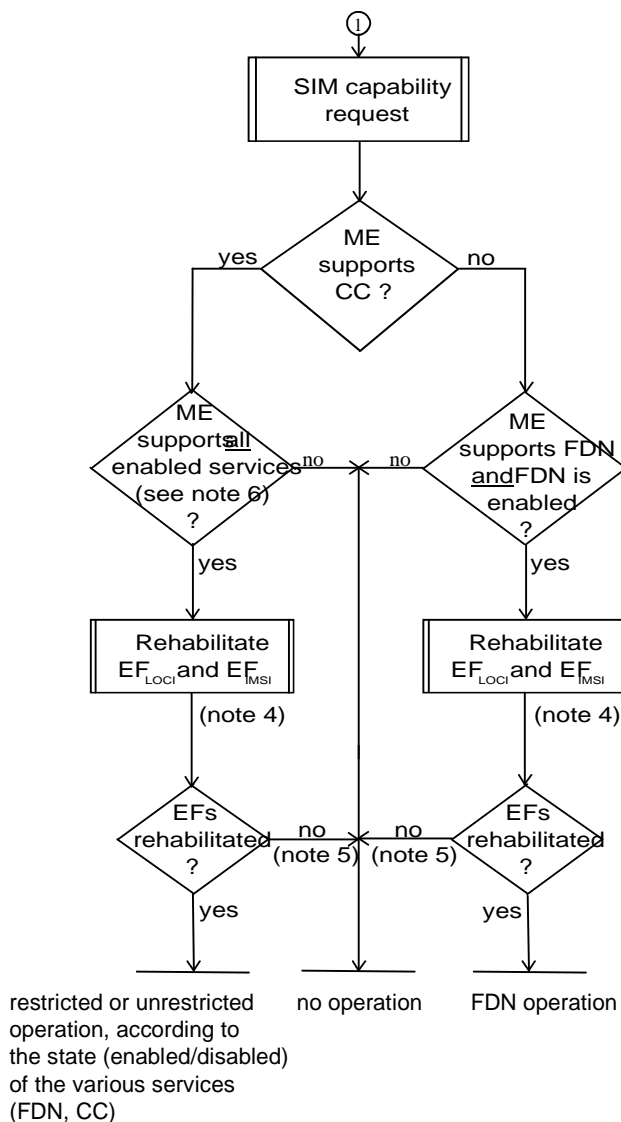

NOTE 4: In case of "BDN enabled", the SIM only allows rehabilitation of the EF<sub>IMSI</sub> and EF<sub>LoCI</sub>, if the ME has indicated its CC-capability to the SIM (by PROFILE\_DOWNLOAD).

NOTE 5: Possibility for future "restricting" services to use the internal SIM mechanism of invalidation of EF<sub>IMSI</sub> and EF<sub>LoCI</sub>.

NOTE 6: If the ME does not support all enabled services (e.g. FDN, BDN), it does not operate. In case of enabled BDN, the support of the "Call Control Feature" by the ME is sufficient for operation. For future use, there may be additional "restricting" services, which are not known to the ME. In that case the ME will perform the subsequent rehabilitation procedure but will fail to rehabilitate EF<sub>IMSI</sub> and EF<sub>LoCI</sub> (see note 4).

Figure C.1: Example of an Initialization Procedure of a FDN/BDN SIM (continued)

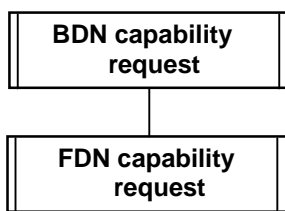

Figure C.2: SIM capability request

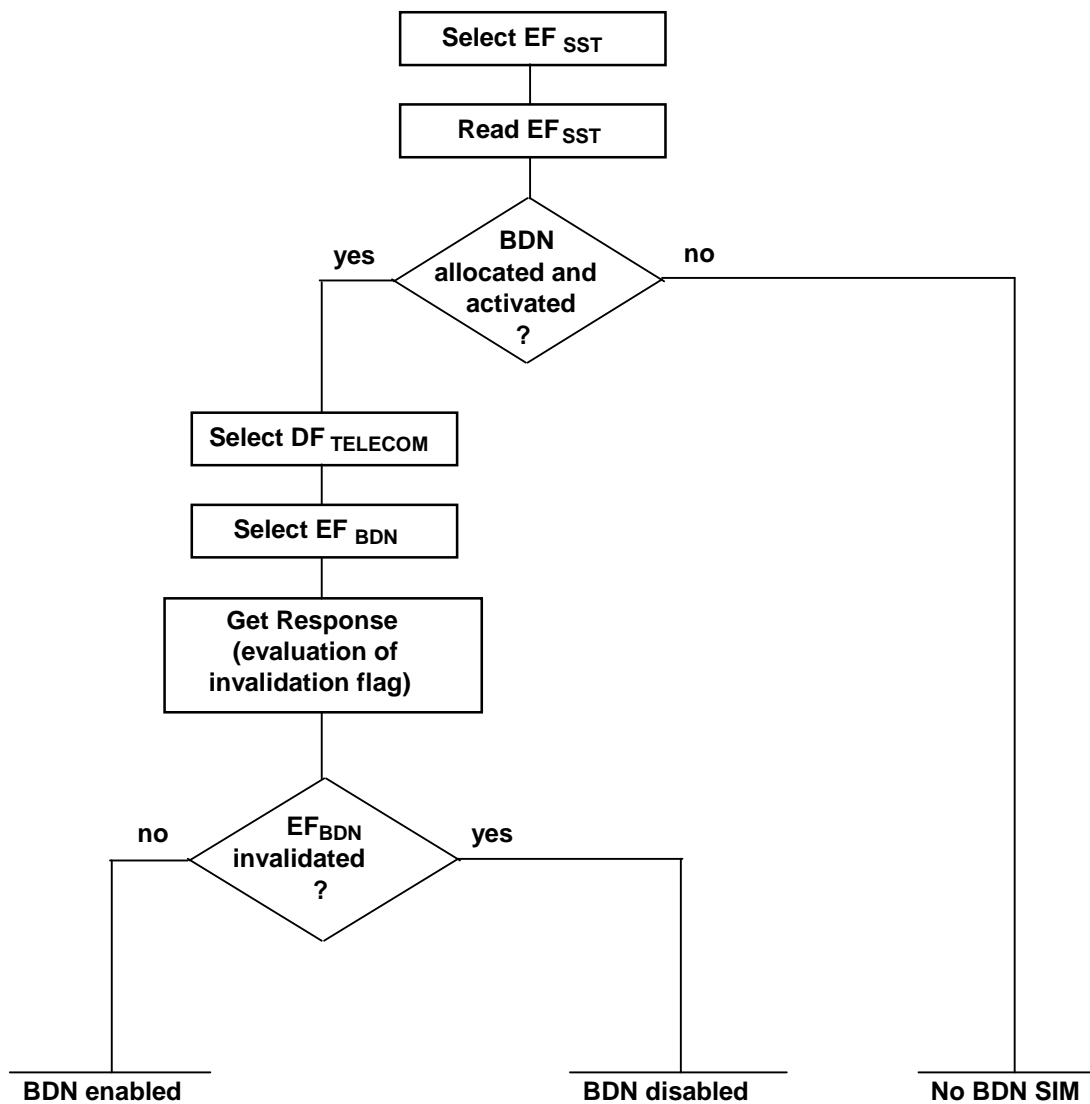
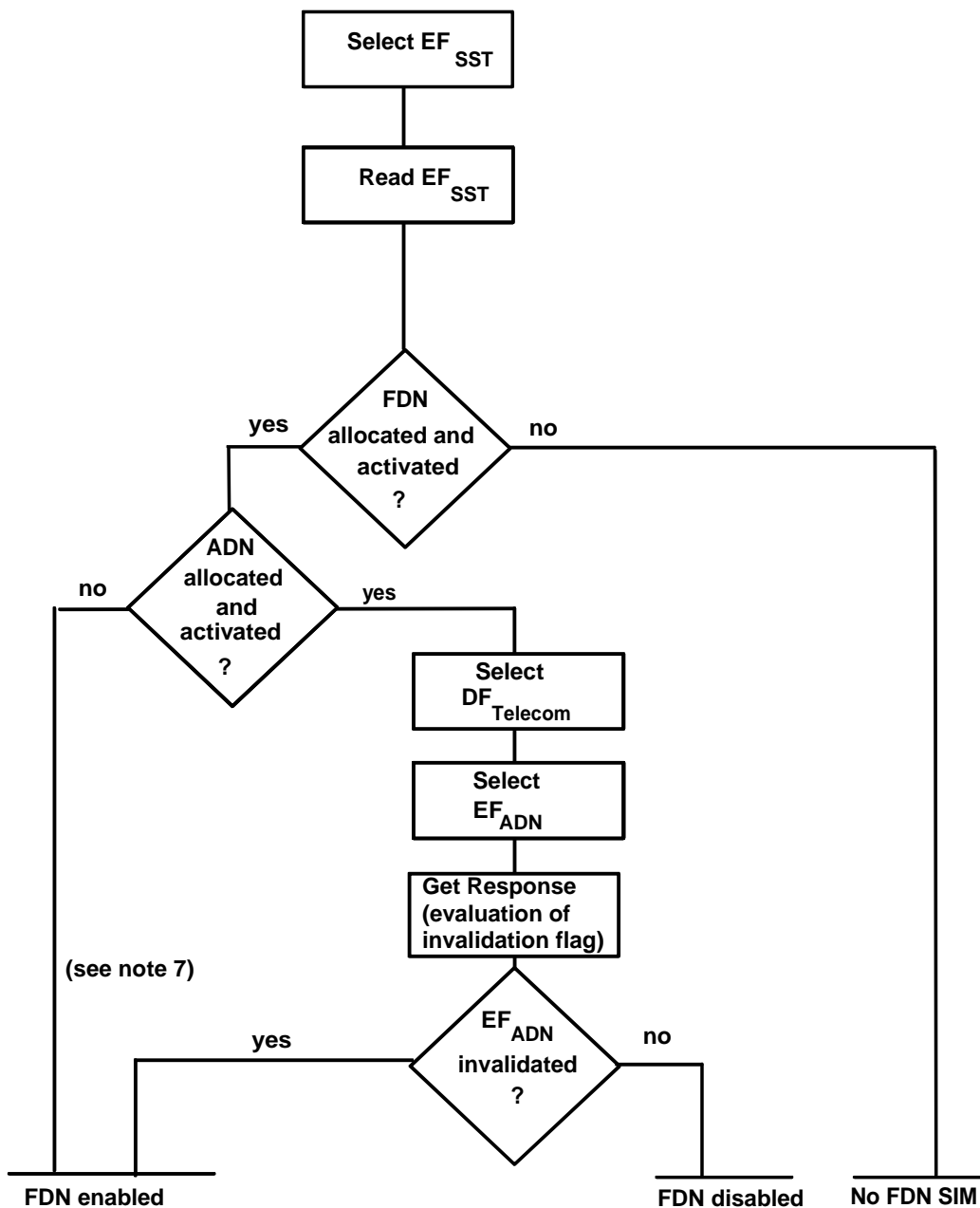
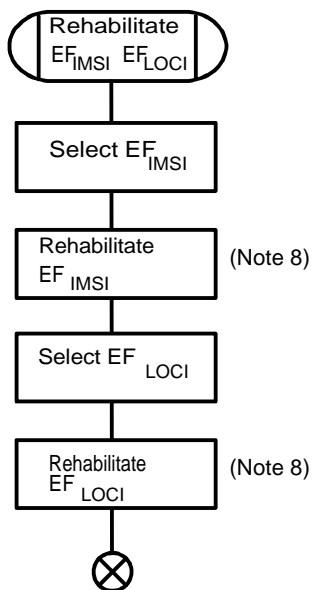

Figure C.3: BDN capability request (see subclause 11.5.1)



NOTE 7: In this case FDN is enabled without the possibility of disabling.

Figure C.4: FDN capability request (see subclause 11.5.1)



NOTE 8: If BDN is enabled in the SIM, and if the Profile download procedure has not indicated that the ME supports Call Control, the EF is not rehabilitated by the SIM.

Figure C.5: Procedure to rehabilitate GSM files

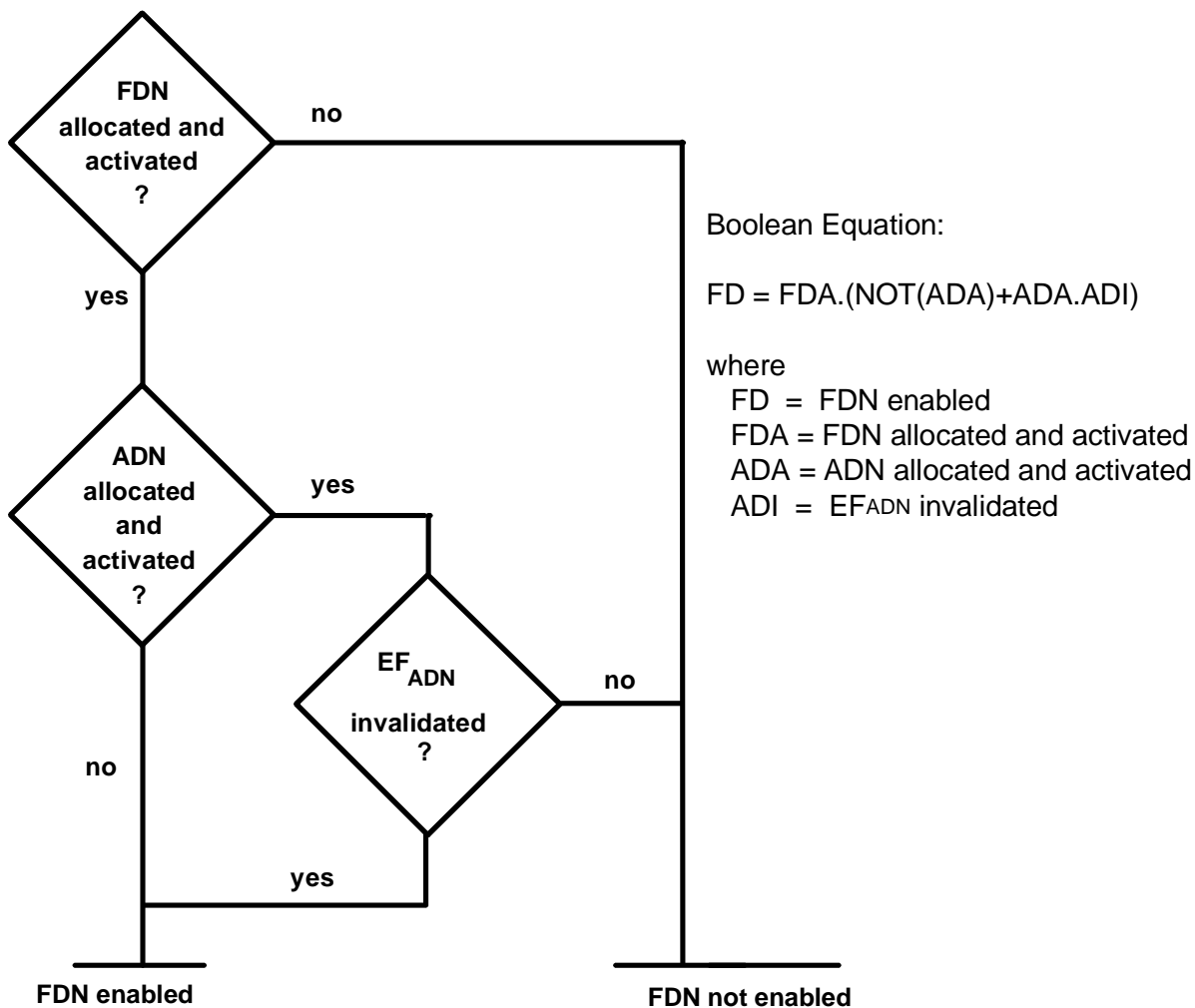

Figure C.6: Coding for state of FDN

---

## Annex D (informative): Suggested contents of the EFs at pre-personalization

If EFs have an unassigned value, it may not be clear from the main text what this value should be. This annex suggests values in these cases.



File Identification	Description	Value
'2FE2'	ICC identification	operator dependant (see 10.1.1)
'2F05'	Extended Language preference	'FF...FF'
'6F05'	Language preference	'FF'
'6F07'	IMSI	operator dependant (see 10.3.2)
'6F20'	Ciphering key Kc	'FF...FF07'
'6F30'	PLMN selector	'FF...FF'
'6F31'	Higher Priority PLMN search period	'FF'
'6F37'	ACM maximum value	'000000' (see note 1)
'6F38'	SIM service table	operator dependant (see 10.3.7)
'6F39'	Accumulated call meter	'000000'
'6F3E'	Group identifier level 1	operator dependant
'6F3F'	Group identifier level 2	operator dependant
'6F41'	PUCT	'FFFFFF0000'
'6F45'	CBMI	'FF...FF'
'6F46'	Service provider name	'FF...FF'
'6F48'	CBMID	'FF...FF'
'6F49'	Service Dialling Numbers	'FF...FF'
'6F74'	BCCH information	'FF...FF'
'6F78'	Access control class	operator dependant (see 10.3.15)
'6F7B'	Forbidden PLMNs	'FF...FF'
'6F7E'	Location information	'FFFFFFF xxxxxx 0000 FF 01' (see note 2)
'6FAD'	Administrative data	operator dependant (see 10.3.18)
'6FAE'	Phase identification	see 10.3.16
'6F3A'	Abbreviated dialling numbers	'FF...FF'
'6F3B'	Fixed dialling numbers	'FF...FF'
'6F3C'	Short messages	'00FF...FF'
'6F3D'	Capability configuration parameters	'FF...FF'
'6F40'	MSISDN storage	'FF...FF'
'6F42'	SMS parameters	'FF...FF'
'6F43'	SMS status	'FF...FF'
'6F44'	Last number dialled	'FF...FF'
'6F47'	Short message status reports	'00FF...FF'
'6F4A'	Extension 1	'FF...FF'
'6F4B'	Extension 2	'FF...FF'
'6F4C'	Extension 3	'FF...FF'
'6F4D'	Barred dialling numbers	'FF...FF'
'6F4E'	Extension 4	'FF...FF'
'6F4F'	Extended capability configuration parameters	'FF...FF'
'6F51'	Network's indication of alerting	'FF...FF'
'6F52'	GPRS Ciphering key KcGPRS	'FF...FF07'
'6F53'	GPRS Location Information	'FFFFFFF FFFFFFF xxxxxx 0000 FF 01' (see note 2)
'6F54'	SetUpMenu Elements	operator dependant (see 10.3.34)
'6F58'	Comparison method information	'FF...FF'
'6F60'	User controlled PLMN Selector with Access Technology	'FFFFFF0000..FFFFFF0000'
'6F61'	Operator controlled PLMN Selector with Access Technology	'FFFFFF0000..FFFFFF0000'
'6F62'	HPLMN Selector with Access Technology	'FFFFFF0000..FFFFFF0000'
'6F63'	CPBCCH information	'FF..FF'
'6F64'	Investigation Scan	'00'
'4F20'	Image data	'00FF...FF'
'4F30'	SoLSA Access Indicator)	'00FF...FF'
'4F31'	SoLSA LSA List	'FF...FF'

NOTE 1: The value '000000' means that ACMmax is not valid, i.e. there is no restriction on the ACM. When assigning a value to ACMmax, care should be taken not to use values too close to the maximum possible value 'FFFFFF', because the INCREASE command does not update  $EF_{ACM}$  if the units to be added would exceed 'FFFFFF'. This could affect the call termination procedure of the Advice of Charge function.

NOTE 2: xxxxxx stands for any valid MCC and MNC, coded according to TS 04.08 [15].

# Annex E (informative): SIM application Toolkit protocol diagrams

The diagrams in this annex are intended to illustrate the data protocols of the SIM toolkit application in various situations. The SIM application is shown as initiated by SMS Data Download messages. Other possibilities exist (as defined in TS 11.14) such as data entry from a menu selection.

## Case 1: Simple

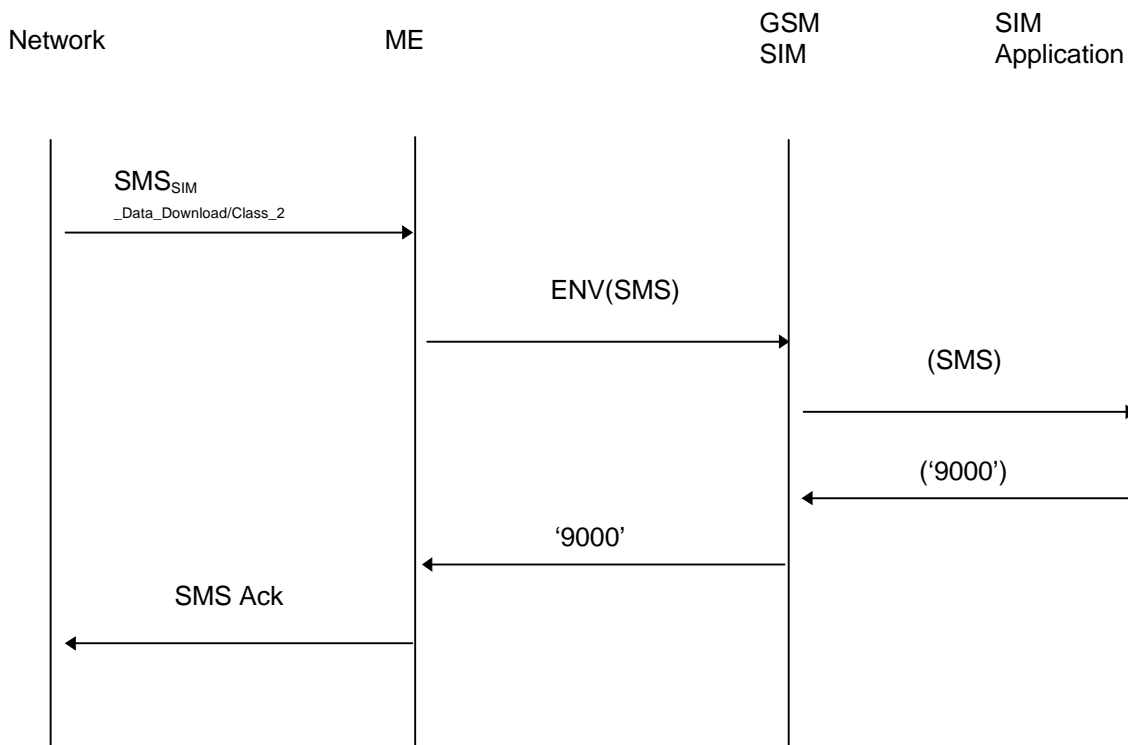

This shows the simple case where an SMS for SIM updating is received from the network, passed to the SIM by the ME and processed immediately by the SIM application. This requires no ME action except to acknowledge the SMS.

**Case 2: Simple with short delay**

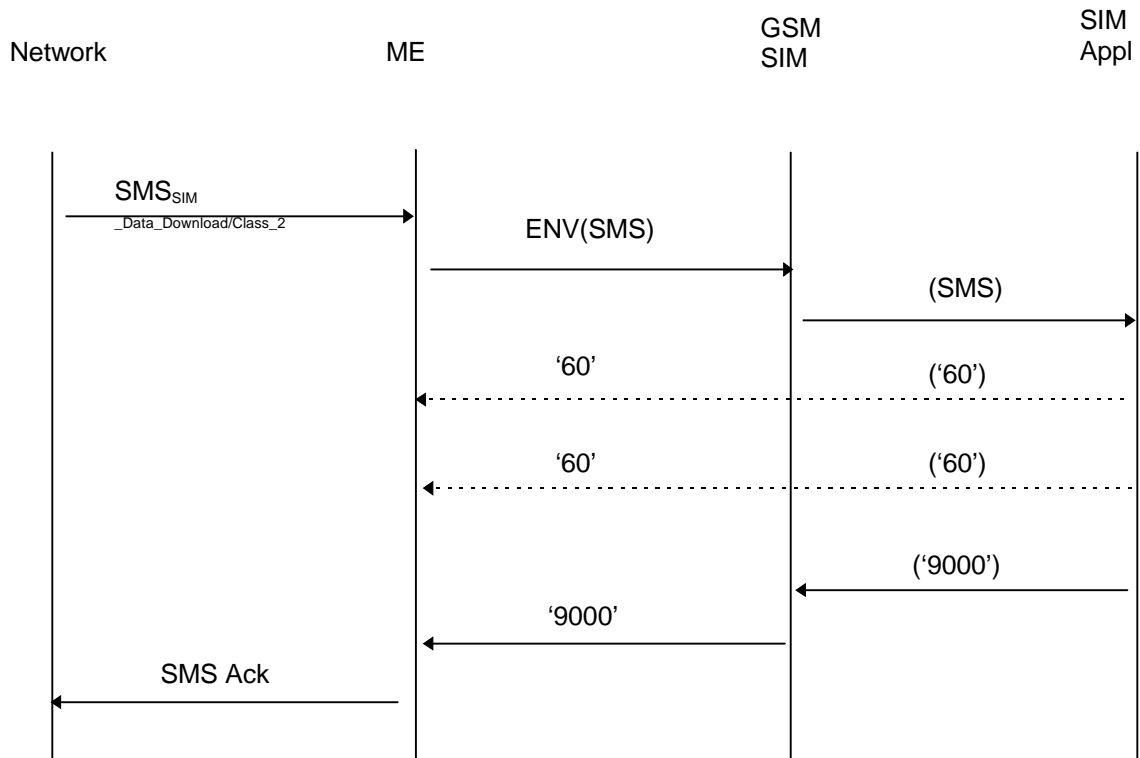

This shows the simple case where an SMS for SIM updating is received from the network, passed to the SIM by the ME and which requires some time to process by the SIM application. The processing time is "not long" and is obtained by the SIM application sending "null procedure bytes" to the ME. Each byte has the effect of restarting the work waiting time so that the ME does not abort the transaction before the SIM application has finished processing the command(s) sent in the SMS.

**Guidelines on timings:**

1. The SMS Ack must be sent back before the network times out and sends the SMS again.
2. Use of null procedure bytes must not be excessive as during this time the ME is unable to issue normal GSM commands to the SIM.

**Case 3: Simple with short delay and SIM Acknowledgement**

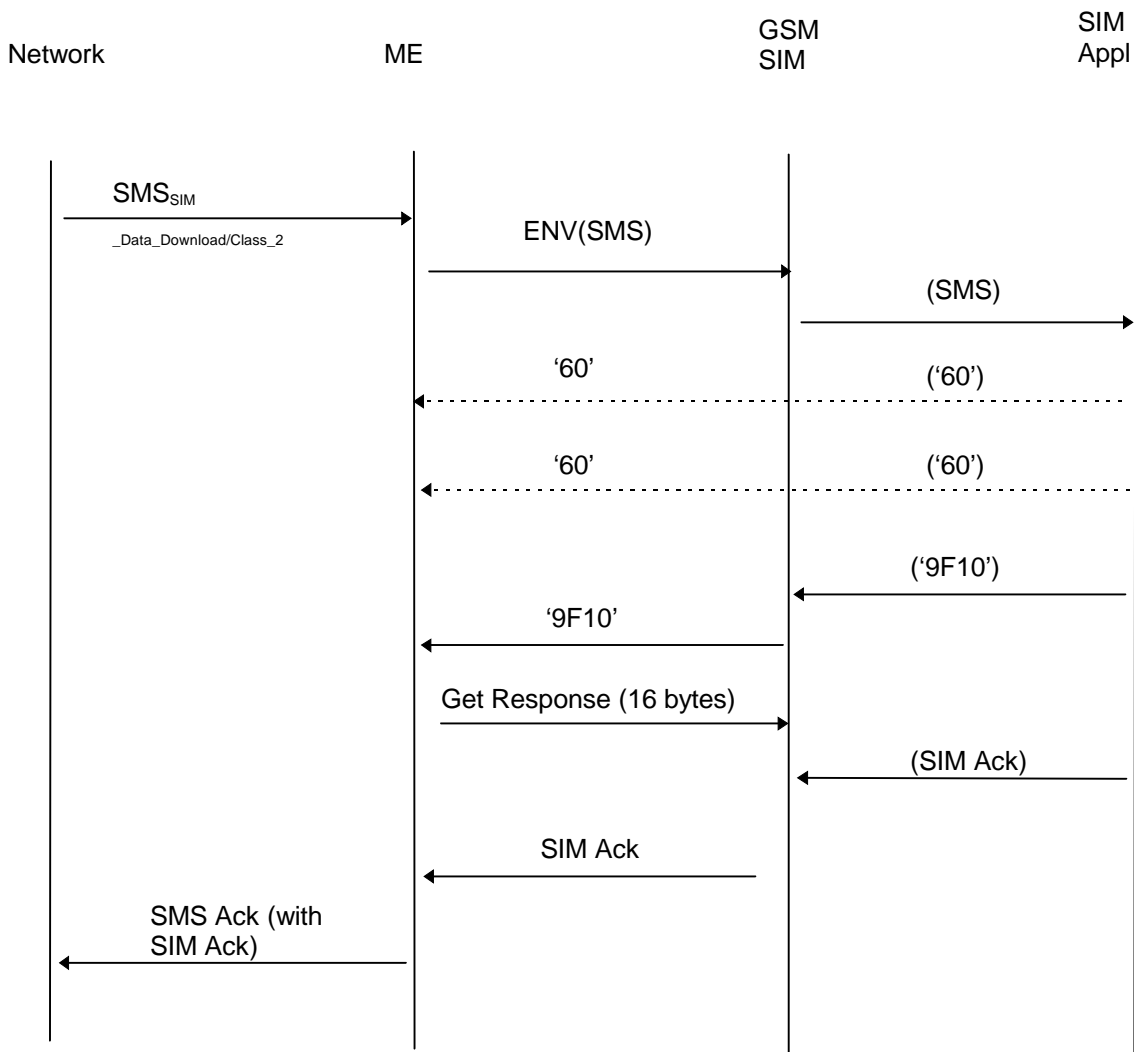

This shows the same case as previously where an SMS for SIM updating is received from the network, passed to the SIM by the ME and which requires some time to process by the SIM application. However in this case the SIM application has SIM acknowledgement data to include in the SMS acknowledgement being returned to the network by the ME.

**Guideline on timings:**

The SMS Ack must be sent back before the network times out and sends the SMS again.

**Case 4: A Toolkit command generated by the SIM application as a result of an SMS from the network**

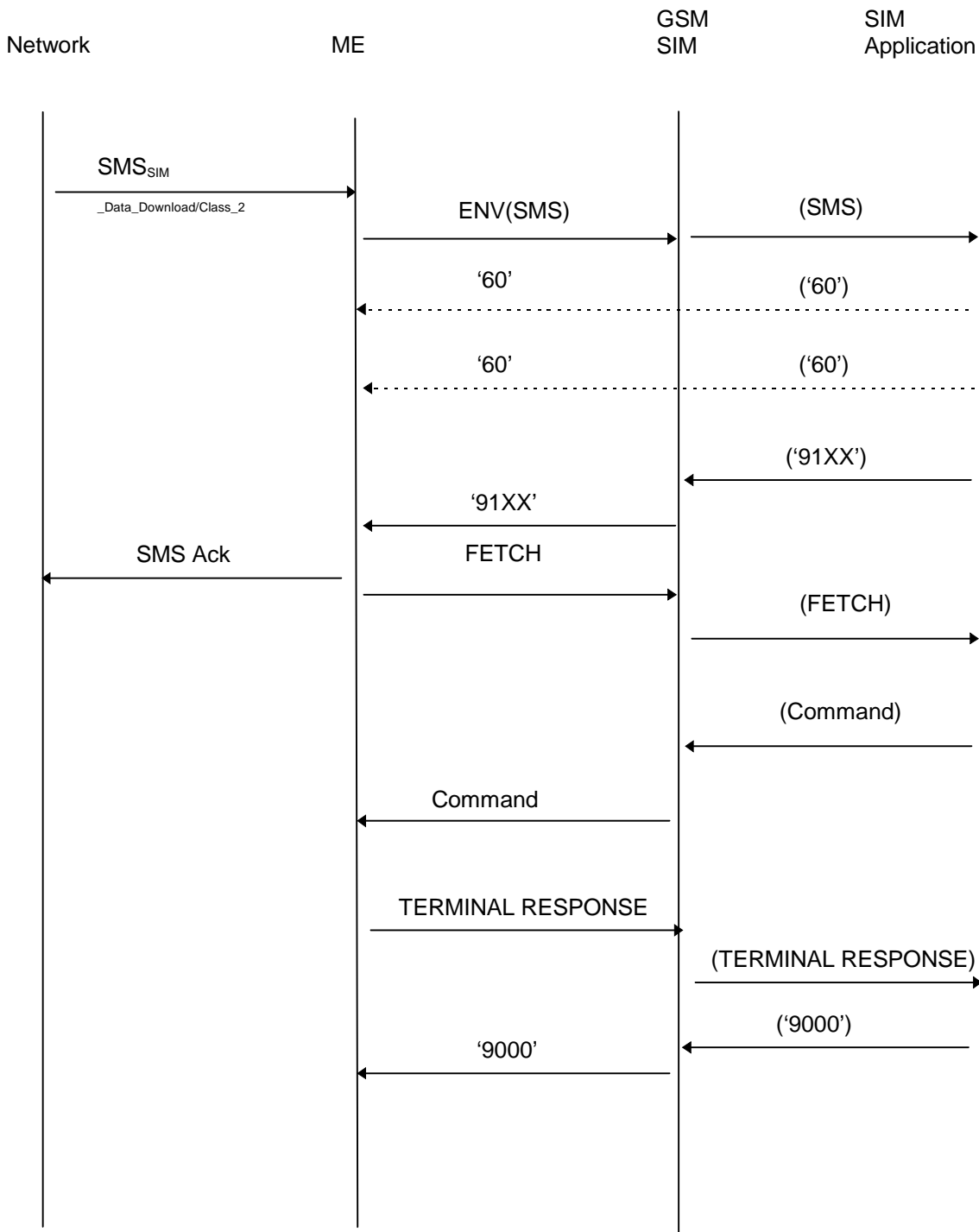

This shows the case where an SMS for SIM updating is received from the network, passed to the SIM by the ME and processed by the SIM application which then generates a command for action by the ME (e.g. PLAYTONE).

NOTE: If a positive acknowledgement to the network of completion of execution of the instructions given in the SMS message is required then the SIM application can issue a command to the ME to send a MO SMS.

**Case 5: A normal GSM command requires processing before the ME can respond to the 91XX from the SIM**

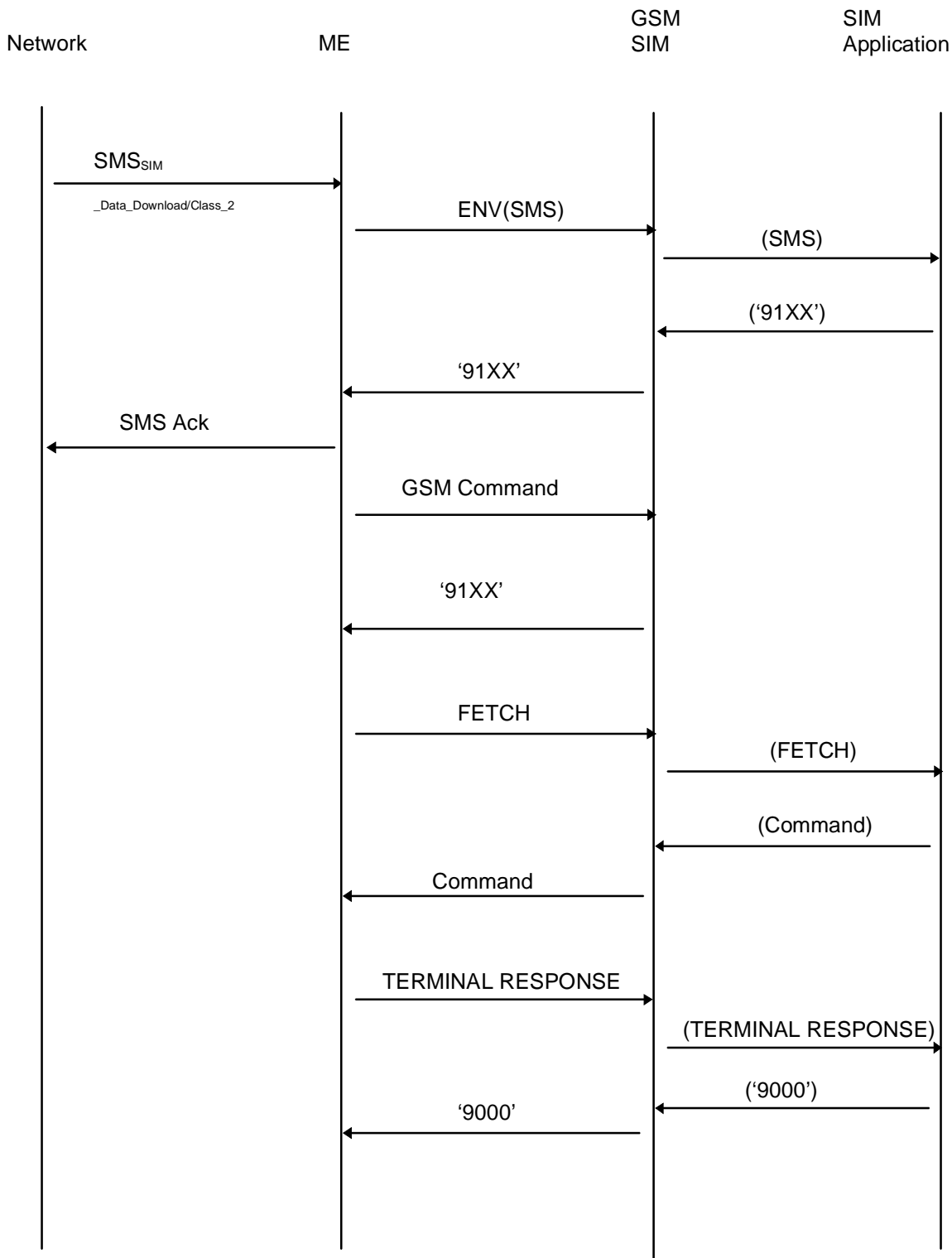

This shows the case where an SMS for SIM updating is received from the network, passed to the SIM by the ME and processed by the SIM application which then generates a command for action by the ME (e.g. PLAYTONE). However a normal GSM command requires processing before the ME can FETCH the command which the SIM is waiting to give it. The response to the normal GSM command is '91XX' in this case to remind the ME of the outstanding SIM application command request.

Case 6: MORE TIME Command

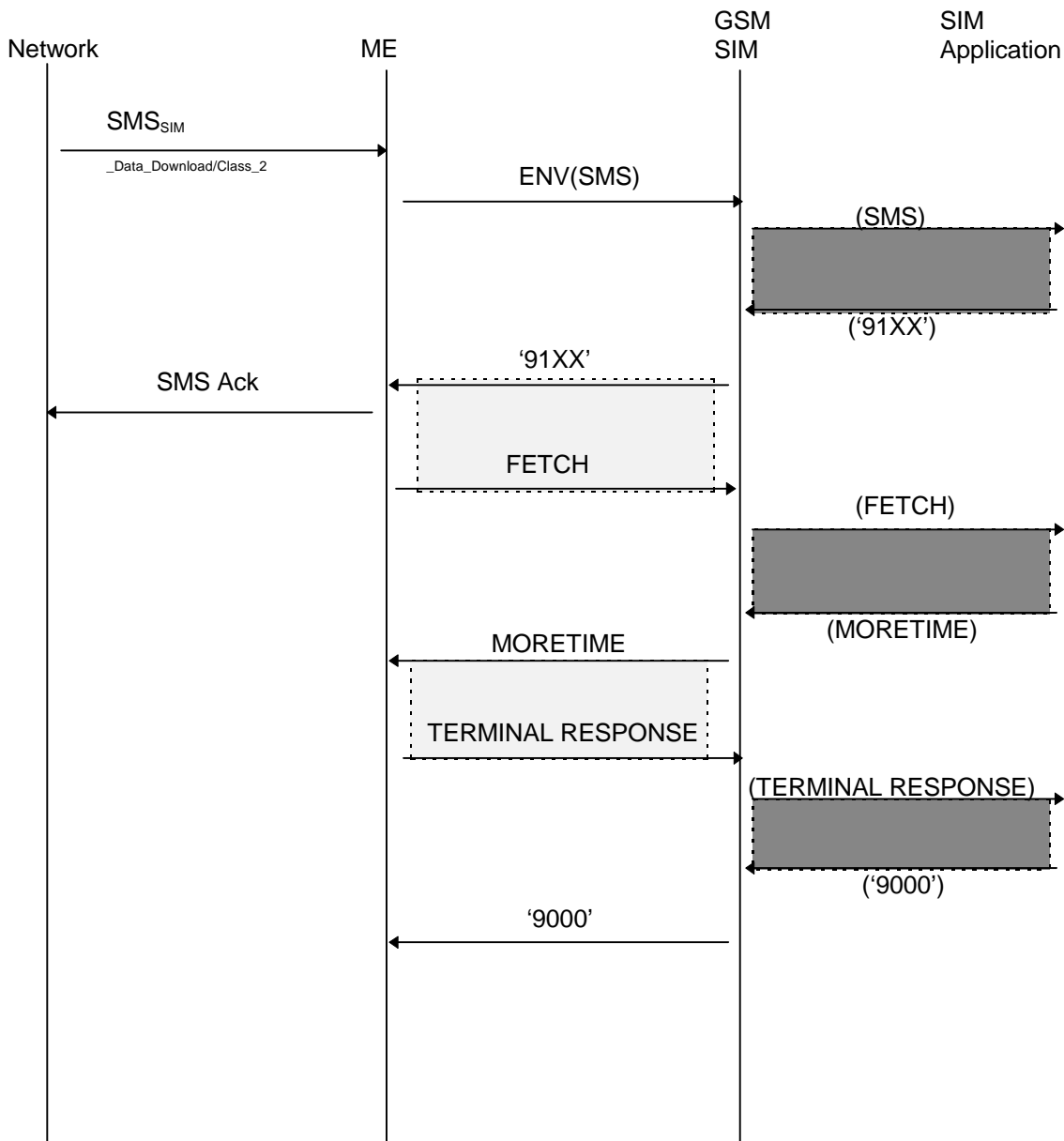

This shows the case where an SMS for SIM updating is received from the network, passed to the SIM by the ME and requires a considerable period of time to be processed by the SIM application. In this case the use of null procedure bytes only is inappropriate as the ME must be given the opportunity to process normal GSM commands. The opportunities gained by the SIM application for processing, and the opportunities for normal GSM commands are shown in the diagram above. The sequence of 91XX, FETCH and MORETIME commands can be repeated if required.

Opportunities to process normal GSM commands are shown thus:



Opportunities for SIM application processing are shown thus:



Case 7: SIM Application Busy

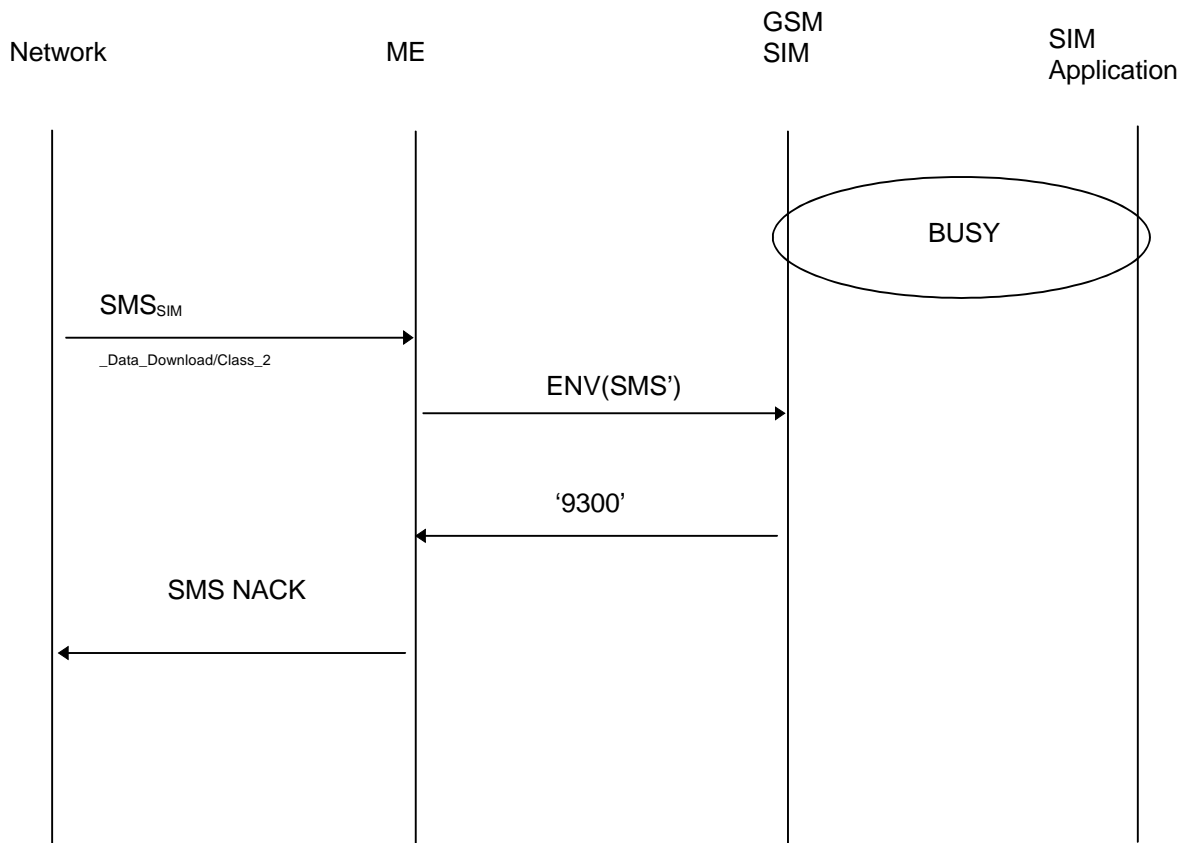

While the SIM application is busy processing a SMS for the SIM application arrives from the network and is sent to the SIM by the ME in the usual manner. The SIM operating system recognizes that the SIM application is busy, and it sends a busy response ('9300') to the ME. The ME then sends negative acknowledgement to the network. The responsibility for a retry rests with the network.



## Annex F (informative): Examples of coding of LSA Descriptor files for SoLSA

The length of all the records is determined by the LSA descriptor containing the largest number of bytes. Combinations containing different numbers of LSA IDs, LAC+ CI and CI or LAC can therefore be done. Various examples are show. Due to the OTA management of the records it is recommended that the record length is maximum 100 bytes in order to leave room for command descriptor and signature information in the SMS.

This first example contains two LSAs, one described by two LSA IDs and another described by three Cell IDs, giving a record length of 8 bytes.

1<sup>st</sup> record:

LSA descriptor type = LSA ID and number = 2 (1 byte)	LSA ID (3 bytes)	LSA ID (3 bytes)	Identifier (1 byte)
---	------------------	------------------	---------------------

2<sup>nd</sup> record:

LSA descriptor type = CI and number = 3 (1 byte)	CI (2 bytes)	CI (2 bytes)	CI (2 bytes)	Identifier (1 byte)
---	--------------	--------------	--------------	---------------------

The second example contains two LSAs, one described by one LSA ID and one described by two Cell Ids, giving a record length of 6 bytes.

1<sup>st</sup> record:

LSA descriptor type = LSA ID and number = 1 (1 byte)	LSA ID (3 bytes)	'FF'	Identifier (1 byte)
---	------------------	------	---------------------

2<sup>nd</sup> record:

LSA descriptor type = CI and number = 2 (1 byte)	CI (2 bytes)	CI (2 bytes)	Identifier (1 byte)
---	--------------	--------------	---------------------

# Annex G (normative): Image Coding Schemes

The following image coding schemes are applicable to rectangular raster images. Raster image points are assumed to be of square shape. They are numbered sequentially from 1 onwards, starting at the upper left corner, proceeding line by line downwards, each line in turn proceeding from left to right, and ending at the image's lower right corner.

The following example illustrates the numbering scheme for raster image points by showing how the corner points are numbered, assuming an image length of  $x$  points and an image height of  $y$  points.



## G.1 Basic Image Coding Scheme

This coding scheme applies to rectangular raster images made up of raster points that are either set or not set. This coding scheme does not support any notion of colour. Image data are coded as follows:

Byte(s)	Description	Length
1	image width = X	1
2	image height = Y	1
3 to K+2	image body	K

Coding of image body:

The status of each raster image point is coded in one bit, to indicate whether the point is set (status = 1) or not set (status = 0).

Byte 1:

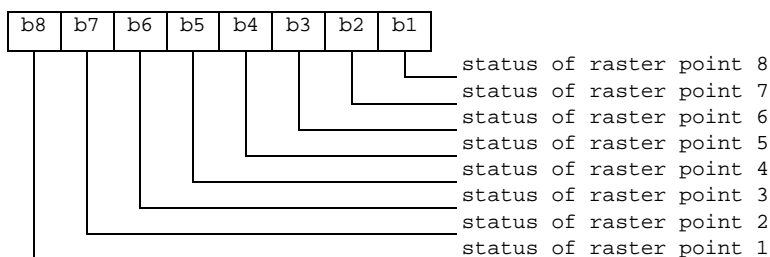

Byte 2:

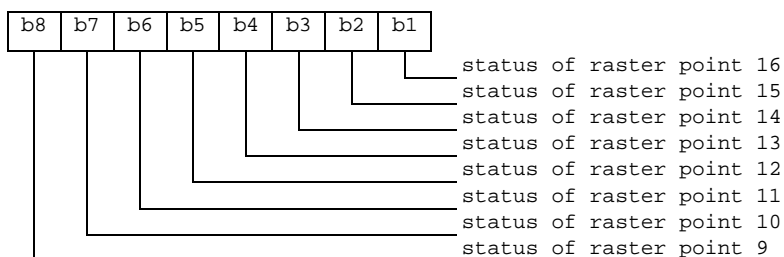

etc.

Unused bits shall be set to 1

## G.2 Colour Image Coding Scheme

This coding scheme applies to coloured rectangular raster images. Raster image point colours are defined as references into a colour look-up table (CLUT), which contains a subset of the red-green-blue colour space. The CLUT in turn is located in the same transparent file as the image instance data themselves, at an offset defined within the image instance data.

Image data are coded as follows:

Byte(s)	Description	Length
1	Image width = X	1
2	Image height = Y	1
3	Bits per raster image point = B	1
4	Number of CLUT entries = C	1
5 to 6	Location of CLUT (Colour Look-up Table)	2
7 to K+6	Image body	K

- Bits per raster image point:

Contents:

The number B of bits used to encode references into the CLUT, thus defining a raster image point's colour.

B shall have a value between 1 and 8.

Coding:

Binary.

- Number of entries in CLUT:

Contents:

The number C of entries in the CLUT which may be referenced from inside the image body. CLUT entries are numbered from 0 to C-1.

C shall have a value between 1 and  $2^{*}B$ .

Coding:

Binary. The value 0 shall be interpreted as 256.

- Location of CLUT:

Contents:

This item specifies where the CLUT for this image instance may be found. The CLUT is always located in the same transparent file as the image instance data themselves, at an offset determined by these two bytes.

Coding:

Byte 1: high byte of offset into Image Instance File.

Byte 2: low byte of offset into Image Instance File.

- Image body:

Coding:

Each raster image point uses B bits to reference one of the C CLUT entries for this image instance. The CLUT entry being thus referenced yields the raster image point's colour.

The image body is arrayed as for the Basic Colour Image Coding Scheme, that is, starting with the highest bit of the first raster image point's colour information.

Byte 1:

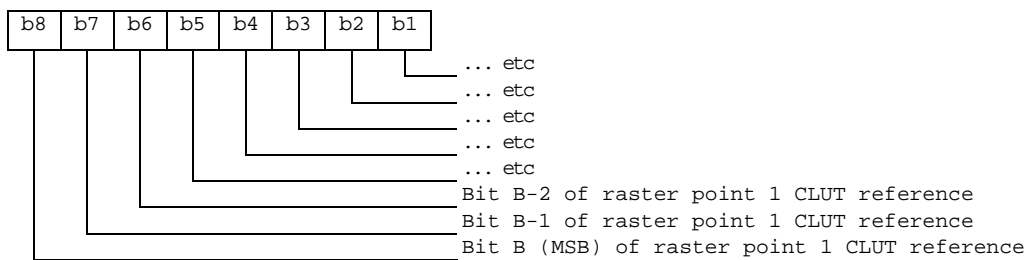

etc.

Unused bits shall be set to 1.

The CLUT (Colour Look-up Table) for an image instance with C colours is defined as follows:

Contents:

C CLUT entries defining one colour each.

Coding:

The C CLUT entries are arranged sequentially:

Byte(s) of CLUT	CLUT Entry
1-3	entry 0
...	...
3*(C-1) +1 to 3*C	Entry C-1

Each CLUT entry in turn comprises 3 bytes defining one colour in the red-green-blue colour space:

Byte(s) of CLUT entry	Intensity of Colour
1	Red
2	Green
3	Blue

A value of 'FF' means maximum intensity, so the definition 'FF' '00' '00' stands for fully saturated red.

NOTE 1: Two or more image instances located in the same file can share a single CLUT.

NOTE 2: Most MEs capable of displaying colour images are likely to support at least a basic palette of red, green, blue and white.

## Annex H (normative): Coding of EFs for NAM and GSM-AMPS Operational Parameters

If the EIA/TIA-553 DF is provisioned on the SIM, then EFs specified in this annex and indicated as mandatory under the DF shall be provided. TIA/EIA-41 [40] based radio access systems should use this DF for storage of NAM parameters.

All quantities shown in the EF descriptions abide by the following rules unless otherwise specified:

- all unused bits of allocated parameters shall be set by default to 0;
- all unused bytes in a series of values (e.g. Partner, Favoured, or Forbidden SID List) should be set by default to 'FF'.

### H.1 Elementary File Definitions and Contents

#### H.1.1 EF<sub>MIN</sub> (Mobile Identification Number)

This EF contains the Mobile Identification Number (MIN). The MIN is a 34-bit number used to address the mobile station across the AMPS and the TIA/EIA-136 air interfaces, and to identify the mobile station's home network. See TIA/EIA-136-005 [36] for further details on MIN.

Identifier: '4F88'		Structure: transparent		Mandatory
File size: 5 bytes		Update Activity: low		
Access Conditions:				
READ		CHV1		
UPDATE		CHV2		
INVALIDATE		ADM		
REHABILITATE		ADM		
Bytes	Description	M/O	Length	
1 – 2	MIN2	M	2 bytes	
3 – 5	MIN1	M	3 bytes	

The MIN field is coded as follows:

- 6 most significant bits are unused;
- next 10 bits are MIN2;
- 24 least significant bits are MIN1;
- default MIN is '00 00 00 00 00' or 'FF FF FF FF FF'. In either case the ME shall interpret this as an invalid MIN and shall not transmit this value over the radio interface.

## H.1.2 EF<sub>ACCOLC</sub> (Access Overload Class)

This file contains the Access Overload Class (ACCOLC). The ACCOLC is a 4-bit indicator used to identify which overload class field controls the access attempts by the mobile station. See EIA/TIA-553 [41] for further details on ACCOLC.

Identifier: '4F89'		Structure: transparent	Mandatory
File size: 1 byte		Update Activity: low	
Access Conditions:			
READ		CHV1	
UPDATE		CHV2	
INVALIDATE		ADM	
REHABILITATE		ADM	
Bytes	Description	M/O	Length
1	ACCOLC  (possible values from '00' to '0F')	M	1 byte

Byte 1:

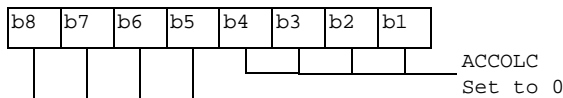

Initial value shall be '00'.

## H.1.3 EF<sub>SID</sub> (System ID Of Home System)

This file contains the system identity of the home system. The SID is a 15-bit number that uniquely identifies an AMPS or TIA/EIA-41 system. See EIA/TIA-553 [41] for further details on Home SID.

Identifier: '4F80'		Structure: transparent	Mandatory
File size: 2 bytes		Update Activity: low	
Access Conditions:			
READ		CHV1	
UPDATE		CHV2	
INVALIDATE		ADM	
REHABILITATE		ADM	
Bytes	Description	M/O	Length
1-2	System ID of Home System (SID)  (Most significant bit = 0)	M	2 bytes

The default value shall be '0000'.

## H.1.4 EF<sub>IPC</sub> (Initial Paging Channel)

The Initial (First) Paging Channel contains two 11-bit first paging channels (FIRSTCHP p-pri and FIRSTCHP p-sec) used to identify the channel number of the first paging channel when the mobile station is 'home'. See EIA/TIA-553 [41] for further details on First (Initial) Paging Channel.

Identifier: '4F82'		Structure: transparent		Mandatory
File size: 2-4 bytes		Update Activity: low		
Access Conditions:				
READ		CHV1		
UPDATE		CHV2		
INVALIDATE		ADM		
REHABILITATE		ADM		
Bytes	Description	M/O	Length	
1 - 2	FIRSTCHPpri (Initial Paging Channel)	M	2 bytes	
3 - 4	FIRSTCHPp-sec	O	2 bytes	

- In the absence of the FIRSTCHPp-sec, the mobile station shall default to '02C4' if the primary channel = '014D' or '02E1' if the primary channel = '014E'
- A file size of 4 bytes may not be backwards compatible with the current dual-mode mobile equipment

The default of FISRTCHPpri value shall be '014D' for A systems, or '014E' for B systems.

## H.1.5 EF<sub>GPI</sub> (Group ID)

This file defines a subset of the most significant bits of the system identification (SID) that is used to identify a group of cellular systems for local control purposes. If the local control option is enabled within the mobile station and the bits of the home system identification that comprise the group identification match the corresponding bits of the SID read by the mobile station over the air, then the Local Control status shall be enabled. Otherwise, the Local Control status shall be disabled. Refer to EIA/TIA-553 [41] for additional details.

Identifier: '4F81'		Structure: transparent		Mandatory
File size: 1 byte		Update Activity: low		
Access Conditions:				
READ		CHV1		
UPDATE		CHV2		
INVALIDATE		ADM		
REHABILITATE		ADM		
Bytes	Description	M/O	Length	
1	Group ID	M	1 byte	

- Group ID default value for North America = '0A'.

### H.1.6 EF<sub>S-ESN</sub> (SIM Electronic Serial Number)

This file stores a 32-bit electronic serial number (ESN) that is unique to the GSM-ANSI-136 SIM. The S-ESN can be unrelated to the ESN of any host equipment to which the GSM-ANSI-136 SIM may be attached. The S-ESN can be used for registration in conjunction with the MIN. The S-ESN may also be used in conjunction with the A-key and CAVE algorithm for authentication. See the ANSI-136 Usage Indicator file for details on the ESN usage indicator which specifies to the mobile equipment how the S-ESN should be used. See EIA/TIA-553 [41] for details on the ESN as it applies to registration and authentication.

The contents of this EF shall not be changed by any over-the-air procedures.

Identifier: '4F8B'		Structure: transparent		Mandatory
File size: 4 bytes		Update Activity: low		
Access Conditions:				
READ		CHV1		
UPDATE		NEVER		
INVALIDATE		ADM		
REHABILITATE		ADM		
Bytes	Description	M/O	Length	
1 – 4	SIM ESN	M	4 bytes	

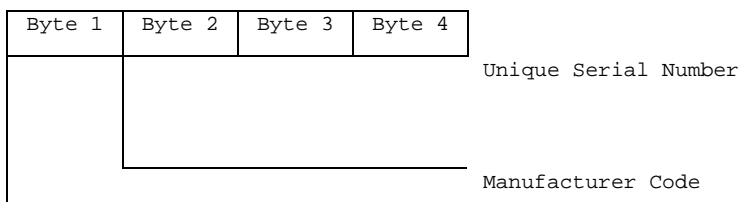

The default value shall be 'FF FF FF FF'.

### H.1.7 EF<sub>COUNT</sub> (Call Count)

This file contains the CALL COUNT parameter. The CALL COUNT is used as a simple 'clone' detector in TIA/EIA-136 and AMPS modes. During the network access signalling in AMPS and other TIA/EIA-41 based networks, the SIM reports its CALL COUNT value to the network. If the value is consistent with the network perception of the CALL COUNT for that SIM, then the network will likely grant access based on the authentication process. During an AMPS or other TIA/EIA-41 based systems call, the value of the CALL COUNT may be incremented upon a command from the network. The value of the CALL COUNT, when incremented, is incremented by 1 using the INCREASE command. See EIA/TIA-553 [41] for further details on COUNTs-p.

Identifier: '4F83'		Structure: Cyclic		Mandatory
File size: 3*N bytes		Update Activity: high		
Access Conditions:				
READ		CHV1		
UPDATE		ADM		
INVALIDATE		ADM		



REHABILITATE		ADM	
Bytes	Description	M/O	Length
Most Recent Record	CALL COUNT	M	3 bytes
---		...	...
Rec N	...	M	3 bytes

- File shall be initialised '00 00 00'
- Minimum file size is 2 records

## H.1.8 EF<sub>PSID</sub> (Positive/Favoured SID list)

This file contains a list of Favoured SIDs for use in identifying Favoured service providers while performing network selection (intelligent roaming).

Identifier: '4F85'		Structure: transparent		Optional
File size: 2*N bytes		Update Activity: low		
Access Conditions:				
READ		CHV1		
UPDATE		ADM		
INVALIDATE		ADM		
REHABILITATE		ADM		
Bytes	Description	M/O	Length	
1 – 2	Favoured SID 1	M	2 bytes	
...	Favoured SID 2	O	...	
(2N-1) – (2N)	Favoured SID N	O	2 bytes	

EOF (End of File) is indicated by 'FFFF'. An entry with all zeros is considered filler.

The most significant bit of the Favoured SID field is not used and it is set to 0.

Coding of the Favoured SID field (2-byte coding)

The default value in the first two bytes shall be 'FFFF'.

Byte 1:

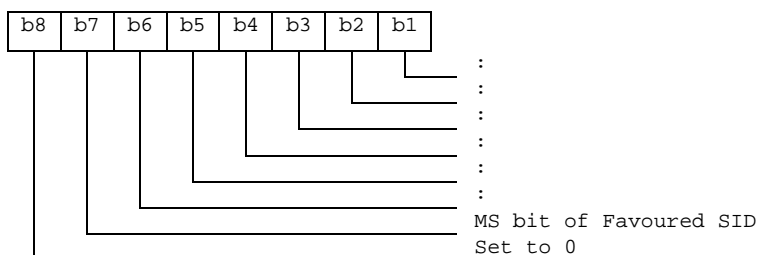

Byte 2:

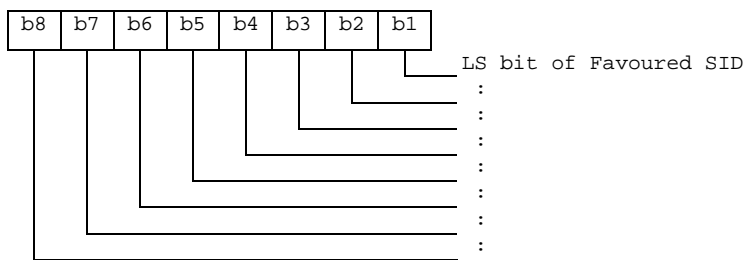

### H.1.9 EF<sub>NSID</sub> (Negative/Forbidden SID List)

This file contains a list of Forbidden SIDs, for use in identifying Forbidden service providers while performing network selection (intelligent roaming).

Identifier: '4F84'		Structure: transparent		Optional
File size: 2*N bytes			Update Activity: low	
Access Conditions:				
READ		CHV1		
UPDATE		ADM		
INVALIDATE		ADM		
REHABILITATE		ADM		
Bytes	Description	M/O	Length	
1 – 2	Forbidden SID 1	M	2 bytes	
...	Forbidden SID 2	O	...	
(2N-1) – (2N)	Forbidden SID N	O	2 bytes	

EOF (End of File) is indicated by 'FFFF.' An entry with all zeros is considered filler.

The most significant bit of the Forbidden SID field is not used and it is set to 0.

Coding of the Forbidden SID field (2-byte coding)

The default value in the first two bytes shall be 'FFFF'.

Byte 1:

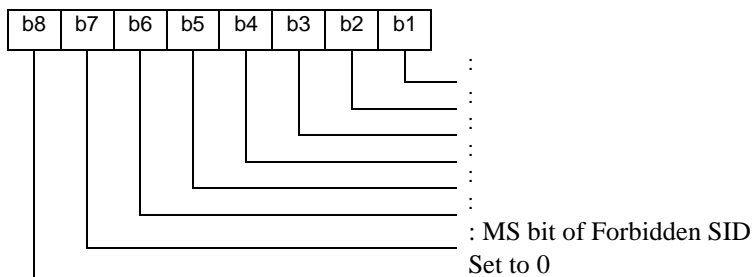

Byte 2:

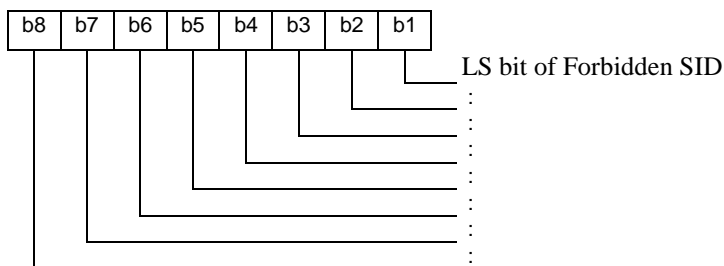

### H.1.10 EF<sub>SPL</sub> (Scanning Priority List)

This file contains the Scanning Priority List. The Scanning Priority List is an array that defines the various types of systems that can be found. It also acts as a reference table, pointing to the various data structures in the SIM. This file is for backwards compatibility with GSM/AMPS mobile equipment. A Mobile Station supporting both TIA/EIA-136 and EIA/TIA-553 [41] is not expected to support this EF for network selection.

Identifier: '4F87'		Structure: transparent		Optional
File size: 27 bytes		Update Activity: low		
Access Conditions:				
READ		CHV1		
UPDATE		ADM		
INVALIDATE		ADM		
REHABILITATE		ADM		
Bytes	Description	M/O	Length	
1	Value 1	M	1 byte	
2 – 3	Pointer 1	M	2 bytes	
...				
...				
25	Value 9	M	1 byte	
26 – 27	Pointer 9	M	2 bytes	

- The position of the pointers is fixed in this file. Highest priority level is 1, lowest priority level is 7. No two entries can have the same priority level with the exception the last two fields (Forbidden PLMNs and Negative SIDs) which both will have a value of 0. Default values are in parentheses. The values 1 or 2 shall reside in the first position (Home PLMN), and the second position (Last registered PLMN) shall contain a higher priority than position 3 (Preferred PLMNs List ) and 4 (Any Other PLMNs).

Format:

Priority Value	Pointer	Reserved For
1 – 7 (2)	SIM ('6F07')	Home PLMN
1 – 7 (1)	SIM ('6F7E')	Last Registered PLMN
1 – 7 (3)	SIM ('6F30')	Preferred PLMNs List
1 – 7 (6)	0	Any Other PLMNs
1 – 7 (4)	SIM ('4F80')	Home SID
1 – 7 (5)	SIM ('4F85')	Positive SIDs List
1 – 7 (7)	0	Any Other SIDs
0	SIM ('6F7B')	Forbidden PLMNs List
0	SIM ('4F84')	Negative SIDs List

Constraints on the Priority List:

Mandatory PLMN priority order (highest to lowest):

Home PLMN or Last Registered PLMN, Preferred PLMNs, Any Other PLMNs

Mandatory SID priority order (highest to lowest):

Home SID, Positive SIs, Any Other SIDs.

## H.1.11 EF<sub>NETSEL</sub> (Network Selection Activation Flag)

This file contains the Network Selection Activation Flag. This flag is used to enable/disable the Manual Mode and some MMI functionality within the ME.

Identifier: '4F86'		Structure: transparent		Mandatory
File size: 1 byte		Update Activity: low		
Access Conditions:				
READ		CHV1		
UPDATE		CHV1		
INVALIDATE		ADM		
REHABILITATE		ADM		
Bytes	Description	M/O	Length	
1	Network Selection Activation Flag	M	1 byte	

Enables / disables Manual Mode and some MMI functionality within the ME, in both AMPS and GSM modes.

Default value = 05 Hex.

Coding:

- Bit 0 =0 GSM Manual Mode disabled
  - =1 GSM Manual Mode enabled (default)
- Bit 1 =0 AMPS Manual Mode disabled (default)
  - =1 AMPS Manual Mode enabled
- Bit 2 =0 Scanning Sequence Flags disabled
  - =1 Scanning Sequence Flags enabled (default)

Bit 3 =0 Disallow home only AMPS selection (default)

=1 Allow home only AMPS selection

Bits 4 through 7 are not used and set to zero.

## H.1.12 EF<sub>CSID</sub> (Current/Last Registered SID)

This file contains the SIDsp value. The most significant bit is unused and set to 0.

Identifier: '4F8C'		Structure: transparent		Optional
File size: 2 bytes		Update Activity: low		
Access Conditions:				
READ		CHV1		
UPDATE		CHV1		
INVALIDATE		ADM		
REHABILITATE		ADM		
Bytes	Description	M/O	Length	
1 -2	SIDsp	M	2 bytes	

The default value shall be 'FFFF'.

## H.1.13 EF<sub>REG-THRESH</sub> (Registration Threshold)

This file contains the NXTREGsp value, specified in EIA/TIA-553 [41]. The three most significant bits are unused and are set to 0.

Identifier: '4F8D'		Structure: transparent		Optional
File size: 3 bytes		Update Activity: low		
Access Conditions:				
READ		CHV1		
UPDATE		CHV1		
INVALIDATE		ADM		
REHABILITATE		ADM		
Bytes	Description	M/O	Length	
1 – 3	NXTREGsp value	M	3 bytes	

- (Default value = '00 00 00')

## H.1.14 EF<sub>CCCH</sub> (Current Control Channel)

This file contains the Current Control Channel information related to the Last Paging Control Channel on which the AMPS phone camped on.

Identifier: '4F8E'		Structure: transparent		Optional
File size: 2 bytes		Update Activity: low		
Access Conditions:				
READ		CHV1		
UPDATE		CHV1		
INVALIDATE		ADM		
REHABILITATE		ADM		
Bytes	Description	M/O	Length	
1 – 2	Current Control Channel	M	2 bytes	

- (Default value = '0000')

### H.1.15 EF<sub>L<sub>DCC</sub></sub> (Latest DCC)

This file contains the DCC value associated with the saved Current Control Channel.

Identifier: '4F8F'		Structure: transparent		Optional
File size: 1 byte		Update Activity: low		
Access Conditions:				
READ		CHV1		
UPDATE		CHV1		
INVALIDATE		ADM		
REHABILITATE		ADM		
Bytes	Description	M/O	Length	
1	DCC (Default value = '00')	M	1 byte	

### H.1.16 EF<sub>GSM-RECON</sub> (GSM Reconnect Timer)

This file specifies, in seconds, the time the ME should remain scanning the GSM-1900 spectrum, after loss of service from a GSM-1900 system, before any scanning of the AMPS spectrum is allowed.

Identifier: '4F90'		Structure: transparent		Optional
File size: 2 bytes		Update Activity: low		
Access Conditions:				
READ		CHV1		
UPDATE		ADM		
INVALIDATE		ADM		

REHABILITATE		ADM	
Bytes	Description	M/O	Length
1-2	GSM Reconnect Timer (Default value = '00 3C' = 60 seconds)	M	2 bytes

## H.1.17 EF<sub>AMPS-2-GSM</sub> (AMPS to GSM Rescan Timing Table)

The EF specifies, in minutes, a series of (typically increasing) intervals for scanning the GSM-1900 spectrum, used while in-service on an AMPS network while in Dual-Mode operation. The time is measured from the end of the last GSM-1900 scan to the start of the next GSM-1900 scan. If the table is not completely filled (i.e. the end-of-table value 'FF' is found), the last filled value may be repeated indefinitely. If a value of 'F0' is encountered, the table is terminated, as are all rescans to GSM until the current AMPS system is lost.

Identifier: '4F91'		Structure: transparent		Optional
File size: 10 bytes		Update Activity: low		
Access Conditions:				
READ		CHV1		
UPDATE		ADM		
INVALIDATE		ADM		
REHABILITATE		ADM		
Bytes	Description	M/O	Length	
1	First Rescan Attempt Interval (Default = '02')	M	1 byte	
2	Second Rescan Attempt Interval (Default = '03')	M	1 byte	
3	Third Rescan Attempt Interval (Default = '04')	M	1 byte	
4	Fourth Rescan Attempt Interval (Default = '05')	M	1 byte	
5	Fifth Rescan Attempt Interval (Default = '06')	M	1 byte	
6	Sixth Rescan Attempt Interval (Default = 'FF')	M	1 byte	
7	Seventh Rescan Attempt Interval (Default = 'FF')	M	1 byte	
8	Eighth Rescan Attempt Interval (Default = 'FF')	M	1 byte	
9	Ninth Rescan Attempt Interval (Default = 'FF')	M	1 byte	
10	Tenth Rescan Attempt Interval (Default = 'FF')	M	1 byte	

## H.1.18 EF<sub>\*FC1</sub> (Feature Activation Codes)

This file contains the feature code table as specified in EIA/TIA-553 [41].

Identifier: '4F8A'		Structure: transparent		Optional
File size: 2 bytes		Update Activity: low		

Access Conditions:			
READ	CHV1		
UPDATE	ADM		
INVALIDATE	ADM		
REHABILITATE	ADM		
Bytes	Description	M/O	Length
1-2	Default value 'B990'.	M	2 bytes

## H.1.19 EF<sub>AMPS-UI</sub> (AMPS USAGE INDICATORS)

This file contains usage indicators for local control and extended address method.

Identifier: 4F93	File Type: Transparent	Optional	
File size: 2 bytes (minimum)	Update Activity: Low		
Access Conditions:			
READ	CHV1		
UPDATE	ADM		
INVALIDATE	ADM		
REHABILITATE	ADM		
Bytes	Description	M/O	Length
1	Number of Services (S)	M	1 byte
2	Services n <sup>o</sup> 1 to n <sup>o</sup> 8	M	1 byte

### -Services:

Contents

Service n <sup>o</sup> 1 :	Local Control Indicator (see Note 1)
Service n <sup>o</sup> 2 :	Extended Address Method indicator – included in any access attempts (see Note 2)
Services n <sup>o</sup> 3-n <sup>o</sup> 8 :	RFU

- Number of Services

Contents:

This byte refers to the number of services defined in the following byte.

Coding:

This byte is coded as BCD

Services

Contents:

This byte describes the services

Coding:



- One bit is used to code each service
- If the bit = 0: service is not enabled
- If the bit = 1: service is enabled
- The bits for services not yet defined shall be set to RFU. For coding of RFU see subclause 9.3.

Byte 2:

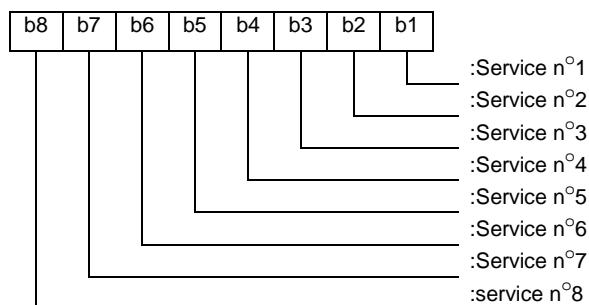

NOTE 1: The Local Control Indicator is a means provided within the mobile station to enable or disable the local control option. Local Control is a mechanism that allows a cellular system to customise operation for home mobile stations, and for those roaming mobile stations whose home systems are members of a group, by sending local orders with the order field set to local control (which informs the mobile station to examine the local control field), and by sending one or both of two local control global action overhead messages.

A group of systems could be formed by participating systems agreeing to a common set of local control protocols and whose system identifications (SID) are recognised by mobile stations as a common group.

NOTE 2: The Extended Address Method indicator determines if the extended address word must be included in all access attempts.

## H.2 Authentication Functionality

### H.2.1 A-KEY (ANSI-41 Authentication Key)

The A-Key is only accessible to the algorithm used for Key generation. The A-Key may be programmed into the SIM directly by the service provider, or it may be programmed into the SIM through a specific over the air procedure. The A-Key is not accessible by the mobile equipment, therefore the method of storage on the SIM is not specified in this document. The SIM command A-KEY\_VALIDATION is used to store the A-Key on the SIM.

### H.2.2 SSD (Shared Secret Data)

The Shared Secret Data is accessible only to the Authentication and the Key Generation functions. SSD is not accessible by the mobile equipment, therefore the method of storage on the SIM is not specified in this document.

An additional Status Code is defined for SSD updating as follows:

98, 34	Error, Update SSD order sequence not respected (should be used if SSD Update commands are received out of sequence).
--------	--

## H.3 Authentication commands

It is necessary to provide six interfaces to the CAVE Algorithm and Secret Data areas, as listed below:

- Generation of Authentication Signature data, and generation of ciphering keys.
- Validation and storage of entered A-Key's
- Ask Random task (generates RANDBS)
- Update Shared Secret Data (Generates SSD\_A\_NEW, SSD\_B\_NEW and AUTHBS values)
- Confirm Shared Secret Data (Updates SSD values)
- CMEA Encryption of voice channel data digits

**NOTE:** For each task, the expected normal (i.e. success) status code is listed in the status word description. A list of possible error codes that apply to all tasks can be found in the SIM Status Codes.

The interpretation of these instruction codes (INS in the table below) is valid only for class A0.

Task Name	CLA	INS	P1	P2	Lc
Internal_Authenticate	'A0'	'88'	'00'	'00'	'0F'
AKEY_validation	'A0'	'86'	'00'	'00'	'12'
Ask_Random	'A0'	'8A'	'00'	'00'	'04'
Update_SSD	'A0'	'84'	'00'	'00'	'0C'
Confirm_SSD	'A0'	'82'	'00'	'00'	'03'
CMEA_encrypt	'A0'	'8C'	'00'	'00'	'nn'

### H.3.1 Generation of Authentication Signature Data and Ciphering Keys

This task produces an Authentication response, and shall be used during mobile Registrations, Originations, Terminations, R\_Data messages, SPACH Confirmations, and for the Unique Challenge-Response Procedure. If Byte 0, Bit 1 is set, the SIM should also generate key bits after completing the Authentication function. Some of those ciphering octets may be passed back to the ME for use with supplementary crypto mechanisms which reside in the ME. This task requires the following input parameters:

Task Name	CLA	INS	P1	P2	Lc
Internal_Authenticate	'A0'	'88'	'00'	'00'	'0F'

Coding::

Byte 0 Process Control Byte

Bit 0 0=RANDs, 1= RANDU

Bit 1 Generate Key Bits flag (0= No, 1= Yes)

Bit 2 Load Internal key flag:

(0= pass all generated key bytes to handset, 1= load first 8 bytes of generated keys internally to SIM, pass all remaining key bytes to ME)

Bits 3-7 Unused, future expansion

Bytes 1-4 RANDs (for Registrations, Originations, and Terminations)

or

Bytes 1-3 RANDU (for Unique Challenge-Response Procedures)

Byte 4 = 0 (MIN2 will be filled in by SIM)

Byte 5 Digits Length (in bits, =0, 4, 8, 12, 16, 20 or 24,  
= 4 x number of digits in bytes 6-8)

Bytes 6-8 =0,0,0 (for Registrations, Terminations, Unique Challenge Response Procedures)

= Last Dialed Digits, unused bits filled with 0's (for Originations). If more than 6 digits are dialed, these are the last 6 digits in the origination string. If less than 6 digits are dialed, MIN1 will be filled in by the SIM for the unused bits.

Byte 9 Use ME ESN (= '00')

Bytes 10-13 ESN

Byte 14 Key\_size (=0 if Byte 0, Bit 1 = 0, =8 (or more) if Byte 0, Bit 1 = 1)

The output of this task shall be:

Status Bytes: SW1 (= '9F' if success)

SW2 (= 'nn' if success)

('nn' is 03+Key\_size if Byte 0, Bit 2 above =0, 03+Key\_size-08 if Byte 0, Bit 2 above =1)

## H.3.2 Validation and Storage of Entered A-Key's

With manual entry of the A-key, the input A-Key must be validated prior to its storage in the SIM. If successful, the A-key is saved in the SIM and the COUNTsp and Shared Secret Data (SSD) are reset to zero. This task requires the following input parameters:

Task Name	CLA	INS	P1	P2	Lc
AKEY_validation	'A0'	'86'	'00'	'00'	'12'

Coding:

Bytes 0 - 12

Authentication digits string (first digit in Most-Significant nibble of byte 0, last digit in Least-Significant nibble of Byte 12, for a total of 26 digits)

Byte 13 Use ME ESN (= '00')

Bytes 14-17 ESN

The output of this task shall be:

Status Bytes: SW1 (= '90' if success)

SW2 (= '00' if success)

## H.3.3 Ask Random Task

This task is used to generate the RANDBS random value. This task must be executed prior to updating the Shared Secret Data (SSD). The value RANDSeed must be generated by the ME prior to calling this task. This task requires the following input parameters:

Task Name	CLA	INS	P1	P2	Lc
Ask_Random	'A0'	'8A'	'00'	'00'	'04'

Coding:

Bytes 0-3 RANDSeed

The output of this task shall be:

Status Bytes: SW1 (= '9F' if success)

SW2 (= '04' if success)

### H.3.4 Update Shared Secret Data

This task is used to generate the preliminary new Shared Secret Data (SSD\_A\_NEW, SSD\_B\_NEW) and the AUTHBS value. The Ask Random Task (see above) must be executed prior to this routine. The task requires the following input parameters:

Task Name	CLA	INS	P1	P2	Lc
Update_SSD	'A0'	'84'	'00'	'00'	'0C'

Coding:

Bytes 0-6 RANDSSD

Byte 7 Use ME ESN (= '00')

Bytes 8-11 ESN

The output of this task shall be:

Status Bytes: SW1 (= '90' if success, = '98' if failure)

SW2 (= '00' if success, = '04' if failure)

### H.3.5 Confirm Shared Secret Data

This task is used to validate the new Shared Secret Data (SSD\_A\_NEW, SSD\_B\_NEW) by comparing the internally computed AUTHBS with the AUTHBSs received from the system. If successful, the SSD\_A and SSD\_B values will be updated to match the SSD\_A\_NEW and SSD\_B\_NEW values, respectively. The task requires the following input parameters:

Task Name	CLA	INS	P1	P2	Lc
Confirm_SSD	'A0'	'82'	'00'	'00'	'03'

Coding:

Bytes 0-2 AUTHBSs

The output of this task shall be:

Status Bytes: SW1 (= '90' if success)

SW2 (= '00' if success)

## H.3.6 CMEA Encryption of Voice Channel Data Digits

This task is used when the MS is on a Voice Channel, to encrypt and decrypt some portions of digital messages transmitted to the BS. These will occur for the following messages:

- Called Address Message (in response to a hookflash, up to 4 bytes per word, 4 words, total of 16 bytes)

Task Name	CLA	INS	P1	P2	Lc
CMEA_encrypt	'A0'	'8C'	'00'	'00'	'nn'

where 'nn' is hex value of data length n

Coding:

Bytes 0 - (n-1) The n-byte data to be encoded, max. size = 32 bytes.

The output of this task shall be:

Status Bytes: SW1 (=9F' if success)

SW2 (=nn' if success) ('nn' is hex value of data length n)

## H.3.7 SIM Status Codes

The following status codes, returned by the SIM in response to the execution of any of the tasks specified in this document, are valid. The first hex value is returned in SW1, the second hex value in SW2.

### Success Codes:

90, 00 Generic success code

9F, xx Success, xx bytes of data available to be read via "Get\_Response" task.

### Error Codes:

92, 40 Error, memory problem

94, 08 Error, file is inconsistent with the command

98, 04 Error, no CHV1 has been presented successfully

98, 34 Error, Update SSD order sequence not respected (should be used if SSD Update commands are received out of sequence).

67, xx Error, incorrect parameter P3 (ISO code)

6B, xx Error, incorrect parameter P1 or P2 (ISO code)

6D, xx Error, unknown instruction code given in the command (ISO code)

6E, xx Error, wrong instruction class given in the command (ISO code)

6F, xx Error, technical problem with no diagnostic given (ISO code)

6F, 00 Error, invalid input parameters to authentication computation

---

## Annex I (informative): EF changes via Data Download or SIM Toolkit applications

This annex defines if changing the content of an EF by the network (e.g. by sending an SMS), or by SIM Toolkit Application (e.g. by using the SIM API), is advisable. Updating of certain EFs, "over the air" such as EF<sub>ACC</sub> could result in unpredictable behaviour of the MS; these are marked "Caution" in the table below. Certain EFs are marked "No"; under no circumstances should "over the air" changes of these EFs be considered.

File identification	Description	Change advised
'2F05'	Extended Language preference	Yes
'2FE2'	ICC identification	No
'4F20'	Image data	Yes
'4Fxx'	Image Instance data Files	Yes
'6F05'	Language preference	Yes
'6F07'	IMSI	Caution (note)
'6F20'	Ciphering key Kc	No
'6F2C'	De-personalization Control Keys	Caution
'6F30'	PLMN selector	Caution
'6F31'	Higher Priority PLMN search period	Caution
'6F32'	Co-operative network	Caution
'6F37'	ACM maximum value	Yes
'6F38'	SIM service table	Caution
'6F39'	Accumulated call meter	Yes
'6F3A'	Abbreviated dialling numbers	Yes
'6F3B'	Fixed dialling numbers	Yes
'6F3C'	Short messages	Yes
'6F3D'	Capability configuration parameters	Yes
'6F3E'	Group identifier level 1	Yes
'6F3F'	Group identifier level 2	Yes
'6F40'	MSISDN storage	Yes
'6F41'	PUCT	Yes
'6F42'	SMS parameters	Yes
'6F43'	SMS status	Yes
'6F44'	Last number dialled	Yes
'6F45'	CBMI	Caution
'6F46'	Service provider name	Yes
'6F47'	Short message status reports	Yes
'6F48'	CBMID	Yes
'6F49'	Service Dialling Numbers	Yes
'6F4A'	Extension 1	Yes
'6F4B'	Extension 2	Yes
'6F4C'	Extension 3	Yes
'6F4D'	Barred dialling numbers	Yes
'6F4E'	Extension 4	Yes
'6F50'	CBMIR	Yes
'6F51'	Network's indication of alerting	Caution
'6F52'	GPRS Ciphering key KcGPRS	No
'6F53'	GPRS Location Information	Caution
'6F58'	Comparison method information	
'6F60'	User controlled PLMN Selector with Access Technology	see 3GPP TS 22.011
'6F61'	Operator controlled PLMN Selector with Access Technology	Caution
'6F62'	HPLMN Selector with Access Technology	Caution
'6F63'	CPBCCCH information	No
'6F64'	Investigation scan	Caution
'6F74'	BCCH information	No
'6F78'	Access control class	Caution
'6F7B'	Forbidden PLMNs	Caution
'6F7E'	Location information	No (note)
'6FAD'	Administrative data	Caution
'6FAE'	Phase identification	Caution

Continued.....

<b>File identification</b>	<b>Description</b>	<b>Change advised</b>
'6FB1'	Voice Group Call Service	Yes
'6FB2'	Voice Group Call Service Status	Yes
'6FB3'	Voice Broadcast Service	Yes
'6FB4'	Voice Broadcast Service Status	Yes
'6FB5'	Enhanced Multi Level Pre-emption and Priority	Yes
'6FB6'	Automatic Answer for eMLPP Service	Yes
'6FB7'	Emergency Call Codes	Caution
NOTE: If EF <sub>IMSI</sub> is changed, the SIM should issue REFRESH as defined in TS 11.14 [27] and update EF <sub>LOCI</sub> accordingly.		



## Annex J (informative): Change history

This annex lists all change requests approved for this document since the first phase2+ version was approved by ETSI SMG and 3GPP.

Meeting	Plenary tdoc	WG tdoc	VERS	CR	RV	Release	CAT	SUBJECT	Resulting Version
s16	709/95	154/95	4.15.0	A008		R96	1	SIM Speed Enhancement	5.0.0
s17	062/96	147/95	5.0.0	A006		R96	B	Service Dialling Numbers	5.1.0
	060/96	06/96		A009		R96	B	ASCI for VGCS and VBS	
	060/96	06/96		A010		R96	B	ASCI for eMLPP	
	059/96	204/95r		A013		R96	C	Interaction between FDNs and ADNs	
	061/96	05/96		A014		R96	D	Correction of baud rate for SIM Speed enhancement	
s18	263/96	57/96	5.1.0	A011	3	R96	B	SIM Application Toolkit protocol enhancements	5.2.0
	260/96	45/96		A016		R96	A	SIM presence detection clarification	
	261/96	54/96		A018		R96	A	Reponse codes and coding of SIM service table	
	262/96	55/96		A020		R96	A	Reference to International Standards	
s19	374/96	102/96	5.2.0	A012		R96	C	Contacting elements	5.3.0
	373/96	105/96		A023		R96	A	Clarification of clock stop timing	
	409/96	107/96		A024	1	R96	B	Emergency Call Codes (ECC)	
	374/96	108/96		A025		R96	C	Using ranges of CBMIs	
s20	580/96	206/96	5.3.0	A021		R96	B	Barred Dialling Numbers	5.4.0
	734/96	197/96		A026		R96	B	Addition of Cooperative Network List EF	
	734/96	197/96		A027		R96	B	Addition of ME Depersonalisation feature and EF	
	702/96	207/96		A031		R96	D	RFU bit taken into use in GSM 11.12	
s21	101/97	97/079	5.4.0	A032	2	R96	D	Ammendment to BDN diagrams in Annex B	5.5.0
	101/97	97/086		A033	1	R96	B	DFs for MSS/ PCS1900/other use	
	101/97	97/056		A034		R96	C	Reading of EFDCK during SIM initialisation	
	101/97	97/058		A036		R96	D	Administrative Access Conditions	
	101/97	97/059		A037		R96	B	Format of EFCNL to include fields for Corporate Personal. Code	
	101/97	97/089		A041		R96	B	Administrative Data field	
s22	356/97	183/97	5.5.0	A042		R97	B	Extended language preference	5.6.0
	356/97	163/97		A044	1	R96	A	Clarification of electrical/mechanical SIM/ME interface	
	356/97	179/97		A045		R96	D	Security procedures for 2nd level; DFs located under DF GSM	
	356/97	187/97		A047		R96	F	Number of bytes returned after a SELECT command	
	356/97	093/97		A048		R96	D	Service table and "radio interface"	
	356/97	109/97		A049		R96	F	Update Access condition of EFDCK (aligns 11.11 & 02.22)	
s23	788/97	97/249	5.6.0	A046	2	R97	B	Short Message Status Reports	5.7.0
	788/97	97/243		A050		R96	F	Addition of SDN and BDN in the description of EFCCP	
	788/97	97/259		A051	1	R97	C	SIM and ME behaviour when SIM is disabled and blocked	
	788/97	97/262		A053		R96	F	Response data following an ENVELOPE command	
	788/97	97/260		A054		R96	F	Coding of EFPhase	
	788/97	97/271		A055		R97	C	Changes to Dialling Number Files and extensions	
	788/97	97/261		A056		R97	B	Network's indication of alerting in the MS	
s24	97-0886	97/365	5.7.0	A052	2	R97	b	Introduction of UCS2	5.8.0
	97-0886	97/383		A057		R97	c	MO SMS control by SIM	
<i>At SMG #25, it was decided to create a version 6.0.0 of every specification that contained at least one release '97 work item and a version 7.0.0 of every specification that contained at least one release '98 work item.</i>									
s25	98-0157	98p052	5.8.0	A058	2	R97	B	Addition of EFs for GPRS	6.0.0
	98-0157	98p108		A059		R97	F	Clarification regarding EFCCP records	
	98-0157	98p094		A061	1	R96	A	Clarification of removal of the SIM	
s26	98-0398	98p228	6.0.0	A062	2	R98	B	Icons - addition of EF IMG and DF GRAPHICS	7.0.0
	98-0398	98p227		A064		R98	B	Operation of ME with multiple card readers	
	98-0400	98p237		A065		R98	F	Deletion of all release 97 markers from the R98 version	
	98-0398	98p240		A066		R97	F	RP-ACK RP-ERROR for SIM data download error	
	98-0398	98p263		A069		R97	D	Allocation of file ID for IS-41	

(continued)

## Change History (continued)

Meeting	Plenary tdoc	WG tdoc	VERS	CR	RV	Release	CAT	SUBJECT	Resulting Version
s27	98-0671	98p339	7.0.0	A071		R98	C	Enhanced image coding schemes (colour icons)	7.1.0
	98-0671			A072	1	R98	D	Addition of reference to PCS 1900	
s28	P-99-185	9-99-076	7.1.0	A073	1	R98	F	Alignment with 2 <sup>nd</sup> edition of ISO/IEC 7816-3 (1997)	7.2.0
	P-99-185	9-99-037		A074		R98	B	Addition of SoLSA data fields	
	P-99-185	9-99-066		A075	1	R98	B	Addition of CTS fields	
	P-99-185	9-99-095		A076	1	R98	B	Definition of a file containing the title of the main menu	
	P-99-185	9-99-072		A077		R98	C	USSD format indication in the SIM Service Table	
	P-99-185	9-99-093		A078		R98	B	Informative annex on EF changes	
	P-99-185	9-99-097		A080		R98	C	Additional GPRS field	
	P-99-188			A082		R98	D	Deletion of \$(.....)\$ release markers	
s29	P-99-412	9-99-163	7.2.0	A083	1	R98	C	EF IMSI changes via data download or SIM toolkit	8.0.0
	P-99-412	9-99-180		A084		R98	F	Addition of RUN AT COMMAND to the SIM service table	
	P-99-412	9-99-208		A085		R99	C	Alignment of maximum of records in a linear fixed file in GSM	
s30	P-99-670	9-99-260	8.0.0	A089		R99	A	Correction for coding of SoLSA "Priority" field	8.1.0
	P-99-670	9-99-277		A090		R99	D	Clarification of the Ciphering Indicator disable bit in the EFad	
	P-99-670	9-99-281		A091		R99	F	Introduction of a new DF for the TIA/EIA-136 technology	
	P-99-670	9-99-294		A092	1	R99	B	Addition of EF definitions under the PCS 1900 DF	
	P-99-670	9-99-310		A093		R99	F	Clarification about "Memory Problem" error for EF <sub>LOC1</sub> update	
	P-99-670	9-99-300		A094		R99	F	Execution time of SIM toolkit procedures	
	P-99-670	9-99-311		A095		R99	B	Introduction of a new DF for the TIA/EIA-95 technology	
	P-99-670	9-99-258		A097		R99	A	Clarification of Optional Status for GPRS files	
s31	P-00-137	9-00-0088	8.1.0	A098		R99	F	Clarification of interactions for CBS and the language files on	8.2.0
	P-00-137	9-00-0092		A101		R99	F	Correction to coding of ASCII EF eMLPP.	
	P-00-137	9-00-0095		A104		R99	F	Addition of coding for ASCII EFs (VGCS and VBS)	
	P-00-137	9-00-0098		A107		R99	F	Correction of the byte numbering related to EF <sub>LOCIGPRS</sub>	
	P-00-137	9-00-0133		A108		R99	F	Corrections and additions to DF-5F40	
	P-00-137	9-00-0146		A109	1	R99	F	Clarification of manual entry of the A-Key.	
	P-00-137	9-00-0151		A110		R99	D	Addition of reference to the File ID as used in the TETRA	
	P-00-137	9-00-0163		A111	1	R99	B	COMPACT Cell Selection	
	P-00-137	9-00-0155		A112		R99	B	COMPACT Cell Selection - Investigation Scan indicator for	
	P-00-139	9-00-0161		A113		R99	B	Enhancement to CCP coding (CR number incorrect in P-00-	
	P-00-139	9-00-0159		A114		R99	B	Enhancement of BDN feature (CR number incorrect in P-00-	
s32	P-00-296	9-00-0232	8.2.0	A120		R99	B	DFs for MExE	8.3.0
	P-00-296	9-00-0276		A122		R99	C	HPLM length	
	P-00-296	9-00-0275		A123		R99	A	LAI, RAI and CNL : alignment with GSM 04.08	
	P-00-296	9-00-0273		A124		R99	F	PLMN Selection Corrections regarding RFU bits	
<p><i>Following the closure of ETSI SMG and the agreement of the 3GPP in July 2000 to undertake responsibility for remaining GSM specifications, the change requests listed below were approved by 3GPP TSG-T. This change in responsibility also changed the specification number from "GSM 11.11" to "3GPP TS 11.11".</i></p>									
TP-09	TP-000176	9-00-0253	8.3.0	A116		R99	F	PLMN Selection Corrections and additions for EDGE	8.4.0
	TP-000176	9-00-0269		A119		R99	C	Addition of RPLMN file	
	TP-000148	T3-000479		A126		R99	F	Standardise the current GAIT commands and reserving	
TP-11	TP-010038	T3-010047	8.4.0	A127		R99	F	Addition of file ID for indicating iDEN access technology	8.5.0
	TP-010038	T3-010045		A128		R99	F	Correction to default HPLMN RAT	
TP-14	TP-010244	T3-010743	8.5.0	A130		R99	F	Corrections	8.6.0
TP-16	TP-020167	T3-020427	8.6.0	A131		R99	F	The identifier of EFRPLMNACT (RPLMN Last used Access Technology) is inconsistent within the specification	8.7.0
TP-17	TP-020218	T3-020716	8.7.0	A132		R99	F	Inconsistent record length of EF(IMG)	8.8.0
TP-18	TP-020278	T3-020917	8.8.0	A133		R99	F	Essential corrections file size and record lengths in several EFs	8.9.0
								Editorial changes to the ranges of bytes within the file as concluded at T3#25.	
			8.9.0					Removal of comments in clause 11 as given in action AP9/26 to the secretary at T3#26.	8.9.1
TP-21	TP-030177	T3-030652	8.9.1	A135		R99	F	Correction to SMS	8.10.0
	TP-030186	T3-030725		A136		R99	F	CR to delete Elementary File EFRPLMNACT, in accordance with TP-020168 from TP#16 in Marco Island.	
TP-22	TP-030247	T3-030948	8.10.0	A137		R99	F	Correction to procedures for service no 21, 22 and 23	8.11.0
	TP-030304			A138	1	R99	F	Alignment of EF-HPLMN Search Period with 22.011 and 23.122	

TP-23	TP-040029	TP-040129	8.110	A139		R99	F	Correction of image instance descriptor for colour icons	8.12.0
CP-28	CP-050136	C6-050367	8.12.0	A140		R99	F	ISO/IEC 7816-series revision	8.13.0
CP-28	CP-050136	C6-050488	8.12.0	A141		R99	F	ISO/IEC 7811-Series Revision	8.13.0
CP-36	CP-070286	C6-070309	8.13.0	A142	1	R99	F	Correction of reference to ISO/IEC 7816-3	8.14.0

---

## History

<b>Document history</b>		
V8.2.0	May 2000	Publication
V8.3.0	August 2000	Publication
V8.4.0	October 2000	Publication
V8.5.0	March 2001	Publication
V8.6.0	December 2001	Publication
V8.7.0	June 2002	Publication
V8.8.0	September 2002	Publication
V8.9.0	December 2002	Publication (Withdrawn)
V8.9.1	June 2003	Publication
V8.10.0	September 2003	Publication
V8.11.0	December 2003	Publication
V8.12.0	March 2004	Publication
V8.13.0	June 2005	Publication
V8.14.0	June 2007	Publication